

Frame & Tile Panel Systems

Price & Specification Guide 2024

Prices Effective February 1, 2024

PDF updated May 9, 2024

Limited Lifetime Warranty

Our unwavering commitment to our customers compels us to care, and our dedication to quality is just one of the ways we show our customers how much they mean to us.

We recognize that keeping up with the pace of change requires having products that work as hard as the people who use them. That's why each of our products is rigorously tested and certified to meet the highest industry standards.

In the unlikely event that any Allsteel product or component covered by the Allsteel Warranty should fail under normal workplace use because of defective material or workmanship, Allsteel promises to fix it. Because taking care of *people* is how Allsteel takes care of business.

For information on Allsteel's warranty coverage, visit AllsteelOffice.com.

Government Support – GovernmentSupport@hniworkplacefurnishings.com
Product, Parts, Non-Warranty Parts Orders – ProductSupport@hniworkplacefurnishings.com
Quick Ship Orders – QuickShip@hniworkplacefurnishings.com
Order Status – OrderStatus@hniworkplacefurnishings.com
General Inquiries – GeneralSupport@hniworkplacefurnishings.com

- Software support packages furnished to the customer, either by Allsteel® or by another source, which support the sale of Allsteel products are superseded by printed price lists.
- Prices are subject to change without notice. All orders are subject to prices in effect at the time of order.
- Please refer to your Allsteel Dealer Sales and Discount Policies for order placement information, terms and conditions.
- Additional copies of this Specification and Price List are available upon request from Allsteel Literature Fulfillment at 1-866-255-7833.

- Ordering information appears at the bottom of each product page complete with examples on how to specify. Fabric and finish pages are referenced at the bottom of product pages.

This publication is available as an interactive or downloadable PDF at www.allsteeloffice.com.

Questions or Comments?

Please call us at: **888-ALLSTEEL**
888-255-7833

Warranty	Inside Front Cover
New, Revised, and Discontinued Products	4
COM, Specials Policies, and Programs.....	5-9
Upholstery and Finishes	10-20

DAYBOOK™

Finishes	22-23
Introduction/Overview	24
Statement of Line	25
Specification Details	26-27
Frames.....	28
Laminate Inserts.....	29
Metal Inserts	30
Slotted Metal Inserts	31
Fabric Inserts.....	32
Glass Inserts	33
Shelves & Bookcases.....	34
Planters	35
Work Tools.....	36

TERRACE® SYSTEM

Finishes	38
Typicals Overview	39
Introduction to Terrace	40

Frames, Connectors, And Tiles

Working with Frames and Connectors.....	41-45
Approach and Involve Laminate Wood Storage.....	46-47
Working with Sliding Doors.....	48
Working with Tiles.....	49-55
Working with Veneer.....	56

Electrical (8-Wire)

Working with Electrical & Data	83-93
--------------------------------------	-------

Worksurfaces & Supports

Working with Worksurfaces and Supports.....	98-104
Working with Cadence® Freestanding Desking	105-113
Laminate Worksurfaces.....	114-121
9120 Worksurfaces.....	122-123

Metal Overheads

Working with Overheads, Shelves, and Hutches	128-131
Overhead Cabinets, Shelves, and Up-mount Kits	132-133
Hutches and Tackboards.....	134

STRIDE® SYSTEM

Finishes	136
Statement of Line	139-140
Overview of Frames.....	141
Working with Frames, Sliding Doors, Connectors, and Tiles	142-160
Panel Frames, Connectors, and Trim.....	161-175
Tiles, Off-Modular, and Acoustic Inserts.....	176-198
Working with Electrical and Data	199-209
Electrical and Data Components.....	210-213

Worksurfaces

Working with Worksurfaces and Supports.....	214-224
Laminate Worksurfaces.....	225-231
9120 Worksurfaces.....	232-233
Veneer Worksurfaces.....	234
Worksurface Supports.....	235-238

Wood Storage

Statement of Line	239
Features and Dimensions	240-241
Filing Capacities.....	242
Working with Wood Storage.....	243-261
Credenzas and Credenza Accessories	262-263
4-Wire Electrical Components	264
Stride Accessories	265
Overhead Cabinets and Horizontal Storage.....	266-268
Working with Metal Overheads.....	269-271
Metal Overheads.....	272-273

ALIGN™ STATEMENT OF LINE..... 275

APPROACH™ STATEMENT OF LINE..... 276-279

INVOLVE® STATEMENT OF LINE..... 280-281

GALLERY PANELS

Finishes	284
Panel Fabrics.....	285
Laminate and Paint Matching.....	286
Gallery-to-Gallery Panels	295
Freestanding Screens	296-297
Connector Kits.....	324
Terrace Connector Kits	325
Gallery Glass.....	326-328
Accessories	329-331

ALTITUDE® TABLES

Paint Finishes, Laminates, Eased Edge	334
Fabrics.....	335
Working with Height-Adjustable Tables	336-341.2
Screens and Power Module	342
Altitude - Metal Screens.....	343-344
Power Rail Specifications	345-351
Working with Electrical and Data	352-356
HAT to Panel Brackets	357-358
Working with Organization Rail & Accessories & Screens.....	359
Altitude Height-Adjustable Tops, Bases, & Accessories.....	360-365.3
Altitude - A6.....	360-361
Worksurfaces for Height-Adjustable Bases	362-364
Cable Management.....	365-365.3
Power Rail - Electrical Components.....	366-368
A8 Screen Kits.....	369
Metal Screens and Tackboard Accessories.....	370-371
Power Rails and Accessories	372-375
HAT to Panel Brackets Pricing	376
Worksurface Mounted Rail and Accessories	377

EXTENSIONS™

Working with Ergonomic Accessories	379-380
Working with Organization Tools.....	381-386
Working with Illumination.....	387-390
Power/Data Modules and Wire Management	391-391.4

ACCESSORIES

Working with Pivot Monitor Arms	392-395
---------------------------------------	---------

APPENDIX AND INDEX

Locking Specification/Easy Lock	396-398
Touch-Up Paint	399
Fabric Grades G-J	400-402
Index — Model Numbers with Page Reference	403-415

COM Program

Allsteel understands that customers may at times want to specify fabrics outside of Allsteel's standard fabric offering. Our COM program was designed to make specifying COMs on Allsteel products a simpler, friendlier, and hassle-free process. This process is simple and easy to use, and is described below under "Allsteel to Supply (ATS)." If a Dealer wishes to manage the COM process themselves, they can do so by following guidelines under "Dealer to Supply (DTS)". **ATS is the preferred method for all COM fabrics.** With ATS, Company will provide acknowledgment based upon planned date of receipt of COM fabric and manage the entire process. DTS is allowed if it is not a partnership fabric or if Company does not have access to the supplier. **DTS may cause order delays and is strongly discouraged.** Find out more about Allsteel's COM process by emailing our COM Department at allsteelcomteam@allsteeloffice.com.

Allsteel to Supply (ATS):

1. Select the fabric you wish to use and check the COM Search on our [Website](#) at: AllsteelOffice.com/Design Resources/Textiles & Finishes/COM Search or COM Search quick link. You will need to have the COM supplier's name, fabric pattern name, and color name to search for approved fabrics.
2. If your fabric is listed as an approved fabric, you may place your order directly with Allsteel Customer Support. Please use the fabric code (e.g., S216426XP) from the COM Test Request on your order in the place of the standard fabric code.

If your fabric is not listed as approved, you will need to select the "Request COM Test" link on the COM Search website. If your fabric is not listed as approved, and it is not a Partnership fabric you may request a "Dealer to Supply" code. Select the "Request COM Test" link on the COM Search website. Your name, company name and email will be prepopulated fields. The secondary email, project name, and bid/contract number are optional information. The supplier, pattern, and color will show a list by clicking in the box and entering the first letter of the name and these are free form text boxes. Once that information is entered click add. (Multiple series can be added to the same request if they are the same supplier, pattern, and color.) Then click submit.
3. An email will be sent to the to the requestor stating the COM Request was successfully submitted. Up to four emails could be received: Testing materials requested, in testing, and final approval/denial with price grade and fabric code. It's rare actual test yardage is required. Testing is mainly done by reviewing the attributes of the fabric. The testing process takes approximately 48 hours. Written COM price quotes hold pricing for 90 days after issue date.
4. Once the fabric has been approved by Allsteel, enter your order directly with Allsteel Customer Support. Allsteel will purchase all COM fabric directly from the COM suppliers and schedule for production.

In the event that the Dealer decides to cancel a COM fabric order, the Dealer is responsible for the cost of the fabric plus a handling charge that is equal to 10% of the fabric cost.

Dealer to Supply (DTS):

1. Select the fabric you wish to use and check the COM Search on our [Website](#) at: AllsteelOffice.com/Design Resources/Textiles & Finishes/COM Search or COM Search quick link. Or call Allsteel Customer Support to see if the fabric you have chosen has already been tested and approved on the product you are interested in.

You will need to have the COM supplier's name, fabric pattern name, and color name for this inquiry.
2. If your fabric is not listed as approved, and it is not a Partnership fabric you may request a "Dealer to Supply" code. Select the "Request COM Test" link on the COM Search website. Your name, company name and email will be prepopulated fields. The secondary email, project name, and bid/contract number are optional information. The supplier, pattern, and color will show a list by clicking in the box and entering the first letter of the name and these are free form text boxes. Once that information is entered click add. (Multiple series can be added to the same request if they are the same supplier, pattern, and color.) Then click submit.
3. An email will be sent to the to the requestor stating the COM Request was successfully submitted. Up to four emails could be received: Testing materials requested, in testing, and final approval/denial with price grade and fabric code. It's rare actual test yardage is required. Testing is mainly done by reviewing the attributes of the fabric. The testing process takes approximately 48 hours.
4. Make sure to use a "Dealer to Supply" COM code (e.g., S216426ZP) and place your order directly with Allsteel Customer Support.
5. All "Dealer to Supply" orders will be charged Grade 4 pricing for seating, Grade 3 for Gather, and Grade D pricing for panels. Dealers will pay for the COM fabric separately.
6. All "Dealer to Supply" fabric must be sent on a fabric roll. Estimate the yardage required by using the yardage requirements listed in the price list by model. For questions please contact Allsteel Customer Support.
7. Place your fabric order directly with the COM Supplier with instructions for the fabric to be sent on a fabric roll to:

HNI Textile Distribution Center

COM Production Yardage — PO Number

Docks 20-22
301 Mulberry Avenue
Muscatine, IA 52761

Information that **MUST** be included in the packing slip attached to the DTS fabric:

1. Dealer's Purchase Order number to Allsteel
2. Allsteel's Tracking number for the COM fabric
3. Dealer Name
4. Yards of Fabric

If the fabric shipment does not match the correct fabric and yardage, Allsteel will notify the Dealer for resolution.

If Allsteel receives fabric with incorrect labeling or fabric yardage that cannot be linked to an Allsteel furniture order, Allsteel will hold the fabric for up to 4 weeks. After 4 weeks Allsteel will dispose of the fabric. There are no exceptions to this policy.

Specific to DTS orders - The customer should send only the amount needed for the order. Excess yardage, or yardage not attached to an order will be disposed of at Allsteel's discretion.

Any canceled orders are subject to cancellation charges up to the full value of the Allsteel product canceled. Allsteel will determine the actual cancellation charge at the time the cancellation is requested.

8. For additional details on "Dealer to Supply" fabric refer to your Allsteel terms and conditions.

Additional Policy Information:

The company assumes no responsibility for the overall appearance, flammability, normal durability, colorfastness, or any other quality standards. The company reserves the right to reject a COM if the quality of the COM is not satisfactory for the product. Should this occur, the customer will be notified with an explanation when the issue is found.

The company is not responsible for fabric that has become obsolete at the COM supplier, that is of poor quality, or that is delivered late to the manufacturer from the COM supplier.

All cancellations or changes to COM orders are subject to Company approval. Because of the nature of COM, special fabrics, finishes, and structural modifications, products ordered as specials and then canceled prior to shipment are subject to cancellation costs up to the full value of the product canceled. The company determines the actual cancellation charge at the time the cancellation is requested. Upon approval, a cancellation number is issued to the Customer.

Purchase orders will not be accepted or entered unless the testing process is complete with positive results.

If all testing has been previously completed, re-testing is only necessary if fabric is to be used on a different product, or pattern direction has changed from that previously approved.

Previous test results can be obtained by a customer on the COM Search on [our Website](#) or by calling Allsteel Customer Support.

All COM fabric will be applied to seating and panel systems Pattern Cut unless Railroad Cut is requested and approved on the COM Test Request. Any fabrics approved as a width pass, the dealer is responsible for clarifying Railroad Cut on orders containing items that are too large to support the Pattern Cut of a fabric application (any items larger than 48" high or wide).

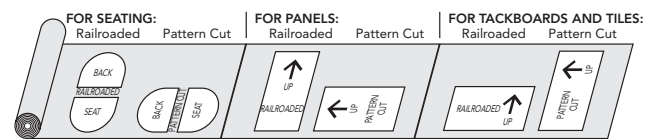

Fire Retardant

The Dealer is responsible for ensuring that the COM fabric is certified to meet all flame retardant requirements.

For more information, please contact Allsteel Customer Support.

YARDAGE REQUIREMENTS FOR FABRIC WITH REPEATS — FOR USE ON GATHER™ PRODUCTS

Fabric Width	Plain Fabric	2"– 14" Repeat	15"– 19" Repeat	20"– 27" Repeat	28"– 36" Repeat
54"	0	+15%	+20%	+25%	+30%
53"	+6%	+19%	+24%	+28%	+36%
52"	+13%	+23%	+28%	+33%	+38%
51"	+19%	+26%	+31%	+36%	+41%
50"	+25%	+30%	+35%	+40%	+45%
49"	+30%	+35%	+40%	+45%	+50%
48"	+35%	+40%	+45%	+50%	+55%
47"	+45%	+50%	+55%	+58%	+65%

Depending upon the pattern repeat, it may be necessary to pattern cut the fabric. This will require 10% additional fabric.

To calculate multiple repeats (vertical and horizontal), add each repeat for total yardage required. For example for a fabric width of 54": 7" vertical requires 15%, 15" horizontal requires 20% total additional yardage required equals 35% (15% + 20%). Therefore, if your chair requires 2 yards of fabric, multiply 2 by 35%. Then 2.7 yards will be yardage required.

Special Paint & Stain Policy

Allsteel at its own discretion may modify its standard products with non-standard paint and stain colors to meet specific needs. Dealer is required to submit a special paint or stain request via the COM Search on [our Website](#). A sample of the non-standard paint or stain color desired will be required for matching. Pricing, lead time, and order information will be provided at the time of approval.

- For each new requested stain or paint, there will be a \$500 net fee to cover supplier costs to match the special item.
- For existing, previously-approved stains or paints, there is no \$500 matching fee, however, there is a sample chip fee of \$175 net for stains and \$100 net for paints.
- Samples, preferably at least 3" x 5" chips, of the exact color desired should be sent to the Allsteel Tailored Products Group. Paint matches require (3) sample chips and stain matches require (3) sample chips. Please mail these sample chips to the address below and reference the Special Item Request Number from Tailored Solutions.

Allsteel Inc.

Attn: COM Team
200 Oak St.
Muscatine, IA 52761

- Allsteel will color match the sample and send control samples to the address provided in the request. Dealer will review Allsteel's color match and approve by signing the back of the sample chip. Send the signed sample back to the Allsteel Tailored Products Group.
- Special paints will be assigned a paint price grade.
- Orders will not be accepted until Allsteel receives the Dealer's written approval on the color match.
- Extended lead times will apply on orders containing special paints or stains.
- Due to manufacturing techniques, materials, and quality issues, some exclusions will apply and some matches may be declined.

Important Notes

- Natural veneer is subject to nature's quality control. Differences in grain and color are naturally occurring variations and cannot be controlled by the manufacturer and cannot be considered as product defects. Natural veneer has the characteristics and beauty of a living organism; with its own variations of grain, growth, and color patterns. For these reasons, Natural veneer is preferred by many for its warmth and personal characteristics.
- Color changes will occur over time when wood is exposed to light. For this reason, when new product is ordered as an addition to existing product, there will be color variances between the old and new product. Please remember when specifying new product that although the species of veneer will be the same, additional product is being manufactured from a different tree. It may take several months for the new furniture to mature to the color level of existing product. Even with this maturation process the additional product will not be an exact match.

Special Laminate Policy

The Company at its own discretion may modify its standard products with non-standard laminates to meet specific needs. Contact the Allsteel Tailored Products Group for pre-approved Wilsonart, Formica, Nevamar and Pionite laminates and pricing for special laminates. When requesting a special laminate please supply manufacturer, along with name and pattern number of laminate.

- Extended lead times will apply on orders containing special laminates.
- Due to manufacturing techniques, materials, and quality issues, some product exclusions will apply and some requests may be declined.

Veneer Care Instructions

Veneer worksurfaces feature the Gunlocke® finishing system. The finishing system is a process that begins with the application of stains, which promote exceptional depth and clarity. Next the worksurface receives a specialized coating that provides exceptional durability and chemical resistance. The remaining surfaces receive a top coat. These finishing processes ensure depth, clarity, color consistency and durability throughout the product.

Caring for your veneer finish:

- General maintenance procedures entail wiping clean the entire surface with a clean, water dampened soft cloth once per week (be sure to wipe with the grain)
- Murphy's® Oil Soap may be used as a general purpose type cleaner with warm water to clean tops.
- The finish may also be polished with Guardsman® Furniture Polish (contains no waxes or silicones) to provide renewed luster.
- Be sure to wipe up all spills immediately. Do not allow spills to dry.

Wood owes its inherent beauty to variations in color, grain and texture, and therefore, these variations are not considered defects. There may be minor variations from one piece of furniture to the next even though they are finished at the same time. Exposure to light and the aging process will cause a darkening of natural wood products. Light finishes on wood products do not mask the natural characteristics of wood. Allsteel does not guarantee the exact matching of grain, pattern and color.

Allsteel Open Line Laminate Program

The Open Line Laminate (OLL) program makes it even easier for a customer to tailor their Allsteel product for a custom look. Select Allsteel furniture products accommodate hundreds of graded-in high-pressure laminates (HPL) from the leading laminate manufacturers' open lines.

Laminates that are currently available in the program can be viewed in specification tools.

Requests to add laminates to the standard specials program can be submitted through the CET Specials Integration tool as well as Community.

Matching edge options are not available offered for laminates in the OLL program. When selecting a laminate please select an edge option from the Allsteel standard offering. If a matching edge is required a modification request can be submitted through the CET Specials Integration tool as well as Community.

Due to manufacturing techniques, materials, quality issues of varying laminates, and minimum order quantities some product exclusions will apply, and some requests may be declined.

Extended lead times may apply on orders containing special laminates.

Contact the Tailored Products Group for questions or additional information regarding pre-approved laminates and pricing.

Allsteel

Phone: 888-255-7833 Option 4.2

Email: ASITPG@allsteeloffice.com

For edge band recommendations from the Allsteel standard offering, please email the HNI Workplace Colors, Materials and Finishes team at allsteel finishes@allsteeloffice.com.

Allsteel edge samples can be ordered through the Allsteel literature [Website](https://www.AllsteelOffice.com), <https://www.AllsteelOffice.com>.

For laminate samples, please contact the manufacturer directly:

Wilsonart

<https://www.wilsonart.com/>

1-800-433-3222

Formica

<https://www.formica.com/en-us/>

1-800-FORMICA (367-6422)

Nevamar and Pionite

<https://www.panolam.com>

877-726-6526

Everyday Advantage®

New terms and conditions for EDA:

1. Orders must clearly state “Everyday Advantage Order” and include the appropriate Everyday Advantage contract number:
 - Everyday Advantage Std-0125, Everyday Advantage Canada-0127
2. Everyday Advantage orders are not eligible for bid pricing.
3. Program discounting includes the complete Optimize, Further, and Terrace systems lines, private office solution, Approach and Involve storage. This program also includes Acuity, Access, Evo, Inspire, Lyric, Mimeo, Nimble, WillQuip, Relate, Seek, and Svelte, seating. Altitude, Aware, and Structure tables are also available, along with Align pedestals, lockers and metal storage and Essentials pedestals, and Radii storage lines. In addition, Extensions ergonomic accessories and lighting are part of the standard offering. All other product not called out is available for order on the contract but will receive standard discounting of 55%–65%.
4. All textiles and finishes except for veneer and some wood finishes are available, depending on quantity and selection, and may have extended lead times.
5. Everyday Advantage orders are not limited to a minimum or maximum.
6. All orders ship based on standard lead times. Large-quantity orders of like products may be subject to longer lead times.
7. Standard freight terms apply.
8. If driver assistance is needed, standard driver assist charges will be added at time of order entry.

Allsteel Inc. reserves the right to amend or terminate this program at anytime with 30 days written notice. Allsteel is not liable for service delays caused by force majeure (circumstances beyond Allsteel's control).

Refer to page 12 for current upholstery availability by model/series.

GSA Reference Page

ALLSTEEL MATERIALS PARTNERSHIP PROGRAM — See program explanation at bottom of page.

UPHOLSTERY

GRADE 2	GRADE 4	GRADE 4 – continued	GRADE 4 – continued	GRADE 4 – continued
Maharam MELD	HBF Textiles BLINK	Maharam METRIC	Maharam MODE	Maharam MUSE
Amethyst.....SMHMMLD18	Bright Blue..... 1048-59	Admiral..... SMHMMET26	Alder*..... SMHMMOD23	Ascend.....SMHMMUS04
Anrler.....SMHMMLD13	Dark Violet..... 1048-77	Alligator..... SMHMMET20	Angelfish*..... SMHMMOD32	Bergamot*.....SMHMMUS11
Bare.....SMHMMLD26	Dove Grey*..... 1048-83	Anchor..... SMHMMET24	Ballpoint*..... SMHMMOD29	Celebrate.....SMHMMUS03
Blonde.....SMHMMLD27	Lemon Yellow*..... 1048-22	Arabica*..... SMHMMET09	Barberry*..... SMHMMOD25	Clear.....SMHMMUS07
Bride.....SMHMMLD10	Ocean Blue*..... 1048-56	Aztec*..... SMHMMET41	Billygoat..... SMHMMOD10	Compass.....SMHMMUS10
Bulb.....SMHMMLD09	Peppery..... 1048-90	Bittersweet*..... SMHMMET08	Blush.....SMHMMOD21	Crescendo.....SMHMMUS01
Clementine.....SMHMMLD23	Red Orange..... 1048-44	Bonsai*..... SMHMMET22	Bonsai*..... SMHMMOD40	Fantasy*.....SMHMMUS08
Comet.....SMHMMLD29	Sea Green*..... 1048-67	Brick*..... SMHMMET11	Carotene*..... SMHMMOD20	Frigid.....SMHMMUS16
Crater.....SMHMMLD14	Silvery..... 1048-80	Canary*..... SMHMMET39	Celtic*..... SMHMMOD38	Goal.....SMHMMUS13
Creek.....SMHMMLD40	Maharam CAPER	Caramel*..... SMHMMET17	Clavicle.....SMHMMOD09	Grasshopper.....SMHMMUS12
Fox.....SMHMMLD24	Bliss.....SMHMCAPO9	Cardinal..... SMHMMET12	Crottontail*..... SMHMMOD16	Haven*.....SMHMMUS24
Fuchsia.....SMHMMLD17	Cactus*.....SMHMCAPO8	Cedar*..... SMHMMET15	Crush.....SMHMMOD34	Jovial.....SMHMMUS27
Globe.....SMHMMLD42	Cameo*.....SMHMCAPO10	Cerise*..... SMHMMET10	Denim.....SMHMMOD33	Mead*.....SMHMMUS25
Gloss.....SMHMMLD08	Cinnamon*.....SMHMCAPO4	Downpour*..... SMHMMET33	Eucalyptus*..... SMHMMOD39	Miso*.....SMHMMUS09
Grate.....SMHMMLD07	Cougar*.....SMHMCAPO3	Driftwood*..... SMHMMET06	Goldenrod..... SMHMMOD15	Mistletoe.....SMHMMUS14
Heat.....SMHMMLD22	Note.....SMHMCAPO6	Envy*..... SMHMMET21	Henge*..... SMHMMOD14	Neat.....SMHMMUS26
Honeydew.....SMHMMLD30	Paprika.....SMHMCAPO5	Film..... SMHMMET31	Hollow.....SMHMMOD07	Noble.....SMHMMUS18
Isle.....SMHMMLD39	Ribbon*.....SMHMCAPO11	Fleece*..... SMHMMET03	Intaglio.....SMHMMOD02	Poinsettia.....SMHMMUS29
Kale.....SMHMMLD34	Sidekick.....SMHMCAPO12	Fog*..... SMHMMET02	Jetty.....SMHMMOD35	Pulsar.....SMHMMUS19
Kiss.....SMHMMLD25	Silverback.....SMHMCAPO7	Fruit*..... SMHMMET42	Kermes*..... SMHMMOD24	Refresh.....SMHMMUS06
Knight.....SMHMMLD04	Smolder*.....SMHMCAPO13	Galah..... SMHMMET43	Lemon*..... SMHMMOD12	Resonate.....SMHMMUS02
Magma.....SMHMMLD20	Whim*.....SMHMCAPO1	Hedgerow*..... SMHMMET36	Lichen*..... SMHMMOD43	Riverbend.....SMHMMUS17
Mariner.....SMHMMLD41	Wise*.....SMHMCAPO2	Highway*..... SMHMMET38	Lioness*..... SMHMMOD17	Runway.....SMHMMUS03
Merlot.....SMHMMLD19	HBF Textiles LOOK-SEE	Hopscotch..... SMHMMET30	Machine..... SMHMMOD04	Sailboat*.....SMHMMUS21
Mimosa.....SMHMMLD28	Electric*..... 1044-77	Kiln*..... SMHMMET44	Mallard*..... SMHMMOD37	Seaglass*.....SMHMMUS15
Mulberry.....SMHMMLD16	Foggy..... 1044-85	Lava..... SMHMMET13	Marsh*..... SMHMMOD06	Sparse*.....SMHMMUS22
Nordic.....SMHMMLD36	Foliage..... 1044-67	Midday..... SMHMMET34	Odyssey.....SMHMMOD28	Spectacle.....SMHMMUS31
Panda.....SMHMMLD02	Lava..... 1044-44	Mineral*..... SMHMMET07	Ominous..... SMHMMOD03	Theater.....SMHMMUS28
Perennial.....SMHMMLD15	Midnight..... 1044-59	Moth*..... SMHMMET45	Oriole.....SMHMMOD18	Vase.....SMHMMUS23
Pipe.....SMHMMLD06	Plum..... 1044-75	Oriole*..... SMHMMET14	Oxeye.....SMHMMOD13	Veil*.....SMHMMUS05
Quill.....SMHMMLD05	Shady..... 1044-80	Phantom*..... SMHMMET01	Paradise*..... SMHMMOD31	Veella*.....SMHMMUS20
Reef.....SMHMMLD37	Snowy..... 1044-11	Pollen*..... SMHMMET18	Petal*.....SMHMMOD26	Maharam TRUNDLE
Rooster.....SMHMMLD21	Stone..... 1044-89	Scuba*..... SMHMMET28	Rust*..... SMHMMOD19	Aloe.....SMHMTRN05
Seashell.....SMHMMLD12	Terra Cotta*..... 1044-46	Seaport..... SMHMMET27	Saltwater..... SMHMMOD36	Cabana*.....SMHMTRN06
Seed.....SMHMMLD33	Ultramarine..... 1044-57	Skate..... SMHMMET29	Sassafras..... SMHMMOD41	Confetti*.....SMHMTRN09
Skyline.....SMHMMLD03	Wavelet*..... 1044-56	Snorkel*..... SMHMMET37	Spindle.....SMHMMOD11	Crabapple*.....SMHMTRN10
Spa.....SMHMMLD43	Wine*..... 1044-74	Sourdough*..... SMHMMET04	Stroll.....SMHMMOD01	Element.....SMHMTRN02
Stark.....SMHMMLD11		Sunny..... SMHMMET40	Sycamore..... SMHMMOD08	Hibernata*.....SMHMTRN04
Vast.....SMHMMLD01		Talisman..... SMHMMET35	Talus.....SMHMMOD05	Magnet.....SMHMTRN11
Vine.....SMHMMLD32		Tar*..... SMHMMET23	Toile*.....SMHMMOD30	Rainstorm*.....SMHMTRN07
Waterfall.....SMHMMLD35		Toffee*..... SMHMMET05	Valley*..... SMHMMOD27	Ray.....SMHMTRN03
Wave.....SMHMMLD38		Tupelo*..... SMHMMET19	Vermilion..... SMHMMOD22	Ski*.....SMHMTRN01
Wild.....SMHMMLD31		Twilight*..... SMHMMET25	Yucca*..... SMHMMOD42	Wake.....SMHMTRN08
		Whale*..... SMHMMET32		HBF Textiles WALKABOUT
			Maharam MURMUR	Alluring Aqua..... 1046-56
			Argan*.....SMHMMUR17	Bewitched Blue..... 1046-59
			Baby.....SMHMMUR10	Bold Burgundy..... 1046-74
			Biome.....SMHMMUR15	Classic Cobalt..... 1046-55
			Canopy*.....SMHMMUR03	Cool Carbon..... 1046-87
			Cask*.....SMHMMUR16	Gallant Green..... 1046-67
			Cauldron.....SMHMMUR06	Gutsy Grey..... 1046-85
			Conquer*.....SMHMMUR07	Jungly Jade..... 1046-64
			Dim.....SMHMMUR04	Noble Navy..... 1046-58
			Elderberry.....SMHMMUR11	Peaceful Pewter..... 1046-89
			Gust.....SMHMMUR01	Reliable Red..... 1046-44
			Harmonica.....SMHMMUR02	Swanky Silver..... 1046-80
			Iceberg.....SMHMMUR12	Wistful White..... 1046-11
			Ignite.....SMHMMUR19	
			Peppercorn.....SMHMMUR05	
			Rapids.....SMHMMUR08	
			Sangria*.....SMHMMUR21	
			Seawater.....SMHMMUR09	
			Sultry*.....SMHMMUR20	
			Sundown*.....SMHMMUR18	
			Tallgrass*.....SMHMMUR13	
			Underground*.....SMHMMUR14	

Multi-use fabrics are noted with the following designators: **B** – Tackboards, **C** – Concensys®, **O** – Optimize™, **T** – Terrace®, **F** – Further™.

* Colorway not shown on Textiles card; all Partnership Program memo samples are available from supplier. See contact information below.

ALLSTEEL PARTNERSHIP PROGRAM

Allsteel understands that customers may want to specify panel and seating textiles outside of Allsteel's standard offering. Allsteel's Partnership Program consists of on-trend and design-forward patterns that have been tested and approved by Allsteel for use on Allsteel products. A subset of these approved patterns is available on cards in the textile binder, while numerous others are available on our website, allsteeloffice.com.

For memo samples, please contact our partners:

- Camira, memos@camirafabrics.com 1.616.288.0655
- CF Stinson, cfstinson.com 1.800.841.6279
- HBF Textiles, hbftextiles.com 1.877.494.5727
- Maharam, maharam.com 1.800.645.3943
- Ultrafabrics, ultrafabricsinc.com 1.877.309.6648

The intent of the Partnership Program is to offer a wide variety of on-trend textiles to meet your varied needs, but since these textiles are not part of our standard offering they may be subject to extended lead times. Because new materials will be introduced regularly, Allsteel reserves the right to change the offering at any time.

Refer to page 12 for current upholstery availability by model/series.

GSA Reference Page

ALLSTEEL MATERIALS PARTNERSHIP PROGRAM — SEE PROGRAM EXPLANATION AT BOTTOM OF PAGE 10.

GRADE 5	GRADE 6	GRADE 7	GRADE 9
HBF Textiles CHECKMATE	Camira BLAZER	Camira SILK	Camira YOREDALE
Aqua Sky..... 1043-56	Aberlour*..... SCAMBLZ15	Arabia*.....SCAMSLK02	Askrigg*.....SCAMYDL03
Blue Green..... 1043-63	Abertay..... SCAMBLZ36	Assam*.....SCAMSLK11	Buckden.....SCAMYDL01
Charcoal Black..... 1043-89	Aston..... SCAMBLZ02	Brunei.....SCAMSLK08	Burnsall.....SCAMYDL22
Forest Mint..... 1043-66	Barlborough*..... SCAMBLZ40	Byzantine*.....SCAMSLK03	Carperby.....SCAMYDL07
Golden Grey..... 1043-22	Barnard..... SCAMBLZ27	Chancellor.....SCAMSLK19	Cracoe.....SCAMYDL23
Purple Indigo..... 1043-77	Bromsgrove*..... SCAMBLZ35	Divine*.....SCAMSLK13	Cray.....SCAMYDL10
Red Brick..... 1043-44	Bryanston..... SCAMBLZ53	Dynasty.....SCAMSLK17	Dacre.....SCAMYDL21
Royal Navy..... 1043-58	Camphill..... SCAMBLZ16	Emperor.....SCAMSLK16	Darley.....SCAMYDL20
Rust..... 1043-43	Cardiff*..... SCAMBLZ04	Empress*.....SCAMSLK05	Fossdale.....SCAMYDL11
Smoke Slate..... 1043-80	Dartmouth..... SCAMBLZ24	Forbidden*.....SCAMSLK07	Gayle.....SCAMYDL08
Tanned Umber..... 1043-25	Dunhurst*..... SCAMBLZ58	Imeon.....SCAMSLK20	Hardraw.....SCAMYDL04
Camira	Edge Hill*..... SCAMBLZ90	Incense*.....SCAMSLK06	Kidstone.....SCAMYDL02
MAIN LINE FLAX	Edinburgh*..... SCAMBLZ23	Kingdom*.....SCAMSLK10	Leyburn.....SCAMYDL25
Aldgate..... SCAMMLF01	Eynesbury*..... SCAMBLZ44	Monarch.....SCAMSLK15	Litton.....SCAMYDL15
Archway*..... SCAMMLF02	Fairfield..... SCAMBLZ47	Oriental*.....SCAMSLK12	Nidd*.....SCAMYDL16
Bank*..... SCAMMLF23	Glasgow*..... SCAMBLZ01	Pamir*.....SCAMSLK14	Ribble.....SCAMYDL17
Barbican..... SCAMMLF03	Glenalmond..... SCAMBLZ62	Parthian*.....SCAMSLK09	Ripley*.....SCAMYDL19
Bayswater..... SCAMMLF24	Goldsmith..... SCAMBLZ39	Persia.....SCAMSLK04	Sedbusk.....SCAMYDL14
Bethnal..... SCAMMLF25	Handcross*..... SCAMBLZ63	Sahara*.....SCAMSLK01	Simonstone*.....SCAMYDL05
Brompton*..... SCAMMLF35	Holyoke*..... SCAMBLZ43	Sovereign.....SCAMSLK18	Thoralby.....SCAMYDL06
Camden*..... SCAMMLF26	Hull*..... SCAMBLZ19	Tussah.....SCAMSLK21	Thornton.....SCAMYDL09
Charing..... SCAMMLF27	Kingsmead*..... SCAMBLZ67	GRADE 8	Walden.....SCAMYDL13
Edgware*..... SCAMMLF28	Knightsbridge*..... SCAMBLZ26	Camira ZAP	Warfe*.....SCAMYDL18
Euston..... SCAMMLF04	Latymer*..... SCAMBLZ33	Argh.....SCAMZAP11	Woden*.....SCAMYDL24
Farringdon..... SCAMMLF29	Magdalene*..... SCAMBLZ42	Awesome*..... SCAMZAP14	Woodale*.....SCAMYDL12
Finsbury..... SCAMMLF30	Manchester..... SCAMBLZ21	Boing.....SCAMZAP21	
Goldhawk*..... SCAMMLF31	Marymount*..... SCAMBLZ38	Bonza.....SCAMZAP25	
Greenford..... SCAMMLF32	Montcrest*..... SCAMBLZ37	Clang*.....SCAMZAP19	
Highgate*..... SCAMMLF33	Napier..... SCAMBLZ08	Clobber*.....SCAMZAP12	
Hillingdon*..... SCAMMLF41	Newcastle..... SCAMBLZ22	Cool*.....SCAMZAP30	
Holborn*..... SCAMMLF05	Newport*..... SCAMBLZ17	Crackle*.....SCAMZAP05	
Kensington..... SCAMMLF07	Oriel*..... SCAMBLZ18	Crash*.....SCAMZAP16	
Kilburn*..... SCAMMLF06	Oxford*..... SCAMBLZ09	Flump.....SCAMZAP17	
Lambeth..... SCAMMLF08	Penola*..... SCAMBLZ45	Gasp*.....SCAMZAP15	
Leyton*..... SCAMMLF13	Plymouth..... SCAMBLZ20	Hahaha*.....SCAMZAP09	
Monument..... SCAMMLF09	Scottsdale*..... SCAMBLZ41	Kapow*.....SCAMZAP06	
Mordon*..... SCAMMLF12	Sheffield*..... SCAMBLZ03	Omg.....SCAMZAP13	
Newbury..... SCAMMLF10	Silcoates..... SCAMBLZ30	Power*.....SCAMZAP18	
Northfields*..... SCAMMLF40	Silverdale..... SCAMBLZ28	Puff.....SCAMZAP26	
Paddington*..... SCAMMLF39	St. Andrews..... SCAMBLZ86	Screech.....SCAMZAP08	
Parsons*..... SCAMMLF14	Stanford..... SCAMBLZ25	Snap*.....SCAMZAP01	
Pimlico*..... SCAMMLF34	Surrey..... SCAMBLZ10	Splash.....SCAMZAP27	
Russell*..... SCAMMLF38	Trevelyan..... SCAMBLZ31	Splat.....SCAMZAP20	
Stanmore..... SCAMMLF37	Tyndale*..... SCAMBLZ46	Thud*.....SCAMZAP29	
Stockwell*..... SCAMMLF15	Ulster*..... SCAMBLZ11	Wham.....SCAMZAP23	
Temple*..... SCAMMLF16	Vassar..... SCAMBLZ34	Whirr.....SCAMZAP03	
Tooting..... SCAMMLF17	Wellington..... SCAMBLZ13	Whomp*.....SCAMZAP28	
Tower*..... SCAMMLF36	Wesley*..... SCAMBLZ82	Whoosh*.....SCAMZAP02	
Tufnell..... SCAMMLF18	Winchester*..... SCAMBLZ12	Wowzers*.....SCAMZAP07	
Upminster*..... SCAMMLF20	Woodcroft*..... SCAMBLZ48	Yeah*.....SCAMZAP04	
Victoria*..... SCAMMLF19	Camira HEMP	Yikes.....SCAMZAP10	
Waterloo*..... SCAMMLF21	Acre.....SCAMHMP19	Zoink.....SCAMZAP24	
Wembley..... SCAMMLF11	Alec*.....SCAMHMP12	Zoom.....SCAMZAP22	
Westminster..... SCAMMLF22	Arable.....SCAMHMP04		
HBF Textiles ZIPPY	Ashworth*.....SCAMHMP26		
Dark Grey..... 1045-89	Bale.....SCAMHMP02		
Deep Red..... 1045-44	Barn*.....SCAMHMP23		
Denim Blue..... 1045-58	Dale*.....SCAMHMP18		
Grey..... 1045-80	Dew.....SCAMHMP16		
Navy..... 1045-59	Fallow.....SCAMHMP28		
Pine..... 1045-67	Gorse*.....SCAMHMP03		
School Blue..... 1045-55	Grain.....SCAMHMP27		
Winter White..... 1045-10	Heath*.....SCAMHMP07		
	Hectare*.....SCAMHMP21		
	Hedgerow*.....SCAMHMP09		
	Oat.....SCAMHMP05		
	Plough.....SCAMHMP01		
	Pollen.....SCAMHMP08		
	Root.....SCAMHMP06		
	Seed.....SCAMHMP13		
	Sickle.....SCAMHMP30		
	Trough*.....SCAMHMP20		
	HBF Textiles POPPY		
	Flame..... 1047-44		
	Graphite..... 1047-85		
	Ink..... 1047-89		
	Khaki..... 1047-35		
	Limelight..... 1047-63		
	Natural..... 1047-16		
	Neutral..... 1047-83		
	Night..... 1047-59		
	Pool..... 1047-56		
	Punch..... 1047-45		

* Colorway not shown on Textiles card; all Partnership Program memo samples are available from supplier. See contact information on page 10.

Upholstery Selections for Storage by Model/Series

Partnership (⊕) upholstery colors and codes are listed in the Seating, Collaboration and Tables Price List.

UPHOLSTERY

Banquette/Seat Cushions

GRADE 1		
Apex	APX	•
Centurion	CU	◆
Contourett	UR	◆
Dapper	DAPR	◆
Ensemble	ENSB	•
Hamilton <i>(De-emphasized)</i>	HAML	◆
Inertia <i>(De-emphasized)</i>	NR	◆
Optic <i>(De-emphasized)</i>	OP	•
GRADE 2		
Appoint Seating	PNS	◆
Blume	BLME	•
Clyde	CLYD	•
Dotty <i>(De-emphasized)</i>	DOT	◆
Meld ⊕	SMHMMLD	•
Rush	RUSH	◆
Spin Seating	SPNN	◆
Taylor <i>(De-emphasized)</i>	TAY	◆
GRADE 3		
Purl	PURL	◆
Quill	QUL	◆
GRADE 4		
Blink ⊕	1048	•
Caper ⊕	SMHMCAP	•
Look-See ⊕	1044	•
Merit ⊕	SMHMMER	•
Metric ⊕	SMHMMET	◆
Mode ⊕	SMHMMOD	•
Multiply ⊕	SMHMMLT	•
Murmur ⊕	SMHMMUR	•
Muse ⊕	SMHMMUS	•
Trundle ⊕	SMHMTRN	•
Walkabout ⊕	1046	•
GRADE 5		
Checkmate ⊕	1043	•
Main Line Flax ⊕	SCAMMLF	•
Zippy ⊕	1045	•

Banquette/Seat Cushions

GRADE 6		
Arris	ARR	•
Blazer ⊕	SCAMBLZ	• ⁵
Hemp ⊕	SCAMHMP	•
Poppy ⊕	1047	•
GRADE 7		
Silk ⊕	SCAMSLK	•
GRADE 8		
Zap ⊕	SCAMZAP	•
GRADE 9		
Yoredale ⊕	SCAMYDL	•

⁵Seat Only

- Available upholstery option
- ◆ Available upholstery option with CTB133 approval — requires FC suffix added to model (FC extra, \$ varies by series)
- ⊕ Partnership Program — See page 10 for details. Partnership colors and codes are listed in the Seating, Collaboration and Tables Price List.

Refer to page 12 for current upholstery availability by model/series.

GSA Reference Page

GRADE 1	GRADE 1 – continued	GRADE 1 – continued	GRADE 2 – continued	GRADE 2 – continued
APEX	DAPPER B^W, F^W, S^W, T^W (100% Polyester)	INERTIA (De-emphasized)	DOTTY (De-emphasized) (100% Polyester)	TAYLOR (De-emphasized) (74% Post-Consumer Recycled Polyester, 26% Polyester)
Basalt.....APX25	Ash.....DAPR20	Amethyst.....NR61	Candy.....DOT63	Autumn.....TAY43
Beet.....APX12	Breeze.....DAPR06	Calypso.....NR98	Gelato.....DOT34	Daffodil.....TAY20
Blackberry.....APX20	Canvas.....DAPR25	Cherry.....NR66	Indigo.....DOT31	Deep Lilac.....TAY75
Chive.....APX05	Charcoal.....DAPR01	Cobalt.....NR91	Onyx.....DOT35	Dreamy.....TAY80
Iris.....APX03	Clover.....DAPR22	Coffee.....NR49	Park.....DOT83	Envious.....TAY58
Kiwi.....APX06	Currant.....DAPR00	Fog.....NR19	Peat.....DOT24	Handkerchief.....TAY90
Lemonade.....APX08	Fawn.....DAPR35	Fuchsia.....NR63	Peony.....DOT32	Luxe.....TAY50
Navy.....APX13	Fern.....DAPR85	Gecko.....NR76	Suit.....DOT20	Malbec.....TAY40
Papaya.....APX09	Gerbera.....DAPR16	Glow.....NR27	Sunflower.....DOT33	Martini.....TAY60
Pumice.....APX23	Grape.....DAPR33	Leaf.....NR75	Tailor.....DOT21	Mink.....TAY30
Rain.....APX19	Jewel.....DAPR08	Lime.....NR82	Tide.....DOT90	Pearl.....TAY15
Resort.....APX15	Marigold.....DAPR65	Loft.....NR22	Velum.....DOT29	Spritz.....TAY45
Royal.....APX14	Onyx.....DAPR10	Mandarin.....NR47	Violet.....DOT30	Tungsten.....TAY85
Tiki.....APX29	Orchid.....DAPR90	Meteor.....NR30		
Tomato.....APX11	Parrot.....DAPR59	Mustard.....NR26	PARKER	
CENTURION B, C, F, O, S, T (Nanotex™ Stain-Resistant finish)	Poppy.....DAPR19	Nickel.....NR23	Aloe.....PRKR01	
Apricot.....CU47	Sapphire.....DAPR07	Onyx.....NR10	Cumulus.....PRKR05	GRADE 3
Bark.....CU25	Scarlet.....DAPR45	Regatta.....NR90	Cyan.....PRKR06	PURL (80% Polyester, 20% Acrylic)
Black.....CU10	Sepia.....DAPR30	Shadow.....NR20	Domino.....PRKR07	Alpaca.....PURL08
Espresso.....CU49	Sky.....DAPR44	Surf.....NR96	Fossil.....PRKR10	Braid.....PURL10
Fog.....CU03	Slate.....DAPR15	Tangelo.....NR46	Graphite.....PRKR11	Deep.....PURL12
Frost.....CU22	Sorbet.....DAPR55	OPTIC (De-emphasized)	Grass.....PRKR12	Graze.....PURL05
Goldenrod.....CU27	Spring.....DAPR80	Aurora.....OP72	Grenadine.....PRKR13	Loom.....PURL06
Indigo.....CU06	Terracotta.....DAPR13	Bark.....OP24	Griffin.....PRKR14	Needle.....PURL07
Iris.....CU50	Titanium.....DAPR17	Canopy.....OP84	Kiln.....PRKR16	Pasture.....PURL02
Iron Ore.....CU19	Varsity.....DAPR09	Char.....OP49	Magnesium.....PRKR18	Ranch.....PURL04
Jade.....CU83	Zest.....DAPR70	Ruby.....OP42	Magnet.....PRKR19	Shuttle.....PURL09
Marsala.....CU63	ENSEMBLE	Sand.....OP17	Mica.....PRKR20	Skein.....PURL01
Morel.....CU24	Aquamarine.....ENSB30	Sky.....OP83	Mink.....PRKR21	Thistle.....PURL11
Navy.....CU98	Ash.....ENSB39	Slate.....OP19	Nightfall.....PRKR22	Yearling.....PURL03
Peacock.....CU97	Greige.....ENSB36	Sprout.....OP74	Paprika.....PRKR24	QUILL
Pear.....CU84	Harbor.....ENSB34	Starry Night.....OP11	Pine.....PRKR25	Aviary.....QUL03
Ruby.....CU67	Navy.....ENSB35	Storm.....OP56	Rapids.....PRKR28	Feather.....QUL02
Sapphire.....CU09	Oat.....ENSB37	Wildfire.....OP66	Rioja.....PRKR30	Fountain.....QUL06
CONTOURETT	Pear.....ENSB33		RUSH (100% Polyester)	Ink.....QUL05
Baltic.....UR94	Sand.....ENSB38	GRADE 2	Anchor.....RUSH07	Metal.....QUL04
Beach.....UR23	Scarlet.....ENSB32	APPOINT SEATING	Basil.....RUSH16	Reed.....QUL08
Black.....UR10	Slate.....ENSB31	Artichoke.....PNS014	Blueberry.....RUSH10	Scroll.....QUL01
Bordeaux.....UR63	Stone.....ENSB40	Blackberry.....PNS012	Flamingo.....RUSH21	Well.....QUL07
Buff.....UR22	HAMILTON (De-emphasized) (100% Polyester)	Bronze.....PNS002	Greenery.....RUSH15	
Cloud.....UR18	Azure.....HAML10	Carbon.....PNS008	Greyhound.....RUSH06	GRADE 6
Coffee Bean.....UR49	Biscotti.....HAML11	Chai.....PNS013	Marina.....RUSH13	ARRIS
Crater.....UR51	Cabernet.....HAML08	Cherry.....PNS010	Merlot.....RUSH19	Artisan.....ARR01
Flame.....UR62	Carolina.....HAML21	Dark Pewter.....PNS017	Midnight.....RUSH11	Baroque.....ARR07
Graphite.....UR19	Chocolate.....HAML13	Dune.....PNS015	Mint.....RUSH09	Noble.....ARR02
Iron.....UR20	Cloud.....HAML18	Espresso.....PNS003	Mulberry.....RUSH18	Rattan.....ARR05
Luggage.....UR26	Dane.....HAML16	Framboise.....PNS011	Pumice.....RUSH01	Rich.....ARR04
Marine.....UR92	Dusty Rose.....HAML07	Frost.....PNS034	Punch.....RUSH20	Tapestry.....ARR03
Navy.....UR95	Esmeralda.....HAML06	Jet.....PNS007	Sage.....RUSH14	Weft.....ARR06
Nimbus.....UR93	Fern.....HAML04	Lawn.....PNS005	Salsa.....RUSH24	
Ocean.....UR96	Fresh.....HAML03	Mandarin.....PNS009	Sand.....RUSH05	
Pumpkin.....UR42	Granola.....HAML19	Nimbus.....PNS016	Seal.....RUSH08	
Quarry.....UR24	Lilac.....HAML14	Platinum.....PNS004	Soot.....RUSH02	
Red.....UR64	Lime.....HAML05	Turquoise.....PNS006	Stout.....RUSH03	
Safari.....UR27	Lipstick.....HAML09	BLUME	Sunshine.....RUSH23	
Sage.....UR82	Oxford.....HAML20	Chalk.....BLME03	Tapestry.....RUSH04	
Steel.....UR21	Passion Fruit.....HAML02	Char.....BLME00	Tiger.....RUSH22	
Storm.....UR17	Pepper.....HAML15	Coin.....BLME02	Vintage.....RUSH17	
Taupe.....UR28	Powder.....HAML12	Driftwood.....BLME05	Wave.....RUSH12	
Trunk.....UR50	Sunrise.....HAML01	Emerald City.....BLME07		
		Fir.....BLME09	SPIN SEATING	
		Harvest.....BLME04	Alabaster.....SPNN02	
		Haze.....BLME08	Cavern.....SPNN03	
		Hyacinth.....BLME14	Cobblestone.....SPNN04	
		Jasper.....BLME13	Ember.....SPNN06	
		Merlot.....BLME10	Flame.....SPNN07	
		Moonstone.....BLME01	Heron.....SPNN13	
		Opal.....BLME06	Oat.....SPNN01	
		Scarlet.....BLME11	Ocean.....SPNN12	
		Slate.....BLME12	Plum.....SPNN15	
		CLYDE	Pool.....SPNN11	
		Antique.....CLYD04	Raven.....SPNN10	
		Artifact.....CLYD01	Rhubarb.....SPNN14	
		Blacksmith.....CLYD10	Tropic.....SPNN08	
		Claret.....CLYD13	Willow.....SPNN05	
		Craftsman.....CLYD08		
		Crate.....CLYD12		
		Fossil.....CLYD02		
		Heirloom.....CLYD05		
		Iron.....CLYD11		
		Linen.....CLYD14		
		Relic.....CLYD06		
		Seasoned.....CLYD03		
		Trestle.....CLYD07		

Multi-use fabrics are noted with the following designators:
B – Tackboards **S** – Stride®
C – Concensys® **T** – Terrace®
O – Optimize™ **F** – Further™
 * limited to 48" W or less

UPHOLSTERY

GRADE A

APPOINT PANEL	
<i>100% Polyester</i>	
Artichoke.....	APN911
Blackberry.....	APN932
Bronze.....	APN922
Carbon.....	APN928
Chai.....	APN912
Cherry.....	APN930
Dark Pewter.....	APN917
Dune.....	APN915
Espresso.....	APN923
Framboise.....	APN931
Frost.....	APN934
Jet.....	APN927
Lawn.....	APN925
Mandarin.....	APN929
Morel.....	APN909
Nimbus.....	APN916
Platinum.....	APN924
Turquoise.....	APN926
BINARY †	
Blush.....	BNRY12
Coal.....	BNRY06
Cream.....	BNRY01
Denim.....	BNRY08
Diamond.....	BNRY03
Graphite.....	BNRY05
Juniper.....	BNRY10
Lagoon.....	BNRY07
Lavendar.....	BNRY11
Mineral.....	BNRY04
Reef.....	BNRY09
Sand Dollar.....	BNRY02
*CENTURION™	
<i>(Nanotex™ Stain-Resistant finish)</i>	
Apricot.....	CU47
Bark.....	CU25
Black.....	CU10
Espresso.....	CU49
Fog.....	CU03
Frost.....	CU22
Goldenrod.....	CU27
Indigo.....	CU06
Iris.....	CU50
Iron Ore.....	CU19
Jade.....	CU83
Marsala.....	CU63
Morel.....	CU24
Navy.....	CU98
Peacock.....	CU97
Pear.....	CU84
Ruby.....	CU67
Sapphire.....	CU09
CIRCUIT † ♣	
Atlas.....	CIRC35
Dolphin.....	CIRC63
Island White.....	CIRC14
Moon.....	CIRC07
Night.....	CIRC49
Pacific.....	CIRC28
Quartz.....	CIRC01
Sienna.....	CIRC56
Silk.....	CIRC21
Snap Pea.....	CIRC42

GRADE A – continued

ETCH	
<i>100% Polyester</i>	
Axis.....	ECH913
Blend.....	ECH914
Cast.....	ECH912
Highlight.....	ECH910
Midtone.....	ECH911
Outline.....	ECH908
Shade.....	ECH909
Tonal.....	ECH916
Vanish.....	ECH915
LANDSCAPE	
<i>100% Polyester</i>	
Cornsilk.....	LN15
Drift.....	LN05
Khaki.....	LN20
Sheen.....	LN10
Slate.....	LN35
Umber.....	LN25
Urban.....	LN30
LUCY	
<i>100% Recycled Polyester</i>	
Aspen.....	LC932
Cornsilk.....	LC930
Dusk.....	LC922
Fawn.....	LC933
Graphite.....	LC934
Mist.....	LC920
Neutra.....	LC924
Pewter.....	LC935
Snowdrop.....	LC928
NOBLE	
Aspen.....	NBLE14
Bordeaux.....	NBLE01
Brick.....	NBLE02
Chambrey.....	NBLE10
Clementine.....	NBLE04
Dawn.....	NBLE13
Denim.....	NBLE09
Grass.....	NBLE07
Gunmetal.....	NBLE15
Harvest.....	NBLE12
Jade.....	NBLE06
Knight.....	NBLE17
Mesa.....	NBLE03
Pacific.....	NBLE08
Rainforest.....	NBLE05
Regal.....	NBLE11
Stormy.....	NBLE16
REFLECTIONS	
<i>100% Recycled Polyester</i>	
Galvanized.....	REF929
Ice.....	REF920
Loggia.....	REF921
Mistral.....	REF928
Moonstone.....	REF923
Pewter.....	REF922
Stainless.....	REF924
Vanilla.....	REF925
Winter.....	REF927

GRADE A – continued

REFUGE	
<i>64% Recycled Polyester</i>	
<i>36% Polyester</i>	
Artesian.....	RFG996
Dune.....	RFG992
Eclipse.....	RFG990
Frost †.....	RFG993
Glacier †.....	RFG991
Mineral.....	RFG998
Tidal.....	RFG994
TEMPEST	
<i>100% Recycled Polyester</i>	
Dragonfly.....	TP930
Frost.....	TP915
Full Stream.....	TP980
Gold Rush.....	TP910
Slate.....	TP945
Tumbleweed.....	TP970
Wind Chill.....	TP940
Zebra.....	TP935

GRADE B

COAST † ♣	
<i>100% Antimony-Free Polyester</i>	
Channel.....	COA914
Dune.....	COA903
Headlands.....	COA910
Marsh.....	COA902
Pebble.....	COA912
Pier.....	COA913
Shoal.....	COA901
Silt.....	COA906
Tide.....	COA908
DISPERSE †	
<i>100% Polyester</i>	
Autumn.....	DISP03
Branch.....	DISP10
Coffee Bean.....	DISP13
Dusk.....	DISP09
Emerald City.....	DISP08
Gold Rush.....	DISP02
Igloo.....	DISP11
Ink.....	DISP06
Mist.....	DISP12
Oatmeal.....	DISP15
Prince.....	DISP07
Reservoir.....	DISP01
Rose.....	DISP04
Spring.....	DISP05
Steel.....	DISP16
Taupe.....	DISP14

GRADE B – continued

MICA (De-emphasized)	
<i>100% Recycled Polyester</i>	
Anthracite.....	MCA911
Breeze.....	MCA918
Bronze.....	MCA913
Buff.....	MCA914
Cremini.....	MCA917
Crystal †.....	MCA917
Dew.....	MCA920
Shale.....	MCA912
Dove.....	MCA916
Fresh.....	MCA916
Mineral.....	MCA915
Nectar.....	MCA919
Shale.....	MCA910
SPIN PANEL	
<i>46% Recycled Polyester,</i>	
<i>56% Polyester</i>	
Alabaster.....	SPIN02
Cavern.....	SPIN03
Cobblestone.....	SPIN04
Ember.....	SPIN06
Flame.....	SPIN07
Heron.....	SPIN13
Oat.....	SPIN01
Ocean.....	SPIN12
Plum.....	SPIN15
Pool.....	SPIN11
Raven.....	SPIN10
Rhubarb.....	SPIN14
Tropic.....	SPIN08
Willow.....	SPIN05
TERRAIN	
<i>52% Recycled Polyester,</i>	
<i>48% Polyester</i>	
Bay.....	TRRN05
Bayou.....	TRRN35
Canyon.....	TRRN30
Cliff.....	TRRN45
Crest.....	TRRN25
Delta.....	TRRN10
Plateau.....	TRRN15
Ridge.....	TRRN20
Valley.....	TRRN40

GRADE D

Camira BLAZER LITE † ▼	
<i>(100% Pure New Wool)</i>	
Angel.....	PCAMBLT49
Aspire.....	PCAMBLT52
Balance.....	PCAMBLT41
Bliss.....	PCAMBLT48
Buddha.....	PCAMBLT56
Cuddle.....	PCAMBLT62
Dainty.....	PCAMBLT64
Daydream.....	PCAMBLT46
Devoted.....	PCAMBLT58
Faith.....	PCAMBLT68
Freedom.....	PCAMBLT69
Graceful.....	PCAMBLT51
Happy.....	PCAMBLT55
Harmony.....	PCAMBLT63
Haven.....	PCAMBLT40
Hope.....	PCAMBLT50
Hush.....	PCAMBLT42
Love.....	PCAMBLT47
Mood.....	PCAMBLT44
Pamper.....	PCAMBLT66
Pastel.....	PCAMBLT65
Pillow.....	PCAMBLT43
Praise.....	PCAMBLT54
Retreat.....	PCAMBLT39
Shelter.....	PCAMBLT60
Solace.....	PCAMBLT70
Tender.....	PCAMBLT53
True.....	PCAMBLT61
Verity.....	PCAMBLT57
Wish.....	PCAMBLT67
Worship.....	PCAMBLT59

^w Limited to 48"W or less

^{*} Not available on 72"W.

▼ Panel fabric is not available on Further.

♣ Panel fabric is not available on Optimize®.

† Panel fabric is not available on Concensys®.

◆ Panel fabric is not available on Involve.

Multi-use fabrics are seating fabrics that can be used on specific Allsteel panels systems, providing more color and pattern options. The applicable Allsteel multi-use fabrics are noted with System designators in the Seating, Collaboration, and Tables Price List.

Notes

UPHOLSTERY

Finishes

FINISHES

Paint Name	Paint Code	Grade	Touch Ups	Pivot Monitor Arms	Pivot GSA Monitor Arms	Terrace	Terrace Footed Panels	Extensions	Stride	Stride Storage	Stride Footed Panels	Stride 5jt to Stand	Stride PR6 Only
Black	P27	1	•			•	•	•	•	•	•	•	
Black	P71	1	•										
Black	BLK	1	•	•									
Brownstone	P7D	1	•			•	•	•	•	•	•		
Bungalow	P7C	1	•			•	•	•	•	•	•		
Carbon	P4Q	1	•										
Charblack	CBK	1	•										
Charblack Metallic*	P80	1	•										
Cinder	P7Q	1	•			•	•	•	•	•	•		
Designer White	WHT	1											
Designer White	PJW	1	•			•	•	•	•	•	•	•	
Flint	P02	1	•			•	•	•	•	•	•		
Fog	FOG	1											
Fossil	P28	1	•			•	•	•	•	•	•		
Loft	P7B	1	•			•	•	•	•	•	•		
Muslin	P4J	1	•			•	•	•	•	•	•		
Nickel	P8L	1											
Parchment	P93	1	•			•	•	•	•	•	•		
Pebble	P8R	1				•	•	•	•	•	•		
Pewter	P8D	1	•			•	•	•	•	•	•		
Platinum Metallic Texture	P6H	1											
Putty	PJS	1											
Salt	P8C	1	•			•	•	•	•	•	•		
Shadow	P4K	1											
Textured Brownstone	P7J	1	•										
Textured Designer White	PK7	1	•										
Textured Flint	P7A	1	•										
Textured Loft	P7L	1	•										
Textured Muslin	P7M	1	•										
Textured Pebble	P8Y	1	•										
Textured Salt	P8Z	1	•										
Textured Titanium	P8V	1	•										
Titanium	P8T / T	1	•			•	•	•	•	•	•		
White	PD8	1											
Anodized Silver	PR0	2	•										
Champagne Metallic	PR5	2				•	•	•	•	•	•		
Designer White High Gloss 65	P8W	2	•										
Graphite Metallic Texture	P85	2	•										
Gunmetal Metallic	PR3	2	•			•	•	•	•	•	•		
Matte Gold	P8G	2											
Night Bronze	P8B	2	•					•					
Platinum Metallic	PR2	2	•			•	•	•	•	•	•		
Pyrite	PJE	2	•					•					
Silver	PR6	2	•			•	•	•	•	•	•	•	•
Silver Generic	SVR	2		•	•								
Silver Texture	PR8	2	•										
Solar Black	P8X	2	•			•	•	•	•	•	•		
Atom	P8S	3	•			•	•	•	•	•	•		
Blossom	P8K	3	•			•	•	•	•	•	•		
Bullseye	PJF	3	•			•	•	•	•	•	•		
Ember	P8P	3	•			•	•	•	•	•	•		
Ion	P8N	3	•			•	•	•	•	•	•		
Iris	P8J	3	•			•	•	•	•	•	•		
Krypton	P8F	3	•			•	•	•	•	•	•		
Regatta	P8M	3	•			•	•	•	•	•	•		
Markerboard White	MKP	6								•			

Finishes

Paint Name	Paint Code	Grade	Stride Hardware (Pulls, Feet, & Trim)	Metal Center Drawers	Power Pole	Cable Management Tray	Altitude A6 Table Bases	Altitude A8 Table Bases Utility Bay	Altitude A8 Table Bases and Power Rails	Altitude Metal Screens	Gallery Panels Connectors	Hands Free Pulls	Universal Screens
Black	P27	1		•	•	•							
Black	P71	1				•	•	•	•	•			•
Black	BLK	1											
Brownstone	P7D	1	•	•	•			•	•	•			•
Bungalow	P7C	1	•	•	•			•	•	•			
Carbon	P4Q	1											
Charblack	CBK	1			•								
Charblack Metallic*	P80	1											
Cinder	P7Q	1	•		•			•	•	•			•
Designer White	WHT	1											
Designer White	PJW	1	•	•	•		•	•	•	•			•
Flint	P02	1	•	•	•			•	•	•			•
Fog	FOG	1											
Fossil	P28	1	•		•			•	•	•			•
Loft	P7B	1	•	•	•			•	•	•			•
Muslin	P4J	1	•	•	•			•	•	•			•
Nickel	P8L	1				•							
Parchment	P93	1	•		•					•			
Pebble	P8R	1	•		•			•	•	•			•
Pewter	P8D	1	•		•			•	•	•			•
Platinum Metallic Texture	P6H	1											
Putty	PJS	1											
Salt	P8C	1	•		•			•	•	•			•
Shadow	P4K	1											
Textured Brownstone	P7J	1											
Textured Designer White	PK7	1											
Textured Flint	P7A	1											
Textured Loft	P7L	1											
Textured Muslin	P7M	1											
Textured Pebble	P8Y	1											
Textured Salt	P8Z	1											
Textured Titanium	P8V	1									•		
Titanium	P8T / T	1	•		•			•	•	•			•
White	PD8	1				•							
Anodized Silver	PR0	2											
Champagne Metallic	PR5	2	•		•			•	•	•			•
Designer White High Gloss 65	P8W	2											
Graphite Metallic Texture	P85	2											
Gunmetal Metallic	PR3	2	•		•					•			•
Matte Gold	P8G	2											
Night Bronze	P8B	2						•	•	•			•
Platinum Metallic	PR2	2	•		•					•			•
Pyrite	PJE	2						•	•	•			•
Silver	PR6	2	•		•		•	•	•	•			•
Silver Generic	SVR	2											
Silver Texture	PR8	2											
Solar Black	P8X	2						•	•	•			•
Atom	P8S	3						•	•	•			•
Blossom	P8K	3						•	•	•			•
Bullseye	PJF	3						•	•	•			•
Ember	P8P	3						•	•	•			•
Ion	P8N	3						•	•	•			•
Iris	P8J	3						•	•	•			•
Krypton	P8F	3						•	•	•			•
Regatta	P8M	3						•	•	•			•
Markerboard White	MKP	6							•				•

FINISHES

Finishes

FINISHES

Pattern Name	Code	Grade	Altitude	Daybook	Gallery Panels	Terrace Doors	Stride Laminate Door	Stride Laminate Tiles	System Worksurfaces	Terrace Laminate Tiles
Ash	LT3B	1	•			•	•	•	•	•
Handspun Chestnut	LAHC	1	•			•	•	•	•	•
Handspun Dove	LAHD	1	•		•	•	•	•	•	•
Handspun Pearl	LAHP	1	•		•	•	•	•	•	•
Handspun Slate	LAHS	1	•		•	•	•	•	•	•
Silver Mesh	LT8D	1	•			•	•	•	•	•
Black	P	1	•	•		•	•	•	•	•
Brownstone	LM13	1	•		•	•	•	•	•	•
Bungalow	LM12	1	•		•	•	•	•	•	•
Designer White 15051	LDW1	1	•	•	•	•	•	•	•	•
Flint	LM16	1	•	•	•	•	•	•	•	•
Fossil Shale	LEH1	1	•		•	•	•	•	•	•
Loft	LM11	1	•	•	•	•	•	•	•	•
Muslin	LM15	1	•		•	•	•	•	•	•
Titanium	LT11	1	•		•	•	•	•	•	•
Belair	LWBA	1	•		•	•	•	•	•	•
Bourbon Cherry	H	1	•	•	•	•	•	•	•	•
Field Elm	LWFE	1	•	•	•	•	•	•	•	•
Florence Walnut	LFW1	1	•	•	•	•	•	•	•	•
Kingswood Walnut	LK11	1	•	•	•	•	•	•	•	•
Natural Maple	LWD	1	•	•	•	•	•	•	•	•
NeoWalnut	LNU1	1	•	•	•	•	•	•	•	•
Pinnacle	PINC	1	•	•	•	•	•	•	•	•
Shaker Cherry	LW7C	1	•	•	•	•	•	•	•	•
Beigewood	LWBE	2	•	•	•	•	•	•	•	•
Fawn Cypress	LFC1	2	•	•	•	•	•	•	•	•
Lowell Ash	LLA1	2	•	•	•	•	•	•	•	•
Mangalore Mango	LMM1	2	•		•	•	•	•	•	•
Natural Recon	LNR1	2	•	•	•	•	•	•	•	•
Phantom Charcoal	LPC1	2	•		•	•	•	•	•	•
Phantom Ecru	LPE1	2	•	•	•	•	•	•	•	•
Portico Teak	LPT1	2	•	•	•	•	•	•	•	•
Skyline Walnut	LSW1	2	•	•	•	•	•	•	•	•
Veranda Teak	LVT1	2	•	•	•	•	•	•	•	•
Natural Walnut	LWNW	3	•		•	•	•	•	•	•
Open Line Laminate Program	N/A	Varies	•		•			•	•	•

Finishes

Veneer Type	Stain Name	Code	Grade	Stride Tiles	Stride Trim	Stride Natural Tile Sets	System Worksurfaces	Terrace Tiles
FSC Stratawood Cherry	Cinnamon Cherry	FSCSC260	2	•	•		•	
FSC Stratawood Cherry	Lowell Ash	FSCSC394	2	•	•		•	
FSC Stratawood Cherry	Clear Cherry	FSCSC700	2	•	•		•	
FSC Stratawood Cherry	Light Cherry	FSCSC701	2	•	•		•	•
FSC Stratawood Cherry	Shaker Cherry	FSCSC774	2	•	•		•	
FSC Stratawood Cherry	Burnished Cherry	FSCSC777	2	•	•		•	•
FSC Stratawood Maple	Field Elm	FSCSE599	2	•	•		•	
FSC Stratawood Maple	Clear Maple	FSCSE800	2	•			•	•
FSC Stratawood Maple	Harvest Maple	FSCSE856	2	•	•		•	
FSC Stratawood Maple	Beigewood	FSCSE878	2	•	•		•	
FSC Stratawood Maple	Phantom Ecu	FSCSE912	2	•	•		•	
FSC Stratawood Maple	Belair	FSCSE934	2	•	•		•	
FSC Stratawood Rift Oak	Clear Oak	FSCSF300	2	•	•		•	•
FSC Stratawood Rift Oak	Dark Rift Oak	FSCSF331	2	•	•		•	•
FSC Stratawood Walnut	Florence Walnut	FSCST579	2	•	•		•	
FSC Stratawood Walnut	Light Walnut	FSCST601	2	•	•		•	•
FSC Stratawood Walnut	Skyline Walnut	FSCST625	2	•	•		•	
FSC Stratawood Walnut	Pinnacle Walnut	FSCST679	2	•	•		•	
FSC Stratawood Walnut	Sumatra Walnut	FSCST693	2	•	•		•	
FSC Natural Cherry	Cinnamon Cherry	FSCNC260	2	•	•	•	•	
FSC Natural Cherry	Lowell Ash	FSCNC394	2	•	•	•	•	
FSC Natural Cherry	Medium Red Cherry	FSCNC512	2	•	•	•	•	
FSC Natural Cherry	Clear Cherry	FSCNC700	2	•	•	•	•	
FSC Natural Cherry	Light Cherry	FSCNC701	2	•	•	•	•	
FSC Natural Cherry	Shaker Cherry	FSCNC774	2	•	•	•	•	
FSC Natural Cherry	Burnished Cherry	FSCNC777	2	•	•	•	•	
FSC Natural Maple	Clear Maple	FSCNE800	2	•		•	•	
FSC Natural Maple	Harvest Maple	FSCNE856	2	•	•	•	•	
FSC Natural Walnut	Ebony Walnut	FSCNT509	2	•	•	•	•	
FSC Natural Walnut	Florence Walnut	FSCNT579	2	•	•	•	•	
FSC Natural Walnut	Light Walnut	FSCNT601	2	•	•	•	•	
FSC Natural Walnut	Skyline Walnut	FSCNT625	2	•	•	•	•	
FSC Natural Walnut	Nutmeg Walnut	FSCNT629	2	•	•	•	•	
FSC Natural Walnut	Pinnacle Walnut	FSCNT679	2	•	•	•	•	
FSC Natural Walnut	Sumatra Walnut	FSCNT693	2	•	•	•	•	
FSC Natural Rift Oak	Fawn Cypress	FSCRF108	3	•	•		•	
FSC Natural Rift Oak	Light Rift Oak	FSCRF301	3	•	•		•	
FSC Rift Oak	Dark Rift Oak	FSCRF331	3	•	•	•	•	
FSC Natural Rift Oak	Phantom Ecu	FSCRF912	3	•	•		•	
Natural Cherry	Cinnamon Cherry	NC260	2	•	•		•	
Natural Cherry	Lowell Cherry	NC394	2	•	•	•	•	
Natural Cherry	Medium Red Cherry	NC512	2	•	•	•	•	
Natural Cherry	Light Cherry	NC701	2	•	•	•	•	
Natural Cherry	Shaker Cherry	NC774	2	•	•	•	•	
Natural Cherry	Burnished Cherry	NC777	2	•	•	•	•	
Natural Maple	Clear Maple	NE800	2	•		•	•	
Natural Maple	Harvest Maple	NE856	2	•	•	•	•	
Natural Rift Cut Oak	Fawn Cypress	RF108	3	•	•		•	
Natural Rift Cut Oak	Light Rift Oak	RF301	3	•	•		•	
Natural Rift Cut Oak	Dark Rift Oak	RF331	2	•	•	•	•	
Natural Rift Cut Oak	Phantom Ecu	RF912	3	•	•		•	
Natural Walnut	Ebony Walnut	NT509	2	•	•	•	•	
Natural Walnut	Florence Walnut	NT579	2	•	•	•	•	
Natural Walnut	Light Walnut	NT601	2	•	•	•	•	
Natural Walnut	Skyline Walnut	NT625	2	•	•	•	•	
Natural Walnut	Nutmeg Walnut	NT629	2	•	•	•	•	
Natural Walnut	Pinnacle Walnut	NT679	2	•	•	•	•	
Natural Walnut	Sumatra Walnut	NT693	2	•	•	•	•	

Finishes

Veneer Type	Stain Name	Code	Grade	Stride Tiles	Stride Trim	Stride Natural Tile Sets	System Worksurfaces	Terrace Tiles
Stratawood Cherry	Stratawood Cherry	SC260	2	•	•		•	
Stratawood Cherry	Lowell Ash	SC394	2	•	•		•	
Stratawood Cherry	Clear Cherry	SC700	2	•	•		•	
Stratawood Cherry	Light Cherry	SC701	2	•	•		•	•
Stratawood Cherry	Shaker Cherry	SC774	2	•	•		•	
Stratawood Cherry	Burnished Cherry	SC777	2	•	•		•	•
Stratawood Maple	Field Elm	SE599	2	•	•		•	
Stratawood Maple	Clear Maple	SE800	2	•			•	•
Stratawood Maple	Harvest Maple	SE856	2	•	•		•	
Stratawood Maple	Beigewood	SE878	2	•	•		•	
Stratawood Maple	Phantom Ecu	SE912	2	•	•		•	
Stratawood Maple	Belair	SE934	2	•	•		•	
Stratawood Silver Oak	Clear	SB100	2	•	•		•	•
Stratawood Silver Oak	Portico Teak	SB150	2	•	•		•	
Stratawood Rift Oak	Clear Oak	SF300	2	•	•		•	•
Stratawood Rift Oak	Dark Rift Oak	SF331	2	•	•		•	•
Stratawood Walnut	Florence Walnut	ST579	2	•	•		•	
Stratawood Walnut	Light Walnut	ST601	2	•	•		•	•
Stratawood Walnut	Skyline Walnut	ST625	2	•	•		•	
Stratawood Walnut	Pinnacle Walnut	ST679	2	•	•		•	
Stratawood Walnut	Sumatra Walnut	ST693	2	•	•		•	

FINISHES

- Finishes 22-23
- Introduction/Overview 24
- Statement of Line 25
- Specification Details 26-27
- Frames..... 28
- Laminate Inserts..... 29
- Metal Inserts 30
- Slotted Metal Inserts 31
- Fabric Inserts..... 32
- Glass Inserts 33
- Shelves & Bookcases..... 34
- Planters 35
- Work Tools..... 36

**FRAME, METAL INSERT,
SLOTTED METAL INSERT**

GRADE P1

Black P71
 Brownstone P7D
 Bungalow P7C
 Carbon P4Q
 Designer White PJW
 Flint P02
 Fossil P28
 Loft P7B
 Muslin P4J
 Parchment P93
 Pebble P8R
 Pewter P8D
 Salt P8C
 Textured Designer White PK7
 Textured Flint P7A
 Titanium P8T

GRADE P2

Champagne Metallic PR5
 Gunmetal Metallic PR3
 Night Bronze P8B
 Platinum Metallic PR2
 Silver PR6
 Solar Black P8X

GRADE P3

Atom P8S
 Blossom P8K
 Bullseye PJF
 Ember P8P
 Ion P8N
 Iris P8J
 Krypton P8F
 Ochre P093
 Regatta P8M
 Sienna P092
 Succulent P8A

**LAMINATE INSERT,
LAMINATE SHELF**

L1 SOLID

Black P
 Designer White LDW1
 Flint LM16
 Loft LOFT

L1 WOODGRAIN

Bourbon Cherry H
 Field Elm LWFE
 Florence Walnut LFW1
 Kingswood Walnut LK11
 Natural Maple LWD
 NeoWalnut LNU1
 Pinnacle PINC
 Shaker Cherry F

L2 WOODGRAIN

Beigewood LWBE
 Fawn Cypress LFC1
 Lowell Ash LLA1
 Natural Recon LNR1
 Phantom Ecu LPE1
 Portico Teak LPT1
 Regatta P8M
 Skyline Walnut LSW1
 Veranda Teak LVT1

LAMINATE EDGE

Beigewood DE
 Belair BA
 Black E4
 Brownstone EY
 Bungalow EX
 Designer White DW
 Fawn Cypress FC
 Field Elm FE
 Flint E9
 Florence Walnut FW
 Fossil EH
 Kingswood Walnut KI
 Loft EV
 Lowell Ash DL
 Mangalore Mango MM
 Muslin EU
 Natural Maple DD
 Natural Recon NR
 Natural Walnut DN
 NeoWalnut NU
 Phantom Ecu PE
 Portico Teak DP
 Shaker Cherry DF
 Skyline Walnut SW
 Titanium TI
 Veranda Teak VT

**SHELF, BOOKCASE,
PLANTER PAINT**

GRADE P1

Black P71
 Brownstone P7D
 Bungalow P7C
 Carbon P4Q
 Designer White PJW
 Flint P02
 Fossil P28
 Loft P7B
 Muslin P4J
 Parchment P93
 Pebble P8R
 Pewter P8D
 Salt P8C
 Textured Designer White PK7
 Textured Flint P7A
 Titanium P8T

GRADE P2

Champagne Metallic PR5
 Gunmetal Metallic PR3
 Night Bronze P8B
 Platinum Metallic PR2
 Silver PR6
 Solar Black P8X

GRADE P3

Atom P8S
 Blossom P8K
 Bullseye PJF
 Ember P8P
 Ion P8N
 Iris P8J
 Krypton P8F
 Ochre P093
 Regatta P8M
 Sienna P092
 Succulent P8A

GRADE A

APPOINT PANEL
100% Polyester

Artichoke APN911
 Blackberry APN932
 Bronze APN922
 Carbon APN928
 Chai APN912
 Cherry APN930
 Dark Pewter APN917
 Dune APN915
 Espresso APN923
 Framboise APN931
 Frost APN934
 Jet APN927
 Lawn APN925
 Mandarin APN929
 Morel APN909
 Nimbus APN916
 Platinum APN924
 Turquoise APN926

BINARY †

Blush BNRY12
 Coal BNRY06
 Cream BNRY01
 Denim BNRY08
 Diamond BNRY03
 Graphite BNRY05
 Juniper BNRY10
 Lagoon BNRY07
 Lavendar BNRY11
 Mineral BNRY04
 Reef BNRY09
 Sand Dollar BNRY02

***CENTURION™**
(Nanotex™ Stain-Resistant finish)

Apricot CU47
 Bark CU25
 Black CU10
 Espresso CU49
 Fog CU03
 Frost CU22
 Goldenrod CU27
 Indigo CU06
 Iris CU50
 Iron Ore CU19
 Jade CU83
 Marsala CU63
 Morel CU24
 Navy CU98
 Peacock CU97
 Pear CU84
 Ruby CU67
 Sapphire CU09

CIRCUIT † ♣

Atlas CIRC35
 Dolphin CIRC63
 Island White CIRC14
 Moon CIRC07
 Night CIRC49
 Pacific CIRC28
 Quartz CIRC01
 Sienna CIRC56
 Silk CIRC21
 Snap Pea CIRC42

GRADE A – continued

ETCH
100% Polyester

Axis ECH913
 Blend ECH914
 Cast ECH912
 Highlight ECH910
 Midtone ECH911
 Outline ECH908
 Shade ECH909
 Tonal ECH916
 Vanish ECH915

EXCHANGE
100% Polyester

Iron EXG916
 Nickel EXG914
 Pistachio EXG910
 Root EXG913
 Rupee EXG903
 Shadow EXG911
 Silver EXG915
 Sisal EXG917
 Stone EXG912

LANDSCAPE
100% Polyester

Cornsilk LN15
 Drift LN05
 Khaki LN20
 Sheen LN10
 Slate LN35
 Umber LN25
 Urban LN30

LUCY
100% Recycled Polyester

Aspen LC932
 Cornsilk LC930
 Dusk LC922
 Fawn LC933
 Graphite LC934
 Mist LC920
 Neutra LC924
 Pewter LC935
 Snowdrop LC928

NOBLE

Agean NBLE18
 Amethyst NBLE19
 Aspen NBLE14
 Aster NBLE20
 Blossom NBLE21
 Bluebell NBLE22
 Bordeaux NBLE01
 Brick NBLE02
 Chambray NBLE10
 Chamomile NBLE23
 Clementine NBLE04
 Conifer NBLE24
 Cottage NBLE25
 Darkness NBLE26
 Dawn NBLE13
 Denim NBLE09
 Desert Sand NBLE27
 Dewfall NBLE28
 Dusted Sage NBLE29
 Flax NBLE30
 Grass NBLE07
 Gunmetal NBLE15
 Harmony NBLE31
 Harvest NBLE12
 Ice Caves NBLE32
 Icicle NBLE33
 Inky NBLE34
 Iris NBLE35
 Jade NBLE06
 Knight NBLE17
 Mesa NBLE03
 Monarch NBLE36
 Pacific NBLE08
 Pitch NBLE37
 Queen Bee NBLE38
 Rainforest NBLE05
 Regal NBLE11
 Sandcastle NBLE39
 Sedona NBLE40
 Stormy NBLE16
 Sunbeam NBLE41
 Voyager NBLE42
 Windy Day NBLE43

GRADE A – continued

REFLECTIONS

100% Recycled Polyester

Galvanized	REF929
Ice	REF920
Loggia	REF921
Mistral	REF928
Moonstone	REF923
Pewter	REF922
Stainless	REF924
Vanilla	REF925
Winter	REF927

REFUGE

64% Recycled Polyester
36% Polyester

Artesian	RFG996
Dune	RFG992
Eclipse	RFG990
Frost †	RFG993
Glacier †	RFG991
Mineral	RFG998
Tidal	RFG994

SARTO ▼

100% Polyester (45% Recycled)

Ash	SRT988
Fog	SRT914
Lemongrass	SRT949
Mist	SRT945
Mushroom	SRT976
Oyster	SRT918
Reef	SRT964
Sesame	SRT993
Shale	SRT952

TEMPEST

100% Recycled Polyester

Dragonfly	TP930
Frost	TP915
Full Stream	TP980
Gold Rush	TP910
Slate	TP945
Tumbleweed	TP970
Wind Chill	TP940
Zebra	TP935

VAST

Vineyard	VST01
Garden	VST02
Grasslands	VST03
Bay	VST04
Open Air	VST05
Atmosphere	VST06
Ocean	VST07
Mountain Range	VST08
Highway	VST09
Tundra	VST10
Beach	VST11
Desert	VST12
Country Side	VST13

GRADE B

COAST † ♣

100% Antimony-Free Polyester

Channel	COA914
Dune	COA903
Headlands	COA910
Marsh	COA902
Pebble	COA912
Pier	COA913
Shoal	COA901
Silt	COA906
Tide	COA908

ALLSTEEL MATERIALS PARTNERSHIP PROGRAM —

See program explanation at bottom of page.

GRADE 4

HBF Textiles BLINK

Bright Blue	1048-59
Dark Violet	1048-77
Dove Grey*	1048-83
Lemon Yellow*	1048-22
Ocean Blue*	1048-56
Peppery	1048-90
Red Orange	1048-44
Sea Green*	1048-67
Silvery	1048-80

HBF Textiles LOOK-SEE

Electric*	1044-77
Foggy	1044-85
Foliage	1044-67
Lava	1044-44
Midnight	1044-59
Plum	1044-75
Shady	1044-80
Snowy	1044-11
Stone	1044-89
Terra Cotta*	1044-46
Ultramarine	1044-57
Wavelet*	1044-56
Wine*	1044-74

ALLSTEEL PARTNERSHIP PROGRAM

Allsteel understands that customers may want to specify panel and seating textiles outside of Allsteel's standard offering. Allsteel's Partnership Program consists of on-trend and design-forward patterns that have been tested and approved by Allsteel for use on Allsteel products. A subset of these approved patterns is available on cards in the textile binder, while numerous others are available on our website, allsteeloffice.com.

For memo samples, please contact our partners:

- Camira, memos@camirafabrics.com 1.616.288.0655
- CF Stinson, cfstinson.com 1.800.841.6279
- HBF Textiles, hbftextiles.com 1.877.494.5727
- Maharam, maharam.com 1.800.645.3943
- Ultrafabrics, ultrafabricsinc.com 1.877.309.6648

The intent of the **Partnership Program** is to offer a wide variety of on-trend textiles to meet your varied needs, but since these textiles are not part of our standard offering they may be subject to extended lead times. Because new materials will be introduced regularly, Allsteel reserves the right to change the offering at any time.

In the open plan, organizations are looking for ways to create spaces to flex with the needs of teams. Daybook creates division and collaboration for adjacent neighborhoods. Inserts can be customized to team needs — from a place to brainstorm to a celebration of project milestones. As teams change and new “neighbors” are added, the partition can be reconfigured to meet the needs of today and tomorrow.

	Top	Middle	Bottom
Metal	X	X	X
Laminate	X		X
Slotted Metal	X	X	X
Fabric	X	X	X
Glass Markerboard		X	
Planter		X	
Shelf		X	
Bookcase			X

Daybook is a furniture partition product, not a structural wall. It cannot support a door or other wall elements. It is anchored to the floor and ceiling/deck (or customer-provided structure) at the top and bottom of each vertical. When installing in a seismic zone, it is up to the trade partner (dealer/installer) managing the site to assess what is needed to be compliant with local codes.

Neighborhood Division

Creates neighborhood division by visibly *dividing space* and *harnessing local collaboration*. Permeable privacy is created through open-air inserts and a floor-to-ceiling design.

Team Culture

Drive team culture through *user choice* and *ownership* of product/space. A variety of materials and finishes enables designers to give teams their own flair and function without straying from corporate standards. The product can be a shared resource, but intuitively can feel owned by groups due to location or application.

Flexible Design

Daybook's flexible design allows it to be used in an *adaptive workplace*. Meaningful applications exist throughout the office; complementing different team and individual settings. Inserts and accessories can be easily swapped out to adjust to changes in team needs.

Frame



Base Frame



Frame Extension

Fabric Panel Inserts

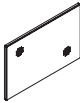

Top/Bottom Fabric Insert, Front



Top/Bottom Fabric Insert, Back



Middle Fabric Insert, Front



Middle Fabric Insert, Back

Laminate Panel Inserts



Top/Bottom Laminate Insert, Front



Top/Bottom Laminate Insert, Back

Metal Panel Inserts

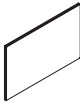

Top/Bottom Metal Insert, Front

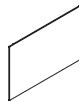

Top/Bottom Metal Insert, Back



Top/Bottom Slotted Metal Insert, Front



Top/Bottom Slotted Metal Insert, Back

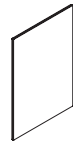

Middle Metal Insert, Front

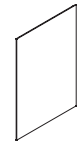

Middle Metal Insert, Back

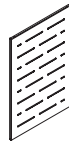

Middle Slotted Metal Insert, Front



Middle Slotted Metal Insert, Back

Glass Panel Inserts

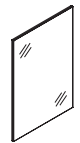

Glass MB Insert, Front

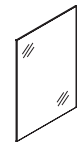

Glass MB Insert, Back

Storage & Shelving



Laminate Shelf

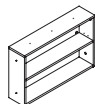

Laminate Bookcase



Steel Planter

Radii Tools



Hot File



Side Saddle



Bag or Coat Hook

DAYBOOK

Frame (page 28)

- Frame is available in standard finishes.
- Recommended 5-6 sections per run (1 base frame, 3-4 frame extensions). Maximum run will depend on slope of floor. Floor must have less than 2" of height variance across the total run of the Daybook partition. Failure to meet this requirement could cause lack of stability resulting in product damage, property damage, or serious bodily injury.
- Every 36" requires ceiling attachment and floor attachment, these attachments come with NHBRHDFRM (base frame) and NHBRHDFRMEXT (frame extension) for simple specification. Hardware not included.
- Hardware finish is always black.
- Linear configurations only. Any configurations needing non-linear runs will need to be separate units on either side of the turn and will not be ganged or connected to each other.
- To add frame extensions after initial installation, you must disassemble frame and add extension pieces to the middle (NHBRHDFRM will always be on outside).

Ceiling Attachment (page 28)

- Attachment brackets ship with frame. Hardware is not included.
- Matches frame color specification.
- Ceiling brackets can be positioned on either side of the partition.
- Above ceiling bracket can mount directly to deck, but can also be mounted to built-out ceiling structure.
- Hardware is not included. Fasteners will vary depending on ceiling construction. Choose fasteners specific for your application.
- Grommets/shrouds for ceiling attachment must be sourced separately.
- "HI" spec: targeted mounting height 162" (13.5') to 207" (17') from floor.
- "MED" spec: targeted mounting height 138" (11.5') to 162" (13.25') from floor.
- "LO" spec: targeted mounting height 109" (9.125'), 126" (10.5') – 138" (11.25').
- For custom heights, please contact the Allsteel Tailored Products Group.



Floor Attachment (page 28)

- Attachment brackets ship with frame. Hardware is not included.
- Matches frame color specification.
- Foot design accepts customer-provided floor fastener up to 3/8" diameter.
- Finished floor anchor overall height maximum 7/16".

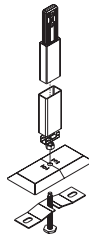

Inserts (pages 29-33)

- Top/Bottom inserts and middle inserts available to create customizable solution.
- Every partition has a "front" and a "back" and models must be specified as such to allow for proper attachment clips.
- Day 2 insert customers will only need to order "back" models for tile to tile retrofit opportunities.
- All front and back inserts can be different to match application need.
- Slotted metal inserts will show back of tile through the slots depending on what insert it is being used with. Weight capacity for slotted metal inserts/Radii tools: 50 lbs. distributed.
- Weight capacity for slotted metal inserts/Radii tools: 50 lbs. distributed.
- Top/Bottom Inserts feature Metal, Slotted Metal, Fabric, and Laminate materials.
- Middle inserts feature Metal, Slotted Metal, Fabric, and Glass Marker Board.
- Laminate inserts have a vertical grain direction. For fabric inserts, all Allsteel standard paints are available for the pan.
- Must install frame before installing inserts. Order in which inserts are installed does not matter.

Floating Shelf/Bookcase (page 34)

- Laminate shelf perfect for team displays and collaboration tools.
- Available in Allsteel standard laminates.
- 20 lbs. (distributed) load capacity per shelf.
- Floating shelf utilizes universal brackets.
- Bookshelf utilizes hardware for frame attachment. Available in Allsteel standard paint finishes.
- Shelves and bookcases are dual-sided inserts. Only one is required within specification (does not require a front and back model, like other inserts).
- Maximum of three shelves per middle section.
- Shelves can only be used as a middle inserts. Bookcases can only be used as a bottom insert.

Planter (page 35)

- Planter can be used for light storage or to introduce biophilia into a space.
- Painted steel planter available in Allsteel standard paints. Brackets will match paint specified with planter.
- Planter liner must be sourced separately, standard sizes available in the market.
- Planters can only be used as a middle insert.
- 30 lbs. weight capacity (distributed).
- Maximum of three planters per middle section.
- Planters are dual-sided inserts. Only one is required within specification (does not require a front and back model, like other inserts).

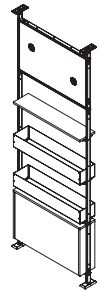

Deck Visual Details

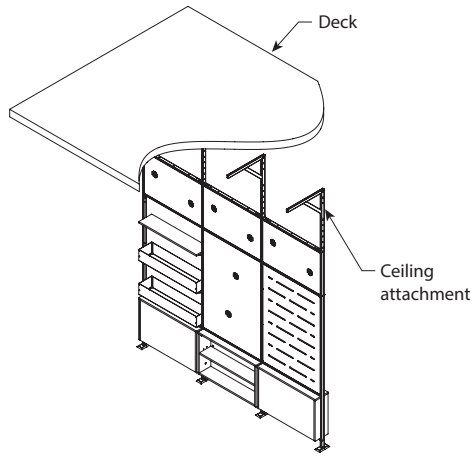

Visual from Top Side

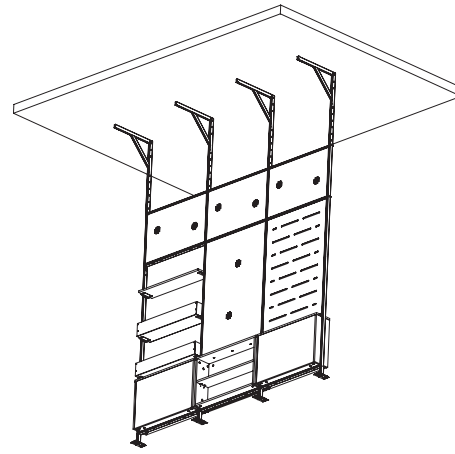

Visual from Bottom Side

Structure Connected to Deck Visual Details

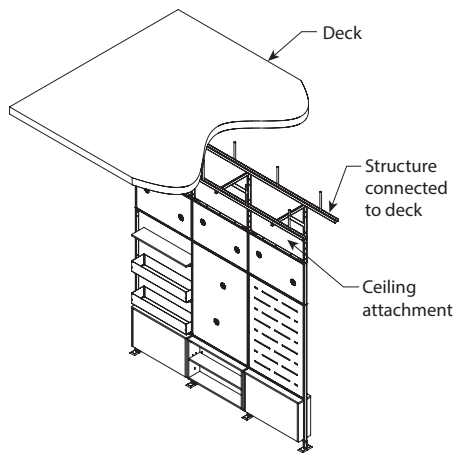

Visual from Top Side

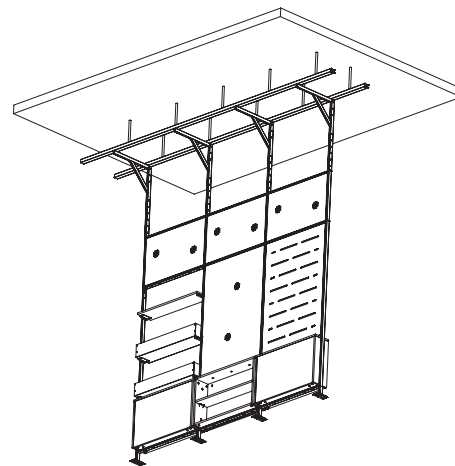

Visual from Bottom Side

Grid Ceiling Visual Details

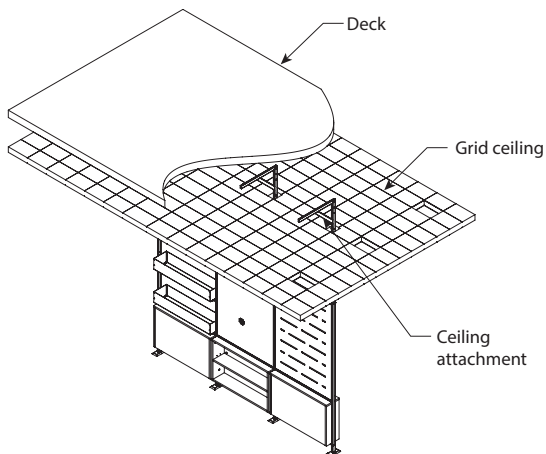

Visual from Top Side

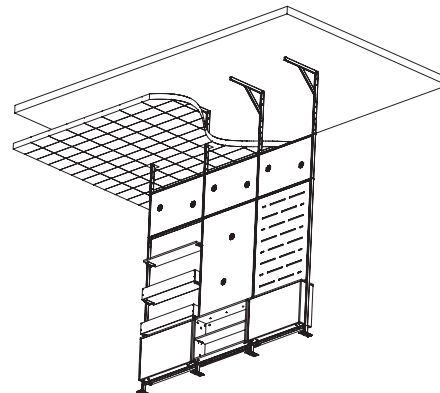

Visual from Bottom Side

For specification information see page 26.

Open Market

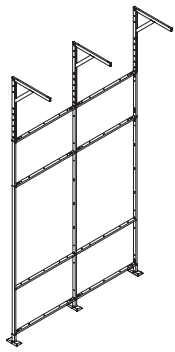

Description	Model	List Price
Daybook Frame		
Base Frame	NHBRHDFRM	\$ 7175

NOTE: For custom heights, please contact the Allsteel Tailored Products Group.

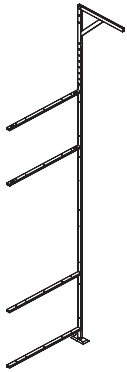

Frame Extension	NHBRHDFRMEXT	\$ 3254
-----------------	--------------	---------

NOTE: For custom heights, please contact the Allsteel Tailored Products Group.

<p>How to specify — Select the Model Number from above.</p>	<p>1st Option: Select the Base Paint Color (if applicable): P1 P2 P3 See page 22 for paint finishes.</p>	<p>2nd Option Select Ceiling Attachment: L Low Ceiling Attachment M Medium Ceiling Attachment H High Ceiling Attachment</p>
--	---	---

Example: NHBRHDFRM.P71.L

For specification information see page 26.

Open Market

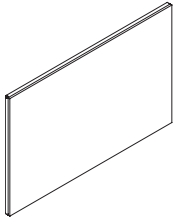

Description	Model	List Price
Daybook Insert		
Top/Bottom Laminate Insert, Front	NHBRHDTBILF	\$ 821
Top/Bottom Laminate Insert, Back	NHBRHDTBILB	\$ 629

Note: Laminate inserts have a vertical grain direction.

<p><i>How to specify —</i> Select the Model Number from above.</p> <p>_____ .</p>	<p><i>1st Option:</i> Select Laminate: See page 22 for finishes.</p> <p>_____ .</p>	<p><i>2nd Option:</i> FSC Wood: F FSC Wood X Non-FSC Wood (Omit)</p> <p>_____</p>
---	--	--

Example: NHBRHDTBILF.P.F

For specification information see page 26.

Open Market

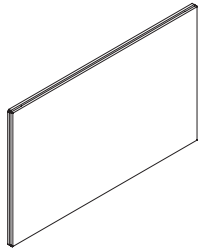

Description	Model	List Price
Daybook Insert		
Top/Bottom Metal Insert, Front	NHBRHDTBIMF	\$ 394
Top/Bottom Metal Insert, Back	NHBRHDTBIMB	\$ 202

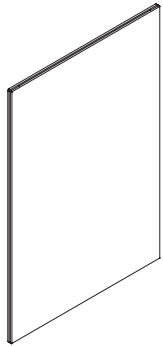

Middle Metal Insert, Front	NHBRHDMIMF	\$ 957
Middle Metal Insert, Back	NHBRHDMIMB	\$ 664

Note: Specify marker board paint to make it a writable surface.

<p><i>How to specify —</i> Select the Model Number from above.</p>	<p><i>1st Option:</i> Select the Paint Color: P1 P2 P3 See page 22 for paint finishes.</p>
--	--

Example: NHBRHDTBIMF.P71

For specification information see page 26.

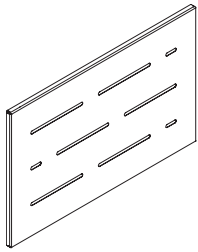

Description	Model	List Price by Paint Grade	
		P1	P2
Daybook Insert			
Top/Bottom Slotted Metal Insert, Front	NHBRHDTBIPMF	\$ 534	\$ 564
Top/Bottom Slotted Metal Insert, Back	NHBRHDTBIPMB	\$ 404	\$ 427

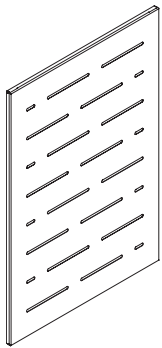

Middle Slotted Metal Insert, Front	NHBRHDMIPMF	\$ 1091	\$ 1151
Middle Slotted Metal Insert, Back	NHBRHDMIPMB	\$ 796	\$ 841

<p>How to specify — Select the Model Number from above.</p>	<p>1st Option: Select the Paint Color: P1 P2 P3 See page 22 for paint finishes.</p>
--	--

Example: NHBRHDTBIPMF.P71

For specification information see page 26.

Open Market

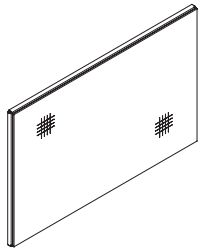

Description	Model	List Price by Fabric Grade	
		A	B
Daybook Insert			
Top/Bottom Fabric Insert, Front	NHBRHDTBIFF	\$ 866	\$ 931
Top/Bottom Fabric Insert, Back	NHBRHDTBIFB	\$ 674	\$ 722

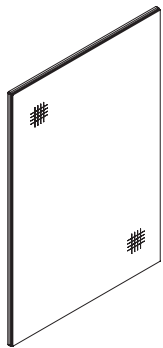

Middle Fabric Insert, Front	NHBRHDMIFF	\$ 1696	\$ 1824
Middle Fabric Insert, Back	NHBRHDMIFB	\$ 1403	\$ 1501

<p>How to specify — Select the Model Number from above.</p> <p>_____ .</p>	<p>1st Option: Select the Paint Color: P1 P2 P3 See page 22 for paint finishes.</p> <p>_____ .</p>	<p>2nd Option: Select Fabric: See pages 22-23 for fabrics.</p> <p>_____</p>
---	---	--

Example: NHBRHDTBIFF.P71.APN911

For specification information see page 26.

Open Market

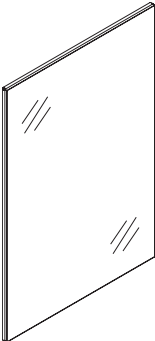

Description	Model	List Price
Daybook Insert		
Middle Glass Marker Board Insert, Front	NHRHDMIGMBF	\$ 4091
Middle Glass Marker Board Insert, Back	NHRHDMIGMBB	\$ 3841

How to specify —
 Select the
 Model Number
 from above.

_____ .

Example: NHRHDMIGMBF

For specification information see page 26.

Open Market

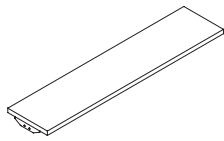

Description	Model	List Price
Daybook Shelves		
Laminate Shelf	NHBRHDSHELF	\$ 380

<p>How to specify — Select the Model Number from above.</p>	<p><i>1st Option:</i> Select Laminate: See page 22 for finishes.</p>	<p><i>2nd Option:</i> Select Laminate Edge: See page 22 for finishes.</p>	<p><i>3rd Option:</i> FSC: F FSC Wood X Non-FSC Wood</p>	<p><i>4th Option:</i> Select the Paint Color: P1 P2 P3 See page 22 for paint finishes.</p>
<p>Example: NHBRHDSHELF.P.E4.F.P71</p>				

DAYBOOK

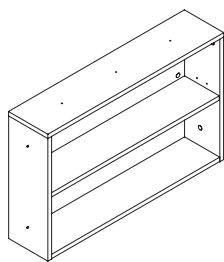

Laminate Bookcase	NHBRHDBKCSE	\$ 1529
-------------------	-------------	---------

<p>How to specify — Select the Model Number from above.</p>	<p><i>1st Option:</i> Select Laminate: See page 22 for finishes.</p>	<p><i>2nd Option:</i> Select Laminate Edge: See page 22 for finishes.</p>	<p><i>3rd Option:</i> FSC: F FSC Wood X Non-FSC Wood</p>	
<p>Example: NHBRHDBKCSE.P.E4.F</p>				

For specification information see page 26.

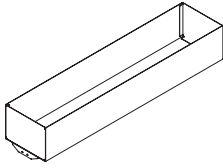

Open Market



Description	Model	List Price
Daybook Planter		
Steel Planter	NHRHDPLANT	\$ 629

<p><i>How to specify —</i> Select the Model Number from above.</p> <p>_____ .</p>	<p><i>1st Option:</i> Select the Paint Color: P1 P2 P3 See page 22 for paint finishes.</p> <p>_____</p>
---	---

Example: NHRHDPLANT.P71

Work Tools	Description	Model	List Price
	Hot File 9½"H x 12¼"W x 3⅜"D	AEHF	\$ 64
	Side Saddle 4"H x 12¼"W x 2⅝"D	AEES	\$ 53
	Bag or Coat Hook 3¼"H x 1⅝"W x 2¼"D	AECH	\$ 41

Terrace® Systems

Finishes	38	WORKSURFACES AND SUPPORTS	
Typicals Overview	39	Working with Worksurfaces and Supports	98-104
Introduction to Terrace	40	Working with Cadence® Freestanding Desking	105-113
FRAMES, CONNECTORS, AND TILES		<i>Laminate Flat Edge</i>	
Working with Frames and Connectors.....	41-45	Primary and Bow Front.....	114-115
Approach and Involve Laminate Wood Storage.....	46-47	External Worksurface Support Channel.....	114
Working with Sliding Doors.....	48	Corner, 120°, 60°, and Corner Cove	116-117
Working with Tiles.....	49-55	Altitude® Height-Adjustable Reference.....	117
Working with Veneer.....	56	Peninsula, P-Shaped, and Jetty	118
<i>Frames</i>		D-Shaped and Quarter-Round	119
Base Panel Frames — Raceway and Footed	57	Countertops, Raised and Countertop Kits	120-121
Stacking Frames and Segment Kits.....	58	9120 Program for Non-Standard Size Worksurfaces.....	122-123
Doors Panels, Sliding Door, and Conversion Kits —		<i>Veneer Square Edge</i>	
Footed and Base Raceway	59	Quarter-Round.....	124
Top Trim — Radius and Flat.....	60	<i>Supports</i>	
Glass Panel Mounted Screens and Trim	61	Panel-mount Worksurface Supports and Brackets.....	125
<i>Connectors</i>		Cadence Desking Worksurface Supports and Brackets.....	126
Connector Kits, Trim, and Stabilizer Brackets.....	62-65	Wall Track Kits and Tile Attachment Brackets	126
Wall Track and Segment Bars.....	66	Cadence Desking Modesty Panels and Gussets	127
<i>Tiles</i>		METAL OVERHEADS	
Fabric Tackable Acoustical and with Port	67-70	Working with Overheads, Shelves, and Hutches	128-131
Steel, Tool, Perforated Steel, Laminate, and		Overhead Cabinets, Shelves, and Up-mount Kits	132-133
Spanning Tiles To-the-Floor	71-77	Hutches and Tackboards.....	134
Glass — Single Pane.....	78		
Marker Board	79		
Landscape Surface and Custom Tile Bracket Kits	80-81		
Veneer	82		
ELECTRICAL (8-WIRE)			
Working with Electrical & Data	83-93		
Power Harnesses, Pass-Thru Cables, and Jumper Cables	94		
Dual Electric Eight-Circuit Power Harness Kit	94		
Duplex Receptacles, Infeeds, and Power Poles	95		
Electrical and Data Components.....	96-97		

Terrace® System

PAINTED METAL FINISHES

GRADE P1	
Black.....	P27
Brownstone.....	P7D
Bungalow.....	P7C
Cinder.....	P7Q
Cove.....	P096
Designer White.....	PJW
Dune.....	P094
Flint.....	P02
Fossil.....	P28
Harbor.....	P097
Loft.....	P7B
Muslin.....	P4J
Parchment.....	P93
Pebble.....	P8R
Pewter.....	P8D
Sage.....	P095
Salt.....	P8C
Titanium.....	P8T

GRADE P2	
Champagne Metallic.....	PR5
Gunmetal Metallic.....	PR3
Platinum Metallic.....	PR2
Silver**.....	PR6
Solar Black.....	P8X

**PR6 - no upcharge on Involve; available as Grade P2 color on stanchions.
PR6 & P8X - not available on Concensys, Essentials bookcases, and vertical files.

GRADE P3	
Atom.....	P8S
Blossom***.....	P8K
Bulseye.....	PJF
Ember.....	P8P
Ion.....	P8N
Iris.....	P8J
Krypton.....	P8F
Ochre.....	P093
Regatta.....	P8M
Sienna.....	P092
Succulent***.....	P8A

*** These colors are intended to be an inspirational option for the trending market. Product application is limited and color availability is approximately two years to coincide with evolving workplace trends.

Metallic paints, due to varying reflectance, may appear to have less visual color consistency than other paint finishes, even when L/A/B values are exactly the same. (L/A/B — measurable aspects of color — values are maintained within a specified range, to ensure consistent appearance of paint colors.)

METAL STORAGE PULLS

Black.....	E4
Bronze (for veneer only).....	EZ
Matte Silver.....	EL

PAINTED WOOD FINISHES

Brownstone.....	M13
Bungalow.....	M12
Designer White.....	M17
Flint.....	M16
Loft.....	M11
Muslin.....	M15

ELECTRICAL AND DATA COMPONENTS

Black.....	E4
Brownstone.....	EY
Designer White.....	DW
Flint.....	E9
Loft.....	EV
Muslin.....	EU
Silver.....	ES

Recommended Coordinate Colors:
Bungalow use Muslin EU
Carob use Black E4
Champagne Metallic use Muslin EU
Cinder use Brownstone EY
Fossil use Flint E9
Gunmetal Metallic use Brownstone EY
Parchment use Muslin EU
Pebble use Loft EV
Pewter use Flint E9
Platinum Metallic use Silver ES
Salt use Silver ES
Titanium use Silver ES

LAMINATES

GRADE L1	
SOLID COLORS	
Black.....	P
Brownstone*.....	LM13
Bungalow*.....	LM12
Designer White*.....	LDW1
Flint*.....	LM16
Fossil Shale*.....	LEH1
Loft*.....	LM11
Muslin*.....	LM15
Titanium*.....	LTI1

ABSTRACT	
Ash.....	LT3B
Handspun Pearl.....	LAHP
Handspun Dove.....	LAHD
Handspun Slate.....	LAHS
Handspun Chestnut.....	LAHC
Silver Mesh.....	LT8D

WOODGRAIN	
Belair.....	LWBA
Bourbon Cherry.....	H
Field Elm.....	LWFE
Florence Walnut*.....	LFW1
Kingswood Walnut*.....	LK11
Natural Maple*.....	LWD
NeoWalnut*.....	LNW1
Pinnacle.....	PINC
Shaker Cherry*.....	LW7C

GRADE L2	
Beigewood*.....	LWBE
Fawn Cypress*.....	LF1C
Lowell Ash*.....	LLA1
Mangalore Mango*.....	LMM1
Natural Recon*.....	LN1
Phantom Charcoal*.....	LPC1
Phantom Ecru*.....	LPE1
Portico Teak*.....	LPT1
Skyline Walnut*.....	LSW1
Veranda Teak.....	LVT1

GRADE L3	
Natural Walnut*.....	LWNW

* Storage available in these 30 laminates.

LAMINATE AND PAINTED WOOD STORAGE PULLS

Silver.....	PR6
-------------	-----

LAMINATE EDGE COLORS

Beigewood.....	DE
Belair.....	BA
Black.....	E4
Bourbon Cherry.....	H
Brownstone.....	EY
Bungalow.....	EX
Designer White.....	DW
Fawn Cypress.....	FC
Field Elm.....	FE
Flint.....	E9
Florence Walnut.....	FW
Fossil.....	EH
Kingswood Walnut.....	KI
Loft.....	EV
Lowell Ash.....	DL
Mangalore Mango.....	MM
Muslin.....	EU
Natural Maple.....	DD
Natural Recon.....	NR
Natural Walnut.....	DN
NeoWalnut.....	NU
Parchment.....	EN
Phantom Charcoal.....	PC
Phantom Ecru.....	PE
Pinnacle.....	PI
Platinum Metallic.....	EP
Plyband.....	PL
Portico Teak.....	DP
Shaker Cherry.....	DF
Skyline Walnut.....	SW
Titanium.....	TI
Veranda Teak.....	VT

◆ Edge is limited to flat edge surfaces: rectangle, square, trapezoid, polygon, or round. No curvilinear or combination curve and straight.

METAL GROMMETS

FOR LAMINATE WORKSURFACES	
Oval/Square:	
Matte Silver.....	EL

FOR VENEER WORKSURFACES	
Oval:	
Black.....	E4
Bronze.....	EZ
Matte Silver.....	EL
Square:	
Matte Silver.....	EL

PLASTIC GROMMETS

FOR WORKSURFACES	
Black.....	E4
Brownstone.....	EY
Bungalow.....	EX
Designer White.....	DW
Flint.....	E9
Fossil.....	EH
Loft.....	EV
Muslin.....	EU
Parchment.....	EN
Titanium.....	TI

PLASTIC GROMMETS WITH WOODGRAIN EDGE	
If woodgrain edge is specified, the plastic grommet color is predetermined, based on finish selection.	
Beigewood, Fawn Cypress, Natural Maple, and Natural Recon.....	Muslin EU
Kingswood Walnut and NeoWalnut.....	Brownstone EY
Phantom Charcoal and Skyline Walnut.....	Flint E9
Phantom Ecru.....	Loft EV
Portico Teak.....	Fossil EH
All other woodgrain options.....	Black E4

STRATAWOOD VENEERS

GRADE V2	
Add FSC prefix to Stratawood codes listed below for Stratawood veneer trim on Stride and Terrace.	
Example: FSCSC777	

CHERRY	
Cinnamon/Biltmore Cherry.....	SC260
Lowell Ash Cherry.....	SC394
Clear Cherry.....	SC700
Light Cherry.....	SC701
Shaker Cherry.....	SC774
Burnished Cherry.....	SC777

MAPLE	
Field Elm.....	SE599
Clear Maple***.....	SE800
Harvest Maple.....	SE856
Beigewood.....	SE878
Phantom Ecru.....	SE912
Belair.....	SE934

OAK	
Clear Oak.....	SF300
Dark Rift Oak.....	SF331

SILVER OAK	
Silver Oak Clear.....	SB100
Portico Teak Silver Oak.....	SB150

WALNUT	
Florence Walnut.....	ST579
Light Walnut.....	ST601
Skyline Walnut.....	ST625
Pinnacle Walnut.....	ST679
Sumatra Walnut.....	ST693

NATURAL VENEERS — FLAT CUT

GRADE V2	
CHERRY	
Cinnamon/Biltmore Cherry.....	NC260
Lowell Ash.....	NC394
Medium Red Cherry.....	NC512
Light Cherry.....	NC701
Shaker Cherry.....	NC774
Burnished Cherry.....	NC777

MAPLE	
Clear Maple.....	NE800
Harvest Maple.....	NE856

WALNUT	
Ebony Walnut.....	NT509
Florence Walnut.....	NT579
Light Walnut.....	NT601
Skyline Walnut.....	NT625
Nutmeg Walnut.....	NT629
Pinnacle Walnut.....	NT679
Sumatra Walnut.....	NT693

NATURAL VENEERS — RIFT CUT

GRADE V3	
Fawn Cypress Rift Cut Oak.....	RF108
Light Rift Cut Oak.....	RF301
Dark Rift Cut Oak.....	RF331
Phantom Ecru Rift Cut Oak.....	RF912

***SE800 and NE800 are not available on Stride trim.

The beauty of wood is the natural variation of grain patterns and colors that make each piece unique. This variation is also influenced by lighting conditions, orientation of mated parts, and varying acceptance of the finishing process. The varying colors and physical characteristics naturally occur in all wood species but are most pronounced in lighter colored woods, and are especially evident in natural finishes.

GROMMETS ON VENEER WORKSURFACES	
Wire management grommets come standard on most veneer work surfaces. Choose between metal or plastic grommet option. Note: Plastic grommet color is predetermined based on finish selection.	
All Maple veneers.....	Muslin EU
All other veneers.....	Black E4

LOCKS

Black.....	E4
Chrome.....	ordered by base model
Matte Silver.....	EL

NOTE: Refer to individual product pages for upcharges.

A full gallery of typicals from each Allsteel system can be found on our website:

<https://www.allsteeloffice.com/design-resources/idea-starters>.

Each typical includes a complete BOM with current pricing, downloadable CAD files and PDFs of each drawing.

Use the Allsteel Typicals Gallery to find the components in a Single Terrace Station...

"Irregular" Shape Station 23' x 6'6" (6-pack)

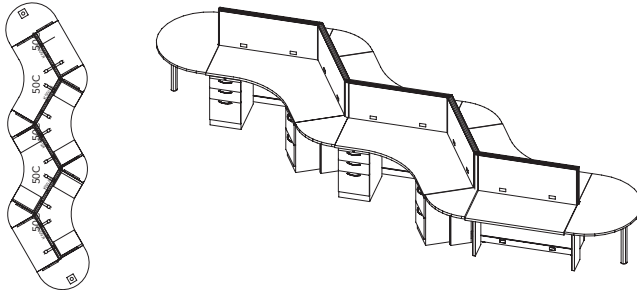

Line Item	Product Description	Qty	Model Number
1	Structural Raceway Panel Frame — No Top Trim 50"H x 48"W	6	TK05048WR
2	Terrace Top Trim 48"W	6	TK348PT
3	E End Trim Connector Kit 50"H	2	TK350E
4	B 2-way 120 Degree Connector Kit 50"H	4	TK350B
5	Terrace Tackable Acoustic Ported Tile 50"H x 48"W	12	TKG45048E
6	Primary 24"D x 48"W Flat Edge Laminate w/o Grommets	2	T52448SN
7	120 Degree Corner 24"D x 48"W Flat Edge	4	TT54824CBN
8	60 Degree Pie Worksurface 24"D Flat Edge	4	TT52424SD
9	D-Shape for 2-24"D x 30"W Flat Edge	2	TN524D
10	Terrace Support Leg 24"D x 29½"H	12	TKSL2429P
11	Support Column 29½"H x 3" Diameter	2	TT629SC
12	Power Harness 48"W	6	A871248
13	Terrace Duplex Receptacle — Circuit 1	10	A873501
14	Electrical Infeed Cable	1	A876072
15	Terrace Electric Mounting Bracket (12 pk)	1	8989EB
16	Jumper Cable 66"W	1	A871366
17	Essentials Support Ped BBF 28"H x 22¾"D Arch Pull	4	PF197-233A
18	Essentials Support Ped FF 28"H x 22¾"D Arch Pull	4	PF198-232A

And how to make the most of your space with Involve®.

Involve "U" Stations 24' x 6' (3-pack)

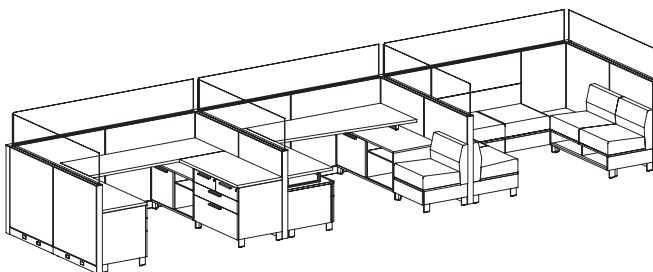

Visit <https://www.allsteeloffice.com/design-resources/idea-starters> to view these typicals and more.

The building blocks for a better office.

What makes a workspace inspiring? The truth is it's different for every office and every worker. The Terrace frame-and-tile solution offers both flexibility and refined design details, so you can keep it basic or dress it up. And, when paired with other Allsteel products, you can create beautiful, functional spaces that look every bit as good as they work.

Ideas often come from collaboration. Other times from focused research. And sometimes they appear out of the blue. Terrace makes it easy to design environments that help people do better work, from individual workstations for focused activities to teaming areas for group collaboration. With lower panels and frameless glass, open, naturally lit workspaces have an aesthetic that inspires. So nothing gets in the way of the next big idea.

More ways to design one-of-a-kind environments.

With Terrace, spaces can be as active as the people who use them. Worksurfaces of varying heights give people the freedom to enjoy the ergonomic benefits of changing postures. Soft seating integrated within primary and secondary work areas encourages spontaneous collaboration. And customized storage options can be integrated into spaces in a variety of ways to better fit individual workstyles.

Terrace offers unique designs that make a strong visual statement customized for any application. From the clean aesthetic of benching to an open, cross-functional collaborative space to an individual workstation for focused activities, Terrace provides the options and features you want and need.

Make the most of your space and your resources.

With real estate at a premium and the need for workspaces to be more agile to accommodate future needs and changing workstyles, office furniture must work harder than ever. That's why Terrace is built to last with sturdy steel panels that stand up to years of use and numerous reconfigurations. And it's designed to work seamlessly with other Allsteel products, so you can easily integrate a variety of other furniture options whenever the need arises.

Terrace, make it yours.

Once you've selected the furniture for your space, a variety of material options are available to give it a personality all its own. Make a bold statement with woodgrain laminate storage and contrasting trim and panel fabric. Or create a brighter look with panels and storage in light fabrics and finishes. Find the perfect palette to complement your brand or style.

The most beautiful thing about Terrace is all the ways you can customize it for functionality, ergonomics, and aesthetics. It can support heads-down concentration or encourage open interaction. You can mix and match a variety of options, from panel heights to worksurfaces, fabrics to frameless glass, and storage to accessories. The choices are endless.

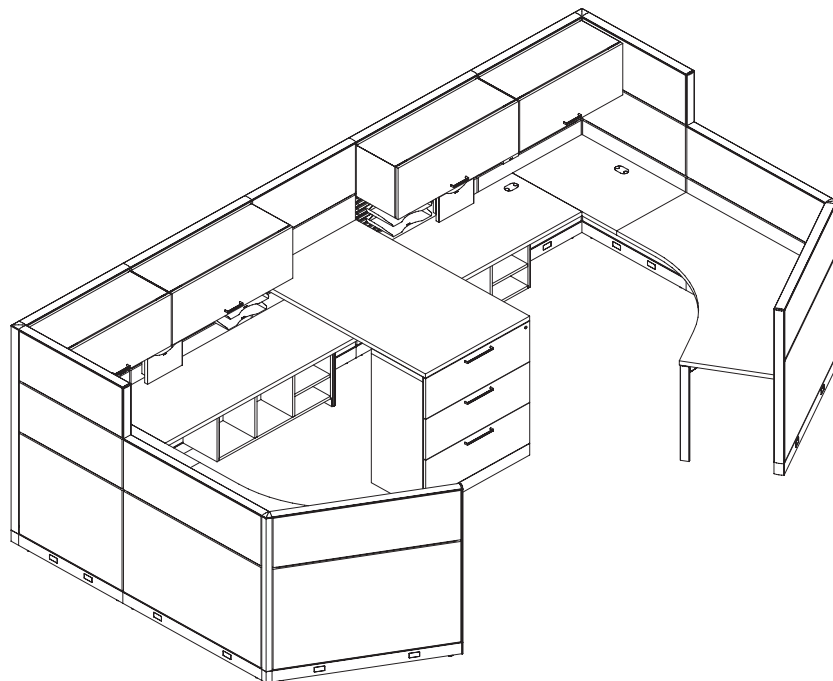

BASE RACEWAY FRAMES

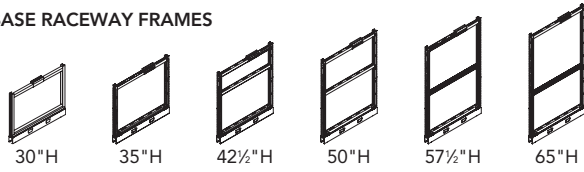

FOOTED PANEL FRAMES

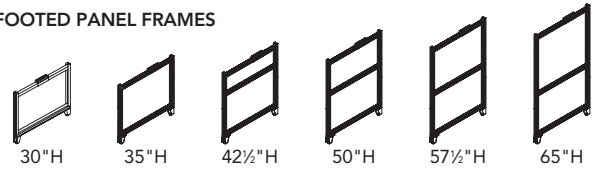

STACKING FRAMES



DOORS

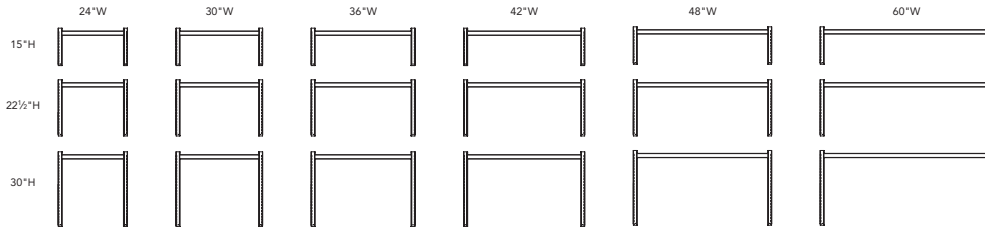
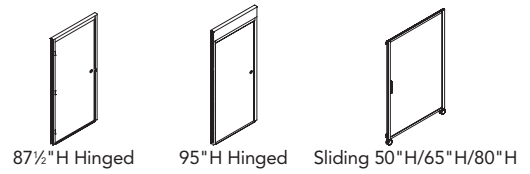

TOP TRIM / SCREENS

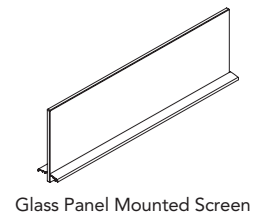
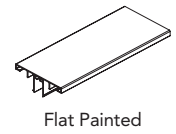

Connector Kits

- "L" 90° Connector Kit
- "T" 3-way Connector Kit
- "X" 4-way Connector Kit
- "S" Extended Straight Connector Kit
- "B" 2-way 120° Connector Kit
- "C" 3-way 120° Connector Kit
- "W" Wall Mount Kit
- "E" End Trim Kit

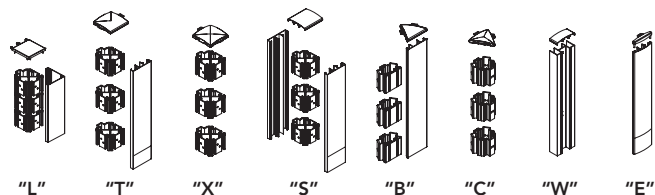

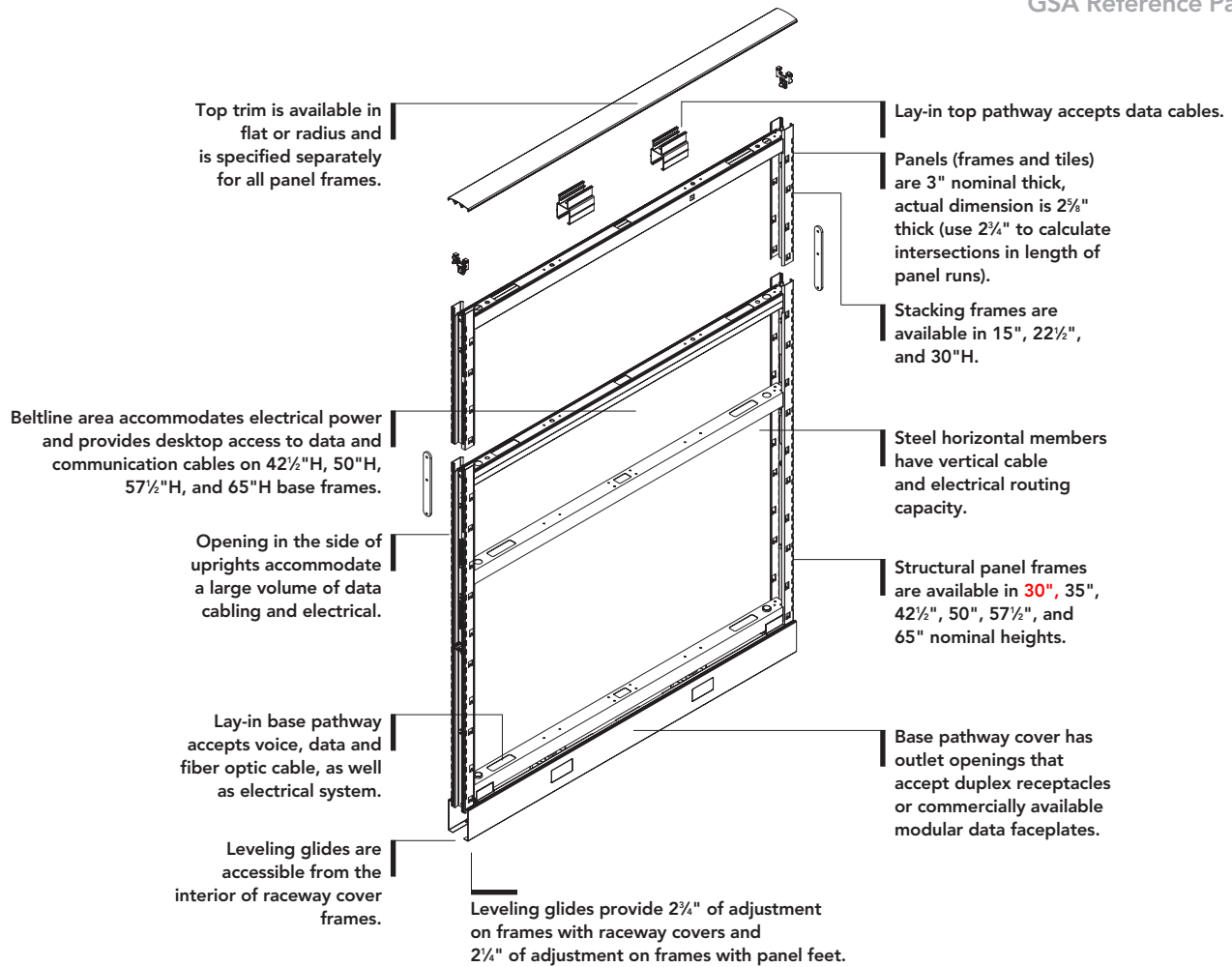

Frame Dimensions (Actual)

Depth: 2 5/8" (use 2 3/4" to calculate intersections in length of panel run)

Widths: 24", 30", 36", 42", 48", 60"

Heights* with radius painted trim: 29 1/4", 34 1/4", 41 1/4", 49 1/4", 56 1/4", 64 1/4"

Stacking Frames: 15"H, 22 1/2"H, 30"H

Leveling Glides on Frames with Raceway Covers: 2 3/4" range

Leveling Glides on Footed Frames: 2 1/4" range

*with levelers fully retracted

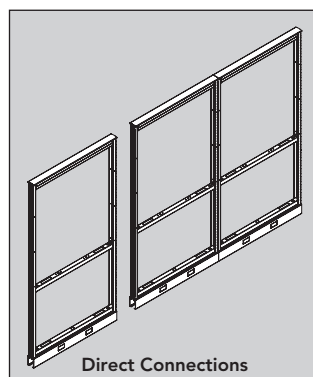
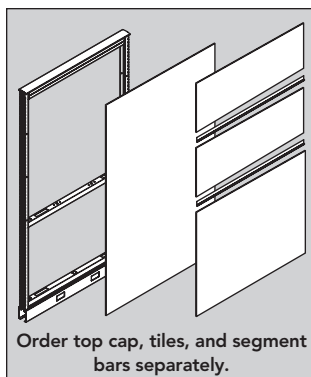

Panel Frames (page 57)

- Specifications: formed, steel vertical members, with tubular steel horizontal members are welded into a sturdy, structural panel frame.
- Panels are shipped with base pathway covers or decorative feet installed.
- Top trim, monolithic or segmented tiles, and segment bars are ordered separately with choices of applications.
- Direct connections between same height frames in a continuous run are accomplished with provided hardware. There is no incremental increase in dimension along the run.
- For adequate stability, one of two methods of stabilization shown on page 43 must be adhered to.
- Base raceway panel frames include: frame, base pathway covers, attaching hardware, and bottom segment clip.
- Footed panel frames include: frame, panel feet, attaching hardware, and bottom segment clip.
- No electrical or data capabilities in footed panel frames. Decorative feet replace base raceway covers.

Panel Frame Conversion Kits (page 59)

- Base raceway to footed and footed to base raceway conversion kits can be used to convert existing frames. Footed to base raceway kits ship with glide tower assembly. Conversion process requires panel to be removed from panel run.

Building Vertically with Terrace Frames

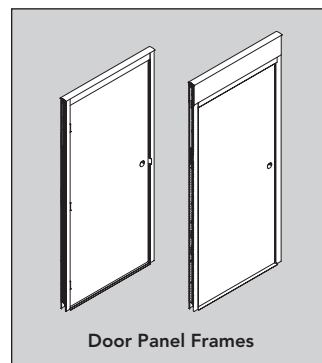
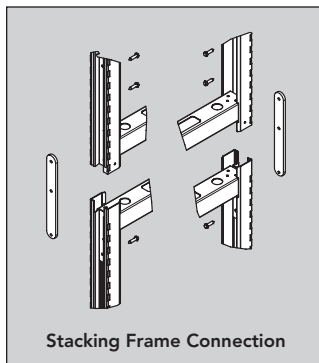
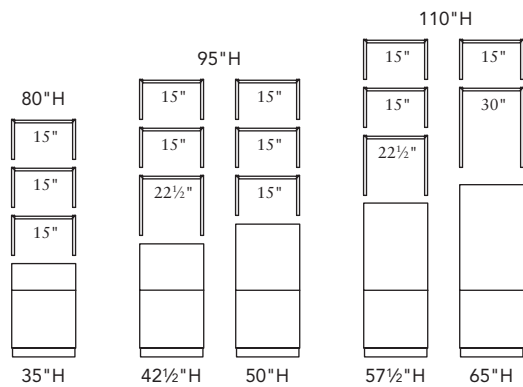

Building Horizontally with Terrace Frames

Method 1—Opposing Returns

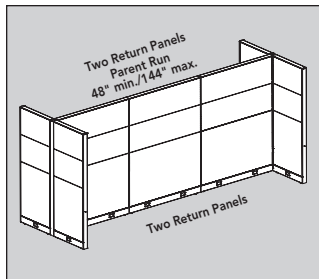

Method 2—Single-Sided Returns

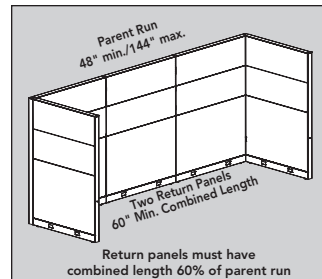

Important planning guidelines: For adequate stability, one of two methods of stabilization must be adhered to:

Method 1—Opposing returns

- A parent run must be a minimum of 48" and a maximum of 144" between return panels. The parent run must have a minimum of two return panels running in opposing directions on each end of run.
- A single return panel (48" nominal minimum length) may be used with a mid-panel connector. The panel must extend at least 24" from one side of the parent run.
- Return panels must not be no more than 30" lower than the maximum height of the parent panel run.

Method 2—Single-sided returns

- A parent run must be a minimum of 48" and a maximum of 144" between return panels. The parent run must have a minimum of two return panels totaling at least 58% of its length, extending in one direction.
- Return panels must not be any more than 30" shorter in height than parent run. When using 120° connections, 12" must be added to length of return panels as determined by methods 1 and 2. Any run under 100" must have a minimum combined length of 60" of return panels.

Stacking Frames (page 58)

- When adding stacking frames, remove the top trim from the structural frame, and install it on top of uppermost stacking frame.
- Stacking connection provides a solid metal-to-metal connection, allowing the stacking frame to accept hang-on components, per Allsteel configuration guidelines.
- Includes attachment hardware and uses specified top trim. Add appropriate connectors.
- Stacking frames can be added to the top of a 35"H base panel frame up to 80"H, added to 42½"H and 50"H base panel frames in any combination up to 95"H, and added to the top of 57½"H and 65"H structural panel frames up to 110"H.
- To maintain panel mounting slot modularity 22½"H stacking frames should only be used with 42½"H, 57½"H base panel frames, or 87½"H door frames.
- To match 87½"H door frame height, use a 65"H base panel frame with a 22½"H stacking frame (slot modularity will be lost on stacker).
- To maintain modularity on 35"H, 50"H, and 65"H base panel frames use 15"H or 30"H stacking frames.
- If panel mounting slots are not being used, any stacking frame can be used on any base panel frame.
- Do not combine differing frame widths in a single stack or span multiple base panel frames with stacking frames.
- Stacking frames cannot be used as base frames.
- Tile options for stacking frames are given on page 51.
- Guidelines for using overhead storage with stacking frames are given on page 129.

Segment Bars (page 58)

- Segment bars are horizontal steel cross members required between tile segments. Must be specified on each side of frame.
- Black only.



Electrical Mount Support Bars (page 58)

- Used to mount electrical in any location in panel frame other than base pathway or beltline. Order electrical mounting brackets separately.
- Tiles must be field ported when electrical is mounted in a location other than just above the worksurface at beltline.
- Can be used with acoustical tiles on one or both sides of the panel frame.
- Includes attaching hardware. Gray only.

Door Panel Frames (page 59)

- The 87½"H door panel includes 42"W frame, 36"W door, hinges, top trim, and attaching hardware. See illustration above left.
- The 95"H door panel includes frame, 42"W door, hinges and attaching hardware, and two 8⅞"H x 42"W fabric tiles for top of door frame.
- Doors available in laminate.
- Painted top caps available in radius or flat.
- Specify fabric for top tiles on 95"H door.
- Lockset with knob or lever ordered separately.

Sliding Door and Mounting Kit (page 59)

- See illustration and specification information on page 48.

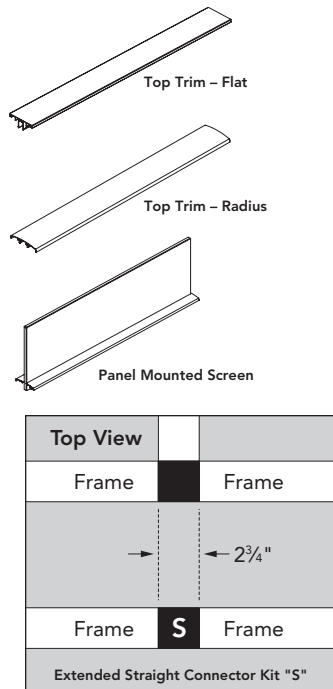
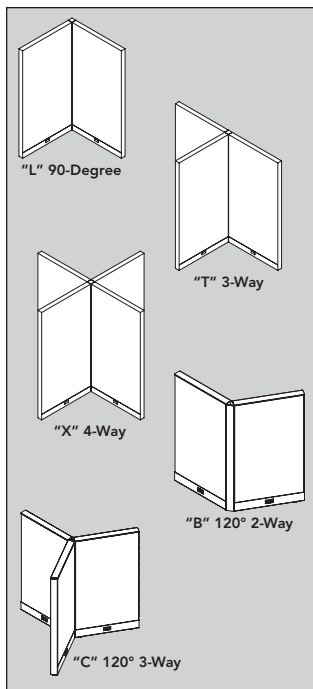

- **Multiple-height connections** also utilize standard “L”, “T”, “X”, “S”, and “E” connectors, with corresponding height connectors stacked according to the number of intersecting panels from the bottom up. (See examples below.)

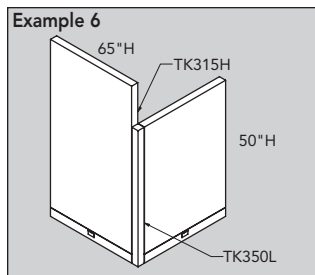
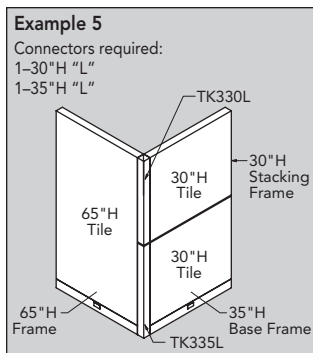
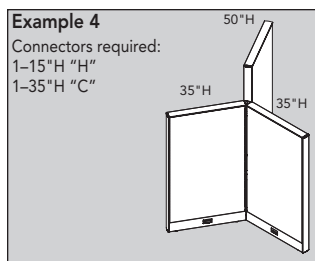
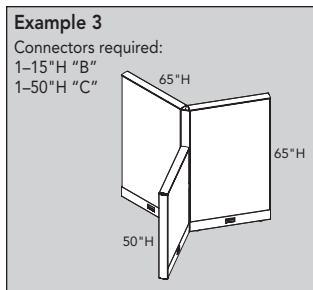
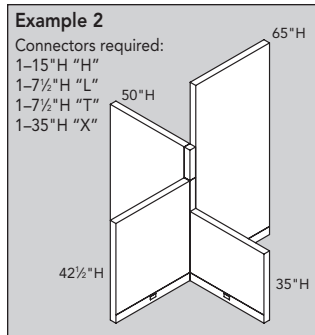
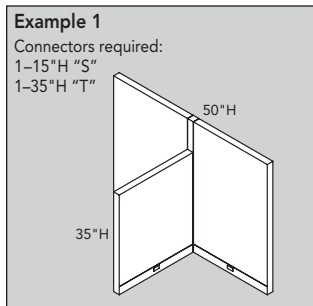

Connectors and Trim

Off-Modular Panel Connection Kit (page 59)

- Includes top and bottom attachment brackets and top trim finished end.
- Must be field installed. Installation requires defacing of the top tile.
- Cannot be mounted in locations where the bottom bracket is closer than 8 inches from the edge of frame in the base pathway on parent run panels.
- Not structural. No panel mounted glass on spine where attaching or on first off-modular panel.
- **Only compatible with panels that have radius top trim.**

Top Trim (page 60)

- Use to finish top on base panel frames and footed panel frames.
- Top trim can span individual or multiple base panel or stacking frames.
- It is possible to span multiple frames when the combined frame width is equal to the top trim width.
- Some spanning examples are listed on page 60, other combinations are possible.
- Available in flat or radius in painted finish.
- Radius trim is not compatible with double-sided laminate tiles on Terrace.

Panel Mounted Screens (page 61)

- Frameless insert integrated into the base panel frame top trim.
- Replaces top trim on structural or stacking frame.
- It is possible to span multiple frames when the combined frame width is equal to the panel mounted screen width.
- Taller adjacent frames require “HG” grooved end trim.
- Panel mounted screens are non-structural. Do not hang or stack on top of panel mounted screens.
- Available in 3/8" thick clear or frosted glass.

Connector Kits (pages 62-64)

- “L”, “T”, “X”, “S”, “B”, and “C” connector kits are used when connecting frames at intersecting runs.
- Base connectors include base pathway and must be specified at base regardless of full height or segmented connection. Specify height that corresponds with segment frame height. See Examples 5 and 6 at left.

“L”, “T”, “X”, and “S” Connector Kits (page 62-64)

- For “L”, “T”, “X”, and “S” connector kits, add 2 3/4" to the total length of the panel run for each intersection, whether located in the middle or at the end of the run.
- “L”, “T”, “X”, and “S” connector kits includes top cap, connectors, vertical cover, light gap extrusion, and attaching hardware.
- “X” connector kits Includes top cap and connectors.
- Extended straight connector kit “S” can be used to keep continuous runs dimensionally consistent with opposing panel runs which incorporate “T” or “X” intersections. (Add 2 3/4" to the length of the run for every extended straight connector used.) See illustration at left.

2-Way 120° Connector Kits (page 63)

- Includes top cap, connectors, vertical cover, and attaching hardware.

3-Way 120° Connector Kits (page 63)

- Includes top cap and connectors

“E” End Trim Kits (page 64)

- End vertical trim cover (includes top cap — adds 3/8" to run).

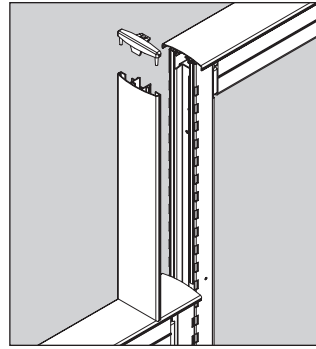

High-Low "H" End Trim

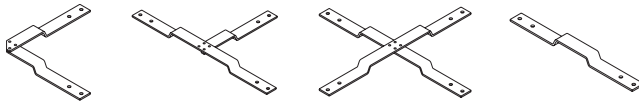

Top Stabilizer Brackets
Top and Bottom

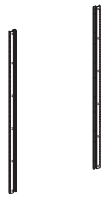

Pair of Wall
Track Ends

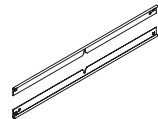

Tile Attachment Kit
Top and Bottom



Segment Bar

High-Low End Trim Kits (page 64)

- High-low "H" covers the exposed end of a frame when joining frames of differing height in certain configurations — profile adds 3/8" to length of panel run. See illustration at left.
- At the end of a panel run use "E" model suffix end trim kit.

Grooved High-Low Trim (page 64)

- For use when the base panel frame of a panel mounted screen is shorter than the adjacent in-line panel. Taller adjacent in-line panel cannot have a panel mounted screen.

"W" Wall Mount Kits (page 64)

- Wall mount kits provide a means to affix a panel run to a permanent building wall.
- Kit adds 1 1/16" to length of panel run.
- Includes top cap. (Color must be specified.)
- Connector is Black only.

Top Stabilizer Brackets (page 65)

- Optional brackets to provide added strength to reduce flex at panel junctions.
- Lay in cabling below top cap is not possible where bracket is installed.
- Panel mounted screen cannot be used where bracket is installed.

Terrace Wall Track/Tile Attachment Kits (page 66)

- Allows for mounting of system panel components on permanent wall structures except cantilevers and sit-to-stand units.
- Begin with one pair of ends; for multiple kits in line, add middle unit(s) between ends.
- Height of wall track coordinates with panel height. Field cut for lower heights.
- Wall track will add 1" to depth of attached components.
- Use Terrace wall track tile attachment kit to install tiles onto wall track. Tool tiles cannot be used on wall track. Kit includes two tile bars. Top bar may only be used in the top uppermost position on wall track. Bottom bar can be used in the bottom position at any location on wall track.
- When segmenting tiles on wall track, segment bars must be ordered for placement between all vertically adjacent tiles or at the top position of a single tile that is not in the uppermost position.
- It is not recommended to use Landscape™ or laminate Terrace tiles with wall track. If these tiles are required consider using Stride wall track.
- When using Terrace wall track and using tiles to create a tackboard situation under overheads hung at 65"H, make sure to use a 30"H tile or 2-15"H tiles to cover the entire area between the overheads and the worksurface.

Approach and Involve Laminate Wood Storage Storage with Panel Frames

Leg or plinth base models available. Leg base units are shown below.

GSA Reference Page

Side-mounted Credenzas

Use 1 storage-to-panel bracket per credenza — 1 LH and 1 RH.

The minimum credenza size is 24"H x 36"W x 18"D.

With a mid-run floor support, the maximum panel run is 144".

Without a mid-run floor support, the maximum panel run is 96".

Overheads and shelves cannot be used with 24"H side mounted credenzas.

Worksurfaces (if specified) must be mounted on the same side of the parent run as the credenzas.

Panel frame maximum height is 65".

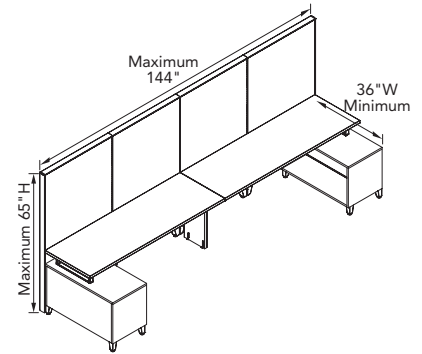

Back-mounted Credenzas — Modular

Use 2 storage-to-panel brackets per credenza — 1 LH and 1 RH.

The minimum credenza size is 24"H x 36"W x 24"D.

The maximum panel run between back-mounted credenzas is 72".

Overheads and shelves cannot be used with 24"H back mounted credenzas.

Worksurfaces (if specified) must be mounted on the same side of the parent run as the credenzas.

Panel frame maximum height is 65".

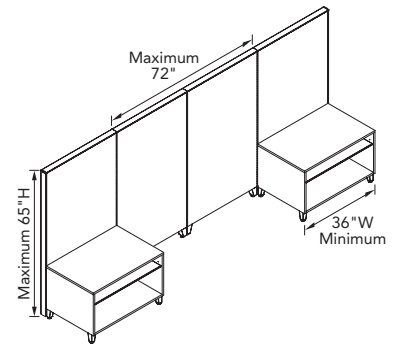

Back-mounted Credenzas — Off-Modular Ends

Use 1 storage-to-panel bracket per credenza — 1 LH and 1 RH.

The minimum credenza size is 24"H x 36"W x 24"D.

With a mid-run floor support, the maximum panel run is 144"

Without a mid-run floor support, the maximum panel run is 96".

Overheads and shelves cannot be used with 24"H back mounted credenzas.

Worksurfaces (if specified) must be mounted on the same side of the parent run as the credenzas.

Panel frame maximum height is 65".

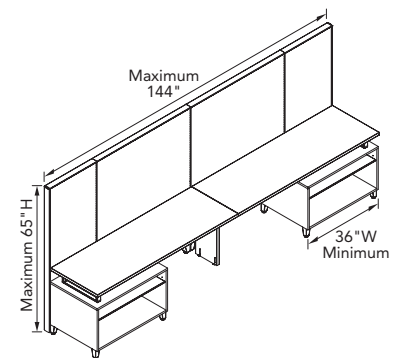

Note: Storage with unfinished metal backs require storage-to-panel bracket kit in order to mount to a panel. Left- or right-handed storage-to-panel bracket is determined by slots on panel — left-handed bracket required when attaching to left panel slots and right-handed bracket required when attaching to right panel slots.

Involve storage with unfinished backs require storage-to-panel bracket kit in order to mount to a panel.

Optional laminate back is available (ordered separately) for use when the back of the unit will be exposed.

Plinth base units require a different laminate back model than leg base units.

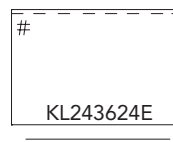
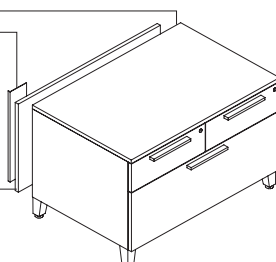

An example of a 2D CAD symbol for Involve is shown at left. Note the dashed line that represents the unfinished metal back. The pound sign indicates that counterweight kits may need to be added depending on the application. See *Casegoods & Storage Price List* page 266 for counterweight specification rules.

Approach and Involve Laminate Wood Storage Storage with Panel Frames

Leg or Plinth Base models available. Leg base units are shown below.

GSA Reference Page

Side-mounted Credenzas — Modular for Overheads and Worksurfaces

Use 2 storage-to-panel brackets per credenza — 1 LH and 1 RH.

The minimum credenza size is 28"H x 36"W x 24"D.

28"H side mounted credenzas must be mounted modular when using overheads and worksurfaces on panels.

With a mid-run floor support, the maximum panel run is 144".

Without a mid-run floor support, the maximum panel run is 96".

Overheads, shelves, and worksurfaces must be mounted on the same side of the parent run as the credenzas.

Maximum overhead height is 15".

Panel frame maximum height is 65".

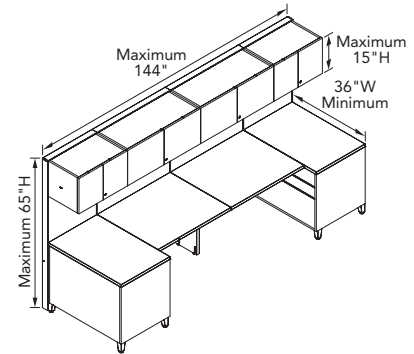

Back-mounted Credenzas — Modular for Overheads and Worksurfaces

Use 2 storage-to-panel brackets per credenza — 1 LH and 1 RH.

The minimum credenza size is 28"H x 36"W x 24"D.

Full back units without trough due to stability, only troughless Approach or Involve allowed.

With a mid-run floor support, the maximum panel run is 144".

Without a mid-run floor support, the maximum panel run is 96".

The maximum panel run between back-mounted credenzas is 72".

Overheads, shelves, and worksurfaces must be mounted on the same side of the parent run as the credenzas.

Maximum overhead height is 15".

Panel frame maximum height is 65".

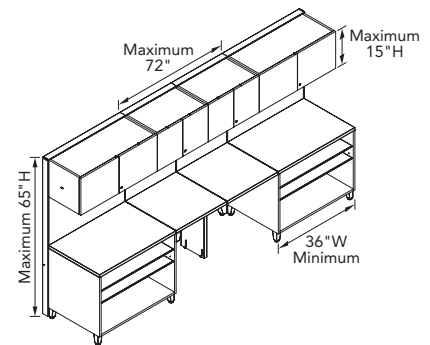

Side-mounted Credenzas — with Return Panel

Use 1 storage-to-panel bracket on credenza.

The minimum credenza size is 24"H x 36"W x 18"D.

The minimum size for panel return is 35"H x 36"W.

With a mid-run floor support, the maximum panel run is 144".

Without a mid-run floor support, the maximum panel run is 96".

Overheads and shelves cannot be used with 24"H side mounted credenzas.

Worksurfaces (if specified) must be mounted on the same side of the parent run as the credenzas.

Panel frame maximum height is 65".

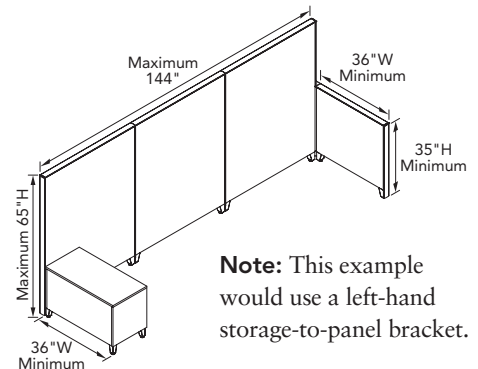

Side-mounted Credenzas — Modular for Overheads and Worksurfaces

Use 2 storage-to-panel brackets per credenza — 1 LH and 1 RH.

The minimum credenza size is 28"H x 36"W x 24"D.

The minimum size for panel return is 50"H x 36"W.

28"H side mounted credenzas must be mounted modular when using overheads and worksurfaces on panels.

With a mid-run floor support, the maximum panel run is 144".

Without a mid-run floor support, the maximum panel run is 72".

Overheads, shelves, and worksurfaces must be mounted on the same side of the parent run as the credenzas.

Maximum overhead height is 15".

Panel frame maximum height is 65".

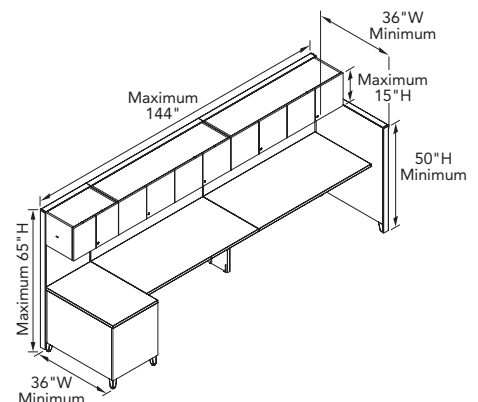

Sliding doors for Terrace are a great addition to any new or existing installations. The sliding door can be specified with specific mounting kits for each door ordered. With a Frosted Translucent insert and your choice of P1 or P2 paint, the sliding door will create a unique look for any office environment.

The sliding doors are available in 50", 65", and 80" H models and can mount to 30", 36", 42", and 48" W panels. They accommodate a 36" W opening and are 42" W, nominally. The doors ship from the factory non-handed and become handed when field installed to fit the scope of the project. The handle pulls located on each side of the door are non-locking and are color matched to the trim to create a uniform style. And with the threshold free design, the sliding door offers better aesthetics and safety by eliminating the potential for tripping.

General Guidelines for Use of Sliding Door

- The system requires the ordering of both a door and a mounting bracket kit.
- All doors are 42" wide to accommodate a 36" W opening and are non-handed. Door leveling is dependent on floor being level.
- A mounting bracket kit must be ordered for each door corresponding to the mounting panels width (30", 36", 42", or 48" W).
- Mounting bracket kits are system specific and for Terrace.

General Guidelines for Layout Planning of Sliding Door

- Stability guidelines must be followed when specifying a sliding door. (Refer to page 43). The sliding door system was designed to close an opening in a run of parallel panels. Doors mounted to long runs of panels without floor support, ties to worksurfaces, or return panels may seem less stable.
- If the door is used to close an opening (A) where the panel opposite the door is at 90°, there will be a gap equal to the panel thickness between the door and the panel end when closed.
- When planning the layout, care must be taken if the plan includes a door mounted on a panel that is less than 42" W. If the panel is at a corner (B), the door will protrude into the aisle or next workstation when in the open position.
- If back-to-back doors are mounted on panels (C) that are less than 42" W they will interfere with each if both are open at the same time.
- The door is attached at the base of the panel at any end position with a wrap around bracket. Bracket kits are ordered in conjunction with appropriate end trim profiles. The slots at the base of the panel must be clear (D) and cannot be utilized by worksurface supports or panel hung components.
- If the door is mounted to a panel run that is positioned adjacent to a wall (E) or an inside 90° angle and there is not a 42" clearance between the track and the wall/inside 90° the assembly of the first stop will be difficult and plans will need to be modified for the assembly.
- If a door is closing an opening of a workstation that includes a "T" connector in the opposite wall, an extended straight connector may need to be used to maintain the 36" required opening.

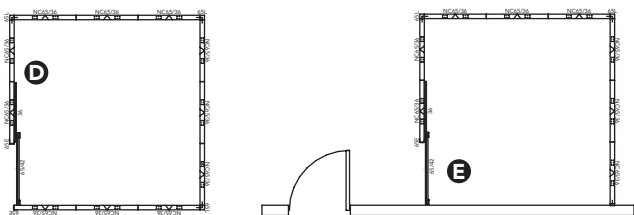
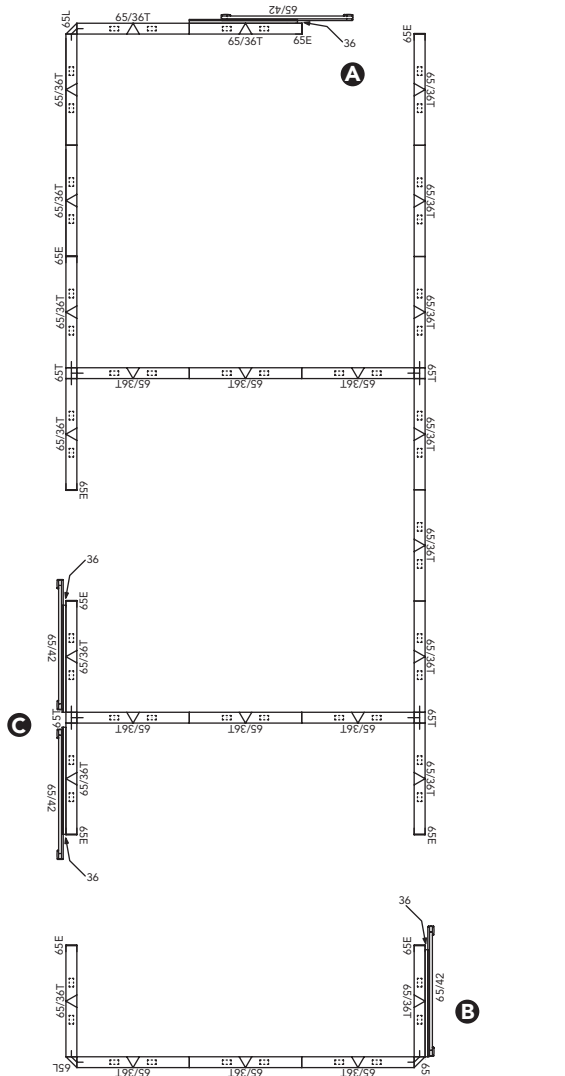

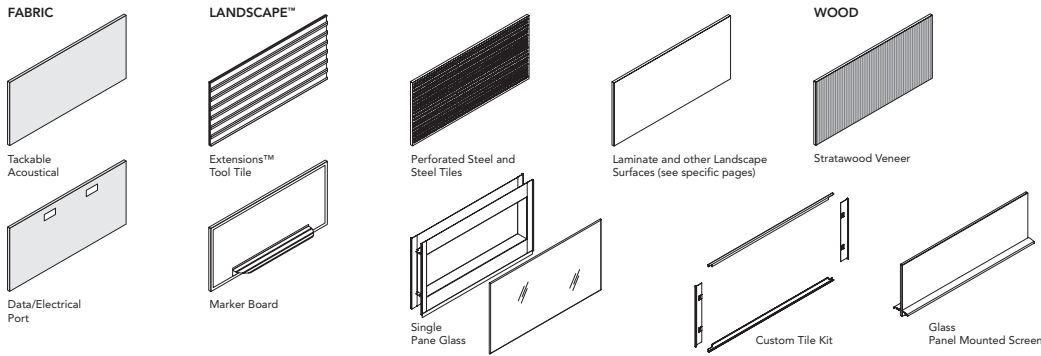

Tiles — Tackable Acoustical, Steel, Perforated Steel, Markerboard*, Foundation™, Laminate*, and Veneer Tiles.

	24"W	30"W	36"W	42"W	48"W	60"W
7½"H						
15"H						
22½"H						
30"H						

*Not available in 7½"H

Data/Electrical Port (port tiles available as acoustical only)

	24"W	30"W	36"W	42"W	48"W	60"W
15"H						
22½"H						
30"H						
42½"H						

Monolithic Tiles — Tackable Acoustical and Port (vener 42½"H non-ported only).

	24"W	30"W	36"W	42"W	48"W	60"W
42½"H						
50"H						
57½"H						
65"H						

Glass Tile Kits

	24"W	30"W	36"W	42"W	48"W	60"W
15"H						
22½"H						
30"H						



Terrace tiles come in a variety of styles. Select the aesthetic* and functional combination that meets your specific requirements. Additional tiles not shown below include Monolithic, Monolithic Port, and Custom.

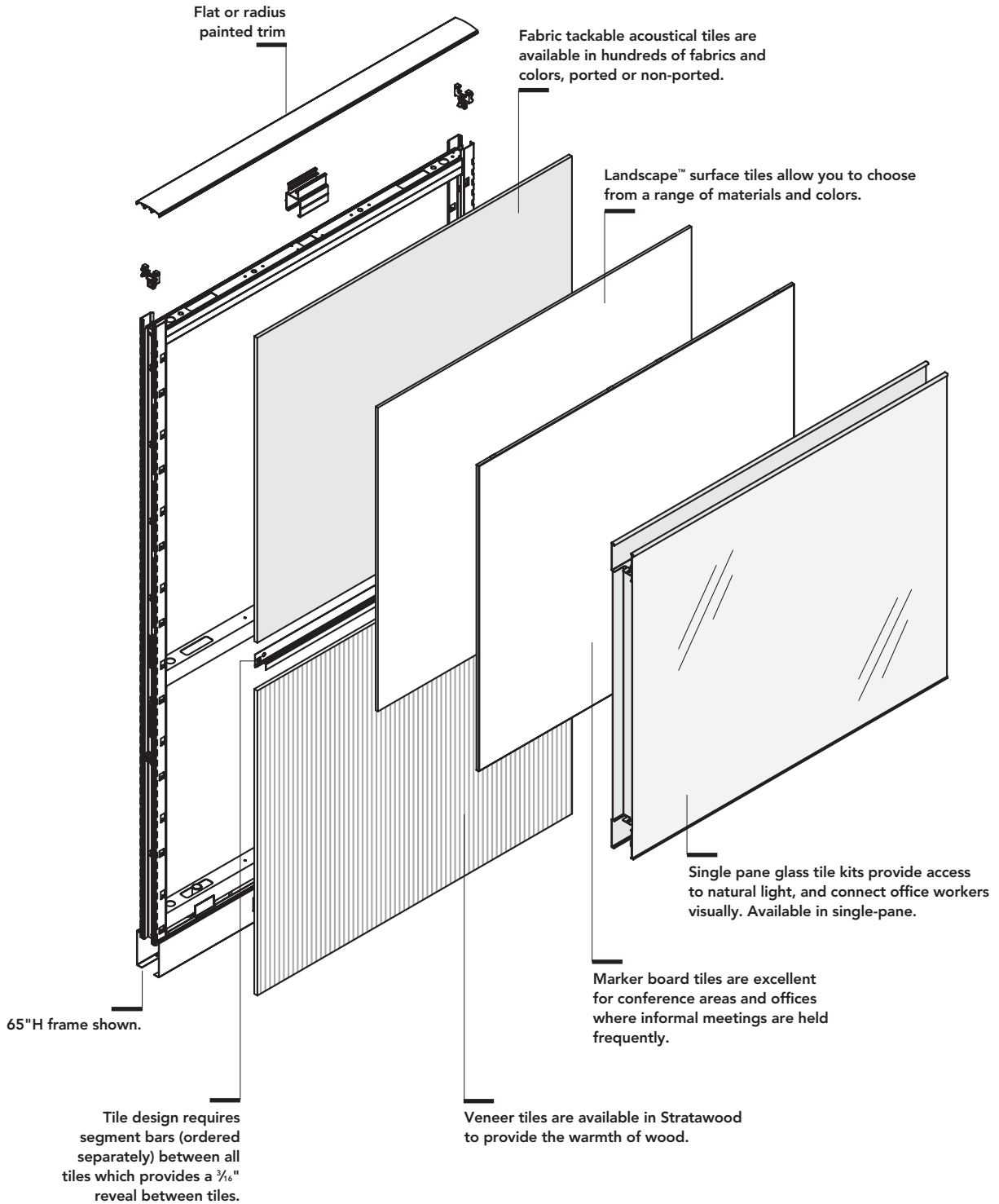

*Aesthetics of opposing tile surface and/or frame interior should be considered when selecting perforated or light colored sheer materials.

GSA Reference Page

To calculate the total height of tiles(s) required, deduct 5" (height of base/top trim) from the total nominal panel height.

Example: 65"H Frame takes 2 30"H tiles. $65 - 5 = 2 \times 30$

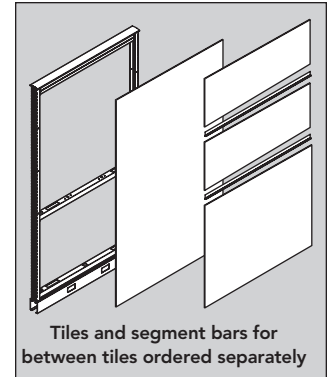

Tiles can be ordered in the size that matches the frame height plus the stacker height.

Example: Order a 65"H monolithic tile if you are using a 35"H frame plus a 30"H stacker.

Terrace tiles are universal (except glass) and can be placed at any 7½" increment on the frame.

Tile Heights

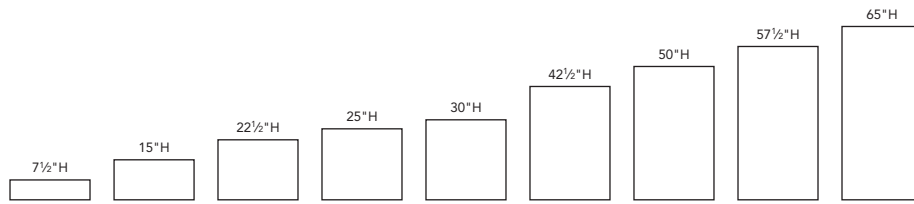

Monolithic tiles are actually 5" shorter to account for base raceway and top trim.

Typical Tile Height Configurations

Middle segment bars are required between any two tiles — order separately based on tile configuration on each side of frame. **Note:** Most CAD specification programs have tools that will calculate quantity of segment bars required.

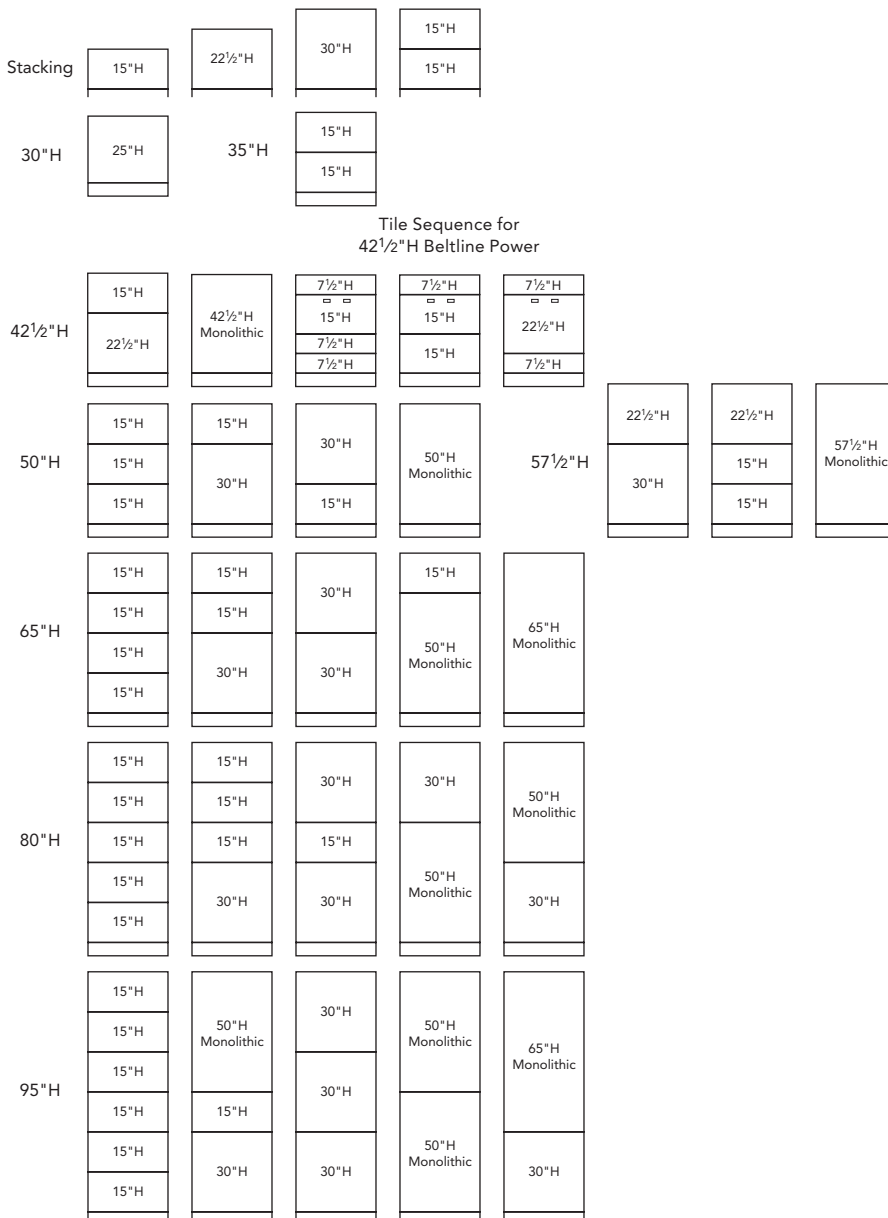

*Additional tile combinations to those shown above are possible; heights above 65" require stacking frames - maximum height is 110".

Tiles

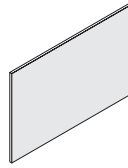

Tackable Acoustical Tiles (pages 67-68)

- Tiles do not include segment bars — order separately.
- 7½"H, 15"H, 22½"H, and 30"H tiles are non-dedicated. They can be used in any combination and in combination with other tile sizes.
- 25"H tiles can be used as monolithic tiles on 30"H frames.
- 30"H tiles can be used as monolithic tiles on 35"H frames.
- 42½"H, 50"H, 57½"H, and 65"H monolithic tiles are non-dedicated.
- 42½"H tiles can be used as monolithic on a 42½"H frame.
- 50"H monolithic tiles are actually 45"H and can be used in any combination with other tiles on a taller frame.
- 50"H tiles can be used as monolithic tiles on a 50"H frame.
- 57½"H tiles can be used as monolithic on a 57½"H frame.
- 65"H monolithic tiles are actually 60"H and can be used in combination with segmented tiles on a frame that is stacked above 65"H.
- 65"H tiles can be used as monolithic on a 65"H frame.

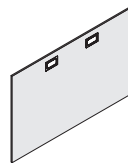

Port Tiles (pages 69-70)

- Receptacle openings with blank covers (1 in 24"W tiles; 2 in wider tiles). Located 29⅞" above bottom of base raceway.
- Tiles do not include segment bars — order separately.
- 15"H and 22½"H port tiles can be used on 42½"H or higher frame for data/power access above beltline. See tile sequence on page 51.
- 25"H tiles for use on 30"H frames.
- 35"H frames do not have beltline data/power capability.
- 30"H port tiles can be used in the base position on 42½"H or higher frames for data/power access above beltline.

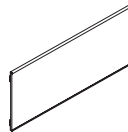

Steel Tiles (page 71)

- Tiles do not include segment bars — order separately.
- Painted steel construction.
- 25"H tiles for use on 30"H frames.
- 7½"H, 15"H, 22½"H, and 30"H tiles are non-dedicated and can be used in any tile position.

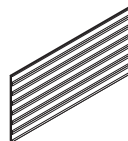

Tool Tiles (page 71)

- Tiles do not include segment bars — order separately.
- Sturdy aluminum extrusion with steel support construction.
- Powder-coated for durable finish.
- Work tools to be hung from this tile available in Extensions™ section.
- Use in place of standard 7½"H or 15"H tiles.
- Cannot be used in the bottom location of a panel frame or on wall track.
- Each tool tile has a suggested weight capacity of 80 lbs. of paper management accessories.



Perforated Steel Tiles (page 72)

- Tiles do not include segment bars — order separately.
- Allows air flow when placed on each side of panel.
- 7½"H, 15"H, 22½"H, and 30"H tiles are non-dedicated and can be used in any tile position.
- Aesthetics of opposing tile surface and/or frame interior should be considered when using perforated or light colored sheer materials.

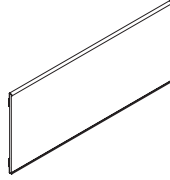

Laminate Tiles (page 73)

- Available in standard laminate colors. See page 38.
- Tiles do not ship with segment bars — order separately.
- Tiles come completely assembled and attach with custom tile bracket kit. Specify paint color.
- It is not recommended to use this tile with wall track.
- 15"H and 30"H tiles are non-dedicated and can be used in any tile position.
- Grain direction runs vertical on all sizes.
- **Made of 3/8" board with HPL laminate.**

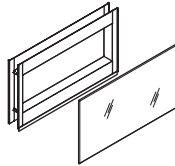

Glass Tiles (page 78)

- Tempered safety glass encased within a frame with built-in shrouds.
- Single-pane construction, glass is flush on one side.
- For use in stacking frames also.
- Glass opening is 4" less than nominal heights and widths.
- Cannot be used in top tile position of a 42½"H panel frame or any frame with integrated power pole.
- Cannot be used at the bottom or beltline location of panel frame.
- 30"H tiles will work in top position of 65"H frames and in 30"H stacking frame. Segment bar needs to be ordered
- Tiles do not ship with segment bars — order separately.

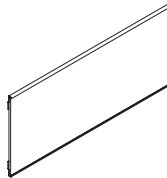

Marker Board Tiles (page 79)

- White marker board tile; painted steel surface.
- Accepts magnetic accessories.
- 15" magnetically attachable tray is natural aluminum color — order separately.
- 15"H, 22½"H, and 30"H tiles are non-dedicated and can be used in any tile position.
- For everyday cleaning of dry-erase marker ink, use Clorox wipes. Should a permanent marker be used, a citrus cleaner such as Quartet will remove the ink. Note that a citrus cleaner is not recommended for everyday cleaning as it leaves a residue on the marker board.
- Tiles do not ship with segment bars — order separately.

Handling and care for marker boards:

1. Leaving ink on the board for an extended period of time may lead to images remaining on the board, commonly known as “ghosting,” after erasing.
2. To avoid ghosting, thoroughly erase your marker board after every use and clean your board weekly with marker board cleaner.
3. Expo® brand dry-erase markers are recommended for best erasing results.
4. Avoid using red and orange markers for easier cleaning and to reduce the likelihood of ghosting.
5. Do not use permanent or non-dry erase markers.
6. To maintain eraser performance, follow manufacturer’s instructions.

Tiles

Spanning Tiles (pages 76-77)

- Not compatible with landscape tiles.
- Base panel height must match tile height. Example: 50"H tile must go on a 50"H base frame, not 50"H tile on 35"H base frame + 15"H stacker.
- Can be used with any combination of two frame widths.
- No more than two frames per tile.
- Bracket Kits:
 - TKSTBRKT1 = 30/35"H
 - TKSTBRKT2 = 42/50"H
- Full laminate and edgeband options available.
- Horizontal grain only.
- For dual-sided spanning tile applications, an additional Bracket Kit must be ordered.
- For dual-sided applications, spanning tiles must be mounted to the same panel frames.
- Laminate is 3/8" thick, edgeband is 0.8mm thick.
- Slotted standard is accessible when using spanning tiles on the two outside slots.
- Cannot be used with Wall Track.

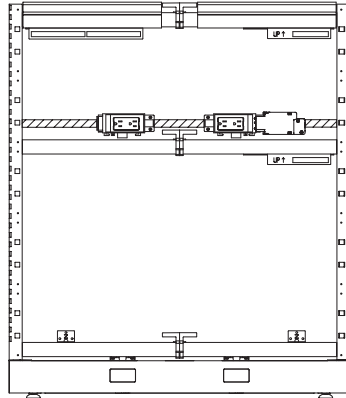
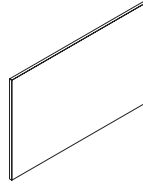

Beltline power is only available above the beltline on the opposite side of the spanning tile.

Frame Combinations

54w		60w		66w		72w		78w		84w		90w		96w	
Frame 1	Frame 2	Frame 1	Frame 2	Frame 1	Frame 2	Frame 1	Frame 2	Frame 1	Frame 2	Frame 1	Frame 2	Frame 1	Frame 2	Frame 1	Frame 2
24	30	24	36	24	42	24	48	30	48	24	60	30	60	36	60
		30	30	30	36	30	42	36	42	36	48	42	48	48	48
						36	36			42	42				

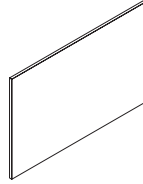

Landscape™ Tiles (page 80)

- ¼" material encased within a painted steel frame.
- Paint color for frame must be specified.
- Tiles do not ship with segment bars — order separately.
- 7½"H, 15"H, 22½"H, and 30"H tiles are non-dedicated and can be used in any tile position.
- Aesthetics of opposing tile surface and/or frame interior should be considered when using perforated or light colored sheer materials.

Foundation™ Tiles (page 80)

- Fabric laminated between recyclable PETG resin sheets.

Custom Tile Bracket Kits (page 81)

- Tile attachment kit allows for any approved ¼" thick "rigid" material to be used as a used as a Terrace tile.
- Use supplied dimensions below for tile size.

Custom Tile Bracket Kits

Custom material used in the custom tile brackets should be sized according to these dimensions:

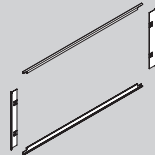

Standard Tile Height	Actual Height Dimensions	Standard Tile Width	Actual Width Dimensions
7½"H	7.198"H	20"W	19.481"W
15"H	14.698"H	24"W	23.481"W
22½"H	22.198"H	30"W	29.481"W
30"H	29.698"H	36"W	35.481"W
Thickness of custom material must be ¼" thick ±.030".		42"W	41.481"W
		48"W	47.481"W
		60"W	59.481"W

Terrace Stratawood Veneer

Wood owes its inherent beauty to variations in color, grain and texture, and therefore, these variations are not considered defects. There may be minor variations from one piece of furniture to the next, even though they are finished at the same time. Exposure to light and the aging process will cause darkening of natural wood products. Light finishes on wood products do not mask the natural characteristics of wood. Therefore, Allsteel does not guarantee the exact matching grain, pattern and color.

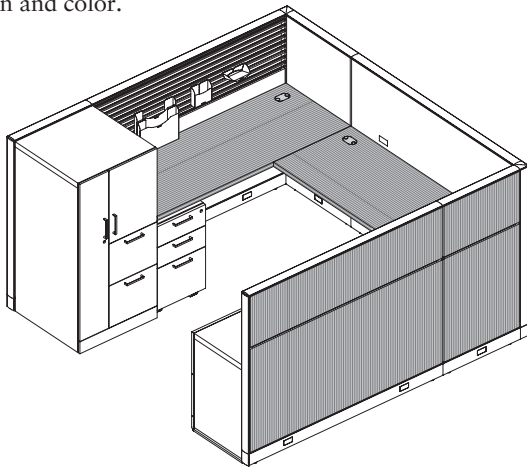

Terrace veneer tiles and worksurfaces are offered in Stratawood (composite). (See page 38 for finishes.) These products offer excellent scratch, stain, and abrasions resistance, plus a high level of clarity.

Terrace Stratawood veneer worksurfaces are protected by one of the world's most advanced wood finishing process. It provides the ultimate in scratch, stain, chemical, and heat resistance for these high-wear surfaces. The jewel-like clarity and depth allow the natural beauty of the wood to glow through.

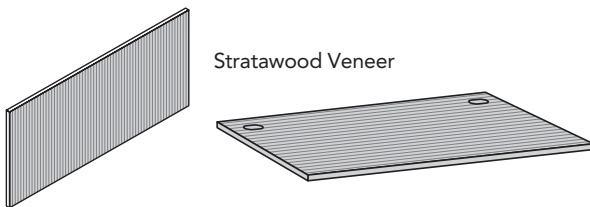

Stratawood Veneer

Stratawood Veneer

Stratawood veneer features a repeatable straight-grain pattern, absent of the cathedrals seen in Natural veneer. Although slight differences in tone should be expected, the Stratawood pattern will maintain a consistent appearance across all products.

Stratawood veneer is an engineered wood veneer enhanced by technology for consistency in both color and grain pattern resulting in very few defects.

Although exposure to light will cause Stratawood veneer to darken slightly, additional orders at later dates will match existing product pattern and will match the color when matured. This creates a smooth process for adding on to existing installations.

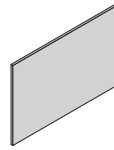

Veneer Tiles (page 82)

- Veneer tiles produced by Gunlocke® available in Stratawood veneer. See page 7 for additional veneer information.
- Stratawood veneer has a consistent straight-grain pattern.
- Veneer tiles ship with factory-installed attachment clips.
- Tiles do not include segment kits — order separately.
- For models TKG4xxxxLS, grain direction runs vertical on all sizes.
- For models TKG4xxxxLM, grain direction can be horizontal or vertical.

Caring for your veneer worksurface finish:

- General maintenance procedures entail wiping clean the entire surface with a clean water dampened soft cloth once per week. (Be sure to wipe with the grain.)
- Murphy's® Oil Soap may be used as a general purpose type cleaner with warm water to clean tops.
- The finish may also be polished with Guardsman® Furniture Polish (contains no waxes or silicones) to provide renewed luster.
- Be sure to wipe up all spills immediately.

Frames

Terrace® — Base Panel Frames without Top Trim

For specification information see pages 41-48.

GSA SIN 33721

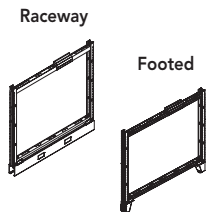
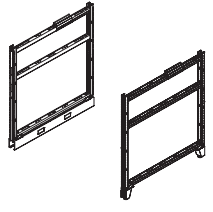
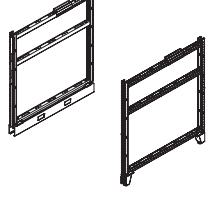
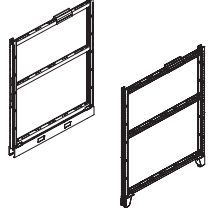
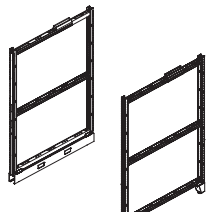
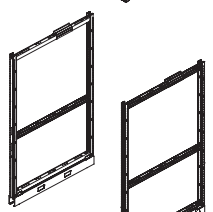
	Description	Model	P1 Paint List Price	P2 Paint List Price	P3 Paint List Price
	30"H Base Panel Frames without Top Trim				
	24"W	TK03224W □	\$ 386	\$ 414	\$ 440
	30"W	TK03230W □	\$ 396	\$ 425	\$ 450
	36"W	TK03236W □	\$ 411	\$ 440	\$ 465
	42"W	TK03242W □	\$ 429	\$ 459	\$ 483
	48"W	TK03248W □	\$ 453	\$ 485	\$ 507
	60"W	TK03260W □	\$ 507	\$ 543	\$ 561
	35"H Base Panel Frames without Top Trim				
	24"W	TK03524W □	\$ 395	\$ 424	\$ 450
	30"W	TK03530W □	\$ 405	\$ 434	\$ 460
	36"W	TK03536W □	\$ 418	\$ 447	\$ 473
	42"W	TK03542W □	\$ 436	\$ 465	\$ 491
	48"W	TK03548W □	\$ 460	\$ 489	\$ 515
	60"W	TK03560W □	\$ 514	\$ 543	\$ 569
	42½"H Base Panel Frames without Top Trim				
	24"W	TK04224W □	\$ 403	\$ 432	\$ 458
	30"W	TK04230W □	\$ 426	\$ 455	\$ 481
	36"W	TK04236W □	\$ 444	\$ 473	\$ 499
	42"W	TK04242W □	\$ 461	\$ 490	\$ 516
	48"W	TK04248W □	\$ 479	\$ 508	\$ 534
	60"W	TK04260W □	\$ 538	\$ 567	\$ 593
	50"H Base Panel Frames without Top Trim				
	24"W	TK05024W □	\$ 433	\$ 462	\$ 488
	30"W	TK05030W □	\$ 459	\$ 488	\$ 514
	36"W	TK05036W □	\$ 469	\$ 498	\$ 524
	42"W	TK05042W □	\$ 486	\$ 515	\$ 541
	48"W	TK05048W □	\$ 501	\$ 530	\$ 556
	60"W	TK05060W □	\$ 552	\$ 581	\$ 607
	57½"H Base Panel Frames without Top Trim				
	24"W	TK05724W □	\$ 460	\$ 489	\$ 515
	30"W	TK05730W □	\$ 471	\$ 500	\$ 526
	36"W	TK05736W □	\$ 487	\$ 516	\$ 542
	42"W	TK05742W □	\$ 507	\$ 536	\$ 562
	48"W	TK05748W □	\$ 531	\$ 560	\$ 586
	60"W	TK05760W □	\$ 581	\$ 610	\$ 636
	65"H Base Panel Frames without Top Trim				
	24"W	TK06524W □	\$ 469	\$ 498	\$ 524
	30"W	TK06530W □	\$ 483	\$ 512	\$ 538
	36"W	TK06536W □	\$ 502	\$ 531	\$ 557
	42"W	TK06542W □	\$ 517	\$ 546	\$ 572
	48"W	TK06548W □	\$ 539	\$ 568	\$ 594
	60"W	TK06560W □	\$ 594	\$ 623	\$ 649

TERRACE

<p>How to specify — Select the Terrace Model Number from above.</p>	<p>1st Option: Select the Base Option: R Raceway Cover F Footed</p>	<p>2nd Option: Paint: P1 P2 P3 See page 38 for finishes. *P3 colors not available on Terrace foot.</p>
<p>T K O W . </p>		<p>P </p>

Examples: TK05060WR.P7C TK04236WF.P27

For specification information see pages 41-48.

GSA SIN 33721



Description	Model	List Price
15"H Stacking Frames		
24"W	TK01524	\$ 359
30"W	TK01530	\$ 382
36"W	TK01536	\$ 391
42"W	TK01542	\$ 404
48"W	TK01548	\$ 407
60"W	TK01560	\$ 425



22½"H Stacking Frames		
24"W	TK02224	\$ 376
30"W	TK02230	\$ 382
36"W	TK02236	\$ 393
42"W	TK02242	\$ 405
48"W	TK02248	\$ 418
60"W	TK02260	\$ 437

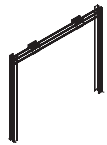

30"H Stacking Frames		
24"W	TK03024	\$ 386
30"W	TK03030	\$ 404
36"W	TK03036	\$ 418
42"W	TK03042	\$ 436
48"W	TK03048	\$ 450
60"W	TK03060	\$ 468



Segment Bars (black only)		
24"W	TKSK24	\$ 32
30"W	TKSK30	\$ 32
36"W	TKSK36	\$ 33
42"W	TKSK42	\$ 36
48"W	TKSK48	\$ 40
60"W	TKSK60	\$ 41



Terrace Horizontal Electrical Mount Support		
24"W	TN24MS	\$ 125
30"W	TN30MS	\$ 135
36"W	TN36MS	\$ 145
42"W	TN42MS	\$ 164
48"W	TN48MS	\$ 177
60"W	TN60MS	\$ 197

TERRACE

How to specify —

Select the Terrace Model Number from above.



Examples: TK02224 TKSK42 TN24MS

Shippable by small-package carrier.

Frames

Terrace® — Door Panel / Sliding Door / Kits

For specification information see pages 41-48.

GSA SIN 33721



TK18742D

Description	Model	List Price	PAINT & LAMINATE UPCHARGES			
			P2	P3	L2	L3
Laminate Door Panels with Radius Painted Top Trim						
87½"H x 42"W	TK18742D	\$ 5060	\$ 53	\$ 106	\$ 174	\$ 350
Laminate Door Panels with Flat Painted Top Trim						
87½"H x 42"W	TK18742DF	\$ 4781	\$ 53	\$ 106	\$ 174	\$ 352

*Upcharges for higher grade paint or laminate are added to list price.

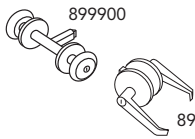

899900

899910

Description	Model	List Price
Lockset		
Door Knob — polished brass, keyed one side	899900 S	\$ 180
Door Lever — brushed aluminum, keyed one side	899910 S	\$ 511

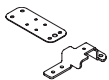
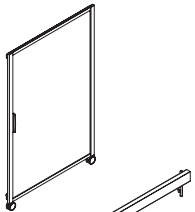

TKRF

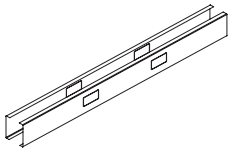

TK36FR

Description	Model	P1 Paint List Price	P2 Paint List Price	P3 Paint List Price
Frosted Translucent Sliding Doors (for 36"W opening)				
50"H x 42"W	Z15042SD	\$ 5704	\$ 5766	\$ 5831
65"H x 42"W	Z16542SD	\$ 6914	\$ 6976	\$ 7041
80"H x 42"W	Z18042SD	\$ 8421	\$ 8483	\$ 8548
Mounting Kit for Sliding Doors (mounts to adjacent Terrace panel)				
30"W	TKDMK30 S	\$ 648	\$ 668	\$ 684
36"W	TKDMK36 S	\$ 648	\$ 668	\$ 684
42"W	TKDMK42 S	\$ 648	\$ 668	\$ 684
48"W	TKDMK48 S	\$ 648	\$ 668	\$ 684
Off-Modular Panel Connection Kit				
Off-Modular Kit	TKOM S	\$ 229	N/A	N/A
Base Raceway to Footed Conversion Kit				
Base Raceway to Footed Kit	TKRF	\$ 270	\$ 299	\$ 325
Footed to Base Raceway Conversion Kit				
24"W	TK24FR	\$ 336	\$ 384	\$ 433
30"W	TK30FR	\$ 336	\$ 384	\$ 433
36"W	TK36FR	\$ 336	\$ 384	\$ 433
42"W	TK42FR	\$ 336	\$ 384	\$ 433
48"W	TK48FR	\$ 336	\$ 384	\$ 433
60"W	TK60FR	\$ 336	\$ 384	\$ 433

How to specify —
Select the Terrace Model Number from above.

1st Option:
Paint
(if applicable):
P1 P2 P3
See page 38 for finishes.

2nd Option:
Door Laminate
(if applicable):
See page 38 for finishes.

2nd Option:
Insert (Sliding Door only):
FT Frosted
Translucent

_____ . P _____ . _____ . F T

Examples: TK18742D.P02.TM65 899900 Z15042SD.P02.FT

For specification information see pages 41-48.

GSA SIN 33721

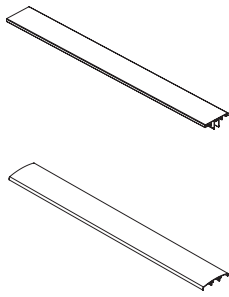

Description/ Examples	Flat Top Trim Model*	Radius Top Trim Model	Flat Top Trim			Radius Top Trim		
			P1 Paint List Price	P2 Paint List Price	P3 Paint List Price	P1 Paint List Price	P2 Paint List Price	P3 Paint List Price
Painted Top Trim (Examples span multiple panels)								
24"W	TK324PTFK S	TK324PT S	\$ 65	\$ 94	\$ 120	\$ 58	\$ 87	\$ 113
30"W	TK330PTFK S	TK330PT S	\$ 74	\$ 103	\$ 129	\$ 68	\$ 97	\$ 123
36"W	TK336PTFK S	TK336PT S	\$ 83	\$ 112	\$ 138	\$ 82	\$ 111	\$ 137
42"W	TK342PTFK S	TK342PT S	\$ 97	\$ 126	\$ 152	\$ 98	\$ 127	\$ 153
48"W	TK348PTFK S	TK348PT S	\$ 105	\$ 134	\$ 160	\$ 110	\$ 139	\$ 165
54"W – 24" + 30"	TK354PTFK S	TK354PT S	\$ 134	\$ 182	\$ 231	\$ 140	\$ 194	\$ 248
60"W	TK360PTFK S	TK360PT S	\$ 130	\$ 159	\$ 185	\$ 132	\$ 161	\$ 187
66"W – 30" + 36"	TK366PTFK	TK366PT	\$ 154	\$ 202	\$ 251	\$ 162	\$ 216	\$ 270
68"W – 48" + 20"	TK368PTFK	TK368PT	\$ 158	\$ 206	\$ 255	\$ 165	\$ 219	\$ 273
72"W – 36" + 36"	TK372PTFK	TK372PT	\$ 161	\$ 209	\$ 258	\$ 171	\$ 225	\$ 279
78"W – 48" + 30"	TK378PTFK	TK378PT	\$ 167	\$ 215	\$ 264	\$ 178	\$ 232	\$ 286
84"W – 36" + 48" or 42" + 42"	TK384PTFK	TK384PT	\$ 181	\$ 229	\$ 278	\$ 193	\$ 247	\$ 301
90"W – 42" + 48"	TK390PTFK	TK390PT	\$ 191	\$ 239	\$ 288	\$ 201	\$ 255	\$ 309
96"W – 48" + 48" or 36" + 60"	TK396PTFK	TK396PT	\$ 203	\$ 251	\$ 300	\$ 214	\$ 268	\$ 322

*"K" suffix was added to flat trim model numbers effective 10/7/2016.

TERRACE

How to specify —
Select the Terrace Model Number from above.

1st Option:
Paint
(if applicable):
P1 P2 P3
See page 38 for finishes.

T
K
3
|
P
T
|
|
|
.
P
|
|
|
.

Examples: TK330PTFK.P7D TK330PT.P7D

S Shippable by small-package carrier.

For specification information see pages 41-48.

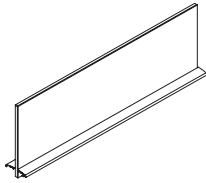

Description	Flat Top Trim Model	Radius Top Trim Model	Painted Trim		
			Clear List Price	Frosted List Price	Smoked List Price
7½"H x ¾" Thick Glass Panel Mounted Screens — Painted Trim (Example spans multiple panels)					
24"W	TK40724TGSF	TKG40724TGSR	\$ 636	\$ 680	\$ 726
30"W	TK40730TGSF	TKG40730TGSR	\$ 684	\$ 730	\$ 779
36"W	TK40736TGSF	TKG40736TGSR	\$ 786	\$ 840	\$ 897
42"W	TK40742TGSF	TKG40742TGSR	\$ 833	\$ 890	\$ 950
48"W	TK40748TGSF	TKG40748TGSR	\$ 891	\$ 951	\$ 1015
54"W – 24" + 30"	TK40754TGSF	TKG40754TGSR	\$ 993	\$ 1061	\$ 1130
60"W	TK40760TGSF	TKG40760TGSR	\$ 1091	\$ 1166	\$ 1244
66"W – 30" + 36"	TK40766TGSF	TKG40766TGSR	\$ 1200	\$ 1282	\$ 1367
72"W – 36" + 36"	TK40772TGSF	TKG40772TGSR	\$ 1297	\$ 1384	\$ 1478
78"W – 48" + 30"	TK40778TGSF	TKG40778TGSR	\$ 1397	\$ 1491	\$ 1592
84"W – 36" + 48" or 42" + 42"	TK40784TGSF	TKG40784TGSR	\$ 1490	\$ 1595	\$ 1698
90"W – 42" + 48"	TK40790TGSF	TKG40790TGSR	\$ 1594	\$ 1704	\$ 1816
96"W – 48" + 48" or 36" + 60"	TK40796TGSF	TKG40796TGSR	\$ 1691	\$ 1807	\$ 1926
15"H x ¾" Thick Glass Panel Mounted Screens — Painted Trim (Example spans multiple panels)					
24"W	TK41524TGSF	TKG41524TGSR	\$ 692	\$ 738	\$ 788
30"W	TK41530TGSF	TKG41530TGSR	\$ 740	\$ 790	\$ 843
36"W	TK41536TGSF	TKG41536TGSR	\$ 854	\$ 912	\$ 974
42"W	TK41542TGSF	TKG41542TGSR	\$ 911	\$ 975	\$ 1039
48"W	TK41548TGSF	TKG41548TGSR	\$ 975	\$ 1042	\$ 1110
54"W – 24" + 30"	TK41554TGSF	TKG41554TGSR	\$ 1081	\$ 1156	\$ 1233
60"W	TK41560TGSF	TKG41560TGSR	\$ 1191	\$ 1273	\$ 1357
66"W – 30" + 36"	TK41566TGSF	TKG41566TGSR	\$ 1302	\$ 1389	\$ 1483
72"W – 36" + 36"	TK41572TGSF	TKG41572TGSR	\$ 1417	\$ 1512	\$ 1614
78"W – 48" + 30"	TK41578TGSF	TKG41578TGSR	\$ 1608	\$ 1719	\$ 1832
84"W – 36" + 48" or 42" + 42"	TK41584TGSF	TKG41584TGSR	\$ 1802	\$ 1924	\$ 2054
90"W – 42" + 48"	TK41590TGSF	TKG41590TGSR	\$ 1852	\$ 1979	\$ 2110
96"W – 48" + 48" or 36" + 60"	TK41596TGSF	TKG41596TGSR	\$ 1908	\$ 2039	\$ 2174

<p>How to specify — Select the Terrace Model Number from above.</p>	<p>1st Option: Glass (if applicable): GSM1 Smoked LC Clear LF Frosted</p>	<p>2nd Option: Paint (if applicable): See page 38 for finishes.</p>
<p>_____ . L .</p>	<p>P _____</p>	

Examples: TK40724TGSF.LC.P52 TKG40724TGSR.LC.P52

Connectors

Terrace® — Connector Kits

For specification information see pages 41-48.

Flat or Radius — Top Cap / Trim

GSA SIN 33721

Description	Flat Top Cap/Trim Model	Radius Top Cap/Trim Model	Painted Top Cap Painted Trim		
			P1 Paint List Price	P2 Paint List Price	P3 Paint List Price
"L" 90° Connector Kits					
7½"H stacking/segmented	TK307LF	TK307L	\$ 148	\$ 176	\$ 201
12"H stacking/segmented	TK312LF	TK312L	\$ 164	\$ 192	\$ 217
15"H stacking/segmented	TK315LF	TK315L	\$ 166	\$ 194	\$ 219
20"H stacking/segmented	TK320LF	TK320L	\$ 188	\$ 216	\$ 241
22½"H stacking/segmented	TK322LF	TK322L	\$ 190	\$ 218	\$ 243
27"H stacking/segmented	TK327LF	TK327L	\$ 208	\$ 236	\$ 261
30"H stacking/segmented	TK330LF	TK330L	\$ 212	\$ 240	\$ 265
30"H base panel	TK332LF	TK332L	\$ 211	\$ 228	\$ 249
35"H base panel	TK335LF	TK335L	\$ 212	\$ 240	\$ 265
42½"H base panel	TK342LF	TK342L	\$ 237	\$ 265	\$ 290
50"H base panel	TK350LF	TK350L	\$ 248	\$ 276	\$ 301
57½"H base panel	TK357LF	TK357L	\$ 254	\$ 282	\$ 307
65"H base panel	TK365LF	TK365L	\$ 258	\$ 286	\$ 311
80"H base panel	TK380LF	TK380L	\$ 327	\$ 355	\$ 380
87½"H base panel	TK387LF	TK387L	\$ 348	\$ 376	\$ 401
"T" 3-way Connector Kit					
7½"H stacking/segmented	TK307TF	TK307T	\$ 148	\$ 176	\$ 201
12"H stacking/segmented	TK312TF	TK312T	\$ 164	\$ 192	\$ 217
15"H stacking/segmented	TK315TF	TK315T	\$ 166	\$ 194	\$ 219
20"H stacking/segmented	TK320TF	TK320T	\$ 188	\$ 216	\$ 241
22½"H stacking/segmented	TK322TF	TK322T	\$ 190	\$ 218	\$ 243
27"H stacking/segmented	TK327TF	TK327T	\$ 208	\$ 236	\$ 261
30"H stacking/segmented	TK330TF	TK330T	\$ 212	\$ 240	\$ 265
30"H base panel	TK332TF	TK332T	\$ 211	\$ 228	\$ 249
35"H base panel	TK335TF	TK335T	\$ 212	\$ 240	\$ 265
42½"H base panel	TK342TF	TK342T	\$ 237	\$ 265	\$ 290
50"H base panel	TK350TF	TK350T	\$ 248	\$ 276	\$ 301
57½"H base panel	TK357TF	TK357T	\$ 254	\$ 282	\$ 307
65"H base panel	TK365TF	TK365T	\$ 258	\$ 286	\$ 311
80"H base panel	TK380TF	TK380T	\$ 327	\$ 355	\$ 380
87½"H base panel	TK387TF	TK387T	\$ 348	\$ 376	\$ 401
"X" 4-way Connector Kits					
7½"H stacking/segmented	TK307XF	TK307X	\$ 116	\$ 133	\$ 145
12"H stacking/segmented	TK312XF	TK312X	\$ 127	\$ 144	\$ 156
15"H stacking/segmented	TK315XF	TK315X	\$ 128	\$ 145	\$ 157
20"H stacking/segmented	TK320XF	TK320X	\$ 146	\$ 163	\$ 175
22½"H stacking/segmented	TK322XF	TK322X	\$ 150	\$ 167	\$ 179
27"H stacking/segmented	TK327XF	TK327X	\$ 164	\$ 181	\$ 193
30"H stacking/segmented	TK330XF	TK330X	\$ 166	\$ 183	\$ 195
30"H base panel	TK332XF	TK332X	\$ 165	\$ 178	\$ 195
35"H base panel	TK335XF	TK335X	\$ 166	\$ 183	\$ 195
42½"H base panel	TK342XF	TK342X	\$ 227	\$ 244	\$ 256
50"H base panel	TK350XF	TK350X	\$ 237	\$ 254	\$ 266
57½"H base panel	TK357XF	TK357X	\$ 243	\$ 260	\$ 272
65"H base panel	TK365XF	TK365X	\$ 248	\$ 265	\$ 277
80"H base panel	TK380XF	TK380X	\$ 284	\$ 301	\$ 313
87½"H base panel	TK387XF	TK387X	\$ 304	\$ 321	\$ 333

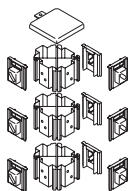
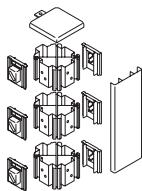
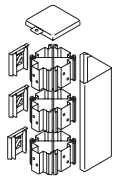

TERRACE

How to specify —
Select the Terrace Model Number from above.

1st Option:
Paint
(if applicable):
P1 P2 P3
See page 38 for finishes.

TK3 | | | | | .

P | | |

Examples: Painted Flat – TK365LF.P02 Painted Radius – TK365L.P02

S Shippable by small-package carrier.

Connectors

Terrace® — Connector Kits

For specification information see pages 41-48.

Flat or Radius — Top Cap / Trim

GSA SIN 33721

Description	Flat Top Cap/Trim Model	Radius Top Cap/Trim Model	Painted Top Cap Painted Trim		
			P1 Paint List Price	P2 Paint List Price	P3 Paint List Price
"S" Extended Straight Connector Kits					
7½" H stacking/segmented	TK307SF	TK307S	\$ 188	\$ 216	\$ 241
12" H stacking/segmented	TK312SF	TK312S	\$ 195	\$ 223	\$ 248
15" H stacking/segmented	TK315SF	TK315S	\$ 199	\$ 227	\$ 252
20" H stacking/segmented	TK320SF	TK320S	\$ 212	\$ 240	\$ 265
22½" H stacking/segmented	TK322SF	TK322S	\$ 215	\$ 243	\$ 268
27" H stacking/segmented	TK327SF	TK327S	\$ 234	\$ 262	\$ 287
30" H stacking/segmented	TK330SF	TK330S	\$ 237	\$ 265	\$ 290
30" H base panel	TK332SF	TK332S	\$ 236	\$ 254	\$ 279
35" H base panel	TK335SF	TK335S	\$ 237	\$ 265	\$ 290
42½" H base panel	TK342SF	TK342S	\$ 276	\$ 304	\$ 329
50" H base panel	TK350SF	TK350S	\$ 286	\$ 314	\$ 339
57½" H base panel	TK357SF	TK357S	\$ 291	\$ 319	\$ 344
65" H base panel	TK365SF	TK365S	\$ 306	\$ 334	\$ 359
80" H base panel	TK380SF	TK380S	\$ 380	\$ 408	\$ 433
87½" H base panel	TK387SF	TK387S	\$ 396	\$ 424	\$ 449
2-Way 120° Connector					
12" H stacking/segmented	TK312BF	TK312B	\$ 157	\$ 185	\$ 210
15" H stacking/segmented	TK315BF	TK315B	\$ 161	\$ 189	\$ 214
20" H stacking/segmented	TK320BF	TK320B	\$ 165	\$ 193	\$ 218
27" H stacking/segmented	TK327BF	TK327B	\$ 197	\$ 225	\$ 250
30" H stacking/segmented	TK330BF	TK330B	\$ 200	\$ 228	\$ 253
32" H base panel	TK332BF	TK332B	\$ 208	\$ 236	\$ 261
35" H base panel	TK335BF	TK335B	\$ 212	\$ 240	\$ 265
42½" H base panel	TK342BF	TK342B	\$ 237	\$ 265	\$ 290
50" H base panel	TK350BF	TK350B	\$ 258	\$ 286	\$ 311
57½" H base panel	TK357BF	TK357B	\$ 271	\$ 299	\$ 324
65" H base panel	TK365BF	TK365B	\$ 286	\$ 314	\$ 339
3-Way 120° Connector					
12" H stacking/segmented	TK312CF	TK312C	\$ 130	\$ 158	\$ 183
15" H stacking/segmented	TK315CF	TK315C	\$ 135	\$ 163	\$ 188
20" H stacking/segmented	TK320CF	TK320C	\$ 142	\$ 170	\$ 195
27" H stacking/segmented	TK327CF	TK327C	\$ 177	\$ 205	\$ 230
30" H stacking/segmented	TK330CF	TK330C	\$ 179	\$ 207	\$ 232
32" H base panel	TK332CF	TK332C	\$ 188	\$ 216	\$ 241
35" H base panel	TK335CF	TK335C	\$ 190	\$ 218	\$ 243
42½" H base panel	TK342CF	TK342C	\$ 212	\$ 240	\$ 265
50" H base panel	TK350CF	TK350C	\$ 237	\$ 265	\$ 290
57½" H base panel	TK357CF	TK357C	\$ 248	\$ 276	\$ 301
65" H base panel	TK365CF	TK365C	\$ 258	\$ 286	\$ 311

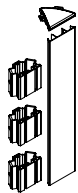
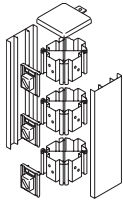

How to specify —
Select the Terrace Model Number from above.

1st Option:
Paint
(if applicable):
P1 P2 P3
See page 38 for finishes.

TK3 | | | | | .

P | | |

Examples: Painted Flat – TK335CF.P27 Painted Radius – TK335C.P27

S Shippable by small-package carrier.

Connectors

Terrace® — Connector Kits

For specification information see pages 41-48.

Flat or Radius — Top Cap / Trim

GSA SIN 33721

Description	Flat Top Cap/Trim Model	Radius Top Cap/Trim Model	Painted Top Cap Painted Trim		
			P1 Paint List Price	P2 Paint List Price	P3 Paint List Price
"E" End Trim Kits					
15"H stacking/segmented	TK315EF	TK315E	\$ 97	\$ 125	\$ 150
22½"H stacking/segmented	TK322EF	TK322E	\$ 106	\$ 134	\$ 159
30"H stacking/segmented	TK330EF	TK330E	\$ 119	\$ 147	\$ 172
30"H base panel	TK332EF	TK332E	\$ 120	\$ 130	\$ 142
35"H base panel	TK335EF	TK335E	\$ 119	\$ 147	\$ 172
42½"H base panel	TK342EF	TK342E	\$ 128	\$ 156	\$ 181
50"H base panel	TK350EF	TK350E	\$ 146	\$ 174	\$ 199
57½"H base panel	TK357EF	TK357E	\$ 152	\$ 180	\$ 205
65"H base panel	TK365EF	TK365E	\$ 157	\$ 185	\$ 210
80"H base panel	TK380EF	TK380E	\$ 223	\$ 251	\$ 276
87½"H base panel	TK387EF	TK387E	\$ 242	\$ 270	\$ 295
High-Low End Trim Kit					
5"H connector kit	TK305HF	TK305H	\$ 95	\$ 112	\$ 124
7½"H	TK307HF	TK307H	\$ 97	\$ 114	\$ 126
12"H stacking/segmented	TK312HF	TK312H	\$ 95	\$ 112	\$ 124
15"H	TK315HF	TK315H	\$ 97	\$ 114	\$ 126
20"H stacking/segmented	TK320HF	TK320H	\$ 118	\$ 135	\$ 147
22½"H	TK322HF	TK322H	\$ 119	\$ 136	\$ 148
27"H stacking/segmented	TK327HF	TK327H	\$ 118	\$ 135	\$ 147
30"H	TK330HF	TK330H	\$ 119	\$ 136	\$ 148
Grooved High-Low Trim — for use with Panel Mounted Screens					
7½"H	TK307HGF	TK307HG	\$ 118	\$ 135	\$ 147
15"H	TK315HGF	TK315HG	\$ 128	\$ 145	\$ 157
"W" Wall Mount Kit					
15"H stacking/segmented	TK315WF	TK315W	\$ 118	\$ 146	\$ 171
22½"H stacking/segmented	TK322WF	TK322W	\$ 140	\$ 168	\$ 193
30"H stacking/segmented	TK330WF	TK330W	\$ 162	\$ 190	\$ 215
32"H wall mount kit for base frame	TK332WF	TK332W	\$ 181	\$ 209	\$ 234
35"H	TK335WF	TK335W	\$ 185	\$ 213	\$ 238
42½"H	TK342WF	TK342W	\$ 201	\$ 229	\$ 254
50"H	TK350WF	TK350W	\$ 231	\$ 259	\$ 284
57½"H	TK357WF	TK357W	\$ 250	\$ 278	\$ 303
65"H	TK365WF	TK365W	\$ 271	\$ 299	\$ 324
87½"H	TK387WF	TK387W	\$ 365	\$ 393	\$ 418



TERRACE

How to specify —
Select the Terrace Model Number from above.

1st Option:
Paint:
P1
P2
P3
 See page 38 for finishes.

TK3 | | | | | . P | | |

Examples: Painted Flat – TK315EF.P27 Painted Radius – TK315E.P27 S Shippable by small-package carrier.

For specification information see pages 41-48.

GSA SIN 33721

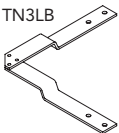
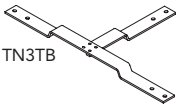
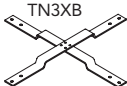
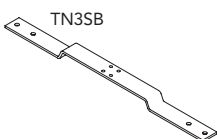
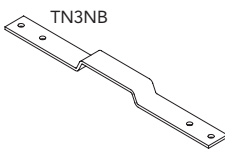
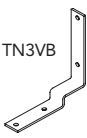
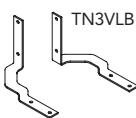
	Description	Model	List Price
 <p>TN3LB</p>	Top Stabilizer Brackets		
	"L" Top Stabilizer Bracket	TN3LB S	\$ 91
 <p>TN3TB</p>	"T" Top Stabilizer Bracket	TN3TB S	\$ 91
 <p>TN3XB</p>	"X" Top Stabilizer Bracket	TN3XB S	\$ 91
 <p>TN3SB</p>	"S" Top Stabilizer Bracket	TN3SB S	\$ 70
 <p>TN3NB</p>	In Line Top Stabilizer Bracket	TN3NB S	\$ 70
 <p>TN3VB</p>	Variable Height Top Stabilizer Bracket	TN3VB S	\$ 91
 <p>TN3VLB</p>	"L" Variable Height Top Stabilizer Bracket	TN3VLB S	\$ 115

How to specify —

Select the Terrace Model Number from above.

--	--	--	--	--	--	--	--	--	--

Example: TN3LB

S Shippable by small-package carrier.





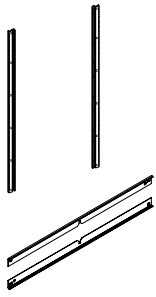

For specification information see pages 41-48.

GSA SIN 33721









Description	Model	List Price
Terrace Wall Track Kit — End/Shared		
65"H — Pair of Ends	TK365YEB 	\$ 353
65"H — Middle Unit	TK365YM 	\$ 184

Terrace Wall Track Tile Attachment Kits — Top and Bottom

24"W	Y324YS 	\$ 261
30"W	Y330YS 	\$ 268
36"W	Y336YS 	\$ 287
42"W	Y342YS 	\$ 326
48"W	Y348YS 	\$ 359
60"W	Y360YS 	\$ 399



Segment Bars (black only)

24"W	TKSK24 	\$ 32
30"W	TKSK30 	\$ 32
36"W	TKSK36 	\$ 33
42"W	TKSK42 	\$ 36
48"W	TKSK48 	\$ 40
60"W	TKSK60 	\$ 41

How to specify —































Select the Terrace Model Number from above.



Examples: TK365YEB Y336YS TKSK42

 Shippable by small-package carrier.

For specification information see pages 49-55.
 (See page 402 for COM pricing on fabric Grades G-J.)

Description	Model	List Price					
		Grade A	Grade B	Grade C	Grade D	Grade E	Grade F
7½"H Tackable Acoustical Tiles							
24"W	TKG40724T 	\$ 115	\$ 120	\$ 124	\$ 131	\$ 137	\$ 143
30"W	TKG40730T 	\$ 122	\$ 128	\$ 132	\$ 140	\$ 147	\$ 155
36"W	TKG40736T 	\$ 128	\$ 135	\$ 140	\$ 150	\$ 159	\$ 169
42"W	TKG40742T 	\$ 140	\$ 148	\$ 153	\$ 164	\$ 174	\$ 186
48"W	TKG40748T 	\$ 148	\$ 157	\$ 164	\$ 176	\$ 189	\$ 201
60"W	TKG40760T 	\$ 169	\$ 179	\$ 188	\$ 203	\$ 219	\$ 234
15"H Tackable Acoustical Tiles							
24"W	TKG41524T 	\$ 118	\$ 127	\$ 134	\$ 146	\$ 159	\$ 171
30"W	TKG41530T 	\$ 125	\$ 135	\$ 144	\$ 159	\$ 175	\$ 190
36"W	TKG41536T 	\$ 135	\$ 147	\$ 158	\$ 178	\$ 196	\$ 216
42"W	TKG41542T 	\$ 145	\$ 160	\$ 172	\$ 194	\$ 216	\$ 238
48"W	TKG41548T 	\$ 152	\$ 168	\$ 183	\$ 208	\$ 233	\$ 258
60"W	TKG41560T 	\$ 173	\$ 193	\$ 211	\$ 243	\$ 274	\$ 305
22½"H Tackable Acoustical Tiles							
24"W	TKG42224T 	\$ 148	\$ 160	\$ 171	\$ 191	\$ 209	\$ 229
30"W	TKG42230T 	\$ 161	\$ 176	\$ 190	\$ 213	\$ 236	\$ 258
36"W	TKG42236T 	\$ 183	\$ 201	\$ 217	\$ 244	\$ 273	\$ 301
42"W	TKG42242T 	\$ 201	\$ 221	\$ 242	\$ 274	\$ 307	\$ 338
48"W	TKG42248T 	\$ 220	\$ 243	\$ 266	\$ 303	\$ 340	\$ 377
60"W	TKG42260T 	\$ 239	\$ 268	\$ 296	\$ 342	\$ 389	\$ 436
25"H Tackable Acoustical Tiles (Tile is 25"H, for use with 30"H Frames)							
24"W	TKG43224T 	\$ 156	\$ 169	\$ 181	\$ 203	\$ 223	\$ 243
30"W	TKG43230T 	\$ 168	\$ 185	\$ 200	\$ 226	\$ 252	\$ 278
36"W	TKG43236T 	\$ 189	\$ 209	\$ 227	\$ 259	\$ 290	\$ 321
42"W	TKG43242T 	\$ 217	\$ 239	\$ 262	\$ 298	\$ 334	\$ 370
48"W	TKG43248T 	\$ 225	\$ 250	\$ 275	\$ 317	\$ 358	\$ 400
60"W	TKG43260T 	\$ 246	\$ 278	\$ 310	\$ 362	\$ 413	\$ 466
30"H Tackable Acoustical Tiles (Tile is 30"H, for use with 35"H Frames)							
24"W	TKG43024T 	\$ 159	\$ 175	\$ 190	\$ 215	\$ 240	\$ 265
30"W	TKG43030T 	\$ 171	\$ 191	\$ 209	\$ 241	\$ 272	\$ 303
36"W	TKG43036T 	\$ 192	\$ 215	\$ 238	\$ 275	\$ 312	\$ 349
42"W	TKG43042T 	\$ 220	\$ 247	\$ 274	\$ 317	\$ 362	\$ 405
48"W	TKG43048T 	\$ 229	\$ 260	\$ 289	\$ 339	\$ 389	\$ 439
60"W	TKG43060T 	\$ 249	\$ 287	\$ 324	\$ 386	\$ 448	\$ 510

Packaging: Tiles will be multi-packed to reduce packaging materials and to provide better structural support during shipping. Items requiring individual shipping should be tagged on the order with different descriptive locations to simplify the staging process.

<p>How to specify — Select the Terrace Model Number from above.</p>	<p><i>1st Option:</i> Fabric: See page 14 for fabrics.</p>
---	---

TKG4 | | | | | T | . | | | | |

Example: TKG43048T.APN911

 Shippable by small-package carrier.

For specification information see pages 49-55.
(See page 402 for COM pricing on fabric Grades G-J.)



Description	Model	List Price					
		Grade A	Grade B	Grade C	Grade D	Grade E	Grade F
42" H Monolithic Tackable Acoustical Tiles (Tile is 37½" H, for use with 42½" H Frames)							
24" W	TKG44224T <input type="checkbox"/>	\$ 208	\$ 230	\$ 251	\$ 286	\$ 320	\$ 355
30" W	TKG44230T <input type="checkbox"/>	\$ 235	\$ 262	\$ 289	\$ 332	\$ 377	\$ 420
36" W	TKG44236T <input type="checkbox"/>	\$ 260	\$ 292	\$ 324	\$ 376	\$ 427	\$ 480
42" W	TKG44242T <input type="checkbox"/>	\$ 289	\$ 327	\$ 363	\$ 423	\$ 485	\$ 546
48" W	TKG44248T <input type="checkbox"/>	\$ 319	\$ 362	\$ 404	\$ 474	\$ 543	\$ 613
60" W	TKG44260T <input type="checkbox"/>	\$ 371	\$ 424	\$ 477	\$ 563	\$ 651	\$ 737



50" H Monolithic Tackable Acoustical Tiles (Tile is 45" H, for use with 50" H Frames)							
24" W	TKG45024T <input type="checkbox"/>	\$ 235	\$ 260	\$ 287	\$ 327	\$ 368	\$ 410
30" W	TKG45030T <input type="checkbox"/>	\$ 269	\$ 301	\$ 333	\$ 385	\$ 436	\$ 489
36" W	TKG45036T <input type="checkbox"/>	\$ 317	\$ 355	\$ 394	\$ 454	\$ 516	\$ 578
42" W	TKG45042T	\$ 354	\$ 399	\$ 443	\$ 514	\$ 587	\$ 660
48" W	TKG45048T	\$ 397	\$ 447	\$ 498	\$ 580	\$ 663	\$ 746
60" W	TKG45060T	\$ 444	\$ 506	\$ 571	\$ 673	\$ 776	\$ 879



57½" H Tackable Acoustical Tiles (Tile is 52½" H, for use with 57½" H Frames)							
24" W	TKG45724T <input type="checkbox"/>	\$ 282	\$ 312	\$ 341	\$ 389	\$ 436	\$ 484
30" W	TKG45730T <input type="checkbox"/>	\$ 317	\$ 354	\$ 390	\$ 449	\$ 509	\$ 569
36" W	TKG45736T <input type="checkbox"/>	\$ 357	\$ 402	\$ 446	\$ 516	\$ 589	\$ 661
42" W	TKG45742T	\$ 402	\$ 454	\$ 505	\$ 587	\$ 671	\$ 756
48" W	TKG45748T	\$ 445	\$ 503	\$ 562	\$ 657	\$ 752	\$ 848
60" W	TKG45760T	\$ 489	\$ 562	\$ 636	\$ 754	\$ 874	\$ 994



65" H Monolithic Tackable Acoustical Tiles (Tile is 60" H, for use with 65" H Frames)							
24" W	TKG46524T <input type="checkbox"/>	\$ 299	\$ 332	\$ 365	\$ 420	\$ 474	\$ 528
30" W	TKG46530T <input type="checkbox"/>	\$ 342	\$ 384	\$ 425	\$ 491	\$ 559	\$ 626
36" W	TKG46536T	\$ 385	\$ 434	\$ 483	\$ 565	\$ 645	\$ 726
42" W	TKG46542T	\$ 428	\$ 486	\$ 543	\$ 637	\$ 732	\$ 826
48" W	TKG46548T	\$ 468	\$ 534	\$ 599	\$ 707	\$ 815	\$ 924
60" W	TKG46560T	\$ 505	\$ 587	\$ 669	\$ 803	\$ 939	\$ 1074

Packaging: Tiles will be multi-packed to reduce packaging materials and to provide better structural support during shipping. Items requiring individual shipping should be tagged on the order with different descriptive locations to simplify the staging process.

TERRACE

<p>How to specify — Select the Terrace Model Number from above.</p>	<p>1st Option: Fabric: See page 14 for fabrics.</p>
--	---

TKG4 | | | | | T | . | | | | | | | | | |

Example: TKG45748T.APN911

























Shippable by small-package carrier.

Tiles

Terrace® — Tackable Acoustical Port Tiles

For specification information see pages 49-55.
(See page 402 for COM pricing on fabric Grades G-J.)

GSA SIN 33721

Description	Model	List Price					
		Grade A	Grade B	Grade C	Grade D	Grade E	Grade F
15"H Port Tiles							
24"W	TKG41524E 	\$ 224	\$ 232	\$ 237	\$ 248	\$ 260	\$ 270
30"W	TKG41530E 	\$ 229	\$ 238	\$ 247	\$ 260	\$ 274	\$ 287
36"W	TKG41536E 	\$ 235	\$ 246	\$ 255	\$ 272	\$ 288	\$ 303
42"W	TKG41542E 	\$ 244	\$ 256	\$ 267	\$ 287	\$ 305	\$ 325
48"W	TKG41548E 	\$ 255	\$ 268	\$ 282	\$ 303	\$ 325	\$ 346
60"W	TKG41560E 	\$ 279	\$ 296	\$ 312	\$ 339	\$ 366	\$ 392
22½"H Port Tiles							
24"W	TKG42224E 	\$ 249	\$ 260	\$ 269	\$ 286	\$ 302	\$ 317
30"W	TKG42230E 	\$ 264	\$ 277	\$ 289	\$ 310	\$ 330	\$ 350
36"W	TKG42236E 	\$ 285	\$ 301	\$ 315	\$ 340	\$ 365	\$ 390
42"W	TKG42242E 	\$ 306	\$ 324	\$ 342	\$ 370	\$ 399	\$ 427
48"W	TKG42248E 	\$ 319	\$ 339	\$ 359	\$ 391	\$ 424	\$ 455
60"W	TKG42260E 	\$ 343	\$ 368	\$ 392	\$ 434	\$ 474	\$ 514
25"H Port Tiles (Tile is 25"H, for use with 30"H Frames)							
24"W	TKG43224E 	\$ 256	\$ 268	\$ 278	\$ 297	\$ 314	\$ 333
30"W	TKG43230E 	\$ 270	\$ 285	\$ 298	\$ 320	\$ 344	\$ 366
36"W	TKG43236E 	\$ 294	\$ 311	\$ 327	\$ 354	\$ 381	\$ 407
42"W	TKG43242E 	\$ 314	\$ 326	\$ 336	\$ 355	\$ 372	\$ 391
48"W	TKG43248E 	\$ 326	\$ 348	\$ 370	\$ 406	\$ 442	\$ 478
60"W	TKG43260E 	\$ 347	\$ 375	\$ 402	\$ 448	\$ 493	\$ 539
30"H Port Tiles (Tile is 30"H, NOT for use with 35"H Frames)							
24"W	TKG43024E 	\$ 260	\$ 273	\$ 287	\$ 308	\$ 330	\$ 351
30"W	TKG43030E 	\$ 272	\$ 289	\$ 305	\$ 332	\$ 359	\$ 385
36"W	TKG43036E 	\$ 297	\$ 317	\$ 337	\$ 369	\$ 402	\$ 433
42"W	TKG43042E 	\$ 318	\$ 341	\$ 365	\$ 403	\$ 441	\$ 479
48"W	TKG43048E 	\$ 330	\$ 357	\$ 384	\$ 426	\$ 471	\$ 514
60"W	TKG43060E 	\$ 349	\$ 382	\$ 415	\$ 469	\$ 524	\$ 578

Packaging: Tiles will be multi-packed to reduce packaging materials and to provide better structural support during shipping. Items requiring individual shipping should be tagged on the order with different descriptive locations to simplify the staging process.

<p>How to specify — Select the Terrace Model Number from above.</p>	<p>1st Option: Fabric: See page 14 for fabrics.</p>	<p>2nd Option: Electrical Grommet Color: See page 38 for finishes.</p>
<p>TKG4 E . . E </p>		

Example: TKG43030E.APN911.E4

 Shippable by small-package carrier.

For specification information see pages 49-55.
(See page 402 for COM pricing on fabric Grades G-J.)

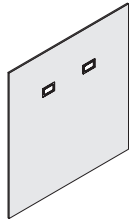

Description	Model	List Price					
		Grade A	Grade B	Grade C	Grade D	Grade E	Grade F
42½"H Monolithic Port Tiles (Tile is 37½"H, for use with 42½"H Frames)							
24"W	TKG44224E S	\$ 321	\$ 343	\$ 365	\$ 400	\$ 434	\$ 470
30"W	TKG44230E S	\$ 342	\$ 370	\$ 396	\$ 440	\$ 485	\$ 528
36"W	TKG44236E S	\$ 377	\$ 409	\$ 442	\$ 495	\$ 547	\$ 601
42"W	TKG44242E S	\$ 402	\$ 440	\$ 477	\$ 537	\$ 599	\$ 661
48"W	TKG44248E S	\$ 428	\$ 472	\$ 513	\$ 584	\$ 655	\$ 724
60"W	TKG44260E S	\$ 476	\$ 530	\$ 583	\$ 671	\$ 760	\$ 847

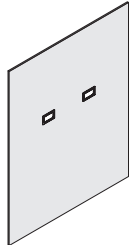

50"H Monolithic Port Tiles (Tile is 45"H, for use with 50"H Frames)							
24"W	TKG45024E S	\$ 342	\$ 367	\$ 394	\$ 435	\$ 476	\$ 519
30"W	TKG45030E S	\$ 380	\$ 412	\$ 444	\$ 497	\$ 549	\$ 601
36"W	TKG45036E S	\$ 421	\$ 459	\$ 498	\$ 561	\$ 623	\$ 685
42"W	TKG45042E	\$ 465	\$ 510	\$ 554	\$ 627	\$ 700	\$ 774
48"W	TKG45048E	\$ 505	\$ 557	\$ 606	\$ 690	\$ 773	\$ 858
60"W	TKG45060E	\$ 553	\$ 617	\$ 680	\$ 785	\$ 889	\$ 995

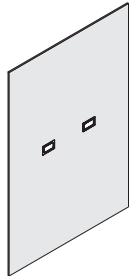

57½"H Monolithic Port Tiles (Tile is 52½"H, for use with 57½"H Frames)							
24"W	TKG45724E S	\$ 391	\$ 421	\$ 450	\$ 499	\$ 547	\$ 595
30"W	TKG45730E S	\$ 391	\$ 428	\$ 464	\$ 524	\$ 585	\$ 646
36"W	TKG45736E S	\$ 422	\$ 467	\$ 511	\$ 583	\$ 656	\$ 728
42"W	TKG45742E	\$ 470	\$ 522	\$ 573	\$ 657	\$ 742	\$ 827
48"W	TKG45748E	\$ 509	\$ 568	\$ 626	\$ 723	\$ 820	\$ 916
60"W	TKG45760E	\$ 558	\$ 632	\$ 705	\$ 825	\$ 947	\$ 1067

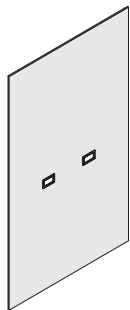

65"H Monolithic Port Tiles (Tile is 60"H, for use with 65"H Frames)							
24"W	TKG46524E S	\$ 409	\$ 442	\$ 475	\$ 529	\$ 584	\$ 638
30"W	TKG46530E S	\$ 453	\$ 495	\$ 536	\$ 603	\$ 672	\$ 740
36"W	TKG46536E	\$ 497	\$ 547	\$ 595	\$ 678	\$ 759	\$ 842
42"W	TKG46542E	\$ 541	\$ 599	\$ 656	\$ 751	\$ 845	\$ 940
48"W	TKG46548E	\$ 574	\$ 640	\$ 705	\$ 814	\$ 923	\$ 1031
60"W	TKG46560E	\$ 614	\$ 697	\$ 778	\$ 915	\$ 1050	\$ 1186

Packaging: Tiles will be multi-packed to reduce packaging materials and to provide better structural support during shipping. Items requiring individual shipping should be tagged on the order with different descriptive locations to simplify the staging process.

TERRACE

<p>How to specify — Select the Terrace Model Number from above.</p>	<p>1st Option: Fabric: See page 14 for fabrics.</p>	<p>2nd Option: Electrical Grommet Color: See page 38 for finishes.</p>
<p>TKG4 E . . E </p>		

Example: TKG45736E.APN911.E4

S Shippable by small-package carrier.

For specification information see pages 49-55.

GSA SIN 33721

	Description	Model	P1 Paint List Price	P2 Paint List Price	P3 Paint List Price
	7½"H Steel Tiles				
	24"W	TKG40724FS	\$ 157	\$ 187	\$ 214
	30"W	TKG40730FS	\$ 162	\$ 192	\$ 219
	36"W	TKG40736FS	\$ 178	\$ 208	\$ 235
	42"W	TKG40742FS	\$ 195	\$ 225	\$ 252
	48"W	TKG40748FS	\$ 209	\$ 239	\$ 266
	60"W	TKG40760FS	\$ 235	\$ 265	\$ 292
	15"H Steel Tiles				
	24"W	TKG41524FS	\$ 161	\$ 191	\$ 218
	30"W	TKG41530FS	\$ 169	\$ 199	\$ 226
	36"W	TKG41536FS	\$ 184	\$ 214	\$ 241
	42"W	TKG41542FS	\$ 202	\$ 232	\$ 259
	48"W	TKG41548FS	\$ 221	\$ 251	\$ 278
	60"W	TKG41560FS	\$ 245	\$ 275	\$ 302
	22½"H Steel Tiles				
	24"W	TKG42224FS	\$ 205	\$ 229	\$ 252
	30"W	TKG42230FS	\$ 214	\$ 244	\$ 271
	36"W	TKG42236FS	\$ 229	\$ 259	\$ 286
	42"W	TKG42242FS	\$ 245	\$ 275	\$ 302
	48"W	TKG42248FS	\$ 266	\$ 296	\$ 323
	60"W	TKG42260FS	\$ 290	\$ 320	\$ 347
	25"H Steel Tiles (Tile is 25"H, for use with 30"H Frames)				
	24"W	TKG43224FS	\$ 219	\$ 236	\$ 259
	30"W	TKG43230FS	\$ 233	\$ 251	\$ 276
	36"W	TKG43236FS	\$ 257	\$ 276	\$ 304
	42"W	TKG43242FS	\$ 279	\$ 299	\$ 329
	48"W	TKG43248FS	\$ 303	\$ 325	\$ 358
	60"W	TKG43260FS	\$ 342	\$ 366	\$ 402
	30"H Steel Tiles (Tile is 30"H, for use with 35"H Frames)				
	24"W	TKG43024FS	\$ 235	\$ 279	\$ 322
	30"W	TKG43030FS	\$ 259	\$ 303	\$ 346
	36"W	TKG43036FS	\$ 292	\$ 336	\$ 379
	42"W	TKG43042FS	\$ 314	\$ 358	\$ 401
	48"W	TKG43048FS	\$ 347	\$ 391	\$ 434
	60"W	TKG43060FS	\$ 396	\$ 440	\$ 483
	7½"H Tool Tiles — used to support Extensions paper management accessories				
	24"W	TK40724SW	\$ 407	\$ 448	\$ 488
	30"W	TK40730SW	\$ 469	\$ 511	\$ 552
	36"W	TK40736SW	\$ 474	\$ 516	\$ 557
	42"W	TK40742SW	\$ 502	\$ 544	\$ 585
	48"W	TK40748SW	\$ 535	\$ 577	\$ 618
	60"W	TK40760SW	\$ 571	\$ 613	\$ 654
	15"H Tool Tiles — used to support Extensions paper management accessories				
	24"W	TK41524SW	\$ 443	\$ 487	\$ 530
	30"W	TK41530SW	\$ 478	\$ 522	\$ 565
	36"W	TK41536SW	\$ 520	\$ 564	\$ 607
	42"W	TK41542SW	\$ 547	\$ 591	\$ 634
	48"W	TK41548SW	\$ 578	\$ 622	\$ 665
	60"W	TK41560SW	\$ 618	\$ 662	\$ 705

Note: Tool tiles placed at worksurface height limit selection of work tools available. Folder holders, multi-media hangers, and binder bins extend below a 7½"H tool tile. Paper wave and contents extend above a single 7½"H tool tile. See page 381.

How to specify —
Select the Terrace
Model Number
from above.

1st Option:
Paint:

P1
P2
P3

 See page 38 for finishes.

T
K
|
|
|
|
|
|
|
|
|
|
.
P
.

Examples: TKG41536FS.P27 TK41530SW.P7D

S Shippable by small-package carrier.



Tiles

Terrace® — Perforated Steel Tiles

For specification information see pages 49-55.

GSA SIN 33721



Description	Model	P1 Paint List Price	P2 Paint List Price	P3 Paint List Price
7½"H Perforated Steel Tiles				
24"W	TKG40724SH <input type="checkbox"/>	\$ 225	\$ 255	\$ 282
30"W	TKG40730SH <input type="checkbox"/>	\$ 232	\$ 262	\$ 289
36"W	TKG40736SH <input type="checkbox"/>	\$ 254	\$ 284	\$ 311
42"W	TKG40742SH <input type="checkbox"/>	\$ 279	\$ 309	\$ 336
48"W	TKG40748SH <input type="checkbox"/>	\$ 314	\$ 344	\$ 371
60"W	TKG40760SH <input type="checkbox"/>	\$ 345	\$ 375	\$ 402



15"H Perforated Steel Tiles				
24"W	TKG41524SH <input type="checkbox"/>	\$ 231	\$ 261	\$ 288
30"W	TKG41530SH <input type="checkbox"/>	\$ 242	\$ 272	\$ 299
36"W	TKG41536SH <input type="checkbox"/>	\$ 265	\$ 295	\$ 322
42"W	TKG41542SH <input type="checkbox"/>	\$ 289	\$ 319	\$ 346
48"W	TKG41548SH <input type="checkbox"/>	\$ 317	\$ 347	\$ 374
60"W	TKG41560SH <input type="checkbox"/>	\$ 350	\$ 380	\$ 407

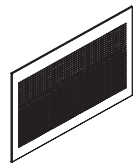

22½"H Perforated Steel Tiles				
24"W	TKG42224SH <input type="checkbox"/>	\$ 235	\$ 265	\$ 292
30"W	TKG42230SH <input type="checkbox"/>	\$ 249	\$ 279	\$ 306
36"W	TKG42236SH <input type="checkbox"/>	\$ 268	\$ 298	\$ 325
42"W	TKG42242SH <input type="checkbox"/>	\$ 295	\$ 325	\$ 352
48"W	TKG42248SH <input type="checkbox"/>	\$ 328	\$ 358	\$ 385
60"W	TKG42260SH <input type="checkbox"/>	\$ 361	\$ 391	\$ 418

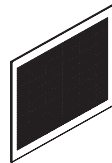

30"H Perforated Steel Tiles (Tile is 30"H, for use with 35"H Frames)				
24"W	TKG43024SH <input type="checkbox"/>	\$ 248	\$ 292	\$ 335
30"W	TKG43030SH <input type="checkbox"/>	\$ 272	\$ 316	\$ 359
36"W	TKG43036SH <input type="checkbox"/>	\$ 316	\$ 360	\$ 403
42"W	TKG43042SH <input type="checkbox"/>	\$ 331	\$ 375	\$ 418
48"W	TKG43048SH <input type="checkbox"/>	\$ 379	\$ 423	\$ 466
60"W	TKG43060SH <input type="checkbox"/>	\$ 424	\$ 468	\$ 511

TERRACE

How to specify —
Select the Terrace Model Number from above.

1st Option:

Paint:



See page 38 for finishes.

TKG4 | | | | | . P | | | | .

Example: TKG40742SH.P27

Shippable by small-package carrier.

For specification information see pages 49-55.

GSA SIN 33721

Description	Model	L1 List Price	L2 List Price	L3 List Price
7½"H Laminate Tile				
24"W	TKG40724LM	\$ 355	\$ 374	\$ 391
30"W	TKG40730LM	\$ 361	\$ 380	\$ 398
36"W	TKG40736LM	\$ 411	\$ 432	\$ 454
42"W	TKG40742LM	\$ 440	\$ 463	\$ 485
48"W	TKG40748LM	\$ 482	\$ 506	\$ 531
60"W	TKG40760LM	\$ 544	\$ 572	\$ 599
15"H Laminate Tile				
24"W	TKG41524LM	\$ 390	\$ 410	\$ 431
30"W	TKG41530LM	\$ 397	\$ 418	\$ 438
36"W	TKG41536LM	\$ 453	\$ 476	\$ 499
42"W	TKG41542LM	\$ 484	\$ 509	\$ 533
48"W	TKG41548LM	\$ 529	\$ 557	\$ 583
60"W	TKG41560LM	\$ 598	\$ 629	\$ 658
22½"H Laminate Tile				
24"W	TKG42224LM	\$ 523	\$ 550	\$ 577
30"W	TKG42230LM	\$ 569	\$ 598	\$ 627
36"W	TKG42236LM	\$ 607	\$ 638	\$ 668
42"W	TKG42242LM	\$ 677	\$ 711	\$ 745
48"W	TKG42248LM	\$ 738	\$ 776	\$ 813
60"W	TKG42260LM	\$ 804	\$ 846	\$ 886
25"H Laminate Tiles				
24"W	TKG42524LM	\$ 582	\$ 612	\$ 641
30"W	TKG42530LM	\$ 616	\$ 647	\$ 678
36"W	TKG42536LM	\$ 661	\$ 694	\$ 728
42"W	TKG42542LM	\$ 723	\$ 760	\$ 796
48"W	TKG42548LM	\$ 782	\$ 823	\$ 862
60"W	TKG42560LM	\$ 903	\$ 949	\$ 994
30"H Laminate Tiles				
24"W	TKG43024LM	\$ 604	\$ 635	\$ 665
30"W	TKG43030LM	\$ 633	\$ 665	\$ 697
36"W	TKG43036LM	\$ 680	\$ 714	\$ 750
42"W	TKG43042LM	\$ 743	\$ 781	\$ 818
48"W	TKG43048LM	\$ 803	\$ 845	\$ 884
60"W	TKG43060LM	\$ 920	\$ 967	\$ 1013

<p>How to specify — Select the Terrace Model Number from above.</p> <p>TKG4 .</p>	<p>1st Option: FSC Wood (if applicable): F FSC Wood X Non-FSC Wood</p> <p> .</p>	<p>2nd Option: Laminate: See page 38 for finishes.</p> <p> .</p>	<p>3rd Option: Edge Color: See page 38 for finishes.</p> <p> .</p>	<p>4th Option: Grain Direction: VLG Horizontal or Solid Grain VST Vertical Grain</p> <p> </p>
--	--	--	--	--

Example: TKG40724LM.F.TM133.E4.VLG

[S] Shippable by small-package carrier.

Tiles

Terrace® — Laminate Tiles

For specification information see pages 49-55.

GSA SIN 33721

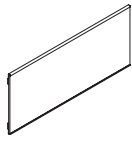

Description	Model	L1 List Price	L2 List Price	L3 List Price
42½"H Laminate Tile				
24"W	TKG43724LM	\$ 669	\$ 703	\$ 737
30"W	TKG43730LM	\$ 729	\$ 766	\$ 803
36"W	TKG43736LM	\$ 759	\$ 799	\$ 837
42"W	TKG43742LM	\$ 868	\$ 913	\$ 955
48"W	TKG43748LM	\$ 933	\$ 981	\$ 1027
60"W	TKG43760LM	\$ 1079	\$ 1134	\$ 1188

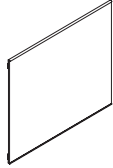

50"H Laminate Tile				
24"W	TKG44524LM	\$ 742	\$ 780	\$ 817
30"W	TKG44530LM	\$ 808	\$ 850	\$ 890
36"W	TKG44536LM	\$ 842	\$ 885	\$ 927
42"W	TKG44542LM	\$ 964	\$ 1013	\$ 1061
48"W	TKG44548LM	\$ 1035	\$ 1088	\$ 1140
60"W	TKG44560LM	\$ 1197	\$ 1257	\$ 1318

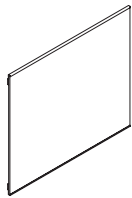

57½"H Laminate Tile				
24"W	TKG45724LM	\$ 816	\$ 858	\$ 899
30"W	TKG45730LM	\$ 889	\$ 935	\$ 979
36"W	TKG45736LM	\$ 926	\$ 973	\$ 1019
42"W	TKG45742LM	\$ 1059	\$ 1113	\$ 1166
48"W	TKG45748LM	\$ 1139	\$ 1197	\$ 1254

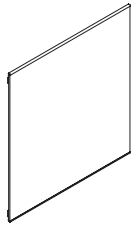

65"H Laminate Tiles				
24"W	TKG46024LM	\$ 832	\$ 875	\$ 916
30"W	TKG46030LM	\$ 906	\$ 952	\$ 998
36"W	TKG46036LM	\$ 943	\$ 991	\$ 1038
42"W	TKG46042LM	\$ 1079	\$ 1134	\$ 1188
48"W	TKG46048LM	\$ 1159	\$ 1218	\$ 1276

TERRACE

<p>How to specify — Select the Terrace Model Number from above.</p> <p>TKG4 .</p>	<p>1st Option: FSC Wood (if applicable): F FSC Wood X Non-FSC Wood</p> <p> .</p>	<p>2nd Option: Laminate: See page 38 for finishes.</p> <p> .</p>	<p>3rd Option: Edge Color: See page 38 for finishes.</p> <p> .</p>	<p>4th Option: Grain Direction: VLG Horizontal or Solid Grain VST Vertical Grain</p> <p> </p>
--	--	--	--	--

Example: TKG43724LM.F.TM133.E4.VLG

Shippable by small-package carrier.

For specification information see pages 49-55.

GSA SIN 33721

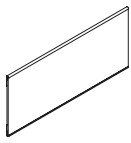

Description	Model	L1 List Price	L2 List Price	L3 List Price
22½"H Laminate To-The-Floor Tile				
24"W	TKG42224LTF	\$ 605	\$ 633	\$ 661
30"W	TKG42230LTF	\$ 632	\$ 661	\$ 690
36"W	TKG42236LTF	\$ 706	\$ 739	\$ 772
42"W	TKG42242LTF	\$ 757	\$ 793	\$ 828
48"W	TKG42248LTF	\$ 819	\$ 859	\$ 897
60"W	TKG42260LTF	\$ 954	\$ 1000	\$ 1045

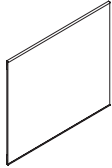

25"H Laminate To-The-Floor Tile				
24"W	TKG42524LTF	\$ 642	\$ 672	\$ 701
30"W	TKG42530LTF	\$ 676	\$ 707	\$ 738
36"W	TKG42536LTF	\$ 721	\$ 754	\$ 788
42"W	TKG42542LTF	\$ 783	\$ 820	\$ 856
48"W	TKG42548LTF	\$ 842	\$ 883	\$ 922
60"W	TKG42560LTF	\$ 963	\$ 1009	\$ 1054

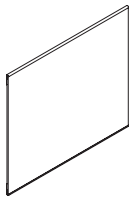

30"H Laminate To-The-Floor Tile				
24"W	TKG43024LTF	\$ 720	\$ 753	\$ 787
30"W	TKG43030LTF	\$ 778	\$ 815	\$ 851
36"W	TKG43036LTF	\$ 843	\$ 884	\$ 923
42"W	TKG43042LTF	\$ 914	\$ 958	\$ 1000
48"W	TKG43048LTF	\$ 991	\$ 1038	\$ 1085
60"W	TKG43060LTF	\$ 1114	\$ 1168	\$ 1221

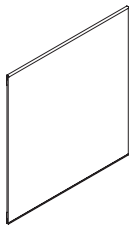

37½"H Laminate Tile To-The-Floor Tile				
24"W	TKG43724LTF	\$ 793	\$ 831	\$ 867
30"W	TKG43730LTF	\$ 857	\$ 898	\$ 938
36"W	TKG43736LTF	\$ 930	\$ 975	\$ 1017
42"W	TKG43742LTF	\$ 1008	\$ 1056	\$ 1103
48"W	TKG43748LTF	\$ 1093	\$ 1146	\$ 1198
60"W	TKG43760LTF	\$ 1230	\$ 1289	\$ 1348

45"H Laminate Tile To-The-Floor Tile				
24"W	TKG44524LTF	\$ 858	\$ 900	\$ 939
30"W	TKG44530LTF	\$ 929	\$ 974	\$ 1016
36"W	TKG44536LTF	\$ 1007	\$ 1055	\$ 1102
42"W	TKG44542LTF	\$ 1094	\$ 1147	\$ 1199
48"W	TKG44548LTF	\$ 1186	\$ 1243	\$ 1299
60"W	TKG44560LTF	\$ 1336	\$ 1401	\$ 1464

57½"H Laminate Tile To-The-Floor Tile				
24"W	TKG45724LTF	\$ 954	\$ 1000	\$ 1045
30"W	TKG45730LTF	\$ 1033	\$ 1082	\$ 1131
36"W	TKG45736LTF	\$ 1120	\$ 1174	\$ 1227
42"W	TKG45742LTF	\$ 1217	\$ 1275	\$ 1334
48"W	TKG45748LTF	\$ 1320	\$ 1384	\$ 1447

60"H Laminate Tile To-The-Floor Tile				
24"W	TKG46024LTF	\$ 1062	\$ 1114	\$ 1163
30"W	TKG46030LTF	\$ 1150	\$ 1205	\$ 1260
36"W	TKG46036LTF	\$ 1249	\$ 1309	\$ 1369
42"W	TKG46042LTF	\$ 1355	\$ 1421	\$ 1485
48"W	TKG46048LTF	\$ 1473	\$ 1545	\$ 1616

TERRACE

How to specify —	<i>1st Option:</i>	<i>2nd Option:</i>	<i>3rd Option:</i>	<i>4th Option:</i>
Select the Terrace Model Number from above.	FSC Wood (if applicable): F FSC Wood X Non-FSC Wood	Laminate: See page 38 for finishes.	Edge Color: See page 38 for finishes.	Grain Direction: VLG Horizontal or Solid Grain VST Vertical Grain
TKG4 	

Example: TKG42224LTF.F.TM133.E4.VLG

 Shippable by small-package carrier.

Tiles

Terrace® — Laminate Spanning Tiles

For specification information see pages 49-55.

GSA SIN 33721



Description	Model	L1 List Price	L2 List Price	L3 List Price
25"H Laminate Spanning Tile				
54"W	TKG42554SLS	\$ 956	\$ 1000	\$ 1043
60"W	TKG42560SLS	\$ 981	\$ 1026	\$ 1071
66"W	TKG42566SLS	\$ 1015	\$ 1062	\$ 1107
72"W	TKG42572SLS	\$ 1085	\$ 1135	\$ 1183
78"W	TKG42578SLS	\$ 1148	\$ 1201	\$ 1253
84"W	TKG42584SLS	\$ 1203	\$ 1258	\$ 1312
90"W	TKG42590SLS	\$ 1254	\$ 1311	\$ 1369
96"W	TKG42596SLS	\$ 1336	\$ 1397	\$ 1457

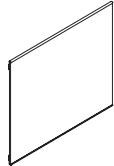

30"H Laminate Spanning Tile				
54"W	TKG43054SLS	\$ 987	\$ 1033	\$ 1077
60"W	TKG43060SLS	\$ 1080	\$ 1129	\$ 1178
66"W	TKG43066SLS	\$ 1125	\$ 1177	\$ 1227
72"W	TKG43072SLS	\$ 1187	\$ 1242	\$ 1295
78"W	TKG43078SLS	\$ 1205	\$ 1260	\$ 1315
84"W	TKG43084SLS	\$ 1334	\$ 1395	\$ 1455
90"W	TKG43090SLS	\$ 1406	\$ 1470	\$ 1534
96"W	TKG43096SLS	\$ 1465	\$ 1532	\$ 1598

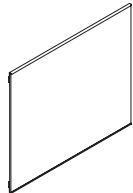

42"H Laminate Spanning Tile				
54"W	TKG44254SLS	\$ 1159	\$ 1213	\$ 1265
60"W	TKG44260SLS	\$ 1244	\$ 1301	\$ 1357
66"W	TKG44266SLS	\$ 1308	\$ 1367	\$ 1427
72"W	TKG44272SLS	\$ 1347	\$ 1408	\$ 1469
78"W	TKG44278SLS	\$ 1380	\$ 1442	\$ 1505
84"W	TKG44284SLS	\$ 1438	\$ 1504	\$ 1568
90"W	TKG44290SLS	\$ 1476	\$ 1543	\$ 1609
96"W	TKG44296SLS	\$ 1503	\$ 1571	\$ 1639

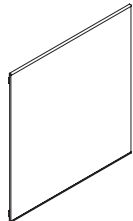

50"H Laminate Spanning Tile				
54"W	TKG45054SLS	\$ 1517	\$ 1587	\$ 1654
60"W	TKG45060SLS	\$ 1533	\$ 1604	\$ 1673
66"W	TKG45066SLS	\$ 1550	\$ 1621	\$ 1691
72"W	TKG45072SLS	\$ 1584	\$ 1657	\$ 1728
78"W	TKG45078SLS	\$ 1758	\$ 1839	\$ 1917
84"W	TKG45084SLS	\$ 1782	\$ 1864	\$ 1943
90"W	TKG45090SLS	\$ 1826	\$ 1909	\$ 1991
96"W	TKG45096SLS	\$ 1862	\$ 1947	\$ 2030

TERRACE

<p>How to specify — Select the Terrace Model Number from above.</p>	<p>1st Option: FSC Wood (if applicable): F FSC Wood X Non-FSC Wood</p>	<p>2nd Option: Laminate: See page 38 for finishes.</p>	<p>3rd Option: Edge Color: See page 38 for finishes.</p>
<p>TKG4 . </p>	<p> .</p>	<p> .</p>	<p> </p>

Example: TKG42554SLS.F.TM133.E4

S Shippable by small-package carrier.

Tiles

Terrace® — Laminate Spanning Tiles To-the-Floor / Bracket Kits

For specification information see pages 49-55.

GSA SIN 33721



Description	Model	L1 List Price	L2 List Price	L3 List Price
25"H Laminate Spanning Tile To-The-Floor				
54"W	TKG42554SLSTF	\$ 1051	\$ 1099	\$ 1146
60"W	TKG42560SLSTF	\$ 1079	\$ 1128	\$ 1177
66"W	TKG42566SLSTF	\$ 1116	\$ 1168	\$ 1218
72"W	TKG42572SLSTF	\$ 1195	\$ 1250	\$ 1304
78"W	TKG42578SLSTF	\$ 1263	\$ 1321	\$ 1378
84"W	TKG42584SLSTF	\$ 1321	\$ 1381	\$ 1441
90"W	TKG42590SLSTF	\$ 1381	\$ 1443	\$ 1506
96"W	TKG42596SLSTF	\$ 1469	\$ 1536	\$ 1602

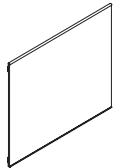

30"H Laminate Spanning Tile To-The-Floor				
54"W	TKG43054SLSTF	\$ 1085	\$ 1135	\$ 1183
60"W	TKG43060SLSTF	\$ 1188	\$ 1243	\$ 1296
66"W	TKG43066SLSTF	\$ 1238	\$ 1295	\$ 1350
72"W	TKG43072SLSTF	\$ 1307	\$ 1366	\$ 1426
78"W	TKG43078SLSTF	\$ 1324	\$ 1384	\$ 1444
84"W	TKG43084SLSTF	\$ 1468	\$ 1535	\$ 1601
90"W	TKG43090SLSTF	\$ 1545	\$ 1616	\$ 1686
96"W	TKG43096SLSTF	\$ 1611	\$ 1685	\$ 1757

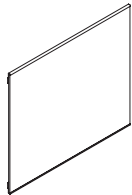

42"H Laminate Spanning Tile To-The-Floor				
54"W	TKG44254SLSTF	\$ 1390	\$ 1454	\$ 1517
60"W	TKG44260SLSTF	\$ 1483	\$ 1551	\$ 1617
66"W	TKG44266SLSTF	\$ 1554	\$ 1625	\$ 1696
72"W	TKG44272SLSTF	\$ 1596	\$ 1669	\$ 1741
78"W	TKG44278SLSTF	\$ 1633	\$ 1708	\$ 1781
84"W	TKG44284SLSTF	\$ 1696	\$ 1774	\$ 1850
90"W	TKG44290SLSTF	\$ 1738	\$ 1818	\$ 1895
96"W	TKG44296SLSTF	\$ 1767	\$ 1848	\$ 1927

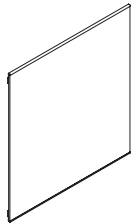

50"H Laminate Spanning Tile To-The-Floor				
54"W	TKG45054SLSTF	\$ 1783	\$ 1865	\$ 1944
60"W	TKG45060SLSTF	\$ 1800	\$ 1882	\$ 1962
66"W	TKG45066SLSTF	\$ 1818	\$ 1901	\$ 1983
72"W	TKG45072SLSTF	\$ 1857	\$ 1942	\$ 2025
78"W	TKG45078SLSTF	\$ 2048	\$ 2141	\$ 2233
84"W	TKG45084SLSTF	\$ 2077	\$ 2171	\$ 2266
90"W	TKG45090SLSTF	\$ 2123	\$ 2219	\$ 2315
96"W	TKG45096SLSTF	\$ 2161	\$ 2259	\$ 2356

Description	Model	List Price
Spanning Tile Bracket Kits		
	Z4STBRKT1	\$ 254
	Z4STBRKT2	\$ 254

<p>How to specify — Select the Terrace Model Number from above.</p>	<p>1st Option: FSC Wood (if applicable): F FSC Wood X Non-FSC Wood</p>	<p>2nd Option: Laminate: See page 38 for finishes.</p>	<p>3rd Option: Edge Color: See page 38 for finishes.</p>
TKG4 .	.	.	

Example: TKG42554SLSTF.F.TM133.E4

Shippable by small-package carrier.

Tiles

Terrace® — Glass Tiles — Single-Pane

GSA SIN 33721

For specification information see pages 49-55.

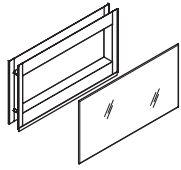

Description	Model	Clear P1 List Price	Clear P2 List Price	Clear P3 List Price	Frosted P1 List Price	Frosted P2 List Price	Frosted P3 List Price
15"H Glass Tiles							
24"W	TK41524GK S	\$ 760	\$ 787	\$ 814	\$ 882	\$ 909	\$ 936
30"W	TK41530GK S	\$ 806	\$ 835	\$ 863	\$ 943	\$ 972	\$ 1000
36"W	TK41536GK S	\$ 853	\$ 883	\$ 913	\$ 1009	\$ 1039	\$ 1069
42"W	TK41542GK S	\$ 913	\$ 945	\$ 978	\$ 1083	\$ 1115	\$ 1148
48"W	TK41548GK S	\$ 981	\$ 1015	\$ 1051	\$ 1168	\$ 1202	\$ 1238
60"W	TK41560GK S	\$ 1166	\$ 1208	\$ 1249	\$ 1367	\$ 1409	\$ 1450

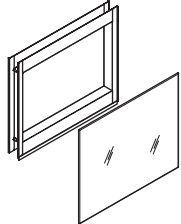

22½"H Glass Tiles							
24"W	TK42224GK S	\$ 889	\$ 920	\$ 951	N/A	N/A	N/A
30"W	TK42230GK S	\$ 933	\$ 966	\$ 999	N/A	N/A	N/A
36"W	TK42236GK S	\$ 983	\$ 1017	\$ 1053	N/A	N/A	N/A
42"W	TK42242GK S	\$ 1042	\$ 1079	\$ 1116	N/A	N/A	N/A
48"W	TK42248GK S	\$ 1108	\$ 1148	\$ 1187	N/A	N/A	N/A
60"W	TK42260GK S	\$ 1297	\$ 1343	\$ 1389	N/A	N/A	N/A

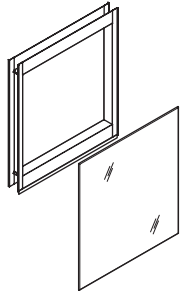

30"H Glass Tiles							
24"W	TK43024GK S	\$ 1018	\$ 1055	\$ 1091	N/A	N/A	N/A
30"W	TK43030GK S	\$ 1084	\$ 1124	\$ 1162	N/A	N/A	N/A
36"W	TK43036GK S	\$ 1154	\$ 1196	\$ 1236	N/A	N/A	N/A
42"W	TK43042GK S	\$ 1251	\$ 1296	\$ 1340	N/A	N/A	N/A
48"W	TK43048GK S	\$ 1343	\$ 1391	\$ 1438	N/A	N/A	N/A
60"W	TK43060GK S	\$ 1574	\$ 1630	\$ 1685	N/A	N/A	N/A

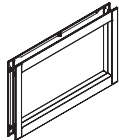

Description	Model	P1 Paint List Price	P2 Paint List Price
22½"H Pass-Thru Trim Kits			
24"W	Z42224PT S	\$ 574	\$ 608
30"W	Z42230PT S	\$ 606	\$ 640
36"W	Z42236PT S	\$ 648	\$ 682
42"W	Z42242PT S	\$ 685	\$ 719
48"W	Z42248PT S	\$ 717	\$ 751
60"W	Z42260PT S	\$ 742	\$ 776

TERRACE

<p>How to specify — Select the Terrace Model Number from above.</p>	<p>1st Option: Paint: P1 P2 P3</p>	<p>2nd Option: Glass (if applicable): C Clear F Frosted (only available on 15"H tiles)</p>
<p>T K 4 . P </p>		

Example: TK41524GK.P27.C

S Shippable by small-package carrier.

For specification information see pages 49-55.

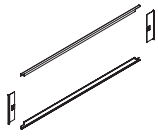

Description	Model	P1 Paint List Price
7½"H Custom Tile Bracket Kits		
24"W	TK40724CTK <input type="checkbox"/>	\$ 89
30"W	TK40730CTK <input type="checkbox"/>	\$ 91
36"W	TK40736CTK <input type="checkbox"/>	\$ 101
42"W	TK40742CTK <input type="checkbox"/>	\$ 105
48"W	TK40748CTK <input type="checkbox"/>	\$ 111
60"W	TK40760CTK <input type="checkbox"/>	\$ 124

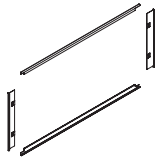

15"H Custom Tile Bracket Kits		
24"W	TK41524CTK <input type="checkbox"/>	\$ 92
30"W	TK41530CTK <input type="checkbox"/>	\$ 102
36"W	TK41536CTK <input type="checkbox"/>	\$ 106
42"W	TK41542CTK <input type="checkbox"/>	\$ 111
48"W	TK41548CTK <input type="checkbox"/>	\$ 117
60"W	TK41560CTK <input type="checkbox"/>	\$ 130

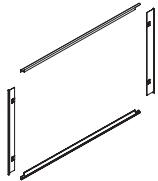

22½"H Custom Tile Bracket Kits		
24"W	TK42224CTK <input type="checkbox"/>	\$ 98
30"W	TK42230CTK <input type="checkbox"/>	\$ 103
36"W	TK42236CTK <input type="checkbox"/>	\$ 111
42"W	TK42242CTK <input type="checkbox"/>	\$ 116
48"W	TK42248CTK <input type="checkbox"/>	\$ 120
60"W	TK42260CTK <input type="checkbox"/>	\$ 137

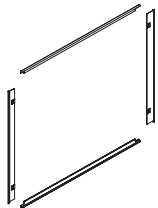

30"H Custom Tile Bracket Kits (Tile is 30"H, for use with 35"H Frames)		
24"W	TK43024CTK <input type="checkbox"/>	\$ 111
30"W	TK43030CTK <input type="checkbox"/>	\$ 116
36"W	TK43036CTK <input type="checkbox"/>	\$ 119
42"W	TK43042CTK <input type="checkbox"/>	\$ 125
48"W	TK43048CTK <input type="checkbox"/>	\$ 130
60"W	TK43060CTK <input type="checkbox"/>	\$ 144

How to specify —
Select the Terrace Model Number from above.

1st Option:
Frame
Paint Color:
See page 38 for finishes.

TK4 | | | | | | | | | | . P | | | |

Example: TK40724CTK.P4J

Shippable by small-package carrier.

For specification information see pages 49-55.

GSA SIN 33721

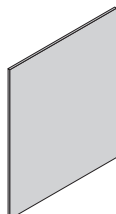
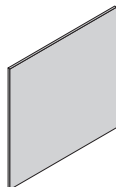
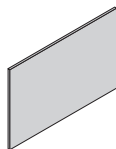

Description	Model	V2 List Price
15"H Veneer Tiles		
30"W	TK41530V S	\$ 535
48"W	TK41548V S	\$ 772

22½"H Veneer Tiles		
48"W	TK42248V S	\$ 1049

30"H Monolithic Veneer Tiles (Tile is 30"H, for use with 35"H Frames)		
30"W	TK43030V S	\$ 801
36"W	TK43036V S	\$ 901
48"W	TK43048V S	\$ 1054

42½"H Monolithic Veneer Tiles (Tile is 37½"H, for use with 42½"H Frames)		
30"W	TK44230V S	\$ 1109
42"W	TK44242V S	\$ 1340
48"W	TK44248V S	\$ 1521

How to specify —
Select the Terrace Model Number from above.

1st Option:

Veneer Type and Finish:

See page 38 for finishes.

S prefix for Stratawood

T | K | 4 | | | | | | | | V | . | | | | | | | |

Example: TK43036V.SC777

S Shippable by small-package carrier.

Terrace features capabilities for cable management, including electrical, voice, and data. The 8-wire electrical system can be integrated at base pathway and beltline. The open structure of the frame allows voice and data cables to be routed both vertically and horizontally.

GSA Reference Page

Ceiling infeed connects to building electrical supply. Ceiling infeed can also be used at the bottom to feed up into footed panels where exposed flex conduit is permitted by codes. This infeed can be prewired before panels are installed. A877006 and A877012 infeeds must be installed in panel before connecting to building wiring.

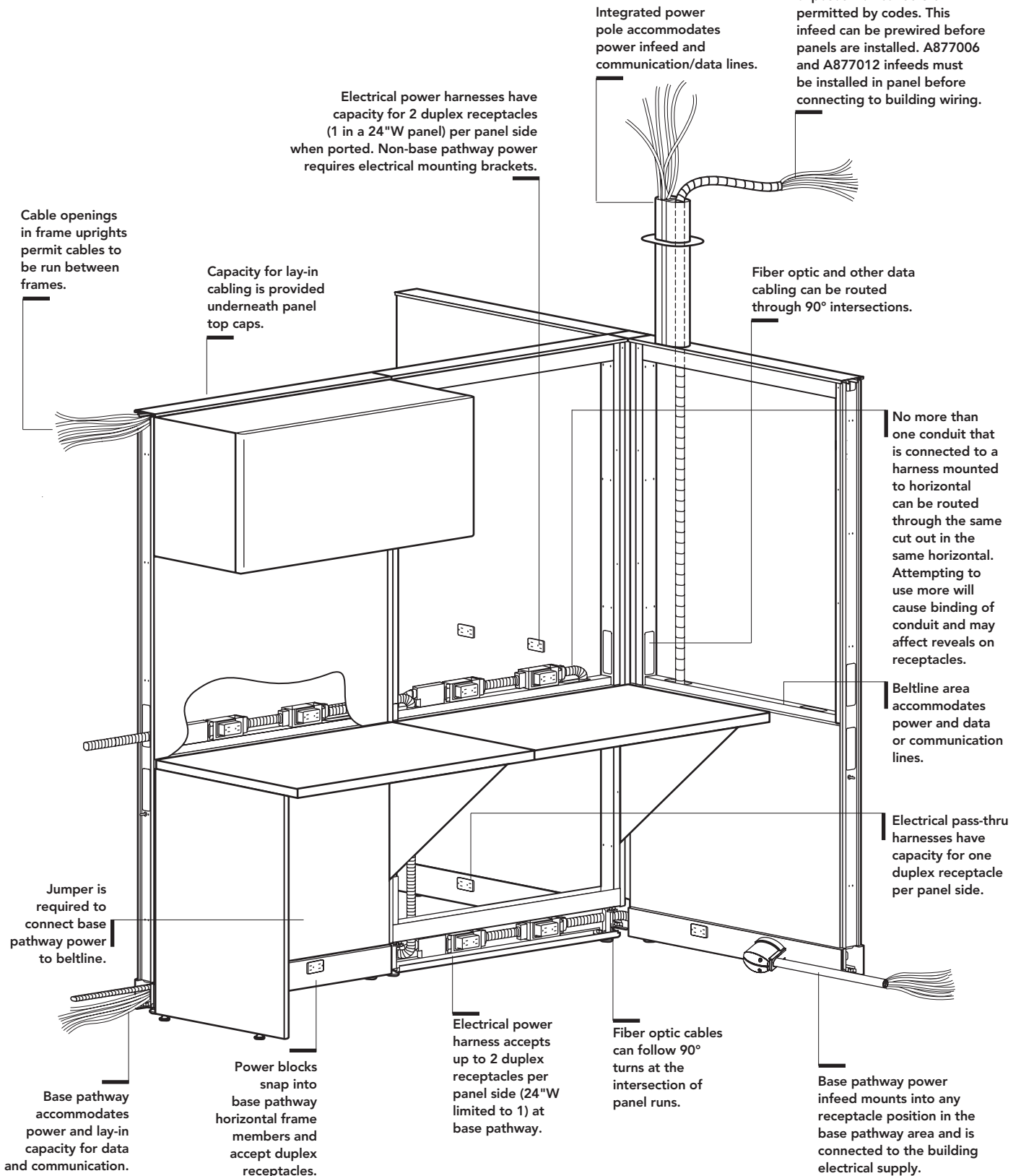

TERRACE

Electrical Systems

Terrace offers a choice of four electrical systems:

- Four-circuit, 3 + 1
- Four-circuit, 2 + 2
- Three-circuit, separate neutrals
- Eight circuits; two four-circuit systems provided back-to-back.
- See pages 85-86 for a detailed explanation of each electrical system.
- All four systems utilize an 8-wire electrical system, rated at 20 amps per circuit (15 amps Canadian) - 16 amps plannable in U.S.
- Terrace panels and electrical components are UL Listed. Electrical components are also CSA certified.
- Installation and use of the electrical system, the number of receptacles used on a given circuit and connections to the building power supply should be in compliance with all local and national electrical codes.
- Use of a 35"H frame in a panel run will block beltline and above power distribution.

Caution: Electrical equipment cords or extension cords MUST NOT BE ROUTED through cable openings in frame sides.

Note: No more than one conduit that is connected to a harness mounted to horizontal can be routed through the same cut out in the same horizontal at beltline. Attempting to use more will cause binding of conduit and may affect reveals on receptacles.

Hardwire New York Code (page 95)

- Hardwire (New York Code) junction box (model A871400) is used when local electrical codes require hardwire entry.
- For use in panels 30"W to 60"W.
- When used in 30"W and 36"W panels, power can be routed only in one direction.
- When used in 42"W, 48"W, and 60"W panels, an electrical pass-thru cable or harness for that panel width can be used to route power back in the opposite direction.
- Unit must connect to a power or pass-thru harness positioned in the base pathway area of an adjacent panel.
- Customer to furnish all cabling and wiring from power entry to power source.
- Junction box can be positioned at any duplex receptacle location.

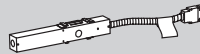

Hardwire Chicago Code (page 96)

- Wiring harnesses and snap connectors are not allowed in Chicago — base pathways must be comprised of all-metallic components.
- The base pathway, junction box (model 873600) clips directly into receptacle locations and can be used both single- and double-sided.
- In the beltline location, junction box (model 873550) can only be used single-sided.
- Base pathway model has a larger volume capacity for wiring to allow for dual-sided applications.
- Customer must furnish conduit, wiring, and designer-type receptacles for the base pathway and conduit, wiring, designer-type receptacles, and receptacle covers for the beltline.
- Tiles at the beltline must be field ported.
- Power entry can be routed from the ceiling, via a Terrace power pole, or from the floor into a junction box (beltline model 873550; or base pathway model 873600).

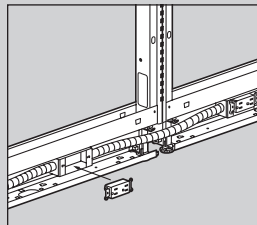

Electrical Infeeds

- Power infeed cables deliver power from building to panel's electrical system.
- Infeed cables are housed in conduit to separate electrical system from communications and data lines.
- Select quantity of base or ceiling infeed cables depending on individual power requirements.

Base Infeed (page 95)

- Sealtight base pathway power infeed mounts into any receptacle position in the base pathway area.
- A heavy rubber sheathing shields conduit, allowing infeed to be exposed.
- A jumper is required to connect base pathway power to beltline.

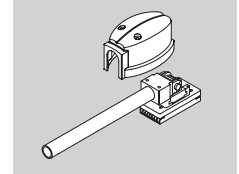

Sealtight Electrical Infeed (page 95)

- Sealtight electrical infeed cable is used with footed panels.
- Should not be ordered prior to installation to have pre-wired as infeed must be routed from inside of panel out to be connected to power.
- Cannot be connected to power harness in panel frame that infeed is brought into unless additional pass-thru harness without power block is used to feed from below beltline to above beltline.

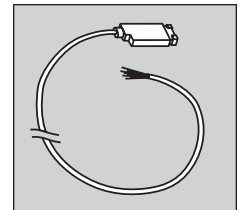

Ceiling Power Infeed (page 95)

- Ceiling power infeed connects to a prewired electrical harness in the beltline or base pathway, traverses through an adjacent panel and terminates in the junction box at the top of the integrated power pole.
- Use models A870535 or A870565 with integrated power pole.
- Can also be used as infeed for footed panels.
- Most codes allow flex conduit to be exposed after installation. Verify code requirements before ordering for exposed application.

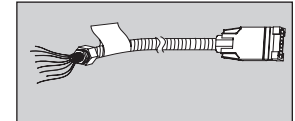

Integrated Power Pole (page 95)

- Integrated power and communications poles provide capacity for routing power supply directly through the top of any structural or stacking frame using same width trim/connector kit in place of top cap.
- Avoid glass or translucent tiles in upper position of frames with integrated power poles.
- Power pole has a cavity on each side of a center septum.
- When using a ceiling power infeed, consider that the infeed must connect into an electrical harness located in an adjacent panel. (See pages 91-92 for cable capacity.)

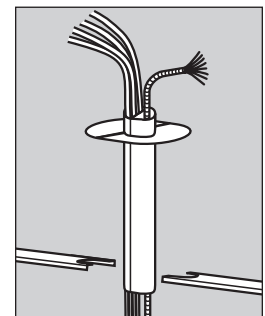

To Order:

- Determine which electrical system you will use after consulting your electrician and computer support personnel:
 - The Four-circuit system (4-Hot/2-Neutral/2-Ground)
 - 3 + 1 option
 - 2 + 2 option
 - The three-circuit system (3-Hot/3-Neutral/2-Ground)
 - The eight-circuit system (back-to-back four-circuit systems)
- Determine location, quantity, and circuit of duplexes.
- Determine the appropriate choice and use of isolated, isolated/dedicated, and separate neutrals circuits.
- Specify appropriate power harnesses* and pass-thru cables.*
- Determine the location, quantity, and type of power infeed needed.

* Select power harness models (A8712XX), pass-thru cables (A8710XX), and pass-thru harness (A8711XX) with the last two digits corresponding with the panel width into which the component is to be positioned. The initial cable length can be stretched approximately 3" to transverse "T", "X", "L", and extended straight connectors.

Flexconnect™ Electrical System Options

The four-circuit, eight-wire electrical system is widely specified and trusted by hundreds of thousands of end-users. This proven system delivers four circuits for every power infeed in either a 3 + 1 or 2 + 2 configuration. The isolated/dedicated circuits are ideal for sensitive computing equipment, while the common circuits are suitable for faxes, copiers, task lights and other peripherals. Both the 3 + 1 and 2 + 2 systems use the same pre-wired components, making it easy to adjust as electrical needs change.

You can also choose a three-circuit, eight-wire system that has a dedicated neutral for every hot circuit. The three-circuit components have model numbers with an "A" suffix and appear in a gray box in this pricer.

All three systems utilize an eight-wire electrical system rated at 20 amps per circuit (15 amps Canadian). Concensys panels and electrical components are UL listed and CSA certified.

Reference the Office Equipment Typical Load Values matrix on page 93.

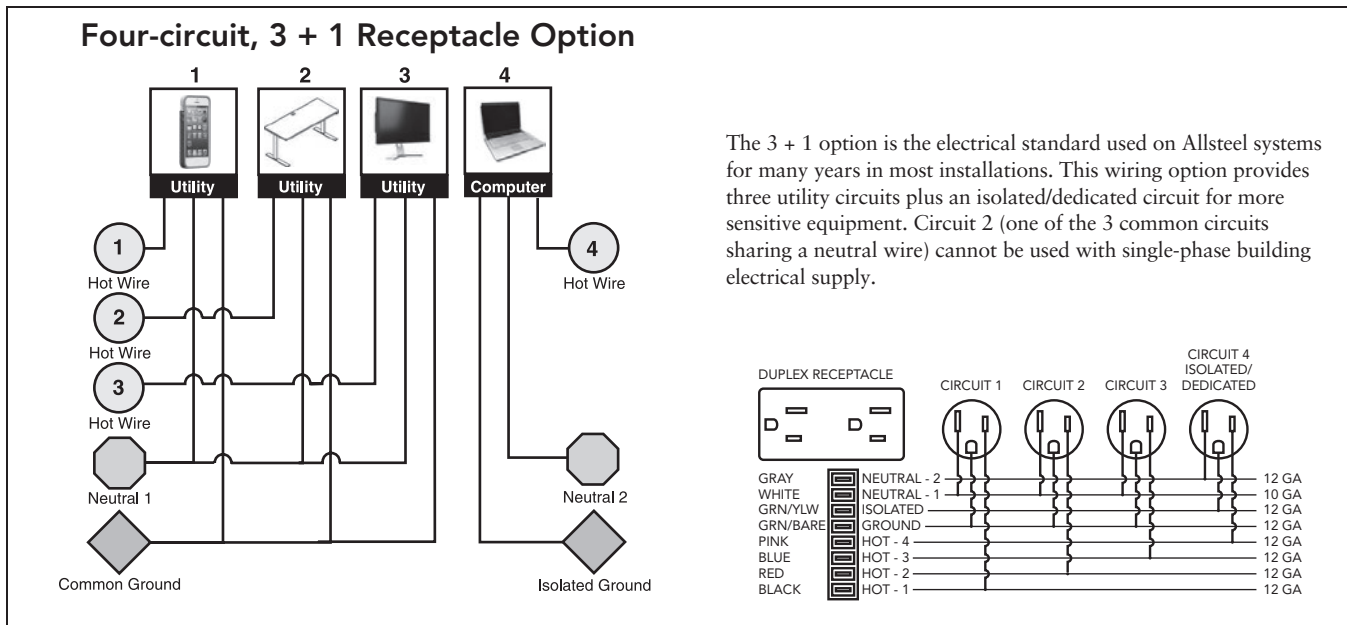

The 3 + 1 option is the electrical standard used on Allsteel systems for many years in most installations. This wiring option provides three utility circuits plus an isolated/dedicated circuit for more sensitive equipment. Circuit 2 (one of the 3 common circuits sharing a neutral wire) cannot be used with single-phase building electrical supply.

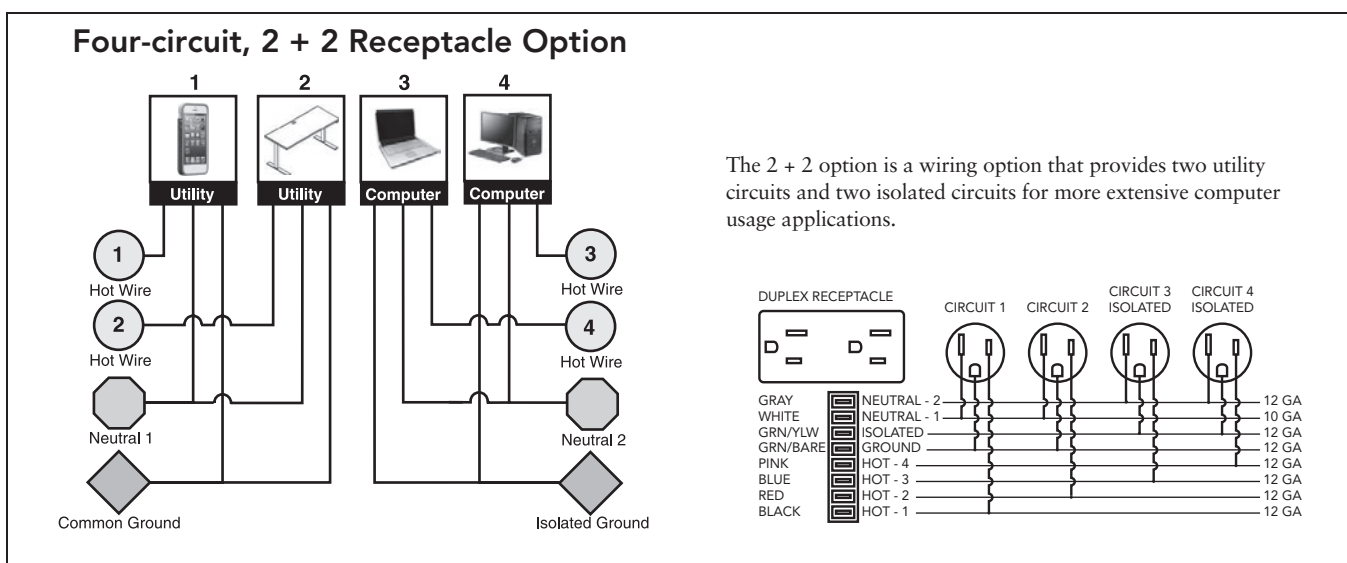

The 2 + 2 option is a wiring option that provides two utility circuits and two isolated circuits for more extensive computer usage applications.

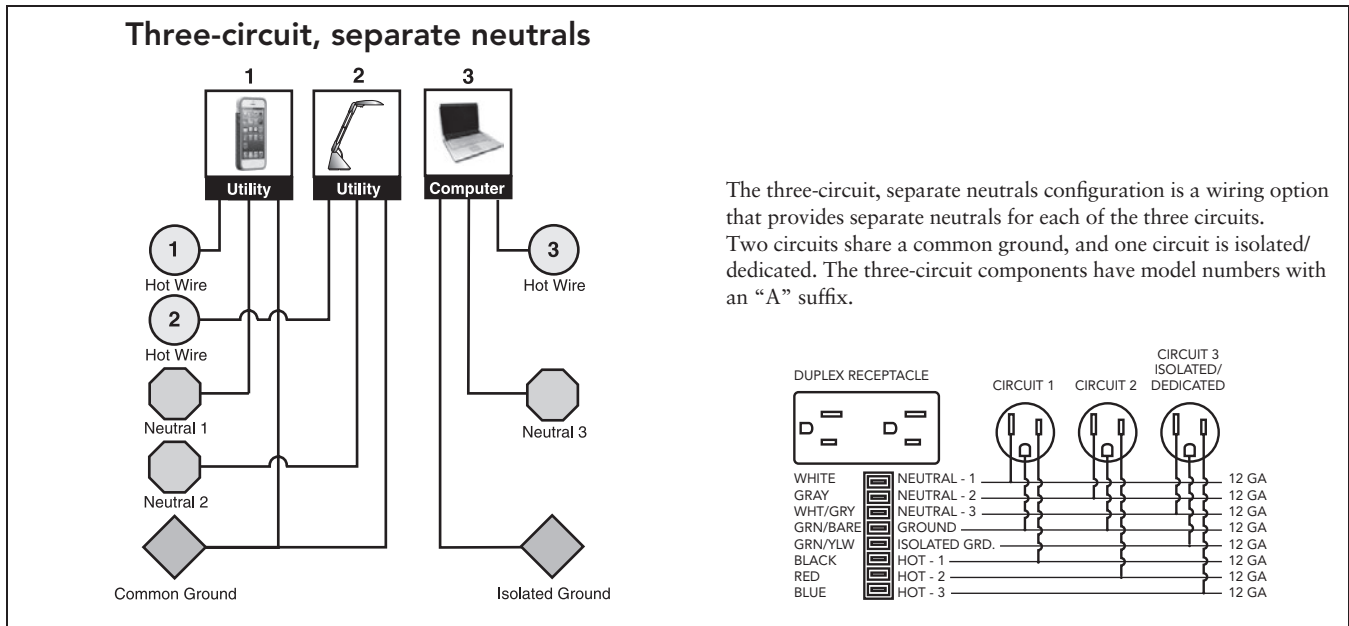

Terrace System Receptacle Usage					
Two 8-wire, 20 amp (15 amp Canadian) electrical systems are offered					
Electrical System	Circuitry	Receptacle Capacity			
Four-circuit 4-Hot/2-Neutral/2-Ground	3 + 1	Common Circuit-1 A873501	Common Circuit-2 ⁽¹⁾ A873502	Common C ircuit-3 A873503	Iso/Dedicated Circuit-4 A873504
	2 + 2	Common Circuit-1 A873501	Common Cir- cuit-2 A873502	Isolated Circuit-3 A873506	Isolated Circuit-4 A873504
Three-circuit 3-Hot/3-Neutral/2-Ground	w/separate neutrals	Common Circuit-1 A871501A	Common Circuit-2 A871502A	Iso/Dedicated Circuit-3 A871503A	N/A

(1) Circuit 2 (one of the 3 common circuits sharing a neutral wire) cannot be used with a single-phase building electrical supply.

Notes:

- Four-circuit components and three-circuit components (with suffix “A”) cannot be used together.
- Components of the two systems are keyed differently to prevent components of one system being connected to components of another system.
- Allsteel model numbers are printed on the UL labels, and components are color-coded to provide visual identification of the different components.
- Four-circuit components have black plastic parts.
- Three-circuit components have rust-colored terminal ends and receptacle backs are rust-colored.

Duplex Receptacle



15 amp receptacle

Power Harnesses, Pass-Thru Cables, and Jumpers

Electrical power harnesses are used to distribute power in Terrace panels. Harnesses can be mounted at base pathway or beltline. **Power blocks** on electrical power harness and pass-thru harness accept duplex receptacles.

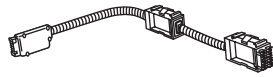

Electrical Power Harness

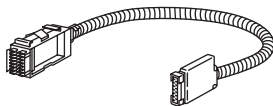

Electrical Pass-Thru Harness With Power Block

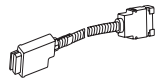

Electrical Pass-Thru Harness Without Power Block

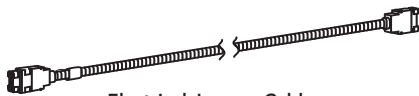

Electrical Jumper Cables

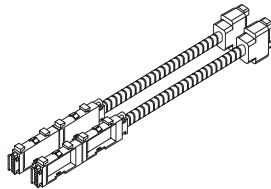

Dual Electrical Eight-circuit Power Harness Kit

All electrical power harnesses and pass-thru harnesses (except 20"W) will stretch 3½", allowing them to span "T", "X", and 120° intersections and "S" extended straight connections.

Note: "T" intersections require a minimum of one power harness and "X" intersections requires a minimum of two power harnesses.

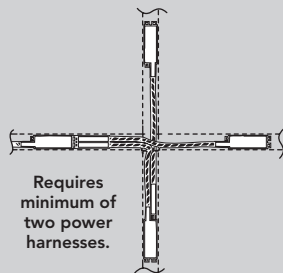
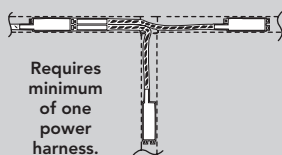

Use of a ceiling infeed or jumper at this location requires an additional power harness.

Electrical Power Harnesses (page 94)

- Specify harness length to match panel width. 24" power harness accepts one receptacle on each side of the harness, all other length power harnesses have power blocks to accept four duplex receptacles (two on each side of panel).
- Connectors at both ends of power harnesses allow power distribution in either direction.
- Harness power blocks snap directly onto brackets in base pathway; harnesses require optional mounting brackets at beltline or other vertical locations
- Use of a ceiling infeed or jumper requires one additional harness.

Electrical Pass-thru Harnesses With Power Block (page 94)

- Specify harness length to match panel width.
- Electrical pass-thru harnesses have capacity to handle one duplex receptacle on each side of the panel.
- A 60" pass-thru harness can be used to jump up to a single duplex receptacle per side at beltline and connecting to a power harness at base pathway.
- Electrical power harnesses and pass-thru cables cannot be routed at 90° at beltline once frames are connected to connector blocks.
- Specify harness length to match panel width.

Electrical Pass-thru Harnesses Without Power Block (page 94)

- Specify harness length to match panel width.
- Electrical pass-thru cables distribute power through any panel where receptacles are not required. Cable length cannot be stretched.

Electrical Jumper Cables (page 94)

- Electrical jumper cables connect power from base pathway or beltline to a harness located on any horizontal member as needed.
- Jumper cable plugs into power block end of electrical power harness or electrical pass-thru harness.
- Model A871366 is 66" to jumper up to 30 inches vertically – base pathway to beltline, beltline to base pathway, or up to 30" above or below beltline when connected to beltline electrical.
- Model A8713108 is 108" to jumper up to 65" vertically – from baserail up to the highest 15" opening on an 80"H frame.
- Jumper can also be used from beltline to adjacent beltline at 90° juncture via baseline.

Dual Electrical Eight-circuit Power Harness Kits (page 94)

- Kit provides back-to-back four-circuit systems giving double the capacity of harness and pass-thru cables. Cannot be used at beltline with Terrace. Restricted to base pathway only.
- Requires two four-circuit infeeds. Uses four-circuit receptacles.
- Models must be positioned "back-to-back" in the panel — single-side use is not permitted.
- Components can only be routed in a single run — a single run cannot branch to multiple panel runs at "T" and "X" junctions.
- Four-circuit jumper cables (A8713xx) can only be connected to a power block at one end of a run — power cannot be routed between a run in the base pathway and beltline area, except at one end of the run.
- Standard four-circuit pass-thru cables (A8710xx) can be used in between power harnesses. Two are required in the back-to back configurations.
- Models can be connected to standard four-circuit power harnesses and pass-thrus, although it is not recommended because of possible circuit number ambiguity.
- Two power infeeds are required to connect the back-to-back runs. Power A8719xx must be connector to a power block at the end of a run.
- Data faceplates and terminals cannot be positioned in a panel into which back-to-back power harnesses are installed.
- Power infeeds A8719xx must be routed from a panel wherein no power harness is positioned, into an adjacent panel where a power harness is positioned and connected to the end of a power block.

Power Blocks

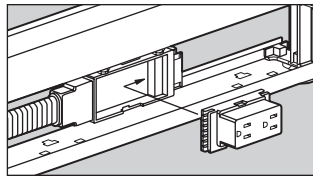

Power Block Base Pathway Mounting

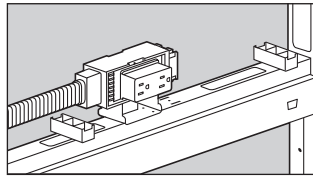

Power Block at Beltline

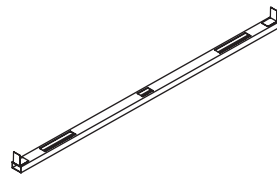

Horizontal Electrical Mount Support

Terrace offers multiple options for mounting electrical:

Base Pathway Mounting

- Power blocks snap directly onto brackets in base pathway area and accept receptacles (sold separately) on each side of harness.

Electrical Mounting Brackets (page 96)

- Package of 12. One bracket required at beltline for each pass-thru harness and 24" W power harness. Two brackets required at beltline for 30"-60" W power harnesses.
- For ported receptacles at beltline or below worksurface, mount power blocks onto electrical mounting brackets which screw into Terrace panel frame.
- Model 8989EB for use with data/electrical port tiles at beltline or directly below standard worksurface height on 42½"H-65"H panels.
- Model 8989BW for use with data/electrical port tiles directly below standard worksurface height on 35"H panels only.
- Data/electrical port tiles must be used where exposed receptacles will be located. No standard port tiles are currently available for below worksurface, either field port using kit model UTP or contact tailored products.
- To connect power between the base pathway and the beltline area, four-circuit jumper cables (A8713xx) must be connected to a power block at one end of a run, routed into an adjacent panel that contains no power harness, then routed back into the panel that contains a power harness (or pass-thru cable), and connected to a power harness in the other pathway.

Horizontal Electrical Mount Support (page 97)

- Use horizontal electrical mount support bar and electrical mounting brackets (sold separately) when mounting power blocks at a location other than beltline or base pathway.
- Specify support bar width to match panel width.
- Tiles must be field ported when electrical is mounted in a location other than just above the worksurface at beltline.
- 22½"H ported tiles can be used to mount power below the worksurface with the electrical mount support bar being field located in the panel to align with the tile's ports.
- Can be used with acoustical tiles on one or both sides of the panel frame.
- One electrical mounting bracket required for each pass-thru harness and 24" W power harness. Two electrical mounting brackets required for 30"- 60" W power harnesses.
- Gray only. Includes attaching hardware.

Receptacles

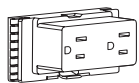

Duplex Receptacle

Receptacle Color Recommended to Coordinate with Paint Color

Paint Color	Receptacle Color
Designer White PJW	use Designer White DW
Bungalow.....	use Muslin EU
Champagne Metallic.....	use Muslin EU
Cinder.....	use Brownstone EY
Fossil.....	use Flint E9
Gunmetal Metallic.....	use Brownstone EY
Parchment.....	use Muslin EU
Pebble	use Loft EV
Pewter	use Flint E9
Platinum Metallic	use Silver ES
Salt.....	use Silver ES
Titanium	use Silver ES

Duplex Receptacles (page 95)

- Duplex receptacles snap into power blocks of power harnesses or pass-through harnesses.
- Duplexes are available in multiple colors. See page 38 for finishes.
- Each receptacle is labeled to indicate which circuit it will be connected to: 1, 2, 3, or 4.
- Duplexes are model specific to support either 3+1 and 2+2 electrical infeed; or have an "A" suffix and are design to support a three-circuit separate neutral electrical infeed.

Cable and Wire Management

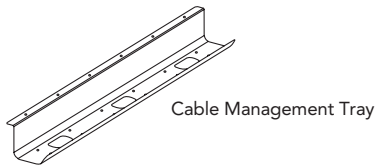

Cable Management Tray (page 96)

- Attaches under the worksurface to contain cables.
- Metal tray shelf is 4" deep. Can hold electrical power strip and/or surge protector.
- 24" and 36" lengths, use multiple units for larger worksurfaces.
- Attachment hardware included, paint option is black only.
- Zip tie attachment points located in base of tray. Zip ties not included.

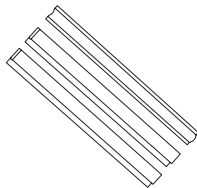

AWRSTRIP

Wire Management Strips/Channels (page 96)

- Self adhesive backing to attach to panels and underside of worksurfaces.
- Flexible strips allow cabling to enter/exit and can be contained inside the strips' cavities.
- Includes two wire management profiles. Smaller profile allows for qty. 3, .3" diameter cords, has area of .32 in². Larger "J" shaped profile allows for qty. 10, .3" diameter cords, has area of 1.14 in².

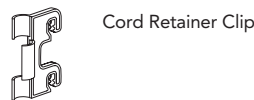

Cord Retainer Clip (page 96)

- Provides confinement of vertical electrical/data wiring.
- 1½"H cord clips snap into vertical panel slots to contain cords.
- 4 clips are provided standard with each task light cord.
- Package of 50. Available in Black only.



Data Management Organizers (page 96)

- Cable organizers are made of rigid polymer, and hang from the horizontal cross members or in the base raceway. Can be stacked infinitely.
- Cables can be placed into the extensions of the organizers to keep cables aligned as they pass through the panel frame.
- Commercially available tie-wraps can also be used to strap cables to the organizer extensions.
- Organizers are ordered separately in packs of 20.



Universal Tile Port Kit (page 96)

- Allows field installation of additional data accessories.
- Grommet opening dimension — 1.375"H x 2.700"W.



Wireway Grommet (page 96)

- Fits into any receptacle opening.
- Used when routing wires through receptacle opening.

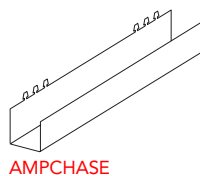

Panel Mounted Wire Chase (page 96)

- Attaches between panels on Stride, Terrace, and Optimize via a slotted standard.
- Designed to sit below a worksurface and provide additional cord management from the base rail to beltline/under-worksurface height.
- Available in standard metal paint finishes.

Lighting

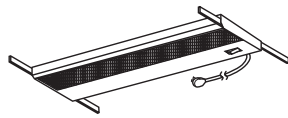

Task Lights

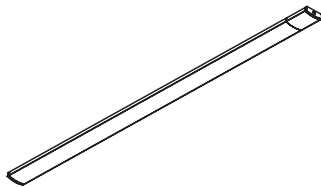

Undercabinet LED Light

Task Lights (page 389)

- Task lights can be recessed under storage cabinets or storage shelves, panel-hung, or freestanding.
- Three styles of recessed task lights in four sizes are available to correspond to cabinet or shelf width.
- All styles have 9' power cords in black, connected in the right rear corner.
- All models feature electronic ballast for longer bulb life and cooler operating temperature.
- Task lights with a fused plug to meet Chicago electrical code are also available.

Recommendation: Provide a separate circuit for task lights for proper long-term operation without RF interference to computers that may be in use.

Undercabinet LED Light (page 389)

- Undercabinet LED light can be mounted beneath overhead cabinets with wood screws or magnets.

Data

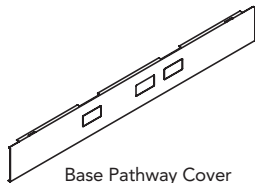

Base Pathway Cover

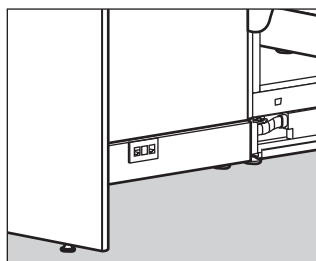

Voice/Data Receptacle

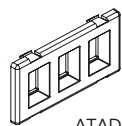

ATADF3

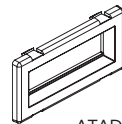

ATADF4

Terrace Base Pathway Covers (page 97)

- Features an additional knockout (offset) for improved utilization of power and data. Knockouts are 2.700" W x 1.377" H.
- Due to panel depth, back-to-back data modules should not be used at beltline or in the base on Terrace.

Data Faceplates (page 97)

- Fit into receptacle and data port openings in base raceway covers or into data port (UTP).
- Due to panel depth, data modules should not be used back-to-back at beltline or in the base on Terrace.



Cord Organizer (page 97)

- Attaches to bottom of worksurface.
- 4" W x 7/8" D, made from sheet metal.
- Top sits flush with worksurface if mounted to worksurface.
- 4 cable cut outs: 2 - .250" diameter and 2 - 0.147" diameter; .250" diameter cut outs are centered between the .147" diameter cut outs.

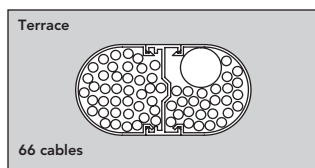
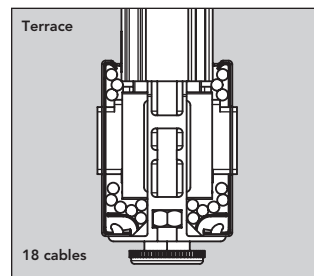
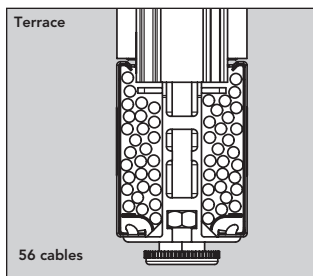
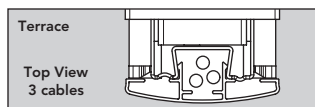
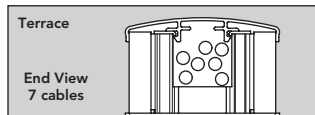
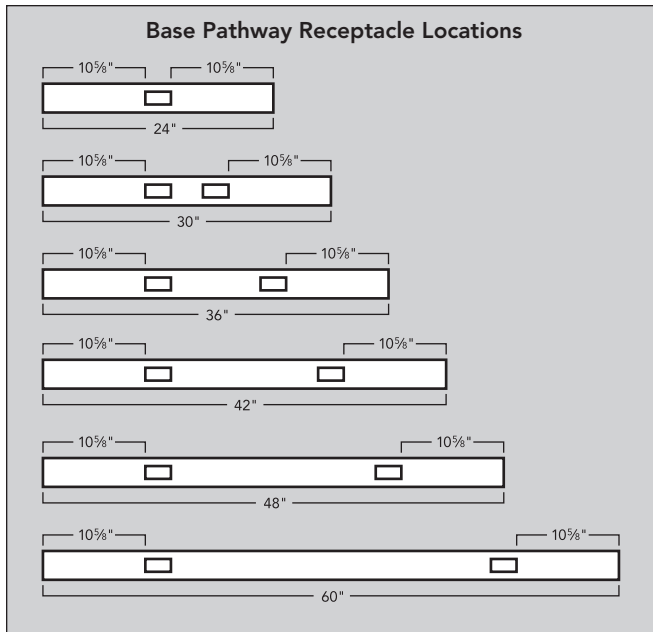

Circuit Usage

Strategy 1

Circuits to Equipment

Assign specific uses for each of the circuits:

- For example, in a four-circuit system:
 - Circuit 1 — Calculators, fans, etc.
 - Circuit 2 — Task lights (could be wired to wall switch)
 - Circuit 3 — CRT or flat screen monitors
 - Circuit 4 — CPUs

Strategy 2

Circuits to Workstations

Assign specific workstations to each of the three available circuits. Use circuit 4 for power-sensitive electronic equipment.

Placement of pedestals and lateral files may render some duplex locations inaccessible. Pedestal placement may also affect compatibility with pull-up receptacles.

Lay-in Cable Capacity

- The top and base pathway allow continuous voice and data lines to run through and between panels without interruption.
- Lay-in is provided for environments where systems furniture or cabling are subject to frequent change.
- Terrace top pathway accepts up to 7 voice/data cables (.25" dia).
- Terrace variable height junctions accept up to 3 voice/data cables (.25" dia.).
- Terrace base pathway accepts up to 56 voice/data cables (.25" dia.) (6.03 sq. in.) at 60% fill.
- When electrical system shares base pathway, the cable capacity in Terrace is reduced to 18 cables (2.25 sq. in.). Cable quantities listed are at 60% fill ratio.
- Cable capacity of the Terrace power pole, in addition to electrical infeed is 2.79 sq. in. on one side and 2.91 sq. in. on the other for a total capacity of 66 cables of .25" diameter.

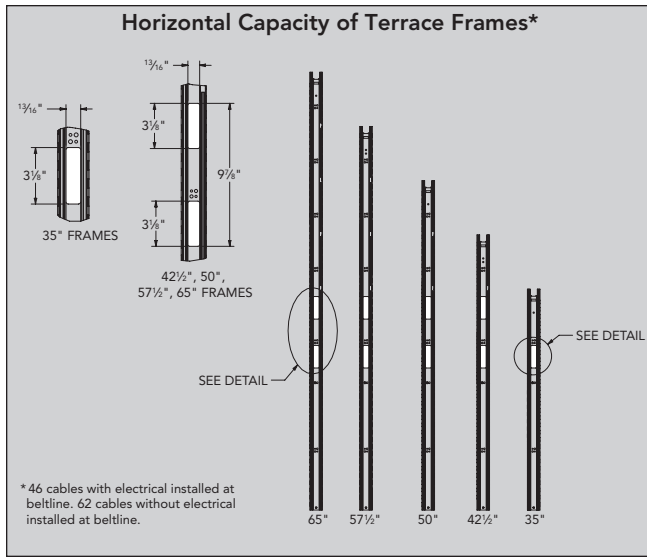

Terrace String-in Capacity

- **Openings in frame sides** permit data and communication cables to be run between frames in Terrace.
- Using tackable acoustical tiles, the beltline pathway accommodates up to 62 cables (.25" dia) or 46 cables with electrical components installed.

DO NOT run electrical equipment or extension cords through cable openings in frame sides. Use beltline or base-mounted electrical system for all electrical supply.

- **Cables can enter/exit panel** through underside of base pathway at juncture between frames.
- Openings are sized as follows (in sq. in.):

Terrace System	Sq. In.
Straight connection	6.0
"S" Extended Straight Connection	10.0
"L" 90° Connection	8.9
"T" Connection	15.9
"X" Connection	17.9
"A" Connection	—
"Y" Connection	—

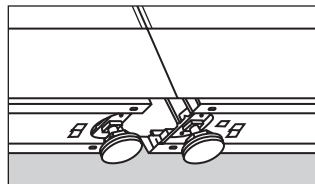

Underside of Base Pathway Juncture Between Frames

- When leveling glides are fully retracted, panel-to-floor clearance is 7/16". This may affect the volume of cabling that can be fed into the frame from the bottom of the pathway.

Vertical Capacity

Vertical Capacity Through Panel Frames

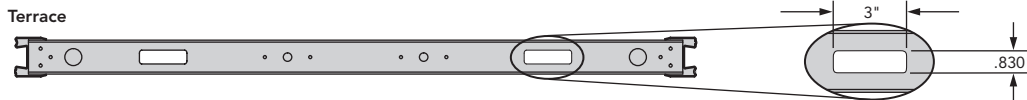

- A 60% fill ratio is achievable; however, when electrical components are installed in the beltline area, cabling capacity through the beltline area will be limited to approximately 45% fill ratio.

	Panel Width	Qty. of .25" Cables at 45% Fill Ratio	Qty. of .25" Cables at 60% Fill Ratio	Total Space (sq. in.)
Terrace	24" – 60" W	45	60	5.26

Office Equipment Typical Load Values

Item	*Amps
Desktop/2 Monitors	4
Laptop Computer	1
Laptop/2 Monitors/Docking Station	3
Paper Shredder	1.22
Radio	0.05
Scanner	3
Space Heater (1500 watts)	12
Task Light (equiv. 60-watt bulb)	
Fluorescent	0.12
LED	0.08
USB Charger	0.17
LCD Television (42")	1
LCD Monitor (21")	0.5
Bluetooth Speaker	0.1
Desktop Printer	
Inkjet	0.15
Laser	4 to 10
Multimedia Projector	1.7
Sit-to-Stand Height-Adjustable Desk	Idle 0.01 / Max 4
Office Kitchen	
Coffee Maker	10
Microwave	10
Toaster	12.5
Compact Refrigerator	1.5

*Chart is recommended for planning purposes. Check device specifications for exact amperage. Consult with your electrician regarding the applicable configurations.

Examples of Component Usage based on the *Office Equipment Typical Load Values* Chart

Power Option 3+1

Dedicated Circuit 4: 4 desktop computers with 2 monitors each; or 10 laptop computers
Utility Circuits 1, 2, 3: Height-adjustable tables and ancillary items

Power Option 2+2

Dedicated Circuit 3: 4 desktop computers with 2 monitors each; or 10 laptop computers
Dedicated Circuit 4: 4 desktop computers with 2 monitors each; or 10 laptop computers
Utility Circuits 1, 2: Height-adjustable tables and ancillary items

Power Option 3 (Circuit-separate neutrals)

Dedicated Circuit 3: 4 desktop computers with 2 monitors each; or 10 laptop computers
Utility Circuits 1, 2: Height-adjustable tables and ancillary items

For specification information see pages 83-93.

GSA SIN 33721

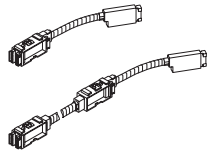

Description	Max. Recept. Cap. per Panel Side	Four-circuit 3 + 1 2 + 2	Three-circuit Separate Neutrals	List Price
Electrical Power Harnesses				
For 24" W Frames	1	A871224	A871224A S	\$ 391
For 30" W Frames	2	A871230	A871230A S	\$ 391
For 36" W Frames	2	A871236*†	A871236A S	\$ 391
For 42" W Frames	2	A871242*	A871242A S	\$ 416
For 48" W Frames	2	A871248*	A871248A S	\$ 416
For 60" W Frames	2	A871260*	A871260A S	\$ 416

†When purchased separately without a configurable TAA compliant end product, not on GSA contract.

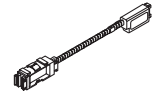

Description	Max. Recept. Cap. per Panel Side	Four-circuit 3 + 1 2 + 2	Three-circuit Separate Neutrals	List Price
Electrical Pass-Thru Harnesses with Power Block				
For 24" W Frames	1	A871124	A871124A S	\$ 239
For 30" W Frames	1	A871130	A871130A S	\$ 239
For 36" W Frames	1	A871136*†	A871136A S	\$ 239
For 42" W Frames	1	A871142*†	A871142A S	\$ 255
For 48" W Frames	1	A871148*†	A871148A S	\$ 255
For 60" W Frames	1	A871160*	A871160A S	\$ 255
For 72" W Frame Runs	1	A871172	A871172A S	\$ 341

Electrical harnesses are intended for use with Allsteel systems furniture and are approved under GSA SIN 33721. When purchased separately and used without Allsteel systems furniture, those electrical harnesses marked by () are considered Open Market.

†When purchased separately without a configurable TAA compliant end product, not on GSA contract.



Description	Max. Recept. Cap. per Panel Side	Four-circuit 3 + 1 2 + 2	Three-circuit Separate Neutrals	List Price
Electrical Pass-Thru Cable without Power Block				
For 24" W Frames	0	A871024	A871024A S	\$ 219
For 30" W Frames	0	A871030	A871030A S	\$ 219
For 36" W Frames	0	A871036	A871036A S	\$ 219
For 42" W Frames	0	A871042	A871042A S	\$ 229
For 48" W Frames	0	A871048	A871048A S	\$ 229
For 60" W Frames	0	A871060	A871060A S	\$ 229



Description	Max. Recept. Cap. per Panel Side	Four-circuit 3 + 1 2 + 2	Three-circuit Separate Neutrals	List Price
Electrical Jumper Cables – Harness to Harness				
Up to 30" vertical jump (66")		A871366	A871366A S	\$ 270
Up to 65" vertical jump (108")		A8713108	A8713108A S	\$ 505

Note: Four-circuit components and Three-circuit components (with an "A" suffix) cannot be connected together.

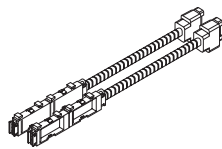

Description	Max. Recept. Cap. per Panel Side	Eight-circuit 3 + 1 (each side) 2 + 2 (each side)	List Price
Dual Electrical Eight-circuit Power Harness Kit			
For 24" W Panels	1	A2-8CIR24 S	\$ 939
For 30" W Panels	2	A2-8CIR30 S	\$ 939
For 36" W Panels	2	A2-8CIR36 S	\$ 1358
For 42" W Panels	2	A2-8CIR42 S	\$ 1358
For 48" W Panels	2	A2-8CIR48 S	\$ 1358
For 60" W Panels	2	A2-8CIR60 S	\$ 1369

Note: Kit consists of two four-circuit harnesses placed "back-to-back" to provide 8 circuits.

How to specify —
Select the Model Number from above.

1st Option:
Color:
P Black

P

Examples: A871224.P A871224A.P A871124.P
A8710144A.P A2-8CIR36.P

S Shippable by small-package carrier.

For specification information see pages 83-93.

GSA SIN 33721

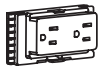

Duplex Receptacle

Description	Four-circuit 3 + 1 2 + 2	Three-circuit Separate Neutrals	List Price
Duplex Receptacles for Beltline or Base Pathway — Terrace (specify color)			
Circuit 1	A873501	A871501A [S]	\$ 72
Circuit 2	A873502	A871502A [S]	\$ 72
Circuit 3 (3+1)	A873503	A871503A [S]	\$ 72
Circuit 3 (2+2)	A873506	N/A [S]	\$ 72
Circuit 4 — iso/dedicated	A873504	N/A [S]	\$ 72
Circuit 1, 20 AMP	A871601	A871601A [S]	\$ 72

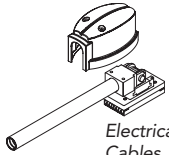

Electrical Infeed Cables

Description	Part Number	Color	List Price
6' Sealight Cable for Terrace Receptacle	A876072	A876072A [S]	\$ 439
6' Flex Cable	A871972	A871972A [S]	\$ 331

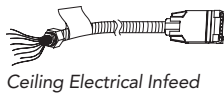

Ceiling Electrical Infeed

Description	Part Number	Color	List Price
12' Flex Cable	A871912	A871912A [S]	\$ 449
18' Flex Cable	A871918	A871918A [S]	\$ 565

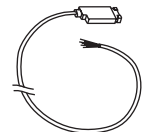

Electrical Infeed Cable

Description	Part Number	Color	List Price
12' Sealight Cable Power Infeed	A877012	N/A [S]	\$ 547

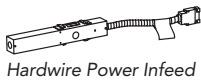

Hardwire Power Infeed

Description	Part Number	Color	List Price
Hardwire Power Infeed (New York Code)			
For 30"–60"W panels	A871400	A871400A [S]	\$ 431

Note: Four-circuit components and Three-circuit components (with an "A" suffix) cannot be connected together.

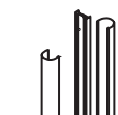

*6" from end to center.

Description/ Examples	Flat Top Trim Model		Flat Top Trim			Radius Top Trim			
	Model	Color	P1 Paint List Price	P2 Paint List Price	P3 Paint List Price	P1 Paint List Price	P2 Paint List Price	P3 Paint List Price	
Integrated Power Poles (Order flat or radius trim kit below) — for Terrace (core paint only)									
For 35"H-57½"H Panels — 78"H	870535 [S]	870535 [S]	\$ 686	N/A	N/A	\$ 686	N/A	N/A	
For 65"H-95"H Panels — 52"H	870565 [S]	870565 [S]	\$ 478	N/A	N/A	\$ 478	N/A	N/A	

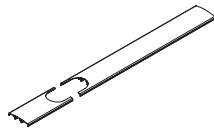

Trim Description	Flat Top Trim Model		Flat Top Trim			Radius Top Trim		
	Model	Color	P1 Paint List Price	P2 Paint List Price	P3 Paint List Price	P1 Paint List Price	P2 Paint List Price	P3 Paint List Price
Integrated Power Pole Trim Kits for Terrace Painted Trim (order pole above)								
24"W Panel Trim	870224NF [S]	870224N [S]	\$ 269	\$ 298	\$ 324	\$ 239	\$ 239	N/A
30"W Panel Trim	870230NF [S]	870230N [S]	\$ 282	\$ 311	\$ 337	\$ 252	\$ 252	N/A
36"W Panel Trim	870236NFK [S]	870236N [S]	\$ 312	\$ 341	\$ 367	\$ 271	\$ 271	N/A
42"W Panel Trim	870242NFK [S]	870242N [S]	\$ 317	\$ 346	\$ 372	\$ 279	\$ 279	N/A
48"W Panel Trim	870248NFK [S]	870248N [S]	\$ 332	\$ 361	\$ 387	\$ 289	\$ 289	N/A
60"W Panel Trim	870260NFK [S]	870260N [S]	\$ 348	\$ 377	\$ 403	\$ 304	\$ 304	N/A





*"K" suffix was added to select flat trim model numbers effective 10/7/2016.

How to specify — Select the Model Number from above. _____ . E _____	1st Option: Electrical Receptacle Color (if applicable): See page 38 for finishes.	1st Option: Color (if applicable): P Black	1st Option: Paint (if applicable): P1 P2 P3 See page 38 for finishes.
--	--	--	--

Examples: A876072.P A871912.P A873501.E4 870224N.PR2

[S] Shippable by small-package carrier.

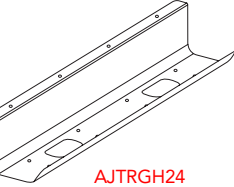
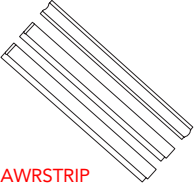
For specification information see pages 83-93.

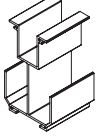
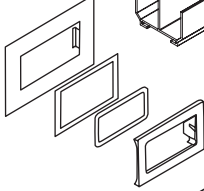
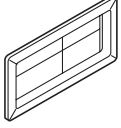
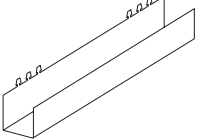
	Description	Model	P1 Paint List Price	P2 Paint List Price	P3 Paint List Price
	Electrical Mounting Brackets (for use with Data/Electrical Port Tiles) (no color specified)				
	Pack of 12 — for use at beltline and below standard worksurface height on 42½"H to 65"H panels	8989EB S	\$ 111	N/A	N/A
	Pack of 12 — for use below standard worksurface height on 35"H panels only	8989BW S	\$ 111	N/A	N/A
	1 bracket required at beltline for each pass-thru harness and 24"W power harness and 2 for 30-60"W power harness.				
	Hardwire (Chicago Code) (Black only)				
	Terrace Base Pathway Junction Box (Pack of 6)	873600 S	\$ 1145	N/A	N/A
	Beltline Junction Box (Pack of 6)	873550 S	\$ 1078	N/A	N/A
	Cable Management Trays				
	24"W	AJTRGH24 S	\$ 123	N/A	N/A
	36"W	AJTRGH36 S	\$ 147	N/A	N/A
	<ul style="list-style-type: none"> • Available in 24" or 36" widths. • Metal Cable Management Trays available in Black only, specify "P" for finish. • Example: AJTRGH24.P 				
	Wire Management Strips/Channels				
		AWRSTRIP S	\$ 270	N/A	N/A
	<ul style="list-style-type: none"> • Four wire management strips/channels in black only, no specification needed. • Example: AWRSTRIP 				
	Cord Retainer Clip (Black only)				
	Package of 50	AAPACM2 S	\$ 56	N/A	N/A
	Data Management Organizer (Black only)				
	Package of 20	A877010 S	\$ 150	N/A	N/A
	Data Port Kit (specify electrical color)				
	Data/Electrical Port Kit	UTP S	\$ 42	N/A	N/A
	Wireway Grommet (Black only)				
	Pack of 6	TAWG S	\$ 187	N/A	N/A
	Panel Mounted Wire Chase				
	17"H	AMPCHASE S	\$ 147	\$ 162	\$ 169
	<ul style="list-style-type: none"> • Panel Chase is 17"H. • Available in standard metal paint finishes, see page 334 for options and specify desired finishes. • Example: AMPCHASE.P27 				

For more power and wire management options, please visit the Extensions pages.

<p>How to specify — Select the Model Number from above.</p>	<p><i>1st Option:</i> Paint Color (if applicable):</p> <p>P1 See page 38 for finishes.</p>	<p><i>1st Option:</i> Electrical Port Kit and Wireway Grommet Color:</p>	
<div style="display: flex; justify-content: space-between; width: 100%;"> P E </div>			

Examples: A870300 8989EB 8989BW 873550.P UTP.E4
AJTRGH24.P TAWG.E4

S Shippable by small-package carrier.

For specification information see pages 83-93.

GSA SIN 33721



Description	Model		P1 Paint List Price	P2 Paint List Price	P3 Paint List Price
Terrace Horizontal Electrical Mount Support					
24"W	TN24MS		\$ 125	N/A	N/A
30"W	TN30MS		\$ 135	N/A	N/A
36"W	TN36MS		\$ 145	N/A	N/A
42"W	TN42MS		\$ 164	N/A	N/A
48"W	TN48MS		\$ 177	N/A	N/A
60"W	TN60MS		\$ 197	N/A	N/A

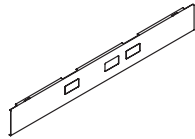

Base Pathway Covers — Knockouts					
36"W	TBPLATE3-36		\$ 101	\$ 119	\$ 132
42"W	TBPLATE3-42		\$ 103	\$ 121	\$ 134
48"W	TBPLATE3-48		\$ 110	\$ 128	\$ 141
60"W	TBPLATE3-60		\$ 127	\$ 145	\$ 158

ATADF3

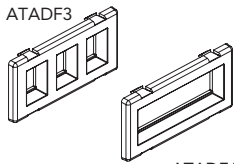

ATADF4

Data Faceplates					
Three-Port Flex-Mode Faceplate, Black (E4)	ATADF3		\$ 42	N/A	N/A
Four-Port Flex-Mode Faceplate, Black (E4)	ATADF4		\$ 42	N/A	N/A

Notes: ATADF3 can install up to 3 jacks (CAT 3, 5E, or 6). ATADF4 can install 4 jacks (CAT 3, 5E, or 6).

ATADF models are compatible with ports in Terrace tiles.

Allsteel's data faceplates are designed for use with the jacks listed below. We do not guarantee compatibility with other manufacturers' product. A faceplate adapter is available for use with alternatively sourced data jacks, see the Standard Specials catalog for details.

ATADJ5

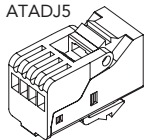

Jacks					
RJ45 CAT 5E Jack — Black only					
Toolless	ATADJ5		\$ 74	N/A	N/A
RJ45 CAT 6 Jack — Black only					
Requires Tool	ATADJ6		\$ 98	N/A	N/A

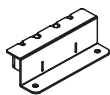

Description	Model	List Price			
		P1 Paint	P2 Paint	P3 Paint	
Cord Organizer					
4"W x 7/8"D Metal with 4 cable cutouts	U9WTC		\$ 196	\$ 205	\$ 212

<p>How to specify — Select the Model Number from above.</p>	<p>1st Option: Paint (Base Pathway Cover and Cord Organizer):</p> <p></p> <p>See page 38 for finishes.</p>	<p>1st Option: Data Faceplate Color:</p> <p>E4 Black</p>
<p>_____ . P _____</p>	<p>E 4</p>	

Examples: TN24MS TBPLATE3-36.P27 ATADF4.E4

Shippable by small-package carrier.

Laminate with Flat Edge or Veneer Worksurfaces

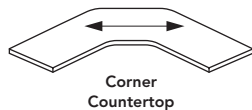
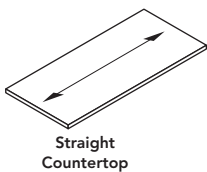
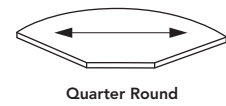
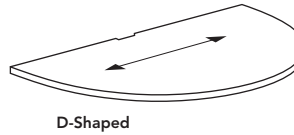
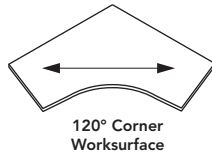
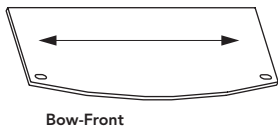
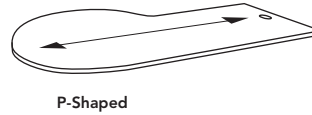
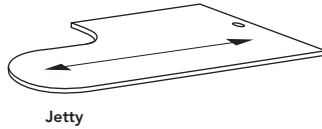
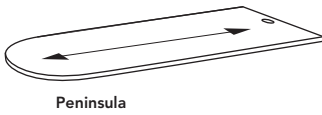
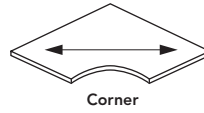
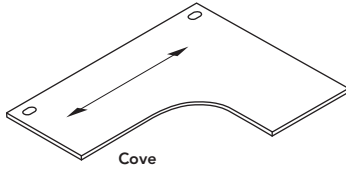
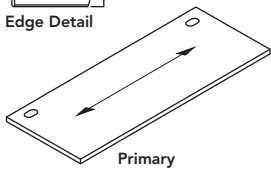

←→ Arrows indicate grain direction for woodgrain laminates.
Grain direction on symmetrical corner worksurfaces runs at a diagonal.

*Laminate only

Note: Add suffix "N" to model number for no grommets, no upcharge.

Worksurfaces are 1½" thick with particleboard core and with top surfaces finished in laminate. Bottom surfaces are covered with a backer sheet. Worksurfaces are available in laminate and Stratawood veneer. Veneer worksurfaces are by Gunlocke.

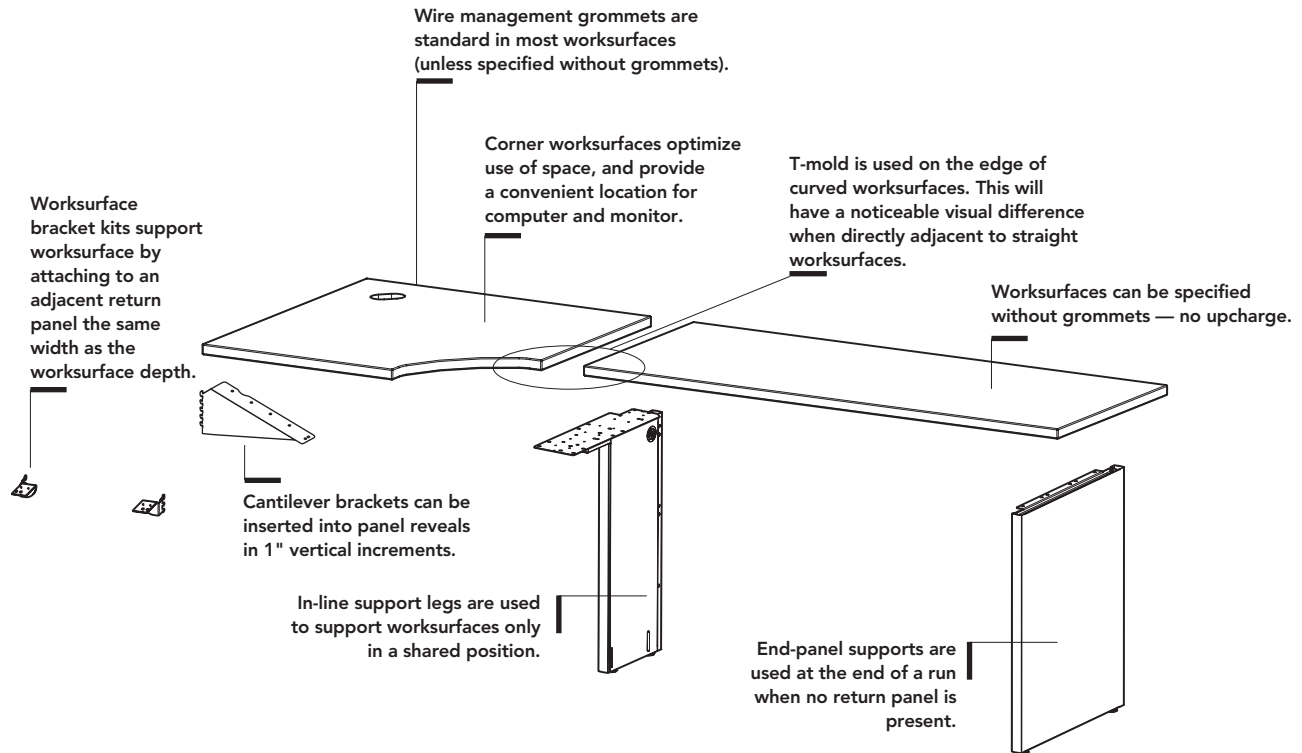

Worksurfaces

- Laminate worksurfaces are 1½" thick with particle board core and with top surfaces finished in high-pressure laminate. Bottom surfaces are covered with a backer sheet.
- Flat edge trim** is available on laminate tops in twenty standard colors (customer specified) to match solid or woodgrain laminates and to complement patterned laminates.
- Veneer worksurfaces have square veneer edge.

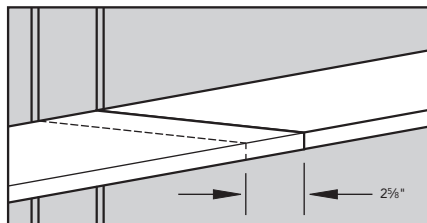
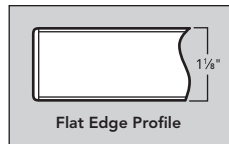

- Optional wider width primary worksurfaces** are available for use with Terrace panel runs having a "T" or "S" connection — upcharge applies.

Wire management grommets are standard in most worksurfaces (unless specified with no grommets) and are specified in plastic or metal.

- Metal grommets** are available in oval or square (shown below).

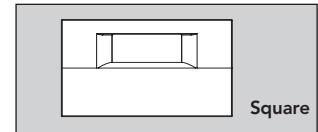
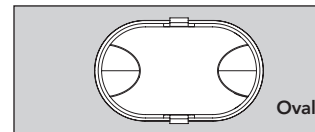

- Rectangular worksurfaces over 42" W have two grommets. Corner cove worksurfaces will have two grommets. Peninsula and corner worksurfaces have one. D-Shaped worksurfaces and countertops do not have grommets.
- Grommets on standard systems worksurfaces are located 6⅛" from side edges and 3⅛" from back edge.
- Add Suffix "N" to a model number for no grommets — no upcharge.

Supports

Worksurfaces can be configured at 29½" H with end-panel supports and in-line support panels, or at various heights on 1" increments using specific product configurations.

Worksurface support options include:

- | | |
|--------------------------------|-------------------------------------|
| • Support column* | • Support storage units* |
| • Flat brackets | • Pedestal-to-panel attachment kit* |
| • External support channel | • Desk-to-panel attachment kit* |
| • Worksurface bracket kits | • Corner desk leg* |
| • Height adjustable mechanisms | • Bridge and return kits |
| • Cantilever brackets | • Modesty panels |
| • In-line support legs* | • Gussets |
| • End-panel supports* | |

*Units provide floor support.

Support Guidelines — See Drawings on page 100

- Panel-mounted worksurface runs 72" or greater are required to have floor support.
- When using overheads in panel mounted worksurface run applications 72" and greater, floor support* is required. (See list at left.)
- When using overheads at the end of a panel run, floor supports* are required.
- Worksurface bracket kit should be used to tie panels to worksurface for added stability.
- A return panel at the end of a panel run can be substituted with one of these floor supports: storage, open or closed end support panel, O-leg.

continued on next page

continued from previous page

- Cantilever brackets cannot be used at the end of a worksurface panel run in place of a return panel or floor support.
- Unsupported worksurfaces 60" W or greater require an external worksurface support channel. When a center support cantilever cannot be used, an external worksurface support channel is recommended for spans greater than 48" W. See pages 104 and 114.

- Support channel may interfere with mounting of some CPU holders and keyboard supports.
- Cantilevers are recommended in place of an external worksurface support channel where feasible.
- Cadence Desking configurations utilize modesty panels and gussets in place of external support channels for worksurfaces up to 72" W. See pages 105-113.

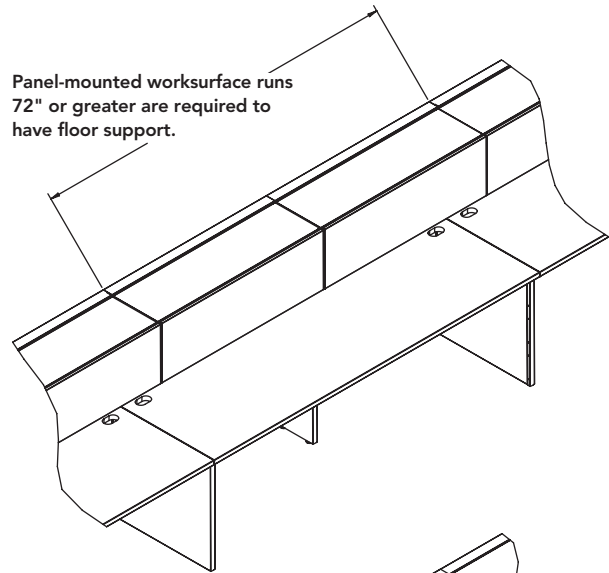
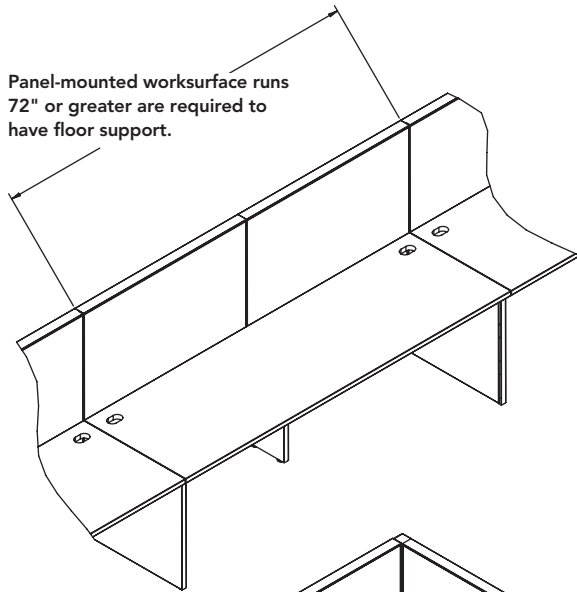

Worksurface bracket kit should be used to tie panels to worksurface for added stability

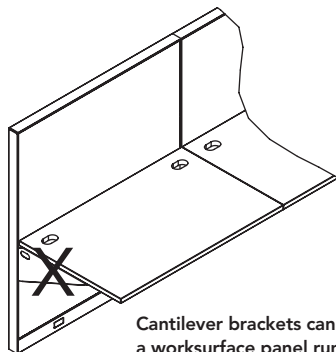
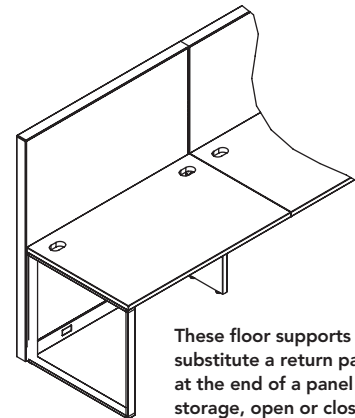
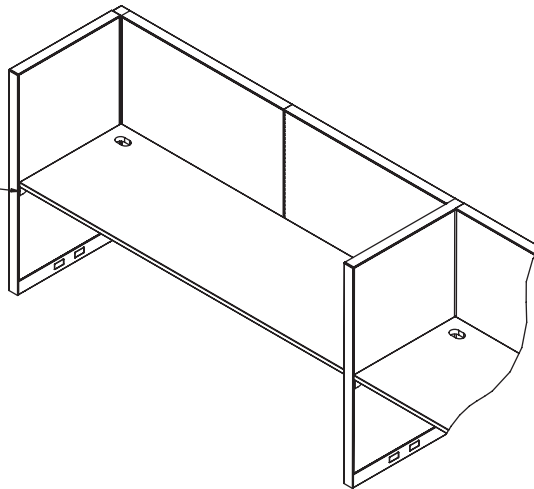
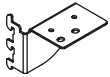

Cantilevers are recommended in place of an external worksurface support channel where feasible.

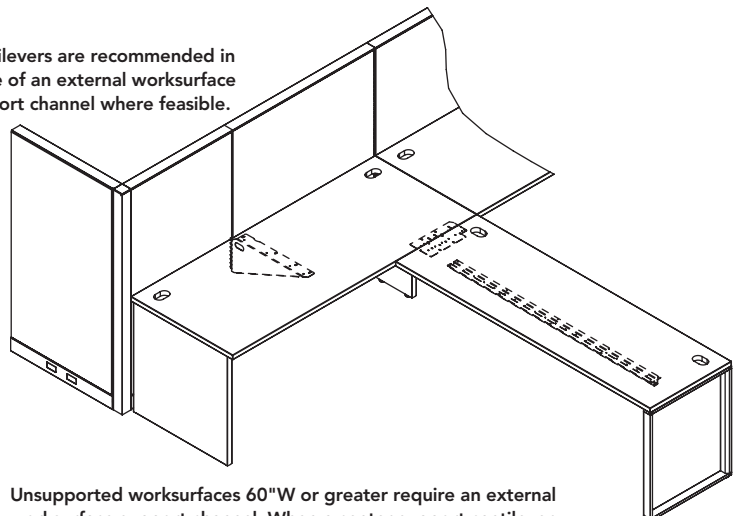

Unsupported worksurfaces 60" W or greater require an external worksurface support channel. When a center support cantilever cannot be used, an external worksurface support channel is recommended for spans greater than 48" W.

Worksurfaces - Laminate (L) w/Flat Edge and Veneer (V) w/Square Edge



Primary Worksurfaces (L page 114)

- Primary worksurfaces are available in 24" and 30" depths.
- Nominal worksurface width is equal to nominal panel width.
- Wire management grommets standard, one for widths up to 42", two on widths 48" W and greater.
- Worksurfaces greater than 60" W require a cantilever bracket for center support in panel mounted applications. Specify 18" cantilever on 18" D, and 24" cantilever on 24" D and 30" D worksurfaces.
- Primary worksurfaces can be used with a modesty panel and appropriate supports to configure freestanding desk(s). Refer to Working With Cadence, pages 105-113.

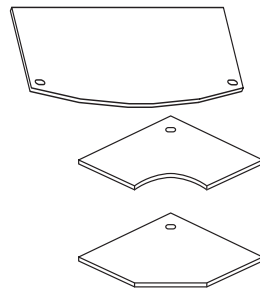

Bow-Front Worksurfaces (L page 115)

- Two wire management grommets standard.
- Bow-front worksurfaces can be used with a modesty panel and appropriate supports to configure freestanding desk(s). Refer to Working With Cadence, pages 105-113.

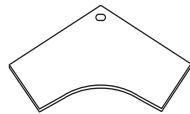

Corner Worksurfaces (L page 116)

- One wire management grommet.
- Corner worksurfaces with woodgrain laminate have grain direction diagonal to adjacent worksurfaces.
- Does NOT include rear support bracket. If rear support bracket is needed, order T6BK. Worksurface bracket kit (order separately) required at junction where a panel is wall-mounted to a permanent wall and wall track stanchion is not positioned in the right-hand corner.
- T-mold is used on the edge of curved worksurfaces. This will have a noticeable visual difference when directly adjacent to straight worksurfaces.



120° Corner Worksurfaces (L page 116)

- Standard with one wire management grommet in corner location.
- Does NOT include rear support bracket. If rear support bracket is needed, order T6BK. Worksurface bracket kit (order separately) required at junction where a panel is wall-mounted to a permanent wall and wall track stanchion is not positioned in the right hand corner.
- T-mold is used on the edge of curved worksurfaces. This will have a noticeable visual difference when directly adjacent to straight worksurfaces.

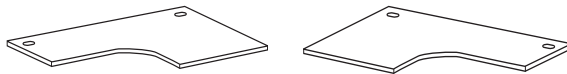

60° Pie Worksurface (L page 116)

- Order support column and two flat brackets separately.

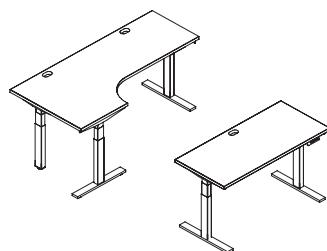

Corner Cove Worksurfaces (L page 117)

- Two wire management grommets standard.
- Does NOT include rear support bracket. If rear support bracket is needed, order T6BK. Worksurface bracket kit (order separately) required at junction where a panel is wall-mounted to a permanent wall and wall track stanchion is not positioned in the right-hand corner. All other support hardware is ordered separately.
- Can be used with a modesty panel and appropriate supports to configure freestanding desk(s). Refer to Cadence pages 105-113.
- Worksurfaces greater than 60" W require a cantilever bracket for center support in panel mounted applications. Specify 24" cantilever on 24" D and 30" D worksurfaces.
- T-mold is used on the edge of curved worksurfaces. This will have a noticeable visual difference when directly adjacent to straight worksurfaces.

Height-Adjustable Worksurfaces

- For freestanding applications, see height-adjustable tables pages in the Seating, Collaboration, and Tables Price List.

Worksurfaces — Laminate(L) w/Flat Edge and Veneer(V) w/Square Edge

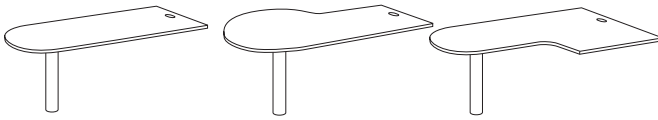

Peninsula, P-Shaped, and Jetty Worksurfaces

(L page 118)

- Wire management grommets standard.
- Support column ordered separately, column includes panel support brackets T6BK.
- Can be used with a modesty panel and appropriate supports to configure freestanding desk(s). Refer to Cadence pages 105-113.

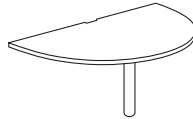

D-Shaped Worksurfaces (L page 119)

- Order support column and two 24"D in-line support legs separately.
- Not recommended for use with T6CB24L or T6CB24R for shared applications.
- Includes attachment bracket.

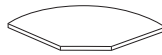

Quarter-Round Worksurfaces (L page 119; V page 124)

- Use to connect two 90° panel-attached worksurfaces.
- Order support column and two flat brackets separately.

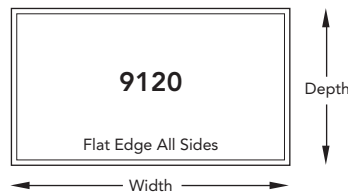

Non-Standard Worksurface Sizes (L, V pages 122-123)

- The 9120 Program can be used to order particle board rectangular worksurfaces in any non-standard width and depth in 1/8" increments up to a maximum of 120"W x 36"D.
- Other modification requests should be made through Allsteel Tailored Products Group.

Countertops - Laminate (L) w/Flat and Veneer (V) w/Square

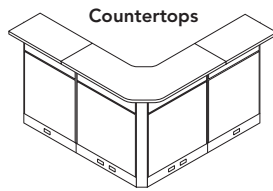

Countertops

- Countertops are available in straight and corner configurations.
- Choose between raised countertops which require raised countertop kit (ordered separately) or flush countertops which include brackets, top trim, and mounting hardware.
- T-mold is used on the edge of curved worksurfaces. This will have a noticeable visual difference when directly adjacent to straight worksurfaces.

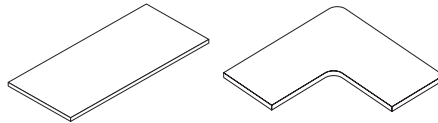

Raised Countertops (L page 120)

- Countertops are raised 5" above panel top cap.
- Order raised countertop kits separately.
- Add appropriate suffix to end of model number for in-line variable height applications.
- Countertop kit can extend up to 6" beyond end of kit.

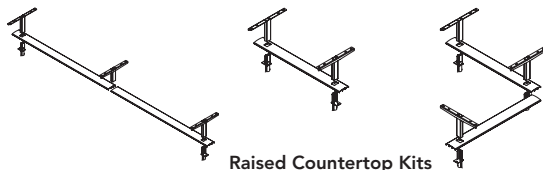

Raised Countertop Kits

Raised Countertop Kits (L page 120)

- Includes top cap and attachment hardware.

Flush Countertops (L page 121)

- Mounting brackets, top trim, and attaching hardware included.
- Flush countertops come with a painted top cap — specify color.
- Countertops are flush with the ends of panel top cap.

Worksurface Supports

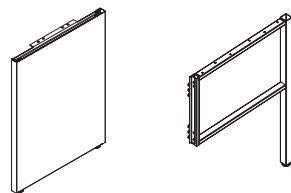

End-Panel and Open End Supports

End Supports and Bracket Kits (page 125)

- End-panels are 1 1/8" thick. For use in place of panels at the end of worksurface runs.
- Levelers provide 1 1/2" vertical adjustment.
- Must be connected into panel slots for panel hung applications.
- Straight worksurfaces adjacent to 120° connections must be supported by full end-panels.
- 11"D end-panel models for use with D-shaped worksurfaces or curvilinear shaped worksurfaces in freestanding applications.
- Panel mounted end-panel supports are ordered for right- or left-handed application.
- Open end panel supports are non-handed and are only for panel mounted applications.
- End-panel models can be converted to freestanding with removal of panel mount bracket.
- End-panel bracket kit converts freestanding end-panel support model to panel mounted.

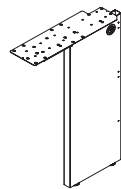

Support Legs

Support Legs and Bracket Kit (page 125)

- Support legs are 1 1/8" thick. Supports the junction of two worksurfaces.
- Non-handed for use at either end of worksurface. Leg portion is 12 3/4"D.
- Provided with flat bracket.
- Worksurface in-line support legs are used to support worksurfaces only in a shared position.
- Levelers provide 1 1/2" vertical adjustment.
- Must be connected into panel slots for panel hung applications.
- Closed full length models can be converted to freestanding with removal of panel mount bracket.
- Support Leg Bracket Kit (non-handed) converts closed full length freestanding model to panel mounted.



Support Columns

Support Columns (page 125)

- Used to support one end of curvilinear worksurfaces.
- Includes column, worksurface bracket kit T6BK, attaching hardware, and adjustable glides.
- D-shaped, P-shaped, peninsula, jetty, boomerang, and reef worksurfaces require support columns (ordered separately).

Worksurface Supports

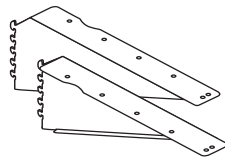

**Handed
Cantilever Brackets**

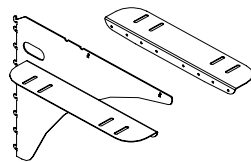

**Non-Handed
Cantilever Brackets**

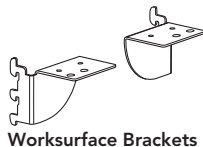

Worksurface Brackets

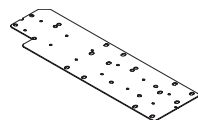
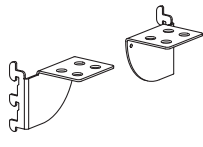

Flat Brackets



**Pedestal-to-Panel
Brackets**

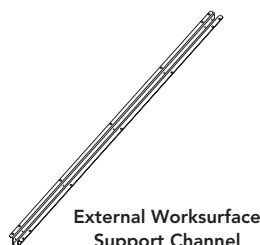

**External Worksurface
Support Channel**

Cantilever Brackets (page 125)

- Use with runs less than 96". Floor support is required for runs 96" and longer.
- Where applicable, cantilevers are recommended over an external worksurface support channel. Unsupported worksurface runs 66"W or greater require an external worksurface support channel when a cantilever cannot be used.
- Do not use at the end of a worksurface where no 90° return panel is positioned.
- Includes tie bracket and attachment hardware.
- Avoid installation on only one side of a straight connection except to support corner worksurfaces.
- DO NOT use to support worksurfaces from which a hanging pedestal is suspended, or to which a peninsula worksurface is attached.
- DO NOT use cantilever brackets to support worksurfaces supported with permanent-wall hanger kit.
- Do not use with wall track or to support a worksurface to which a return worksurface is attached.

Cantilever Bracket — Handed (page 125)

- Cantilever brackets are handed (left or right) and can be inserted into panel reveals in 1" vertical increments. No assembly required.
- Left- and right-hand brackets required in shared applications.
- 24"D cantilevers are required to be used for both 24"D or 30"D worksurfaces.
- 18"D cantilevers are required to be used for 20"D worksurfaces or center support for 24"D.
- 12"D cantilevers are required to be used for 12"D worksurfaces.

Cantilever Bracket — Non-Handed (page 125)

- Cantilever brackets are non-handed and can be inserted into panel reveals in 1" vertical increments. Assembly required.
- One bracket in shared applications — includes two angled brackets.
- Bracket accommodates 24"D or 30"D worksurfaces.

Worksurface Bracket Kit — T6BK (page 125)

- Worksurface bracket kit allows one end of a worksurface to be supported by a return panel. Return panel width must be the same as the depth of the worksurface.
- Brackets — one pair. Attachment hardware included.

Worksurface Bracket — T6SB (page 125)

- Worksurface storage bracket kit (T6SB) is used for aesthetics where under-desk storage is immediately adjacent to the return panel. In all other applications use worksurface bracket kit (T6BK) to utilize worksurface threaded metal inserts. Black only.
- Brackets do not align with worksurface threaded metal inserts, and therefore require wood screws (included).

Flat Brackets (page 125)

- Bracket and attaching hardware.
- Can be used to connect one worksurface perpendicular to another worksurface.

Pedestal-to-Panel Attachment Bracket (page 125)

- Can be used in place of full end panel or return panel.
- Provides structural support to panel run by securing panel directly to pedestal.
- Attachment hardware included.

External Worksurface Support Channel (page 114)

- An external worksurface support channel is required on unsupported worksurfaces 60"W or greater. Width of worksurface span can be reduced by using support storage.
- The support channel extends 1½" below the worksurface. Installs 7" from user's edge.
- When using 28"H mobile pedestals the length of support channel needs to be reduced to accommodate width of the pedestal.
- Support channel may interfere with mounting of some CPU holders and keyboard supports. May require spacer kit AKMH.

Cadence offers unlimited versatility. Its modular flexibility creates office solutions of all shapes, sizes, and styles.

Configurations

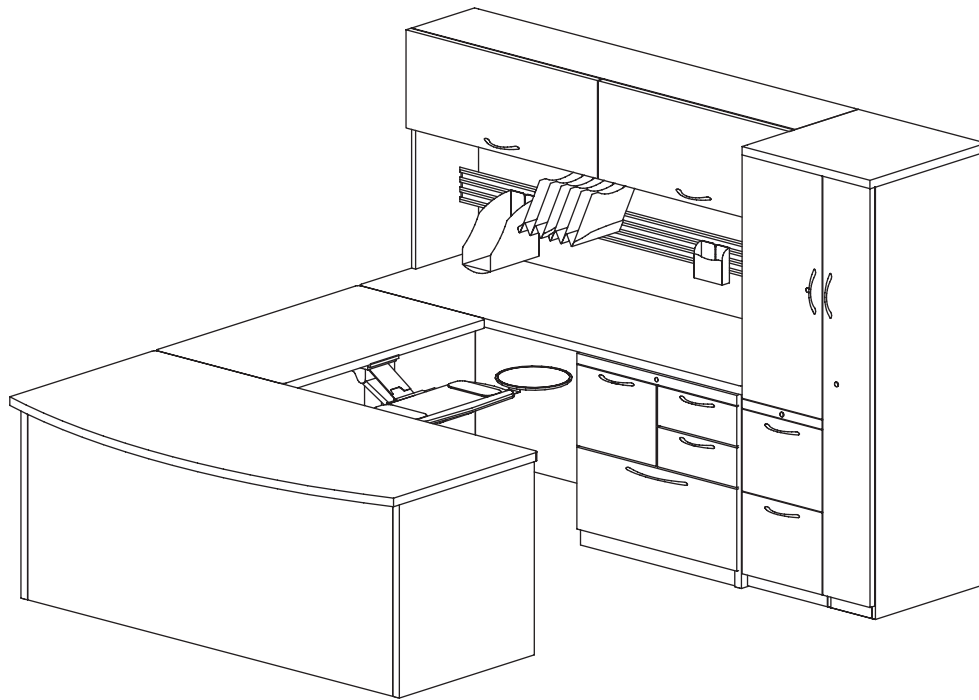

Full Modesty

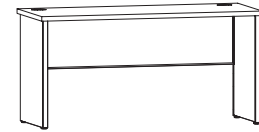

Half Modesty

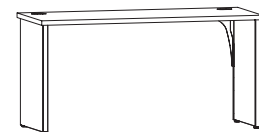

Gussets

All the right choices

Choose Cadence freestanding desking with confidence. It personalizes any work environment, accommodates a range of needs, and offers all the right features — curvilinear worksurface shapes, multiple worksurface edges, and a complete paint finish and laminate offering. Cadence is made to last with heavy-gauge steel construction. Metal-to-metal worksurface connection points make installation and reconfiguration reliable and easy. And Cadence is backed by a lifetime warranty.

Universally flexible

Cadence sets up easily and reconfigures time after time. It even shares components with Terrace, Optimize™, and Concensys®, which simplifies inventory management. Cadence is created with worksurfaces, supports, modesty panels, end panels, and brackets. Cadence is compatible with the entire line of Allsteel metal storage solutions and Extensions™ — work tools to provide personalized organization for every workstyle.

Systems integration — Cadence works in combination with Terrace, Optimize, or Concensys panels, extending the functionality of both product lines.

Highly adaptable — Make the most of building architecture by using an existing wall to create a semi-private workspace.

Space utilization — Multiple worksurface shapes offer unlimited design potential for using space creatively and efficiently.

Team interaction — Cadence design flexibility allows you to create personal workspace and a team collaboration area in the same office.

The Cadence Choice

It works in the open plan, the private office, or in combination with Terrace, Optimize, or Concensys panels, allowing complete office coordination. The flexible, universal design of Cadence supports virtually any workstyle and any interior aesthetic. Backed by Allsteel's Lifetime Warranty and manufactured to strict environmental standards, Cadence provides one high-value package.

Configurations

End Panels **E** and Support Legs **L**

Each are available in two options: freestanding or panel-mount. The only difference between the two options are the panel-mount models come with a left- or right-handed bracket to attach the support to a panel in a Cadence systems application. If the freestanding version is purchased and later needs to be converted to panel-mount, the proper handed panel-mount bracket may be purchased separately.

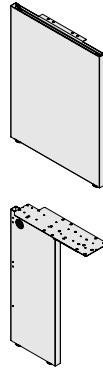

The 11"D end panel is used to freestand peninsulas, curvilinear shapes, and D-Tops in panel applications.

Corner Desk Legs **C**

Corner desk legs have a 90-degree bend and welded construction. The strong construction allows gussets or half-height modesty panels to be used with corner legs.

Bridge Kits **B**

Bridge kits include: two flat brackets, two modesty panel-to-end panel attachment brackets, and two tie straps. This kit is used when attaching a bridge unit between two rectangular worksurfaces.

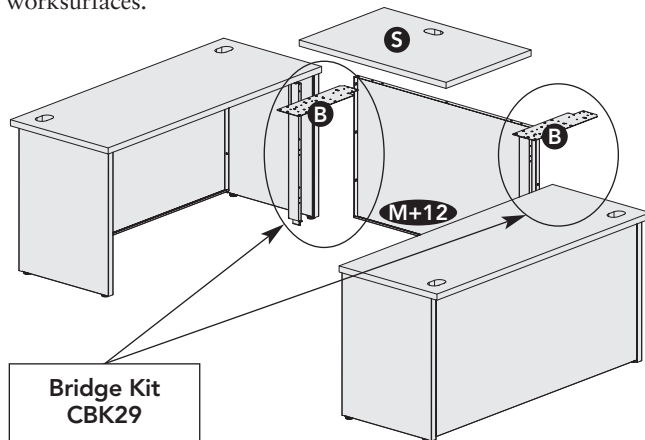

Return Kits **R**

Return kits include: one flat bracket, one modesty panel-to-end panel attachment bracket, and one tie strap. These are used when attaching a return to a primary desk. Return kits can also be used in some bridge applications — one example is shown below when using a peninsula.

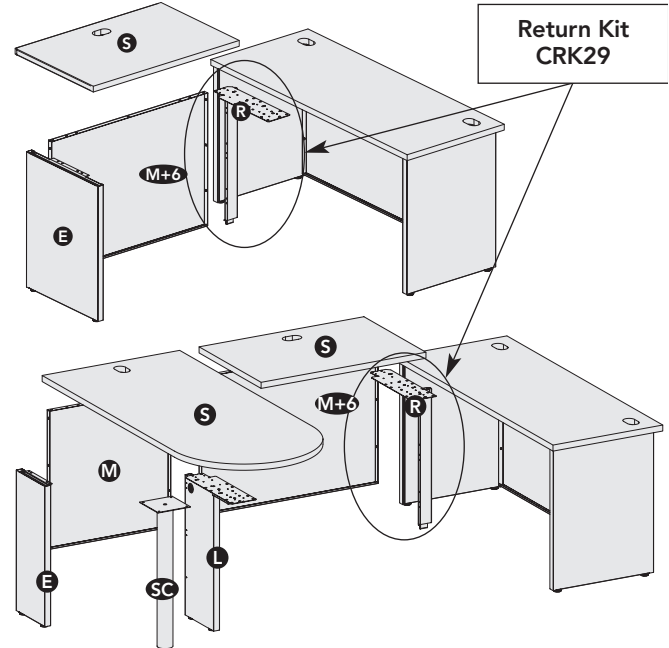

Desk-to-Panel Attachment Kits **D**

Desk-to-panel attachment kits are used to connect a worksurface and modesty panel perpendicular to a panel of corresponding width. Opposing end of worksurface must be attached with an end-panel, support leg or corner leg mounted directly under this worksurface.

When using a corner or corner cove worksurface with the rear corner attached to a panel, and opposing end of worksurface is attached to a freestanding desk — use corner w/desk attachment kit. “Hand” of unit is determined from the user’s side of the desk (right hand unit attaches to right side of modesty).

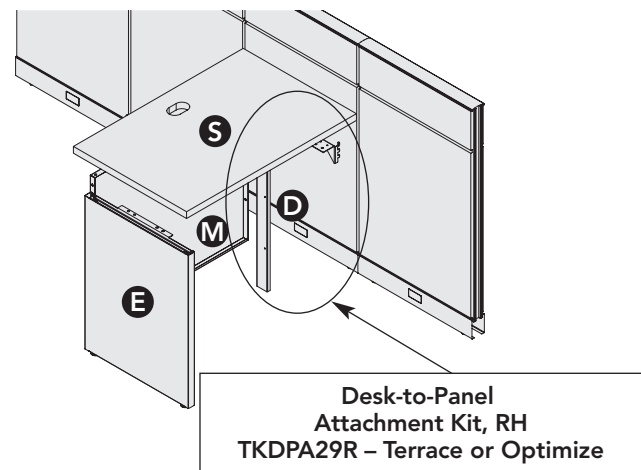

There are some bridge instances where only half of a bridge kit is needed (e.g. using a bridge between a rectangular worksurface and a corner or peninsula). A return kit may be ordered for these instances.

Surface **S**

Support Column **SC**

Used to support one end of curvilinear worksurfaces. Includes column, worksurface bracket kit T6BK, attaching hardware, and adjustable glides.

Corner w/Desk Panel Attachment Kit **CW**

Corner w/desk panel attachment kit connects the rear corner of a corner or corner cove worksurface and modesty panel to a panel when the opposing end of the worksurface shares a support leg with an adjacent freestanding desk and the support leg is mounted under the freestanding desk. “Hand” of unit is determined from the user’s side of the desk (left hand unit attaches to left side of modesty).

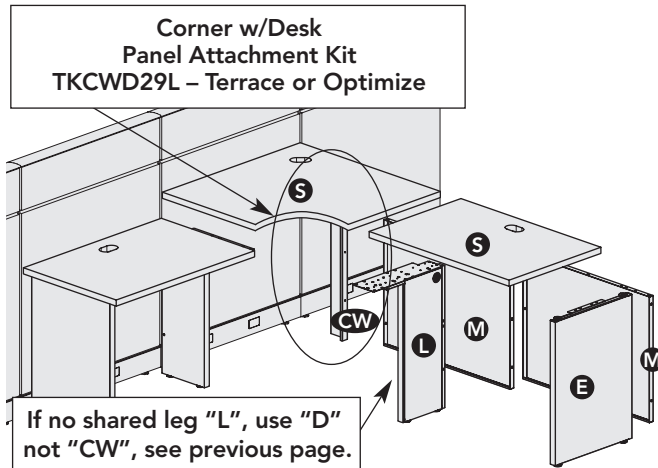

Corner Worksurfaces

Corner worksurfaces to accommodate 90-degree corner desk legs.

In-Line Connections of Desks

Freestanding full end panels must be used to support adjacent rectangular desks, corner desks, and corner desks with returns. Freestanding support legs should NOT be used at the in-line junction. 24" D full end panels may be used at the in-line junction on 30" D rectangular desks if two worksurface tie straps are used to secure the desks together. Contact Allsteel Customer Support for ordering information.

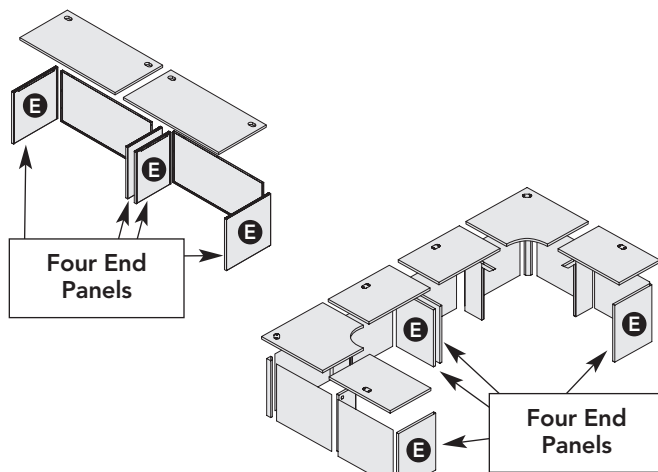

Pedestals and Storage

Pedestals must be ordered one size smaller than the depth of the worksurface. For example, 18" D or 20" D peds should be used with 24" D worksurfaces. 18" D, 20" D, or 23" D pedestals can be used with 30" D worksurfaces. Using 18" D laterals or personal files provide additional pull style and storage options under 24" D worksurfaces.

Modesty Panels **M**

The following are some general guidelines for Cadence modesty panels:

- **Desk:** Modesty panel width is the same width as the worksurface
- **Return:** Modesty panel width is 6" greater than the width of the worksurface
- **Bridge connecting two rectangular worksurfaces:** Modesty panel width is 12" greater than the width of the bridge worksurface
- **Bridge connecting a rectangular worksurface and corner or peninsula:** Modesty panel width is 6" greater than the width of the worksurface
- **Corner connecting to an adjacent worksurface:** Modesty panel width is the same width as the worksurface.

Stand-Alone Corner Modesty Panels **SM**

Stand-alone corner modesty panels are used only when one or both sides of a corner or corner cove worksurface are freestanding and NOT attached to another worksurface. Specify the width the same as the width of the worksurface.

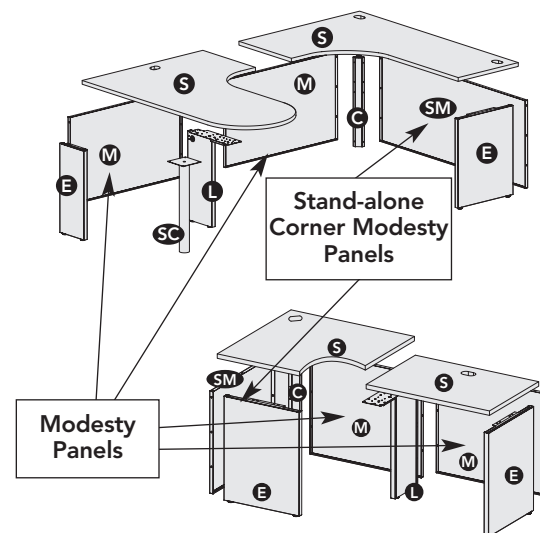

Gussets **G**

Gussets can be used in place of a modesty panel with desks 36" W to 60" W. Gussets can also be used with corner desk legs.

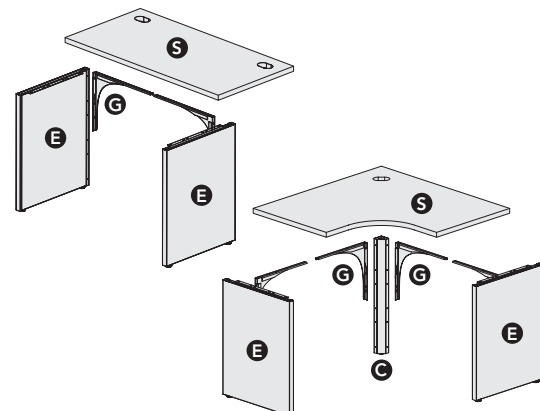

Configurations

Freestanding Desk

Example Shown		
Qty.	Model	Description
1	T52436S	Flat Edge Worksurface 24"D x 36"W
2	CEP2429F	End-Panel Support 24"D x 29½"H
1	CS369	Modesty Panel 36"W x 29½"H

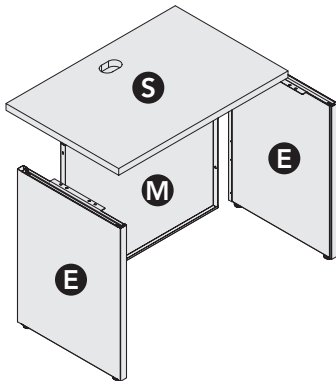

Panel-Attached Desk

Example Shown		
Qty.	Model	Description
1	T52436S	Flat Edge Worksurface 24"D x 36"W
1	CEP2429F	End-Panel Support 24"D x 29½"H
1	CS369	Modesty Panel 36"W x 29½"H
1	□DPA29R	Desk-to-Panel Attachment Kit 29½"H – RH C – Concensys® TK – Terrace or Optimize™

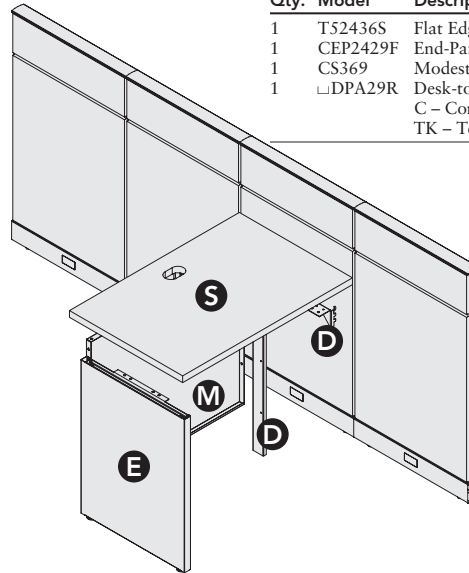

CONFIGURATION OPTIONS	Work-surface (S)	End-Panel Support (E)	Desk Support Leg (L)	Modesty Panel			Desk-to-Panel Attachment Kit (D)	Corner Desk Leg (C)
				Same width as Work-surface (M)	6" wider than Work-surface (M+6)	12" wider than Work-surface (M+12)		
Freestanding Desk	1	2		1				
Panel-Attached Desk	1	1		1			1 RH	

Return Desk (Attached to a primary or return desk.)

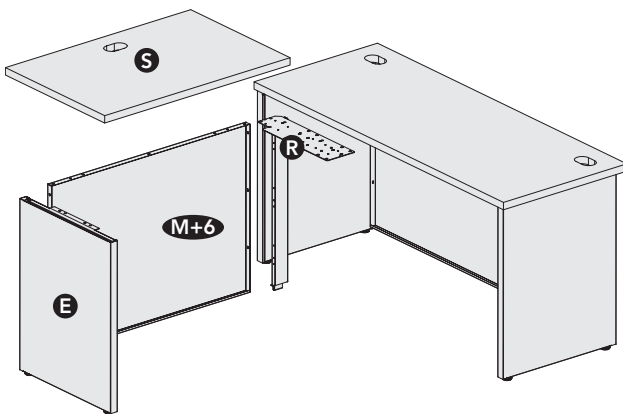

Example Shown		
Qty.	Model	Description
1	T52436S	Flat Edge Worksurface 24"D x 36"W
1	CS429	Modesty Panel 42"W x 29½"H
1	CEP2429F	End-Panel Support 24"D x 29½"H
1	CRK29	Return Kit

Note: The widest modesty panel is 72"W which limits return worksurfaces to a maximum of 66"W.

Return Desk (Attached to a panel-hung worksurface.)

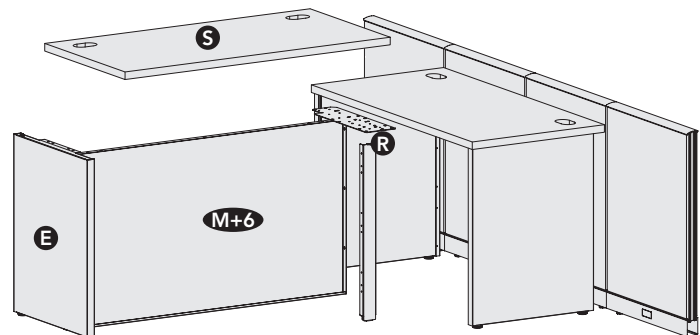

Example Shown		
Qty.	Model	Description
1	T52448S	Flat Edge Worksurface 24"D x 48"W
1	CS549	Modesty Panel 54"W x 29½"H
1	CEP2429F	End-Panel Support 24"D x 29½"H
1	CRK29	Return Kit

CONFIGURATION OPTIONS	Work-surface (S)	End-Panel Support (E)	Desk Support Leg (L)	Modesty Panel			Desk-to-Panel Attachment Kit (D)	Corner Desk Leg (C)	Return Kit (R)
				Same width as Work-surface (M)	6" wider than Work-surface (M+6)	12" wider than Work-surface (M+12)			
Return Desk	1	1			1				1

Configurations

Bridge Desk (Attached between two primary desks.)

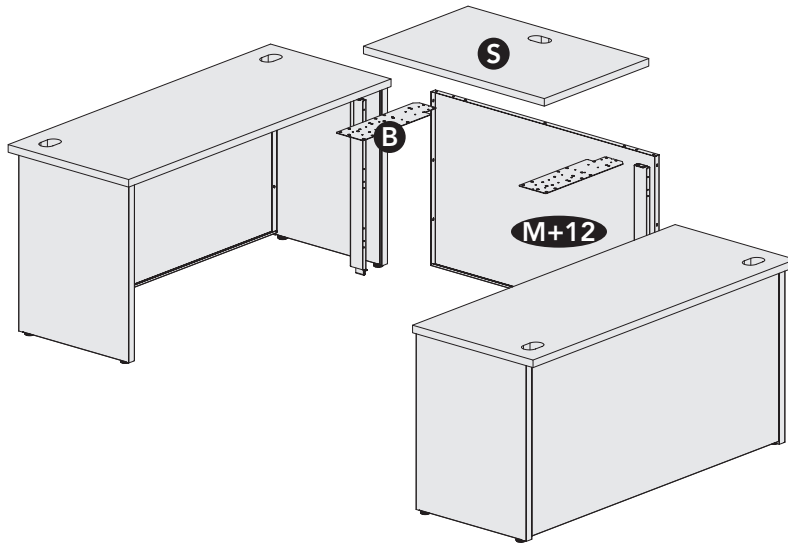

Example Shown

Qty.	Model	Description
1	T52442S	Flat Edge Worksurface 24"D x 42"W
1	CS549	Modesty Panel 54"W x 29½"H
1	CBK29	Bridge Kit

CONFIGURATION	Work-surface (S)	End-Panel Support (E)	Desk Support Leg (L)	Modesty Panel			Desk-to-Panel Attachment Kit (D)	Corner Desk Leg (C)	Bridge Kit (B)
				Same width as Work-surface (M)	6" wider than Work-surface (M+6)	12" wider than Work-surface (M+12)			
Bridge Desk	1					1			1

Bridge Desk and Peninsula (Attached to a primary desk).

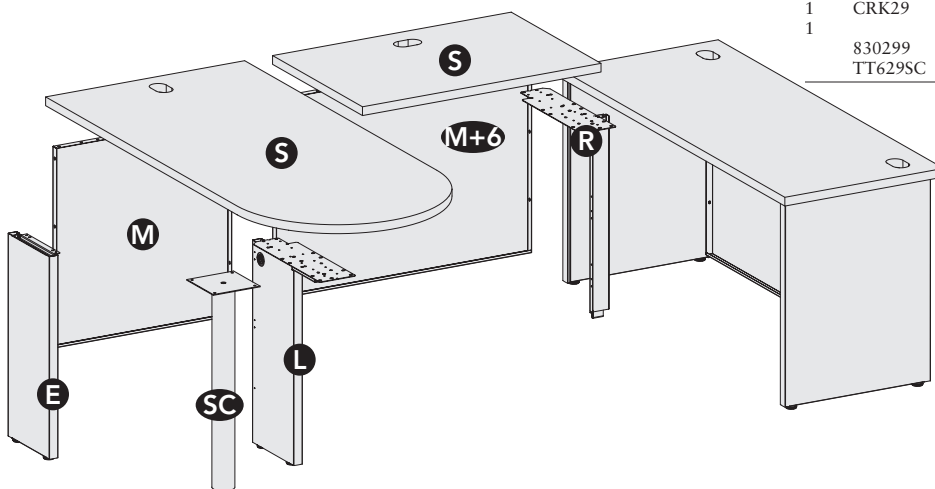

Example Shown

Qty.	Model	Description
1	T52442S	Flat Edge Worksurface 24"D x 42"W
1	T53060B	Flat Edge Peninsula Worksurface 30"W x 60"L
1	CS489	Modesty Panel 48"W x 29½"H
1	CS309	Modesty Panel 30"W x 29½"H
1	CEP1129F	End-Panel Support 11"D x 29½"H
1	CSL2429F	Support Leg 24"D x 29½"H
1	CRK29	Return Kit
1	830299	Support Column for Peninsula Worksurface 29½"H (Concensys®)
1	TT629SC	(Terrace or Optimize™)

CONFIGURATION OPTION	Work-surface (S)	End-Panel Support (E)	Desk Support Leg (L)	Modesty Panel			Desk-to-Panel Attachment Kit (D)	Support Column (SC)	Return Kit (R)
				Same width as Work-surface (M)	6" wider than Work-surface (M+6)	12" wider than Work-surface (M+12)			
Bridge Desk and Peninsula	2	1	1	1	1			1	1

Configurations

Corner Desk (Stand-alone)

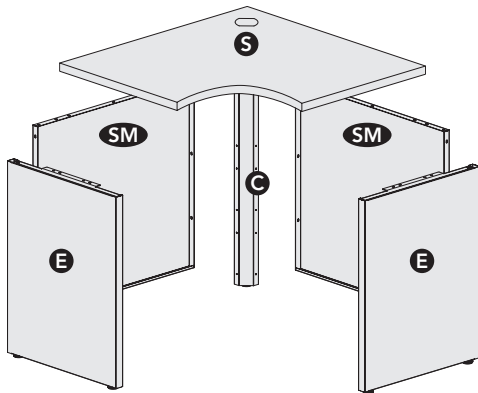

Qty.	Model	Description
1	T53624CR	Flat Edge Worksurface 24"D x 36"W (<i>De-emphasized</i>)
2	CSCMP3629	Stand-Alone Corner Modesty Panel 36"W x 29½"H
2	CEP2429F	End-Panel Support 24"D x 29½"H
1	CDL29	Corner Desk Leg 29½"H

Corner Desk (With an adjacent desk attached at one side.)

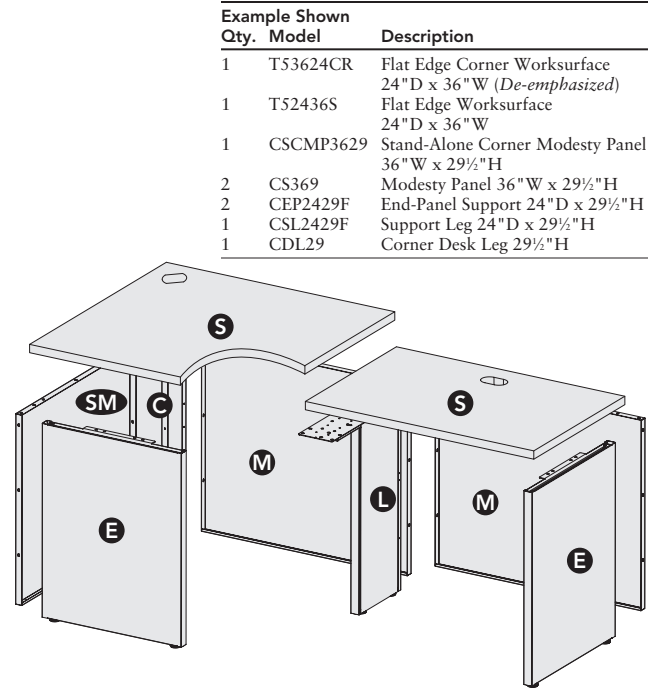

Qty.	Model	Description
1	T53624CR	Flat Edge Corner Worksurface 24"D x 36"W (<i>De-emphasized</i>)
1	T52436S	Flat Edge Worksurface 24"D x 36"W
1	CSCMP3629	Stand-Alone Corner Modesty Panel 36"W x 29½"H
2	CS369	Modesty Panel 36"W x 29½"H
2	CEP2429F	End-Panel Support 24"D x 29½"H
1	CSL2429F	Support Leg 24"D x 29½"H
1	CDL29	Corner Desk Leg 29½"H

CONFIGURATION OPTION	Work-surface (S)	End-Panel Support (E)	Desk Support Leg (L)	Modesty Panel		Stand-Alone Corner Modesty Panel	Desk-to-Panel Attachment Kit (D)	Corner Desk Leg (C)
				Same width as Work-surface (M)	6" wider than Work-surface (M+6)			
Corner Desk	1	2				2		1
Corner Desk (with adjacent desk)	2	2	1	2		1		1

Bridge Desk (Attached between corner and primary desk.)

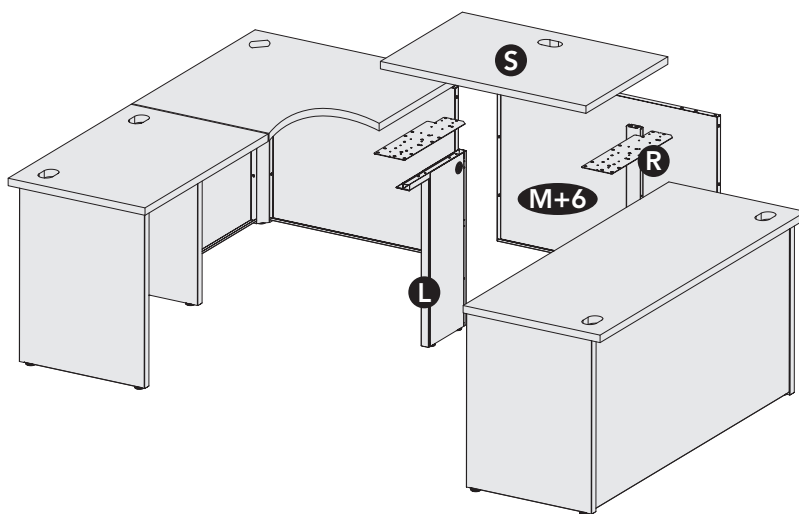

Qty.	Model	Description
1	T52436S	Flat Edge Worksurface 24"D x 36"W
1	CS429	Modesty Panel 42"W x 29½"H
1	CRK29	Return Kit
1	CSL2429F	Support Leg 24"D x 29½"H

CONFIGURATION	Work-surface (S)	End-Panel Support (E)	Desk Support Leg (L)	Modesty Panel			Desk-to-Panel Attachment Kit (D)	Corner Desk Leg (C)	Return Kit (R)
				Same width as Work-surface (M)	6" wider than Work-surface (M+6)	12" wider than Work-surface (M+12)			
Bridge Desk	1		1		1				1

Configurations

Corner Desk (Attached to a panel with an adjacent desk at one side.)

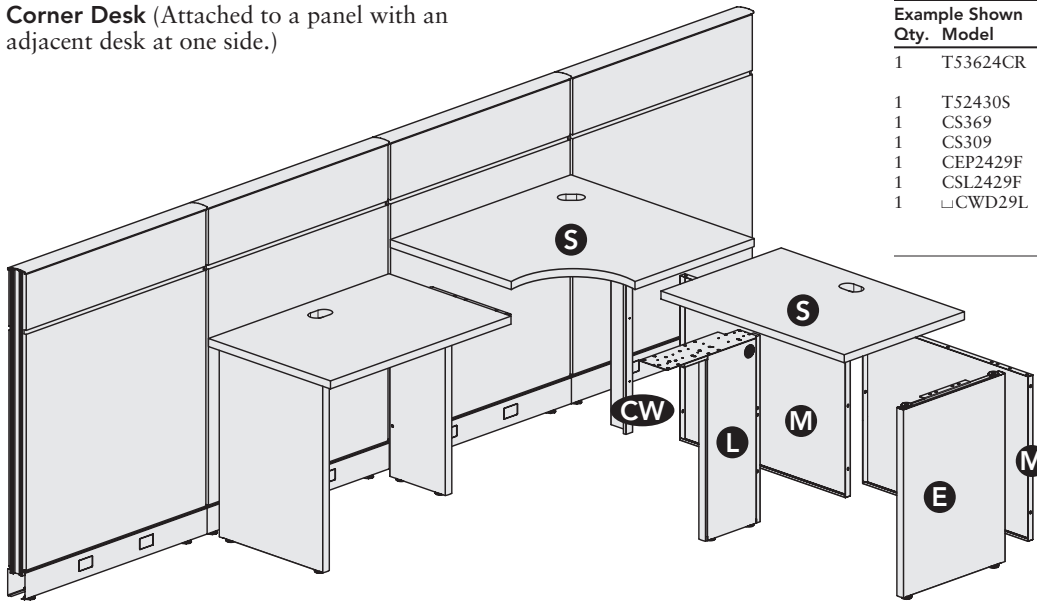

Example Shown		
Qty.	Model	Description
1	T53624CR	Flat Edge Corner Worksurface 36" W x 24" D (<i>De-emphasized</i>)
1	T52430S	Flat Edge Worksurface 24" D x 30" W
1	CS369	Modesty Panel 36" W x 29½" H
1	CS309	Modesty Panel 30" W x 29½" H
1	CEP2429F	End-Panel Support 24" D x 29½" H
1	CSL2429F	Support Leg 24" D x 29½" H
1	□CWD29L	Corner w/Desk Attachment Kit 29" H LH
C – Concensys®		
TK – Terrace or Optimize™		

CONFIGURATION	Work-surface (S)	End-Panel Support (E)	Desk Support Leg (L)	Modesty Panel			Desk-to-Panel Attachment Kit (D)	Corner Desk Leg (C)	Corner w/Desk Panel Attachment Kit (CW)
				Same width as Work-surface (M)	6" wider than Work-surface (M+6)	12" wider than Work-surface (M+12)			
Corner Desk	2	1	1	2					1 LH

"U" with Jetty and Corner Cove

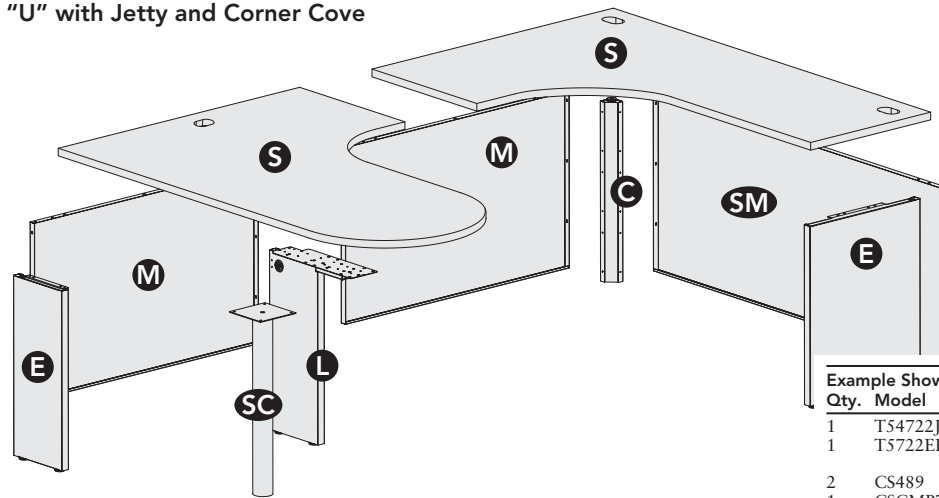

Example Shown		
Qty.	Model	Description
1	T54722JR	Flat Edge Jetty RH 48" D x 72" W x 24" x 30"
1	T5722ER	Flat Edge Corner Cove RH 48" D x 72" W x 24"
2	CS489	Modesty Panel 48" W x 29½" H
1	CSCMP7229	Stand-Alone Corner Modesty Panel 72" W x 29½" H
1	CEP1129F	End-Panel Support 11" D x 29½" H
1	CSL2429F	Support Leg 24" D x 29½" H
1	CEP2429F	Full End-Panel Support 24" D x 29½" H
1	CDL29	Corner Desk Leg 29½" H
1	830299	Support Column for Jetty 29½" H (Concensys)
1	TT629SC	(Terrace or Optimize)

CONFIGURATION OPTION	Work-surface (S)	End-Panel Support (E)	Desk Support Leg (L)	Modesty Panel		Stand-Alone Corner Modesty Panel Same width as Work-surface (SM)	Support Column (SC)	Corner Desk Leg (C)
				Same width as Work-surface (M)	6" wider than Work-surface (M+6)			
Cove and Jetty	2	2	1	2		1	1	1

Cadence Supports

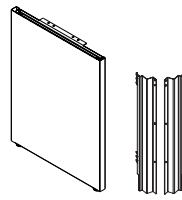

End-Panel Supports

End-Panel Supports (page 126)

- End panels are 1½" thick. For use at the end of worksurface runs.
- Levelers provide 1½" vertical adjustment.
- Freestanding models can be converted to Terrace panel-mount with end panel bracket kit.
- Must be connected into panel slots for panel hung applications.
- Straight worksurfaces adjacent to 120° and 135° connections must be supported by full end panels.
- 11"D models for use with D-shaped worksurfaces or curvilinear shaped worksurfaces in freestanding applications.

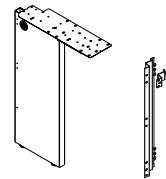

Support Leg

Support Legs (page 126)

- Support legs are non-handed. Supports the junction of two worksurfaces.
- Leg portion is 12¼"D and is 1½" thick.
- Flat bracket included.
- Levelers provide 2¾" vertical adjustment.
- Freestanding models can be converted to Terrace panel-mount with support leg bracket (non-handed).
- Must be connected into panel slots for panel hung applications.

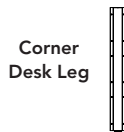

Corner Desk Leg

Corner Desk Leg (page 126)

- Attaches two modesty panels at rear of corner desk.
- Leveler provides 2¾" vertical adjustment.
- See examples on pages 110 and 111.



Bridge Kit

Bridge Kit (page 126)

- Connects bridge worksurface and modesty panel to end panels and worksurfaces that are perpendicular to the bridge worksurface.
- Includes two flat brackets and two modesty panel-to-end-panel brackets.
- See examples on pages 106 and 109.

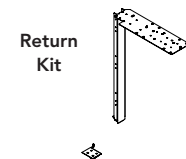

Return Kit

Return Kit (page 126)

- Connects return worksurface and modesty panel to end panel and perpendicular worksurface — non-handed.
- Includes one flat brackets and one modesty panel-to-end-panel bracket.
- See examples on pages 106 and 108.

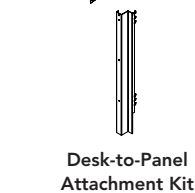

Desk-to-Panel Attachment Kit

Desk-to-Panel Attachment Kits for Terrace (page 126)

- Used to connect a worksurface and modesty panel perpendicularly to a Terrace Panel of corresponding width. Opposing end of worksurface must be attached with an end-panel, support leg or corner leg mounted directly under this worksurface.
- If using corner or corner cove with the rear corner attached to a panel, and opposing end of worksurface is attached to a freestanding desk — use corner w/desk panel attachment kit.
- “Hand” of unit is determined from the user’s side of the desk (left hand unit attaches to left side of modesty).

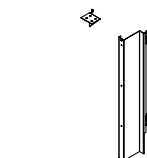

Corner w/Desk Attachment Kit

Corner w/Desk Panel Attachment Kit for Terrace (page 126)

- Used when the rear corner of a corner or corner cove worksurface and modesty panel is attached to a Terrace panel and opposing end of worksurface is attached to a freestanding desk. Opposing end of worksurface shares the support leg that is mounted under the adjacent freestanding desk.
- “Hand” of unit is determined from the user’s side of the desk.

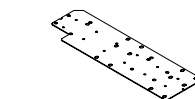

Flat Bracket

Flat Brackets (page 126)

- Bracket and attaching hardware.
- Can be used to connect one worksurface perpendicular to another worksurface.

Wall Track, Tile attachment Kits, Modesty Panels, and Gussets

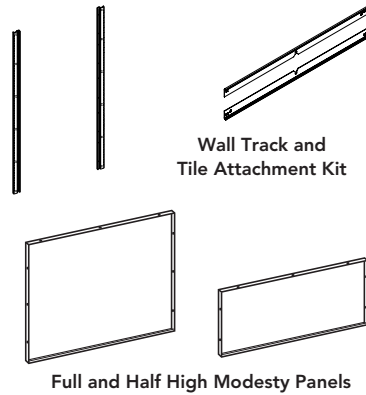

Terrace Wall Track/Tile Attachment Kits (page 126)

- Allows for mounting of system panel components on permanent wall structures.
- Begin with one pair of ends; for multiple kits in line, add middle unit(s) between ends.
- Height of wall track coordinates with panel height. Field cut for lower heights.
- Wall track will add 1" to depth of attached components.
- Use Terrace wall track tile attachment kit to install tiles onto wall track. Kit includes two tile bars. Top bar may only be used in the top uppermost position on wall track. Bottom bar can be used in the bottom position at any location on wall track.
- When segmenting tiles on wall track, segment bars must be ordered for placement between all vertically adjacent tiles or at the top position of a single tile that is not in the uppermost position.
- When using Terrace wall track and using tiles to create a tackboard situation under overheads hung at 65"H, make sure to use a 30"H tile or 2-15"H tiles to cover the entire area between the overheads and the worksurface.

Freestanding Pedestals

- Can also be used to support one end of a panel-attached worksurface in conjunction with worksurface bracket.

Freestanding Desks

- **Freestanding desks** can be created by combining primary and corner worksurfaces with modesty panels and appropriate desk supports. See pages 105-111.

Pedestal Compatibility with Cadence and Panel-hung Worksurfaces

Cadence Desking	24" Deep	30" Deep
18"D Ped	Yes	Yes
19 ⁷ / ₈ "D Ped	Yes*	Yes
23 ³ / ₈ "D Ped		Yes
29 ³ / ₈ "D Ped		
Systems Panel-hung	24" Deep	30" Deep
18"D Ped	Yes	Yes
19 ⁷ / ₈ "D Ped	Yes*	Yes
23 ³ / ₈ "D Ped	Yes*	Yes
29 ³ / ₈ "D Ped		Yes*

*Wire management grommet is blocked in these applications.

Note: Pedestal placement may affect access to receptacles in base pathway.

Modesty Panel (page 127)

- Mounts to end-panel supports, desk support legs, bridge kit, return kit, desk-to-panel, and corner w/desk panel attachment kits.
- 29¹/₂"H units provide 3/4" of space between bottom of modesty panel and floor.
- Actual width of 29¹/₂"H modesty panel is 3/4" less than the nominal dimension listed in the Systems Price List.
- 14"H units provide 14/4" of space between bottom of modesty panel and floor.
- Refer to pages 105-111 to select proper width.
- Use 14"H modesty panels for desks positioned against a wall to provide access to electrical receptacles.
- 14"H modesty panels, stand-alone corner modesty panels, or gussets can be used with corner or corner cove worksurfaces.

Stand-alone Corner Modesty Panel (page 127)

- 29¹/₂"H units provide 3/4" of spacing between bottom of panel and floor.
- 14"H units provide 14/4" of space between bottom of modesty panel and floor.
- Actual width of modesty panel is 6¹/₁₆" less than the nominal dimension listed in the Systems Price List.
- Modesty panels are inset 2⁷/₈"; when adding pedestals consult chart at left.

Pedestal-to-Pedestal Modesty Panels (page 127)

- Widths available to work with 60"W, 66"W, and 72"W worksurfaces to create freestanding double pedestal desk using two medal support pedestals.

Gussets (page 127)

- Provides easy access to wall outlets.
- Cannot be used with suspended pedestals.
- Gussets can be used on corner and corner cove worksurfaces.

Universal Modesty Panel (page 127)

- Mounts under peninsula, P-Shape and jetty worksurfaces. Refer to chart below to select proper width.
- Can be used with panel-mounted and freestanding worksurfaces.
- Provides 8¹/₂" of privacy and is non-handed.
- Constructed of steel. No upcharge for P2 paint.
- Only requires attachment to the worksurface.
- Does not provide electrical, data or structural support.
- Panel is 1¹/₂" thick and can be mounted at various distances from edge of worksurface based on user's preference for clearance and conferencing requirements.

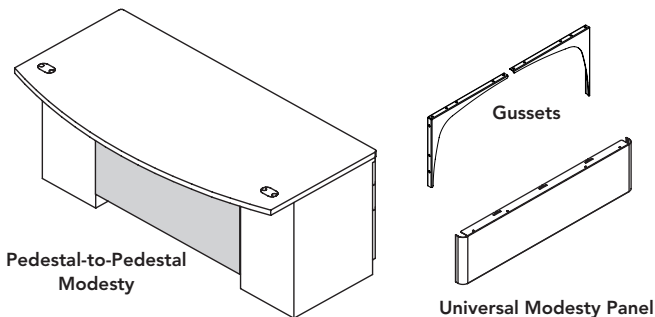

Universal Modesty Panels

Model	Peninsula			P-Shape	Jetty	
	60"L	66"L	72"L	72"L	66"L	72"L
PMP41	•					
PMP47		•		•	•	
PMP53			•			•

Worksurfaces

Terrace® — Primary

Laminate

GSA SIN 33721

For specification information see pages 99-104
For non-standard worksurface sizes see page 122.

Description	Laminate w/Flat Edge Model	Laminate w/Flat Edge		
		L1 List Price	L2 List Price	L3 List Price
24"D Primary Worksurfaces				
24"W	T52424S	\$ 407	\$ 426	\$ 441
30"W	T52430S	\$ 429	\$ 449	\$ 465
36"W	T52436S	\$ 484	\$ 505	\$ 524
42"W	T52442S	\$ 540	\$ 562	\$ 583
48"W	T52448S	\$ 586	\$ 611	\$ 631
54"W	T52454S	\$ 633	\$ 662	\$ 681
60"W	T52460S	\$ 718	\$ 749	\$ 771
66"W	T52466S	\$ 781	\$ 814	\$ 839
72"W	T52472S	\$ 815	\$ 849	\$ 874
78"W	T52478S	\$ 1058	\$ 1100	\$ 1136
84"W	T52484S	\$ 1109	\$ 1153	\$ 1191
90"W	T52490S	\$ 1310	\$ 1359	\$ 1406
96"W	T52496S	\$ 1370	\$ 1422	\$ 1472
30"D Primary Worksurfaces				
24"W	T53024S	\$ 429	\$ 449	\$ 465
30"W	T53030S	\$ 517	\$ 539	\$ 559
36"W	T53036S	\$ 556	\$ 579	\$ 600
42"W	T53042S	\$ 599	\$ 624	\$ 645
48"W	T53048S	\$ 633	\$ 662	\$ 681
54"W	T53054S	\$ 707	\$ 738	\$ 760
60"W	T53060S	\$ 787	\$ 820	\$ 845
66"W	T53066S	\$ 850	\$ 886	\$ 912
72"W	T53072S	\$ 922	\$ 960	\$ 989
78"W	T53078S	\$ 1197	\$ 1243	\$ 1287
84"W	T53084S	\$ 1251	\$ 1298	\$ 1344
90"W	T53090S	\$ 1492	\$ 1548	\$ 1603
96"W	T53096S	\$ 1540	\$ 1597	\$ 1655



- Notes:**
- 1) Add suffix and upcharge for primary worksurfaces up to 72"W to span a "T" or extended straight connection.
Suffix = T2 (Terrace — adds 2 3/8" to width) \$39 upcharge.
Examples: **T53030ST2**, **T52460ST2**
 - 2) Add Suffix "N" to model number for no grommet, no upcharge. Example: **T53078SN**

Sample Worksurface

12"W x 12"D	831212M	\$ 381	\$ 398	\$ 411
-------------	---------	--------	--------	--------

Description	Model	List Price
External Worksurface Support Channel (no color option) — 1 1/2"H		
30"W External Support Channel for use on 42"W Worksurface	Z5SC42 S	\$ 86
36"W External Support Channel for use on 48"W Worksurface	Z5SC48 S	\$ 89
42"W External Support Channel for use on 54"W Worksurface	Z5SC54 S	\$ 102
48"W External Support Channel for use on 60"W Worksurface	Z5SC60	\$ 110
54"W External Support Channel for use on 66"W Worksurface	Z5SC66	\$ 128
60"W External Support Channel for use on 72"W Worksurface	Z5SC72	\$ 137
66"W External Support Channel for use on 78"W Worksurface	Z5SC78	\$ 150
72"W External Support Channel for use on 84"W Worksurface	Z5SC84	\$ 165

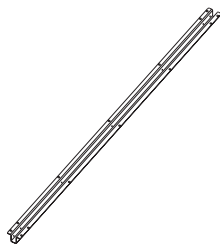

TERRACE

<p>How to specify — Select the Model Number from above. Suffix T2 T-Span for Terrace N No Grommets</p>	<p>1st Option: Laminate: See page 38 for finishes.</p>	<p>2nd Option: Edge Trim Color: See page 38 for finishes.</p>	<p>3rd Option: Grommet Type: P Oval Plastic (will match edge trim) M Oval Metal (Add \$13 per grommet) S Square Metal (Add \$13 per grommet)</p>	<p>4th Option: Grommet Color (Metal only): Oval: EL Matte Silver Square: EL Matte Silver</p>
--	--	---	--	--

Examples: T52424S.LT3B.E9.P Z5SC42

For specification information see pages 99-104.

Laminate

GSA SIN 33721



Description	S	Laminate w/Flat Edge Model	Laminate w/Flat Edge		
			L1 List Price	L2 List Price	L3 List Price
30"D Bow-Front Worksurfaces					
30"A x 36"B x 60"C		TT53660BT	\$ 1177	\$ 1223	\$ 1266
30"A x 36"B x 66"C		TT53666BT	\$ 1278	\$ 1326	\$ 1372
30"A x 36"B x 72"C		TT53672BT	\$ 1375	\$ 1427	\$ 1477

Note: Add Suffix "N" to model number for no grommet, no upcharge.



TERRACE

<p>How to specify — Select the Model Number from above.</p>	<p>1st Option: Laminate: See page 38 for finishes.</p>	<p>2nd Option: Edge Trim Color See page 38 for finishes.</p>	<p>3rd Option: Grommet Type: P Oval Plastic (will match edge trim) M Oval Metal (Add \$13 per grommet) S Square Metal (Add \$13 per grommet)</p>	<p>4th Option: Grommet Color (Metal only): EL Matte Silver</p>
<p>_____ . _____</p>	<p>_____ . _____</p>	<p>_____ . _____</p>	<p>_____</p>	<p>E L</p>

Examples: TT53660BT.LT3B.E9.MEL TT53660BTN.LT3B.E9P

Worksurfaces

Terrace® — Corner / 120° / 60°

For specification information see pages 99-104

Laminate

GSA SIN 33721

Description	Laminate w/Flat Edge Model	Laminate w/Flat Edge		
		L1 List Price	L2 List Price	L3 List Price
24"D Corner Worksurfaces w/Straight Leading Edge				
36"W	T53624SC	\$ 715	\$ 746	\$ 775
42"W	T54224SC	\$ 754	\$ 786	\$ 816
48"W	T54824SC	\$ 853	\$ 889	\$ 925
30"D Corner Worksurfaces w/Straight Leading Edge				
42"W	T54230SC	\$ 932	\$ 972	\$ 1010
48"W	T54830SC	\$ 964	\$ 1005	\$ 1044
60° Pie Worksurface				
24"D	TN52424SD	\$ 663	\$ 693	\$ 713
120° Corner Worksurface				
30"W x 24"D	TT53024CB	\$ 993	\$ 1035	\$ 1072
36"W x 24"D	TT53624CB	\$ 1105	\$ 1151	\$ 1194
42"W x 24"D	TT54224CB	\$ 1189	\$ 1237	\$ 1283
48"W x 24"D	TT54824CB	\$ 1317	\$ 1369	\$ 1420

Note: Add Suffix "N" to model number for no grommet, no upcharge.

Corner Worksurfaces with Radial Leading Edge

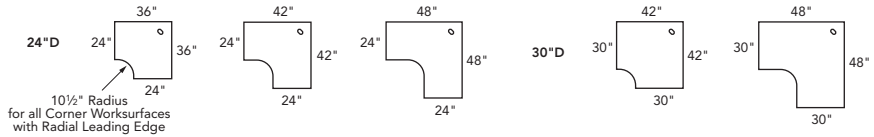

Corner Worksurfaces with Straight Leading Edge

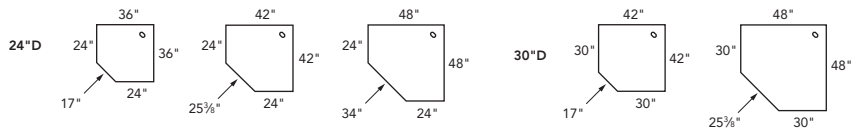

TERRACE

<p>How to specify — Select the Model Number from above.</p>	<p>1st Option: Laminate: See page 38 for finishes.</p>	<p>2nd Option: Edge Trim Color : See page 38 for finishes.</p>	<p>3rd Option: Grommet Type (if applicable): P Oval Plastic (will match edge trim) M Oval Metal (Add \$13 per grommet) S Square Metal (Add \$13 per grommet)</p>	<p>4th Option: Grommet Color (Metal only) (if applicable): Oval: EL Matte Silver Square: EL Matte Silver</p>
--	--	--	---	--

Examples: T53624SC.LT3B.E9.P TT53024CB.LT3B.E9.MEL

For specification information see pages 99-104

Laminate

GSA SIN 33721



Description	Laminate w/Flat Edge Model	Laminate w/Flat Edge		
		L1 List Price	L2 List Price	L3 List Price
Corner Cove Worksurfaces – Extended Left				
60" x 36"-24"L / 24"R	T5822EL	\$ 856	\$ 894	\$ 927
60" x 36"-24"L / 30"R	T5832EL	\$ 897	\$ 937	\$ 970
60" x 48"-24"L / 24"R	T5622EL	\$ 959	\$ 1001	\$ 1036
60" x 48"-30"L / 24"R	T5623EL	\$ 1004	\$ 1047	\$ 1085
60" x 48"-24"L / 30"R	T5632EL	\$ 1004	\$ 1047	\$ 1085
60" x 48"-30"L / 30"R	T5633EL	\$ 1041	\$ 1085	\$ 1125
72" x 36"-24"L / 24"R	T5922EL	\$ 959	\$ 1001	\$ 1036
72" x 36"-24"L / 30"R	T5932EL	\$ 1004	\$ 1047	\$ 1085
72" x 48"-24"L / 24"R	T5722EL	\$ 1243	\$ 1292	\$ 1339
72" x 48"-30"L / 24"R	T5723EL	\$ 1288	\$ 1338	\$ 1390
72" x 48"-24"L / 30"R	T5732EL	\$ 1288	\$ 1338	\$ 1390
72" x 48"-30"L / 30"R	T5733EL	\$ 1326	\$ 1379	\$ 1432



Description	Laminate w/Flat Edge Model	Laminate w/Flat Edge		
		L1 List Price	L2 List Price	L3 List Price
Corner Cove Worksurfaces – Extended Right				
36" x 60"-24"L / 24"R	T5822ER	\$ 856	\$ 894	\$ 927
36" x 60"-30"L / 24"R	T5832ER	\$ 897	\$ 937	\$ 970
48" x 60"-24"L / 24"R	T5622ER	\$ 959	\$ 1001	\$ 1036
48" x 60"-24"L / 30"R	T5623ER	\$ 1004	\$ 1047	\$ 1085
48" x 60"-30"L / 24"R	T5632ER	\$ 1004	\$ 1047	\$ 1085
48" x 60"-30"L / 30"R	T5633ER	\$ 1041	\$ 1085	\$ 1125
36" x 72"-24"L / 24"R	T5922ER	\$ 959	\$ 1001	\$ 1036
36" x 72"-30"L / 24"R	T5932ER	\$ 1004	\$ 1047	\$ 1085
48" x 72"-24"L / 24"R	T5722ER	\$ 1243	\$ 1292	\$ 1339
48" x 72"-24"L / 30"R	T5723ER	\$ 1288	\$ 1338	\$ 1390
48" x 72"-30"L / 24"R	T5732ER	\$ 1288	\$ 1338	\$ 1390
48" x 72"-30"L / 30"R	T5733ER	\$ 1326	\$ 1379	\$ 1432

Note: Add Suffix "N" to model number for no grommet, no upcharge.

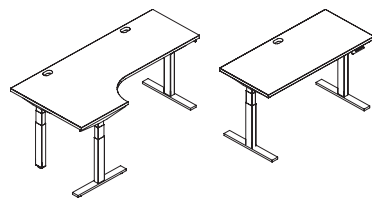

For Altitude® height-adjustable tables see the Seating, Collaboration, and Tables Price List.



<p>How to specify — Select the Model Number from above. Prefix T Laminate w/Flat 8 Laminate w/T-Mold</p>	<p>1st Option: Laminate: See page 38 for finishes.</p>	<p>2nd Option: Edge Trim Color : See page 38 for finishes.</p>	<p>3rd Option: Grommet Type: P Oval Plastic (will match edge trim) M Oval Metal (Add \$13 per grommet) S Square Metal (Add \$13 per grommet)</p>	<p>4th Option: Grommet Color (Metal only): Oval: EL Matte Silver Square: EL Matte Silver</p>
--	--	--	--	--

Examples: T5822EL.LT3B.E9.P T5622EL.LT3B.E9.MEL

For specification information see pages 99-104

Laminate



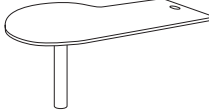
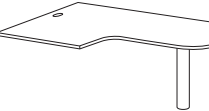
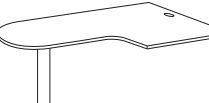

GSA SIN 33721

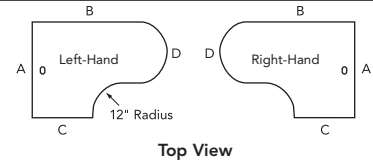
Support column ordered separately.	Description	Laminate w/Flat Edge Model	Laminate w/Flat Edge		
			L1 List Price	L2 List Price	L3 List Price
Peninsula Worksurfaces					
	30"W x 60"L	T53060B	\$ 1077	\$ 1120	\$ 1158
	30"W x 66"L	T53066B	\$ 1190	\$ 1236	\$ 1280
	30"W x 72"L	T53072B	\$ 1298	\$ 1347	\$ 1394
	36"W x 60"L	T53660B	\$ 796	\$ 845	\$ 892
	36"W x 66"L	T53666B	\$ 853	\$ 907	\$ 961
	36"W x 72"L	T53672B	\$ 964	\$ 1022	\$ 1084
P-Shaped Worksurfaces w/42" Diameter End					
	30"W x 72"L	T53072PR	\$ 1488	\$ 1544	\$ 1600
	30"W x 72"L (shown)	T53072PL	\$ 1488	\$ 1544	\$ 1600
Jetty Worksurfaces – Left-Hand					
	48"A x 66"B x 24"C x 30"D	T54662JL	\$ 1243	\$ 1296	\$ 1349
	48"A x 72"B x 24"C x 30"D	T54722JL	\$ 1326	\$ 1379	\$ 1433
	48"A x 66"B x 30"C x 30"D	T54663JL	\$ 1288	\$ 1342	\$ 1397
	48"A x 72"B x 30"C x 30"D	T54723JL	\$ 897	\$ 953	\$ 1009
Jetty Worksurfaces – Right-Hand					
	48"A x 66"B x 24"C x 30"D	T54662JR	\$ 1243	\$ 1296	\$ 1349
	48"A x 72"B x 24"C x 30"D	T54722JR	\$ 1326	\$ 1379	\$ 1433
	48"A x 66"B x 30"C x 30"D	T54663JR	\$ 1288	\$ 1342	\$ 1397
	48"A x 72"B x 30"C x 30"D	T54723JR	\$ 897	\$ 953	\$ 1009

Note: Add Suffix "N" to model number for no grommet, no upcharge.



TERRACE

<p>How to specify — Select the Model Number from above.</p>	<p>1st Option: Laminate: See page 38 for finishes.</p>	<p>2nd Option: Edge Trim Color : See page 38 for finishes.</p>	<p>3rd Option: Grommet Type: P Oval Plastic (will match edge trim) M Oval Metal (Add \$13 per grommet) S Square Metal (Add \$13 per grommet)</p>	<p>4th Option: Grommet Color (Metal only): Oval: EL Matte Silver Square: EL Matte Silver</p>
				

Examples: T53060B.LT3B.E9.P T54662JR.LT3B.EU.MEL

For specification information see pages [99-104](#)

Laminate

GSA SIN 33721



Support column ordered separately.

Description	Laminate w/Flat Edge Model	Laminate w/Flat Edge		
		L1 List Price	L2 List Price	L3 List Price
D-Shaped Worksurfaces – Half Round for Terrace				
For 2 - 24"D	TN524D	\$ 1066	\$ 1108	\$ 1145
For 2 - 30"D	TN530D	\$ 1240	\$ 1287	\$ 1332



Woodgrain Grain Direction

Quarter-Round Worksurfaces				
24"D x 24"D	TN52424Q	\$ 553	\$ 576	\$ 597
30"D x 30"D	TN53030Q	\$ 697	\$ 728	\$ 749

Note: Add Suffix "N" to model number for no grommet, no upcharge.

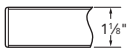

Flat Edge

TERRACE

<p>How to specify — Select the Model Number from above.</p>	<p>1st Option: Laminate: See page 38 for finishes.</p>	<p>2nd Option: Edge Trim Color: See page 38 for finishes.</p>
--	--	---

T|N|5| | | | | | | | | | . | | | | | | | | | | . | | |

Examples: TN524D.LT3B.E9 TN52424Q.LT3B.E9

For specification information see pages 99-104

Laminate

GSA SIN 33721

Description	Laminate w/Flat Edge Model	Laminate w/Flat Edge		
		L1 List Price	L2 List Price	L3 List Price
15"D Straight Countertops (order Raised Kit below)				
24"W	Y51524S	\$ 355	\$ 373	\$ 386
30"W	Y51530S	\$ 393	\$ 412	\$ 426
36"W	Y51536S	\$ 441	\$ 461	\$ 478
42"W	Y51542S	\$ 458	\$ 478	\$ 496
48"W	Y51548S	\$ 484	\$ 505	\$ 524
54"W	Y51554S	\$ 548	\$ 571	\$ 591
60"W	Y51560S	\$ 611	\$ 636	\$ 658
66"W	Y51566S	\$ 633	\$ 662	\$ 681
72"W	Y51572S	\$ 659	\$ 689	\$ 708
15"D Corner Countertops (order Raised Kit below)				
24"W x 24"W	Y52424C	\$ 692	\$ 723	\$ 744
30"W x 30"W	Y53030C	\$ 804	\$ 838	\$ 863
36"W x 36"W	Y53636C	\$ 892	\$ 929	\$ 958

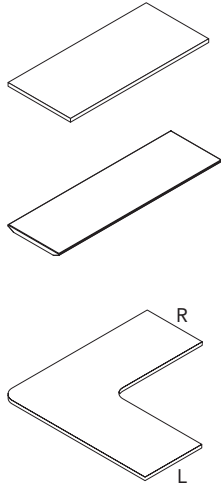

- Note:** **V** For a straight countertop, when used with "H" in-line high-low trim kit on one side. No upcharge.
Example: Y51530SV
- RV** For a corner countertop, when used with "H" in-line high-low trim kit on the right side. No upcharge.
Example: Y52424CRV
- LV** For a corner countertop, when used with "H" in-line high-low trim kit on the left side. No upcharge.
Example: Y53636CLV

Description	Flat Top Trim Painted Model	Radius Top Trim Model	Flat Painted Top Trim			Radius Painted Top Trim		
			P1 List Price	P2 List Price	P3 List Price	P1 List Price	P2 List Price	P3 List Price
Raised Straight Countertop Kits (order Countertop above)								
24"W	TK851524PF	TK851524P	\$ 149	\$ 172	\$ 192	\$ 180	\$ 205	\$ 227
30"W	TK851530PF	TK851530P	\$ 158	\$ 181	\$ 201	\$ 188	\$ 213	\$ 235
36"W	TK851536PF	TK851536P	\$ 165	\$ 188	\$ 208	\$ 197	\$ 222	\$ 244
42"W	TK851542PF	TK851542P	\$ 173	\$ 196	\$ 216	\$ 206	\$ 231	\$ 253
48"W	TK851548PF	TK851548P	\$ 182	\$ 205	\$ 225	\$ 217	\$ 242	\$ 264
54"W	TK851554PF	TK851554P	\$ 198	\$ 221	\$ 241	\$ 238	\$ 263	\$ 285
60"W	TK851560PF	TK851560P	\$ 215	\$ 238	\$ 258	\$ 259	\$ 284	\$ 306
66"W	TK851566PF	TK851566P	\$ 234	\$ 257	\$ 277	\$ 277	\$ 302	\$ 324
72"W	TK851572PF	TK851572P	\$ 252	\$ 275	\$ 295	\$ 298	\$ 323	\$ 345
Raised Corner Countertop Kits (order Countertop above)								
24"W		TK851524CP	N/A	N/A	N/A	\$ 230	\$ 255	\$ 277
30"W		TK851530CP	N/A	N/A	N/A	\$ 238	\$ 263	\$ 285
36"W		TK851536CP	N/A	N/A	N/A	\$ 248	\$ 273	\$ 295

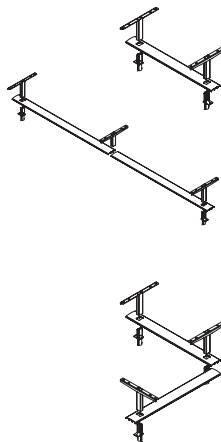

TERRACE

<p>How to specify — Select the Model Number from above.</p>	<p><i>1st Option:</i> Paint (Countertop Kit Supports) (if applicable):</p> <p>P1 P2 P3</p> <p>See page 38 for finishes.</p>	<p><i>1st Option:</i> Laminate or Veneer Type and Finish (if applicable):</p> <p>See page 38 for finishes.</p> <p>Veneer S prefix for Stratawood</p>	<p><i>2nd Option:</i> Edge Trim Color (if applicable):</p> <p>See page 38 for finishes.</p>
<p>_____ . P _____</p>			

Examples: T53030C.TM20.EN TK851524P.P02

ORDERING

The 9120 Program can be used to order particle board rectangular worksurfaces in any non-standard width and depth in 1/8" increments up to a maximum of 120" W x 36" D.

Specify:

- Model Number** (see page 123)
Specify closest nominal width/depth model (round up).
- Grommet Option** (if desired)
See grommet specification instructions on this page.
- Grommet Type:**
P Plastic
M Metal (add \$13 per grommet for laminate)
- Grommet Color:**
(Metal only)
EL Matte Silver
Note: Plastic grommet will match flat edge.
- Laminate and Veneer Choices**
See page 38.
- Flat Edge Color Choices**
See edge colors page 38 for laminates.
- Exact Size**
Specify the **exact width** and **exact depth** you require.
Width and depth is specified in 1/8" increments which is denoted as a single digit following the whole number dimension at the end of the model number string.

1/8" = 1	5/8" = 5
2/8" = 2	6/8" = 6
3/8" = 3	7/8" = 7
4/8" = 4	no extra increment = 0

For example, when ordering a worksurface that is 34 3/8" W x 20 1/2" D, specification should be 345Wx204D.
Example: 9120R3624.G0.TM33.EU.345Wx204D.

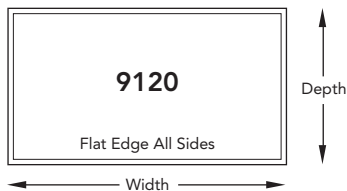

PRODUCT SPECIFICATIONS

- Flat edge on all sides
- 45 lb. particle board
- 1 1/8" top thickness
- .020 resin impregnated paper backer sheet
- Grommets available
- Maximum width 120" (maximum recommended unsupported span is 42")
- Maximum depth 36"
- Standard Allsteel laminates and veneers
- Quantities of 10 or greater are palletized; less than 10 are individually cartoned.

Note: 9120 worksurface maximum unsupported span is 42".
9120 worksurfaces do not have pre-drilled pilot holes or threaded metal inserts.

When spanning multiple freestanding storage units with one worksurface, add 1/8" for each additional storage unit. For example, when ordering a worksurface for three 30"W lateral files. 3 units x 30" = 90" + 1/8" + 1/8" = 90 1/4" worksurface. Do NOT follow this rule if panel wrapping storage units.

CHANGES / CANCELLATIONS

No changes/cancellations for 9120 Program worksurfaces.

GROMMET SPECIFICATIONS

Plastic grommets are made of durable ABS plastic and grommets match edge color on laminate worksurfaces. Metal grommets are only available Matte Silver oval for laminate and square for veneer.

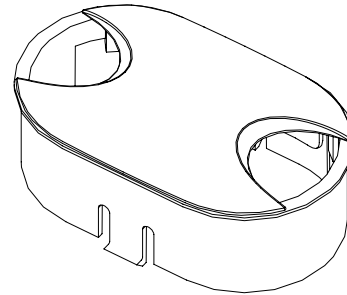

PRICING

See page 123 for laminate and veneer 9120 worksurface pricing.

One Grommet — GC, GL, or GR Position..... \$20.00
Two Grommets — G3 or G4 Position..... \$40.00

Note: Add \$13 per grommet for metal grommets with laminate.

ORDERING

Specify grommet location and color.

Example: 9120R10836.GCP.TM33.EU.1022Wx326D

Code Grommet Position

- GC Centered side-to-side — 3/8" from rear to grommet edge; 4 1/2" from rear to grommet center
- GL 6 1/16" from left side to grommet edge — 3/8" from rear to grommet edge; 4 1/2" from rear to grommet center
- GR 6 1/16" from right side to grommet edge — 3/8" from rear to grommet edge; 4 1/2" from rear to grommet center
- G3 Pair of grommets each 18" from side edge — 3/8" from rear to grommet edge; 4 1/2" from rear to grommet center (Position G3 not available on tops 60"W or less.)
- G4 Pair of grommets each 6 1/16" from side edge to grommet edge — 3/8" from rear to grommet edge; 4 1/2" from rear to grommet center
- G0 No grommets

Dimensions are from grommet center line to top edge.

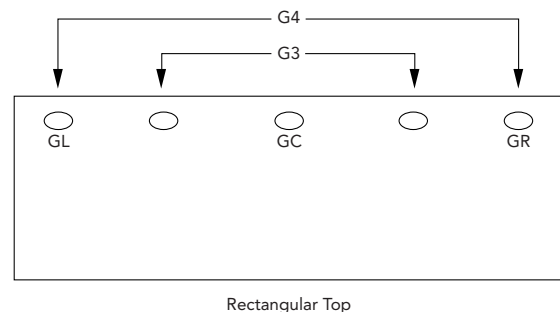

Grommet positions other than those shown above are considered non-standard.

Worksurfaces

Terrace® — 9120 Program

For specification information see page 122.

Laminate and Veneer Worksurfaces / Non-Standard Sizes

GSA SIN 33721

*Model Number — Add "R" for laminate or "V" for veneer

Maximum	Model Number*	Width		Depth		Laminate List Price			Veneer List Price	
		MIN	MAX	MIN	MAX	L1	L2	L3	V2	V3
18"D										
18"W	9120□1818	180W	180W	121D	180D	\$ 468	\$ 489	\$ 506	\$ 1100	\$ 1200
24"W	9120□2418	181W	240W	121D	180D	\$ 489	\$ 510	\$ 529	\$ 1173	\$ 1280
30"W	9120□3018	241W	300W	121D	180D	\$ 535	\$ 557	\$ 576	\$ 1240	\$ 1353
36"W	9120□3618	301W	360W	121D	180D	\$ 556	\$ 579	\$ 600	\$ 1287	\$ 1404
42"W	9120□4218	361W	420W	121D	180D	\$ 643	\$ 668	\$ 690	\$ 1366	\$ 1490
48"W	9120□4818	421W	480W	121D	180D	\$ 709	\$ 740	\$ 762	\$ 1436	\$ 1566
60"W	9120□6018	481W	600W	121D	180D	\$ 925	\$ 962	\$ 990	\$ 1634	\$ 1782
72"W	9120□7218	601W	720W	121D	180D	\$ 1119	\$ 1161	\$ 1198	\$ 1779	\$ 1941
84"W	9120□8418	721W	840W	121D	180D	\$ 1463	\$ 1515	\$ 1569	\$ 1914	\$ 2088
96"W	9120□9618	841W	960W	121D	180D	\$ 1513	\$ 1567	\$ 1621	\$ 2070	\$ 2258
108"W	9120□10818	961W	1080W	121D	180D	\$ 1730	\$ 1790	\$ 1853	\$ 2090	\$ 2280
120"W	9120□12018	1081W	1200W	121D	180D	\$ 1877	\$ 1948	\$ 2018	\$ 2235	\$ 2438
24"D										
24"W	9120□2424	181W	240W	181D	240D	\$ 531	\$ 553	\$ 574	\$ 1151	\$ 1256
30"W	9120□3024	241W	300W	181D	240D	\$ 580	\$ 603	\$ 624	\$ 1207	\$ 1317
36"W	9120□3624	301W	360W	181D	240D	\$ 605	\$ 630	\$ 651	\$ 1273	\$ 1389
42"W	9120□4224	361W	420W	181D	240D	\$ 695	\$ 725	\$ 744	\$ 1342	\$ 1464
48"W	9120□4824	421W	480W	181D	240D	\$ 750	\$ 782	\$ 806	\$ 1476	\$ 1610
60"W	9120□6024	481W	600W	181D	240D	\$ 971	\$ 1009	\$ 1042	\$ 1687	\$ 1840
72"W	9120□7224	601W	720W	181D	240D	\$ 1162	\$ 1206	\$ 1244	\$ 1901	\$ 2074
84"W	9120□8424	721W	840W	181D	240D	\$ 1513	\$ 1567	\$ 1621	\$ 2070	\$ 2258
96"W	9120□9624	841W	960W	181D	240D	\$ 1488	\$ 1544	\$ 1600	\$ 2238	\$ 2441
108"W	9120□10824	961W	1080W	181D	240D	\$ 1780	\$ 1842	\$ 1907	\$ 2408	\$ 2627
120"W	9120□12024	1081W	1200W	181D	240D	\$ 1920	\$ 1992	\$ 2065	\$ 2469	\$ 2693
30"D										
30"W	9120□3030	241W	300W	241D	300D	\$ 638	\$ 667	\$ 686	\$ 1207	\$ 1317
36"W	9120□3630	301W	360W	241D	300D	\$ 671	\$ 701	\$ 721	\$ 1383	\$ 1509
42"W	9120□4230	361W	420W	241D	300D	\$ 715	\$ 746	\$ 768	\$ 1491	\$ 1626
48"W	9120□4830	421W	480W	241D	300D	\$ 774	\$ 807	\$ 832	\$ 1626	\$ 1774
60"W	9120□6030	481W	600W	241D	300D	\$ 1016	\$ 1056	\$ 1089	\$ 1892	\$ 2064
72"W	9120□7230	601W	720W	241D	300D	\$ 1161	\$ 1206	\$ 1247	\$ 2145	\$ 2340
84"W	9120□8430	721W	840W	241D	300D	\$ 1763	\$ 1828	\$ 1894	\$ 2284	\$ 2492
96"W	9120□9630	841W	960W	241D	300D	\$ 1805	\$ 1871	\$ 1939	\$ 2431	\$ 2652
108"W	9120□10830	961W	1080W	241D	300D	\$ 2033	\$ 2108	\$ 2186	\$ 2585	\$ 2820
120"W	9120□12030	1081W	1200W	241D	300D	\$ 2265	\$ 2350	\$ 2434	\$ 2859	\$ 3119
36"D										
36"W	9120□3636	301W	360W	301D	360D	\$ 911	\$ 948	\$ 978	\$ 1998	\$ 2180
42"W	9120□4236	361W	420W	301D	360D	\$ 1035	\$ 1077	\$ 1112	\$ 2133	\$ 2327
48"W	9120□4836	421W	480W	301D	360D	\$ 1163	\$ 1208	\$ 1249	\$ 2280	\$ 2487
60"W	9120□6036	481W	600W	301D	360D	\$ 1498	\$ 1551	\$ 1605	\$ 2286	\$ 2494
72"W	9120□7236	601W	720W	301D	360D	\$ 1764	\$ 1826	\$ 1889	\$ 2425	\$ 2645
84"W	9120□8436	721W	840W	301D	360D	\$ 2135	\$ 2210	\$ 2288	\$ 2471	\$ 2696
96"W	9120□9636	841W	960W	301D	360D	\$ 2188	\$ 2266	\$ 2343	\$ 2691	\$ 2936
108"W	9120□10836	961W	1080W	301D	360D	\$ 2426	\$ 2512	\$ 2601	\$ 2922	\$ 3188
120"W	9120□12036	1081W	1200W	301D	360D	\$ 2538	\$ 2632	\$ 2729	\$ 3159	\$ 3446

TERRACE

For specification information see pages [99-104](#)

Veneer
GSA SIN 33721

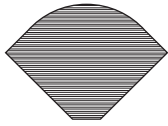

Stratawood Veneer
Grain Direction

Description	Veneer "V" Model	Veneer "V" V2 List Price
Quarter-Round Worksurfaces		
24"D x 24"D	TNV52424Q	\$ 1020
30"D x 30"D	TNV53030Q	\$ 1271

Note: Add Suffix "N" to model number for no grommet, no upcharge.



Veneer Edge

How to specify —
Select the
Model Number
from above.

1st Option:

**Veneer Type and
Finish:**

See page [38](#) for
finishes.

S prefix for Stratawood

T | | | | | | | | | | | | | | | | | | | | | | .

| | | | | | | | | | |

Example: TNV52424Q.SC777

For specification information see pages 99-104

GSA SIN 33721

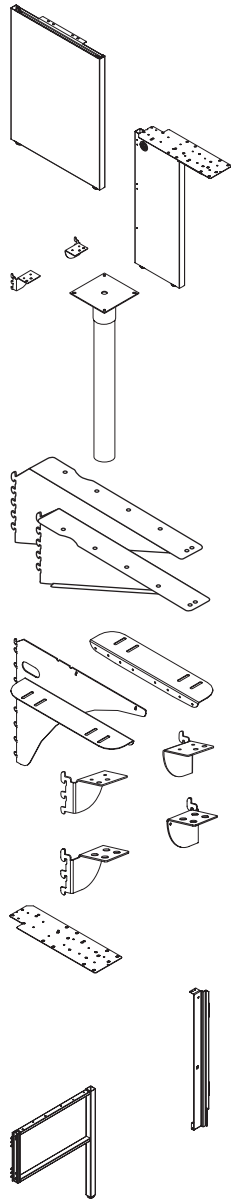

Description	Model	P1 Paint List Price	P2 Paint List Price	P3 Paint List Price
End-Panel Supports				
11"D x 29½"H — Left – Panel-Mount	TKEP1129PL	\$ 286	\$ 328	\$ 369
11"D x 29½"H — Right – Panel-Mount	TKEP1129PR	\$ 286	\$ 328	\$ 369
24"D x 29½"H — Left – Panel-Mount	TKEP2429PL	\$ 305	\$ 347	\$ 388
24"D x 29½"H — Right – Panel-Mount	TKEP2429PR	\$ 305	\$ 347	\$ 388
30"D x 29½"H — Left – Panel-Mount	TKEP3029PL	\$ 334	\$ 376	\$ 417
30"D x 29½"H — Right – Panel-Mount	TKEP3029PR	\$ 334	\$ 376	\$ 417
Support Legs				
24"D x 29½"H — Panel-Mount	TKSL2429P	\$ 269	\$ 311	\$ 352
30"D x 29½"H — Panel-Mount	TKSL3029P	\$ 294	\$ 336	\$ 377
Support Columns				
29½"H / 3"Diameter	TT629SC S	\$ 257	\$ 299	\$ 340
Cantilever Bracket — Terrace				
12"D Left-Hand	T6CB12L S	\$ 72	\$ 89	\$ 101
12"D Right-Hand	T6CB12R S	\$ 72	\$ 89	\$ 101
18"D Left-Hand	T6CB18L S	\$ 77	\$ 94	\$ 106
18"D Right-Hand	T6CB18R S	\$ 77	\$ 94	\$ 106
24" or 30"D Left-Hand	T6CB24L S	\$ 84	\$ 101	\$ 113
24" or 30"D Right-Hand	T6CB24R S	\$ 84	\$ 101	\$ 113
Cantilever Bracket — non-handed (Core P1 paint colors only)				
24" or 30"D	T624CB S	\$ 228	N/A	N/A
Worksurface Bracket Kit				
One pair	T6BK S	\$ 73	\$ 89	\$ 100
Worksurface Storage Bracket Kit (no color option — black only)				
One Pair	T6SB S	\$ 98	N/A	N/A
Flat Brackets (no color option)				
For 12"D	T612FB S	\$ 70	N/A	N/A
For 24"D	T624FB S	\$ 80	N/A	N/A
For 30"D	T630FB S	\$ 91	N/A	N/A
Pedestal-to-Panel Bracket				
Left	TKPPBL S	\$ 121	\$ 138	\$ 150
Right	TKPPBR S	\$ 121	\$ 138	\$ 150
Open End Panel Supports				
12"D x 29½"H Panel-Mount	AYBHEP1229	\$ 282	\$ 324	\$ 365
18"D x 29½"H Panel-Mount	AYBHEP1829	\$ 287	\$ 329	\$ 370
24"D x 29½"H Panel-Mount	AYBHEP2429	\$ 297	\$ 339	\$ 380
30"D x 29½"H Panel-Mount	AYBHEP3029	\$ 320	\$ 362	\$ 403

How to specify —
Select the Model Number from above.

1st Option:

Paint:
P1 P2 P3

See page 38 for finishes.

_____ . P _____

Example: TKEP1129PL.P02

S Shippable by small-package carrier.

For specification information see pages 105-113.

GSA SIN 33721

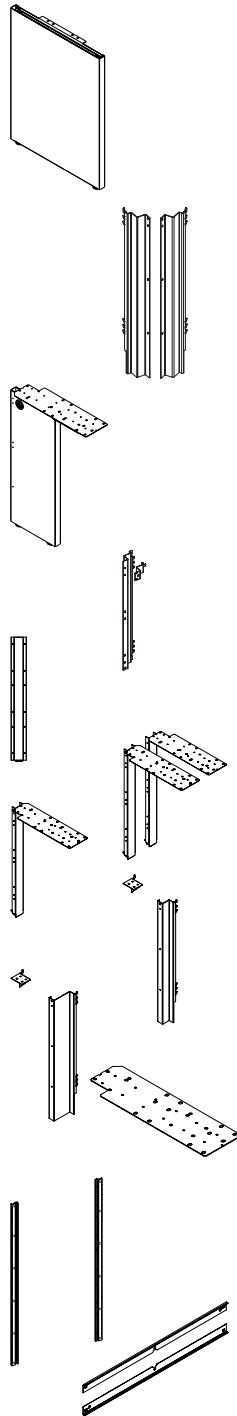

Description	Model	P1 Paint List Price	P2 Paint List Price	P3 Paint List Price
End-Panel Supports				
11"D x 29½"H — Freestanding	CEP1129F	\$ 277	\$ 319	\$ 360
24"D x 29½"H — Freestanding	CEP2429F	\$ 297	\$ 339	\$ 380
30"D x 29½"H — Freestanding	CEP3029F	\$ 329	\$ 371	\$ 412
<hr/>				
11"D x 29½"H — Left – Panel-Mount	TKEP1129PL	\$ 286	\$ 328	\$ 369
11"D x 29½"H — Right – Panel-Mount	TKEP1129PR	\$ 286	\$ 328	\$ 369
24"D x 29½"H — Left – Panel-Mount	TKEP2429PL	\$ 305	\$ 347	\$ 388
24"D x 29½"H — Right – Panel-Mount	TKEP2429PR	\$ 305	\$ 347	\$ 388
30"D x 29½"H — Left – Panel-Mount	TKEP3029PL	\$ 334	\$ 376	\$ 417
30"D x 29½"H — Right – Panel-Mount	TKEP3029PR	\$ 334	\$ 376	\$ 417
<hr/>				
End-Panel Bracket Kits for Terrace				
29½"H Bracket Kit — Left	TKEB29L	\$ 58	\$ 75	\$ 87
29½"H Bracket Kit — Right	TKEB29R	\$ 58	\$ 75	\$ 87
<hr/>				
Support Legs				
24"D x 29½"H — Freestanding	CSL2429F S	\$ 257	\$ 299	\$ 340
30"D x 29½"H — Freestanding	CSL3029F S	\$ 285	\$ 327	\$ 368
<hr/>				
24"D x 29½"H — Panel-Mount	TKSL2429P	\$ 269	\$ 311	\$ 352
30"D x 29½"H — Panel-Mount	TKSL3029P	\$ 294	\$ 336	\$ 377
<hr/>				
Support Leg Bracket for Terrace				
29½"H	TKSB29	\$ 58	\$ 75	\$ 87
<hr/>				
Corner Desk Leg				
29½"H	CDL29 S	\$ 236	\$ 261	\$ 283
<hr/>				
Bridge Kit				
29½"H	CBK29 S	\$ 248	\$ 265	\$ 277
<hr/>				
Return Kit				
29½"H	CRK29 S	\$ 127	\$ 140	\$ 149
<hr/>				
Desk-to-Panel Attachment Kits for Terrace				
29½"H – Left-Hand	TKDPA29L	\$ 115	\$ 132	\$ 144
29½"H – Right-Hand	TKDPA29R	\$ 115	\$ 132	\$ 144
<hr/>				
Corner w/Desk Panel Attachment Kit for Terrace				
29½"H – Left-Hand	TKCWD29L	\$ 115	\$ 132	\$ 144
29½"H – Right-Hand	TKCWD29R	\$ 115	\$ 132	\$ 144
<hr/>				
Flat Brackets				
24"D	831124 S	\$ 79	N/A	N/A
30"D	831130 S	\$ 86	N/A	N/A
Note: Flint only.				
<hr/>				
Terrace Wall Track Kit — End/Shared				
65"H — Pair of Ends	TK365YEB S	\$ 353	\$ 402	\$ 452
65"H — Middle Unit	TK365YM S	\$ 184	\$ 213	\$ 239
<hr/>				
Terrace Wall Track Tile Attachment Kits — Top and Bottom				
24"W	Y324YS S	\$ 261	N/A	N/A
30"W	Y330YS S	\$ 268	N/A	N/A
36"W	Y336YS S	\$ 287	N/A	N/A
42"W	Y342YS S	\$ 326	N/A	N/A
48"W	Y348YS S	\$ 359	N/A	N/A
60"W	Y360YS S	\$ 399	N/A	N/A

How to specify —
Select the Model Number from above.

1st Option:

Paint:



See page 38 for finishes.

P

Examples: CEP1129F.P02 Y324YS.P02

S Shippable by small-package carrier.

For specification information see pages 105-113.

GSA SIN 33721

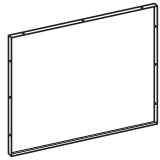

Description	Model	P1 Paint List Price	P2 Paint List Price	P3 Paint List Price
Modesty Panels				
29½"H x 24"W	CS249 <input type="checkbox"/>	\$ 268	\$ 293	\$ 315
29½"H x 30"W	CS309 <input type="checkbox"/>	\$ 277	\$ 302	\$ 324
29½"H x 36"W	CS369 <input type="checkbox"/>	\$ 283	\$ 308	\$ 330
29½"H x 42"W	CS429 <input type="checkbox"/>	\$ 289	\$ 314	\$ 336
29½"H x 48"W	CS489 <input type="checkbox"/>	\$ 294	\$ 319	\$ 341
29½"H x 54"W	CS549 <input type="checkbox"/>	\$ 297	\$ 322	\$ 344
29½"H x 60"W	CS609	\$ 302	\$ 327	\$ 349
29½"H x 66"W	CS669	\$ 307	\$ 332	\$ 354
29½"H x 72"W	CS729	\$ 319	\$ 344	\$ 366

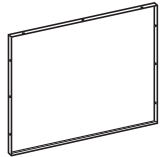

Stand-alone Corner Modesty Panels				
29½"H x 36"W	CSCMP3629 <input type="checkbox"/>	\$ 283	\$ 308	\$ 330
29½"H x 42"W	CSCMP4229 <input type="checkbox"/>	\$ 289	\$ 314	\$ 336
29½"H x 48"W	CSCMP4829 <input type="checkbox"/>	\$ 294	\$ 319	\$ 341
29½"H x 60"W	CSCMP6029	\$ 302	\$ 327	\$ 349
29½"H x 72"W	CSCMP7229	\$ 319	\$ 344	\$ 366

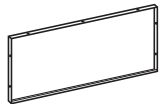

Modesty Panels				
14"H x 24"W	CS244 <input type="checkbox"/>	\$ 253	\$ 278	\$ 300
14"H x 30"W	CS304 <input type="checkbox"/>	\$ 258	\$ 283	\$ 305
14"H x 36"W	CS364 <input type="checkbox"/>	\$ 265	\$ 290	\$ 312
14"H x 42"W	CS424 <input type="checkbox"/>	\$ 272	\$ 297	\$ 319
14"H x 48"W	CS484 <input type="checkbox"/>	\$ 282	\$ 307	\$ 329
14"H x 54"W	CS544 <input type="checkbox"/>	\$ 285	\$ 310	\$ 332
14"H x 60"W	CS604	\$ 294	\$ 319	\$ 341
14"H x 66"W	CS664	\$ 297	\$ 322	\$ 344
14"H x 72"W	CS724	\$ 302	\$ 327	\$ 349

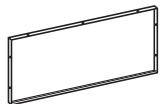

Stand-alone Corner Modesty Panels				
14"H x 36"W	CSCMP3614 <input type="checkbox"/>	\$ 265	\$ 290	\$ 312
14"H x 42"W	CSCMP4214 <input type="checkbox"/>	\$ 272	\$ 297	\$ 319
14"H x 48"W	CSCMP4814 <input type="checkbox"/>	\$ 282	\$ 307	\$ 329
14"H x 60"W	CSCMP6014	\$ 294	\$ 319	\$ 341
14"H x 72"W	CSCMP7214	\$ 302	\$ 327	\$ 349

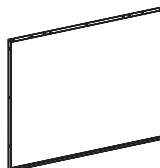

Pedestal-to-Pedestal Modesty Panel				
27"H x 30"W to create a 60"W Desk	TKMP60	\$ 259	\$ 284	\$ 306
27"H x 36"W to create a 66"W Desk	TKMP66	\$ 261	\$ 286	\$ 308
27"H x 42"W to create a 72"W Desk	TKMP72	\$ 270	\$ 295	\$ 317

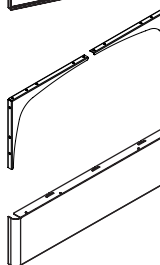

Gussets				
One pair	CDG <input type="checkbox"/>	\$ 193	\$ 218	\$ 240

Modesty Panels				
41"W for 60"L Peninsula	PMP41 <input type="checkbox"/>	\$ 371	\$ 371	\$ 371
47"W for 66"L Peninsula, 72"L P-Shape, or 66"L Jetty	PMP47 <input type="checkbox"/>	\$ 379	\$ 379	\$ 379
53"W for 72"L Peninsula, Jetty, or Boomerang	PMP53 <input type="checkbox"/>	\$ 391	\$ 391	\$ 391

How to specify —
Select the Model Number from above.

1st Option:

Paint:



See page 38 for finishes.

. P

Examples: TKMP60.P4J CS244.P28

Shippable by small-package carrier.

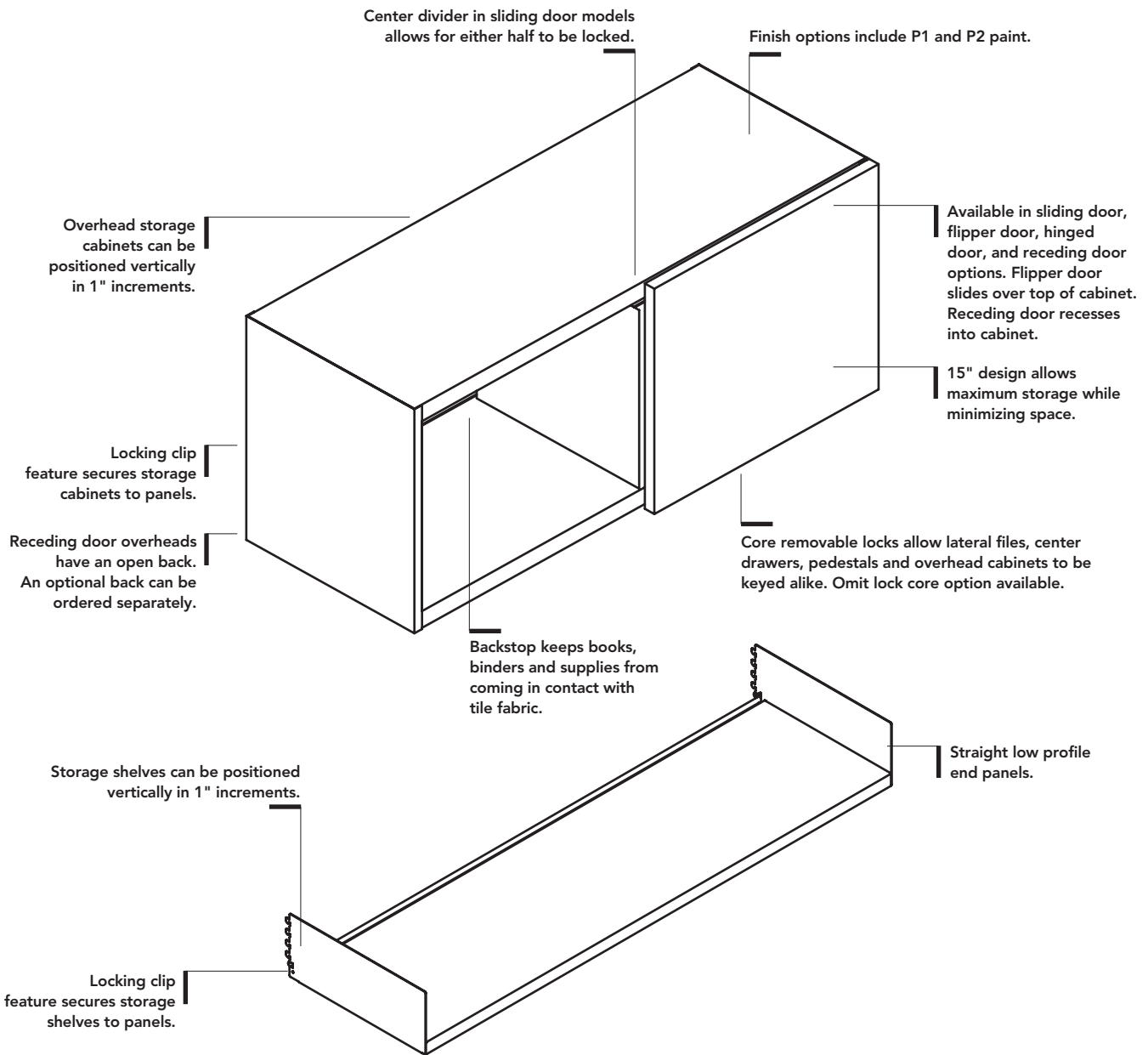

Product dimensions

Overhead Storage Cabinet

Width 24", 30", 36", 42", 48", 60"

Inside width Flipper or 24"-36" W Hinged door — 3/8" less than width
42"-48" W Hinged or Sliding door — two compartments that are half of 3/8" less than width

Depth 14 1/4" RTA models 12"

Inside depth 12 7/8" Receding door 12 1/2" RTA models 11 5/8"

Height 15"

Inside height 12 3/4" Receding door 11 5/8" RTA models 12 3/4"

Open Shelf

Width 24", 30", 36", 42", 48", 60"

Depth 12 7/8" RTA models 11 1/2"

Height 4 5/8" RTA models 5 5/8"

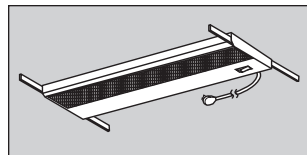

- **Task lights** can be mounted beneath storage shelves and overhead storage cabinets.
- Additional panel hung and freestanding lighting options are available.

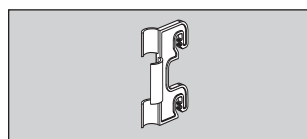

- **Cord retainer clips** fasten into panel slots to anchor power cords.
- Available in black only.
- Clips are provided with under-shelf mounted task lights. Additional clips can be purchased separately.

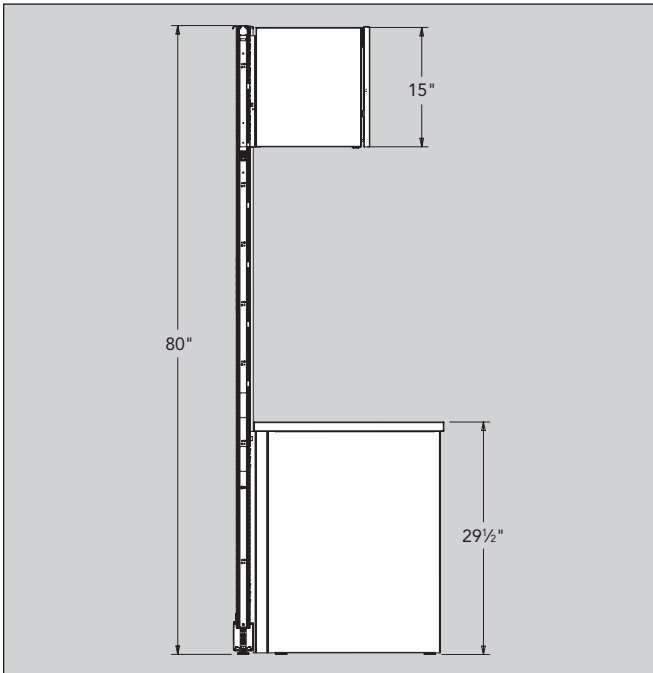
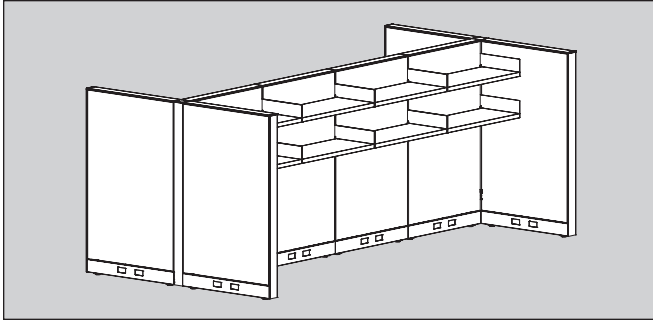

Specification Guidelines

- In a panel run, only two overhead storage cabinets or open storage shelves are recommended per panel side.
- Do not suspend more than one overhead storage unit per side from panels in a panel run which is mounted, at one or both ends, with an off-module connector kit.
- Overhead storage cabinets and open storage shelves can be mounted on Terrace structural and stacking panels to a maximum height of 80"H.
- When mounting an overhead on a 57½"H base panel frame, select the option for Z57 bracket.
- For all other base panel frame and base panel frames with stacking frames the YZ bracket should be selected.
- Base panel frames with stacking frames that have an overall height of 57½" also use the YZ bracket.

When overhead storage units are suspended from stacking frames, the following guidelines should be adhered to:

- Stacking frames should be added to all the parent run panels, and to, at least the first panel of each return-panel run. Stacking panels added to return panel must match the parent run configuration.
- A maximum of two overhead storage units should be suspended from each side of stacking frames on any given panel.
- With Terrace, a full height panel end cover is required for adequate stability when using overhead storage on the end of a run, or on a return panel.

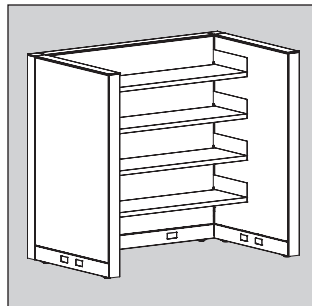

- No limitation to the number of units on structural frames when run is supported with return panels on each side of storage shelves or overhead storage cabinets.

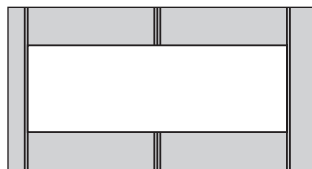

- **Storage shelf, receding door overhead, RTA overhead, and RTA shelf width** must correspond with width of panel(s).
- It is possible to span two panels when combined panel width equals cabinet or shelf width.

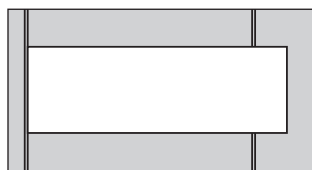

- **Terrace assembled metal overhead cabinets** can be mounted on a panel equal to or up to 18" narrower than cabinet using provided panel attachment brackets.

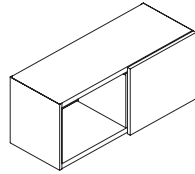

Sliding Door Overhead

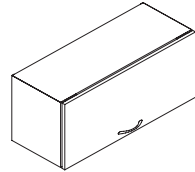

Flipper Door Overhead

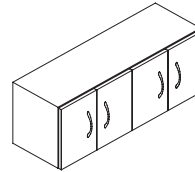

Hinged Door Overhead

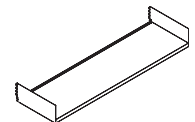

Open Shelf

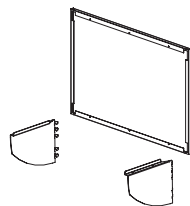

Upmount Kit for Overhead Cabinets

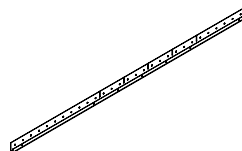

Horizontal Wall Track

Overhead Storage Cabinet (page 132)

- Steel cabinet with backstop.
- Available with sliding, hinged, or flipper door(s).
- Easy-Assist flipper door optional — requires minimal assistance in opening and closing. Not available on 60"W cabinets, specify 2–30"W cabinets with Easy-Assist.
- Self-engaging safety latch to secure cabinet to panel.
- Width can correspond with width of panel, or 2 panels joined without a connector.
- Arch or square pull optional on flipper and hinged doors.
- 60"W flipper door cabinet has 2–30"W doors with 2 independent locks.
- 24"-36"W hinged door cabinets have 1 lock and 2 optional pulls, 42"-48"W have 2 locks and 4 optional pulls.
- Accommodates recessed task lighting (specified separately).
- For locking specifications, see pages 396-398.
- Cabinets are 14¼"D x 15"H.
- 15"H cabinets can also be mounted on a panel equal to or up to 18" narrower than cabinet using provided panel attachment brackets.
- Sliding doors have a built in pull.
- Sliding, hinged, and flipper door overhead weight limits:

24"W	59 lbs.	42"W	105 lbs.
30"W	74 lbs.	48"W	121 lbs.
36"W	90 lbs.	60"W	152 lbs.
- When mounting an overhead on a 57½"H base panel frame, select the option for Z57 bracket. For all other base panel frame and base panel frames with stacking frames the YZ bracket should be selected. Base panel frames with stacking frames that have an overall height of 57½"H also use the YZ bracket.

Open Shelf (page 132)

- Metal shelf with back stop.
- Locking clips (2) standard.
- Will accommodate recessed task lighting — ordered separately.
- Weight Limits:

24"W	61 lbs.	42"W	108 lbs.
30"W	77 lbs.	48"W	124 lbs.
36"W	93 lbs.	60"W	155 lbs.

Upmount Kits for Assembled Overhead Cabinets (page 132)

- Consists of two upmount brackets, full back panel and required installation hardware.
- Allows mounting of an assembled overhead cabinet up to 15" above height of panel.
- Specify "Z2" prefix model number upmount kits with 15"H, 30"H, 35"H, 50"H, or 65"H frames; and "Z4" prefix model numbers for use with 22½"H, 42½"H, or 57½"H frames.
- Brackets require a clearance of 6½" below bottom of overhead cabinet.
- Width must correspond with width of panel frame or 2 panel frames joined directly in-line.
- Full back panel adds ½" to depth of overhead case. Full back panel only used when upmounting cabinet.
- Cannot be used with RTA models.

Horizontal Wall Track (page 132)

- Allows mounting overheads on permanent wall structures only.
- Cannot be used with RTA models.
- Track is 60"W and notched at 6" intervals as a guide for field cutting.
- For use with 15"H sliding door overhead, field modification is necessary.
- Available in Black only.
- Attachment hardware not included.

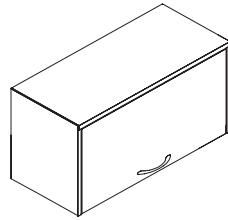

Receding Door Overhead

Receding Door Overhead Storage Cabinet (page 133)

- Steel cabinet with open back. Optional back can be ordered separately.
- Arch or Square pull optional.
- 60" W cabinet has 2 30" W doors with 2 independent locks.
- Accommodates recessed task lighting — ordered separately.
- For locking specifications, see pages 396-398.
- Cabinets are 13¼" D x 15" H. When door is recessed, interior dimensions are 12½" D x 11½" H.
- Weight Limits:

30" W	70 lbs.	48" W	110 lbs.
36" W	85 lbs.	60" W	138 lbs.
42" W	100 lbs.		

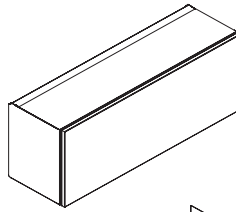

Ready to Assemble (RTA) Flipper Door Overhead (page 133)

- Steel cabinet with open back.
- 60" W and 72" W cabinets have 2 doors with independent locks.
- Accommodates recessed task lighting — ordered separately.
- Random keying, for locking specifications see pages 396-398.
- Cabinets are 12" D x 15" H. Interior dimensions 11½" D x 12¼" H.

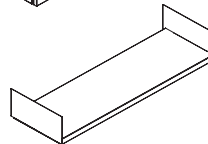

Ready to Assemble (RTA) Shelf (page 133)

- Metal shelf with locking clips.
- Accommodates recessed task lighting — ordered separately.

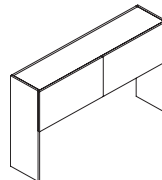

Stack-On Hutch

Stack-on Hutch (page 134)

- Have flipper doors with square horizontal edges.
- Universal model can be converted to open hutch.
- Doors are standard with a core removable lock (60" W, 66" W and 72" W have two doors and two locks.)
- Attachment tape provided.
- Order hutch to match width of worksurface(s) it covers.
- Hutches have clearance of 19¼" for computers, etc.
- Ship easy to assemble.
- Depth dimensions shown includes thickness of door.
- Universal model inside depth dimension is 12¾"
- Stack-on hutches accommodate recessed task lighting.
- For locking specification see pages 396-398.
- Chicago task light cords cannot be routed through the Hutch end panels, due to the large size of the fused plugs.

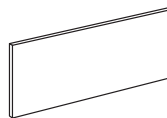

Tackboards for Hutches

Tackboards (page 134)

- Use tackboard to close the back of stack-on or hutch below storage unit.
- Due to width of fabric roll, 72" W tackboards are available in railroad cut only.
- Back of tackboard is painted steel, a finished surface.

Metal Overheads

Terrace® — Overheads / Shelves and Mounting Kits

For specification information see pages 128-131.

GSA SIN 33721

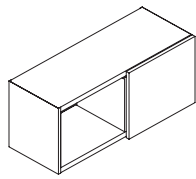

Description	Model	P1 Paint List Price	P2 Paint List Price	P3 Paint List Price
15"H x 14 1/4"D Sliding Single Door Overhead Cabinets				
24"W	OH1524SD	\$ 1041	\$ 1120	\$ 1197
30"W	OH1530SD	\$ 1064	\$ 1143	\$ 1220
36"W	OH1536SD	\$ 1116	\$ 1195	\$ 1272
42"W	OH1542SD	\$ 1166	\$ 1245	\$ 1322
48"W	OH1548SD	\$ 1219	\$ 1298	\$ 1375
60"W	OH1560SD	\$ 1609	\$ 1688	\$ 1765

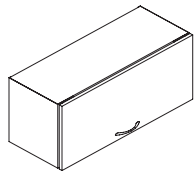

15"H x 14 1/4"D Flipper Door Overhead Cabinets				
24"W	OH1524FD	\$ 1041	\$ 1120	\$ 1197
30"W	OH1530FD	\$ 1064	\$ 1143	\$ 1220
36"W	OH1536FD	\$ 1116	\$ 1195	\$ 1272
42"W	OH1542FD	\$ 1166	\$ 1245	\$ 1322
48"W	OH1548FD	\$ 1219	\$ 1298	\$ 1375
60"W	OH1560FD	\$ 1609	\$ 1688	\$ 1765

Note: Add suffix **A** for arch pull or **S** for square pull to model number — add \$42 per pull.
For “Easy-Assist” on 24"W-48"W change FD suffix to FE – add \$240

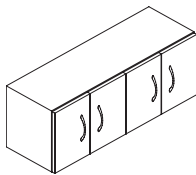

15"H x 14 1/4"D Hinged Door Overhead Cabinets				
24"W	OH1524HD	\$ 1781	\$ 1859	\$ 1936
30"W	OH1530HD	\$ 1862	\$ 1940	\$ 2017
36"W	OH1536HD	\$ 1949	\$ 2027	\$ 2104
42"W	OH1542HD	\$ 2032	\$ 2110	\$ 2187
48"W	OH1548HD	\$ 2107	\$ 2185	\$ 2262

Note: Add suffix **A** for arch pull or **S** for square pull to model number — add \$42 per pull.

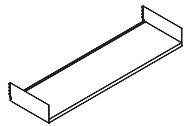

Open Shelf (to line up with 15"H Overheads) — 12 1/2"D					
24"W	ZS24	<input type="checkbox"/> S	\$ 444	\$ 472	\$ 497
30"W	ZS30	<input type="checkbox"/> S	\$ 482	\$ 510	\$ 535
36"W	ZS36	<input type="checkbox"/> S	\$ 508	\$ 536	\$ 561
42"W	ZS42	<input type="checkbox"/> S	\$ 532	\$ 560	\$ 585
48"W	ZS48	<input type="checkbox"/> S	\$ 558	\$ 586	\$ 611
60"W	ZS60		\$ 679	\$ 707	\$ 732

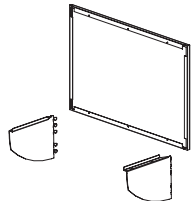

Upmount Kits for Overhead Cabinets					
Specify “Z4” prefix models with 22 1/2"H, 42 1/2"H, or 57 1/2"H frames; “Z2” prefix for other heights.					
24"W	Z <input type="checkbox"/> UP24		\$ 269	\$ 298	\$ 324
30"W	Z <input type="checkbox"/> UP30		\$ 282	\$ 311	\$ 337
36"W	Z <input type="checkbox"/> UP36		\$ 290	\$ 319	\$ 345
42"W	Z <input type="checkbox"/> UP42		\$ 305	\$ 334	\$ 360
48"W	Z <input type="checkbox"/> UP48		\$ 320	\$ 349	\$ 375
60"W	Z <input type="checkbox"/> UP60		\$ 342	\$ 371	\$ 397

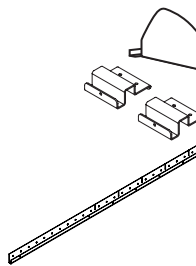

Shelf Dividers					
Package of 6	T7DV	<input type="checkbox"/> S	\$ 144	\$ 162	\$ 173

Note: Not compatible with RTA models.

Horizontal Wall Track					
60"W Track	TWTH	<input type="checkbox"/> S	\$ 135	N/A	N/A

How to specify —
Select the Model Number from above.

1st Option:
Pull
(if applicable):

A Arch pull, add \$42 per pull
S Square pull, add \$42 per pull

2nd Option:
System
(if applicable):

YZ Terrace, Stride®, or Optimize™
Z57 57"H Terrace or Stride

3rd Option:
Paint:

P1 P2 P3
See page 38 for finishes.

4th Option:
Pull Color
(if applicable):

Arch:
E4 Black
EL Matte Silver
Square:
EL Matte Silver

5th Option:
Lock Type:

STD Standard — Random Keyed
OMT Omit Lock Core (Deduct \$20 per lock)

Examples: OH1536FEA.YZ.P01.E4.STD OH1548FDS.YZ.P52.EL.OMT Shippable by small-package carrier.

OH1560SD.YZ.PR2.EL.STD Z2UP24.P27 TWTH

Frame & Tile Panel Systems – 02/2024

Metal Overheads

For specification information see pages 128-131.

GSA SIN 33721

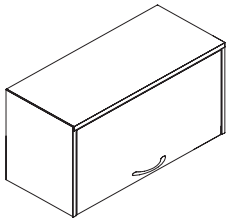

Description	Model	P1 Paint List Price	P2 Paint List Price	P3 Paint List Price
15"H x 13¼"D Receding Door Overheads (Inside dimensions with door recessed — 11½"H x 12½"D)				
30"W	OH1530RD	\$ 1221	\$ 1300	\$ 1377
36"W	OH1536RD	\$ 1288	\$ 1367	\$ 1444
42"W	OH1542RD	\$ 1368	\$ 1447	\$ 1524
48"W	OH1548RD	\$ 1483	\$ 1562	\$ 1639
60"W	OH1560RD	\$ 2243	\$ 2322	\$ 2399

Note: Add Suffix **A** for arch pull or **S** for square pull option — add \$42 per pull.

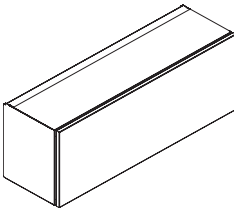

15"H x 12"D Ready to Assemble (RTA) Flipper Door Overhead (Inside dimensions 12¼"H x 11½"D)				
36"W RTA — Flipper Door	POHRTA1536FD	\$ 875	\$ 954	\$ 1031
42"W RTA — Flipper Door	POHRTA1542FD	\$ 914	\$ 993	\$ 1070
48"W RTA — Flipper Door	POHRTA1548FD	\$ 953	\$ 1032	\$ 1109

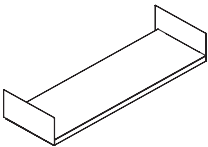

5½"H x 12"D Ready to Assemble (RTA) Shelf				
36"W RTA — Shelf	POHRTA36S	\$ 456	\$ 483	\$ 506
48"W RTA — Shelf	POHRTA48S	\$ 501	\$ 528	\$ 551

TERRACE

<p>How to specify — Select the Model Number from above.</p> <p>_____</p> <p>_____</p>	<p>1st Option: Receding Door Pull (if applicable): A Arch Pull, add \$42 per pull S Square Pull, add \$42 per pull</p>	<p>2nd Option: System for Receding Door Overhead (if applicable): YZ Terrace, Stride®, Optimize™, or Concensys® Z57 57½"H Stride or Terrace</p>	<p>3rd Option: Paint: P1 P2 P3 See page 38 for finishes.</p>	<p>4th Option: Receding Door Pull Color (if applicable): Arch: E4 Black EL Silver Square: EL Silver</p>	<p>5th Option: Receding Door Lock (if applicable): STD Standard OMT Omit Lock Core (Deduct \$20 per lock)</p>
	.	.	P	E	.

Examples: OH1560RD.YZ.P7C.STD OH1536RDA.Z57.P27.E4.OMT

Metal Hutches

Terrace® — Hutches, Tackboards, and Accessories

For specification information see pages 128-131.

GSA SIN 33721

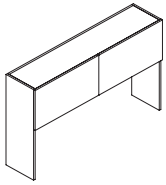

Description	Universal Hutch Model	P1 Paint List Price	P2 Paint List Price	P3 Paint List Price
Hutch w/Square Flipper Doors and Lock — 14½"D, Universal 35"H				
36"W	UH6536FD	\$ 1200	\$ 1282	\$ 1362
42"W	UH6542FD	\$ 1255	\$ 1337	\$ 1417
48"W	UH6548FD	\$ 1297	\$ 1379	\$ 1459
60"W	UH6560FD	\$ 1838	\$ 1920	\$ 2000
66"W	UH6566FD	\$ 1928	\$ 2010	\$ 2090
72"W	UH6572FD	\$ 2020	\$ 2102	\$ 2182

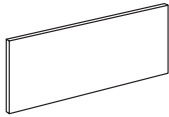

Description	Universal Hutch Model	P1 Paint List Price — Fabric			P2 Paint List Price — Fabric			P3 Paint List Price — Fabric		
		Grades A/B	Grades C/D	Grades E/F	Grades A/B	Grades C/D	Grades E/F	Grades A/B	Grades C/D	Grades E/F
20"H Tackboards for Stack-on Hutches										
36"W Tackboard	UHTB36	\$ 540	\$ 637	\$ 798	\$ 567	\$ 664	\$ 825	\$ 590	\$ 687	\$ 848
42"W Tackboard	UHTB42	\$ 567	\$ 669	\$ 837	\$ 594	\$ 696	\$ 864	\$ 617	\$ 719	\$ 887
48"W Tackboard	UHTB48	\$ 618	\$ 734	\$ 924	\$ 645	\$ 761	\$ 951	\$ 668	\$ 784	\$ 974
60"W Tackboard	UHTB60	\$ 692	\$ 837	\$ 1077	\$ 719	\$ 864	\$ 1104	\$ 742	\$ 887	\$ 1127
66"W Tackboard	UHTB66	\$ 728	\$ 886	\$ 1149	\$ 755	\$ 913	\$ 1176	\$ 778	\$ 936	\$ 1199
72"W Tackboard	UHTB72	\$ 767	\$ 924	\$ 1184	\$ 794	\$ 951	\$ 1211	\$ 817	\$ 974	\$ 1234



Description	Model	P1 Paint List Price	P2 Paint List Price	P3 Paint List Price
Shelf Dividers				
Package of 6	T7DV	\$ 144	\$ 162	\$ 173

Note: Not compatible with RTA models.

TERRACE

<p>How to specify — Select the Model Number from above.</p>	<p>1st Option: Pull (if applicable): add \$43 per pull. A Arch Pull S Square Pull</p>	<p>2nd Option: Paint: P1 P2 P3 See page 38 for finishes.</p>	<p>3rd Option: Fabric (if applicable): See page 14 for fabrics.</p>	<p>3rd Option: Lock Type (if applicable): STD Standard — Random Keyed OMT Omit Lock Core (Deduct \$20 per lock)</p>	<p>4th Option: Railroad Cut (Tackboard only): (Only applicable to 72"W Fabric Tackboards.)</p>
_____	_____	_____	_____	_____	_____

Examples: UH6536FDA.P27.STD UHTB66.P52.CS918.RR
UH6536FD.P27.OMT

S Shippable by small-package carrier.

Finishes	136
Introduction	137-138
Statement of Line	139-140
Overview of Frames	141
Working with Frames, Sliding Doors, Connectors, and Tiles	142-160
Panel Frames, Connectors, and Trim.....	161-175
Tiles, Off-Modular, and Acoustic Inserts... ..	176-198
Working with Electrical and Data for Panels	199-209
Electrical (8-Wire) and Data for Panels.....	210-213
WORKSURFACES	
Working with Worksurfaces and Supports.....	214-224
Laminate Worksurfaces... ..	225-231
9120 Worksurfaces.....	232-233
Veneer Worksurfaces	234
Worksurface Supports.....	235-238
WOOD STORAGE	
Statement of Line	239
Features and Dimensions	240-241
Filing Capacities.....	242
Working with Wood Storage	243-261
Credenzas and Credenza Accessories	262-263
4-Wire Electrical Components	264
Stride Accessories	265
Overhead Cabinets and Horizontal Storage.....	266-268
Working with Metal Overheads.....	269-271
Metal Overheads.....	272-273

Stride® System

PAINTED METAL FINISHES

GRADE P1	
Black.....	P27
Brownstone.....	P7D
Bungalow.....	P7C
Cinder.....	P7Q
Cove.....	P096
Designer White.....	PJW
Dune.....	P094
Flint.....	P02
Fossil.....	P28
Harbor.....	P097
Loft.....	P7B
Muslin.....	P4J
Parchment.....	P93
Pebble.....	P8R
Pewter.....	P8D
Sage.....	P095
Salt.....	P8C
Titanium.....	P8T

GRADE P2	
Champagne Metallic.....	PR5
Gunmetal Metallic.....	PR3
Platinum Metallic.....	PR2
Silver**.....	PR6
Solar Black.....	P8X

**PR6 no upcharge on Involve; available as a Grade P2 color on stanchions; is not available on Concensus, Essentials, and vertical files.

GRADE P3	
Atom.....	P8S
Blossom***.....	P8K
Bulseye.....	PJF
Ember.....	P8P
Ion.....	P8N
Iris.....	P8J
Krypton.....	P8F
Ochre.....	P093
Regatta.....	P8M
Sienna.....	P092
Succulent***.....	P8A

*** These colors are intended to be an inspirational option for the trending market. Product application is limited and color availability is approximately two years to coincide with evolving workplace trends.

Metallic paints, due to varying reflectance, may appear to have less visual color consistency than other paint finishes, even when L/A/B values are exactly the same. (L/A/B — measurable aspects of color — values are maintained within a specified range, to ensure consistent appearance of paint colors.)

METAL STORAGE PULLS

Black.....	E4
Bronze (for veneer only).....	EZ
Matte Silver.....	EL

PAINTED WOOD FINISHES

Brownstone.....	M13
Bungalow.....	M12
Designer White.....	M17
Flint.....	M16
Loft.....	M11
Muslin.....	M15

ELECTRICAL AND DATA COMPONENTS

Black.....	E4
Brownstone.....	EY
Designer White.....	DW
Flint.....	E9
Loft.....	EV
Muslin.....	EU
Silver.....	ES

Recommended Coordinate Colors:
 Bungalow use Muslin EU
 Carob use Black E4
 Champagne Metallic use Muslin EU
 Cinder use Brownstone EY
 Fossil use Flint E9
 Gunmetal Metallic use Brownstone EY
 Parchment use Muslin EU
 Pebble use Loft EV
 Pewter use Flint E9
 Platinum Metallic use Silver ES
 Salt use Silver ES
 Titanium use Silver ES

LAMINATES

GRADE L1	
SOLID COLORS	
Black.....	P
Brownstone*.....	LM13
Bungalow*.....	LM12
Designer White*.....	LDW1
Flint*.....	LM16
Fossil Shale*.....	LEH1
Loft*.....	LM11
Muslin*.....	LM15
Titanium*.....	LT11

ABSTRACT	
Ash.....	LT3B
Handspun Pearl.....	LAHP
Handspun Dove.....	LAHD
Handspun Slate.....	LAHS
Handspun Chestnut.....	LAHC
Silver Mesh.....	LT8D

WOODGRAIN	
Belair.....	LWBA
Bourbon Cherry.....	H
Field Elm.....	LWFE
Florence Walnut*.....	LFW1
Kingswood Walnut*.....	LK11
Natural Maple*.....	LWD
NeoWalnut*.....	LN11
Pinnacle.....	PINC
Shaker Cherry*.....	LW7C

GRADE L2	
Beigewood*.....	LWBE
Fawn Cypress*.....	LFC1
Lowell Ash*.....	LLA1
Mangalore Mango*.....	LMM1
Natural Recon*.....	LNR1
Phantom Charcoal*.....	LPC1
Phantom Ecru*.....	LPE1
Portico Teak*.....	LPT1
Skyline Walnut*.....	LSW1
Veranda Teak.....	LVT1

GRADE L3	
Natural Walnut*.....	LWNW

* Storage available in these 30 laminates.
 All laminate surfaces are also offered in an FSC wood option. Add FSC in front of the laminate option. Refer to specification tools.

LAMINATE AND PAINTED WOOD STORAGE PULLS

Silver.....	PR6
-------------	-----

LAMINATE EDGE COLORS

Beigewood.....	DE
Belair.....	BA
Black.....	E4
Bourbon Cherry.....	H
Brownstone.....	EY
Bungalow.....	EX
Designer White.....	DW
Fawn Cypress.....	FC
Field Elm.....	FE
Flint.....	E9
Florence Walnut.....	FW
Fossil.....	EH
Kingswood Walnut.....	KI
Loft.....	EV
Lowell Ash.....	DL
Mangalore Mango.....	MM
Muslin.....	EU
Natural Maple.....	DD
Natural Recon.....	NR
Natural Walnut.....	DN
NeoWalnut.....	NU
Parchment.....	EN
Phantom Charcoal.....	PC
Phantom Ecru.....	PE
Pinnacle.....	PI
Platinum Metallic.....	EP
Plyband.....	PL
Portico Teak.....	DP
Shaker Cherry.....	DF
Skyline Walnut.....	SW
Titanium.....	TI
Veranda Teak.....	VT

◆ Edge is limited to flat edge surfaces: rectangle, square, trapezoid, polygon, or round. No curvilinear or combination curve and straight.

METAL GROMMETS

FOR LAMINATE WORKSURFACES

Oval/Square:	
Matte Silver.....	EL

FOR VENEER WORKSURFACES

Oval:	
Black.....	E4
Bronze.....	EZ
Matte Silver.....	EL
Square:	
Matte Silver.....	EL

PLASTIC GROMMETS

FOR WORKSURFACES

Black.....	E4
Brownstone.....	EY
Bungalow.....	EX
Designer White.....	DW
Flint.....	E9
Fossil.....	EH
Loft.....	EV
Muslin.....	EU
Parchment.....	EN
Titanium.....	TI

PLASTIC GROMMETS WITH WOODGRAIN EDGE

If woodgrain edge is specified, the plastic grommet color is predetermined, based on finish selection.

Beigewood, Fawn Cypress, Natural Maple, and Natural Recon.....	Muslin EU
Kingswood Walnut and NeoWalnut.....	Brownstone EY
Phantom Charcoal and Skyline Walnut.....	Flint E9
Phantom Ecru.....	Loft EV
Portico Teak.....	Fossil EH
All other woodgrain options.....	Black E4

STRATAWOOD VENEERS

GRADE V2

Add FSC prefix to Stratawood codes listed below for Stratawood veneer trim on Stride and Terrace.
 Example: FSCSC777

CHERRY	
Cinnamon/Biltmore Cherry.....	SC260
Lowell Ash Cherry.....	SC394
Clear Cherry.....	SC700
Light Cherry.....	SC701
Shaker Cherry.....	SC774
Burnished Cherry.....	SC777

MAPLE	
Field Elm.....	SE599
Clear Maple***.....	SE800
Harvest Maple.....	SE856
Beigewood.....	SE878
Phantom Ecru.....	SE912
Belair.....	SE934

OAK	
Clear Oak.....	SF300
Dark Rift Oak.....	SF331

SILVER OAK	
Silver Oak Clear.....	SB100
Portico Teak Silver Oak.....	SB150

WALNUT	
Florence Walnut.....	ST579
Light Walnut.....	ST601
Skyline Walnut.....	ST625
Pinnacle Walnut.....	ST679
Sumatra Walnut.....	ST693

NATURAL VENEERS — FLAT CUT

GRADE V2

CHERRY	
Cinnamon/Biltmore Cherry.....	NC260
Lowell Ash.....	NC394
Medium Red Cherry.....	NC512
Light Cherry.....	NC701
Shaker Cherry.....	NC774
Burnished Cherry.....	NC777

MAPLE	
Clear Maple.....	NE800
Harvest Maple.....	NE856

WALNUT	
Ebony Walnut.....	NT509
Florence Walnut.....	NT579
Light Walnut.....	NT601
Skyline Walnut.....	NT625
Nutmeg Walnut.....	NT629
Pinnacle Walnut.....	NT679
Sumatra Walnut.....	NT693

NATURAL VENEERS — RIFT CUT

GRADE V3

Fawn Cypress Rift Cut Oak.....	RF108
Light Rift Cut Oak.....	RF301
Dark Rift Cut Oak.....	RF331
Phantom Ecru Rift Cut Oak.....	RF912

** SE800 and NE800 are not available on Stride trim.

The beauty of wood is the natural variation of grain patterns and colors that make each piece unique. This variation is also influenced by lighting conditions, orientation of mated parts, and varying acceptance of the finishing process. The varying colors and physical characteristics naturally occur in all wood species but are most pronounced in lighter colored woods, and are especially evident in natural finishes.

GROMMETS ON VENEER WORKSURFACES

Wire management grommets come standard on most veneer worksurfaces. Choose between metal or plastic grommet option. Note: Plastic grommet color is predetermined based on finish selection.
 All Maple veneers.....Muslin EU
 All other veneers.....Black E4

LOCKS

Black.....	E4
Chrome.....	ordered by base model
Matte Silver.....	EL

NOTE: Refer to individual product pages for upcharges.

Keep pace with your environment.

When designing Stride, we set out to discover a furniture platform that could evolve to reflect the changes today's organizations are experiencing. To create components that could adapt to personal preferences and demands of different job functions. To make of the most sustainably minded and manufactured products available. What we found is a whole new way to build a better office environment.

You're asking more of your staff. So we asked more of our furniture.

Today, you have to get more done in less time and in a smaller space. Stride responds by maximizing every inch you have. We made storage smarter with details like under-desk corner drawers for tucking away a recycle bin or binders, and sliding shelves for quick, easy access to projects. Perch overhead cabinets and rail-mounted screens bring storage within easy reach and create desktop privacy. And a clever credenza rail not only supports worksurfaces at different heights for managing multiple tasks, it offers easy access to technology.

Designed for real people and real work.

Stride supports multiple job functions, not rigid hierarchy. So it's possible to create an office that serves everyone, whether they work side-by-side or back-to-back. We found a simple way to make every task more comfortable with sit-to-stand worksurfaces that allow users to change postures. Staying organized is easy with a variety of open and enclosed storage options. Low panels and glass screens keep the space clean, lean, and light.

Space that works like an office, but feels like home.

Because each component of Stride was designed with every other component in mind, the entire collection works together seamlessly. Countless thoughtful details have been designed to increase comfort, improve effectiveness, and add visual appeal. Storage dresses up with elegant pulls, a sophisticated mix of materials, footed bases, and the welcome surprise of a Landscape™ surface tower sidelight. A work wall with both open and enclosed storage makes the private office elegant, inviting, and functional.

As Stride was being developed, we considered everything from raw materials to end-of-life for each component. But we also considered the needs of the person using the furniture. A range of contemporary worksurface shapes makes it easier to get work done. Segmentation every 7½" offers unlimited access to power. And design details like footed panels, tiles to-the-floor, and spanning glass create a welcoming aesthetic. So even the most straightforward workspace can be more inspiring, long-lasting, and productive.

With simplification of form and subtlety of strength, Stride benching supports highly collaborative users who need dedicated spaces, as well as mobile workers who only need to touch down for part of the day. Exceptionally easy access to power and data allows people to settle in or come and go. Cantilever storage combines space division and personal storage in one functional, visually dynamic solution. And the elegantly designed open leg supports long spans, creating uninterrupted workspaces.

A people-centric approach to furniture design makes spaces more comfortable, functional, and friendly. It's flexible enough to support the different ways that people work. As your company grows and changes, so does Stride; built-in flexibility allows the collection to adapt to your organization's evolving needs. Yet it's more than furniture. It's a platform for building better environments, while protecting the one we have.

An exceptional new collection of materials — textiles, finishes, landscape material options and color palette — were also developed for Stride and many of these additions help to bring a more residential vs. contract ethos to the furnishings.

With an integrated and cohesive kit of universal components, Stride supports a broad range of applications from private office to open plan, and a seamless migration from an environment with more separation to one with more openness or vice versa. Stride can be scaled down or up with ease — adding, subtracting, or rearranging, providing a stunning degree of versatility and flexibility to adapt to the organization and the individual.

Stride brings it all together in one complete collection of surfaces, storage, and space division.

Mix and match worksurfaces, storage and space division for your own unique solution. Stride achieves a stunning degree of versatility and flexibility. The use of cohesive, scalable materials and finishes creates a beautiful aesthetic in every application.

PRIVATE OFFICE

OPEN PLAN

Traditional

Stride Desking with traditional Painted Wood Storage workwall.

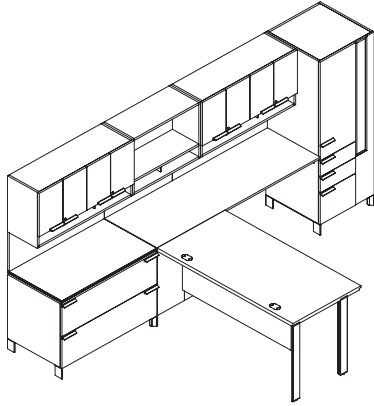

Stride Panels with Metal Storage

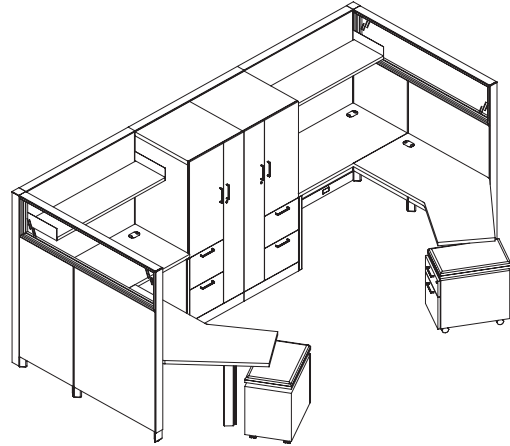

Stride Panels with Painted Wood Storage and Desk Screens

Progressive

Stride Desking with Painted Wood Storage workwall.

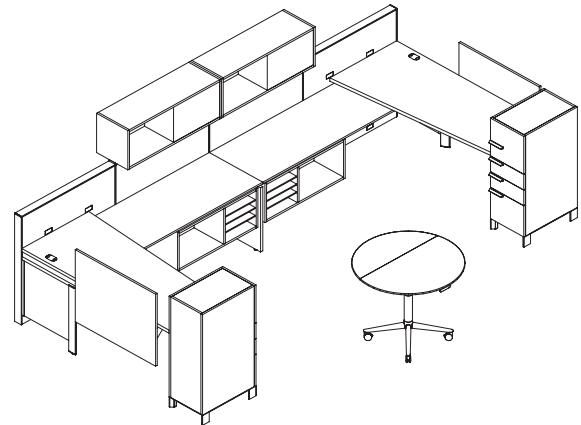
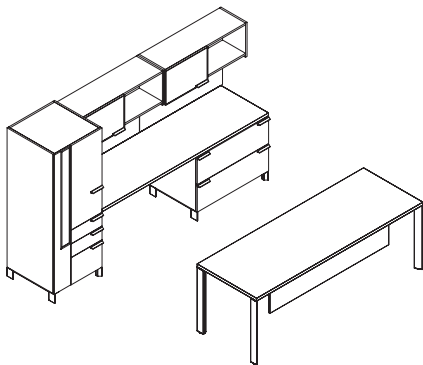

Stride Desking with Painted Wood Storage Spine

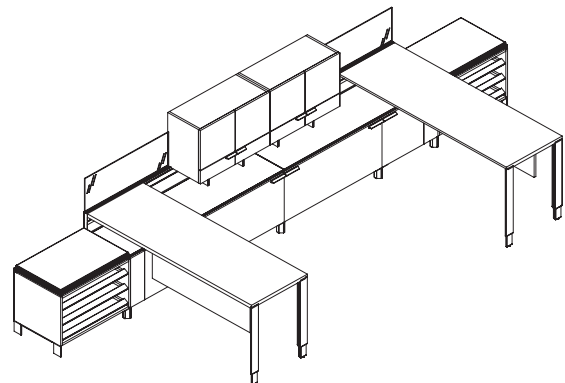

Note: Stride Typical can be found at <https://www.allsteeloffice.com/design-resources/idea-starters>.

SPACE DIVISION

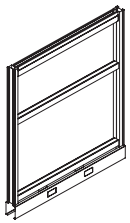

Raceway Panel

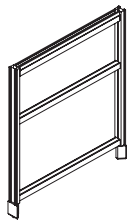

Footed Panel



Low Profile
Glass Stacker Kit

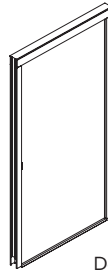

Doors

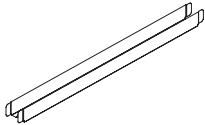

Segment Kits

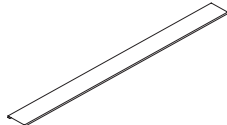

Top Trim and Spanning
Top Trim

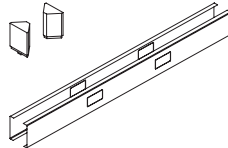

Panel Conversion Kits



Connector Blocks



Trim



Light Block Kits

TILES

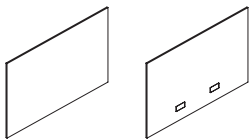

Tackable Acoustical
(Non-Ported and Ported;
To-the-Floor)



Steel
(Perforated and
To-the-Floor)

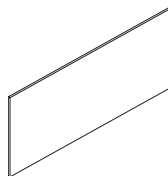

Landscape

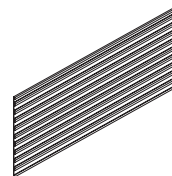

Tool Tile

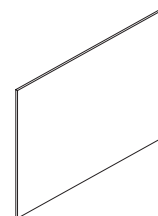

Laminate

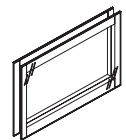

Glass Tile Kits

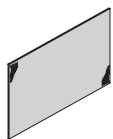

Veneer

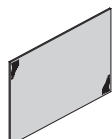

Veneer
(To-the-Floor)

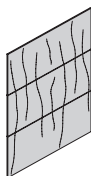

Natural Veneer Tile Sets

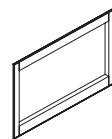

Pass-Thru Trim Kits

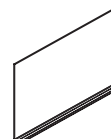

Marker Board
(Porcelain, Steel)

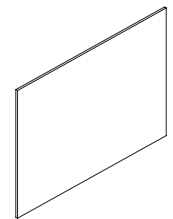

Laminate
(To-the-Floor)

SCREENS

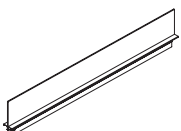

Panel Mounted Screens

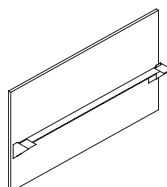

Desk Screens

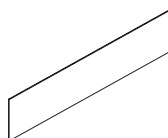

Credenza Rail Mounted
Screens

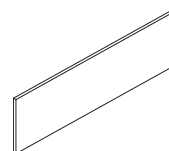

Modesty Panels

WORKSURFACES & SUPPORTS

Linear Worksurfaces — Laminate with Flat Edges

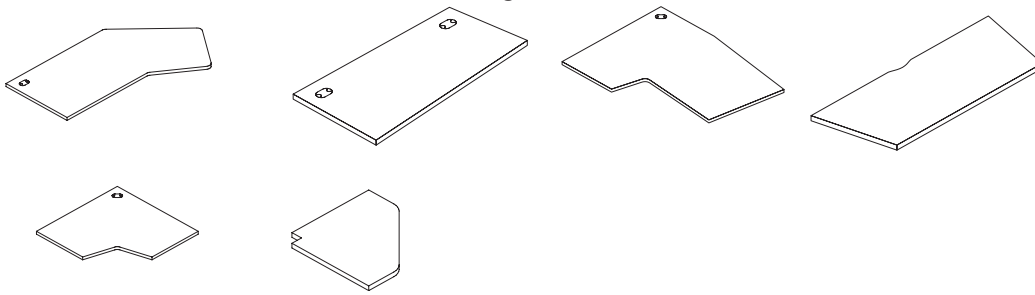

Additional standard laminate and veneer worksurfaces available.

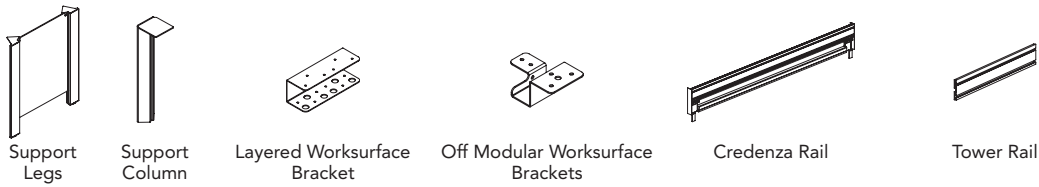

STORAGE

Wood Storage — Painted Wood

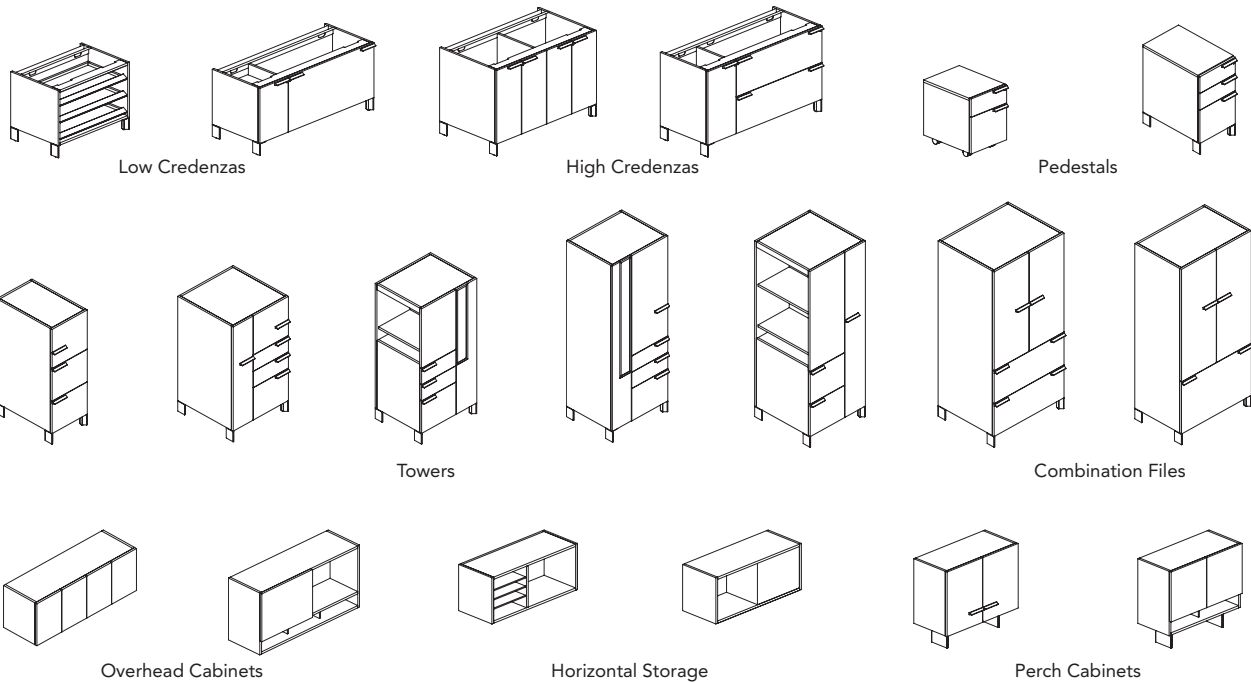

Metal Storage

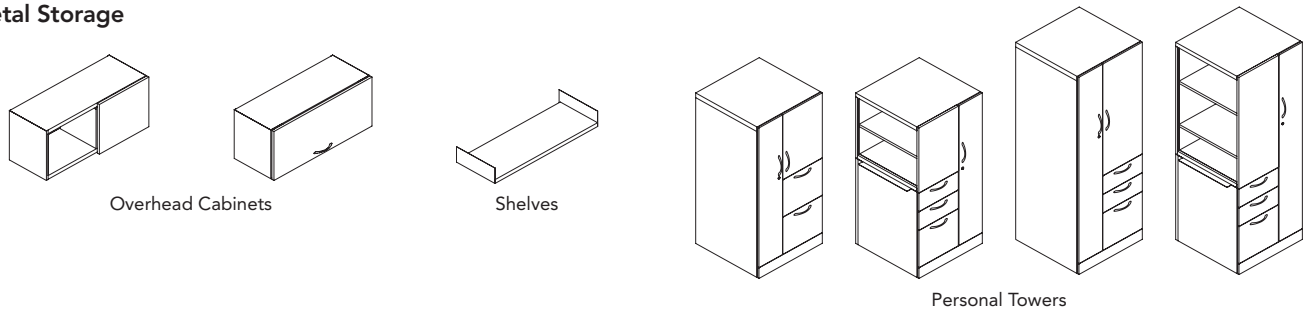

Structural Base Panel Frames

35"H Raceway 42½"H Raceway 50"H Raceway 57½"H Raceway 65"H Raceway

35"H Footed 42½"H Footed 50"H Footed 57½"H Footed 65"H Footed

87½"H Hinged Door

50"H Sliding Door 65"H Sliding Door 80"H Sliding Door

	24"W	30"W	36"W	42"W	48"W	60"W
35"H						
42½"H						
50"H						
57½"H						
65"H						

Stacking Frames

Low Profile Glass Stacker

15"H Stacking Frame 22½"H Stacking Frame 30"H Stacking Frame 15"H Stacker Kit

	24"W	30"W	36"W	42"W	48"W	60"W
15"H						
22½"H						
30"H						

Stride base raceway panel frames include frame, base pathway covers, and in-line connection attachment hardware. Footed panel frames include panel feet. No electrical or data capabilities in base of footed panel frames. Base raceway to footed and footed-to-base raceway kits can be used to convert existing frames to footed style or to base raceway covered style.

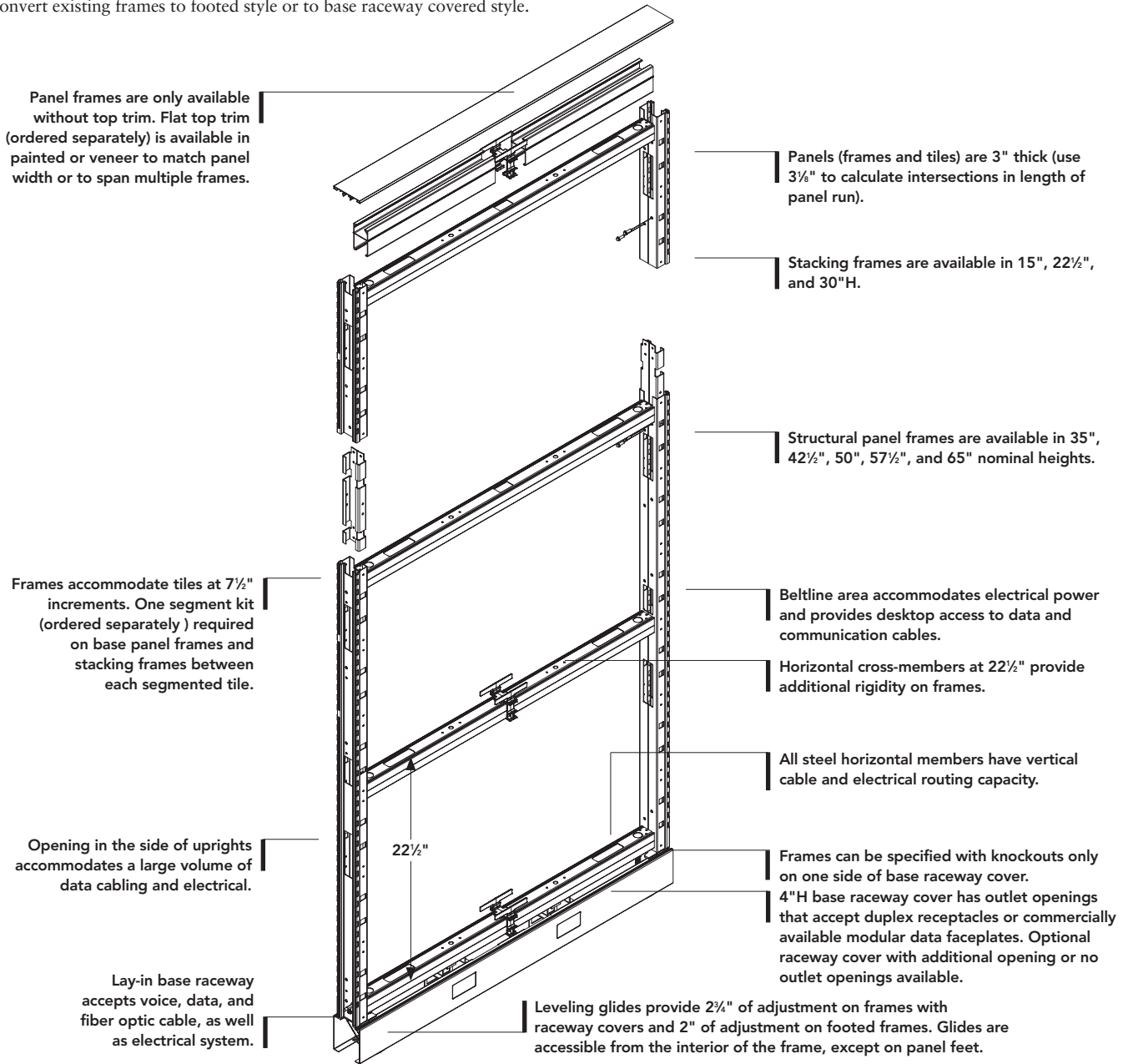

Stride Frame Dimensions (Actual)	
Depth:	3" (use 3⅜" to calculate intersections in length of panel run)
Widths:	24", 30", 36", 42", 48", 60"
Heights*:	34⅝", 41⅝", 49⅝", 56⅝", 64⅝"
Stacking Frames:	15", 22½", 30"H
Leveling Glides on Frames with Raceway Covers:	2¼" range
Leveling Glides on Footed Frames:	2" range

*with levelers fully retracted

Panel Frames and Conversion Kits (pages 161-162)

- Specifications: formed steel vertical members, with tubular steel horizontal members are welded into a strong, sturdy structural panel frame.
- Top trim, tiles, and segment kits are ordered separately depending on application choice.
- Panel frames are standardly shipped with base raceway covers or decorative feet installed. There is no electrical or data capabilities in base of footed panel frames.
- Base raceway to footed and footed-to-base raceway kits can be used to convert existing frames. Footed-to-base raceway kits ship with glide tower assembly. Conversion process requires panel to be removed from panel run.
- Direct connections between same height frames in a continuous run are accomplished with provided hardware. There is no incremental increase in length along the run.
- For adequate stability, one of two methods of stabilization shown on page 144 must be adhered to.

Building vertically with Stride frames

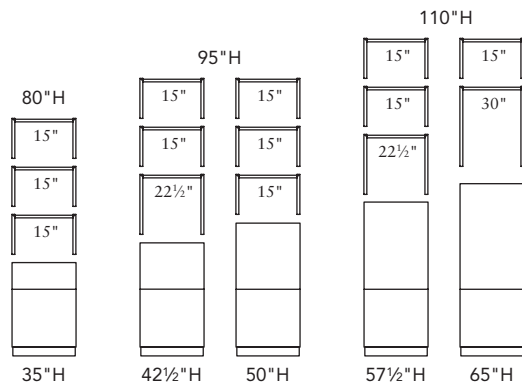

Stacking Connection

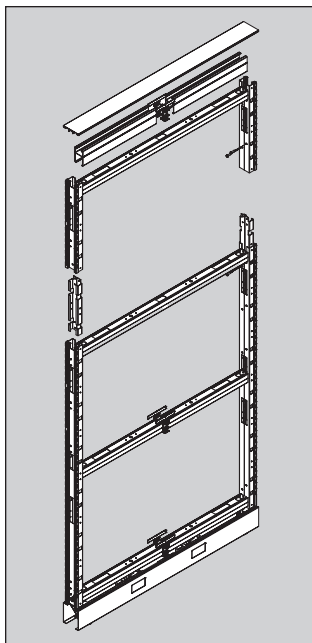

Segmented Panels

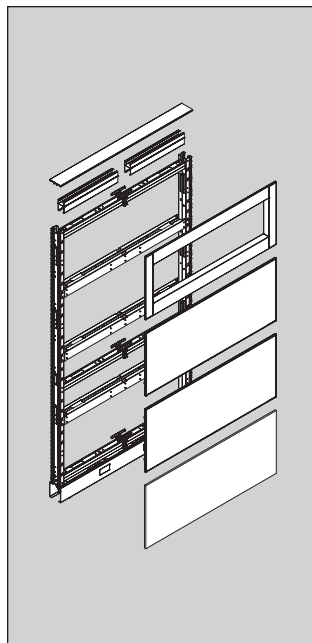

A low profile glass stacker kit is a single pane of clear or frosted safety tempered glass centered within a silver metal frame.

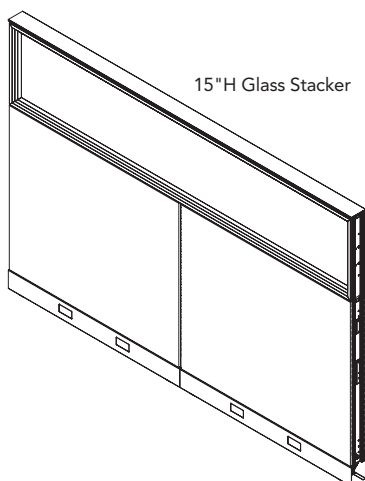

Stacking Frames (page 162)

- Stacking frames can be added to the top of any base panel frame.
- This stacking connection provides a solid metal-to-metal connection, allowing the stacking frame to accept hang-on components, per Allsteel configuration guidelines.
- A maximum of three stacking frames are allowed on base panel frames 35"H-65"H up to a maximum height of 110". Do not combine differing frame widths in a single stack or span multiple base panel frames with stacking frames.
- Guidelines for using overhead storage with stacking frames are given on page 270.
- Includes attachment hardware.
- Add appropriate connector blocks (2 per stacker level).
- When adding stacking frames, the top trim and top trim retainer are removed from the base frame and installed on the uppermost stacking frame.
- To maintain panel mounting slot modularity 22½"H stacking frames should only be used with 42½"H, 57½"H base panel frames or 87½"H door frames. To match 87½"H door frame height, use a 65"H base panel frame with a 22½"H stacking frame (slot modularity will be lost on stacker).
- To maintain modularity on 35"H, 50"H, and 65"H base panel frames use 15"H or 30"H stacking frames.
- If panel mounting slots are not being used, any stacking frame can be used on any base panel frame of matching width.

Segment Kits (page 162)

- One segment kit required (order segment kit separately) on base panel frames and stacking frames between each segmented tile.
- Segment kit not required at beltline (22½" above the base raceway).
- One segment kit accommodates segmentation on both sides of the frame.
- Segment kit is required to mount electrical other than at beltline or base raceway. Kit provides support for components at 7½"H increments.
- Segment kit not required between low profile glass and base frame.

Low Profile Glass Stacker Kits and Tie Brackets (page 163)

- Single pane clear or frosted safety tempered glass encased within a frame.
- Glass is positioned in the middle of the stacking frame.
- Can be used to span multiple frames when the combined frame width is equal to the low profile glass stacker width.
- Mounts to base panel frame(s) as a stacking unit.
- The top trim from the base panel frame or spanning top trim is used to finish the top of low profile glass stacker kit.
- For use at top position only.
- Low profile glass stackers are non-structural. Do not hang or stack on top of low profile glass stacker kits.
- Cannot mount a countertop on low profile glass stacker kits.
- Tie bracket kit(s) required when two or more low profile glass stackers are adjacent (order separately). Specify based on low profile glass stacker kit intersections at the same height only, ignoring base frames at the same height.
- Tie bracket kits only connect to low profile glass stacker kits. They do not attach to base frames.
- Low profile glass stackers do not have panel slots.
- Height of low profile glass stackers must be considered when calculating overall height.
- Horizontal segment kit is not needed below low profile glass stacker.
- Add appropriate additional connector blocks.
- Uppermost tile(s) on base frame(s) below low profile glass stacker must be removed for stacker installation.

Building horizontally with Stride frames

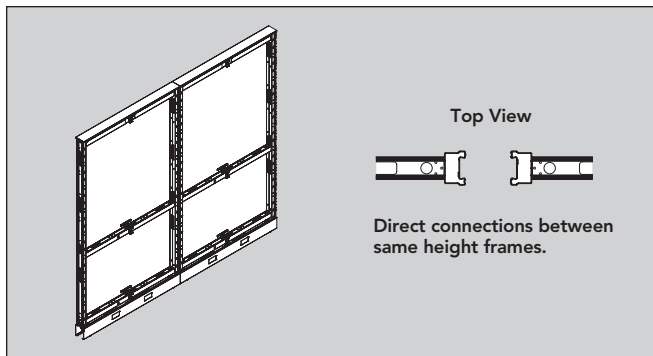

Important planning guidelines: For adequate stability, one of two methods of stabilization must be adhered to:

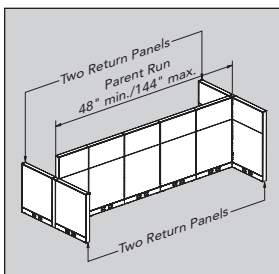

- **Method 1—Opposing returns:** A parent run must be a minimum of 48" and a maximum of 144" between return panels. The parent run must have a minimum of two return panels running in opposing directions on each end of run. Return panels must be a minimum of 24"W; and must not be any more than 30" shorter in height than parent run.

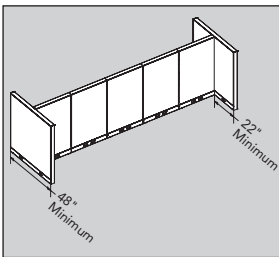

- **An off-modular return panel** must be at least 48"W and there must be at least 22"W on one side of the parent run.

Note: Alternate stabilization methods available using back- or side-mounted Stride credenzas — see pages 145-146.

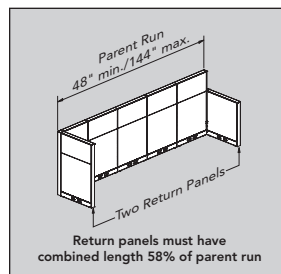

- **Method 2—Single-sided returns:** A parent run must be a minimum of 48" and a maximum of 144" between return panels. The parent run must have a minimum of two return panels totaling at least 58% of its length, extending in one direction. Return panels must not be any more than 30" shorter in height than parent run. Any run under 100" must have a minimum combined length of 60" of return panels.

Tie Bracket Kits for Low Profile Glass Stackers (page 163)

- For use with low profile glass stackers when two or more low profile glass staker kits come together at a connector juncture.
- Only used when attaching one low profile glass staker kit to another low profile glass staker kit.
- Specify based on low profile glass staker kit intersections at the same height only, ignoring base frames at the same height.
- Tie bracket kits only connect to low profile glass staker kits. Brackets do not attach to base frames.

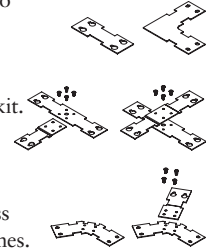

Panel Mounted Screens (pages 164-165)

- A panel mounted screen is a frameless insert that is integrated into the top trim on a base panel frame.
- The panel mounted screen replaces the top trim on base panel frame or stacking frame on which it is mounted.
- Panel mounted screens cannot be mounted on low profile glass stackers.
- "G" grooved end trim must be used when a base panel frame below a panel mounted screen is shorter than the adjacent in-line panel.
- Panel mounted screens are non-structural and therefore cannot be stacked on top of support hanging elements.
- Finishes and Sizes:
Clear or Frosted safety glass — available in 7½"H and 15"H

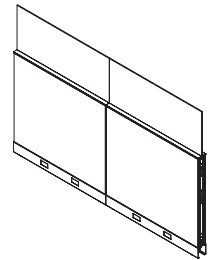

Hinged Door Panel Frame (page 166)

- Includes 42"W frame, top trim, 36"W door, hinges, and attachment hardware.
- Door is available in laminate.
- Order door knob or lever separately, see page 166.



Sliding Door and Mounting Kit (page 166)

- See illustration and specification information on page 147.

Standard Flat Top Trim (page 167)

- Used when specifying base panel frames without top trim.
- Top trim can span individual or multiple base panel or stacking frames.
- It is possible to span multiple frames when the combined frame width is equal to the top trim width.
- Some examples are listed on page 167, other combinations are possible.
- Available in painted or veneer finish.

Connector Span Flat Top Trim (page 167)

- It is possible to span multiple frames and one ("TS", "XS", or "SS") connector when the combined frame width is equal to the top trim width and one "S" style connector.
- Only to be used on a parent run where all return panels are at a lower height (extended straight connections only).
- Available in painted or veneer finish.

Low Credenza Side to Panel Bracket

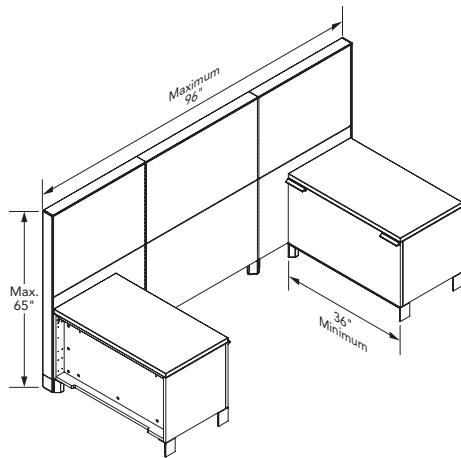

Side-mounted low credenzas

- The minimum Stride low credenza width is 36" on each end.
- With a mid-run floor support the maximum panel run is 144".
- Without a mid-run floor support, the maximum panel run is 96".
- Overheads and shelves cannot be used with side-mounted low credenzas.
- Worksurfaces (if specified) must be mounted on the same side of the parent run as the credenzas.
- Panel frame maximum height is 65"H. Stacking frames can be used.

Credenza Back to Panel Bracket — Modular

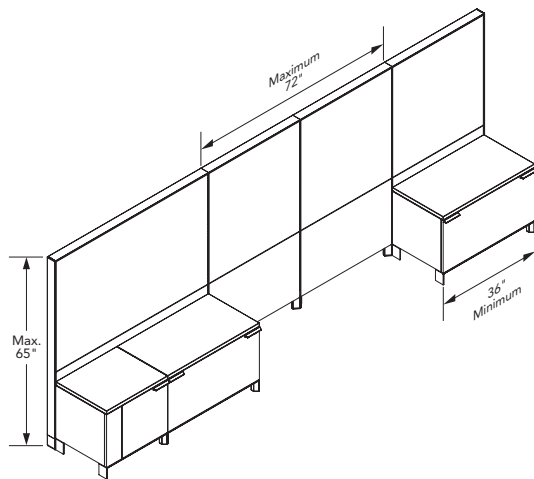

Back-mounted credenzas

- The minimum Stride credenza width is 36"W on each end.
- The maximum panel run between back-mounted credenzas is 72".
- With the use of one bracket kit, two credenzas can be ganged together up to 72"W and can span two panels. Each panel must be the same width as each credenza.
- When using overhead cabinets or shelves, both sides of the run must have credenzas that are the same width as the panel or panels joined without a connector.
- Overheads, shelves, and worksurfaces must be mounted on the same side of the parent run as the credenzas. Stacking frames cannot be used with overheads.
- Panel frame maximum height is 65"H.

Credenza Back to Panel Bracket — Off-Modular Ends

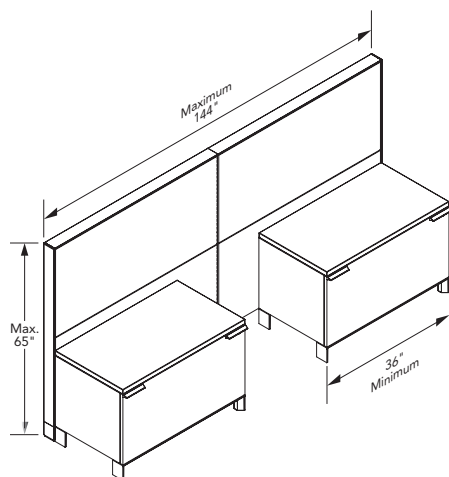

Off-Modular back-mounted Credenzas

- The minimum Stride credenza width is 36"W.
- With a floor support the maximum panel run is 144".
- Without a floor support, the maximum panel run is 96".
- Overheads and shelves cannot be used if both ends of the credenza are not on modular.
- Panel frame maximum height is 65"H. Stacking frames can be used.

High Credenza Side to Panel Bracket

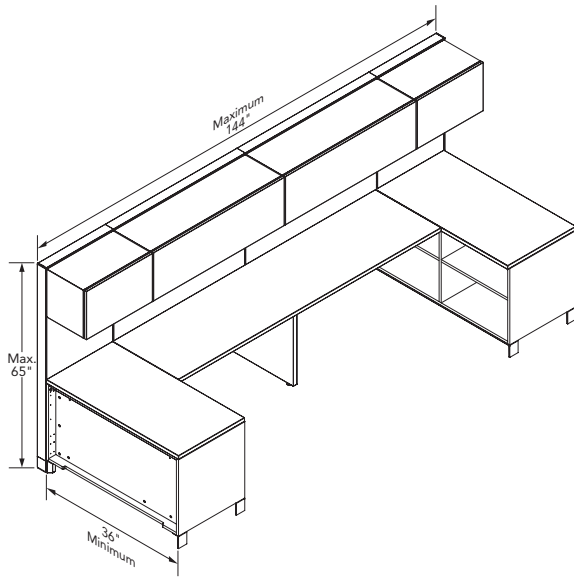

Side-mounted high credenzas

- The minimum Stride high credenza width is 36" W on each end.
- With a floor support the maximum panel run is 144".
- Without a floor support, the maximum panel run is 96".
- Overheads, shelves, and worksurfaces must be mounted on the same side of the parent run as the credenzas. Stacking frames cannot be used with overheads.
- Panel frame maximum height is 65" H.

Credenza Side to Panel Bracket with Return Panel

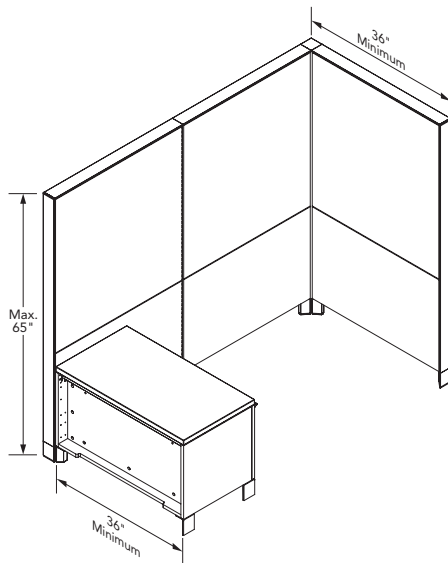

Bracket with return panel

- Minimum Stride credenza width 36".
- With a floor support the maximum panel run is 144".
- Without a floor support, the maximum panel run is 96".
- The minimum size for panel return is 36" W x 35" H.
- Overheads, shelves, and worksurfaces must be mounted on the same side of the parent run as the high credenza.
- Panel frame maximum height is 65" H.

The sliding door for Stride is system specific; one model for Stride with specific mounting kits for each door ordered. With a frosted translucent insert and your choice of P1 or P2 paint, the sliding door will create a unique look for any office environment.

Sliding doors are available in 50", 65", and 80"H models and can mount to 30", 36", 42", and 48"W panels. They accommodate a 36"W opening and are 42"W, nominally. The doors ship from the factory non-handed and become handed when field installed to fit the specifications of the project. The handle pulls located on each side of the door are color matched to the trim to create a uniform style. And with the threshold free design, the sliding door offers better aesthetics and safety by eliminating the potential for tripping.

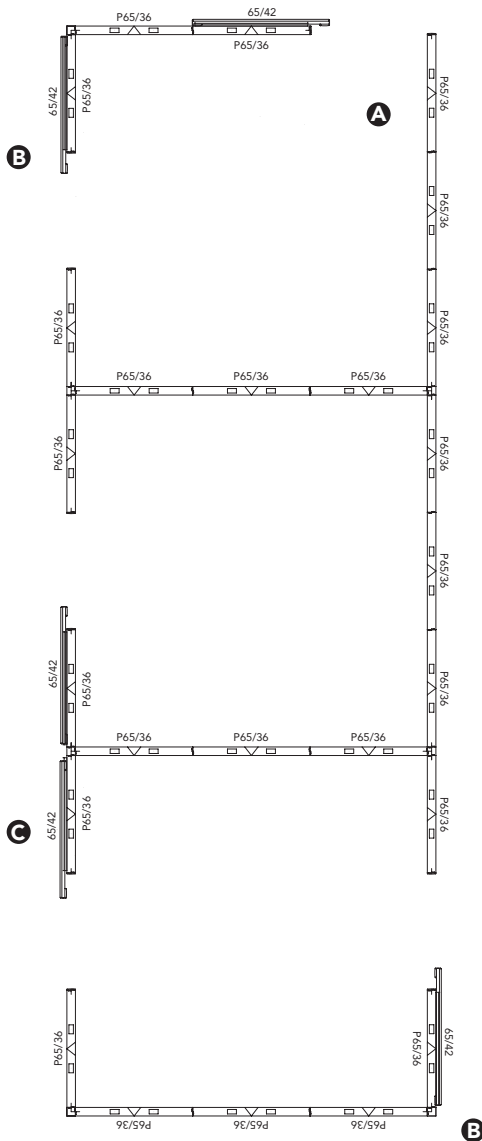

Sliding Doors and Mounting Bracket Kits (page 166)

- The system requires the ordering of both a door and a mounting bracket kit.
- The door and mounting bracket kits are system specific. The Stride door and mounting kit only works with Stride.
- All sliding doors are 42" wide to accommodate a 36"W opening. Doors are non-handed and non-locking.
- A mounting bracket kit must be ordered for each door corresponding to the mounting panels width (30", 36", 42", or 48"W) on which the kit is being installed.

General Guidelines for Layout Planning of Sliding Door

- Stability guidelines must be followed when specifying a sliding door. (Refer to page 144). The sliding door system was designed to close an opening in a run of parallel panels. Doors mounted to long runs of panels without floor support, ties to worksurfaces or return panels may seem less stable.
- If the door is used to close an opening (A) where the panel opposite the door is at 90°, there will be a gap equal to the panel thickness between the door and the panel end when closed.
- When planning the layout, care must be taken if the plan includes a door mounted on a panel that is less than 42" W.
- If the panel is at a corner (B), the door will protrude into the aisle or next workstation when in the open position.
- If back-to-back doors are mounted on panels (C) that are less than 42" W they will interfere with each if both are open at the same time.
- The door is attached at the base of the panel at any end position with a wrap around bracket. Bracket kits are ordered in conjunction with appropriate end trim profiles. The slots at the base of the panel must be clear (D) and cannot be utilized by worksurface supports or panel hung components.
- If the door is mounted to a panel run that is positioned adjacent to a wall (E) or an inside 90° angle and there is not a 42" clearance between the track and the wall/inside 90° the assembly of the first stop will be difficult and plans will need to be modified for the assembly.
- If a door is closing an opening of a workstation that includes a "T" connector in the opposite wall, an extended straight connector may need to be used to maintain the 36" required opening.
- Door leveling is dependent on floor being level.

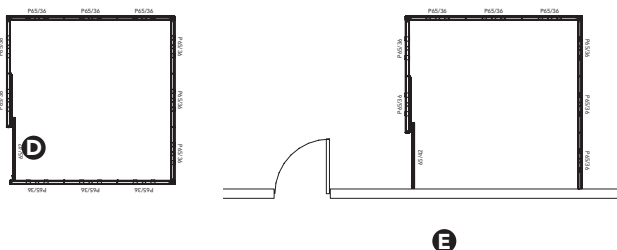

There are three components to consider when specifying Stride connectors: 1) connector blocks 2) light block kit 3) vertical trim. Light block and trim must be ordered separately. See examples of “L”, “T”, and “X” configurations on pages 150 and 151.

Connector Blocks

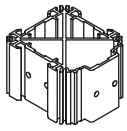

2-Way, 3-Way, and 4-Way Universal Connector Blocks

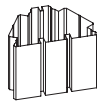

2-Way 120° Connector Blocks

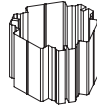

3-Way 120° Connector Blocks

<p>35" H Frames = 2 Connector Blocks 42½" H Frames = 3 Connector Blocks 50" H Frames = 3 Connector Blocks 57½" H Frames = 3 Connector Blocks 65" H Frames = 4 Connector Blocks</p>
<p>Add connector blocks for each level: 7½" H = 1 connector block 15, 22½ or 30" H = 2 connector blocks</p>

STEP 1: CONNECTOR BLOCKS (page 168)

- Universal connector blocks are used to connect frames at “L”, “T”, “X”, or “S” connector junctures, 2-Way “B” 120° connector blocks are used for 120° connector junctures, and 3-Way “C” 120° connector blocks are used for 3-way connector junctures.
- At all connector junctures, specify the number of base frame connector blocks based on the height of the shortest base frame(s).
- Starting at the top of the lowest base frame and going up, add additional connector blocks for each level change. A *level change* is any difference in height between frames and/or stacking frames within a connector juncture, not necessarily top cap to top cap. A *level change* includes a stacking frame (each stacking frame level requires 2 connector blocks).
- Continue adding blocks for each level until there are fewer than two frames remaining above the last specified level.
- When specifying the 2-, 3-, or 4-way Universal Connector Blocks, CAP/CET specification tools will auto-pick the Z3UCON10P model which comes as a pack of 10. You can manually overwrite this model to Z3UCON and adjust the quantity as needed.

Light Block

2-Way Light Block

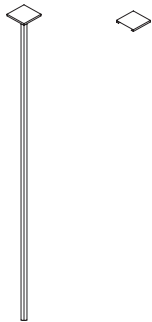

2-Way “L” 2-Way “S”

3-Way Light Block



4-Way Light Block

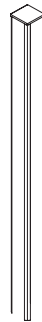

120° Light Block



2-Way “B”

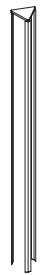

3-Way “C”

<p>2 Frames (90°) = 2-Way Light Block Kit (L) 3 Frames = 3-Way Light Block Kit (T) 4 Frames = 4-Way Light Block Kit (X)</p>
<p>2 Frames (120°) = 2-Way Light Block Kit (B) 3 Frames (120°) = 3-Way Light Block Kit (C)</p>

STEP 2: LIGHT BLOCK KIT (pages 169-174)

- Each light block kit includes a top cap transition piece and light block. Light block can be specified without top cap for use in extended straight specifications when using spanning top trim.
- Connector blocks and trim must be ordered separately. Trim is available in painted or veneer finish. If top cap only (for use at a 2-way extended straight connector juncture) no light block is required.
- Light block height is equal to the tallest frames. **Exception:** When there is only one tallest frame, determine the light block height considering the frames(s) at the next highest frame height.
- Light block quantity is determined by the number of frames at the connector juncture.
- The top cap transition piece is determined by the configuration of the tallest frames at a connector juncture. **Exception:** When there is only one tallest frame, specify the top cap transition piece considering the frame(s) at the next highest frame height and the tallest frame.
- The top cap transition piece will be located at the height of the light block light block kits can also be specified without a top cap transition piece.

Light Block Model Logic:

Stride connector = Z365XS

	6	5	X	S
Z3	2a.	2b.	2c.	Top
	Height	Connector	Cap Trans.	Piece
		Juncture	(config.)	

- 2a. Light block height = □ □ □
- 2b. Connector junction = □ □ □
 - X – 4-Way
 - T – 3-Way
 - L – 2-Way
 - B – 120° – 2-Way
 - C – 120° – 3-Way
- 2c. Top cap transition piece (configuration): X, T, L, S, B, C = □ □ □
 Letter codes will be the same if panels are all the same height.

Vertical Trim



"VH" Variable Height End Trim



"EG" Grooved Variable Height End Trim



"L" 2-Way 90° Filler Trim



"F" Flat Filler Trim (Use 2 for "S" Extended Straight)



"B" 2-Way 120° Filler Trim



"E" End Trim



"EF" End Trim for Footed Panel

STEP 3: TRIM (pages 169-174)

- Vertical trim finishes off panel frames and connectors - available in painted or veneer finish. Connector and light blocks must be ordered separately.
- Vertical filler trim is specified by first considering the location (height) of the top cap transition piece at the connector juncture. (Step 2)

Variable Height (pages 169-174)

- Directly above the top cap transition piece, specify variable height vertical trim "VH" to cover the exposed frame. "VH" attaches directly to the end of the panel frame to finish ends in a high-low condition.
- "G" grooved variable height end trim is used when the base frame of a panel mounted screen is shorter than the adjacent in-line panel.

Filler Trim (pages 169-174)

- Below the top cap transition piece, fill voids to cover exposed connector blocks. If there are two adjacent exposed sides (90°) use "L" 90° vertical filler trim. "L" 90° vertical filler trim attaches to connector blocks
- Fill in remaining voids with "F" flat vertical filler trim, which also attaches to connector blocks.
- For "S" extended straight configurations, specify 2 "F" flat vertical filler trim pieces.
- "B" vertical filler trim is used below the top cap transition piece in 120° configurations.

Finished Ends (page 174)

- "E" vertical end trim attaches to the end of the panel frame for use as a finished end on base raceway panel frames.
- "EF" vertical end trim for footed panel is used as a finished end on footed panels frames.
- Wall mount kits provide a means to affix a panel frame to a permanent building wall. Kit adds ¼" to length of panel run.

Wall Kits



Wall Mount Kit

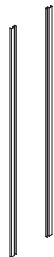

Wall Track

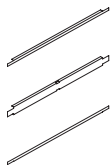

Wall Track Tile Attachment Kit



Wall Track Tile Segment

"W" Wall Mount Kit (page 175)

- Includes top cap.
- Adds ¼" to run.
- Provides means to affix a panel run to permanent building wall.
- Anchor devices are not supplied.
- Available in painted or veneer finish.

Wall Track (page 175)

- Allows for mounting of system panel components on permanent wall structures.
- Vertical wall track is 60"H. Field cut for lower heights.
- Wall track will add ⅜" to depth of attached components.
- One pair — left and right included.

Wall Track Tile Attachment Kit (page 175)

- Allows mounting of Stride tiles to wall track segments.
- Includes two top/bottom bars and one middle segment bar.
- Add additional wall track tile segment(s) if attaching more than two tiles.

Wall Track Tile Segment (page 175)

- Includes one middle segment bar for additional segmentation.

"L" CONFIGURATION — 65"H / 65"H
Models:
 Step 1: Connector Blocks
Z3UCON

Step 2: Light Block Kit
Z365LL

Step 3: Trim
Z365PL

"T" CONFIGURATION — 65"H / 65"H / 65"H
Models:
 Step 1: Connector Blocks
Z3UCON

Step 2: Light Block Kit
Z365TT

Step 3: Trim
Z365PF

"T" CONFIGURATION — 65"H / 65"H / 50"H
Models:
 Step 1: Connector Blocks
Z3UCON

Step 2: Light Block Kit
Z350T

Step 3: Trim
Z365PF
Z315PF
Z375PT (Spanning Top Trim)

"X" CONFIGURATION — 65"H / 57½"H / 50"H / 42½"H
Models:
 Step 1: Connector Blocks
Z3UCON

Step 2: Light Block Kit
Z357XL

Step 3: Trim
Z307PF
Z307PL
Z307PVH

"X" CONFIGURATION — 65"H / 50"H / 65"H / 50"H
Models:
 Step 1: Connector Blocks
Z3UCON

Step 2: Light Block Kit
Z350X

Step 3: Trim
Z315PF
Z315PF
Z375PT (Spanning Top Trim)

"X" CONFIGURATION — 80"H (65"H frame + 15"H stacker) / 80"H (57½"H frame + 22"H stacker) / 50"H / 42½"H
Models:
 Step 1: Connector Blocks
Z3UCON

Step 2: Light Block Kit
Z380XL

Step 3: Trim
Z330PL
Z307PF

Stride tiles come in a variety of styles. Select the aesthetic* and functional combination that meets your specific requirements.

Additional tiles available, see pages [153-159](#).

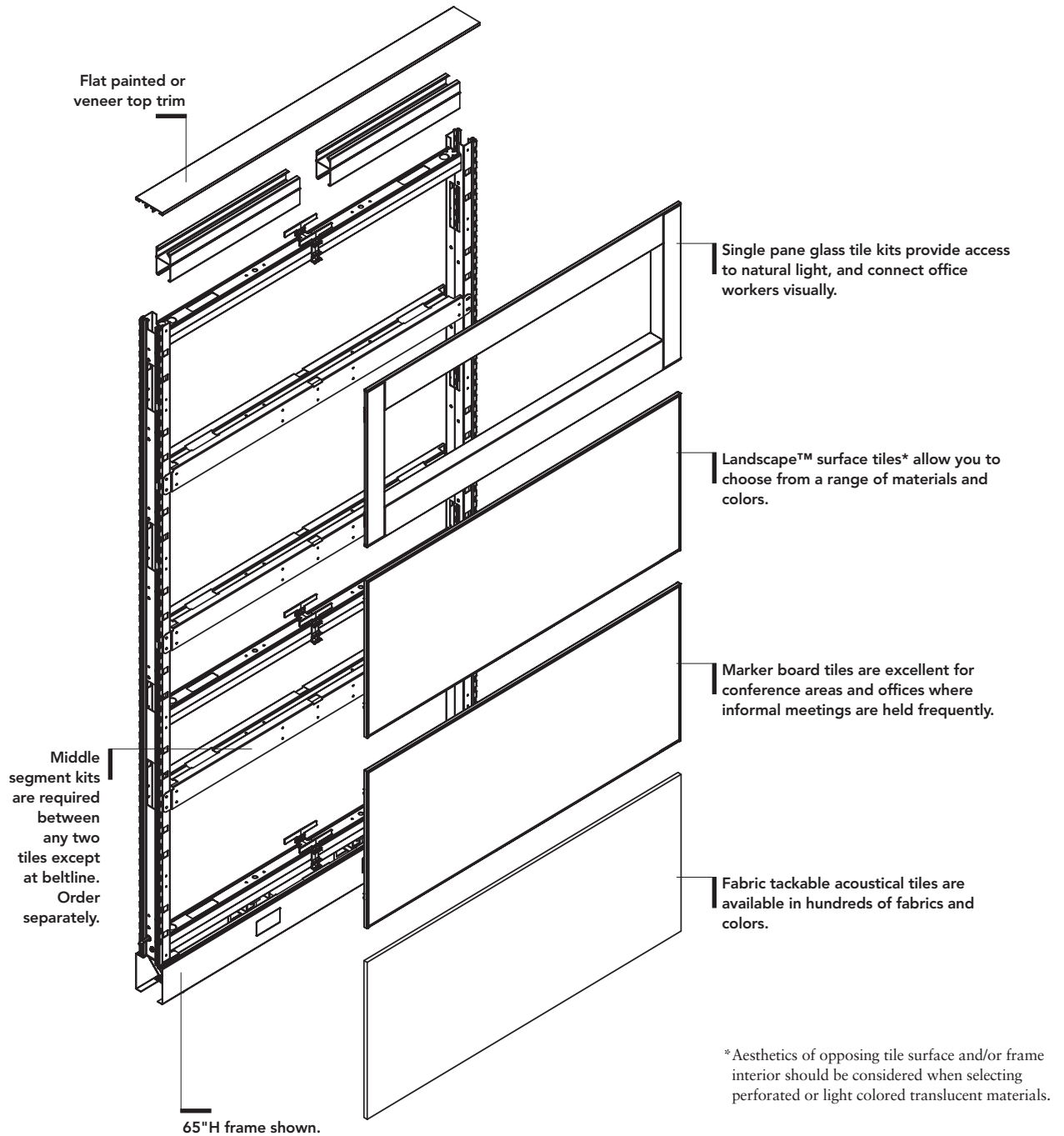

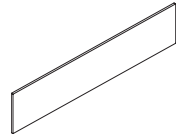

7½"H Tile

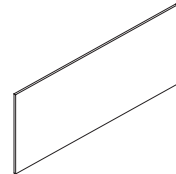

15"H Tile

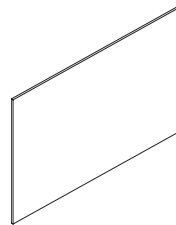

22½"H Tile

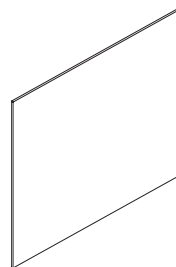

30"H Tile

Landscape™ Surface Material is a ¼" thick material that is available for use on tiles, tower sidelights, storage fronts, panel mounted screens, and modesty panels. The Landscape surface material offering for Stride includes: Foundation and Quattro. Refer to the matrix below for usage guidelines.

Foundation

- Foundation is a fabric material laminated between recyclable PETG resin sheets.
- Foundation is available in two color options: Pure White and Sand.

Quattro

- Quattro is fabric laminated between recyclable PETG resin sheets.
- Quattro is available in Platinum.

Frosted Translucent

- Frosted Translucent is ¼" thick Plexiglas acrylic with flat polished edge.
- Frosted Translucent is available in one color option: Frost.

	Tiles	Tower Sidelights	Storage Fronts	Panel Mounted Screens	Desk Screens	Modesty Panels
Foundation	•	•	•			
Quattro	•	•	•			
Frosted Translucent					•	

Tiles ship with attachment clips installed. Tiles do not include segment kits, order separately.

Tackable Acoustical Tiles

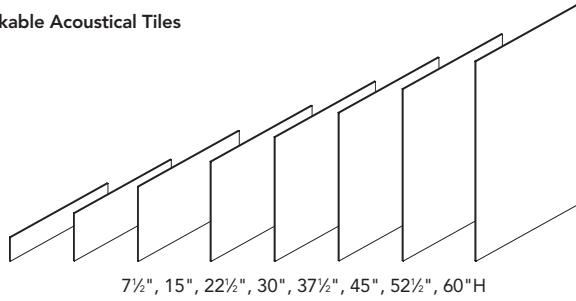

7 1/2", 15", 22 1/2", 30", 37 1/2", 45", 52 1/2", 60" H

Port Tiles

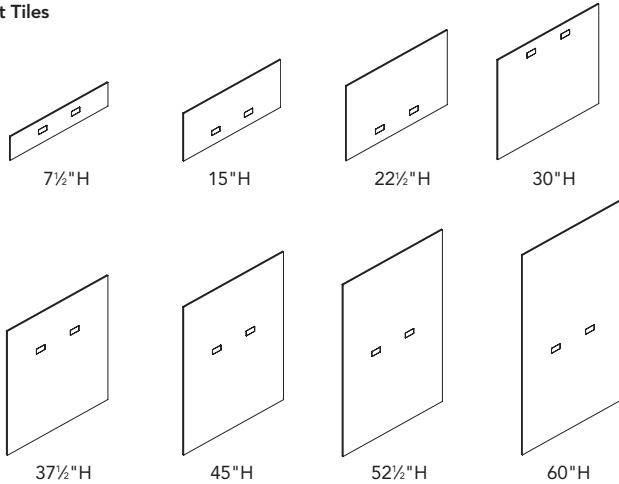

Coordinate Grommet Color with Paint Color:

Paint Color	Grommet Color
Carob — P52.....	Black — E4
Champagne Metallic — PR5.....	Muslin — EU
Fossil — P28.....	Flint — E9
Gunmetal Metallic — PR3.....	Brownstone — EY
Parchment — P93.....	Muslin — EU
Platinum Metallic — PR2.....	Loft — EV

Tackable Acoustical Tile-to-the-Floor

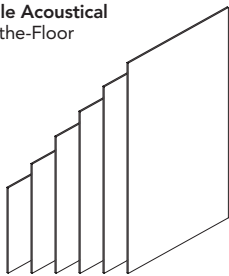

22 1/2", 30", 37 1/2", 45", 52 1/2", 60" H

Steel Tiles

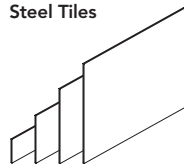

7 1/2", 15", 22 1/2", 30" H

Steel Tile-to-the-Floor

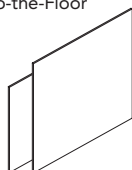

22 1/2", 30" H

Perforated Steel Tiles

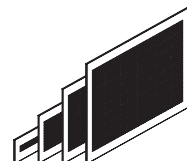

7 1/2", 15", 22 1/2", 30" H

Tool Tiles

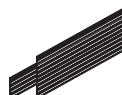

7 1/2", 15" H

Tackable Acoustical Tiles (pages 176-177)

- Tackable and acoustical. 7 1/2" H-60" H, 20" W-60" W.
- Tiles do not include segment kits — order separately.
- Tiles are level® 2 when a level® 2 fabric is used.

Port Tiles (pages 178-179)

- Receptacle openings with blank covers (1 in 24" W tiles; 2 in wider tiles).
- Receptacle openings have the ability to accept most commercially available modular data plates.
- Tackable and acoustical. 7 1/2" H-60" H, 24" W-60" W.
- Grommet opening dimension is 1.375" H x 2.700" W.
- When using rail based off-modular, ported tile grommets may interfere with frames mounted perpendicular to the spine.
- 7 1/2"-15" H port tiles can be mounted in any position except bottom position on frame.
- 7 1/2"-22 1/2" H are ported in the bottom for use when segmenting.
- 22" H port tiles can be flipped for below worksurface power access.
- 30"-60" H port tiles are used to position grommets above a worksurface mounted at 29 1/2" H. Designed for use in bottom position, but can be used in any position.
- Tiles do not include segment kits — order separately.
- Tiles are level® 2 when a level® 2 fabric is used.

Tackable Acoustical Tiles to-the-Floor (page 180)

- Tackable and acoustical. 22 1/2" H-60" H, 20" W-60" W.
- Tiles to-the-floor are to be used in the bottom position only.
- Tiles to-the-floor are 5" longer to accommodate to-the-floor applications and replace base raceway cover.
- Tiles do not include segment kits — order separately.
- Tiles are level® 2 when a level® 2 fabric is used.
- Cannot use tiles to-the-floor with footed panel frames.
- Requires simple in field modification to frame glide tower. After modification, base raceway cover cannot be used with fabric or steel tiles.

Steel Tiles (page 181)

- Painted steel construction. 7 1/2" H-30" H, 20" W-60" W.
- Tiles do not include segment kits — order separately.
- Steel tiles can be used in any location.

Steel Tiles to-the-Floor (page 181)

- Painted steel construction. 22 1/2" H-30" H, 20" W-60" W.
- Tiles do not include segment kits — order separately.
- Tiles to-the-floor are to be used in the bottom position only.
- Tiles to-the-floor are 5" longer to accommodate to-the-floor applications and replace base raceway cover.
- Attachment hardware included.
- Cannot use tiles to-the-floor with footed panel frames.

Perforated Steel Tiles (page 182)

- Tiles do not include segment kits — order separately.
- Allows air flow when placed on each side of panel.
- Aesthetics of opposing tile surface and/or frame interior should be considered when selecting perforated steel tiles.
- Should not be used at locations that span horizontal segment kits or at beltline.

Tool Tiles (page 183)

- Sturdy aluminum extrusion.
- Accommodates Extensions™ work tools — weight capacity not to exceed 80 lbs. If monitor arm attached subtract 25 lbs.
- Consideration needs to be given to height of tools and location of worksurfaces and storage.
- Do not segment within the center of the back side of a 15" H tool tile, instead use two 7 1/2" H tool tiles.
- Tiles do not include segment kits — order separately.
- Do not use at top of wall track.

Tiles ship with attachment clips installed. Tiles do not include segment kits, order separately.

Porcelain Marker Board Tiles

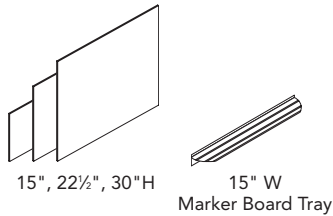

Steel Marker Board Tiles

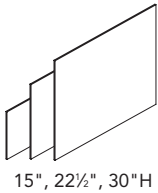

Landscape Surface Tiles

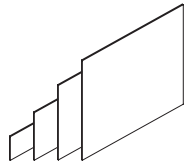

Infinite Spectrum™, Pearlescent Strata, Foundation, Quattro

Handling and care for marker boards:

1. Leaving ink on the board for an extended period of time may lead to images remaining on the board, commonly known as "ghosting," after erasing.
2. To avoid ghosting, thoroughly erase your marker board after every use and clean your board weekly with marker board cleaner.
3. Expo® brand dry-erase markers are recommended for best erasing results.
4. Avoid using red and orange markers for easier cleaning and to reduce the likelihood of ghosting.
5. Do not use permanent or non-dry erase markers.
6. To maintain eraser performance, follow manufacturer's instructions.

Porcelain Marker Board Tiles (page 184)

- White porcelain-coated steel surface encased within a steel frame.
- Accepts magnetic accessories.
- Paint color for frame must be specified.
- Marker boards ship with tile attachment clips installed.
- Tiles do not include segment kits — order separately.
- 15"W magnetic marker board tray that is natural aluminum is available. Order model TK4TRAYMS separately.
- For everyday cleaning of dry-erase marker ink, use Clorox wipes. Should a permanent marker be used, a citrus cleaner such as Quartet will remove the ink. Note that a citrus cleaner is not recommended for everyday cleaning as it leaves a residue on the marker board.

Steel Marker Board Tiles (page 184)

- White marker board tile; painted steel surface.
- Accepts magnetic accessories.
- Tiles do not include segment kits — order separately.
- 15"W magnetic marker board tray that is natural aluminum is available. Order model TK4TRAYMS separately.
- For everyday cleaning of dry-erase marker ink, use Clorox wipes. Should a permanent marker be used, a citrus cleaner such as Quartet will remove the ink. Note that a citrus cleaner is not recommended for everyday cleaning as it leaves a residue on the marker board.

Landscape Surface Tiles (page 185)

- ¼" material encased within a painted steel frame.
- Paint color for frame must be specified.
- Tiles do not ship with segment kits — order separately.
- Should not be used at locations that span horizontal segment kits or at beltline.
- Available in Foundation™ and Quattro.

Laminate Tiles

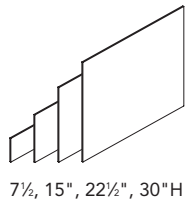

Laminate Tiles to-the-Floor

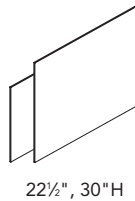

Laminate Tiles (pages 186-187)

- Laminate construction, available in all standard laminate finishes.
- Tiles do not include segment kits — order separately.
- Grain direction runs vertical on all sizes.
- **Made of ¾" board with HPL laminate.**

Laminate Tiles to-the-Floor (pages 188-190)

- Laminate construction, available in all standard laminate finishes.
- Tiles to-the-floor are to be used in the bottom position only.
- Tiles to-the-floor are 5" longer to accommodate to-the-floor applications and replace base raceway cover.
- Do not use tiles to-the-floor with footed panel frames.
- Tiles do not include segment kits — order separately.

Glass Tile Kit

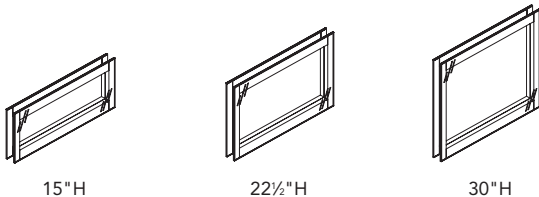

Single Pane Glass Tile Kits (page 191)

- Kit includes single pane of tempered safety glass for one side of frame and trim for the other side of frame.
- Glass is flush on one side.
- Tiles do not include segment kits — order separately.
- Kits ship with tile attachment clips installed.
- Attachment hardware included.
- Should not be used at locations that span horizontal segment kits or at beltline.
- Low profile glass stacker kits also available.

Pass-Thru Trim Kit

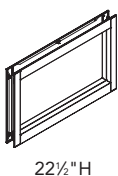

Pass-Thru Trim Kits (page 191)

- Painted steel frame.
- Open frame without tiles, used for ability to pass objects from one side of frame to the other.
- Segment kits not included — order separately.
- One kit accommodates both sides of panel frame.
- Attachment hardware included.
- Should not be used at locations that span horizontal segment kits or at beltline.

Tiles

Spanning Tiles (pages 189-190)

- Not compatible with landscape tiles.
- Base panel height must match tile height. Example: 50"H tile must go on a 50"H base frame, not 50"H tile on 35"H base frame + 15"H stacker.
- Can be used with any combination of two frame widths.
- No more than two frames per tile.
- Bracket Kits:
 - Z4STBRKT1 = 30/35"H
 - Z4STBRKT2 = 42/50"H
- Full laminate and edgeband options available.
- Horizontal grain only.
- For dual-sided spanning tile applications, an additional Bracket Kit must be ordered.
- For dual-sided applications, spanning tiles must be mounted to the same panel frames.
- Laminate is 3/8" thick, edgeband is 0.8mm thick.
- Slotted standard is accessible when using spanning tiles on the two outside slots.
- Cannot be used with Wall Track.
- Spanning tiles are not compatible with panel frames produced prior to July 2014. For applications with panels produced prior to July 2014, please reach out to the Tailored Products Group.

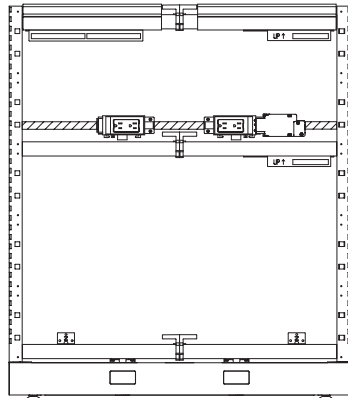
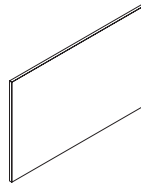

Beltline power is only available above the beltline on the opposite side of the spanning tile.

Frame Combinations

54w		60w		66w		72w		78w		84w		90w		96w	
Frame 1	Frame 2	Frame 1	Frame 2	Frame 1	Frame 2	Frame 1	Frame 2	Frame 1	Frame 2	Frame 1	Frame 2	Frame 1	Frame 2	Frame 1	Frame 2
24	30	24	36	24	42	24	48	30	48	24	60	30	60	36	60
		30	30	30	36	30	42	36	42	36	48	42	48	48	48
						36	36			42	42				

Stride Stratawood and Natural Veneer

Wood owes its inherent beauty to variations in color, grain and texture, and therefore, these variations are not considered defects. There may be minor variations from one piece of furniture to the next, even though they are finished at the same time. Exposure to light and the aging process will cause darkening of natural wood products. Light finishes on wood products do not mask the natural characteristics of wood. Therefore, Allsteel does not guarantee the exact matching grain, pattern and color.

Stride veneer trim, connectors, tiles and storage fronts are offered in Stratawood (composite) finishes and in Natural veneer finishes. (See page 136 for finishes.)

Stride Stratawood and Natural veneer worksurfaces are protected by one of the world’s most advanced wood finishing process by Gunlocke®. It provides the ultimate in scratch, stain, chemical, and heat resistance for these high-wear surfaces. The jewel-like clarity and depth allow the natural beauty of the wood to glow through.

Stratawood Veneer Vs. Natural Veneer: Which is best for you?

Stratawood and Natural veneer have similarities and differences. Both options provide a wood surface. Exposure to light will cause both options to darken. Both Stratawood and Natural veneer will be a stylish addition to any specification. However the look, feel and process for Stratawood and Natural veneer are different.

Stratawood Veneer

Stratawood veneer features a repeatable straight-grain pattern, absent of the cathedrals seen in Natural veneer. Although slight differences in tone should be expected, the Stratawood pattern will maintain a consistent appearance across all products.

Stratawood veneer is an engineered wood veneer enhanced by technology for consistency in both color and grain pattern resulting in very few defects.

Although exposure to light will cause Stratawood veneer to darken slightly, additional orders at later dates will match existing product pattern and will match the color when matured. This creates a smooth process for adding on to existing installations.

Natural Veneer

Natural veneer is subject to nature’s quality control. Differences in grain and color are naturally occurring variations and can not be controlled by the manufacturer and cannot be considered as product defects. Natural veneer has the characteristics and beauty of a living organism; with its own variations of grain, growth, and color patterns. For these reasons, Natural veneer is preferred by many for its warmth and personal characteristics.

Color changes will occur over time when wood is exposed to light. For this reason, when new product is ordered as an addition to existing product, there will be color variances between the old and new product. Please remember when specifying new product that although the species of veneer will be the same, additional product is being manufactured from a different tree. It may take several months for the new furniture to mature to the color level of the existing product. Even with this maturation process the additional product may not be an exact match.

When ordering Natural veneer tiles for Stride frames, please refer to pages 157-158 for information. Natural tiles sets must be ordered to ensure grain pattern matching. All panels with two or more continual natural veneer segments will need to be ordered as a set and will be grain matched for consistency. These tile sets must remain together throughout the manufacturing and installation process.

Natural veneer worksurfaces may exhibit a color variance between the surface and the edge detail or when butted together at a 90 degree angle. This natural phenomenon is called polarization (or grain flip) which alters the color and appearance of adjacent worksurfaces with grain running perpendicular. The appearance of wood veneer may change slightly depending on what angle it is viewed from, although it is most often noticed on worksurfaces installed at 90 degree angles to each other. For your guidance, please see illustrations within the worksurface section when specifying for an understanding of grain direction in your installation.

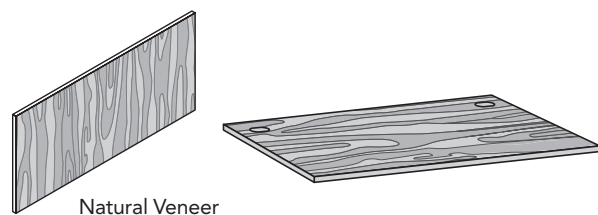
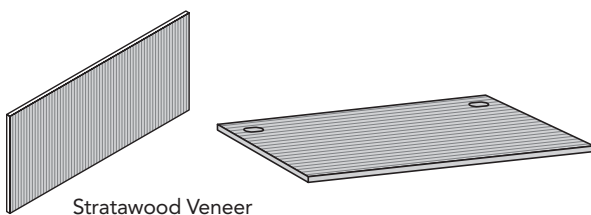

Caring for your Veneer finish:

- General maintenance procedures entail wiping clean the entire surface with a clean, water dampened soft cloth once per week. (Be sure to wipe with the grain.)
- Murphy's® Oil Soap may be used as a general purpose type cleaner with warm water to clean tops.
- The finish may also be polished with Guardsman® Furniture Polish (contains no waxes or silicones) to provide renewed luster.
- Be sure to wipe up all spills immediately.

Veneer on Stride

2 Different Veneer Types

Natural veneer is subject to nature's quality control. Each specimen will exhibit differences in grain pattern and tone. This is to be expected, and, in fact contributes to the individuality of each product.

Stratawood veneer features a straight-grain pattern, absent of the cathedrals seen in natural veneer. Although slight differences in tone should be expected, the Stratawood pattern will maintain a consistent appearance across all products.

Veneer Finish Options

See page 136 for available finishes and finish indicators in both Natural and Stratawood.

Natural Veneer Tile Sets for Stride

- Natural veneer tile sets are used when 2 or more natural veneer tiles are vertically adjacent to each other on the same panel (see illustration below) in order to maximize the beauty of real wood and carry the grain pattern from tile to tile.
- Tile sets do not apply to Stratawood tiles, as the grain pattern is consistent from tile to tile.

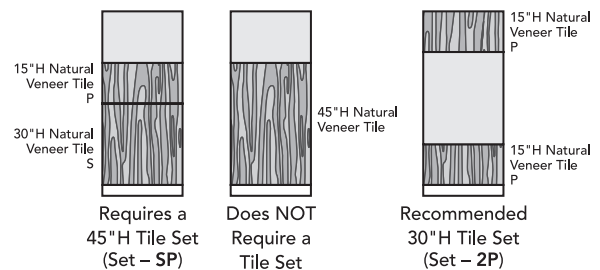

Specifying Standard Natural Veneer Tile Sets

1. Determine the height of the natural veneer tile set.
 - a. The total height of tile required can be calculated by deducting 5" (the height of the frame base) from the nominal panel height.
 - b. To calculate set height simply add the heights of the tiles in the set (for example, one 15" H tile and one 30" H tile would require a 45" H tile set — see illustration above).
2. Natural veneer to-the-floor tile sets are available following regular sets.
 - A 45" H Natural veneer to-the-floor tile set will fully fill a 50" H frame.
 - A 52½" H Natural veneer to-the-floor tile set will fully fill a 57½" H frame.
 - A 60" H Natural veneer to-the-floor tile set will fully fill a 65" H frame.

Note

1. Tile sets MUST remain together throughout the installation process in order to maximize the beauty of real wood and carry the grain pattern vertically from tile to tile.
2. The backside of each tile in the tile set is marked with a set number so that the tiles comprising that specific set do not get confused with any other natural veneer tile sets.
3. The backside of each tile in the tile set with a letter denoting the placement of each tile in the set. The tile marked A is the top tile in the set, followed by B, C, and so on.

Natural Veneer Tile Set Position Options Chart

Natural Veneer Tile Sets	Nominal Panel Height	Natural Veneer Tile Set Code	Tile Set Height	Tiles Included (bottom to top)
	35"H	2P	30"H	PP
42½"H	QP	37½"H	QP	
50"H	3P	45"H	PPP	
	SP	45"H	SP	
57½"H	Q2P	52½"H	QPP	
	SQ	52½"H	SQ	
65"H	4P	60"H	PPPP	
	S2P	60"H	SPP	

Veneer Tiles (page 192)

- Veneer tiles produced by Gunlocke® available in Stratawood or Natural veneer.
- Stratawood veneer has a consistent straight-grain pattern.
- Natural veneer will have cathedrals and as a natural material is subject to nature's quality control with variations in grain pattern and tone.
- Tiles do not include segment kits — order separately.
- Veneer tiles, kits, and tile sets all ship with attachment clips installed.
- If two or more natural veneer tiles are vertically adjacent, Natural veneer tile sets should be ordered to carry the grain pattern.
- Grain direction runs vertical on all sizes.

Veneer Tiles to-the-Floor Kits (page 193)

- Tiles do not include segment kits — order separately.
- Tiles to-the-floor are to be used in the bottom position only.
- Tiles to-the-floor are 5" longer to accommodate to-the-floor applications.
- Tiles to-the-floor replace base raceway cover.
- Tiles to-the-floor cannot be used with footed panel frames.

Natural Veneer Tile Sets (pages 194-195)

- Specify when two or more natural veneer tiles are adjacent to carry the vertical grain pattern from tile to tile.

Veneer to-the-Floor Tile Sets (page 196)

- Specify when two or more natural veneer tiles are adjacent to carry the vertical grain pattern from tile to tile.
- Veneer to-the-floor tile set are 5" longer to accommodate to-the-floor applications.
- Veneer to-the-floor tile sets replace base raceway cover.
- Veneer to-the-floor tile sets cannot be used with footed panel frames.

Natural Veneer Tile Sets

Tile Height Codes used for Natural Veneer Sets below:

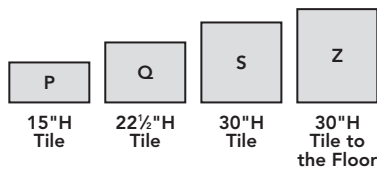

Letters on tiles represent height of individual tiles, see codes above.

Ordering code is listed above each tile set, and total height of set is listed below.

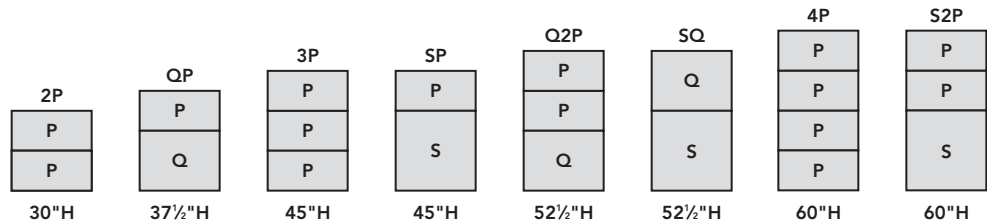

Veneer to-the-floor tile sets have a base tile that is 5" longer to accommodate "to-the-floor" applications.

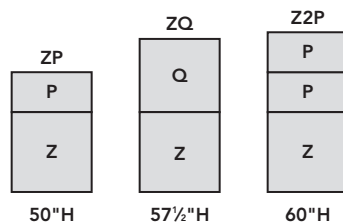

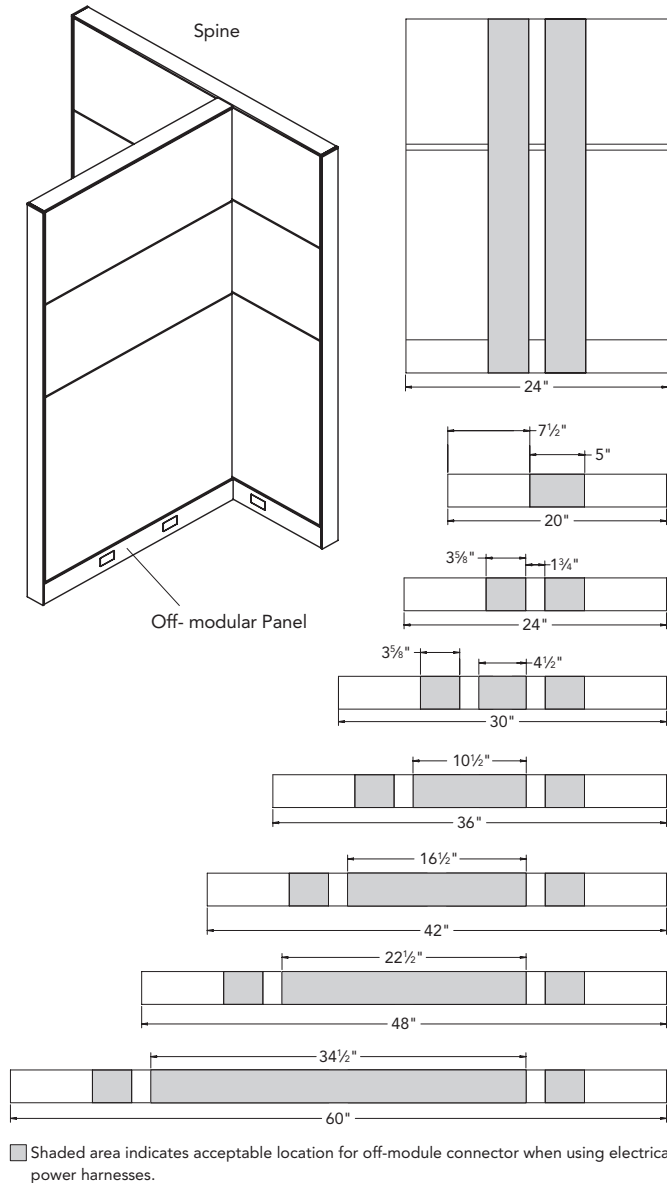

Off-Module Non-Rail Based Connector Guidelines

- Off-module connector kits join panels off-module at 90° angles. The total 3" panel thickness must be positioned within the confines of the shaded areas, as depicted in the illustration, but cannot be positioned directly over electrical cutouts in the frame horizontal.
- Tiles and base pathway covers cannot be removed from the face of a panel to which an off-module connected panel is mounted.
- Base panel frames must be the same height.
- Do not stack on an off-modular return panel.
- Do not suspend more than one overhead storage unit per side from panels in a panel run which is mounted, at one or both ends, with an off-module connector kit.
- Use data port (model UTP) to route data and electrical between primary panel run and panel-mounted off-modular.
- Panel mounted screens or low profile glass stackers cannot be used on the parent run or on an off-modular panel.
- Footed panel frames can be used on the spine wall but cannot be used as the off-modular panel frame.
- To-the-floor tiles cannot be used on the side of the spine wall where off-modular return panel is attached.

Off-Modular Non Rail-Based Accessories

Panel Attachment Kit (page 197)

- Connector allows for off-module connection, does not add to length of run.
- Black only.

End Panel Kit (page 197)

- Used to attach an end panel off-modular.
- Bracket requires a segmented panel at 22 1/2" H for mounting.

Worksurface Bracket (page 197)

- Allows in-line support legs and end-panels to be attached off-module.
- Bracket requires a segmented panel at 22 1/2" H for mounting.
- Cannot be used closer than 12" from end of panel.

3" Layered Worksurface Bracket (page 197)

- Used to mount off-modular worksurface at 26 1/2" H.
- Bracket requires a segmented panel at 22 1/2" H for mounting.

Layered Worksurface Connection Bracket (page 197)

- Used to attach a worksurface 3" higher or lower to an installed worksurface.

Overhead Cabinet Off-Modular Mounting Kit (page 197)

- Used to mount overhead cabinet on a panel which is up to 18" narrower than cabinet width.
- Requires one side of cabinet to be held on module.

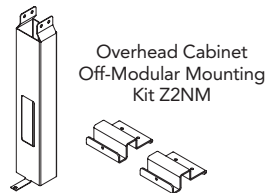
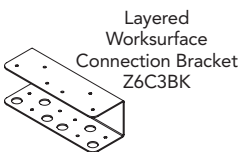
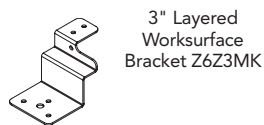
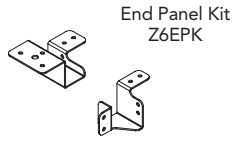

For specification information see pages 141-147.

GSA SIN 33721

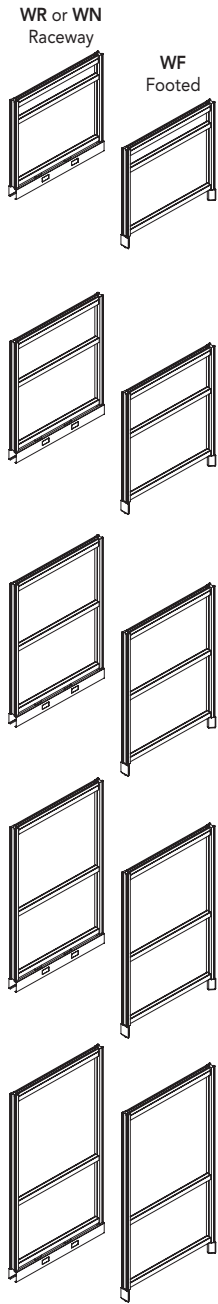

Description	Model	List Price WR or WN	List Price WF
35"H Panel Frames without Top Trim			
24"W	Z03524 □□ [S]	\$ 415	\$ 465
30"W	Z03530 □□	\$ 450	\$ 494
36"W	Z03536 □□	\$ 474	\$ 528
42"W	Z03542 □□	\$ 508	\$ 556
48"W	Z03548 □□	\$ 540	\$ 587
60"W	Z03560 □□	\$ 615	\$ 667

42½"H Panel Frames without Top Trim			
24"W	Z04224 □□ [S]	\$ 431	\$ 483
30"W	Z04230 □□	\$ 467	\$ 518
36"W	Z04236 □□	\$ 497	\$ 552
42"W	Z04242 □□	\$ 530	\$ 579
48"W	Z04248 □□	\$ 569	\$ 618
60"W	Z04260 □□	\$ 634	\$ 685

50"H Panel Frames without Top Trim			
24"W	Z05024 □□	\$ 456	\$ 506
30"W	Z05030 □□	\$ 485	\$ 539
36"W	Z05036 □□	\$ 518	\$ 570
42"W	Z05042 □□	\$ 556	\$ 607
48"W	Z05048 □□	\$ 587	\$ 643
60"W	Z05060 □□	\$ 676	\$ 730

57½"H Panel Frames without Top Trim			
24"W	Z05724 □□	\$ 474	\$ 524
30"W	Z05730 □□	\$ 515	\$ 560
36"W	Z05736 □□	\$ 547	\$ 594
42"W	Z05742 □□	\$ 582	\$ 630
48"W	Z05748 □□	\$ 623	\$ 676
60"W	Z05760 □□	\$ 714	\$ 760

65"H Panel Frames without Top Trim			
24"W	Z06524 □□	\$ 497	\$ 543
30"W	Z06530 □□	\$ 534	\$ 582
36"W	Z06536 □□	\$ 576	\$ 620
42"W	Z06542 □□	\$ 613	\$ 658
48"W	Z06548 □□	\$ 656	\$ 698
60"W	Z06560 □□	\$ 743	\$ 795

<p>How to specify — Select the Panel Frame Model Number from above.</p> <p>Z 0 </p>	<p>1st Option: Select the Base Option:</p> <p>WR Without Top Trim; With Raceway Cover Knockouts on both sides</p> <p>WN Without Top Trim; With Raceway Cover Knockouts on 1 side.</p> <p>WF Without Top Trim; With Footed Panel Frame.</p> <p> .</p>	<p>2nd Option: Select the Paint Color:</p> <p>[P1] [P2] [P3]</p> <p>See page 136 for finishes.</p> <p>For P2 Paints — add \$30.</p> <p>For P3 Paint — add \$57.</p> <p>Footed frames not available in P3 paint.</p> <p>P </p>
---	---	---

Examples: Z04224WR.P4J Z04224WN.P7D Z04260WF.P02

[S] Shippable by small-package carrier.

Frames

Stride® — Stacking Panel Frames / Segment Kits / Conversion Kits

For specification information see pages 141-147.

GSA SIN 33721



Z01536P

Description	Model	List Price
15"H Stacking Frames		
24"W	Z01524P S	\$ 438
30"W	Z01530P S	\$ 455
36"W	Z01536P S	\$ 468
42"W	Z01542P S	\$ 487
48"W	Z01548P S	\$ 506
60"W	Z01560P S	\$ 534

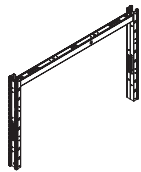

Z02236P

22½"H Stacking Frames		
24"W	Z02224P S	\$ 450
30"W	Z02230P S	\$ 473
36"W	Z02236P S	\$ 506
42"W	Z02242P S	\$ 534
48"W	Z02248P S	\$ 566
60"W	Z02260P S	\$ 635



Z03036P

30"H Stacking Frames		
24"W	Z03024P S	\$ 464
30"W	Z03030P	\$ 503
36"W	Z03036P	\$ 542
42"W	Z03042P	\$ 577
48"W	Z03048P	\$ 632
60"W	Z03060P	\$ 730

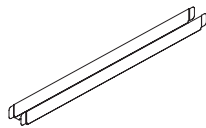

Z236SK

Segment Kits (no color option) — for Base Panel Frames and Stacking Frames		
24"W	Z224SK S	\$ 80
30"W	Z230SK S	\$ 84
36"W	Z236SK S	\$ 89
42"W	Z242SK S	\$ 91
48"W	Z248SK S	\$ 99
60"W	Z260SK S	\$ 105



Z2RF

Description	Model	P1 Paint List Price	P2 Paint List Price
Raceway to Footed Conversion Kit			
Base Raceway to Footed Kit	Z2RF S	\$ 272	\$ 302

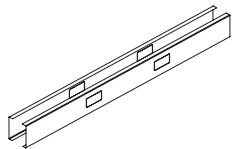

Z236FR

Footed-to-Base Raceway Conversion Kits			
24"W Footed-to-Base Raceway Kit	Z224FR S	\$ 340	\$ 390
30"W Footed-to-Base Raceway Kit	Z230FR S	\$ 340	\$ 390
36"W Footed-to-Base Raceway Kit	Z236FR S	\$ 340	\$ 390
42"W Footed-to-Base Raceway Kit	Z242FR S	\$ 340	\$ 390
48"W Footed-to-Base Raceway Kit	Z248FR S	\$ 340	\$ 390
60"W Footed-to-Base Raceway Kit	Z260FR S	\$ 340	\$ 390

How to specify —
Select the Model Number from above.

1st Option:
Segment Kit Color
(if applicable):
P Black

1st Option:
Paint
(if applicable):
See page 136 for finishes.

Z | | | | | | | | | |

P |

P | | | |

Examples: Z01548P Z224SK.P Z236FR.P7C

S Shippable by small-package carrier.

Frames

Stride® — Low Profile Glass Stacker Kits

For specification information see pages 141-147.

GSA SIN 33721



Description	Model	Clear List Price	Frosted List Price
15"H Low Profile Glass Stacker Kits (Examples span multiple panels)			
24"W	Z41524GL	\$ 966	\$ 1164
30"W	Z41530GL	\$ 1038	\$ 1255
36"W	Z41536GL	\$ 1119	\$ 1350
42"W	Z41542GL	\$ 1204	\$ 1451
48"W	Z41548GL	\$ 1273	\$ 1538
60"W (30" + 30" or 24" + 36")	Z41560GL	\$ 1454	\$ 1753
72"W (36" + 36" or 24" + 48")	Z41572GL	\$ 1682	\$ 2028
84"W (36" + 48")	Z41584GL	\$ 1852	\$ 2236
90"W (42" + 48" or 30" + 30" + 30")	Z41590GL	\$ 1940	\$ 2342
96"W (48" + 48" or 30" + 30" + 36")	Z41596GL	\$ 2055	\$ 2481

Description	Model	List Price
Tie Bracket Kit for Low Profile Glass Stacker Kits		
In-Line Connection	Z3TBGI	\$ 42
"L" Connection	Z3TBGL	\$ 42
"T" Connection	Z3TBGT	\$ 42
"X" Connection	Z3TBGX	\$ 42
"S" Connection	Z3TBGS	\$ 42
2-Way 120° Connection	Z3TBGB	\$ 42
3-Way 120° Connection	Z3TBGC	\$ 42

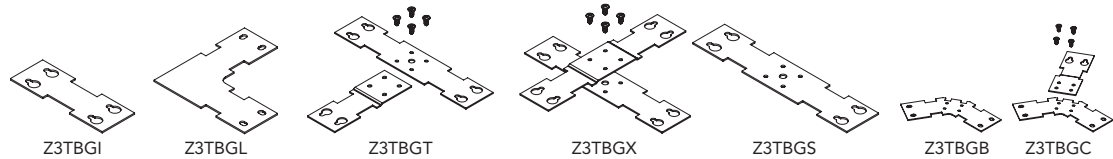

<p>How to specify — Select the Model Number from above.</p>	<p>1st Option: Paint — Interior Shroud (if applicable): P1 P2 P3 See page 136 for finishes.</p>	<p>2nd Option: Glass Type (if applicable): C Clear F Frosted</p>	
<p>Z . P .</p>			

Examples: Z41530GL.P27.C Z3TBGL

Shippable by small-package carrier.

For specification information see page 144.

GSA SIN 33721

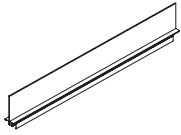

Description	Model	Clear List Price	Frosted List Price	Smoked List Price
7½"H x ¾" Thick Glass Panel Mounted Screens — Painted Trim				
24"W	Z40724TGS	\$ 674	\$ 722	\$ 769
30"W	Z40730TGS	\$ 732	\$ 782	\$ 835
36"W	Z40736TGS	\$ 840	\$ 898	\$ 959
42"W	Z40742TGS	\$ 897	\$ 957	\$ 1024
48"W	Z40748TGS	\$ 964	\$ 1030	\$ 1099
54"W	Z40754TGS	\$ 1070	\$ 1145	\$ 1222
60"W	Z40760TGS	\$ 1176	\$ 1257	\$ 1341
66"W	Z40766TGS	\$ 1294	\$ 1383	\$ 1477
72"W	Z40772TGS	\$ 1410	\$ 1508	\$ 1608
78"W	Z40778TGS	\$ 1514	\$ 1620	\$ 1728
84"W	Z40784TGS	\$ 1615	\$ 1726	\$ 1843
90"W	Z40790TGS	\$ 1727	\$ 1848	\$ 1971
96"W	Z40796TGS	\$ 1833	\$ 1961	\$ 2091
15"H x ¾" Thick Glass Panel Mounted Screens — Painted Trim				
24"W	Z41524TGS	\$ 732	\$ 782	\$ 835
30"W	Z41530TGS	\$ 791	\$ 846	\$ 903
36"W	Z41536TGS	\$ 909	\$ 971	\$ 1037
42"W	Z41542TGS	\$ 971	\$ 1038	\$ 1107
48"W	Z41548TGS	\$ 1048	\$ 1122	\$ 1196
54"W	Z41554TGS	\$ 1163	\$ 1243	\$ 1327
60"W	Z41560TGS	\$ 1277	\$ 1364	\$ 1458
66"W	Z41566TGS	\$ 1403	\$ 1499	\$ 1600
72"W	Z41572TGS	\$ 1526	\$ 1633	\$ 1742
78"W	Z41578TGS	\$ 1727	\$ 1847	\$ 1971
84"W	Z41584TGS	\$ 1928	\$ 2061	\$ 2198
90"W	Z41590TGS	\$ 1990	\$ 2126	\$ 2271
96"W	Z41596TGS	\$ 2056	\$ 2199	\$ 2346

How to specify —
Select the Model Number from above.

1st Option:
Glass
(if applicable):
LC Clear
LF Frosted
GSM1 Smoked

2nd Option:
Paint Color:
P1 P2 P3
See page 136 for finishes.

Z 4 . L . P

Example: Z40742TGS.LC.P7D

Shippable by small-package carrier.

Tiles

Stride® — Panel Mounted Screens

For specification information see page 144.

GSA SIN 33721

Description	Model	V2			V3		
		Clear List Price	Frosted List Price	Smoked List Price	Clear List Price	Frosted List Price	Smoked List Price
7½"H x ¾" Thick Glass Panel Mounted Screens — Veneer Trim							
24"W	Z40724TGSV	\$ 861	\$ 923	\$ 990	\$ 939	\$ 1001	\$ 1068
30"W	Z40730TGSV	\$ 934	\$ 1000	\$ 1075	\$ 1019	\$ 1085	\$ 1160
36"W	Z40736TGSV	\$ 1069	\$ 1146	\$ 1229	\$ 1166	\$ 1243	\$ 1326
42"W	Z40742TGSV	\$ 1135	\$ 1217	\$ 1304	\$ 1238	\$ 1320	\$ 1407
48"W	Z40748TGSV	\$ 1224	\$ 1314	\$ 1408	\$ 1335	\$ 1425	\$ 1519
54"W	Z40754TGSV	\$ 1362	\$ 1461	\$ 1566	\$ 1486	\$ 1585	\$ 1690
60"W	Z40760TGSV	\$ 1495	\$ 1605	\$ 1719	\$ 1631	\$ 1741	\$ 1855
66"W	Z40766TGSV	\$ 1588	\$ 1708	\$ 1835	\$ 1732	\$ 1852	\$ 1979
72"W	Z40772TGSV	\$ 1788	\$ 1919	\$ 2056	\$ 1950	\$ 2081	\$ 2218
78"W	Z40778TGSV	\$ 1922	\$ 2066	\$ 2211	\$ 2097	\$ 2241	\$ 2386
84"W	Z40784TGSV	\$ 2049	\$ 2199	\$ 2355	\$ 2235	\$ 2385	\$ 2541
90"W	Z40790TGSV	\$ 2188	\$ 2348	\$ 2516	\$ 2387	\$ 2547	\$ 2715
96"W	Z40796TGSV	\$ 2329	\$ 2498	\$ 2678	\$ 2541	\$ 2710	\$ 2890

15"H x ¾" Thick Glass Panel Mounted Screens — Veneer Trim

24"W	Z41524TGSV	\$ 934	\$ 1000	\$ 1075	\$ 1019	\$ 1085	\$ 1160
30"W	Z41530TGSV	\$ 1003	\$ 1075	\$ 1153	\$ 1094	\$ 1166	\$ 1244
36"W	Z41536TGSV	\$ 1153	\$ 1236	\$ 1326	\$ 1258	\$ 1341	\$ 1431
42"W	Z41542TGSV	\$ 1236	\$ 1327	\$ 1421	\$ 1348	\$ 1439	\$ 1533
48"W	Z41548TGSV	\$ 1330	\$ 1428	\$ 1529	\$ 1451	\$ 1549	\$ 1650
54"W	Z41554TGSV	\$ 1427	\$ 1536	\$ 1648	\$ 1557	\$ 1666	\$ 1778
60"W	Z41560TGSV	\$ 1619	\$ 1737	\$ 1863	\$ 1766	\$ 1884	\$ 2010
66"W	Z41566TGSV	\$ 1721	\$ 1852	\$ 1987	\$ 1877	\$ 2008	\$ 2143
72"W	Z41572TGSV	\$ 2225	\$ 2370	\$ 2516	\$ 2427	\$ 2572	\$ 2718
78"W	Z41578TGSV	\$ 2188	\$ 2348	\$ 2516	\$ 2387	\$ 2547	\$ 2715
84"W	Z41584TGSV	\$ 2445	\$ 2627	\$ 2811	\$ 2667	\$ 2849	\$ 3033
90"W	Z41590TGSV	\$ 2904	\$ 3089	\$ 3283	\$ 3168	\$ 3353	\$ 3547
96"W	Z41596TGSV	\$ 2610	\$ 2804	\$ 3001	\$ 2847	\$ 3041	\$ 3238

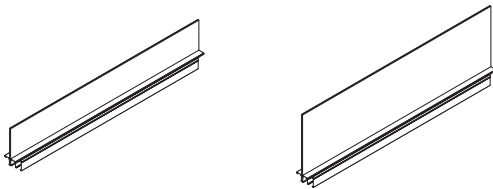

<p>How to specify — Select the Model Number from above.</p>	<p><i>1st Option:</i> Glass: LC Clear LF Frosted GSM1 Smoked</p>	<p><i>2nd Option:</i> Paint (if applicable): P1 P2 P3 See page 136 for finishes.</p>	<p><i>2nd Option:</i> Veneer (if applicable): See page 136 for finishes.</p>
<p>Z 4 T G S . L . P </p>			

Example: Z41536TGSV.LC.NC260

Frames

Stride® — Door Panel Frames and Sliding Doors

For specification information see pages 141-147.

GSA SIN 33721



Description	Model	Painted		
		P1 Paint List Price	P2 Paint List Price	P3 Paint List Price
Door Panel — Laminate				
87½"H x 42"W	Z18742PDL	\$ 6979	\$ 7045	\$ 7112

Description	Model	List Price
Lock Set		
Door Knob Polished Brass, keyed on one side	899900 S	\$ 180
Door Lever Brushed Aluminum, keyed on one side	899910 S	\$ 511

Description	Model	P1 Paint List Price	P2 Paint List Price	P3 Paint List Price
Frosted Translucent Sliding Doors (non-locking)				
50"H x 42"W for 36"W opening	Z15042SD	\$ 5704	\$ 5766	\$ 5831
65"H x 42"W for 36"W opening	Z16542SD	\$ 6914	\$ 6976	\$ 7041
80"H x 42"W for 36"W opening	Z18042SD	\$ 8421	\$ 8483	\$ 8548



Mounting Kit For Sliding Doors				
Description	Model	P1 Paint List Price	P2 Paint List Price	P3 Paint List Price
30"W	Z130DMK S	\$ 885	\$ 908	\$ 928
36"W	Z136DMK S	\$ 885	\$ 908	\$ 928
42"W	Z142DMK S	\$ 885	\$ 908	\$ 928
48"W	Z148DMK S	\$ 885	\$ 908	\$ 928

How to specify —
Select the Model Number from above.

1st Option:
Select the Paint Color:
P1 P2 P3
See page 136 for finishes.

2nd Option:
Door Laminate (if applicable):
See page 136 for finishes.

2nd Option:
Insert (Sliding Door only):
FT Frosted Translucent

_____ . P _____ . _____ F I T

Examples: Z18742PDL.P28.TM20 Z18042SD.PR2.FT
Z148DMK.P4J 899900

S Shippable by small-package carrier.

For specification information see pages 141-147.

GSA SIN 33721

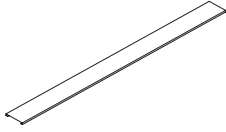

Description	Painted Model	Veneer Model	P1 Paint List Price	P2 Paint List Price	V2 Veneer List Price
Standard Flat Top Trim (Example Spans Multiple Panels)					
24"W	Z324PT <input type="checkbox"/>	Z324VT <input type="checkbox"/>	\$ 60	\$ 90	\$ 377
30"W	Z330PT <input type="checkbox"/>	Z330VT <input type="checkbox"/>	\$ 66	\$ 96	\$ 357
36"W	Z336PT <input type="checkbox"/>	Z336VT <input type="checkbox"/>	\$ 78	\$ 108	\$ 392
42"W	Z342PT <input type="checkbox"/>	Z342VT <input type="checkbox"/>	\$ 89	\$ 119	\$ 446
48"W	Z348PT <input type="checkbox"/>	Z348VT <input type="checkbox"/>	\$ 101	\$ 131	\$ 492
54"W — (24" + 30")	Z354PT <input type="checkbox"/>	Z354VT <input type="checkbox"/>	\$ 118	\$ 168	\$ 677
60"W — (30" + 30" or 24" + 36")	Z360PT <input type="checkbox"/>	Z360VT <input type="checkbox"/>	\$ 124	\$ 154	\$ 803
66"W — (30" + 36" or 24" + 42")	Z366PT	Z366VT	\$ 150	\$ 200	\$ 788
68"W — (20" + 48")	Z368PT	Z368VT	\$ 153	\$ 203	\$ 882
72"W — (36" + 36" or 24" + 48")	Z372PT	Z372VT	\$ 156	\$ 206	\$ 1117
78"W — (30" + 48" or 36" + 42")	Z378PT	Z378VT	\$ 160	\$ 210	\$ 1061
84"W — (36" + 48")	Z384PT	Z384VT	\$ 175	\$ 225	\$ 1150
90"W — (42" + 48" or 30" + 30" + 30")	Z390PT	Z390VT	\$ 184	\$ 234	\$ 1236
96"W — (48" + 48" or 30" + 30" + 36")	Z396PT	Z396VT	\$ 193	\$ 243	\$ 1318

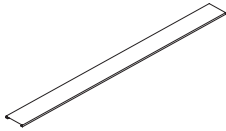

Connector Span Flat Top Trim (Example Spans Two Panels and One Connector)					
51"W — (24" + 3" + 24")	Z351PT <input type="checkbox"/>	Z351VT <input type="checkbox"/>	\$ 152	\$ 202	\$ 571
63"W — (24" + 3" + 36" or 30" + 3" + 30")	Z363PT <input type="checkbox"/>	Z363VT <input type="checkbox"/>	\$ 171	\$ 221	\$ 818
75"W — (36" + 3" + 36")	Z375PT	Z375VT	\$ 187	\$ 237	\$ 873

NOTE: Not all possible spanning combinations are shown. Illustration on page 150.

<p>How to specify — Select the Model Number from above.</p> <p>Z 3 T .</p>	<p>1st Option: Paint Color (if applicable):</p> <p><input type="radio"/> P1 <input type="radio"/> P2 <input type="radio"/> P3</p> <p>See page 136 for finishes.</p> <p>P </p>	<p>1st Option: Veneer Type and Finish (if applicable):</p> <p>See page 136 for finishes.</p> <p> </p>
---	--	---

Example: Z360PT.P4J

Shippable by small-package carrier.

For specification information see pages 148-151.

GSA SIN 33721

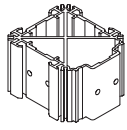

Z3UCON

Description	Model	List Price
2-Way 3-Way and 4-Way Universal Connector Blocks		
Universal Connector Block	Z3UCON S	\$ 45
Universal Connector Block - Pack of 10	Z3UCON10P	\$ 414

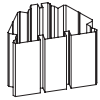

Z3CONB

120° Connector Blocks — 2-Way		
2-Way 120° Connector Block	Z3CONB S	\$ 52

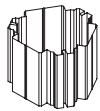

Z3CONC

120° Connector Blocks — 3-Way		
3-Way 120° Connector Block	Z3CONC S	\$ 52

How to specify —

Select the Model Number from above.



Examples: Z3UCON Z3CONB Z3CONC

S Shippable by small-package carrier.

For specification information see pages 148-151.

GSA SIN 33721



Z335PL



Z335PF



Z315PVH

Description	Painted Model	Veneer Model	P1 Paint List Price	P2 Paint List Price	V2 Veneer List Price
"L" 90° Vertical Filler Trim					
7½"H Variable Height	Z307PL S	Z307PLV S	\$ 105	\$ 134	\$ 288
15"H Variable Height	Z315PL S	Z315PLV S	\$ 115	\$ 144	\$ 400
22½"H Variable Height	Z322PL S	Z322PLV S	\$ 122	\$ 151	\$ 512
30"H Variable Height	Z330PL S	Z330PLV S	\$ 127	\$ 156	\$ 622
"F" Flat Vertical Filler Trim					
7½"H Variable Height	Z307PF S	Z307PFV S	\$ 82	\$ 111	\$ 258
15"H Variable Height	Z315PF S	Z315PFV S	\$ 90	\$ 119	\$ 361
22½"H Variable Height	Z322PF S	Z322PFV S	\$ 101	\$ 130	\$ 448
30"H Variable Height	Z330PF S	Z330PFV S	\$ 111	\$ 140	\$ 512
35"H Base Panel	Z335PF S	Z335PFV S	\$ 117	\$ 146	\$ 571
42½"H Base Panel	Z342PF S	Z342PFV S	\$ 124	\$ 153	\$ 634
50"H Base Panel	Z350PF S	Z350PFV S	\$ 135	\$ 164	\$ 721
57½"H Base Panel	Z357PF S	Z357PFV S	\$ 148	\$ 177	\$ 805
65"H Base Panel	Z365PF S	Z365PFV S	\$ 156	\$ 185	\$ 893
80"H Base Panel	Z380PF	Z380PFV	\$ 165	\$ 194	\$ 1049
87½"H Base Panel	Z387PF	Z387PFV	\$ 175	\$ 204	\$ 1158
"VH" Variable Height Vertical Filler Trim					
7½"H	Z307PVH S	Z307PVHV S	\$ 82	\$ 111	\$ 535
15"H	Z315PVH S	Z315PVHV S	\$ 90	\$ 119	\$ 622
22½"H	Z322PVH S	Z322PVHV S	\$ 101	\$ 130	\$ 699
30"H	Z330PVH S	Z330PVHV S	\$ 111	\$ 140	\$ 755

How to specify —
Select the Model Number from above.

1st Option:
Paint Color
(if applicable):
P1 P2 P3
See page 136 for finishes.

1st Option:
Veneer Type and Finish
(if applicable):
See page 136 for finishes.

Z | 3 | | | | | | | | .

P | | | | |

| | | | | | | |

Examples: Z307PL.P93 Z307PVH.PR2 Z315PFV.CC260

S Shippable by small-package carrier.

For specification information see pages 152-159. (See page 400 for COM pricing on fabric Grades G-J.)

GSA SIN 33721

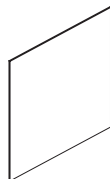

Description	Model	List Price					
		Grade A	Grade B	Grade C	Grade D	Grade E	Grade F
37½"H Tackable Acoustical Tiles (Monolithic tile for 42½"H frame)							
24"W	Z43724T S	\$ 267	\$ 279	\$ 289	\$ 309	\$ 326	\$ 345
30"W	Z43730T S	\$ 284	\$ 299	\$ 312	\$ 336	\$ 358	\$ 380
36"W	Z43736T S	\$ 312	\$ 330	\$ 345	\$ 372	\$ 401	\$ 428
42"W	Z43742T S	\$ 331	\$ 351	\$ 371	\$ 403	\$ 434	\$ 465
48"W	Z43748T S	\$ 357	\$ 379	\$ 402	\$ 438	\$ 475	\$ 511
60"W	Z43760T	\$ 408	\$ 436	\$ 464	\$ 509	\$ 554	\$ 600

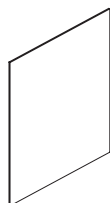

45"H Tackable Acoustical Tiles (Monolithic tile for 50"H frame)							
24"W	Z44524T S	\$ 302	\$ 317	\$ 329	\$ 351	\$ 373	\$ 395
30"W	Z44530T S	\$ 323	\$ 341	\$ 356	\$ 383	\$ 412	\$ 439
36"W	Z44536T S	\$ 353	\$ 373	\$ 394	\$ 426	\$ 459	\$ 490
42"W	Z44542T S	\$ 379	\$ 402	\$ 426	\$ 464	\$ 502	\$ 540
48"W	Z44548T S	\$ 410	\$ 437	\$ 464	\$ 506	\$ 551	\$ 594
60"W	Z44560T	\$ 456	\$ 489	\$ 522	\$ 577	\$ 631	\$ 686

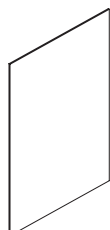

52½"H Tackable Acoustical Tiles (Monolithic tile for 57½"H frame)							
24"W	Z45224T S	\$ 333	\$ 350	\$ 364	\$ 390	\$ 415	\$ 441
30"W	Z45230T S	\$ 361	\$ 381	\$ 401	\$ 433	\$ 464	\$ 495
36"W	Z45236T S	\$ 393	\$ 416	\$ 440	\$ 478	\$ 516	\$ 554
42"W	Z45242T S	\$ 420	\$ 448	\$ 475	\$ 518	\$ 564	\$ 609
48"W	Z45248T	\$ 456	\$ 487	\$ 517	\$ 569	\$ 620	\$ 671
60"W	Z45260T	\$ 510	\$ 550	\$ 588	\$ 652	\$ 714	\$ 778



60"H Tackable Acoustical Tiles (Monolithic tile for 65"H frame)							
24"W	Z46024T S	\$ 376	\$ 395	\$ 412	\$ 441	\$ 470	\$ 499
30"W	Z46030T	\$ 408	\$ 430	\$ 453	\$ 489	\$ 526	\$ 562
36"W	Z46036T	\$ 474	\$ 501	\$ 528	\$ 570	\$ 615	\$ 658
42"W	Z46042T	\$ 504	\$ 535	\$ 565	\$ 617	\$ 668	\$ 719
48"W	Z46048T	\$ 532	\$ 568	\$ 603	\$ 661	\$ 719	\$ 777
60"W	Z46060T	\$ 562	\$ 607	\$ 651	\$ 722	\$ 795	\$ 868

How to specify —
Select the Model Number from above.

1st Option:
Fabric:
See page 14 for fabrics.

Z												T							
---	--	--	--	--	--	--	--	--	--	--	--	---	--	--	--	--	--	--	--

Example: Z45260T.ECH901

S Shippable by small-package carrier.



Tiles

Stride® — Tackable Acoustical Port Tiles

For specification information see pages 152-159. (See page 400 for COM pricing on fabric Grades G-J.)

GSA SIN 33721

Description	Model	List Price					
		Grade A	Grade B	Grade C	Grade D	Grade E	Grade F
7½"H Tackable Acoustical Port Tiles							
24"W	Z40724E	\$ 233	\$ 239	\$ 243	\$ 250	\$ 256	\$ 263
30"W	Z40730E	\$ 239	\$ 246	\$ 251	\$ 260	\$ 268	\$ 277
36"W	Z40736E	\$ 255	\$ 263	\$ 270	\$ 279	\$ 291	\$ 302
42"W	Z40742E	\$ 264	\$ 273	\$ 280	\$ 292	\$ 305	\$ 317
48"W	Z40748E	\$ 274	\$ 284	\$ 292	\$ 306	\$ 320	\$ 334
60"W	Z40760E	\$ 294	\$ 306	\$ 316	\$ 335	\$ 352	\$ 371
15"H Tackable Acoustical Port Tiles							
24"W	Z41524E	\$ 270	\$ 280	\$ 288	\$ 302	\$ 316	\$ 330
30"W	Z41530E	\$ 282	\$ 294	\$ 304	\$ 323	\$ 340	\$ 359
36"W	Z41536E	\$ 294	\$ 307	\$ 321	\$ 342	\$ 362	\$ 384
42"W	Z41542E	\$ 305	\$ 321	\$ 336	\$ 361	\$ 386	\$ 411
48"W	Z41548E	\$ 321	\$ 339	\$ 355	\$ 383	\$ 413	\$ 441
60"W	Z41560E	\$ 348	\$ 370	\$ 392	\$ 427	\$ 463	\$ 497
22½"H Tackable Acoustical Port Tiles							
24"W	Z42224E	\$ 304	\$ 317	\$ 331	\$ 352	\$ 372	\$ 394
30"W	Z42230E	\$ 318	\$ 335	\$ 350	\$ 377	\$ 403	\$ 430
36"W	Z42236E	\$ 333	\$ 353	\$ 373	\$ 405	\$ 436	\$ 468
42"W	Z42242E	\$ 349	\$ 372	\$ 395	\$ 432	\$ 469	\$ 506
48"W	Z42248E	\$ 365	\$ 392	\$ 417	\$ 459	\$ 501	\$ 545
60"W	Z42260E	\$ 399	\$ 431	\$ 464	\$ 517	\$ 570	\$ 623
30"H Tackable Acoustical Port Tiles							
24"W	Z43024E	\$ 336	\$ 354	\$ 370	\$ 398	\$ 428	\$ 456
30"W	Z43030E	\$ 354	\$ 376	\$ 398	\$ 433	\$ 469	\$ 503
36"W	Z43036E	\$ 376	\$ 403	\$ 428	\$ 470	\$ 512	\$ 556
42"W	Z43042E	\$ 393	\$ 423	\$ 453	\$ 503	\$ 552	\$ 602
48"W	Z43048E	\$ 415	\$ 449	\$ 483	\$ 540	\$ 597	\$ 652
60"W	Z43060E	\$ 449	\$ 493	\$ 534	\$ 605	\$ 676	\$ 746

<p>How to specify — Select the Model Number from above.</p>	<p><i>1st Option:</i> Fabric: See page 14 for fabrics.</p>	<p><i>2nd Option:</i> Electrical Grommet Color: See page 136 for finishes.</p>
<p>Z 4 E . . </p> <p><i>Example: Z40748E.ECH901.E9</i></p>		

Shippable by small-package carrier.

Tiles

Stride® — Tackable Acoustical Tiles to-the-Floor

For specification information see pages 152-159. (See page 401 for COM pricing on fabric Grades G-J.)

GSA SIN 33721

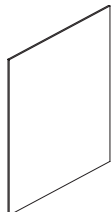
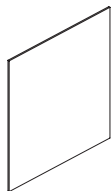
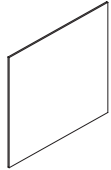
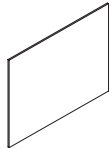

Description	Model	List Price					
		Grade A	Grade B	Grade C	Grade D	Grade E	Grade F
22½"H Tackable Acoustical Base Tiles to-the-Floor							
24"W	Z42224TF [S]	\$ 253	\$ 266	\$ 280	\$ 301	\$ 323	\$ 344
30"W	Z42230TF [S]	\$ 266	\$ 283	\$ 299	\$ 326	\$ 353	\$ 381
36"W	Z42236TF [S]	\$ 287	\$ 307	\$ 327	\$ 359	\$ 392	\$ 423
42"W	Z42242TF [S]	\$ 311	\$ 334	\$ 357	\$ 395	\$ 433	\$ 471
48"W	Z42248TF [S]	\$ 326	\$ 353	\$ 379	\$ 421	\$ 466	\$ 508
60"W	Z42260TF [S]	\$ 360	\$ 393	\$ 425	\$ 479	\$ 533	\$ 587

30"H Tackable Acoustical Base Tiles to-the-Floor (Tile for 35"H frame)							
24"W	Z43024TF [S]	\$ 286	\$ 304	\$ 322	\$ 350	\$ 379	\$ 407
30"W	Z43030TF [S]	\$ 307	\$ 329	\$ 351	\$ 387	\$ 423	\$ 459
36"W	Z43036TF [S]	\$ 329	\$ 356	\$ 382	\$ 424	\$ 469	\$ 511
42"W	Z43042TF [S]	\$ 351	\$ 382	\$ 412	\$ 462	\$ 512	\$ 563
48"W	Z43048TF [S]	\$ 375	\$ 411	\$ 445	\$ 502	\$ 559	\$ 617
60"W	Z43060TF	\$ 412	\$ 456	\$ 499	\$ 570	\$ 642	\$ 714

37½"H Tackable Acoustical Base Tiles to-the-Floor (Tile for 42.5"H frame)							
24"W	Z43724TF [S]	\$ 336	\$ 358	\$ 380	\$ 416	\$ 452	\$ 488
30"W	Z43730TF [S]	\$ 359	\$ 387	\$ 414	\$ 458	\$ 504	\$ 549
36"W	Z43736TF [S]	\$ 384	\$ 417	\$ 449	\$ 503	\$ 557	\$ 611
42"W	Z43742TF [S]	\$ 412	\$ 452	\$ 489	\$ 552	\$ 614	\$ 678
48"W	Z43748TF [S]	\$ 439	\$ 483	\$ 526	\$ 597	\$ 669	\$ 741
60"W	Z43760TF	\$ 484	\$ 539	\$ 593	\$ 682	\$ 771	\$ 861

45"H Tackable Acoustical Base Tiles to-the-Floor (Tile for 50"H frame)							
24"W	Z44524TF [S]	\$ 373	\$ 400	\$ 426	\$ 468	\$ 513	\$ 555
30"W	Z44530TF [S]	\$ 395	\$ 428	\$ 460	\$ 514	\$ 568	\$ 622
36"W	Z44536TF [S]	\$ 430	\$ 470	\$ 509	\$ 573	\$ 638	\$ 701
42"W	Z44542TF [S]	\$ 460	\$ 506	\$ 551	\$ 626	\$ 702	\$ 777
48"W	Z44548TF [S]	\$ 485	\$ 538	\$ 590	\$ 675	\$ 762	\$ 847
60"W	Z44560TF	\$ 540	\$ 605	\$ 670	\$ 777	\$ 885	\$ 993

52½"H Tackable Acoustical Base Tiles to-the-Floor (Tile for 57.5"H frame)							
24"W	Z45224TF [S]	\$ 408	\$ 439	\$ 469	\$ 519	\$ 569	\$ 620
30"W	Z45230TF [S]	\$ 435	\$ 475	\$ 512	\$ 575	\$ 637	\$ 701
36"W	Z45236TF [S]	\$ 491	\$ 537	\$ 582	\$ 657	\$ 733	\$ 808
42"W	Z45242TF	\$ 522	\$ 576	\$ 629	\$ 717	\$ 805	\$ 892
48"W	Z45248TF	\$ 545	\$ 606	\$ 666	\$ 767	\$ 867	\$ 967
60"W	Z45260TF	\$ 597	\$ 674	\$ 749	\$ 875	\$ 999	\$ 1125

60"H Tackable Acoustical Base Tiles to-the-Floor (Tile for 65"H frame)							
24"W	Z46024TF [S]	\$ 445	\$ 481	\$ 515	\$ 572	\$ 629	\$ 687
30"W	Z46030TF	\$ 473	\$ 517	\$ 560	\$ 631	\$ 703	\$ 775
36"W	Z46036TF	\$ 534	\$ 587	\$ 639	\$ 724	\$ 811	\$ 896
42"W	Z46042TF	\$ 566	\$ 627	\$ 687	\$ 788	\$ 888	\$ 988
48"W	Z46048TF	\$ 598	\$ 668	\$ 738	\$ 852	\$ 966	\$ 1081
60"W	Z46060TF	\$ 652	\$ 739	\$ 825	\$ 969	\$ 1111	\$ 1255

How to specify —
Select the Model Number
from above.

1st Option:
Fabric:
See page 14 for
fabrics.

Z | 4 | | | | | | | | | | T | F | . | | | | | | | | |

Example: Z44560TF.IMP07



































[S] Shippable by small-package carrier.

Tiles

Stride® — Steel Tiles / Steel Tiles to-the-Floor

For specification information see pages 152-159.

GSA SIN 33721

Description	Model	P1 Paint List Price	P2 Paint List Price	P3 Paint List Price
7½"H Steel Tiles				
24"W	Z40724S 	\$ 157	\$ 179	\$ 198
30"W	Z40730S 	\$ 164	\$ 186	\$ 205
36"W	Z40736S 	\$ 178	\$ 200	\$ 219
42"W	Z40742S 	\$ 193	\$ 215	\$ 234
48"W	Z40748S 	\$ 209	\$ 231	\$ 250
60"W	Z40760S 	\$ 234	\$ 256	\$ 275
15"H Steel Tiles				
24"W	Z41524S 	\$ 181	\$ 203	\$ 222
30"W	Z41530S 	\$ 192	\$ 214	\$ 233
36"W	Z41536S 	\$ 211	\$ 233	\$ 252
42"W	Z41542S 	\$ 231	\$ 253	\$ 272
48"W	Z41548S 	\$ 252	\$ 274	\$ 293
60"W	Z41560S 	\$ 283	\$ 305	\$ 324
22½"H Steel Tiles				
24"W	Z42224S 	\$ 271	\$ 293	\$ 312
30"W	Z42230S 	\$ 292	\$ 314	\$ 333
36"W	Z42236S 	\$ 317	\$ 339	\$ 358
42"W	Z42242S 	\$ 337	\$ 359	\$ 378
48"W	Z42248S 	\$ 364	\$ 386	\$ 405
60"W	Z42260S 	\$ 421	\$ 443	\$ 462
30"H Steel Tiles				
24"W	Z43024S 	\$ 323	\$ 345	\$ 364
30"W	Z43030S 	\$ 353	\$ 375	\$ 394
36"W	Z43036S 	\$ 377	\$ 399	\$ 418
42"W	Z43042S 	\$ 410	\$ 432	\$ 451
48"W	Z43048S 	\$ 444	\$ 466	\$ 485
60"W	Z43060S	\$ 508	\$ 530	\$ 549
22½"H Steel Base Tiles to-the-Floor Kit				
24"W	Z42224SF 	\$ 333	\$ 355	\$ 374
30"W	Z42230SF 	\$ 356	\$ 378	\$ 397
36"W	Z42236SF 	\$ 388	\$ 410	\$ 429
42"W	Z42242SF 	\$ 413	\$ 435	\$ 454
48"W	Z42248SF 	\$ 443	\$ 465	\$ 484
60"W	Z42260SF 	\$ 507	\$ 529	\$ 548
30"H Steel Base Tiles to-the-Floor Kit				
24"W	Z43024SF 	\$ 445	\$ 467	\$ 486
30"W	Z43030SF 	\$ 485	\$ 507	\$ 526
36"W	Z43036SF 	\$ 523	\$ 545	\$ 564
42"W	Z43042SF 	\$ 561	\$ 583	\$ 602
48"W	Z43048SF 	\$ 597	\$ 619	\$ 638
60"W	Z43060SF	\$ 689	\$ 711	\$ 730

How to specify —
Select the
Model Number
from above.

1st Option:

Paint Color:



See page 136 for
finishes.























Z | 4 | | | | | | | | | | . P | | | | |

Examples: Z41524S.P4J Z43060SF.P7C

 Shippable by small-package carrier.

For specification information see pages 152-159.

GSA SIN 33721

Description	Model	P1 Paint List Price	P2 Paint List Price	P3 Paint List Price
7½"H Perforated Steel Tiles				
24"W	Z40724SH 	\$ 174	\$ 197	\$ 217
30"W	Z40730SH 	\$ 181	\$ 204	\$ 224
36"W	Z40736SH 	\$ 193	\$ 216	\$ 236
42"W	Z40742SH 	\$ 214	\$ 237	\$ 257
48"W	Z40748SH 	\$ 231	\$ 254	\$ 274
60"W	Z40760SH 	\$ 260	\$ 283	\$ 303
15"H Perforated Steel Tiles				
24"W	Z41524SH 	\$ 199	\$ 222	\$ 242
30"W	Z41530SH 	\$ 212	\$ 235	\$ 255
36"W	Z41536SH 	\$ 233	\$ 256	\$ 276
42"W	Z41542SH 	\$ 252	\$ 275	\$ 295
48"W	Z41548SH 	\$ 283	\$ 306	\$ 326
60"W	Z41560SH 	\$ 317	\$ 340	\$ 360
22½"H Perforated Steel Tiles				
24"W	Z42224SH 	\$ 293	\$ 316	\$ 336
30"W	Z42230SH 	\$ 326	\$ 349	\$ 369
36"W	Z42236SH 	\$ 345	\$ 368	\$ 388
42"W	Z42242SH 	\$ 372	\$ 395	\$ 415
48"W	Z42248SH 	\$ 402	\$ 425	\$ 445
60"W	Z42260SH 	\$ 469	\$ 492	\$ 512
30"H Perforated Steel Tiles				
24"W	Z43024SH 	\$ 360	\$ 383	\$ 403
30"W	Z43030SH 	\$ 387	\$ 410	\$ 430
36"W	Z43036SH 	\$ 420	\$ 443	\$ 463
42"W	Z43042SH 	\$ 450	\$ 473	\$ 493
48"W	Z43048SH 	\$ 487	\$ 510	\$ 530
60"W	Z43060SH	\$ 564	\$ 587	\$ 607

How to specify —
Select the Model Number from above.

1st Option:
Paint Color:

See page 136 for finishes.

Z
4

S
H
.
P

Example: Z43060SH.PJW

 Shippable by small-package carrier.

Tiles

Stride® — Tool Tiles

For specification information see pages 152-159.

GSA SIN 33721

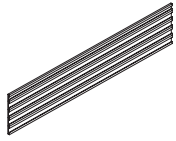

Description	Model	P1 Paint List Price	P2 Paint List Price	P3 Paint List Price
7½"H Tool Tiles				
24"W	Z40724SW S	\$ 281	\$ 325	\$ 368
30"W	Z40730SW S	\$ 289	\$ 333	\$ 376
36"W	Z40736SW S	\$ 302	\$ 346	\$ 389
42"W	Z40742SW S	\$ 312	\$ 356	\$ 399
48"W	Z40748SW S	\$ 336	\$ 380	\$ 423
60"W	Z40760SW S	\$ 357	\$ 401	\$ 444

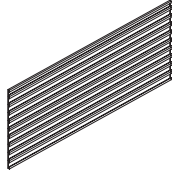

15"H Tool Tiles				
24"W	Z41524SW S	\$ 431	\$ 475	\$ 518
30"W	Z41530SW S	\$ 467	\$ 511	\$ 554
36"W	Z41536SW S	\$ 506	\$ 550	\$ 593
42"W	Z41542SW S	\$ 532	\$ 576	\$ 619
48"W	Z41548SW S	\$ 566	\$ 610	\$ 653
60"W	Z41560SW S	\$ 602	\$ 646	\$ 689

NOTE: Tool tiles placed at worksurface height limit selection of work tools available. Folder Holders, Multi-Media Hangers, and Binder Bins extend below a 7½"H tool tile. Paper Wave and contents extend above a single 7½"H tool tile. See page 381.

How to specify —
Select the Model Number from above.

1st Option:

Paint Color:



See page 136 for finishes.

Z | 4 | | | | | | | | | | . P | | | | |

Example: Z41524SW.P52

S Shippable by small-package carrier.

For specification information see pages 152-159.

GSA SIN 33721

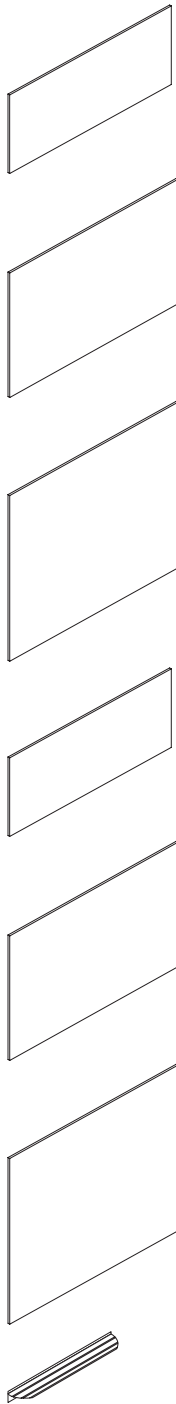

Description	Model	List Price
15"H Porcelain Marker Board Tiles		
24"W	Z41524MB <input type="checkbox"/>	\$ 706
30"W	Z41530MB <input type="checkbox"/>	\$ 767
36"W	Z41536MB <input type="checkbox"/>	\$ 826
42"W	Z41542MB <input type="checkbox"/>	\$ 887
48"W	Z41548MB <input type="checkbox"/>	\$ 947
60"W	Z41560MB <input type="checkbox"/>	\$ 1067
22½"H Porcelain Marker Board Tiles		
24"W	Z42224MB <input type="checkbox"/>	\$ 826
30"W	Z42230MB <input type="checkbox"/>	\$ 887
36"W	Z42236MB <input type="checkbox"/>	\$ 947
42"W	Z42242MB <input type="checkbox"/>	\$ 1008
48"W	Z42248MB <input type="checkbox"/>	\$ 1067
60"W	Z42260MB <input type="checkbox"/>	\$ 1187
30"H Porcelain Marker Board Tiles		
24"W	Z43024MB <input type="checkbox"/>	\$ 947
30"W	Z43030MB <input type="checkbox"/>	\$ 1008
36"W	Z43036MB <input type="checkbox"/>	\$ 1067
42"W	Z43042MB <input type="checkbox"/>	\$ 1126
48"W	Z43048MB <input type="checkbox"/>	\$ 1187
60"W	Z43060MB	\$ 1302
15"H Steel Marker Board Tiles (no color option)		
24"W	Z41524MBS	\$ 492
30"W	Z41530MBS	\$ 534
36"W	Z41536MBS	\$ 576
42"W	Z41542MBS	\$ 618
48"W	Z41548MBS	\$ 661
60"W	Z41560MBS	\$ 746
22½"H Steel Marker Board Tiles (no color option)		
24"W	Z42224MBS	\$ 576
30"W	Z42230MBS	\$ 618
36"W	Z42236MBS	\$ 661
42"W	Z42242MBS	\$ 706
48"W	Z42248MBS	\$ 746
60"W	Z42260MBS	\$ 828
30"H Steel Marker Board Tiles (no color option)		
24"W	Z43024MBS	\$ 661
30"W	Z43030MBS	\$ 706
36"W	Z43036MBS	\$ 746
42"W	Z43042MBS	\$ 789
48"W	Z43048MBS	\$ 828
60"W	Z43060MBS	\$ 914
15"W Marker Board Tray — Natural Aluminum		
Magnetic Markerboard Tray	TK4TRAYMS <input type="checkbox"/>	\$ 98

How to specify —
Select the Model Number from above.

1st Option:
Paint Color:

P1 P2 P3
See page 136 for finishes.

1st Option:
Color
(if applicable):

X No color option

P X

Examples: Z42242MB.P7C Z43036MBS.X TK4TRAYMS

Shippable by small-package carrier.

For specification information see pages 152-159.

GSA SIN 33721

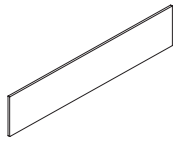

Description	Model	Grade 1 List Price	Grade 2 List Price
7 1/2"H Landscape Surface Tiles			
24"W	Z40724L S	\$ 433	\$ 523
30"W	Z40730L S	\$ 559	\$ 667
36"W	Z40736L S	\$ 682	\$ 804
42"W	Z40742L S	\$ 805	\$ 942
48"W	Z40748L S	\$ 929	\$ 1082
60"W	Z40760L S	\$ 1179	\$ 1349

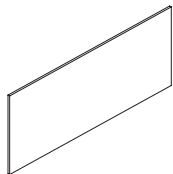

15"H Landscape Surface Tiles			
24"W	Z41524L S	\$ 682	\$ 859
30"W	Z41530L S	\$ 805	\$ 997
36"W	Z41536L S	\$ 929	\$ 1132
42"W	Z41542L S	\$ 1052	\$ 1276
48"W	Z41548L S	\$ 1179	\$ 1415
60"W	Z41560L S	\$ 1422	\$ 1674

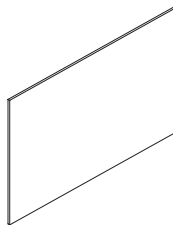

22 1/2"H Landscape Surface Tiles			
24"W	Z42224L S	\$ 929	\$ 1269
30"W	Z42230L S	\$ 1052	\$ 1413
36"W	Z42236L S	\$ 1179	\$ 1553
42"W	Z42242L S	\$ 1303	\$ 1694
48"W	Z42248L S	\$ 1422	\$ 1827
60"W	Z42260L S	\$ 1669	\$ 2092

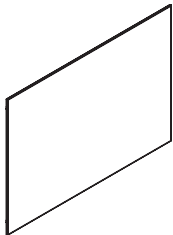

30"H Landscape Surface Tiles			
24"W	Z43024L	\$ 1179	\$ 1772
30"W	Z43030L	\$ 1303	\$ 1910
36"W	Z43036L	\$ 1422	\$ 2045
42"W	Z43042L	\$ 1549	\$ 2189
48"W	Z43048L	\$ 1669	\$ 2325
60"W	Z43060L	\$ 1918	\$ 2590

LANDSCAPE™ SURFACE MATERIAL OPTIONS

GRADE 2

Foundation™	Quattro
FD01 Sand	QU44 Platinum**
FD02 Taupe	
FD04 Pure White	

<p><i>How to specify —</i> Select the Model Number from above.</p>	<p><i>1st Option:</i> Landscape Surface Material and Finish: See above for material options.</p>	<p><i>2nd Option:</i> Frame Paint Color: P1 P2 P3 See page 136 for finishes.</p>
<p>Z 4 L .</p>	<p> . P </p>	

Examples: Z40724L.QU44.P27 Z41536L.FD01.P02

S Shippable by small-package carrier.

For specification information see pages 152-159.

GSA SIN 33721

Description	Model	L1 List Price	L2 List Price	L3 List Price
7½"H Laminate Tile				
24"W	Z40724LM	\$ 357	\$ 376	\$ 394
30"W	Z40730LM	\$ 370	\$ 389	\$ 408
36"W	Z40736LM	\$ 396	\$ 417	\$ 437
42"W	Z40742LM	\$ 434	\$ 456	\$ 479
48"W	Z40748LM	\$ 467	\$ 491	\$ 515
60"W	Z40760LM	\$ 527	\$ 554	\$ 581
15"H Laminate Tile				
24"W	Z41524LM	\$ 415	\$ 436	\$ 458
30"W	Z41530LM	\$ 432	\$ 454	\$ 476
36"W	Z41536LM	\$ 482	\$ 506	\$ 531
42"W	Z41542LM	\$ 517	\$ 544	\$ 570
48"W	Z41548LM	\$ 561	\$ 590	\$ 618
60"W	Z41560LM	\$ 634	\$ 666	\$ 698
22½"H Laminate Tile				
24"W	Z42224LM	\$ 522	\$ 549	\$ 575
30"W	Z42230LM	\$ 564	\$ 593	\$ 621
36"W	Z42236LM	\$ 613	\$ 644	\$ 675
42"W	Z42242LM	\$ 656	\$ 689	\$ 722
48"W	Z42248LM	\$ 705	\$ 741	\$ 777
60"W	Z42260LM	\$ 822	\$ 865	\$ 905
30"H Laminate Tile				
24"W	Z43024LM	\$ 628	\$ 660	\$ 692
30"W	Z43030LM	\$ 678	\$ 712	\$ 746
36"W	Z43036LM	\$ 728	\$ 765	\$ 802
42"W	Z43042LM	\$ 793	\$ 834	\$ 874
48"W	Z43048LM	\$ 855	\$ 899	\$ 941
60"W	Z43060LM	\$ 981	\$ 1031	\$ 1079
42½"H Laminate Tile				
24"W	Z44224LM	\$ 752	\$ 790	\$ 829
30"W	Z44230LM	\$ 902	\$ 948	\$ 993
36"W	Z44236LM	\$ 982	\$ 1032	\$ 1080
42"W	Z44242LM	\$ 1070	\$ 1125	\$ 1178
48"W	Z44248LM	\$ 1166	\$ 1225	\$ 1284
60"W	Z44260LM	\$ 1272	\$ 1337	\$ 1400
50"H Laminate Tile				
24"W	Z45024LM	\$ 919	\$ 966	\$ 1012
30"W	Z45030LM	\$ 1002	\$ 1054	\$ 1103
36"W	Z45036LM	\$ 1091	\$ 1147	\$ 1201
42"W	Z45042LM	\$ 1190	\$ 1250	\$ 1310
48"W	Z45048LM	\$ 1296	\$ 1362	\$ 1426
60"W	Z45060LM	\$ 1414	\$ 1486	\$ 1557

<p>How to specify — Select the Model Number from above.</p>	<p>1st Option: FSC Wood (if applicable): F FSC Wood X Non-FSC Wood</p>	<p>2nd Option: Laminate: See page 136 for finishes.</p>	<p>3rd Option: Edge Color: See page 136 for finishes.</p>	<p>4th Option: Grain Direction: VLG Horizontal or Solid Grain VST Vertical Grain</p>
<p>Z 4 .</p>	<p> .</p>	<p> .</p>	<p> .</p>	<p> </p>

Example: Z40724LM.F.TM133.E4.VLG

[5] Shippable by small-package carrier.

For specification information see pages 152-159.

GSA SIN 33721

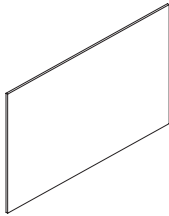

Description	Model	L1	L2	L3
		List Price	List Price	List Price
57½"H Laminate Tile				
24"W	Z45724LM	\$ 1258	\$ 1322	\$ 1385
30"W	Z45730LM	\$ 1409	\$ 1481	\$ 1551
36"W	Z45736LM	\$ 1577	\$ 1657	\$ 1735
42"W	Z45742LM	\$ 1767	\$ 1857	\$ 1945
48"W	Z45748LM	\$ 1979	\$ 2078	\$ 2177
65"H Laminate Tile				
24"W	Z46524LM	\$ 1393	\$ 1464	\$ 1534
30"W	Z46530LM	\$ 1559	\$ 1638	\$ 1716
36"W	Z46536LM	\$ 1746	\$ 1835	\$ 1923
42"W	Z46542LM	\$ 1956	\$ 2054	\$ 2152
48"W	Z46548LM	\$ 2191	\$ 2302	\$ 2411

<p>How to specify — Select the Model Number from above.</p> <p>Z 4 .</p>	<p>1st Option: FSC Wood (if applicable): F FSC Wood X Non-FSC Wood</p> <p> .</p>	<p>2nd Option: Laminate: See page 136 for finishes.</p> <p> .</p>	<p>3rd Option: Edge Color: See page 136 for finishes.</p> <p> .</p>	<p>4th Option: Grain Direction: VLG Horizontal or Solid Grain VST Vertical Grain</p> <p> </p>
---	---	--	--	---

Example: Z45724LM.F.TM133.E4.VLG

 Shippable by small-package carrier.

For specification information see pages 152-159.

GSA SIN 33721

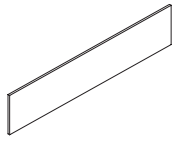

Description	Model	L1	L2	L3
		List Price	List Price	List Price
22½"H Laminate To-The-Floor Tiles				
24"W	Z42224LTF	\$ 576	\$ 603	\$ 629
30"W	Z42230LTF	\$ 618	\$ 647	\$ 675
36"W	Z42236LTF	\$ 667	\$ 698	\$ 729
42"W	Z42242LTF	\$ 710	\$ 743	\$ 776
48"W	Z42248LTF	\$ 759	\$ 795	\$ 831
60"W	Z42260LTF	\$ 876	\$ 919	\$ 959

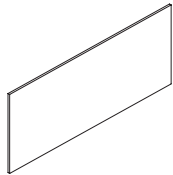

30"H Laminate To-The-Floor Tiles				
24"W	Z43024LTF	\$ 682	\$ 714	\$ 746
30"W	Z43030LTF	\$ 732	\$ 766	\$ 800
36"W	Z43036LTF	\$ 782	\$ 819	\$ 856
42"W	Z43042LTF	\$ 847	\$ 888	\$ 928
48"W	Z43048LTF	\$ 909	\$ 953	\$ 995
60"W	Z43060LTF	\$ 1035	\$ 1085	\$ 1133

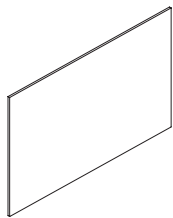

37½"H Laminate To-The-Floor Tiles				
24"W	Z43724LTF	\$ 787	\$ 825	\$ 861
30"W	Z43730LTF	\$ 910	\$ 954	\$ 996
36"W	Z43736LTF	\$ 1056	\$ 1108	\$ 1157
42"W	Z43742LTF	\$ 1225	\$ 1284	\$ 1343
48"W	Z43748LTF	\$ 1423	\$ 1493	\$ 1560
60"W	Z43760LTF	\$ 1656	\$ 1737	\$ 1817

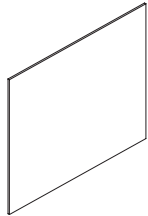

45"H Laminate To-The-Floor Tiles				
24"W	Z44524LTF	\$ 933	\$ 978	\$ 1022
30"W	Z44530LTF	\$ 1081	\$ 1134	\$ 1184
36"W	Z44536LTF	\$ 1255	\$ 1315	\$ 1376
42"W	Z44542LTF	\$ 1458	\$ 1530	\$ 1600
48"W	Z44548LTF	\$ 1696	\$ 1779	\$ 1861
60"W	Z44560LTF	\$ 1974	\$ 2071	\$ 2167

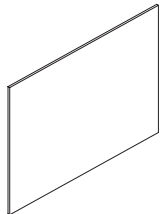

55½"H Laminate To-The-Floor Tiles				
24"W	Z45724LTF	\$ 1081	\$ 1134	\$ 1184
30"W	Z45730LTF	\$ 1257	\$ 1318	\$ 1378
36"W	Z45736LTF	\$ 1460	\$ 1532	\$ 1602
42"W	Z45742LTF	\$ 1699	\$ 1782	\$ 1865
48"W	Z45748LTF	\$ 1980	\$ 2077	\$ 2173

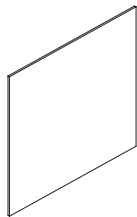

60"H Laminate To-The-Floor Tiles				
24"W	Z46024LTF	\$ 1255	\$ 1315	\$ 1376
30"W	Z46030LTF	\$ 1459	\$ 1531	\$ 1601
36"W	Z46036LTF	\$ 1697	\$ 1780	\$ 1862
42"W	Z46042LTF	\$ 1978	\$ 2075	\$ 2171
48"W	Z46048LTF	\$ 2304	\$ 2417	\$ 2529

How to specify —
Select the Model Number from above.

1st Option:
FSC Wood
(if applicable):

F FSC Wood
X Non-FSC Wood

2nd Option:
Laminate:
See page 136 for finishes.

3rd Option:
Edge Color:
See page 136 for finishes.

4th Option:
Grain Direction:
VLG Horizontal or Solid Grain
VST Vertical Grain

Z 4 | | | | | | | | .

| | .

| | | | | | .

| | | .

| | | |

Example: Z42224LTF.F.TM133.E4.VLG

Shippable by small-package carrier.

Tiles

Stride® — Laminate Spanning Hard Surface Tiles / Laminate Tiles To-the-Floor Kits

For specification information see pages 152-159.

GSA SIN 33721

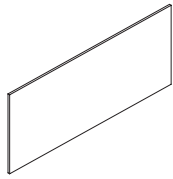

Description	Model	L1 List Price	L2 List Price	L3 List Price
25"H Laminate Spanning Tile				
54"W	Z42554SHS	\$ 1130	\$ 1182	\$ 1233
60"W	Z42560SHS	\$ 1160	\$ 1214	\$ 1266
66"W	Z42566SHS	\$ 1203	\$ 1258	\$ 1312
72"W	Z42572SHS	\$ 1285	\$ 1344	\$ 1402
78"W	Z42578SHS	\$ 1358	\$ 1420	\$ 1481
84"W	Z42584SHS	\$ 1422	\$ 1487	\$ 1551
90"W	Z42590SHS	\$ 1485	\$ 1553	\$ 1619
96"W	Z42596SHS	\$ 1582	\$ 1654	\$ 1726

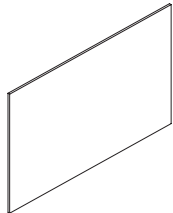

30"H Laminate Spanning Tile				
54"W	Z43054SHS	\$ 1169	\$ 1223	\$ 1276
60"W	Z43060SHS	\$ 1279	\$ 1337	\$ 1396
66"W	Z43066SHS	\$ 1330	\$ 1390	\$ 1451
72"W	Z43072SHS	\$ 1404	\$ 1468	\$ 1532
78"W	Z43078SHS	\$ 1426	\$ 1491	\$ 1555
84"W	Z43084SHS	\$ 1579	\$ 1651	\$ 1723
90"W	Z43090SHS	\$ 1664	\$ 1741	\$ 1816
96"W	Z43096SHS	\$ 1734	\$ 1814	\$ 1891

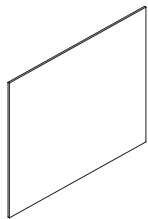

42"H Laminate Spanning Tile				
54"W	Z43754SHS	\$ 1395	\$ 1459	\$ 1522
60"W	Z43760SHS	\$ 1494	\$ 1562	\$ 1629
66"W	Z43766SHS	\$ 1570	\$ 1642	\$ 1713
72"W	Z43772SHS	\$ 1618	\$ 1692	\$ 1765
78"W	Z43778SHS	\$ 1656	\$ 1731	\$ 1806
84"W	Z43784SHS	\$ 1725	\$ 1804	\$ 1881
90"W	Z43790SHS	\$ 1769	\$ 1850	\$ 1929
96"W	Z43796SHS	\$ 1801	\$ 1883	\$ 1965

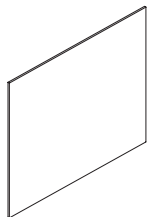

50"H Laminate Spanning Tile				
54"W	Z44554SHS	\$ 1818	\$ 1901	\$ 1983
60"W	Z44560SHS	\$ 1837	\$ 1921	\$ 2003
66"W	Z44566SHS	\$ 1856	\$ 1940	\$ 2024
72"W	Z44572SHS	\$ 1899	\$ 1985	\$ 2070
78"W	Z44578SHS	\$ 2103	\$ 2198	\$ 2294
84"W	Z44584SHS	\$ 2133	\$ 2230	\$ 2326
90"W	Z44590SHS	\$ 2182	\$ 2281	\$ 2379
96"W	Z44596SHS	\$ 2225	\$ 2326	\$ 2427

Description	Model	List Price
Spanning Tile Bracket Kits		
	Z4STBRKT1	\$ 254
	Z4STBRKT2	\$ 254

<p>How to specify — Select the Model Number from above.</p> <p>Z 4 .</p>	<p>1st Option: FSC Wood (if applicable): F FSC Wood X Non-FSC Wood</p> <p> .</p>	<p>2nd Option: Laminate: See page 136 for finishes.</p> <p> .</p>	<p>3rd Option: Edge Color: See page 136 for finishes.</p> <p> .</p>
---	--	---	---

Example: Z42554SHS.F.TM133.E4

Shippable by small-package carrier.

For specification information see pages 152-159.

GSA SIN 33721

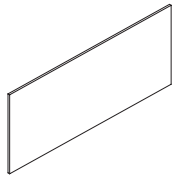

Description	Model	L1 List Price	L2 List Price	L3 List Price
25"H Laminate Spanning Tile To-The Floor				
54"W	Z42554SHTF	\$ 1243	\$ 1300	\$ 1356
60"W	Z42560SHTF	\$ 1277	\$ 1335	\$ 1393
66"W	Z42566SHTF	\$ 1320	\$ 1380	\$ 1440
72"W	Z42572SHTF	\$ 1415	\$ 1480	\$ 1544
78"W	Z42578SHTF	\$ 1494	\$ 1562	\$ 1629
84"W	Z42584SHTF	\$ 1565	\$ 1637	\$ 1708
90"W	Z42590SHTF	\$ 1634	\$ 1709	\$ 1782
96"W	Z42596SHTF	\$ 1740	\$ 1820	\$ 1898

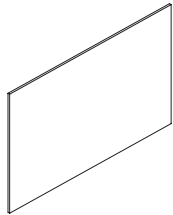

30"H Laminate Spanning Tile To-The-Floor				
54"W	Z43054SHTF	\$ 1285	\$ 1344	\$ 1402
60"W	Z43060SHTF	\$ 1406	\$ 1470	\$ 1534
66"W	Z43066SHTF	\$ 1464	\$ 1531	\$ 1596
72"W	Z43072SHTF	\$ 1545	\$ 1616	\$ 1686
78"W	Z43078SHTF	\$ 1567	\$ 1639	\$ 1710
84"W	Z43084SHTF	\$ 1739	\$ 1819	\$ 1897
90"W	Z43090SHTF	\$ 1830	\$ 1913	\$ 1996
96"W	Z43096SHTF	\$ 1907	\$ 1994	\$ 2080

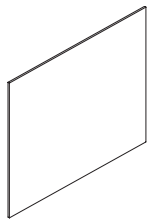

42"H Laminate Spanning Tile To-The-Floor				
54"W	Z43754SHTF	\$ 1661	\$ 1738	\$ 1811
60"W	Z43760SHTF	\$ 1770	\$ 1851	\$ 1930
66"W	Z43766SHTF	\$ 1853	\$ 1937	\$ 2021
72"W	Z43772SHTF	\$ 1905	\$ 1991	\$ 2078
78"W	Z43778SHTF	\$ 1946	\$ 2035	\$ 2123
84"W	Z43784SHTF	\$ 2023	\$ 2115	\$ 2206
90"W	Z43790SHTF	\$ 2071	\$ 2165	\$ 2258
96"W	Z43796SHTF	\$ 2106	\$ 2202	\$ 2297

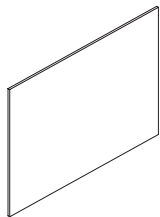

50"H Laminate Spanning Tile To-The-Floor				
54"W	Z44554SHTF	\$ 2126	\$ 2222	\$ 2319
60"W	Z44560SHTF	\$ 2146	\$ 2243	\$ 2340
66"W	Z44566SHTF	\$ 2168	\$ 2266	\$ 2364
72"W	Z44572SHTF	\$ 2214	\$ 2315	\$ 2415
78"W	Z44578SHTF	\$ 2440	\$ 2551	\$ 2661
84"W	Z44584SHTF	\$ 2474	\$ 2586	\$ 2697
90"W	Z44590SHTF	\$ 2528	\$ 2643	\$ 2757
96"W	Z44596SHTF	\$ 2574	\$ 2691	\$ 2807

How to specify —
Select the
Model Number
from above.

1st Option:

FSC Wood
(if applicable):

F FSC Wood
X Non-FSC
Wood

2nd Option:

Laminate:

See page 136 for
finishes.

3rd Option:

Edge Color:

See page 136 for
finishes.

Z | 4 | | | | | | | | | | .

| .

| | | | | .

| | |

Example: Z42554SHTF.F.TM133.E4

Shippable by small-package carrier.

Tiles

Stride® — Single Pane Glass Tile Kits / Pass Thru Kits

For specification information see pages 152-159.

GSA SIN 33721

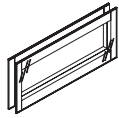

Description	Model	Clear List Price	Frosted List Price
15"H Glass Tile Kits			
24"W	Z41524G S	\$ 782	\$ 889
30"W	Z41530G S	\$ 891	\$ 1012
36"W	Z41536G S	\$ 956	\$ 1086
42"W	Z41542G S	\$ 1021	\$ 1158
48"W	Z41548G S	\$ 1080	\$ 1226
60"W	Z41560G S	\$ 1243	\$ 1412

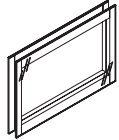

22½"H Glass Tile Kits			
24"W	Z42224G S	\$ 1002	\$ 1137
30"W	Z42230G S	\$ 1054	\$ 1198
36"W	Z42236G S	\$ 1103	\$ 1251
42"W	Z42242G S	\$ 1164	\$ 1322
48"W	Z42248G S	\$ 1215	\$ 1381
60"W	Z42260G S	\$ 1294	\$ 1472

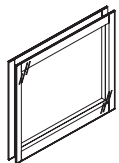

30"H Glass Tile Kits			
24"W	Z43024G S	\$ 1165	\$ 1323
30"W	Z43030G S	\$ 1232	\$ 1401
36"W	Z43036G S	\$ 1332	\$ 1514
42"W	Z43042G S	\$ 1439	\$ 1635
48"W	Z43048G S	\$ 1526	\$ 1734
60"W	Z43060G	\$ 1695	\$ 1926

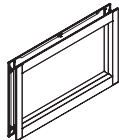

Description	Model	P1 Paint List Price	P2 Paint List Price
22½"H Pass-Thru Trim Kits			
24"W	Z42224PT S	\$ 574	\$ 608
30"W	Z42230PT S	\$ 606	\$ 640
36"W	Z42236PT S	\$ 648	\$ 682
42"W	Z42242PT S	\$ 685	\$ 719
48"W	Z42248PT S	\$ 717	\$ 751
60"W	Z42260PT S	\$ 742	\$ 776

<p>How to specify — Select the Model Number from above.</p>	<p>1st Option: Paint (Interior Shroud): P1 P2 P3 See page 136 for finishes.</p>	<p>2nd Option: Glass Type (if applicable): C Clear F Frosted</p>
--	--	--

Z | 4 | | | | | | | | | | . P | | | | | | .

Examples: Z41530G.P27.C Z42260PT.PJW

S Shippable by small-package carrier.

For specification information see pages 152-159.

GSA SIN 33721

Description	Model	V2	V3
		List Price	List Price
7½"H Veneer Tiles			
24"W	Z40724V S	\$ 515	\$ 562
30"W	Z40730V S	\$ 560	\$ 611
36"W	Z40736V S	\$ 644	\$ 702
42"W	Z40742V S	\$ 717	\$ 782
48"W	Z40748V S	\$ 762	\$ 831
60"W	Z40760V S	\$ 846	\$ 923
15"H Veneer Tiles			
24"W	Z41524V S	\$ 608	\$ 663
30"W	Z41530V S	\$ 651	\$ 710
36"W	Z41536V S	\$ 745	\$ 813
42"W	Z41542V S	\$ 833	\$ 909
48"W	Z41548V S	\$ 879	\$ 959
60"W	Z41560V S	\$ 977	\$ 1066
22½"H Veneer Tiles			
24"W	Z42224V S	\$ 736	\$ 803
30"W	Z42230V S	\$ 807	\$ 880
36"W	Z42236V S	\$ 901	\$ 983
42"W	Z42242V S	\$ 1010	\$ 1102
48"W	Z42248V S	\$ 1049	\$ 1144
60"W	Z42260V S	\$ 1181	\$ 1288
30"H Veneer Tiles			
24"W	Z43024V S	\$ 857	\$ 935
30"W	Z43030V S	\$ 951	\$ 1037
36"W	Z43036V S	\$ 1051	\$ 1146
42"W	Z43042V S	\$ 1179	\$ 1286
48"W	Z43048V S	\$ 1219	\$ 1330
60"W	Z43060V	\$ 1379	\$ 1504
37½"H Veneer Tiles			
24"W	Z43724V S	\$ 1001	\$ 1092
30"W	Z43730V S	\$ 1138	\$ 1241
36"W	Z43736V S	\$ 1231	\$ 1343
42"W	Z43742V S	\$ 1371	\$ 1496
48"W	Z43748V S	\$ 1498	\$ 1634
60"W	Z43760V	\$ 1722	\$ 1878
45"H Veneer Tiles			
24"W	Z44524V S	\$ 1133	\$ 1236
30"W	Z44530V S	\$ 1307	\$ 1426
36"W	Z44536V S	\$ 1413	\$ 1541
42"W	Z44542V S	\$ 1553	\$ 1694
48"W	Z44548V S	\$ 1773	\$ 1934
60"W	Z44560V	\$ 2006	\$ 2188

How to specify —
Select the Model Number from above.

1st Option:
Veneer Type and Finish:
See page 136 for finishes.
S prefix for Stratawood
N prefix for Natural

Z | 4 | | | | | | | | | | V | . | | | | | | | | | |

Example: Z43024V.NE800

S Shippable by small-package carrier.



For specification information see pages 152-159.

GSA SIN 33721

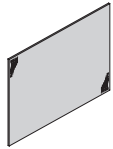

Description	Model	V2	V3
		List Price	List Price
22½"H Veneer Base Tiles to-the-Floor Kits			
24"W	Z42224VTF S	\$ 1040	\$ 1134
30"W	Z42230VTF S	\$ 1129	\$ 1232
36"W	Z42236VTF S	\$ 1238	\$ 1350
42"W	Z42242VTF S	\$ 1362	\$ 1486
48"W	Z42248VTF S	\$ 1399	\$ 1526
60"W	Z42260VTF S	\$ 1560	\$ 1702

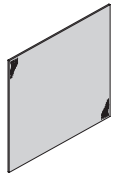

30"H Veneer Base Tiles to-the-Floor Kits			
24"W	Z43024VTF S	\$ 1175	\$ 1282
30"W	Z43030VTF S	\$ 1311	\$ 1430
36"W	Z43036VTF S	\$ 1411	\$ 1539
42"W	Z43042VTF S	\$ 1545	\$ 1685
48"W	Z43048VTF S	\$ 1674	\$ 1826
60"W	Z43060VTF	\$ 1909	\$ 2082

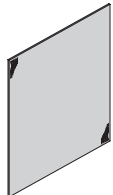

37½"H Veneer Base Tiles to-the-Floor Kits			
24"W	Z43724VTF S	\$ 1309	\$ 1428
30"W	Z43730VTF S	\$ 1494	\$ 1630
36"W	Z43736VTF S	\$ 1594	\$ 1739
42"W	Z43742VTF S	\$ 1730	\$ 1887
48"W	Z43748VTF S	\$ 1956	\$ 2134
60"W	Z43760VTF	\$ 2185	\$ 2384



45"H Veneer Base Tiles to-the-Floor Kits			
24"W	Z44524VTF S	\$ 1533	\$ 1672
30"W	Z44530VTF S	\$ 1768	\$ 1929
36"W	Z44536VTF S	\$ 1862	\$ 2031
42"W	Z44542VTF S	\$ 2010	\$ 2193
48"W	Z44548VTF S	\$ 2318	\$ 2529
60"W	Z44560VTF	\$ 2558	\$ 2790

How to specify —
Select the Model Number from above.

1st Option:

Veneer Type and Finish:

See page 136 for finishes.

- S** prefix for Stratawood
- N** prefix for Natural

Z | 4 | | | | | | | | | | V | T | F | . | | | | | | | | | | .

Example: Z43036VTF.NE800

S Shippable by small-package carrier.

Tiles

Stride® — Natural Veneer Sets

For specification information see pages 152-159.

GSA SIN 33721

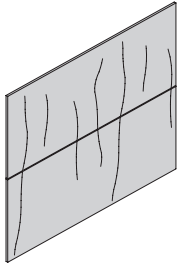

Description	Model	2P	
		Natural-1 V2 List Price	Natural-2 V3 List Price
Natural Veneer Tile Set — 30"H			
24"W	Z43024NVS-2P <input type="checkbox"/>	\$ 1214	\$ 1324
30"W	Z43030NVS-2P <input type="checkbox"/>	\$ 1318	\$ 1438
36"W	Z43036NVS-2P <input type="checkbox"/>	\$ 1500	\$ 1636
42"W	Z43042NVS-2P <input type="checkbox"/>	\$ 1678	\$ 1830
48"W	Z43048NVS-2P <input type="checkbox"/>	\$ 1773	\$ 1934
60"W	Z43060NVS-2P <input type="checkbox"/>	\$ 1980	\$ 2160

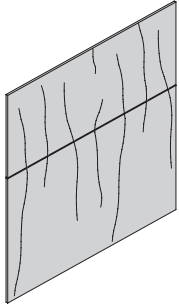

Description	Model	QP	
		Natural-1 V2 List Price	Natural-2 V3 List Price
Natural Veneer Tile Set — 37½"H			
24"W	Z43724NVS-QP <input type="checkbox"/>	\$ 1346	\$ 1468
30"W	Z43730NVS-QP <input type="checkbox"/>	\$ 1469	\$ 1602
36"W	Z43736NVS-QP <input type="checkbox"/>	\$ 1664	\$ 1815
42"W	Z43742NVS-QP <input type="checkbox"/>	\$ 1850	\$ 2018
48"W	Z43748NVS-QP <input type="checkbox"/>	\$ 1939	\$ 2115
60"W	Z43760NVS-QP <input type="checkbox"/>	\$ 2181	\$ 2379

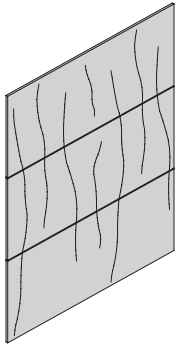

Description	Model	3P	
		Natural-1 V2 List Price	Natural-2 V3 List Price
Natural Veneer Tile Set — 45"H			
24"W	Z44524NVS-3P <input type="checkbox"/>	\$ 1820	\$ 1985
30"W	Z44530NVS-3P <input type="checkbox"/>	\$ 1979	\$ 2159
36"W	Z44536NVS-3P <input type="checkbox"/>	\$ 2247	\$ 2451
42"W	Z44542NVS-3P <input type="checkbox"/>	\$ 2521	\$ 2750
48"W	Z44548NVS-3P <input type="checkbox"/>	\$ 2648	\$ 2889
60"W	Z44560NVS-3P <input type="checkbox"/>	\$ 2966	\$ 3236

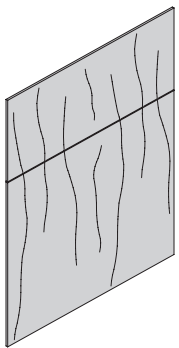

Description	Model	SP	
		Natural-1 V2 List Price	Natural-2 V3 List Price
Natural Veneer Tile Set — 45"H			
24"W	Z44524NVS-SP <input type="checkbox"/>	\$ 1479	\$ 1613
30"W	Z44530NVS-SP <input type="checkbox"/>	\$ 1758	\$ 1918
36"W	Z44536NVS-SP <input type="checkbox"/>	\$ 1975	\$ 2154
42"W	Z44542NVS-SP <input type="checkbox"/>	\$ 2026	\$ 2210
48"W	Z44548NVS-SP <input type="checkbox"/>	\$ 2114	\$ 2306
60"W	Z44560NVS-SP <input type="checkbox"/>	\$ 2382	\$ 2598

How to specify —
Select the Model Number from above.

1st Option:
Tile Set:
2P for 30"H
QP for 37½"H
3P or SP for 45"H

2nd Option:
Veneer Type and Finish:
See page 136 for finishes.

Z | 4 | | | | | | | | N | V | S | - | | | | .

Example: Z43042NVS-2P.NE800

Shippable by small-package carrier.

Tiles

Stride® — Natural Veneer Sets

For specification information see pages 152-159.

GSA SIN 33721

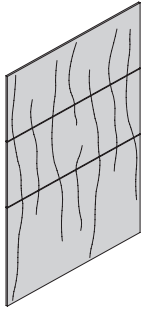

Description	Model	Q2P	
		Natural-1 V2 List Price	Natural-2 V3 List Price
Natural Veneer Tile Set — 52½"H			
24"W	Z45224NVS-Q2P	\$ 1956	\$ 2134
30"W	Z45230NVS-Q2P	\$ 2125	\$ 2318
36"W	Z45236NVS-Q2P	\$ 2406	\$ 2625
42"W	Z45242NVS-Q2P	\$ 2693	\$ 2938
48"W	Z45248NVS-Q2P	\$ 2824	\$ 3081
60"W	Z45260NVS-Q2P	\$ 3168	\$ 3456

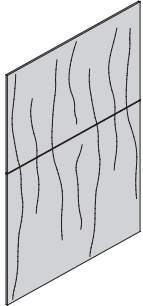

Description	Model	SQ	
		Natural-1 V2 List Price	Natural-2 V3 List Price
Natural Veneer Tile Set — 52½"H			
24"W	Z45224NVS-SQ	\$ 1608	\$ 1754
30"W	Z45230NVS-SQ	\$ 1764	\$ 1924
36"W	Z45236NVS-SQ	\$ 1971	\$ 2150
42"W	Z45242NVS-SQ	\$ 2205	\$ 2405
48"W	Z45248NVS-SQ	\$ 2288	\$ 2496
60"W	Z45260NVS-SQ	\$ 2578	\$ 2812

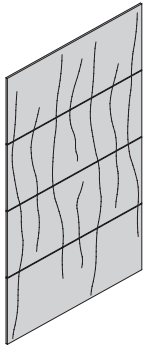

Description	Model	4P	
		Natural-1 V2 List Price	Natural-2 V3 List Price
Natural Veneer Tile Set — 60"H			
24"W	Z46024NVS-4P	\$ 2428	\$ 2649
30"W	Z46030NVS-4P	\$ 2634	\$ 2873
36"W	Z46036NVS-4P	\$ 3001	\$ 3274
42"W	Z46042NVS-4P	\$ 3358	\$ 3663
48"W	Z46048NVS-4P	\$ 3536	\$ 3857
60"W	Z46060NVS-4P	\$ 3954	\$ 4313

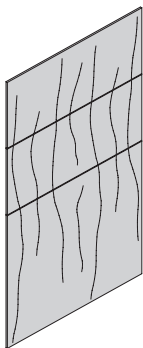

Description	Model	S2P	
		Natural-1 V2 List Price	Natural-2 V3 List Price
Natural Veneer Tile Set — 60"H			
24"W	Z46024NVS-S2P	\$ 2082	\$ 2271
30"W	Z46030NVS-S2P	\$ 2273	\$ 2480
36"W	Z46036NVS-S2P	\$ 2563	\$ 2796
42"W	Z46042NVS-S2P	\$ 3128	\$ 3412
48"W	Z46048NVS-S2P	\$ 2996	\$ 3268
60"W	Z46060NVS-S2P	\$ 3369	\$ 3675

How to specify —
Select the Model Number from above.

1st Option:

Tile Set:

Q2P or SQ for 52½"H
4P or S2P for 60"H

2nd Option:

Veneer Type and Finish:

See page 136 for finishes.

Z | 4 | | | | | | | | | | N | V | S | - | | | | | .

Example: Z45260NVS-Q2P.NE800

Shippable by small-package carrier.

Tiles

Stride® — Natural Veneer to-the-Floor Tile Sets

For specification information see pages 152-159.

GSA SIN 33721

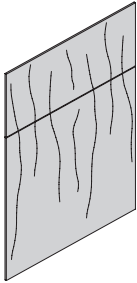

Description	Model	ZP	
		Natural-1 V2 List Price	Natural-2 V3 List Price
Veneer to-the-Floor Base Tile Sets — 45"H			
24"W	Z44524NVS-ZP <input type="checkbox"/>	\$ 1931	\$ 2106
30"W	Z44530NVS-ZP <input type="checkbox"/>	\$ 2147	\$ 2342
36"W	Z44536NVS-ZP <input type="checkbox"/>	\$ 2163	\$ 2360
42"W	Z44542NVS-ZP <input type="checkbox"/>	\$ 2594	\$ 2830
48"W	Z44548NVS-ZP <input type="checkbox"/>	\$ 2560	\$ 2793
60"W	Z44560NVS-ZP	\$ 2900	\$ 3164

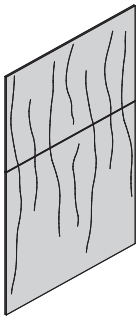

Description	Model	ZQ	
		Natural-1 V2 List Price	Natural-2 V3 List Price
Veneer to-the-Floor Base Tile Sets — 52½"H			
24"W	Z45224NVS-ZQ <input type="checkbox"/>	\$ 1911	\$ 2085
30"W	Z45230NVS-ZQ <input type="checkbox"/>	\$ 2120	\$ 2313
36"W	Z45236NVS-ZQ <input type="checkbox"/>	\$ 2320	\$ 2531
42"W	Z45242NVS-ZQ <input type="checkbox"/>	\$ 2560	\$ 2793
48"W	Z45248NVS-ZQ <input type="checkbox"/>	\$ 2733	\$ 2981
60"W	Z45260NVS-ZQ	\$ 3105	\$ 3387

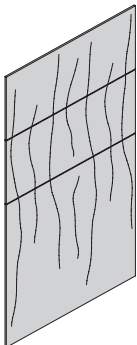

Description	Model	Z2P	
		Natural-1 V2 List Price	Natural-2 V3 List Price
Veneer to-the-Floor Base Tile Sets — 60"H			
24"W	Z46024NVS-Z2P <input type="checkbox"/>	\$ 2387	\$ 2604
30"W	Z46030NVS-Z2P <input type="checkbox"/>	\$ 2626	\$ 2865
36"W	Z46036NVS-Z2P <input type="checkbox"/>	\$ 3172	\$ 3460
42"W	Z46042NVS-Z2P <input type="checkbox"/>	\$ 3506	\$ 3825
48"W	Z46048NVS-Z2P <input type="checkbox"/>	\$ 3748	\$ 4089
60"W	Z46060NVS-Z2P	\$ 3887	\$ 4240

How to specify —
Select the
Model Number
from above.

1st Option:

Tile Set:
ZP for 45"H
ZQ for 52½"H
Z2P for 60"H

2nd Option:

**Veneer Type and
Finish:**
See page 136 for
finishes.

Z | 4 | | | | | N | V | S | - | | | | | .

Example: Z45224NVS-ZQ.NE800

Shippable by small-package carrier.

For specification information see page 160.

GSA SIN 33721

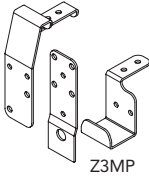
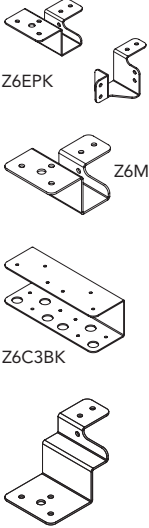
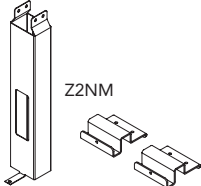
	Description	Model	P1 Paint List Price	P2 Paint List Price	P3 Paint List Price
 <p>Z3MP</p>	Off-Modular Panel Attachment Kit (no color option)				
	Non-Rail Based "M" Off-Modular Connector Kit	Z3MP S	\$ 302	N/A	N/A
 <p>Z6EPK</p> <p>Z6MK</p> <p>Z6C3BK</p> <p>Z6Z3MK</p>	Off-Modular Worksurface Brackets				
	Non-Rail Based End Panel Kit	Z6EPK	\$ 61	\$ 74	\$ 83
	Non-Rail Based Worksurface Bracket (1)	Z6MK	\$ 73	\$ 86	\$ 95
	Non-Rail Based 3" Layered Worksurface Bracket (1)	Z6Z3MK S	\$ 82	\$ 95	\$ 104
	Layered Worksurface Connection Bracket (1)	Z6C3BK S	\$ 118	\$ 137	\$ 151
 <p>Z2NM</p>	Off-Modular Mounting Kits for Overhead Cabinets				
	Non-Rail Based Overhead Mounting Kit	Z2NM S	\$ 255	\$ 284	\$ 310

How to specify —
Select the Model Number from above.

1st Option:

Color
(if applicable):

P1 P2 P3

See page 136 for finishes.

















































Z | | | | | | | .

P | | |

Examples: Z3MP Z6MK.P7C Z6Z3MK.PJW Z2NM.PR2

S Shippable by small-package carrier.

- Optional Acoustic Inserts enhance the acoustic value of Stride Panels.
- Full Acoustic Insert provides two fillers to span from lower horizontal cross member to upper horizontal cross member.
- Upper Acoustic Insert spans from above beltline horizontal to upper horizontal cross member.
- Acoustic Insert material can be compressed up to 90% to allow for power and data cables routed in panels between tiles.

Description	Full Insert Model	Upper Insert Model	Full Insert List Price	Upper Insert List Price
42½"H Stride Panel Frame Acoustic Inserts (fits between tiles)				
For 24" W	Z04224AIF 	Z04224AIU 	\$ 147	\$ 87
For 30" W	Z04230AIF 	Z04230AIU 	\$ 171	\$ 90
For 36" W	Z04236AIF 	Z04236AIU 	\$ 178	\$ 102
For 42" W	Z04242AIF 	Z04242AIU 	\$ 198	\$ 118
For 48" W	Z04248AIF 	Z04248AIU 	\$ 217	\$ 141
For 60" W	Z04260AIF 	Z04260AIU 	\$ 353	\$ 205
50"H Stride Panel Frame Acoustic Inserts (fits between tiles)				
For 24" W	Z05024AIF 	Z05024AIU 	\$ 134	\$ 90
For 30" W	Z05030AIF 	Z05030AIU 	\$ 180	\$ 111
For 36" W	Z05036AIF 	Z05036AIU 	\$ 203	\$ 140
For 42" W	Z05042AIF 	Z05042AIU 	\$ 219	\$ 164
For 48" W	Z05048AIF 	Z05048AIU 	\$ 232	\$ 180
For 60" W	Z05060AIF 	Z05060AIU 	\$ 397	\$ 234
57½"H Stride Panel Frame Acoustic Inserts (fits between tiles)				
For 24" W	Z05724AIF 	Z05724AIU 	\$ 152	\$ 99
For 30" W	Z05730AIF 	Z05730AIU 	\$ 211	\$ 141
For 36" W	Z05736AIF 	Z05736AIU 	\$ 224	\$ 160
For 42" W	Z05742AIF 	Z05742AIU 	\$ 248	\$ 180
For 48" W	Z05748AIF 	Z05748AIU 	\$ 292	\$ 233
For 60" W	Z05760AIF 	Z05760AIU 	\$ 469	\$ 321
65"H Stride Panel Frame Acoustic Inserts (fits between tiles)				
For 24" W	Z06524AIF 	Z06524AIU 	\$ 183	\$ 123
For 30" W	Z06530AIF 	Z06530AIU 	\$ 219	\$ 156
For 36" W	Z06536AIF 	Z06536AIU 	\$ 256	\$ 183
For 42" W	Z06542AIF 	Z06542AIU 	\$ 290	\$ 208
For 48" W	Z06548AIF 	Z06548AIU 	\$ 301	\$ 252
For 60" W	Z06560AIF 	Z06560AIU 	\$ 473	\$ 353

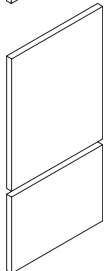
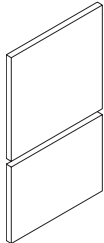
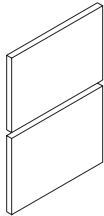
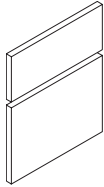

How to specify —
Select the Model Number from above.

Z | 0 | | | | | A | I | | | |

Examples: Z04220AIF Z06560AIU

 Shippable by small-package carrier.

Stride features high capacity for cable management, including electrical, voice, and data capabilities. The 8-wire electrical system can be integrated at base pathway and beltline. The open structure of the frame allows voice and data cables to be routed both vertically and horizontally.

Ceiling infeed connects to building electrical supply. Ceiling infeed can also be used at the bottom to feed up into footed panels where exposed flex conduit is permitted by codes. This infeed can be prewired before panels are installed. A877006 and A877012 infeeds must be installed in panel before connecting to building wiring.

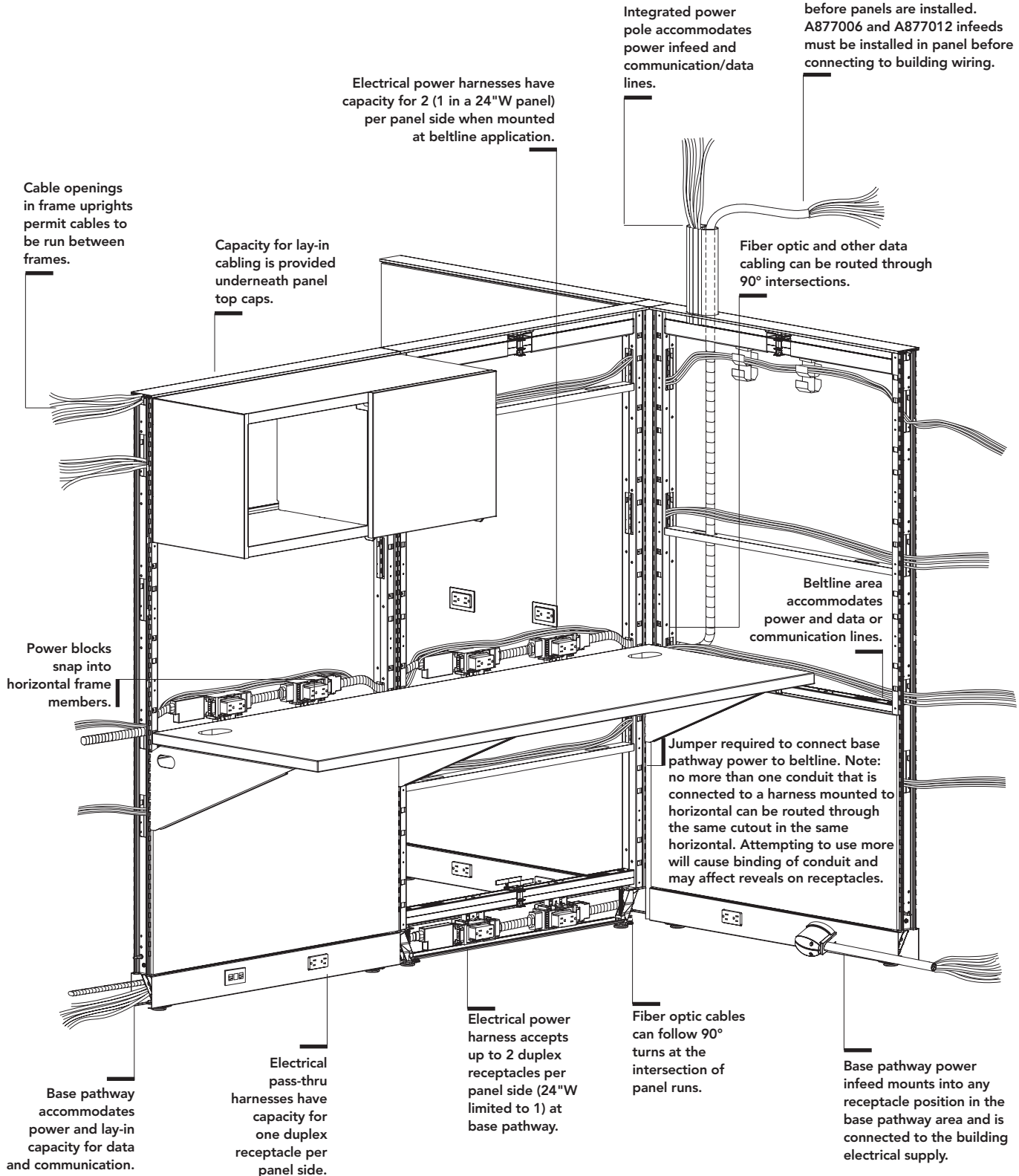

Electrical Systems

Stride electrical offers a choice of four electrical systems:

- Four-circuit, 3 + 1
- Four-circuit, 2 + 2
- Three-circuit, separate neutrals
- Eight circuits; two four-circuit systems provided back-to-back.
- See pages 201-202 for a detailed explanation of each electrical system.
- All four systems utilize an 8-wire electrical system, rated at 20 amps per circuit (16 amps plan-able U.S. and 15 amps Canadian).
- Stride panels and electrical components are UL Listed. Electrical components are also CSA certified. PVC-free models are C2C certified.
- Installation and use of the electrical system, the number of receptacles used on a given circuit and connections to the building power supply should be in compliance with all local and national electrical codes.

Caution: Electrical equipment cords or extension cords MUST NOT BE ROUTED through cable openings in frame sides.

Note: No more than one conduit that is connected to a harness mounted to horizontal can be routed through the same cut out in the same horizontal. Attempting to use more will cause binding of conduit and may affect reveals on receptacles.

Hardwire New York Code (page 210)

- **Hardwire (New York Code) junction box** (model A871400C) is used when local electrical codes require hardwire entry. 
- For use in panels 30" W to 60" W.
- When used in 30" W and 36" W panels, power can be routed only in one direction.
- When used in 42" W, 48" W, and 60" W panels, an electrical pass-thru cable or harness for that panel width can be used to route power back in the opposite direction.
- Unit must connect to a power or pass-thru harness positioned in the base pathway area of an adjacent panel.
- Customer to furnish all cabling and wiring from power entry to power source.
- Junction box can be positioned at any duplex receptacle location.

Hardwire Chicago Code (page 212)

- Wiring harnesses and snap connectors are not allowed in Chicago — base pathways must be comprised of all-metallic components.
- For the base pathway, junction box (model 877600) clips directly into receptacle locations and can be used both single- and double-sided. 
- In the beltline location, junction box (model 877550) can only be used single-sided.
- Base pathway model has a larger volume capacity for wiring to allow for dual-sided applications.
- Customer must furnish conduit, wiring, and designer-type receptacles for the base pathway and conduit, wiring, designer-type receptacles, and receptacle covers for the beltline.
- Tiles at the beltline must be field ported.
- Power entry can be routed from the ceiling, via a Stride power pole, or from the floor into a junction box (beltline model 877550; or base pathway model 877600).

Electrical Infeeds

- **Power infeed cables** deliver power from building to panel's electrical system.
- Infeed cables are housed in conduit to separate electrical system from communications and data lines.
- Select quantity of base or ceiling infeed cables depending on individual power requirements.

Base Infeed (page 210)

- **Sealtight base pathway power infeed** attaches to any receptacle opening at the base pathway.
- A heavy rubber sheathing shields conduit, allowing infeed to be exposed.
- A jumper is required to connect base pathway power to beltline.

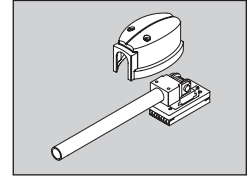

Sealtight Electrical Infeed Cable (page 210)

- **Sealtight electrical infeed cable** is used with footed panels.
- Should not be ordered prior to installation to have prewired as infeed must be routed from inside of panel out to be connected to power.
- Cannot be connected to power harness in panel frame that infeed is brought into unless additional pass-thru harness without power block is used to feed from below beltline to above beltline.

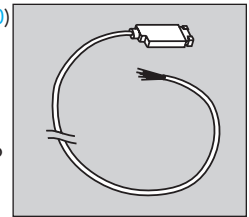

Ceiling Power Infeed (page 210)

- **Ceiling power infeed** connects to a prewired electrical harness in the beltline or base pathway, traverses through an adjacent panel and terminates in the junction box at the top of the integrated power pole.
- For use with integrated power pole models Z235PP and Z265PP.
- Can also be used as infeed for footed panels.
- Most codes permit flex conduit to be exposed after installation. Verify code requirements before ordering for exposed application.

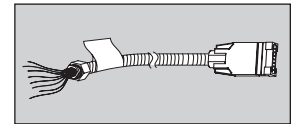

Integrated Power Pole (page 210)

- **Integrated power and communications poles** provide capacity for routing power supply directly through the top of any structural or stacking frame using same width trim/connector kit in place of top cap.
- Power pole has a cavity on each side of a center septum.
- See page 207 for cable capacity.
- When using a ceiling power infeed, consider that the infeed must connect into an electrical harness located in an adjacent panel.
- Integrated power pole will not work with low profile glass stackers, panel mounted glass screens, or panel mounted screens.
- Avoid glass or translucent tiles in upper position of frames with integrated power poles.

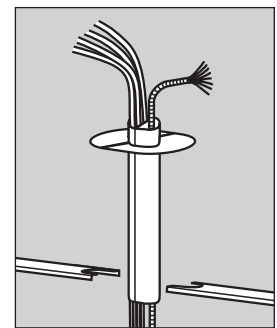

To Order:

- Determine which electrical system you will use after consulting your electrician and computer support personnel:
 - The Four-circuit system (4-Hot/2-Neutral/2-Ground)
 - 3 + 1 option
 - 2 + 2 option
 - The Three-circuit system (3-Hot/3-Neutral/2-Ground)
 - The Eight-circuit system (back-to-back four-circuit systems)
- Determine location, quantity, and circuit of duplexes.
- Determine the appropriate choice and use of Isolated, Isolated/Dedicated, and Separate Neutrals circuits.
- Specify appropriate Power Harnesses* and Pass-Thru Cables.*
- Determine the location, quantity, and type of Power Infeeds needed.

GSA Reference Page

* Select Power Harness models (A8712XX), Pass-Thru Cables (A8710XX) and Pass-Thru Harness (A8711XX) with the last two digits corresponding with the panel width into which the component is to be positioned. The initial cable length can be stretched approximately 3" to transverse "T", "X", "L" and Extended Straight Connectors.

Flexconnect™ Electrical System Options

The four-circuit, eight-wire electrical system is widely specified and trusted by hundreds of thousands of end-users. This proven system delivers four circuits for every power infeed in either a 3 + 1 or 2 + 2 configuration. The isolated/dedicated circuits are ideal for sensitive computing equipment, while the common circuits are suitable for faxes, copiers, task lights and other peripherals. Both the 3 + 1 and 2 + 2 systems use the same prewired components, making it easy to adjust as electrical needs change.

You can also choose a three-circuit, eight-wire system that has a dedicated neutral for every hot circuit. The three-circuit components have model numbers with an "A" suffix.

All three systems utilize an eight-wire electrical system rated at 20 amps per circuit (15 amps Canadian). Concensys panels and electrical components are UL listed and CSA certified.

Reference the Office Equipment Typical Load Values matrix on page 209.

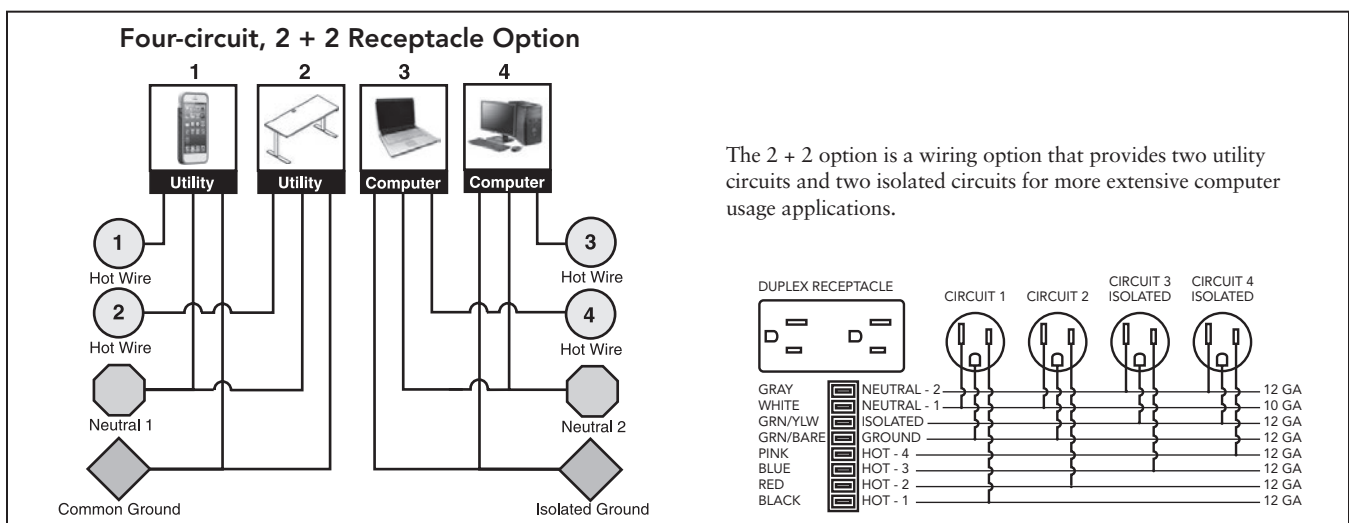
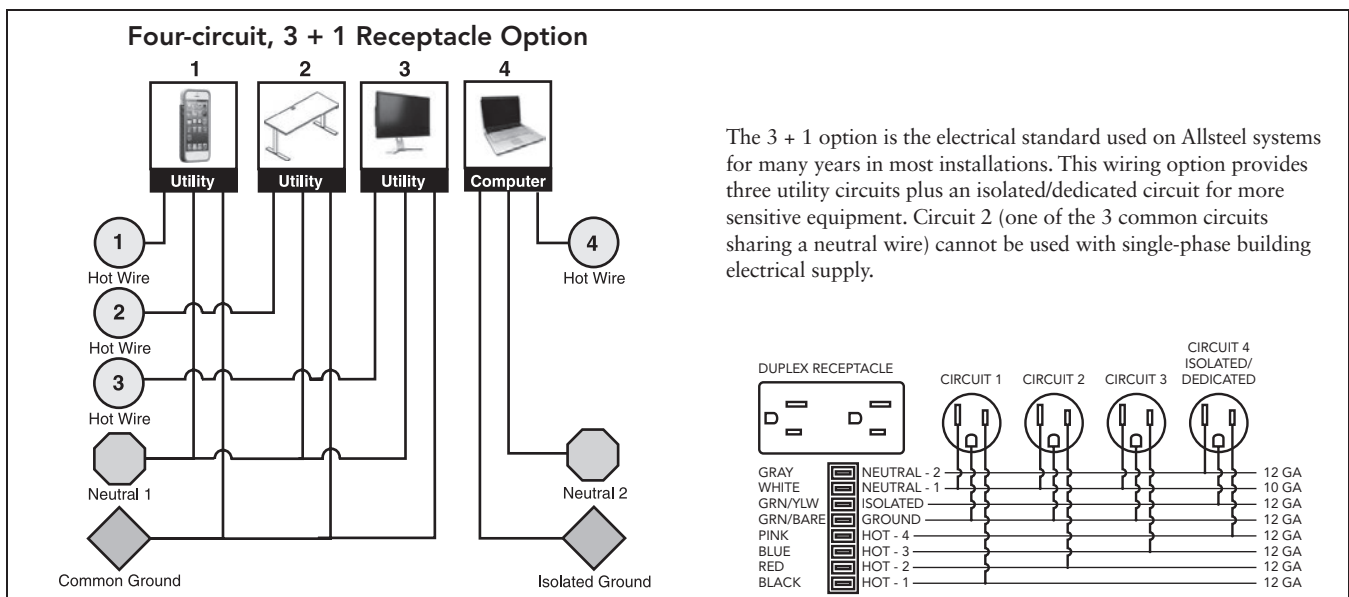

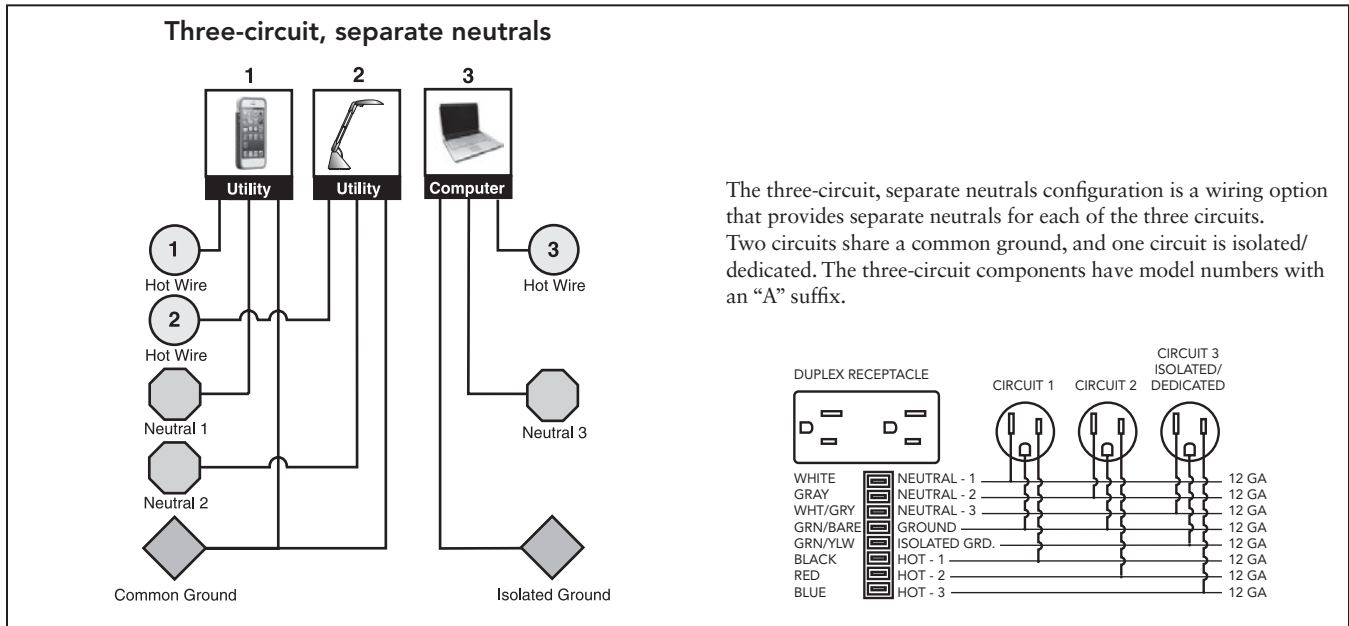

Stride System Receptacle Usage					
Two 8-wire, 20 amp (15 amp Canadian) electrical systems are offered					
Electrical System	Circuitry	Receptacle Capacity			
Four-circuit 4-Hot/2-Neutral/2-Ground	3 + 1	Common Circuit-1 A877501	Common Circuit-2 ⁽¹⁾ A877502	Common Circuit-3 A877503	Iso/Dedicated Circuit-4 A877504
	2 + 2	Common Circuit-1 A877501	Common Circuit-2 A877502	Isolated Circuit-3 A877506	Isolated Circuit-4 A877504
Three-circuit 3-Hot/3-Neutral/2-Ground	w/separate neutrals	Common Circuit-1 A877501A	Common Circuit-2 A877502A	Iso/Dedicated Circuit-3 A877503A	N/A

Notes:

- Four-circuit components and three-circuit components (with suffix "A") cannot be used together.
- Components of the two systems are keyed differently to prevent components of one system being connected to components of another system.
- Allsteel Model Numbers are printed on the UL labels, and components are color-coded to provide visual identification of the different components.
- Four-circuit components have black plastic parts.
- Three-circuit components have rust-colored terminal ends and receptacle backs are rust colored.

(1) Circuit 2 (one of the 3 common circuits sharing a neutral wire) cannot be used with a single-phase building electrical supply.

Duplex Receptacle

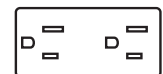

15 amp Receptacle

Power Harnesses, Pass-Thru Cables, and Jumpers

Electrical power harnesses are used to distribute power in Stride panels. Harnesses can be mounted at the base pathway and at 7½" vertical intervals above the base pathway using mounting brackets or power block beltline mounting brackets. **Power blocks** on electrical power harnesses and pass-thru harnesses accept duplex receptacles.

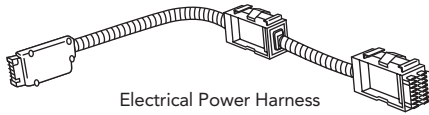

Electrical Power Harness

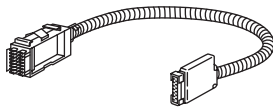

Electrical Pass-Thru Harness

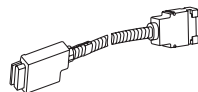

Electrical Pass-Thru Harness without Power Block

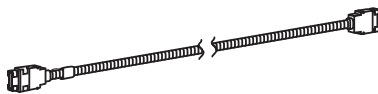

Electrical Jumper Cables

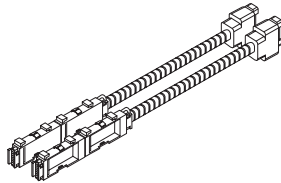

Dual Electrical Eight-circuit Power Harness Kit

All electrical power harnesses and pass-thru harnesses (except 20"W) will stretch 3½", allowing them to span "T", "X", and "A" intersections and "S" extended straight connections.

Note: "T" intersections require a minimum of one power harness and "X" intersections requires a minimum of two power harnesses.

Use of a ceiling infeed or jumper requires one additional harness.

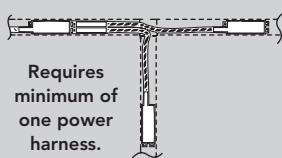

Requires minimum of one power harness.

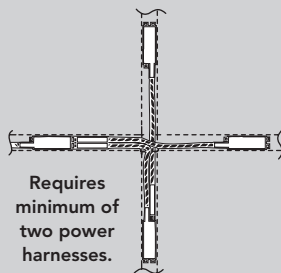

Requires minimum of two power harnesses.

Use of a ceiling infeed or jumper at this location requires an additional power harness.

Power Harnesses (page 211)

- Specify harness length to match panel width. 24" power harnesses accept one receptacle on each side of the harness when exposed, all other power harnesses have power blocks to accept four duplex receptacles (two on each side of panel).
- Connectors at both ends of power harnesses allow power distribution in either direction.
- Harness power blocks snap directly onto brackets in base pathway; at beltline or other vertical locations harnesses require optional mounting brackets.

Pass-thru Harnesses (page 211)

- Electrical pass-thru harnesses have capacity to handle one duplex receptacle on each side of panel.
- Electrical pass-thru harnesses distribute power in panels — specify harness length to match panel width.
- Electrical pass-thru cables distribute power through any panel where receptacles are not required.
- 20"W frames use 20"W pass-thru cables since they do not have electrical knockouts or ported tiles. Cable length cannot be stretched.

Jumper Cables (page 211)

- Electrical jumper cables connect power from base pathway or beltline to a harness located on any horizontal member as needed.
- Jumper cable plugs into power block end of electrical power harness or electrical pass-thru harness.
- Model A871366 is 66" and connects beltline power harnesses at 90° juncture to adjacent base line power.
- Model A8713108 is 106" to jumper up to 69" vertically – from base rail up to the highest 7½" opening on a 65"H frame.

Dual Electrical Eight-circuit Power Harness Kits (page 211)

- Kit provides back-to-back four-circuit systems giving double the capacity of harness and pass-thru cables
- Requires two four-circuit infeeds. Uses four-circuit receptacles.
- Models must be positioned "back-to-back" in the panel — single-side use is not permitted
- Components can only be routed in a single run — a single run cannot branch to multiple panel runs at "T" and "X" junctions.
- Four-circuit jumper cables (A8713xx) can only be connected to a power block at one end of a run. Power cannot be routed between a run in the base pathway and a run in the beltline area, except at one end of the run.
- To connect power between the base pathway and the beltline area, four-circuit jumper cables (A8713xx) must be connected to a power block at one end of a run, routed into an adjacent panel that contains no power harness, then routed back into the panel that contains a power harness (or pass-thru cable), and connected to a power harness in the other pathway.
- Standard four-circuit pass-thru cables (A8710xx) can be used in between power harnesses. Two are required in the back-to-back configurations.
- Models can be connected to standard four-circuit power harnesses and pass-thrus, although it is not recommended because of possible circuit number ambiguity
- Two power infeeds are required to connect the back-to-back runs. Power infeed A8719xx must be connector to a power block at the end of a run.
- Data faceplates and terminals cannot be positioned in a panel into which back-to-back power harnesses are installed
- Power infeeds A8719xx must be routed from a panel wherein no power harness is positioned, into an adjacent panel where a power harness is positioned and connected to the end of a power block.

Power Blocks

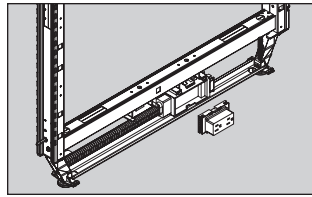

Stride offers multiple options for mounting electrical:

Base Pathway Mounting

- Power blocks snap directly onto brackets in base pathway area and accept receptacles on each side of harness.

Beltline Mounting Brackets (page 212)

- For exposed receptacles at beltline mount power blocks onto electrical mounting bracket (8988EBZ or 8988EBZ3 for 35"H base panel frames — sold separately) which screw into the panel frame or segment kit.
- Port tiles must be used where exposed receptacles will be located.

Segment Kit Mounting Brackets (page 212)

- When using segment kits at other locations mount power blocks onto electrical mounting bracket (8988EBZS — sold separately) which screw into segment kit.
- Port tiles must be used where exposed receptacles will be located.

Below Worksurface Mounting Brackets (page 212)

- When using a 22½" ported tile for power below the worksurface, use beltline electrical mounting bracket (8988EBZ — sold separately) and mount the bracket underneath the standard beltline horizontal.

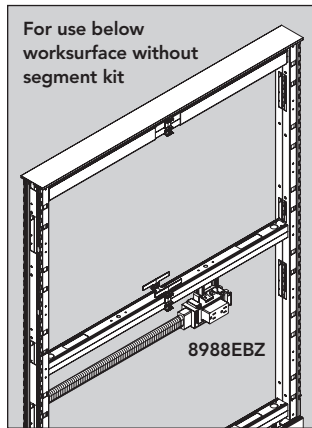
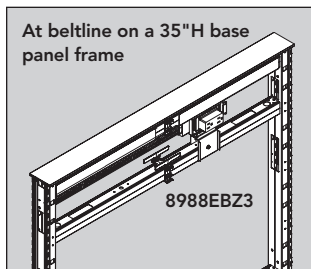
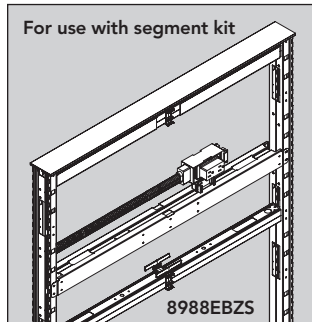
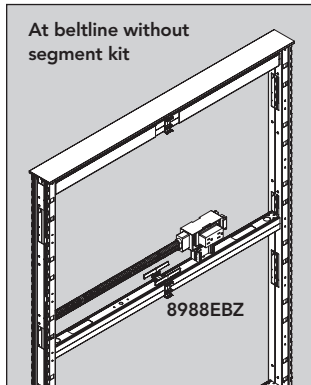

Receptacles

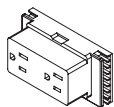

Duplex Receptacles

Duplex Receptacles (page 212)

- Duplex receptacles snap into power blocks of power harnesses or pass-through harnesses.
- Duplexes are available in multiple colors. See page 136 for finishes.
- Each receptacle is labeled to indicate which circuit it will be connected to: 1, 2, 3, or 4.
- Duplexes are model specific to support either 3+1 and 2+2 electrical infeed; or have an "A" suffix and are design to support a three-circuit separate neutral electrical infeed.

Receptacle Color Recommended to Coordinate with Paint Color

Paint Color	Receptacle Color
Bungalow P7C.....	Muslin — EU
Carob — P52.....	Black — E4
Champagne Metallic — PR5.....	Muslin — EU
Cinder P7Q.....	Brownstone — EY
Fossil — P28.....	Flint — E9
Gunmetal Metallic — PR3.....	Brownstone — EY
Parchment — P93.....	Muslin — EU
Pebble P8R.....	Loft — EV
Pewter P8D.....	Flint — E9
Platinum Metallic — PR2.....	Loft — EV
Salt P8C.....	Silver — ES
Titanium P8T.....	Silver — ES

Cable and Wire Management

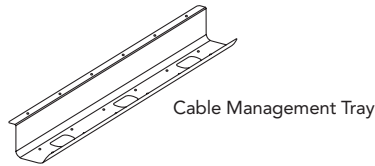

Cable Management Tray (page 212)

- Attaches under the worksurface to contain cables.
- Metal tray shelf is 4" deep. Can hold electrical power strip and/or surge protector.
- 24" and 36" lengths, use multiple units for larger worksurfaces.
- Attachment hardware included, paint option is black only.
- Zip tie attachment points located in base of tray. Zip ties not included.

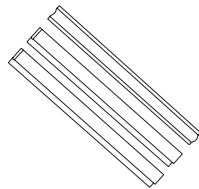

Wire Management Strips/Channels (page 212)

- Self adhesive backing to attach to panels and underside of worksurfaces.
- Flexible strips allow cabling to enter/exit and can be contained inside the strips' cavities.
- Includes two wire management profiles. Smaller profile allows for qty. 3, .3" diameter cords, has area of .32 in². Larger "J" shaped profile allows for qty. 10, .3" diameter cords, has area of 1.14 in².

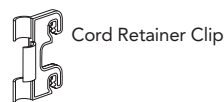

Cord Retainer Clip (page 212)

- Provides confinement of vertical electrical/data wiring.
- 1½"H cord clips snap into vertical panel slots to contain cords.
- 4 clips are provided standard with each task light cord.



Data Management Organizers (page 212)

- **Cable organizers** are made of rigid polymer, and hang from the horizontal cross members or in the base raceway. Can be stacked infinitely.
- Cables can be placed into the extensions of the organizers to keep cables aligned as they pass through the panel frame.
- Commercially available tie-wraps can also be used to strap cables to the organizer extensions.
- Organizers are ordered separately in packs of 20.

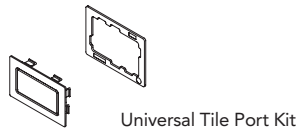

Universal Tile Port Kit (page 212)

- Allows field installation of additional data accessories.
- Grommet opening dimension — 1.375"H x 2.700"W.



Wireway Grommet (page 212)

- Fits into any receptacle opening.
- Used when routing wires through receptacle opening.

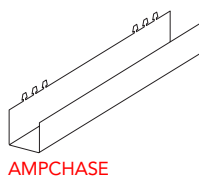

Panel Mounted Wire Chase (page 212)

- Attaches between panels on Stride, Terrace, and Optimize via a slotted standard.
- Designed to sit below a worksurface and provide additional cord management from the base rail to beltline/under-worksurface height.
- Available in standard metal paint finishes.

For more power and wire management options, please visit the Extensions pages.

Lighting

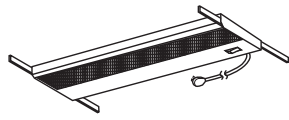

Task Lights

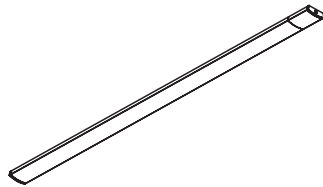

Undercabinet LED Light

Task Lights (page 389)

- Task lights can be recessed under storage cabinets or storage shelves, panel-hung, or freestanding.
- Three styles of recessed task lights in four sizes are available to correspond to cabinet or shelf width.
- All styles have 9' power cords in black, connected in the right rear corner.
- All models feature electronic ballast for longer bulb life and cooler operating temperature.
- Task lights with a fused plug to meet Chicago electrical code are also available.

Recommendation: Provide a separate circuit for task lights for proper long-term operation without RF interference to computers that may be in use.

Undercabinet LED Light (page 389)

- Undercabinet LED light can be mounted beneath overhead cabinets with wood screws or magnets.

Data

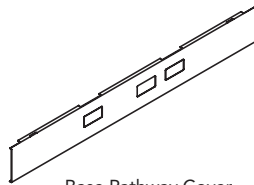

Base Pathway Cover

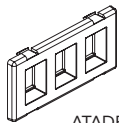

ATADF3

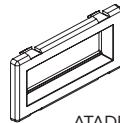

ATADF4

Base Pathway Covers (page 213)

- Features an additional knockout (offset) for improved utilization of power and data. Knockouts are 2.700" W x 1.377" H.
- Due to panel depth, back-to-back data modules should not be used at beltline or in the base on Stride.

Data Faceplates (page 213)

- Fit into receptacle and data port openings in base raceway covers or into data port (UTP).
- Due to panel depth, back-to-back data modules should not be used at beltline or in the base on Stride.

Base Pathway Receptacle Locations

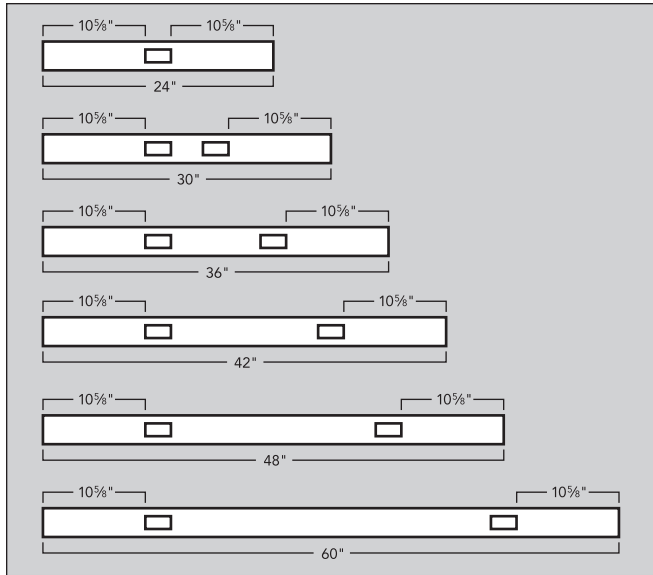

Circuit Usage

Strategy 1

Circuits to Equipment

Assign specific uses for each of the circuits. For example, in a four-circuit system:

- Circuit 1 — calculators, fans, etc.
- Circuit 2 — task lights (could be wired to wall switch)
- Circuit 3 — CRT or flat screen monitors
- Circuit 4 — CPUs

Strategy 2

Circuits to Workstations

Assign specific workstations to each of the three available circuits. Use circuit 4 for power-sensitive electronic equipment.

Placement of pedestals and lateral files may render some duplex locations inaccessible. Pedestal placement may also affect compatibility with pull-up receptacles.

Lay-in Cable Capacity — Stride cable quantities listed at 60% fill ratio

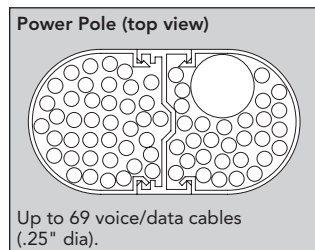
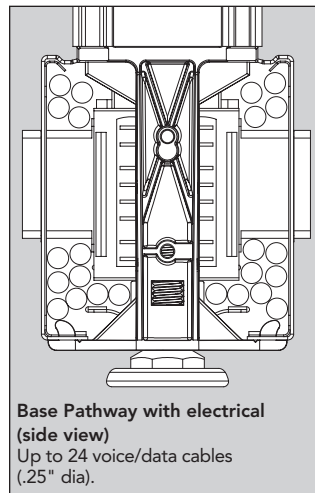
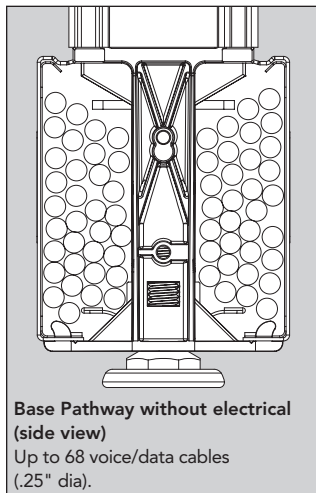
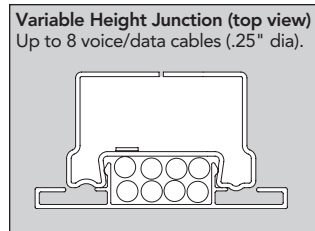
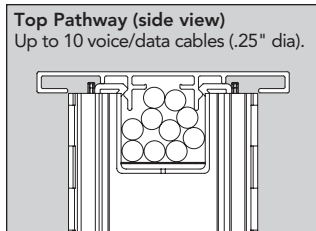

The top and base pathway allow continuous voice and data lines to run through and between panels without interruption. Lay-in is provided for environments where systems furniture or cabling are subject to frequent change.

- Stride panels top pathway accepts up to 10 voice/data cables (.25" dia).
- Stride panels variable height junctions accept up to 8 voice/data cables (.25" dia.) with a bend radius of approximately 1/2" to 3/4".
- Stride panels base pathway accepts up to 68 (5.56 sq. in.) voice/data cables (.25" dia.) when electrical system is located in beltline pathway.
- When electrical system shares base pathway, the cable capacity in Stride panels is reduced to 24 (1.95 sq. in.) voice/data cables (.25" dia.) Cable quantities listed are at 60% fill ratio.
- Cable capacity of the Stride power pole, in addition to electrical infeed, is 2.79 sq. in. on one side and 2.91 sq. in. on the other for a total capacity of 69 cables of .25" diameter. Cable quantities listed are at 60% fill ratio.

Horizontal Capacity of Stride Frames

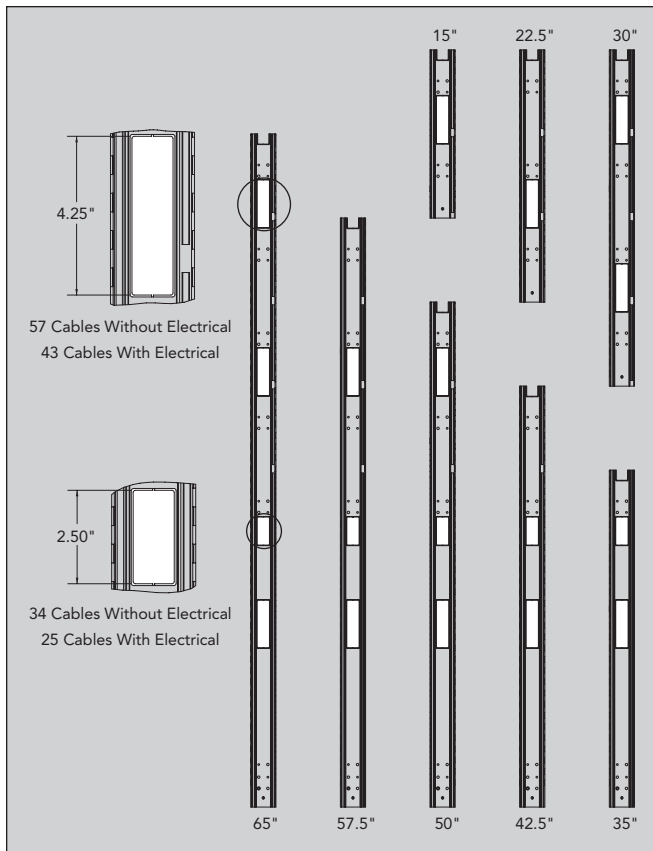

DO NOT run electrical equipment or extension cords through cable openings in frame sides. Use beltline or base-mounted electrical system for all electrical supply.

String-in Capacity

- Openings in frame sides permit data and communication cables to be run between frames at up to five levels in a 65"H Stride frame.
- Using tackable acoustical tiles, each opening accommodates up to 57 cables (.25" dia) and the beltline pathway accommodates 25 cables with electrical components installed.
- Cables can enter/exit panel through underside of base pathway at juncture between frames. Openings are sized as follows:

Stride Connections	Sq. In.
Straight	5.4
"S" Extended Straight	12.9
"L" 90°	13.0
"T"	16.6
"X"	20.4

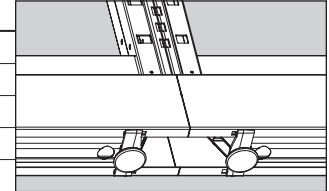

- When leveling glides are fully retracted, panel-to-floor clearance is 7/16". This may affect the volume of cabling that can be fed into the frame from the bottom of the pathway.

Vertical Capacity

Vertical Capacity Through Stride Panel Frames

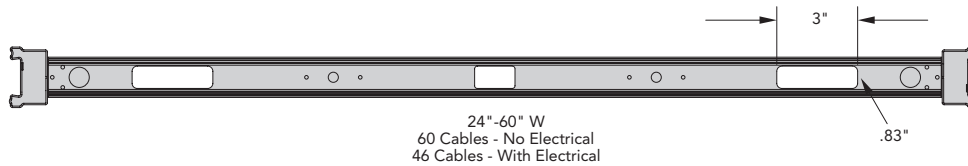

- A 60% fill ratio is achievable; however, when electrical components are installed in the beltline area, cabling capacity through the beltline area will be limited to approximately 45% fill ratio.

	Panel Width	Qty of .25" Cables at 40% Fill Ratio	Qty of .25" Cables at 60% Fill Ratio	Total Space (sq. in.)
Stride	24" – 60"W	46	60	4.90

Office Equipment Typical Load Values

Item	*Amps
Desktop Computer/2 Monitors	4
Laptop Computer	1
Laptop/2 Monitors/Docking Station	4
Paper Shredder	1.22
Radio	0.05
Scanner	3
Space Heater (1500 watts)	12
Task Light (equiv. 60-watt bulb)	
Fluorescent	0.12
LED	0.08
USB Charger	0.17
LCD Television (42")	1
LCD Monitor (21")	0.5
Bluetooth Speaker	0.1
Desktop Printer	
Inkjet	0.15
Laser	4 to 10
Multimedia Projector	1.7
Sit-to-Stand Height-Adjustable Desk	Idle 0.01 / Max 4
Office Kitchen	
Coffee Maker	10
Microwave	10
Toaster	12.5
Compact Refrigerator	1.5

*Chart is recommended for planning purposes. Check device specifications for exact amperage. Consult with your electrician regarding the applicable configurations.

Examples of Component Usage based on the *Office Equipment Typical Load Values Chart*

Power Option 3+1

Dedicated Circuit 4: 4 desktop computers with 2 monitors each; or 10 laptop computers
Utility Circuits 1, 2, 3: Height-adjustable tables and ancillary items

Power Option 2+2

Dedicated Circuit 3: 4 desktop computers with 2 monitors each; or 10 laptop computers
Dedicated Circuit 4: 4 desktop computers with 2 monitors each; or 10 laptop computers
Utility Circuits 1, 2: Height-adjustable tables and ancillary items

Power Option 3 (Circuit-separate neutrals)

Dedicated Circuit 3: 4 desktop computers with 2 monitors each; or 10 laptop computers
Utility Circuits 1, 2: Height-adjustable tables and ancillary items

Electrical & Data

Stride® — 8-Wire Electrical Components and Power Poles

For specification information see pages 199-209.

GSA SIN 33721

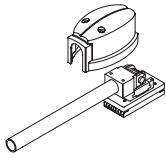

Description	Four-circuit 3 + 1 2 + 2	Three-circuit Separate Neutrals	List Price
Electrical Infeed Cables			
6' Sealight cable	A877072	A877072A S	\$ 457
6' Flex Cable	A871972	A871972A S	\$ 331



Ceiling Electrical Infeed Cables			
12' Flex Cable	A871912	A871912A S	\$ 449
18' Flex Cable	A871918	A871918A S	\$ 565

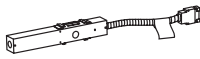

Hardware Power Infeed (New York Code)			
30-60"W Panels	A871400	A871400A S	\$ 431

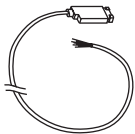

Electrical Base Infeed Cable			
12' Sealight Cable Power Infeed	A877012	N/A S	\$ 547



Description	Model	P1 Paint List Price	P2 Paint List Price
Integrated Power Pole			
42½" to 57½"H Panels	Z235PP S	\$ 707	\$ 735
65"H or higher Panels	Z265PP S	\$ 465	\$ 493

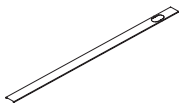

Description	Painted Model	Veneer Model	P1 Paint List Price	P2 Paint List Price	Veneer V2 List Price
Power Pole Trim Kit					
24"W	Z324PP S	Z324PPV S	\$ 249	\$ 278	\$ 1218
30"W	Z330PP S	Z330PPV S	\$ 256	\$ 285	\$ 1264
36"W	Z336PP S	Z336PPV S	\$ 267	\$ 296	\$ 1317
42"W	Z342PP S	Z342PPV S	\$ 279	\$ 308	\$ 1363
48"W	Z348PP S	Z348PPV S	\$ 284	\$ 313	\$ 1406
54"W	Z354PP S	Z354PPV S	\$ 293	\$ 322	\$ 1450
60"W	Z360PP S	Z360PPV S	\$ 304	\$ 333	\$ 1495
68"W	Z368PP	Z368PPV	\$ 317	\$ 346	\$ 1548
72"W	Z372PP	Z372PPV	\$ 321	\$ 350	\$ 1595
78"W	Z378PP	Z378PPV	\$ 331	\$ 360	\$ 1639
84"W	Z384PP	Z384PPV	\$ 341	\$ 370	\$ 1683
90"W	Z390PP	Z390PPV	\$ 349	\$ 378	\$ 1727
96"W	Z396PP	Z396PPV	\$ 356	\$ 385	\$ 1769

How to specify —
Select the
Model Number
from above.

1st Option:
Color
(if applicable):
P Black only

1st Option:
Paint
(if applicable):
See page 136 for
finishes.

1st Option:
Veneer Type and Finish
(if applicable):
See page 136 for finishes.

Examples: A871912.P Z235PP.P7D Z324PPV.SC777

S Shippable by small-package carrier.

For specification information see pages 199-209.

GSA SIN 33721

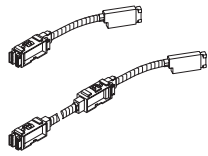

Description	Four-circuit 3 + 1 2 + 2	Three-circuit Separate Neutrals	List Price
Electrical Power Harnesses			
For 24" W Frames	A871224	A871224A S	\$ 391
For 30" W Frames	A871230	A871230A S	\$ 391
For 36" W Frames	A871236*†	A871236A S	\$ 391
For 42" W Frames	A871242*	A871242A S	\$ 416
For 48" W Frames	A871248*	A871248A S	\$ 416
For 60" W Frames	A871260*	A871260A S	\$ 416

†When purchased separately without a configurable TAA compliant end product, not on GSA contract.

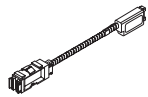

Description	Four-circuit 3 + 1 2 + 2	Three-circuit Separate Neutrals	List Price
Electrical Pass-Thru Harnesses with Power Block			
For 24" W Frames	A871124	A871124A S	\$ 239
For 30" W Frames	A871130	A871130A S	\$ 239
For 36" W Frames	A871136*†	A871136A S	\$ 239
For 42" W Frames	A871142*†	A871142A S	\$ 255
For 48" W Frames	A871148*†	A871148A S	\$ 255
For 60" W Frames	A871160*	A871160A S	\$ 255
For 72" W Frame Runs	A871172	A871172A S	\$ 341

Electrical harnesses are intended for use with Allsteel systems furniture and are approved under GSA SIN 33721. When purchased separately and used without Allsteel systems furniture, those electrical harnesses marked by () are considered Open Market.

†When purchased separately without a configurable TAA compliant end product, not on GSA contract.



Description	Four-circuit 3 + 1 2 + 2	Three-circuit Separate Neutrals	List Price
Electrical Jumper Cables – Harness to Harness			
Up to 30" vertical jump (66")	A871366	A871366A S	\$ 270
Up to 69" vertical jump (108")	A8713108	A8713108A S	\$ 505

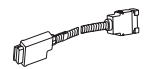

Description	Four-circuit 3 + 1 2 + 2	Three-circuit Separate Neutrals	List Price
Electrical Pass-Thru Cable without Power Block			
For 24" W Frames	A871024	A871024A S	\$ 219
For 30" W Frames	A871030	A871030A S	\$ 219
For 36" W Frames	A871036	A871036A S	\$ 219
For 42" W Frames	A871042	A871042A S	\$ 229
For 48" W Frames	A871048	A871048A S	\$ 229
For 60" W Frames	A871060	A871060A S	\$ 229

NOTE: Four-circuit components and Three-circuit components (with an "A" suffix) cannot be connected together.

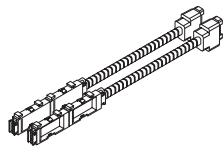

Description	Max. Recept. Cap. per Panel Side	Eight-circuit 3 + 1 (each side) 2 + 2 (each side)	List Price
Dual Electrical Eight-circuit Power Harness Kit			
For 24" W Panels	1	A2-8CIR24 S	\$ 939
For 30" W Panels	2	A2-8CIR30 S	\$ 939
For 36" W Panels	2	A2-8CIR36 S	\$ 1358
For 42" W Panels	2	A2-8CIR42 S	\$ 1358
For 48" W Panels	2	A2-8CIR48 S	\$ 1358
For 60" W Panels	2	A2-8CIR60 S	\$ 1369

NOTE: Kit consists of two four-circuit harnesses placed "back-to-back" to provide 8 circuits.

How to specify —
Select the Model Number from above.

1st Option:
Color
(if applicable):
P Black only

P									

Examples: A871224.P A871224A.P

S Shippable by small-package carrier.

For specification information see pages 199-209.

GSA SIN 33721

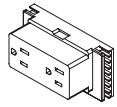

Description	Four-circuit 3 + 1 2 + 2	Three-circuit Separate Neutrals	List Price
Duplex Receptacles — (specify color)			
Circuit 1	A877501	A877501A S	\$ 72
Circuit 2	A877502	A877502A S	\$ 72
Circuit 3 (3+1)	A877503	A877503A S	\$ 72
Circuit 3 (2+2)	A877506	N/A S	\$ 72
Circuit 4 — iso/dedicated	A877504	N/A S	\$ 72



Description	Model	P1 Paint List Price	P2 Paint List Price	P3 Paint List Price
Electrical Mounting Brackets (Black only)				
Pack of 12 (for use with Segment Kit)	8988EBZS S	\$ 108	N/A	N/A
Pack of 12 (for use at Beltline without Segment Kit)	8988EBZ S	\$ 108	N/A	N/A
Pack of 12 (for use at Beltline on a 35"H Base Panel Frame)	8988EBZ3 S	\$ 108	N/A	N/A



Hardwire (Chicago Code) (Black only)				
Stride Base Pathway Junction Box (Pack of 6)	877600 S	\$ 1145	N/A	N/A
Beltline Junction Box (Pack of 6)	877550 S	\$ 1078	N/A	N/A

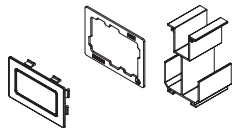

Data/Electrical Port Kit (specify color)				
Universal Tile Port Kit	UTP S	\$ 42	N/A	N/A
Data Management Organizer (Pack of 20)	A877010 S	\$ 150	N/A	N/A

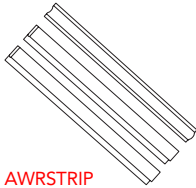

Wire Management Strips/Channels				
	AWRSTRIP S	\$ 270	N/A	N/A

- Four wire management strips/channels in black only, no specification needed.
- Example: AWRSTRIP

AWRSTRIP

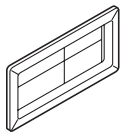

Wireway Grommet (Black only)				
Pack of 6	TAWG S	\$ 187	N/A	N/A

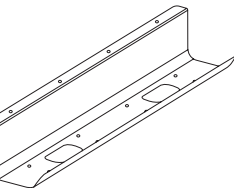

Cable Management Trays				
24"W	AJTRGH24 S	\$ 123	N/A	N/A
36"W	AJTRGH36 S	\$ 147	N/A	N/A

- Available in 24" or 36" widths.
- Metal Cable Management Trays available in Black only, specify "P" for finish.
- Example: AJTRGH24.P

AJTRGH24



Cord Retainer Clip (Black only)				
Package of 50	AAPACM2 S	\$ 56	N/A	N/A

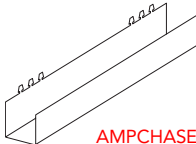

Panel Mounted Wire Chase				
17"H	AMPCHASE S	\$ 147	\$ 162	\$ 169

- Panel Chase is 17"H.
- Available in standard metal paint finishes, see page 334 for options and specify desired finishes.
- Example: AMPCHASE.P27

For more power and wire management options, please visit the Extensions pages.

How to specify — Select the Model Number from above.	1st Option: Electrical Receptacle Color (if applicable): See page 136 for finishes.	1st Option: Data Port Grommet Color (if applicable): See page 136 for finishes.	1st Option: Color (if applicable): P Black only	1st Option: Wireway Grommet Color (if applicable): Black only.	1st Option: Paint (if applicable):
_____ . E	_____ E	_____ E	_____ P	_____ E 4	_____ P

Examples: A877501.E4 8988EBZS.P A877010.P 877550.P

S Shippable by small-package carrier.

8988EBZ.P UTP.E4 AJTRGH24.P TAWG.E4

Frame & Tile Panel Systems – 02/2024

For specification information see pages 199-209.

GSA SIN 33721

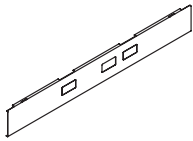

Description	Model	P1 Paint List Price	P2 Paint List Price	P3 Paint List Price
Base Raceway Covers — Knockouts (Stride)				
36"W	TBPLATE3-36 S	\$ 101	\$ 119	\$ 132
42"W	TBPLATE3-42 S	\$ 103	\$ 121	\$ 134
48"W	TBPLATE3-48 S	\$ 110	\$ 128	\$ 141
60"W	TBPLATE3-60 S	\$ 127	\$ 145	\$ 158

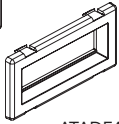
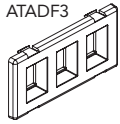

ATADF4

Data Faceplates

Three-Port Flex-Mode Faceplate, Black (E4)	ATADF3 S	\$ 42	N/A	N/A
Four-Port Flex-Mode Faceplate, Black (E4)	ATADF4 S	\$ 42	N/A	N/A

Note: ATADF3 can install up to 3 jacks (CAT 3, 5E, or 6).

ATADF4 can install 4 jacks (CAT 3, 5E, or 6).

Allsteel's data faceplates are designed for use with the jacks listed below. We do not guarantee compatibility with other manufacturers' product. A faceplate adapter is available for use with alternatively sourced data jacks, see the Standard Specials catalog for details.

Note: ATADF models are compatible with ports in Stride Tiles.

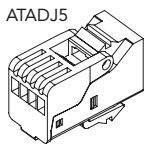

Jacks

RJ45 CAT 5E Jack — Black only Toolless	ATADJ5 S	\$ 74	N/A	N/A
RJ45 CAT 6 Jack — Black only Requires Tool	ATADJ6 S	\$ 98	N/A	N/A

How to specify —
Select the Model Number from above.

1st Option:
Paint
(Base Pathway Cover only):
P1 P2 P3
See page 136 for finishes.

1st Option:
Data Faceplate Color:
E4 Black

_____ . **P** _____

E _____

Examples: TBPLATE3-36.P27 ATADF4.E4

S Shippable by small-package carrier.

Laminate with Flat Edge or Veneer with Square Edge Worksurfaces

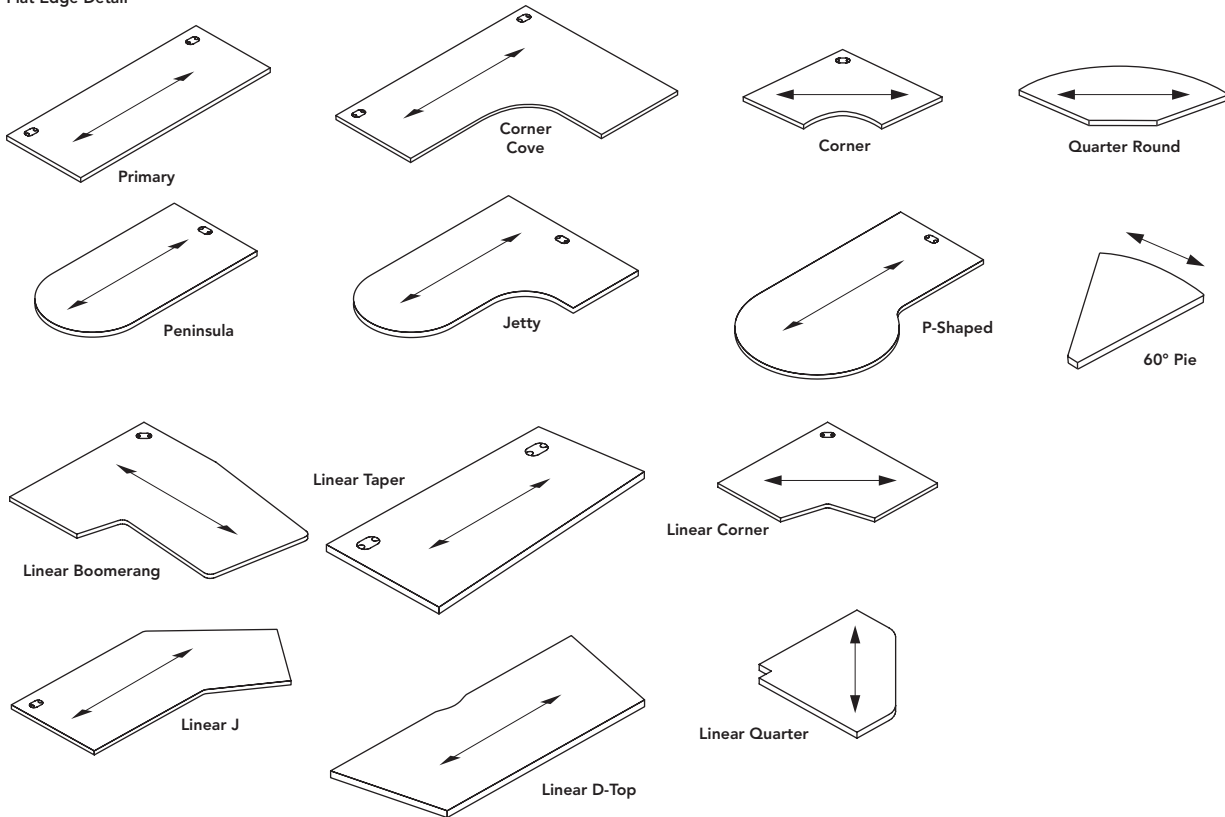
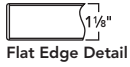

Note: Add suffix “N” to model number for no grommets, no upcharge.

←→ Arrows indicate grain direction for woodgrain laminates.
Grain direction on symmetrical corner worksurfaces runs at a diagonal.

Laminate worksurfaces are 1½" thick with particleboard core and with top surfaces finished in laminate. Bottom surfaces are covered with a backer sheet. Wall track allows for mounting of systems panel components on permanent wall structures.

Corner worksurfaces optimize use of space, and provide a convenient location for computer and monitor.

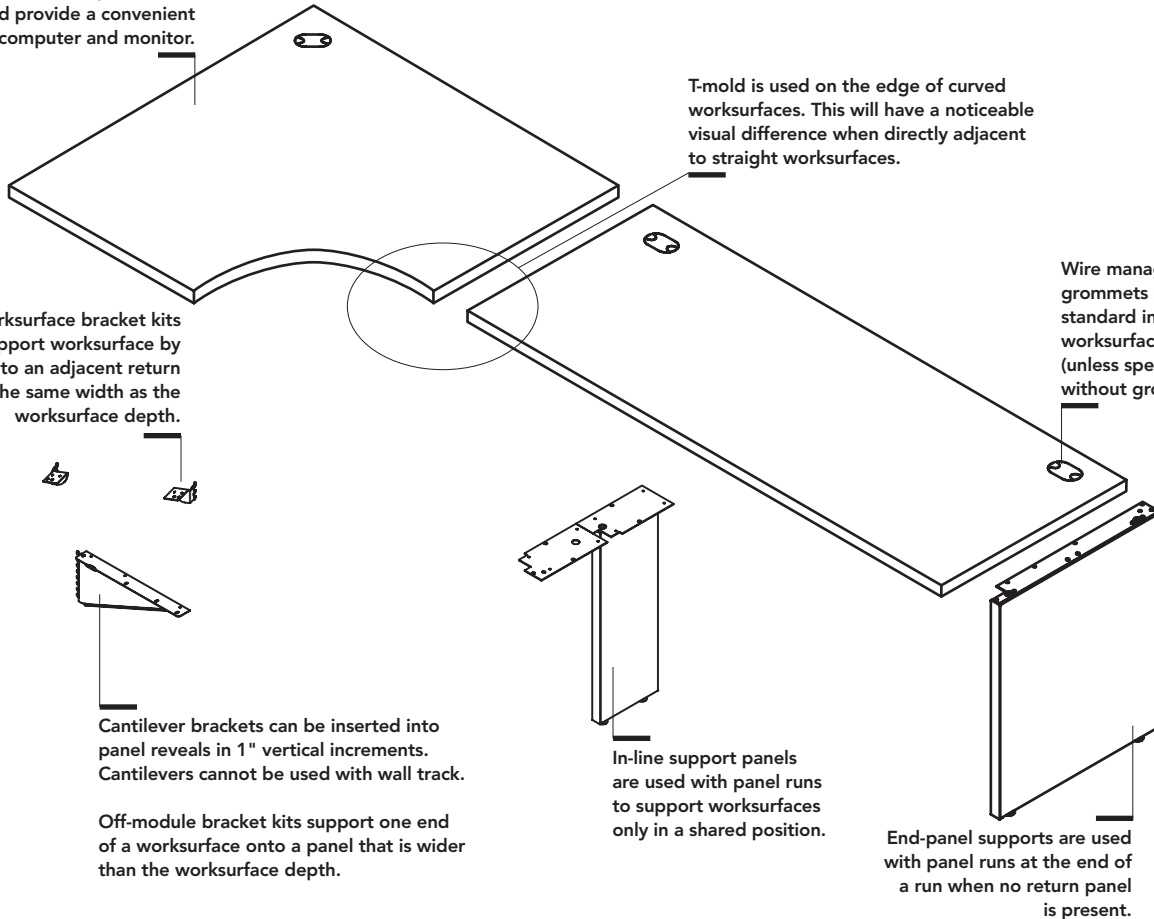

Worksurfaces can be configured at 29½"H or 26½"H with end-panel supports and in-line support panels, or at various heights on 1" increments using specific product configurations.

Worksurface support options include:

- Support column*
- Off-module bracket kit
- Flat brackets
- External support channel
- Worksurface bracket kit
- Height adjustable mechanism
- Cantilever bracket
- In-line support panels*
- End support panel*
- Support storage units*
- Storage unit with stanchion*
- C-Legs*
- Post Legs*

*Units provide floor support.

Support Guidelines — See Drawings on page 216

- Panel mounted worksurface runs 96" and greater need floor support for improved stability when overheads are not used.
- When using overheads in panel mounted worksurface run applications 72" and greater, floor support* is required. (See list at left.)
- When using overheads at the end of a panel run, floor supports* are required.
- Worksurface bracket kit should be used to tie panels to worksurface for added stability.
- A return panel at the end of a panel run can be substituted with one of these floor supports: storage, open or closed end support panel, O-leg.
- Cantilever brackets cannot be used at the end of a worksurface panel run in place of a return panel or floor support.
- Unsupported worksurfaces 60"W or greater require an external worksurface support channel. When a center support cantilever cannot be used, an external worksurface support channel is recommended for spans greater than 48"W.
- Support channel may interfere with mounting of some CPU holders and keyboard supports.
- Cantilevers are recommended in place of an external worksurface support channel where feasible.

Panel mounted worksurface runs 96" and greater need floor support for improved stability when overheads are not used.

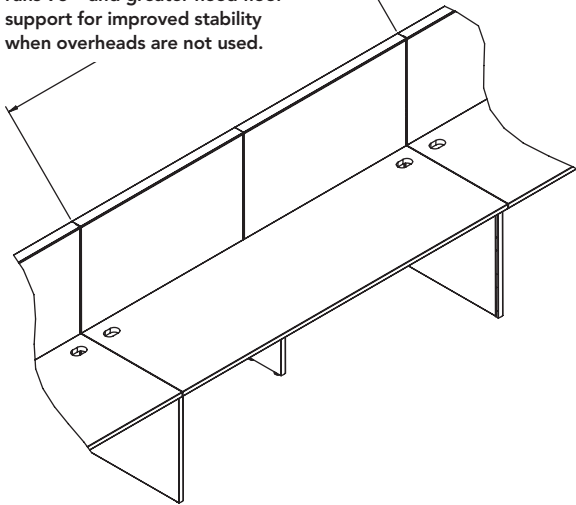

When using overheads in panel mounted worksurface run applications 72" and greater, floor support is required.

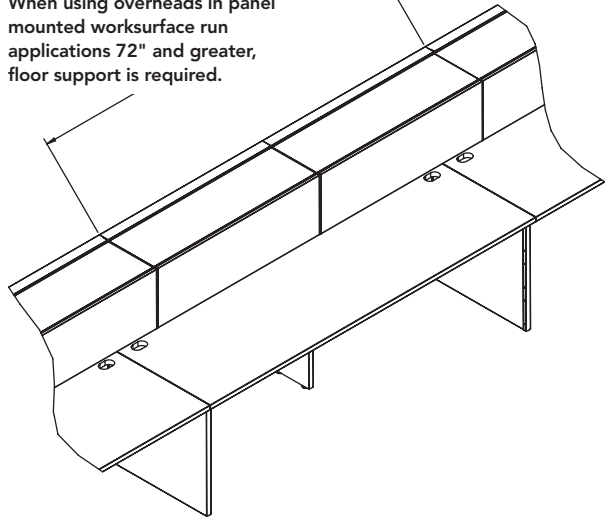

Worksurface bracket kit should be used to tie panels to worksurface for added stability

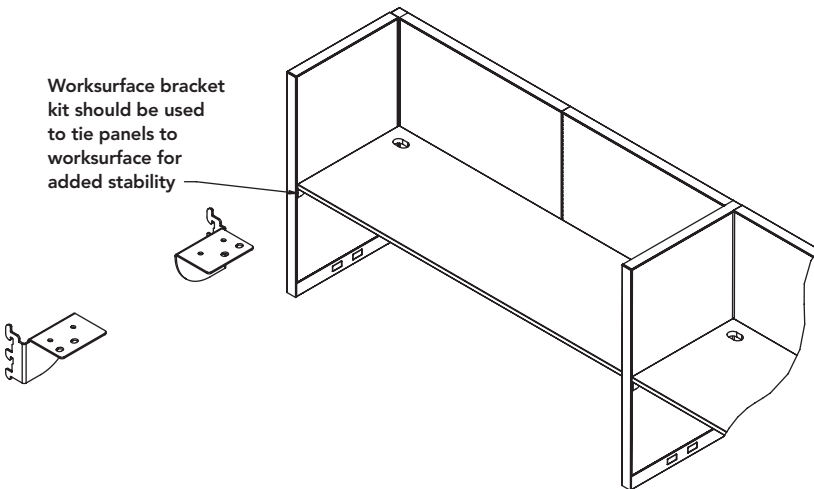

These floor supports can substitute a return panel at the end of a panel run: storage, open or closed end support panel, O-legs (shown, additional drawing on page 217)

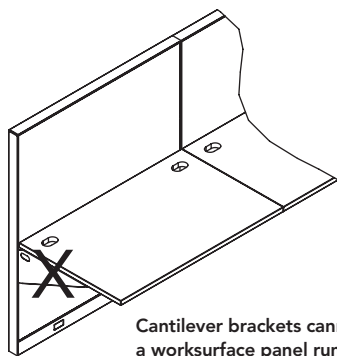
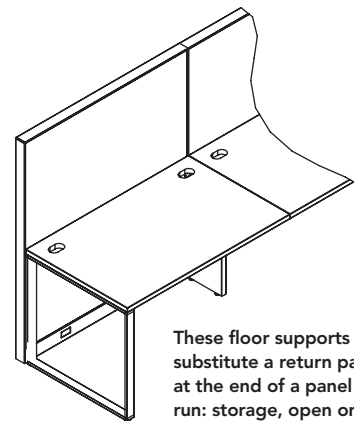

Cantilever brackets cannot be used at the end of a worksurface panel run in place of a return or floor support.

Cantilevers are recommended in place of an external worksurface support channel where feasible.

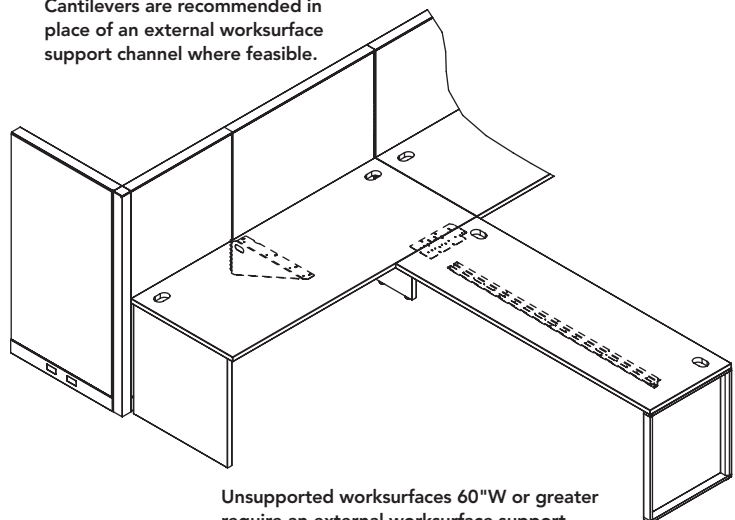

Unsupported worksurfaces 60"W or greater require an external worksurface support channel. When a center support cantilever cannot be used, an external worksurface support channel is recommended for spans greater than 48"W.

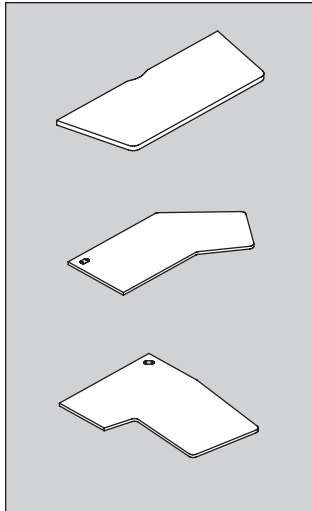

Linear D-shape, linear J, Linear boomerang, D-shaped, P-shaped, peninsula, jetty, boomerang, and reef worksurfaces require support columns (ordered separately).

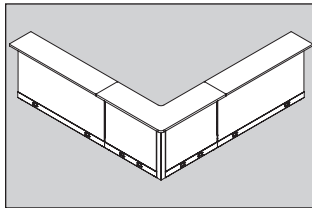

Stride countertops are flush with the top cap and are available in straight, corner, and 120° configurations. Mounting hardware is included with Stride countertops. Panel top caps need to be ordered separately.

Worksurface Application Versatility

Credenza tops are specified separately to allow spanning of multiple credenzas. Corner credenza makes use of under-desk space.

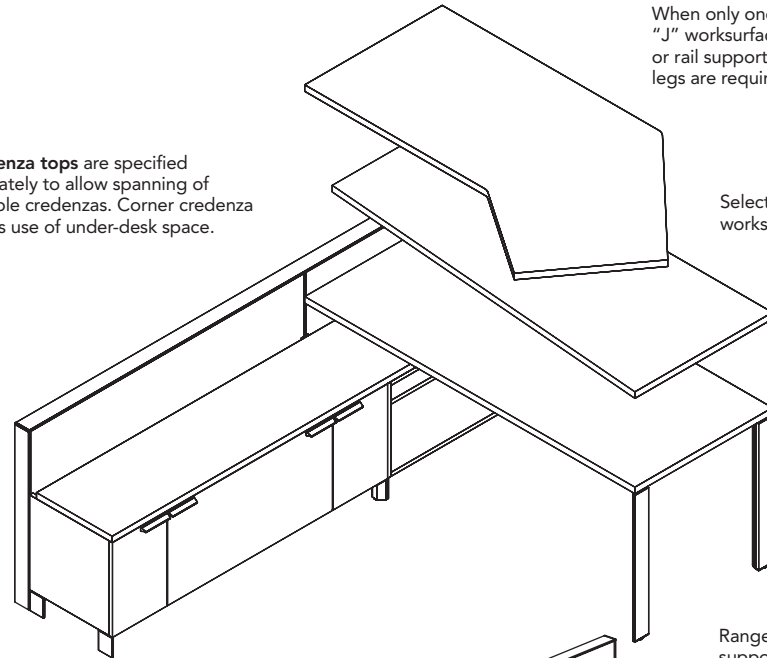

When only one end of a "J" worksurface is panel or rail supported, three legs are required.

Select from a range of worksurface shapes.

Range of light-scale support options with height adjustability.

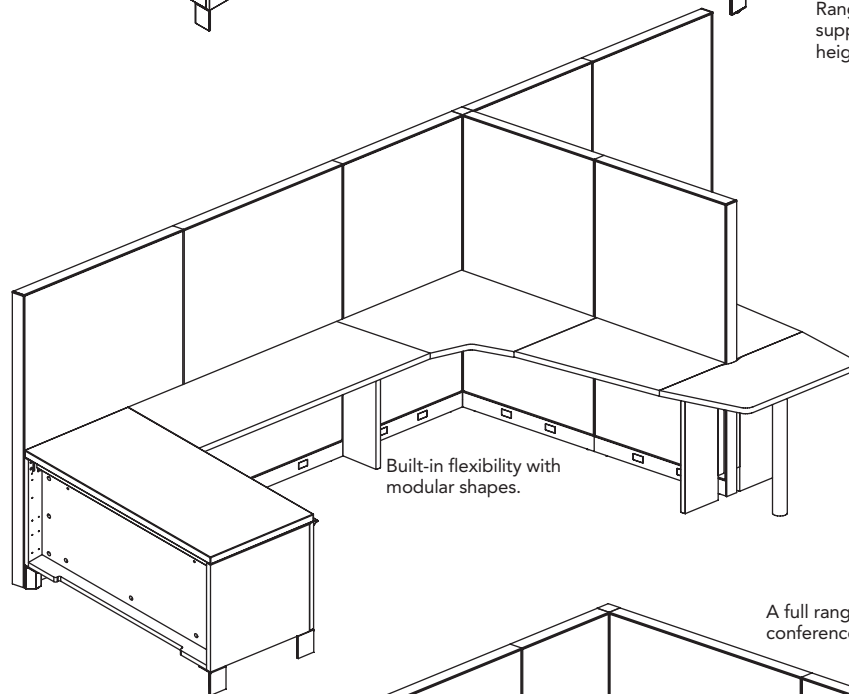

Built-in flexibility with modular shapes.

A full range of worksurface conference shapes are available.

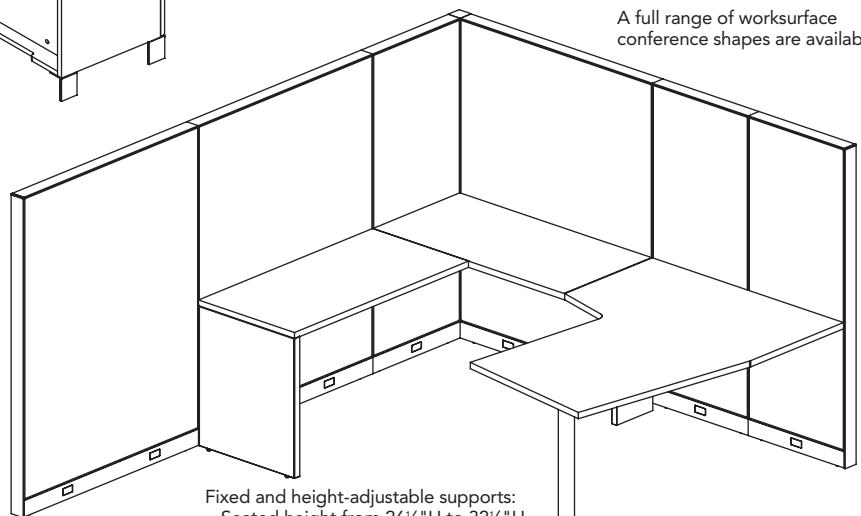

Fixed and height-adjustable supports:
Seated height from 26½" H to 32½" H
Standing height from 37½" H to 43½" H

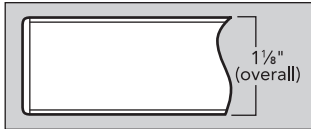

Flat Edge Trim

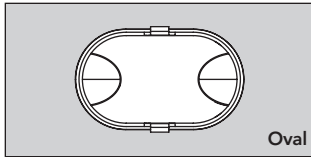

Oval

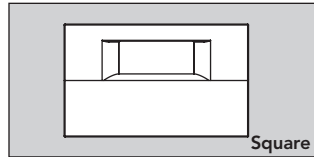

Square

Wire Management Grommets

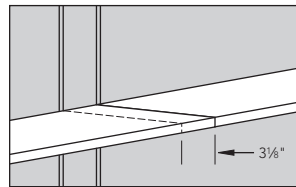
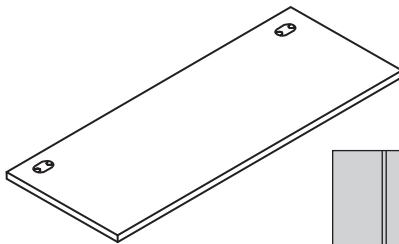

Optional width worksurfaces to span "T" or "S" panel connection.

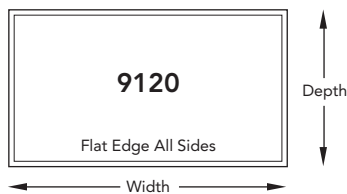

9120

Flat Edge All Sides

Depth

Width

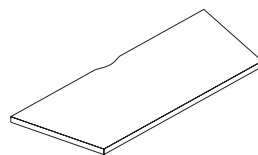

Worksurfaces

- Laminate (L) worksurfaces are 1 1/8" thick with particleboard core and with top surfaces finished in laminate. Bottom surfaces are covered with a backer sheet.
- Flat edge trim is available on laminate tops in standard colors (customer specified) to match solid laminates and to complement patterned or woodgrain laminates.
- Veneer (V) worksurfaces have square veneer edge.

Wire management grommets are standard in most worksurfaces and are specified in plastic or metal.

- Metal grommets are available in oval or square (shown at left).
- Grommets on standard systems worksurfaces are located 6 1/16" from side edges and 3 1/16" from back edge.
- Add Suffix "N" to a model number for no grommets, no upcharge.

Primary Worksurfaces (L pages 225-226)

- Primary worksurfaces are available in 20", 24", 30", and 36" depths.
- One grommet for widths up to 42", two on widths 48"W and greater.
- Worksurfaces greater than 60"W require a cantilever bracket for center support in panel mounted applications. Specify 12" cantilever on 12"D, 18" cantilever on 20"D, and 24" cantilever on 24"D and 30"D worksurfaces.
- Optional width worksurfaces, 3/8" wider than standard panel widths, are available for use with Stride panel runs having a "T" or "S" connection.
- Bracketry on post legs will interfere with grommets on systems (non-desking) worksurfaces.
- Nominal worksurface width is equal to nominal panel width.
- Does NOT include rear support bracket. Support hardware is ordered separately.
- Desking worksurfaces should be specified whenever worksurfaces 48"W and wider are not attached to a panel.

Non-Standard Worksurface Sizes (L and V on pages 232 and 233)

- The 9120 Program can be used to order laminate and veneer rectangular worksurfaces in any non-standard width and depth in 1/8" increments up to a maximum of 120"W x 36"D.
- Other modification requests should be made through Allsteel Tailored Products Group.

Linear D-Shaped Worksurfaces (L page 227)

- Order support column and two 10"D in-line support panels.
- Worksurface includes attachment bracket.
- Not recommended for use with T6CB24L or T6CB24R for shared applications.

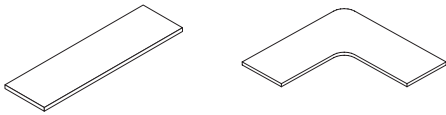

Countertops (L page 228)

- Available in Straight and Corner.
- Mounting bracket and attachment hardware included. When used with in-line high-low “H” trim kit add “V” suffix for straight countertop and “RV” for right or “LV” for left on corner countertops. Not available with fluid form models.
- Countertops are flush with panel top cap. Stride top caps need to be ordered separately.
- T-mold is used on the edge of curved worksurfaces. This will have a noticeable visual difference when directly adjacent to straight worksurfaces.

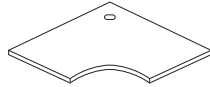

Corner Worksurfaces (L page 229)

- Does NOT include rear support bracket. If rear support bracket is needed, order T6BK. All other support hardware is ordered separately.
- Worksurface bracket kit (order separately) required at junction where a panel is wall-mounted to a permanent wall and wall track stanchion is not positioned in the right-hand corner.
- Corner worksurfaces with woodgrain laminate and veneer have grain direction diagonal to adjacent worksurfaces.
- T-mold is used on the edge of curved worksurfaces. This will have a noticeable visual difference when directly adjacent to straight worksurfaces.

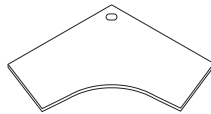

120° Corner Worksurfaces (L page 229)

- Standard with one wire management grommet in corner location.
- Does NOT include rear support bracket. If rear support bracket is needed, order T6BK.
- Worksurface bracket kit (order separately) required at junction where a panel is wall-mounted to a permanent wall and Wall Track stanchion is not positioned in the right-hand corner.
- T-mold is used on the edge of curved worksurfaces. This will have a noticeable visual difference when directly adjacent to straight worksurfaces.

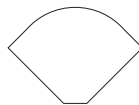

Quarter-Round Worksurface (V page 234)

- Connect to 90° panel-attached worksurfaces.
- Order support column and shared cantilevers or in-line support legs separately.

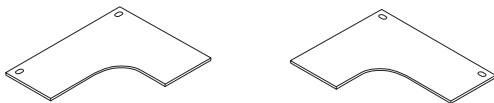

Corner Cove Worksurfaces (L page 230)

- Worksurfaces 66" and over require a cantilever bracket for center support in panel mounted applications. Specify 24" cantilever on 24"D and 30"D worksurfaces.
- Does NOT include rear support bracket. If rear support bracket is needed, order T6BK.
- Worksurface bracket kit (order separately) required at junction where a panel is wall-mounted to a permanent wall and wall track stanchion is not positioned in the right-hand corner.
- T-mold is used on the edge of curved worksurfaces. This will have a noticeable visual difference when directly adjacent to straight worksurfaces.

Support columns shown below ordered separately.

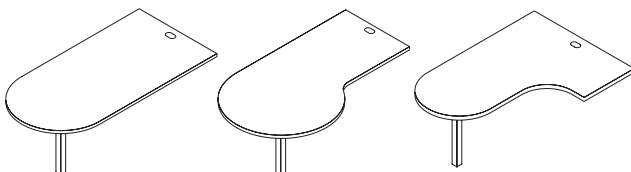

Peninsula, P-Shaped and Jetty Worksurfaces

(L page 231)

- Support column ordered separately, column includes panel support brackets T6BK.

End Panels and Panel Brackets

Worksurfaces can be configured at 29½"H with end-panel supports and in-line support panels, or at various heights on 1" increments using specific product configurations.

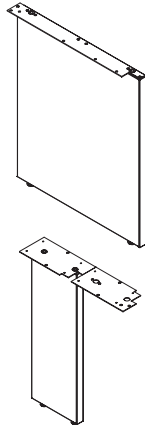

End Support Panel — Metal (page 235)

- Includes end-panel (non-handed), attaching hardware, and adjustable glides. (Panel mount version includes panel mount bracket.)
- End support panels are used in place of return panels at the end of worksurface runs.
- Leveling glides provide 3" of adjustment.
- Cannot be used with rabbet edge worksurfaces.

In-Line Support Panel — Metal (page 235)

- Includes support panel (non-handed), attaching hardware, adjustable glides, and wire management grommet. (Panel-mount version includes panel mount brackets.)
- Cannot be used with rabbet edge worksurfaces.

Panel Mount Bracket — Non-Handed (page 235)

- Includes hardware to convert freestanding end-panel or support leg to panel mount.

Pedestal-to-Panel Attachment Bracket (page 235)

- Can be used with Align™ pedestal in place of full end-panel or return panel. Provides structural support to panel run by securing panel directly to pedestal.
- Freestanding pedestals can also be used to support one end of a panel-attached worksurface in conjunction with ped-to-panel attachment kit.



Panel Mount Bracket

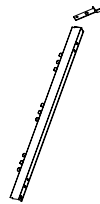

Ped-to-Panel

Legs

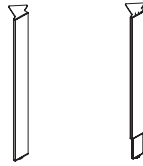

Post Legs (page 236)

- Used to support one corner of a panel attached worksurface. Cannot be used in freestanding applications, use table post legs.
- Fixed height is for support at 29½"H and 40½"H.
- 26½"H to 32½"H height adjustable legs provide a 6" range of adjustment in ½" increments.
- 37½"H to 43½"H height adjustable legs provide a 6" range of adjustment in ½" increments.
- Telescoping legs require common tools to adjust height.
- Leveling glides provide 1" of additional adjustment.
- Attachment hardware included.
- Post leg will interfere with the grommet location on systems (non-desking) worksurfaces.

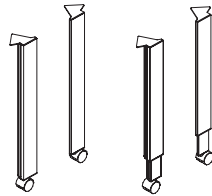

Freestanding Post Legs (page 236)

- Reinforced post leg with an integrated gusset is used to build a freestanding table.
- For use with Stride desking worksurfaces.
- Fixed height is for support at 29½"H.
- 26½"H to 32½"H height adjustable legs provide a 6" range of adjustment in ½" increments.
- Telescoping legs require common tools to adjust height.
- Leveling glides provide 1" of additional adjustment. Caster version aligns with glide version when glide is fully retracted.
- Attachment hardware included.

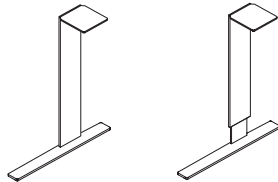

C-Legs (page 237)

- Used to support one end of a worksurface or table. Cannot be shared between surfaces.
- C-Legs cannot be used at both ends of a surface to create a freestanding desk.
- Fixed Height is for support at 29½"H.
- 26½"H to 32½"H height adjustable legs provide a 6" range of adjustment in ½" increments.
- Height adjustable C-legs are for use on worksurface spans up to 72"W. Fixed height C-legs must be used if the span is greater than 72"W.
- Telescoping legs require common tools to adjust height.
- Leveling glides provide ½" of additional adjustment.
- Attachment hardware included.

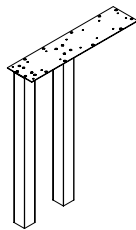

Post In-line Support Leg (page 237)

- Includes legs (non-handed, mounted to bracket) and attaching hardware.

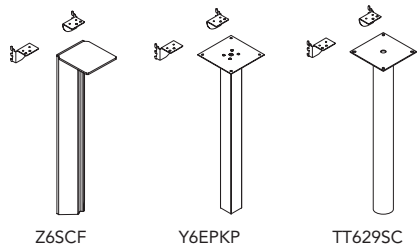

Z6SCF

Y6EPKP

TT629SC

Support Columns (page 237)

- Includes column, worksurface bracket kit T6BK, attaching hardware, and adjustable glides.
- Fixed height column is for support at 29½"H.
- Height adjustable column provides a 6" range of adjustment in ½" increments from 26½"H to 30½"H.

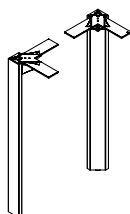

Light-scale Wire Management Table Post Legs (page 237)

- Includes pair of legs (non-handed, mounted to bracket) and attaching hardware. Available for modesty panel or not for modesty.
- Available painted or anodized.

Worksurface Support Brackets

Cantilever Brackets

- Use with runs less than 96". Floor support is required for runs 96" and longer.
- Where applicable, cantilevers are recommended over an external worksurface support channel. Unsupported worksurface runs 60"W or greater require an external worksurface support channel when a cantilever cannot be used.
- Do not use at the end of a worksurface where no 90° return panel is positioned.
- Includes tie bracket and attachment hardware.
- Avoid installation on only one side of a straight connection except to support corner worksurfaces.
- DO NOT use to support worksurfaces from which a hanging pedestal is suspended, or to which a peninsula worksurface is attached.
- DO NOT use cantilever brackets to support worksurfaces supported with permanent-wall hanger kit.
- Do not use with wall track or to support a worksurface to which a return worksurface is attached.

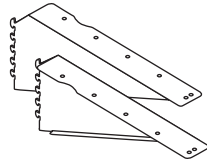

Cantilever Brackets — Handed

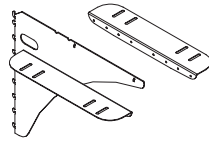

Cantilever Brackets — Non-Handed

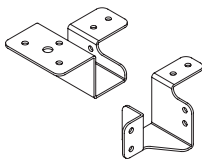

Non Rail-Based End Panel Kit
Z6EPK

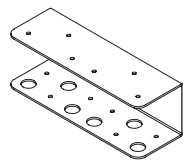

Layered Worksurface Bracket
Z6C3BK

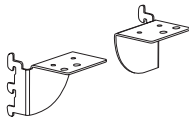

Worksurface Bracket Kit
T6BK

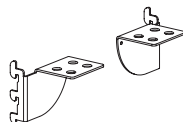

Worksurface Bracket Kit
T6SB

Cantilever Bracket — Handed (page 238)

- Cantilever brackets are handed (left or right) and can be inserted into panel reveals in 1" vertical increments. No assembly required.
- Left- and right-hand brackets required in shared applications.
- 24"D cantilevers are required to be used for both 24"D or 30"D worksurfaces.
- 18"D cantilevers are required to be used for 20"D worksurfaces or center support for 24"D.
- 12"D cantilevers are required to be used for 12"D worksurfaces.

Cantilever Bracket — Non-Handed (page 238)

- Cantilever brackets are non-handed and can be inserted into panel reveals in 1" vertical increments. Assembly required.
- One bracket in shared applications — includes two angled brackets.
- Bracket accommodates 24"D or 30"D worksurfaces.

Non Rail-based End Panel Kit (page 238)

- Non rail-based end panel kit Z6EPK is used to attach an end panel off-module to a segmented panel.

Layered Worksurface Bracket (page 238)

- Layered worksurface bracket model Z6C3BK, used for mounting off-modular worksurfaces 3" higher or lower than the installed worksurface.

Worksurface Bracket Kits (Pair)— T6BK (page 238)

- Worksurface bracket kit allows one end of a worksurface to be supported by a return panel. Attachment hardware included.
- Return panel width must be the same as the depth of the worksurface.

Worksurface Bracket — T6SB (page 238)

- Worksurface storage bracket kit (T6SB) is used for aesthetics where under-desk storage is immediately adjacent to the return panel. In all other applications use worksurface bracket kit (T6BK) to utilize worksurface threaded metal inserts.
- Brackets — one pair. Black only.
- Attachment hardware included.
- Brackets do not align with worksurface threaded metal inserts, and therefore require wood screws (included).

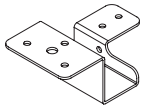

Off-Module Worksurface
Bracket Z6MK

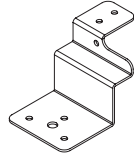

Off-Module Worksurface
Bracket Z6Z3MK

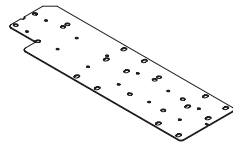

Flat Bracket

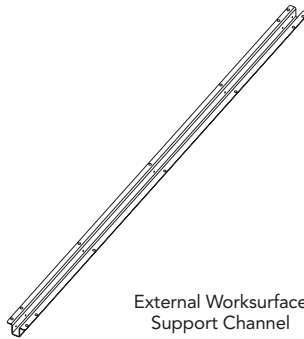

External Worksurface
Support Channel

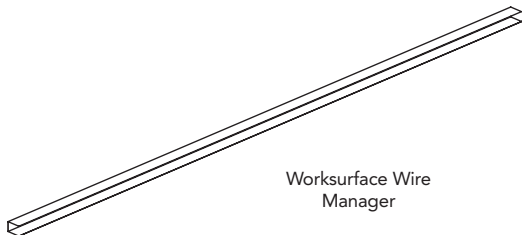

Worksurface Wire
Manager

Off-Modular Worksurface Brackets (page 238)

- Allows in-line support legs and end-panels to be attached off-module.
- Cannot be used closer than 12" from end of panel.
- Non-rail based 3" layered worksurface bracket used to mount off-modular worksurface at 26½".
- Off-module worksurface bracket model Z6MK can only be used for attachment of a worksurface end to a segmented panel at 29½"H.
- Off-module worksurface bracket model Z6Z3MK is used for mounting non-rail based off-modular worksurfaces to a segmented panel at 26½"H.

Flat Brackets (page 238)

- Flat brackets can be used to connect one worksurface perpendicular to another worksurface.
- Use two 12"D flat brackets (T612FB) side-by-side with rabbet edge worksurfaces and when placing flat or rabbet edge worksurfaces perpendicular to high credenzas.

External Worksurface Support Channel (page 238)

- Support channel should be specified separately for use with non-desking worksurfaces.
- Extends 1½" below the worksurface. Installs 7" from user's edge.
- When using 28"H mobile pedestals the length of support channel needs to be reduced to accommodate width of the pedestal.
- Support channel may interfere with mounting of some CPU holders and keyboard supports.
- Is required on a systems worksurface for additional support for unsupported spans 66"W or greater. Width of worksurface span can be reduced by using support storage.
- Required when mounting a modesty panel.
- 36"D worksurfaces require two external support channels distributed equally from the center of the worksurface.

Worksurface Wire Manager (page 238)

- Provides channel to run wires under a worksurface.
- Extends 1½" below the worksurface.
- Wire manager (ordered separately) is mounted in front of the desk support channel to hide exposed hardware.

Desk screens and modesty panels provide light-scale space division. There are four options available: full desk screens, shared desk screens, desk modesty panels, and leg modesty panels.

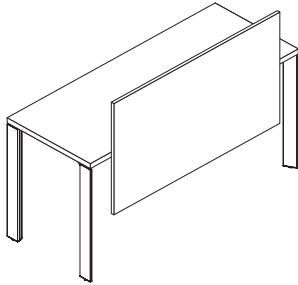

Full desk screens extend above and below the work surface acting as both a screen and a modesty panel. They are 28"H and available in painted wood or painted wood with fabric Insert. Landscape™ surface material will soon be available as an additional finish option.

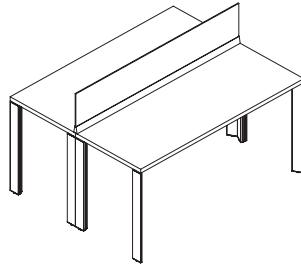

Shared desk screens are for use above the work surface in a back-to-back application for added privacy. They are 13"H and are available in 3/8" Clear or Frosted Glass.

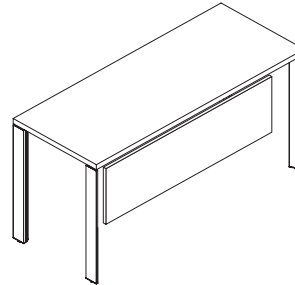

Modesty panels are for use below the work surface. They must be used with Stride desking worksurfaces or a systems work surface with an external support channel installed. An optional work surface wire manager conceals hardware. They are 14"H and available in 3/4" thick painted wood or 1/4" thick Landscape surface material.

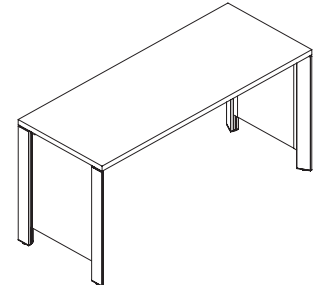

Leg modesty panels are used between two post legs on either a 24"D or a 30"D work surface. They are 29"H and are available in Landscape surface material.

Specification Rules for Desk-Mounted Screens and Modesty Panels

FRONT VIEW

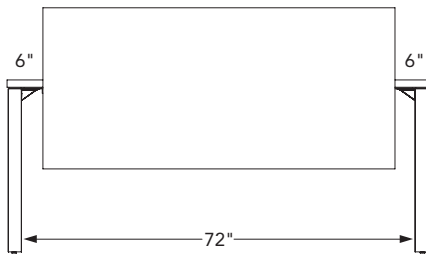

Freestanding Table Applications:

Subtract 12" from the size of the table/work surface to get the recommended screen or modesty widths.

Example for an 84" W table: 84" - 12" = 72" W

Specify a 72" W screen and center-mount on the table.

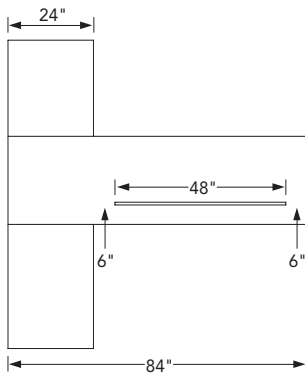

High Credenzas — TOP VIEW

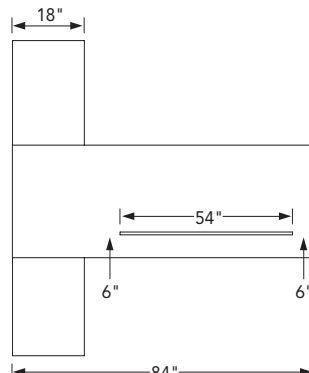

Low Credenzas — TOP VIEW

Credenza-based Layered Applications:

- **High credenzas** — Subtract 24" for the credenza depth and an additional 12" from the width of the work surface to get the recommended width.

Example for an 84" W table: 84" - (24" + 12") = 48" W

Specify a 48" W screen and center-mount on the work surface opening.

- **Low credenzas** — Subtract 18" for the credenza depth and an additional 12" from the width of the work surface to get the recommended screen width.

Example for an 84" W table: 84" - (18" + 12") = 54" W

Specify a 54" W screen and center-mount on the work surface opening.

For specification information see pages 214-224. For non-standard worksurface sizes see page 232.

Laminate
GSA SIN 33721

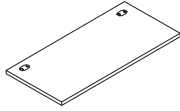

Description	Laminate w/Flat Edge Model	Laminate w/Flat Edge		
		L1 List Price	L2 List Price	L3 List Price
20"D Primary Worksurfaces				
24"W	T52024S	\$ 385	\$ 403	\$ 418
30"W	T52030S	\$ 408	\$ 427	\$ 442
36"W	T52036S	\$ 456	\$ 476	\$ 494
42"W	T52042S	\$ 512	\$ 534	\$ 554
48"W	T52048S	\$ 553	\$ 576	\$ 597
54"W	T52054S	\$ 600	\$ 625	\$ 646
60"W	T52060S	\$ 682	\$ 712	\$ 734
66"W	T52066S	\$ 739	\$ 771	\$ 795
72"W	T52072S	\$ 770	\$ 803	\$ 827
78"W	T52078S	\$ 1003	\$ 1044	\$ 1078
84"W	T52084S	\$ 1048	\$ 1090	\$ 1126
90"W	T52090S	\$ 1239	\$ 1286	\$ 1331
96"W	T52096S	\$ 1298	\$ 1347	\$ 1394

- Notes:**
- 1) Add Suffix and upcharge for primary worksurfaces to span a "T" or extended straight connection:
Suffix = TZ (Stride — adds 3/8" to width) \$39 upcharge. *Example:* T52060STZ
 - 2) Add Suffix "N" to a model number for no grommets, no upcharge. *Examples:* T52036SN T52060STZN T52024SN

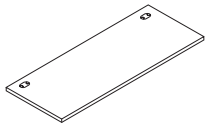

Description	Laminate w/Flat Edge Model	Laminate w/Flat Edge		
		L1 List Price	L2 List Price	L3 List Price
24"D Primary Worksurfaces				
24"W	T52424S	\$ 407	\$ 426	\$ 441
30"W	T52430S	\$ 429	\$ 449	\$ 465
36"W	T52436S	\$ 484	\$ 505	\$ 524
42"W	T52442S	\$ 540	\$ 562	\$ 583
48"W	T52448S	\$ 586	\$ 611	\$ 631
54"W	T52454S	\$ 633	\$ 662	\$ 681
60"W	T52460S	\$ 718	\$ 749	\$ 771
66"W	T52466S	\$ 781	\$ 814	\$ 839
72"W	T52472S	\$ 815	\$ 849	\$ 874
78"W	T52478S	\$ 1058	\$ 1100	\$ 1136
84"W	T52484S	\$ 1109	\$ 1153	\$ 1191
90"W	T52490S	\$ 1310	\$ 1359	\$ 1406
96"W	T52496S	\$ 1370	\$ 1422	\$ 1472

- Notes:**
- 1) Add Suffix and upcharge for primary worksurfaces to span a "T" or extended straight connection:
Suffix = TZ (Stride — adds 3/8" to width) \$39 upcharge
Examples: T52460STZ T52424STZ
 - 2) Add Suffix "N" to a model number for no grommets, no upcharge. *Examples:* T52436SN T52460STZN T52424SN

<p>How to specify — Select the Model Number from above. Add suffix if applicable: "N" for No Grommets — no upcharge "TZ" for Stride T-Span — \$39 upcharge</p>	<p><i>1st Option:</i> Laminate See page 136 for finishes.</p>	<p><i>2nd Option:</i> Edge Trim Color: See page 136 for finishes.</p>	<p><i>3rd Option:</i> Grommet Type: P Oval Plastic (will match edge trim on laminate) M Oval Metal (Add \$13 per grommet) S Square Metal (Add \$13 per grommet)</p>	<p><i>4th Option:</i> Grommet Color (Metal only): EL Matte Silver</p>
<p>Example: T52084S.TM33.EU.P</p>				<p>E L</p>

For specification information see pages 214-224.

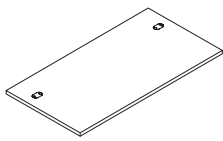
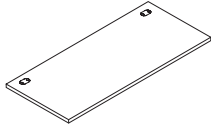

Recessed Grommets shown

Description	Laminate w/Flat Edge Model	Laminate w/Flat Edge		
		L1 List Price	L2 List Price	L3 List Price
30"D Primary Worksurfaces				
24"W	T53024S	\$ 429	\$ 449	\$ 465
30"W	T53030S	\$ 517	\$ 539	\$ 559
36"W	T53036S	\$ 556	\$ 579	\$ 600
42"W	T53042S	\$ 599	\$ 624	\$ 645
48"W	T53048S	\$ 633	\$ 662	\$ 681
54"W	T53054S	\$ 707	\$ 738	\$ 760
60"W	T53060S	\$ 787	\$ 820	\$ 845
66"W	T53066S	\$ 850	\$ 886	\$ 912
72"W	T53072S	\$ 922	\$ 960	\$ 989
78"W	T53078S	\$ 1197	\$ 1243	\$ 1287
84"W	T53084S	\$ 1251	\$ 1298	\$ 1344
90"W	T53090S	\$ 1492	\$ 1548	\$ 1603
96"W	T53096S	\$ 1540	\$ 1597	\$ 1655
36"D Primary Worksurfaces				
60"W	T53660S	\$ 754	\$ 794	\$ 828
66"W	T53666S	\$ 1060	\$ 1103	\$ 1139
72"W	T53672S	\$ 959	\$ 1004	\$ 1044

- Notes:**
- 1) Add Suffix and upcharge for 30"D primary worksurfaces to span a "T" or extended straight connection:
 Suffix = TZ (Stride — adds 3/8" to width) \$39 upcharge
 Examples: T53060STZ T53024STZ
 - 2) Add Suffix "N" to a model number for no grommets, no upcharge.
 Examples: T53036SN T53024SN T53024STZN
 - 3) Add Suffix "R" to a model number for recessed grommets on 36"D primary worksurfaces only, no upcharge. Recessed grommets are inset 6" from standard location to provide conference overhang in desking applications. Example: T53660SR

How to specify —

Select the Model Number from above. Add suffix if applicable:
 "N" for No Grommets — no upcharge
 "TZ" for Stride T-Span — \$39 upcharge

1st Option:
 Laminate:
 See page 136 for finishes.

2nd Option:
 Edge Trim Color:
 See page 136 for finishes.

3rd Option:
 Grommet Type:
 P Oval Plastic (will match edge trim on laminate)
 M Oval Metal (Add \$13 per grommet)
 S Square Metal (Add \$13 per grommet)

4th Option:
 Grommet Color (Metal only):
 EL Matte Silver

Example: T53084STZ.TM33.EU.P

For specification information see pages 214-224.

Laminate
GSA SIN 33721

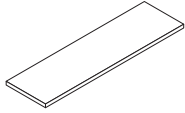

Description	Laminate w/Flat Edge Model	Laminate w/Flat Edge		
		L1 List Price	L2 List Price	L3 List Price
15"D Straight Countertops				
24"W	Z51524S	\$ 373	\$ 390	\$ 403
30"W	Z51530S	\$ 416	\$ 434	\$ 448
36"W	Z51536S	\$ 462	\$ 481	\$ 496
42"W	Z51542S	\$ 476	\$ 496	\$ 512
48"W	Z51548S	\$ 504	\$ 524	\$ 541
54"W	Z51554S	\$ 578	\$ 600	\$ 620
60"W	Z51560S	\$ 645	\$ 670	\$ 690
66"W	Z51566S	\$ 670	\$ 695	\$ 716
72"W	Z51572S	\$ 695	\$ 723	\$ 742

Note: V For a straight countertop, when used with "H" in-line high-low trim kit on one side. No upcharge.
Example: Z51554SV



15"D Corner Countertops				
24"W x 24"W	Z52424C	\$ 712	\$ 741	\$ 761
30"W x 30"W	Z53030C	\$ 829	\$ 861	\$ 886
36"W x 36"W	Z53636C	\$ 920	\$ 956	\$ 982

Note: RV For a corner countertop, when used with "H" in-line high-low trim kit on the right side. No upcharge.
LV For a corner countertop, when used with "H" in-line high-low trim kit on the left side. No upcharge.
Not available with Fluid Form. *Example: Z52424CLV*

How to specify —
Select the Model Number from above.

1st Option:
Laminate:
See page 136 for finishes.

2nd Option:
Edge Trim Color:
See page 136 for finishes.

Examples: Z51572S.TM33.EU Z52424C.TM33.EY

For specification information see pages 214-224.

Laminate
GSA SIN 33721

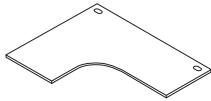
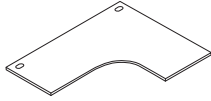

Description	Laminate w/Flat Edge Model	Laminate w/Flat Edge		
		L1 List Price	L2 List Price	L3 List Price
Corner Cove Worksurfaces — Extended Left				
60" x 36"-24"L / 24"R	T5822EL	\$ 856	\$ 894	\$ 927
60" x 36"-24"L / 30"R	T5832EL	\$ 897	\$ 937	\$ 970
60" x 48"-24"L / 24"R	T5622EL	\$ 959	\$ 1001	\$ 1036
60" x 48"-30"L / 24"R	T5623EL	\$ 1004	\$ 1047	\$ 1085
60" x 48"-24"L / 30"R	T5632EL	\$ 1004	\$ 1047	\$ 1085
60" x 48"-30"L / 30"R	T5633EL	\$ 1041	\$ 1085	\$ 1125
72" x 36"-24"L / 24"R	T5922EL	\$ 959	\$ 1001	\$ 1036
72" x 36"-24"L / 30"R	T5932EL	\$ 1004	\$ 1047	\$ 1085
72" x 48"-24"L / 24"R	T5722EL	\$ 1243	\$ 1292	\$ 1339
72" x 48"-30"L / 24"R	T5723EL	\$ 1288	\$ 1338	\$ 1390
72" x 48"-24"L / 30"R	T5732EL	\$ 1288	\$ 1338	\$ 1390
72" x 48"-30"L / 30"R	T5733EL	\$ 1326	\$ 1379	\$ 1432
Corner Cove Worksurfaces — Extended Right				
36" x 60"-24"L / 24"R	T5822ER	\$ 856	\$ 894	\$ 927
36" x 60"-30"L / 24"R	T5832ER	\$ 897	\$ 937	\$ 970
48" x 60"-24"L / 24"R	T5622ER	\$ 959	\$ 1001	\$ 1036
48" x 60"-24"L / 30"R	T5623ER	\$ 1004	\$ 1047	\$ 1085
48" x 60"-30"L / 24"R	T5632ER	\$ 1004	\$ 1047	\$ 1085
48" x 60"-30"L / 30"R	T5633ER	\$ 1041	\$ 1085	\$ 1125
36" x 72"-24"L / 24"R	T5922ER	\$ 959	\$ 1001	\$ 1036
36" x 72"-30"L / 24"R	T5932ER	\$ 1004	\$ 1047	\$ 1085
48" x 72"-24"L / 24"R	T5722ER	\$ 1243	\$ 1292	\$ 1339
48" x 72"-24"L / 30"R	T5723ER	\$ 1288	\$ 1338	\$ 1390
48" x 72"-30"L / 24"R	T5732ER	\$ 1288	\$ 1338	\$ 1390
48" x 72"-30"L / 30"R	T5733ER	\$ 1326	\$ 1379	\$ 1432

Note: Add Suffix "N" to model number for no grommets, no upcharge. *Example:* T5722ERN

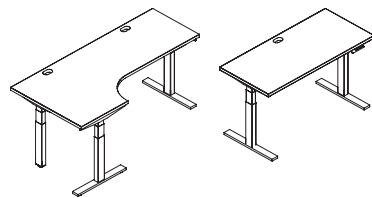

For Altitude® height-adjustable tables see the Seating, Collaboration, and Tables Price List.

How to specify —

Select the Model Number from above. Add suffix if applicable:

"N" for No Grommets — no upcharge

1st Option:

Laminate:

See page 136 for finishes.

2nd Option:

Edge Trim Color:

See page 136 for finishes.

3rd Option:

Grommet Type:

- P Oval Plastic (will match edge trim on laminate)
- M Oval Metal (Add \$13 per grommet)
- S Square Metal (Add \$13 per grommet)

4th Option:

Grommet Color (if applicable):

See page 136 for finishes.

_____ .

_____ .

_____ .

E _____

Examples: T5922EL.LT3B.E9.SEL T5822ER.LT3B.E9.P

Worksurfaces

Stride® — Peninsula / P-Shaped / Jetty

For specification information see pages 214-224.

Laminate
GSA SIN 33721

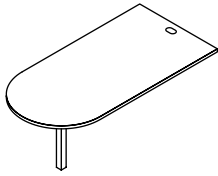

Support column ordered separately.

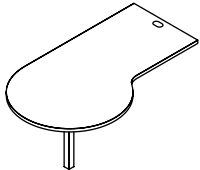

Support column ordered separately.

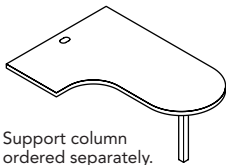

Support column ordered separately.

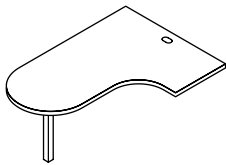

Support column ordered separately.

Description	Laminate w/Flat Edge Model	Laminate w/Flat Edge		
		L1 List Price	L2 List Price	L3 List Price
Peninsula Worksurfaces				
30"W x 60"L	T53060B	\$ 1077	\$ 1120	\$ 1158
30"W x 66"L	T53066B	\$ 1190	\$ 1236	\$ 1280
30"W x 72"L	T53072B	\$ 1298	\$ 1347	\$ 1394
36"W x 60"L	T53660B	\$ 796	\$ 845	\$ 892
36"W x 66"L	T53666B	\$ 853	\$ 907	\$ 961
36"W x 72"L	T53672B	\$ 964	\$ 1022	\$ 1084

P-Shaped Worksurfaces w/42" Diameter End				
30"W x 72"L	T53072PR (shown)	\$ 1488	\$ 1544	\$ 1600
30"W x 72"L	T53072PL	\$ 1488	\$ 1544	\$ 1600

Jetty Worksurfaces — Left Hand				
48"A x 66"B x 24"C x 30"D	T54662JL	\$ 1243	\$ 1296	\$ 1349
48"A x 72"B x 24"C x 30"D	T54722JL	\$ 1326	\$ 1379	\$ 1433
48"A x 66"B x 30"C x 30"D	T54663JL	\$ 1288	\$ 1342	\$ 1397
48"A x 72"B x 30"C x 30"D	T54723JL	\$ 897	\$ 953	\$ 1009

Jetty Worksurfaces — Right Hand				
48"A x 66"B x 24"C x 30"D	T54662JR	\$ 1243	\$ 1296	\$ 1349
48"A x 72"B x 24"C x 30"D	T54722JR	\$ 1326	\$ 1379	\$ 1433
48"A x 66"B x 30"C x 30"D	T54663JR	\$ 1288	\$ 1342	\$ 1397
48"A x 72"B x 30"C x 30"D	T54723JR	\$ 897	\$ 953	\$ 1009

Note: Add Suffix "N" to model number for no grommets, no upcharge.

Example: T53060BN

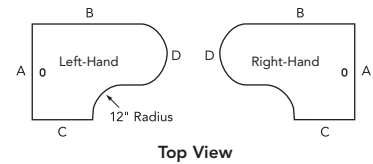

<p>How to specify — Select the Model Number from above. Add suffix if applicable: "N" for No Grommets — no upcharge</p>	<p>1st Option: Laminate: See page 136 for finishes.</p>	<p>2nd Option: Edge Trim Color: See page 136 for finishes.</p>	<p>3rd Option: Grommet Type: P Oval Plastic (will match edge trim on laminate) M Oval Metal (Add \$13 per grommet) S Square Metal (Add \$13 per grommet)</p>	<p>4th Option: Grommet Color (if applicable): See page 136 for finishes.</p>
--	---	--	--	--

Examples: T54662JL.LT3B.E9.P T53060B.LT3B.E9.MEL

ORDERING

The 9120 Program can be used to order particle board rectangular worksurfaces in any non-standard width and depth in 1/8" increments up to a maximum of 120" W x 36" D.

Specify:

- Model Number**
Specify closest nominal width/depth model (round up).
- Grommet Option** (if desired)
See grommet specification instructions on this page.
- Grommet Type:**
P Plastic
M Metal (add \$13 per grommet for laminate)
- Grommet Color:**
(Metal only)
EL Matte Silver
Note: Plastic grommet will match flat edge.
- Laminate and Veneer Choices**
See page 136.
- Flat Edge Color Choices**
See edge colors page 136 for laminates.
- Exact Size**
Specify the **exact width** and **exact depth** you require. Width and depth is specified in 1/8" increments which is denoted as a single digit following the whole number dimension at the end of the model number string.

1/8" = 1	5/8" = 5
3/8" = 2	7/8" = 6
1/2" = 3	no extra increment = 0
5/8" = 4	

For example, when ordering a worksurface that is 34 5/8" W x 20 1/2" D, specification should be 345Wx204D.
Example: 9120R3624.G0.TM33.EU.345Wx204D.

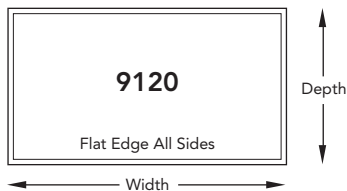

PRODUCT SPECIFICATIONS

- Flat edge on all sides
- 45 lb. particle board
- 1 1/8" top thickness
- .020 resin impregnated paper backer sheet
- Grommets available
- Maximum width 120" (maximum recommended unsupported span is 42")
- Maximum depth 36"
- Standard Allsteel laminates and veneers
- Quantities of 10 or greater are palletized; less than 10 are individually cartoned.

Note: 9120 worksurface maximum unsupported span is 42".
9120 worksurfaces do not have pre-drilled pilot holes or threaded metal inserts.

When spanning multiple freestanding storage units with one worksurface, add 1/8" for each additional storage unit. For example, when ordering a worksurface for three 30"W lateral files. 3 units x 30" = 90" + 1/8" + 1/8" = 90 1/4" worksurface. Do NOT follow this rule if panel wrapping storage units.

CHANGES / CANCELLATIONS

No changes/cancellations for 9120 Program worksurfaces.

GROMMET SPECIFICATIONS

Plastic grommets are made of durable ABS plastic and grommets match edge color on laminate worksurfaces. Metal grommets are only available Matte Silver oval for laminate and square for veneer.

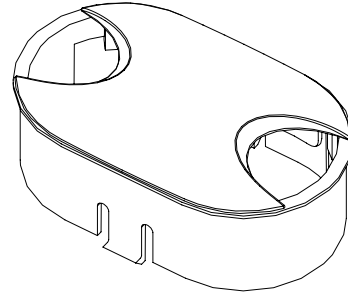

PRICING

See page 233 for laminate and veneer 9120 worksurface pricing.

One Grommet — GC, GL, or GR Position..... \$20.00
Two Grommets — G3 or G4 Position..... \$40.00
Note: Add \$13 per grommet for metal grommets with laminate.

ORDERING

Specify grommet location and color.
Example: 9120R10836.GCP.TM33.EU.1022Wx326D

Code Grommet Position

- GC Centered side-to-side – 3/8" from rear to grommet edge; 4 1/2" from rear to grommet center
- GL 6 1/16" from left side to grommet edge – 3/8" from rear to grommet edge; 4 1/2" from rear to grommet center
- GR 6 1/16" from right side to grommet edge – 3/8" from rear to grommet edge; 4 1/2" from rear to grommet center
- G3 Pair of grommets each 18" from side edge – 3/8" from rear to grommet edge; 4 1/2" from rear to grommet center (Position G3 not available on tops 60"W or less.)
- G4 Pair of grommets each 6 1/16" from side edge to grommet edge – 3/8" from rear to grommet edge; 4 1/2" from rear to grommet center
- G0 No grommets

Dimensions are from grommet center line to top edge.

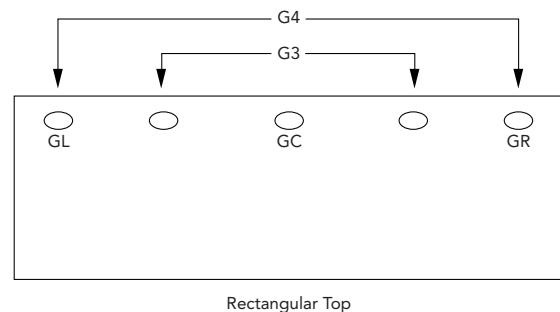

Grommet positions other than those shown above are considered non-standard.

Worksurfaces

9120 Program

For specification information see page 232.

Laminate and Veneer Worksurfaces / Non-Standard Sizes

GSA SIN 33721

*Model Number — Add "R" for laminate or "V" for veneer

Maximum	Model Number*	Width		Depth		Laminate List Price			Veneer List Price	
		MIN	MAX	MIN	MAX	L1	L2	L3	V2	V3
18"D										
18"W	9120□1818	180W	180W	121D	180D	\$ 468	\$ 489	\$ 506	\$ 1100	\$ 1200
24"W	9120□2418	181W	240W	121D	180D	\$ 489	\$ 510	\$ 529	\$ 1173	\$ 1280
30"W	9120□3018	241W	300W	121D	180D	\$ 535	\$ 557	\$ 576	\$ 1240	\$ 1353
36"W	9120□3618	301W	360W	121D	180D	\$ 556	\$ 579	\$ 600	\$ 1287	\$ 1404
42"W	9120□4218	361W	420W	121D	180D	\$ 643	\$ 668	\$ 690	\$ 1366	\$ 1490
48"W	9120□4818	421W	480W	121D	180D	\$ 709	\$ 740	\$ 762	\$ 1436	\$ 1566
60"W	9120□6018	481W	600W	121D	180D	\$ 925	\$ 962	\$ 990	\$ 1634	\$ 1782
72"W	9120□7218	601W	720W	121D	180D	\$ 1119	\$ 1161	\$ 1198	\$ 1779	\$ 1941
84"W	9120□8418	721W	840W	121D	180D	\$ 1463	\$ 1515	\$ 1569	\$ 1914	\$ 2088
96"W	9120□9618	841W	960W	121D	180D	\$ 1513	\$ 1567	\$ 1621	\$ 2070	\$ 2258
108"W	9120□10818	961W	1080W	121D	180D	\$ 1730	\$ 1790	\$ 1853	\$ 2090	\$ 2280
120"W	9120□12018	1081W	1200W	121D	180D	\$ 1877	\$ 1948	\$ 2018	\$ 2235	\$ 2438
24"D										
24"W	9120□2424	181W	240W	181D	240D	\$ 531	\$ 553	\$ 574	\$ 1151	\$ 1256
30"W	9120□3024	241W	300W	181D	240D	\$ 580	\$ 603	\$ 624	\$ 1207	\$ 1317
36"W	9120□3624	301W	360W	181D	240D	\$ 605	\$ 630	\$ 651	\$ 1273	\$ 1389
42"W	9120□4224	361W	420W	181D	240D	\$ 695	\$ 725	\$ 744	\$ 1342	\$ 1464
48"W	9120□4824	421W	480W	181D	240D	\$ 750	\$ 782	\$ 806	\$ 1476	\$ 1610
60"W	9120□6024	481W	600W	181D	240D	\$ 971	\$ 1009	\$ 1042	\$ 1687	\$ 1840
72"W	9120□7224	601W	720W	181D	240D	\$ 1162	\$ 1206	\$ 1244	\$ 1901	\$ 2074
84"W	9120□8424	721W	840W	181D	240D	\$ 1513	\$ 1567	\$ 1621	\$ 2070	\$ 2258
96"W	9120□9624	841W	960W	181D	240D	\$ 1488	\$ 1544	\$ 1600	\$ 2238	\$ 2441
108"W	9120□10824	961W	1080W	181D	240D	\$ 1780	\$ 1842	\$ 1907	\$ 2408	\$ 2627
120"W	9120□12024	1081W	1200W	181D	240D	\$ 1920	\$ 1992	\$ 2065	\$ 2469	\$ 2693
30"D										
30"W	9120□3030	241W	300W	241D	300D	\$ 638	\$ 667	\$ 686	\$ 1207	\$ 1317
36"W	9120□3630	301W	360W	241D	300D	\$ 671	\$ 701	\$ 721	\$ 1383	\$ 1509
42"W	9120□4230	361W	420W	241D	300D	\$ 715	\$ 746	\$ 768	\$ 1491	\$ 1626
48"W	9120□4830	421W	480W	241D	300D	\$ 774	\$ 807	\$ 832	\$ 1626	\$ 1774
60"W	9120□6030	481W	600W	241D	300D	\$ 1016	\$ 1056	\$ 1089	\$ 1892	\$ 2064
72"W	9120□7230	601W	720W	241D	300D	\$ 1161	\$ 1206	\$ 1247	\$ 2145	\$ 2340
84"W	9120□8430	721W	840W	241D	300D	\$ 1763	\$ 1828	\$ 1894	\$ 2284	\$ 2492
96"W	9120□9630	841W	960W	241D	300D	\$ 1805	\$ 1871	\$ 1939	\$ 2431	\$ 2652
108"W	9120□10830	961W	1080W	241D	300D	\$ 2033	\$ 2108	\$ 2186	\$ 2585	\$ 2820
120"W	9120□12030	1081W	1200W	241D	300D	\$ 2265	\$ 2350	\$ 2434	\$ 2859	\$ 3119
36"D										
36"W	9120□3636	301W	360W	301D	360D	\$ 911	\$ 948	\$ 978	\$ 1998	\$ 2180
42"W	9120□4236	361W	420W	301D	360D	\$ 1035	\$ 1077	\$ 1112	\$ 2133	\$ 2327
48"W	9120□4836	421W	480W	301D	360D	\$ 1163	\$ 1208	\$ 1249	\$ 2280	\$ 2487
60"W	9120□6036	481W	600W	301D	360D	\$ 1498	\$ 1551	\$ 1605	\$ 2286	\$ 2494
72"W	9120□7236	601W	720W	301D	360D	\$ 1764	\$ 1826	\$ 1889	\$ 2425	\$ 2645
84"W	9120□8436	721W	840W	301D	360D	\$ 2135	\$ 2210	\$ 2288	\$ 2471	\$ 2696
96"W	9120□9636	841W	960W	301D	360D	\$ 2188	\$ 2266	\$ 2343	\$ 2691	\$ 2936
108"W	9120□10836	961W	1080W	301D	360D	\$ 2426	\$ 2512	\$ 2601	\$ 2922	\$ 3188
120"W	9120□12036	1081W	1200W	301D	360D	\$ 2538	\$ 2632	\$ 2729	\$ 3159	\$ 3446

For specification information see pages 214-224.

GSA SIN 33721

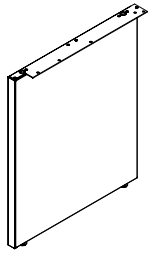

Description	Model	P1 Paint List Price	P2 Paint List Price	P3 Paint List Price
End Support Panels — Metal				
29½"H x 10"D Freestanding	Y62910FENP	\$ 364	\$ 393	\$ 419
29½"H x 24"D Freestanding	Y62924FENP	\$ 395	\$ 424	\$ 450
29½"H x 30"D Freestanding	Y62930FENP	\$ 418	\$ 447	\$ 473
<hr/>				
29½"H x 10"D Panel-Mount	Y62910PENP	\$ 407	\$ 436	\$ 462
29½"H x 20"D Panel-Mount	Y62920PENP	\$ 428	\$ 457	\$ 483
29½"H x 24"D Panel-Mount	Y62924PENP	\$ 433	\$ 462	\$ 488
29½"H x 30"D Panel-Mount	Y62930PENP	\$ 452	\$ 481	\$ 507
<hr/>				
26½"H x 20"D Panel-Mount	Y62620PENP	\$ 395	\$ 424	\$ 450
26½"H x 24"D Panel-Mount	Y62624PENP	\$ 409	\$ 438	\$ 464

Note: Not for use with rabbet edge worksurfaces.

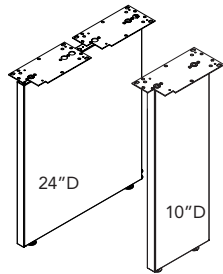

In-Line Support Panels — Metal				
29½"H to support 24"D Freestanding	Y62910SLFP	\$ 352	\$ 381	\$ 407
29½"H to support 30"D Freestanding	Y62924SLFP	\$ 375	\$ 404	\$ 430
<hr/>				
29½"H to support 24"D Panel-Mount	Y62910SLPP	\$ 395	\$ 424	\$ 450
29½"H to support 30"D Panel-Mount	Y62924SLPP	\$ 419	\$ 448	\$ 474
<hr/>				
26½"H x 10"D Panel-Mount	Y62610SLPP	\$ 373	\$ 402	\$ 428

Note: Not for use with rabbet edge worksurfaces.

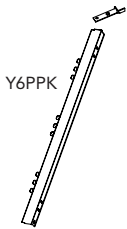

Pedestal-to-Systems Panel Attachment Bracket — Non-handed				
Bracket Kit	Y6PPK	\$ 177	\$ 199	\$ 218

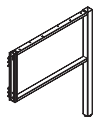

Open End Panel Supports				
12"D x 29½"H Panel-Mount	AYBHEP1229	\$ 282	\$ 324	\$ 365
18"D x 29½"H Panel-Mount	AYBHEP1829	\$ 287	\$ 329	\$ 370
24"D x 29½"H Panel-Mount	AYBHEP2429	\$ 297	\$ 339	\$ 380
30"D x 29½"H Panel-Mount	AYBHEP3029	\$ 320	\$ 362	\$ 403

Note: Not for use with rabbet edge worksurfaces.

How to specify —
Select the Model Number from above.

1st Option:
Paint (if applicable):
 See page 136 for finishes.

P

Examples: Y62924SLPP.P27 Y6PEN.P27

Shippable by small-package carrier.

For specification information see pages 214-224.

GSA SIN 33721



Description	Model		P1 Paint List Price	P2 Paint List Price	P3 Paint List Price
29½"H Post Legs — Fixed Height					
for Flat/Square Edge Worksurfaces — Left	Z6PL29FL	[S]	\$ 360	\$ 389	\$ 415
for Flat/Square Edge Worksurfaces — Right	Z6PL29FR (shown)	[S]	\$ 360	\$ 389	\$ 415
for Flat/Square Edge Worksurfaces — Pair	Z6PL29FP	[S]	\$ 718	\$ 768	\$ 817

26½"H-32½"H Post Legs — Height Adjustable					
for Flat/Square Edge Worksurfaces — Pair	Z6PL29HP	[S]	\$ 951	\$ 1001	\$ 1050

40½"H Post Legs — Fixed Height					
for Flat/Square Edge Worksurfaces — Left	Z6PL40FL	[S]	\$ 422	\$ 451	\$ 477
for Flat/Square Edge Worksurfaces — Right	Z6PL40FR (shown)	[S]	\$ 422	\$ 451	\$ 477
for Flat/Square Edge Worksurfaces — Pair	Z6PL40FP	[S]	\$ 843	\$ 893	\$ 942

37½"H-43½"H Post Legs — Height Adjustable					
for Flat/Square Edge Worksurfaces — Left	Z6PL40HL	[S]	\$ 540	\$ 569	\$ 595
for Flat/Square Edge Worksurfaces — Right	Z6PL40HR (shown)	[S]	\$ 540	\$ 569	\$ 595
for Flat/Square Edge Worksurfaces — Pair	Z6PL40HP	[S]	\$ 1078	\$ 1128	\$ 1177

29½"H Freestanding Post Legs — Fixed Height					
Pair with Locking Casters for Flat/Square Edge Worksurfaces	Z6PTLFPC (shown)	[S]	\$ 807	\$ 857	\$ 906
Pair with Glides for Flat/Square Edge Worksurfaces	Z6PTLFPG	[S]	\$ 807	\$ 857	\$ 906

26½"H-32½"H Freestanding Post Legs — Height Adjustable					
Pair with Locking Casters for Flat/Square Edge Worksurfaces	Z6PTLHPC (shown)	[S]	\$ 1042	\$ 1092	\$ 1141
Pair with Glides for Flat/Square Edge Worksurfaces	Z6PTLHPG	[S]	\$ 1042	\$ 1092	\$ 1141

How to specify —
Select the Model Number from above.

1st Option:

Color:



See page 136 for finishes.

Z _____ . P _____

Example: Z6PL29FL.P02

[S] Shippable by small-package carrier.

For specification information see pages 214-224.

GSA SIN 33721

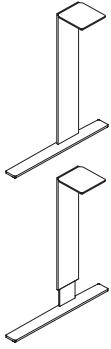

Description	Model	P1 Paint List Price	P2 Paint List Price	P3 Paint List Price
C-Legs — Fixed Height — 29½"H				
for Flat/Square Edge Worksurfaces — Left	Z6CLFL S	\$ 602	\$ 631	\$ 657
for Flat/Square Edge Worksurfaces — Right	Z6CLFR S	\$ 602	\$ 631	\$ 657

C-Legs — Height Adjustable — 26½"H-32½"H				
for Flat/Square Edge Worksurfaces — Left	Z6CLHL S	\$ 794	\$ 823	\$ 849
for Flat/Square Edge Worksurfaces — Right	Z6CLHR S	\$ 794	\$ 823	\$ 849

Note: Height adjustable C-legs are not for use on worksurface spans greater than 72"W.

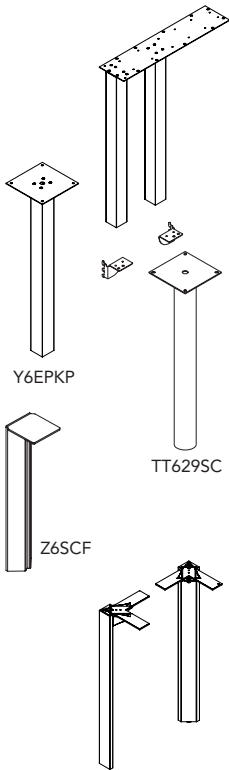

Post In-Line Support Leg				
29½"H x 24"D Freestanding — Painted	Y629NLK	\$ 648	\$ 695	\$ 743

Support Columns — Metal				
29½"H / 2¼" Square Painted	Y6EPPK	\$ 286	\$ 315	\$ 341
29½"H / 3" Diameter Round	TT629SC S	\$ 257	\$ 299	\$ 340
29½"H — Linear Fixed	Z6SCF S	\$ 383	\$ 412	\$ 438
26½"H-30½"H — Linear Height Adjustable	Z6SCH S	\$ 569	\$ 598	\$ 624

Light-scale Legs — Metal				
Pair (Left and Right) 29½"H				
for Modesty Panel attachment — Painted	Y629LKMP	\$ 724	\$ 753	\$ 779
Individual Leg — Non-handed				
NOT for Modesty Panel attachment — Painted	Y629LKNP	\$ 397	\$ 426	\$ 452

<p>How to specify — Select the Model Number from above.</p>	<p><i>1st Option:</i> Color: P1 P2 P3 See page 136 for finishes.</p>	<p><i>1st Option:</i> Landscape Surface Material and Finish (if applicable):</p>
<div style="border-bottom: 1px solid black; width: 100%; height: 20px;"></div>	<div style="border-bottom: 1px solid black; width: 100%; height: 20px;"></div>	<div style="border-bottom: 1px solid black; width: 100%; height: 20px;"></div>

Examples: Z6CLFL.P27 Y629NLK.P7D

S Shippable by small-package carrier.

For specification information see pages 214-224.

GSA SIN 33721

Description	Model	P1 Paint List Price	P2 Paint List Price	P3 Paint List Price
Cantilever Brackets				
12"D Left-Hand	T6CB12L S	\$ 72	\$ 89	\$ 101
12"D Right-Hand	T6CB12R S	\$ 72	\$ 89	\$ 101
18"D Left-Hand	T6CB18L S	\$ 77	\$ 94	\$ 106
18"D Right-Hand	T6CB18R S	\$ 77	\$ 94	\$ 106
24" or 30"D Left-Hand	T6CB24L S	\$ 84	\$ 101	\$ 113
24" or 30"D Right-Hand	T6CB24R S	\$ 84	\$ 101	\$ 113
Cantilever Bracket — non-handed (Core paint colors only)				
24" or 30"D	T624CB S	\$ 228	N/A	N/A
Worksurface Bracket Kits				
Flat, Square, and Eased Edge Worksurface Bracket Kit	T6BK S	\$ 73	\$ 89	\$ 100
Flat, Square, and Eased Edge Worksurface Storage Bracket Kit (Black only)	T6SB S	\$ 98	N/A	N/A
Off-Module Worksurface Brackets				
Non-Rail Based End Panel Kit	Z6EPK S	\$ 61	\$ 74	\$ 83
Non-Rail Based Worksurface Bracket (1)	Z6MK S	\$ 73	\$ 86	\$ 95
Non-Rail Based 3" Layered Worksurface Bracket (1)	Z6Z3MK S	\$ 82	\$ 95	\$ 104
Layered Worksurface Connection Bracket (1)	Z6C3BK S	\$ 118	\$ 137	\$ 151
Worksurface Stanchion — Painted Metal				
12"D x 4"H for Stride 22"H Credenza	APOLG0512 S	\$ 416	\$ 445	\$ 468
18"D x 4"H for Stride 22"H Credenza	APOLG0518 S	\$ 453	\$ 482	\$ 505
Flat Brackets (no color option)				
For 12"D	T612FB S	\$ 70	N/A	N/A
For 24"D	T624FB S	\$ 80	N/A	N/A
For 30"D	T630FB S	\$ 91	N/A	N/A
External Worksurface Support Channel (no color option) — 1½"H				
30"W External Support Channel for use on 42"W Worksurface	Z5SC42 S	\$ 86	N/A	N/A
36"W External Support Channel for use on 48"W Worksurface	Z5SC48 S	\$ 89	N/A	N/A
42"W External Support Channel for use on 54"W Worksurface	Z5SC54 S	\$ 102	N/A	N/A
48"W External Support Channel for use on 60"W Worksurface	Z5SC60	\$ 110	N/A	N/A
54"W External Support Channel for use on 66"W Worksurface	Z5SC66	\$ 128	N/A	N/A
60"W External Support Channel for use on 72"W Worksurface	Z5SC72	\$ 137	N/A	N/A
66"W External Support Channel for use on 78"W Worksurface	Z5SC78	\$ 150	N/A	N/A
72"W External Support Channel for use on 84"W Worksurface	Z5SC84	\$ 165	N/A	N/A
Worksurface Wire Manager (no color option)				
36"W Wire Manager for use on 48"W Worksurface	Z5WM48 <i>(De-emphasized)</i> S	\$ 55	N/A	N/A
42"W Wire Manager for use on 54"W Worksurface	Z5WM54 <i>(De-emphasized)</i> S	\$ 64	N/A	N/A
48"W Wire Manager for use on 60"W Worksurface	Z5WM60 <i>(De-emphasized)</i>	\$ 70	N/A	N/A
54"W Wire Manager for use on 66"W Worksurface	Z5WM66 <i>(De-emphasized)</i>	\$ 80	N/A	N/A
60"W Wire Manager for use on 72"W Worksurface	Z5WM72 <i>(De-emphasized)</i>	\$ 86	N/A	N/A
66"W Wire Manager for use on 78"W Worksurface	Z5WM78 <i>(De-emphasized)</i>	\$ 92	N/A	N/A
72"W Wire Manager for use on 84"W Worksurface	Z5WM84 <i>(De-emphasized)</i>	\$ 101	N/A	N/A

How to specify —
Select the Model Number from above.

1st Option:
Paint
(if applicable):
P1
P2
P3
 See page 136 for finishes.

P | | | |

Examples: T6BK.P01 T624FB

S Shippable by small-package carrier.

Low Credenzas

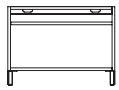

Open

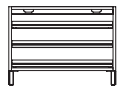

Open with Project Shelves

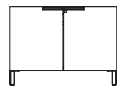

Hinged Doors

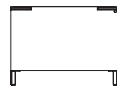

Lateral File with Project Drawer

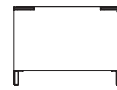

Lateral File

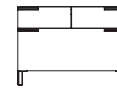

Box/Box/Lateral



Corner Bin

High Credenzas

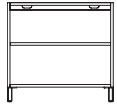

Open

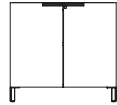

Hinged Doors



Lateral File



Lateral File with Doors

Pedestals



Box/File Mobile



File/File Support



Box/Box/File Support

Towers

42½"H

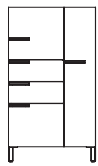

Box/Box/File



File/File

50"H

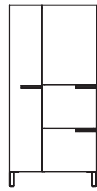

File/File Side Access Side Light

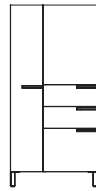

Box/Box/File Side Access Side Light

65"H

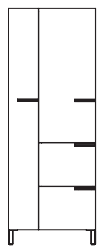

File/File Side Access

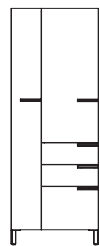

Box/Box/File Side Access

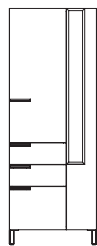

Box/Box/File Side Access Sidelight

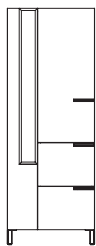

File/File Side Access Sidelight

Combination Files

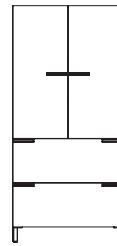

Lateral Drawers

Overhead Cabinets



Sliding Door



Hinged Doors



Shelf with Nitch



Hinged Door/ Nitch



Open/ Nitch

Horizontal Storage



Full Depth



Shared

Painted Wood		GSA Reference Page				
	Low Credenzas		High Credenzas		Towers	
Widths	Open	24", 30", 36", 42", 48", 60"	Open	24", 30", 36", 42", 48", 60"	Box/Box/File	15½" (42½" and 50"H); 24" (all heights)
	Open with Project Shelf	24", 30", 36"			File/File	15½" (42½" and 50"H); 24"
	Hinged Door	24", 30", 36", 42", 48", 60"	Hinged Door	24", 30", 36", 42", 48", 60"		
	Lateral with Project Drawer	30", 36", 42", 48", 60"	Lateral File	30", 36", 42", 48", 60"		
	Box/Box/Lateral	30"				
	Corner with Bin	24", 30"				
Heights	22" (23½" with top)		28" (29½" with top)		42½"H, 50"H, 65"H	
Depth	18"		24"		Box/Box/File	18", 24"
					File/File	
Pull	Linear		Linear		Linear	
Lock Options:						
Lock	Standard		Standard		Standard	
Omit Lock Core	Optional		Optional		Optional	
Master Keyed Lock	Standard		Standard		Standard	
Removable Lock Core	Yes — with Special Key		Yes — with Special Key		Yes — with Special Key	
Dual-Side Locking	Yes		Yes		Yes	
Suspension	Ball Bearing		Ball Bearing		Ball Bearing — Full Extension	
Drawer Front Construction	¾" thick Painted Wood*		¾" thick Painted Wood*		¾" thick Painted Wood*	
Hinged Door Construction	¾" thick Painted Wood*		¾" thick Painted Wood*		¾" thick Painted Wood*	
Hex-head Glide	Yes		Yes		Yes	
Counterweights	Required on freestanding lateral units and corner credenza.		Optional		Optional	
Drawer Interiors:						
Drawers	9⅞"		9⅞"			
Project Drawer	2⅞"					
Pull Out Shelf	4½"					
Front-to-Back Filing	Standard		Standard		Standard	
Filing Options	Letter		Letter		Letter	

WOOD STORAGE LOCKING

Pedestals	15"W					
File/File	1 lock					
Box/Box/File	1 lock					
Low Credenzas	24"W	30"W	36"W	42"W	48"W	60"W
Hinged Doors	1 lock	1 lock	1 lock	2 locks	2 locks	2 locks
Lateral File with Project Drawers	—	1 lock	1 lock	2 locks	2 locks	3 locks
Box/File	—	2 locks				
Corner — Bin	1 lock		1 lock			
High Credenzas	24"W	30"W	36"W	42"W	48"W	60"W
Hinged Doors	1 lock	1 lock	1 lock	2 locks	2 locks	2 locks
Lateral/Combination File	—	1 lock	1 lock	1 lock	2 locks	3 locks
Personal Towers	15"W	24"W	24"W with Sidelight			
Box/Box/File	1 lock	2 locks	1 lock			
File/File	1 lock	2 locks	1 lock			
Personal Towers	30"W					
2H Lateral File	1 lock					

* Painted wood is powder-coated medium density fiberboard

Load Capacity for Painted Wood Pedestals, Personal Towers, and Credenzas

Pedestals	18"D [Mobile]	24"D [Support]
Box	17 lbs.	23 lbs.
File	33 lbs.	49 lbs.

Personal Towers	18"D	24"D
Box	17 lbs.	23 lbs.
File	33 lbs.	49 lbs.
Unit w/project drawer	32 lbs.	NA
Lateral	61 lbs.	73 lbs.
Unit w/project drawer	55 lbs.	NA

Credenzas	24"W	30"W	36"W	42"W	48"W	60"W
Low Credenzas						
Project shelves	21 lbs.	27 lbs.	34 lbs.	NA	NA	NA
Lateral w/project drawer	NA	62lbs.	76 lbs.	91 lbs.	76 lbs.	76 lbs.
Lateral project drawer	NA	29 lbs.	35 lbs.	42 lbs.	35 lbs.	35 lbs.
Bin	52 lbs.	52 lbs.	NA	NA	NA	NA
Box	NA	10 lbs.	NA	NA	NA	NA
High Credenzas						
Lateral	NA	68 lbs.	84 lbs.	99 lbs.	84 lbs.	84 lbs.

Interior Dimensions for Painted Wood Pedestals, Personal Towers, Combination Files, and Credenzas

	Height	Depth	Width
PEDESTALS	Box — 27" File — 9¾"	Mobile — 14½" Support — 19"	12½"
PERSONAL TOWERS	Box — 27" File — 9¾" Project Drawer — 3¾"	20" — 17" 24" — 19" Project Drawer — 16½"	12½"
COMBINATION FILES	Lateral — 9¾" Project Drawer — 3¾"	Lateral — 15" Lateral (w/project drawer) — 13¾" Project Drawer — 13¾"	Lateral — 25¾" Project Drawer — 26¾"
CREDENZAS			
<i>Open Shelves</i>			
Low Credenza	Bottom: 12½" Top: 3¾"	16½"	24" exterior = 22½" interior 30" exterior = 28½" interior 36" exterior = 34½" interior
High Credenza	Bottom: 12½" Top: 9½"	20½"	42" exterior = (2) 19¾" interior 48" exterior = (2) 22¾" interior 60" exterior = (2) 28¾" interior
<i>Project Shelves</i>			
Low Credenza	4½"	13¾"	24" exterior = 19¾" interior
<i>Hinged Doors</i>			
Low Credenza	Bottom: 12½" Top: 3¾"	15¾"	24" exterior = 22½" interior 30" exterior = 28½" interior 36" exterior = 34½" interior
High Credenza	Bottom: 12½" Top: 9½"	19¾"	42" exterior = (2) 19¾" interior 48" exterior = (2) 22¾" interior 60" exterior = (2) 28¾" interior
<i>Lateral</i>			
Low Credenza	Lateral — 9¾" Project Drawer — 2¾"	30"W & 42"W Lateral — 13¾" 36"W & 60"W Lateral — 12½" Project Drawer — 13¾"	30" exterior = 26¾" interior 36" exterior = 32¾" interior 42" exterior = 26¾" interior
High Credenza	9½"	15"	48" exterior = 32¾" interior 60" exterior = 32¾" interior
<i>Corner</i>			
Low Credenza	Bin — 12½"	Bin — 14½"	Bin — 15¾"
<i>Box/Box/Lateral</i>			
Low Credenza	Lateral — 9¾" Box — 2¾"	Lateral — 13¾" Box — 11½"	Lateral — 25¾" Box — 10¾"

Top View of Drawers

15"W Pedestal
and Tower Drawers

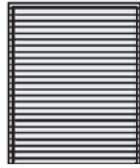

Letter Front-to-Back
18"D Mobile – 14½" of filing
24"D Support – 19" of filing

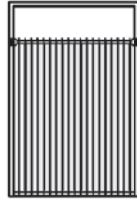

Legal Side-to-Side
24"D Support – 12" of filing

24"W Credenza
Lateral Drawers

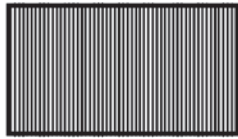

Letter Side-to-Side
18"D – 20½" of filing



Letter Front-to-Back
18"D – 15" of filing
24"D – 17½" of filing

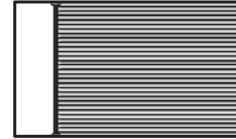

Legal Front-to-Back
18"D – 15" of filing
24"D – 17½" of filing

30"W Credenza
Lateral Drawers



Letter Front-to-Back
18"D – 30" of filing
24"D – 35" of filing



Legal Front-to-Back
18"D – 15" of filing
24"D – 17½" of filing

36"W Credenza
Lateral Drawers



Letter Front-to-Back
18"D and 24"D – 30" of filing



Legal Front-to-Back
18"D and 24"D – 15" of filing

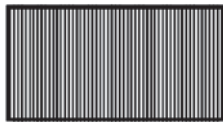

Letter Side-to-Side
18"D and 24"D – 32½" of filing

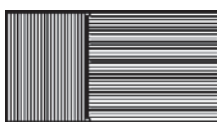

Letter Side-to-Side and Legal Front-to-Back
18"D and 24"D – 17" of Letter S-T-S filing and
15" of Legal F-T-B filing

GSA Reference Page

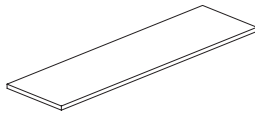

Credenza Top

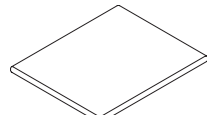

Seat Cushion

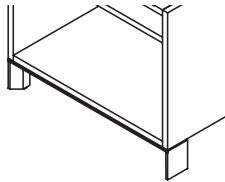

Credenza Bottom Trim

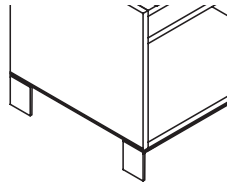

Credenza Side Trim

Credenzas ship fully assembled except for the credenza top, which must be ordered separately. Credenza tops in laminate or veneer with flat/square details are available in various depths. Veneer fronts by Gunlocke®.

Laminate credenza tops, a footed base, and aluminum trim along the front edge of the credenza enhance the durability of the credenza.

A relocatable seat cushion can be placed on the credenza top of a low credenza for additional seating.

Credenza bottom trim is standard on the front of all credenzas.

Optional side trim is an aesthetic piece for end of run credenzas and is ordered separately and field installed.

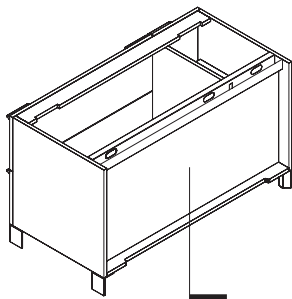

Relocatable wire trough provides a channel for wire management.

Each credenza ships with one front bracket that can be used to gang (multiple) credenzas in-line.

All credenzas have a recessed back with a cavity to support wire management. An optional metal back should be specified separately to finish the credenza in a single-sided application where the back is exposed. Finished back configurations should not utilize rail as the top cap required shows an unfinished top groove.

Credenza top must be ordered separately and can span multiple credenzas.

Corner credenzas with bin when housing a CPU must be used with credenza tops for wire trough or rail (not full depth) to minimize heat buildup.

Credenzas can support panels in certain applications with the addition of a credenza-to-panel bracket, see guidelines on pages 145-146 and bracket on page 265.

Credenzas can be shipped with lock cores removed; cores can be installed after files are in place. Core removable lock feature allows key numbers to be easily changed in the field.

All credenzas feature silver linear pulls. Pulls, feet, and bottom trim are all PR6 Silver finish.

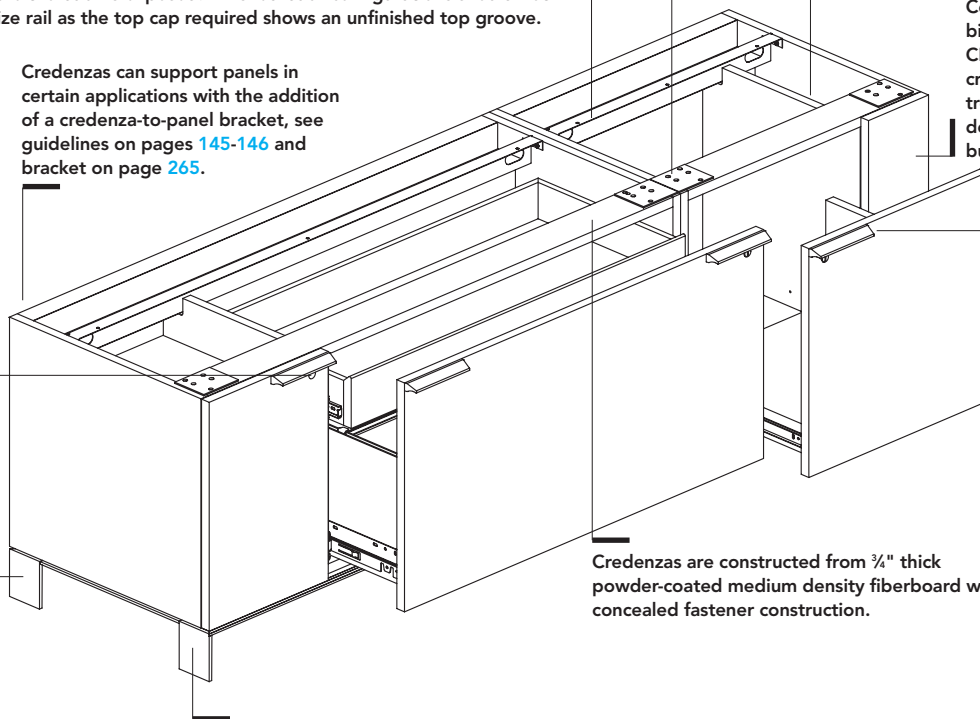

Credenza feet have sleeves to conceal the leveling glides. Leveling range is 1 1/8". The hex-head design of the stem allows leveling to be done even when the credenza is fully loaded.

Credenzas are constructed from 3/4" thick powder-coated medium density fiberboard with concealed fastener construction.

Credenzas ship with the feet located at the outside corners. Alternate mounting holes are provided for front feet to be inset 4" on mid-run credenzas, during installation.

High Credenza Side to Panel Bracket

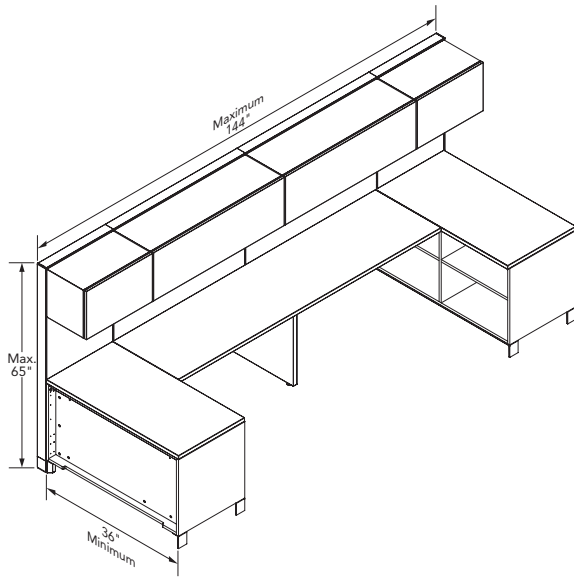

Side-mounted high credenzas

- The minimum Stride high credenza width is 36" W on each end.
- With a floor support the maximum panel run is 144".
- Without a floor support, the maximum panel run is 96".
- Overheads, shelves, and worksurfaces must be mounted on the same side of the parent run as the credenzas. Stacking frames cannot be used with overheads.
- Panel frame maximum height is 65" H.

Credenza Side to Panel Bracket with Return Panel

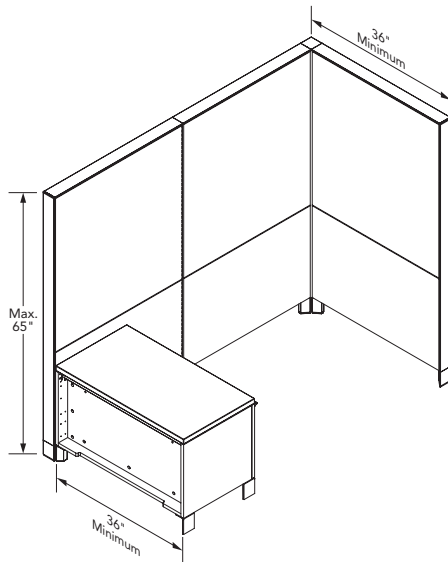

Bracket with return panel

- Minimum Stride credenza width 36".
- With a floor support the maximum panel run is 144".
- Without a floor support, the maximum panel run is 96".
- The minimum size for panel return is 36" W x 35" H.
- Overheads, shelves, and worksurfaces must be mounted on the same side of the parent run as the high credenza.
- Panel frame maximum height is 65" H.

Recommended Seat Cushion Sizes for Mobile Pedestals and Low Credenzas

18"D Cushions for use with Pedestals and Full Depth Credenza Tops

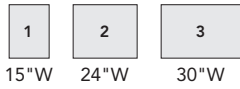

15"W Mobile Pedestal
15"W Cushion



24"W Credenza
24"W Cushion



30"W Credenza
30"/15"W Cushion



36"W Credenza
15"/24"W Cushion

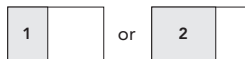

42"W Credenza
24"W Cushion



48"W Credenza
24"W Cushion



60"W Credenza
30"W Cushion



Seat Cushions

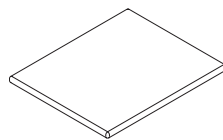

Seat Cushions (page 262)

- Place on top of low credenza tops or mobile pedestal for quick and convenient additional seating.
- For use on low credenzas only.
- Seat cushion must rest on top of credenza top — order separately.
- COM yardage for seat cushion is 1 yard.

The credenza rail is a single-sided 1½" thick frame that can be fitted atop credenza units.

Credenza Rail (page 263)

- Provides support for perpendicular run-off worksurfaces.
- When used on low credenzas, credenza rail supports a height adjustment range of 27½" to 30½" in 1" increments.
- Channel for power and data.
- Connection point for accessories.
- Will show groove on top of rail if adding a back panel.

Guidelines:

1. The credenza rail may have only one worksurface mounted to each individual rail.
2. The credenza rail can span multiple credenzas, but must stay on-module with credenzas.
3. Credenza rail must be fully supported by a run of credenzas.
4. A worksurface can be mounted off-modular along the rail at four heights — 27½"-30½" H in 1" increments.
5. All components must be specified separately.

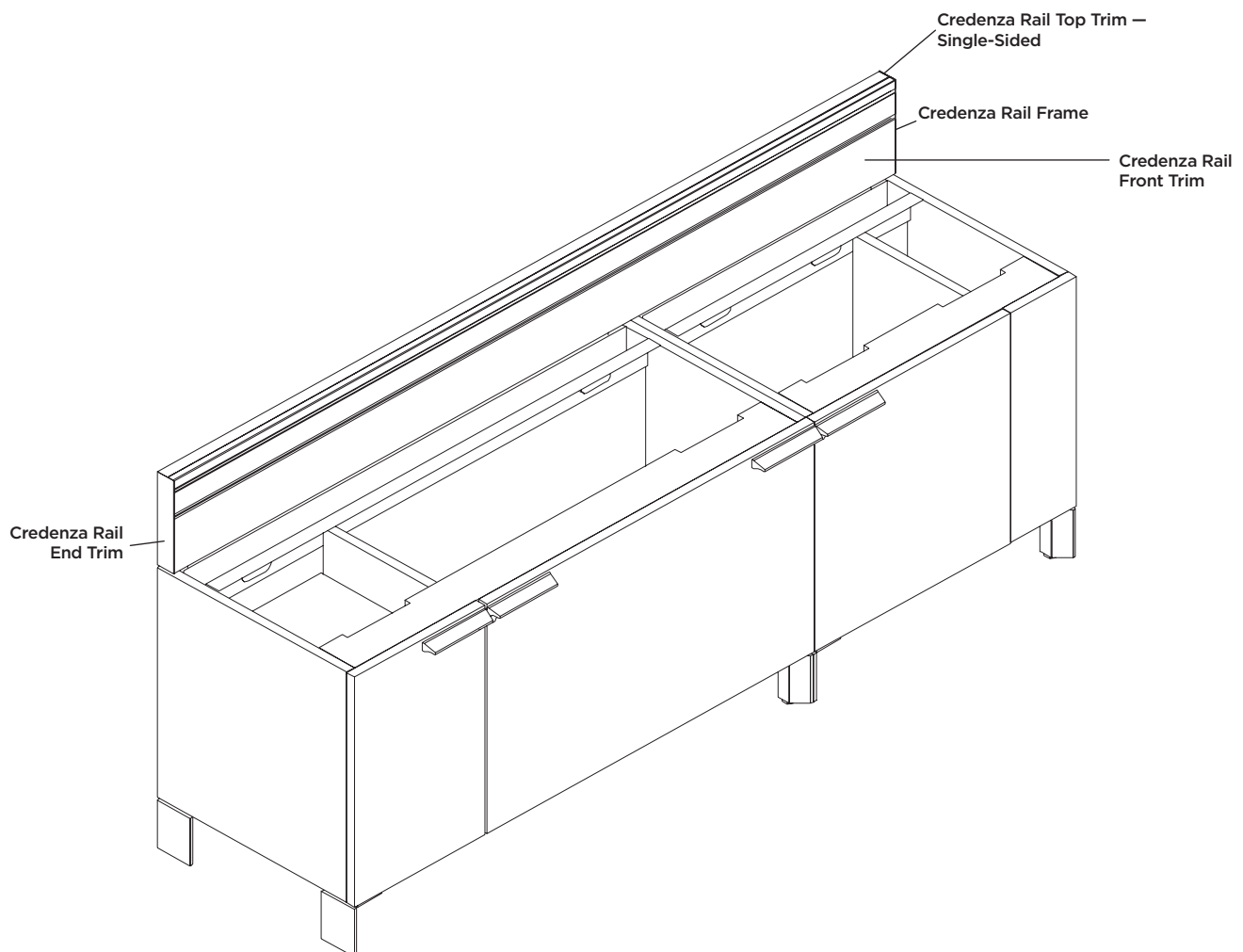

All credenza rail components must be ordered separately.

- Credenza rail frame
- Credenza rail front trim
- Credenza rail end trim
- Credenza rail bracket kit
- Credenza rail top trim

DOUBLE-SIDED CREDENZA RUN

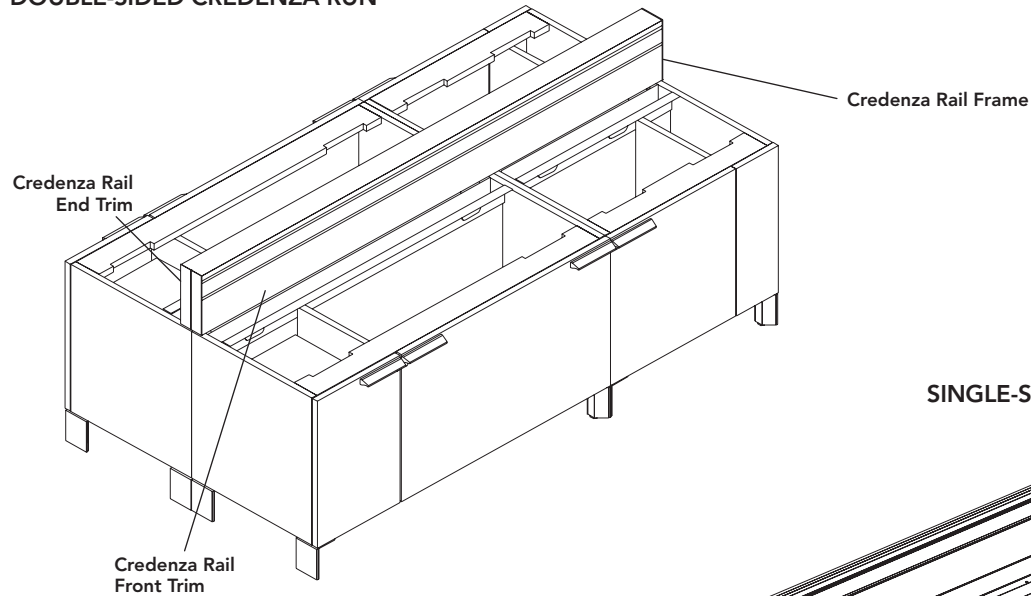

SINGLE-SIDED CREDENZA RUN

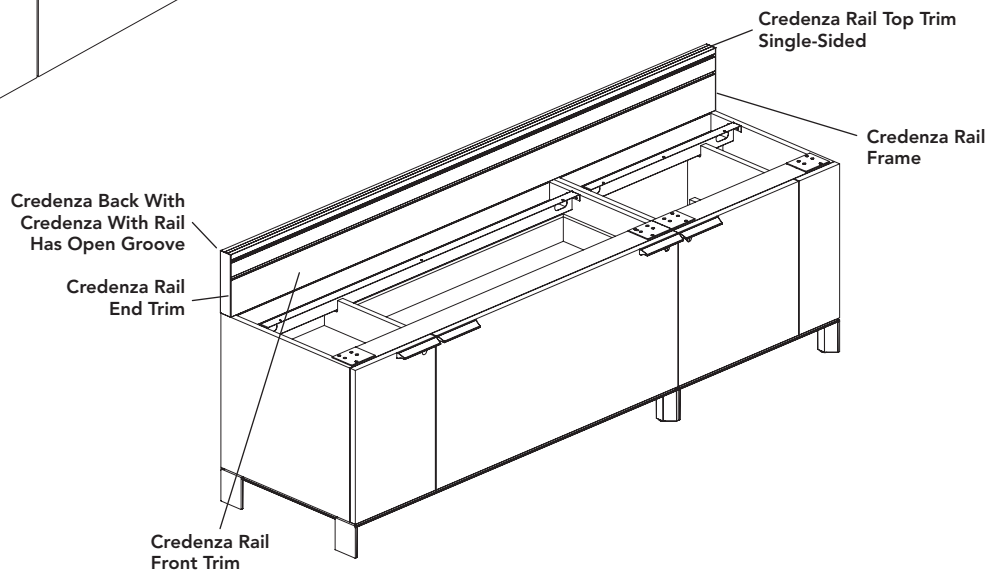

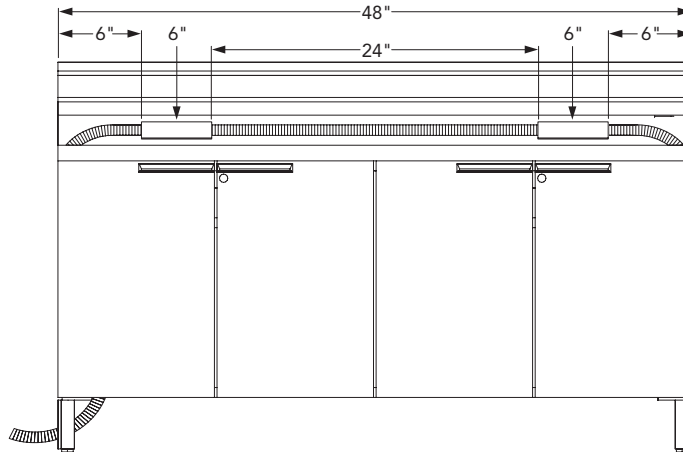

Routing Electrical: Credenzas

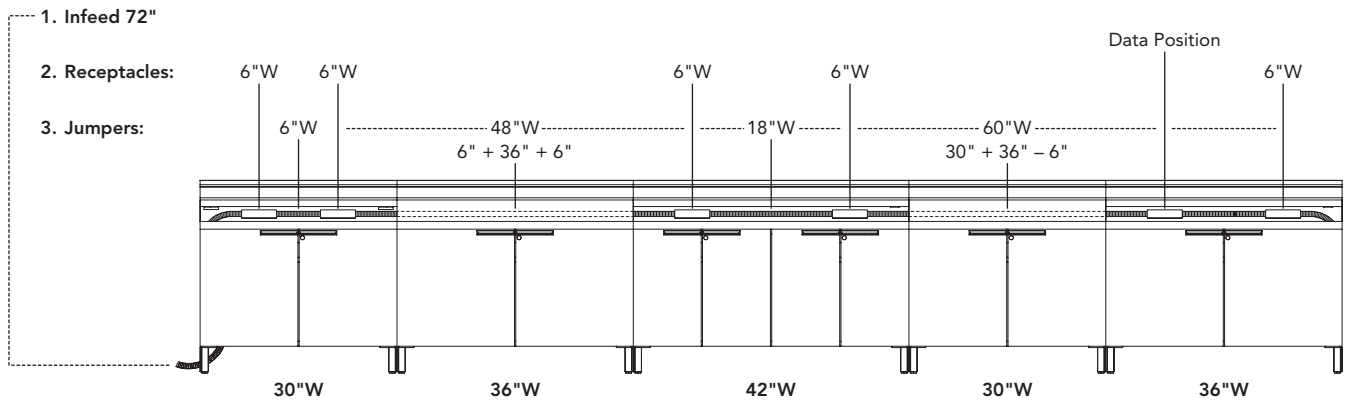

Jumper Situation:	Within a credenza	Spanning a credenza	Spanning a credenza with an open position for data.
Formula:	Subtract 24" from width of credenza. $30"W - 24" = 6" \text{ Jumper}$	Add 12" to width of spanned credenza. $36"W + 12" = 48" \text{ Jumper}$	Subtract 6" from total width of middle and end credenzas. $(30"W + 36"W) - 6" = 60" \text{ Jumper}$

Routing Electrical: Credenzas with a Tower

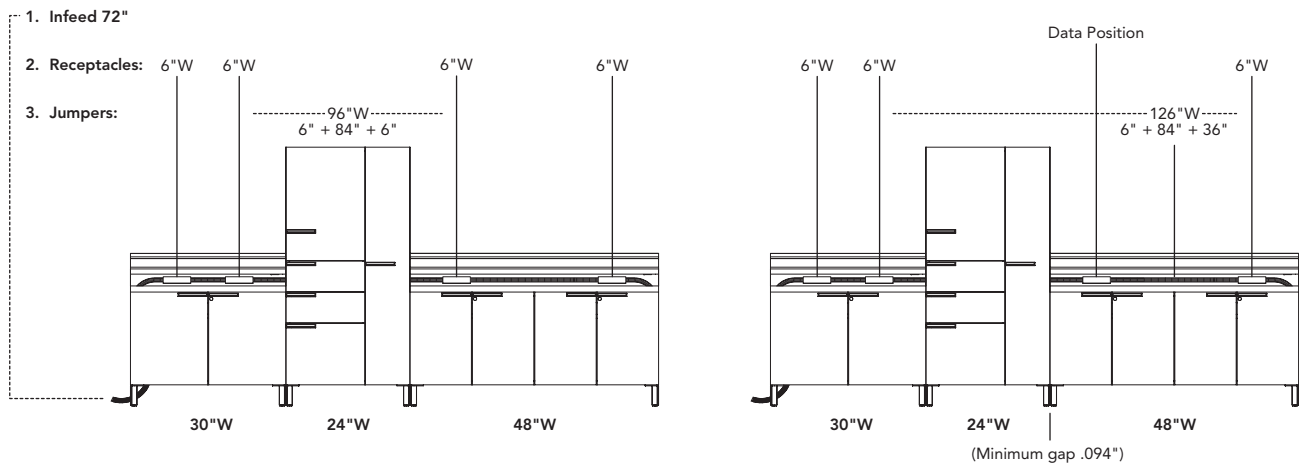

Jumper Situation:	Spanning a tower	Spanning a tower with an open position for data.
Formula:	$6" + 84" + 6" = 96" \text{ Jumper}$	$6" + 84" + 6" + 6" + 24" = 126" \text{ Jumper}$

The 4-wire electrical system is a UL183-listed 2 circuit non-dedicated electrical system. The credenza rail supports continuous power and data distribution. With ported trim, the credenza rail provides easy access to power and data. In addition to the standard electrical components, PVC-free components are also available.

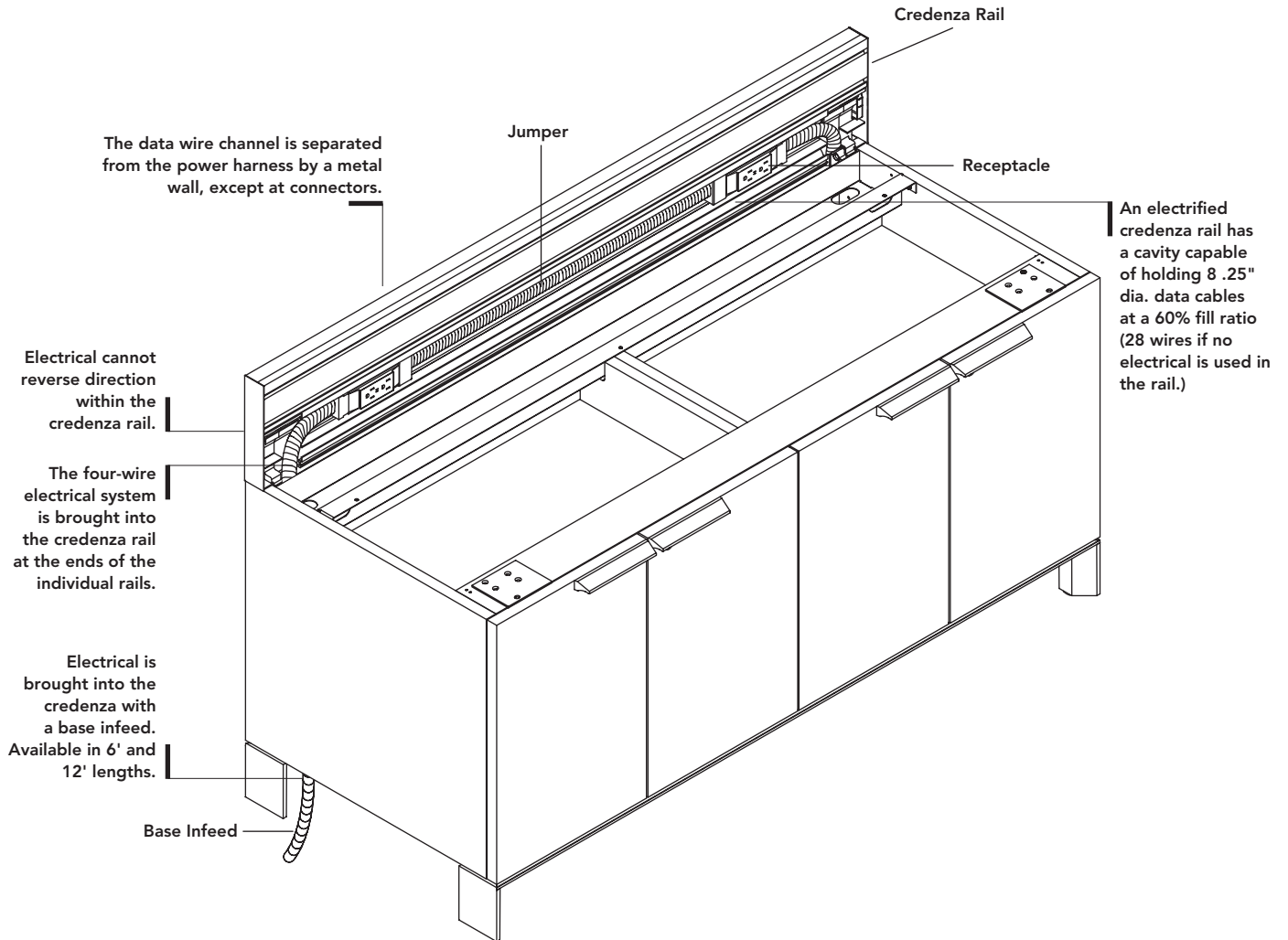

SPECIFICATION INFORMATION

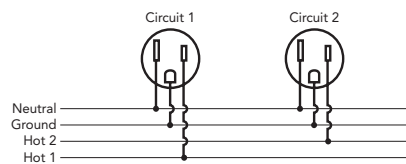

This electrical system has two hot wires, a shared neutral wire, and a shared ground wire. Each circuit is rated at 20 amps. A maximum of 13 duplex receptacles is permitted per circuit. Each receptacle is rated at 15 amps. Consult your electrician to ensure the planned electrical load is within permissible limits.

1. Determine location, quantity, and circuit number for duplex receptacles and power entry.
2. Base electrical infeed delivers power from building to system.
3. Desking power jumpers connect together duplex receptacles or groups of duplex receptacles.

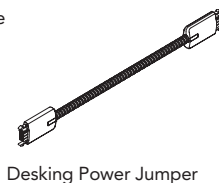
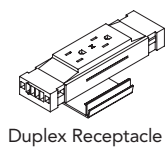

It is the customer's responsibility to ensure that the installation of the electrical components meets all local and national building codes and all other applicable regulations.

A. Routing Electrical: Within Credenza

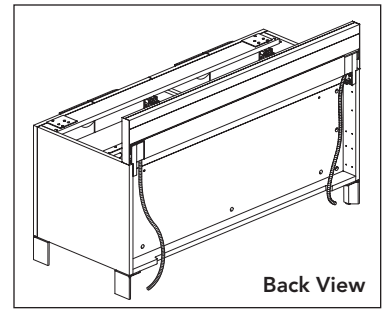
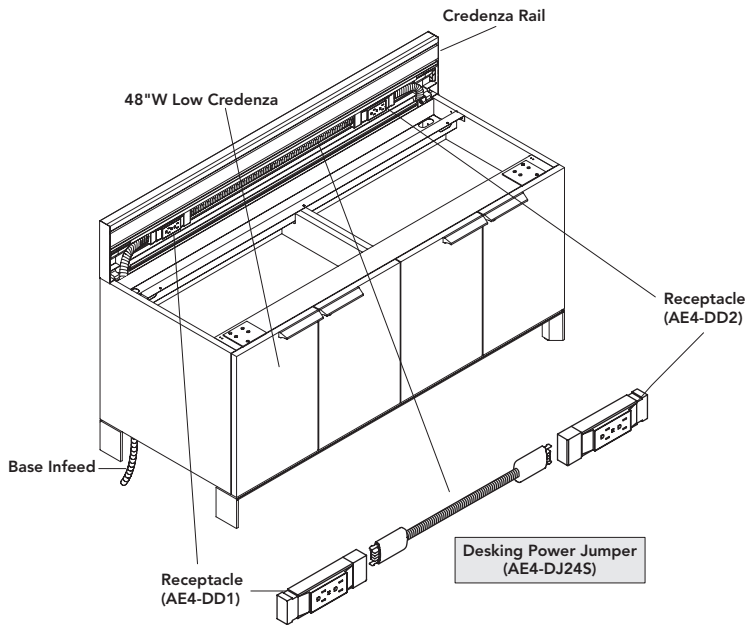

Credenza Width	Jumper Size	Jumper Model
24"	0"	AE4-DJ0S
30"	6"	AE4-DJ6S
36"	12"	AE4-DJ12S
42"	18"	AE4-DJ18S
48"	24"	AE4-DJ24S
60"	36"	AE4-DJ36S

B. Routing Electrical: Within Credenza Back-to-Back

All electrical components must be duplicated in a back-to-back situation. The credenza rail provides power to only one side of the credenza.

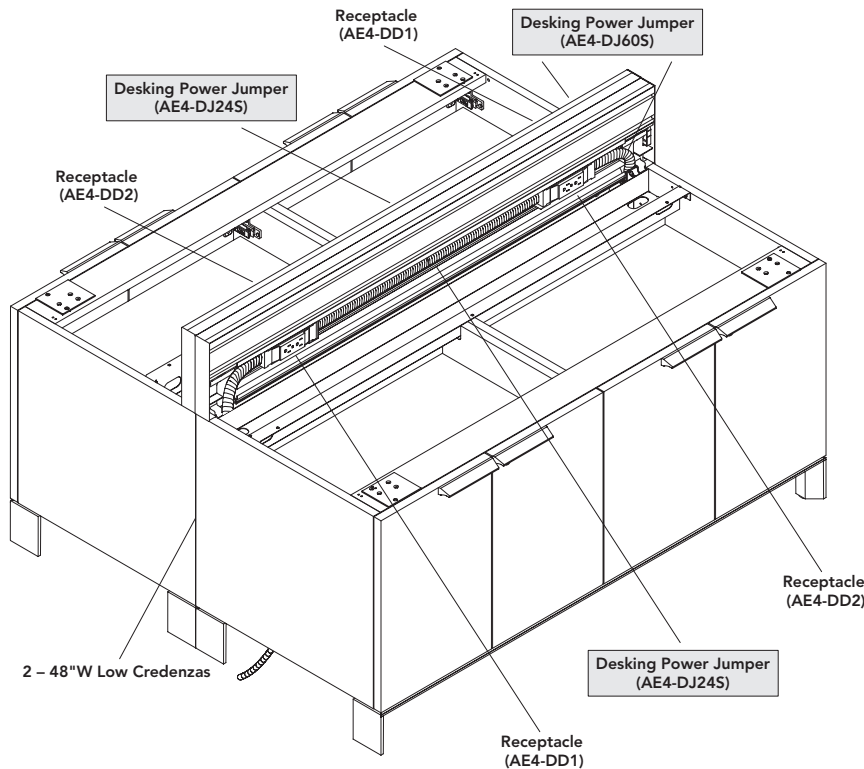

When routing from the front side to the back side in back-to-back credenzas use a 60" desking power jumper.

C. Routing Electrical: Spanning a Credenza

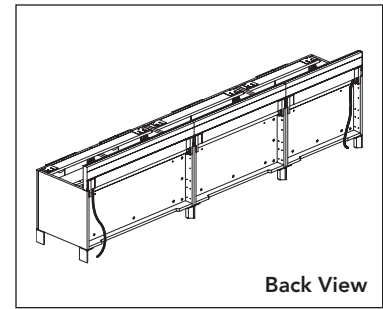
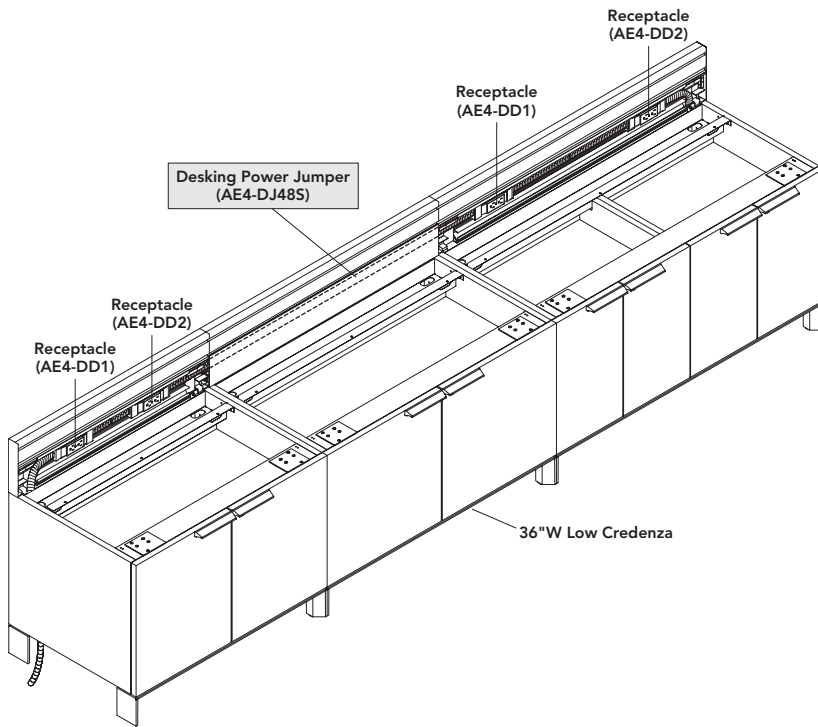

Credenza Width	Jumper Size	Jumper Model
0"	12"	AE4-DJ12S
24"	36"	AE4-DJ36S
30"	42"	AE4-DJ42S
36"	48"	AE4-DJ48S
42"	54"	AE4-DJ54S
48"	60"	AE4-DJ60S
60"	72"	AE4-DJ72S

D. Routing Electrical: Spanning a Credenza and an Open Position for Data

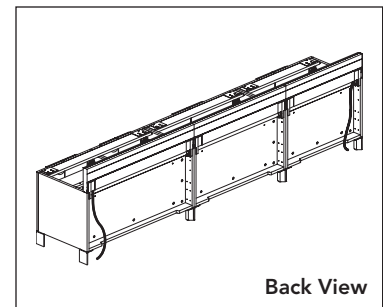
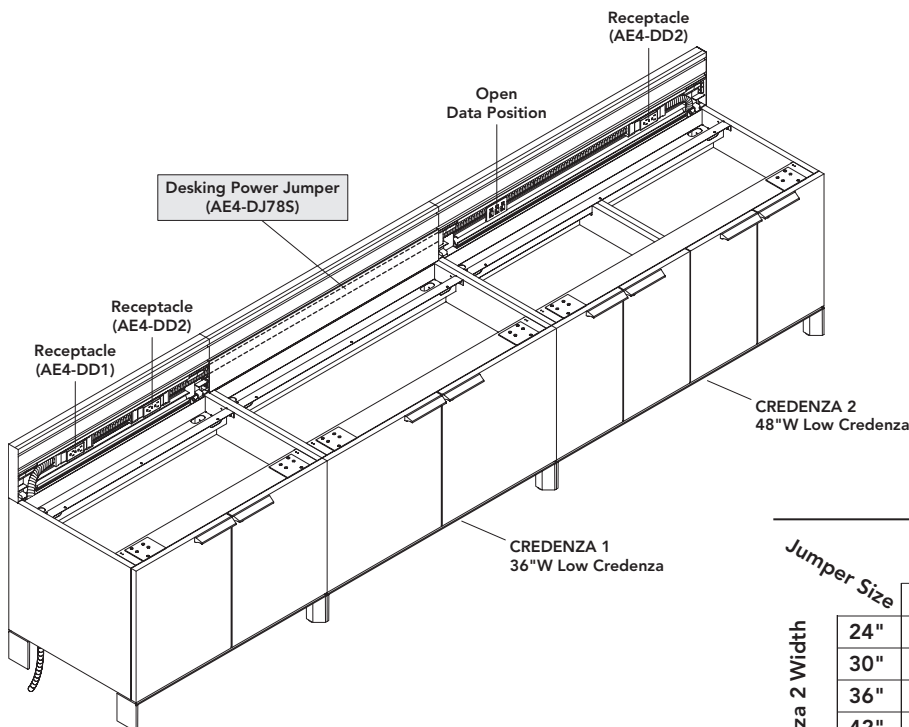

		Credenza 1 Width						
		Jumper Size						
		0"	24"	30"	36"	42"	48"	60"
Credenza 2 Width	24"	18"	42"	48"	54"	60"	66"	78"
	30"	24"	48"	54"	60"	66"	72"	84"
	36"	30"	54"	60"	66"	72"	78"	90"
	42"	36"	60"	66"	72"	78"	84"	96"
	48"	42"	66"	72"	78"	84"	90"	102"
	60"	54"	78"	84"	90"	96"	102"	114"

E. Routing Electrical: Spanning a Tower

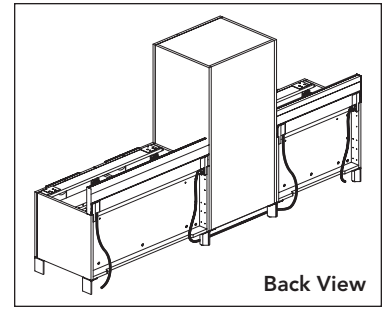
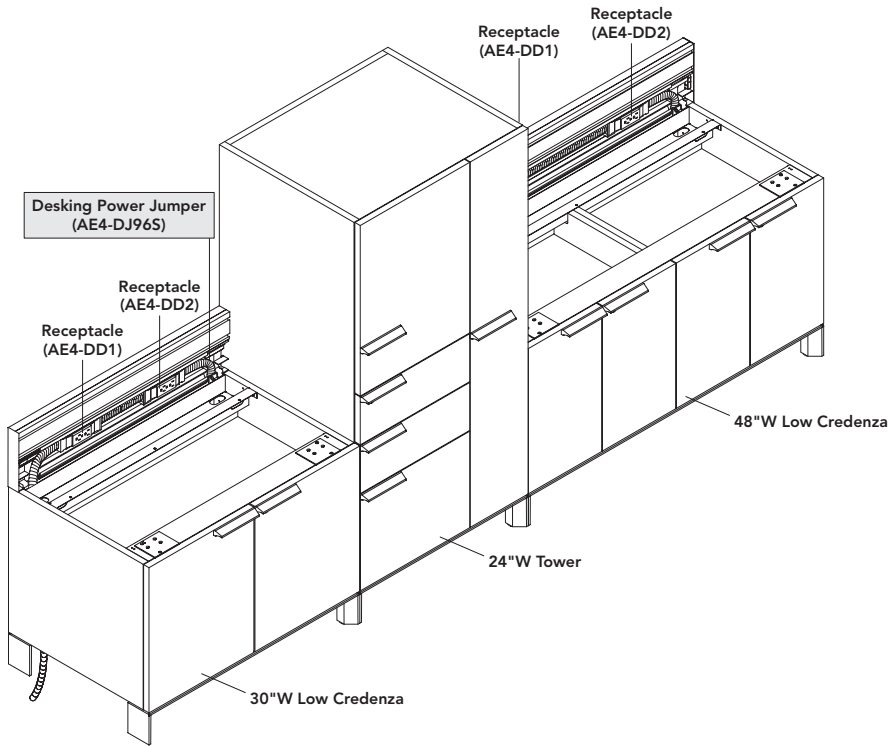

$$\text{Jumper} = 6'' + 84'' + 6'' = 96''$$

AE4-DJ96S

F. Routing Electrical: Spanning a Tower with an Open Position For Data

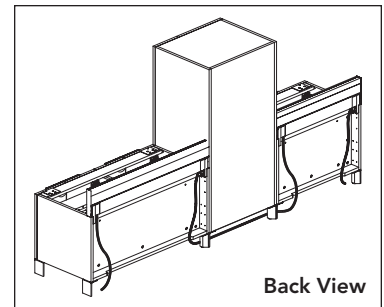
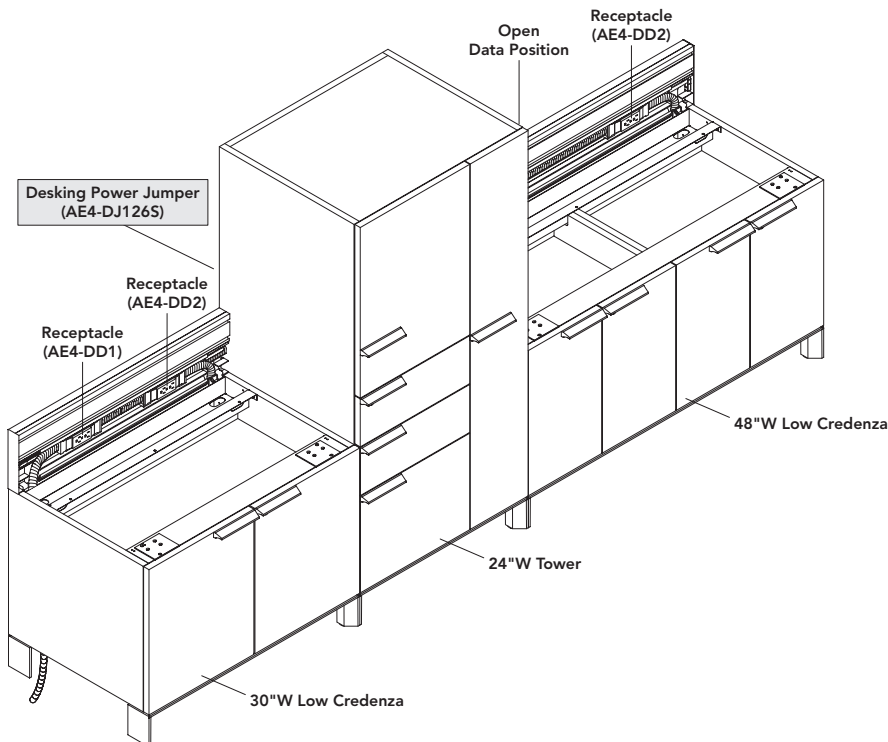

Credenza* Width	Jumper Size	Jumper Model
24"	102"	AE4-DJ102S
30"	108"	AE4-DJ108S
36"	114"	AE4-DJ114S
42"	120"	AE4-DJ120S
48"	126"	AE4-DJ126S
60"	136"	AE4-DJ136S

*Credenza with open data position

An electrified credenza rail has a cavity capable of holding 8 .25" dia. cables at 60% fill ratio (28 wires if no electrical is used in the rail).

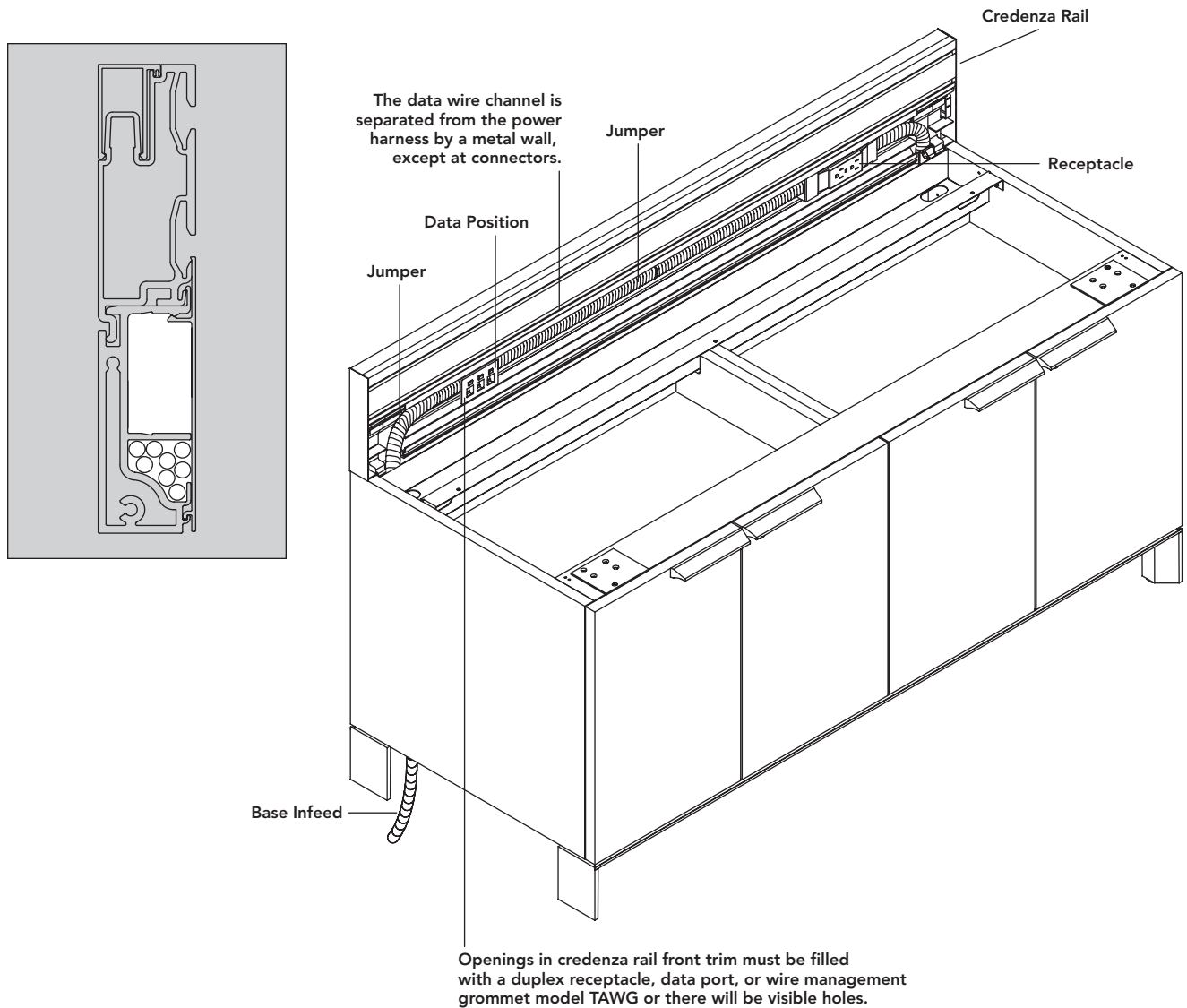

AMP data faceplates (models ATADF3 and ATADF4) and a jack (model ATADJ5) can also be used. An AMP data port extender is needed to install the data faceplate and jack in the credenza rail. The following data port extenders can be ordered from AMP: 1933468-1 (Black), 1993468-2 (Light Almond), and 1933468-4 (Nema Gray).

4-Wire Electrical Components for Stride Credenzas

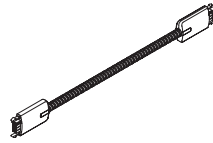

Desking Power Jumpers (page 264)

- UL-listed 4-wire electrical system.
- Ability to conceal power and data receptacles below primary worksurface.
- PVC-free electrical components available.
- Mounting brackets included.
- Cannot reverse direction within credenza rail.
- Length of 4-wire jumper needs to match distance between receptacles as there is not room to loop additional cable.

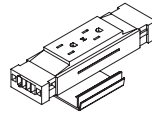

Duplex Receptacles (page 264)

- 4-wire receptacles are ordered separately for circuit 1 or 2 and are only available in ES Silver.
- 4-wire Infeed cable or jumper plug directly into each end of a 4-wire duplex receptacle.
- 4-wire receptacle adds 6" to length of electrical run.

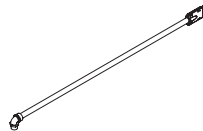

Base Electrical Infeed Cable (page 264)

- Feed in from floor.
- UL183 listed to be exposed.
- 4-wire infeed can enter from the end of a credenza rail only.
- Credenzas ship with clips under the case for holding infeed off the floor.
- Select quantity of infeed cables depending on individual power requirements.

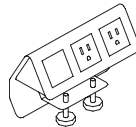

Worksurface Power/Data Module (page 264)

- Provides easy access to technology at primary worksurface.
- Mounts to edge of a worksurface and requires $\frac{3}{8}$ " gap. Consider whether $\frac{3}{8}$ " gap will work with layout.
- Must be mounted at time of initial worksurface installation if mounting between a worksurface and a panel. Maintaining a $\frac{3}{8}$ " gap may not be possible with worksurfaces that are panel wrapped.

Configurations

Towers are available in three heights: 42½", 50", and 65"H. Configurations include box/box/file, file/file, file with project drawer. 50" and 65"H towers are available with side access and Landscape™ surface sidelight.

Combination File

Combination files are 65"H and are available either 18"D or 24"D. They can either be specified with a 2 drawer lateral or lateral with a project drawer.

Aesthetic Alignment

Drawer configuration matches across Stride painted wood storage offering and tower heights align with Stride panel segmentation. Towers feature a bottom aesthetic trim piece that provides protection for the bottom edge for the tower.

Painted Wood Construction

¾" thick powder-coated medium density fiberboard with concealed fastener construction.

Footed Base

All towers have a metal footed base with concealed leveling glides. Feet on wood storage match style of Stride footed panels.

Four Hex-head Leveling Glides

The hex-head design of the stem allows leveling to be done even when the tower is fully loaded. Range is 1½".

Linear Pull Style

Elegant asymmetric pull style matches across wood storage offering.

Suspension

Heavy-duty ball bearing slides.

European Hinges

Wardrobe and cabinet door both feature European-style hinged door.

Filing

File drawers can accommodate front-to-back letter filing.

Shelves

Shelves in the cabinet door are adjustable in 2" increments. Shelves in side-access towers are fixed.

Wardrobe Door

All 24"W towers have wardrobe doors. 24"D with a coat rod; 18"D with a coat hook.

Lock Cores

Towers can be shipped with lock cores removed; cores can then be installed after towers are placed. Core removable lock feature allows key numbers to be easily changed in the field. It also facilitates installation.

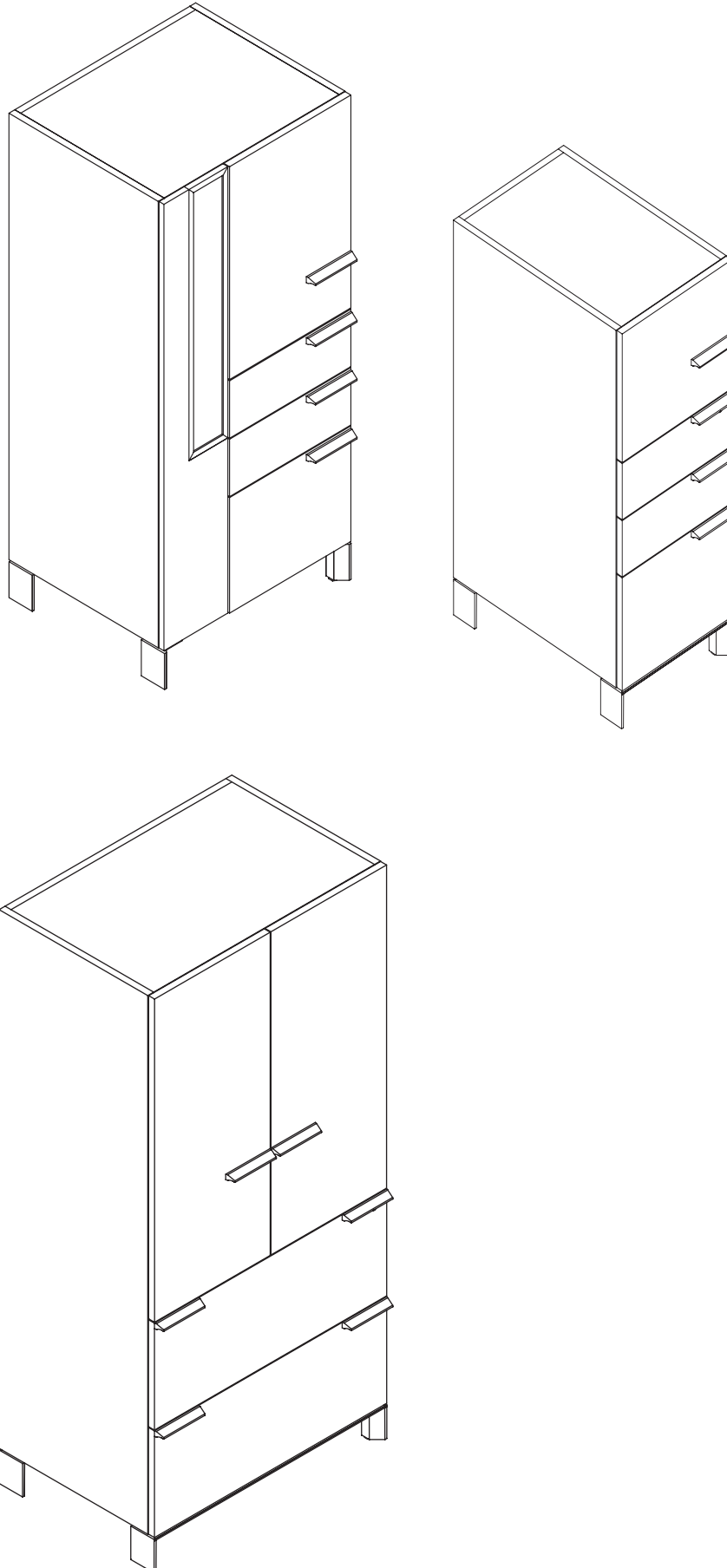

Painted Wood Towers and Combination File Accessories

Worksurface Supports

Tower has pre-drilled pilot holes on pull side of cabinet to accommodate addition of the "L" tower bracket.

"L" Tower Bracket - An "L" tower bracket can be ordered separately and fitted to any tower to support worksurfaces at 29½"H.

15½"W Tower
and "L" Tower Bracket

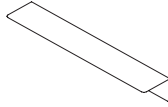
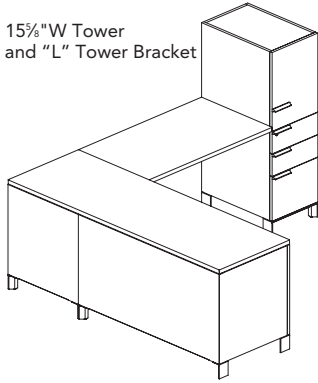

"L" Tower Bracket (page 265)

- Used to support a worksurface at 29½"H.
- Attaches using pre-drilled holes inside the tower.
- Can be attached to 18"D or 24"D towers.
- When using the "L" tower bracket, the depth of the worksurface and tower should be equal.
 - 18"D worksurface — 18"D tower
 - 24"D worksurface — 24"D tower
- "L" tower bracket is for use with laminate and painted wood storage only.

Overhead storage components maximize the use of space in the workstation and also provide convenient access to binders, reference materials, software packages, and miscellaneous supplies. There are three options available in laminate and painted wood: overhead, overhead with nitch, and shelf with nitch.

Overhead cabinets are available with hinged or sliding doors. Overhead cabinets with nitch are available as open, or with hinged or sliding doors. Door fronts on overhead storage are available in painted wood.

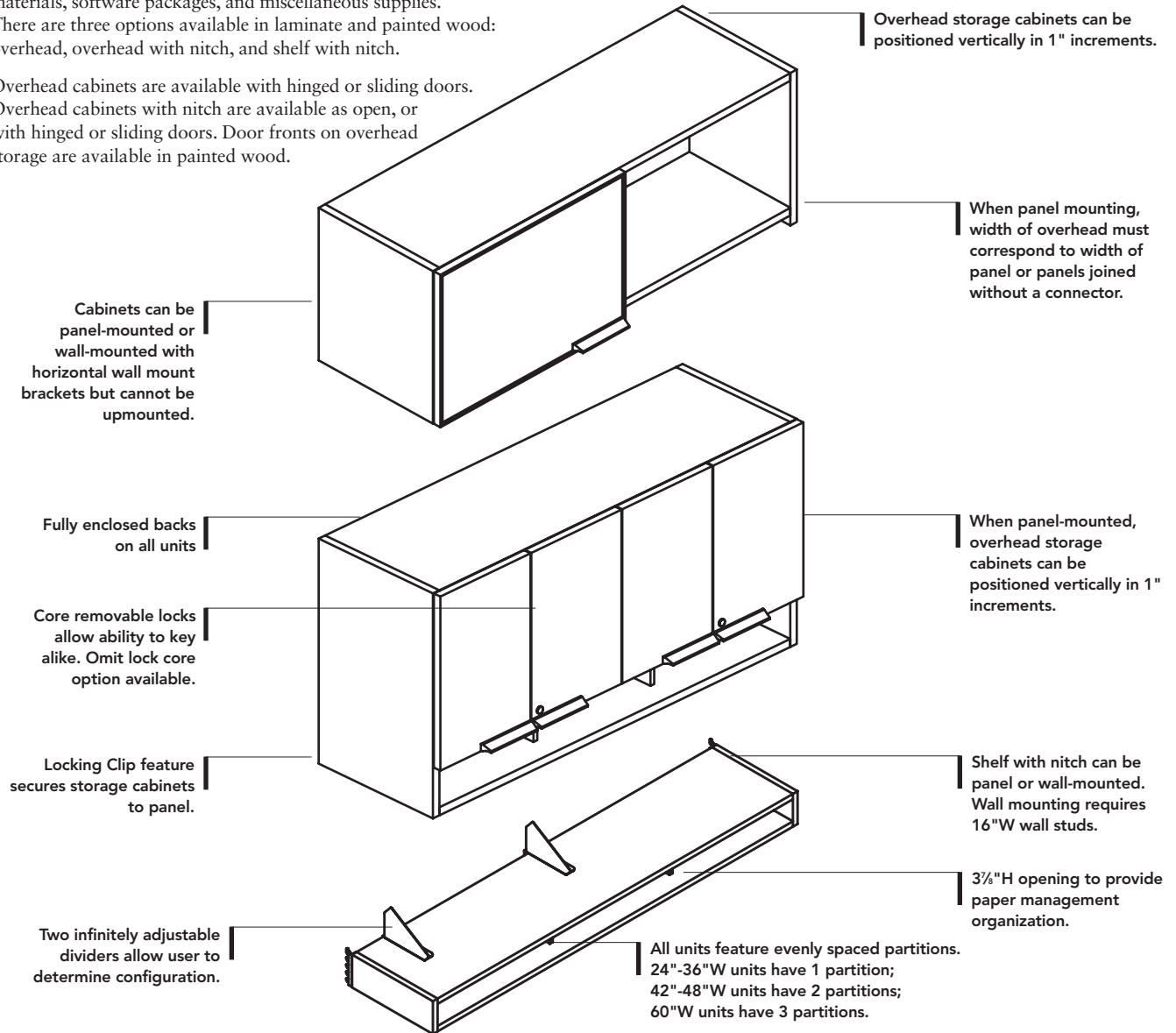

Product Dimensions	
Overhead Storage Cabinet	
Width	24", 30", 36", 42", 48", 60"
Inside width	22 ³ / ₈ ", 28 ³ / ₈ ", 34 ³ / ₈ ", 40 ³ / ₈ ", 46 ³ / ₈ ", 58 ³ / ₈ "
Depth	14"
Inside depth	11 ³ / ₄ "
Height	15"
Inside height	13 ¹ / ₂ "
Overhead Storage Cabinet with Nitch	
Width	24", 30", 36", 42", 48", 60"
Inside width	22 ³ / ₈ ", 28 ³ / ₈ ", 34 ³ / ₈ ", 40 ³ / ₈ ", 46 ³ / ₈ ", 58 ³ / ₈ "
Depth	14"
Inside depth	11 ³ / ₄ "
Height	19 ³ / ₈ "
Inside height	13 ¹ / ₂ "
Cabinet inside height	13 ⁷ / ₈ "
Nitch inside height	3 ³ / ₈ "
Shelf with Nitch	
Width	24", 30", 36", 42", 48", 60"
Inside width	22 ³ / ₈ ", 28 ³ / ₈ ", 34 ³ / ₈ ", 40 ³ / ₈ ", 46 ³ / ₈ ", 58 ³ / ₈ "
Depth	14"
Inside depth	11 ³ / ₄ "
Height	4 ³ / ₈ "
Inside height	3 ³ / ₈ "

LED undercabinet light can be mounted beneath laminate or painted wood overhead cabinets for a low profile lighting option. (Do not use recessed tasklights with painted wood storage.)

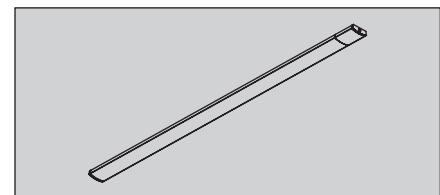

Cord retainer clips fasten into panel slots to anchor power cords. Available in black only. Three clips ship with each LED undercabinet light.

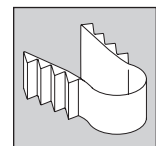

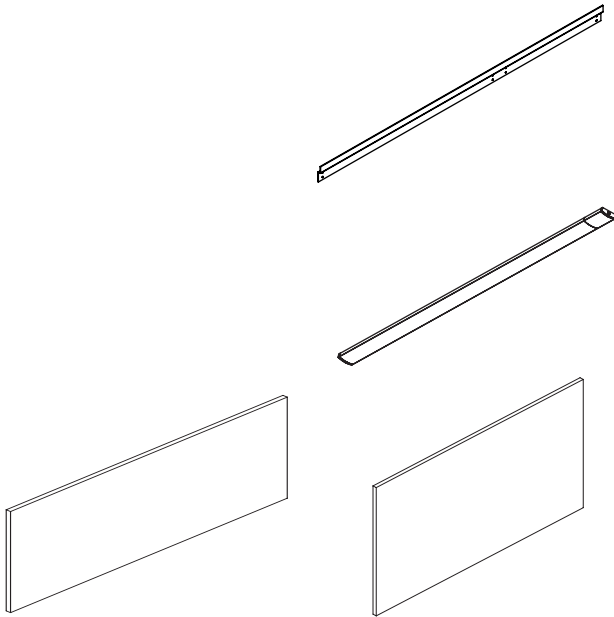

Horizontal Wall-Mount Brackets (page 266)

- Use to attach an overhead directly to wall.
- Attachment hardware not included.

Undercabinet LED Light (page 266)

- Low profile energy-efficient LED tasklight for use with overhead storage cabinets.
- 15W power supply (0.125 amp).
- 3500K color temperature.
- 95 footcandles at 18".
- Magnetic or screw-mount option — attachment hardware included.
- Power drive is attached to plug; allow 1 $\frac{7}{8}$ " D space at outlet.
- Includes 3 cord retainer clips.
- For daisy chain capabilities and additional information see page 387.

Tackboards (page 266)

- 15"H tackboards are designed to work with overheads with nitch.
- 20"H tackboards are designed to work with overheads without nitch.
- Wall-mounted tackboards come with brackets to mount to wall. Does not require wall track.

Full-depth horizontal storage can be panel-mounted or hung below the worksurface. Worksurface attachment hardware included. Specify panel mounting brackets separately.

24"W and 36"W units are available left- or right-handed. The side with shelves determines the handedness.

When panel-mounting cabinet must be same width as panel, or panels joined without a connector.

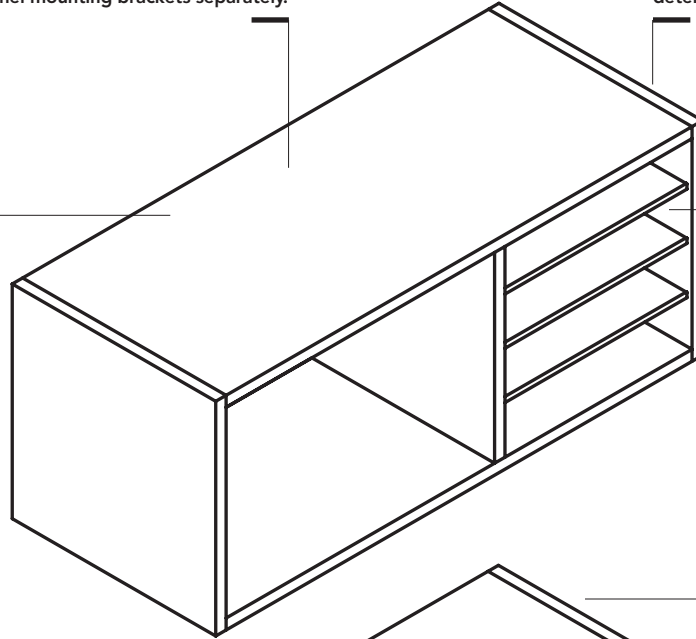

Cabinet is open with removable shelves. 24"W and 36"W cabinets have three shelves and must be specified left or right handed; 30"W cabinets have three shelves that can be positioned on either side; 42"W, 48"W, and 60"W units have six shelves, three on each side.

Shared cabinet splits access between the front and back.

Shared horizontal storage can be mounted on a panel or credenza rail. Specify either panel mounting bracket or credenza rail mounting bracket kits separately.

When mounting on credenza rail, must be mounted on two back-to-back rails.

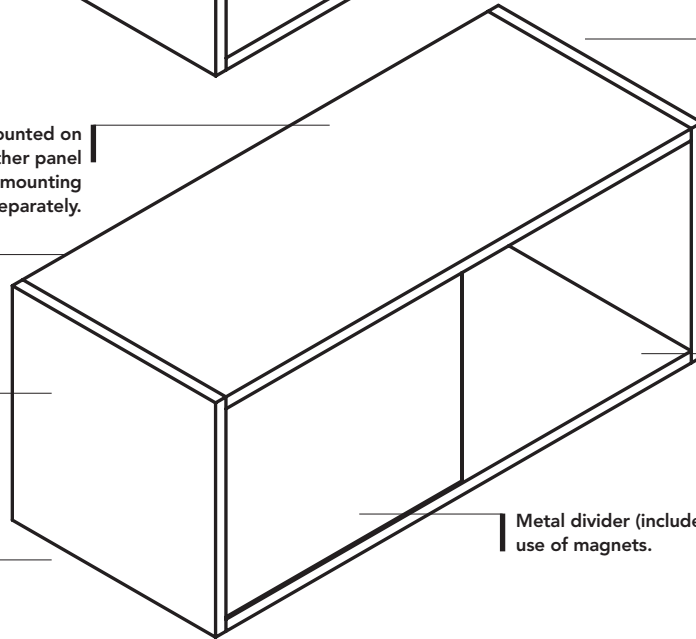

When panel-mounting, cabinet must be same width as panel, or panels joined without a connector.

Available left or right handed. The open side of the cabinet determines the handedness.

When mounted on credenza rail the cabinet can be mounted on or off-module.

Metal divider (included) allows use of magnets.

Product Dimensions

Full Depth Horizontal Storage Cabinet

Width	24", 30", 36", 42", 48", 60"
Inside width	22 ³ / ₈ ", 28 ³ / ₈ ", 34 ³ / ₈ ", 40 ³ / ₈ ", 46 ³ / ₈ ", 58 ³ / ₈ "
Depth	15"
Inside depth	12 ¹ / ₂ "
Height	15"
Inside height	13 ¹ / ₂ "

Shared Horizontal Storage Cabinet

Width	30", 36", 42", 48", 60"
Inside width	13 ³ / ₄ ", 16 ³ / ₄ ", 19 ³ / ₄ ", 22 ³ / ₄ ", 28 ³ / ₄ " (per user side)
Depth	15"
Inside depth	13 ¹ / ₂ "
Height	15"
Inside height	13 ¹ / ₂ "

Horizontal Storage Mounting Kits (page 267)

- Unique mounting kits for: full depth horizontal, shared horizontal based on panel width, and credenza rail mount

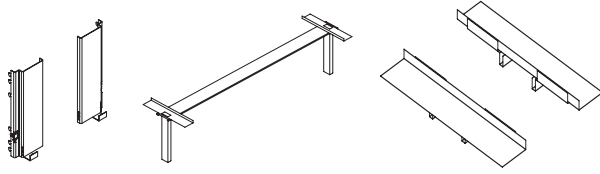

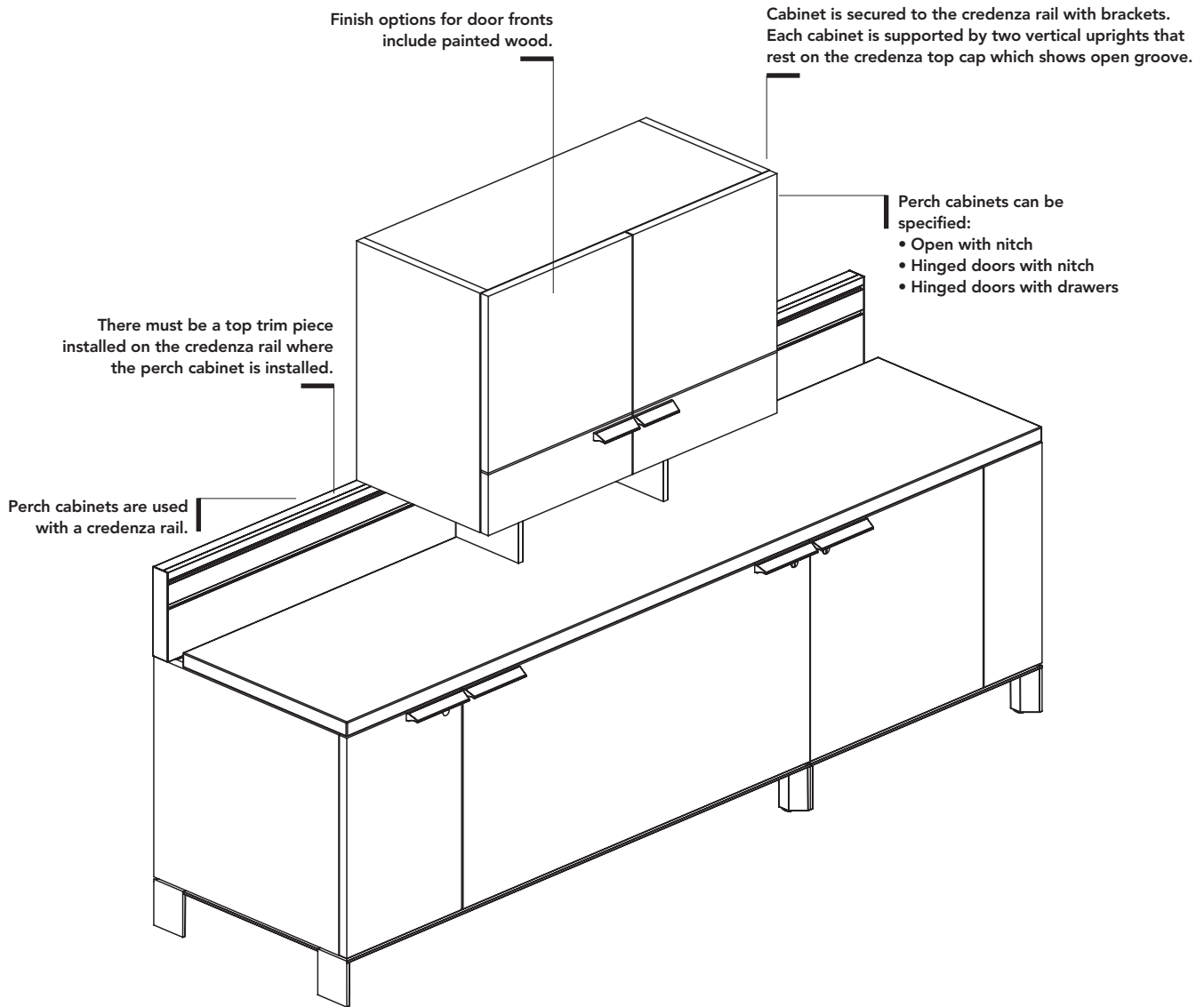

Product Dimensions		
Perch Cabinet	Perch Cabinet with Nitch	Perch Cabinet with Drawers
Width 30"	Width 30"	Width 30"
Inside width 28½"	Inside width 28½"	Inside width 28½"
Depth 14"	Depth 14"	Depth 14"
Inside depth 12"	Inside depth 12"	Inside depth 12"
Height 19½"	Height 19½"	Height 19½"
Inside height 17⅝"	Cabinet inside height 13¼"	Cabinet inside height 13¼"
	Nitch inside height 3⅞"	Drawer inside height 3"
	Nitch inside width 14" (each side)	Drawer inside width 11⅝"

For specification information see pages 239-245. (See pages 401-402 for COM pricing on fabric Grades 9-22.)

GSA SIN 33721

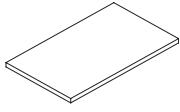

Description	Model	List Price									
		Grade 1	Grade 2	Grade 3	Grade 4	Grade 5	Grade 6	Grade 7	Grade 8	Grade L1	Grade L2
Ped/Credenza Cushions — 18"D											
15½"W	K5CT1815SC	\$ 357	\$ 387	\$ 416	\$ 446	\$ 485	\$ 524	\$ 563	\$ 602	\$ 581	\$ 741
18"W	K5CT1818SC	\$ 380	\$ 410	\$ 439	\$ 469	\$ 508	\$ 547	\$ 586	\$ 625	\$ 604	\$ 764
24"W	K5CT1824SC	\$ 408	\$ 438	\$ 467	\$ 497	\$ 536	\$ 575	\$ 614	\$ 653	\$ 632	\$ 792
30"W	K5CT1830SC	\$ 440	\$ 470	\$ 499	\$ 529	\$ 568	\$ 607	\$ 646	\$ 685	\$ 664	\$ 824
36"W	K5CT1836SC	\$ 496	\$ 526	\$ 555	\$ 585	\$ 624	\$ 663	\$ 702	\$ 741	\$ 720	\$ 880
42"W	K5CT1842SC	\$ 494	\$ 524	\$ 553	\$ 583	\$ 622	\$ 661	\$ 700	\$ 739	\$ 718	\$ 878
48"W	K5CT1848SC	\$ 511	\$ 541	\$ 570	\$ 600	\$ 639	\$ 678	\$ 717	\$ 756	\$ 735	\$ 895

COM Yardage: 0.7 yards, 15½"W and 18"W yield one cushion. COL 3.5 sq.ft. 15½"W and 18"W; 7 sq.ft. others. No vinyls.

How to specify —
Select the Model Number from above.

1st Option:
Seat Cushion Upholstery:
Specify Seating upholstery.

Example: K5CT1815SC.BOX14

Shippable by small-package carrier.

For specification information see pages 246-247.

GSA SIN 33721

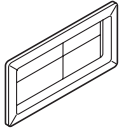

Description	Model	List Price
Wireway Grommet		
Pack of 6 (Black only)	TAWG <input type="checkbox"/>	\$ 187

How to specify —
Select the Model Number from above.

1st Option:

Color:
E4 Black

Z | | | | | | | | | | . E 4

Examples: TAWG.E4

Shippable by small-package carrier.

For specification information see pages 248-254.

GSA SIN 33721

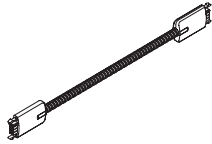

Description	Model	List Price
Desking Power Jumpers, 4-wire, Two-circuit		
0"W Desking Power Jumper	AE4-DJ0S [S]	\$ 65
6"W Desking Power Jumper	AE4-DJ6S [S]	\$ 118
12"W Desking Power Jumper	AE4-DJ12S [S]	\$ 132
18"W Desking Power Jumper	AE4-DJ18S [S]	\$ 144
24"W Desking Power Jumper	AE4-DJ24S [S]	\$ 160
30"W Desking Power Jumper	AE4-DJ30S [S]	\$ 177
36"W Desking Power Jumper	AE4-DJ36S [S]	\$ 189
42"W Desking Power Jumper	AE4-DJ42S [S]	\$ 209
48"W Desking Power Jumper	AE4-DJ48S [S]	\$ 225
54"W Desking Power Jumper	AE4-DJ54S [S]	\$ 255
60"W Desking Power Jumper	AE4-DJ60S [S]	\$ 271
66"W Desking Power Jumper	AE4-DJ66S [S]	\$ 289
72"W Desking Power Jumper	AE4-DJ72S [S]	\$ 299
78"W Desking Power Jumper	AE4-DJ78S [S]	\$ 317
84"W Desking Power Jumper	AE4-DJ84S [S]	\$ 330
90"W Desking Power Jumper	AE4-DJ90S [S]	\$ 345
96"W Desking Power Jumper	AE4-DJ96S [S]	\$ 357
102"W Desking Power Jumper	AE4-DJ102S [S]	\$ 377
108"W Desking Power Jumper	AE4-DJ108S [S]	\$ 387
114"W Desking Power Jumper	AE4-DJ114S [S]	\$ 397
126"W Desking Power Jumper	AE4-DJ126S [S]	\$ 428
132"W Desking Power Jumper	AE4-DJ132S [S]	\$ 438
138"W Desking Power Jumper	AE4-DJ138S [S]	\$ 446
144"W Desking Power Jumper	AE4-DJ144S [S]	\$ 458

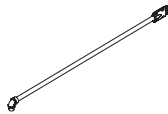
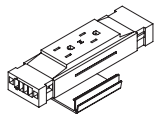

Duplex Receptacles, 4-wire — with mounting bracket (ES Silver only)		
Circuit 1	AE4-DD1 [S]	\$ 125
Circuit 2	AE4-DD2 [S]	\$ 125

Base Electrical, 4-wire Infeed Cable (Black only)		
72" Sealtight Cable	AE4-PS72 [S]	\$ 345
144" Sealtight Cable	AE4-PS144 [S]	\$ 504

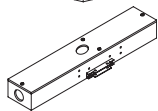
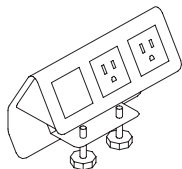

Worksurface Power/Data Module (PR6 Silver only)		
2 Simplex receptacles, 1 data position	A870302 [S]	\$ 395

Hardwire, 4-wire Infeed (New York Code)		
	AE4-HW [S]	\$ 452

<p>How to specify — Select the Model Number from above.</p>	<p>1st Option: Color: P Black</p>	<p>1st Option: Duplex Receptacle Color: ES Silver</p>	<p>1st Option: Worksurface Power/Data Module Color: PR6 Silver</p>
	<p>_____ . P E S P R 6</p>		

Examples: AE4-DJ66S.P AE4-PS72.P AE4-DD2.ES A870302.PR6 [S] Shippable by small-package carrier.

For specification information see pages [255-256](#).

GSA SIN 33721

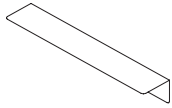

Description	Model	P1 Paint List Price	P2 Paint List Price	P3 Paint List Price
"L" Tower Bracket — for Painted Wood Towers				
"L" Tower Bracket for 18"D or 24"D	Z6LB S	\$ 82	\$ 102	\$ 118

How to specify —
Select the Model Number from above.

1st Option:
Paint Color:
P1 P2 P3

Z | | | | | | | .

P | | | |

Examples: Z6LB.PJW

S Shippable by small-package carrier.

For specification information see pages 257-258. (See page 401 for COM pricing on fabric Grades G-J.)

GSA SIN 33721

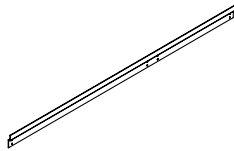

Description	Model	List Price
Horizontal Wall-Mount Brackets — for use with Painted Wood Overhead Cabinets		
24"W	YWC24Z	\$ 122
30"W	YWC30Z	\$ 141
36"W	YWC36Z	\$ 153
42"W	YWC42Z	\$ 173
48"W	YWC48Z	\$ 189
60"W	YWC60Z	\$ 232

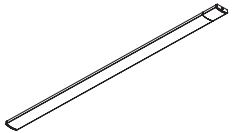

Undercabinet LED Lights (white end caps)		
17" Undercabinet LED Tasklight	ALED17U <input type="checkbox"/>	\$ 1045
31" Undercabinet LED Tasklight	ALED31U <input type="checkbox"/>	\$ 1568

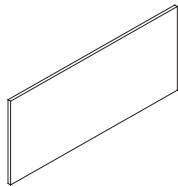

Description	Model	List Price					
		Grade A	Grade B	Grade C	Grade D	Grade E	Grade F
15"H Wall-Mounted Tackboards — for use with Overheads with Nitch							
30"W	ZWMTB1530 <input type="checkbox"/>	\$ 951	\$ 973	\$ 995	\$ 1030	\$ 1064	\$ 1100
36"W	ZWMTB1536 <input type="checkbox"/>	\$ 963	\$ 990	\$ 1015	\$ 1057	\$ 1099	\$ 1142
42"W	ZWMTB1542 <input type="checkbox"/>	\$ 981	\$ 1011	\$ 1041	\$ 1091	\$ 1140	\$ 1190
48"W	ZWMTB1548 <input type="checkbox"/>	\$ 995	\$ 1029	\$ 1063	\$ 1120	\$ 1177	\$ 1232
60"W	ZWMTB1560 <input type="checkbox"/>	\$ 1019	\$ 1063	\$ 1104	\$ 1175	\$ 1246	\$ 1316

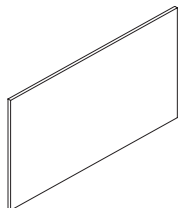

Description	Model	List Price					
		Grade A	Grade B	Grade C	Grade D	Grade E	Grade F
20"H Wall-Mounted Tackboards — for use with Overheads without Nitch							
24"W	ZWMTB2024 <input type="checkbox"/>	\$ 982	\$ 1005	\$ 1028	\$ 1066	\$ 1103	\$ 1141
30"W	ZWMTB2030 <input type="checkbox"/>	\$ 998	\$ 1027	\$ 1055	\$ 1103	\$ 1150	\$ 1196
36"W	ZWMTB2036 <input type="checkbox"/>	\$ 1009	\$ 1043	\$ 1077	\$ 1134	\$ 1191	\$ 1246
42"W	ZWMTB2042 <input type="checkbox"/>	\$ 1029	\$ 1070	\$ 1109	\$ 1175	\$ 1241	\$ 1307
48"W	ZWMTB2048 <input type="checkbox"/>	\$ 1036	\$ 1082	\$ 1127	\$ 1202	\$ 1278	\$ 1353
60"W	ZWMTB2060 <input type="checkbox"/>	\$ 1059	\$ 1116	\$ 1172	\$ 1267	\$ 1361	\$ 1455

How to specify —
Select the Model Number from above.

1st Option:

Tackboard Fabric:

See page 14 for fabrics.

_____ . _____

Examples: YWC24Z ALED17U ZWMTB1530.COA901

Shippable by small-package carrier.

For specification information see pages 259-260.

Painted Wood
GSA SIN 33721

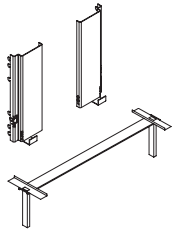

Description	Model	List Price
Full Depth Horizontal Storage Mounting Kit		
Panel Mounting Kit	ZHFPMK <input type="checkbox"/>	\$ 195
Shared Horizontal Storage Mounting Kits		
30"W Panel Mounting Kit	ZHSPMK30 <input type="checkbox"/>	\$ 248
36"W Panel Mounting Kit	ZHSPMK36 <input type="checkbox"/>	\$ 264
42"W Panel Mounting Kit	ZHSPMK42 (shown) <input type="checkbox"/>	\$ 274
48"W Panel Mounting Kit	ZHSPMK48 <input type="checkbox"/>	\$ 292
60"W Panel Mounting Kit	ZHSPMK60 <input type="checkbox"/>	\$ 304

How to specify —
Select the Model Number from above.

1st Option:
Paint Color for Mounting Kits (if applicable):

P1 P2 P3

P2 add \$22
P3 add \$41

Z | | | | | | | | | | | | | | | | . P | | | |

Examples: ZHSPMK30.P4J ZHFPMK.PJW

Shippable by small-package carrier.

Benching Storage

For specification information see page 261.

GSA SIN 33721

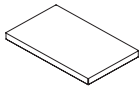

Description	Model	List Price by Grade											
		1	2	3	4	5	6	7	8	9	10	11	12
Seat Cushion for Toy Box and Combination Storage													
15"D x 24"W	K5CT1524SC	\$409	\$441	\$474	\$505	\$549	\$591	\$632	\$675	\$717	\$761	\$803	\$844
Seat Cushion for Mobile Pedestal													
18"D x 15"W	K5CT1815SC	\$357	\$387	\$416	\$446	\$485	\$524	\$563	\$602	\$641	\$680	\$719	\$759

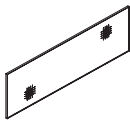

Description	Model	List Price					
		Grade A	Grade B	Grade C	Grade D	Grade E	Grade F
Tackable Cantilever Storage Accessory							
for use with 42½"H Single-Sided Cantilever Unit							
	ZS42SF	\$503	\$533	\$562	\$610	\$658	\$706
for use with 50"H Single-Sided Cantilever Unit							
	ZS50SF	\$597	\$643	\$687	\$761	\$834	\$909

How to specify —
Select the Model Number from above.

1st Option:
Upholstery for Seat Cushion:
See pages 17-19 of Seating Price List for upholsteries.

1st Option:
Fabric for Cantilevered Storage Accessory:
See page 10 of Desking and Benching Price List for fabrics.

2nd Option:
Trim Paint for Cantilevered Storage Accessory:
P1 P2 P3
See page 188 of Desking and Benching Price List for finishes.

Examples: K5CT1524SC ZS50SF.EXG903.P27

S Shippable by small-package carrier.

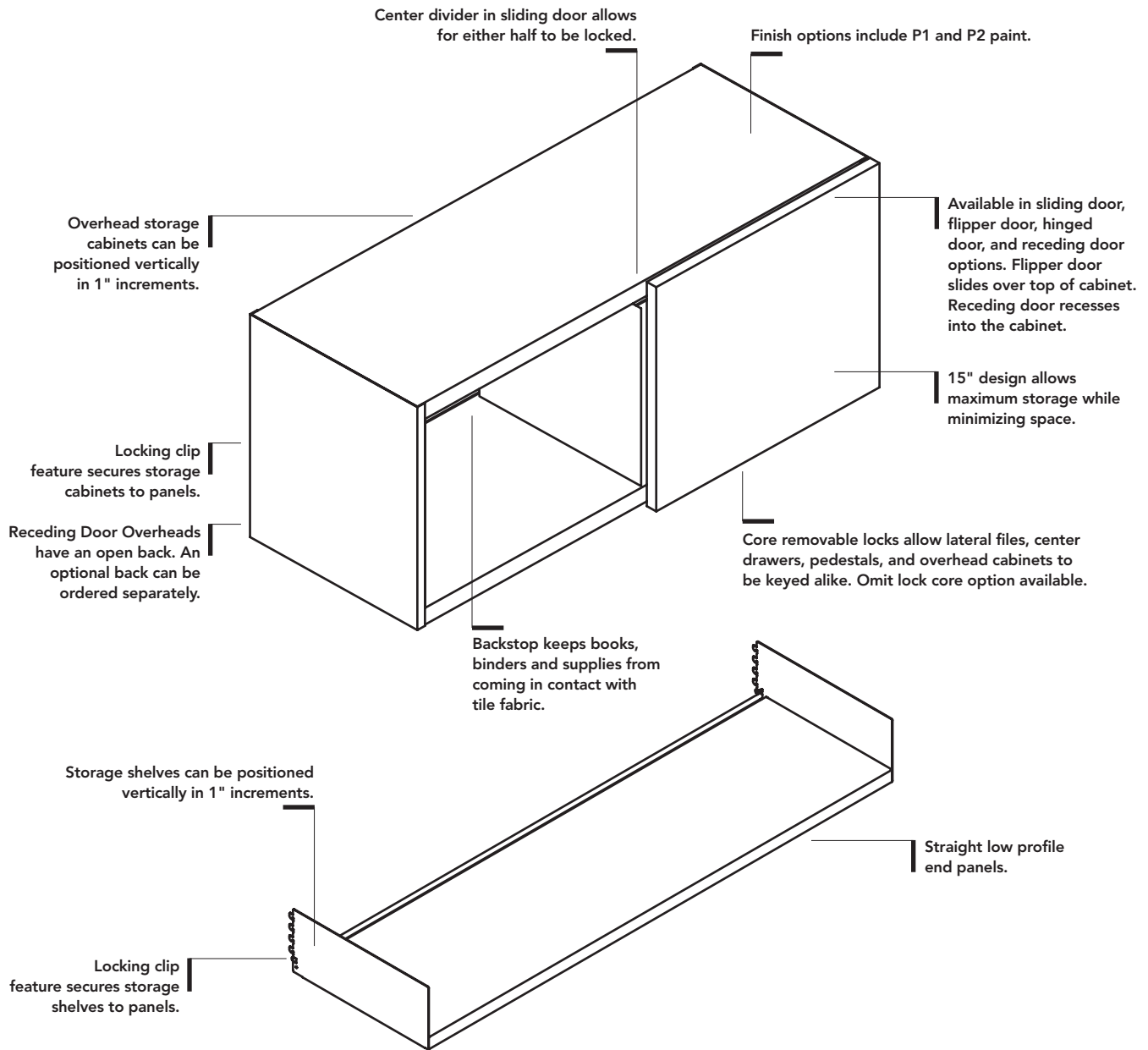

Product dimensions	
Overhead Storage Cabinet	
Width	24", 30", 36", 42", 48", 60"
Inside width	Flipper or 24" -36"W Hinged door — 3/8" less than width 42"-48"W Hinged or Sliding door — two compartments that are half of 3/8" less than width
Depth	14 1/4" RTA models 12"
Inside depth	12 7/8" Receding door 12 1/8" RTA models 11 5/8"
Height	15"
Inside height	12 3/4" Receding door 11 5/8" RTA models 12 3/4"
Open Shelf	
Width	24", 30", 36", 42", 48", 60"
Depth	12 7/8" RTA models 11 1/2"
Height	4 5/8" RTA models 5 3/8"

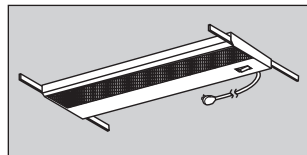

Recessed task lights can be mounted beneath storage shelves and overhead storage cabinets. Additional panel hung and freestanding lighting options are available.
Note: Do not use with laminate or painted wood storage.

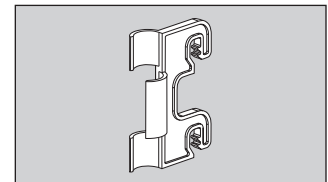

Cord retainer clips fasten into panel slots to anchor power cords. Available in black only. Clips are provided with under-shelf mounted task lights. Additional clips can be purchased separately.

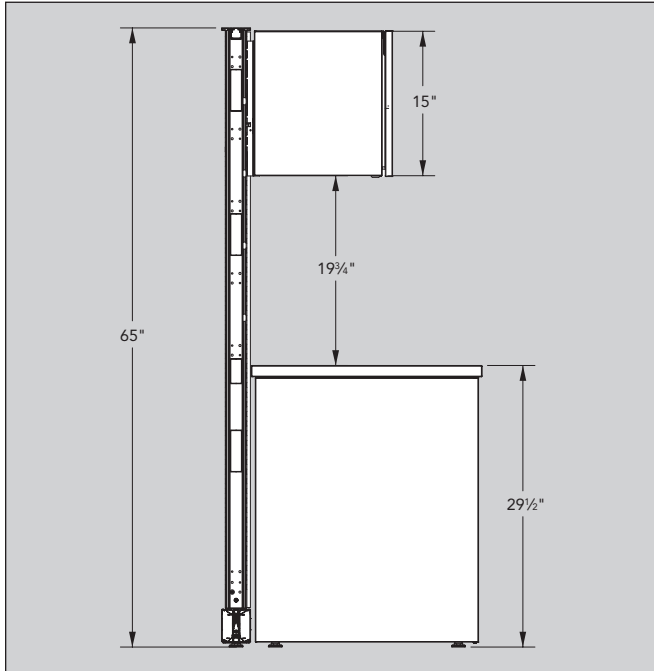

Overhead storage cabinets and open storage shelves can be mounted on Stride structural and stacking panels to a maximum height of 80". When mounting an overhead on a 57½"H base panel frame, select the option for Z57 bracket. For all other base panel frame and base panel frames with stacking frames the YZ bracket should be selected. Base panel frames with stacking frames that have an overall height of 57½" also use the YZ bracket.

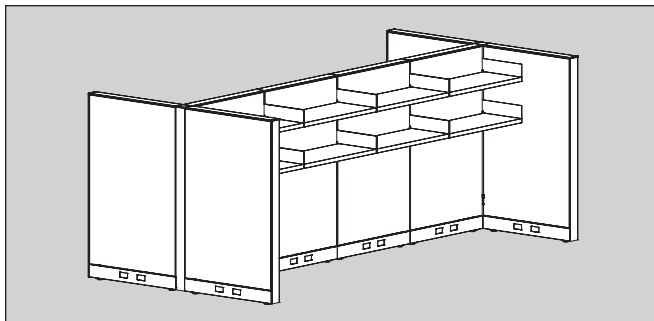

In a panel run, only two overhead storage cabinets or open storage shelves are recommended per panel side. Do not suspend more than one overhead storage unit per side from panels in a panel run which is mounted, at one or both ends, with an off-module connector kit.

When overhead storage units are suspended from stacking frames, the following guidelines should be adhered to:

- Stacking frames should be added to all the parent run panels, and to each return-panel run.
- Stacking panels added to return panel must match the parent run configuration.
- A maximum of two overhead storage units should be suspended from each side of stacking frames on any given panel.

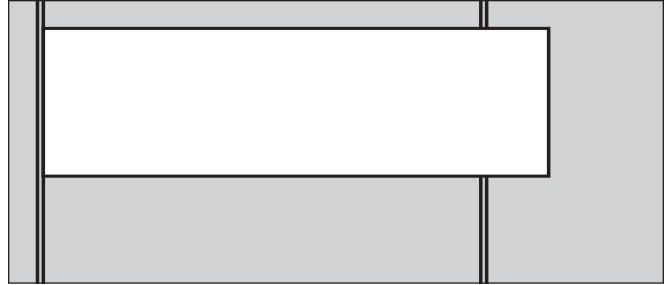

Metal Overhead Cabinets can be mounted on a panel equal to or up to 18" narrower than cabinet using provided panel attachment brackets. Overhead cabinets can also be mounted on panels wider than the overhead cabinet when using off-module kit **Z2NM**. One side of overhead must be held on module.

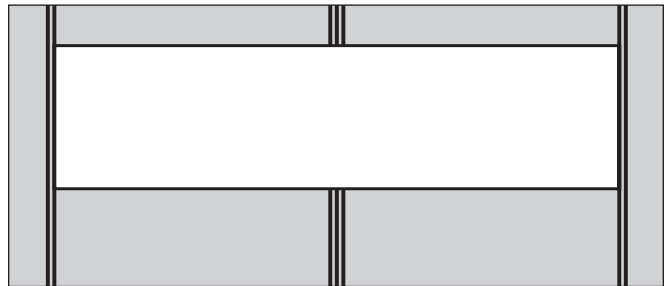

Storage shelf, receding door overhead, RTA overhead, and RTA shelf width must correspond with width of panel(s). It is possible to span two panels when combined panel width equals cabinet or shelf width.

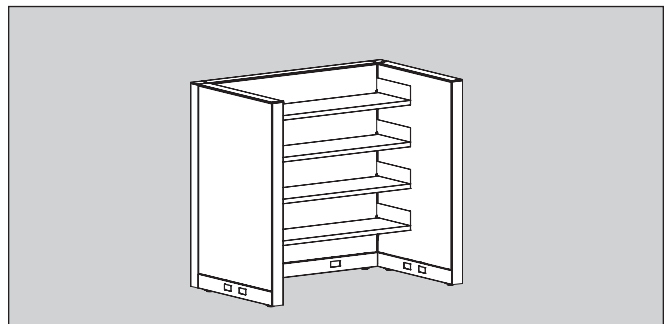

Up to 5 units can be hung on structural frames when run is supported with return panels on each side of storage shelves or overhead storage cabinets.

Overhead Storage Cabinets

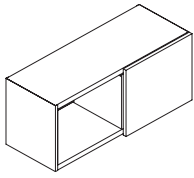

Metal Case with Single Sliding Door

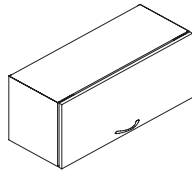

Metal Case with Metal Flipper Door

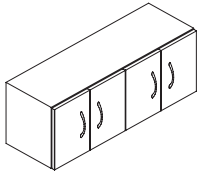

Metal Case with Metal Hinged Doors

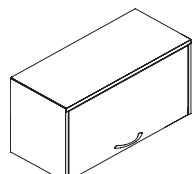

Metal Case with Metal Receding Door

Open Shelf

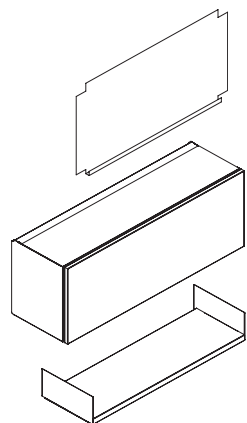
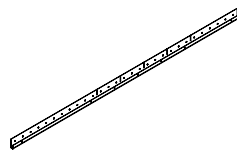
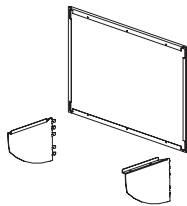
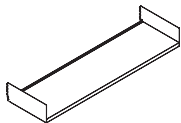

WEIGHT LIMITS

15"H Sliding, Hinged, and Flipper Door Overheads

24"W.....	59 lbs.
30"W.....	74 lbs.
36"W.....	90 lbs.
42"W.....	105 lbs.
48"W.....	121 lbs.
60"W.....	152 lbs.

Open Shelf

24"W.....	61 lbs.
30"W.....	77 lbs.
36"W.....	93 lbs.
42"W.....	108 lbs.
48"W.....	124 lbs.
60"W.....	155 lbs.

15"H Receding Door Overheads

30"W.....	70 lbs.
36"W.....	85 lbs.
42"W.....	100 lbs.
48"W.....	110 lbs.
60"W.....	138 lbs.

15"H Overhead Storage Cabinet (page 272)

- Steel cabinet with backstop. Cabinets are 14¼"D x 15"H.
- Available with sliding, hinged, or flipper door(s).
- Easy-Assist flipper door optional — requires minimal assistance in opening and closing. Not available on 60"W cabinets, specify 2–30"W flipper door cabinets with Easy-Assist.
- Self-engaging safety latch to secure cabinet to panel.
- Arch or Square pull optional on flipper and hinged doors.
- 60"W flipper cabinet has 2–30"W doors with 2 independent locks.
- 24"-36"W hinged door cabinets have 1 lock and 2 optional pulls, 42"-48"W have 2 locks and 4 optional pulls.
- Accommodates recessed task lighting — ordered separately.
- For locking specifications, see pages 396-398.
- 15"H cabinets can be mounted on a panel equal or up to 18" narrower than the cabinet using provided panel attachment brackets.
- Sliding doors have a built in pull.
- When mounting an overhead on a 57½"H base panel frame, select the option for Z57 bracket. For all other base panel frame and base panel frames with stacking frames the YZ bracket should be selected. Base panel frames with stacking frames that have an overall height of 57½"H also use the YZ bracket.

Open Shelf (page 273)

- Metal shelf with back stop. Locking clips (2) standard.
- Will accommodate recessed task lighting —ordered separately.
- Width can correspond with width of panel, or 2 panels joined without a connector.

Upmount Kits for Assembled Overhead Cabinets (page 272)

- Consists of two upmount brackets, full back panel and required installation hardware.
- Allows mounting of an assembled cabinet up to 15" above height of panel. Cannot be used with RTA models.
- Specify "Z2" prefix model number upmount kits with 15"H, 30"H, 35"H, 50"H, or 65"H frames; and "Z4" prefix model numbers for use with 22½"H, 42½"H, or 57½"H frames.
- Brackets require a clearance of 6" below bottom of overhead cabinet.
- Width must correspond with width of panel frame or 2 panel frames joined directly in-line.
- Full back panel adds ½" to depth of overhead case.
- Full back panel only used when upmounting cabinet.

Horizontal Wall Track (page 272)

- Allows mounting overheads on permanent wall structures ONLY.
- Cannot be used with RTA models.
- Track is 60"W and notched at 6" intervals as a guide for field cutting.
- Field modification necessary for use with sliding door overhead.
- Available in black only. Attachment hardware not included.

15"H Receding Door Overhead (page 273)

- Steel cabinet with open back. Optional back ordered separately.
- Arch or Square pull optional.
- 60"W cabinet has 2 30"W doors with 2 independent locks.
- Accommodates recessed task lighting — ordered separately.
- For locking specification, see pages 396-398.
- Cabinets are 13¼"D x 15"H. When door is recessed, interior dimensions are 12⅝"D x 11⅝"H.

Receding Door Overhead Back (page 273)

- Optional, order width to match receding door overhead.

Ready to Assemble (RTA) Flipper Door Overhead (page 273)

- Steel cabinet with open back.
- 60"W and 72"W cabinets have 2 doors with independent locks.
- Accommodates recessed task lighting — ordered separately.
- Random keying, for locking specifications see pages 396-398.
- Cabinets are 12"D x 15"H. Interior dimensions 11⅝"D x 12¾"H.

Ready to Assemble (RTA) Shelf (page 273)

- Metal shelf with locking clips.
- Accommodates recessed task lighting — ordered separately.

Metal Overheads & Shelves

Stride® — Overheads

For specification information see pages 269-271.

GSA SIN 33721

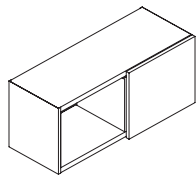

Description	Model	P1 Paint List Price	P2 Paint List Price	P3 Paint List Price
15"H x 14 1/4"D Sliding Single Door Overhead Cabinets				
24"W	OH1524SD	\$ 1041	\$ 1120	\$ 1197
30"W	OH1530SD	\$ 1064	\$ 1143	\$ 1220
36"W	OH1536SD	\$ 1116	\$ 1195	\$ 1272
42"W	OH1542SD	\$ 1166	\$ 1245	\$ 1322
48"W	OH1548SD	\$ 1219	\$ 1298	\$ 1375
60"W	OH1560SD	\$ 1609	\$ 1688	\$ 1765

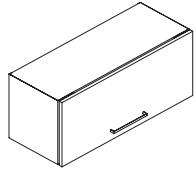

15"H x 14 1/4"D Flipper Door Overhead Cabinets				
24"W	OH1524FD	\$ 1041	\$ 1120	\$ 1197
30"W	OH1530FD	\$ 1064	\$ 1143	\$ 1220
36"W	OH1536FD	\$ 1116	\$ 1195	\$ 1272
42"W	OH1542FD	\$ 1166	\$ 1245	\$ 1322
48"W	OH1548FD	\$ 1219	\$ 1298	\$ 1375
60"W	OH1560FD	\$ 1609	\$ 1688	\$ 1765

Note: Add suffix **A** for arch pull or **S** for square pull to model number — add \$43 per pull.
For “Easy-Assist” on 24"W-48"W change FD suffix to FE – add \$240

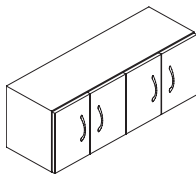

15"H x 14 1/4"D Hinged Door Overhead Cabinets				
24"W	OH1524HD	\$ 1781	\$ 1859	\$ 1936
30"W	OH1530HD	\$ 1862	\$ 1940	\$ 2017
36"W	OH1536HD	\$ 1949	\$ 2027	\$ 2104
42"W	OH1542HD	\$ 2032	\$ 2110	\$ 2187
48"W	OH1548HD	\$ 2107	\$ 2185	\$ 2262

Note: Add suffix **A** for arch pull or **S** for square pull to model number — add \$43 per pull.

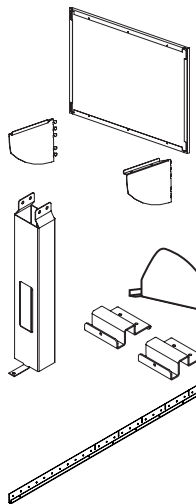

Upmount Kits for Overhead Cabinets —				
Specify “Z4” prefix models with 22 1/2"H, 42 1/2"H, or 57 1/2"H frames; “Z2” prefix for other heights.				
24"W	Z □ UP24	\$ 269	\$ 298	\$ 324
30"W	Z □ UP30	\$ 282	\$ 311	\$ 337
36"W	Z □ UP36	\$ 290	\$ 319	\$ 345
42"W	Z □ UP42	\$ 305	\$ 334	\$ 360
48"W	Z □ UP48	\$ 320	\$ 349	\$ 375
60"W	Z □ UP60	\$ 342	\$ 371	\$ 397

Shelf Dividers				
Package of 6	T7DV	\$ 144	\$ 162	\$ 173

Note: Not compatible with RTA models.

Off-Modular Overhead Bracket Kit				
Mounting Kit	Z2NM	\$ 255	\$ 284	\$ 310

Horizontal Wall Track				
60"W Track	TWTH	\$ 135	N/A	N/A

How to specify — Select the Model Number from above.	1st Option: Pull (if applicable): A Arch pull, add \$43 per pull S Square pull, add \$43 per pull	2nd Option: System (if applicable): YZ Stride or Terrace (except 57"H) Z57 Stride or Terrace 57"H	3rd Option: Paint: P1 P2 P3 See page 136 for finishes.	4th Option: Pull Color (if applicable): Arch: E4 Black EL Matte Silver Square: EL Matte Silver	5th Option: Lock Type: (if applicable): STD Standard — Random Keyed OMT Omit Lock Core (Deduct \$20 per lock)
	_____ .	_____ .	_____ .	P _____ .	E _____ .

Examples: OH1524FEA.YZ.P4J.E4.STD OH1548FDS.YZ.P52.EL.OMT [S] Shippable by small-package carrier.
 OH1560SD.YZ.PR2.STD ZS24.P4J T7DV.P7D TWTH.P27 Frame & Tile Panel Systems – 02/2024

Metal Overheads

Stride® — Overheads

For specification information see pages 269-271.

GSA SIN 33721

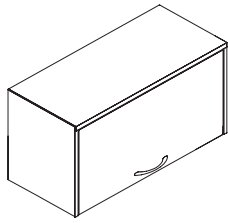

Description	Model	P1 Paint List Price	P2 Paint List Price	P3 Paint List Price
15"H x 13¼"D Receding Door Overheads (Inside dimensions with door recessed — 11⅞"H x 12⅞"D)				
30"W	OH1530RD	\$ 1221	\$ 1300	N/A
36"W	OH1536RD	\$ 1288	\$ 1367	N/A
42"W	OH1542RD	\$ 1368	\$ 1447	N/A
48"W	OH1548RD	\$ 1483	\$ 1562	N/A
60"W	OH1560RD	\$ 2243	\$ 2322	N/A

Note: Add Suffix **A** for arch pull or **S** for square pull option — add \$43 per pull.

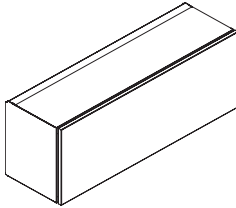

15"H x 12"D Ready to Assemble (RTA) Flipper Door Overhead (Inside dimensions 12¼"H x 11⅞"D)				
36"W RTA — Flipper Door	POHRTA1536FD	\$ 875	\$ 954	\$ 1031
42"W RTA — Flipper Door	POHRTA1542FD	\$ 914	\$ 993	\$ 1070
48"W RTA — Flipper Door	POHRTA1548FD	\$ 953	\$ 1032	\$ 1109

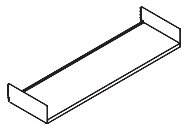

Description	Model	P1 Paint List Price	P2 Paint List Price	P3 Paint List Price
Open Shelf (to line up with 15"H Overheads) — 12½"D				
24"W	ZS24 S	\$ 444	\$ 472	N/A
30"W	ZS30 S	\$ 482	\$ 510	N/A
36"W	ZS36 S	\$ 508	\$ 536	N/A
42"W	ZS42 S	\$ 532	\$ 560	N/A
48"W	ZS48 S	\$ 558	\$ 586	N/A
60"W	ZS60	\$ 679	\$ 707	N/A

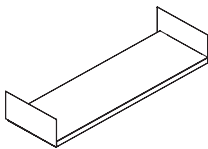

5⅞"H x 12"D Ready to Assemble (RTA) Shelf				
36"W RTA — Shelf	POHRTA36S	\$ 456	\$ 483	\$ 506
48"W RTA — Shelf	POHRTA48S	\$ 501	\$ 528	\$ 551

<p>How to specify — Select the Model Number from above.</p>	<p>1st Option: Receding Door Pull (if applicable): A Arch Pull, add \$43 per pull S Square Pull, add \$43 per pull</p>	<p>2nd Option: System for Receding Door Overhead (if applicable): YZ Stride, Terrace, or Concensys Z57 57½"H Stride or Terrace</p>	<p>3rd Option: Paint: P1 P2 P3 <i>P3 available for Open Shelf and RTA Shelf only. See page 136 for finishes.</i></p>	<p>4th Option: Receding Door Pull Color (if applicable): Arch: E4 Black EL Silver Square: EL Silver</p>	<p>5th Option: Receding Door Lock (if applicable): STD Standard OMT Omit Lock Core (Deduct \$20 per lock)</p>																																																						
<table style="width: 100%; border-collapse: collapse;"> <tr> <td style="border: 1px solid black; width: 20px; height: 15px;"></td> <td style="border: 1px solid black; width: 20px; height: 15px;"></td> <td style="border: 1px solid black; width: 20px; height: 15px;"></td> <td style="border: 1px solid black; width: 20px; height: 15px;"></td> <td style="border: 1px solid black; width: 20px; height: 15px;"></td> <td style="border: 1px solid black; width: 20px; height: 15px;"></td> <td style="border: 1px solid black; width: 20px; height: 15px;"></td> <td style="border: 1px solid black; width: 20px; height: 15px;"></td> <td style="border: 1px solid black; width: 20px; height: 15px;"></td> <td style="border: 1px solid black; width: 20px; height: 15px;"></td> <td style="border: 1px solid black; width: 20px; height: 15px;"></td> </tr> </table>												<table style="width: 100%; border-collapse: collapse;"> <tr> <td style="border: 1px solid black; width: 20px; height: 15px;"></td> <td style="border: 1px solid black; width: 20px; height: 15px;"></td> <td style="border: 1px solid black; width: 20px; height: 15px;"></td> <td style="border: 1px solid black; width: 20px; height: 15px;"></td> <td style="border: 1px solid black; width: 20px; height: 15px;"></td> <td style="border: 1px solid black; width: 20px; height: 15px;"></td> <td style="border: 1px solid black; width: 20px; height: 15px;"></td> <td style="border: 1px solid black; width: 20px; height: 15px;"></td> <td style="border: 1px solid black; width: 20px; height: 15px;"></td> <td style="border: 1px solid black; width: 20px; height: 15px;"></td> <td style="border: 1px solid black; width: 20px; height: 15px;"></td> </tr> </table>												<table style="width: 100%; border-collapse: collapse;"> <tr> <td style="border: 1px solid black; width: 20px; height: 15px;"></td> <td style="border: 1px solid black; width: 20px; height: 15px;"></td> <td style="border: 1px solid black; width: 20px; height: 15px;"></td> <td style="border: 1px solid black; width: 20px; height: 15px;"></td> <td style="border: 1px solid black; width: 20px; height: 15px;"></td> <td style="border: 1px solid black; width: 20px; height: 15px;"></td> <td style="border: 1px solid black; width: 20px; height: 15px;"></td> <td style="border: 1px solid black; width: 20px; height: 15px;"></td> <td style="border: 1px solid black; width: 20px; height: 15px;"></td> <td style="border: 1px solid black; width: 20px; height: 15px;"></td> <td style="border: 1px solid black; width: 20px; height: 15px;"></td> </tr> </table>												<table style="width: 100%; border-collapse: collapse;"> <tr> <td style="border: 1px solid black; width: 20px; height: 15px;"></td> <td style="border: 1px solid black; width: 20px; height: 15px;"></td> <td style="border: 1px solid black; width: 20px; height: 15px;"></td> <td style="border: 1px solid black; width: 20px; height: 15px;"></td> <td style="border: 1px solid black; width: 20px; height: 15px;"></td> <td style="border: 1px solid black; width: 20px; height: 15px;"></td> <td style="border: 1px solid black; width: 20px; height: 15px;"></td> <td style="border: 1px solid black; width: 20px; height: 15px;"></td> <td style="border: 1px solid black; width: 20px; height: 15px;"></td> <td style="border: 1px solid black; width: 20px; height: 15px;"></td> <td style="border: 1px solid black; width: 20px; height: 15px;"></td> </tr> </table>												<table style="width: 100%; border-collapse: collapse;"> <tr> <td style="border: 1px solid black; width: 20px; height: 15px;"></td> <td style="border: 1px solid black; width: 20px; height: 15px;"></td> <td style="border: 1px solid black; width: 20px; height: 15px;"></td> <td style="border: 1px solid black; width: 20px; height: 15px;"></td> <td style="border: 1px solid black; width: 20px; height: 15px;"></td> <td style="border: 1px solid black; width: 20px; height: 15px;"></td> <td style="border: 1px solid black; width: 20px; height: 15px;"></td> <td style="border: 1px solid black; width: 20px; height: 15px;"></td> <td style="border: 1px solid black; width: 20px; height: 15px;"></td> <td style="border: 1px solid black; width: 20px; height: 15px;"></td> <td style="border: 1px solid black; width: 20px; height: 15px;"></td> </tr> </table>											

Examples: OH1560RD.YZ.P7C.STD OH1536RDA.YZ.P27.E4.OMT

S Shippable by small-package carrier.

Notes

For complete specification and pricing information see the Storage Price List.

GSA Reference Page

Align Metal Pedestals — support or mobile



File/File
28½"H x 15"W
18", 23¼", 29¼"D



Box/Box/File
28½"H x 15"W
18", 23¼", 29¼"D



File/File
26½"H x 15"W
18", 23¼", 29¼"D



Box/Box/File
26½"H x 15"W
18", 23¼", 29¼"D



Box/File
20½"H Mobile,
22"H Freestanding
18", 23¼", 29¼"D x 15"W

Plinth base shown, models available with Stride or Terrace feet. Choice of metal or laminate fronts.

Align Low Metal Storage — credenzas, right and left configurations available

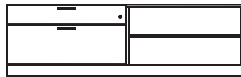

Box/Lateral/Open
72"W
22"H x 18", 24"D

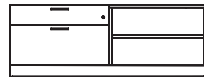

Box/Lateral/Open
60"W
22"H x 18", 24"D



Box/Lateral/Open
48"W
22"H x 18", 24"D



Box/Lateral/Open
42"W
22"H x 18", 24"D



Box/Lateral
24", 30", 36", 42"W
22"H x 18", 24"D

Plinth base shown, models available with Stride or Terrace feet. Choice of metal or laminate fronts.

Align Metal Lateral and Personal Files



2-High
28"H
30", 36", 42"W
18"D



2-High
28"H
30"W
18"D



2-High
28"H
24", 30", 36"W
18"D



Open
24", 30", 36", 42"W
22"H x 18", 24"D

Plinth base shown, models available with Stride or Terrace feet. Choice of metal or laminate fronts.

Align Metal Personal Towers — Stride®/Terrace®/Optimize™ Height — left configuration shown, also available right

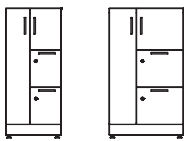

42½"H
18", 24"W
24"D

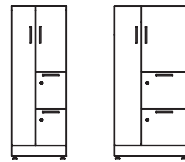

50"H
18", 24"W
24"D

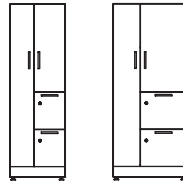

57½"H
18", 24"W
24"D



65"H
18", 24"W
24"D

Plinth base shown, models available with Stride or Terrace feet. Choice of metal or laminate fronts.

Align Lockers — Overview — Left configurations shown, also available right

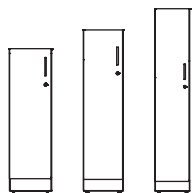

Single 12"W
42½", 50", 65"H / 18", 24"D

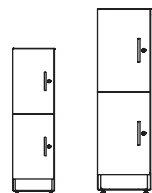

Double 12"W
42½", 65"H / 18"D

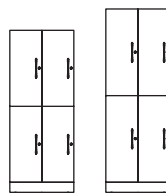

Quad 24"W
42½", 65"H / 18"D

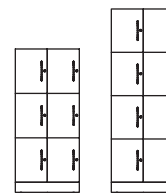

Cubby 24"W
50", 65"H / 18"D

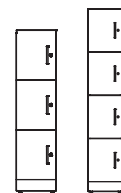

Cubby 12"W
50", 65"H / 18"D

Plinth base shown, models available with Stride or Terrace feet. Choice of metal or laminate fronts.

Approach Pre-configured Desks & Tables — height-adjustable 27¼"-47¾"H, fixed height 29½"H, left and right configurations

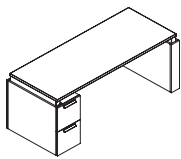

Height-Adjustable w/Storage
72", 66"W x 36", 30"D

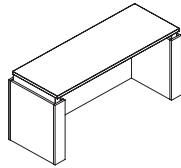

Height-Adjustable w/ and w/o Modesty
72"-48"W x 36", 30"D

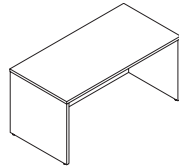

Shell Desk
60, 66, 72"W x 30"D

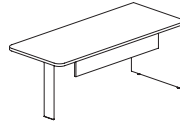

Racetrack Top w/Column, End Panel, and Modesty
72", 66"W x 30"D

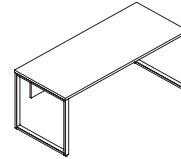
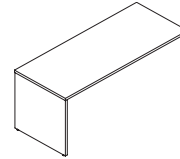
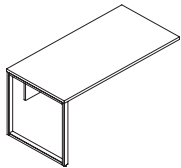

Table Desk with "O" Legs
72", 66"W x 30"D



With End Panel
84"-48"W x 30"D



With "O" leg
84"-48"W x 30"D

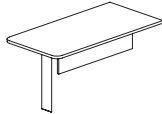

Racetrack Top w/Column
60", 54", 48"W x 30"D

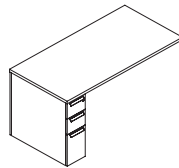

With Pedestal
72"-48"W x 30"D

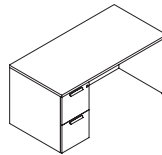

Single 15"W Ped Desk
60, 66, 72"W x 30"D

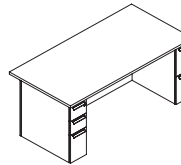

Double Ped Desk
72"W x 36"D

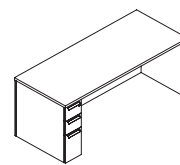

Single Slim Ped Desk
72", 66", 60"W x 36", 30"D

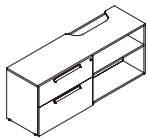

Credenza for Integrated HAT
60, 72"W
18, 24"D

Approach Credenzas — 28"H (shown) x 18"D or 24"D, 24"H x 18"D; most available to-the-floor base or feet with or without troughs.

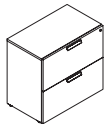

Multi File
30"W

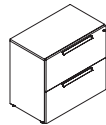

Lateral File
Only 28"H x 36", 30"W

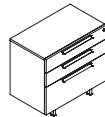

Box/Box/File 28"H
Box/File 24"H
36", 30"W

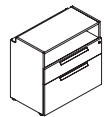

Open/Box/File
Only 28"H x 36", 30"W

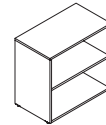

Open and Adjustable Shelf
36", 30"W

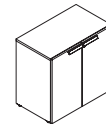

Hinged Doors and Adjustable Shelf
36", 30"W

Approach 28"H Double Credenzas — 18" or 24"D, left and right configurations, available to-the-floor base or feet with or without troughs.

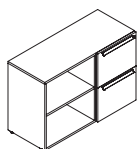

Open/Box/File
42"-48"W
18", 24"D

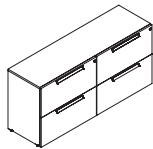

Lateral File/Lateral File
72", 60"W

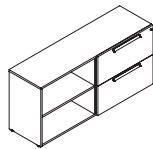

Lateral File/Open Shelf
72", 60"W

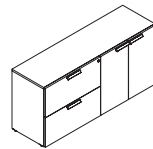

Lateral File/Hinged Doors
72", 60"W

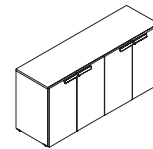

Four Hinged Doors
72", 60"W

Approach 24"H Double Credenzas — 24"H x 18"D; left and right configurations, most available to-the-floor base or feet with or without troughs.

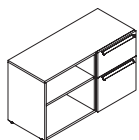

Open/Box/File
42"-48"W
18", 24"D

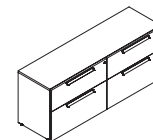

Box File/Box File
To-the-floor 72", 60"W

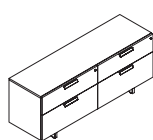

Box File/Box File
With Feet 72", 60"W

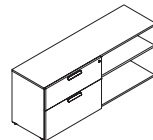

Box File/Open Shelf
72", 60"W

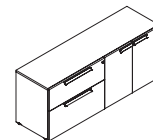

Box File/Hinged Doors
72", 60"W

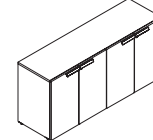

Hinged Doors/Hinged Doors
72", 60"W

Approach Pedestals — Mobile models have recessed casters



Mobile Box/File
21½"H x 16"W x 20"D

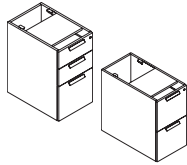

Support Pedestal
w/o Trough
28"H x 15"W
24, 30"D



Support Box/File
24"H x 18"W x 18"D

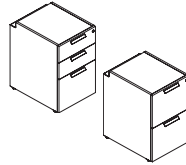

Support Box/Box/File and
File/File w/Troughs
28"H x 18"W x 18", 24"D

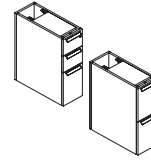

Support Slim Box/Box/File
and File/File w/Back Panel
28"H x 9½"W x 24", 30"D

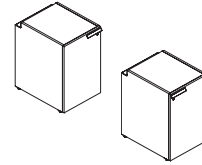

Support Left- and Right-Hand
Hinged Door w/Troughs
28"H x 18"W x 18", 24"D

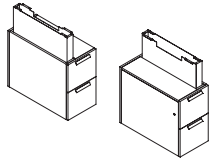

Height-Adjustable Slim
Ped & Shroud Kit
14½"W x 30"D

Approach False Peds, Wall Access Panels, Bridges, and Back Panels

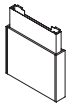

Height-Adjustable Shroud Kit
5¼"W x 30"D
27¼"-47¼"H

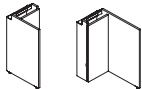

False Ped Left/Right
28"H x 12"W x
14, 18", 24"D



Wall Access Panel
28"H x 18", 24", 30", 36",
42", 48"W

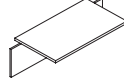

Bridge w/14"H Modesty
42", 48"W x 24"D



Back Panels 28", 24", 20"H
18", 30", 36", 60" 72"W

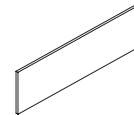

Modesty Panels
14"H x 30"-72"W

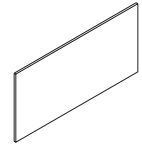

Full Height Modesty
42"-72"W

Approach Tops, Worksurfaces, and Supports — End Panels left- and right-handed



Cushion Tops for Mobile Ped
& Credenzas
16" x 20" / 30", 36" x 18"

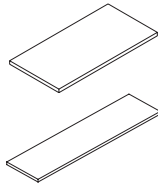

True and Shortened Depth
Laminate Tops
18"D, 24"D x 18"W-96"W

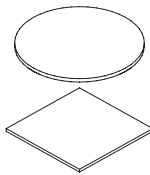

Round & Square Table Tops
36" / 42" / 48"

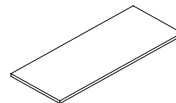

Laminate Worksurfaces
24"D, 30"D x 30"W-96"W
36"D x 72"W-84"W

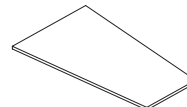

Double Sight line Wksfc.
36"-24"D x 60"-72"W
42"-30"D x 60"-72"W

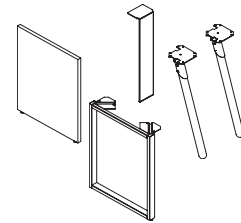

End Panels, O-Legs, Column &
Splay Leg Supports 28"H
14", 24", 30", 36"D

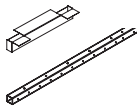

Stanchions & Support
Channel
3"H, 4"H x 12"D, 18"D
& 30"W-72"W

Approach Lateral Files, Bookcases, and Cubby — Laterals are 30" or 36"W x 18½"D, Bookcases are 30"W x 14¼"D, Cubby 7"H x 14"D

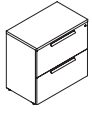

2-Drawer Lateral
29½"H



3-Drawer Lateral
42¼"H

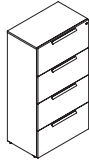

4-Drawer Lateral
56¼"H

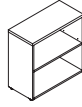

2-High Bookcase
29½"H

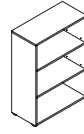

3-High Bookcase
42¼"H



4-High Bookcase
56¼"H



5-High Bookcase
71¼"H



Cubby Storage
18", 24", 30"W



8"D Floating Shelf
30"-78"

APPROACH

Approach Towers & Stack-On Storage — Towers 18"D, 24"D; Storage w/doors & Side Access 15"D, Open units 14½"D

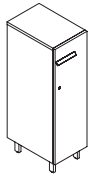

Wardrobe
42"-72"H
12", 18", 24"W
18", 24"D

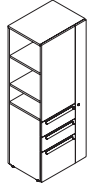

Side Access
42"-72"H
18", 24"W
18", 24"D

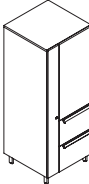

Combination
42"-72"H
18", 24"W
18", 24"D

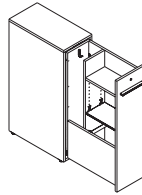

Pull Out Towers
42", 50"H
24", 30"D

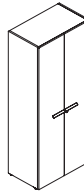

Tower w/Hinged Doors
30"W x 57½", 72"H

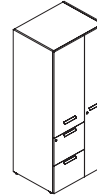

Combo Tower File/File
L- and R-Handed
30"W x 72"H

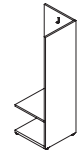

Open Access
L- and R-Handed
18"W x 57½", 72"H

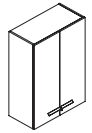

Stack-On w/Doors
18", 30", 36"W
x 29½, 42½"H

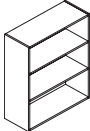

Stack-On Open
18", 30", 36"W
x 29½, 42½"H

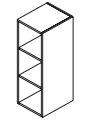

Stack-On Side Access
18"W
x 29½, 42½"H

Approach Overhead Storage — 15½"H x 15½"D with doors, open units 15½"D

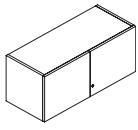

Hinged Doors
30"–78"W

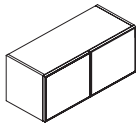

Writable Doors
30", 36", 60", 72"W

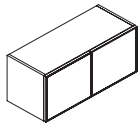

Frosted Glass Doors
30"–78"W

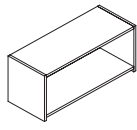

Open
30", 36"W

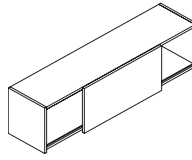

Sliding Door
48"–78"W



Overhead Mounting Kit
for Beyond Walls

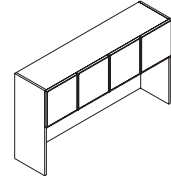

35"H Hutch
Lam. or Frosty Doors
48"–72"W

Approach Tackboards, Writable Boards, and Accessories — Tackboards and Writable Boards 30", 34", 45", 49"H

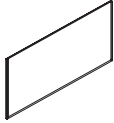

Tackboards for Hutchess
48"W–72"W

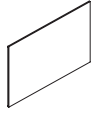

Tackboards
30"W–96"W

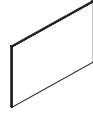

Writable Boards
30"W–96"W

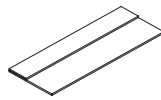

Counterweights
25, 35, 50, 60 lbs.

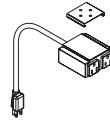

Mini Tap Power
6' Cord



End Cap

Altitude® Height-Adjustable Tops, Bases, and Accessories for Approach

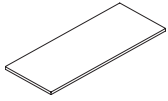

Altitude Tops
24", 30", 36"D x
48"-72"W

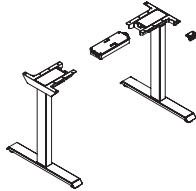

A6 T-leg Base 2-stage
22½"H-48½"H for
24"-30"D x 48"-84"W Tops

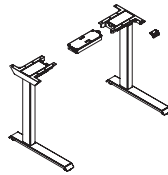

A6 C-leg Base 2-stage
27½"H-47½"H for
24"-30"D x 48"-72"W Tops

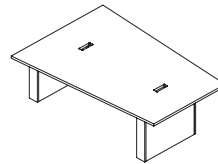

Collaborative
Height-Adjustable Tables
60"-48"D, 54-42"D, 42"-30"D

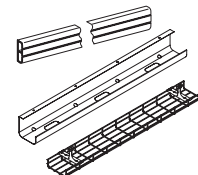

Cable Management
Channel, Tray, and Trough

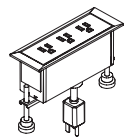

Power Modules
Power & USB

Extensions for Approach

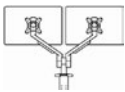

Monitor Arms
21"

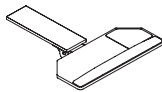

Articulating Keyboard
25"W x 10½"D



CPU Hammock
CPU 3-6"W x 16-23"H

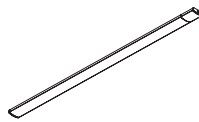

Under Cabinet LED Lights
17" & 31"

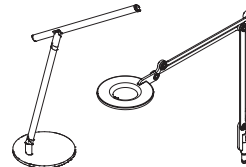

Link™ and Wand™ LED Lights
Base or Clamp

Leg or Plinth Base models available. Leg base units are shown below.

Pedestals — 24"H and 28"H



Mobile
Box/File



Freestanding
Box/File



Freestanding
Open



Support
Box/Box/File



Support
File/File



Support
Open

Credenzas — 17½"H, left- and right-handed models available for handed units.



Single Lateral



Single Lateral
w/Open Cubby



Corner Table

Credenzas — 24"H, left- and right-handed models available for handed units.



Box/Lateral



Box/Box
Lateral

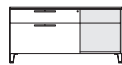

Box/Lateral
w/Open Cubby



Sliding Door
Open



Open

Credenzas — 28"H, left- and right-handed models available for handed units.



2-High
Lateral



Box/Box
Lateral



Box/Box
Project/Lateral



Sliding Door
Open w/Cubbies



Open

Credenzas and Bookcase — 42"H



3-High
Lateral

Bookcases — 65"H and 72½"H



Bookcase
w/Lateral

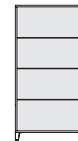

Bookcase



Bookcase
w/Lateral

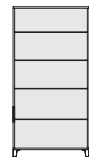

Bookcase

Towers — 42"H (12"W only), 50"H and 57½"H (50"H shown); left- and right-handed models available.

12"W



Full-Width Door

18"W



Hinged Door
Box/Box/File

18"W



Side Access
File/File

24"W



Hinged Door
Box/Box/File

24"W

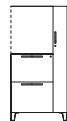

Side Access
File/File

Towers — 65"H and 72½"H (65"H shown); left- and right-handed models available.

12"W



Full-Width Door
(65"H)

18"W



Hinged Door
Box/Box/File

18"W



Hinged Door
File/File

18"W



Full-Width
Door

24"W



Hinged Door
Box/Box/File

24"W

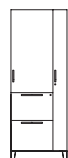

Hinged Door
File/File

24"W



Full-Width Door

Leg or Plinth Base models available. Leg base units are shown below.

Stacking Storage — Hinged Door, left- and right-handed models available

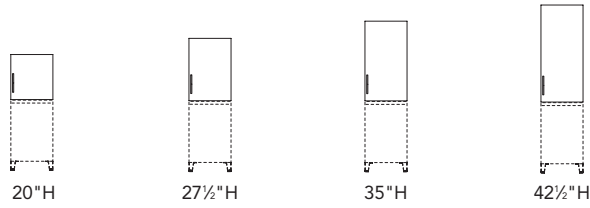

Stacking Storage — Open

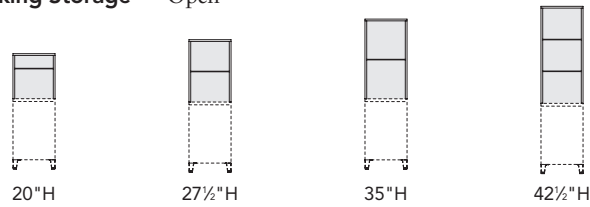

Overheads and Shelves

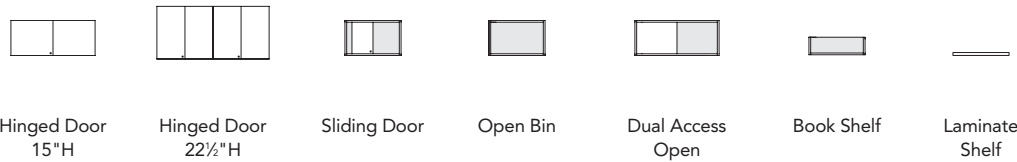

Soft Seating and Tables

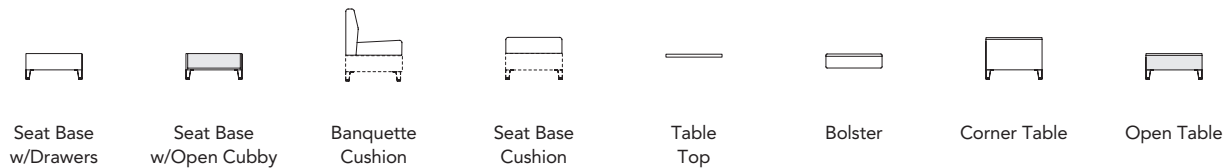

Worksurfaces — Shapes below added for Involve to the hundreds available in our existing Worksurface selection.

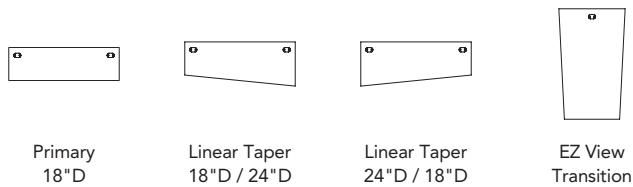

Supports and Accessories

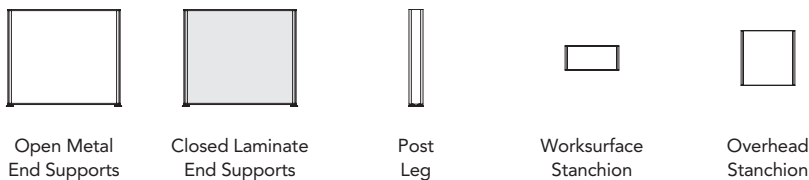

Modesty Panels and Screens

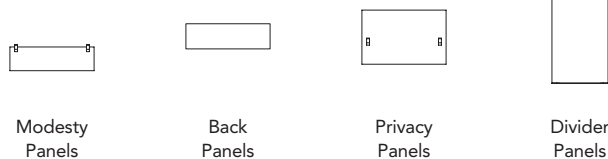

Accessories

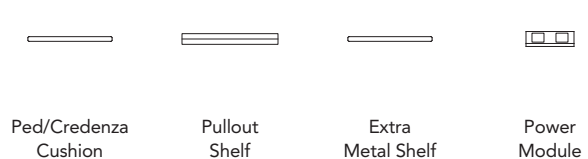

INVOLVE

Notes

INVOLVE

Gallery Panels

Finishes	284
Panel Fabrics	285
Laminate and Paint Matching.....	286
Gallery Panels	287
Basic Characteristics.....	288
Dimensions	289
Working with Integrated Glass.....	290-291
Stride and Terrace - End Panel (Dual-Sided).....	292
Stride and Terrace - End Panel (Single-Sided)	293
Stride and Terrace - Mid Panel	294
Gallery-to-Gallery Panels	295
Freestanding Screens	296-297
Storage and Worksurface Connectors	298
Accessories - Tackboards.....	299
Working with Accessories	300-301
Gallery Panels HAT Brackets	302
Panel Systems HAT Brackets.....	303
Gallery-to-Gallery Panels: 30"H Application.....	304
Gallery-to-Gallery Panels: 35"H Application.....	305
Gallery-to-Gallery Panels: 42"H Application.....	306
Gallery-to-Gallery Panels: 50"H Application.....	307
Gallery-to-Gallery Panels: 57½"H Application	308
Gallery-to-Gallery Panels: 30"H Application for use with Glass.....	309
Gallery-to-Gallery Panels: 35"H Application for use with Glass	310
Gallery-to-Gallery Panels: 42"H Application for use with Glass	311
Gallery-to-Gallery Panels: 50"H Application for use with Glass	312
Gallery-to-Gallery Panels: 57½"H Application for use with Glass.....	313
30"H Application	314
35"H Application	315
42"H Application	316
50"H Application	317
57½"H Application	318
30"H Application for Use with Glass	319
35"H Application for Use with Glass	320
42"H Application for Use with Glass	321
50"H Application for Use with Glass	322
57½"H Application for Use with Glass	323
Connector Kits	324
Terrace Connector Kits	325
Panel Systems Gallery Glass.....	326-328
Accessories	329-331

PAINT FINISHES

GRADE P1

Black.....	P71
Brownstone.....	P7D
Bungalow.....	P7C
Charblack.....	CBK
Cinder.....	P7Q
Designer White.....	PJW
Flint.....	P02
Fossil.....	P28
Loft.....	P7B
Muslin.....	P4J
Parchment.....	P93
Pebble.....	P8R
Pewter.....	P8D
Salt.....	P8C
Textured Brownstone.....	P7J
Textured Designer White.....	PK7
Textured Flint.....	P7A
Textured Loft.....	P7L
Textured Muslin.....	P7M
Textured Pebble.....	P8Y
Textured Salt.....	P8Z
Textured Titanium.....	P8V
Titanium.....	P8T

GRADE P2

Champagne Metallic.....	PR5
Gunmetal Metallic.....	PR3
Matte Gold.....	P8G
Night Bronze.....	P8B
Platinum Metallic.....	PR2
Pyrite.....	PJE
Silver.....	PR6
Silver Texture.....	PR8
Solar Black.....	P8X

Metallic paints, due to varying reflectance, may appear to have less visual color consistency than other paint finishes, even when L/A/B values are exactly the same. (L/A/B — measurable aspects of color — values are maintained within a specified range, to ensure consistent appearance of paint colors.)

GRADE P3

Atom.....	P8S
Blossom***.....	P8K
Bullseye.....	PJF
Ember.....	P8P
Ion.....	P8N
Iris.....	P8J
Krypton.....	P8F
Ochre.....	P093
Regatta.....	P8M
Sienna.....	P092
Succulent***.....	P8A

***These colors are intended to be an inspirational option for the trending market. Product application is limited and color availability is approximately two years to coincide with evolving workplace trends.

LAMINATES

GRADE L1

SOLID COLOR	
Black.....	P
Brownstone.....	LM13
Bungalow.....	LM12
Designer White.....	LDW1
Flint.....	LM16
Fossil Shale.....	LEH1
Loft.....	LM11
Muslin.....	LM15
Titanium.....	LTI1
ABSTRACT	
Handspun Pearl.....	LAHP
Handspun Dove.....	LAHD
Handspun Slate.....	LAHS
Handspun Chestnut.....	LAHC

WOODGRAIN

Belair.....	LWBA
Bourbon Cherry.....	H
Field Elm.....	LWFE
Florence Walnut.....	LFW1
Kingswood Walnut.....	LKI1
Natural Maple.....	LWD
NeoWalnut.....	LNU1
Pinnacle.....	PINC
Shaker Cherry.....	LW7C

GRADE L2

Beigewood.....	LWBE
Fawn Cypress.....	LFC1
Lowell Ash.....	LLA1
Mangalore Mango.....	LMM1
Natural Recon.....	LNR1
Phantom Charcoal.....	LPC1
Phantom Ecru.....	LPE1
Portico Teak.....	LPT1
Skyline Walnut.....	LSW1
Veranda Teak.....	LVT1

GRADE L3

Natural Walnut.....	LWNW
---------------------	------

LAMINATE EDGE COLORS

Beigewood.....	DE
Belair.....	BA
Black.....	E4
Bourbon Cherry.....	H
Brownstone.....	EY
Bungalow.....	EX
Designer White.....	DW
Fawn Cypress.....	FC
Field Elm.....	FE
Flint.....	E9
Florence Walnut.....	FW
Fossil.....	EH
Kingswood Walnut.....	KI
Loft.....	EV
Lowell Ash.....	DL
Mangalore Mango.....	MM
Muslin.....	EU
Natural Maple.....	DD
Natural Recon.....	NR
Natural Walnut.....	DN
NeoWalnut.....	NU
Parchment.....	EN
Phantom Charcoal.....	PC
Phantom Ecru.....	PE
Pinnacle.....	PI
Plyband.....	PL
Portico Teak.....	DP
Shaker Cherry.....	DF
Skyline Walnut.....	SW
Titanium.....	TI
Veranda Teak.....	VT

Forest Stewardship Council (FSC) is a non-profit organization devoted to encouraging the responsible management of the world's forests. FSC sets high standards that ensure forestry is practiced in an environmentally responsible, socially beneficial, and economically viable way. Allsteel received its FSC Chain of Custody certification in 2010 and can offer FSC Certified products. Select wood-based products can be ordered as FSC certified, either by choosing the FSC option or selecting an FSC laminate or veneer finish at the time of order. For more information, please contact Customer Support at 888-255-7833. (FSC Trademark license code: FSC-CO14704.)

NOTE: Refer to individual product pages for upcharges.

GRADE A

APPOINT PANEL
100% Polyester

Artichoke.....	APN911
Blackberry.....	APN932
Bronze.....	APN922
Carbon.....	APN928
Chai.....	APN912
Cherry.....	APN930
Dark Pewter.....	APN917
Dune.....	APN915
Espresso.....	APN923
Framboise.....	APN931
Frost.....	APN934
Jet.....	APN927
Lawn.....	APN925
Mandarin.....	APN929
Morel.....	APN909
Nimbus.....	APN916
Platinum.....	APN924
Turquoise.....	APN926

BINARY †

Blush.....	BNRY12
Coal.....	BNRY06
Cream.....	BNRY01
Denim.....	BNRY08
Diamond.....	BNRY03
Graphite.....	BNRY05
Juniper.....	BNRY10
Lagoon.....	BNRY07
Lavendar.....	BNRY11
Mineral.....	BNRY04
Reef.....	BNRY09
Sand Dollar.....	BNRY02

CENTURION^w
(Nanotex™ Stain-Resistant finish)

Apricot.....	CU47
Bark.....	CU25
Black.....	CU10
Espresso.....	CU49
Fog.....	CU03
Frost.....	CU22
Goldenrod.....	CU27
Indigo.....	CU06
Iris.....	CU50
Iron Ore.....	CU19
Jade.....	CU83
Marsala.....	CU63
Morel.....	CU24
Navy.....	CU98
Peacock.....	CU97
Pear.....	CU84
Ruby.....	CU67
Sapphire.....	CU09

CIRCUIT † ♣

Atlas.....	CIRC35
Dolphin.....	CIRC63
Island White.....	CIRC14
Moon.....	CIRC07
Night.....	CIRC49
Pacific.....	CIRC28
Quartz.....	CIRC01
Sienna.....	CIRC56
Silk.....	CIRC21
Snap Pea.....	CIRC42

ETCH
100% Polyester

Axis.....	ECH913
Blend.....	ECH914
Cast.....	ECH912
Highlight.....	ECH910
Midtone.....	ECH911
Outline.....	ECH908
Shade.....	ECH909
Tonal.....	ECH916
Vanish.....	ECH915

GRADE A – continued

EXCHANGE
100% Polyester

Iron.....	EXG916
Nickel.....	EXG914
Pistachio.....	EXG910
Root.....	EXG913
Rupee.....	EXG903
Shadow.....	EXG911
Silver.....	EXG915
Sisal.....	EXG917
Stone.....	EXG912

LANDSCAPE
100% Polyester

Cornsilk.....	LN15
Drift.....	LN05
Khaki.....	LN20
Sheen.....	LN10
Slate.....	LN35
Umber.....	LN25
Urban.....	LN30

LUCY
100% Recycled Polyester

Aspen.....	LC932
Cornsilk.....	LC930
Dusk.....	LC922
Fawn.....	LC933
Graphite.....	LC934
Mist.....	LC920
Neutra.....	LC924
Pewter.....	LC935
Snowdrop.....	LC928

NOBLE

Aegean.....	NBLE18
Amethyst.....	NBLE19
Aspen.....	NBLE14
Aster.....	NBLE20
Blossom.....	NBLE21
Bluebell.....	NBLE22
Bordeaux.....	NBLE01
Brick.....	NBLE02
Chambray.....	NBLE10
Chamomile.....	NBLE23
Clementine.....	NBLE04
Conifer.....	NBLE24
Cottage.....	NBLE25
Darkness.....	NBLE26
Dawn.....	NBLE13
Denim.....	NBLE09
Desert Sand.....	NBLE27
Dewfall.....	NBLE28
Dusted Sage.....	NBLE29
Flax.....	NBLE30
Grass.....	NBLE07
Gunmetal.....	NBLE15
Harmony.....	NBLE31
Harvest.....	NBLE12
Ice Caves.....	NBLE32
Icicle.....	NBLE33
Inky.....	NBLE34
Iris.....	NBLE35
Jade.....	NBLE06
Knight.....	NBLE17
Mesa.....	NBLE03
Monarch.....	NBLE36
Pacific.....	NBLE08
Pitch.....	NBLE37
Queen Bee.....	NBLE38
Rainforest.....	NBLE05
Regal.....	NBLE11
Sandcastle.....	NBLE39
Sedona.....	NBLE40
Stormy.....	NBLE16
Sunbeam.....	NBLE41
Voyager.....	NBLE42
Windy Day.....	NBLE43

GRADE A – continued

REFLECTIONS
100% Recycled Polyester

Galvanized.....	REF929
Ice.....	REF920
Loggia.....	REF921
Mistral.....	REF928
Moonstone.....	REF923
Pewter.....	REF922
Stainless.....	REF924
Vanilla.....	REF925
Winter.....	REF927

REFUGE
64% Recycled Polyester
36% Polyester

Artesian.....	RFG996
Dune.....	RFG992
Eclipse.....	RFG990
Frost †.....	RFG993
Glacier †.....	RFG991
Mineral.....	RFG998
Tidal.....	RFG994

SARTO ▼
100% Polyester (45% Recycled)

Ash.....	SRT988
Fog.....	SRT914
Lemongrass.....	SRT949
Mist.....	SRT945
Mushroom.....	SRT976
Oyster.....	SRT918
Reef.....	SRT964
Sesame.....	SRT993
Shale.....	SRT952

TEMPEST
100% Recycled Polyester

Dragonfly.....	TP930
Frost.....	TP915
Full Stream.....	TP980
Gold Rush.....	TP910
Slate.....	TP945
Tumbleweed.....	TP970
Wind Chill.....	TP940
Zebra.....	TP935

VAST

Vineyard.....	VST01
Garden.....	VST02
Grasslands.....	VST03
Bay.....	VST04
Open Air.....	VST05
Atmosphere.....	VST06
Ocean.....	VST07
Mountain Range.....	VST08
Highway.....	VST09
Tundra.....	VST10
Beach.....	VST11
Desert.....	VST12
Country Side.....	VST13

GRADE B

COAST † ♣
100% Antimony-Free Polyester

Channel.....	COA914
Dune.....	COA903
Headlands.....	COA910
Marsh.....	COA902
Pebble.....	COA912
Pier.....	COA913
Shoal.....	COA901
Silt.....	COA906
Tide.....	COA908

GRADE B – continued

DISPERSE †
100% Polyester

Autumn.....	DISP03
Branch.....	DISP10
Coffee Bean.....	DISP13
Dusk.....	DISP09
Emerald City.....	DISP08
Gold Rush.....	DISP02
Igloo.....	DISP11
Ink.....	DISP06
Mist.....	DISP12
Oatmeal.....	DISP15
Prince.....	DISP07
Reservoir.....	DISP01
Rose.....	DISP04
Spring.....	DISP05
Steel.....	DISP16
Taupe.....	DISP14

MICA (De-emphasized)
100% Recycled Polyester

Anthracite.....	MCA911
Breeze.....	MCA918
Bronze.....	MCA913
Buff.....	MCA914
Cremini.....	MCA917
Crystal †.....	MCA917
Dew.....	MCA920
Dove.....	MCA912
Fresh.....	MCA916
Mineral.....	MCA915
Nectar.....	MCA919
Shale.....	MCA910

SPIN PANEL
46% Recycled Polyester
56% Polyester

Alabaster.....	SPIN02
Cavern.....	SPIN03
Cobblestone.....	SPIN04
Ember.....	SPIN06
Flame.....	SPIN07
Heron.....	SPIN13
Oat.....	SPIN01
Ocean.....	SPIN12
Plum.....	SPIN15
Pool.....	SPIN11
Raven.....	SPIN10
Rhubarb.....	SPIN14
Tropic.....	SPIN08
Willow.....	SPIN05

TERRAIN
52% Recycled Polyester
48% Polyester

Bay.....	TRRN05
Bayou.....	TRRN35
Canyon.....	TRRN30
Cliff.....	TRRN45
Crest.....	TRRN25
Delta.....	TRRN10
Plateau.....	TRRN15
Ridge.....	TRRN20
Valley.....	TRRN40

ALLSTEEL PARTNERSHIP PROGRAM

Allsteel understands that customers may want to specify panel and seating textiles outside of Allsteel's standard offering. Allsteel's **Partnership Program** consists of on-trend and design-forward patterns that have been tested and approved by Allsteel for use on Allsteel products. A subset of these approved patterns is available on cards in the textile binder, while numerous others are available on our website, allsteeloffice.com.

For memo samples, please contact our partners:

- Camira, memos@camirafabrics.com
1.616.288.0655
- CF Stinson, cfstinson.com
1.800.841.6279
- HBF Textiles, hbftextiles.com
1.877.494.5727
- Maharam, maharam.com
1.800.645.3943
- Ultrafabrics, ultrafabricsllc.com

The intent of the **Partnership Program** is to offer a wide variety of on-trend textiles to meet your varied needs, but since these textiles are not part of our standard offering they may be subject to extended lead times. Because new materials will be introduced regularly, Allsteel reserves the right to change the offering at any time.

PARTNERSHIP – GRADE D

Camira BLAZER LITE † ▼
(100% Pure New Wool)

Angel.....	PCAMBLT49
Aspire.....	PCAMBLT52
Balance.....	PCAMBLT41
Bliss.....	PCAMBLT48
Buddha.....	PCAMBLT56
Cuddle.....	PCAMBLT62
Dainty.....	PCAMBLT64
Daydream.....	PCAMBLT46
Devoted.....	PCAMBLT58
Faith.....	PCAMBLT68
Freedom.....	PCAMBLT69
Graceful.....	PCAMBLT51
Happy.....	PCAMBLT55
Harmony.....	PCAMBLT63
Haven.....	PCAMBLT40
Hope.....	PCAMBLT50
Hush.....	PCAMBLT42
Love.....	PCAMBLT47
Mood.....	PCAMBLT44
Pamper.....	PCAMBLT66
Pastel.....	PCAMBLT65
Pillow.....	PCAMBLT43
Praise.....	PCAMBLT54
Retreat.....	PCAMBLT39
Shelter.....	PCAMBLT60
Solace.....	PCAMBLT70
Tender.....	PCAMBLT53
True.....	PCAMBLT61
Verity.....	PCAMBLT57
Wish.....	PCAMBLT67
Worship.....	PCAMBLT59

^w Limited to product 48" W or less.
 ▼ Panel fabric is not available on Further.
 ♣ Panel fabric is not available on Optimize®.
 † Panel fabric is not available on Concensys®.
 ♦ Panel fabric is not available on Involve.

Multi-use fabrics are seating fabrics that can be used on specific Allsteel panels systems, providing more color and pattern options. The applicable Allsteel multi-use fabrics are noted with System designators in the Seating, Collaboration, and Tables Price List.

Paint Recommendations for Gallery-to-Gallery Cover

Laminate	Code	Recommended Paint
Brownstone	LM13	Brownstone
Bungalow	LM12	Bungalow
Designer White 15051	LDW1	Designer White
Flint	LM16	Flint
Fossil Shale	LEH1	Fossil
Loft	LM11	Loft
Muslin	LM15	Muslin
Titanium	LT11	Titanium
Florence Walnut	LFW1	Cinder, Brownstone, Flint
Kingswood Walnut	LKI1	Fossil, Flint, Loft
Natural Maple	LWD	Muslin
NeoWalnut	LNU1	Cinder
Shaker Cherry	LW7C	Black, Cinder
Beigewood	LWBE	Muslin, Loft, Fossil
Fawn Cypress	LFC1	Cinder, Brownstone, Flint
Lowell Ash	LLA1	Cinder
Mangalore Mango	LMM1	Cinder
Natural Recon	LNR1	Cinder, Brownstone
Phantom Charcoal	LPC1	Flint, Salt, Cinder
Phantom Ecrú	LPE1	Flint, Brownstone, Muslin
Portico Teak	LPT1	Fossil, Brownstone, Pewter
Skyline Walnut	LSW1	Cinder, Flint, Fossil
Veranda Teak	LVT1	Fossil, Brownstone, Pewter
Natural Walnut	LWNW	Cinder

Gallery Panels are ideal for bringing natural wood elements to workstations and providing privacy. Allsteel Gallery Panels are designed to work universally across 4 product platforms. Please follow the product guidelines for proper specification.

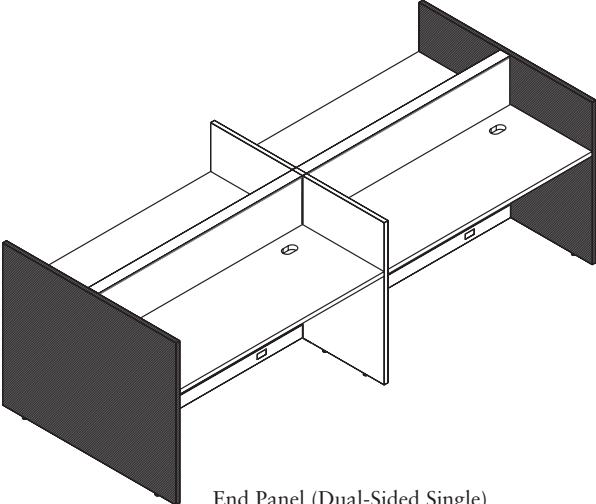

End Panel (Dual-Sided Single)

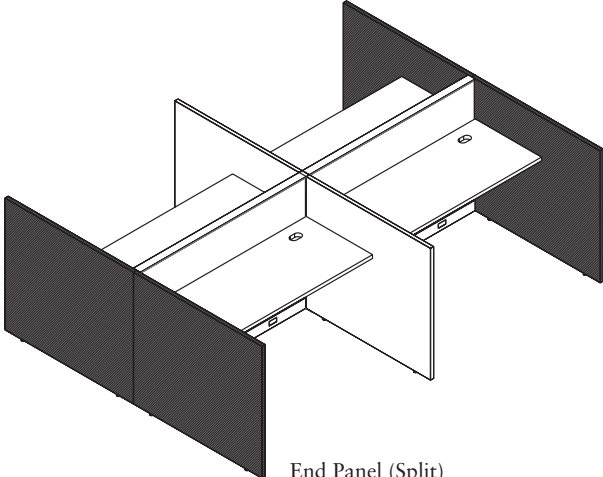

End Panel (Split)

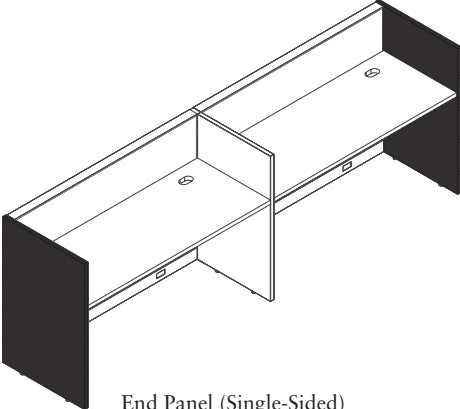

End Panel (Single-Sided)

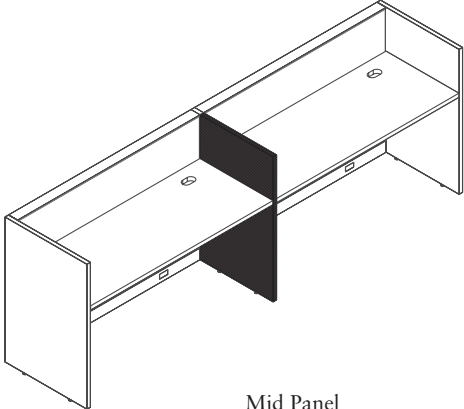

Mid Panel

GALLERY PANELS

- Available to connect to Frame & Tile, Benching systems, and other Gallery Panels
- Standard Gallery Panels connect to Benching and Frame & Tile systems, and Gallery-to-Gallery panels connect to other Gallery Panels
- Gallery Panels can be used in freestanding applications. See page 296 for specification requirements.

Standard Gallery Panels

- Standard Gallery panels connect to Benching and Frame & Tile systems and are available as End-of-Run Single, End-of-Run Split (panel systems only), and Mid Panels (panel systems only)
- Made of 1½" board with HPL laminate.
- Can be specified with matching or contrasting edge.
- Edge band is 2mm ABS
- Available in woodgrain and solid laminates.
- Woodgrain laminates can be specified with vertical grain up to 60"W. Horizontal grain is available on all sizes.
- Single Panel widths are available in 3" increments from 18"W to 84"W. Split Panel widths are available in 6" increments from 87"W to 147"W.
- Standard Gallery Panel sizes up to 84"W come as a single piece. Sizes 87"W though 147"W are split panels and come in two pieces.
- Grain matching is not available on split panels.
- Split panels can only be used in End-of-Run configurations with Stride or Terrace panel systems.
- Gallery Panels offer 2½" leveling capability.
- Overall heights line up with adjacent panel or benching systems.
- Standard Gallery panel widths are true to size
- Available with and without the integrated glass option.
- Glass is specified separately.
- Gallery Panels for use with glass have separate model numbers.
- Standard Gallery panels can be used with Single Sided Further adaptive for privacy and stability along the beam.
- All configurations are non-handed.
- Please adhere to all standard systems specification guidelines.
- Additional support is required after every 60" in gallery panel width (i.e. storage or worksurface tie-in)

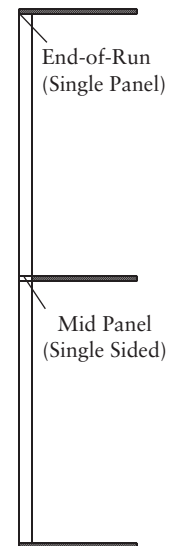
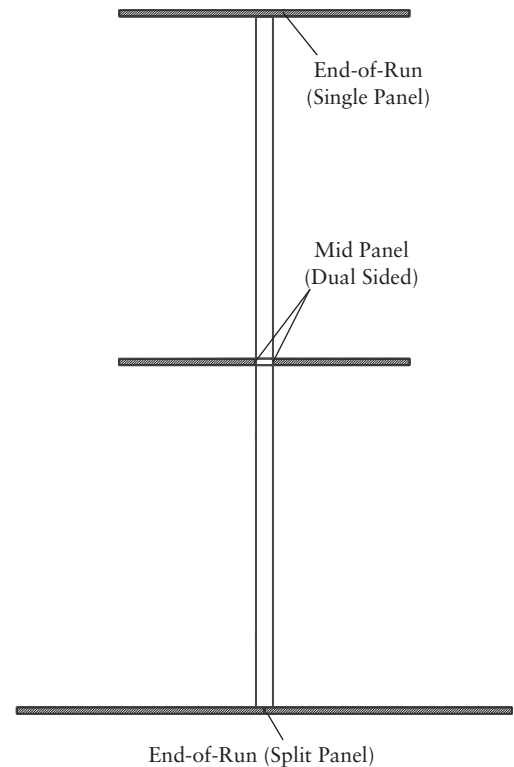

GSA SIN 33721

Standard Gallery Panel Widths

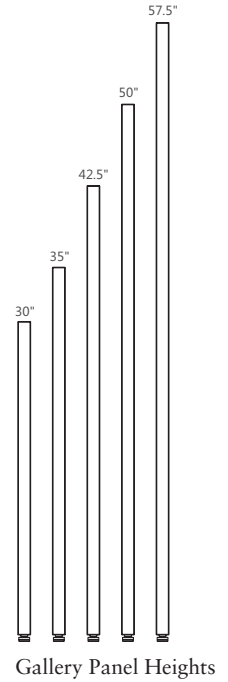
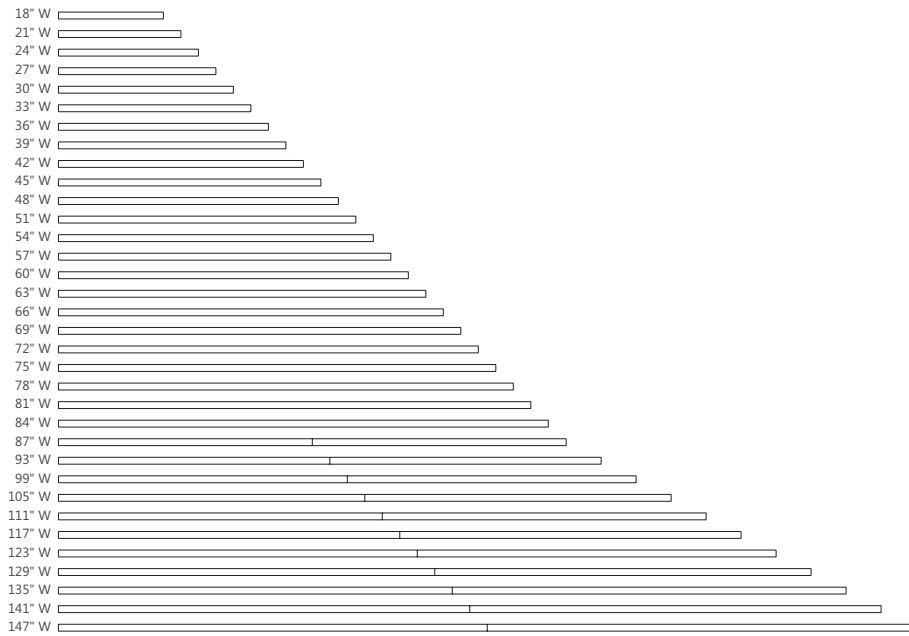

Gallery-to-Gallery Panel L/T Widths

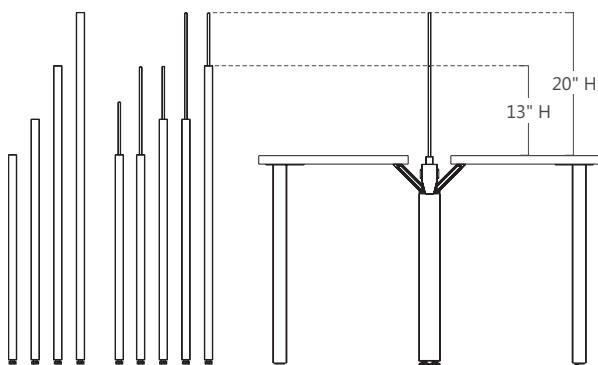
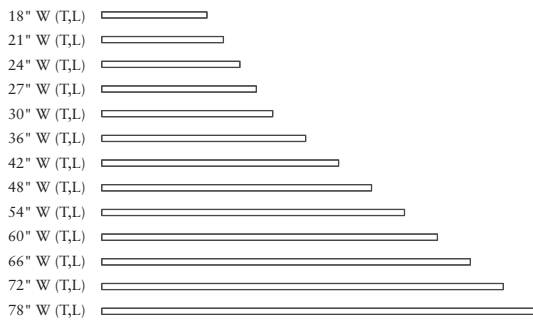

GALLERY PANELS

Standard Gallery Panels

- Gallery Panels for use with glass offer a routed top edge.
- Glass mounts directly into the Gallery Panel route via a gasket.
- The routing is inset 1½" from each end of the panel.
- Single-piece Gallery Panels for use with integrated glass require glass 3" shorter than the panel width.
- For split Gallery Panels, specify glass for each piece separately.
- Split Gallery Panels for use with integrated glass require glass that is 4½" shorter than panel width (individual piece).
- Glass is available in 3 colors: Clear, Frosted, Smoked.
- Glass height is available in 7½"H, 13"H, and 15"H.
- Glass is available on all Gallery Panel widths.
- For benching systems, maximum allowable benching height cannot exceed 50"H with or without glass. Overall Gallery Panel height includes the glass.
- Specify glass models separate from Gallery Panel models.
- Glass Panels at 30"W and under are not UL listed.

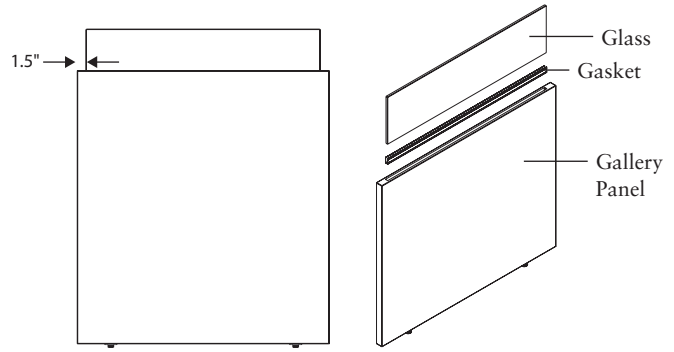

Standard Single Panel with Glass

Find the Gallery Glass width appropriate for your Gallery Panel width.

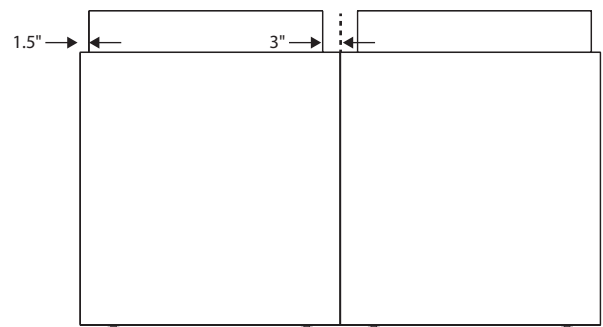

Standard Split Panel with Glass

Shaded example:
For the 18"W
Gallery Panel,
Gallery Glass
should be ordered
with width of 15".

Gallery Panel Width	Gallery Glass Height	7.5"H, 13"H, 15"H
		Gallery Glass Order Width
18"W Gallery Panel		15" W
21"W Gallery Panel		18" W
24"W Gallery Panel		21" W
27"W Gallery Panel		24" W
30"W Gallery Panel		27" W
33"W Gallery Panel		30" W
36"W Gallery Panel		33" W
39"W Gallery Panel		36" W
42"W Gallery Panel		39" W
45"W Gallery Panel		42" W
48"W Gallery Panel		45" W
51"W Gallery Panel		48" W
54"W Gallery Panel		51" W
57"W Gallery Panel		54" W
60"W Gallery Panel		57" W
63"W Gallery Panel		60" W
66"W Gallery Panel		63" W
69"W Gallery Panel		66" W
72"W Gallery Panel		69" W
75"W Gallery Panel		72" W
78"W Gallery Panel		75" W
81"W Gallery Panel		78" W
84"W Gallery Panel		81" W
87"W Split Panel		39" W
93"W Split Panel		42" W
99"W Split Panel		45" W
105"W Split Panel		48" W
111"W Split Panel		51" W
117"W Split Panel		54" W
123"W Split Panel		57" W
129"W Split Panel		60" W
135"W Split Panel		63" W
141"W Split Panel		66" W
147"W Split Panel		69" W

NOTE: Integrated glass height will align with Frameless Glass on Stride and will sit ¼" higher than Frameless Glass on Terrace (see detail below).

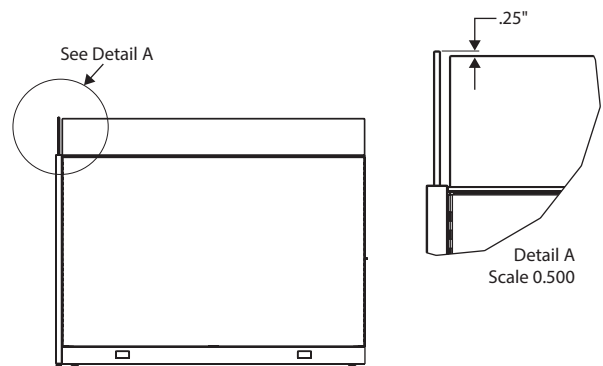

Gallery-to-Gallery Panels

- Gallery Panels for use with glass offer a routed top edge.
- Glass mounts directly into the Gallery Panel route via a gasket.
- The routing is inset $\frac{1}{2}$ " from each end of the panel.
- Gallery-to-Gallery Panels for use with integrated glass require glass equal to the panel width.
- Glass is available in 3 colors: Clear, Frosted, Smoked.
- Glass height is available in 7½"H, 13"H, and 15"H
- Glass is available on all Gallery Panel widths. Glass panels at 30"W and under are not UL listed.
- For benching systems, maximum allowable benching height cannot exceed 50"H with or without glass. Overall Gallery Panel height includes the glass.
- Specify glass models separate from Gallery Panel models

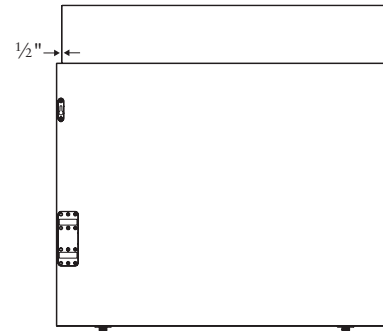

Gallery-to-Gallery Panel with Glass

Find the Gallery Glass width appropriate for your Gallery Panel width.

Gallery Panel Width	Gallery Glass Height	7.5"H, 13"H, 15"H
	Gallery Glass Order Width	
18"W Gallery Panel		18"W
21"W Gallery Panel		21"W
24"W Gallery Panel		24"W
27"W Gallery Panel		27"W
30"W Gallery Panel		30"W
36"W Gallery Panel		36"W
42"W Gallery Panel		42"W
48"W Gallery Panel		48"W
54"W Gallery Panel		54"W
60"W Gallery Panel		60"W
66"W Gallery Panel		66"W
72"W Gallery Panel		72"W
78"W Gallery Panel		78"W

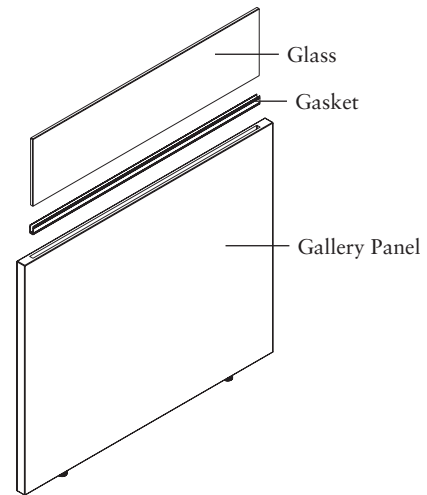

Gallery Panels

Stride® and Terrace® System - End Panel (Dual-Sided)

GSA SIN 33721

- Provides privacy to one or both ends of the system in a dual sided application.
- All Stride End Panels connect using GZCKP connector kit.
- All Terrace Single End Panels (Dual-Sided) connect using GTKCKP connector kit.
- All Terrace Split End Panels connect using GTSKCKP connector kit.
- GTKGK30 is required when a 30"H Terrace panel with frameless glass is attached to a Gallery Panel in an End configuration.
- Gallery Panel sizes 129"W or greater require storage or worksurface tie in on both sides of panel. Please reference storage and worksurface support sections for more details.
- When System panel is higher than the Gallery Panel, variable height System's trim must be specified to finish off exposed frame.
- Stride 30"H panel frames can be ordered via the Standard Specials catalog until available as standard.
- Single piece End Panels can be used for off-modular planning. Connector kit location must be field measured.
- Split End Panel seams must align with parent run.
- Split End Panels can be specified as asymmetrical. Contact Allsteel Tailored Solutions Group for details.

Front edge of Gallery Panel will sit flush with front edge of worksurface on Stride and will sit $\frac{3}{16}$ " proud of front edge of worksurface on Terrace.

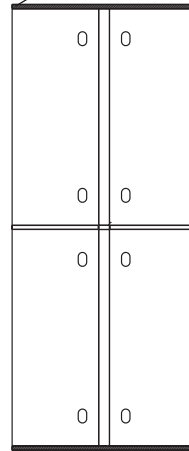

Single Panel Configuration

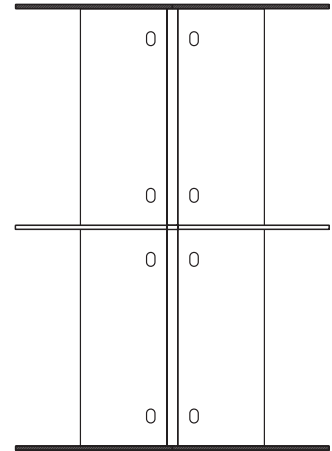

Split Panel Configuration

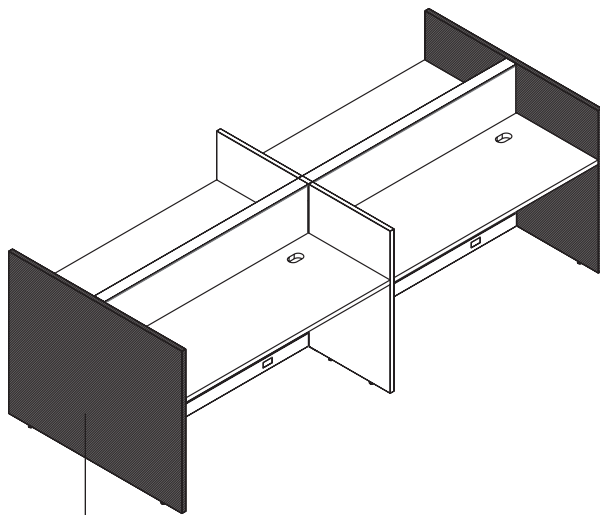

Single panel up to 84"W

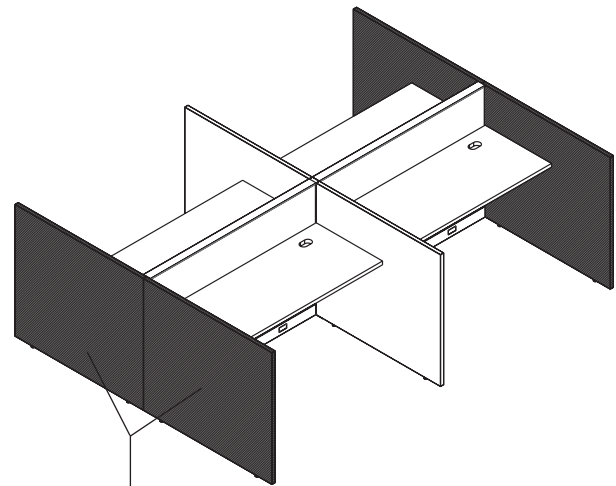

Split panel 87" W and greater

GSA SIN 33721

- Provides privacy to one or both ends of the system in a single sided application.
- Single-Sided End Panels cap over the System panel. Accommodate for 3" frame thickness when planning with Stride panel system and 2 3/8" frame thickness when planning with Terrace panel system.
- All Stride End Panels (Single-Sided) require connector kit GZCKP to attach to parent run.
- All Terrace End Panels (Single-Sided) require connector kit GTKCKP to attach to parent run.
- Gallery Panel sizes 63"W or greater require storage or worksurface tie-in. Please reference storage and worksurface support sections for more details.
- When System panel is higher than the Gallery Panel, variable height system's trim must be specified to finish off exposed frame.
- Stride 30"H panel frames can be ordered via the Standard Specials catalog until available as standard.
- Due to thickness of the Terrace panel Single-Sided End Panel overhangs by approximately 3/16" on both sides.
- Accommodate for 2 3/8" frame thickness planning when with Terrace panel system.
- GTKGK30 is required when a 30"H Terrace panel with frameless glass is attached to a Gallery Panel in an End configuration.

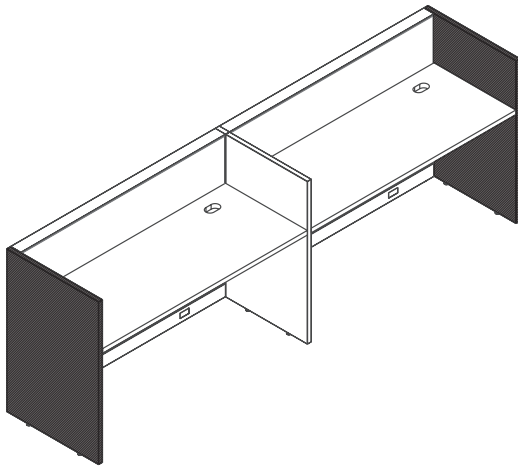
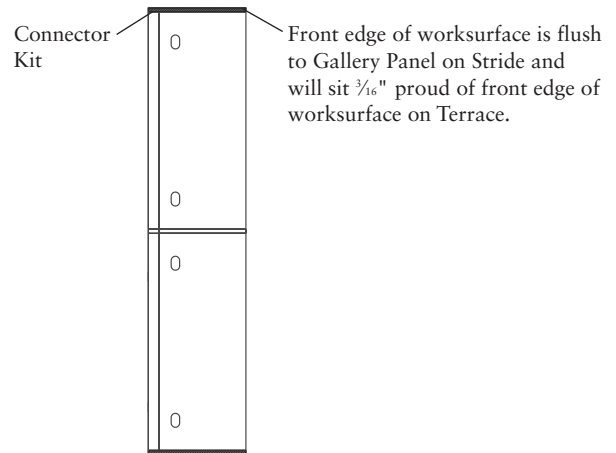

Gallery Panels

Stride® and Terrace® System - Mid Panel

GSA SIN 33721

- Mid panels do not overlap parent system panel.
- When specifying Mid panels, one gallery panel “block and trim” kit (GZ3CONxx for Stride, GTK3CONXX for Terrace) is required to space the System panels out 1 1/8". Kits include: Connector blocks, vertical trim and a top cap.
- “Block and trim” models must match the height of the parent run.
- Specify one mid-connector kit (GCKPM) per gallery panel to attach to parent run. Gallery panel and mid-connector kit attach over “block and trim” kit. Dual sided application requires two connector kit models.
- When using a Mid panel, both panel frames in spine must be of equal height.
- Mid Panels may not exceed height of parent run by more than 15".
- Trims can be painted to match the System panel trims.
- Mid Panels are available in 18"-84" widths in 3" increments.
- Gallery Panel sizes 63"W or greater require storage or worksurface tie-in. Please reference storage and worksurface support sections for more details.
- Spanning top cap available through Allsteel Tailored Solution Group.

Mid panel must be 3" shorter than end panel due to panel frame thickness

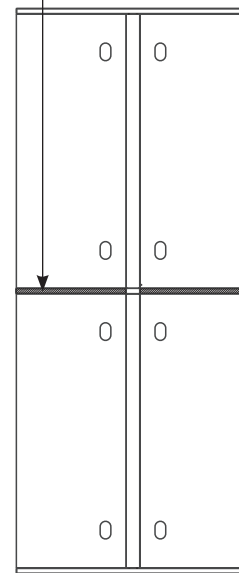

Dual-sided

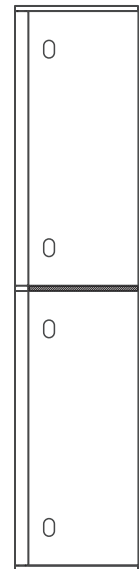

Single-sided

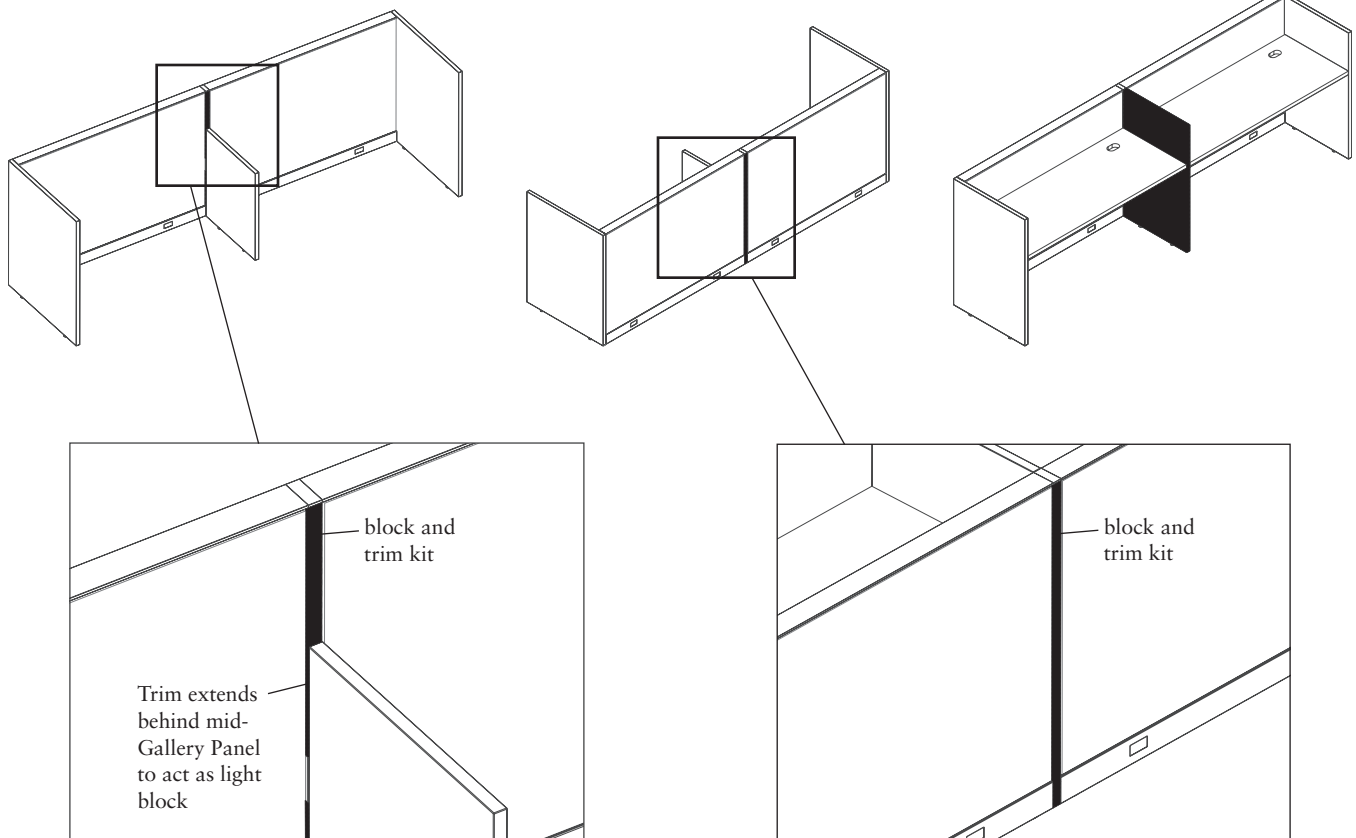

GALLERY PANELS

Gallery-to-Gallery Panels

- Gallery-to-Gallery panels connect to other gallery panels and are available in L-, T-, and Nonsymmetrical T- configurations.
- When specifying Gallery-to-Gallery panels, the installation template (GTEMP) is required. The recommendation is 1 template for every 30 panels. Templates are reusable.
- Gallery-to-Gallery panels cap over Standard Gallery panels and are oversized by 1/8" to maintain true interior dimensions
- Gallery-to-Gallery panels must be of equal or lower height than the Standard Gallery panel attached. The Gallery-to-Gallery panel cannot be taller than the adjacent panel. If this is required, please reach out to TPG for a custom solution.
- Made of 1/8" board with HPL laminate.
- Can be specified with matching or contrasting edge.
- Edge band is 2mm ABS
- Available in woodgrain and solid laminates.
- Woodgrain laminates can be specified with vertical grain up to 54"W. Horizontal grain is available on all sizes.
- Gallery-to-Gallery panel widths are available in 3" increments from 18"W to 30"W and in 6" increments from 30"W to 78"W
- Gallery Panels offer 2 1/2" leveling capability.
- Overall heights line up with adjacent panel or benching systems.
- Available with and without the integrated glass option.
- Glass is specified separately.
- Gallery Panels for use with glass have separate model numbers.
- Gallery-to-Gallery panels are secured with an inset flat bracket under a painted metal cover.
- L- and Nonsymmetrical T- panels are handed.
- Please adhere to all standard systems specification guidelines.
- Additional support is required after every 60" in gallery panel width (i.e. storage or worksurface tie-in)
- Nonsymmetrical T Panels are specified in the format GTyyxxzz. Substitute yy as panel height, xx as LH nominal length, and zz as RH nominal length

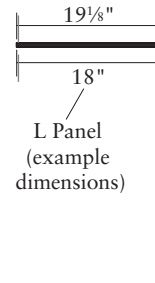

Note: Gallery-to-Gallery Panels cap over standard Gallery Panels and are oversized by 1/8" to maintain modular interior dimensions. (ex: 18" panel is actually 19 1/8"W)

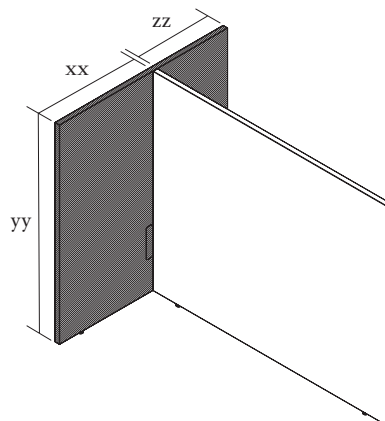
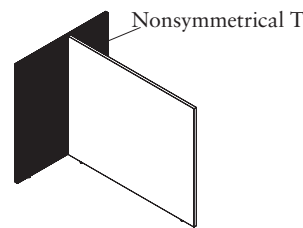
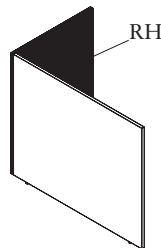
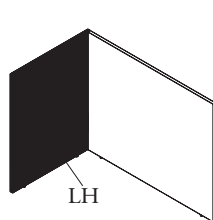
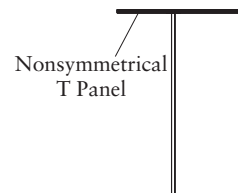
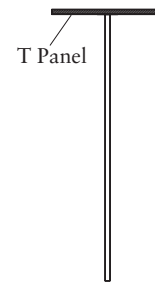

Freestanding Screens can be specified using Standard Gallery panels and Gallery-to-Gallery (depicted by the shaded panels in the illustrations below). Overall height, including glass, cannot exceed 72.5". Gallery Panel sizes 63"W or greater require storage or worksurface tie-in.

Freestanding L-Screens

Parent	Minimum Return
18-24	Not Valid
30-36	30
39-60	36
63-84	42

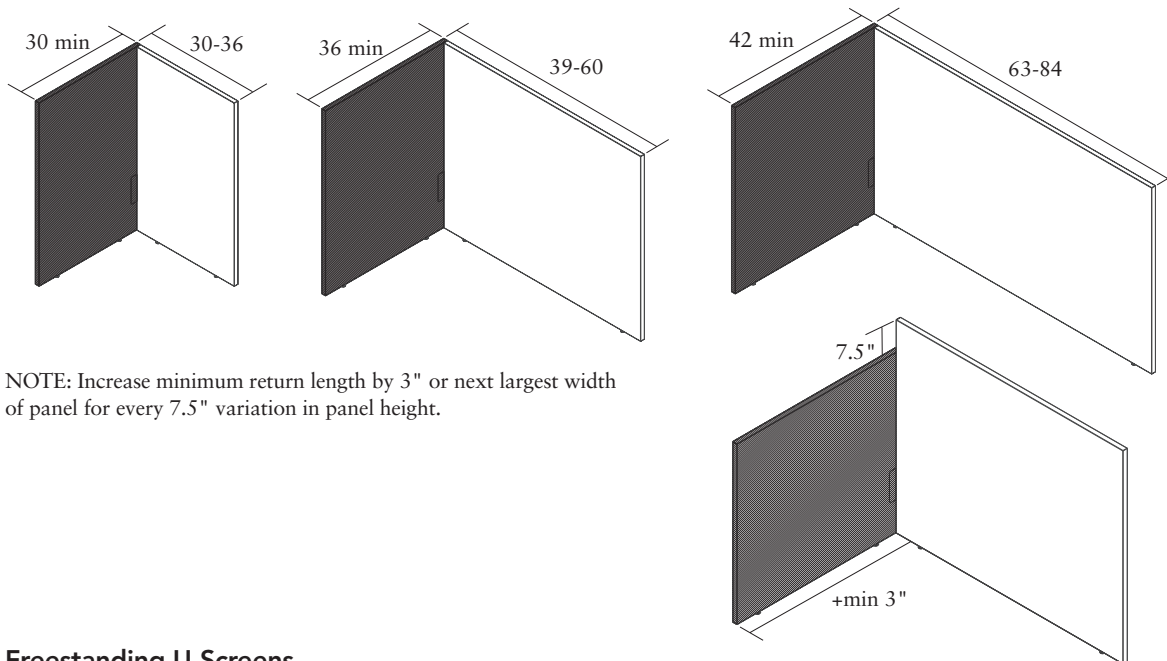

NOTE: Increase minimum return length by 3" or next largest width of panel for every 7.5" variation in panel height.

Freestanding U-Screens

Parent	Minimum Return
18-21	Not Valid
24-48	24
51-60	27
63-84	30

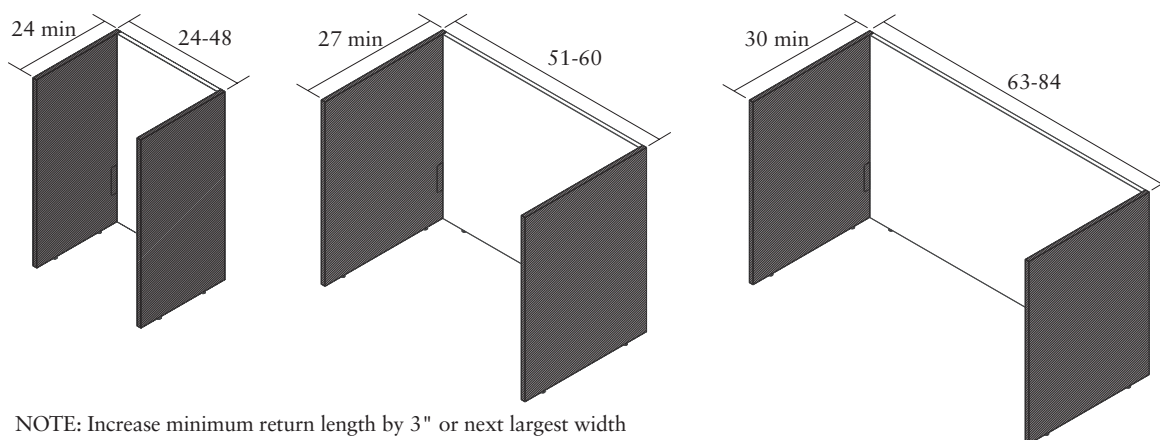

NOTE: Increase minimum return length by 3" or next largest width of panel for every 7.5" variation in panel height.

Freestanding T-Screens

T-Return	Minimum Parent
18-21	Not Valid
24-36	30-84
42-60	36-84
66-78	42-84

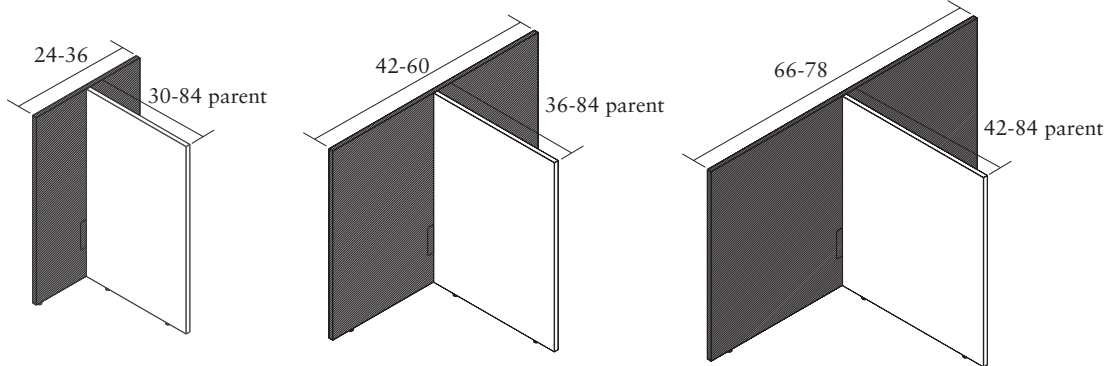

NOTE: Increase minimum return length by 3" or next largest width of panel for every 7.5" variation in panel height.

Freestanding H-Screens

Parent	Minimum H-Return
30-84	18

NOTE: Increase minimum return length by 3" or next largest width of panel for every 7.5" variation in panel height.

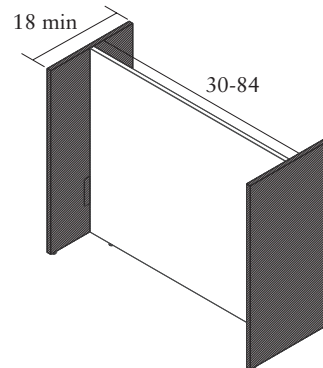

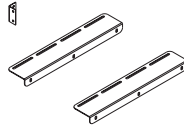

Worksurface Mounting Bracket (page 329)

- Used to mount a fixed-height worksurface to a Gallery panel.
- Can be painted any Allsteel Standard Paint color.
- A worksurface stiffener is required for surfaces 60" W or greater.
- One bracket kit (GWSBK) is required for each worksurface end attached to Gallery Panels.
- One bracket kit (GWSBK) includes two large L- brackets and one small corner L- bracket.

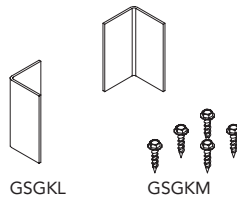
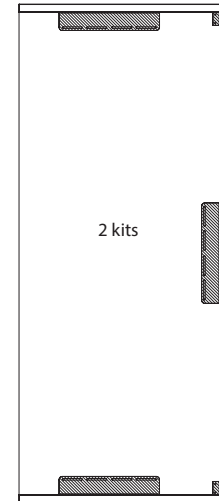
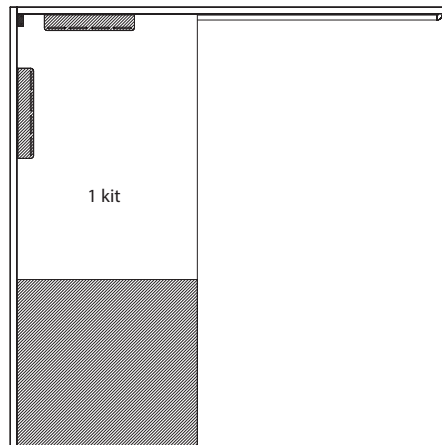
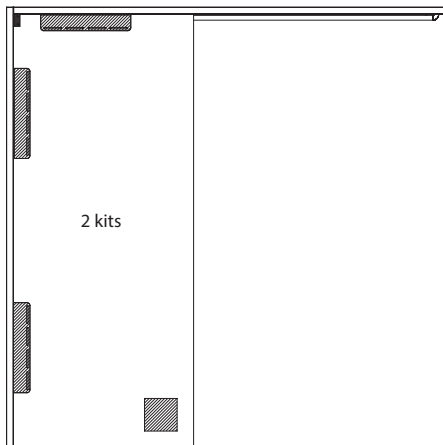

Storage Ganging Kits (page 324)

- The laminate storage ganging kit (GSGKL) is used to connect a Gallery Panel to a laminate storage unit.
- The metal storage ganging kit (GSGKM) is used to connect a Gallery Panel to a metal storage unit.

Gallery Panel Stiffeners (page 324)

- Required for single-piece panels 75" W and greater that are used in a wing or single-sided end condition and do not have a horizontally-mounted credenza.
- For panels 75" W and 78" W, order model (GSTFN7578). Stiffener width is 72".
- For panels 81" W and 84" W, order model (GSTFN8184). Stiffener width is 78".
- Attaches directly to one side of the Gallery Panel with a painted metal cover, attachment hardware included.
- Placement on panel face must be at least 18" above the floor but is not restricted to a specific location on the panel.
- Stiffener is 1½" x 1½".
- Available in any Allsteel standard paint color

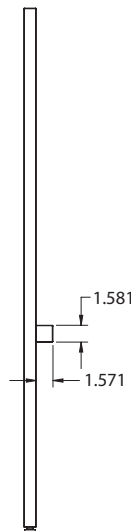

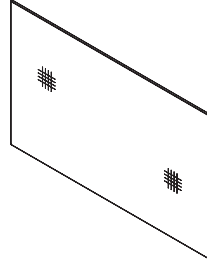

Tackboards (page 330)

- Provides tackable surface.
- Comes with steel-painted trim.
- Available in the following heights: 15", 22½"
- Available in the following *widths: 24", 30", 36", 42", 48", 54", 60".
*Nominal widths, true width is undersized by ½"
- Depth of .45"
- Mounts directly to Gallery Panel. Mounting hardware included. Will deface the panel.

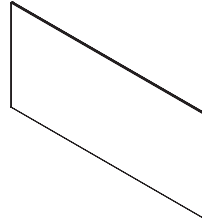

Magnet or Marker Boards (page 330)

- Provides writable and magnetic surface when painted in marker board paint.
- Provides magnetic surface, NON-writable, when painted in other Allsteel paint colors.
- Available in the following heights: 15", 22½"
- Available in the following *widths: 24", 30", 36", 42", 48", 54", 60".
*Nominal widths, true width is undersized by ½"
- Depth of .45"
- Mounts directly to Gallery Panel. Mounting hardware included. Will deface the panel.

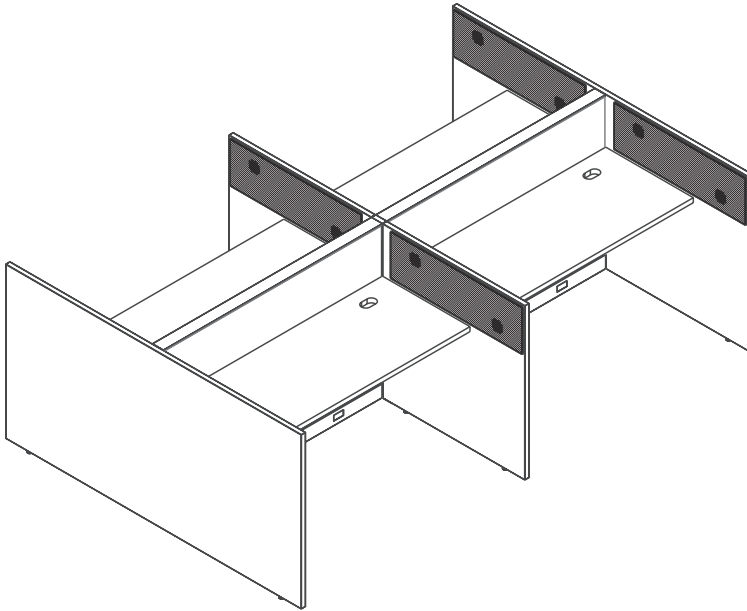

Tackboard Accessory on Mid and End Gallery Panels

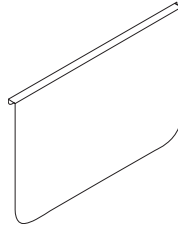

Hanging Magnet or Marker Boards (page 330)

- Hangs over Gallery panel or sits on top of worksurface.
- Provides writable and magnetic surface when painted in marker board paint.
- Provides magnetic surface, NON-writable, when painted in other Allsteel paint colors.
- Cannot be installed back-to-back when hanging in the same location.
- Available in 30"W and in two heights: 20"H and 26"H.
- Cannot be installed on panels with integrated glass.

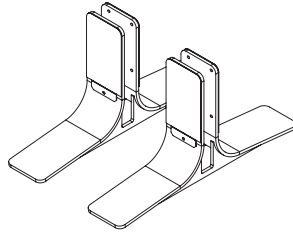

Gallery Panel Foot (page 330)

- Single foot provides rigidity to large wing panel.
- Using two feet on a single Gallery Panel allows for a freestanding application on panels greater than 24"W.
- Available in any textured Allsteel paint.
- Foot extends 9" from either side of the panel.

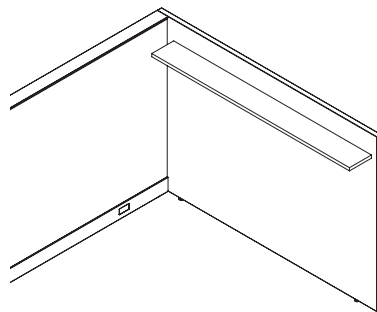
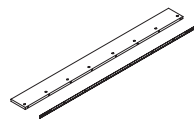
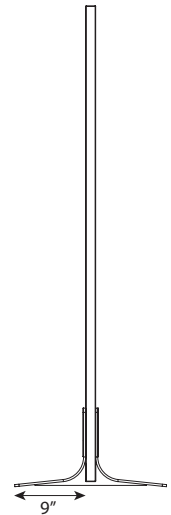
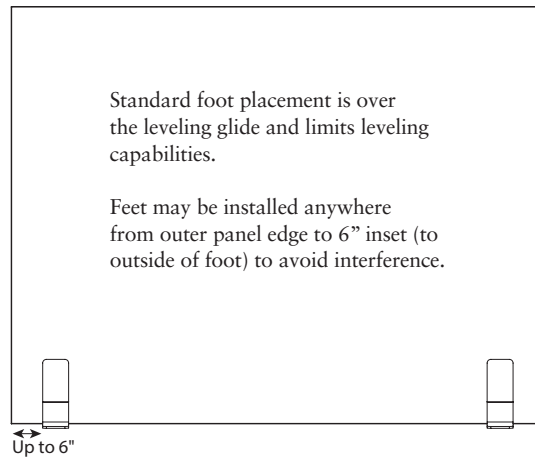
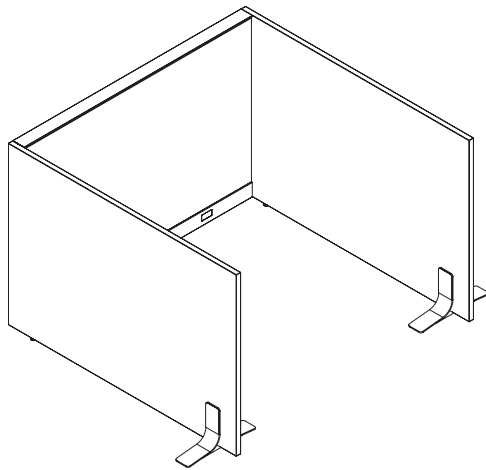

Floating Laminate Shelves (page 331)

- 6" depth.
- 3/4" thickness.
- Constructed of HPL laminate with 0.8mm ABS edgebanding.
- Available in solid or horizontal woodgrain laminate.
- Available with contrasting or matching edge.
- Widths available every 6" from 12" to 78"W.
- Widths from 54" to 78" satisfy a stiffener requirement and are meant to be mounted to a panel that is 6" wider than the shelf. (e.g., 84"W panel would accept a 78"W stiffener shelf.)
- Shelves narrower than 54"W do not act as a stiffener.
- Weight capacity is 10lbs per linear foot.



GACRL12

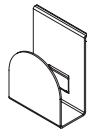

GCHRB

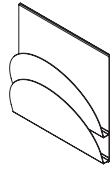

G2AGF

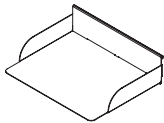

G1PTR

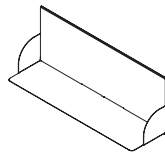

GWPSF

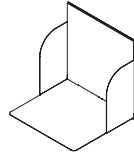

GBRSF

Accessory Rail and Paper Management (page 331)

- Accessory Rail provides mounting for paper management accessories, listed below.
- Rail is 2.6"H and is available in the following widths: 12", 18", 24", 30", 36".
- Rails can be installed in any location on the Gallery Panel, as long as the rail does not extend beyond the top of the panel, and can be placed in-line to span panel length.
- Rail and accessories can be painted any standard Allsteel paint color.
- Mounts directly to the Gallery panel, attachment hardware included.
- Extensions accessories are NOT compatible with the accessory rail.
- These accessories are compatible with panel system tool tiles and rails.
- Includes a rail cover to hide hardware and provide magnetic surface.
- Compatible Rail Accessories:
 - Coat Hook (Rail-based, a mounted version is also available to attach directly to the panel)
 - Rail Based dimensions: 4" x 3" x 1¼"
 - Mounted dimensions: 4" x 3" x 1½"
 - Weight limit: 25 lbs
 - Angle File (Triple, Dual, and Single heights)
 - Depth of 2"
 - Heights: Triple = 15½", Dual = 12½", Single = 9½"
 - Paper Tray (Triple, Dual, and Single heights)
 - Depth of 10"
 - Heights: Triple = 9½", Dual = 6½", Single = 3½"
 - Personal Shelf
 - 9½" x 24" x 10½"
 - Weight limit: 25 lbs
 - Binder Shelf
 - 12½" x 12" x 11½"
 - Weight limit: 25lbs

NOTE: When accessory tools are attached to freestanding Gallery Panel screens, excess weight may affect overall panel stability.



Wall Start (page 329)

- Wall Starts are 1⅝" by 1⅝" rectangular mounting posts that are meant to affix a Gallery Panel to a permanent building wall.
- Wall starts add 1⅝" to panel run.
- Attachment hardware not included.
- Must be specified at the same height as the connecting panel.

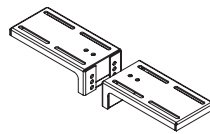

Countertop Brackets (page 329)

- Includes attachment hardware.
- Countertops are flush with the top of the panel and can be flush with the ends of the panel or shorter than the panel width.
- For straight countertops, two countertop brackets must be ordered.
- For corner countertops, three countertop brackets must be ordered.
- Will deface the Gallery Panel.
- May be used in conjunction with Stride, Terrace, or Optimize panels. When transitioning from a Panel spine to a Gallery Panel wing with a corner countertop, use countertop model of the panel system.

Height Adjustable Table Tie-In Brackets (Gallery Panels)

- Improves panel rigidity. Does not function as a panel stability solution.
- AGBKT to be specified for connection to a T leg HAT
- AGBKC to be specified for connection to a C leg HAT
- Reusable mounting template is required and must be ordered separately (AGBKTMP).
- Brackets telescope to account for 24" and 30" worksurface depths and screen attachments.
- A6 C legs with a 30"D worksurface and a screen must be specified with T leg brackets
- **Can be used with Altitude MAX bases when attaching to Gallery panels or Fit panels.**
- Height adjustable table brackets must be installed to both sides of the panel to substitute for a return panel in a dual-sided panel bench application. When a single bracket is connected to a wing panel as shown in the 4-pack image, the HAT bracket can substitute for a return panel.
- Freestanding panel can be connected to height adjustable table if it is supported by HAT brackets on both sides of the table and panel spine.

SINGLE BRACKET

Gallery Panel Application:

Max Height (with Glass): 65"H

Max Width: 75"W; No top size restrictions

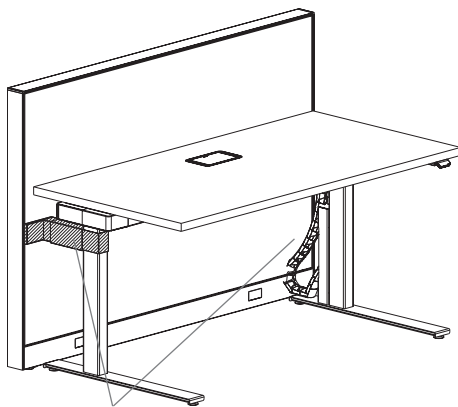
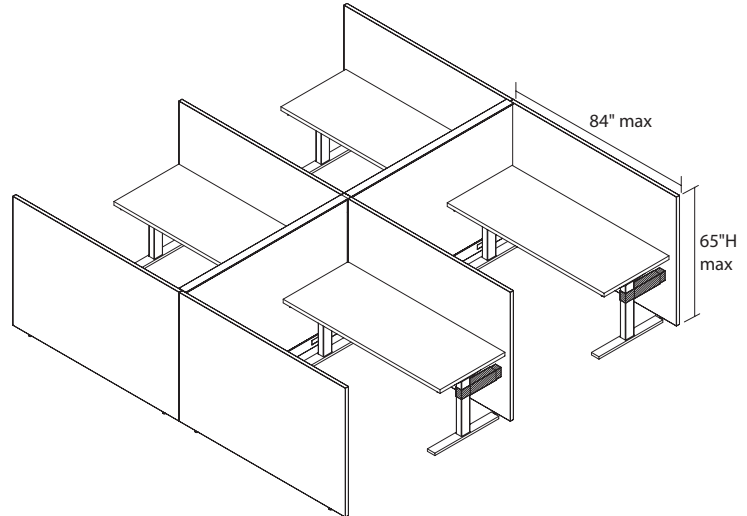

Note: Wire chain cannot be installed on the same leg as a HAT tie-in bracket.

DUAL SIDED PANEL BENCH

Gallery Panel Application:

Max Height (with Glass): 65"H

Bracket Needed: Single Panel (75" max) with Brackets on each leg (placed at the same height)

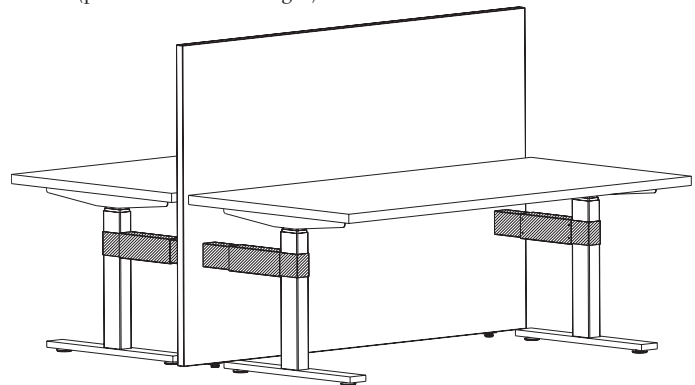

Freestanding Gallery Panel Application

Height Adjustable Table Tie-In Brackets (Optimize, Stride, and Terrace)

- Improves panel rigidity.
- ABKTL to be specified for connection to a LH T-leg HAT
- ABKTR to be specified for connection to a RH T-leg HAT
- ABKCL to be specified for connection to a LH C-leg HAT
- ABKCR to be specified for connection to a RH C-leg HAT
- Brackets mount into slotted standard.
- Brackets telescope to account for 24" and 30" worksurface depths and screen attachments.
- A6 C legs with a 30"D worksurface and a screen must be specified with T leg brackets
- NOT compatible with Altitude MAX bases
- Height adjustable table brackets must be installed to both sides of the panel to substitute for a return panel in a dual-sided panel bench application. When a single bracket is connected to a wing panel as shown in the 4-pack image, the HAT bracket can substitute for a return panel.
- Freestanding panel can be connected to height adjustable table if it is supported by HAT brackets on both sides of the table and panel spine for A8, A3, and A6.
- Dual sided A5 tables cannot support a freestanding panel. (A5 was discontinued on 12/31/2020)

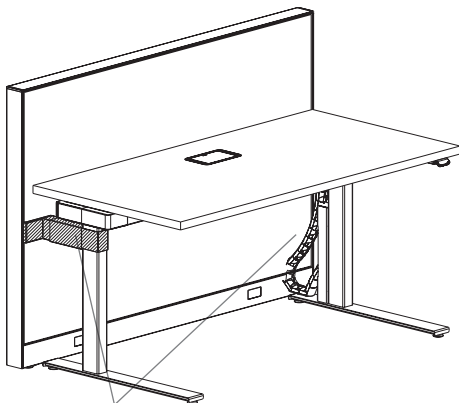

Note: Wire chain cannot be installed on the same leg as a HAT tie-in bracket.

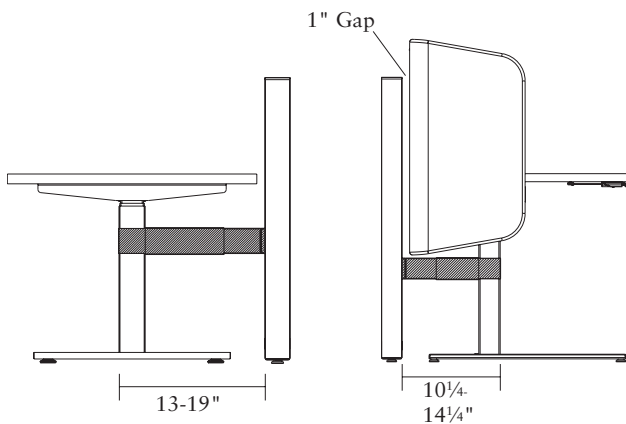

SINGLE BRACKET

Systems Application (not compatible with Concensys):

Max Height (with Glass): 65" H

Max Width: 96" W; Note: tops greater than 72" W will not align.

Overheads cannot be used without return panel

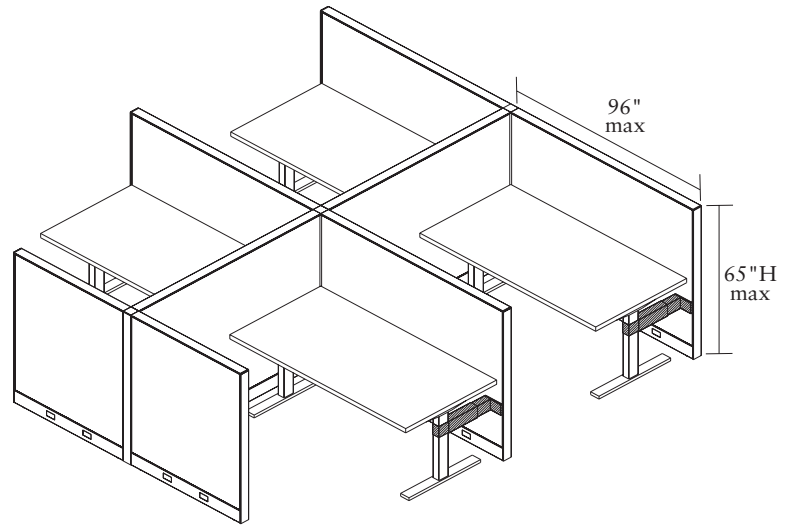

DUAL SIDED PANEL BENCH

Systems Application (not compatible with Concensys):

Max Height (with Glass): 65" H

Bracket Needed: Every 96" on both sides (placed at the same height).

Note: tops greater than 72" W will not align.

Overheads cannot be used without return panel

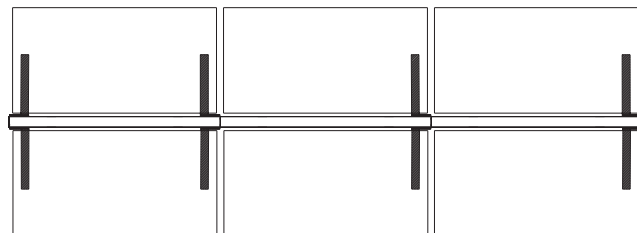
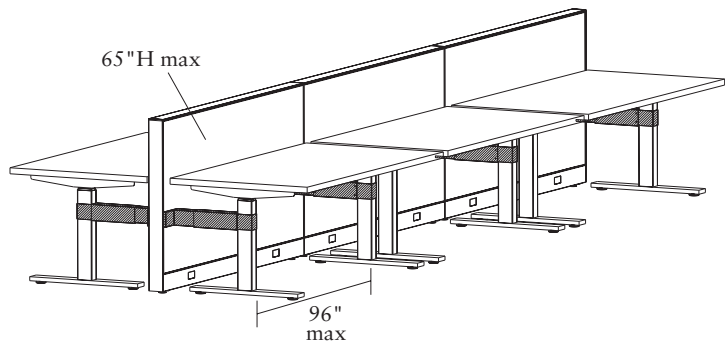

Gallery Panels

Gallery-to-Gallery Panels: 30"H Application

GSA SIN 33721

Description	Model	List Price		
		L1	L2	L3
30"H L- Gallery-to-Gallery Panels				
18"W (RH)	GL3018R	\$ 719	\$ 746	\$ 772
18"W (LH)	GL3018L	\$ 719	\$ 746	\$ 772
21"W (RH)	GL3021R	\$ 734	\$ 761	\$ 788
21"W (LH)	GL3021L	\$ 734	\$ 761	\$ 788
24"W (RH)	GL3024R	\$ 767	\$ 795	\$ 823
24"W (LH)	GL3024L	\$ 767	\$ 795	\$ 823
27"W (RH)	GL3027R	\$ 805	\$ 835	\$ 863
27"W (LH)	GL3027L	\$ 805	\$ 835	\$ 863
30"W (RH)	GL3030R	\$ 887	\$ 919	\$ 952
30"W (LH)	GL3030L	\$ 887	\$ 919	\$ 952
36"W (RH)	GL3036R	\$ 960	\$ 996	\$ 1030
36"W (LH)	GL3036L	\$ 960	\$ 996	\$ 1030
42"W (RH)	GL3042R	\$ 1049	\$ 1089	\$ 1126
42"W (LH)	GL3042L	\$ 1049	\$ 1089	\$ 1126
48"W (RH)	GL3048R	\$ 1172	\$ 1215	\$ 1257
48"W (LH)	GL3048L	\$ 1172	\$ 1215	\$ 1257
54"W (RH)	GL3054R	\$ 1239	\$ 1284	\$ 1329
54"W (LH)	GL3054L	\$ 1239	\$ 1284	\$ 1329
60"W (RH)	GL3060R	\$ 1336	\$ 1385	\$ 1432
60"W (LH)	GL3060L	\$ 1336	\$ 1385	\$ 1432
66"W (RH)	GL3066R	\$ 1377	\$ 1427	\$ 1476
66"W (LH)	GL3066L	\$ 1377	\$ 1427	\$ 1476
72"W (RH)	GL3072R	\$ 1499	\$ 1554	\$ 1608
72"W (LH)	GL3072L	\$ 1499	\$ 1554	\$ 1608
78"W (RH)	GL3078R	\$ 1730	\$ 1792	\$ 1854
78"W (LH)	GL3078L	\$ 1730	\$ 1792	\$ 1854

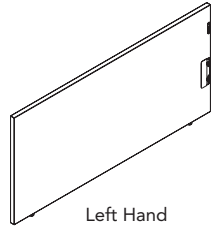
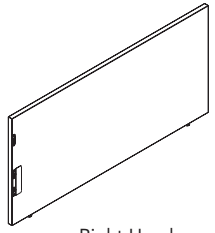

Description	Model	L1	L2	L3
30"H T- Gallery-to-Gallery Panels				
18"W	GT3018	\$ 718	\$ 745	\$ 771
21"W	GT3021	\$ 735	\$ 762	\$ 789
24"W	GT3024	\$ 767	\$ 795	\$ 823
27"W	GT3027	\$ 805	\$ 835	\$ 863
30"W	GT3030	\$ 884	\$ 916	\$ 949
36"W	GT3036	\$ 958	\$ 994	\$ 1028
42"W	GT3042	\$ 1051	\$ 1091	\$ 1128
48"W	GT3048	\$ 1174	\$ 1217	\$ 1259
54"W	GT3054	\$ 1236	\$ 1281	\$ 1326
60"W	GT3060	\$ 1334	\$ 1383	\$ 1430
66"W	GT3066	\$ 1378	\$ 1428	\$ 1477
72"W	GT3072	\$ 1499	\$ 1554	\$ 1608
78"W	GT3078	\$ 1730	\$ 1792	\$ 1854

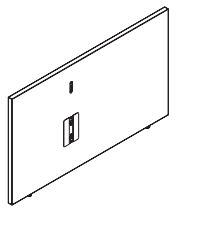
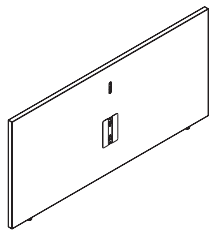

Description	Model	L1	L2	L3
30"H Nonsym T- Gallery-to-Gallery Panels				
42"W 18L 24R	GT301824	\$ 1051	\$ 1091	\$ 1128
42"W 24L 18R	GT302418	\$ 1051	\$ 1091	\$ 1128
48"W 18L 30R	GT301830	\$ 1072	\$ 1115	\$ 1157
48"W 30L 18R	GT303018	\$ 1072	\$ 1115	\$ 1157
54"W 24L 30R	GT302430	\$ 1236	\$ 1281	\$ 1326
54"W 30L 24R	GT303024	\$ 1236	\$ 1281	\$ 1326

Description	Model	List Price
Gallery-to-Gallery Installation Template (<i>Black only, code P</i>)	GTEMP	\$ 79



How to specify — Select the Model Number from above.	1st Option: FSC: (if applicable): F FSC Wood X Non-FSC Wood	2nd Option: Laminate: (if applicable): See page 284 for finishes.	3rd Option: Edge: See page 284 for finishes.	4th Option: Grain: (if applicable): VLG Horizontal grain or Solid only. VST Vertical Grain (available only for single panels 60"W or less, and for split panels between 87"W and 117"W).	5th Option: Paint See page 284 for finishes.	6th Option: Glide: (if applicable):
G 	V .	.	G

GALLERY PANELS

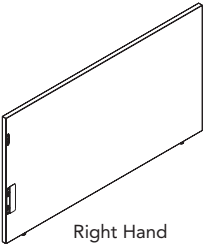
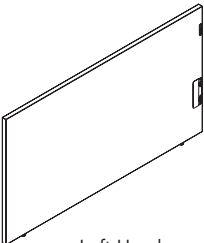
	Description	Model	List Price		
			L1	L2	L3
 <p>Right Hand</p>  <p>Left Hand</p>	35"H L- Gallery-to-Gallery Panels				
	18"W (RH)	GL3518R	\$ 811	\$ 841	\$ 870
	18"W (LH)	GL3518L	\$ 811	\$ 841	\$ 870
	21"W (RH)	GL3521R	\$ 830	\$ 860	\$ 890
	21"W (LH)	GL3521L	\$ 830	\$ 860	\$ 890
	24"W (RH)	GL3524R	\$ 867	\$ 899	\$ 929
	24"W (LH)	GL3524L	\$ 867	\$ 899	\$ 929
	27"W (RH)	GL3527R	\$ 901	\$ 934	\$ 967
	27"W (LH)	GL3527L	\$ 901	\$ 934	\$ 967
	30"W (RH)	GL3530R	\$ 1005	\$ 1042	\$ 1078
	30"W (LH)	GL3530L	\$ 1005	\$ 1042	\$ 1078
	36"W (RH)	GL3536R	\$ 1094	\$ 1135	\$ 1174
	36"W (LH)	GL3536L	\$ 1094	\$ 1135	\$ 1174
	42"W (RH)	GL3542R	\$ 1164	\$ 1207	\$ 1248
	42"W (LH)	GL3542L	\$ 1164	\$ 1207	\$ 1248
	48"W (RH)	GL3548R	\$ 1265	\$ 1311	\$ 1357
	48"W (LH)	GL3548L	\$ 1265	\$ 1311	\$ 1357
	54"W (RH)	GL3554R	\$ 1341	\$ 1390	\$ 1438
	54"W (LH)	GL3554L	\$ 1341	\$ 1390	\$ 1438
	60"W (RH)	GL3560R	\$ 1426	\$ 1479	\$ 1529
60"W (LH)	GL3560L	\$ 1426	\$ 1479	\$ 1529	
66"W (RH)	GL3566R	\$ 1490	\$ 1545	\$ 1598	
66"W (LH)	GL3566L	\$ 1490	\$ 1545	\$ 1598	
72"W (RH)	GL3572R	\$ 1616	\$ 1675	\$ 1733	
72"W (LH)	GL3572L	\$ 1616	\$ 1675	\$ 1733	
78"W (RH)	GL3578R	\$ 1804	\$ 1870	\$ 1934	
78"W (LH)	GL3578L	\$ 1804	\$ 1870	\$ 1934	

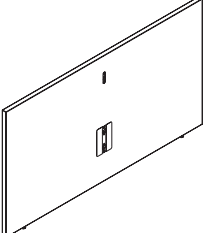
	35"H T- Gallery-to-Gallery Panels				
	18"W	GT3518	\$ 810	\$ 840	\$ 869
	21"W	GT3521	\$ 830	\$ 860	\$ 890
	24"W	GT3524	\$ 868	\$ 900	\$ 930
	27"W	GT3527	\$ 902	\$ 935	\$ 968
	30"W	GT3530	\$ 1005	\$ 1042	\$ 1078
	36"W	GT3536	\$ 1094	\$ 1135	\$ 1174
	42"W	GT3542	\$ 1163	\$ 1206	\$ 1247
	48"W	GT3548	\$ 1266	\$ 1312	\$ 1358
	54"W	GT3554	\$ 1342	\$ 1391	\$ 1439
	60"W	GT3560	\$ 1426	\$ 1479	\$ 1529
	66"W	GT3566	\$ 1490	\$ 1545	\$ 1598
	72"W	GT3572	\$ 1615	\$ 1674	\$ 1732
78"W	GT3578	\$ 1804	\$ 1870	\$ 1934	

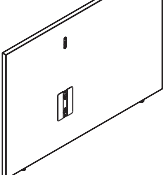
	35"H Nonsym T- Gallery-to-Gallery Panels				
	42"W 18L 24R	GT351824	\$ 1163	\$ 1206	\$ 1247
	42"W 24L 18R	GT352418	\$ 1163	\$ 1206	\$ 1247
	48"W 18L 30R	GT351830	\$ 1266	\$ 1312	\$ 1358
	48"W 30L 18R	GT353018	\$ 1266	\$ 1312	\$ 1358
	54"W 24L 30R	GT352430	\$ 1342	\$ 1391	\$ 1439
54"W 30L 24R	GT353024	\$ 1342	\$ 1391	\$ 1439	

Description	Model	List Price
Gallery-to-Gallery Installation Template (<i>Black only, code P</i>)	GTEMP	\$ 79

<p>How to specify — Select the Model Number from above.</p>	<p><i>1st Option:</i> FSC: (if applicable): F FSC Wood X Non-FSC Wood</p>	<p><i>2nd Option:</i> Laminate: (if applicable): See page 284 for finishes.</p>	<p><i>3rd Option:</i> Edge: See page 284 for finishes.</p>	<p><i>4th Option:</i> Grain: (if applicable): VLG Horizontal grain or Solid only. VST Vertical Grain (available only for single panels 60"W or less, and for split panels between 87"W and 117"W).</p>	<p><i>5th Option:</i> Paint See page 284 for finishes.</p>	<p><i>6th Option:</i> Glide: (if applicable):</p>
	<p>G . .</p>	<p> .</p>	<p> .</p>	<p>V .</p>	<p> .</p>	<p>G </p>

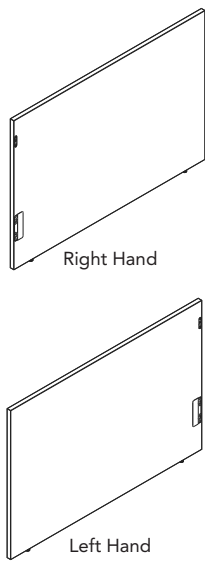

Description	Model	List Price		
		L1	L2	L3
42"H L- Gallery-to-Gallery Panels				
18"W (RH)	GL4218R	\$ 880	\$ 912	\$ 944
18"W (LH)	GL4218L	\$ 880	\$ 912	\$ 944
21"W (RH)	GL4221R	\$ 895	\$ 928	\$ 960
21"W (LH)	GL4221L	\$ 895	\$ 928	\$ 960
24"W (RH)	GL4224R	\$ 941	\$ 975	\$ 1009
24"W (LH)	GL4224L	\$ 941	\$ 975	\$ 1009
27"W (RH)	GL4227R	\$ 983	\$ 1019	\$ 1055
27"W (LH)	GL4227L	\$ 983	\$ 1019	\$ 1055
30"W (RH)	GL4230R	\$ 1096	\$ 1137	\$ 1176
30"W (LH)	GL4230L	\$ 1096	\$ 1137	\$ 1176
36"W (RH)	GL4236R	\$ 1196	\$ 1240	\$ 1282
36"W (LH)	GL4236L	\$ 1196	\$ 1240	\$ 1282
42"W (RH)	GL4242R	\$ 1278	\$ 1325	\$ 1371
42"W (LH)	GL4242L	\$ 1278	\$ 1325	\$ 1371
48"W (RH)	GL4248R	\$ 1360	\$ 1409	\$ 1458
48"W (LH)	GL4248L	\$ 1360	\$ 1409	\$ 1458
54"W (RH)	GL4254R	\$ 1470	\$ 1524	\$ 1577
54"W (LH)	GL4254L	\$ 1470	\$ 1524	\$ 1577
60"W (RH)	GL4260R	\$ 1550	\$ 1606	\$ 1662
60"W (LH)	GL4260L	\$ 1550	\$ 1606	\$ 1662
66"W (RH)	GL4266R	\$ 1631	\$ 1690	\$ 1749
66"W (LH)	GL4266L	\$ 1631	\$ 1690	\$ 1749
72"W (RH)	GL4272R	\$ 1744	\$ 1808	\$ 1869
72"W (LH)	GL4272L	\$ 1744	\$ 1808	\$ 1869
78"W (RH)	GL4278R	\$ 1899	\$ 1969	\$ 2035
78"W (LH)	GL4278L	\$ 1899	\$ 1969	\$ 2035

Description	Model	List Price		
		L1	L2	L3
42"H T- Gallery-to-Gallery Panels				
18"W	GT4218	\$ 881	\$ 913	\$ 945
21"W	GT4221	\$ 896	\$ 929	\$ 961
24"W	GT4224	\$ 943	\$ 977	\$ 1011
27"W	GT4227	\$ 982	\$ 1018	\$ 1054
30"W	GT4230	\$ 1099	\$ 1140	\$ 1179
36"W	GT4236	\$ 1197	\$ 1241	\$ 1283
42"W	GT4242	\$ 1279	\$ 1326	\$ 1372
48"W	GT4248	\$ 1363	\$ 1412	\$ 1461
54"W	GT4254	\$ 1472	\$ 1526	\$ 1579
60"W	GT4260	\$ 1551	\$ 1607	\$ 1663
66"W	GT4266	\$ 1632	\$ 1691	\$ 1750
72"W	GT4272	\$ 1744	\$ 1808	\$ 1869
78"W	GT4278	\$ 1900	\$ 1970	\$ 2036

Description	Model	List Price		
		L1	L2	L3
42"H Nonsym T- Gallery-to-Gallery Panels				
42"W 18L 24R	GT421824	\$ 1279	\$ 1326	\$ 1372
42"W 24L 18R	GT422418	\$ 1279	\$ 1326	\$ 1372
48"W 18L 30R	GT421830	\$ 1363	\$ 1412	\$ 1461
48"W 30L 18R	GT423018	\$ 1363	\$ 1412	\$ 1461
54"W 24L 30R	GT422430	\$ 1472	\$ 1526	\$ 1579
54"W 30L 24R	GT423024	\$ 1472	\$ 1526	\$ 1579

Description	Model	List Price
Gallery-to-Gallery Installation Template (<i>Black only, code P</i>)	GTEMP	\$ 79



GALLERY PANELS

How to specify — Select the Model Number from above.	1st Option: FSC: (if applicable): F FSC Wood X Non-FSC Wood	2nd Option: Laminate: (if applicable): See page 284 for finishes.	3rd Option: Edge: See page 284 for finishes.	4th Option: Grain: (if applicable): VLG Horizontal grain or Solid only. VST Vertical Grain (available only for single panels 60"W or less, and for split panels between 87"W and 117"W).	5th Option: Paint See page 284 for finishes.	6th Option: Glide: (if applicable):
	G 	V .	.	G

Gallery Panels

Gallery-to-Gallery Panels: 50"H Application

GSA SIN 33721

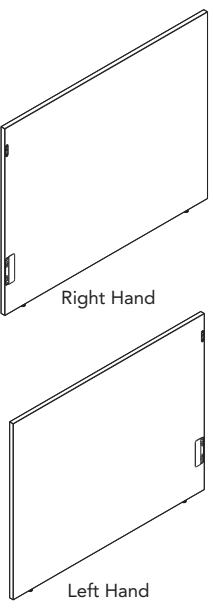
	Description	Model	List Price		
			L1	L2	L3
 <p>Right Hand</p> <p>Left Hand</p>	50"H L- Gallery-to-Gallery Panels				
	18"W (RH)	GL5018R	\$ 989	\$ 1026	\$ 1061
	18"W (LH)	GL5018L	\$ 989	\$ 1026	\$ 1061
	21"W (RH)	GL5021R	\$ 1011	\$ 1048	\$ 1085
	21"W (LH)	GL5021L	\$ 1011	\$ 1048	\$ 1085
	24"W (RH)	GL5024R	\$ 1049	\$ 1089	\$ 1126
	24"W (LH)	GL5024L	\$ 1049	\$ 1089	\$ 1126
	27"W (RH)	GL5027R	\$ 1093	\$ 1134	\$ 1173
	27"W (LH)	GL5027L	\$ 1093	\$ 1134	\$ 1173
	30"W (RH)	GL5030R	\$ 1192	\$ 1236	\$ 1278
	30"W (LH)	GL5030L	\$ 1192	\$ 1236	\$ 1278
	36"W (RH)	GL5036R	\$ 1294	\$ 1341	\$ 1388
	36"W (LH)	GL5036L	\$ 1294	\$ 1341	\$ 1388
	42"W (RH)	GL5042R	\$ 1387	\$ 1437	\$ 1486
	42"W (LH)	GL5042L	\$ 1387	\$ 1437	\$ 1486
	48"W (RH)	GL5048R	\$ 1505	\$ 1560	\$ 1614
	48"W (LH)	GL5048L	\$ 1505	\$ 1560	\$ 1614
	54"W (RH)	GL5054R	\$ 1594	\$ 1652	\$ 1710
	54"W (LH)	GL5054L	\$ 1594	\$ 1652	\$ 1710
	60"W (RH)	GL5060R	\$ 1672	\$ 1732	\$ 1793
	60"W (LH)	GL5060L	\$ 1672	\$ 1732	\$ 1793
	66"W (RH)	GL5066R	\$ 1745	\$ 1809	\$ 1870
	66"W (LH)	GL5066L	\$ 1745	\$ 1809	\$ 1870
	72"W (RH)	GL5072R	\$ 1835	\$ 1902	\$ 1967
	72"W (LH)	GL5072L	\$ 1835	\$ 1902	\$ 1967
	78"W (RH)	GL5078R	\$ 2113	\$ 2190	\$ 2266
	78"W (LH)	GL5078L	\$ 2113	\$ 2190	\$ 2266

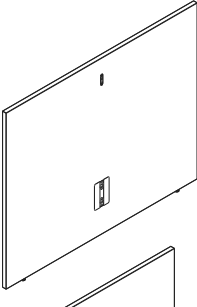
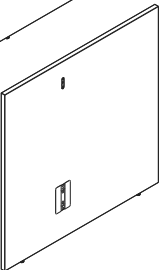
	50"H T- Gallery-to-Gallery Panels				
	18"W	GT5018	\$ 990	\$ 1027	\$ 1062
	21"W	GT5021	\$ 1013	\$ 1050	\$ 1087
	24"W	GT5024	\$ 1051	\$ 1091	\$ 1128
	27"W	GT5027	\$ 1092	\$ 1133	\$ 1172
	30"W	GT5030	\$ 1190	\$ 1234	\$ 1276
	36"W	GT5036	\$ 1294	\$ 1341	\$ 1388
	42"W	GT5042	\$ 1387	\$ 1437	\$ 1486
	48"W	GT5048	\$ 1503	\$ 1558	\$ 1612
	54"W	GT5054	\$ 1595	\$ 1653	\$ 1711
	60"W	GT5060	\$ 1673	\$ 1733	\$ 1794
	66"W	GT5066	\$ 1748	\$ 1812	\$ 1873
72"W	GT5072	\$ 1834	\$ 1901	\$ 1966	
78"W	GT5078	\$ 2112	\$ 2189	\$ 2265	
	50"H Nonsym T- Gallery-to-Gallery Panels				
	42"W 18L 24R	GT501824	\$ 1387	\$ 1437	\$ 1486
	42"W 24L 18R	GT502418	\$ 1387	\$ 1437	\$ 1486
	48"W 18L 30R	GT501830	\$ 1503	\$ 1558	\$ 1612
	48"W 30L 18R	GT503018	\$ 1503	\$ 1558	\$ 1612
	54"W 24L 30R	GT502430	\$ 1595	\$ 1653	\$ 1711
54"W 30L 24R	GT503024	\$ 1595	\$ 1653	\$ 1711	

Description	Model	List Price
Gallery-to-Gallery Installation Template (<i>Black only, code P</i>)	GTEMP	\$ 79

<p>How to specify —</p> <p>Select the Model Number from above.</p>	<p>1st Option:</p> <p>FSC: (if applicable): F FSC Wood X Non-FSC Wood</p>	<p>2nd Option:</p> <p>Laminate: (if applicable): See page 284 for finishes.</p>	<p>3rd Option:</p> <p>Edge: See page 284 for finishes.</p>	<p>4th Option:</p> <p>Grain: (if applicable): VLG Horizontal grain or Solid only. VST Vertical Grain (available only for single panels 60"W or less, and for split panels between 87"W and 117"W).</p>	<p>5th Option:</p> <p>Paint See page 284 for finishes.</p>	<p>6th Option:</p> <p>Glide: (if applicable):</p>
	<p>G . </p>	<p> </p>	<p> </p>	<p> </p>	<p>V .</p>	<p> . G</p>

GALLERY PANELS

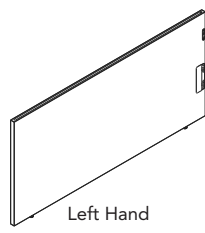
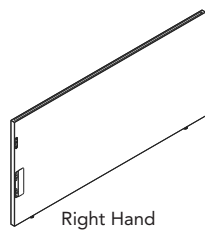

Description	Model	List Price			Accepts Glass Models 7½"H, 13"H, 15"H
		L1	L2	L3	
30"H L- Gallery-to-Gallery Panels For Use w/ Glass					
18"W (RH)	GL3018RG	\$ 959	\$ 995	\$ 1029	G4 □□ 18GS
18"W (LH)	GL3018LG	\$ 959	\$ 995	\$ 1029	G4 □□ 18GS
21"W (RH)	GL3021RG	\$ 974	\$ 1010	\$ 1045	G4 □□ 21GS
21"W (LH)	GL3021LG	\$ 974	\$ 1010	\$ 1045	G4 □□ 21GS
24"W (RH)	GL3024RG	\$ 1007	\$ 1044	\$ 1080	G4 □□ 24GS
24"W (LH)	GL3024LG	\$ 1007	\$ 1044	\$ 1080	G4 □□ 24GS
27"W (RH)	GL3027RG	\$ 1046	\$ 1084	\$ 1123	G4 □□ 27GS
27"W (LH)	GL3027LG	\$ 1046	\$ 1084	\$ 1123	G4 □□ 27GS
30"W (RH)	GL3030RG	\$ 1124	\$ 1166	\$ 1206	G4 □□ 30GS
30"W (LH)	GL3030LG	\$ 1124	\$ 1166	\$ 1206	G4 □□ 30GS
36"W (RH)	GL3036RG	\$ 1200	\$ 1244	\$ 1287	G4 □□ 36GS
36"W (LH)	GL3036LG	\$ 1200	\$ 1244	\$ 1287	G4 □□ 36GS
42"W (RH)	GL3042RG	\$ 1290	\$ 1337	\$ 1383	G4 □□ 42GS
42"W (LH)	GL3042LG	\$ 1290	\$ 1337	\$ 1383	G4 □□ 42GS
48"W (RH)	GL3048RG	\$ 1413	\$ 1465	\$ 1515	G4 □□ 48GS
48"W (LH)	GL3048LG	\$ 1413	\$ 1465	\$ 1515	G4 □□ 48GS
54"W (RH)	GL3054RG	\$ 1477	\$ 1531	\$ 1584	G4 □□ 54GS
54"W (LH)	GL3054LG	\$ 1477	\$ 1531	\$ 1584	G4 □□ 54GS
60"W (RH)	GL3060RG	\$ 1577	\$ 1634	\$ 1692	G4 □□ 60GS
60"W (LH)	GL3060LG	\$ 1577	\$ 1634	\$ 1692	G4 □□ 60GS
66"W (RH)	GL3066RG	\$ 1617	\$ 1676	\$ 1734	G4 □□ 66GS
66"W (LH)	GL3066LG	\$ 1617	\$ 1676	\$ 1734	G4 □□ 66GS
72"W (RH)	GL3072RG	\$ 1739	\$ 1801	\$ 1864	G4 □□ 72GS
72"W (LH)	GL3072LG	\$ 1739	\$ 1801	\$ 1864	G4 □□ 72GS
78"W (RH)	GL3078RG	\$ 1969	\$ 2041	\$ 2112	G4 □□ 78GS
78"W (LH)	GL3078LG	\$ 1969	\$ 2041	\$ 2112	G4 □□ 78GS

30"H T- Gallery-to-Gallery Panels For Use w/ Glass

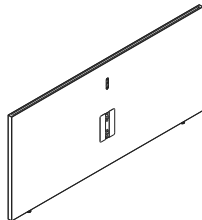

Description	Model	L1	L2	L3	Accepts Glass Models
18"W	GT3018G	\$ 957	\$ 993	\$ 1027	G4 □□ 18GS
21"W	GT3021G	\$ 977	\$ 1013	\$ 1048	G4 □□ 21GS
24"W	GT3024G	\$ 1006	\$ 1043	\$ 1079	G4 □□ 24GS
27"W	GT3027G	\$ 1045	\$ 1083	\$ 1122	G4 □□ 27GS
30"W	GT3030G	\$ 1126	\$ 1168	\$ 1208	G4 □□ 30GS
36"W	GT3036G	\$ 1198	\$ 1242	\$ 1285	G4 □□ 36GS
42"W	GT3042G	\$ 1291	\$ 1338	\$ 1384	G4 □□ 42GS
48"W	GT3048G	\$ 1414	\$ 1466	\$ 1516	G4 □□ 48GS
54"W	GT3054G	\$ 1478	\$ 1532	\$ 1585	G4 □□ 54GS
60"W	GT3060G	\$ 1574	\$ 1631	\$ 1689	G4 □□ 60GS
66"W	GT3066G	\$ 1616	\$ 1675	\$ 1733	G4 □□ 66GS
72"W	GT3072G	\$ 1740	\$ 1802	\$ 1865	G4 □□ 72GS
78"W	GT3078G	\$ 1970	\$ 2042	\$ 2113	G4 □□ 78GS

30"H Nonsym T- Gallery-to-Gallery Panels For Use w/ Glass

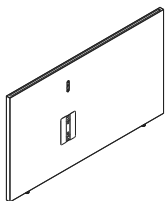

Description	Model	L1	L2	L3	Accepts Glass Models
42"W 18L 24R	GT301824G	\$ 1291	\$ 1338	\$ 1384	G4 □□ 42GS
42"W 24L 18R	GT302418G	\$ 1291	\$ 1338	\$ 1384	G4 □□ 42GS
48"W 18L 30R	GT301830G	\$ 1414	\$ 1466	\$ 1516	G4 □□ 48GS
48"W 30L 18R	GT303018G	\$ 1414	\$ 1466	\$ 1516	G4 □□ 48GS
54"W 24L 30R	GT302430G	\$ 1478	\$ 1532	\$ 1585	G4 □□ 54GS
54"W 30L 24R	GT303024G	\$ 1478	\$ 1532	\$ 1585	G4 □□ 54GS

Note: Fill in model number blanks with one of the following options to determine glass height.

- 07 7.5"H glass
- 13 13"H glass
- 15 15"H glass

Description	Model	List Price
Gallery-to-Gallery Installation Template (<i>Black only, code P</i>)	GTEMP	\$ 79

How to specify — Select the Model Number from above. G . .	1st Option: FSC: (if applicable): F FSC Wood X Non-FSC Wood	2nd Option: Laminate: (if applicable): See page 284 for finishes.	3rd Option: Edge: See page 284 for finishes.	4th Option: Grain: (if applicable): VLG Horizontal grain or Solid only. VST Vertical Grain (available only for single panels 60"W or less, and for split panels between 87"W and 117"W).	5th Option: Paint See page 284 for finishes.	6th Option: Glide: (if applicable):
	V .	.	G

Gallery Panels

Gallery-to-Gallery Panels for use with Glass: 42" Application

GSA SIN 33721

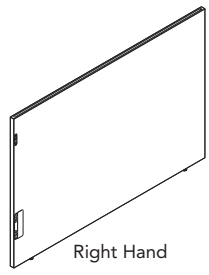

Right Hand

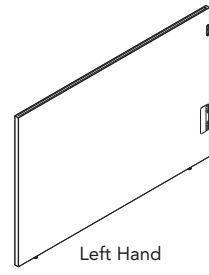

Left Hand

Description	Model	List Price			Accepts Glass Models 7½"H, 13"H, 15"H
		L1	L2	L3	
42"H L- Gallery-to-Gallery Panels For Use w/ Glass					
18"W (RH)	GL4218RG	1120	1162	1202	G4 □□ 18GS
18"W (LH)	GL4218LG	1120	1162	1202	G4 □□ 18GS
21"W (RH)	GL4221RG	1134	1176	1216	G4 □□ 21GS
21"W (LH)	GL4221LG	1134	1176	1216	G4 □□ 21GS
24"W (RH)	GL4224RG	1183	1227	1268	G4 □□ 24GS
24"W (LH)	GL4224LG	1183	1227	1268	G4 □□ 24GS
27"W (RH)	GL4227RG	1224	1269	1313	G4 □□ 27GS
27"W (LH)	GL4227LG	1224	1269	1313	G4 □□ 27GS
30"W (RH)	GL4230RG	1337	1386	1433	G4 □□ 30GS
30"W (LH)	GL4230LG	1337	1386	1433	G4 □□ 30GS
36"W (RH)	GL4236RG	1436	1489	1541	G4 □□ 36GS
36"W (LH)	GL4236LG	1436	1489	1541	G4 □□ 36GS
42"W (RH)	GL4242RG	1518	1573	1628	G4 □□ 42GS
42"W (LH)	GL4242LG	1518	1573	1628	G4 □□ 42GS
48"W (RH)	GL4248RG	1602	1660	1718	G4 □□ 48GS
48"W (LH)	GL4248LG	1602	1660	1718	G4 □□ 48GS
54"W (RH)	GL4254RG	1710	1772	1833	G4 □□ 54GS
54"W (LH)	GL4254LG	1710	1772	1833	G4 □□ 54GS
60"W (RH)	GL4260RG	1791	1856	1920	G4 □□ 60GS
60"W (LH)	GL4260LG	1791	1856	1920	G4 □□ 60GS
66"W (RH)	GL4266RG	1873	1941	2007	G4 □□ 66GS
66"W (LH)	GL4266LG	1873	1941	2007	G4 □□ 66GS
72"W (RH)	GL4272RG	1986	2058	2130	G4 □□ 72GS
72"W (LH)	GL4272LG	1986	2058	2130	G4 □□ 72GS
78"W (RH)	GL4278RG	2140	2218	2294	G4 □□ 78GS
78"W (LH)	GL4278LG	2140	2218	2294	G4 □□ 78GS

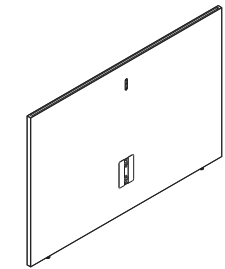

42"H T- Gallery-to-Gallery Panels For Use w/ Glass					
18"W	GT4218G	1121	1163	1203	G4 □□ 18GS
21"W	GT4221G	1137	1179	1219	G4 □□ 21GS
24"W	GT4224G	1183	1227	1268	G4 □□ 24GS
27"W	GT4227G	1222	1267	1311	G4 □□ 27GS
30"W	GT4230G	1340	1389	1436	G4 □□ 30GS
36"W	GT4236G	1438	1491	1543	G4 □□ 36GS
42"W	GT4242G	1518	1573	1628	G4 □□ 42GS
48"W	GT4248G	1601	1659	1717	G4 □□ 48GS
54"W	GT4254G	1711	1773	1834	G4 □□ 54GS
60"W	GT4260G	1791	1856	1920	G4 □□ 60GS
66"W	GT4266G	1872	1940	2006	G4 □□ 66GS
72"W	GT4272G	1985	2057	2129	G4 □□ 72GS
78"W	GT4278G	2139	2217	2293	G4 □□ 78GS

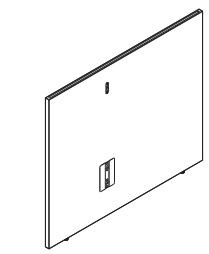

42"H Nonsym T- Gallery-to-Gallery Panels For Use w/ Glass					
42"W 18L 24R	GT421824G	1518	1573	1628	G4 □□ 42GS
42"W 24L 18R	GT422418G	1518	1573	1628	G4 □□ 42GS
48"W 18L 30R	GT421830G	1601	1659	1717	G4 □□ 48GS
48"W 30L 18R	GT423018G	1601	1659	1717	G4 □□ 48GS
54"W 24L 30R	GT422430G	1711	1773	1834	G4 □□ 54GS
54"W 30L 24R	GT423024G	1711	1773	1834	G4 □□ 54GS

Note: Fill in model number blanks with one of the following options to determine glass height.
07 7.5"H glass
13 13"H glass
15 15"H glass

Description	Model	List Price
Gallery-to-Gallery Installation Template (<i>Black only, code P</i>)	GTEMP	\$ 79

<p>How to specify — Select the Model Number from above.</p> <p>G . .</p>	<p>1st Option: FSC: (if applicable): F FSC Wood X Non-FSC Wood</p>	<p>2nd Option: Laminate: (if applicable): See page 284 for finishes.</p>	<p>3rd Option: Edge: See page 284 for finishes.</p>	<p>4th Option: Grain: (if applicable): VLG Horizontal grain or Solid only. VST Vertical Grain (available only for single panels 60"W or less, and for split panels between 87"W and 117"W).</p>	<p>5th Option: Paint See page 284 for finishes.</p>	<p>6th Option: Glide: (if applicable):</p>
	<p> . G</p>					

GALLERY PANELS

Gallery Panels

Gallery-to-Gallery Panels for use with Glass: 50" Application

GSA SIN 33721

Description	Model	List Price			Accepts Glass Models 7½"H, 13"H, 15"H
		L1	L2	L3	
50"H L- Gallery-to-Gallery Panels For Use w/ Glass					
18"W (RH)	GL5018RG	1229	1274	1318	G4 □□ 18GS
18"W (LH)	GL5018LG	1229	1274	1318	G4 □□ 18GS
21"W (RH)	GL5021RG	1251	1297	1342	G4 □□ 21GS
21"W (LH)	GL5021LG	1251	1297	1342	G4 □□ 21GS
24"W (RH)	GL5024RG	1290	1337	1383	G4 □□ 24GS
24"W (LH)	GL5024LG	1290	1337	1383	G4 □□ 24GS
27"W (RH)	GL5027RG	1334	1383	1430	G4 □□ 27GS
27"W (LH)	GL5027LG	1334	1383	1430	G4 □□ 27GS
30"W (RH)	GL5030RG	1432	1485	1535	G4 □□ 30GS
30"W (LH)	GL5030LG	1432	1485	1535	G4 □□ 30GS
36"W (RH)	GL5036RG	1534	1590	1645	G4 □□ 36GS
36"W (LH)	GL5036LG	1534	1590	1645	G4 □□ 36GS
42"W (RH)	GL5042RG	1627	1686	1745	G4 □□ 42GS
42"W (LH)	GL5042LG	1627	1686	1745	G4 □□ 42GS
48"W (RH)	GL5048RG	1744	1808	1869	G4 □□ 48GS
48"W (LH)	GL5048LG	1744	1808	1869	G4 □□ 48GS
54"W (RH)	GL5054RG	1835	1902	1967	G4 □□ 54GS
54"W (LH)	GL5054LG	1835	1902	1967	G4 □□ 54GS
60"W (RH)	GL5060RG	1913	1983	2050	G4 □□ 60GS
60"W (LH)	GL5060LG	1913	1983	2050	G4 □□ 60GS
66"W (RH)	GL5066RG	1987	2059	2131	G4 □□ 66GS
66"W (LH)	GL5066LG	1987	2059	2131	G4 □□ 66GS
72"W (RH)	GL5072RG	2074	2149	2223	G4 □□ 72GS
72"W (LH)	GL5072LG	2074	2149	2223	G4 □□ 72GS
78"W (RH)	GL5078RG	2352	2437	2521	G4 □□ 78GS
78"W (LH)	GL5078LG	2352	2437	2521	G4 □□ 78GS

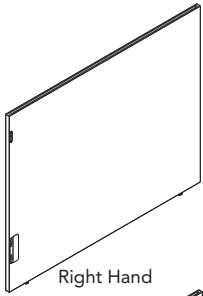

Right Hand

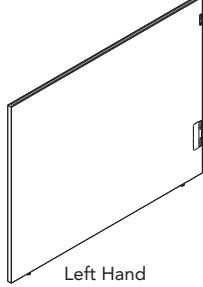

Left Hand

50"H T- Gallery-to-Gallery Panels For Use w/ Glass					
18"W	GT5018G	1230	1275	1319	G4 □□ 18GS
21"W	GT5021G	1251	1297	1342	G4 □□ 21GS
24"W	GT5024G	1291	1338	1384	G4 □□ 24GS
27"W	GT5027G	1332	1381	1428	G4 □□ 27GS
30"W	GT5030G	1432	1485	1535	G4 □□ 30GS
36"W	GT5036G	1534	1590	1645	G4 □□ 36GS
42"W	GT5042G	1627	1686	1745	G4 □□ 42GS
48"W	GT5048G	1744	1808	1869	G4 □□ 48GS
54"W	GT5054G	1834	1901	1966	G4 □□ 54GS
60"W	GT5060G	1912	1982	2049	G4 □□ 60GS
66"W	GT5066G	1986	2058	2130	G4 □□ 66GS
72"W	GT5072G	2074	2149	2223	G4 □□ 72GS
78"W	GT5078G	2353	2438	2522	G4 □□ 78GS

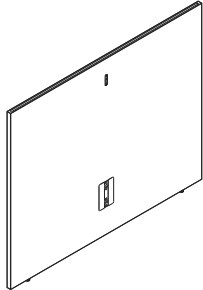

50"H Nonsym T- Gallery-to-Gallery Panels For Use w/ Glass					
42"W 18L 24R	GT501824G	1627	1686	1745	G4 □□ 42GS
42"W 24L 18R	GT502418G	1627	1686	1745	G4 □□ 42GS
48"W 18L 30R	GT501830G	1744	1808	1869	G4 □□ 48GS
48"W 30L 18R	GT503018G	1744	1808	1869	G4 □□ 48GS
54"W 24L 30R	GT502430G	1834	1901	1966	G4 □□ 54GS
54"W 30L 24R	GT503024G	1834	1901	1966	G4 □□ 54GS

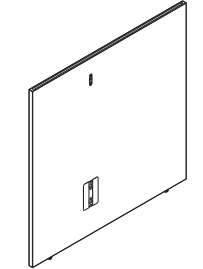

Note: Fill in model number blanks with one of the following options to determine glass height.

- 07 7.5"H glass
- 13 13"H glass
- 15 15"H glass

Description	Model	List Price
Gallery-to-Gallery Installation Template (<i>Black only, code P</i>)	GTEMP	\$ 79

<p>How to specify — Select the Model Number from above.</p>	<p><i>1st Option:</i> FSC: (if applicable): F FSC Wood X Non-FSC Wood</p>	<p><i>2nd Option:</i> Laminate: (if applicable): See page 284 for finishes.</p>	<p><i>3rd Option:</i> Edge: See page 284 for finishes.</p>	<p><i>4th Option:</i> Grain: (if applicable): VLG Horizontal grain or Solid only. VST Vertical Grain (available only for single panels 60"W or less, and for split panels between 87"W and 117"W).</p>	<p><i>5th Option:</i> Paint See page 284 for finishes.</p>	<p><i>6th Option:</i> Glide: (if applicable):</p>
G . .				V .		G

GALLERY PANELS

Gallery Panels

30"H Application

For Gallery Panel connectors see pages 324-325.

GSA SIN 33721

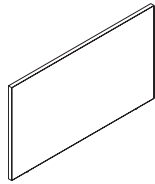

Description	Model	Configuration	List Price		
			L1	L2	L3
30"H Gallery Panels					
18"W	G3018	Mid	\$ 479	\$ 497	\$ 513
21"W	G3021	Mid	\$ 498	\$ 517	\$ 534
24"W	G3024	Mid	\$ 529	\$ 549	\$ 567
27"W	G3027	Mid	\$ 567	\$ 588	\$ 609
30"W	G3030	Mid	\$ 646	\$ 669	\$ 693
33"W	G3033	S, Mid	\$ 685	\$ 710	\$ 734
36"W	G3036	S, Mid	\$ 720	\$ 747	\$ 772
39"W	G3039	S, Mid	\$ 782	\$ 811	\$ 838
42"W	G3042	S, Mid	\$ 846	\$ 876	\$ 906
45"W	G3045	S, Mid	\$ 923	\$ 956	\$ 989
48"W	G3048	S, Mid	\$ 967	\$ 1001	\$ 1037
51"W	G3051	D, S, Mid	\$ 983	\$ 1019	\$ 1054
54"W	G3054	D, S, Mid	\$ 1030	\$ 1067	\$ 1104
57"W	G3057	D, S, Mid	\$ 1076	\$ 1116	\$ 1153
60"W	G3060	D, S, Mid	\$ 1128	\$ 1169	\$ 1209
63"W	G3063	D, S, Mid	\$ 1148	\$ 1190	\$ 1230
66"W	G3066	D, S, Mid	\$ 1173	\$ 1216	\$ 1256
69"W	G3069	D, S, Mid	\$ 1256	\$ 1301	\$ 1346
72"W	G3072	D, S, Mid	\$ 1292	\$ 1338	\$ 1384
75"W	G3075	D, S, Mid	\$ 1465	\$ 1518	\$ 1570
78"W	G3078	D, S, Mid	\$ 1522	\$ 1577	\$ 1630
81"W	G3081	D, S, Mid	\$ 1575	\$ 1631	\$ 1687
84"W	G3084	D, S, Mid	\$ 1731	\$ 1792	\$ 1853

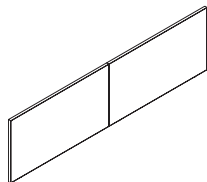

30"H Gallery Split Panels (model number includes two units)					
81"W	GS3081	D	\$ 1498	\$ 1554	\$ 1610
87"W	GS3087	D	\$ 1809	\$ 1874	\$ 1937
93"W	GS3093	D	\$ 1865	\$ 1931	\$ 1997
99"W	GS3099	D	\$ 1888	\$ 1955	\$ 2021
105"W	GS30105	D	\$ 1923	\$ 1991	\$ 2058
111"W	GS30111	D	\$ 2016	\$ 2088	\$ 2159
117"W	GS30117	D	\$ 2071	\$ 2145	\$ 2218
123"W	GS30123	D	\$ 2088	\$ 2162	\$ 2236
129"W	GS30129	D	\$ 2137	\$ 2214	\$ 2289
135"W	GS30135	D	\$ 2226	\$ 2306	\$ 2383
141"W	GS30141	D	\$ 2328	\$ 2411	\$ 2493
147"W	GS30147	D	\$ 2441	\$ 2527	\$ 2614

Note: Configuration is not included in model number

- Mid Mid Panel
- S End Single Sided
- D End Dual Sided

GALLERY PANELS

How to specify — Select the Model Number from above.	1st Option: FSC: F FSC Wood X Non-FSC Wood	2nd Option: Laminate: See page 284 for finishes.	3rd Option: Edge: See page 284 for finishes.	4th Option: Grain: VLG Horizontal grain or Solid only. VST Vertical Grain (available only for single panels 60"W or less, and for split panels between 87"W and 117"W).	5th Option: Glide:
G . .				V	G

Examples: G3018.X.LT11.TI.VLG.G GS3087.F.LLA1.TI.VST.G

Gallery Panels

35"H Application

For Gallery Panel connectors see pages 324-325.

GSA SIN 33721

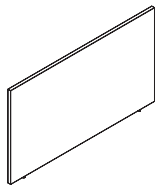

Description	Model	Configuration	List Price		
			L1	L2	L3
35"H Gallery Panels					
18"W	G3518	Mid	\$ 575	\$ 597	\$ 618
21"W	G3521	Mid	\$ 594	\$ 616	\$ 638
24"W	G3524	Mid	\$ 631	\$ 655	\$ 678
27"W	G3527	Mid	\$ 666	\$ 691	\$ 715
30"W	G3530	Mid	\$ 770	\$ 799	\$ 827
33"W	G3533	S, Mid	\$ 811	\$ 841	\$ 870
36"W	G3536	S, Mid	\$ 860	\$ 892	\$ 922
39"W	G3539	S, Mid	\$ 918	\$ 952	\$ 985
42"W	G3542	S, Mid	\$ 959	\$ 995	\$ 1030
45"W	G3545	S, Mid	\$ 1018	\$ 1056	\$ 1092
48"W	G3548	S, Mid	\$ 1062	\$ 1102	\$ 1140
51"W	G3551	D, S, Mid	\$ 1098	\$ 1139	\$ 1178
54"W	G3554	D, S, Mid	\$ 1138	\$ 1181	\$ 1221
57"W	G3557	D, S, Mid	\$ 1184	\$ 1228	\$ 1270
60"W	G3560	D, S, Mid	\$ 1222	\$ 1267	\$ 1311
63"W	G3563	D, S, Mid	\$ 1250	\$ 1296	\$ 1341
66"W	G3566	D, S, Mid	\$ 1286	\$ 1333	\$ 1379
69"W	G3569	D, S, Mid	\$ 1348	\$ 1397	\$ 1445
72"W	G3572	D, S, Mid	\$ 1411	\$ 1463	\$ 1513
75"W	G3575	D, S, Mid	\$ 1521	\$ 1577	\$ 1631
78"W	G3578	D, S, Mid	\$ 1600	\$ 1658	\$ 1716
81"W	G3581	D, S, Mid	\$ 1720	\$ 1782	\$ 1844
84"W	G3584	D, S, Mid	\$ 1883	\$ 1951	\$ 2018

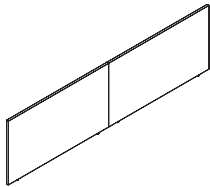

35"H Gallery Split Panels (model number includes two units)					
81"W	G3581	D	\$ 1664	\$ 1726	\$ 1788
87"W	G3587	D	\$ 1956	\$ 2028	\$ 2098
93"W	G3593	D	\$ 2028	\$ 2102	\$ 2175
99"W	G3599	D	\$ 2111	\$ 2189	\$ 2264
105"W	G35105	D	\$ 2138	\$ 2217	\$ 2293
111"W	G35111	D	\$ 2215	\$ 2296	\$ 2374
117"W	G35117	D	\$ 2283	\$ 2366	\$ 2448
123"W	G35123	D	\$ 2342	\$ 2427	\$ 2511
129"W	G35129	D	\$ 2372	\$ 2458	\$ 2543
135"W	G35135	D	\$ 2480	\$ 2570	\$ 2659
141"W	G35141	D	\$ 2576	\$ 2670	\$ 2762
147"W	G35147	D	\$ 2644	\$ 2740	\$ 2835

Note: Configuration is not included in model number

- Mid Mid Panel
- S End Single Sided
- D End Dual Sided

GALLERY PANELS

How to specify — Select the Model Number from above.	1st Option: FSC: F FSC Wood X Non-FSC Wood	2nd Option: Laminate: See page 284 for finishes.	3rd Option: Edge: See page 284 for finishes.	4th Option: Grain: VLG Horizontal grain or Solid only. VST Vertical Grain (available only for single panels 60"W or less, and for split panels between 87"W and 117"W).	5th Option: Glide:
G . .				V	G

Examples: G3518.X.LT11.TI.VLG.G GS3587.F.LLA1.TI.VST.G

Gallery Panels

42"H Application

For Gallery Panel connectors see pages 324-325.

GSA SIN 33721

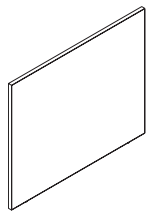

Description	Model	Configuration	List Price		
			L1	L2	L3
42"H Gallery Panels					
18"W	G4218	Mid	\$ 642	\$ 665	\$ 688
21"W	G4221	Mid	\$ 660	\$ 684	\$ 707
24"W	G4224	Mid	\$ 705	\$ 730	\$ 755
27"W	G4227	Mid	\$ 746	\$ 773	\$ 800
30"W	G4230	Mid	\$ 861	\$ 892	\$ 922
33"W	G4233	S, Mid	\$ 906	\$ 938	\$ 971
36"W	G4236	S, Mid	\$ 959	\$ 993	\$ 1027
39"W	G4239	S, Mid	\$ 1027	\$ 1064	\$ 1100
42"W	G4242	S, Mid	\$ 1071	\$ 1111	\$ 1148
45"W	G4245	S, Mid	\$ 1110	\$ 1151	\$ 1190
48"W	G4248	S, Mid	\$ 1155	\$ 1197	\$ 1237
51"W	G4251	D, S, Mid	\$ 1228	\$ 1272	\$ 1315
54"W	G4254	D, S, Mid	\$ 1266	\$ 1312	\$ 1356
57"W	G4257	D, S, Mid	\$ 1297	\$ 1344	\$ 1389
60"W	G4260	D, S, Mid	\$ 1346	\$ 1394	\$ 1441
63"W	G4263	D, S, Mid	\$ 1382	\$ 1431	\$ 1480
66"W	G4266	D, S, Mid	\$ 1427	\$ 1479	\$ 1528
69"W	G4269	D, S, Mid	\$ 1455	\$ 1508	\$ 1558
72"W	G4272	D, S, Mid	\$ 1538	\$ 1593	\$ 1647
75"W	G4275	D, S, Mid	\$ 1593	\$ 1650	\$ 1706
78"W	G4278	D, S, Mid	\$ 1693	\$ 1753	\$ 1813
81"W	G4281	D, S, Mid	\$ 1891	\$ 1958	\$ 2024
84"W	G4284	D, S, Mid	\$ 2036	\$ 2109	\$ 2180

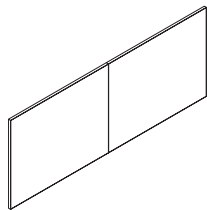

42"H Gallery Split Panels (model number includes two units)					
81"W	GS4281	D	\$ 1793	\$ 1860	\$ 1926
87"W	GS4287	D	\$ 2076	\$ 2150	\$ 2223
93"W	GS4293	D	\$ 2115	\$ 2190	\$ 2264
99"W	GS4299	D	\$ 2210	\$ 2289	\$ 2366
105"W	GS42105	D	\$ 2244	\$ 2324	\$ 2402
111"W	GS42111	D	\$ 2299	\$ 2381	\$ 2461
117"W	GS42117	D	\$ 2354	\$ 2438	\$ 2520
123"W	GS42123	D	\$ 2414	\$ 2499	\$ 2584
129"W	GS42129	D	\$ 2500	\$ 2589	\$ 2677
135"W	GS42135	D	\$ 2602	\$ 2694	\$ 2786
141"W	GS42141	D	\$ 2699	\$ 2794	\$ 2890
147"W	GS42147	D	\$ 2755	\$ 2852	\$ 2949

Note: Configuration is not included in model number

- Mid Mid Panel
- S End Single Sided
- D End Dual Sided

GALLERY PANELS

How to specify — Select the Model Number from above.	1st Option: FSC: F FSC Wood X Non-FSC Wood	2nd Option: Laminate: See page 284 for finishes.	3rd Option: Edge: See page 284 for finishes.	4th Option: Grain: VLG Horizontal grain or Solid only. VST Vertical Grain (available only for single panels 60"W or less, and for split panels between 87"W and 117"W.	5th Option: Glide:
G 	V .	G

Examples: G4218.X.LT11.TI.VLG.G GS4287.F.LLA1.TI.VST.G

Gallery Panels

50"H Application

For Gallery Panel connectors see pages 324-325.

GSA SIN 33721

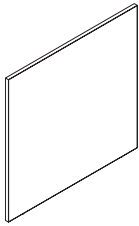

Description	Model	Configuration	List Price		
			L1	L2	L3
50"H Gallery Panels					
18"W	G5018	Mid	\$ 752	\$ 780	\$ 806
21"W	G5021	Mid	\$ 775	\$ 803	\$ 831
24"W	G5024	Mid	\$ 812	\$ 841	\$ 870
27"W	G5027	Mid	\$ 857	\$ 888	\$ 918
30"W	G5030	Mid	\$ 955	\$ 989	\$ 1023
33"W	G5033	S, Mid	\$ 1005	\$ 1041	\$ 1077
36"W	G5036	S, Mid	\$ 1054	\$ 1092	\$ 1129
39"W	G5039	S, Mid	\$ 1119	\$ 1160	\$ 1199
42"W	G5042	S, Mid	\$ 1179	\$ 1222	\$ 1263
45"W	G5045	S, Mid	\$ 1266	\$ 1312	\$ 1356
48"W	G5048	S, Mid	\$ 1297	\$ 1344	\$ 1389
51"W	G5051	D, S, Mid	\$ 1332	\$ 1380	\$ 1426
54"W	G5054	D, S, Mid	\$ 1388	\$ 1437	\$ 1486
57"W	G5057	D, S, Mid	\$ 1424	\$ 1476	\$ 1525
60"W	G5060	D, S, Mid	\$ 1466	\$ 1519	\$ 1571
63"W	G5063	D, S, Mid	\$ 1498	\$ 1552	\$ 1605
66"W	G5066	D, S, Mid	\$ 1539	\$ 1594	\$ 1648
69"W	G5069	D, S, Mid	\$ 1585	\$ 1642	\$ 1697
72"W	G5072	D, S, Mid	\$ 1628	\$ 1686	\$ 1744
75"W	G5075	D, S, Mid	\$ 1737	\$ 1798	\$ 1860
78"W	G5078	D, S, Mid	\$ 1907	\$ 1975	\$ 2041
81"W	G5081	D, S, Mid	\$ 2069	\$ 2143	\$ 2216
84"W	G5084	D, S, Mid	\$ 2212	\$ 2291	\$ 2368

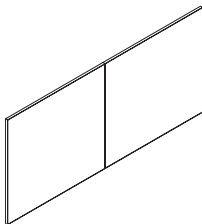

50"H Gallery Split Panels (model number includes two units)

81"W	GS5081	D	\$ 1962	\$ 2036	\$ 2109
87"W	GS5087	D	\$ 2250	\$ 2330	\$ 2409
93"W	GS5093	D	\$ 2368	\$ 2452	\$ 2535
99"W	GS5099	D	\$ 2417	\$ 2503	\$ 2587
105"W	GS50105	D	\$ 2504	\$ 2593	\$ 2682
111"W	GS50111	D	\$ 2538	\$ 2628	\$ 2718
117"W	GS50117	D	\$ 2564	\$ 2655	\$ 2745
123"W	GS50123	D	\$ 2590	\$ 2682	\$ 2773
129"W	GS50129	D	\$ 2660	\$ 2754	\$ 2847
135"W	GS50135	D	\$ 2710	\$ 2806	\$ 2902
141"W	GS50141	D	\$ 2755	\$ 2852	\$ 2949
147"W	GS50147	D	\$ 2853	\$ 2954	\$ 3055

Note: Configuration is not included in model number

- Mid Mid Panel
- S End Single Sided
- D End Dual Sided

GALLERY PANELS

How to specify — Select the Model Number from above.	1st Option: FSC: F FSC Wood X Non-FSC Wood	2nd Option: Laminate: See page 284 for finishes.	3rd Option: Edge: See page 284 for finishes.	4th Option: Grain: VLG Horizontal grain or Solid only. VST Vertical Grain (available only for single panels 60"W or less, and for split panels between 87"W and 117"W).	5th Option: Glide:
G . .				V	G

Examples: G5018.X.LT11.TI.VLG.G GS5087.F.LLA1.TI.VST.G

Gallery Panels

57½"H Application

For Gallery Panel connectors see pages 324-325.

GSA SIN 33721

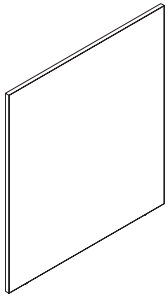

Description	Model	Configuration	List Price		
			L1	L2	L3
57½"H Gallery Panels					
18"W	G5718	Mid	\$ 915	\$ 948	\$ 980
21"W	G5721	Mid	\$ 937	\$ 970	\$ 1004
24"W	G5724	Mid	\$ 974	\$ 1010	\$ 1044
27"W	G5727	Mid	\$ 1018	\$ 1055	\$ 1091
30"W	G5730	Mid	\$ 1118	\$ 1159	\$ 1198
33"W	G5733	S, Mid	\$ 1165	\$ 1208	\$ 1248
36"W	G5736	S, Mid	\$ 1218	\$ 1262	\$ 1304
39"W	G5739	S, Mid	\$ 1284	\$ 1330	\$ 1375
42"W	G5742	S, Mid	\$ 1345	\$ 1393	\$ 1440
45"W	G5745	S, Mid	\$ 1428	\$ 1480	\$ 1529
48"W	G5748	S, Mid	\$ 1462	\$ 1515	\$ 1567
51"W	G5751	D, S, Mid	\$ 1496	\$ 1550	\$ 1603
54"W	G5754	D, S, Mid	\$ 1551	\$ 1607	\$ 1661
57"W	G5757	D, S, Mid	\$ 1587	\$ 1644	\$ 1699
60"W	G5760	D, S, Mid	\$ 1629	\$ 1687	\$ 1745
63"W	G5763	D, S, Mid	\$ 1661	\$ 1720	\$ 1779
66"W	G5766	D, S, Mid	\$ 1703	\$ 1763	\$ 1824
69"W	G5769	D, S, Mid	\$ 1745	\$ 1807	\$ 1868
72"W	G5772	D, S, Mid	\$ 1790	\$ 1854	\$ 1917
75"W	G5775	D, S, Mid	\$ 1899	\$ 1966	\$ 2033
78"W	G5778	D, S, Mid	\$ 2069	\$ 2143	\$ 2216
81"W	G5781	D, S, Mid	\$ 2235	\$ 2315	\$ 2393
84"W	G5784	D, S, Mid	\$ 2373	\$ 2457	\$ 2541

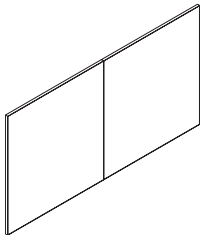

57½"H Gallery Split Panels (model number includes two units)					
81"W	GS5781	D	\$ 2116	\$ 2196	\$ 2274
87"W	GS5787	D	\$ 2416	\$ 2502	\$ 2586
93"W	GS5793	D	\$ 2533	\$ 2623	\$ 2712
99"W	GS5799	D	\$ 2578	\$ 2670	\$ 2760
105"W	GS57105	D	\$ 2668	\$ 2762	\$ 2857
111"W	GS57111	D	\$ 2703	\$ 2799	\$ 2894
117"W	GS57117	D	\$ 2728	\$ 2824	\$ 2921
123"W	GS57123	D	\$ 2755	\$ 2852	\$ 2949
129"W	GS57129	D	\$ 2823	\$ 2922	\$ 3022
135"W	GS57135	D	\$ 2875	\$ 2977	\$ 3078
141"W	GS57141	D	\$ 2918	\$ 3021	\$ 3124
147"W	GS57147	D	\$ 3017	\$ 3124	\$ 3231

Note: Configuration is not included in model number

- Mid Mid Panel
- S End Single Sided
- D End Dual Sided

GALLERY PANELS

<p>How to specify — Select the Model Number from above.</p>	<p>1st Option: FSC: F FSC Wood X Non-FSC Wood</p>	<p>2nd Option: Laminate: See page 284 for finishes.</p>	<p>3rd Option: Edge: See page 284 for finishes.</p>	<p>4th Option: Grain: VLG Horizontal grain or Solid only. VST Vertical Grain (available only for single panels 60"W or less, and for split panels between 87"W and 117"W).</p>	<p>5th Option: Glide:</p>
G . .				V .	G .

Examples: G5718.X.LT11.TI.VLG.G GS5787.F.LLA1.TI.VST.G

Gallery Panels

30"H Application for Use with Glass

For Gallery Panel Glass see pages 326-328.
 For Gallery Panel connectors see pages 324-325.

GSA SIN 33721

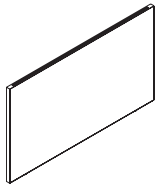

Description	Model	Configuration	List Price			Accepts Glass Models 7½"H, 13"H, 15"H
			L1	L2	L3	
30"H Gallery Panels with Glass						
18"W	G3018G	Mid	\$ 724	\$ 751	\$ 776	G4 □□ 15GS
21"W	G3021G	Mid	\$ 742	\$ 769	\$ 796	G4 □□ 18GS
24"W	G3024G	Mid	\$ 775	\$ 803	\$ 831	G4 □□ 21GS
27"W	G3027G	Mid	\$ 812	\$ 841	\$ 870	G4 □□ 24GS
30"W	G3030G	Mid	\$ 894	\$ 926	\$ 958	G4 □□ 27GS
33"W	G3033G	S, Mid	\$ 933	\$ 966	\$ 999	G4 □□ 30GS
36"W	G3036G	S, Mid	\$ 967	\$ 1001	\$ 1037	G4 □□ 33GS
39"W	G3039G	S, Mid	\$ 1027	\$ 1064	\$ 1100	G4 □□ 36GS
42"W	G3042G	S, Mid	\$ 1090	\$ 1130	\$ 1168	G4 □□ 39GS
45"W	G3045G	S, Mid	\$ 1166	\$ 1209	\$ 1249	G4 □□ 42GS
48"W	G3048G	S, Mid	\$ 1211	\$ 1255	\$ 1297	G4 □□ 45GS
51"W	G3051G	D, S, Mid	\$ 1228	\$ 1272	\$ 1315	G4 □□ 48GS
54"W	G3054G	D, S, Mid	\$ 1276	\$ 1322	\$ 1367	G4 □□ 51GS
57"W	G3057G	D, S, Mid	\$ 1321	\$ 1368	\$ 1415	G4 □□ 54GS
60"W	G3060G	D, S, Mid	\$ 1371	\$ 1420	\$ 1468	G4 □□ 57GS
63"W	G3063G	D, S, Mid	\$ 1391	\$ 1441	\$ 1489	G4 □□ 60GS
66"W	G3066G	D, S, Mid	\$ 1416	\$ 1466	\$ 1517	G4 □□ 63GS
69"W	G3069G	D, S, Mid	\$ 1501	\$ 1555	\$ 1608	G4 □□ 66GS
72"W	G3072G	D, S, Mid	\$ 1537	\$ 1592	\$ 1646	G4 □□ 69GS
75"W	G3075G	D, S, Mid	\$ 1708	\$ 1769	\$ 1829	G4 □□ 72GS
78"W	G3078G	D, S, Mid	\$ 1768	\$ 1830	\$ 1893	G4 □□ 75GS
81"W	G3081G	D, S, Mid	\$ 1822	\$ 1887	\$ 1951	G4 □□ 78GS
84"W	G3084G	D, S, Mid	\$ 1975	\$ 2046	\$ 2116	G4 □□ 81GS

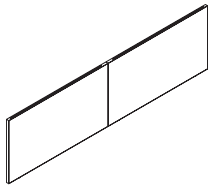

30"H Gallery Split Panels with Glass (corresponding glass models must be ordered in quantities of 2 for split panels)						
81"W	GS3081G	D	\$ 1728	\$ 1793	\$ 1857	G4 □□ 36GS
87"W	GS3087G	D	\$ 2053	\$ 2126	\$ 2199	G4 □□ 39GS
93"W	GS3093G	D	\$ 2111	\$ 2186	\$ 2260	G4 □□ 42GS
99"W	GS3099G	D	\$ 2133	\$ 2210	\$ 2285	G4 □□ 45GS
105"W	GS30105G	D	\$ 2167	\$ 2245	\$ 2321	G4 □□ 48GS
111"W	GS30111G	D	\$ 2261	\$ 2342	\$ 2421	G4 □□ 51GS
117"W	GS30117G	D	\$ 2316	\$ 2398	\$ 2480	G4 □□ 54GS
123"W	GS30123G	D	\$ 2332	\$ 2415	\$ 2497	G4 □□ 57GS
129"W	GS30129G	D	\$ 2382	\$ 2467	\$ 2550	G4 □□ 60GS
135"W	GS30135G	D	\$ 2469	\$ 2556	\$ 2644	G4 □□ 63GS
141"W	GS30141G	D	\$ 2572	\$ 2663	\$ 2754	G4 □□ 66GS
147"W	GS30147G	D	\$ 2685	\$ 2780	\$ 2875	G4 □□ 69GS

Note: Configuration is not included in model number

- Mid** Mid Panel
- S** End Single Sided
- D** End Dual Sided

Note: Fill in model number blanks with one of the following options to determine glass height.

- 07** 7.5"H glass
- 13** 13"H glass
- 15** 15"H glass

How to specify — Select the Model Number from above.	1st Option: FSC: F FSC Wood X Non-FSC Wood	2nd Option: Laminate: See page 284 for finishes.	3rd Option: Edge: See page 284 for finishes.	4th Option: Grain: VLG Horizontal grain or Solid only. VST Vertical Grain (available only for single panels 60"W or less, and for split panels between 87"W and 117"W).	5th Option: Glide:
G 	V .	G

Examples: G3018G.X.LT11.TI.VLG.G GS3087G.F.LLA1.TI.VST.G

Gallery Panels

35"H Application for Use with Glass

For Gallery Panel Glass see pages 326-328.
For Gallery Panel connectors see pages 324-325.

GSA SIN 33721

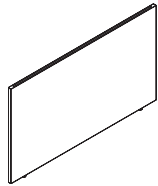

Description	Model	Configuration	List Price			Accepts Glass Models 7½"H, 13"H, 15"H
			L1	L2	L3	
35"H Gallery Panels with Glass						
18"W	G3518G	Mid	\$ 814	\$ 844	\$ 873	G4 □□ 15GS
21"W	G3521G	Mid	\$ 834	\$ 865	\$ 895	G4 □□ 18GS
24"W	G3524G	Mid	\$ 871	\$ 903	\$ 935	G4 □□ 21GS
27"W	G3527G	Mid	\$ 906	\$ 939	\$ 972	G4 □□ 24GS
30"W	G3530G	Mid	\$ 1009	\$ 1047	\$ 1083	G4 □□ 27GS
33"W	G3533G	S, Mid	\$ 1051	\$ 1091	\$ 1128	G4 □□ 30GS
36"W	G3536G	S, Mid	\$ 1100	\$ 1142	\$ 1181	G4 □□ 33GS
39"W	G3539G	S, Mid	\$ 1160	\$ 1203	\$ 1244	G4 □□ 36GS
42"W	G3542G	S, Mid	\$ 1199	\$ 1244	\$ 1286	G4 □□ 39GS
45"W	G3545G	S, Mid	\$ 1258	\$ 1305	\$ 1350	G4 □□ 42GS
48"W	G3548G	S, Mid	\$ 1299	\$ 1347	\$ 1393	G4 □□ 45GS
51"W	G3551G	D, S, Mid	\$ 1335	\$ 1384	\$ 1432	G4 □□ 48GS
54"W	G3554G	D, S, Mid	\$ 1380	\$ 1430	\$ 1479	G4 □□ 51GS
57"W	G3557G	D, S, Mid	\$ 1416	\$ 1469	\$ 1519	G4 □□ 54GS
60"W	G3560G	D, S, Mid	\$ 1466	\$ 1520	\$ 1573	G4 □□ 57GS
63"W	G3563G	D, S, Mid	\$ 1492	\$ 1547	\$ 1601	G4 □□ 60GS
66"W	G3566G	D, S, Mid	\$ 1528	\$ 1584	\$ 1639	G4 □□ 63GS
69"W	G3569G	D, S, Mid	\$ 1585	\$ 1643	\$ 1700	G4 □□ 66GS
72"W	G3572G	D, S, Mid	\$ 1642	\$ 1702	\$ 1761	G4 □□ 69GS
75"W	G3575G	D, S, Mid	\$ 1753	\$ 1817	\$ 1880	G4 □□ 72GS
78"W	G3578G	D, S, Mid	\$ 1831	\$ 1898	\$ 1963	G4 □□ 75GS
81"W	G3581G	D, S, Mid	\$ 1960	\$ 2032	\$ 2102	G4 □□ 78GS
84"W	G3584G	D, S, Mid	\$ 2123	\$ 2201	\$ 2277	G4 □□ 81GS

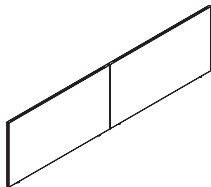

35"H Gallery Split Panels with Glass <i>(corresponding glass models must be ordered in quantities of 2 for split panels)</i>						
81"W	GS3581G	D	\$ 1895	\$ 1967	\$ 2037	G4 □□ 36GS
87"W	GS3587G	D	\$ 2196	\$ 2276	\$ 2354	G4 □□ 39GS
93"W	GS3593G	D	\$ 2269	\$ 2352	\$ 2433	G4 □□ 42GS
99"W	GS3599G	D	\$ 2349	\$ 2434	\$ 2518	G4 □□ 45GS
105"W	GS35105G	D	\$ 2378	\$ 2464	\$ 2549	G4 □□ 48GS
111"W	GS35111G	D	\$ 2433	\$ 2522	\$ 2608	G4 □□ 51GS
117"W	GS35117G	D	\$ 2524	\$ 2616	\$ 2706	G4 □□ 54GS
123"W	GS35123G	D	\$ 2582	\$ 2676	\$ 2768	G4 □□ 57GS
129"W	GS35129G	D	\$ 2612	\$ 2707	\$ 2801	G4 □□ 60GS
135"W	GS35135G	D	\$ 2721	\$ 2819	\$ 2917	G4 □□ 63GS
141"W	GS35141G	D	\$ 2816	\$ 2918	\$ 3019	G4 □□ 66GS
147"W	GS35147G	D	\$ 2883	\$ 2988	\$ 3091	G4 □□ 69GS

Note: Configuration is not included in model number

- Mid Mid Panel
- S End Single Sided
- D End Dual Sided

Note: Fill in model number blanks with one of the following options to determine glass height.

- 07 7.5"H glass
- 13 13"H glass
- 15 15"H glass

GALLERY PANELS

How to specify — Select the Model Number from above.	1st Option: FSC: F FSC Wood X Non-FSC Wood	2nd Option: Laminate: See page 284 for finishes.	3rd Option: Edge: See page 284 for finishes.	4th Option: Grain: VLG Horizontal grain or Solid only. VST Vertical Grain (available only for single panels 60"W or less, and for split panels between 87"W and 117"W).	5th Option: Glide: G
G . .				V .	G

Examples: G3518G.X.LT11.TI.VLG.G GS3587G.F.LLA1.TI.VST.G

Gallery Panels

42"H Application for Use with Glass

For Gallery Panel Glass see pages 326-328.
For Gallery Panel connectors see pages 324-325.

GSA SIN 33721

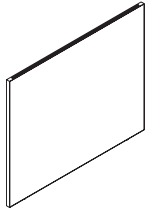

Description	Model	Configuration	List Price			Accepts Glass Models 7½"H, 13"H, 15"H
			L1	L2	L3	
42"H Gallery Panels with Glass						
18"W	G4218G	Mid	\$ 887	\$ 919	\$ 951	G4 □□ 15GS
21"W	G4221G	Mid	\$ 903	\$ 935	\$ 968	G4 □□ 18GS
24"W	G4224G	Mid	\$ 949	\$ 983	\$ 1017	G4 □□ 21GS
27"W	G4227G	Mid	\$ 991	\$ 1027	\$ 1062	G4 □□ 24GS
30"W	G4230G	Mid	\$ 1105	\$ 1146	\$ 1184	G4 □□ 27GS
33"W	G4233G	S, Mid	\$ 1151	\$ 1193	\$ 1233	G4 □□ 30GS
36"W	G4236G	S, Mid	\$ 1204	\$ 1248	\$ 1289	G4 □□ 33GS
39"W	G4239G	S, Mid	\$ 1273	\$ 1319	\$ 1364	G4 □□ 36GS
42"W	G4242G	S, Mid	\$ 1318	\$ 1365	\$ 1411	G4 □□ 39GS
45"W	G4245G	S, Mid	\$ 1355	\$ 1403	\$ 1451	G4 □□ 42GS
48"W	G4248G	S, Mid	\$ 1400	\$ 1450	\$ 1499	G4 □□ 45GS
51"W	G4251G	D, S, Mid	\$ 1472	\$ 1525	\$ 1577	G4 □□ 48GS
54"W	G4254G	D, S, Mid	\$ 1510	\$ 1564	\$ 1618	G4 □□ 51GS
57"W	G4257G	D, S, Mid	\$ 1544	\$ 1599	\$ 1654	G4 □□ 54GS
60"W	G4260G	D, S, Mid	\$ 1590	\$ 1647	\$ 1703	G4 □□ 57GS
63"W	G4263G	D, S, Mid	\$ 1626	\$ 1684	\$ 1742	G4 □□ 60GS
66"W	G4266G	D, S, Mid	\$ 1671	\$ 1730	\$ 1790	G4 □□ 63GS
69"W	G4269G	D, S, Mid	\$ 1700	\$ 1760	\$ 1820	G4 □□ 66GS
72"W	G4272G	D, S, Mid	\$ 1782	\$ 1846	\$ 1909	G4 □□ 69GS
75"W	G4275G	D, S, Mid	\$ 1836	\$ 1902	\$ 1966	G4 □□ 72GS
78"W	G4278G	D, S, Mid	\$ 1936	\$ 2006	\$ 2072	G4 □□ 75GS
81"W	G4281G	D, S, Mid	\$ 2136	\$ 2213	\$ 2288	G4 □□ 78GS
84"W	G4284G	D, S, Mid	\$ 2281	\$ 2362	\$ 2442	G4 □□ 81GS

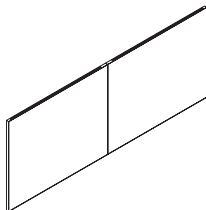

42"H Gallery Split Panels with Glass (corresponding glass models must be ordered in quantities of 2 for split panels)

81"W	GS4281G	D	\$ 2024	\$ 2101	\$ 2176	G4 □□ 36GS
87"W	GS4287G	D	\$ 2320	\$ 2403	\$ 2484	G4 □□ 39GS
93"W	GS4293G	D	\$ 2359	\$ 2443	\$ 2526	G4 □□ 42GS
99"W	GS4299G	D	\$ 2455	\$ 2542	\$ 2629	G4 □□ 45GS
105"W	GS42105G	D	\$ 2489	\$ 2578	\$ 2666	G4 □□ 48GS
111"W	GS42111G	D	\$ 2545	\$ 2636	\$ 2725	G4 □□ 51GS
117"W	GS42117G	D	\$ 2600	\$ 2692	\$ 2784	G4 □□ 54GS
123"W	GS42123G	D	\$ 2658	\$ 2752	\$ 2845	G4 □□ 57GS
129"W	GS42129G	D	\$ 2744	\$ 2841	\$ 2938	G4 □□ 60GS
135"W	GS42135G	D	\$ 2847	\$ 2948	\$ 3048	G4 □□ 63GS
141"W	GS42141G	D	\$ 2944	\$ 3049	\$ 3152	G4 □□ 66GS
147"W	GS42147G	D	\$ 2999	\$ 3106	\$ 3211	G4 □□ 69GS

Note: Configuration is not included in model number

- Mid** Mid Panel
- S** End Single Sided
- D** End Dual Sided

Note: Fill in model number blanks with one of the following options to determine glass height.

- 07** 7.5"H glass
- 13** 13"H glass
- 15** 15"H glass

How to specify — Select the Model Number from above.	1st Option: FSC: F FSC Wood X Non-FSC Wood	2nd Option: Laminate: See page 284 for finishes.	3rd Option: Edge: See page 284 for finishes.	4th Option: Grain: VLG Horizontal grain or Solid only. VST Vertical Grain (available only for single panels 60"W or less, and for split panels between 87"W and 117"W).	5th Option: Glide:
G . .				V .	G

Examples: G4218G.X.LT11.TI.VLG.G GS4287G.F.LLA1.TI.VST.G

Gallery Panels

57½"H Application for Use with Glass

For Gallery Panel Glass see pages 326-328.
For Gallery Panel connectors see pages 324-325.

GSA SIN 33721

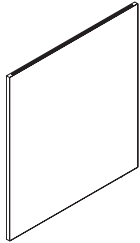

Description	Model	Configuration	List Price			Accepts Glass Models 7½"H, 13"H, 15"H
			L1	L2	L3	
57½"H Gallery Panels with Glass						
18"W	G5718G	Mid	\$ 1161	\$ 1203	\$ 1244	G4 □□ 15GS
21"W	G5721G	Mid	\$ 1183	\$ 1226	\$ 1267	G4 □□ 18GS
24"W	G5724G	Mid	\$ 1220	\$ 1264	\$ 1306	G4 □□ 21GS
27"W	G5727G	Mid	\$ 1262	\$ 1308	\$ 1352	G4 □□ 24GS
30"W	G5730G	Mid	\$ 1363	\$ 1412	\$ 1459	G4 □□ 27GS
33"W	G5733G	S, Mid	\$ 1411	\$ 1461	\$ 1510	G4 □□ 30GS
36"W	G5736G	S, Mid	\$ 1464	\$ 1517	\$ 1569	G4 □□ 33GS
39"W	G5739G	S, Mid	\$ 1527	\$ 1582	\$ 1636	G4 □□ 36GS
42"W	G5742G	S, Mid	\$ 1589	\$ 1646	\$ 1701	G4 □□ 39GS
45"W	G5745G	S, Mid	\$ 1673	\$ 1732	\$ 1792	G4 □□ 42GS
48"W	G5748G	S, Mid	\$ 1706	\$ 1766	\$ 1827	G4 □□ 45GS
51"W	G5751G	D, S, Mid	\$ 1740	\$ 1801	\$ 1863	G4 □□ 48GS
54"W	G5754G	D, S, Mid	\$ 1795	\$ 1859	\$ 1922	G4 □□ 51GS
57"W	G5757G	D, S, Mid	\$ 1831	\$ 1896	\$ 1961	G4 □□ 54GS
60"W	G5760G	D, S, Mid	\$ 1873	\$ 1940	\$ 2005	G4 □□ 57GS
63"W	G5763G	D, S, Mid	\$ 1906	\$ 1974	\$ 2040	G4 □□ 60GS
66"W	G5766G	D, S, Mid	\$ 1946	\$ 2016	\$ 2083	G4 □□ 63GS
69"W	G5769G	D, S, Mid	\$ 1991	\$ 2062	\$ 2133	G4 □□ 66GS
72"W	G5772G	D, S, Mid	\$ 2036	\$ 2109	\$ 2180	G4 □□ 69GS
75"W	G5775G	D, S, Mid	\$ 2142	\$ 2219	\$ 2294	G4 □□ 72GS
78"W	G5778G	D, S, Mid	\$ 2316	\$ 2398	\$ 2480	G4 □□ 75GS
81"W	G5781G	D, S, Mid	\$ 2478	\$ 2567	\$ 2653	G4 □□ 78GS
84"W	G5784G	D, S, Mid	\$ 2621	\$ 2714	\$ 2806	G4 □□ 81GS

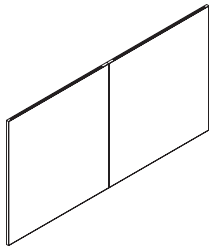

57½"H Gallery Split Panels with Glass (corresponding glass models must be ordered in quantities of 2 for split panels)

81"W	GS5781G	D	\$ 2346	\$ 2435	\$ 2521	G4 □□ 36GS
87"W	GS5787G	D	\$ 2659	\$ 2753	\$ 2846	G4 □□ 39GS
93"W	GS5793G	D	\$ 2776	\$ 2874	\$ 2972	G4 □□ 42GS
99"W	GS5799G	D	\$ 2823	\$ 2922	\$ 3022	G4 □□ 45GS
105"W	GS57105G	D	\$ 2914	\$ 3017	\$ 3119	G4 □□ 48GS
111"W	GS57111G	D	\$ 2948	\$ 3053	\$ 3156	G4 □□ 51GS
117"W	GS57117G	D	\$ 2972	\$ 3078	\$ 3182	G4 □□ 54GS
123"W	GS57123G	D	\$ 2999	\$ 3106	\$ 3211	G4 □□ 57GS
129"W	GS57129G	D	\$ 3069	\$ 3178	\$ 3286	G4 □□ 60GS
135"W	GS57135G	D	\$ 3119	\$ 3230	\$ 3339	G4 □□ 63GS
141"W	GS57141G	D	\$ 3161	\$ 3273	\$ 3384	G4 □□ 66GS
147"W	GS57147G	D	\$ 3262	\$ 3378	\$ 3492	G4 □□ 69GS

Note: Configuration is not included in model number

- Mid** Mid Panel
- S** End Single Sided
- D** End Dual Sided

Note: Fill in model number blanks with one of the following options to determine glass height.

- 07** 7.5"H glass
- 13** 13"H glass
- 15** 15"H glass

How to specify — Select the Model Number from above.	1st Option: FSC: F FSC Wood X Non-FSC Wood	2nd Option: Laminate: See page 284 for finishes.	3rd Option: Edge: See page 284 for finishes.	4th Option: Grain: VLG Horizontal grain or Solid only. VST Vertical Grain (available only for single panels 60"W or less, and for split panels between 87"W and 117"W.	5th Option: Glide: G
G				V	G

Examples: G5718G.X.LT11.TI.VLG.G GS5787G.F.LLA1.TI.VST.G

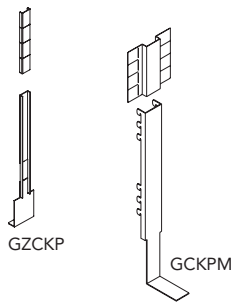

Description	Model	List Price		
		P1	P2	P3
Stride Connector Kit				
End Panel Connector Kit for Stride System	GZCKP	\$ 145	\$ 156	\$ 172
Intermediate Mid connector	GCKPM	\$ 169	\$ 182	\$ 199

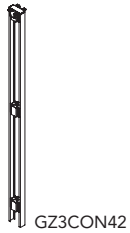

Stride Mid-Connector Block and Trim				
30" - Block & Trim	GZ3CON30	\$ 229	\$ 257	\$ 294
35" - Block & Trim	GZ3CON35	\$ 237	\$ 265	\$ 304
42" - Block & Trim	GZ3CON42	\$ 270	\$ 302	\$ 351
50" - Block & Trim	GZ3CON50	\$ 282	\$ 316	\$ 365
57" - Block & Trim	GZ3CON57	\$ 292	\$ 326	\$ 377
65" - Block & Trim	GZ3CON65	\$ 321	\$ 358	\$ 411
72" - Block & Trim	GZ3CON72	\$ 352	\$ 396	\$ 460
80" - Block & Trim	GZ3CON80	\$ 381	\$ 427	\$ 493
87" - Block & Trim	GZ3CON87	\$ 389	\$ 437	\$ 510

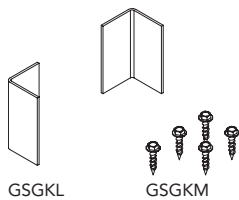

Storage Mounting Brackets				
Gallery Laminate Storage Ganging Kit	GSGKL	\$ 80	N/A	N/A
Gallery Metal Storage Ganging Kit	GSGKM	\$ 19	N/A	N/A

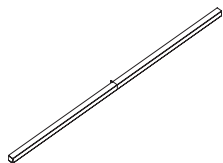

Gallery Panel Stiffener				
Stiffener for 75"W/78"W Panels	GSTFN7578	\$ 181	\$ 196	\$ 215
Stiffener for 81"W/84"W Panels	GSTFN8184	\$ 202	\$ 219	\$ 242

Shippable by small-package carrier.

<p>How to specify — Select the Model Number from above.</p>	<p><i>1st Option:</i> Paint for Connector Kits and Brackets (if available): P1 P2 P3 See page 284 for finishes.</p>	<p><i>1st Option:</i> Fabric for Cantilevered Storage Accessory: See page 285 for fabrics.</p>	<p><i>2nd Option:</i> Trim Paint for Cantilevered Storage Accessory: P1 P2 P3 See page 284 for finishes.</p>
<p>_____ .</p>	<p>_____</p>	<p>_____ .</p>	<p>P _____</p>

Examples: GZCKP.P71 GCKPM.P71 GZ3CON30.P71 GSGKL GSGKM

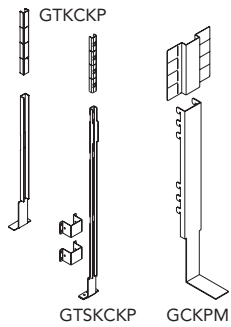

Description	Model	List Price		
		P1	P2	P3
Terrace Connector Kit				
End Panel Connector Kit for Terrace System (black only)	GTKCKP	\$ 145	N/A	N/A
Split Connector Kit (black only)	GTSKCKP	\$ 165	N/A	N/A
Intermediate Mid connector	GCKPM	\$ 169	\$ 182	\$ 199
Panel Glass Kit for 30"H Panel	GTKGK30	\$ 79	N/A	N/A

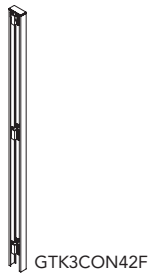

Terrace Connector Kit for Flat Trim				
30" - Flat Trim	GTK3CON30F	\$ 222	\$ 250	\$ 287
35" - Flat Trim	GTK3CON35F	\$ 297	\$ 303	\$ 311
42" - Flat Trim	GTK3CON42F	\$ 359	\$ 375	\$ 295
50" - Flat Trim	GTK3CON50F	\$ 309	\$ 358	\$ 366
57½" - Flat Trim	GTK3CON57F	\$ 378	\$ 388	\$ 406
65" - Flat Trim	GTK3CON65F	\$ 439	\$ 358	\$ 422
72½" - Flat Trim	GTK3CON72F	\$ 457	\$ 467	\$ 479
80" - Flat Trim	GTK3CON80F	\$ 518	\$ 542	\$ 422
87½" - Flat Trim	GTK3CON87F	\$ 382	\$ 409	\$ 449



Terrace Connector Kit for Radius Trim				
30" - Radius Trim	GTK3CON30R	\$ 250	\$ 287	\$ 293
35" - Radius Trim	GTK3CON35R	\$ 303	\$ 311	\$ 324
42" - Radius Trim	GTK3CON42R	\$ 375	\$ 297	\$ 346
50" - Radius Trim	GTK3CON50R	\$ 360	\$ 368	\$ 378
57½" - Radius Trim	GTK3CON57R	\$ 393	\$ 410	\$ 322
65" - Radius Trim	GTK3CON65R	\$ 358	\$ 422	\$ 432
72½" - Radius Trim	GTK3CON72R	\$ 467	\$ 479	\$ 502
80" - Radius Trim	GTK3CON80R	\$ 542	\$ 399	\$ 436
87½" - Radius Trim	GTK3CON87R	\$ 382	\$ 409	\$ 449

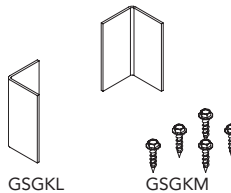

Storage Mounting Brackets				
Gallery Laminate Storage Ganging Kit	GSGKL	\$ 80	N/A	N/A
Gallery Metal Storage Ganging Kit	GSGKM	\$ 19	N/A	N/A

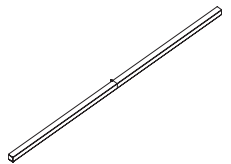

Gallery Panel Stiffener				
Stiffener for 75"W/78"W Panels	GSTFN7578	\$ 181	\$ 196	\$ 215
Stiffener for 81"W/84"W Panels	GSTFN8184	\$ 202	\$ 219	\$ 242

Shippable by small-package carrier.

<p>How to specify — Select the Model Number from above.</p>	<p><i>1st Option:</i> Paint for Connector Kits and Brackets (if available): P1 P2 P3 See page 284 for finishes.</p>	<p><i>1st Option:</i> Fabric for Cantilevered Storage Accessory: See page 285 for fabrics.</p>	<p><i>2nd Option:</i> Trim Paint for Cantilevered Storage Accessory: P1 P2 P3 See page 284 for finishes.</p>
--	--	---	---

Examples: GTKCKP.P71 GCKPM.P71 GT3CON30F.PJW GSGKL GSGKM

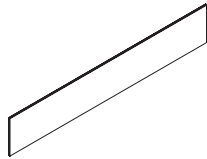

Description	Model	List Price		
		Clear Glass	Frosted Glass	Smoked Glass
7½"H Gallery Glass — Single Panel				
15"W	G40715GS	\$ 212	\$ 233	\$ 240
18"W	G40718GS	\$ 218	\$ 240	\$ 247
21"W	G40721GS	\$ 222	\$ 244	\$ 252
24"W	G40724GS	\$ 226	\$ 249	\$ 256
27"W	G40727GS	\$ 246	\$ 270	\$ 278
30"W	G40730GS	\$ 263	\$ 290	\$ 297
33"W	G40733GS	\$ 289	\$ 318	\$ 327
36"W	G40736GS	\$ 325	\$ 357	\$ 368
39"W	G40739GS	\$ 352	\$ 386	\$ 399
42"W	G40742GS	\$ 394	\$ 434	\$ 446
45"W	G40745GS	\$ 428	\$ 471	\$ 484
48"W	G40748GS	\$ 465	\$ 511	\$ 525
51"W	G40751GS	\$ 475	\$ 522	\$ 537
54"W	G40754GS	\$ 514	\$ 564	\$ 581
57"W	G40757GS	\$ 569	\$ 625	\$ 643
60"W	G40760GS	\$ 667	\$ 732	\$ 754
63"W	G40763GS	\$ 776	\$ 853	\$ 877
66"W	G40766GS	\$ 839	\$ 921	\$ 948
69"W	G40769GS	\$ 918	\$ 1008	\$ 1037
72"W	G40772GS	\$ 982	\$ 1078	\$ 1110
75"W	G40775GS	\$ 1050	\$ 1152	\$ 1186
78"W	G40778GS	\$ 1156	\$ 1268	\$ 1306
81"W	G40781GS	\$ 1215	\$ 1334	\$ 1372

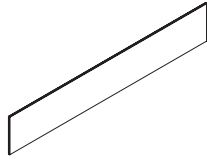

7½"H Gallery Glass — Split Panels (order quantity must be in multiples of 2)				
39"W	G40739GS	\$ 352	\$ 386	\$ 399
42"W	G40742GS	\$ 394	\$ 434	\$ 446
45"W	G40745GS	\$ 428	\$ 471	\$ 484
48"W	G40748GS	\$ 465	\$ 511	\$ 525
51"W	G40751GS	\$ 475	\$ 522	\$ 537
54"W	G40754GS	\$ 514	\$ 564	\$ 581
57"W	G40757GS	\$ 569	\$ 625	\$ 643
60"W	G40760GS	\$ 667	\$ 732	\$ 754
63"W	G40763GS	\$ 776	\$ 853	\$ 877
66"W	G40766GS	\$ 839	\$ 921	\$ 948
69"W	G40769GS	\$ 918	\$ 1008	\$ 1037

GALLERY PANELS

<p>How to specify — Select the Model Number from above.</p>	<p>1st Option: Glass: LC Clear Glass LF Frosted Glass GSM1 Smoked Glass</p>
<p>G 4 0 7 .</p>	<p> .</p>

Examples: G40715GS.LC G40739GS.GSM1

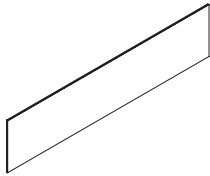

Description	Model	List Price		
		Clear Glass	Frosted Glass	Smoked Glass
13"H Gallery Glass — Single Panel				
24"W	G41324GS	\$ 515	\$ 572	\$ 590
27"W	G41327GS	\$ 562	\$ 623	\$ 644
30"W	G41330GS	\$ 604	\$ 670	\$ 691
33"W	G41333GS	\$ 635	\$ 705	\$ 728
36"W	G41336GS	\$ 673	\$ 747	\$ 770
39"W	G41339GS	\$ 726	\$ 806	\$ 832
42"W	G41342GS	\$ 750	\$ 832	\$ 859
45"W	G41345GS	\$ 766	\$ 850	\$ 877
48"W	G41348GS	\$ 791	\$ 877	\$ 906
51"W	G41351GS	\$ 804	\$ 891	\$ 921
54"W	G41354GS	\$ 861	\$ 955	\$ 985
57"W	G41357GS	\$ 880	\$ 976	\$ 1008
60"W	G41360GS	\$ 905	\$ 1003	\$ 1036
63"W	G41363GS	\$ 970	\$ 1076	\$ 1111
66"W	G41366GS	\$ 1052	\$ 1167	\$ 1205
69"W	G41369GS	\$ 1113	\$ 1234	\$ 1274
72"W	G41372GS	\$ 1193	\$ 1323	\$ 1366
75"W	G41375GS	\$ 1281	\$ 1421	\$ 1466
78"W	G41378GS	\$ 1363	\$ 1511	\$ 1560
81"W	G41381GS	\$ 1438	\$ 1594	\$ 1646

13"H Gallery Glass — Split Panels (order quantity must be in multiples of 2)

39"W	G41339GS	\$ 726	\$ 806	\$ 832
42"W	G41342GS	\$ 750	\$ 832	\$ 859
45"W	G41345GS	\$ 766	\$ 850	\$ 877
48"W	G41348GS	\$ 791	\$ 877	\$ 906
51"W	G41351GS	\$ 804	\$ 891	\$ 921
54"W	G41354GS	\$ 861	\$ 955	\$ 985
57"W	G41357GS	\$ 880	\$ 976	\$ 1008
60"W	G41360GS	\$ 905	\$ 1003	\$ 1036
63"W	G41363GS	\$ 970	\$ 1076	\$ 1111
66"W	G41366GS	\$ 1052	\$ 1167	\$ 1205
69"W	G41369GS	\$ 1113	\$ 1234	\$ 1274

<p>How to specify — Select the Model Number from above.</p>	<p>1st Option: Glass: LC Clear Glass LF Frosted Glass GSM1 Smoked Glass</p>
<p>G 4 1 3 .</p>	<p> .</p>

Examples: G41324GS.LC G41339GS.GSM1

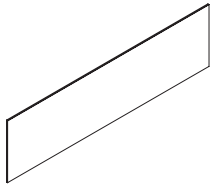

Description	Model	List Price		
		Clear Glass	Frosted Glass	Smoked Glass
15"H Gallery Glass — Single Panel				
15"W	G41515GS	\$ 538	\$ 597	\$ 617
18"W	G41518GS	\$ 562	\$ 623	\$ 644
21"W	G41521GS	\$ 588	\$ 653	\$ 673
24"W	G41524GS	\$ 618	\$ 685	\$ 708
27"W	G41527GS	\$ 638	\$ 708	\$ 731
30"W	G41530GS	\$ 664	\$ 737	\$ 760
33"W	G41533GS	\$ 697	\$ 774	\$ 798
36"W	G41536GS	\$ 759	\$ 842	\$ 869
39"W	G41539GS	\$ 794	\$ 880	\$ 910
42"W	G41542GS	\$ 814	\$ 903	\$ 932
45"W	G41545GS	\$ 828	\$ 919	\$ 948
48"W	G41548GS	\$ 848	\$ 941	\$ 971
51"W	G41551GS	\$ 867	\$ 961	\$ 992
54"W	G41554GS	\$ 922	\$ 1023	\$ 1055
57"W	G41557GS	\$ 935	\$ 1037	\$ 1070
60"W	G41560GS	\$ 943	\$ 1046	\$ 1079
63"W	G41563GS	\$ 1000	\$ 1109	\$ 1145
66"W	G41566GS	\$ 1083	\$ 1201	\$ 1240
69"W	G41569GS	\$ 1139	\$ 1263	\$ 1304
72"W	G41572GS	\$ 1218	\$ 1350	\$ 1395
75"W	G41575GS	\$ 1315	\$ 1458	\$ 1506
78"W	G41578GS	\$ 1386	\$ 1536	\$ 1585
81"W	G41581GS	\$ 1467	\$ 1626	\$ 1679

15"H Gallery Glass — Split Panels (order quantity must be in multiples of 2)

39"W	G41539GS	\$ 794	\$ 880	\$ 910
42"W	G41542GS	\$ 814	\$ 903	\$ 932
45"W	G41545GS	\$ 828	\$ 919	\$ 948
48"W	G41548GS	\$ 848	\$ 941	\$ 971
51"W	G41551GS	\$ 867	\$ 961	\$ 992
54"W	G41554GS	\$ 922	\$ 1023	\$ 1055
57"W	G41557GS	\$ 935	\$ 1037	\$ 1070
60"W	G41560GS	\$ 943	\$ 1046	\$ 1079
63"W	G41563GS	\$ 1000	\$ 1109	\$ 1145
66"W	G41566GS	\$ 1083	\$ 1201	\$ 1240
69"W	G41569GS	\$ 1139	\$ 1263	\$ 1304

GALLERY PANELS

<p><i>How to specify —</i> Select the Model Number from above.</p>	<p><i>1st Option:</i> Glass: LC Clear Glass LF Frosted Glass GSM1 Smoked Glass</p>
<p>G 4 1 5 .</p>	<p> .</p>

Examples: G41515GS.LC G41539GS.GSM1

GSA SIN Pending

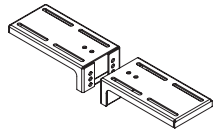

GCTKS

Description	Model	P1 List Price	P2 List Price	P3 List Price
Countertop Bracket				
Countertop Connector Bracket	GCTKS	\$ 121	\$ 128	\$ 132

Note: 2 brackets needed for straight countertops, 3 brackets are needed for corner countertops

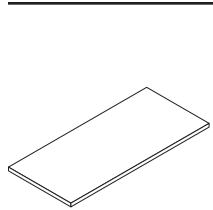

Description	Laminate w/Flat Edge Model	Laminate w/Flat Edge		
		L1 List Price	L2 List Price	L3 List Price
Straight Countertops — must order 2 sets of brackets per surface				
24"W x 15"D	851524M	\$ 387	\$ 405	\$ 418
30"W x 15"D	851530M	\$ 429	\$ 448	\$ 462
36"W x 15"D	851536M	\$ 482	\$ 502	\$ 519
42"W x 15"D	851542M	\$ 499	\$ 519	\$ 537
48"W x 15"D	851548M	\$ 528	\$ 549	\$ 568
54"W x 15"D	851554M	\$ 598	\$ 621	\$ 641
60"W x 15"D	851560M	\$ 667	\$ 687	\$ 704
66"W x 15"D	851566M	\$ 691	\$ 720	\$ 739
72"W x 15"D	851572M	\$ 718	\$ 748	\$ 767



Corner Countertops 15"D at ends — must order 3 sets of brackets per surface				
24"W x 24"W	852424M	\$ 754	\$ 785	\$ 806
30"W x 30"W	853030M	\$ 877	\$ 911	\$ 936
36"W x 36"W	853636M	\$ 973	\$ 1010	\$ 1039
42"W x 42"W	854242M	\$ 1056	\$ 1096	\$ 1129



Flat Edge



Description	Model	P1 List Price	P2 List Price	P3 List Price
Gallery Panel Wall Start				
30"H Wall Start	GWS30	\$ 124	\$ 131	\$ 135
35"H Wall Start	GWS35	\$ 142	\$ 149	\$ 155
42"H Wall Start	GWS42	\$ 154	\$ 162	\$ 167
50"H Wall Start	GWS50	\$ 177	\$ 186	\$ 193
57½"H Wall Start	GWS57	\$ 190	\$ 199	\$ 207

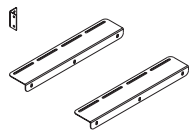

Worksurface Mounting Bracket Kit				
Worksurface Mounting Bracket	GWSBK	\$ 80		

Note: Ships with 2 brackets.

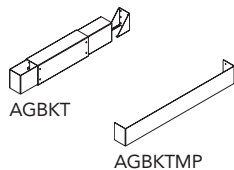

HAT Bracket				
HAT to Gallery Panel Bracket T-Leg	AGBKT (shown)	\$ 258	\$ 280	\$ 308
HAT to Gallery Panel Bracket C-Leg	AGBKC	\$ 258	\$ 280	\$ 308
HAT to Gallery Panel Installation Template (Black only, code P)	AGBKTMP (shown)	\$ 63		

How to specify —
Select the
Model Number
from above.

1st Option:

Paint:

P1 P2 P3

See page 284 for finishes.

Example: AGBKT.PJW

GSA SIN Pending

Description	Model	L1 List Price	L2 List Price	L3 List Price
Laminate Floating Shelves				
12"W Floating Shelf	GSTF12	\$ 271	\$ 283	\$ 294
18"W Floating Shelf	GSTF18	\$ 302	\$ 315	\$ 329
24"W Floating Shelf	GSTF24	\$ 332	\$ 347	\$ 361
30"W Floating Shelf	GSTF30	\$ 362	\$ 379	\$ 393
36"W Floating Shelf	GSTF36	\$ 393	\$ 411	\$ 426
42"W Floating Shelf	GSTF42	\$ 423	\$ 442	\$ 460
48"W Floating Shelf	GSTF48	\$ 453	\$ 473	\$ 493
54"W Floating Stiffener Shelf	GSTF54	\$ 483	\$ 504	\$ 525
60"W Floating Stiffener Shelf	GSTF60	\$ 513	\$ 535	\$ 557
66"W Floating Stiffener Shelf	GSTF66 (shown)	\$ 543	\$ 566	\$ 590
72"W Floating Stiffener Shelf	GSTF72	\$ 572	\$ 596	\$ 621
78"W Floating Stiffener Shelf	GSTF78	\$ 604	\$ 631	\$ 656

Accessory Rail & Paper Management				
Gallery Panel 12"W Accessory Rail	GACRL12 (shown)	\$ 238	\$ 249	\$ 259
Gallery Panel 18"W Accessory Rail	GACRL18	\$ 255	\$ 267	\$ 277
Gallery Panel 24"W Accessory Rail	GACRL24	\$ 257	\$ 269	\$ 279
Gallery Panel 30"W Accessory Rail	GACRL30	\$ 271	\$ 283	\$ 294
Gallery Panel 36"W Accessory Rail	GACRL36	\$ 286	\$ 299	\$ 310
Triple Angle File	G3AGF	\$ 226	\$ 236	\$ 246
Double Angle File	G2AGF (shown)	\$ 190	\$ 199	\$ 207
Single Angle File	G1AGF	\$ 155	\$ 163	\$ 170
Triple Paper Tray	G3PTR	\$ 226	\$ 236	\$ 246
Double Paper Tray	G2PTR	\$ 190	\$ 199	\$ 207
Single Paper Tray	G1PTR (shown)	\$ 155	\$ 163	\$ 170
Personal Shelf	GWPSF (shown)	\$ 190	\$ 199	\$ 207
Binder Shelf	GBRSF (shown)	\$ 190	\$ 199	\$ 207
Coat Hook Rail-Based	GCHRB (shown)	\$ 77	\$ 82	\$ 85
Coat Hook Mounted	GCHMT	\$ 90	\$ 95	\$ 99

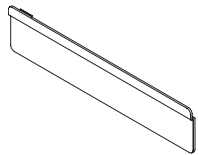
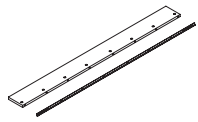

GACRL12

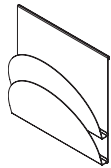

G2AGF

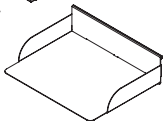

G1PTR

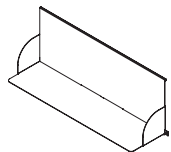

GWPSF

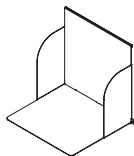

GBRSF

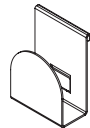

GCHRB

<p>How to specify — Select the Model Number from above.</p>	<p>1st Option: Paint: P1 P2 P3 See page 284 for finishes.</p>
--	---

Example: GCHMT.PJW

Notes

GALLERY PANELS

- Software support packages furnished to the customer, either by Allsteel® or by another source, which support the sale of Allsteel products are superseded by printed price lists.
- Prices are subject to change without notice. All orders are subject to prices in effect at the time of order.
- Please refer to your Allsteel Dealer Sales and Discount Policies for order placement information, terms and conditions.
- Additional copies of this Specification and Price List are available upon request from Allsteel Literature at 1-866-255-7833.

- Ordering information appears at the bottom of each product page complete with examples on how to specify. Fabric and finish pages are referenced at the bottom of product pages.

This publication is available as an interactive or downloadable PDF at www.allsteeloffice.com.

Questions or Comments?

Please call us at: **888-ALLSTEEL**
888-255-7833

Paint Finishes, Laminates, Eased Edge	334
Fabrics.....	335
Working with Height-Adjustable Tables	336-341.2
Screens and Power Module	342
Altitude - Metal Screens.....	343-344
Power Rail Specifications	345-351
General Overview	345
Power Rail Typical.....	346
Working with Altitude Power Rails	347
Low Rail with Floor Legs	347
Raised Rail.....	347
Screens	347
Working with Cable Management	348
Working with Power Rail Electricals	349
General Notes about Electrical and Circuitry	349
Electrical Infeeds.....	349
Routing Power.....	350-351
Working with Electrical and Data	352-356
HAT to Panel Brackets.....	357-358
Working with Organization Rail & Accessories & Screens.....	359
Altitude Height-Adjustable Tops, Bases, & Accessories.....	360-365.3
Altitude – A6.....	360-361
Worksurfaces for Height-Adjustable Bases	362-364
Cable Management.....	365-365.3
Power Rail – Electrical Components	366-368
A8 Screen Kits.....	369
Metal Screens and Tackboard Accessories.....	370-371
Power Rails and Accessories	372-375
HAT to Panel Brackets Pricing.....	376
Worksurface Mounted Rail and Accessories	377

BASE COLORS

GRADE P1

Black.....	P71
Brownstone.....	P7D
Cinder.....	P7Q
Cove.....	P096
Designer White.....	PJW
Dune.....	P094
Flint.....	P02
Fossil.....	P28
Harbor.....	P097
Loft.....	P7B
Muslin.....	P4J
Nickel.....	P8L
Parchment.....	P93
Pebble.....	P8R
Pewter.....	P8D
Sage.....	P095
Salt.....	P8C
Titanium.....	P8T

GRADE P2

Champagne Metallic.....	PR5
Gunmetal Metallic.....	PR3
Night Bronze.....	P8B
Platinum Metallic.....	PR2
Silver.....	PR6

GRADE P3

Bullseye*.....	PJF
Regatta*.....	P8M

***Altitude Basic is only offered in one finish, Silver (SVR)

POWER RAIL PAINT COLORS

GRADE P1

Black.....	P71
Brownstone.....	P7D
Bungalow.....	P7C
Cinder.....	P7Q
Designer White.....	PJW
Flint.....	P02
Fossil.....	P28
Loft.....	P7B
Muslin.....	P4J
Pebble.....	P8R
Pewter.....	P8D
Salt.....	P8C
Titanium.....	P8T

GRADE P2

Champagne Metallic.....	PR5
Gunmetal Metallic.....	PR3
Night Bronze.....	P8B
Pyrite.....	PJE
Silver.....	PR6
Solar Black.....	P8X

GRADE P3

Atom.....	P8S
Blossom***.....	P8K
Ember.....	P8P
Ion.....	P8N
Iris.....	P8J
Krypton.....	P8F
Ochre.....	P093
Regatta.....	P8M
Sienna.....	P092
Succulent***.....	P8A

***These colors are intended to be an inspirational option for the trending market. Product application is limited and color availability is approximately two years to coincide with evolving workplace trends.

A8 SCREEN BRACKET PAINT COLORS

GRADE P1

Black.....	P71
Designer White.....	PJW

GRADE P2

Silver.....	PR6
-------------	-----

LAMINATES

GRADE L1

SOLID COLORS

Black.....	P
Brownstone.....	LM13
Bungalow.....	LM12
Designer White.....	LDW1
Flint.....	LM16
Fossil Shale.....	LEH1
Loft.....	LM11
Muslin.....	LM15
Titanium.....	LTI1

ABSTRACT

Ash.....	LT3B
Handspun Pearl.....	LAHP
Handspun Dove.....	LAHD
Handspun Slate.....	LAHS
Handspun Chestnut.....	LAHC
Silver Mesh.....	LT8D

WOODGRAIN

Belair.....	LWBA
Bourbon Cherry.....	H
Field Elm.....	LWFE
Florence Walnut.....	LWF1
Kingswood Walnut.....	LK11
Natural Maple.....	LWD
NeoWalnut.....	LNU1
Pinnacle.....	PINC
Shaker Cherry.....	LW7C

GRADE L2

Beigewood.....	LWBE
Fawn Cypress.....	LFC1
Lowell Ash.....	LLA1
Mangalore Mango.....	LMM1
Natural Recon.....	LNR1
Phantom Charcoal.....	LPC1
Phantom Ecru.....	LPE1
Portico Teak.....	LPT1
Skyline Walnut.....	LSW1
Veranda Teak.....	LVT1

GRADE L3

Natural Walnut.....	LWNW
---------------------	------

EASED EDGE LAMINATES

GRADE L1

Designer White.....	LDW1
Loft.....	LM11
Natural Maple.....	LWD

GRADE L2

Natural Recon.....	LNR1
--------------------	------

STRAIGHT/ROUNDED EDGE COLORS

Beigewood.....	DE
Belair.....	BA
Black.....	E4
Bourbon Cherry.....	H
Brownstone.....	EY
Bungalow.....	EX
Designer White.....	DW
Fawn Cypress.....	FC
Field Elm.....	FE
Flint.....	E9
Florence Walnut.....	FW
Fossil.....	EH
Kingswood Walnut.....	KI
Loft.....	EV
Lowell Ash.....	DL
Mangalore Mango.....	MM
Muslin.....	EU
Natural Maple.....	DD
Natural Recon.....	NR
Natural Walnut.....	DN
NeoWalnut.....	NU
Parchment.....	EN
Phantom Charcoal.....	PC
Phantom Ecru.....	PE
Pinnacle.....	PI
Platinum Metallic.....	EP
Plyband.....	PL
Portico Teak.....	DP
Shaker Cherry.....	DF
Skyline Walnut.....	SW
Titanium.....	TI
Veranda Teak.....	VT

ELECTRICAL & DATA COMPONENTS

Black.....	E4
Brownstone.....	EY
Designer White.....	DW
Flint.....	E9
Loft.....	EV
Muslin.....	EU
Silver.....	ES

METAL ACCESSORIES PAINT COLORS

GRADE P1

Black.....	P71
Brownstone.....	P7D
Bungalow.....	P7C
Charblack.....	CBK
Cinder.....	P7Q
Cove.....	P096
Designer White.....	PJW
Dune.....	P094
Flint.....	P02
Fossil.....	P28
Harbor.....	P097
Loft.....	P7B
Muslin.....	P4J
Parchment.....	P93
Pebble.....	P8R
Pewter.....	P8D
Platinum Metallic Texture.....	P6H
Sage.....	P095
Salt.....	P8C
Textured Brownstone.....	P7J
Textured Designer White.....	PK7
Textured Flint.....	P7A
Textured Loft.....	P7L
Textured Muslin.....	P7M
Textured Pebble.....	P8Y
Textured Salt.....	P8Z
Textured Titanium.....	P8V
Titanium.....	P8T
White.....	PD8

GRADE P2

Champagne Metallic.....	PR5
Graphite Metallic Texture.....	P85
Gunmetal Metallic.....	PR3
Matte Gold.....	P8G
Night Bronze.....	P8B
Platinum Metallic.....	PR2
Pyrite.....	PJE
Silver.....	PR6
Silver Generic.....	SVR
Silver Texture.....	PR8
Solar Black.....	P8X

GRADE P3

Atom.....	P8S
Blossom.....	P8K
Bullseye.....	PJF
Ember.....	P8P
Ion.....	P8N
Iris.....	P8J
Krypton.....	P8F
Regatta.....	P8M
Succulent.....	P8A
Ochre.....	P093
Sienna.....	P092

All of Allsteel's tables are level® – 2 certified to the ANSI/BIFMA e3 Furniture Sustainability Standard. See www.levelcertified.org for more information.

NOTE: Refer to individual product pages for upcharges.

Fabrics

For use with Screen Kits.

GRADE A

NOBLE

Aegean	NBLE18
Amethyst.....	NBLE19
Aspen	NBLE14
Aster	NBLE20
Blossom.....	NBLE21
Bluebell	NBLE22
Bordeaux.....	NBLE01
Brick	NBLE02
Chambray	NBLE10
Chamomile.....	NBLE23
Clementine	NBLE04
Conifer.....	NBLE24
Cottage	NBLE25
Darkness	NBLE26
Dawn	NBLE13
Denim	NBLE09
Desert Sand.....	NBLE27
Dewfall	NBLE28
Dusted Sage.....	NBLE29
Flax.....	NBLE30
Grass.....	NBLE07
Gunmetal	NBLE15
Harmony.....	NBLE31
Harvest	NBLE12
Ice Caves	NBLE32
Icicle.....	NBLE33
Inky.....	NBLE34
Iris.....	NBLE35
Jade.....	NBLE06
Knight	NBLE17
Mesa	NBLE03
Monarch	NBLE36
Pacific	NBLE08
Pitch.....	NBLE37
Queen Bee	NBLE38
Rainforest	NBLE05
Regal.....	NBLE11
Sandcastle	NBLE39
Sedona	NBLE40
Stormy	NBLE16
Sunbeam	NBLE41
Voyager.....	NBLE42
Windy Day	NBLE43

GRADE D

BLAZER LITE

(100% Pure New Wool)

Haven	PCAMBLT40
Retreat	PCAMBLT39
Solace.....	PCAMBLT70

Altitude height-adjustable bases are available in five styles:

A6

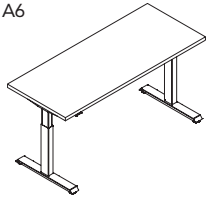

T-leg with
Rectangular Worksurface

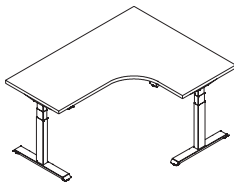

T-leg with
Corner Cove Worksurface

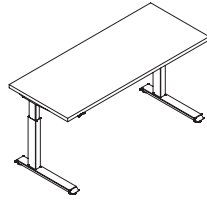

C-leg with
Rectangular Worksurface

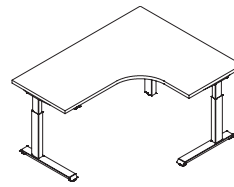

C-leg with
Corner Cove Worksurface

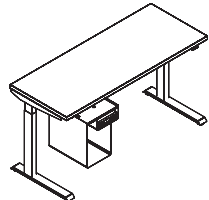

Altitude HAT
with Undermount
Radii Console

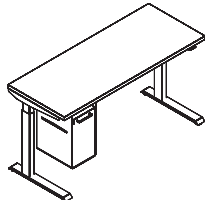

Altitude HAT
with Flush Undermount
Radii

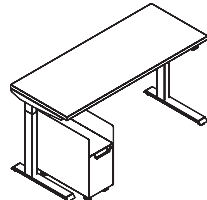

Altitude HAT
with Freestanding Mobile
Alcove Radii

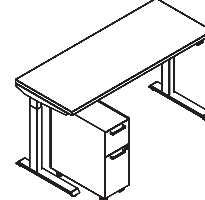

Altitude HAT
with Freestanding Mobile
Alcove Radii

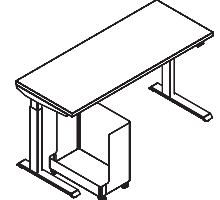

Altitude HAT with
Freestanding Mobile
Radii Caddy

A8 Screens

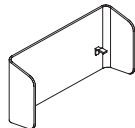

U Screen Kit

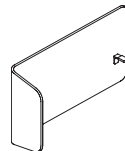

L Screen Kit (Left)

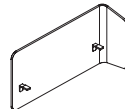

L Screen Kit (Right)

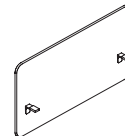

Rectangular Screen Kit

Metal Screens



L Screen (Left)



L Screen (Right)



U Screen

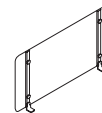

Straight

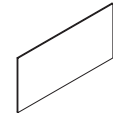

Tackboard Accessory

Altitude Power Rail

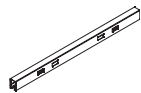

Altitude Power Rail

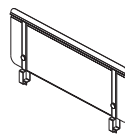

Altitude Rail Screen

A6 Clearance Dimensions

Rectangle

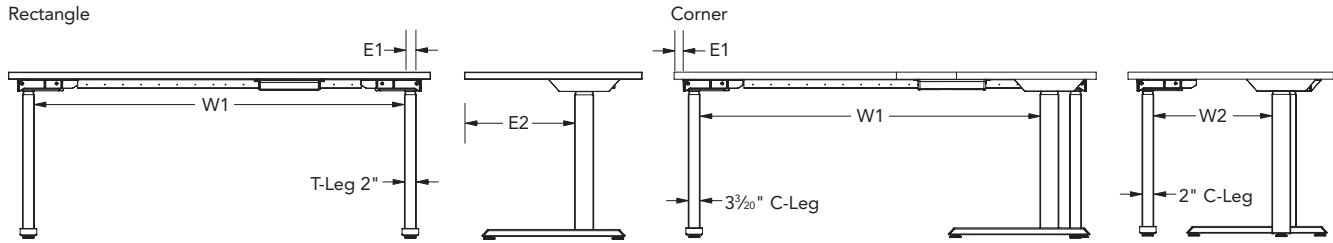

Base Style:	A6-T Base				A6-C Base				
	Dimension Location:	E1	W1	W2	E2	E1	W1	W2	E2
Altitude Top: (Surface dimensions are nominal. Actual widths are reduced by 2")	Edge of table to outside of leg	Between legs	Between legs	Edge of table to the outside of leg	Edge of table to outside of leg	Between legs	Between legs	Edge of table to the outside of leg	
24" x 48" Rectangle*	2½"	35¼"	—	10%"	2½"	35¼"	—	14¼"	
24" x 54" Rectangle	2½"	41¼"	—	10%"	2½"	41¼"	—	14¼"	
24" x 60" Rectangle	2½"	47¼"	—	10%"	2½"	47¼"	—	14¼"	
24" x 66" Rectangle	2½"	53¼"	—	10%"	2½"	53¼"	—	14¼"	
24" x 72" Rectangle	2½"	59¼"	—	10%"	2½"	59¼"	—	14¼"	
30" x 48" Rectangle	2½"	35¼"	—	13%"	2½"	35¼"	—	17%"	
30" x 54" Rectangle	2½"	41¼"	—	13%"	2½"	41¼"	—	17%"	
30" x 60" Rectangle	2½"	47¼"	—	13%"	2½"	47¼"	—	17%"	
30" x 66" Rectangle	2½"	53¼"	—	13%"	2½"	53¼"	—	17%"	
30" x 72" Rectangle	2½"	59¼"	—	13%"	2½"	59¼"	—	17%"	
60" x 36" Corner Cove	2½"	43"	26"	10%"	2½"	43"	29½"	14¼"	
60" x 48" Corner Cove	2½"	43"	32"	10%"	2½"	43"	35½"	14¼"	
72" x 36" Corner Cove	2½"	55"	26"	10%"	2½"	55"	29½"	14¼"	
72" x 48" Corner Cove	2½"	55"	32"	10%"	2½"	55"	35½"	14¼"	

Bottom Views

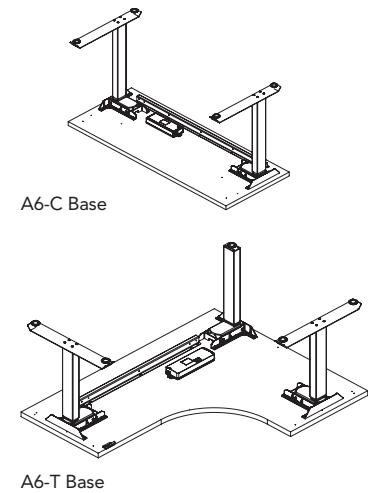

Feature	Altitude Basic	A6
Range Adjustment	26¼" – 43½"H + Adjustable Glide	2-Stage 26½" to 45¼" + ½" Adjustable Glide
Base Only, Without Work Surface		3-Stage 21¼" to 47½" + ½" Adjustable Glide
Range Adjustment	27¾" to 44"H + Adjustable Glide	2-Stage 27¾" to 46¾" + ½" Adjustable Glide
Includes Standard Allsteel 1½" Work Surface		3-Stage 22¾" to 48¾" + ½" Adjustable Glide
Foot Configuration	<ul style="list-style-type: none"> T Foot Standard leveling glide 	<ul style="list-style-type: none"> T Foot or C Foot Standard options include leveling glide, slide glides, and casters
Leg Options	2 leg	2 and 3 leg
UL Certified Weight Rating	180 lbs	<ul style="list-style-type: none"> 250 lbs for 2-leg 350 lbs for 2-leg Max 375 lbs for 3-leg 500 lbs for 3-leg Max
Cross Bar Design	Yes	A6 models ordered prior to 4/5/2021 have cross bar understructure, A6 models ordered after 4/5/2021 do not
Colors	Silver Only	20 Allsteel Paint Finishes offered, see Altitude Tables Finishes page
Control Pad	Up/down only	Basic up/down, memory preset, paddle, foot pedal
Wire Management	Allsteel standard options available Hinged trough not recommended	Allsteel standard options available
Power Access	Desktop power modules available	Desktop power modules available
Warranty	5 years	If Purchased Before 3/1/2021: 10 Years Metal Base, 7 Years Electronics If Purchased After 3/1/2021: 10 Years for Entire Product

Height-Adjustable Worksurfaces, Bases, and Controls

Height-Adjustable Worksurfaces (page 362)

- Height-adjustable worksurfaces are available in laminate with flat edge and rectangular veneer with matching square edge.
- Matrix with actual worksurface sizes can be found on page 339.
- T-mold is used on the edge of curved worksurfaces. This will have a noticeable visual difference when directly adjacent to straight worksurfaces.
- Worksurface dimensions are nominal. Actual widths are reduced by 2" (1" each side) and worksurface depths are reduced by ¼". Corner cove depth is nominal, actual is 1" less.
- Rectangular undersized worksurface models' (model number ending in -U) actual widths and depths are reduced by 2".
- Corner Cove undersized worksurface models' (model number ending in -LD) actual dimensions are reduced by 2".
- Altitude worksurfaces are pre-drilled with mounting location for bases.
- Rectangular worksurface grommet location is limited to center location due to mounting of worksurface supports at each end of the worksurface.
- Certain two-piece top configurations may require two stiffeners depending on the footprint of your station.
- 2-leg standard bases can accommodate worksurface configurations from 24"D x 24"W to 30"D x 72"W.
- 2-leg Max bases can accommodate worksurface configurations from 24"D x 24"W to 30"D x 96"W.
- 3-Leg standard bases can accommodate worksurface configurations from 24"D x 48"W x 36"W to 30"D x 72"W x 48"W.
- 3-Leg Max bases can accommodate worksurface configurations from 24"D x 48"W x 36"W to 30"D x 72"W x 72"W.
- Altitude A6 bases specified with a work surface 60"W and greater require the use of an external stiffener. An external stiffener is included in Altitude work surface models 60"W and greater (all models ending with letter -D). If a non-Altitude work surface is being used, an external stiffener may need to be specified separately.

Height-Adjustable Bases (pages 360-361)

- Electronic height-adjustable base units are available in six styles: A6-T Base with 2 legs, A6-C Base with 2 legs, A6-T Base with 3 legs, A6-C Base with 3 legs, A6-T Max Base with 2 legs, A6-C Max Base with 2 legs, A6-T Max Base with 3 legs, and A6-C Max Base with 3 legs.
- **A6 2-stage and 3-stage have a travel speed of 1.25"/second. A-6 Max bases have a travel speed of 1.96"/second.** Motor devices have a continuous cycle time of 2 minutes with an 18 minute rest period before it can be cycled again.
- Control box is powered by 110-120V/60Hz/4A. Standby power is < 0.1 Watts. Power cords on A6-T models are 10'.
- Pedestals taller than 24½" for 2-stage models and 19½" for 3-stage models when placed under table will limit range in lowest position.
- Mobile box/file pedestals will clear feet on height adjustable base but will extend past edge of worksurface in that position. See chart on page 337.
- Moving worksurfaces can collide with other components. It is important to ensure free range of motion prior to operating the table.
- All tables have adjustable glides providing ½" adjustment on A6.
- Slide glides offered as a .option and model level. Only available on 2-leg bases.
- Casters available on model level for retrofitting on 2-Leg Bases ONLY.
- Altitude A6 tables feature collision detection, a feature designed to stop table travel when the table detects an obstacle.
- A6 load capacity is 250 lbs for 2-leg models, 375 lbs for 3-leg models, 350 lbs for 2-leg Max models, and 500 lbs for 3-leg Max models. This includes the weight of the worksurface.
- G1 Glide enables the A63-stage height adjustable bases to reach the BIFMA G1 height requirements. Glides come in a pack of 4. Glide is always black.

A6 Control Options

- Memory Controls are now a .option.
- Up/Down: Basic Up/Down control.
- Memory Control: 4 memory pre-set options allow the user to adjust their height to their preferred heights.
- Paddle: Simple, aesthetic control with 1 memory pre-set option and reminder mode.
- Bluetooth Capability: A6 optional Bluetooth capability is sold as accessory model A6BLUETOOTH. Bluetooth is enabled through smartphone app AiDesk. Bluetooth control will only work with 2-leg A6 tables. Bluetooth control will **not** work with 3-leg A6 tables. No additional controls are required for use, but they can be used in addition to the bluetooth control (bluetooth plug in uses different port than other controls).

Note: HAT-to-Panel bracket does not work with the Max Base.

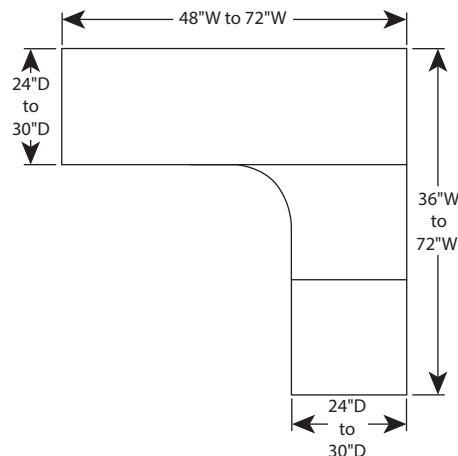
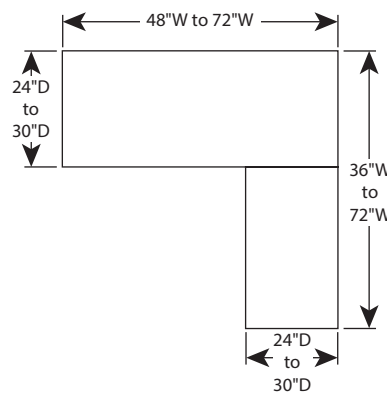
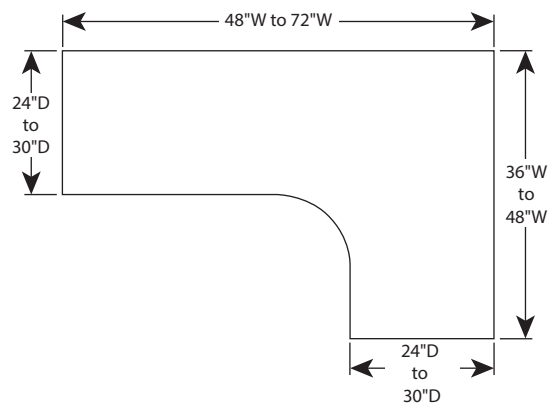

ALTITUDE

For specification information see page 338.

Rectangular Laminate Tops – 24"D

Base Model(s)	Actual Dimensions
AF5RS4824, AVF5RS4824	46"W x 23¼"D
AF5RS5424, AVF5RS5424	52"W x 23¼"D
AF5RS6024D, AVF5RS6024D	58"W x 23¼"D
AF5RS6624D, AVF5RS6624D	64"W x 23¼"D
AF5RS7224D, AVF5RS7224D	70"W x 23¼"D
AF5RS7824D	76"W x 23¼"D
AF5RS8424D	82"W x 23¼"D
AF5RS9024D	88"W x 23¼"D
AF5RS9624D	94"W x 23¼"D

Rounded Corner Laminate Tops – 24"D

Base Model(s)	Actual Dimensions
AF5RND4824	46"W x 23¼"D
AF5RND5424	52"W x 23¼"D
AF5RND6024D	58"W x 23¼"D
AF5RND6624D	64"W x 23¼"D
AF5RND7224D	70"W x 23¼"D
AF5RND7824D	76"W x 23¼"D
AF5RND8424D	82"W x 23¼"D
AF5RND9024D	88"W x 23¼"D
AF5RND9624D	94"W x 23¼"D

Rectangular Laminate Tops – 30"D

Base Model(s)	Actual Dimensions
AF5RS4830, AVF5RS4830	46"W x 29¼"D
AF5RS5430, AVF5RS5430	52"W x 29¼"D
AF5RS6030D, AVF5RS6030D	58"W x 29¼"D
AF5RS6630D, AVF5RS6630D	64"W x 29¼"D
AF5RS7230D, AVF5RS7230D	70"W x 29¼"D
AF5RS7830D	76"W x 29¼"D
AF5RS8430D	82"W x 29¼"D
AF5RS9030D	88"W x 29¼"D
AF5RS9630D	94"W x 29¼"D

Rounded Corner Laminate Tops – 30"D

Base Model(s)	Actual Dimensions
AF5RND4830	46"W x 29¼"D
AF5RND5430	52"W x 29¼"D
AF5RND6030D	58"W x 29¼"D
AF5RND6630D	64"W x 29¼"D
AF5RND7230D	70"W x 29¼"D
AF5RND7830D	76"W x 29¼"D
AF5RND8430D	82"W x 29¼"D
AF5RND9030D	88"W x 29¼"D
AF5RND9630D	94"W x 29¼"D

Undersized Rectangular Worksurface – 24"D

Base Model(s)	Actual Dimensions
AF5RS3624U	34"W x 22"D
AF5RS4224U	40"W x 22"D
AF5RS4824U	46"W x 22"D
AF5RS5424U	52"W x 22"D
AF5RS6024UD	58"W x 22"D
AF5RS6624UD	64"W x 22"D
AF5RS7224UD	70"W x 22"D
AF5RS7824UD	76"W x 22"D
AF5RS8424UD	82"W x 22"D
AF5RS9024UD	88"W x 22"D
AF5RS9624UD	94"W x 22"D

Undersized Rectangular Worksurface – 30"D

Base Model(s)	Actual Dimensions
AF5RS3630U	34"W x 28"D
AF5RS4230U	40"W x 28"D
AF5RS4830U	46"W x 28"D
AF5RS5430U	52"W x 28"D
AF5RS6030UD	58"W x 28"D
AF5RS6630UD	64"W x 28"D
AF5RS7230UD	70"W x 28"D
AF5RS7830UD	76"W x 28"D
AF5RS8430UD	82"W x 28"D
AF5RS9030UD	88"W x 28"D
AF5RS9630UD	94"W x 28"D

120 Degree Corner Worksurface – 24"D

Base Model(s)	Actual Dimensions
AF5120S4224D	22"A x 40"B x 40"C x 22"D
AF5120S4824D	22"A x 46"B x 46"C x 22"D
AF5120S5424D	22"A x 52"B x 52"C x 22"D

120 Degree Corner Worksurface – 30"D

Base Model(s)	Actual Dimensions
AF5120S4224D	28"A x 40"B x 40"C x 28"D
AF5120S4824D	28"A x 46"B x 46"C x 28"D
AF5120S5424D	28"A x 52"B x 52"C x 28"D

For specification information see page 338.

Corner Cove Laminate Tops – 24"D Extended Left

Base Model(s)	Actual Dimensions
A5822ELS	23¼"A x 58¼"B x 34½"C x 23¼"D
A5622ELS	23¼"A x 58¼"B x 46¼"C x 23¼"D
A5922ELS	23¼"A x 70¼"B x 34½"C x 23¼"D
A7222ELS	23¼"A x 70¼"B x 46¼"C x 23¼"D

Undersized Corner Cove Worksurface, Left Hand – 24"D

Base Model(s)	Actual Dimensions
AF5CCS603624LD	22"A x 58"B x 34"C x 22"D
AF5CCS604824LD	22"A x 58"B x 46"C x 22"D
AF5CCS723624LD	22"A x 70"B x 34"C x 22"D
AF6CCS724824LD	22"A x 70"B x 46"C x 22"D

Undersized Corner Cove Worksurface, Left Hand – 30"D

Base Model(s)	Actual Dimensions
AF5CCS604830LD	28"A x 58"B x 46"C x 28"D
AF5CCS724830LD	28"A x 70"B x 46"C x 28"D

Corner Cove Laminate Tops – 24"D Extended Right

Base Model(s)	Actual Dimensions
A5822ERS	23¼"A x 58¼"B x 34½"C x 23¼"D
A5622ERS	23¼"A x 58¼"B x 46¼"C x 23¼"D
A5922ERS	23¼"A x 70¼"B x 34½"C x 23¼"D
A7222ERS	23¼"A x 70¼"B x 46¼"C x 23¼"D

Undersized Corner Cove Worksurface, Right Hand – 24"D

Base Model(s)	Actual Dimensions
AF5CCS603624RD	22"A x 58"B x 34"C x 22"D
AF5CCS604824RD	22"A x 58"B x 46"C x 22"D
AF5CCS723624RD	22"A x 70"B x 34"C x 22"D
AF6CCS724824RD	22"A x 70"B x 46"C x 22"D

Undersized Corner Cove Worksurface, Right Hand – 30"D

Base Model(s)	Actual Dimensions
AF5CCS604830RD	28"A x 58"B x 46"C x 28"D
AF5CCS724830RD	28"A x 70"B x 46"C x 28"D

Cable & Wire Management

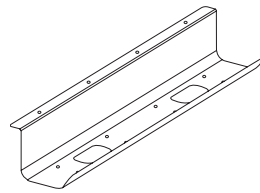

AJTRGH24 or AJTRGH36

Cable Management Tray (page 365)

- Attaches under the worksurface to contain cables.
- Metal tray shelf is 4" deep. Can hold electrical power strip and/or surge protector.
- 24" and 36" lengths, use multiple units for larger worksurfaces.
- Attachment hardware included, paint option is black only.
- Zip tie attachment points located in base of tray. Zip ties not included.

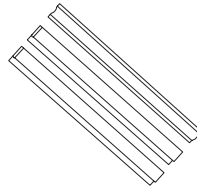

AWRSTRIP

Wire Management Strips/Channels (page 365)

- Self adhesive backing to attach to panels and underside of worksurfaces.
- Flexible strips allow cabling to enter/exit and can be contained inside the strips' cavities.
- Includes two wire management profiles. Smaller profile allows for qty. 3, .3" diameter cords, has area of .32 in². Larger "J" shaped profile allows for qty. 10, .3" diameter cords, has area of 1.14 in².

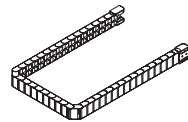

A9CLWMC or WKSWMC

Cord Management Chains (page 365)

- Works with Approach and Altitude A6-units.
- Used to route and conceal power/data cables from control box and other devices. Includes all mounting hardware and a plate to secure to a leveling glide.
- Houses 6 cables at 0.300" diameter.
- Made of plastic chain with plastic attachment brackets at each end.
- Specify WKSWMC for 58" chain. Only comes in Black finish.
- Specify A9CLWMC for 36" chain. Comes in Black, White, and Silver.
- Has two connecting points: Top section connects underneath a worksurface and bottom section can connect underneath power rails or to panel raceways using double-sided tape. Hardware included.

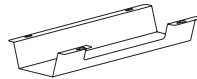

APWRTRGH17 or APWRTRGH36

Under Worksurface Trough (page 365)

- Used to conceal wires and control box below worksurfaces. Trough can be configured at various height/width combinations to meet capacity needs. Ships flat and is bent to desired shape.
- On 48"W and 54"W worksurfaces use one 17"W trough. 54"W has space to use 2 – 17"W, if necessary.
- On 60"W, 66"W, and 72"W worksurfaces use the 36" trough.
- On 84"W worksurface use 2 – 17"W troughs.

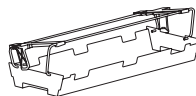

AFDTRGH20

Flip-Down Wire Trough (page 365)

- Mounts beneath a worksurface. Used to conceal extra cord slack and power strips.
- May be used in conjunction with quad tap unit APWR4TAP to reduce the number of cords routed from a worksurface to a beam.
- For any worksurface less than 58"W, a 20"W Flip-Down Trough is recommended.
- For worksurfaces 58"W and wider, a 20"W or 32"W Flip-Down Trough may be used.
- Flush-mount Raddi Storages are not recommended to use in conjunction with Flip-Down Trough.
- Only AKTSHORT keyboard tray is recommended for use in conjunction with the Flip-Down Trough.



AFDTRGH32

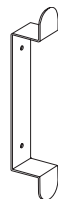

AWIRECLT

Metal Wire Cleat (page 365)

- Supplied with screws and VHB tape for attachment to various surface types.
- For wood/particle board/MDF surfaces, use screw attachment.
- For painted metal/glass/non-porous surfaces, use VHB tape.
- Example use cases:
 - 1) Used alongside telescoping/fabric HAT wire chases to secure excess length of cord at plug-end.
 - 2) Secured to wall next to TV monitor in meeting room to manage HDMI cable when not in use.
 - 3) Screwed underneath worksurface to provide quick and easy management of excess length of cords and cabling.

Cable & Wire Management

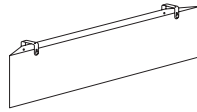

APWRMODEST36 or APWRMODEST48

Fabric Power Modesty (page 365.2)

- Fabric Power Modesty presents as modesty panel hanging by leather straps under a worksurface; inner compartment conceals cords and power strips as a wire management application.
- Recommended worksurface width pairings:
 - 1) 48-60" W Desk — Use APWRMODEST36 Centered.
 - 2) 66-72" W Desk — Use APWRMODEST48 Centered or APWRMODEST36 offset.
 - 3) 84" W Desk — Use APWRMODEST48 offset.
- Modesty fills 11.5 inches below the bottom of the worksurface with space for cords to enter/exit between the worksurface and the top of the Power Modesty.
- Two entry/exit points for cords are located at the bottom of the Power Modesty unit.
- Modesty panel is designed to present as a thin modesty panel from the front, but provides 3" depth cavity for wires, power strips, etc.
- Maximum weight capacity for Power Modesty is 25 lbs.
- Modesty panel not to be used to store electronics that require airflow for thermal management (computers).
- Users can access interior of panel (to modify wire placement) via "wings" on either side of product, secured via user-operable Velcro connection.
- Users may also dismount Power Modesty from leather straps by unlooping leather straps from button attachments.
- Leather straps on Power Modesty always come in medium brown color.
- Power Modesty available in Appoint, Binary, Centurion, Noble, Reflections, Disperse, and Spin fabric series.

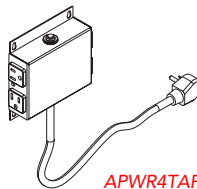

APWR4TAP

Power Module — Under Worksurface, Quad Tap (page 365.1)

- Under surface mounting, used on any worksurface with a 5" x 5" x 1.5" clearance.
- 10' Power cord. UL Listed.
- May be used in conjunction with Flip-Down Trough to reduce the number of cords routed from a worksurface to a beam.
- 4 receptacles, unit is black finish only, no specification needed.

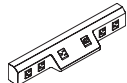

FDPWRC, CFDPWRC, FDPWRSC, or CFDPWRSC

Concealed Power Module (page 365.1)

- Contains 5 simplex outlets, 1 USB-A, and 1 USB-C.
- Available in plastic or metal. Metal power module is required for Chicago code.
- Cord options include straight and curly.
 - Straight cord is 144"
 - Curly cord is 120"
- If desired application is to set power module inside an under worksurface trough, MUST be specified with SPLA-ALT-BEAMA (contact Allsteel TPG for more information).
- Cannot be attached directly to the bottom of the worksurface.

Power Module — Above/Below Worksurface (page 365.2)

- Above/Below power module provides access to power on the desktop and below the worksurface.
- Desktop mount can be used on any surface with a 6" W x 3" D clearance along the worksurface edge.
- Under surface mounting can be used with a 12" W x 3" D x 2" H clearance under the surface.
- Plugs will take additional depth (approx. 3").
- Two wire management "P-Clips" included with mounting hardware.
- Below worksurface power strip supplies six grounded A/C receptacles, desktop unit supplies two receptacles, 1 USB-A port, and 1 USB-C port.
- Desktop and under worksurface units are connected by a 2' long straight cord and cannot be disconnected.
- Power cord choices include a 6' straight cord or a coiled cord that is 6' long uncoiled, approximately 8" long coiled (compressed).
- Desktop unit available in White and Gray finishes.
- Under worksurface unit available in black only, no specification needed.
- UL 962A and UL 111 Listed. UL 1310 Recognized.

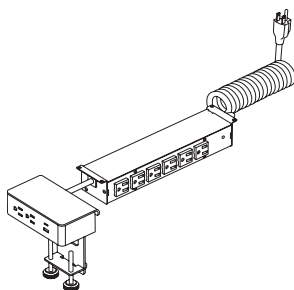

AABPWRMOD.AC.Q

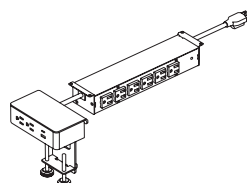

AABPWRMOD.AC.S

Cable & Wire Management

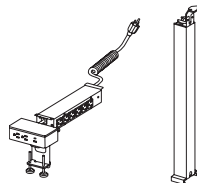

AHATPWORMOD2S or AHATPWORMOD3S

Metal Telescoping HAT Wire Management (page 365.3)

- Separate models available for use on either 2-Stage or 3-Stage Altitude A6 Tables. Not compatible with Altitude A3, A5, or A8.
- Equipped with 2-Stage or 3-Stage Telescoping Wire Chase and custom Above/Below Power Module intended for cord management on 2- and 3-Stage height adjustable tables.
- Telescoping chase includes a unique Above/Below Power Module and is NOT compatible with any other power module.
- Above/Below Power Module supplies 6 grounded A/C receptacles below the worksurface and 2 receptacles, 1 USB-A, and 1 USB-C port above the worksurface on the desktop unit. Desktop power module available in White and Gray finishes, below-worksurface power strip only available in black only.
- Telescoping Chase available in the same paint finishes as the Altitude height adjustable bases except for “Nickel.”
- To match Metal Telescoping Chase to HAT base, specify matching paint color as HAT base. To match Telescoping Chase to a “Nickel” HAT base, specify “Platinum Metallic,” or “PR2.”
- Two “P-Clips” included for wire management between desktop power module and under worksurface power strip.

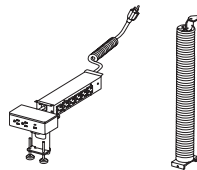

AHATPWORMOD2S or AHATPWORMOD3S

Fabric Elastic HAT Wire Management (page 365.3)

- Model compatible for use on either 2-Stage or 3-Stage Altitude A6 Tables. Not compatible with Altitude A3, A5, or A8.
- Equipped with Fabric Elastic Wire Chase and custom Above/Below Power Module intended for cord management on 2- and 3-Stage height adjustable tables.
- Fabric Elastic Chase includes a unique Above/Below Power Module and is NOT compatible with any other power module.
- Above/Below Power Module supplies 6 grounded A/C receptacles below the worksurface and 2 receptacles, 1 USB-A, and 1 USB-C port above the worksurface on the desktop unit.
- Desktop power module available in White and Gray finishes, below-worksurface power strip only available in black only.
- Fabric Elastic Chase available in Light, Medium, and Dark fabric finishes.
- Includes a metal foot and an under worksurface mounting bracket to attach Fabric Elastic Chase along the side of a HAT leg.
- To match metal brackets to HAT base, specify matching paint color as HAT base. To match brackets to a “Nickel” HAT base, specify “Platinum Metallic,” or “PR2.”
- Two “P-Clips” included for wire management between desktop power module and under worksurface power strip.

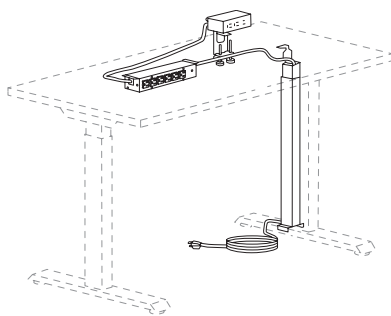

2-Stage Metal Telescoping HAT Wire Management

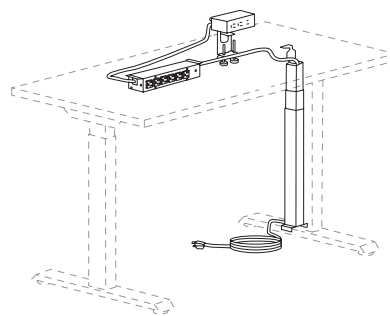

3-Stage Metal Telescoping HAT Wire Management

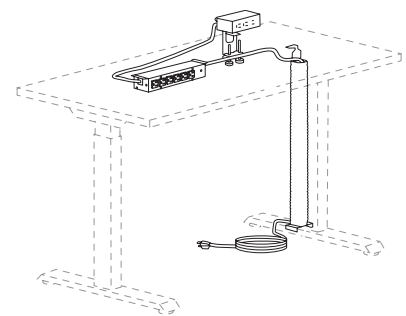

2 or 3-stage Fabric Elastic HAT Wire Management

For more power and wire management options, please visit the Extensions pages.

Screens

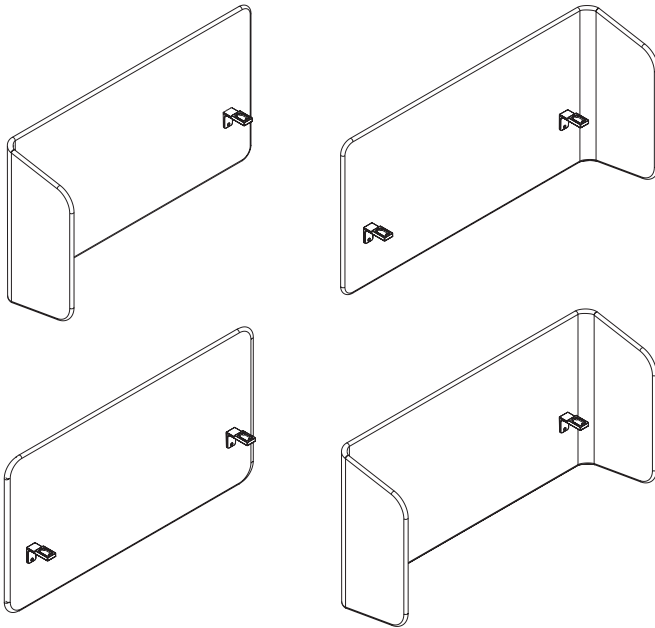

- See Table 1 for overall table width and depth for each screen shape.
- Adding a screen adds 3" to depth of the table.
- Adding a screen adds 1" to the width of the table per return wing.
- RH L-screens have return wing on user's right; LH opposite.
- When using a 24"D worksurface with Altitude screens, you must specify a T-foot.

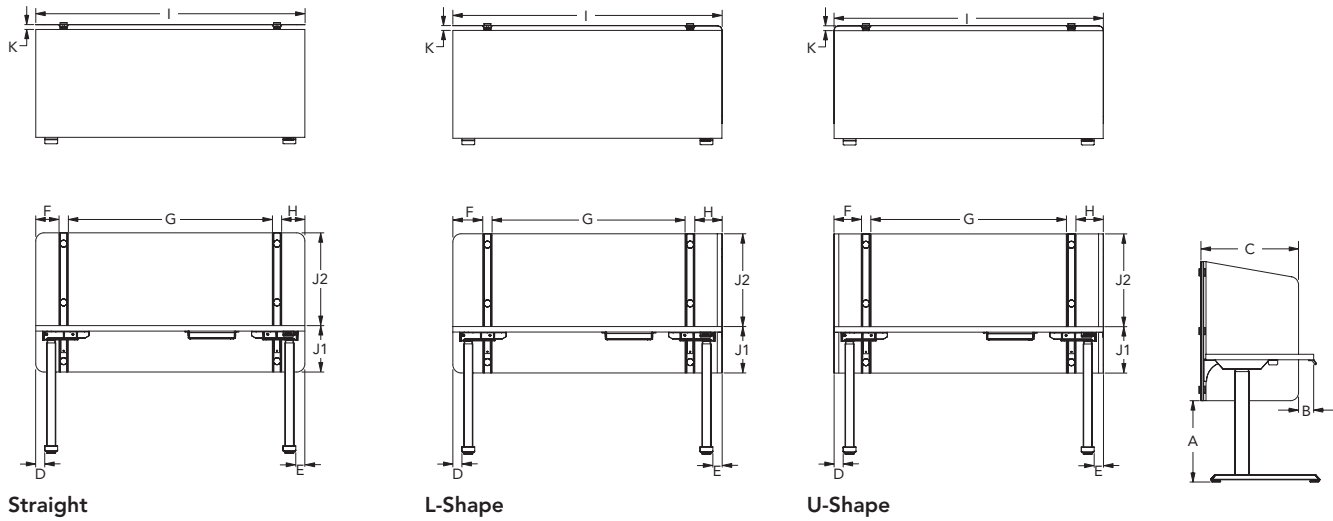

Size Reference Matrix

Models	A	B	C1	C2	D	E	F	G1	G2	H	I	J1	J2	K
	Under Desk Height	Wing to Front	Wing Width STD	Wing Width EXT	Left Leg to Edge	Right Leg to Edge	Left Side Panel to Support	Distance Between Supports	Distance Between Center/Right Support	Right Side Panel to Support	Overall Width	Desktop To Base of Panel	Desktop To Top of Panel	Cable Drop Space
AMS2048LH	24.7	3.3	21.1	24.3	2.0	2.0	5.9	29.7	-	6.4	46.1	2.9	20.0	1.0
AMS2054LH	24.7	3.3	21.1	24.3	2.0	2.0	5.9	35.7	-	6.4	52.1	2.9	20.0	1.0
AMS2060LH	24.7	3.3	21.1	24.3	2.0	2.0	5.9	41.7	-	6.4	58.1	2.9	20.0	1.0
AMS2066LH	24.7	3.3	21.1	24.3	2.0	2.0	5.9	22.8	22.8	6.4	64.1	2.9	20.0	1.0
AMS2072LH	24.7	3.3	21.1	24.3	2.0	2.0	5.9	25.8	25.8	6.4	70.1	2.9	20.0	1.0
AMS2048RH	24.7	3.3	21.1	24.3	2.0	2.0	6.4	29.7	-	5.9	46.1	2.9	20.0	1.0
AMS2054RH	24.7	3.3	21.1	24.3	2.0	2.0	6.4	35.7	-	5.9	52.1	2.9	20.0	1.0
AMS2060RH	24.7	3.3	21.1	24.3	2.0	2.0	6.4	41.7	-	5.9	58.1	2.9	20.0	1.0
AMS2066RH	24.7	3.3	21.1	24.3	2.0	2.0	6.4	22.8	22.8	5.9	64.1	2.9	20.0	1.0
AMS2072RH	24.7	3.3	21.1	24.3	2.0	2.0	6.4	25.8	25.8	5.9	70.1	2.9	20.0	1.0
AMS3248LH	17.5	3.3	21.1	24.3	2.0	2.0	5.9	29.7	-	6.4	46.1	10.0	20.0	1.0
AMS3254LH	17.5	3.3	21.1	24.3	2.0	2.0	5.9	35.7	-	6.4	52.1	10.0	20.0	1.0
AMS3260LH	17.5	3.3	21.1	24.3	2.0	2.0	5.9	41.7	-	6.4	58.1	10.0	20.0	1.0
AMS3266LH	17.5	3.3	21.1	24.3	2.0	2.0	5.9	22.8	22.8	6.4	64.1	10.0	20.0	1.0
AMS3272LH	17.5	3.3	21.1	24.3	2.0	2.0	5.9	25.8	25.8	6.4	70.1	10.0	20.0	1.0
AMS3248RH	17.5	3.3	21.1	24.3	2.0	2.0	6.4	29.7	-	5.9	46.1	10.0	20.0	1.0
AMS3254RH	17.5	3.3	21.1	24.3	2.0	2.0	6.4	35.7	-	5.9	52.1	10.0	20.0	1.0
AMS3260RH	17.5	3.3	21.1	24.3	2.0	2.0	6.4	41.7	-	5.9	58.1	10.0	20.0	1.0
AMS3266RH	17.5	3.3	21.1	24.3	2.0	2.0	6.4	22.8	22.8	5.9	64.1	10.0	20.0	1.0
AMS3272RH	17.5	3.3	21.1	24.3	2.0	2.0	6.4	25.8	25.8	5.9	70.1	10.0	20.0	1.0
AMS2048US	24.7	3.3	21.1	24.3	2.0	2.0	5.9	30.3	-	5.9	46.1	2.9	20.0	1.0
AMS2054US	24.7	3.3	21.1	24.3	2.0	2.0	5.9	36.3	-	5.9	52.1	2.9	20.0	1.0
AMS2060US	24.7	3.3	21.1	24.3	2.0	2.0	5.9	42.3	-	5.9	58.1	2.9	20.0	1.0
AMS2066US	24.7	3.3	21.1	24.3	2.0	2.0	5.9	23.1	23.1	5.9	64.1	2.9	20.0	1.0
AMS2072US	24.7	3.3	21.1	24.3	2.0	2.0	5.9	26.1	26.1	5.9	70.1	2.9	20.0	1.0
AMS3248US	17.5	3.3	21.1	24.3	2.0	2.0	5.9	30.3	-	5.9	46.1	10.0	20.0	1.0
AMS3254US	17.5	3.3	21.1	24.3	2.0	2.0	5.9	36.3	-	5.9	52.1	10.0	20.0	1.0
AMS3260US	17.5	3.3	21.1	24.3	2.0	2.0	5.9	42.3	-	5.9	58.1	10.0	20.0	1.0
AMS3266US	17.5	3.3	21.1	24.3	2.0	2.0	5.9	23.1	23.1	5.9	64.1	10.0	20.0	1.0
AMS3272US	17.5	3.3	21.1	24.3	2.0	2.0	5.9	26.1	26.1	5.9	70.1	10.0	20.0	1.0
AMS2048SS	24.7	-	-	-	2.0	2.0	5.0	32.0	-	5.0	46.0	2.9	20.0	1.0
AMS2054SS	24.7	-	-	-	2.0	2.0	5.0	38.0	-	5.0	52.0	2.9	20.0	1.0
AMS2060SS	24.7	-	-	-	2.0	2.0	5.0	44.0	-	5.0	58.0	2.9	20.0	1.0
AMS2066SS	24.7	-	-	-	2.0	2.0	5.0	24.0	24.0	5.0	64.0	2.9	20.0	1.0
AMS2072SS	24.7	-	-	-	2.0	2.0	5.0	27.0	27.0	5.0	70.0	2.9	20.0	1.0
AMS3248SS	17.5	-	-	-	2.0	2.0	5.0	32.0	-	5.0	46.0	10.0	20.0	1.0
AMS3254SS	17.5	-	-	-	2.0	2.0	5.0	38.0	-	5.0	52.0	10.0	20.0	1.0
AMS3260SS	17.5	-	-	-	2.0	2.0	5.0	44.0	-	5.0	58.0	10.0	20.0	1.0
AMS3266SS	17.5	-	-	-	2.0	2.0	5.0	24.0	24.0	5.0	64.0	10.0	20.0	1.0
AMS3272SS	17.5	-	-	-	2.0	2.0	5.0	27.0	27.0	5.0	70.0	10.0	20.0	1.0

ALTITUDE

Altitude — Metal Screens (page 370)

- Powder coated magnetic metal privacy screen.
- Metal surfaces can be easily disinfected with cleaners. See cleaning guide for more details at AllsteelOffice.com.
- Available in all standard paint colors.
- Provides 1" gap along the back for accessory mount and cord drop.
- Available in 48"W, 54"W, 60"W, 66"W and 72"W.
- 66"W and 72"W screens include 3rd center bracket.
- Available in Straight, L- and U-shape configurations. Above and Above/Below desk applications.
- L- and U-Shape screens are not compatible with shrouded Height Adjustable Table legs.
- Optional tackable accessories specified separately.
- 66"W tackable accessory comes as a set of (2) 24"W.
- 72"W tackable accessory comes as a set of (2) 20"W.
- Available in standard and extended wings.
- Wings mount flush to the edge of the surface with an L-Bracket.
- 20"W tackable accessory must only be applied to both standard and extended wings without accessory slots.
- Wings are available with accessory slots that accept Radii Hot File, Side Saddle and Coat hook.
- Top slot can accept one Radii accessory.
- Bottom slot can accept a Coat hook and one other accessory.
- Accessories can hang on either side of the wing.
- TIP: If the Hot File is used in the top slot, it will block access for accessories in the bottom slot.
- Do not hang more than 5lbs of weight on wings.
- Screens are compatible with Radii undermount storage.
- Not compatible with standard 120-worksurfaces. Contact Allsteel TPG for custom sizes.
- When using a 24"D worksurface with Altitude screens, you must specify a T-foot.

Size Reference Matrix

Tackboards	Wing	48"W	54"W	60"W	66"W	72"W
Actual Dimensions	20"W	30"W	36"W	42"W	20"W	24"W
Set of Tackboards	1	1	1	1	2	2

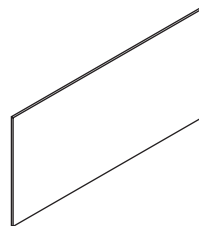

Accessories — Tackboard (page 371)

- Tackable accessories come with metal frame available in standard paint colors and fabric options.
- Attach to the screen using a dual lock tape (included in hardware).

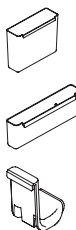

Accessories — Radii (page 371)

- Wings are available with accessory slots that accept Radii Hot File, Side Saddle and Coat hook.
- Top slot can accept one Radii accessory.
- Bottom slot can accept a Coat hook and one other accessory.
- Accessories can hang on either side of the wing.
- TIP: If the Hot File is used in the top slot, it will block access for accessories in the bottom slot.

Accessories — Further Worksurface Rail Mount (page 377)

- Accessory rail must be field cut to fit between the screen brackets.
- The following accessories are not compatible with screens: U9WTC and U9TM.

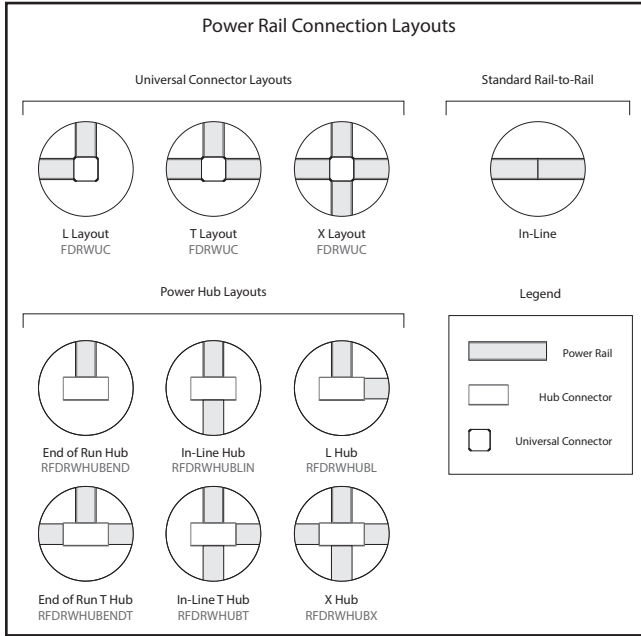

GENERAL OVERVIEW

- Accommodates power and lay-in capacity for data cables.
- Available in 48", 54", 60", 66", and 72" lengths.
- Maximum of 2 duplexes and 2 data ports per side of rail.
- Models come equipped with hardware for in-line connections.
- Fiber optic cables can follow 90 degree turns at the intersection of the power rails.
- Power harnesses snap into electrical brackets within the power rail and accept duplex receptacles.
- Electrical power harness accepts up to 2 duplex receptacles per side of rail.
- End caps are required at an end-of-run, unless connected to an end-of-run power pole or a hub.
- Power rail can be set low to the floor using the floor legs or raised off the floor at 20½" H with elevated legs.

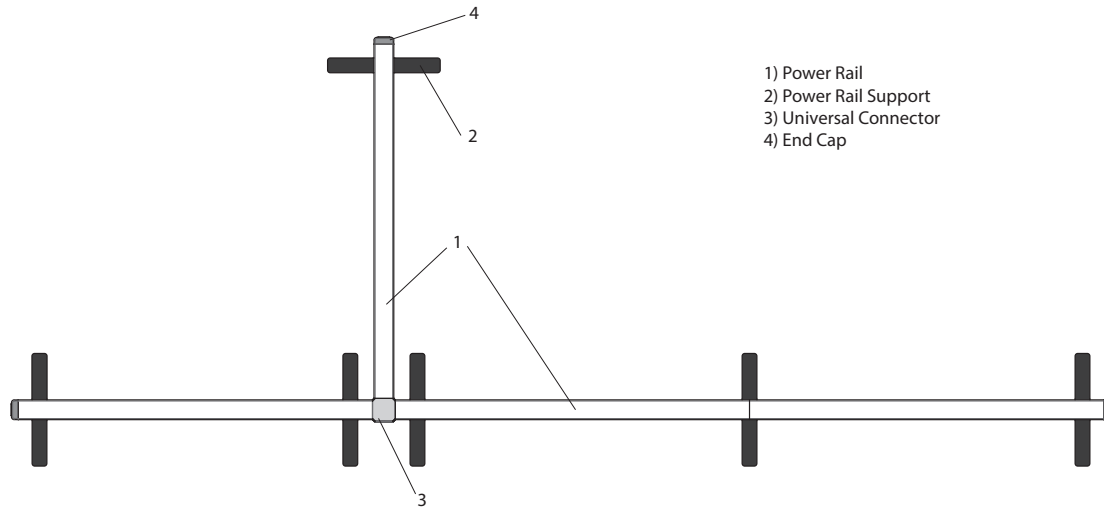

ALTITUDE

Power Rail Typicals

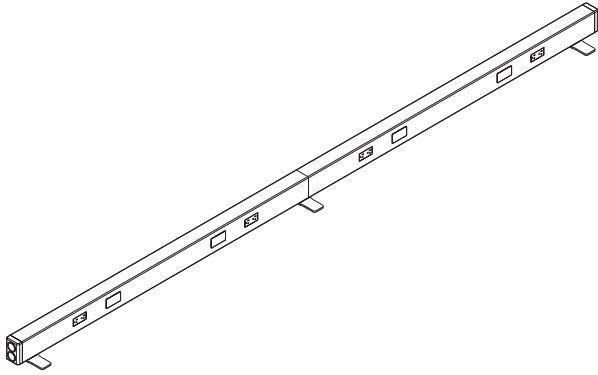

Low Rail, (2) 60"W Rail
Linear Configuration

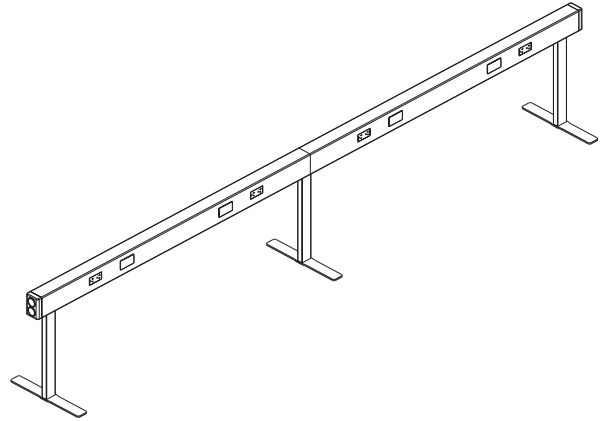

Raised Rail, (2) 60"W Rail
Linear Configuration

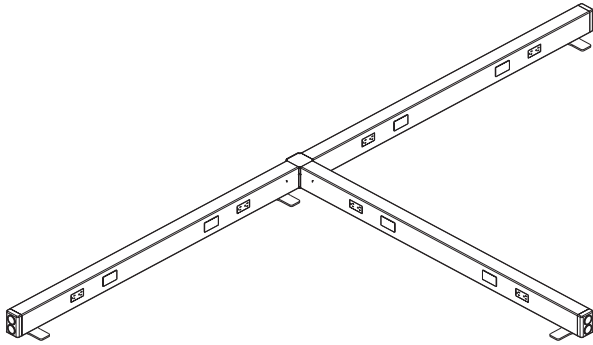

Low Rail, (3) 60"W Rail
T-Configuration

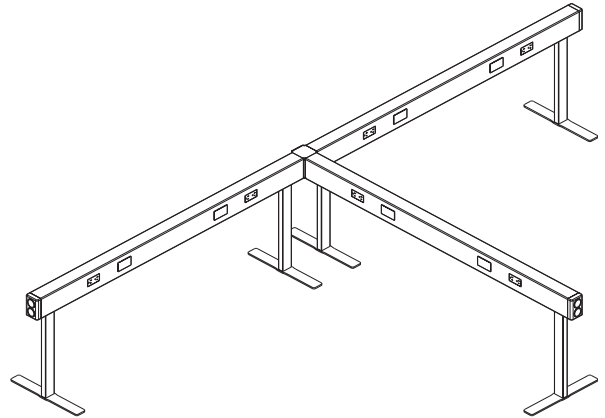

Raised Rail, (3) 60"W Rail
T-Configuration

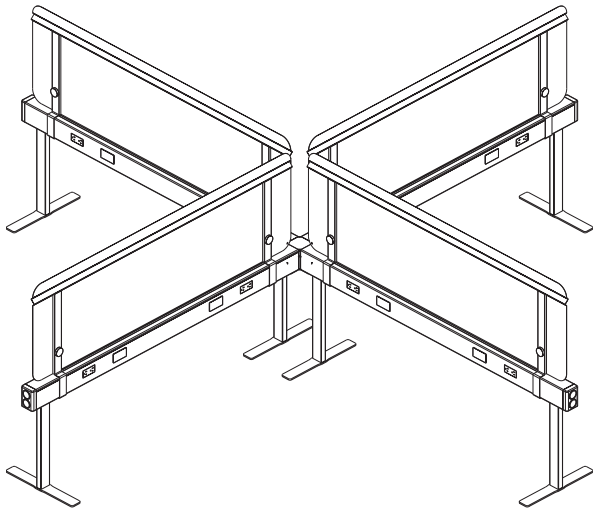

Raised Rail, (4) 60"W Rail
X-Configuration with Screens

WORKING WITH ALTITUDE POWER RAILS

Low Rail with Floor Legs:

- Each power rail is supported by (2) floor legs.
- Floor legs have a leveling mechanism that can adjust up to 1¼"H.
- Legs are specified separately and come in qty of 1. Each leg is 7¼"D x 2¼"W.
- Leg is inset 2.8" from end of the power rail.
- Universal connector allows "L", "T" and "X" configurations.
- Can connect directly to another power rail in linear applications without use of the universal connector.
- Cannot mount screens on the low rail.
- Power infeed can access the power rail in multiple ways:
 - through a receptacle position on the power rail (side infeed).
 - through the end cap on to the first power block.
 - through power pole using a power pole connector kit.

Raised Rail

- Power rails can be raised up to 20½"H using Elevated Legs and/or Hubs.
- Elevated Legs and Hubs can be used in conjunction to create the desired capability and aesthetic.
- Can be in Linear, L-, T- or X-configurations using Elevated Legs, Hubs or Universal Connector.
- Supports screens. See screens section for more details.
- Elevated Legs
 - Inset 2.8" from end of the power rail.
 - Can be shared in between the two rails in linear configuration.
 - Cannot route power and/or data.
 - Specified separately and come in qty of 1. Foot is included.
 - Leg is 15¼"D x 2¼"W x 17¾"H.
 - Order RFDRAWAB separately to anchor to floor. Appropriate fasteners per floor type sourced locally.
- Support Hubs
 - Connect directly to the power rail.
 - Can be shared in between the two rails.
 - L-, T- and X-hubs can be shared in between power rails.
 - End of Run hub is only specified at end condition.
 - Can route power and/or data.
 - Can integrate power pole. Power Pole connector kit is specified separately and come in qty of 1. Foot is included.

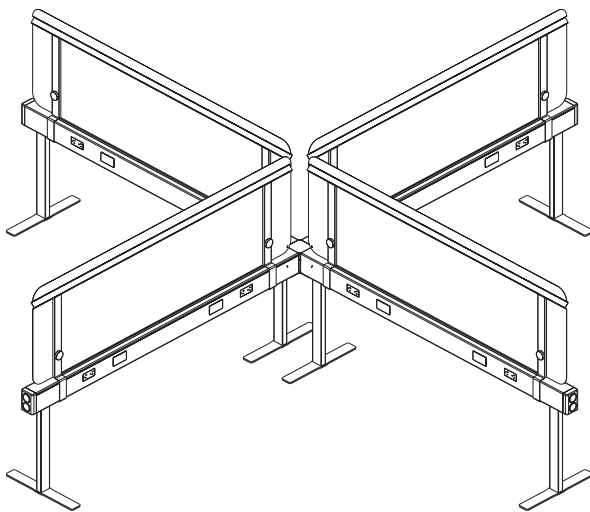

Screens

- Constructed of painted steel material.
- Standard Allsteel paint options can be applied.
- Screen height is 20"H, provides overall height of 42"H above fixed floor.
- Painted steel is magnetic and cleanable. Refer to cleaning solutions page at Allsteel Office website.
- Attachment hardware included.

ALTITUDE

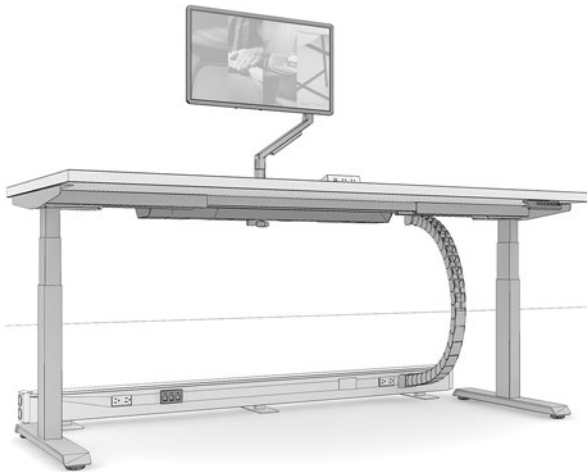

Altitude Desk + 60"W Low Rail + WKSVMC

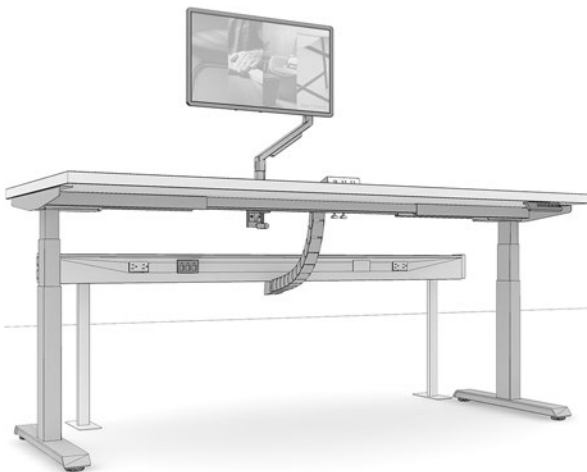

Altitude Desk + 60"W Raised Rail + A9CLWMC

WORKING WITH CABLE MANAGEMENT

- Used to route and conceal power/data cables from control box and other devices. Includes all mounting hardware.
- Houses 6 cables @ 0.300" diameter.
- Specify WKSVMC for 58" chain. Only comes in Black Finish. Recommended for use with Low Rail.
- Specify A9CLWMC for 36" chain. Comes in Black, White and Silver. Recommended for use with Raised Rail.
- Links the power rail to a height adjustable desk.
- Has two connecting points: Top section connects underneath the Height Adjustable Desk and the bottom section connects underneath the power rail using a double-sided tape. Hardware included.
- When mounting the chain to underneath the rail, an adapter link is required. Included in the hardware.

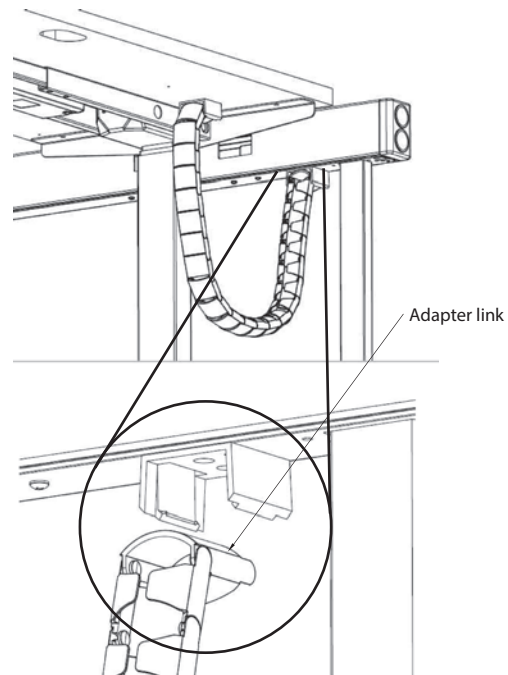

ALTITUDE

WORKING WITH POWER RAIL ELECTRICALS

General Notes about Electrical and Circuitry:

- Power Rail offers a choice of four electrical systems:
 - Four-circuit, 3 + 1
 - Four-circuit, 2 + 2
 - Three-circuit, separate neutrals
 - Eight circuits; two four-circuit systems provided back to back.
 - See Altitude Pricer section “Working with Electrical” for a detailed explanation of each electrical system.
 - All four systems utilize an 8-wire electrical system, rated at 20 amps.
- Per circuit (15 amps Canadian) — 16 amps plannable in U.S.
 - Power Rail and electrical components are UL Listed. Electrical
- Components are also CSA certified.
 - Installation and use of the electrical system, the number of receptacles.
- Used on a given circuit and connections to the building power supply.
- Should follow all local and national electrical codes.

Electrical Infeeds

- Power infeed cables deliver power from building to panel's electrical system.
- Infeed cables are housed in conduit to separate electrical system from communications and data lines.
- Select quantity of base or ceiling infeed cables depending on individual power requirements.
- Refer to rail supports for infeed access points.

Routing Power

- Power infeed can access the raised power rail in multiple ways:
 - Through power pole using a power pole connector kit.
 - Through Support Hubs.
 - Through the infeed vertebrae.

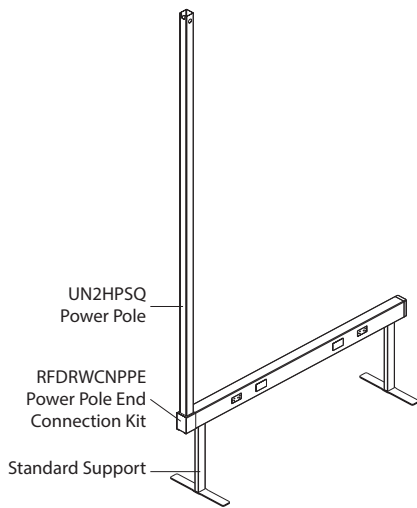
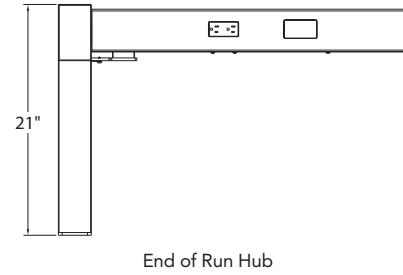
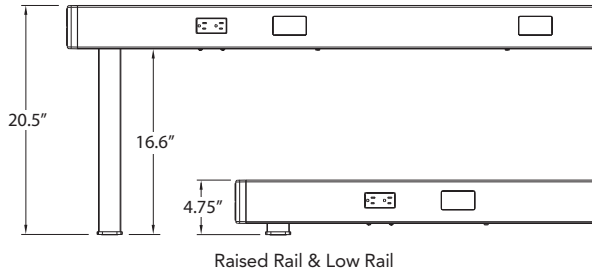

RFDRWCNPPE + UN2HPSQ
Connected to 60"W Rail

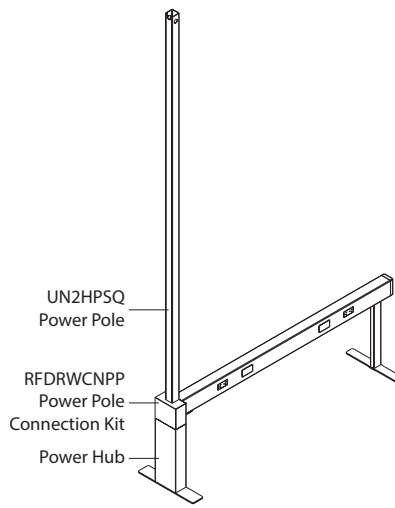

RFDRWHUBEND + RFDRWCNPP
UN2HPSQ connected to 60"W Rail

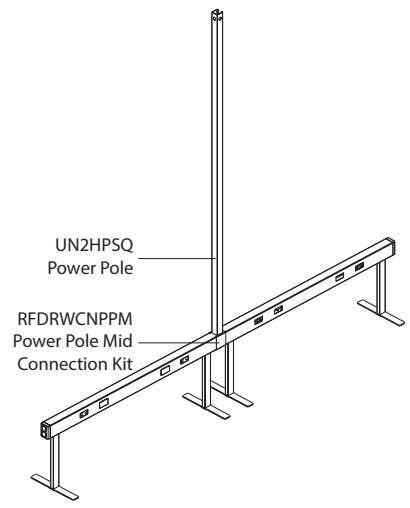

UN2HPSQ + RFDRWCNPPM
Connected to 60"W Rail

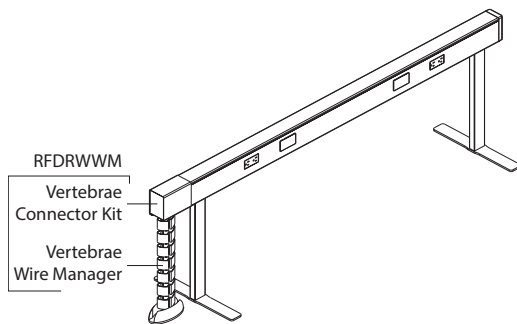

RFDRWWM
Connected to 60"W Rail

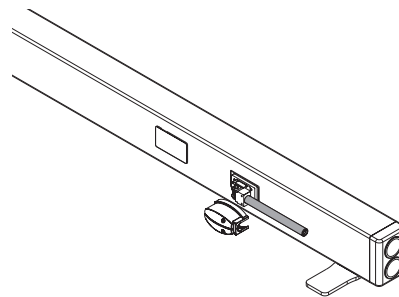

A876072 Infeed
Connected to 60"W Rail through
Receptacle Knockout

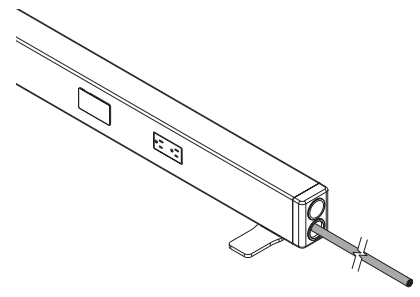

A877012 Infeed
Connected to 60"W Rail through End Cap

ALTITUDE

Electrical Systems

General Notes about Electric, Circuitry, and Chicago Code:

- Power Rail offers a choice of four electrical systems:
 - Four-circuit, 3 + 1
 - Four-circuit, 2 + 2
 - Three-circuit, separate neutrals
 - Eight circuits; two four-circuit systems provided back to back.
- See pages 352-353 for a detailed explanation of each electrical system.
- All four systems utilize an 8-wire electrical system, rated at 20 amps per circuit (15 amps Canadian) — 16 amps plannable in U.S.
- Power Rail and electrical components are UL Listed. Electrical components are also CSA certified.
- Installation and use of the electrical system, the number of receptacles used on a given circuit and connections to the building power supply should be in compliance with all local and national electrical codes.

Caution: Electrical equipment cords or extension cords MUST NOT BE ROUTED through cable openings in frame sides.

Note: No more than one conduit that is connected to a harness mounted to horizontal can be routed through the same cut out in the same horizontal at beltline. Attempting to use more will cause binding of conduit and may affect reveals on receptacles.

Hardwire New York Code (page 367)

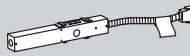
- Hardwire (New York Code) junction box (model A871400) is used when local electrical codes require hardwire entry. 
- For use in panels 48" W to 72" W.
- Unit must connect to a power harness.
- Customer to furnish all cabling and wiring from power entry to power source.
- Junction box can be positioned at any duplex receptacle location.
- For NY infeed through the end cap:
 - Order 24" pass-thru harness with power block A871124.
 - Will not have power at first cut-out from infeed.
- For NY infeed through a power rail cut-out:
 - Order 48"-72" pass-thru harness with power block. *Harness width must match power rail width.*
 - Will not have power at cut-out location used for infeed.
- For any power rail not used for infeed, order standard electrical power harness.

Hardwire Chicago Code (page 368)

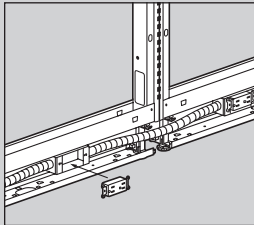
- Wiring harnesses and snap connectors are not allowed in Chicago — base pathways must be comprised of all-metallic components.
- The base pathway, junction box (model 873600) clips directly into receptacle locations and can be used both single- and double-sided.
- Customer must furnish conduit, wiring, and designer-type receptacles for the base pathway and conduit, wiring, designer-type receptacles, and receptacle covers for the beltline.
- Power entry can be routed from the floor into a junction box (model 873600). 

Electrical Infeeds

- Power infeed cables deliver power from building to panel's electrical system.
- Infeed cables are housed in conduit to separate electrical system from communications and data lines.
- Select quantity of base or ceiling infeed cables depending on individual power requirements.

Base Infeed (page 367)

- Sealtight base pathway power infeed mounts into any receptacle position in the base pathway area.
- A heavy rubber sheathing shields conduit, allowing infeed to be exposed.
- A jumper is required to connect base pathway power to beltline.

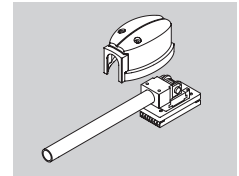

Sealtight Electrical Infeed (page 367)

- Sealtight electrical infeed cable is used with footed panels.
- Should not be ordered prior to installation to have pre-wired as infeed must be routed from inside of panel out to be connected to power.
- Cannot be connected to power harness in panel frame that infeed is brought into unless additional pass-thru harness without power block is used to feed from below beltline to above beltline.

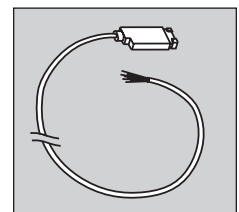

Power Infeed (page 367)

- Power infeed connects to a prewired electrical harness in the power rail.
- Most codes allow flex conduit to be exposed after installation. Verify code requirements before ordering for exposed application.

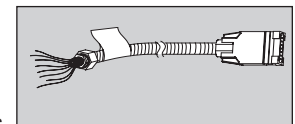

To Order:

- Determine which electrical system you will use after consulting your electrician and computer support personnel:
 - The Four-circuit system (4-Hot/2-Neutral/2-Ground)
 - 3 + 1 option
 - 2 + 2 option
 - The three-circuit system (3-Hot/3-Neutral/2-Ground)
 - The eight-circuit system (back-to-back four-circuit systems)
- Determine location, quantity, and circuit of duplexes.
- Determine the appropriate choice and use of isolated, isolated/dedicated, and separate neutrals circuits.
- Specify appropriate power harnesses* and pass-thru cables.*
- Determine the location, quantity, and type of power infeed needed.

* Select power harness models (A8712XX), with the last two digits corresponding with the panel width into which the component is to be positioned.
The initial cable length can be stretched approximately 3" to transverse "T", "X", "L", and extended straight connectors.

Flexconnect™ Electrical System Options

The four-circuit, eight-wire electrical system is widely specified and trusted by hundreds of thousands of end-users. This proven system delivers four circuits for every power infeed in either a 3 + 1 or 2 + 2 configuration. The isolated/dedicated circuits are ideal for sensitive computing equipment, while the common circuits are suitable for faxes, copiers, task lights and other peripherals. Both the 3 + 1 and 2 + 2 systems use the same pre-wired components, making it easy to adjust as electrical needs change.

You can also choose a three-circuit, eight-wire system that has a dedicated neutral for every hot circuit. The three-circuit components have model numbers with an "A" suffix and appear in a gray box in this price.

All three systems utilize an eight-wire electrical system rated at 20 amps per circuit (15 amps Canadian). Concensys panels and electrical components are UL listed and CSA certified.

Four-circuit, 3 + 1 Receptacle Option

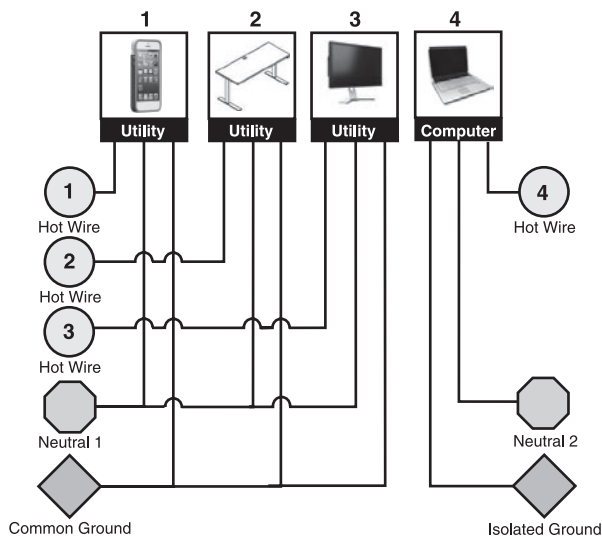

The 3 + 1 option is the electrical standard used on Allsteel systems for many years in most installations. This wiring option provides three utility circuits plus an isolated/dedicated circuit for more sensitive equipment. Circuit 2 (one of the 3 common circuits sharing a neutral wire) cannot be used with single-phase building electrical supply.

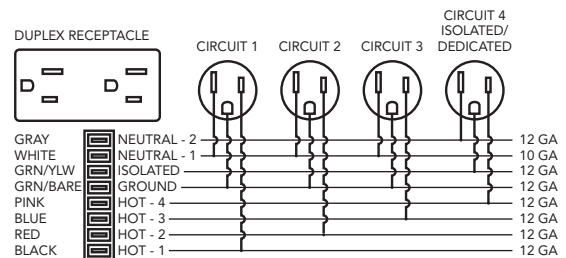

Four-circuit, 2 + 2 Receptacle Option

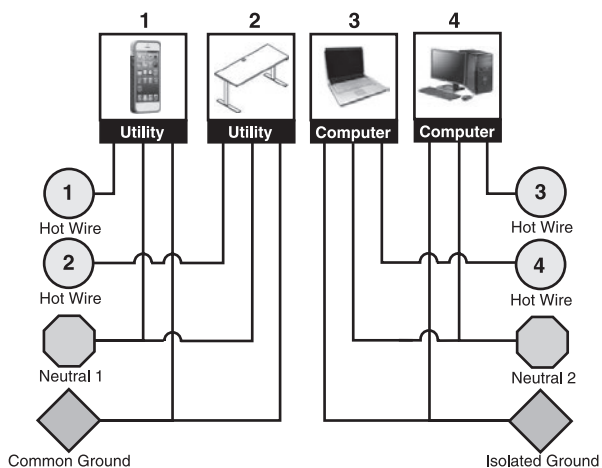

The 2 + 2 option is a wiring option that provides two utility circuits and two isolated circuits for more extensive computer usage applications.

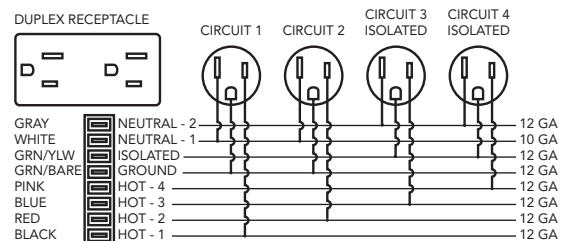

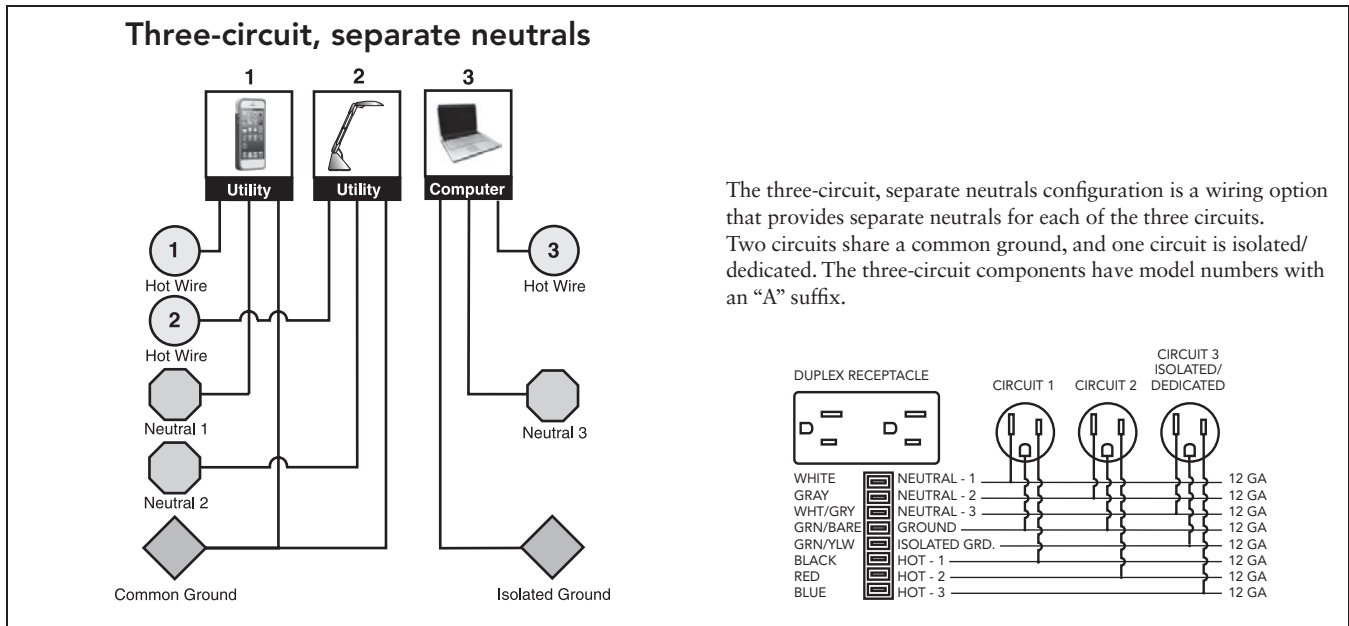

Altitude System Receptacle Usage					
Two 8-wire, 20 amp (15 amp Canadian) electrical systems are offered					
Electrical System	Circuitry	Receptacle Capacity			
Four-circuit 4-Hot/2-Neutral/2-Ground	3 + 1	Common Circuit-1 A873501	Common Circuit-2 ⁽¹⁾ A873502	Common C ircuit-3 A873503	Iso/Dedicated Circuit-4 A873504
	2 + 2	Common Circuit-1 A873501	Common Cir- cuit-2 A873502	Isolated Circuit-3 A873506	Isolated Circuit-4 A873504
Three-circuit 3-Hot/3-Neutral/2-Ground	w/separate neutrals	Common Circuit-1 A871501A	Common Circuit-2 A871502A	Iso/Dedicated Circuit-3 A871503A	N/A

(1) Circuit 2 (one of the 3 common circuits sharing a neutral wire) cannot be used with a single-phase building electrical supply.

Notes:

- Four-circuit components and three-circuit components (with suffix "A") cannot be used together.
- Components of the two systems are keyed differently to prevent components of one system being connected to components of another system.
- Allsteel model numbers are printed on the UL labels, and components are color-coded to provide visual identification of the different components.
- Four-circuit components have black plastic parts.
- Three-circuit components have rust-colored terminal ends and receptacle backs are rust-colored.

Duplex Receptacle



15 amp receptacle

Infeeds

- Power infeed cables deliver power from building to Power Rail's electrical system.
- Infeed cables are housed in conduit to separate electrical system from communications and data lines.
- Select quantity of infeed cables depending on individual power requirements.

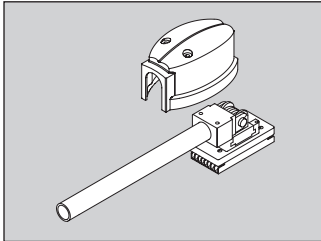

Base Infeed:

- Sealight base pathway power infeed mounts into any receptacle position in the power rail housing.
- A heavy rubber sheathing shields conduit, allowing infeed to be exposed.

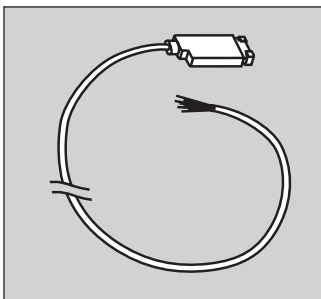

Sealtight Electrical Infeed:

- Sealtight electrical infeed is used for power entering through the end cap.
- Should not be ordered prior to installation to have pre-wired as infeed must be routed from inside of the power rail out to be connected to power.

Power Harness

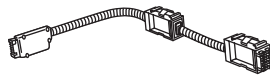

Electrical power harnesses are used to distribute power in the power rail. **Power blocks** on electrical power harness accept duplex receptacles.

- Electrical power harnesses are used to distribute power in Power Rails. Harnesses must be installed in each power rail housing.
- Specify harness length to match rail housing length. Each power harness accepts four duplex receptacles (two on each side of power rail housing).
- Connectors at both ends of power harnesses allow power distribution in either direction.
- Harness power blocks snap directly onto brackets in power rail housing.

Power Blocks

- Power blocks snap directly onto brackets in the power rail and accept receptacles (sold separately) on each side of harness.

Duplexes

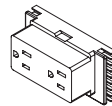

Duplex Receptacles

Receptacle Color Recommended to Coordinate with Paint Color

Paint Color	Receptacle Color
Bungalow — P7C	Muslin — EU
Champagne Metallic — PR5	Muslin — EU
Cinder — P7Q	Brownstone — EY
Fossil — P28	Flint — E9
Gunmetal Metallic — PR3	Brownstone — EY
Parchment — P93	Muslin — EU
Pebble — P8R	Loft — EV
Pewter — P8D	Flint — E9
Platinum — PR2	Loft — EV
Platinum Metallic — P42	Silver — E5
Salt — P8C	Silver — E5
Titanium — P8T	Silver — E5

- Duplex receptacles snap into power blocks of power harnesses.
- Duplexes are available in multiple colors. See inside front cover for finishes.
- Each receptacle is labeled to indicate which circuit it will be connected to: 1, 2, 3 or 4.
- Duplexes are model specific to support either 3 + 1 and 2 + 2 electrical infeed; or have an "A" suffix and are designed to support a three-circuit separate neutral electrical infeed.
- At least one duplex must be installed in upper housing side of rail housing assembly (see page 356, "Working with Electrical and Data").

Data

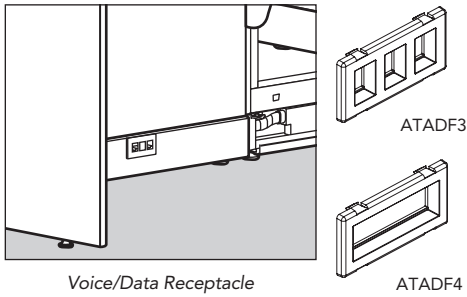

Data Faceplates:

- Fit into data port openings in Power Rail Housing.
- Due to rail housing depth, data modules should not be used back-to-back.

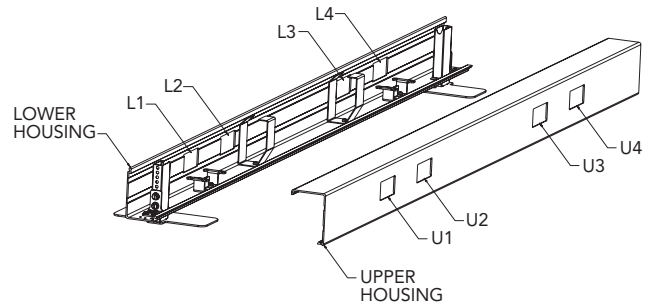

- Ports 1 and 4 accept duplexes, port covers and base infeeds.
- Ports 2 and 3 accept data and port covers.
- Either U1 or U4 must always contain a duplex.
- Data cannot be back-to-back (data in L2 + U2 or L3 + U3 combinations are not permitted).

Port Cover

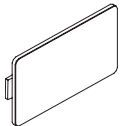

- Port covers must be used where no duplex or data faceplate is present.
- Fits into Power Rail port locations in place of duplex receptacles and data faceplates.
- Does not fit into port sizes of other product lines.

Cable Capacity

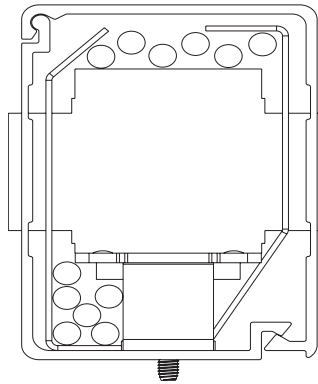

- The power rail housing allows continuous voice and data lines to run without interruption.
- Lay-in is provided for environments where systems furniture or cabling are subject to frequent change.
- Lower cavity allows 6 voice/data cables (1/4" dia).
- Upper cavity lay-in allows 6 voice/data cables (1/4" dia).

Power Rail Receptacle Locations

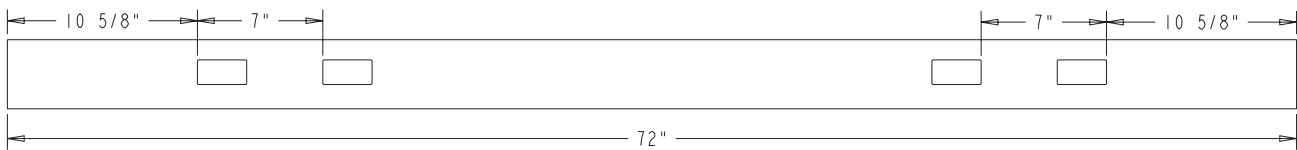
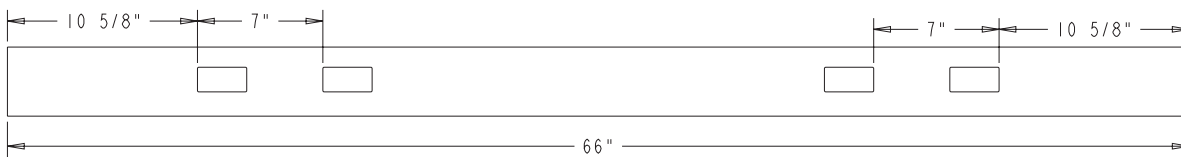
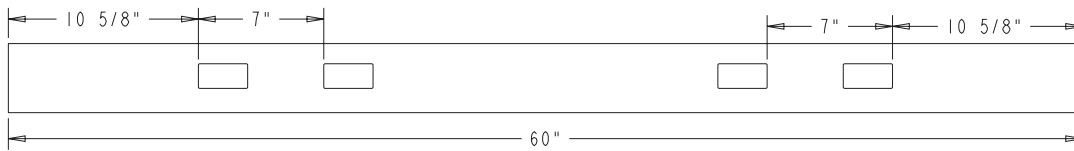
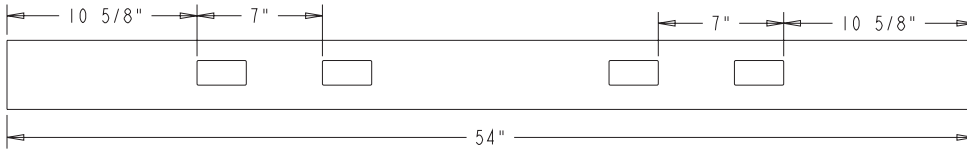
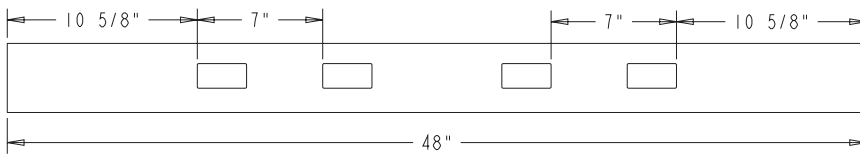

- For example, in a four-circuit system:
 - Circuit 1 — calculators, fans, etc.
 - Circuit 2 — task lights (could be wired to wall switch)
 - Circuit 3 — CRT or flat screen monitors
 - Circuit 4 — CPUs
- Use circuit 4 for power-sensitive electronic equipment.

Placement of pedestals and lateral files may render some duplex locations inaccessible. Pedestal placement may also affect compatibility with pull-up receptacles.

Height Adjustable Table Tie-In Brackets (Gallery Panels)

- Improves panel rigidity. Does not function as a panel stability solution.
- AGBKT to be specified for connection to a T leg HAT
- AGBKC to be specified for connection to a C leg HAT
- Reusable mounting template is required and must be ordered separately (AGBKTMP).
- Brackets telescope to account for 24" and 30" worksurface depths and screen attachments.
- A6 C legs with a 30"D worksurface and a screen must be specified with T leg brackets
- NOT compatible with Altitude MAX bases
- Height adjustable table brackets must be installed to both sides of the panel to substitute for a return panel in a dual-sided panel bench application. When a single bracket is connected to a wing panel as shown in the 4-pack image, the HAT bracket can substitute for a return panel.
- Freestanding panel can be connected to height adjustable table if it is supported by HAT brackets on both sides of the table and panel spine.

SINGLE BRACKET

Gallery Panel Application:

Max Height (with Glass): 65"H

Max Width: 75"W; No top size restrictions

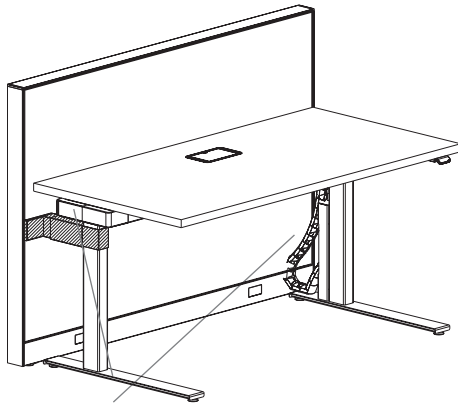
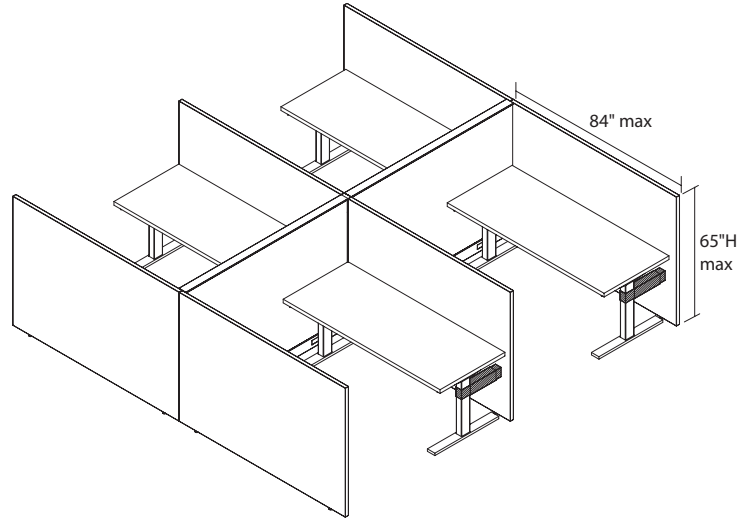

Note: Wire chain cannot be installed on the same leg as a HAT tie-in bracket.

DUAL SIDED PANEL BENCH

Gallery Panel Application:

Max Height (with Glass): 65"H

Bracket Needed: Single Panel (75" max) with Brackets on each leg (placed at the same height)

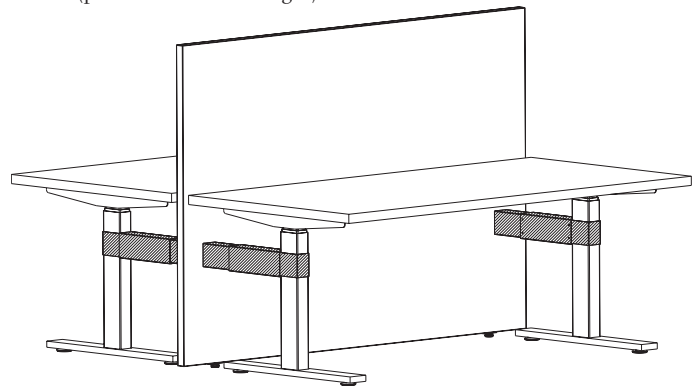

Freestanding Gallery Panel Application

Height Adjustable Table Tie-In Brackets (Optimize, Stride, and Terrace)

- Improves panel rigidity.
- ABKTL to be specified for connection to a LH T-leg HAT
- ABKTR to be specified for connection to a RH T-leg HAT
- ABKCL to be specified for connection to a LH C-leg HAT
- ABKCR to be specified for connection to a RH C-leg HAT
- Brackets mount into slotted standard.
- Brackets telescope to account for 24" and 30" worksurface depths and screen attachments.
- A6 C legs with a 30"D worksurface and a screen must be specified with T leg brackets
- NOT compatible with Altitude MAX bases
- Height adjustable table brackets must be installed to both sides of the panel to substitute for a return panel in a dual-sided panel bench application. When a single bracket is connected to a wing panel as shown in the 4-pack image, the HAT bracket can substitute for a return panel.
- Freestanding panel can be connected to height adjustable table if it is supported by HAT brackets on both sides of the table and panel spine for A8, A3, and A6.
- Dual sided A5 tables cannot support a freestanding panel. (A5 was discontinued on 12/31/2020)

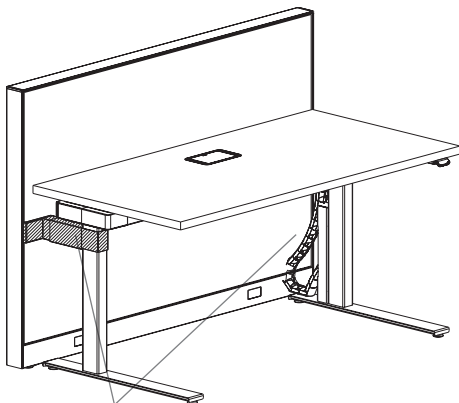

Note: Wire chain cannot be installed on the same leg as a HAT tie-in bracket.

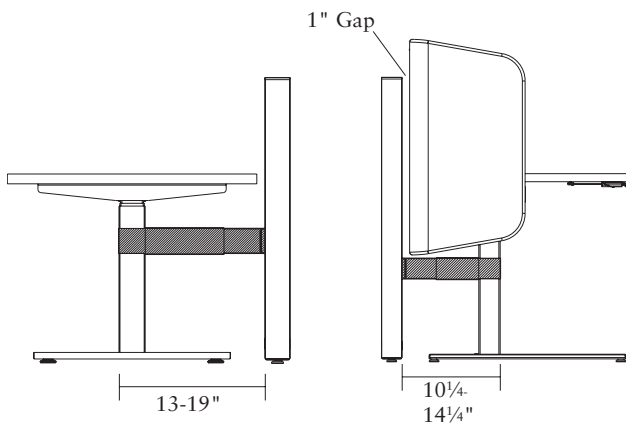

SINGLE BRACKET

Systems Application (not compatible with Concensys):

Max Height (with Glass): 65" H

Max Width: 96" W; Note: tops greater than 72" W will not align.

Overheads cannot be used without return panel

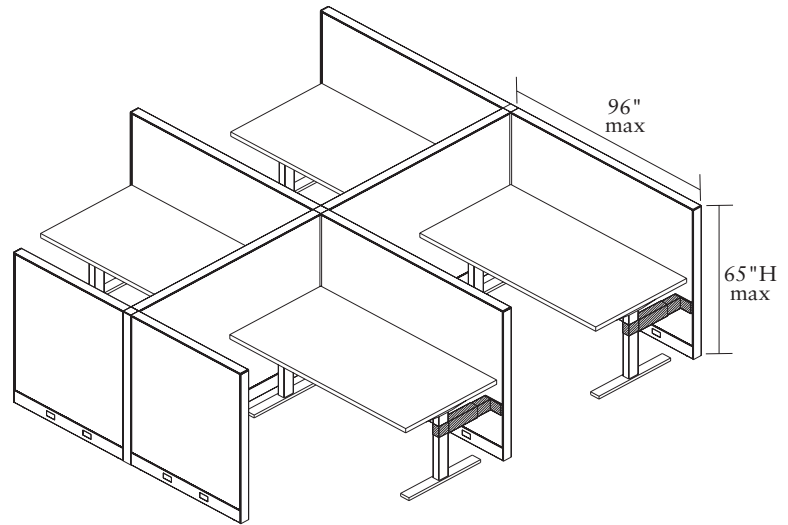

DUAL SIDED PANEL BENCH

Systems Application (not compatible with Concensys):

Max Height (with Glass): 65" H

Bracket Needed: Every 96" on both sides (placed at the same height).

Note: tops greater than 72" W will not align.

Overheads cannot be used without return panel

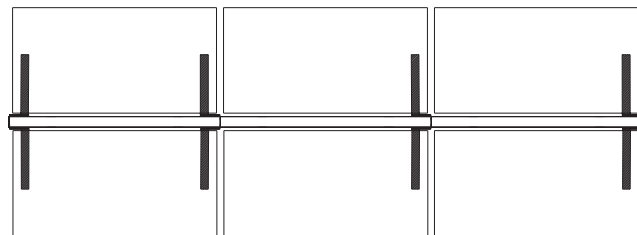
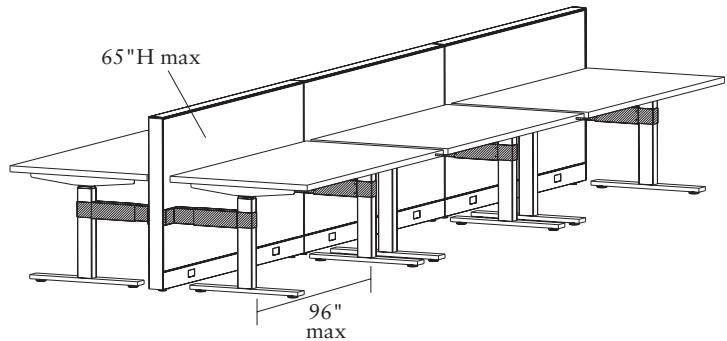

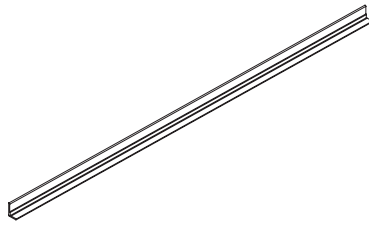

Rail Accessories

Side View



Top View

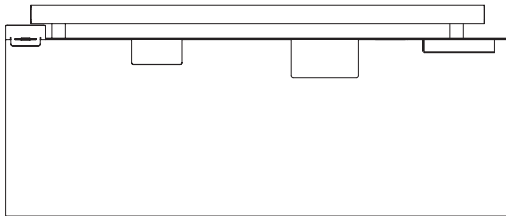

Phone/
Tablet
Stand

Pencil
Holder

Rail
Mounted
Shelf

Vertical
Paper Tray

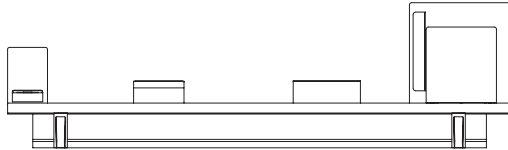

Front View

Worksurface Mounted Rail (page 377)

- Aluminum extrusion designed to mount to flat edge worksurfaces. Comes with rail and hardware for mounting.
- Mounted rail extends $\frac{3}{4}$ " on underside of worksurface which may interfere with the mounting of storage and screens.
- Widths available for Altitude tables 12" through 66" in 6" increments. Can pass across seams of ganged worksurfaces in tethered applications.
- Passes behind worksurface bracket on tethered applications.
- For freestanding applications rail should be 6" shorter than worksurface (i.e. 54" rail for 60" worksurface).

Rail Mounted Accessories

Not recommended for use on panel systems with attached worksurfaces due to fit up issues created with worksurface and panel. Adding accessory rail shifts worksurface $\frac{3}{8}$ " away from panel along that edge. Forcing worksurface into place crushes fabric tile and with tiles of other material (steel, marker board, etc) is likely to scratch, dent, or otherwise damage tile during installation.

U9TM Phone/Tablet Stand (page 377)

- $6\frac{1}{2}$ "H x $4\frac{3}{4}$ "W and angles back $1\frac{1}{4}$ ".
- Has a $\frac{1}{4}$ " x 1" slot in bottom flange to allow for routing cables. Requires $1\frac{1}{4}$ " space behind worksurface edge in order to be used.



U9TP Pencil Holder (page 377)

- $2\frac{3}{8}$ "H x 6"W x 3"D.
- Holds approximately twenty #2 pencils.



U9TS Rail Mounted Shelf (page 377)

- 8"W x $4\frac{1}{2}$ "D and sits $2\frac{3}{8}$ " higher than top of worksurface.
- Holds up to 8 pounds.

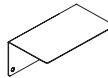

U9TF Vertical Paper Tray (page 377)

- Sits 12"H x $1\frac{1}{2}$ "W x 12"D from back of worksurface.
- Folder front stands 9" high from worksurface top, $1\frac{1}{4}$ " space holds about 280 sheets of copy paper.

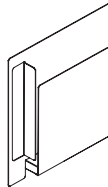

U9WTC Cord Organizer (page 377)

- Can attach to both bottom of worksurface or slides into rail.
- 4"W x $\frac{7}{8}$ "D, made from sheet metal.
- Top sits flush with worksurface if mounted to worksurface.
- 4 cable cut outs: 2 - .250" diameter and 2 - 0.147" diameter; .250" diameter cut outs are centered between the .147" diameter cut outs.



Universal Hook (page 377)

- Mounts to underside of worksurface and provides storage for bags, coats and purses. Can be used as a horizontal wire manager.



For specification information see pages 337-338.

GSA SIN 33721

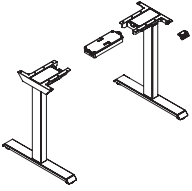
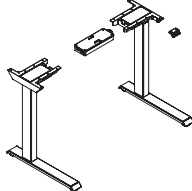
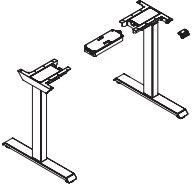
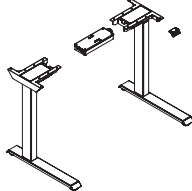
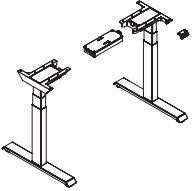
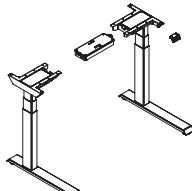
Description	Model	List Price		
		P1	P2	P3
2-Stage				
 2 Stage, 2 Leg Rectangle T Foot	A6REC2S2LTF	\$ 2151	\$ 2324	\$ 2582
*Bases purchased in April 2021 or later accommodate 24"D-30"D Rectangular Worksurfaces 24"W-72"W, bases purchased prior to this date accommodate 24"D-30"D Rectangular Worksurfaces 48"W-72"W				
 2 Stage, 2 Leg Rectangle C Foot	A6REC2S2LCF	\$ 2151	\$ 2324	\$ 2892
*Bases purchased in April 2021 or later accommodate 24"D-30"D Rectangular Worksurfaces 24"W-72"W, bases purchased prior to this date accommodate 24"D-30"D Rectangular Worksurfaces 48"W-72"W				
3-Stage				
 A6 3 Stage, 2 Leg Rectangle T Foot	A6REC3S2LTF	\$ 2413	\$ 2607	\$ 2897
*Bases purchased in April 2021 or later accommodate 24"D-30"D Rectangular Worksurfaces 24"W-72"W, bases purchased prior to this date accommodate 24"D-30"D Rectangular Worksurfaces 48"W-72"W				
 A6 3 Stage, 2 Leg Rectangle C Foot	A6REC3S2LCF	\$ 2413	\$ 2607	\$ 2897
*Bases purchased in April 2021 or later accommodate 24"D-30"D Rectangular Worksurfaces 24"W-72"W, bases purchased prior to this date accommodate 24"D-30"D Rectangular Worksurfaces 48"W-72"W				
 A6 Max 3 Stage, 2 Leg T Foot	A6MREC3S2LTF	\$ 3349	\$ 3617	\$ 4020
*Bases purchased in April 2021 or later accommodate 24"D-30"D Rectangular Worksurfaces 24"W-96"W, bases purchased prior to this date accommodate 24"D-30"D Rectangular Worksurfaces 48"W-96"W				
*350 LB Max Lift Capacity				
 A6 Max 3 Stage, 2 Leg C Foot	A6MREC3S2LCF	\$ 3349	\$ 3617	\$ 4020
*Bases purchased in April 2021 or later accommodate 24"D-30"D Rectangular Worksurfaces 24"W-96"W, bases purchased prior to this date accommodate 24"D-30"D Rectangular Worksurfaces 48"W-96"W				
*350 LB Max Lift Capacity				

ALTITUDE

<p>How to specify — Select the Model Number from above.</p>	<p>1st Option: Select the Base Paint Color (if applicable):</p> <p>P1 P2 P3</p> <p>See page 334 for paint finishes.</p>	<p>2nd Option: Select Feet Options (if applicable):</p> <p>X Standard Glides S Slide Glides (\$153 extra)</p>	<p>3rd Option: Select the Keypad (if applicable):</p> <p>UD Basic Up/Down MEM Memory Preset PDL Paddle</p>
<p>_____ .</p>	<p>_____ .</p>	<p>_____ .</p>	<p>_____ .</p>

Example: A6RND3S2LCF.P8L.X.PDL

For specification information see pages 337-338.

GSA SIN 33721

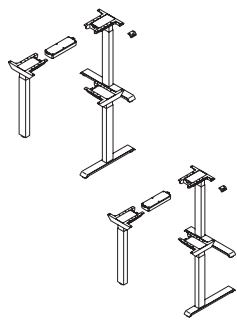

Description	Model	List Price		
		P1	P2	P3
2-Stage				
A6 2 Stage, 3 Leg Rectangle T Foot	A6REC2S3LTF	\$ 3480	\$ 3829	\$ 4351
A6 2 Stage, 3 Leg Rectangle C Foot	A6REC2S3LCF	\$ 3480	\$ 3829	\$ 4351

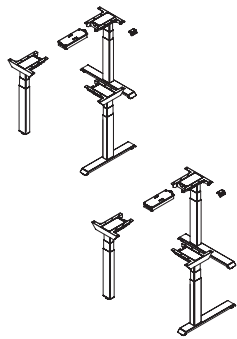

3-Stage				
A6 3 Stage, 3 Leg Rectangle T Foot	A6REC3S3LTF	\$ 3792	\$ 4096	\$ 4552
*3-leg standard bases can accommodate worksurface configurations from 24"D x 48"W x 36"W to 30"D x 72"W x 48"W.				
A6 3 Stage, 3 Leg Rectangle C Foot	A6REC3S3LCF	\$ 3792	\$ 4096	\$ 4552
*3-leg standard bases can accommodate worksurface configurations from 24"D x 48"W x 36"W to 30"D x 72"W x 48"W.				

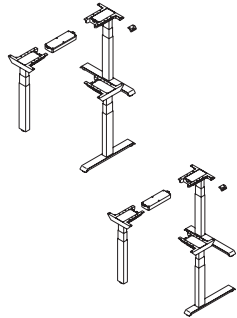

A6 Max 3 Stage, 3 Leg Rectangle T Foot	A6MREC3S3LTF	\$ 4378	\$ 4817	\$ 5473
*3-Leg Max bases can accommodate worksurface configurations from 24"D x 48"W x 36"W to 30"D x 72"W x 72"W. *500 lb Max Lift Capacity				
A6 Max 3 Stage, 3 Leg Rectangle C Foot	A6MREC3S3LCF	\$ 4378	\$ 4817	\$ 5473
*3-Leg Max bases can accommodate worksurface configurations from 24"D x 48"W x 36"W to 30"D x 72"W x 72"W. *500 lb Max Lift Capacity				

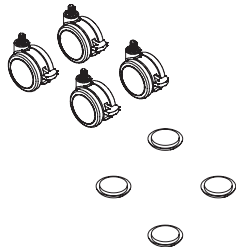

Foot Retrofit Options				
Casters (Use on 2-leg bases ONLY)	A6CASTER*	\$ 277	N/A	N/A
* A6 casters are intended for use with Allsteel A6 height-adjustable tables. When purchased separately and used without Allsteel furniture, the A6 casters marked by (*) are considered Open Market.				
Slide Glides (Use on 2-leg bases ONLY)	A6SLDGLIDE	\$ 201	N/A	N/A
G1 Glide (4-Pack)	A6G1GLIDE	\$ 217	N/A	N/A
*Glide enables 3-stage base to reach G1 requirement heights.				

Bluetooth Control				
A6 Bluetooth Accessory	A6BLUETOOTH	\$ 142	N/A	N/A
* Bluetooth control will only work with 2-leg A6 tables. Bluetooth control will not work with 3-leg A6 tables.				

<p>How to specify — Select the Model Number from above.</p>	<p>1st Option: Select the Base Paint Color (if applicable): P1 P2 P3 See page 334 for paint finishes.</p>	<p>2nd Option: Select Feet Options (if applicable): X Standard Glides</p>	<p>3rd Option: Select the Keypad (if applicable): UD Basic Up/Down MEM Memory Preset PDL Paddle</p>
<p>Example: A6RND3S3LCF.P8L.X.PDL</p>			

For specification information see page 338.

GSA SIN PENDING

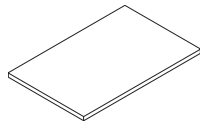

Description	Laminate w/Flat Edge Model	Ship Weight	List Price		
			L1	L2	L3
Undersized Rectangular Worksurface - 24"D (60" to 96" ships with stiffener)					
78"W - 96"W Tops can ONLY be used with Altitude MAX base.					
36"W	AF5RS3624U	23	\$ 511	\$ 536	\$ 560
42"W	AF5RS4224U	27	\$ 558	\$ 586	\$ 612
48"W	AF5RS4824U	31	\$ 626	\$ 657	\$ 686
54"W	AF5RS5424U	35	\$ 679	\$ 712	\$ 744
60"W	AF5RS6024UD	49	\$ 896	\$ 938	\$ 977
66"W	AF5RS6624UD	53	\$ 936	\$ 979	\$ 1020
72"W	AF5RS7224UD	57	\$ 966	\$ 1010	\$ 1052
78"W	AF5RS7824UD	62	\$ 1009	\$ 1054	\$ 1098
84"W	AF5RS8424UD	66	\$ 918	\$ 959	\$ 998
90"W	AF5RS9024UD	70	\$ 1066	\$ 1113	\$ 1159
96"W	AF5RS9624UD	74	\$ 1099	\$ 1147	\$ 1194

Undersized Rectangular Worksurface - 30"D (60" to 96" ships with stiffener)

78"W - 96"W Tops can ONLY be used with Altitude MAX base.

36"W	AF5RS3630U	29	\$ 568	\$ 596	\$ 623
42"W	AF5RS4230U	35	\$ 604	\$ 634	\$ 662
48"W	AF5RS4830U	40	\$ 704	\$ 738	\$ 771
54"W	AF5RS5430U	45	\$ 798	\$ 838	\$ 875
60"W	AF5RS6030UD	60	\$ 997	\$ 1043	\$ 1087
66"W	AF5RS6630UD	65	\$ 1062	\$ 1110	\$ 1157
72"W	AF5RS7230UD	70	\$ 1094	\$ 1143	\$ 1191
78"W	AF5RS7830UD	76	\$ 1137	\$ 1189	\$ 1238
84"W	AF5RS8430UD	81	\$ 1052	\$ 1099	\$ 1145
90"W	AF5RS9030UD	86	\$ 1205	\$ 1259	\$ 1312
96"W	AF5RS9630UD	91	\$ 1241	\$ 1296	\$ 1350

120 Degree Corner Worksurface - 24"D

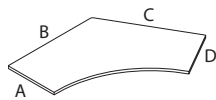

24" A x 42" B x 42" C x 24" D	AF5120S4224D	59	\$ 1073	\$ 1122	\$ 1170
24" A x 48" B x 48" C x 24" D	AF5120S4824D	69	\$ 1185	\$ 1239	\$ 1292
24" A x 54" B x 54" C x 24" D	AF5120S5424D	79	\$ 1400	\$ 1464	\$ 1525

120 Degree Corner Worksurface - 30"D

30" A x 42" B x 42" C x 30" D	AF5120S4230D	68	\$ 1073	\$ 1122	\$ 1170
30" A x 48" B x 48" C x 30" D	AF5120S4830D	79	\$ 1508	\$ 1578	\$ 1644
30" A x 54" B x 54" C x 30" D	AF5120S5430D	92	\$ 1723	\$ 1802	\$ 1879

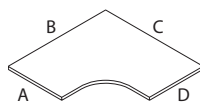

Symmetrical Corner Cove Worksurface — 24"D

24" A x 54" B x 54" C x 24" D	AF5CCS5424	56	\$ 1190	\$ 1247	\$ 1303
-------------------------------	------------	----	---------	---------	---------

Symmetrical Corner Cove Worksurface — 30"D

30" A x 54" B x 54" C x 30" D	AF5CCS5430	66	\$ 1300	\$ 1362	\$ 1423
-------------------------------	------------	----	---------	---------	---------

How to specify — Select the Model Number from above.	1st Option: FSC Certified Wood:	2nd Option: Laminate:	3rd Option: Laminate Edge Color:	4th Option: Grommet Location (if applicable):	5th Option: Grommet Type (if applicable):	6th Option: Grommet Color (Metal only):
FSC FSC Mixed Credit X Standard Wood	See page 334 for finishes.	See page 334 for finishes.	GC Grommet Center GO No Grommet	P Oval Plastic M Oval Metal S Square Metal (Add \$13 per grommet for metal.)	EL Matte Silver Plastic grommet color determined by worksurface finish.	
_____ _____	_____ _____	_____ _____	_____ _____	_____ _____	_____ _____	

Example:

For specification information see page 338.

GSA SIN 33721

Description	Laminate w/Flat Edge Model	Ship Weight	List Price		
			L1	L2	L3
Corner Cove Laminate Tops — 24"D Extended Left					
24" A x 60" B x 36" C x 24" D	A5822ELS	54	\$ 1048	\$ 1084	\$ 1118
24" A x 60" B x 48" C x 24" D	A5622ELS	75	\$ 1148	\$ 1188	\$ 1225
24" A x 72" B x 36" C x 24" D	A5922ELS	63	\$ 1169	\$ 1209	\$ 1246
24" A x 72" B x 48" C x 24" D	A5722ELS	86	\$ 1462	\$ 1511	\$ 1557
Corner Cove Laminate Tops — 24"D Extended Right					
24" A x 60" B x 36" C x 24" D	A5822ERS	54	\$ 1048	\$ 1084	\$ 1118
24" A x 60" B x 48" C x 24" D	A5622ERS	75	\$ 1148	\$ 1188	\$ 1225
24" A x 72" B x 36" C x 24" D	A5922ERS	63	\$ 1169	\$ 1209	\$ 1246
24" A x 72" B x 48" C x 24" D	A5722ERS	86	\$ 1462	\$ 1511	\$ 1557
Note: Height-adjustable worksurface dimensions are nominal. Actual widths are reduced by 2" (1" on each side" and worksurface depths are reduced by 3/4". Corner cove depth is nominal, actual is 1" less. This is to allow for pinch-points and unobstructed table movement.					
Undersized Corner Cove Worksurface, Left Hand — 24"D					
24" A x 60" B x 36" C x 24" D	AF5CCS603624LD	58	\$ 1098	\$ 1148	\$ 1197
24" A x 60" B x 48" C x 24" D	AF5CCS604824LD	67	\$ 1199	\$ 1254	\$ 1308
24" A x 72" B x 36" C x 24" D	AF5CCS723624LD	66	\$ 1236	\$ 1292	\$ 1347
24" A x 72" B x 48" C x 24" D	AF5CCS724824LD	75	\$ 1527	\$ 1597	\$ 1664
Undersized Corner Cove Worksurface, Right Hand — 24"D					
24" A x 60" B x 36" C x 24" D	AF5CCS603624RD	58	\$ 1098	\$ 1148	\$ 1197
24" A x 60" B x 48" C x 24" D	AF5CCS604824RD	67	\$ 1199	\$ 1254	\$ 1308
24" A x 72" B x 36" C x 24" D	AF5CCS723624RD	66	\$ 1236	\$ 1292	\$ 1347
24" A x 72" B x 48" C x 24" D	AF5CCS724824RD	75	\$ 1527	\$ 1597	\$ 1664
Undersized Corner Cove Worksurface, Left Hand — 30"D					
30" A x 60" B x 48" C x 30" D	AF5CCS604830LD	77	\$ 1282	\$ 1341	\$ 1399
30" A x 72" B x 48" C x 30" D	AF5CCS724830LD	88	\$ 1617	\$ 1691	\$ 1764
Undersized Corner Cove Worksurface, Right Hand — 30"D					
30" A x 60" B x 48" C x 30" D	AF5CCS604830RD	77	\$ 1282	\$ 1341	\$ 1399
30" A x 72" B x 48" C x 30" D	AF5CCS724830RD	88	\$ 1617	\$ 1691	\$ 1764

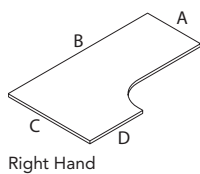
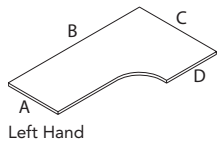
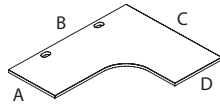
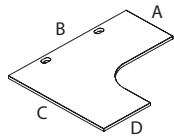

<p>How to specify — Select the Model Number from above.</p>	<p>1st Option: Laminate or Veneer Type and Finish (if applicable): See page 334 for finishes.</p>	<p>2nd Option: Paint (if applicable): See page 334 for finishes.</p>	<p>3rd Option: Laminate Edge Color (if applicable): See page 334 for finishes.</p>	<p>4th Option: Grommet Location and Type: GC Center P Oval Plastic M Oval Metal GB Grommet LH/RH P Oval Plastic M Oval Metal S Square Metal GO No Grommet</p>
<p>Examples:</p>				

For specification information see page 341.

GSA SIN 33721

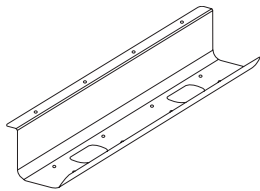

AJTRGH24

Description	Model	List Price		
		P1	P2	P3
Cable Management Trays				
24"W	AJTRGH24 <input type="checkbox"/>	\$ 123	N/A	N/A
36"W	AJTRGH36 <input type="checkbox"/>	\$ 147	N/A	N/A

- Available in 24" or 36" widths.
- Metal Cable Management Trays available in Black only, specify "P" for finish.
- Example: AJTRGH24.P

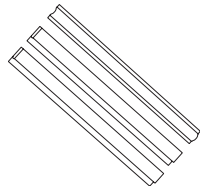

AWRSTRIP

Wire Management Strips/Channels				
	AWRSTRIP <input type="checkbox"/>	\$ 270	N/A	N/A

- Four wire management strips/channels in black only, no specification needed.
- Example: AWRSTRIP

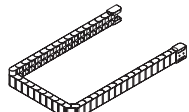

WKSWMC

Wire Management Chains				
36"	A9CLWMC <input type="checkbox"/>	\$ 357	N/A	N/A
58"	WKSWMC <input type="checkbox"/>	\$ 428	N/A	N/A

- Specify model A9CLWMC for 36" chain, specify model WKSWMC for 58" chain.
- A9CLWMC available in Black (E4), White (DW), or Silver (TI).
- WKSWMC available in Black only, no specification needed.
- Example: A9CLWMC.DW or WKSWMC

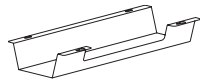

APWRTRGH17

Under Worksurface Troughs				
17"W	APWRTRGH17 <input type="checkbox"/>	\$ 108	N/A	N/A
36"W	APWRTRGH36 <input type="checkbox"/>	\$ 189	N/A	N/A

- Available in 17" or 36" widths.
- Under Worksurface Troughs available in Black only, no specification needed.
- Example: APWRTRGH17

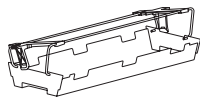

AFDTRGH20

Flip-Down Wire Management Trough				
20"W	AFDTRGH20 <input type="checkbox"/>	\$ 378	N/A	N/A
32"W	AFDTRGH32 <input type="checkbox"/>	\$ 429	N/A	N/A

- Available in 20" or 32" widths.
- Flip-Down Troughs available in Black only, specify "P" for Black.
- Example: AFTRGH20.P



AWIRECLT

Metal Wire Cleat				
	AWIRECLT <input type="checkbox"/>	\$ 129	\$ 142	\$ 148

- Available in standard metal paint finishes, see page 334 for options and specify desired finish.
- Example: AWIRECLT.PJW

<p>How to specify — Select the Model Number from above.</p>	<p>1st Option: Paint (if applicable): See page 334 for finishes.</p> <p>Plastics (if applicable): DW White TI Silver E4 Black</p>
--	---

Examples: AJTRGH24.P A9CLWMC.DW AWIRECLT.PR6

Shippable by small-package carrier.

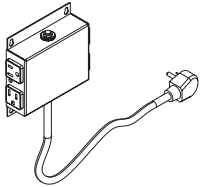

APWR4TAP

Description	Model	List Price
Power Module — Under Worksurface, Quad Tap		
7"W x 12"D x 3"H	APWR4TAP S	\$ 456

- 4 receptacles.
- 10' Straight cord only, no specification needed.
- Available in Black only, no specification needed.
- *Example: APWR4TAP*

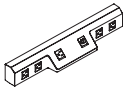

FDPWRC

Concealed Power Module		
Corded, 1 USB-A, 1 USB-C	FDPWRC S	\$ 766
Corded Chicago Code, 1 USB-A, 1 USB-C	CFDPWRC S	\$ 1306
Spiral Cord, 1 USB-A, 1 USB-C	FDPWRSC S	\$ 806
Spiral Cord Chicago Code, 1 USB-A, 1 USB-C	CFDPWRSC S	\$ 1338

- FDPWRC is plastic, straight cord unit with 4 receptacles, 1 USB-A and 1 USB-C port.
- CFDPWRC is metal, straight cord Chicago Code unit with 4 receptacles, 1 USB-A and 1 USB-C port.
- FDPWRSC is plastic, coiled cord unit with 4 receptacles, 1 USB-A and 1-USB-C port.
- CFDPWRSC is metal, coiled cord unit with 4 receptacles, 1 USB-A and 1 USB-C port.
- Available in Storm (STRM) only, specify Storm.
- *Example: FDPWRC.STRM*

ALTITUDE

<p>How to specify — Select the Model Number from above.</p>	<p><i>1st Option:</i> Paint (if applicable): STRM Storm</p>
<div style="display: flex; justify-content: space-between; width: 100%;"> <div style="display: flex; gap: 5px;"> <div style="width: 20px; height: 20px; border: 1px solid black;"></div> <div style="width: 20px; height: 20px; border: 1px solid black;"></div> <div style="width: 20px; height: 20px; border: 1px solid black;"></div> <div style="width: 20px; height: 20px; border: 1px solid black;"></div> <div style="width: 20px; height: 20px; border: 1px solid black;"></div> <div style="width: 20px; height: 20px; border: 1px solid black;"></div> <div style="width: 20px; height: 20px; border: 1px solid black;"></div> <div style="width: 20px; height: 20px; border: 1px solid black;"></div> <div style="width: 20px; height: 20px; border: 1px solid black;"></div> <div style="width: 20px; height: 20px; border: 1px solid black;"></div> <div style="width: 20px; height: 20px; border: 1px solid black;"></div> <div style="width: 20px; height: 20px; border: 1px solid black;"></div> <div style="width: 20px; height: 20px; border: 1px solid black;"></div> <div style="width: 20px; height: 20px; border: 1px solid black;"></div> <div style="width: 20px; height: 20px; border: 1px solid black;"></div> <div style="width: 20px; height: 20px; border: 1px solid black;"></div> <div style="width: 20px; height: 20px; border: 1px solid black;"></div> <div style="width: 20px; height: 20px; border: 1px solid black;"></div> <div style="width: 20px; height: 20px; border: 1px solid black;"></div> <div style="width: 20px; height: 20px; border: 1px solid black;"></div> <div style="width: 20px; height: 20px; border: 1px solid black;"></div> </div> </div>	<div style="display: flex; justify-content: space-between; width: 100%;"> <div style="width: 20px; height: 20px; border: 1px solid black;"></div> <div style="width: 20px; height: 20px; border: 1px solid black;"></div> <div style="width: 20px; height: 20px; border: 1px solid black;"></div> <div style="width: 20px; height: 20px; border: 1px solid black;"></div> </div>

Examples: APWR4TAP FDPWRC.STRM

S *Shippable by small-package carrier.*

For specification information see page 341.1.

GSA SIN 33721

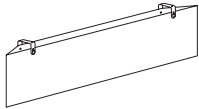

APWRMODEST36

Description	Model	List Price	
		A	B
Fabric Power Modesty			
	APWRMODEST36 S	\$ 1162	\$ 1196
	APWRMODEST48 S	\$ 1258	\$ 1297

- Available in Appoint, Binary, Centurion, Noble, Reflections, Disperse, and Spin panel fabric series.
- Specify desired fabric.
- Example: APWRMODEST36.NBLE16

<p>How to specify — Select the Model Number from above.</p> <p>_____ .</p>	<p><i>1st Option:</i> Fabric (if applicable): See page 14 for fabrics.</p> <p>_____</p>
---	--

Example: APWRMODEST36.NBLE16

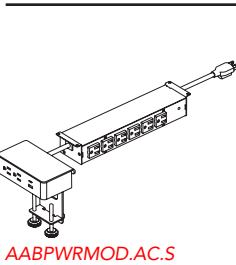

AABPWRMOD.AC.S

Description	Model	List Price
Power Module — Above/Below Worksurface 8¼"W x 16"D x 4½"H	AABPWRMOD S	\$ 1234

- Desktop unit includes 2 receptacles, 1 USB-A, & 1 USB-C (AC).
- Under worksurface unit include 6 receptacles.
- Power cord choices include a 6' Straight cord (S) or Coiled cord (Q).
- Desktop unit available in White (DWT) or Gray (DGY).
- Example: AABPWRMOD.AC.S.DWT

<p>How to specify — Select the Model Number from above.</p> <p>A A B P W R M O D .</p>	<p><i>1st Option:</i> Ports (Final port option if applicable): AC USB-A+C</p> <p>A C .</p>	<p><i>2nd Option:</i> Cord Type (Power Module cord type if applicable): S Straight Cord Q Coiled Cord</p> <p>_____ .</p>	<p><i>3rd Option:</i> Color Option (if applicable): DWT White DGY Gray</p> <p>_____</p>
---	---	---	--

Example: AABPWRMOD.AC.Q.DWT

S Shippable by small-package carrier.

ALTITUDE

For specification information see page 341.2.

GSA SIN 33721

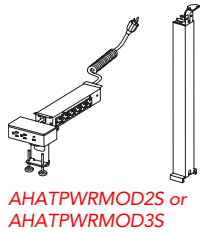

Description	Model	List Price		
		P1	P2	P3
Metal Telescoping HAT Wire Management				
	AHATPWRMOD2S	\$ 1614	\$ 1654	\$ 1675
	AHATPWRMOD3S	\$ 1646	\$ 1690	\$ 1711

- AHATPWRMOD2S pairs with 2-stage HAT bases.
- AHATPWRMOD3S pairs with 3-stage HAT bases.
- Desktop power module comes with 2 receptacles, 1 USB-A, and 1 USB-C port only, specify “AC” for this power configuration.
- Desktop power module available in White (DWT) or Gray (DGY) finishes, specify desired finish.
- Under worksurface power strip comes with 6 receptacles and is available in Black only, no specification needed.
- Metal Telescoping Chase available in the same paint finishes as Altitude HAT bases, specify desired paint finish.
- *Example: AHATPWRMOD2S.AC.DWT.PJW*

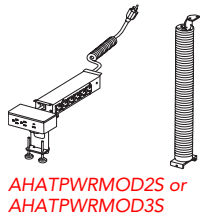

Description	Model	List Price		
		P1	P2	P3
Fabric HAT Wire Management				
	AHATPWRMODF	\$ 1476	\$ 1503	\$ 1516

- AHATPWRMODF pairs with 2-stage and 3-stage HAT bases.
- Desktop power module comes with 2 receptacles, 1 USB-A, and 1 USB-C port only, specify “AC” for this power configuration.
- Desktop power module available in White (DWT) or Gray (DGY) finishes, specify desired finish.
- Under worksurface power strip comes with 6 receptacles and is available in Black only, no specification needed.
- Fabric HAT Chase available in three fabric finishes of Light (LGT), Medium (MDD), and Dark (DRK), specify desired fabric finish.
- Fabric HAT mounting brackets available in the same paint finishes as Altitude HAT bases, specify desired paint finish.
- *Example: AHATPWRMODF.AC.DGY.LGT.PR5*

ALTITUDE

<p>How to specify — Select the Model Number from above.</p> <p>AHATPWRMOD . AC . D . . .</p>	<p><i>1st Option:</i> Ports (Final port option if applicable): AC USB-A+C</p>	<p><i>2nd Option:</i> Power Module Color Option (if applicable): DWT White DGY Gray</p>	<p><i>3rd Option:</i> Fabric Chase Finish (if applicable): LGT Light MDD Medium DRK Dark</p>	<p><i>4th Option:</i> Metal Paint Option (if applicable): See page 334 for finishes.</p>
---	--	--	---	---

Example: AHATPWRMOD3S.AC.DWT.P8C AHATPWRMODF.AC.DGY.LGT.PR5

S Shippable by small-package carrier.

For specification information see page 354.

GSA SIN 33721

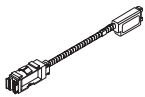
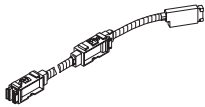

Description	Max. Recept. Cap. per Panel Side	Four-circuit 3 + 1 2 + 2	Three-circuit Separate Neutrals		List Price
Electrical Power Harnesses					
For 48" W Frames	2	A871248*	A871248A	<input type="checkbox"/>	\$ 416
For 54" W Frames	2	A871254*	A871254A	<input type="checkbox"/>	\$ 414
For 60" W Frames	2	A871260*	A871260A	<input type="checkbox"/>	\$ 416
For 66" W Frames	2	A871266*	A871266A	<input type="checkbox"/>	\$ 414
For 72" W Frames	2	A871272*	A871272A	<input type="checkbox"/>	\$ 417

Note: Four-circuit components and Three-circuit components (with an "A" suffix) cannot be connected together.

Electrical Pass-Thru Harnesses with Power Block

For 24" W Frames**	1	A871124	A871124A	<input type="checkbox"/>	\$ 239
For 48" W Frames†	1	A871148*	A871148A	<input type="checkbox"/>	\$ 255
For 60" W Frames†	1	A871160*	A871160A	<input type="checkbox"/>	\$ 255
For 72" W Frames†	1	A871172	A871172A	<input type="checkbox"/>	\$ 341

Electrical harnesses are intended for use with Allsteel systems furniture and are approved under GSA SIN 33721. When purchased separately and used without Allsteel systems furniture, those electrical harnesses marked by () are considered Open Market.

**Only used with NY Infeed through End Cap.

†48"-72" are only used with NY infeed through power rail cut-out.

<p>How to specify — Select the Model Number from above.</p> <p>_____ .</p>	<p><i>1st Option:</i> Color: P Black</p>
---	---

Examples: A871248.P A871224.P A871224A.P A871124.P
A8710144A.P A2-8CIR36.P

Shippable by small-package carrier.

For specification information see page 354.

GSA SIN 33721

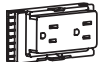

Duplex Receptacle

Description	Four-circuit 3 + 1 2 + 2	Three-circuit Separate Neutrals		List Price
Duplex Receptacles for Beltline or Base Pathway — Altitude (specify color)				
Circuit 1	A873501	A871501A	S	\$ 72
Circuit 2	A873502	A871502A	S	\$ 72
Circuit 3 (3+1)	A873503	A871503A	S	\$ 72
Circuit 3 (2+2)	A873506	N/A	S	\$ 72
Circuit 4 — iso/dedicated	A873504	N/A	S	\$ 72
Circuit 1, 20 AMP	A871601	A871601A	S	\$ 72

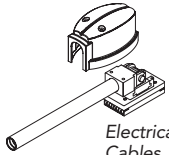

Electrical Infeed Cables

Electrical Infeed Cables				
6' Sealtight Cable for Terrace Receptacle	A876072	A8716072A	S	\$ 439
6' Flex Cable	A871972	A871972A	S	\$ 331

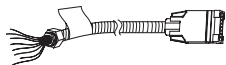

Ceiling Electrical Infeed

Ceiling Electrical Infeed Cables				
12' Flex Cable	A871912	A871912A	S	\$ 449
18' Flex Cable	A871918	A871918A	S	\$ 565

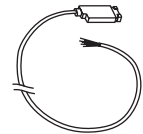

Electrical Infeed Cable

Electrical Infeed Cables (for use with footed panels)				
12' Sealtight Cable Power Infeed	A877012	N/A	S	\$ 547

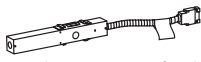

Hardwire Power Infeed

Hardwire Power Infeed (New York Code)				
For 48"-72" W rails	A871400	A871400A	S	\$ 431

Note: Four-circuit components and Three-circuit components (with an "A" suffix) cannot be connected together.

ALTITUDE

<p>How to specify — Select the Model Number from above.</p> <p>_____ .</p>	<p><i>1st Option:</i> Electrical Receptacle Color (if applicable): See page 334 for finishes.</p> <p>E S</p>
---	---

Example: A873501.E4

For specification information see page 354.

GSA SIN 33721



Description	Model	List Price
Hardwire (Chicago Code) (Black only)		
Altitude Base Pathway Junction Box (Pack of 6)	873600	\$ 1145

For specification information see page 355.

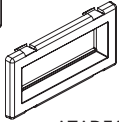
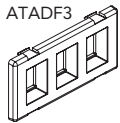

Description	Model	P1 Paint List Price
Data Faceplates		
Three-Port Flex-Mode Faceplate, Black (E4)	ATADF3	\$ 42
Four-Port Flex-Mode Faceplate, Black (E4)	ATADF4	\$ 42

Notes: ATADF3 can install up to 3 jacks (CAT 3, 5E, or 6). ATADF4 can install 4 jacks (CAT 3, 5E, or 6).

ATADF models are compatible with ports in Altitude tiles.

Allsteel's data faceplates are designed for use with the jacks listed below. We do not guarantee compatibility with other manufacturers' product. A faceplate adapter is available for use with alternatively sourced data jacks, see the Standard Specials catalog for details.

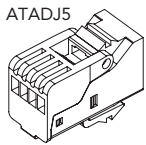

Jacks		
RJ45 CAT 5E Jack — Black only		
Toolless	ATADJ5	\$ 74
RJ45 CAT 6 Jack — Black only		
Requires Tool	ATADJ6	\$ 98

How to specify —

Select the Model Number from above.



Example: 873600

How to specify —

Select the Model Number from above.

1st Option:

Data Faceplate Color:

E4 Black



Example: ATADF4.E4

Shippable by small-package carrier.

For specification information see page 342.
 (See page 401 for COM pricing on fabric grades G-J.)

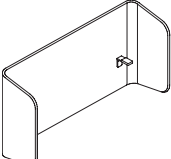

Description	Model	Ship Weight	Cubes	List Price	
				A	D
U Screen Kit					
48"	FDSC48U	30.0	16.6	\$ 2032	\$ 2157
54"	FDSC54U	31.0	18.6	\$ 2102	\$ 2232
60"	FDSC60U (shown)	32.0	20.6	\$ 2163	\$ 2297
66"	FDSC66U	33.0	22.6	\$ 2290	\$ 2434
72"	FDSC72U	34.0	24.6	\$ 2463	\$ 2618

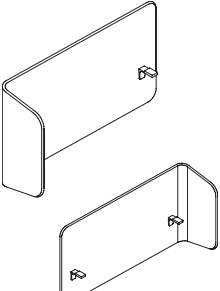

Description	Model	Ship Weight	Cubes	List Price	
				A	D
L Screen Kit					
Left Hand 48"	FDSC48LL	26.5	16.6	\$ 1322	\$ 1395
Right Hand 48"	FDSC48LR	26.5	16.6	\$ 1322	\$ 1395
Left Hand 54"	FDSC54LL	27.5	18.6	\$ 1549	\$ 1636
Right Hand 54"	FDSC54LR	27.5	18.6	\$ 1549	\$ 1636
Left Hand 60"	FDSC60LL (shown)	28.5	20.6	\$ 1619	\$ 1712
Right Hand 60"	FDSC60LR (shown)	28.5	20.6	\$ 1619	\$ 1712
Left Hand 66"	FDSC66LL	29.5	22.6	\$ 1928	\$ 2047
Right Hand 66"	FDSC66LR	29.5	22.6	\$ 1928	\$ 2047
Left Hand 72"	FDSC72LL	30.5	24.6	\$ 2030	\$ 2155
Right Hand 72"	FDSC72LR	30.5	24.6	\$ 2030	\$ 2155

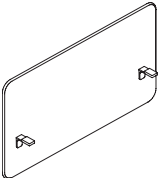

Description	Model	Ship Weight	Cubes	List Price	
				A	D
Rectangular Screen Kit					
48"	FDSC48R	23.0	3.7	\$ 1279	\$ 1350
54"	FDSC54R	24.0	4.1	\$ 1310	\$ 1383
60"	FDSC60R (shown)	25.0	4.6	\$ 1407	\$ 1486
66"	FDSC66R	26.0	5.0	\$ 1617	\$ 1714
72"	FDSC72R	27.0	5.6	\$ 1721	\$ 1826

Note: Installation brackets are now attached to the screen from the factory.

<p>How to specify — Select the Model Number from above.</p>	<p>1st Option: Select the Screen Fabric: See page 335 for selections and color codes.</p>	<p>2nd Option: Select the Screen Bracket Paint: P1 P2 See page 334 for selections and color codes.* P2 (\$16 extra)</p>
<p>_____ .</p>	<p>_____ .</p>	<p>_____</p>

Examples: FDSC48U.PCAMBLT40.P71 FDSC48LL.PCAMBLT70.P71 FDSC48R.PCAMBLT39.P71

For specification information see pages 343-344.

GSA SIN 33721

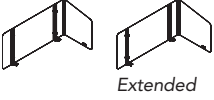
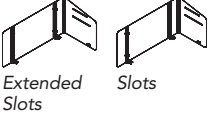
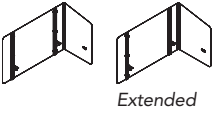
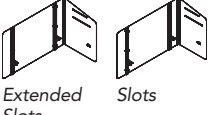
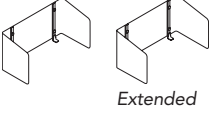
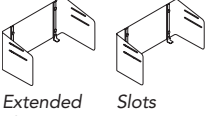
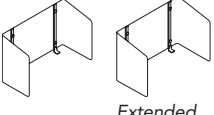
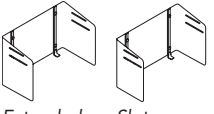
		Description	Model	P1 Paint List Price	P2 Paint Upcharge	P3 Paint Upcharge
20"H Metal L-Screen						
 <p>Extended</p>	48"W		AMS2048LH	\$ 833	\$ 866	\$ 899
	54"W		AMS2054LH	\$ 906	\$ 942	\$ 978
	60"W		AMS2060LH	\$ 1014	\$ 1055	\$ 1094
	66"W		AMS2066LH	\$ 1109	\$ 1153	\$ 1196
	72"W		AMS2072LH	\$ 1160	\$ 1206	\$ 1251
 <p>Extended Slots</p>	48"W		AMS2048RH (shown)	\$ 833	\$ 866	\$ 899
	54"W		AMS2054RH	\$ 906	\$ 942	\$ 978
	60"W		AMS2060RH	\$ 1014	\$ 1055	\$ 1094
	66"W		AMS2066RH	\$ 1109	\$ 1153	\$ 1196
	72"W		AMS2072RH	\$ 1160	\$ 1206	\$ 1251
30"H Metal L-Screen						
 <p>Extended</p>	48"W		AMS3248LH	\$ 1081	\$ 1124	\$ 1166
	54"W		AMS3254LH	\$ 1145	\$ 1191	\$ 1235
	60"W		AMS3260LH	\$ 1196	\$ 1243	\$ 1290
	66"W		AMS3266LH	\$ 1312	\$ 1364	\$ 1415
	72"W		AMS3272LH	\$ 1363	\$ 1417	\$ 1470
 <p>Extended Slots</p>	48"W		AMS3248RH (shown)	\$ 1081	\$ 1124	\$ 1166
	54"W		AMS3254RH	\$ 1145	\$ 1191	\$ 1235
	60"W		AMS3260RH	\$ 1196	\$ 1243	\$ 1290
	66"W		AMS3266RH	\$ 1312	\$ 1364	\$ 1415
	72"W		AMS3272RH	\$ 1363	\$ 1417	\$ 1470
20"H Metal U-Screen						
 <p>Extended</p>	48"W		AMS2048US (shown)	\$ 1086	\$ 1130	\$ 1171
	54"W		AMS2054US	\$ 1145	\$ 1191	\$ 1235
	60"W		AMS2060US	\$ 1196	\$ 1243	\$ 1290
	66"W		AMS2066US	\$ 1312	\$ 1364	\$ 1415
	72"W		AMS2072US	\$ 1377	\$ 1432	\$ 1485
 <p>Extended Slots</p>	48"W		AMS3248US (shown)	\$ 1304	\$ 1356	\$ 1406
	54"W		AMS3254US	\$ 1374	\$ 1428	\$ 1482
	60"W		AMS3260US	\$ 1435	\$ 1492	\$ 1547
	66"W		AMS3266US	\$ 1574	\$ 1635	\$ 1697
	72"W		AMS3272US	\$ 1653	\$ 1718	\$ 1782
30"H Metal U-Screen						
 <p>Extended</p>	48"W		AMS3248US (shown)	\$ 1304	\$ 1356	\$ 1406
	54"W		AMS3254US	\$ 1374	\$ 1428	\$ 1482
	60"W		AMS3260US	\$ 1435	\$ 1492	\$ 1547
	66"W		AMS3266US	\$ 1574	\$ 1635	\$ 1697
	72"W		AMS3272US	\$ 1653	\$ 1718	\$ 1782
 <p>Extended Slots</p>	48"W		AMS3248US (shown)	\$ 1304	\$ 1356	\$ 1406
	54"W		AMS3254US	\$ 1374	\$ 1428	\$ 1482
	60"W		AMS3260US	\$ 1435	\$ 1492	\$ 1547
	66"W		AMS3266US	\$ 1574	\$ 1635	\$ 1697
	72"W		AMS3272US	\$ 1653	\$ 1718	\$ 1782

<p>How to specify — Select the Model Number from above.</p>	<p>1st Option: Wing Type :</p> <p>STD Standard EXT Extended</p>	<p>2nd Option: Accessories Slots:</p> <p>X No Accessory Cut Out SLT Accessory Cut Out</p>	<p>3rd Option: Paint Option:</p> <p>P1 P2 P3 See page 334 for finishes.</p>	<p>4th Option: Paint Option:</p> <p>NA Screen</p>
	<p>_____ . _____ . _____ . P ____ . NA</p>			

Examples: AMS2048LH.STD.SLT.PR6.NA AMS2048SS.PR6.NA



 Shippable by small-package carrier.

For specification information see pages 343-344.

GSA SIN 33721

Description	Model	P1 Paint List Price	P2 Paint Upcharge	P3 Paint Upcharge
20"H Metal Rectangular Screen				
48"W	AMS2048SS (shown)	\$ 710	\$ 739	\$ 766
54"W	AMS2054SS	\$ 746	\$ 776	\$ 805
60"W	AMS2060SS	\$ 796	\$ 828	\$ 858
66"W	AMS2066SS	\$ 906	\$ 942	\$ 978
72"W	AMS2072SS	\$ 978	\$ 1018	\$ 1056
30"H Metal Rectangular Screen				
48"W	AMS3248SS (shown)	\$ 870	\$ 904	\$ 938
54"W	AMS3254SS	\$ 906	\$ 942	\$ 978
60"W	AMS3260SS	\$ 964	\$ 1002	\$ 1041
66"W	AMS3266SS	\$ 1086	\$ 1130	\$ 1171
72"W	AMS3272SS	\$ 1145	\$ 1191	\$ 1235
15"H Tackboard Accessories				
20"W	AAS1520 S	\$ 309	\$ 322	\$ 333
48"W	AAS1548 S (shown)	\$ 367	\$ 383	\$ 396
54"W	AAS1554 S	\$ 406	\$ 423	\$ 438
60"W	AAS1560 S	\$ 423	\$ 441	\$ 456
66"W	AAS1566 S	\$ 617	\$ 641	\$ 666
72"W	AAS1572 S	\$ 675	\$ 702	\$ 729

<p>How to specify — Select the Model Number from above.</p>	<p>1st Option: Wing Type : STD Standard EXT Extended</p>	<p>2nd Option: Accessories Slots: X No Accessory Cut Out SLT Accessory Cut Out</p>	<p>3rd Option: Paint Option: P1 P2 P3 See page 334 for finishes.</p>	<p>4th Option: Paint Option: NA Screen</p>	<p>5th Option: Accessories Color (if applicable): DW Designer White E9 Flint</p>
<p>Examples: AAS1548.PR6.APN911 AFAMS2048LH.STD.SLT.PR6.NA AFAMS2048SS.PR6.NA</p>					

Work Tools	Description	Model	List Price
	Hot File (Designer White Only) 9½"H x 12¼"W x 3¾"D	AEHF	\$ 64
	Side Saddle (Designer White Only) 4"H x 12¼"W x 2½"D	AESS	\$ 53
	Bag or Coat Hook (Designer White Only) 3¼"H x 1½"W x 2¼"D	AECH	\$ 41

<p>How to specify — Select the Model Number from above.</p>	<p>1st Option: Paint Option (if applicable): P1 P2 P3 See page 334 for finishes.</p>	<p>2nd Option: Fabric Option (if applicable): See page 335 for fabric options.</p>	<p>3rd Option: Paint Option: NA Screen</p>	<p>4th Option: Accessories Color (if applicable): DW Designer White E9 Flint</p>
<p>Example: AEHF.PJW</p>				

S Shippable by small-package carrier.

For specification information see pages 345-350.

GSA SIN 33721

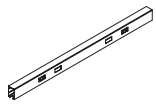

Description	Model	Ship Weight	Cubes	List Price		
				P1	P2	P3
Power Rail						
48"	RFDRW48	7	0.6	\$ 632	\$ 680	\$ 750
54"	RFDRW54	8	0.6	\$ 667	\$ 717	\$ 790
60"	RFDRW60 (shown)	9	0.7	\$ 768	\$ 824	\$ 909
66"	RFDRW66	10	0.8	\$ 819	\$ 879	\$ 967
72"	RFDRW72	11	0.9	\$ 924	\$ 991	\$ 1090

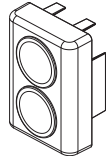

Power Rail End Cap	FDRWEC	1.5	0.1	\$ 235	\$ 253	\$ 278
--------------------	--------	-----	-----	--------	--------	--------

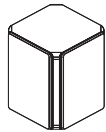

Power Rail Universal Connector	FDRWUC	3	0.1	\$ 428	\$ 458	\$ 503
--------------------------------	--------	---	-----	--------	--------	--------

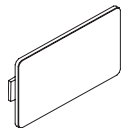

Electrical Port Cover						
2 Pack	FDEPC2	1	0.1	\$ 64	\$ 70	\$ 76
12 Pack	FDEPC12	2	0.1	\$ 220	\$ 237	\$ 260

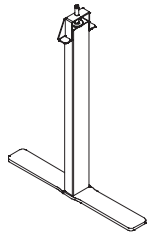

Elevated Power Rail Legs 20.5"H	RFDRWLEG	5	0.1	\$ 385	\$ 388	\$ 388
---------------------------------	----------	---	-----	--------	--------	--------

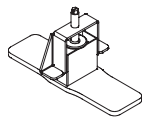

Floor Mount Legs	FDRWLEG	5	0.1	\$ 84	\$ 87	\$ 89
------------------	---------	---	-----	-------	-------	-------



Altitude Power Rail Floor Anchor Bracket	RFDRWAB	2	0.1	\$ 55	\$ 73	\$ 80
--	---------	---	-----	-------	-------	-------

How to specify —

Select the Model Number from above.



1st Option:

Paint:



See page 334 for selections and color codes.*



Examples:

For specification information see pages 345-350.

GSA SIN 33721

Description	Model	Ship Weight	Cubes	List Price		
				P1	P2	P3
Hubs						
End of Run Linear Configuration	RFDRWHUBEND	10	4	\$ 1097	\$ 1104	\$ 1110
End of Run T-Configuration	RFDRWHUBENDT	10	4	\$ 1097	\$ 1104	\$ 1110
Inline Linear Configuration	RFDRWHUBLIN	14	4	\$ 1097	\$ 1104	\$ 1110
Inline X-Configuration	RFDRWHUBX	14	4	\$ 1097	\$ 1104	\$ 1110
Inline T-Configuration	RFDRWHUBT	13	4	\$ 1097	\$ 1104	\$ 1110
L-Configuration Hub	RFDRWHUBL	13	4	\$ 1097	\$ 1104	\$ 1110

How to specify —

Select the Model Number from above.

1st Option:

Paint:

P1 P2 P3

See page 334 for selections and color codes.*

_____ .

Examples:

For specification information see pages 345-350.

GSA SIN 33721

Description	Model	Ship Weight	Cubes	List Price		
				P1	P2	P3
Power Pole						
8' H Square Power Pole	UN2HPSQ	17	1	\$ 1138	\$ 1156	\$ 1169
Square Power Pole Splicer Kit	UN2HPSQSK	0.5	0.1	\$ 125	\$ 129	\$ 130
Power Pole Connector	RFDRWCNPP	1	0.1	\$ 236	\$ 239	\$ 241
Power Pole Connector - End Condition	RFDRWCNPPE	1	0.1	\$ 236	\$ 239	\$ 241
Power Pole Connector - Mid Condition	RFDRWCNPPM	1	0.1	\$ 236	\$ 239	\$ 241

UN2HPSQ



UN2HPSQSK

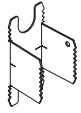

RFDRWCNPP

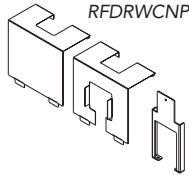

RFDRWCNPPE

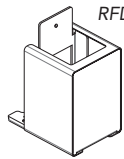

RFDRWCNPPM

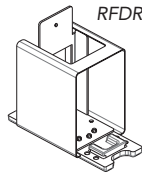

Wire Management

Vertebrae Wire Manager	RFDRWWM	3	0.1	\$ 721	\$ 739	\$ 746
------------------------	---------	---	-----	--------	--------	--------

*Includes connector for Power Rail attachment

*Vertebrae available in black only, connector available in 32 standard paints.

How to specify —

Select the Model Number from above.



Examples:

1st Option:

Paint:



See page 334 for selections and color codes.*



For specification information see pages 345-350.

GSA SIN 33721

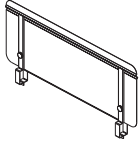

Description	Model	Ship Weight	Cubes	List Price		
				P1	P2	P3
Allsteel Metal Screen						
48"	RFDRWSC48	10	3.52	\$ 394	\$ 404	\$ 416
54"	RFDRWSC54	11	3.84	\$ 418	\$ 428	\$ 440
60"	RFDRWSC60	12	4.21	\$ 433	\$ 445	\$ 458
66"	RFDRWSC66	13	4.58	\$ 441	\$ 453	\$ 466
72"	RFDRWSC72	14	4.96	\$ 473	\$ 485	\$ 498

ALTITUDE

<p>How to specify — Select the Model Number from above.</p> <p>_____ .</p>	<p>1st Option: Paint: P1 P2 P3 See page 334 for selections and color codes.*</p> <p>_____</p>
---	---

Examples:

HAT to Panel Brackets

HAT to Panel Bracket Pricing

For specification information see pages 357-358.

GSA SIN 33721

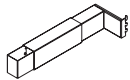

ABKTR

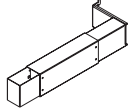

ABKTL

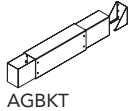

ABKCR

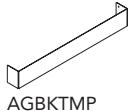

ABKCL

Description	Model	List Price
HAT to Panel Bracket T-leg RH	ABKTR	\$ 258
HAT to Panel Bracket T-leg LH	ABKTL	\$ 258
HAT to Panel Bracket C-leg RH	ABKCR	\$ 258
HAT to Panel Bracket C-leg LH	ABKCL	\$ 258
HAT to Gallery Panel Bracket T-leg	AGBKT	\$ 258
HAT to Gallery Panel Bracket C-leg	AGBKC	\$ 258
HAT to Gallery Panel Install Template <i>(Black only, code P)</i>	AGBKTMP	\$ 63

ALTITUDE

















<p>How to specify — Select the Model Number from above.</p>	<p><i>1st Option:</i> Paint (if applicable):</p>
<p>A . </p>	

Accessories

Worksurface Mounted Rail and Accessories

For specification information see page 359.

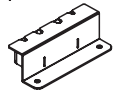
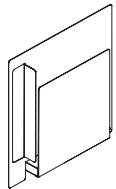
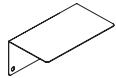
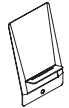
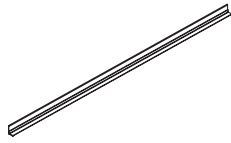

GSA SIN 33721

Description	Model	List Price		
		P1	P2	P3
Accessories Rail — Worksurface Mounted				
12"W	U912WTR 	\$ 120	\$ 128	\$ 132
18"W	U918WTR 	\$ 128	\$ 136	\$ 140
24"W	U924WTR 	\$ 147	\$ 155	\$ 159
30"W	U930WTR 	\$ 164	\$ 175	\$ 182
36"W	U936WTR 	\$ 186	\$ 197	\$ 204
42"W	U942WTR 	\$ 201	\$ 212	\$ 219
48"W	U948WTR 	\$ 212	\$ 227	\$ 232
54"W	U954WTR 	\$ 221	\$ 237	\$ 241
60"W	U960WTR 	\$ 232	\$ 249	\$ 255
66"W	U966WTR 	\$ 279	\$ 296	\$ 302
Rail Mounted Accessories				
Phone/Tablet Stand — 6½"H x 4¼"W	U9TM 	\$ 181	\$ 194	\$ 204
Pencil Holder — 2½"H x 6"W x 3"D	U9TP 	\$ 110	\$ 121	\$ 128
Shelf — 8"W x 4½"D; 2½" above top of worksurface	U9TS 	\$ 132	\$ 145	\$ 155
Vertical Paper Tray — 12"H x 1⅝"W x 12"D	U9TF 	\$ 198	\$ 211	\$ 221
Cord Organizer				
4"W x ⅞"D Metal with 4 cable cutouts	U9WTC 	\$ 196	\$ 205	\$ 212
Universal Hook (Black only)				
Package of 2	AGSAUHK 	\$ 132	—	—



How to specify —
Select the Model Number from above.

U | 9 | | | | | | | .

1st Option:
Paint:
  
See page 334 for selections and color codes.*

Examples: U912WTR.PR6 U9TF.P7G AGSAUHK.P27

 Shippable by small-package carrier.

Extensions — Introduction

Extensions accessory line by Allsteel is designed to help you create your own space.

- **Create a personalized space**

Each person works differently, different work styles require different tools. As our workplace needs shift from paper filing to personal storage, the tools that support us day-to-day need to adapt to the changing ways we are expected to work. Whether it's the need for paper filing, a place to plug a charger in, or a small shelf for trinkets, Extensions help you bear it all.

- **Create a comfortable space**

Encourage wellness and peace of mind while you work with Extensions. Whether by clearing valuable desk space, routing cords out of the way, powering your technology, or illuminating tasks with a gentle glow, this full line of work tools help you stay calm and in control of your workspace.

- **Create an empowered space**

Without all the right tools you need to succeed, having a productive workday can feel like an impossible task. With a full line of ergonomic, organization, illumination, power, and wire management tools, Extensions put the right tools within reach, allowing you to get your work done seamlessly and efficiently.

- **Organization tools**

Embracing organization work tools can help add efficiency and excitement to your daily workflow. Durably made but thoughtfully designed to help you organize and store the tools you need throughout your day, Extensions organizational tools help you find that perfect place for anything.

- **Ergonomic tools**

Ergonomics is more than just comfort, it's flexibility and safety. The adjustable keyboard options allow users to maintain and vary comfortable wrist and arm positions throughout the day, whether typing or mousing. Monitor Arms offer versatile adjustability while providing optimum comfort for the eyes, neck, and shoulders.

- **Illumination tools**

Sleek and flexible, our lighting components offer you several choices. Recessed task lights conserve space and feature electronic ballast for longer bulb life and cooler operating temperature. LED tasklights' slim design blends in with its surrounding while utilizing energy-efficient LED technology.

- **Power/Data tools**

At the heart of every workspace is a power module that keeps you plugged-in and running throughout the day. These indispensable accessories provide wired or wireless connectivity anywhere and everywhere you could possibly need it, transforming your workplace into a hub of activity.

- **Wire Management tools**

Eliminate the cord clutter under your desk with our extensive wire management offering. Allsteel wire management accessories effortlessly weave wires out of the way and clear your workspace with ease. Both free-standing and height adjustable, table-integrated solutions ensure that your space stays as clear as your workflow.

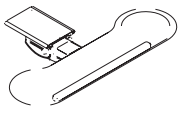
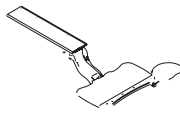
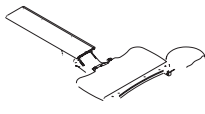
Articulating Keyboard Supports			
Features	Model AKTSHORT	Model AKTLONG	Model AKTMID
			
Keyboard Support	Platform style 28"W x 8"D	Platform Style 19"Wx11"D	Platform Style 19"Wx11"D
Keyboard Support Material	Phenolic	Phenolic	Phenolic
Suspension	<ul style="list-style-type: none"> Nylon glides on lubricated slide track Intuitive lift and lock one touch height adjustment 	Lubricated slide track system: spring assisted	Lubricated slide track system: spring assisted
Platform Rotation	360 degrees	360 degrees	360 degrees
Platform Tilt	+10/-20 degrees	+10/-20 degrees	+10/-20 degrees
Platform Tilt Adjustment	Soft touch lever for precise tilt adjustment	Convenient tilt wheel assists desired tilt angle	Convenient tilt wheel assists desired tilt angle
Platform Height Adjustment Range	6 1/2" (1 1/2" above / 5 1/4" below)	12 1/2" (7" above to 5 1/2" below)	8" (3" above / 5" below)
Platform Height Adjustment	Lift platform to raise, lift slightly and tilt back to lower	Lift platform to raise, lift slightly and tilt back to lower	Lift platform to raise, lift slightly and tilt back to lower
Palm Rest	Detachable leatherette-covered gel palm rest	Fabric covered gel palm rest	Fabric covered gel palm rest
Mouse Pad	In-line to accommodate mouse on same level as keyboard.	Circular, swivel, tilt, LH/RH mounting, mouse catcher, gel rest	Circular, swivel, tilt, LH/RH mounting, mouse catcher, gel rest
Microsoft Natural Compatible	No	Yes — by removing palm rest	Yes — by removing palm rest
Track Depth	8"	23"	21"
Required Mounting Clearance	20"W x 8"D x 1/4" Recess	19"W x 23"D + 1/4" Recess	19"W x 23"D + 1/4" Recess
Adjustable Wrist Rest	No	Fixed mounting and height	Fixed mounting and height
Ideal For	<ul style="list-style-type: none"> Straight worksurfaces ADA/HFES compliance Extensive adjustability with mouse in line, mouse over or mouse forward of keyboard Height-Adjustable Table 	<ul style="list-style-type: none"> Corner worksurface applications Sit to stand applications 	<ul style="list-style-type: none"> Shallow worksurfaces Corner worksurface (17" or 21") Radius worksurface (42" or 48")
Additional Information		<ul style="list-style-type: none"> Track can be cut in the field to shorten track depth — may affect ability to fully recess platform 	<ul style="list-style-type: none"> Track can be cut in the field to shorten track depth — may affect ability to fully recess platform

AKTSHORT Keyboard Support (page 380)

- Lift and lock intuitive height adjustment.
- Compatible with Altitude Height Adjustable Tables
- Positive and negative tilt for best ergonomic positioning.
- +10°/-20° tilt adjustment and 360° rotation provides support of neutral position of shoulders, arms and wrists while accommodating multiple working postures.
- Surpasses ANSI/BIFMA standards.
- Black powder coat finish.
- Patented secondary slide and unique arm design provide minimal footprint.

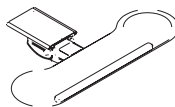

Keyboard Spacer Kit (page 380)

- Keyboard Spacer Kit required for mounting under Altitude worksurfaces.
- Kit provides ten spacers and hardware for mounting keyboard supports beneath an external worksurface support channel.
- Spacers are 2 1/8" H providing more room beneath surface for mounting.

CPU Hammock (page 380)

- Features 360-degree swivel with an 11" track.
- Load capacity is 75 lbs.
- CPU must be minimum of 3/4"W with maximum dimension of 64" in perimeter.
- Handy adjustment tool stores within unit.
- Safety feature prevents accidental release of straps and straps can be adjusted while CPU is installed.
- Can be used on Height Adjustable Tables as long as it is attached with spacer model AKMH. Take into account required leg room for users.







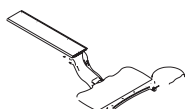
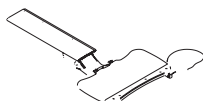



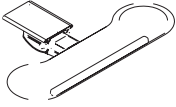

AKTMID and AKTLONG Keyboard Support (page 380)

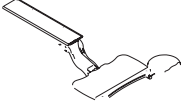
- Lift and lock intuitive height adjustment.
- Positive and negative tilt for the best ergonomic positioning.
- +10°/-20° tilt adjustment and 360° rotation provides support of neutral position of shoulders, arms, and wrists while accommodating multiple working postures.
- Non-handed mouse tray can be moved from right hand to left hand side.
- Surpasses ANSI/BIFMA standards.
- Black powder-coat finish.

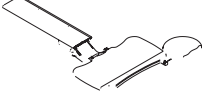

For specification information see page 379.

GSA SIN 33721

	Description	Model	List Price						
	Compact Keyboard Support with 8" Track 30"W x 13"D	AKTSHORT 	\$ 603						
	STS Keyboard Support with 23" Track 24"W x 12"D	AKTLONG 	\$ 739						
	Articulating Keyboard Support with 21" Track 24"W x 12"D	AKTMID 	\$ 635						
	Keyboard Spacer Kit 10 – 2½"H Spacers and Hardware	AKMH 	\$ 65						
	CPU Hammock™ (Silver only) 360° swivel CPU holder with adjustable straps	ACPU1 	\$ 431						
	Metal Corner Sleeve — for use with Optimize™, Concensys®, and Terrace® • Fits 1¼" thick square edge detail. (T-Mold worksurfaces) 22½"W leading edge x 18"D.	AWCS	<table border="1"> <thead> <tr> <th>P1 Paint List Price</th> <th>P2 Paint List Price</th> <th>P3 Paint List Price</th> </tr> </thead> <tbody> <tr> <td>\$ 152</td> <td>\$ 158</td> <td>\$ 163</td> </tr> </tbody> </table>	P1 Paint List Price	P2 Paint List Price	P3 Paint List Price	\$ 152	\$ 158	\$ 163
P1 Paint List Price	P2 Paint List Price	P3 Paint List Price							
\$ 152	\$ 158	\$ 163							

Edge Details

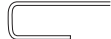

Model AWCS

How to specify —

Select the Model Number from above.



Examples: AKMH ACPU1

 Shippable by small-package carrier.

Allsteel's tool rail works in conjunction with a variety of accessories. Modular accessories free up worksurface space and provide orderly storage that is well within reach. Units can be arranged and rearranged to respond to changing workflow. The work tools that attach to the tool rail are:

- Mail Box
- Folder Holder
- Phone Caddy
- Binder Bin
- Tool Box
- Clip Caddy™
- Sidebar™ Personal Shelf
- Paper Wave™
- Cup Holder
- Hook
- Hanging File Holder
- Magnetic Picture Holder
- Small Bin
- Small Shelf
- Small Tray

Additional accessories that work with the **tool rail work tools** aesthetically are:

- Bookends
- Freestanding Mail Box

Coat hooks, marker boards and center drawers round out the organization offering.

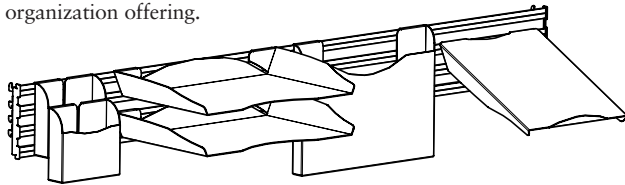

Tool rail, shown above, is height-adjustable in 1" increments using slots in panels or metal hutch. Tool rail shown with two tool boxes, two mail boxes, folder holder, and phone caddy. Folder holders and binder bins extend below a tool rail. Paper Wave and contents extend above a tool rail.

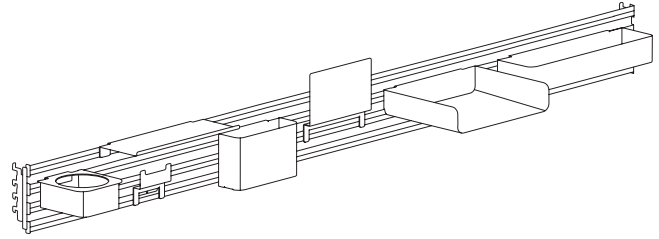

Tool rail, shown with cup holder, small shelf, hook, small bin, magnetic picture holder, small tray, and hanging file holder.

Tool Rails and Work Tools (page 384)

- Sturdy aluminum extrusion with steel support construction.
- Powder coated for durable finish.
- Use to hang Extensions tools. Cannot be used to support monitor arms.
- Suggested weight capacity not to exceed 80 lbs.
- Consideration needs to be given to height of tools and location of worksurfaces.
- For use with Terrace®, Concensys®, and Optimize™ systems.
- 5" high rail (widths coordinate with panels).
- Attachment via vertical reveals.
- Can be hung from wall track. Good solution for above copiers.
- Systems tool rail is off-modular — can be used on a panel of equal width or one size smaller.
- May span two panels of appropriate size, i.e., 60" W Tool Rail on two 30" W panels.

Tool Rail for Hutches (page 384)

- Will work on Universal, Terrace, Optimize, and Concensys system hutches produced after July 2, 2000 and Align™ metal hutches.
- Sturdy aluminum extrusion with steel support construction.
- Powder coated for durable finish.
- Use to hang Extensions tools. Cannot be used to support monitor arms.
- Suggested weight capacity not to exceed 80 lbs.
- Consideration needs to be given to height of tools and location of worksurfaces.

Mail Box (page 385)

- Holds standard letter-size paper and inter-office envelopes.
- Minimal horizontal intrusion.



Folder Holder (page 385)

- Holds manila envelopes.
- Is capable of hanging on other folder holders to maximize space.
- Stores vertically for easy access to files.

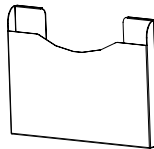

Phone Caddy (page 385)

- Holds telephone at optimum ergonomic angle.
- Wire management cut-outs.
- Accommodates standard phone sizes.



Binder Bin (page 385)

- Holds folders, binders, and manuals.

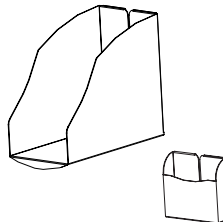

Tool Box (page 385)

- Holds pencils and other writing utensils, large post-it notes, and other desk top accessories.



Clip Caddy™ (page 385)

- Holds paper clips and other small objects.





Sidebar™ Personal Shelf (page 385)

- Holds office supplies and personal effects.

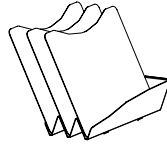

Paper Wave™ (page 385)

- Provides 3 fully divided slots for organizing files.
- Keeps papers from “bowing” at bottom.

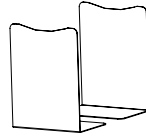

Bookends (page 385)

- Can be used on shelves or in cabinets.
- Used to hold books, binders, and catalogs upright.

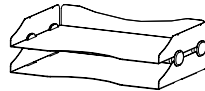

Freestanding Mail Box (page 385)

- Incorporates similar aesthetic to mounted Mail Box.
- Mounting brackets allow for free access from front and back.
- Sold in pairs of two; will stack up to eight high.
- Individual mail box dimension = 1¼"H.
- Stacking brackets are black.



Coat Hook APMC6 (page 385)

- Hangs directly into slotted Terrace® or Optimize™ panel frame.
- Use for coat or bag.
- Package of six.
- Available in black only.

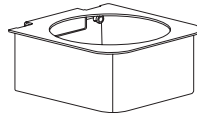

Cup Holder (page 385.1)

- Holds most cups and thermoses. Weight capacity is 5 lbs.

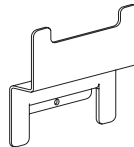

Hook (page 385.1)

- Hangs small personal effects such as headphones, keys, or hand wallets. Weight capacity is 10 lbs.



Hanging File Holder (page 385.1)

- Hangs files and folders from hanging file clips. Hanging file clips not included. Weight capacity is 5 lbs.

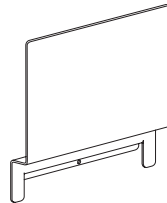

Magnetic Picture Holder (page 385.1)

- Allows for pictures to be hung via magnets. Magnets not included. Weight capacity is 5 lbs.

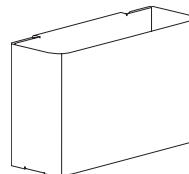

Small Bin (page 385.1)

- Houses office supplies or other personal effects such as pencils, pens, sticky notes, journals, etc. Weight capacity is 5 lbs.



Small Shelf (page 385.1)

- Provides additional shelf storage in workstation and displays office supplies or personal effects. Weight capacity is 5 lbs.



Small Tray (page 385.1)

- Holds office supplies and other personal effects. Weight capacity is 5 lbs.



ACPWRMOD

Power/Data Module — Clamp On Worksurface (page 391)

- On-surface mounting option, fits on any worksurface with a 4" overhang.
- 10' straight power cord only. UL Listed.
- Includes adapters to allow use of commercially available data terminals or blanks to fill unused openings. Many of the AMP, AT&T, Krone, Leviton, and most commercial data terminals can be used.
- Available in Fog only.

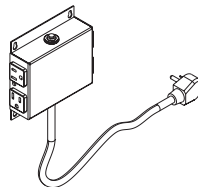

APWR4TAP

Power Module — Under Worksurface, Quad Tap (page 391)

- Under surface mounting can be used under any surface with a 5" x 5" x 1.5" clearance.
- 10' straight power cord only, no specification needed.
- 4 receptacles, unit is black finish only, no specification needed.

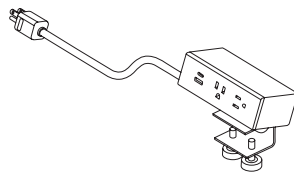

APWRMOD.AC.S

Power Modules — Clamp On Worksurface, Rectangular (page 391)

- Worksurface clamp can be used on any surface with a 2½" overhang.
- Must be installed at time of initial worksurface installation if installing between a worksurface and panel.
- 10' straight power cord only. UL Listed.
- The USB hub allows simultaneous powering of 2 receptacles, 1 USB-A device, and 1 USB-C device. The USB hub is a charger only, no ability to connect to a PC. The charging capacity is limited and may not charge all devices.
- Four wire management "P-Clips" included with mounting hardware.
- Specify "QA" for Qi compatible wireless charging on AWPRMOD. USB-C port no longer included when wireless charging specified.
- Available in Snow and Storm finishes.

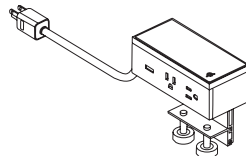

APWRMOD.QA.S

Power Modules — Clamp On Worksurface, Round (page 391)

- Worksurface clamp can be used on any surface with a 2½" overhang.
- Must be installed at time of initial worksurface installation if installing between a worksurface and panel.
- 9' straight power cord only. UL Listed.
- The USB hub allows simultaneous powering of 1 USB-A device and 1 USB-C device. The USB hub is a charger only, no ability to connect to a PC. The charging capacity is limited and may not charge all devices.
- Specify "QA" for Qi compatible wireless charging on ARNDPWRMOD.
- Available in Snow and Storm finishes.

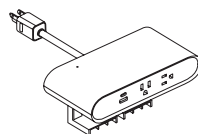

ARNDPWRMOD.QA.S

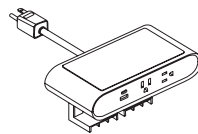

ARNDPWRMOD.AC.S

Power Module — Under Worksurface, Rectangular (page 391)

- Under surface mounting can be used on any surface with a 5" clearance.
- Power cord choices include 10' Straight, 5' Interlink, 10' Hardwire, and 10' Chevron Fog & Storm Braided cords. All are UL listed.
- Four wire management "P-Clips" included with mounting hardware.
- Available in Snow, Storm, and Black finishes.

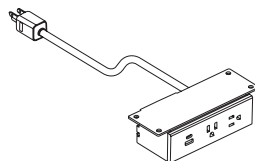

AUPWRMOD.AC.S

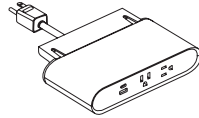

AURNDPWRMOD.AC.S

Power Module — Under Worksurface, Round (page 391)

- Under surface mounting can be used on any surface with a 5" clearance.
- 9' straight power cord only. UL Listed.
- Available in Snow, Storm, and Black finishes.

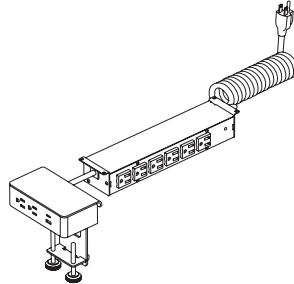

AABPWRMOD.AC.Q

Power Module — Above/Below Worksurface (page 391)

- Above/Below power module provides access to power on the desktop and below the worksurface.
- Desktop mount can be used on any surface with a 6"W x 3"D clearance along the worksurface edge.
- Under surface mounting can be used with a 12"W x 3"D x 2"H clearance under the surface.
- Plugs will take additional depth (approx. 3").
- Two wire management "P-Clips" included with mounting hardware.
- Below worksurface power strip supplies six grounded A/C receptacles, desktop unit supplies two receptacles, 1 USB-A port, and 1 USB-C port.
- Desktop and under worksurface units are connected by a 2' long straight cord and cannot be disconnected.
- Power cord choices include a 6' straight cord or a coiled cord that is 6' long uncoiled, approximately 8" long coiled (compressed).
- Desktop unit available in White and Gray finishes.
- Under worksurface unit available in black only, no specification needed.
- UL 962A and UL 111 Listed. UL 1310 Recognized.

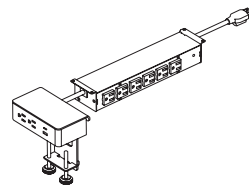

AABPWRMOD.AC.S

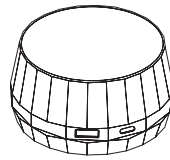

APWRPCK

Power Module — Sit-on-Surface, Puck (page 391.1)

- Unit sits on top of a worksurface.
- Includes 5' DC Connector cord, transformer block, and 6' AC straight cord for 11' of total cord length. UL 1310 Listed.
- Unit allows for simultaneous powering of 1 USB-A and 1 USB-C device.
- Unit is a charger only, no ability to connect to a PC other than to charge.
- Available in White and Silver finish only, no specification needed.

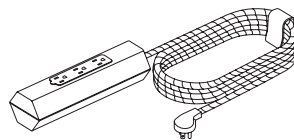

APWRSTRP

Power Strip — Sit-on-Surface, Wood (page 391.1)

- Unit sits on top of a worksurface.
- 10' Braided cord in White nylon, leather cord management strap included. UL Listed.
- Ultra-low profile 45 degree flat plug.
- 3 grounded power outlets.
- Solid Ash Wooden housing, no specification needed.

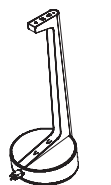

AVSTA3PWR

Vesta Mobile Power (page 391.1)

- 3 AC power simplex, 1 dual USB-A, 1 USB-C configuration.
- 10' Retractable power cord, UL Listed.
- Unit weighs 13 lbs.
- For cordless, battery-powered unit, please contact the Tailored Product Group (TPG).
- Available in Snow, Storm, Black, and Fog. Separate finish options available for outside and inside of unit.

Cable & Wire Management

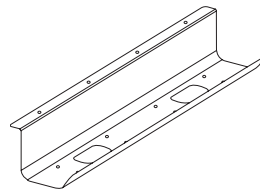

AJTRGH24 or AJTRGH36

Cable Management Tray (page 391.2)

- Attaches under the worksurface to contain cables.
- Metal tray shelf is 4" deep. Can hold electrical power strip and/or surge protector.
- 24" and 36" lengths, use multiple units for larger worksurfaces.
- Attachment hardware included, paint option is black only.
- Zip tie attachment points located in base of tray. Zip ties not included.

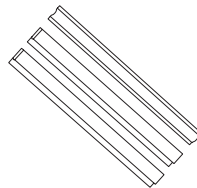

AWRSTRIP

Wire Management Strips/Channels (page 391.2)

- Self adhesive backing to attach to panels and underside of worksurfaces.
- Flexible strips allow cabling to enter/exit and can be contained inside the strips' cavities.
- Includes two wire management profiles. Smaller profile allows for qty. 3, .3" diameter cords, has area of .32 in². Larger "J" shaped profile allows for qty. 10, .3" diameter cords, has area of 1.14 in².

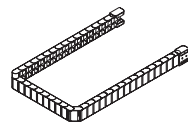

A9CLWMC or WKSWMC

Cord Management Chains (page 391.2)

- Works with Approach and Altitude A6-units.
- Used to route and conceal power/data cables from control box and other devices. Includes all mounting hardware and a plate to secure to a leveling glide.
- Houses 6 cables at 0.300" diameter.
- Made of plastic chain with plastic attachment brackets at each end.
- Specify WKSWMC for 58" chain. Only comes in Black finish.
- Specify A9CLWMC for 36" chain. Comes in Black, White, and Silver.
- Has two connecting points: Top section connects underneath a worksurface and bottom section can connect underneath power rails or to panel raceways using double-sided tape. Hardware included.

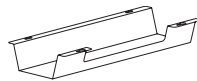

APWRTRGH17 or APWRTRGH36

Under Worksurface Trough (page 391.2)

- Used to conceal wires and control box below worksurfaces. Trough can be configured at various height/width combinations to meet capacity needs. Ships flat and is bent to desired shape.
- On 48"W and 54"W worksurfaces use one 17"W trough. 54"W has space to use 2 – 17"W, if necessary.
- On 60"W, 66"W, and 72"W worksurfaces use the 36" trough.
- On 84"W worksurface use 2 – 17"W troughs.

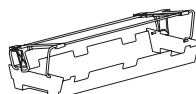

AFDTRGH20

Flip-Down Wire Trough (page 391.2)

- Mounts beneath a worksurface. Used to conceal extra cord slack and power strips.
- May be used in conjunction with quad tap unit APWR4TAP to reduce the number of cords routed from a worksurface to a beam.
- For any worksurface less than 58"W, a 20"W Flip-Down Trough is recommended.
- For worksurfaces 58"W and wider, a 20"W or 32"W Flip-Down Trough may be used.
- Flush-mount Raddi Storages are not recommended to use in conjunction with Flip-Down Trough.
- Only AKTSHORT keyboard tray is recommended for use in conjunction with the Flip-Down Trough.



AFDTRGH32

O-Leg Chase (page 391.3)

- Works with O-Legs from Allsteel Approach.
- Matches leg profile on models WKTBT2824 and WKTBT2830.
- Magnetically aligns and adheres itself to the inside of the leg and allows for user to reposition and adjust wires as needed without the use of tools.
- Metal chase measures 26"H, can fit qty. 12, .3" diameter cords. Has cross section area of 1.56 in².
- Available in standard metal paint finishes.



ALEGCHASE26

Cable & Wire Management

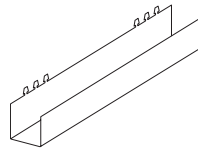

AMPCHASE

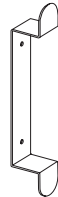

AWIRECLT

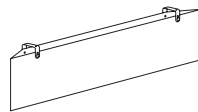

APWRMODEST36 or APWRMODEST48

Panel Mounted Wire Chase (page 391.3)

- Attaches between panels on Stride, Terrace, and Optimize via a slotted standard.
- Designed to sit below a worksurface and provide additional cord management from the base rail to beltline/under-worksurface height.
- Available in standard metal paint finishes.

Metal Wire Cleat (page 391.2)

- Supplied with screws and VHB tape for attachment to various surface types.
- For wood/particle board/MDF surfaces, use screw attachment.
- For painted metal/glass/non-porous surfaces, use VHB tape.
- Example use cases:
 - 1) Used alongside telescoping/fabric HAT wire chases to secure excess length of cord at plug-end.
 - 2) Secured to wall next to TV monitor in meeting room to manage HDMI cable when not in use.
 - 3) Screwed underneath worksurface to provide quick and easy management of excess length of cords and cabling.

Fabric Power Modesty (page 391.4)

- Fabric Power Modesty presents as modesty panel hanging by leather straps under a worksurface; inner compartment conceals cords and power strips as a wire management application.
- Recommended worksurface width pairings:
 - 1) 48-60" W Desk — Use APWRMODEST36 Centered.
 - 2) 66-72" W Desk — Use APWRMODEST48 Centered or APWRMODEST36 offset.
 - 3) 84" W Desk — Use APWRMODEST48 offset.
- Modesty fills 11.5 inches below the bottom of the worksurface with space for cords to enter/exit between the worksurface and the top of the Power Modesty.
- Two entry/exit points for cords are located at the bottom of the Power Modesty unit.
- Modesty panel is designed to present as a thin modesty panel from the front, but provides 3" depth cavity for wires, power strips, etc.
- Maximum weight capacity for Power Modesty is 25 lbs.
- Modesty panel not to be used to store electronics that require airflow for thermal management (computers).
- Users can access interior of panel (to modify wire placement) via "wings" on either side of product, secured via user-operable Velcro connection.
- Users may also dismount Power Modesty from leather straps by unlooping leather straps from button attachments.
- Leather straps on Power Modesty always come in medium brown color.
- Power Modesty available in Appoint, Binary, Centurion, Noble, Reflections, Disperse, and Spin fabric series.

Cable & Wire Management

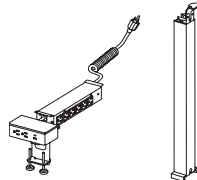

AHATPWORMOD2S or AHATPWORMOD3S

Metal Telescoping HAT Wire Management (page 391.4)

- Separate models available for use on either 2-Stage or 3-Stage Altitude A6 Tables. Not compatible with Altitude A3, A5, or A8.
- Equipped with 2-Stage or 3-Stage Telescoping Wire Chase and custom Above/Below Power Module intended for cord management on 2- and 3-Stage height adjustable tables.
- Telescoping chase includes a unique Above/Below Power Module and is NOT compatible with any other power module.
- Above/Below Power Module supplies 6 grounded A/C receptacles below the worksurface and 2 receptacles, 1 USB-A, and 1 USB-C port above the worksurface on the desktop unit. Desktop power module available in White and Gray finishes, below-worksurface power strip only available in black only.
- Telescoping Chase available in the same paint finishes as the Altitude height adjustable bases except for “Nickel.”
- To match Metal Telescoping Chase to HAT base, specify matching paint color as HAT base. To match Telescoping Chase to a “Nickel” HAT base, specify “Platinum Metallic,” or “PR2.”
- Two “P-Clips” included for wire management between desktop power module and under worksurface power strip.

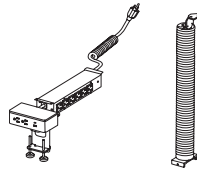

AHATPWORMOD2S or AHATPWORMOD3S

Fabric Elastic HAT Wire Management (page 391.4)

- Model compatible for use on either 2-Stage or 3-Stage Altitude A6 Tables. Not compatible with Altitude A3, A5, or A8.
- Equipped with Fabric Elastic Wire Chase and custom Above/Below Power Module intended for cord management on 2- and 3-Stage height adjustable tables.
- Fabric Elastic Chase includes a unique Above/Below Power Module and is NOT compatible with any other power module.
- Above/Below Power Module supplies 6 grounded A/C receptacles below the worksurface and 2 receptacles, 1 USB-A, and 1 USB-C port above the worksurface on the desktop unit.
- Desktop power module available in White and Gray finishes, below-worksurface power strip only available in black only.
- Fabric Elastic Chase available in Light, Medium, and Dark fabric finishes.
- Includes a metal foot and an under worksurface mounting bracket to attach Fabric Elastic Chase along the side of a HAT leg.
- To match metal brackets to HAT base, specify matching paint color as HAT base. To match brackets to a “Nickel” HAT base, specify “Platinum Metallic,” or “PR2.”
- Two “P-Clips” included for wire management between desktop power module and under worksurface power strip.

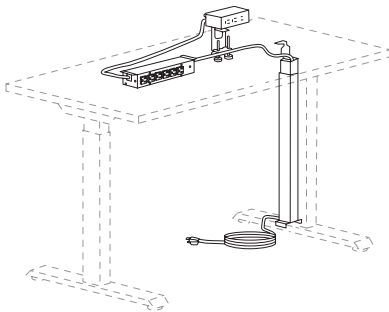

2-Stage Metal Telescoping HAT Wire Management

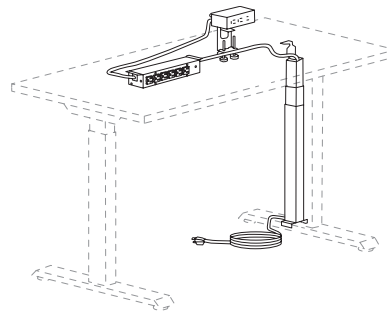

3-Stage Metal Telescoping HAT Wire Management

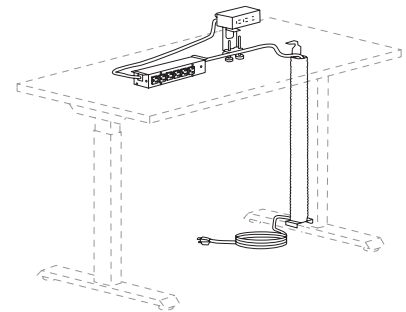

2 or 3-stage Fabric Elastic HAT Wire Management

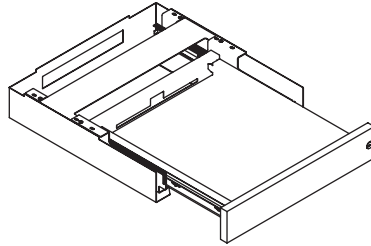
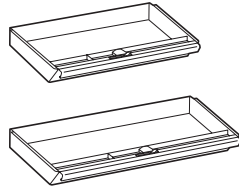

Flat Brackets

Front View

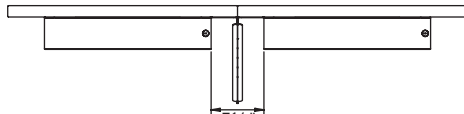

Top View

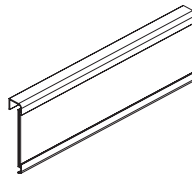
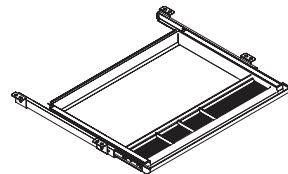
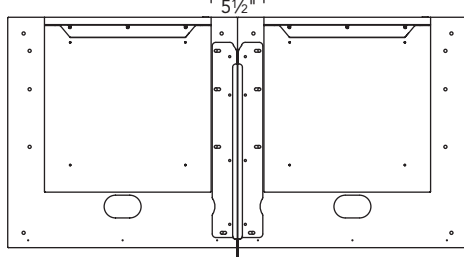

Metal Center Drawers (page 386)

- All metal center drawers feature pencil trays with three compartments for storage.
- Center drawers will not fit in center of 24" D worksurfaces which are wider than 60" due to location of center support bracket.
- For locking specifications, see pages 396-398.
- Ball-bearing slide suspension.

Laptop Drawer — U7WDA (page 386)

- Drawer body made of sheet metal.
- Drawer front made of 3/4" particleboard with laminate on both sides and fused laser edge banding.
- Core removable lock is located on right side drawer front
- 17 5/8" W x 18" D x 3 3/8" H Outside (interior 13" W x 16" D x 1 7/8" H)
- Minimum surface depth is 21" for surfaces not using an external stiffener; and 27" for surfaces using an external stiffener.
- Drawer extends 16"
- Maximum load: 45 lbs (functional BIFMA load)
- Drawer assembly and cover have cut out in back to allow for cables to exit drawer.
- Distance from floor to bottom of unit w/glides fully retracted is 24 3/4".
- Does not interfere with Further leg mounting plates so drawer can be placed directly next to either a system or table leg.
- When being placed next tower storage using the tower ell bracket (Z6LB) to support surface the drawer must be inset 3" to clear the ell bracket.
- Can be placed directly next to any support storage from any Allsteel product line (excluding towers).
- Flat brackets — drawer must be offset 3" from seam between surfaces to clear the bracket. See illustration at left.
- Can be used with rabbit edge worksurface models but there will be a larger reveal between surface and drawer.
- Can be used with knife edge worksurface models but reveal and depth need to be considered.

Polymer Center Drawer - ACD1 (page 386)

- 20 1/2" W x 17" D x 2" H
- Available in black only
- Made from ABS.
- Minimum clearance for mounting: 23" W x 16 1/4" D x 2" H.
- Retracts on 16" ball-bearing slides.
- Can be used on worksurfaces with Height Adjustable Bases as long as it is attached with spacer model AKMH.
- Can store up to 25 lbs.





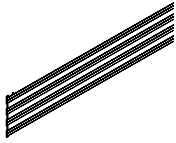

Name Plate (page 385)

- Comes in a 10-pack.
- Metal backer installs under a Terrace or Optimize top cap, can be used with frameless glass.
- Cover is a transparent polycarbonate insert.
- Full plate is 8 1/2" W x 2 5/8" H.



For specification information see pages 381-382.

GSA SIN 33721

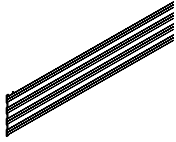

Description	Model	P1 Paint List Price	P2 Paint List Price	P3 Paint List Price
5"H Tool Rails — for Panels				
24"W	EASR24 	\$ 267	\$ 305	\$ 340
30"W	EASR30 	\$ 283	\$ 321	\$ 356
36"W	EASR36 	\$ 295	\$ 333	\$ 368
42"W	EASR42 	\$ 308	\$ 346	\$ 381
48"W	EASR48 	\$ 317	\$ 355	\$ 390
60"W	EASR60 	\$ 373	\$ 411	\$ 446



5"H Tool Rails — for Metal Hatches				
36"W	EAHSR36 	\$ 295	\$ 332	\$ 366
42"W	EAHSR42 	\$ 308	\$ 345	\$ 379
48"W	EAHSR48 	\$ 317	\$ 354	\$ 388
60"W	EAHSR60 	\$ 373	\$ 410	\$ 444
66"W	EAHSR66 	\$ 385	\$ 422	\$ 456
72"W	EAHSR72 	\$ 415	\$ 452	\$ 486

How to specify —
Select the Model Number from above.

1st Option:

Paint:



See page 16 for finishes.







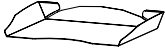
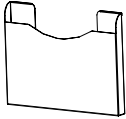

_____ . **P** _____

Example: EASR36.P02

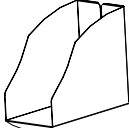
 Shippable by small-package carrier.

For specification information see pages 381-382.

GSA SIN 33721

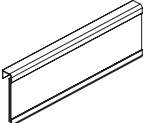
	Description	Model	P1 Paint List Price	P2 Paint List Price	P3 Paint List Price
	Mail Box 9"D x 15"W	EAPT S	\$ 132	\$ 152	\$ 168
	Folder Holder 9"H x 12"W	EAFS S	\$ 135	\$ 155	\$ 171
	Phone Caddy 9"W x 11"D	EATS S	\$ 165	\$ 185	\$ 201
	Binder Bin 8½"H x 5¼"W x 10"D	EABS S	\$ 132	\$ 152	\$ 168
	Tool Box 5"H x 5¼"W x 1½"D	EADH S	\$ 106	\$ 126	\$ 142
	Clip Caddy™ 2"H x 7"W x 3½"D	EAAC S	\$ 94	\$ 114	\$ 130
	Sidebar™ Personal Shelf 2"H x 21"W x 7"D	EAPS S	\$ 135	\$ 155	\$ 171
	Paper Wave™ Tray size: 2½"H x 6"W x 10"D Dividers: 9½"H x 9"W	EASS S	\$ 189	\$ 209	\$ 225
	Freestanding Mail Box (specify paint color) Pair — 4½"H x 13¼"W x 9"D	EAFT S	\$ 271	\$ 291	\$ 307
	Coat Hooks (black only) Package of six	APMC6 S	\$ 132	N/A	N/A
	Panel Name Plate Package of 10	EACS S	\$ 360	\$ 380	\$ 396
	Note: Not for use on tool tile or rail, name plate installs under top cap on Terrace and Optimize.				











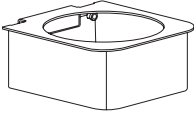

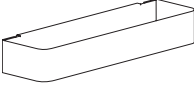

<p>How to specify — Select the Model Number from above.</p> <p>_____ .</p>	<p><i>1st Option:</i> Paint: P1 P2 P3 See page 16 for finishes.</p> <p>P _____</p>
---	---

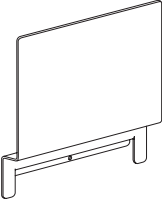
Examples: EAPT.P4J APMC6.P

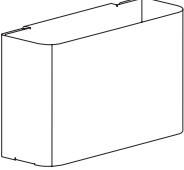
S Shippable by small-package carrier.

For specification information see pages 381-382.

GSA SIN 33721

	Description	Model	P1 Paint List Price	P2 Paint List Price	P3 Paint List Price
	Cup Holder 4 7/8"H x 2"W x 11 1/8"D	AAPAC 	\$ 259	\$ 285	\$ 298
	Hook 4 1/8"H x 3 3/8"W x 7 1/4"D	AAPAH 	\$ 195	\$ 215	\$ 224
	Hanging Folder Holder 4 7/8"H x 2 1/2"W x 14"D	AAPAHF 	\$ 258	\$ 284	\$ 297
	Magnetic Picture Holder 9"H x 10"W x 10 1/2"D	AAPAMP 	\$ 231	\$ 254	\$ 266
	Small Bin 5 1/8"H x 3 3/8"W x 7 1/4"D	AAPASB 	\$ 237	\$ 261	\$ 273
	Small Shelf 4 7/8"H x 2"W x 11 1/8"D	AAPASH 	\$ 222	\$ 244	\$ 255
	Small Tray 8 3/8"H x 2 7/8"W x 10 1/4"D	AAPAST 	\$ 260	\$ 286	\$ 299

How to specify —
Select the
Model Number
from above.

1st Option:

Paint:



See page 16 for
finishes.

P | | | |

Examples: AAPAST.P4J AAPASB.P

 Shippable by small-package carrier.

allsteeloffice.com | 385.1

For specification information see page 383.

GSA SIN 33721

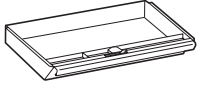
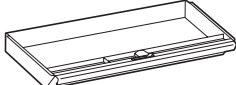
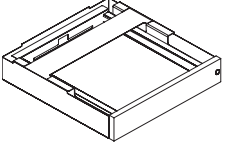
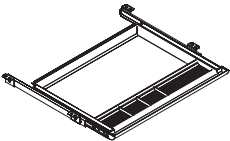
	Description	Model	List Price		
			P1	P2	P3
 <p>Angled front</p>	Metal Center Drawer w/Lock 19"W x 14¼"D x 3"H • 12" drawer extension (3/4). • Inside drawer dimension: 19"W x 13"D x 2⅝"H. • Minimum clearance for mounting: 21¼"W x 19¼"D.	CSDC19 <input type="checkbox"/>	\$ 305	\$ 327	\$ 346
 <p>Angled front</p>	24½"W x 14¼"D x 3"H • 12" drawer extension (3/4). • Inside drawer dimension: 24½"W x 13½"D x 2⅝"H. • Minimum clearance for mounting: 27⅝"W x 19¼"D.	CSDC25 <input type="checkbox"/>	\$ 314	\$ 336	\$ 355
	Laptop Drawer — Locking, laminate front, metal case 17⅝"W x 18"D x 3⅜"H • 16" drawer extension • Inside drawer dimensions: 13"W x 16"D x 1⅞"H • Minimum clearance for mounting: 17⅝"W x 21"D x 3⅜"H (see illustration)	U7WDA <input type="checkbox"/>	\$ 1750	\$ 1773	\$ 1792
	Polymer Center Drawer 20½"W x 17"D x 2"H • 11½" extension • Minimum clearance for mounting: 23"W x 16¼"D x 2"H	ACD1	\$ 244	N/A	N/A

How to specify —
Select the Model Number from above.

1st Option:
Laminate
(Laptop drawer front if applicable):
See page 38 for finishes.

2nd Option:
Edge
(Laptop drawer edge if applicable):
See page 38 for finishes.

3rd Option:
Paint
(If laptop drawer, list exterior case color here):
See page 16 for finishes.
Power Data Module
PR6 Silver.

4th Option:
Paint
(Interior of laptop drawer if applicable):
See page 16 for finishes.

5th Option:
Lock
(if applicable):
STD Standard
OMT Omit (Deduct \$20)

6th Option:
Lock or Tech
Module Color
(if applicable):
EL Silver (Lock)

Example: U7WDA.LM11EV.P27.PR6.STDEL

Shippable by small-package carrier.

Allsteel Extensions offers Illumination in three styles — Undercabinet LED Light, Wand Light, and Splitty Light.

Recessed Undercabinet LED Light

Recessed task lights conserve space and provide an efficient solution for illuminating the workplace. All models are equipped with LED strips.

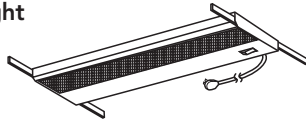

Recessed task light models mount under storage cabinets or shelves to provide optimal space utilization. Models are available in two styles and three sizes to correspond with the width of the cabinet or shelf. Task lights with a fused plug are available to meet Chicago electrical code.

Undercabinet LED Light

The Undercabinet LED Light is a low-profile, linear solution for overhead cabinets and shelves and is an ideal solution for painted wood storage. It utilizes energy-efficient LED technology which provides a long life. The Undercabinet LED Light provides the opportunity to mount the fixture where light is needed most.

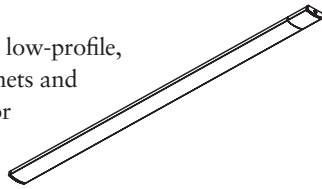

The Undercabinet LED Light features a metal trough reflector with diffuser lens. The light has a sleek 1/2" thick profile and provides two options for mounting, either magnetically or with hardware. Undercabinet LED Lights can be daisy-chained.

Optional undercabinet occupancy sensor is available which will automatically turn off the fixture after 30 minutes of no detection and back on immediately as the user re-enters the detection range using Passive Infrared (PIR) sensor technology. Unit features 360° lens with 90° outward detection angle, providing a 36" coverage diameter at 18". Occupancy sensor comes with connector and is required to be connected in the sequence shown below. Connect occupancy sensor to a light, or first light in daisy chain to control all linked lights.

CONNECTION SEQUENCE*

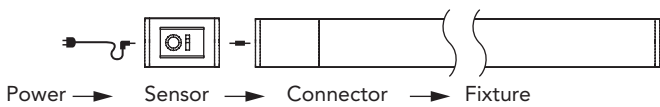

*Cannot deviate from this sequence

Recessed Task Lights (page 389)

- Black Metal Construction with 9' long black cord attached to right rear corner of the fixture.
- LED strip comes installed within light.
 - 50,000 hour life span
 - 120V-277V
 - CCT 4000K
 - CRI 80+
- Includes 4 cord retainer clips.
- Shorter width models can be used on wider overheads, shelves and hutches.
- On/Off switch provides individual control of tasklight within the workstation.
- Daisy chain models require a master control model — 10 fixtures maximum.
- RECOMMENDATION: Provide a separate circuit for task lights to ensure proper, long-term operation.

Undercabinet LED Lights (page 389)

- Low profile energy-efficient LED task light for use with overhead storage cabinets and shelves.
- 20W power supply for 10W 17" unit (.166 amps).
- 20W power supply for 20W 31" unit (.166 amps).
- 60W power supply for daisy-chain starter units (.5 amps). Must order one starter unit for each daisy-chain application.

LED Light Combinations Must Not Exceed 60W in Combination	Power Usage
6X 17"	60W
3X 31"	60W
1X 31" + 4X 17"	60W
2X 31" + 2X 17"	60W

- The combinations that could max out 60W are featured above. *Daisy chained units have a power limit of 60W from one power entry. 17W units use 10W and 31W units use 20W.*
- Specify up to 5 additional 17" interconnect units (ALED17UJMP30) to daisy-chain together with 17" daisy-chain starter fixture (ALED17U60).
Example: Daisy-chain 4-17" undercabinet LED lights:
Specify: 1 ALED17U60
Specify: 3 ALED17UJMP30 with 10" jumper cord
- Specify up to 2 additional 31" interconnect units (ALED31UJMP30) with 10" jumper cords to daisy-chain together with 31" tasklight (ALED31U60); or 17" daisy-chain starter fixture (ALED17U60).
- 3500K color temperature.
- 131 footcandles at 18" on ALED31U; 76 footcandles at 18" on ALED17U.
- Magnetic or screw-mount option — attachment hardware included.
- On 20 watt models, power drive is attached to plug: allow 1 1/8" D space at outlet.
- On 60 watt models, power drive brick is in center of cord.
- Includes 3 cord retainer clips.
- Meets California Title 24 Energy Efficiency Standards.
- "Instant On" switch with infinite dimming cycle from 100% to 15% with the last state memory, allowing the user to set their desired level of lighting.
- Fixture automatically turns off after 10 hours of use to reduce unwanted energy use.
- Optional occupancy sensor automatically turns off all interlinked fixtures after 30 minutes of no detection and back on immediately when detection is found.

Overhead Length	Suggested LED Sizes
24	17
30	17
36	17
42	31
48	17 + 17
60	31 + 17
72	31 + 31

Note: LED lights may need to be positioned along length properly to allow jumping to additional overheads. Suggested sizes above are recommendations for single overheads to provide as much light along length of overhead as possible.

The suggested sizes factor in 4 inches of room for the power inlet and occupancy sensor (optional).

Wand™ Task Light

Wand freestanding task light offers a clean, simple design along with powerful LED technology to illuminate the workspace. The swivel base and arm tilt allow users to position the light just where they need it. The 7.7 watt LED light offers efficiency and long life, providing up to 25 years of daily use. The slim, sleek design makes it easy to integrate into any workspace. Wand task light is 97% recyclable. Occupancy sensor and/or charging models available.

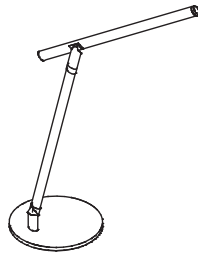

Wand LED Freestanding Task Light (page 390)

- Available in Silver or White. 9'4" cord is Silver.
- Full range dimming from 100% – 10% with last state memory.
- Uses 5W at highest setting and as low as 1 watt at its lowest setting, providing 75 to 12.7 footcandles of light, respectively (16" above worksurface).
- 7½" round swivel base and 16½"H tilt arm allow versatile positioning of the 13" lampshade.
- Designed for 50,000 hours of life.
- Color Temperature: 3500K. Color Rendering Index (CRI): 80.
- Materials: aluminum arm and lampshade, steel base.
- Weight: 4.4 lbs. 97% recyclable, 76% post-consumer.
- Certifications: UL and CUL. TAA compliant.
- Occupancy sensor available with automatic shut-off after 15 minutes if no motion is detected.
- USB model features USB-A (1), USB-C (1) charging within base of unit.
- USB model also features occupancy sensor. 7.5W (A) & 18W (C) power consumption.

Splitty Task Light

Splitty's organic and modern design compliments the workstation while also bringing rich features to the user. In addition to illuminating the space, Splitty can also be a teleconferencing tool through Splitty's 360-degree light head adjustment and soft touch, continuous dimming. Integrated charging allows for small personal device charging crucial to the modern worker's workplace toolkit while minimizing clutter within the station. Optional clamp or tool tile mounts available as accessories.

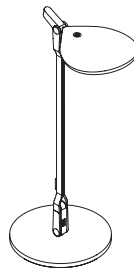

Splitty Task Light (page 390)

- Available in Silver, White, or Black (accessories available in silver only).
- Cord is 12' long.
- Cord is silver when black or silver finish specified, white when white light is specified.
- Soft touch on/off, dimming.
- Continuous dimming (100% – 3%) with last state memory.
- 5.8W of energy consumption. 7W at highest setting, 0.6W at lowest.
- 5" 360-degree swivel light head, 6.54" round swivel base and 17"H arm. Arm has full 180 degree rotation and 360 degree swivel.
- Designed for 60,000 hours of life.
- Color Temperature: 3500K, Color Rendering Index: 90.
- Materials: aluminum, plastic.
- USB-A has 5W of power consumption.
- USB-A (1) charging at bottom of light arm stem. Charging feature compatible for any mounting method.
- Clamp mount compatible with surfaces ¼" – 2¼" thick.
- Tool tile mount has 1½" adjustment range, minimum slot height of ⅜".

For specification information see pages 387-388.

Open Market / GSA SIN 33721 (as noted)

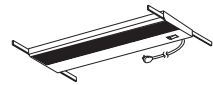

Open Market

Description	Watt Usage	Model	List Price
Recessed Task Lights (Black only) — Use recessed under overhead cabinets, storage shelves, or hutches, comes with cord retainer clips			
Task Light for 24"W	10	A870824 S	\$ 442
Task Light for 30"W and 36"W	14	A870830 S	\$ 446
Task Light for 42"W and 48"W	21	A870842 S	\$ 483
Task Light for 60"W, 66"W, and 72"W	28	A870860 S	\$ 522

Recessed Task Lights (Black only) — With fused plug (satisfies Chicago electrical code)

Task Light for 24"W	10	A870824CH S	\$ 570
Task Light for 30"W and 36"W	14	A870830CH S	\$ 581
Task Light for 42"W and 48"W	21	A870842CH S	\$ 618
Task Light for 60"W, 66"W, and 72"W	28	A870860CH S	\$ 654

Note: See below for GSA Approved Task Lights.

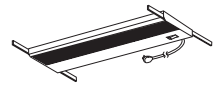

GSA SIN 33721

GSA Recessed Task Lights — Use recessed under overhead cabinets, storage shelves, or hutches

Base Models — Stand Alone

Task Light for 24"W	15	GS870924 S	\$ 565
Task Light for 30"W and 36"W	17	GS870930 S	\$ 583
Task Light for 42"W and 48"W	25	GS870948 S	\$ 627
Task Light for 60"W, 66"W, and 72"W	32	GS870960 S	\$ 671



GSA SIN 33721

Cord Retainer Clips (Black only)

Bag of 50 clips		AAPACM2 S	\$ 56
-----------------	--	---	-------

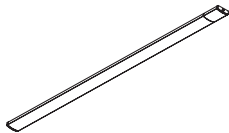

GSA SIN 33721

LED Undercabinet Light (white end caps)

17" Task Light w/20 watt power supply for 24"W or wider overhead	ALED17U	S	\$ 1045
17" Task Light w/60 watt power supply for daisy chain	ALED17U60**	S	\$ 1144
17" 10 watt Interconnect Task Light w/10" Jumper Cord	ALED17UJMP30	S	\$ 807
31" Task Light w/20 watt power supply 36"W or wider overhead	ALED31U	S	\$ 1568
31" Task Light w/60 watt power supply for daisy chain	ALED31U60**	S	\$ 1653
31" 20 watt Interconnect Task Light w/10" Jumper Cord	ALED31UJMP30	S	\$ 942
Undercabinet Occupancy Sensor 2 3/4"W + 1"W Connector	ALEDOCC*		\$ 636

*Undercabinet Occupancy Sensor works with LED Undercabinet lights shipped after 11/1/2013.

**When purchased separately without a configurable TAA compliant end product, not on GSA contract.

How to specify —
Select the Model Number from above.

1st Option:
Cord Retainer
Clip Color:
Black only.

P | 2 | 7

Examples: A870824

A870824CH
ALED17U

GS870924

AAPACM2.P27

S Shippable by small-package carrier.

For specification information see pages 387-388.

Open Market / GSA SIN 33721



GSA SIN 33721

Description	Model	List Price
Wand™ LED Task Light (Silver or White)		
Freestanding LED Task Light	WANDFS	\$ 509
Freestanding LED Task Light (Occupancy Sensor)	WANDFSOC S	\$ 724

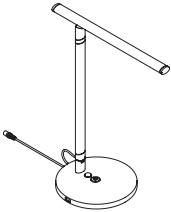

Freestanding LED Task light (Occupancy Sensor & Charging)	WANDFSUSB	\$ 754
---	-----------	--------



Splitty Task Light (Silver, White, or Black)		
Freestanding LED Task Light (Charging)	PRFTSKFS	\$ 690

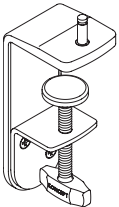

Clamp Mount (Silver only)	PRFTSKCL	\$ 80
---------------------------	----------	-------

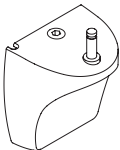

Tool Tile Mount (Silver only)	PRFTSKTR	\$ 80
-------------------------------	----------	-------

How to specify —
Select the Model Number from above.

1st Option:

Color
(for Splitty):

SVR Silver
WHT White
BLK Black

(for Wand LED):

SVR Silver
WHT White

Example: WANDFS.WHT

S Shippable by small-package carrier.

For specification information see pages 382.1-382.2.

GSA Reference Page

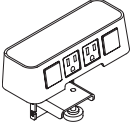
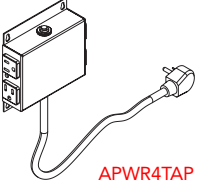
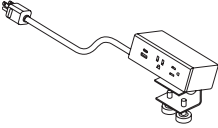
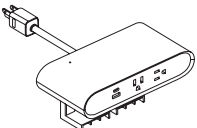
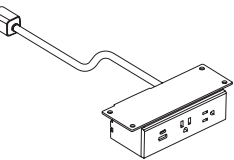
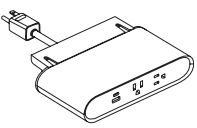
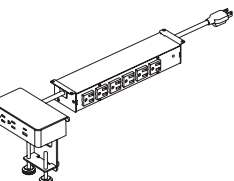
	Description	Model	List Price
 ACPWRMOD	Power/Data Module — Clamp On Worksurface 8"W x 7"D x 5½"H <ul style="list-style-type: none"> • 2 receptacles, 2 data terminals/blanks • 10' straight power cord only. UL Listed. • Available in Fog only, specify ACPWRMOD.FOG 	ACPWRMOD	\$ 515
 APWR4TAP	Power/Data Module — Under Worksurface, Quad Tap 7"W x 12"D x 3"H <ul style="list-style-type: none"> • 4 receptacles • 10' Straight cord only, no specification needed. • Available in Black only, no specification needed. • Example: APWR4TAP 	APWR4TAP	\$ 456
 APWRMOD.AC.S	Power Modules — Clamp On Worksurface, Rectangular 7½"W x 12¼"D x 5⅜"H <ul style="list-style-type: none"> • 2 receptacles, 1 USB-A, & 1 USB-C (AC) • Specify "QA" for 2 receptacles, 1 USB-A, & Qi wireless charging. • 10' Straight cord only (S). • Available in Snow (SNW) & Storm (STRM). • Example: APWRMOD.AC.S.SNW 	APWRMOD	\$ 761
 ARNDPWRMOD.QA.S	Power Modules — Clamp On Worksurface, Round 8¼"W x 16"D x 4½"H <ul style="list-style-type: none"> • 2 receptacles, 1 USB-A, & 1 USB-C (AC) • Specify "QA" for 2 receptacles, 1 USB-A, 1 USB-C, & Qi wireless charging. • 9' Straight cord only (S). • Available in Snow (SNW) & Storm (STRM.) • Example: ARNDPWRMOD.AC.S.SNW 	ARNDPWRMOD	\$ 713
 AUPWRMOD.AC.S	Power Module — Under Worksurface, Rectangular 7⅞"W x 9¼"D x 5⅜"H <ul style="list-style-type: none"> • 2 receptacles, 1 USB-A, & 1 USB-C (AC) • Power cord choices include a 10' Straight (S), 5' Interlink (I), 10' Hardwire (H), and 10' Chevron Fog & Storm Braided (B) cord. • Available in Snow (SNW), Storm (STRM), & Black (BLK). • Example: AUPWRMOD.AC.S.BLK 	AUPWRMOD	\$ 761
 AURNDPWRMOD.AC.S	Power Module — Under Worksurface, Round 8¼"W x 16"D x 4½"H <ul style="list-style-type: none"> • 2 receptacles, 1 USB-A, & 1 USB-C (AC) • 9' Straight cord only (S). • Available in Snow (SNW), Storm (STRM), & Black (BLK). • Example: AURNDPWRMOD.AC.S.BLK 	AURNDPWRMOD	\$ 713
 AABPWRMOD.AC.S	Power Module — Above/Below Worksurface 8¼"W x 16"D x 4½"H <ul style="list-style-type: none"> • Desktop unit includes 2 receptacles, 1 USB-A, & 1 USB-C (AC) • Under worksurface unit includes 6 receptacles. • Power cord choices include a 6' Straight cord (S) or Coiled cord (Q). • Desktop unit available in White (DWT) or Gray (DGY). • Example: AABPWRMOD.AC.S.DWT 	AABPWRMOD	\$ 1234

<p>How to specify — Select the Model Number from above.</p>	<p>1st Option: Ports (Final port option if applicable): AC USB-A+C QA Wireless Charging with 1 USB-A port (+\$125)</p>	<p>2nd Option: Cord Type (Power Module cord type if applicable): S Straight Cord B Braided Chevron Fog & Storm Cord (+\$91) I Interlink Cord (+\$55) H Hardwire Cord (+\$106) Q Coiled Cord</p>	<p>3rd Option: Color Option (if applicable): SNW Snow STRM Storm BLK Black DWT White DGY Gray</p>
--	--	---	---

Example: APWRMOD.AC.S.SNW ACPWRMOD.FOG

 Shippable by small-package carrier.

For specification information see pages 382.1-382.2.

GSA SIN 33721

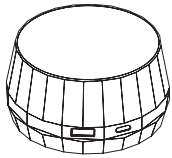

APWRPCK

Description	Model	List Price
Power/Data Module — Clamp On Worksurface		
5"W x 8"D x 4"H	APWRPCK <input type="checkbox"/>	\$ 693
<ul style="list-style-type: none"> • 1 USB-A & 1 USB-C port • 11' straight cord only, no specification needed. • Available in White & Silver only, no specification needed. • <i>Example: APWRPCK</i> 		

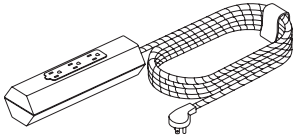

APWRSTRP

Power Strip — Sit-on-Surface, Wood		
4 3/8"W x 18 3/8"D x 4 3/8"H	APWRSTRP <input type="checkbox"/>	\$ 795
<ul style="list-style-type: none"> • 3 receptacles • 10' Braided cord in white nylon only, leather cord management strap included, no specification needed. • Available in wood finish only, no specification needed. • <i>Example: APWRSTRP</i> 		



AVSTA3PWR

Vesta Mobile Power		
6 1/2"W x 10"D x 8"H	AVSTA3PWR <input type="checkbox"/>	\$ 2000
<ul style="list-style-type: none"> • 3 receptacles, 1 dual USB-A, 1 USB-C • 10' Straight retractable cord only, no specification needed. • Available in Snow, Storm, Black, and Fog. Separate finish options available for outside and inside of unit. • <i>Example: AVSTA3PWR.STRM.SNW</i> 		

<p>How to specify — Select the Model Number from above.</p> <p>_____ .</p>	<p><i>1st Option:</i> Color Option 1 (if applicable):</p> <p>FOG Fog SNW Snow STRM Storm BLK Black</p> <p>_____ .</p>	<p><i>2nd Option:</i> Color Option 2 (if applicable):</p> <p>FOG Fog SNW Snow STRM Storm BLK Black</p> <p>_____</p>
---	--	--

Example: AVSTA3PWR.STRM.SNW

Shippable by small-package carrier.

For specification information see pages 382.3-382.4.

GSA SIN 33721

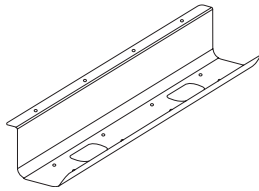

AJTRGH24

Description	Model	List Price		
		P1	P2	P3
Cable Management Trays				
24"W	AJTRGH24 S	\$ 123	N/A	N/A
36"W	AJTRGH36 S	\$ 147	N/A	N/A

- Available in 24" or 36" widths.
- Metal Cable Management Trays available in Black only, specify "P" for finish.
- Example: AJTRGH24.P

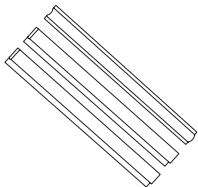

AWRSTRIP

Wire Management Strips/Channels				
	AWRSTRIP S	\$ 270	N/A	N/A

- Four wire management strips/channels in black only, no specification needed.
- Example: AWRSTRIP

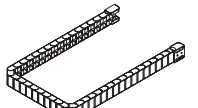

WKSWMC

Wire Management Chains				
36"	A9CLWMC S	\$ 357	N/A	N/A
58"	WKSWMC S	\$ 428	N/A	N/A

- Specify model A9CLWMC for 36" chain, specify model WKSWMC for 58" chain.
- A9CLWMC available in Black (E4), White (DW), or Silver (TI).
- WKSWMC available in Black only, no specification needed.
- Example: A9CLWMC.DW or WKSWMC

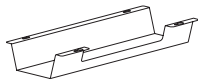

APWRTRGH17

Under Worksurface Troughs				
17"W	APWRTRGH17 S	\$ 108	N/A	N/A
36"W	APWRTRGH36 S	\$ 189	N/A	N/A

- Available in 17" or 36" widths.
- Under Worksurface Troughs available in Black only, no specification needed.
- Example: APWRTRGH17

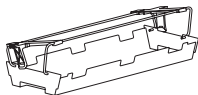

AFDTRGH20

Flip-Down Wire Management Trough				
20"W	AFDTRGH20 S	\$ 378	N/A	N/A
32"W	AFDTRGH32 S	\$ 429	N/A	N/A

- Available in 20" or 32" widths.
- Flip-Down Troughs available in Black only, no specification needed.
- Example: AFDTRGH20



AWIRECLT

Metal Wire Cleat				
	AWIRECLT S	\$ 129	\$ 142	\$ 148

- Available in standard metal paint finishes, see page 334 for options and specify desired finishes.
- Example: AWIRECLT.PJW

<p>How to specify — Select the Model Number from above.</p>	<p>1st Option: Paint (if applicable): See page 334 for finishes.</p> <p>Plastics (if applicable): DW White TI Silver E4 Black</p>
--	---

Examples: AJTRGH24.P A9CLWMC.DW

S Shippable by small-package carrier.

For specification information see pages 382.3-382.4.

GSA SIN 33721



ALEGCHASE26

Description	Model	List Price		
		P1	P2	P3
O-Leg Chase				
26"H	ALEGCHASE26 S	\$ 174	\$ 191	\$ 200

- O-Leg Chase is 26"H.
- Available in standard metal paint finishes, see page 334 for options and specify desired finishes.
- *Example: ALEGCHASE26.P27*

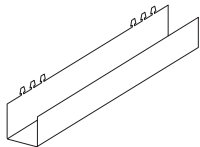

AMPCHASE

Panel Mounted Wire Chase				
17"H	AMPCHASE S	\$ 147	\$ 162	\$ 169

- Panel Chase is 17"H.
- Available in standard metal paint finishes, see page 334 for options and specify desired finishes.
- *Example: AMPCHASE.P27*

How to specify —
Select the Model Number from above.

1st Option:
Paint
(if applicable):
See page 334 for finishes.

Plastics
(if applicable):
DW White
TI Silver
E4 Black

Examples: ALEGCHASE26.P27

S *Shippable by small-package carrier.*

For specification information see pages 382.4-382.5.

GSA SIN 33721

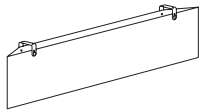

APWRMODEST36

Description	Model	List Price	
		A	B
Fabric Power Modesty			
	APWRMODEST36 <input type="checkbox"/>	\$ 1162	\$ 1196
	APWRMODEST48 <input type="checkbox"/>	\$ 1258	\$ 1297

- Available in Appoint, Binary, Centurion, Noble, Reflections, Disperse, and Spin panel fabric series.
- Specify desired fabric.
- Example: APWRMODEST36.NBLE16

How to specify —
Select the Model Number from above.

1st Option:
Fabric
(if applicable):
See page 14 for fabrics.

Example: APWRMODEST36.NBLE16

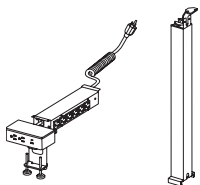

AHATPWRMOD2S or AHATPWRMOD3S

Description	Model	List Price		
		P1	P2	P3
Metal Telescoping HAT Wire Management				
	AHATPWRMOD2S <input type="checkbox"/>	\$ 1614	\$ 1654	\$ 1675
	AHATPWRMOD3S <input type="checkbox"/>	\$ 1646	\$ 1690	\$ 1711

- AHATPWRMOD2S pairs with 2-stage HAT bases.
- AHATPWRMOD3S pairs with 3-stage HAT bases.
- Desktop power module comes with 2 receptacles, 1 USB-A, and 1 USB-C port only, specify “AC” for this power configuration.
- Desktop power module available in White (DWT) or Gray (DGY) finishes, specify desired finish.
- Under worksurface power strip comes with 6 receptacles and is available in Black only, no specification needed.
- Metal Telescoping Chase available in the same paint finishes as Altitude HAT bases, specify desired paint finish.
- Example: AHATPWRMOD2S.AC.DWT.PJW

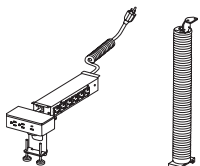

AHATPWRMOD2S or AHATPWRMOD3S

Fabric HAT Wire Management		AHATPWRMODF <input type="checkbox"/>	\$ 1476	\$ 1503	\$ 1516
-----------------------------------	--	--------------------------------------	---------	---------	---------

- AHATPWRMODF pairs with 2-stage and 3-stage HAT bases.
- Desktop power module comes with 2 receptacles, 1 USB-A, and 1 USB-C port only, specify “AC” for this power configuration.
- Desktop power module available in White (DWT) or Gray (DGY) finishes, specify desired finish.
- Under worksurface power strip comes with 6 receptacles and is available in Black only, no specification needed.
- Fabric HAT Chase available in three fabric finishes of Light (LGT), Medium (MDD), and Dark (DRK), specify desired fabric finish.
- Fabric HAT mounting brackets available in the same paint finishes as Altitude HAT bases, specify desired paint finish.
- Example: AHATPWRMODF.AC.DGY.LGT.PR5

How to specify —
Select the Model Number from above.

1st Option:
Ports
(Final port option if applicable):
AC USB-A+C

2nd Option:
Power Module Color Option
(if applicable):
DWT White
DGY Gray

3rd Option:
Fabric Chase Finish
(if applicable):
LGT Light
MDD Medium
DRK Dark

4th Option:
Metal Paint Option
(if applicable):
See page 334 for finishes.

AHATPWRMOD . AC . D

*Example: AHATPWRMOD3S.AC.DWT.P8C
AHATPWRMODF.AC.DGY.LGT.PR5*

Shippable by small-package carrier.

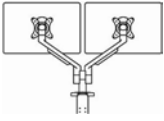
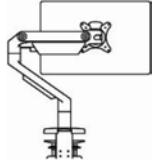
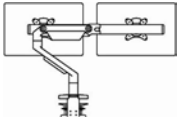
PIVOT MONITOR ARMS	Standard Dynamic Single	Standard Dynamic Dual	Heavy Duty Dynamic Single	Heavy Duty Dynamic Dual with Crossbar
Allsteel Model:	AMASTS	AMASD	AMASHD	AMADHD
				
Features:				
Price	\$488	\$983	\$838	\$1160
Colors	Black and Silver	Black and Silver	Black and Silver	Black and Silver
Monitor Rotation	180°	180°	180°	180°
Monitor Extension	18.75"	18.26"	20.75"	23"
Monitor Tilt Adjustment	+25°/-25°	+25°/-25°	+25°/-25°	+25°/-25°
Arm Height Adjustment	8.4" to 19"	9.6" to 20.1"	8.5" to 20"	8.5" to 20"
Weight Capacity	6.2 to 17 lbs.	6.2 to 17 lbs. per Arm	8 to 35 lbs.	17.5 lbs. per VESA Plate
Mounting Option	Grommet and Clamp Mounts	Grommet and Clamp Mounts	Grommet and Clamp Mounts	Grommet and Clamp Mounts
360° Lockout Feature	Yes	Yes	Yes	Yes
VESA Compatibility	75mm and 100mm	75mm and 100mm	75mm and 100mm	75mm and 100mm
Pole Height	N/A	N/A	N/A	N/A
Maximum Width per Monitor*	N/A	25"	N/A	25"
Worksurface Clamp Requirements	¾" to 2" Thick	¾" to 2" Thick	¾" to 2" Thick	¾" to 2" Thick
Worksurface Grommet Clamp Requirements	¾" to 2" Thick/Hole Diameter ⅜" to 2"	¾" to 2" Thick/Hole Diameter ⅜" to 2"	¾" to 2" Thick/Hole Diameter ⅜" to 2"	¾" to 2" Thick/Hole Diameter ⅜" to 2"
Environmental Info	94% Recycled Content	94% Recycled Content	94% Recycled Content	94% Recycled Content

*Use of APACSM Slider Model will allow for wider monitor capabilities

Pivot Standard Weight Monitor Arms

- Adaptable and adjustable to user preference the Pivot monitor arm offers a slim and refined design coupled with easy fingertip adjustment.
- Multiple points of adjustment including 360 degree swivel with optional 180 degree lockout, 18.75" extension, and 10" of height adjustment.
- Monitor tilts +25/-25 degrees.
- Standard weight arms utilize a tension spring that allows for effortless adjustment of monitors to proper ergonomic positions.
- Tension adjustment at multiple points allows for proper adjustment for monitors weight between 6-17 lbs.
- Model includes grommet and worksurface mounting options.
- Desk clamp mounts require ¾" – 2" thick surfaces; grommet mount requires hole diameter of ⅜" to 2" wide and accommodates up to 2" thick surfaces.
- Integrated cable management included with each model. Black models ship with all black cable management pieces, Silver models ship with grey wire management but optional white pieces ship in the box and can be installed on site.
- Dual monitor arm supports up to 25" wide monitors. Wider monitors may require use of optional slider mount model.
- Pivot arms are VESA 75mm and 100mm compatible.
- Quick release feature simplifies monitor installation and changes.

Pivot Slider Mount

- Provides 11.8" of horizontal movement.
- Allows for wider monitors to be used on dual monitor arms and sit flush side by side.
- Not compatible with Pivot Heavy Duty Series.

Pivot Heavy Duty Series

- Adaptable and adjustable to user preference the Pivot monitor arm offers a slim and refined design coupled with easy fingertip adjustment.
- Multiple points of adjustment including 360 degree swivel with optional 180 degree lockout, 20.75" extension, and 12" of height adjustment.
- Monitor tilts +25/-25 degrees.
- Tension adjustment at multiple points allows for proper adjustment for monitors weight between 8-35 lbs.
- Model includes grommet and worksurface mounting options.
- Desk clamp mounts require ¾" – 2" thick surfaces; grommet mount requires hole diameter of ⅜" to 2" wide and accommodates up to 2" thick surfaces.
- Integrated cable management included with each model. Black models ship with all black cable management pieces, Silver models ship with grey wire management but optional white pieces ship in the box and can be installed on site.
- Dual monitor arm supports up to 2 monitors weight 4-17.5 lbs each.
- Pivot arms are VESA 75mm and 100mm compatible.
- Quick release feature simplifies monitor installation and changes.

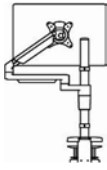
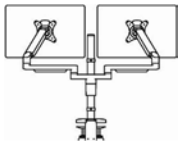
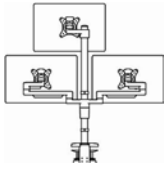
PIVOT MONITOR ARMS	Dynamic Single Post	Dynamic Dual Post	Triple Fixed Post
Allsteel Model:	APASD	APADD	APATF
			
Features:			
Price	\$660	\$923	\$1166
Colors	Silver	Silver	Silver
Monitor Rotation	180°	180°	180°
Monitor Extension	21"	21"	23"
Monitor Tilt Adjustment	+25°/-25°	+25°/-25°	+25°/-25°
Arm Height Adjustment	10.6"	10.6"	N/A
Weight Capacity	6.2 to 17 lbs.	6.2 to 17 lbs. per Arm	17 lbs. per arm
Mounting Option	Grommet and Clamp Mounts	Grommet and Clamp Mounts	Grommet and Clamp Mounts
360° Lockout Feature	Yes	Yes	Yes
VESA Compatibility	75mm and 100mm	75mm and 100mm	75mm and 100mm
Pole Height	17.7"	17.7"	27.5"
Maximum Width per Monitor*	25"	25"	25"
Worksurface Clamp Requirements	7/8" to 2" Thick	7/8" to 2" Thick	7/8" to 2" Thick
Worksurface Grommet Clamp Requirements	7/8" to 2" Thick/Hole Diameter 3/16" to 2"	7/8" to 2" Thick/Hole Diameter 3/16" to 2"	7/8" to 2" Thick/Hole Diameter 3/16" to 2"
Environmental Info	94% Recycled Content	94% Recycled Content	94% Recycled Content

*Use of APACSM Slider Model will allow for wider monitor capabilities

Pivot Post Series

- Adaptable and adjustable to user preference the Pivot monitor arm offers a slim and refined design coupled with easy fingertip adjustment.
- Multiple points of adjustment including 360 degree swivel with 21" extension and 10.6" of height adjustment.
- Monitor tilts +25/-25 degrees.
- Tension adjustment at multiple points allows for proper adjustment for monitors weight between 6.5-17 lbs per arm.
- Model includes grommet and worksurface mounting options.
- Desk clamp mounts require 7/8" – 2" thick surfaces; grommet mount requires hole diameter of 3/16" to 2" wide and accommodates up to 2" thick surfaces.
- Integrated cable management included with each model. Silver color option with grey wire management only.
- Dual monitor arm supports up to 25" wide monitors. Wider monitors may require use of optional slider mount model.
- Single and dual models have a post height of 17.7"; Triple monitor model has a post height of 27.5".
- Pivot arms are VESA 75mm and 100mm compatible.
- Quick release feature simplifies monitor installation and changes.

Pivot Counterweight Kit

- Counterweight Kit to be used with monitors weighing less than 6 lbs.
- Gray color only.
- Counterweight weighs 1 lb. 6 oz.

Pivot Conversion Kits





- Kit allows user to transform single monitor arm (Standard, Heavy Duty, or Post) into Dual Arm configuration
- Available in black and silver, Post arm only available in silver
- Required wire management included
- Once assembled, will aesthetically emulate dual configuration of chosen arm

Accessories — Pivot Monitor Arms

Pivot

For specification information see pages 392-393.

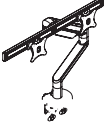
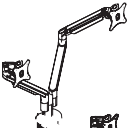
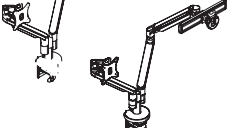
GSA SIN PENDING, GSA SIN 33721

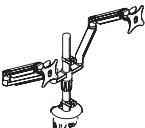
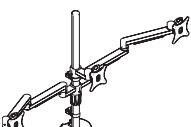
Description	Model	List Price
Pivot Monitor Arms		
 Dynamic Single Monitor - Standard Weight	AMASTS S	\$ 488
Dynamic Single Monitor - Standard Weight for GSA *Silver Only Open for order Fall 2020 – GSA SIN 33721.	AMASTS-G	\$ 576
 Dynamic Single Monitor - Heavy Weight	AMASHD S	\$ 838
 Dynamic Dual Monitor with Crossbar	AMADHD S	\$ 1160
 Dynamic Dual Monitor - Standard Weight	AMASD S	\$ 983
 Dynamic Dual Monitor - Standard Weight for GSA *Silver Only **Slider Mount included. Open for order Fall 2020 – GSA SIN 33721.	AMASD-G	\$ 1048
 Single Dynamic Post Arm *Silver Only	APASD S	\$ 660
 Double Dynamic Post Arm *Silver Only	APADD S	\$ 923
 Triple Fixed Post Mount *Silver Only	APATF S	\$ 1166

<p>How to specify — Select the Model Number from above.</p> <p>A .</p>	<p>1st Option: Select the Color: SVR Silver BLK Black</p> <p> </p>
---	---

Example: AMADHD.BLK

S Shippable by small-package carrier.

Accessories — Pivot Monitor Arms

Pivot

For specification information see pages 392-393.

Open Market



Description	Model	List Price
Pivot Monitor Arms		
Monitor Arm Sliding Mount	APACSM <input type="checkbox"/>	\$ 233

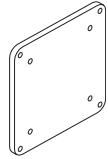

Monitor Arm Counterweight	APACW <input type="checkbox"/>	\$ 55
---------------------------	--------------------------------	-------

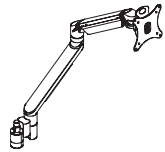

Pivot Monitor Arm Standard Single Conversion Kit	AMASTSCK	\$ 546
--	----------	--------

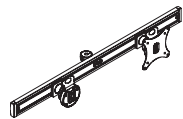

Pivot Monitor Arm Heavy Duty Single Conversion Kit	AMASHDCK	\$ 477
--	----------	--------

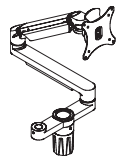

Pivot Single Post Arm Conversion Kit	APASDCK	\$ 695
* Silver Only		

<p>How to specify — Select the Model Number from above.</p>	<p>1st Option: Select the Color: SVR Silver BLK Black</p>
<p>A .</p>	<p> </p>

Example:

Laterals, Pedestals and Storage, Painted Wood Storage

Standard Options

- Random Keying — The factory will assign key(s) arbitrarily using key numbers from chart below.
- Omit Lock Core — The factory will omit lock cores. Removable lock core kits with specific key number must be ordered to facilitate keying alike in the field.

Replacing Lock Cores

- Lock must be in the unlocked position.
- Insert core removal key and pull core straight out. (Reach units require rotating key 90° clockwise past unlocked position.)
- Insert new core with core removable key, hold core into lock and withdraw core removal key.
- Retain original core for future use.

Vertical Files

Standard Options







- Random Keying — The factory will assign key(s) arbitrarily (see below chart for key numbers).

Key Alike Process

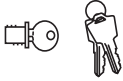
- Order standard product which will be shipped with factory installed locks and random numbered cores.
- Order the appropriate quantity of like numbered cores required for each workstation or keyed area.
- Simply replace the factory installed core with the replacement cores after product has been installed.





	Random Keying	Omit Lock Core	Key Numbers	Lock Core Kit	Master Key
Align™ Laterals	X	X	101E-225E	ALKF23C*	AMKF22
Align New Low Credenzas, Towers, Pedestals (“YP” prefix models)	X	X	101E-225E	ALKF26EL	AMKF22
Align Old Pedestals (for New Pedestals after 11/2015 see above)	X	X	101E-225E	ALKF23C*	AMKF22
Align Old Towers (for New Towers after 2/2016 see above)	X	X	101E-225E	ALKF23C*	AMKF22
Align Metal Front Lockers	X	X	101E-225E	ALKF26EL	AMKF22
Align Laminate Front Lockers	X	X	101E-225E	ALKF23C*	AMKF22
Approach™ Desking and Storage	X	X	101E-225E	ALKF26EL	AMKF22
Center Drawer (CSDC19/25)	X	X	101E-225E	ALKF23C*	AMKF22
Essentials™ Laterals	X	X	101E-225E	ALKF23C	AMKF22
Essentials Overfile Cabinets	X	X	101E-225E	ALKF23C*	AMKF22
Essentials Pedestals	X	X	101E-225E	ALKF23C*	AMKF22
Essentials Personal Tower and Files	X	X	101E-225E	ALKF23C*	AMKF22
Further™ Laminate Storage	X	X	101E-225E	ALKF23C*	AMKF22
Hutches	X	X	101E-225E	ALKF23C*	AMKF22
Involve® Laminate Storage	X	X	101E-225E	ALKF23C*	AMKF22
Overheads (Flipper Door, including RTA)	X	X	101E-225E	ALKF23C*	AMKF22
Overheads (Receding Door)	X	X	101E-225E	ALKF23C*	AMKF22
Vertical Files A990/A940	X		101E-225E	ALKF23C*	AMKF22

*ALKF23C is chrome. Optional black core for wood casegoods is ALKF23CE4. Optional matte silver core is ALKF26EL.

	Description	Model	List Price
	Removable Lock Core Kits**	Key Numbers 101E-225E	
	Brushed Chrome used on metal and painted wood casegoods product produced after 2/3/97; A980, A990, and A940 Series vertical files; Persona™ pedestals produced after 8/22/09; Reach® Storage units produced after 10/5/09; and receding door overheads produced after 8/1/10. Includes one core, two keys, one core removal tool, adapter and instructions	ALKF23C*** 	\$ 30
	Black used on veneer casegoods product. Includes one core, two keys, one core removal tool, adapter and instructions. Core matches manufactured lock on metal casegoods but Black core can be used with veneer and laminate product.	ALKF23CE4*** 	\$ 30
	Matte Silver used on Approach and Align metal credenzas, new pedestals, and new towers. Includes one core, two keys, one core removal tool, adapter, and instructions.	ALKF26EL*** 	\$ 30
 Open Market	Master Key (One key) Available to authorized dealers only on faxed orders. Will open ALKF23C, LKF23C, ALKF23CE4, LKF23CE4, LKF24, LKF25EL, and LKF25E4 locks numbered 101E-225E.	AMKF22 	\$ 31

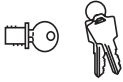
HOW TO ORDER:
Note: Numbers 101E-225E are available. Orders without numbers specified will be keyed at random.
SAMPLE ORDER:

Quantity	Model	Color
6	ALKF23C	X121E
1	AMKF22	X

	Brushed Chrome Removable Lock Core Kit* **	Key Numbers 101N-225N	
	Includes one core, two keys, one core removal tool, adapter, and instructions	ALKF23CN*** 	\$ 30
 Open Market	Master Key* (One key) Available to authorized dealers only on electronic orders. Will open ALKF23CN and LKF23CN locks numbered 101N-225N.	AMF22 	\$ 31

N series lock cores (ALKF23CN) are a replacement part for legacy Allsteel products. N series lock cores were used in all Persona pedestals produced between January 1996 and August 2009 as well as Receding Door Overheads produced between January 1996 and August 2010. N series lock cores are NOT used in current product and should not be ordered for product produced after these dates. E series lock cores are used in current product, see above.

***On existing Premium and Asset lateral, use N-Series locks.**

** Removable Lock Core Kits are intended for use with Allsteel systems furniture and are approved under GSA SIN 33721. When purchased separately and used without Allsteel systems furniture, those Removable Lock Core Kits marked by (**) are considered Open Market.

*** When purchased separately without a configurable TAA compliant end product, not on GSA contract.

EASY LOCK PROGRAM

The Allsteel Easy Lock Program simplifies the lock-core ordering process when multiple cores are being specified. The Easy Lock cores can be used with Allsteel storage that currently uses the **ALKF23C** cores (all storage except Receding Door Overheads).

To ensure ease of ordering in different situations the Easy Lock cores can be specified in three different ways — Random, Specified or Sequential.

Random Keying

The Random Keying option is provided for instances where there are multiple orders or phases to a project and the offices need to be keyed alike but the key numbering is not required. With the random keying option key numbers are not specified, however, the core kits will be in sequential order from a random starting point.

Example: There are 15 offices which each have 5 black locks that need to be keyed alike, but the actual key numbers are not important.

This order would look like: **LKFE5BLK.X.15**

This specifies that 15 5-core kits are needed in black with random key numbers.

Specified Keying

The Specified Keying option is provided for the instances where there is a specific key number desired for all of the cores ordered.

Example: There are 10 offices which each have 2 silver locks that need to be keyed-alike with key number 202.

This order would look like: **LKFE2SLV.X202.10**

This specifies that 10 2-core kits are needed in silver with key number 202.

Sequential Keying

Allsteel Sequential Keying option is provided for the instances when there are multiple orders or phases to a project and it is imperative that key numbers are not duplicated.

Example: A multiple phase project has 60 total offices — 40 offices in Phase I, and 20 offices in Phase II. The project manager has expressed a need to have keyed-alike offices but doesn't want any of the offices to use the same key numbers.

The first 40 offices have 4 silver locks each that need to be keyed-alike.

This order would look like: **LKFE4SLV.SEQ/101.40**

This specifies that 40 4-core kits are needed in silver and the starting number is 101.

The second set of 20 offices only have 3 silver locks each that need to be keyed-alike; and it is important which key number starts off the sequence to ensure that no key number is duplicated. It is known that the first key range was key numbers 101-140.

The second order would look like: **LKFE3SLV.SEQ/141.20**

This specifies that 20 3-core kits are needed in silver and key sequence has to start at key number 141.

HOW TO ORDER:

Numbers 101-225 are available. Orders without key numbers specified will be keyed at random.

SAMPLE ORDER FOR EXAMPLES GIVEN:

Model	Key Type	Quantity
LKFE5BLK.	X.	15
LKFE2SLV.	X202.	10
LKFE4SLV.	SEQ/101.	40
LKFE3SLV.	SEQ/141.	20

NOTE: Quantity required is last number in model.option string.

Description	Model / Color	List Price
Easy Lock Lock-Core		
Lock Core Kit — 1 core, 2 keys	LKFE1 _____	\$ 30
Lock Core Kit — 2 cores, 2 keys	LKFE2 _____	\$ 61
Lock Core Kit — 3 cores, 2 keys	LKFE3 _____	\$ 91
Lock Core Kit — 4 cores, 2 keys	LKFE4 _____	\$ 121
Lock Core Kit — 5 cores, 2 keys	LKFE5 _____	\$ 151
Add color suffix to model: SLV Silver, BLK Black, MTS Matte Silver		
Note: One core removal key minimum per order. One additional core removal key per 25 lock-cores will be shipped.		
Note: When purchased separately without a configurable TAA compliant end product, not on GSA contract.		
Master Key		
(One key) Available to authorized dealers only on faxed orders.		
	AMKF22	\$ 31

How to specify using Easy Lock Program:

Step 1 — Count the number of lock cores and color required in each workstation that need to be keyed alike.

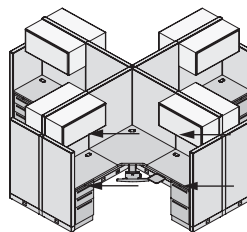

2 overheads with 1 lock-core each = 2
 2 pedestals with 1 lock-core each = 2
Total silver lock-cores per station = 4

Step 2 — Count the total number of workstations needing 4 lock-cores.

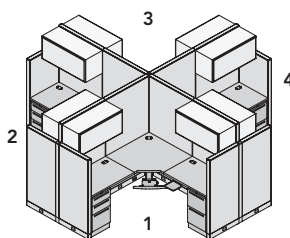

4 total workstations

Step 3 — Specify model number based on total number of lock-cores in a station and quantity of kits based on number of workstations.

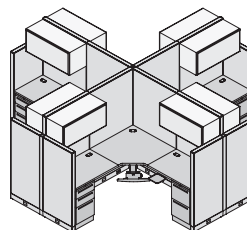

LKFE4SLV.X.4

Lock-Cores per station
 Color of Core
 Number of workstations

Description	Model	P1 Paint List Price	P2 Paint List Price	P3 Paint List Price
Touch-Up Paint — Brush				
Bottle of Touch-Up Paint with Brush — 0.5 oz.	APTK S	\$ 102	\$ 114	\$ 122
Touch-Up Paint — Spray				
Spray Can of Touch-Up Paint — 12 oz.	ARSLCC S	\$ 102	\$ 114	\$ 122

How to specify —
Select the Model Number from above.

A | | | | | | | | | | .

1st Option:
Paint Color:
P1 P2 P3

See page 16 for options. Some colors are limited to brush or spray.

| | | | | | | | | |

Examples: APTK.P02 ARSLCC.P02

S Shippable by small-package carrier.

Model Number	Description	Grade G	Grade H	Grade J
Stride® Tackable Acoustical Tiles — see pages 176-177				
Z40724T	7½"H x 24"W Tile	\$ 137	\$ 144	\$ 151
Z40730T	7½"H x 30"W Tile	\$ 154	\$ 162	\$ 171
Z40736T	7½"H x 36"W Tile	\$ 169	\$ 180	\$ 190
Z40742T	7½"H x 42"W Tile	\$ 189	\$ 200	\$ 210
Z40748T	7½"H x 48"W Tile	\$ 201	\$ 213	\$ 227
Z40760T	7½"H x 60"W Tile	\$ 230	\$ 246	\$ 263
Z41524T	15"H x 24"W Tile	\$ 197	\$ 209	\$ 223
Z41530T	15"H x 30"W Tile	\$ 215	\$ 231	\$ 248
Z41536T	15"H x 36"W Tile	\$ 240	\$ 260	\$ 280
Z41542T	15"H x 42"W Tile	\$ 265	\$ 286	\$ 310
Z41548T	15"H x 48"W Tile	\$ 292	\$ 318	\$ 344
Z41560T	15"H x 60"W Tile	\$ 338	\$ 371	\$ 403
Z42224T	22½"H x 24"W Tile	\$ 247	\$ 267	\$ 287
Z42230T	22½"H x 30"W Tile	\$ 279	\$ 304	\$ 328
Z42236T	22½"H x 36"W Tile	\$ 309	\$ 340	\$ 369
Z42242T	22½"H x 42"W Tile	\$ 346	\$ 379	\$ 414
Z42248T	22½"H x 48"W Tile	\$ 384	\$ 422	\$ 462
Z42260T	22½"H x 60"W Tile	\$ 446	\$ 495	\$ 543
Z43024T	30"H x 24"W Tile	\$ 309	\$ 335	\$ 361
Z43030T	30"H x 30"W Tile	\$ 343	\$ 376	\$ 408
Z43036T	30"H x 36"W Tile	\$ 387	\$ 425	\$ 465
Z43042T	30"H x 42"W Tile	\$ 426	\$ 471	\$ 517
Z43048T	30"H x 48"W Tile	\$ 469	\$ 522	\$ 575
Z43060T	30"H x 60"W Tile	\$ 548	\$ 613	\$ 679
Z43724T	37½"H x 24"W Tile	\$ 377	\$ 410	\$ 442
Z43730T	37½"H x 30"W Tile	\$ 421	\$ 464	\$ 504
Z43736T	37½"H x 36"W Tile	\$ 477	\$ 526	\$ 574
Z43742T	37½"H x 42"W Tile	\$ 524	\$ 581	\$ 638
Z43748T	37½"H x 48"W Tile	\$ 576	\$ 641	\$ 707
Z43760T	37½"H x 60"W Tile	\$ 681	\$ 764	\$ 844
Z44524T	45"H x 24"W Tile	\$ 434	\$ 472	\$ 512
Z44530T	45"H x 30"W Tile	\$ 488	\$ 537	\$ 585
Z44536T	45"H x 36"W Tile	\$ 550	\$ 609	\$ 669
Z44542T	45"H x 42"W Tile	\$ 609	\$ 677	\$ 746
Z44548T	45"H x 48"W Tile	\$ 672	\$ 751	\$ 830
Z44560T	45"H x 60"W Tile	\$ 784	\$ 883	\$ 980
Z45224T	52½"H x 24"W Tile	\$ 487	\$ 532	\$ 578
Z45230T	52½"H x 30"W Tile	\$ 554	\$ 611	\$ 668
Z45236T	52½"H x 36"W Tile	\$ 623	\$ 691	\$ 760
Z45242T	52½"H x 42"W Tile	\$ 689	\$ 769	\$ 850
Z45248T	52½"H x 48"W Tile	\$ 762	\$ 853	\$ 946
Z45260T	52½"H x 60"W Tile	\$ 893	\$ 1007	\$ 1121
Z46024T	60"H x 24"W Tile	\$ 551	\$ 604	\$ 657
Z46030T	60"H x 30"W Tile	\$ 627	\$ 692	\$ 758
Z46036T	60"H x 36"W Tile	\$ 736	\$ 815	\$ 894
Z46042T	60"H x 42"W Tile	\$ 810	\$ 901	\$ 994
Z46048T	60"H x 48"W Tile	\$ 882	\$ 987	\$ 1091
Z46060T	60"H x 60"W Tile	\$ 998	\$ 1130	\$ 1260

Model Number	Description	Grade G	Grade H	Grade J
Stride Tackable Acoustical Port Tiles — see pages 176-177				
Z40724E	7½"H x 24"W Tile	\$ 277	\$ 289	\$ 301
Z40730E	7½"H x 30"W Tile	\$ 294	\$ 310	\$ 325
Z40736E	7½"H x 36"W Tile	\$ 321	\$ 340	\$ 361
Z40742E	7½"H x 42"W Tile	\$ 338	\$ 360	\$ 383
Z40748E	7½"H x 48"W Tile	\$ 359	\$ 385	\$ 410
Z40760E	7½"H x 60"W Tile	\$ 403	\$ 435	\$ 467
Z41524E	15"H x 24"W Tile	\$ 355	\$ 381	\$ 406
Z41530E	15"H x 30"W Tile	\$ 391	\$ 423	\$ 455
Z41536E	15"H x 36"W Tile	\$ 422	\$ 460	\$ 498
Z41542E	15"H x 42"W Tile	\$ 455	\$ 500	\$ 545
Z41548E	15"H x 48"W Tile	\$ 491	\$ 542	\$ 593
Z41560E	15"H x 60"W Tile	\$ 562	\$ 625	\$ 688
Z42224E	22½"H x 24"W Tile	\$ 432	\$ 470	\$ 508
Z42230E	22½"H x 30"W Tile	\$ 477	\$ 524	\$ 572
Z42236E	22½"H x 36"W Tile	\$ 526	\$ 583	\$ 641
Z42242E	22½"H x 42"W Tile	\$ 573	\$ 640	\$ 707
Z42248E	22½"H x 48"W Tile	\$ 620	\$ 696	\$ 772
Z42260E	22½"H x 60"W Tile	\$ 719	\$ 816	\$ 910
Z43024E	30"H x 24"W Tile	\$ 506	\$ 557	\$ 608
Z43030E	30"H x 30"W Tile	\$ 568	\$ 631	\$ 694
Z43036E	30"H x 36"W Tile	\$ 631	\$ 707	\$ 783
Z43042E	30"H x 42"W Tile	\$ 690	\$ 779	\$ 869
Z43048E	30"H x 48"W Tile	\$ 755	\$ 857	\$ 958
Z43060E	30"H x 60"W Tile	\$ 873	\$ 1002	\$ 1128
Z43724E	37½"H x 24"W Tile	\$ 607	\$ 670	\$ 733
Z43730E	37½"H x 30"W Tile	\$ 682	\$ 761	\$ 841
Z43736E	37½"H x 36"W Tile	\$ 754	\$ 851	\$ 945
Z43742E	37½"H x 42"W Tile	\$ 835	\$ 946	\$ 1057
Z43748E	37½"H x 48"W Tile	\$ 907	\$ 1036	\$ 1162
Z43760E	37½"H x 60"W Tile	\$ 1064	\$ 1224	\$ 1383
Z44524E	45"H x 24"W Tile	\$ 677	\$ 753	\$ 829
Z44530E	45"H x 30"W Tile	\$ 772	\$ 869	\$ 963
Z44536E	45"H x 36"W Tile	\$ 857	\$ 971	\$ 1084
Z44542E	45"H x 42"W Tile	\$ 952	\$ 1085	\$ 1219
Z44548E	45"H x 48"W Tile	\$ 1043	\$ 1197	\$ 1349
Z44560E	45"H x 60"W Tile	\$ 1215	\$ 1407	\$ 1597
Z45224E	52½"H x 24"W Tile	\$ 764	\$ 853	\$ 943
Z45230E	52½"H x 30"W Tile	\$ 858	\$ 969	\$ 1080
Z45236E	52½"H x 36"W Tile	\$ 969	\$ 1102	\$ 1236
Z45242E	52½"H x 42"W Tile	\$ 1072	\$ 1228	\$ 1384
Z45248E	52½"H x 48"W Tile	\$ 1173	\$ 1351	\$ 1529
Z45260E	52½"H x 60"W Tile	\$ 1383	\$ 1606	\$ 1829
Z46024E	60"H x 24"W Tile	\$ 832	\$ 934	\$ 1035
Z46030E	60"H x 30"W Tile	\$ 956	\$ 1085	\$ 1211
Z46036E	60"H x 36"W Tile	\$ 1112	\$ 1266	\$ 1418
Z46042E	60"H x 42"W Tile	\$ 1225	\$ 1403	\$ 1581
Z46048E	60"H x 48"W Tile	\$ 1334	\$ 1537	\$ 1740
Z46060E	60"H x 60"W Tile	\$ 1542	\$ 1797	\$ 2051

Appendix

Fabric Grade Pricing

Model Number	Description	Grade G	Grade H	Grade J
Stride® Tackable Acoustical Tiles to-the-Floor — see page 180				
Z42224TF	22½"H x 24"W Tile	\$ 383	\$ 421	\$ 461
Z42230TF	22½"H x 30"W Tile	\$ 430	\$ 478	\$ 527
Z42236TF	22½"H x 36"W Tile	\$ 481	\$ 540	\$ 598
Z42242TF	22½"H x 42"W Tile	\$ 539	\$ 607	\$ 676
Z42248TF	22½"H x 48"W Tile	\$ 585	\$ 662	\$ 741
Z42260TF	22½"H x 60"W Tile	\$ 683	\$ 780	\$ 878
Z43024TF	30"H x 24"W Tile	\$ 459	\$ 510	\$ 563
Z43030TF	30"H x 30"W Tile	\$ 523	\$ 588	\$ 652
Z43036TF	30"H x 36"W Tile	\$ 588	\$ 665	\$ 744
Z43042TF	30"H x 42"W Tile	\$ 653	\$ 743	\$ 834
Z43048TF	30"H x 48"W Tile	\$ 720	\$ 823	\$ 927
Z43060TF	30"H x 60"W Tile	\$ 843	\$ 972	\$ 1102

Z43724TF	37½"H x 24"W Tile	\$ 552	\$ 617	\$ 681
Z43730TF	37½"H x 30"W Tile	\$ 630	\$ 712	\$ 792
Z43736TF	37½"H x 36"W Tile	\$ 707	\$ 804	\$ 902
Z43742TF	37½"H x 42"W Tile	\$ 791	\$ 904	\$ 1017
Z43748TF	37½"H x 48"W Tile	\$ 870	\$ 999	\$ 1129
Z43760TF	37½"H x 60"W Tile	\$ 1023	\$ 1183	\$ 1345

Z44524TF	45"H x 24"W Tile	\$ 632	\$ 709	\$ 788
Z44530TF	45"H x 30"W Tile	\$ 718	\$ 815	\$ 913
Z44536TF	45"H x 36"W Tile	\$ 819	\$ 934	\$ 1050
Z44542TF	45"H x 42"W Tile	\$ 913	\$ 1049	\$ 1183
Z44548TF	45"H x 48"W Tile	\$ 1003	\$ 1156	\$ 1312
Z44560TF	45"H x 60"W Tile	\$ 1185	\$ 1380	\$ 1573

Z45224TF	52½"H x 24"W Tile	\$ 710	\$ 800	\$ 891
Z45230TF	52½"H x 30"W Tile	\$ 814	\$ 927	\$ 1040
Z45236TF	52½"H x 36"W Tile	\$ 944	\$ 1080	\$ 1214
Z45242TF	52½"H x 42"W Tile	\$ 1051	\$ 1211	\$ 1368
Z45248TF	52½"H x 48"W Tile	\$ 1148	\$ 1328	\$ 1510
Z45260TF	52½"H x 60"W Tile	\$ 1350	\$ 1576	\$ 1802

Z46024TF	60"H x 24"W Tile	\$ 790	\$ 893	\$ 997
Z46030TF	60"H x 30"W Tile	\$ 904	\$ 1033	\$ 1163
Z46036TF	60"H x 36"W Tile	\$ 1052	\$ 1205	\$ 1361
Z46042TF	60"H x 42"W Tile	\$ 1169	\$ 1349	\$ 1531
Z46048TF	60"H x 48"W Tile	\$ 1288	\$ 1494	\$ 1700
Z46060TF	60"H x 60"W Tile	\$ 1513	\$ 1771	\$ 2029

Model Number	Description	Grade G	Grade H	Grade J
Stride Wall-Mounted Tackboards — see page 266				
ZWMTB1530	15"H x 30"W Tackboard	\$ 1163	\$ 1228	\$ 1290
ZWMTB1536	15"H x 36"W Tackboard	\$ 1218	\$ 1294	\$ 1370
ZWMTB1542	15"H x 42"W Tackboard	\$ 1278	\$ 1367	\$ 1455
ZWMTB1548	15"H x 48"W Tackboard	\$ 1334	\$ 1436	\$ 1537
ZWMTB1560	15"H x 60"W Tackboard	\$ 1443	\$ 1571	\$ 1697
ZWMTB2024	20"H x 24"W Tackboard	\$ 1209	\$ 1276	\$ 1344
ZWMTB2030	20"H x 30"W Tackboard	\$ 1281	\$ 1366	\$ 1451
ZWMTB2036	20"H x 36"W Tackboard	\$ 1348	\$ 1450	\$ 1551
ZWMTB2042	20"H x 42"W Tackboard	\$ 1425	\$ 1543	\$ 1662
ZWMTB2048	20"H x 48"W Tackboard	\$ 1489	\$ 1625	\$ 1759
ZWMTB2060	20"H x 60"W Tackboard	\$ 1624	\$ 1793	\$ 1963

Model Number	Description	Grade G	Grade H	Grade J
Stride Tackable Fabric Accessory for Cantilever Storage — see page 268				
ZS42SF	for use w/ 42½"H unit	\$ 794	\$ 880	\$ 967
ZS50SF	for use w/ 50"H unit	\$ 1042	\$ 1176	\$ 1308

Model Number	Description	Grade G	Grade H	Grade J
Altitude® A8 Screen Kits — see page 369				
FDSC48U	48"W	\$ 2257	\$ 2282	\$ 2344
FDSC54U	54"W	\$ 2335	\$ 2361	\$ 2426
FDSC60U	60"W	\$ 2405	\$ 2431	\$ 2497
FDSC66U	66"W	\$ 2547	\$ 2575	\$ 2647
FDSC72U	72"W	\$ 2742	\$ 2771	\$ 2849

FDSC48LL	48"W	\$ 1453	\$ 1468	\$ 1504
FDSC48LR	48"W	\$ 1453	\$ 1468	\$ 1504
FDSC54LL	54"W	\$ 1706	\$ 1724	\$ 1767
FDSC54LR	54"W	\$ 1706	\$ 1724	\$ 1767
FDSC60LL	60"W	\$ 1785	\$ 1803	\$ 1849
FDSC60LR	60"W	\$ 1785	\$ 1803	\$ 1849
FDSC66LL	66"W	\$ 2140	\$ 2163	\$ 2223
FDSC66LR	66"W	\$ 2140	\$ 2163	\$ 2223
FDSC72LL	72"W	\$ 2254	\$ 2280	\$ 2342
FDSC72LR	72"W	\$ 2254	\$ 2280	\$ 2342

FDSC48R	48"W	\$ 1404	\$ 1420	\$ 1454
FDSC54R	54"W	\$ 1439	\$ 1454	\$ 1490
FDSC60R	60"W	\$ 1549	\$ 1564	\$ 1602
FDSC66R	66"W	\$ 1791	\$ 1811	\$ 1860
FDSC72R	72"W	\$ 1908	\$ 1929	\$ 1980

Model Number	Grade 9	Grade 10	Grade 11	Grade 12	Grade 13	Grade 14	Grade 15	Grade 16	Grade 17	Grade 18	Grade 19	Grade 20	Grade 21	Grade 22
Stride® Seat Cushions for Painted Wood Storage — see page 262														
K5CT1815SC	\$ 641	\$ 680	\$ 719	\$ 759	\$ 807	\$ 856	\$ 904	\$ 954	\$ 1002	\$ 1052	\$ 1100	\$ 1150	\$ 1198	\$ 1247
K5CT1818SC	\$ 664	\$ 703	\$ 742	\$ 782	\$ 830	\$ 879	\$ 927	\$ 977	\$ 1025	\$ 1075	\$ 1123	\$ 1173	\$ 1221	\$ 1270
K5CT1824SC	\$ 692	\$ 731	\$ 770	\$ 810	\$ 858	\$ 907	\$ 955	\$ 1005	\$ 1053	\$ 1103	\$ 1151	\$ 1201	\$ 1249	\$ 1298
K5CT1830SC	\$ 724	\$ 763	\$ 802	\$ 842	\$ 890	\$ 939	\$ 987	\$ 1037	\$ 1085	\$ 1135	\$ 1183	\$ 1233	\$ 1281	\$ 1330
K5CT1836SC	\$ 780	\$ 819	\$ 858	\$ 898	\$ 946	\$ 995	\$ 1043	\$ 1093	\$ 1141	\$ 1191	\$ 1239	\$ 1289	\$ 1337	\$ 1386
K5CT1848SC	\$ 795	\$ 834	\$ 873	\$ 913	\$ 961	\$ 1010	\$ 1058	\$ 1108	\$ 1156	\$ 1206	\$ 1254	\$ 1304	\$ 1352	\$ 1401

Model Number	Description	Grade G	Grade H	Grade J
Terrace® Tackable Acoustical Tiles — see pages 67-68				
TKG40724T	7½"H x 24"W Tile	\$ 156	\$ 167	\$ 179
TKG40730T	7½"H x 30"W Tile	\$ 169	\$ 182	\$ 197
TKG40736T	7½"H x 36"W Tile	\$ 186	\$ 203	\$ 220
TKG40742T	7½"H x 42"W Tile	\$ 205	\$ 224	\$ 243
TKG40748T	7½"H x 48"W Tile	\$ 223	\$ 245	\$ 268
TKG40760T	7½"H x 60"W Tile	\$ 262	\$ 290	\$ 317
TKG41524T	15"H x 24"W Tile	\$ 193	\$ 215	\$ 238
TKG41530T	15"H x 30"W Tile	\$ 218	\$ 246	\$ 273
TKG41536T	15"H x 36"W Tile	\$ 250	\$ 283	\$ 318
TKG41542T	15"H x 42"W Tile	\$ 277	\$ 316	\$ 356
TKG41548T	15"H x 48"W Tile	\$ 302	\$ 346	\$ 391
TKG41560T	15"H x 60"W Tile	\$ 362	\$ 419	\$ 475
TKG42224T	22½"H x 24"W Tile	\$ 263	\$ 296	\$ 331
TKG42230T	22½"H x 30"W Tile	\$ 301	\$ 342	\$ 383
TKG42236T	22½"H x 36"W Tile	\$ 350	\$ 401	\$ 451
TKG42242T	22½"H x 42"W Tile	\$ 397	\$ 456	\$ 515
TKG42248T	22½"H x 48"W Tile	\$ 444	\$ 512	\$ 578
TKG42260T	22½"H x 60"W Tile	\$ 521	\$ 604	\$ 688
TKG43024T	30"H x 24"W Tile	\$ 309	\$ 353	\$ 398
TKG43030T	30"H x 30"W Tile	\$ 360	\$ 417	\$ 473
TKG43036T	30"H x 36"W Tile	\$ 416	\$ 484	\$ 550
TKG43042T	30"H x 42"W Tile	\$ 484	\$ 562	\$ 641
TKG43048T	30"H x 48"W Tile	\$ 527	\$ 618	\$ 707
TKG43060T	30"H x 60"W Tile	\$ 622	\$ 734	\$ 846
TKG44224T	42"H x 24"W Tile	\$ 418	\$ 480	\$ 543
TKG44230T	42"H x 30"W Tile	\$ 499	\$ 577	\$ 656
TKG44236T	42"H x 36"W Tile	\$ 574	\$ 666	\$ 761
TKG44242T	42"H x 42"W Tile	\$ 655	\$ 765	\$ 875
TKG44248T	42"H x 48"W Tile	\$ 739	\$ 864	\$ 989
TKG44260T	42"H x 60"W Tile	\$ 893	\$ 1050	\$ 1206
TKG45024T	50"H x 24"W Tile	\$ 484	\$ 558	\$ 633
TKG45030T	50"H x 30"W Tile	\$ 583	\$ 675	\$ 770
TKG45036T	50"H x 36"W Tile	\$ 690	\$ 802	\$ 914
TKG45042T	50"H x 42"W Tile	\$ 792	\$ 922	\$ 1053
TKG45048T	50"H x 48"W Tile	\$ 894	\$ 1043	\$ 1193
TKG45060T	50"H x 60"W Tile	\$ 1066	\$ 1252	\$ 1437
TKG45724T	57½"H x 24"W Tile	\$ 571	\$ 656	\$ 742
TKG45730T	57½"H x 30"W Tile	\$ 676	\$ 784	\$ 890
TKG45736T	57½"H x 36"W Tile	\$ 790	\$ 921	\$ 1051
TKG45742T	57½"H x 42"W Tile	\$ 907	\$ 1058	\$ 1209
TKG45748T	57½"H x 48"W Tile	\$ 1021	\$ 1192	\$ 1365
TKG45760T	57½"H x 60"W Tile	\$ 1209	\$ 1427	\$ 1642
TKG46524T	65"H x 24"W Tile	\$ 627	\$ 725	\$ 822
TKG46530T	65"H x 30"W Tile	\$ 747	\$ 869	\$ 989
TKG46536T	65"H x 36"W Tile	\$ 872	\$ 1018	\$ 1163
TKG46542T	65"H x 42"W Tile	\$ 996	\$ 1167	\$ 1337
TKG46548T	65"H x 48"W Tile	\$ 1118	\$ 1312	\$ 1508
TKG46560T	65"H x 60"W Tile	\$ 1318	\$ 1561	\$ 1805

Model Number	Description	Grade G	Grade H	Grade J
Terrace® Tackable Acoustical Ported Tiles — see pages 69-70				
TKG41524E	15"H x 24"W Tile	\$ 289	\$ 309	\$ 329
TKG41530E	15"H x 30"W Tile	\$ 312	\$ 337	\$ 361
TKG41536E	15"H x 36"W Tile	\$ 332	\$ 362	\$ 391
TKG41542E	15"H x 42"W Tile	\$ 360	\$ 394	\$ 428
TKG41548E	15"H x 48"W Tile	\$ 385	\$ 423	\$ 463
TKG41560E	15"H x 60"W Tile	\$ 441	\$ 490	\$ 538
TKG42224E	22½"H x 24"W Tile	\$ 346	\$ 376	\$ 405
TKG42230E	22½"H x 30"W Tile	\$ 386	\$ 423	\$ 460
TKG42236E	22½"H x 36"W Tile	\$ 433	\$ 477	\$ 520
TKG42242E	22½"H x 42"W Tile	\$ 479	\$ 530	\$ 583
TKG42248E	22½"H x 48"W Tile	\$ 513	\$ 572	\$ 630
TKG42260E	22½"H x 60"W Tile	\$ 588	\$ 661	\$ 734
TKG43024E	30"H x 24"W Tile	\$ 390	\$ 428	\$ 468
TKG43030E	30"H x 30"W Tile	\$ 434	\$ 483	\$ 531
TKG43036E	30"H x 36"W Tile	\$ 491	\$ 550	\$ 608
TKG43042E	30"H x 42"W Tile	\$ 548	\$ 616	\$ 686
TKG43048E	30"H x 48"W Tile	\$ 592	\$ 671	\$ 750
TKG43060E	30"H x 60"W Tile	\$ 676	\$ 773	\$ 871
TKG44224E	42"H x 24"W Tile	\$ 533	\$ 598	\$ 660
TKG44230E	42"H x 30"W Tile	\$ 608	\$ 688	\$ 768
TKG44236E	42"H x 36"W Tile	\$ 697	\$ 793	\$ 887
TKG44242E	42"H x 42"W Tile	\$ 772	\$ 882	\$ 994
TKG44248E	42"H x 48"W Tile	\$ 851	\$ 979	\$ 1105
TKG44260E	42"H x 60"W Tile	\$ 1007	\$ 1167	\$ 1324
TKG45024E	50"H x 24"W Tile	\$ 594	\$ 669	\$ 744
TKG45030E	50"H x 30"W Tile	\$ 697	\$ 790	\$ 885
TKG45036E	50"H x 36"W Tile	\$ 798	\$ 911	\$ 1024
TKG45042E	50"H x 42"W Tile	\$ 906	\$ 1038	\$ 1171
TKG45048E	50"H x 48"W Tile	\$ 1008	\$ 1159	\$ 1308
TKG45060E	50"H x 60"W Tile	\$ 1184	\$ 1373	\$ 1562
TKG45724E	57½"H x 24"W Tile	\$ 682	\$ 770	\$ 856
TKG45730E	57½"H x 30"W Tile	\$ 753	\$ 862	\$ 970
TKG45736E	57½"H x 36"W Tile	\$ 860	\$ 991	\$ 1123
TKG45742E	57½"H x 42"W Tile	\$ 979	\$ 1133	\$ 1285
TKG45748E	57½"H x 48"W Tile	\$ 1090	\$ 1264	\$ 1439
TKG45760E	57½"H x 60"W Tile	\$ 1287	\$ 1504	\$ 1722
TKG46524E	65"H x 24"W Tile	\$ 736	\$ 833	\$ 931
TKG46530E	65"H x 30"W Tile	\$ 862	\$ 985	\$ 1108
TKG46536E	65"H x 36"W Tile	\$ 989	\$ 1136	\$ 1282
TKG46542E	65"H x 42"W Tile	\$ 1111	\$ 1282	\$ 1452
TKG46548E	65"H x 48"W Tile	\$ 1228	\$ 1422	\$ 1618
TKG46560E	65"H x 60"W Tile	\$ 1431	\$ 1676	\$ 1922

Model Number	Grade 9	Grade 10	Grade 11	Grade 12	Grade 13	Grade 14	Grade 15	Grade 16	Grade 17	Grade 18	Grade 19	Grade 20	Grade 21	Grade 22
Involve® Ped/Credenza Cushions – 18"D — see page 262														
K5CT1815SC	\$ 641	\$ 680	\$ 719	\$ 759	\$ 807	\$ 856	\$ 904	\$ 954	\$ 1002	\$ 1052	\$ 1100	\$ 1150	\$ 1198	\$ 1247
K5CT1818SC	\$ 664	\$ 703	\$ 742	\$ 782	\$ 830	\$ 879	\$ 927	\$ 977	\$ 1025	\$ 1075	\$ 1123	\$ 1173	\$ 1221	\$ 1270
K5CT1824SC	\$ 692	\$ 731	\$ 770	\$ 810	\$ 858	\$ 907	\$ 955	\$ 1005	\$ 1053	\$ 1103	\$ 1151	\$ 1201	\$ 1249	\$ 1298
K5CT1830SC	\$ 724	\$ 763	\$ 802	\$ 842	\$ 890	\$ 939	\$ 987	\$ 1037	\$ 1085	\$ 1135	\$ 1183	\$ 1233	\$ 1281	\$ 1330
K5CT1836SC	\$ 780	\$ 819	\$ 858	\$ 898	\$ 946	\$ 995	\$ 1043	\$ 1093	\$ 1141	\$ 1191	\$ 1239	\$ 1289	\$ 1337	\$ 1386
K5CT1848SC	\$ 795	\$ 834	\$ 873	\$ 913	\$ 961	\$ 1010	\$ 1058	\$ 1108	\$ 1156	\$ 1206	\$ 1254	\$ 1304	\$ 1352	\$ 1401

Cross Reference Index

by Model Number

Model	Page	Model	Page	Model	Page	Model	Page	Model	Page
8988EBZ	212	A5622ERS	364	A871503A	95, 367	AE4-DJ72S	264	AF5RS6624D	362
8988EBZ3	212	A5722ELS	364	A871601	95, 367	AE4-DJ78S	264	AF5RS6624UD	363
8988EBZS	212	A5722ERS	364	A871601A	95, 367	AE4-DJ84S	264	AF5RS6630D	362
8989BW	96	A5822ELS	364	A871912	95, 210, 367	AE4-DJ90S	264	AF5RS6630UD	363
8989EB	96	A5822ERS	364	A871912A	95, 210, 367	AE4-DJ96S	264	AF5RS7224D	362
9120 Program	123, 233	A5922ELS	364	A871918	95, 210, 367	AE4-DJ102S	264	AF5RS7224UD	363
831124	126	A5922ERS	364	A871918A	95, 210, 367	AE4-DJ108S	264	AF5RS7230D	362
831130	126	A870302	264	A871972	95, 210, 367	AE4-DJ114S	264	AF5RS7230UD	363
831212M	114	A870824	389	A871972A	95, 210, 367	AE4-DJ126S	264	AF5RS7824D	362
851524M	329	A870824CH	389	A873501	95, 367	AE4-DJ132S	264	AF5RS7824UD	363
851530M	329	A870830	389	A873502	95, 367	AE4-DJ138S	264	AF5RS7830D	362
851536M	329	A870830CH	389	A873503	95, 367	AE4-DJ144S	264	AF5RS7830UD	363
851542M	329	A870842	389	A873504	95, 367	AE4-HW	264	AF5RS8424D	362
851548M	329	A870842CH	389	A873506	95, 367	AE4-PS72	264	AF5RS8424UD	363
851554M	329	A870860	389	A876072	95, 367	AE4-PS144	264	AF5RS8430D	362
851560M	329	A870860CH	389	A876072A	95, 367	AECH	36, 371	AF5RS8430UD	363
851566M	329	A871024	94, 211	A877010	96, 212	AEHF	36, 371	AF5RS9024D	362
851572M	329	A871024A	94, 211	A877012	95, 210, 367	AESS	36, 371	AF5RS9024UD	363
852424M	329	A871030	94, 211	A877072	210	AF5CCS5424	363	AF5RS9030D	362
853030M	329	A871030A	94, 211	A877072A	210	AF5CCS5430	363	AF5RS9030UD	363
853636M	329	A871036	94, 211	A877501	212	AF5CCS603624LD	364	AF5RS9624D	362
854242M	329	A871036A	94, 211	A877501A	212	AF5CCS603624RD	364	AF5RS9624UD	363
870224N	95	A871042	94, 211	A877502	212	AF5CCS604824LD	364	AF5RS9630D	362
870224NF	95	A871042A	94, 211	A877502A	212	AF5CCS604824RD	364	AF5RS9630UD	363
870230N	95	A871048	94, 211	A877503	212	AF5CCS604830LD	364	AF5120S4224D	363
870230NF	95	A871048A	94, 211	A877503A	212	AF5CCS604830RD	364	AF5120S4230D	363
870236N	95	A871060	94, 211	A877504	212	AF5CCS723624LD	364	AF5120S4824D	363
870236NFK	95	A871060A	94, 211	A877506	212	AF5CCS723624RD	364	AF5120S4830D	363
870242N	95	A871124	94, 211, 366	A8713108	94, 211	AF5CCS724824LD	364	AF5120S5424D	363
870242NFK	95	A871124A	94, 211, 366	A8713108A	94, 211	AF5CCS724824RD	364	AF5120S5430D	363
870248N	95	A871130	94, 211	AABPWRMOD	365.2, 391	AF5CCS724830LD	364	AFDTRGH20	365, 391.2
870248NFK	95	A871130A	94, 211	AAPAC	385.1	AF5CCS724830RD	364	AFDTRGH32	365, 391.2
870260N	95	A871136	94, 211	AAPACM2	96, 212, 389	AF5RND4824	362	AGBKC	329, 376
870260NFK	95	A871136A	94, 211	AAPAH	385.1	AF5RND4830	362	AGBKT	329, 376
870535	95	A871142	94, 211	AAPAHF	385.1	AF5RND5424	362	AGBKTMP	329, 376
870565	95	A871142A	94, 211	AAPAMP	385.1	AF5RND5430	362	AGSAUHK	377
873550	96	A871148	94, 211, 366	AAPASB	385.1	AF5RND6024D	362	AHATPWRMOD2S	365.3, 391.4
873600	96, 368	A871148A	94, 211, 366	AAPASH	385.1	AF5RND6030D	362	AHATPWRMOD3S	365.3, 391.4
877550	212	A871160	94, 211, 366	AAPAST	385.1	AF5RND6624D	362	AHATPWRMODF	365.3, 391.4
877600	212	A871160A	94, 211, 366	AAS1520	371	AF5RND6630D	362	AJTRGH24	96, 212, 365, 391.2
899900	59, 166	A871172	94, 211, 366	AAS1548	371	AF5RND7224D	362	AJTRGH36	96, 212, 365, 391.2
899910	59, 166	A871172A	94, 211, 366	AAS1554	371	AF5RND7230D	362	AKMH	380
A2-8CIR24	94, 211	A871224	94, 211	AAS1560	371	AF5RND7824D	362	AKTLONG	380
A2-8CIR30	94, 211	A871224A	94, 211	AAS1566	371	AF5RND7830D	362	AKTMID	380
A2-8CIR36	94, 211	A871230	94, 211	AAS1572	371	AF5RND8424D	362	AKTSHORT	380
A2-8CIR42	94, 211	A871230A	94, 211	ABKCL	376	AF5RND8430D	362	ALED17U	266, 389
A2-8CIR48	94, 211	A871236	94, 211	ABKCR	376	AF5RND9024D	362	ALED17U60	389
A2-8CIR60	94, 211	A871236A	94, 211	ABKTL	376	AF5RND9030D	362	ALED17UJMP30	389
A6BLUETOOTH	361	A871242	94, 211	ABKTR	376	AF5RND9624D	362	ALED31U	266, 389
A6CASTER	361	A871242A	94, 211	ACD1	386	AF5RND9630D	362	ALED31U60	389
A6G1GLIDE	361	A871248	94, 211, 366	ACPU1	380	AF5RS3624U	363	ALED31UJMP30	389
A6MREC3S2LCF	360	A871248A	94, 211, 366	ACPWRMOD	391	AF5RS3630U	363	ALED31UJMP30	389
A6MREC3S2LTF	360	A871254	366	AE4-DD1	264	AF5RS4224U	363	ALED31U60	389
A6MREC3S3LCF	361	A871254A	366	AE4-DD2	264	AF5RS4230U	363	ALED31U60	389
A6MREC3S3LTF	361	A871260	94, 211, 366	AE4-DJ0S	264	AF5RS4824	362	ALED31UJMP30	389
A6REC2S2LCF	360	A871260A	94, 211, 366	AE4-DJ6S	264	AF5RS4824U	363	ALED31UJMP30	389
A6REC2S2LTF	360	A871266	366	AE4-DJ12S	264	AF5RS4830	362	ALED31UJMP30	389
A6REC2S3LCF	361	A871266A	366	AE4-DJ18S	264	AF5RS4830U	362	ALED31U60	389
A6REC2S3LTF	361	A871272	366	AE4-DJ24S	264	AF5RS4830U	363	ALED31U60	389
A6REC3S2LCF	360	A871272A	366	AE4-DJ30S	264	AF5RS5424	362	ALKF23C	397
A6REC3S2LTF	360	A871366	94, 211	AE4-DJ36S	264	AF5RS5424U	363	ALKF23CE4	397
A6REC3S3LCF	361	A871366A	94, 211	AE4-DJ42S	264	AF5RS5430	362	ALKF23CN	397
A6REC3S3LTF	361	A871400	95, 210, 367	AE4-DJ48S	264	AF5RS5430U	363	ALKF26EL	397
A6SLDGLIDE	361	A871400A	95, 210, 367	AE4-DJ54S	264	AF5RS6024D	362	AMADHD	394
A9CLWMC	365, 391.2	A871501A	95, 367	AE4-DJ60S	264	AF5RS6024UD	363	AMASD	394
A5622ELS	364	A871502A	95, 367	AE4-DJ66S	264	AF5RS6030D	362	AMASD-G	394
						AF5RS6030UD	363	AMASHD	394

INDEX

Cross Reference Index

by Model Number

Model	Page	Model	Page	Model	Page	Model	Page	Model	Page
AMASHDCK	395	APWRTRGH36	365, 391.2	CSDC25	386	G3030	314	G3560	315
AMASTS	394	ARNDPWRMOD	391	CSL2429F	126	G3030G	319	G3560G	320
AMASTSCK	395	ARSLCC	399	CSL3029F	126	G3033	314	G3563	315
AMASTS-G	394	ATADF3	97, 213, 368	EAAC	385	G3033G	319	G3563G	320
AMF22	397	ATADF4	97, 213, 368	EABS	385	G3036	314	G3566	315
AMKF22	397	ATADJ5	97, 213, 368	EACS	385	G3036G	319	G3566G	320
AMPCHASE	96, 212, 391.3	ATADJ6	97, 213, 368	EADH	385	G3039	314	G3569	315
AMS2048LH	370	AUPWRMOD	391	EAFS	385	G3039G	319	G3569G	320
AMS2048RH	370	AURNDPWRMOD	391	EAFU	385	G3042	314	G3572	315
AMS2048SS	371	AVF5RS4824	362	EAHSR36	384	G3042G	319	G3572G	320
AMS2048US	370	AVF5RS4830	362	EAHSR42	384	G3045	314	G3575	315
AMS2054LH	370	AVF5RS5424	362	EAHSR48	384	G3045G	319	G3575G	320
AMS2054RH	370	AVF5RS5430	362	EAHSR60	384	G3048	314	G3578	315
AMS2054SS	371	AVF5RS6024D	362	EAHSR66	384	G3048G	319	G3578G	320
AMS2054US	370	AVF5RS6030D	362	EAHSR72	384	G3051	314	G3581	315
AMS2060LH	370	AVF5RS6624D	362	EAPS	385	G3051G	319	G3581G	320
AMS2060RH	370	AVF5RS6630D	362	EAPT	385	G3054	314	G3584	315
AMS2060SS	371	AVF5RS7224D	362	EASR24	384	G3054G	319	G3584G	320
AMS2060US	370	AVF5RS7230D	362	EASR30	384	G3057	314	G4218	316
AMS2066LH	370	AVSTA3PWR	391.1	EASR36	384	G3057G	319	G4218G	321
AMS2066RH	370	AWCS	380	EASR42	384	G3060	314	G4221	316
AMS2066SS	371	AWIRECLT	365, 391.2	EASR48	384	G3060G	319	G4221G	321
AMS2066US	370	AWRSTRIP	96, 212, 365, 391.2	EASR60	384	G3063	314	G4224	316
AMS2072LH	370	AYBHEP1229	125, 235	EASS	385	G3063G	319	G4224G	321
AMS2072RH	370	AYBHEP1829	125, 235	EATS	385	G3066	314	G4227	316
AMS2072SS	371	AYBHEP2429	125, 235	FDEPC2	372	G3066G	319	G4227G	321
AMS2072US	370	AYBHEP3029	125, 235	FDEPC12	372	G3069	314	G4230	316
AMS3248LH	370	AYBHEP3029	125, 235	FDPWRC	365.1	G3069G	319	G4230G	321
AMS3248RH	370	CBK29	126	FDPWRSC	365.1	G3072	314	G4233	316
AMS3248SS	371	CDG	127	FDRWEC	372	G3072G	319	G4233G	321
AMS3248US	370	CDL29	126	FDRWLEG	372	G3075	314	G4236	316
AMS3254LH	370	CEP1129F	126	FDRWUC	372	G3075G	319	G4236G	321
AMS3254RH	370	CEP2429F	126	FDSC48LL	369	G3078	314	G4239	316
AMS3254SS	371	CEP3029F	126	FDSC48LR	369	G3078G	319	G4239G	321
AMS3254US	370	CFDPWRC	365.1	FDSC48R	369	G3081	314	G4242	316
AMS3260LH	370	CFDPWRSC	365.1	FDSC48U	369	G3081G	319	G4242G	321
AMS3260RH	370	CRK29	126	FDSC54LL	369	G3084	314	G4245	316
AMS3260SS	371	CS244	127	FDSC54LR	369	G3084G	319	G4245G	321
AMS3260US	370	CS249	127	FDSC54R	369	G3518	315	G4248	316
AMS3266LH	370	CS304	127	FDSC54U	369	G3518G	320	G4248G	321
AMS3266RH	370	CS309	127	FDSC60LL	369	G3521	315	G4251	316
AMS3266SS	371	CS364	127	FDSC60LR	369	G3521G	320	G4251G	321
AMS3266US	370	CS369	127	FDSC60R	369	G3524	315	G4254	316
AMS3272LH	370	CS424	127	FDSC60U	369	G3524G	320	G4254G	321
AMS3272RH	370	CS429	127	FDSC66LL	369	G3527	315	G4257	316
AMS3272SS	371	CS484	127	FDSC66LR	369	G3527G	320	G4257G	321
AMS3272US	370	CS489	127	FDSC66R	369	G3530	315	G4260	316
APACSM	395	CS544	127	FDSC66U	369	G3530G	320	G4260G	321
APACW	395	CS549	127	FDSC72LL	369	G3533	315	G4263	316
APADD	394	CS604	127	FDSC72LR	369	G3533G	320	G4263G	321
APASD	394	CS609	127	FDSC72R	369	G3536	315	G4266	316
APASDCK	395	CS664	127	FDSC72U	369	G3536G	320	G4266G	321
APATF	394	CS669	127	G1AGF	331	G3539	315	G4269	316
APMC6	385	CS724	127	G1PTR	331	G3539G	320	G4269G	321
APOLG0512	238	CS729	127	G2AGF	331	G3542	315	G4272	316
APOLG0518	238	CSCMP3614	127	G2PTR	331	G3542G	320	G4272G	321
APTK	399	CSCMP3629	127	G3AGF	331	G3545	315	G4275	316
APWR4TAP	365.1, 391	CSCMP4214	127	G3PTR	331	G3545G	320	G4275G	321
APWRMOD	391	CSCMP4229	127	G3018	314	G3548	315	G4278	316
APWRMODEST36	365.2, 391.4	CSCMP4814	127	G3018G	319	G3548G	320	G4278G	321
APWRMODEST48	365.2, 391.4	CSCMP4829	127	G3021	314	G3551	315	G4281	316
APWRPCK	391.1	CSCMP6014	127	G3021G	319	G3551G	320	G4281G	321
APWRSTRP	391.1	CSCMP6029	127	G3024	314	G3554	315	G4284	316
APWRTRGH17	365, 391.2	CSCMP7214	127	G3024G	319	G3554G	320	G4284G	321
		CSCMP7229	127	G3027	314	G3557	315	G5018	317
		CSDC19	386	G3027G	319	G3557G	320	G5018G	322

INDEX

Cross Reference Index

by Model Number

Model	Page	Model	Page	Model	Page	Model	Page	Model	Page
G5021.....	317	G5751.....	318	G41381GS.....	327	GL3048L.....	304	GL3566R.....	305
G5021G.....	322	G5751G.....	323	G41515GS.....	328	GL3048LG.....	309	GL3566RG.....	310
G5024.....	317	G5754.....	318	G41518GS.....	328	GL3048R.....	304	GL3572L.....	305
G5024G.....	322	G5754G.....	323	G41521GS.....	328	GL3048RG.....	309	GL3572LG.....	310
G5027.....	317	G5757.....	318	G41524GS.....	328	GL3054L.....	304	GL3572R.....	305
G5027G.....	322	G5757G.....	323	G41527GS.....	328	GL3054LG.....	309	GL3572RG.....	310
G5030.....	317	G5760.....	318	G41530GS.....	328	GL3054R.....	304	GL3578L.....	305
G5030G.....	322	G5760G.....	323	G41533GS.....	328	GL3054RG.....	309	GL3578LG.....	310
G5033.....	317	G5763.....	318	G41536GS.....	328	GL3060L.....	304	GL3578R.....	305
G5033G.....	322	G5763G.....	323	G41539GS.....	328	GL3060LG.....	309	GL3578RG.....	310
G5036.....	317	G5766.....	318	G41542GS.....	328	GL3060R.....	304	GL4218L.....	306
G5036G.....	322	G5766G.....	323	G41545GS.....	328	GL3060RG.....	309	GL4218LG.....	311
G5039.....	317	G5769.....	318	G41548GS.....	328	GL3066L.....	304	GL4218R.....	306
G5039G.....	322	G5769G.....	323	G41551GS.....	328	GL3066LG.....	309	GL4218RG.....	311
G5042.....	317	G5772.....	318	G41554GS.....	328	GL3066R.....	304	GL4221L.....	306
G5042G.....	322	G5772G.....	323	G41557GS.....	328	GL3066RG.....	309	GL4221LG.....	311
G5045.....	317	G5775.....	318	G41560GS.....	328	GL3072L.....	304	GL4221R.....	306
G5045G.....	322	G5775G.....	323	G41563GS.....	328	GL3072LG.....	309	GL4221RG.....	311
G5048.....	317	G5778.....	318	G41566GS.....	328	GL3072R.....	304	GL4224L.....	306
G5048G.....	322	G5778G.....	323	G41569GS.....	328	GL3072RG.....	309	GL4224LG.....	311
G5051.....	317	G5781.....	318	G41572GS.....	328	GL3078L.....	304	GL4224R.....	306
G5051G.....	322	G5781G.....	323	G41575GS.....	328	GL3078LG.....	309	GL4224RG.....	311
G5054.....	317	G5784.....	318	G41578GS.....	328	GL3078R.....	304	GL4227L.....	306
G5054G.....	322	G5784G.....	323	G41581GS.....	328	GL3078RG.....	309	GL4227LG.....	311
G5057.....	317	G40715GS.....	326	GACRL12.....	331	GL3518L.....	305	GL4227R.....	306
G5057G.....	322	G40718GS.....	326	GACRL18.....	331	GL3518LG.....	310	GL4227RG.....	311
G5060.....	317	G40721GS.....	326	GACRL24.....	331	GL3518R.....	305	GL4230L.....	306
G5060G.....	322	G40724GS.....	326	GACRL30.....	331	GL3518RG.....	310	GL4230LG.....	311
G5063.....	317	G40727GS.....	326	GACRL36.....	331	GL3521L.....	305	GL4230R.....	306
G5063G.....	322	G40730GS.....	326	GBRSF.....	331	GL3521LG.....	310	GL4230RG.....	311
G5066.....	317	G40733GS.....	326	GCHMT.....	331	GL3521R.....	305	GL4236L.....	306
G5066G.....	322	G40736GS.....	326	GCHRB.....	331	GL3521RG.....	310	GL4236LG.....	311
G5069.....	317	G40739GS.....	326	GCKPM.....	324, 325	GL3524L.....	305	GL4236R.....	306
G5069G.....	322	G40742GS.....	326	GCTKS.....	329	GL3524LG.....	310	GL4236RG.....	311
G5072.....	317	G40745GS.....	326	GFT1.....	330	GL3524R.....	305	GL4242L.....	306
G5072G.....	322	G40748GS.....	326	GFT2.....	330	GL3524RG.....	310	GL4242LG.....	311
G5075.....	317	G40751GS.....	326	GHMB2030.....	330	GL3527L.....	305	GL4242R.....	306
G5075G.....	322	G40754GS.....	326	GHMB2630.....	330	GL3527LG.....	310	GL4242RG.....	311
G5078.....	317	G40757GS.....	326	GL3018L.....	304	GL3527R.....	305	GL4248L.....	306
G5078G.....	322	G40760GS.....	326	GL3018LG.....	309	GL3527RG.....	310	GL4248LG.....	311
G5081.....	317	G40763GS.....	326	GL3018R.....	304	GL3530L.....	305	GL4248R.....	306
G5081G.....	322	G40766GS.....	326	GL3018RG.....	309	GL3530LG.....	310	GL4248RG.....	311
G5084.....	317	G40769GS.....	326	GL3021L.....	304	GL3530R.....	305	GL4254L.....	306
G5084G.....	322	G40772GS.....	326	GL3021LG.....	309	GL3530RG.....	310	GL4254LG.....	311
G5718.....	318	G40775GS.....	326	GL3021R.....	304	GL3536L.....	305	GL4254R.....	306
G5718G.....	323	G40778GS.....	326	GL3021RG.....	309	GL3536LG.....	310	GL4254RG.....	311
G5721.....	318	G40781GS.....	326	GL3024L.....	304	GL3536R.....	305	GL4260L.....	306
G5721G.....	323	G41324GS.....	327	GL3024LG.....	309	GL3536RG.....	310	GL4260LG.....	311
G5724.....	318	G41327GS.....	327	GL3024R.....	304	GL3542L.....	305	GL4260R.....	306
G5724G.....	323	G41330GS.....	327	GL3024RG.....	309	GL3542LG.....	310	GL4260RG.....	311
G5727.....	318	G41333GS.....	327	GL3027L.....	304	GL3542R.....	305	GL4266L.....	306
G5727G.....	323	G41336GS.....	327	GL3027LG.....	309	GL3542RG.....	310	GL4266LG.....	311
G5730.....	318	G41339GS.....	327	GL3027R.....	304	GL3548L.....	305	GL4266R.....	306
G5730G.....	323	G41342GS.....	327	GL3027RG.....	309	GL3548LG.....	310	GL4266RG.....	311
G5733.....	318	G41345GS.....	327	GL3030L.....	304	GL3548R.....	305	GL4272L.....	306
G5733G.....	323	G41348GS.....	327	GL3030LG.....	309	GL3548RG.....	310	GL4272LG.....	311
G5736.....	318	G41351GS.....	327	GL3030R.....	304	GL3554L.....	305	GL4272R.....	306
G5736G.....	323	G41354GS.....	327	GL3030RG.....	309	GL3554LG.....	310	GL4272RG.....	311
G5739.....	318	G41357GS.....	327	GL3036L.....	304	GL3554R.....	305	GL4278L.....	306
G5739G.....	323	G41360GS.....	327	GL3036LG.....	309	GL3554RG.....	310	GL4278LG.....	311
G5742.....	318	G41363GS.....	327	GL3036R.....	304	GL3560L.....	305	GL4278R.....	306
G5742G.....	323	G41366GS.....	327	GL3036RG.....	309	GL3560LG.....	310	GL4278RG.....	311
G5745.....	318	G41369GS.....	327	GL3042L.....	304	GL3560R.....	305	GL5018L.....	307
G5745G.....	323	G41372GS.....	327	GL3042LG.....	309	GL3560RG.....	310	GL5018LG.....	312
G5748.....	318	G41375GS.....	327	GL3042R.....	304	GL3566L.....	305	GL5018R.....	307
G5748G.....	323	G41378GS.....	327	GL3042RG.....	309	GL3566LG.....	310	GL5018RG.....	312

INDEX

Cross Reference Index

by Model Number

Model	Page	Model	Page	Model	Page	Model	Page	Model	Page
GL5021L.....	307	GL5730R.....	308	GS4287.....	316	GS42141.....	316	GT3036.....	304
GL5021LG.....	312	GL5730RG.....	313	GS4287G.....	321	GS42141G.....	321	GT3036G.....	309
GL5021R.....	307	GL5736L.....	308	GS4293.....	316	GS42147.....	316	GT3042.....	304
GL5021RG.....	312	GL5736LG.....	313	GS4293G.....	321	GS42147G.....	321	GT3042G.....	309
GL5024L.....	307	GL5736R.....	308	GS4299.....	316	GS50105.....	317	GT3048.....	304
GL5024LG.....	312	GL5736RG.....	313	GS4299G.....	321	GS50105G.....	322	GT3048G.....	309
GL5024R.....	307	GL5742L.....	308	GS5081.....	317	GS50111.....	317	GT3054.....	304
GL5024RG.....	312	GL5742LG.....	313	GS5081G.....	322	GS50111G.....	322	GT3054G.....	309
GL5027L.....	307	GL5742R.....	308	GS5087.....	317	GS50117.....	317	GT3060.....	304
GL5027LG.....	312	GL5742RG.....	313	GS5087G.....	322	GS50117G.....	322	GT3060G.....	309
GL5027R.....	307	GL5748L.....	308	GS5093.....	317	GS50123.....	317	GT3066.....	304
GL5027RG.....	312	GL5748LG.....	313	GS5093G.....	322	GS50123G.....	322	GT3066G.....	309
GL5030L.....	307	GL5748R.....	308	GS5099.....	317	GS50129.....	317	GT3072.....	304
GL5030LG.....	312	GL5748RG.....	313	GS5099G.....	322	GS50129G.....	322	GT3072G.....	309
GL5030R.....	307	GL5754L.....	308	GS5781.....	318	GS50135.....	317	GT3078.....	304
GL5030RG.....	312	GL5754LG.....	313	GS5781G.....	323	GS50135G.....	322	GT3078G.....	309
GL5036L.....	307	GL5754R.....	308	GS5787.....	318	GS50141.....	317	GT3518.....	305
GL5036LG.....	312	GL5754RG.....	313	GS5787G.....	323	GS50141G.....	322	GT3518G.....	310
GL5036R.....	307	GL5760L.....	308	GS5793.....	318	GS50147.....	317	GT3521.....	305
GL5036RG.....	312	GL5760LG.....	313	GS5793G.....	323	GS50147G.....	322	GT3521G.....	310
GL5042L.....	307	GL5760R.....	308	GS5799.....	318	GS57105.....	318	GT3524.....	305
GL5042LG.....	312	GL5760RG.....	313	GS5799G.....	323	GS57105G.....	323	GT3524G.....	310
GL5042R.....	307	GL5766L.....	308	GS30105.....	314	GS57111.....	318	GT3527.....	305
GL5042RG.....	312	GL5766LG.....	313	GS30105G.....	319	GS57111G.....	323	GT3527G.....	310
GL5048L.....	307	GL5766R.....	308	GS30111.....	314	GS57117.....	318	GT3530.....	305
GL5048LG.....	312	GL5766RG.....	313	GS30111G.....	319	GS57117G.....	323	GT3530G.....	310
GL5048R.....	307	GL5772L.....	308	GS30117.....	314	GS57123.....	318	GT3536.....	305
GL5048RG.....	312	GL5772LG.....	313	GS30117G.....	319	GS57123G.....	323	GT3536G.....	310
GL5054L.....	307	GL5772R.....	308	GS30123.....	314	GS57129.....	318	GT3542.....	305
GL5054LG.....	312	GL5772RG.....	313	GS30123G.....	319	GS57129G.....	323	GT3542G.....	310
GL5054R.....	307	GL5778L.....	308	GS30129.....	314	GS57135.....	318	GT3548.....	305
GL5054RG.....	312	GL5778LG.....	313	GS30129G.....	319	GS57135G.....	323	GT3548G.....	310
GL5060L.....	307	GL5778R.....	308	GS30135.....	314	GS57141.....	318	GT3554.....	305
GL5060LG.....	312	GL5778RG.....	313	GS30135G.....	319	GS57141G.....	323	GT3554G.....	310
GL5060R.....	307	GMB1524.....	330	GS30141.....	314	GS57147.....	318	GT3560.....	305
GL5060RG.....	312	GMB1530.....	330	GS30141G.....	319	GS57147G.....	323	GT3560G.....	310
GL5066L.....	307	GMB1536.....	330	GS30147.....	314	GS870924.....	389	GT3566.....	305
GL5066LG.....	312	GMB1542.....	330	GS30147G.....	319	GS870930.....	389	GT3566G.....	310
GL5066R.....	307	GMB1548.....	330	GS35105.....	315	GS870948.....	389	GT3572.....	305
GL5066RG.....	312	GMB1554.....	330	GS35105G.....	320	GS870960.....	389	GT3572G.....	310
GL5072L.....	307	GMB1560.....	330	GS35111.....	315	GSGKL.....	324, 325	GT3578.....	305
GL5072LG.....	312	GMB2224.....	330	GS35111G.....	320	GSGKM.....	324, 325	GT3578G.....	310
GL5072R.....	307	GMB2230.....	330	GS35117.....	315	GSTF12.....	331	GT4218.....	306
GL5072RG.....	312	GMB2236.....	330	GS35117G.....	320	GSTF18.....	331	GT4218G.....	311
GL5078L.....	307	GMB2242.....	330	GS35123.....	315	GSTF24.....	331	GT4221.....	306
GL5078LG.....	312	GMB2248.....	330	GS35123G.....	320	GSTF30.....	331	GT4221G.....	311
GL5078R.....	307	GMB2254.....	330	GS35129.....	315	GSTF36.....	331	GT4224.....	306
GL5078RG.....	312	GMB2260.....	330	GS35129G.....	320	GSTF42.....	331	GT4224G.....	311
GL5718L.....	308	GS3081.....	314	GS35135.....	315	GSTF48.....	331	GT4227.....	306
GL5718LG.....	313	GS3081G.....	319	GS35135G.....	320	GSTF54.....	331	GT4227G.....	311
GL5718R.....	308	GS3087.....	314	GS35141.....	315	GSTF60.....	331	GT4230.....	306
GL5718RG.....	313	GS3087G.....	319	GS35141G.....	320	GSTF66.....	331	GT4230G.....	311
GL5721L.....	308	GS3093.....	314	GS35147.....	315	GSTF72.....	331	GT4236.....	306
GL5721LG.....	313	GS3093G.....	319	GS35147G.....	320	GSTF78.....	331	GT4236G.....	311
GL5721R.....	308	GS3099.....	314	GS42105.....	316	GSTFN7578.....	324, 325	GT4242.....	306
GL5721RG.....	313	GS3099G.....	319	GS42105G.....	321	GSTFN8184.....	324, 325	GT4242G.....	311
GL5724L.....	308	GS3581.....	315	GS42111.....	316	GT3018.....	304	GT4248.....	306
GL5724LG.....	313	GS3581G.....	320	GS42111G.....	321	GT3018G.....	309	GT4248G.....	311
GL5724R.....	308	GS3587.....	315	GS42117.....	316	GT3021.....	304	GT4254.....	306
GL5724RG.....	313	GS3587G.....	320	GS42117G.....	321	GT3021G.....	309	GT4254G.....	311
GL5727L.....	308	GS3593.....	315	GS42123.....	316	GT3024.....	304	GT4260.....	306
GL5727LG.....	313	GS3593G.....	320	GS42123G.....	321	GT3024G.....	309	GT4260G.....	311
GL5727R.....	308	GS3599.....	315	GS42129.....	316	GT3027.....	304	GT4266.....	306
GL5727RG.....	313	GS3599G.....	320	GS42129G.....	321	GT3027G.....	309	GT4266G.....	311
GL5730L.....	308	GS4281.....	316	GS42135.....	316	GT3030.....	304	GT4272.....	306
GL5730LG.....	313	GS4281G.....	321	GS42135G.....	321	GT3030G.....	309	GT4272G.....	311

Cross Reference Index

by Model Number

Model	Page	Model	Page	Model	Page	Model	Page	Model	Page
GT4278	306	GT351824	305	GTK3CON30R	325	NHBRHDTBIPMF	31	T624CB	125, 238
GT4278G	311	GT351824G	310	GTK3CON35F	325	OH1524FD	132, 272	T624FB	125, 238
GT5018	307	GT351830	305	GTK3CON35R	325	OH1524HD	132, 272	T630FB	125, 238
GT5018G	312	GT351830G	310	GTK3CON42F	325	OH1524SD	132, 272	T5622EL	117, 230
GT5021	307	GT352418	305	GTK3CON42R	325	OH1530FD	132, 272	T5622ER	117, 230
GT5021G	312	GT352418G	310	GTK3CON50F	325	OH1530HD	132, 272	T5623EL	117, 230
GT5024	307	GT352430	305	GTK3CON50R	325	OH1530RD	133, 273	T5623ER	117, 230
GT5024G	312	GT352430G	310	GTK3CON57F	325	OH1530SD	132, 272	T5632EL	117, 230
GT5027	307	GT353018	305	GTK3CON57R	325	OH1536FD	132, 272	T5632ER	117, 230
GT5027G	312	GT353018G	310	GTK3CON65F	325	OH1536HD	132, 272	T5633EL	117, 230
GT5030	307	GT353024	305	GTK3CON65R	325	OH1536RD	133, 273	T5633ER	117, 230
GT5030G	312	GT353024G	310	GTK3CON72F	325	OH1536SD	132, 272	T5722EL	117, 230
GT5036	307	GT421824	306	GTK3CON72R	325	OH1542FD	132, 272	T5722ER	117, 230
GT5036G	312	GT421824G	311	GTK3CON80F	325	OH1542HD	132, 272	T5723EL	117, 230
GT5042	307	GT421830	306	GTK3CON80R	325	OH1542RD	133, 273	T5723ER	117, 230
GT5042G	312	GT421830G	311	GTK3CON87F	325	OH1542SD	132, 272	T5732EL	117, 230
GT5048	307	GT422418	306	GTK3CON87R	325	OH1548FD	132, 272	T5732ER	117, 230
GT5048G	312	GT422418G	311	GTKCKP	325	OH1548HD	132, 272	T5733EL	117, 230
GT5054	307	GT422430	306	GTKGK30	325	OH1548RD	133, 273	T5733ER	117, 230
GT5054G	312	GT422430G	311	GTSKCKP	325	OH1548SD	132, 272	T5822EL	117, 230
GT5060	307	GT423018	306	GWPSF	331	OH1560FD	132, 272	T5822ER	117, 230
GT5060G	312	GT423018G	311	GWS30	329	OH1560RD	133, 273	T5832EL	117, 230
GT5066	307	GT423024	306	GWS35	329	OH1560SD	132, 272	T5832ER	117, 230
GT5066G	312	GT423024G	311	GWS42	329	PMP41	127	T5922EL	117, 230
GT5072	307	GT501824	307	GWS50	329	PMP47	127	T5922ER	117, 230
GT5072G	312	GT501824G	312	GWS57	329	PMP53	127	T5932EL	117, 230
GT5078	307	GT501830	307	GWSBK	329	POHRTA36S	133, 273	T5932ER	117, 230
GT5078G	312	GT501830G	312	GZ3CON30	324	POHRTA48S	133, 273	T52024S	225
GT5718	308	GT502418	307	GZ3CON35	324	POHRTA1536FD	133, 273	T52030S	225
GT5718G	313	GT502418G	312	GZ3CON42	324	POHRTA1542FD	133, 273	T52036S	225
GT5721	308	GT502430	307	GZ3CON50	324	POHRTA1548FD	133, 273	T52042S	225
GT5721G	313	GT502430G	312	GZ3CON57	324	PRFTSKCL	390	T52048S	225
GT5724	308	GT503018	307	GZ3CON65	324	PRFTSKFS	390	T52054S	225
GT5724G	313	GT503018G	312	GZ3CON72	324	PRFTSKTR	390	T52060S	225
GT5727	308	GT503024	307	GZ3CON80	324	RFDWR48	372	T52066S	225
GT5727G	313	GT503024G	312	GZ3CON87	324	RFDWR54	372	T52072S	225
GT5730	308	GT571824	308	GZCKP	324	RFDWR60	372	T52078S	225
GT5730G	313	GT571824G	313	K5CT1524SC	268	RFDWR66	372	T52084S	225
GT5736	308	GT571830	308	K5CT1815SC	262, 268	RFDWR72	372	T52090S	225
GT5736G	313	GT571830G	313	K5CT1818SC	262	RFDRWAB	372	T52096S	225
GT5742	308	GT572418	308	K5CT1824SC	262	RFDRCNPP	374	T52424S	114, 225
GT5742G	313	GT572418G	313	K5CT1830SC	262	RFDRCNPPPE	374	T52430S	114, 225
GT5748	308	GT572430	308	K5CT1836SC	262	RFDRCNPPM	374	T52436S	114, 225
GT5748G	313	GT572430G	313	K5CT1842SC	262	RFDRWHUBEND	373	T52442S	114, 225
GT5754	308	GT573018	308	K5CT1848SC	262	RFDRWHUBENDT	373	T52448S	114, 225
GT5754G	313	GT573018G	313	LKFE	398	RFDRWHUBL	373	T52454S	114, 225
GT5760	308	GT573024	308	NHBRHDBKCE	34	RFDRWHUBLIN	373	T52460S	114, 225
GT5760G	313	GT573024G	313	NHBRHDFRM	28	RFDRWHUBT	373	T52466S	114, 225
GT5766	308	GTB1524	330	NHBRHDFRMEXT	28	RFDRWHUBX	373	T52472S	114, 225
GT5766G	313	GTB1530	330	NHBRHDMIFB	32	RFDRWLEG	372	T52478S	114, 225
GT5772	308	GTB1536	330	NHBRHDMIFF	32	RFDRWSC48	375	T52484S	114, 225
GT5772G	313	GTB1542	330	NHBRHDMIGMBB	33	RFDRWSC54	375	T52490S	114, 225
GT5778	308	GTB1548	330	NHBRHDMIGMBF	33	RFDRWSC60	375	T52496S	114, 225
GT5778G	313	GTB1554	330	NHBRHDMIMB	30	RFDRWSC66	375	T53024S	114, 226
GT301824	304	GTB1560	330	NHBRHDMIMF	30	RFDRWSC72	375	T53030S	114, 226
GT301824G	309	GTB2224	330	NHBRHDMIPMB	31	RFDRWWM	374	T53036S	114, 226
GT301830	304	GTB2230	330	NHBRHDMIPMF	31	T6BK	125, 238	T53042S	114, 226
GT301830G	309	GTB2236	330	NHBRHDPLANT	35	T6CB12L	125, 238	T53048S	114, 226
GT302418	304	GTB2242	330	NHBRHDSHELF	34	T6CB12R	125, 238	T53054S	114, 226
GT302418G	309	GTB2248	330	NHBRHDTBIFB	32	T6CB18L	125, 238	T53060B	118, 231
GT302430	304	GTB2254	330	NHBRHDTBIFF	32	T6CB18R	125, 238	T53060S	114, 226
GT302430G	309	GTB2260	330	NHBRHDTBILB	29	T6CB24L	125, 238	T53066B	118, 231
GT303018	304	GTEMP	304, 305, 306, 307, 308, 309, 310, 311, 312, 313	NHBRHDTBILF	29	T6CB24R	125, 238	T53066S	114, 226
GT303018G	309			NHBRHDTBIMB	30	T6SB	125, 238	T53072B	118, 231
GT303024	304			NHBRHDTBIMF	30	T7DV	132, 134, 272	T53072PL	118, 231
GT303024G	309	GTK3CON30F	325	NHBRHDTBIPMB	31	T612FB	125, 238	T53072PR	118, 231

INDEX

Cross Reference Index

by Model Number

Model	Page	Model	Page	Model	Page	Model	Page	Model	Page
T53072S	114, 226	TK315C	63	TK330E	64	TK342X	62	TK380E	64
T53078S	114, 226	TK315CF	63	TK330EF	64	TK342XF	62	TK380EF	64
T53084S	114, 226	TK315E	64	TK330H	64	TK348PT	60	TK380L	62
T53090S	114, 226	TK315EF	64	TK330HF	64	TK348PTFK	60	TK380LF	62
T53096S	114, 226	TK315H	64	TK330L	62	TK350B	63	TK380S	63
T53624SC	116, 229	TK315HF	64	TK330LF	62	TK350BF	63	TK380SF	63
T53660B	118, 231	TK315HG	64	TK330PT	60	TK350C	63	TK380T	62
T53660S	226	TK315HGF	64	TK330PTFK	60	TK350CF	63	TK380TF	62
T53666B	118, 231	TK315L	62	TK330S	63	TK350E	64	TK380X	62
T53666S	226	TK315LF	62	TK330SF	63	TK350EF	64	TK380XF	62
T53672B	118, 231	TK315S	63	TK330T	62	TK350L	62	TK384PT	60
T53672S	226	TK315SF	63	TK330TF	62	TK350LF	62	TK384PTFK	60
T54224SC	116, 229	TK315T	62	TK330W	64	TK350S	63	TK387E	64
T54230SC	116, 229	TK315TF	62	TK330WF	64	TK350SF	63	TK387EF	64
T54662JL	118, 231	TK315W	64	TK330X	62	TK350T	62	TK387L	62
T54662JR	118, 231	TK315WF	64	TK330XF	62	TK350TF	62	TK387LF	62
T54663JL	118, 231	TK315X	62	TK332B	63	TK350W	64	TK387S	63
T54663JR	118, 231	TK315XF	62	TK332BF	63	TK350WF	64	TK387SF	63
T54722JL	118, 231	TK320B	63	TK332C	63	TK350X	62	TK387T	62
T54722JR	118, 231	TK320BF	63	TK332CF	63	TK350XF	62	TK387TF	62
T54723JL	118, 231	TK320C	63	TK332E	64	TK354PT	60	TK387W	64
T54723JR	118, 231	TK320CF	63	TK332EF	64	TK354PTFK	60	TK387WF	64
T54824SC	116, 229	TK320H	64	TK332L	62	TK357B	63	TK387X	62
T54830SC	116, 229	TK320HF	64	TK332LF	62	TK357BF	63	TK387XF	62
TAWG	96, 212, 263	TK320L	62	TK332S	63	TK357C	63	TK390PT	60
TBPLATE3-36	97, 213	TK320LF	62	TK332SF	63	TK357CF	63	TK390PTFK	60
TBPLATE3-42	97, 213	TK320S	63	TK332T	62	TK357E	64	TK396PT	60
TBPLATE3-48	97, 213	TK320SF	63	TK332TF	62	TK357EF	64	TK396PTFK	60
TBPLATE3-60	97, 213	TK320T	62	TK332W	64	TK357L	62	TK01524	58
TK4TRAYMS	79, 184	TK320TF	62	TK332WF	64	TK357LF	62	TK01530	58
TK24FR	59	TK320X	62	TK332X	62	TK357S	63	TK01536	58
TK30FR	59	TK320XF	62	TK332XF	62	TK357SF	63	TK01542	58
TK36FR	59	TK322E	64	TK335B	63	TK357T	62	TK01548	58
TK42FR	59	TK322EF	64	TK335BF	63	TK357TF	62	TK01560	58
TK48FR	59	TK322H	64	TK335C	63	TK357W	64	TK02224	58
TK60FR	59	TK322HF	64	TK335CF	63	TK357WF	64	TK02230	58
TK305H	64	TK322L	62	TK335E	64	TK357X	62	TK02236	58
TK305HF	64	TK322LF	62	TK335EF	64	TK357XF	62	TK02242	58
TK307H	64	TK322S	63	TK335L	62	TK360PT	60	TK02248	58
TK307HF	64	TK322SF	63	TK335LF	62	TK360PTFK	60	TK02260	58
TK307HG	64	TK322T	62	TK335S	63	TK365B	63	TK03024	58
TK307HGF	64	TK322TF	62	TK335SF	63	TK365BF	63	TK03030	58
TK307L	62	TK322W	64	TK335T	62	TK365C	63	TK03036	58
TK307LF	62	TK322WF	64	TK335TF	62	TK365CF	63	TK03042	58
TK307S	63	TK322X	62	TK335W	64	TK365E	64	TK03048	58
TK307SF	63	TK322XF	62	TK335WF	64	TK365EF	64	TK03060	58
TK307T	62	TK324PT	60	TK335X	62	TK365L	62	TK03224WF	57
TK307TF	62	TK324PTFK	60	TK335XF	62	TK365LF	62	TK03224WR	57
TK307X	62	TK327B	63	TK336PT	60	TK365S	63	TK03230WF	57
TK307XF	62	TK327BF	63	TK336PTFK	60	TK365SF	63	TK03230WR	57
TK312B	63	TK327C	63	TK342B	63	TK365T	62	TK03236WF	57
TK312BF	63	TK327CF	63	TK342BF	63	TK365TF	62	TK03236WR	57
TK312C	63	TK327H	64	TK342C	63	TK365W	64	TK03242WF	57
TK312CF	63	TK327HF	64	TK342CF	63	TK365WF	64	TK03242WR	57
TK312H	64	TK327L	62	TK342E	64	TK365X	62	TK03248WF	57
TK312HF	64	TK327LF	62	TK342EF	64	TK365XF	62	TK03248WR	57
TK312L	62	TK327S	63	TK342L	62	TK365YEB	66, 126	TK03260WF	57
TK312LF	62	TK327SF	63	TK342LF	62	TK365YM	66, 126	TK03260WR	57
TK312S	63	TK327T	62	TK342PT	60	TK366PT	60	TK03524WF	57
TK312SF	63	TK327TF	62	TK342PTFK	60	TK366PTFK	60	TK03524WR	57
TK312T	62	TK327X	62	TK342S	63	TK368PT	60	TK03530WF	57
TK312TF	62	TK327XF	62	TK342SF	63	TK368PTFK	60	TK03530WR	57
TK312X	62	TK330B	63	TK342T	62	TK372PT	60	TK03536WF	57
TK312XF	62	TK330BF	63	TK342TF	62	TK372PTFK	60	TK03536WR	57
TK315B	63	TK330C	63	TK342W	64	TK378PT	60	TK03542WF	57
TK315BF	63	TK330CF	63	TK342WF	64	TK378PTFK	60	TK03542WR	57

Cross Reference Index

by Model Number

Model	Page	Model	Page	Model	Page	Model	Page	Model	Page
TK03548WF.....	57	TK40736CTK.....	81	TK41548TGSF.....	61	TK43042GK.....	78	TKG40730T.....	67
TK03548WR.....	57	TK40736FD.....	80	TK41548V.....	82	TK43042PS.....	80	TKG40730TGSR.....	61
TK03560WF.....	57	TK40736PS.....	80	TK41554TGSF.....	61	TK43042SP.....	80	TKG40736FS.....	71
TK03560WR.....	57	TK40736SP.....	80	TK41560CTK.....	81	TK43048CTK.....	81	TKG40736LFD.....	80
TK04224WF.....	57	TK40736SW.....	71	TK41560FD.....	80	TK43048FD.....	80	TKG40736LM.....	73
TK04224WR.....	57	TK40736TGSF.....	61	TK41560GK.....	78	TK43048GK.....	78	TKG40736MS.....	79
TK04230WF.....	57	TK40742CTK.....	81	TK41560PS.....	80	TK43048PS.....	80	TKG40736SH.....	72
TK04230WR.....	57	TK40742FD.....	80	TK41560SP.....	80	TK43048SP.....	80	TKG40736T.....	67
TK04236WF.....	57	TK40742PS.....	80	TK41560SW.....	71	TK43048V.....	82	TKG40736TGSR.....	61
TK04236WR.....	57	TK40742SP.....	80	TK41560TGSF.....	61	TK43060CTK.....	81	TKG40742FS.....	71
TK04242WF.....	57	TK40742SW.....	71	TK41566TGSF.....	61	TK43060FD.....	80	TKG40742LFD.....	80
TK04242WR.....	57	TK40742TGSF.....	61	TK41572TGSF.....	61	TK43060GK.....	78	TKG40742LM.....	73
TK04248WF.....	57	TK40748CTK.....	81	TK41578TGSF.....	61	TK43060PS.....	80	TKG40742MS.....	79
TK04248WR.....	57	TK40748FD.....	80	TK41584TGSF.....	61	TK43060SP.....	80	TKG40742SH.....	72
TK04260WF.....	57	TK40748PS.....	80	TK41590TGSF.....	61	TK44230V.....	82	TKG40742T.....	67
TK04260WR.....	57	TK40748SP.....	80	TK41596TGSF.....	61	TK44242V.....	82	TKG40742TGSR.....	61
TK05024WF.....	57	TK40748SW.....	71	TK42224CTK.....	81	TK44248V.....	82	TKG40748FD.....	80
TK05024WR.....	57	TK40748TGSF.....	61	TK42224FD.....	80	TK851524CP.....	120	TKG40748FS.....	71
TK05030WF.....	57	TK40754TGSF.....	61	TK42224GK.....	78	TK851524P.....	120	TKG40748LM.....	73
TK05030WR.....	57	TK40760CTK.....	81	TK42224PS.....	80	TK851524PF.....	120	TKG40748MS.....	79
TK05036WF.....	57	TK40760FD.....	80	TK42224SP.....	80	TK851530CP.....	120	TKG40748SH.....	72
TK05036WR.....	57	TK40760PS.....	80	TK42230CTK.....	81	TK851530P.....	120	TKG40748T.....	67
TK05042WF.....	57	TK40760SP.....	80	TK42230FD.....	80	TK851530PF.....	120	TKG40748TGSR.....	61
TK05042WR.....	57	TK40760SW.....	71	TK42230GK.....	78	TK851536CP.....	120	TKG40754TGSR.....	61
TK05048WF.....	57	TK40760TGSF.....	61	TK42230PS.....	80	TK851536P.....	120	TKG40760FS.....	71
TK05048WR.....	57	TK40766TGSF.....	61	TK42230SP.....	80	TK851536PF.....	120	TKG40760LFD.....	80
TK05060WF.....	57	TK40772TGSF.....	61	TK42236CTK.....	81	TK851542P.....	120	TKG40760LM.....	73
TK05060WR.....	57	TK40778TGSF.....	61	TK42236FD.....	80	TK851542PF.....	120	TKG40760MS.....	79
TK05724WF.....	57	TK40784TGSF.....	61	TK42236GK.....	78	TK851548P.....	120	TKG40760SH.....	72
TK05724WR.....	57	TK40790TGSF.....	61	TK42236PS.....	80	TK851548PF.....	120	TKG40760T.....	67
TK05730WF.....	57	TK40796TGSF.....	61	TK42236SP.....	80	TK851554P.....	120	TKG40760TGSR.....	61
TK05730WR.....	57	TK41524CTK.....	81	TK42242CTK.....	81	TK851554PF.....	120	TKG40766TGSR.....	61
TK05736WF.....	57	TK41524FD.....	80	TK42242FD.....	80	TK851560P.....	120	TKG40772TGSR.....	61
TK05736WR.....	57	TK41524GK.....	78	TK42242GK.....	78	TK851560PF.....	120	TKG40778TGSR.....	61
TK05742WF.....	57	TK41524PS.....	80	TK42242PS.....	80	TK851566P.....	120	TKG40784TGSR.....	61
TK05742WR.....	57	TK41524SP.....	80	TK42242SP.....	80	TK851566PF.....	120	TKG40790TGSR.....	61
TK05748WF.....	57	TK41524SW.....	71	TK42248CTK.....	81	TK851572P.....	120	TKG40796TGSR.....	61
TK05748WR.....	57	TK41524TGSF.....	61	TK42248FD.....	80	TK851572PF.....	120	TKG41524E.....	69
TK05760WF.....	57	TK41530CTK.....	81	TK42248GK.....	78	TKCWD29L.....	126	TKG41524FS.....	71
TK05760WR.....	57	TK41530FD.....	80	TK42248PS.....	80	TKCWD29R.....	126	TKG41524LFD.....	80
TK06524WF.....	57	TK41530GK.....	78	TK42248SP.....	80	TKDKM30.....	59	TKG41524LM.....	73
TK06524WR.....	57	TK41530PS.....	80	TK42248V.....	82	TKDKM36.....	59	TKG41524MS.....	79
TK06530WF.....	57	TK41530SP.....	80	TK42260CTK.....	81	TKDKM42.....	59	TKG41524SH.....	72
TK06530WR.....	57	TK41530SW.....	71	TK42260FD.....	80	TKDKM48.....	59	TKG41524T.....	67
TK06536WF.....	57	TK41530TGSF.....	61	TK42260GK.....	78	TKDPA29L.....	126	TKG41524TGSR.....	61
TK06536WR.....	57	TK41530V.....	82	TK42260PS.....	80	TKDPA29R.....	126	TKG41530E.....	69
TK06542WF.....	57	TK41536CTK.....	81	TK42260SP.....	80	TKEB29L.....	126	TKG41530FS.....	71
TK06542WR.....	57	TK41536FD.....	80	TK43024CTK.....	81	TKEB29R.....	126	TKG41530LFD.....	80
TK06548WF.....	57	TK41536GK.....	78	TK43024FD.....	80	TKEP1129PL.....	125, 126	TKG41530LM.....	73
TK06548WR.....	57	TK41536PS.....	80	TK43024GK.....	78	TKEP1129PR.....	125, 126	TKG41530MS.....	79
TK06560WF.....	57	TK41536SP.....	80	TK43024PS.....	80	TKEP2429PL.....	125, 126	TKG41530SH.....	72
TK06560WR.....	57	TK41536SW.....	71	TK43024SP.....	80	TKEP2429PR.....	125, 126	TKG41530T.....	67
TK18742D.....	59	TK41536TGSF.....	61	TK43024SP.....	80	TKEP3029PL.....	125, 126	TKG41530TGSR.....	61
TK18742DF.....	59	TK41542CTK.....	81	TK43030CTK.....	81	TKEP3029PR.....	125, 126	TKG41536E.....	69
TK40724CTK.....	81	TK41542FD.....	80	TK43030FD.....	80	TKG40724FS.....	71	TKG41536FS.....	71
TK40724FD.....	80	TK41542GK.....	78	TK43030GK.....	78	TKG40724LFD.....	80	TKG41536LFD.....	80
TK40724PS.....	80	TK41542PS.....	80	TK43030PS.....	80	TKG40724LM.....	73	TKG41536LM.....	73
TK40724SP.....	80	TK41542SP.....	80	TK43030SP.....	80	TKG40724MS.....	79	TKG41536MS.....	79
TK40724SW.....	71	TK41542SW.....	71	TK43030V.....	82	TKG40724SH.....	72	TKG41536SH.....	72
TK40724TGSF.....	61	TK41542TGSF.....	61	TK43036CTK.....	81	TKG40724T.....	67	TKG41536T.....	67
TK40730CTK.....	81	TK41548CTK.....	81	TK43036FD.....	80	TKG40724TGSR.....	61	TKG41536TGSR.....	61
TK40730FD.....	80	TK41548FD.....	80	TK43036GK.....	78	TKG40730FS.....	71	TKG41542E.....	69
TK40730PS.....	80	TK41548GK.....	78	TK43036PS.....	80	TKG40730LFD.....	80	TKG41542FD.....	80
TK40730SP.....	80	TK41548PS.....	80	TK43036SP.....	80	TKG40730LM.....	73	TKG41542FS.....	71
TK40730SW.....	71	TK41548SP.....	80	TK43036V.....	82	TKG40730MS.....	79	TKG41542LM.....	73
TK40730TGSF.....	61	TK41548SW.....	71	TK43042CTK.....	81	TKG40730SH.....	72	TKG41542MS.....	79
				TK43042FD.....	80				

INDEX

Cross Reference Index

by Model Number

Model	Page	Model	Page	Model	Page	Model	Page	Model	Page
TKG41542SH	72	TKG42260E	69	TKG43042SH	72	TKG44230E	70	TKG45724E	70
TKG41542T	67	TKG42260FS	71	TKG43042T	67	TKG44230T	68	TKG45724LM	74
TKG41542TGRS	61	TKG42260LFD	80	TKG43048E	69	TKG44236E	70	TKG45724LTF	75
TKG41548E	69	TKG42260LM	73	TKG43048FS	71	TKG44236T	68	TKG45724T	68
TKG41548FS	71	TKG42260LTF	75	TKG43048LFD	80	TKG44242E	70	TKG45730E	70
TKG41548LFD	80	TKG42260MS	79	TKG43048LM	73	TKG44242T	68	TKG45730LM	74
TKG41548LM	73	TKG42260SH	72	TKG43048LTF	75	TKG44248E	70	TKG45730LTF	75
TKG41548MS	79	TKG42260T	67	TKG43048MS	79	TKG44248T	68	TKG45730T	68
TKG41548SH	72	TKG42524LM	73	TKG43048SH	72	TKG44254SLS	76	TKG45736E	70
TKG41548T	67	TKG42524LTF	75	TKG43048T	67	TKG44254SLSTF	77	TKG45736LM	74
TKG41548TGRS	61	TKG42530LM	73	TKG43054SLS	76	TKG44260E	70	TKG45736LTF	75
TKG41554TGRS	61	TKG42530LTF	75	TKG43054SLSTF	77	TKG44260SLS	76	TKG45736T	68
TKG41560E	69	TKG42536LM	73	TKG43060E	69	TKG44260SLSTF	77	TKG45742E	70
TKG41560FS	71	TKG42536LTF	75	TKG43060FS	71	TKG44260T	68	TKG45742LM	74
TKG41560LFD	80	TKG42542LM	73	TKG43060LFD	80	TKG44266SLS	76	TKG45742LTF	75
TKG41560LM	73	TKG42542LTF	75	TKG43060LM	73	TKG44266SLSTF	77	TKG45742T	68
TKG41560MS	79	TKG42548LM	73	TKG43060LTF	75	TKG44272SLS	76	TKG45748E	70
TKG41560SH	72	TKG42548LTF	75	TKG43060MS	79	TKG44272SLSTF	77	TKG45748LM	74
TKG41560T	67	TKG42554SLS	76	TKG43060SH	72	TKG44278SLS	76	TKG45748LTF	75
TKG41560TGRS	61	TKG42554SLSTF	77	TKG43060SLS	76	TKG44278SLSTF	77	TKG45748T	68
TKG41566TGRS	61	TKG42560LM	73	TKG43060SLSTF	77	TKG44284SLS	76	TKG45760E	70
TKG41572TGRS	61	TKG42560LTF	75	TKG43060T	67	TKG44284SLSTF	77	TKG45760T	68
TKG41578TGRS	61	TKG42560SLS	76	TKG43066SLS	76	TKG44290SLS	76	TKG46024LM	74
TKG41584TGRS	61	TKG42560SLSTF	77	TKG43066SLSTF	77	TKG44290SLSTF	77	TKG46024LTF	75
TKG41590TGRS	61	TKG42566SLS	76	TKG43072SLS	76	TKG44296SLS	76	TKG46030LM	74
TKG41596TGRS	61	TKG42566SLSTF	77	TKG43072SLSTF	77	TKG44296SLSTF	77	TKG46030LTF	75
TKG42224E	69	TKG42572SLS	76	TKG43078SLS	76	TKG44524LM	74	TKG46036LM	74
TKG42224FS	71	TKG42572SLSTF	77	TKG43078SLSTF	77	TKG44524LTF	75	TKG46036LTF	75
TKG42224LFD	80	TKG42578SLS	76	TKG43084SLS	76	TKG44530LM	74	TKG46042LM	74
TKG42224LM	73	TKG42578SLSTF	77	TKG43084SLSTF	77	TKG44530LTF	75	TKG46042LTF	75
TKG42224LTF	75	TKG42584SLS	76	TKG43090SLS	76	TKG44536LM	74	TKG46048LM	74
TKG42224MS	79	TKG42584SLSTF	77	TKG43090SLSTF	77	TKG44536LTF	75	TKG46048LTF	75
TKG42224SH	72	TKG42590SLS	76	TKG43096SLS	76	TKG44542LM	74	TKG46524E	70
TKG42224T	67	TKG42590SLSTF	77	TKG43096SLSTF	77	TKG44542LTF	75	TKG46524T	68
TKG42230E	69	TKG42596SLS	76	TKG43224E	69	TKG44548LM	74	TKG46530E	70
TKG42230FS	71	TKG42596SLSTF	77	TKG43224FS	71	TKG44548LTF	75	TKG46530T	68
TKG42230LFD	80	TKG43024E	69	TKG43224T	67	TKG44560LM	74	TKG46536E	70
TKG42230LM	73	TKG43024FS	71	TKG43230E	69	TKG44560LTF	75	TKG46536T	68
TKG42230LTF	75	TKG43024LFD	80	TKG43230FS	71	TKG45024E	70	TKG46542E	70
TKG42230MS	79	TKG43024LM	73	TKG43230T	67	TKG45024T	68	TKG46542T	68
TKG42230SH	72	TKG43024LTF	75	TKG43236E	69	TKG45030E	70	TKG46548E	70
TKG42230T	67	TKG43024MS	79	TKG43236FS	71	TKG45030T	68	TKG46548T	68
TKG42236E	69	TKG43024SH	72	TKG43236T	67	TKG45036E	70	TKG46560E	70
TKG42236FS	71	TKG43024T	67	TKG43242E	69	TKG45036T	68	TKG46560T	68
TKG42236LFD	80	TKG43030E	69	TKG43242FS	71	TKG45042E	70	TKMP60	127
TKG42236LM	73	TKG43030FS	71	TKG43242T	67	TKG45042T	68	TKMP66	127
TKG42236LTF	75	TKG43030LFD	80	TKG43248E	69	TKG45048E	70	TKMP72	127
TKG42236MS	79	TKG43030LM	73	TKG43248FS	71	TKG45048T	68	TKOM	59
TKG42236SH	72	TKG43030LTF	75	TKG43248T	67	TKG45054SLS	76	TKPPBL	125
TKG42236T	67	TKG43030MS	79	TKG43260E	69	TKG45054SLSTF	77	TKPPBR	125
TKG42242E	69	TKG43030SH	72	TKG43260FS	71	TKG45060E	70	TKRF	59
TKG42242FS	71	TKG43030T	67	TKG43260T	67	TKG45060SLS	76	TKSB29	126
TKG42242LFD	80	TKG43036E	69	TKG43724LM	74	TKG45060SLSTF	77	TKSK24	58, 66
TKG42242LM	73	TKG43036FS	71	TKG43724LTF	75	TKG45060T	68	TKSK30	58, 66
TKG42242LTF	75	TKG43036LFD	80	TKG43730LM	74	TKG45066SLS	76	TKSK36	58, 66
TKG42242MS	79	TKG43036LM	73	TKG43730LTF	75	TKG45066SLSTF	77	TKSK42	58, 66
TKG42242SH	72	TKG43036LTF	75	TKG43736LM	74	TKG45072SLS	76	TKSK48	58, 66
TKG42242T	67	TKG43036MS	79	TKG43736LTF	75	TKG45072SLSTF	77	TKSK60	58, 66
TKG42248E	69	TKG43036SH	72	TKG43742LM	74	TKG45078SLS	76	TKSL2429P	125, 126
TKG42248FS	71	TKG43036T	67	TKG43742LTF	75	TKG45078SLSTF	77	TKSL3029P	125, 126
TKG42248LFD	80	TKG43042E	69	TKG43748LM	74	TKG45084SLS	76	TN3LB	65
TKG42248LM	73	TKG43042FS	71	TKG43748LTF	75	TKG45084SLSTF	77	TN3NB	65
TKG42248LTF	75	TKG43042LFD	80	TKG43760LM	74	TKG45090SLS	76	TN3SB	65
TKG42248MS	79	TKG43042LM	73	TKG43760LTF	75	TKG45090SLSTF	77	TN3TB	65
TKG42248SH	72	TKG43042LTF	75	TKG44224E	70	TKG45096SLS	76	TN3VB	65
TKG42248T	67	TKG43042MS	79	TKG44224T	68	TKG45096SLSTF	77	TN3VLB	65

Cross Reference Index

by Model Number

Model	Page	Model	Page	Model	Page	Model	Page	Model	Page
TN3XB.....	65	UH6560FD.....	134	Z2UP60.....	132, 272	Z148DMK.....	166	Z330PEV.....	174
TN24MS.....	58, 97	UH6566FD.....	134	Z3CONB.....	168	Z224FR.....	162	Z330PF.....	169, 170, 172
TN30MS.....	58, 97	UH6572FD.....	134	Z3CONC.....	168	Z224SK.....	162	Z330PFV.....	169, 170, 172
TN36MS.....	58, 97	UHTB36.....	134	Z3MP.....	197	Z230FR.....	162	Z330PL.....	169, 170, 172
TN42MS.....	58, 97	UHTB42.....	134	Z3SS.....	169	Z230SK.....	162	Z330PLV.....	169, 170, 172
TN48MS.....	58, 97	UHTB48.....	134	Z3SSV.....	169	Z235PP.....	210	Z330PP.....	210
TN60MS.....	58, 97	UHTB60.....	134	Z3TBGB.....	163	Z236FR.....	162	Z330PPV.....	210
TN524D.....	119	UHTB66.....	134	Z3TBGC.....	163	Z236SK.....	162	Z330PT.....	167
TN530D.....	119	UHTB72.....	134	Z3TBGI.....	163	Z242FR.....	162	Z330PVH.....	169, 170, 172, 173
TN51524S.....	121	UN2HPSQ.....	374	Z3TBGL.....	163	Z242SK.....	162	Z330PVHV.....	169, 170, 172, 173
TN51524SF.....	121	UN2HPSQSK.....	374	Z3TBGS.....	163	Z248FR.....	162	Z330PW.....	175
TN51530S.....	121	UTP.....	96, 212	Z3TBGT.....	163	Z248SK.....	162	Z330PWV.....	175
TN51530SF.....	121	WANDFS.....	390	Z3TBGX.....	163	Z260FR.....	162	Z330VT.....	167
TN51536S.....	121	WANDFSOC.....	390	Z3UCON.....	168	Z260SK.....	162	Z335BB.....	173
TN51536SF.....	121	WANDFSUSB.....	390	Z3UCON10P.....	168	Z265PP.....	210	Z335BBV.....	173
TN51542S.....	121	WKSWMC.....	365, 391.2	Z4STBRKT1.....	77, 189	Z307PB.....	173	Z335CB.....	173
TN51542SF.....	121	Y6EPKP.....	237	Z4STBRKT2.....	77, 189	Z307PBV.....	173	Z335CBV.....	173
TN51548S.....	121	Y6PPK.....	235	Z4UP24.....	132, 272	Z307PE.....	174	Z335CC.....	173
TN51548SF.....	121	Y324YS.....	66, 126	Z4UP30.....	132, 272	Z307PEV.....	174	Z335CCV.....	173
TN51554S.....	121	Y330YS.....	66, 126	Z4UP36.....	132, 272	Z307PF.....	169, 170, 172	Z335LL.....	169
TN51554SF.....	121	Y336YS.....	66, 126	Z4UP42.....	132, 272	Z307PFV.....	169, 170, 172	Z335LLV.....	169
TN51560S.....	121	Y342YS.....	66, 126	Z4UP48.....	132, 272	Z307PL.....	169, 170, 172	Z335PB.....	173
TN51560SF.....	121	Y348YS.....	66, 126	Z4UP60.....	132, 272	Z307PLV.....	169, 170, 172	Z335PBV.....	173
TN51566S.....	121	Y360YS.....	66, 126	Z5SC42.....	114, 238	Z307PTG.....	174	Z335PE.....	174
TN51566SF.....	121	Y629LKMP.....	237	Z5SC48.....	114, 238	Z307PTGV.....	169, 170, 172, 173	Z335PEF.....	174
TN51572S.....	121	Y629LKNP.....	237	Z5SC54.....	114, 238	Z307PVH.....	169, 170, 172, 173	Z335PEFV.....	174
TN51572SF.....	121	Y629NLK.....	237	Z5SC60.....	114, 238	Z307PVHV.....	169, 170, 172, 173	Z335PEV.....	174
TN52424C.....	121	Y51524S.....	120	Z5SC66.....	114, 238	Z315PB.....	173	Z335PF.....	169, 170, 172
TN52424CF.....	121	Y51530S.....	120	Z5SC72.....	114, 238	Z315PBV.....	173	Z335PFV.....	169, 170, 172
TN52424Q.....	119	Y51536S.....	120	Z5SC78.....	114, 238	Z315PE.....	174	Z335PL.....	169
TN52424SD.....	116	Y51542S.....	120	Z5SC84.....	114, 238	Z315PEV.....	174	Z335PLV.....	169
TN53030C.....	121	Y51548S.....	120	Z5WM48.....	238	Z315PF.....	169, 170, 172	Z335PW.....	175
TN53030CF.....	121	Y51554S.....	120	Z5WM54.....	238	Z315PFV.....	169, 170, 172	Z335PWV.....	175
TN53030Q.....	119	Y51560S.....	120	Z5WM60.....	238	Z315PL.....	169, 170, 172	Z335ST.....	174
TN53636C.....	121	Y51566S.....	120	Z5WM66.....	238	Z315PLV.....	169, 170, 172	Z335STL.....	170
TN53636CF.....	121	Y51572S.....	120	Z5WM72.....	238	Z315PTG.....	174	Z335STLV.....	170
TNV52424Q.....	124, 234	Y52424C.....	120	Z5WM78.....	238	Z315PTGV.....	174	Z335STS.....	170
TNV53030Q.....	124, 234	Y53030C.....	120	Z5WM84.....	238	Z315PVH.....	169, 170, 172, 173	Z335TSV.....	170
TT629SC.....	125, 237	Y53636C.....	120	Z6C3BK.....	197, 238	Z315PVHV.....	169, 170, 172, 173	Z335TT.....	170
TT53024CB.....	116, 229	Y62610SLPP.....	235	Z6CLFL.....	237	Z315PW.....	175	Z335TTV.....	170
TT53624CB.....	116, 229	Y62620PENP.....	235	Z6CLFR.....	237	Z315PWV.....	175	Z335TV.....	171
TT53660BT.....	115	Y62624PENP.....	235	Z6CLHL.....	237	Z322PB.....	173	Z335XL.....	171
TT53666BT.....	115	Y62910FENP.....	235	Z6CLHR.....	237	Z322PBV.....	173	Z335XLV.....	171
TT53672BT.....	115	Y62910PENP.....	235	Z6EPK.....	197, 238	Z322PE.....	174	Z335XS.....	171
TT54224CB.....	116, 229	Y62910SLFP.....	235	Z6LB.....	265	Z322PEV.....	174	Z335XSV.....	171
TT54824CB.....	116, 229	Y62910SLPP.....	235	Z6MK.....	197, 238	Z322PF.....	169, 170, 172	Z335XT.....	171
TWTH.....	132, 272	Y62920PENP.....	235	Z6PL29FL.....	236	Z322PFV.....	169, 170, 172	Z335XTV.....	171
U7WDA.....	386	Y62924FENP.....	235	Z6PL29FP.....	236	Z322PL.....	169, 170, 172	Z336PP.....	210
U9TF.....	377	Y62924PENP.....	235	Z6PL29FR.....	236	Z322PLV.....	169, 170, 172	Z336PPV.....	210
U9TM.....	377	Y62924SLFP.....	235	Z6PL29HP.....	236	Z322PVH.....	169, 170, 172, 173	Z336PT.....	167
U9TP.....	377	Y62924SLPP.....	235	Z6PL40FL.....	236	Z322PVHV.....	169, 170, 172, 173	Z336VT.....	167
U9TS.....	377	Y62930FENP.....	235	Z6PL40FP.....	236	Z322PW.....	175	Z342BB.....	173
U9WTC.....	97, 377	Y62930PENP.....	235	Z6PL40FR.....	236	Z322PWV.....	175	Z342BBV.....	173
U912WTR.....	377	YWC24Z.....	266	Z6PL40HL.....	236	Z324PP.....	210	Z342CC.....	173
U918WTR.....	377	YWC30Z.....	266	Z6PL40HP.....	236	Z324PPV.....	210	Z342CCV.....	173
U924WTR.....	377	YWC36Z.....	266	Z6PL40HR.....	236	Z324PT.....	167	Z342LL.....	169
U930WTR.....	377	YWC42Z.....	266	Z6PTLFP.....	236	Z324VT.....	167	Z342LIV.....	169
U936WTR.....	377	YWC48Z.....	266	Z6PTLFPG.....	236	Z330PB.....	173	Z342PB.....	173
U942WTR.....	377	YWC60Z.....	266	Z6PTLHPC.....	236	Z330PBV.....	173	Z342PBV.....	173
U948WTR.....	377	Z2NM.....	197, 272	Z6PTLHPG.....	236	Z330PE.....	174	Z342PE.....	174
U954WTR.....	377	Z2RF.....	162	Z6SCF.....	237				
U960WTR.....	377	Z2UP24.....	132, 272	Z6SCH.....	237				
U966WTR.....	377	Z2UP30.....	132, 272	Z6Z3MK.....	197, 238				
UH6536FD.....	134	Z2UP36.....	132, 272	Z130DMK.....	166				
UH6542FD.....	134	Z2UP42.....	132, 272	Z136DMK.....	166				
UH6548FD.....	134	Z2UP48.....	132, 272	Z142DMK.....	166				

INDEX

Cross Reference Index

by Model Number

Model	Page	Model	Page	Model	Page	Model	Page	Model	Page
Z342PEF	174	Z350XTV	171	Z365PFV	169, 170, 172	Z380LLV	169	Z390PPV	210
Z342PEFV	174	Z350XX	171	Z365SPL	169	Z380PB	173	Z390PT	167
Z342PEV	174	Z350XXV	171	Z365SPLV	169	Z380PBV	173	Z390VT	167
Z342PF	169, 170, 172	Z351PT	167	Z365PW	175	Z380PE	174	Z395BB	173
Z342PFV	169, 170, 172	Z351VT	167	Z365PWV	175	Z380PEF	174	Z395BBV	173
Z342PL	169	Z354PP	210	Z365T	174	Z380PEFV	174	Z395CB	173
Z342PLV	169	Z354PPV	210	Z365TL	170	Z380PEV	174	Z395CBV	173
Z342PP	210	Z354PT	167	Z365TLV	170	Z380PF	169, 170, 172	Z395CC	173
Z342PPV	210	Z354VT	167	Z365TS	170	Z380PFV	169, 170, 172	Z395CCV	173
Z342PT	167	Z357BB	173	Z365TSV	170	Z380PL	169	Z395LL	169
Z342PW	175	Z357BBV	173	Z365TT	170	Z380PLV	169	Z395LLV	169
Z342PWW	175	Z357CB	173	Z365TTV	170	Z380PW	175	Z395TL	170
Z342T	174	Z357CBV	173	Z365X	174	Z380PWV	175	Z395TLV	170
Z342TL	170	Z357CC	173	Z365XL	171	Z380T	174	Z395TS	170
Z342TLV	170	Z357CCV	173	Z365XLV	171	Z380TL	170	Z395TSV	170
Z342TS	170	Z357LL	169	Z365XS	171	Z380TLV	170	Z395TT	170
Z342TSV	170	Z357LLV	169	Z365XSV	171	Z380TS	170	Z395TTV	170
Z342TT	170	Z357PB	173	Z365XT	171	Z380TSV	170	Z395XL	171
Z342TTV	170	Z357PBV	173	Z365XTV	171	Z380TT	170	Z395XLV	171
Z342VT	167	Z357PE	174	Z365XX	171	Z380TTV	170	Z395XS	171
Z342X	174	Z357PEF	174	Z365XXV	171	Z380X	174	Z395XSV	171
Z342XL	171	Z357PEFV	174	Z366PT	167	Z380XL	171	Z395XT	171
Z342XLV	171	Z357PEV	174	Z366VT	167	Z380XLV	171	Z395XTV	171
Z342XS	171	Z357PF	169, 170, 172	Z368PP	210	Z380XS	171	Z395XXX	171
Z342XSV	171	Z357PFV	169, 170, 172	Z368PPV	210	Z380XSV	171	Z395XXV	171
Z342XT	171	Z357PL	169	Z368PT	167	Z380XT	171	Z396PP	210
Z342XTV	171	Z357PLV	169	Z368VT	167	Z380XTV	171	Z396PPV	210
Z342XX	171	Z357PW	175	Z372BB	173	Z380XX	171	Z396PT	167
Z342XXV	171	Z357PWV	175	Z372BBV	173	Z380XXV	171	Z396VT	167
Z348PP	210	Z357T	174	Z372CB	173	Z384PP	210	Z01524P	162
Z348PPV	210	Z357TL	170	Z372CBV	173	Z384PPV	210	Z01530P	162
Z348PT	167	Z357TLV	170	Z372CC	173	Z384PT	167	Z01536P	162
Z348VT	167	Z357TS	170	Z372CCV	173	Z384VT	167	Z01542P	162
Z350BB	173	Z357TSV	170	Z372LL	169	Z387BB	173	Z01548P	162
Z350BBV	173	Z357TT	170	Z372LLV	169	Z387BBV	173	Z01560P	162
Z350CB	173	Z357TTV	170	Z372PP	210	Z387CB	173	Z02224P	162
Z350CBV	173	Z357X	174	Z372PPV	210	Z387CBV	173	Z02230P	162
Z350CC	173	Z357XL	171	Z372PT	167	Z387CC	173	Z02236P	162
Z350CCV	173	Z357XLV	171	Z372TL	170	Z387CCV	173	Z02242P	162
Z350LL	169	Z357XS	171	Z372TLV	170	Z387LL	169	Z02248P	162
Z350LLV	169	Z357XSV	171	Z372TS	170	Z387LLV	169	Z02260P	162
Z350PB	173	Z357XT	171	Z372TSS	170	Z387PE	174	Z03024P	162
Z350PBV	173	Z357XTV	171	Z372TSP	210	Z387PEV	174	Z03030P	162
Z350PE	174	Z357XX	171	Z372TSPV	170	Z387PF	169, 170, 172	Z03036P	162
Z350PEF	174	Z357XXV	171	Z372TST	167	Z387PFV	169, 170, 172	Z03042P	162
Z350PEFV	174	Z360PP	210	Z372TSTV	171	Z387PL	169	Z03048P	162
Z350PEV	174	Z360PPV	210	Z372TTL	171	Z387PLV	169	Z03060P	162
Z350PF	169, 170, 172	Z360PT	167	Z372TTLV	171	Z387PW	175	Z3102BB	173
Z350PFV	169, 170, 172	Z360VT	167	Z372XS	171	Z387PWV	175	Z3102BBV	173
Z350PL	169	Z363PT	167	Z372XSV	171	Z387T	174	Z3102CB	173
Z350PLV	169	Z363VT	167	Z372XT	171	Z387TL	170	Z3102CBV	173
Z350PW	175	Z365BB	173	Z372XTV	171	Z387TLV	170	Z3102CC	173
Z350PWW	175	Z365BBV	173	Z372XX	171	Z387TIV	170	Z3102CCV	173
Z350T	174	Z365BBV	173	Z372XXV	171	Z387TS	170	Z3102LL	169
Z350TL	170	Z365CB	173	Z375SPT	167	Z387TSV	170	Z3102LLV	169
Z350TLV	170	Z365CBV	173	Z375VT	167	Z387TT	170	Z3102LLV	169
Z350TS	170	Z365CC	173	Z378PP	210	Z387TTV	170	Z3102TL	170
Z350TSV	170	Z365CCV	173	Z378PPV	210	Z387X	174	Z3102TLV	170
Z350TT	170	Z365LL	169	Z378PT	167	Z387XL	171	Z3102TS	170
Z350TTV	170	Z365LLV	169	Z378VT	167	Z387XLV	171	Z3102TSV	170
Z350X	174	Z365PB	173	Z380BB	173	Z387XS	171	Z3102TT	170
Z350XL	171	Z365PBV	173	Z380BBV	173	Z387XSV	171	Z3102TTV	170
Z350XLV	171	Z365PE	174	Z380CB	173	Z387XT	171	Z3102XL	171
Z350XS	171	Z365PEF	174	Z380CBV	173	Z387XTV	171	Z3102XLV	171
Z350XSV	171	Z365PEFV	174	Z380CC	173	Z387XX	171	Z3102XS	171
Z350XT	171	Z365PEV	174	Z380CCV	173	Z387XXV	171	Z3102XSV	171
		Z365PF	169, 170, 172	Z380LL	169	Z390PP	210	Z3102XT	171

Cross Reference Index

by Model Number

Model	Page	Model	Page	Model	Page	Model	Page	Model	Page
Z3102XTV	171	Z04248WN	161	Z05760WR	161	Z40742L	185	Z41530SW	183
Z3102XX	171	Z04248WR	161	Z06524AIF	198	Z40742LM	186	Z41530T	176
Z3102XXV	171	Z04260AIF	198	Z06524AIU	198	Z40742S	181	Z41530TGS	164
Z3110BB	173	Z04260AIU	198	Z06524WF	161	Z40742SH	182	Z41530TGSV	165
Z3110BBV	173	Z04260WF	161	Z06524WN	161	Z40742SW	183	Z41530V	192
Z3110CB	173	Z04260WN	161	Z06524WR	161	Z40742T	176	Z41536E	178
Z3110CBV	173	Z04260WR	161	Z06530AIF	198	Z40742TGS	164	Z41536G	191
Z3110CC	173	Z05024AIF	198	Z06530AIU	198	Z40742TGSV	165	Z41536GL	163
Z3110CCV	173	Z05024AIU	198	Z06530WF	161	Z40742V	192	Z41536L	185
Z3110LL	169	Z05024WF	161	Z06530WN	161	Z40748E	178	Z41536LM	186
Z3110LLV	169	Z05024WN	161	Z06530WR	161	Z40748L	185	Z41536MB	184
Z3110TL	170	Z05024WR	161	Z06536AIF	198	Z40748LM	186	Z41536MBS	184
Z3110TLV	170	Z05030AIF	198	Z06536AIU	198	Z40748S	181	Z41536S	181
Z3110TS	170	Z05030AIU	198	Z06536WF	161	Z40748SH	182	Z41536SH	182
Z3110TSV	170	Z05030WF	161	Z06536WN	161	Z40748SW	183	Z41536SW	183
Z3110TT	170	Z05030WN	161	Z06536WR	161	Z40748T	176	Z41536T	176
Z3110TTV	170	Z05030WR	161	Z06542AIF	198	Z40748TGS	164	Z41536TGS	164
Z3110XL	171	Z05036AIF	198	Z06542AIU	198	Z40748TGSV	165	Z41536TGSV	165
Z3110XLV	171	Z05036AIU	198	Z06542WF	161	Z40748V	192	Z41536V	192
Z3110XS	171	Z05036WF	161	Z06542WN	161	Z40754TGS	164	Z41542E	178
Z3110XSV	171	Z05036WN	161	Z06542WR	161	Z40754TGSV	165	Z41542G	191
Z3110XT	171	Z05036WR	161	Z06548AIF	198	Z40760E	178	Z41542GL	163
Z3110XTV	171	Z05042AIF	198	Z06548AIU	198	Z40760L	185	Z41542L	185
Z3110XX	171	Z05042AIU	198	Z06548WF	161	Z40760LM	186	Z41542LM	186
Z3110XXV	171	Z05042WF	161	Z06548WN	161	Z40760S	181	Z41542MB	184
Z03524WF	161	Z05042WN	161	Z06548WR	161	Z40760SH	182	Z41542MBS	184
Z03524WN	161	Z05042WR	161	Z06560AIF	198	Z40760SW	183	Z41542S	181
Z03524WR	161	Z05048AIF	198	Z06560AIU	198	Z40760T	176	Z41542SH	182
Z03530WF	161	Z05048AIU	198	Z06560WF	161	Z40760TGS	164	Z41542SW	183
Z03530WN	161	Z05048WF	161	Z06560WN	161	Z40760TGSV	165	Z41542T	176
Z03530WR	161	Z05048WN	161	Z06560WR	161	Z40760V	192	Z41542TGS	164
Z03536WF	161	Z05048WR	161	Z15042SD	59, 166	Z40766TGS	164	Z41542TGSV	165
Z03536WN	161	Z05060AIF	198	Z16542SD	59, 166	Z40766TGSV	165	Z41542V	192
Z03536WR	161	Z05060AIU	198	Z18042SD	59, 166	Z40772TGS	164	Z41548E	178
Z03542WF	161	Z05060WF	161	Z18742PDL	166	Z40772TGSV	165	Z41548G	191
Z03542WN	161	Z05060WN	161	Z40724E	178	Z40778TGS	164	Z41548GL	163
Z03542WR	161	Z05060WR	161	Z40724L	185	Z40778TGSV	165	Z41548L	185
Z03548WF	161	Z05724AIF	198	Z40724LM	186	Z40784TGS	164	Z41548LM	186
Z03548WN	161	Z05724AIU	198	Z40724S	181	Z40784TGSV	165	Z41548MB	184
Z03548WR	161	Z05724WF	161	Z40724SH	182	Z40790TGS	164	Z41548MBS	184
Z03560WF	161	Z05724WN	161	Z40724SW	183	Z40790TGSV	165	Z41548S	181
Z03560WN	161	Z05724WR	161	Z40724T	176	Z40796TGS	164	Z41548SH	182
Z03560WR	161	Z05730AIF	198	Z40724TGS	164	Z40796TGSV	165	Z41548SW	183
Z04224AIF	198	Z05730AIU	198	Z40724TGSV	165	Z41524E	178	Z41548T	176
Z04224AIU	198	Z05730WF	161	Z40724V	192	Z41524G	191	Z41548TGS	164
Z04224WF	161	Z05730WN	161	Z40730E	178	Z41524GL	163	Z41548TGSV	165
Z04224WN	161	Z05730WR	161	Z40730L	185	Z41524L	185	Z41548V	192
Z04224WR	161	Z05736AIF	198	Z40730LM	186	Z41524LM	186	Z41554TGS	164
Z04230AIF	198	Z05736AIU	198	Z40730S	181	Z41524MB	184	Z41554TGSV	165
Z04230AIU	198	Z05736WF	161	Z40730SH	182	Z41524MBS	184	Z41560E	178
Z04230WF	161	Z05736WN	161	Z40730SW	183	Z41524S	181	Z41560G	191
Z04230WN	161	Z05736WR	161	Z40730T	176	Z41524SH	182	Z41560GL	163
Z04230WR	161	Z05742AIF	198	Z40730TGS	164	Z41524SW	183	Z41560L	185
Z04236AIF	198	Z05742AIU	198	Z40730TGSV	165	Z41524T	176	Z41560LM	186
Z04236AIU	198	Z05742WF	161	Z40730V	192	Z41524TGS	164	Z41560MB	184
Z04236WF	161	Z05742WN	161	Z40736E	178	Z41524TGSV	165	Z41560MBS	184
Z04236WN	161	Z05742WR	161	Z40736L	185	Z41524V	192	Z41560S	181
Z04236WR	161	Z05748AIF	198	Z40736LM	186	Z41530E	178	Z41560SH	182
Z04242AIF	198	Z05748AIU	198	Z40736S	181	Z41530G	191	Z41560SW	183
Z04242AIU	198	Z05748WF	161	Z40736SH	182	Z41530GL	163	Z41560T	176
Z04242WF	161	Z05748WN	161	Z40736SW	183	Z41530L	185	Z41560TGS	164
Z04242WN	161	Z05748WR	161	Z40736T	176	Z41530LM	186	Z41560TGSV	165
Z04242WR	161	Z05760AIF	198	Z40736TGS	164	Z41530MB	184	Z41560V	192
Z04248AIF	198	Z05760AIU	198	Z40736TGSV	165	Z41530MBS	184	Z41566TGS	164
Z04248AIU	198	Z05760WF	161	Z40736V	192	Z41530S	181	Z41566TGSV	165
Z04248WF	161	Z05760WN	161	Z40742E	178	Z41530SH	182	Z41572GL	163

INDEX

Cross Reference Index

by Model Number

Model	Page	Model	Page	Model	Page	Model	Page	Model	Page
Z41572TGS.....	164	Z42242S.....	181	Z43024V.....	192	Z43060L.....	185	Z43760NVS-QP.....	194
Z41572TGSV.....	165	Z42242SF.....	181	Z43024VTF.....	193	Z43060LM.....	186	Z43760SHS.....	189
Z41578TGS.....	164	Z42242SH.....	182	Z43030E.....	178	Z43060LTF.....	188	Z43760SHTF.....	190
Z41578TGSV.....	165	Z42242T.....	176	Z43030G.....	191	Z43060MB.....	184	Z43760T.....	177
Z41584GL.....	163	Z42242TF.....	180	Z43030L.....	185	Z43060MBS.....	184	Z43760TF.....	180
Z41584TGS.....	164	Z42242V.....	192	Z43030LM.....	186	Z43060NVS-2P.....	194	Z43760V.....	192
Z41584TGSV.....	165	Z42242VTF.....	193	Z43030LTF.....	188	Z43060S.....	181	Z43760VTF.....	193
Z41590GL.....	163	Z42248E.....	178	Z43030MB.....	184	Z43060SF.....	181	Z43766SHS.....	189
Z41590TGS.....	164	Z42248G.....	191	Z43030MBS.....	184	Z43060SH.....	182	Z43766SHTF.....	190
Z41590TGSV.....	165	Z42248L.....	185	Z43030NVS-2P.....	194	Z43060SHS.....	189	Z43772SHS.....	189
Z41596GL.....	163	Z42248LM.....	186	Z43030S.....	181	Z43060SHTF.....	190	Z43772SHTF.....	190
Z41596TGS.....	164	Z42248LTF.....	188	Z43030SF.....	181	Z43060T.....	176	Z43778SHS.....	189
Z41596TGSV.....	165	Z42248MB.....	184	Z43030SH.....	182	Z43060TF.....	180	Z43778SHTF.....	190
Z42224E.....	178	Z42248MBS.....	184	Z43030T.....	176	Z43060V.....	192	Z43784SHS.....	189
Z42224G.....	191	Z42248PT.....	78, 191	Z43030TF.....	180	Z43060VTF.....	193	Z43784SHTF.....	190
Z42224L.....	185	Z42248S.....	181	Z43030V.....	192	Z43066SHS.....	189	Z43790SHS.....	189
Z42224LM.....	186	Z42248SF.....	181	Z43030VTF.....	193	Z43066SHTF.....	190	Z43790SHTF.....	190
Z42224LTF.....	188	Z42248SH.....	182	Z43036E.....	178	Z43072SHS.....	189	Z43796SHS.....	189
Z42224MB.....	184	Z42248T.....	176	Z43036G.....	191	Z43072SHTF.....	190	Z43796SHTF.....	190
Z42224MBS.....	184	Z42248TF.....	180	Z43036L.....	185	Z43078SHS.....	189	Z44224LM.....	186
Z42224PT.....	78, 191	Z42248V.....	192	Z43036LM.....	186	Z43078SHTF.....	190	Z44230LM.....	186
Z42224S.....	181	Z42248VTF.....	193	Z43036LTF.....	188	Z43084SHS.....	189	Z44236LM.....	186
Z42224SF.....	181	Z42260E.....	178	Z43036MB.....	184	Z43084SHTF.....	190	Z44242LM.....	186
Z42224SH.....	182	Z42260G.....	191	Z43036MBS.....	184	Z43090SHS.....	189	Z44248LM.....	186
Z42224T.....	176	Z42260L.....	185	Z43036NVS-2P.....	194	Z43090SHTF.....	190	Z44260LM.....	186
Z42224TF.....	180	Z42260LM.....	186	Z43036S.....	181	Z43096SHS.....	189	Z44524E.....	179
Z42224V.....	192	Z42260LTF.....	188	Z43036SF.....	181	Z43096SHTF.....	190	Z44524LTF.....	188
Z42224VTF.....	193	Z42260MB.....	184	Z43036SH.....	182	Z43724E.....	179	Z44524NVS-3P.....	194
Z42230E.....	178	Z42260MBS.....	184	Z43036T.....	176	Z43724LTF.....	188	Z44524NVS-SP.....	194
Z42230G.....	191	Z42260PT.....	78, 191	Z43036TF.....	180	Z43724NVS-QP.....	194	Z44524NVS-ZP.....	196
Z42230L.....	185	Z42260S.....	181	Z43036V.....	192	Z43724T.....	177	Z44524T.....	177
Z42230LM.....	186	Z42260SF.....	181	Z43036VTF.....	193	Z43724TF.....	180	Z44524TF.....	180
Z42230LTF.....	188	Z42260SH.....	182	Z43042E.....	178	Z43724V.....	192	Z44524V.....	192
Z42230MB.....	184	Z42260T.....	176	Z43042G.....	191	Z43724VTF.....	193	Z44524VTF.....	193
Z42230MBS.....	184	Z42260TF.....	180	Z43042L.....	185	Z43730E.....	179	Z44530E.....	179
Z42230PT.....	78, 191	Z42260V.....	192	Z43042LM.....	186	Z43730LTF.....	188	Z44530LTF.....	188
Z42230S.....	181	Z42260VTF.....	193	Z43042LTF.....	188	Z43730NVS-QP.....	194	Z44530NVS-3P.....	194
Z42230SF.....	181	Z42554SHS.....	189	Z43042MBS.....	184	Z43730T.....	177	Z44530NVS-SP.....	194
Z42230SH.....	182	Z42554SHTF.....	190	Z43042MBS.....	184	Z43730TF.....	180	Z44530NVS-ZP.....	196
Z42230T.....	176	Z42560SHS.....	189	Z43042NVS-2P.....	194	Z43730V.....	192	Z44530T.....	177
Z42230TF.....	180	Z42560SHTF.....	190	Z43042S.....	181	Z43730VTF.....	193	Z44530TF.....	180
Z42230V.....	192	Z42566SHS.....	189	Z43042SF.....	181	Z43736E.....	179	Z44530V.....	192
Z42230VTF.....	193	Z42566SHTF.....	190	Z43042SH.....	182	Z43736LTF.....	188	Z44530VTF.....	193
Z42236E.....	178	Z42572SHS.....	189	Z43042T.....	176	Z43736NVS-QP.....	194	Z44536E.....	179
Z42236G.....	191	Z42572SHTF.....	190	Z43042TF.....	180	Z43736T.....	177	Z44536LTF.....	188
Z42236L.....	185	Z42578SHS.....	189	Z43042V.....	192	Z43736TF.....	180	Z44536NVS-3P.....	194
Z42236LM.....	186	Z42578SHTF.....	190	Z43042VTF.....	193	Z43736V.....	192	Z44536NVS-SP.....	194
Z42236LTF.....	188	Z42584SHS.....	189	Z43048E.....	178	Z43736VTF.....	193	Z44536NVS-ZP.....	196
Z42236MB.....	184	Z42584SHTF.....	190	Z43048G.....	191	Z43742E.....	179	Z44536T.....	177
Z42236MBS.....	184	Z42590SHS.....	189	Z43048L.....	185	Z43742LTF.....	188	Z44536TF.....	180
Z42236PT.....	78, 191	Z42590SHTF.....	190	Z43048LM.....	186	Z43742NVS-QP.....	194	Z44536V.....	192
Z42236S.....	181	Z42596SHS.....	189	Z43048LTF.....	188	Z43742T.....	177	Z44536VTF.....	193
Z42236SF.....	181	Z42596SHTF.....	190	Z43048MB.....	184	Z43742TF.....	180	Z44542E.....	179
Z42236SH.....	182	Z43024E.....	178	Z43048MBS.....	184	Z43742V.....	192	Z44542LTF.....	188
Z42236T.....	176	Z43024G.....	191	Z43048NVS-2P.....	194	Z43742VTF.....	193	Z44542NVS-3P.....	194
Z42236TF.....	180	Z43024L.....	185	Z43048S.....	181	Z43748E.....	179	Z44542NVS-SP.....	194
Z42236V.....	192	Z43024LM.....	186	Z43048SF.....	181	Z43748LTF.....	188	Z44542NVS-ZP.....	196
Z42236VTF.....	193	Z43024LTF.....	188	Z43048SH.....	182	Z43748NVS-QP.....	194	Z44542T.....	177
Z42242E.....	178	Z43024MB.....	184	Z43048T.....	176	Z43748T.....	177	Z44542TF.....	180
Z42242G.....	191	Z43024MBS.....	184	Z43048TF.....	180	Z43748TF.....	180	Z44542V.....	192
Z42242L.....	185	Z43024NVS-2P.....	194	Z43048V.....	192	Z43748V.....	192	Z44542VTF.....	193
Z42242LM.....	186	Z43024S.....	181	Z43048VTF.....	193	Z43748VTF.....	193	Z44548E.....	179
Z42242LTF.....	188	Z43024SF.....	181	Z43054SHS.....	189	Z43754SHS.....	189	Z44548LTF.....	188
Z42242MB.....	184	Z43024SH.....	182	Z43054SHTF.....	190	Z43754SHTF.....	190	Z44548NVS-3P.....	194
Z42242MBS.....	184	Z43024T.....	176	Z43060E.....	178	Z43760E.....	179	Z44548NVS-SP.....	194
Z42242PT.....	78, 191	Z43024TF.....	180	Z43060G.....	191	Z43760LTF.....	188	Z44548NVS-ZP.....	196

Cross Reference Index

by Model Number

Model	Page	Model	Page	Model	Page
Z44548T	177	Z45260NVS-Q2P	195	Z51554S	228
Z44548TF	180	Z45260NVS-SQ	195	Z51560S	228
Z44548V	192	Z45260NVS-ZQ	196	Z51566S	228
Z44548VTF	193	Z45260T	177	Z51572S	228
Z44554SHS	189	Z45260TF	180	Z52043LD	227
Z44554SHTF	190	Z45724LM	187	Z52051LD	227
Z44560E	179	Z45724LTF	188	Z52424C	228
Z44560LTF	188	Z45730LM	187	Z52443LD	227
Z44560NVS-3P	194	Z45730LTF	188	Z52451LD	227
Z44560NVS-SP	194	Z45736LM	187	Z53030C	228
Z44560NVS-ZP	196	Z45736LTF	188	Z53636C	228
Z44560SHS	189	Z45742LM	187	ZHFPMK	267
Z44560SHTF	190	Z45742LTF	188	ZHSPMK30	267
Z44560T	177	Z45748LM	187	ZHSPMK36	267
Z44560TF	180	Z45748LTF	188	ZHSPMK42	267
Z44560V	192	Z46024E	179	ZHSPMK48	267
Z44560VTF	193	Z46024LTF	188	ZHSPMK60	267
Z44566SHS	189	Z46024NVS-4P	195	ZS24	132, 273
Z44566SHTF	190	Z46024NVS-S2P	195	ZS30	132, 273
Z44572SHS	189	Z46024NVS-Z2P	196	ZS36	132, 273
Z44572SHTF	190	Z46024T	177	ZS42	132, 273
Z44578SHS	189	Z46024TF	180	ZS42SF	268
Z44578SHTF	190	Z46030E	179	ZS48	132, 273
Z44584SHS	189	Z46030LTF	188	ZS50SF	268
Z44584SHTF	190	Z46030NVS-4P	195	ZS60	132, 273
Z44590SHS	189	Z46030NVS-S2P	195	ZWMTB1530	266
Z44590SHTF	190	Z46030NVS-Z2P	196	ZWMTB1536	266
Z44596SHS	189	Z46030T	177	ZWMTB1542	266
Z44596SHTF	190	Z46030TF	180	ZWMTB1548	266
Z45024LM	186	Z46036E	179	ZWMTB1560	266
Z45030LM	186	Z46036LTF	188	ZWMTB2024	266
Z45036LM	186	Z46036NVS-4P	195	ZWMTB2030	266
Z45042LM	186	Z46036NVS-S2P	195	ZWMTB2036	266
Z45048LM	186	Z46036NVS-Z2P	196	ZWMTB2042	266
Z45060LM	186	Z46036T	177	ZWMTB2048	266
Z45224E	179	Z46036TF	180	ZWMTB2060	266
Z45224NVS-Q2P	195	Z46042E	179	ZWTAK24	175
Z45224NVS-SQ	195	Z46042LTF	188	ZWTAK24S	175
Z45224NVS-ZQ	196	Z46042NVS-4P	195	ZWTAK30	175
Z45224T	177	Z46042NVS-S2P	195	ZWTAK30S	175
Z45224TF	180	Z46042NVS-Z2P	196	ZWTAK36	175
Z45230E	179	Z46042T	177	ZWTAK36S	175
Z45230NVS-Q2P	195	Z46042TF	180	ZWTAK42	175
Z45230NVS-SQ	195	Z46048E	179	ZWTAK42S	175
Z45230NVS-ZQ	196	Z46048LTF	188	ZWTAK48	175
Z45230T	177	Z46048NVS-4P	195	ZWTAK48S	175
Z45230TF	180	Z46048NVS-S2P	195	ZWTAK60	175
Z45236E	179	Z46048NVS-Z2P	196	ZWTAK60S	175
Z45236NVS-Q2P	195	Z46048T	177	ZWTS	175
Z45236NVS-SQ	195	Z46048TF	180		
Z45236NVS-ZQ	196	Z46060E	179		
Z45236T	177	Z46060NVS-4P	195		
Z45236TF	180	Z46060NVS-S2P	195		
Z45242E	179	Z46060NVS-Z2P	196		
Z45242NVS-Q2P	195	Z46060T	177		
Z45242NVS-SQ	195	Z46060TF	180		
Z45242NVS-ZQ	196	Z46524LM	187		
Z45242T	177	Z46530LM	187		
Z45242TF	180	Z46536LM	187		
Z45248E	179	Z46542LM	187		
Z45248NVS-Q2P	195	Z46548LM	187		
Z45248NVS-SQ	195	Z51524S	228		
Z45248NVS-ZQ	196	Z51530S	228		
Z45248T	177	Z51536S	228		
Z45248TF	180	Z51542S	228		
Z45260E	179	Z51548S	228		

INDEX



Allsteel®

Allsteel Inc.
Muscatine, Iowa 52761

allsteeloffice.com

Form #A8746.A5 (05/24)