

Frame & Tile Panel Systems

Price & Specification Guide 2022

Prices effective May 13, 2022

PDF updated December 22, 2022

Limited Lifetime Warranty

Our unwavering commitment to our customers compels us to care, and our dedication to quality is just one of the ways we show our customers how much they mean to us.

We recognize that keeping up with the pace of change requires having products that work as hard as the people who use them. That's why each of our products is rigorously tested and certified to meet the highest industry standards.

In the unlikely event that any Allsteel product or component covered by the Allsteel Warranty should fail under normal workplace use because of defective material or workmanship, Allsteel promises to fix it. Because taking care of *people* is how Allsteel takes care of business.

For information on Allsteel's warranty coverage, visit AllsteelOffice.com.

Government Support – GovernmentSupport@hniworkplacefurnishings.com
Product, Parts, Non-Warranty Parts Orders – ProductSupport@hniworkplacefurnishings.com
Quick Ship Orders – QuickShip@hniworkplacefurnishings.com
Order Status – OrderStatus@hniworkplacefurnishings.com
General Inquiries – GeneralSupport@hniworkplacefurnishings.com

- Software support packages furnished to the customer, either by Allsteel® or by another source, which support the sale of Allsteel products are superseded by printed price lists.
- Prices are subject to change without notice. All orders are subject to prices in effect at the time of order.
- Please refer to your Allsteel Dealer Sales and Discount Policies for order placement information, terms and conditions.
- Additional copies of this Specification and Price List are available upon request from Allsteel Literature Fulfillment at 1-866-255-7833.

- Ordering information appears at the bottom of each product page complete with examples on how to specify. Fabric and finish pages are referenced at the bottom of product pages.

This publication is available as an interactive or downloadable PDF at www.allsteeloffice.com.

Questions or Comments?

Please call us at: **888-ALLSTEEL**
888-255-7833

Warranty	Inside Front Cover
New, Revised, and Discontinued Products	4
COM, Specials Policies, and Programs	5-8
Upholstery and Finishes	9-18
DAYBOOK™	
Finishes	18.2-18.3
Introduction/Overview	18.4
Statement of Line	18.5
Specification Details	18.6-18.7
Frames	18.8
Laminate Inserts	18.9
Metal Inserts	18.10
Slotted Metal Inserts	18.11
Fabric Inserts	18.12
Glass Inserts	18.13
Shelves & Bookcases	18.14
Planters	18.15
Work Tools	18.16
TERRACE® SYSTEM	
Finishes	20
Typicals Overview	21
Introduction to Terrace	22
<i>Frames, Connectors, And Tiles</i>	
Working with Frames and Connectors	23-27
Approach and Involve Laminate Wood Storage	28-29
Working with Sliding Doors	30
Working with Tiles	31-37
Working with Veneer	38
<i>Electrical (8-Wire)</i>	
Working with Electrical & Data	66-76
<i>Worksurfaces & Supports</i>	
Working with Worksurfaces and Supports	81-87
Working with Cadence® Freestanding Desking	88-96
Laminate Worksurfaces	97-104
9120 Worksurfaces	105-106
<i>Metal Overheads</i>	
Working with Overheads, Shelves, and Hutches	111-114
Overhead Cabinets, Shelves, and Up-mount Kits	115-116
Hutches and Tackboards	117
STRIDE® SYSTEM	
Finishes	120
Typicals Overview	121
Statement of Line	124-125
Overview of Frames	126
Working with Frames, Sliding Doors, Connectors, and Tiles	127-145
Panel Frames, Connectors, and Trim	146-160
Tiles, Off-Modular, and Acoustic Inserts	161-183
Working with Electrical and Data	184-194
Electrical and Data Components	195-198
<i>Worksurfaces</i>	
Working with Worksurfaces and Supports	199-210
Laminate Worksurfaces	211-217
9120 Worksurfaces	218-219
Veneer Worksurfaces	220
Worksurface Supports	221-225

<i>Wood Storage</i>	
Statement of Line	228
Features and Dimensions	229-230
Filing Capacities	231
Working with Wood Storage	232-256
Credenzas and Pedestals	257-265
4-Wire Electrical Components	266
Storage Towers	267-271
Overhead Cabinets and Horizontal Storage	272-277
Working with Metal Overheads	278-280
Metal Overheads	281-282
ALIGN™ STATEMENT OF LINE	283
APPROACH™ STATEMENT OF LINE	284-287
INVOLVE® STATEMENT OF LINE	288-289
GALLERY PANELS	
Finishes	292
Panel Fabrics	293
Laminate and Paint Matching	294
Gallery-to-Gallery Panels	303
Freestanding Screens	304-305
Connector Kits	332
Terrace Connector Kits	333
Gallery Glass	334-336
Accessories	337-339
ALTITUDE® TABLES	
Paint Finishes, Laminates, Eased Edge	342
Fabrics	343
Working with Height-Adjustable Tables	344-347
Altitude Height-Adjustable Tops, Bases, & Accessories	348-388
Altitude – A6	348-349
Altitude – Basic	350
Worksurfaces for Height-Adjustable Base	351-355
Cable Management	356
Screens and Power Module	357
Altitude - Metal Screens	358-359
Power Rail Specifications	361-368
Working with Electrical and Data	369-373
Power Rail – Electrical Components	374-376
A8 Screen Kits	377
Metal Screens and Tackboard Accessories	378-379
Power Rails and Accessories	380-383
HAT to Panel Brackets	384-386
Working with Organization Rail & Accessories & Screens	387
Worksurface Mounted Rail and Accessories	388
EXTENSIONS™	
Working with Ergonomic Accessories	390-391
Working with Organization Tools	392-397
Working with Illumination	398-401
Power/Data Modules	402
ACCESSORIES	
Working with Pivot Monitor Arms	404-407
APPENDIX AND INDEX	
Locking Specification/Easy Lock	408-410
Touch-Up Paint	411
Fabric Grades G-J	412-414
Index — Model Numbers with Page Reference	415-429

NEW FINISHES

Studio Paints

- Amethyst — P091
- Cobalt Mica — P090
- Ochre — P093
- Sienna — P092

- Handspun Pearl laminate LAHP — 6/1/2021
- Handspun Dove laminate LAHD — 6/1/2021
- Handspun Slate laminate LAHS — 6/1/2021
- Handspun Chestnut laminate LAHC — 6/1/2021
- Stratawood Beigewood Maple SE878
- Stratawood Field Elm Maple SE599
- Stratawood Belair Maple SE934
- Stratawood Florence Walnut ST579
- Natural Florence Walnut NT579
- Quarter Florence Walnut QT579

- Belair LWBA
- Field Elm LWFE

NEW TEXTILES

- Parker
- Moxie
- Dapper new colors – Charcoal, Clover, Gerbera, Grape, Parrot, Poppy, Sky, Terracotta, Titanium
- Taylor

DE-EMPHASIZED FINISHES

- Conifer and Cabernet — 12/31/2020

DISCONTINUED FINISHES

- Paint — Carob P52, Carob Plastic & Edge E8 — 12/31/2020
- Camelstone laminate LT6A — 10/1/2021
- Greystone laminate TM65 — 10/1/2021
- Whitestone laminate TM33 — 10/1/2021
- Cafelle laminate — LWC Disco 12/31/2021
- Cafelle edge — DG Disco 12/31/2021
- Branded Oak laminate — LBO1 Disco 12/31/2021
- Branded Oak edge — BO Disco 12/31/2021
- Ebony Recon laminate — LER1 Disco 12/31/2021
- Ebony Recon edge — DR Disco 12/31/2021
- Charcoal Walnut laminate — LWCW Disco 6/30/2022
- Columbian Walnut laminate — LWZ Disco 6/30/2022
- Amber Cherry laminate — LWAC Disco 6/30/2022
- Charcoal Walnut edge — DC Disco 6/30/2022
- Columbian Walnut edge — DZ Disco 6/30/2022
- Amber Cherry edge — DA Disco 6/30/2022
- Canyon Zephyr laminate — LT5B Disco 6/30/2022
- Desert Zephyr laminate — LT5A Disco 6/30/2022
- Ebony laminate — LT3E Disco 6/30/2022
- Grey Mesh laminate — LT8A Disco 6/30/2022
- Parchment laminate — TM20 Disco 6/30/2022
- Pewter Mesh laminate — LT8C Disco 6/30/2022
- Sheer Mesh laminate — LT8B Disco 6/30/2022
- White Tigris laminate — LT2A Disco 6/30/2022

DISCONTINUED TEXTILES

- Silvertext
- Dotty (select colors only): Berry, Black, Crimini, Mosaic, Pewter, Sepia, Toffee, Tomatillo — Disco 12/31/2021
- Burst — Disco 12/31/2021
- Clyde Weathered — Disco 12/31/2021

DISCONTINUED PRODUCTS

- Z-Series Monitor Arms discontinued 6/30/2020, recommended replacement is Pivot Monitor Arms
- Altitude A3 height-adjustable tables discontinued 12/31/2020, recommended replacement is Altitude A6 height-adjustable tables

COM Program

Allsteel understands that customers may at times want to specify fabrics outside of Allsteel's standard fabric offering. Our COM program was designed to make specifying COMs on Allsteel products a simpler, friendlier, and hassle-free process. This process is simple and easy to use, and is described below under "Allsteel to Supply (ATS)." If a Dealer wishes to manage the COM process themselves, they can do so by following guidelines under "Dealer to Supply (DTS)". **ATS is the preferred method for all COM fabrics.** With ATS, Company will provide acknowledgment based upon planned date of receipt of COM fabric and manage the entire process. DTS is allowed if it is not a partnership fabric or if Company does not have access to the supplier. **DTS may cause order delays and is strongly discouraged.** Find out more about Allsteel's COM process by emailing our COM Department at allsteelcomteam@allsteeloffice.com.

Allsteel to Supply (ATS):

1. Select the fabric you wish to use and check the COM Search on Synergy at: [Allsteelsynergy/Design Resources/Textiles & Finishes/COM Search](#) or [COM Search quick link](#). You will need to have the COM supplier's name, fabric pattern name, and color name to search for approved fabrics.
2. If your fabric is listed as an approved fabric, you may place your order directly with Allsteel Customer Support. Please use the fabric code (e.g., S216426XP) from the COM Test Request on your order in the place of the standard fabric code.

If your fabric is not listed as approved, you will need to select the "Request COM Test" link on the COM Search website. If your fabric is not listed as approved, and it is not a Partnership fabric you may request a "Dealer to Supply" code. Select the "Request COM Test" link on the COM Search website. Your name, company name and email will be prepopulated fields. The secondary email, project name, and bid/contract number are optional information. The supplier, pattern, and color will show a list by clicking in the box and entering the first letter of the name and these are free form text boxes. Once that information is entered click add. (Multiple series can be added to the same request if they are the same supplier, pattern, and color.) Then click submit.
3. An email will be sent to the to the requestor stating the COM Request was successfully submitted. Up to four emails could be received: Testing materials requested, in testing, and final approval/denial with price grade and fabric code. It's rare actual test yardage is required. Testing is mainly done by reviewing the attributes of the fabric. The testing process takes approximately 48 hours. Written COM price quotes hold pricing for 90 days after issue date.
4. Once the fabric has been approved by Allsteel, enter your order directly with Allsteel Customer Support. Allsteel will purchase all COM fabric directly from the COM suppliers and schedule for production.

In the event that the Dealer decides to cancel a COM fabric order, the Dealer is responsible for the cost of the fabric plus a handling charge that is equal to 10% of the fabric cost.

Dealer to Supply (DTS):

1. Select the fabric you wish to use and check the COM Search on Synergy at: [Allsteelsynergy/Design Resources/Textiles & Finishes/COM Search](#) or [COM Search quick link](#). Or call Allsteel Customer Support to see if the fabric you have chosen has already been tested and approved on the product you are interested in.

You will need to have the COM supplier's name, fabric pattern name, and color name for this inquiry.
2. If your fabric is not listed as approved, and it is not a Partnership fabric you may request a "Dealer to Supply" code. Select the "Request COM Test" link on the COM Search website. Your name, company name and email will be prepopulated fields. The secondary email, project name, and bid/contract number are optional information. The supplier, pattern, and color will show a list by clicking in the box and entering the first letter of the name and these are free form text boxes. Once that information is entered click add. (Multiple series can be added to the same request if they are the same supplier, pattern, and color.) Then click submit.
3. An email will be sent to the to the requestor stating the COM Request was successfully submitted. Up to four emails could be received: Testing materials requested, in testing, and final approval/denial with price grade and fabric code. It's rare actual test yardage is required. Testing is mainly done by reviewing the attributes of the fabric. The testing process takes approximately 48 hours.
4. Make sure to use a "Dealer to Supply" COM code (e.g., S216426ZP) and place your order directly with Allsteel Customer Support.
5. All "Dealer to Supply" orders will be charged Grade 4 pricing for seating, Grade 3 for Gather, and Grade D pricing for panels. Dealers will pay for the COM fabric separately.
6. All "Dealer to Supply" fabric must be sent on a fabric roll. Estimate the yardage required by using the yardage requirements listed in the price list by model. For questions please contact Allsteel Customer Support.
7. Place your fabric order directly with the COM Supplier with instructions for the fabric to be sent on a fabric roll to:

HNI Textile Distribution Center

COM Production Yardage — PO Number

Docks 20-22
301 Mulberry Avenue
Muscatine, IA 52761

Information that **MUST** be included in the packing slip attached to the DTS fabric:

1. Dealer's Purchase Order number to Allsteel
2. Allsteel's Tracking number for the COM fabric
3. Dealer Name
4. Yards of Fabric

If the fabric shipment does not match the correct fabric and yardage, Allsteel will notify the Dealer for resolution.

If Allsteel receives fabric with incorrect labeling or fabric yardage that cannot be linked to an Allsteel furniture order, Allsteel will hold the fabric for up to 4 weeks. After 4 weeks Allsteel will dispose of the fabric. There are no exceptions to this policy.

Specific to DTS orders - The customer should send only the amount needed for the order. Excess yardage, or yardage not attached to an order will be disposed of at Allsteel's discretion.

Any canceled orders are subject to cancellation charges up to the full value of the Allsteel product canceled. Allsteel will determine the actual cancellation charge at the time the cancellation is requested.

8. For additional details on "Dealer to Supply" fabric refer to your Allsteel terms and conditions.

Additional Policy Information:

The company assumes no responsibility for the overall appearance, flammability, normal durability, colorfastness, or any other quality standards. The company reserves the right to reject a COM if the quality of the COM is not satisfactory for the product. Should this occur, the customer will be notified with an explanation when the issue is found.

The company is not responsible for fabric that has become obsolete at the COM supplier, that is of poor quality, or that is delivered late to the manufacturer from the COM supplier.

All cancellations or changes to COM orders are subject to Company approval. Because of the nature of COM, special fabrics, finishes, and structural modifications, products ordered as specials and then canceled prior to shipment are subject to cancellation costs up to the full value of the product canceled. The company determines the actual cancellation charge at the time the cancellation is requested. Upon approval, a cancellation number is issued to the Customer.

Purchase orders will not be accepted or entered unless the testing process is complete with positive results.

If all testing has been previously completed, re-testing is only necessary if fabric is to be used on a different product, or pattern direction has changed from that previously approved.

Previous test results can be obtained by a customer on the COM Search on Synergy or by calling Allsteel Customer Support.

All COM fabric will be applied to seating and panel systems Pattern Cut unless Railroad Cut is requested and approved on the COM Test Request. Any fabrics approved as a width pass, the dealer is responsible for clarifying Railroad Cut on orders containing items that are too large to support the Pattern Cut of a fabric application (any items larger than 48" high or wide).

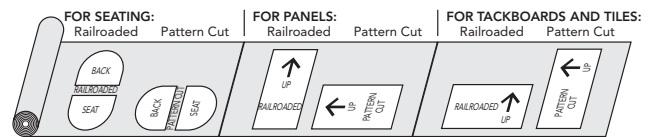

Fire Retardant

The Dealer is responsible for ensuring that the COM fabric is certified to meet all flame retardant requirements.

For more information, please contact Allsteel Customer Support.

YARDAGE REQUIREMENTS FOR FABRIC WITH REPEATS — FOR USE ON GATHER™ PRODUCTS

Fabric Width	Plain Fabric	2"– 14" Repeat	15"– 19" Repeat	20"– 27" Repeat	28"– 36" Repeat
54"	0	+15%	+20%	+25%	+30%
53"	+6%	+19%	+24%	+28%	+36%
52"	+13%	+23%	+28%	+33%	+38%
51"	+19%	+26%	+31%	+36%	+41%
50"	+25%	+30%	+35%	+40%	+45%
49"	+30%	+35%	+40%	+45%	+50%
48"	+35%	+40%	+45%	+50%	+55%
47"	+45%	+50%	+55%	+58%	+65%

Depending upon the pattern repeat, it may be necessary to pattern cut the fabric. This will require 10% additional fabric.

To calculate multiple repeats (vertical and horizontal), add each repeat for total yardage required. For example for a fabric width of 54": 7" vertical requires 15%, 15" horizontal requires 20% total additional yardage required equals 35% (15% + 20%). Therefore, if your chair requires 2 yards of fabric, multiply 2 by 35%. Then 2.7 yards will be yardage required.

Special Paint & Stain Policy

Allsteel at its own discretion may modify its standard products with non-standard paint and stain colors to meet specific needs. Dealer is required to submit a special paint or stain request via the COM Search on Synergy. A sample of the non-standard paint or stain color desired will be required for matching. Pricing, lead time, and order information will be provided at the time of approval.

- For each new requested stain or paint, there will be a \$500 net fee to cover supplier costs to match the special item.
- For existing, previously-approved stains or paints, there is no \$500 matching fee, however, there is a sample chip fee of \$175 net for stains and \$100 net for paints.
- Samples, preferably at least 3" x 5" chips, of the exact color desired should be sent to the Allsteel Tailored Products Group. Paint matches require (3) sample chips and stain matches require (3) sample chips. Please mail these sample chips to the address below and reference the Special Item Request Number from Tailored Solutions.

Allsteel Inc.

Attn: Tailored Products Group
2210 Second Avenue
Muscatine, IA 52761

- Allsteel will color match the sample and send control samples to the address provided in the request. Dealer will review Allsteel's color match and approve by signing the back of the sample chip. Send the signed sample back to the Allsteel Tailored Products Group.
- Special paints will be assigned a paint price grade.
- Orders will not be accepted until Allsteel receives the Dealer's written approval on the color match.
- Extended lead times will apply on orders containing special paints or stains.
- Due to manufacturing techniques, materials, and quality issues, some exclusions will apply and some matches may be declined.

Important Notes

- Natural veneer is subject to nature's quality control. Differences in grain and color are naturally occurring variations and cannot be controlled by the manufacturer and cannot be considered as product defects. Natural veneer has the characteristics and beauty of a living organism; with its own variations of grain, growth, and color patterns. For these reasons, Natural veneer is preferred by many for its warmth and personal characteristics.
- Color changes will occur over time when wood is exposed to light. For this reason, when new product is ordered as an addition to existing product, there will be color variances between the old and new product. Please remember when specifying new product that although the species of veneer will be the same, additional product is being manufactured from a different tree. It may take several months for the new furniture to mature to the color level of existing product. Even with this maturation process the additional product will not be an exact match.

Special Laminate Policy

The Company at its own discretion may modify its standard products with non-standard laminates to meet specific needs. Contact the Allsteel Tailored Products Group for pre-approved Wilsonart, Formica, Nevamar and Pionite laminates and pricing for special laminates. When requesting a special laminate please supply manufacturer, along with name and pattern number of laminate.

- Extended lead times will apply on orders containing special laminates.
- Due to manufacturing techniques, materials, and quality issues, some product exclusions will apply and some requests may be declined.

Veneer Care Instructions

Veneer worksurfaces feature the Gunlocke® finishing system. The finishing system is a process that begins with the application of stains, which promote exceptional depth and clarity. Next the worksurface receives a specialized coating that provides exceptional durability and chemical resistance. The remaining surfaces receive a top coat. These finishing processes ensure depth, clarity, color consistency and durability throughout the product.

Veneer worksurfaces have exceptional resistance to:

- Heat and moisture (hot beverages, pizza boxes)
- Chemicals (liquid paper, nail polish)
- Stains (permanent markers)
- Scratches and impact (everyday wear and tear)

Caring for your veneer finish:

- General maintenance procedures entail wiping clean the entire surface with a clean, water dampened soft cloth once per week (be sure to wipe with the grain)
- Murphy's® Oil Soap may be used as a general purpose type cleaner with warm water to clean tops.
- The finish may also be polished with Guardsman® Furniture Polish (contains no waxes or silicones) to provide renewed luster.
- Be sure to wipe up all spills immediately. Do not allow spills to dry.

Wood owes its inherent beauty to variations in color, grain and texture, and therefore, these variations are not considered defects. There may be minor variations from one piece of furniture to the next even though they are finished at the same time. Exposure to light and the aging process will cause a darkening of natural wood products. Light finishes on wood products do not mask the natural characteristics of wood. Allsteel does not guarantee the exact matching of grain, pattern and color.

Everyday Advantage[®]

New terms and conditions for EDA:

1. Orders must clearly state “Everyday Advantage Order” and include the appropriate Everyday Advantage contract number:
 - Everyday Advantage Std-0125, Everyday Advantage Canada-0127
2. Everyday Advantage orders are not eligible for bid pricing.
3. Program discounting includes the complete Optimize, Further, **and** Terrace systems lines, private office solution, Approach and Involve storage. This program also includes Acuity, Access, Evo, Inspire, Lyric, Mimeo, Nimble, WillQuip, Relate, Seek, and Svelte, seating. Altitude, Aware, and Structure tables are also available, along with Align pedestals, lockers and metal storage and Essentials pedestals, and Radii storage lines. In addition, Extensions ergonomic accessories and lighting are part of the standard offering. All other product not called out is available for order on the contract but will receive standard discounting of 55%–65%.
4. All textiles and finishes except for veneer and some wood finishes are available, depending on quantity and selection, and may have extended lead times.
5. Everyday Advantage orders are not limited to a minimum or maximum.
6. All orders ship based on standard lead times. Large-quantity orders of like products may be subject to longer lead times.
7. Standard freight terms apply.
8. If driver assistance is needed, standard driver assist charges will be added at time of order entry.

Allsteel Inc. reserves the right to amend or terminate this program at anytime with 30 days written notice. Allsteel is not liable for service delays caused by force majeure (circumstances beyond Allsteel's control).

Refer to page 11 for current upholstery availability by model/series.

GSA Reference Page

ALLSTEEL MATERIALS PARTNERSHIP PROGRAM — See program explanation at bottom of page.

GRADE 2	GRADE 4	GRADE 4 – continued	GRADE 4 – continued	GRADE 4 – continued
Maharam MELD	HBF Textiles BLINK	Maharam METRIC	Maharam MODE	Maharam MUSE
Amethyst.....SMHMMLD18	Bright Blue..... 1048-59	Admiral..... SMHMMET26	Alder*..... SMHMMOD23	Ascend.....SMHMMUS04
Anrler..... SMHMMLD13	Dark Violet..... 1048-77	Alligator..... SMHMMET20	Angelfish*..... SMHMMOD32	Bergamot*.....SMHMMUS11
Bare..... SMHMMLD26	Dove Grey*..... 1048-83	Anchor..... SMHMMET24	Ballpoint*..... SMHMMOD29	Celebrate.....SMHMMUS03
Blonde..... SMHMMLD27	Lemon Yellow*..... 1048-22	Arabica*..... SMHMMET09	Barberry*..... SMHMMOD25	Clear..... SMHMMUS07
Bride..... SMHMMLD10	Ocean Blue*..... 1048-56	Aztec*..... SMHMMET41	Billygoat..... SMHMMOD10	Compass.....SMHMMUS10
Bulb..... SMHMMLD09	Peppery..... 1048-90	Bittersweet*..... SMHMMET08	Blush..... SMHMMOD21	Crescendo.....SMHMMUS01
Clementine..... SMHMMLD23	Red Orange..... 1048-44	Bonsai*..... SMHMMET22	Bonsai*..... SMHMMOD40	Fantasy*.....SMHMMUS08
Comet..... SMHMMLD29	Sea Green*..... 1048-67	Brick*..... SMHMMET11	Carotene*..... SMHMMOD20	Frigid..... SMHMMUS16
Crater..... SMHMMLD14	Silvery..... 1048-80	Canary*..... SMHMMET39	Celtic*..... SMHMMOD38	Goal..... SMHMMUS13
Creek..... SMHMMLD40		Caramel*..... SMHMMET17	Clavicle..... SMHMMOD09	Grasshopper.....SMHMMUS12
Fox..... SMHMMLD24	Maharam CAPER	Cardinal..... SMHMMET12	Crottontail*..... SMHMMOD16	Haven*..... SMHMMUS24
Fuchsia..... SMHMMLD17	Bliss..... SMHMCAPO9	Cedar*..... SMHMMET15	Crush..... SMHMMOD34	Jovial..... SMHMMUS27
Globe..... SMHMMLD42	Cactus*..... SMHMCAPO8	Cerise*..... SMHMMET10	Denim..... SMHMMOD33	Mead*..... SMHMMUS25
Gloss..... SMHMMLD08	Cameo*..... SMHMCAPO10	Downpour*..... SMHMMET33	Eucalyptus*..... SMHMMOD39	Miso*..... SMHMMUS09
Grate..... SMHMMLD07	Cinnamon*..... SMHMCAPO4	Driftwood*..... SMHMMET06	Goldenrod..... SMHMMOD15	Mistletoe.....SMHMMUS14
Heat..... SMHMMLD22	Cougar*..... SMHMCAPO3	Envy*..... SMHMMET21	Henge*..... SMHMMOD14	Neat..... SMHMMUS26
Honeydew..... SMHMMLD30	Note..... SMHMCAPO6	Film..... SMHMMET31	Hollow..... SMHMMOD07	Noble..... SMHMMUS18
Isle..... SMHMMLD39	Paprika..... SMHMCAPO5	Fleece*..... SMHMMET03	Intaglio..... SMHMMOD02	Poinsettia.....SMHMMUS29
Kale..... SMHMMLD34	Ribbon*..... SMHMCAPO11	Fog*..... SMHMMET02	Jetty..... SMHMMOD35	Pulsar..... SMHMMUS19
Kiss..... SMHMMLD25	Sidekick..... SMHMCAPO12	Fruit*..... SMHMMET42	Kermes*..... SMHMMOD24	Refresh..... SMHMMUS06
Knight..... SMHMMLD04	Silverback..... SMHMCAPO7	Galah..... SMHMMET43	Lemon*..... SMHMMOD12	Resonate..... SMHMMUS02
Magma..... SMHMMLD20	Smolder*..... SMHMCAPO13	Hedgerow*..... SMHMMET36	Lichen*..... SMHMMOD43	Riverbend.....SMHMMUS17
Mariner..... SMHMMLD41	Whim*..... SMHMCAPO1	Highway*..... SMHMMET38	Lioness*..... SMHMMOD17	Runway..... SMHMMUS03
Merlot..... SMHMMLD19	Wise*..... SMHMCAPO2	Hopscotch..... SMHMMET30	Machine..... SMHMMOD04	Sailboat*.....SMHMMUS21
Mimosa..... SMHMMLD28	HBF Textiles LOOK-SEE	Kiln*..... SMHMMET44	Mallard*..... SMHMMOD37	Seaglass*.....SMHMMUS15
Mulberry..... SMHMMLD16	Electric*..... 1044-77	Lava..... SMHMMET13	Marsh*..... SMHMMOD06	Sparse*..... SMHMMUS22
Nordic..... SMHMMLD36	Foggy..... 1044-85	Midday..... SMHMMET34	Odyssey..... SMHMMOD28	Spectacle.....SMHMMUS31
Panda..... SMHMMLD02	Foliage..... 1044-67	Mineral*..... SMHMMET07	Ominous..... SMHMMOD03	Theater..... SMHMMUS28
Perennial..... SMHMMLD15	Lava..... 1044-44	Moth*..... SMHMMET45	Oriole..... SMHMMOD18	Vase..... SMHMMUS23
Pipe..... SMHMMLD06	Midnight..... 1044-59	Oriole*..... SMHMMET14	Oxeye..... SMHMMOD13	Veil*..... SMHMMUS05
Quill..... SMHMMLD05	Plum..... 1044-75	Phantom*..... SMHMMET01	Paradise*..... SMHMMOD31	Vevela*..... SMHMMUS20
Reef..... SMHMMLD37	Shady..... 1044-80	Pollen*..... SMHMMET18	Petal*..... SMHMMOD26	Camira PATINA
Rooster..... SMHMMLD21	Snowy..... 1044-11	Scuba*..... SMHMMET28	Rust*..... SMHMMOD19	Aged*..... SCAMPAT02
Seashell..... SMHMMLD12	Stone..... 1044-89	Seaport..... SMHMMET27	Saltwater..... SMHMMOD36	Anneal*..... SCAMPAT35
Seed..... SMHMMLD33	Terra Cotta*..... 1044-46	Skate..... SMHMMET29	Sassafras..... SMHMMOD41	Anodised..... SCAMPAT32
Skyline..... SMHMMLD03	Ultramarine..... 1044-57	Snorkel*..... SMHMMET37	Spindle..... SMHMMOD11	Bloomed..... SCAMPAT15
Spa..... SMHMMLD43	Wavelet*..... 1044-56	Sourdough*..... SMHMMET04	Stroll..... SMHMMOD01	Blurred..... SCAMPAT18
Stark..... SMHMMLD11	Wine*..... 1044-74	Sunny..... SMHMMET40	Sycamore..... SMHMMOD08	Braise*..... SCAMPAT27
Vast..... SMHMMLD01		Talisman..... SMHMMET35	Talus..... SMHMMOD05	Chiselled*..... SCAMPAT24
Vine..... SMHMMLD32		Tar*..... SMHMMET23	Toile*..... SMHMMOD30	Covered*..... SCAMPAT14
Waterfall..... SMHMMLD35		Toffee*..... SMHMMET05	Valley*..... SMHMMOD27	Dusted*..... SCAMPAT13
Wave..... SMHMMLD38		Tupelo*..... SMHMMET19	Vermilion..... SMHMMOD22	Engrave..... SCAMPAT43
Wild..... SMHMMLD31		Twilight*..... SMHMMET25	Yucca*..... SMHMMOD42	Evolved*..... SCAMPAT11
		Whale*..... SMHMMET32		Flecked*..... SCAMPAT38
			Maharam MURMUR	Glazed..... SCAMPAT26
			Argan*..... SMHMMUR17	Glisten..... SCAMPAT25
			Baby..... SMHMMUR10	Imprint..... SCAMPAT39
			Biome..... SMHMMUR15	Inlay..... SCAMPAT37
			Canopy*..... SMHMMUR03	Irregular..... SCAMPAT09
			Cask*..... SMHMMUR16	Lacquer..... SCAMPAT42
			Cauldron..... SMHMMUR06	Languish*..... SCAMPAT31
			Conquer*..... SMHMMUR07	Layered*..... SCAMPAT12
			Dim..... SMHMMUR04	Lustre..... SCAMPAT16
			Elderberry..... SMHMMUR11	Matured*..... SCAMPAT10
			Gust..... SMHMMUR01	Meander..... SCAMPAT21
			Harmonica..... SMHMMUR02	Petrology..... SCAMPAT29
			Iceberg..... SMHMMUR12	Reclaimed..... SCAMPAT05
			Ignite..... SMHMMUR19	Restored*..... SCAMPAT07
			Peppercorn..... SMHMMUR05	Rippled..... SCAMPAT19
			Rapids..... SMHMMUR08	Salvaged*..... SCAMPAT06
			Sangria*..... SMHMMUR21	Seamless*..... SCAMPAT23
			Seawater..... SMHMMUR09	Seasoned*..... SCAMPAT03
			Sultry*..... SMHMMUR20	Sheen..... SCAMPAT17
			Sundown*..... SMHMMUR18	Smudged*..... SCAMPAT30
			Tallgrass*..... SMHMMUR13	Speckled..... SCAMPAT41
			Underground*..... SMHMMUR14	

Multi-use fabrics are noted with the following designators: **B** – Tackboards, **C** – Concensys®, **O** – Optimize™, **T** – Terrace®, **F** – Further™.

* Colorway not shown on Textiles card; all Partnership Program memo samples are available from supplier. See contact information below.

ALLSTEEL PARTNERSHIP PROGRAM

Allsteel understands that customers may want to specify panel and seating textiles outside of Allsteel's standard offering. Allsteel's Partnership Program consists of on-trend and design-forward patterns that have been tested and approved by Allsteel for use on Allsteel products. A subset of these approved patterns is available on cards in the textile binder, while numerous others are available on our website, allsteeloffice.com.

For memo samples, please contact our partners:

- Camira, memos@camirafabrics.com 1.616.288.0655
- CF Stinson, cfstinson.com 1.800.841.6279
- HBF Textiles, hbftextiles.com 1.877.494.5727
- Maharam, maharam.com 1.800.645.3943
- Ultrafabrics, ultrafabricsinc.com 1.877.309.6648

The intent of the **Partnership Program** is to offer a wide variety of on-trend textiles to meet your varied needs, but since these textiles are not part of our standard offering they may be subject to extended lead times. Because new materials will be introduced regularly, Allsteel reserves the right to change the offering at any time.

Refer to page 11 for current upholstery availability by model/series.

GSA Reference Page

ALLSTEEL MATERIALS PARTNERSHIP PROGRAM — SEE PROGRAM EXPLANATION AT BOTTOM OF PAGE 9.

UPHOLSTERY

GRADE 4 – continued	
Maharam PATINA – continued	
Stoney*	SCAMPAT34
Strata*	SCAMPAT33
Striated*	SCAMPAT40
Temper	SCAMPAT28
Tessellate	SCAMPAT22
Timeworn*	SCAMPAT08
Toughened*	SCAMPAT20
Twisted*	SCAMPAT36
Veneer*	SCAMPAT04
Weathered	SCAMPAT01
Maharam SPRY	
Blast*	SMHMSPY05
Cabin*	SMHMSPY04
Fame*	SMHMSPY01
Fizz	SMHMSPY03
Jam	SMHMSPY06
Lunar*	SMHMSPY02
Seaweed	SMHMSPY08
Trance	SMHMSPY07
Tuxedo	SMHMSPY09
Maharam TRUNDLE	
Aloe	SMHMTRN05
Cabana*	SMHMTRN06
Confetti*	SMHMTRN09
Crabapple*	SMHMTRN10
Element	SMHMTRN02
Hibernata*	SMHMTRN04
Magnet	SMHMTRN11
Rainstorm*	SMHMTRN07
Ray	SMHMTRN03
Ski*	SMHMTRN01
Wake	SMHMTRN08
HBF Textiles WALKABOUT	
Alluring Aqua	1046-56
Bewitched Blue	1046-59
Bold Burgundy	1046-74
Classic Cobalt	1046-55
Cool Carbon	1046-87
Gallant Green	1046-67
Gutsy Grey	1046-85
Jungly Jade	1046-64
Noble Navy	1046-58
Peaceful Pewter	1046-89
Reliable Red	1046-44
Swanky Silver	1046-80
Wistful White	1046-11
GRADE 5	
Camira BLAZER	
Aberlour*	SCAMBLZ15
Abertay	SCAMBLZ36
Aston	SCAMBLZ02
Barlborough*	SCAMBLZ40
Barnard	SCAMBLZ27
Bromsgrove*	SCAMBLZ35
Bryanston	SCAMBLZ53
Camphill	SCAMBLZ16
Cardiff*	SCAMBLZ04
Dartmouth	SCAMBLZ24
Dunhurst*	SCAMBLZ58
Edge Hill*	SCAMBLZ90
Edinburgh*	SCAMBLZ23
Eynesbury*	SCAMBLZ44
Fairfield	SCAMBLZ47
Glasgow*	SCAMBLZ01
Glenalmond	SCAMBLZ62
Goldsmith	SCAMBLZ39
Handcross*	SCAMBLZ63
Holyoke*	SCAMBLZ43
Hull*	SCAMBLZ19
Kingsmead*	SCAMBLZ67
Knightsbridge*	SCAMBLZ26
Latymer*	SCAMBLZ33
Magdalene*	SCAMBLZ42
Manchester	SCAMBLZ21
Marymount*	SCAMBLZ38
Montcrest*	SCAMBLZ37
Napier	SCAMBLZ08
Newcastle	SCAMBLZ22
Newport*	SCAMBLZ17
Oriel*	SCAMBLZ18
Oxford*	SCAMBLZ09

GRADE 5	
Camira BLAZER – continued	
Penola*	SCAMBLZ45
Plymouth	SCAMBLZ20
Scottsdale*	SCAMBLZ41
Sheffield*	SCAMBLZ03
Silcoates	SCAMBLZ30
Silverdale	SCAMBLZ28
St. Andrews	SCAMBLZ86
Stanford	SCAMBLZ25
Surrey	SCAMBLZ10
Trevelyan	SCAMBLZ31
Tyndale*	SCAMBLZ46
Ulster	SCAMBLZ14
Vassar	SCAMBLZ34
Wellington	SCAMBLZ13
Wesley*	SCAMBLZ82
Winchester*	SCAMBLZ12
Woodcroft*	SCAMBLZ48
HBF Textiles CHECKMATE	
Aqua Sky	1043-56
Blue Green	1043-63
Charcoal Black	1043-89
Forest Mint	1043-66
Golden Grey	1043-22
Purple Indigo	1043-77
Red Brick	1043-44
Royal Navy	1043-58
Rust	1043-43
Smoke Slate	1043-80
Tanned Umber	1043-25
Camira MAIN LINE FLAX	
Aldgate	SCAMMLF01
Archway*	SCAMMLF02
Bank*	SCAMMLF23
Barbican	SCAMMLF03
Bayswater	SCAMMLF24
Bethnal	SCAMMLF25
Brompton*	SCAMMLF35
Camden*	SCAMMLF26
Charing	SCAMMLF27
Edgware*	SCAMMLF28
Euston	SCAMMLF04
Farringdon	SCAMMLF09
Finsbury	SCAMMLF30
Goldhawk*	SCAMMLF31
Greenford	SCAMMLF32
Highgate*	SCAMMLF33
Hillingdon*	SCAMMLF41
Holborn*	SCAMMLF05
Kensington	SCAMMLF07
Kilburn*	SCAMMLF06
Lambeth	SCAMMLF08
Leyton*	SCAMMLF13
Monument	SCAMMLF09
Mordon*	SCAMMLF12
Newbury	SCAMMLF10
Northfields*	SCAMMLF40
Paddington*	SCAMMLF39
Parsons*	SCAMMLF14
Pimlico*	SCAMMLF34
Russell*	SCAMMLF38
Stanmore	SCAMMLF37
Stockwell*	SCAMMLF15
Temple*	SCAMMLF16
Tooting	SCAMMLF17
Tower*	SCAMMLF36
Tufnell	SCAMMLF18
Upminster*	SCAMMLF20
Victoria*	SCAMMLF19
Waterloo*	SCAMMLF21
Wembley	SCAMMLF11
Westminster	SCAMMLF22
CF Stinson RIDDLE	
Black Coffee*	SCFSRID26
Chalkboard	SCFSRID25
Citron	SCFSRID22
Frost	SCFSRID21
Iris	SCFSRID20
Malt	SCFSRID19
Peppercorn*	SCFSRID23
Siren	SCFSRID18
Surf	SCFSRID24

GRADE 5 – continued	
HBF Textiles ZIPPY	
Dark Grey	1045-89
Deep Red	1045-44
Denim Blue	1045-58
Grey	1045-80
Navy	1045-59
Pine	1045-67
School Blue	1045-55
Winter White	1045-10
GRADE 6	
Camira HEMP	
Acre	SCAMHMP19
Alec*	SCAMHMP12
Arable	SCAMHMP04
Ashworth*	SCAMHMP26
Bale	SCAMHMP02
Barn*	SCAMHMP23
Dale*	SCAMHMP18
Dew	SCAMHMP16
Fallow	SCAMHMP28
Gorse*	SCAMHMP03
Grain	SCAMHMP27
Heath*	SCAMHMP07
Hectare*	SCAMHMP21
Hedgerow*	SCAMHMP09
Oat	SCAMHMP05
Plough	SCAMHMP01
Pollen	SCAMHMP08
Root	SCAMHMP06
Seed	SCAMHMP13
Sickle	SCAMHMP30
Trough*	SCAMHMP20
HBF Textiles POPPY	
Flame	1047-44
Graphite	1047-85
Ink	1047-89
Khaki	1047-35
Limelight	1047-63
Natural	1047-16
Neutral	1047-83
Night	1047-59
Pool	1047-56
Punch	1047-45
GRADE 7	
Camira SILK	
Arabia*	SCAMSLK02
Assam*	SCAMSLK11
Brunei	SCAMSLK08
Byzantine*	SCAMSLK03
Chancellor	SCAMSLK19
Divine*	SCAMSLK13
Dynasty	SCAMSLK17
Emperor	SCAMSLK16
Empress*	SCAMSLK05
Forbidden*	SCAMSLK07
Imeon	SCAMSLK20
Incese*	SCAMSLK06
Kingdom*	SCAMSLK10
Monarch	SCAMSLK15
Oriental*	SCAMSLK12
Pamir*	SCAMSLK14
Parthian*	SCAMSLK09
Persia	SCAMSLK04
Sahara*	SCAMSLK01
Sovereign	SCAMSLK18
Tussah	SCAMSLK21
CF Stinson TANGRAM	
Blackboard	SCFSTAN90
Denim	SCFSTAN89
Flax*	SCFSTAN87
Fuchsia	SCFSTAN85
Grotto	SCFSTAN86
Guava	SCFSTAN82
Key Lime	SCFSTAN81
Parchment	SCFSTAN80
Slate	SCFSTAN88
Sunflower	SCFSTAN83
Tomato*	SCFSTAN84

GRADE 8	
CF Stinson KINETIC	
Acacia	SCFSKIN29
After Dark	SCFSKIN36
Bering	SCFSKIN35
Cadmium	SCFSKIN37
Ginger	SCFSKIN34
Pomegranate	SCFSKIN32
Quartz	SCFSKIN33
Shale	SCFSKIN31
Sunset	SCFSKIN30
NIMBLE	
Butternut	SCFSNIM70
Ivory	SCFSNIM71
Lemon Drop	SCFSNIM65
Mulberry	SCFSNIM68
Palladium	SCFSNIM64
Sunset	SCFSNIM72
Tahiti	SCFSNIM66
Tomatillo	SCFSNIM69
Wedgewood Blue	SCFSNIM67
CF Stinson PINBALL	
Canyon*	SCFSPIN56
Lipstick	SCFSPIN51
Midnight	SCFSPIN58
Moonbeam*	SCFSPIN58
Nickel*	SCFSPIN57
Sunshine	SCFSPIN54
Surf	SCFSPIN52
Zest	SCFSPIN55
Camira ZAP	
Argh	SCAMZAP11
Awesome*	SCAMZAP14
Boing	SCAMZAP21
Bonza	SCAMZAP25
Clang*	SCAMZAP19
Clobber*	SCAMZAP12
Cool*	SCAMZAP30
Crackle*	SCAMZAP05
Crash*	SCAMZAP16
Flump	SCAMZAP17
Gasp*	SCAMZAP15
Hahaha*	SCAMZAP09
Kapow*	SCAMZAP06
Omg	SCAMZAP13
Power*	SCAMZAP18
Puff	SCAMZAP26
Screech	SCAMZAP08
Snap*	SCAMZAP01
Splash	SCAMZAP27
Splat	SCAMZAP20
Thud*	SCAMZAP29
Wham	SCAMZAP23
Whirr	SCAMZAP03
Whomp*	SCAMZAP28
Whoosh*	SCAMZAP02
Wowzers*	SCAMZAP07
Yeah*	SCAMZAP04
Yikes	SCAMZAP10
Zoink	SCAMZAP24
Zoom	SCAMZAP22

* Colorway not shown on Textiles card; all Partnership Program memo samples are available from supplier. See contact information on page 9.

Upholstery Selections for Storage by Model/Series

Partnership (⊕) upholstery colors and codes are listed in the Seating, Collaboration and Tables Price List.

Banquette/Seat Cushions		
GRADE 1		
Apex	APX	•
Attire (<i>De-emphasized</i>)	AI	◆
Centurion	CU	◆
Contourett	UR	◆
Dapper	DAPR	◆
Ensemble	ENSB	•
Hamilton	HAML	◆
Inertia	NR	◆
Optic	OP	•
GRADE 2		
Appoint Seating	PNS	◆
Blume	BLME	•
Clyde	CLYD	•
Dotty	DOT	◆
Meld ⊕	SMHMMLD	•
Rush	RUSH	◆
Seed	SED	◆
Spin Seating	SPNN	◆
Taylor	TAY	◆
GRADE 3		
In Season	ISN	◆
Purl	PURL	◆
Quill	QUL	◆
GRADE 4		
Blink ⊕	1048	•
Caper ⊕	SMHMCAP	•
Look-See ⊕	1044	•
Merit ⊕	SMHMMER	•
Metric ⊕	SMHMMET	◆
Mode ⊕	SMHMMOD	•
Multiply ⊕	SMHMMLT	•
Murmur ⊕	SMHMMUR	•
Muse ⊕	SMHMMUS	•
Patina ⊕	SCAMPAT	•
Spry ⊕	SMHMSPY	•
Square One ⊕	SCFSSQU	•
Trundle ⊕	SMHMTRN	•
Walkabout ⊕	1046	•

Banquette/Seat Cushions		
GRADE 5		
Blazer ⊕	SCAMBLZ	• ⁵
Checkmate ⊕	1043	•
Euclid ⊕	SCFSEUC	•
Main Line Flax ⊕	SCAMMLF	•
Perimeter ⊕	SCFSPER	•
Riddle ⊕	SCFSRID	•
Zippy ⊕	1045	•
GRADE 6		
Arris	ARR	•
Hemp ⊕	SCAMHMP	•
Poppy ⊕	1047	•
GRADE 7		
Silk ⊕	SCAMSLK	•
Tangram ⊕	SCFSTAN	•
GRADE 8		
Kinetic ⊕	SCFSKIN	•
Nimble ⊕	SCFSNIM	•
Pinball ⊕	SCFSPIN	•
Zap ⊕	SCAMZAP	•
GRADE 9		
Yoredale ⊕	SCAMYDL	•

⁵Seat Only

• Available upholstery option

◆ Available upholstery option with CTB133 approval — requires FC suffix added to model (FC extra, \$ varies by series)

⊕ Partnership Program — See page 9 for details. Partnership colors and codes are listed in the Seating, Collaboration and Tables Price List.

Refer to page 11 for current upholstery availability by model/series.

GSA Reference Page

GRADE 1

APEX	
Basalt	APX25
Beet	APX12
Blackberry	APX20
Chive	APX05
Iris	APX03
Kiwi	APX06
Lemonade	APX08
Navy	APX13
Papaya	APX09
Pumice	APX23
Rain	APX19
Resort	APX15
Royal	APX14
Tiki	APX29
Tomato	APX11

ATTIRE D

Blaze	A142
Blue Lagoon	A190
Crimson	A162
Fatigue	A176
Ivy	A182
Lithium	A119
Onyx	A110
Sable	A149
Taupe	A126
Turquoise	A196

CENTURION B, C, F, O, S, T

<i>(Nanotex™ Stain-Resistant finish)</i>	
Apricot	CU47
Bark	CU25
Black	CU10
Espresso	CU49
Fog	CU03
Frost	CU22
Goldenrod	CU27
Indigo	CU06
Iris	CU50
Iron Ore	CU19
Jade	CU83
Marsala	CU63
Morel	CU24
Navy	CU98
Peacock	CU97
Pear	CU84
Ruby	CU67
Sapphire	CU09

CONTOURETT

Baltic	UR94
Beach	UR23
Black	UR10
Bordeaux	UR63
Buff	UR22
Cloud	UR18
Coffee Bean	UR49
Crater	UR51
Flame	UR62
Graphite	UR19
Iron	UR20
Luggage	UR26
Marine	UR92
Navy	UR95
Nimbus	UR93
Ocean	UR96
Pumpkin	UR42
Quarry	UR24
Red	UR64
Safari	UR27
Sage	UR82
Steel	UR21
Storm	UR17
Taupe	UR28
Trunk	UR50

GRADE 1 – continued

DAPPER B^w, F^w, S^w, T^w	
<i>(100% Polyester)</i>	
Ash	DAPR20
Azalea	DAPR95
Breeze	DAPR06
Canvas	DAPR25
Charcoal	DAPR01
Clover	DAPR22
Currant	DAPR00
Emerald	DAPR75
Fawn	DAPR35
Fern	DAPR85
Gerbera	DAPR16
Grape	DAPR33
Jewel	DAPR08
Marigold	DAPR65
Onyx	DAPR10
Orchid	DAPR90
Parrot	DAPR59
Peony	DAPR50
Pool	DAPR05
Poppy	DAPR19
Rose	DAPR40
Sapphire	DAPR07
Scarlet	DAPR45
Sepia	DAPR30
Sky	DAPR44
Slate	DAPR15
Sorbet	DAPR55
Spice	DAPR60
Spring	DAPR80
Terracotta	DAPR13
Titanium	DAPR17
Varsity	DAPR09
Zest	DAPR70

ENSEMBLE

Aquamarine	ENSB30
Ash	ENSB39
Greige	ENSB36
Harbor	ENSB34
Navy	ENSB35
Oat	ENSB37
Pear	ENSB33
Sand	ENSB38
Scarlet	ENSB32
Slate	ENSB31
Stone	ENSB40

HAMILTON

<i>(100% Polyester)</i>	
Azure	HAML10
Biscotti	HAML11
Cabernet	HAML08
Carolina	HAML21
Charcoal	HAML17
Chocolate	HAML13
Cloud	HAML18
Dane	HAML16
Dusty Rose	HAML07
Esmeralda	HAML06
Fern	HAML04
Fresh	HAML03
Granola	HAML19
Lilac	HAML14
Lime	HAML05
Lipstick	HAML09
Oxford	HAML20
Passion Fruit	HAML02
Pepper	HAML15
Powder	HAML12
Sunrise	HAML01

GRADE 1 – continued

INERTIA	
Amethyst	NR61
Calypso	NR98
Cherry	NR66
Cobalt	NR91
Coffee	NR49
Fog	NR19
Fuchsia	NR63
Gecko	NR76
Glow	NR27
Leaf	NR75
Lime	NR82
Loft	NR22
Mandarin	NR47
Meteor	NR30
Mustard	NR26
Nickel	NR23
Onyx	NR10
Regatta	NR90
Shadow	NR20
Surf	NR96
Tangelo	NR46
OPTIC	
Aurora	OP72
Bark	OP24
Canopy	OP84
Char	OP49
Ruby	OP42
Sand	OP17
Sky	OP83
Slate	OP19
Sprout	OP74
Starry Night	OP11
Storm	OP56
Wildfire	OP66

GRADE 2

APPOINT SEATING

Artichoke	PNS014
Blackberry	PNS012
Bronze	PNS002
Carbon	PNS008
Chai	PNS013
Cherry	PNS010
Dark Pewter	PNS017
Dune	PNS015
Espresso	PNS003
Framboise	PNS011
Frost	PNS034
Jet	PNS007
Lawn	PNS005
Mandarin	PNS009
Nimbus	PNS016
Platinum	PNS004
Turquoise	PNS006

BLUME

Chalk	BLME03
Char	BLME00
Coin	BLME02
Driftwood	BLME05
Emerald City	BLME07
Fir	BLME09
Harvest	BLME04
Haze	BLME08
Hyacinth	BLME14
Jasper	BLME13
Merlot	BLME10
Moonstone	BLME01
Opal	BLME06
Scarlet	BLME11
Slate	BLME12

CLYDE

Antique	CLYD04
Artifact	CLYD01
Blacksmith	CLYD10
Claret	CLYD13
Craftsman	CLYD08
Crate	CLYD12
Fossil	CLYD02
Heirloom	CLYD05
Iron	CLYD11
Linen	CLYD14
Relic	CLYD06
Seasoned	CLYD03
Trestle	CLYD07

GRADE 2 – continued

DOTTY	
<i>(100% Polyester)</i>	
Candy	DOT63
Gelato	DOT34
Indigo	DOT31
Onyx	DOT35
Park	DOT83
Peat	DOT24
Peony	DOT32
Suit	DOT20
Sunflower	DOT33
Tailor	DOT21
Tide	DOT90
Velum	DOT29
Violet	DOT30

PARKER

Aloe	PRKR01
Cumulus	PRKR05
Cyan	PRKR06
Domino	PRKR07
Fossil	PRKR10
Graphite	PRKR11
Grass	PRKR12
Grenadine	PRKR13
Griffin	PRKR14
Kiln	PRKR16
Magnesium	PRKR18
Magnet	PRKR19
Mica	PRKR20
Mink	PRKR21
Nightfall	PRKR22
Paprika	PRKR24
Pine	PRKR25
Rapids	PRKR28
Rioja	PRKR30

RUSH

<i>(100% Polyester)</i>	
Anchor	RUSH07
Basil	RUSH16
Blueberry	RUSH10
Flamingo	RUSH21
Greenery	RUSH15
Greyhound	RUSH06
Marina	RUSH13
Merlot	RUSH19
Midnight	RUSH11
Mint	RUSH09
Mulberry	RUSH18
Pumice	RUSH01
Punch	RUSH20
Sage	RUSH14
Salsa	RUSH24
Sand	RUSH05
Seal	RUSH08
Soot	RUSH04
Stout	RUSH03
Sunshine	RUSH23
Tapestry	RUSH04
Tiger	RUSH22
Vintage	RUSH17
Wave	RUSH12

SEED

<i>(100% Recycled Polyester)</i>	
<i>(Greenshield Stain-Resistant)</i>	
Apple	SED11
Ash	SED15
Cardinal	SED09
Cinder	SED17
Cream	SED12
Driftwood	SED13
Harbor	SED10
Onyx	SED18
Smoke	SED16
Truffle	SED14

GRADE 2 – continued

SPIN SEATING

Alabaster	SPNN02
Cavern	SPNN03
Cobblestone	SPNN04
Ember	SPNN06
Flame	SPNN07
Heron	SPNN13
Oat	SPNN01
Ocean	SPNN12
Plum	SPNN15
Pool	SPNN11
Raven	SPNN10
Rhubarb	SPNN14
Tropic	SPNN08
Willow	SPNN05

TAYLOR

<i>(74% Post-Consumer Recycled Polyester, 26% Polyester)</i>	
Autumn	TAY43
Daffodil	TAY20
Deep Lilac	TAY75
Dreamy	TAY80
Envious	TAY58
Handkerchief	TAY90
Luxe	TAY50
Malbec	TAY40
Martini	TAY60
Mink	TAY30
Pearl	TAY15
Spritz	TAY45
Tungsten	TAY85

GRADE 3

IN SEASON

Black	ISN001
Blue Jay	ISN007
Fire	ISN004
Jungle	ISN008
Lake	ISN006
Lead	ISN002
Limestone	ISN041
Ocean	ISN005
Silver	ISN003
Smoke	ISN020
Tundra	ISN011

PURL

<i>(80% Polyester, 20% Acrylic)</i>	
Alpaca	PURL08
Braid	PURL10
Deep	PURL12
Graze	PURL05
Loom	PURL06
Needle	PURL07
Pasture	PURL02
Ranch	PURL04
Shuttle	PURL09
Skein	PURL01
Thistle	PURL11
Yearling	PURL03

QUILL

Aviary	QUL03
Feather	QUL02
Fountain	QUL06
Ink	QUL05
Metal	QUL04
Reed	QUL08
Scroll	QUL01
Well	QUL07

GRADE 6

ARRIS

Artisan	ARR01
Baroque	ARR07
Noble	ARR02
Rattan	ARR05
Rich	ARR04
Tapestry	ARR03
Weft	ARR06

Multi-use fabrics are noted with the following designators:

B – Tackboards **S** – Stride®
C – Concensys® **T** – Terrace®
O – Optimize™ **F** – Further™

* limited to 48"W or less

GRADE A

APPOINT PANEL
100% Polyester

Artichoke.....	APN911
Blackberry.....	APN932
Bronze.....	APN922
Carbon.....	APN928
Chai.....	APN912
Cherry.....	APN930
Dark Pewter.....	APN917
Dune.....	APN915
Espresso.....	APN923
Framboise.....	APN931
Frost.....	APN934
Jet.....	APN927
Lawn.....	APN925
Mandarin.....	APN929
Morel.....	APN909
Nimbus.....	APN916
Platinum.....	APN924
Turquoise.....	APN926

BINARY †

Blush.....	BNRY12
Coal.....	BNRY06
Cream.....	BNRY01
Denim.....	BNRY08
Diamond.....	BNRY03
Graphite.....	BNRY05
Juniper.....	BNRY10
Lagoon.....	BNRY07
Lavendar.....	BNRY11
Mineral.....	BNRY04
Reef.....	BNRY09
Sand Dollar.....	BNRY02

***CENTURION™**
(Nanotex™ Stain-Resistant finish)

Apricot.....	CU47
Bark.....	CU25
Black.....	CU10
Espresso.....	CU49
Fog.....	CU03
Frost.....	CU22
Goldenrod.....	CU27
Indigo.....	CU06
Iris.....	CU50
Iron Ore.....	CU19
Jade.....	CU83
Marsala.....	CU63
Morel.....	CU24
Navy.....	CU98
Peacock.....	CU97
Pear.....	CU84
Ruby.....	CU67
Sapphire.....	CU09

CIRCUIT † ♣

Atlas.....	CIRC35
Dolphin.....	CIRC63
Island White.....	CIRC14
Moon.....	CIRC07
Night.....	CIRC49
Pacific.....	CIRC28
Quartz.....	CIRC01
Sienna.....	CIRC56
Silk.....	CIRC21
Snap Pea.....	CIRC42

GRADE A – continued

ETCH
100% Polyester

Axis.....	ECH913
Blend.....	ECH914
Cast.....	ECH912
Highlight.....	ECH910
Midtone.....	ECH911
Outline.....	ECH908
Shade.....	ECH909
Tonal.....	ECH916
Vanish.....	ECH915

EXCHANGE
100% Polyester

Iron.....	EXG916
Nickel.....	EXG914
Pistachio.....	EXG910
Root.....	EXG913
Rupee.....	EXG903
Shadow.....	EXG911
Silver.....	EXG915
Sisal.....	EXG917
Stone.....	EXG912

LANDSCAPE
100% Polyester

Cornsilk.....	LN15
Drift.....	LN05
Khaki.....	LN20
Sheen.....	LN10
Slate.....	LN35
Umber.....	LN25
Urban.....	LN30

LUCY
100% Recycled Polyester

Aspen.....	LC932
Cornsilk.....	LC930
Dusk.....	LC922
Fawn.....	LC933
Graphite.....	LC934
Mist.....	LC920
Neutra.....	LC924
Pewter.....	LC935
Snowdrop.....	LC928

NOBLE

Aspen.....	NBLE14
Bordeaux.....	NBLE01
Brick.....	NBLE02
Chambray.....	NBLE10
Clementine.....	NBLE04
Dawn.....	NBLE13
Denim.....	NBLE09
Grass.....	NBLE07
Gunmetal.....	NBLE15
Harvest.....	NBLE12
Jade.....	NBLE06
Knight.....	NBLE17
Mesa.....	NBLE03
Pacific.....	NBLE08
Rainforest.....	NBLE05
Regal.....	NBLE11
Stormy.....	NBLE16

REFLECTIONS
100% Recycled Polyester

Galvanized.....	REF929
Ice.....	REF920
Loggia.....	REF921
Mistral.....	REF928
Moonstone.....	REF923
Pewter.....	REF922
Stainless.....	REF924
Vanilla.....	REF925
Winter.....	REF927

GRADE A – continued

REFUGE
64% Recycled Polyester
36% Polyester

Artesian.....	RFG996
Dune.....	RFG992
Eclipse.....	RFG990
Frost †.....	RFG993
Glacier †.....	RFG991
Mineral.....	RFG998
Tidal.....	RFG994

SARTO ▼
100% Polyester (45% Recycled)

Ash.....	SRT988
Fog.....	SRT914
Lemongrass.....	SRT949
Mist.....	SRT945
Mushroom.....	SRT976
Oyster.....	SRT918
Reef.....	SRT964
Sesame.....	SRT993
Shale.....	SRT952

TEMPEST
100% Recycled Polyester

Dragonfly.....	TP930
Frost.....	TP915
Full Stream.....	TP980
Gold Rush.....	TP910
Slate.....	TP945
Tumbleweed.....	TP970
Wind Chill.....	TP940
Zebra.....	TP935

GRADE B

ANALOG

Album.....	ANLG06
Cartridge.....	ANLG04
Cassette.....	ANLG09
Dial.....	ANLG02
Media.....	ANLG08
Reel.....	ANLG07
Signal.....	ANLG03
Stereo.....	ANLG01
Track.....	ANLG05

COAST † ♣
100% Antimony-Free Polyester

Channel.....	COA914
Dune.....	COA903
Headlands.....	COA910
Marsh.....	COA902
Pebble.....	COA912
Pier.....	COA913
Shoal.....	COA901
Silt.....	COA906
Tide.....	COA908

DISPERSE †
100% Polyester

Autumn.....	DISP03
Branch.....	DISP10
Coffee Bean.....	DISP13
Dusk.....	DISP09
Emerald City.....	DISP08
Gold Rush.....	DISP02
Igloo.....	DISP11
Ink.....	DISP06
Mist.....	DISP12
Oatmeal.....	DISP15
Prince.....	DISP07
Reservoir.....	DISP01
Rose.....	DISP04
Spring.....	DISP05
Steel.....	DISP16
Taupe.....	DISP14

GRADE B – continued

MICA
100% Recycled Polyester

Anthracite.....	MCA911
Breeze.....	MCA918
Bronze.....	MCA913
Buff.....	MCA914
Cremini.....	MCA917
Crystal †.....	MCA917
Dew.....	MCA920
Dove.....	MCA912
Fresh.....	MCA916
Mineral.....	MCA915
Nectar.....	MCA919
Shale.....	MCA910

SPIN PANEL
46% Recycled Polyester,
56% Polyester

Alabaster.....	SPIN02
Cavern.....	SPIN03
Cobblestone.....	SPIN04
Ember.....	SPIN06
Flame.....	SPIN07
Heron.....	SPIN13
Oat.....	SPIN01
Ocean.....	SPIN12
Plum.....	SPIN15
Pool.....	SPIN11
Raven.....	SPIN10
Rhubarb.....	SPIN14
Tropic.....	SPIN08
Willow.....	SPIN05

TERRAIN
52% Recycled Polyester,
48% Polyester

Bay.....	TRRN05
Bayou.....	TRRN35
Canyon.....	TRRN30
Cliff.....	TRRN45
Crest.....	TRRN25
Delta.....	TRRN10
Freedom.....	TRRN15
Graceful.....	TRRN20
Ridge.....	TRRN40
Valley.....	TRRN40

ALLSTEEL PARTNERSHIP PROGRAM

Allsteel understands that customers may want to specify panel and seating textiles outside of Allsteel's standard offering. Allsteel's **Partnership Program** consists of on-trend and design-forward patterns that have been tested and approved by Allsteel for use on Allsteel products. A subset of these approved patterns is available on cards in the textile binder, while numerous others are available on our website, allsteeloffice.com.

For memo samples, please contact our partners:

- Camira, memos@camirafabrics.com
1.616.288.0655
- HBF Textiles, hbftextiles.com
1.877.494.5727

The intent of the **Partnership Program** is to offer a wide variety of on-trend textiles to meet your varied needs, but since these textiles are not part of our standard offering they may be subject to extended lead times. Because new materials will be introduced regularly, Allsteel reserves the right to change the offering at any time.

PARTNERSHIP – GRADE 4

HBF Textiles BLINK

Bright Blue.....	1048-59
Dark Violet.....	1048-77
Dove Grey.....	1048-83
Lemon Yellow.....	1048-22
Ocean Blue.....	1048-56
Peppery.....	1048-90
Red Orange.....	1048-44
Sea Green.....	1048-67
Silvery.....	1048-80

HBF Textiles LOOK-SEE

Electric.....	1044-77
Foggy.....	1044-85
Foliage.....	1044-67
Lava.....	1044-44
Midnight.....	1044-59
Plum.....	1044-75
Shady.....	1044-80
Snowy.....	1044-11
Stone.....	1044-89
Terra Cotta.....	1044-46
Ultramarine.....	1044-57
Wavelet.....	1044-56
Wine.....	1044-74

GRADE D

Camira BLAZER LITE † ▼
(100% Pure New Wool)

Angel.....	PCAMBLT49
Aspire.....	PCAMBLT52
Balance.....	PCAMBLT41
Bliss.....	PCAMBLT48
Buddha.....	PCAMBLT56
Cuddle.....	PCAMBLT62
Dainty.....	PCAMBLT64
Daydream.....	PCAMBLT46
Devoted.....	PCAMBLT58
Faith.....	PCAMBLT68
Freedom.....	PCAMBLT69
Graceful.....	PCAMBLT51
Happy.....	PCAMBLT55
Harmony.....	PCAMBLT63
Haven.....	PCAMBLT40
Hope.....	PCAMBLT50
Hush.....	PCAMBLT42
Love.....	PCAMBLT47
Mood.....	PCAMBLT44
Pamper.....	PCAMBLT66
Pastel.....	PCAMBLT65
Pillow.....	PCAMBLT43
Praise.....	PCAMBLT54
Retreat.....	PCAMBLT39
Shelter.....	PCAMBLT60
Solace.....	PCAMBLT70
Tender.....	PCAMBLT53
True.....	PCAMBLT61
Verity.....	PCAMBLT57
Wish.....	PCAMBLT67
Worship.....	PCAMBLT59

^w Limited to 48" W or less

^{*} Not available on 72" W.

▼ Panel fabric is not available on Further.

♣ Panel fabric is not available on Optimize®.

† Panel fabric is not available on Concensys®.

◆ Panel fabric is not available on Involve.

Multi-use fabrics are seating fabrics that can be used on specific Allsteel panels systems, providing more color and pattern options. The applicable Allsteel multi-use fabrics are noted with System designators in the Seating, Collaboration, and Tables Price List.

Finishes

FINISHES

Paint Name	Paint Code	Grade	Touch Ups	Pivot Monitor Arms	Pivot GSA Monitor Arms	Terrace	Terrace Footed Panels	Extensions	Stride	Stride Storage	Stride Footed Panels	Stride 5ft to Stand	Stride PR6 Only
Black	P27	1	•			•	•	•	•	•	•	•	
Black	P71	1	•										
Black	BLK	1		•									
Brownstone	P7D	1	•			•	•	•	•	•	•		
Bungalow	P7C	1	•			•	•	•	•	•	•		
Carbon	P4Q	1	•										
Charblack	CBK	1	•										
Charblack Metallic*	P80	1	•										
Cinder	P7Q	1	•			•	•	•	•	•	•		
Designer White	WHT	1											
Designer White	PJW	1	•			•	•	•	•	•	•	•	
Flint	P02	1	•			•	•	•	•	•	•		
Fog	FOG	1											
Fossil	P28	1	•			•	•	•	•	•	•		
Loft	P7B	1	•			•	•	•	•	•	•		
Muslin	P4J	1	•			•	•	•	•	•	•		
Nickel	P8L	1											
Parchment	P93	1	•			•	•	•	•	•	•		
Pebble	P8R	1				•	•	•	•	•	•		
Pewter	P8D	1	•			•	•	•	•	•	•		
Platinum Metallic Texture	P6H	1											
Putty	PJS	1											
Salt	P8C	1	•			•	•	•	•	•	•		
Shadow	P4K	1											
Black Mica Texture	P6P	1	•										
Textured Brownstone	P7J	1	•										
Textured Designer White	PK7	1	•										
Textured Flint	P7A	1	•										
Textured Loft	P7L	1	•										
Textured Muslin	P7M	1	•										
Textured Pebble	P8Y	1	•										
Textured Salt	P8Z	1	•										
Textured Titanium	P8V	1	•										
Titanium	P8T / T	1	•			•	•	•	•	•	•		
White	PD8	1											
Anodized Silver	PR0	2	•										
Champagne Metallic	PR5	2	•			•	•	•	•	•	•		
Designer White High Gloss 65	P8W	2	•										
Graphite Metallic Texture	P85	2	•										
Gunmetal Metallic	PR3	2	•			•	•	•	•	•	•		
Matte Gold	P8G	2											
Night Bronze	P8B	2	•					•					
Platinum Metallic	PR2	2	•			•	•	•	•	•	•		
Pyrite	PJE	2	•					•					
Silver	PR6	2	•			•	•	•	•	•	•	•	•
Silver Generic	SVR	2		•	•								
Silver Texture	PR8	2	•										
Solar Black	P8X	2	•			•	•	•	•	•	•		
Atom	P8S	3	•			•	•	•	•	•	•		
Blossom	P8K	3	•			•	•	•	•	•	•		
Bullseye	PJF	3	•			•	•	•	•	•	•		
Cabernet	P7T	3	•			•	•	•	•	•	•		
Conifer	P8H	3	•			•	•	•	•	•	•		
Ember	P8P	3	•			•	•	•	•	•	•		
Ion	P8N	3	•			•	•	•	•	•	•		
Iris	P8J	3	•			•	•	•	•	•	•		
Krypton	P8F	3	•			•	•	•	•	•	•		
Regatta	P8M	3	•			•	•	•	•	•	•		
Markerboard White	MKP	6								•			

Finishes

Paint Name	Paint Code	Grade	Stride Hardware (Pulls, Feet, & Trim)	Metal Center Drawers	Power Pole	Cable Management Tray	Altitude A6 Table Bases	Altitude A8 Table Bases Utility Bay	Altitude A8 Table Bases and Power Rails	Altitude Metal Screens	Gallery Panels Connectors	Hands Free Pulls	Universal Screens
Black	P27	1		•	•	•							
Black	P71	1				•	•	•	•	•			•
Black	BLK	1											
Brownstone	P7D	1	•	•	•			•	•	•			•
Bungalow	P7C	1	•	•	•			•	•	•			
Carbon	P4Q	1											
Charblack	CBK	1			•								
Charblack Metallic*	P80	1											
Cinder	P7Q	1	•		•			•	•	•			•
Designer White	WHT	1											
Designer White	PJW	1	•	•	•		•	•	•	•			•
Flint	P02	1	•	•	•			•	•	•			•
Fog	FOG	1											
Fossil	P28	1	•		•			•	•	•			•
Loft	P7B	1	•	•	•			•	•	•			•
Muslin	P4J	1	•	•	•			•	•	•			•
Nickel	P8L	1				•							
Parchment	P93	1	•		•					•			
Pebble	P8R	1	•		•			•	•	•			•
Pewter	P8D	1	•		•			•	•	•			•
Platinum Metallic Texture	P6H	1											
Putty	PJS	1											
Salt	P8C	1	•		•			•	•	•			•
Shadow	P4K	1											
Black Mica Texture	P6P	1									•		
Textured Brownstone	P7J	1											
Textured Designer White	PK7	1											
Textured Flint	P7A	1											
Textured Loft	P7L	1											
Textured Muslin	P7M	1											
Textured Pebble	P8Y	1											
Textured Salt	P8Z	1											
Textured Titanium	P8V	1									•		
Titanium	P8T / T	1	•		•			•	•	•			•
White	PD8	1				•							
Anodized Silver	PR0	2											
Champagne Metallic	PR5	2	•		•			•	•	•			•
Designer White High Gloss 65	P8W	2											
Graphite Metallic Texture	P85	2											
Gunmetal Metallic	PR3	2	•		•					•			•
Matte Gold	P8G	2											
Night Bronze	P8B	2						•	•	•			
Platinum Metallic	PR2	2	•		•					•			
Pyrite	PJE	2						•	•	•			
Silver	PR6	2	•		•		•	•	•	•			•
Silver Generic	SVR	2											
Silver Texture	PR8	2											
Solar Black	P8X	2						•	•	•			•
Atom	P8S	3						•	•	•			•
Blossom	P8K	3						•	•	•			•
Bullseye	PJF	3						•	•	•			•
Cabernet	P7T	3						•	•	•			•
Conifer	P8H	3						•	•	•			•
Ember	P8P	3						•	•	•			•
Ion	P8N	3						•	•	•			•
Iris	P8J	3						•	•	•			•
Krypton	P8F	3						•	•	•			•
Regatta	P8M	3						•	•	•			•
Markerboard White	MKP	6							•				•

FINISHES

Finishes

FINISHES

Pattern Name	Code	Grade	Altitude	Gallery Panels	Terrace Doors	Stride Laminate Door	Stride	Stride Worksurfaces	Terrace Laminate Tiles
Ash	LT3B	1	•		•	•	•	•	•
Handspun Chestnut	LAHC	1	•	•	•	•	•	•	•
Handspun Dove	LAHD	1	•	•	•	•	•	•	•
Handspun Pearl	LAHP	1	•	•	•	•	•	•	•
Handspun Slate	LAHS	1	•	•	•	•	•	•	•
Silver Mesh	LT8D	1	•		•	•	•	•	•
Black	P	1	•	•	•	•	•	•	•
Brownstone	LM13	1	•	•	•	•	•	•	•
Bungalow	LM12	1	•	•	•	•	•	•	•
Designer White 15051	LDW1	1	•	•	•	•	•	•	•
Flint	LM16	1	•	•	•	•	•	•	•
Fossil Shale	LEH1	1	•	•	•	•	•	•	•
Loft	LM11	1	•	•	•	•	•	•	•
Muslin	LM15	1	•	•	•	•	•	•	•
Titanium	LT11	1	•	•	•	•	•	•	•
Belair	LWBA	1	•	•	•	•	•	•	•
Bourbon Cherry	H	1	•	•	•	•	•	•	•
Field Elm	LWFE	1	•	•	•	•	•	•	•
Florence Walnut	LFW1	1	•	•	•	•	•	•	•
Kingswood Walnut	LK11	1	•	•	•	•	•	•	•
Natural Maple	LWD	1	•	•	•	•	•	•	•
NeoWalnut	LNU1	1	•	•	•	•	•	•	•
Pinnacle	PINC	1	•	•	•	•	•	•	•
Shaker Cherry	LW7C	1	•	•	•	•	•	•	•
Beigewood	LWBE	2	•	•	•	•	•	•	•
Fawn Cypress	LFC1	2	•	•	•	•	•	•	•
Lowell Ash	LLA1	2	•	•	•	•	•	•	•
Mangalore Mango	LMM1	2	•	•	•	•	•	•	•
Natural Recon	LNR1	2	•	•	•	•	•	•	•
Phantom Charcoal	LPC1	2	•	•	•	•	•	•	•
Phantom Ecru	LPE1	2	•	•	•	•	•	•	•
Portico Teak	LPT1	2	•	•	•	•	•	•	•
Skyline Walnut	LSW1	2	•	•	•	•	•	•	•
Veranda Teak	LVT1	2	•	•	•	•	•	•	•
Natural Walnut	LWNW	3	•	•	•	•	•	•	•

Finishes

Veneer Type	Stain Name	Code	Grade	Stride Tiles	Stride Trim	Stride Natural Tile Sets	System Worksurfaces	Terrace Tiles
FSC Stratawood Cherry	Cinnamon Cherry	FSCSC260	1	•	•	•	•	•
FSC Stratawood Cherry	Lowell Ash	FSCSC394	1	•	•	•	•	•
FSC Stratawood Cherry	Clear Cherry	FSCSC700	1	•	•	•	•	•
FSC Stratawood Cherry	Light Cherry	FSCSC701	1	•	•	•	•	•
FSC Stratawood Cherry	Shaker Cherry	FSCSC774	1	•	•	•	•	•
FSC Stratawood Cherry	Burnished Cherry	FSCSC777	1	•	•	•	•	•
FSC Stratawood Maple	Field Elm	FSCSE599	1	•	•	•	•	•
FSC Stratawood Maple	Clear Maple	FSCSE800	1	•	•	•	•	•
FSC Stratawood Maple	Harvest Maple	FSCSE856	1	•	•	•	•	•
FSC Stratawood Maple	Beigewood	FSCSE878	1	•	•	•	•	•
FSC Stratawood Maple	Phantom Ecu	FSCSE912	1	•	•	•	•	•
FSC Stratawood Maple	Belair	FSCSE934	1	•	•	•	•	•
FSC Stratawood Rift Oak	Clear Oak	FSCSF300	1	•	•	•	•	•
FSC Stratawood Rift Oak	Dark Rift Oak	FSCSF331	1	•	•	•	•	•
FSC Stratawood Walnut	Florence Walnut	FSCST579	1	•	•	•	•	•
FSC Stratawood Walnut	Light Walnut	FSCST601	1	•	•	•	•	•
FSC Stratawood Walnut	Skyline Walnut	FSCST625	1	•	•	•	•	•
FSC Stratawood Walnut	Pinnacle Walnut	FSCST679	1	•	•	•	•	•
FSC Stratawood Walnut	Sumatra Walnut	FSCST693	1	•	•	•	•	•
FSC Natural Cherry	Cinnamon Cherry	FSCNC260	1	•	•	•	•	•
FSC Natural Cherry	Lowell Ash	FSCNC394	1	•	•	•	•	•
FSC Natural Cherry	Medium Red Cherry	FSCNC512	1	•	•	•	•	•
FSC Natural Cherry	Clear Cherry	FSCNC700	1	•	•	•	•	•
FSC Natural Cherry	Light Cherry	FSCNC701	1	•	•	•	•	•
FSC Natural Cherry	Shaker Cherry	FSCNC774	1	•	•	•	•	•
FSC Natural Cherry	Burnished Cherry	FSCNC777	1	•	•	•	•	•
FSC Natural Maple	Clear Maple	FSCNE800	1	•	•	•	•	•
FSC Natural Maple	Harvest Maple	FSCNE856	1	•	•	•	•	•
FSC Natural Walnut	Ebony Walnut	FSCNT509	1	•	•	•	•	•
FSC Natural Walnut	Florence Walnut	FSCNT579	1	•	•	•	•	•
FSC Natural Walnut	Light Walnut	FSCNT601	1	•	•	•	•	•
FSC Natural Walnut	Skyline Walnut	FSCNT625	1	•	•	•	•	•
FSC Natural Walnut	Nutmeg Walnut	FSCNT629	1	•	•	•	•	•
FSC Natural Walnut	Pinnacle Walnut	FSCNT679	1	•	•	•	•	•
FSC Natural Walnut	Sumatra Walnut	FSCNT693	1	•	•	•	•	•
FSC Natural Rift Oak	Fawn Cypress	FSCRF108	2	•	•	•	•	•
FSC Natural Rift Oak	Light Rift Oak	FSCRF301	2	•	•	•	•	•
FSC Rift Oak	Dark Rift Oak	FSCRF331	2	•	•	•	•	•
FSC Natural Rift Oak	Phantom Ecu	FSCRF912	2	•	•	•	•	•
Natural Cherry	Cinnamon Cherry	NC260	1	•	•	•	•	•
Natural Cherry	Lowell Cherry	NC394	1	•	•	•	•	•
Natural Cherry	Medium Red Cherry	NC512	1	•	•	•	•	•
Natural Cherry	Light Cherry	NC701	1	•	•	•	•	•
Natural Cherry	Shaker Cherry	NC774	1	•	•	•	•	•
Natural Cherry	Burnished Cherry	NC777	1	•	•	•	•	•
Natural Maple	Clear Maple	NE800	1	•	•	•	•	•
Natural Maple	Harvest Maple	NE856	1	•	•	•	•	•
Natural Rift Cut Oak	Fawn Cypress	RF108	2	•	•	•	•	•
Natural Rift Cut Oak	Light Rift Oak	RF301	2	•	•	•	•	•
Natural Rift Cut Oak	Dark Rift Oak	RF331	1	•	•	•	•	•
Natural Rift Cut Oak	Phantom Ecu	RF912	2	•	•	•	•	•
Natural Walnut	Ebony Walnut	NT509	1	•	•	•	•	•
Natural Walnut	Florence Walnut	NT579	1	•	•	•	•	•
Natural Walnut	Light Walnut	NT601	1	•	•	•	•	•
Natural Walnut	Skyline Walnut	NT625	1	•	•	•	•	•
Natural Walnut	Nutmeg Walnut	NT629	1	•	•	•	•	•
Natural Walnut	Pinnacle Walnut	NT679	1	•	•	•	•	•
Natural Walnut	Sumatra Walnut	NT693	1	•	•	•	•	•

Finishes

Veneer Type	Stain Name	Code	Grade	Stride Tiles	Stride Trim	Stride Natural Tile Sets	System Worksurfaces	Terrace Tiles
Stratawood Cherry	Stratawood Cherry	SC260	1	•	•		•	
Stratawood Cherry	Lowell Ash	SC394	1	•	•		•	
Stratawood Cherry	Clear Cherry	SC700	1	•	•		•	
Stratawood Cherry	Light Cherry	SC701	1	•	•		•	•
Stratawood Cherry	Shaker Cherry	SC774	1	•	•		•	
Stratawood Cherry	Burnished Cherry	SC777	1	•	•		•	•
Stratawood Maple	Field Elm	SE599	1	•	•		•	
Stratawood Maple	Clear Maple	SE800	1	•			•	•
Stratawood Maple	Harvest Maple	SE856	1	•	•		•	
Stratawood Maple	Beigewood	SE878	1	•	•		•	
Stratawood Maple	Phantom Ecu	SE912	1	•	•		•	
Stratawood Maple	Belair	SE934	1	•	•		•	
Stratawood Silver Oak	Clear	SB100	1	•	•		•	•
Stratawood Silver Oak	Portico Teak	SB150	1	•	•		•	
Stratawood Rift Oak	Clear Oak	SF300	1	•	•		•	•
Stratawood Rift Oak	Dark Rift Oak	SF331	1	•	•		•	•
Stratawood Walnut	Florence Walnut	ST579	1	•	•		•	
Stratawood Walnut	Light Walnut	ST601	1	•	•		•	•
Stratawood Walnut	Skyline Walnut	ST625	1	•	•		•	
Stratawood Walnut	Pinnacle Walnut	ST679	1	•	•		•	
Stratawood Walnut	Sumatra Walnut	ST693	1	•	•		•	

- Finishes 18.2-18.3
- Introduction/Overview 18.4
- Statement of Line 18.5
- Specification Details 18.6
- Frames..... 18.8
- Laminate Inserts..... 18.9
- Metal Inserts 18.10
- Slotted Metal Inserts 18.11
- Fabric Inserts..... 18.12
- Glass Inserts 18.13
- Shelves & Bookcases..... 18.14
- Planters 18.15
- Work Tools..... 18.16

FRAME, METAL INSERT, SLOTTED METAL INSERT

GRADE P1

Black	P71
Brownstone	P7D
Bungalow	P7C
Carbon	P4Q
Designer White	PJW
Flint	P02
Fossil	P28
Loft	P7B
Muslin	P4J
Parchment	P93
Pebble	P8R
Pewter	P8D
Salt	P8C
Textured Designer White	PK7
Textured Flint	P7A
Titanium	P8T

GRADE P2

Champagne Metallic	PR5
Gunmetal Metallic	PR3
Night Bronze	P8B
Platinum Metallic	PR2
Silver	PR6
Solar Black	P8X

GRADE P3

Amethyst	P091
Atom	P8S
Blossom	P8K
Bullseye	PJF
Cobalt Mica	P090
Ember	P8P
Ion	P8N
Iris	P8J
Krypton	P8F
Ochre	P093
Regatta	P8M
Sienna	P092
Succulent	P8A

LAMINATE INSERT, LAMINATE SHELF

L1 SOLID

Black	P
Designer White	LDW1
Flint	LM16
Loft	LOFT

L1 WOODGRAIN

Bourbon Cherry	H
Field Elm	LWFE
Florence Walnut	LFW1
Kingswood Walnut	LK11
Natural Maple	LWD
NeoWalnut	LNU1
Pinnacle	PINC
Shaker Cherry	F

L2 WOODGRAIN

Fawn Cypress	LFC1
Lowell Ash	LLA1
Natural Recon	LNR1
Phantom Ecu	LPE1
Portico Teak	LPT1
Skyline Walnut	LSW1
Veranda Teak	LVT1

LAMINATE EDGE

Beigewood	DE
Belair	BA
Black	E4
Brownstone	EY
Bungalow	EX
Designer White	DW
Fawn Cypress	FC
Field Elm	FE
Flint	E9
Florence Walnut	FW
Fossil	EH
Kingswood Walnut	KI
Loft	EV
Lowell Ash	DL
Mangalore Mango	MM
Muslin	EU
Natural Maple	DD
Natural Recon	NR
Natural Walnut	DN
NeoWalnut	NU
Phantom Ecu	PE
Portico Teak	DP
Shaker Cherry	DF
Skyline Walnut	SW
Titanium	TI
Veranda Teak	VT

SHELF, BOOKCASE, PLANTER PAINT

GRADE P1

Black	P71
Brownstone	P7D
Bungalow	P7C
Carbon	P4Q
Designer White	PJW
Flint	P02
Fossil	P28
Loft	P7B
Muslin	P4J
Parchment	P93
Pebble	P8R
Pewter	P8D
Salt	P8C
Textured Designer White	PK7
Textured Flint	P7A
Titanium	P8T

GRADE P2

Champagne Metallic	PR5
Gunmetal Metallic	PR3
Night Bronze	P8B
Platinum Metallic	PR2
Silver	PR6
Solar Black	P8X

GRADE P3

Amethyst	P091
Atom	P8S
Blossom	P8K
Bullseye	PJF
Cobalt Mica	P090
Ember	P8P
Ion	P8N
Iris	P8J
Krypton	P8F
Ochre	P093
Regatta	P8M
Sienna	P092
Succulent	P8A

GRADE A

APPOINT PANEL

100% Polyester

Artichoke	APN911
Blackberry	APN932
Bronze	APN922
Carbon	APN928
Chai	APN912
Cherry	APN930
Dark Pewter	APN917
Dune	APN915
Espresso	APN923
Framboise	APN931
Frost	APN934
Jet	APN927
Lawn	APN925
Mandarin	APN929
Morel	APN909
Nimbus	APN916
Platinum	APN924
Turquoise	APN926

BINARY †

Blush	BNRY12
Coal	BNRY06
Cream	BNRY01
Denim	BNRY08
Diamond	BNRY03
Graphite	BNRY05
Juniper	BNRY10
Lagoon	BNRY07
Lavendar	BNRY11
Mineral	BNRY04
Reef	BNRY09
Sand Dollar	BNRY02

***CENTURION™**

(Nanotex™ Stain-Resistant finish)

Apricot	CU47
Bark	CU25
Black	CU10
Espresso	CU49
Fog	CU03
Frost	CU22
Goldenrod	CU27
Indigo	CU06
Iris	CU50
Iron Ore	CU19
Jade	CU83
Marsala	CU63
Morel	CU24
Navy	CU98
Peacock	CU97
Pear	CU84
Ruby	CU67
Sapphire	CU09

CIRCUIT † ♣

Atlas	CIRC35
Dolphin	CIRC63
Island White	CIRC14
Moon	CIRC07
Night	CIRC49
Pacific	CIRC28
Quartz	CIRC01
Sienna	CIRC56
Silk	CIRC21
Snap Pea	CIRC42

GRADE A – continued

ETCH

100% Polyester

Axis	ECH913
Blend	ECH914
Cast	ECH912
Highlight	ECH910
Midtone	ECH911
Outline	ECH908
Shade	ECH909
Tonal	ECH916
Vanish	ECH915

EXCHANGE

100% Polyester

Iron	EXG916
Nickel	EXG914
Pistachio	EXG910
Root	EXG913
Rupee	EXG903
Shadow	EXG911
Silver	EXG915
Sisal	EXG917
Stone	EXG912

LANDSCAPE

100% Polyester

Corn silk	LN15
Drift	LN05
Khaki	LN20
Sheen	LN10
Slate	LN35
Umber	LN25
Urban	LN30

LUCY

100% Recycled Polyester

Aspen	LC932
Corn silk	LC930
Dusk	LC922
Fawn	LC933
Graphite	LC934
Mist	LC920
Neutra	LC924
Pewter	LC935
Snowdrop	LC928

NOBLE

Aspen	NBLE14
Bordeaux	NBLE01
Brick	NBLE02
Chambray	NBLE10
Clementine	NBLE04
Dawn	NBLE13
Denim	NBLE09
Grass	NBLE07
Gunmetal	NBLE15
Harvest	NBLE12
Jade	NBLE06
Knight	NBLE17
Mesa	NBLE03
Pacific	NBLE08
Rainforest	NBLE05
Regal	NBLE11
Stormy	NBLE16

REFLECTIONS

100% Recycled Polyester

Galvanized	REF929
Ice	REF920
Loggia	REF921
Mistral	REF928
Moonstone	REF923
Pewter	REF922
Stainless	REF924
Vanilla	REF925
Winter	REF927

GRADE A – continued

REFUGE
64% Recycled Polyester
36% Polyester

Artesian.....	RFG996
Dune.....	RFG992
Eclipse.....	RFG990
Frost †.....	RFG993
Glacier †.....	RFG991
Mineral.....	RFG998
Tidal.....	RFG994

SARTO ▼
100% Polyester (45% Recycled)

Ash.....	SRT988
Fog.....	SRT914
Lemongrass.....	SRT949
Mist.....	SRT945
Mushroom.....	SRT976
Oyster.....	SRT918
Reef.....	SRT964
Sesame.....	SRT993
Shale.....	SRT952

TEMPEST
100% Recycled Polyester

Dragonfly.....	TP930
Frost.....	TP915
Full Stream.....	TP980
Gold Rush.....	TP910
Slate.....	TP945
Tumbleweed.....	TP970
Wind Chill.....	TP940
Zebra.....	TP935

GRADE B

ANALOG

Album.....	ANLG06
Cartridge.....	ANLG04
Cassette.....	ANLG09
Dial.....	ANLG02
Media.....	ANLG08
Reel.....	ANLG07
Signal.....	ANLG03
Stereo.....	ANLG01
Track.....	ANLG05

COAST † ♣
100% Antimony-Free Polyester

Channel.....	COA914
Dune.....	COA903
Headlands.....	COA910
Marsh.....	COA902
Pebble.....	COA912
Pier.....	COA913
Shoal.....	COA901
Silt.....	COA906
Tide.....	COA908

GRADE B – continued

DISPERSE †
100% Polyester

Autumn.....	DISP03
Branch.....	DISP10
Coffee Bean.....	DISP13
Dusk.....	DISP09
Emerald City.....	DISP08
Gold Rush.....	DISP02
Igloo.....	DISP11
Ink.....	DISP06
Mist.....	DISP12
Oatmeal.....	DISP15
Prince.....	DISP07
Reservoir.....	DISP01
Rose.....	DISP04
Spring.....	DISP05
Steel.....	DISP16
Taupe.....	DISP14

MICA
100% Recycled Polyester

Anthracite.....	MCA911
Breeze.....	MCA918
Bronze.....	MCA913
Buff.....	MCA914
Cremini.....	MCA917
Crystal †.....	MCAWIT
Dew.....	MCA920
Dove.....	MCA912
Fresh.....	MCA916
Mineral.....	MCA915
Nectar.....	MCA919
Shale.....	MCA910

SPIN PANEL

46% Recycled Polyester,
56% Polyester

Alabaster.....	SPIN02
Cavern.....	SPIN03
Cobblestone.....	SPIN04
Ember.....	SPIN06
Flame.....	SPIN07
Heron.....	SPIN13
Oat.....	SPIN01
Ocean.....	SPIN12
Plum.....	SPIN15
Pool.....	SPIN11
Raven.....	SPIN10
Rhubarb.....	SPIN14
Tropic.....	SPIN08
Willow.....	SPIN05

TERRAIN

52% Recycled Polyester,
48% Polyester

Bay.....	TRRN05
Bayou.....	TRRN35
Canyon.....	TRRN30
Cliff.....	TRRN45
Crest.....	TRRN25
Delta.....	TRRN10
Plateau.....	TRRN15
Ridge.....	TRRN20
Valley.....	TRRN40

ALLSTEEL MATERIALS PARTNERSHIP PROGRAM —

See program explanation at bottom of page.

GRADE 4

HBF Textiles BLINK

Bright Blue.....	1048-59
Dark Violet.....	1048-77
Dove Grey*.....	1048-83
Lemon Yellow*.....	1048-22
Ocean Blue*.....	1048-56
Peppery.....	1048-90
Red Orange.....	1048-44
Sea Green*.....	1048-67
Silvery.....	1048-80

HBF Textiles LOOK-SEE

Electric*.....	1044-77
Foggy.....	1044-85
Foliage.....	1044-67
Lava.....	1044-44
Midnight.....	1044-59
Plum.....	1044-75
Shady.....	1044-80
Snowy.....	1044-11
Stone.....	1044-89
Terra Cotta*.....	1044-46
Ultramarine.....	1044-57
Wavelet*.....	1044-56
Wine*.....	1044-74

ALLSTEEL PARTNERSHIP PROGRAM

Allsteel understands that customers may want to specify panel and seating textiles outside of Allsteel's standard offering. Allsteel's Partnership Program consists of on-trend and design-forward patterns that have been tested and approved by Allsteel for use on Allsteel products. A subset of these approved patterns is available on cards in the textile binder, while numerous others are available on our website, allsteeloffice.com.

For memo samples, please contact our partners:

- Camira, memos@camirafabrics.com 1.616.288.0655
- CF Stinson, cfstinson.com 1.800.841.6279
- HBF Textiles, hbftextiles.com 1.877.494.5727
- Maharam, maharam.com 1.800.645.3943
- Ultrafabrics, ultrafabricsinc.com 1.877.309.6648

The intent of the **Partnership Program** is to offer a wide variety of on-trend textiles to meet your varied needs, but since these textiles are not part of our standard offering they may be subject to extended lead times. Because new materials will be introduced regularly, Allsteel reserves the right to change the offering at any time.

In the open plan, organizations are looking for ways to create spaces to flex with the needs of teams. Daybook creates division and collaboration for adjacent neighborhoods. Inserts can be customized to team needs — from a place to brainstorm to a celebration of project milestones. As teams change and new “neighbors” are added, the wall can be reconfigured to meet the needs of today and tomorrow.

	Top	Middle	Bottom
Metal	X	X	X
Laminate	X		X
Slotted Metal	X	X	X
Fabric	X	X	X
Glass Markerboard		X	
Planter		X	
Shelf		X	
Bookcase			X

Neighborhood Division

Creates neighborhood division by visibly *dividing space* and *harnessing local collaboration*. Permeable privacy is created through open-air inserts and a floor-to-ceiling design.

Team Culture

Drive team culture through *user choice* and *ownership* of product/space. A variety of materials and finishes enables designers to give teams their own flair and function without straying from corporate standards. The product can be a shared resource, but intuitively can feel owned by groups due to location or application.

Flexible Design

Daybook's flexible design allows it to be used in an *adaptive workplace*. Meaningful applications exist throughout the office; complementing different team and individual settings. Inserts and accessories can be easily swapped out to adjust to changes in team needs.

Frame



Base Frame



Frame Extension

Fabric Panel Inserts

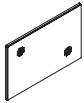

Top/Bottom Fabric Insert, Front

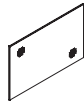

Top/Bottom Fabric Insert, Back



Middle Fabric Insert, Front

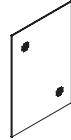

Middle Fabric Insert, Back

Laminate Panel Inserts



Top/Bottom Laminate Insert, Front



Top/Bottom Laminate Insert, Back

Metal Panel Inserts

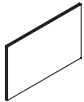

Top/Bottom Metal Insert, Front

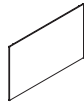

Top/Bottom Metal Insert, Back



Top/Bottom Slotted Metal Insert, Front



Top/Bottom Slotted Metal Insert, Back

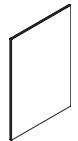

Middle Metal Insert, Front

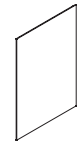

Middle Metal Insert, Back



Middle Slotted Metal Insert, Front



Middle Slotted Metal Insert, Back

Glass Panel Inserts

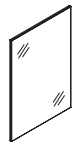

Glass MB Insert, Front

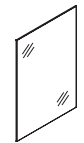

Glass MB Insert, Back

Storage & Shelving



Laminate Shelf

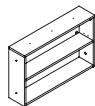

Laminate Bookcase



Steel Planter

Radii Tools



Hot File



Side Saddle



Bag or Coat Hook

Frame (page 18.8)

- Frame is available in standard finishes.
- Recommended 5-6 sections per run (1 base frame, 3-4 frame extensions). Maximum run will depend on slope of floor. Floor must have less than 2" of height variance across the total run of the Daybook Wall. Failure to meet this requirement could cause wall to be unstable resulting in product damage, property damage, or serious bodily injury.
- Every 36" requires ceiling attachment and floor attachment, these attachments come pppwith NHBRHDFRM (base frame) and NHBRHDFRMEXT (frame extension) for simple specification. Hardware not included.
- Hardware finish is always black.
- Linear configurations only. Any configurations needing non-linear runs will need to be separate units on either side of the turn and will not be ganged or connected to each other.
- To add frame extensions after initial installation, you must disassemble frame and add extension pieces to the middle (NHBRHDFRM will always be on outside).

Ceiling Attachment (page 18.8)

- Attachment brackets ship with frame. Hardware is not included.
- Matches frame color specification.
- Ceiling brackets can be positioned on either side of wall.
- Above ceiling bracket can mount directly to deck, but can also be mounted to built-out ceiling structure.
- Hardware is not included. Fasteners will vary depending on ceiling construction. Choose fasteners specific for your application.
- Grommets/shrouds for ceiling attachment must be sourced separately.
- "HI" spec: targeted mounting height 162" (13.5') to 207" (17') from floor.
- "MED" spec: targeted mounting height 138" (11.5') to 162" (13.25') from floor.
- "LO" spec: targeted mounting height 109" (9.125'), 126" (10.5') – 138" (11.25').



Floor Attachment (page 18.8)

- Attachment brackets ship with frame. Hardware is not included.
- Matches frame color specification.
- Foot design accepts customer-provided floor fastener up to 3/8" diameter.
- Finished floor anchor overall height maximum 7/16".

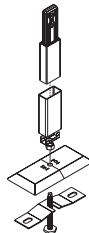

Inserts (pages 18.9-18.13)

- Top/Bottom inserts and middle inserts available to create customizable wall solution.
- Every wall has a "front" and a "back" and models must be specified as such to allow for proper attachment clips.
- Day 2 insert customers will only need to order "back" models for tile to tile retrofit opportunities.
- All front and back inserts can be different to match application need.
- Slotted metal inserts will show back of tile through the slots depending on what insert it is being used with. Weight capacity for slotted metal inserts/Radii tools: 50 lbs. distributed.
- Weight capacity for slotted metal inserts/Radii tools: 50 lbs. distributed.
- Top/Bottom Inserts feature Metal, Slotted Metal, Fabric, and Laminate materials.
- Middle inserts feature Metal, Slotted Metal, Fabric, and Glass Marker Board.
- Laminate inserts have a vertical grain direction. For fabric inserts, all Allsteel standard paints are available for the pan.
- Must install frame before installing inserts. Order in which inserts are installed does not matter.

Floating Shelf/Bookcase (page 18.14)

- Laminate shelf perfect for team displays and collaboration tools.
- Available in Allsteel standard laminates.
- 20 lbs. (distributed) load capacity per shelf.
- Floating shelf utilizes universal brackets.
- Bookshelf utilizes hardware for frame attachment. Available in Allsteel standard paint finishes.
- Shelves and bookcases are dual-sided inserts. Only one is required within specification (does not require a front and back model, like other inserts).
- Maximum of three shelves per middle section.
- Shelves can only be used as a middle inserts. Bookcases can only be used as a bottom insert.

Planter (page 18.15)

- Planter can be used for light storage or to introduce biophilia into a space.
- Painted steel planter available in Allsteel standard paints. Brackets will match paint specified with planter.
- Plant liner must be sourced separately, standard sizes available in the market.
- Planters can only be used as a middle insert.
- 30 lbs. weight capacity (distributed).
- Maximum of three planters per middle section.
- Planters are dual-sided inserts. Only one is required within specification (does not require a front and back model, like other inserts).

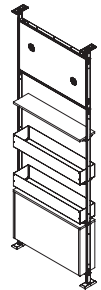

Deck Visual Details

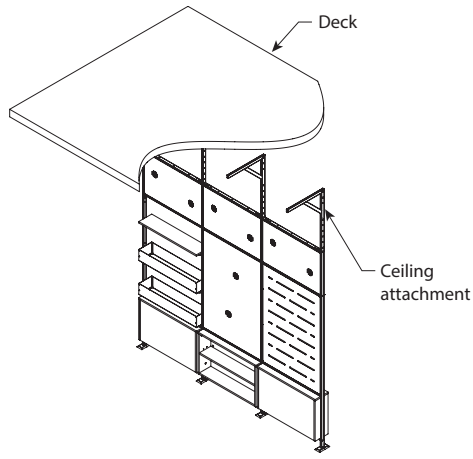

Visual from Top Side

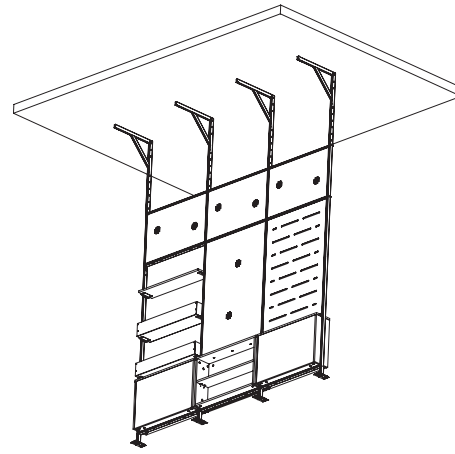

Visual from Bottom Side

Structure Connected to Deck Visual Details

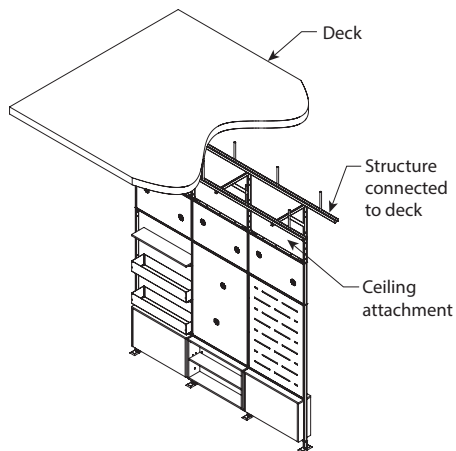

Visual from Top Side

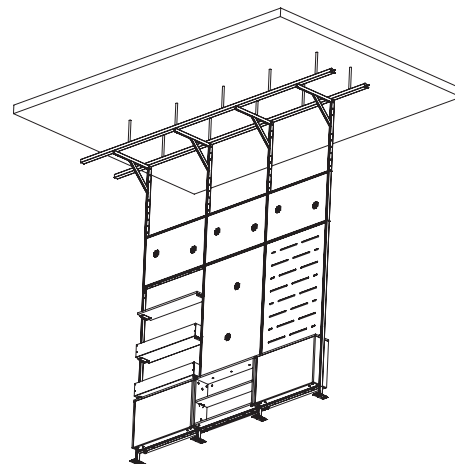

Visual from Bottom Side

Grid Ceiling Visual Details

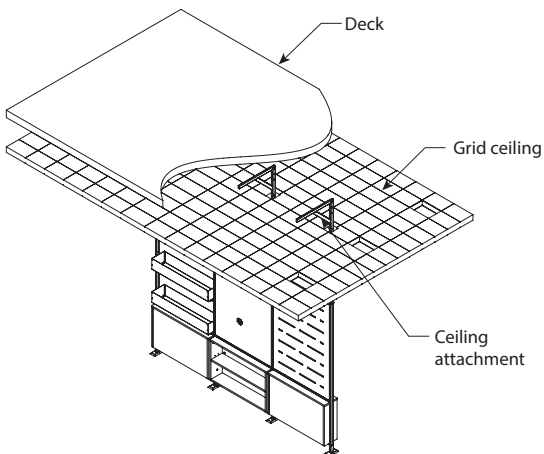

Visual from Top Side

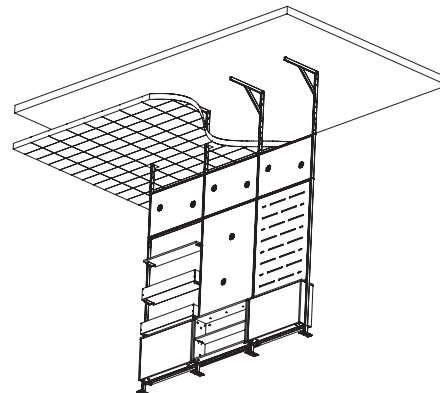

Visual from Bottom Side

For specification information see page 18.6.

GSA SIN 33721

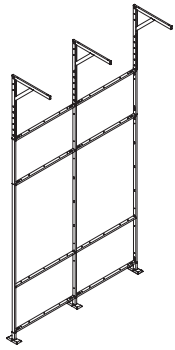

Description	Model	List Price
Neighborhood Wall Frame		
Base Frame	NHBRHDFRM	\$ 6966

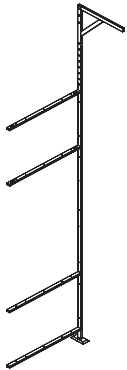

Frame Extension	NHBRHDFRMEXT	\$ 3159
-----------------	--------------	---------

<p>How to specify — Select the Model Number from above.</p> <p>_____ .</p>	<p>1st Option: Select the Base Paint Color (if applicable): P1 P2 P3 See page 18.2 for paint finishes.</p> <p>_____ .</p>	<p>2nd Option Select Ceiling Attachment: L Low Ceiling Attachment M Medium Ceiling Attachment H High Ceiling Attachment</p> <p>_____</p>
---	--	---

Example: NHBRHDFRM.P71.L

For specification information see page 18.6.

GSA SIN 33721

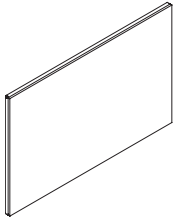

Description	Model	List Price
Daybook Insert		
Top/Bottom Laminate Insert, Front	NHBRHDTBILF	\$ 794
Top/Bottom Laminate Insert, Back	NHBRHDTBILB	\$ 610

Note: Laminate inserts have a vertical grain direction.

<p><i>How to specify —</i> Select the Model Number from above.</p> <p>_____ .</p>	<p><i>1st Option:</i> FSC Wood: F FSC Wood X Non-FSC Wood (Omit)</p> <p>_____ .</p>	<p><i>2nd Option:</i> Select Laminate: See page 18.2 for finishes.</p> <p>_____</p>
---	--	--

Example: NHBRHDTBILF.F.P

For specification information see page 18.6.

GSA SIN 33721

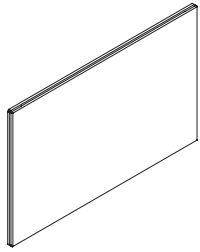

Description	Model	List Price
Daybook Insert		
Top/Bottom Metal Insert, Front	NHBRHDTBIMF	\$ 392
Top/Bottom Metal Insert, Back	NHBRHDTBIMB	\$ 196

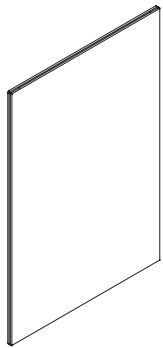

Middle Metal Insert, Front	NHBRHDMIMF	\$ 932
Middle Metal Insert, Back	NHBRHDMIMB	\$ 644

Note: Specify marker board paint to make it a writable surface.

DAYBOOK

<p><i>How to specify —</i> Select the Model Number from above.</p>	<p><i>1st Option:</i> Select the Paint Color: P1 P2 P3 See page 18.2 for paint finishes.</p>
--	--

Example: NHBRHDTBIMF.P71

For specification information see page 18.6.

GSA SIN 33721

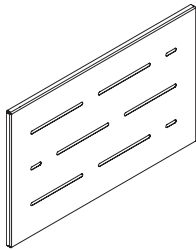

Description	Model	List Price by Paint Grade	
		P1	P2
Daybook Insert			
Top/Bottom Slotted Metal Insert, Front	NHBRHDTBIPMF	\$ 518	\$ 526
Top/Bottom Slotted Metal Insert, Back	NHBRHDTBIPMB	\$ 392	\$ 397

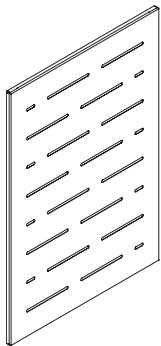

Middle Slotted Metal Insert, Front	NHBRHDMIPMF	\$ 1058	\$ 1077
Middle Slotted Metal Insert, Back	NHBRHDMIPMB	\$ 772	\$ 791

<p>How to specify — Select the Model Number from above.</p>	<p>1st Option: Select the Paint Color: P1 P2 P3 See page 18.2 for paint finishes.</p>
--	--

Example: NHBRHDTBIPMF.P71

For specification information see page 18.6.

GSA SIN 33721

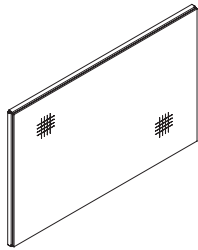

Description	Model	List Price by Fabric Grade	
		A	B
Daybook Insert			
Top/Bottom Fabric Insert, Front	NHBRHDTBIFF	\$ 819	\$ 876
Top/Bottom Fabric Insert, Back	NHBRHDTBIFB	\$ 654	\$ 700

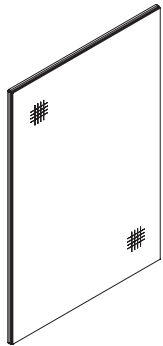

Middle Fabric Insert, Front	NHBRHDMIFF	\$ 1608	\$ 1721
Middle Fabric Insert, Back	NHBRHDMIFB	\$ 1362	\$ 1457

<p>How to specify — Select the Model Number from above.</p> <p>_____ .</p>	<p>1st Option: Select the Paint Color: P1 P2 P3 See page 18.2 for paint finishes.</p> <p>_____ .</p>	<p>2nd Option: Select Fabric: See pages 18.2-18.3 for fabrics.</p> <p>_____</p>
---	---	--

Example: NHBRHDTBIFF.P71.APN911

For specification information see page 18.6.

GSA SIN 33721

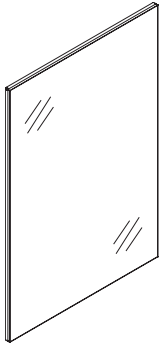

Description	Model	List Price
Daybook Insert		
Middle Glass Marker Board Insert, Front	NHRHDMIGMBF	\$ 3971
Middle Glass Marker Board Insert, Back	NHRHDMIGMBB	\$ 3731

How to specify —
 Select the Model Number from above.

_____.

Example: NHRBRHDMIGMBF

For specification information see page 18.6.

GSA SIN 33721

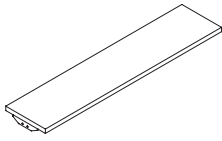

Description	Model	List Price
Neighborhood Wall Shelves		
Laminate Shelf	NHBRHDSHELF	\$ 368

<p>How to specify — Select the Model Number from above.</p>	<p><i>1st Option:</i> Select Laminate: See page 18.2 for finishes.</p>	<p><i>2nd Option:</i> Select Laminate Edge: See page 18.2 for finishes.</p>	<p><i>3rd Option:</i> FSC: F FSC Wood X Non-FSC Wood</p>	<p><i>4th Option:</i> Select the Paint Color: P1 P2 P3 See page 18.2 for paint finishes.</p>
<p>Example: NHBRHDSHELF.P.E4.F.P71</p>				

DAYBOOK

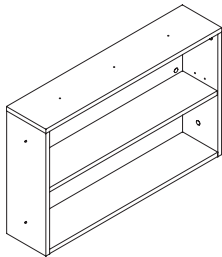

Laminate Bookcase	NHBRHDBKCSE	\$ 1484
-------------------	-------------	---------

<p>How to specify — Select the Model Number from above.</p>	<p><i>1st Option:</i> Select Laminate: See page 18.2 for finishes.</p>	<p><i>2nd Option:</i> Select Laminate Edge: See page 18.2 for finishes.</p>	<p><i>3rd Option:</i> FSC: F FSC Wood X Non-FSC Wood</p>	
<p>Example: NHBRHDBKCSE.P.E4.F</p>				

For specification information see page 18.6.

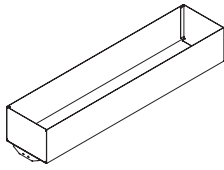

GSA SIN 33721



Description	Model	List Price
Neighborhood Wall Planter		
Steel Planter	NHRHDPLANT	\$ 610

<p><i>How to specify —</i> Select the Model Number from above.</p> <p>_____ .</p>	<p><i>1st Option:</i> Select the Paint Color: P1 P2 P3 See page 18.2 for paint finishes.</p> <p>_____</p>
---	---

Example: NHRHDPLANT.P71

Work Tools	Description	Model	List Price
	Hot File 9½"H x 12¼"W x 3⅜"D	AEHF	\$ 59
	Side Saddle 4"H x 12¼"W x 2⅝"D	AEES	\$ 48
	Bag or Coat Hook 3¼"H x 1⅝"W x 2¼"D	AECH	\$ 37

Terrace® Systems

Finishes	20	Electrical and Data Components.....	79-80
Typicals Overview	21	WORKSURFACES AND SUPPORTS	
Introduction to Terrace	22	Working with Worksurfaces and Supports.....	81-87
FRAMES, CONNECTORS, AND TILES		Working with Cadence® Freestanding Desking	88-96
Working with Frames and Connectors.....	23-27	<i>Laminate Flat Edge</i>	
Approach and Involve Laminate Wood Storage.....	28-29	Primary and Bow Front.....	97-98
Working with Sliding Doors.....	30	External Worksurface Support Channel.....	97
Working with Tiles.....	31-37	Corner, 120°, 60°, and Corner Cove	99-100
Working with Veneer.....	38	Altitude® Height-Adjustable Reference.....	100
<i>Frames</i>		Peninsula, P-Shaped, and Jetty	101
Base Panel Frames — Raceway and Footed	39	D-Shaped and Quarter-Round	102
Stacking Frames and Segment Kits.....	40	Countertops	103-104
Doors Panels, Sliding Door, and Conversion Kits —		9120 Program for Non-Standard Size Worksurfaces.....	105-106
Footed and Base Raceway	41	<i>Veneer Square Edge</i>	
Top Trim — Radius and Flat.....	42	Quarter-Round.....	107
Glass Panel Mounted Screens and Trim	43	<i>Supports</i>	
<i>Connectors</i>		Panel-mount Worksurface Supports and Brackets.....	108
Connector Kits, Trim, and Stabilizer Brackets.....	44-47	Cadence Desking Worksurface Supports and Brackets.....	109
Wall Track, Tile Attachment Kits, and Segment Bars.....	48	Wall Track Kits and Tile Attachment Brackets	109
<i>Tiles</i>		Cadence Desking Modesty Panels and Gussets	110
Fabric Tackable Acoustical and with Port	49-52	METAL OVERHEADS	
Steel, Tool, Perforated Steel, Laminate, and Hard Surface	53-60	Working with Overheads, Shelves, and Hutches	111-114
Glass — Single Pane.....	61	Overhead Cabinets, Shelves, and Up-mount Kits	115-116
Marker Board	62	Hutches and Tackboards.....	117
Landscape Surface and Custom Tile Bracket Kits	63-64		
Veneer	65		
ELECTRICAL (8-WIRE)			
Working with Electrical & Data	66-76		
Power Harnesses, Pass-Thru Cables, and Jumper Cables.....	77		
Dual Electric Eight-Circuit Power Harness Kit	77		
Duplex Receptacles, Infeeds, and Power Poles	78		

PAINTED METAL FINISHES

GRADE P1	
Black.....	P27
Brownstone.....	P7D
Bungalow.....	P7C
Cinder.....	P7Q
Designer White.....	PJW
Flint.....	P02
Fossil.....	P28
Loft.....	P7B
Muslin.....	P4J
Parchment.....	P93
Pebble.....	P8R
Pewter.....	P8D
Salt.....	P8C
Titanium.....	P8T

GRADE P2	
Champagne Metallic.....	PR5
Gunmetal Metallic.....	PR3
Platinum Metallic.....	PR2
Silver**.....	PR6
Solar Black.....	P8X

**PR6 - no upcharge on Involve; available as Grade P2 color on stanchions.
PR6 & P8X - not available on Concensys, Essentials bookcases, and vertical files.

GRADE P3	
Atom.....	P8S
Blossom**.....	P8K
Bulseye.....	PJF
Cabernet***.....	P7T
Conifer***.....	P8H
Ember.....	P8P
Ion.....	P8N
Iris.....	P8J
Krypton.....	P8F
Regatta.....	P8M
Succulent***.....	P8A

*** These colors are intended to be an inspirational option for the trending market. Product application is limited and color availability is approximately two years to coincide with evolving workplace trends.

Metallic paints, due to varying reflectance, may appear to have less visual color consistency than other paint finishes, even when L/A/B values are exactly the same. (L/A/B — measurable aspects of color — values are maintained within a specified range, to ensure consistent appearance of paint colors.)

METAL STORAGE PULLS

Black.....	E4
Bronze (for veneer only).....	EZ
Matte Silver.....	EL

PAINTED WOOD FINISHES

Brownstone.....	M13
Bungalow.....	M12
Designer White.....	M17
Flint.....	M16
Loft.....	M11
Muslin.....	M15

ELECTRICAL AND DATA COMPONENTS

Black.....	E4
Brownstone.....	EY
Designer White.....	DW
Flint.....	E9
Loft.....	EV
Muslin.....	EU
Silver.....	ES

Recommended Coordinate Colors:
Bungalow use Muslin EU
Carob use Black E4
Champagne Metallic use Muslin EU
Cinder use Brownstone EY
Fossil use Flint E9
Gunmetal Metallic use Brownstone EY
Parchment use Muslin EU
Pebble use Loft EV
Pewter use Flint E9
Platinum Metallic use Silver ES
Salt use Silver ES
Titanium use Silver ES

LAMINATES

GRADE L1	
SOLID COLORS	
Black.....	P
Brownstone*.....	LM13
Bungalow*.....	LM12
Designer White*.....	LDW1
Flint*.....	LM16
Fossil Shale*.....	LEH1
Loft*.....	LM11
Muslin*.....	LM15
Titanium*.....	LTI1

ABSTRACT	
Ash.....	LT3B
Handspun Pearl.....	LHP
Handspun Dove.....	LAHD
Handspun Slate.....	LAHS
Handspun Chestnut.....	LACH
Silver Mesh.....	LT8D

WOODGRAIN	
Belair.....	LWBA
Bourbon Cherry.....	H
Field Elm.....	LWFE
Florence Walnut*.....	LFW1
Kingswood Walnut*.....	LK11
Natural Maple*.....	LWD
NeoWalnut*.....	LNU1
Pinnacle.....	PINC
Shaker Cherry*.....	LW7C

GRADE L2	
Beigewood*.....	LWBE
Fawn Cypress*.....	LFC1
Lowell Ash*.....	LLA1
Mangalore Mango*.....	LMM1
Natural Recon*.....	LNR1
Phantom Charcoal*.....	LPC1
Phantom Ecru*.....	LPE1
Portico Teak*.....	LPT1
Skyline Walnut*.....	LSW1
Veranda Teak.....	LVT1

GRADE L3	
Natural Walnut*.....	LWNW

* Storage available in these 30 laminates.

LAMINATE AND PAINTED WOOD STORAGE PULLS

Silver.....	PR6
-------------	-----

LAMINATE EDGE COLORS

Beigewood.....	DE
Belair.....	BA
Black.....	E4
Bourbon Cherry.....	H
Brownstone.....	EY
Bungalow.....	EX
Designer White.....	DW
Fawn Cypress.....	FC
Field Elm.....	FE
Flint.....	E9
Florence Walnut.....	FW
Fossil.....	EH
Kingswood Walnut.....	K1
Loft.....	EV
Lowell Ash.....	DL
Mangalore Mango.....	MM
Muslin.....	EU
Natural Maple.....	DD
Natural Recon.....	NR
Natural Walnut.....	DN
NeoWalnut.....	NU
Parchment.....	EN
Phantom Charcoal.....	PC
Phantom Ecru.....	PE
Pinnacle.....	PI
Platinum Metallic.....	EP
Plyband◆.....	PL
Portico Teak.....	DP
Shaker Cherry.....	DF
Skyline Walnut.....	SW
Titanium.....	TI
Veranda Teak.....	VT

◆ Edge is limited to flat edge surfaces: rectangle, square, trapezoid, polygon, or round. No curvilinear or combination curve and straight.

METAL GROMMETS

FOR LAMINATE WORKSURFACES	
Oval/Square:	
Matte Silver.....	EL

FOR VENEER WORKSURFACES	
Oval:	
Black.....	E4
Bronze.....	EZ
Matte Silver.....	EL

Square:	
Matte Silver.....	EL

PLASTIC GROMMETS

FOR WORKSURFACES	
Black.....	E4
Brownstone.....	EY
Bungalow.....	EX
Designer White.....	DW
Flint.....	E9
Fossil.....	EH
Loft.....	EV
Muslin.....	EU
Parchment.....	EN
Titanium.....	TI

PLASTIC GROMMETS WITH WOODGRAIN EDGE
If woodgrain edge is specified, the plastic grommet color is predetermined, based on finish selection.

Beigewood, Fawn Cypress, Natural Maple, and Natural Recon.....	Muslin EU
Kingswood Walnut and NeoWalnut.....	Brownstone EY
Phantom Charcoal and Skyline Walnut.....	Flint E9
Phantom Ecru.....	Loft EV
Portico Teak.....	Fossil EH
All other woodgrain options.....	Black E4

STRATAWOOD VENEERS

GRADE V1
Add FSC prefix to Stratawood codes listed below for Stratawood veneer trim on Stride and Terrace.
Example: **FSCSC777**

CHERRY	
Cinnamon/Biltmore Cherry.....	SC260
Lowell Ash Cherry.....	SC394
Clear Cherry.....	SC700
Light Cherry.....	SC701
Shaker Cherry.....	SC774
Burnished Cherry.....	SC777

MAPLE	
Field Elm.....	SE599
Clear Maple***.....	SE800
Harvest Maple.....	SE856
Beigewood.....	SE878
Phantom Ecru.....	SE912
Belair.....	SE934

OAK	
Clear Oak.....	SF300
Dark Rift Oak.....	SF331

SILVER OAK	
Silver Oak Clear.....	SB100
Portico Teak Silver Oak.....	SB150

WALNUT	
Florence Walnut.....	ST579
Light Walnut.....	ST601
Skyline Walnut.....	ST625
Pinnacle Walnut.....	ST679
Sumatra Walnut.....	ST693

NATURAL VENEERS — FLAT CUT

GRADE V1	
CHERRY	
Cinnamon/Biltmore Cherry.....	NC260
Lowell Ash.....	NC394
Medium Red Cherry.....	NC512
Light Cherry.....	NC701
Shaker Cherry.....	NC774
Burnished Cherry.....	NC777

MAPLE	
Clear Maple.....	NE800
Harvest Maple.....	NE856

WALNUT	
Ebony Walnut.....	NT509
Florence Walnut.....	NT579
Light Walnut.....	NT601
Skyline Walnut.....	NT625
Nutmeg Walnut.....	NT629
Pinnacle Walnut.....	NT679
Sumatra Walnut.....	NT693

NATURAL VENEERS — RIFT CUT

GRADE V2	
Fawn Cypress Rift Cut Oak.....	RF108
Light Rift Cut Oak.....	RF301
Dark Rift Cut Oak.....	RF331
Phantom Ecru Rift Cut Oak.....	RF912

***SE800 and NE800 are not available on Stride trim.

The beauty of wood is the natural variation of grain patterns and colors that make each piece unique. This variation is also influenced by lighting conditions, orientation of mated parts, and varying acceptance of the finishing process. The varying colors and physical characteristics naturally occur in all wood species but are most pronounced in lighter colored woods, and are especially evident in natural finishes.

GROMMETS ON VENEER WORKSURFACES
Wire management grommets come standard on most veneer worksurfaces. Choose between metal or plastic grommet option. Note: Plastic grommet color is predetermined based on finish selection.
All Maple veneers.....Muslin EU
All other veneers.....Black E4

LOCKS

Black.....	E4
Chrome.....	ordered by base model
Matte Silver.....	EL

NOTE: Refer to individual product pages for upcharges.

A full gallery of typicals from each Allsteel system can be found on our website:

<https://www.allsteeloffice.com/design-resources/idea-starters>.

Each typical includes a complete BOM with current pricing, downloadable CAD files and PDFs of each drawing.

Use the Allsteel Typicals Gallery to find the components in a Single Terrace Station...

"Irregular" Shape Station 23' x 6'6" (6-pack)

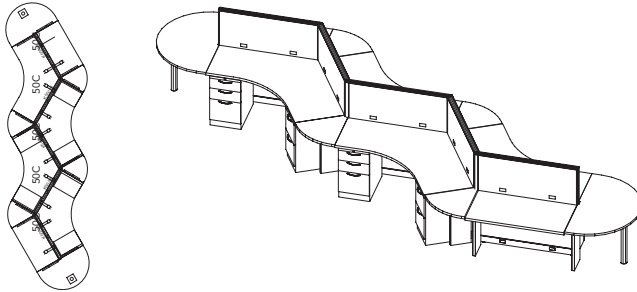

Line Item	Product Description	Qty	Model Number
1	Structural Raceway Panel Frame — No Top Trim 50"H x 48"W	6	TK05048WR
2	Terrace Top Trim 48"W	6	TK348PT
3	E End Trim Connector Kit 50"H	2	TK350E
4	B 2-way 120 Degree Connector Kit 50"H	4	TK350B
5	Terrace Tackable Acoustic Ported Tile 50"H x 48"W	12	TKG45048E
6	Primary 24"D x 48"W Flat Edge Laminate w/o Grommets	2	T52448SN
7	120 Degree Corner 24"D x 48"W Flat Edge	4	TT54824CBN
8	60 Degree Pie Worksurface 24"D Flat Edge	4	TT52424SD
9	D-Shape for 2-24"D x 30"W Flat Edge	2	TN524D
10	Terrace Support Leg 24"D x 29½"H	12	TKSL2429P
11	Support Column 29½"H x 3" Diameter	2	TT629SC
12	Power Harness 48"W	6	A871248
13	Terrace Duplex Receptacle — Circuit 1	10	A873501
14	Electrical Base Infeed	1	A876072
15	Terrace Electric Mounting Bracket (12 pk)	1	8989EB
16	Jumper Cable 66"W	1	A871366
17	Essentials Support Ped BBF 28"H x 22¾"D Arch Pull	4	PF197-233A
18	Essentials Support Ped FF 28"H x 22¾"D Arch Pull	4	PF198-232A

And how to make the most of your space with Involve®.

Involve "U" Stations 24' x 6' (3-pack)

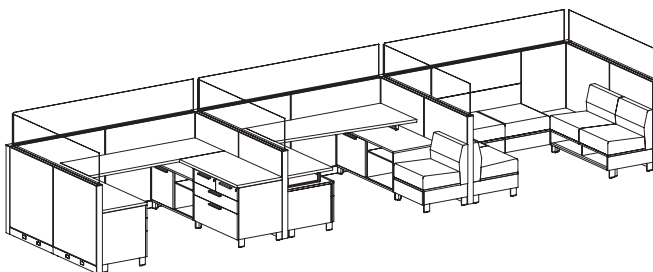

Visit <https://www.allsteeloffice.com/design-resources/idea-starters> to view these typicals and more.

The building blocks for a better office.

What makes a workspace inspiring? The truth is it's different for every office and every worker. The Terrace frame-and-tile solution offers both flexibility and refined design details, so you can keep it basic or dress it up. And, when paired with other Allsteel products, you can create beautiful, functional spaces that look every bit as good as they work.

Ideas often come from collaboration. Other times from focused research. And sometimes they appear out of the blue. Terrace makes it easy to design environments that help people do better work, from individual workstations for focused activities to teaming areas for group collaboration. With lower panels and frameless glass, open, naturally lit workspaces have an aesthetic that inspires. So nothing gets in the way of the next big idea.

More ways to design one-of-a-kind environments.

With Terrace, spaces can be as active as the people who use them. Worksurfaces of varying heights give people the freedom to enjoy the ergonomic benefits of changing postures. Soft seating integrated within primary and secondary work areas encourages spontaneous collaboration. And customized storage options can be integrated into spaces in a variety of ways to better fit individual workstyles.

Terrace offers unique designs that make a strong visual statement customized for any application. From the clean aesthetic of benching to an open, cross-functional collaborative space to an individual workstation for focused activities, Terrace provides the options and features you want and need.

Make the most of your space and your resources.

With real estate at a premium and the need for workspaces to be more agile to accommodate future needs and changing workstyles, office furniture must work harder than ever. That's why Terrace is built to last with sturdy steel panels that stand up to years of use and numerous reconfigurations. And it's designed to work seamlessly with other Allsteel products, so you can easily integrate a variety of other furniture options whenever the need arises.

Terrace, make it yours.

Once you've selected the furniture for your space, a variety of material options are available to give it a personality all its own. Make a bold statement with woodgrain laminate storage and contrasting trim and panel fabric. Or create a brighter look with panels and storage in light fabrics and finishes. Find the perfect palette to complement your brand or style.

The most beautiful thing about Terrace is all the ways you can customize it for functionality, ergonomics, and aesthetics. It can support heads-down concentration or encourage open interaction. You can mix and match a variety of options, from panel heights to worksurfaces, fabrics to frameless glass, and storage to accessories. The choices are endless.

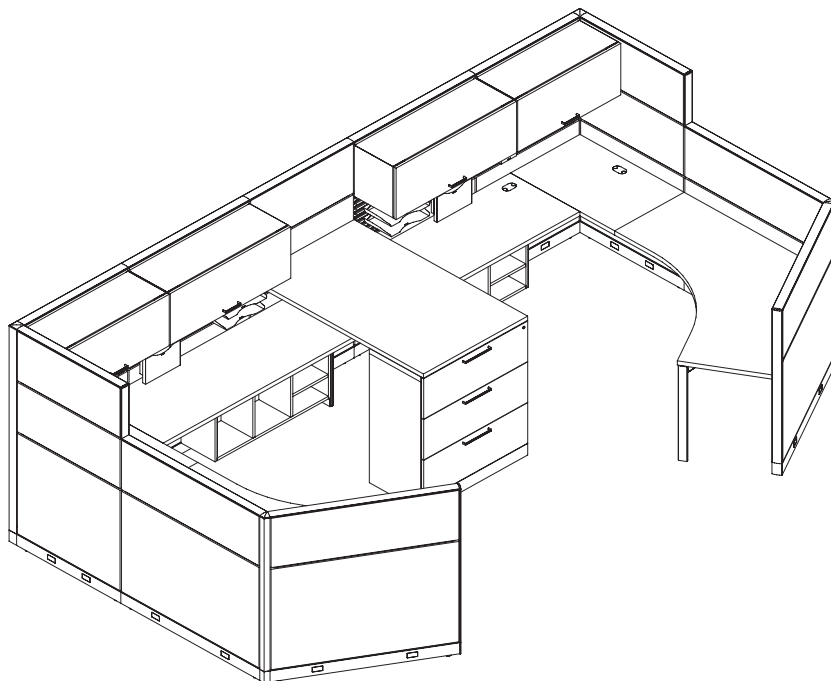

BASE RACEWAY FRAMES

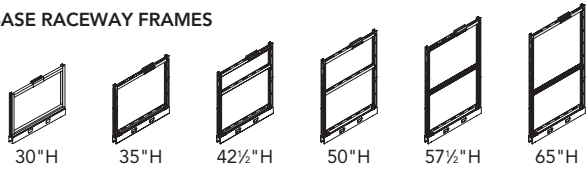

FOOTED PANEL FRAMES

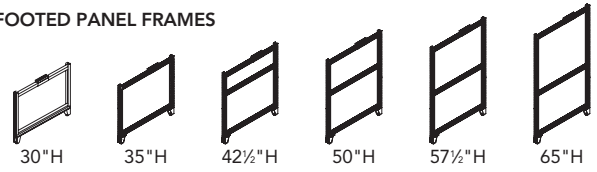

STACKING FRAMES



DOORS

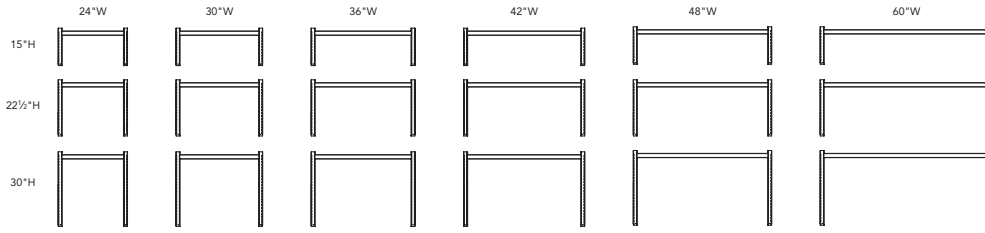
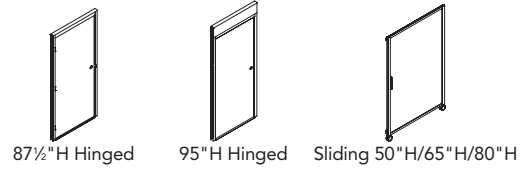

TOP TRIM / SCREENS

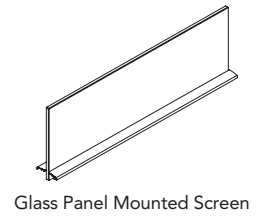
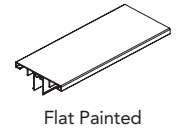

Connector Kits

- "L" 90° Connector Kit
- "T" 3-way Connector Kit
- "X" 4-way Connector Kit
- "S" Extended Straight Connector Kit
- "B" 2-way 120° Connector Kit
- "C" 3-way 120° Connector Kit
- "W" Wall Mount Kit
- "E" End Trim Kit

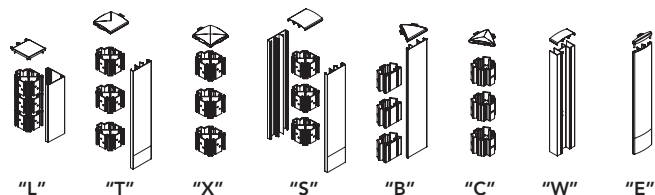

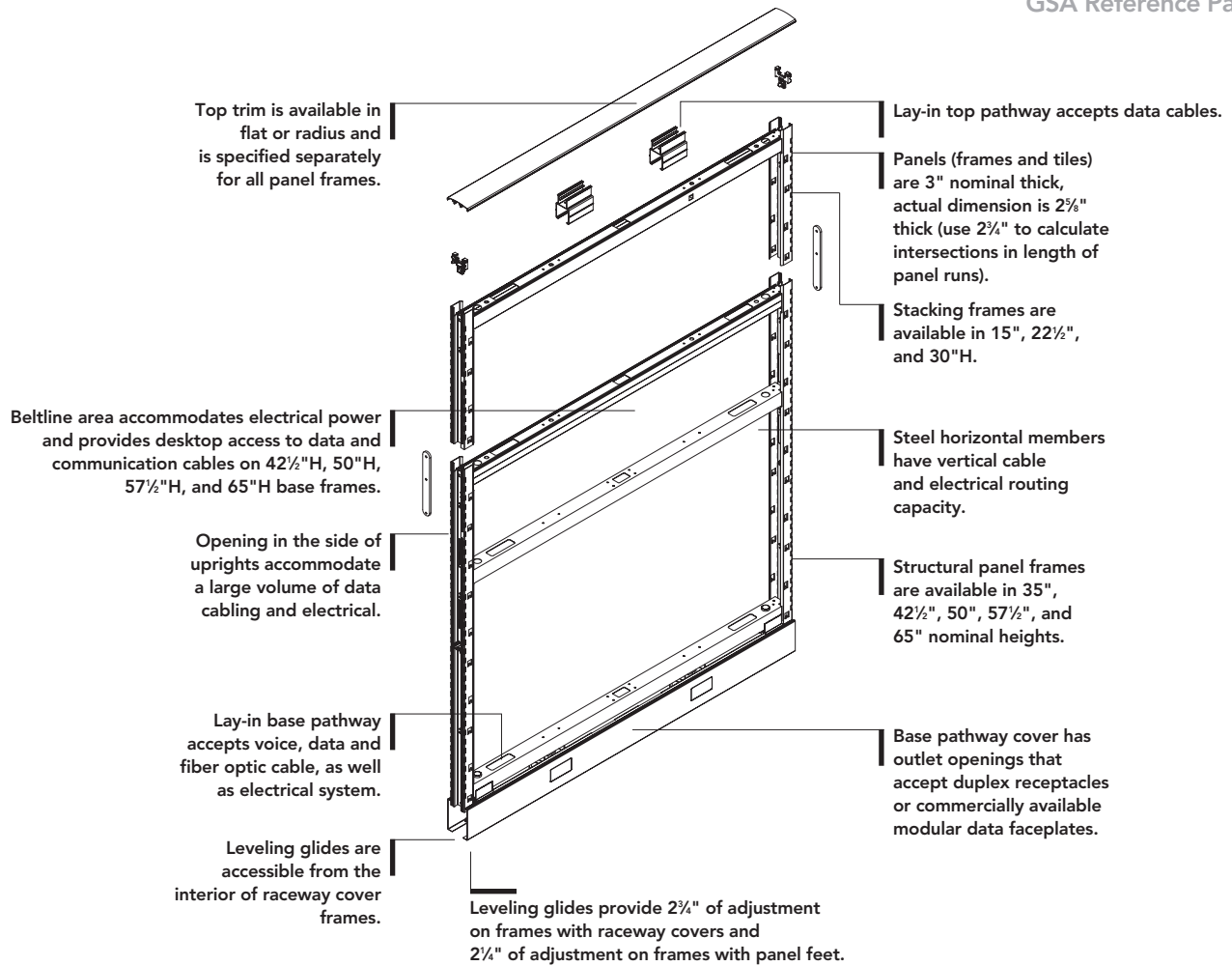

Frame Dimensions (Actual)

Depth: 2 5/8" (use 2 3/4" to calculate intersections in length of panel run)

Widths: 24", 30", 36", 42", 48", 60"

Heights* with radius painted trim: 29 1/4", 34 1/4", 41 1/4", 49 1/4", 56 1/4", 64 1/4"

Stacking Frames: 15"H, 22 1/2"H, 30"H

Leveling Glides on Frames with Raceway Covers: 2 3/4" range

Leveling Glides on Footed Frames: 2 1/4" range

*with levelers fully retracted

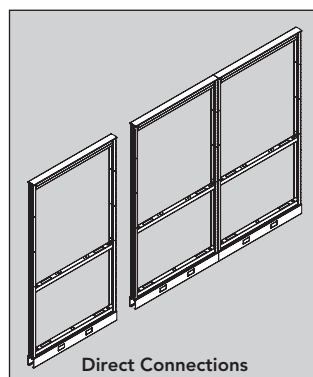
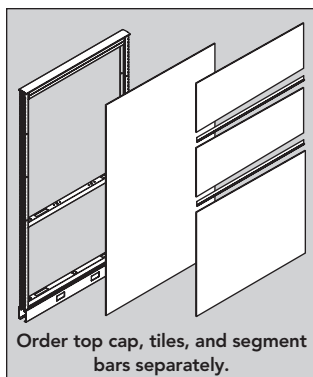

Panel Frames (page 39)

- Specifications: formed, steel vertical members, with tubular steel horizontal members are welded into a sturdy, structural panel frame.
- Panels are shipped with base pathway covers or decorative feet installed.
- Top trim, monolithic or segmented tiles, and segment bars are ordered separately with choices of applications.
- Direct connections between same height frames in a continuous run are accomplished with provided hardware. There is no incremental increase in dimension along the run.
- For adequate stability, one of two methods of stabilization shown on page 25 must be adhered to.
- Base raceway panel frames include: frame, base pathway covers, attaching hardware, and bottom segment clip.
- Footed panel frames include: frame, panel feet, attaching hardware, and bottom segment clip.
- No electrical or data capabilities in footed panel frames. Decorative feet replace base raceway covers.

Panel Frame Conversion Kits (page 41)

- Base raceway to footed and footed to base raceway conversion kits can be used to convert existing frames. Footed to base raceway kits ship with glide tower assembly. Conversion process requires panel to be removed from panel run.

Building Vertically with Terrace Frames

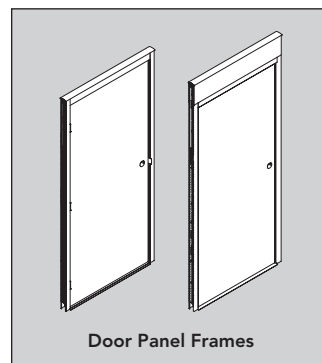
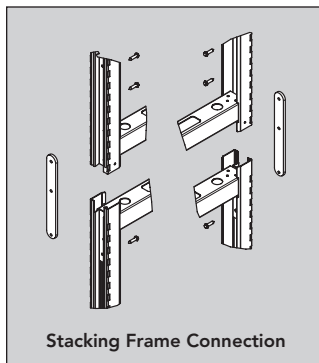
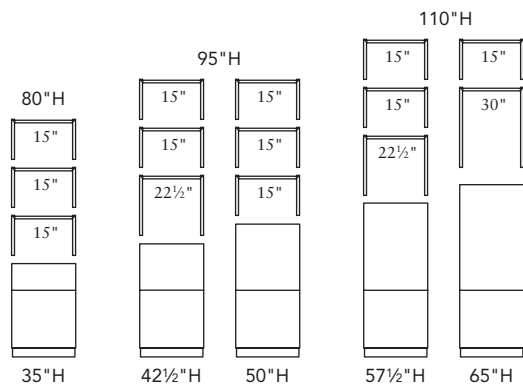

Building Horizontally with Terrace Frames

Method 1—Opposing Returns

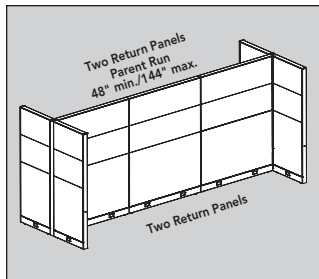

Method 2—Single-Sided Returns

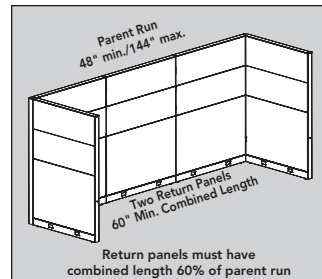

Important planning guidelines: For adequate stability, one of two methods of stabilization must be adhered to:

Method 1—Opposing returns

- A parent run must be a minimum of 48" and a maximum of 144" between return panels. The parent run must have a minimum of two return panels running in opposing directions on each end of run.
- A single return panel (48" nominal minimum length) may be used with a mid-panel connector. The panel must extend at least 24" from one side of the parent run.
- Return panels must not be no more than 30" lower than the maximum height of the parent panel run.

Method 2—Single-sided returns

- A parent run must be a minimum of 48" and a maximum of 144" between return panels. The parent run must have a minimum of two return panels totaling at least 58% of its length, extending in one direction.
- Return panels must not be any more than 30" shorter in height than parent run. When using 120° connections, 12" must be added to length of return panels as determined by methods 1 and 2. Any run under 100" must have a minimum combined length of 60" of return panels.

Stacking Frames (page 40)

- When adding stacking frames, remove the top trim from the structural frame, and install it on top of uppermost stacking frame.
- Stacking connection provides a solid metal-to-metal connection, allowing the stacking frame to accept hang-on components, per Allsteel configuration guidelines.
- Includes attachment hardware and uses specified top trim. Add appropriate connectors.
- Stacking frames can be added to the top of a 35"H base panel frame up to 80"H, added to 42½"H and 50"H base panel frames in any combination up to 95"H, and added to the top of 57½"H and 65"H structural panel frames up to 110"H.
- To maintain panel mounting slot modularity 22½"H stacking frames should only be used with 42½"H, 57½"H base panel frames, or 87½"H door frames.
- To match 87½"H door frame height, use a 65"H base panel frame with a 22½"H stacking frame (slot modularity will be lost on stacker).
- To maintain modularity on 35"H, 50"H, and 65"H base panel frames use 15"H or 30"H stacking frames.
- If panel mounting slots are not being used, any stacking frame can be used on any base panel frame.
- Do not combine differing frame widths in a single stack or span multiple base panel frames with stacking frames.
- Stacking frames cannot be used as base frames.
- Tile options for stacking frames are given on page 33.
- Guidelines for using overhead storage with stacking frames are given on page 112.

Segment Bars (page 40)

- Segment bars are horizontal steel cross members required between tile segments. Must be specified on each side of frame.
- Black only.



Electrical Mount Support Bars (page 40)

- Used to mount electrical in any location in panel frame other than base pathway or beltline. Order electrical mounting brackets separately.
- Tiles must be field ported when electrical is mounted in a location other than just above the worksurface at beltline.
- Can be used with acoustical tiles on one or both sides of the panel frame.
- Includes attaching hardware. Gray only.

Door Panel Frames (page 41)

- The 87½"H door panel includes 42"W frame, 36"W door, hinges, top trim, and attaching hardware. See illustration above left.
- The 95"H door panel includes frame, 42"W door, hinges and attaching hardware, and two 8⅞"H x 42"W fabric tiles for top of door frame.
- Doors available in laminate.
- Painted top caps available in radius or flat.
- Specify fabric for top tiles on 95"H door.
- Lockset with knob or lever ordered separately.

Sliding Door and Mounting Kit (page 41)

- See illustration and specification information on page 30.

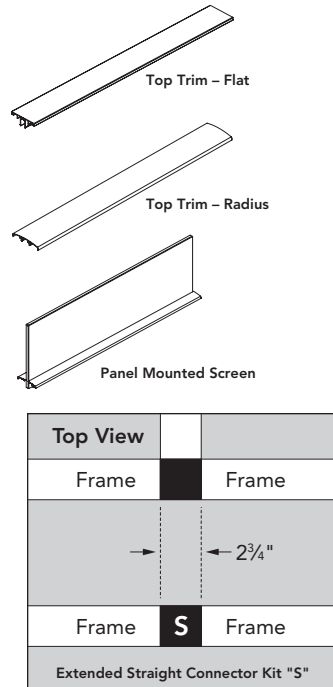
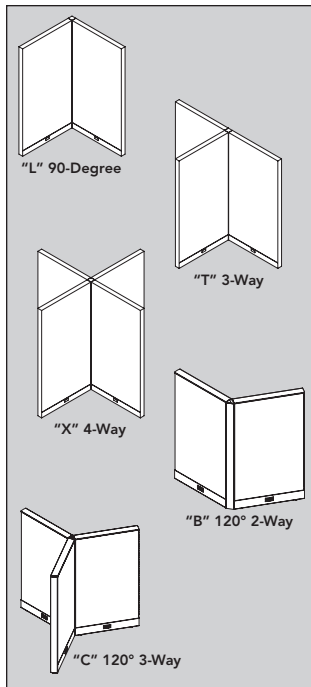

• **Multiple-height connections** also utilize standard “L”, “T”, “X”, “S”, and “E” connectors, with corresponding height connectors stacked according to the number of intersecting panels from the bottom up. (See examples below.)

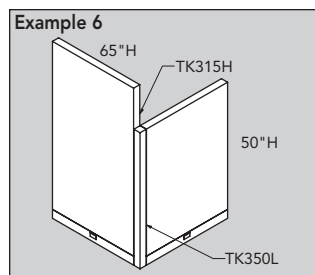
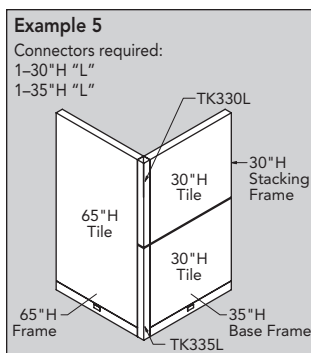
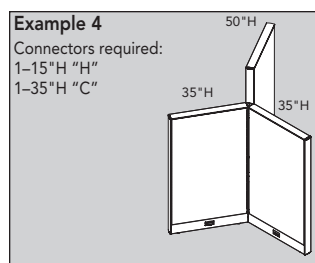
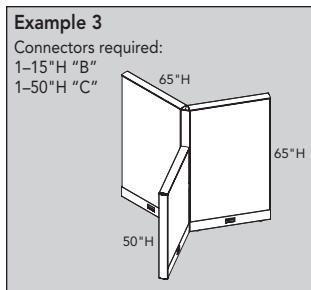
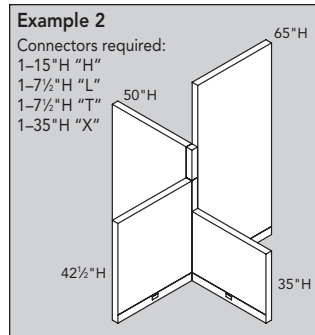
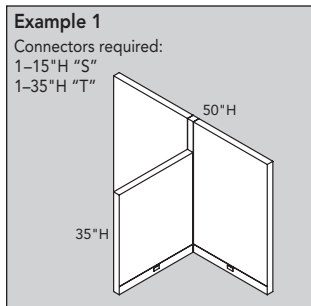

Connectors and Trim

Off-Modular Panel Connection Kit (page 41)

- Includes top and bottom attachment brackets and top trim finished end.
- Must be field installed. Installation requires defacing of the top tile.
- Cannot be mounted in locations where the bottom bracket is closer than 8 inches from the edge of frame in the base pathway on parent run panels.
- Not structural. No panel mounted glass on spine where attaching or on first off-modular panel.

Top Trim (page 42)

- Use to finish top on base panel frames and footed panel frames.
- Top trim can span individual or multiple base panel or stacking frames.
- It is possible to span multiple frames when the combined frame width is equal to the top trim width.
- Some spanning examples are listed on page 42, other combinations are possible.
- Available in flat or radius in painted finish.

Panel Mounted Screens (page 43)

- Frameless insert integrated into the base panel frame top trim.
- Replaces top trim on structural or stacking frame.
- It is possible to span multiple frames when the combined frame width is equal to the panel mounted screen width.
- Taller adjacent frames require “HG” grooved end trim.
- Panel mounted screens are non-structural. Do not hang or stack on top of panel mounted screens.
- Available in 3/8" thick clear or frosted glass.

Connector Kits (pages 45-46)

- “L”, “T”, “X”, “S”, “B”, and “C” connector kits are used when connecting frames at intersecting runs.
- Base connectors include base pathway and must be specified at base regardless of full height or segmented connection. Specify height that corresponds with segment frame height. See Examples 5 and 6 at left.

“L”, “T”, “X”, and “S” Connector Kits (page 45-46)

- For “L”, “T”, “X”, and “S” connector kits, add 2 3/4" to the total length of the panel run for each intersection, whether located in the middle or at the end of the run.
- “L”, “T”, “X”, and “S” connector kits includes top cap, connectors, vertical cover, light gap extrusion, and attaching hardware.
- “X” connector kits Includes top cap and connectors.
- Extended straight connector kit “S” can be used to keep continuous runs dimensionally consistent with opposing panel runs which incorporate “T” or “X” intersections. (Add 2 3/4" to the length of the run for every extended straight connector used.) See illustration at left.

2-Way 120° Connector Kits (page 45)

- Includes top cap, connectors, vertical cover, and attaching hardware.

3-Way 120° Connector Kits (page 45)

- Includes top cap and connectors

“E” End Trim Kits (page 46)

- End vertical trim cover (includes top cap — adds 3/8" to run).

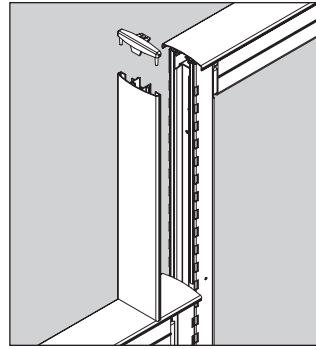

High-Low "H" End Trim

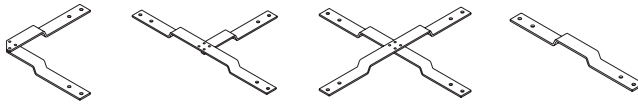

Top Stabilizer Brackets
Top and Bottom



Pair of Wall
Track Ends

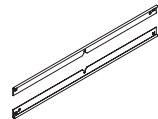

Tile Attachment Kit
Top and Bottom



Segment Bar

High-Low End Trim Kits (page 46)

- High-low "H" covers the exposed end of a frame when joining frames of differing height in certain configurations — profile adds 3/8" to length of panel run. See illustration at left.
- At the end of a panel run use "E" model suffix end trim kit.

Grooved High-Low Trim (page 46)

- For use when the base panel frame of a panel mounted screen is shorter than the adjacent in-line panel. Taller adjacent in-line panel cannot have a panel mounted screen.

"W" Wall Mount Kits (page 46)

- Wall mount kits provide a means to affix a panel run to a permanent building wall.
- Kit adds 1 1/16" to length of panel run.
- Includes top cap. (Color must be specified.)
- Connector is Black only.

Top Stabilizer Brackets (page 47)

- Optional brackets to provide added strength to reduce flex at panel junctions.
- Lay in cabling below top cap is not possible where bracket is installed.
- Panel mounted screen cannot be used where bracket is installed.

Terrace Wall Track/Tile Attachment Kits (page 48)

- Allows for mounting of system panel components on permanent wall structures except cantilevers and sit-to-stand units.
- Begin with one pair of ends; for multiple kits in line, add middle unit(s) between ends.
- Height of wall track coordinates with panel height. Field cut for lower heights.
- Wall track will add 1" to depth of attached components.
- Use Terrace wall track tile attachment kit to install tiles onto wall track. Tool tiles cannot be used on wall track. Kit includes two tile bars. Top bar may only be used in the top uppermost position on wall track. Bottom bar can be used in the bottom position at any location on wall track.
- When segmenting tiles on wall track, segment bars must be ordered for placement between all vertically adjacent tiles or at the top position of a single tile that is not in the uppermost position.
- It is not recommended to use Landscape™ or laminate Terrace tiles with wall track. If these tiles are required consider using Stride wall track.
- When using Terrace wall track and using tiles to create a tackboard situation under overheads hung at 65"H, make sure to use a 30"H tile or 2-15"H tiles to cover the entire area between the overheads and the worksurface.

Approach and Involve Laminate Wood Storage Storage with Panel Frames

Leg or plinth base models available. Leg base units are shown below.

GSA Reference Page

Side-mounted Credenzas

Use 1 storage-to-panel bracket per credenza — 1 LH and 1 RH.

The minimum credenza size is 24"H x 36"W x 18"D.

With a mid-run floor support, the maximum panel run is 144".

Without a mid-run floor support, the maximum panel run is 96".

Overheads and shelves cannot be used with 24"H side mounted credenzas.

Worksurfaces (if specified) must be mounted on the same side of the parent run as the credenzas.

Panel frame maximum height is 65".

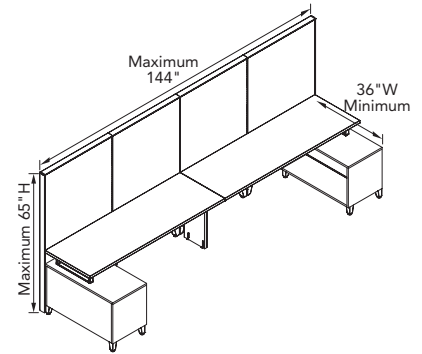

Back-mounted Credenzas — Modular

Use 2 storage-to-panel brackets per credenza — 1 LH and 1 RH.

The minimum credenza size is 24"H x 36"W x 24"D.

The maximum panel run between back-mounted credenzas is 72".

Overheads and shelves cannot be used with 24"H back mounted credenzas.

Worksurfaces (if specified) must be mounted on the same side of the parent run as the credenzas.

Panel frame maximum height is 65".

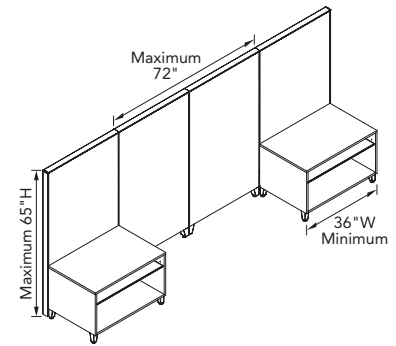

Back-mounted Credenzas — Off-Modular Ends

Use 1 storage-to-panel bracket per credenza — 1 LH and 1 RH.

The minimum credenza size is 24"H x 36"W x 24"D.

With a mid-run floor support, the maximum panel run is 144"

Without a mid-run floor support, the maximum panel run is 96".

Overheads and shelves cannot be used with 24"H back mounted credenzas.

Worksurfaces (if specified) must be mounted on the same side of the parent run as the credenzas.

Panel frame maximum height is 65".

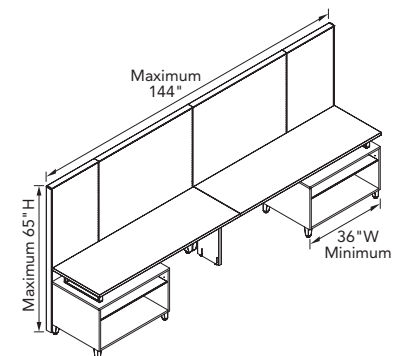

Note: Storage with unfinished metal backs require storage-to-panel bracket kit in order to mount to a panel. Left- or right-handed storage-to-panel bracket is determined by slots on panel — left-handed bracket required when attaching to left panel slots and right-handed bracket required when attaching to right panel slots.

Involve storage with unfinished backs require **storage-to-panel bracket kit** in order to mount to a panel.

Optional laminate back is available (ordered separately) for use when the back of the unit will be exposed.

Plinth base units require a different laminate back model than leg base units.

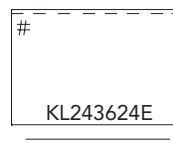
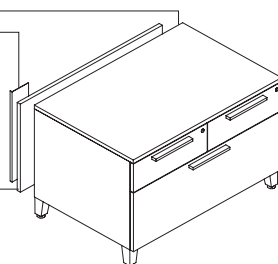

An example of a 2D CAD symbol for Involve is shown at left. Note the dashed line that represents the unfinished metal back. The pound sign indicates that counterweight kits may need to be added depending on the application. See [Casegoods & Storage Price List page 258](#) for counterweight specification rules.

TERRACE

Side-mounted Credenzas — Modular for Overheads and Worksurfaces

Use 2 storage-to-panel brackets per credenza — 1 LH and 1 RH.

The minimum credenza size is 28"H x 36"W x 24"D.

28"H side mounted credenzas must be mounted modular when using overheads and worksurfaces on panels.

With a mid-run floor support, the maximum panel run is 144".

Without a mid-run floor support, the maximum panel run is 96".

Overheads, shelves, and worksurfaces must be mounted on the same side of the parent run as the credenzas.

Maximum overhead height is 15".

Panel frame maximum height is 65".

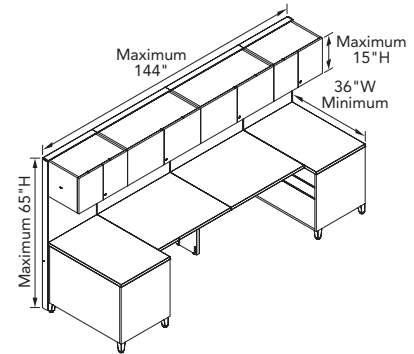

Back-mounted Credenzas — Modular for Overheads and Worksurfaces

Use 2 storage-to-panel brackets per credenza — 1 LH and 1 RH.

The minimum credenza size is 28"H x 36"W x 24"D.

Full back units without trough due to stability, only troughless Approach or Involve allowed.

With a mid-run floor support, the maximum panel run is 144".

Without a mid-run floor support, the maximum panel run is 96".

The maximum panel run between back-mounted credenzas is 72".

Overheads, shelves, and worksurfaces must be mounted on the same side of the parent run as the credenzas.

Maximum overhead height is 15".

Panel frame maximum height is 65".

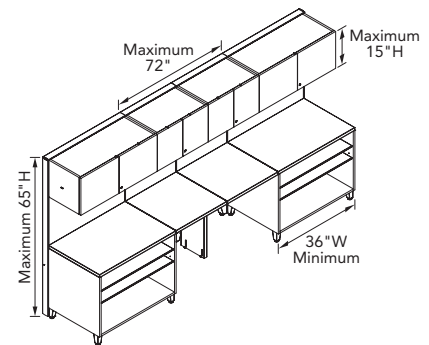

Side-mounted Credenzas — with Return Panel

Use 1 storage-to-panel bracket on credenza.

The minimum credenza size is 24"H x 36"W x 18"D.

The minimum size for panel return is 35"H x 36"W.

With a mid-run floor support, the maximum panel run is 144".

Without a mid-run floor support, the maximum panel run is 96".

Overheads and shelves cannot be used with 24"H side mounted credenzas.

Worksurfaces (if specified) must be mounted on the same side of the parent run as the credenzas.

Panel frame maximum height is 65".

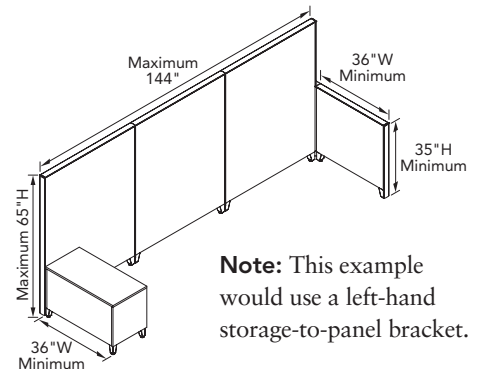

Side-mounted Credenzas — Modular for Overheads and Worksurfaces

Use 2 storage-to-panel brackets per credenza — 1 LH and 1 RH.

The minimum credenza size is 28"H x 36"W x 24"D.

The minimum size for panel return is 50"H x 36"W.

28"H side mounted credenzas must be mounted modular when using overheads and worksurfaces on panels.

With a mid-run floor support, the maximum panel run is 144".

Without a mid-run floor support, the maximum panel run is 72".

Overheads, shelves, and worksurfaces must be mounted on the same side of the parent run as the credenzas.

Maximum overhead height is 15".

Panel frame maximum height is 65".

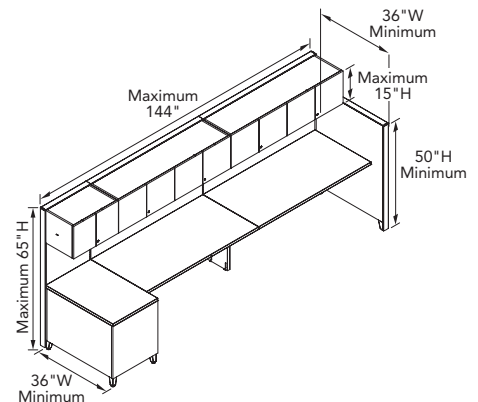

Sliding doors for Terrace are a great addition to any new or existing installations. The sliding door can be specified with specific mounting kits for each door ordered. With a Frosted Translucent insert and your choice of P1 or P2 paint, the sliding door will create a unique look for any office environment.

The sliding doors are available in 50", 65", and 80" H models and can mount to 30", 36", 42", and 48" W panels. They accommodate a 36" W opening and are 42" W, nominally. The doors ship from the factory non-handed and become handed when field installed to fit the scope of the project. The handle pulls located on each side of the door are non-locking and are color matched to the trim to create a uniform style. And with the threshold free design, the sliding door offers better aesthetics and safety by eliminating the potential for tripping.

General Guidelines for Use of Sliding Door

- The system requires the ordering of both a door and a mounting bracket kit.
- All doors are 42" wide to accommodate a 36" W opening and are non-handed. Door leveling is dependent on floor being level.
- A mounting bracket kit must be ordered for each door corresponding to the mounting panels width (30", 36", 42", or 48" W).
- Mounting bracket kits are system specific and for Terrace.

General Guidelines for Layout Planning of Sliding Door

- Stability guidelines must be followed when specifying a sliding door. (Refer to page 25). The sliding door system was designed to close an opening in a run of parallel panels. Doors mounted to long runs of panels without floor support, ties to worksurfaces, or return panels may seem less stable.
- If the door is used to close an opening (A) where the panel opposite the door is at 90°, there will be a gap equal to the panel thickness between the door and the panel end when closed.
- When planning the layout, care must be taken if the plan includes a door mounted on a panel that is less than 42" W. If the panel is at a corner (B), the door will protrude into the aisle or next workstation when in the open position.
- If back-to-back doors are mounted on panels (C) that are less than 42" W they will interfere with each if both are open at the same time.
- The door is attached at the base of the panel at any end position with a wrap around bracket. Bracket kits are ordered in conjunction with appropriate end trim profiles. The slots at the base of the panel must be clear (D) and cannot be utilized by worksurface supports or panel hung components.
- If the door is mounted to a panel run that is positioned adjacent to a wall (E) or an inside 90° angle and there is not a 42" clearance between the track and the wall/inside 90° the assembly of the first stop will be difficult and plans will need to be modified for the assembly.
- If a door is closing an opening of a workstation that includes a "T" connector in the opposite wall, an extended straight connector may need to be used to maintain the 36" required opening.

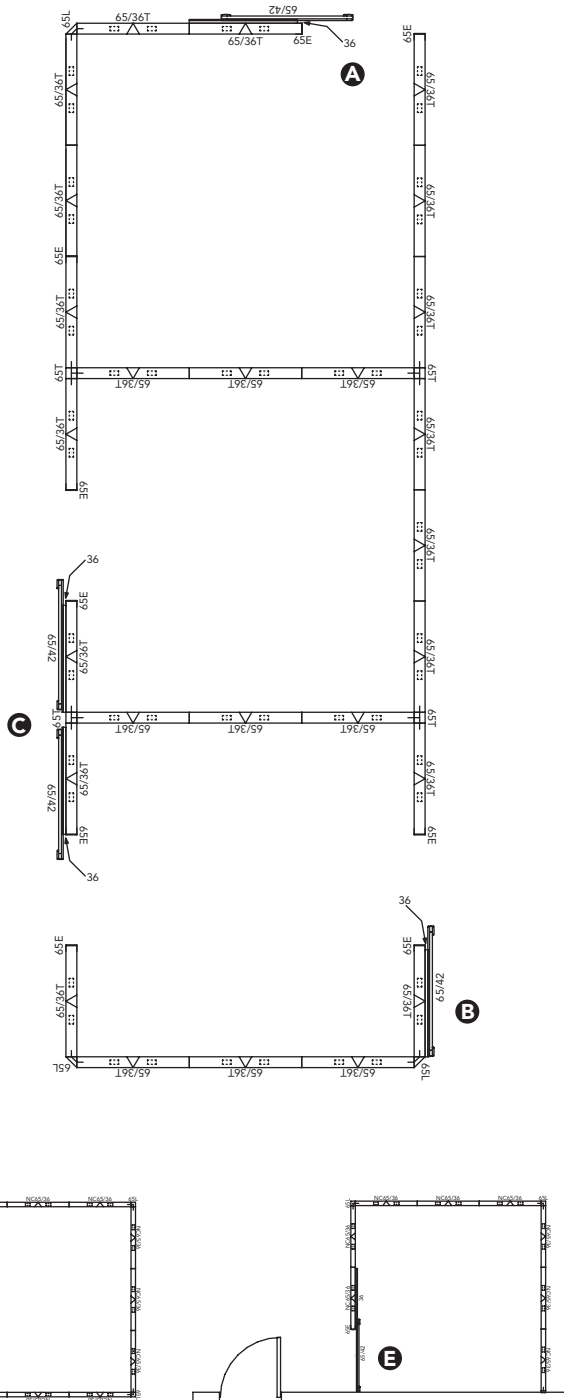

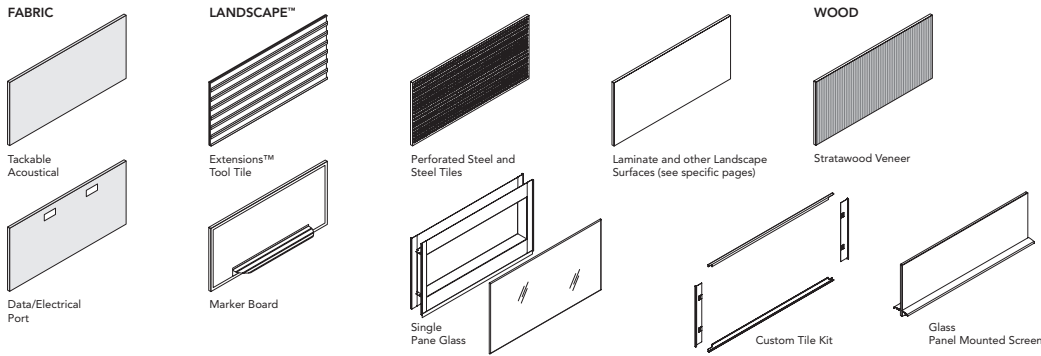

Tiles — Tackable Acoustical, Steel, Perforated Steel, Markerboard*, Foundation™, Laminate*, and Veneer Tiles.

	24"W	30"W	36"W	42"W	48"W	60"W
7½"H						
15"H						
22½"H						
30"H						

*Not available in 7½"H

Data/Electrical Port (port tiles available as acoustical only)

	24"W	30"W	36"W	42"W	48"W	60"W
15"H						
22½"H						
30"H						
42½"H						

Monolithic Tiles — Tackable Acoustical and Port (vener 42½"H non-ported only).

	24"W	30"W	36"W	42"W	48"W	60"W
42½"H						
50"H						
57½"H						
65"H						

Glass Tile Kits

	24"W	30"W	36"W	42"W	48"W	60"W
15"H						
22½"H						
30"H						

TERRACE

Terrace tiles come in a variety of styles. Select the aesthetic* and functional combination that meets your specific requirements. Additional tiles not shown below include Monolithic, Monolithic Port, and Custom.

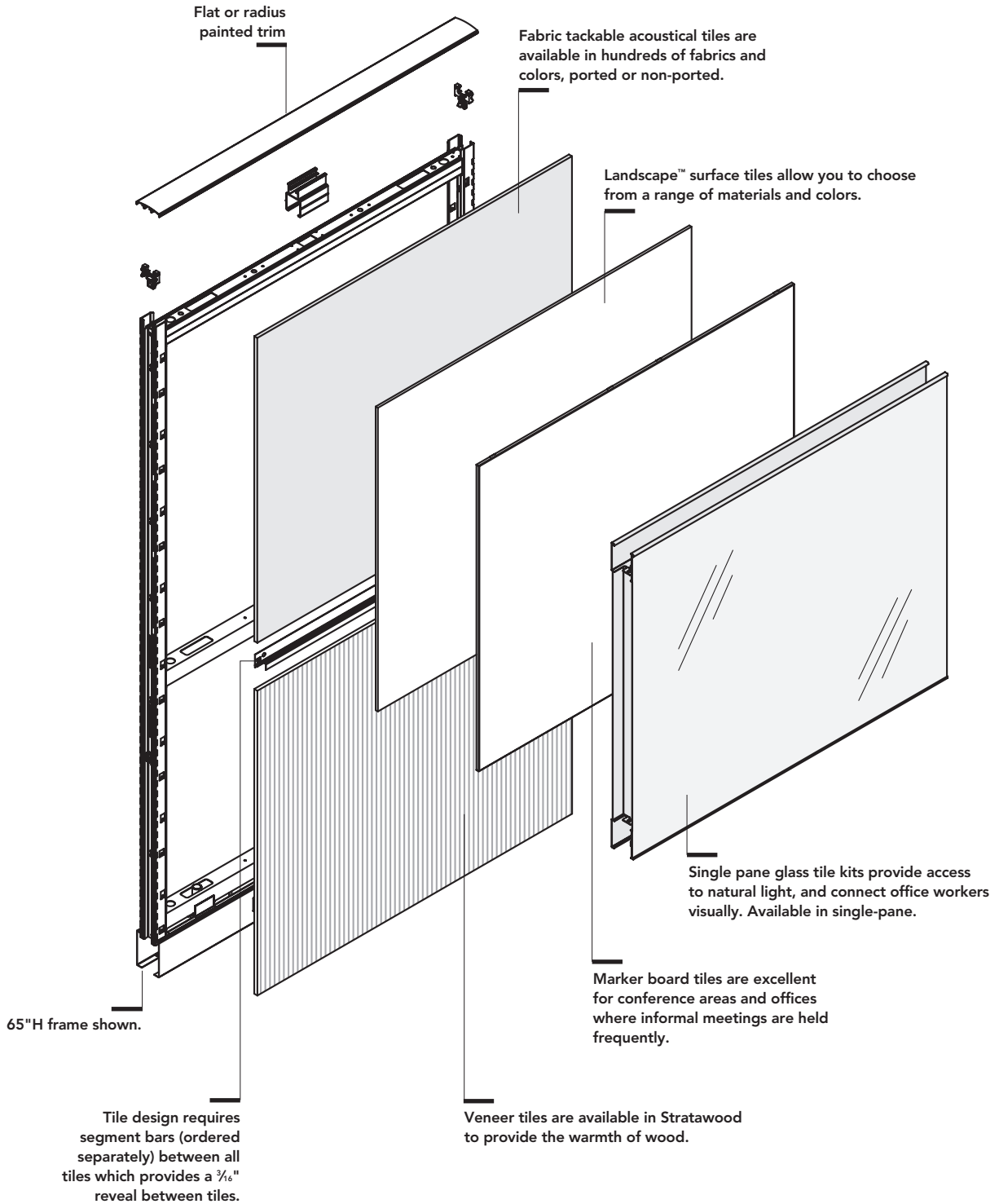

TERRACE

*Aesthetics of opposing tile surface and/or frame interior should be considered when selecting perforated or light colored sheer materials.

GSA Reference Page

To calculate the total height of tiles(s) required, deduct 5" (height of base/top trim) from the total nominal panel height.

Example: 65"H Frame takes 2 30"H tiles. $65 - 5 = 2 \times 30$

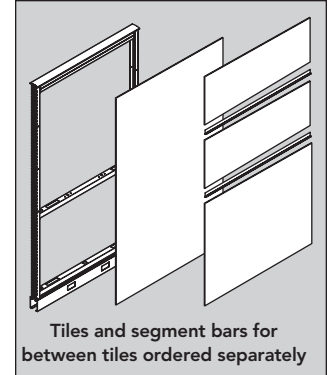

Tiles can be ordered in the size that matches the frame height plus the stacker height.

Example: Order a 65"H monolithic tile if you are using a 35"H frame plus a 30"H stacker.

Terrace tiles are universal (except glass) and can be placed at any 7½" increment on the frame.

Tile Heights

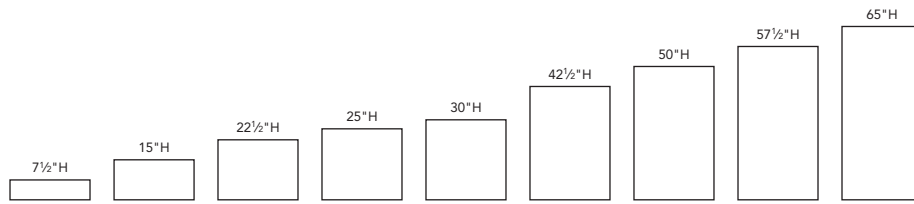

Monolithic tiles are actually 5" shorter to account for base raceway and top trim.

Typical Tile Height Configurations

Middle segment bars are required between any two tiles — order separately based on tile configuration on each side of frame. **Note:** Most CAD specification programs have tools that will calculate quantity of segment bars required.

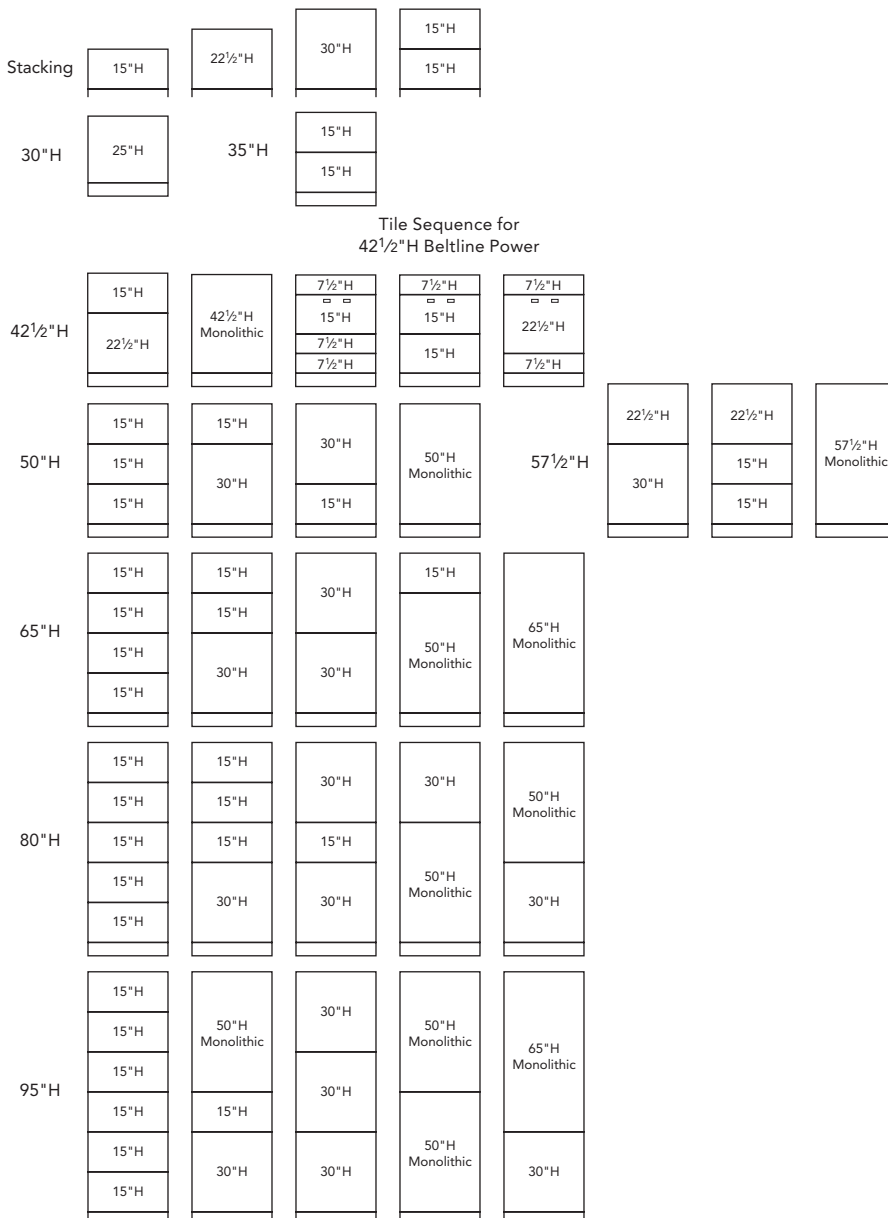

*Additional tile combinations to those shown above are possible; heights above 65" require stacking frames - maximum height is 110".

Tiles

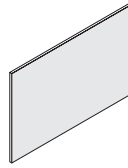

Tackable Acoustical Tiles (pages 49-50)

- Tiles do not include segment bars — order separately.
- 7½"H, 15"H, 22½"H, and 30"H tiles are non-dedicated. They can be used in any combination and in combination with other tile sizes.
- 25"H tiles can be used as monolithic tiles on 30"H frames.
- 30"H tiles can be used as monolithic tiles on 35"H frames.
- 42½"H, 50"H, 57½"H, and 65"H monolithic tiles are non-dedicated.
- 42½"H tiles can be used as monolithic on a 42½"H frame.
- 50"H monolithic tiles are actually 45"H and can be used in any combination with other tiles on a taller frame.
- 50"H tiles can be used as monolithic tiles on a 50"H frame.
- 57½"H tiles can be used as monolithic on a 57½"H frame.
- 65"H monolithic tiles are actually 60"H and can be used in combination with segmented tiles on a frame that is stacked above 65"H.
- 65"H tiles can be used as monolithic on a 65"H frame.

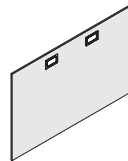

Port Tiles (pages 51-52)

- Receptacle openings with blank covers (1 in 24"W tiles; 2 in wider tiles). Located 29¾" above bottom of base raceway.
- Tiles do not include segment bars — order separately.
- 15"H and 22½"H port tiles can be used on 42½"H or higher frame for data/power access above beltline. See tile sequence on page 33.
- 25"H tiles for use on 30"H frames.
- 35"H frames do not have beltline data/power capability.
- 30"H port tiles can be used in the base position on 42½"H or higher frames for data/power access above beltline.
- Specify the size that matches the frame size. One tile per frame side on 42½"H, 50"H, 57½"H, and 65"H.

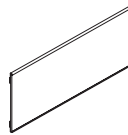

Steel Tiles (page 53)

- Tiles do not include segment bars — order separately.
- Painted steel construction.
- 25"H tiles for use on 30"H frames.
- 7½"H, 15"H, 22½"H, and 30"H tiles are non-dedicated and can be used in any tile position.

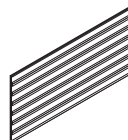

Tool Tiles (page 53)

- Tiles do not include segment bars — order separately.
- Sturdy aluminum extrusion with steel support construction.
- Powder-coated for durable finish.
- Work tools to be hung from this tile available in Extensions™ section.
- Use in place of standard 7½"H or 15"H tiles.
- Cannot be used in the bottom location of a panel frame or on wall track.
- Each tool tile has a suggested weight capacity of 80 lbs. of paper management accessories.



Perforated Steel Tiles (page 54)

- Tiles do not include segment bars — order separately.
- Allows air flow when placed on each side of panel.
- 7½"H, 15"H, 22½"H, and 30"H tiles are non-dedicated and can be used in any tile position.
- Aesthetics of opposing tile surface and/or frame interior should be considered when using perforated or light colored sheer materials.

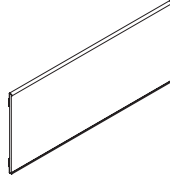

Laminate Tiles (page 55)

- Available in standard laminate colors. See page 20.
- Tiles do not ship with segment bars — order separately.
- Tiles come completely assembled and attach with custom tile bracket kit. Specify paint color.
- It is not recommended to use this tile with wall track.
- 15"H and 30"H tiles are non-dedicated and can be used in any tile position.
- Grain direction runs vertical on all sizes.

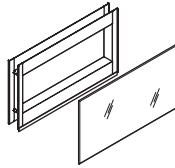

Glass Tiles (page 61)

- Tempered safety glass encased within a frame with built-in shrouds.
- Single-pane construction, glass is flush on one side.
- For use in stacking frames also.
- Glass opening is 4" less than nominal heights and widths.
- Cannot be used in top tile position of a 42½"H panel frame or any frame with integrated power pole.
- Cannot be used at the bottom or beltline location of panel frame.
- 30"H tiles will work in top position of 65"H frames and in 30"H stacking frame. Segment bar needs to be ordered
- Tiles do not ship with segment bars — order separately.

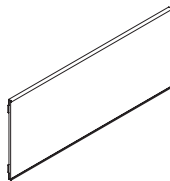

Marker Board Tiles (page 62)

- White marker board tile; painted steel surface.
- Accepts magnetic accessories.
- 15" magnetically attachable tray is natural aluminum color — order separately.
- 15"H, 22½"H, and 30"H tiles are non-dedicated and can be used in any tile position.
- For everyday cleaning of dry-erase marker ink, use Clorox wipes. Should a permanent marker be used, a citrus cleaner such as Quartet will remove the ink. Note that a citrus cleaner is not recommended for everyday cleaning as it leaves a residue on the marker board.
- Tiles do not ship with segment bars — order separately.

Handling and care for marker boards:

1. Leaving ink on the board for an extended period of time may lead to images remaining on the board, commonly known as "ghosting," after erasing.
2. To avoid ghosting, thoroughly erase your marker board after every use and clean your board weekly with marker board cleaner.
3. Expo® brand dry-erase markers are recommended for best erasing results.
4. Avoid using red and orange markers for easier cleaning and to reduce the likelihood of ghosting.
5. Do not use permanent or non-dry erase markers.
6. To maintain eraser performance, follow manufacturer's instructions.

Tiles

Spanning Tiles (pages 59-60)

- Not compatible with landscape tiles.
- Base panel height must match tile height. Example: 50"H tile must go on a 50"H base frame, not 50"H tile on 35"H base frame + 15"H stacker.
- Can be used with any combination of two frame widths.
- No more than two frames per tile.
- Bracket Kits:
 - TKSTBRKT1 = 30/35"H
 - TKSTBRKT2 = 42/50"H
- Full laminate and edgeband options available.
- Horizontal grain only.
- For dual-sided spanning tile applications, an additional Bracket Kit must be ordered.
- For dual-sided applications, spanning tiles must be mounted to the same panel frames.
- Laminate is 3/8" thick, edgeband is 0.8mm thick.
- Slotted standard is accessible when using spanning tiles on the two outside slots.
- Cannot be used with Wall Track.

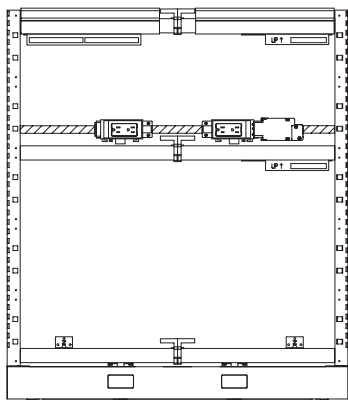
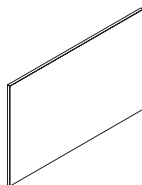

Beltline power is only available above the beltline on the opposite side of the spanning tile.

Frame Combinations

54w		60w		66w		72w		78w		84w		90w		96w	
Frame 1	Frame 2	Frame 1	Frame 2	Frame 1	Frame 2	Frame 1	Frame 2	Frame 1	Frame 2	Frame 1	Frame 2	Frame 1	Frame 2	Frame 1	Frame 2
24	30	24	36	24	42	24	48	30	48	24	60	30	60	36	60
		30	30	30	36	30	42	36	42	36	48	42	48	48	48
						36	36			42	42				

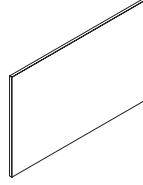

Landscape™ Tiles (page 63)

- ¼" material encased within a painted steel frame.
- Paint color for frame must be specified.
- Tiles do not ship with segment bars — order separately.
- 7½"H, 15"H, 22½"H, and 30"H tiles are non-dedicated and can be used in any tile position.
- Aesthetics of opposing tile surface and/or frame interior should be considered when using perforated or light colored sheer materials.

Foundation™ Tiles (page 63)

- Fabric laminated between recyclable PETG resin sheets.

Custom Tile Bracket Kits (page 64)

- Tile attachment kit allows for any approved ¼" thick "rigid" material to be used as a used as a Terrace tile.
- Use supplied dimensions below for tile size.

Custom Tile Bracket Kits

Custom material used in the custom tile brackets should be sized according to these dimensions:

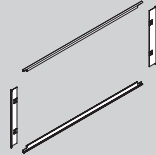

Standard Tile Height	Actual Height Dimensions	Standard Tile Width	Actual Width Dimensions
7½"H	7.198"H	20"W	19.481"W
15"H	14.698"H	24"W	23.481"W
22½"H	22.198"H	30"W	29.481"W
30"H	29.698"H	36"W	35.481"W
Thickness of custom material must be ¼" thick ±.030".		42"W	41.481"W
		48"W	47.481"W
		60"W	59.481"W

Terrace Stratawood Veneer

Wood owes its inherent beauty to variations in color, grain and texture, and therefore, these variations are not considered defects. There may be minor variations from one piece of furniture to the next, even though they are finished at the same time. Exposure to light and the aging process will cause darkening of natural wood products. Light finishes on wood products do not mask the natural characteristics of wood. Therefore, Allsteel does not guarantee the exact matching grain, pattern and color.

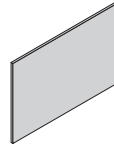
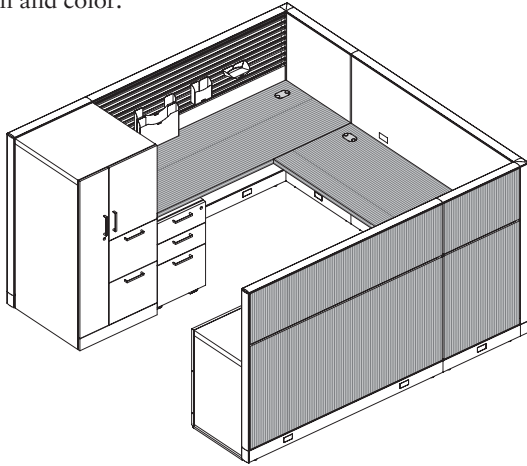

Veneer Tiles (page 65)

- Veneer tiles produced by Gunlocke® available in Stratawood veneer. See page 7 for additional veneer information.
- Stratawood veneer has a consistent straight-grain pattern.
- Veneer tiles ship with factory-installed attachment clips.
- Tiles do not include segment kits — order separately.
- Grain direction runs vertical on all sizes.

Terrace veneer tiles and worksurfaces are offered in Stratawood (composite). (See page 20 for finishes.) These products offer excellent scratch, stain, and abrasions resistance, plus a high level of clarity.

Terrace Stratawood veneer worksurfaces are protected by one of the world's most advanced wood finishing process. It provides the ultimate in scratch, stain, chemical, and heat resistance for these high-wear surfaces. The jewel-like clarity and depth allow the natural beauty of the wood to glow through.

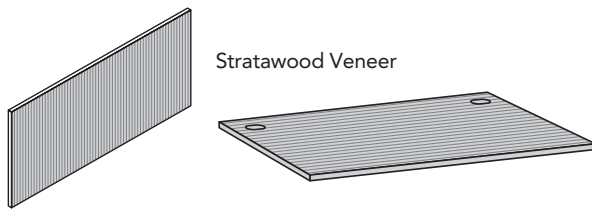

Stratawood Veneer

Stratawood Veneer

Stratawood veneer features a repeatable straight-grain pattern, absent of the cathedrals seen in Natural veneer. Although slight differences in tone should be expected, the Stratawood pattern will maintain a consistent appearance across all products.

Stratawood veneer is an engineered wood veneer enhanced by technology for consistency in both color and grain pattern resulting in very few defects.

Although exposure to light will cause Stratawood veneer to darken slightly, additional orders at later dates will match existing product pattern and will match the color when matured. This creates a smooth process for adding on to existing installations.

Caring for your veneer worksurface finish:

- General maintenance procedures entail wiping clean the entire surface with a clean water dampened soft cloth once per week. (Be sure to wipe with the grain.)
- Murphy's® Oil Soap may be used as a general purpose type cleaner with warm water to clean tops.
- The finish may also be polished with Guardsman® Furniture Polish (contains no waxes or silicones) to provide renewed luster.
- Be sure to wipe up all spills immediately.

Frames

Terrace® — Base Panel Frames without Top Trim

For specification information see pages 23-30.

GSA SIN 33721

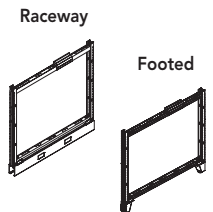
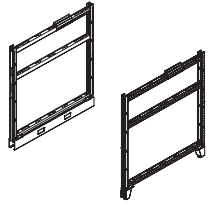
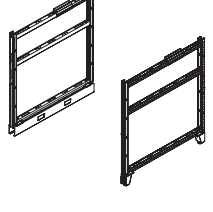
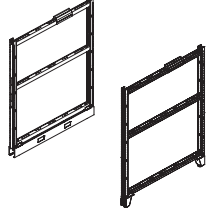
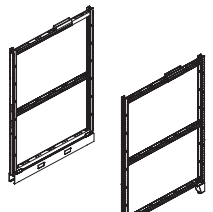
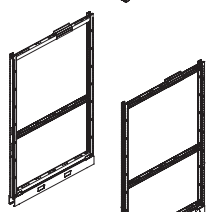
	Description	Model	P1 Paint List Price	P2 Paint List Price	P3 Paint List Price
	30"H Base Panel Frames without Top Trim				
	24"W	TK03224W □	\$ 340	\$ 364	\$ 387
	30"W	TK03230W □	\$ 349	\$ 374	\$ 396
	36"W	TK03236W □	\$ 362	\$ 387	\$ 409
	42"W	TK03242W □	\$ 378	\$ 404	\$ 425
	48"W	TK03248W □	\$ 399	\$ 427	\$ 446
	60"W	TK03260W □	\$ 447	\$ 478	\$ 494
	35"H Base Panel Frames without Top Trim				
	24"W	TK03524W □	\$ 348	\$ 373	\$ 396
	30"W	TK03530W □	\$ 357	\$ 382	\$ 405
	36"W	TK03536W □	\$ 368	\$ 393	\$ 416
	42"W	TK03542W □	\$ 384	\$ 409	\$ 432
	48"W	TK03548W □	\$ 405	\$ 430	\$ 453
	60"W	TK03560W □	\$ 453	\$ 478	\$ 501
	42½"H Base Panel Frames without Top Trim				
	24"W	TK04224W □	\$ 355	\$ 380	\$ 403
	30"W	TK04230W □	\$ 375	\$ 400	\$ 423
	36"W	TK04236W □	\$ 391	\$ 416	\$ 439
	42"W	TK04242W □	\$ 406	\$ 431	\$ 454
	48"W	TK04248W □	\$ 422	\$ 447	\$ 470
	60"W	TK04260W □	\$ 474	\$ 499	\$ 522
	50"H Base Panel Frames without Top Trim				
	24"W	TK05024W □	\$ 381	\$ 406	\$ 429
	30"W	TK05030W □	\$ 404	\$ 429	\$ 452
	36"W	TK05036W □	\$ 413	\$ 438	\$ 461
	42"W	TK05042W □	\$ 428	\$ 453	\$ 476
	48"W	TK05048W □	\$ 441	\$ 466	\$ 489
	60"W	TK05060W □	\$ 486	\$ 511	\$ 534
	57½"H Base Panel Frames without Top Trim				
	24"W	TK05724W □	\$ 405	\$ 430	\$ 453
	30"W	TK05730W □	\$ 415	\$ 440	\$ 463
	36"W	TK05736W □	\$ 429	\$ 454	\$ 477
	42"W	TK05742W □	\$ 447	\$ 472	\$ 495
	48"W	TK05748W □	\$ 468	\$ 493	\$ 516
	60"W	TK05760W □	\$ 512	\$ 537	\$ 560
	65"H Base Panel Frames without Top Trim				
	24"W	TK06524W □	\$ 413	\$ 438	\$ 461
	30"W	TK06530W □	\$ 425	\$ 450	\$ 473
	36"W	TK06536W □	\$ 442	\$ 467	\$ 490
	42"W	TK06542W □	\$ 455	\$ 480	\$ 503
	48"W	TK06548W □	\$ 475	\$ 500	\$ 523
	60"W	TK06560W □	\$ 523	\$ 548	\$ 571

TERRACE

<p>How to specify — Select the Terrace Model Number from above.</p>	<p>1st Option: Select the Base Option: R Raceway Cover F Footed</p>	<p>2nd Option: Paint: P1 P2 P3 See page 20 for finishes. *P3 colors not available on Terrace foot.</p>	<p>T K O W . P </p>
--	--	---	--

Examples: TK05060WR.P7C TK04236WF.P27

For specification information see pages 23-30.

GSA SIN 33721



Description	Model	List Price
15"H Stacking Frames		
24"W	TK01524	\$ 316
30"W	TK01530	\$ 336
36"W	TK01536	\$ 344
42"W	TK01542	\$ 356
48"W	TK01548	\$ 359
60"W	TK01560	\$ 374



22½"H Stacking Frames		
24"W	TK02224	\$ 331
30"W	TK02230	\$ 336
36"W	TK02236	\$ 346
42"W	TK02242	\$ 357
48"W	TK02248	\$ 368
60"W	TK02260	\$ 385

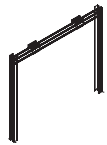

30"H Stacking Frames		
24"W	TK03024	\$ 340
30"W	TK03030	\$ 356
36"W	TK03036	\$ 368
42"W	TK03042	\$ 384
48"W	TK03048	\$ 396
60"W	TK03060	\$ 412



Segment Bars (black only)		
24"W	TKSK24	\$ 28
30"W	TKSK30	\$ 28
36"W	TKSK36	\$ 29
42"W	TKSK42	\$ 31
48"W	TKSK48	\$ 34
60"W	TKSK60	\$ 35



Terrace Horizontal Electrical Mount Support		
24"W	TN24MS	\$ 111
30"W	TN30MS	\$ 120
36"W	TN36MS	\$ 128
42"W	TN42MS	\$ 145
48"W	TN48MS	\$ 156
60"W	TN60MS	\$ 175

TERRACE

How to specify —

Select the Terrace Model Number from above.



Examples: TK02224 TKSK42 TN24MS

Shippable by small-package carrier.

Frames

Terrace® — Door Panel / Sliding Door / Kits

For specification information see pages 23-30.

GSA SIN 33721



TK18742D

Description	Model	List Price	PAINT & LAMINATE UPCHARGES			
			P2	P3	L2	L3
Laminate Door Panels with Radius Painted Top Trim						
87½"H x 42"W	TK18742D	\$ 4465	\$ 46	\$ 93	\$ 154	\$ 311
Laminate Door Panels with Flat Painted Top Trim						
87½"H x 42"W	TK18742DF	\$ 4219	\$ 46	\$ 93	\$ 154	\$ 312

*Upcharges for higher grade paint or laminate are added to list price.

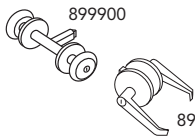

Description	Model	List Price
Lockset		
Door Knob — polished brass, keyed one side	899900 S	\$ 159
Door Lever — brushed aluminum, keyed one side	899910 S	\$ 455

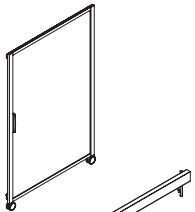

Description	Model	P1 Paint List Price	P2 Paint List Price	P3 Paint List Price
Frosted Translucent Sliding Doors (for 36"W opening)				
50"H x 42"W	Z15042SD	\$ 5079	\$ 5134	\$ 5191
65"H x 42"W	Z16542SD	\$ 6157	\$ 6212	\$ 6269
80"H x 42"W	Z18042SD	\$ 7500	\$ 7555	\$ 7612

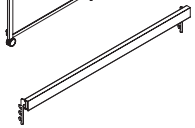

Mounting Kit for Sliding Doors (mounts to adjacent Terrace panel)				
30"W	TKDMK30 S	\$ 571	\$ 588	\$ 602
36"W	TKDMK36 S	\$ 571	\$ 588	\$ 602
42"W	TKDMK42 S	\$ 571	\$ 588	\$ 602
48"W	TKDMK48 S	\$ 571	\$ 588	\$ 602

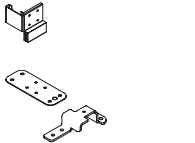

Off-Modular Panel Connection Kit				
Off-Modular Kit	TKOM S	\$ 203	N/A	N/A

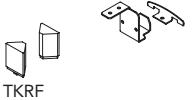

TKRF

Base Raceway to Footed Conversion Kit				
Base Raceway to Footed Kit	TKRF	\$ 240	\$ 265	\$ 288

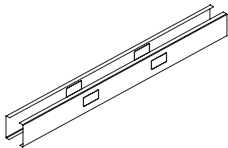

TK36FR

Footed to Base Raceway Conversion Kit				
24"W	TK24FR	\$ 299	\$ 341	\$ 385
30"W	TK30FR	\$ 299	\$ 341	\$ 385
36"W	TK36FR	\$ 299	\$ 341	\$ 385
42"W	TK42FR	\$ 299	\$ 341	\$ 385
48"W	TK48FR	\$ 299	\$ 341	\$ 385
60"W	TK60FR	\$ 299	\$ 341	\$ 385

<p>How to specify — Select the Terrace Model Number from above.</p>	<p><i>1st Option:</i> Paint (if applicable): P1 P2 P3 See page 20 for finishes.</p>	<p><i>2nd Option:</i> Door Laminate (if applicable): See page 20 for finishes.</p>	<p><i>2nd Option:</i> Insert (Sliding Door only): FT Frosted Translucent</p>
<div style="display: flex; justify-content: space-between;"> _____ . P _____ . _____ . FT _____ </div>			

Examples: TK18742D.P02.TM65 899900 Z15042SD.P02.FT

S Shippable by small-package carrier.

For specification information see pages 23-30.

GSA SIN 33721

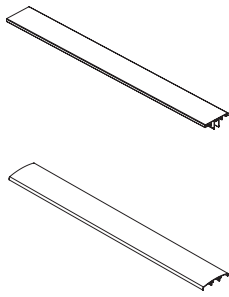

Description/ Examples	Flat Top Trim Model*	Radius Top Trim Model	Flat Top Trim			Radius Top Trim		
			P1 Paint List Price	P2 Paint List Price	P3 Paint List Price	P1 Paint List Price	P2 Paint List Price	P3 Paint List Price
Painted Top Trim (Examples span multiple panels)								
24"W	TK324PTFK [S]	TK324PT [S]	\$ 56	\$ 81	\$ 104	\$ 51	\$ 76	\$ 99
30"W	TK330PTFK [S]	TK330PT [S]	\$ 65	\$ 90	\$ 113	\$ 60	\$ 85	\$ 108
36"W	TK336PTFK [S]	TK336PT [S]	\$ 72	\$ 97	\$ 120	\$ 72	\$ 97	\$ 120
42"W	TK342PTFK [S]	TK342PT [S]	\$ 85	\$ 110	\$ 133	\$ 87	\$ 112	\$ 135
48"W	TK348PTFK [S]	TK348PT [S]	\$ 92	\$ 117	\$ 140	\$ 97	\$ 122	\$ 145
54"W - 24" + 30"	TK354PTFK [S]	TK354PT [S]	\$ 117	\$ 159	\$ 203	\$ 123	\$ 170	\$ 218
60"W	TK360PTFK [S]	TK360PT [S]	\$ 114	\$ 139	\$ 162	\$ 117	\$ 142	\$ 165
66"W - 30" + 36"	TK366PTFK	TK366PT	\$ 136	\$ 178	\$ 222	\$ 144	\$ 191	\$ 239
68"W - 48" + 20"	TK368PTFK	TK368PT	\$ 138	\$ 180	\$ 224	\$ 146	\$ 193	\$ 241
72"W - 36" + 36"	TK372PTFK	TK372PT	\$ 141	\$ 183	\$ 227	\$ 152	\$ 199	\$ 247
78"W - 48" + 30"	TK378PTFK	TK378PT	\$ 147	\$ 189	\$ 233	\$ 157	\$ 204	\$ 252
84"W - 36" + 48" or 42" + 42"	TK384PTFK	TK384PT	\$ 159	\$ 201	\$ 245	\$ 171	\$ 218	\$ 266
90"W - 42" + 48"	TK390PTFK	TK390PT	\$ 168	\$ 210	\$ 254	\$ 178	\$ 225	\$ 273
96"W - 48" + 48" or 36" + 60"	TK396PTFK	TK396PT	\$ 179	\$ 221	\$ 265	\$ 189	\$ 236	\$ 284

**K" suffix was added to flat trim model numbers effective 10/7/2016.

TERRACE

How to specify —
Select the Terrace Model Number from above.

1st Option:
Paint
(if applicable):
P1 P2 P3
See page 20 for finishes.

T | K | 3 | | | | P | T | | | | . P | | | | .

Examples: TK330PTFK.P7D TK330PT.P7D

[S] Shippable by small-package carrier.

For specification information see pages 23-30.

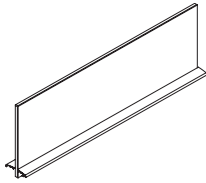

Description	Flat Top Trim Model	Radius Top Trim Model	Painted Trim		
			Clear List Price	Frosted List Price	Smoked List Price
7½"H x ¾" Thick Glass Panel Mounted Screens — Painted Trim (Example spans multiple panels)					
24"W	TK40724TGSF	TKG40724TGSR	\$ 566	\$ 604	\$ 645
30"W	TK40730TGSF	TKG40730TGSR	\$ 609	\$ 649	\$ 693
36"W	TK40736TGSF	TKG40736TGSR	\$ 700	\$ 747	\$ 798
42"W	TK40742TGSF	TKG40742TGSR	\$ 741	\$ 791	\$ 844
48"W	TK40748TGSF	TKG40748TGSR	\$ 793	\$ 846	\$ 903
54"W – 24" + 30"	TK40754TGSF	TKG40754TGSR	\$ 884	\$ 944	\$ 1006
60"W	TK40760TGSF	TKG40760TGSR	\$ 971	\$ 1037	\$ 1106
66"W – 30" + 36"	TK40766TGSF	TKG40766TGSR	\$ 1068	\$ 1140	\$ 1216
72"W – 36" + 36"	TK40772TGSF	TKG40772TGSR	\$ 1155	\$ 1232	\$ 1315
78"W – 48" + 30"	TK40778TGSF	TKG40778TGSR	\$ 1244	\$ 1327	\$ 1417
84"W – 36" + 48" or 42" + 42"	TK40784TGSF	TKG40784TGSR	\$ 1326	\$ 1418	\$ 1510
90"W – 42" + 48"	TK40790TGSF	TKG40790TGSR	\$ 1419	\$ 1516	\$ 1616
96"W – 48" + 48" or 36" + 60"	TK40796TGSF	TKG40796TGSR	\$ 1505	\$ 1607	\$ 1714
15"H x ¾" Thick Glass Panel Mounted Screens — Painted Trim (Example spans multiple panels)					
24"W	TK41524TGSF	TKG41524TGSR	\$ 615	\$ 655	\$ 700
30"W	TK41530TGSF	TKG41530TGSR	\$ 658	\$ 702	\$ 749
36"W	TK41536TGSF	TKG41536TGSR	\$ 760	\$ 811	\$ 866
42"W	TK41542TGSF	TKG41542TGSR	\$ 811	\$ 867	\$ 924
48"W	TK41548TGSF	TKG41548TGSR	\$ 867	\$ 926	\$ 987
54"W – 24" + 30"	TK41554TGSF	TKG41554TGSR	\$ 962	\$ 1028	\$ 1096
60"W	TK41560TGSF	TKG41560TGSR	\$ 1060	\$ 1132	\$ 1207
66"W – 30" + 36"	TK41566TGSF	TKG41566TGSR	\$ 1159	\$ 1236	\$ 1319
72"W – 36" + 36"	TK41572TGSF	TKG41572TGSR	\$ 1261	\$ 1345	\$ 1436
78"W – 48" + 30"	TK41578TGSF	TKG41578TGSR	\$ 1432	\$ 1530	\$ 1631
84"W – 36" + 48" or 42" + 42"	TK41584TGSF	TKG41584TGSR	\$ 1604	\$ 1712	\$ 1827
90"W – 42" + 48"	TK41590TGSF	TKG41590TGSR	\$ 1649	\$ 1761	\$ 1878
96"W – 48" + 48" or 36" + 60"	TK41596TGSF	TKG41596TGSR	\$ 1699	\$ 1815	\$ 1935

<p>How to specify — Select the Terrace Model Number from above.</p>	<p>1st Option: Glass (if applicable): GSM1 Smoked LC Clear LF Frosted</p>	<p>2nd Option: Paint (if applicable): See page 20 for finishes.</p>
<p>_____ . L .</p>	<p>P _____</p>	

Examples: TK40724TGSF.LC.P52 TKG40724TGSR.LC.P52

Connectors

Terrace® — Connector Kits

For specification information see pages 23-30.

Flat or Radius — Top Cap / Trim

GSA SIN 33721

Description	Flat Top Cap/Trim Model	Radius Top Cap/Trim Model	Painted Top Cap Painted Trim		
			P1 Paint List Price	P2 Paint List Price	P3 Paint List Price
"L" 90° Connector Kits					
7½"H stacking/segmented	TK307LF	TK307L	\$ 130	\$ 154	\$ 176
12"H stacking/segmented	TK312LF	TK312L	\$ 144	\$ 168	\$ 190
15"H stacking/segmented	TK315LF	TK315L	\$ 146	\$ 170	\$ 192
20"H stacking/segmented	TK320LF	TK320L	\$ 165	\$ 189	\$ 211
22½"H stacking/segmented	TK322LF	TK322L	\$ 167	\$ 191	\$ 213
27"H stacking/segmented	TK327LF	TK327L	\$ 182	\$ 206	\$ 228
30"H stacking/segmented	TK330LF	TK330L	\$ 186	\$ 210	\$ 232
30"H base panel	TK332LF	TK332L	\$ 187	\$ 201	\$ 220
35"H base panel	TK335LF	TK335L	\$ 186	\$ 210	\$ 232
42½"H base panel	TK342LF	TK342L	\$ 209	\$ 233	\$ 255
50"H base panel	TK350LF	TK350L	\$ 218	\$ 242	\$ 264
57½"H base panel	TK357LF	TK357L	\$ 223	\$ 247	\$ 269
65"H base panel	TK365LF	TK365L	\$ 227	\$ 251	\$ 273
80"H base panel	TK380LF	TK380L	\$ 288	\$ 312	\$ 334
87½"H base panel	TK387LF	TK387L	\$ 306	\$ 330	\$ 352
"T" 3-way Connector Kit					
7½"H stacking/segmented	TK307TF	TK307T	\$ 130	\$ 154	\$ 176
12"H stacking/segmented	TK312TF	TK312T	\$ 144	\$ 168	\$ 190
15"H stacking/segmented	TK315TF	TK315T	\$ 146	\$ 170	\$ 192
20"H stacking/segmented	TK320TF	TK320T	\$ 165	\$ 189	\$ 211
22½"H stacking/segmented	TK322TF	TK322T	\$ 167	\$ 191	\$ 213
27"H stacking/segmented	TK327TF	TK327T	\$ 182	\$ 206	\$ 228
30"H stacking/segmented	TK330TF	TK330T	\$ 186	\$ 210	\$ 232
30"H base panel	TK332TF	TK332T	\$ 187	\$ 201	\$ 220
35"H base panel	TK335TF	TK335T	\$ 186	\$ 210	\$ 232
42½"H base panel	TK342TF	TK342T	\$ 209	\$ 233	\$ 255
50"H base panel	TK350TF	TK350T	\$ 218	\$ 242	\$ 264
57½"H base panel	TK357TF	TK357T	\$ 223	\$ 247	\$ 269
65"H base panel	TK365TF	TK365T	\$ 227	\$ 251	\$ 273
80"H base panel	TK380TF	TK380T	\$ 288	\$ 312	\$ 334
87½"H base panel	TK387TF	TK387T	\$ 306	\$ 330	\$ 352
"X" 4-way Connector Kits					
7½"H stacking/segmented	TK307XF	TK307X	\$ 101	\$ 115	\$ 126
12"H stacking/segmented	TK312XF	TK312X	\$ 111	\$ 125	\$ 136
15"H stacking/segmented	TK315XF	TK315X	\$ 112	\$ 126	\$ 137
20"H stacking/segmented	TK320XF	TK320X	\$ 128	\$ 142	\$ 153
22½"H stacking/segmented	TK322XF	TK322X	\$ 131	\$ 145	\$ 156
27"H stacking/segmented	TK327XF	TK327X	\$ 144	\$ 158	\$ 169
30"H stacking/segmented	TK330XF	TK330X	\$ 146	\$ 160	\$ 171
30"H base panel	TK332XF	TK332X	\$ 146	\$ 157	\$ 172
35"H base panel	TK335XF	TK335X	\$ 146	\$ 160	\$ 171
42½"H base panel	TK342XF	TK342X	\$ 200	\$ 214	\$ 225
50"H base panel	TK350XF	TK350X	\$ 209	\$ 223	\$ 234
57½"H base panel	TK357XF	TK357X	\$ 213	\$ 227	\$ 238
65"H base panel	TK365XF	TK365X	\$ 218	\$ 232	\$ 243
80"H base panel	TK380XF	TK380X	\$ 250	\$ 264	\$ 275
87½"H base panel	TK387XF	TK387X	\$ 268	\$ 282	\$ 293

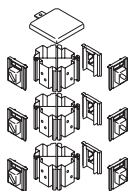
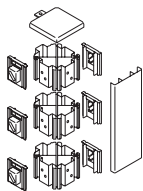
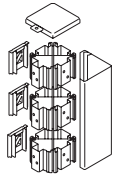

TERRACE

How to specify —
Select the Terrace Model Number from above.

1st Option:
Paint
(if applicable):
P1 P2 P3
See page 20 for finishes.

TK3 | | | | | .

P | | |

Examples: Painted Flat – TK365LF.P02 Painted Radius – TK365L.P02

S Shippable by small-package carrier.

Connectors

For specification information see pages 23-30.

Terrace® — Connector Kits

Flat or Radius — Top Cap / Trim

GSA SIN 33721

Description	Flat Top Cap/Trim Model	Radius Top Cap/Trim Model	Painted Top Cap Painted Trim		
			P1 Paint List Price	P2 Paint List Price	P3 Paint List Price
"S" Extended Straight Connector Kits					
7½"H stacking/segmented	TK307SF	TK307S	\$ 165	\$ 189	\$ 211
12"H stacking/segmented	TK312SF	TK312S	\$ 171	\$ 195	\$ 217
15"H stacking/segmented	TK315SF	TK315S	\$ 175	\$ 199	\$ 221
20"H stacking/segmented	TK320SF	TK320S	\$ 186	\$ 210	\$ 232
22½"H stacking/segmented	TK322SF	TK322S	\$ 189	\$ 213	\$ 235
27"H stacking/segmented	TK327SF	TK327S	\$ 206	\$ 230	\$ 252
30"H stacking/segmented	TK330SF	TK330S	\$ 209	\$ 233	\$ 255
30"H base panel	TK332SF	TK332S	\$ 210	\$ 225	\$ 247
35"H base panel	TK335SF	TK335S	\$ 209	\$ 233	\$ 255
42½"H base panel	TK342SF	TK342S	\$ 242	\$ 266	\$ 288
50"H base panel	TK350SF	TK350S	\$ 251	\$ 275	\$ 297
57½"H base panel	TK357SF	TK357S	\$ 256	\$ 280	\$ 302
65"H base panel	TK365SF	TK365S	\$ 270	\$ 294	\$ 316
80"H base panel	TK380SF	TK380S	\$ 334	\$ 358	\$ 380
87½"H base panel	TK387SF	TK387S	\$ 349	\$ 373	\$ 395
2-Way 120° Connector					
12"H stacking/segmented	TK312BF	TK312B	\$ 138	\$ 162	\$ 184
15"H stacking/segmented	TK315BF	TK315B	\$ 141	\$ 165	\$ 187
20"H stacking/segmented	TK320BF	TK320B	\$ 145	\$ 169	\$ 191
27"H stacking/segmented	TK327BF	TK327B	\$ 173	\$ 197	\$ 219
30"H stacking/segmented	TK330BF	TK330B	\$ 176	\$ 200	\$ 222
32"H base panel	TK332BF	TK332B	\$ 182	\$ 206	\$ 228
35"H base panel	TK335BF	TK335B	\$ 186	\$ 210	\$ 232
42½"H base panel	TK342BF	TK342B	\$ 209	\$ 233	\$ 255
50"H base panel	TK350BF	TK350B	\$ 227	\$ 251	\$ 273
57½"H base panel	TK357BF	TK357B	\$ 239	\$ 263	\$ 285
65"H base panel	TK365BF	TK365B	\$ 251	\$ 275	\$ 297
3-Way 120° Connector					
12"H stacking/segmented	TK312CF	TK312C	\$ 114	\$ 138	\$ 160
15"H stacking/segmented	TK315CF	TK315C	\$ 119	\$ 143	\$ 165
20"H stacking/segmented	TK320CF	TK320C	\$ 124	\$ 148	\$ 170
27"H stacking/segmented	TK327CF	TK327C	\$ 155	\$ 179	\$ 201
30"H stacking/segmented	TK330CF	TK330C	\$ 157	\$ 181	\$ 203
32"H base panel	TK332CF	TK332C	\$ 165	\$ 189	\$ 211
35"H base panel	TK335CF	TK335C	\$ 167	\$ 191	\$ 213
42½"H base panel	TK342CF	TK342C	\$ 186	\$ 210	\$ 232
50"H base panel	TK350CF	TK350C	\$ 209	\$ 233	\$ 255
57½"H base panel	TK357CF	TK357C	\$ 218	\$ 242	\$ 264
65"H base panel	TK365CF	TK365C	\$ 227	\$ 251	\$ 273

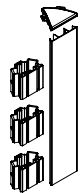
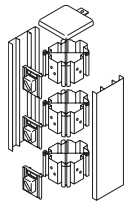

TERRACE

How to specify —
Select the Terrace Model Number from above.

1st Option:
Paint
(if applicable):
P1 P2 P3
See page 20 for finishes.

TK3 | | | | | .

P | | |

Examples: Painted Flat – TK335CF.P27 Painted Radius – TK335C.P27

S Shippable by small-package carrier.

Connectors

Terrace® — Connector Kits

For specification information see pages 23-30.

Flat or Radius — Top Cap / Trim

GSA SIN 33721

Description	Flat Top Cap/Trim Model	Radius Top Cap/Trim Model	Painted Top Cap Painted Trim		
			P1 Paint List Price	P2 Paint List Price	P3 Paint List Price
"E" End Trim Kits					
15"H stacking/segmented	TK315EF	TK315E	\$ 85	\$ 109	\$ 131
22½"H stacking/segmented	TK322EF	TK322E	\$ 92	\$ 116	\$ 138
30"H stacking/segmented	TK330EF	TK330E	\$ 104	\$ 128	\$ 150
30"H base panel	TK332EF	TK332E	\$ 106	\$ 114	\$ 125
35"H base panel	TK335EF	TK335E	\$ 104	\$ 128	\$ 150
42½"H base panel	TK342EF	TK342E	\$ 112	\$ 136	\$ 158
50"H base panel	TK350EF	TK350E	\$ 128	\$ 152	\$ 174
57½"H base panel	TK357EF	TK357E	\$ 133	\$ 157	\$ 179
65"H base panel	TK365EF	TK365E	\$ 138	\$ 162	\$ 184
80"H base panel	TK380EF	TK380E	\$ 196	\$ 220	\$ 242
87½"H base panel	TK387EF	TK387E	\$ 212	\$ 236	\$ 258
High-Low End Trim Kit					
5"H connector kit	TK305HF	TK305H	\$ 83	\$ 97	\$ 108
7½"H	TK307HF	TK307H	\$ 85	\$ 99	\$ 110
12"H stacking/segmented	TK312HF	TK312H	\$ 83	\$ 97	\$ 108
15"H	TK315HF	TK315H	\$ 85	\$ 99	\$ 110
20"H stacking/segmented	TK320HF	TK320H	\$ 103	\$ 117	\$ 128
22½"H	TK322HF	TK322H	\$ 104	\$ 118	\$ 129
27"H stacking/segmented	TK327HF	TK327H	\$ 103	\$ 117	\$ 128
30"H	TK330HF	TK330H	\$ 104	\$ 118	\$ 129
Grooved High-Low Trim — for use with Panel Mounted Screens					
7½"H	TK307HGF	TK307HG	\$ 103	\$ 117	\$ 128
15"H	TK315HGF	TK315HG	\$ 112	\$ 126	\$ 137
"W" Wall Mount Kit					
15"H stacking/segmented	TK315WF	TK315W	\$ 103	\$ 127	\$ 149
22½"H stacking/segmented	TK322WF	TK322W	\$ 122	\$ 146	\$ 168
30"H stacking/segmented	TK330WF	TK330W	\$ 142	\$ 166	\$ 188
32"H wall mount kit for base frame	TK332WF	TK332W	\$ 159	\$ 183	\$ 205
35"H	TK335WF	TK335W	\$ 162	\$ 186	\$ 208
42½"H	TK342WF	TK342W	\$ 177	\$ 201	\$ 223
50"H	TK350WF	TK350W	\$ 203	\$ 227	\$ 249
57½"H	TK357WF	TK357W	\$ 220	\$ 244	\$ 266
65"H	TK365WF	TK365W	\$ 239	\$ 263	\$ 285
87½"H	TK387WF	TK387W	\$ 321	\$ 345	\$ 367

How to specify —
Select the Terrace Model Number from above.

1st Option:

Paint:
P1 P2 P3

See page 20 for finishes.

TK3 | | | | | .

P | | |

Examples: Painted Flat – TK315EF.P27 Painted Radius – TK315E.P27

 Shippable by small-package carrier.

For specification information see pages 23-30.

GSA SIN 33721

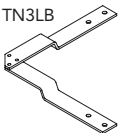
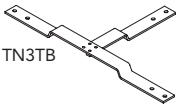
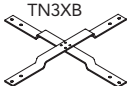
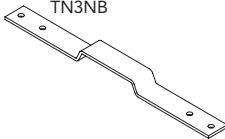
	Description	Model	List Price
 <p>TN3LB</p>	Top Stabilizer Brackets		
	"L" Top Stabilizer Bracket	TN3LB S	\$ 80
 <p>TN3TB</p>	"T" Top Stabilizer Bracket	TN3TB S	\$ 80
	"X" Top Stabilizer Bracket	TN3XB S	\$ 80
 <p>TN3SB</p>	"S" Top Stabilizer Bracket	TN3SB S	\$ 61
	In Line Top Stabilizer Bracket	TN3NB S	\$ 61
 <p>TN3VB</p>	Variable Height Top Stabilizer Bracket	TN3VB S	\$ 80
	"L" Variable Height Top Stabilizer Bracket	TN3VLB S	\$ 101

TERRACE

How to specify —
 Select the Terrace Model Number from above.

Example: TN3LB

S Shippable by small-package carrier.

For specification information see pages 23-30.

GSA SIN 33721

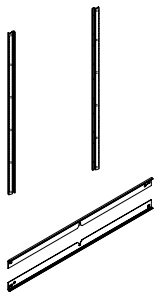

Description	Model	List Price
Terrace Wall Track Kit — End/Shared		
65"H — Pair of Ends	TK365YEB	\$ 313
65"H — Middle Unit	TK365YM	\$ 163

Terrace Wall Track Tile Attachment Kits — Top and Bottom

24"W	Y324YS	\$ 232
30"W	Y330YS	\$ 238
36"W	Y336YS	\$ 255
42"W	Y342YS	\$ 289
48"W	Y348YS	\$ 319
60"W	Y360YS	\$ 355

Segment Bars (black only)

24"W	TKSK24	\$ 28
30"W	TKSK30	\$ 28
36"W	TKSK36	\$ 29
42"W	TKSK42	\$ 31
48"W	TKSK48	\$ 34
60"W	TKSK60	\$ 35



TERRACE

How to specify —































Select the Terrace Model Number from above.



Examples: TK365YEB Y336YS TKSK42

Shippable by small-package carrier.

For specification information see pages 31-37.
 (See page 414 for COM pricing on fabric Grades G-J.)

Description	Model	List Price					
		Grade A	Grade B	Grade C	Grade D	Grade E	Grade F
7½"H Tackable Acoustical Tiles							
24"W	TKG40724T 	\$ 101	\$ 104	\$ 108	\$ 114	\$ 120	\$ 125
30"W	TKG40730T 	\$ 108	\$ 112	\$ 116	\$ 123	\$ 130	\$ 137
36"W	TKG40736T 	\$ 113	\$ 118	\$ 123	\$ 132	\$ 140	\$ 148
42"W	TKG40742T 	\$ 123	\$ 129	\$ 134	\$ 144	\$ 153	\$ 163
48"W	TKG40748T 	\$ 131	\$ 138	\$ 144	\$ 155	\$ 166	\$ 177
60"W	TKG40760T 	\$ 150	\$ 158	\$ 166	\$ 180	\$ 194	\$ 207
15"H Tackable Acoustical Tiles							
24"W	TKG41524T 	\$ 104	\$ 111	\$ 117	\$ 128	\$ 139	\$ 150
30"W	TKG41530T 	\$ 111	\$ 119	\$ 127	\$ 141	\$ 155	\$ 168
36"W	TKG41536T 	\$ 120	\$ 130	\$ 140	\$ 157	\$ 174	\$ 191
42"W	TKG41542T 	\$ 128	\$ 140	\$ 151	\$ 171	\$ 190	\$ 210
48"W	TKG41548T 	\$ 134	\$ 147	\$ 161	\$ 183	\$ 205	\$ 227
60"W	TKG41560T 	\$ 153	\$ 170	\$ 186	\$ 214	\$ 242	\$ 270
22½"H Tackable Acoustical Tiles							
24"W	TKG42224T 	\$ 131	\$ 141	\$ 151	\$ 168	\$ 185	\$ 202
30"W	TKG42230T 	\$ 143	\$ 155	\$ 168	\$ 188	\$ 209	\$ 229
36"W	TKG42236T 	\$ 162	\$ 177	\$ 192	\$ 216	\$ 241	\$ 266
42"W	TKG42242T 	\$ 178	\$ 195	\$ 213	\$ 242	\$ 271	\$ 300
48"W	TKG42248T 	\$ 195	\$ 215	\$ 235	\$ 268	\$ 301	\$ 334
60"W	TKG42260T 	\$ 212	\$ 237	\$ 262	\$ 303	\$ 345	\$ 387
25"H Tackable Acoustical Tiles (Tile is 25"H, for use with 30"H Frames)							
24"W	TKG43224T 	\$ 138	\$ 149	\$ 160	\$ 179	\$ 197	\$ 215
30"W	TKG43230T 	\$ 149	\$ 163	\$ 177	\$ 200	\$ 223	\$ 246
36"W	TKG43236T 	\$ 167	\$ 184	\$ 200	\$ 228	\$ 256	\$ 284
42"W	TKG43242T 	\$ 192	\$ 211	\$ 231	\$ 263	\$ 295	\$ 327
48"W	TKG43248T 	\$ 200	\$ 222	\$ 244	\$ 281	\$ 318	\$ 355
60"W	TKG43260T 	\$ 218	\$ 246	\$ 274	\$ 320	\$ 366	\$ 413
30"H Tackable Acoustical Tiles (Tile is 30"H, for use with 35"H Frames)							
24"W	TKG43024T 	\$ 141	\$ 154	\$ 168	\$ 190	\$ 212	\$ 234
30"W	TKG43030T 	\$ 152	\$ 169	\$ 185	\$ 213	\$ 241	\$ 269
36"W	TKG43036T 	\$ 170	\$ 190	\$ 210	\$ 243	\$ 276	\$ 309
42"W	TKG43042T 	\$ 195	\$ 218	\$ 242	\$ 281	\$ 320	\$ 359
48"W	TKG43048T 	\$ 203	\$ 230	\$ 256	\$ 300	\$ 345	\$ 389
60"W	TKG43060T 	\$ 221	\$ 254	\$ 287	\$ 343	\$ 398	\$ 453

Packaging: Tiles will be multi-packed to reduce packaging materials and to provide better structural support during shipping. Items requiring individual shipping should be tagged on the order with different descriptive locations to simplify the staging process.







<p>How to specify — Select the Terrace Model Number from above.</p>	<p>1st Option: Fabric: See page 13 for fabrics.</p>
---	---



TKG4 | | | | | T . | | | | |



Example: TKG43048T.APN911



 Shippable by small-package carrier.

For specification information see pages 31-37.
(See page 414 for COM pricing on fabric Grades G-J.)

Description	Model	List Price					
		Grade A	Grade B	Grade C	Grade D	Grade E	Grade F
42½"H Monolithic Tackable Acoustical Tiles (Tile is 37½"H, for use with 42½"H Frames)							
24"W	TKG44224T 	\$ 184	\$ 203	\$ 221	\$ 252	\$ 283	\$ 314
30"W	TKG44230T 	\$ 209	\$ 232	\$ 256	\$ 295	\$ 334	\$ 373
36"W	TKG44236T 	\$ 231	\$ 259	\$ 287	\$ 333	\$ 379	\$ 426
42"W	TKG44242T 	\$ 256	\$ 289	\$ 321	\$ 375	\$ 430	\$ 484
48"W	TKG44248T 	\$ 283	\$ 320	\$ 358	\$ 420	\$ 482	\$ 544
60"W	TKG44260T 	\$ 330	\$ 376	\$ 423	\$ 500	\$ 578	\$ 655

50"H Monolithic Tackable Acoustical Tiles (Tile is 45"H, for use with 50"H Frames)							
24"W	TKG45024T 	\$ 209	\$ 231	\$ 254	\$ 290	\$ 327	\$ 364
30"W	TKG45030T 	\$ 239	\$ 267	\$ 295	\$ 341	\$ 387	\$ 434
36"W	TKG45036T 	\$ 281	\$ 314	\$ 348	\$ 403	\$ 458	\$ 513
42"W	TKG45042T	\$ 314	\$ 353	\$ 392	\$ 456	\$ 521	\$ 586
48"W	TKG45048T	\$ 353	\$ 397	\$ 442	\$ 515	\$ 589	\$ 663
60"W	TKG45060T	\$ 395	\$ 450	\$ 507	\$ 598	\$ 690	\$ 782

57½"H Tackable Acoustical Tiles (Tile is 52½"H, for use with 57½"H Frames)							
24"W	TKG45724T 	\$ 250	\$ 276	\$ 302	\$ 344	\$ 386	\$ 429
30"W	TKG45730T 	\$ 281	\$ 313	\$ 345	\$ 398	\$ 451	\$ 504
36"W	TKG45736T 	\$ 317	\$ 356	\$ 395	\$ 458	\$ 523	\$ 587
42"W	TKG45742T	\$ 357	\$ 402	\$ 448	\$ 521	\$ 596	\$ 671
48"W	TKG45748T	\$ 396	\$ 447	\$ 499	\$ 584	\$ 669	\$ 754
60"W	TKG45760T	\$ 434	\$ 498	\$ 564	\$ 669	\$ 776	\$ 883

65"H Monolithic Tackable Acoustical Tiles (Tile is 60"H, for use with 65"H Frames)							
24"W	TKG46524T 	\$ 266	\$ 295	\$ 324	\$ 373	\$ 421	\$ 469
30"W	TKG46530T 	\$ 304	\$ 340	\$ 377	\$ 436	\$ 496	\$ 556
36"W	TKG46536T	\$ 342	\$ 385	\$ 429	\$ 501	\$ 573	\$ 645
42"W	TKG46542T	\$ 380	\$ 431	\$ 481	\$ 565	\$ 650	\$ 734
48"W	TKG46548T	\$ 416	\$ 474	\$ 532	\$ 628	\$ 724	\$ 821
60"W	TKG46560T	\$ 449	\$ 521	\$ 594	\$ 714	\$ 835	\$ 955

Packaging: Tiles will be multi-packed to reduce packaging materials and to provide better structural support during shipping. Items requiring individual shipping should be tagged on the order with different descriptive locations to simplify the staging process.

<p>How to specify — Select the Terrace Model Number from above.</p>	<p>1st Option: Fabric: See page 13 for fabrics.</p>
--	---

TKG4 | | | | | T | . | | | | | | | | | |

Example: TKG45748T.APN911

























 Shippable by small-package carrier.

Tiles

Terrace® — Tackable Acoustical Port Tiles

GSA SIN 33721

For specification information see pages 31-37.
(See page 414 for COM pricing on fabric Grades G-J.)

Description	Model	List Price					
		Grade A	Grade B	Grade C	Grade D	Grade E	Grade F
15"H Port Tiles							
24"W	TKG41524E 	\$ 199	\$ 205	\$ 210	\$ 220	\$ 230	\$ 239
30"W	TKG41530E 	\$ 203	\$ 210	\$ 218	\$ 230	\$ 242	\$ 254
36"W	TKG41536E 	\$ 209	\$ 218	\$ 226	\$ 241	\$ 255	\$ 269
42"W	TKG41542E 	\$ 216	\$ 226	\$ 236	\$ 253	\$ 270	\$ 287
48"W	TKG41548E 	\$ 226	\$ 237	\$ 249	\$ 268	\$ 287	\$ 306
60"W	TKG41560E 	\$ 247	\$ 261	\$ 276	\$ 300	\$ 324	\$ 347
22½"H Port Tiles							
24"W	TKG42224E 	\$ 221	\$ 230	\$ 238	\$ 253	\$ 267	\$ 281
30"W	TKG42230E 	\$ 234	\$ 245	\$ 256	\$ 274	\$ 292	\$ 310
36"W	TKG42236E 	\$ 253	\$ 266	\$ 279	\$ 301	\$ 323	\$ 345
42"W	TKG42242E 	\$ 272	\$ 287	\$ 303	\$ 328	\$ 354	\$ 379
48"W	TKG42248E 	\$ 283	\$ 300	\$ 317	\$ 346	\$ 375	\$ 404
60"W	TKG42260E 	\$ 305	\$ 327	\$ 348	\$ 385	\$ 421	\$ 457
25"H Port Tiles (Tile is 25"H, for use with 30"H Frames)							
24"W	TKG43224E 	\$ 227	\$ 237	\$ 246	\$ 262	\$ 278	\$ 294
30"W	TKG43230E 	\$ 240	\$ 252	\$ 264	\$ 284	\$ 305	\$ 325
36"W	TKG43236E 	\$ 261	\$ 275	\$ 290	\$ 314	\$ 338	\$ 361
42"W	TKG43242E 	\$ 278	\$ 288	\$ 297	\$ 313	\$ 329	\$ 345
48"W	TKG43248E 	\$ 289	\$ 308	\$ 327	\$ 359	\$ 391	\$ 423
60"W	TKG43260E 	\$ 308	\$ 332	\$ 356	\$ 397	\$ 437	\$ 478
30"H Port Tiles (Tile is 30"H, NOT for use with 35"H Frames)							
24"W	TKG43024E 	\$ 231	\$ 242	\$ 254	\$ 273	\$ 292	\$ 311
30"W	TKG43030E 	\$ 242	\$ 256	\$ 271	\$ 295	\$ 319	\$ 342
36"W	TKG43036E 	\$ 264	\$ 281	\$ 298	\$ 327	\$ 356	\$ 385
42"W	TKG43042E 	\$ 282	\$ 302	\$ 323	\$ 357	\$ 391	\$ 425
48"W	TKG43048E 	\$ 293	\$ 316	\$ 340	\$ 378	\$ 417	\$ 456
60"W	TKG43060E 	\$ 310	\$ 339	\$ 368	\$ 416	\$ 465	\$ 513

Packaging: Tiles will be multi-packed to reduce packaging materials and to provide better structural support during shipping. Items requiring individual shipping should be tagged on the order with different descriptive locations to simplify the staging process.

<p>How to specify — Select the Terrace Model Number from above.</p>	<p>1st Option: Fabric: See page 13 for fabrics.</p>	<p>2nd Option: Electrical Grommet Color: See page 20 for finishes.</p>
--	---	--

TKG4 | | | | | E . | | | | | . E |

Example: TKG43030E.APN911.E4

 Shippable by small-package carrier.

For specification information see pages 31-37.
(See page 414 for COM pricing on fabric Grades G-J.)

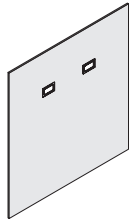

Description	Model	List Price					
		Grade A	Grade B	Grade C	Grade D	Grade E	Grade F
42½"H Monolithic Port Tiles (Tile is 37½"H, for use with 42½"H Frames)							
24"W	TKG44224E S	\$ 285	\$ 304	\$ 323	\$ 354	\$ 385	\$ 417
30"W	TKG44230E S	\$ 304	\$ 328	\$ 351	\$ 391	\$ 430	\$ 469
36"W	TKG44236E S	\$ 335	\$ 363	\$ 392	\$ 439	\$ 486	\$ 534
42"W	TKG44242E S	\$ 357	\$ 390	\$ 423	\$ 477	\$ 532	\$ 587
48"W	TKG44248E S	\$ 380	\$ 418	\$ 455	\$ 518	\$ 581	\$ 643
60"W	TKG44260E S	\$ 423	\$ 470	\$ 517	\$ 596	\$ 675	\$ 753

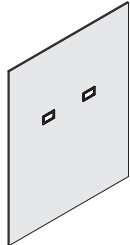

50"H Monolithic Port Tiles (Tile is 45"H, for use with 50"H Frames)							
24"W	TKG45024E S	\$ 304	\$ 326	\$ 349	\$ 386	\$ 423	\$ 460
30"W	TKG45030E S	\$ 337	\$ 365	\$ 393	\$ 440	\$ 487	\$ 533
36"W	TKG45036E S	\$ 374	\$ 407	\$ 441	\$ 497	\$ 553	\$ 608
42"W	TKG45042E	\$ 413	\$ 452	\$ 491	\$ 557	\$ 622	\$ 688
48"W	TKG45048E	\$ 449	\$ 494	\$ 538	\$ 613	\$ 687	\$ 762
60"W	TKG45060E	\$ 491	\$ 547	\$ 603	\$ 697	\$ 790	\$ 884

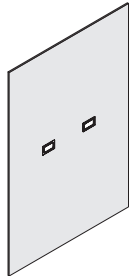

57½"H Monolithic Port Tiles (Tile is 52½"H, for use with 57½"H Frames)							
24"W	TKG45724E S	\$ 347	\$ 373	\$ 399	\$ 442	\$ 485	\$ 528
30"W	TKG45730E S	\$ 347	\$ 379	\$ 411	\$ 465	\$ 519	\$ 573
36"W	TKG45736E S	\$ 375	\$ 414	\$ 453	\$ 518	\$ 583	\$ 647
42"W	TKG45742E	\$ 418	\$ 463	\$ 509	\$ 584	\$ 660	\$ 735
48"W	TKG45748E	\$ 453	\$ 505	\$ 556	\$ 642	\$ 729	\$ 815
60"W	TKG45760E	\$ 496	\$ 561	\$ 626	\$ 733	\$ 841	\$ 949

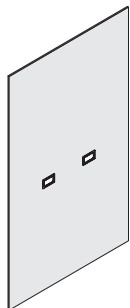

65"H Monolithic Port Tiles (Tile is 60"H, for use with 65"H Frames)							
24"W	TKG46524E S	\$ 364	\$ 393	\$ 422	\$ 470	\$ 519	\$ 567
30"W	TKG46530E S	\$ 402	\$ 438	\$ 475	\$ 535	\$ 596	\$ 657
36"W	TKG46536E	\$ 442	\$ 486	\$ 529	\$ 602	\$ 675	\$ 748
42"W	TKG46542E	\$ 481	\$ 532	\$ 582	\$ 667	\$ 751	\$ 836
48"W	TKG46548E	\$ 511	\$ 569	\$ 627	\$ 724	\$ 821	\$ 917
60"W	TKG46560E	\$ 546	\$ 619	\$ 691	\$ 813	\$ 934	\$ 1055

Packaging: Tiles will be multi-packed to reduce packaging materials and to provide better structural support during shipping. Items requiring individual shipping should be tagged on the order with different descriptive locations to simplify the staging process.

TERRACE











































<p>How to specify — Select the Terrace Model Number from above.</p>	<p>1st Option: Fabric: See page 13 for fabrics.</p>	<p>2nd Option: Electrical Grommet Color: See page 20 for finishes.</p>
<p>TKG4 E . . E </p>		

Example: TKG45736E.APN911.E4

S Shippable by small-package carrier.

For specification information see pages 31-37.

GSA SIN 33721

Description	Model	P1 Paint List Price	P2 Paint List Price	P3 Paint List Price
7½"H Steel Tiles				
24"W	TKG40724FS 	\$ 139	\$ 165	\$ 189
30"W	TKG40730FS 	\$ 144	\$ 170	\$ 194
36"W	TKG40736FS 	\$ 157	\$ 183	\$ 207
42"W	TKG40742FS 	\$ 173	\$ 199	\$ 223
48"W	TKG40748FS 	\$ 185	\$ 211	\$ 235
60"W	TKG40760FS 	\$ 209	\$ 235	\$ 259
15"H Steel Tiles				
24"W	TKG41524FS 	\$ 143	\$ 169	\$ 193
30"W	TKG41530FS 	\$ 150	\$ 176	\$ 200
36"W	TKG41536FS 	\$ 163	\$ 189	\$ 213
42"W	TKG41542FS 	\$ 179	\$ 205	\$ 229
48"W	TKG41548FS 	\$ 196	\$ 222	\$ 246
60"W	TKG41560FS 	\$ 217	\$ 243	\$ 267
22½"H Steel Tiles				
24"W	TKG42224FS 	\$ 182	\$ 203	\$ 223
30"W	TKG42230FS 	\$ 189	\$ 215	\$ 239
36"W	TKG42236FS 	\$ 203	\$ 229	\$ 253
42"W	TKG42242FS 	\$ 217	\$ 243	\$ 267
48"W	TKG42248FS 	\$ 236	\$ 262	\$ 286
60"W	TKG42260FS 	\$ 257	\$ 283	\$ 307
25"H Steel Tiles (Tile is 25"H, for use with 30"H Frames)				
24"W	TKG43224FS 	\$ 194	\$ 208	\$ 228
30"W	TKG43230FS 	\$ 207	\$ 222	\$ 244
36"W	TKG43236FS 	\$ 228	\$ 244	\$ 269
42"W	TKG43242FS 	\$ 247	\$ 264	\$ 291
48"W	TKG43248FS 	\$ 269	\$ 288	\$ 317
60"W	TKG43260FS 	\$ 304	\$ 325	\$ 357
30"H Steel Tiles (Tile is 30"H, for use with 35"H Frames)				
24"W	TKG43024FS 	\$ 209	\$ 247	\$ 286
30"W	TKG43030FS 	\$ 230	\$ 268	\$ 307
36"W	TKG43036FS 	\$ 259	\$ 297	\$ 336
42"W	TKG43042FS 	\$ 278	\$ 316	\$ 355
48"W	TKG43048FS 	\$ 308	\$ 346	\$ 385
60"W	TKG43060FS 	\$ 352	\$ 390	\$ 429
7½"H Tool Tiles — used to support Extensions paper management accessories				
24"W	TK40724SW 	\$ 362	\$ 397	\$ 433
30"W	TK40730SW 	\$ 417	\$ 453	\$ 490
36"W	TK40736SW 	\$ 422	\$ 458	\$ 495
42"W	TK40742SW 	\$ 446	\$ 482	\$ 519
48"W	TK40748SW 	\$ 476	\$ 512	\$ 549
60"W	TK40760SW 	\$ 508	\$ 544	\$ 581
15"H Tool Tiles — used to support Extensions paper management accessories				
24"W	TK41524SW 	\$ 394	\$ 432	\$ 471
30"W	TK41530SW 	\$ 425	\$ 463	\$ 502
36"W	TK41536SW 	\$ 462	\$ 500	\$ 539
42"W	TK41542SW 	\$ 487	\$ 525	\$ 564
48"W	TK41548SW 	\$ 514	\$ 552	\$ 591
60"W	TK41560SW 	\$ 550	\$ 588	\$ 627

Note: Tool tiles placed at worksurface height limit selection of work tools available. Folder holders, multi-media hangers, and binder bins extend below a 7½"H tool tile. Paper wave and contents extend above a single 7½"H tool tile. See page 392.

How to specify —
Select the Terrace
Model Number
from above.

1st Option:

Paint:



See page 20 for finishes.

T | K | | | | | | | | | | . P | | | | | .

Examples: TKG41536FS.P27 TK41530SW.P7D

 Shippable by small-package carrier.

For specification information see pages 31-37.



Description	Model	P1 Paint List Price	P2 Paint List Price	P3 Paint List Price
7½"H Perforated Steel Tiles				
24"W	TKG40724SH S	\$ 200	\$ 226	\$ 250
30"W	TKG40730SH S	\$ 206	\$ 232	\$ 256
36"W	TKG40736SH S	\$ 225	\$ 251	\$ 275
42"W	TKG40742SH S	\$ 247	\$ 273	\$ 297
48"W	TKG40748SH S	\$ 278	\$ 304	\$ 328
60"W	TKG40760SH S	\$ 306	\$ 332	\$ 356



15"H Perforated Steel Tiles				
24"W	TKG41524SH S	\$ 205	\$ 231	\$ 255
30"W	TKG41530SH S	\$ 214	\$ 240	\$ 264
36"W	TKG41536SH S	\$ 235	\$ 261	\$ 285
42"W	TKG41542SH S	\$ 256	\$ 282	\$ 306
48"W	TKG41548SH S	\$ 281	\$ 307	\$ 331
60"W	TKG41560SH S	\$ 311	\$ 337	\$ 361

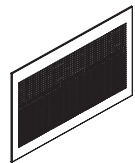

22½"H Perforated Steel Tiles				
24"W	TKG42224SH S	\$ 209	\$ 235	\$ 259
30"W	TKG42230SH S	\$ 221	\$ 247	\$ 271
36"W	TKG42236SH S	\$ 238	\$ 264	\$ 288
42"W	TKG42242SH S	\$ 262	\$ 288	\$ 312
48"W	TKG42248SH S	\$ 291	\$ 317	\$ 341
60"W	TKG42260SH S	\$ 321	\$ 347	\$ 371



30"H Perforated Steel Tiles (Tile is 30"H, for use with 35"H Frames)				
24"W	TKG43024SH S	\$ 220	\$ 258	\$ 297
30"W	TKG43030SH S	\$ 242	\$ 280	\$ 319
36"W	TKG43036SH S	\$ 280	\$ 318	\$ 357
42"W	TKG43042SH S	\$ 294	\$ 332	\$ 371
48"W	TKG43048SH S	\$ 336	\$ 374	\$ 413
60"W	TKG43060SH S	\$ 377	\$ 415	\$ 454

TERRACE

How to specify —
Select the Terrace Model Number from above.

1st Option:

Paint:



See page 20 for finishes.

TKG4 | | | | | | | | | | . P | | | | | .

Example: TKG40742SH.P27

S Shippable by small-package carrier.

Tiles

Terrace® — Laminate and Monolithic Laminate Tiles

For specification information see pages 31-37.

GSA SIN 33721



Description	Model		L1 List Price	L2 List Price	L3 List Price
15"H Laminate Tiles (<i>De-emphasized</i>)					
24"W	TKG41524LS	☒	\$ 346	\$ 359	\$ 372
30"W	TKG41530LS	☒	\$ 353	\$ 367	\$ 379
36"W	TKG41536LS	☒	\$ 402	\$ 417	\$ 432
42"W	TKG41542LS	☒	\$ 430	\$ 446	\$ 462
48"W	TKG41548LS	☒	\$ 470	\$ 488	\$ 505
60"W	TKG41560LS	☒	\$ 532	\$ 552	\$ 571

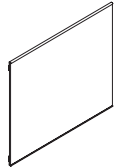

25"H Laminate Tiles (Tile is 25"H, for use with 30"H Frames) (<i>De-emphasized</i>)					
24"W	TKG43224LS	☒	\$ 518	\$ 538	\$ 556
30"W	TKG43230LS	☒	\$ 548	\$ 569	\$ 588
36"W	TKG43236LS	☒	\$ 588	\$ 610	\$ 631
42"W	TKG43242LS	☒	\$ 643	\$ 667	\$ 690
48"W	TKG43248LS	☒	\$ 696	\$ 722	\$ 747
60"W	TKG43260LS	☒	\$ 803	\$ 833	\$ 861

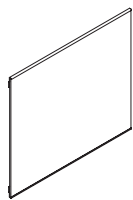

30"H Laminate Tiles (Tile is 30"H, for use with 35"H Frames) (<i>De-emphasized</i>)					
24"W	TKG43024LS	☒	\$ 537	\$ 557	\$ 576
30"W	TKG43030LS	☒	\$ 563	\$ 584	\$ 604
36"W	TKG43036LS	☒	\$ 605	\$ 628	\$ 649
42"W	TKG43042LS	☒	\$ 661	\$ 686	\$ 709
48"W	TKG43048LS	☒	\$ 714	\$ 740	\$ 766
60"W	TKG43060LS	☒	\$ 819	\$ 849	\$ 878

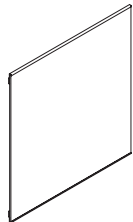

42½"H Monolithic Laminate Tiles (Tile is 37½"H, for use with 42½"H Frames) (<i>De-emphasized</i>)					
24"W	TKG44224LS	☒	\$ 595	\$ 617	\$ 638
30"W	TKG44230LS	☒	\$ 648	\$ 672	\$ 695
36"W	TKG44236LS	☒	\$ 675	\$ 700	\$ 724
42"W	TKG44242LS	☒	\$ 772	\$ 801	\$ 828
48"W	TKG44248LS	☒	\$ 830	\$ 861	\$ 890
60"W	TKG44260LS	☒	\$ 960	\$ 995	\$ 1030

TERRACE

<p>How to specify — Select the Terrace Model Number from above.</p>	<p>1st Option: Laminate Tiles Laminate Color (if applicable): See page 20 for laminates.</p>	<p>1st Option: Hard Surface Tiles Low-Pressure Laminate Color (if applicable): TM33 Whitestone WAA3 Black</p>	<p>2nd Option: Paint: P1 P2 P3 See page 20 for finishes.</p>
<p>T K 4 .</p>	<p> .</p>	<p> .</p>	<p>P .</p>

Example: TKG41524LS.LM13.P7D

☒ Shippable by small-package carrier.

Tiles

Terrace® — Laminate Tiles

For specification information see pages 31-37.

GSA SIN 33721

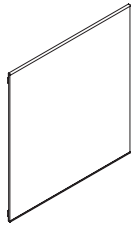
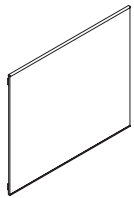
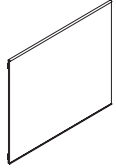
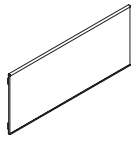

Description	Model	L1 List Price	L2 List Price	L3 List Price
42½"H Laminate Tile				
24"W	TKG43724LM	\$ 595	\$ 625	\$ 655
30"W	TKG43730LM	\$ 648	\$ 680	\$ 713
36"W	TKG43736LM	\$ 675	\$ 709	\$ 743
42"W	TKG43742LM	\$ 772	\$ 811	\$ 848
48"W	TKG43748LM	\$ 830	\$ 873	\$ 913
60"W	TKG43760LM	\$ 960	\$ 1008	\$ 1056
50"H Laminate Tile				
24"W	TKG44524LM	\$ 660	\$ 693	\$ 726
30"W	TKG44530LM	\$ 719	\$ 755	\$ 791
36"W	TKG44536LM	\$ 749	\$ 786	\$ 824
42"W	TKG44542LM	\$ 857	\$ 900	\$ 943
48"W	TKG44548LM	\$ 921	\$ 967	\$ 1013
60"W	TKG44560LM	\$ 1066	\$ 1119	\$ 1173
57½"H Laminate Tile				
24"W	TKG45724LM	\$ 726	\$ 762	\$ 799
30"W	TKG45730LM	\$ 791	\$ 831	\$ 870
36"W	TKG45736LM	\$ 824	\$ 865	\$ 906
42"W	TKG45742LM	\$ 943	\$ 990	\$ 1056
48"W	TKG45748LM	\$ 1013	\$ 1064	\$ 1114
65"H Laminate Tiles				
24"W	TKG46024LM	\$ 740	\$ 737	\$ 814
30"W	TKG46030LM	\$ 806	\$ 846	\$ 887
36"W	TKG46036LM	\$ 839	\$ 881	\$ 923
42"W	TKG46042LM	\$ 960	\$ 1008	\$ 1056
48"W	TKG46048LM	\$ 1032	\$ 1084	\$ 1135

TERRACE

<p>How to specify — Select the Terrace Model Number from above.</p>	<p>1st Option: FSC Wood (if applicable): F FSC Wood X Non-FSC Wood</p>	<p>2nd Option: Laminate: See page 20 for finishes.</p>	<p>3rd Option: Edge Color: See page 20 for finishes.</p>	<p>4th Option: Grain Direction: VLG Horizontal or Solid Grain VST Vertical Grain</p>
<p>TKG4 .</p>	<p> .</p>	<p> .</p>	<p> .</p>	<p> .</p>

Example: TKG43724LM.F.TM133.E4.VLG

Shippable by small-package carrier.

For specification information see pages 31-37.

GSA SIN 33721

Description	Model	L1 List Price	L2 List Price	L3 List Price
22½"H Laminate To-The-Floor Tile				
24"W	TKG42224LTF	\$ 538	\$ 562	\$ 587
30"W	TKG42230LTF	\$ 562	\$ 587	\$ 613
36"W	TKG42236LTF	\$ 628	\$ 657	\$ 686
42"W	TKG42242LTF	\$ 673	\$ 704	\$ 735
48"W	TKG42248LTF	\$ 728	\$ 762	\$ 796
60"W	TKG42260LTF	\$ 848	\$ 888	\$ 928
25"H Laminate To-The-Floor Tile				
24"W	TKG42524LTF	\$ 571	\$ 597	\$ 623
30"W	TKG42530LTF	\$ 601	\$ 628	\$ 656
36"W	TKG42536LTF	\$ 641	\$ 670	\$ 700
42"W	TKG42542LTF	\$ 696	\$ 728	\$ 760
48"W	TKG42548LTF	\$ 749	\$ 784	\$ 819
60"W	TKG42560LTF	\$ 856	\$ 896	\$ 936
30"H Laminate To-The-Floor Tile				
24"W	TKG43024LTF	\$ 640	\$ 669	\$ 699
30"W	TKG43030LTF	\$ 692	\$ 724	\$ 756
36"W	TKG43036LTF	\$ 750	\$ 785	\$ 820
42"W	TKG43042LTF	\$ 813	\$ 851	\$ 889
48"W	TKG43048LTF	\$ 881	\$ 922	\$ 964
60"W	TKG43060LTF	\$ 991	\$ 1038	\$ 1085
37½"H Laminate Tile To-The-Floor Tile				
24"W	TKG43724LTF	\$ 705	\$ 738	\$ 770
30"W	TKG43730LTF	\$ 762	\$ 797	\$ 833
36"W	TKG43736LTF	\$ 827	\$ 866	\$ 904
42"W	TKG43742LTF	\$ 897	\$ 939	\$ 981
48"W	TKG43748LTF	\$ 972	\$ 1018	\$ 1064
60"W	TKG43760LTF	\$ 1094	\$ 1146	\$ 1198
45"H Laminate Tile To-The-Floor Tile				
24"W	TKG44524LTF	\$ 763	\$ 799	\$ 834
30"W	TKG44530LTF	\$ 826	\$ 865	\$ 903
36"W	TKG44536LTF	\$ 896	\$ 938	\$ 980
42"W	TKG44542LTF	\$ 973	\$ 1019	\$ 1065
48"W	TKG44548LTF	\$ 1055	\$ 1105	\$ 1155
60"W	TKG44560LTF	\$ 1188	\$ 1245	\$ 1301
57½"H Laminate Tile To-The-Floor Tile				
24"W	TKG45724LTF	\$ 848	\$ 888	\$ 928
30"W	TKG45730LTF	\$ 919	\$ 962	\$ 1006
36"W	TKG45736LTF	\$ 997	\$ 1044	\$ 1091
42"W	TKG45742LTF	\$ 1083	\$ 1134	\$ 1186
48"W	TKG45748LTF	\$ 1175	\$ 1231	\$ 1287
60"H Laminate Tile To-The-Floor Tile				
24"W	TKG46024LTF	\$ 944	\$ 989	\$ 1033
30"W	TKG46030LTF	\$ 1023	\$ 1071	\$ 1120
36"W	TKG46036LTF	\$ 1111	\$ 1164	\$ 1217
42"W	TKG46042LTF	\$ 1206	\$ 1264	\$ 1321
48"W	TKG46048LTF	\$ 1310	\$ 1373	\$ 1436

<p>How to specify —</p> <p>Select the Terrace Model Number from above.</p>	<p><i>1st Option:</i></p> <p>FSC Wood (if applicable):</p> <p>F FSC Wood X Non-FSC Wood</p>	<p><i>2nd Option:</i></p> <p>Laminate:</p> <p>See page 20 for finishes.</p>	<p><i>3rd Option:</i></p> <p>Edge Color:</p> <p>See page 20 for finishes.</p>	<p><i>4th Option:</i></p> <p>Grain Direction:</p> <p>VLG Horizontal or Solid Grain VST Vertical Grain</p>
	<p>TKG4 .</p>	<p> .</p>	<p> .</p>	<p> .</p>

Example: **TKG42224LTF.F.TM133.E4.VLG**

☐ Shippable by small-package carrier.

For specification information see pages 31-37.

GSA SIN 33721



Description	Model	L1 List Price	L2 List Price	L3 List Price
25"H Laminate Spanning Tile To-The-Floor				
54"W	TKG42554SLSTF	\$ 948	\$ 995	\$ 1043
60"W	TKG42560SLSTF	\$ 973	\$ 1022	\$ 1070
66"W	TKG42566SLSTF	\$ 1006	\$ 1056	\$ 1107
72"W	TKG42572SLSTF	\$ 1078	\$ 1132	\$ 1186
78"W	TKG42578SLSTF	\$ 1139	\$ 1196	\$ 1253
84"W	TKG42584SLSTF	\$ 1192	\$ 1252	\$ 1311
90"W	TKG42590SLSTF	\$ 1246	\$ 1308	\$ 1371
96"W	TKG42596SLSTF	\$ 1326	\$ 1392	\$ 1459

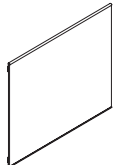

30"H Laminate Spanning Tile To-The-Floor				
54"W	TKG43054SLSTF	\$ 979	\$ 1028	\$ 1077
60"W	TKG43060SLSTF	\$ 1072	\$ 1126	\$ 1179
66"W	TKG43066SLSTF	\$ 1116	\$ 1172	\$ 1228
72"W	TKG43072SLSTF	\$ 1179	\$ 1238	\$ 1297
78"W	TKG43078SLSTF	\$ 1194	\$ 1254	\$ 1313
84"W	TKG43084SLSTF	\$ 1325	\$ 1391	\$ 1458
90"W	TKG43090SLSTF	\$ 1395	\$ 1465	\$ 1535
96"W	TKG43096SLSTF	\$ 1453	\$ 1526	\$ 1598

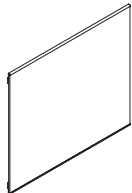

42"H Laminate Spanning Tile To-The-Floor				
54"W	TKG44254SLSTF	\$ 1254	\$ 1317	\$ 1379
60"W	TKG44260SLSTF	\$ 1338	\$ 1405	\$ 1472
66"W	TKG44266SLSTF	\$ 1401	\$ 1471	\$ 1541
72"W	TKG44272SLSTF	\$ 1441	\$ 1513	\$ 1585
78"W	TKG44278SLSTF	\$ 1473	\$ 1547	\$ 1620
84"W	TKG44284SLSTF	\$ 1531	\$ 1608	\$ 1684
90"W	TKG44290SLSTF	\$ 1568	\$ 1646	\$ 1725
96"W	TKG44296SLSTF	\$ 1595	\$ 1675	\$ 1755

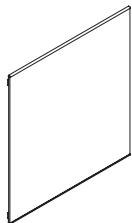

50"H Laminate Spanning Tile To-The-Floor				
54"W	TKG45054SLSTF	\$ 1609	\$ 1689	\$ 1770
60"W	TKG45060SLSTF	\$ 1624	\$ 1705	\$ 1786
66"W	TKG45066SLSTF	\$ 1641	\$ 1723	\$ 1805
72"W	TKG45072SLSTF	\$ 1676	\$ 1760	\$ 1844
78"W	TKG45078SLSTF	\$ 1848	\$ 1940	\$ 2033
84"W	TKG45084SLSTF	\$ 1874	\$ 1968	\$ 2061
90"W	TKG45090SLSTF	\$ 1915	\$ 2011	\$ 2107
96"W	TKG45096SLSTF	\$ 1950	\$ 2048	\$ 2145

Description	Model	List Price
Spanning Tile Bracket Kits		
	Z4STBRKT1	\$ 225
	Z4STBRKT2	\$ 225

<p>How to specify — Select the Terrace Model Number from above.</p> <p>TKG4 . .</p>	<p>1st Option: FSC Wood (if applicable):</p> <p>F FSC Wood X Non-FSC Wood</p>	<p>2nd Option: Laminate: See page 20 for finishes.</p>	<p>3rd Option: Edge Color: See page 20 for finishes.</p>
---	---	--	--

Example: TKG42554SLSTF.F.TM133.E4

Shippable by small-package carrier.

For specification information see pages 31-37.

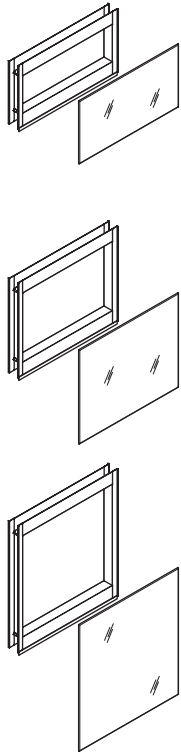

Description	Model	Clear P1 List Price	Clear P2 List Price	Clear P3 List Price	Frosted P1 List Price	Frosted P2 List Price	Frosted P3 List Price
15"H Glass Tiles							
24"W	TK41524GK S	\$ 676	\$ 699	\$ 723	\$ 784	\$ 807	\$ 831
30"W	TK41530GK S	\$ 717	\$ 742	\$ 767	\$ 839	\$ 864	\$ 889
36"W	TK41536GK S	\$ 759	\$ 785	\$ 812	\$ 897	\$ 923	\$ 950
42"W	TK41542GK S	\$ 812	\$ 840	\$ 869	\$ 963	\$ 991	\$ 1020
48"W	TK41548GK S	\$ 873	\$ 903	\$ 934	\$ 1039	\$ 1069	\$ 1100
60"W	TK41560GK S	\$ 1038	\$ 1074	\$ 1111	\$ 1216	\$ 1252	\$ 1289
22½"H Glass Tiles							
24"W	TK42224GK S	\$ 791	\$ 818	\$ 846	N/A	N/A	N/A
30"W	TK42230GK S	\$ 830	\$ 859	\$ 888	N/A	N/A	N/A
36"W	TK42236GK S	\$ 875	\$ 905	\$ 936	N/A	N/A	N/A
42"W	TK42242GK S	\$ 927	\$ 959	\$ 992	N/A	N/A	N/A
48"W	TK42248GK S	\$ 986	\$ 1020	\$ 1055	N/A	N/A	N/A
60"W	TK42260GK S	\$ 1155	\$ 1195	\$ 1236	N/A	N/A	N/A
30"H Glass Tiles							
24"W	TK43024GK S	\$ 906	\$ 938	\$ 970	N/A	N/A	N/A
30"W	TK43030GK S	\$ 965	\$ 999	\$ 1033	N/A	N/A	N/A
36"W	TK43036GK S	\$ 1027	\$ 1063	\$ 1099	N/A	N/A	N/A
42"W	TK43042GK S	\$ 1113	\$ 1152	\$ 1191	N/A	N/A	N/A
48"W	TK43048GK S	\$ 1195	\$ 1237	\$ 1279	N/A	N/A	N/A
60"W	TK43060GK S	\$ 1401	\$ 1450	\$ 1499	N/A	N/A	N/A

<p>How to specify — Select the Terrace Model Number from above.</p>	<p>1st Option: Paint: P1 P2 P3</p>	<p>2nd Option: Glass (if applicable): C Clear F Frosted (only available on 15"H tiles)</p>
<p>TK4 . P </p>	<p style="text-align: center;">Example: TK41524GK.P27.C</p>	

S Shippable by small-package carrier.

For specification information see pages 31-37.

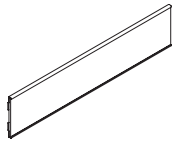

Description	Model	List Price
7 1/2"H Marker Board Tiles		
24" W	TKG40724MS	\$ 306
30" W	TKG40730MS	\$ 327
36" W	TKG40736MS	\$ 344
42" W	TKG40742MS	\$ 363
48" W	TKG40748MS	\$ 373
60" W	TKG40760MS	\$ 398

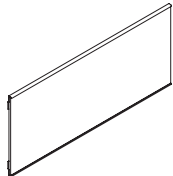

15"H Marker Board Tiles		
24" W	TKG41524MS	\$ 329
30" W	TKG41530MS	\$ 352
36" W	TKG41536MS	\$ 370
42" W	TKG41542MS	\$ 389
48" W	TKG41548MS	\$ 398
60" W	TKG41560MS	\$ 420

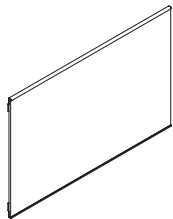

22 1/2"H Marker Board Tiles		
24" W	TKG42224MS	\$ 364
30" W	TKG42230MS	\$ 389
36" W	TKG42236MS	\$ 433
42" W	TKG42242MS	\$ 462
48" W	TKG42248MS	\$ 507
60" W	TKG42260MS	\$ 566

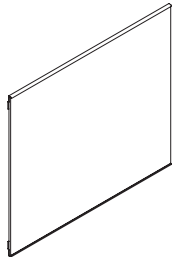

30"H Marker Board Tiles (Tile is 30"H, for use with 35"H Frames)		
24" W	TKG43024MS	\$ 372
30" W	TKG43030MS	\$ 396
36" W	TKG43036MS	\$ 441
42" W	TKG43042MS	\$ 470
48" W	TKG43048MS	\$ 520
60" W	TKG43060MS	\$ 577



15"W Marker Board Tray — Natural Aluminum		
Magnetic Marker Board Tray	TK4TRAYMS	\$ 87

How to specify —

Select the
Terrace
Model Number
from above.

T	K																	.
---	---	--	--	--	--	--	--	--	--	--	--	--	--	--	--	--	--	---

Examples: TKG41520MS TK4TRAYMS

Shippable by small-package carrier.

For specification information see pages 31-37.

GSA SIN 33721

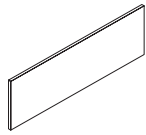

Description	Model	Old Model Number For Reference	P1 Grade 2 List Price	P2 Grade 2 List Price	P3 Grade 2 List Price
7½"H Landscape Tiles (Tile comes assembled)					
24"W	TKG40724L □ □ S	TK40724 □ □	\$ 571	\$ 591	\$ 611
30"W	TKG40730L □ □ S	TK40730 □ □	\$ 650	\$ 672	\$ 695
36"W	TKG40736L □ □ S	TK40736 □ □	\$ 767	\$ 793	\$ 820
42"W	TKG40742L □ □ S	TK40742 □ □	\$ 870	\$ 900	\$ 931
48"W	TKG40748L □ □ S	TK40748 □ □	\$ 976	\$ 1010	\$ 1044
60"W	TKG40760L □ □ S	TK40760 □ □	\$ 1141	\$ 1180	\$ 1220

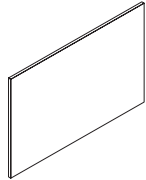

15"H Landscape Tiles (Tile comes assembled)					
24"W	TKG41524L □ □ S	TK41524 □ □	\$ 579	\$ 599	\$ 619
30"W	TKG41530L □ □ S	TK41530 □ □	\$ 665	\$ 688	\$ 711
36"W	TKG41536L □ □ S	TK41536 □ □	\$ 777	\$ 804	\$ 831
42"W	TKG41542L □ □ S	TK41542 □ □	\$ 883	\$ 913	\$ 944
48"W	TKG41548L □ □ S	TK41548 □ □	\$ 985	\$ 1019	\$ 1054
60"W	TKG41560L □ □ S	TK41560 □ □	\$ 1186	\$ 1227	\$ 1268

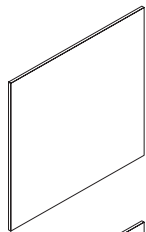

22½"H Landscape Tiles (Tile comes assembled)					
24"W	TKG42224L □ □ S	TK42224 □ □	\$ 970	\$ 1003	\$ 1037
30"W	TKG42230L □ □ S	TK42230 □ □	\$ 1034	\$ 1070	\$ 1106
36"W	TKG42236L □ □ S	TK42236 □ □	\$ 1269	\$ 1313	\$ 1357
42"W	TKG42242L □ □ S	TK42242 □ □	\$ 1495	\$ 1547	\$ 1599
48"W	TKG42248L □ □ S	TK42248 □ □	\$ 1681	\$ 1739	\$ 1798
60"W	TKG42260L □ □ S	TK42260 □ □	\$ 2271	\$ 2350	\$ 2429

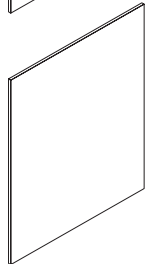

30"H Landscape Tiles (Tile comes assembled) (Tile is 30"H, for use with 35"H Frames)					
24"W	TKG43024L □ □ S	TK43024 □ □	\$ 993	\$ 1027	\$ 1062
30"W	TKG43030L □ □ S	TK43030 □ □	\$ 1056	\$ 1092	\$ 1129
36"W	TKG43036L □ □ S	TK43036 □ □	\$ 1284	\$ 1328	\$ 1373
42"W	TKG43042L □ □ S	TK43042 □ □	\$ 1507	\$ 1559	\$ 1612
48"W	TKG43048L □ □ S	TK43048 □ □	\$ 1683	\$ 1741	\$ 1800
60"W	TKG43060L □ □ S	TK43060 □ □	\$ 2282	\$ 2361	\$ 2441

TERRACE

<p>How to specify — Select the Terrace Model Number from above.</p>	<p>1st Option: Landscape Option: Grade 2 Foundation™ FD</p>	<p>2nd Option: Landscape Material and Finish: FD01 Sand FD02 Taupe FD04 Pure White</p>	<p>3rd Option: Paint Color: P1 P2 P3 See page 20 for finishes.</p>
<div style="display: flex; justify-content: space-between; width: 100%;"> F D . </div>	<div style="display: flex; justify-content: space-between; width: 100%;"> F D 0 . </div>	<div style="display: flex; justify-content: space-between; width: 100%;"> P </div>	





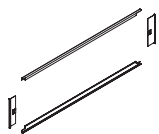

Example: TKG43042LFD.FD04.P27

S Shippable by small-package carrier.





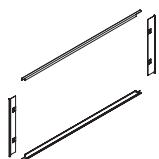

For specification information see pages 31-37.

GSA SIN 33721







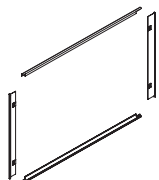

Description	Model	P1 Paint List Price
7½"H Custom Tile Bracket Kits		
24"W	TK40724CTK 	\$ 78
30"W	TK40730CTK 	\$ 80
36"W	TK40736CTK 	\$ 89
42"W	TK40742CTK 	\$ 92
48"W	TK40748CTK 	\$ 98
60"W	TK40760CTK 	\$ 110







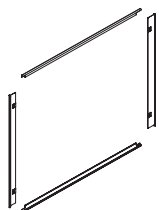

15"H Custom Tile Bracket Kits		
24"W	TK41524CTK 	\$ 81
30"W	TK41530CTK 	\$ 90
36"W	TK41536CTK 	\$ 93
42"W	TK41542CTK 	\$ 98
48"W	TK41548CTK 	\$ 103
60"W	TK41560CTK 	\$ 115



22½"H Custom Tile Bracket Kits		
24"W	TK42224CTK 	\$ 87
30"W	TK42230CTK 	\$ 91
36"W	TK42236CTK 	\$ 98
42"W	TK42242CTK 	\$ 102
48"W	TK42248CTK 	\$ 106
60"W	TK42260CTK 	\$ 122



30"H Custom Tile Bracket Kits (Tile is 30"H, for use with 35"H Frames)		
24"W	TK43024CTK 	\$ 98
30"W	TK43030CTK 	\$ 102
36"W	TK43036CTK 	\$ 105
42"W	TK43042CTK 	\$ 111
48"W	TK43048CTK 	\$ 115
60"W	TK43060CTK 	\$ 127

TERRACE

How to specify —

Select the Terrace Model Number from above.

1st Option:

Frame
Paint Color:

See page 20 for finishes.

T | K | 4 | | | | | | | | | . | P | | | |

Example: TK40724CTK.P4J

 Shippable by small-package carrier.



For specification information see pages 31-37.

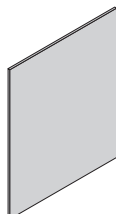
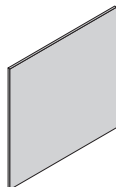
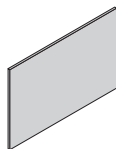

GSA SIN 33721



Description	Model	V1 List Price
15"H Veneer Tiles		
30"W	TK41530V 	\$ 494
48"W	TK41548V 	\$ 713

22½"H Veneer Tiles		
48"W	TK42248V 	\$ 970

30"H Monolithic Veneer Tiles (Tile is 30"H, for use with 35"H Frames)		
30"W	TK43030V 	\$ 741
36"W	TK43036V 	\$ 834
48"W	TK43048V 	\$ 976

42½"H Monolithic Veneer Tiles (Tile is 37½"H, for use with 42½"H Frames)		
30"W	TK44230V 	\$ 1026
42"W	TK44242V 	\$ 1241
48"W	TK44248V 	\$ 1408

<p>How to specify — Select the Terrace Model Number from above.</p>	<p><i>1st Option:</i> Veneer Type and Finish: See page 20 for finishes. S prefix for Stratawood</p>
--	---

T | K | 4 | | | | | | | | V | . | | | | | | | |

Example: TK43036V.SC777

 Shippable by small-package carrier.

GSA Reference Page

Terrace features capabilities for cable management, including electrical, voice, and data. The 8-wire electrical system can be integrated at base pathway and beltline. The open structure of the frame allows voice and data cables to be routed both vertically and horizontally.

Ceiling infeed connects to building electrical supply. Ceiling infeed can also be used at the bottom to feed up into footed panels where exposed flex conduit is permitted by codes. This infeed can be prewired before panels are installed. A877006 and A877012 infeeds must be installed in panel before connecting to building wiring.

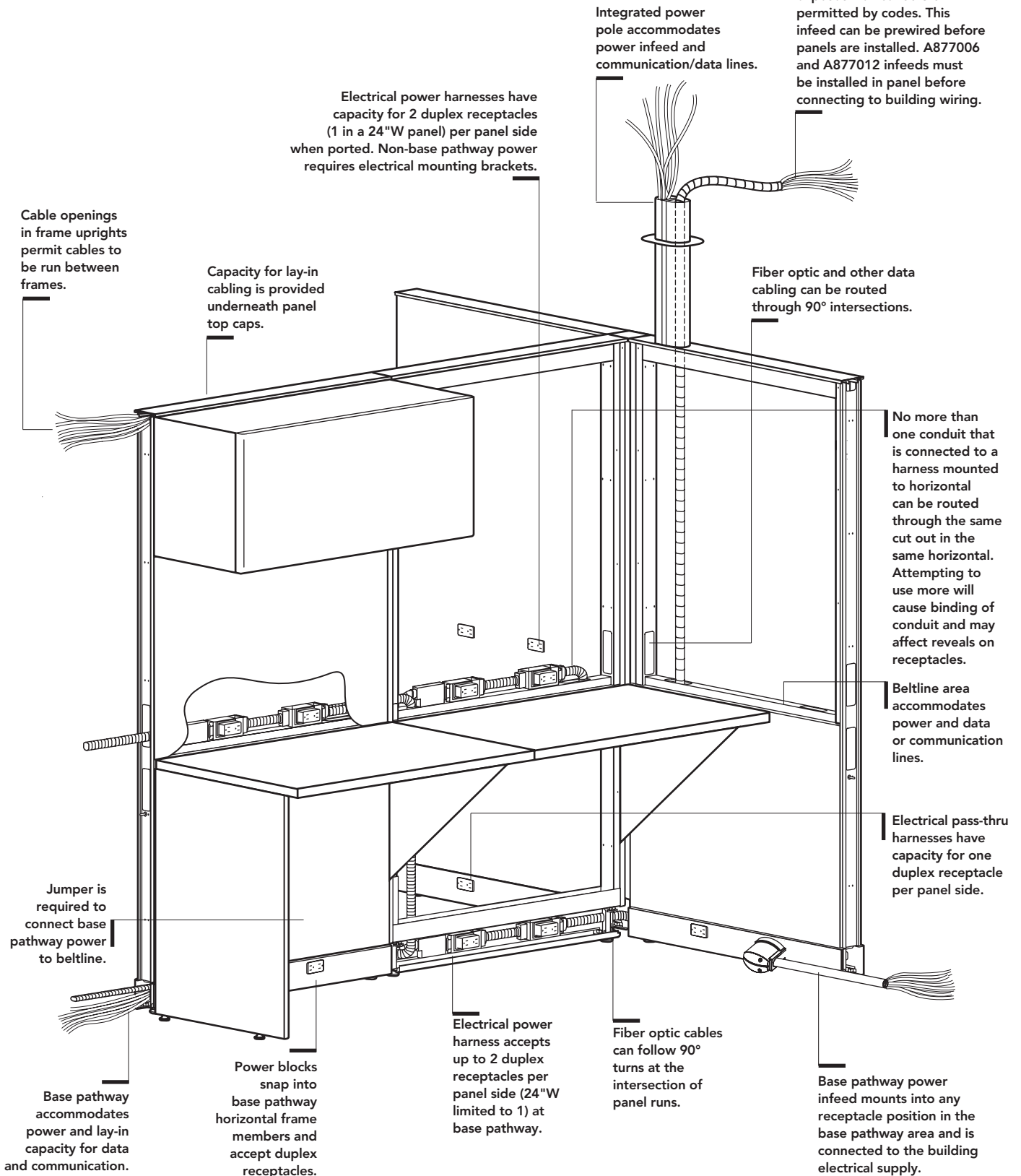

TERRACE

Electrical Systems

Terrace offers a choice of four electrical systems:

- Four-circuit, 3 + 1
- Four-circuit, 2 + 2
- Three-circuit, separate neutrals
- Eight circuits; two four-circuit systems provided back-to-back.
- See pages 68-69 for a detailed explanation of each electrical system.
- All four systems utilize an 8-wire electrical system, rated at 20 amps per circuit (15 amps Canadian) - 16 amps plannable in U.S.
- Terrace panels and electrical components are UL Listed. Electrical components are also CSA certified.
- Installation and use of the electrical system, the number of receptacles used on a given circuit and connections to the building power supply should be in compliance with all local and national electrical codes.
- Use of a 35"H frame in a panel run will block beltline and above power distribution.

Caution: Electrical equipment cords or extension cords MUST NOT BE ROUTED through cable openings in frame sides.

Note: No more than one conduit that is connected to a harness mounted to horizontal can be routed through the same cut out in the same horizontal at beltline. Attempting to use more will cause binding of conduit and may affect reveals on receptacles.

Hardwire New York Code (page 78)

- Hardwire (New York Code) junction box (model A871400) is used when local electrical codes require hardwire entry.
- For use in panels 30"W to 60"W.
- When used in 30"W and 36"W panels, power can be routed only in one direction.
- When used in 42"W, 48"W, and 60"W panels, an electrical pass-thru cable or harness for that panel width can be used to route power back in the opposite direction.
- Unit must connect to a power or pass-thru harness positioned in the base pathway area of an adjacent panel.
- Customer to furnish all cabling and wiring from power entry to power source.
- Junction box can be positioned at any duplex receptacle location.

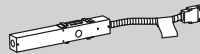

Hardwire Chicago Code (page 79)

- Wiring harnesses and snap connectors are not allowed in Chicago — base pathways must be comprised of all-metallic components.
- The base pathway, junction box (model 873600) clips directly into receptacle locations and can be used both single- and double-sided.
- In the beltline location, junction box (model 873550) can only be used single-sided.
- Base pathway model has a larger volume capacity for wiring to allow for dual-sided applications.
- Customer must furnish conduit, wiring, and designer-type receptacles for the base pathway and conduit, wiring, designer-type receptacles, and receptacle covers for the beltline.
- Tiles at the beltline must be field ported.
- Power entry can be routed from the ceiling, via a Terrace power pole, or from the floor into a junction box (beltline model 873550; or base pathway model 873600).

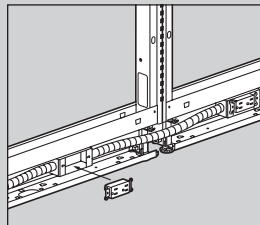

Electrical Infeeds

- Power infeed cables deliver power from building to panel's electrical system.
- Infeed cables are housed in conduit to separate electrical system from communications and data lines.
- Select quantity of base or ceiling infeed cables depending on individual power requirements.

Base Infeed (page 78)

- Sealtight base pathway power infeed mounts into any receptacle position in the base pathway area.
- A heavy rubber sheathing shields conduit, allowing infeed to be exposed.
- A jumper is required to connect base pathway power to beltline.

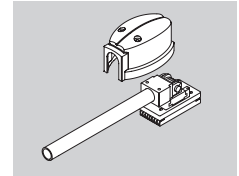

Sealtight Electrical Infeed (page 78)

- Sealtight electrical infeed cable is used with footed panels.
- Should not be ordered prior to installation to have pre-wired as infeed must be routed from inside of panel out to be connected to power.
- Cannot be connected to power harness in panel frame that infeed is brought into unless additional pass-thru harness without power block is used to feed from below beltline to above beltline.

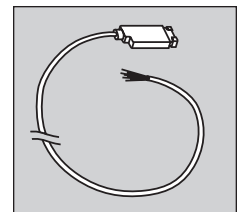

Ceiling Power Infeed (page 78)

- Ceiling power infeed connects to a prewired electrical harness in the beltline or base pathway, traverses through an adjacent panel and terminates in the junction box at the top of the integrated power pole.
- Use models A870535 or A870565 with integrated power pole.
- Can also be used as infeed for footed panels.
- Most codes allow flex conduit to be exposed after installation. Verify code requirements before ordering for exposed application.

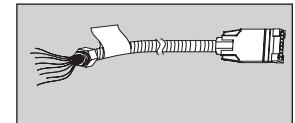

Integrated Power Pole (page 78)

- Integrated power and communications poles provide capacity for routing power supply directly through the top of any structural or stacking frame using same width trim/connector kit in place of top cap.
- Avoid glass or translucent tiles in upper position of frames with integrated power poles.
- Power pole has a cavity on each side of a center septum.
- When using a ceiling power infeed, consider that the infeed must connect into an electrical harness located in an adjacent panel. (See pages 74-75 for cable capacity.)

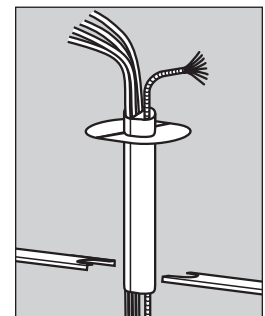

To Order:

- Determine which electrical system you will use after consulting your electrician and computer support personnel:
 - The Four-circuit system (4-Hot/2-Neutral/2-Ground)
 - 3 + 1 option
 - 2 + 2 option
 - The three-circuit system (3-Hot/3-Neutral/2-Ground)
 - The eight-circuit system (back-to-back four-circuit systems)
- Determine location, quantity, and circuit of duplexes.
- Determine the appropriate choice and use of isolated, isolated/dedicated, and separate neutrals circuits.
- Specify appropriate power harnesses* and pass-thru cables.*
- Determine the location, quantity, and type of power infeed needed.

* Select power harness models (A8712XX), pass-thru cables (A8710XX), and pass-thru harness (A8711XX) with the last two digits corresponding with the panel width into which the component is to be positioned. The initial cable length can be stretched approximately 3" to transverse "T", "X", "L", and extended straight connectors.

Flexconnect™ Electrical System Options

The four-circuit, eight-wire electrical system is widely specified and trusted by hundreds of thousands of end-users. This proven system delivers four circuits for every power infeed in either a 3 + 1 or 2 + 2 configuration. The isolated/dedicated circuits are ideal for sensitive computing equipment, while the common circuits are suitable for faxes, copiers, task lights and other peripherals. Both the 3 + 1 and 2 + 2 systems use the same pre-wired components, making it easy to adjust as electrical needs change.

You can also choose a three-circuit, eight-wire system that has a dedicated neutral for every hot circuit. The three-circuit components have model numbers with an "A" suffix and appear in a gray box in this pricer.

All three systems utilize an eight-wire electrical system rated at 20 amps per circuit (15 amps Canadian). Concensys panels and electrical components are UL listed and CSA certified.

Reference the Office Equipment Typical Load Values matrix on page 76.

Four-circuit, 3 + 1 Receptacle Option

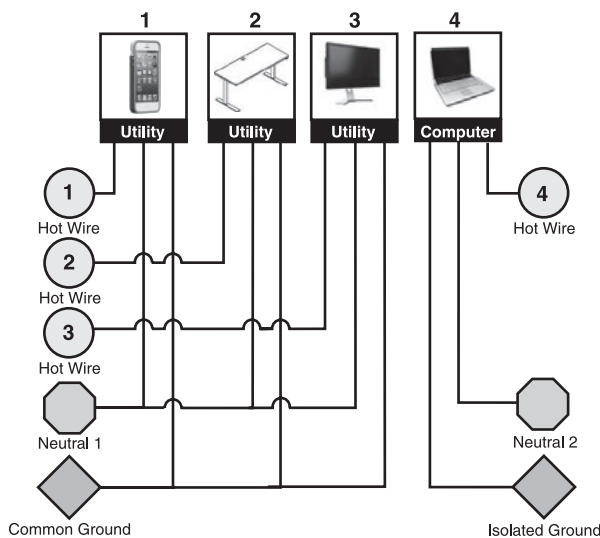

The 3 + 1 option is the electrical standard used on Allsteel systems for many years in most installations. This wiring option provides three utility circuits plus an isolated/dedicated circuit for more sensitive equipment. Circuit 2 (one of the 3 common circuits sharing a neutral wire) cannot be used with single-phase building electrical supply.

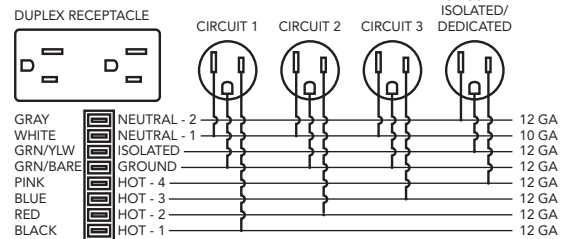

Four-circuit, 2 + 2 Receptacle Option

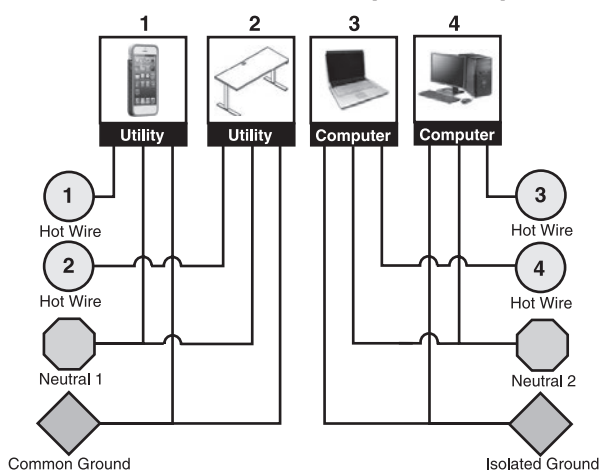

The 2 + 2 option is a wiring option that provides two utility circuits and two isolated circuits for more extensive computer usage applications.

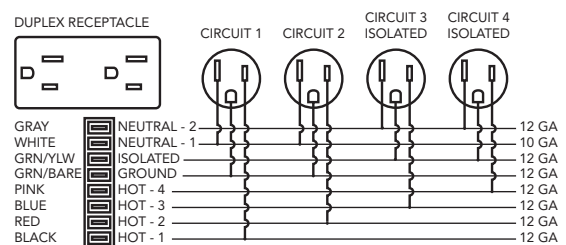

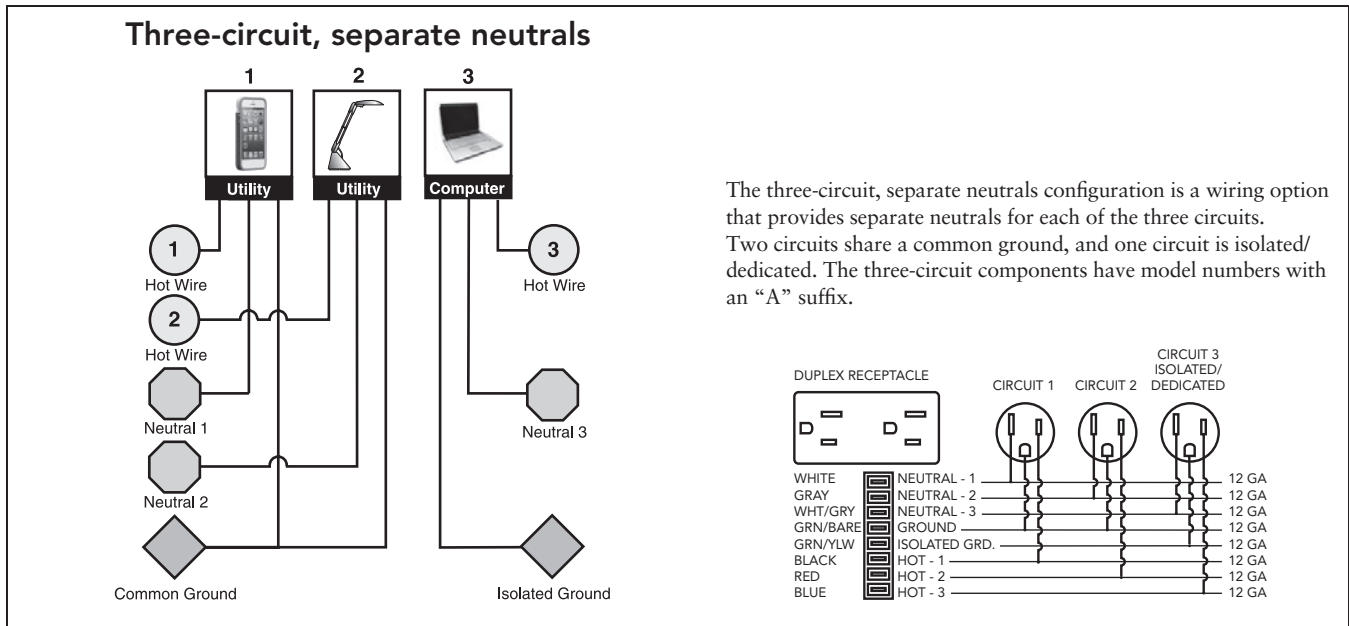

Terrace System Receptacle Usage					
Two 8-wire, 20 amp (15 amp Canadian) electrical systems are offered					
Electrical System	Circuitry	Receptacle Capacity			
Four-circuit 4-Hot/2-Neutral/2-Ground	3 + 1	Common Circuit-1 A873501	Common Circuit-2 ⁽¹⁾ A873502	Common Circuit-3 A873503	Iso/Dedicated Circuit-4 A873504
	2 + 2	Common Circuit-1 A873501	Common Circuit-2 A873502	Isolated Circuit-3 A873506	Isolated Circuit-4 A873504
Three-circuit 3-Hot/3-Neutral/2-Ground	w/separate neutrals	Common Circuit-1 A871501A	Common Circuit-2 A871502A	Iso/Dedicated Circuit-3 A871503A	N/A

(1) Circuit 2 (one of the 3 common circuits sharing a neutral wire) cannot be used with a single-phase building electrical supply.

Notes:

- Four-circuit components and three-circuit components (with suffix “A”) cannot be used together.
- Components of the two systems are keyed differently to prevent components of one system being connected to components of another system.
- Allsteel model numbers are printed on the UL labels, and components are color-coded to provide visual identification of the different components.
- Four-circuit components have black plastic parts.
- Three-circuit components have rust-colored terminal ends and receptacle backs are rust-colored.

Duplex Receptacle



15 amp receptacle

TERRACE

Power Harnesses, Pass-Thru Cables, and Jumpers

Electrical power harnesses are used to distribute power in Terrace panels. Harnesses can be mounted at base pathway or beltline. **Power blocks** on electrical power harness and pass-thru harness accept duplex receptacles.

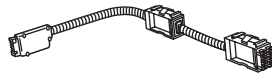

Electrical Power Harness

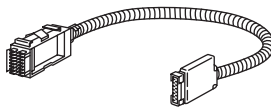

Electrical Pass-Thru Harness With Power Block

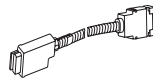

Electrical Pass-Thru Harness Without Power Block

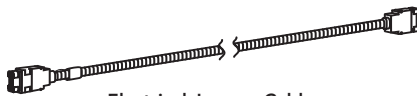

Electrical Jumper Cables

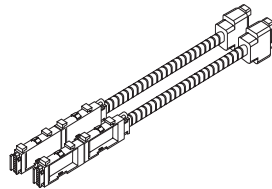

Dual Electrical Eight-circuit Power Harness Kit

All electrical power harnesses and pass-thru harnesses (except 20"W) will stretch 3½", allowing them to span "T", "X", and 120° intersections and "S" extended straight connections.

Note: "T" intersections require a minimum of one power harness and "X" intersections requires a minimum of two power harnesses.

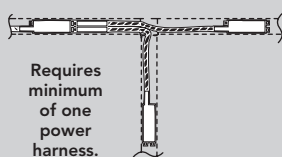

Requires minimum of one power harness.

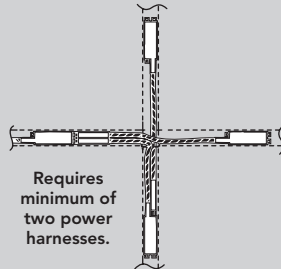

Requires minimum of two power harnesses.

Use of a ceiling infeed or jumper at this location requires an additional power harness.

Electrical Power Harnesses (page 77)

- Specify harness length to match panel width. 24" power harness accepts one receptacle on each side of the harness, all other length power harnesses have power blocks to accept four duplex receptacles (two on each side of panel).
- Connectors at both ends of power harnesses allow power distribution in either direction.
- Harness power blocks snap directly onto brackets in base pathway; harness require optional mounting brackets at beltline or other vertical locations
- Use of a ceiling infeed or jumper requires one additional harness.

Electrical Pass-thru Harnesses With Power Block (page 77)

- Specify harness length to match panel width.
- Electrical pass-thru harnesses have capacity to handle one duplex receptacle on each side of the panel.
- A 60" pass-thru harness can be used to jump up to a single duplex receptacle per side at beltline and connecting to a power harness at base pathway.
- Electrical power harnesses and pass-thru cables cannot be routed at 90° at beltline once frames are connected to connector blocks.
- Specify harness length to match panel width.

Electrical Pass-thru Harnesses Without Power Block (page 77)

- Specify harness length to match panel width.
- Electrical pass-thru cables distribute power through any panel where receptacles are not required. Cable length cannot be stretched.

Electrical Jumper Cables (page 77)

- Electrical jumper cables connect power from base pathway or beltline to a harness located on any horizontal member as needed.
- Jumper cable plugs into power block end of electrical power harness or electrical pass-thru harness.
- Model A871366 is 66" to jumper up to 30 inches vertically – base pathway to beltline, beltline to base pathway, or up to 30" above or below beltline when connected to beltline electrical.
- Model A8713108 is 108" to jumper up to 65" vertically – from baserail up to the highest 15" opening on an 80"H frame.
- Jumper can also be used from beltline to adjacent beltline at 90° juncture via baseline.

Dual Electrical Eight-circuit Power Harness Kits (page 77)

- Kit provides back-to-back four-circuit systems giving double the capacity of harness and pass-thru cables. Cannot be used at beltline with Terrace. Restricted to base pathway only.
- Requires two four-circuit infeeds. Uses four-circuit receptacles.
- Models must be positioned "back-to-back" in the panel — single-side use is not permitted.
- Components can only be routed in a single run — a single run cannot branch to multiple panel runs at "T" and "X" junctions.
- Four-circuit jumper cables (A8713xx) can only be connected to a power block at one end of a run — power cannot be routed between a run in the base pathway and beltline area, except at one end of the run.
- Standard four-circuit pass-thru cables (A8710xx) can be used in between power harnesses. Two are required in the back-to back configurations.
- Models can be connected to standard four-circuit power harnesses and pass-thrus, although it is not recommended because of possible circuit number ambiguity.
- Two power infeeds are required to connect the back-to-back runs. Power A8719xx must be connector to a power block at the end of a run.
- Data faceplates and terminals cannot be positioned in a panel into which back-to-back power harnesses are installed.
- Power infeeds A8719xx must be routed from a panel wherein no power harness is positioned, into an adjacent panel where a power harness is positioned and connected to the end of a power block.

Power Blocks

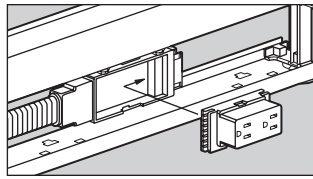

Power Block Base Pathway Mounting

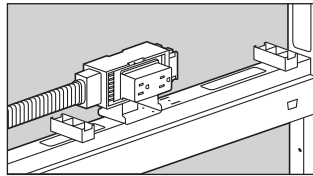

Power Block at Beltline

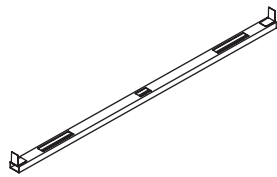

Horizontal Electrical Mount Support

Terrace offers multiple options for mounting electrical:

Base Pathway Mounting

- Power blocks snap directly onto brackets in base pathway area and accept receptacles (sold separately) on each side of harness.

Electrical Mounting Brackets (page 79)

- Package of 12. One bracket required at beltline for each pass-thru harness and 24" W power harness. Two brackets required at beltline for 30"-60" W power harnesses.
- For ported receptacles at beltline or below worksurface, mount power blocks onto electrical mounting brackets which screw into Terrace panel frame.
- Model 8989EB for use with data/electrical port tiles at beltline or directly below standard worksurface height on 42½"H-65"H panels.
- Model 8989BW for use with data/electrical port tiles directly below standard worksurface height on 35"H panels only.
- Data/electrical port tiles must be used where exposed receptacles will be located. No standard port tiles are currently available for below worksurface, either field port using kit model UTP or contact tailored products.
- To connect power between the base pathway and the beltline area, four-circuit jumper cables (A8713xx) must be connected to a power block at one end of a run, routed into an adjacent panel that contains no power harness, then routed back into the panel that contains a power harness (or pass-thru cable), and connected to a power harness in the other pathway.

Horizontal Electrical Mount Support (page 80)

- Use horizontal electrical mount support bar and electrical mounting brackets (sold separately) when mounting power blocks at a location other than beltline or base pathway.
- Specify support bar width to match panel width.
- Tiles must be field ported when electrical is mounted in a location other than just above the worksurface at beltline.
- 22½"H ported tiles can be used to mount power below the worksurface with the electrical mount support bar being field located in the panel to align with the tile's ports.
- Can be used with acoustical tiles on one or both sides of the panel frame.
- One electrical mounting bracket required for each pass-thru harness and 24" W power harness. Two electrical mounting brackets required for 30"- 60" W power harnesses.
- Gray only. Includes attaching hardware.

Receptacles

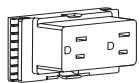

Duplex Receptacle

Receptacle Color Recommended to Coordinate with Paint Color

Paint Color	Receptacle Color
Designer White PJW	use Designer White DW
Bungalow.....	use Muslin EU
Carob (<i>De-emphasized</i>) D	use Black E4
Champagne Metallic.....	use Muslin EU
Cinder.....	use Brownstone EY
Fossil.....	use Flint E9
Gunmetal Metallic.....	use Brownstone EY
Parchment.....	use Muslin EU
Pebble	use Loft EV
Pewter.....	use Flint E9
Platinum Metallic	use Silver ES
Salt.....	use Silver ES
Titanium	use Silver ES

Duplex Receptacles (page 78)

- Duplex receptacles snap into power blocks of power harnesses or pass-through harnesses.
- Duplexes are available in multiple colors. See page 20 for finishes.
- Each receptacle is labeled to indicate which circuit it will be connected to: 1, 2, 3, or 4.
- Duplexes are model specific to support either 3+1 and 2+2 electrical infeed; or have an "A" suffix and are design to support a three-circuit separate neutral electrical infeed.

D Discontinued 12/31/2020

Cable and Wire Management

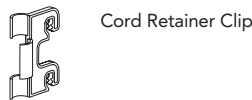
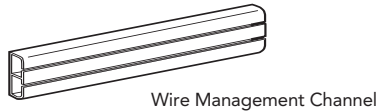
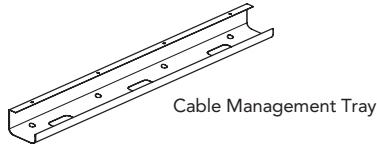

Cable Management Tray (page 79)

- Attaches under the worksurface to contain cables.
- Metal tray shelf is 4" deep. Can hold electrical power strip and/or surge protector.
- 24" and 36" lengths, use multiple units for larger worksurfaces.
- Attachment hardware included, specify paint color.

Wire Management Channel (page 79)

- Self adhesive backing to attach to panels and underside of worksurfaces.
- Flexible strips allow cabling to enter/exit and can be contained inside the 2-cavity profile.
- Each cavity provides space for a maximum of six .22" dia. cables. Total capacity = 1 sq. in.

Cord Retainer Clip (page 79)

- Provides confinement of vertical electrical/data wiring.
- 1½"H cord clips snap into vertical panel slots to contain cords.
- 4 clips are provided standard with each task light cord.
- Package of 50. Available in Black only.

Data Management Organizers (page 79)

- Cable organizers are made of rigid polymer, and hang from the horizontal cross members or in the base raceway. Can be stacked infinitely.
- Cables can be placed into the extensions of the organizers to keep cables aligned as they pass through the panel frame.
- Commercially available tie-wraps can also be used to strap cables to the organizer extensions.
- Organizers are ordered separately in packs of 20.

Universal Tile Port Kit (page 79)

- Allows field installation of additional data accessories.
- Grommet opening dimension — 1.375"H x 2.700"W.

Wireway Grommet (page 79)

- Fits into any receptacle opening.
- Used when routing wires through receptacle opening.

Lighting

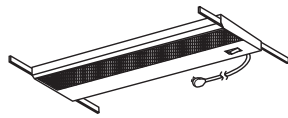

Task Lights

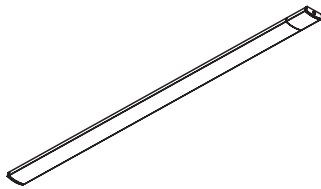

Undercabinet LED Light

Task Lights (page 400)

- Task lights can be recessed under storage cabinets or storage shelves, panel-hung, or freestanding.
- Three styles of recessed task lights in four sizes are available to correspond to cabinet or shelf width.
- All styles have 9' power cords in black, connected in the right rear corner.
- All models feature electronic ballast for longer bulb life and cooler operating temperature.
- Task lights with a fused plug to meet Chicago electrical code are also available.

Recommendation: Provide a separate circuit for task lights for proper long-term operation without RF interference to computers that may be in use.

Undercabinet LED Light (page 400)

- Undercabinet LED light can be mounted beneath overhead cabinets with wood screws or magnets.

Data

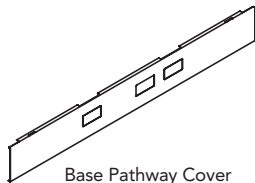

Base Pathway Cover

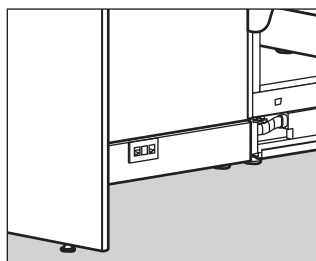

Voice/Data Receptacle

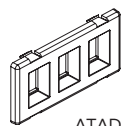

ATADF3

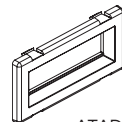

ATADF4

Terrace Base Pathway Covers (page 80)

- Features an additional knockout (offset) for improved utilization of power and data. Knockouts are 2.700" W x 1.377" H.
- Due to panel depth, back-to-back data modules should not be used at beltline or in the base on Terrace.

Data Faceplates (page 80)

- Fit into receptacle and data port openings in base raceway covers or into data port (UTP).
- Due to panel depth, data modules should not be used back-to-back at beltline or in the base on Terrace.



Cord Organizer (page 80)

- Attaches to bottom of worksurface.
- 4" W x 7/8" D, made from sheet metal.
- Top sits flush with worksurface if mounted to worksurface.
- 4 cable cut outs: 2 - .250" diameter and 2 - 0.147" diameter; .250" diameter cut outs are centered between the .147" diameter cut outs.

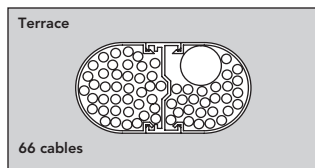
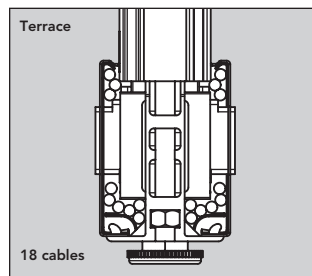
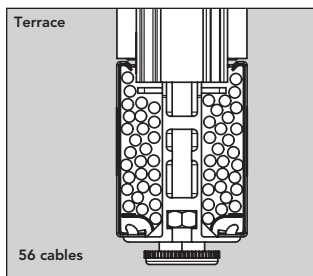
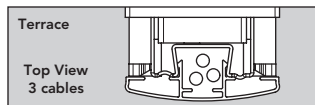
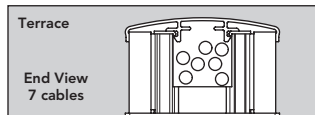
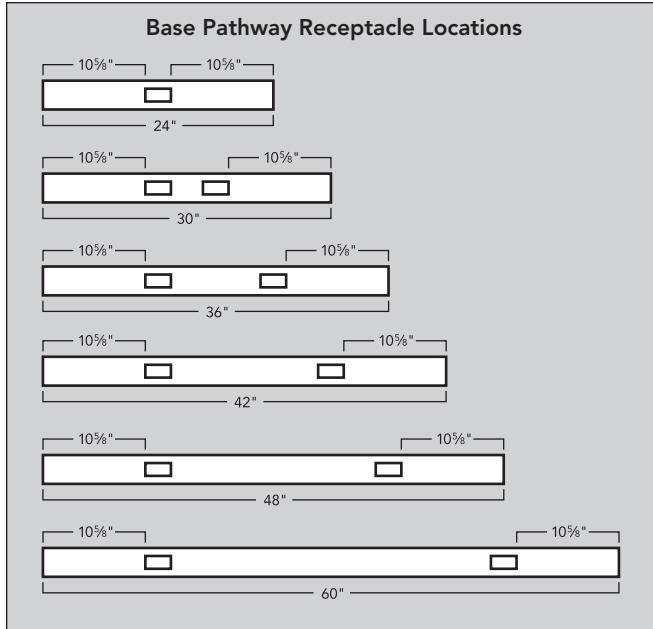

Circuit Usage

Strategy 1

Circuits to Equipment

Assign specific uses for each of the circuits:

- For example, in a four-circuit system:
Circuit 1 — Calculators, fans, etc.
Circuit 2 — Task lights (could be wired to wall switch)
Circuit 3 — CRT or flat screen monitors
Circuit 4 — CPUs

Strategy 2

Circuits to Workstations

Assign specific workstations to each of the three available circuits. Use circuit 4 for power-sensitive electronic equipment.

Placement of pedestals and lateral files may render some duplex locations inaccessible. Pedestal placement may also affect compatibility with pull-up receptacles.

Lay-in Cable Capacity

- The top and base pathway allow continuous voice and data lines to run through and between panels without interruption.
- Lay-in is provided for environments where systems furniture or cabling are subject to frequent change.
- Terrace top pathway accepts up to 7 voice/data cables (.25" dia).
- Terrace variable height junctions accept up to 3 voice/data cables (.25" dia.).
- Terrace base pathway accepts up to 56 voice/data cables (.25" dia.) (6.03 sq. in.) at 60% fill.
- When electrical system shares base pathway, the cable capacity in Terrace is reduced to 18 cables (2.25 sq. in.). Cable quantities listed are at 60% fill ratio.
- Cable capacity of the Terrace power pole, in addition to electrical infeed is 2.79 sq. in. on one side and 2.91 sq. in. on the other for a total capacity of 66 cables of .25" diameter.

TERRACE

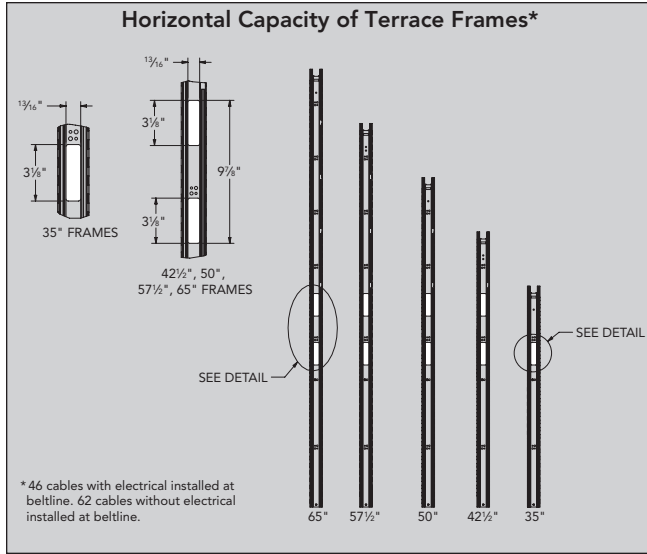

Terrace String-in Capacity

- **Openings in frame sides** permit data and communication cables to be run between frames in Terrace.
- Using tackable acoustical tiles, the beltline pathway accommodates up to 62 cables (.25" dia) or 46 cables with electrical components installed.

DO NOT run electrical equipment or extension cords through cable openings in frame sides. Use beltline or base-mounted electrical system for all electrical supply.

- **Cables can enter/exit panel** through underside of base pathway at juncture between frames.
- Openings are sized as follows (in sq. in.):

Terrace System	Sq. In.
Straight connection	6.0
"S" Extended Straight Connection	10.0
"L" 90° Connection	8.9
"T" Connection	15.9
"X" Connection	17.9
"A" Connection	—
"Y" Connection	—

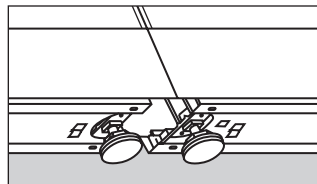

Underside of Base Pathway Juncture Between Frames

- When leveling glides are fully retracted, panel-to-floor clearance is 7/16". This may affect the volume of cabling that can be fed into the frame from the bottom of the pathway.

TERRACE

Vertical Capacity

Vertical Capacity Through Panel Frames

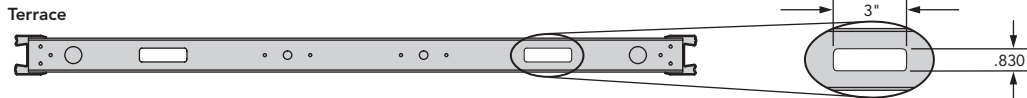

- A 60% fill ratio is achievable; however, when electrical components are installed in the beltline area, cabling capacity through the beltline area will be limited to approximately 45% fill ratio.

	Panel Width	Qty. of .25" Cables at 45% Fill Ratio	Qty. of .25" Cables at 60% Fill Ratio	Total Space (sq. in.)
Terrace	24" – 60" W	45	60	5.26

Office Equipment Typical Load Values

Item	*Amps
Desktop/2 Monitors	4
Laptop Computer	1
Laptop/2 Monitors/Docking Station	3
Paper Shredder	1.22
Radio	0.05
Scanner	3
Space Heater (1500 watts)	12
Task Light (equiv. 60-watt bulb)	
Fluorescent	0.12
LED	0.08
USB Charger	0.17
LCD Television (42")	1
LCD Monitor (21")	0.5
Bluetooth Speaker	0.1
Desktop Printer	
Inkjet	0.15
Laser	4 to 10
Multimedia Projector	1.7
Sit-to-Stand Height-Adjustable Desk	Idle 0.01 / Max 4
Office Kitchen	
Coffee Maker	10
Microwave	10
Toaster	12.5
Compact Refrigerator	1.5

*Chart is recommended for planning purposes. Check device specifications for exact amperage. Consult with your electrician regarding the applicable configurations.

Examples of Component Usage based on the *Office Equipment Typical Load Values Chart*

Power Option 3+1

Dedicated Circuit 4: 4 desktop computers with 2 monitors each; or 10 laptop computers
Utility Circuits 1, 2, 3: Height-adjustable tables and ancillary items

Power Option 2+2

Dedicated Circuit 3: 4 desktop computers with 2 monitors each; or 10 laptop computers
Dedicated Circuit 4: 4 desktop computers with 2 monitors each; or 10 laptop computers
Utility Circuits 1, 2: Height-adjustable tables and ancillary items

Power Option 3 (Circuit-separate neutrals)

Dedicated Circuit 3: 4 desktop computers with 2 monitors each; or 10 laptop computers
Utility Circuits 1, 2: Height-adjustable tables and ancillary items

For specification information see pages 66-76.

GSA SIN 33721

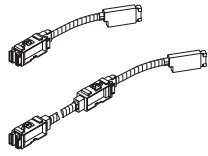

Description	Max. Recept. Cap. per Panel Side	Four-circuit 3 + 1 2 + 2	Three-circuit Separate Neutrals	List Price
Electrical Power Harnesses				
For 24" W Frames	1	A871224	A871224A S	\$ 347
For 30" W Frames	2	A871230	A871230A S	\$ 347
For 36" W Frames	2	A871236*	A871236A S	\$ 347
For 42" W Frames	2	A871242*	A871242A S	\$ 369
For 48" W Frames	2	A871248*	A871248A S	\$ 369
For 60" W Frames	2	A871260*	A871260A S	\$ 369

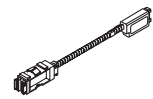

Electrical Pass-Thru Harnesses with Power Block				
For 24" W Frames	1	A871124	A871124A S	\$ 212
For 30" W Frames	1	A871130	A871130A S	\$ 212
For 36" W Frames	1	A871136*	A871136A S	\$ 212
For 42" W Frames	1	A871142*	A871142A S	\$ 226
For 48" W Frames	1	A871148*	A871148A S	\$ 226
For 60" W Frames	1	A871160*	A871160A S	\$ 226
For 72" W Frame Runs	1	A871172	A871172A S	\$ 303

Electrical harnesses are intended for use with Allsteel systems furniture and are approved under GSA SIN 33721. When purchased separately and used without Allsteel systems furniture, those electrical harnesses marked by () are considered Open Market.

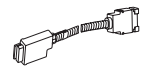

Electrical Pass-Thru Cable without Power Block				
For 24" W Frames	0	A871024	A871024A S	\$ 194
For 30" W Frames	0	A871030	A871030A S	\$ 194
For 36" W Frames	0	A871036	A871036A S	\$ 194
For 42" W Frames	0	A871042	A871042A S	\$ 203
For 48" W Frames	0	A871048	A871048A S	\$ 203
For 60" W Frames	0	A871060	A871060A S	\$ 203



Electrical Jumper Cables – Harness to Harness				
Up to 30" vertical jump (66")		A871366	A871366A S	\$ 240
Up to 65" vertical jump (108")		A8713108	A8713108A S	\$ 449

Note: Four-circuit components and Three-circuit components (with an "A" suffix) cannot be connected together.

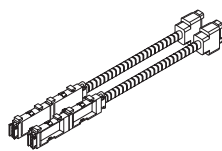

Description	Max. Recept. Cap. per Panel Side	Eight-circuit 3 + 1 (each side) 2 + 2 (each side)	List Price
Dual Electrical Eight-circuit Power Harness Kit			
For 24" W Panels	1	A2-8CIR24 S	\$ 835
For 30" W Panels	2	A2-8CIR30 S	\$ 835
For 36" W Panels	2	A2-8CIR36 S	\$ 1209
For 42" W Panels	2	A2-8CIR42 S	\$ 1209
For 48" W Panels	2	A2-8CIR48 S	\$ 1209
For 60" W Panels	2	A2-8CIR60 S	\$ 1219

Note: Kit consists of two four-circuit harnesses placed "back-to-back" to provide 8 circuits.

TERRACE

<p>How to specify — Select the Model Number from above.</p>	<p><i>1st Option:</i> Color: P Black</p> <p style="text-align: center; font-size: 2em; font-weight: bold;">P</p>
--	---

Examples: A871224.P A871224A.P A871124.P

S Shippable by small-package carrier.

For specification information see pages 66-76.

GSA SIN 33721

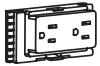

Duplex Receptacle

Description	Four-circuit 3 + 1 2 + 2	Three-circuit Separate Neutrals	List Price
Duplex Receptacles for Beltline or Base Pathway — Terrace (specify color)			
Circuit 1	A873501	A871501A [S]	\$ 63
Circuit 2	A873502	A871502A [S]	\$ 63
Circuit 3 (3+1)	A873503	A871503A [S]	\$ 63
Circuit 3 (2+2)	A873506	N/A [S]	\$ 63
Circuit 4 — iso/dedicated	A873504	N/A [S]	\$ 63
Circuit 1, 20 AMP	A871601	A871601A [S]	\$ 63

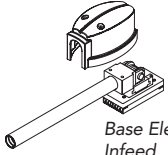

Base Electrical Infeed

Base Electrical Infeed Cable			
6' Sealtight Cable for Terrace Receptacle	A876072	A876072A [S]	\$ 390
6' Flex Cable	A871972	A871972A [S]	\$ 294



Ceiling Electrical Infeed

Ceiling Electrical Infeed Cables			
12' Flex Cable	A871912	A871912A [S]	\$ 399
18' Flex Cable	A871918	A871918A [S]	\$ 502

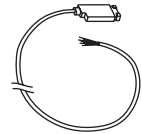

Electrical Infeed Cable

Electrical Infeed Cables (for use with footed panels)			
12' Sealtight Cable Power Infeed	A877012	N/A [S]	\$ 487

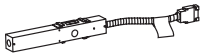

Hardwire Power Infeed

Hardwire Power Infeed (New York Code)			
For 30"–60"W panels	A871400	A871400A [S]	\$ 383

Note: Four-circuit components and Three-circuit components (with an “A” suffix) cannot be connected together.

TERRACE

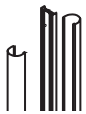

Description/ Examples	Trim Model		P1 Paint List Price	Flat Top Trim			Radius Top Trim		
	Flat Top	Radius Top		P2 Paint List Price	P3 Paint List Price	P1 Paint List Price	P2 Paint List Price	P3 Paint List Price	
Integrated Power Poles (Order flat or radius trim kit below) — for Terrace (core paint only)									
For 35"H-57½"H									
Panels – 78"H	870535 [S]	870535 [S]	\$ 611	N/A	N/A	\$ 611	N/A	N/A	N/A
For 65"H-95"H									
Panels – 52"H	870565 [S]	870565 [S]	\$ 425	N/A	N/A	\$ 425	N/A	N/A	N/A

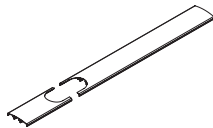

*6" from end to center.

Integrated Power Pole Trim Kits for Terrace Painted Trim (order pole above)									
24"W Panel Trim	870224NF [S]	870224N [S]	\$ 239	\$ 264	\$ 287	\$ 212	\$ 212	N/A	N/A
30"W Panel Trim	870230NF [S]	870230N [S]	\$ 250	\$ 275	\$ 298	\$ 223	\$ 223	N/A	N/A
36"W Panel Trim	870236NFK [S]	870236N [S]	\$ 277	\$ 302	\$ 325	\$ 241	\$ 241	N/A	N/A
42"W Panel Trim	870242NFK [S]	870242N [S]	\$ 281	\$ 306	\$ 329	\$ 247	\$ 247	N/A	N/A
48"W Panel Trim	870248NFK [S]	870248N [S]	\$ 294	\$ 319	\$ 342	\$ 256	\$ 256	N/A	N/A
60"W Panel Trim	870260NFK [S]	870260N [S]	\$ 309	\$ 334	\$ 357	\$ 270	\$ 270	N/A	N/A



*“K” suffix was added to select flat trim model numbers effective 10/7/2016.

<p>How to specify — Select the Model Number from above.</p>	<p><i>1st Option:</i> Electrical Receptacle Color (if applicable): See page 20 for finishes.</p> <p>E </p>	<p><i>1st Option:</i> Color (if applicable): P Black</p> <p>P </p>	<p><i>1st Option:</i> Paint (if applicable): P1 P2 P3 See page 20 for finishes.</p> <p>P </p>
--	---	---	--

Examples: A876072.P A871912.P A873501.E4 870224N.PR2 [S] Shippable by small-package carrier.

For specification information see pages 66-76.

GSA SIN 33721

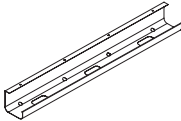
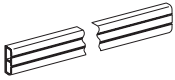
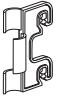
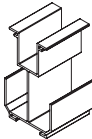
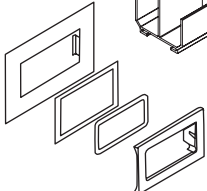
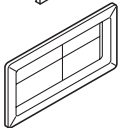
	Description	Model	List Price
	Electrical Mounting Brackets (for use with Data/Electrical Port Tiles) (no color specified)		
	Pack of 12 — for use at beltline and below standard worksurface height on 42½"H to 65"H panels	8989EB S	\$ 98
	Pack of 12 — for use below standard worksurface height on 35"H panels only	8989BW S	\$ 98
	1 bracket required at beltline for each pass-thru harness and 24"W power harness and 2 for 30-60"W power harness.		
	Hardwire (Chicago Code) (Black only)		
	Terrace Base Pathway Junction Box (Pack of 6)	873600 S	\$ 1019
	Beltline Junction Box (Pack of 6)	873550 S	\$ 959
	Cable Management Tray		
	24" Tray	CMT24 S	\$ 112
	36" Tray	CMT36 S	\$ 134
	Wire Management Channel (Black only)		
	92" Long	AEV920 S	\$ 208
	Cord Retainer Clip (Black only)		
	Package of 50	AAPACM2 S	\$ 49
	Data Management Organizer (Black only)		
	Package of 20	A877010 S	\$ 133
	Data Port Kit (specify electrical color)		
	Data/Electrical Port Kit	UTP S	\$ 36
	Wireway Grommet (Black only)		
	Pack of 6	TAWG S	\$ 166

TERRACE

<p>How to specify — Select the Model Number from above.</p>	<p><i>1st Option:</i> Paint Color (if applicable):</p> <p>P1 See page 20 for finishes.</p>	<p><i>1st Option:</i> Electrical Port Kit and Wireway Grommet Color:</p>	
<div style="display: flex; justify-content: space-around;"> <div style="border-bottom: 1px solid black; width: 20px; height: 20px;"></div> <div style="border-bottom: 1px solid black; width: 20px; height: 20px;"></div> <div style="border-bottom: 1px solid black; width: 20px; height: 20px;"></div> <div style="border-bottom: 1px solid black; width: 20px; height: 20px;"></div> <div style="border-bottom: 1px solid black; width: 20px; height: 20px;"></div> <div style="border-bottom: 1px solid black; width: 20px; height: 20px;"></div> <div style="border-bottom: 1px solid black; width: 20px; height: 20px;"></div> <div style="border-bottom: 1px solid black; width: 20px; height: 20px;"></div> <div style="border-bottom: 1px solid black; width: 20px; height: 20px;"></div> <div style="border-bottom: 1px solid black; width: 20px; height: 20px;"></div> </div>	<div style="display: flex; justify-content: space-around;"> <div style="border-bottom: 1px solid black; width: 20px; height: 20px; text-align: center;">P</div> <div style="border-bottom: 1px solid black; width: 20px; height: 20px;"></div> <div style="border-bottom: 1px solid black; width: 20px; height: 20px;"></div> <div style="border-bottom: 1px solid black; width: 20px; height: 20px;"></div> </div>	<div style="display: flex; justify-content: space-around;"> <div style="border-bottom: 1px solid black; width: 20px; height: 20px; text-align: center;">E</div> <div style="border-bottom: 1px solid black; width: 20px; height: 20px;"></div> <div style="border-bottom: 1px solid black; width: 20px; height: 20px;"></div> </div>	

Examples: A870300 8989EB 8989BW 873550.P UTP.E4

S Shippable by small-package carrier.

For specification information see pages 66-76.

GSA SIN 33721



Description	Model		P1 Paint List Price	P2 Paint List Price	P3 Paint List Price
Terrace Horizontal Electrical Mount Support					
24"W	TN24MS		\$ 111	N/A	N/A
30"W	TN30MS		\$ 120	N/A	N/A
36"W	TN36MS		\$ 128	N/A	N/A
42"W	TN42MS		\$ 145	N/A	N/A
48"W	TN48MS		\$ 156	N/A	N/A
60"W	TN60MS		\$ 175	N/A	N/A

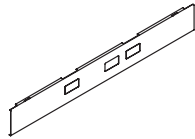

Base Pathway Covers — Knockouts					
36"W	TBPLATE3-36		\$ 89	\$ 104	\$ 116
42"W	TBPLATE3-42		\$ 91	\$ 106	\$ 118
48"W	TBPLATE3-48		\$ 97	\$ 112	\$ 124
60"W	TBPLATE3-60		\$ 112	\$ 127	\$ 139

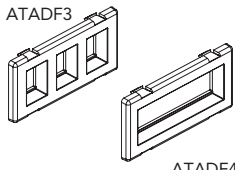

Data Faceplates					
Three-Port Flex-Mode Faceplate, Black (E4)	ATADF3		\$ 36	N/A	N/A
Four-Port Flex-Mode Faceplate, Black (E4)	ATADF4		\$ 36	N/A	N/A

Notes: ATADF3 can install up to 3 jacks (CAT 3, 5E, or 6). ATADF4 can install 4 jacks (CAT 3, 5E, or 6).

ATADF models are compatible with ports in Terrace tiles.

Allsteel's data faceplates are designed for use with the jacks listed below. We do not guarantee compatibility with other manufacturers' product. A faceplate adapter is available for use with alternatively sourced data jacks, see the Standard Specials catalog for details.

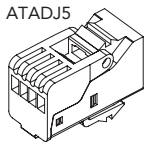

Jacks					
RJ45 CAT 5E Jack — Black only					
Toolless	ATADJ5		\$ 65	N/A	N/A
RJ45 CAT 6 Jack — Black only					
Requires Tool	ATADJ6		\$ 87	N/A	N/A

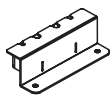

Description	Model	List Price			
		P1 Paint	P2 Paint	P3 Paint	
Cord Organizer					
4"W x 7/8"D Metal with 4 cable cutouts	U9WTC		\$ 174	\$ 181	\$ 187

TERRACE

<p>How to specify — Select the Model Number from above.</p>	<p>1st Option: Paint (Base Pathway Cover and Cord Organizer):</p> <p> </p> <p>See page 20 for finishes.</p>	<p>1st Option: Data Faceplate Color:</p> <p>E4 Black</p>
<p>_____ . P _____</p>		<p>E 4</p>

Examples: TN24MS TBPLATE3-36.P27 ATADF4.E4

Shippable by small-package carrier.

Laminate with Flat Edge or Veneer Worksurfaces

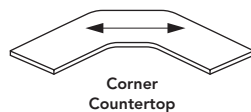
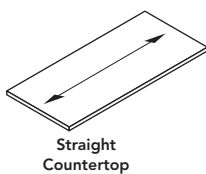
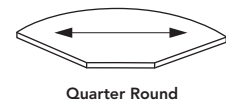
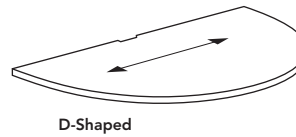
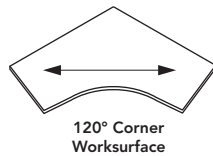
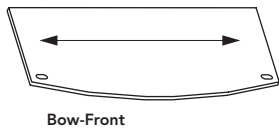
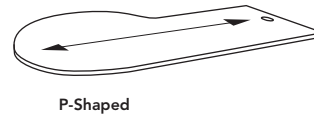
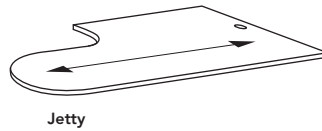
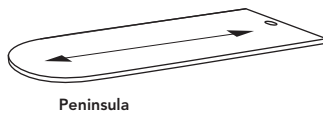
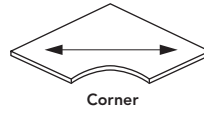
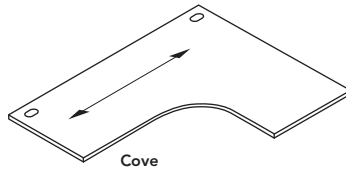
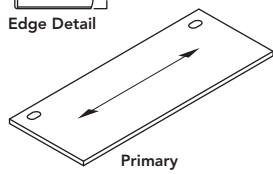

←→ Arrows indicate grain direction for woodgrain laminates.
Grain direction on symmetrical corner worksurfaces runs at a diagonal.

*Laminate only

Note: Add suffix "N" to model number for no grommets, no upcharge.

Worksurfaces are 1½" thick with particleboard core and with top surfaces finished in laminate. Bottom surfaces are covered with a backer sheet. Worksurfaces are available in laminate and Stratawood veneer. Veneer worksurfaces are by Gunlocke.

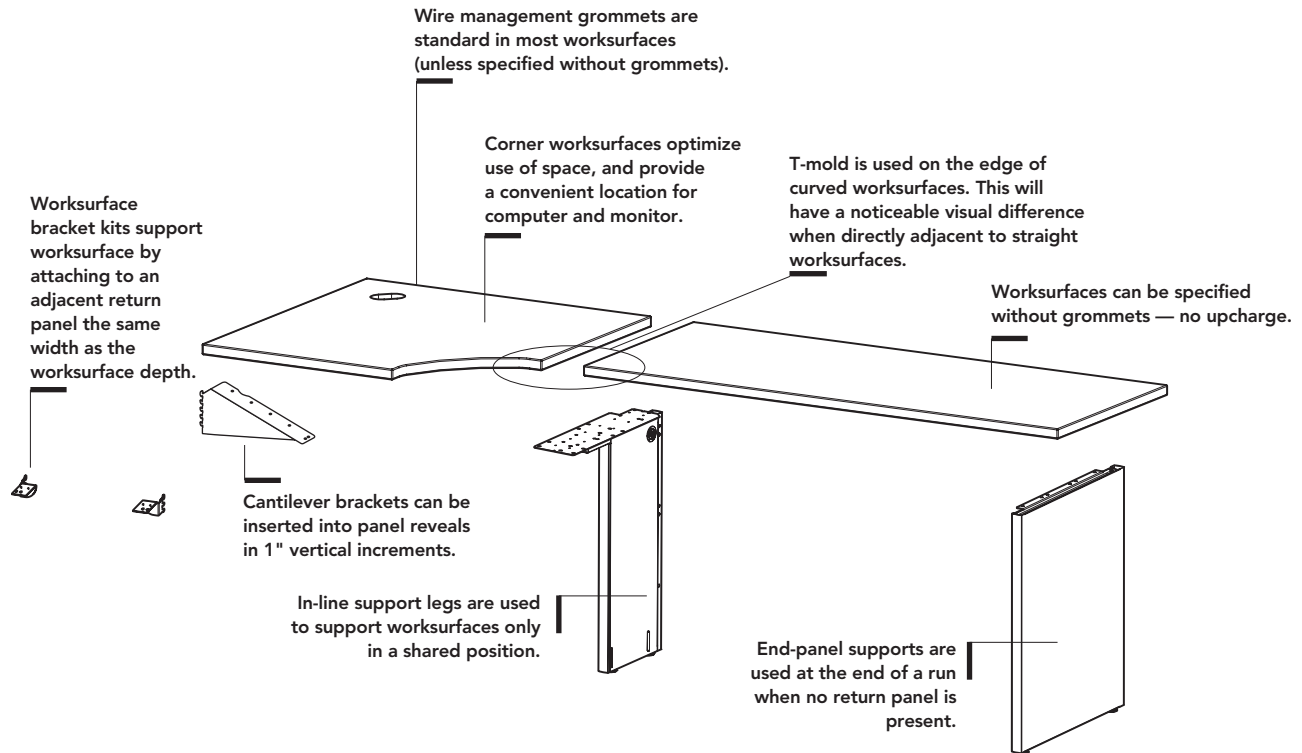

Worksurfaces

- Laminate worksurfaces are 1½" thick with particle board core and with top surfaces finished in high-pressure laminate. Bottom surfaces are covered with a backer sheet.
- Flat edge trim** is available on laminate tops in twenty standard colors (customer specified) to match solid or woodgrain laminates and to complement patterned laminates.
- Veneer worksurfaces have square veneer edge.

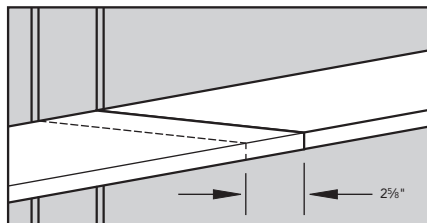
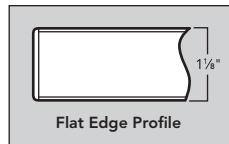

- Optional wider width primary worksurfaces** are available for use with Terrace panel runs having a "T" or "S" connection — upcharge applies.

Wire management grommets are standard in most worksurfaces (unless specified with no grommets) and are specified in plastic or metal.

- Metal grommets** are available in oval or square (shown below).

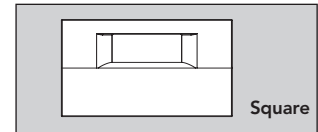
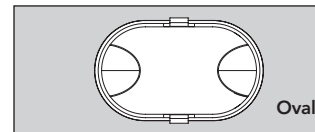

- Rectangular worksurfaces over 42" W have two grommets. Corner cove worksurfaces will have two grommets. Peninsula and corner worksurfaces have one. D-Shaped worksurfaces and countertops do not have grommets.
- Grommets on standard systems worksurfaces are located 6⅛" from side edges and 3⅛" from back edge.
- Add Suffix "N" to a model number for no grommets — no upcharge.

Supports

Worksurfaces can be configured at 29½" H with end-panel supports and in-line support panels, or at various heights on 1" increments using specific product configurations.

Worksurface support options include:

- | | |
|--------------------------------|-------------------------------------|
| • Support column* | • Support storage units* |
| • Flat brackets | • Pedestal-to-panel attachment kit* |
| • External support channel | • Desk-to-panel attachment kit* |
| • Worksurface bracket kits | • Corner desk leg* |
| • Height adjustable mechanisms | • Bridge and return kits |
| • Cantilever brackets | • Modesty panels |
| • In-line support legs* | • Gussets |
| • End-panel supports* | |

*Units provide floor support.

Support Guidelines — See Drawings on page 83

- Panel-mounted work surface runs 72" or greater are required to have floor support.
- When using overheads in panel mounted work surface run applications 72" and greater, floor support* is required. (See list at left.)
- When using overheads at the end of a panel run, floor supports* are required.
- Worksurface bracket kit should be used to tie panels to work surface for added stability.
- A return panel at the end of a panel run can be substituted with one of these floor supports: storage, open or closed end support panel, O-leg.

continued on next page

continued from previous page

- Cantilever brackets cannot be used at the end of a worksurface panel run in place of a return panel or floor support.
- Unsupported worksurfaces 60" W or greater require an external worksurface support channel. When a center support cantilever cannot be used, an external worksurface support channel is recommended for spans greater than 48" W. See pages 87 and 97.

- Support channel may interfere with mounting of some CPU holders and keyboard supports.
- Cantilevers are recommended in place of an external worksurface support channel where feasible.
- Cadence Desking configurations utilize modesty panels and gussets in place of external support channels for worksurfaces up to 72" W. See pages 88-96.

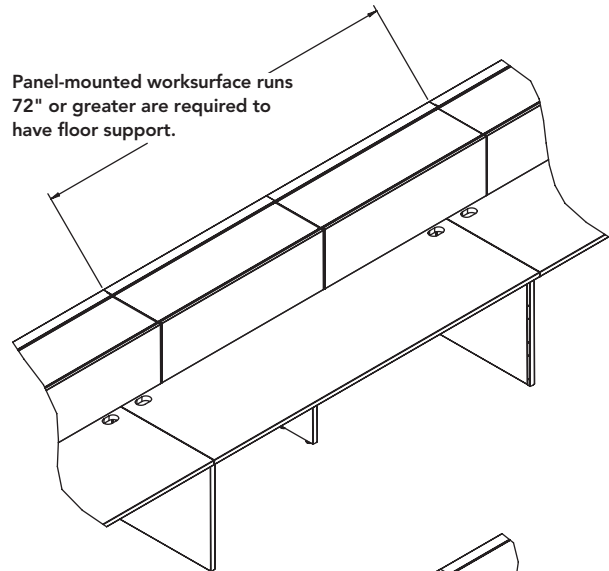
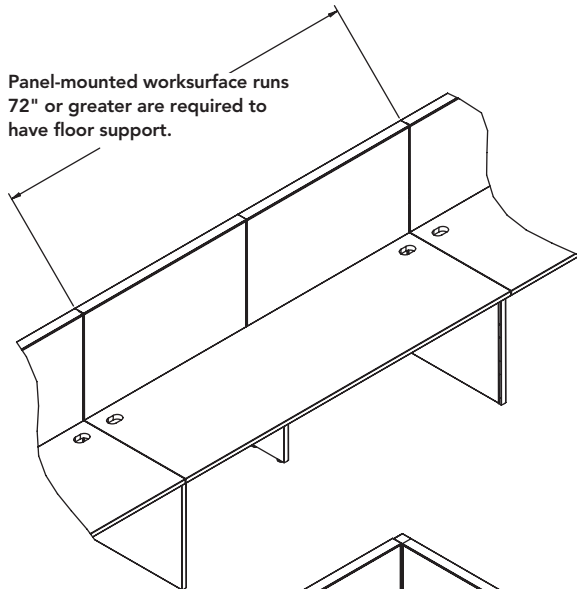

Worksurface bracket kit should be used to tie the panels to worksurface for added stability

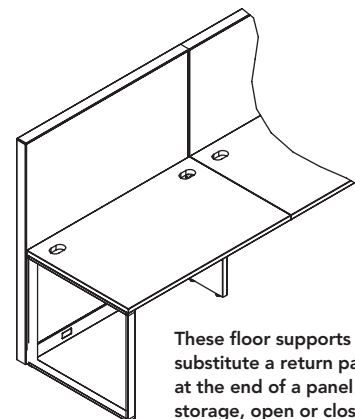
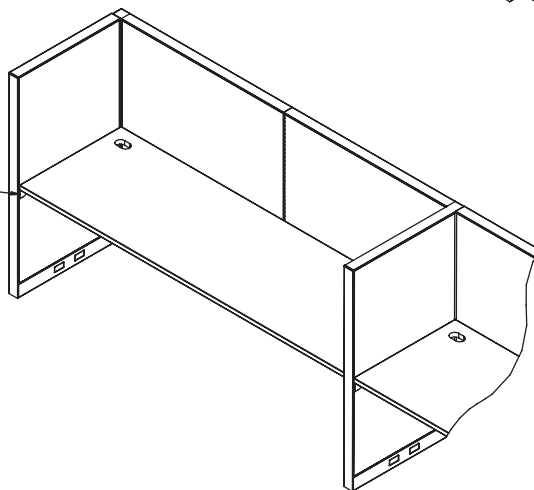
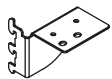

These floor supports can substitute a return panel at the end of a panel run: storage, open or closed end support panel, O-legs.

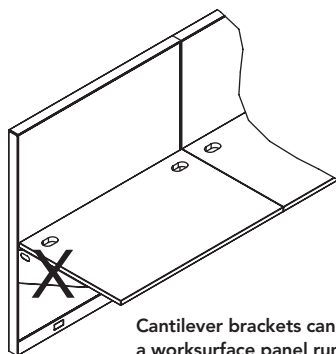

Cantilever brackets cannot be used at the end of a worksurface panel run in place of a return or floor support.

Cantilevers are recommended in place of an external worksurface support channel where feasible.

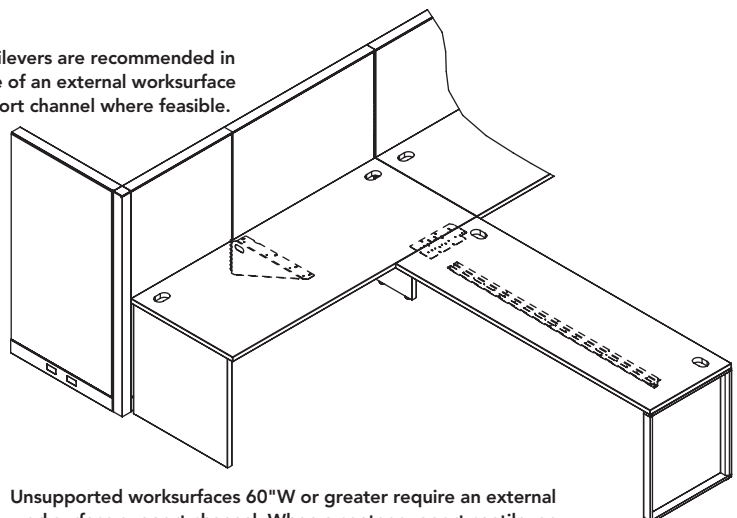

Unsupported worksurfaces 60" W or greater require an external worksurface support channel. When a center support cantilever cannot be used, an external worksurface support channel is recommended for spans greater than 48" W.

Worksurfaces - Laminate (L) w/Flat Edge and Veneer (V) w/Square Edge



Primary Worksurfaces (L page 97; V page 45)

- Primary worksurfaces are available in 24" and 30" depths.
- Nominal worksurface width is equal to nominal panel width.
- Wire management grommets standard, one for widths up to 42", two on widths 48" W and greater.
- Center support bracket included on 54" W-60" W. Other support hardware is ordered separately.
- Worksurfaces greater than 60" W require a cantilever bracket for center support in panel mounted applications. Specify 18" cantilever on 18" D, and 24" cantilever on 24" D and 30" D worksurfaces.
- Primary worksurfaces can be used with a modesty panel and appropriate supports to configure freestanding desk(s). Refer to Working With Cadence, pages 88-96.

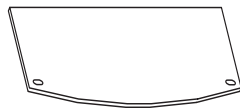

Bow-Front Worksurfaces (L page 98; V page 46)

- Two wire management grommets standard.
- Bow-front worksurfaces can be used with a modesty panel and appropriate supports to configure freestanding desk(s). Refer to Working With Cadence, pages 88-96.

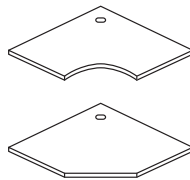

Corner Worksurfaces (L page 99; V page 47)

- One wire management grommet.
- Corner worksurfaces with woodgrain laminate have grain direction diagonal to adjacent worksurfaces.
- Rear corner left-handed support bracket included. Worksurface bracket kit (order separately) required at junction where a panel is wall-mounted to a permanent wall and wall track stanchion is not positioned in the right-hand corner.
- T-mold is used on the edge of curved worksurfaces. This will have a noticeable visual difference when directly adjacent to straight worksurfaces.

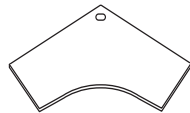

120° Corner Worksurfaces (L page 99; V page 47)

- Standard with one wire management grommet in corner location.
- Rear support bracket included (left-handed). Worksurface bracket kit (order separately) required at junction where a panel is wall-mounted to a permanent wall and wall track stanchion is not positioned in the right hand corner.
- T-mold is used on the edge of curved worksurfaces. This will have a noticeable visual difference when directly adjacent to straight worksurfaces.



60° Pie Worksurface (L page 99)

- Order support column and two flat brackets separately.

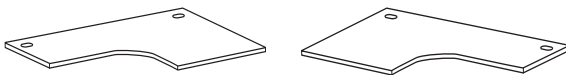

Corner Cove Worksurfaces (L page 100; V page 48)

- Two wire management grommets standard.
- Rear corner support bracket included with all surfaces. Worksurface bracket kit (order separately) required at junction where a panel is wall-mounted to a permanent wall and wall track stanchion is not positioned in the right-hand corner. All other support hardware is ordered separately.
- Can be used with a modesty panel and appropriate supports to configure freestanding desk(s). Refer to Cadence pages 88-96.
- Worksurfaces greater than 60" W require a cantilever bracket for center support in panel mounted applications. Specify 24" cantilever on 24" D and 30" D worksurfaces.
- T-mold is used on the edge of curved worksurfaces. This will have a noticeable visual difference when directly adjacent to straight worksurfaces.

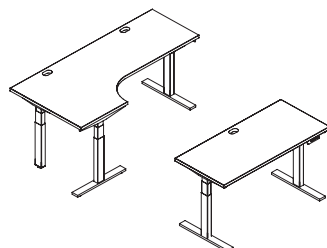

Height-Adjustable Worksurfaces

- For freestanding applications, see height-adjustable tables pages in the Seating, Collaboration, and Tables Price List.

Worksurfaces — Laminate(L) w/Flat Edge and Veneer(V) w/Square Edge

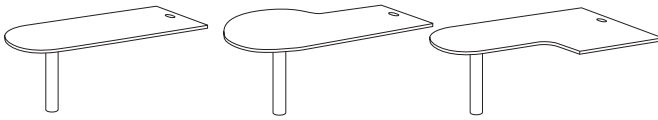

Peninsula, P-Shaped, and Jetty Worksurfaces

(L page 101; V page 49)

- Wire management grommets standard.
- Support column ordered separately, column includes panel support brackets T6BK.
- Can be used with a modesty panel and appropriate supports to configure freestanding desk(s). Refer to Cadence pages 88-96.

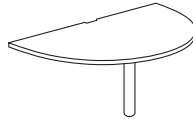

D-Shaped Worksurfaces (L page 102; V page 50)

- Order support column and two 24" D in-line support legs separately.
- Not recommended for use with T6CB24L or T6CB24R for shared applications.
- Includes attachment bracket.



Quarter-Round Worksurfaces (L page 102; V page 50)

- Use to connect two 90° panel-attached worksurfaces.
- Order support column and two flat brackets separately.

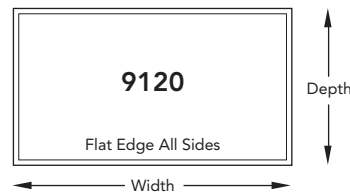

Non-Standard Worksurface Sizes (L, V pages 105 and 106)

- The 9120 Program can be used to order particle board rectangular worksurfaces in any non-standard width and depth in 1/8" increments up to a maximum of 120"W x 36"D.
- Other modification requests should be made through Allsteel Tailored Products Group.

Countertops - Laminate (L) w/Flat and Veneer (V) w/Square

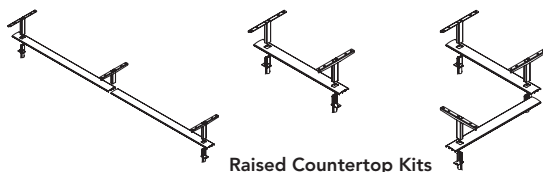
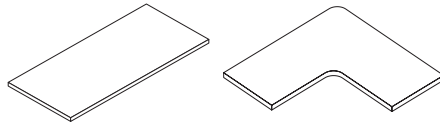
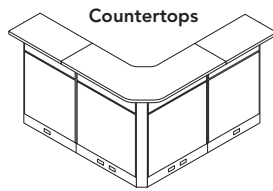

Countertops

- Countertops are available in straight and corner configurations.
- Choose between raised countertops which require raised countertop kit (ordered separately) or flush countertops which include brackets, top trim, and mounting hardware.
- T-mold is used on the edge of curved worksurfaces. This will have a noticeable visual difference when directly adjacent to straight worksurfaces.

Raised Countertops (L page 103; V page 103)

- Countertops are raised 5" above panel top cap.
- Order raised countertop kits separately.
- Add appropriate suffix to end of model number for in-line variable height applications.
- Countertop kit can extend up to 6" beyond end of kit.

Raised Countertop Kits (L page 103; V page 103)

- Includes top cap and attachment hardware.

Flush Countertops (L page 104; V page 104)

- Mounting brackets, top trim, and attaching hardware included.
- Flush countertops come with a painted top cap — specify color.
- Countertops are flush with the ends of panel top cap.

Worksurface Supports

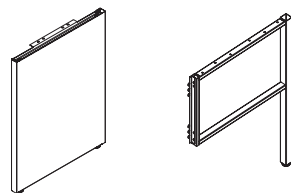

End Supports and Bracket Kits (page 108)

- End-panels are 1 1/8" thick. For use in place of panels at the end of worksurface runs.
- Levelers provide 1 1/2" vertical adjustment.
- Must be connected into panel slots for panel hung applications.
- Straight worksurfaces adjacent to 120° connections must be supported by full end-panels.
- 11"D end-panel models for use with D-shaped worksurfaces or curvilinear shaped worksurfaces in freestanding applications.
- Panel mounted end-panel supports are ordered for right- or left-handed application.
- Open end panel supports are non-handed and are only for panel mounted applications.
- End-panel models can be converted to freestanding with removal of panel mount bracket.
- End-panel bracket kit converts freestanding end-panel support model to panel mounted.

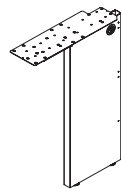

Support Legs and Bracket Kit (page 108)

- Support legs are 1 1/8" thick. Supports the junction of two worksurfaces.
- Non-handed for use at either end of worksurface. Leg portion is 12 3/4"D.
- Provided with flat bracket.
- Worksurface in-line support legs are used to support worksurfaces only in a shared position.
- Levelers provide 1 1/2" vertical adjustment.
- Must be connected into panel slots for panel hung applications.
- Closed full length models can be converted to freestanding with removal of panel mount bracket.
- Support Leg Bracket Kit (non-handed) converts closed full length freestanding model to panel mounted.



Support Columns (page 108)

- Used to support one end of curvilinear worksurfaces.
- Includes column, worksurface bracket kit T6BK, attaching hardware, and adjustable glides.
- D-shaped, P-shaped, peninsula, jetty, boomerang, and reef worksurfaces require support columns (ordered separately).

Worksurface Supports

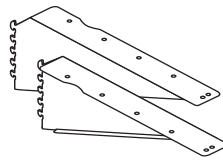

**Handed
Cantilever Brackets**

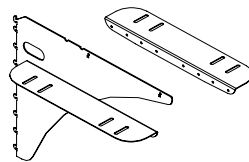

**Non-Handed
Cantilever Brackets**

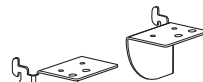

Worksurface Brackets

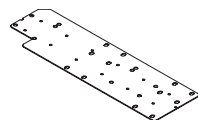
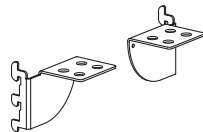

Flat Brackets



**Pedestal-to-Panel
Brackets**

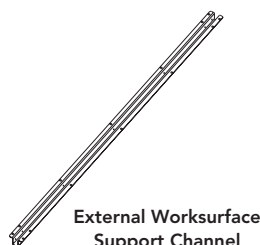

**External Worksurface
Support Channel**

Cantilever Brackets (page 108)

- Use with runs less than 96". Floor support is required for runs 96" and longer.
- Where applicable, cantilevers are recommended over an external worksurface support channel. Unsupported worksurface runs 66"W or greater require an external worksurface support channel when a cantilever cannot be used.
- Do not use at the end of a worksurface where no 90° return panel is positioned.
- Includes tie bracket and attachment hardware.
- Avoid installation on only one side of a straight connection except to support corner worksurfaces.
- DO NOT use to support worksurfaces from which a hanging pedestal is suspended, or to which a peninsula worksurface is attached.
- DO NOT use cantilever brackets to support worksurfaces supported with permanent-wall hanger kit.
- Do not use with wall track or to support a worksurface to which a return worksurface is attached.

Cantilever Bracket — Handed (page 108)

- Cantilever brackets are handed (left or right) and can be inserted into panel reveals in 1" vertical increments. No assembly required.
- Left- and right-hand brackets required in shared applications.
- 24"D cantilevers are required to be used for both 24"D or 30"D worksurfaces.
- 18"D cantilevers are required to be used for 20"D worksurfaces or center support for 24"D.
- 12"D cantilevers are required to be used for 12"D worksurfaces.

Cantilever Bracket — Non-Handed (page 108)

- Cantilever brackets are non-handed and can be inserted into panel reveals in 1" vertical increments. Assembly required.
- One bracket in shared applications — includes two angled brackets.
- Bracket accommodates 24"D or 30"D worksurfaces.

Worksurface Bracket Kit — T6BK (page 108)

- Worksurface bracket kit allows one end of a worksurface to be supported by a return panel. Return panel width must be the same as the depth of the worksurface.
- Brackets — one pair. Attachment hardware included.

Worksurface Bracket — T6SB (page 108)

- Worksurface storage bracket kit (T6SB) is used for aesthetics where under-desk storage is immediately adjacent to the return panel. In all other applications use worksurface bracket kit (T6BK) to utilize worksurface threaded metal inserts. Black only.
- Brackets do not align with worksurface threaded metal inserts, and therefore require wood screws (included).

Flat Brackets (page 108)

- Bracket and attaching hardware.
- Can be used to connect one worksurface perpendicular to another worksurface.

Pedestal-to-Panel Attachment Bracket (page 108)

- Can be used in place of full end panel or return panel.
- Provides structural support to panel run by securing panel directly to pedestal.
- Attachment hardware included.

External Worksurface Support Channel (page 97)

- An external worksurface support channel is required on unsupported worksurfaces 60"W or greater. Width of worksurface span can be reduced by using support storage.
- The support channel extends 1½" below the worksurface. Installs 7" from user's edge.
- When using 28"H mobile pedestals the length of support channel needs to be reduced to accommodate width of the pedestal.
- Support channel may interfere with mounting of some CPU holders and keyboard supports. May require spacer kit AKMH.

Cadence offers unlimited versatility. Its modular flexibility creates office solutions of all shapes, sizes, and styles.

Configurations

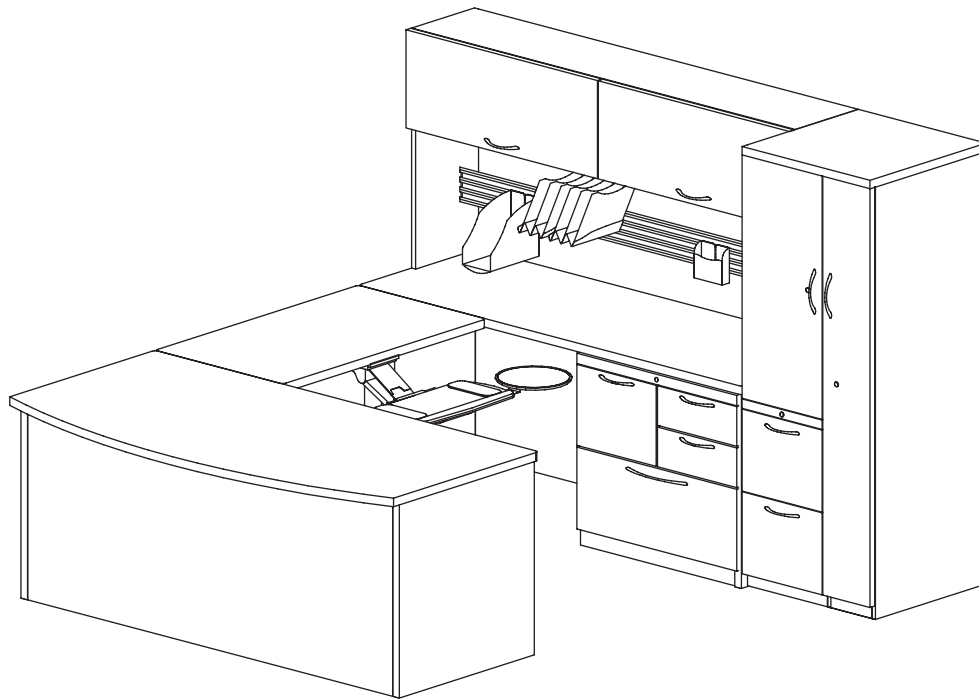

Full Modesty

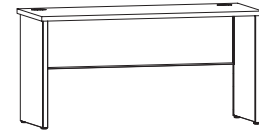

Half Modesty



Gussets

All the right choices

Choose Cadence freestanding desking with confidence. It personalizes any work environment, accommodates a range of needs, and offers all the right features — curvilinear worksurface shapes, multiple worksurface edges, and a complete paint finish and laminate offering. Cadence is made to last with heavy-gauge steel construction. Metal-to-metal worksurface connection points make installation and reconfiguration reliable and easy. And Cadence is backed by a lifetime warranty.

Universally flexible

Cadence sets up easily and reconfigures time after time. It even shares components with Terrace, Optimize™, and Concensys®, which simplifies inventory management. Cadence is created with worksurfaces, supports, modesty panels, end panels, and brackets. Cadence is compatible with the entire line of Allsteel metal storage solutions and Extensions™ — work tools to provide personalized organization for every workstyle.

Systems integration — Cadence works in combination with Terrace, Optimize, or Concensys panels, extending the functionality of both product lines.

Highly adaptable — Make the most of building architecture by using an existing wall to create a semi-private workspace.

Space utilization — Multiple worksurface shapes offer unlimited design potential for using space creatively and efficiently.

Team interaction — Cadence design flexibility allows you to create personal workspace and a team collaboration area in the same office.

The Cadence Choice

It works in the open plan, the private office, or in combination with Terrace, Optimize, or Concensys panels, allowing complete office coordination. The flexible, universal design of Cadence supports virtually any workstyle and any interior aesthetic. Backed by Allsteel's Lifetime Warranty and manufactured to strict environmental standards, Cadence provides one high-value package.

Configurations

End Panels **E** and Support Legs **L**

Each are available in two options: freestanding or panel-mount. The only difference between the two options are the panel-mount models come with a left- or right-handed bracket to attach the support to a panel in a Cadence systems application. If the freestanding version is purchased and later needs to be converted to panel-mount, the proper handed panel-mount bracket may be purchased separately.

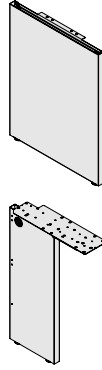

The 11" D end panel is used to freestand peninsulas, curvilinear shapes, and D-Tops in panel applications.

Corner Desk Legs **C**

Corner desk legs have a 90-degree bend and welded construction. The strong construction allows gussets or half-height modesty panels to be used with corner legs.

Bridge Kits **B**

Bridge kits include: two flat brackets, two modesty panel-to-end panel attachment brackets, and two tie straps. This kit is used when attaching a bridge unit between two rectangular worksurfaces.

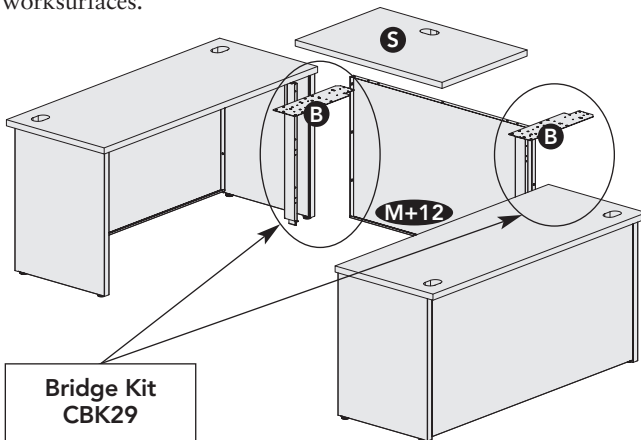

Return Kits **R**

Return kits include: one flat bracket, one modesty panel-to-end panel attachment bracket, and one tie strap. These are used when attaching a return to a primary desk. Return kits can also be used in some bridge applications — one example is shown below when using a peninsula.

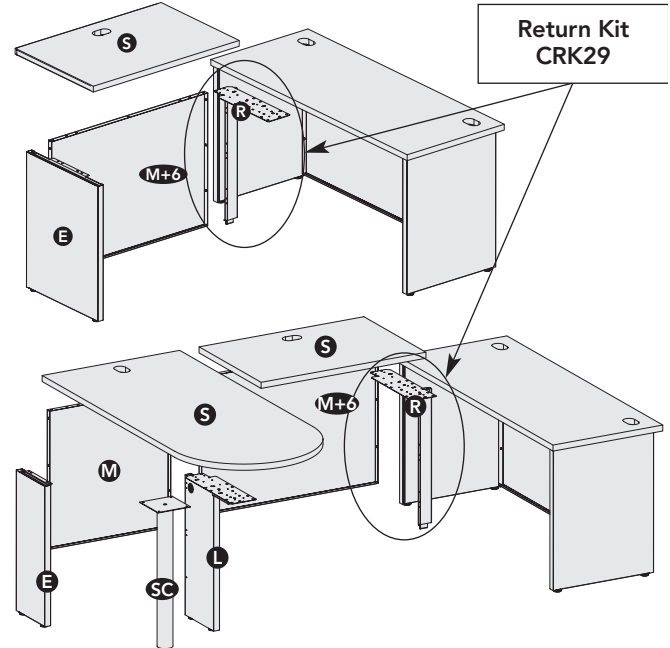

Desk-to-Panel Attachment Kits **D**

Desk-to-panel attachment kits are used to connect a worksurface and modesty panel perpendicular to a panel of corresponding width. Opposing end of worksurface must be attached with an end-panel, support leg or corner leg mounted directly under this worksurface.

When using a corner or corner cove worksurface with the rear corner attached to a panel, and opposing end of worksurface is attached to a freestanding desk — use corner w/desk attachment kit. “Hand” of unit is determined from the user’s side of the desk (right hand unit attaches to right side of modesty).

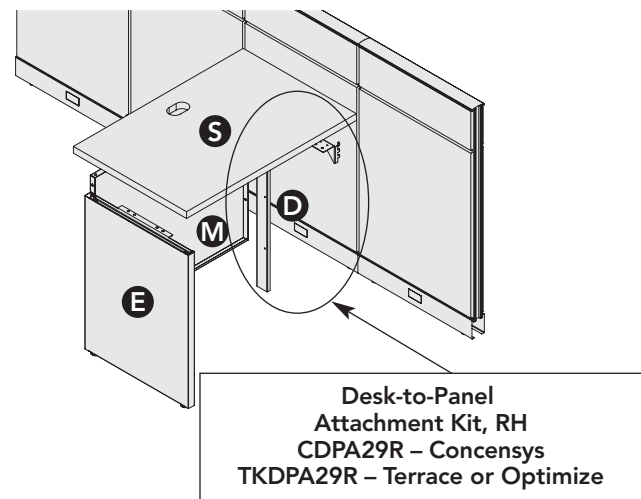

There are some bridge instances where only half of a bridge kit is needed (e.g. using a bridge between a rectangular worksurface and a corner or peninsula). A return kit may be ordered for these instances.

Surface **S**

Support Column **SC**

Used to support one end of curvilinear worksurfaces. Includes column, worksurface bracket kit T6BK, attaching hardware, and adjustable glides.

Corner w/Desk Panel Attachment Kit **CW**

Corner w/desk panel attachment kit connects the rear corner of a corner or corner cove worksurface and modesty panel to a panel when the opposing end of the worksurface shares a support leg with an adjacent freestanding desk and the support leg is mounted under the freestanding desk. “Hand” of unit is determined from the user’s side of the desk (left hand unit attaches to left side of modesty).

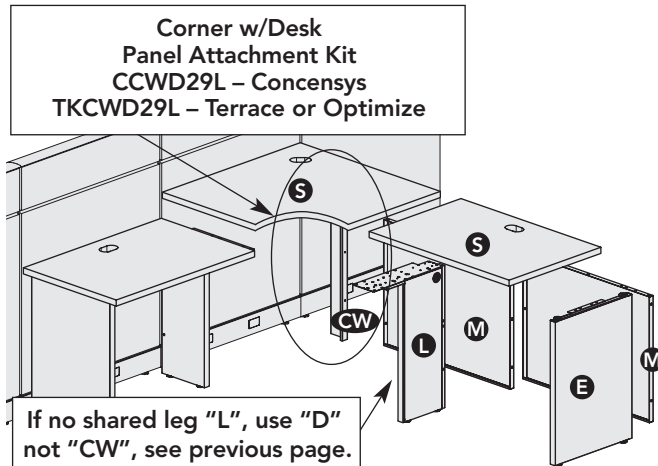

Corner Worksurfaces

Corner worksurfaces to accommodate 90-degree corner desk legs.

In-Line Connections of Desks

Freestanding full end panels must be used to support adjacent rectangular desks, corner desks, and corner desks with returns. Freestanding support legs should NOT be used at the in-line junction. 24" D full end panels may be used at the in-line junction on 30" D rectangular desks if two worksurface tie straps are used to secure the desks together. Contact Allsteel Customer Support for ordering information.

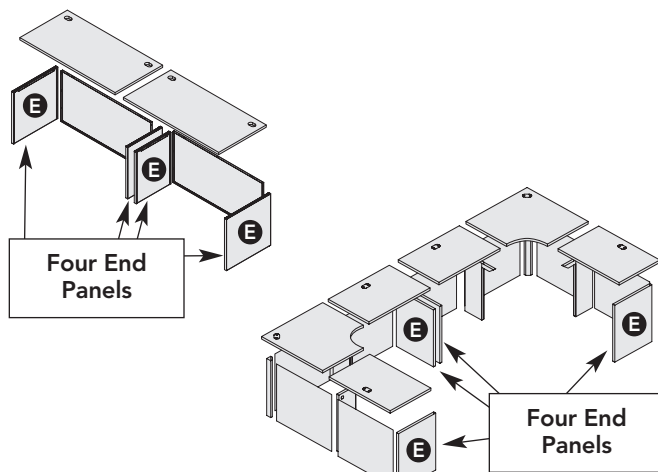

Pedestals and Storage

Pedestals must be ordered one size smaller than the depth of the worksurface. For example, 18" D or 20" D peds should be used with 24" D worksurfaces. 18" D, 20" D, or 23" D pedestals can be used with 30" D worksurfaces. Using 18" D laterals or personal files provide additional pull style and storage options under 24" D worksurfaces.

Modesty Panels **M**

The following are some general guidelines for Cadence modesty panels:

- **Desk:** Modesty panel width is the same width as the worksurface
- **Return:** Modesty panel width is 6" greater than the width of the worksurface
- **Bridge connecting two rectangular worksurfaces:** Modesty panel width is 12" greater than the width of the bridge worksurface
- **Bridge connecting a rectangular worksurface and corner or peninsula:** Modesty panel width is 6" greater than the width of the worksurface
- **Corner connecting to an adjacent worksurface:** Modesty panel width is the same width as the worksurface.

Stand-Alone Corner Modesty Panels **SM**

Stand-alone corner modesty panels are used only when one or both sides of a corner or corner cove worksurface are freestanding and NOT attached to another worksurface. Specify the width the same as the width of the worksurface.

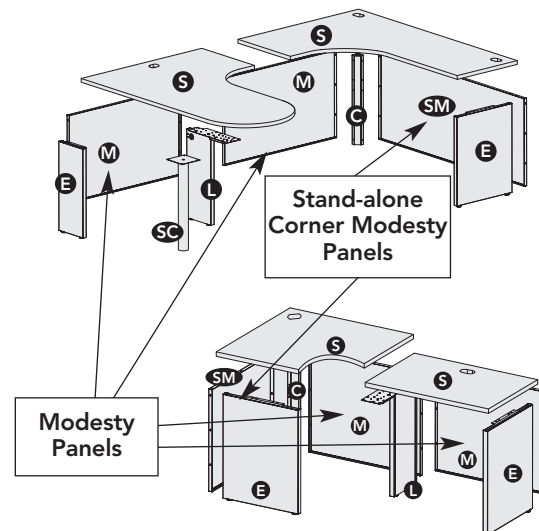

Gussets **G**

Gussets can be used in place of a modesty panel with desks 36" W to 60" W. Gussets can also be used with corner desk legs.

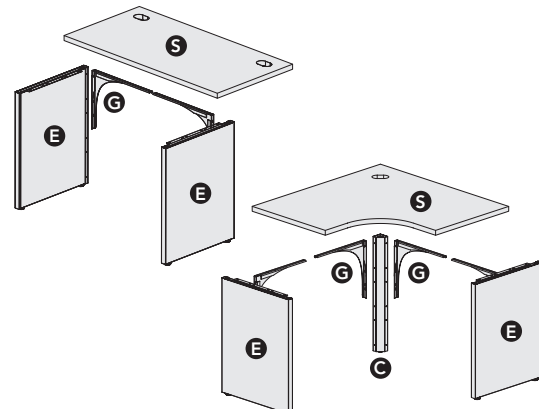

Configurations

Freestanding Desk

Example Shown		
Qty.	Model	Description
1	T52436S	Flat Edge Worksurface 24"D x 36"W
2	CEP2429F	End-Panel Support 24"D x 29½"H
1	CS369	Modesty Panel 36"W x 29½"H

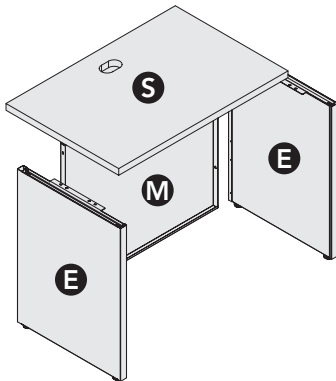

Panel-Attached Desk

Example Shown		
Qty.	Model	Description
1	T52436S	Flat Edge Worksurface 24"D x 36"W
1	CEP2429F	End-Panel Support 24"D x 29½"H
1	CS369	Modesty Panel 36"W x 29½"H
1	□DPA29R	Desk-to-Panel Attachment Kit 29½"H – RH C – Concensys® TK – Terrace or Optimize™

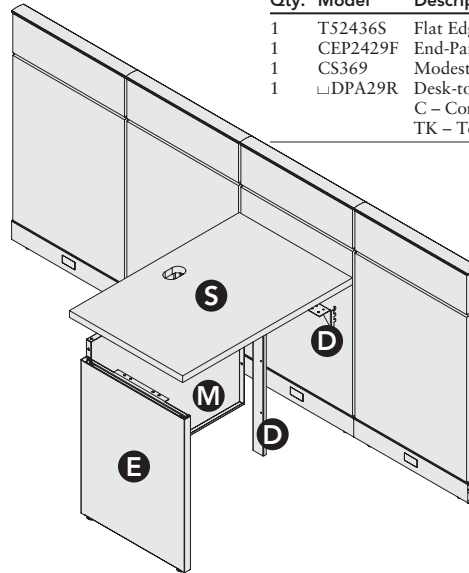

CONFIGURATION OPTIONS	Work-surface (S)	End-Panel Support (E)	Desk Support Leg (L)	Modesty Panel			Desk-to-Panel Attachment Kit (D)	Corner Desk Leg (C)
				Same width as Work-surface (M)	6" wider than Work-surface (M+6)	12" wider than Work-surface (M+12)		
Freestanding Desk	1	2		1				
Panel-Attached Desk	1	1		1			1 RH	

Return Desk (Attached to a primary or return desk.)

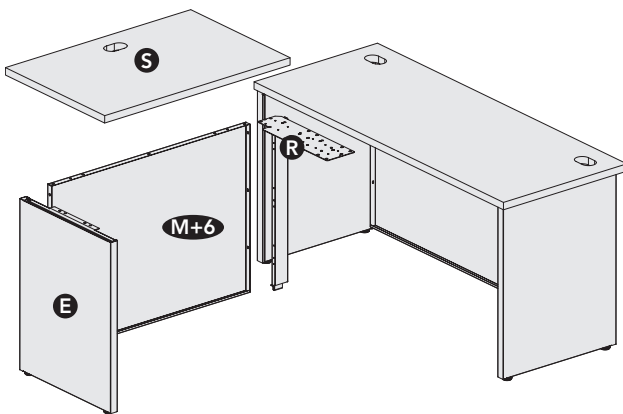

Example Shown		
Qty.	Model	Description
1	T52436S	Flat Edge Worksurface 24"D x 36"W
1	CS429	Modesty Panel 42"W x 29½"H
1	CEP2429F	End-Panel Support 24"D x 29½"H
1	CRK29	Return Kit

Note: The widest modesty panel is 72"W which limits return worksurfaces to a maximum of 66"W.

Return Desk (Attached to a panel-hung worksurface.)

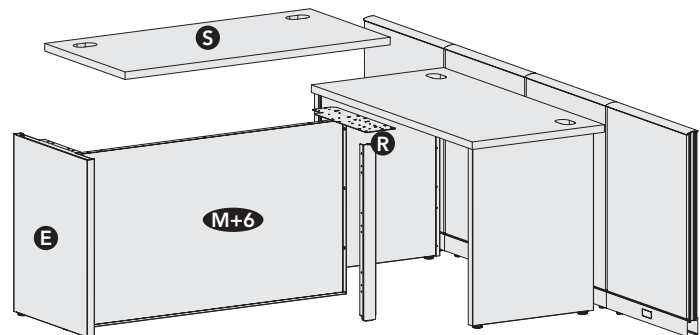

Example Shown		
Qty.	Model	Description
1	T52448S	Flat Edge Worksurface 24"D x 48"W
1	CS549	Modesty Panel 54"W x 29½"H
1	CEP2429F	End-Panel Support 24"D x 29½"H
1	CRK29	Return Kit

CONFIGURATION OPTIONS	Work-surface (S)	End-Panel Support (E)	Desk Support Leg (L)	Modesty Panel			Desk-to-Panel Attachment Kit (D)	Corner Desk Leg (C)	Return Kit (R)
				Same width as Work-surface (M)	6" wider than Work-surface (M+6)	12" wider than Work-surface (M+12)			
Return Desk	1	1			1				1

TERRACE

Configurations

Bridge Desk (Attached between two primary desks.)

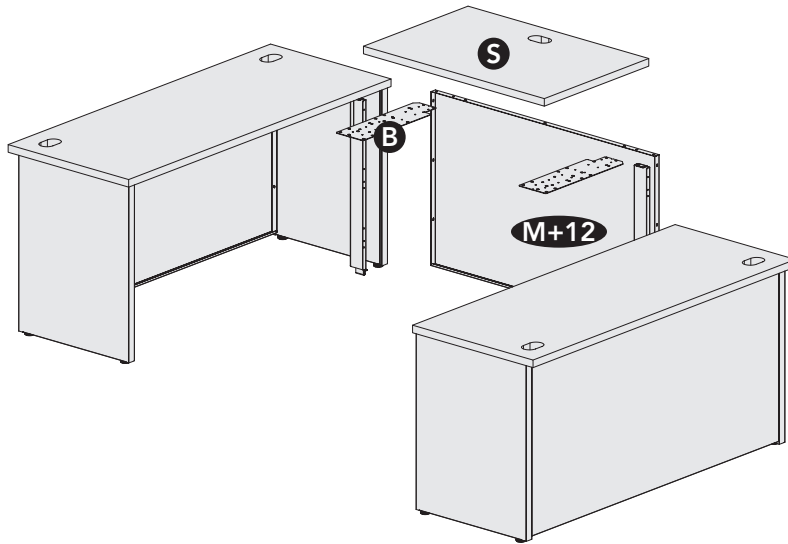

Example Shown

Qty.	Model	Description
1	T52442S	Flat Edge Worksurface 24"D x 42"W
1	CS549	Modesty Panel 54"W x 29½"H
1	CBK29	Bridge Kit

CONFIGURATION	Work-surface (S)	End-Panel Support (E)	Desk Support Leg (L)	Modesty Panel			Desk-to-Panel Attachment Kit (D)	Corner Desk Leg (C)	Bridge Kit (B)
				Same width as Work-surface (M)	6" wider than Work-surface (M+6)	12" wider than Work-surface (M+12)			
Bridge Desk	1					1			1

Bridge Desk and Peninsula (Attached to a primary desk).

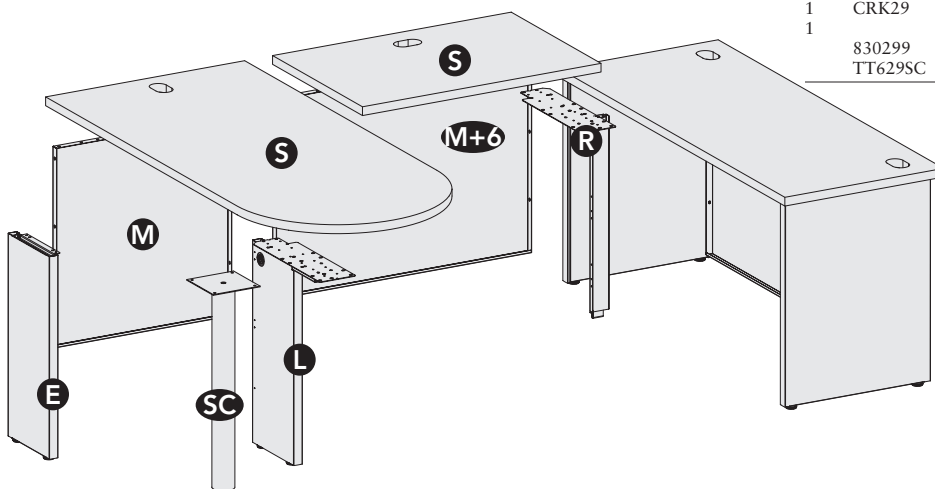

Example Shown

Qty.	Model	Description
1	T52442S	Flat Edge Worksurface 24"D x 42"W
1	T53060B	Flat Edge Peninsula Worksurface 30"W x 60"L
1	CS489	Modesty Panel 48"W x 29½"H
1	CS309	Modesty Panel 30"W x 29½"H
1	CEP1129F	End-Panel Support 11"D x 29½"H
1	CSL2429F	Support Leg 24"D x 29½"H
1	CRK29	Return Kit
1	830299	Support Column for Peninsula Worksurface 29½"H (Concensys®)
1	TT629SC	(Terrace or Optimize™)

CONFIGURATION OPTION	Work-surface (S)	End-Panel Support (E)	Desk Support Leg (L)	Modesty Panel			Desk-to-Panel Attachment Kit (D)	Support Column (SC)	Return Kit (R)
				Same width as Work-surface (M)	6" wider than Work-surface (M+6)	12" wider than Work-surface (M+12)			
Bridge Desk and Peninsula	2	1	1	1	1			1	1

Configurations

Corner Desk (Stand-alone)

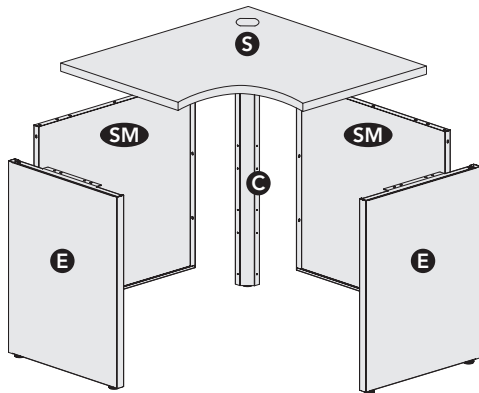

Qty.	Model	Description
1	T53624CR	Flat Edge Worksurface 24"D x 36"W
2	CSCMP3629	Stand-Alone Corner Modesty Panel 36"W x 29½"H
2	CEP2429F	End-Panel Support 24"D x 29½"H
1	CDL29	Corner Desk Leg 29½"H

Corner Desk (With an adjacent desk attached at one side.)

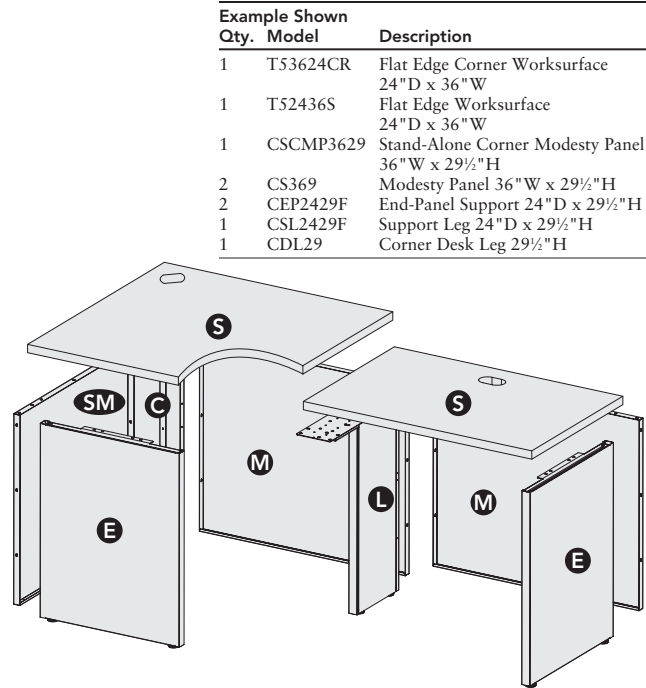

Qty.	Model	Description
1	T53624CR	Flat Edge Corner Worksurface 24"D x 36"W
1	T52436S	Flat Edge Worksurface 24"D x 36"W
1	CSCMP3629	Stand-Alone Corner Modesty Panel 36"W x 29½"H
2	CS369	Modesty Panel 36"W x 29½"H
2	CEP2429F	End-Panel Support 24"D x 29½"H
1	CSL2429F	Support Leg 24"D x 29½"H
1	CDL29	Corner Desk Leg 29½"H

CONFIGURATION OPTION	Work-surface (S)	End-Panel Support (E)	Desk Support Leg (L)	Modesty Panel		Stand-Alone Corner Modesty Panel (SM)	Desk-to-Panel Attachment Kit (D)	Corner Desk Leg (C)
				Same width as Work-surface (M)	6" wider than Work-surface (M+6)			
Corner Desk	1	2				2		1
Corner Desk (with adjacent desk)	2	2	1	2		1		1

Bridge Desk (Attached between corner and primary desk.)

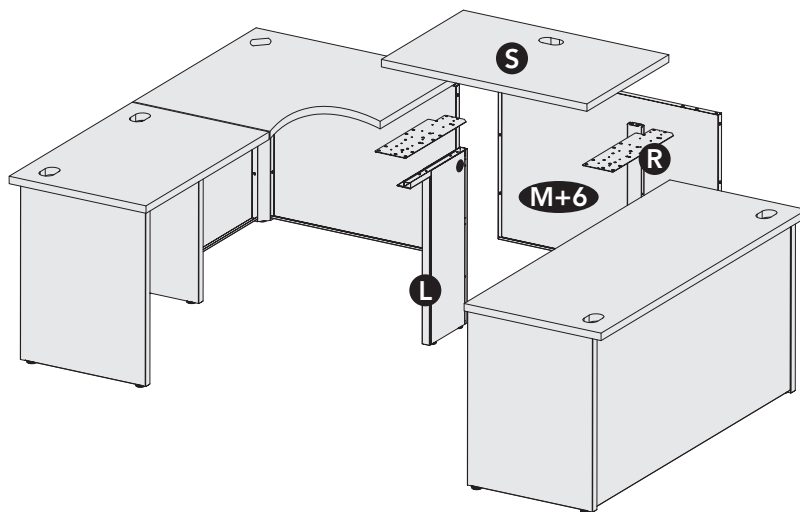

Qty.	Model	Description
1	T52436S	Flat Edge Worksurface 24"D x 36"W
1	CS429	Modesty Panel 42"W x 29½"H
1	CRK29	Return Kit
1	CSL2429F	Support Leg 24"D x 29½"H

CONFIGURATION	Work-surface (S)	End-Panel Support (E)	Desk Support Leg (L)	Modesty Panel			Desk-to-Panel Attachment Kit (D)	Corner Desk Leg (C)	Return Kit (R)
				Same width as Work-surface (M)	6" wider than Work-surface (M+6)	12" wider than Work-surface (M+12)			
Bridge Desk	1		1		1				1

Configurations

Corner Desk (Attached to a panel with an adjacent desk at one side.)

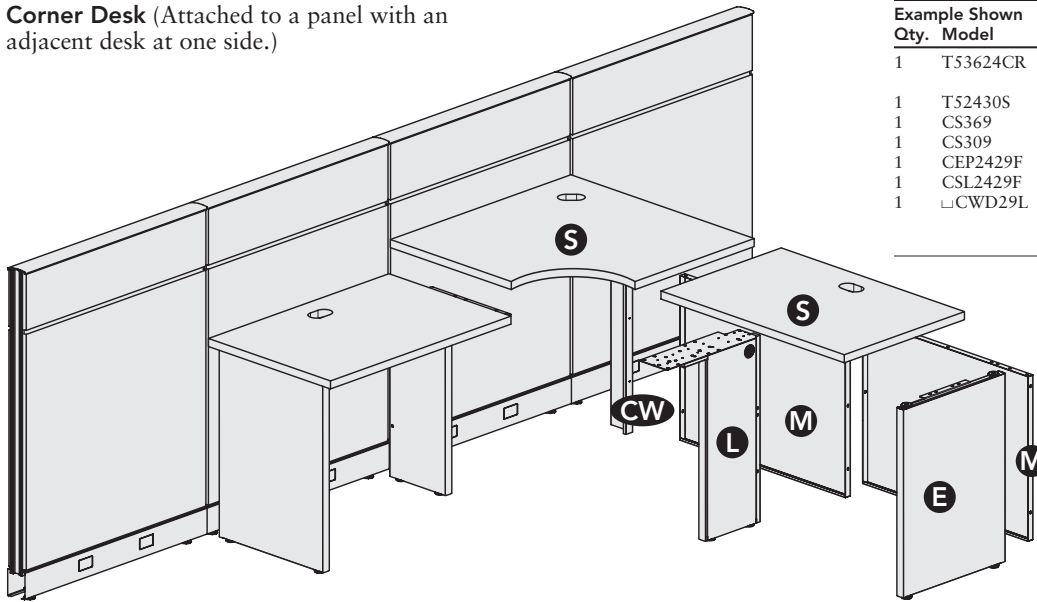

Example Shown		
Qty.	Model	Description
1	T53624CR	Flat Edge Corner Worksurface 36" W x 24" D
1	T52430S	Flat Edge Worksurface 24" D x 30" W
1	CS369	Modesty Panel 36" W x 29½" H
1	CS309	Modesty Panel 30" W x 29½" H
1	CEP2429F	End-Panel Support 24" D x 29½" H
1	CSL2429F	Support Leg 24" D x 29½" H
1	□CWD29L	Corner w/Desk Attachment Kit 29" H LH
C – Concensys®		
TK – Terrace or Optimize™		

CONFIGURATION	Work-surface (S)	End-Panel Support (E)	Desk Support Leg (L)	Modesty Panel			Desk-to-Panel Attachment Kit (D)	Corner Desk Leg (C)	Corner w/Desk Panel Attachment Kit (CW)
				Same width as Work-surface (M)	6" wider than Work-surface (M+6)	12" wider than Work-surface (M+12)			
Corner Desk	2	1	1	2					1 LH

"U" with Jetty and Corner Cove

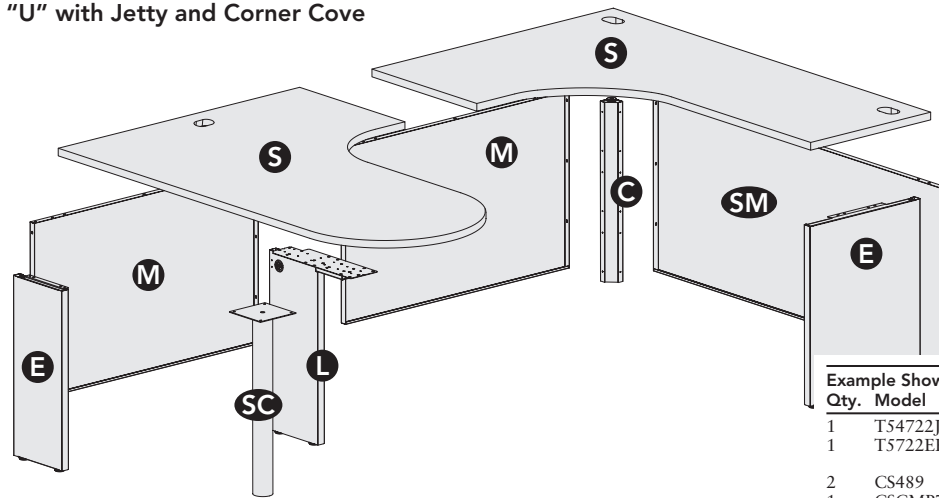

Example Shown		
Qty.	Model	Description
1	T54722JR	Flat Edge Jetty RH 48" D x 72" W x 24" x 30"
1	T5722ER	Flat Edge Corner Cove RH 48" D x 72" W x 24"
2	CS489	Modesty Panel 48" W x 29½" H
1	CSCMP7229	Stand-Alone Corner Modesty Panel 72" W x 29½" H
1	CEP1129F	End-Panel Support 11" D x 29½" H
1	CSL2429F	Support Leg 24" D x 29½" H
1	CEP2429F	Full End-Panel Support 24" D x 29½" H
1	CDL29	Corner Desk Leg 29½" H
1	830299	Support Column for Jetty 29½" H (Concensys)
1	TT629SC	(Terrace or Optimize)

CONFIGURATION OPTION	Work-surface (S)	End-Panel Support (E)	Desk Support Leg (L)	Modesty Panel		Stand-Alone Corner Modesty Panel Same width as Work-surface (SM)	Support Column (SC)	Corner Desk Leg (C)
				Same width as Work-surface (M)	6" wider than Work-surface (M+6)			
Cove and Jetty	2	2	1	2		1	1	1

Cadence Supports

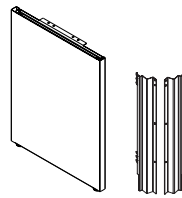

End-Panel Supports

End-Panel Supports (page 109)

- End panels are 1½" thick. For use at the end of worksurface runs.
- Levelers provide 1½" vertical adjustment.
- Freestanding models can be converted to Terrace panel-mount with end panel bracket kit.
- Must be connected into panel slots for panel hung applications.
- Straight worksurfaces adjacent to 120° and 135° connections must be supported by full end panels.
- 11"D models for use with D-shaped worksurfaces or curvilinear shaped worksurfaces in freestanding applications.

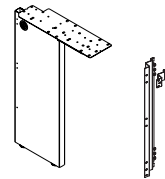

Support Leg

Support Legs (page 109)

- Support legs are non-handed. Supports the junction of two worksurfaces.
- Leg portion is 12¼"D and is 1½" thick.
- Flat bracket included.
- Levelers provide 2¾" vertical adjustment.
- Freestanding models can be converted to Terrace panel-mount with support leg bracket (non-handed).
- Must be connected into panel slots for panel hung applications.

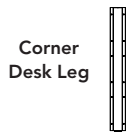

Corner Desk Leg

Corner Desk Leg (page 109)

- Attaches two modesty panels at rear of corner desk.
- Leveler provides 2¾" vertical adjustment.
- See examples on pages 93 and 94.



Bridge Kit

Bridge Kit (page 109)

- Connects bridge worksurface and modesty panel to end panels and worksurfaces that are perpendicular to the bridge worksurface.
- Includes two flat brackets and two modesty panel-to-end-panel brackets.
- See examples on pages 89 and 92.

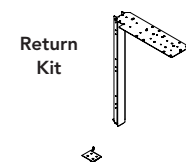

Return Kit

Return Kit (page 109)

- Connects return worksurface and modesty panel to end panel and perpendicular worksurface — non-handed.
- Includes one flat brackets and one modesty panel-to-end-panel bracket.
- See examples on pages 89 and 91.



Desk-to-Panel Attachment Kit

Desk-to-Panel Attachment Kits for Terrace (page 109)

- Used to connect a worksurface and modesty panel perpendicularly to a Terrace Panel of corresponding width. Opposing end of worksurface must be attached with an end-panel, support leg or corner leg mounted directly under this worksurface.
- If using corner or corner cove with the rear corner attached to a panel, and opposing end of worksurface is attached to a freestanding desk — use corner w/desk panel attachment kit.
- “Hand” of unit is determined from the user’s side of the desk (left hand unit attaches to left side of modesty).

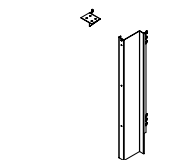

Corner w/Desk Attachment Kit

Corner w/Desk Panel Attachment Kit for Terrace (page 109)

- Used when the rear corner of a corner or corner cove worksurface and modesty panel is attached to a Terrace panel and opposing end of worksurface is attached to a freestanding desk. Opposing end of worksurface shares the support leg that is mounted under the adjacent freestanding desk.
- “Hand” of unit is determined from the user’s side of the desk.

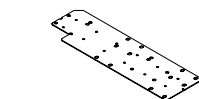

Flat Bracket

Flat Brackets (page 109)

- Bracket and attaching hardware.
- Can be used to connect one worksurface perpendicular to another worksurface.

TERRACE

Wall Track, Tile attachment Kits, Modesty Panels, and Gussets

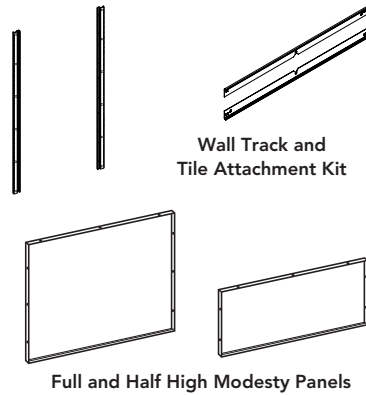

Wall Track and Tile Attachment Kit

Full and Half High Modesty Panels

Freestanding Pedestals

- Can also be used to support one end of a panel-attached worksurface in conjunction with worksurface bracket.

Freestanding Desks

- **Freestanding desks** can be created by combining primary and corner worksurfaces with modesty panels and appropriate desk supports. See pages 88-94.

Pedestal Compatibility with Cadence and Panel-hung Worksurfaces

Cadence Desking	24" Deep	30" Deep
18"D Ped	Yes	Yes
19 ⁷ / ₈ "D Ped	Yes*	Yes
23 ³ / ₈ "D Ped		Yes
29 ¹ / ₂ "D Ped		
Systems Panel-hung	24" Deep	30" Deep
18"D Ped	Yes	Yes
19 ⁷ / ₈ "D Ped	Yes*	Yes
23 ³ / ₈ "D Ped	Yes*	Yes
29 ¹ / ₂ "D Ped		Yes*

*Wire management grommet is blocked in these applications.

Note: Pedestal placement may affect access to receptacles in base pathway.

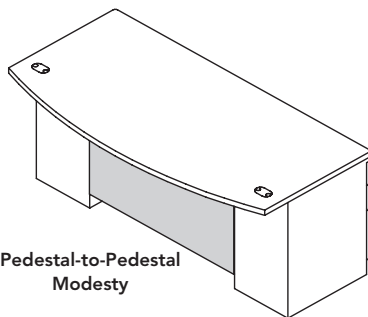

Pedestal-to-Pedestal Modesty

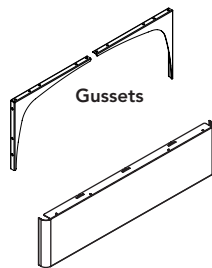

Universal Modesty Panel

Universal Modesty Panels

Model	Peninsula			P-Shape	Jetty	
	60"L	66"L	72"L	72"L	66"L	72"L
PMP41	•					
PMP47		•		•	•	
PMP53			•			•

Terrace Wall Track/Tile Attachment Kits (page 109)

- Allows for mounting of system panel components on permanent wall structures.
- Begin with one pair of ends; for multiple kits in line, add middle unit(s) between ends.
- Height of wall track coordinates with panel height. Field cut for lower heights.
- Wall track will add 1" to depth of attached components.
- Use Terrace wall track tile attachment kit to install tiles onto wall track. Kit includes two tile bars. Top bar may only be used in the top uppermost position on wall track. Bottom bar can be used in the bottom position at any location on wall track.
- When segmenting tiles on wall track, segment bars must be ordered for placement between all vertically adjacent tiles or at the top position of a single tile that is not in the uppermost position.
- When using Terrace wall track and using tiles to create a tackboard situation under overheads hung at 65"H, make sure to use a 30"H tile or 2-15"H tiles to cover the entire area between the overheads and the worksurface.

Modesty Panel (page 110)

- Mounts to end-panel supports, desk support legs, bridge kit, return kit, desk-to-panel, and corner w/desk panel attachment kits.
- 29¹/₂"H units provide 3/4" of space between bottom of modesty panel and floor.
- Actual width of 29¹/₂"H modesty panel is 3/4" less than the nominal dimension listed in the Systems Price List.
- 14"H units provide 14/4" of space between bottom of modesty panel and floor.
- Refer to pages 88-94 to select proper width.
- Use 14"H modesty panels for desks positioned against a wall to provide access to electrical receptacles.
- 14"H modesty panels, stand-alone corner modesty panels, or gussets can be used with corner or corner cove worksurfaces.

Stand-alone Corner Modesty Panel (page 110)

- 29¹/₂"H units provide 3/4" of spacing between bottom of panel and floor.
- 14"H units provide 14/4" of space between bottom of modesty panel and floor.
- Actual width of modesty panel is 6/16" less than the nominal dimension listed in the Systems Price List.
- Modesty panels are inset 2/8"; when adding pedestals consult chart at left.

Pedestal-to-Pedestal Modesty Panels (page 110)

- Widths available to work with 60"W, 66"W, and 72"W worksurfaces to create freestanding double pedestal desk using two medal support pedestals.

Gussets (page 110)

- Provides easy access to wall outlets.
- Cannot be used with suspended pedestals.
- Gussets can be used on corner and corner cove worksurfaces.

Universal Modesty Panel (page 110)

- Mounts under peninsula, P-Shape and jetty worksurfaces. Refer to chart below to select proper width.
- Can be used with panel-mounted and freestanding worksurfaces.
- Provides 8 1/2" of privacy and is non-handed.
- Constructed of steel. No upcharge for P2 paint.
- Only requires attachment to the worksurface.
- Does not provide electrical, data or structural support.
- Panel is 1 1/2" thick and can be mounted at various distances from edge of worksurface based on user's preference for clearance and conferencing requirements.

Worksurfaces

Terrace® — Primary

Laminate

GSA SIN 33721

For specification information see pages 82-87
For non-standard worksurface sizes see page 105.

Description	Laminate w/Flat Edge Model	Laminate w/Flat Edge		
		L1 List Price	L2 List Price	L3 List Price
24"D Primary Worksurfaces				
24"W	T52424S	\$ 395	\$ 411	\$ 425
30"W	T52430S	\$ 416	\$ 433	\$ 447
36"W	T52436S	\$ 469	\$ 487	\$ 503
42"W	T52442S	\$ 524	\$ 543	\$ 561
48"W	T52448S	\$ 568	\$ 590	\$ 607
54"W	T52454S	\$ 614	\$ 639	\$ 656
60"W	T52460S	\$ 697	\$ 724	\$ 743
66"W	T52466S	\$ 758	\$ 787	\$ 809
72"W	T52472S	\$ 791	\$ 821	\$ 843
78"W	T52478S	\$ 1027	\$ 1063	\$ 1095
84"W	T52484S	\$ 1076	\$ 1114	\$ 1148
90"W	T52490S	\$ 1271	\$ 1314	\$ 1356
96"W	T52496S	\$ 1330	\$ 1375	\$ 1420
30"D Primary Worksurfaces				
24"W	T53024S	\$ 416	\$ 433	\$ 447
30"W	T53030S	\$ 501	\$ 520	\$ 537
36"W	T53036S	\$ 539	\$ 559	\$ 577
42"W	T53042S	\$ 581	\$ 603	\$ 621
48"W	T53048S	\$ 614	\$ 639	\$ 656
54"W	T53054S	\$ 686	\$ 713	\$ 732
60"W	T53060S	\$ 764	\$ 793	\$ 815
66"W	T53066S	\$ 825	\$ 856	\$ 880
72"W	T53072S	\$ 895	\$ 928	\$ 954
78"W	T53078S	\$ 1162	\$ 1202	\$ 1241
84"W	T53084S	\$ 1214	\$ 1255	\$ 1296
90"W	T53090S	\$ 1448	\$ 1497	\$ 1546
96"W	T53096S	\$ 1495	\$ 1545	\$ 1596



- Notes:**
- 1) Add suffix and upcharge for primary worksurfaces up to 72"W to span a "T" or extended straight connection.
Suffix = T2 (Terrace — adds 2 3/8" to width) \$38 upcharge.
Examples: **T53030ST2**, **T52460ST2**
 - 2) Add Suffix "N" to model number for no grommet, no upcharge. Example: **T53078SN**

Sample Worksurface

12"W x 12"D	831212M	\$ 338	\$ 352	\$ 364
-------------	---------	--------	--------	--------

Description	Model	List Price
External Worksurface Support Channel (no color option) — 1 1/2"H		
30"W External Support Channel for use on 42"W Worksurface	Z5SC42 S	\$ 76
36"W External Support Channel for use on 48"W Worksurface	Z5SC48 S	\$ 78
42"W External Support Channel for use on 54"W Worksurface	Z5SC54 S	\$ 90
48"W External Support Channel for use on 60"W Worksurface	Z5SC60	\$ 97
54"W External Support Channel for use on 66"W Worksurface	Z5SC66	\$ 113
60"W External Support Channel for use on 72"W Worksurface	Z5SC72	\$ 122
66"W External Support Channel for use on 78"W Worksurface	Z5SC78	\$ 133
72"W External Support Channel for use on 84"W Worksurface	Z5SC84	\$ 146

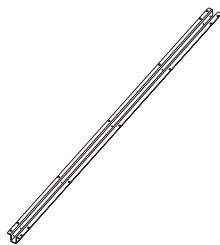

<p>How to specify — Select the Model Number from above. Suffix T2 T-Span for Terrace N No Grommets</p>	<p>1st Option: Laminate: See page 20 for finishes.</p>	<p>2nd Option: Edge Trim Color: See page 20 for finishes.</p>	<p>3rd Option: Grommet Type: P Oval Plastic (will match edge trim) M Oval Metal (Add \$11 per grommet) S Square Metal (Add \$11 per grommet)</p>	<p>4th Option: Grommet Color (Metal only): Oval: EL Matte Silver Square: EL Matte Silver</p>
--	--	---	--	--

Examples: T52424S.LT3B.E9.P Z5SC42

For specification information see pages 82-87.

Laminate

GSA SIN 33721

Description	S	Laminate w/Flat Edge Model	Laminate w/Flat Edge		
			L1 List Price	L2 List Price	L3 List Price
30"D Bow-Front Worksurfaces					
30"A x 36"B x 60"C		TT53660BT	\$ 1142	\$ 1182	\$ 1220
30"A x 36"B x 66"C		TT53666BT	\$ 1240	\$ 1282	\$ 1323
30"A x 36"B x 72"C		TT53672BT	\$ 1334	\$ 1379	\$ 1424



Note: Add Suffix "N" to model number for no grommet, no upcharge.

TERRACE

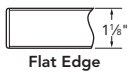





<p>How to specify — Select the Model Number from above.</p>	<p>1st Option: Laminate: See page 20 for finishes.</p>	<p>2nd Option: Edge Trim Color See page 20 for finishes.</p>	<p>3rd Option: Grommet Type: P Oval Plastic (will match edge trim) M Oval Metal (Add \$11 per grommet) S Square Metal (Add \$11 per grommet)</p>	<p>4th Option: Grommet Color (Metal only): EL Matte Silver</p>

Examples: TT53660BT.LT3B.E9.MEL TT53660BTN.LT3B.E9P

For specification information see pages 82-87

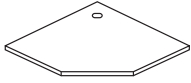
Laminate

GSA SIN 33721

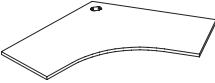
Description	Laminate w/Flat Edge Model	Laminate w/Flat Edge		
		L1 List Price	L2 List Price	L3 List Price
24"D Corner Worksurfaces w/Radial Leading Edge				
 36"W	T53624CR	\$ 790	\$ 820	\$ 843
42"W	T54224CR	\$ 842	\$ 873	\$ 899
48"W	T54824CR	\$ 958	\$ 993	\$ 1023
24"D Corner Worksurfaces w/Straight Leading Edge				
 36"W	T53624SC	\$ 764	\$ 791	\$ 817
42"W	T54224SC	\$ 802	\$ 830	\$ 857
48"W	T54824SC	\$ 898	\$ 929	\$ 961
30"D Corner Worksurfaces w/Radial Leading Edge				
 42"W	T54230CR	\$ 1018	\$ 1054	\$ 1086
48"W	T54830CR	\$ 1099	\$ 1137	\$ 1174
30"D Corner Worksurfaces w/Straight Leading Edge				
 42"W	T54230SC	\$ 974	\$ 1008	\$ 1042
48"W	T54830SC	\$ 1005	\$ 1040	\$ 1075
60° Pie Worksurface				
 24"D	TN52424SD	\$ 643	\$ 669	\$ 687
120° Corner Worksurface				
 30"W x 24"D	TT53024CB	\$ 1034	\$ 1070	\$ 1103
36"W x 24"D	TT53624CB	\$ 1142	\$ 1182	\$ 1220
42"W x 24"D	TT54224CB	\$ 1224	\$ 1266	\$ 1307
48"W x 24"D	TT54824CB	\$ 1348	\$ 1393	\$ 1439

Note: Add Suffix "N" to model number for no grommet, no upcharge.

Corner Worksurfaces with Radial Leading Edge

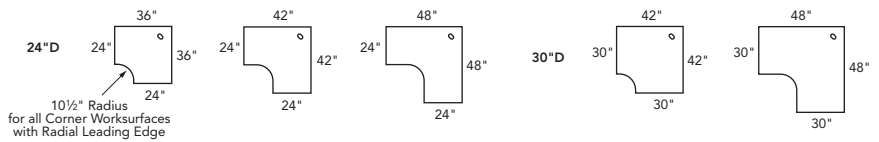

Corner Worksurfaces with Straight Leading Edge

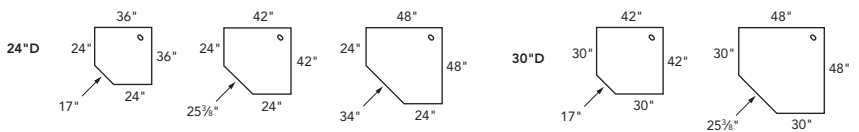

<p>How to specify — Select the Model Number from above.</p>	<p>1st Option: Laminate: See page 20 for finishes.</p>	<p>2nd Option: Edge Trim Color : See page 20 for finishes.</p>	<p>3rd Option: Grommet Type (if applicable): P Oval Plastic (will match edge trim) M Oval Metal (Add \$11 per grommet) S Square Metal (Add \$11 per grommet)</p>	<p>4th Option: Grommet Color (Metal only) (if applicable): Oval: EL Matte Silver Square: EL Matte Silver</p>
--	--	--	--	--

Examples: T53624C.LT3B.E9.P TT53024CB.LT3B.E9.MEL

For specification information see pages 82-87

Laminate

GSA SIN 33721



Description	Laminate w/Flat Edge Model	Laminate w/Flat Edge		
		L1 List Price	L2 List Price	L3 List Price
Corner Cove Worksurfaces – Extended Left				
60" x 36"-24"L / 24"R	T5822EL	\$ 901	\$ 934	\$ 963
60" x 36"-24"L / 30"R	T5832EL	\$ 940	\$ 974	\$ 1004
60" x 48"-24"L / 24"R	T5622EL	\$ 1001	\$ 1037	\$ 1068
60" x 48"-30"L / 24"R	T5623EL	\$ 1044	\$ 1081	\$ 1115
60" x 48"-24"L / 30"R	T5632EL	\$ 1044	\$ 1081	\$ 1115
60" x 48"-30"L / 30"R	T5633EL	\$ 1080	\$ 1118	\$ 1154
72" x 36"-24"L / 24"R	T5922EL	\$ 1001	\$ 1037	\$ 1068
72" x 36"-24"L / 30"R	T5932EL	\$ 1044	\$ 1081	\$ 1115
72" x 48"-24"L / 24"R	T5722EL	\$ 1276	\$ 1319	\$ 1361
72" x 48"-30"L / 24"R	T5723EL	\$ 1320	\$ 1364	\$ 1410
72" x 48"-24"L / 30"R	T5732EL	\$ 1320	\$ 1364	\$ 1410
72" x 48"-30"L / 30"R	T5733EL	\$ 1357	\$ 1403	\$ 1450



Description	Laminate w/Flat Edge Model	Laminate w/Flat Edge		
		L1 List Price	L2 List Price	L3 List Price
Corner Cove Worksurfaces – Extended Right				
36" x 60"-24"L / 24"R	T5822ER	\$ 901	\$ 934	\$ 963
36" x 60"-30"L / 24"R	T5832ER	\$ 940	\$ 974	\$ 1004
48" x 60"-24"L / 24"R	T5622ER	\$ 1001	\$ 1037	\$ 1068
48" x 60"-24"L / 30"R	T5623ER	\$ 1044	\$ 1081	\$ 1115
48" x 60"-30"L / 24"R	T5632ER	\$ 1044	\$ 1081	\$ 1115
48" x 60"-30"L / 30"R	T5633ER	\$ 1080	\$ 1118	\$ 1154
36" x 72"-24"L / 24"R	T5922ER	\$ 1001	\$ 1037	\$ 1068
36" x 72"-30"L / 24"R	T5932ER	\$ 1044	\$ 1081	\$ 1115
48" x 72"-24"L / 24"R	T5722ER	\$ 1276	\$ 1319	\$ 1361
48" x 72"-24"L / 30"R	T5723ER	\$ 1320	\$ 1364	\$ 1410
48" x 72"-30"L / 24"R	T5732ER	\$ 1320	\$ 1364	\$ 1410
48" x 72"-30"L / 30"R	T5733ER	\$ 1357	\$ 1403	\$ 1450

Note: Add Suffix "N" to model number for no grommet, no upcharge.

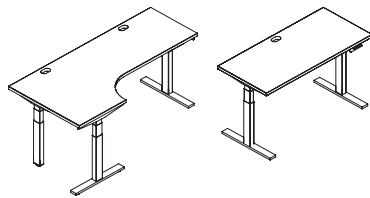

For Altitude® height-adjustable tables see the Seating, Collaboration, and Tables Price List.





<p>How to specify — Select the Model Number from above. Prefix T Laminate w/Flat 8 Laminate w/T-Mold</p>	<p>1st Option: Laminate: See page 20 for finishes.</p>	<p>2nd Option: Edge Trim Color : See page 20 for finishes.</p>	<p>3rd Option: Grommet Type: P Oval Plastic (will match edge trim) M Oval Metal (Add \$11 per grommet) S Square Metal (Add \$11 per grommet)</p>	<p>4th Option: Grommet Color (Metal only): Oval: EL Matte Silver Square: EL Matte Silver</p>
--	--	--	--	--

Examples: T5822EL.LT3B.E9.P T5622EL.LT3B.E9.MEL

For specification information see pages 82-87

Laminate

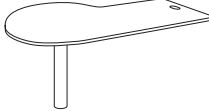
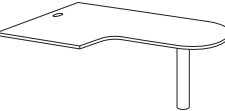
GSA SIN 33721

Support column ordered separately.	Description	Laminate w/Flat Edge Model	Laminate w/Flat Edge		
			L1 List Price	L2 List Price	L3 List Price
Peninsula Worksurfaces					
	30"W x 60"L	T53060B	\$ 1045	\$ 1082	\$ 1116
	30"W x 66"L	T53066B	\$ 1155	\$ 1195	\$ 1234
	30"W x 72"L	T53072B	\$ 1260	\$ 1303	\$ 1345
	36"W x 60"L	T53660B	\$ 1260	\$ 1303	\$ 1345
	36"W x 66"L	T53666B	\$ 1398	\$ 1445	\$ 1493
	36"W x 72"L	T53672B	\$ 1539	\$ 1590	\$ 1645
P-Shaped Worksurfaces w/42" Diameter End					
	30"W x 72"L	T53072PR	\$ 1444	\$ 1493	\$ 1543
	30"W x 72"L (shown)	T53072PL	\$ 1444	\$ 1493	\$ 1543
Jetty Worksurfaces – Left-Hand					
	48"A x 66"B x 24"C x 30"D	T54662JL	\$ 1357	\$ 1403	\$ 1450
	48"A x 72"B x 24"C x 30"D	T54722JL	\$ 1387	\$ 1433	\$ 1481
	48"A x 66"B x 30"C x 30"D	T54663JL	\$ 1417	\$ 1464	\$ 1513
	48"A x 72"B x 30"C x 30"D	T54723JL	\$ 1443	\$ 1492	\$ 1542
Jetty Worksurfaces – Right-Hand					
	48"A x 66"B x 24"C x 30"D	T54662JR	\$ 1357	\$ 1403	\$ 1450
	48"A x 72"B x 24"C x 30"D	T54722JR	\$ 1387	\$ 1433	\$ 1481
	48"A x 66"B x 30"C x 30"D	T54663JR	\$ 1417	\$ 1464	\$ 1513
	48"A x 72"B x 30"C x 30"D	T54723JR	\$ 1443	\$ 1492	\$ 1542

Note: Add Suffix "N" to model number for no grommet, no upcharge.

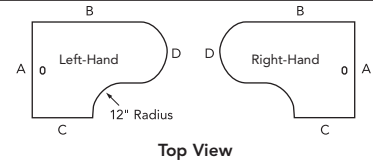

<p>How to specify — Select the Model Number from above.</p>	<p>1st Option: Laminate: See page 20 for finishes.</p>	<p>2nd Option: Edge Trim Color : See page 20 for finishes.</p>	<p>3rd Option: Grommet Type: P Oval Plastic (will match edge trim) M Oval Metal (Add \$11 per grommet) S Square Metal (Add \$11 per grommet)</p>	<p>4th Option: Grommet Color (Metal only): Oval: EL Matte Silver Square: EL Matte Silver</p>
--	--	--	--	--

Examples: T53060B.LT3B.E9.P T54662JR.LT3B.EU.MEL

For specification information see pages 82-87

Laminate

GSA SIN 33721

Description	Laminate w/Flat Edge Model	Laminate w/Flat Edge		
		L1 List Price	L2 List Price	L3 List Price
D-Shaped Worksurfaces – Half Round for Terrace				
For 2 - 24"D	TN524D	\$ 1034	\$ 1070	\$ 1103
For 2 - 30"D	TN530D	\$ 1203	\$ 1244	\$ 1284

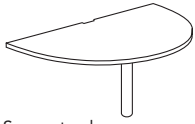

Support column ordered separately.

Quarter-Round Worksurfaces

24"D x 24"D	TN52424Q	\$ 536	\$ 556	\$ 574
30"D x 30"D	TN53030Q	\$ 676	\$ 703	\$ 721



Woodgrain Grain Direction

Note: Add Suffix "N" to model number for no grommet, no upcharge.

TERRACE



Flat Edge

<p>How to specify — Select the Model Number from above.</p>	<p><i>1st Option:</i> Laminate: See page 20 for finishes.</p>	<p><i>2nd Option:</i> Edge Trim Color: See page 20 for finishes.</p>
--	--	---

T|N|5| | | | | | | | | | | | | | | | . | | | | | | | | | | . | | |

Examples: TN524D.LT3B.E9 TN52424Q.LT3B.E9

For specification information see pages 82-87

Laminate

GSA SIN 33721

Description	Laminate w/Flat Edge Model	Laminate w/Flat Edge		
		L1 List Price	L2 List Price	L3 List Price
15"D Straight Countertops (order Raised Kit below)				
24"W	Y51524S	\$ 344	\$ 359	\$ 371
30"W	Y51530S	\$ 381	\$ 397	\$ 410
36"W	Y51536S	\$ 428	\$ 445	\$ 460
42"W	Y51542S	\$ 444	\$ 461	\$ 477
48"W	Y51548S	\$ 469	\$ 487	\$ 503
54"W	Y51554S	\$ 532	\$ 552	\$ 569
60"W	Y51560S	\$ 593	\$ 615	\$ 634
66"W	Y51566S	\$ 614	\$ 639	\$ 656
72"W	Y51572S	\$ 639	\$ 665	\$ 682
15"D Corner Countertops (order Raised Kit below)				
24"W x 24"W	Y52424C	\$ 671	\$ 698	\$ 716
30"W x 30"W	Y53030C	\$ 780	\$ 810	\$ 832
36"W x 36"W	Y53636C	\$ 866	\$ 898	\$ 924

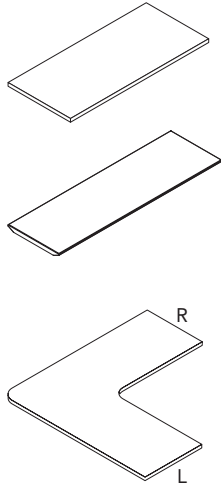

Note: **V** For a straight countertop, when used with "H" in-line high-low trim kit on one side. No upcharge.
Example: Y51530SV

RV For a corner countertop, when used with "H" in-line high-low trim kit on the right side. No upcharge.
Example: Y52424CRV

LV For a corner countertop, when used with "H" in-line high-low trim kit on the left side. No upcharge.
Example: Y53636CLV

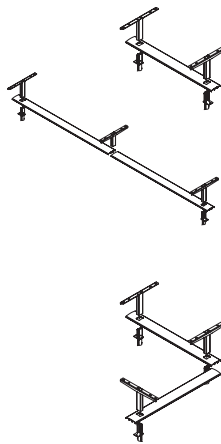

Description	Flat Top Trim Painted Model	Radius Top Trim Model	Flat Painted Top Trim			Radius Painted Top Trim		
			P1 List Price	P2 List Price	P3 List Price	P1 List Price	P2 List Price	P3 List Price
Raised Straight Countertop Kits (order Countertop above)								
24"W	TK851524PF	TK851524P	\$ 144	\$ 164	\$ 181	\$ 174	\$ 196	\$ 215
30"W	TK851530PF	TK851530P	\$ 153	\$ 173	\$ 190	\$ 182	\$ 204	\$ 223
36"W	TK851536PF	TK851536P	\$ 160	\$ 180	\$ 197	\$ 191	\$ 213	\$ 232
42"W	TK851542PF	TK851542P	\$ 167	\$ 187	\$ 204	\$ 200	\$ 222	\$ 241
48"W	TK851548PF	TK851548P	\$ 176	\$ 196	\$ 213	\$ 210	\$ 232	\$ 251
54"W	TK851554PF	TK851554P	\$ 192	\$ 212	\$ 229	\$ 231	\$ 253	\$ 272
60"W	TK851560PF	TK851560P	\$ 208	\$ 228	\$ 245	\$ 251	\$ 273	\$ 292
66"W	TK851566PF	TK851566P	\$ 227	\$ 247	\$ 264	\$ 268	\$ 290	\$ 309
72"W	TK851572PF	TK851572P	\$ 244	\$ 264	\$ 281	\$ 289	\$ 311	\$ 330
Raised Corner Countertop Kits (order Countertop above)								
24"W		TK851524CP	N/A	N/A	N/A	\$ 223	\$ 245	\$ 264
30"W		TK851530CP	N/A	N/A	N/A	\$ 231	\$ 253	\$ 272
36"W		TK851536CP	N/A	N/A	N/A	\$ 240	\$ 262	\$ 281

<p>How to specify — Select the Model Number from above.</p>	<p><i>1st Option:</i> Paint (Countertop Kit Supports) (if applicable):</p> <p>P1 P2 P3</p> <p>See page 20 for finishes.</p>	<p><i>1st Option:</i> Laminate or Veneer Type and Finish (if applicable):</p> <p>See page 20 for finishes.</p> <p>Veneer S prefix for Stratawood</p>	<p><i>2nd Option:</i> Edge Trim Color (if applicable):</p> <p>See page 20 for finishes.</p>
<p>_____ . P _____</p>			

Examples: T53030C.TM20.EN TK851524P.P02

ORDERING

The 9120 Program can be used to order particle board rectangular worksurfaces in any non-standard width and depth in 1/8" increments up to a maximum of 120" W x 36" D.

Specify:

- Model Number** (see page 106)
Specify closest nominal width/depth model (round up).
- Grommet Option** (if desired)
See grommet specification instructions on this page.
- Grommet Type:**
P Plastic
M Metal (add \$11 per grommet for laminate)
- Grommet Color:**
(Metal only)
EL Matte Silver
Note: Plastic grommet will match flat edge.
- Laminate and Veneer Choices**
See page 20.
- Flat Edge Color Choices**
See edge colors page 20 for laminates.
- Exact Size**
Specify the **exact width** and **exact depth** you require.
Width and depth is specified in 1/8" increments which is denoted as a single digit following the whole number dimension at the end of the model number string.

1/8" = 1	5/8" = 5
2/8" = 2	6/8" = 6
3/8" = 3	7/8" = 7
4/8" = 4	no extra increment = 0

For example, when ordering a worksurface that is 34 3/8" W x 20 1/2" D, specification should be 345Wx204D.
Example: 9120R3624.G0.TM33.EU.345Wx204D.

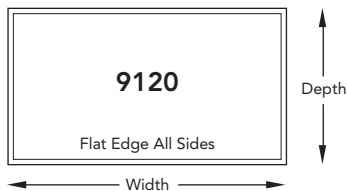

PRODUCT SPECIFICATIONS

- Flat edge on all sides
- 45 lb. particle board
- 1 1/8" top thickness
- .020 resin impregnated paper backer sheet
- Grommets available
- Maximum width 120" (maximum recommended unsupported span is 42")
- Maximum depth 36"
- Standard Allsteel laminates and veneers
- Quantities of 10 or greater are palletized; less than 10 are individually cartoned.

Note: 9120 worksurface maximum unsupported span is 42".
9120 worksurfaces do not have pre-drilled pilot holes or threaded metal inserts.

When spanning multiple freestanding storage units with one worksurface, add 1/8" for each additional storage unit. For example, when ordering a worksurface for three 30"W lateral files. 3 units x 30" = 90" + 1/8" + 1/8" = 90 1/4" worksurface. Do NOT follow this rule if panel wrapping storage units.

CHANGES / CANCELLATIONS

No changes/cancellations for 9120 Program worksurfaces.

GROMMET SPECIFICATIONS

Plastic grommets are made of durable ABS plastic and grommets match edge color on laminate worksurfaces. Metal grommets are only available Matte Silver oval for laminate and square for veneer.

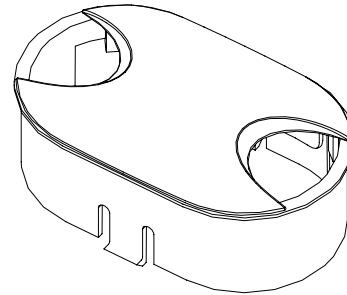

PRICING

See page 106 for laminate and veneer 9120 worksurface pricing.

One Grommet — GC, GL, or GR Position..... \$17.00
Two Grommets — G3 or G4 Position..... \$34.00

Note: Add \$10 per grommet for metal grommets with laminate.

ORDERING

Specify grommet location and color.

Example: 9120R10836.GCP.TM33.EU.1022Wx326D

Code Grommet Position

- GC Centered side-to-side — 3/8" from rear to grommet edge; 4 1/2" from rear to grommet center
- GL 6 1/16" from left side to grommet edge — 3/8" from rear to grommet edge; 4 1/2" from rear to grommet center
- GR 6 1/16" from right side to grommet edge — 3/8" from rear to grommet edge; 4 1/2" from rear to grommet center
- G3 Pair of grommets each 18" from side edge — 3/8" from rear to grommet edge; 4 1/2" from rear to grommet center (Position G3 not available on tops 60"W or less.)
- G4 Pair of grommets each 6 1/16" from side edge to grommet edge — 3/8" from rear to grommet edge; 4 1/2" from rear to grommet center
- G0 No grommets

Dimensions are from grommet center line to top edge.

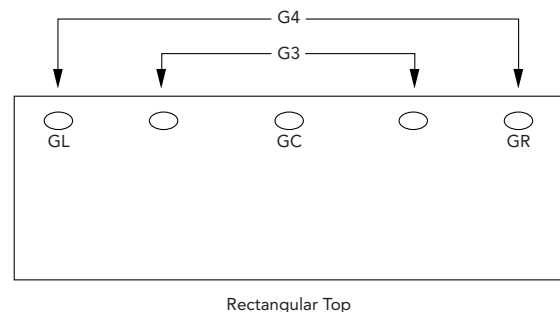

Grommet positions other than those shown above are considered non-standard.

TERRACE

For specification information see page 105.

Laminate and Veneer Worksurfaces / Non-Standard Sizes

GSA SIN 33721

*Model Number — Add "R" for laminate or "V" for veneer

Maximum	Model Number*	Width		Depth		Laminate List Price			Veneer List Price		
		MIN	MAX	MIN	MAX	L1	L2	L3	V1	V3	V5
18"D											
18"W	9120□1818	180W	180W	121D	180D	\$ 454	\$ 472	\$ 487	\$ 1111	\$ 1235	\$ 1318
24"W	9120□2418	181W	240W	121D	180D	\$ 474	\$ 492	\$ 508	\$ 1184	\$ 1316	\$ 1404
30"W	9120□3018	241W	300W	121D	180D	\$ 494	\$ 513	\$ 529	\$ 1252	\$ 1392	\$ 1485
36"W	9120□3618	301W	360W	121D	180D	\$ 539	\$ 559	\$ 577	\$ 1299	\$ 1444	\$ 1541
42"W	9120□4218	361W	420W	121D	180D	\$ 594	\$ 616	\$ 635	\$ 1378	\$ 1532	\$ 1634
48"W	9120□4818	421W	480W	121D	180D	\$ 688	\$ 715	\$ 734	\$ 1450	\$ 1612	\$ 1720
60"W	9120□6018	481W	600W	121D	180D	\$ 855	\$ 887	\$ 912	\$ 1649	\$ 1833	\$ 1956
72"W	9120□7218	601W	720W	121D	180D	\$ 1034	\$ 1070	\$ 1103	\$ 1796	\$ 1997	\$ 2130
84"W	9120□8418	721W	840W	121D	180D	\$ 1352	\$ 1397	\$ 1445	\$ 1933	\$ 2149	\$ 2293
96"W	9120□9618	841W	960W	121D	180D	\$ 1398	\$ 1445	\$ 1493	\$ 2089	\$ 2322	\$ 2478
108"W	9120□10818	961W	1080W	121D	180D	\$ 1599	\$ 1652	\$ 1708	\$ 2111	\$ 2347	\$ 2504
120"W	9120□12018	1081W	1200W	121D	180D	\$ 1822	\$ 1884	\$ 1946	\$ 2256	\$ 2508	\$ 2676
24"D											
24"W	9120□2424	181W	240W	181D	240D	\$ 515	\$ 534	\$ 552	\$ 1162	\$ 1292	\$ 1378
30"W	9120□3024	241W	300W	181D	240D	\$ 536	\$ 556	\$ 574	\$ 1218	\$ 1354	\$ 1445
36"W	9120□3624	301W	360W	181D	240D	\$ 587	\$ 609	\$ 627	\$ 1285	\$ 1429	\$ 1524
42"W	9120□4224	361W	420W	181D	240D	\$ 641	\$ 667	\$ 684	\$ 1355	\$ 1506	\$ 1607
48"W	9120□4824	421W	480W	181D	240D	\$ 728	\$ 756	\$ 777	\$ 1490	\$ 1656	\$ 1767
60"W	9120□6024	481W	600W	181D	240D	\$ 897	\$ 930	\$ 959	\$ 1703	\$ 1893	\$ 2020
72"W	9120□7224	601W	720W	181D	240D	\$ 1074	\$ 1112	\$ 1146	\$ 1919	\$ 2133	\$ 2276
84"W	9120□8424	721W	840W	181D	240D	\$ 1398	\$ 1445	\$ 1493	\$ 2089	\$ 2322	\$ 2478
96"W	9120□9624	841W	960W	181D	240D	\$ 1444	\$ 1493	\$ 1543	\$ 2260	\$ 2512	\$ 2681
108"W	9120□10824	961W	1080W	181D	240D	\$ 1645	\$ 1700	\$ 1757	\$ 2432	\$ 2704	\$ 2885
120"W	9120□12024	1081W	1200W	181D	240D	\$ 1864	\$ 1927	\$ 1992	\$ 2493	\$ 2771	\$ 2957
30"D											
30"W	9120□3030	241W	300W	241D	300D	\$ 619	\$ 644	\$ 661	\$ 1218	\$ 1354	\$ 1445
36"W	9120□3630	301W	360W	241D	300D	\$ 651	\$ 677	\$ 695	\$ 1396	\$ 1552	\$ 1656
42"W	9120□4230	361W	420W	241D	300D	\$ 694	\$ 721	\$ 740	\$ 1505	\$ 1673	\$ 1785
48"W	9120□4830	421W	480W	241D	300D	\$ 751	\$ 780	\$ 802	\$ 1642	\$ 1825	\$ 1948
60"W	9120□6030	481W	600W	241D	300D	\$ 986	\$ 1020	\$ 1050	\$ 1911	\$ 2124	\$ 2267
72"W	9120□7230	601W	720W	241D	300D	\$ 1127	\$ 1166	\$ 1203	\$ 2166	\$ 2408	\$ 2569
84"W	9120□8430	721W	840W	241D	300D	\$ 1711	\$ 1768	\$ 1827	\$ 2306	\$ 2564	\$ 2735
96"W	9120□9630	841W	960W	241D	300D	\$ 1752	\$ 1810	\$ 1871	\$ 2455	\$ 2729	\$ 2912
108"W	9120□10830	961W	1080W	241D	300D	\$ 1973	\$ 2039	\$ 2108	\$ 2611	\$ 2902	\$ 3097
120"W	9120□12030	1081W	1200W	241D	300D	\$ 2199	\$ 2274	\$ 2349	\$ 2887	\$ 3209	\$ 3424
36"D											
36"W	9120□3636	301W	360W	301D	360D	\$ 884	\$ 916	\$ 943	\$ 2017	\$ 2242	\$ 2392
42"W	9120□4236	361W	420W	301D	360D	\$ 1004	\$ 1040	\$ 1071	\$ 2154	\$ 2394	\$ 2555
48"W	9120□4836	421W	480W	301D	360D	\$ 1129	\$ 1168	\$ 1205	\$ 2302	\$ 2559	\$ 2730
60"W	9120□6036	481W	600W	301D	360D	\$ 1384	\$ 1430	\$ 1478	\$ 2308	\$ 2566	\$ 2738
72"W	9120□7236	601W	720W	301D	360D	\$ 1630	\$ 1685	\$ 1741	\$ 2448	\$ 2721	\$ 2904
84"W	9120□8436	721W	840W	301D	360D	\$ 1973	\$ 2039	\$ 2108	\$ 2495	\$ 2774	\$ 2959
96"W	9120□9636	841W	960W	301D	360D	\$ 2022	\$ 2090	\$ 2159	\$ 2717	\$ 3020	\$ 3223
108"W	9120□10836	961W	1080W	301D	360D	\$ 2242	\$ 2318	\$ 2397	\$ 2951	\$ 3280	\$ 3500
120"W	9120□12036	1081W	1200W	301D	360D	\$ 2464	\$ 2547	\$ 2633	\$ 3189	\$ 3545	\$ 3783

For specification information see pages 82-87

Veneer

GSA SIN 33721



Stratawood Veneer
Grain Direction

Description	Veneer "V" Model	Veneer "V" V1 List Price
Quarter-Round Worksurfaces		
24"D x 24"D	TNV52424Q	\$ 1029
30"D x 30"D	TNV53030Q	\$ 1283

Note: Add Suffix "N" to model number for no grommet, no upcharge.

TERRACE



Veneer Edge

<p><i>How to specify —</i> Select the Model Number from above.</p> <p>T .</p>	<p><i>1st Option:</i> Veneer Type and Finish: See page 20 for finishes. S prefix for Stratawood</p> <p> </p>
---	---

Example: TNV52424Q.SC777

For specification information see pages 82-87

GSA SIN 33721

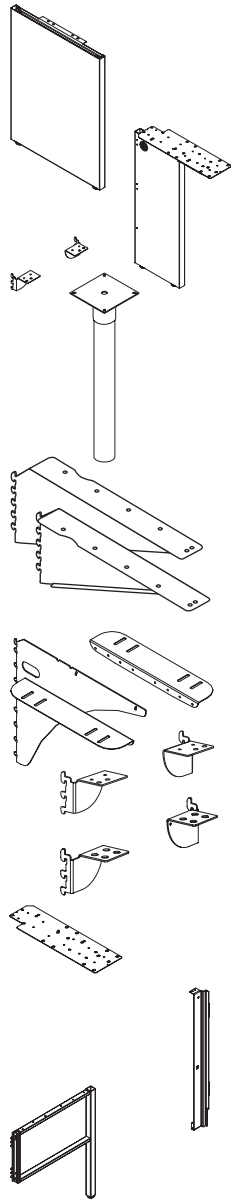

Description	Model	P1 Paint List Price	P2 Paint List Price	P3 Paint List Price
End-Panel Supports				
11"D x 29½"H — Left – Panel-Mount	TKEP1129PL	\$ 277	\$ 313	\$ 350
11"D x 29½"H — Right – Panel-Mount	TKEP1129PR	\$ 277	\$ 313	\$ 350
24"D x 29½"H — Left – Panel-Mount	TKEP2429PL	\$ 296	\$ 332	\$ 369
24"D x 29½"H — Right – Panel-Mount	TKEP2429PR	\$ 296	\$ 332	\$ 369
30"D x 29½"H — Left – Panel-Mount	TKEP3029PL	\$ 324	\$ 360	\$ 397
30"D x 29½"H — Right – Panel-Mount	TKEP3029PR	\$ 324	\$ 360	\$ 397
Support Legs				
24"D x 29½"H — Panel-Mount	TKSL2429P	\$ 261	\$ 297	\$ 334
30"D x 29½"H — Panel-Mount	TKSL3029P	\$ 285	\$ 321	\$ 358
Support Columns				
29½"H / 3"Diameter	TT629SC S	\$ 249	\$ 285	\$ 322
Cantilever Bracket — Terrace				
12"D Left-Hand	T6CB12L S	\$ 69	\$ 83	\$ 94
12"D Right-Hand	T6CB12R S	\$ 69	\$ 83	\$ 94
18"D Left-Hand	T6CB18L S	\$ 74	\$ 88	\$ 99
18"D Right-Hand	T6CB18R S	\$ 74	\$ 88	\$ 99
24" or 30"D Left-Hand	T6CB24L S	\$ 81	\$ 95	\$ 106
24" or 30"D Right-Hand	T6CB24R S	\$ 81	\$ 95	\$ 106
Cantilever Bracket — non-handed (Core P1 paint colors only)				
24" or 30"D	T624CB S	\$ 202	N/A	N/A
Worksurface Bracket Kit				
One pair	T6BK S	\$ 70	\$ 83	\$ 93
Worksurface Storage Bracket Kit (no color option — black only)				
One Pair	T6SB S	\$ 95	N/A	N/A
Flat Brackets (no color option)				
For 12"D	T612FB S	\$ 61	N/A	N/A
For 24"D	T624FB S	\$ 70	N/A	N/A
For 30"D	T630FB S	\$ 80	N/A	N/A
Pedestal-to-Panel Bracket				
Left	TKPPBL S	\$ 117	\$ 131	\$ 142
Right	TKPPBR S	\$ 117	\$ 131	\$ 142
Open End Panel Supports				
12"D x 29½"H Panel-Mount	AYBHEP1229	\$ 273	\$ 309	\$ 346
18"D x 29½"H Panel-Mount	AYBHEP1829	\$ 278	\$ 314	\$ 351
24"D x 29½"H Panel-Mount	AYBHEP2429	\$ 288	\$ 324	\$ 361
30"D x 29½"H Panel-Mount	AYBHEP3029	\$ 310	\$ 346	\$ 383

How to specify —
Select the Model Number from above.

1st Option:

Paint:
P1 P2 P3

See page 20 for finishes.

_____ . P _____

Example: TKEP1129PL.P02

S Shippable by small-package carrier.

For specification information see pages 88-96.

GSA SIN 33721

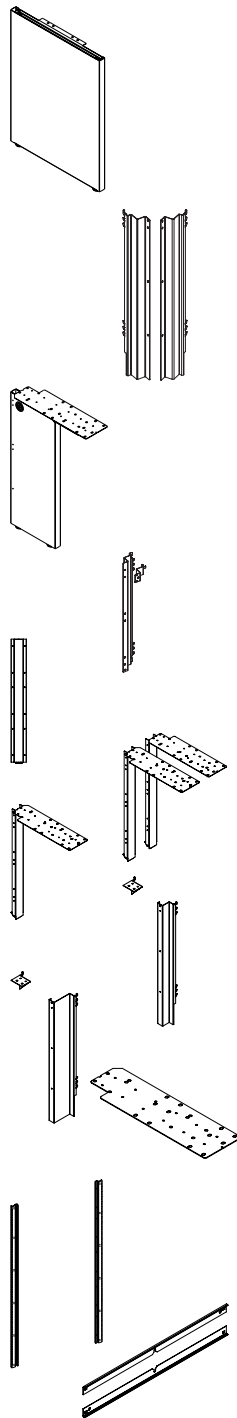

Description	Model	P1 Paint List Price	P2 Paint List Price	P3 Paint List Price
End-Panel Supports				
11"D x 29½"H — Freestanding	CEP1129F	\$ 245	\$ 281	\$ 318
24"D x 29½"H — Freestanding	CEP2429F	\$ 264	\$ 300	\$ 337
30"D x 29½"H — Freestanding	CEP3029F	\$ 292	\$ 328	\$ 365
End-Panel Bracket Kits for Terrace				
11"D x 29½"H — Left – Panel-Mount	TKEP1129PL	\$ 277	\$ 313	\$ 350
11"D x 29½"H — Right – Panel-Mount	TKEP1129PR	\$ 277	\$ 313	\$ 350
24"D x 29½"H — Left – Panel-Mount	TKEP2429PL	\$ 296	\$ 332	\$ 369
24"D x 29½"H — Right – Panel-Mount	TKEP2429PR	\$ 296	\$ 332	\$ 369
30"D x 29½"H — Left – Panel-Mount	TKEP3029PL	\$ 324	\$ 360	\$ 397
30"D x 29½"H — Right – Panel-Mount	TKEP3029PR	\$ 324	\$ 360	\$ 397
End-Panel Bracket Kits for Terrace				
29½"H Bracket Kit — Left	TKEB29L	\$ 56	\$ 70	\$ 81
29½"H Bracket Kit — Right	TKEB29R	\$ 56	\$ 70	\$ 81
Support Legs				
24"D x 29½"H — Freestanding	CSL2429F S	\$ 228	\$ 264	\$ 301
30"D x 29½"H — Freestanding	CSL3029F S	\$ 253	\$ 289	\$ 326
24"D x 29½"H — Panel-Mount	TKSL2429P	\$ 261	\$ 297	\$ 334
30"D x 29½"H — Panel-Mount	TKSL3029P	\$ 285	\$ 321	\$ 358
Support Leg Bracket for Terrace				
29½"H	TKSB29	\$ 56	\$ 70	\$ 81
Corner Desk Leg				
29½"H	CDL29 S	\$ 210	\$ 232	\$ 251
Bridge Kit				
29½"H	CBK29 S	\$ 220	\$ 234	\$ 245
Return Kit				
29½"H	CRK29 S	\$ 112	\$ 123	\$ 131
Desk-to-Panel Attachment Kits for Terrace				
29½"H – Left-Hand	TKDPA29L	\$ 111	\$ 125	\$ 136
29½"H – Right-Hand	TKDPA29R	\$ 111	\$ 125	\$ 136
Corner w/Desk Panel Attachment Kit for Terrace				
29½"H – Left-Hand	TKCWD29L	\$ 111	\$ 125	\$ 136
29½"H – Right-Hand	TKCWD29R	\$ 111	\$ 125	\$ 136
Flat Brackets				
24"D	831124 S	\$ 69	N/A	N/A
30"D	831130 S	\$ 76	N/A	N/A
Note: Flint only.				
Terrace Wall Track Kit — End/Shared				
65"H — Pair of Ends	TK365YEB S	\$ 313	\$ 356	\$ 401
65"H — Middle Unit	TK365YM S	\$ 163	\$ 188	\$ 211
Terrace Wall Track Tile Attachment Kits — Top and Bottom				
24"W	Y324YS S	\$ 232	N/A	N/A
30"W	Y330YS S	\$ 238	N/A	N/A
36"W	Y336YS S	\$ 255	N/A	N/A
42"W	Y342YS S	\$ 289	N/A	N/A
48"W	Y348YS S	\$ 319	N/A	N/A
60"W	Y360YS S	\$ 355	N/A	N/A

TERRACE

How to specify —
Select the Model Number from above.

1st Option:
Paint:
P1
P2
P3
 See page 20 for finishes.

P

Examples: CEP1129F.P02 Y324YS.P02

S Shippable by small-package carrier.

For specification information see pages 88-96.

GSA SIN 33721

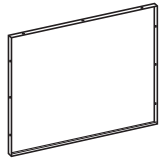

Description	Model	P1 Paint List Price	P2 Paint List Price	P3 Paint List Price
Modesty Panels				
29½"H x 24"W	CS249 <input type="checkbox"/>	\$ 238	\$ 260	\$ 279
29½"H x 30"W	CS309 <input type="checkbox"/>	\$ 245	\$ 267	\$ 286
29½"H x 36"W	CS369 <input type="checkbox"/>	\$ 251	\$ 273	\$ 292
29½"H x 42"W	CS429 <input type="checkbox"/>	\$ 256	\$ 278	\$ 297
29½"H x 48"W	CS489 <input type="checkbox"/>	\$ 261	\$ 283	\$ 302
29½"H x 54"W	CS549 <input type="checkbox"/>	\$ 264	\$ 286	\$ 305
29½"H x 60"W	CS609	\$ 268	\$ 290	\$ 309
29½"H x 66"W	CS669	\$ 273	\$ 295	\$ 314
29½"H x 72"W	CS729	\$ 283	\$ 305	\$ 324

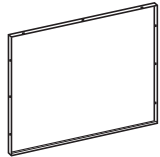

Stand-alone Corner Modesty Panels				
29½"H x 36"W	CSCMP3629 <input type="checkbox"/>	\$ 251	\$ 273	\$ 292
29½"H x 42"W	CSCMP4229 <input type="checkbox"/>	\$ 256	\$ 278	\$ 297
29½"H x 48"W	CSCMP4829 <input type="checkbox"/>	\$ 261	\$ 283	\$ 302
29½"H x 60"W	CSCMP6029	\$ 268	\$ 290	\$ 309
29½"H x 72"W	CSCMP7229	\$ 283	\$ 305	\$ 324

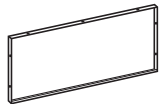

Modesty Panels				
14"H x 24"W	CS244 <input type="checkbox"/>	\$ 224	\$ 246	\$ 265
14"H x 30"W	CS304 <input type="checkbox"/>	\$ 229	\$ 251	\$ 270
14"H x 36"W	CS364 <input type="checkbox"/>	\$ 235	\$ 257	\$ 276
14"H x 42"W	CS424 <input type="checkbox"/>	\$ 242	\$ 264	\$ 283
14"H x 48"W	CS484 <input type="checkbox"/>	\$ 250	\$ 272	\$ 291
14"H x 54"W	CS544 <input type="checkbox"/>	\$ 253	\$ 275	\$ 294
14"H x 60"W	CS604	\$ 261	\$ 283	\$ 302
14"H x 66"W	CS664	\$ 264	\$ 286	\$ 305
14"H x 72"W	CS724	\$ 268	\$ 290	\$ 309

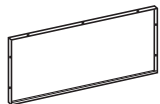

Stand-alone Corner Modesty Panels				
14"H x 36"W	CSCMP3614 <input type="checkbox"/>	\$ 235	\$ 257	\$ 276
14"H x 42"W	CSCMP4214 <input type="checkbox"/>	\$ 242	\$ 264	\$ 283
14"H x 48"W	CSCMP4814 <input type="checkbox"/>	\$ 250	\$ 272	\$ 291
14"H x 60"W	CSCMP6014	\$ 261	\$ 283	\$ 302
14"H x 72"W	CSCMP7214	\$ 268	\$ 290	\$ 309

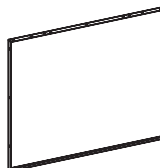

Pedestal-to-Pedestal Modesty Panel				
27"H x 30"W to create a 60"W Desk	TKMP60	\$ 251	\$ 273	\$ 292
27"H x 36"W to create a 66"W Desk	TKMP66	\$ 253	\$ 275	\$ 294
27"H x 42"W to create a 72"W Desk	TKMP72	\$ 262	\$ 284	\$ 303

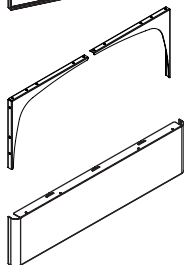

Gussets				
One pair	CDG <input type="checkbox"/>	\$ 171	\$ 193	\$ 212

Modesty Panels				
41"W for 60"L Peninsula	PMP41 <input type="checkbox"/>	\$ 330	\$ 330	\$ 330
47"W for 66"L Peninsula, 72"L P-Shape, or 66"L Jetty	PMP47 <input type="checkbox"/>	\$ 336	\$ 336	\$ 336
53"W for 72"L Peninsula, Jetty, or Boomerang	PMP53 <input type="checkbox"/>	\$ 347	\$ 347	\$ 347

How to specify —
Select the Model Number from above.

1st Option:

Paint:



See page 20 for finishes.

. P

Examples: TKMP60.P4J CS244.P28

Shippable by small-package carrier.

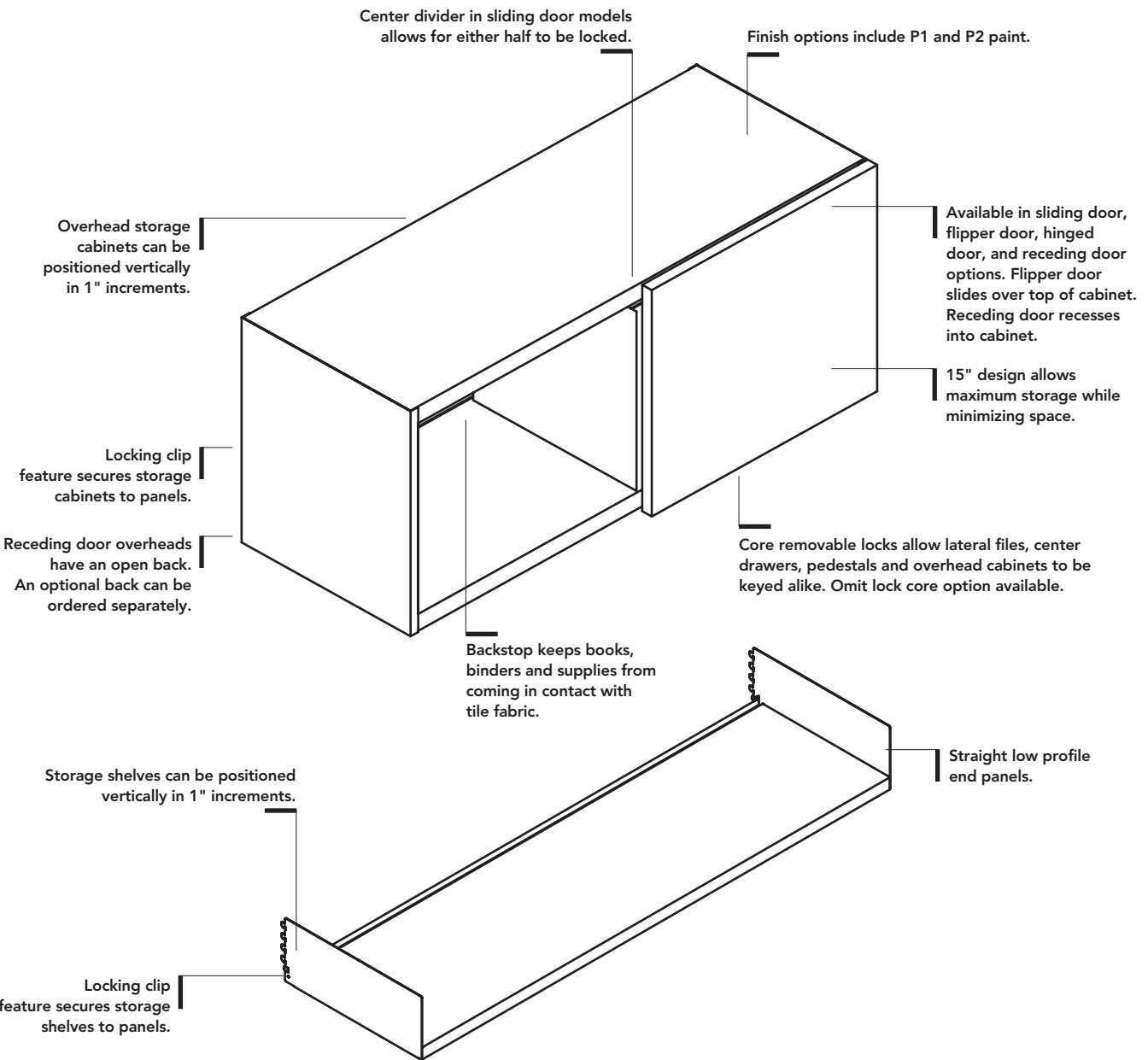

TERRACE

Product dimensions	
Overhead Storage Cabinet	
Width	24", 30", 36", 42", 48", 60"
Inside width	Flipper or 24"-36" W Hinged door — 3/8" less than width 42"-48" W Hinged or Sliding door — two compartments that are half of 3/8" less than width
Depth	14 1/4" RTA models 12"
Inside depth	12 7/8" Receding door 12 1/2" RTA models 11 5/8"
Height	15"
Inside height	12 3/4" Receding door 11 5/8" RTA models 12 3/4"
Open Shelf	
Width	24", 30", 36", 42", 48", 60"
Depth	12 7/8" RTA models 11 1/2"
Height	4 5/8" RTA models 5 5/8"

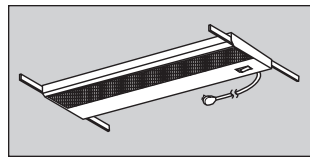

- **Task lights** can be mounted beneath storage shelves and overhead storage cabinets.
- Additional panel hung and freestanding lighting options are available.

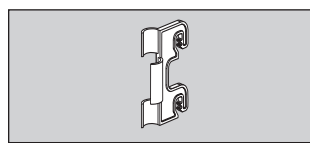

- **Cord retainer clips** fasten into panel slots to anchor power cords.
- Available in black only.
- Clips are provided with under-shelf mounted task lights. Additional clips can be purchased separately.

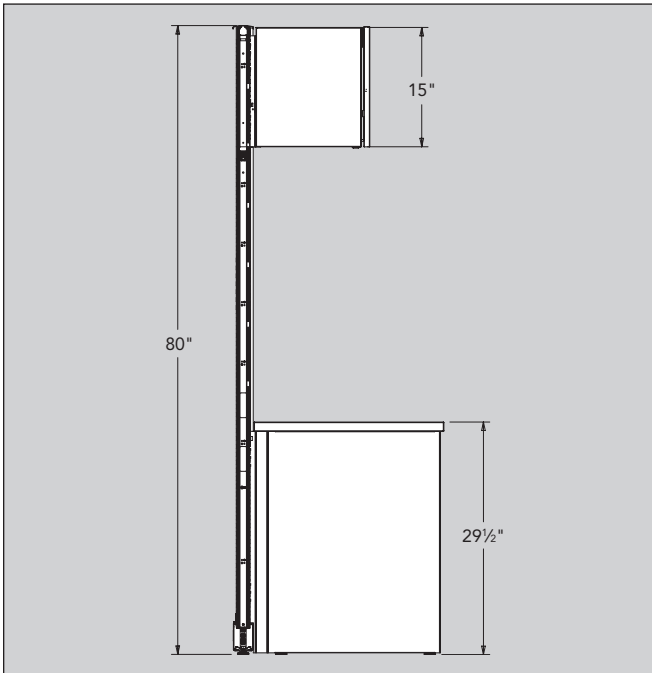
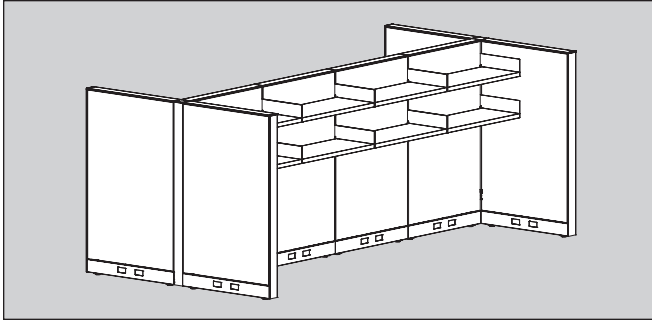

Specification Guidelines

- In a panel run, only two overhead storage cabinets or open storage shelves are recommended per panel side.
- Do not suspend more than one overhead storage unit per side from panels in a panel run which is mounted, at one or both ends, with an off-module connector kit.
- Overhead storage cabinets and open storage shelves can be mounted on Terrace structural and stacking panels to a maximum height of 80"H.
- When mounting an overhead on a 57½"H base panel frame, select the option for Z57 bracket.
- For all other base panel frame and base panel frames with stacking frames the YZ bracket should be selected.
- Base panel frames with stacking frames that have an overall height of 57½" also use the YZ bracket.

When overhead storage units are suspended from stacking frames, the following guidelines should be adhered to:

- Stacking frames should be added to all the parent run panels, and to, at least the first panel of each return-panel run. Stacking panels added to return panel must match the parent run configuration.
- A maximum of two overhead storage units should be suspended from each side of stacking frames on any given panel.
- With Terrace, a full height panel end cover is required for adequate stability when using overhead storage on the end of a run, or on a return panel.

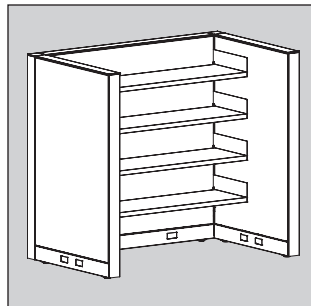

- No limitation to the number of units on structural frames when run is supported with return panels on each side of storage shelves or overhead storage cabinets.

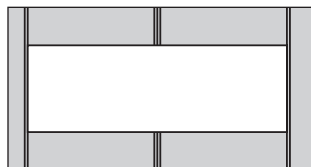

- **Storage shelf, receding door overhead, RTA overhead, and RTA shelf width** must correspond with width of panel(s).
- It is possible to span two panels when combined panel width equals cabinet or shelf width.

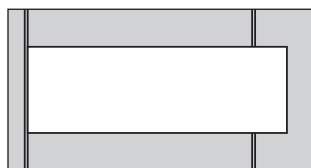

- **Terrace assembled metal overhead cabinets** can be mounted on a panel equal to or up to 18" narrower than cabinet using provided panel attachment brackets.

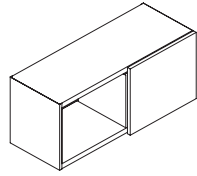

Sliding Door Overhead

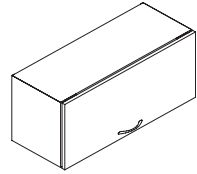

Flipper Door Overhead

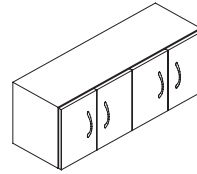

Hinged Door Overhead

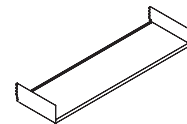

Open Shelf

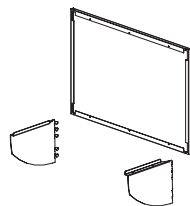

Upmount Kit for Overhead Cabinets

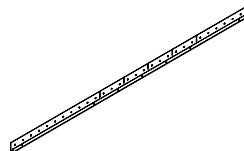

Horizontal Wall Track

Overhead Storage Cabinet (page 115)

- Steel cabinet with backstop.
- Available with sliding, hinged, or flipper door(s).
- Easy-Assist flipper door optional — requires minimal assistance in opening and closing. Not available on 60"W cabinets, specify 2–30"W cabinets with Easy-Assist.
- Self-engaging safety latch to secure cabinet to panel.
- Width can correspond with width of panel, or 2 panels joined without a connector.
- Arch or square pull optional on flipper and hinged doors.
- 60"W flipper door cabinet has 2–30"W doors with 2 independent locks.
- 24"-36"W hinged door cabinets have 1 lock and 2 optional pulls, 42"-48"W have 2 locks and 4 optional pulls.
- Accommodates recessed task lighting (specified separately).
- For locking specifications, see pages 408-410.
- Cabinets are 14¼"D x 15"H.
- 15"H cabinets can also be mounted on a panel equal to or up to 18" narrower than cabinet using provided panel attachment brackets.
- Sliding doors have a built in pull.
- Sliding, hinged, and flipper door overhead weight limits:

24"W	59 lbs.	42"W	105 lbs.
30"W	74 lbs.	48"W	121 lbs.
36"W	90 lbs.	60"W	152 lbs.
- When mounting an overhead on a 57½"H base panel frame, select the option for Z57 bracket. For all other base panel frame and base panel frames with stacking frames the YZ bracket should be selected. Base panel frames with stacking frames that have an overall height of 57½"H also use the YZ bracket.

Open Shelf (page 115)

- Metal shelf with back stop.
- Locking clips (2) standard.
- Will accommodate recessed task lighting — ordered separately.
- Weight Limits:

24"W	61 lbs.	42"W	108 lbs.
30"W	77 lbs.	48"W	124 lbs.
36"W	93 lbs.	60"W	155 lbs.

Upmount Kits for Assembled Overhead Cabinets (page 115)

- Consists of two upmount brackets, full back panel and required installation hardware.
- Allows mounting of an assembled overhead cabinet up to 15" above height of panel.
- Specify "Z2" prefix model number upmount kits with 15"H, 30"H, 35"H, 50"H, or 65"H frames; and "Z4" prefix model numbers for use with 22½"H, 42½"H, or 57½"H frames.
- Brackets require a clearance of 6½" below bottom of overhead cabinet.
- Width must correspond with width of panel frame or 2 panel frames joined directly in-line.
- Full back panel adds ½" to depth of overhead case. Full back panel only used when upmounting cabinet.
- Cannot be used with RTA models.

Horizontal Wall Track (page 115)

- Allows mounting overheads on permanent wall structures only.
- Cannot be used with RTA models.
- Track is 60"W and notched at 6" intervals as a guide for field cutting.
- For use with 15"H sliding door overhead, field modification is necessary.
- Available in Black only.
- Attachment hardware not included.

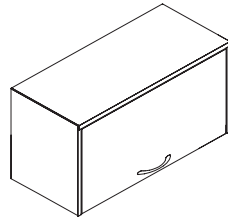

Receding Door Overhead

Receding Door Overhead Storage Cabinet (page 116)

- Steel cabinet with open back. Optional back can be ordered separately.
- Arch or Square pull optional.
- 60" W cabinet has 2 30" W doors with 2 independent locks.
- Accommodates recessed task lighting — ordered separately.
- For locking specifications, see pages 408-410.
- Cabinets are 13 1/4" D x 15" H. When door is recessed, interior dimensions are 12 1/8" D x 11 1/8" H.

Weight Limits:

30" W	70 lbs.	48" W	110 lbs.
36" W	85 lbs.	60" W	138 lbs.
42" W	100 lbs.		

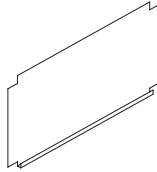

Receding Door Overhead Back

Receding Door Overhead Back (page 116)

- Optional for use with receding door overhead.
- Order width to match overhead cabinet.

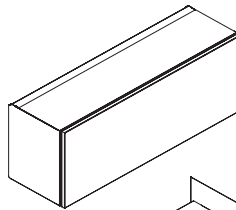

Ready to Assemble (RTA) Flipper Door Overhead (page 116)

- Steel cabinet with open back.
- 60" W and 72" W cabinets have 2 doors with independent locks.
- Accommodates recessed task lighting — ordered separately.
- Random keying, for locking specifications see pages 408-410.
- Cabinets are 12" D x 15" H. Interior dimensions 11 3/8" D x 12 3/4" H.

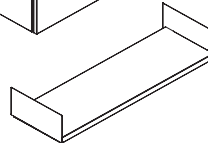

Ready to Assemble (RTA) Shelf (page 116)

- Metal shelf with locking clips.
- Accommodates recessed task lighting — ordered separately.

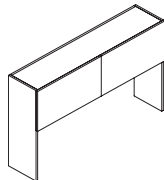

Stack-On Hutch

Stack-on Hutch (page 117)

- Have flipper doors with square horizontal edges.
- Universal model can be converted to open hutch.
- Doors are standard with a core removable lock (60" W, 66" W and 72" W have two doors and two locks.)
- Attachment tape provided.
- Order hutch to match width of worksurface(s) it covers.
- Hutches have clearance of 19 1/4" for computers, etc.
- Ship easy to assemble.
- Depth dimensions shown includes thickness of door.
- Universal model inside depth dimension is 12 3/4"
- Stack-on hutches accommodate recessed task lighting.
- For locking specification see pages 408-410.
- Chicago task light cords cannot be routed through the Hutch end panels, due to the large size of the fused plugs.

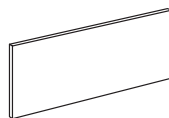

Tackboards for Hutches

Tackboards (page 117)

- Use tackboard to close the back of stack-on or hutch below storage unit.
- Due to width of fabric roll, 72" W tackboards are available in railroad cut only.
- Back of tackboard is painted steel, a finished surface.

Metal Overheads

Terrace® — Overheads / Shelves and Mounting Kits

For specification information see pages 111-114.

GSA SIN 33721

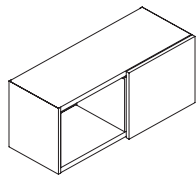

Description	Model	P1 Paint List Price	P2 Paint List Price	P3 Paint List Price
15"H x 14 1/4"D Sliding Single Door Overhead Cabinets				
24"W	OH1524SD	\$ 926	\$ 995	\$ 1064
30"W	OH1530SD	\$ 947	\$ 1016	\$ 1085
36"W	OH1536SD	\$ 993	\$ 1062	\$ 1131
42"W	OH1542SD	\$ 1038	\$ 1107	\$ 1176
48"W	OH1548SD	\$ 1085	\$ 1154	\$ 1223
60"W	OH1560SD	\$ 1433	\$ 1502	\$ 1571

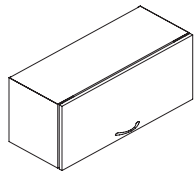

15"H x 14 1/4"D Flipper Door Overhead Cabinets				
24"W	OH1524FD	\$ 926	\$ 995	\$ 1064
30"W	OH1530FD	\$ 947	\$ 1016	\$ 1085
36"W	OH1536FD	\$ 993	\$ 1062	\$ 1131
42"W	OH1542FD	\$ 1038	\$ 1107	\$ 1176
48"W	OH1548FD	\$ 1085	\$ 1154	\$ 1223
60"W	OH1560FD	\$ 1433	\$ 1502	\$ 1571

Note: Add suffix **A** for arch pull or **S** for square pull to model number — add \$38 per pull.
For “Easy-Assist” on 24"W-48"W change FD suffix to FE – add \$214

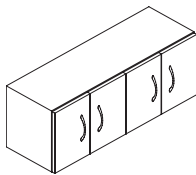

15"H x 14 1/4"D Hinged Door Overhead Cabinets				
24"W	OH1524HD	\$ 1586	\$ 1654	\$ 1723
30"W	OH1530HD	\$ 1657	\$ 1725	\$ 1794
36"W	OH1536HD	\$ 1735	\$ 1803	\$ 1872
42"W	OH1542HD	\$ 1809	\$ 1877	\$ 1946
48"W	OH1548HD	\$ 1876	\$ 1944	\$ 2013

Note: Add suffix **A** for arch pull or **S** for square pull to model number — add \$38 per pull.

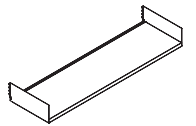

Open Shelf (to line up with 15"H Overheads) — 12 1/8"D					
24"W	ZS24	<input type="checkbox"/> S	\$ 395	\$ 419	\$ 441
30"W	ZS30	<input type="checkbox"/> S	\$ 428	\$ 452	\$ 474
36"W	ZS36	<input type="checkbox"/> S	\$ 452	\$ 476	\$ 498
42"W	ZS42	<input type="checkbox"/> S	\$ 473	\$ 497	\$ 519
48"W	ZS48	<input type="checkbox"/> S	\$ 496	\$ 520	\$ 542
60"W	ZS60		\$ 604	\$ 628	\$ 650

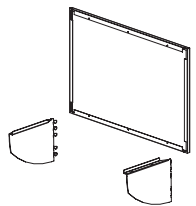

Upmount Kits for Overhead Cabinets					
Specify “Z4” prefix models with 22 1/2"H, 42 1/2"H, or 57 1/2"H frames; “Z2” prefix for other heights.					
24"W	Z <input type="checkbox"/> UP24		\$ 239	\$ 264	\$ 287
30"W	Z <input type="checkbox"/> UP30		\$ 250	\$ 275	\$ 298
36"W	Z <input type="checkbox"/> UP36		\$ 257	\$ 282	\$ 305
42"W	Z <input type="checkbox"/> UP42		\$ 271	\$ 296	\$ 319
48"W	Z <input type="checkbox"/> UP48		\$ 284	\$ 309	\$ 332
60"W	Z <input type="checkbox"/> UP60		\$ 304	\$ 329	\$ 352

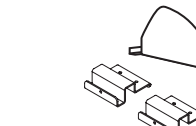

Shelf Dividers					
Package of 6	T7DV	<input type="checkbox"/> S	\$ 127	\$ 142	\$ 152

Note: Not compatible with RTA models.

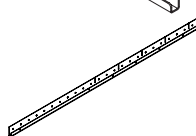

Horizontal Wall Track					
60"W Track	TWTH	<input type="checkbox"/> S	\$ 120	N/A	N/A

<p>How to specify — Select the Model Number from above.</p>	<p>1st Option: Pull (if applicable): A Arch pull, add \$38 per pull S Square pull, add \$38 per pull</p>	<p>2nd Option: System (if applicable): YZ Terrace, Stride®, or Optimize™ Z57 57"H Terrace or Stride</p>	<p>3rd Option: Paint: <input type="checkbox"/> P1 <input type="checkbox"/> P2 <input type="checkbox"/> P3 See page 20 for finishes.</p>	<p>4th Option: Pull Color (if applicable): Arch: E4 Black EL Matte Silver Square: EL Matte Silver</p>	<p>5th Option: Lock Type: STD Standard — Random Keyed OMT Omit Lock Core (Deduct \$18 per lock)</p>
<p>_____</p>	<p>_____</p>	<p>_____</p>	<p>P _____</p>	<p>E _____</p>	<p>_____</p>

Examples: OH1536FEA.YZ.P01.E4.STD OH1548FDS.YZ.P52.EL.OMT Shippable by small-package carrier.

Metal Overheads

Terrace® — Overheads

For specification information see pages 111-114.

GSA SIN 33721

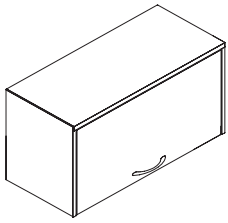

Description	Model	P1 Paint List Price	P2 Paint List Price	P3 Paint List Price
15"H x 13¼"D Receding Door Overheads (Inside dimensions with door recessed — 11½"H x 12½"D)				
30"W	OH1530RD	\$ 1087	\$ 1156	\$ 1225
36"W	OH1536RD	\$ 1146	\$ 1215	\$ 1284
42"W	OH1542RD	\$ 1218	\$ 1287	\$ 1356
48"W	OH1548RD	\$ 1320	\$ 1389	\$ 1458
60"W	OH1560RD	\$ 1997	\$ 2066	\$ 2135

Note: Add Suffix **A** for arch pull or **S** for square pull option — add \$38 per pull.

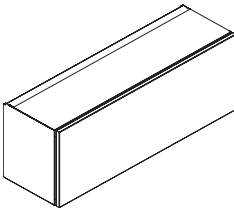

15"H x 12"D Ready to Assemble (RTA) Flipper Door Overhead (Inside dimensions 12¼"H x 11½"D)				
36"W RTA — Flipper Door	POHRTA1536FD	\$ 778	\$ 847	\$ 916
42"W RTA — Flipper Door	POHRTA1542FD	\$ 813	\$ 882	\$ 951
48"W RTA — Flipper Door	POHRTA1548FD	\$ 848	\$ 917	\$ 986

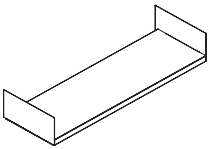

5½"H x 12"D Ready to Assemble (RTA) Shelf				
36"W RTA — Shelf	POHRTA36S	\$ 405	\$ 428	\$ 449
48"W RTA — Shelf	POHRTA48S	\$ 445	\$ 468	\$ 489

TERRACE

<p>How to specify — Select the Model Number from above.</p> <div style="border: 1px solid black; width: 100px; height: 100px; margin: 10px 0;"></div>	<p>1st Option: Receding Door Pull (if applicable):</p> <p>A Arch Pull, add \$38 per pull S Square Pull, add \$38 per pull</p>	<p>2nd Option: System for Receding Door Overhead (if applicable):</p> <p>YZ Terrace, Stride®, Optimize™, or Concensys® Z57 57½"H Stride or Terrace</p>	<p>3rd Option: Paint:</p> <p>P1 P2 P3 See page 20 for finishes.</p>	<p>4th Option: Receding Door Pull Color (if applicable):</p> <p>Arch: E4 Black EL Silver</p> <p>Square: EL Silver</p>	<p>5th Option: Receding Door Lock (if applicable):</p> <p>STD Standard OMT Omit Lock Core (Deduct \$18 per lock)</p>
--	---	--	--	--	--

Examples: OH1560RD.YZ.P7C.STD OH1536RDA.Z57.P27.E4.OMT
POHRTA1536FD.P27

Metal Hutches

Terrace® — Hutches, Tackboards, and Accessories

For specification information see pages 111-114.

GSA SIN 33721

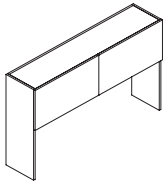

Description	Universal Hutch Model	P1 Paint List Price	P2 Paint List Price	P3 Paint List Price
Hutch w/Square Flipper Doors and Lock — 14½"D, Universal 35"H				
36"W	UH6536FD	\$ 1068	\$ 1140	\$ 1212
42"W	UH6542FD	\$ 1117	\$ 1189	\$ 1261
48"W	UH6548FD	\$ 1155	\$ 1227	\$ 1299
60"W	UH6560FD	\$ 1636	\$ 1708	\$ 1780
66"W	UH6566FD	\$ 1716	\$ 1788	\$ 1860
72"W	UH6572FD	\$ 1799	\$ 1871	\$ 1943

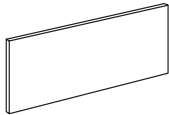

Description	Universal Hutch Model	P1 Paint List Price — Fabric			P2 Paint List Price — Fabric			P3 Paint List Price — Fabric		
		Grades A/B	Grades C/D	Grades E/F	Grades A/B	Grades C/D	Grades E/F	Grades A/B	Grades C/D	Grades E/F
20"H Tackboards for Stack-on Hutches										
36"W Tackboard	UHTB36	\$ 480	\$ 566	\$ 709	\$ 503	\$ 589	\$ 732	\$ 524	\$ 610	\$ 753
42"W Tackboard	UHTB42	\$ 504	\$ 594	\$ 744	\$ 527	\$ 617	\$ 767	\$ 548	\$ 638	\$ 788
48"W Tackboard	UHTB48	\$ 550	\$ 652	\$ 822	\$ 573	\$ 675	\$ 845	\$ 594	\$ 696	\$ 866
60"W Tackboard	UHTB60	\$ 615	\$ 743	\$ 957	\$ 638	\$ 766	\$ 980	\$ 659	\$ 787	\$ 1001
66"W Tackboard	UHTB66	\$ 647	\$ 787	\$ 1021	\$ 670	\$ 810	\$ 1044	\$ 691	\$ 831	\$ 1065
72"W Tackboard	UHTB72	\$ 682	\$ 821	\$ 1052	\$ 705	\$ 844	\$ 1075	\$ 726	\$ 865	\$ 1096



Description	Model	P1 Paint List Price	P2 Paint List Price	P3 Paint List Price
Shelf Dividers				
Package of 6	T7DV	\$ 127	\$ 142	\$ 152

Note: Not compatible with RTA models.

TERRACE

<p>How to specify — Select the Model Number from above.</p>	<p>1st Option: Pull (if applicable): Add \$38 per pull. A Arch Pull S Square Pull</p>	<p>2nd Option: Paint: P1 P2 P3 See page 20 for finishes.</p>	<p>3rd Option: Fabric (if applicable): See page 13 for fabrics.</p>	<p>3rd Option: Lock Type (if applicable): STD Standard — Random Keyed OMT Omit Lock Core (Deduct \$18 per lock)</p>	<p>4th Option: Railroad Cut (Tackboard only): (Only applicable to 72"W Fabric Tackboards.)</p>
_____	_____	_____	_____	_____	_____

Examples: UH6536FDA.P27.STD UHTB66.P52.CS918.RR

Shippable by small-package carrier.

Finishes	120
Typicals Overview	121
Introduction	122-123
Statement of Line	124-125
Overview of Frames	126
Working with Frames, Sliding Doors, Connectors, and Tiles	127-145
Panel Frames, Connectors, and Trim.....	146-160
Tiles, Off-Modular, and Acoustic Inserts... ..	161-183
Working with Electrical and Data for Panels	184-194
Electrical (8-Wire) and Data for Panels.....	195-198
WORKSURFACES	
Working with Worksurfaces and Supports.....	199-210
Laminate Worksurfaces... ..	211-217
9120 Worksurfaces.....	218-219
Veneer Worksurfaces	220
Worksurface Supports.....	221-225
WOOD STORAGE	
Statement of Line	228
Features and Dimensions	229-230
Filing Capacities.....	231
Working with Wood Storage	232-256
Credenzas and Pedestals.....	257-265
4-Wire Electrical Components	266
Storage Towers.....	267-271
Overhead Cabinets and Horizontal Storage.....	272-277
Working with Metal Overheads.....	278-280
Metal Overheads.....	281-282



Stride® System

PAINTED METAL FINISHES

GRADE P1

Black	P27
Brownstone	P7D
Bungalow	P7C
Cinder	P7Q
Designer White	PJW
Flint	P02
Fossil	P28
Loft	P7B
Muslin	P4J
Parchment	P93
Pebble	P8R
Pewter	P8D
Salt	P8C
Titanium	P8T

GRADE P2

Champagne Metallic	PR5
Gunmetal Metallic	PR3
Platinum Metallic	PR2
Silver**	PR6
Solar Black	PR8X

**PR6 no upcharge on Involve; available as a Grade P2 color on stanchions; is not available on Concensys, Essentials, and vertical files.

GRADE P3

Atom	P8S
Blossom**	P8K
Bullseye	PJF
Cabernet**	P7T
Conifer**	P8H
Ember	P8P
Ion	P8N
Iris	P8J
Krypton	P8F
Regatta	P8M
Succulent**	P8A

*** These colors are intended to be an inspirational option for the trending market. Product application is limited and color availability is approximately two years to coincide with evolving workplace trends.

Metallic paints, due to varying reflectance, may appear to have less visual color consistency than other paint finishes, even when L/A/B values are exactly the same. (L/A/B — measurable aspects of color — values are maintained within a specified range, to ensure consistent appearance of paint colors.)

METAL STORAGE PULLS

Black	E4
Bronze (for veneer only)	EZ
Matte Silver	EL

PAINTED WOOD FINISHES

Brownstone	M13
Bungalow	M12
Designer White	M17
Flint	M16
Loft	M11
Muslin	M15

ELECTRICAL AND DATA COMPONENTS

Black	E4
Brownstone	EY
Designer White	DW
Flint	E9
Loft	EV
Muslin	EU
Silver	ES

Recommended Coordinate Colors:
 Bungalow use Muslin EU
 Carob use Black E4
 Champagne Metallic use Muslin EU
 Cinder use Brownstone EY
 Fossil use Flint E9
 Gunmetal Metallic use Brownstone EY
 Parchment use Muslin EU
 Pebble use Loft EV
 Pewter use Flint E9
 Platinum Metallic use Silver ES
 Salt use Silver ES
 Titanium use Silver ES

LAMINATES

GRADE L1

SOLID COLORS	
Black	P
Brownstone*	LM13
Bungalow*	LM12
Designer White*	LDW1
Flint*	LM16
Fossil Shale*	LEH1
Loft*	LM11
Muslin*	LM15
Titanium*	LT11

ABSTRACT

Ash	LT3B
Handspun Pearl	LAHP
Handspun Dove	LAHD
Handspun Slate	LAHS
Handspun Chestnut	LAHC
Silver Mesh	LT8D

WOODGRAIN

Belair	LWBA
Bourbon Cherry	H
Field Elm	LWFE
Florence Walnut*	LFW1
Kingswood Walnut*	LK11
Natural Maple*	LWD
NeoWalnut*	LNU1
Pinnacle	PINC
Shaker Cherry*	LW7C

GRADE L2

Beigewood*	LWBE
Fawn Cypress*	LFC1
Lowell Ash*	LLA1
Mangalore Mango*	LMM1
Natural Recon*	LNR1
Phantom Charcoal*	LPC1
Phantom Ecru*	LPE1
Portico Teak*	LPT1
Skyline Walnut*	LSW1
Veranda Teak	LVT1

GRADE L3

Natural Walnut*	LWNW
-----------------	------

* Storage available in these 30 laminates.

All laminate surfaces are also offered in an FSC wood option. Add FSC in front of the laminate option. Refer to specification tools.

LAMINATE AND PAINTED WOOD STORAGE PULLS

Silver	PR6
--------	-----

LAMINATE EDGE COLORS

Beigewood	DE
Belair	BA
Black	E4
Bourbon Cherry	H
Brownstone	EY
Bungalow	EX
Designer White	DW
Fawn Cypress	FC
Field Elm	FE
Flint	E9
Florence Walnut	FW
Fossil	EH
Kingswood Walnut	K1
Loft	EV
Lowell Ash	DL
Mangalore Mango	MM
Muslin	EU
Natural Maple	DD
Natural Recon	NR
Natural Walnut	DN
NeoWalnut	NU
Parchment	EN
Phantom Charcoal	PC
Phantom Ecru	PE
Pinnacle	PI
Platinum Metallic	EP
Plyband ♦	PL
Portico Teak	DP
Shaker Cherry	DF
Skyline Walnut	SW
Titanium	TI
Veranda Teak	VT

♦ Edge is limited to flat edge surfaces: rectangle, square, trapezoid, polygon, or round. No curvilinear or combination curve and straight.

METAL GROMMETS

FOR LAMINATE WORKSURFACES

Oval/Square:	
Matte Silver	EL

FOR VENEER WORKSURFACES

Oval:	
Black	E4
Bronze	EZ
Matte Silver	EL
Square:	
Matte Silver	EL

PLASTIC GROMMETS

FOR WORKSURFACES

Black	E4
Brownstone	EY
Bungalow	EX
Designer White	DW
Flint	E9
Fossil	EH
Loft	EV
Muslin	EU
Parchment	EN
Titanium	TI

PLASTIC GROMMETS WITH WOODGRAIN EDGE

If woodgrain edge is specified, the plastic grommet color is predetermined, based on finish selection.

Beigewood, Fawn Cypress, Natural Maple, and Natural Recon	Muslin EU
Kingswood Walnut and NeoWalnut	Brownstone EY
Phantom Charcoal and Skyline Walnut	Flint E9
Phantom Ecru	Loft EV
Portico Teak	Fossil EH
All other woodgrain options	Black E4

STRATAWOOD VENEERS

GRADE V1

Add FSC prefix to Stratawood codes listed below for Stratawood veneer trim on Stride and Terrace.
 Example: FSCSC777

CHERRY

Cinnamon/Biltmore Cherry	SC260
Lowell Ash Cherry	SC394
Clear Cherry	SC700
Light Cherry	SC701
Shaker Cherry	SC774
Burnished Cherry	SC777

MAPLE

Field Elm	SE599
Clear Maple***	SE800
Harvest Maple	SE856
Beigewood	SE878
Phantom Ecru	SE912
Belair	SE934

OAK

Clear Oak	SF300
Dark Rift Oak	SF331

SILVER OAK

Silver Oak Clear	SB100
Portico Teak Silver Oak	SB150

WALNUT

Florence Walnut	ST579
Light Walnut	ST601
Skyline Walnut	ST625
Pinnacle Walnut	ST679
Sumatra Walnut	ST693

NATURAL VENEERS — FLAT CUT

GRADE V1

CHERRY

Cinnamon/Biltmore Cherry	NC260
Lowell Ash	NC394
Medium Red Cherry	NC512
Light Cherry	NC701
Shaker Cherry	NC774
Burnished Cherry	NC777

MAPLE

Clear Maple	NE800
Harvest Maple	NE856

WALNUT

Ebony Walnut	NT509
Florence Walnut	NT579
Light Walnut	NT601
Skyline Walnut	NT625
Nutmeg Walnut	NT629
Pinnacle Walnut	NT679
Sumatra Walnut	NT693

NATURAL VENEERS — RIFT CUT

GRADE V2

Fawn Cypress Rift Cut Oak	RF108
Light Rift Cut Oak	RF301
Dark Rift Cut Oak	RF331
Phantom Ecru Rift Cut Oak	RF912

***SE800 and NE800 are not available on Stride trim.

The beauty of wood is the natural variation of grain patterns and colors that make each piece unique. This variation is also influenced by lighting conditions, orientation of mated parts, and varying acceptance of the finishing process. The varying colors and physical characteristics naturally occur in all wood species but are most pronounced in lighter colored woods, and are especially evident in natural finishes.

GROMMETS ON VENEER WORKSURFACES

Wire management grommets come standard on most veneer worksurfaces. Choose between metal or plastic grommet option. Note: Plastic grommet color is predetermined based on finish selection.
 All Maple veneers.....Muslin EU
 All other veneersBlack E4

LOCKS

Black	E4
Chrome	ordered by base model
Matte Silver	EL

NOTE: Refer to individual product pages for upcharges.

A full gallery of typicals from each Allsteel system can be found on our website:

<https://www.allsteeloffice.com/design-resources/idea-starters>.

Each typical includes a complete BOM with current pricing, downloadable CAD files, and PDFs of each drawing.

Use the Allsteel Typicals Gallery to find the components in a Single Stride Station...

Learn how Stride can move from Private Office...

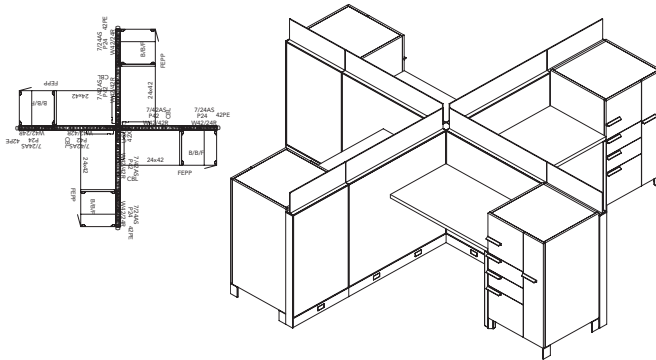

Private Office 9' x 8'6"

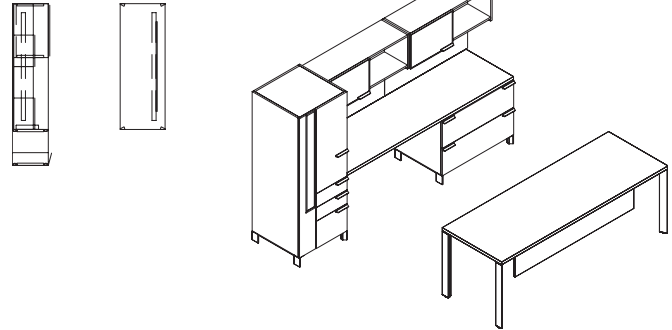

L Station 5'-6" x 5'-6" (4-pack)

Line Item	Product Description	Model Qty	Number
1	Raceway Panel Frame w/o Top Trim 42½"H x 42"W	4	Z04242WR
2	Raceway Panel Frame w/o Top Trim 42½"H x 24"W	4	Z04224WR
3	Flat Top Trim 24"W	4	Z324PT
4	Flat Top Trim 42"W	4	Z342PT
5	Universal Connector Blocks (42½"H to 57½"H)	3	Z3UCON
6	Panel Mounted 24"D x 29½"H End Support Panel	4	Y62924PENP
7	42½"H E-End Trim	4	Z342PE
8	42½"H 4-Way Light Block Kit with 'X' Top Cap	1	Z342XX
9	37½"H x 42"W Tackable Acoustic Non-Ported Tile	8	Z43742T
10	37½"H x 24"W Tackable Acoustic Non-Ported Tile	8	Z43724T
11	7½"H x 42"W Panel Mounted Screen	4	Z40742AS
12	7½"H x 24"W Panel Mounted Screen	4	Z40724AS
13	Primary 24"D x 42"W Flat Edge Laminate w/o Grommets	4	T52442SN
14	Cantilever Bracket 24"D Left-Hand	4	T6CB24L
15	Stride 42½"H x 24"W x 24"D Tower Right B/B/F Linear Pull	4	ZDT422424RGL

...to Open Plan.

Open Plan "L" Station 16' x 8' (2-pack)

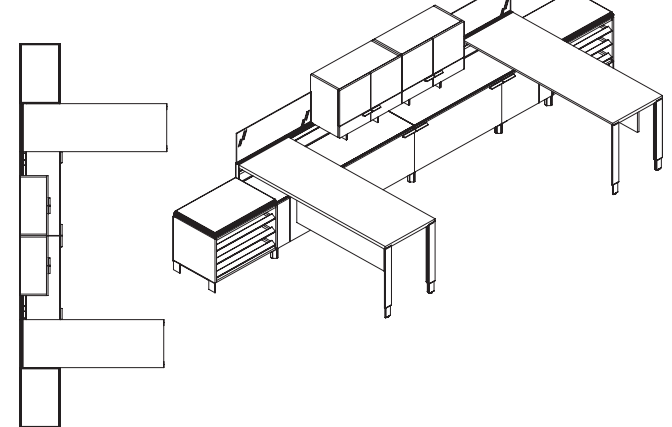

Visit <https://www.allsteeloffice.com/design-resources/idea-starters> to view these typicals and more.

Keep pace with your environment.

When designing Stride, we set out to discover a furniture platform that could evolve to reflect the changes today's organizations are experiencing. To create components that could adapt to personal preferences and demands of different job functions. To make of the most sustainably minded and manufactured products available. What we found is a whole new way to build a better office environment.

You're asking more of your staff. So we asked more of our furniture.

Today, you have to get more done in less time and in a smaller space. Stride responds by maximizing every inch you have. We made storage smarter with details like under-desk corner drawers for tucking away a recycle bin or binders, and sliding shelves for quick, easy access to projects. Perch overhead cabinets and rail-mounted screens bring storage within easy reach and create desktop privacy. And a clever credenza rail not only supports worksurfaces at different heights for managing multiple tasks, it offers easy access to technology.

Designed for real people and real work.

Stride supports multiple job functions, not rigid hierarchy. So it's possible to create an office that serves everyone, whether they work side-by-side or back-to-back. We found a simple way to make every task more comfortable with sit-to-stand worksurfaces that allow users to change postures. Staying organized is easy with a variety of open and enclosed storage options. Low panels and glass screens keep the space clean, lean, and light.

Space that works like an office, but feels like home.

Because each component of Stride was designed with every other component in mind, the entire collection works together seamlessly. Countless thoughtful details have been designed to increase comfort, improve effectiveness, and add visual appeal. Storage dresses up with elegant pulls, a sophisticated mix of materials, footed bases, and the welcome surprise of a Landscape™ surface tower sidelight. A work wall with both open and enclosed storage makes the private office elegant, inviting, and functional.

As Stride was being developed, we considered everything from raw materials to end-of-life for each component. But we also considered the needs of the person using the furniture. A range of contemporary worksurface shapes makes it easier to get work done. Segmentation every 7½" offers unlimited access to power. And design details like footed panels, tiles to-the-floor, and spanning glass create a welcoming aesthetic. So even the most straightforward workspace can be more inspiring, long-lasting, and productive.

With simplification of form and subtleness of strength, Stride benching supports highly collaborative users who need dedicated spaces, as well as mobile workers who only need to touch down for part of the day. Exceptionally easy access to power and data allows people to settle in or come and go. Cantilever storage combines space division and personal storage in one functional, visually dynamic solution. And the elegantly designed open leg supports long spans, creating uninterrupted workspaces.

A people-centric approach to furniture design makes spaces more comfortable, functional, and friendly. It's flexible enough to support the different ways that people work. As your company grows and changes, so does Stride; built-in flexibility allows the collection to adapt to your organization's evolving needs. Yet it's more than furniture. It's a platform for building better environments, while protecting the one we have.

An exceptional new collection of materials — textiles, finishes, landscape material options and color palette — were also developed for Stride and many of these additions help to bring a more residential vs. contract ethos to the furnishings.

With an integrated and cohesive kit of universal components, Stride supports a broad range of applications from private office to open plan, and a seamless migration from an environment with more separation to one with more openness or vice versa. Stride can be scaled down or up with ease — adding, subtracting, or rearranging, providing a stunning degree of versatility and flexibility to adapt to the organization and the individual.

Stride brings it all together in one complete collection of surfaces, storage, and space division.

Mix and match worksurfaces, storage and space division for your own unique solution. Stride achieves a stunning degree of versatility and flexibility. The use of cohesive, scalable materials and finishes creates a beautiful aesthetic in every application.

PRIVATE OFFICE

OPEN PLAN

Traditional

Stride Desking with traditional Painted Wood Storage workwall.

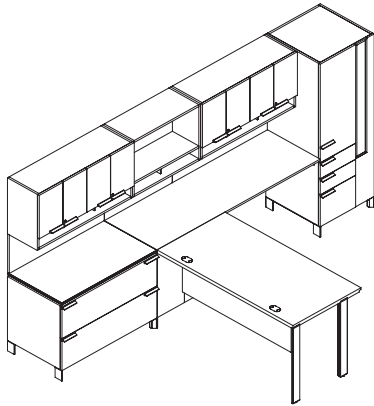

Stride Panels with Metal Storage

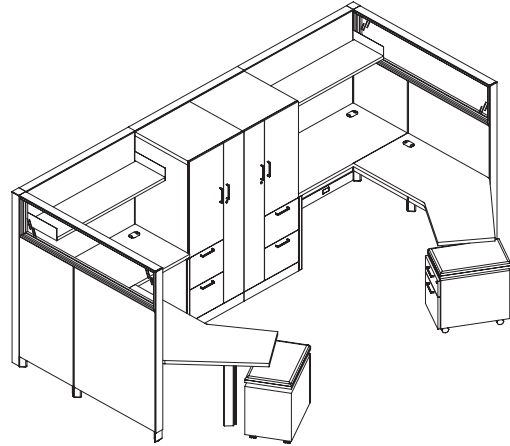

Stride Panels with Painted Wood Storage and Desk Screens

Progressive

Stride Desking with Painted Wood Storage workwall.

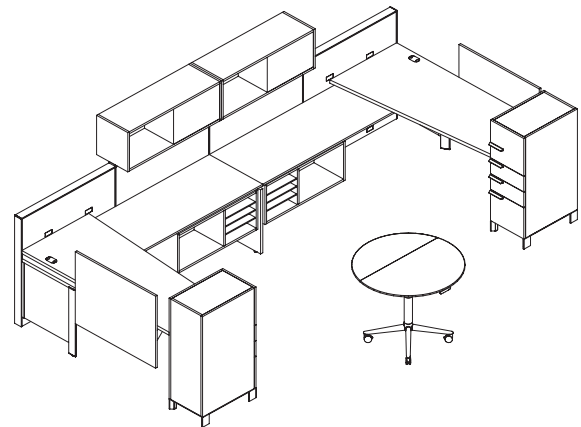
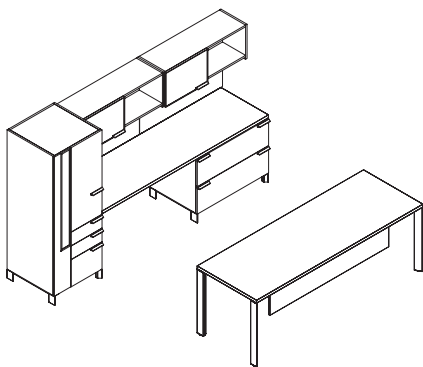

Stride Desking with Painted Wood Storage Spine

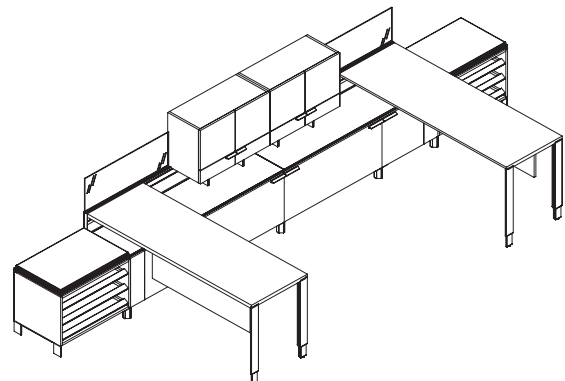

Note: Stride Typical can be found at <https://www.allsteeloffice.com/design-resources/idea-starters>.

SPACE DIVISION

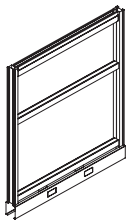

Raceway Panel

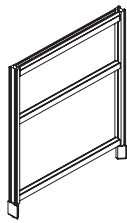

Footed Panel



Low Profile
Glass Stacker Kit



Doors

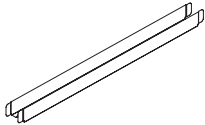

Segment Kits

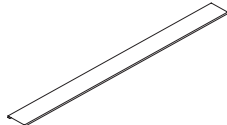

Top Trim and Spanning
Top Trim

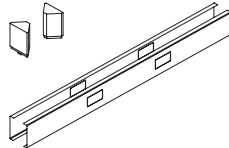

Panel Conversion Kits



Connector Blocks



Trim



Light Block Kits

TILES

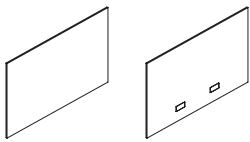

Tackable Acoustical
(Non-Ported and Ported;
To-the-Floor)



Steel
(Perforated and
To-the-Floor)

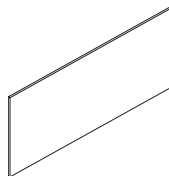

Landscape

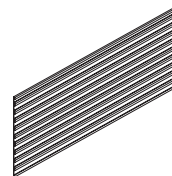

Tool Tile

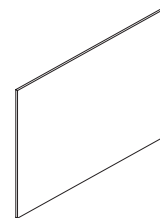

Laminate

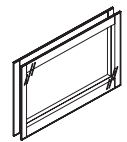

Glass Tile Kits

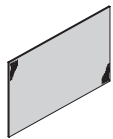

Veneer

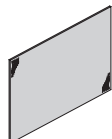

Veneer
(To-the-Floor)

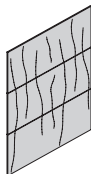

Natural Veneer Tile Sets

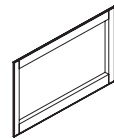

Pass-Thru Trim Kits

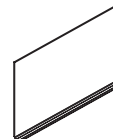

Marker Board
(Porcelain, Steel)

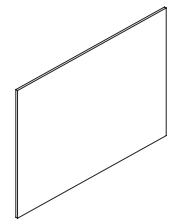

Laminate
(To-the-Floor)

SCREENS

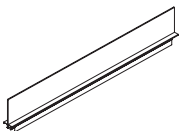

Panel Mounted Screens

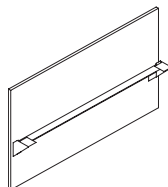

Desk Screens

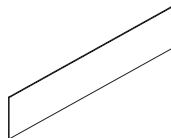

Credenza Rail Mounted
Screens

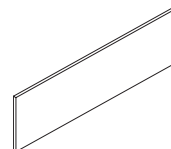

Modesty Panels

WORKSURFACES & SUPPORTS

Linear Worksurfaces — Laminate with Flat Edges

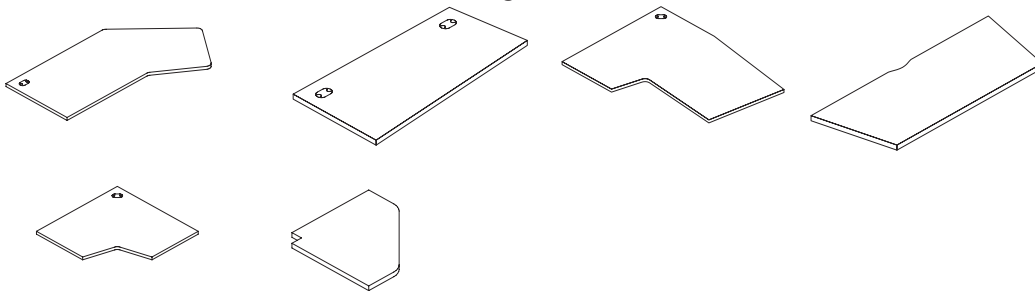

Additional standard laminate and veneer worksurfaces available.

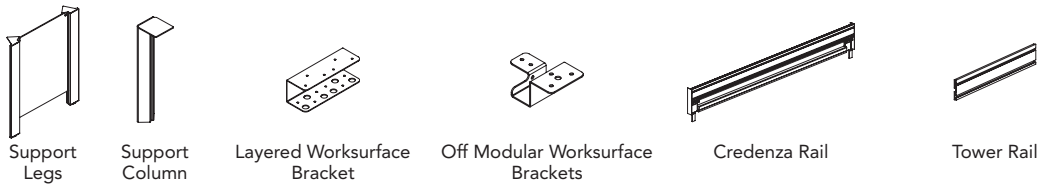

STORAGE

Wood Storage — Painted Wood

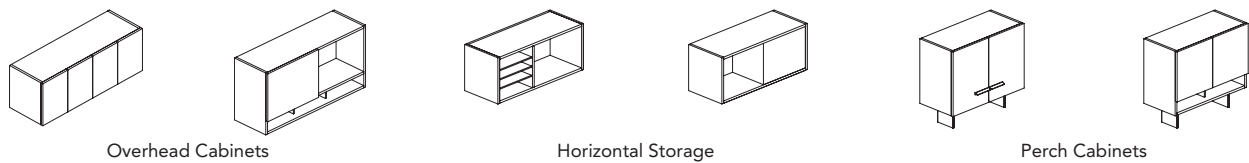
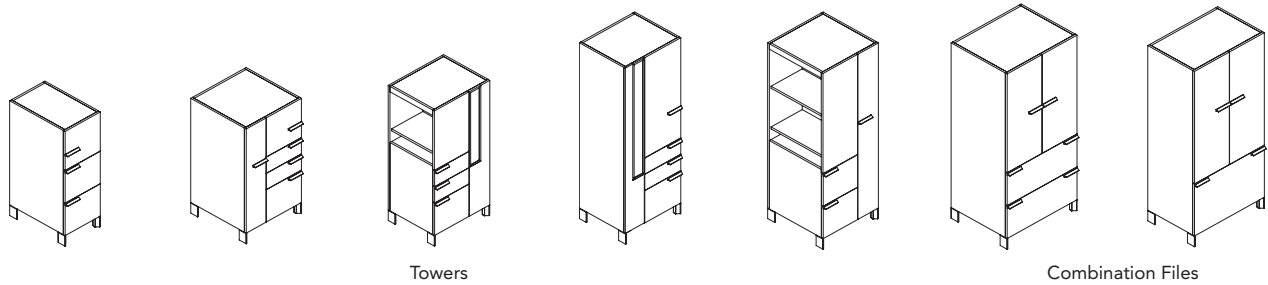
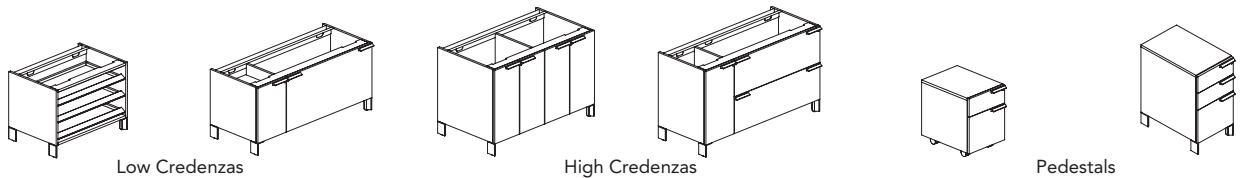

Metal Storage

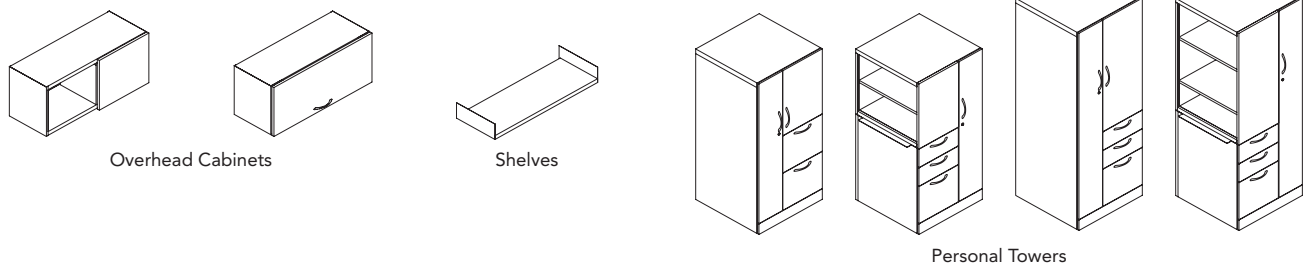

Structural Base Panel Frames

35"H Raceway 42½"H Raceway 50"H Raceway 57½"H Raceway 65"H Raceway

35"H Footed 42½"H Footed 50"H Footed 57½"H Footed 65"H Footed

24"W 30"W 36"W 42"W 48"W 60"W

35"H

42½"H

50"H

57½"H

65"H

87½"H Hinged Door

50"H Sliding Door 65"H Sliding Door 80"H Sliding Door

Stacking Frames

Low Profile Glass Stacker

15"H Stacking Frame 22½"H Stacking Frame 30"H Stacking Frame 15"H Stacker Kit

24"W 30"W 36"W 42"W 48"W 60"W

15"H

22½"H

30"H

STRIDE

Stride base raceway panel frames include frame, base pathway covers, and in-line connection attachment hardware. Footed panel frames include panel feet. No electrical or data capabilities in base of footed panel frames. Base raceway to footed and footed-to-base raceway kits can be used to convert existing frames to footed style or to base raceway covered style.

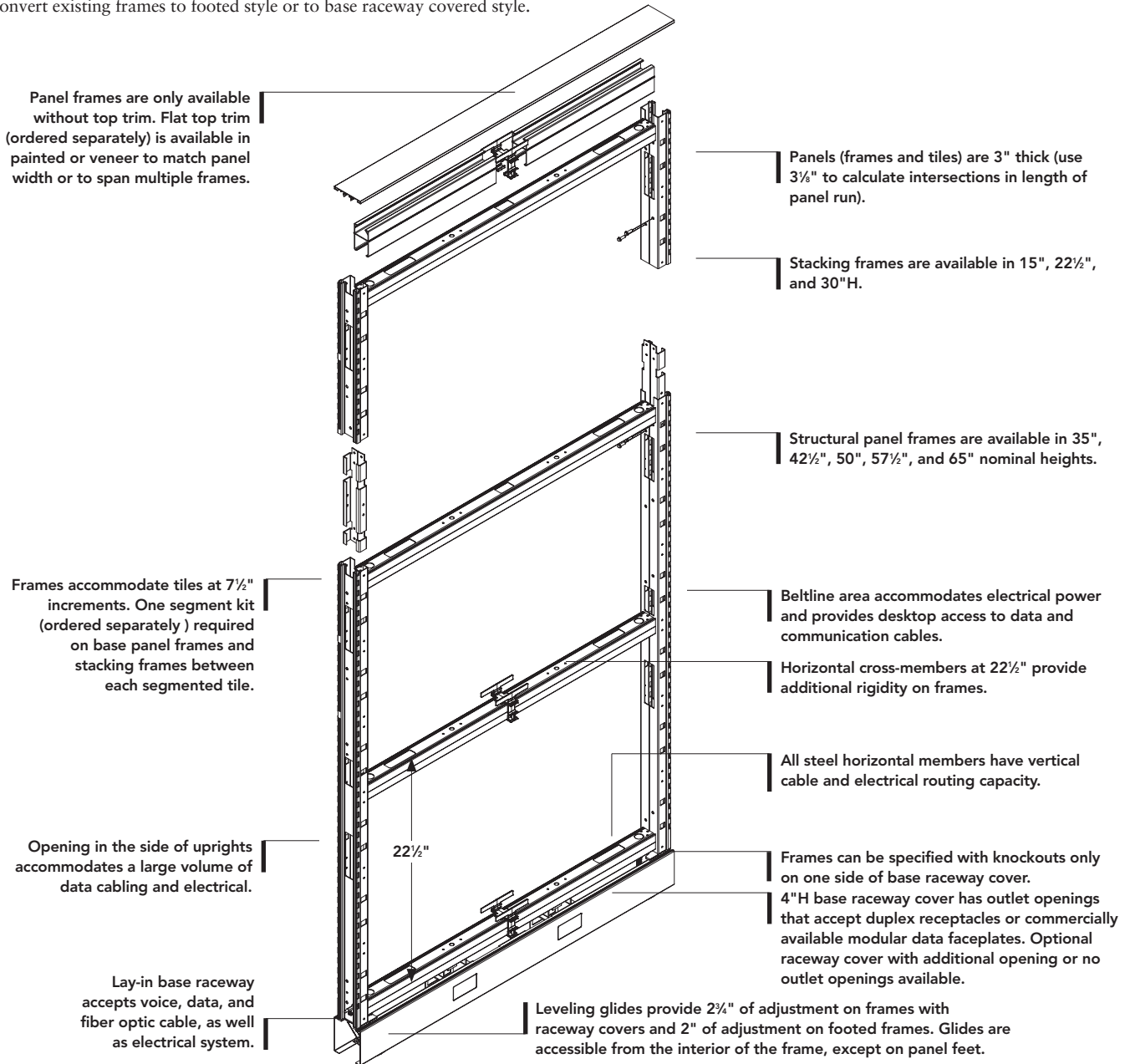

Stride Frame Dimensions (Actual)	
Depth:	3" (use 3⅜" to calculate intersections in length of panel run)
Widths:	24", 30", 36", 42", 48", 60"
Heights*:	34⅝", 41⅞", 49⅜", 56⅞", 64⅝"
Stacking Frames:	15", 22½", 30"H
Leveling Glides on Frames with Raceway Covers:	2¼" range
Leveling Glides on Footed Frames:	2" range

*with levelers fully retracted

Panel Frames and Conversion Kits (pages 146-147)

- Specifications: formed steel vertical members, with tubular steel horizontal members are welded into a strong, sturdy structural panel frame.
- Top trim, tiles, and segment kits are ordered separately depending on application choice.
- Panel frames are standardly shipped with base raceway covers or decorative feet installed. There is no electrical or data capabilities in base of footed panel frames.
- Base raceway to footed and footed-to-base raceway kits can be used to convert existing frames. Footed-to-base raceway kits ship with glide tower assembly. Conversion process requires panel to be removed from panel run.
- Direct connections between same height frames in a continuous run are accomplished with provided hardware. There is no incremental increase in length along the run.
- For adequate stability, one of two methods of stabilization shown on page 129 must be adhered to.

Building vertically with Stride frames

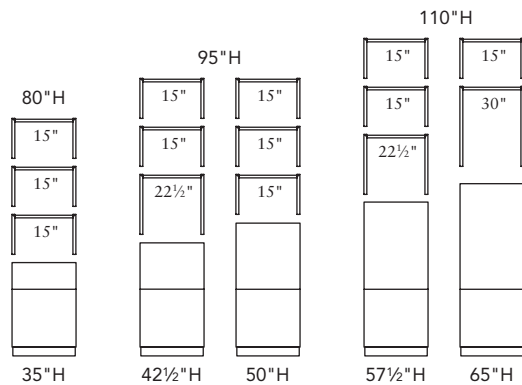

Stacking Connection

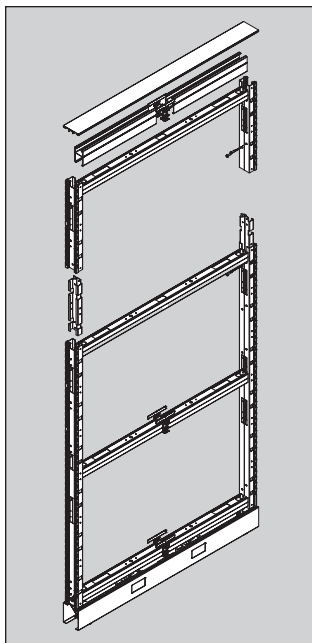

Segmented Panels

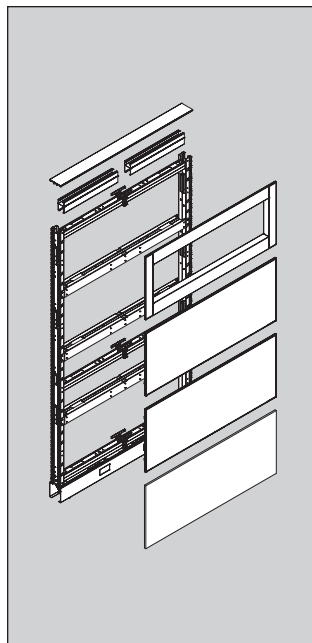

A low profile glass stacker kit is a single pane of clear or frosted safety tempered glass centered within a silver metal frame.

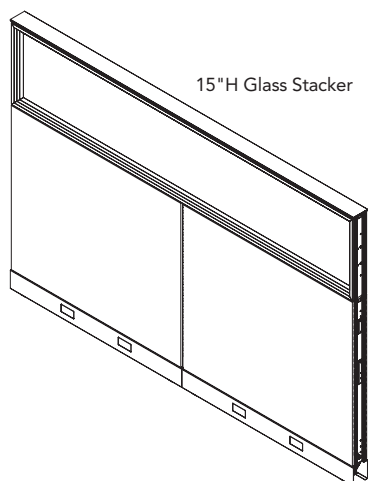

Stacking Frames (page 147)

- Stacking frames can be added to the top of any base panel frame.
- This stacking connection provides a solid metal-to-metal connection, allowing the stacking frame to accept hang-on components, per Allsteel configuration guidelines.
- A maximum of three stacking frames are allowed on base panel frames 35"H-65"H up to a maximum height of 110". Do not combine differing frame widths in a single stack or span multiple base panel frames with stacking frames.
- Guidelines for using overhead storage with stacking frames are given on page 279.
- Includes attachment hardware.
- Add appropriate connector blocks (2 per stacker level).
- When adding stacking frames, the top trim and top trim retainer are removed from the base frame and installed on the uppermost stacking frame.
- To maintain panel mounting slot modularity 22½"H stacking frames should only be used with 42½"H, 57½"H base panel frames or 87½"H door frames. To match 87½"H door frame height, use a 65"H base panel frame with a 22½"H stacking frame (slot modularity will be lost on stacker). To maintain modularity on 35"H, 50"H, and 65"H base panel frames use 15"H or 30"H stacking frames.
- If panel mounting slots are not being used, any stacking frame can be used on any base panel frame of matching width.

Segment Kits (page 147)

- One segment kit required (order segment kit separately) on base panel frames and stacking frames between each segmented tile.
- Segment kit not required at beltline (22½" above the base raceway).
- One segment kit accommodates segmentation on both sides of the frame.
- Segment kit is required to mount electrical other than at beltline or base raceway. Kit provides support for components at 7½"H increments.
- Segment kit not required between low profile glass and base frame.

Low Profile Glass Stacker Kits and Tie Brackets (page 148)

- Single pane clear or frosted safety tempered glass encased within a frame.
- Glass is positioned in the middle of the stacking frame.
- Can be used to span multiple frames when the combined frame width is equal to the low profile glass stacker width.
- Mounts to base panel frame(s) as a stacking unit.
- The top trim from the base panel frame or spanning top trim is used to finish the top of low profile glass stacker kit.
- For use at top position only.
- Low profile glass stackers are non-structural. Do not hang or stack on top of low profile glass stacker kits.
- Cannot mount a countertop on low profile glass stacker kits.
- Tie bracket kit(s) required when two or more low profile glass stackers are adjacent (order separately). Specify based on low profile glass stacker kit intersections at the same height only, ignoring base frames at the same height.
- Tie bracket kits only connect to low profile glass stacker kits. They do not attach to base frames.
- Low profile glass stackers do not have panel slots.
- Height of low profile glass stackers must be considered when calculating overall height.
- Horizontal segment kit is not needed below low profile glass stacker.
- Add appropriate additional connector blocks.
- Uppermost tile(s) on base frame(s) below low profile glass stacker must be removed for stacker installation.

Building horizontally with Stride frames

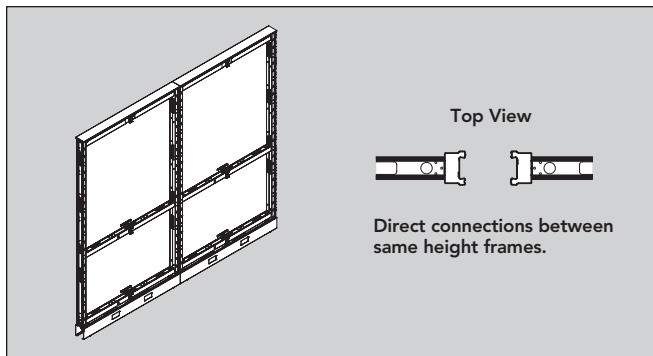

Important planning guidelines: For adequate stability, one of two methods of stabilization must be adhered to:

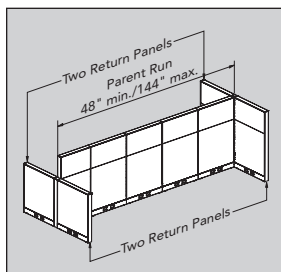

- **Method 1—Opposing returns:** A parent run must be a minimum of 48" and a maximum of 144" between return panels. The parent run must have a minimum of two return panels running in opposing directions on each end of run. Return panels must be a minimum of 24"W; and must not be any more than 30" shorter in height than parent run.

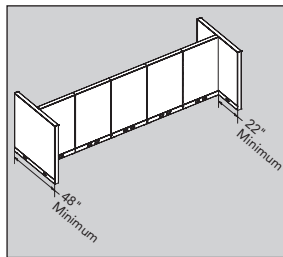

- **An off-modular return panel** must be at least 48"W and there must be at least 22"W on one side of the parent run.

Note: Alternate stabilization methods available using back- or side-mounted Stride credenzas — see pages 130-131.

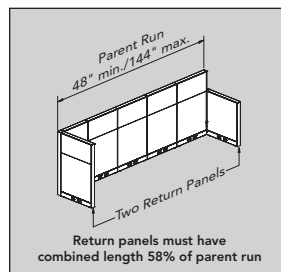

- **Method 2—Single-sided returns:** A parent run must be a minimum of 48" and a maximum of 144" between return panels. The parent run must have a minimum of two return panels totaling at least 58% of its length, extending in one direction. Return panels must not be any more than 30" shorter in height than parent run. Any run under 100" must have a minimum combined length of 60" of return panels.

Tie Bracket Kits for Low Profile Glass Stackers (page 148)

- For use with low profile glass stackers when two or more low profile glass stacker kits come together at a connector juncture.
- Only used when attaching one low profile glass stacker kit to another low profile glass stacker kit.
- Specify based on low profile glass stacker kit intersections at the same height only, ignoring base frames at the same height.
- Tie bracket kits only connect to low profile glass stacker kits. Brackets do not attach to base frames.

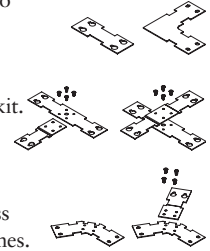

Panel Mounted Screens (pages 149-150)

- A panel mounted screen is a frameless insert that is integrated into the top trim on a base panel frame.
- The panel mounted screen replaces the top trim on base panel frame or stacking frame on which it is mounted.
- Panel mounted screens cannot be mounted on low profile glass stackers.
- "G" grooved end trim must be used when a base panel frame below a panel mounted screen is shorter than the adjacent in-line panel.
- Panel mounted screens are non-structural and therefore cannot be stacked on top of support hanging elements.
- Finishes and Sizes:
Clear or Frosted safety glass — available in 7½"H and 15"H

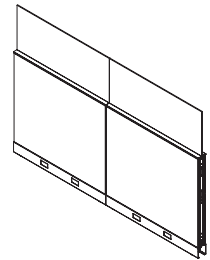

Hinged Door Panel Frame (page 151)

- Includes 42"W frame, top trim, 36"W door, hinges, and attachment hardware.
- Door is available in laminate.
- Order door knob or lever separately, see page 151.



Sliding Door and Mounting Kit (page 151)

- See illustration and specification information on page 132.

Standard Flat Top Trim (page 152)

- Used when specifying base panel frames without top trim.
- Top trim can span individual or multiple base panel or stacking frames.
- It is possible to span multiple frames when the combined frame width is equal to the top trim width.
- Some examples are listed on page 152, other combinations are possible.
- Available in painted or veneer finish.

Connector Span Flat Top Trim (page 152)

- It is possible to span multiple frames and one ("TS", "XS", or "SS") connector when the combined frame width is equal to the top trim width and one "S" style connector.
- Only to be used on a parent run where all return panels are at a lower height (extended straight connections only).
- Available in painted or veneer finish.

Low Credenza Side to Panel Bracket

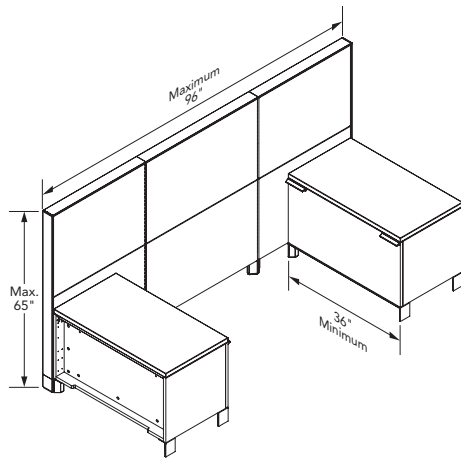

Side-mounted low credenzas

- The minimum Stride low credenza width is 36" on each end.
- With a mid-run floor support the maximum panel run is 144".
- Without a mid-run floor support, the maximum panel run is 96".
- Overheads and shelves cannot be used with side-mounted low credenzas.
- Worksurfaces (if specified) must be mounted on the same side of the parent run as the credenzas.
- Panel frame maximum height is 65"H. Stacking frames can be used.

Credenza Back to Panel Bracket — Modular

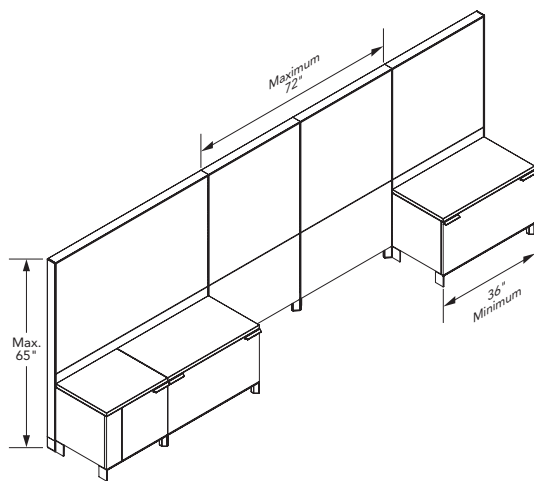

Back-mounted credenzas

- The minimum Stride credenza width is 36"W on each end.
- The maximum panel run between back-mounted credenzas is 72".
- With the use of one bracket kit, two credenzas can be ganged together up to 72"W and can span two panels. Each panel must be the same width as each credenza.
- When using overhead cabinets or shelves, both sides of the run must have credenzas that are the same width as the panel or panels joined without a connector.
- Overheads, shelves, and worksurfaces must be mounted on the same side of the parent run as the credenzas. Stacking frames cannot be used with overheads.
- Panel frame maximum height is 65"H.

Credenza Back to Panel Bracket — Off-Modular Ends

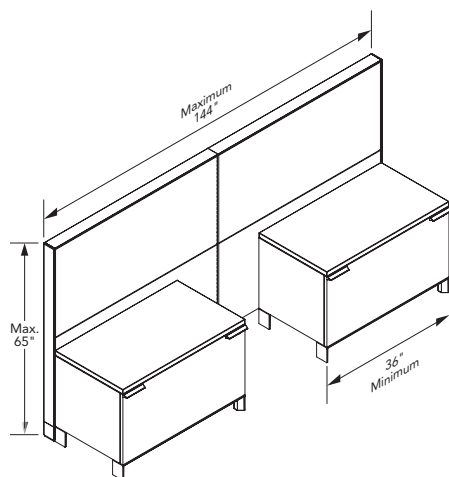

Off-Modular back-mounted Credenzas

- The minimum Stride credenza width is 36"W.
- With a floor support the maximum panel run is 144".
- Without a floor support, the maximum panel run is 96".
- Overheads and shelves cannot be used if both ends of the credenza are not on modular.
- Panel frame maximum height is 65"H. Stacking frames can be used.

High Credenza Side to Panel Bracket

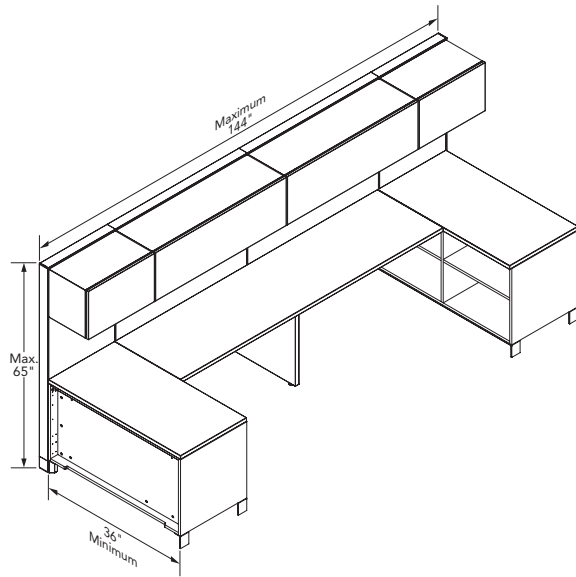

Side-mounted high credenzas

- The minimum Stride high credenza width is 36" W on each end.
- With a floor support the maximum panel run is 144".
- Without a floor support, the maximum panel run is 96".
- Overheads, shelves, and worksurfaces must be mounted on the same side of the parent run as the credenzas. Stacking frames cannot be used with overheads.
- Panel frame maximum height is 65" H.

Credenza Side to Panel Bracket with Return Panel

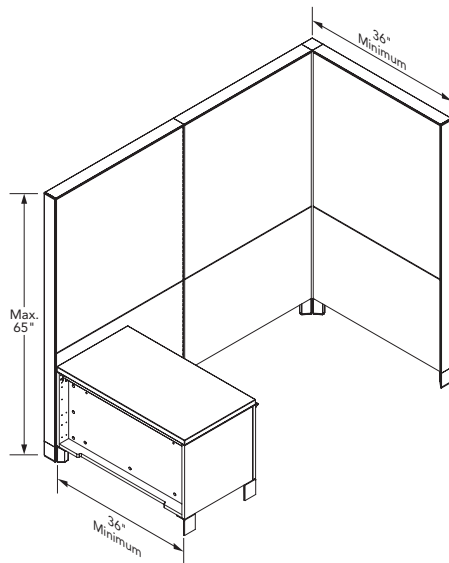

Bracket with return panel

- Minimum Stride credenza width 36".
- With a floor support the maximum panel run is 144".
- Without a floor support, the maximum panel run is 96".
- The minimum size for panel return is 36" W x 35" H.
- Overheads, shelves, and worksurfaces must be mounted on the same side of the parent run as the high credenza.
- Panel frame maximum height is 65" H.

The sliding door for Stride is system specific; one model for Stride with specific mounting kits for each door ordered. With a frosted translucent insert and your choice of P1 or P2 paint, the sliding door will create a unique look for any office environment.

Sliding doors are available in 50", 65", and 80"H models and can mount to 30", 36", 42", and 48"W panels. They accommodate a 36"W opening and are 42"W, nominally. The doors ship from the factory non-handed and become handed when field installed to fit the specifications of the project. The handle pulls located on each side of the door are color matched to the trim to create a uniform style. And with the threshold free design, the sliding door offers better aesthetics and safety by eliminating the potential for tripping.

Sliding Doors and Mounting Bracket Kits (page 151)

- The system requires the ordering of both a door and a mounting bracket kit.
- The door and mounting bracket kits are system specific. The Stride door and mounting kit only works with Stride.
- All sliding doors are 42" wide to accommodate a 36"W opening. Doors are non-handed and non-locking.
- A mounting bracket kit must be ordered for each door corresponding to the mounting panels width (30", 36", 42", or 48"W) on which the kit is being installed.

General Guidelines for Layout Planning of Sliding Door

- Stability guidelines must be followed when specifying a sliding door. (Refer to page 129). The sliding door system was designed to close an opening in a run of parallel panels. Doors mounted to long runs of panels without floor support, ties to worksurfaces or return panels may seem less stable.
- If the door is used to close an opening (A) where the panel opposite the door is at 90°, there will be a gap equal to the panel thickness between the door and the panel end when closed.
- When planning the layout, care must be taken if the plan includes a door mounted on a panel that is less than 42"W.
- If the panel is at a corner (B), the door will protrude into the aisle or next workstation when in the open position.
- If back-to-back doors are mounted on panels (C) that are less than 42"W they will interfere with each if both are open at the same time.
- The door is attached at the base of the panel at any end position with a wrap around bracket. Bracket kits are ordered in conjunction with appropriate end trim profiles. The slots at the base of the panel must be clear (D) and cannot be utilized by worksurface supports or panel hung components.
- If the door is mounted to a panel run that is positioned adjacent to a wall (E) or an inside 90° angle and there is not a 42" clearance between the track and the wall/inside 90° the assembly of the first stop will be difficult and plans will need to be modified for the assembly.
- If a door is closing an opening of a workstation that includes a "T" connector in the opposite wall, an extended straight connector may need to be used to maintain the 36" required opening.
- Door leveling is dependent on floor being level.

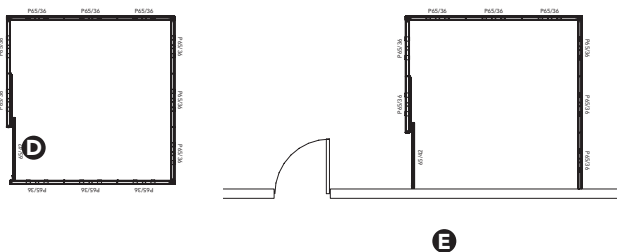
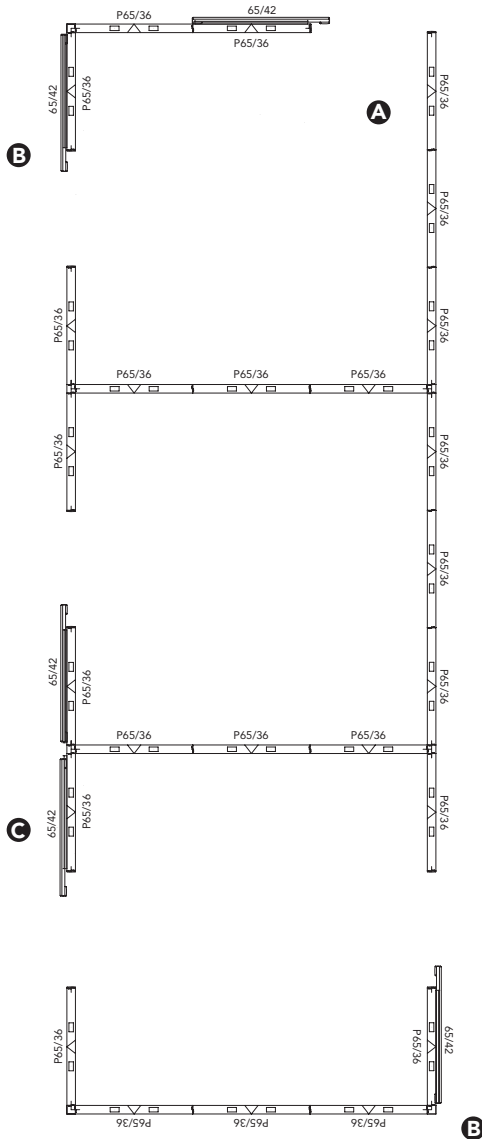

There are three components to consider when specifying Stride connectors: 1) connector blocks 2) light block kit 3) vertical trim. Light block and trim must be ordered separately. See examples of “L”, “T”, and “X” configurations on pages 135 and 136.

Connector Blocks

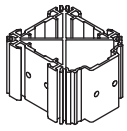

2-Way, 3-Way, and 4-Way Universal Connector Blocks

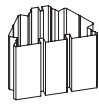

2-Way 120° Connector Blocks

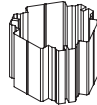

3-Way 120° Connector Blocks

<p>35" H Frames = 2 Connector Blocks 42½" H Frames = 3 Connector Blocks 50" H Frames = 3 Connector Blocks 57½" H Frames = 3 Connector Blocks 65" H Frames = 4 Connector Blocks</p>
<p>Add connector blocks for each level: 7½" H = 1 connector block 15, 22½ or 30" H = 2 connector blocks</p>

STEP 1: CONNECTOR BLOCKS (page 153)

- Universal connector blocks are used to connect frames at “L”, “T”, “X”, or “S” connector junctures, 2-Way “B” 120° connector blocks are used for 120° connector junctures, and 3-Way “C” 120° connector blocks are used for 3-way connector junctures.
- At all connector junctures, specify the number of base frame connector blocks based on the height of the shortest base frame(s).
- Starting at the top of the lowest base frame and going up, add additional connector blocks for each level change. A *level change* is any difference in height between frames and/or stacking frames within a connector juncture, not necessarily top cap to top cap. A level change includes a stacking frame (each stacking frame level requires 2 connector blocks).
- Continue adding blocks for each level until there are fewer than two frames remaining above the last specified level.
- When specifying the 2-, 3-, or 4-way Universal Connector Blocks, CAP/CET specification tools will auto-pick the Z3UCON10P model which comes as a pack of 10. You can manually overwrite this model to Z3UCON and adjust the quantity as needed.

Light Block

2-Way Light Block

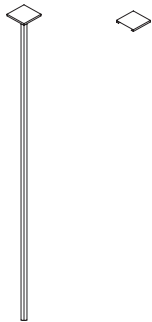

2-Way “L” 2-Way “S”

3-Way Light Block



4-Way Light Block



120° Light Block



2-Way “B”

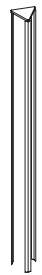

3-Way “C”

<p>2 Frames (90°) = 2-Way Light Block Kit (L) 3 Frames = 3-Way Light Block Kit (T) 4 Frames = 4-Way Light Block Kit (X)</p>
<p>2 Frames (120°) = 2-Way Light Block Kit (B) 3 Frames (120°) = 3-Way Light Block Kit (C)</p>

STEP 2: LIGHT BLOCK KIT (pages 154-159)

- Each light block kit includes a top cap transition piece and light block. Light block can be specified without top cap for use in extended straight specifications when using spanning top trim.
- Connector blocks and trim must be ordered separately. Trim is available in painted or veneer finish. If top cap only (for use at a 2-way extended straight connector juncture) no light block is required.
- Light block height is equal to the tallest frames. **Exception:** When there is only one tallest frame, determine the light block height considering the frames(s) at the next highest frame height.
- Light block quantity is determined by the number of frames at the connector juncture.
- The top cap transition piece is determined by the configuration of the tallest frames at a connector juncture. **Exception:** When there is only one tallest frame, specify the top cap transition piece considering the frame(s) at the next highest frame height and the tallest frame.
- The top cap transition piece will be located at the height of the light block light block kits can also be specified without a top cap transition piece.

Light Block Model Logic:

Stride connector = Z365XS

	6	5	X	S
Z3	2a.	2b.	2c.	2c.
	Height	Connector Junction	Cap Trans. Piece (config.)	

- 2a. Light block height = □ □ □
- 2b. Connector junction = □
 X – 4-Way
 T – 3-Way
 L – 2-Way
 B – 120° – 2-Way
 C – 120° – 3-Way
- 2c. Top cap transition piece (configuration): X, T, L, S, B, C = □
 Letter codes will be the same if panels are all the same height.

Vertical Trim



"VH" Variable Height End Trim



"EG" Grooved Variable Height End Trim



"L" 2-Way 90° Filler Trim



"F" Flat Filler Trim (Use 2 for "S" Extended Straight)



"B" 2-Way 120° Filler Trim



"E" End Trim



"EF" End Trim for Footed Panel

STEP 3: TRIM (pages 154-159)

- Vertical trim finishes off panel frames and connectors - available in painted or veneer finish. Connector and light blocks must be ordered separately.
- Vertical filler trim is specified by first considering the location (height) of the top cap transition piece at the connector juncture. (Step 2)

Variable Height (pages 154-159)

- Directly above the top cap transition piece, specify variable height vertical trim "VH" to cover the exposed frame. "VH" attaches directly to the end of the panel frame to finish ends in a high-low condition.
- "G" grooved variable height end trim is used when the base frame of a panel mounted screen is shorter than the adjacent in-line panel.

Filler Trim (pages 154-159)

- Below the top cap transition piece, fill voids to cover exposed connector blocks. If there are two adjacent exposed sides (90°) use "L" 90° vertical filler trim. "L" 90° vertical filler trim attaches to connector blocks
- Fill in remaining voids with "F" flat vertical filler trim, which also attaches to connector blocks.
- For "S" extended straight configurations, specify 2 "F" flat vertical filler trim pieces.
- "B" vertical filler trim is used below the top cap transition piece in 120° configurations.

Finished Ends (page 159)

- "E" vertical end trim attaches to the end of the panel frame for use as a finished end on base raceway panel frames.
- "EF" vertical end trim for footed panel is used as a finished end on footed panels frames.
- Wall mount kits provide a means to affix a panel frame to a permanent building wall. Kit adds ¼" to length of panel run.

Wall Kits



Wall Mount Kit

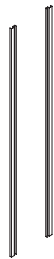

Wall Track

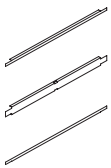

Wall Track Tile Attachment Kit



Wall Track Tile Segment

"W" Wall Mount Kit (page 160)

- Includes top cap.
- Adds ¼" to run.
- Provides means to affix a panel run to permanent building wall.
- Anchor devices are not supplied.
- Available in painted or veneer finish.

Wall Track (page 160)

- Allows for mounting of system panel components on permanent wall structures.
- Vertical wall track is 60"H. Field cut for lower heights.
- Wall track will add ⅝" to depth of attached components.
- One pair — left and right included.

Wall Track Tile Attachment Kit (page 160)

- Allows mounting of Stride tiles to wall track segments.
- Includes two top/bottom bars and one middle segment bar.
- Add additional wall track tile segment(s) if attaching more than two tiles.

Wall Track Tile Segment (page 160)

- Includes one middle segment bar for additional segmentation.

"L" CONFIGURATION — 65"H / 65"H
Models:
 Step 1: Connector Blocks
Z3UCON

Step 2: Light Block Kit
Z365LL

Step 3: Trim
Z365PL

"T" CONFIGURATION — 65"H / 65"H / 65"H
Models:
 Step 1: Connector Blocks
Z3UCON

Step 2: Light Block Kit
Z365TT

Step 3: Trim
Z365PF

"T" CONFIGURATION — 65"H / 65"H / 50"H
Models:
 Step 1: Connector Blocks
Z3UCON

Step 2: Light Block Kit
Z350T

Step 3: Trim
Z365PF
Z315PF
Z375PT (Spanning Top Trim)

"X" CONFIGURATION — 65"H / 57½"H / 50"H / 42½"H
Models:
 Step 1: Connector Blocks
Z3UCON

Step 2: Light Block Kit
Z357XL

Step 3: Trim
Z307PF
Z307PL
Z307PVH

"X" CONFIGURATION — 65"H / 50"H / 65"H / 50"H
Models:
 Step 1: Connector Blocks
Z3UCON

Step 2: Light Block Kit
Z350X

Step 3: Trim
Z315PF
Z315PF
Z375PT (Spanning Top Trim)

"X" CONFIGURATION — 80"H (65"H frame + 15"H stacker) / 80"H (57½"H frame + 22"H stacker) / 50"H / 42½"H
Models:
 Step 1: Connector Blocks
Z3UCON

Step 2: Light Block Kit
Z380XL

Step 3: Trim
Z330PL
Z307PF

STRIDE

Stride tiles come in a variety of styles. Select the aesthetic* and functional combination that meets your specific requirements.

Additional tiles available, see pages [138-144](#).

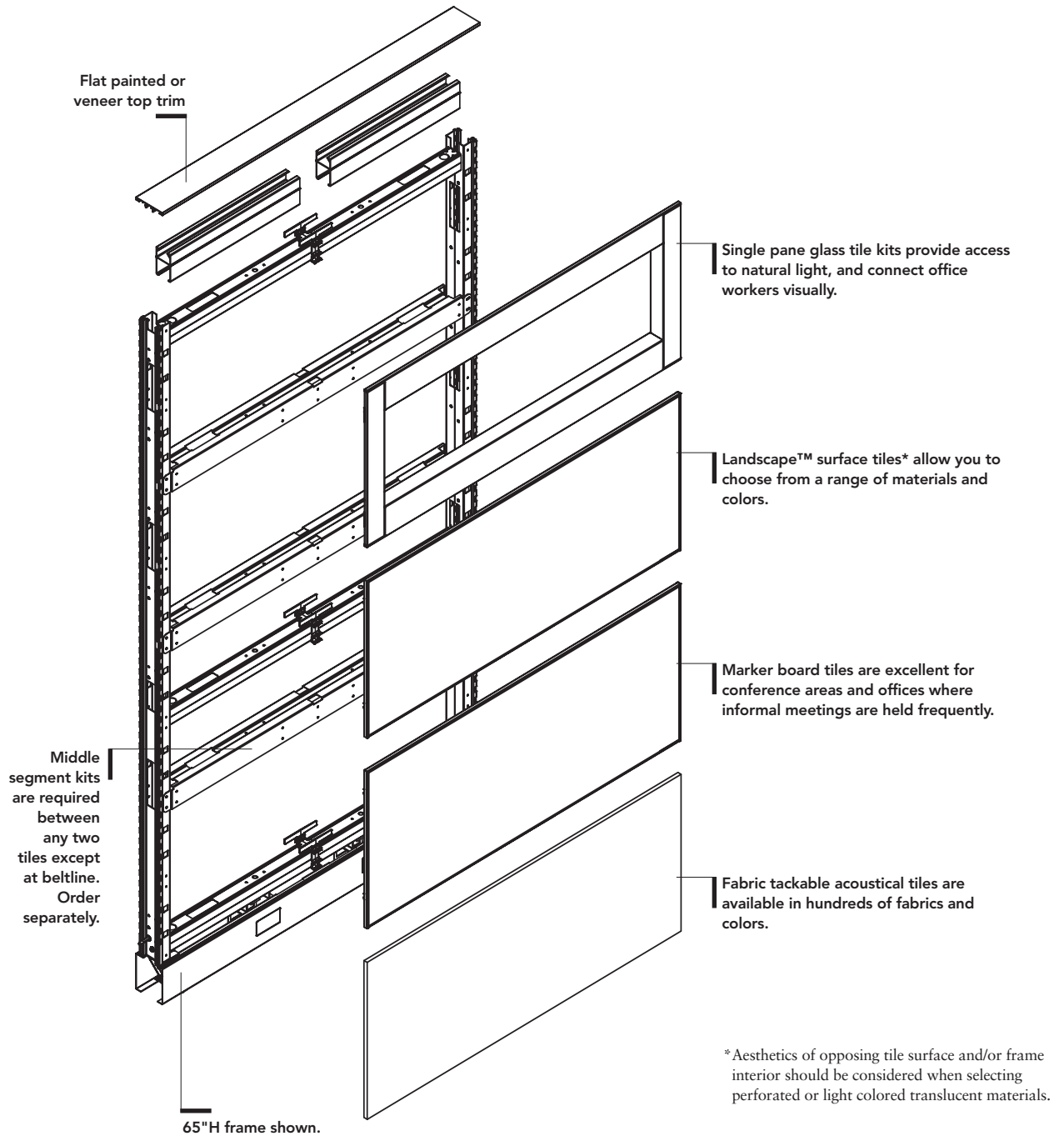

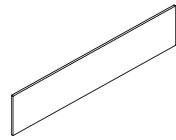

7½"H Tile

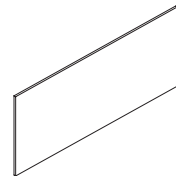

15"H Tile

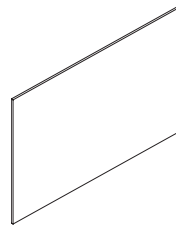

22½"H Tile

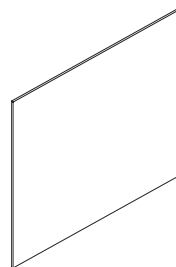

30"H Tile

Landscape™ Surface Material is a ¼" thick material that is available for use on tiles, tower sidelights, storage fronts, panel mounted screens, and modesty panels. The Landscape surface material offering for Stride includes: Foundation and Quattro. Refer to the matrix below for usage guidelines.

Foundation

- Foundation is a fabric material laminated between recyclable PETG resin sheets.
- Foundation is available in two color options: Pure White and Sand.

Quattro

- Quattro is fabric laminated between recyclable PETG resin sheets.
- Quattro is available in Platinum.

Frosted Translucent

- Frosted Translucent is ¼" thick Plexiglas acrylic with flat polished edge.
- Frosted Translucent is available in one color option: Frost.

	Tiles	Tower Sidelights	Storage Fronts	Panel Mounted Screens	Desk Screens	Modesty Panels
Foundation	•	•	•			
Quattro	•	•	•			
Frosted Translucent					•	

Tiles ship with attachment clips installed. Tiles do not include segment kits, order separately.

Tackable Acoustical Tiles

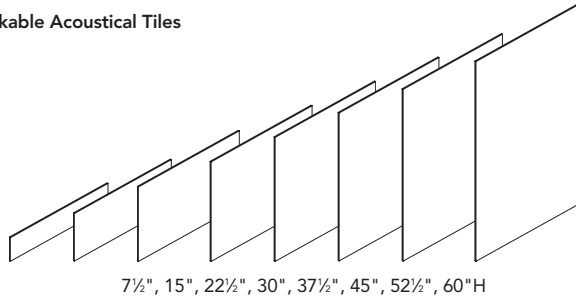

7½", 15", 22½", 30", 37½", 45", 52½", 60"H

Tackable Acoustical Tiles (pages 161-162)

- Tackable and acoustical. 7½"H-60"W, 20"W-60"W.
- Tiles do not include segment kits — order separately.
- Tiles are level® 2 when a level® 2 fabric is used.

Port Tiles

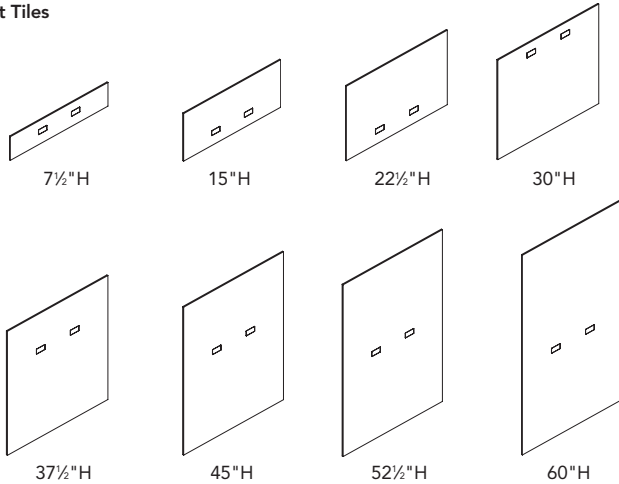

7½"H

15"H

22½"H

30"H

37½"H

45"H

52½"H

60"H

Port Tiles (pages 163-164)

- Receptacle openings with blank covers (1 in 24" W tiles; 2 in wider tiles).
- Receptacle openings have the ability to accept most commercially available modular data plates.
- Tackable and acoustical. 7½"H-60"H, 24"W-60"W.
- Grommet opening dimension is 1.375"H x 2.700"W.
- When using rail based off-modular, ported tile grommets may interfere with frames mounted perpendicular to the spine.
- 7½"-15"H port tiles can be mounted in any position except bottom position on frame.
- 7½"-22½"H are ported in the bottom for use when segmenting.
- 22½"H port tiles can be flipped for below worksurface power access.
- 30"-60"H port tiles are used to position grommets above a worksurface mounted at 29½"H. Designed for use in bottom position, but can be used in any position.
- Tiles do not include segment kits — order separately.
- Tiles are level® 2 when a level® 2 fabric is used.

Coordinate Grommet Color with Paint Color:

Paint Color	Grommet Color
Carob — P52.....	Black — E4
Champagne Metallic — PR5.....	Muslin — EU
Fossil — P28.....	Flint — E9
Gunmetal Metallic — PR3.....	Brownstone — EY
Parchment — P93.....	Muslin — EU
Platinum Metallic — PR2.....	Loft — EV

Tackable Acoustical Tiles to-the-Floor (page 165)

- Tackable and acoustical. 22½"H-60"H, 20"W-60"W.
- Tiles to-the-floor are to be used in the bottom position only.
- Tiles to-the-floor are 5" longer to accommodate to-the-floor applications and replace base raceway cover.
- Tiles do not include segment kits — order separately.
- Tiles are level® 2 when a level® 2 fabric is used.
- Cannot use tiles to-the-floor with footed panel frames.
- Requires simple in field modification to frame glide tower. After modification, base raceway cover cannot be used with fabric or steel tiles.

Tackable Acoustical Tile-to-the-Floor

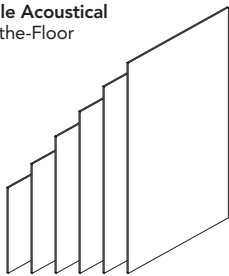

22½", 30", 37½", 45", 52½", 60"H

Steel Tiles

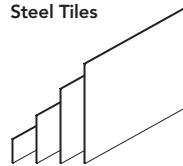

7½", 15", 22½", 30"H

Steel Tiles (page 166)

- Painted steel construction. 7½"H-30"H, 20"W-60"W.
- Tiles do not include segment kits — order separately.
- Steel tiles can be used in any location.

Steel Tiles to-the-Floor (page 166)

- Painted steel construction. 22½"H-30"H, 20"W-60"W.
- Tiles do not include segment kits — order separately.
- Tiles to-the-floor are to be used in the bottom position only.
- Tiles to-the-floor are 5" longer to accommodate to-the-floor applications and replace base raceway cover.
- Attachment hardware included.
- Cannot use tiles to-the-floor with footed panel frames.

Perforated Steel Tiles (page 167)

- Tiles do not include segment kits — order separately.
- Allows air flow when placed on each side of panel.
- Aesthetics of opposing tile surface and/or frame interior should be considered when selecting perforated steel tiles.
- Should not be used at locations that span horizontal segment kits or at beltline.

Steel Tile-to-the-Floor

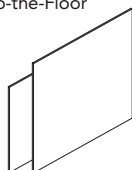

22½", 30"H

Perforated Steel Tiles

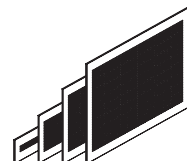

7½", 15", 22½", 30"H

Tool Tiles

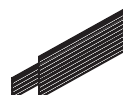

7½", 15"H

Tool Tiles (page 168)

- Sturdy aluminum extrusion.
- Accommodates Extensions™ work tools — weight capacity not to exceed 80 lbs. If monitor arm attached subtract 25 lbs.
- Consideration needs to be given to height of tools and location of worksurfaces and storage.
- Do not segment within the center of the back side of a 15"H tool tile, instead use two 7½"H tool tiles.
- Tiles do not include segment kits — order separately.
- Do not use at top of wall track.

Tiles ship with attachment clips installed. Tiles do not include segment kits, order separately.

Porcelain Marker Board Tiles

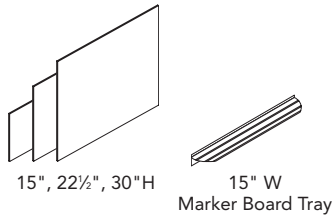

Steel Marker Board Tiles

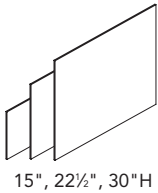

Landscape Surface Tiles

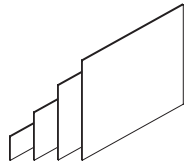

Infinite Spectrum™, Pearlescent Strata, Foundation, Quattro

Handling and care for marker boards:

1. Leaving ink on the board for an extended period of time may lead to images remaining on the board, commonly known as “ghosting,” after erasing.
2. To avoid ghosting, thoroughly erase your marker board after every use and clean your board weekly with marker board cleaner.
3. Expo® brand dry-erase markers are recommended for best erasing results.
4. Avoid using red and orange markers for easier cleaning and to reduce the likelihood of ghosting.
5. Do not use permanent or non-dry erase markers.
6. To maintain eraser performance, follow manufacturer’s instructions.

Porcelain Marker Board Tiles (page 169)

- White porcelain-coated steel surface encased within a steel frame.
- Accepts magnetic accessories.
- Paint color for frame must be specified.
- Marker boards ship with tile attachment clips installed.
- Tiles do not include segment kits — order separately.
- 15" W magnetic marker board tray that is natural aluminum is available. Order model TK4TRAYMS separately.
- For everyday cleaning of dry-erase marker ink, use Clorox wipes. Should a permanent marker be used, a citrus cleaner such as Quartet will remove the ink. Note that a citrus cleaner is not recommended for everyday cleaning as it leaves a residue on the marker board.

Steel Marker Board Tiles (page 169)

- White marker board tile; painted steel surface.
- Accepts magnetic accessories.
- Tiles do not include segment kits — order separately.
- 15" W magnetic marker board tray that is natural aluminum is available. Order model TK4TRAYMS separately.
- For everyday cleaning of dry-erase marker ink, use Clorox wipes. Should a permanent marker be used, a citrus cleaner such as Quartet will remove the ink. Note that a citrus cleaner is not recommended for everyday cleaning as it leaves a residue on the marker board.

Landscape Surface Tiles (page 170)

- ¼" material encased within a painted steel frame.
- Paint color for frame must be specified.
- Tiles do not ship with segment kits — order separately.
- Should not be used at locations that span horizontal segment kits or at beltline.
- Available in Foundation™ and Quattro.

Laminate Tiles

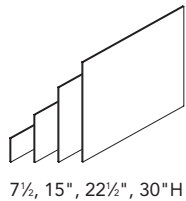

Laminate Tiles to-the-Floor

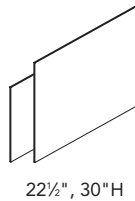

Laminate Tiles (pages 171-172)

- Laminate construction, available in all standard laminate finishes.
- Tiles do not include segment kits — order separately.
- Grain direction runs vertical on all sizes.

Laminate Tiles to-the-Floor (pages 173-175)

- Laminate construction, available in all standard laminate finishes.
- Tiles to-the-floor are to be used in the bottom position only.
- Tiles to-the-floor are 5" longer to accommodate to-the-floor applications and replace base raceway cover.
- Do not use tiles to-the-floor with footed panel frames.
- Tiles do not include segment kits — order separately.

Glass Tile Kit

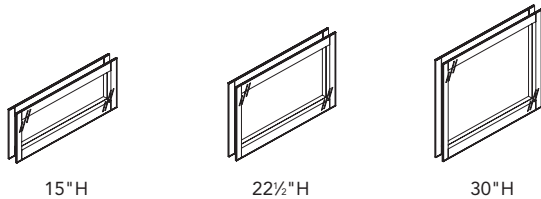

Single Pane Glass Tile Kits (page 176)

- Kit includes single pane of tempered safety glass for one side of frame and trim for the other side of frame.
- Glass is flush on one side.
- Tiles do not include segment kits — order separately.
- Kits ship with tile attachment clips installed.
- Attachment hardware included.
- Should not be used at locations that span horizontal segment kits or at beltline.
- Low profile glass stacker kits also available.

Pass-Thru Trim Kit

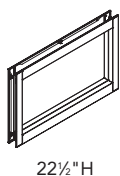

Pass-Thru Trim Kits (page 176)

- Painted steel frame.
- Open frame without tiles, used for ability to pass objects from one side of frame to the other.
- Segment kits not included — order separately.
- One kit accommodates both sides of panel frame.
- Attachment hardware included.
- Should not be used at locations that span horizontal segment kits or at beltline.

Tiles

Spanning Tiles (pages 174-175)

- Not compatible with landscape tiles.
- Base panel height must match tile height. Example: 50"H tile must go on a 50"H base frame, not 50"H tile on 35"H base frame + 15"H stacker.
- Can be used with any combination of two frame widths.
- No more than two frames per tile.
- Bracket Kits:
 - Z4STBRKT1 = 30/35"H
 - Z4STBRKT2 = 42/50"H
- Full laminate and edgeband options available.
- Horizontal grain only.
- For dual-sided spanning tile applications, an additional Bracket Kit must be ordered.
- For dual-sided applications, spanning tiles must be mounted to the same panel frames.
- Laminate is 3/8" thick, edgeband is 0.8mm thick.
- Slotted standard is accessible when using spanning tiles on the two outside slots.
- Cannot be used with Wall Track.
- Spanning tiles are not compatible with panel frames produced prior to July 2014. For applications with panels produced prior to July 2014, please reach out to the Tailored Products Group.

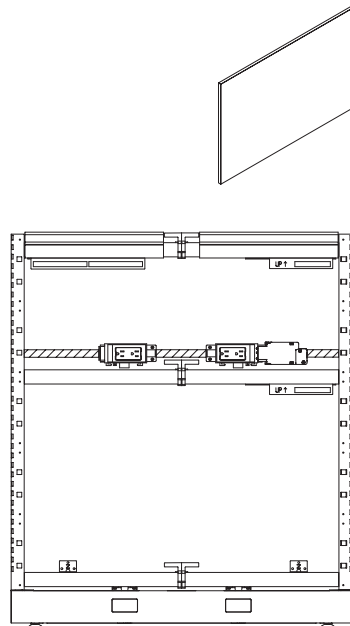

Beltline power is only available above the beltline on the opposite side of the spanning tile.

Frame Combinations

54w		60w		66w		72w		78w		84w		90w		96w	
Frame 1	Frame 2	Frame 1	Frame 2	Frame 1	Frame 2	Frame 1	Frame 2	Frame 1	Frame 2	Frame 1	Frame 2	Frame 1	Frame 2	Frame 1	Frame 2
24	30	24	36	24	42	24	48	30	48	24	60	30	60	36	60
		30	30	30	36	30	42	36	42	36	48	42	48	48	48
						36	36			42	42				

Stride Stratawood and Natural Veneer

Wood owes its inherent beauty to variations in color, grain and texture, and therefore, these variations are not considered defects. There may be minor variations from one piece of furniture to the next, even though they are finished at the same time. Exposure to light and the aging process will cause darkening of natural wood products. Light finishes on wood products do not mask the natural characteristics of wood. Therefore, Allsteel does not guarantee the exact matching grain, pattern and color.

Stride veneer trim, connectors, tiles and storage fronts are offered in Stratawood (composite) finishes and in Natural veneer finishes. (See page 120 for finishes.)

Stride Stratawood and Natural veneer worksurfaces are protected by one of the world's most advanced wood finishing process by Gunlocke®. It provides the ultimate in scratch, stain, chemical, and heat resistance for these high-wear surfaces. The jewel-like clarity and depth allow the natural beauty of the wood to glow through.

Stratawood Veneer Vs. Natural Veneer: Which is best for you?

Stratawood and Natural veneer have similarities and differences. Both options provide a wood surface. Exposure to light will cause both options to darken. Both Stratawood and Natural veneer will be a stylish addition to any specification. However the look, feel and process for Stratawood and Natural veneer are different.

Stratawood Veneer

Stratawood veneer features a repeatable straight-grain pattern, absent of the cathedrals seen in Natural veneer. Although slight differences in tone should be expected, the Stratawood pattern will maintain a consistent appearance across all products.

Stratawood veneer is an engineered wood veneer enhanced by technology for consistency in both color and grain pattern resulting in very few defects.

Although exposure to light will cause Stratawood veneer to darken slightly, additional orders at later dates will match existing product pattern and will match the color when matured. This creates a smooth process for adding on to existing installations.

Natural Veneer

Natural veneer is subject to nature's quality control. Differences in grain and color are naturally occurring variations and can not be controlled by the manufacturer and cannot be considered as product defects. Natural veneer has the characteristics and beauty of a living organism; with its own variations of grain, growth, and color patterns. For these reasons, Natural veneer is preferred by many for its warmth and personal characteristics.

Color changes will occur over time when wood is exposed to light. For this reason, when new product is ordered as an addition to existing product, there will be color variances between the old and new product. Please remember when specifying new product that although the species of veneer will be the same, additional product is being manufactured from a different tree. It may take several months for the new furniture to mature to the color level of the existing product. Even with this maturation process the additional product may not be an exact match.

When ordering Natural veneer tiles for Stride frames, please refer to pages 143-144 for information. Natural tiles sets must be ordered to ensure grain pattern matching. All panels with two or more continual natural veneer segments will need to be ordered as a set and will be grain matched for consistency. These tile sets must remain together throughout the manufacturing and installation process.

Natural veneer worksurfaces may exhibit a color variance between the surface and the edge detail or when butted together at a 90 degree angle. This natural phenomenon is called polarization (or grain flip) which alters the color and appearance of adjacent worksurfaces with grain running perpendicular. The appearance of wood veneer may change slightly depending on what angle it is viewed from, although it is most often noticed on worksurfaces installed at 90 degree angles to each other. For your guidance, please see illustrations within the worksurface section when specifying for an understanding of grain direction in your installation.

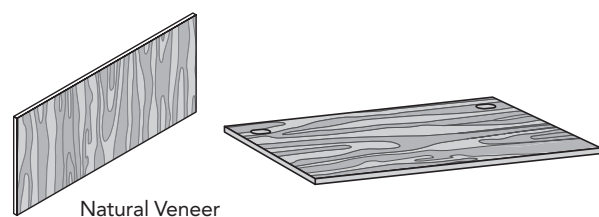
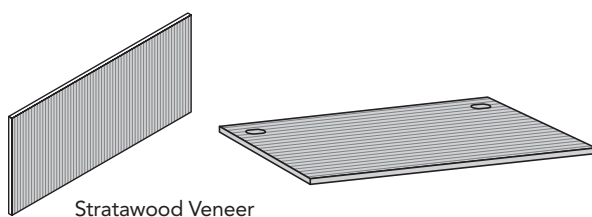

Caring for your Veneer finish:

- General maintenance procedures entail wiping clean the entire surface with a clean, water dampened soft cloth once per week. (Be sure to wipe with the grain.)
- Murphy's® Oil Soap may be used as a general purpose type cleaner with warm water to clean tops.
- The finish may also be polished with Guardsman® Furniture Polish (contains no waxes or silicones) to provide renewed luster.
- Be sure to wipe up all spills immediately.

Veneer on Stride

2 Different Veneer Types

Natural veneer is subject to nature's quality control. Each specimen will exhibit differences in grain pattern and tone. This is to be expected, and, in fact contributes to the individuality of each product.

Stratawood veneer features a straight-grain pattern, absent of the cathedrals seen in natural veneer. Although slight differences in tone should be expected, the Stratawood pattern will maintain a consistent appearance across all products.

Veneer Finish Options

See page 120 for available finishes and finish indicators in both Natural and Stratawood.

Natural Veneer Tile Sets for Stride

- Natural veneer tile sets are used when 2 or more natural veneer tiles are vertically adjacent to each other on the same panel (see illustration below) in order to maximize the beauty of real wood and carry the grain pattern from tile to tile.
- Tile sets do not apply to Stratawood tiles, as the grain pattern is consistent from tile to tile.

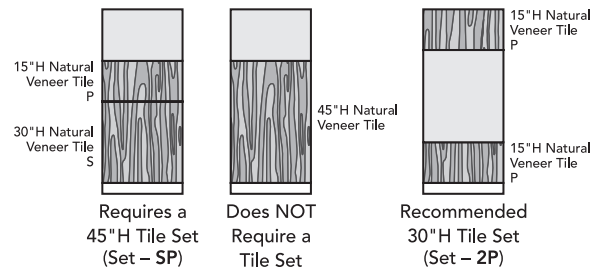

Specifying Standard Natural Veneer Tile Sets

1. Determine the height of the natural veneer tile set.
 - a. The total height of tile required can be calculated by deducting 5" (the height of the frame base) from the nominal panel height.
 - b. To calculate set height simply add the heights of the tiles in the set (for example, one 15"H tile and one 30"H tile would require a 45"H tile set — see illustration above).
2. Natural veneer to-the-floor tile sets are available following regular sets.
 - A 45"H Natural veneer to-the-floor tile set will fully fill a 50"H frame.
 - A 52½"H Natural veneer to-the-floor tile set will fully fill a 57½"H frame.
 - A 60"H Natural veneer to-the-floor tile set will fully fill a 65"H frame.

Note

1. Tile sets **MUST** remain together throughout the installation process in order to maximize the beauty of real wood and carry the grain pattern vertically from tile to tile.
2. The backside of each tile in the tile set is marked with a set number so that the tiles comprising that specific set do not get confused with any other natural veneer tile sets.
3. The backside of each tile in the tile set with a letter denoting the placement of each tile in the set. The tile marked A is the top tile in the set, followed by B, C, and so on.

Natural Veneer Tile Set Position Options Chart

Natural Veneer Tile Sets	Nominal Panel Height	Natural Veneer Tile Set Code	Tile Set Height	Tiles Included (bottom to top)
Natural Veneer Tile Sets	35"H	2P	30"H	PP
	42½"H	QP	37½"H	QP
	50"H	3P	45"H	PPP
		SP	45"H	SP
	57½"H	Q2P	52½"H	QPP
		SQ	52½"H	SQ
	65"H	4P	60"H	PPPP
		S2P	60"H	SPP

Veneer Tiles (page 177)

- Veneer tiles produced by Gunlocke® available in Stratawood or Natural veneer.
- Stratawood veneer has a consistent straight-grain pattern.
- Natural veneer will have cathedrals and as a natural material is subject to nature's quality control with variations in grain pattern and tone.
- Tiles do not include segment kits — order separately.
- Veneer tiles, kits, and tile sets all ship with attachment clips installed.
- If two or more natural veneer tiles are vertically adjacent, Natural veneer tile sets should be ordered to carry the grain pattern.
- Grain direction runs vertical on all sizes.

Veneer Tiles to-the-Floor Kits (page 178)

- Tiles do not include segment kits — order separately.
- Tiles to-the-floor are to be used in the bottom position only.
- Tiles to-the-floor are 5" longer to accommodate to-the-floor applications.
- Tiles to-the-floor replace base raceway cover.
- Tiles to-the-floor cannot be used with footed panel frames.

Natural Veneer Tile Sets (pages 179-180)

- Specify when two or more natural veneer tiles are adjacent to carry the vertical grain pattern from tile to tile.

Veneer to-the-Floor Tile Sets (page 181)

- Specify when two or more natural veneer tiles are adjacent to carry the vertical grain pattern from tile to tile.
- Veneer to-the-floor tile set are 5" longer to accommodate to-the-floor applications.
- Veneer to-the-floor tile sets replace base raceway cover.
- Veneer to-the-floor tile sets cannot be used with footed panel frames.

Natural Veneer Tile Sets

Tile Height Codes used for Natural Veneer Sets below:

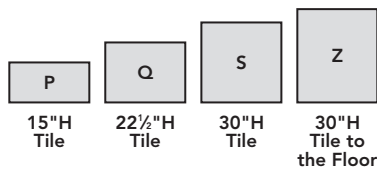

Letters on tiles represent height of individual tiles, see codes above.

Ordering code is listed above each tile set, and total height of set is listed below.

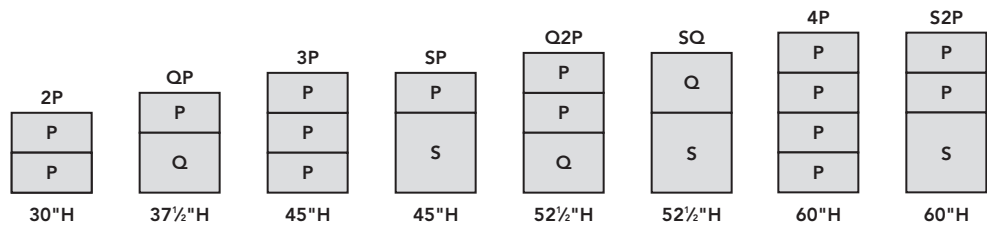

Veneer to-the-floor tile sets have a base tile that is 5" longer to accommodate "to-the-floor" applications.

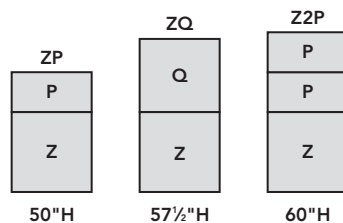

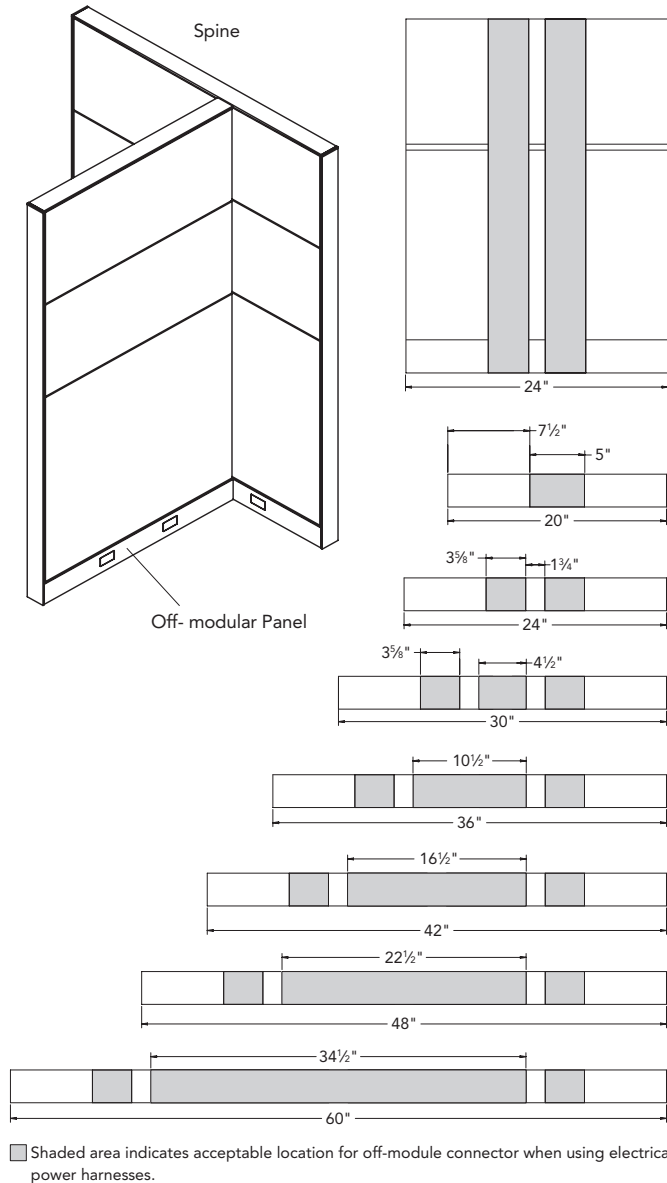

Off-Module Non-Rail Based Connector Guidelines

- Off-module connector kits join panels off-module at 90° angles. The total 3" panel thickness must be positioned within the confines of the shaded areas, as depicted in the illustration, but cannot be positioned directly over electrical cutouts in the frame horizontal.
- Tiles and base pathway covers cannot be removed from the face of a panel to which an off-module connected panel is mounted.
- Base panel frames must be the same height.
- Do not stack on an off-modular return panel.
- Do not suspend more than one overhead storage unit per side from panels in a panel run which is mounted, at one or both ends, with an off-module connector kit.
- Use data port (model UTP) to route data and electrical between primary panel run and panel-mounted off-modular.
- Panel mounted screens or low profile glass stackers cannot be used on the parent run or on an off-modular panel.
- Footed panel frames can be used on the spine wall but cannot be used as the off-modular panel frame.
- To-the-floor tiles cannot be used on the side of the spine wall where off-modular return panel is attached.

Off-Modular Non Rail-Based Accessories

Panel Attachment Kit (page 182)

- Connector allows for off-module connection, does not add to length of run.
- Black only.

End Panel Kit (page 182)

- Used to attach an end panel off-modular.
- Bracket requires a segmented panel at 22 1/2" H for mounting.

Worksurface Bracket (page 182)

- Allows in-line support legs and end-panels to be attached off-module.
- Bracket requires a segmented panel at 22 1/2" H for mounting.
- Cannot be used closer than 12" from end of panel.

3" Layered Worksurface Bracket (page 182)

- Used to mount off-modular worksurface at 26 1/2" H.
- Bracket requires a segmented panel at 22 1/2" H for mounting.

Layered Worksurface Connection Bracket (page 182)

- Used to attach a worksurface 3" higher or lower to an installed worksurface.

Overhead Cabinet Off-Modular Mounting Kit (page 182)

- Used to mount overhead cabinet on a panel which is up to 18" narrower than cabinet width.
- Requires one side of cabinet to be held on module.

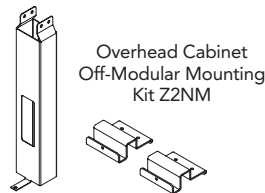
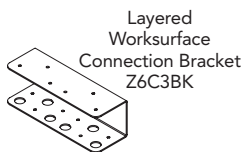
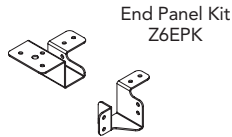
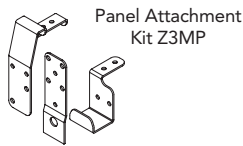

For specification information see pages 126-132.

GSA SIN 33721

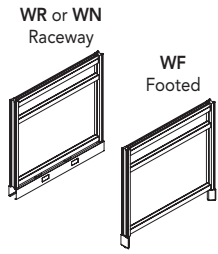

Description	Model	List Price WR or WN	List Price WF
35"H Panel Frames without Top Trim			
24"W	Z03524 □□ [S]	\$ 368	\$ 413
30"W	Z03530 □□	\$ 400	\$ 439
36"W	Z03536 □□	\$ 422	\$ 469
42"W	Z03542 □□	\$ 452	\$ 494
48"W	Z03548 □□	\$ 480	\$ 522
60"W	Z03560 □□	\$ 547	\$ 593

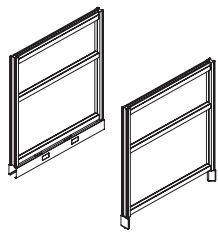

42½"H Panel Frames without Top Trim			
24"W	Z04224 □□ [S]	\$ 383	\$ 429
30"W	Z04230 □□	\$ 415	\$ 460
36"W	Z04236 □□	\$ 442	\$ 490
42"W	Z04242 □□	\$ 471	\$ 515
48"W	Z04248 □□	\$ 506	\$ 550
60"W	Z04260 □□	\$ 564	\$ 610

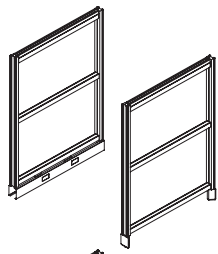

50"H Panel Frames without Top Trim			
24"W	Z05024 □□	\$ 405	\$ 450
30"W	Z05030 □□	\$ 431	\$ 479
36"W	Z05036 □□	\$ 460	\$ 507
42"W	Z05042 □□	\$ 494	\$ 540
48"W	Z05048 □□	\$ 522	\$ 572
60"W	Z05060 □□	\$ 601	\$ 649

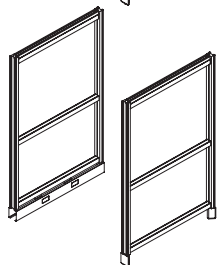

57½"H Panel Frames without Top Trim			
24"W	Z05724 □□	\$ 422	\$ 466
30"W	Z05730 □□	\$ 458	\$ 498
36"W	Z05736 □□	\$ 487	\$ 528
42"W	Z05742 □□	\$ 518	\$ 560
48"W	Z05748 □□	\$ 554	\$ 601
60"W	Z05760 □□	\$ 635	\$ 676

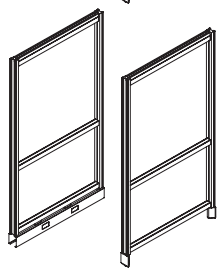

65"H Panel Frames without Top Trim			
24"W	Z06524 □□	\$ 442	\$ 483
30"W	Z06530 □□	\$ 475	\$ 518
36"W	Z06536 □□	\$ 512	\$ 551
42"W	Z06542 □□	\$ 545	\$ 585
48"W	Z06548 □□	\$ 583	\$ 621
60"W	Z06560 □□	\$ 661	\$ 707

STRIDE

<p>How to specify — Select the Panel Frame Model Number from above.</p> <p>Z 0 </p>	<p>1st Option: Select the Base Option:</p> <p>WR Without Top Trim; With Raceway Cover Knockouts on both sides</p> <p>WN Without Top Trim; With Raceway Cover Knockouts on 1 side.</p> <p>WF Without Top Trim; With Footed Panel Frame.</p> <p> .</p>	<p>2nd Option: Select the Paint Color:</p> <p>[P1] [P2] [P3]</p> <p>See page 120 for finishes.</p> <p>For P2 Paints — add \$26.</p> <p>For P3 Paint — add \$50.</p> <p>Footed frames not available in P3 paint.</p> <p>P </p>
---	---	---

Examples: Z04224WR.P4J Z04224WN.P7D Z04260WF.P02

[S] Shippable by small-package carrier.

Frames

Stride® — Stacking Panel Frames / Segment Kits / Conversion Kits

For specification information see pages 126-132.

GSA SIN 33721



Z01536P

Description	Model	List Price
15"H Stacking Frames		
24"W	Z01524P <input type="checkbox"/>	\$ 389
30"W	Z01530P <input type="checkbox"/>	\$ 404
36"W	Z01536P <input type="checkbox"/>	\$ 416
42"W	Z01542P <input type="checkbox"/>	\$ 433
48"W	Z01548P <input type="checkbox"/>	\$ 450
60"W	Z01560P <input type="checkbox"/>	\$ 475

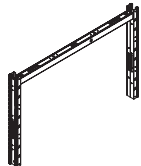

Z02236P

22½"H Stacking Frames		
24"W	Z02224P <input type="checkbox"/>	\$ 400
30"W	Z02230P <input type="checkbox"/>	\$ 421
36"W	Z02236P <input type="checkbox"/>	\$ 450
42"W	Z02242P <input type="checkbox"/>	\$ 475
48"W	Z02248P <input type="checkbox"/>	\$ 503
60"W	Z02260P <input type="checkbox"/>	\$ 565

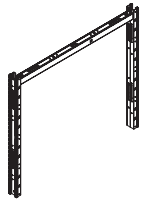

Z03036P

30"H Stacking Frames		
24"W	Z03024P <input type="checkbox"/>	\$ 412
30"W	Z03030P <input type="checkbox"/>	\$ 447
36"W	Z03036P <input type="checkbox"/>	\$ 482
42"W	Z03042P <input type="checkbox"/>	\$ 513
48"W	Z03048P <input type="checkbox"/>	\$ 562
60"W	Z03060P <input type="checkbox"/>	\$ 649

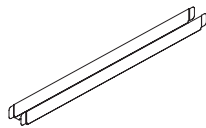

Z236SK

Segment Kits (no color option) — for Base Panel Frames and Stacking Frames		
24"W	Z224SK <input type="checkbox"/>	\$ 70
30"W	Z230SK <input type="checkbox"/>	\$ 74
36"W	Z236SK <input type="checkbox"/>	\$ 78
42"W	Z242SK <input type="checkbox"/>	\$ 80
48"W	Z248SK <input type="checkbox"/>	\$ 88
60"W	Z260SK <input type="checkbox"/>	\$ 92



Z2RF

Description	Model	P1 Paint List Price	P2 Paint List Price
Raceway to Footed Conversion Kit			
Base Raceway to Footed Kit	Z2RF <input type="checkbox"/>	\$ 242	\$ 268

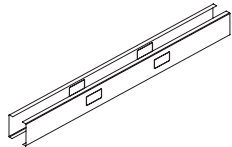

Z236FR

Footed-to-Base Raceway Conversion Kits			
24"W Footed-to-Base Raceway Kit	Z224FR <input type="checkbox"/>	\$ 302	\$ 346
30"W Footed-to-Base Raceway Kit	Z230FR <input type="checkbox"/>	\$ 302	\$ 346
36"W Footed-to-Base Raceway Kit	Z236FR <input type="checkbox"/>	\$ 302	\$ 346
42"W Footed-to-Base Raceway Kit	Z242FR <input type="checkbox"/>	\$ 302	\$ 346
48"W Footed-to-Base Raceway Kit	Z248FR <input type="checkbox"/>	\$ 302	\$ 346
60"W Footed-to-Base Raceway Kit	Z260FR <input type="checkbox"/>	\$ 302	\$ 346

How to specify —
Select the Model Number from above.

Z | | | | | | | | | |

1st Option:
Segment Kit Color (if applicable):
P Black

P | | | |

1st Option:
Paint (if applicable):
See page 120 for finishes.

P | | | |







Examples: Z01548P Z224SK.P Z236FR.P7C







Shippable by small-package carrier.

For specification information see pages 126-132.

GSA SIN 33721



Description	Model	Clear List Price	Frosted List Price
15"H Low Profile Glass Stacker Kits (Examples span multiple panels)			
24"W	Z41524GL 	\$ 859	\$ 1035
30"W	Z41530GL 	\$ 923	\$ 1115
36"W	Z41536GL 	\$ 996	\$ 1201
42"W	Z41542GL 	\$ 1071	\$ 1290
48"W	Z41548GL 	\$ 1133	\$ 1368
60"W (30" + 30" or 24" + 36")	Z41560GL 	\$ 1294	\$ 1560
72"W (36" + 36" or 24" + 48")	Z41572GL	\$ 1498	\$ 1805
84"W (36" + 48")	Z41584GL	\$ 1649	\$ 1990
90"W (42" + 48" or 30" + 30" + 30")	Z41590GL	\$ 1727	\$ 2084
96"W (48" + 48" or 30" + 30" + 36")	Z41596GL	\$ 1830	\$ 2208

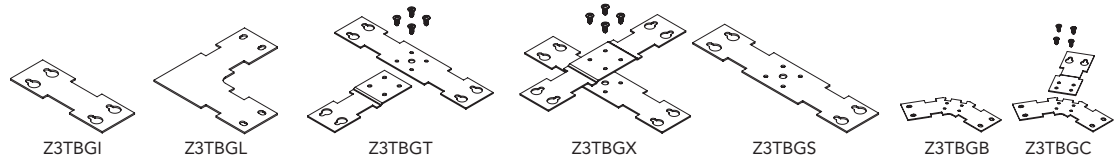

Description	Model	List Price
Tie Bracket Kit for Low Profile Glass Stacker Kits		
In-Line Connection	Z3TBGI 	\$ 36
"L" Connection	Z3TBGL 	\$ 36
"T" Connection	Z3TBGT 	\$ 36
"X" Connection	Z3TBGX 	\$ 36
"S" Connection	Z3TBGS 	\$ 36
2-Way 120° Connection	Z3TBGB 	\$ 36
3-Way 120° Connection	Z3TBGC 	\$ 36



How to specify —
Select the Model Number from above.

Z | | | | | | | | | | | | | | | | . P | | | | | .

1st Option:
Paint — Interior Shroud
(if applicable):

See page 120 for finishes.

2nd Option:
Glass Type
(if applicable):

C Clear
F Frosted

Examples: Z41530GL.P27.C Z3TBGL

 Shippable by small-package carrier.

For specification information see page 129.

GSA SIN 33721

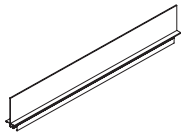

Description	Model	Clear List Price	Frosted List Price	Smoked List Price
7½"H x ¾" Thick Glass Panel Mounted Screens — Painted Trim				
24"W	Z40724TGS	\$ 600	\$ 642	\$ 684
30"W	Z40730TGS	\$ 651	\$ 695	\$ 742
36"W	Z40736TGS	\$ 747	\$ 798	\$ 852
42"W	Z40742TGS	\$ 798	\$ 851	\$ 910
48"W	Z40748TGS	\$ 857	\$ 915	\$ 977
54"W	Z40754TGS	\$ 952	\$ 1018	\$ 1086
60"W	Z40760TGS	\$ 1046	\$ 1117	\$ 1192
66"W	Z40766TGS	\$ 1152	\$ 1230	\$ 1314
72"W	Z40772TGS	\$ 1255	\$ 1342	\$ 1431
78"W	Z40778TGS	\$ 1347	\$ 1440	\$ 1536
84"W	Z40784TGS	\$ 1437	\$ 1535	\$ 1639
90"W	Z40790TGS	\$ 1537	\$ 1644	\$ 1753
96"W	Z40796TGS	\$ 1632	\$ 1745	\$ 1861
15"H x ¾" Thick Glass Panel Mounted Screens — Painted Trim				
24"W	Z41524TGS	\$ 651	\$ 695	\$ 742
30"W	Z41530TGS	\$ 703	\$ 751	\$ 802
36"W	Z41536TGS	\$ 809	\$ 864	\$ 922
42"W	Z41542TGS	\$ 864	\$ 923	\$ 985
48"W	Z41548TGS	\$ 933	\$ 998	\$ 1064
54"W	Z41554TGS	\$ 1035	\$ 1105	\$ 1180
60"W	Z41560TGS	\$ 1136	\$ 1213	\$ 1296
66"W	Z41566TGS	\$ 1249	\$ 1334	\$ 1424
72"W	Z41572TGS	\$ 1358	\$ 1452	\$ 1549
78"W	Z41578TGS	\$ 1537	\$ 1643	\$ 1753
84"W	Z41584TGS	\$ 1716	\$ 1834	\$ 1956
90"W	Z41590TGS	\$ 1772	\$ 1893	\$ 2021
96"W	Z41596TGS	\$ 1831	\$ 1957	\$ 2088

<p>How to specify — Select the Model Number from above.</p>	<p><i>1st Option:</i> Glass (if applicable): LC Clear LF Frosted GSM1 Smoked</p>	<p><i>2nd Option:</i> Paint Color: P1 P2 P3 See page 120 for finishes.</p>
--	---	---

Z 4 | | | | | | . L | | . P | | | |

Example: Z40742TGS.LC.P7D

Shippable by small-package carrier.

For specification information see page 129.

GSA SIN 33721

Description	Model	V1			V3			V5		
		Clear List Price	Frosted List Price	Smoked List Price	Clear List Price	Frosted List Price	Smoked List Price	Clear List Price	Frosted List Price	Smoked List Price
7½"H x ¾" Thick Glass Panel Mounted Screens — Veneer Trim										
24"W	Z40724TGSV	\$ 868	\$ 923	\$ 982	\$ 962	\$ 1017	\$ 1076	\$ 1025	\$ 1080	\$ 1139
30"W	Z40730TGSV	\$ 943	\$ 1001	\$ 1067	\$ 1045	\$ 1103	\$ 1169	\$ 1113	\$ 1171	\$ 1237
36"W	Z40736TGSV	\$ 1078	\$ 1145	\$ 1220	\$ 1195	\$ 1262	\$ 1337	\$ 1273	\$ 1340	\$ 1415
42"W	Z40742TGSV	\$ 1145	\$ 1217	\$ 1295	\$ 1269	\$ 1341	\$ 1419	\$ 1352	\$ 1424	\$ 1502
48"W	Z40748TGSV	\$ 1235	\$ 1314	\$ 1398	\$ 1369	\$ 1448	\$ 1532	\$ 1458	\$ 1537	\$ 1621
54"W	Z40754TGSV	\$ 1375	\$ 1463	\$ 1556	\$ 1524	\$ 1612	\$ 1705	\$ 1624	\$ 1712	\$ 1805
60"W	Z40760TGSV	\$ 1509	\$ 1606	\$ 1708	\$ 1673	\$ 1770	\$ 1872	\$ 1782	\$ 1879	\$ 1981
66"W	Z40766TGSV	\$ 1603	\$ 1709	\$ 1822	\$ 1777	\$ 1883	\$ 1996	\$ 1893	\$ 1999	\$ 2112
72"W	Z40772TGSV	\$ 1805	\$ 1921	\$ 2043	\$ 2001	\$ 2117	\$ 2239	\$ 2131	\$ 2247	\$ 2369
78"W	Z40778TGSV	\$ 1941	\$ 2068	\$ 2197	\$ 2151	\$ 2278	\$ 2407	\$ 2292	\$ 2419	\$ 2548
84"W	Z40784TGSV	\$ 2068	\$ 2201	\$ 2340	\$ 2292	\$ 2425	\$ 2564	\$ 2442	\$ 2575	\$ 2714
90"W	Z40790TGSV	\$ 2209	\$ 2351	\$ 2500	\$ 2449	\$ 2591	\$ 2740	\$ 2608	\$ 2750	\$ 2899
96"W	Z40796TGSV	\$ 2352	\$ 2502	\$ 2662	\$ 2607	\$ 2757	\$ 2917	\$ 2777	\$ 2927	\$ 3087

15"H x ¾" Thick Glass Panel Mounted Screens — Veneer Trim										
24"W	Z41524TGSV	\$ 943	\$ 1001	\$ 1067	\$ 1045	\$ 1103	\$ 1169	\$ 1113	\$ 1171	\$ 1237
30"W	Z41530TGSV	\$ 1012	\$ 1075	\$ 1145	\$ 1122	\$ 1185	\$ 1255	\$ 1195	\$ 1258	\$ 1328
36"W	Z41536TGSV	\$ 1164	\$ 1237	\$ 1317	\$ 1290	\$ 1363	\$ 1443	\$ 1375	\$ 1448	\$ 1528
42"W	Z41542TGSV	\$ 1247	\$ 1327	\$ 1411	\$ 1382	\$ 1462	\$ 1546	\$ 1473	\$ 1553	\$ 1637
48"W	Z41548TGSV	\$ 1343	\$ 1430	\$ 1520	\$ 1489	\$ 1576	\$ 1666	\$ 1586	\$ 1673	\$ 1763
54"W	Z41554TGSV	\$ 1441	\$ 1537	\$ 1637	\$ 1597	\$ 1693	\$ 1793	\$ 1701	\$ 1797	\$ 1897
60"W	Z41560TGSV	\$ 1634	\$ 1738	\$ 1850	\$ 1811	\$ 1915	\$ 2027	\$ 1929	\$ 2033	\$ 2145
66"W	Z41566TGSV	\$ 1737	\$ 1853	\$ 1973	\$ 1925	\$ 2041	\$ 2161	\$ 2051	\$ 2167	\$ 2287
72"W	Z41572TGSV	\$ 1953	\$ 2081	\$ 2211	\$ 2165	\$ 2293	\$ 2423	\$ 2306	\$ 2434	\$ 2564
78"W	Z41578TGSV	\$ 2210	\$ 2352	\$ 2501	\$ 2450	\$ 2592	\$ 2741	\$ 2610	\$ 2752	\$ 2901
84"W	Z41584TGSV	\$ 2468	\$ 2629	\$ 2793	\$ 2736	\$ 2897	\$ 3061	\$ 2914	\$ 3075	\$ 3239
90"W	Z41590TGSV	\$ 2550	\$ 2714	\$ 2886	\$ 2826	\$ 2990	\$ 3162	\$ 3011	\$ 3175	\$ 3347
96"W	Z41596TGSV	\$ 2635	\$ 2807	\$ 2982	\$ 2921	\$ 3093	\$ 3268	\$ 3111	\$ 3283	\$ 3458

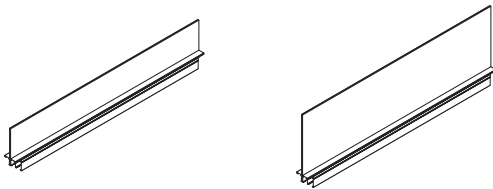

STRIDE

<p>How to specify — Select the Model Number from above.</p>	<p>1st Option: Glass: LC Clear LF Frosted GSM1 Smoked</p>	<p>2nd Option: Paint (if applicable): P1 P2 P3 See page 120 for finishes.</p>	<p>2nd Option: Veneer (if applicable): See page 120 for finishes.</p>
<p>Z 4 T G S . L . P </p>	<p><i>Example: Z41536TGSV.LC.NC260</i></p>		

Frames

Stride® — Door Panel Frames and Sliding Doors

For specification information see pages 126-132.

GSA SIN 33721



Description	Model	Painted		
		P1 Paint List Price	P2 Paint List Price	P3 Paint List Price
Door Panel — Laminate				
87½"H x 42"W	Z18742PDL	\$ 6215	\$ 6273	\$ 6333

Description	Model	List Price
Lock Set		
Door Knob Polished Brass, keyed on one side	899900	\$ 159
Door Lever Brushed Aluminum, keyed on one side	899910	\$ 455

Description	Model	P1 Paint List Price	P2 Paint List Price	P3 Paint List Price
Frosted Translucent Sliding Doors (non-locking)				
50"H x 42"W for 36"W opening	Z15042SD	\$ 5079	\$ 5134	\$ 5191
65"H x 42"W for 36"W opening	Z16542SD	\$ 6157	\$ 6212	\$ 6269
80"H x 42"W for 36"W opening	Z18042SD	\$ 7500	\$ 7555	\$ 7612



Mounting Kit For Sliding Doors				
Description	Model	P1 Paint List Price	P2 Paint List Price	P3 Paint List Price
30"W	Z130DMK	\$ 788	\$ 808	\$ 825
36"W	Z136DMK	\$ 788	\$ 808	\$ 825
42"W	Z142DMK	\$ 788	\$ 808	\$ 825
48"W	Z148DMK	\$ 788	\$ 808	\$ 825

<p>How to specify — Select the Model Number from above.</p>	<p>1st Option: Select the Paint Color: P1 P2 P3 See page 120 for finishes.</p>	<p>2nd Option: Door Laminate (if applicable): See page 120 for finishes.</p>	<p>2nd Option: Insert (Sliding Door only): FT Frosted Translucent</p>
<p>_____ . P _____ .</p>		<p>_____ F T _____</p>	

Examples: Z18742PDL.P28.TM20 Z18042SD.PR2.FT

For specification information see pages 126-132.

GSA SIN 33721

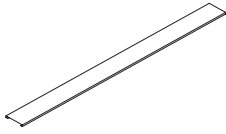

Description	Painted Model	Veneer Model	P1 Paint List Price	P2 Paint List Price	Veneer List Price
Standard Flat Top Trim (Example Spans Multiple Panels)					
24"W	Z324PT <input type="checkbox"/>	Z324VT <input type="checkbox"/>	\$ 53	\$ 79	\$ 330
30"W	Z330PT <input type="checkbox"/>	Z330VT <input type="checkbox"/>	\$ 58	\$ 84	\$ 359
36"W	Z336PT <input type="checkbox"/>	Z336VT <input type="checkbox"/>	\$ 68	\$ 94	\$ 395
42"W	Z342PT <input type="checkbox"/>	Z342VT <input type="checkbox"/>	\$ 78	\$ 104	\$ 449
48"W	Z348PT <input type="checkbox"/>	Z348VT <input type="checkbox"/>	\$ 89	\$ 115	\$ 496
54"W — (24" + 30")	Z354PT <input type="checkbox"/>	Z354VT <input type="checkbox"/>	\$ 104	\$ 148	\$ 683
60"W — (30" + 30" or 24" + 36")	Z360PT <input type="checkbox"/>	Z360VT <input type="checkbox"/>	\$ 110	\$ 136	\$ 705
66"W — (30" + 36" or 24" + 42")	Z366PT	Z366VT	\$ 133	\$ 177	\$ 795
68"W — (20" + 48")	Z368PT	Z368VT	\$ 135	\$ 179	\$ 889
72"W — (36" + 36" or 24" + 48")	Z372PT	Z372VT	\$ 138	\$ 182	\$ 980
78"W — (30" + 48" or 36" + 42")	Z378PT	Z378VT	\$ 142	\$ 186	\$ 1071
84"W — (36" + 48")	Z384PT	Z384VT	\$ 155	\$ 199	\$ 1161
90"W — (42" + 48" or 30" + 30" + 30")	Z390PT	Z390VT	\$ 163	\$ 207	\$ 1247
96"W — (48" + 48" or 30" + 30" + 36")	Z396PT	Z396VT	\$ 171	\$ 215	\$ 1331

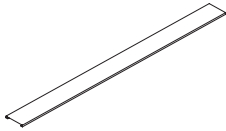

Connector Span Flat Top Trim (Example Spans Two Panels and One Connector)					
51"W — (24" + 3" + 24")	Z351PT <input type="checkbox"/>	Z351VT <input type="checkbox"/>	\$ 134	\$ 178	\$ 576
63"W — (24" + 3" + 36" or 30" + 3" + 30")	Z363PT <input type="checkbox"/>	Z363VT <input type="checkbox"/>	\$ 152	\$ 196	\$ 825
75"W — (36" + 3" + 36")	Z375PT	Z375VT	\$ 166	\$ 210	\$ 881

NOTE: Not all possible spanning combinations are shown. Illustration on page 135.

<p>How to specify — Select the Model Number from above.</p> <p>Z 3 T .</p>	<p><i>1st Option:</i> Paint Color (if applicable):</p> <p><input type="radio"/> P1 <input type="radio"/> P2 <input type="radio"/> P3</p> <p>See page 120 for finishes.</p> <p>P </p>	<p><i>1st Option:</i> Veneer Type and Finish (if applicable):</p> <p>See page 120 for finishes.</p> <p> </p>
---	--	---

Example: Z360PT.P4J

Shippable by small-package carrier.

For specification information see pages 133-136.

GSA SIN 33721

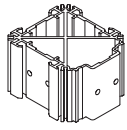

Z3UCON

Description	Model	List Price
2-Way 3-Way and 4-Way Universal Connector Blocks		
Universal Connector Block	Z3UCON S	\$ 39
Universal Connector Block - Pack of 10	Z3UCON10P	\$ 367

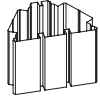

Z3CONB

120° Connector Blocks — 2-Way		
2-Way 120° Connector Block	Z3CONB S	\$ 45

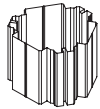

Z3CONC

120° Connector Blocks — 3-Way		
3-Way 120° Connector Block	Z3CONC S	\$ 45

How to specify —
Select the
Model Number
from above.

Z | 3 | | | | | | | | | |

Examples: Z3UCON Z3CONB Z3CONC

S Shippable by small-package carrier.

For specification information see pages 133-136.

GSA SIN 33721



Description	Painted Model	Veneer Model	P1 Paint List Price	P2 Paint List Price	Veneer List Price
2-Way 90° Light Block Kit with "L" Top Cap Transition Piece					
35"H	Z335LL [S]	Z335LLV [S]	\$ 74	\$ 88	\$ 326
42½"H	Z342LL [S]	Z342LLV [S]	\$ 78	\$ 92	\$ 331
50"H	Z350LL [S]	Z350LLV [S]	\$ 81	\$ 95	\$ 336
57½"H	Z357LL [S]	Z357LLV [S]	\$ 89	\$ 103	\$ 341
65"H	Z365LL [S]	Z365LLV [S]	\$ 95	\$ 109	\$ 355
72½"H	Z372LL [S]	Z372LLV [S]	\$ 101	\$ 115	\$ 359
80"H	Z380LL [S]	Z380LLV [S]	\$ 103	\$ 117	\$ 363
87½"H	Z387LL [S]	Z387LLV [S]	\$ 109	\$ 123	\$ 373
95"H	Z395LL [S]	Z395LLV [S]	\$ 112	\$ 126	\$ 380
102½"H	Z3102LL [S]	Z3102LLV [S]	\$ 123	\$ 137	\$ 387
110"H	Z3110LL [S]	Z3110LLV [S]	\$ 131	\$ 145	\$ 392



Description	Painted Model	Veneer Model	P1 Paint List Price	P2 Paint List Price	Veneer List Price
2-Way Extended Straight "S" Top Cap Transition Piece					
Extended Straight "S" Top Cap	Z3SS [S]	Z3SSV [S]	\$ 74	\$ 88	\$ 326



Z335PL

Description	Painted Model	Veneer Model	P1 Paint List Price	P2 Paint List Price	Veneer List Price
"L" 90° Vertical Filler Trim					
7½"H Stacking/Segmented	Z307PL [S]	Z307PLV [S]	\$ 92	\$ 117	\$ 290
15"H Stacking/Segmented	Z315PL [S]	Z315PLV [S]	\$ 101	\$ 126	\$ 403
22½"H Stacking/Segmented	Z322PL [S]	Z322PLV [S]	\$ 108	\$ 133	\$ 516
30"H Stacking/Segmented	Z330PL [S]	Z330PLV [S]	\$ 112	\$ 137	\$ 627
35"H	Z335PL [S]	Z335PLV [S]	\$ 124	\$ 149	\$ 737
42½"H	Z342PL [S]	Z342PLV [S]	\$ 135	\$ 160	\$ 850
50"H	Z350PL [S]	Z350PLV [S]	\$ 142	\$ 167	\$ 959
57½"H	Z357PL [S]	Z357PLV [S]	\$ 152	\$ 177	\$ 1071
65"H	Z365PL [S]	Z365PLV [S]	\$ 157	\$ 182	\$ 1181
80"H	Z380PL	Z380PLV	\$ 165	\$ 190	\$ 1294
87½"H	Z387PL	Z387PLV	\$ 171	\$ 196	\$ 1405

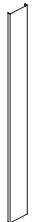

Z335PF

Description	Painted Model	Veneer Model	P1 Paint List Price	P2 Paint List Price	Veneer List Price
"F" Flat Vertical Filler Trim					
7½"H Stacking/Segmented	Z307PF [S]	Z307PFV [S]	\$ 72	\$ 97	\$ 259
15"H Stacking/Segmented	Z315PF [S]	Z315PFV [S]	\$ 79	\$ 104	\$ 364
22½"H Stacking/Segmented	Z322PF [S]	Z322PFV [S]	\$ 89	\$ 114	\$ 452
30"H Stacking/Segmented	Z330PF [S]	Z330PFV [S]	\$ 98	\$ 123	\$ 516
35"H Base frame	Z335PF [S]	Z335PFV [S]	\$ 103	\$ 128	\$ 576
42½"H Base frame	Z342PF [S]	Z342PFV [S]	\$ 110	\$ 135	\$ 640
50"H Base frame	Z350PF [S]	Z350PFV [S]	\$ 120	\$ 145	\$ 727
57½"H Base frame	Z357PF [S]	Z357PFV [S]	\$ 131	\$ 156	\$ 812
65"H Base frame	Z365PF [S]	Z365PFV [S]	\$ 138	\$ 163	\$ 901
80"H Base frame	Z380PF	Z380PFV	\$ 146	\$ 171	\$ 1058
87½"H Base frame	Z387PF	Z387PFV	\$ 155	\$ 180	\$ 1168



Z315PVH

Description	Painted Model	Veneer Model	P1 Paint List Price	P2 Paint List Price	Veneer List Price
"VH" Variable Height Vertical End Trim					
7½"H	Z307PVH [S]	Z307PVHV [S]	\$ 72	\$ 97	\$ 540
15"H	Z315PVH [S]	Z315PVHV [S]	\$ 79	\$ 104	\$ 627
22½"H	Z322PVH [S]	Z322PVHV [S]	\$ 89	\$ 114	\$ 705
30"H	Z330PVH [S]	Z330PVHV [S]	\$ 98	\$ 123	\$ 762



























































STRIDE

<p>How to specify — Select the Model Number from above.</p>	<p>1st Option: Paint Color (if applicable):</p> <p>[P1] [P2] [P3]</p> <p>See page 120 for finishes.</p>	<p>1st Option: Veneer Type and Finish (if applicable):</p> <p>See page 120 for finishes.</p>	<p>Z 3 . P </p>
--	---	--	--

Examples: Z380LL.P02 Z3SS.P52 Z335PF.P7C Z307PLV.CC260 [S] Shippable by small-package carrier.

For specification information see pages 133-136.

GSA SIN 33721

Description	Painted Model	Veneer Model	P1 Paint List Price	P2 Paint List Price	Veneer List Price
3-Way Light Block Kit with "L" Top Cap Transition Piece					
35"H	Z335TL 	Z335TLV 	\$ 81	\$ 95	\$ 336
42½"H	Z342TL 	Z342TLV 	\$ 89	\$ 103	\$ 341
50"H	Z350TL 	Z350TLV 	\$ 95	\$ 109	\$ 355
57½"H	Z357TL 	Z357TLV 	\$ 100	\$ 114	\$ 358
65"H	Z365TL	Z365TLV	\$ 103	\$ 117	\$ 363
72½"H	Z372TL	Z372TLV	\$ 109	\$ 123	\$ 373
80"H	Z380TL	Z380TLV	\$ 111	\$ 125	\$ 378
87½"H	Z387TL	Z387TLV	\$ 120	\$ 134	\$ 386
95"H	Z395TL	Z395TLV	\$ 125	\$ 139	\$ 391
102½"H	Z3102TL	Z3102TLV	\$ 135	\$ 149	\$ 400
110"H	Z3110TL	Z3110TLV	\$ 139	\$ 153	\$ 409
3-Way Light Block Kit with "T" Top Cap Transition Piece					
35"H	Z335TT 	Z335TTV 	\$ 81	\$ 95	\$ 336
42½"H	Z342TT 	Z342TTV 	\$ 89	\$ 103	\$ 341
50"H	Z350TT 	Z350TTV 	\$ 95	\$ 109	\$ 355
57½"H	Z357TT 	Z357TTV 	\$ 100	\$ 114	\$ 358
65"H	Z365TT	Z365TTV	\$ 103	\$ 117	\$ 363
72½"H	Z372TT	Z372TTV	\$ 109	\$ 123	\$ 373
80"H	Z380TT	Z380TTV	\$ 111	\$ 125	\$ 378
87½"H	Z387TT	Z387TTV	\$ 120	\$ 134	\$ 386
95"H	Z395TT	Z395TTV	\$ 125	\$ 139	\$ 391
102½"H	Z3102TT	Z3102TTV	\$ 135	\$ 149	\$ 400
110"H	Z3110TT	Z3110TTV	\$ 139	\$ 153	\$ 409
3-Way Light Block Kit with "S" Top Cap Transition Piece					
35"H	Z335TS 	Z335TSV 	\$ 81	\$ 95	\$ 336
42½"H	Z342TS 	Z342TSV 	\$ 89	\$ 103	\$ 341
50"H	Z350TS 	Z350TSV 	\$ 95	\$ 109	\$ 355
57½"H	Z357TS 	Z357TSV 	\$ 100	\$ 114	\$ 358
65"H	Z365TS	Z365TSV	\$ 103	\$ 117	\$ 363
72½"H	Z372TS	Z372TSV	\$ 109	\$ 123	\$ 373
80"H	Z380TS	Z380TSV	\$ 111	\$ 125	\$ 378
87½"H	Z387TS	Z387TSV	\$ 120	\$ 134	\$ 386
95"H	Z395TS	Z395TSV	\$ 125	\$ 139	\$ 391
102½"H	Z3102TS	Z3102TSV	\$ 135	\$ 149	\$ 400
110"H	Z3110TS	Z3110TSV	\$ 139	\$ 153	\$ 409
"L" 90° Vertical Filler Trim					
7½"H Variable Height	Z307PL 	Z307PLV 	\$ 92	\$ 117	\$ 290
15"H Variable Height	Z315PL 	Z315PLV 	\$ 101	\$ 126	\$ 403
22½"H Variable Height	Z322PL 	Z322PLV 	\$ 108	\$ 133	\$ 516
30"H Variable Height	Z330PL 	Z330PLV 	\$ 112	\$ 137	\$ 627
"F" Flat Vertical Filler Trim					
7½"H Variable Height	Z307PF 	Z307PFV 	\$ 72	\$ 97	\$ 259
15"H Variable Height	Z315PF 	Z315PFV 	\$ 79	\$ 104	\$ 364
22½"H Variable Height	Z322PF 	Z322PFV 	\$ 89	\$ 114	\$ 452
30"H Variable Height	Z330PF 	Z330PFV 	\$ 98	\$ 123	\$ 516
35"H Base Panel	Z335PF 	Z335PFV 	\$ 103	\$ 128	\$ 576
42½"H Base Panel	Z342PF 	Z342PFV 	\$ 110	\$ 135	\$ 640
50"H Base Panel	Z350PF 	Z350PFV 	\$ 120	\$ 145	\$ 727
57½"H Base Panel	Z357PF 	Z357PFV 	\$ 131	\$ 156	\$ 812
65"H Base Panel	Z365PF 	Z365PFV 	\$ 138	\$ 163	\$ 901
80"H Base Panel	Z380PF	Z380PFV	\$ 146	\$ 171	\$ 1058
87½"H Base Panel	Z387PF	Z387PFV	\$ 155	\$ 180	\$ 1168
"VH" Variable Height Vertical End Trim					
7½"H	Z307PVH 	Z307PVHV 	\$ 72	\$ 97	\$ 540
15"H	Z315PVH 	Z315PVHV 	\$ 79	\$ 104	\$ 627
22½"H	Z322PVH 	Z322PVHV 	\$ 89	\$ 114	\$ 705
30"H	Z330PVH 	Z330PVHV 	\$ 98	\$ 123	\$ 762



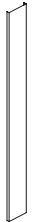

Z330PL



Z335PF



Z315PVH

<p>How to specify — Select the Model Number from above.</p>	<p><i>1st Option:</i> Paint Color (if applicable):</p> <p>  </p> <p>See page 120 for finishes.</p>	<p><i>1st Option:</i> Veneer Type and Finish (if applicable):</p> <p>See page 120 for finishes.</p>	<p>Z 3 . P </p>
--	--	--	--

Examples: Z350TL.P4J Z372TT.P27 Z3110TS.PR5

 Shippable by small-package carrier.



For specification information see pages 133-136.

GSA SIN 33721



Description	Painted Model	Veneer Model	P1 Paint List Price	P2 Paint List Price	Veneer List Price
4-Way Light Block Kit with "X" Top Cap Transition Piece					
35"H	Z335XX	Z335XXV	\$ 95	\$ 109	\$ 355
42½"H	Z342XX	Z342XXV	\$ 100	\$ 114	\$ 358
50"H	Z350XX	Z350XXV	\$ 103	\$ 117	\$ 363
57½"H	Z357XX	Z357XXV	\$ 108	\$ 122	\$ 368
65"H	Z365XX	Z365XXV	\$ 111	\$ 125	\$ 378
72½"H	Z372XX	Z372XXV	\$ 120	\$ 134	\$ 386
80"H	Z380XX	Z380XXV	\$ 124	\$ 138	\$ 390
87½"H	Z387XX	Z387XXV	\$ 133	\$ 147	\$ 394
95"H	Z395XX	Z395XXV	\$ 136	\$ 150	\$ 402
102½"H	Z3102XX	Z3102XXV	\$ 142	\$ 156	\$ 412
110"H	Z3110XX	Z3110XXV	\$ 146	\$ 160	\$ 414

4-Way Light Block Kit with "L" Top Cap Transition Piece					
35"H	Z335XL	Z335XLV	\$ 95	\$ 109	\$ 355
42½"H	Z342XL	Z342XLV	\$ 100	\$ 114	\$ 358
50"H	Z350XL	Z350XLV	\$ 103	\$ 117	\$ 363
57½"H	Z357XL	Z357XLV	\$ 108	\$ 122	\$ 368
65"H	Z365XL	Z365XLV	\$ 111	\$ 125	\$ 378
72½"H	Z372XL	Z372XLV	\$ 120	\$ 134	\$ 386
80"H	Z380XL	Z380XLV	\$ 124	\$ 138	\$ 390
87½"H	Z387XL	Z387XLV	\$ 133	\$ 147	\$ 394
95"H	Z395XL	Z395XLV	\$ 136	\$ 150	\$ 402
102½"H	Z3102XL	Z3102XLV	\$ 142	\$ 156	\$ 412
110"H	Z3110XL	Z3110XLV	\$ 146	\$ 160	\$ 414

4-Way Light Block Kit with "T" Top Cap Transition Piece					
35"H	Z335XT	Z335XTV	\$ 95	\$ 109	\$ 355
42½"H	Z342XT	Z342XTV	\$ 100	\$ 114	\$ 358
50"H	Z350XT	Z350XTV	\$ 103	\$ 117	\$ 363
57½"H	Z357XT	Z357XTV	\$ 108	\$ 122	\$ 368
65"H	Z365XT	Z365XTV	\$ 111	\$ 125	\$ 378
72½"H	Z372XT	Z372XTV	\$ 120	\$ 134	\$ 386
80"H	Z380XT	Z380XTV	\$ 124	\$ 138	\$ 390
87½"H	Z387XT	Z387XTV	\$ 133	\$ 147	\$ 394
95"H	Z395XT	Z395XTV	\$ 136	\$ 150	\$ 402
102½"H	Z3102XT	Z3102XTV	\$ 142	\$ 156	\$ 412
110"H	Z3110XT	Z3110XTV	\$ 146	\$ 160	\$ 414

4-Way Light Block Kit with "S" Top Cap Transition Piece					
35"H	Z335XS	Z335XSV	\$ 95	\$ 109	\$ 355
42½"H	Z342XS	Z342XSV	\$ 100	\$ 114	\$ 358
50"H	Z350XS	Z350XSV	\$ 103	\$ 117	\$ 363
57½"H	Z357XS	Z357XSV	\$ 108	\$ 122	\$ 368
65"H	Z365XS	Z365XSV	\$ 111	\$ 125	\$ 378
72½"H	Z372XS	Z372XSV	\$ 120	\$ 134	\$ 386
80"H	Z380XS	Z380XSV	\$ 124	\$ 138	\$ 390
87½"H	Z387XS	Z387XSV	\$ 133	\$ 147	\$ 394
95"H	Z395XS	Z395XSV	\$ 136	\$ 150	\$ 402
102½"H	Z3102XS	Z3102XSV	\$ 142	\$ 156	\$ 412
110"H	Z3110XS	Z3110XSV	\$ 146	\$ 160	\$ 414

STRIDE

<p>How to specify — Select the Model Number from above.</p>	<p><i>1st Option:</i> Paint Color (if applicable):</p> <p> </p> <p>See page 120 for finishes.</p>	<p><i>1st Option:</i> Veneer Type and Finish (if applicable):</p> <p>See page 120 for finishes.</p>
Z 3 .	P	

Examples: Z335XX.P93 Z365XS.PR2 Z350XLV.NC260

Shippable by small-package carrier.

For specification information see pages 133-136.

GSA SIN 33721



Z335PL



Z335PF



Z315PVH

Description	Painted Model	Veneer Model	P1 Paint List Price	P2 Paint List Price	Veneer List Price
"L" 90° Vertical Filler Trim					
7½"H Variable Height	Z307PL	Z307PLV	\$ 92	\$ 117	\$ 290
15"H Variable Height	Z315PL	Z315PLV	\$ 101	\$ 126	\$ 403
22½"H Variable Height	Z322PL	Z322PLV	\$ 108	\$ 133	\$ 516
30"H Variable Height	Z330PL	Z330PLV	\$ 112	\$ 137	\$ 627
"F" Flat Vertical Filler Trim					
7½"H Variable Height	Z307PF	Z307PFV	\$ 72	\$ 97	\$ 259
15"H Variable Height	Z315PF	Z315PFV	\$ 79	\$ 104	\$ 364
22½"H Variable Height	Z322PF	Z322PFV	\$ 89	\$ 114	\$ 452
30"H Variable Height	Z330PF	Z330PFV	\$ 98	\$ 123	\$ 516
35"H Base Panel	Z335PF	Z335PFV	\$ 103	\$ 128	\$ 576
42½"H Base Panel	Z342PF	Z342PFV	\$ 110	\$ 135	\$ 640
50"H Base Panel	Z350PF	Z350PFV	\$ 120	\$ 145	\$ 727
57½"H Base Panel	Z357PF	Z357PFV	\$ 131	\$ 156	\$ 812
65"H Base Panel	Z365PF	Z365PFV	\$ 138	\$ 163	\$ 901
80"H Base Panel	Z380PF	Z380PFV	\$ 146	\$ 171	\$ 1058
87½"H Base Panel	Z387PF	Z387PFV	\$ 155	\$ 180	\$ 1168
"VH" Variable Height Vertical Filler Trim					
7½"H	Z307PVH	Z307PVHV	\$ 72	\$ 97	\$ 540
15"H	Z315PVH	Z315PVHV	\$ 79	\$ 104	\$ 627
22½"H	Z322PVH	Z322PVHV	\$ 89	\$ 114	\$ 705
30"H	Z330PVH	Z330PVHV	\$ 98	\$ 123	\$ 762

<p>How to specify — Select the Model Number from above.</p> <p>Z 3 .</p>	<p><i>1st Option:</i> Paint Color (if applicable):</p> <p> </p> <p>See page 120 for finishes.</p> <p>P </p>	<p><i>1st Option:</i> Veneer Type and Finish (if applicable):</p> <p>See page 120 for finishes.</p> <p> </p>
---	---	---

Examples: Z307PL.P93 Z307PVH.PR2 Z315PFV.CC260

Shippable by small-package carrier.

For specification information see pages 133-136.

GSA SIN 33721



Z335PB



Z315PVH

Description	Painted Model	Veneer Model	P1 Paint List Price	P2 Paint List Price	Veneer List Price
2-Way 120° Light Block Kit with "B" Top Cap Transition Piece					
35"H	Z335BB [S]	Z335BBV [S]	\$ 103	\$ 117	\$ 488
42½"H	Z342BB [S]	Z342BBV [S]	\$ 108	\$ 122	\$ 490
50"H	Z350BB [S]	Z350BBV [S]	\$ 111	\$ 125	\$ 496
57½"H	Z357BB [S]	Z357BBV [S]	\$ 119	\$ 133	\$ 501
65"H	Z365BB [S]	Z365BBV [S]	\$ 124	\$ 138	\$ 507
72½"H	Z372BB [S]	Z372BBV [S]	\$ 133	\$ 147	\$ 516
80"H	Z380BB [S]	Z380BBV [S]	\$ 136	\$ 150	\$ 522
87½"H	Z387BB [S]	Z387BBV [S]	\$ 141	\$ 155	\$ 533
95"H	Z395BB [S]	Z395BBV [S]	\$ 146	\$ 160	\$ 538
102½"H	Z3102BB [S]	Z3102BBV [S]	\$ 153	\$ 167	\$ 541
110"H	Z3110BB [S]	Z3110BBV [S]	\$ 157	\$ 171	\$ 546
3-Way 120° Light Block Kit with "B" Top Cap Transition Piece					
35"H	Z335CB [S]	Z335CBV [S]	\$ 111	\$ 125	\$ 496
42½"H	Z342CB [S]	Z342CBV [S]	\$ 119	\$ 133	\$ 501
50"H	Z350CB [S]	Z350CBV [S]	\$ 124	\$ 138	\$ 507
57½"H	Z357CB [S]	Z357CBV [S]	\$ 131	\$ 145	\$ 515
65"H	Z365CB [S]	Z365CBV [S]	\$ 136	\$ 150	\$ 522
72½"H	Z372CB [S]	Z372CBV [S]	\$ 141	\$ 155	\$ 533
80"H	Z380CB [S]	Z380CBV [S]	\$ 146	\$ 160	\$ 538
87½"H	Z387CB [S]	Z387CBV [S]	\$ 153	\$ 167	\$ 541
95"H	Z395CB [S]	Z395CBV [S]	\$ 157	\$ 171	\$ 546
102½"H	Z3102CB [S]	Z3102CBV [S]	\$ 163	\$ 177	\$ 554
110"H	Z3110CB [S]	Z3110CBV [S]	\$ 170	\$ 184	\$ 570
3-Way 120° Light Block Kit with "C" Top Cap Transition Piece					
35"H	Z335CC [S]	Z335CCV [S]	\$ 111	\$ 125	\$ 496
42½"H	Z342CC [S]	Z342CCV [S]	\$ 119	\$ 133	\$ 501
50"H	Z350CC [S]	Z350CCV [S]	\$ 124	\$ 138	\$ 507
57½"H	Z357CC [S]	Z357CCV [S]	\$ 131	\$ 145	\$ 515
65"H	Z365CC [S]	Z365CCV [S]	\$ 136	\$ 150	\$ 522
72½"H	Z372CC [S]	Z372CCV [S]	\$ 141	\$ 155	\$ 533
80"H	Z380CC [S]	Z380CCV [S]	\$ 146	\$ 160	\$ 538
87½"H	Z387CC [S]	Z387CCV [S]	\$ 153	\$ 167	\$ 541
95"H	Z395CC [S]	Z395CCV [S]	\$ 157	\$ 171	\$ 546
102½"H	Z3102CC [S]	Z3102CCV [S]	\$ 163	\$ 177	\$ 554
110"H	Z3110CC [S]	Z3110CCV [S]	\$ 170	\$ 184	\$ 570
2-Way 120° Vertical Filler Trim					
7½"H Variable Height	Z307PB [S]	Z307PBV [S]	\$ 92	\$ 117	\$ 276
15"H Variable Height	Z315PB [S]	Z315PBV [S]	\$ 101	\$ 126	\$ 363
22½"H Variable Height	Z322PB [S]	Z322PBV [S]	\$ 108	\$ 133	\$ 450
30"H Variable Height	Z330PB [S]	Z330PBV [S]	\$ 112	\$ 137	\$ 539
35"H Base Panel	Z335PB [S]	Z335PBV [S]	\$ 124	\$ 149	\$ 625
42½"H Base Panel	Z342PB [S]	Z342PBV [S]	\$ 135	\$ 160	\$ 710
50"H Base Panel	Z350PB [S]	Z350PBV [S]	\$ 142	\$ 167	\$ 795
57½"H Base Panel	Z357PB [S]	Z357PBV [S]	\$ 152	\$ 177	\$ 882
65"H Base Panel	Z365PB [S]	Z365PBV [S]	\$ 157	\$ 182	\$ 968
80"H Base Panel	Z380PB [S]	Z380PBV [S]	\$ 165	\$ 190	\$ 1106
"VH" Variable Height Vertical End Trim					
7½"H	Z307PVH [S]	Z307PVHV [S]	\$ 72	\$ 97	\$ 540
15"H	Z315PVH [S]	Z315PVHV [S]	\$ 79	\$ 104	\$ 627
22½"H	Z322PVH [S]	Z322PVHV [S]	\$ 89	\$ 114	\$ 705
30"H	Z330PVH [S]	Z330PVHV [S]	\$ 98	\$ 123	\$ 762

How to specify —
Select the Model Number from above.

1st Option:
Select the Paint Color:

P1 P2 P3

See page 120 for finishes.

Z | 3 | | | | | .

P | | | |

Examples: Z380BB.P52 Z335CB.PR5 Z330PVH.P7B

[S] Shippable by small-package carrier.

For specification information see pages 133-136.

GSA SIN 33721



Z335PE

Description	Painted Model	Veneer Model	P1 Paint List Price	P2 Paint List Price	Veneer List Price
"E" Vertical End Trim					
7½"H Stacking/Segmented	Z307PE [S]	Z307PEV [S]	\$ 72	\$ 97	\$ 540
15"H Stacking/Segmented	Z315PE [S]	Z315PEV [S]	\$ 79	\$ 104	\$ 627
22½"H Stacking/Segmented	Z322PE [S]	Z322PEV [S]	\$ 89	\$ 114	\$ 705
30"H Stacking/Segmented	Z330PE [S]	Z330PEV [S]	\$ 98	\$ 123	\$ 762
35"H Base Panel	Z335PE [S]	Z335PEV [S]	\$ 103	\$ 128	\$ 827
42½"H Base Panel	Z342PE [S]	Z342PEV [S]	\$ 110	\$ 135	\$ 884
50"H Base Panel	Z350PE [S]	Z350PEV [S]	\$ 120	\$ 145	\$ 948
57½"H Base Panel	Z357PE [S]	Z357PEV [S]	\$ 131	\$ 156	\$ 1011
65"H Base Panel	Z365PE [S]	Z365PEV [S]	\$ 138	\$ 163	\$ 1071
80"H Base Panel	Z380PE	Z380PEV	\$ 146	\$ 171	\$ 1136
87½"H Base Panel	Z387PE	Z387PEV	\$ 155	\$ 180	\$ 1198



Z335PEF

"EF" Vertical End Trim for Footed Panels					
35"H	Z335PEF [S]	Z335PEFV [S]	\$ 103	\$ 128	\$ 827
42½"H	Z342PEF [S]	Z342PEFV [S]	\$ 110	\$ 135	\$ 884
50"H	Z350PEF [S]	Z350PEFV [S]	\$ 120	\$ 145	\$ 948
57½"H	Z357PEF [S]	Z357PEFV [S]	\$ 131	\$ 156	\$ 1011
65"H	Z365PEF [S]	Z365PEFV [S]	\$ 138	\$ 163	\$ 1071
80"H	Z380PEF	Z380PEFV	\$ 146	\$ 171	\$ 1136



Z315PG

"G" Grooved End Trim for use with Panel Mounted Screens					
7½"H for ⅜" thick Glass	Z307PTG [S]	Z307PTGV [S]	\$ 108	\$ 133	\$ 604
15"H for ⅜" thick Glass	Z315PTG [S]	Z315PTGV [S]	\$ 120	\$ 145	\$ 687



Z350T

Description	Model	List Price
3-Way Light Block Kit without Top Cap Transition Piece		
35"H	Z335T [S]	\$ 74
42½"H	Z342T [S]	\$ 78
50"H	Z350T [S]	\$ 81
57½"H	Z357T [S]	\$ 89
65"H	Z365T	\$ 95
80"H	Z380T	\$ 103
87½"H	Z387T	\$ 109



Z350X

4-Way Light Block Kit without Top Cap Transition Piece		
35"H	Z335X [S]	\$ 81
42½"H	Z342X [S]	\$ 89
50"H	Z350X [S]	\$ 95
57½"H	Z357X [S]	\$ 100
65"H	Z365X	\$ 103
80"H	Z380X	\$ 111
87½"H	Z387X	\$ 120

How to specify —
Select the Model Number from above.

1st Option:
Paint Color
(if applicable):
P1 P2 P3
See page 120 for finishes.

1st Option:
Veneer Type
and Finish
(if applicable):
See page 120 for finishes.

Z | 3 | | | | | | | . | P | | | |

Examples: Z307PE.P52 Z342PEF.P02 Z307PG.PR5

Frame & Tile Panel Systems – 05/2022 Z335X

Z307PGV.NC260

[S] Shippable by small-package carrier.

allsteeloffice.com | 159

Connectors

Stride® — "W" Wall Mount and Wall Track

For specification information see pages 133-136.

GSA SIN 33721



Z342PW

Description	Painted Model	Veneer Model	P1 Paint List Price	P2 Paint List Price	Veneer List Price
"W" Wall Mount Kit					
15"H	Z315PW <input type="checkbox"/>	Z315PWV <input type="checkbox"/>	\$ 108	\$ 133	\$ 158
22½"H	Z322PW <input type="checkbox"/>	Z322PWV <input type="checkbox"/>	\$ 131	\$ 156	\$ 189
30"H	Z330PW <input type="checkbox"/>	Z330PWV <input type="checkbox"/>	\$ 149	\$ 174	\$ 217
35"H	Z335PW <input type="checkbox"/>	Z335PWV <input type="checkbox"/>	\$ 167	\$ 192	\$ 247
42½"	Z342PW <input type="checkbox"/>	Z342PWV <input type="checkbox"/>	\$ 188	\$ 213	\$ 275
50"H	Z350PW <input type="checkbox"/>	Z350PWV <input type="checkbox"/>	\$ 209	\$ 234	\$ 309
57½"H	Z357PW <input type="checkbox"/>	Z357PWV <input type="checkbox"/>	\$ 229	\$ 254	\$ 336
65"H	Z365PW <input type="checkbox"/>	Z365PWV <input type="checkbox"/>	\$ 252	\$ 277	\$ 368
80"H	Z380PW <input type="checkbox"/>	Z380PWV <input type="checkbox"/>	\$ 294	\$ 319	\$ 433
87½"H	Z387PW <input type="checkbox"/>	Z387PWV <input type="checkbox"/>	\$ 338	\$ 363	\$ 489

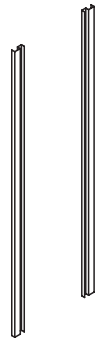

ZWTS

Description	Model	List Price
Vertical Wall Track (Core Paint colors only)		
60"H Stride Wall Track (pair)	ZWTS <input type="checkbox"/>	\$ 232

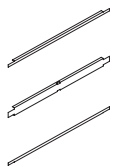

ZWTAK36

Wall Track Tile Attachment Kits (no color option)		
24"W	ZWTAK24 <input type="checkbox"/>	\$ 202
30"W	ZWTAK30 <input type="checkbox"/>	\$ 212
36"W	ZWTAK36 <input type="checkbox"/>	\$ 226
42"W	ZWTAK42 <input type="checkbox"/>	\$ 237
48"W	ZWTAK48 <input type="checkbox"/>	\$ 250
60"W	ZWTAK60 <input type="checkbox"/>	\$ 274



ZWTAK36S

Wall Track Tile Segment (no color option)		
24"W	ZWTAK24S <input type="checkbox"/>	\$ 70
30"W	ZWTAK30S <input type="checkbox"/>	\$ 72
36"W	ZWTAK36S <input type="checkbox"/>	\$ 77
42"W	ZWTAK42S <input type="checkbox"/>	\$ 79
48"W	ZWTAK48S <input type="checkbox"/>	\$ 81
60"W	ZWTAK60S <input type="checkbox"/>	\$ 92

STRIDE

<p>How to specify — Select the Model Number from above.</p> <p>Z .</p>	<p>1st Option: Paint Color (if applicable):</p> <p><input type="checkbox"/> P1 <input type="checkbox"/> P2 <input type="checkbox"/> P3</p> <p>See page 120 for finishes.</p> <p>P </p>	<p>2nd Option: Veneer Type and Finish (if applicable):</p> <p>See page 120 for finishes.</p> <p> </p>
---	---	---

Examples: Z357PW.P4J ZWTS.P27 ZWTAK48 Z357PWV.P4J.NC777

Shippable by small-package carrier.

For specification information see pages 137-144. (See page 412 for COM pricing on fabric Grades G-J.)

GSA SIN 33721



Description	Model	List Price					
		Grade A	Grade B	Grade C	Grade D	Grade E	Grade F
7½"H Tackable Acoustical Tiles							
24"W	Z40724T S	\$ 101	\$ 103	\$ 105	\$ 108	\$ 111	\$ 115
30"W	Z40730T S	\$ 111	\$ 113	\$ 116	\$ 120	\$ 124	\$ 128
36"W	Z40736T S	\$ 121	\$ 124	\$ 127	\$ 132	\$ 137	\$ 141
42"W	Z40742T S	\$ 131	\$ 134	\$ 138	\$ 144	\$ 149	\$ 155
48"W	Z40748T S	\$ 138	\$ 142	\$ 146	\$ 152	\$ 159	\$ 165
60"W	Z40760T S	\$ 154	\$ 159	\$ 164	\$ 172	\$ 180	\$ 188

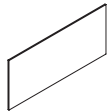

15"H Tackable Acoustical Tiles							
24"W	Z41524T S	\$ 134	\$ 138	\$ 142	\$ 148	\$ 155	\$ 161
30"W	Z41530T S	\$ 141	\$ 146	\$ 151	\$ 159	\$ 167	\$ 175
36"W	Z41536T S	\$ 154	\$ 160	\$ 166	\$ 175	\$ 185	\$ 195
42"W	Z41542T S	\$ 166	\$ 173	\$ 180	\$ 191	\$ 202	\$ 214
48"W	Z41548T S	\$ 180	\$ 188	\$ 196	\$ 208	\$ 221	\$ 234
60"W	Z41560T S	\$ 202	\$ 212	\$ 221	\$ 238	\$ 254	\$ 270

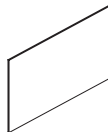

22½"H Tackable Acoustical Tiles							
24"W	Z42224T S	\$ 160	\$ 166	\$ 172	\$ 181	\$ 191	\$ 201
30"W	Z42230T S	\$ 173	\$ 180	\$ 188	\$ 200	\$ 212	\$ 224
36"W	Z42236T S	\$ 187	\$ 196	\$ 204	\$ 219	\$ 234	\$ 248
42"W	Z42242T S	\$ 203	\$ 213	\$ 224	\$ 241	\$ 258	\$ 275
48"W	Z42248T S	\$ 223	\$ 235	\$ 246	\$ 266	\$ 285	\$ 305
60"W	Z42260T S	\$ 249	\$ 264	\$ 278	\$ 302	\$ 327	\$ 351

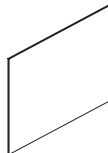

30"H Tackable Acoustical Tiles							
24"W	Z43024T S	\$ 195	\$ 203	\$ 211	\$ 223	\$ 236	\$ 249
30"W	Z43030T S	\$ 207	\$ 217	\$ 226	\$ 243	\$ 259	\$ 275
36"W	Z43036T S	\$ 226	\$ 238	\$ 249	\$ 269	\$ 288	\$ 308
42"W	Z43042T S	\$ 242	\$ 256	\$ 269	\$ 292	\$ 314	\$ 337
48"W	Z43048T S	\$ 261	\$ 277	\$ 292	\$ 318	\$ 344	\$ 370
60"W	Z43060T S	\$ 292	\$ 311	\$ 331	\$ 363	\$ 396	\$ 428

How to specify —
Select the Model Number from above.

1st Option:

Fabric:

See page 13 for fabrics.

Z | 4 | | | | | | | | | | T | . | | | | | | | | | |

Example: Z40748T.GLW910

S Shippable by small-package carrier.

For specification information see pages 137-144. (See page 412 for COM pricing on fabric Grades G-J.)

GSA SIN 33721

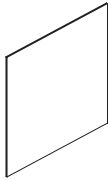

Description	Model	List Price					
		Grade A	Grade B	Grade C	Grade D	Grade E	Grade F
37½"H Tackable Acoustical Tiles (Monolithic tile for 42½"H frame)							
24"W	Z43724T S	\$ 237	\$ 247	\$ 256	\$ 273	\$ 289	\$ 305
30"W	Z43730T S	\$ 252	\$ 264	\$ 276	\$ 297	\$ 317	\$ 337
36"W	Z43736T S	\$ 277	\$ 292	\$ 306	\$ 330	\$ 355	\$ 379
42"W	Z43742T S	\$ 294	\$ 311	\$ 328	\$ 357	\$ 385	\$ 413
48"W	Z43748T S	\$ 317	\$ 336	\$ 356	\$ 388	\$ 421	\$ 453
60"W	Z43760T	\$ 363	\$ 387	\$ 412	\$ 452	\$ 492	\$ 533

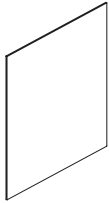

45"H Tackable Acoustical Tiles (Monolithic tile for 50"H frame)							
24"W	Z44524T S	\$ 268	\$ 280	\$ 291	\$ 311	\$ 330	\$ 350
30"W	Z44530T S	\$ 287	\$ 302	\$ 316	\$ 340	\$ 365	\$ 389
36"W	Z44536T S	\$ 313	\$ 330	\$ 348	\$ 377	\$ 406	\$ 435
42"W	Z44542T S	\$ 336	\$ 356	\$ 377	\$ 411	\$ 445	\$ 479
48"W	Z44548T S	\$ 365	\$ 388	\$ 412	\$ 450	\$ 489	\$ 528
60"W	Z44560T	\$ 405	\$ 434	\$ 463	\$ 512	\$ 560	\$ 609

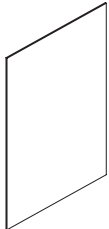

52½"H Tackable Acoustical Tiles (Monolithic tile for 57½"H frame)							
24"W	Z45224T S	\$ 296	\$ 310	\$ 323	\$ 346	\$ 368	\$ 391
30"W	Z45230T S	\$ 321	\$ 338	\$ 355	\$ 384	\$ 412	\$ 440
36"W	Z45236T S	\$ 349	\$ 369	\$ 390	\$ 424	\$ 458	\$ 492
42"W	Z45242T S	\$ 373	\$ 397	\$ 421	\$ 460	\$ 500	\$ 540
48"W	Z45248T	\$ 405	\$ 432	\$ 459	\$ 505	\$ 550	\$ 595
60"W	Z45260T	\$ 454	\$ 488	\$ 522	\$ 579	\$ 635	\$ 692



60"H Tackable Acoustical Tiles (Monolithic tile for 65"H frame)							
24"W	Z46024T S	\$ 334	\$ 350	\$ 365	\$ 391	\$ 417	\$ 443
30"W	Z46030T	\$ 363	\$ 382	\$ 402	\$ 434	\$ 467	\$ 499
36"W	Z46036T	\$ 422	\$ 445	\$ 469	\$ 507	\$ 546	\$ 585
42"W	Z46042T	\$ 448	\$ 475	\$ 502	\$ 548	\$ 593	\$ 638
48"W	Z46048T	\$ 473	\$ 504	\$ 535	\$ 587	\$ 639	\$ 690
60"W	Z46060T	\$ 500	\$ 539	\$ 578	\$ 642	\$ 707	\$ 772

STRIDE

How to specify —
Select the Model Number from above.

1st Option:

Fabric:

See page 13 for fabrics.

Z | 4 | | | | | | | | | | T | . | | | | | | | | | |

Example: Z45260T.ECH901

S Shippable by small-package carrier.

For specification information see pages 137-144. (See page 412 for COM pricing on fabric Grades G-J.)

GSA SIN 33721

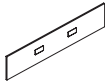

Description	Model	List Price					
		Grade A	Grade B	Grade C	Grade D	Grade E	Grade F
7 1/2" H Tackable Acoustical Port Tiles							
24" W	Z40724E S	\$ 207	\$ 211	\$ 215	\$ 221	\$ 227	\$ 233
30" W	Z40730E S	\$ 212	\$ 217	\$ 222	\$ 230	\$ 237	\$ 245
36" W	Z40736E S	\$ 226	\$ 232	\$ 238	\$ 247	\$ 257	\$ 267
42" W	Z40742E S	\$ 234	\$ 241	\$ 247	\$ 258	\$ 269	\$ 280
48" W	Z40748E S	\$ 244	\$ 252	\$ 259	\$ 272	\$ 284	\$ 297
60" W	Z40760E S	\$ 261	\$ 271	\$ 280	\$ 296	\$ 312	\$ 328

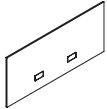

15" H Tackable Acoustical Port Tiles							
24" W	Z41524E S	\$ 240	\$ 248	\$ 255	\$ 268	\$ 280	\$ 293
30" W	Z41530E S	\$ 250	\$ 260	\$ 269	\$ 285	\$ 301	\$ 317
36" W	Z41536E S	\$ 261	\$ 272	\$ 284	\$ 303	\$ 321	\$ 340
42" W	Z41542E S	\$ 271	\$ 284	\$ 298	\$ 320	\$ 342	\$ 364
48" W	Z41548E S	\$ 285	\$ 300	\$ 315	\$ 340	\$ 366	\$ 391
60" W	Z41560E S	\$ 309	\$ 328	\$ 347	\$ 378	\$ 410	\$ 441

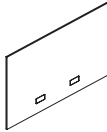

22 1/2" H Tackable Acoustical Port Tiles							
24" W	Z42224E S	\$ 270	\$ 281	\$ 293	\$ 312	\$ 330	\$ 349
30" W	Z42230E S	\$ 282	\$ 296	\$ 310	\$ 334	\$ 357	\$ 381
36" W	Z42236E S	\$ 296	\$ 313	\$ 330	\$ 359	\$ 387	\$ 416
42" W	Z42242E S	\$ 310	\$ 330	\$ 350	\$ 383	\$ 416	\$ 449
48" W	Z42248E S	\$ 324	\$ 347	\$ 369	\$ 407	\$ 445	\$ 483
60" W	Z42260E S	\$ 355	\$ 383	\$ 412	\$ 459	\$ 507	\$ 554

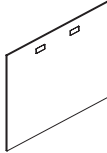

30" H Tackable Acoustical Port Tiles							
24" W	Z43024E S	\$ 299	\$ 314	\$ 329	\$ 354	\$ 380	\$ 405
30" W	Z43030E S	\$ 314	\$ 333	\$ 352	\$ 383	\$ 415	\$ 446
36" W	Z43036E S	\$ 334	\$ 357	\$ 379	\$ 417	\$ 455	\$ 493
42" W	Z43042E S	\$ 349	\$ 375	\$ 402	\$ 446	\$ 490	\$ 534
48" W	Z43048E S	\$ 368	\$ 398	\$ 428	\$ 479	\$ 529	\$ 579
60" W	Z43060E	\$ 399	\$ 437	\$ 474	\$ 537	\$ 600	\$ 663

<p>How to specify — Select the Model Number from above.</p>	<p><i>1st Option:</i> Fabric: See page 13 for fabrics.</p>	<p><i>2nd Option:</i> Electrical Grommet Color: See page 120 for finishes.</p>
<p>Z 4 E . . </p>		

Example: Z40748E.ECH901.E9

S Shippable by small-package carrier.



For specification information see pages 137-144. (See page 412 for COM pricing on fabric Grades G-J.)

GSA SIN 33721

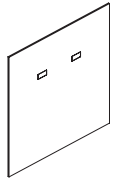

Description	Model	List Price					
		Grade A	Grade B	Grade C	Grade D	Grade E	Grade F
37½"H Tackable Acoustical Port Tiles (Monolithic tile for 42½"H frame)							
24"W	Z43724E	\$ 349	\$ 368	\$ 387	\$ 418	\$ 450	\$ 481
30"W	Z43730E	\$ 368	\$ 392	\$ 415	\$ 455	\$ 494	\$ 534
36"W	Z43736E	\$ 386	\$ 414	\$ 443	\$ 490	\$ 538	\$ 585
42"W	Z43742E	\$ 412	\$ 445	\$ 478	\$ 533	\$ 588	\$ 643
48"W	Z43748E	\$ 429	\$ 467	\$ 504	\$ 567	\$ 630	\$ 693
60"W	Z43760E	\$ 473	\$ 520	\$ 568	\$ 646	\$ 725	\$ 804

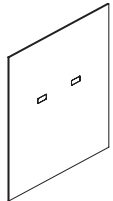

45 H Tackable Acoustical Port Tiles (Monolithic tile for 50"H frame)							
24"W	Z44524E	\$ 375	\$ 398	\$ 420	\$ 458	\$ 496	\$ 534
30"W	Z44530E	\$ 401	\$ 429	\$ 458	\$ 505	\$ 553	\$ 600
36"W	Z44536E	\$ 422	\$ 456	\$ 490	\$ 547	\$ 603	\$ 660
42"W	Z44542E	\$ 448	\$ 488	\$ 528	\$ 594	\$ 660	\$ 726
48"W	Z44548E	\$ 475	\$ 520	\$ 566	\$ 641	\$ 717	\$ 792
60"W	Z44560E	\$ 515	\$ 572	\$ 628	\$ 723	\$ 817	\$ 911

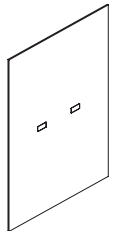

52½"H Tackable Acoustical Port Tiles (Monolithic tile for 57½"H frame)							
24"W	Z45224E	\$ 415	\$ 441	\$ 468	\$ 512	\$ 556	\$ 600
30"W	Z45230E	\$ 433	\$ 466	\$ 499	\$ 554	\$ 609	\$ 664
36"W	Z45236E	\$ 463	\$ 503	\$ 543	\$ 609	\$ 675	\$ 741
42"W	Z45242E	\$ 489	\$ 535	\$ 582	\$ 659	\$ 736	\$ 813
48"W	Z45248E	\$ 515	\$ 568	\$ 621	\$ 709	\$ 797	\$ 885
60"W	Z45260E	\$ 568	\$ 634	\$ 700	\$ 811	\$ 921	\$ 1031

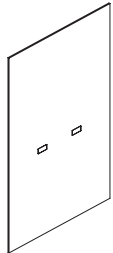

60"H Tackable Acoustical Port Tiles (Monolithic tile for 65"H frame)							
24"W	Z46024E	\$ 437	\$ 467	\$ 497	\$ 548	\$ 598	\$ 648
30"W	Z46030E	\$ 473	\$ 511	\$ 548	\$ 611	\$ 674	\$ 737
36"W	Z46036E	\$ 536	\$ 581	\$ 627	\$ 702	\$ 778	\$ 853
42"W	Z46042E	\$ 561	\$ 614	\$ 667	\$ 755	\$ 843	\$ 931
48"W	Z46048E	\$ 582	\$ 642	\$ 703	\$ 803	\$ 904	\$ 1005
60"W	Z46060E	\$ 617	\$ 692	\$ 768	\$ 894	\$ 1020	\$ 1145

<p>How to specify — Select the Model Number from above.</p>	<p>1st Option: Fabric: See page 13 for fabrics.</p>	<p>2nd Option: Electrical Grommet Color: See page 120 for finishes.</p>
<p>Z 4 E .</p>		

Example: Z44536E.ECH901.E9

Shippable by small-package carrier.

Tiles

Stride® — Tackable Acoustical Tiles to-the-Floor

For specification information see pages 137-144. (See page 413 for COM pricing on fabric Grades G-J.)

GSA SIN 33721

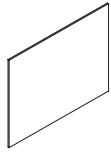

Description	Model	List Price					
		Grade A	Grade B	Grade C	Grade D	Grade E	Grade F
22 1/2"H Tackable Acoustical Base Tiles to-the-Floor							
24"W	Z42224TF	\$ 224	\$ 235	\$ 247	\$ 266	\$ 285	\$ 304
30"W	Z42230TF	\$ 235	\$ 249	\$ 264	\$ 288	\$ 312	\$ 336
36"W	Z42236TF	\$ 254	\$ 271	\$ 288	\$ 317	\$ 346	\$ 375
42"W	Z42242TF	\$ 275	\$ 295	\$ 315	\$ 349	\$ 383	\$ 417
48"W	Z42248TF	\$ 289	\$ 312	\$ 335	\$ 373	\$ 412	\$ 450
60"W	Z42260TF	\$ 319	\$ 348	\$ 376	\$ 424	\$ 472	\$ 520

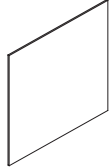

30"H Tackable Acoustical Base Tiles to-the-Floor (Tile for 35"H frame)							
24"W	Z43024TF	\$ 253	\$ 268	\$ 284	\$ 309	\$ 335	\$ 360
30"W	Z43030TF	\$ 271	\$ 290	\$ 309	\$ 341	\$ 373	\$ 405
36"W	Z43036TF	\$ 292	\$ 315	\$ 338	\$ 376	\$ 415	\$ 453
42"W	Z43042TF	\$ 311	\$ 338	\$ 365	\$ 409	\$ 454	\$ 499
48"W	Z43048TF	\$ 332	\$ 363	\$ 393	\$ 444	\$ 495	\$ 546
60"W	Z43060TF	\$ 365	\$ 403	\$ 442	\$ 505	\$ 569	\$ 633

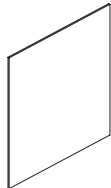

37 1/2"H Tackable Acoustical Base Tiles to-the-Floor (Tile for 42.5"H frame)							
24"W	Z43724TF	\$ 297	\$ 316	\$ 335	\$ 367	\$ 399	\$ 431
30"W	Z43730TF	\$ 318	\$ 342	\$ 366	\$ 406	\$ 446	\$ 486
36"W	Z43736TF	\$ 340	\$ 369	\$ 397	\$ 445	\$ 493	\$ 541
42"W	Z43742TF	\$ 365	\$ 399	\$ 432	\$ 488	\$ 544	\$ 601
48"W	Z43748TF	\$ 389	\$ 427	\$ 466	\$ 529	\$ 593	\$ 657
60"W	Z43760TF	\$ 429	\$ 477	\$ 525	\$ 605	\$ 684	\$ 764

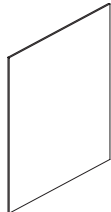

45"H Tackable Acoustical Base Tiles to-the-Floor (Tile for 50"H frame)							
24"W	Z44524TF	\$ 330	\$ 353	\$ 376	\$ 414	\$ 453	\$ 491
30"W	Z44530TF	\$ 350	\$ 379	\$ 407	\$ 455	\$ 503	\$ 551
36"W	Z44536TF	\$ 382	\$ 416	\$ 451	\$ 508	\$ 566	\$ 623
42"W	Z44542TF	\$ 408	\$ 448	\$ 488	\$ 555	\$ 622	\$ 689
48"W	Z44548TF	\$ 430	\$ 476	\$ 522	\$ 598	\$ 675	\$ 752
60"W	Z44560TF	\$ 479	\$ 536	\$ 594	\$ 690	\$ 785	\$ 881



52 1/2"H Tackable Acoustical Base Tiles to-the-Floor (Tile for 57.5"H frame)							
24"W	Z45224TF	\$ 361	\$ 388	\$ 415	\$ 459	\$ 504	\$ 549
30"W	Z45230TF	\$ 385	\$ 419	\$ 452	\$ 508	\$ 564	\$ 621
36"W	Z45236TF	\$ 436	\$ 476	\$ 516	\$ 583	\$ 650	\$ 717
42"W	Z45242TF	\$ 463	\$ 510	\$ 557	\$ 636	\$ 714	\$ 792
48"W	Z45248TF	\$ 484	\$ 538	\$ 591	\$ 681	\$ 770	\$ 859
60"W	Z45260TF	\$ 530	\$ 597	\$ 664	\$ 776	\$ 887	\$ 999



60"H Tackable Acoustical Base Tiles to-the-Floor (Tile for 65"H frame)							
24"W	Z46024TF	\$ 394	\$ 425	\$ 455	\$ 506	\$ 557	\$ 608
30"W	Z46030TF	\$ 419	\$ 457	\$ 496	\$ 559	\$ 623	\$ 687
36"W	Z46036TF	\$ 474	\$ 520	\$ 566	\$ 642	\$ 719	\$ 796
42"W	Z46042TF	\$ 503	\$ 557	\$ 610	\$ 700	\$ 789	\$ 878
48"W	Z46048TF	\$ 531	\$ 592	\$ 654	\$ 756	\$ 858	\$ 960
60"W	Z46060TF	\$ 579	\$ 656	\$ 732	\$ 860	\$ 987	\$ 1115

How to specify —

Select the Model Number from above.

1st Option:

Fabric:

See page 13 for fabrics.

Z | 4 | | | | | | | | | | T | F | . | | | | | | | | |

Example: Z44560TF.IMP07

Shippable by small-package carrier.



































STRIDE

Tiles

Stride® — Steel Tiles / Steel Tiles to-the-Floor

For specification information see pages 137-144.

GSA SIN 33721

Description	Model	P1 Paint List Price	P2 Paint List Price	P3 Paint List Price
7½"H Steel Tiles				
24"W	Z40724S 	\$ 139	\$ 158	\$ 174
30"W	Z40730S 	\$ 145	\$ 164	\$ 180
36"W	Z40736S 	\$ 157	\$ 176	\$ 192
42"W	Z40742S 	\$ 171	\$ 190	\$ 206
48"W	Z40748S 	\$ 185	\$ 204	\$ 220
60"W	Z40760S 	\$ 208	\$ 227	\$ 243
15"H Steel Tiles				
24"W	Z41524S 	\$ 160	\$ 179	\$ 195
30"W	Z41530S 	\$ 170	\$ 189	\$ 205
36"W	Z41536S 	\$ 187	\$ 206	\$ 222
42"W	Z41542S 	\$ 205	\$ 224	\$ 240
48"W	Z41548S 	\$ 223	\$ 242	\$ 258
60"W	Z41560S 	\$ 251	\$ 270	\$ 286
22½"H Steel Tiles				
24"W	Z42224S 	\$ 241	\$ 260	\$ 276
30"W	Z42230S 	\$ 259	\$ 278	\$ 294
36"W	Z42236S 	\$ 281	\$ 300	\$ 316
42"W	Z42242S 	\$ 300	\$ 319	\$ 335
48"W	Z42248S 	\$ 323	\$ 342	\$ 358
60"W	Z42260S 	\$ 374	\$ 393	\$ 409
30"H Steel Tiles				
24"W	Z43024S 	\$ 287	\$ 306	\$ 322
30"W	Z43030S 	\$ 313	\$ 332	\$ 348
36"W	Z43036S 	\$ 335	\$ 354	\$ 370
42"W	Z43042S 	\$ 365	\$ 384	\$ 400
48"W	Z43048S 	\$ 395	\$ 414	\$ 430
60"W	Z43060S	\$ 452	\$ 471	\$ 487
22½"H Steel Base Tiles to-the-Floor Kit				
24"W	Z42224SF 	\$ 294	\$ 313	\$ 329
30"W	Z42230SF 	\$ 315	\$ 334	\$ 350
36"W	Z42236SF 	\$ 344	\$ 363	\$ 379
42"W	Z42242SF 	\$ 366	\$ 385	\$ 401
48"W	Z42248SF 	\$ 393	\$ 412	\$ 428
60"W	Z42260SF 	\$ 450	\$ 469	\$ 485
30"H Steel Base Tiles to-the-Floor Kit				
24"W	Z43024SF 	\$ 394	\$ 413	\$ 429
30"W	Z43030SF 	\$ 430	\$ 449	\$ 465
36"W	Z43036SF 	\$ 464	\$ 483	\$ 499
42"W	Z43042SF 	\$ 498	\$ 517	\$ 533
48"W	Z43048SF 	\$ 530	\$ 549	\$ 565
60"W	Z43060SF	\$ 612	\$ 631	\$ 647

STRIDE

How to specify —
Select the
Model Number
from above.

1st Option:

Paint Color:



See page 120 for
finishes.























Z | 4 | | | | | | | | | | . P | | | | |

Examples: Z41524S.P4J Z43060SF.P7C

 Shippable by small-package carrier.

For specification information see pages 137-144.

GSA SIN 33721

Description	Model	P1 Paint List Price	P2 Paint List Price	P3 Paint List Price
7½"H Perforated Steel Tiles				
24"W	Z40724SH 	\$ 154	\$ 174	\$ 191
30"W	Z40730SH 	\$ 160	\$ 180	\$ 197
36"W	Z40736SH 	\$ 171	\$ 191	\$ 208
42"W	Z40742SH 	\$ 189	\$ 209	\$ 226
48"W	Z40748SH 	\$ 205	\$ 225	\$ 242
60"W	Z40760SH 	\$ 231	\$ 251	\$ 268
15"H Perforated Steel Tiles				
24"W	Z41524SH 	\$ 177	\$ 197	\$ 214
30"W	Z41530SH 	\$ 188	\$ 208	\$ 225
36"W	Z41536SH 	\$ 207	\$ 227	\$ 244
42"W	Z41542SH 	\$ 223	\$ 243	\$ 260
48"W	Z41548SH 	\$ 251	\$ 271	\$ 288
60"W	Z41560SH 	\$ 281	\$ 301	\$ 318
22½"H Perforated Steel Tiles				
24"W	Z42224SH 	\$ 260	\$ 280	\$ 297
30"W	Z42230SH 	\$ 289	\$ 309	\$ 326
36"W	Z42236SH 	\$ 306	\$ 326	\$ 343
42"W	Z42242SH 	\$ 331	\$ 351	\$ 368
48"W	Z42248SH 	\$ 357	\$ 377	\$ 394
60"W	Z42260SH 	\$ 417	\$ 437	\$ 454
30"H Perforated Steel Tiles				
24"W	Z43024SH 	\$ 320	\$ 340	\$ 357
30"W	Z43030SH 	\$ 344	\$ 364	\$ 381
36"W	Z43036SH 	\$ 373	\$ 393	\$ 410
42"W	Z43042SH 	\$ 400	\$ 420	\$ 437
48"W	Z43048SH 	\$ 433	\$ 453	\$ 470
60"W	Z43060SH	\$ 501	\$ 521	\$ 538

How to specify —
Select the Model Number from above.

1st Option:
Paint Color:
  
See page 120 for finishes.

Z | 4 | | | | | S | H | . | P | | | |

Example: Z43060SH.PJW

 Shippable by small-package carrier.

Tiles

For specification information see pages 137-144.

GSA SIN 33721

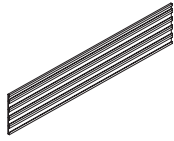

Description	Model	P1 Paint List Price	P2 Paint List Price	P3 Paint List Price
7½"H Tool Tiles				
24"W	Z40724SW S	\$ 249	\$ 287	\$ 326
30"W	Z40730SW S	\$ 256	\$ 294	\$ 333
36"W	Z40736SW S	\$ 268	\$ 306	\$ 345
42"W	Z40742SW S	\$ 277	\$ 315	\$ 354
48"W	Z40748SW S	\$ 299	\$ 337	\$ 376
60"W	Z40760SW S	\$ 317	\$ 355	\$ 394

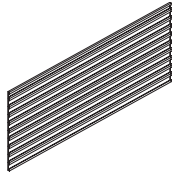

15"H Tool Tiles				
24"W	Z41524SW S	\$ 383	\$ 421	\$ 460
30"W	Z41530SW S	\$ 415	\$ 453	\$ 492
36"W	Z41536SW S	\$ 450	\$ 488	\$ 527
42"W	Z41542SW S	\$ 473	\$ 511	\$ 550
48"W	Z41548SW S	\$ 503	\$ 541	\$ 580
60"W	Z41560SW S	\$ 535	\$ 573	\$ 612

NOTE: Tool tiles placed at worksurface height limit selection of work tools available. Folder Holders, Multi-Media Hangers, and Binder Bins extend below a 7½"H tool tile. Paper Wave and contents extend above a single 7½"H tool tile. See page 392.

How to specify —
Select the Model Number from above.

1st Option:

Paint Color:



See page 120 for finishes.

Z | 4 | | | | | | | | | | . P | | | | |

Example: Z41524SW.P52

S Shippable by small-package carrier.

For specification information see pages 137-144.

GSA SIN 33721

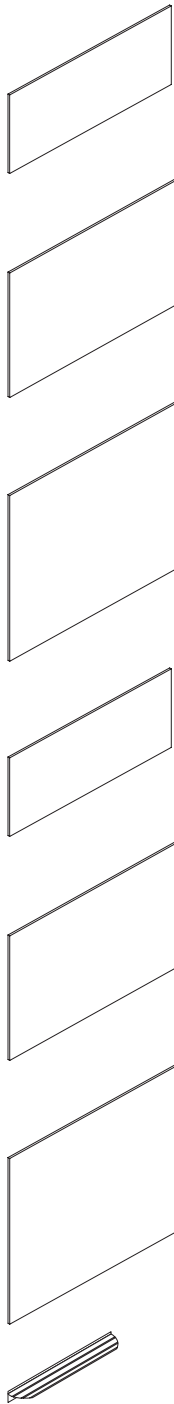

Description	Model	List Price
15"H Porcelain Marker Board Tiles		
24"W	Z41524MB <input type="checkbox"/>	\$ 628
30"W	Z41530MB <input type="checkbox"/>	\$ 682
36"W	Z41536MB <input type="checkbox"/>	\$ 734
42"W	Z41542MB <input type="checkbox"/>	\$ 789
48"W	Z41548MB <input type="checkbox"/>	\$ 843
60"W	Z41560MB <input type="checkbox"/>	\$ 949
22½"H Porcelain Marker Board Tiles		
24"W	Z42224MB <input type="checkbox"/>	\$ 734
30"W	Z42230MB <input type="checkbox"/>	\$ 789
36"W	Z42236MB <input type="checkbox"/>	\$ 843
42"W	Z42242MB <input type="checkbox"/>	\$ 897
48"W	Z42248MB <input type="checkbox"/>	\$ 949
60"W	Z42260MB <input type="checkbox"/>	\$ 1056
30"H Porcelain Marker Board Tiles		
24"W	Z43024MB <input type="checkbox"/>	\$ 843
30"W	Z43030MB <input type="checkbox"/>	\$ 897
36"W	Z43036MB <input type="checkbox"/>	\$ 949
42"W	Z43042MB <input type="checkbox"/>	\$ 1002
48"W	Z43048MB <input type="checkbox"/>	\$ 1056
60"W	Z43060MB	\$ 1159
15"H Steel Marker Board Tiles (no color option)		
24"W	Z41524MBS	\$ 437
30"W	Z41530MBS	\$ 475
36"W	Z41536MBS	\$ 512
42"W	Z41542MBS	\$ 550
48"W	Z41548MBS	\$ 588
60"W	Z41560MBS	\$ 664
22½"H Steel Marker Board Tiles (no color option)		
24"W	Z42224MBS	\$ 512
30"W	Z42230MBS	\$ 550
36"W	Z42236MBS	\$ 588
42"W	Z42242MBS	\$ 628
48"W	Z42248MBS	\$ 664
60"W	Z42260MBS	\$ 736
30"H Steel Marker Board Tiles (no color option)		
24"W	Z43024MBS	\$ 588
30"W	Z43030MBS	\$ 628
36"W	Z43036MBS	\$ 664
42"W	Z43042MBS	\$ 702
48"W	Z43048MBS	\$ 736
60"W	Z43060MBS	\$ 813
15"W Marker Board Tray — Natural Aluminum		
Magnetic Markerboard Tray	TK4TRAYMS <input type="checkbox"/>	\$ 87

How to specify —
Select the Model Number from above.

1st Option:
Paint Color:

P1 P2 P3
See page 120 for finishes.

1st Option:
Color
(if applicable):

X No color option

_____ . P _____ X

Examples: Z42242MB.P7C Z43036MBS.X TK4TRAYMS

Shippable by small-package carrier.

For specification information see pages 137-144.

GSA SIN 33721

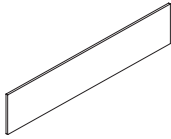

Description	Model	Grade 1 List Price	Grade 2 List Price
7 1/2"H Landscape Surface Tiles			
24"W	Z40724L	\$ 385	\$ 464
30"W	Z40730L	\$ 497	\$ 592
36"W	Z40736L	\$ 607	\$ 715
42"W	Z40742L	\$ 716	\$ 838
48"W	Z40748L	\$ 826	\$ 961
60"W	Z40760L	\$ 1049	\$ 1200

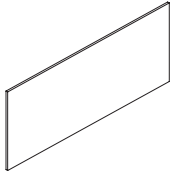

15"H Landscape Surface Tiles			
24"W	Z41524L	\$ 607	\$ 763
30"W	Z41530L	\$ 716	\$ 886
36"W	Z41536L	\$ 826	\$ 1006
42"W	Z41542L	\$ 936	\$ 1135
48"W	Z41548L	\$ 1049	\$ 1259
60"W	Z41560L	\$ 1266	\$ 1489

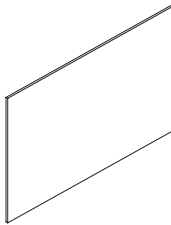

22 1/2"H Landscape Surface Tiles			
24"W	Z42224L	\$ 826	\$ 1128
30"W	Z42230L	\$ 936	\$ 1257
36"W	Z42236L	\$ 1049	\$ 1382
42"W	Z42242L	\$ 1160	\$ 1507
48"W	Z42248L	\$ 1266	\$ 1626
60"W	Z42260L	\$ 1486	\$ 1862

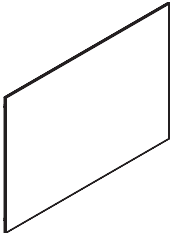

30"H Landscape Surface Tiles			
24"W	Z43024L	\$ 1049	\$ 1576
30"W	Z43030L	\$ 1160	\$ 1700
36"W	Z43036L	\$ 1266	\$ 1820
42"W	Z43042L	\$ 1378	\$ 1947
48"W	Z43048L	\$ 1486	\$ 2069
60"W	Z43060L	\$ 1708	\$ 2306

LANDSCAPE™ SURFACE MATERIAL OPTIONS

GRADE 2

Foundation™	Quattro
FD01 Sand	QU44 Platinum**
FD02 Taupe	
FD04 Pure White	

<p>How to specify — Select the Model Number from above.</p>	<p>1st Option: Landscape Surface Material and Finish: See above for material options.</p>	<p>2nd Option: Frame Paint Color: See page 120 for finishes.</p>
<p>Z 4 L .</p>	<p> .</p>	<p>P </p>

Examples: Z40724L.QU44.P27 Z41536L.FD01.P02

Shippable by small-package carrier.

Tiles

For specification information see pages 137-144.

GSA SIN 33721

Description	Model	L1 List Price	L2 List Price	L3 List Price
7½"H Laminate Tile				
24"W	Z40724LM	\$ 317	\$ 333	\$ 349
30"W	Z40730LM	\$ 329	\$ 345	\$ 362
36"W	Z40736LM	\$ 352	\$ 370	\$ 387
42"W	Z40742LM	\$ 386	\$ 405	\$ 425
48"W	Z40748LM	\$ 415	\$ 436	\$ 457
60"W	Z40760LM	\$ 468	\$ 491	\$ 515
15"H Laminate Tile				
24"W	Z41524LM	\$ 368	\$ 386	\$ 405
30"W	Z41530LM	\$ 384	\$ 403	\$ 422
36"W	Z41536LM	\$ 428	\$ 449	\$ 471
42"W	Z41542LM	\$ 459	\$ 482	\$ 505
48"W	Z41548LM	\$ 499	\$ 524	\$ 549
60"W	Z41560LM	\$ 564	\$ 592	\$ 620
22½"H Laminate Tile				
24"W	Z42224LM	\$ 464	\$ 487	\$ 510
30"W	Z42230LM	\$ 501	\$ 526	\$ 551
36"W	Z42236LM	\$ 545	\$ 572	\$ 600
42"W	Z42242LM	\$ 583	\$ 612	\$ 641
48"W	Z42248LM	\$ 627	\$ 658	\$ 690
60"W	Z42260LM	\$ 732	\$ 769	\$ 805
30"H Laminate Tile				
24"W	Z43024LM	\$ 558	\$ 586	\$ 614
30"W	Z43030LM	\$ 603	\$ 633	\$ 663
36"W	Z43036LM	\$ 647	\$ 679	\$ 712
42"W	Z43042LM	\$ 705	\$ 740	\$ 776
48"W	Z43048LM	\$ 761	\$ 799	\$ 837
60"W	Z43060LM	\$ 873	\$ 917	\$ 960
42½"H Laminate Tile				
24"W	Z44224LM	\$ 669	\$ 702	\$ 736
30"W	Z44230LM	\$ 802	\$ 842	\$ 882
36"W	Z44236LM	\$ 874	\$ 918	\$ 961
42"W	Z44242LM	\$ 952	\$ 1000	\$ 1047
48"W	Z44248LM	\$ 1038	\$ 1090	\$ 1142
60"W	Z44260LM	\$ 1132	\$ 1189	\$ 1245
50"H Laminate Tile				
24"W	Z45024LM	\$ 818	\$ 859	\$ 900
30"W	Z45030LM	\$ 891	\$ 936	\$ 980
36"W	Z45036LM	\$ 971	\$ 1020	\$ 1068
42"W	Z45042LM	\$ 1059	\$ 1112	\$ 1165
48"W	Z45048LM	\$ 1154	\$ 1212	\$ 1269
60"W	Z45060LM	\$ 1258	\$ 1321	\$ 1384

<p>How to specify — Select the Model Number from above.</p>	<p>1st Option: FSC Wood (if applicable): F FSC Wood X Non-FSC Wood</p>	<p>2nd Option: Laminate: See page 120 for finishes.</p>	<p>3rd Option: Edge Color: See page 120 for finishes.</p>	<p>4th Option: Grain Direction: VLG Horizontal or Solid Grain VST Vertical Grain</p>
Z 4 	

Example: Z40724LM.F.TM133.E4.VLG

[S] Shippable by small-package carrier.

Tiles

For specification information see pages 137-144.

GSA SIN 33721

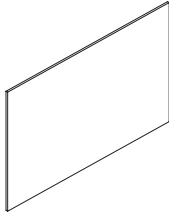

Description	Model	L1 List Price	L2 List Price	L3 List Price
57½"H Laminate Tile				
24"W	Z45724LM	\$ 1120	\$ 1176	\$ 1232
30"W	Z45730LM	\$ 1254	\$ 1317	\$ 1379
36"W	Z45736LM	\$ 1404	\$ 1474	\$ 1544
42"W	Z45742LM	\$ 1573	\$ 1652	\$ 1730
48"W	Z45748LM	\$ 1762	\$ 1850	\$ 1938
65"H Laminate Tile				
24"W	Z46524LM	\$ 1240	\$ 1302	\$ 1364
30"W	Z46530LM	\$ 1388	\$ 1457	\$ 1527
36"W	Z46536LM	\$ 1555	\$ 1633	\$ 1711
42"W	Z46542LM	\$ 1742	\$ 1829	\$ 1916
48"W	Z46548LM	\$ 1951	\$ 2049	\$ 2146

STRIDE

<p>How to specify — Select the Model Number from above.</p> <p>Z 4 .</p>	<p>1st Option: FSC Wood (if applicable): F FSC Wood X Non-FSC Wood</p> <p> .</p>	<p>2nd Option: Laminate: See page 120 for finishes.</p> <p> .</p>	<p>3rd Option: Edge Color: See page 120 for finishes.</p> <p> .</p>	<p>4th Option: Grain Direction: VLG Horizontal or Solid Grain VST Vertical Grain</p> <p> </p>
---	---	--	--	---

Example: Z45724LM.F.TM133.E4.VLG

Shippable by small-package carrier.

For specification information see pages 137-144.

GSA SIN 33721

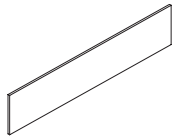

Description	Model	L1	L2	L3
		List Price	List Price	List Price
22½"H Laminate To-The-Floor Tiles				
24"W	Z42224LTF	\$ 511	\$ 534	\$ 557
30"W	Z42230LTF	\$ 548	\$ 573	\$ 598
36"W	Z42236LTF	\$ 592	\$ 619	\$ 647
42"W	Z42242LTF	\$ 630	\$ 659	\$ 688
48"W	Z42248LTF	\$ 674	\$ 705	\$ 737
60"W	Z42260LTF	\$ 779	\$ 816	\$ 852

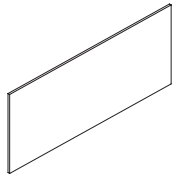

30"H Laminate To-The-Floor Tiles				
24"W	Z43024LTF	\$ 605	\$ 633	\$ 661
30"W	Z43030LTF	\$ 650	\$ 680	\$ 710
36"W	Z43036LTF	\$ 694	\$ 726	\$ 759
42"W	Z43042LTF	\$ 752	\$ 787	\$ 823
48"W	Z43048LTF	\$ 808	\$ 846	\$ 884
60"W	Z43060LTF	\$ 920	\$ 964	\$ 1007

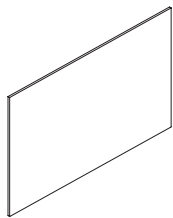

37½"H Laminate To-The-Floor Tiles				
24"W	Z43724LTF	\$ 699	\$ 732	\$ 764
30"W	Z43730LTF	\$ 809	\$ 847	\$ 885
36"W	Z43736LTF	\$ 938	\$ 983	\$ 1027
42"W	Z43742LTF	\$ 1089	\$ 1141	\$ 1193
48"W	Z43748LTF	\$ 1266	\$ 1327	\$ 1388
60"W	Z43760LTF	\$ 1473	\$ 1544	\$ 1616

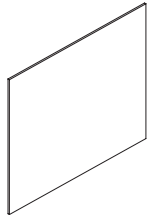

45"H Laminate To-The-Floor Tiles				
24"W	Z44524LTF	\$ 829	\$ 868	\$ 907
30"W	Z44530LTF	\$ 961	\$ 1007	\$ 1052
36"W	Z44536LTF	\$ 1116	\$ 1169	\$ 1223
42"W	Z44542LTF	\$ 1297	\$ 1360	\$ 1422
48"W	Z44548LTF	\$ 1509	\$ 1582	\$ 1655
60"W	Z44560LTF	\$ 1757	\$ 1843	\$ 1928

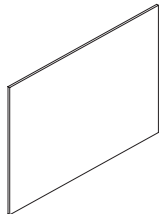

55½"H Laminate To-The-Floor Tiles				
24"W	Z45724LTF	\$ 961	\$ 1007	\$ 1052
30"W	Z45730LTF	\$ 1117	\$ 1171	\$ 1224
36"W	Z45736LTF	\$ 1299	\$ 1362	\$ 1424
42"W	Z45742LTF	\$ 1512	\$ 1585	\$ 1659
48"W	Z45748LTF	\$ 1761	\$ 1847	\$ 1932

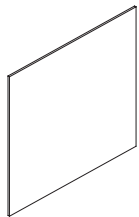

60"H Laminate To-The-Floor Tiles				
24"W	Z46024LTF	\$ 1116	\$ 1169	\$ 1223
30"W	Z46030LTF	\$ 1298	\$ 1361	\$ 1423
36"W	Z46036LTF	\$ 1510	\$ 1583	\$ 1656
42"W	Z46042LTF	\$ 1759	\$ 1845	\$ 1930
48"W	Z46048LTF	\$ 2050	\$ 2150	\$ 2250

<p>How to specify — Select the Model Number from above.</p>	<p>1st Option: FSC Wood (if applicable): F FSC Wood X Non-FSC Wood</p>	<p>2nd Option: Laminate: See page 120 for finishes.</p>	<p>3rd Option: Edge Color: See page 120 for finishes.</p>	<p>4th Option: Grain Direction: VLG Horizontal or Solid Grain VST Vertical Grain</p>
<p>Z 4 .</p>	<p> .</p>	<p> .</p>	<p> .</p>	<p> </p>

Example: Z42224LTF.F.TM133.E4.VLG

[5] Shippable by small-package carrier.

For specification information see pages 137-144.

GSA SIN 33721

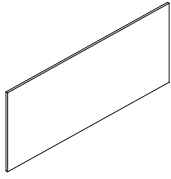

Description	Model	L1 List Price	L2 List Price	L3 List Price
25"H Laminate Spanning Tile				
54"W	Z42554SHS	\$ 807	\$ 847	\$ 888
60"W	Z42560SHS	\$ 828	\$ 869	\$ 911
66"W	Z42566SHS	\$ 857	\$ 900	\$ 943
72"W	Z42572SHS	\$ 917	\$ 963	\$ 1009
78"W	Z42578SHS	\$ 969	\$ 1017	\$ 1066
84"W	Z42584SHS	\$ 1015	\$ 1066	\$ 1117
90"W	Z42590SHS	\$ 1059	\$ 1112	\$ 1165
96"W	Z42596SHS	\$ 1128	\$ 1184	\$ 1241

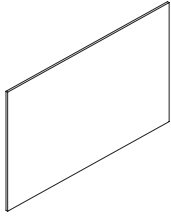

30"H Laminate Spanning Tile				
54"W	Z43054SHS	\$ 833	\$ 875	\$ 916
60"W	Z43060SHS	\$ 912	\$ 958	\$ 1003
66"W	Z43066SHS	\$ 949	\$ 996	\$ 1044
72"W	Z43072SHS	\$ 1002	\$ 1052	\$ 1102
78"W	Z43078SHS	\$ 1017	\$ 1068	\$ 1119
84"W	Z43084SHS	\$ 1127	\$ 1183	\$ 1240
90"W	Z43090SHS	\$ 1187	\$ 1246	\$ 1306
96"W	Z43096SHS	\$ 1237	\$ 1299	\$ 1361

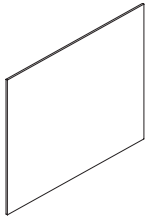

42"H Laminate Spanning Tile				
54"W	Z43754SHS	\$ 995	\$ 1045	\$ 1095
60"W	Z43760SHS	\$ 1066	\$ 1119	\$ 1173
66"W	Z43766SHS	\$ 1120	\$ 1176	\$ 1232
72"W	Z43772SHS	\$ 1154	\$ 1212	\$ 1269
78"W	Z43778SHS	\$ 1181	\$ 1240	\$ 1299
84"W	Z43784SHS	\$ 1230	\$ 1292	\$ 1353
90"W	Z43790SHS	\$ 1262	\$ 1325	\$ 1388
96"W	Z43796SHS	\$ 1285	\$ 1349	\$ 1414

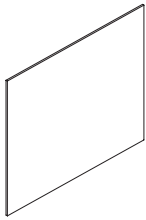

50"H Laminate Spanning Tile				
54"W	Z44554SHS	\$ 1297	\$ 1362	\$ 1427
60"W	Z44560SHS	\$ 1310	\$ 1376	\$ 1441
66"W	Z44566SHS	\$ 1324	\$ 1390	\$ 1456
72"W	Z44572SHS	\$ 1354	\$ 1422	\$ 1489
78"W	Z44578SHS	\$ 1500	\$ 1575	\$ 1650
84"W	Z44584SHS	\$ 1521	\$ 1597	\$ 1673
90"W	Z44590SHS	\$ 1557	\$ 1635	\$ 1713
96"W	Z44596SHS	\$ 1587	\$ 1666	\$ 1746

Description	Model	List Price
Spanning Tile Bracket Kits		
	Z4STBRKT1	\$ 225
	Z4STBRKT2	\$ 225

STRIDE

<p>How to specify — Select the Model Number from above.</p>	<p>1st Option: FSC Wood (if applicable): F FSC Wood X Non-FSC Wood</p>	<p>2nd Option: Laminate: See page 120 for finishes.</p>	<p>3rd Option: Edge Color: See page 120 for finishes.</p>
<p>Z 4 .</p>	<p> .</p>	<p> .</p>	<p> .</p>

Example: Z42554SHS.F.TM133.E4

Shippable by small-package carrier.

For specification information see pages 137-144.

GSA SIN 33721

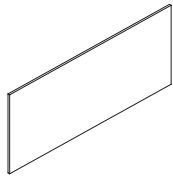

Description	Model	L1 List Price	L2 List Price	L3 List Price
25"H Laminate Spanning Tile To-The Floor				
54"W	Z42554SHTF	\$ 887	\$ 931	\$ 976
60"W	Z42560SHTF	\$ 911	\$ 957	\$ 1002
66"W	Z42566SHTF	\$ 942	\$ 989	\$ 1036
72"W	Z42572SHTF	\$ 1009	\$ 1059	\$ 1110
78"W	Z42578SHTF	\$ 1066	\$ 1119	\$ 1173
84"W	Z42584SHTF	\$ 1116	\$ 1172	\$ 1228
90"W	Z42590SHTF	\$ 1166	\$ 1224	\$ 1283
96"W	Z42596SHTF	\$ 1241	\$ 1303	\$ 1365

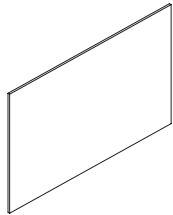

30"H Laminate Spanning Tile To-The-Floor				
54"W	Z43054SHTF	\$ 917	\$ 963	\$ 1009
60"W	Z43060SHTF	\$ 1003	\$ 1053	\$ 1103
66"W	Z43066SHTF	\$ 1044	\$ 1096	\$ 1148
72"W	Z43072SHTF	\$ 1103	\$ 1158	\$ 1213
78"W	Z43078SHTF	\$ 1118	\$ 1174	\$ 1230
84"W	Z43084SHTF	\$ 1240	\$ 1302	\$ 1364
90"W	Z43090SHTF	\$ 1305	\$ 1370	\$ 1436
96"W	Z43096SHTF	\$ 1360	\$ 1428	\$ 1496

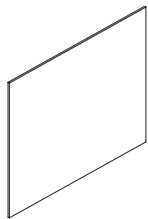

42"H Laminate Spanning Tile To-The-Floor				
54"W	Z43754SHTF	\$ 1184	\$ 1243	\$ 1302
60"W	Z43760SHTF	\$ 1263	\$ 1326	\$ 1389
66"W	Z43766SHTF	\$ 1322	\$ 1388	\$ 1454
72"W	Z43772SHTF	\$ 1359	\$ 1427	\$ 1495
78"W	Z43778SHTF	\$ 1389	\$ 1458	\$ 1528
84"W	Z43784SHTF	\$ 1443	\$ 1515	\$ 1587
90"W	Z43790SHTF	\$ 1478	\$ 1552	\$ 1626
96"W	Z43796SHTF	\$ 1503	\$ 1578	\$ 1653

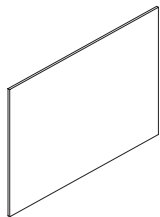

50"H Laminate Spanning Tile To-The-Floor				
54"W	Z44554SHTF	\$ 1517	\$ 1593	\$ 1669
60"W	Z44560SHTF	\$ 1531	\$ 1608	\$ 1684
66"W	Z44566SHTF	\$ 1546	\$ 1623	\$ 1701
72"W	Z44572SHTF	\$ 1579	\$ 1658	\$ 1737
78"W	Z44578SHTF	\$ 1740	\$ 1827	\$ 1914
84"W	Z44584SHTF	\$ 1764	\$ 1852	\$ 1940
90"W	Z44590SHTF	\$ 1803	\$ 1893	\$ 1983
96"W	Z44596SHTF	\$ 1836	\$ 1928	\$ 2020

<p>How to specify — Select the Model Number from above.</p> <p>Z 4 .</p>	<p>1st Option: FSC Wood (if applicable): F FSC Wood X Non-FSC Wood</p> <p> .</p>	<p>2nd Option: Laminate: See page 120 for finishes.</p> <p> .</p>	<p>3rd Option: Edge Color: See page 120 for finishes.</p> <p> </p>
--	---	--	--

Example: Z42554SHTF.F.TM133.E4

Shippable by small-package carrier.

Tiles

Stride® — Single Pane Glass Tile Kits / Pass Thru Kits

For specification information see pages 137-144.

GSA SIN 33721

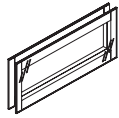

Description	Model	Clear List Price	Frosted List Price
15"H Glass Tile Kits			
24"W	Z41524G S	\$ 696	\$ 790
30"W	Z41530G S	\$ 793	\$ 900
36"W	Z41536G S	\$ 851	\$ 966
42"W	Z41542G S	\$ 909	\$ 1031
48"W	Z41548G S	\$ 961	\$ 1090
60"W	Z41560G S	\$ 1106	\$ 1256

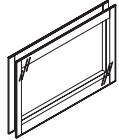

22½"H Glass Tile Kits			
24"W	Z42224G S	\$ 891	\$ 1011
30"W	Z42230G S	\$ 938	\$ 1065
36"W	Z42236G S	\$ 981	\$ 1112
42"W	Z42242G S	\$ 1036	\$ 1176
48"W	Z42248G S	\$ 1081	\$ 1228
60"W	Z42260G S	\$ 1152	\$ 1309

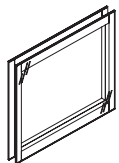

30"H Glass Tile Kits			
24"W	Z43024G S	\$ 1037	\$ 1177
30"W	Z43030G S	\$ 1097	\$ 1247
36"W	Z43036G S	\$ 1186	\$ 1347
42"W	Z43042G S	\$ 1281	\$ 1455
48"W	Z43048G S	\$ 1358	\$ 1542
60"W	Z43060G	\$ 1509	\$ 1714

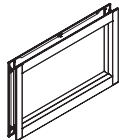

Description	Model	P1 Paint List Price	P2 Paint List Price
22½"H Pass-Thru Trim Kits			
24"W	Z42224PT S	\$ 511	\$ 541
30"W	Z42230PT S	\$ 539	\$ 569
36"W	Z42236PT S	\$ 577	\$ 607
42"W	Z42242PT S	\$ 610	\$ 640
48"W	Z42248PT S	\$ 638	\$ 668
60"W	Z42260PT S	\$ 660	\$ 690

STRIDE





































<p>How to specify — Select the Model Number from above.</p>	<p>1st Option: Paint (Interior Shroud): P1 P2 P3 See page 120 for finishes.</p>	<p>2nd Option: Glass Type (if applicable): C Clear F Frosted</p>
<p>Z 4 . P .</p>		

Examples: Z41530G.P27.C Z42260PT.PJW

S Shippable by small-package carrier.

For specification information see pages 137-144.

GSA SIN 33721

Description	Model	V1 List Price	V3 List Price	V5 List Price
7½"H Veneer Tiles				
24"W	Z40724V 	\$ 477	\$ 529	\$ 563
30"W	Z40730V 	\$ 518	\$ 574	\$ 612
36"W	Z40736V 	\$ 596	\$ 661	\$ 704
42"W	Z40742V 	\$ 663	\$ 735	\$ 783
48"W	Z40748V 	\$ 704	\$ 780	\$ 831
60"W	Z40760V 	\$ 783	\$ 868	\$ 925
15"H Veneer Tiles				
24"W	Z41524V 	\$ 562	\$ 623	\$ 663
30"W	Z41530V 	\$ 601	\$ 666	\$ 710
36"W	Z41536V 	\$ 689	\$ 764	\$ 814
42"W	Z41542V 	\$ 771	\$ 855	\$ 910
48"W	Z41548V 	\$ 813	\$ 901	\$ 960
60"W	Z41560V 	\$ 904	\$ 1002	\$ 1068
22½"H Veneer Tiles				
24"W	Z42224V 	\$ 681	\$ 755	\$ 804
30"W	Z42230V 	\$ 746	\$ 827	\$ 881
36"W	Z42236V 	\$ 834	\$ 924	\$ 985
42"W	Z42242V 	\$ 934	\$ 1035	\$ 1103
48"W	Z42248V 	\$ 970	\$ 1075	\$ 1145
60"W	Z42260V 	\$ 1093	\$ 1212	\$ 1291
30"H Veneer Tiles				
24"W	Z43024V 	\$ 793	\$ 879	\$ 936
30"W	Z43030V 	\$ 880	\$ 975	\$ 1039
36"W	Z43036V 	\$ 973	\$ 1079	\$ 1149
42"W	Z43042V 	\$ 1091	\$ 1209	\$ 1288
48"W	Z43048V 	\$ 1129	\$ 1251	\$ 1333
60"W	Z43060V 	\$ 1277	\$ 1415	\$ 1508
37½"H Veneer Tiles				
24"W	Z43724V 	\$ 927	\$ 1028	\$ 1095
30"W	Z43730V 	\$ 1053	\$ 1167	\$ 1243
36"W	Z43736V 	\$ 1140	\$ 1264	\$ 1346
42"W	Z43742V 	\$ 1269	\$ 1406	\$ 1498
48"W	Z43748V 	\$ 1387	\$ 1537	\$ 1638
60"W	Z43760V 	\$ 1594	\$ 1767	\$ 1882
45"H Veneer Tiles				
24"W	Z44524V 	\$ 1049	\$ 1163	\$ 1239
30"W	Z44530V 	\$ 1210	\$ 1341	\$ 1429
36"W	Z44536V 	\$ 1308	\$ 1450	\$ 1544
42"W	Z44542V 	\$ 1437	\$ 1593	\$ 1696
48"W	Z44548V 	\$ 1641	\$ 1819	\$ 1937
60"W	Z44560V 	\$ 1857	\$ 2058	\$ 2192

How to specify —
Select the Model Number from above.

1st Option:
Veneer Type and Finish:
See page 120 for finishes.
S prefix for Stratawood
N prefix for Natural

Z | 4 | | | | | | | | | | V | . | | | | | | | | | |

Example: Z43024V.NE800

 Shippable by small-package carrier.



For specification information see pages 137-144.

GSA SIN 33721

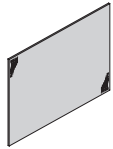

Description	Model	V1 List Price	V3 List Price	V5 List Price
22½"H Veneer Base Tiles to-the-Floor Kits				
24"W	Z42224VTF S	\$ 954	\$ 1052	\$ 1118
30"W	Z42230VTF S	\$ 1037	\$ 1144	\$ 1216
36"W	Z42236VTF S	\$ 1138	\$ 1256	\$ 1335
42"W	Z42242VTF S	\$ 1253	\$ 1384	\$ 1471
48"W	Z42248VTF S	\$ 1287	\$ 1421	\$ 1511
60"W	Z42260VTF S	\$ 1436	\$ 1587	\$ 1687

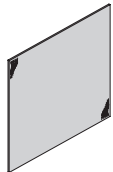

30"H Veneer Base Tiles to-the-Floor Kits				
24"W	Z43024VTF S	\$ 1080	\$ 1192	\$ 1266
30"W	Z43030VTF S	\$ 1205	\$ 1330	\$ 1414
36"W	Z43036VTF S	\$ 1298	\$ 1434	\$ 1524
42"W	Z43042VTF S	\$ 1422	\$ 1571	\$ 1670
48"W	Z43048VTF S	\$ 1542	\$ 1704	\$ 1812
60"W	Z43060VTF	\$ 1759	\$ 1944	\$ 2068

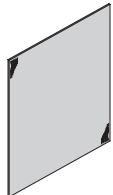

37½"H Veneer Base Tiles to-the-Floor Kits				
24"W	Z43724VTF S	\$ 1204	\$ 1329	\$ 1413
30"W	Z43730VTF S	\$ 1375	\$ 1519	\$ 1615
36"W	Z43736VTF S	\$ 1468	\$ 1622	\$ 1725
42"W	Z43742VTF S	\$ 1593	\$ 1760	\$ 1872
48"W	Z43748VTF S	\$ 1803	\$ 1993	\$ 2120
60"W	Z43760VTF	\$ 2015	\$ 2228	\$ 2370



45"H Veneer Base Tiles to-the-Floor Kits				
24"W	Z44524VTF S	\$ 1411	\$ 1559	\$ 1657
30"W	Z44530VTF S	\$ 1629	\$ 1800	\$ 1915
36"W	Z44536VTF S	\$ 1716	\$ 1897	\$ 2018
42"W	Z44542VTF S	\$ 1854	\$ 2050	\$ 2180
48"W	Z44548VTF S	\$ 2139	\$ 2366	\$ 2517
60"W	Z44560VTF	\$ 2361	\$ 2612	\$ 2779

How to specify —
Select the Model Number from above.

1st Option:

Veneer Type and Finish:

See page 120 for finishes.

- S** prefix for Stratawood
- N** prefix for Natural

Z | 4 | | | | | | | | | | V | T | F | . | | | | | | | | | | .

Example: Z43036VTF.NE800

S Shippable by small-package carrier.

Tiles

Stride® — Natural Veneer Sets

For specification information see pages 137-144.

GSA SIN 33721

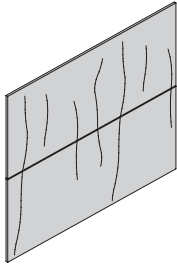

Description	Model	2P	
		Natural-1 V3 List Price	Natural-2 V5 List Price
Natural Veneer Tile Set — 30"H			
24"W	Z43024NVS-2P	\$ 1358	\$ 1446
30"W	Z43030NVS-2P	\$ 1475	\$ 1571
36"W	Z43036NVS-2P	\$ 1678	\$ 1787
42"W	Z43042NVS-2P	\$ 1877	\$ 2000
48"W	Z43048NVS-2P	\$ 1983	\$ 2112
60"W	Z43060NVS-2P	\$ 2215	\$ 2360

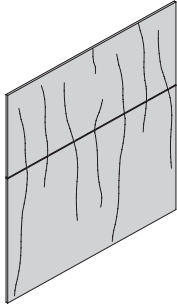

Description	Model	QP	
		Natural-1 V3 List Price	Natural-2 V5 List Price
Natural Veneer Tile Set — 37½"H			
24"W	Z43724NVS-QP	\$ 1505	\$ 1603
30"W	Z43730NVS-QP	\$ 1644	\$ 1751
36"W	Z43736NVS-QP	\$ 1861	\$ 1982
42"W	Z43742NVS-QP	\$ 2069	\$ 2204
48"W	Z43748NVS-QP	\$ 2169	\$ 2310
60"W	Z43760NVS-QP	\$ 2441	\$ 2600

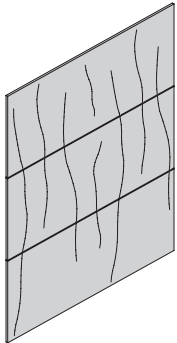

Description	Model	3P	
		Natural-1 V3 List Price	Natural-2 V5 List Price
Natural Veneer Tile Set — 45"H			
24"W	Z44524NVS-3P	\$ 2036	\$ 2169
30"W	Z44530NVS-3P	\$ 2214	\$ 2359
36"W	Z44536NVS-3P	\$ 2514	\$ 2677
42"W	Z44542NVS-3P	\$ 2821	\$ 3004
48"W	Z44548NVS-3P	\$ 2964	\$ 3157
60"W	Z44560NVS-3P	\$ 3319	\$ 3535

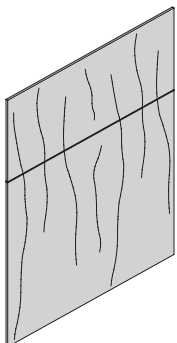

Description	Model	SP	
		Natural-1 V3 List Price	Natural-2 V5 List Price
Natural Veneer Tile Set — 45"H			
24"W	Z44524NVS-SP	\$ 1655	\$ 1763
30"W	Z44530NVS-SP	\$ 1804	\$ 1922
36"W	Z44536NVS-SP	\$ 2027	\$ 2159
42"W	Z44542NVS-SP	\$ 2267	\$ 2414
48"W	Z44548NVS-SP	\$ 2365	\$ 2519
60"W	Z44560NVS-SP	\$ 2665	\$ 2839

How to specify —
Select the Model Number from above.

1st Option:
Tile Set:
2P for 30"H
QP for 37½"H
3P or SP for 45"H

2nd Option:
Veneer Type and Finish:
See page 120 for finishes.

Z | 4 | | | | | N | V | S | - | | | | .

Example: Z43042NVS-2P.NE800

Shippable by small-package carrier.

Tiles

Stride® — Natural Veneer Sets

For specification information see pages 137-144.

GSA SIN 33721

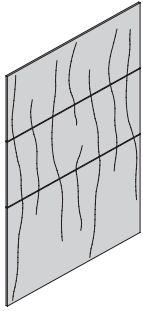

Description	Model	Q2P	
		Natural-1 V3 List Price	Natural-2 V5 List Price
Natural Veneer Tile Set — 52½"H			
24"W	Z45224NVS-Q2P	\$ 2189	\$ 2331
30"W	Z45230NVS-Q2P	\$ 2377	\$ 2532
36"W	Z45236NVS-Q2P	\$ 2692	\$ 2868
42"W	Z45242NVS-Q2P	\$ 3015	\$ 3211
48"W	Z45248NVS-Q2P	\$ 3161	\$ 3367
60"W	Z45260NVS-Q2P	\$ 3547	\$ 3778

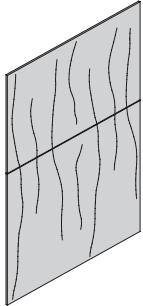

Description	Model	SQ	
		Natural-1 V3 List Price	Natural-2 V5 List Price
Natural Veneer Tile Set — 52½"H			
24"W	Z45224NVS-SQ	\$ 1799	\$ 1916
30"W	Z45230NVS-SQ	\$ 1974	\$ 2103
36"W	Z45236NVS-SQ	\$ 2204	\$ 2348
42"W	Z45242NVS-SQ	\$ 2467	\$ 2628
48"W	Z45248NVS-SQ	\$ 2561	\$ 2728
60"W	Z45260NVS-SQ	\$ 2885	\$ 3073

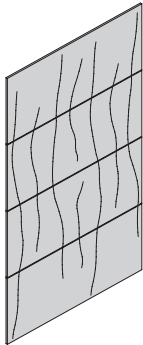

Description	Model	4P	
		Natural-1 V3 List Price	Natural-2 V5 List Price
Natural Veneer Tile Set — 60"H			
24"W	Z46024NVS-4P	\$ 2718	\$ 2895
30"W	Z46030NVS-4P	\$ 2948	\$ 3140
36"W	Z46036NVS-4P	\$ 3359	\$ 3578
42"W	Z46042NVS-4P	\$ 3758	\$ 4003
48"W	Z46048NVS-4P	\$ 3958	\$ 4216
60"W	Z46060NVS-4P	\$ 4425	\$ 4713

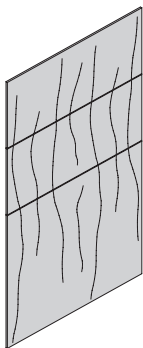

Description	Model	S2P	
		Natural-1 V3 List Price	Natural-2 V5 List Price
Natural Veneer Tile Set — 60"H			
24"W	Z46024NVS-S2P	\$ 2330	\$ 2482
30"W	Z46030NVS-S2P	\$ 2544	\$ 2709
36"W	Z46036NVS-S2P	\$ 2868	\$ 3055
42"W	Z46042NVS-S2P	\$ 3211	\$ 3420
48"W	Z46048NVS-S2P	\$ 3353	\$ 3571
60"W	Z46060NVS-S2P	\$ 3770	\$ 4016

STRIDE

How to specify —
Select the
Model Number
from above.

1st Option:

Tile Set:

Q2P or SQ for 52½"H
4P or S2P for 60"H

2nd Option:

**Veneer Type and
Finish:**

See page 120 for
finishes.

Z | 4 | | | | | | | | | | N | V | S | - | | | | | .

Example: Z45260NVS-Q2P.NE800

Shippable by small-package carrier.

Tiles

Stride® — Natural Veneer to-the-Floor Tile Sets

For specification information see pages 137-144.

GSA SIN 33721

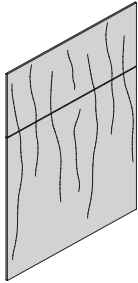

Description	Model	ZP	
		Natural-1 V3 List Price	Natural-2 V5 List Price
Veneer to-the-Floor Base Tile Sets — 45"H			
24"W	Z44524NVS-ZP S	\$ 1968	\$ 2093
30"W	Z44530NVS-ZP S	\$ 2189	\$ 2329
36"W	Z44536NVS-ZP S	\$ 2401	\$ 2555
42"W	Z44542NVS-ZP S	\$ 2649	\$ 2819
48"W	Z44548NVS-ZP S	\$ 2845	\$ 3028
60"W	Z44560NVS-ZP	\$ 3226	\$ 3433

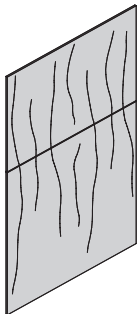

Description	Model	ZQ	
		Natural-1 V3 List Price	Natural-2 V5 List Price
Veneer to-the-Floor Base Tile Sets — 52½"H			
24"W	Z45224NVS-ZQ S	\$ 2119	\$ 2254
30"W	Z45230NVS-ZQ S	\$ 2353	\$ 2504
36"W	Z45236NVS-ZQ S	\$ 2577	\$ 2742
42"W	Z45242NVS-ZQ S	\$ 2845	\$ 3028
48"W	Z45248NVS-ZQ S	\$ 3039	\$ 3234
60"W	Z45260NVS-ZQ	\$ 3455	\$ 3677

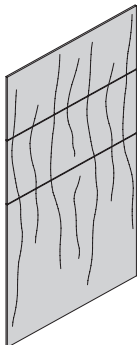

Description	Model	Z2P	
		Natural-1 V3 List Price	Natural-2 V5 List Price
Veneer to-the-Floor Base Tile Sets — 60"H			
24"W	Z46024NVS-Z2P S	\$ 2653	\$ 2822
30"W	Z46030NVS-Z2P S	\$ 2920	\$ 3107
36"W	Z46036NVS-Z2P S	\$ 3242	\$ 3450
42"W	Z46042NVS-Z2P S	\$ 3586	\$ 3816
48"W	Z46048NVS-Z2P S	\$ 3834	\$ 4081
60"W	Z46060NVS-Z2P	\$ 4331	\$ 4610

How to specify —
Select the
Model Number
from above.

1st Option:

Tile Set:
ZP for 45"H
ZQ for 52½"H
Z2P for 60"H

2nd Option:

**Veneer Type and
Finish:**
See page 120 for
finishes.

Z | 4 | | | | | | | | N | V | S | - | | | | | .

Example: Z45224NVS-ZQ.NE800

S Shippable by small-package carrier.

For specification information see page 145.

GSA SIN 33721

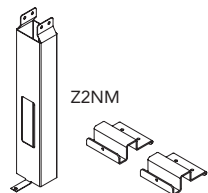
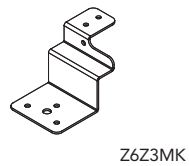
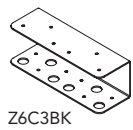
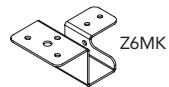
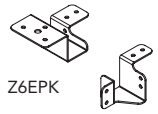
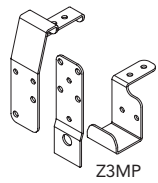

Description	Model	P1 Paint List Price	P2 Paint List Price	P3 Paint List Price
Off-Modular Panel Attachment Kit (no color option)				
Non-Rail Based "M" Off-Modular Connector Kit	Z3MP S	\$ 268	N/A	N/A

Off-Modular Worksurface Brackets

Non-Rail Based End Panel Kit	Z6EPK	\$ 59	\$ 70	\$ 78
Non-Rail Based Worksurface Bracket (1)	Z6MK	\$ 70	\$ 81	\$ 89
Non-Rail Based 3" Layered Worksurface Bracket (1)	Z6Z3MK S	\$ 79	\$ 90	\$ 98
Layered Worksurface Connection Bracket (1)	Z6C3BK S	\$ 114	\$ 130	\$ 143

Off-Modular Mounting Kits for Overhead Cabinets

Non-Rail Based Overhead Mounting Kit	Z2NM S	\$ 226	\$ 251	\$ 274
--------------------------------------	--	--------	--------	--------

How to specify —
Select the Model Number from above.

1st Option:

Color
(if applicable):

P1 P2 P3

See page 120 for finishes.

















































Z | | | | | | | .

P | | | |

Examples: Z3MP Z6MK.P7C Z6Z3MK.PJW Z2NM.PR2

S Shippable by small-package carrier.

- Optional Acoustic Inserts enhance the acoustic value of Stride Panels.
- Full Acoustic Insert provides two fillers to span from lower horizontal cross member to upper horizontal cross member.
- Upper Acoustic Insert spans from above beltline horizontal to upper horizontal cross member.
- Acoustic Insert material can be compressed up to 90% to allow for power and data cables routed in panels between tiles.

Description	Full Insert Model	Upper Insert Model	Full Insert List Price	Upper Insert List Price
42½"H Stride Panel Frame Acoustic Inserts (fits between tiles)				
For 24" W	Z04224AIF 	Z04224AIU 	\$ 130	\$ 77
For 30" W	Z04230AIF 	Z04230AIU 	\$ 152	\$ 79
For 36" W	Z04236AIF 	Z04236AIU 	\$ 157	\$ 90
For 42" W	Z04242AIF 	Z04242AIU 	\$ 176	\$ 104
For 48" W	Z04248AIF 	Z04248AIU 	\$ 192	\$ 124
For 60" W	Z04260AIF 	Z04260AIU 	\$ 313	\$ 182
50"H Stride Panel Frame Acoustic Inserts (fits between tiles)				
For 24" W	Z05024AIF 	Z05024AIU 	\$ 119	\$ 79
For 30" W	Z05030AIF 	Z05030AIU 	\$ 159	\$ 98
For 36" W	Z05036AIF 	Z05036AIU 	\$ 180	\$ 123
For 42" W	Z05042AIF 	Z05042AIU 	\$ 194	\$ 145
For 48" W	Z05048AIF 	Z05048AIU 	\$ 206	\$ 159
For 60" W	Z05060AIF 	Z05060AIU 	\$ 353	\$ 208
57½"H Stride Panel Frame Acoustic Inserts (fits between tiles)				
For 24" W	Z05724AIF 	Z05724AIU 	\$ 134	\$ 88
For 30" W	Z05730AIF 	Z05730AIU 	\$ 187	\$ 124
For 36" W	Z05736AIF 	Z05736AIU 	\$ 199	\$ 142
For 42" W	Z05742AIF 	Z05742AIU 	\$ 220	\$ 159
For 48" W	Z05748AIF 	Z05748AIU 	\$ 259	\$ 207
For 60" W	Z05760AIF 	Z05760AIU 	\$ 417	\$ 285
65"H Stride Panel Frame Acoustic Inserts (fits between tiles)				
For 24" W	Z06524AIF 	Z06524AIU 	\$ 162	\$ 109
For 30" W	Z06530AIF 	Z06530AIU 	\$ 194	\$ 138
For 36" W	Z06536AIF 	Z06536AIU 	\$ 227	\$ 162
For 42" W	Z06542AIF 	Z06542AIU 	\$ 257	\$ 184
For 48" W	Z06548AIF 	Z06548AIU 	\$ 267	\$ 223
For 60" W	Z06560AIF 	Z06560AIU 	\$ 421	\$ 313

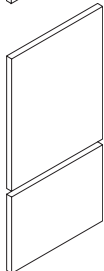
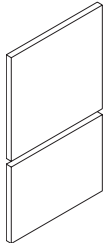
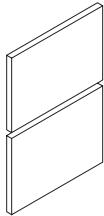
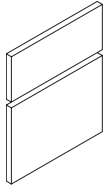

How to specify —
Select the Model Number from above.

Z | 0 | | | | | A | I | |

Examples: Z04220AIF Z06560AIU

 Shippable by small-package carrier.

[GSA Reference Page](#)

Stride features high capacity for cable management, including electrical, voice, and data capabilities. The 8-wire electrical system can be integrated at base pathway and beltline. The open structure of the frame allows voice and data cables to be routed both vertically and horizontally.

Ceiling infeed connects to building electrical supply. Ceiling infeed can also be used at the bottom to feed up into footed panels where exposed flex conduit is permitted by codes. This infeed can be prewired before panels are installed. A877006 and A877012 infeeds must be installed in panel before connecting to building wiring.

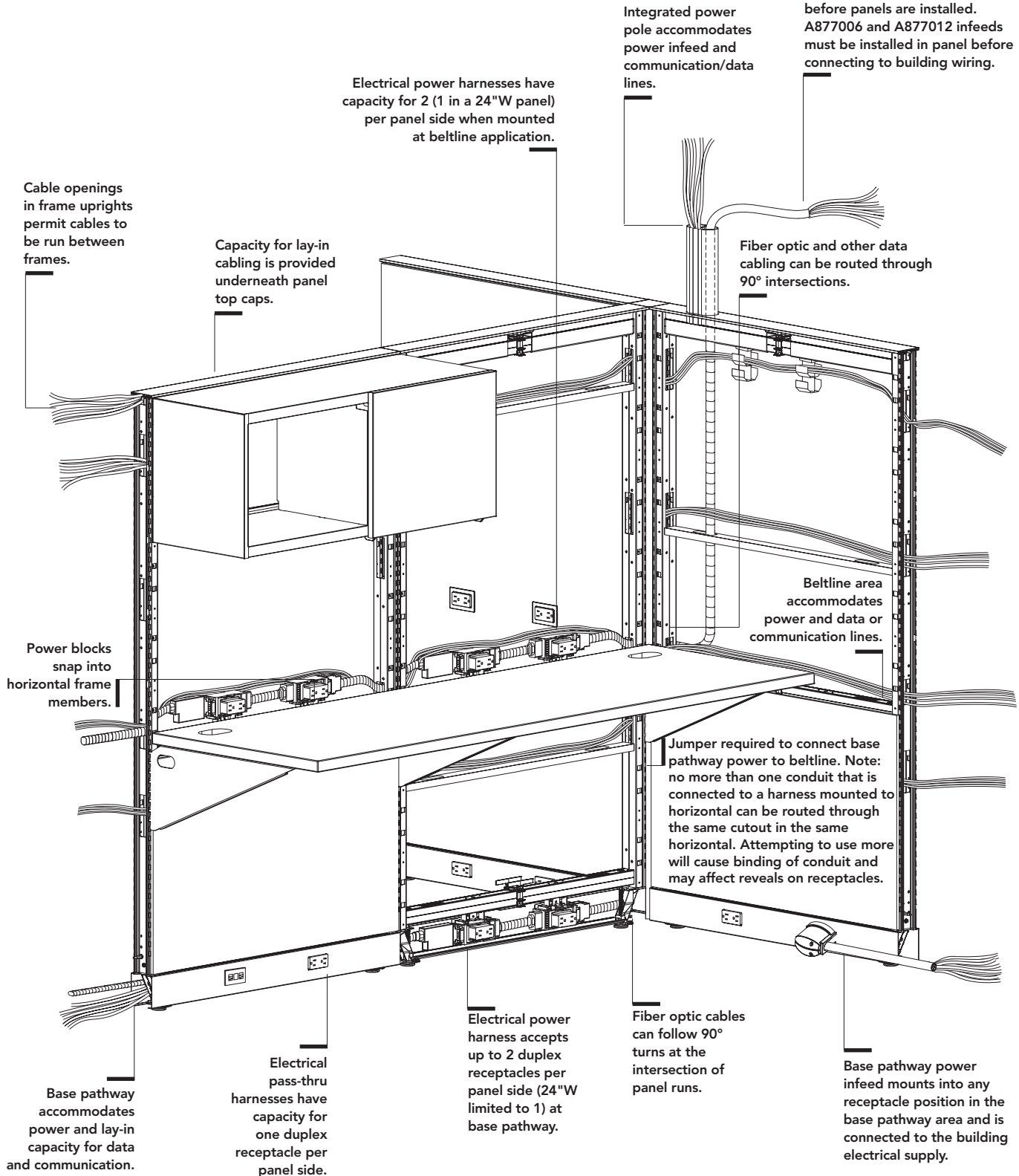

STRIDE

Electrical Systems

Stride electrical offers a choice of four electrical systems:

- Four-circuit, 3 + 1
- Four-circuit, 2 + 2
- Three-circuit, separate neutrals
- Eight circuits; two four-circuit systems provided back-to-back.
- See pages 186-187 for a detailed explanation of each electrical system.
- All four systems utilize an 8-wire electrical system, rated at 20 amps per circuit (16 amps plan-able U.S. and 15 amps Canadian).
- Stride panels and electrical components are UL Listed. Electrical components are also CSA certified. PVC-free models are C2C certified.
- Installation and use of the electrical system, the number of receptacles used on a given circuit and connections to the building power supply should be in compliance with all local and national electrical codes.

Caution: Electrical equipment cords or extension cords MUST NOT BE ROUTED through cable openings in frame sides.

Note: No more than one conduit that is connected to a harness mounted to horizontal can be routed through the same cut out in the same horizontal. Attempting to use more will cause binding of conduit and may affect reveals on receptacles.

Hardwire New York Code (page 195)

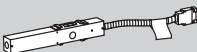
- **Hardwire (New York Code) junction box** (model A871400C) is used when local electrical codes require hardwire entry. 
- For use in panels 30"W to 60"W.
- When used in 30"W and 36"W panels, power can be routed only in one direction.
- When used in 42"W, 48"W, and 60"W panels, an electrical pass-thru cable or harness for that panel width can be used to route power back in the opposite direction.
- Unit must connect to a power or pass-thru harness positioned in the base pathway area of an adjacent panel.
- Customer to furnish all cabling and wiring from power entry to power source.
- Junction box can be positioned at any duplex receptacle location.

Hardwire Chicago Code (page 197)

- Wiring harnesses and snap connectors are not allowed in Chicago — base pathways must be comprised of all-metallic components.
- For the base pathway, junction box (model 877600) clips directly into receptacle locations and can be used both single- and double-sided. 
- In the beltline location, junction box (model 877550) can only be used single-sided.
- Base pathway model has a larger volume capacity for wiring to allow for dual-sided applications.
- Customer must furnish conduit, wiring, and designer-type receptacles for the base pathway and conduit, wiring, designer-type receptacles, and receptacle covers for the beltline.
- Tiles at the beltline must be field ported.
- Power entry can be routed from the ceiling, via a Stride power pole, or from the floor into a junction box (beltline model 877550; or base pathway model 877600).

Electrical Infeeds

- **Power infeed cables** deliver power from building to panel's electrical system.
- Infeed cables are housed in conduit to separate electrical system from communications and data lines.
- Select quantity of base or ceiling infeed cables depending on individual power requirements.

Base Infeed (page 195)

- **Sealtight base pathway power infeed** attaches to any receptacle opening at the base pathway.
- A heavy rubber sheathing shields conduit, allowing infeed to be exposed.
- A jumper is required to connect base pathway power to beltline.

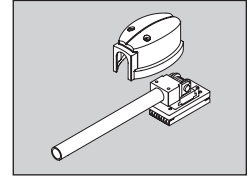

Sealtight Electrical Infeed Cable (page 195)

- **Sealtight electrical infeed cable** is used with footed panels.
- Should not be ordered prior to installation to have prewired as infeed must be routed from inside of panel out to be connected to power.
- Cannot be connected to power harness in panel frame that infeed is brought into unless additional pass-thru harness without power block is used to feed from below beltline to above beltline.

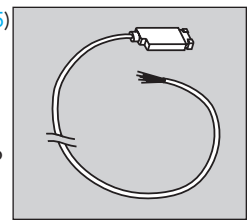

Ceiling Power Infeed (page 195)

- **Ceiling power infeed** connects to a prewired electrical harness in the beltline or base pathway, traverses through an adjacent panel and terminates in the junction box at the top of the integrated power pole.
- For use with integrated power pole models Z235PP and Z265PP.
- Can also be used as infeed for footed panels.
- Most codes permit flex conduit to be exposed after installation. Verify code requirements before ordering for exposed application.

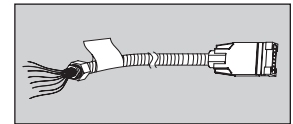

Integrated Power Pole (page 195)

- **Integrated power and communications poles** provide capacity for routing power supply directly through the top of any structural or stacking frame using same width trim/connector kit in place of top cap.
- Power pole has a cavity on each side of a center septum.
- See page 192 for cable capacity.
- When using a ceiling power infeed, consider that the infeed must connect into an electrical harness located in an adjacent panel.
- Integrated power pole will not work with low profile glass stackers, panel mounted glass screens, or panel mounted screens.
- Avoid glass or translucent tiles in upper position of frames with integrated power poles.

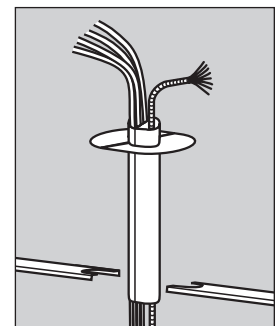

To Order:

- Determine which electrical system you will use after consulting your electrician and computer support personnel:
 - The Four-circuit system (4-Hot/2-Neutral/2-Ground)
 - 3 + 1 option
 - 2 + 2 option
 - The Three-circuit system (3-Hot/3-Neutral/2-Ground)
 - The Eight-circuit system (back-to-back four-circuit systems)
- Determine location, quantity, and circuit of duplexes.
- Determine the appropriate choice and use of Isolated, Isolated/Dedicated, and Separate Neutrals circuits.
- Specify appropriate Power Harnesses* and Pass-Thru Cables.*
- Determine the location, quantity, and type of Power Infeeds needed.

GSA Reference Page

* Select Power Harness models (A8712XX), Pass-Thru Cables (A8710XX) and Pass-Thru Harness (A8711XX) with the last two digits corresponding with the panel width into which the component is to be positioned. The initial cable length can be stretched approximately 3" to transverse "T", "X", "L" and Extended Straight Connectors.

Flexconnect™ Electrical System Options

The four-circuit, eight-wire electrical system is widely specified and trusted by hundreds of thousands of end-users. This proven system delivers four circuits for every power infeed in either a 3 + 1 or 2 + 2 configuration. The isolated/dedicated circuits are ideal for sensitive computing equipment, while the common circuits are suitable for faxes, copiers, task lights and other peripherals. Both the 3 + 1 and 2 + 2 systems use the same prewired components, making it easy to adjust as electrical needs change.

You can also choose a three-circuit, eight-wire system that has a dedicated neutral for every hot circuit. The three-circuit components have model numbers with an "A" suffix.

All three systems utilize an eight-wire electrical system rated at 20 amps per circuit (15 amps Canadian). Concensys panels and electrical components are UL listed and CSA certified.

Reference the Office Equipment Typical Load Values matrix on page 76.

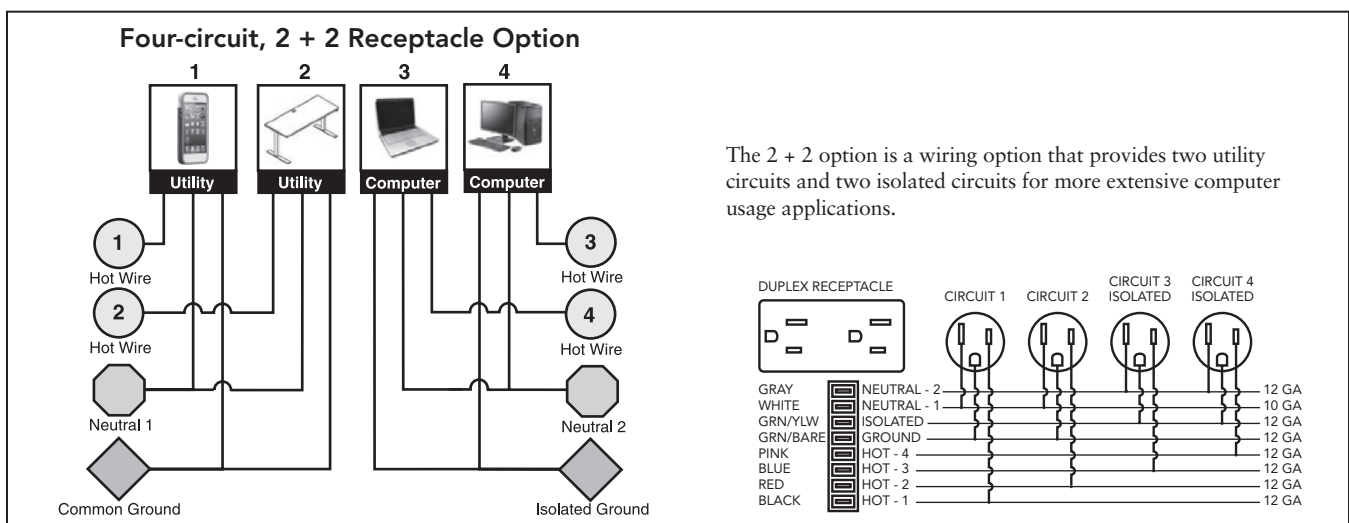
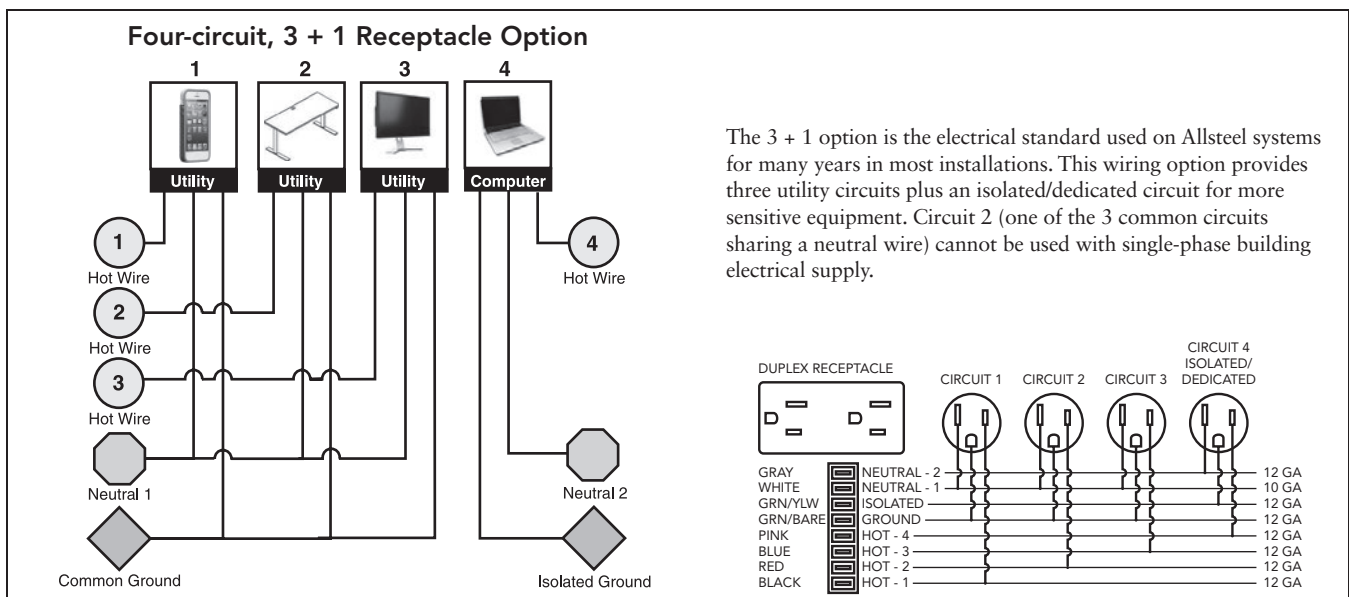

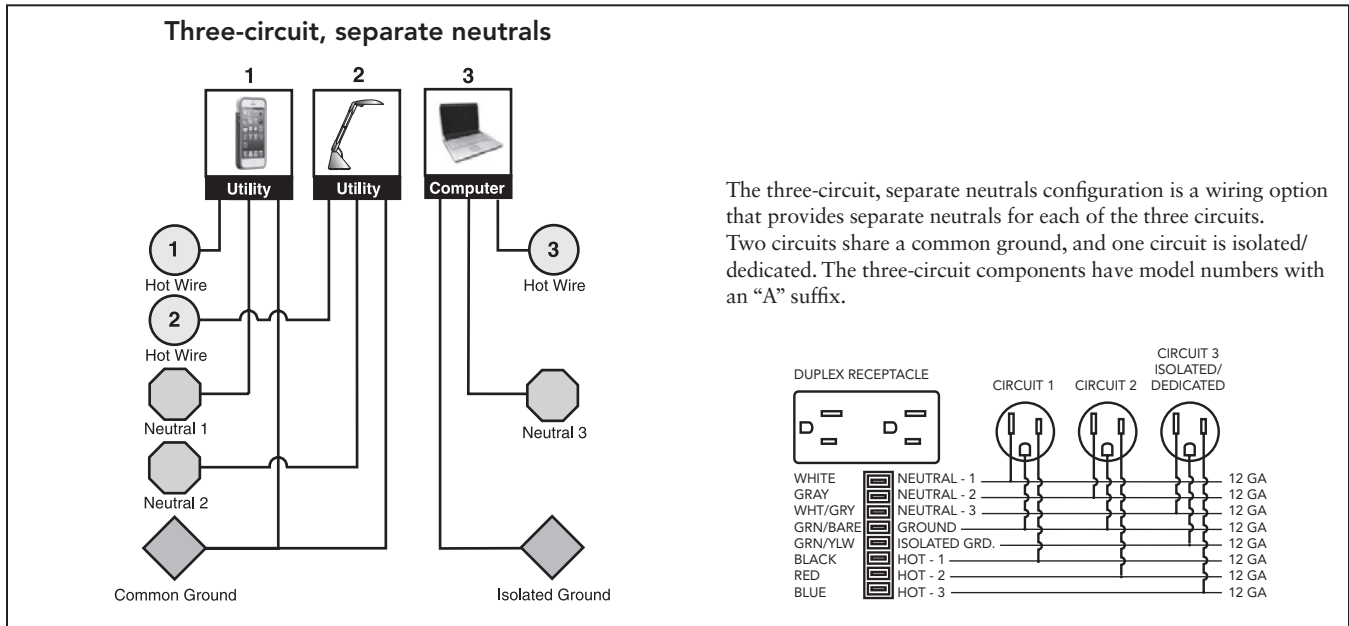

Stride System Receptacle Usage					
Two 8-wire, 20 amp (15 amp Canadian) electrical systems are offered					
Electrical System	Circuitry	Receptacle Capacity			
Four-circuit 4-Hot/2-Neutral/2-Ground	3 + 1	Common Circuit-1 A877501	Common Circuit-2 ⁽¹⁾ A877502	Common Circuit-3 A877503	Iso/Dedicated Circuit-4 A877504
	2 + 2	Common Circuit-1 A877501	Common Circuit-2 A877502	Isolated Circuit-3 A877506	Isolated Circuit-4 A877504
Three-circuit 3-Hot/3-Neutral/2-Ground	w/separate neutrals	Common Circuit-1 A877501A	Common Circuit-2 A877502A	Iso/Dedicated Circuit-3 A877503A	N/A

Notes:

- Four-circuit components and three-circuit components (with suffix "A") cannot be used together.
- Components of the two systems are keyed differently to prevent components of one system being connected to components of another system.
- Allsteel Model Numbers are printed on the UL labels, and components are color-coded to provide visual identification of the different components.
- Four-circuit components have black plastic parts.
- Three-circuit components have rust-colored terminal ends and receptacle backs are rust colored.

(1) Circuit 2 (one of the 3 common circuits sharing a neutral wire) cannot be used with a single-phase building electrical supply.

Duplex Receptacle

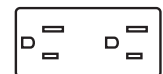

15 amp Receptacle

Power Harnesses, Pass-Thru Cables, and Jumpers

Electrical power harnesses are used to distribute power in Stride panels. Harnesses can be mounted at the base pathway and at 7½" vertical intervals above the base pathway using mounting brackets or power block beltline mounting brackets. **Power blocks** on electrical power harnesses and pass-thru harnesses accept duplex receptacles.

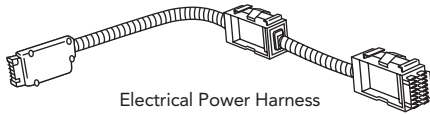

Electrical Power Harness

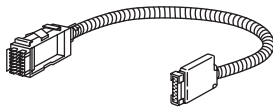

Electrical Pass-Thru Harness

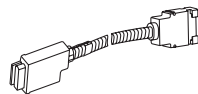

Electrical Pass-Thru Harness without Power Block

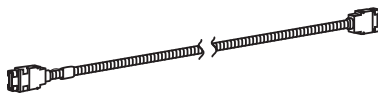

Electrical Jumper Cables

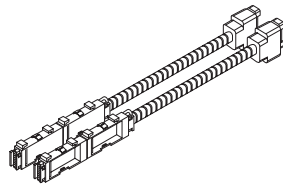

Dual Electrical Eight-circuit Power Harness Kit

All electrical power harnesses and pass-thru harnesses (except 20"W) will stretch 3½", allowing them to span "T", "X", and "A" intersections and "S" extended straight connections.

Note: "T" intersections require a minimum of one power harness and "X" intersections requires a minimum of two power harnesses.

Use of a ceiling infeed or jumper requires one additional harness.

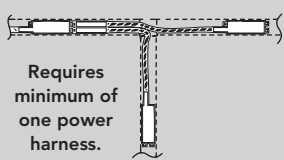

Requires minimum of one power harness.

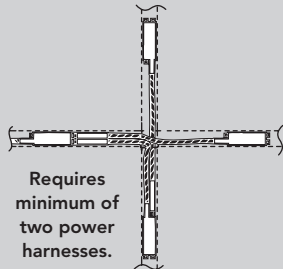

Requires minimum of two power harnesses.

Use of a ceiling infeed or jumper at this location requires an additional power harness.

Power Harnesses (page 196)

- Specify harness length to match panel width. 24" power harnesses accept one receptacle on each side of the harness when exposed, all other power harnesses have power blocks to accept four duplex receptacles (two on each side of panel).
- Connectors at both ends of power harnesses allow power distribution in either direction.
- Harness power blocks snap directly onto brackets in base pathway; at beltline or other vertical locations harnesses require optional mounting brackets.

Pass-thru Harnesses (page 196)

- Electrical pass-thru harnesses have capacity to handle one duplex receptacle on each side of panel.
- Electrical pass-thru harnesses distribute power in panels — specify harness length to match panel width.
- Electrical pass-thru cables distribute power through any panel where receptacles are not required.
- 20"W frames use 20"W pass-thru cables since they do not have electrical knockouts or ported tiles. Cable length cannot be stretched.

Jumper Cables (page 196)

- Electrical jumper cables connect power from base pathway or beltline to a harness located on any horizontal member as needed.
- Jumper cable plugs into power block end of electrical power harness or electrical pass-thru harness.
- Model A871366 is 66" and connects beltline power harnesses at 90° juncture to adjacent base line power.
- Model A8713108 is 106" to jumper up to 69" vertically – from base rail up to the highest 7½" opening on a 65"H frame.

Dual Electrical Eight-circuit Power Harness Kits (page 196)

- Kit provides back-to-back four-circuit systems giving double the capacity of harness and pass-thru cables
- Requires two four-circuit infeeds. Uses four-circuit receptacles.
- Models must be positioned "back-to-back" in the panel — single-side use is not permitted
- Components can only be routed in a single run — a single run cannot branch to multiple panel runs at "T" and "X" junctions.
- Four-circuit jumper cables (A8713xx) can only be connected to a power block at one end of a run. Power cannot be routed between a run in the base pathway and a run in the beltline area, except at one end of the run.
- To connect power between the base pathway and the beltline area, four-circuit jumper cables (A8713xx) must be connected to a power block at one end of a run, routed into an adjacent panel that contains no power harness, then routed back into the panel that contains a power harness (or pass-thru cable), and connected to a power harness in the other pathway.
- Standard four-circuit pass-thru cables (A8710xx) can be used in between power harnesses. Two are required in the back-to-back configurations.
- Models can be connected to standard four-circuit power harnesses and pass-thrus, although it is not recommended because of possible circuit number ambiguity
- Two power infeeds are required to connect the back-to-back runs. Power infeed A8719xx must be connector to a power block at the end of a run.
- Data faceplates and terminals cannot be positioned in a panel into which back-to-back power harnesses are installed
- Power infeeds A8719xx must be routed from a panel wherein no power harness is positioned, into an adjacent panel where a power harness is positioned and connected to the end of a power block.

Power Blocks

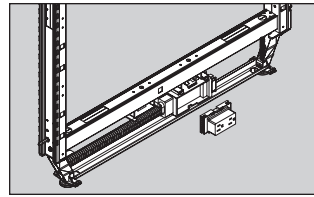

Stride offers multiple options for mounting electrical:

Base Pathway Mounting

- Power blocks snap directly onto brackets in base pathway area and accept receptacles on each side of harness.

Beltline Mounting Brackets (page 197)

- For exposed receptacles at beltline mount power blocks onto electrical mounting bracket (8988EBZ or 8988EBZ3 for 35" H base panel frames — sold separately) which screw into the panel frame or segment kit.
- Port tiles must be used where exposed receptacles will be located.

Segment Kit Mounting Brackets (page 197)

- When using segment kits at other locations mount power blocks onto electrical mounting bracket (8988EBZS — sold separately) which screw into segment kit.
- Port tiles must be used where exposed receptacles will be located.

Below Worksurface Mounting Brackets (page 197)

- When using a 22½" ported tile for power below the worksurface, use beltline electrical mounting bracket (8988EBZ — sold separately) and mount the bracket underneath the standard beltline horizontal.

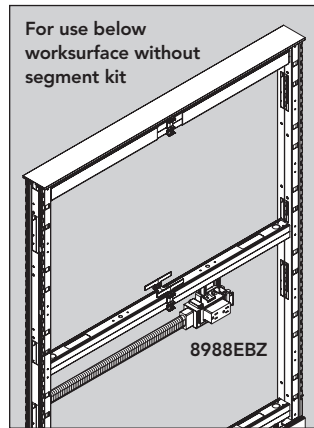
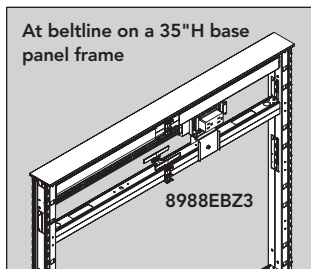
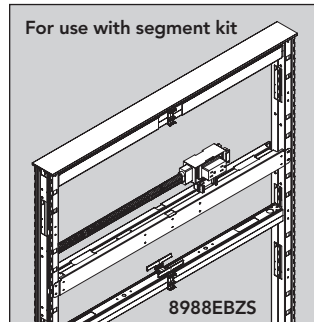
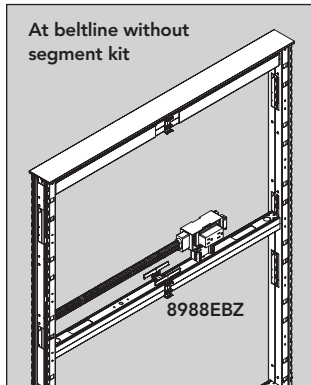

Receptacles

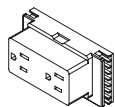

Duplex Receptacles

Duplex Receptacles (page 197)

- Duplex receptacles snap into power blocks of power harnesses or pass-through harnesses.
- Duplexes are available in multiple colors. See page 120 for finishes.
- Each receptacle is labeled to indicate which circuit it will be connected to: 1, 2, 3, or 4.
- Duplexes are model specific to support either 3+1 and 2+2 electrical infeed; or have an “A” suffix and are design to support a three-circuit separate neutral electrical infeed.

Receptacle Color Recommended to Coordinate with Paint Color

Paint Color	Receptacle Color
Bungalow P7C.....	Muslin — EU
Carob — P52.....	Black — E4
Champagne Metallic — PR5.....	Muslin — EU
Cinder P7Q.....	Brownstone — EY
Fossil — P28.....	Flint — E9
Gunmetal Metallic — PR3.....	Brownstone — EY
Parchment — P93.....	Muslin — EU
Pebble P8R.....	Loft — EV
Pewter P8D.....	Flint — E9
Platinum Metallic — PR2.....	Loft — EV
Salt P8C.....	Silver — ES
Titanium P8T.....	Silver — ES

Cable and Wire Management

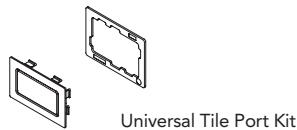
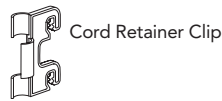
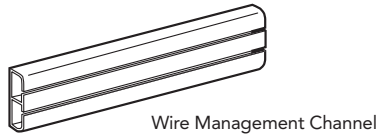
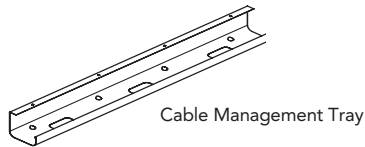

Cable Management Tray (page 197)

- Attaches under the worksurface to contain cables.
- Metal tray shelf is 4" deep. Can hold electrical power strip and/or surge protector.
- 24" and 36" lengths, use multiple units for larger worksurfaces.
- Attachment hardware included, specify paint color.

Wire Management Channel (page 197)

- Self adhesive backing to attach to panels and underside of worksurfaces.
- Flexible strips allow cabling to enter/exit and can be contained inside the 2-cavity profile.
- Each cavity provides space for a maximum of six .22" dia. cables. Total capacity = 1 sq. in.

Cord Retainer Clip (page 197)

- Provides confinement of vertical electrical/data wiring.
- 1½"H cord clips snap into vertical panel slots to contain cords.
- 4 clips are provided standard with each task light cord.

Data Management Organizers (page 197)

- **Cable organizers** are made of rigid polymer, and hang from the horizontal cross members or in the base raceway. Can be stacked infinitely.
- Cables can be placed into the extensions of the organizers to keep cables aligned as they pass through the panel frame.
- Commercially available tie-wraps can also be used to strap cables to the organizer extensions.
- Organizers are ordered separately in packs of 20.

Universal Tile Port Kit (page 197)

- Allows field installation of additional data accessories.
- Grommet opening dimension — 1.375"H x 2.700"W.

Wireway Grommet (page 197)

- Fits into any receptacle opening.
- Used when routing wires through receptacle opening.

Lighting

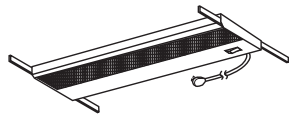

Task Lights

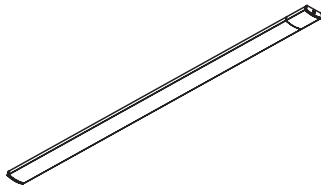

Undercabinet LED Light

Task Lights (page 400)

- Task lights can be recessed under storage cabinets or storage shelves, panel-hung, or freestanding.
- Three styles of recessed task lights in four sizes are available to correspond to cabinet or shelf width.
- All styles have 9' power cords in black, connected in the right rear corner.
- All models feature electronic ballast for longer bulb life and cooler operating temperature.
- Task lights with a fused plug to meet Chicago electrical code are also available.

Recommendation: Provide a separate circuit for task lights for proper long-term operation without RF interference to computers that may be in use.

Undercabinet LED Light (page 400)

- Undercabinet LED light can be mounted beneath overhead cabinets with wood screws or magnets.

Data

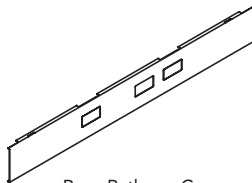

Base Pathway Cover

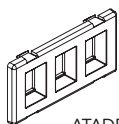

ATADF3

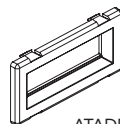

ATADF4

Base Pathway Covers (page 198)

- Features an additional knockout (offset) for improved utilization of power and data. Knockouts are 2.700" W x 1.377" H.
- Due to panel depth, back-to-back data modules should not be used at beltline or in the base on Stride.

Data Faceplates (page 198)

- Fit into receptacle and data port openings in base raceway covers or into data port (UTP).
- Due to panel depth, back-to-back data modules should not be used at beltline or in the base on Stride.

Base Pathway Receptacle Locations

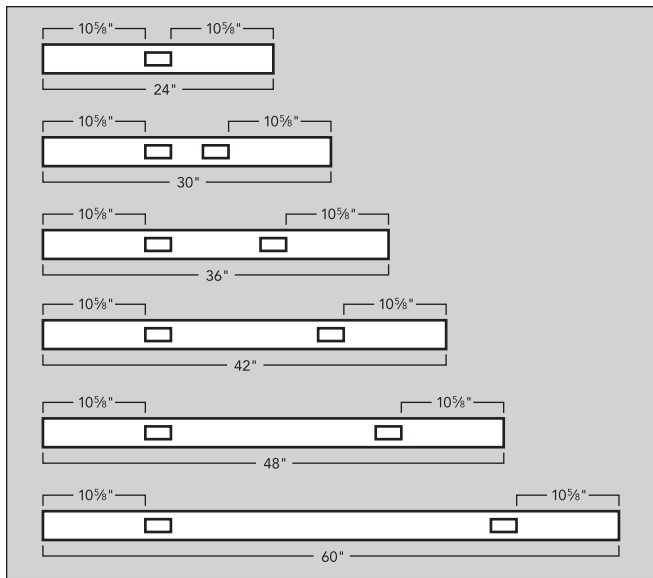

Circuit Usage

Strategy 1

Circuits to Equipment

Assign specific uses for each of the circuits. For example, in a four-circuit system:

- Circuit 1 — calculators, fans, etc.
- Circuit 2 — task lights (could be wired to wall switch)
- Circuit 3 — CRT or flat screen monitors
- Circuit 4 — CPUs

Strategy 2

Circuits to Workstations

Assign specific workstations to each of the three available circuits. Use circuit 4 for power-sensitive electronic equipment.

Placement of pedestals and lateral files may render some duplex locations inaccessible. Pedestal placement may also affect compatibility with pull-up receptacles.

Lay-in Cable Capacity — Stride cable quantities listed at 60% fill ratio

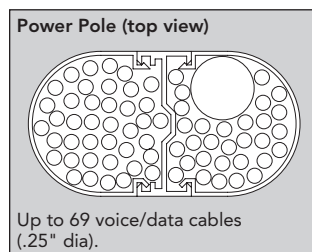
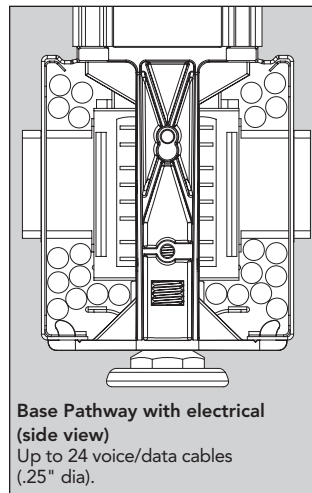
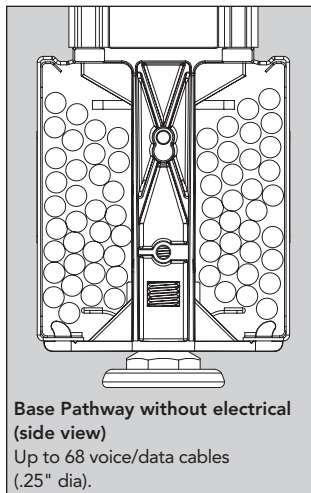
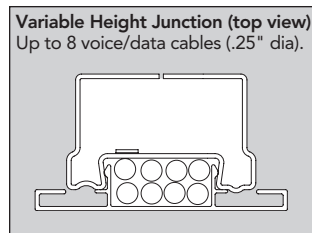
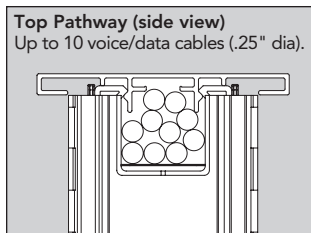

The top and base pathway allow continuous voice and data lines to run through and between panels without interruption. Lay-in is provided for environments where systems furniture or cabling are subject to frequent change.

- Stride panels top pathway accepts up to 10 voice/data cables (.25" dia).
- Stride panels variable height junctions accept up to 8 voice/data cables (.25" dia.) with a bend radius of approximately 1/2" to 3/4".
- Stride panels base pathway accepts up to 68 (5.56 sq. in.) voice/data cables (.25" dia.) when electrical system is located in beltline pathway.
- When electrical system shares base pathway, the cable capacity in Stride panels is reduced to 24 (1.95 sq. in.) voice/data cables (.25" dia.) Cable quantities listed are at 60% fill ratio.
- Cable capacity of the Stride power pole, in addition to electrical infeed, is 2.79 sq. in. on one side and 2.91 sq. in. on the other for a total capacity of 69 cables of .25" diameter. Cable quantities listed are at 60% fill ratio.

Horizontal Capacity of Stride Frames

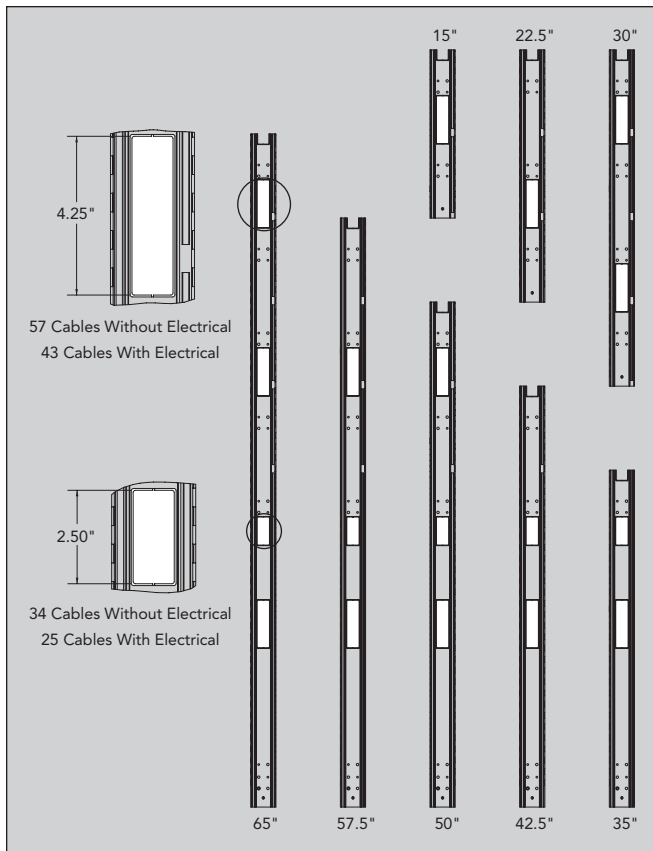

DO NOT run electrical equipment or extension cords through cable openings in frame sides. Use beltline or base-mounted electrical system for all electrical supply.

String-in Capacity

- Openings in frame sides permit data and communication cables to be run between frames at up to five levels in a 65"H Stride frame.
- Using tackable acoustical tiles, each opening accommodates up to 57 cables (.25" dia) and the beltline pathway accommodates 25 cables with electrical components installed.
- Cables can enter/exit panel through underside of base pathway at juncture between frames. Openings are sized as follows:

Stride Connections	Sq. In.
Straight	5.4
"S" Extended Straight	12.9
"L" 90°	13.0
"T"	16.6
"X"	20.4

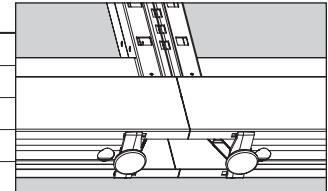

- When leveling glides are fully retracted, panel-to-floor clearance is 7/16". This may affect the volume of cabling that can be fed into the frame from the bottom of the pathway.

Vertical Capacity

Vertical Capacity Through Stride Panel Frames

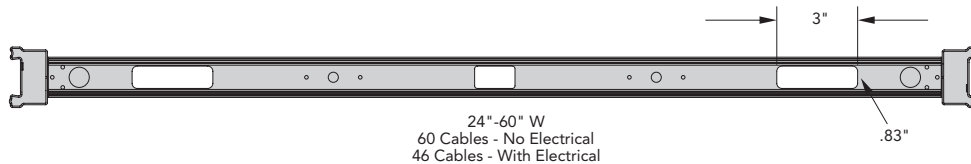

- A 60% fill ratio is achievable; however, when electrical components are installed in the beltline area, cabling capacity through the beltline area will be limited to approximately 45% fill ratio.

	Panel Width	Qty of .25" Cables at 40% Fill Ratio	Qty of .25" Cables at 60% Fill Ratio	Total Space (sq. in.)
Stride	24" – 60"W	46	60	4.90

STRIDE

Office Equipment Typical Load Values

Item	*Amps
Desktop Computer/2 Monitors	4
Laptop Computer	1
Laptop/2 Monitors/Docking Station	4
Paper Shredder	1.22
Radio	0.05
Scanner	3
Space Heater (1500 watts)	12
Task Light (equiv. 60-watt bulb)	
Fluorescent	0.12
LED	0.08
USB Charger	0.17
LCD Television (42")	1
LCD Monitor (21")	0.5
Bluetooth Speaker	0.1
Desktop Printer	
Inkjet	0.15
Laser	4 to 10
Multimedia Projector	1.7
Sit-to-Stand Height-Adjustable Desk	Idle 0.01 / Max 4
Office Kitchen	
Coffee Maker	10
Microwave	10
Toaster	12.5
Compact Refrigerator	1.5

*Chart is recommended for planning purposes. Check device specifications for exact amperage. Consult with your electrician regarding the applicable configurations.

Examples of Component Usage based on the *Office Equipment Typical Load Values Chart*

Power Option 3+1

Dedicated Circuit 4: 4 desktop computers with 2 monitors each; or 10 laptop computers
Utility Circuits 1, 2, 3: Height-adjustable tables and ancillary items

Power Option 2+2

Dedicated Circuit 3: 4 desktop computers with 2 monitors each; or 10 laptop computers
Dedicated Circuit 4: 4 desktop computers with 2 monitors each; or 10 laptop computers
Utility Circuits 1, 2: Height-adjustable tables and ancillary items

Power Option 3 (Circuit-separate neutrals)

Dedicated Circuit 3: 4 desktop computers with 2 monitors each; or 10 laptop computers
Utility Circuits 1, 2: Height-adjustable tables and ancillary items

For specification information see pages 184-194.

GSA SIN 33721

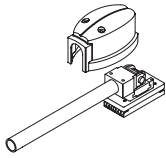

Description	Four-circuit 3 + 1 2 + 2	Three-circuit Separate Neutrals	List Price
Base Electrical Infeed Cable			
6' Sealtight cable	A877072	A877072A S	\$ 406
6' Flex Cable	A871972	A871972A S	\$ 294



Ceiling Electrical Infeed Cables			
12' Flex Cable	A871912	A871912A S	\$ 399
18' Flex Cable	A871918	A871918A S	\$ 502

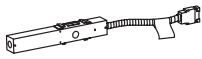

Hardwire Power Infeed (New York Code)			
30-60"W Panels	A871400	A871400A S	\$ 383

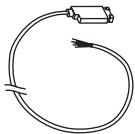

Electrical Base Infeed Cable			
12' Sealtight Cable Power Infeed	A877012	N/A S	\$ 487



Description	Model	P1 Paint List Price	P2 Paint List Price
Integrated Power Pole			
42½" to 57½"H Panels	Z235PP S	\$ 629	\$ 653
65"H or higher Panels	Z265PP S	\$ 413	\$ 437

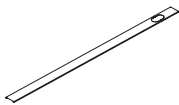

Description	Painted Model	Veneer Model	P1 Paint List Price	P2 Paint List Price	Veneer V1 List Price
Power Pole Trim Kit					
24"W	Z324PP S	Z324PPV S	\$ 221	\$ 246	\$ 1230
30"W	Z330PP S	Z330PPV S	\$ 227	\$ 252	\$ 1276
36"W	Z336PP S	Z336PPV S	\$ 237	\$ 262	\$ 1330
42"W	Z342PP S	Z342PPV S	\$ 247	\$ 272	\$ 1376
48"W	Z348PP S	Z348PPV S	\$ 252	\$ 277	\$ 1420
54"W	Z354PP S	Z354PPV S	\$ 260	\$ 285	\$ 1464
60"W	Z360PP S	Z360PPV S	\$ 270	\$ 295	\$ 1509
68"W	Z368PP	Z368PPV	\$ 281	\$ 306	\$ 1563
72"W	Z372PP	Z372PPV	\$ 285	\$ 310	\$ 1611
78"W	Z378PP	Z378PPV	\$ 294	\$ 319	\$ 1655
84"W	Z384PP	Z384PPV	\$ 303	\$ 328	\$ 1699
90"W	Z390PP	Z390PPV	\$ 310	\$ 335	\$ 1744
96"W	Z396PP	Z396PPV	\$ 316	\$ 341	\$ 1786

STRIDE

<p>How to specify — Select the Model Number from above.</p>	<p><i>1st Option:</i> Color (if applicable): P Black only</p>	<p><i>1st Option:</i> Paint (if applicable): See page 120 for finishes.</p>	<p><i>1st Option:</i> Veneer Type and Finish (if applicable): See page 120 for finishes.</p>
<div style="display: flex; justify-content: space-between; width: 100%;"> _ _ _ _ _ _ _ _ _ _ </div>	<div style="display: flex; justify-content: space-between; width: 100%;"> _ _ _ _ </div>	<div style="display: flex; justify-content: space-between; width: 100%;"> _ _ _ _ _ _ </div>	<div style="display: flex; justify-content: space-between; width: 100%;"> _ _ _ _ _ _ _ _ </div>

Examples: A871912.P Z235PP.P7D Z324PPV.SC777

S Shippable by small-package carrier.

For specification information see pages 184-194.

GSA SIN 33721

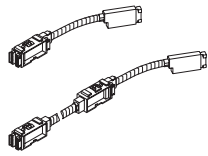

Description	Four-circuit 3 + 1 2 + 2	Three-circuit Separate Neutrals	List Price
Electrical Power Harnesses			
For 24" W Frames	A871224	A871224A S	\$ 347
For 30" W Frames	A871230	A871230A S	\$ 347
For 36" W Frames	A871236*	A871236A S	\$ 347
For 42" W Frames	A871242*	A871242A S	\$ 369
For 48" W Frames	A871248*	A871248A S	\$ 369
For 60" W Frames	A871260*	A871260A S	\$ 369

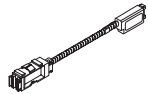

Electrical Pass-Thru Harnesses with Power Block			
For 24" W Frames	A871124	A871124A S	\$ 212
For 30" W Frames	A871130	A871130A S	\$ 212
For 36" W Frames	A871136*	A871136A S	\$ 212
For 42" W Frames	A871142*	A871142A S	\$ 226
For 48" W Frames	A871148*	A871148A S	\$ 226
For 60" W Frames	A871160*	A871160A S	\$ 226
For 72" W Frame Runs	A871172	A871172A S	\$ 303

Electrical harnesses are intended for use with Allsteel systems furniture and are approved under GSA SIN 33721. When purchased separately and used without Allsteel systems furniture, those electrical harnesses marked by () are considered Open Market.



Electrical Jumper Cables – Harness to Harness			
Up to 30" vertical jump (66")	A871366	A871366A S	\$ 240
Up to 69" vertical jump (108")	A8713108	A8713108A S	\$ 449



Electrical Pass-Thru Cable without Power Block			
For 24" W Frames	A871024	A871024A S	\$ 194
For 30" W Frames	A871030	A871030A S	\$ 194
For 36" W Frames	A871036	A871036A S	\$ 194
For 42" W Frames	A871042	A871042A S	\$ 203
For 48" W Frames	A871048	A871048A S	\$ 203
For 60" W Frames	A871060	A871060A S	\$ 203

NOTE: Four-circuit components and Three-circuit components (with an "A" suffix) cannot be connected together.

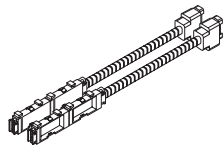

Description	Max. Recept. Cap. per Panel Side	Eight-circuit 3 + 1 (each side) 2 + 2 (each side)	List Price
Dual Electrical Eight-circuit Power Harness Kit			
For 24" W Panels	1	A2-8CIR24 S	\$ 835
For 30" W Panels	2	A2-8CIR30 S	\$ 835
For 36" W Panels	2	A2-8CIR36 S	\$ 1209
For 42" W Panels	2	A2-8CIR42 S	\$ 1209
For 48" W Panels	2	A2-8CIR48 S	\$ 1209
For 60" W Panels	2	A2-8CIR60 S	\$ 1219

NOTE: Kit consists of two four-circuit harnesses placed "back-to-back" to provide 8 circuits.

STRIDE

How to specify —
Select the
Model Number
from above.

1st Option:
Color
(if applicable):
P Black only

P

Examples: A871224.P A871224A.P

S Shippable by small-package carrier.

For specification information see pages 184-194.

GSA SIN 33721

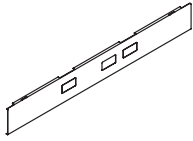

Description	Model	P1 Paint List Price	P2 Paint List Price	P3 Paint List Price
Base Raceway Covers — Knockouts (Stride)				
36" W	TBPLATE3-36 S	\$ 89	\$ 104	\$ 116
42" W	TBPLATE3-42 S	\$ 91	\$ 106	\$ 118
48" W	TBPLATE3-48 S	\$ 97	\$ 112	\$ 124
60" W	TBPLATE3-60 S	\$ 112	\$ 127	\$ 139

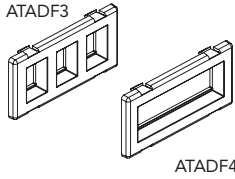

Data Faceplates

Three-Port Flex-Mode Faceplate, Black (E4)	ATADF3 S	\$ 36	N/A	N/A
Four-Port Flex-Mode Faceplate, Black (E4)	ATADF4 S	\$ 36	N/A	N/A

Note: ATADF3 can install up to 3 jacks (CAT 3, 5E, or 6).

ATADF4 can install 4 jacks (CAT 3, 5E, or 6).

Allsteel's data faceplates are designed for use with the jacks listed below. We do not guarantee compatibility with other manufacturers' product. A faceplate adapter is available for use with alternatively sourced data jacks, see the Standard Specials catalog for details.

Note: ATADF models are compatible with ports in Stride Tiles.

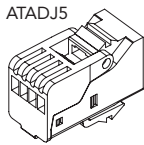

Jacks

RJ45 CAT 5E Jack — Black only Toolless	ATADJ5 S	\$ 65	N/A	N/A
RJ45 CAT 6 Jack — Black only Requires Tool	ATADJ6 S	\$ 87	N/A	N/A

STRIDE

How to specify —
Select the
Model Number
from above.

1st Option:
Paint
(Base Pathway Cover only):
P1 P2 P3
See page 120 for finishes.

1st Option:
Data Faceplate Color:
E4 Black

_____ . P _____

E _____

Examples: TBPLATE3-36.P27 ATADF4.E4

S Shippable by small-package carrier.

Laminate with Flat Edge or Veneer with Square Edge Worksurfaces

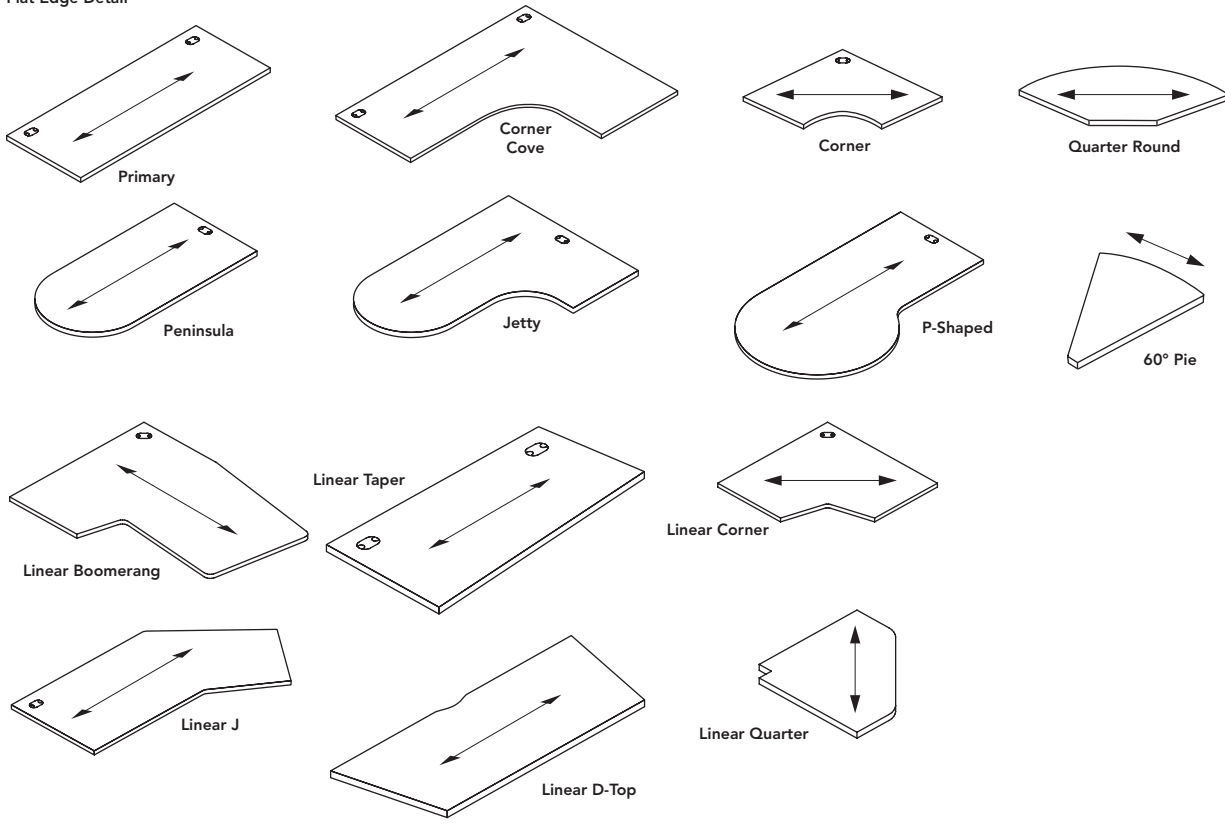
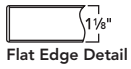

Note: Add suffix “N” to model number for no grommets, no upcharge.

←→ Arrows indicate grain direction for woodgrain laminates.
Grain direction on symmetrical corner worksurfaces runs at a diagonal.



Laminate worksurfaces are 1½" thick with particleboard core and with top surfaces finished in laminate. Bottom surfaces are covered with a backer sheet. Wall track allows for mounting of systems panel components on permanent wall structures.

Corner worksurfaces optimize use of space, and provide a convenient location for computer and monitor.

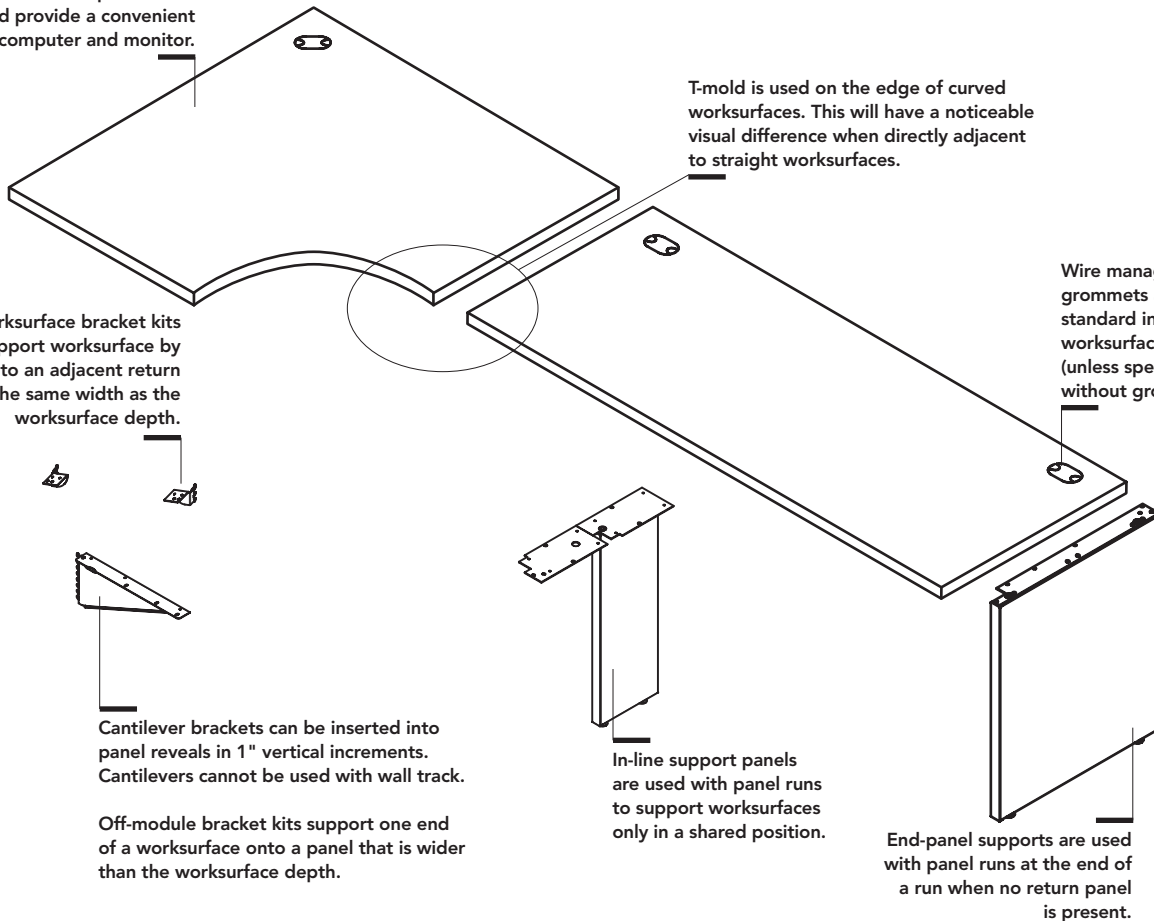

Worksurfaces can be configured at 29½"H or 26½"H with end-panel supports and in-line support panels, or at various heights on 1" increments using specific product configurations.

Worksurface support options include:

- Support column*
- Off-module bracket kit
- Flat brackets
- External support channel
- Worksurface bracket kit
- Height adjustable mechanism
- Cantilever bracket
- In-line support panels*
- End support panel*
- Support storage units*
- Storage unit with stanchion*
- C-Legs*
- Post Legs*

*Units provide floor support.

Support Guidelines — See Drawings on page 201

- Panel mounted worksurface runs 96" and greater need floor support for improved stability when overheads are not used.
- When using overheads in panel mounted worksurface run applications 72" and greater, floor support* is required. (See list at left.)
- When using overheads at the end of a panel run, floor supports* are required.
- Worksurface bracket kit should be used to tie panels to worksurface for added stability.
- A return panel at the end of a panel run can be substituted with one of these floor supports: storage, open or closed end support panel, O-leg.
- Cantilever brackets cannot be used at the end of a worksurface panel run in place of a return panel or floor support.
- Unsupported worksurfaces 60"W or greater require an external worksurface support channel. When a center support cantilever cannot be used, an external worksurface support channel is recommended for spans greater than 48"W.
- Support channel may interfere with mounting of some CPU holders and keyboard supports.
- Cantilevers are recommended in place of an external worksurface support channel where feasible.

Panel mounted worksurface runs 96" and greater need floor support for improved stability when overheads are not used.

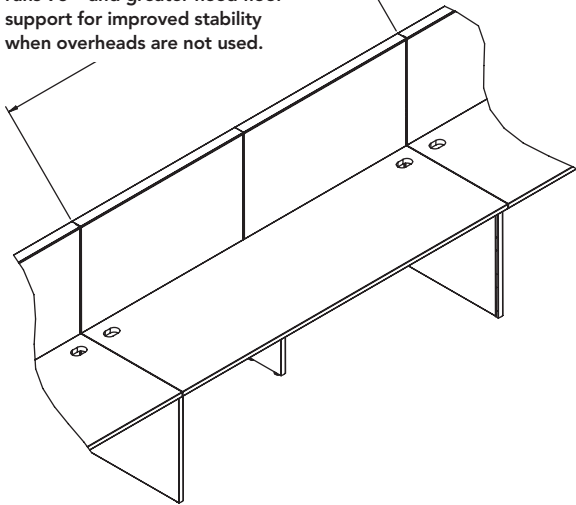

When using overheads in panel mounted worksurface run applications 72" and greater, floor support is required.

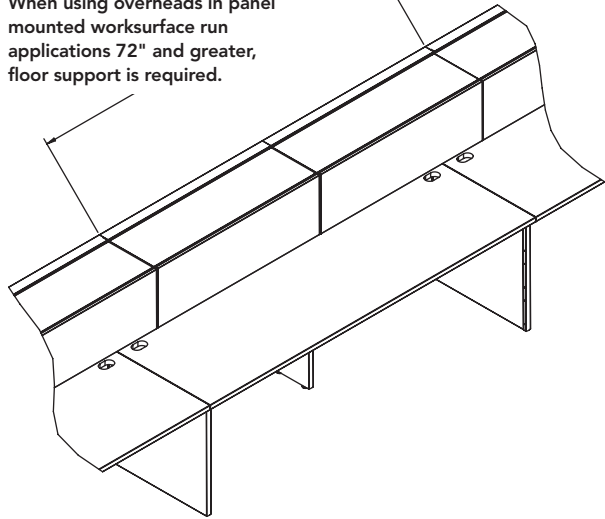

Worksurface bracket kit should be used to tie panels to worksurface for added stability

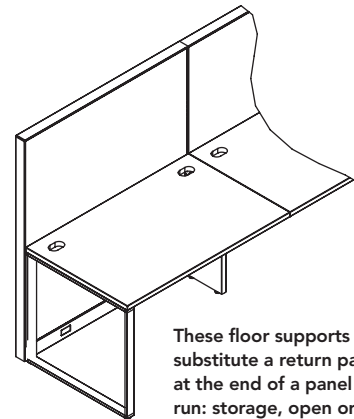
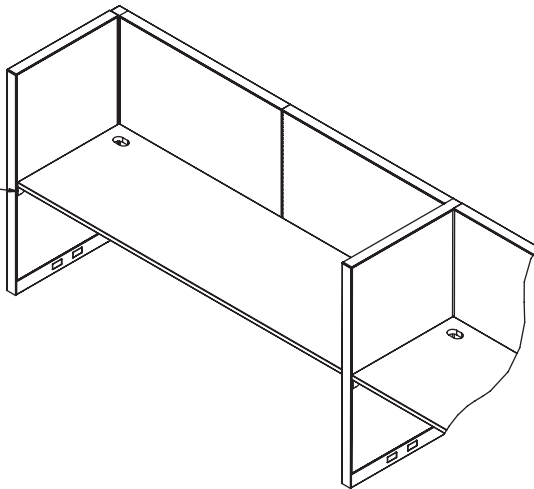
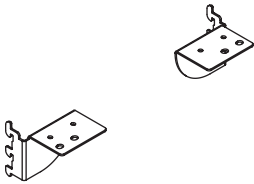

These floor supports can substitute a return panel at the end of a panel run: storage, open or closed end support panel, O-legs (shown, additional drawing on page 202)

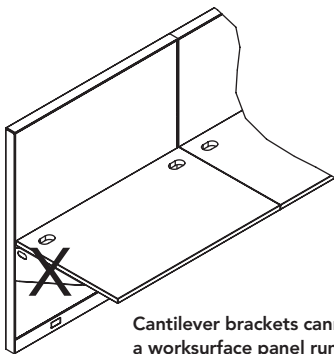

Cantilever brackets cannot be used at the end of a worksurface panel run in place of a return or floor support.

Cantilevers are recommended in place of an external worksurface support channel where feasible.

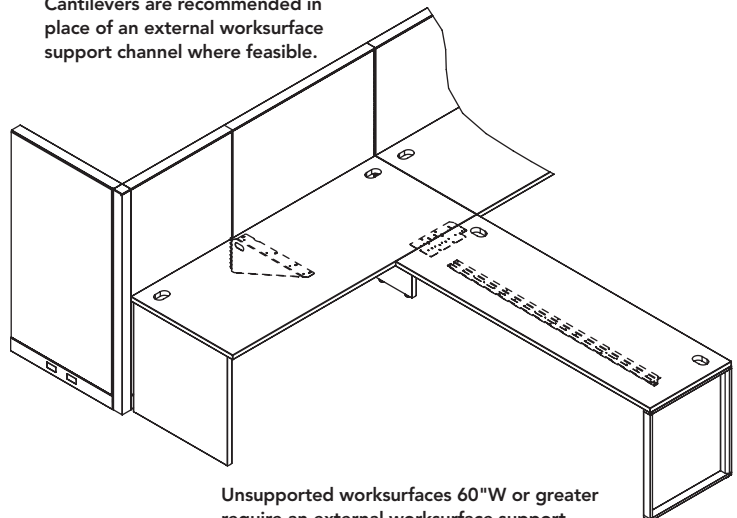

Unsupported worksurfaces 60"W or greater require an external worksurface support channel. When a center support cantilever cannot be used, an external worksurface support channel is recommended for spans greater than 48"W.

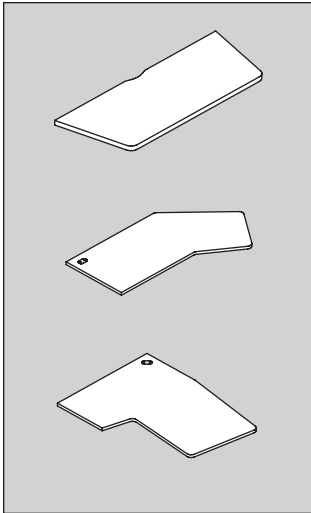

Linear D-shape, linear J, Linear boomerang, D-shaped, P-shaped, peninsula, jetty, boomerang, and reef worksurfaces require support columns (ordered separately).

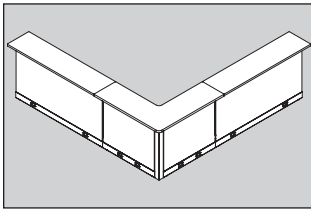

Stride countertops are flush with the top cap and are available in straight, corner, and 120° configurations. Mounting hardware is included with Stride countertops. Panel top caps need to be ordered separately.

Worksurface Application Versatility

Credenza tops are specified separately to allow spanning of multiple credenzas. Corner credenza makes use of under-desk space.

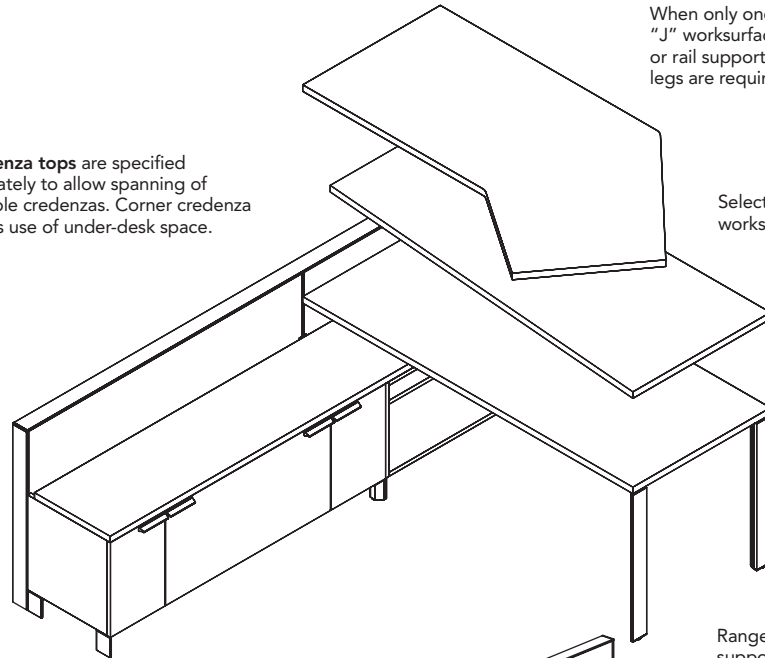

When only one end of a "J" worksurface is panel or rail supported, three legs are required.

Select from a range of worksurface shapes.

Range of light-scale support options with height adjustability.

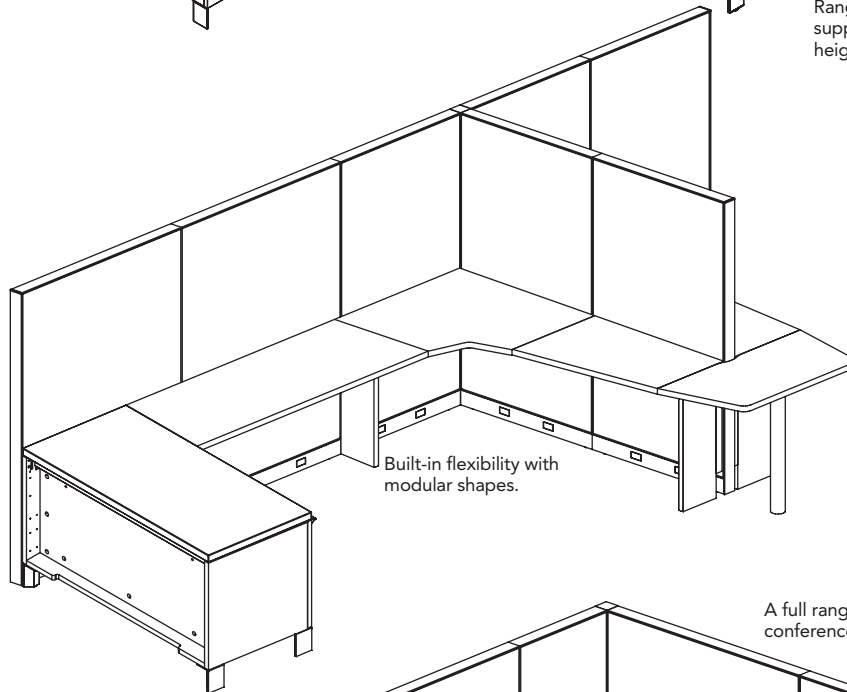

Built-in flexibility with modular shapes.

A full range of worksurface conference shapes are available.

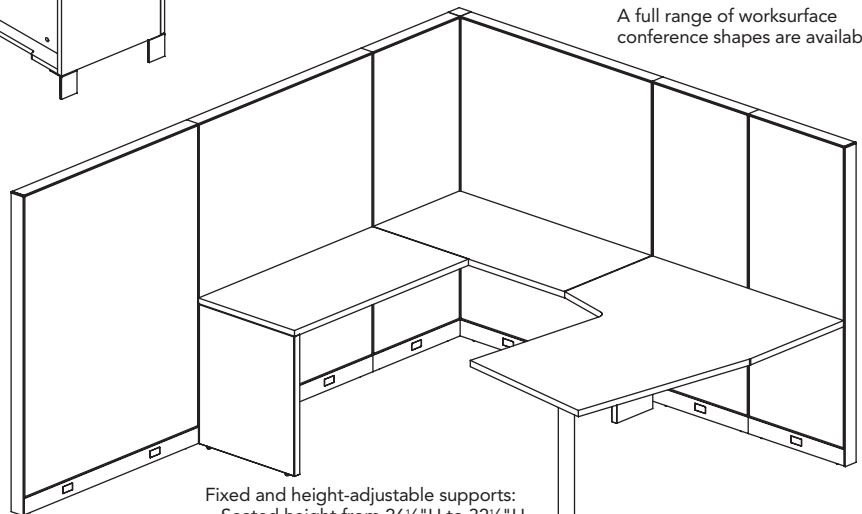

Fixed and height-adjustable supports:
Seated height from 26½" H to 32½" H
Standing height from 37½" H to 43½" H

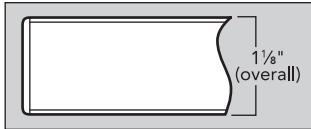

Flat Edge Trim

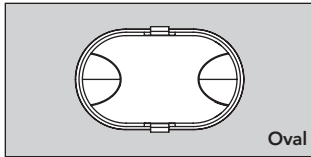

Oval

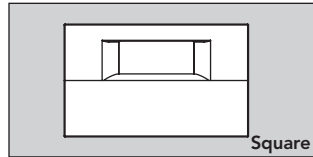

Square

Wire Management Grommets

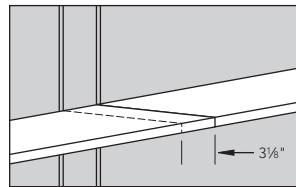
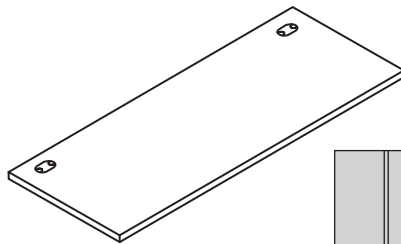

Optional width worksurfaces to span "T" or "S" panel connection.

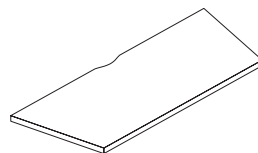
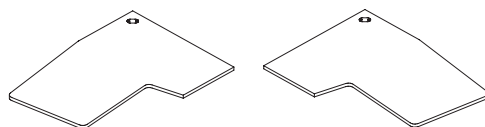
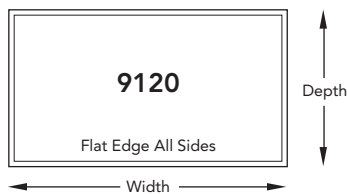

Worksurfaces

- Laminate (L) worksurfaces are 1 $\frac{1}{8}$ " thick with particleboard core and with top surfaces finished in laminate. Bottom surfaces are covered with a backer sheet.
- Flat edge trim is available on laminate tops in standard colors (customer specified) to match solid laminates and to complement patterned or woodgrain laminates.
- Veneer (V) worksurfaces have square veneer edge.

Wire management grommets are standard in most worksurfaces and are specified in plastic or metal.

- Metal grommets are available in oval or square (shown at left).
- Grommets on standard systems worksurfaces are located 6 $\frac{1}{16}$ " from side edges and 3 $\frac{3}{16}$ " from back edge.
- Add Suffix "N" to a model number for no grommets, no upcharge.

Primary Worksurfaces (L pages 211-212)

- Primary worksurfaces are available in 20", 24", 30", and 36" depths.
- One grommet for widths up to 42", two on widths 48"W and greater.
- Worksurfaces greater than 60"W require a cantilever bracket for center support in panel mounted applications. Specify 12" cantilever on 12"D, 18" cantilever on 20"D, and 24" cantilever on 24"D and 30"D worksurfaces.
- Optional width worksurfaces, 3 $\frac{3}{8}$ " wider than standard panel widths, are available for use with Stride panel runs having a "T" or "S" connection.
- Bracketry on post legs will interfere with grommets on systems (non-desking) worksurfaces.
- Nominal worksurface width is equal to nominal panel width.
- Corner worksurfaces include a corner left-handed support bracket. Other support hardware is ordered separately.
- Desking worksurfaces should be specified whenever worksurfaces 48"W and wider are not attached to a panel.

Non-Standard Worksurface Sizes (L and V on pages 218 and 219)

- The 9120 Program can be used to order laminate and veneer rectangular worksurfaces in any non-standard width and depth in $\frac{1}{8}$ " increments up to a maximum of 120"W x 36"D.
- Other modification requests should be made through Allsteel Tailored Products Group.

Linear Boomerang Worksurfaces (L page 213)

- Support column ordered separately.

Linear D-Shaped Worksurfaces (L page 213)

- Order support column and two 10"D in-line support panels.
- Worksurface includes attachment bracket.
- Not recommended for use with T6CB24L or T6CB24R for shared applications.

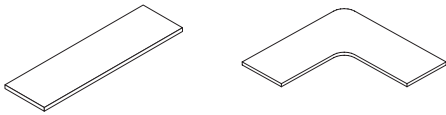

Countertops (L page 214)

- Available in Straight and Corner.
- Mounting bracket and attachment hardware included. When used with in-line high-low “H” trim kit add “V” suffix for straight countertop and “RV” for right or “LV” for left on corner countertops. Not available with fluid form models.
- Countertops are flush with panel top cap. Stride top caps need to be ordered separately.
- T-mold is used on the edge of curved worksurfaces. This will have a noticeable visual difference when directly adjacent to straight worksurfaces.

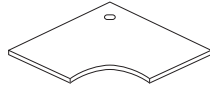

Corner Worksurfaces (L page 215)

- One rear corner support bracket included (left-handed). All other support hardware is ordered separately.
- Worksurface bracket kit (order separately) required at junction where a panel is wall-mounted to a permanent wall and wall track stanchion is not positioned in the right-hand corner.
- Corner worksurfaces with woodgrain laminate and veneer have grain direction diagonal to adjacent worksurfaces.
- T-mold is used on the edge of curved worksurfaces. This will have a noticeable visual difference when directly adjacent to straight worksurfaces.

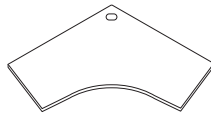

120° Corner Worksurfaces (L page 215)

- Standard with one wire management grommet in corner location.
- Rear support bracket included (left-handed).
- Worksurface bracket kit (order separately) required at junction where a panel is wall-mounted to a permanent wall and Wall Track stanchion is not positioned in the right-hand corner.
- T-mold is used on the edge of curved worksurfaces. This will have a noticeable visual difference when directly adjacent to straight worksurfaces.



60° Pie Worksurface (L page 215)

- Order support column and two flat brackets separately.

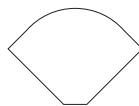

Quarter-Round Worksurface (L page 215, V page 220)

- Connect to 90° panel-attached worksurfaces.
- Order support column and shared cantilevers or in-line support legs separately.

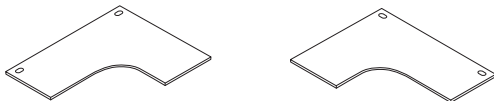

Corner Cove Worksurfaces (L page 216)

- Worksurfaces 66" and over require a cantilever bracket for center support in panel mounted applications. Specify 24" cantilever on 24"D and 30"D worksurfaces.
- Rear corner support bracket included (left-handed).
- Worksurface bracket kit (order separately) required at junction where a panel is wall-mounted to a permanent wall and wall track stanchion is not positioned in the right-hand corner.
- T-mold is used on the edge of curved worksurfaces. This will have a noticeable visual difference when directly adjacent to straight worksurfaces.

Support columns shown below ordered separately.

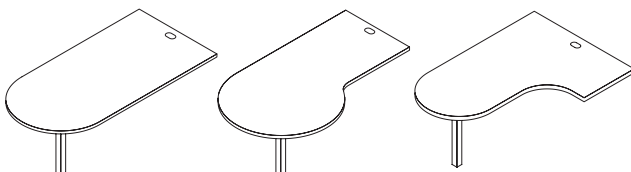

Peninsula, P-Shaped and Jetty Worksurfaces

(L page 217)

- Support column ordered separately, column includes panel support brackets T6BK.

End Panels and Panel Brackets

Worksurfaces can be configured at 29½"H with end-panel supports and in-line support panels, or at various heights on 1" increments using specific product configurations.

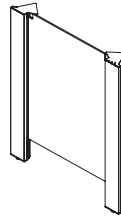

Freestanding End Panel Legs — Painted Wood (page 221)

- Available in 29½" height and 24" and 30" depths.
- Freestanding end panel leg includes two post legs, painted wood modesty panel, and attachment hardware.
- Order according to type of worksurface (flat/square or rabbet edge) the end panel leg will support.
- End panel leg will interfere with the grommet location on systems (non-desking) worksurfaces.

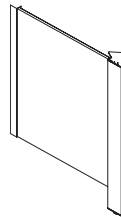

Panel-Mount End Panel Legs — Painted Wood (page 221)

- Available in 29½" height and 20" and 24" depths.
- Panel-mount end panel leg includes one post leg, painted wood modesty panel, panel-mount bracket, and attachment hardware.
- Order according to type of worksurface (flat/square or rabbet edge) the end panel leg will support.
- Handedness is determined by position relative to the user. Specify a left hand leg to be on the user's left hand side, specify a right hand leg to be on the user's right hand side.
- End panel leg will interfere with the grommet location on systems (non-desking) worksurfaces.

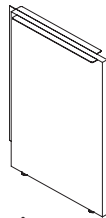

In-Line Panel Supports — Painted Wood (page 221)

- Worksurface in-line support panels are used to support worksurfaces only in a shared position.
- Available in 29½" height and 10", 20", and 24" depths.
- Includes painted wood support panel with wire management grommet, panel-mount bracket, and attachment hardware.
- Supports will interfere with the grommet location on systems (non-desking) worksurfaces.

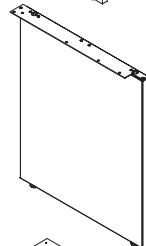

End Support Panel — Metal (page 222)

- Includes end-panel (non-handed), attaching hardware, and adjustable glides. (Panel mount version includes panel mount bracket.)
- End support panels are used in place of return panels at the end of worksurface runs.
- Leveling glides provide 3" of adjustment.
- Cannot be used with rabbet edge worksurfaces.

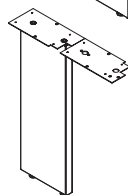

In-Line Support Panel — Metal (page 222)

- Includes support panel (non-handed), attaching hardware, adjustable glides, and wire management grommet. (Panel-mount version includes panel mount brackets.)
- Cannot be used with rabbet edge worksurfaces.

Panel Mount Bracket — Non-Handed (page 222)

- Includes hardware to convert freestanding end-panel or support leg to panel mount.

Pedestal-to-Panel Attachment Bracket (page 222)

- Can be used with Align™ pedestal in place of full end-panel or return panel. Provides structural support to panel run by securing panel directly to pedestal.
- Freestanding pedestals can also be used to support one end of a panel-attached worksurface in conjunction with ped-to-panel attachment kit.

Credenza-to-Panel Brackets (page 222)

- Used to attach the back or side of a credenza to a panel frame to provide stability when used with Stride panel frames.
- Handedness on side-to-panel bracket is determined by side of credenza that attaches to panel when facing panel run.

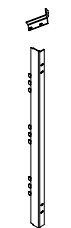

Panel Mount Bracket

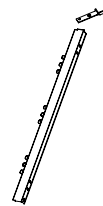

Ped-to-Panel



Credenza-to-Panel

Legs

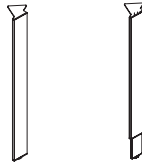

Post Legs (page 223)

- Used to support one corner of a panel attached worksurface. Cannot be used in freestanding applications, use table post legs.
- Fixed height is for support at 29½"H and 40½"H.
- 26½"H to 32½"H height adjustable legs provide a 6" range of adjustment in ½" increments.
- 37½"H to 43½"H height adjustable legs provide a 6" range of adjustment in ½" increments.
- Telescoping legs require common tools to adjust height.
- Leveling glides provide 1" of additional adjustment.
- Attachment hardware included.
- Post leg will interfere with the grommet location on systems (non-desking) worksurfaces.

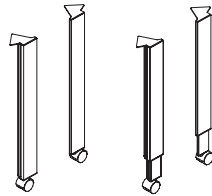

Freestanding Post Legs (page 223)

- Reinforced post leg with an integrated gusset is used to build a freestanding table.
- For use with Stride desking worksurfaces.
- Fixed height is for support at 29½"H.
- 26½"H to 32½"H height adjustable legs provide a 6" range of adjustment in ½" increments.
- Telescoping legs require common tools to adjust height.
- Leveling glides provide 1" of additional adjustment. Caster version aligns with glide version when glide is fully retracted.
- Attachment hardware included.

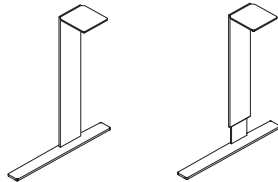

C-Legs (page 224)

- Used to support one end of a worksurface or table. Cannot be shared between surfaces.
- C-Legs cannot be used at both ends of a surface to create a freestanding desk.
- Fixed Height is for support at 29½"H.
- 26½"H to 32½"H height adjustable legs provide a 6" range of adjustment in ½" increments.
- Height adjustable C-legs are for use on worksurface spans up to 72"W. Fixed height C-legs must be used if the span is greater than 72"W.
- Telescoping legs require common tools to adjust height.
- Leveling glides provide ½" of additional adjustment.
- Attachment hardware included.

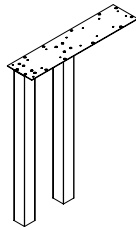

Post In-line Support Leg (page 224)

- Includes legs (non-handed, mounted to bracket) and attaching hardware.

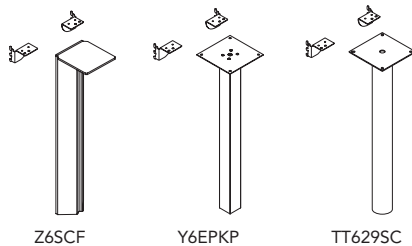

Z6SCF

Y6EPKP

TT629SC

Support Columns (page 224)

- Includes column, worksurface bracket kit T6BK, attaching hardware, and adjustable glides.
- Fixed height column is for support at 29½"H.
- Height adjustable column provides a 6" range of adjustment in ½" increments from 26½"H to 30½"H.

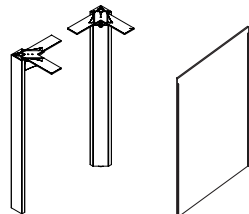

Light-scale Wire Management Table Post Legs (page 224)

- Includes pair of legs (non-handed, mounted to bracket) and attaching hardware. Available for modesty panel or not for modesty.
- Available painted or anodized.

Leg Modesty Panels (page 224)

- Height adjustable table post legs cannot be used with leg modesty panels.
- Available in ¼" thick Landscape™ surface material.

Worksurface Support Brackets

Cantilever Brackets

- Use with runs less than 96". Floor support is required for runs 96" and longer.
- Where applicable, cantilevers are recommended over an external worksurface support channel. Unsupported worksurface runs 60"W or greater require an external worksurface support channel when a cantilever cannot be used.
- Do not use at the end of a worksurface where no 90° return panel is positioned.
- Includes tie bracket and attachment hardware.
- Avoid installation on only one side of a straight connection except to support corner worksurfaces.
- DO NOT use to support worksurfaces from which a hanging pedestal is suspended, or to which a peninsula worksurface is attached.
- DO NOT use cantilever brackets to support worksurfaces supported with permanent-wall hanger kit.
- Do not use with wall track or to support a worksurface to which a return worksurface is attached.

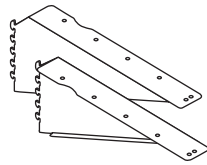

Cantilever Brackets — Handed

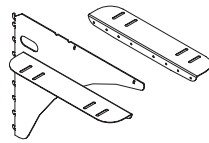

Cantilever Brackets — Non-Handed

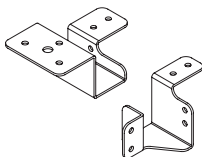

Non Rail-Based End Panel Kit Z6EPK

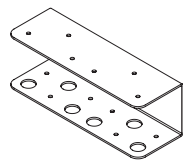

Layered Worksurface Bracket Z6C3BK

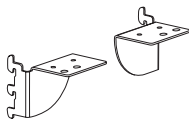

Worksurface Bracket Kit T6BK

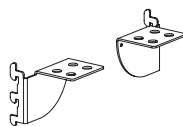

Worksurface Bracket Kit T6SB

Cantilever Bracket — Handed (page 225)

- Cantilever brackets are handed (left or right) and can be inserted into panel reveals in 1" vertical increments. No assembly required.
- Left- and right-hand brackets required in shared applications.
- 24"D cantilevers are required to be used for both 24"D or 30"D worksurfaces.
- 18"D cantilevers are required to be used for 20"D worksurfaces or center support for 24"D.
- 12"D cantilevers are required to be used for 12"D worksurfaces.

Cantilever Bracket — Non-Handed (page 225)

- Cantilever brackets are non-handed and can be inserted into panel reveals in 1" vertical increments. Assembly required.
- One bracket in shared applications — includes two angled brackets.
- Bracket accommodates 24"D or 30"D worksurfaces.

Non Rail-based End Panel Kit (page 225)

- Non rail-based end panel kit Z6EPK is used to attach an end panel off-module to a segmented panel.

Layered Worksurface Bracket (page 225)

- Layered worksurface bracket model Z6C3BK, used for mounting off-modular worksurfaces 3" higher or lower than the installed worksurface.

Worksurface Bracket Kits (Pair)— T6BK (page 225)

- Worksurface bracket kit allows one end of a worksurface to be supported by a return panel. Attachment hardware included.
- Return panel width must be the same as the depth of the worksurface.

Worksurface Bracket — T6SB (page 225)

- Worksurface storage bracket kit (T6SB) is used for aesthetics where under-desk storage is immediately adjacent to the return panel. In all other applications use worksurface bracket kit (T6BK) to utilize worksurface threaded metal inserts.
- Brackets — one pair. Black only.
- Attachment hardware included.
- Brackets do not align with worksurface threaded metal inserts, and therefore require wood screws (included).

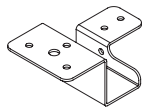

Off-Module Worksurface Bracket Z6MK

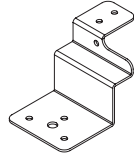

Off-Module Worksurface Bracket Z6Z3MK

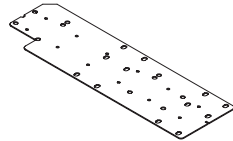

Flat Bracket

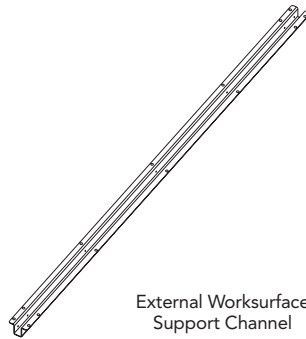

External Worksurface Support Channel

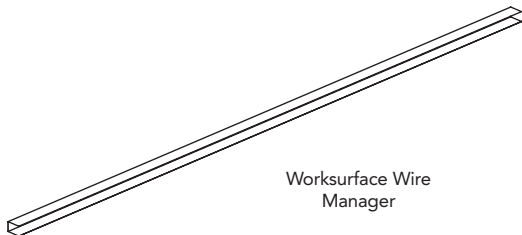

Worksurface Wire Manager

Off-Modular Worksurface Brackets (page 225)

- Allows in-line support legs and end-panels to be attached off-module.
- Cannot be used closer than 12" from end of panel.
- Non-rail based 3" layered worksurface bracket used to mount off-modular worksurface at 26½".
- Off-module worksurface bracket model Z6MK can only be used for attachment of a worksurface end to a segmented panel at 29½"H.
- Off-module worksurface bracket model Z6Z3MK is used for mounting non-rail based off-modular worksurfaces to a segmented panel at 26½"H.

Flat Brackets (page 225)

- Flat brackets can be used to connect one worksurface perpendicular to another worksurface.
- Use two 12"D flat brackets (T612FB) side-by-side with rabbet edge worksurfaces and when placing flat or rabbet edge worksurfaces perpendicular to high credenzas.

External Worksurface Support Channel (page 225)

- Support channel should be specified separately for use with non-desking worksurfaces.
- Extends 1½" below the worksurface. Installs 7" from user's edge.
- When using 28"H mobile pedestals the length of support channel needs to be reduced to accommodate width of the pedestal.
- Support channel may interfere with mounting of some CPU holders and keyboard supports.
- Is required on a systems worksurface for additional support for unsupported spans 66"W or greater. Width of worksurface span can be reduced by using support storage.
- Required when mounting a modesty panel.
- 36"D worksurfaces require two external support channels distributed equally from the center of the worksurface.

Worksurface Wire Manager (page 225)

- Provides channel to run wires under a worksurface.
- Extends 1½" below the worksurface.
- Wire manager (ordered separately) is mounted in front of the desk support channel to hide exposed hardware.

Desk screens and modesty panels provide light-scale space division. There are four options available: full desk screens, shared desk screens, desk modesty panels, and leg modesty panels.

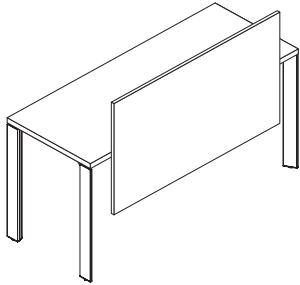

Full desk screens extend above and below the worksurface acting as both a screen and a modesty panel. They are 28"H and available in painted wood or painted wood with fabric Insert. Landscape™ surface material will soon be available as an additional finish option.

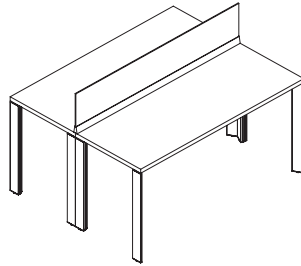

Shared desk screens are for use above the worksurface in a back-to-back application for added privacy. They are 13"H and are available in 3/8" Clear or Frosted Glass.

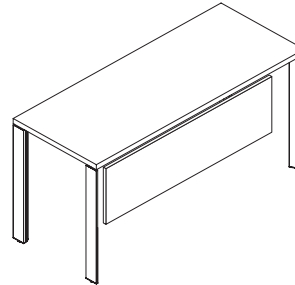

Modesty panels are for use below the worksurface. They must be used with Stride desking worksurfaces or a systems worksurface with an external support channel installed. An optional worksurface wire manager conceals hardware. They are 14"H and available in 3/4" thick painted wood or 1/4" thick Landscape surface material.

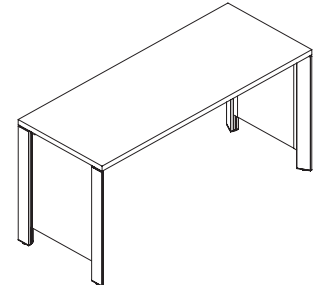

Leg modesty panels are used between two post legs on either a 24"D or a 30"D worksurface. They are 29"H and are available in Landscape surface material.

Specification Rules for Desk-Mounted Screens and Modesty Panels

FRONT VIEW

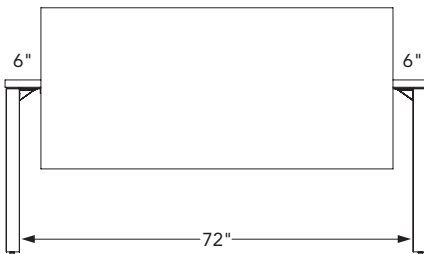

Freestanding Table Applications:

Subtract 12" from the size of the table/worksurface to get the recommended screen or modesty widths.

Example for an 84" W table: 84" - 12" = 72" W

Specify a 72" W screen and center-mount on the table.

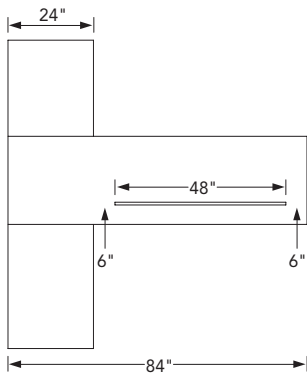

High Credenzas — TOP VIEW

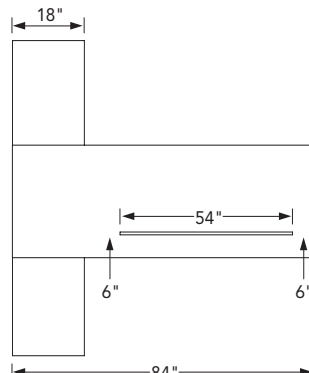

Low Credenzas — TOP VIEW

Credenza-based Layered Applications:

- **High credenzas** — Subtract 24" for the credenza depth and an additional 12" from the width of the worksurface to get the recommended width.

Example for an 84" W table: 84" - (24" + 12") = 48" W

Specify a 48" W screen and center-mount on the worksurface opening.

- **Low credenzas** — Subtract 18" for the credenza depth and an additional 12" from the width of the worksurface to get to the recommended screen width.

Example for an 84" W table: 84" - (18" + 12") = 54" W

Specify a 54" W screen and center-mount on the worksurface opening.



Screens and Modesty Panels

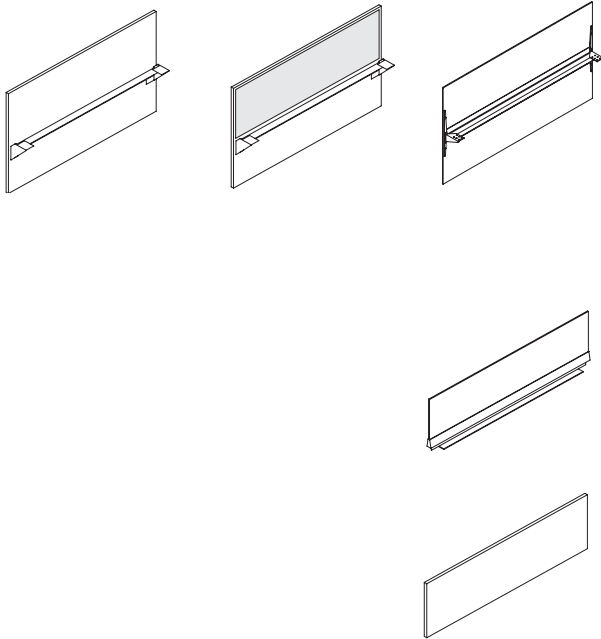

Full Desk Screens (page 226)

- Extend 13" above the worksurface to provide desktop privacy and 14" below the worksurface as a modesty panel.
- Width of full screen must be 12" less than the width of the worksurface. If used on a worksurface attached to a credenza rail, the width of the screen must be 3½" less than the width of the worksurface.
- Painted wood full desk screens are ¼" thick, plus a 1" gap for cord management between worksurface and screen.
- Painted wood with fabric insert screens are ¾" thick painted wood with a tackable fabric insert on the user's side.
- Landscape™ surface screens are ¼" thick Frosted Translucent.

Shared Desk Screens (page 226)

- Provide privacy above the worksurface in back-to-back or side-to-side applications.
- Shared screens extend 13" above the worksurface to align with 42½"H panels and storage.
- Available in ⅜" thick Clear or Frosted glass.

Modesty Panels (page 227)

- Includes attachment hardware.

For specification information see pages 199-210. For non-standard worksurface sizes see page 218.

Laminate
GSA SIN 33721

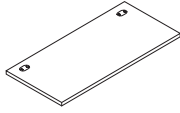

Description	Laminate w/Flat Edge Model	Laminate w/Flat Edge		
		L1 List Price	L2 List Price	L3 List Price
20"D Primary Worksurfaces				
24"W	T52024S	\$ 373	\$ 388	\$ 402
30"W	T52030S	\$ 396	\$ 412	\$ 426
36"W	T52036S	\$ 442	\$ 459	\$ 475
42"W	T52042S	\$ 497	\$ 516	\$ 533
48"W	T52048S	\$ 536	\$ 556	\$ 574
54"W	T52054S	\$ 582	\$ 604	\$ 622
60"W	T52060S	\$ 662	\$ 688	\$ 707
66"W	T52066S	\$ 717	\$ 745	\$ 766
72"W	T52072S	\$ 747	\$ 776	\$ 797
78"W	T52078S	\$ 973	\$ 1008	\$ 1039
84"W	T52084S	\$ 1017	\$ 1053	\$ 1085
90"W	T52090S	\$ 1202	\$ 1243	\$ 1283
96"W	T52096S	\$ 1260	\$ 1303	\$ 1345

- Notes:**
- 1) Add Suffix and upcharge for primary worksurfaces to span a "T" or extended straight connection:
Suffix = TZ (Stride — adds 3/8" to width) \$38 upcharge. *Example:* T52060STZ
 - 2) Add Suffix "N" to a model number for no grommets, no upcharge. *Examples:* T52036SN T52060STZN T52024SN

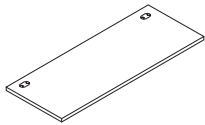

Description	Laminate w/Flat Edge Model	Laminate w/Flat Edge		
		L1 List Price	L2 List Price	L3 List Price
24"D Primary Worksurfaces				
24"W	T52424S	\$ 395	\$ 411	\$ 425
30"W	T52430S	\$ 416	\$ 433	\$ 447
36"W	T52436S	\$ 469	\$ 487	\$ 503
42"W	T52442S	\$ 524	\$ 543	\$ 561
48"W	T52448S	\$ 568	\$ 590	\$ 607
54"W	T52454S	\$ 614	\$ 639	\$ 656
60"W	T52460S	\$ 697	\$ 724	\$ 743
66"W	T52466S	\$ 758	\$ 787	\$ 809
72"W	T52472S	\$ 791	\$ 821	\$ 843
78"W	T52478S	\$ 1027	\$ 1063	\$ 1095
84"W	T52484S	\$ 1076	\$ 1114	\$ 1148
90"W	T52490S	\$ 1271	\$ 1314	\$ 1356
96"W	T52496S	\$ 1330	\$ 1375	\$ 1420

- Notes:**
- 1) Add Suffix and upcharge for primary worksurfaces to span a "T" or extended straight connection:
Suffix = TZ (Stride — adds 3/8" to width) \$38 upcharge
Examples: T52460STZ T52424STZ
 - 2) Add Suffix "N" to a model number for no grommets, no upcharge. *Examples:* T52436SN T52460STZN T52424SN

<p>How to specify — Select the Model Number from above. Add suffix if applicable: "N" for No Grommets — no upcharge "TZ" for Stride T-Span — \$38 upcharge</p>	<p>1st Option: Laminate See page 120 for finishes.</p>	<p>2nd Option: Edge Trim Color: See page 120 for finishes.</p>	<p>3rd Option: Grommet Type: P Oval Plastic (will match edge trim on laminate) M Oval Metal (Add \$11 per grommet) S Square Metal (Add \$11 per grommet)</p>	<p>4th Option: Grommet Color (Metal only): EL Matte Silver</p>
<p>Example: T52084S.TM33.EU.P</p>				<p>E L</p>

Worksurfaces

Stride® — Primary

For specification information see pages 199-210.

Laminate
GSA SIN 33721

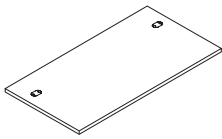
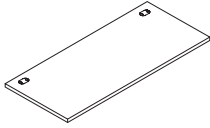

Recessed Grommets shown

Description	Laminate w/Flat Edge Model	Laminate w/Flat Edge		
		L1 List Price	L2 List Price	L3 List Price
30"D Primary Worksurfaces				
24"W	T53024S	\$ 416	\$ 433	\$ 447
30"W	T53030S	\$ 501	\$ 520	\$ 537
36"W	T53036S	\$ 539	\$ 559	\$ 577
42"W	T53042S	\$ 581	\$ 603	\$ 621
48"W	T53048S	\$ 614	\$ 639	\$ 656
54"W	T53054S	\$ 686	\$ 713	\$ 732
60"W	T53060S	\$ 764	\$ 793	\$ 815
66"W	T53066S	\$ 825	\$ 856	\$ 880
72"W	T53072S	\$ 895	\$ 928	\$ 954
78"W	T53078S	\$ 1162	\$ 1202	\$ 1241
84"W	T53084S	\$ 1214	\$ 1255	\$ 1296
90"W	T53090S	\$ 1448	\$ 1497	\$ 1546
96"W	T53096S	\$ 1495	\$ 1545	\$ 1596
36"D Primary Worksurfaces				
60"W	T53660S	\$ 955	\$ 989	\$ 1020
66"W	T53666S	\$ 1040	\$ 1077	\$ 1109
72"W	T53672S	\$ 1112	\$ 1151	\$ 1187

- Notes:**
- 1) Add Suffix and upcharge for 30"D primary worksurfaces to span a "T" or extended straight connection:
Suffix = TZ (Stride — adds 3/8" to width) \$38 upcharge
Examples: T53060STZ T53024STZ
 - 2) Add Suffix "N" to a model number for no grommets, no upcharge.
Examples: T53036SN T53024SN T53024STZN
 - 3) Add Suffix "R" to a model number for recessed grommets on 36"D primary worksurfaces only, no upcharge. Recessed grommets are inset 6" from standard location to provide conference overhang in desking applications. *Example:* T53660SR

STRIDE

<p>How to specify — Select the Model Number from above. Add suffix if applicable: "N" for No Grommets — no upcharge "TZ" for Stride T-Span — \$38 upcharge</p>	<p>1st Option: Laminate: See page 120 for finishes.</p>	<p>2nd Option: Edge Trim Color: See page 120 for finishes.</p>	<p>3rd Option: Grommet Type: P Oval Plastic (will match edge trim on laminate) M Oval Metal (Add \$11 per grommet) S Square Metal (Add \$11 per grommet)</p>	<p>4th Option: Grommet Color (Metal only): EL Matte Silver</p>
<p>_____ . _____ . _____ .</p>	<p>_____ . _____ . _____ .</p>	<p>_____ . _____ . _____ .</p>	<p>_____ . _____ . _____ .</p>	<p>EL</p>

Example: T53084STZ.TM33.EU.P

Worksurfaces

Stride® — Linear — D-Shape

For specification information see pages 199-210.

Laminate
GSA SIN 33721

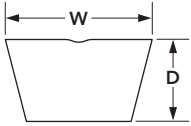
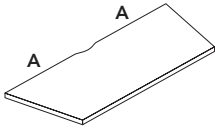
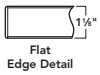

Top View

Description	Laminate w/Flat Edge Model	Laminate w/Flat Edge		
		L1 List Price	L2 List Price	L3 List Price
Linear D-Shape Worksurfaces for Stride				
For 2 - 20" A - 43"W x 20"D	Z52043LD	\$ 927	\$ 961	\$ 990
For 2 - 24" A - 51"W x 20"D	Z52051LD	\$ 980	\$ 1015	\$ 1046
For 2 - 20" A - 43"W x 24"D	Z52443LD	\$ 980	\$ 1015	\$ 1046
For 2 - 24" A - 51"W x 24"D	Z52451LD	\$ 1035	\$ 1072	\$ 1104

How to specify —

Select the Model Number from above. Add suffix if applicable:

“N” for No Grommets — no upcharge

Z | | | | | | | | | | | | | | | . | | | | | | | | | | | | |

1st Option:

Laminate:

See page 120 for finishes.

. | | | | | | | | | | | | | | |

2nd Option:

Edge Trim Color:

See page 120 for finishes.

. | | | |

3rd Option:

Grommet Type
(if applicable):

- P** Oval Plastic (will match edge trim on laminate)
- M** Oval Metal (Add \$11 per grommet)
- S** Square Metal (Add \$11 per grommet)

|

4th Option:

Grommet Color
(Metal only):

EL Matte Silver

E | L

Example: Z52043LD.TM33.EU



For specification information see pages [199-210](#).

Laminate
GSA SIN 33721

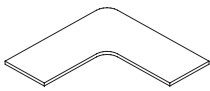
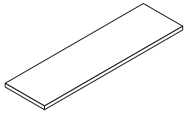

Description	Laminate w/Flat Edge Model	Laminate w/Flat Edge		
		L1 List Price	L2 List Price	L3 List Price
15"D Straight Countertops				
24"W	Z51524S	\$ 361	\$ 375	\$ 387
30"W	Z51530S	\$ 403	\$ 418	\$ 431
36"W	Z51536S	\$ 447	\$ 463	\$ 477
42"W	Z51542S	\$ 461	\$ 478	\$ 492
48"W	Z51548S	\$ 488	\$ 505	\$ 520
54"W	Z51554S	\$ 560	\$ 579	\$ 596
60"W	Z51560S	\$ 625	\$ 647	\$ 664
66"W	Z51566S	\$ 649	\$ 671	\$ 689
72"W	Z51572S	\$ 674	\$ 698	\$ 715

Note: V For a straight countertop, when used with "H" in-line high-low trim kit on one side. No upcharge.

Example: Z51554SV

15"D Corner Countertops				
24"W x 24"W	Z52424C	\$ 690	\$ 715	\$ 733
30"W x 30"W	Z53030C	\$ 804	\$ 832	\$ 854
36"W x 36"W	Z53636C	\$ 892	\$ 923	\$ 947

Note: RV For a corner countertop, when used with "H" in-line high-low trim kit on the right side. No upcharge.

LV For a corner countertop, when used with "H" in-line high-low trim kit on the left side. No upcharge.

Not available with Fluid Form. *Example: Z52424CLV*

<p>How to specify — Select the Model Number from above.</p>	<p>1st Option: Laminate: See page 120 for finishes.</p>	<p>2nd Option: Edge Trim Color: See page 120 for finishes.</p>
<input type="text"/> . <input type="text"/> .		

Examples: Z51572S.TM33.EU Z52424C.TM33.EY

For specification information see pages [199-210](#).

Laminate
GSA SIN 33721

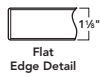

Description	Laminate w/Flat Edge Model	Laminate w/Flat Edge		
		L1 List Price	L2 List Price	L3 List Price
24"D Corner Worksurfaces w/Radial Leading Edge				
36"W	T53624CR	\$ 790	\$ 820	\$ 843
42"W	T54224CR	\$ 842	\$ 873	\$ 899
48"W	T54824CR	\$ 958	\$ 993	\$ 1023
24"D Corner Worksurfaces w/Straight Leading Edge				
36"W	T53624SC	\$ 764	\$ 791	\$ 817
42"W	T54224SC	\$ 802	\$ 830	\$ 857
48"W	T54824SC	\$ 898	\$ 929	\$ 961
30"D Corner Worksurfaces w/Radial Leading Edge				
42"W	T54230CR	\$ 1018	\$ 1054	\$ 1086
48"W	T54830CR	\$ 1099	\$ 1137	\$ 1174
30"D Corner Worksurfaces w/Straight Leading Edge				
42"W	T54230SC	\$ 974	\$ 1008	\$ 1042
48"W	T54830SC	\$ 1005	\$ 1040	\$ 1075
120° Corner Worksurface				
30"W x 24"D	TT53024CB	\$ 1034	\$ 1070	\$ 1103
36"W x 24"D	TT53624CB	\$ 1142	\$ 1182	\$ 1220
42"W x 24"D	TT54224CB	\$ 1224	\$ 1266	\$ 1307
48"W x 24"D	TT54824CB	\$ 1348	\$ 1393	\$ 1439

Note: Add Suffix “N” to model number for no grommet, no upcharge.

Corner Worksurfaces with Radial Leading Edge

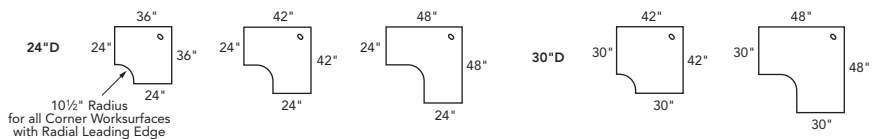

Corner Worksurfaces with Straight Leading Edge

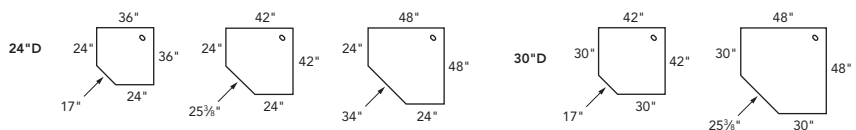

<p>How to specify — Select the Model Number from above. Add suffix if applicable: “N” for No Grommets — no upcharge</p> <p>T .</p>	<p>1st Option: Laminate: See page 120 for finishes.</p> <p> .</p>	<p>2nd Option: Edge Trim Color: See page 120 for finishes.</p> <p> .</p>	<p>3rd Option: Grommet Type (if applicable): P Oval Plastic (will match edge trim on laminate) M Oval Metal (Add \$11 per grommet) S Square Metal (Add \$11 per grommet)</p> <p> </p>	<p>4th Option: Grommet Color (Metal only) (if applicable): EL Matte Silver</p> <p>E L </p>
---	---	--	--	--

Examples: T53624C.LT3B.E9.P



For specification information see pages 199-210.

Laminate
GSA SIN 33721

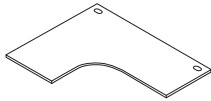
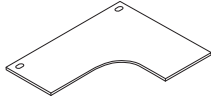

Description	Laminate w/Flat Edge Model	Laminate w/Flat Edge		
		L1 List Price	L2 List Price	L3 List Price
Corner Cove Worksurfaces — Extended Left				
60" x 36"-24"L / 24"R	T5822EL	\$ 901	\$ 934	\$ 963
60" x 36"-24"L / 30"R	T5832EL	\$ 940	\$ 974	\$ 1004
60" x 48"-24"L / 24"R	T5622EL	\$ 1001	\$ 1037	\$ 1068
60" x 48"-30"L / 24"R	T5623EL	\$ 1044	\$ 1081	\$ 1115
60" x 48"-24"L / 30"R	T5632EL	\$ 1044	\$ 1081	\$ 1115
60" x 48"-30"L / 30"R	T5633EL	\$ 1080	\$ 1118	\$ 1154
72" x 36"-24"L / 24"R	T5922EL	\$ 1001	\$ 1037	\$ 1068
72" x 36"-24"L / 30"R	T5932EL	\$ 1044	\$ 1081	\$ 1115
72" x 48"-24"L / 24"R	T5722EL	\$ 1276	\$ 1319	\$ 1361
72" x 48"-30"L / 24"R	T5723EL	\$ 1320	\$ 1364	\$ 1410
72" x 48"-24"L / 30"R	T5732EL	\$ 1320	\$ 1364	\$ 1410
72" x 48"-30"L / 30"R	T5733EL	\$ 1357	\$ 1403	\$ 1450
Corner Cove Worksurfaces — Extended Right				
36" x 60"-24"L / 24"R	T5822ER	\$ 901	\$ 934	\$ 963
36" x 60"-30"L / 24"R	T5832ER	\$ 940	\$ 974	\$ 1004
48" x 60"-24"L / 24"R	T5622ER	\$ 1001	\$ 1037	\$ 1068
48" x 60"-24"L / 30"R	T5623ER	\$ 1044	\$ 1081	\$ 1115
48" x 60"-30"L / 24"R	T5632ER	\$ 1044	\$ 1081	\$ 1115
48" x 60"-30"L / 30"R	T5633ER	\$ 1080	\$ 1118	\$ 1154
36" x 72"-24"L / 24"R	T5922ER	\$ 1001	\$ 1037	\$ 1068
36" x 72"-30"L / 24"R	T5932ER	\$ 1044	\$ 1081	\$ 1115
48" x 72"-24"L / 24"R	T5722ER	\$ 1276	\$ 1319	\$ 1361
48" x 72"-24"L / 30"R	T5723ER	\$ 1320	\$ 1364	\$ 1410
48" x 72"-30"L / 24"R	T5732ER	\$ 1320	\$ 1364	\$ 1410
48" x 72"-30"L / 30"R	T5733ER	\$ 1357	\$ 1403	\$ 1450

Note: Add Suffix "N" to model number for no grommets, no upcharge. *Example:* T5722ERN

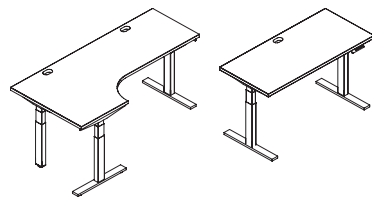

For Altitude® height-adjustable tables see the Seating, Collaboration, and Tables Price List.

STRIDE

<p>How to specify — Select the Model Number from above. Add suffix if applicable: "N" for No Grommets — no upcharge</p>	<p>1st Option: Laminate: See page 120 for finishes.</p>	<p>2nd Option: Edge Trim Color: See page 120 for finishes.</p>	<p>3rd Option: Grommet Type: P Oval Plastic (will match edge trim on laminate) M Oval Metal (Add \$11 per grommet) S Square Metal (Add \$11 per grommet)</p>	<p>4th Option: Grommet Color (if applicable): See page 120 for finishes.</p>
<p>_____ .</p>	<p>_____ .</p>	<p>_____ .</p>	<p>_____</p>	<p>E _____</p>

Examples: T5922EL.LT3B.E9.SEL T5822ER.LT3B.E9.P

Worksurfaces

Stride® — Peninsula / P-Shaped / Jetty

For specification information see pages 199-210.

Laminate
GSA SIN 33721

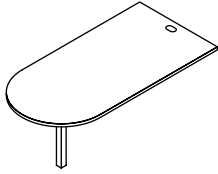

Support column ordered separately.

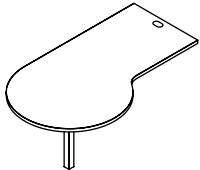

Support column ordered separately.

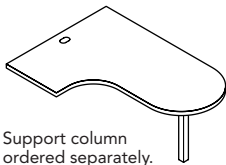

Support column ordered separately.

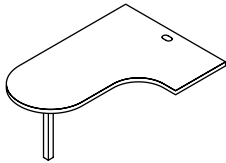

Support column ordered separately.

Description	Laminate w/Flat Edge Model	Laminate w/Flat Edge		
		L1 List Price	L2 List Price	L3 List Price
Peninsula Worksurfaces				
30"W x 60"L	T53060B	\$ 1045	\$ 1082	\$ 1116
30"W x 66"L	T53066B	\$ 1155	\$ 1195	\$ 1234
30"W x 72"L	T53072B	\$ 1260	\$ 1303	\$ 1345
36"W x 60"L	T53660B	\$ 1260	\$ 1303	\$ 1345
36"W x 66"L	T53666B	\$ 1398	\$ 1445	\$ 1493
36"W x 72"L	T53672B	\$ 1539	\$ 1590	\$ 1645

P-Shaped Worksurfaces w/42" Diameter End				
30"W x 72"L	T53072PR (shown)	\$ 1444	\$ 1493	\$ 1543
30"W x 72"L	T53072PL	\$ 1444	\$ 1493	\$ 1543

Jetty Worksurfaces — Left Hand				
48"A x 66"B x 24"C x 30"D	T54662JL	\$ 1357	\$ 1403	\$ 1450
48"A x 72"B x 24"C x 30"D	T54722JL	\$ 1387	\$ 1433	\$ 1481
48"A x 66"B x 30"C x 30"D	T54663JL	\$ 1417	\$ 1464	\$ 1513
48"A x 72"B x 30"C x 30"D	T54723JL	\$ 1443	\$ 1492	\$ 1542

Jetty Worksurfaces — Right Hand				
48"A x 66"B x 24"C x 30"D	T54662JR	\$ 1357	\$ 1403	\$ 1450
48"A x 72"B x 24"C x 30"D	T54722JR	\$ 1387	\$ 1433	\$ 1481
48"A x 66"B x 30"C x 30"D	T54663JR	\$ 1417	\$ 1464	\$ 1513
48"A x 72"B x 30"C x 30"D	T54723JR	\$ 1443	\$ 1492	\$ 1542

Note: Add Suffix "N" to model number for no grommets, no upcharge.
Example: T53060BN

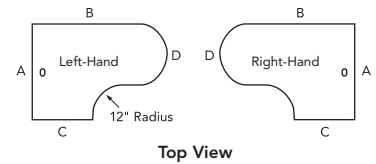

<p>How to specify — Select the Model Number from above. Add suffix if applicable: "N" for No Grommets — no upcharge</p>	<p>1st Option: Laminate: See page 120 for finishes.</p>	<p>2nd Option: Edge Trim Color: See page 120 for finishes.</p>	<p>3rd Option: Grommet Type: P Oval Plastic (will match edge trim on laminate) M Oval Metal (Add \$11 per grommet) S Square Metal (Add \$11 per grommet)</p>	<p>4th Option: Grommet Color (if applicable): See page 120 for finishes.</p>
<p>_____ .</p>	<p>_____ .</p>	<p>_____ .</p>	<p>_____</p>	<p>E _____</p>

Examples: T54662JL.LT3B.E9.P T53060B.LT3B.E9.MEL

ORDERING

The 9120 Program can be used to order particle board rectangular worksurfaces in any non-standard width and depth in 1/8" increments up to a maximum of 120" W x 36" D.

Specify:

1. **Model Number**
Specify closest nominal width/depth model (round up).
2. **Grommet Option** (if desired)
See grommet specification instructions on this page.
3. **Grommet Type:**
P Plastic
M Metal (add \$11 per grommet for laminate)
4. **Grommet Color:**
(Metal only)
EL Matte Silver
Note: Plastic grommet will match flat edge.
5. **Laminate and Veneer Choices**
See page 120.
6. **Flat Edge Color Choices**
See edge colors page 120 for laminates.
7. **Exact Size**
Specify the **exact width** and **exact depth** you require.
Width and depth is specified in 1/8" increments which is denoted as a single digit following the whole number dimension at the end of the model number string.

1/8" = 1	5/8" = 5
2/8" = 2	6/8" = 6
3/8" = 3	7/8" = 7
4/8" = 4	no extra increment = 0

For example, when ordering a worksurface that is 34 3/8" W x 20 1/2" D, specification should be 345Wx204D.
Example: 9120R3624.G0.TM33.EU.345Wx204D.

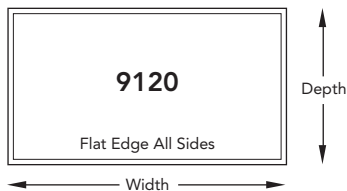

PRODUCT SPECIFICATIONS

- Flat edge on all sides
- 45 lb. particle board
- 1 1/8" top thickness
- .020 resin impregnated paper backer sheet
- Grommets available
- Maximum width 120" (maximum recommended unsupported span is 42")
- Maximum depth 36"
- Standard Allsteel laminates and veneers
- Quantities of 10 or greater are palletized; less than 10 are individually cartoned.

Note: 9120 worksurface maximum unsupported span is 42".
9120 worksurfaces do not have pre-drilled pilot holes or threaded metal inserts.

When spanning multiple freestanding storage units with one worksurface, add 1/8" for each additional storage unit. For example, when ordering a worksurface for three 30"W lateral files. 3 units x 30" = 90" + 1/8" + 1/8" = 90 1/4" worksurface. Do NOT follow this rule if panel wrapping storage units.

CHANGES / CANCELLATIONS

No changes/cancellations for 9120 Program worksurfaces.

GROMMET SPECIFICATIONS

Plastic grommets are made of durable ABS plastic and grommets match edge color on laminate worksurfaces. Metal grommets are only available Matte Silver oval for laminate and square for veneer.

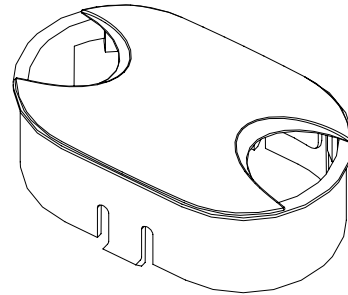

PRICING

See page 219 for laminate and veneer 9120 worksurface pricing.

One Grommet — GC, GL, or GR Position..... \$17.00
Two Grommets — G3 or G4 Position..... \$34.00

Note: Add \$11 per grommet for metal grommets with laminate.

ORDERING

Specify grommet location and color.

Example: 9120R10836.GCP.TM33.EU.1022Wx326D

Code Grommet Position

- GC Centered side-to-side – 3/8" from rear to grommet edge; 4 1/2" from rear to grommet center
- GL 6 1/16" from left side to grommet edge – 3/8" from rear to grommet edge; 4 1/2" from rear to grommet center
- GR 6 1/16" from right side to grommet edge – 3/8" from rear to grommet edge; 4 1/2" from rear to grommet center
- G3 Pair of grommets each 18" from side edge – 3/8" from rear to grommet edge; 4 1/2" from rear to grommet center (Position G3 not available on tops 60"W or less.)
- G4 Pair of grommets each 6 1/16" from side edge to grommet edge – 3/8" from rear to grommet edge; 4 1/2" from rear to grommet center
- G0 No grommets

Dimensions are from grommet center line to top edge.

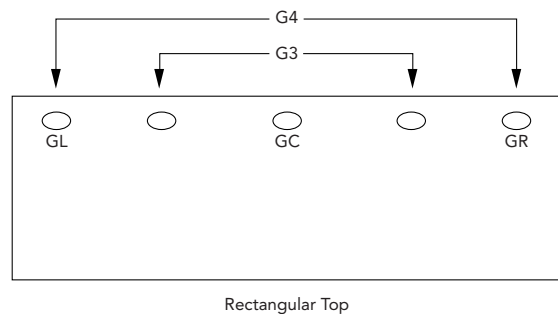

Grommet positions other than those shown above are considered non-standard.

Worksurfaces

9120 Program

For specification information see page 218.

Laminate and Veneer Worksurfaces / Non-Standard Sizes

GSA SIN 33721

*Model Number — Add "R" for laminate or "V" for veneer

Maximum	Model Number*	Width		Depth		Laminate List Price			Veneer List Price		
		MIN	MAX	MIN	MAX	L1	L2	L3	V1	V3	V5
18"D											
18"W	9120□1818	180W	180W	121D	180D	\$ 454	\$ 472	\$ 487	\$ 1111	\$ 1235	\$ 1318
24"W	9120□2418	181W	240W	121D	180D	\$ 474	\$ 492	\$ 508	\$ 1184	\$ 1316	\$ 1404
30"W	9120□3018	241W	300W	121D	180D	\$ 494	\$ 513	\$ 529	\$ 1252	\$ 1392	\$ 1485
36"W	9120□3618	301W	360W	121D	180D	\$ 539	\$ 559	\$ 577	\$ 1299	\$ 1444	\$ 1541
42"W	9120□4218	361W	420W	121D	180D	\$ 594	\$ 616	\$ 635	\$ 1378	\$ 1532	\$ 1634
48"W	9120□4818	421W	480W	121D	180D	\$ 688	\$ 715	\$ 734	\$ 1450	\$ 1612	\$ 1720
60"W	9120□6018	481W	600W	121D	180D	\$ 855	\$ 887	\$ 912	\$ 1649	\$ 1833	\$ 1956
72"W	9120□7218	601W	720W	121D	180D	\$ 1034	\$ 1070	\$ 1103	\$ 1796	\$ 1997	\$ 2130
84"W	9120□8418	721W	840W	121D	180D	\$ 1352	\$ 1397	\$ 1445	\$ 1933	\$ 2149	\$ 2293
96"W	9120□9618	841W	960W	121D	180D	\$ 1398	\$ 1445	\$ 1493	\$ 2089	\$ 2322	\$ 2478
108"W	9120□10818	961W	1080W	121D	180D	\$ 1599	\$ 1652	\$ 1708	\$ 2111	\$ 2347	\$ 2504
120"W	9120□12018	1081W	1200W	121D	180D	\$ 1822	\$ 1884	\$ 1946	\$ 2256	\$ 2508	\$ 2676
24"D											
24"W	9120□2424	181W	240W	181D	240D	\$ 515	\$ 534	\$ 552	\$ 1162	\$ 1292	\$ 1378
30"W	9120□3024	241W	300W	181D	240D	\$ 536	\$ 556	\$ 574	\$ 1218	\$ 1354	\$ 1445
36"W	9120□3624	301W	360W	181D	240D	\$ 587	\$ 609	\$ 627	\$ 1285	\$ 1429	\$ 1524
42"W	9120□4224	361W	420W	181D	240D	\$ 641	\$ 667	\$ 684	\$ 1355	\$ 1506	\$ 1607
48"W	9120□4824	421W	480W	181D	240D	\$ 728	\$ 756	\$ 777	\$ 1490	\$ 1656	\$ 1767
60"W	9120□6024	481W	600W	181D	240D	\$ 897	\$ 930	\$ 959	\$ 1703	\$ 1893	\$ 2020
72"W	9120□7224	601W	720W	181D	240D	\$ 1074	\$ 1112	\$ 1146	\$ 1919	\$ 2133	\$ 2276
84"W	9120□8424	721W	840W	181D	240D	\$ 1398	\$ 1445	\$ 1493	\$ 2089	\$ 2322	\$ 2478
96"W	9120□9624	841W	960W	181D	240D	\$ 1444	\$ 1493	\$ 1543	\$ 2260	\$ 2512	\$ 2681
108"W	9120□10824	961W	1080W	181D	240D	\$ 1645	\$ 1700	\$ 1757	\$ 2432	\$ 2704	\$ 2885
120"W	9120□12024	1081W	1200W	181D	240D	\$ 1864	\$ 1927	\$ 1992	\$ 2493	\$ 2771	\$ 2957
30"D											
30"W	9120□3030	241W	300W	241D	300D	\$ 619	\$ 644	\$ 661	\$ 1218	\$ 1354	\$ 1445
36"W	9120□3630	301W	360W	241D	300D	\$ 651	\$ 677	\$ 695	\$ 1396	\$ 1552	\$ 1656
42"W	9120□4230	361W	420W	241D	300D	\$ 694	\$ 721	\$ 740	\$ 1505	\$ 1673	\$ 1785
48"W	9120□4830	421W	480W	241D	300D	\$ 751	\$ 780	\$ 802	\$ 1642	\$ 1825	\$ 1948
60"W	9120□6030	481W	600W	241D	300D	\$ 986	\$ 1020	\$ 1050	\$ 1911	\$ 2124	\$ 2267
72"W	9120□7230	601W	720W	241D	300D	\$ 1127	\$ 1166	\$ 1203	\$ 2166	\$ 2408	\$ 2569
84"W	9120□8430	721W	840W	241D	300D	\$ 1711	\$ 1768	\$ 1827	\$ 2306	\$ 2564	\$ 2735
96"W	9120□9630	841W	960W	241D	300D	\$ 1752	\$ 1810	\$ 1871	\$ 2455	\$ 2729	\$ 2912
108"W	9120□10830	961W	1080W	241D	300D	\$ 1973	\$ 2039	\$ 2108	\$ 2611	\$ 2902	\$ 3097
120"W	9120□12030	1081W	1200W	241D	300D	\$ 2199	\$ 2274	\$ 2349	\$ 2887	\$ 3209	\$ 3424
36"D											
36"W	9120□3636	301W	360W	301D	360D	\$ 884	\$ 916	\$ 943	\$ 2017	\$ 2242	\$ 2392
42"W	9120□4236	361W	420W	301D	360D	\$ 1004	\$ 1040	\$ 1071	\$ 2154	\$ 2394	\$ 2555
48"W	9120□4836	421W	480W	301D	360D	\$ 1129	\$ 1168	\$ 1205	\$ 2302	\$ 2559	\$ 2730
60"W	9120□6036	481W	600W	301D	360D	\$ 1384	\$ 1430	\$ 1478	\$ 2308	\$ 2566	\$ 2738
72"W	9120□7236	601W	720W	301D	360D	\$ 1630	\$ 1685	\$ 1741	\$ 2448	\$ 2721	\$ 2904
84"W	9120□8436	721W	840W	301D	360D	\$ 1973	\$ 2039	\$ 2108	\$ 2495	\$ 2774	\$ 2959
96"W	9120□9636	841W	960W	301D	360D	\$ 2022	\$ 2090	\$ 2159	\$ 2717	\$ 3020	\$ 3223
108"W	9120□10836	961W	1080W	301D	360D	\$ 2242	\$ 2318	\$ 2397	\$ 2951	\$ 3280	\$ 3500
120"W	9120□12036	1081W	1200W	301D	360D	\$ 2464	\$ 2547	\$ 2633	\$ 3189	\$ 3545	\$ 3783

STRIDE

Worksurfaces

Stride® — Quarter-Round

For specification information see pages 199-210.

Veneer
GSA SIN 33721

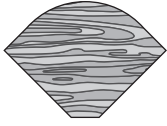
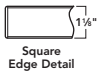

Veneer Grain Direction

Description	Veneer w/Square Edge Model	V1 w/Square Edge List Price	V3 w/Square Edge List Price	V5 w/Square Edge List Price
Quarter-Round Worksurfaces				
24"D x 24"D	TNV52424Q	\$ 1029	\$ 1144	\$ 1221
30"D x 30"D	TNV53030Q	\$ 1283	\$ 1426	\$ 1522

STRIDE

Corner Worksurfaces with Straight Leading Edge

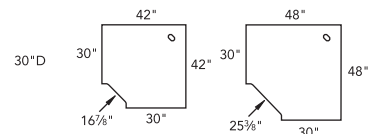
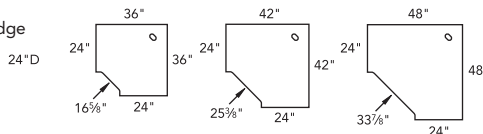

Corner Worksurfaces with Radial Leading Edge

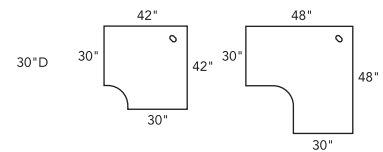
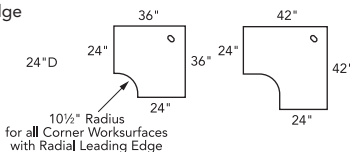

How to specify —

Select the Model Number from above. Add suffix if applicable:

"N" for No Grommets — no upcharge

1st Option:

Veneer:

See page 120 for finishes.

2nd Option:

Grommet Type (if applicable):

- P Oval Plastic (will be E2 on ALL Maple or E4 on ALL other veneers)
- M Oval Metal
- S Square Metal

3rd Option:

Grommet Color (Metal only) (if applicable):

- Oval:
- E4 Black
- EZ Bronze
- EL Matte Silver

Square:

- EL Matte Silver

T | | | | | | | | | | . | | | | | | | | | | . |

E | |

Example: TNV52424Q.SC777

Worksurfaces

Stride® — Worksurface Supports

For specification information see pages 199-210.

GSA SIN 33721

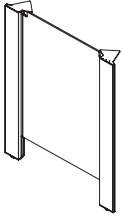

Description	Model	P1 Paint List Price	P2 Paint List Price	P3 Paint List Price
29½"H End Panel Legs — Freestanding — Painted Wood				
24"D for Flat/Square Edge Worksurfaces	ZD62429FEN <input type="checkbox"/>	\$ 923	\$ 954	\$ 985
30"D for Flat/Square Edge Worksurfaces	ZD63029FEN <input type="checkbox"/>	\$ 995	\$ 1028	\$ 1062

How to specify —
Select the Model Number from above.

1st Option:
Wood Paint Color:
See page 120 for Painted Wood Finish.

2nd Option:
Metal Paint Color:
 P1 P2 P3

Z | D | | | | | | | | | | | | | | | | | | | | . M | 1 | | | |

Example: ZD62429FEN.M17.PR6

P | | | | .

Shippable by small-package carrier.

For specification information see pages 199-210.

GSA SIN 33721

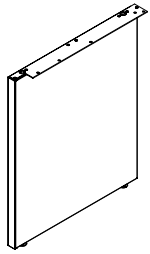

Description	Model	P1 Paint List Price	P2 Paint List Price	P3 Paint List Price
End Support Panels — Metal				
29½"H x 10"D Freestanding	Y62910FENP	\$ 353	\$ 378	\$ 401
29½"H x 24"D Freestanding	Y62924FENP	\$ 383	\$ 408	\$ 431
29½"H x 30"D Freestanding	Y62930FENP	\$ 405	\$ 430	\$ 453
<hr/>				
29½"H x 10"D Panel-Mount	Y62910PENP	\$ 395	\$ 420	\$ 443
29½"H x 20"D Panel-Mount	Y62920PENP	\$ 415	\$ 440	\$ 463
29½"H x 24"D Panel-Mount	Y62924PENP	\$ 420	\$ 445	\$ 468
29½"H x 30"D Panel-Mount	Y62930PENP	\$ 438	\$ 463	\$ 486
<hr/>				
26½"H x 20"D Panel-Mount	Y62620PENP	\$ 383	\$ 408	\$ 431
26½"H x 24"D Panel-Mount	Y62624PENP	\$ 397	\$ 422	\$ 445

Note: Not for use with rabbet edge worksurfaces.

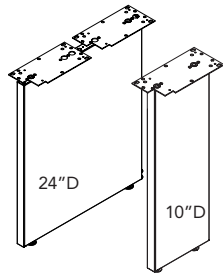

In-Line Support Panels — Metal				
29½"H to support 24"D Freestanding	Y62910SLFP	\$ 341	\$ 366	\$ 389
29½"H to support 30"D Freestanding	Y62924SLFP	\$ 364	\$ 389	\$ 412
<hr/>				
29½"H to support 24"D Panel-Mount	Y62910SLPP	\$ 383	\$ 408	\$ 431
29½"H to support 30"D Panel-Mount	Y62924SLPP	\$ 406	\$ 431	\$ 454
<hr/>				
26½"H x 10"D Panel-Mount	Y62610SLPP	\$ 362	\$ 387	\$ 410

Note: Not for use with rabbet edge worksurfaces.

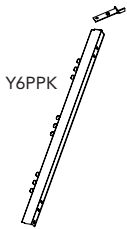

Pedestal-to-Systems Panel Attachment Bracket — Non-handed				
Bracket Kit	Y6PPK S	\$ 171	\$ 190	\$ 206

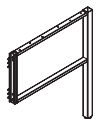

Open End Panel Supports				
12"D x 29½"H Panel-Mount	AYBHEP1229 S	\$ 273	\$ 309	\$ 346
18"D x 29½"H Panel-Mount	AYBHEP1829	\$ 278	\$ 314	\$ 351
24"D x 29½"H Panel-Mount	AYBHEP2429 S	\$ 288	\$ 324	\$ 361
30"D x 29½"H Panel-Mount	AYBHEP3029 S	\$ 310	\$ 346	\$ 383

Note: Not for use with rabbet edge worksurfaces.

<p>How to specify — Select the Model Number from above.</p>	<p><i>1st Option:</i> Paint (if applicable): P1 P2 P3 See page 120 for finishes.</p>
--	---

Examples: Y62924SLPP.P27 Y6PEN.P27

S Shippable by small-package carrier.

For specification information see pages 199-210.

GSA SIN 33721



Description	Model		P1 Paint List Price	P2 Paint List Price	P3 Paint List Price
29½"H Post Legs — Fixed Height					
for Flat/Square Edge Worksurfaces — Left	Z6PL29FL		\$ 320	\$ 345	\$ 368
for Flat/Square Edge Worksurfaces — Right	Z6PL29FR (shown)		\$ 320	\$ 345	\$ 368
for Flat/Square Edge Worksurfaces — Pair	Z6PL29FP		\$ 639	\$ 683	\$ 727

26½"H-32½"H Post Legs — Height Adjustable					
for Flat/Square Edge Worksurfaces — Pair	Z6PL29HP		\$ 846	\$ 890	\$ 934

40½"H Post Legs — Fixed Height					
for Flat/Square Edge Worksurfaces — Left	Z6PL40FL		\$ 375	\$ 400	\$ 423
for Flat/Square Edge Worksurfaces — Right	Z6PL40FR (shown)		\$ 375	\$ 400	\$ 423
for Flat/Square Edge Worksurfaces — Pair	Z6PL40FP		\$ 750	\$ 794	\$ 838

37½"H-43½"H Post Legs — Height Adjustable					
for Flat/Square Edge Worksurfaces — Left	Z6PL40HL		\$ 480	\$ 505	\$ 528
for Flat/Square Edge Worksurfaces — Right	Z6PL40HR (shown)		\$ 480	\$ 505	\$ 528
for Flat/Square Edge Worksurfaces — Pair	Z6PL40HP		\$ 959	\$ 1003	\$ 1047

29½"H Freestanding Post Legs — Fixed Height					
Pair with Locking Casters for Flat/Square Edge Worksurfaces	Z6PTLFPC (shown)		\$ 718	\$ 762	\$ 806
Pair with Glides for Flat/Square Edge Worksurfaces	Z6PTLFPG		\$ 718	\$ 762	\$ 806

26½"H-32½"H Freestanding Post Legs — Height Adjustable					
Pair with Locking Casters for Flat/Square Edge Worksurfaces	Z6PTLHPC (shown)		\$ 927	\$ 971	\$ 1015
Pair with Glides for Flat/Square Edge Worksurfaces	Z6PTLHPG		\$ 927	\$ 971	\$ 1015

How to specify —
Select the
Model Number
from above.

1st Option:

Color:



See page 120 for
finishes.

Z | | | | | | | | | | | | | | | | | | | | | | . P | | | | |

Example: Z6PL29FL.P02

Shippable by small-package carrier.

For specification information see pages 199-210.

GSA SIN 33721

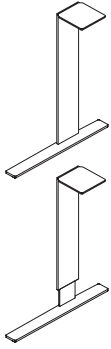

Description	Model	P1 Paint List Price	P2 Paint List Price	P3 Paint List Price
C-Legs — Fixed Height — 29½"H				
for Flat/Square Edge Worksurfaces — Left	Z6CLFL S	\$ 535	\$ 560	\$ 583
for Flat/Square Edge Worksurfaces — Right	Z6CLFR S	\$ 535	\$ 560	\$ 583

C-Legs — Height Adjustable — 26½"H-32½"H				
for Flat/Square Edge Worksurfaces — Left	Z6CLHL S	\$ 706	\$ 731	\$ 754
for Flat/Square Edge Worksurfaces — Right	Z6CLHR S	\$ 706	\$ 731	\$ 754

Note: Height adjustable C-legs are not for use on worksurface spans greater than 72"W.

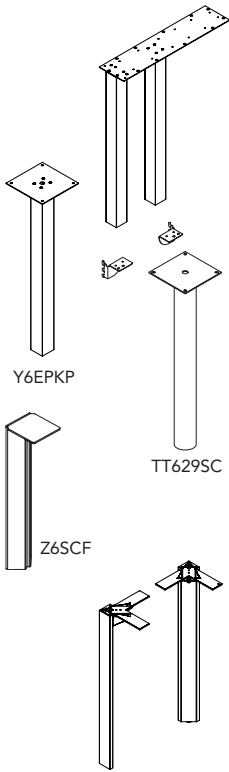

Post In-Line Support Leg				
29½"H x 24"D Freestanding — Painted	Y629NLK	\$ 629	\$ 670	\$ 713

Support Columns — Metal				
29½"H / 2¼" Square Painted	Y6EPPK	\$ 277	\$ 302	\$ 325
29½"H / 3" Diameter Round	TT629SC S	\$ 249	\$ 285	\$ 322
29½"H — Linear Fixed	Z6SCF S	\$ 340	\$ 365	\$ 388
26½"H-30½"H — Linear Height Adjustable	Z6SCH S	\$ 506	\$ 531	\$ 554

Light-scale Legs — Metal				
Pair (Left and Right) 29½"H				
for Modesty Panel attachment — Painted	Y629LKMP	\$ 702	\$ 727	\$ 750
Individual Leg — Non-handed				
NOT for Modesty Panel attachment — Painted	Y629LKNP	\$ 353	\$ 378	\$ 401

<p>How to specify — Select the Model Number from above.</p>	<p><i>1st Option:</i> Color: P1 P2 P3 See page 120 for finishes.</p>	<p><i>1st Option:</i> Landscape Surface Material and Finish (if applicable):</p>
<div style="border-bottom: 1px solid black; width: 100%; height: 20px; margin-bottom: 5px;"></div> P <div style="border-bottom: 1px solid black; width: 100%; height: 20px;"></div>		

Examples: Z6CLFL.P27 Y629NLK.P7D

S Shippable by small-package carrier.

For specification information see pages 199-210.

GSA SIN 33721

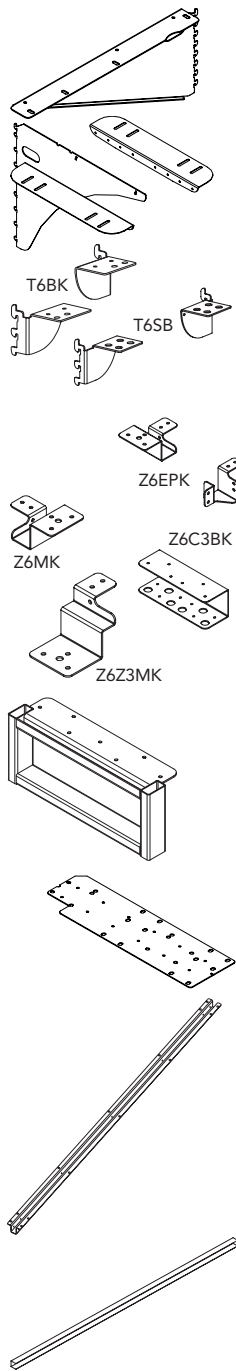

Description	Model	P1 Paint List Price	P2 Paint List Price	P3 Paint List Price
Cantilever Brackets				
12"D Left-Hand	T6CB12L S	\$ 69	\$ 83	\$ 94
12"D Right-Hand	T6CB12R S	\$ 69	\$ 83	\$ 94
18"D Left-Hand	T6CB18L S	\$ 74	\$ 88	\$ 99
18"D Right-Hand	T6CB18R S	\$ 74	\$ 88	\$ 99
24" or 30"D Left-Hand	T6CB24L S	\$ 81	\$ 95	\$ 106
24" or 30"D Right-Hand	T6CB24R S	\$ 81	\$ 95	\$ 106

Cantilever Bracket — non-handed (Core paint colors only)				
24" or 30"D	T624CB S	\$ 202	N/A	N/A

Worksurface Bracket Kits				
Flat, Square, and Eased Edge Worksurface Bracket Kit	T6BK S	\$ 70	\$ 83	\$ 93
Flat, Square, and Eased Edge Worksurface Storage Bracket Kit (Black only)	T6SB S	\$ 95	N/A	N/A

Off-Module Worksurface Brackets				
Non-Rail Based End Panel Kit	Z6EPK S	\$ 59	\$ 70	\$ 78
Non-Rail Based Worksurface Bracket (1)	Z6MK S	\$ 70	\$ 81	\$ 89
Non-Rail Based 3" Layered Worksurface Bracket (1)	Z6Z3MK S	\$ 79	\$ 90	\$ 98
Layered Worksurface Connection Bracket (1)	Z6C3BK S	\$ 114	\$ 130	\$ 143

Worksurface Stanchion — Painted Metal				
12"D x 4"H for Stride 22"H Credenza	APOLG0512 S	\$ 383	\$ 408	\$ 428
18"D x 4"H for Stride 22"H Credenza	APOLG0518 S	\$ 418	\$ 443	\$ 463

Flat Brackets (no color option)				
For 12"D	T612FB S	\$ 61	N/A	N/A
For 24"D	T624FB S	\$ 70	N/A	N/A
For 30"D	T630FB S	\$ 80	N/A	N/A

External Worksurface Support Channel (no color option) — 1½"H				
36"W External Support Channel for use on 42"W Worksurface	Z5SC42 S	\$ 76	N/A	N/A
36"W External Support Channel for use on 48"W Worksurface	Z5SC48 S	\$ 78	N/A	N/A
42"W External Support Channel for use on 54"W Worksurface	Z5SC54 S	\$ 90	N/A	N/A
48"W External Support Channel for use on 60"W Worksurface	Z5SC60	\$ 97	N/A	N/A
54"W External Support Channel for use on 66"W Worksurface	Z5SC66	\$ 113	N/A	N/A
60"W External Support Channel for use on 72"W Worksurface	Z5SC72	\$ 122	N/A	N/A
66"W External Support Channel for use on 78"W Worksurface	Z5SC78	\$ 133	N/A	N/A
72"W External Support Channel for use on 84"W Worksurface	Z5SC84	\$ 146	N/A	N/A

Worksurface Wire Manager (no color option)				
36"W Wire Manager for use on 48"W Worksurface	Z5WM48 S	\$ 48	N/A	N/A
42"W Wire Manager for use on 54"W Worksurface	Z5WM54 S	\$ 56	N/A	N/A
48"W Wire Manager for use on 60"W Worksurface	Z5WM60	\$ 61	N/A	N/A
54"W Wire Manager for use on 66"W Worksurface	Z5WM66	\$ 70	N/A	N/A
60"W Wire Manager for use on 72"W Worksurface	Z5WM72	\$ 76	N/A	N/A
66"W Wire Manager for use on 78"W Worksurface	Z5WM78	\$ 81	N/A	N/A
72"W Wire Manager for use on 84"W Worksurface	Z5WM84	\$ 89	N/A	N/A

How to specify —
Select the Model Number from above.

1st Option:
Paint
(if applicable):
P1 P2 P3
See page 120 for finishes.

P | | | | |

Examples: T6BK.P01 T624FB

S Shippable by small-package carrier.

For specification information see pages 209-210. (See page 413 for COM pricing on fabrics Grades G-J.)

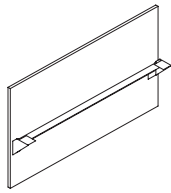

Description	Model	List Price
28"H Full Desk Screens — Painted Wood		
30"W	Z6DF2830D	\$ 667
36"W	Z6DF2836D	\$ 676
42"W	Z6DF2842D	\$ 716
48"W	Z6DF2848D (shown)	\$ 745
54"W	Z6DF2854D	\$ 821
60"W	Z6DF2860D	\$ 873

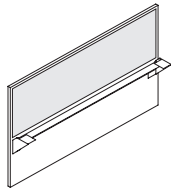

Description	Model	List Price					
		Grade A	Grade B	Grade C	Grade D	Grade E	Grade F
28"H Full Desk Screens — Painted Wood with Fabric Insert							
30"W	Z6DF2830F	\$ 819	\$ 828	\$ 838	\$ 853	\$ 869	\$ 885
36"W	Z6DF2836F	\$ 831	\$ 842	\$ 854	\$ 872	\$ 891	\$ 910
42"W	Z6DF2842F	\$ 884	\$ 897	\$ 910	\$ 932	\$ 954	\$ 976
48"W	Z6DF2848F (shown)	\$ 944	\$ 959	\$ 974	\$ 999	\$ 1024	\$ 1049
54"W	Z6DF2854F	\$ 1034	\$ 1051	\$ 1068	\$ 1096	\$ 1124	\$ 1152
60"W	Z6DF2860F	\$ 1103	\$ 1122	\$ 1141	\$ 1172	\$ 1203	\$ 1235

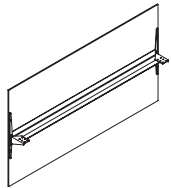

Description	Model	List Price
28"H Full Desk Screens — Landscape Surface		
30"W	Z6DF2830L	\$ 1550
36"W	Z6DF2836L	\$ 1863
42"W	Z6DF2842L	\$ 1976
48"W	Z6DF2848L (shown)	\$ 2124
54"W	Z6DF2854L	\$ 2280
60"W	Z6DF2860L	\$ 2434

LANDSCAPE SURFACE MATERIAL OPTIONS

Frosted Translucent
FT01 Frost

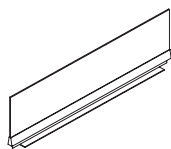

Description	Model	Clear List Price	Frosted List Price
13"H x 3/8" Thick Shared Desk Screens — Glass			
24"W	Z6DS1324TG S	\$ 1385	\$ 1478
30"W	Z6DS1330TG S	\$ 1400	\$ 1496
36"W	Z6DS1336TG S	\$ 1421	\$ 1518
42"W	Z6DS1342TG	\$ 1489	\$ 1591
48"W	Z6DS1348TG (shown)	\$ 1619	\$ 1729
54"W	Z6DS1354TG	\$ 1792	\$ 1913
60"W	Z6DS1360TG	\$ 1949	\$ 2084

STRIDE

<p>How to specify — Select the Model Number from above.</p> <p>Z 6 D . M 1 .</p>	<p><i>1st Option:</i> Wood Paint Color (if applicable): See page 120 for Painted Wood Finish.</p>	<p><i>1st Option:</i> Landscape Surface Material and Finish (if applicable):</p>	<p><i>1st Option:</i> Glass (if applicable): LC Clear LF Frosted</p>	<p><i>2nd Option:</i> Fabric (if applicable): See page 13 for fabrics.</p>	<p><i>2nd Option:</i> Hardware Color: PR6 Silver</p> <p> . P R 6 </p>
---	--	---	---	---	--

Examples: Z6DF2842F.M17.JST901.PR6 Z6DS1342TG.LC.PR6 Z6DF2842D.M17.PR6

S Shippable by small-package carrier.

For specification information see pages 209-210.

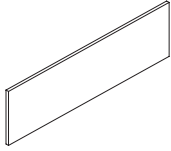

Description	Model	List Price
14"H Modesty Panels — Painted Wood		
30"W	Z6DM1430D S	\$ 363
36"W	Z6DM1436D S	\$ 373
42"W	Z6DM1442D	\$ 418
48"W	Z6DM1448D (shown)	\$ 460
54"W	Z6DM1454D	\$ 506
60"W	Z6DM1460D	\$ 549

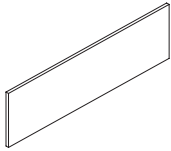

Description	Model	List Price
14"H Modesty Panels — Landscape Surface		
30"W	Z6DM1430L	\$ 750
36"W	Z6DM1436L	\$ 767
42"W	Z6DM1442L	\$ 857
48"W	Z6DM1448L (shown)	\$ 950
54"W	Z6DM1454L	\$ 1040
60"W	Z6DM1460L	\$ 1132

LANDSCAPE SURFACE MATERIAL OPTIONS

GRADE 2

Foundation™

- FD01** Sand
- FD02** Taupe
- FD03** Pure White

<p>How to specify — Select the Model Number from above.</p>	<p><i>1st Option:</i> Wood Paint Color (if applicable): See page 120 for Painted Wood Finish.</p>	<p><i>1st Option:</i> Landscape Surface Material and Finish (if applicable):</p>
<p>Z . M 1 .</p>	<p> </p>	

Examples: Z6DM1448L.SG01 Z6LM2930L.14-1210TPX

S Shippable by small-package carrier.



Low Credenzas

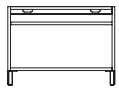

Open

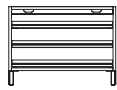

Open with Project Shelves

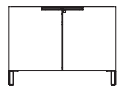

Hinged Doors

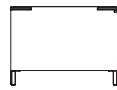

Lateral File with Project Drawer

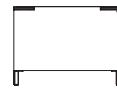

Lateral File

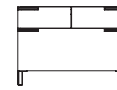

Box/Box/Lateral



Corner Bin

High Credenzas

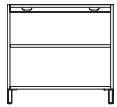

Open

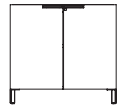

Hinged Doors



Lateral File



Lateral File with Doors

Pedestals



Box/File Mobile



File/File Support



Box/Box/File Support

Towers

42½"H

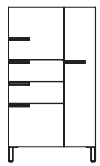

Box/Box/File

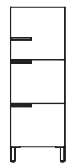

File/File

50"H

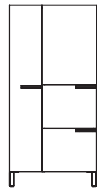

File/File Side Access Side Light

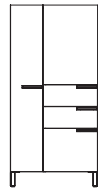

Box/Box/File Side Access Side Light

65"H

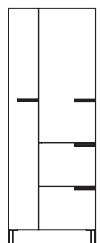

File/File Side Access

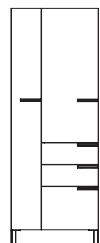

Box/Box/File Side Access

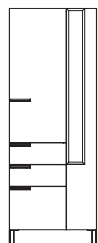

Box/Box/File Side Access Sidelight

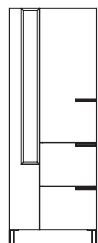

File/File Side Access Sidelight

Combination Files

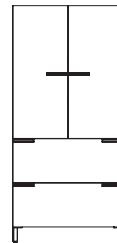

Lateral Drawers

Overhead Cabinets

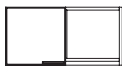

Sliding Door

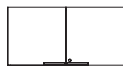

Hinged Doors



Shelf with Nitch

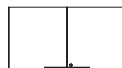

Hinged Door/ Nitch



Open/ Nitch

Horizontal Storage



Full Depth



Shared

Painted Wood		GSA Reference Page				
	Low Credenzas		High Credenzas		Towers	
Widths	Open	24", 30", 36", 42", 48", 60"	Open	24", 30", 36", 42", 48", 60"	Box/Box/File	15½" (42½" and 50"H); 24" (all heights)
	Open with Project Shelf	24", 30", 36"			File/File	15½" (42½" and 50"H); 24"
	Hinged Door	24", 30", 36", 42", 48", 60"	Hinged Door	24", 30", 36", 42", 48", 60"		
	Lateral with Project Drawer	30", 36", 42", 48", 60"	Lateral File	30", 36", 42", 48", 60"		
	Box/Box/Lateral	30"				
	Corner with Bin	24", 30"				
Heights	22" (23½" with top)		28" (29½" with top)		42½"H, 50"H, 65"H	
Depth	18"		24"		Box/Box/File	18", 24"
					File/File	
Pull	Linear		Linear		Linear	
Lock Options:						
Lock	Standard		Standard		Standard	
Omit Lock Core	Optional		Optional		Optional	
Master Keyed Lock	Standard		Standard		Standard	
Removable Lock Core	Yes — with Special Key		Yes — with Special Key		Yes — with Special Key	
Dual-Side Locking	Yes		Yes		Yes	
Suspension	Ball Bearing		Ball Bearing		Ball Bearing — Full Extension	
Drawer Front Construction	¾" thick Painted Wood*		¾" thick Painted Wood*		¾" thick Painted Wood*	
Hinged Door Construction	¾" thick Painted Wood*		¾" thick Painted Wood*		¾" thick Painted Wood*	
Hex-head Glide	Yes		Yes		Yes	
Counterweights	Required on freestanding lateral units and corner credenza.		Optional		Optional	
Drawer Interiors:						
Drawers	9⅞"		9⅞"			
Project Drawer	2⅞"					
Pull Out Shelf	4½"					
Front-to-Back Filing	Standard		Standard		Standard	
Filing Options	Letter		Letter		Letter	

WOOD STORAGE LOCKING

Pedestals	15"W					
File/File	1 lock					
Box/Box/File	1 lock					
Low Credenzas	24"W	30"W	36"W	42"W	48"W	60"W
Hinged Doors	1 lock	1 lock	1 lock	2 locks	2 locks	2 locks
Lateral File with Project Drawers	—	1 lock	1 lock	2 locks	2 locks	3 locks
Box/File	—	2 locks				
Corner — Bin	1 lock					
High Credenzas	24"W	30"W	36"W	42"W	48"W	60"W
Hinged Doors	1 lock	1 lock	1 lock	2 locks	2 locks	2 locks
Lateral/Combination File	—	1 lock	1 lock	1 lock	2 locks	3 locks
Personal Towers	15"W	24"W	24"W with Sidelight			
Box/Box/File	1 lock	2 locks	1 lock			
File/File	1 lock	2 locks	1 lock			
Personal Towers	30"W					
2H Lateral File	1 lock					

* Painted wood is powder-coated medium density fiberboard

Load Capacity for Painted Wood Pedestals, Personal Towers, and Credenzas

Pedestals	18"D [Mobile]	24"D [Support]
Box	17 lbs.	23 lbs.
File	33 lbs.	49 lbs.

Personal Towers	18"D	24"D
Box	17 lbs.	23 lbs.
File	33 lbs.	49 lbs.
Unit w/project drawer	32 lbs.	NA
Lateral	61 lbs.	73 lbs.
Unit w/project drawer	55 lbs.	NA

Credenzas	24"W	30"W	36"W	42"W	48"W	60"W
Low Credenzas						
Project shelves	21 lbs.	27 lbs.	34 lbs.	NA	NA	NA
Lateral w/project drawer	NA	62lbs.	76 lbs.	91 lbs.	76 lbs.	76 lbs.
Lateral project drawer	NA	29 lbs.	35 lbs.	42 lbs.	35 lbs.	35 lbs.
Bin	52 lbs.	52 lbs.	NA	NA	NA	NA
Box	NA	10 lbs.	NA	NA	NA	NA
High Credenzas						
Lateral	NA	68 lbs.	84 lbs.	99 lbs.	84 lbs.	84 lbs.

Interior Dimensions for Painted Wood Pedestals, Personal Towers, Combination Files, and Credenzas

	Height	Depth	Width
PEDESTALS	Box — 27" File — 9¾"	Mobile — 14½" Support — 19"	12½"
PERSONAL TOWERS	Box — 27" File — 9¾" Project Drawer — 3¾"	20" — 17" 24" — 19" Project Drawer — 16¾"	12½"
COMBINATION FILES	Lateral — 9¾" Project Drawer — 3¾"	Lateral — 15" Lateral (w/project drawer) — 13¾" Project Drawer — 13¾"	Lateral — 25¾" Project Drawer — 26¾"
CREDENZAS			
<i>Open Shelves</i>			
Low Credenza	Bottom: 12½" Top: 3¾"	16½"	24" exterior = 22½" interior 30" exterior = 28½" interior 36" exterior = 34½" interior
High Credenza	Bottom: 12½" Top: 9½"	20½"	42" exterior = (2) 19¾" interior 48" exterior = (2) 22¾" interior 60" exterior = (2) 28¾" interior
<i>Project Shelves</i>			
Low Credenza	4½"	13¾"	24" exterior = 19¾" interior
<i>Hinged Doors</i>			
Low Credenza	Bottom: 12½" Top: 3¾"	15¾"	24" exterior = 22½" interior 30" exterior = 28½" interior 36" exterior = 34½" interior
High Credenza	Bottom: 12½" Top: 9½"	19¾"	42" exterior = (2) 19¾" interior 48" exterior = (2) 22¾" interior 60" exterior = (2) 28¾" interior
<i>Lateral</i>			
Low Credenza	Lateral — 9¾" Project Drawer — 2¾"	30"W & 42"W Lateral — 13¾" 36"W & 60"W Lateral — 12½" Project Drawer — 13¾"	30" exterior = 26¾" interior 36" exterior = 32¾" interior 42" exterior = 26¾" interior
High Credenza	9½"	15"	48" exterior = 32¾" interior 60" exterior = 32¾" interior
<i>Corner</i>			
Low Credenza	Bin — 12¼"	Bin — 14¼"	Bin — 15¾"
<i>Box/Box/Lateral</i>			
Low Credenza	Lateral — 9¾" Box — 27"	Lateral — 13¾" Box — 11½"	Lateral — 25¾" Box — 10¾"

Top View of Drawers

15"W Pedestal
and Tower Drawers

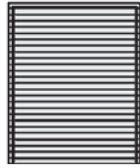

Letter Front-to-Back
18"D Mobile – 14½" of filing
24"D Support – 19" of filing

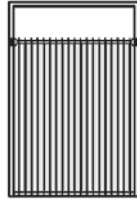

Legal Side-to-Side
24"D Support – 12" of filing

24"W Credenza
Lateral Drawers

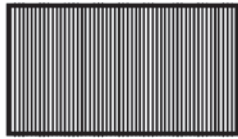

Letter Side-to-Side
18"D – 20½" of filing



Letter Front-to-Back
18"D – 15" of filing
24"D – 17½" of filing

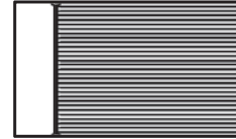

Legal Front-to-Back
18"D – 15" of filing
24"D – 17½" of filing

30"W Credenza
Lateral Drawers



Letter Front-to-Back
18"D – 30" of filing
24"D – 35" of filing



Legal Front-to-Back
18"D – 15" of filing
24"D – 17½" of filing

36"W Credenza
Lateral Drawers



Letter Front-to-Back
18"D and 24"D – 30" of filing



Legal Front-to-Back
18"D and 24"D – 15" of filing

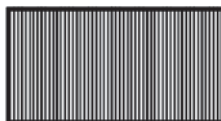

Letter Side-to-Side
18"D and 24"D – 32½" of filing



Letter Side-to-Side and Legal Front-to-Back
18"D and 24"D – 17" of Letter S-T-S filing and
15" of Legal F-T-B filing

GSA Reference Page

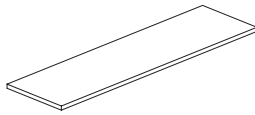

Credenza Top

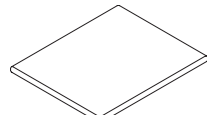

Seat Cushion

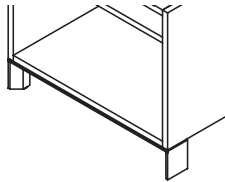

Credenza Bottom Trim

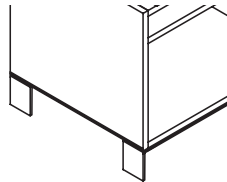

Credenza Side Trim

Credenzas ship fully assembled except for the credenza top, which must be ordered separately. Credenza tops in laminate or veneer with flat/square details are available in various depths. Veneer fronts by Gunlocke®.

Laminate credenza tops, a footed base, and aluminum trim along the front edge of the credenza enhance the durability of the credenza.

A relocatable seat cushion can be placed on the credenza top of a low credenza for additional seating.

Credenza bottom trim is standard on the front of all credenzas.

Optional side trim is an aesthetic piece for end of run credenzas and is ordered separately and field installed.

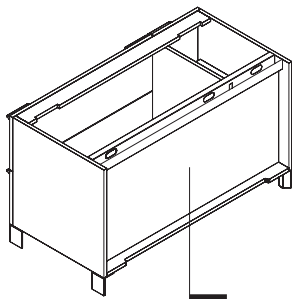

Relocatable wire trough provides a channel for wire management.

Each credenza ships with one front bracket that can be used to gang (multiple) credenzas in-line.

All credenzas have a recessed back with a cavity to support wire management. An optional metal back should be specified separately to finish the credenza in a single-sided application where the back is exposed. Finished back configurations should not utilize rail as the top cap required shows an unfinished top groove.

Credenza top must be ordered separately and can span multiple credenzas.

Corner credenzas with bin when housing a CPU must be used with credenza tops for wire trough or rail (not full depth) to minimize heat buildup.

Credenzas can support panels in certain applications with the addition of a credenza-to-panel bracket, see guidelines on pages 130-131 and bracket on page 236.

Credenzas can be shipped with lock cores removed; cores can be installed after files are in place. Core removable lock feature allows key numbers to be easily changed in the field.

All credenzas feature silver linear pulls. Pulls, feet, and bottom trim are all PR6 Silver finish.

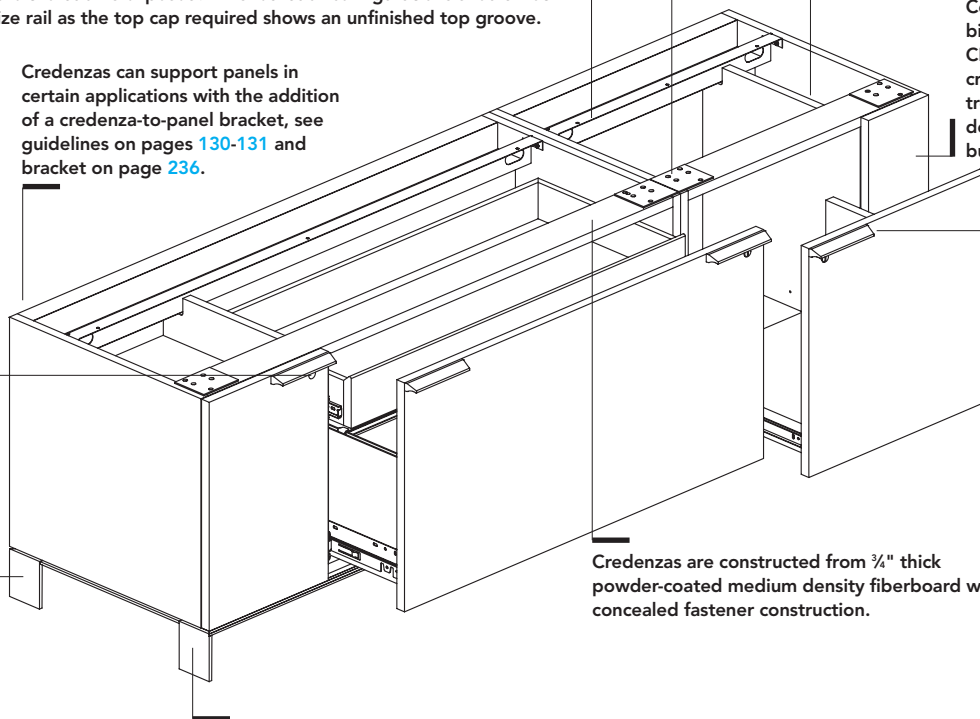

Credenza feet have sleeves to conceal the leveling glides. Leveling range is 1 1/8". The hex-head design of the stem allows leveling to be done even when the credenza is fully loaded.

Credenzas are constructed from 3/4" thick powder-coated medium density fiberboard with concealed fastener construction.

Credenzas ship with the feet located at the outside corners. Alternate mounting holes are provided for front feet to be inset 4" on mid-run credenzas, during installation.

High Credenza Side to Panel Bracket

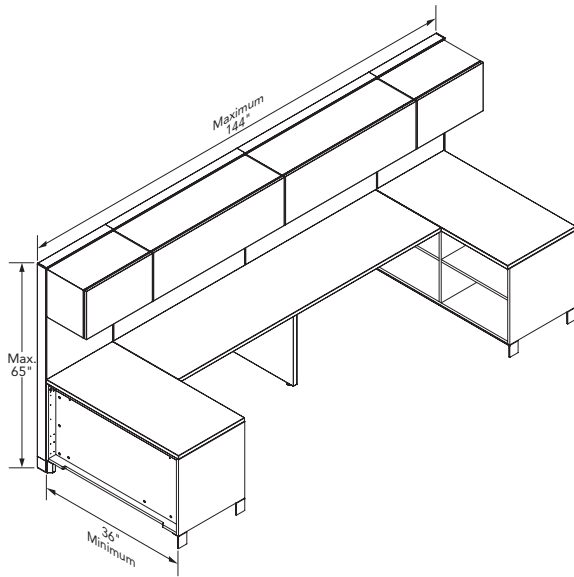

Side-mounted high credenzas

- The minimum Stride high credenza width is 36" W on each end.
- With a floor support the maximum panel run is 144".
- Without a floor support, the maximum panel run is 96".
- Overheads, shelves, and worksurfaces must be mounted on the same side of the parent run as the credenzas. Stacking frames cannot be used with overheads.
- Panel frame maximum height is 65" H.

Credenza Side to Panel Bracket with Return Panel

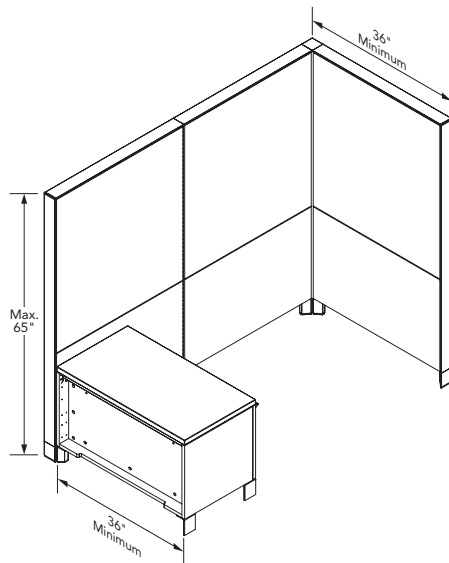

Bracket with return panel

- Minimum Stride credenza width 36".
- With a floor support the maximum panel run is 144".
- Without a floor support, the maximum panel run is 96".
- The minimum size for panel return is 36" W x 35" H.
- Overheads, shelves, and worksurfaces must be mounted on the same side of the parent run as the high credenza.
- Panel frame maximum height is 65" H.

22"H Low Credenzas

22"H low credenzas are constructed of painted wood and are available with painted fronts. Low credenzas range from 24" W to 60" W x 22" H (without top; or 23½" H with top) x 18" D.

Low Credenza Configurations (page 257)

- Open
- Open with Project Shelves#
- Hinged Doors
- Lateral File with Project Drawer#
- Box/File
- Corner Bin#

Low Credenza — Open (page 257)

- Low open credenzas have one removable shelf.
- Bottom shelf opening is 12½" H and will accommodate binders.
- Top shelf opening is 3½" H.

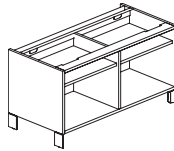

Low Credenza — Open with Project Shelves (page 257)

- Available in 24"-36" widths.
- Units have three pull out shelves at fixed height.
- Shelves have an opening clearance of 4½" H.

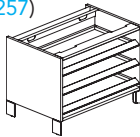

Low Credenza — Hinged Doors (page 257)

- 24"-36" W units have two doors with one lock and one adjustable shelf.
- 42"-60" W units have four doors with two locks and a center septum, with one shelf on each side that can be adjusted in 2" increments.

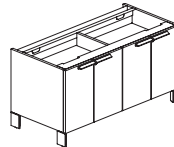

Low Credenza — Lateral File with Project Drawer # (page 257)

- Available in 30"-60" W.
- A 2½" H optional pull out project drawer is located behind the lateral file drawer front.
- When used freestanding, counterweight kit model ZD-CW must be specified.
- 30"-36" W are lateral files with one lock.
- 42-48" W is a combination unit with a lateral drawer and either a left or right 12" W hinged door with an adjustable shelf inside. Unit has two locks.
- 60" W is a combination unit with a lateral drawer and both left and right 12" W hinged doors each with an adjustable shelf. Unit has three locks.

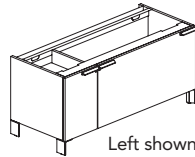

Left shown

Low Credenza — Box/Box/Lateral # (page 257)

- 30" W box/box/lateral credenza provides a combination of personal and file storage.
- Unit has two locks.

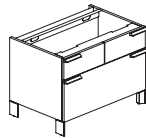

Low Credenza — Corner with Bin # (page 257)

- For use under perpendicular layered worksurfaces.
- Available 24" W or 30" W and are either left or right handed with one lock.
- Handedness on corner credenzas is determined by the location of the credenza in the credenza run, considered when facing the run.
- Corner slide out bin has an open side to allow for easy side access of the stored content, and can be used for storing binders or a CPU (up to 12¼" H).
- There is venting to allow airflow, however, if a CPU is being stored in a corner credenza, a credenza top for wire trough or rail must be used to minimize heat buildup (do not use full depth credenza tops).
- All units have a side panel that provides clearance for modesty panel attachment. It is removable and can be used for cord management and power/data access.
- Side panel is 6" W on 24" W credenzas and 12" W on 30" W credenzas.

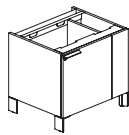

Right shown

28"H High Credenzas

28"H high credenzas are constructed of painted wood and are available with painted fronts. High Credenzas range from 24" W to 60" W x 28" H (without top; or 29½" H with top) x 24" D.

High Credenza Configurations (page 258)

- Open
- Hinged Doors
- Lateral File#

High Credenza — Open (page 258)

- Open credenzas have two fixed shelves.
- Bottom shelf opening is 12½" H and will accommodate binders.
- Top shelf opening is 9½" H.
- Open credenzas 42" W-60" W have a center septum.

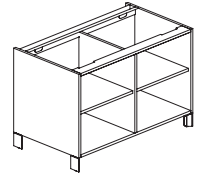

High Credenza — Hinged Doors (page 258)

- 24"-36" W units have two doors with one lock and one adjustable shelf.
- 42-60" W units have four doors with two locks and a center septum, and one shelf on each side of the center septum that can be adjusted in 2" increments.

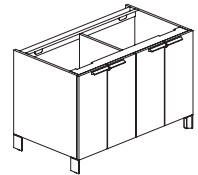

High Credenza — Lateral File (page 258)

- Available in 30-60" W.
- 30-36" W are lateral files with one lock.
- 42-48" W is a combination unit with two 36" W lateral drawers and either a left or right 12" W hinged door with an adjustable shelf inside. Unit has two locks.
- 60" W is a combination unit with two 36" W lateral drawers and both left and right 12" W hinged doors each with an adjustable shelf inside. Unit has three locks.

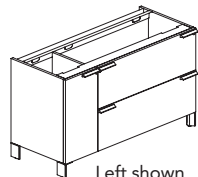

Left shown

Counterweight Kits for Credenzas

Counterweight Kit (page 263)

- Weight attached to the back of a credenza to inhibit tipping. Must be ordered separately and field installed.
- Counterweight kits required for freestanding low credenzas:
 - Open with Project Shelves, all widths..... 1 Kit
 - Lateral Files, all widths 2 Kits
 - 30" W Box/Box/Lateral 1 Kit
 - Corner Credenza, all widths 1 Kit
- For every 30" of added and ganged credenzas with spanning credenza tops, one counterweight kit can be removed.
- Stability bracket model number Z6CSBK can be used in place of a counterweight kit. See pages 130-131 and 263.

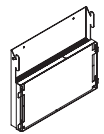

Unit may require counterweight depending on application, see chart above..

Credenza Tops:

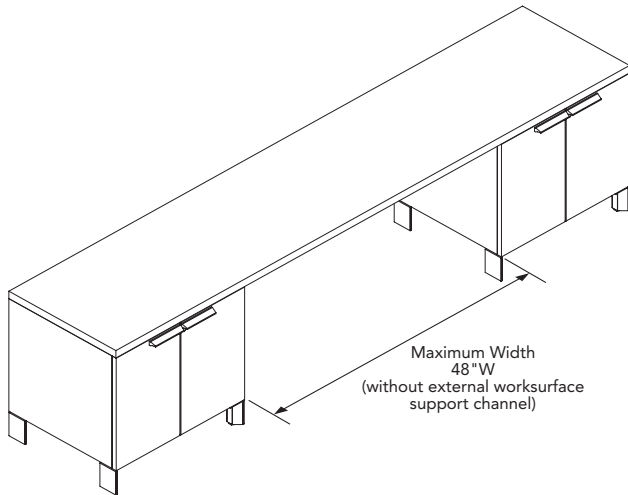

Credenza tops are required to finish top surface of low and high credenzas.

- Credenza tops are 1/4" thick.
- Two types (depths) of credenza tops:
 - Full Depth — to match depth of the credenza.
 - For Wire Trough — 1/2" less than depth of the credenza, providing access to the wire trough and a channel for wire management when credenza is used along powered panel spine.
- Tops are available in laminate or veneer and with flat/square edge detail.
- Veneer credenza tops are by Gunlocke®. Stratawood veneer has a consistent straight-grain pattern. Natural veneer will have cathedrals and as a natural material is subject to nature's quality control with variations in grain pattern and tone.
- Credenza tops have threaded metal inserts at the ends for attachment to credenzas.
- The maximum span of credenza tops is 48". With the addition of an external worksurface support channel the maximum span for credenza tops is 72". Note: The maximum span of standard systems worksurfaces is 60". Grommets on standard systems worksurfaces will interfere with the wire trough on credenzas.

Credenza Top Configurations:

Full Depth Credenza Tops 66"W or greater (pages 260-261)

- Specify when there is no requirement for wire trough accessibility.
- 18"D Top for use on low credenzas.
- 24"D Top for use on high credenzas.

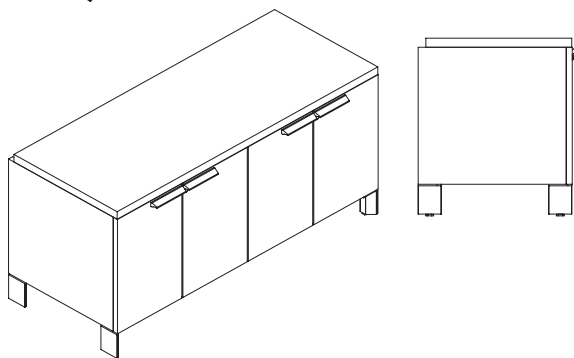
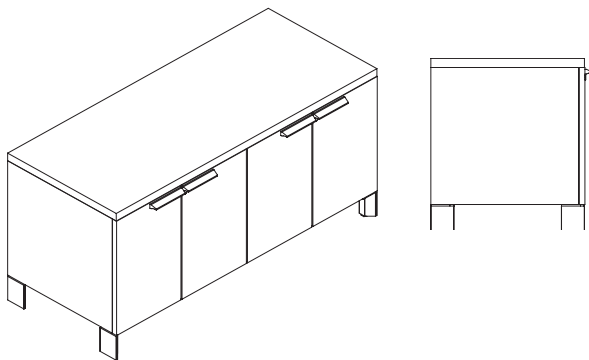

Credenza Top for Wire Trough (pages 260-261)

- Specify when using credenzas along a powered panel spine or wall if wire management capability is desired.
- 17"D (actual 16 1/2"D) Top for use on low credenzas.
- 23"D (actual 22 1/2"D) Top for use on high credenzas.
- Veneer tops that accommodate wire trough for high credenzas are available through the 9120 Program on page 218.

Credenza Backs

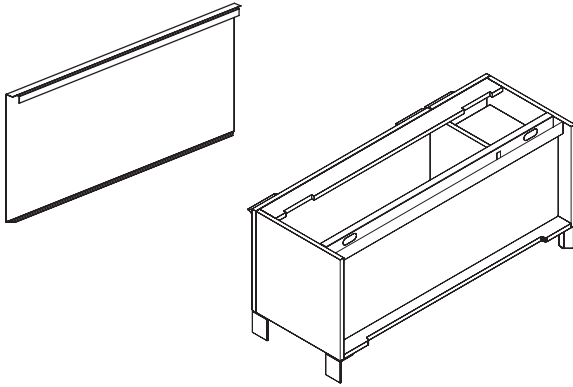

Credenza Backs (page 262)

- Metal credenza backs are optional, and should be specified in single-sided applications where the back side of the credenza will be visible and not using a rail.

Credenza backs can be specified for:

- Low credenza with rail will show an open groove on top cap
- High credenza with rail will show an open groove on top cap
- Low credenza without credenza rail
- High credenza without credenza rail
- Credenza backs cannot be specified with credenzas outfitted with credenza tops for wire trough.
- Credenza backs should be specified to match width of each credenza in the run; backs cannot span multiple credenzas.
- When using credenza back for credenzas with credenza rail, there is an open groove on top cap.
- If working in conjunction with perch cabinet a credenza rail is required for support.

Painted Wood Credenza Accessories

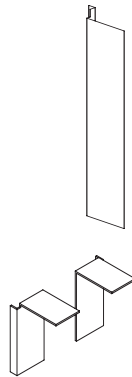

Credenza to Panel Brackets (page 263)

- Attaches credenza to panel run.
- Used to attach credenza to panel frame to provide stability when used with Stride panel frames.
- Handedness is determined by side of credenza that attaches to panel when facing the credenza.
- Back-to-panel bracket kits include left and right brackets.

Stability Bracket Kit (page 263)

- Can be used in place of counterweight kit if the freestanding credenza is in front of a panel and one side of the credenza is modular with the panel.

Note: A credenza is freestanding if it is not ganged to another credenza, is not sharing a credenza top with another credenza, and not attached to a panel. See pages 130-131 for planning guidelines.

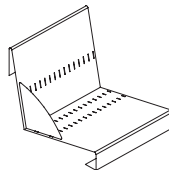

Binder Shelf for Corner Credenzas (page 263)

- Provides easy access and visibility for binders stored in corner bin.

Pedestals

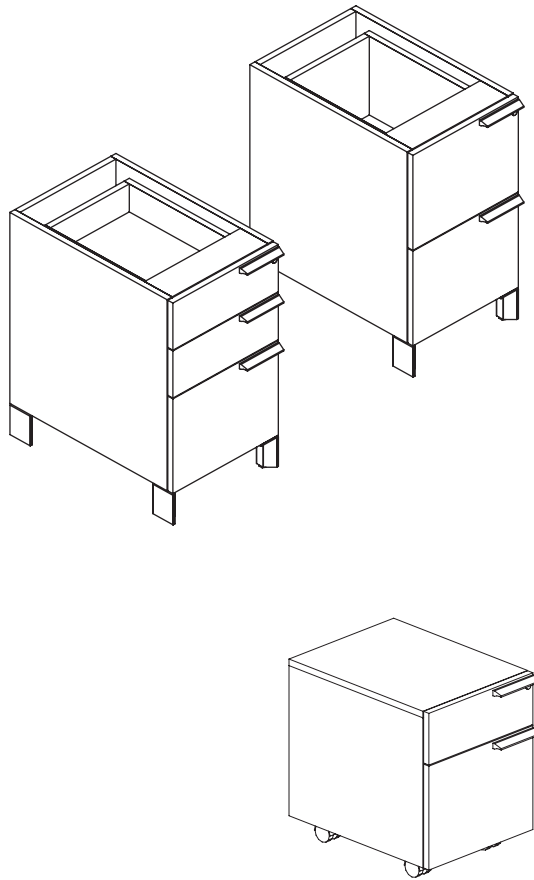

Pedestal Configurations:

- Box/Box/File Support
- File/File Support
- Box/File Mobile
- Pedestals are constructed of ¾" thick powder-coated medium density fiberboard with concealed fasteners.
- All pedestals have asymmetric linear pulls in silver finish. Optional seat cushion can be added.
- Pedestals have one core removable lock.

Pedestals are specified as either left- or right-hand units.

- Handedness is determined by user's side, placing the pull on the side closest to the user. Specify a left unit to be on the user's left side (linear pull will be on the right side of the unit); specify a right unit to be on the user's right side (linear pull will be on the left side of the unit).
- Pedestals come fully assembled with a top and back. Support Pedestals will have pilot holes on the top for mounting under worksurfaces.

Support Pedestals (page 259)

- Support pedestals are 15½"W x 24"D x 28"H and are for use under a worksurface or credenza top. Support pedestals have four feet with sleeves to conceal the leveling glides. Bottom trim is standard on all support pedestals.
- Optional side and back trim are aesthetic pieces and are ordered separately and field installed.

Mobile Pedestals (page 259)

- Mobile pedestals are 15½"W x 18"D x 20"H, 22" H with optional seat cushion. Mobile pedestals have 4 casters (2 locking). Counterweight kit is included.

Trim for Credenzas, Pedestals, and Towers

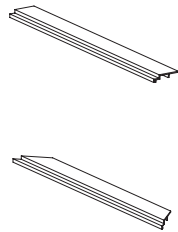

Trim for Credenzas, Pedestals, and Towers

Side Trim (page 263)

- Side trim is an optional aesthetic piece for credenzas, pedestals, and towers. Used at the end of a run to match standard front bottom trim.

Back Trim (page 263)

- Back trim is an optional aesthetic piece for pedestals and towers. Used to match standard front bottom trim.
- Order to match the width of each component.

Recommended Seat Cushion Sizes for Mobile Pedestals and Low Credenzas

18"D Cushions for use with Pedestals and Full Depth Credenza Tops

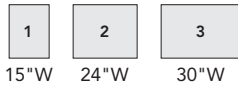

15"W Mobile Pedestal
15"W Cushion



24"W Credenza
24"W Cushion



30"W Credenza
30"/15"W Cushion

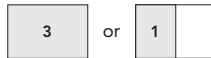

36"W Credenza
15"/24"W Cushion

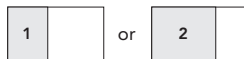

42"W Credenza
24"W Cushion



48"W Credenza
24"W Cushion



60"W Credenza
30"W Cushion



Seat Cushions

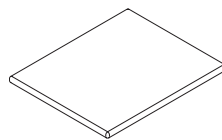

Seat Cushions (page 263)

- Place on top of low credenza tops or mobile pedestal for quick and convenient additional seating.
- For use on low credenzas only.
- Seat cushion must rest on top of credenza top — order separately.
- COM yardage for seat cushion is 1 yard.

The credenza rail is a single-sided 1½" thick frame that can be fitted atop credenza units.

Credenza Rail (pages 264-265)

- Provides support for perpendicular run-off worksurfaces.
- When used on low credenzas, credenza rail supports a height adjustment range of 27½" to 30½" in 1" increments.
- Channel for power and data.
- Connection point for accessories.
- Will show groove on top of rail if adding a back panel.

Guidelines:

1. The credenza rail may have only one worksurface mounted to each individual rail.
2. The credenza rail can span multiple credenzas, but must stay on-module with credenzas.
3. Credenza rail must be fully supported by a run of credenzas.
4. A worksurface can be mounted off-modular along the rail at four heights — 27½"-30½" H in 1" increments.
5. All components must be specified separately.

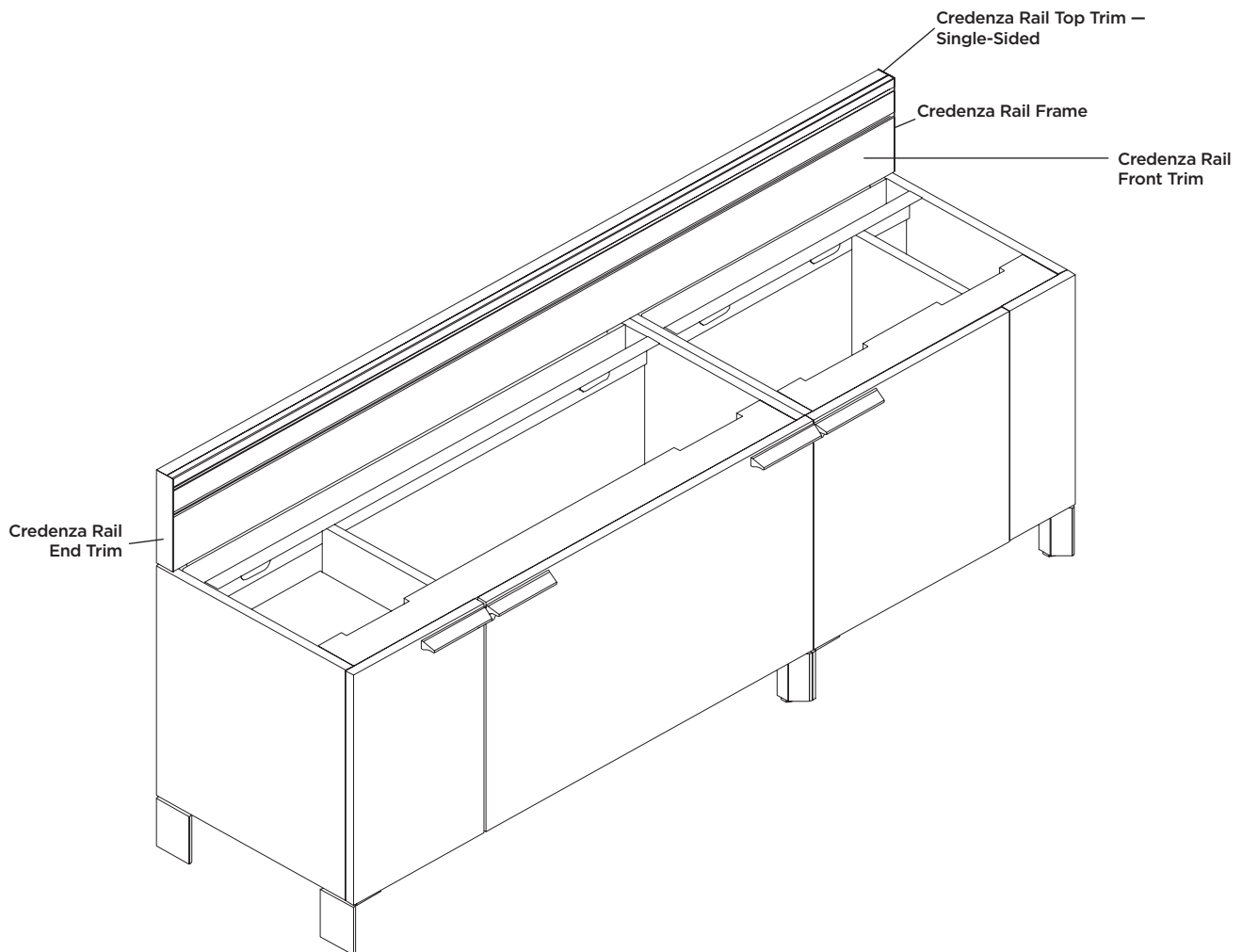

All credenza rail components must be ordered separately.

- Credenza rail frame
- Credenza rail front trim
- Credenza rail end trim
- Credenza rail bracket kit
- Credenza rail top trim

Credenza Rail Frame (page 264)

- Available 24"-96" W in 6" increments and can span multiple credenzas. Mounts atop storage credenzas — mounting hardware is included.



Credenza Rail Front Trim (page 264)

- Can be specified ported or non-ported. Ported trim has two openings positioned 6" from the edge and must match the size of the credenza.
- Openings (2.7"W x 1.377"H) must be filled with a duplex receptacle, data port or wire management grommet (TAWG) or there will be visible holes. Non-ported trim is available 24"-96" W in 6" increments and can span multiple credenzas.

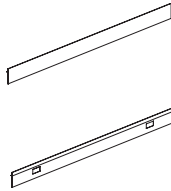

Credenza Rail End Trim (page 264)

- Specify in an end of run condition to finish an exposed end of the rail. End trim is not required on the end of a credenza rail when adjacent to a tower.



Rail Bracket Kit (page 264)

- Reversible bracket used to mount worksurface on credenza rail.
- Supports height adjustment range from 27½" to 30½".
- Includes two sets of brackets and attachment hardware.



Credenza Rail Top Trim (page 265)

- Available in 24"-96" W in 6" increments and can span multiple credenzas.
- 13"H for overall height of 42½".
- Top trim may be specified off-module to the credenza rail as long as the total length equals the length of the credenza rail frame.

DOUBLE-SIDED CREDENZA RUN

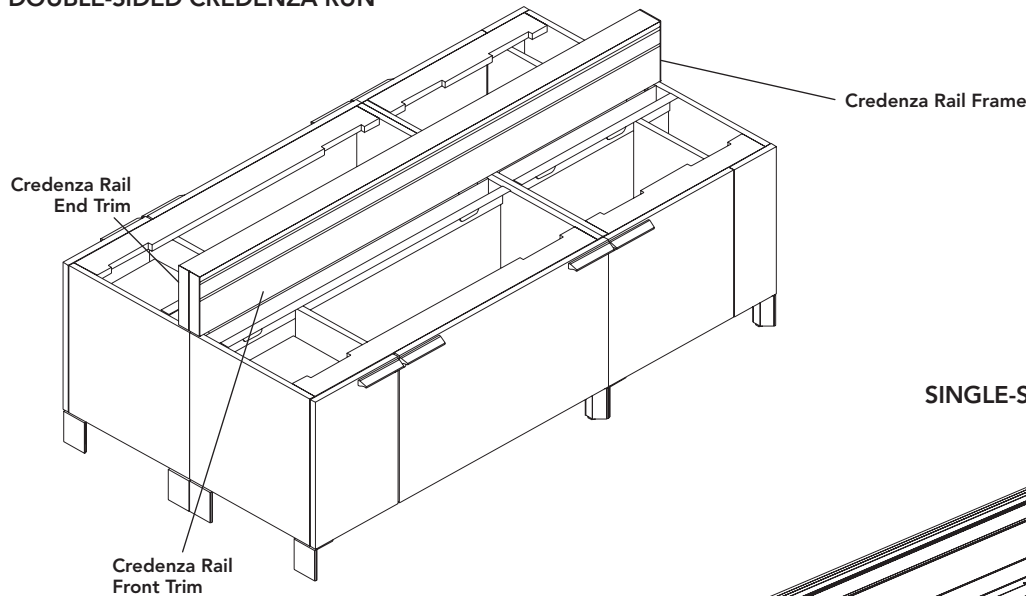

SINGLE-SIDED CREDENZA RUN

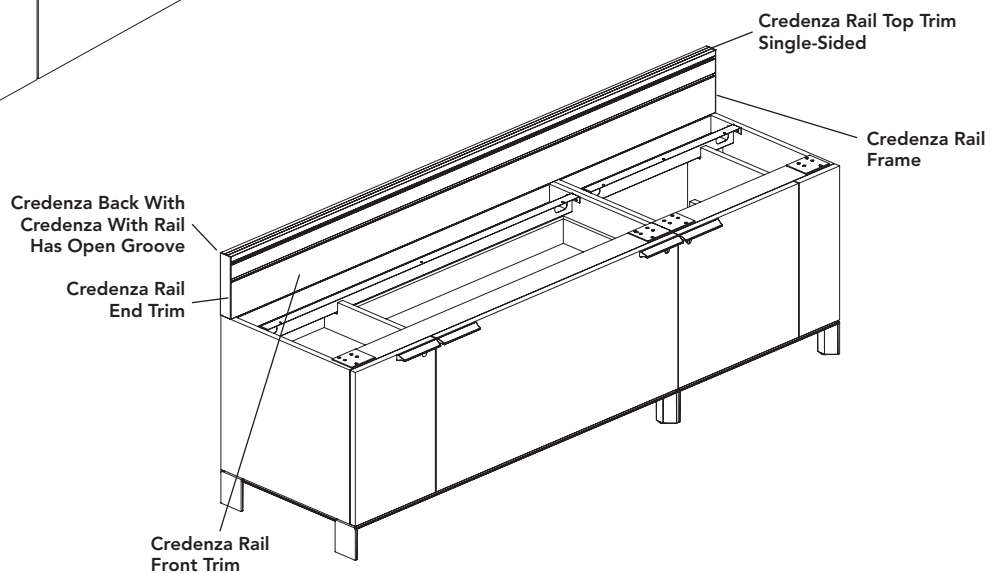

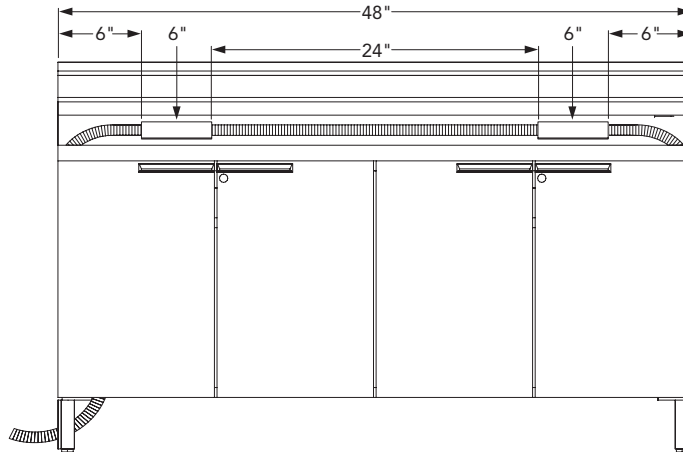

Routing Electrical: Credenzas

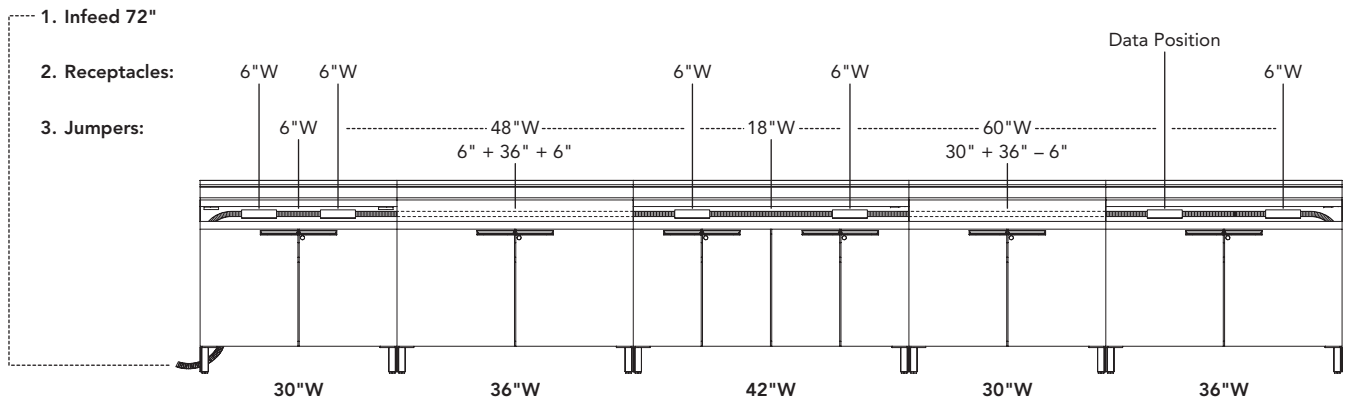

Jumper Situation:	Within a credenza	Spanning a credenza	Spanning a credenza with an open position for data.
Formula:	Subtract 24" from width of credenza. $30"W - 24" = 6"$ Jumper	Add 12" to width of spanned credenza. $36"W + 12" = 48"$ Jumper	Subtract 6" from total width of middle and end credenzas. $(30"W + 36"W) - 6" = 60"$ Jumper

Routing Electrical: Credenzas with a Tower

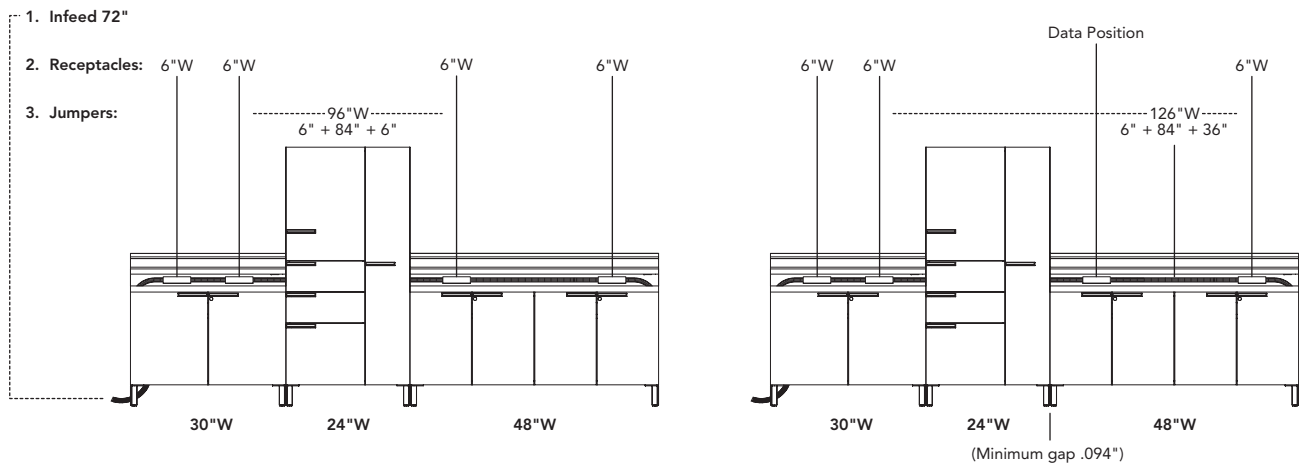

Jumper Situation:	Spanning a tower	Spanning a tower with an open position for data.
Formula:	$6" + 84" + 6" = 96"$ Jumper	$6" + 84" + 6" + 6" + 24" = 126"$ Jumper



The 4-wire electrical system is a UL183-listed 2 circuit non-dedicated electrical system. The credenza rail supports continuous power and data distribution. With ported trim, the credenza rail provides easy access to power and data. In addition to the standard electrical components, PVC-free components are also available.

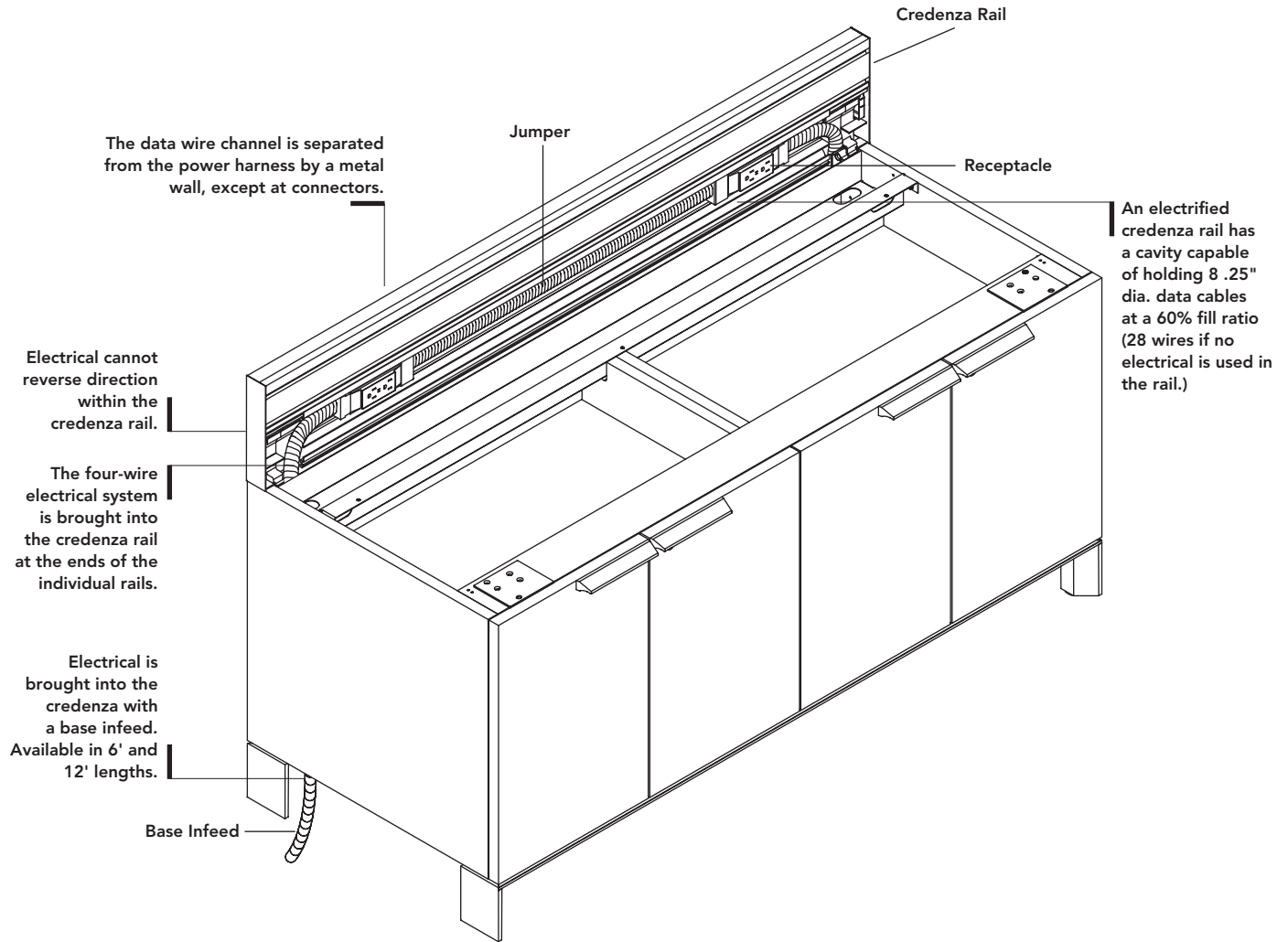

SPECIFICATION INFORMATION

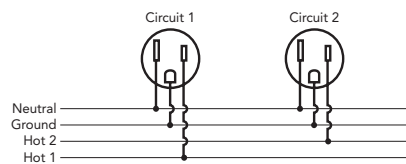

This electrical system has two hot wires, a shared neutral wire, and a shared ground wire. Each circuit is rated at 20 amps. A maximum of 13 duplex receptacles is permitted per circuit. Each receptacle is rated at 15 amps. Consult your electrician to ensure the planned electrical load is within permissible limits.

1. Determine location, quantity, and circuit number for duplex receptacles and power entry.
2. Base electrical infeed delivers power from building to system.
3. Desking power jumpers connect together duplex receptacles or groups of duplex receptacles.

It is the customer's responsibility to ensure that the installation of the electrical components meets all local and national building codes and all other applicable regulations.

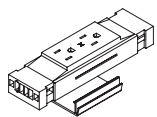

Duplex Receptacle



0" W Desking Power Jumper

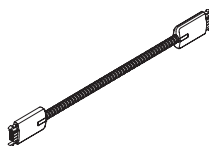

Desking Power Jumper

A. Routing Electrical: Within Credenza

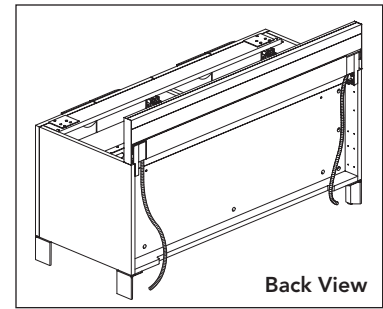
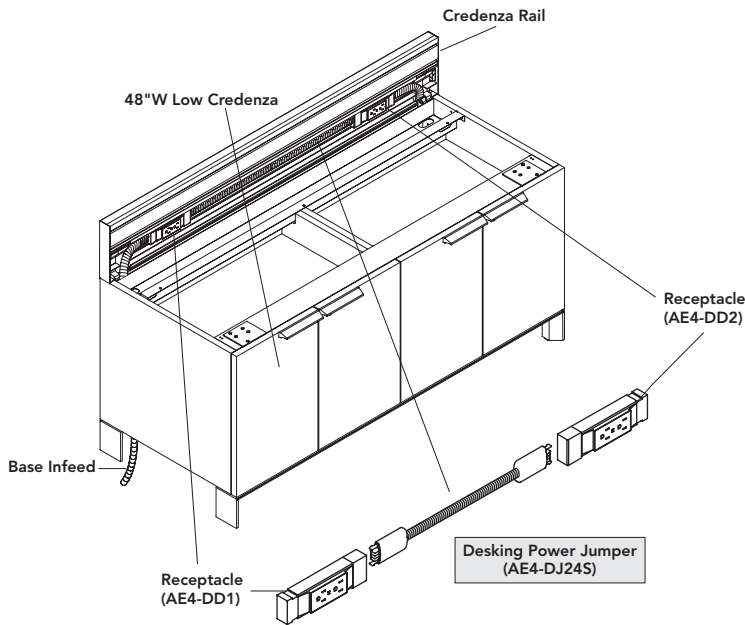

Credenza Width	Jumper Size	Jumper Model
24"	0"	AE4-DJ0S
30"	6"	AE4-DJ6S
36"	12"	AE4-DJ12S
42"	18"	AE4-DJ18S
48"	24"	AE4-DJ24S
60"	36"	AE4-DJ36S

B. Routing Electrical: Within Credenza Back-to-Back

All electrical components must be duplicated in a back-to-back situation. The credenza rail provides power to only one side of the credenza.

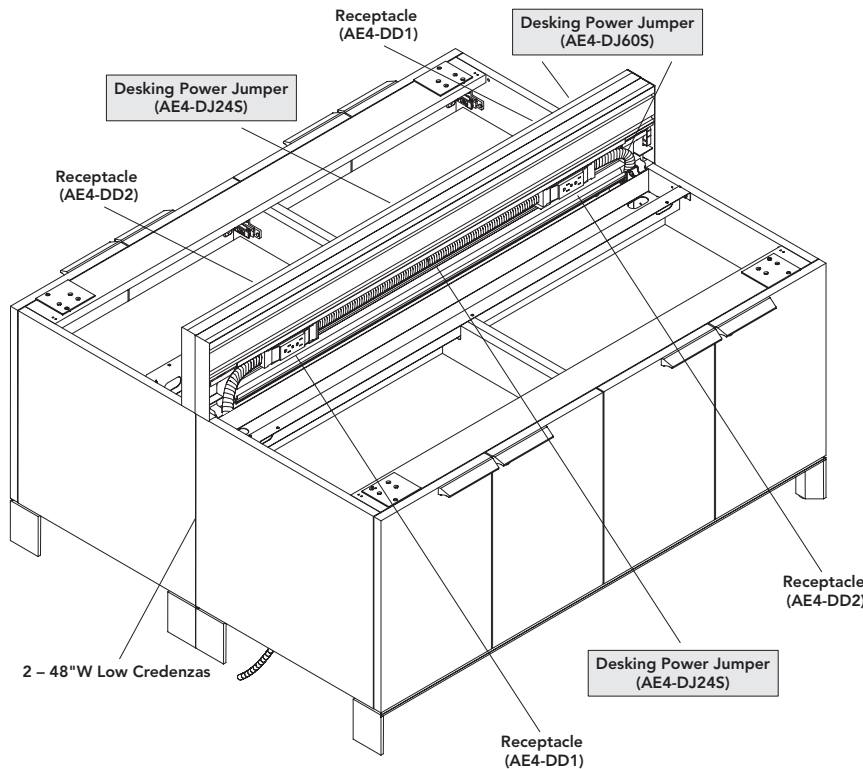

When routing from the front side to the back side in back-to-back credenzas use a 60" desking power jumper.

C. Routing Electrical: Spanning a Credenza

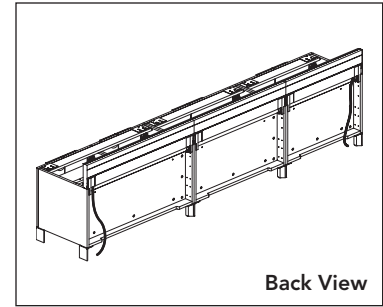
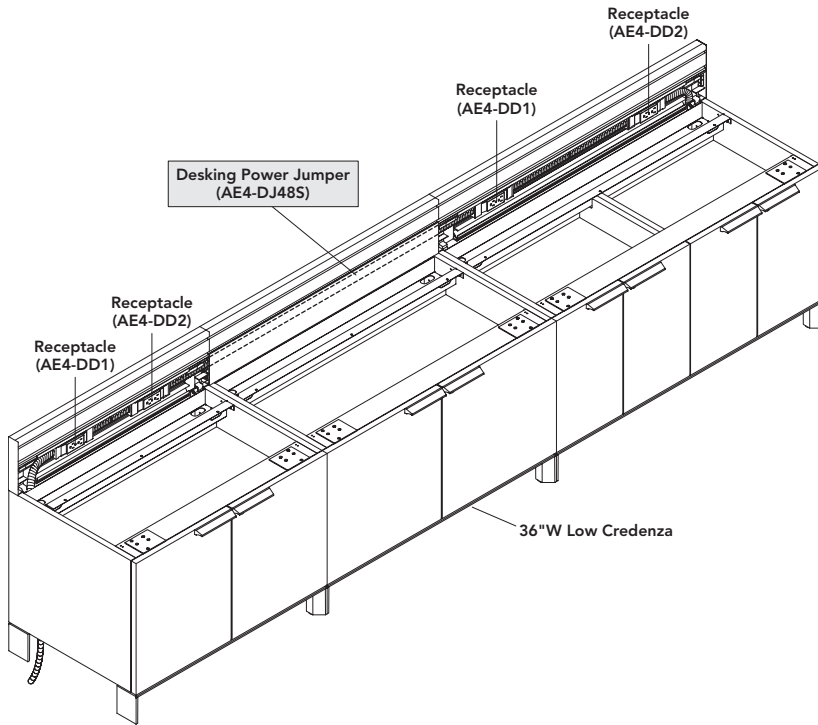

Credenza Width	Jumper Size	Jumper Model
0"	12"	AE4-DJ12S
24"	36"	AE4-DJ36S
30"	42"	AE4-DJ42S
36"	48"	AE4-DJ48S
42"	54"	AE4-DJ54S
48"	60"	AE4-DJ60S
60"	72"	AE4-DJ72S

D. Routing Electrical: Spanning a Credenza and an Open Position for Data

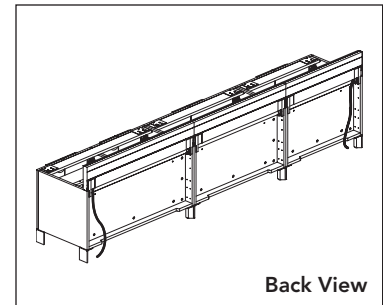
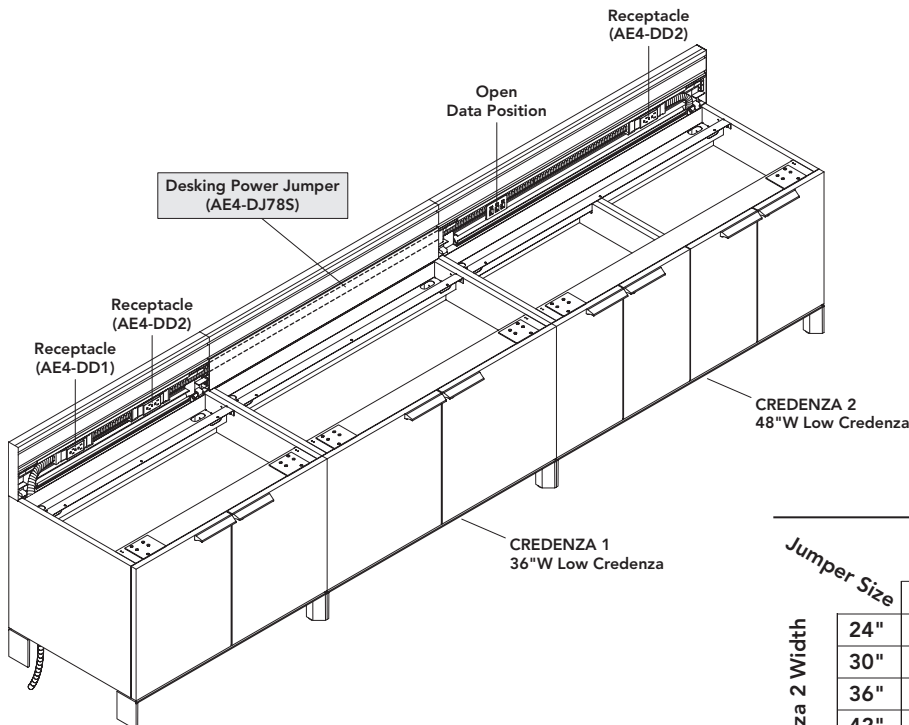

		Credenza 1 Width						
		Jumper Size						
		0"	24"	30"	36"	42"	48"	60"
Credenza 2 Width	24"	18"	42"	48"	54"	60"	66"	78"
	30"	24"	48"	54"	60"	66"	72"	84"
	36"	30"	54"	60"	66"	72"	78"	90"
	42"	36"	60"	66"	72"	78"	84"	96"
	48"	42"	66"	72"	78"	84"	90"	102"
	60"	54"	78"	84"	90"	96"	102"	114"

STRIDE

E. Routing Electrical: Spanning a Tower

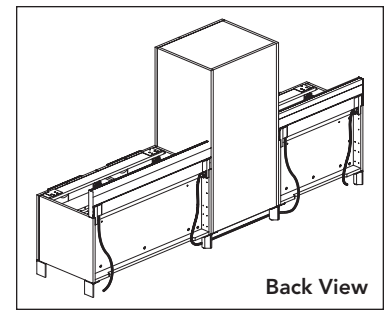
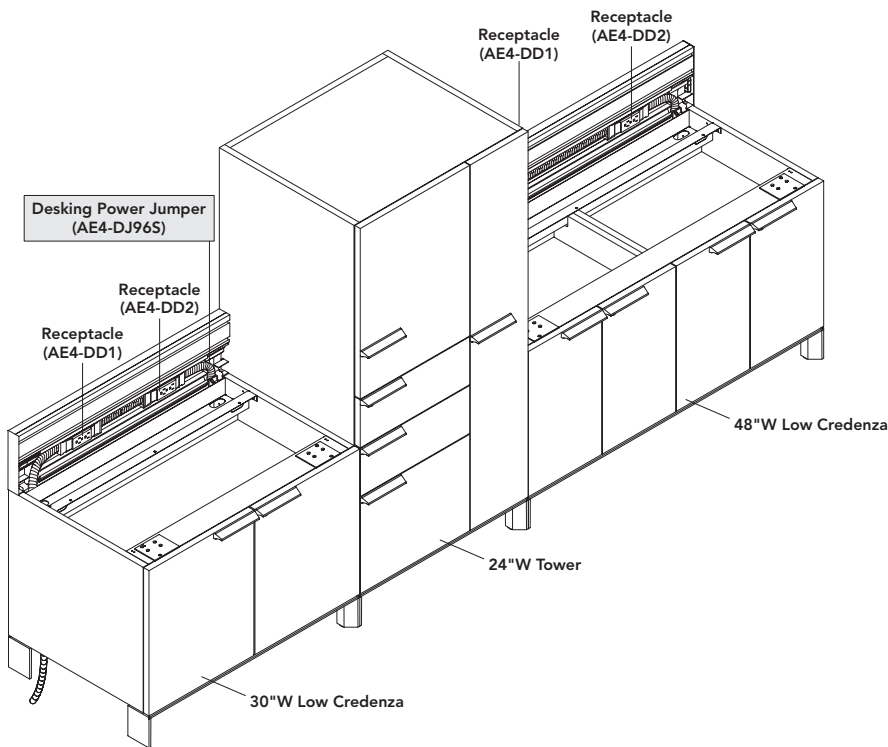

$$\text{Jumper} = 6'' + 84'' + 6'' = 96''$$

AE4-DJ96S

F. Routing Electrical: Spanning a Tower with an Open Position For Data

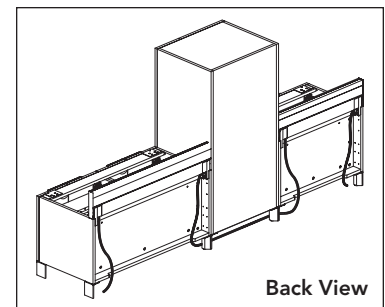
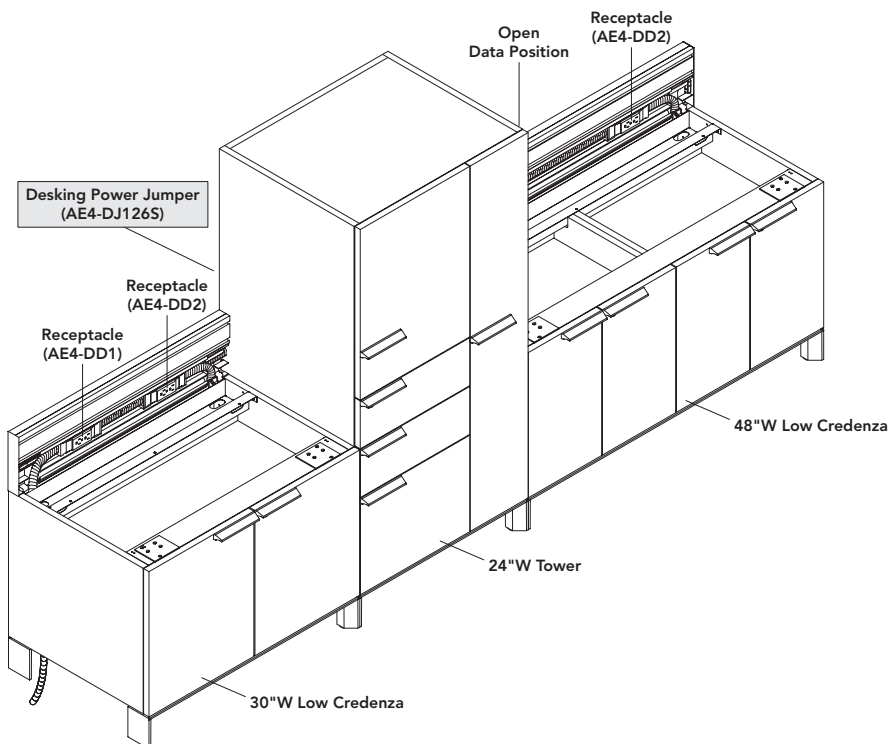

Credenza* Width	Jumper Size	Jumper Model
24"	102"	AE4-DJ102S
30"	108"	AE4-DJ108S
36"	114"	AE4-DJ114S
42"	120"	AE4-DJ120S
48"	126"	AE4-DJ126S
60"	136"	AE4-DJ136S

*Credenza with open data position

An electrified credenza rail has a cavity capable of holding 8 .25" dia. cables at 60% fill ratio (28 wires if no electrical is used in the rail).

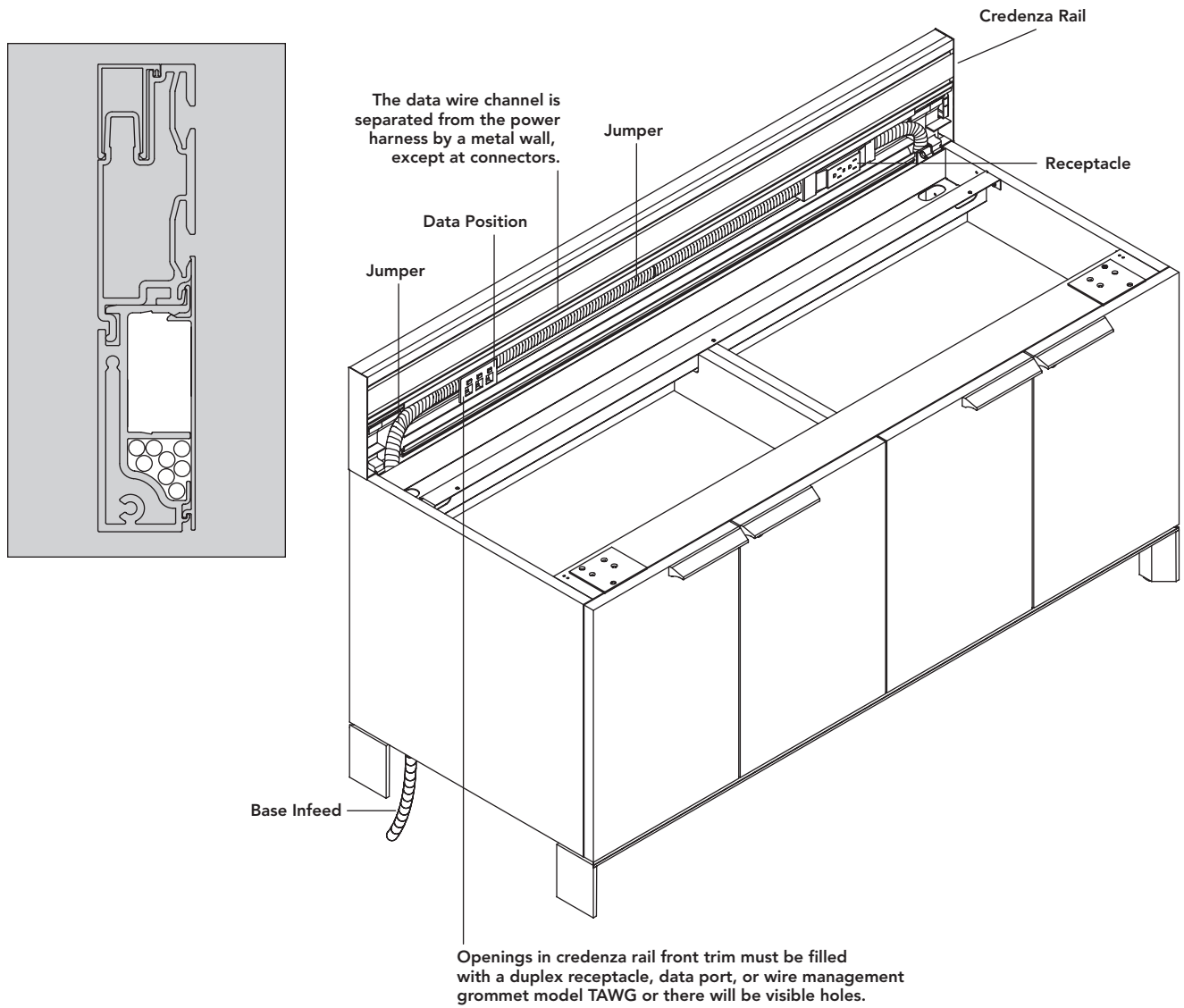

AMP data faceplates (models ATADF3 and ATADF4) and a jack (model ATADJ5) can also be used. An AMP data port extender is needed to install the data faceplate and jack in the credenza rail. The following data port extenders can be ordered from AMP: 1933468-1 (Black), 1993468-2 (Light Almond), and 1933468-4 (Nema Gray).

4-Wire Electrical Components for Stride Credenzas

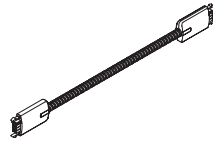

Desking Power Jumpers (page 266)

- UL-listed 4-wire electrical system.
- Ability to conceal power and data receptacles below primary worksurface.
- PVC-free electrical components available.
- Mounting brackets included.
- Cannot reverse direction within credenza rail.
- Length of 4-wire jumper needs to match distance between receptacles as there is not room to loop additional cable.

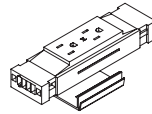

Duplex Receptacles (page 266)

- 4-wire receptacles are ordered separately for circuit 1 or 2 and are only available in ES Silver.
- 4-wire Infeed cable or jumper plug directly into each end of a 4-wire duplex receptacle.
- 4-wire receptacle adds 6" to length of electrical run.

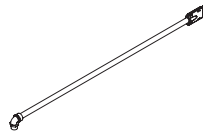

Base Electrical Infeed Cable (page 266)

- Feed in from floor.
- UL183 listed to be exposed.
- 4-wire infeed can enter from the end of a credenza rail only.
- Credenzas ship with clips under the case for holding infeed off the floor.
- Select quantity of infeed cables depending on individual power requirements.

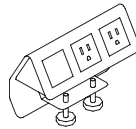

Worksurface Power/Data Module (page 266)

- Provides easy access to technology at primary worksurface.
- Mounts to edge of a worksurface and requires $\frac{3}{8}$ " gap. Consider whether $\frac{3}{8}$ " gap will work with layout.
- Must be mounted at time of initial worksurface installation if mounting between a worksurface and a panel. Maintaining a $\frac{3}{8}$ " gap may not be possible with worksurfaces that are panel wrapped.

Configurations

Towers are available in three heights: 42½", 50", and 65"H. Configurations include box/box/file, file/file, file with project drawer. 50" and 65"H towers are available with side access and Landscape™ surface sidelight.

Combination File

Combination files are 65"H and are available either 18"D or 24"D. They can either be specified with a 2 drawer lateral or lateral with a project drawer.

Aesthetic Alignment

Drawer configuration matches across Stride painted wood storage offering and tower heights align with Stride panel segmentation. Towers feature a bottom aesthetic trim piece that provides protection for the bottom edge for the tower.

Painted Wood Construction

¾" thick powder-coated medium density fiberboard with concealed fastener construction.

Footed Base

All towers have a metal footed base with concealed leveling glides. Feet on wood storage match style of Stride footed panels.

Four Hex-head Leveling Glides

The hex-head design of the stem allows leveling to be done even when the tower is fully loaded. Range is 1½".

Linear Pull Style

Elegant asymmetric pull style matches across wood storage offering.

Suspension

Heavy-duty ball bearing slides.

European Hinges

Wardrobe and cabinet door both feature European-style hinged door.

Filing

File drawers can accommodate front-to-back letter filing.

Shelves

Shelves in the cabinet door are adjustable in 2" increments. Shelves in side-access towers are fixed.

Wardrobe Door

All 24"W towers have wardrobe doors. 24"D with a coat rod; 18"D with a coat hook.

Lock Cores

Towers can be shipped with lock cores removed; cores can then be installed after towers are placed. Core removable lock feature allows key numbers to be easily changed in the field. It also facilitates installation.

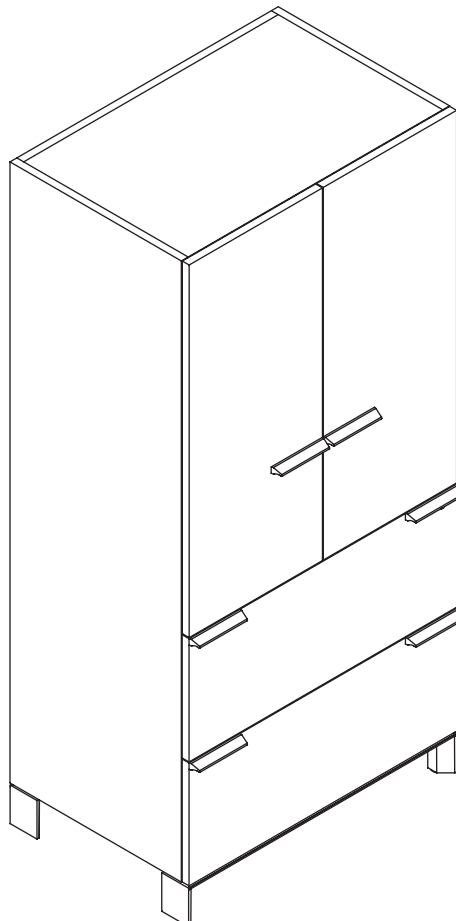
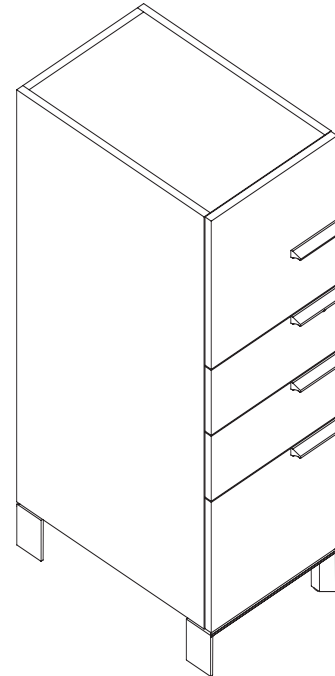
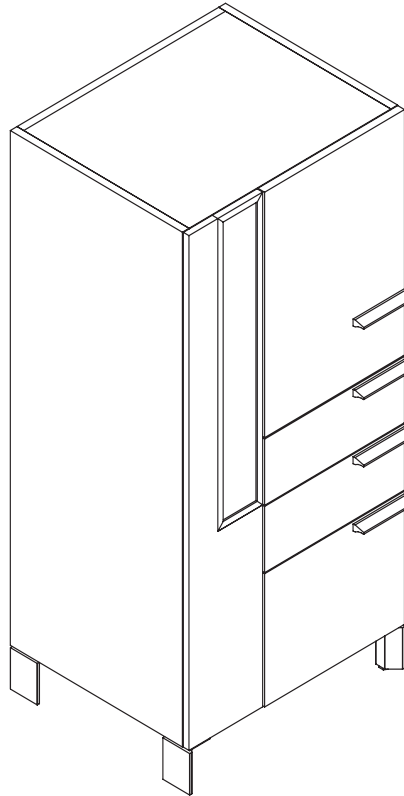

42½"H Personal Towers

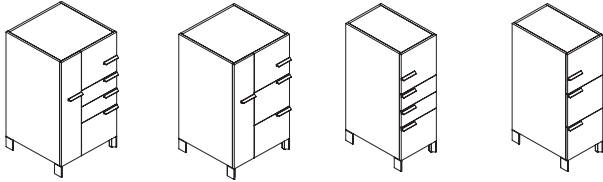

50"H Personal Towers

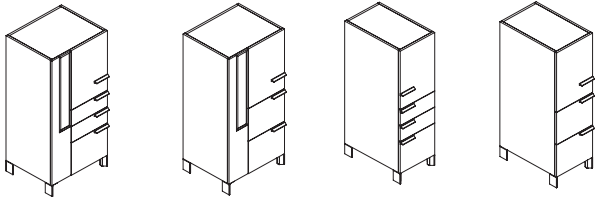

50"H Personal Side Access Towers

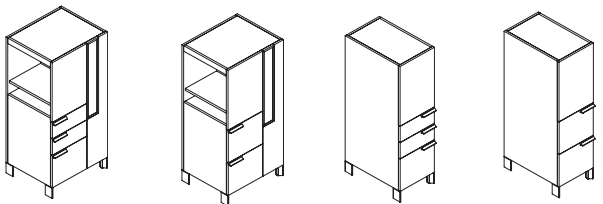

65"H Personal Towers, Side Access Towers, and Combination Files

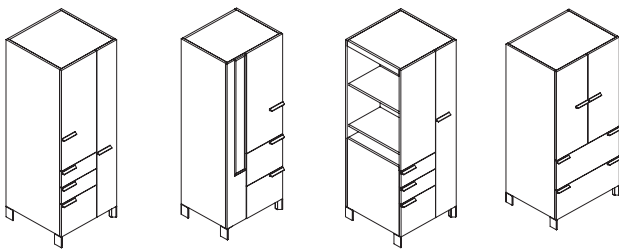

Landscape™ Surface Sidelight

Optional Landscape surface sidelight ships installed in tower wardrobe door, available in the following materials:

- **Foundation™**
Fabric laminated between recyclable PETG resin sheets. Available in two finish options: Sand and Pure White.
- **Quattro**
Fabric encapsulated between recyclable PETG resin sheets. Available in finish option Platinum.

Painted Wood Towers and Combination Files

Personal Towers

- 18"D towers match the depth of low credenzas.
- 24"D towers match the depth of high credenzas.
- 24"W towers have a 7½"W wardrobe door. 24"D with a coat rod; 18"D with a coat hook.
- Towers feature Silver linear pulls.
- Locks — 24"W towers with sidelight, 15"W towers and combination files have one lock to secure drawers. All other towers have two locks. One secures the wardrobe door and the other secures all drawers. Cabinet doors do not lock.

42½"H Personal Towers (page 267)

- 15"W towers must be attached to a worksurface or a credenza top.
- Actual tower height is 37½" with a 5"H footed base. The feet are located at the outside corners of the tower.

50"H Personal Towers (page 267)

- Actual tower height is 45" with a 5"H footed base. The feet are located at the outside corners of the tower.
- 15½"W towers and 24"W towers with sidelight have one lock. All other 24"W towers have two independent locks.
- Back and side trim can be ordered separately to match standard front bottom trim.
- Shelves inside the cabinet door are height adjustable in 2" increments.

50"H Personal Side Access Towers (page 268)

- 15½"W towers must be attached to a worksurface or a credenza top.
- Actual tower height is 45" with a 5"H footed base. The feet are located at the outside corners of the tower.
- Shelves are fixed and not removable in side access personal towers.
- Back and side trim can be ordered separately to match standard front bottom trim.

65"H Personal Towers (page 269)

- Actual tower height is 60" with a 5"H footed base. The feet are located at the outside corners of the tower.
- 24"W towers with sidelight have one lock. All other 24"W towers have two independent locks.
- Back and side trim can be ordered separately to match standard front bottom trim.
- Cabinet door on 65"H towers has two shelves, adjustable in 2" increments.

65"H Personal Side Access Towers (page 269)

- Actual tower height is 60" with a 5"H footed base. The feet are located at the outside corners of the tower.
- Shelves are fixed and not removable in side access towers.
- Back and side trim can be ordered separately to match standard front bottom trim.

65"H Combination Files (page 270)

- 18"D combination files match the depth of low credenzas.
- 24"D combination files match the depth of high credenzas.
- Combination files feature Silver linear pulls.
- Actual combination file height is 60" with a 5"H footed base. The feet are located at the outside corners of the combination file.
- Each combination file has two shelves, adjustable in 2" increments.
- Combination files have one lock.
- Stratawood veneer has a consistent straight-grain pattern.
- Natural veneer will have cathedrals and as a natural material is subject to nature's quality control with variations in grain pattern and tone.

Painted Wood Towers and Combination File Accessories

Worksurface Supports

Tower has pre-drilled pilot holes on pull side of cabinet to accommodate addition of the "L" tower bracket.

"L" Tower Bracket - An "L" tower bracket can be ordered separately and fitted to any tower to support worksurfaces at 29½"H.

15½"W Tower
and "L" Tower Bracket

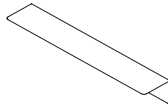
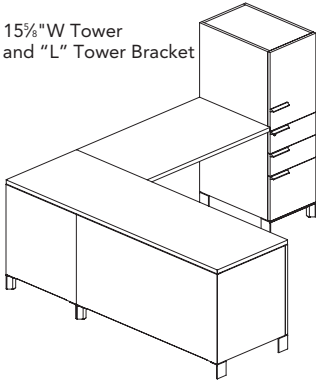

"L" Tower Bracket (page 271)

- Used to support a worksurface at 29½"H.
- Attaches using pre-drilled holes inside the tower.
- Can be attached to 18"D or 24"D towers.
- When using the "L" tower bracket, the depth of the worksurface and tower should be equal.
 - 18"D worksurface — 18"D tower
 - 24"D worksurface — 24"D tower
- "L" tower bracket is for use with laminate and painted wood storage only.

Side Trim for Credenzas, Pedestals, and Towers (page 271)

- Side trim is an optional aesthetic piece for credenzas, pedestals, and towers. Used at the end of a run to match standard front bottom trim.

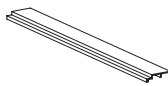

Back Trim for Pedestals and Towers (page 271)

- Back trim is an optional aesthetic piece for pedestals and towers used to match standard front bottom trim.
- Order to match with each individual component.

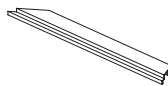

Overhead storage components maximize the use of space in the workstation and also provide convenient access to binders, reference materials, software packages, and miscellaneous supplies. There are three options available in laminate and painted wood: overhead, overhead with nitch, and shelf with nitch.

Overhead cabinets are available with hinged or sliding doors. Overhead cabinets with nitch are available as open, or with hinged or sliding doors. Door fronts on overhead storage are available in painted wood.

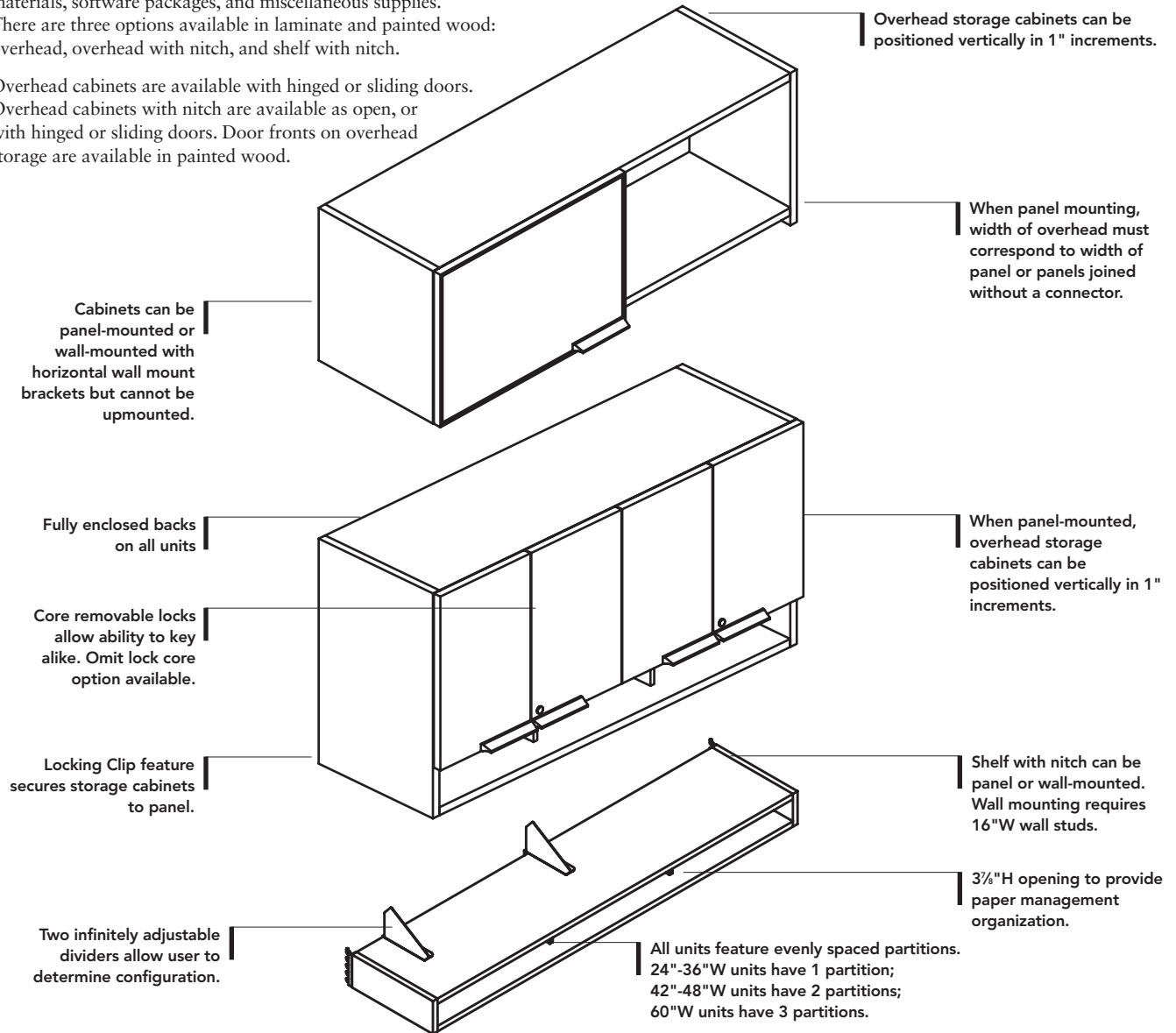

Product Dimensions	
Overhead Storage Cabinet	
Width	24", 30", 36", 42", 48", 60"
Inside width	22 ³ / ₈ ", 28 ³ / ₈ ", 34 ³ / ₈ ", 40 ³ / ₈ ", 46 ³ / ₈ ", 58 ³ / ₈ "
Depth	14"
Inside depth	11 ³ / ₄ "
Height	15"
Inside height	13 ¹ / ₂ "
Overhead Storage Cabinet with Nitch	
Width	24", 30", 36", 42", 48", 60"
Inside width	22 ³ / ₈ ", 28 ³ / ₈ ", 34 ³ / ₈ ", 40 ³ / ₈ ", 46 ³ / ₈ ", 58 ³ / ₈ "
Depth	14"
Inside depth	11 ³ / ₄ "
Height	19 ³ / ₈ "
Inside height	13 ¹ / ₂ "
Cabinet inside height	13 ⁷ / ₈ "
Nitch inside height	3 ³ / ₈ "
Shelf with Nitch	
Width	24", 30", 36", 42", 48", 60"
Inside width	22 ³ / ₈ ", 28 ³ / ₈ ", 34 ³ / ₈ ", 40 ³ / ₈ ", 46 ³ / ₈ ", 58 ³ / ₈ "
Depth	14"
Inside depth	11 ³ / ₄ "
Height	4 ³ / ₈ "
Inside height	3 ³ / ₈ "

LED undercabinet light can be mounted beneath laminate or painted wood overhead cabinets for a low profile lighting option. (Do not use recessed tasklights with painted wood storage.)

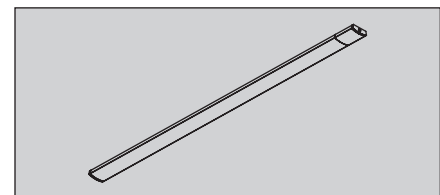

Cord retainer clips fasten into panel slots to anchor power cords. Available in black only. Three clips ship with each LED undercabinet light.

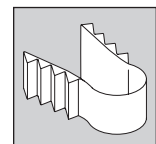

STRIDE

Painted Wood Overheads

Overhead Cabinets (pages 272-273)

- 24"-36"W hinged door cabinets have 2 doors with one lock on the front of the cabinet; 42"-60"W have 4 doors with 2 independent locks on the front of cabinet.
- Overhead cabinets have Silver linear pulls.
- 42"W-60"W overhead cabinets have a center security septum.
- Sliding door overheads have one door with one lock that can only be locked when the door is in the left-hand position.
- Overhead cabinets feature self-engaging safety latch to secure the cabinet to panel.
- Specify low profile LED tasklights.
- Width can correspond with the width of a panel or panel joined without a connector.
- Attachment hardware included for panel-mounting. Cannot be upmounted.
- Order horizontal wall-mount brackets separately. Add for wall-mounted application.
- For locking specification see pages 408-410.
- Overhead cabinets with niche feature a paper management shelf with a 3/8"H opening.
- Stratawood veneer has a consistent straight-grain pattern.
- Natural veneer will have cathedrals and as a natural material is subject to nature's quality control with variations in grain pattern and tone.

Shelf with Nitch (page 272)

- Painted wood.
- Paper management shelf with a 3/8"H opening.
- Ships with attachment hardware for panel-mounting applications.
- Order horizontal wall-mount brackets separately. Add for wall-mounted application, requires 16"W wall studs..
- Shelf with nitch has two metal shelf dividers on top that are infinitely adjustable and removable.

Horizontal Wall-Mount Brackets (page 274)

- Use to attach an overhead directly to wall.
- Attachment hardware not included.

Undercabinet LED Light (page 274)

- Low profile energy-efficient LED tasklight for use with overhead storage cabinets.
- 15W power supply (0.125 amp).
- 3500K color temperature.
- 95 footcandles at 18".
- Magnetic or screw-mount option — attachment hardware included.
- Power drive is attached to plug; allow 1/8"D space at outlet.
- Includes 3 cord retainer clips.
- For daisy chain capabilities and additional information see page 398.

Tackboards (page 274)

- 15"H tackboards are designed to work with overheads with nitch.
- 20"H tackboards are designed to work with overheads without nitch.
- Wall-mounted tackboards come with brackets to mount to wall. Does not require wall track.

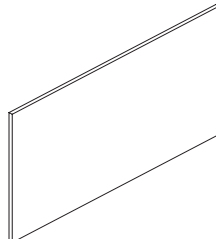
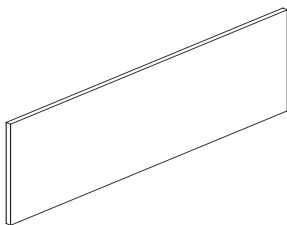
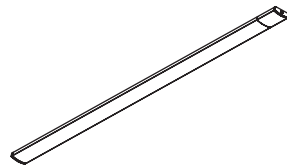
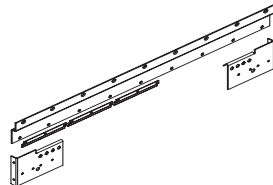
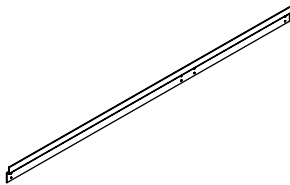
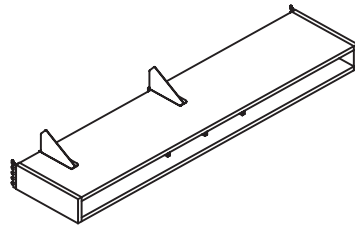
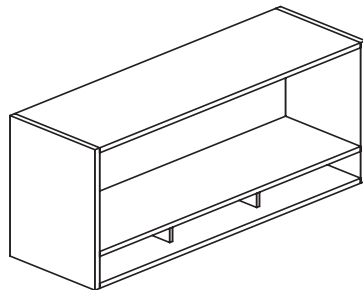
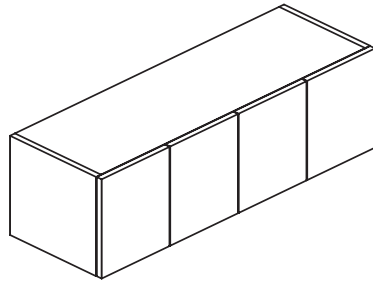

Full-depth horizontal storage can be panel-mounted or hung below the worksurface. Worksurface attachment hardware included. Specify panel mounting brackets separately.

24"W and 36"W units are available left- or right-handed. The side with shelves determines the handedness.

When panel-mounting cabinet must be same width as panel, or panels joined without a connector.

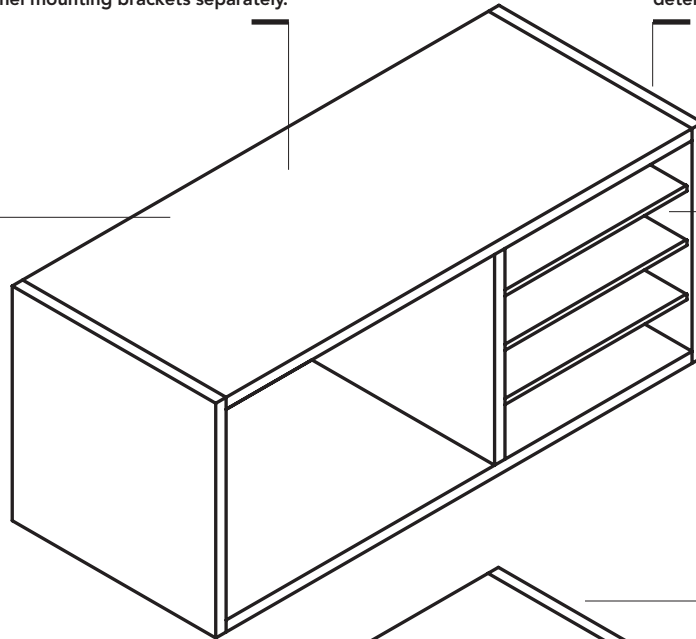

Cabinet is open with removable shelves. 24"W and 36"W cabinets have three shelves and must be specified left or right handed; 30"W cabinets have three shelves that can be positioned on either side; 42"W, 48"W, and 60"W units have six shelves, three on each side.

Shared cabinet splits access between the front and back.

Shared horizontal storage can be mounted on a panel or credenza rail. Specify either panel mounting bracket or credenza rail mounting bracket kits separately.

When mounting on credenza rail, must be mounted on two back-to-back rails.

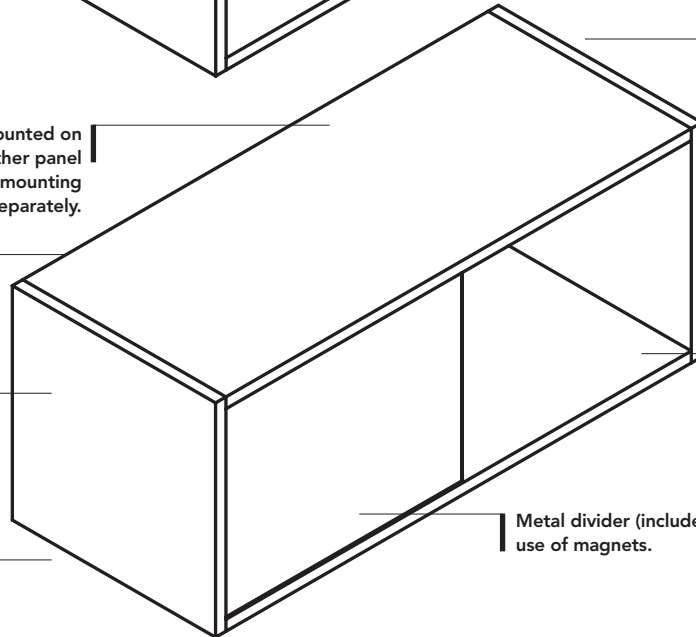

Available left or right handed. The open side of the cabinet determines the handedness.

When panel-mounting, cabinet must be same width as panel, or panels joined without a connector.

Metal divider (included) allows use of magnets.

When mounted on credenza rail the cabinet can be mounted on or off-module.

Product Dimensions

Full Depth Horizontal Storage Cabinet

Width	24", 30", 36", 42", 48", 60"
Inside width	22 ³ / ₈ ", 28 ³ / ₈ ", 34 ³ / ₈ ", 40 ³ / ₈ ", 46 ³ / ₈ ", 58 ³ / ₈ "
Depth	15"
Inside depth	12 ¹ / ₂ "
Height	15"
Inside height	13 ¹ / ₂ "

Shared Horizontal Storage Cabinet

Width	30", 36", 42", 48", 60"
Inside width	13 ³ / ₄ ", 16 ³ / ₄ ", 19 ³ / ₄ ", 22 ³ / ₄ ", 28 ³ / ₄ " (per user side)
Depth	15"
Inside depth	13 ¹ / ₂ "
Height	15"
Inside height	13 ¹ / ₂ "

Painted Wood Horizontal Storage & Perch Cabinets

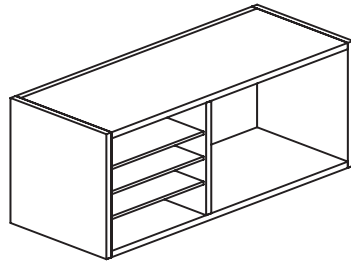

Full Depth Horizontal Storage (page 275)

- Can be panel-mounted with panel mounting kit ZHFPMK specified separately. The width of the unit must match the width of the panels.
- If horizontal storage is mounted under a panel-mounted worksurface, it must be undersized to accommodate supports.
- With overhead storage, floor support is needed within 24" of each side of the horizontal storage cabinet.
- Horizontal storage can be supported using a floor support when overhead storage is not being utilized. The floor support needs to be within 24" of the unit on one side and a cantilever on the opposite side. The cantilever must be within 6" of the horizontal storage, and no more than 48" from the floor support.
- If a 9120 worksurface is used it must have an external worksurface support channel installed and must be a minimum of 24"D to provide clearance for mounting hardware. For worksurfaces less than 24"D a special worksurface with an internal stiffener must be ordered.
- Hardware for wall-mounting is not included.
- Removable shelves included.
- 24"W-36"W units have 3 metal shelves. 42"W-60"W units have a total of six shelves (three on each side.)

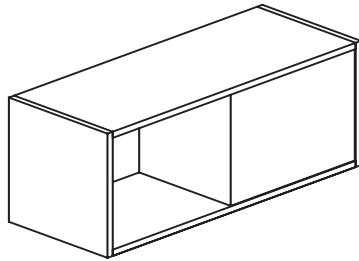

Shared Horizontal Storage (page 275)

- Can be mounted atop panels or credenza rails. When mounting on credenza rails, it must be mounted on two back-to-back credenza rails. Mounting hardware ordered separately.
- For panel mounting specify panel mounting kit model ZHSPMKXX.
- For rail mounting specify model ZHSRMK.
- Splits the access between front and back.
- Includes a metal divider which provides a magnetic surface.
- Metal divider can be specified in markerboard paint MKP.
- When panel-mounting, width of unit must match width of panel.
- Cannot be mounted on panels taller than 50".

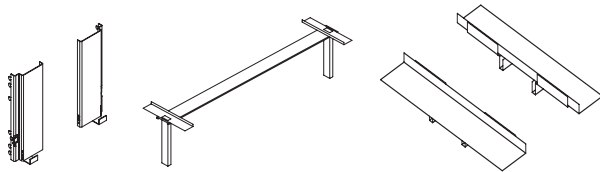

Horizontal Storage Mounting Kits (page 275)

- Unique mounting kits for: full depth horizontal, shared horizontal based on panel width, and credenza rail mount

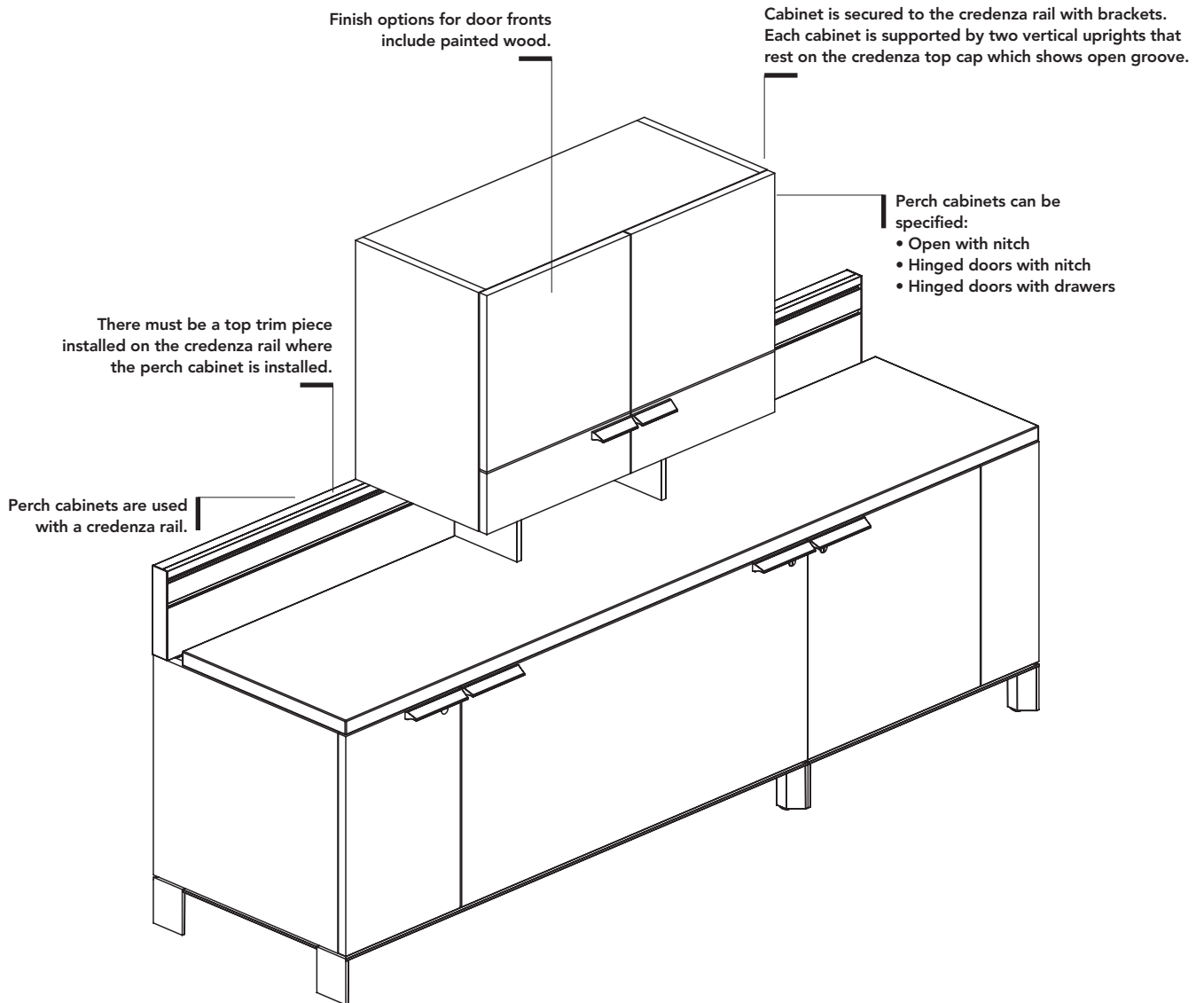

Product Dimensions		
Perch Cabinet	Perch Cabinet with Nitch	Perch Cabinet with Drawers
Width 30"	Width 30"	Width 30"
Inside width 28½"	Inside width 28½"	Inside width 28½"
Depth 14"	Depth 14"	Depth 14"
Inside depth 12"	Inside depth 12"	Inside depth 12"
Height 19½"	Height 19½"	Height 19½"
Inside height 17⅝"	Cabinet inside height 13¼"	Cabinet inside height 13¼"
	Nitch inside height 3⅞"	Drawer inside height 3"
	Nitch inside width 14" (each side)	Drawer inside width 11⅞"

STRIDE

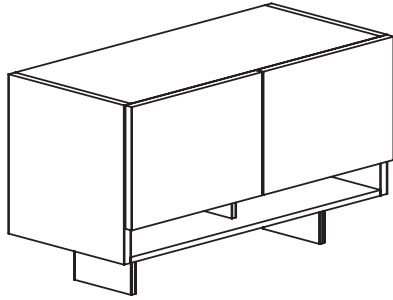

Perch Cabinets (page 276)

- Perch cabinets are attached to the credenza rail.
- Ships with rail attachment bracket and two vertical uprights that rest on on the credenza top.
- Painted wood perch cabinets feature Silver linear pulls.
- The back of the perch cabinet is flush with the back of the credenza rail.
- The credenza rail must have a top trim piece installed where the perch cabinet is installed.
- All perch cabinets are non-locking.

Wood Storage

Stride® — Low Credenzas

For specification information see pages 228-238.

Painted Wood
GSA SIN 33721

	Description	Model	List Price
	18"D Low Credenza — Open		
	24"W	ZDLC2418A	\$ 2261
	30"W	ZDLC3018A	\$ 2394
	36"W	ZDLC3618A	\$ 2527
	42"W	ZDLC4218A (shown)	\$ 2791
	48"W	ZDLC4818A	\$ 2920
	18"D Low Credenza — Open with Project Shelves		
	24"W	ZDLC2418D	\$ 2841
	30"W	ZDLC3018D (shown)	\$ 3006
	18"D Low Credenza — Hinged Doors		
	24"W	ZDLC2418BL	\$ 3029
	30"W	ZDLC3018BL	\$ 3207
	36"W	ZDLC3618BL	\$ 3373
	42"W	ZDLC4218BL (shown)	\$ 4163
	18"D Low Credenza — Lateral File with Project Drawer		
	30"W Lateral File	ZDLC3018CL	\$ 3608
	36"W Lateral File	ZDLC3618CL	\$ 3924
	42"W Left Combination	ZDLC4218LCL	\$ 4343
	42"W Right Combination	ZDLC4218RCL	\$ 4343
	48"W Left Combination	ZDLC4818LCL (shown)	\$ 4739
	18"D Low Credenza — Lateral File		
	30"W Lateral File	ZDLC3018FL	\$ 3279
	36"W Lateral File	ZDLC3618FL	\$ 3575
	42"W Left Combination	ZDLC4218LFL	\$ 3971
	42"W Right Combination	ZDLC4218RFL	\$ 3971
	48"W Left Combination	ZDLC4818LFL	\$ 4345
	48"W Right Combination	ZDLC4818RFL	\$ 4345
60"W Combination	ZDLC6018FL (shown)	\$ 5090	
	18"D Low Credenza — Box/Box/Lateral		
30"W Box/Box/Lateral	ZDLC3018EL (shown)	\$ 3688	
	18"D Low Credenza — Corner with Bin		
	24"W Left	ZDCLC2418LKL	\$ 3762
	24"W Right	ZDCLC2418RKL (shown)	\$ 3762
	30"W Left	ZDCLC3018LKL	\$ 3868
	30"W Right	ZDCLC3018RKL	\$ 3868

<p>How to specify — Select the Model Number from above.</p> <p>Z D . M 1 .</p>	<p>1st Option: Painted Wood Paint Color: See page 120 for Painted Wood Finish.</p>	<p>2nd Option: Hardware Color: PR6 Silver</p>	<p>3rd Option: Lock Option: STD Standard OMT Omit Lock Core (Deduct \$18 per lock)</p>	<p>4th Option: Lock Color: EL Silver</p> <p>E L .</p>
---	--	---	--	---

Examples: ZDLC24218A.M11.PR6 ZDLC2418BL.M15.PR6.OMT

STRIDE

For specification information see pages [228-238](#).

Painted Wood
GSA SIN 33721

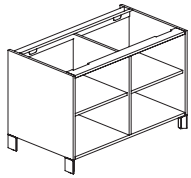

Description	Model	List Price
24" D High Credenza — Open		
24" W	ZDHC2424A	\$ 2607
30" W	ZDHC3024A	\$ 2791
36" W	ZDHC3624A	\$ 2920
42" W	ZDHC4224A (shown)	\$ 3207
48" W	ZDHC4824A	\$ 3394
60" W	ZDHC6024A	\$ 3577

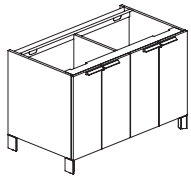

24" D High Credenza — Hinged Doors		
24" W	ZDHC2424BL	\$ 3291
30" W	ZDHC3024BL	\$ 3476
36" W	ZDHC3624BL	\$ 3630
42" W	ZDHC4224BL (shown)	\$ 4688
48" W	ZDHC4824BL	\$ 4948
60" W	ZDHC6024BL	\$ 5215

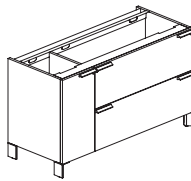

24" D High Credenza — Lateral File		
30" W 2H Lateral File	ZDHC3024FL	\$ 4134
36" W 2H Lateral File	ZDHC3624FL	\$ 4450
42" W Left Combination	ZDHC4224LFL	\$ 4596
42" W Right Combination	ZDHC4224RFL	\$ 4596
48" W Left Combination	ZDHC4824LFL (shown)	\$ 5241
48" W Right Combination	ZDHC4824RFL	\$ 5241
60" W Combination	ZDHC6024FL	\$ 6029

STRIDE

How to specify — Select the Model Number from above.	1st Option: Painted Wood Paint Color: See page 120 for Painted Wood Finish.	2nd Option: Hardware Color: PR6 Silver	3rd Option: Lock Option (if applicable): STD Standard OMT Omit Lock Core (Deduct \$18 per lock)	4th Option: Lock Color: EL Silver
Z D	M 1	P R 6		E L

Examples: ZDHC6024A.M11.PR6 ZDHC6024FL.M17.PR6.OMT

For specification information see pages [228-238](#).

Laminate
GSA SIN 33721

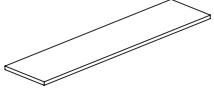

Description	Laminate w/Flat Edge Model	Laminate w/Rabbit Edge Model	Flat Edge List Price	Rabbit Edge List Price
Laminate Credenza Top for 18"D Low Credenzas — Full Depth For Wire Trough				
18"D x 24"W	Z5CT □ □ 24	ZR5CT □ □ 24	\$ 525	\$ 716
18"D x 30"W	Z5CT □ □ 30	ZR5CT □ □ 30	\$ 551	\$ 752
18"D x 36"W	Z5CT □ □ 36	ZR5CT □ □ 36	\$ 600	\$ 830
18"D x 42"W	Z5CT □ □ 42	ZR5CT □ □ 42	\$ 660	\$ 917
18"D x 48"W	Z5CT □ □ 48	ZR5CT □ □ 48	\$ 707	\$ 981
18"D x 54"W	Z5CT □ □ 54	ZR5CT □ □ 54	\$ 754	\$ 1054
18"D x 60"W	Z5CT □ □ 60	ZR5CT □ □ 60	\$ 841	\$ 1184
18"D x 66"W	Z5CT □ □ 66	ZR5CT □ □ 66	\$ 903	\$ 1270
18"D x 72"W	Z5CT □ □ 72	ZR5CT □ □ 72	\$ 936	\$ 1320
18"D x 78"W	Z5CT □ □ 78	ZR5CT □ □ 78	\$ 1185	\$ 1684
18"D x 84"W	Z5CT □ □ 84	ZR5CT □ □ 84	\$ 1235	\$ 1754
18"D x 90"W	Z5CT □ □ 90	ZR5CT □ □ 90	\$ 1440	\$ 2054
18"D x 96"W	Z5CT □ □ 96	ZR5CT □ □ 96	\$ 1507	\$ 2151
Laminate Credenza Top for 24"D High Credenzas — Full Depth For Wire Trough				
24"D x 24"W	Z5CT □ □ 24		\$ 539	—
24"D x 30"W	Z5CT □ □ 30		\$ 561	—
24"D x 36"W	Z5CT □ □ 36		\$ 616	—
24"D x 42"W	Z5CT □ □ 42		\$ 675	—
24"D x 48"W	Z5CT □ □ 48		\$ 728	—
24"D x 54"W	Z5CT □ □ 54		\$ 776	—
24"D x 60"W	Z5CT □ □ 60		\$ 863	—
24"D x 66"W	Z5CT □ □ 66		\$ 927	—
24"D x 72"W	Z5CT □ □ 72		\$ 965	—
24"D x 78"W	Z5CT □ □ 78		\$ 1216	—
24"D x 84"W	Z5CT □ □ 84		\$ 1268	—
24"D x 90"W	Z5CT □ □ 90		\$ 1476	—
24"D x 96"W	Z5CT □ □ 96		\$ 1541	—

Note: Fill in model number blanks with one of the following options to determine credenza top:
Low Credenzas:
 18 Full Depth Credenza Top for Low Credenza
 17 Credenza Top for Low Credenza with Wire Trough (Actual top 16½"D); No 42", 66", 96"W
High Credenzas:
 24 Full Depth Credenza Top for High Credenza
 23 Credenza Top for High Credenza with Wire Trough (Actual top 22½"D)
Example: Model number for a 72"W flat edge credenza top for a low credenza with wire trough is **Z5CT1772**.

<p>How to specify — Select the Model Number from above. See note above to determine option for blank.</p>	<p><i>1st Option:</i> Laminate Color: See page 120 for finishes.</p>	<p><i>2nd Option:</i> Edge Trim Color: See page 120 for finishes.</p>
<p>Z . . </p>		
<p>Examples: Z5CT1872.TM33.EU ZR5CT2454.TM33.EU</p>		

For specification information see pages 228-238.

GSA SIN 33721

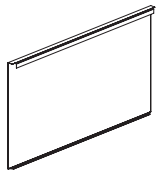
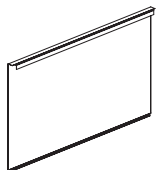
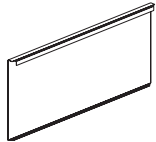
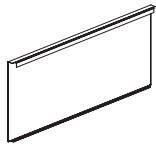

Description	Model	List Price
Credenza Backs for Low Credenzas without Rail		
24"W	ZDLCBN24 S	\$ 418
30"W	ZDLCBN30 S	\$ 463
36"W	ZDLCBN36 S	\$ 486
42"W	ZDLCBN42	\$ 509
48"W	ZDLCBN48	\$ 526
60"W	ZDLCBN60	\$ 560

Credenza Backs for Low Credenzas with Rail		
24"W	ZDLCBR24 S	\$ 418
30"W	ZDLCBR30 S	\$ 463
36"W	ZDLCBR36 S	\$ 486
42"W	ZDLCBR42	\$ 509
48"W	ZDLCBR48	\$ 526
60"W	ZDLCBR60	\$ 560

*Only compatible with single-sided credenzas and will leave open groove of top cap visible.

Credenza Backs for High Credenzas without Rail		
24"W	ZDHCBN24 S	\$ 465
30"W	ZDHCBN30 S	\$ 513
36"W	ZDHCBN36 S	\$ 535
42"W	ZDHCBN42	\$ 566
48"W	ZDHCBN48	\$ 585
60"W	ZDHCBN60	\$ 617

Credenza Backs for High Credenzas with Rail		
24"W	ZDHCBR24 S	\$ 465
30"W	ZDHCBR30 S	\$ 513
36"W	ZDHCBR36 S	\$ 535
42"W	ZDHCBR42	\$ 566
48"W	ZDHCBR48	\$ 585
60"W	ZDHCBR60	\$ 617

*Only compatible with single-sided credenzas and will leave open groove of top cap visible.

<p>How to specify — Select the Model Number from above.</p>	<p>1st Option: Paint Color: P1 P2 P3</p> <p>P2 Select Paint: (Add \$19 for low; \$21 for high)</p> <p>P3 Select Paint: (Add \$35 for low; \$39 for high)</p>
<p>Z D . P </p>	

Example: ZDLCBN48.PJW

S Shippable by small-package carrier.

Wood Storage

For specification information see pages 228-238. (See pages 413-414 for COM pricing on fabric Grades 9-22.)

GSA SIN 33721

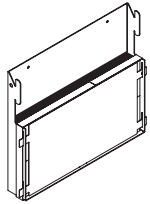

Description	Model	P1 Paint List Price	P2 Paint List Price	P3 Paint List Price
Counterweight Kit (no color option)				
Counterweight Kit for Wood Storage	ZDCWK	\$ 239	N/A	N/A

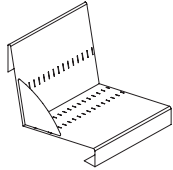

Binder Shelf for Corner Credenzas (PR6 Silver only)				
Binder shelf for Low Corner Credenza	ZBS18	\$ 177	N/A	N/A

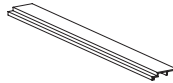

Side Trim for Credenzas, Pedestals, and Towers (PR6 Silver only)				
18" Side Trim	ZST18	\$ 53	N/A	N/A
24" Side Trim	ZST24	\$ 67	N/A	N/A

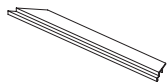

Back Trim for Pedestals and Towers (PR6 Silver only)				
15" Back Trim	ZBT15	\$ 55	N/A	N/A
24" Back Trim	ZBT24	\$ 67	N/A	N/A

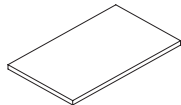

Description	Model	List Price									
		Grade 1	Grade 2	Grade 3	Grade 4	Grade 5	Grade 6	Grade 7	Grade 8	Grade L1	Grade L2
Ped/Credenza Cushions — 18"D											
15 1/2"W	K5CT1815SC	\$ 317	\$ 343	\$ 369	\$ 395	\$ 430	\$ 465	\$ 500	\$ 534	\$ 516	\$ 658
18"W	K5CT1818SC	\$ 337	\$ 363	\$ 389	\$ 415	\$ 450	\$ 485	\$ 520	\$ 554	\$ 536	\$ 678
24"W	K5CT1824SC	\$ 363	\$ 389	\$ 415	\$ 441	\$ 476	\$ 511	\$ 546	\$ 580	\$ 562	\$ 704
30"W	K5CT1830SC	\$ 391	\$ 417	\$ 443	\$ 469	\$ 504	\$ 539	\$ 574	\$ 608	\$ 590	\$ 732
36"W	K5CT1836SC	\$ 441	\$ 467	\$ 493	\$ 519	\$ 554	\$ 589	\$ 624	\$ 658	\$ 640	\$ 782
42"W	K5CT1842SC	\$ 439	\$ 465	\$ 491	\$ 517	\$ 552	\$ 587	\$ 622	\$ 656	\$ 638	\$ 780
48"W	K5CT1848SC	\$ 455	\$ 481	\$ 507	\$ 533	\$ 568	\$ 603	\$ 638	\$ 672	\$ 654	\$ 796

COM Yardage: 0.7 yards, 15 1/2"W and 18"W yield one cushion. COL 3.5 sq.ft. 15"W and 18"W; 7 sq.ft. others. No vinyls.

<p>How to specify — Select the Model Number from above.</p>	<p><i>1st Option:</i> Hardware Color PR6 Silver</p>	<p><i>1st Option:</i> Paint Color (if applicable): P1 P2 P3</p>	<p><i>1st Option:</i> Seat Cushion Upholstery: Specify Seating upholstery.</p>																
<table border="1" style="width: 100%;"> <tr> <td style="width: 25%;"> </td> <td style="width: 25%;"> </td> <td style="width: 25%;"> </td> <td style="width: 25%;"> </td> </tr> </table>					<table border="1" style="width: 100%;"> <tr> <td style="width: 25%;"> </td> <td style="width: 25%;"> </td> <td style="width: 25%;"> </td> <td style="width: 25%;"> </td> </tr> </table>					<table border="1" style="width: 100%;"> <tr> <td style="width: 25%;"> </td> <td style="width: 25%;"> </td> <td style="width: 25%;"> </td> <td style="width: 25%;"> </td> </tr> </table>					<table border="1" style="width: 100%;"> <tr> <td style="width: 25%;"> </td> <td style="width: 25%;"> </td> <td style="width: 25%;"> </td> <td style="width: 25%;"> </td> </tr> </table>				

Examples: ZDCWK ZBS18.PR6 ZST18.PR6 K5CT1815SC.BOX14 S Shippable by small-package carrier.

For specification information see pages 239-240.

GSA SIN 33721



Description	Model	List Price
Credenza Rail Frame (PR6 only)		
24"W	Z6CRF24 <input type="checkbox"/>	\$ 447
30"W	Z6CRF30 <input type="checkbox"/>	\$ 494
36"W	Z6CRF36 <input type="checkbox"/>	\$ 538
42"W	Z6CRF42	\$ 587
48"W	Z6CRF48	\$ 631
54"W	Z6CRF54	\$ 707
60"W	Z6CRF60	\$ 777
66"W	Z6CRF66	\$ 844
72"W	Z6CRF72	\$ 917
78"W	Z6CRF78	\$ 976
84"W	Z6CRF84	\$ 1034
90"W	Z6CRF90	\$ 1097
96"W	Z6CRF96	\$ 1172



Credenza Rail Front Trim — Non-Ported (PR6 only)		
24"W	Z6CFN24 <input type="checkbox"/>	\$ 154
30"W	Z6CFN30 <input type="checkbox"/>	\$ 166
36"W	Z6CFN36 <input type="checkbox"/>	\$ 182
42"W	Z6CFN42	\$ 199
48"W	Z6CFN48	\$ 221
54"W	Z6CFN54	\$ 235
60"W	Z6CFN60	\$ 251
66"W	Z6CFN66	\$ 264
72"W	Z6CFN72	\$ 283
78"W	Z6CFN78	\$ 296
84"W	Z6CFN84	\$ 313
90"W	Z6CFN90	\$ 337
96"W	Z6CFN96	\$ 355

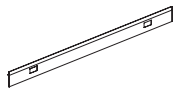

Credenza Rail Front Trim — Ported (PR6 only)		
24"W	Z6CFP24 <input type="checkbox"/>	\$ 178
30"W	Z6CFP30 <input type="checkbox"/>	\$ 186
36"W	Z6CFP36 <input type="checkbox"/>	\$ 202
42"W	Z6CFP42	\$ 219
48"W	Z6CFP48	\$ 249
60"W	Z6CFP60	\$ 271

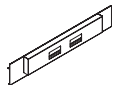

Credenza Rail End Trim — Ported Chicago Code (PR6 only)		
24"W	Z6CFC24	\$ 251
30"W	Z6CFC30	\$ 330



Z6CE

Credenza Rail End Trim (PR6 only)		
End Trim for Credenza Rail	Z6CE <input type="checkbox"/>	\$ 70

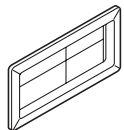

Wireway Grommet		
Pack of 6 (Black only)	TAWG <input type="checkbox"/>	\$ 166

STRIDE

<p>How to specify — Select the Model Number from above.</p>	<p><i>1st Option:</i> Color: PR6 Silver</p>	<p><i>1st Option:</i> Color: E4 Black</p>
<p>Z . P R 6 E 4 </p>		

Examples: Z6CRF78.PR6 Z6CFN24.PR6 Z6CFP24.PR6 Z6CE.PR6 TAWG.E4

Shippable by small-package carrier.

Wood Storage

Stride® — Credenza Rail Top Trim

For specification information see pages 239-240.

GSA SIN 33721

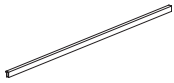

Description	Model	List Price
Credenza Rail Top Trim — for Double-Sided Application without Back		
24" W	Z6CT2N24 <input type="checkbox"/>	\$ 123
30" W	Z6CT2N30 <input type="checkbox"/>	\$ 131
36" W	Z6CT2N36 <input type="checkbox"/>	\$ 139
42" W	Z6CT2N42	\$ 150
48" W	Z6CT2N48	\$ 167
54" W	Z6CT2N54	\$ 177
60" W	Z6CT2N60	\$ 187
66" W	Z6CT2N66	\$ 199
72" W	Z6CT2N72	\$ 207
78" W	Z6CT2N78	\$ 219
84" W	Z6CT2N84	\$ 229
90" W	Z6CT2N90	\$ 242
96" W	Z6CT2N96	\$ 253

NOTE: New model will not retrofit.



Description	Single Sided Model	List Price
Credenza Rail Top Trim — for Single-Sided Applications without Back		
24" W	Z6CTSS124 <input type="checkbox"/>	\$ 178
30" W	Z6CTSS130 <input type="checkbox"/>	\$ 194
36" W	Z6CTSS136 <input type="checkbox"/>	\$ 209
42" W	Z6CTSS142	\$ 220
48" W	Z6CTSS148	\$ 239
54" W	Z6CTSS154	\$ 252
60" W	Z6CTSS160	\$ 267
66" W	Z6CTSS166	\$ 283
72" W	Z6CTSS172	\$ 296
78" W	Z6CTSS178	\$ 310
84" W	Z6CTSS184	\$ 327
90" W	Z6CTSS190	\$ 340
96" W	Z6CTSS196	\$ 357

How to specify —
Select the Model Number from above.

1st Option:
Color:
PR6 Silver

Z | 6 | C | T | | | | | . P | R | 6

Examples: Z6CT2N60.PR6 Z6CTSS124.PR6

Shippable by small-package carrier.

For specification information see pages 241-247.

GSA SIN 33721

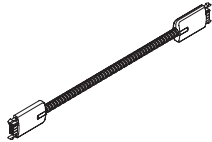

Description	Model	List Price
Desking Power Jumpers, 4-wire, Two-circuit		
0"W Desking Power Jumper	AE4-DJ0S <input type="checkbox"/>	\$ 57
6"W Desking Power Jumper	AE4-DJ6S <input type="checkbox"/>	\$ 104
12"W Desking Power Jumper	AE4-DJ12S <input type="checkbox"/>	\$ 117
18"W Desking Power Jumper	AE4-DJ18S <input type="checkbox"/>	\$ 127
24"W Desking Power Jumper	AE4-DJ24S <input type="checkbox"/>	\$ 142
30"W Desking Power Jumper	AE4-DJ30S <input type="checkbox"/>	\$ 156
36"W Desking Power Jumper	AE4-DJ36S <input type="checkbox"/>	\$ 167
42"W Desking Power Jumper	AE4-DJ42S <input type="checkbox"/>	\$ 185
48"W Desking Power Jumper	AE4-DJ48S <input type="checkbox"/>	\$ 200
54"W Desking Power Jumper	AE4-DJ54S <input type="checkbox"/>	\$ 226
60"W Desking Power Jumper	AE4-DJ60S <input type="checkbox"/>	\$ 241
66"W Desking Power Jumper	AE4-DJ66S <input type="checkbox"/>	\$ 256
72"W Desking Power Jumper	AE4-DJ72S <input type="checkbox"/>	\$ 266
78"W Desking Power Jumper	AE4-DJ78S <input type="checkbox"/>	\$ 281
84"W Desking Power Jumper	AE4-DJ84S <input type="checkbox"/>	\$ 293
90"W Desking Power Jumper	AE4-DJ90S <input type="checkbox"/>	\$ 306
96"W Desking Power Jumper	AE4-DJ96S <input type="checkbox"/>	\$ 317
102"W Desking Power Jumper	AE4-DJ102S <input type="checkbox"/>	\$ 335
108"W Desking Power Jumper	AE4-DJ108S <input type="checkbox"/>	\$ 344
114"W Desking Power Jumper	AE4-DJ114S <input type="checkbox"/>	\$ 353
126"W Desking Power Jumper	AE4-DJ126S <input type="checkbox"/>	\$ 380
132"W Desking Power Jumper	AE4-DJ132S <input type="checkbox"/>	\$ 389
138"W Desking Power Jumper	AE4-DJ138S <input type="checkbox"/>	\$ 397
144"W Desking Power Jumper	AE4-DJ144S <input type="checkbox"/>	\$ 407

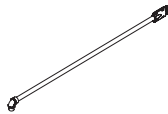
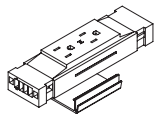

Duplex Receptacles, 4-wire — with mounting bracket (ES Silver only)		
Circuit 1	AE4-DD1 <input type="checkbox"/>	\$ 111
Circuit 2	AE4-DD2 <input type="checkbox"/>	\$ 111

Base Electrical, 4-wire Infeed Cable (Black only)		
72" Sealtight Cable	AE4-PS72 <input type="checkbox"/>	\$ 306
144" Sealtight Cable	AE4-PS144 <input type="checkbox"/>	\$ 448

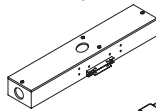
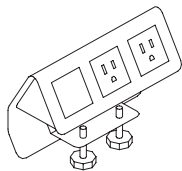

Worksurface Power/Data Module (PR6 Silver only)		
2 Simplex receptacles, 1 data position	A870302 <input type="checkbox"/>	\$ 351

Hardwire, 4-wire Infeed (New York Code)		
	AE4-HW <input type="checkbox"/>	\$ 401

Hardwire (Chicago Code)		
Electrical Box	87750Z <input type="checkbox"/>	\$ 683

STRIDE

<p>How to specify — Select the Model Number from above.</p>	<p><i>1st Option:</i> Color: P Black</p>	<p><i>1st Option:</i> Duplex Receptacle Color: ES Silver</p>	<p><i>1st Option:</i> Worksurface Power/Data Module Color: PR6 Silver</p>
<div style="border: 1px solid black; display: flex; justify-content: space-around; width: 100px; height: 20px;"> P </div>	<div style="border: 1px solid black; display: flex; justify-content: space-around; width: 100px; height: 20px;"> E S </div>	<div style="border: 1px solid black; display: flex; justify-content: space-around; width: 100px; height: 20px;"> P R 6 </div>	

Examples: AE4-DJ66S.P AE4-PS72.P

AE4-DD2.ES A870302.PR6 87750Z

Shippable by small-package carrier.

Wood Storage

Stride® — 42½"H and 50"H Personal Towers

For specification information see pages 248-250.

Painted Wood
GSA SIN 33721

	Description	Model	List Price
	42½" H Personal Towers — Box/Box/File		
	24"W x 18"D, Wardrobe Left*	ZDT422418LGL	\$ 5154
	24"W x 18"D, Wardrobe Right*	ZDT422418RGL	\$ 5154
	24"W x 24"D, Wardrobe Left	ZDT422424LGL (shown)	\$ 5594
	24"W x 24"D, Wardrobe Right	ZDT422424RGL	\$ 5594
	15¾"W x 24"D, Left	ZDT421524LGL	\$ 4576
	15¾"W x 24"D, Right	ZDT421524RGL (shown)	\$ 4576
	42½" H Personal Towers — File/File		
	24"W x 18"D, Wardrobe Left*	ZDT422418LFL	\$ 4924
	24"W x 18"D, Wardrobe Right*	ZDT422418RFL	\$ 4924
	24"W x 24"D, Wardrobe Left	ZDT422424LFL (shown)	\$ 5360
	24"W x 24"D, Wardrobe Right	ZDT422424RFL	\$ 5360
	15¾"W x 24"D, Left	ZDT421524LFL	\$ 4343
	15¾"W x 24"D, Right	ZDT421524RFL (shown)	\$ 4343

	Description	Model	List Price
	50"H Personal Towers — Box/Box/File		
	24"W x 18"D, Wardrobe Left*	ZDT502418LGL	\$ 5519
	24"W x 18"D, Wardrobe Right*	ZDT502418RGL	\$ 5519
	24"W x 24"D, Wardrobe Left	ZDT502424LGL	\$ 5984
	24"W x 24"D, Wardrobe Right	ZDT502424RGL	\$ 5984
	24"W x 18"D with Sidelight, Wardrobe Left*	ZDT502418LGSL (shown)	\$ 6441
	24"W x 18"D with Sidelight, Wardrobe Right*	ZDT502418RGSL	\$ 6441
	24"W x 24"D with Sidelight, Wardrobe Left	ZDT502424LGSL	\$ 6905
	24"W x 24"D with Sidelight, Wardrobe Right	ZDT502424RGSL	\$ 6905
	15¾"W x 24"D, Left	ZDT501524LGL	\$ 4907
		15¾"W x 24"D, Right	ZDT501524RGL (shown)
	50"H Personal Towers — File/File		
	24"W x 18"D, Wardrobe Left*	ZDT502418LFL	\$ 5270
	24"W x 18"D, Wardrobe Right*	ZDT502418RFL	\$ 5270
	24"W x 24"D, Wardrobe Left	ZDT502424LFL	\$ 5738
	24"W x 24"D, Wardrobe Right	ZDT502424RFL	\$ 5738
	24"W x 18"D with Sidelight, Wardrobe Left*	ZDT502418LFSL (shown)	\$ 6189
	24"W x 18"D with Sidelight, Wardrobe Right*	ZDT502418RFSL	\$ 6189
	24"W x 24"D with Sidelight, Wardrobe Left	ZDT502424LFSL	\$ 6656
	24"W x 24"D with Sidelight, Wardrobe Right	ZDT502424RFSL	\$ 6656
	15¾"W x 24"D, Left	ZDT501524LFL (shown)	\$ 4658
		15¾"W x 24"D, Right	ZDT501524RFL

How to specify — Select the Model Number from above.	1st Option: Painted Wood Paint Color: See page 120 for for Painted Wood Finish.	2nd Option: Landscape™ Surface Material and Finish: See page 120. (Models with Sidelight only) Add \$26 for Grade 2	3rd Option: Hardware Color: PR6 Silver	4th Option: Lock Option: STD Standard OMT Omit Lock Core (Deduct \$18 per lock)	5th Option: Lock Color (if applicable): EL Silver
	Z D T . M 1 .		. P R 6		. E L

Examples: ZDT502418LFL.M11.PR6.STDEL ZDT501524RFL.M12.PR6.STDEL

For specification information see pages 248-250.

Painted Wood
GSA SIN 33721

LANDSCAPE™ SURFACE MATERIAL OPTIONS

GRADE 2

Foundation™		Quattro
FD01	Sand	QU44 Platinum
FD02	Taupe	
FD04	Pure White	

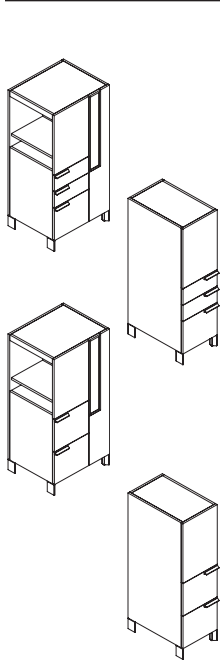

Description	Model	List Price
50" Personal Side Access Towers — Box/Box/File		
24"W x 18"D, Wardrobe Left*	ZDST502418LGL	\$ 5519
24"W x 18"D, Wardrobe Right*	ZDST502418RGL	\$ 5519
24"W x 24"D, Wardrobe Left	ZDST502424LGL	\$ 5984
24"W x 24"D, Wardrobe Right	ZDST502424RGL	\$ 5984
24"W x 18"D with Sidelight, Wardrobe Left*	ZDST502418LGSL	\$ 6441
24"W x 18"D with Sidelight, Wardrobe Right*	ZDST502418RGS (shown)	\$ 6441
24"W x 24"D with Sidelight, Wardrobe Left	ZDST502424LGSL	\$ 6905
24"W x 24"D with Sidelight, Wardrobe Right	ZDST502424RGS (shown)	\$ 6905
15½"W x 24"D, Left	ZDST501524LGL (shown)	\$ 4907
15½"W x 24"D, Right	ZDST501524RGL	\$ 4907
50" Personal Side Access Towers — File/File		
24"W x 18"D, Wardrobe Left*	ZDST502418LFL	\$ 5270
24"W x 18"D, Wardrobe Right*	ZDST502418RFL	\$ 5270
24"W x 24"D, Wardrobe Left	ZDST502424LFL	\$ 5738
24"W x 24"D, Wardrobe Right	ZDST502424RFL	\$ 5738
24"W x 18"D with Sidelight, Wardrobe Left*	ZDST502418LFSL	\$ 6189
24"W x 18"D with Sidelight, Wardrobe Right*	ZDST502418RFSL (shown)	\$ 6189
24"W x 24"D with Sidelight, Wardrobe Left	ZDST502424LFSL	\$ 6656
24"W x 24"D with Sidelight, Wardrobe Right	ZDST502424RFSL	\$ 6656
15½"W x 24"D, Left	ZDST501524LFL (shown)	\$ 4658
15½"W x 24"D, Right	ZDST501524RFL	\$ 4658

STRIDE

<p>How to specify — Select the Model Number from above.</p>	<p><i>1st Option:</i> Painted Wood Paint Color: See page 120 for Painted Wood Finish.</p>	<p><i>2nd Option:</i> Landscape Surface Material and Finish: (Models with Sidelight only) Add \$26 for Grade 2</p>	<p><i>3rd Option:</i> Hardware Color: PR6 Silver</p>	<p><i>4th Option:</i> Lock Option: STD Standard OMT Omit Lock Core (Deduct \$18 per lock)</p>	<p><i>5th Option:</i> Lock Color (if applicable): EL Silver</p>
	Z D S T 5 0	M 1	P R 6	E L	

Examples: ZDST502418LGSL.M11.FD01.PR6.STDEL ZDST501524RFL.M12.PR6.STDEL

Wood Storage

Stride® — 65"H Personal Towers

For specification information see pages 248-250.

Painted Wood
GSA SIN 33721

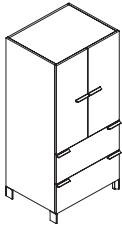

Description	Model	List Price
65"H Combination File — with Lateral Drawers		
30"W x 18"D*	ZDCF653018FL	\$ 6766
30"W x 24"D	ZDCF653024FL (shown)	\$ 6962

STRIDE

<p>How to specify — Select the Model Number from above.</p> <p>Z D C F 6 5 . M 1 . P R 6 E L</p>	<p><i>1st Option:</i> Painted Wood Paint Color: See page 120 for Painted Wood Finish.</p>	<p><i>2nd Option:</i> Hardware Color: PR6 Silver</p>	<p><i>3rd Option:</i> Lock Option: STD Standard OMT Omit Lock Core (Deduct \$18 per lock)</p>	<p><i>4th Option:</i> Lock Color (if applicable): EL Silver</p>
---	--	---	--	--

Example: ZDCF653024FL.M17.PR6.STDEL

For specification information see pages 248-250.

GSA SIN 33721

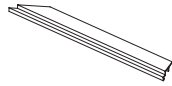
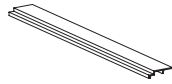
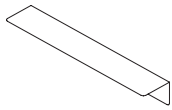

Description	Model	P1 Paint List Price	P2 Paint List Price	P3 Paint List Price
"L" Tower Bracket — for Painted Wood Towers				
"L" Tower Bracket for 18"D or 24"D	Z6LB S	\$ 72	\$ 89	\$ 103
Side Trim for Credenzas, Pedestals and Towers (PR6 Silver only)				
18" Side Trim*	ZST18 S	N/A	\$ 53	N/A
24" Side Trim	ZST24 S	N/A	\$ 67	N/A
Back Trim for Pedestals and Towers (PR6 Silver only)				
15" Back Trim	ZBT15 S	N/A	\$ 55	N/A
24" Back Trim	ZBT24 S	N/A	\$ 67	N/A

How to specify —
Select the Model Number from above.

1st Option:
Paint Color:
P1 P2 P3

Z | | | | | | | .

P | | | |

Examples: Z6LB.PJW ZST18.PR6

S Shippable by small-package carrier.

Wood Storage

Stride® — Overhead Cabinets

For specification information see pages 251-252.

Painted Wood
GSA SIN 33721

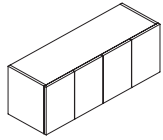

Description	Model	List Price
Overhead Cabinets — Hinged Door — 14"D x 15"H		
24"W	ZDOC24ML	\$ 2341
30"W	ZDOC30ML	\$ 2417
36"W	ZDOC36ML	\$ 2496
42"W	ZDOC42ML (shown)	\$ 2576
48"W	ZDOC48ML	\$ 2896
60"W	ZDOC60ML	\$ 3184

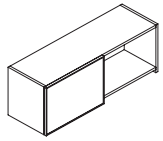

Overhead Cabinets — Sliding Door — 14"D x 15"H		
24"W	ZDOC24NL	\$ 2209
30"W	ZDOC30NL	\$ 2288
36"W	ZDOC36NL	\$ 2367
42"W	ZDOC42NL (shown)	\$ 2448
48"W	ZDOC48NL	\$ 2761
60"W	ZDOC60NL	\$ 3050

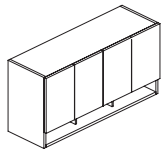

Overhead Cabinets — Hinged Door with Nitch — 14"D x 19½"H		
24"W	ZDOC24QL	\$ 2543
30"W	ZDOC30QL	\$ 2620
36"W	ZDOC36QL	\$ 2700
42"W	ZDOC42QL (shown)	\$ 2907
48"W	ZDOC48QL	\$ 3270
60"W	ZDOC60QL	\$ 3689

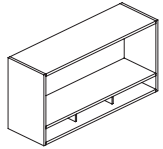

Overhead Cabinets — Open with Nitch — 14"D x 19½"H		
24"W	ZDOC24U	\$ 2103
30"W	ZDOC30U	\$ 2184
36"W	ZDOC36U	\$ 2261
42"W	ZDOC42U (shown)	\$ 2473
48"W	ZDOC48U	\$ 2845
60"W	ZDOC60U	\$ 3263

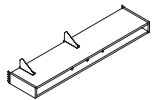

Shelf with Nitch — 14"D x 4½"H		
24"W	ZDOC24P	\$ 1093
30"W	ZDOC30P	\$ 1144
36"W	ZDOC36P	\$ 1175
42"W	ZDOC42P	\$ 1219
48"W	ZDOC48P	\$ 1299
60"W	ZDOC60P	\$ 1431

STRIDE

<p>How to specify — Select the Model Number from above.</p>	<p>1st Option: Painted Wood Paint Color (if applicable): See page 120 for Painted Wood Finish.</p>	<p>2nd Option: Metal Paint Color (for Divider on Shelf with Nitch): P1 P2 P3 See page 120 for finishes.</p>	<p>2nd Option: Hardware Color (if applicable): PR6 Silver</p>	<p>3rd Option: Lock Option (if applicable): STD Standard OMT Omit Lock Core (Deduct \$18 per lock)</p>	<p>4th Option: Lock Color (if applicable): EL Silver</p>
Z D O C .	M 1 .	P .	P R 6 .		E

Examples: ZDOC24ML.M17.PR6.STDEL ZDOC24NL.M17.PR6.OMT ZDOC60P.M16.P02

Wood Storage

Stride® — Overhead Cabinets

For specification information see pages 251-252.

Landscape™ Surface Front — Painted Wood

GSA SIN 33721

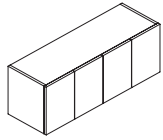

Description	Model	Grade 1 List Price	Grade 2 List Price	Grade 3 List Price
Overhead Cabinets – Hinged Door with Landscape Surface Front — 14"D x 15"H				
24"W	ZDOC24MLD	\$ 3711	\$ 3819	\$ 3922
30"W	ZDOC30MLD	\$ 3979	\$ 4095	\$ 4217
36"W	ZDOC36MLD	\$ 4134	\$ 4257	\$ 4385
42"W	ZDOC42MLD (shown)	\$ 5271	\$ 5468	\$ 5663
48"W	ZDOC48MLD	\$ 5824	\$ 6034	\$ 6253
60"W	ZDOC60MLD	\$ 6460	\$ 6699	\$ 6939

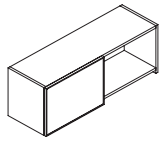

Overhead Cabinets – Sliding Door with Landscape Surface Front — 14"D x 15"H				
24"W	ZDOC24NLD	\$ 2903	\$ 2953	\$ 3011
30"W	ZDOC30NLD	\$ 3068	\$ 3125	\$ 3188
36"W	ZDOC36NLD	\$ 3189	\$ 3247	\$ 3312
42"W	ZDOC42NLD (shown)	\$ 3803	\$ 3899	\$ 3999
48"W	ZDOC48NLD	\$ 4230	\$ 4338	\$ 4441
60"W	ZDOC60NLD	\$ 4697	\$ 4813	\$ 4935

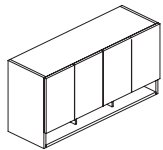

Overhead Cabinets – Hinged Door with Nitch with Landscape Surface Front — 14"D x 19"H				
24"W	ZDOC24QLD	\$ 3918	\$ 4026	\$ 4129
30"W	ZDOC30QLD	\$ 4176	\$ 4292	\$ 4414
36"W	ZDOC36QLD	\$ 4334	\$ 4457	\$ 4585
42"W	ZDOC42QLD (shown)	\$ 5605	\$ 5802	\$ 5997
48"W	ZDOC48QLD	\$ 6204	\$ 6414	\$ 6633
60"W	ZDOC60QLD	\$ 6966	\$ 7205	\$ 7445

LANDSCAPE™ SURFACE MATERIAL OPTIONS

GRADE 2

Foundation™

FD01	Sand	Quattro	
FD02	Taupe	QU44	Platinum
FD04	Pure White		

<p>How to specify — Select the Model Number from above.</p>	<p>1st Option: Painted Wood Paint Color: See page 120 for Painted Wood Finish.</p>	<p>2nd Option: Landscape Surface Material and Finish:</p>	<p>2nd Option: Hardware Color: PR6 Silver</p>
<p>Z D O C D . M 1 .</p>		<p> .</p>	<p>P R 6 .</p>

Example: ZDOC24QLD.M17.FD01.PR6

For specification information see pages 251-252. (See page 413 for COM pricing on fabric Grades G-J.)

GSA SIN 33721

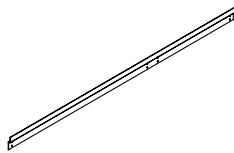

Description	Model	List Price
Horizontal Wall-Mount Brackets — for use with Painted Wood Overhead Cabinets		
24"W	YWC24Z	\$ 108
30"W	YWC30Z	\$ 124
36"W	YWC36Z	\$ 135
42"W	YWC42Z	\$ 153
48"W	YWC48Z	\$ 167
60"W	YWC60Z	\$ 206

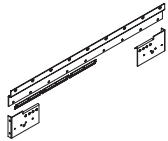

Description	Model	List Price
Horizontal Wall-Mount Brackets — for use with Painted Wood Shelf with Nitch		
24"W	ZWN24Z <input type="checkbox"/>	\$ 122
30"W	ZWN30Z <input type="checkbox"/>	\$ 135
36"W	ZWN36Z <input type="checkbox"/>	\$ 150
42"W	ZWN42Z <input type="checkbox"/>	\$ 165
48"W	ZWN48Z <input type="checkbox"/>	\$ 184
60"W	ZWN60Z <input type="checkbox"/>	\$ 226

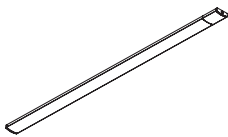

Undercabinet LED Lights (white end caps)		
17" Undercabinet LED Tasklight	ALED17U <input type="checkbox"/>	\$ 930
31" Undercabinet LED Tasklight	ALED31U <input type="checkbox"/>	\$ 1396

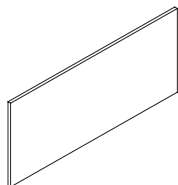

Description	Model	List Price					
		Grade A	Grade B	Grade C	Grade D	Grade E	Grade F
15"H Wall-Mounted Tackboards — for use with Overheads with Nitch							
30"W	ZWMTB1530 <input type="checkbox"/>	\$ 846	\$ 865	\$ 884	\$ 915	\$ 946	\$ 978
36"W	ZWMTB1536 <input type="checkbox"/>	\$ 856	\$ 879	\$ 901	\$ 939	\$ 977	\$ 1014
42"W	ZWMTB1542 <input type="checkbox"/>	\$ 873	\$ 899	\$ 926	\$ 970	\$ 1014	\$ 1058
48"W	ZWMTB1548 <input type="checkbox"/>	\$ 886	\$ 916	\$ 946	\$ 997	\$ 1047	\$ 1097
60"W	ZWMTB1560 <input type="checkbox"/>	\$ 907	\$ 945	\$ 982	\$ 1045	\$ 1108	\$ 1171

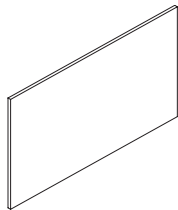

20"H Wall-Mounted Tackboards — for use with Overheads without Nitch							
24"W	ZWMTB2024 <input type="checkbox"/>	\$ 874	\$ 894	\$ 914	\$ 948	\$ 981	\$ 1015
30"W	ZWMTB2030 <input type="checkbox"/>	\$ 888	\$ 913	\$ 938	\$ 980	\$ 1022	\$ 1064
36"W	ZWMTB2036 <input type="checkbox"/>	\$ 898	\$ 928	\$ 958	\$ 1009	\$ 1059	\$ 1109
42"W	ZWMTB2042 <input type="checkbox"/>	\$ 916	\$ 951	\$ 986	\$ 1045	\$ 1104	\$ 1162
48"W	ZWMTB2048 <input type="checkbox"/>	\$ 922	\$ 962	\$ 1002	\$ 1069	\$ 1136	\$ 1203
60"W	ZWMTB2060 <input type="checkbox"/>	\$ 943	\$ 993	\$ 1043	\$ 1127	\$ 1211	\$ 1295

STRIDE

<p>How to specify — Select the Model Number from above.</p>	<p><i>1st Option:</i> Tackboard Fabric: See page 13 for fabrics.</p>
--	---

Examples: YWC24Z ZWN24Z ALED17U ZWMTB1530.COA901

Shippable by small-package carrier.

Wood Storage

Stride® — Horizontal Storage

For specification information see pages 253-254.

Painted Wood
GSA SIN 33721

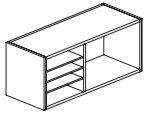

Description	Model	List Price
Full Depth Horizontal Storage — 15"D x 15"H (for mounting on panels or below worksurface)		
24"W Left	ZDHF24LS	\$ 2026
24"W Right	ZDHF24RS	\$ 2026
30"W	ZDHF30S	\$ 2108
36"W Left	ZDHF36LS (shown)	\$ 2187
36"W Right	ZDHF36RS	\$ 2187
42"W	ZDHF42S	\$ 2400
48"W	ZDHF48S	\$ 2766
60"W	ZDHF60S	\$ 3186

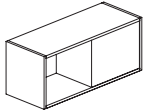

Shared Horizontal Storage — 15"D x 15"H (for mounting on panels or credenza rail)		
30"W Left	ZDHS30LS	\$ 2004
30"W Right	ZDHS30RS	\$ 2004
36"W Left	ZDHS36LS (shown)	\$ 2088
36"W Right	ZDHS36RS	\$ 2088
42"W Left	ZDHS42LS	\$ 2296
42"W Right	ZDHS42RS	\$ 2296
48"W Left	ZDHS48LS	\$ 2666
48"W Right	ZDHS48RS	\$ 2666
60"W Left	ZDHS60LS	\$ 3090
60"W Right	ZDHS60RS	\$ 3090

Note: Metal divider on shared storage available in markerboard paint MKP.

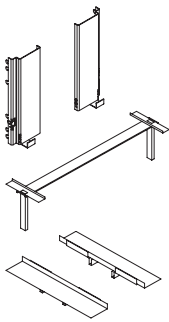

Description	Model	List Price
Full Depth Horizontal Storage Mounting Kit		
Panel Mounting Kit	ZHFPMK <input type="checkbox"/>	\$ 173
Shared Horizontal Storage Mounting Kits		
30"W Panel Mounting Kit	ZHSPMK30 <input type="checkbox"/>	\$ 220
36"W Panel Mounting Kit	ZHSPMK36 <input type="checkbox"/>	\$ 234
42"W Panel Mounting Kit	ZHSPMK42 (shown) <input type="checkbox"/>	\$ 244
48"W Panel Mounting Kit	ZHSPMK48 <input type="checkbox"/>	\$ 259
60"W Panel Mounting Kit	ZHSPMK60 <input type="checkbox"/>	\$ 270
Credenza Rail Mounting Kit	ZHSRMK (shown) <input type="checkbox"/>	\$ 199

How to specify —
Select the Model Number from above.

1st Option:
Paint Color for Mounting Kits (if applicable):
 P1 P2 P3
P2 add \$19
P3 add \$35

1st Option:
Painted Wood Paint Color (if applicable):
See page 120 for Painted Wood Finish.

2nd Option:
Metal Paint Color (for divider or shelves):
 P1 P2 P3
P2 add \$18
P3 add \$33
MKP (add \$82) Markerboard paint available on Shared Horizontal Storage (Grade 6)

Z | | | | | | | | | | .

P | | | |

M | 1 | | .

| | | |

Examples: ZDHF24LS.M17.PR6 ZDHS30RS.M17.MKP

Frame & Tile Panel Systems – 05/2022 ZHSPMK30.P4J ZHFPMK.PJW

Shippable by small-package carrier.

allsteeloffice.com | 275

Wood Storage

Stride® — Perch Cabinets

For specification information see pages 255-256.

Painted, Landscape™ Surface — Painted Wood

GSA SIN 33721

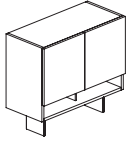

Description	Model	List Price
30"W Perch Cabinets — 14"D x 19½"H		
Hinged Doors with Nitch	ZDPC30QL	\$ 2672
Hinged Doors with Drawers	ZDPC30TL	\$ 3099

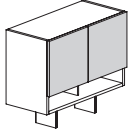

Description	Model	Grade 1 List Price	Grade 2 List Price	Grade 3 List Price
30"W Landscape Surface Front Perch Cabinets — 14"D x 19½"H				
Hinged Door with Nitch	ZDPC30QLD (shown)	\$ 4303	\$ 4426	\$ 4554
Hinged Door with Drawers	ZDPC30TLDL	\$ 4727	\$ 4850	\$ 4978

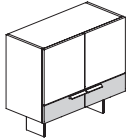

Description	Model	V1 List Price	V3 List Price	V5 List Price
30"W Landscape Surface Front Perch Cabinets — 14"D x 19½"H				
Hinged Door with Veneer Drawers	ZDPC30TWL (shown)	\$ 4856	\$ 5354	\$ 5686

Note: Top rail will show open groove in top cap required for these applications.

FRONT VIEW

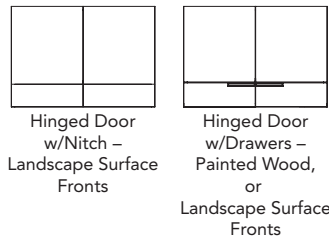

LANDSCAPE™ SURFACE MATERIAL OPTIONS

GRADE 2	
Foundation™	Quattro
FD01 Sand	QU44 Platinum
FD02 Taupe	
FD04 Pure White	

STRIDE

<p>How to specify — Select the Model Number from above.</p>	<p>1st Option: Painted Wood Paint Color: See page 120 for Painted Wood Finish.</p>	<p>2nd Option: Landscape Surface Material and Finish (if applicable):</p>	<p>3rd Option: Hardware Color: PR6 Silver</p>
<p>Z D P C 3 0 . M .</p>			<p> . P R 6 </p>

Examples: ZDPC30QLD.M17.FD01.PR6 ZDPC30TWL.M17.SE800.FD01.PR6

ZDPC30TLDL.M17.PR6

Benching Storage

For specification information see pages 255-256.

GSA SIN 33721

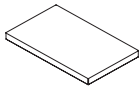

Description	Model	List Price by Grade											
		1	2	3	4	5	6	7	8	9	10	11	12
Seat Cushion for Toy Box and Combination Storage													
15"D x 24"W	K5CT1524SC	\$ 364	\$ 392	\$ 421	\$ 449	\$ 487	\$ 525	\$ 562	\$ 600	\$ 638	\$ 676	\$ 714	\$ 751
Seat Cushion for Mobile Pedestal													
18"D x 15"W	K5CT1815SC	\$ 317	\$ 343	\$ 369	\$ 395	\$ 430	\$ 465	\$ 500	\$ 534	\$ 569	\$ 604	\$ 639	\$ 674

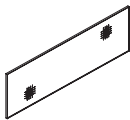

Description	Model	List Price					
		Grade A	Grade B	Grade C	Grade D	Grade E	Grade F
Tackable Cantilever Storage Accessory							
for use with 42½"H Single-Sided Cantilever Unit							
	ZS42SF	\$ 437	\$ 463	\$ 489	\$ 531	\$ 574	\$ 617
for use with 50"H Single-Sided Cantilever Unit							
	ZS50SF	\$ 519	\$ 559	\$ 598	\$ 664	\$ 730	\$ 796

<p>How to specify — Select the Model Number from above.</p>	<p><i>1st Option:</i> Upholstery for Seat Cushion: See pages 16-17 of Seating Price List for upholsteries.</p>	<p><i>1st Option:</i> Fabric for Cantilevered Storage Accessory: See page 10 of Desking and Benching Price List for fabrics.</p>	<p><i>2nd Option:</i> Trim Paint for Cantilevered Storage Accessory: P1 P2 P3 See page 194 of Desking and Benching Price List for finishes.</p>
_____ .	_____ .	_____ .	P _____

Examples: K5CT1524SC ZS50SF.EXG903.P27

S Shippable by small-package carrier.

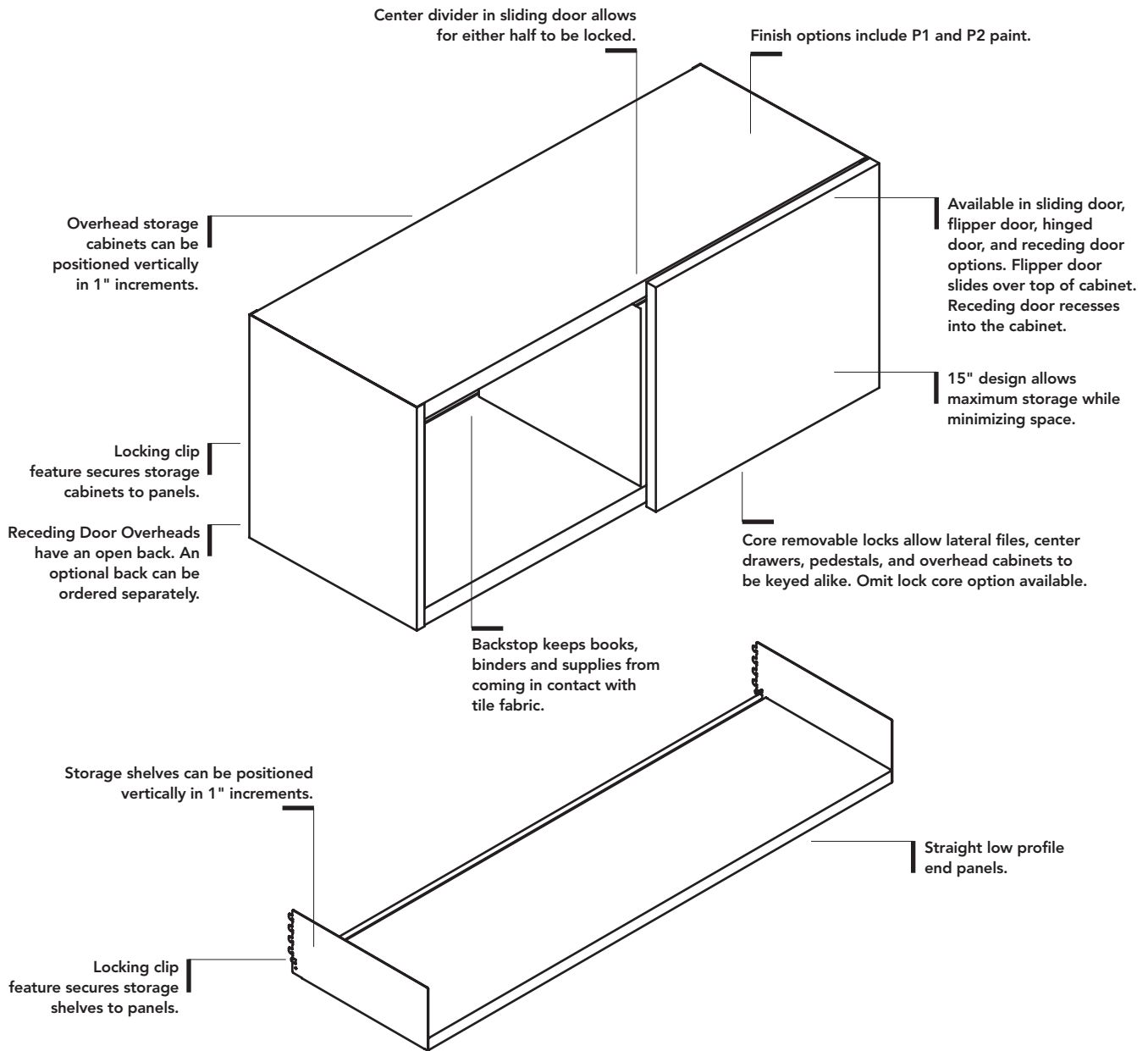

Product dimensions	
Overhead Storage Cabinet	
Width	24", 30", 36", 42", 48", 60"
Inside width	Flipper or 24" -36"W Hinged door — 3/8" less than width 42" -48" W Hinged or Sliding door — two compartments that are half of 3/8" less than width
Depth	14 1/4" RTA models 12"
Inside depth	12 7/8" Receding door 12 1/8" RTA models 11 5/8"
Height	15"
Inside height	12 3/4" Receding door 11 5/8" RTA models 12 3/4"
Open Shelf	
Width	24", 30", 36", 42", 48", 60"
Depth	12 7/8" RTA models 11 1/2"
Height	4 5/8" RTA models 5 3/8"

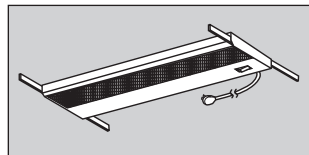

Recessed task lights can be mounted beneath storage shelves and overhead storage cabinets. Additional panel hung and freestanding lighting options are available.
Note: Do not use with laminate or painted wood storage.

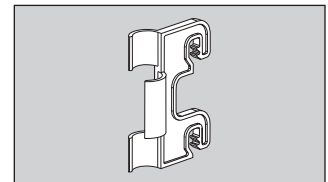

Cord retainer clips fasten into panel slots to anchor power cords. Available in black only. Clips are provided with under-shelf mounted task lights. Additional clips can be purchased separately.

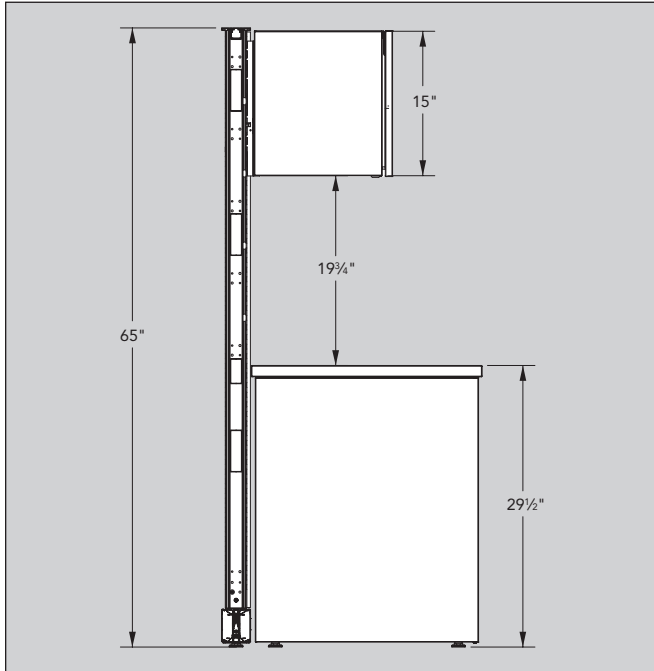

Overhead storage cabinets and open storage shelves can be mounted on Stride structural and stacking panels to a maximum height of 80". When mounting an overhead on a 57½"H base panel frame, select the option for Z57 bracket. For all other base panel frame and base panel frames with stacking frames the YZ bracket should be selected. Base panel frames with stacking frames that have an overall height of 57½" also use the YZ bracket.

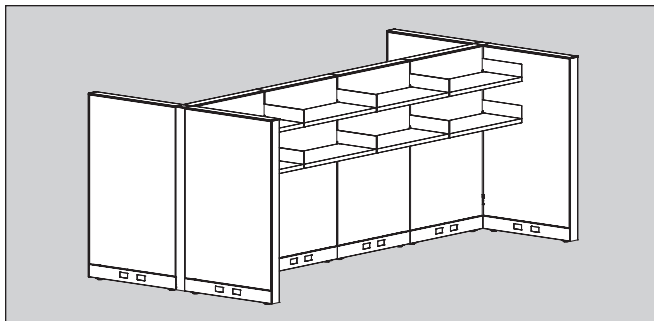

In a panel run, only two overhead storage cabinets or open storage shelves are recommended per panel side. Do not suspend more than one overhead storage unit per side from panels in a panel run which is mounted, at one or both ends, with an off-module connector kit.

When overhead storage units are suspended from stacking frames, the following guidelines should be adhered to:

- Stacking frames should be added to all the parent run panels, and to each return-panel run.
- Stacking panels added to return panel must match the parent run configuration.
- A maximum of two overhead storage units should be suspended from each side of stacking frames on any given panel.

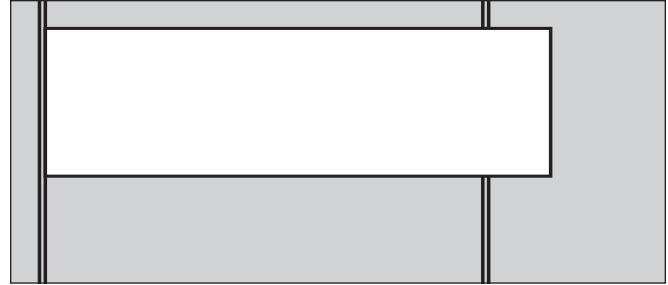

Metal Overhead Cabinets can be mounted on a panel equal to or up to 18" narrower than cabinet using provided panel attachment brackets. Overhead cabinets can also be mounted on panels wider than the overhead cabinet when using off-module kit **Z2NM**. One side of overhead must be held on module.



Storage shelf, receding door overhead, RTA overhead, and RTA shelf width must correspond with width of panel(s). It is possible to span two panels when combined panel width equals cabinet or shelf width.

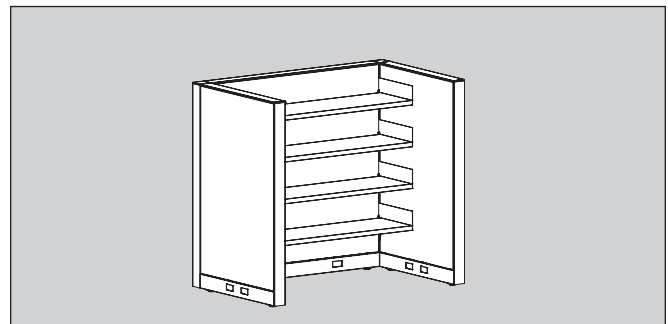

Up to 5 units can be hung on structural frames when run is supported with return panels on each side of storage shelves or overhead storage cabinets.

Overhead Storage Cabinets

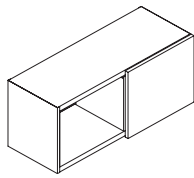

Metal Case with Single Sliding Door

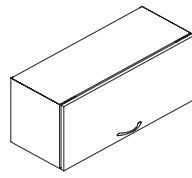

Metal Case with Metal Flipper Door

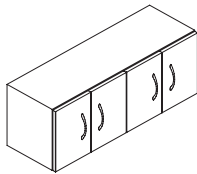

Metal Case with Metal Hinged Doors

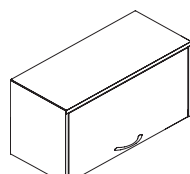

Metal Case with Metal Receding Door

Open Shelf

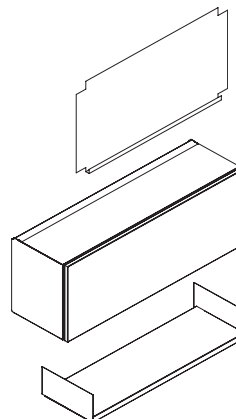
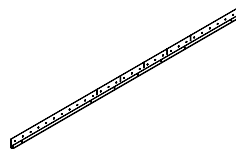
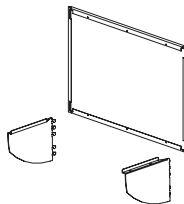
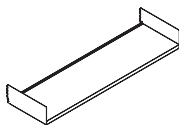

WEIGHT LIMITS

15"H Sliding, Hinged, and Flipper Door Overheads

24"W.....	59 lbs.
30"W.....	74 lbs.
36"W.....	90 lbs.
42"W.....	105 lbs.
48"W.....	121 lbs.
60"W.....	152 lbs.

Open Shelf

24"W.....	61 lbs.
30"W.....	77 lbs.
36"W.....	93 lbs.
42"W.....	108 lbs.
48"W.....	124 lbs.
60"W.....	155 lbs.

15"H Receding Door Overheads

30"W.....	70 lbs.
36"W.....	85 lbs.
42"W.....	100 lbs.
48"W.....	110 lbs.
60"W.....	138 lbs.

15"H Overhead Storage Cabinet (page 281)

- Steel cabinet with backstop. Cabinets are 14¼"D x 15"H.
- Available with sliding, hinged, or flipper door(s).
- Easy-Assist flipper door optional — requires minimal assistance in opening and closing. Not available on 60"W cabinets, specify 2–30"W flipper door cabinets with Easy-Assist.
- Self-engaging safety latch to secure cabinet to panel.
- Arch or Square pull optional on flipper and hinged doors.
- 60"W flipper cabinet has 2–30"W doors with 2 independent locks.
- 24"-36"W hinged door cabinets have 1 lock and 2 optional pulls, 42"-48"W have 2 locks and 4 optional pulls.
- Accommodates recessed task lighting — ordered separately.
- For locking specifications, see pages 408-410.
- 15"H cabinets can be mounted on a panel equal or up to 18" narrower than the cabinet using provided panel attachment brackets.
- Sliding doors have a built in pull.
- When mounting an overhead on a 57½"H base panel frame, select the option for Z57 bracket. For all other base panel frame and base panel frames with stacking frames the YZ bracket should be selected. Base panel frames with stacking frames that have an overall height of 57½"H also use the YZ bracket.

Open Shelf (page 282)

- Metal shelf with back stop. Locking clips (2) standard.
- Will accommodate recessed task lighting — ordered separately.
- Width can correspond with width of panel, or 2 panels joined without a connector.

Upmount Kits for Assembled Overhead Cabinets (page 281)

- Consists of two upmount brackets, full back panel and required installation hardware.
- Allows mounting of an assembled cabinet up to 15" above height of panel. Cannot be used with RTA models.
- Specify "Z2" prefix model number upmount kits with 15"H, 30"H, 35"H, 50"H, or 65"H frames; and "Z4" prefix model numbers for use with 22½"H, 42½"H, or 57½"H frames.
- Brackets require a clearance of 6" below bottom of overhead cabinet.
- Width must correspond with width of panel frame or 2 panel frames joined directly in-line.
- Full back panel adds ½" to depth of overhead case.
- Full back panel only used when upmounting cabinet.

Horizontal Wall Track (page 281)

- Allows mounting overheads on permanent wall structures ONLY.
- Cannot be used with RTA models.
- Track is 60"W and notched at 6" intervals as a guide for field cutting.
- Field modification necessary for use with sliding door overhead.
- Available in black only. Attachment hardware not included.

15"H Receding Door Overhead (page 282)

- Steel cabinet with open back. Optional back ordered separately.
- Arch or Square pull optional.
- 60"W cabinet has 2 30"W doors with 2 independent locks.
- Accommodates recessed task lighting — ordered separately.
- For locking specification, see pages 408-410.
- Cabinets are 13¼"D x 15"H. When door is recessed, interior dimensions are 12⅝"D x 11⅝"H.

Receding Door Overhead Back (page 282)

- Optional, order width to match receding door overhead.

Ready to Assemble (RTA) Flipper Door Overhead (page 282)

- Steel cabinet with open back.
- 60"W and 72"W cabinets have 2 doors with independent locks.
- Accommodates recessed task lighting — ordered separately.
- Random keying, for locking specifications see pages 408-410.
- Cabinets are 12"D x 15"H. Interior dimensions 11⅝"D x 12¾"H.

Ready to Assemble (RTA) Shelf (page 282)

- Metal shelf with locking clips.
- Accommodates recessed task lighting — ordered separately.

Metal Overheads & Shelves

Stride® — Overheads

For specification information see pages 278-280.

GSA SIN 33721

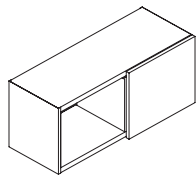

Description	Model	P1 Paint List Price	P2 Paint List Price	P3 Paint List Price
15"H x 14 1/4"D Sliding Single Door Overhead Cabinets				
24"W	OH1524SD	\$ 926	\$ 995	\$ 1064
30"W	OH1530SD	\$ 947	\$ 1016	\$ 1085
36"W	OH1536SD	\$ 993	\$ 1062	\$ 1131
42"W	OH1542SD	\$ 1038	\$ 1107	\$ 1176
48"W	OH1548SD	\$ 1085	\$ 1154	\$ 1223
60"W	OH1560SD	\$ 1433	\$ 1502	\$ 1571

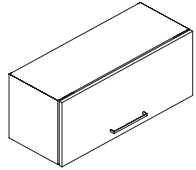

15"H x 14 1/4"D Flipper Door Overhead Cabinets				
24"W	OH1524FD	\$ 926	\$ 995	\$ 1064
30"W	OH1530FD	\$ 947	\$ 1016	\$ 1085
36"W	OH1536FD	\$ 993	\$ 1062	\$ 1131
42"W	OH1542FD	\$ 1038	\$ 1107	\$ 1176
48"W	OH1548FD	\$ 1085	\$ 1154	\$ 1223
60"W	OH1560FD	\$ 1433	\$ 1502	\$ 1571

Note: Add suffix **A** for arch pull or **S** for square pull to model number — add \$38 per pull.
For “Easy-Assist” on 24"W-48"W change FD suffix to FE – add \$214

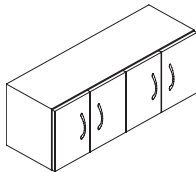

15"H x 14 1/4"D Hinged Door Overhead Cabinets				
24"W	OH1524HD	\$ 1586	\$ 1654	\$ 1723
30"W	OH1530HD	\$ 1657	\$ 1725	\$ 1794
36"W	OH1536HD	\$ 1735	\$ 1803	\$ 1872
42"W	OH1542HD	\$ 1809	\$ 1877	\$ 1946
48"W	OH1548HD	\$ 1876	\$ 1944	\$ 2013

Note: Add suffix **A** for arch pull or **S** for square pull to model number — add \$38 per pull.

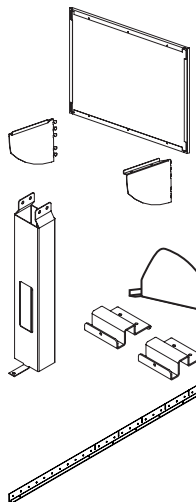

Upmount Kits for Overhead Cabinets —				
Specify “Z4” prefix models with 22 1/2"H, 42 1/2"H, or 57 1/2"H frames; “Z2” prefix for other heights.				
24"W	Z □ UP24	\$ 239	\$ 264	\$ 287
30"W	Z □ UP30	\$ 250	\$ 275	\$ 298
36"W	Z □ UP36	\$ 257	\$ 282	\$ 305
42"W	Z □ UP42	\$ 271	\$ 296	\$ 319
48"W	Z □ UP48	\$ 284	\$ 309	\$ 332
60"W	Z □ UP60	\$ 304	\$ 329	\$ 352

Shelf Dividers				
Package of 6	T7DV	\$ 127	\$ 142	\$ 152

Note: Not compatible with RTA models.

Off-Modular Overhead Bracket Kit				
Mounting Kit	Z2NM	\$ 226	\$ 251	\$ 274

Horizontal Wall Track				
60"W Track	TWTH	\$ 120	N/A	N/A

How to specify — Select the Model Number from above.	1st Option: Pull (if applicable): A Arch pull, add \$38 per pull S Square pull, add \$38 per pull	2nd Option: System (if applicable): YZ Stride or Terrace (except 57"H) Z57 Stride or Terrace 57"H	3rd Option: Paint: P1 P2 P3 See page 120 for finishes.	4th Option: Pull Color (if applicable): Arch: E4 Black EL Matte Silver Square: EL Matte Silver	5th Option: Lock Type: (if applicable): STD Standard — Random Keyed OMT Omit Lock Core (Deduct \$18 per lock)
_____ .	_____ .	_____ .	P _____ .	E _____ .	_____ .

Examples: OH1524FEA.YZ.P4J.E4.STD OH1548FDS.YZ.P52.EL.OMT [S] Shippable by small-package carrier.



Metal Overheads

Stride® — Overheads

For specification information see pages 278-280.

GSA SIN 33721

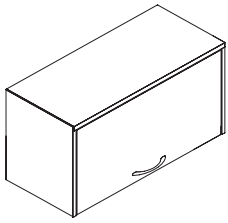

Description	Model	P1 Paint List Price	P2 Paint List Price	P3 Paint List Price
15"H x 13 1/4"D Receding Door Overheads (Inside dimensions with door recessed — 11 1/8"H x 12 1/8"D)				
30"W	OH1530RD	\$ 1087	\$ 1156	N/A
36"W	OH1536RD	\$ 1146	\$ 1215	N/A
42"W	OH1542RD	\$ 1218	\$ 1287	N/A
48"W	OH1548RD	\$ 1320	\$ 1389	N/A
60"W	OH1560RD	\$ 1997	\$ 2066	N/A

Note: Add Suffix **A** for arch pull or **S** for square pull option — add \$38 per pull.

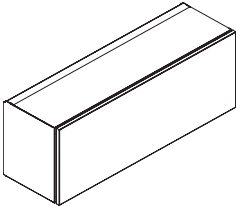

Description	Model	P1 Paint List Price	P2 Paint List Price	P3 Paint List Price
15"H x 12"D Ready to Assemble (RTA) Flipper Door Overhead (Inside dimensions 12 1/4"H x 11 1/8"D)				
36"W RTA — Flipper Door	POHRTA1536FD	\$ 778	\$ 847	\$ 916
42"W RTA — Flipper Door	POHRTA1542FD	\$ 813	\$ 882	\$ 951
48"W RTA — Flipper Door	POHRTA1548FD	\$ 848	\$ 917	\$ 986

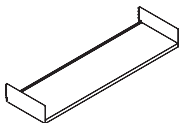

Description	Model	P1 Paint List Price	P2 Paint List Price	P3 Paint List Price
Open Shelf (to line up with 15"H Overheads) — 12 1/2"D				
24"W	ZS24 S	\$ 395	\$ 419	N/A
30"W	ZS30 S	\$ 428	\$ 452	N/A
36"W	ZS36 S	\$ 452	\$ 476	N/A
42"W	ZS42 S	\$ 473	\$ 497	N/A
48"W	ZS48 S	\$ 496	\$ 520	N/A
60"W	ZS60	\$ 604	\$ 628	N/A

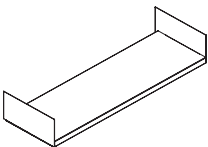

Description	Model	P1 Paint List Price	P2 Paint List Price	P3 Paint List Price
5 7/8"H x 12"D Ready to Assemble (RTA) Shelf				
36"W RTA — Shelf	POHRTA36S	\$ 405	\$ 428	\$ 449
48"W RTA — Shelf	POHRTA48S	\$ 445	\$ 468	\$ 489

STRIDE

<p>How to specify — Select the Model Number from above.</p>	<p>1st Option: Receding Door Pull (if applicable): A Arch Pull, add \$38 per pull S Square Pull, add \$38 per pull</p>	<p>2nd Option: System for Receding Door Overhead (if applicable): YZ Stride, Terrace, or Concensys Z57 5 7/8"H Stride or Terrace</p>	<p>3rd Option: Paint: P1 P2 P3 P3 available for Open Shelf and RTA Shelf only. See page 120 for finishes.</p>	<p>4th Option: Receding Door Pull Color (if applicable): Arch: E4 Black EL Silver Square: EL Silver</p>	<p>5th Option: Receding Door Lock (if applicable): STD Standard OMT Omit Lock Core (Deduct \$18 per lock)</p>

Examples: OH1560RD.YZ.P7C.STD OH1536RDA.YZ.P27.E4.OMT
POHRTA1536FD.P27

S Shippable by small-package carrier.

For complete specification and pricing information see the Storage Price List.

GSA Reference Page

Align Metal Pedestals — support or mobile



File/File
28½"H x 15"W
18", 23¼", 29¼"D



Box/Box/File
28½"H x 15"W
18", 23¼", 29¼"D



File/File
26½"H x 15"W
18", 23¼", 29¼"D



Box/Box/File
26½"H x 15"W
18", 23¼", 29¼"D



Box/File
20½"H Mobile,
22"H Freestanding
18", 23¼", 29¼"D x 15"W

Plinth base shown, models available with Stride or Terrace feet. Choice of metal or laminate fronts.

Align Low Metal Storage — credenzas, right and left configurations available

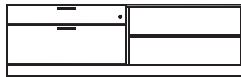

Box/Lateral/Open
72"W
22"H x 18", 24"D

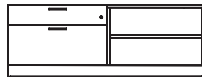

Box/Lateral/Open
60"W
22"H x 18", 24"D



Box/Lateral/Open
48"W
22"H x 18", 24"D



Box/Lateral/Open
42"W
22"H x 18", 24"D

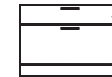

Box/Lateral
24", 30", 36", 42"W
22"H x 18", 24"D

Plinth base shown, models available with Stride or Terrace feet. Choice of metal or laminate fronts.

Align Metal Lateral and Personal Files



2-High
28"H
30", 36", 42"W
18"D



2-High
28"H
30"W
18"D



2-High
28"H
24", 30", 36"W
18"D



Open
24", 30", 36", 42"W
22"H x 18", 24"D

Plinth base shown, models available with Stride or Terrace feet. Choice of metal or laminate fronts.

Align Metal Personal Towers — Stride®/Terrace®/Optimize™ Height — left configuration shown, also available right

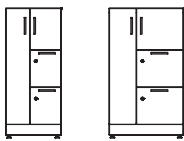

42½"H
18", 24"W
24"D

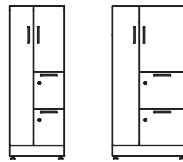

50"H
18", 24"W
24"D

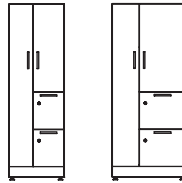

57½"H
18", 24"W
24"D

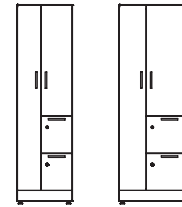

65"H
18", 24"W
24"D

Plinth base shown, models available with Stride or Terrace feet. Choice of metal or laminate fronts.

Align Lockers — Overview — Left configurations shown, also available right

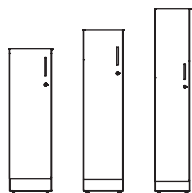

Single 12"W
42½", 50", 65"H / 18", 24"D

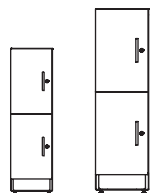

Double 12"W
42½", 65"H / 18"D

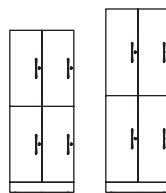

Quad 24"W
42½", 65"H / 18"D

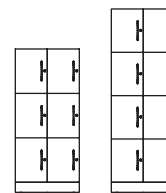

Cubby 24"W
50", 65"H / 18"D

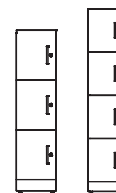

Cubby 12"W
50", 65"H / 18"D

Plinth base shown, models available with Stride or Terrace feet. Choice of metal or laminate fronts.

Approach Pre-configured Desks & Tables — height-adjustable 27¼"-47¾"H, fixed height 29½"H, left and right configurations

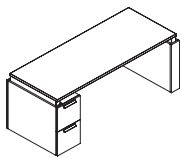

Height-Adjustable w/Storage
72", 66"W x 36", 30"D

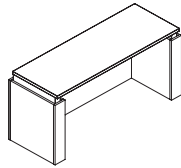

Height-Adjustable w/ and w/o Modesty
72"-48"W x 36", 30"D

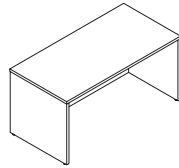

Shell Desk
60, 66, 72"W x 30"D

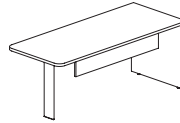

Racetrack Top w/Column, End Panel, and Modesty
72", 66"W x 30"D

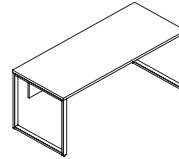
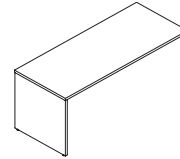
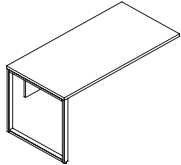

Table Desk with "O" Legs
72", 66"W x 30"D



With End Panel
84"-48"W x 30"D



With "O" leg
84"-48"W x 30"D

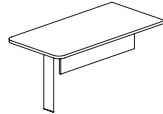

Racetrack Top w/Column
60", 54", 48"W x 30"D

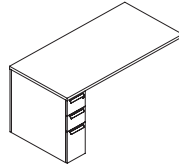

With Pedestal
72"-48"W x 30"D

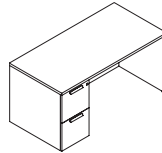

Single 15"W Ped Desk
60, 66, 72"W x 30"D

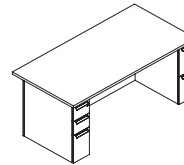

Double Ped Desk
72"W x 36"D

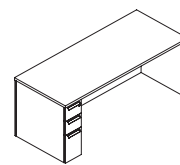

Single Slim Ped Desk
72", 66", 60"W x 36", 30"D

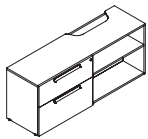

Credenza for Integrated HAT
60, 72"W
18, 24"D

Approach Credenzas — 28"H (shown) x 18"D or 24"D, 24"H x 18"D; most available to-the-floor base or feet with or without troughs.



Multi File
30"W

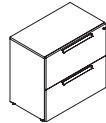

Lateral File
Only 28"H x 36", 30"W

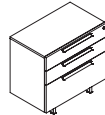

Box/Box/File 28"H
Box/File 24"H
36", 30"W

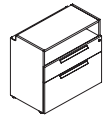

Open/Box/File
Only 28"H x 36", 30"W

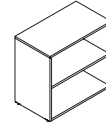

Open and Adjustable Shelf
36", 30"W

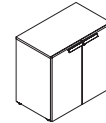

Hinged Doors and Adjustable Shelf
36", 30"W

Approach 28"H Double Credenzas — 18" or 24"D, left and right configurations, available to-the-floor base or feet with or without troughs.

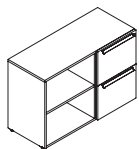

Open/Box/File
42"-48"W
18", 24"D

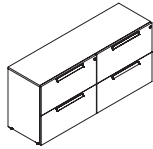

Lateral File/Lateral File
72", 60"W

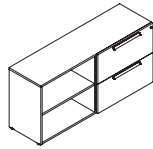

Lateral File/Open Shelf
72", 60"W

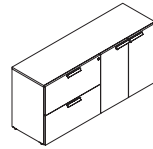

Lateral File/Hinged Doors
72", 60"W

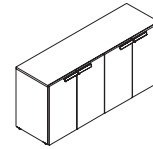

Four Hinged Doors
72", 60"W

Approach 24"H Double Credenzas — 24"H x 18"D; left and right configurations, most available to-the-floor base or feet with or without troughs.

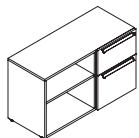

Open/Box/File
42"-48"W
18", 24"D

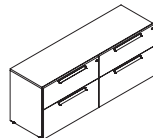

Box File/Box File
To-the-floor 72", 60"W

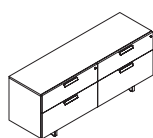

Box File/Box File
With Feet 72", 60"W

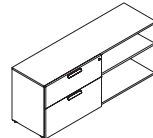

Box File/Open Shelf
72", 60"W

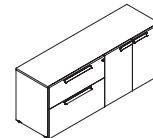

Box File/Hinged Doors
72", 60"W

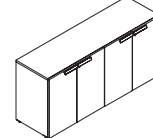

Hinged Doors/Hinged Doors
72", 60"W

Approach Pedestals — Mobile models have recessed casters



Mobile Box/File
21½"H x 16"W x 20"D

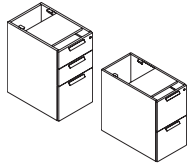

Support Pedestal
w/o Trough
28"H x 15"W
24, 30"D

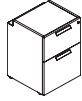

Support Box/File
24"H x 18"W x 18"D

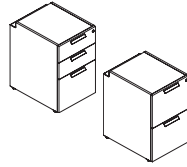

Support Box/Box/File and
File/File w/Troughs
28"H x 18"W x 18", 24"D

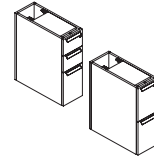

Support Slim Box/Box/File
and File/File w/Back Panel
28"H x 9½"W x 24", 30"D

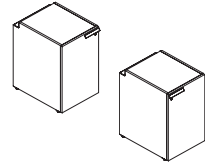

Support Left- and Right-Hand
Hinged Door w/Troughs
28"H x 18"W x 18", 24"D

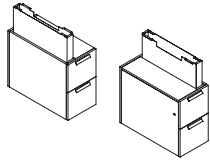

Height-Adjustable Slim
Ped & Shroud Kit
14½"W x 30"D

Approach False Peds, Wall Access Panels, Bridges, and Back Panels

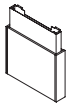

Height-Adjustable Shroud Kit
5½"W x 30"D
27½"-47½"H

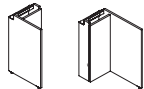

False Ped Left/Right
28"H x 12"W x
14, 18", 24"D



Wall Access Panel
28"H x 18", 24", 30", 36",
42", 48"W

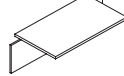

Bridge w/14"H Modesty
42", 48"W x 24"D



Back Panels 28", 24", 20"H
18", 30", 36", 60" 72"W

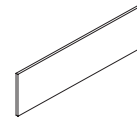

Modesty Panels
14"H x 30"-72"W

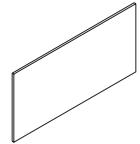

Full Height Modesty
42"-72"W

Approach Tops, Worksurfaces, and Supports — End Panels left- and right-handed



Cushion Tops for Mobile Ped
& Credenzas
16" x 20" / 30", 36" x 18"

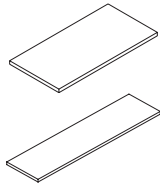

True and Shortened Depth
Laminate Tops
18"D, 24"D x 18"W-96"W

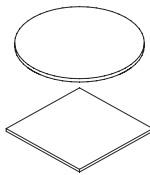

Round & Square Table Tops
36" / 42" / 48"

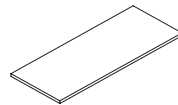

Laminate Worksurfaces
24"D, 30"D x 30"W-96"W
36"D x 72"W-84"W

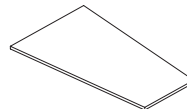

Double Sight line Wksfc.
36"-24"D x 60"-72"W
42"-30"D x 60"-72"W

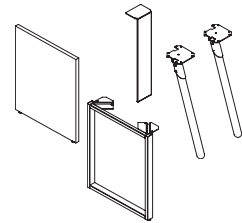

End Panels, O-Legs, Column &
Splay Leg Supports 28"H
14", 24", 30", 36"D

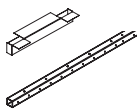

Stanchions & Support
Channel
3"H, 4"H x 12"D, 18"D
& 30"W-72"W

Approach Lateral Files, Bookcases, and Cubby — Laterals are 30" or 36"W x 18½"D, Bookcases are 30"W x 14¼"D, Cubby 7"H x 14"D

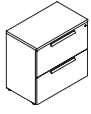

2-Drawer Lateral
29½"H



3-Drawer Lateral
42¼"H

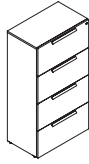

4-Drawer Lateral
56¼"H

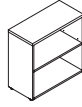

2-High Bookcase
29½"H

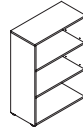

3-High Bookcase
42¼"H



4-High Bookcase
56¼"H



5-High Bookcase
71¼"H



Cubby Storage
18", 24", 30"W



8"D Floating Shelf
30"-78"

Approach Towers & Stack-On Storage — Towers 18"D, 24"D; Storage w/doors & Side Access 15"D, Open units 14½"D

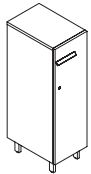

Wardrobe
42"-72"H
12", 18", 24"W
18", 24"D

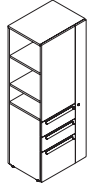

Side Access
42"-72"H
18", 24"W
18", 24"D

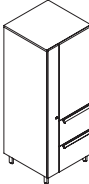

Combination
42"-72"H
18", 24"W
18", 24"D

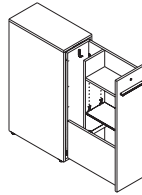

Pull Out Towers
42", 50"H
24", 30"D

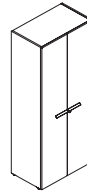

Tower w/Hinged Doors
30"W x 57½", 72"H

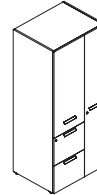

Combo Tower File/File
L- and R-Handed
30"W x 72"H

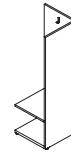

Open Access
L- and R-Handed
18"W x 57½", 72"H

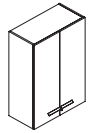

Stack-On w/Doors
18", 30", 36"W
x 29½, 42½"H

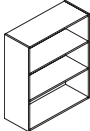

Stack-On Open
18", 30", 36"W
x 29½, 42½"H

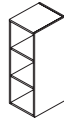

Stack-On Side Access
18"W
x 29½, 42½"H

Approach Overhead Storage — 15½"H x 15½"D with doors, open units 15½"D

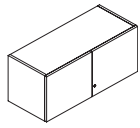

Hinged Doors
30"–78"W

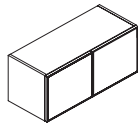

Writable Doors
30", 36", 60", 72"W

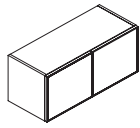

Frosted Glass Doors
30"–78"W

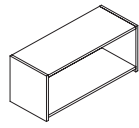

Open
30", 36"W

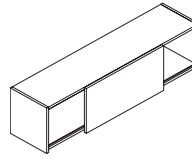

Sliding Door
48"–78"W



Overhead Mounting Kit
for Beyond Walls

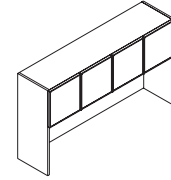

35"H Hutch
Lam. or Frosty Doors
48"–72"W

Approach Tackboards, Writable Boards, and Accessories — Tackboards and Writable Boards 30", 34", 45", 49"H

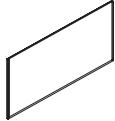

Tackboards for Hutches
48"W–72"W

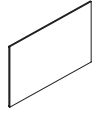

Tackboards
30"W–96"W

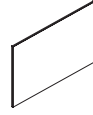

Writable Boards
30"W–96"W

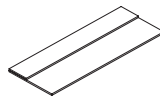

Counterweights
25, 35, 50, 60 lbs.

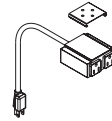

Mini Tap Power
6' Cord



End Cap

Altitude® Height-Adjustable Tops, Bases, and Accessories for Approach

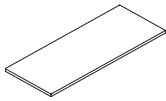

Altitude Tops
24", 30", 36"D x
48"-72"W

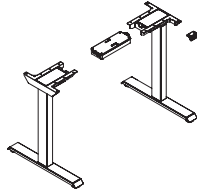

A6 T-leg Base 2-stage
22½"H-48½"H for
24"-30"D x 48"-84"W Tops

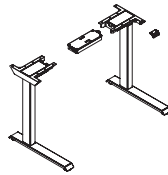

A6 C-leg Base 2-stage
27½"H-47½"H for
24"-30"D x 48"-72"W Tops

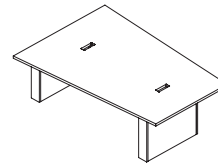

Collaborative
Height-Adjustable Tables
60"-48"D, 54-42"D, 42"-30"D

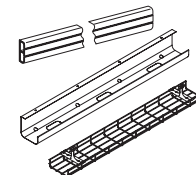

Cable Management
Channel, Tray, and Trough

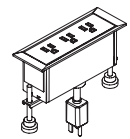

Power Modules
Power & USB

Extensions for Approach

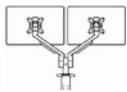

Monitor Arms
21"

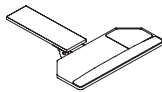

Articulating Keyboard
25"W x 10½"D



CPU Hammock
CPU 3-6"W x 16-23"H

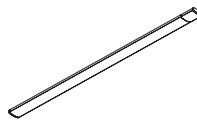

Under Cabinet LED Lights
17" & 31"

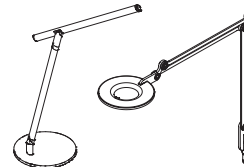

Link™ and Wand™ LED Lights
Base or Clamp

Leg or Plinth Base models available. Leg base units are shown below.

Pedestals — 24"H and 28"H



Mobile
Box/File



Freestanding
Box/File



Freestanding
Open



Support
Box/Box/File



Support
File/File



Support
Open

Credenzas — 17½"H, left- and right-handed models available for handed units.



Single Lateral

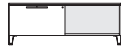

Single Lateral
w/Open Cubby



Corner Table

Credenzas — 24"H, left- and right-handed models available for handed units.



Box/Lateral



Box/Box
Lateral

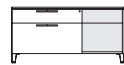

Box/Lateral
w/Open Cubby



Sliding Door
Open



Open

Credenzas — 28"H, left- and right-handed models available for handed units.



2-High
Lateral



Box/Box
Lateral



Box/Box
Project/Lateral



Sliding Door
Open w/Cubbies



Open

Credenzas and Bookcase — 42"H



3-High
Lateral

Bookcases — 65"H and 72½"H



Bookcase
w/Lateral



Bookcase



Bookcase
w/Lateral

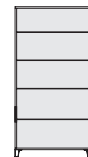

Bookcase

Towers — 42"H (12"W only), 50"H and 57½"H (50"H shown); left- and right-handed models available.

12"W



Full-Width Door

18"W



Hinged Door
Box/Box/File

18"W



Side Access
File/File

24"W



Hinged Door
Box/Box/File

24"W

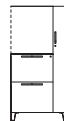

Side Access
File/File

Towers — 65"H and 72½"H (65"H shown); left- and right-handed models available.

12"W



Full-Width Door
(65"H)

18"W



Hinged Door
Box/Box/File

18"W



Hinged Door
File/File

18"W



Full-Width
Door

24"W



Hinged Door
Box/Box/File

24"W



Hinged Door
File/File

24"W



Full-Width Door

Leg or Plinth Base models available. Leg base units are shown below.

Stacking Storage — Hinged Door, left- and right-handed models available

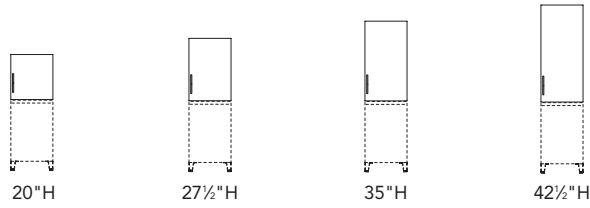

Stacking Storage — Open

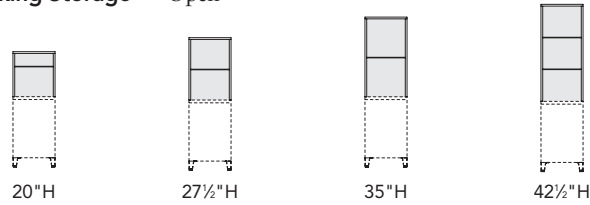

Overheads and Shelves

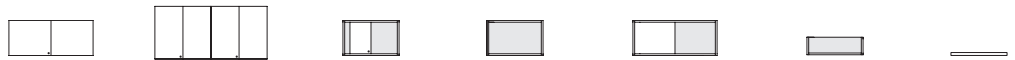

Hinged Door 15"H Hinged Door 22½"H Sliding Door Open Bin Dual Access Open Book Shelf Laminate Shelf

Soft Seating and Tables



Seat Base w/Drawers Seat Base w/Open Cubby Banquette Cushion Seat Base Cushion Table Top Bolster Corner Table Open Table

Worksurfaces — Shapes below added for Involve to the hundreds available in our existing Worksurface selection.

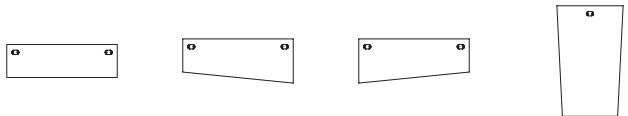

Primary 18"D Linear Taper 18"D / 24"D Linear Taper 24"D / 18"D EZ View Transition

Supports and Accessories



Open Metal End Supports Closed Laminate End Supports Post Leg Worksurface Stanchion Overhead Stanchion

Modesty Panels and Screens

Accessories



Modesty Panels Back Panels Privacy Panels Divider Panels Ped/Credenza Cushion Pullout Shelf Extra Metal Shelf Power Module

INVOLVE

Notes

INVOLVE

Gallery Panels

Finishes	292
Panel Fabrics	293
Laminate and Paint Matching.....	294
Gallery Panels	295
Basic Characteristics.....	296
Dimensions	297
Working with Integrated Glass.....	298-299
Stride and Terrace - End Panel (Dual-Sided).....	300
Stride and Terrace - End Panel (Single-Sided)	301
Stride and Terrace - Mid Panel	302
Gallery-to-Gallery Panels	303
Freestanding Screens	304-305
Storage and Worksurface Connectors	306
Accessories - Tackboards.....	307
Working with Accessories	308-309
Gallery Panels HAT Brackets	310
Panel Systems HAT Brackets.....	311
Gallery-to-Gallery Panels: 30"H Application.....	312
Gallery-to-Gallery Panels: 35"H Application.....	313
Gallery-to-Gallery Panels: 42"H Application.....	314
Gallery-to-Gallery Panels: 50"H Application.....	315
Gallery-to-Gallery Panels: 57½"H Application	316
Gallery-to-Gallery Panels: 30"H Application for use with Glass.....	317
Gallery-to-Gallery Panels: 35"H Application for use with Glass	318
Gallery-to-Gallery Panels: 42"H Application for use with Glass	319
Gallery-to-Gallery Panels: 50"H Application for use with Glass	320
Gallery-to-Gallery Panels: 57½"H Application for use with Glass.....	321
30"H Application	322
35"H Application	323
42"H Application	324
50"H Application	325
57½"H Application	326
30"H Application for Use with Glass	327
35"H Application for Use with Glass	328
42"H Application for Use with Glass	329
50"H Application for Use with Glass	330
57½"H Application for Use with Glass	331
Connector Kits	332
Terrace Connector Kits	333
Panel Systems Gallery Glass.....	334-336
Accessories	337-339

PAINT FINISHES

GRADE P1

Black	P7I
Brownstone	P7D
Bungalow	P7C
Cinder	P7Q
Designer White	PJW
Flint	P02
Fossil	P28
Loft	P7B
Muslin	P4J
Parchment	P93
Pebble	P8R
Pewter	P8D
Salt	P8C
Textured Brownstone	P7J
Textured Designer White	PK7
Textured Flint	P7A
Textured Loft	P7L
Textured Muslin	P7M
Textured Pebble	P8Y
Textured Salt	P8Z
Textured Titanium	P8V
Titanium	P8T

GRADE P2

Champagne Metallic	PR5
Gunmetal Metallic	PR3
Night Bronze	P8B
Platinum Metallic	PR2
Pyrite	PJE
Silver	PR6
Silver Texture	PR8
Solar Black	P8X

Metallic paints, due to varying reflectance, may appear to have less visual color consistency than other paint finishes, even when L/A/B values are exactly the same. (L/A/B — measurable aspects of color — values are maintained within a specified range, to ensure consistent appearance of paint colors.)

GRADE P3

Atom	P8S
Blossom***	P8K
Bullseye	PJF
Cabernet***	P7T
Conifer***	P8H
Ember	P8P
Ion	P8N
Iris	P8J
Krypton	P8F
Regatta	P8M
Succulent***	P8A

***These colors are intended to be an inspirational option for the trending market. Product application is limited and color availability is approximately two years to coincide with evolving workplace trends.

LAMINATES

GRADE L1

SOLID COLOR	
Black	P
Brownstone	LM13
Bungalow	LM12
Designer White	LDW1
Flint	LM16
Fossil Shale	LEH1
Loft	LM11
Muslin	LM15
Titanium	LTI1
ABSTRACT	
Handspun Pearl	L AHP
Handspun Dove	L AHD
Handspun Slate	L AHS
Handspun Chestnut	L AHC
WOODGRAIN	
Belair	LWBA
Bourbon Cherry	H
Field Elm	LWFE
Florence Walnut	LFW1
Kingswood Walnut	LK11
Natural Maple	LWD
NeoWalnut	LNU1
Pinnacle	PINC
Shaker Cherry	LW7C

GRADE L2

Beigewood	LWBE
Fawn Cypress	LFC1
Lowell Ash	LLA1
Mangalore Mango	LMM1
Natural Recon	LNR1
Phantom Charcoal	LPC1
Phantom Ecu	LPE1
Portico Teak	LPT1
Skyline Walnut	LSW1
Veranda Teak	LVT1

GRADE L3

Natural Walnut	LWNW
----------------------	------

LAMINATE EDGE COLORS

Beigewood	DE
Belair	BA
Black	E4
Bourbon Cherry	H
Brownstone	EY
Bungalow	EX
Designer White	DW
Fawn Cypress	FC
Field Elm	FE
Flint	E9
Florence Walnut	FW
Fossil	EH
Kingswood Walnut	KI
Loft	EV
Lowell Ash	DL
Mangalore Mango	MM
Muslin	EU
Natural Maple	DD
Natural Recon	NR
Natural Walnut	DN
NeoWalnut	NU
Parchment	EN
Phantom Charcoal	PC
Phantom Ecu	PE
Pinnacle	PI
Plyband	PL
Portico Teak	DP
Shaker Cherry	DF
Skyline Walnut	SW
Titanium	TI
Veranda Teak	VT

Forest Stewardship Council (FSC) is a non-profit organization devoted to encouraging the responsible management of the world's forests. FSC sets high standards that ensure forestry is practiced in an environmentally responsible, socially beneficial, and economically viable way. Allsteel received its FSC Chain of Custody certification in 2010 and can offer FSC Certified products. Select wood-based products can be ordered as FSC certified, either by choosing the FSC option or selecting an FSC laminate or veneer finish at the time of order. For more information, please contact Customer Support at 888-255-7833. (FSC Trademark license code: FSC-CO14704.)

NOTE: Refer to individual product pages for upcharges.

GRADE A

APPOINT PANEL

100% Polyester

Artichoke.....	APN911
Blackberry.....	APN932
Bronze.....	APN922
Carbon.....	APN928
Chai.....	APN912
Cherry.....	APN930
Dark Pewter.....	APN917
Dune.....	APN915
Espresso.....	APN923
Framboise.....	APN931
Frost.....	APN934
Jet.....	APN927
Lawn.....	APN925
Mandarin.....	APN929
Morel.....	APN909
Nimbus.....	APN916
Platinum.....	APN924
Turquoise.....	APN926

BINARY †

Blush.....	BNRY12
Coal.....	BNRY06
Cream.....	BNRY01
Denim.....	BNRY08
Diamond.....	BNRY03
Graphite.....	BNRY05
Juniper.....	BNRY10
Lagoon.....	BNRY07
Lavendar.....	BNRY11
Mineral.....	BNRY04
Reef.....	BNRY09
Sand Dollar.....	BNRY02

CENTURION^w

(Nanotex™ Stain-Resistant finish)

Apricot.....	CU47
Bark.....	CU25
Black.....	CU10
Espresso.....	CU49
Fog.....	CU03
Frost.....	CU22
Goldenrod.....	CU27
Indigo.....	CU06
Iris.....	CU50
Iron Ore.....	CU19
Jade.....	CU83
Marsala.....	CU63
Morel.....	CU24
Navy.....	CU98
Peacock.....	CU97
Pear.....	CU84
Ruby.....	CU67
Sapphire.....	CU09

CIRCUIT † ♣

Atlas.....	CIRC35
Dolphin.....	CIRC63
Island White.....	CIRC14
Moon.....	CIRC07
Night.....	CIRC49
Pacific.....	CIRC28
Quartz.....	CIRC01
Sienna.....	CIRC56
Silk.....	CIRC21
Snap Pea.....	CIRC42

GRADE A – continued

ETCH

100% Polyester

Axis.....	ECH913
Blend.....	ECH914
Cast.....	ECH912
Highlight.....	ECH910
Midtone.....	ECH911
Outline.....	ECH908
Shade.....	ECH909
Tonal.....	ECH916
Vanish.....	ECH915

EXCHANGE

100% Polyester

Iron.....	EXG916
Nickel.....	EXG914
Pistachio.....	EXG910
Root.....	EXG913
Rupee.....	EXG903
Shadow.....	EXG911
Silver.....	EXG915
Sisal.....	EXG917
Stone.....	EXG912

LANDSCAPE

100% Polyester

Corn silk.....	LN15
Drift.....	LN05
Khaki.....	LN20
Sheen.....	LN10
Slate.....	LN35
Umber.....	LN25
Urban.....	LN30

LUCY

100% Recycled Polyester

Aspen.....	LC932
Corn silk.....	LC930
Dusk.....	LC922
Fawn.....	LC933
Graphite.....	LC934
Mist.....	LC920
Neutra.....	LC924
Pewter.....	LC935
Snowdrop.....	LC928

NOBLE

Aspen.....	NBLE14
Bordeaux.....	NBLE01
Brick.....	NBLE02
Chambray.....	NBLE10
Clementine.....	NBLE04
Dawn.....	NBLE13
Grass.....	NBLE07
Gunmetal.....	NBLE15
Harvest.....	NBLE12
Jade.....	NBLE06
Knight.....	NBLE17
Mesa.....	NBLE03
Pacific.....	NBLE08
Rainforest.....	NBLE05
Regal.....	NBLE11
Stormy.....	NBLE16

REFLECTIONS

100% Recycled Polyester

Galvanized.....	REF929
Ice.....	REF920
Loggia.....	REF921
Mistral.....	REF928
Moonstone.....	REF923
Pewter.....	REF922
Stainless.....	REF924
Vanilla.....	REF925
Winter.....	REF927

GRADE A – continued

REFUGE

64% Recycled Polyester
36% Polyester

Artesian.....	RFG996
Dune.....	RFG992
Eclipse.....	RFG990
Frost †.....	RFG993
Glacier †.....	RFG991
Mineral.....	RFG998
Tidal.....	RFG994

SARTO ▼

100% Polyester (45% Recycled)

Ash.....	SRT988
Fog.....	SRT914
Lemongrass.....	SRT949
Mist.....	SRT945
Mushroom.....	SRT976
Oyster.....	SRT918
Reef.....	SRT964
Sesame.....	SRT993
Shale.....	SRT952

TEMPEST

100% Recycled Polyester

Dragonfly.....	TP930
Frost.....	TP915
Full Stream.....	TP980
Gold Rush.....	TP910
Slate.....	TP945
Tumbleweed.....	TP970
Wind Chill.....	TP940
Zebra.....	TP935

GRADE B

ANALOG

Album.....	ANLG06
Cartridge.....	ANLG04
Cassette.....	ANLG09
Dial.....	ANLG02
Media.....	ANLG08
Reel.....	ANLG07
Signal.....	ANLG03
Stereo.....	ANLG01
Track.....	ANLG05

COAST † ♣

100% Antimony-Free Polyester

Channel.....	COA914
Dune.....	COA903
Headlands.....	COA910
Marsh.....	COA902
Pebble.....	COA912
Pier.....	COA913
Shoal.....	COA901
Silt.....	COA906
Tide.....	COA908

GRADE B – continued

DISPERSE †

100% Polyester

Autumn.....	DISP03
Branch.....	DISP10
Coffee Bean.....	DISP13
Dusk.....	DISP09
Emerald City.....	DISP08
Gold Rush.....	DISP02
Igloo.....	DISP11
Ink.....	DISP06
Mist.....	DISP12
Oatmeal.....	DISP15
Prince.....	DISP07
Reservoir.....	DISP01
Rose.....	DISP04
Spring.....	DISP05
Steel.....	DISP16
Taupe.....	DISP14

MICA

100% Recycled Polyester

Anthracite.....	MCA911
Breeze.....	MCA918
Bronze.....	MCA913
Buff.....	MCA914
Cremini.....	MCA917
Crystal †.....	MCAWIT
Dew.....	MCA920
Dove.....	MCA912
Fresh.....	MCA916
Mineral.....	MCA915
Nectar.....	MCA919
Shale.....	MCA910

SPIN PANEL

46% Recycled Polyester,
56% Polyester

Alabaster.....	SPIN02
Cavern.....	SPIN03
Cobblestone.....	SPIN04
Ember.....	SPIN06
Flame.....	SPIN07
Heron.....	SPIN13
Oat.....	SPIN01
Ocean.....	SPIN12
Plum.....	SPIN15
Pool.....	SPIN11
Raven.....	SPIN10
Rhubarb.....	SPIN14
Tropic.....	SPIN08
Willow.....	SPIN05

TERRAIN

52% Recycled Polyester,
48% Polyester

Bay.....	TRRN05
Bayou.....	TRRN35
Canyon.....	TRRN30
Cliff.....	TRRN45
Crest.....	TRRN25
Delta.....	TRRN10
Plateau.....	TRRN15
Ridge.....	TRRN20
Valley.....	TRRN40

ALLSTEEL PARTNERSHIP PROGRAM

Allsteel understands that customers may want to specify panel and seating textiles outside of Allsteel's standard offering. Allsteel's **Partnership Program** consists of on-trend and design-forward patterns that have been tested and approved by Allsteel for use on Allsteel products. A subset of these approved patterns is available on cards in the textile binder, while numerous others are available on our website, allsteeloffice.com.

For memo samples, please contact our partners:

- Camira, memos@camirafabrics.com
1.616.288.0655
- CF Stinson, cfstinson.com
1.800.841.6279
- HBF Textiles, hbftextiles.com
1.877.494.5727
- Maharam, maharam.com
1.800.645.3943
- Ultrafabrics, ultrafabricsllc.com

The intent of the **Partnership Program** is to offer a wide variety of on-trend textiles to meet your varied needs, but since these textiles are not part of our standard offering they may be subject to extended lead times. Because new materials will be introduced regularly, Allsteel reserves the right to change the offering at any time.

PARTNERSHIP—GRADE D

Camira **BLAZER LITE † ▼**
(100% Pure New Wool)

Angel.....	PCAMBLT49
Aspire.....	PCAMBLT52
Balance.....	PCAMBLT41
Bliss.....	PCAMBLT48
Buddha.....	PCAMBLT56
Cuddle.....	PCAMBLT62
Dainty.....	PCAMBLT64
Daydream.....	PCAMBLT46
Devoted.....	PCAMBLT58
Faith.....	PCAMBLT68
Freedom.....	PCAMBLT69
Graceful.....	PCAMBLT51
Happy.....	PCAMBLT55
Harmony.....	PCAMBLT63
Haven.....	PCAMBLT40
Hope.....	PCAMBLT50
Hush.....	PCAMBLT42
Love.....	PCAMBLT47
Mood.....	PCAMBLT44
Pamper.....	PCAMBLT66
Pastel.....	PCAMBLT65
Pillow.....	PCAMBLT43
Praise.....	PCAMBLT54
Retreat.....	PCAMBLT39
Shelter.....	PCAMBLT60
Solace.....	PCAMBLT70
Tender.....	PCAMBLT53
True.....	PCAMBLT61
Verity.....	PCAMBLT57
Wish.....	PCAMBLT67
Worship.....	PCAMBLT59

^w Limited to product 48" W or less.

▼ Panel fabric is not available on Further.

♣ Panel fabric is not available on Optimize®.

† Panel fabric is not available on Concensys®.

◆ Panel fabric is not available on Involve.

Multi-use fabrics are seating fabrics that can be used on specific Allsteel panels systems, providing more color and pattern options. The applicable Allsteel multi-use fabrics are noted with System designators in the Seating, Collaboration, and Tables Price List.

Paint Recommendations for Gallery-to-Gallery Cover

Laminate	Code	Recommended Paint
Brownstone	LM13	Brownstone
Bungalow	LM12	Bungalow
Designer White 15051	LDW1	Designer White
Flint	LM16	Flint
Fossil Shale	LEH1	Fossil
Loft	LM11	Loft
Muslin	LM15	Muslin
Titanium	LT11	Titanium
Florence Walnut	LFW1	Cinder, Brownstone, Flint
Kingswood Walnut	LK11	Fossil, Flint, Loft
Natural Maple	LWD	Muslin
NeoWalnut	LNU1	Cinder
Shaker Cherry	LW7C	Black, Cinder
Beigewood	LWBE	Muslin, Loft, Fossil
Fawn Cypress	LFC1	Cinder, Brownstone, Flint
Lowell Ash	LLA1	Cinder
Mangalore Mango	LMM1	Cinder
Natural Recon	LNR1	Cinder, Brownstone
Phantom Charcoal	LPC1	Flint, Salt, Cinder
Phantom Ecrú	LPE1	Flint, Brownstone, Muslin
Portico Teak	LPT1	Fossil, Brownstone, Pewter
Skyline Walnut	LSW1	Cinder, Flint, Fossil
Veranda Teak	LVT1	Fossil, Brownstone, Pewter
Natural Walnut	LWNW	Cinder

Gallery Panels are ideal for bringing natural wood elements to workstations and providing privacy. Allsteel Gallery Panels are designed to work universally across 4 product platforms. Please follow the product guidelines for proper specification.

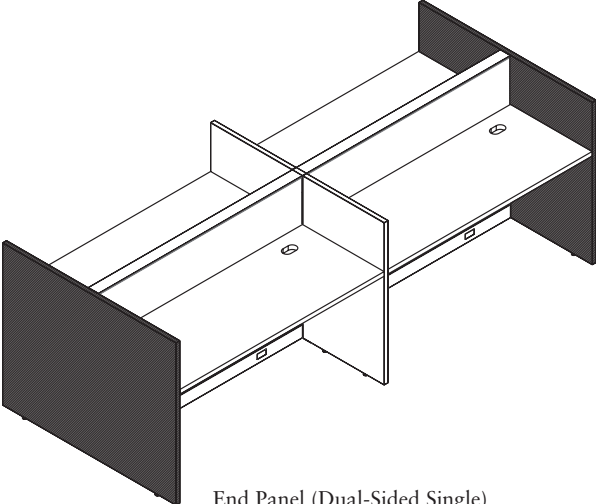

End Panel (Dual-Sided Single)

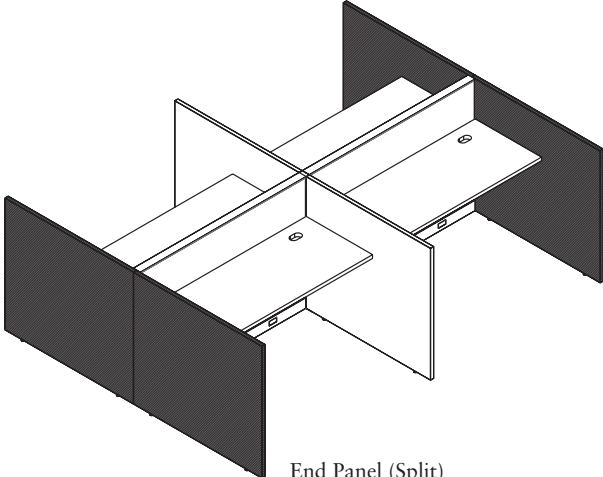

End Panel (Split)

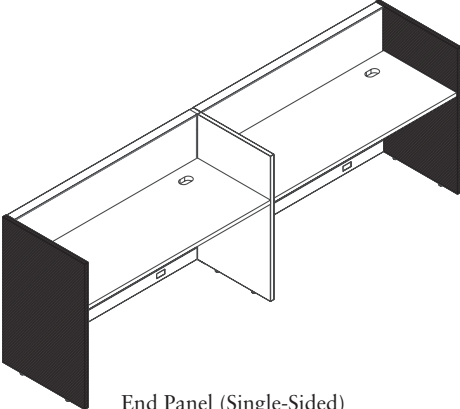

End Panel (Single-Sided)

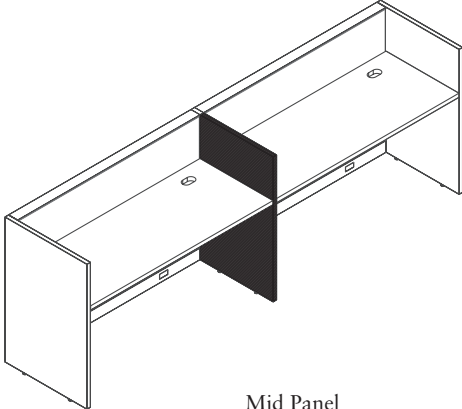

Mid Panel

GALLERY PANELS

- Available to connect to Frame & Tile, Benching systems, and other Gallery Panels
- Standard Gallery Panels connect to Benching and Frame & Tile systems, and Gallery-to-Gallery panels connect to other Gallery Panels
- Gallery Panels can be used in freestanding applications. See page 304 for specification requirements.

Standard Gallery Panels

- Standard Gallery panels connect to Benching and Frame & Tile systems and are available as End-of-Run Single, End-of-Run Split (panel systems only), and Mid Panels (panel systems only)
- Made of 1½" board with HPL laminate.
- Can be specified with matching or contrasting edge.
- Edge band is 2mm ABS
- Available in woodgrain and solid laminates.
- Woodgrain laminates can be specified with vertical grain up to 60"W. Horizontal grain is available on all sizes.
- Single Panel widths are available in 3" increments from 18"W to 84"W. Split Panel widths are available in 6" increments from 87"W to 147"W.
- Standard Gallery Panel sizes up to 84"W come as a single piece. Sizes 87"W though 147"W are split panels and come in two pieces.
- Grain matching is not available on split panels.
- Split panels can only be used in End-of-Run configurations with Stride or Terrace panel systems.
- Gallery Panels offer 2½" leveling capability.
- Overall heights line up with adjacent panel or benching systems.
- Standard Gallery panel widths are true to size
- Available with and without the integrated glass option.
- Glass is specified separately.
- Gallery Panels for use with glass have separate model numbers.
- Standard Gallery panels can be used with Single Sided Further adaptive for privacy and stability along the beam.
- All configurations are non-handed.
- Please adhere to all standard systems specification guidelines.
- Additional support is required after every 60" in gallery panel width (i.e. storage or worksurface tie-in)

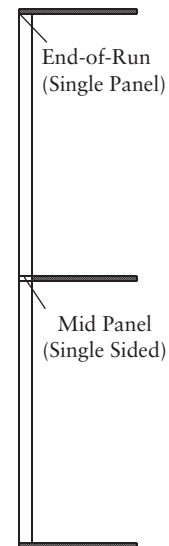
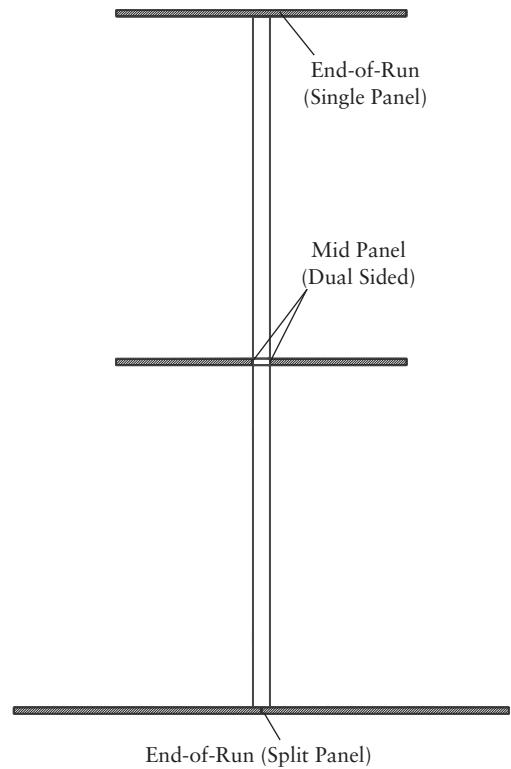

GSA SIN 33721

Standard Gallery Panel Widths

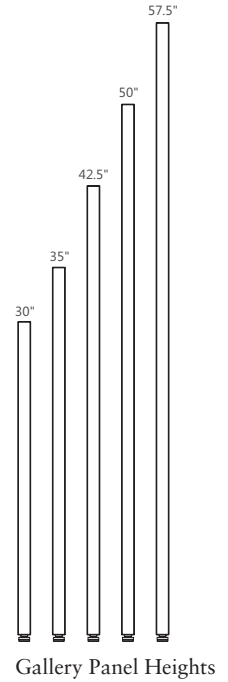
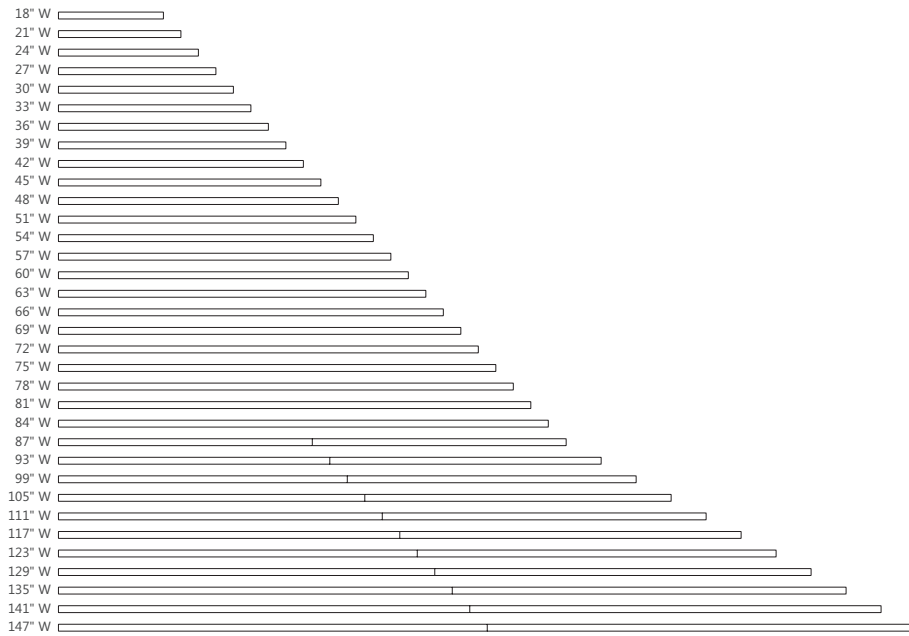

Gallery-to-Gallery Panel L/T Widths

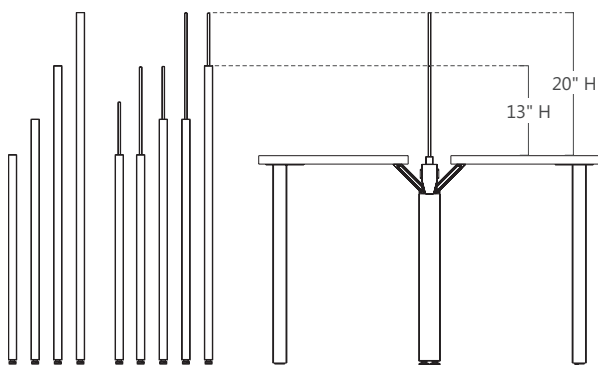
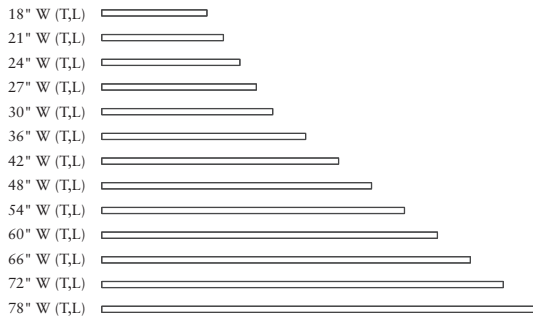

GALLERY PANELS

Standard Gallery Panels

- Gallery Panels for use with glass offer a routed top edge.
- Glass mounts directly into the Gallery Panel route via a gasket.
- The routing is inset 1½" from each end of the panel.
- Single-piece Gallery Panels for use with integrated glass require glass 3" shorter than the panel width.
- For split Gallery Panels, specify glass for each piece separately.
- Split Gallery Panels for use with integrated glass require glass that is 4½" shorter than panel width (individual piece).
- Glass is available in 3 colors: Clear, Frosted, Smoked.
- Glass height is available in 7½"H, 13"H, and 15"H.
- Glass is available on all Gallery Panel widths.
- For benching systems, maximum allowable benching height cannot exceed 50"H with or without glass. Overall Gallery Panel height includes the glass.
- Specify glass models separate from Gallery Panel models.
- Glass Panels at 30"W and under are not UL listed.

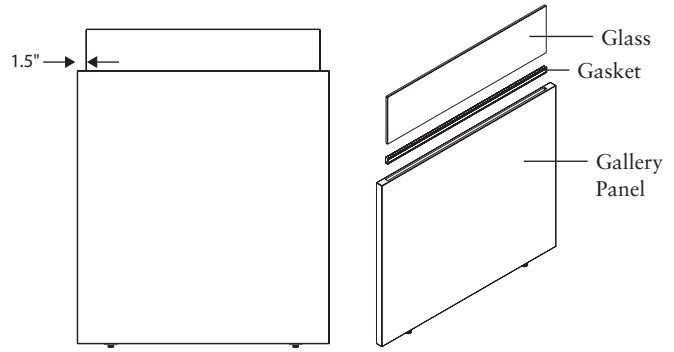

Standard Single Panel with Glass

Find the Gallery Glass width appropriate for your Gallery Panel width.

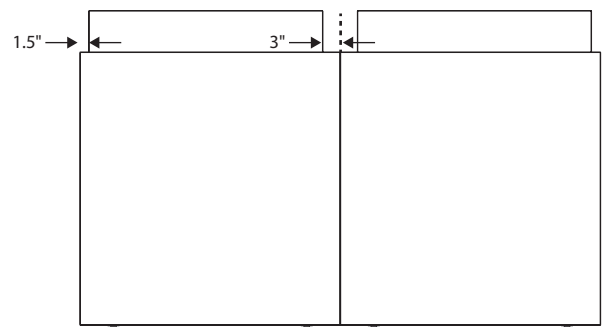

Standard Split Panel with Glass

Shaded example:
For the 18"W
Gallery Panel,
Gallery Glass
should be ordered
with width of 15".

Gallery Panel Width	Gallery Glass Height	7.5"H, 13"H, 15"H
		Gallery Glass Order Width
18"W Gallery Panel		15"W
21"W Gallery Panel		18"W
24"W Gallery Panel		21"W
27"W Gallery Panel		24"W
30"W Gallery Panel		27"W
33"W Gallery Panel		30"W
36"W Gallery Panel		33"W
39"W Gallery Panel		36"W
42"W Gallery Panel		39"W
45"W Gallery Panel		42"W
48"W Gallery Panel		45"W
51"W Gallery Panel		48"W
54"W Gallery Panel		51"W
57"W Gallery Panel		54"W
60"W Gallery Panel		57"W
63"W Gallery Panel		60"W
66"W Gallery Panel		63"W
69"W Gallery Panel		66"W
72"W Gallery Panel		69"W
75"W Gallery Panel		72"W
78"W Gallery Panel		75"W
81"W Gallery Panel		78"W
84"W Gallery Panel		81"W
87"W Split Panel		39"W
93"W Split Panel		42"W
99"W Split Panel		45"W
105"W Split Panel		48"W
111"W Split Panel		51"W
117"W Split Panel		54"W
123"W Split Panel		57"W
129"W Split Panel		60"W
135"W Split Panel		63"W
141"W Split Panel		66"W
147"W Split Panel		69"W

NOTE: Integrated glass height will align with Frameless Glass on Stride and will sit ¼" higher than Frameless Glass on Terrace (see detail below).

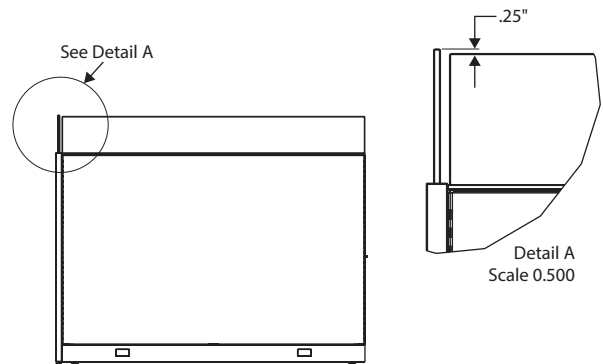

Gallery-to-Gallery Panels

- Gallery Panels for use with glass offer a routed top edge.
- Glass mounts directly into the Gallery Panel route via a gasket.
- The routing is inset $\frac{1}{2}$ " from each end of the panel.
- Gallery-to-Gallery Panels for use with integrated glass require glass equal to the panel width.
- Glass is available in 3 colors: Clear, Frosted, Smoked.
- Glass height is available in 7½"H, 13"H, and 15"H
- Glass is available on all Gallery Panel widths. Glass panels at 30"W and under are not UL listed.
- For benching systems, maximum allowable benching height cannot exceed 50"H with or without glass. Overall Gallery Panel height includes the glass.
- Specify glass models separate from Gallery Panel models

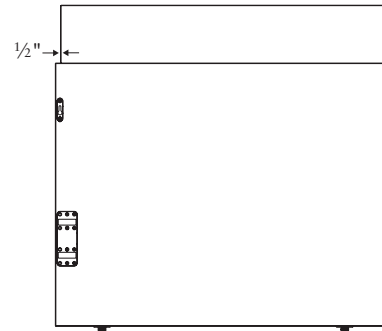

Gallery-to-Gallery Panel with Glass

Find the Gallery Glass width appropriate for your Gallery Panel width.

Gallery Panel Width	Gallery Glass Height	7.5"H, 13"H, 15"H
	Gallery Glass Order Width	
18"W Gallery Panel		18"W
21"W Gallery Panel		21"W
24"W Gallery Panel		24"W
27"W Gallery Panel		27"W
30"W Gallery Panel		30"W
36"W Gallery Panel		36"W
42"W Gallery Panel		42"W
48"W Gallery Panel		48"W
54"W Gallery Panel		54"W
60"W Gallery Panel		60"W
66"W Gallery Panel		66"W
72"W Gallery Panel		72"W
78"W Gallery Panel		78"W

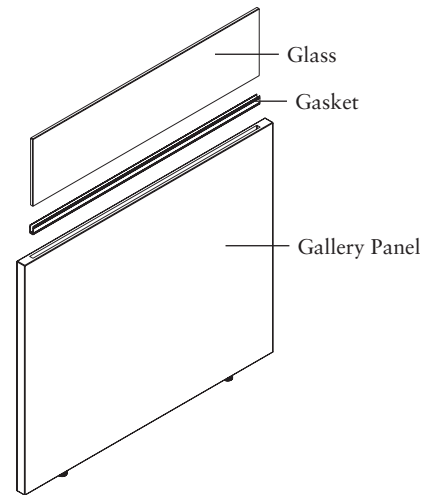

Gallery Panels

Stride® and Terrace® System - End Panel (Dual-Sided)

GSA SIN 33721

- Provides privacy to one or both ends of the system in a dual sided application.
- All Stride End Panels connect using GZCKP connector kit.
- All Terrace Single End Panels (Dual-Sided) connect using GTKCKP connector kit.
- All Terrace Split End Panels connect using GTSKCKP connector kit.
- GTKGK30 is required when a 30"H Terrace panel with frameless glass is attached to a Gallery Panel in an End configuration.
- Gallery Panel sizes 129"W or greater require storage or worksurface tie in on both sides of panel. Please reference storage and worksurface support sections for more details.
- When System panel is higher than the Gallery Panel, variable height System's trim must be specified to finish off exposed frame.
- Stride 30"H panel frames can be ordered via the Standard Specials catalog until available as standard.
- Single piece End Panels can be used for off-modular planning. Connector kit location must be field measured.
- Split End Panel seams must align with parent run.
- Split End Panels can be specified as asymmetrical. Contact Allsteel Tailored Solutions Group for details.

Front edge of Gallery Panel will sit flush with front edge of worksurface on Stride and will sit $\frac{3}{16}$ " proud of front edge of worksurface on Terrace.

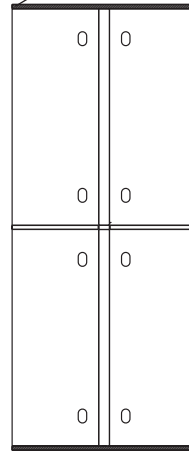

Single Panel Configuration

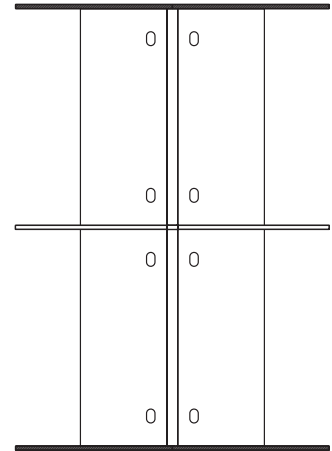

Split Panel Configuration

GALLERY PANELS

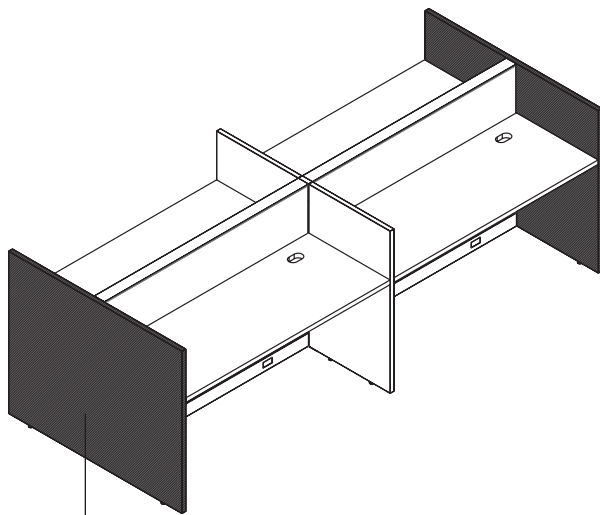

Single panel up to 84"W

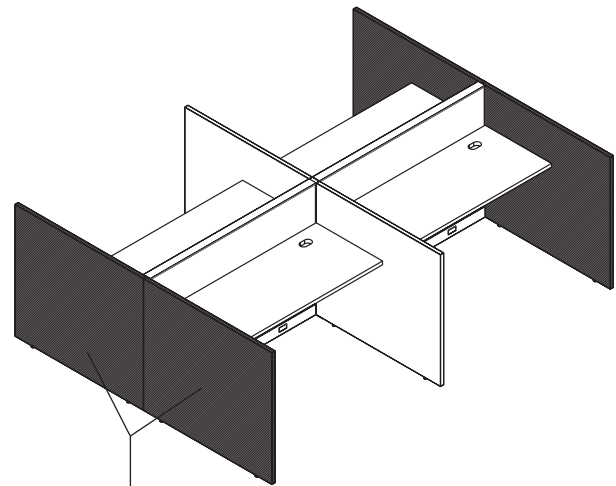

Split panel 87" W and greater

GSA SIN 33721

- Provides privacy to one or both ends of the system in a single sided application.
- Single-Sided End Panels cap over the System panel. Accommodate for 3" frame thickness when planning with Stride panel system and 2½" frame thickness when planning with Terrace panel system.
- All Stride End Panels (Single-Sided) require connector kit GZCKP to attach to parent run.
- All Terrace End Panels (Single-Sided) require connector kit GTKCKP to attach to parent run.
- Gallery Panel sizes 63"W or greater require storage or worksurface tie-in. Please reference storage and worksurface support sections for more details.
- When System panel is higher than the Gallery Panel, variable height system's trim must be specified to finish off exposed frame.
- Stride 30"H panel frames can be ordered via the Standard Specials catalog until available as standard.
- Due to thickness of the Terrace panel Single-Sided End Panel overhangs by approximately ⅜" on both sides.
- Accommodate for 2½" frame thickness planning when with Terrace panel system.
- GTKGK30 is required when a 30"H Terrace panel with frameless glass is attached to a Gallery Panel in an End configuration.

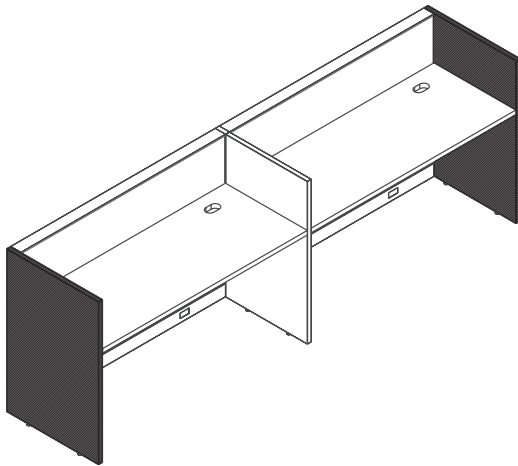
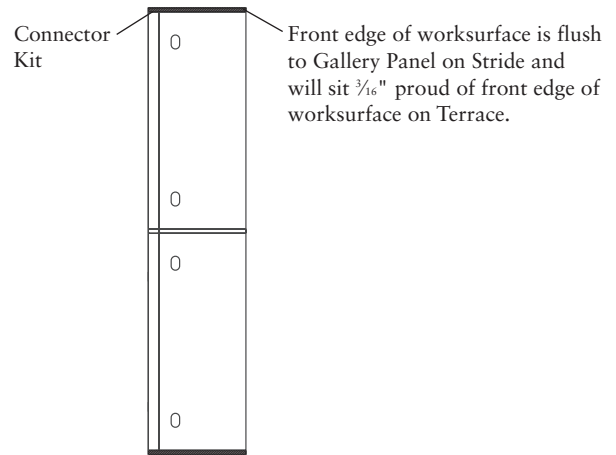

Gallery Panels

Stride® and Terrace® System - Mid Panel

GSA SIN 33721

- Mid panels do not overlap parent system panel.
- When specifying Mid panels, one gallery panel “block and trim” kit (GZ3CONxx for Stride, GTK3CONXX for Terrace) is required to space the System panels out 1 1/8". Kits include: Connector blocks, vertical trim and a top cap.
- “Block and trim” models must match the height of the parent run.
- Specify one mid-connector kit (GCKPM) per gallery panel to attach to parent run. Gallery panel and mid-connector kit attach over “block and trim” kit. Dual sided application requires two connector kit models.
- When using a Mid panel, both panel frames in spine must be of equal height.
- Mid Panels may not exceed height of parent run by more than 15".
- Trims can be painted to match the System panel trims.
- Mid Panels are available in 18"-84" widths in 3" increments.
- Gallery Panel sizes 63"W or greater require storage or worksurface tie-in. Please reference storage and worksurface support sections for more details.
- Spanning top cap available through Allsteel Tailored Solution Group.

Mid panel must be 3" shorter than end panel due to panel frame thickness

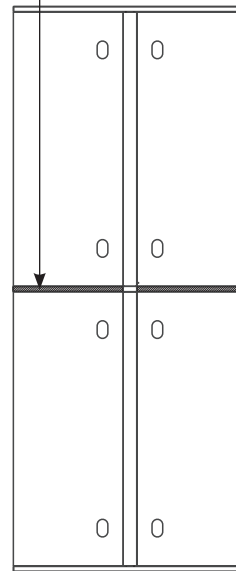

Dual-sided

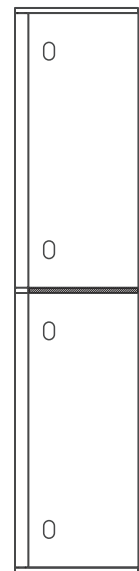

Single-sided

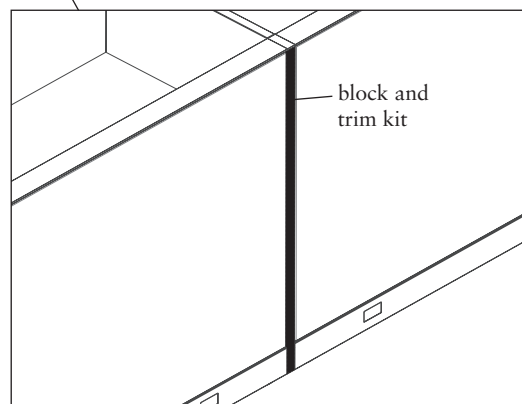
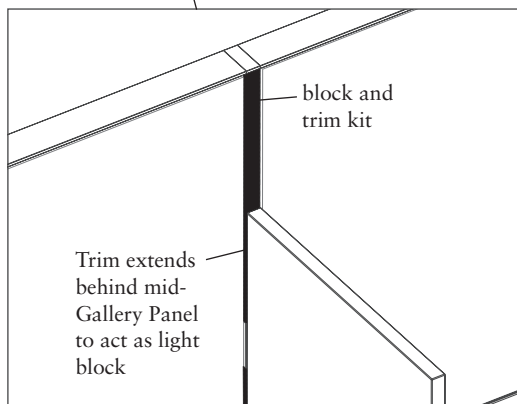
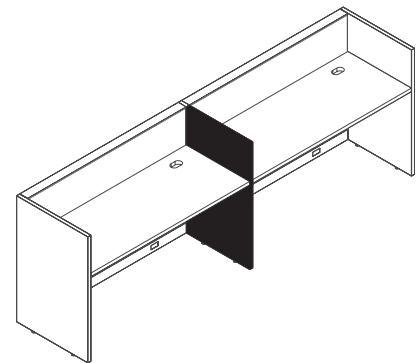
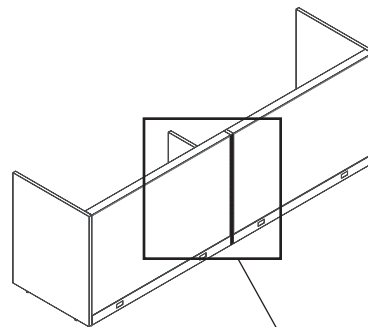
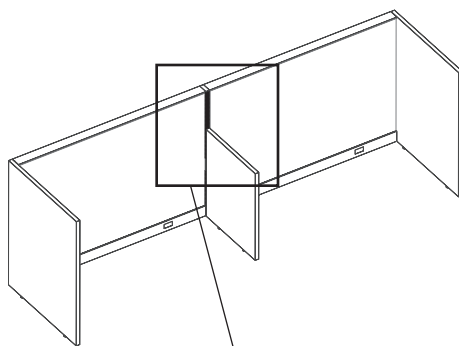

Gallery-to-Gallery Panels

- Gallery-to-Gallery panels connect to other gallery panels and are available in L-, T-, and Nonsymmetrical T- configurations.
- When specifying Gallery-to-Gallery panels, the installation template (GTEMP) is required. The recommendation is 1 template for every 30 panels. Templates are reusable.
- Gallery-to-Gallery panels cap over Standard Gallery panels and are oversized by 1/8" to maintain true interior dimensions
- Gallery-to-Gallery panels must be of equal or lower height than the Standard Gallery panel attached. The Gallery-to-Gallery panel cannot be taller than the adjacent panel. If this is required, please reach out to TPG for a custom solution.
- Made of 1/8" board with HPL laminate.
- Can be specified with matching or contrasting edge.
- Edge band is 2mm ABS
- Available in woodgrain and solid laminates.
- Woodgrain laminates can be specified with vertical grain up to 54"W. Horizontal grain is available on all sizes.
- Gallery-to-Gallery panel widths are available in 3" increments from 18"W to 30"W and in 6" increments from 30"W to 78"W
- Gallery Panels offer 2 1/2" leveling capability.
- Overall heights line up with adjacent panel or benching systems.
- Available with and without the integrated glass option.
- Glass is specified separately.
- Gallery Panels for use with glass have separate model numbers.
- Gallery-to-Gallery panels are secured with an inset flat bracket under a painted metal cover.
- L- and Nonsymmetrical T- panels are handed.
- Please adhere to all standard systems specification guidelines.
- Additional support is required after every 60" in gallery panel width (i.e. storage or worksurface tie-in)
- Nonsymmetrical T Panels are specified in the format GTyyxxzz. Substitute yy as panel height, xx as LH nominal length, and zz as RH nominal length

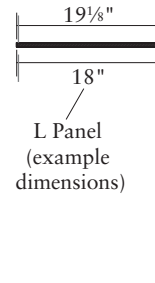

Note: Gallery-to-Gallery Panels cap over standard Gallery Panels and are oversized by 1/8" to maintain modular interior dimensions. (ex: 18" panel is actually 19 1/8"W)

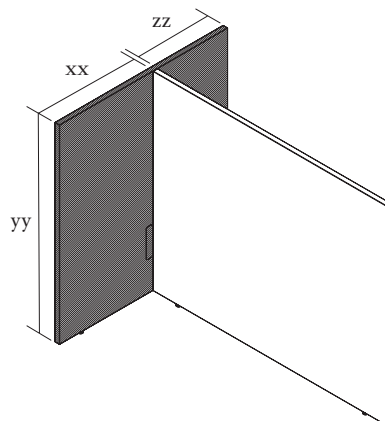
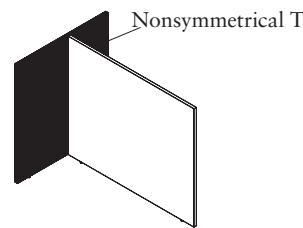
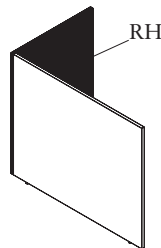
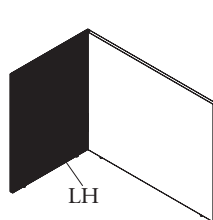
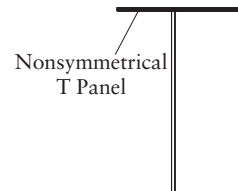
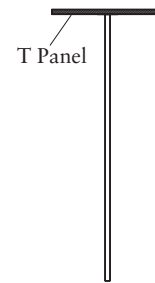

Freestanding Screens can be specified using Standard Gallery panels and Gallery-to-Gallery (depicted by the shaded panels in the illustrations below). Overall height, including glass, cannot exceed 72.5". Gallery Panel sizes 63"W or greater require storage or worksurface tie-in.

Freestanding L-Screens

Parent	Minimum Return
18-24	Not Valid
30-36	30
39-60	36
63-84	42

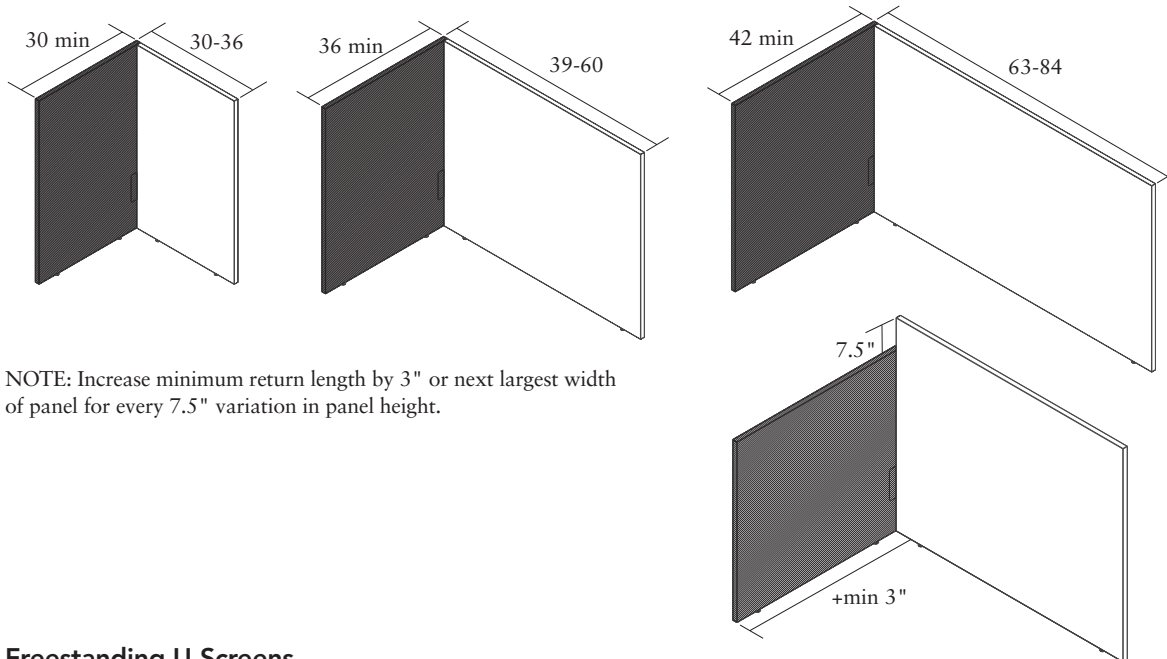

NOTE: Increase minimum return length by 3" or next largest width of panel for every 7.5" variation in panel height.

Freestanding U-Screens

Parent	Minimum Return
18-21	Not Valid
24-48	24
51-60	27
63-84	30

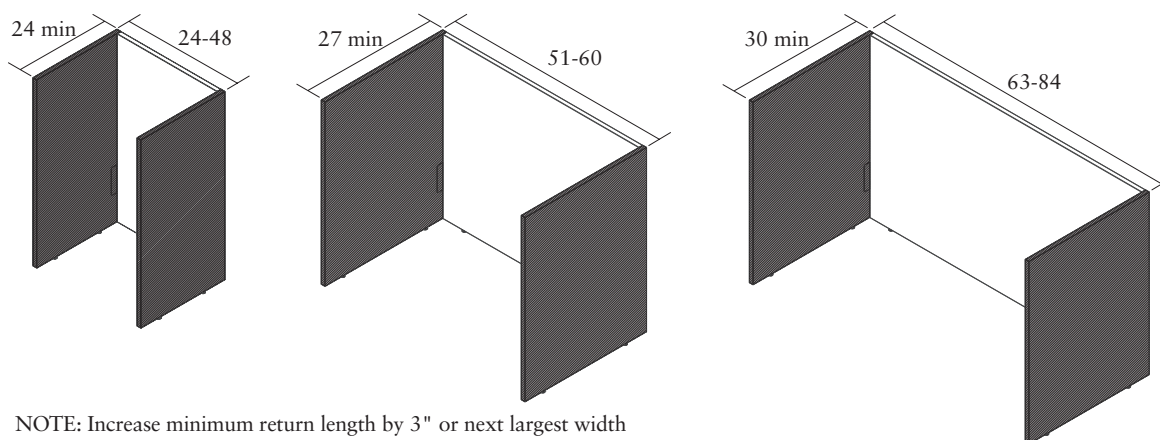

NOTE: Increase minimum return length by 3" or next largest width of panel for every 7.5" variation in panel height.

Freestanding T-Screens

T-Return	Minimum Parent
18-21	Not Valid
24-36	30-84
42-60	36-84
66-78	42-84

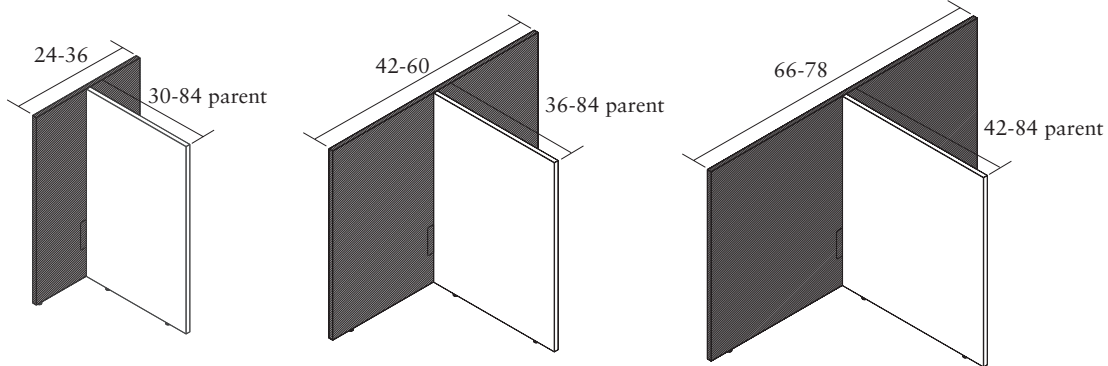

NOTE: Increase minimum return length by 3" or next largest width of panel for every 7.5" variation in panel height.

Freestanding H-Screens

Parent	Minimum H-Return
30-84	18

NOTE: Increase minimum return length by 3" or next largest width of panel for every 7.5" variation in panel height.

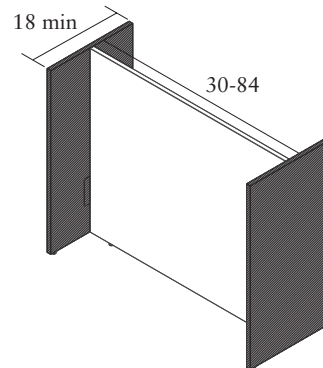

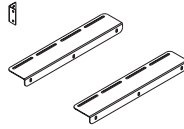

Worksurface Mounting Bracket (page 337)

- Used to mount a fixed-height worksurface to a Gallery panel.
- Can be painted any Allsteel Standard Paint color.
- A worksurface stiffener is required for surfaces 60" W or greater.
- One bracket kit (GWSBK) is required for each worksurface end attached to Gallery Panels.
- One bracket kit (GWSBK) includes two large L- brackets and one small corner L- bracket.

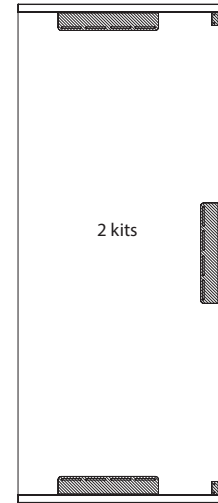
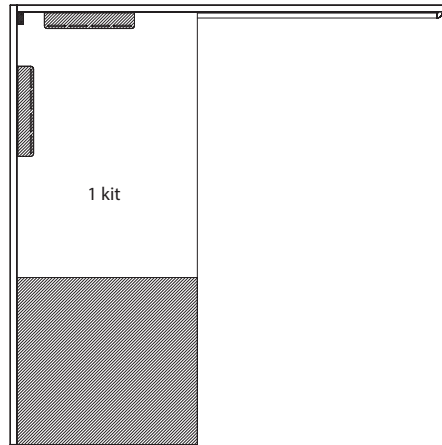
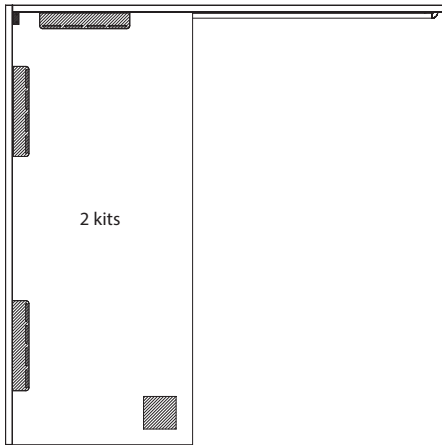

GALLERY PANELS

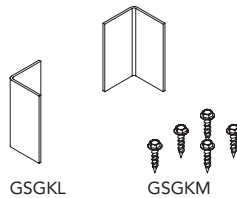

Storage Ganging Kits (page 332)

- The laminate storage ganging kit (GSGKL) is used to connect a Gallery Panel to a laminate storage unit.
- The metal storage ganging kit (GSGKM) is used to connect a Gallery Panel to a metal storage unit.

Gallery Panel Stiffeners (page 332)

- Required for single-piece panels 75" W and greater that are used in a wing or single-sided end condition and do not have a horizontally-mounted credenza.
- For panels 75" W and 78" W, order model (GSTFN7578). Stiffener width is 72".
- For panels 81" W and 84" W, order model (GSTFN8184). Stiffener width is 78".
- Attaches directly to one side of the Gallery Panel with a painted metal cover, attachment hardware included.
- Placement on panel face must be at least 18" above the floor but is not restricted to a specific location on the panel.
- Stiffener is 1½" x 1½".
- Available in any Allsteel standard paint color

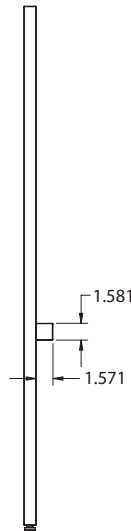

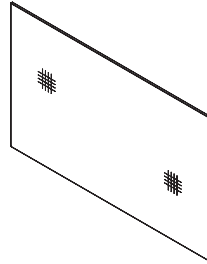

Tackboards (page 338)

- Provides tackable surface.
- Comes with steel-painted trim.
- Available in the following heights: 15", 22½"
- Available in the following *widths: 24", 30", 36", 42", 48", 54", 60".
*Nominal widths, true width is undersized by ½"
- Depth of .45"
- Mounts directly to Gallery Panel. Mounting hardware included. Will deface the panel.

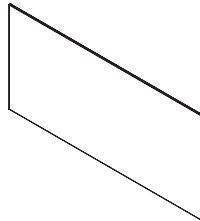

Magnet or Marker Boards (page 338)

- Provides writable and magnetic surface when painted in marker board paint.
- Provides magnetic surface, NON-writable, when painted in other Allsteel paint colors.
- Available in the following heights: 15", 22½"
- Available in the following *widths: 24", 30", 36", 42", 48", 54", 60".
*Nominal widths, true width is undersized by ½"
- Depth of .45"
- Mounts directly to Gallery Panel. Mounting hardware included. Will deface the panel.

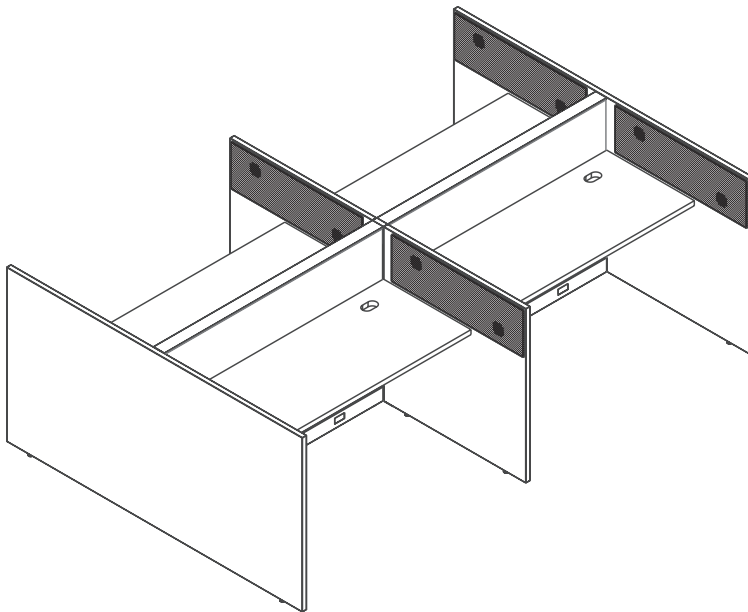

Tackboard Accessory on Mid and End Gallery Panels

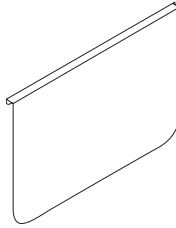

Hanging Magnet or Marker Boards (page 338)

- Hangs over Gallery panel or sits on top of worksurface.
- Provides writable and magnetic surface when painted in marker board paint.
- Provides magnetic surface, NON-writable, when painted in other Allsteel paint colors.
- Cannot be installed back-to-back when hanging in the same location.
- Available in 30"W and in two heights: 20"H and 26"H.
- Cannot be installed on panels with integrated glass.

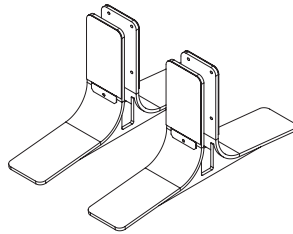

Gallery Panel Foot (page 338)

- Single foot provides rigidity to large wing panel.
- Using two feet on a single Gallery Panel allows for a freestanding application on panels greater than 24"W.
- Available in any textured Allsteel paint.
- Foot extends 9" from either side of the panel.

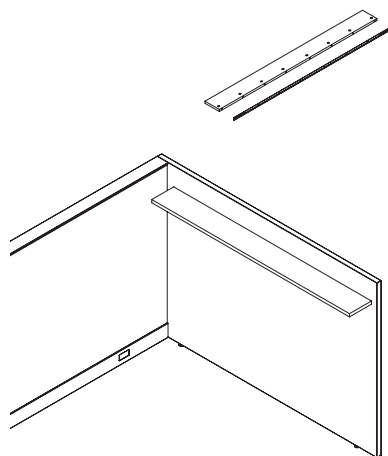
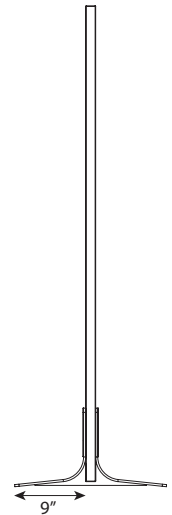
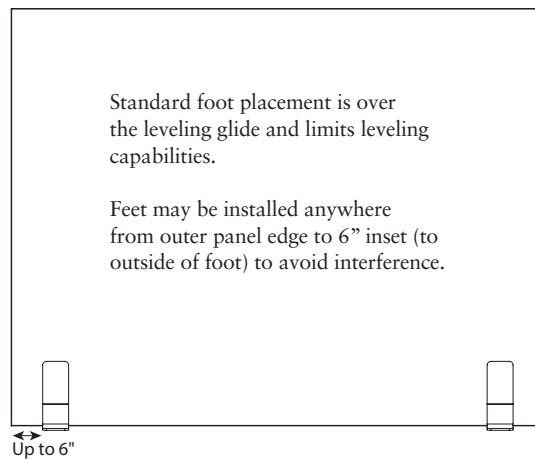
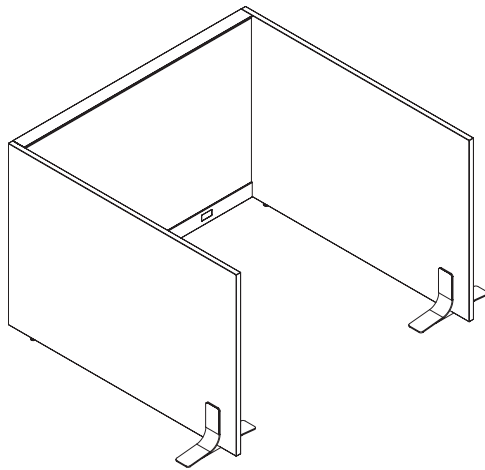

Floating Laminate Shelves (page 339)

- 6" depth.
- 3/4" thickness.
- Constructed of HPL laminate with 0.8mm ABS edgebanding.
- Available in solid or horizontal woodgrain laminate.
- Available with contrasting or matching edge.
- Widths available every 6" from 12" to 78"W.
- Widths from 54" to 78" satisfy a stiffener requirement and are meant to be mounted to a panel that is 6" wider than the shelf. (e.g., 84"W panel would accept a 78"W stiffener shelf.)
- Shelves narrower than 54"W do not act as a stiffener.
- Weight capacity is 10lbs per linear foot.



GACRL12

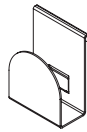

GCHRB

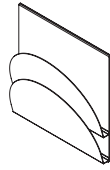

G2AGF

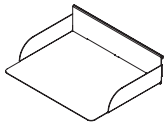

G1PTR

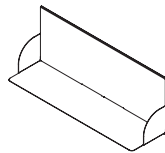

GWPSF

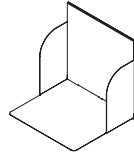

GBRSF

Accessory Rail and Paper Management (page 339)

- Accessory Rail provides mounting for paper management accessories, listed below.
- Rail is 2.6"H and is available in the following widths: 12", 18", 24", 30", 36".
- Rails can be installed in any location on the Gallery Panel, as long as the rail does not extend beyond the top of the panel, and can be placed in-line to span panel length.
- Rail and accessories can be painted any standard Allsteel paint color.
- Mounts directly to the Gallery panel, attachment hardware included.
- Extensions accessories are NOT compatible with the accessory rail.
- These accessories are compatible with panel system tool tiles and rails.
- Includes a rail cover to hide hardware and provide magnetic surface.
- Compatible Rail Accessories:
 - Coat Hook (Rail-based, a mounted version is also available to attach directly to the panel)
 - Rail Based dimensions: 4" x 3" x 1¼"
 - Mounted dimensions: 4" x 3" x 1½"
 - Weight limit: 25 lbs
 - Angle File (Triple, Dual, and Single heights)
 - Depth of 2"
 - Heights: Triple = 15½", Dual = 12½", Single = 9½"
 - Paper Tray (Triple, Dual, and Single heights)
 - Depth of 10"
 - Heights: Triple = 9½", Dual = 6½", Single = 3½"
 - Personal Shelf
 - 9½" x 24" x 10½"
 - Weight limit: 25 lbs
 - Binder Shelf
 - 12½" x 12" x 11½"
 - Weight limit: 25lbs

NOTE: When accessory tools are attached to freestanding Gallery Panel screens, excess weight may affect overall panel stability.



Wall Start (page 337)

- Wall Starts are 1⅞" by 1⅞" rectangular mounting posts that are meant to affix a Gallery Panel to a permanent building wall.
- Wall starts add 1⅞" to panel run.
- Attachment hardware not included.
- Must be specified at the same height as the connecting panel.

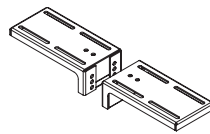

Countertop Brackets (page 337)

- Includes attachment hardware.
- Countertops are flush with the top of the panel and can be flush with the ends of the panel or shorter than the panel width.
- For straight countertops, two countertop brackets must be ordered.
- For corner countertops, three countertop brackets must be ordered.
- Will deface the Gallery Panel.
- May be used in conjunction with Stride, Terrace, or Optimize panels. When transitioning from a Panel spine to a Gallery Panel wing with a corner countertop, use countertop model of the panel system.

Height Adjustable Table Tie-In Brackets (Gallery Panels)

- Improves panel rigidity. Does not function as a panel stability solution.
- AGBKT to be specified for connection to a T leg HAT
- AGBKC to be specified for connection to a C leg HAT
- Reusable mounting template is required and must be ordered separately (AGBKTMP).
- Brackets telescope to account for 24" and 30" worksurface depths and screen attachments.
- A6 C legs with a 30"D worksurface and a screen must be specified with T leg brackets
- NOT compatible with Altitude MAX bases
- Height adjustable table brackets must be installed to both sides of the panel to substitute for a return panel in a dual-sided panel bench application. When a single bracket is connected to a wing panel as shown in the 4-pack image, the HAT bracket can substitute for a return panel.
- Freestanding panel can be connected to height adjustable table if it is supported by HAT brackets on both sides of the table and panel spine.

SINGLE BRACKET

Gallery Panel Application:

Max Height (with Glass): 65"H

Max Width: 75"W; No top size restrictions

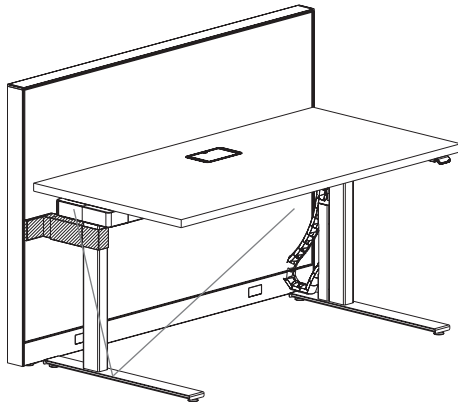
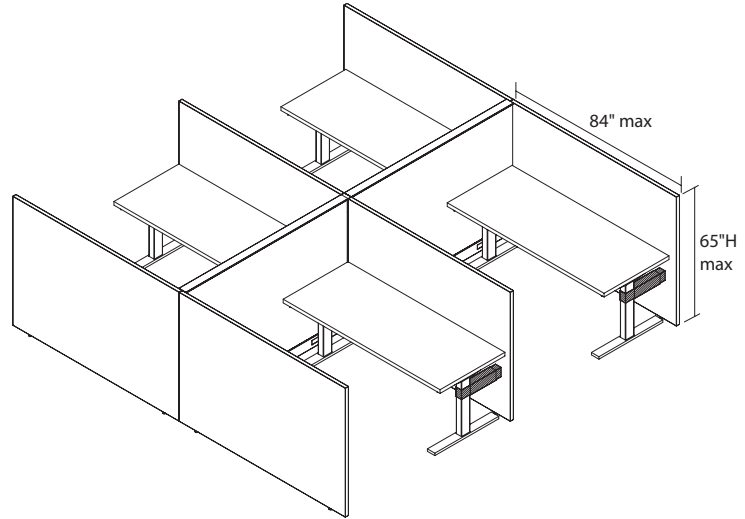

Note: Wire chain cannot be installed on the same leg as a HAT tie-in bracket.

DUAL SIDED PANEL BENCH

Gallery Panel Application:

Max Height (with Glass): 65"H

Bracket Needed: Single Panel (75" max) with Brackets on each leg (placed at the same height)

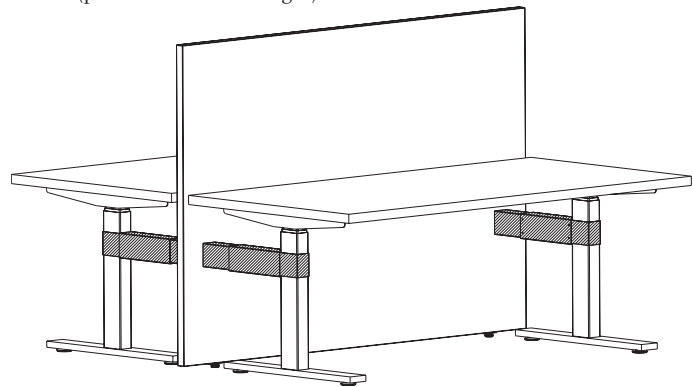

Freestanding Gallery Panel Application

Height Adjustable Table Tie-In Brackets (Optimize, Stride, and Terrace)

- Improves panel rigidity.
- ABKTL to be specified for connection to a LH T-leg HAT
- ABKTR to be specified for connection to a RH T-leg HAT
- ABKCL to be specified for connection to a LH C-leg HAT
- ABKCR to be specified for connection to a RH C-leg HAT
- Brackets mount into slotted standard.
- Brackets telescope to account for 24" and 30" worksurface depths and screen attachments.
- A6 C legs with a 30"D worksurface and a screen must be specified with T leg brackets
- NOT compatible with Altitude MAX bases
- Height adjustable table brackets must be installed to both sides of the panel to substitute for a return panel in a dual-sided panel bench application. When a single bracket is connected to a wing panel as shown in the 4-pack image, the HAT bracket can substitute for a return panel.
- Freestanding panel can be connected to height adjustable table if it is supported by HAT brackets on both sides of the table and panel spine for A8, A3, and A6.
- Dual sided A5 tables cannot support a freestanding panel. (A5 was discontinued on 12/31/2020)

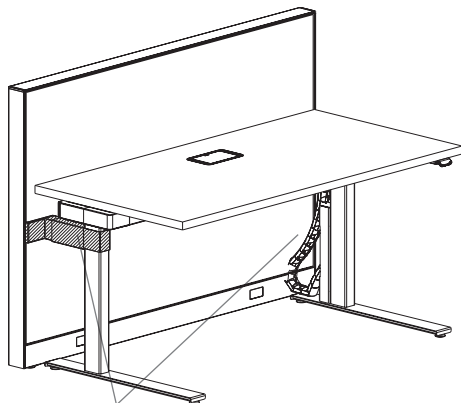

Note: Wire chain cannot be installed on the same leg as a HAT tie-in bracket.

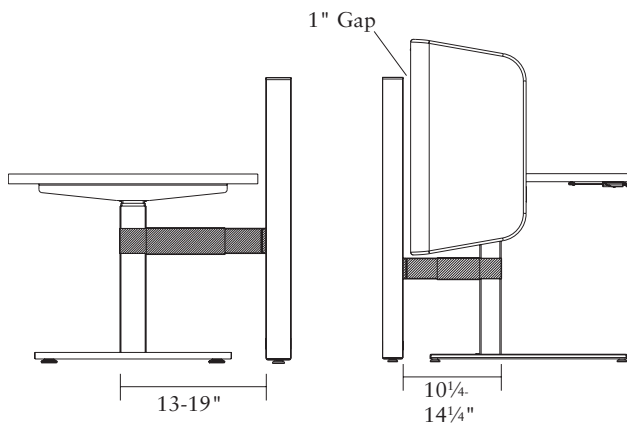

SINGLE BRACKET

Systems Application (not compatible with Concensys):

Max Height (with Glass): 65" H

Max Width: 96" W; Note: tops greater than 72" W will not align.

Overheads cannot be used without return panel

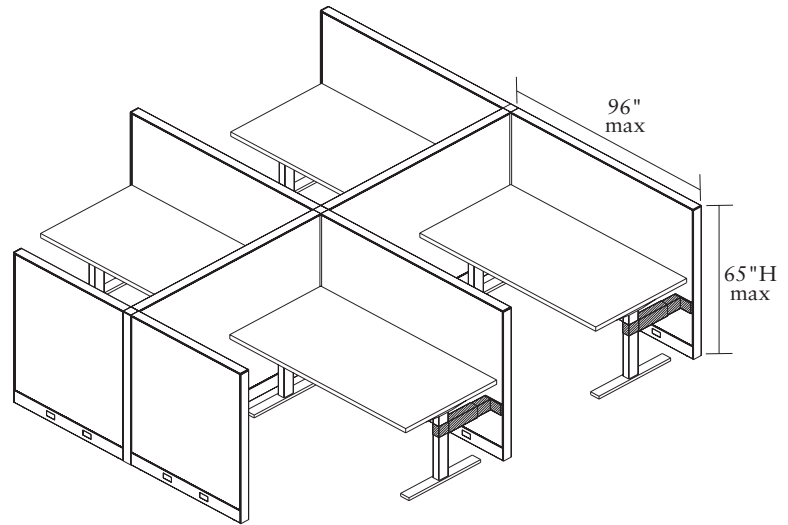

DUAL SIDED PANEL BENCH

Systems Application (not compatible with Concensys):

Max Height (with Glass): 65" H

Bracket Needed: Every 96" on both sides (placed at the same height).

Note: tops greater than 72" W will not align.

Overheads cannot be used without return panel

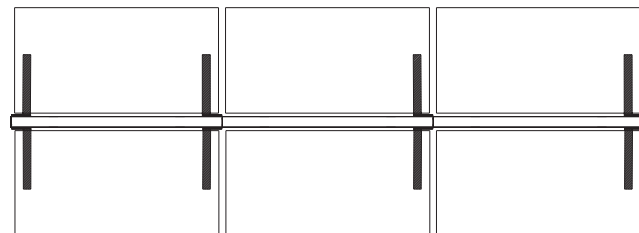
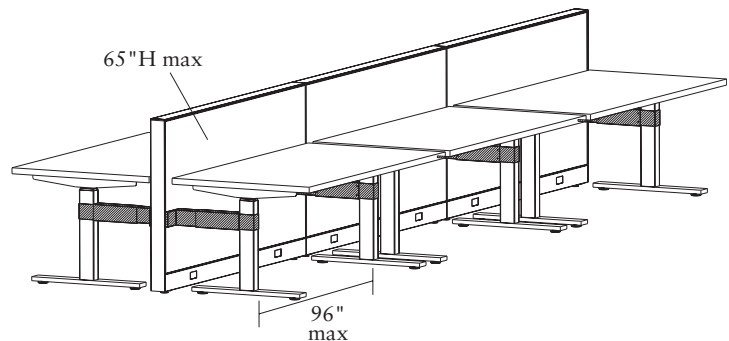

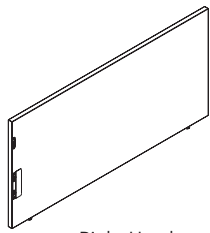

Right Hand

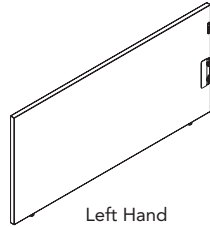

Left Hand

Description	Model	List Price		
		L1	L2	L3
30"H L- Gallery-to-Gallery Panels				
18"W (RH)	GL3018R	\$ 634	\$ 657	\$ 680
18"W (LH)	GL3018L	\$ 634	\$ 657	\$ 680
21"W (RH)	GL3021R	\$ 647	\$ 670	\$ 694
21"W (LH)	GL3021L	\$ 647	\$ 670	\$ 694
24"W (RH)	GL3024R	\$ 676	\$ 700	\$ 725
24"W (LH)	GL3024L	\$ 676	\$ 700	\$ 725
27"W (RH)	GL3027R	\$ 710	\$ 736	\$ 761
27"W (LH)	GL3027L	\$ 710	\$ 736	\$ 761
30"W (RH)	GL3030R	\$ 782	\$ 810	\$ 839
30"W (LH)	GL3030L	\$ 782	\$ 810	\$ 839
36"W (RH)	GL3036R	\$ 847	\$ 878	\$ 908
36"W (LH)	GL3036L	\$ 847	\$ 878	\$ 908
42"W (RH)	GL3042R	\$ 925	\$ 959	\$ 992
42"W (LH)	GL3042L	\$ 925	\$ 959	\$ 992
48"W (RH)	GL3048R	\$ 1033	\$ 1070	\$ 1108
48"W (LH)	GL3048L	\$ 1033	\$ 1070	\$ 1108
54"W (RH)	GL3054R	\$ 1092	\$ 1131	\$ 1171
54"W (LH)	GL3054L	\$ 1092	\$ 1131	\$ 1171
60"W (RH)	GL3060R	\$ 1179	\$ 1222	\$ 1264
60"W (LH)	GL3060L	\$ 1179	\$ 1222	\$ 1264
66"W (RH)	GL3066R	\$ 1214	\$ 1258	\$ 1302
66"W (LH)	GL3066L	\$ 1214	\$ 1258	\$ 1302
72"W (RH)	GL3072R	\$ 1322	\$ 1370	\$ 1418
72"W (LH)	GL3072L	\$ 1322	\$ 1370	\$ 1418
78"W (RH)	GL3078R	\$ 1526	\$ 1581	\$ 1636
78"W (LH)	GL3078L	\$ 1526	\$ 1581	\$ 1636

30"H T- Gallery-to-Gallery Panels

18"W	GT3018	\$ 633	\$ 656	\$ 679
21"W	GT3021	\$ 648	\$ 671	\$ 695
24"W	GT3024	\$ 676	\$ 700	\$ 725
27"W	GT3027	\$ 710	\$ 736	\$ 761
30"W	GT3030	\$ 780	\$ 808	\$ 837
36"W	GT3036	\$ 845	\$ 876	\$ 906
42"W	GT3042	\$ 927	\$ 961	\$ 994
48"W	GT3048	\$ 1035	\$ 1072	\$ 1110
54"W	GT3054	\$ 1090	\$ 1129	\$ 1169
60"W	GT3060	\$ 1177	\$ 1220	\$ 1262
66"W	GT3066	\$ 1215	\$ 1259	\$ 1303
72"W	GT3072	\$ 1322	\$ 1370	\$ 1418
78"W	GT3078	\$ 1526	\$ 1581	\$ 1636

30"H Nonsym T- Gallery-to-Gallery Panels

42"W 18L 24R	GT301824	\$ 927	\$ 961	\$ 994
42"W 24L 18R	GT302418	\$ 927	\$ 961	\$ 994
48"W 18L 30R	GT301830	\$ 945	\$ 982	\$ 1020
48"W 30L 18R	GT303018	\$ 945	\$ 982	\$ 1020
54"W 24L 30R	GT302430	\$ 1090	\$ 1129	\$ 1169
54"W 30L 24R	GT303024	\$ 1090	\$ 1129	\$ 1169

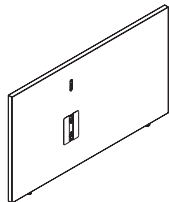

Description	Model	List Price
Gallery-to-Gallery Installation Template (<i>Black only, code P</i>)	GTEMP	\$ 69



<p>How to specify — Select the Model Number from above.</p>	<p><i>1st Option:</i> FSC: (if applicable): F FSC Wood X Non-FSC Wood</p>	<p><i>2nd Option:</i> Laminate: (if applicable): See page 292 for finishes.</p>	<p><i>3rd Option:</i> Edge: See page 292 for finishes.</p>	<p><i>4th Option:</i> Grain: (if applicable): VLG Horizontal grain or Solid only. VST Vertical Grain (available only for single panels 60"W or less, and for split panels between 87"W and 117"W).</p>	<p><i>5th Option:</i> Paint See page 292 for finishes.</p>	<p><i>6th Option:</i> Glide: (if applicable):</p>
	<p>G . .</p>	<p> .</p>	<p> .</p>	<p>V .</p>	<p> .</p>	<p>G </p>

Gallery Panels

Gallery-to-Gallery Panels: 35"H Application

GSA SIN 33721

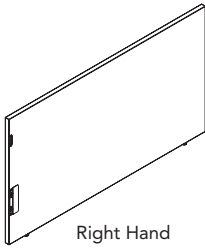
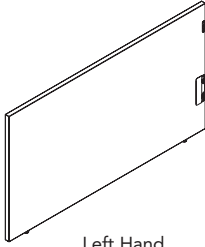
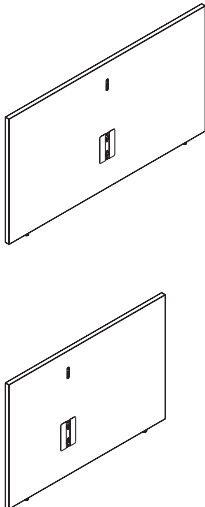
	Description	Model	List Price		
			L1	L2	L3
 Right Hand	35"H L- Gallery-to-Gallery Panels				
	18"W (RH)	GL3518R	\$ 715	\$ 741	\$ 767
	18"W (LH)	GL3518L	\$ 715	\$ 741	\$ 767
	21"W (RH)	GL3521R	\$ 731	\$ 757	\$ 784
	21"W (LH)	GL3521L	\$ 731	\$ 757	\$ 784
	24"W (RH)	GL3524R	\$ 764	\$ 792	\$ 819
	24"W (LH)	GL3524L	\$ 764	\$ 792	\$ 819
	27"W (RH)	GL3527R	\$ 794	\$ 823	\$ 852
	27"W (LH)	GL3527L	\$ 794	\$ 823	\$ 852
	30"W (RH)	GL3530R	\$ 886	\$ 918	\$ 950
	30"W (LH)	GL3530L	\$ 886	\$ 918	\$ 950
	36"W (RH)	GL3536R	\$ 965	\$ 1000	\$ 1035
	36"W (LH)	GL3536L	\$ 965	\$ 1000	\$ 1035
	42"W (RH)	GL3542R	\$ 1027	\$ 1064	\$ 1101
	42"W (LH)	GL3542L	\$ 1027	\$ 1064	\$ 1101
	48"W (RH)	GL3548R	\$ 1116	\$ 1156	\$ 1197
	48"W (LH)	GL3548L	\$ 1116	\$ 1156	\$ 1197
	54"W (RH)	GL3554R	\$ 1182	\$ 1225	\$ 1268
	54"W (LH)	GL3554L	\$ 1182	\$ 1225	\$ 1268
	60"W (RH)	GL3560R	\$ 1258	\$ 1304	\$ 1349
	60"W (LH)	GL3560L	\$ 1258	\$ 1304	\$ 1349
	66"W (RH)	GL3566R	\$ 1314	\$ 1362	\$ 1409
66"W (LH)	GL3566L	\$ 1314	\$ 1362	\$ 1409	
72"W (RH)	GL3572R	\$ 1425	\$ 1477	\$ 1528	
72"W (LH)	GL3572L	\$ 1425	\$ 1477	\$ 1528	
78"W (RH)	GL3578R	\$ 1591	\$ 1649	\$ 1706	
78"W (LH)	GL3578L	\$ 1591	\$ 1649	\$ 1706	
 Left Hand	35"H T- Gallery-to-Gallery Panels				
	18"W	GT3518	\$ 714	\$ 740	\$ 766
	21"W	GT3521	\$ 731	\$ 757	\$ 784
	24"W	GT3524	\$ 765	\$ 793	\$ 820
	27"W	GT3527	\$ 795	\$ 824	\$ 853
	30"W	GT3530	\$ 886	\$ 918	\$ 950
	36"W	GT3536	\$ 965	\$ 1000	\$ 1035
	42"W	GT3542	\$ 1026	\$ 1063	\$ 1100
	48"W	GT3548	\$ 1117	\$ 1157	\$ 1198
	54"W	GT3554	\$ 1183	\$ 1226	\$ 1269
	60"W	GT3560	\$ 1258	\$ 1304	\$ 1349
	66"W	GT3566	\$ 1314	\$ 1362	\$ 1409
	72"W	GT3572	\$ 1424	\$ 1476	\$ 1527
78"W	GT3578	\$ 1591	\$ 1649	\$ 1706	
	35"H Nonsym T- Gallery-to-Gallery Panels				
	42"W 18L 24R	GT351824	\$ 1026	\$ 1063	\$ 1100
	42"W 24L 18R	GT352418	\$ 1026	\$ 1063	\$ 1100
	48"W 18L 30R	GT351830	\$ 1117	\$ 1157	\$ 1198
	48"W 30L 18R	GT353018	\$ 1117	\$ 1157	\$ 1198
	54"W 24L 30R	GT352430	\$ 1183	\$ 1226	\$ 1269
54"W 30L 24R	GT353024	\$ 1183	\$ 1226	\$ 1269	

GALLERY PANELS

Description	Model	List Price
Gallery-to-Gallery Installation Template (<i>Black only, code P</i>)	GTEMP	\$ 69

How to specify — Select the Model Number from above.	1st Option: FSC: (if applicable): F FSC Wood X Non-FSC Wood	2nd Option: Laminate: (if applicable): See page 292 for finishes.	3rd Option: Edge: See page 292 for finishes.	4th Option: Grain: (if applicable): VLG Horizontal grain or Solid only. VST Vertical Grain (available only for single panels 60"W or less, and for split panels between 87"W and 117"W.	5th Option: Paint See page 292 for finishes.	6th Option: Glide: (if applicable):
	G

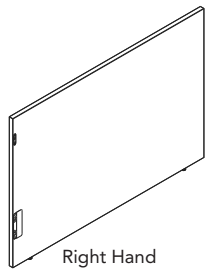

Right Hand

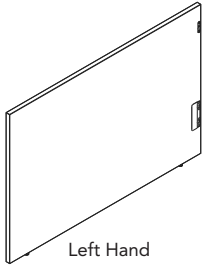

Left Hand

Description	Model	List Price		
		L1	L2	L3
42"H L- Gallery-to-Gallery Panels				
18"W (RH)	GL4218R	\$ 776	\$ 804	\$ 832
18"W (LH)	GL4218L	\$ 776	\$ 804	\$ 832
21"W (RH)	GL4221R	\$ 789	\$ 818	\$ 846
21"W (LH)	GL4221L	\$ 789	\$ 818	\$ 846
24"W (RH)	GL4224R	\$ 830	\$ 860	\$ 890
24"W (LH)	GL4224L	\$ 830	\$ 860	\$ 890
27"W (RH)	GL4227R	\$ 867	\$ 898	\$ 930
27"W (LH)	GL4227L	\$ 867	\$ 898	\$ 930
30"W (RH)	GL4230R	\$ 967	\$ 1002	\$ 1037
30"W (LH)	GL4230L	\$ 967	\$ 1002	\$ 1037
36"W (RH)	GL4236R	\$ 1055	\$ 1093	\$ 1131
36"W (LH)	GL4236L	\$ 1055	\$ 1093	\$ 1131
42"W (RH)	GL4242R	\$ 1127	\$ 1168	\$ 1209
42"W (LH)	GL4242L	\$ 1127	\$ 1168	\$ 1209
48"W (RH)	GL4248R	\$ 1200	\$ 1243	\$ 1287
48"W (LH)	GL4248L	\$ 1200	\$ 1243	\$ 1287
54"W (RH)	GL4254R	\$ 1297	\$ 1344	\$ 1391
54"W (LH)	GL4254L	\$ 1297	\$ 1344	\$ 1391
60"W (RH)	GL4260R	\$ 1367	\$ 1416	\$ 1466
60"W (LH)	GL4260L	\$ 1367	\$ 1416	\$ 1466
66"W (RH)	GL4266R	\$ 1439	\$ 1491	\$ 1543
66"W (LH)	GL4266L	\$ 1439	\$ 1491	\$ 1543
72"W (RH)	GL4272R	\$ 1539	\$ 1595	\$ 1650
72"W (LH)	GL4272L	\$ 1539	\$ 1595	\$ 1650
78"W (RH)	GL4278R	\$ 1675	\$ 1736	\$ 1796
78"W (LH)	GL4278L	\$ 1675	\$ 1736	\$ 1796

42"H T- Gallery-to-Gallery Panels

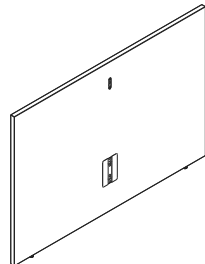

Description	Model	L1	L2	L3
18"W	GT4218	\$ 777	\$ 805	\$ 833
21"W	GT4221	\$ 790	\$ 819	\$ 847
24"W	GT4224	\$ 831	\$ 861	\$ 891
27"W	GT4227	\$ 866	\$ 897	\$ 929
30"W	GT4230	\$ 969	\$ 1004	\$ 1039
36"W	GT4236	\$ 1056	\$ 1094	\$ 1132
42"W	GT4242	\$ 1128	\$ 1169	\$ 1210
48"W	GT4248	\$ 1202	\$ 1245	\$ 1289
54"W	GT4254	\$ 1299	\$ 1346	\$ 1393
60"W	GT4260	\$ 1368	\$ 1417	\$ 1467
66"W	GT4266	\$ 1440	\$ 1492	\$ 1544
72"W	GT4272	\$ 1539	\$ 1595	\$ 1650
78"W	GT4278	\$ 1676	\$ 1737	\$ 1797

42"H Nonsym T- Gallery-to-Gallery Panels

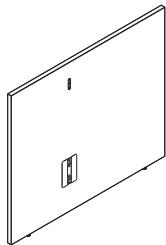

Description	Model	L1	L2	L3
42"W 18L 24R	GT421824	\$ 1128	\$ 1169	\$ 1210
42"W 24L 18R	GT422418	\$ 1128	\$ 1169	\$ 1210
48"W 18L 30R	GT421830	\$ 1202	\$ 1245	\$ 1289
48"W 30L 18R	GT423018	\$ 1202	\$ 1245	\$ 1289
54"W 24L 30R	GT422430	\$ 1299	\$ 1346	\$ 1393
54"W 30L 24R	GT423024	\$ 1299	\$ 1346	\$ 1393



Description	Model	List Price
Gallery-to-Gallery Installation Template (<i>Black only, code P</i>)	GTEMP	\$ 69

<p>How to specify — Select the Model Number from above.</p>	<p><i>1st Option:</i> FSC: (if applicable): F FSC Wood X Non-FSC Wood</p>	<p><i>2nd Option:</i> Laminate: (if applicable): See page 292 for finishes.</p>	<p><i>3rd Option:</i> Edge: See page 292 for finishes.</p>	<p><i>4th Option:</i> Grain: (if applicable): VLG Horizontal grain or Solid only. VST Vertical Grain (available only for single panels 60"W or less, and for split panels between 87"W and 117"W).</p>	<p><i>5th Option:</i> Paint See page 292 for finishes.</p>	<p><i>6th Option:</i> Glide: (if applicable):</p>
	<p>G . .</p>	<p> .</p>	<p> .</p>	<p>V .</p>	<p> .</p>	<p>G </p>

Gallery Panels

Gallery-to-Gallery Panels: 50"H Application

GSA SIN 33721

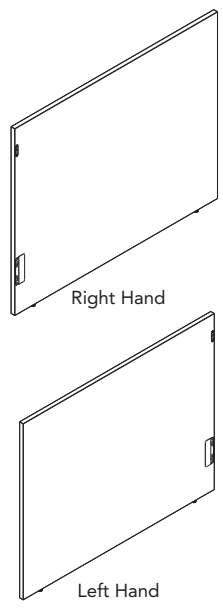

Description	Model	List Price		
		L1	L2	L3
50"H L- Gallery-to-Gallery Panels				
18"W (RH)	GL5018R	\$ 872	\$ 904	\$ 935
18"W (LH)	GL5018L	\$ 872	\$ 904	\$ 935
21"W (RH)	GL5021R	\$ 891	\$ 923	\$ 956
21"W (LH)	GL5021L	\$ 891	\$ 923	\$ 956
24"W (RH)	GL5024R	\$ 925	\$ 959	\$ 992
24"W (LH)	GL5024L	\$ 925	\$ 959	\$ 992
27"W (RH)	GL5027R	\$ 964	\$ 999	\$ 1034
27"W (LH)	GL5027L	\$ 964	\$ 999	\$ 1034
30"W (RH)	GL5030R	\$ 1051	\$ 1089	\$ 1127
30"W (LH)	GL5030L	\$ 1051	\$ 1089	\$ 1127
36"W (RH)	GL5036R	\$ 1141	\$ 1182	\$ 1224
36"W (LH)	GL5036L	\$ 1141	\$ 1182	\$ 1224
42"W (RH)	GL5042R	\$ 1223	\$ 1267	\$ 1311
42"W (LH)	GL5042L	\$ 1223	\$ 1267	\$ 1311
48"W (RH)	GL5048R	\$ 1328	\$ 1376	\$ 1424
48"W (LH)	GL5048L	\$ 1328	\$ 1376	\$ 1424
54"W (RH)	GL5054R	\$ 1406	\$ 1457	\$ 1508
54"W (LH)	GL5054L	\$ 1406	\$ 1457	\$ 1508
60"W (RH)	GL5060R	\$ 1475	\$ 1528	\$ 1582
60"W (LH)	GL5060L	\$ 1475	\$ 1528	\$ 1582
66"W (RH)	GL5066R	\$ 1540	\$ 1596	\$ 1651
66"W (LH)	GL5066L	\$ 1540	\$ 1596	\$ 1651
72"W (RH)	GL5072R	\$ 1619	\$ 1678	\$ 1736
72"W (LH)	GL5072L	\$ 1619	\$ 1678	\$ 1736
78"W (RH)	GL5078R	\$ 1864	\$ 1931	\$ 1999
78"W (LH)	GL5078L	\$ 1864	\$ 1931	\$ 1999

50"H T- Gallery-to-Gallery Panels

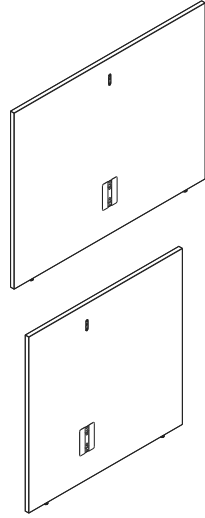

18"W	GT5018	\$ 873	\$ 905	\$ 936
21"W	GT5021	\$ 893	\$ 925	\$ 958
24"W	GT5024	\$ 927	\$ 961	\$ 994
27"W	GT5027	\$ 963	\$ 998	\$ 1033
30"W	GT5030	\$ 1050	\$ 1088	\$ 1126
36"W	GT5036	\$ 1141	\$ 1182	\$ 1224
42"W	GT5042	\$ 1223	\$ 1267	\$ 1311
48"W	GT5048	\$ 1326	\$ 1374	\$ 1422
54"W	GT5054	\$ 1407	\$ 1458	\$ 1509
60"W	GT5060	\$ 1476	\$ 1529	\$ 1583
66"W	GT5066	\$ 1542	\$ 1598	\$ 1653
72"W	GT5072	\$ 1618	\$ 1677	\$ 1735
78"W	GT5078	\$ 1863	\$ 1930	\$ 1998

50"H Nonsym T- Gallery-to-Gallery Panels

42"W 18L 24R	GT501824	\$ 1223	\$ 1267	\$ 1311
42"W 24L 18R	GT502418	\$ 1223	\$ 1267	\$ 1311
48"W 18L 30R	GT501830	\$ 1326	\$ 1374	\$ 1422
48"W 30L 18R	GT503018	\$ 1326	\$ 1374	\$ 1422
54"W 24L 30R	GT502430	\$ 1407	\$ 1458	\$ 1509
54"W 30L 24R	GT503024	\$ 1407	\$ 1458	\$ 1509



Description	Model	List Price
Gallery-to-Gallery Installation Template (<i>Black only, code P</i>)	GTEMP	\$ 69

<p>How to specify — Select the Model Number from above.</p> <p>G</p>	<p><i>1st Option:</i> FSC: (if applicable): F FSC Wood X Non-FSC Wood</p>	<p><i>2nd Option:</i> Laminate: (if applicable): See page 292 for finishes.</p>	<p><i>3rd Option:</i> Edge: See page 292 for finishes.</p>	<p><i>4th Option:</i> Grain: (if applicable): VLG Horizontal grain or Solid only. VST Vertical Grain (available only for single panels 60"W or less, and for split panels between 87"W and 117"W.</p>	<p><i>5th Option:</i> Paint See page 292 for finishes.</p>	<p><i>6th Option:</i> Glide: (if applicable):</p>	
	<p> . .</p>	<p> .</p>	<p> .</p>	<p> .</p>	<p> .</p>	<p> .</p>	<p>G</p>
	<p> </p>	<p> </p>	<p> </p>	<p> </p>	<p> </p>	<p> </p>	<p> </p>

Gallery Panels

Gallery-to-Gallery Panels: 57½"H Application

GSA SIN 33721

GALLERY PANELS

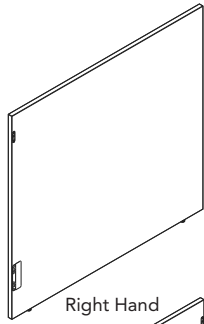

Right Hand

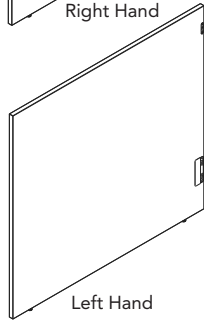

Left Hand

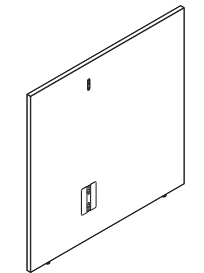
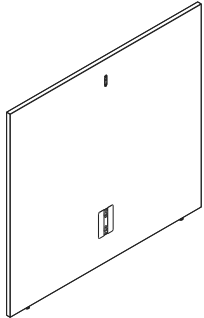

Description	Model	List Price		
		L1	L2	L3
57½"H L- Gallery-to-Gallery Panels				
18"W (RH)	GL5718R	\$ 1017	\$ 1054	\$ 1091
18"W (LH)	GL5718L	\$ 1017	\$ 1054	\$ 1091
21"W (RH)	GL5721R	\$ 1034	\$ 1071	\$ 1109
21"W (LH)	GL5721L	\$ 1034	\$ 1071	\$ 1109
24"W (RH)	GL5724R	\$ 1070	\$ 1109	\$ 1147
24"W (LH)	GL5724L	\$ 1070	\$ 1109	\$ 1147
27"W (RH)	GL5727R	\$ 1108	\$ 1148	\$ 1188
27"W (LH)	GL5727L	\$ 1108	\$ 1148	\$ 1188
30"W (RH)	GL5730R	\$ 1194	\$ 1237	\$ 1280
30"W (LH)	GL5730L	\$ 1194	\$ 1237	\$ 1280
36"W (RH)	GL5736R	\$ 1285	\$ 1331	\$ 1378
36"W (LH)	GL5736L	\$ 1285	\$ 1331	\$ 1378
42"W (RH)	GL5742R	\$ 1366	\$ 1415	\$ 1465
42"W (LH)	GL5742L	\$ 1366	\$ 1415	\$ 1465
48"W (RH)	GL5748R	\$ 1471	\$ 1524	\$ 1577
48"W (LH)	GL5748L	\$ 1471	\$ 1524	\$ 1577
54"W (RH)	GL5754R	\$ 1551	\$ 1607	\$ 1663
54"W (LH)	GL5754L	\$ 1551	\$ 1607	\$ 1663
60"W (RH)	GL5760R	\$ 1620	\$ 1679	\$ 1737
60"W (LH)	GL5760L	\$ 1620	\$ 1679	\$ 1737
66"W (RH)	GL5766R	\$ 1686	\$ 1747	\$ 1808
66"W (LH)	GL5766L	\$ 1686	\$ 1747	\$ 1808
72"W (RH)	GL5772R	\$ 1763	\$ 1827	\$ 1890
72"W (LH)	GL5772L	\$ 1763	\$ 1827	\$ 1890
78"W (RH)	GL5778R	\$ 2007	\$ 2080	\$ 2152
78"W (LH)	GL5778L	\$ 2007	\$ 2080	\$ 2152

57½"H T- Gallery-to-Gallery Panels				
18"W	GT5718	\$ 1015	\$ 1052	\$ 1089
21"W	GT5721	\$ 1036	\$ 1073	\$ 1111
24"W	GT5724	\$ 1070	\$ 1109	\$ 1147
27"W	GT5727	\$ 1108	\$ 1148	\$ 1188
30"W	GT5730	\$ 1195	\$ 1238	\$ 1281
36"W	GT5736	\$ 1284	\$ 1330	\$ 1377
42"W	GT5742	\$ 1367	\$ 1416	\$ 1466
48"W	GT5748	\$ 1472	\$ 1525	\$ 1578
54"W	GT5754	\$ 1550	\$ 1606	\$ 1662
60"W	GT5760	\$ 1619	\$ 1678	\$ 1736
66"W	GT5766	\$ 1685	\$ 1746	\$ 1807
72"W	GT5772	\$ 1762	\$ 1826	\$ 1889
78"W	GT5778	\$ 2008	\$ 2081	\$ 2153

57½"H Nonsym T- Gallery-to-Gallery Panels				
42"W 18L 24R	GT571824	\$ 1367	\$ 1416	\$ 1466
42"W 24L 18R	GT572418	\$ 1367	\$ 1416	\$ 1466
48"W 18L 30R	GT571830	\$ 1472	\$ 1525	\$ 1578
48"W 30L 18R	GT573018	\$ 1472	\$ 1525	\$ 1578
54"W 24L 30R	GT572430	\$ 1550	\$ 1606	\$ 1662
54"W 30L 24R	GT573024	\$ 1550	\$ 1606	\$ 1662

Description	Model	List Price
Gallery-to-Gallery Installation Template (<i>Black only, code P</i>)	GTEMP	\$ 69

How to specify — Select the Model Number from above.	1st Option: FSC: (if applicable): F FSC Wood X Non-FSC Wood	2nd Option: Laminate: (if applicable): See page 292 for finishes.	3rd Option: Edge: See page 292 for finishes.	4th Option: Grain: (if applicable): VLG Horizontal grain or Solid only. VST Vertical Grain (available only for single panels 60"W or less, and for split panels between 87"W and 117"W).	5th Option: Paint See page 292 for finishes.	6th Option: Glide: (if applicable):
G . .				V		G

Gallery Panels

Gallery-to-Gallery Panels for use with Glass: 30" Application

GSA SIN 33721

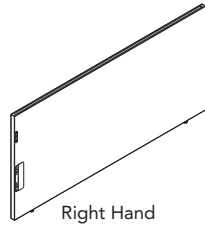

Right Hand

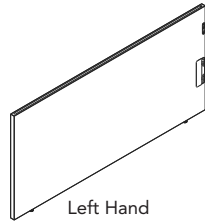

Left Hand

Description	Model	List Price			Accepts Glass Models 7½"H, 13"H, 15"H
		L1	L2	L3	
30"H L- Gallery-to-Gallery Panels For Use w/ Glass					
18"W (RH)	GL3018RG	\$ 846	\$ 877	\$ 907	G4 □□ 18GS
18"W (LH)	GL3018LG	\$ 846	\$ 877	\$ 907	G4 □□ 18GS
21"W (RH)	GL3021RG	\$ 859	\$ 890	\$ 921	G4 □□ 21GS
21"W (LH)	GL3021LG	\$ 859	\$ 890	\$ 921	G4 □□ 21GS
24"W (RH)	GL3024RG	\$ 888	\$ 920	\$ 952	G4 □□ 24GS
24"W (LH)	GL3024LG	\$ 888	\$ 920	\$ 952	G4 □□ 24GS
27"W (RH)	GL3027RG	\$ 922	\$ 955	\$ 989	G4 □□ 27GS
27"W (LH)	GL3027LG	\$ 922	\$ 955	\$ 989	G4 □□ 27GS
30"W (RH)	GL3030RG	\$ 991	\$ 1027	\$ 1063	G4 □□ 30GS
30"W (LH)	GL3030LG	\$ 991	\$ 1027	\$ 1063	G4 □□ 30GS
36"W (RH)	GL3036RG	\$ 1059	\$ 1097	\$ 1136	G4 □□ 36GS
36"W (LH)	GL3036LG	\$ 1059	\$ 1097	\$ 1136	G4 □□ 36GS
42"W (RH)	GL3042RG	\$ 1138	\$ 1179	\$ 1220	G4 □□ 42GS
42"W (LH)	GL3042LG	\$ 1138	\$ 1179	\$ 1220	G4 □□ 42GS
48"W (RH)	GL3048RG	\$ 1246	\$ 1291	\$ 1336	G4 □□ 48GS
48"W (LH)	GL3048LG	\$ 1246	\$ 1291	\$ 1336	G4 □□ 48GS
54"W (RH)	GL3054RG	\$ 1302	\$ 1349	\$ 1396	G4 □□ 54GS
54"W (LH)	GL3054LG	\$ 1302	\$ 1349	\$ 1396	G4 □□ 54GS
60"W (RH)	GL3060RG	\$ 1391	\$ 1441	\$ 1492	G4 □□ 60GS
60"W (LH)	GL3060LG	\$ 1391	\$ 1441	\$ 1492	G4 □□ 60GS
66"W (RH)	GL3066RG	\$ 1426	\$ 1478	\$ 1529	G4 □□ 66GS
66"W (LH)	GL3066LG	\$ 1426	\$ 1478	\$ 1529	G4 □□ 66GS
72"W (RH)	GL3072RG	\$ 1534	\$ 1589	\$ 1645	G4 □□ 72GS
72"W (LH)	GL3072LG	\$ 1534	\$ 1589	\$ 1645	G4 □□ 72GS
78"W (RH)	GL3078RG	\$ 1737	\$ 1800	\$ 1863	G4 □□ 78GS
78"W (LH)	GL3078LG	\$ 1737	\$ 1800	\$ 1863	G4 □□ 78GS

30"H T- Gallery-to-Gallery Panels For Use w/ Glass

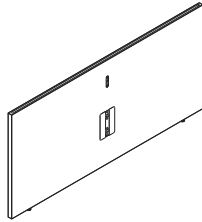

18"W	GT3018G	\$ 844	\$ 875	\$ 905	G4 □□ 18GS
21"W	GT3021G	\$ 861	\$ 892	\$ 923	G4 □□ 21GS
24"W	GT3024G	\$ 887	\$ 919	\$ 951	G4 □□ 24GS
27"W	GT3027G	\$ 921	\$ 954	\$ 988	G4 □□ 27GS
30"W	GT3030G	\$ 993	\$ 1029	\$ 1065	G4 □□ 30GS
36"W	GT3036G	\$ 1057	\$ 1095	\$ 1134	G4 □□ 36GS
42"W	GT3042G	\$ 1139	\$ 1180	\$ 1221	G4 □□ 42GS
48"W	GT3048G	\$ 1247	\$ 1292	\$ 1337	G4 □□ 48GS
54"W	GT3054G	\$ 1303	\$ 1350	\$ 1397	G4 □□ 54GS
60"W	GT3060G	\$ 1389	\$ 1439	\$ 1490	G4 □□ 60GS
66"W	GT3066G	\$ 1425	\$ 1477	\$ 1528	G4 □□ 66GS
72"W	GT3072G	\$ 1535	\$ 1590	\$ 1646	G4 □□ 72GS
78"W	GT3078G	\$ 1738	\$ 1801	\$ 1864	G4 □□ 78GS

30"H Nonsym T- Gallery-to-Gallery Panels For Use w/ Glass

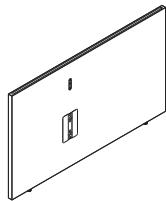

42"W 18L 24R	GT301824G	\$ 1139	\$ 1180	\$ 1221	G4 □□ 42GS
42"W 24L 18R	GT302418G	\$ 1139	\$ 1180	\$ 1221	G4 □□ 42GS
48"W 18L 30R	GT301830G	\$ 1247	\$ 1292	\$ 1337	G4 □□ 48GS
48"W 30L 18R	GT303018G	\$ 1247	\$ 1292	\$ 1337	G4 □□ 48GS
54"W 24L 30R	GT302430G	\$ 1303	\$ 1350	\$ 1397	G4 □□ 54GS
54"W 30L 24R	GT303024G	\$ 1303	\$ 1350	\$ 1397	G4 □□ 54GS

Note: Fill in model number blanks with one of the following options to determine glass height.

- 07 7.5"H glass
- 13 13"H glass
- 15 15"H glass

Description	Model	List Price
Gallery-to-Gallery Installation Template (<i>Black only, code P</i>)	GTEMP	\$ 69

<p>How to specify — Select the Model Number from above.</p>	<p>1st Option: FSC: (if applicable): F FSC Wood X Non-FSC Wood</p>	<p>2nd Option: Laminate: (if applicable): See page 292 for finishes.</p>	<p>3rd Option: Edge: See page 292 for finishes.</p>	<p>4th Option: Grain: (if applicable): VLG Horizontal grain or Solid only. VST Vertical Grain (available only for single panels 60"W or less, and for split panels between 87"W and 117"W).</p>	<p>5th Option: Paint See page 292 for finishes.</p>	<p>6th Option: Glide: (if applicable):</p>
G . .	F .	.	.	V .	.	G .

Gallery Panels

Gallery-to-Gallery Panels for use with Glass: 35" Application

GSA SIN 33721

Description	Model	List Price			Accepts Glass Models 7½"H, 13"H, 15"H
		L1	L2	L3	
35"H L- Gallery-to-Gallery Panels For Use w/ Glass					
18"W (RH)	GL3518RG	925	959	992	G4 □□ 18GS
18"W (LH)	GL3518LG	925	959	992	G4 □□ 18GS
21"W (RH)	GL3521RG	944	978	1012	G4 □□ 21GS
21"W (LH)	GL3521LG	944	978	1012	G4 □□ 21GS
24"W (RH)	GL3524RG	977	1012	1048	G4 □□ 24GS
24"W (LH)	GL3524LG	977	1012	1048	G4 □□ 24GS
27"W (RH)	GL3527RG	1007	1043	1080	G4 □□ 27GS
27"W (LH)	GL3527LG	1007	1043	1080	G4 □□ 27GS
30"W (RH)	GL3530RG	1097	1137	1176	G4 □□ 30GS
30"W (LH)	GL3530LG	1097	1137	1176	G4 □□ 30GS
36"W (RH)	GL3536RG	1178	1221	1263	G4 □□ 36GS
36"W (LH)	GL3536LG	1178	1221	1263	G4 □□ 36GS
42"W (RH)	GL3542RG	1236	1281	1326	G4 □□ 42GS
42"W (LH)	GL3542LG	1236	1281	1326	G4 □□ 42GS
48"W (RH)	GL3548RG	1328	1376	1424	G4 □□ 48GS
48"W (LH)	GL3548LG	1328	1376	1424	G4 □□ 48GS
54"W (RH)	GL3554RG	1394	1444	1495	G4 □□ 54GS
54"W (LH)	GL3554LG	1394	1444	1495	G4 □□ 54GS
60"W (RH)	GL3560RG	1470	1523	1576	G4 □□ 60GS
60"W (LH)	GL3560LG	1470	1523	1576	G4 □□ 60GS
66"W (RH)	GL3566RG	1526	1581	1636	G4 □□ 66GS
66"W (LH)	GL3566LG	1526	1581	1636	G4 □□ 66GS
72"W (RH)	GL3572RG	1636	1695	1754	G4 □□ 72GS
72"W (LH)	GL3572LG	1636	1695	1754	G4 □□ 72GS
78"W (RH)	GL3578RG	1803	1868	1933	G4 □□ 78GS
78"W (LH)	GL3578LG	1803	1868	1933	G4 □□ 78GS

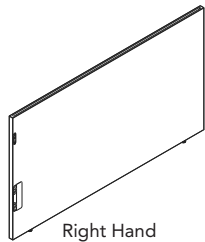

Right Hand

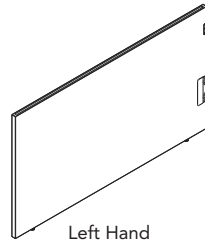

Left Hand

35"H T- Gallery-to-Gallery Panels For Use w/ Glass					
18"W	GT3518G	927	961	994	G4 □□ 18GS
21"W	GT3521G	942	976	1010	G4 □□ 21GS
24"W	GT3524G	976	1011	1047	G4 □□ 24GS
27"W	GT3527G	1006	1042	1079	G4 □□ 27GS
30"W	GT3530G	1099	1139	1178	G4 □□ 30GS
36"W	GT3536G	1176	1219	1261	G4 □□ 36GS
42"W	GT3542G	1238	1283	1328	G4 □□ 42GS
48"W	GT3548G	1326	1374	1422	G4 □□ 48GS
54"W	GT3554G	1394	1444	1495	G4 □□ 54GS
60"W	GT3560G	1471	1524	1577	G4 □□ 60GS
66"W	GT3566G	1526	1581	1636	G4 □□ 66GS
72"W	GT3572G	1637	1696	1755	G4 □□ 72GS
78"W	GT3578G	1801	1866	1931	G4 □□ 78GS

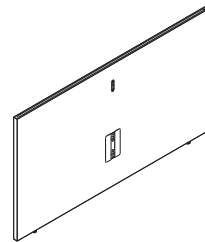

35"H Nonsym T- Gallery-to-Gallery Panels For Use w/ Glass					
42"W 18L 24R	GT351824G	1238	1283	1328	G4 □□ 42GS
42"W 24L 18R	GT352418G	1238	1283	1328	G4 □□ 42GS
48"W 18L 30R	GT351830G	1326	1374	1422	G4 □□ 48GS
48"W 30L 18R	GT353018G	1326	1374	1422	G4 □□ 48GS
54"W 24L 30R	GT352430G	1394	1444	1495	G4 □□ 54GS
54"W 30L 24R	GT353024G	1394	1444	1495	G4 □□ 54GS

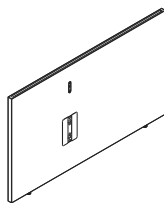

Note: Fill in model number blanks with one of the following options to determine glass height.

- 07 7.5"H glass
- 13 13"H glass
- 15 15"H glass

Description	Model	List Price
Gallery-to-Gallery Installation Template (<i>Black only, code P</i>)	GTEMP	\$ 69

<p>How to specify — Select the Model Number from above.</p>	<p><i>1st Option:</i> FSC: (if applicable): F FSC Wood X Non-FSC Wood</p>	<p><i>2nd Option:</i> Laminate: (if applicable): See page 292 for finishes.</p>	<p><i>3rd Option:</i> Edge: See page 292 for finishes.</p>	<p><i>4th Option:</i> Grain: (if applicable): VLG Horizontal grain or Solid only. VST Vertical Grain (available only for single panels 60" W or less, and for split panels between 87" W and 117" W).</p>	<p><i>5th Option:</i> Paint See page 292 for finishes.</p>	<p><i>6th Option:</i> Glide: (if applicable):</p>
	<p>G . .</p>	<p> .</p>	<p> .</p>	<p> .</p>	<p>V .</p>	<p> .</p>

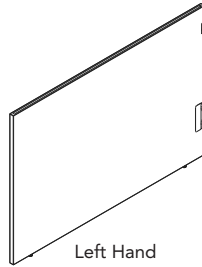
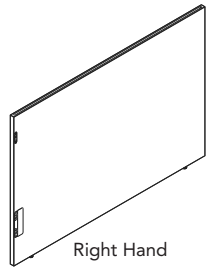

Description	Model	List Price			Accepts Glass Models 7½"H, 13"H, 15"H
		L1	L2	L3	
42"H L- Gallery-to-Gallery Panels For Use w/ Glass					
18"W (RH)	GL4218RG	988	1024	1060	G4 □□ 18GS
18"W (LH)	GL4218LG	988	1024	1060	G4 □□ 18GS
21"W (RH)	GL4221RG	1000	1036	1072	G4 □□ 21GS
21"W (LH)	GL4221LG	1000	1036	1072	G4 □□ 21GS
24"W (RH)	GL4224RG	1043	1081	1118	G4 □□ 24GS
24"W (LH)	GL4224LG	1043	1081	1118	G4 □□ 24GS
27"W (RH)	GL4227RG	1080	1119	1158	G4 □□ 27GS
27"W (LH)	GL4227LG	1080	1119	1158	G4 □□ 27GS
30"W (RH)	GL4230RG	1180	1223	1265	G4 □□ 30GS
30"W (LH)	GL4230LG	1180	1223	1265	G4 □□ 30GS
36"W (RH)	GL4236RG	1267	1313	1359	G4 □□ 36GS
36"W (LH)	GL4236LG	1267	1313	1359	G4 □□ 36GS
42"W (RH)	GL4242RG	1339	1387	1436	G4 □□ 42GS
42"W (LH)	GL4242LG	1339	1387	1436	G4 □□ 42GS
48"W (RH)	GL4248RG	1413	1464	1515	G4 □□ 48GS
48"W (LH)	GL4248LG	1413	1464	1515	G4 □□ 48GS
54"W (RH)	GL4254RG	1509	1564	1618	G4 □□ 54GS
54"W (LH)	GL4254LG	1509	1564	1618	G4 □□ 54GS
60"W (RH)	GL4260RG	1580	1637	1694	G4 □□ 60GS
60"W (LH)	GL4260LG	1580	1637	1694	G4 □□ 60GS
66"W (RH)	GL4266RG	1652	1712	1771	G4 □□ 66GS
66"W (LH)	GL4266LG	1652	1712	1771	G4 □□ 66GS
72"W (RH)	GL4272RG	1752	1815	1879	G4 □□ 72GS
72"W (LH)	GL4272LG	1752	1815	1879	G4 □□ 72GS
78"W (RH)	GL4278RG	1888	1956	2024	G4 □□ 78GS
78"W (LH)	GL4278LG	1888	1956	2024	G4 □□ 78GS

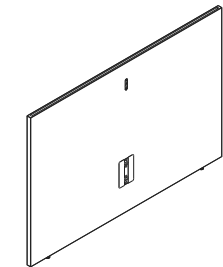

42"H T- Gallery-to-Gallery Panels For Use w/ Glass					
18"W	GT4218G	989	1025	1061	G4 □□ 18GS
21"W	GT4221G	1002	1038	1074	G4 □□ 21GS
24"W	GT4224G	1043	1081	1118	G4 □□ 24GS
27"W	GT4227G	1078	1117	1156	G4 □□ 27GS
30"W	GT4230G	1181	1224	1266	G4 □□ 30GS
36"W	GT4236G	1269	1315	1361	G4 □□ 36GS
42"W	GT4242G	1339	1387	1436	G4 □□ 42GS
48"W	GT4248G	1412	1463	1514	G4 □□ 48GS
54"W	GT4254G	1510	1565	1619	G4 □□ 54GS
60"W	GT4260G	1580	1637	1694	G4 □□ 60GS
66"W	GT4266G	1651	1711	1770	G4 □□ 66GS
72"W	GT4272G	1751	1814	1878	G4 □□ 72GS
78"W	GT4278G	1887	1955	2023	G4 □□ 78GS

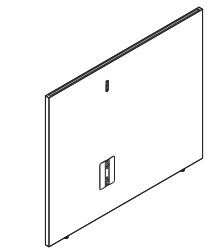

42"H Nonsym T- Gallery-to-Gallery Panels For Use w/ Glass					
42"W 18L 24R	GT421824G	1339	1387	1436	G4 □□ 42GS
42"W 24L 18R	GT422418G	1339	1387	1436	G4 □□ 42GS
48"W 18L 30R	GT421830G	1412	1463	1514	G4 □□ 48GS
48"W 30L 18R	GT423018G	1412	1463	1514	G4 □□ 48GS
54"W 24L 30R	GT422430G	1510	1565	1619	G4 □□ 54GS
54"W 30L 24R	GT423024G	1510	1565	1619	G4 □□ 54GS

Note: Fill in model number blanks with one of the following options to determine glass height.

- 07 7.5"H glass
- 13 13"H glass
- 15 15"H glass

Description	Model	List Price
Gallery-to-Gallery Installation Template (<i>Black only, code P</i>)	GTEMP	\$ 69

<p>How to specify — Select the Model Number from above.</p>	<p>1st Option: FSC: (if applicable): F FSC Wood X Non-FSC Wood</p>	<p>2nd Option: Laminate: (if applicable): See page 292 for finishes.</p>	<p>3rd Option: Edge: See page 292 for finishes.</p>	<p>4th Option: Grain: (if applicable): VLG Horizontal grain or Solid only. VST Vertical Grain (available only for single panels 60"W or less, and for split panels between 87"W and 117"W.</p>	<p>5th Option: Paint See page 292 for finishes.</p>	<p>6th Option: Glide: (if applicable):</p>
G 	V .	.	G

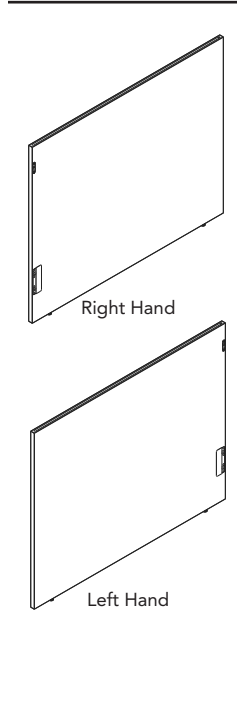

Description	Model	List Price			Accepts Glass Models 7½"H, 13"H, 15"H
		L1	L2	L3	
50"H L- Gallery-to-Gallery Panels For Use w/ Glass					
18"W (RH)	GL5018RG	1084	1123	1162	G4 □□ 18GS
18"W (LH)	GL5018LG	1084	1123	1162	G4 □□ 18GS
21"W (RH)	GL5021RG	1103	1143	1183	G4 □□ 21GS
21"W (LH)	GL5021LG	1103	1143	1183	G4 □□ 21GS
24"W (RH)	GL5024RG	1138	1179	1220	G4 □□ 24GS
24"W (LH)	GL5024LG	1138	1179	1220	G4 □□ 24GS
27"W (RH)	GL5027RG	1177	1220	1262	G4 □□ 27GS
27"W (LH)	GL5027LG	1177	1220	1262	G4 □□ 27GS
30"W (RH)	GL5030RG	1263	1309	1354	G4 □□ 30GS
30"W (LH)	GL5030LG	1263	1309	1354	G4 □□ 30GS
36"W (RH)	GL5036RG	1353	1402	1451	G4 □□ 36GS
36"W (LH)	GL5036LG	1353	1402	1451	G4 □□ 36GS
42"W (RH)	GL5042RG	1435	1487	1539	G4 □□ 42GS
42"W (LH)	GL5042LG	1435	1487	1539	G4 □□ 42GS
48"W (RH)	GL5048RG	1539	1595	1650	G4 □□ 48GS
48"W (LH)	GL5048LG	1539	1595	1650	G4 □□ 48GS
54"W (RH)	GL5054RG	1619	1678	1736	G4 □□ 54GS
54"W (LH)	GL5054LG	1619	1678	1736	G4 □□ 54GS
60"W (RH)	GL5060RG	1688	1749	1810	G4 □□ 60GS
60"W (LH)	GL5060LG	1688	1749	1810	G4 □□ 60GS
66"W (RH)	GL5066RG	1753	1816	1880	G4 □□ 66GS
66"W (LH)	GL5066LG	1753	1816	1880	G4 □□ 66GS
72"W (RH)	GL5072RG	1830	1896	1962	G4 □□ 72GS
72"W (LH)	GL5072LG	1830	1896	1962	G4 □□ 72GS
78"W (RH)	GL5078RG	2075	2150	2225	G4 □□ 78GS
78"W (LH)	GL5078LG	2075	2150	2225	G4 □□ 78GS

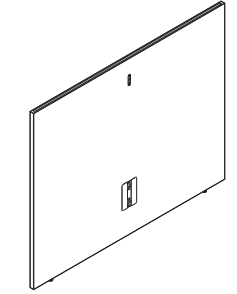

50"H T- Gallery-to-Gallery Panels For Use w/ Glass					
18"W	GT5018G	1085	1124	1163	G4 □□ 18GS
21"W	GT5021G	1103	1143	1183	G4 □□ 21GS
24"W	GT5024G	1139	1180	1221	G4 □□ 24GS
27"W	GT5027G	1175	1218	1260	G4 □□ 27GS
30"W	GT5030G	1263	1309	1354	G4 □□ 30GS
36"W	GT5036G	1353	1402	1451	G4 □□ 36GS
42"W	GT5042G	1435	1487	1539	G4 □□ 42GS
48"W	GT5048G	1539	1595	1650	G4 □□ 48GS
54"W	GT5054G	1618	1677	1735	G4 □□ 54GS
60"W	GT5060G	1687	1748	1809	G4 □□ 60GS
66"W	GT5066G	1752	1815	1879	G4 □□ 66GS
72"W	GT5072G	1830	1896	1962	G4 □□ 72GS
78"W	GT5078G	2076	2151	2226	G4 □□ 78GS

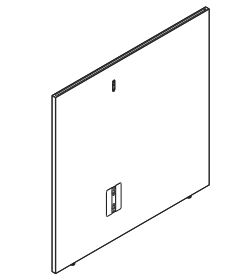

50"H Nonsym T- Gallery-to-Gallery Panels For Use w/ Glass					
42"W 18L 24R	GT501824G	1435	1487	1539	G4 □□ 42GS
42"W 24L 18R	GT502418G	1435	1487	1539	G4 □□ 42GS
48"W 18L 30R	GT501830G	1539	1595	1650	G4 □□ 48GS
48"W 30L 18R	GT503018G	1539	1595	1650	G4 □□ 48GS
54"W 24L 30R	GT502430G	1618	1677	1735	G4 □□ 54GS
54"W 30L 24R	GT503024G	1618	1677	1735	G4 □□ 54GS

Note: Fill in model number blanks with one of the following options to determine glass height.
 07 7.5"H glass
 13 13"H glass
 15 15"H glass

Description	Model	List Price
Gallery-to-Gallery Installation Template (<i>Black only, code P</i>)	GTEMP	\$ 69

<p>How to specify — Select the Model Number from above.</p> <p>G . .</p>	<p><i>1st Option:</i> FSC: (if applicable): F FSC Wood X Non-FSC Wood</p>	<p><i>2nd Option:</i> Laminate: (if applicable): See page 292 for finishes.</p>	<p><i>3rd Option:</i> Edge: See page 292 for finishes.</p>	<p><i>4th Option:</i> Grain: (if applicable): VLG Horizontal grain or Solid only. VST Vertical Grain (available only for single panels 60"W or less, and for split panels between 87"W and 117"W).</p> <p>V .</p>	<p><i>5th Option:</i> Paint See page 292 for finishes.</p>	<p><i>6th Option:</i> Glide: (if applicable):</p> <p> . G </p>
---	--	--	---	--	---	---

GALLERY PANELS

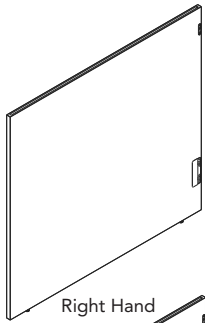

Right Hand

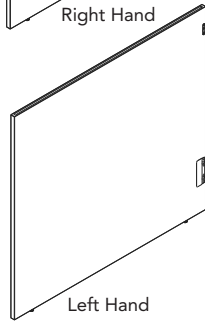

Left Hand

Description	Model	List Price			Accepts Glass Models 7½"H, 13"H, 15"H
		L1	L2	L3	
57½"H L- Gallery-to-Gallery Panels For Use w/ Glass					
18"W (RH)	GL5718RG	1228	1272	1317	G4 □□ 18GS
18"W (LH)	GL5718LG	1228	1272	1317	G4 □□ 18GS
21"W (RH)	GL5721RG	1247	1292	1337	G4 □□ 21GS
21"W (LH)	GL5721LG	1247	1292	1337	G4 □□ 21GS
24"W (RH)	GL5724RG	1282	1328	1375	G4 □□ 24GS
24"W (LH)	GL5724LG	1282	1328	1375	G4 □□ 24GS
27"W (RH)	GL5727RG	1320	1368	1415	G4 □□ 27GS
27"W (LH)	GL5727LG	1320	1368	1415	G4 □□ 27GS
30"W (RH)	GL5730RG	1406	1457	1508	G4 □□ 30GS
30"W (LH)	GL5730LG	1406	1457	1508	G4 □□ 30GS
36"W (RH)	GL5736RG	1496	1550	1604	G4 □□ 36GS
36"W (LH)	GL5736LG	1496	1550	1604	G4 □□ 36GS
42"W (RH)	GL5742RG	1579	1636	1693	G4 □□ 42GS
42"W (LH)	GL5742LG	1579	1636	1693	G4 □□ 42GS
48"W (RH)	GL5748RG	1684	1745	1806	G4 □□ 48GS
48"W (LH)	GL5748LG	1684	1745	1806	G4 □□ 48GS
54"W (RH)	GL5754RG	1763	1827	1890	G4 □□ 54GS
54"W (LH)	GL5754LG	1763	1827	1890	G4 □□ 54GS
60"W (RH)	GL5760RG	1832	1898	1964	G4 □□ 60GS
60"W (LH)	GL5760LG	1832	1898	1964	G4 □□ 60GS
66"W (RH)	GL5766RG	1897	1966	2034	G4 □□ 66GS
66"W (LH)	GL5766LG	1897	1966	2034	G4 □□ 66GS
72"W (RH)	GL5772RG	1974	2045	2117	G4 □□ 72GS
72"W (LH)	GL5772LG	1974	2045	2117	G4 □□ 72GS
78"W (RH)	GL5778RG	2219	2299	2379	G4 □□ 78GS
78"W (LH)	GL5778LG	2219	2299	2379	G4 □□ 78GS

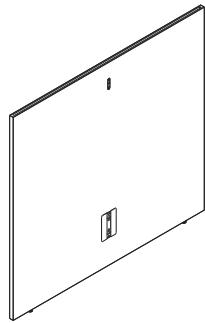

57½"H T- Gallery-to-Gallery Panels For Use w/ Glass					
18"W	GT5718G	1228	1272	1317	G4 □□ 18GS
21"W	GT5721G	1248	1293	1338	G4 □□ 21GS
24"W	GT5724G	1282	1328	1375	G4 □□ 24GS
27"W	GT5727G	1320	1368	1415	G4 □□ 27GS
30"W	GT5730G	1407	1458	1509	G4 □□ 30GS
36"W	GT5736G	1496	1550	1604	G4 □□ 36GS
42"W	GT5742G	1579	1636	1693	G4 □□ 42GS
48"W	GT5748G	1683	1744	1805	G4 □□ 48GS
54"W	GT5754G	1762	1826	1889	G4 □□ 54GS
60"W	GT5760G	1831	1897	1963	G4 □□ 60GS
66"W	GT5766G	1896	1965	2033	G4 □□ 66GS
72"W	GT5772G	1974	2045	2117	G4 □□ 72GS
78"W	GT5778G	2219	2299	2379	G4 □□ 78GS

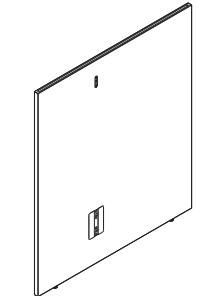

57½"H Nonsym T- Gallery-to-Gallery Panels For Use w/ Glass					
42"W 18L 24R	GT571824G	1579	1636	1693	G4 □□ 42GS
42"W 24L 18R	GT572418G	1579	1636	1693	G4 □□ 42GS
48"W 18L 30R	GT571830G	1683	1744	1805	G4 □□ 48GS
48"W 30L 18R	GT573018G	1683	1744	1805	G4 □□ 48GS
54"W 24L 30R	GT572430G	1762	1826	1889	G4 □□ 54GS
54"W 30L 24R	GT573024G	1762	1826	1889	G4 □□ 54GS

Note: Fill in model number blanks with one of the following options to determine glass height.
 07 7.5"H glass
 13 13"H glass
 15 15"H glass

Description	Model	List Price
Gallery-to-Gallery Installation Template (<i>Black only, code P</i>)	GTEMP	\$ 69

<p>How to specify — Select the Model Number from above.</p> <p>G . .</p>	<p>1st Option: FSC: (if applicable): F FSC Wood X Non-FSC Wood</p>	<p>2nd Option: Laminate: (if applicable): See page 292 for finishes.</p>	<p>3rd Option: Edge: See page 292 for finishes.</p>	<p>4th Option: Grain: (if applicable): VLG Horizontal grain or Solid only. VST Vertical Grain (available only for single panels 60"W or less, and for split panels between 87"W and 117"W).</p>	<p>5th Option: Paint See page 292 for finishes.</p>	<p>6th Option: Glide: (if applicable):</p>

Gallery Panels

30"H Application

For Gallery Panel connectors see pages 332-333.

GSA SIN 33721

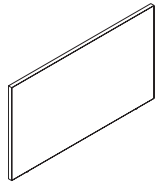

Description	Model	Configuration	List Price		
			L1	L2	L3
30"H Gallery Panels					
18"W	G3018	Mid	\$ 422	\$ 437	\$ 452
21"W	G3021	Mid	\$ 439	\$ 455	\$ 470
24"W	G3024	Mid	\$ 466	\$ 483	\$ 499
27"W	G3027	Mid	\$ 500	\$ 518	\$ 536
30"W	G3030	Mid	\$ 570	\$ 590	\$ 611
33"W	G3033	S, Mid	\$ 604	\$ 626	\$ 647
36"W	G3036	S, Mid	\$ 635	\$ 658	\$ 680
39"W	G3039	S, Mid	\$ 690	\$ 715	\$ 739
42"W	G3042	S, Mid	\$ 746	\$ 772	\$ 799
45"W	G3045	S, Mid	\$ 814	\$ 843	\$ 872
48"W	G3048	S, Mid	\$ 852	\$ 882	\$ 913
51"W	G3051	D, S, Mid	\$ 867	\$ 898	\$ 929
54"W	G3054	D, S, Mid	\$ 909	\$ 941	\$ 974
57"W	G3057	D, S, Mid	\$ 949	\$ 983	\$ 1016
60"W	G3060	D, S, Mid	\$ 995	\$ 1030	\$ 1066
63"W	G3063	D, S, Mid	\$ 1012	\$ 1048	\$ 1084
66"W	G3066	D, S, Mid	\$ 1034	\$ 1071	\$ 1107
69"W	G3069	D, S, Mid	\$ 1108	\$ 1147	\$ 1187
72"W	G3072	D, S, Mid	\$ 1140	\$ 1180	\$ 1221
75"W	G3075	D, S, Mid	\$ 1292	\$ 1338	\$ 1384
78"W	G3078	D, S, Mid	\$ 1342	\$ 1390	\$ 1437
81"W	G3081	D, S, Mid	\$ 1390	\$ 1439	\$ 1489
84"W	G3084	D, S, Mid	\$ 1527	\$ 1581	\$ 1635

30"H Gallery Split Panels (model number includes two units)

81"W	GS3081	D	\$ 1320	\$ 1369	\$ 1419
87"W	GS3087	D	\$ 1595	\$ 1652	\$ 1708
93"W	GS3093	D	\$ 1644	\$ 1702	\$ 1761
99"W	GS3099	D	\$ 1665	\$ 1724	\$ 1783
105"W	GS30105	D	\$ 1696	\$ 1756	\$ 1816
111"W	GS30111	D	\$ 1778	\$ 1841	\$ 1904
117"W	GS30117	D	\$ 1826	\$ 1891	\$ 1956
123"W	GS30123	D	\$ 1841	\$ 1906	\$ 1972
129"W	GS30129	D	\$ 1885	\$ 1952	\$ 2019
135"W	GS30135	D	\$ 1963	\$ 2033	\$ 2102
141"W	GS30141	D	\$ 2053	\$ 2126	\$ 2199
147"W	GS30147	D	\$ 2153	\$ 2229	\$ 2306

Note: Configuration is not included in model number

- Mid Mid Panel
- S End Single Sided
- D End Dual Sided

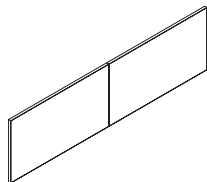

GALLERY PANELS

How to specify — Select the Model Number from above.	1st Option: FSC: F FSC Wood X Non-FSC Wood	2nd Option: Laminate: See page 292 for finishes.	3rd Option: Edge: See page 292 for finishes.	4th Option: Grain: VLG Horizontal grain or Solid only. VST Vertical Grain (available only for single panels 60"W or less, and for split panels between 87"W and 117"W).	5th Option: Glide:
G 	V .	G

Examples: G3018.X.LT11.TI.VLG.G GS3087.F.LLA1.TI.VST.G

Gallery Panels

35"H Application

For Gallery Panel connectors see pages 332-333.

GSA SIN 33721

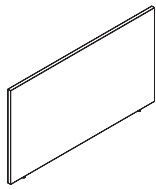

Description	Model	Configuration	List Price		
			L1	L2	L3
35"H Gallery Panels					
18"W	G3518	Mid	\$ 507	\$ 526	\$ 544
21"W	G3521	Mid	\$ 523	\$ 542	\$ 561
24"W	G3524	Mid	\$ 556	\$ 577	\$ 597
27"W	G3527	Mid	\$ 587	\$ 609	\$ 630
30"W	G3530	Mid	\$ 679	\$ 704	\$ 729
33"W	G3533	S, Mid	\$ 715	\$ 741	\$ 767
36"W	G3536	S, Mid	\$ 758	\$ 786	\$ 813
39"W	G3539	S, Mid	\$ 810	\$ 840	\$ 869
42"W	G3542	S, Mid	\$ 846	\$ 877	\$ 908
45"W	G3545	S, Mid	\$ 898	\$ 931	\$ 963
48"W	G3548	S, Mid	\$ 937	\$ 971	\$ 1005
51"W	G3551	D, S, Mid	\$ 969	\$ 1004	\$ 1039
54"W	G3554	D, S, Mid	\$ 1003	\$ 1040	\$ 1076
57"W	G3557	D, S, Mid	\$ 1044	\$ 1082	\$ 1120
60"W	G3560	D, S, Mid	\$ 1078	\$ 1117	\$ 1156
63"W	G3563	D, S, Mid	\$ 1102	\$ 1142	\$ 1182
66"W	G3566	D, S, Mid	\$ 1134	\$ 1175	\$ 1216
69"W	G3569	D, S, Mid	\$ 1189	\$ 1232	\$ 1275
72"W	G3572	D, S, Mid	\$ 1244	\$ 1289	\$ 1334
75"W	G3575	D, S, Mid	\$ 1341	\$ 1390	\$ 1438
78"W	G3578	D, S, Mid	\$ 1411	\$ 1462	\$ 1513
81"W	G3581	D, S, Mid	\$ 1517	\$ 1572	\$ 1627
84"W	G3584	D, S, Mid	\$ 1661	\$ 1721	\$ 1781

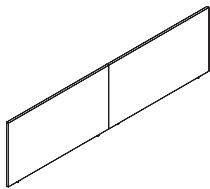

35"H Gallery Split Panels (model number includes two units)					
81"W	GS3581	D	\$ 1467	\$ 1522	\$ 1577
87"W	GS3587	D	\$ 1725	\$ 1788	\$ 1850
93"W	GS3593	D	\$ 1789	\$ 1854	\$ 1919
99"W	GS3599	D	\$ 1861	\$ 1929	\$ 1996
105"W	GS35105	D	\$ 1886	\$ 1955	\$ 2023
111"W	GS35111	D	\$ 1953	\$ 2024	\$ 2094
117"W	GS35117	D	\$ 2013	\$ 2086	\$ 2159
123"W	GS35123	D	\$ 2066	\$ 2141	\$ 2216
129"W	GS35129	D	\$ 2092	\$ 2168	\$ 2244
135"W	GS35135	D	\$ 2188	\$ 2267	\$ 2346
141"W	GS35141	D	\$ 2272	\$ 2355	\$ 2437
147"W	GS35147	D	\$ 2332	\$ 2417	\$ 2501

Note: Configuration is not included in model number

- Mid Mid Panel
- S End Single Sided
- D End Dual Sided

GALLERY PANELS

How to specify — Select the Model Number from above.	1st Option: FSC: F FSC Wood X Non-FSC Wood	2nd Option: Laminate: See page 292 for finishes.	3rd Option: Edge: See page 292 for finishes.	4th Option: Grain: VLG Horizontal grain or Solid only. VST Vertical Grain (available only for single panels 60"W or less, and for split panels between 87"W and 117"W).	5th Option: Glide:
G 	V .	G

Examples: G3518.X.LT11.TI.VLG.G GS3587.F.LLA1.TI.VST.G

Gallery Panels

42"H Application

For Gallery Panel connectors see pages 332-333.

GSA SIN 33721

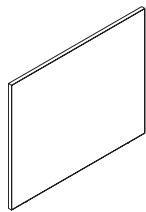

Description	Model	Configuration	List Price		
			L1	L2	L3
42"H Gallery Panels					
18"W	G4218	Mid	\$ 566	\$ 586	\$ 606
21"W	G4221	Mid	\$ 581	\$ 602	\$ 622
24"W	G4224	Mid	\$ 621	\$ 643	\$ 665
27"W	G4227	Mid	\$ 658	\$ 681	\$ 705
30"W	G4230	Mid	\$ 759	\$ 786	\$ 813
33"W	G4233	S, Mid	\$ 799	\$ 827	\$ 856
36"W	G4236	S, Mid	\$ 846	\$ 876	\$ 906
39"W	G4239	S, Mid	\$ 906	\$ 938	\$ 970
42"W	G4242	S, Mid	\$ 944	\$ 978	\$ 1011
45"W	G4245	S, Mid	\$ 979	\$ 1014	\$ 1049
48"W	G4248	S, Mid	\$ 1019	\$ 1055	\$ 1091
51"W	G4251	D, S, Mid	\$ 1083	\$ 1121	\$ 1160
54"W	G4254	D, S, Mid	\$ 1117	\$ 1157	\$ 1196
57"W	G4257	D, S, Mid	\$ 1144	\$ 1185	\$ 1225
60"W	G4260	D, S, Mid	\$ 1187	\$ 1229	\$ 1271
63"W	G4263	D, S, Mid	\$ 1219	\$ 1262	\$ 1306
66"W	G4266	D, S, Mid	\$ 1259	\$ 1304	\$ 1348
69"W	G4269	D, S, Mid	\$ 1283	\$ 1329	\$ 1374
72"W	G4272	D, S, Mid	\$ 1357	\$ 1405	\$ 1453
75"W	G4275	D, S, Mid	\$ 1405	\$ 1455	\$ 1505
78"W	G4278	D, S, Mid	\$ 1493	\$ 1546	\$ 1599
81"W	G4281	D, S, Mid	\$ 1668	\$ 1727	\$ 1786
84"W	G4284	D, S, Mid	\$ 1796	\$ 1860	\$ 1923

42"H Gallery Split Panels (model number includes two units)

81"W	GS4281	D	\$ 1581	\$ 1640	\$ 1699
87"W	GS4287	D	\$ 1830	\$ 1895	\$ 1960
93"W	GS4293	D	\$ 1865	\$ 1931	\$ 1997
99"W	GS4299	D	\$ 1949	\$ 2018	\$ 2087
105"W	GS42105	D	\$ 1979	\$ 2049	\$ 2119
111"W	GS42111	D	\$ 2028	\$ 2100	\$ 2172
117"W	GS42117	D	\$ 2076	\$ 2150	\$ 2223
123"W	GS42123	D	\$ 2129	\$ 2204	\$ 2280
129"W	GS42129	D	\$ 2205	\$ 2283	\$ 2361
135"W	GS42135	D	\$ 2295	\$ 2376	\$ 2458
141"W	GS42141	D	\$ 2380	\$ 2464	\$ 2549
147"W	GS42147	D	\$ 2430	\$ 2516	\$ 2602

Note: Configuration is not included in model number

- Mid Mid Panel
- S End Single Sided
- D End Dual Sided

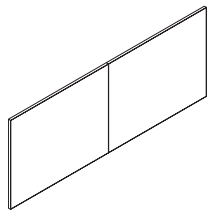

GALLERY PANELS

How to specify — Select the Model Number from above.	1st Option: FSC: F FSC Wood X Non-FSC Wood	2nd Option: Laminate: See page 292 for finishes.	3rd Option: Edge: See page 292 for finishes.	4th Option: Grain: VLG Horizontal grain or Solid only. VST Vertical Grain (available only for single panels 60"W or less, and for split panels between 87"W and 117"W).	5th Option: Glide:
G 	V .	G

Examples: G4218.X.LT11.TI.VLG.G GS4287.F.LLA1.TI.VST.G

Gallery Panels

50"H Application

For Gallery Panel connectors see pages 332-333.

GSA SIN 33721

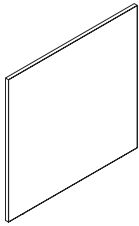

Description	Model	Configuration	List Price		
			L1	L2	L3
50"H Gallery Panels					
18"W	G5018	Mid	\$ 663	\$ 687	\$ 710
21"W	G5021	Mid	\$ 683	\$ 707	\$ 732
24"W	G5024	Mid	\$ 716	\$ 741	\$ 767
27"W	G5027	Mid	\$ 756	\$ 783	\$ 810
30"W	G5030	Mid	\$ 842	\$ 872	\$ 902
33"W	G5033	S, Mid	\$ 886	\$ 917	\$ 949
36"W	G5036	S, Mid	\$ 930	\$ 963	\$ 996
39"W	G5039	S, Mid	\$ 987	\$ 1022	\$ 1057
42"W	G5042	S, Mid	\$ 1040	\$ 1077	\$ 1114
45"W	G5045	S, Mid	\$ 1117	\$ 1157	\$ 1196
48"W	G5048	S, Mid	\$ 1144	\$ 1185	\$ 1225
51"W	G5051	D, S, Mid	\$ 1175	\$ 1217	\$ 1258
54"W	G5054	D, S, Mid	\$ 1224	\$ 1267	\$ 1311
57"W	G5057	D, S, Mid	\$ 1256	\$ 1301	\$ 1345
60"W	G5060	D, S, Mid	\$ 1293	\$ 1339	\$ 1385
63"W	G5063	D, S, Mid	\$ 1321	\$ 1368	\$ 1415
66"W	G5066	D, S, Mid	\$ 1358	\$ 1406	\$ 1454
69"W	G5069	D, S, Mid	\$ 1398	\$ 1448	\$ 1497
72"W	G5072	D, S, Mid	\$ 1436	\$ 1487	\$ 1538
75"W	G5075	D, S, Mid	\$ 1532	\$ 1586	\$ 1641
78"W	G5078	D, S, Mid	\$ 1682	\$ 1742	\$ 1801
81"W	G5081	D, S, Mid	\$ 1825	\$ 1890	\$ 1955
84"W	G5084	D, S, Mid	\$ 1951	\$ 2020	\$ 2089

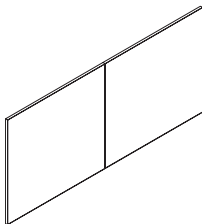

50"H Gallery Split Panels (model number includes two units)					
81"W	GS5081	D	\$ 1730	\$ 1795	\$ 1860
87"W	GS5087	D	\$ 1984	\$ 2054	\$ 2125
93"W	GS5093	D	\$ 2089	\$ 2163	\$ 2237
99"W	GS5099	D	\$ 2131	\$ 2207	\$ 2282
105"W	GS50105	D	\$ 2209	\$ 2287	\$ 2366
111"W	GS50111	D	\$ 2239	\$ 2318	\$ 2398
117"W	GS50117	D	\$ 2261	\$ 2341	\$ 2421
123"W	GS50123	D	\$ 2284	\$ 2365	\$ 2446
129"W	GS50129	D	\$ 2346	\$ 2429	\$ 2512
135"W	GS50135	D	\$ 2390	\$ 2475	\$ 2560
141"W	GS50141	D	\$ 2430	\$ 2516	\$ 2602
147"W	GS50147	D	\$ 2517	\$ 2606	\$ 2696

Note: Configuration is not included in model number

- Mid Mid Panel
- S End Single Sided
- D End Dual Sided

GALLERY PANELS

How to specify — Select the Model Number from above.	1st Option: FSC: F FSC Wood X Non-FSC Wood	2nd Option: Laminate: See page 292 for finishes.	3rd Option: Edge: See page 292 for finishes.	4th Option: Grain: VLG Horizontal grain or Solid only. VST Vertical Grain (available only for single panels 60"W or less, and for split panels between 87"W and 117"W).	5th Option: Glide:
G 	V .	G

Examples: G5018.X.LT11.TI.VLG.G GS5087.F.LLA1.TI.VST.G

Gallery Panels

57½"H Application

For Gallery Panel connectors see pages 332-333.

GSA SIN 33721

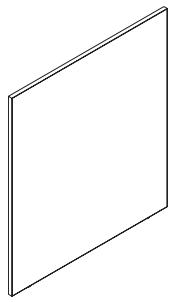

Description	Model	Configuration	List Price		
			L1	L2	L3
57½"H Gallery Panels					
18"W	G5718	Mid	\$ 807	\$ 836	\$ 864
21"W	G5721	Mid	\$ 826	\$ 855	\$ 885
24"W	G5724	Mid	\$ 859	\$ 890	\$ 920
27"W	G5727	Mid	\$ 898	\$ 930	\$ 962
30"W	G5730	Mid	\$ 986	\$ 1021	\$ 1056
33"W	G5733	S, Mid	\$ 1028	\$ 1065	\$ 1101
36"W	G5736	S, Mid	\$ 1074	\$ 1112	\$ 1150
39"W	G5739	S, Mid	\$ 1132	\$ 1172	\$ 1212
42"W	G5742	S, Mid	\$ 1186	\$ 1228	\$ 1270
45"W	G5745	S, Mid	\$ 1260	\$ 1305	\$ 1349
48"W	G5748	S, Mid	\$ 1290	\$ 1336	\$ 1382
51"W	G5751	D, S, Mid	\$ 1320	\$ 1367	\$ 1414
54"W	G5754	D, S, Mid	\$ 1368	\$ 1417	\$ 1465
57"W	G5757	D, S, Mid	\$ 1400	\$ 1450	\$ 1499
60"W	G5760	D, S, Mid	\$ 1437	\$ 1488	\$ 1539
63"W	G5763	D, S, Mid	\$ 1465	\$ 1517	\$ 1569
66"W	G5766	D, S, Mid	\$ 1502	\$ 1555	\$ 1609
69"W	G5769	D, S, Mid	\$ 1540	\$ 1595	\$ 1649
72"W	G5772	D, S, Mid	\$ 1579	\$ 1635	\$ 1691
75"W	G5775	D, S, Mid	\$ 1675	\$ 1734	\$ 1794
78"W	G5778	D, S, Mid	\$ 1825	\$ 1890	\$ 1955
81"W	G5781	D, S, Mid	\$ 1971	\$ 2041	\$ 2111
84"W	G5784	D, S, Mid	\$ 2093	\$ 2167	\$ 2242

57½"H Gallery Split Panels (model number includes two units)

81"W	GS5781	D	\$ 1866	\$ 1936	\$ 2006
87"W	GS5787	D	\$ 2130	\$ 2206	\$ 2281
93"W	GS5793	D	\$ 2234	\$ 2313	\$ 2392
99"W	GS5799	D	\$ 2274	\$ 2355	\$ 2435
105"W	GS57105	D	\$ 2353	\$ 2436	\$ 2520
111"W	GS57111	D	\$ 2384	\$ 2469	\$ 2553
117"W	GS57117	D	\$ 2406	\$ 2491	\$ 2577
123"W	GS57123	D	\$ 2430	\$ 2516	\$ 2602
129"W	GS57129	D	\$ 2490	\$ 2578	\$ 2667
135"W	GS57135	D	\$ 2536	\$ 2626	\$ 2716
141"W	GS57141	D	\$ 2574	\$ 2665	\$ 2757
147"W	GS57147	D	\$ 2661	\$ 2755	\$ 2850

Note: Configuration is not included in model number

- Mid Mid Panel
- S End Single Sided
- D End Dual Sided

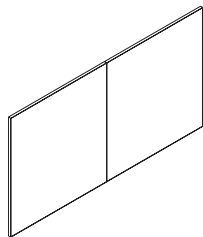

GALLERY PANELS

<p>How to specify — Select the Model Number from above.</p>	<p>1st Option: FSC: F FSC Wood X Non-FSC Wood</p>	<p>2nd Option: Laminate: See page 292 for finishes.</p>	<p>3rd Option: Edge: See page 292 for finishes.</p>	<p>4th Option: Grain: VLG Horizontal grain or Solid only. VST Vertical Grain (available only for single panels 60"W or less, and for split panels between 87"W and 117"W).</p>	<p>5th Option: Glide:</p>
G . .				V .	G .

Examples: G5718.X.LT11.TI.VLG.G GS5787.F.LLA1.TI.VST.G

Gallery Panels

30"H Application for Use with Glass

For Gallery Panel Glass see page 334.
For Gallery Panel connectors see pages 332-333.

GSA SIN 33721

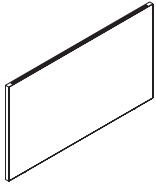

Description	Model	Configuration	List Price			Accepts Glass Models
			L1	L2	L3	7½"H, 13"H, 15"H
30"H Gallery Panels with Glass						
18"W	G3018G	Mid	\$ 638	\$ 661	\$ 683	G4 □□ 15GS
21"W	G3021G	Mid	\$ 654	\$ 677	\$ 701	G4 □□ 18GS
24"W	G3024G	Mid	\$ 683	\$ 707	\$ 732	G4 □□ 21GS
27"W	G3027G	Mid	\$ 716	\$ 741	\$ 767	G4 □□ 24GS
30"W	G3030G	Mid	\$ 788	\$ 816	\$ 844	G4 □□ 27GS
33"W	G3033G	S, Mid	\$ 822	\$ 851	\$ 880	G4 □□ 30GS
36"W	G3036G	S, Mid	\$ 852	\$ 882	\$ 913	G4 □□ 33GS
39"W	G3039G	S, Mid	\$ 906	\$ 938	\$ 970	G4 □□ 36GS
42"W	G3042G	S, Mid	\$ 961	\$ 995	\$ 1029	G4 □□ 39GS
45"W	G3045G	S, Mid	\$ 1029	\$ 1066	\$ 1102	G4 □□ 42GS
48"W	G3048G	S, Mid	\$ 1068	\$ 1106	\$ 1144	G4 □□ 45GS
51"W	G3051G	D, S, Mid	\$ 1083	\$ 1121	\$ 1160	G4 □□ 48GS
54"W	G3054G	D, S, Mid	\$ 1125	\$ 1165	\$ 1205	G4 □□ 51GS
57"W	G3057G	D, S, Mid	\$ 1165	\$ 1206	\$ 1248	G4 □□ 54GS
60"W	G3060G	D, S, Mid	\$ 1210	\$ 1253	\$ 1296	G4 □□ 57GS
63"W	G3063G	D, S, Mid	\$ 1227	\$ 1271	\$ 1314	G4 □□ 60GS
66"W	G3066G	D, S, Mid	\$ 1249	\$ 1293	\$ 1338	G4 □□ 63GS
69"W	G3069G	D, S, Mid	\$ 1324	\$ 1371	\$ 1418	G4 □□ 66GS
72"W	G3072G	D, S, Mid	\$ 1356	\$ 1404	\$ 1452	G4 □□ 69GS
75"W	G3075G	D, S, Mid	\$ 1507	\$ 1561	\$ 1614	G4 □□ 72GS
78"W	G3078G	D, S, Mid	\$ 1560	\$ 1615	\$ 1671	G4 □□ 75GS
81"W	G3081G	D, S, Mid	\$ 1607	\$ 1664	\$ 1721	G4 □□ 78GS
84"W	G3084G	D, S, Mid	\$ 1742	\$ 1804	\$ 1866	G4 □□ 81GS

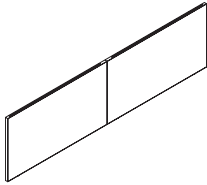

30"H Gallery Split Panels with Glass <i>(corresponding glass models must be ordered in quantities of 2 for split panels)</i>						
81"W	GS3081G	D	\$ 1523	\$ 1580	\$ 1637	G4 □□ 36GS
87"W	GS3087G	D	\$ 1810	\$ 1874	\$ 1939	G4 □□ 39GS
93"W	GS3093G	D	\$ 1861	\$ 1927	\$ 1993	G4 □□ 42GS
99"W	GS3099G	D	\$ 1881	\$ 1948	\$ 2015	G4 □□ 45GS
105"W	GS30105G	D	\$ 1911	\$ 1979	\$ 2047	G4 □□ 48GS
111"W	GS30111G	D	\$ 1994	\$ 2065	\$ 2136	G4 □□ 51GS
117"W	GS30117G	D	\$ 2042	\$ 2114	\$ 2187	G4 □□ 54GS
123"W	GS30123G	D	\$ 2057	\$ 2130	\$ 2203	G4 □□ 57GS
129"W	GS30129G	D	\$ 2100	\$ 2175	\$ 2249	G4 □□ 60GS
135"W	GS30135G	D	\$ 2178	\$ 2255	\$ 2333	G4 □□ 63GS
141"W	GS30141G	D	\$ 2269	\$ 2349	\$ 2430	G4 □□ 66GS
147"W	GS30147G	D	\$ 2369	\$ 2453	\$ 2537	G4 □□ 69GS

Note: Configuration is not included in model number

- Mid** Mid Panel
- S** End Single Sided
- D** End Dual Sided

Note: Fill in model number blanks with one of the following options to determine glass height.

- 07** 7.5"H glass
- 13** 13"H glass
- 15** 15"H glass

GALLERY PANELS

How to specify — Select the Model Number from above.	1st Option: FSC: F FSC Wood X Non-FSC Wood	2nd Option: Laminate: See page 292 for finishes.	3rd Option: Edge: See page 292 for finishes.	4th Option: Grain: VLG Horizontal grain or Solid only. VST Vertical Grain (available only for single panels 60"W or less, and for split panels between 87"W and 117"W).	5th Option: Glide: G
G 	V .	G .

Examples: G3018G.X.LT11.TI.VLG.G GS3087G.F.LLA1.TI.VST.G

Gallery Panels

35"H Application for Use with Glass

For Gallery Panel Glass see page 334.
For Gallery Panel connectors see pages 332-333.

GSA SIN 33721

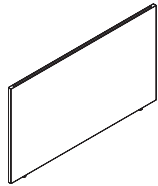

Description	Model	Configuration	List Price			Accepts Glass Models 7½"H, 13"H, 15"H
			L1	L2	L3	
35"H Gallery Panels with Glass						
18"W	G3518G	Mid	\$ 718	\$ 744	\$ 770	G4 □□ 15GS
21"W	G3521G	Mid	\$ 735	\$ 762	\$ 789	G4 □□ 18GS
24"W	G3524G	Mid	\$ 768	\$ 796	\$ 824	G4 □□ 21GS
27"W	G3527G	Mid	\$ 799	\$ 828	\$ 857	G4 □□ 24GS
30"W	G3530G	Mid	\$ 890	\$ 923	\$ 955	G4 □□ 27GS
33"W	G3533G	S, Mid	\$ 927	\$ 961	\$ 994	G4 □□ 30GS
36"W	G3536G	S, Mid	\$ 970	\$ 1006	\$ 1041	G4 □□ 33GS
39"W	G3539G	S, Mid	\$ 1023	\$ 1060	\$ 1097	G4 □□ 36GS
42"W	G3542G	S, Mid	\$ 1058	\$ 1097	\$ 1135	G4 □□ 39GS
45"W	G3545G	S, Mid	\$ 1110	\$ 1151	\$ 1191	G4 □□ 42GS
48"W	G3548G	S, Mid	\$ 1146	\$ 1188	\$ 1229	G4 □□ 45GS
51"W	G3551G	D, S, Mid	\$ 1178	\$ 1221	\$ 1264	G4 □□ 48GS
54"W	G3554G	D, S, Mid	\$ 1217	\$ 1261	\$ 1305	G4 □□ 51GS
57"W	G3557G	D, S, Mid	\$ 1249	\$ 1295	\$ 1340	G4 □□ 54GS
60"W	G3560G	D, S, Mid	\$ 1293	\$ 1340	\$ 1387	G4 □□ 57GS
63"W	G3563G	D, S, Mid	\$ 1316	\$ 1364	\$ 1412	G4 □□ 60GS
66"W	G3566G	D, S, Mid	\$ 1348	\$ 1397	\$ 1446	G4 □□ 63GS
69"W	G3569G	D, S, Mid	\$ 1398	\$ 1449	\$ 1499	G4 □□ 66GS
72"W	G3572G	D, S, Mid	\$ 1449	\$ 1502	\$ 1554	G4 □□ 69GS
75"W	G3575G	D, S, Mid	\$ 1546	\$ 1602	\$ 1658	G4 □□ 72GS
78"W	G3578G	D, S, Mid	\$ 1615	\$ 1674	\$ 1732	G4 □□ 75GS
81"W	G3581G	D, S, Mid	\$ 1729	\$ 1792	\$ 1854	G4 □□ 78GS
84"W	G3584G	D, S, Mid	\$ 1873	\$ 1941	\$ 2009	G4 □□ 81GS

35"H Gallery Split Panels with Glass (corresponding glass models must be ordered in quantities of 2 for split panels)

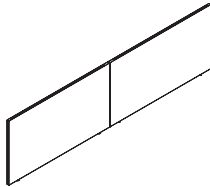

81"W	GS3581G	D	\$ 1671	\$ 1734	\$ 1796	G4 □□ 36GS
87"W	GS3587G	D	\$ 1937	\$ 2007	\$ 2077	G4 □□ 39GS
93"W	GS3593G	D	\$ 2001	\$ 2074	\$ 2146	G4 □□ 42GS
99"W	GS3599G	D	\$ 2071	\$ 2146	\$ 2221	G4 □□ 45GS
105"W	GS35105G	D	\$ 2098	\$ 2174	\$ 2250	G4 □□ 48GS
111"W	GS35111G	D	\$ 2146	\$ 2224	\$ 2301	G4 □□ 51GS
117"W	GS35117G	D	\$ 2226	\$ 2307	\$ 2387	G4 □□ 54GS
123"W	GS35123G	D	\$ 2278	\$ 2361	\$ 2443	G4 □□ 57GS
129"W	GS35129G	D	\$ 2304	\$ 2388	\$ 2471	G4 □□ 60GS
135"W	GS35135G	D	\$ 2400	\$ 2487	\$ 2574	G4 □□ 63GS
141"W	GS35141G	D	\$ 2484	\$ 2574	\$ 2664	G4 □□ 66GS
147"W	GS35147G	D	\$ 2543	\$ 2635	\$ 2727	G4 □□ 69GS

Note: Configuration is not included in model number

- Mid** Mid Panel
- S** End Single Sided
- D** End Dual Sided

Note: Fill in model number blanks with one of the following options to determine glass height.

- 07** 7.5"H glass
- 13** 13"H glass
- 15** 15"H glass

How to specify — Select the Model Number from above.	1st Option: FSC: F FSC Wood X Non-FSC Wood	2nd Option: Laminate: See page 292 for finishes.	3rd Option: Edge: See page 292 for finishes.	4th Option: Grain: VLG Horizontal grain or Solid only. VST Vertical Grain (available only for single panels 60"W or less, and for split panels between 87"W and 117"W.	5th Option: Glide:
G . .				V .	G .

Examples: G3518G.X.LT11.TI.VLG.G GS3587G.F.LLA11.TI.VST.G

GALLERY PANELS

Gallery Panels

42"H Application for Use with Glass

For Gallery Panel Glass see page 334.
For Gallery Panel connectors see pages 332-333.

GSA SIN 33721

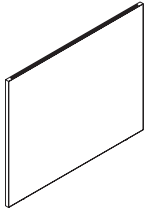

Description	Model	Configuration	List Price			Accepts Glass Models
			L1	L2	L3	7½"H, 13"H, 15"H
42"H Gallery Panels with Glass						
18"W	G4218G	Mid	\$ 782	\$ 810	\$ 838	G4 ▢▢ 15GS
21"W	G4221G	Mid	\$ 796	\$ 824	\$ 853	G4 ▢▢ 18GS
24"W	G4224G	Mid	\$ 837	\$ 867	\$ 897	G4 ▢▢ 21GS
27"W	G4227G	Mid	\$ 874	\$ 905	\$ 936	G4 ▢▢ 24GS
30"W	G4230G	Mid	\$ 974	\$ 1009	\$ 1043	G4 ▢▢ 27GS
33"W	G4233G	S, Mid	\$ 1015	\$ 1051	\$ 1087	G4 ▢▢ 30GS
36"W	G4236G	S, Mid	\$ 1061	\$ 1099	\$ 1136	G4 ▢▢ 33GS
39"W	G4239G	S, Mid	\$ 1122	\$ 1162	\$ 1202	G4 ▢▢ 36GS
42"W	G4242G	S, Mid	\$ 1162	\$ 1203	\$ 1244	G4 ▢▢ 39GS
45"W	G4245G	S, Mid	\$ 1195	\$ 1237	\$ 1280	G4 ▢▢ 42GS
48"W	G4248G	S, Mid	\$ 1235	\$ 1279	\$ 1323	G4 ▢▢ 45GS
51"W	G4251G	D, S, Mid	\$ 1299	\$ 1345	\$ 1391	G4 ▢▢ 48GS
54"W	G4254G	D, S, Mid	\$ 1332	\$ 1379	\$ 1427	G4 ▢▢ 51GS
57"W	G4257G	D, S, Mid	\$ 1362	\$ 1410	\$ 1459	G4 ▢▢ 54GS
60"W	G4260G	D, S, Mid	\$ 1402	\$ 1452	\$ 1502	G4 ▢▢ 57GS
63"W	G4263G	D, S, Mid	\$ 1434	\$ 1485	\$ 1536	G4 ▢▢ 60GS
66"W	G4266G	D, S, Mid	\$ 1474	\$ 1526	\$ 1579	G4 ▢▢ 63GS
69"W	G4269G	D, S, Mid	\$ 1500	\$ 1553	\$ 1606	G4 ▢▢ 66GS
72"W	G4272G	D, S, Mid	\$ 1572	\$ 1628	\$ 1684	G4 ▢▢ 69GS
75"W	G4275G	D, S, Mid	\$ 1620	\$ 1678	\$ 1735	G4 ▢▢ 72GS
78"W	G4278G	D, S, Mid	\$ 1708	\$ 1769	\$ 1829	G4 ▢▢ 75GS
81"W	G4281G	D, S, Mid	\$ 1884	\$ 1951	\$ 2018	G4 ▢▢ 78GS
84"W	G4284G	D, S, Mid	\$ 2012	\$ 2083	\$ 2155	G4 ▢▢ 81GS

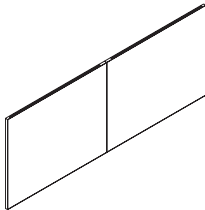

42"H Gallery Split Panels with Glass (corresponding glass models must be ordered in quantities of 2 for split panels)

81"W	GS4281G	D	\$ 1785	\$ 1852	\$ 1919	G4 ▢▢ 36GS
87"W	GS4287G	D	\$ 2046	\$ 2119	\$ 2191	G4 ▢▢ 39GS
93"W	GS4293G	D	\$ 2080	\$ 2154	\$ 2228	G4 ▢▢ 42GS
99"W	GS4299G	D	\$ 2165	\$ 2242	\$ 2319	G4 ▢▢ 45GS
105"W	GS42105G	D	\$ 2195	\$ 2273	\$ 2351	G4 ▢▢ 48GS
111"W	GS42111G	D	\$ 2245	\$ 2325	\$ 2404	G4 ▢▢ 51GS
117"W	GS42117G	D	\$ 2293	\$ 2374	\$ 2456	G4 ▢▢ 54GS
123"W	GS42123G	D	\$ 2344	\$ 2427	\$ 2510	G4 ▢▢ 57GS
129"W	GS42129G	D	\$ 2420	\$ 2506	\$ 2592	G4 ▢▢ 60GS
135"W	GS42135G	D	\$ 2511	\$ 2600	\$ 2689	G4 ▢▢ 63GS
141"W	GS42141G	D	\$ 2597	\$ 2689	\$ 2781	G4 ▢▢ 66GS
147"W	GS42147G	D	\$ 2645	\$ 2739	\$ 2833	G4 ▢▢ 69GS

Note: Configuration is not included in model number

- Mid** Mid Panel
- S** End Single Sided
- D** End Dual Sided

Note: Fill in model number blanks with one of the following options to determine glass height.

- 07** 7.5"H glass
- 13** 13"H glass
- 15** 15"H glass

How to specify — Select the Model Number from above.	1st Option: FSC: F FSC Wood X Non-FSC Wood	2nd Option: Laminate: See page 292 for finishes.	3rd Option: Edge: See page 292 for finishes.	4th Option: Grain: VLG Horizontal grain or Solid only. VST Vertical Grain (available only for single panels 60"W or less, and for split panels between 87"W and 117"W.	5th Option: Glide: G
G . .				V .	G

Examples: G4218G.X.LT11.TI.VLG.G GS4287G.F.LLA1.TI.VST.G

Gallery Panels

50"H Application for Use with Glass

For Gallery Panel Glass see page 334.
For Gallery Panel connectors see pages 332-333.

GSA SIN 33721

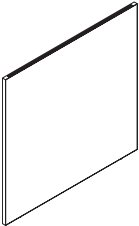

Description	Model	Configuration	List Price			Accepts Glass Models
			L1	L2	L3	7½"H, 13"H, 15"H
50"H Gallery Panels with Glass						
18"W	G5018G	Mid	\$ 879	\$ 910	\$ 941	G4 □□ 15GS
21"W	G5021G	Mid	\$ 898	\$ 930	\$ 962	G4 □□ 18GS
24"W	G5024G	Mid	\$ 931	\$ 964	\$ 997	G4 □□ 21GS
27"W	G5027G	Mid	\$ 971	\$ 1005	\$ 1040	G4 □□ 24GS
30"W	G5030G	Mid	\$ 1058	\$ 1096	\$ 1133	G4 □□ 27GS
33"W	G5033G	S, Mid	\$ 1101	\$ 1140	\$ 1179	G4 □□ 30GS
36"W	G5036G	S, Mid	\$ 1145	\$ 1186	\$ 1226	G4 □□ 33GS
39"W	G5039G	S, Mid	\$ 1203	\$ 1246	\$ 1288	G4 □□ 36GS
42"W	G5042G	S, Mid	\$ 1258	\$ 1303	\$ 1347	G4 □□ 39GS
45"W	G5045G	S, Mid	\$ 1332	\$ 1379	\$ 1427	G4 □□ 42GS
48"W	G5048G	S, Mid	\$ 1362	\$ 1410	\$ 1459	G4 □□ 45GS
51"W	G5051G	D, S, Mid	\$ 1391	\$ 1440	\$ 1490	G4 □□ 48GS
54"W	G5054G	D, S, Mid	\$ 1439	\$ 1490	\$ 1541	G4 □□ 51GS
57"W	G5057G	D, S, Mid	\$ 1471	\$ 1523	\$ 1575	G4 □□ 54GS
60"W	G5060G	D, S, Mid	\$ 1509	\$ 1563	\$ 1616	G4 □□ 57GS
63"W	G5063G	D, S, Mid	\$ 1537	\$ 1592	\$ 1646	G4 □□ 60GS
66"W	G5066G	D, S, Mid	\$ 1575	\$ 1631	\$ 1687	G4 □□ 63GS
69"W	G5069G	D, S, Mid	\$ 1613	\$ 1670	\$ 1727	G4 □□ 66GS
72"W	G5072G	D, S, Mid	\$ 1651	\$ 1710	\$ 1768	G4 □□ 69GS
75"W	G5075G	D, S, Mid	\$ 1747	\$ 1809	\$ 1871	G4 □□ 72GS
78"W	G5078G	D, S, Mid	\$ 1898	\$ 1965	\$ 2033	G4 □□ 75GS
81"W	G5081G	D, S, Mid	\$ 2043	\$ 2115	\$ 2188	G4 □□ 78GS
84"W	G5084G	D, S, Mid	\$ 2167	\$ 2244	\$ 2321	G4 □□ 81GS

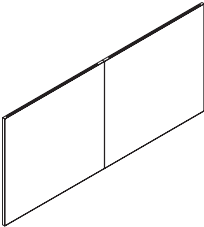

50"H Gallery Split Panels with Glass <i>(corresponding glass models must be ordered in quantities of 2 for split panels)</i>						
81"W	GS5081G	D	\$ 1934	\$ 2006	\$ 2079	G4 □□ 36GS
87"W	GS5087G	D	\$ 2202	\$ 2280	\$ 2358	G4 □□ 39GS
93"W	GS5093G	D	\$ 2304	\$ 2386	\$ 2468	G4 □□ 42GS
99"W	GS5099G	D	\$ 2346	\$ 2429	\$ 2512	G4 □□ 45GS
105"W	GS50105G	D	\$ 2425	\$ 2511	\$ 2597	G4 □□ 48GS
111"W	GS50111G	D	\$ 2455	\$ 2542	\$ 2629	G4 □□ 51GS
117"W	GS50117G	D	\$ 2476	\$ 2564	\$ 2652	G4 □□ 54GS
123"W	GS50123G	D	\$ 2502	\$ 2591	\$ 2679	G4 □□ 57GS
129"W	GS50129G	D	\$ 2563	\$ 2654	\$ 2745	G4 □□ 60GS
135"W	GS50135G	D	\$ 2607	\$ 2699	\$ 2792	G4 □□ 63GS
141"W	GS50141G	D	\$ 2645	\$ 2739	\$ 2833	G4 □□ 66GS
147"W	GS50147G	D	\$ 2735	\$ 2832	\$ 2929	G4 □□ 69GS

Note: Configuration is not included in model number

Mid Mid Panel
S End Single Sided
D End Dual Sided

Note: Fill in model number blanks with one of the following options to determine glass height.

07 7.5"H glass
13 13"H glass
15 15"H glass

<p>How to specify — Select the Model Number from above.</p>	<p>1st Option: FSC: F FSC Wood X Non-FSC Wood</p>	<p>2nd Option: Laminate: See page 292 for finishes.</p>	<p>3rd Option: Edge: See page 292 for finishes.</p>	<p>4th Option: Grain: VLG Horizontal grain or Solid only. VST Vertical Grain (available only for single panels 60"W or less, and for split panels between 87"W and 117"W).</p>	<p>5th Option: Glide:</p>
<p>G . .</p>	<p> .</p>	<p> .</p>	<p>V .</p>	<p>G </p>	

Examples: G5018G.X.LT11.TI.VLG.G GS5087G.F.LLA11.TI.VST.G

Gallery Panels

57½"H Application for Use with Glass

For Gallery Panel Glass see page 334.
For Gallery Panel connectors see pages 332-333.

GSA SIN 33721

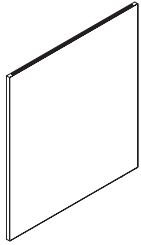

Description	Model	Configuration	List Price			Accepts Glass Models 7½"H, 13"H, 15"H
			L1	L2	L3	
57½"H Gallery Panels with Glass						
18"W	G5718G	Mid	\$ 1024	\$ 1060	\$ 1097	G4 □□ 15GS
21"W	G5721G	Mid	\$ 1043	\$ 1080	\$ 1117	G4 □□ 18GS
24"W	G5724G	Mid	\$ 1076	\$ 1114	\$ 1152	G4 □□ 21GS
27"W	G5727G	Mid	\$ 1113	\$ 1153	\$ 1192	G4 □□ 24GS
30"W	G5730G	Mid	\$ 1202	\$ 1245	\$ 1287	G4 □□ 27GS
33"W	G5733G	S, Mid	\$ 1244	\$ 1288	\$ 1332	G4 □□ 30GS
36"W	G5736G	S, Mid	\$ 1291	\$ 1337	\$ 1383	G4 □□ 33GS
39"W	G5739G	S, Mid	\$ 1347	\$ 1395	\$ 1443	G4 □□ 36GS
42"W	G5742G	S, Mid	\$ 1401	\$ 1451	\$ 1500	G4 □□ 39GS
45"W	G5745G	S, Mid	\$ 1476	\$ 1528	\$ 1581	G4 □□ 42GS
48"W	G5748G	S, Mid	\$ 1505	\$ 1558	\$ 1612	G4 □□ 45GS
51"W	G5751G	D, S, Mid	\$ 1535	\$ 1589	\$ 1644	G4 □□ 48GS
54"W	G5754G	D, S, Mid	\$ 1583	\$ 1639	\$ 1695	G4 □□ 51GS
57"W	G5757G	D, S, Mid	\$ 1615	\$ 1672	\$ 1730	G4 □□ 54GS
60"W	G5760G	D, S, Mid	\$ 1652	\$ 1711	\$ 1769	G4 □□ 57GS
63"W	G5763G	D, S, Mid	\$ 1681	\$ 1741	\$ 1800	G4 □□ 60GS
66"W	G5766G	D, S, Mid	\$ 1717	\$ 1778	\$ 1839	G4 □□ 63GS
69"W	G5769G	D, S, Mid	\$ 1757	\$ 1819	\$ 1882	G4 □□ 66GS
72"W	G5772G	D, S, Mid	\$ 1796	\$ 1860	\$ 1923	G4 □□ 69GS
75"W	G5775G	D, S, Mid	\$ 1890	\$ 1957	\$ 2024	G4 □□ 72GS
78"W	G5778G	D, S, Mid	\$ 2043	\$ 2115	\$ 2188	G4 □□ 75GS
81"W	G5781G	D, S, Mid	\$ 2186	\$ 2264	\$ 2341	G4 □□ 78GS
84"W	G5784G	D, S, Mid	\$ 2312	\$ 2394	\$ 2476	G4 □□ 81GS

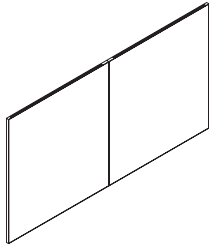

57½"H Gallery Split Panels with Glass (<i>corresponding glass models must be ordered in quantities of 2 for split panels</i>)						
81"W	GS5781G	D	\$ 2069	\$ 2147	\$ 2224	G4 □□ 36GS
87"W	GS5787G	D	\$ 2345	\$ 2428	\$ 2511	G4 □□ 39GS
93"W	GS5793G	D	\$ 2449	\$ 2536	\$ 2623	G4 □□ 42GS
99"W	GS5799G	D	\$ 2490	\$ 2578	\$ 2667	G4 □□ 45GS
105"W	GS57105G	D	\$ 2570	\$ 2661	\$ 2752	G4 □□ 48GS
111"W	GS57111G	D	\$ 2600	\$ 2692	\$ 2784	G4 □□ 51GS
117"W	GS57117G	D	\$ 2621	\$ 2714	\$ 2807	G4 □□ 54GS
123"W	GS57123G	D	\$ 2645	\$ 2739	\$ 2833	G4 □□ 57GS
129"W	GS57129G	D	\$ 2707	\$ 2803	\$ 2899	G4 □□ 60GS
135"W	GS57135G	D	\$ 2751	\$ 2849	\$ 2946	G4 □□ 63GS
141"W	GS57141G	D	\$ 2789	\$ 2888	\$ 2987	G4 □□ 66GS
147"W	GS57147G	D	\$ 2878	\$ 2980	\$ 3082	G4 □□ 69GS

Note: Configuration is not included in model number

- Mid Mid Panel
- S End Single Sided
- D End Dual Sided

Note: Fill in model number blanks with one of the following options to determine glass height.

- 07 7.5"H glass
- 13 13"H glass
- 15 15"H glass

How to specify — Select the Model Number from above.	1st Option: FSC: F FSC Wood X Non-FSC Wood	2nd Option: Laminate: See page 292 for finishes.	3rd Option: Edge: See page 292 for finishes.	4th Option: Grain: VLG Horizontal grain or Solid only. VST Vertical Grain (available only for single panels 60"W or less, and for split panels between 87"W and 117"W.	5th Option: Glide: G
G				V	G

Examples: G5718G.X.LT11.TI.VLG.G GS5787G.F.LLA1.TI.VST.G

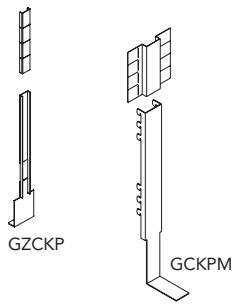

Description	Model	List Price		
		P1	P2	P3
Stride Connector Kit				
End Panel Connector Kit for Stride System	GZCKP	\$ 127	\$ 136	\$ 150
Intermediate Mid connector	GCKPM	\$ 149	\$ 160	\$ 175



Stride Mid-Connector Block and Trim				
30" - Block & Trim	GZ3CON30	\$ 197	\$ 221	\$ 254
35" - Block & Trim	GZ3CON35	\$ 205	\$ 229	\$ 264
42" - Block & Trim	GZ3CON42	\$ 234	\$ 262	\$ 305
50" - Block & Trim	GZ3CON50	\$ 244	\$ 274	\$ 317
57" - Block & Trim	GZ3CON57	\$ 254	\$ 284	\$ 329
65" - Block & Trim	GZ3CON65	\$ 279	\$ 311	\$ 358
72" - Block & Trim	GZ3CON72	\$ 306	\$ 344	\$ 401
80" - Block & Trim	GZ3CON80	\$ 331	\$ 371	\$ 430
87" - Block & Trim	GZ3CON87	\$ 335	\$ 377	\$ 442

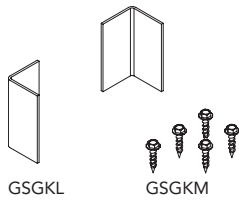

Storage Mounting Brackets				
Gallery Laminate Storage Ganging Kit	GSGKL	\$ 70	N/A	N/A
Gallery Metal Storage Ganging Kit	GSGKM	\$ 16	N/A	N/A

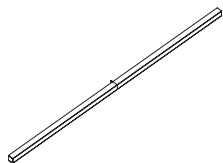

Gallery Panel Stiffener				
Stiffener for 75"W/78"W Panels	GSTFN7578	\$ 159	\$ 171	\$ 189
Stiffener for 81"W/84"W Panels	GSTFN8184	\$ 178	\$ 192	\$ 212

GALLERY PANELS

Shippable by small-package carrier.

<p>How to specify — Select the Model Number from above.</p>	<p><i>1st Option:</i> Paint for Connector Kits and Brackets (if available): P1 P2 P3 See page 292 for finishes.</p>	<p><i>1st Option:</i> Fabric for Cantilevered Storage Accessory: See page 13 for fabrics.</p>	<p><i>2nd Option:</i> Trim Paint for Cantilevered Storage Accessory: P1 P2 P3 See page 292 for finishes.</p>
<p>_____ .</p>	<p>_____</p>	<p>_____ .</p>	<p>P _____</p>

Examples: GZCKP.P71 GCKPM.P71 GZ3CON30.P71 GSGKL GSGKM

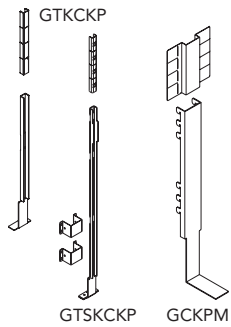

Description	Model	List Price		
		P1	P2	P3
Terrace Connector Kit				
End Panel Connector Kit for Terrace System (black only)	GTKCKP	\$ 127	N/A	N/A
Split Connector Kit (black only)	GTSKCKP	\$ 145	N/A	N/A
Intermediate Mid connector	GCKPM	\$ 149	\$ 160	\$ 175
Panel Glass Kit for 30"H Panel	GTKGK30	\$ 69	N/A	N/A

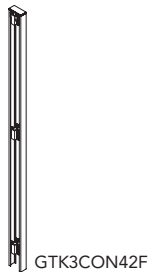

Terrace Connector Kit for Flat Trim				
30" - Flat Trim	GTK3CON30F	\$ 192	\$ 216	\$ 249
35" - Flat Trim	GTK3CON35F	\$ 259	\$ 264	\$ 271
42" - Flat Trim	GTK3CON42F	\$ 314	\$ 328	\$ 257
50" - Flat Trim	GTK3CON50F	\$ 269	\$ 312	\$ 319
57½" - Flat Trim	GTK3CON57F	\$ 331	\$ 340	\$ 356
65" - Flat Trim	GTK3CON65F	\$ 385	\$ 312	\$ 369
72½" - Flat Trim	GTK3CON72F	\$ 400	\$ 409	\$ 420
80" - Flat Trim	GTK3CON80F	\$ 453	\$ 475	\$ 368
87½" - Flat Trim	GTK3CON87F	\$ 330	\$ 353	\$ 389



Terrace Connector Kit for Radius Trim				
30" - Radius Trim	GTK3CON30R	\$ 216	\$ 249	\$ 254
35" - Radius Trim	GTK3CON35R	\$ 264	\$ 271	\$ 283
42" - Radius Trim	GTK3CON42R	\$ 328	\$ 259	\$ 302
50" - Radius Trim	GTK3CON50R	\$ 314	\$ 321	\$ 330
57½" - Radius Trim	GTK3CON57R	\$ 344	\$ 360	\$ 281
65" - Radius Trim	GTK3CON65R	\$ 312	\$ 369	\$ 378
72½" - Radius Trim	GTK3CON72R	\$ 409	\$ 420	\$ 440
80" - Radius Trim	GTK3CON80R	\$ 475	\$ 348	\$ 381
87½" - Radius Trim	GTK3CON87R	\$ 330	\$ 353	\$ 389

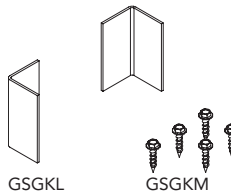

Storage Mounting Brackets				
Gallery Laminate Storage Ganging Kit	GSGKL	\$ 70	N/A	N/A
Gallery Metal Storage Ganging Kit	GSGKM	\$ 16	N/A	N/A

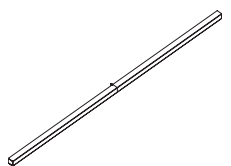

Gallery Panel Stiffener				
Stiffener for 75"W/78"W Panels	GSTFN7578	\$ 159	\$ 171	\$ 189
Stiffener for 81"W/84"W Panels	GSTFN8184	\$ 178	\$ 192	\$ 212

GALLERY PANELS

Shippable by small-package carrier.

<p>How to specify — Select the Model Number from above.</p>	<p><i>1st Option:</i> Paint for Connector Kits and Brackets (if available): P1 P2 P3 See page 292 for finishes.</p>	<p><i>1st Option:</i> Fabric for Cantilevered Storage Accessory: See page 13 for fabrics.</p>	<p><i>2nd Option:</i> Trim Paint for Cantilevered Storage Accessory: P1 P2 P3 See page 292 for finishes.</p>
--	--	--	---

Examples: GTKCKP.P71 GCKPM.P71 GT3CON30F.PJW GSGKL GSGKM

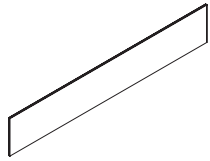

Description	Model	List Price		
		Clear Glass	Frosted Glass	Smoked Glass
7½"H Gallery Glass — Single Panel				
15"W	G40715GS	\$ 177	\$ 195	\$ 201
18"W	G40718GS	\$ 182	\$ 201	\$ 207
21"W	G40721GS	\$ 186	\$ 205	\$ 212
24"W	G40724GS	\$ 189	\$ 209	\$ 215
27"W	G40727GS	\$ 205	\$ 226	\$ 233
30"W	G40730GS	\$ 220	\$ 243	\$ 250
33"W	G40733GS	\$ 241	\$ 266	\$ 274
36"W	G40736GS	\$ 272	\$ 300	\$ 309
39"W	G40739GS	\$ 294	\$ 324	\$ 335
42"W	G40742GS	\$ 330	\$ 364	\$ 375
45"W	G40745GS	\$ 358	\$ 395	\$ 407
48"W	G40748GS	\$ 390	\$ 430	\$ 443
51"W	G40751GS	\$ 399	\$ 440	\$ 454
54"W	G40754GS	\$ 431	\$ 475	\$ 490
57"W	G40757GS	\$ 477	\$ 526	\$ 542
60"W	G40760GS	\$ 560	\$ 617	\$ 637
63"W	G40763GS	\$ 650	\$ 717	\$ 739
66"W	G40766GS	\$ 703	\$ 775	\$ 799
69"W	G40769GS	\$ 770	\$ 849	\$ 875
72"W	G40772GS	\$ 824	\$ 909	\$ 937
75"W	G40775GS	\$ 880	\$ 970	\$ 1001
78"W	G40778GS	\$ 970	\$ 1069	\$ 1103
81"W	G40781GS	\$ 1019	\$ 1124	\$ 1158

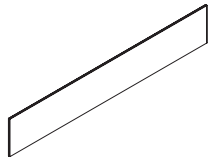

7½"H Gallery Glass — Split Panels (order quantity must be in multiples of 2)				
39"W	G40739GS	\$ 294	\$ 324	\$ 335
42"W	G40742GS	\$ 330	\$ 364	\$ 375
45"W	G40745GS	\$ 358	\$ 395	\$ 407
48"W	G40748GS	\$ 390	\$ 430	\$ 443
51"W	G40751GS	\$ 399	\$ 440	\$ 454
54"W	G40754GS	\$ 431	\$ 475	\$ 490
57"W	G40757GS	\$ 477	\$ 526	\$ 542
60"W	G40760GS	\$ 560	\$ 617	\$ 637
63"W	G40763GS	\$ 650	\$ 717	\$ 739
66"W	G40766GS	\$ 703	\$ 775	\$ 799
69"W	G40769GS	\$ 770	\$ 849	\$ 875

GALLERY PANELS

How to specify —
Select the Model Number from above.

1st Option:

Glass:

- LC Clear Glass
- LF Frosted Glass
- GSM1 Smoked Glass

G 4 0 7 | | | | | .

| | | | | .

Examples: G40715GS.LC G40739GS.GSM1

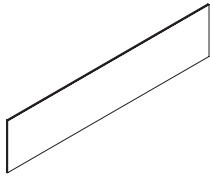

Description	Model	List Price		
		Clear Glass	Frosted Glass	Smoked Glass
13"H Gallery Glass — Single Panel				
24"W	G41324GS	\$ 461	\$ 511	\$ 527
27"W	G41327GS	\$ 502	\$ 556	\$ 574
30"W	G41330GS	\$ 539	\$ 597	\$ 616
33"W	G41333GS	\$ 568	\$ 629	\$ 650
36"W	G41336GS	\$ 601	\$ 666	\$ 687
39"W	G41339GS	\$ 649	\$ 719	\$ 742
42"W	G41342GS	\$ 670	\$ 742	\$ 766
45"W	G41345GS	\$ 684	\$ 758	\$ 782
48"W	G41348GS	\$ 707	\$ 783	\$ 808
51"W	G41351GS	\$ 719	\$ 796	\$ 822
54"W	G41354GS	\$ 769	\$ 852	\$ 879
57"W	G41357GS	\$ 788	\$ 873	\$ 901
60"W	G41360GS	\$ 810	\$ 897	\$ 926
63"W	G41363GS	\$ 867	\$ 960	\$ 991
66"W	G41366GS	\$ 941	\$ 1042	\$ 1076
69"W	G41369GS	\$ 995	\$ 1102	\$ 1138
72"W	G41372GS	\$ 1067	\$ 1182	\$ 1220
75"W	G41375GS	\$ 1146	\$ 1269	\$ 1310
78"W	G41378GS	\$ 1219	\$ 1350	\$ 1394
81"W	G41381GS	\$ 1287	\$ 1425	\$ 1471

13"H Gallery Glass — Split Panels *(order quantity must be in multiples of 2)*

39"W	G41339GS	\$ 649	\$ 719	\$ 742
42"W	G41342GS	\$ 670	\$ 742	\$ 766
45"W	G41345GS	\$ 684	\$ 758	\$ 782
48"W	G41348GS	\$ 707	\$ 783	\$ 808
51"W	G41351GS	\$ 719	\$ 796	\$ 822
54"W	G41354GS	\$ 769	\$ 852	\$ 879
57"W	G41357GS	\$ 788	\$ 873	\$ 901
60"W	G41360GS	\$ 810	\$ 897	\$ 926
63"W	G41363GS	\$ 867	\$ 960	\$ 991
66"W	G41366GS	\$ 941	\$ 1042	\$ 1076
69"W	G41369GS	\$ 995	\$ 1102	\$ 1138

<p>How to specify — Select the Model Number from above.</p>	<p>1st Option: Glass: LC Clear Glass LF Frosted Glass GSM1 Smoked Glass</p>
<p>G 4 1 3 .</p>	<p> .</p>

Examples: G41324GS.LC G41339GS.GSM1

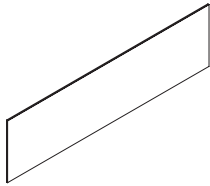

Description	Model	List Price		
		Clear Glass	Frosted Glass	Smoked Glass
15"H Gallery Glass — Single Panel				
15"W	G41515GS	\$ 481	\$ 533	\$ 550
18"W	G41518GS	\$ 502	\$ 556	\$ 574
21"W	G41521GS	\$ 526	\$ 583	\$ 601
24"W	G41524GS	\$ 553	\$ 612	\$ 632
27"W	G41527GS	\$ 570	\$ 631	\$ 652
30"W	G41530GS	\$ 594	\$ 658	\$ 679
33"W	G41533GS	\$ 622	\$ 689	\$ 711
36"W	G41536GS	\$ 679	\$ 752	\$ 776
39"W	G41539GS	\$ 710	\$ 786	\$ 812
42"W	G41542GS	\$ 728	\$ 806	\$ 832
45"W	G41545GS	\$ 741	\$ 821	\$ 847
48"W	G41548GS	\$ 759	\$ 841	\$ 868
51"W	G41551GS	\$ 775	\$ 858	\$ 886
54"W	G41554GS	\$ 825	\$ 914	\$ 943
57"W	G41557GS	\$ 835	\$ 925	\$ 955
60"W	G41560GS	\$ 843	\$ 934	\$ 964
63"W	G41563GS	\$ 894	\$ 990	\$ 1022
66"W	G41566GS	\$ 969	\$ 1073	\$ 1108
69"W	G41569GS	\$ 1019	\$ 1129	\$ 1165
72"W	G41572GS	\$ 1089	\$ 1206	\$ 1245
75"W	G41575GS	\$ 1176	\$ 1302	\$ 1345
78"W	G41578GS	\$ 1239	\$ 1372	\$ 1416
81"W	G41581GS	\$ 1313	\$ 1454	\$ 1501

15"H Gallery Glass — Split Panels *(order quantity must be in multiples of 2)*

39"W	G41539GS	\$ 710	\$ 786	\$ 812
42"W	G41542GS	\$ 728	\$ 806	\$ 832
45"W	G41545GS	\$ 741	\$ 821	\$ 847
48"W	G41548GS	\$ 759	\$ 841	\$ 868
51"W	G41551GS	\$ 775	\$ 858	\$ 886
54"W	G41554GS	\$ 825	\$ 914	\$ 943
57"W	G41557GS	\$ 835	\$ 925	\$ 955
60"W	G41560GS	\$ 843	\$ 934	\$ 964
63"W	G41563GS	\$ 894	\$ 990	\$ 1022
66"W	G41566GS	\$ 969	\$ 1073	\$ 1108
69"W	G41569GS	\$ 1019	\$ 1129	\$ 1165

GALLERY PANELS

How to specify —
Select the Model Number from above.

1st Option:

Glass:

- LC Clear Glass
- LF Frosted Glass
- GSM1 Smoked Glass

G 4 1 5 | | | | | .

| | | | | .

Examples: G41515GS.LC G41539GS.GSM1

GSA SIN Pending

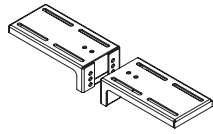

GCTKS

Description	Model	P1 List Price	P2 List Price	P3 List Price
Countertop Bracket				
Countertop Connector Bracket	GCTKS	\$ 106	\$ 111	\$ 115

Note: 2 brackets needed for straight countertops, 3 brackets are needed for corner countertops

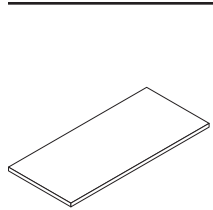

Description	Laminate w/Flat Edge Model	Laminate w/Flat Edge		
		L1 List Price	L2 List Price	L3 List Price
Straight Countertops — must order 2 sets of brackets per surface				
24"W x 15"D	851524M	\$ 344	\$ 359	\$ 371
30"W x 15"D	851530M	\$ 381	\$ 397	\$ 410
36"W x 15"D	851536M	\$ 428	\$ 445	\$ 460
42"W x 15"D	851542M	\$ 444	\$ 461	\$ 477
48"W x 15"D	851548M	\$ 469	\$ 487	\$ 503
54"W x 15"D	851554M	\$ 532	\$ 552	\$ 569
60"W x 15"D	851560M	\$ 593	\$ 610	\$ 625
66"W x 15"D	851566M	\$ 614	\$ 639	\$ 656
72"W x 15"D	851572M	\$ 639	\$ 665	\$ 682



Corner Countertops 15"D at ends — must order 3 sets of brackets per surface				
24"W x 24"W	852424M	\$ 671	\$ 698	\$ 716
30"W x 30"W	853030M	\$ 780	\$ 810	\$ 832
36"W x 36"W	853636M	\$ 866	\$ 898	\$ 924
42"W x 42"W	854242M	\$ 940	\$ 974	\$ 1004



Flat Edge



Description	Model	P1 List Price	P2 List Price	P3 List Price
Gallery Panel Wall Start				
30"H Wall Start	GWS30	\$ 109	\$ 114	\$ 118
35"H Wall Start	GWS35	\$ 124	\$ 129	\$ 135
42"H Wall Start	GWS42	\$ 135	\$ 141	\$ 146
50"H Wall Start	GWS50	\$ 155	\$ 162	\$ 168
57½"H Wall Start	GWS57	\$ 167	\$ 174	\$ 181

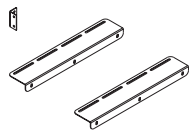

Worksurface Mounting Bracket Kit				
Worksurface Mounting Bracket	GWSBK	\$ 70		

Note: Ships with 2 brackets.

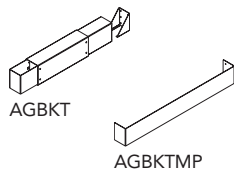

HAT Bracket				
HAT to Gallery Panel Bracket T-Leg	AGBKT (shown)	\$ 227	\$ 246	\$ 271
HAT to Gallery Panel Bracket C-Leg	AGBKC	\$ 227	\$ 246	\$ 271
HAT to Gallery Panel Installation Template (Black only, code P)	AGBKTMP (shown)	\$ 55		

How to specify —
Select the
Model Number
from above.

1st Option:

Paint:

P1 P2 P3

See page 292 for finishes.

Example: AGBKT.PJW

GSA SIN Pending

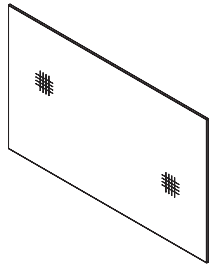

Description	Model	P1 List Price	P2 List Price	P3 List Price
Tackboards				
Tackboard 15"H x 24"W	GTB1524	\$ 309	\$ 322	\$ 335
Tackboard 15"H x 30"W	GTB1530	\$ 336	\$ 350	\$ 364
Tackboard 15"H x 36"W	GTB1536	\$ 372	\$ 388	\$ 404
Tackboard 15"H x 42"W	GTB1542	\$ 388	\$ 404	\$ 421
Tackboard 15"H x 48"W	GTB1548	\$ 396	\$ 413	\$ 430
Tackboard 15"H x 54"W	GTB1554	\$ 415	\$ 433	\$ 450
Tackboard 15"H x 60"W	GTB1560	\$ 421	\$ 439	\$ 457
Tackboard 22.5"H x 24"W	GTB2224	\$ 348	\$ 363	\$ 377
Tackboard 22.5"H x 30"W	GTB2230	\$ 378	\$ 394	\$ 410
Tackboard 22.5"H x 36"W	GTB2236 (shown)	\$ 412	\$ 429	\$ 447
Tackboard 22.5"H x 42"W	GTB2242	\$ 421	\$ 439	\$ 457
Tackboard 22.5"H x 48"W	GTB2248	\$ 454	\$ 473	\$ 492
Tackboard 22.5"H x 54"W	GTB2254	\$ 477	\$ 497	\$ 517
Tackboard 22.5"H x 60"W	GTB2260	\$ 490	\$ 511	\$ 532

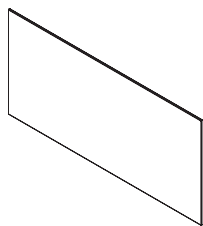

Magnet/Marker Boards				
Magnet/Marker Board 15"H x 24"W	GMB1524	\$ 409	\$ 426	\$ 444
Magnet/Marker Board 15"H x 30"W	GMB1530	\$ 441	\$ 460	\$ 478
Magnet/Marker Board 15"H x 36"W	GMB1536	\$ 470	\$ 490	\$ 510
Magnet/Marker Board 15"H x 42"W	GMB1542	\$ 493	\$ 514	\$ 535
Magnet/Marker Board 15"H x 48"W	GMB1548	\$ 517	\$ 539	\$ 561
Magnet/Marker Board 15"H x 54"W	GMB1554	\$ 532	\$ 555	\$ 577
Magnet/Marker Board 15"H x 60"W	GMB1560	\$ 562	\$ 586	\$ 610
Magnet/Marker Board 22.5"H x 24"W	GMB2224	\$ 504	\$ 525	\$ 547
Magnet/Marker Board 22.5"H x 30"W	GMB2230	\$ 530	\$ 552	\$ 575
Magnet/Marker Board 22.5"H x 36"W	GMB2236	\$ 551	\$ 574	\$ 598
Magnet/Marker Board 22.5"H x 42"W	GMB2242	\$ 578	\$ 602	\$ 627
Magnet/Marker Board 22.5"H x 48"W	GMB2248 (shown)	\$ 606	\$ 632	\$ 657
Magnet/Marker Board 22.5"H x 54"W	GMB2254	\$ 625	\$ 651	\$ 678
Magnet/Marker Board 22.5"H x 60"W	GMB2260	\$ 647	\$ 674	\$ 702

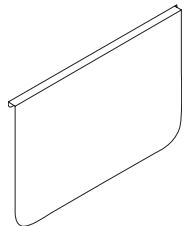

Hanging Magnet/Marker Boards & Blotter				
Hanging Magnet/Marker Board or Blotter 20"H x 30"W	GHMB2030 (shown)	\$ 321	\$ 335	\$ 348
Hanging Magnet/Marker Board or Blotter 26"H x 30"W	GHMB2630	\$ 447	\$ 466	\$ 485

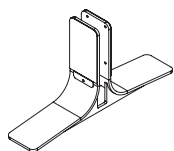

Gallery Panel Foot				
Gallery Panel Foot (Single)	GFT1	\$ 305	\$ 318	\$ 331
Gallery Panel Foot (Dual)	GFT2	\$ 611	\$ 637	\$ 663

Note: Available in textured paint only

<p>How to specify — Select the Model Number from above.</p> <p>G .</p>	<p>1st Option: Paint: P1 P2 P3 See page 292 for finishes.</p> <p> .</p>	<p>2nd Option: Fabric (if applicable): See page 293 for fabrics.</p> <p> .</p>
--	--	---

Example: GHMB2630.MKP

GSA SIN Pending

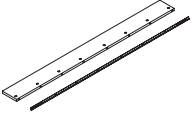
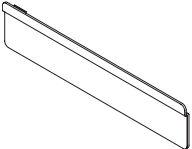
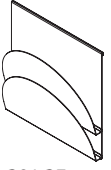
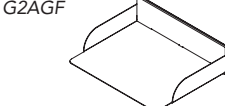
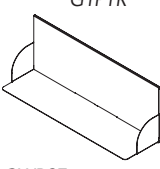
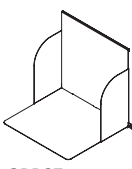
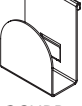
	Description	Model	L1 List Price	L2 List Price	L3 List Price
	Laminate Floating Shelves				
	12"W Floating Shelf	GSTF12	\$ 239	\$ 249	\$ 259
	18"W Floating Shelf	GSTF18	\$ 266	\$ 277	\$ 289
	24"W Floating Shelf	GSTF24	\$ 292	\$ 304	\$ 317
	30"W Floating Shelf	GSTF30	\$ 319	\$ 333	\$ 346
	36"W Floating Shelf	GSTF36	\$ 346	\$ 361	\$ 375
	42"W Floating Shelf	GSTF42	\$ 372	\$ 388	\$ 404
	48"W Floating Shelf	GSTF48	\$ 399	\$ 416	\$ 433
	54"W Floating Stiffener Shelf	GSTF54	\$ 425	\$ 443	\$ 461
	60"W Floating Stiffener Shelf	GSTF60	\$ 452	\$ 471	\$ 490
	66"W Floating Stiffener Shelf	GSTF66 (shown)	\$ 479	\$ 499	\$ 520
72"W Floating Stiffener Shelf	GSTF72	\$ 504	\$ 525	\$ 547	
78"W Floating Stiffener Shelf	GSTF78	\$ 532	\$ 555	\$ 577	
     	Accessory Rail & Paper Management				
	Gallery Panel 12"W Accessory Rail	GACRL12 (shown)	\$ 210	\$ 219	\$ 228
	Gallery Panel 18"W Accessory Rail	GACRL18	\$ 224	\$ 234	\$ 243
	Gallery Panel 24"W Accessory Rail	GACRL24	\$ 226	\$ 236	\$ 245
	Gallery Panel 30"W Accessory Rail	GACRL30	\$ 239	\$ 249	\$ 259
	Gallery Panel 36"W Accessory Rail	GACRL36	\$ 251	\$ 262	\$ 272
	Triple Angle File	G3AGF	\$ 199	\$ 207	\$ 216
	Double Angle File	G2AGF (shown)	\$ 167	\$ 174	\$ 181
	Single Angle File	G1AGF	\$ 136	\$ 142	\$ 148
	Triple Paper Tray	G3PTR	\$ 199	\$ 207	\$ 216
	Double Paper Tray	G2PTR	\$ 167	\$ 174	\$ 181
	Single Paper Tray	G1PTR (shown)	\$ 136	\$ 142	\$ 148
	Personal Shelf	GWPSF (shown)	\$ 167	\$ 174	\$ 181
	Binder Shelf	GBRSF (shown)	\$ 167	\$ 174	\$ 181
	Coat Hook Rail-Based	GCHRB (shown)	\$ 67	\$ 70	\$ 73
	Coat Hook Mounted	GCHMT	\$ 79	\$ 82	\$ 86

GALLERY PANELS

How to specify —
Select the Model Number from above.

1st Option:
Paint:
P1 P2 P3
See page 292 for finishes.

Example: GCHMT.PJW

Notes

GALLERY PANELS

- Software support packages furnished to the customer, either by Allsteel® or by another source, which support the sale of Allsteel products are superseded by printed price lists.
- Prices are subject to change without notice. All orders are subject to prices in effect at the time of order.
- Please refer to your Allsteel Dealer Sales and Discount Policies for order placement information, terms and conditions.
- Additional copies of this Specification and Price List are available upon request from Allsteel Literature at 1-866-255-7833.

- Ordering information appears at the bottom of each product page complete with examples on how to specify. Fabric and finish pages are referenced at the bottom of product pages.

This publication is available as an interactive or downloadable PDF at www.allsteeloffice.com.

Questions or Comments?

Please call us at: **888-ALLSTEEL**
888-255-7833

Paint Finishes, Laminates, Eased Edge	342
Fabrics.....	343
Working with Height-Adjustable Tables	344-347
Altitude Height-Adjustable Tops, Bases, & Accessories	348-388
Altitude – A6.....	348-349
Altitude – Basic	350
Worksurfaces for Height-Adjustable Base.....	351-355
Cable Management.....	356
Screens and Power Module.....	357
Altitude - Metal Screens.....	358-359
Power Rail Specifications.....	361-368
Working with Electrical and Data.....	369-373
Power Rail – Electrical Components.....	374-376
A8 Screen Kits.....	377
Metal Screens and Tackboard Accessories	378-379
Power Rails and Accessories	380-383
HAT to Panel Brackets	384-386
Working with Organization Rail & Accessories & Screens.....	387
Worksurface Mounted Rail and Accessories	388

BASE COLORS

GRADE P1

Black	P71
Brownstone	P7D
Cinder	P7Q
Designer White	PJW
Flint	P02
Fossil	P28
Loft	P7B
Muslin	P4J
Nickel	P8L
Parchment	P93
Pebble	P8R
Pewter	P8D
Salt	P8C
Titanium	P8T

GRADE P2

Champagne Metallic	PR5
Gunmetal Metallic	PR3
Night Bronze	P8B
Platinum Metallic	PR2
Silver	PR6

GRADE P3

Bullseye*	PJF
Regatta*	P8M
*** Altitude Basic is only offered in one finish, Silver (SVR)		

POWER RAIL PAINT COLORS

GRADE P1

Black	P71
Brownstone	P7D
Bungalow	P7C
Cinder	P7Q
Designer White	PJW
Flint	P02
Fossil	P28
Loft	P7B
Muslin	P4J
Pebble	P8R
Pewter	P8D
Salt	P8C
Titanium	P8T

GRADE P2

Champagne Metallic	PR5
Gunmetal Metallic	PR3
Night Bronze	P8B
Pyrite	PJE
Silver	PR6
Solar Black	P8X

GRADE P3

Atom	P8S
Blossom***	P8K
Cabernet***	P7T
Conifer***	P8H
Ember	P8P
Ion	P8N
Iris	P8J
Krypton	P8F
Regatta	P8M
Succulent***	P8A

***These colors are intended to be an inspirational option for the trending market. Product application is limited and color availability is approximately two years to coincide with evolving workplace trends.

A8 SCREEN BRACKET PAINT COLORS

GRADE P1

Black	P71
Designer White	PJW

GRADE P2

Silver	PR6
--------	-------	-----

LAMINATES

GRADE L1

SOLID COLORS

Black	P
Brownstone*	LM13
Bungalow*	LM12
Designer White*	LDW1
Flint*	LM16
Fossil Shale*	LEH1
Loft*	LM11
Muslin*	LM15
Titanium*	LTI1

ABSTRACT

Ash	LT3B
Handspun Pearl	LAHP
Handspun Dove	LAHD
Handspun Slate	LAHS
Handspun Chestnut	LAHC
Silver Mesh	LT8D

WOODGRAIN

Belair	LWBA
Bourbon Cherry	H
Field Elm	LWFE
Florence Walnut	LFW1
Kingswood Walnut	LK11
Natural Maple	LWD
NeoWalnut	LNU1
Pinnacle	PINC
Shaker Cherry	LW7C

GRADE L2

Beigewood	LWBE
Fawn Cypress	LFC1
Lowell Ash	LLA1
Mangalore Mango	LMM1
Natural Recon	LNR1
Phantom Charcoal	LPC1
Phantom Ecru	LPE1
Portico Teak	LPT1
Skyline Walnut	LSW1
Veranda Teak	LVT1

GRADE L3

Natural Walnut	LWNW
----------------	-------	------

EASED EDGE LAMINATES

GRADE L1

Designer White	LDW1
Loft	LM11
Natural Maple	LWD

GRADE L2

Natural Recon	LNR1
---------------	-------	------

STRAIGHT/ROUNDED EDGE COLORS

Beigewood	DE
Belair	BA
Black	E4
Bourbon Cherry	H
Brownstone	EY
Bungalow	EX
Designer White	DW
Fawn Cypress	FC
Field Elm	FE
Flint	E9
Florence Walnut	FW
Fossil	EH
Kingswood Walnut	KI
Loft	EV
Lowell Ash	DL
Mangalore Mango	MM
Muslin	EU
Natural Maple	DD
Natural Recon	NR
Natural Walnut	DN
NeoWalnut	NU
Parchment	EN
Phantom Charcoal	PC
Phantom Ecru	PE
Pinnacle	PI
Platinum Metallic	EP
Plyband	PL
Portico Teak	DP
Shaker Cherry	DF
Skyline Walnut	SW
Titanium	TI
Veranda Teak	VT

ELECTRICAL & DATA COMPONENTS

Black	E4
Brownstone	EY
Designer White	DW
Flint	E9
Loft	EV
Muslin	EU
Silver	ES

All of Allsteel's tables are level® - 2 certified to the ANSI/BIFMA e3 Furniture Sustainability Standard. See www.levelcertified.org for more information.

NOTE: Refer to individual product pages for upcharges.

Fabrics

For use with Screen Kits.

GSA Reference Page

GRADE A

NOBLE

Aspen	NBLE14
Bordeaux.....	NBLE01
Brick	NBLE02
Chambray	NBLE10
Clementine	NBLE04
Dawn	NBLE13
Denim	NBLE09
Grass.....	NBLE07
Gunmetal	NBLE15
Harvest	NBLE12
Jade.....	NBLE06
Knight	NBLE17
Mesa	NBLE03
Pacific	NBLE08
Rainforest	NBLE05
Regal.....	NBLE11
Stormy	NBLE16

GRADE D

BLAZER LITE

(100% Pure New Wool)

Haven	PCAMBLT40
Retreat	PCAMBLT39
Solace.....	PCAMBLT70

Altitude height-adjustable bases are available in five styles:

A6

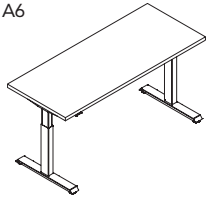

T-leg with
Rectangular Worksurface

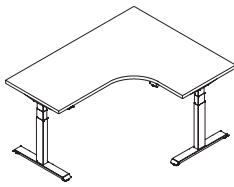

T-leg with
Corner Cove Worksurface

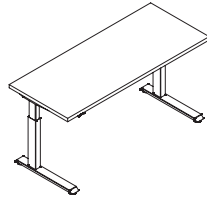

C-leg with
Rectangular Worksurface

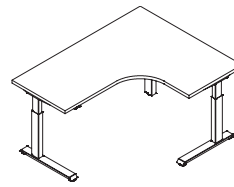

C-leg with
Corner Cove Worksurface

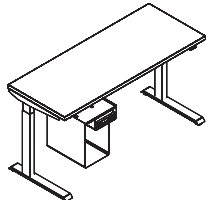

Altitude HAT
with Undermount
Radii Console

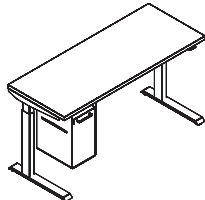

Altitude HAT
with Flush Undermount
Radii

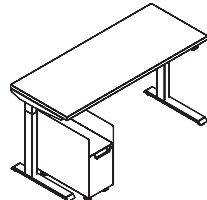

Altitude HAT
with Freestanding Mobile
Alcove Radii

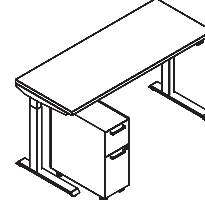

Altitude HAT
with Freestanding Mobile
Alcove Radii

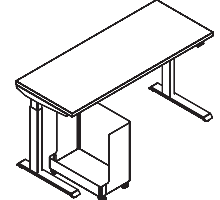

Altitude HAT with
Freestanding Mobile
Radii Caddy

A8 Screens

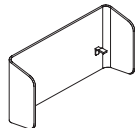

U Screen Kit

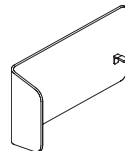

L Screen Kit (Left)

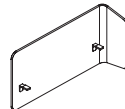

L Screen Kit (Right)

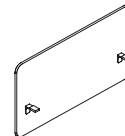

Rectangular Screen Kit

Metal Screens



L Screen (Left)



L Screen (Right)



U Screen

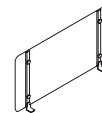

Straight

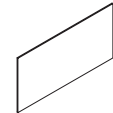

Tackboard Accessory

Altitude Power Rail

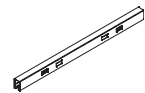

Altitude Power Rail

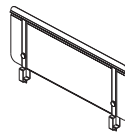

Altitude Rail Screen

A6 Clearance Dimensions

Rectangle

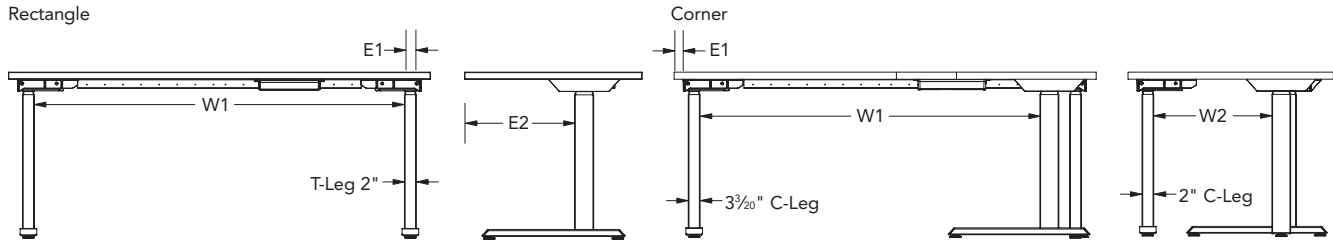

Base Style:	A6-T Base				A6-C Base				
	Dimension Location:	E1	W1	W2	E2	E1	W1	W2	E2
Altitude Top: (Surface dimensions are nominal. Actual widths are reduced by 2")	Edge of table to outside of leg	Between legs	Between legs	Edge of table to the outside of leg	Edge of table to outside of leg	Between legs	Between legs	Edge of table to the outside of leg	
24" x 48" Rectangle*	2½"	35¼"	—	10%"	2½"	35¼"	—	14½"	
24" x 54" Rectangle	2½"	41¼"	—	10%"	2½"	41¼"	—	14½"	
24" x 60" Rectangle	2½"	47¼"	—	10%"	2½"	47¼"	—	14½"	
24" x 66" Rectangle	2½"	53¼"	—	10%"	2½"	53¼"	—	14½"	
24" x 72" Rectangle	2½"	59¼"	—	10%"	2½"	59¼"	—	14½"	
30" x 48" Rectangle	2½"	35¼"	—	13%"	2½"	35¼"	—	17½"	
30" x 54" Rectangle	2½"	41¼"	—	13%"	2½"	41¼"	—	17½"	
30" x 60" Rectangle	2½"	47¼"	—	13%"	2½"	47¼"	—	17½"	
30" x 66" Rectangle	2½"	53¼"	—	13%"	2½"	53¼"	—	17½"	
30" x 72" Rectangle	2½"	59¼"	—	13%"	2½"	59¼"	—	17½"	
60" x 36" Corner Cove	2½"	43"	26"	10%"	2½"	43"	29½"	14½"	
60" x 48" Corner Cove	2½"	43"	32"	10%"	2½"	43"	35½"	14½"	
72" x 36" Corner Cove	2½"	55"	26"	10%"	2½"	55"	29½"	14½"	
72" x 48" Corner Cove	2½"	55"	32"	10%"	2½"	55"	35½"	14½"	

Bottom Views

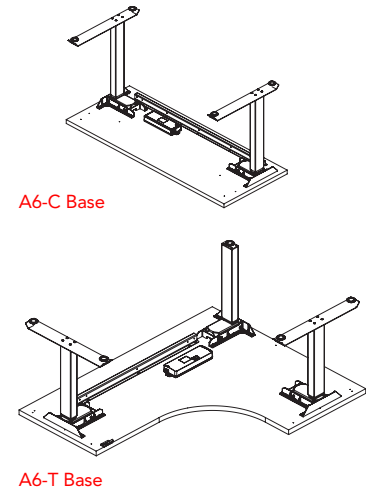

A6-C Base

A6-T Base

Feature	Altitude Basic	A6
Range Adjustment	26¼" – 43¾"H + Adjustable Glide	2-Stage 26½" to 45¾" + ½" Adjustable Glide
Base Only, Without Work Surface		3-Stage 21¼" to 47½" + ½" Adjustable Glide
Range Adjustment	27¾" to 44"H + Adjustable Glide	2-Stage 27¾" to 46¾" + ½" Adjustable Glide
Includes Standard Allsteel 1½" Work Surface		3-Stage 22¾" to 48¾" + ½" Adjustable Glide
Foot Configuration	<ul style="list-style-type: none"> T Foot Standard leveling glide 	<ul style="list-style-type: none"> T Foot or C Foot Standard options include leveling glide, slide glides, and casters Foot Control
Leg Options	2 leg	2 and 3 leg
UL Certified Weight Rating	180 lbs	<ul style="list-style-type: none"> 250 lbs for 2 leg 350 lbs for 2-leg Max 320 lbs for 3-leg 500 lbs for 3-leg Max
Cross Bar Design	Yes	A6 models ordered prior to 4/5/2021 have cross bar understructure, A6 models ordered after 4/5/2021 do not
Colors	Silver Only	20 Allsteel Paint Finishes offered, see Altitude Tables Finishes page
Control Pad	Up/down only	Basic up/down, memory preset, paddle, foot pedal
Wire Management	Allsteel standard options available Hinged trough not recommended	Allsteel standard options available
Power Access	Desktop power modules available	Desktop power modules available
Warranty	5 years	If Purchased Before 3/1/2021: 10 Years Metal Base, 7 Years Electronics If Purchased After 3/1/2021: 10 Years for Entire Product

Height-Adjustable Worksurfaces, Bases, and Controls

Height-Adjustable Worksurfaces (page 351)

- Height-adjustable worksurfaces are available in laminate with flat edge and rectangular veneer with matching square edge.
- T-mold is used on the edge of curved worksurfaces. This will have a noticeable visual difference when directly adjacent to straight worksurfaces.
- Worksurface dimensions are nominal. Actual widths are reduced by 2" (1" each side) and worksurface depths are reduced by ¼". Corner cove depth is nominal, actual is 1" less.
- **Rectangular undersized worksurface models' (model number ending in -U) actual widths and depths are reduced by 2".**
- **Corner Cove undersized worksurface models' (model number ending in -LD) actual dimensions are reduced by 2".**
- Altitude worksurfaces are pre-drilled with mounting location for bases.
- Rectangular worksurface grommet location is limited to center location due to mounting of worksurface supports at each end of the worksurface.
- **A6 load capacity is 250 lbs for 2-leg models, 320 lbs for 3-leg models, 350 lbs for 2-leg Max models, and 500 lbs for 3-leg Max models. This includes the weight of the worksurface.**
- **Certain two-piece top configurations may require two stiffeners depending on the footprint of your station.**

Height-Adjustable Bases (pages 348-349)

- Electronic height-adjustable base units are available in six styles: A6-T Base with 2 legs, A6-C Base with 2 legs, A6-T Base with 3 legs, A6-C Base with 3 legs, A6-T Max Base with 2 legs, A6-C Max Base with 2 legs, **A6-T Max Base with 3 legs, and A6-C Max Base with 3 legs.**
- A6 2-stage 1.2"/sec, A6 3-stage 1.4"/sec, A6 Max .8"/sec. Motor devices have a continuous cycle time of 2 minutes with an 18 minute rest period before it can be cycled again.
- Control box is powered by 110-120V/60Hz/4A. Standby power is < 0.1 Watts. Power cords on A6-T models are 10'.
- Pedestals taller than 24½" for 2-stage models and 19½" for 3-stage models when placed under table will limit range in lowest position.
- Mobile box/file pedestals will clear feet on height adjustable base but will extend past edge of worksurface in that position. See chart on page 345.
- Moving worksurfaces can collide with other components. It is important to ensure free range of motion prior to operating the table.
- All tables have adjustable glides providing ½" adjustment on A6.
- Slide glides offered as a .option and model level. Only available on 2-leg bases.
- **3-Leg standard bases can accommodate worksurface configurations from 24"D x 48"W x 36"W to 30"D x 72"W x 48"W.**
- **3-Leg Max bases can accommodate worksurface configurations from 24"D x 48"W x 36"W to 30"D x 72"W x 72"W.**
- Casters available on model level for retrofitting on 2-Leg Bases ONLY.
- Altitude A6 tables feature **collision detection**, a feature designed to stop table travel when the table detects an obstacle.
- Altitude A6 bases specified with a work surface 60"W and greater require the use of an external stiffener. An external stiffener is included in Altitude work surface models 60"W and greater (all models ending with letter -D). If a non-Altitude work surface is being used, an external stiffener may need to be specified separately.

A6 Control Options

- Memory Controls are now a .option.
- Up/Down: Basic Up/Down control.
- Memory Control: 4 memory pre-set options allow the user to adjust their height to their preferred heights.
- Paddle: Simple, aesthetic control with 1 memory pre-set option and reminder mode.
- Foot Control: Basic up/down wireless, hands free control. Can be paired with hand controls for multi-control option.
- Bluetooth Capability: A6 optional Bluetooth capability is sold as accessory model A6BLUETOOTH. Bluetooth is enabled through smartphone app AiDesk. Bluetooth control will only work with 2-leg A6 tables. Bluetooth control will **not** work with 3-leg A6 tables.

Altitude Basic (page 350)

- Altitude Basic can accommodate either 24"D or 30"D work surfaces
- Altitude Basic can accommodate work surfaces ranging from 48"W to 60"W, 60"W is the maximum work surface size for the Altitude Basic
- Supports weight capacity of 180 lbs.
- Control Box: 100-240V, 3.6A, 50/60Hz, 400W
- 9' grounded power cord
- 1½"/second travel speed
- Available in silver only
- Available with up/down control only
- Features "easy-to-assemble" installation

Foot Controls

- Wireless, hands free control.
- Can be paired with hand control for multi-control option.
- 2 AAA batteries needed. Batteries not included.

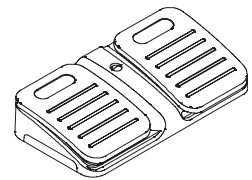

Cross-sectional Area Inside Under Worksurface Troughs

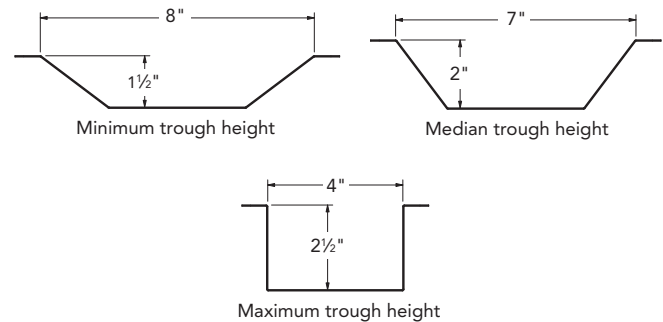

Cable & Wire Management

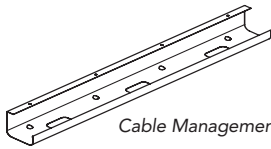

Cable Management Tray

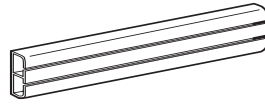

Wire Management Channel

Cable Management Tray (page 356)

- Attaches under the worksurface to contain cables.
- Metal tray shelf is 4" deep. Can hold electrical power strip and/or surge protector.
- 24" and 36" lengths, use multiple units for larger worksurfaces.
- Attachment hardware included, specify paint color.

Wire Management Channel (page 356)

- Self adhesive backing to attach to panels and underside of worksurfaces.
- Flexible strips allow cabling to enter/exit and can be contained inside the 2-cavity profile.
- Each cavity provides space for a maximum of six .22" dia. cables. Total capacity = 1 sq. in.

Cord Management Chain (page 356)

- Works with Approach and Altitude **A6-units**.
- Used to route and conceal power/data cables from control box and other devices. Includes all mounting hardware and a plate to secure to a leveling glide.
- Houses 6 cables @ 0.300" diameter.
- Made of plastic chain with plastic attachment brackets at each end. Only comes in Black finish.

Under Worksurface Trough (page 356)

- Used to conceal wires and control box below worksurfaces. Trough can be configured at various height/width combinations to meet capacity needs — see illustrations below.
- On 48"W and 54"W worksurfaces use one 17"W trough. 54"W has space to use 2 – 17"W, if necessary.
- On 60"W, 66"W, and 72"W worksurfaces use the 36" trough.
- On 84"W worksurface use 2 – 17"W troughs.

Quad Tap (page 356)

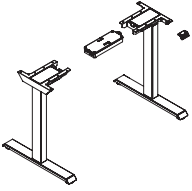
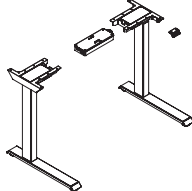
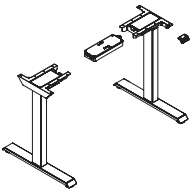
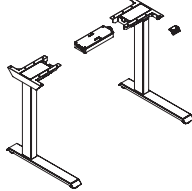
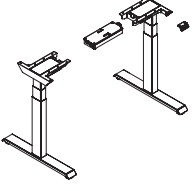
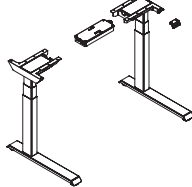

- Under surface mounting, used on any worksurface.
- 10' Power cord. UL Listed
- 4 Simplex receptacles.
- May be used in conjunction with hinged trough to reduce the number of cords routed from a worksurface to a beam.

	Description	Model	List Price		
			P1	P2	P3
	2-Stage				
	2 Stage, 2 Leg Rectangle T Foot	A6REC2S2LTF	\$ 1915	\$ 2068	\$ 2298
	*Bases purchased in April 2021 or later accommodate 24"D-30"D Rectangular Worksurfaces 24"W-72"W, bases purchased prior to this date accommodate 24"D-30"D Rectangular Worksurfaces 48"W-72"W				
	2 Stage, 2 Leg Rectangle C Foot	A6REC2S2LCF	\$ 1915	\$ 2068	\$ 2298
	*Bases purchased in April 2021 or later accommodate 24"D-30"D Rectangular Worksurfaces 24"W-72"W, bases purchased prior to this date accommodate 24"D-30"D Rectangular Worksurfaces 48"W-72"W				
	3-Stage				
	A6 3 Stage, 2 Leg Rectangle T Foot	A6REC3S2LTF	\$ 2148	\$ 2320	\$ 2578
	*Bases purchased in April 2021 or later accommodate 24"D-30"D Rectangular Worksurfaces 24"W-72"W, bases purchased prior to this date accommodate 24"D-30"D Rectangular Worksurfaces 48"W-72"W				
	A6 3 Stage, 2 Leg Rectangle C Foot	A6REC3S2LCF	\$ 2148	\$ 2320	\$ 2578
	*Bases purchased in April 2021 or later accommodate 24"D-30"D Rectangular Worksurfaces 24"W-72"W, bases purchased prior to this date accommodate 24"D-30"D Rectangular Worksurfaces 48"W-72"W				
	A6 Max 3 Stage, 2 Leg T Foot	A6MREC3S2LTF	\$ 2982	\$ 3220	\$ 3579
	*Bases purchased in April 2021 or later accommodate 24"D-30"D Rectangular Worksurfaces 24"W-96"W, bases purchased prior to this date accommodate 24"D-30"D Rectangular Worksurfaces 48"W-96"W *350 LB Max Lift Capacity				
	A6 Max 3 Stage, 2 Leg C Foot	A6MREC3S2LCF	\$ 2982	\$ 3220	\$ 3579
	*Bases purchased in April 2021 or later accommodate 24"D-30"D Rectangular Worksurfaces 24"W-96"W, bases purchased prior to this date accommodate 24"D-30"D Rectangular Worksurfaces 48"W-96"W *350 LB Max Lift Capacity				

ALTITUDE

<p>How to specify — Select the Model Number from above.</p>	<p>1st Option: Select the Base Paint Color (if applicable): P1 P2 P3 See page 342 for paint finishes.</p>	<p>2nd Option: Select Feet Options (if applicable): X Standard Glides S Slide Glides (\$135 extra)</p>	<p>3rd Option: Select the Keypad (if applicable): UD Basic Up/Down MEM Memory Preset PDL Paddle</p>
_____.	_____.	_____.	_____.

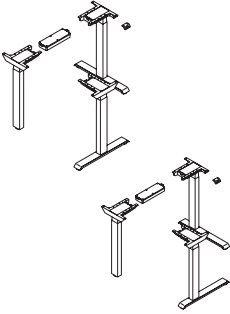
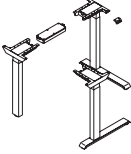
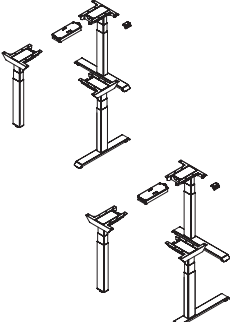
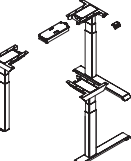
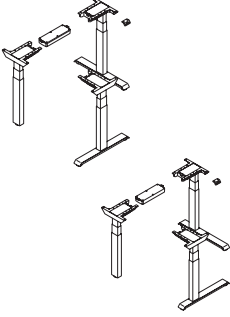
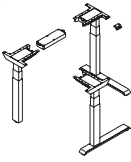
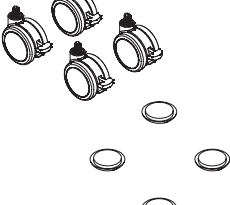
Example: A6RND3S2LCF.P8L.X.PDL

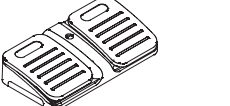
Description	Model	List Price		
		P1	P2	P3
2-Stage				
 A6 2 Stage, 3 Leg Rectangle T Foot	A6REC2S3LTF	\$ 3099	\$ 3409	\$ 3874
 A6 2 Stage, 3 Leg Rectangle C Foot	A6REC2S3LCF	\$ 3099	\$ 3409	\$ 3874
3-Stage				
 A6 3 Stage, 3 Leg Rectangle T Foot	A6REC3S3LTF	\$ 3377	\$ 3647	\$ 4053
*3-leg standard bases can accommodate worksurface configurations from 24"D x 48"W x 36"W to 30"D x 72"W x 48"W.				
 A6 3 Stage, 3 Leg Rectangle C Foot	A6REC3S3LCF	\$ 3377	\$ 3647	\$ 4053
*3-leg standard bases can accommodate worksurface configurations from 24"D x 48"W x 36"W to 30"D x 72"W x 48"W.				
 A6 Max 3 Stage, 3 Leg Rectangle T Foot	A6MREC3S3LTF	\$ 3899	\$ 4289	\$ 4874
*3-Leg Max bases can accommodate worksurface configurations from 24"D x 48"W x 36"W to 30"D x 72"W x 72"W.				
 A6 Max 3 Stage, 3 Leg Rectangle C Foot	A6MREC3S3LCF	\$ 3899	\$ 4289	\$ 4874
*3-Leg Max bases can accommodate worksurface configurations from 24"D x 48"W x 36"W to 30"D x 72"W x 72"W.				
Foot Retrofit Options				
 Casters (Use on 2-leg bases ONLY)	A6CASTER*	\$ 245	N/A	N/A
* A6 casters are intended for use with Allsteel A6 height-adjustable tables. When purchased separately and used without Allsteel furniture, the A6 casters marked by (*) are considered Open Market.				
 Slide Glides (Use on 2-leg bases ONLY)	A6SLDGLIDE	\$ 178	N/A	N/A
Foot Control				
 A6 Wireless Foot Control Pad	A6FOOTCNTL	\$ 319	N/A	N/A
Bluetooth Control				
A6 Bluetooth Accessory	A6BLUETOOTH	\$ 125	N/A	N/A
* Bluetooth control will only work with 2-leg A6 tables. Bluetooth control will not work with 3-leg A6 tables.				

ALTITUDE

<p>How to specify — Select the Model Number from above.</p>	<p>1st Option: Select the Base Paint Color (if applicable): P1 P2 P3 See page 342 for paint finishes.</p>	<p>2nd Option: Select Feet Options (if applicable): X Standard Glides</p>	<p>3rd Option: Select the Keypad (if applicable): UD Basic Up/Down MEM Memory Preset PDL Paddle</p>
--	--	--	--

Example: A6RND3S3LCF.P8L.X.PDL

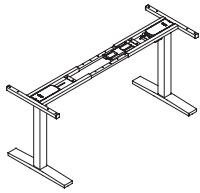

Description	D	W	H	Model
Altitude Basic 2 Stage, 2 Leg T Foot				A2REC2S2L
				\$ 1439

Note: Altitude Basic meets HNI Commercial Performance Standards, Altitude Basic does not meet ANSI/BIFMA performance standard.

ALTITUDE

<p>How to specify — Select the Model Number from above.</p> <p>_____.</p>	<p><i>1st Option:</i> Select the Base Paint Color (if applicable): SVR Silver</p> <p>____.</p>	<p><i>2nd Option:</i> Select Feet Options (if applicable): X Standard Glides</p> <p>_____.</p>	<p><i>3rd Option:</i> Select the Keypad (if applicable): UD Basic Up/Down</p> <p>____.</p>
--	---	---	---

Example: A2REC2S2L.SVR.X.UD

For specification information see page 346.

GSA SIN 33721

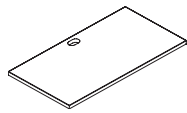

Description	Laminate w/Flat Edge Model	Veneer w/Square Edge Model	Ship Weight	List Price Laminate w/Flat Edge			List Price Veneer w/Square Edge		
				L1	L2	L3	V1	V3	V5
Rectangular Laminate Tops — 24"D (60" to 96" ships with stiffener)									
78"W – 96"W Tops can ONLY be used with Altitude MAX Base									
48"W	AF5RS4824	AVF5RS4824	46	\$ 556	\$ 578	\$ 595	\$ 1856	\$ 2057	\$ 2191
54"W	AF5RS5424	AVF5RS5424	48	\$ 604	\$ 627	\$ 646	\$ 1945	\$ 2156	\$ 2296
60"W	AF5RS6024D	AVF5RS6024D	53	\$ 752	\$ 776	\$ 796	\$ 2152	\$ 2373	\$ 2520
66"W	AF5RS6624D	AVF5RS6624D	74	\$ 779	\$ 804	\$ 824	\$ 2157	\$ 2379	\$ 2526
72"W	AF5RS7224D	AVF5RS7224D	82	\$ 801	\$ 826	\$ 846	\$ 2258	\$ 2488	\$ 2642
78"W	AF5RS7824D		76	\$ 829	\$ 844	\$ 859	—	—	—
84"W	AF5RS8424D		81	\$ 744	\$ 759	\$ 774	—	—	—
90"W	AF5RS9024D		86	\$ 867	\$ 882	\$ 897	—	—	—
96"W	AF5RS9624D		91	\$ 888	\$ 903	\$ 918	—	—	—

Rounded Corner Laminate Tops — 24"D (60" to 96" ships with stiffener)

78"W – 96"W Tops can ONLY be used with Altitude MAX Base

48"W	AF5RND4824		46	\$ 641	\$ 656	\$ 671	—	—	—
54"W	AF5RND5424		48	\$ 695	\$ 710	\$ 725	—	—	—
60"W	AF5RND6024D		53	\$ 847	\$ 862	\$ 877	—	—	—
66"W	AF5RND6624D		78	\$ 892	\$ 907	\$ 922	—	—	—
72"W	AF5RND7224D		85	\$ 921	\$ 936	\$ 951	—	—	—
78"W	AF5RND7824D		76	\$ 951	\$ 966	\$ 981	—	—	—
84"W	AF5RND8424D		81	\$ 871	\$ 886	\$ 901	—	—	—
90"W	AF5RND9024D		86	\$ 997	\$ 1012	\$ 1027	—	—	—
96"W	AF5RND9624D		91	\$ 1019	\$ 1034	\$ 1049	—	—	—

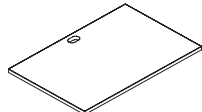

Rectangular Laminate Tops — 30"D (60" to 96" ships with stiffener)

78"W – 96"W Tops can ONLY be used with Altitude MAX Base

48"W	AF5RS4830	AVF5RS4830	52	\$ 626	\$ 649	\$ 669	\$ 2041	\$ 2262	\$ 2409
54"W	AF5RS5430	AVF5RS5430	59	\$ 710	\$ 735	\$ 758	\$ 2132	\$ 2363	\$ 2517
60"W	AF5RS6030D	AVF5RS6030D	63	\$ 841	\$ 868	\$ 889	\$ 2335	\$ 2576	\$ 2737
66"W	AF5RS6630D	AVF5RS6630D	78	\$ 891	\$ 919	\$ 942	\$ 2343	\$ 2585	\$ 2746
72"W	AF5RS7230D	AVF5RS7230D	87	\$ 914	\$ 942	\$ 966	\$ 2440	\$ 2690	\$ 2857
78"W	AF5RS7830D		92	\$ 944	\$ 959	\$ 974	—	—	—
84"W	AF5RS8430D		98	\$ 863	\$ 878	\$ 893	—	—	—
90"W	AF5RS9030D		105	\$ 991	\$ 1006	\$ 1021	—	—	—
96"W	AF5RS9630D		111	\$ 1014	\$ 1029	\$ 1044	—	—	—



Rounded Corner Laminate Tops — 30"D (60" to 96" ships with stiffener)

78"W – 96"W Tops can ONLY be used with Altitude MAX Base

48"W	AF5RND4830		52	\$ 719	\$ 734	\$ 749	—	—	—
54"W	AF5RND5430		59	\$ 815	\$ 830	\$ 845	—	—	—
60"W	AF5RND6030D		63	\$ 953	\$ 968	\$ 983	—	—	—
66"W	AF5RND6630D		82	\$ 1024	\$ 1039	\$ 1054	—	—	—
72"W	AF5RND7230D		90	\$ 1051	\$ 1066	\$ 1081	—	—	—
78"W	AF5RND7830D		92	\$ 1084	\$ 1099	\$ 1114	—	—	—
84"W	AF5RND8430D		98	\$ 1009	\$ 1024	\$ 1039	—	—	—
90"W	AF5RND9030D		105	\$ 1139	\$ 1154	\$ 1169	—	—	—
96"W	AF5RND9630D		111	\$ 1167	\$ 1182	\$ 1197	—	—	—

Note: Height-adjustable worksurface dimensions are nominal. Actual widths are reduced by 2" (1" on each side, and worksurface depths are reduced by 3/4". Corner cove depth is nominal, actual is 1" less. This is to allow for pinch-points and unobstructed table movement.

How to specify — Select the Model Number from above.	1st Option: Laminate or Veneer Type and Finish (if applicable): See page 342 for finishes.	2nd Option: Paint (if applicable): See page 342 for finishes.	3rd Option: Laminate Edge Color (if applicable): See page 342 for finishes.	4th Option: Grommet Location (if applicable): GC Grommet Center GO No Grommet	5th Option: Grommet Type (if applicable): P Oval Plastic M Oval Metal S Square Metal (Add \$11 per grommet for metal.)	6th Option: Grommet Color (Metal only): EL Matte Silver Plastic grommet color determined by worksurface finish.
<input type="checkbox"/> <input type="checkbox"/> <input type="checkbox"/> <input type="checkbox"/> <input type="checkbox"/> <input type="checkbox"/> <input type="checkbox"/> <input type="checkbox"/> <input type="checkbox"/> <input type="checkbox"/>	<input type="checkbox"/> <input type="checkbox"/> <input type="checkbox"/> <input type="checkbox"/> <input type="checkbox"/> <input type="checkbox"/> <input type="checkbox"/> <input type="checkbox"/> <input type="checkbox"/> <input type="checkbox"/>	<input type="checkbox"/> <input type="checkbox"/> <input type="checkbox"/> <input type="checkbox"/> <input type="checkbox"/> <input type="checkbox"/>	<input type="checkbox"/> <input type="checkbox"/> <input type="checkbox"/> <input type="checkbox"/>	<input type="checkbox"/> <input type="checkbox"/>	<input type="checkbox"/>	<input type="checkbox"/> <input type="checkbox"/>

Examples: AF5RS4824.LM14EW.GO AVF5RS4824.SC777.GC.SEL

For specification information see page 346.

GSA SIN PENDING

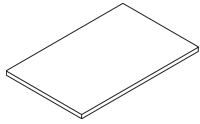

Description	Laminate w/Flat Edge Model	Ship Weight	List Price		
			L1	L2	L3
Undersized Rectangular Worksurface - 24"D (60" to 96" ships with stiffener)					
78"W - 96"W Tops can ONLY be used with Altitude MAX base.					
36"W	AF5RS3624U	23	\$ 427	\$ 448	\$ 470
42"W	AF5RS4224U	27	\$ 465	\$ 488	\$ 512
48"W	AF5RS4824U	31	\$ 522	\$ 548	\$ 574
54"W	AF5RS5424U	35	\$ 567	\$ 595	\$ 624
60"W	AF5RS6024UD	49	\$ 705	\$ 740	\$ 776
66"W	AF5RS6624UD	53	\$ 731	\$ 768	\$ 804
72"W	AF5RS7224UD	57	\$ 751	\$ 789	\$ 826
78"W	AF5RS7824UD	62	\$ 778	\$ 817	\$ 856
84"W	AF5RS8424UD	66	\$ 698	\$ 733	\$ 768
90"W	AF5RS9024UD	70	\$ 814	\$ 855	\$ 895
96"W	AF5RS9624UD	74	\$ 833	\$ 875	\$ 916

Undersized Rectangular Worksurface - 30"D (60" to 96" ships with stiffener)					
78"W - 96"W Tops can ONLY be used with Altitude MAX base.					
36"W	AF5RS3630U	29	\$ 474	\$ 498	\$ 521
42"W	AF5RS4230U	35	\$ 504	\$ 529	\$ 554
48"W	AF5RS4830U	40	\$ 587	\$ 616	\$ 646
54"W	AF5RS5430U	45	\$ 666	\$ 699	\$ 733
60"W	AF5RS6030UD	60	\$ 789	\$ 828	\$ 868
66"W	AF5RS6630UD	65	\$ 836	\$ 878	\$ 920
72"W	AF5RS7230UD	70	\$ 868	\$ 911	\$ 955
78"W	AF5RS7830UD	76	\$ 886	\$ 930	\$ 975
84"W	AF5RS8430UD	81	\$ 810	\$ 851	\$ 891
90"W	AF5RS9030UD	86	\$ 930	\$ 977	\$ 1023
96"W	AF5RS9630UD	91	\$ 952	\$ 1000	\$ 1047

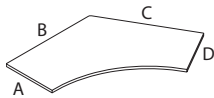

120 Degree Corner Worksurface - 24"D					
24" A x 42" B x 42" C x 24" D	AF5120S4224D	59	\$ 853	\$ 939	\$ 939
24" A x 48" B x 48" C x 24" D	AF5120S4824D	69	\$ 934	\$ 981	\$ 1027
24" A x 54" B x 54" C x 24" D	AF5120S5424D	79	\$ 1101	\$ 1156	\$ 1211

120 Degree Corner Worksurface - 30"D					
30" A x 42" B x 42" C x 30" D	AF5120S4230D	68	\$ 853	\$ 896	\$ 939
30" A x 48" B x 48" C x 30" D	AF5120S4830D	79	\$ 1204	\$ 1265	\$ 1325
30" A x 54" B x 54" C x 30" D	AF5120S5430D	92	\$ 1371	\$ 1440	\$ 1508

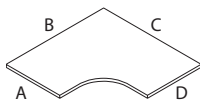

Symmetrical Corner Cove Worksurface — 24"D					
24" A x 54" B x 54" C x 24" D	AF5CCS5424	56	\$ 994	\$ 1044	\$ 1093

Symmetrical Corner Cove Worksurface — 30"D					
30" A x 54" B x 54" C x 30" D	AF5CCS5430	66	\$ 1086	\$ 1140	\$ 1195

ALTITUDE

How to specify — Select the Model Number from above.	1st Option: FSC Certified Wood:	2nd Option: Laminate:	3rd Option: Laminate Edge Color:	4th Option: Grommet Location (if applicable):	5th Option: Grommet Type (if applicable):	6th Option: Grommet Color (Metal only):
_____ _____	FSC FSC Mixed Credit X Standard Wood	See page 342 for finishes.	See page 342 for finishes.	GC Grommet Center GO No Grommet	P Oval Plastic M Oval Metal S Square Metal (Add \$11 per grommet for metal.)	EL Matte Silver Plastic grommet color determined by worksurface finish.
_____ _____	_____	_____	_____	_____	_____	_____

Example:

For specification information see page 346.

GSA SIN 33721

Description	Laminate w/Flat Edge Model	Ship Weight	List Price		
			L1	L2	L3
Corner Cove Laminate Tops — 24"D Extended Left					
24"A x 60"B x 36"C x 24"D	A5822ELS	54	\$ 931	\$ 962	\$ 992
24"A x 60"B x 48"C x 24"D	A5622ELS	75	\$ 1021	\$ 1055	\$ 1088
24"A x 72"B x 36"C x 24"D	A5922ELS	63	\$ 1040	\$ 1074	\$ 1107
24"A x 72"B x 48"C x 24"D	A5722ELS	86	\$ 1300	\$ 1343	\$ 1384
Corner Cove Laminate Tops — 24"D Extended Right					
24"A x 60"B x 36"C x 24"D	A5822ERS	54	\$ 931	\$ 962	\$ 992
24"A x 60"B x 48"C x 24"D	A5622ERS	75	\$ 1021	\$ 1055	\$ 1088
24"A x 72"B x 36"C x 24"D	A5922ERS	63	\$ 1040	\$ 1074	\$ 1107
24"A x 72"B x 48"C x 24"D	A5722ERS	86	\$ 1300	\$ 1343	\$ 1384
Note: Height-adjustable worksurface dimensions are nominal. Actual widths are reduced by 2" (1" on each side" and worksurface depths are reduced by 3/4". Corner cove depth is nominal, actual is 1" less. This is to allow for pinch-points and unobstructed table movement.					
Undersized Corner Cove Worksurface, Left Hand — 24"D					
24"A x 60"B x 36"C x 24"D	AF5CCS603624LD	58	\$ 874	\$ 918	\$ 916
24"A x 60"B x 48"C x 24"D	AF5CCS604824LD	67	\$ 958	\$ 1006	\$ 1054
24"A x 72"B x 36"C x 24"D	AF5CCS723624LD	66	\$ 976	\$ 1025	\$ 1074
24"A x 72"B x 48"C x 24"D	AF5CCS724824LD	75	\$ 1220	\$ 1281	\$ 1342
Undersized Corner Cove Worksurface, Right Hand — 24"D					
24"A x 60"B x 36"C x 24"D	AF5CCS603624RD	58	\$ 874	\$ 918	\$ 916
24"A x 60"B x 48"C x 24"D	AF5CCS604824RD	67	\$ 958	\$ 1006	\$ 1054
24"A x 72"B x 36"C x 24"D	AF5CCS723624RD	66	\$ 976	\$ 1025	\$ 1074
24"A x 72"B x 48"C x 24"D	AF5CCS724824RD	75	\$ 1220	\$ 1281	\$ 1342
Undersized Corner Cove Worksurface, Left Hand — 30"D					
30"A x 60"B x 48"C x 30"D	AF5CCS604830LD	77	\$ 1028	\$ 1080	\$ 1131
30"A x 72"B x 48"C x 30"D	AF5CCS724830LD	88	\$ 1294	\$ 1359	\$ 1424
Undersized Corner Cove Worksurface, Right Hand — 30"D					
30"A x 60"B x 48"C x 30"D	AF5CCS604830RD	77	\$ 1028	\$ 1080	\$ 1131
30"A x 72"B x 48"C x 30"D	AF5CCS724830RD	88	\$ 1294	\$ 1359	\$ 1424

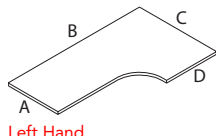
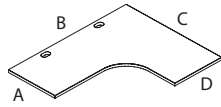
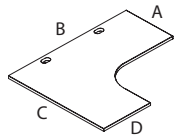

Left Hand

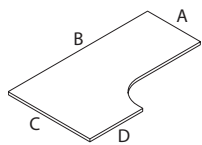

Right Hand

ALTITUDE

<p>How to specify — Select the Model Number from above.</p>	<p>1st Option: Laminate or Veneer Type and Finish (if applicable): See page 342 for finishes.</p>	<p>2nd Option: Paint (if applicable): See page 342 for finishes.</p>	<p>3rd Option: Laminate Edge Color (if applicable): See page 342 for finishes.</p>	<p>4th Option: Grommet Location and Type: GC Center P Oval Plastic M Oval Metal GB Grommet LH/RH P Oval Plastic M Oval Metal S Square Metal GO No Grommet</p>
<p>Examples:</p>				

For specification information see page 346.

Rectangular Laminate Tops – 24"D

Base Model(s)	Actual Dimensions
AF5RS4824, AVF5RS4824	46"W x 23¼"D
AF5RS5424, AVF5RS5424	52"W x 23¼"D
AF5RS6024D, AVF5RS6024D	58"W x 23¼"D
AF5RS6624D, AVF5RS6624D	64"W x 23¼"D
AF5RS7224D, AVF5RS7224D	70"W x 23¼"D
AF5RS7824D	76"W x 23¼"D
AF5RS8424D	82"W x 23¼"D
AF5RS9024D	88"W x 23¼"D
AF5RS9624D	94"W x 23¼"D

Rounded Corner Laminate Tops – 24"D

Base Model(s)	Actual Dimensions
AF5RND4824	46"W x 23¼"D
AF5RND5424	52"W x 23¼"D
AF5RND6024D	58"W x 23¼"D
AF5RND6624D	64"W x 23¼"D
AF5RND7224D	70"W x 23¼"D
AF5RND7824D	76"W x 23¼"D
AF5RND8424D	82"W x 23¼"D
AF5RND9024D	88"W x 23¼"D
AF5RND9624D	94"W x 23¼"D

Rectangular Laminate Tops – 30"D

Base Model(s)	Actual Dimensions
AF5RS4830, AVF5RS4830	46"W x 29¼"D
AF5RS5430, AVF5RS5430	52"W x 29¼"D
AF5RS6030D, AVF5RS6030D	58"W x 29¼"D
AF5RS6630D, AVF5RS6630D	64"W x 29¼"D
AF5RS7230D, AVF5RS7230D	70"W x 29¼"D
AF5RS7830D	76"W x 29¼"D
AF5RS8430D	82"W x 29¼"D
AF5RS9030D	88"W x 29¼"D
AF5RS9630D	94"W x 29¼"D

Rounded Corner Laminate Tops – 30"D

Base Model(s)	Actual Dimensions
AF5RND4830	46"W x 29¼"D
AF5RND5430	52"W x 29¼"D
AF5RND6030D	58"W x 29¼"D
AF5RND6630D	64"W x 29¼"D
AF5RND7230D	70"W x 29¼"D
AF5RND7830D	76"W x 29¼"D
AF5RND8430D	82"W x 29¼"D
AF5RND9030D	88"W x 29¼"D
AF5RND9630D	94"W x 29¼"D

Undersized Rectangular Worksurface – 24"D

Base Model(s)	Actual Dimensions
AF5RS3624U	34"W x 22"D
AF5RS4224U	40"W x 22"D
AF5RS4824U	46"W x 22"D
AF5RS5424U	52"W x 22"D
AF5RS6024UD	58"W x 22"D
AF5RS6624UD	64"W x 22"D
AF5RS7224UD	70"W x 22"D
AF5RS7824UD	76"W x 22"D
AF5RS8424UD	82"W x 22"D
AF5RS9024UD	88"W x 22"D
AF5RS9624UD	94"W x 22"D

Undersized Rectangular Worksurface – 30"D

Base Model(s)	Actual Dimensions
AF5RS3630U	34"W x 28"D
AF5RS4230U	40"W x 28"D
AF5RS4830U	46"W x 28"D
AF5RS5430U	52"W x 28"D
AF5RS6030UD	58"W x 28"D
AF5RS6630UD	64"W x 28"D
AF5RS7230UD	70"W x 28"D
AF5RS7830UD	76"W x 28"D
AF5RS8430UD	82"W x 28"D
AF5RS9030UD	88"W x 28"D
AF5RS9630UD	94"W x 28"D

120 Degree Corner Worksurface – 24"D

Base Model(s)	Actual Dimensions
AF5120S4224D	22"A x 40"B x 40"C x 22"D
AF5120S4824D	22"A x 46"B x 46"C x 22"D
AF5120S5424D	22"A x 52"B x 52"C x 22"D

120 Degree Corner Worksurface – 30"D

Base Model(s)	Actual Dimensions
AF5120S4224D	28"A x 40"B x 40"C x 28"D
AF5120S4824D	28"A x 46"B x 46"C x 28"D
AF5120S5424D	28"A x 52"B x 52"C x 28"D

For specification information see page 346.

Corner Cove Laminate Tops – 24"D Extended Left

Base Model(s)	Actual Dimensions
A5822ELS	23¼"A x 58¼"B x 34½"C x 23¼"D
A5622ELS	23¼"A x 58¼"B x 46¼"C x 23¼"D
A5922ELS	23¼"A x 70¼"B x 34½"C x 23¼"D
A7222ELS	23¼"A x 70¼"B x 46¼"C x 23¼"D

Undersized Corner Cove Worksurface, Left Hand – 24"D

Base Model(s)	Actual Dimensions
AF5CCS603624LD	22"A x 58"B x 34"C x 22"D
AF5CCS604824LD	22"A x 58"B x 46"C x 22"D
AF5CCS723624LD	22"A x 70"B x 34"C x 22"D
AF6CCS724824LD	22"A x 70"B x 46"C x 22"D

Undersized Corner Cove Worksurface, Left Hand – 30"D

Base Model(s)	Actual Dimensions
AF5CCS604830LD	28"A x 58"B x 46"C x 28"D
AF5CCS724830LD	28"A x 70"B x 46"C x 28"D

Corner Cove Laminate Tops – 24"D Extended Right

Base Model(s)	Actual Dimensions
A5822ERS	23¼"A x 58¼"B x 34½"C x 23¼"D
A5622ERS	23¼"A x 58¼"B x 46¼"C x 23¼"D
A5922ERS	23¼"A x 70¼"B x 34½"C x 23¼"D
A7222ERS	23¼"A x 70¼"B x 46¼"C x 23¼"D

Undersized Corner Cove Worksurface, Right Hand – 24"D

Base Model(s)	Actual Dimensions
AF5CCS603624RD	22"A x 58"B x 34"C x 22"D
AF5CCS604824RD	22"A x 58"B x 46"C x 22"D
AF5CCS723624RD	22"A x 70"B x 34"C x 22"D
AF6CCS724824RD	22"A x 70"B x 46"C x 22"D

Undersized Corner Cove Worksurface, Right Hand – 30"D

Base Model(s)	Actual Dimensions
AF5CCS604830RD	28"A x 58"B x 46"C x 28"D
AF5CCS724830RD	28"A x 70"B x 46"C x 28"D

For specification information see page 347.

GSA SIN 33721

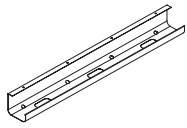

Description	Model	List Price
Cable Management Tray		
24" Tray	CMT24 <input type="checkbox"/>	\$ 112
36" Tray	CMT36 <input type="checkbox"/>	\$ 134

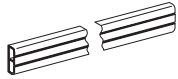

Wire Management Channel (Black only)		
92" Long	AEV920 <input type="checkbox"/>	\$ 208

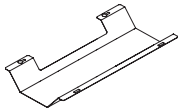

Under Worksurface Trough (Black only)		
17"W — Single Pack	Z617UWTRGH	\$ 95
17"W — Ten Pack	Z61710UWTRGH	\$ 966
36"W — Single Pack	Z636UWTRGH	\$ 167
36"W — Ten Pack	Z63610UWTRGH	\$ 1637

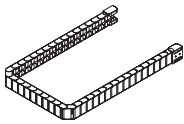

Cord Management Chain (Black Only)		
58"	WKSWMC	\$ 380

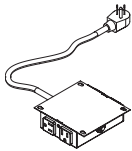

Power/Data Modules — Under Worksurface Mount		
4 Power Quad Tap	UNQTMP	\$ 405

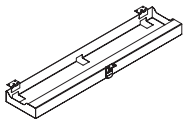

Description	Model	List Price		
		P1	P2	P3
Hinged Wire Management Troughs for under Worksurfaces (Black only)				
24"W	UN924HT	\$ 310	\$ 327	\$ 353
36"W	UN936HT	\$ 324	\$ 342	\$ 369
48"W	UN948HT	\$ 342	\$ 361	\$ 390

ALTITUDE

How to specify —
Select the Model Number from above.

2nd Option:
Paint
(if applicable):
See page 342 for finishes.

Examples: Z617UWTRGH CMT24.P27 AEV920 UNQTMP.P71 UN924HT.PR6

Shippable by small-package carrier.

Screens

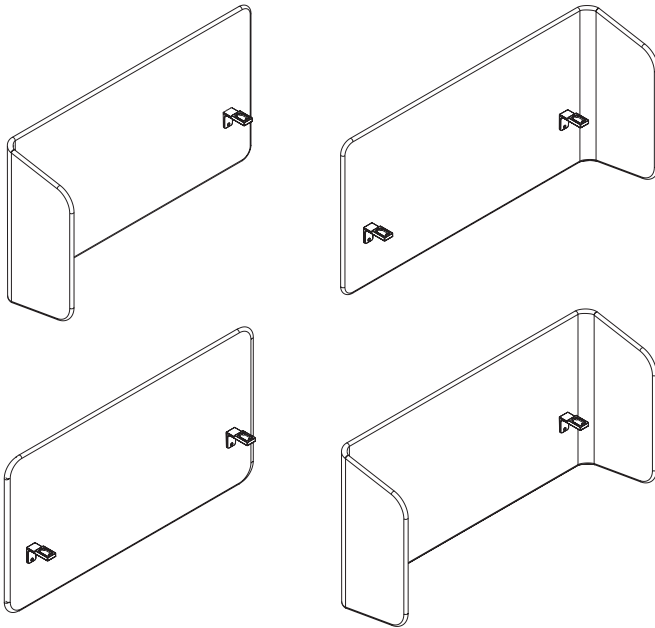

- See Table 1 for overall table width and depth for each screen shape.
- Adding a screen adds 3" to depth of the table.
- Adding a screen adds 1" to the width of the table per return wing.
- RH L-screens have return wing on user's right; LH opposite.
- **When using a 24"D worksurface with Altitude screens, you must specify a T-foot.**

Power Module

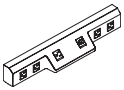

- Contains 5 simplex outlets and 1 dual USB.
- Available in plastic or metal. Metal power module is required for Chicago code.
- Cord options include straight and curly.
 - Straight cord is 144"
 - Curly cord is 120"

Privacy Screens available for Altitude Rectangular Tables

Altitude Table	Stride Landscape Surface Screen	Stride Painted Wood Screen	Involve Laminate End Screen	Involve Glass End Screen
Rectangular Top	Page 226	Page 226	See Casegoods & Storage Price List Page 295	See Casegoods & Storage Price List Page 295
48"W	—	—	36"W	—
54"W	48"W	48"W	36"W	48"W
60"W	30"W	30"W, 36"W	36"W, 42"W, 48"W	—
66"W	30"W, 36"W, 42"W	30"W, 36"W, 42"W	36"W, 42"W, 48"W, 54"W, 60"W	36"W, 42"W
72"W	30"W, 36"W, 42"W, 48"W	30"W, 36"W, 42"W, 48"W	36"W, 42"W, 48"W, 54"W, 60"W	36"W, 42"W, 48"W

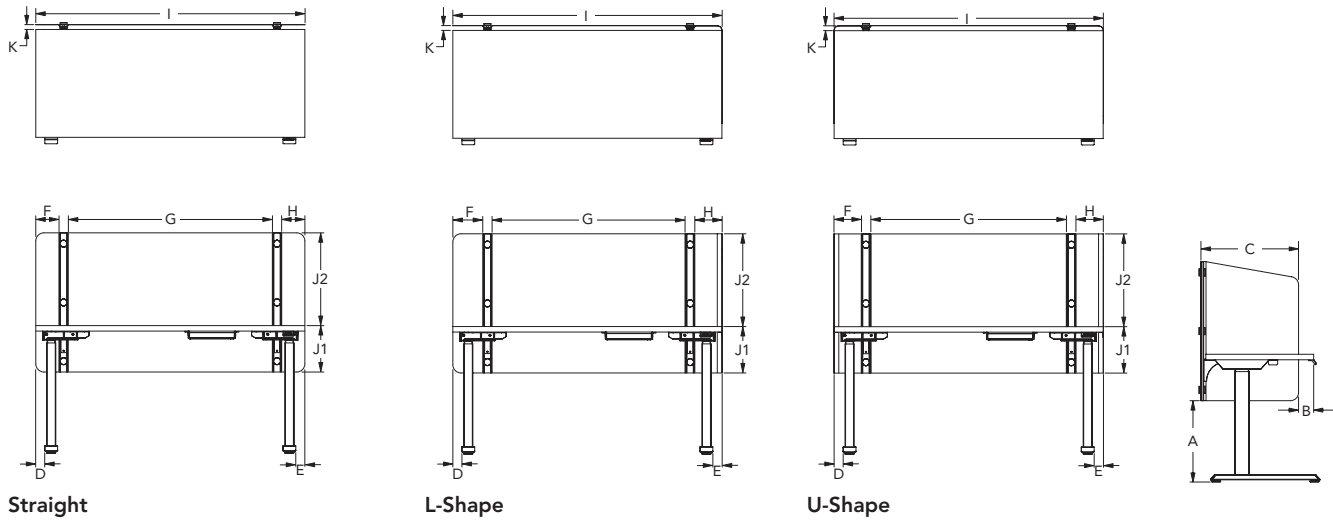

Size Reference Matrix

Models	A	B	C1	C2	D	E	F	G1	G2	H	I	J1	J2	K
	Under Desk Height	Wing to Front	Wing Width STD	Wing Width EXT	Left Leg to Edge	Right Leg to Edge	Left Side Panel to Support	Distance Between Supports	Distance Between Center/Right Support	Right Side Panel to Support	Overall Width	Desktop To Base of Panel	Desktop to Top of Panel	Cable Drop Space
AMS2048LH	24.7	3.3	21.1	24.3	2.0	2.0	5.9	29.7	-	6.4	46.1	2.9	20.0	1.0
AMS2054LH	24.7	3.3	21.1	24.3	2.0	2.0	5.9	35.7	-	6.4	52.1	2.9	20.0	1.0
AMS2060LH	24.7	3.3	21.1	24.3	2.0	2.0	5.9	41.7	-	6.4	58.1	2.9	20.0	1.0
AMS2066LH	24.7	3.3	21.1	24.3	2.0	2.0	5.9	22.8	22.8	6.4	64.1	2.9	20.0	1.0
AMS2072LH	24.7	3.3	21.1	24.3	2.0	2.0	5.9	25.8	25.8	6.4	70.1	2.9	20.0	1.0
AMS2048RH	24.7	3.3	21.1	24.3	2.0	2.0	6.4	29.7	-	5.9	46.1	2.9	20.0	1.0
AMS2054RH	24.7	3.3	21.1	24.3	2.0	2.0	6.4	35.7	-	5.9	52.1	2.9	20.0	1.0
AMS2060RH	24.7	3.3	21.1	24.3	2.0	2.0	6.4	41.7	-	5.9	58.1	2.9	20.0	1.0
AMS2066RH	24.7	3.3	21.1	24.3	2.0	2.0	6.4	22.8	22.8	5.9	64.1	2.9	20.0	1.0
AMS2072RH	24.7	3.3	21.1	24.3	2.0	2.0	6.4	25.8	25.8	5.9	70.1	2.9	20.0	1.0
AMS3248LH	17.5	3.3	21.1	24.3	2.0	2.0	5.9	29.7	-	6.4	46.1	10.0	20.0	1.0
AMS3254LH	17.5	3.3	21.1	24.3	2.0	2.0	5.9	35.7	-	6.4	52.1	10.0	20.0	1.0
AMS3260LH	17.5	3.3	21.1	24.3	2.0	2.0	5.9	41.7	-	6.4	58.1	10.0	20.0	1.0
AMS3266LH	17.5	3.3	21.1	24.3	2.0	2.0	5.9	22.8	22.8	6.4	64.1	10.0	20.0	1.0
AMS3272LH	17.5	3.3	21.1	24.3	2.0	2.0	5.9	25.8	25.8	6.4	70.1	10.0	20.0	1.0
AMS3248RH	17.5	3.3	21.1	24.3	2.0	2.0	6.4	29.7	-	5.9	46.1	10.0	20.0	1.0
AMS3254RH	17.5	3.3	21.1	24.3	2.0	2.0	6.4	35.7	-	5.9	52.1	10.0	20.0	1.0
AMS3260RH	17.5	3.3	21.1	24.3	2.0	2.0	6.4	41.7	-	5.9	58.1	10.0	20.0	1.0
AMS3266RH	17.5	3.3	21.1	24.3	2.0	2.0	6.4	22.8	22.8	5.9	64.1	10.0	20.0	1.0
AMS3272RH	17.5	3.3	21.1	24.3	2.0	2.0	6.4	25.8	25.8	5.9	70.1	10.0	20.0	1.0
AMS2048US	24.7	3.3	21.1	24.3	2.0	2.0	5.9	30.3	-	5.9	46.1	2.9	20.0	1.0
AMS2054US	24.7	3.3	21.1	24.3	2.0	2.0	5.9	36.3	-	5.9	52.1	2.9	20.0	1.0
AMS2060US	24.7	3.3	21.1	24.3	2.0	2.0	5.9	42.3	-	5.9	58.1	2.9	20.0	1.0
AMS2066US	24.7	3.3	21.1	24.3	2.0	2.0	5.9	23.1	23.1	5.9	64.1	2.9	20.0	1.0
AMS2072US	24.7	3.3	21.1	24.3	2.0	2.0	5.9	26.1	26.1	5.9	70.1	2.9	20.0	1.0
AMS3248US	17.5	3.3	21.1	24.3	2.0	2.0	5.9	30.3	-	5.9	46.1	10.0	20.0	1.0
AMS3254US	17.5	3.3	21.1	24.3	2.0	2.0	5.9	36.3	-	5.9	52.1	10.0	20.0	1.0
AMS3260US	17.5	3.3	21.1	24.3	2.0	2.0	5.9	42.3	-	5.9	58.1	10.0	20.0	1.0
AMS3266US	17.5	3.3	21.1	24.3	2.0	2.0	5.9	23.1	23.1	5.9	64.1	10.0	20.0	1.0
AMS3272US	17.5	3.3	21.1	24.3	2.0	2.0	5.9	26.1	26.1	5.9	70.1	10.0	20.0	1.0
AMS2048SS	24.7	-	-	-	2.0	2.0	5.0	32.0	-	5.0	46.0	2.9	20.0	1.0
AMS2054SS	24.7	-	-	-	2.0	2.0	5.0	38.0	-	5.0	52.0	2.9	20.0	1.0
AMS2060SS	24.7	-	-	-	2.0	2.0	5.0	44.0	-	5.0	58.0	2.9	20.0	1.0
AMS2066SS	24.7	-	-	-	2.0	2.0	5.0	24.0	24.0	5.0	64.0	2.9	20.0	1.0
AMS2072SS	24.7	-	-	-	2.0	2.0	5.0	27.0	27.0	5.0	70.0	2.9	20.0	1.0
AMS3248SS	17.5	-	-	-	2.0	2.0	5.0	32.0	-	5.0	46.0	10.0	20.0	1.0
AMS3254SS	17.5	-	-	-	2.0	2.0	5.0	38.0	-	5.0	52.0	10.0	20.0	1.0
AMS3260SS	17.5	-	-	-	2.0	2.0	5.0	44.0	-	5.0	58.0	10.0	20.0	1.0
AMS3266SS	17.5	-	-	-	2.0	2.0	5.0	24.0	24.0	5.0	64.0	10.0	20.0	1.0
AMS3272SS	17.5	-	-	-	2.0	2.0	5.0	27.0	27.0	5.0	70.0	10.0	20.0	1.0

ALTITUDE

Altitude — Metal Screens (page 378)

- Powder coated magnetic metal privacy screen.
- Metal surfaces can be easily disinfected with cleaners. See cleaning guide for more details at AllsteelOffice.com.
- Available in all standard paint colors.
- Provides 1" gap along the back for accessory mount and cord drop.
- Available in 48"W, 54"W, 60"W, 66"W and 72"W.
- 66"W and 72"W screens include 3rd center bracket.
- Available in Straight, L- and U-shape configurations. Above and Above/Below desk applications.
- L- and U-Shape screens are not compatible with shrouded Height Adjustable Table legs.
- Optional tackable accessories specified separately.
- 66"W tackable accessory comes as a set of (2) 24"W.
- 72"W tackable accessory comes as a set of (2) 20"W.
- Available in standard and extended wings.
- Wings mount flush to the edge of the surface with an L-Bracket.
- 20"W tackable accessory must only be applied to both standard and extended wings without accessory slots.
- Wings are available with accessory slots that accept Radii Hot File, Side Saddle and Coat hook.
- Top slot can accept one Radii accessory.
- Bottom slot can accept a Coat hook and one other accessory.
- Accessories can hang on either side of the wing.
- TIP: If the Hot File is used in the top slot, it will block access for accessories in the bottom slot.
- Do not hang more than 5lbs of weight on wings.
- Screens are compatible with Radii undermount storage.
- Not compatible with standard 120-worksurfaces. Contact Allsteel TPG for custom sizes.
- **When using a 24"D worksurface with Altitude screens, you must specify a T-foot.**

Size Reference Matrix

Tackboards	Wing	48"W	54"W	60"W	66"W	72"W
Actual Dimensions	20"W	30"W	36"W	42"W	20"W	24"W
Set of Tackboards	1	1	1	1	2	2

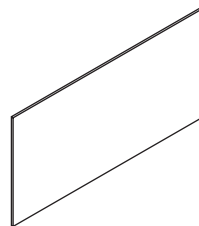

Accessories — Tackboard (page 379)

- Tackable accessories come with metal frame available in standard paint colors and fabric options.
- Attach to the screen using a dual lock tape (included in hardware).

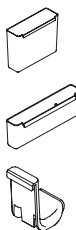

Accessories — Radii (page 379)

- Wings are available with accessory slots that accept Radii Hot File, Side Saddle and Coat hook.
- Top slot can accept one Radii accessory.
- Bottom slot can accept a Coat hook and one other accessory.
- Accessories can hang on either side of the wing.
- TIP: If the Hot File is used in the top slot, it will block access for accessories in the bottom slot.

Accessories — Further Worksurface Rail Mount (page 388)

- Accessory rail must be field cut to fit between the screen brackets.
- The following accessories are not compatible with screens: U9WTC and U9TM.

Notes

ALTITUDE

General Overview 362
Working with Altitude Power Rails..... 364
Low Rail with Floor Legs..... 364
Raised Rail..... 364
Screens 364
Working with Cable Management 365
Working with Power Rail Electricals..... 366
General Notes about Electrical and Circuitry 366
Electrical Infeeds 366
Routing Power 367

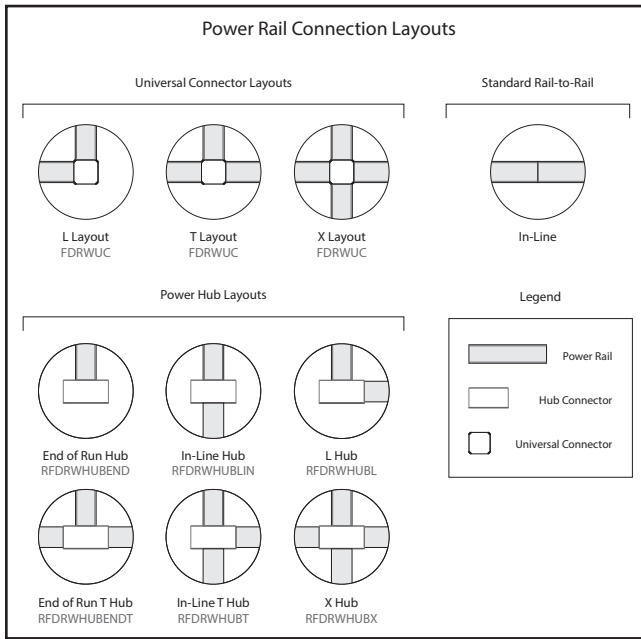

GENERAL OVERVIEW

- Accommodates power and lay-in capacity for data cables.
- Available in 48", 54", 60", 66", and 72" lengths.
- Maximum of 2 duplexes and 2 data ports per side of rail.
- Models come equipped with hardware for in-line connections.
- Fiber optic cables can follow 90 degree turns at the intersection of the power rails.
- Power harnesses snap into electrical brackets within the power rail and accept duplex receptacles.
- Electrical power harness accepts up to 2 duplex receptacles per side of rail.
- End caps are required at an end-of-run, unless connected to an end-of-run power pole or a hub.
- Power rail can be set low to the floor using the floor legs or raised off the floor at 20½" H with elevated legs.

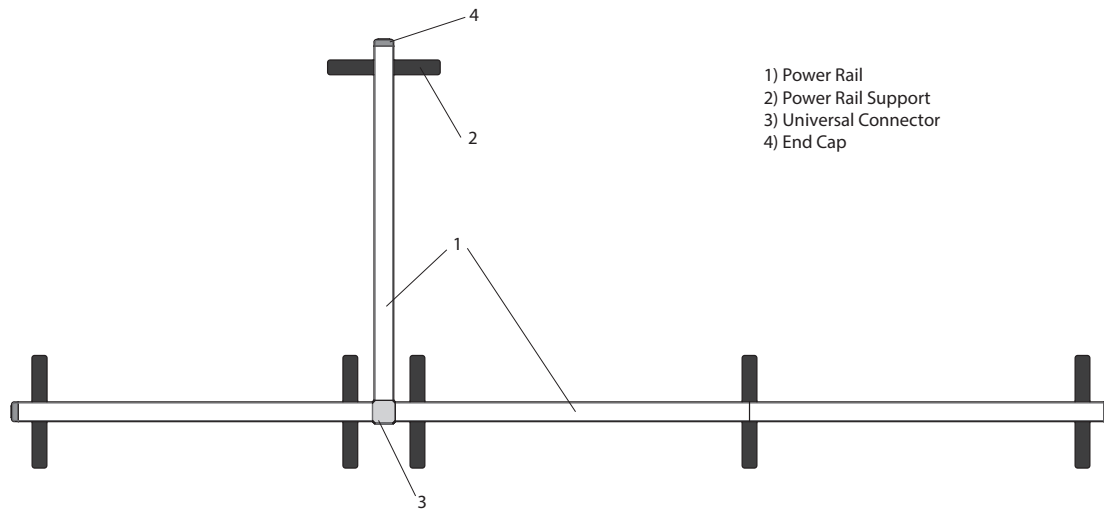

ALTITUDE

Power Rail Typicals

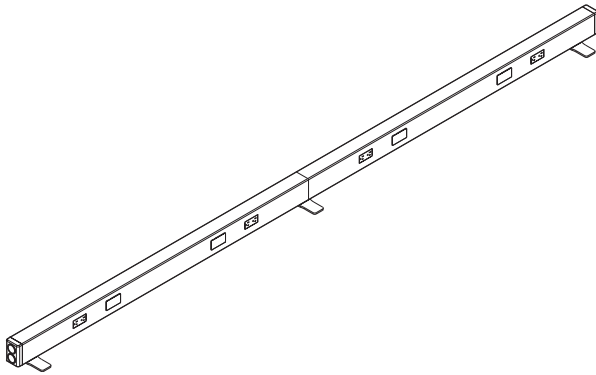

Low Rail, (2) 60"W Rail
Linear Configuration

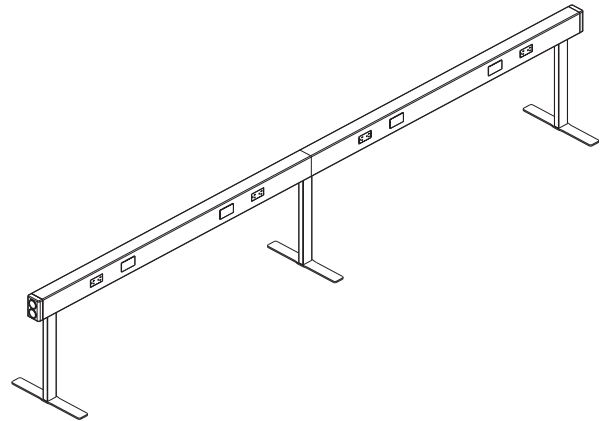

Raised Rail, (2) 60"W Rail
Linear Configuration

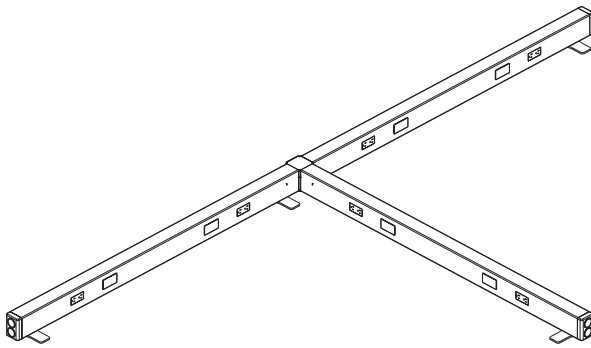

Low Rail, (3) 60"W Rail
T-Configuration

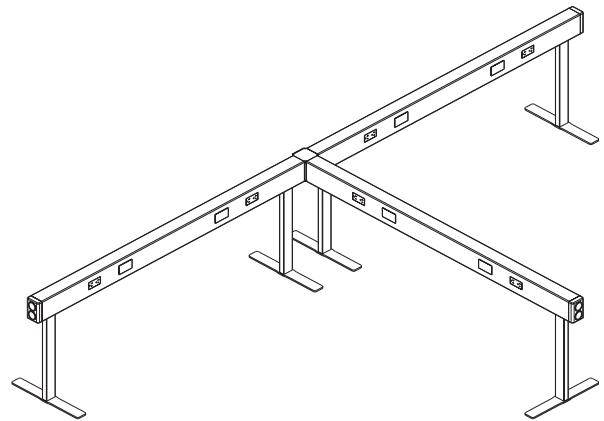

Raised Rail, (3) 60"W Rail
T-Configuration

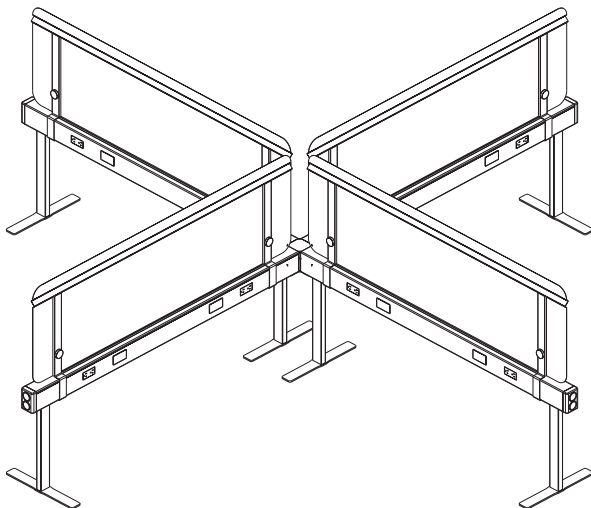

Raised Rail, (4) 60"W Rail
X-Configuration with Screens

ALTITUDE

WORKING WITH ALTITUDE POWER RAILS

Low Rail with Floor Legs:

- Each power rail is supported by (2) floor legs.
- Floor legs have a leveling mechanism that can adjust up to 1¼"H.
- Legs are specified separately and come in qty of 1. Each leg is 7¼"D x 2¼"W.
- Leg is inset 2.8" from end of the power rail.
- Universal connector allows "L", "T" and "X" configurations.
- Can connect directly to another power rail in linear applications without use of the universal connector.
- Cannot mount screens on the low rail.
- Power infeed can access the power rail in multiple ways:
 - through a receptacle position on the power rail (side infeed).
 - through the end cap on to the first power block.
 - through power pole using a power pole connector kit.

Raised Rail

- Power rails can be raised up to 20½"H using Elevated Legs and/or Hubs.
- Elevated Legs and Hubs can be used in conjunction to create the desired capability and aesthetic.
- Can be in Linear, L-, T- or X-configurations using Elevated Legs, Hubs or Universal Connector.
- Supports screens. See screens section for more details.
- Elevated Legs
 - Inset 2.8" from end of the power rail.
 - Can be shared in between the two rails in linear configuration.
 - Cannot route power and/or data.
 - Specified separately and come in qty of 1. Foot is included.
 - Leg is 15¼"D x 2¼"W x 17¾"H.
 - Order RFDRAWAB separately to anchor to floor. Appropriate fasteners per floor type sourced locally.
- Support Hubs
 - Connect directly to the power rail.
 - Can be shared in between the two rails.
 - L-, T- and X-hubs can be shared in between power rails.
 - End of Run hub is only specified at end condition.
 - Can route power and/or data.
 - Can integrate power pole. Power Pole connector kit is specified separately and come in qty of 1. Foot is included.

Screens

- Constructed of painted steel material.
- Standard Allsteel paint options can be applied.
- Screen height is 20"H, provides overall height of 42"H above fixed floor.
- Painted steel is magnetic and cleanable. Refer to cleaning solutions page at Allsteel Office website.
- Attachment hardware included.

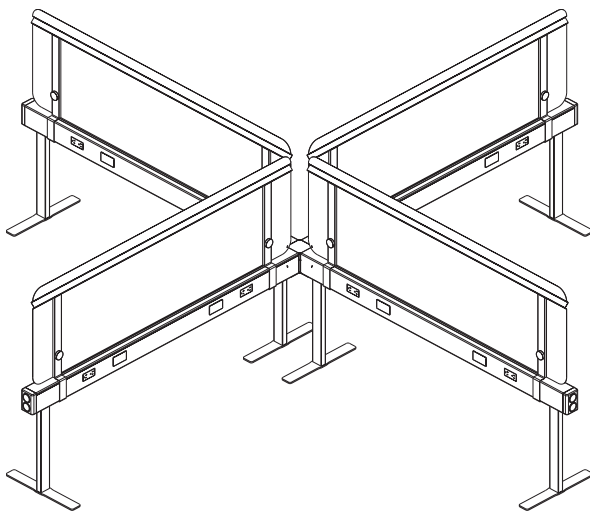

ALTITUDE

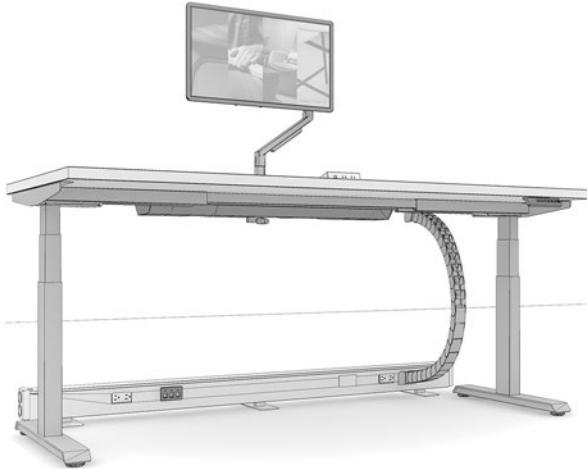

Altitude Desk + 60"W Low Rail + WKSVMC

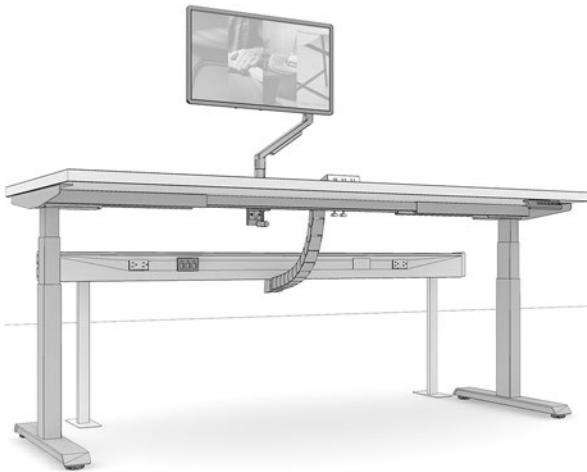

Altitude Desk + 60"W Raised Rail + A9CLWMC

WORKING WITH CABLE MANAGEMENT

- Used to route and conceal power/data cables from control box and other devices. Includes all mounting hardware.
- Houses 6 cables @ 0.300" diameter.
- Specify WKSVMC for 58" chain. Only comes in Black Finish. Recommended for use with Low Rail.
- Specify A9CLWMC for 36" chain. Comes in Black, White and Silver. Recommended for use with Raised Rail.
- Links the power rail to a height adjustable desk.
- Has two connecting points: Top section connects underneath the Height Adjustable Desk and the bottom section connects underneath the power rail using a double-sided tape. Hardware included.
- When mounting the chain to underneath the rail, an adapter link is required. Included in the hardware.

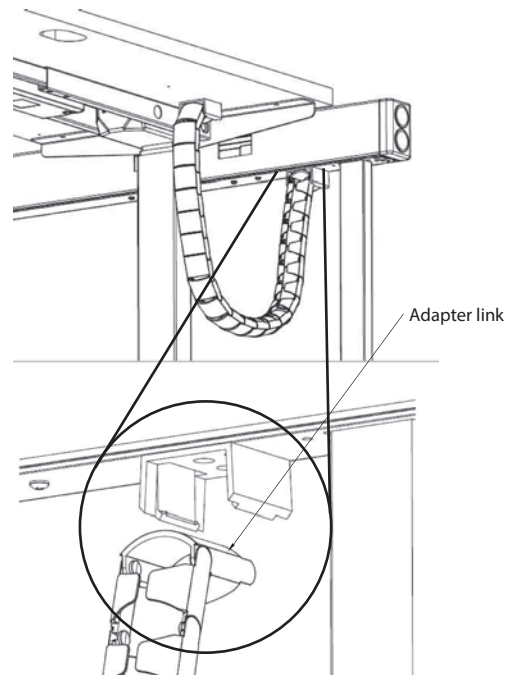

ALTITUDE

WORKING WITH POWER RAIL ELECTRICALS

General Notes about Electrical and Circuitry:

- Power Rail offers a choice of four electrical systems:
 - Four-circuit, 3 + 1
 - Four-circuit, 2 + 2
 - Three-circuit, separate neutrals
 - Eight circuits; two four-circuit systems provided back to back.
 - See Altitude Pricer section “Working with Electrical” for a detailed explanation of each electrical system.
 - All four systems utilize an 8-wire electrical system, rated at 20 amps.
- Per circuit (15 amps Canadian) — 16 amps plannable in U.S.
 - Power Rail and electrical components are UL Listed. Electrical
- Components are also CSA certified.
 - Installation and use of the electrical system, the number of receptacles.
- Used on a given circuit and connections to the building power supply.
- Should follow all local and national electrical codes.

Electrical Infeeds

- Power infeed cables deliver power from building to panel's electrical system.
- Infeed cables are housed in conduit to separate electrical system from communications and data lines.
- Select quantity of base or ceiling infeed cables depending on individual power requirements.
- Refer to rail supports for infeed access points.

Routing Power

- Power infeed can access the raised power rail in multiple ways:
 - Through power pole using a power pole connector kit.
 - Through Support Hubs.
 - Through the infeed vertebrae.

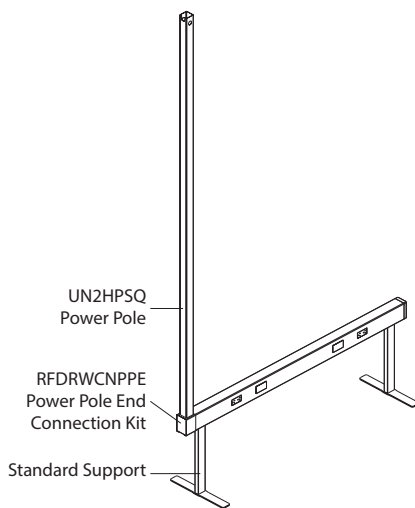
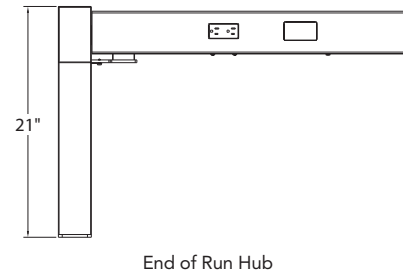
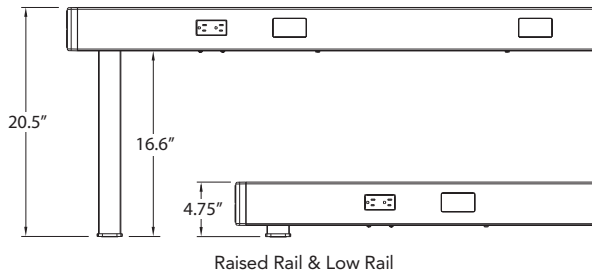

RFDRWCNPPE + UN2HPSQ
Connected to 60"W Rail

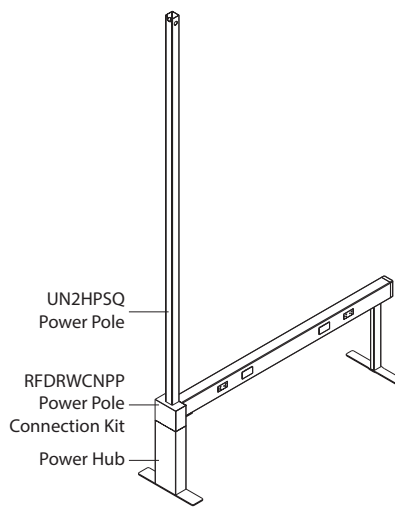

RFDRWHUBEND + RFDRWCNPP
UN2HPSQ connected to 60"W Rail

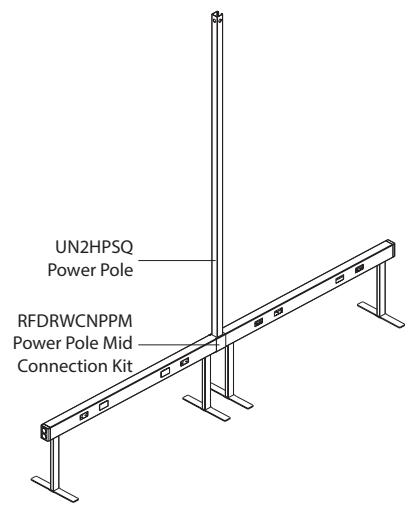

UN2HPSQ + RFDRWCNPPM
Connected to 60"W Rail

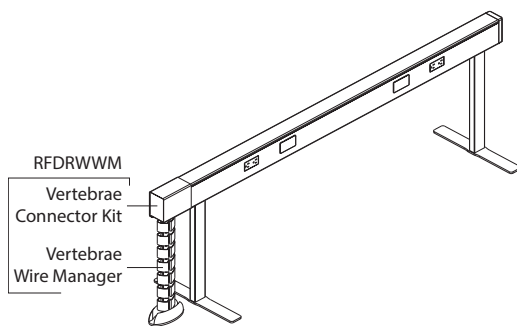

RFDRWWM
Connected to 60"W Rail

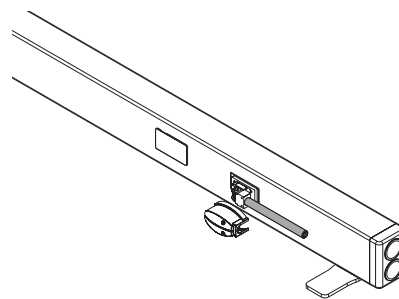

A876072 Infeed
Connected to 60"W Rail through End Cap

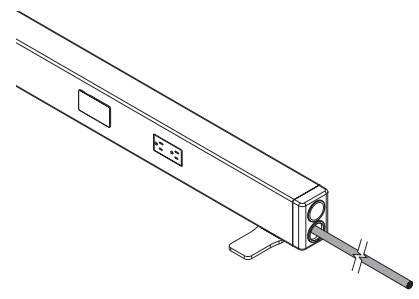

A877012 Infeed
Connected to 60"W Rail through End Cap

ALTITUDE

Electrical Systems

General Notes about Electric, Circuitry, and Chicago Code:

- Power Rail offers a choice of four electrical systems:
 - Four-circuit, 3 + 1
 - Four-circuit, 2 + 2
 - Three-circuit, separate neutrals
 - Eight circuits; two four-circuit systems provided back to back.
- See pages 369-370 for a detailed explanation of each electrical system.
- All four systems utilize an 8-wire electrical system, rated at 20 amps per circuit (15 amps Canadian) — 16 amps plannable in U.S.
- Power Rail and electrical components are UL Listed. Electrical components are also CSA certified.
- Installation and use of the electrical system, the number of receptacles used on a given circuit and connections to the building power supply should be in compliance with all local and national electrical codes.

Caution: Electrical equipment cords or extension cords MUST NOT BE ROUTED through cable openings in frame sides.

Note: No more than one conduit that is connected to a harness mounted to horizontal can be routed through the same cut out in the same horizontal at beltline. Attempting to use more will cause binding of conduit and may affect reveals on receptacles.

Hardwire New York Code (page 374)

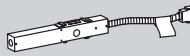
- Hardwire (New York Code) junction box (model A871400) is used when local electrical codes require hardwire entry. 
- For use in panels 48" W to 72" W.
- Unit must connect to a power harness.
- Customer to furnish all cabling and wiring from power entry to power source.
- Junction box can be positioned at any duplex receptacle location.
- For NY infeed through the end cap:
 - Order 24" pass-thru harness with power block A871124.
 - Will not have power at first cut-out from infeed.
- For NY infeed through a power rail cut-out:
 - Order 48"-72" pass-thru harness with power block. *Harness width must match power rail width.*
 - Will not have power at cut-out location used for infeed.
- For any power rail not used for infeed, order standard electrical power harness.

Hardwire Chicago Code (page 376)

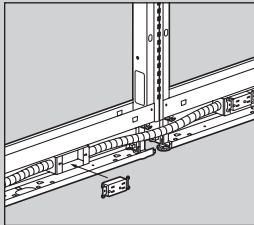
- Wiring harnesses and snap connectors are not allowed in Chicago — base pathways must be comprised of all-metallic components.
- The base pathway, junction box (model 873600) clips directly into receptacle locations and can be used both single- and double-sided.
- Customer must furnish conduit, wiring, and designer-type receptacles for the base pathway and conduit, wiring, designer-type receptacles, and receptacle covers for the beltline.
- Power entry can be routed from the floor into a junction box (model 873600). 

Electrical Infeeds

- Power infeed cables deliver power from building to panel's electrical system.
- Infeed cables are housed in conduit to separate electrical system from communications and data lines.
- Select quantity of base or ceiling infeed cables depending on individual power requirements.

Base Infeed (page 375)

- Sealtight base pathway power infeed mounts into any receptacle position in the base pathway area.
- A heavy rubber sheathing shields conduit, allowing infeed to be exposed.
- A jumper is required to connect base pathway power to beltline.

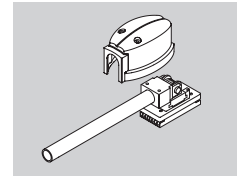

Sealtight Electrical Infeed (page 375)

- Sealtight electrical infeed cable is used with footed panels.
- Should not be ordered prior to installation to have pre-wired as infeed must be routed from inside of panel out to be connected to power.
- Cannot be connected to power harness in panel frame that infeed is brought into unless additional pass-thru harness without power block is used to feed from below beltline to above beltline.

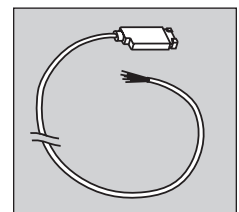

Power Infeed (page 375)

- Power infeed connects to a prewired electrical harness in the power rail.
- Most codes allow flex conduit to be exposed after installation. Verify code requirements before ordering for exposed application.

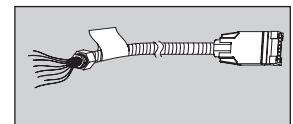

To Order:

- Determine which electrical system you will use after consulting your electrician and computer support personnel:
 - The Four-circuit system (4-Hot/2-Neutral/2-Ground)
 - 3 + 1 option
 - 2 + 2 option
 - The three-circuit system (3-Hot/3-Neutral/2-Ground)
 - The eight-circuit system (back-to-back four-circuit systems)
- Determine location, quantity, and circuit of duplexes.
- Determine the appropriate choice and use of isolated, isolated/dedicated, and separate neutrals circuits.
- Specify appropriate power harnesses* and pass-thru cables.*
- Determine the location, quantity, and type of power infeed needed.

* Select power harness models (A8712XX), with the last two digits corresponding with the panel width into which the component is to be positioned.
The initial cable length can be stretched approximately 3" to transverse "T", "X", "L", and extended straight connectors.

Flexconnect™ Electrical System Options

The four-circuit, eight-wire electrical system is widely specified and trusted by hundreds of thousands of end-users. This proven system delivers four circuits for every power infeed in either a 3 + 1 or 2 + 2 configuration. The isolated/dedicated circuits are ideal for sensitive computing equipment, while the common circuits are suitable for faxes, copiers, task lights and other peripherals. Both the 3 + 1 and 2 + 2 systems use the same pre-wired components, making it easy to adjust as electrical needs change.

You can also choose a three-circuit, eight-wire system that has a dedicated neutral for every hot circuit. The three-circuit components have model numbers with an "A" suffix and appear in a gray box in this price.

All three systems utilize an eight-wire electrical system rated at 20 amps per circuit (15 amps Canadian). Concensys panels and electrical components are UL listed and CSA certified.

Four-circuit, 3 + 1 Receptacle Option

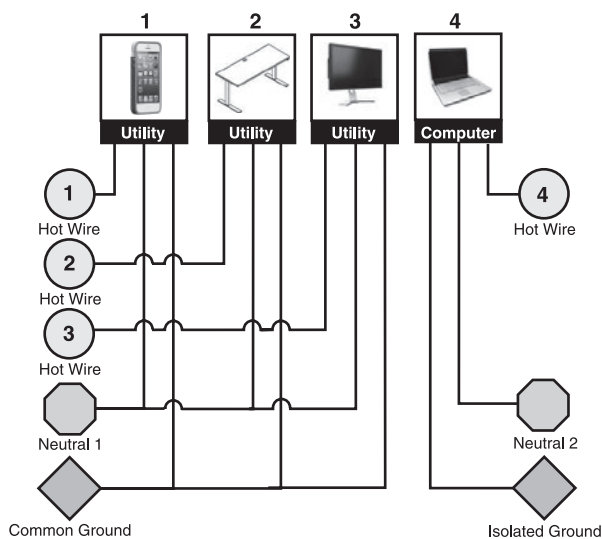

The 3 + 1 option is the electrical standard used on Allsteel systems for many years in most installations. This wiring option provides three utility circuits plus an isolated/dedicated circuit for more sensitive equipment. Circuit 2 (one of the 3 common circuits sharing a neutral wire) cannot be used with single-phase building electrical supply.

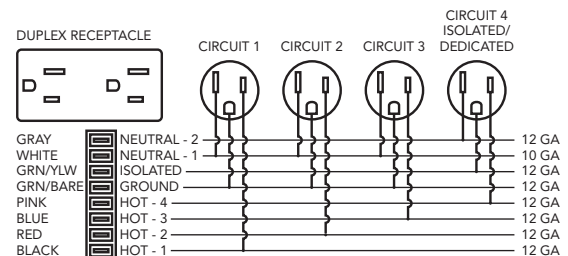

Four-circuit, 2 + 2 Receptacle Option

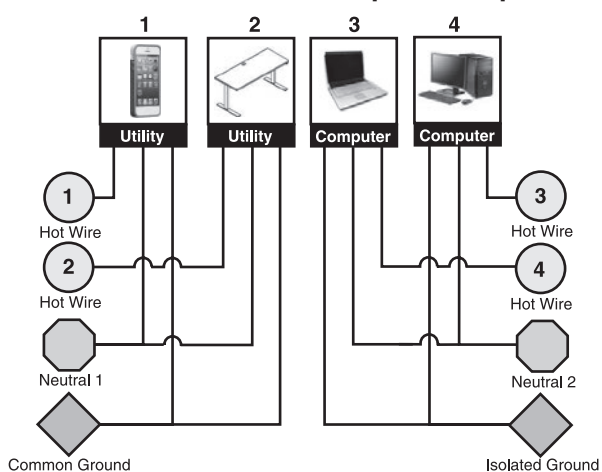

The 2 + 2 option is a wiring option that provides two utility circuits and two isolated circuits for more extensive computer usage applications.

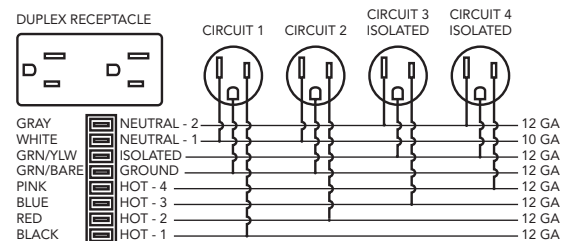

ALTITUDE

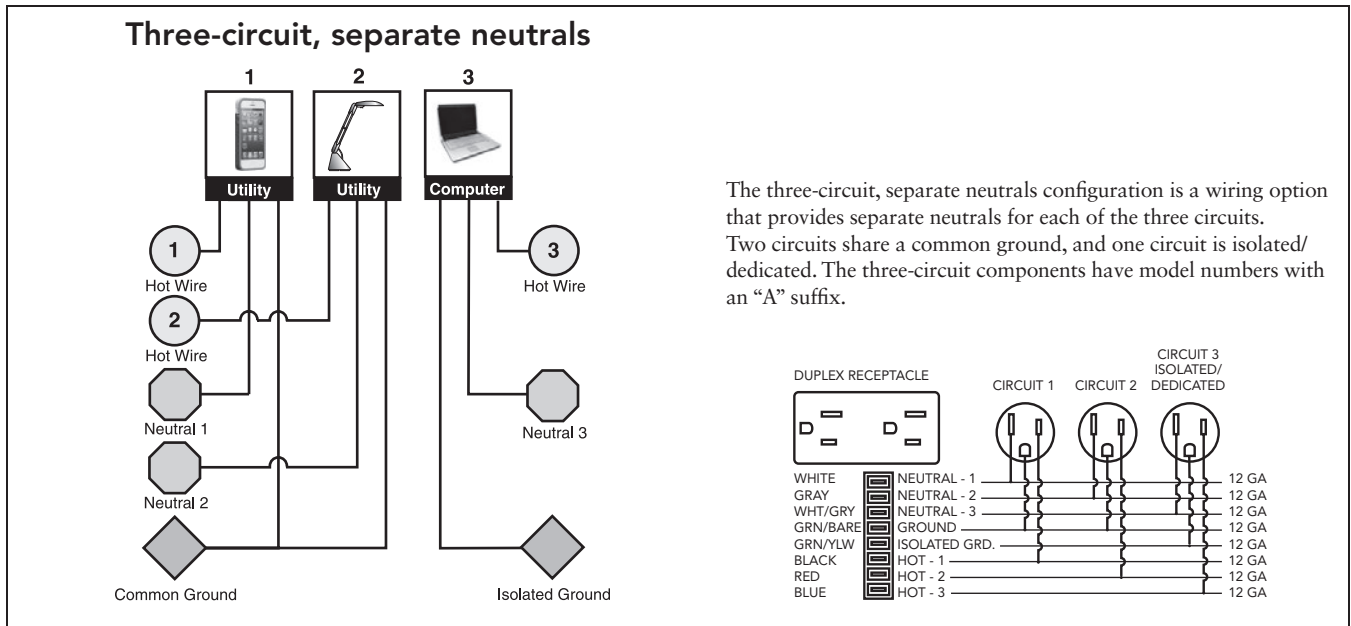

Altitude System Receptacle Usage					
Two 8-wire, 20 amp (15 amp Canadian) electrical systems are offered					
Electrical System	Circuitry	Receptacle Capacity			
Four-circuit 4-Hot/2-Neutral/2-Ground	3 + 1	Common Circuit-1 A873501	Common Circuit-2 ⁽¹⁾ A873502	Common Circuit-3 A873503	Iso/Dedicated Circuit-4 A873504
	2 + 2	Common Circuit-1 A873501	Common Circuit-2 A873502	Isolated Circuit-3 A873506	Isolated Circuit-4 A873504
Three-circuit 3-Hot/3-Neutral/2-Ground	w/separate neutrals	Common Circuit-1 A871501A	Common Circuit-2 A871502A	Iso/Dedicated Circuit-3 A871503A	N/A

(1) Circuit 2 (one of the 3 common circuits sharing a neutral wire) cannot be used with a single-phase building electrical supply.

Notes:

- Four-circuit components and three-circuit components (with suffix "A") cannot be used together.
- Components of the two systems are keyed differently to prevent components of one system being connected to components of another system.
- Allsteel model numbers are printed on the UL labels, and components are color-coded to provide visual identification of the different components.
- Four-circuit components have black plastic parts.
- Three-circuit components have rust-colored terminal ends and receptacle backs are rust-colored.

Duplex Receptacle



15 amp receptacle

Infeeds

- Power infeed cables deliver power from building to Power Rail's electrical system.
- Infeed cables are housed in conduit to separate electrical system from communications and data lines.
- Select quantity of infeed cables depending on individual power requirements.

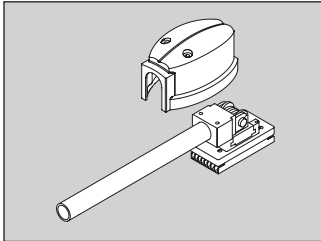

Base Infeed:

- Sealtight base pathway power infeed mounts into any receptacle position in the power rail housing.
- A heavy rubber sheathing shields conduit, allowing infeed to be exposed.

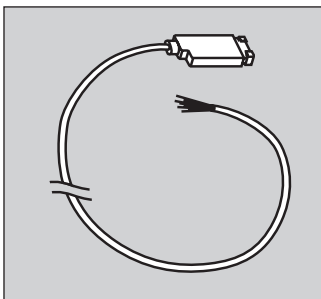

Sealtight Electrical Infeed:

- Sealtight electrical infeed is used for power entering through the end cap.
- Should not be ordered prior to installation to have pre-wired as infeed must be routed from inside of the power rail out to be connected to power.

Power Harness

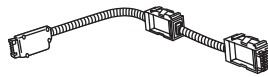

Electrical power harnesses are used to distribute power in the power rail. **Power blocks** on electrical power harness accept duplex receptacles.

- Electrical power harnesses are used to distribute power in Power Rails. Harnesses must be installed in each power rail housing.
- Specify harness length to match rail housing length. Each power harness accepts four duplex receptacles (two on each side of power rail housing).
- Connectors at both ends of power harnesses allow power distribution in either direction.
- Harness power blocks snap directly onto brackets in power rail housing.

Power Blocks

- Power blocks snap directly onto brackets in the power rail and accept receptacles (sold separately) on each side of harness.

Duplexes

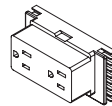

Duplex Receptacles

Receptacle Color Recommended to Coordinate with Paint Color

Paint Color	Receptacle Color
Bungalow — P7C	Muslin — EU
Champagne Metallic — PR5	Muslin — EU
Cinder — P7Q	Brownstone — EY
Fossil — P28	Flint — E9
Gunmetal Metallic — PR3	Brownstone — EY
Parchment — P93	Muslin — EU
Pebble — P8R	Loft — EV
Pewter — P8D	Flint — E9
Platinum — PR2	Loft — EV
Platinum Metallic — P42	Silver — E5
Salt — P8C	Silver — E5
Titanium — P8T	Silver — E5

- Duplex receptacles snap into power blocks of power harnesses.
- Duplexes are available in multiple colors. See inside front cover for finishes.
- Each receptacle is labeled to indicate which circuit it will be connected to: 1, 2, 3 or 4.
- Duplexes are model specific to support either 3 + 1 and 2 + 2 electrical infeed; or have an "A" suffix and are designed to support a three-circuit separate neutral electrical infeed.
- At least one duplex must be installed in upper housing side of rail housing assembly (see page 373, "Working with Electrical and Data").

Data

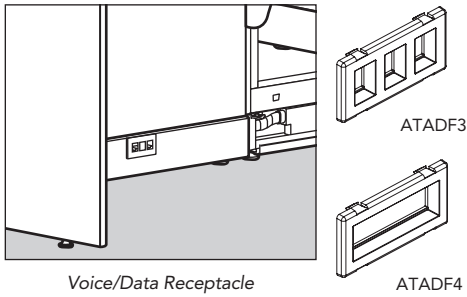

Voice/Data Receptacle

Data Faceplates:

- Fit into data port openings in Power Rail Housing.
- Due to rail housing depth, data modules should not be used back-to-back.

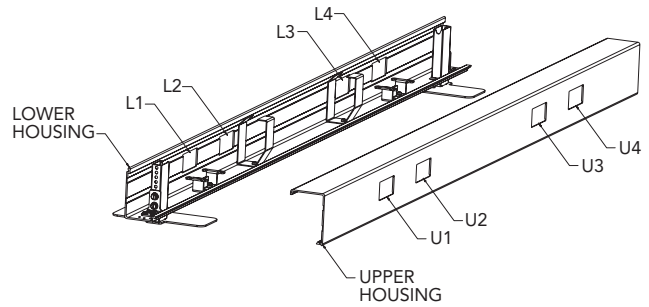

- Ports 1 and 4 accept duplexes, port covers and base infeeds.
- Ports 2 and 3 accept data and port covers.
- Either U1 or U4 must always contain a duplex.
- Data cannot be back-to-back (data in L2 + U2 or L3 + U3 combinations are not permitted).

Port Cover

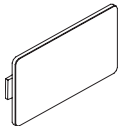

- Port covers must be used where no duplex or data faceplate is present.
- Fits into Power Rail port locations in place of duplex receptacles and data faceplates.
- Does not fit into port sizes of other product lines.

Cable Capacity

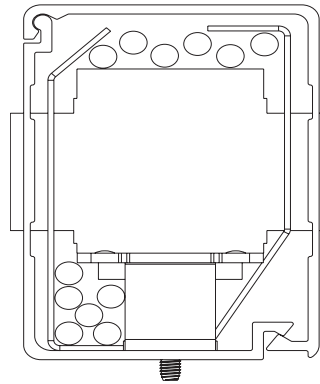

- The power rail housing allows continuous voice and data lines to run without interruption.
- Lay-in is provided for environments where systems furniture or cabling are subject to frequent change.
- Lower cavity allows 6 voice/data cables (1/4" dia).
- Upper cavity lay-in allows 6 voice/data cables (1/4" dia).

Power Rail Receptacle Locations

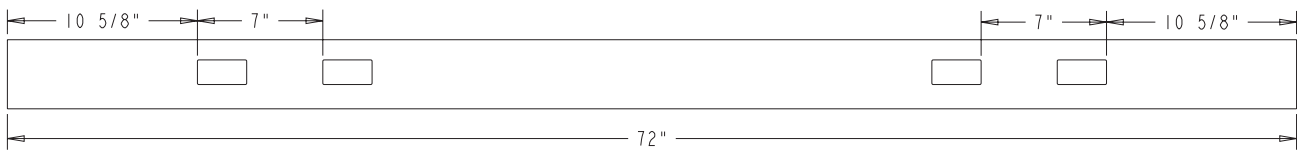
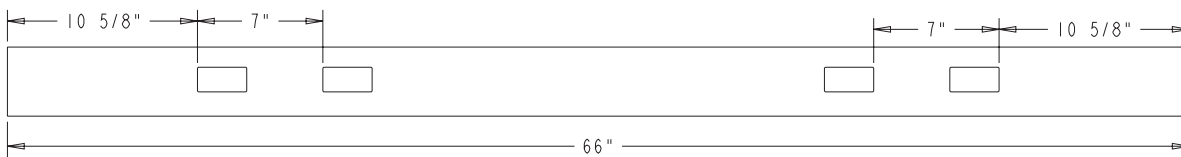
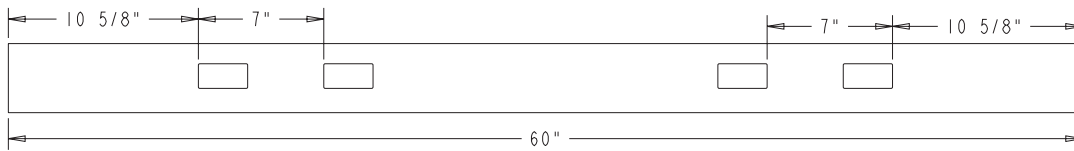
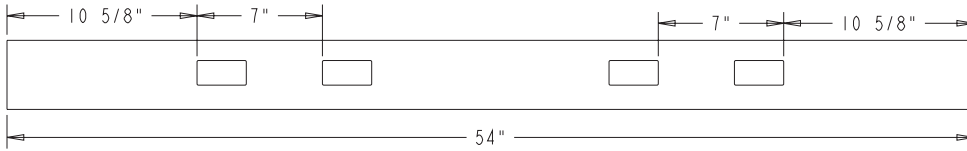
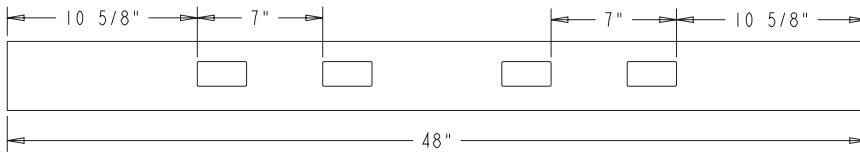

- For example, in a four-circuit system:
 - Circuit 1 — calculators, fans, etc.
 - Circuit 2 — task lights (could be wired to wall switch)
 - Circuit 3 — CRT or flat screen monitors
 - Circuit 4 — CPUs
- Use circuit 4 for power-sensitive electronic equipment.

Placement of pedestals and lateral files may render some duplex locations inaccessible. Pedestal placement may also affect compatibility with pull-up receptacles.

For specification information see page 371.

GSA SIN 33721

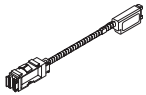
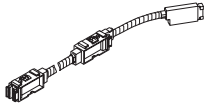

Description	Max. Recept. Cap. per Panel Side	Four-circuit 3 + 1 2 + 2	Three-circuit Separate Neutrals	List Price
Electrical Power Harnesses				
For 48" W Frames	2	A871248*	A871248A [S]	\$ 369
For 54" W Frames	2	A871254*	A871254A [S]	\$ 362
For 60" W Frames	2	A871260*	A871260A [S]	\$ 369
For 66" W Frames	2	A871266*	A871266A [S]	\$ 362
For 72" W Frames	2	A871272*	A871272A [S]	\$ 370

Note: Four-circuit components and Three-circuit components (with an "A" suffix) cannot be connected together.

Electrical Pass-Thru Harnesses with Power Block

For 24" W Frames**	1	A871124	A871124A [S]	\$ 212
For 48" W Frames†	1	A871148*	A871148A [S]	\$ 226
For 60" W Frames†	1	A871160*	A871160A [S]	\$ 226
For 72" W Frames†	1	A871172	A871172A [S]	\$ 303

Electrical harnesses are intended for use with Allsteel systems furniture and are approved under GSA SIN 33721. When purchased separately and used without Allsteel systems furniture, those electrical harnesses marked by () are considered Open Market.

**Only used with NY Infeed through End Cap.

†48"-72" are only used with NY infeed through power rail cut-out.

Description	Model	List Price
Altitude Power Rail — NY End Infeed		
4 Circuit	FDNYE4CIRK	\$ 586
3 Circuit	FDNYE3CIRK	\$ 586
Altitude Power Rail — NY Middle Infeed		
4 Circuit	FDNYM4CIRK48K	\$ 598
4 Circuit	FDNYM4CIRK54K	\$ 598
4 Circuit	FDNYM4CIRK60K	\$ 598
4 Circuit	FDNYM4CIRK66K	\$ 674
4 Circuit	FDNYM4CIRK72K	\$ 674
3 Circuit	FDNYM3CIRK48K	\$ 598
3 Circuit	FDNYM3CIRK54K	\$ 598
3 Circuit	FDNYM3CIRK60K	\$ 598
3 Circuit	FDNYM3CIRK66K	\$ 674
3 Circuit	FDNYM3CIRK72K	\$ 674

ALTITUDE

How to specify —
Select the Model Number from above.

1st Option:

Color:

P Black

Examples: A871248.P A871224.P A871224A.P A871124.P
A8710144A.P A2-8CIR36.P

[S] Shippable by small-package carrier.

For specification information see page 371.

GSA SIN 33721

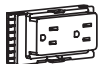

Duplex Receptacle

Description	Four-circuit 3 + 1 2 + 2	Three-circuit Separate Neutrals		List Price
Duplex Receptacles for Beltline or Base Pathway — Altitude (specify color)				
Circuit 1	A873501	A871501A	S	\$ 63
Circuit 2	A873502	A871502A	S	\$ 63
Circuit 3 (3+1)	A873503	A871503A	S	\$ 63
Circuit 3 (2+2)	A873506	N/A	S	\$ 63
Circuit 4 — iso/dedicated	A873504	N/A	S	\$ 63
Circuit 1, 20 AMP	A871601	A871601A	S	\$ 63

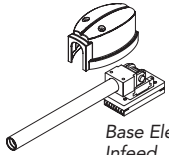

Base Electrical Infeed

Base Electrical Infeed Cable				
6' Sealtight Cable for Terrace Receptacle	A876072	A8716072A	S	\$ 390
6' Flex Cable	A871972	A871972A	S	\$ 294

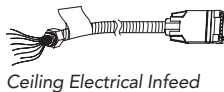

Ceiling Electrical Infeed

Ceiling Electrical Infeed Cables				
12' Flex Cable	A871912	A871912A	S	\$ 399
18' Flex Cable	A871918	A871918A	S	\$ 502

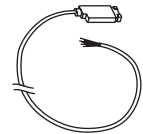

Electrical Infeed Cable

Electrical Infeed Cables (for use with footed panels)				
12' Sealtight Cable Power Infeed	A877012	N/A	S	\$ 487

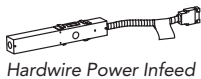

Hardwire Power Infeed

Hardwire Power Infeed (New York Code)				
For 48"-72" W rails	A871400	A871400A	S	\$ 383

Note: Four-circuit components and Three-circuit components (with an "A" suffix) cannot be connected together.

ALTITUDE

<p>How to specify — Select the Model Number from above.</p> <p>_____ .</p>	<p><i>1st Option:</i> Electrical Receptacle Color (if applicable): See page 342 for finishes.</p> <p>E S</p>
---	--

Example: A873501.E4

For specification information see page 371.

GSA SIN 33721



Description	Model	List Price
Hardwire (Chicago Code) (Black only)		
Altitude Base Pathway Junction Box (Pack of 6)	873600	\$ 1019

For specification information see page 372.

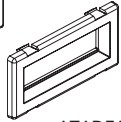
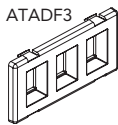

Description	Model	P1 Paint List Price
Data Faceplates		
Three-Port Flex-Mode Faceplate, Black (E4)	ATADF3	\$ 36
Four-Port Flex-Mode Faceplate, Black (E4)	ATADF4	\$ 36

Notes: ATADF3 can install up to 3 jacks (CAT 3, 5E, or 6). ATADF4 can install 4 jacks (CAT 3, 5E, or 6).

ATADF models are compatible with ports in Altitude tiles.

Allsteel's data faceplates are designed for use with the jacks listed below. We do not guarantee compatibility with other manufacturers' product. A faceplate adapter is available for use with alternatively sourced data jacks, see the Standard Specials catalog for details.

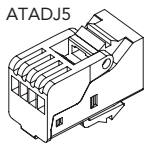

Jacks		
RJ45 CAT 5E Jack — Black only		
Toolless	ATADJ5	\$ 65
RJ45 CAT 6 Jack — Black only		
Requires Tool	ATADJ6	\$ 87

How to specify —

Select the Model Number from above.

--	--	--	--	--	--	--	--	--	--	--

Example: 873600

How to specify —

Select the Model Number from above.

1st Option:

Data Faceplate Color:
E4 Black

A	T	A	D					.	E	4
---	---	---	---	--	--	--	--	---	---	---

Example: ATADF4.E4

Shippable by small-package carrier.

For specification information see page 357.
 (See page 413 for COM pricing on fabric grades G-J.)

Description	Model	Old Model Numbers	Ship Weight	Cubes	List Price	
					A	D
U Screen Kit						
48"	FDSC48U	FDSCU48K	30.0	16.6	\$ 1809	\$ 1920
54"	FDSC54U	FDSCU54K	31.0	18.6	\$ 1871	\$ 1986
60"	FDSC60U (shown)	FDSCU60K	32.0	20.6	\$ 1926	\$ 2045
66"	FDSC66U	FDSCU66K	33.0	22.6	\$ 2039	\$ 2166
72"	FDSC72U	FDSCU72K	34.0	24.6	\$ 2193	\$ 2330

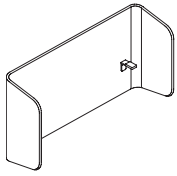

L Screen Kit						
Left Hand 48"	FDSC48LL	FDSC48LK	26.5	16.6	\$ 1177	\$ 1241
Right Hand 48"	FDSC48LR	FDSC48RK	26.5	16.6	\$ 1177	\$ 1241
Left Hand 54"	FDSC54LL	FDSC54LK	27.5	18.6	\$ 1378	\$ 1455
Right Hand 54"	FDSC54LR	FDSC54RK	27.5	18.6	\$ 1378	\$ 1455
Left Hand 60"	FDSC60LL (shown)	FDSC60LK	28.5	20.6	\$ 1441	\$ 1523
Right Hand 60"	FDSC60LR (shown)	FDSC60RK	28.5	20.6	\$ 1441	\$ 1523
Left Hand 66"	FDSC66LL	FDSC66LK	29.5	22.6	\$ 1716	\$ 1821
Right Hand 66"	FDSC66LR	FDSC66RK	29.5	22.6	\$ 1716	\$ 1821
Left Hand 72"	FDSC72LL	FDSC72LK	30.5	24.6	\$ 1807	\$ 1918
Right Hand 72"	FDSC72LR	FDSC72RK	30.5	24.6	\$ 1807	\$ 1918

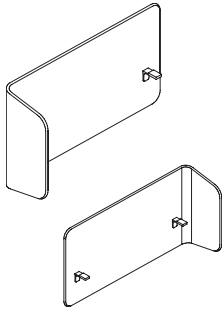

Rectangular Screen Kit						
48"	FDSC48R	FDSCR48K	23.0	3.7	\$ 1138	\$ 1200
54"	FDSC54R	FDSCR54K	24.0	4.1	\$ 1166	\$ 1230
60"	FDSC60R (shown)	FDSCR60K	25.0	4.6	\$ 1253	\$ 1322
66"	FDSC66R	FDSCR66K	26.0	5.0	\$ 1439	\$ 1525
72"	FDSC72R	FDSCR72K	27.0	5.6	\$ 1532	\$ 1624

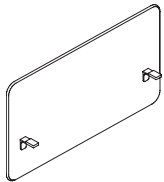

Note: Installation brackets are now attached to the screen from the factory.

<p>How to specify — Select the Model Number from above.</p>	<p>1st Option: Select the Screen Fabric: See page 343 for selections and color codes.</p>	<p>2nd Option: Select the Screen Bracket Paint: P1 P2 See page 342 for selections and color codes.* P2 (\$13 extra)</p>
--	--	--

Examples: FDSCU48K.PCAMBLT40.P71 FDSC48LK.PCAMBLT70.P71 FDSCR48K.PCAMBLT39.P71

For specification information see pages 358-359.

GSA SIN 33721

		Description	Model	P1 Paint List Price	P2 Paint Upcharge	P3 Paint Upcharge
20"H Metal L-Screen						
		48"W	AMS2048LH	\$ 764	\$ 793	\$ 822
		54"W	AMS2054LH	\$ 831	\$ 862	\$ 894
		60"W	AMS2060LH	\$ 930	\$ 965	\$ 1000
		66"W	AMS2066LH	\$ 1017	\$ 1055	\$ 1094
		72"W	AMS2072LH	\$ 1064	\$ 1104	\$ 1144
20"H Metal L-Screen (Right Hand)						
		48"W	AMS2048RH (shown)	\$ 764	\$ 793	\$ 822
		54"W	AMS2054RH	\$ 831	\$ 862	\$ 894
		60"W	AMS2060RH	\$ 930	\$ 965	\$ 1000
		66"W	AMS2066RH	\$ 1017	\$ 1055	\$ 1094
		72"W	AMS2072RH	\$ 1064	\$ 1104	\$ 1144
30"H Metal L-Screen						
		48"W	AMS3248LH	\$ 991	\$ 1028	\$ 1066
		54"W	AMS3254LH	\$ 1050	\$ 1090	\$ 1129
		60"W	AMS3260LH	\$ 1097	\$ 1138	\$ 1180
		66"W	AMS3266LH	\$ 1203	\$ 1248	\$ 1294
		72"W	AMS3272LH	\$ 1250	\$ 1297	\$ 1344
30"H Metal L-Screen (Right Hand)						
		48"W	AMS3248RH (shown)	\$ 991	\$ 1028	\$ 1066
		54"W	AMS3254RH	\$ 1050	\$ 1090	\$ 1129
		60"W	AMS3260RH	\$ 1097	\$ 1138	\$ 1180
		66"W	AMS3266RH	\$ 1203	\$ 1248	\$ 1294
		72"W	AMS3272RH	\$ 1250	\$ 1297	\$ 1344
20"H Metal U-Screen						
		48"W	AMS2048US (shown)	\$ 996	\$ 1034	\$ 1071
		54"W	AMS2054US	\$ 1050	\$ 1090	\$ 1129
		60"W	AMS2060US	\$ 1097	\$ 1138	\$ 1180
		66"W	AMS2066US	\$ 1203	\$ 1248	\$ 1294
		72"W	AMS2072US	\$ 1263	\$ 1311	\$ 1358
30"H Metal U-Screen						
		48"W	AMS3248US (shown)	\$ 1196	\$ 1241	\$ 1286
		54"W	AMS3254US	\$ 1260	\$ 1307	\$ 1355
		60"W	AMS3260US	\$ 1316	\$ 1366	\$ 1415
		66"W	AMS3266US	\$ 1444	\$ 1498	\$ 1553
		72"W	AMS3272US	\$ 1516	\$ 1573	\$ 1630

ALTITUDE

<p>How to specify — Select the Model Number from above.</p>	<p>1st Option: Wing Type : STD Standard EXT Extended</p>	<p>2nd Option: Accessories Slots: X No Accessory Cut Out SLT Accessory Cut Out</p>	<p>3rd Option: Paint Option: P1 P2 P3 See page 342 for finishes.</p>	<p>4th Option: Paint Option: NA Screen</p>
	<p>P . N A</p>			

Examples: AMS2048LH.STD.SLT.PR6.NA AMS2048SS.PR6.NA



S Shippable by small-package carrier.

For specification information see pages 358-359.

GSA SIN 33721

Description	Model	P1 Paint List Price	P2 Paint Upcharge	P3 Paint Upcharge
20"H Metal Rectangular Screen				
48"W	AMS2048SS (shown)	\$ 651	\$ 676	\$ 700
54"W	AMS2054SS	\$ 684	\$ 710	\$ 736
60"W	AMS2060SS	\$ 730	\$ 758	\$ 785
66"W	AMS2066SS	\$ 831	\$ 862	\$ 894
72"W	AMS2072SS	\$ 897	\$ 931	\$ 965
30"H Metal Rectangular Screen				
48"W	AMS3248SS (shown)	\$ 798	\$ 828	\$ 858
54"W	AMS3254SS	\$ 831	\$ 862	\$ 894
60"W	AMS3260SS	\$ 884	\$ 917	\$ 951
66"W	AMS3266SS	\$ 996	\$ 1034	\$ 1071
72"W	AMS3272SS	\$ 1050	\$ 1090	\$ 1129
15"H Tackboard Accessories				
20"W	AAS1520 S	\$ 283	\$ 294	\$ 304
48"W	AAS1548 S (shown)	\$ 336	\$ 349	\$ 361
54"W	AAS1554 S	\$ 372	\$ 386	\$ 400
60"W	AAS1560 S	\$ 388	\$ 403	\$ 417
66"W	AAS1566 S	\$ 566	\$ 587	\$ 609
72"W	AAS1572 S	\$ 619	\$ 642	\$ 666

<p>How to specify — Select the Model Number from above.</p>	<p><i>1st Option:</i> Wing Type : STD Standard EXT Extended</p>	<p><i>2nd Option:</i> Accessories Slots: X No Accessory Cut Out SLT Accessory Cut Out</p>	<p><i>3rd Option:</i> Paint Option: P1 P2 P3 See page 342 for finishes.</p>	<p><i>4th Option:</i> Paint Option: NA Screen</p>	<p><i>5th Option:</i> Accessories Color (if applicable): DW Designer White E9 Flint</p>
<p>Examples: AAS1548.PR6.APN911 AFAMS2048LH.STD.SLT.PR6.NA AFAMS2048SS.PR6.NA</p>					

Work Tools	Description	Model	List Price
	Hot File (Designer White Only) 9½"H x 12¼"W x 3¾"D	AEHF	\$ 59
	Side Saddle (Designer White Only) 4"H x 12¼"W x 2½"D	AESS	\$ 48
	Bag or Coat Hook (Designer White Only) 3¼"H x 1½"W x 2¼"D	AECH	\$ 37

<p>How to specify — Select the Model Number from above.</p>	<p><i>1st Option:</i> Paint Option (if applicable): P1 P2 P3 See page 342 for finishes.</p>	<p><i>2nd Option:</i> Fabric Option (if applicable): See page 343 for fabric options.</p>	<p><i>3rd Option:</i> Paint Option: NA Screen</p>	<p><i>4th Option:</i> Accessories Color (if applicable): DW Designer White E9 Flint</p>
<p>Example: AEHF.PJW</p>				

S Shippable by small-package carrier.

For specification information see pages 362-367.

GSA SIN 33721

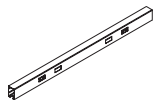

Description	Model	Ship Weight	Cubes	List Price		
				P1	P2	P3
Power Rail						
48"	RFDRW48	7	0.6	\$ 533	\$ 575	\$ 637
54"	RFDRW54	8	0.6	\$ 562	\$ 606	\$ 671
60"	RFDRW60 (shown)	9	0.7	\$ 647	\$ 696	\$ 771
66"	RFDRW66	10	0.8	\$ 691	\$ 744	\$ 822
72"	RFDRW72	11	0.9	\$ 780	\$ 839	\$ 927

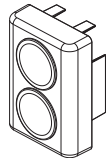

Power Rail End Cap	FDRWEC	1.5	0.1	\$ 209	\$ 224	\$ 246
--------------------	--------	-----	-----	--------	--------	--------

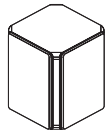

Power Rail Universal Connector	FDRWUC	3	0.1	\$ 380	\$ 406	\$ 446
--------------------------------	--------	---	-----	--------	--------	--------

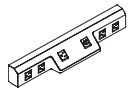

Concealed Power Module						
Corded	FDPWRC	5	0.3	\$ 681	N/A	N/A
Corded Chicago Code	CFDPWRC	6	0.3	\$ 1162	N/A	N/A
Spiral Cord	FDPWRSC	5	0.3	\$ 717	N/A	N/A
Spiral Cord Chicago Code	CFDPWRSC	6	0.3	\$ 1191	N/A	N/A

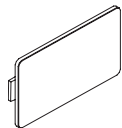

Electrical Port Cover						
2 Pack	FDEPC2	1	0.1	\$ 56	\$ 60	\$ 66
12 Pack	FDEPC12	2	0.1	\$ 195	\$ 209	\$ 229

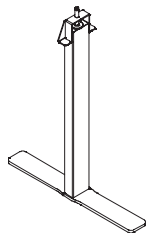

Elevated Power Rail Legs 20.5"H	RFDRWLEG	5	0.1	\$ 324	\$ 325	\$ 325
---------------------------------	----------	---	-----	--------	--------	--------

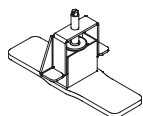

Floor Mount Legs	FDRWLEG	5	0.1	\$ 70	\$ 71	\$ 73
------------------	---------	---	-----	-------	-------	-------

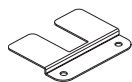

Altitude Power Rail Floor Anchor Bracket	RFDRWAB	2	0.1	\$ 46	\$ 61	\$ 68
--	---------	---	-----	-------	-------	-------

ALTITUDE

<p>How to specify — Select the Model Number from above.</p> <p>_____ .</p>	<p>1st Option: Paint: P1 P2 P3 See page 342 for selections and color codes.*</p> <p>_____</p>
---	---

Examples:

For specification information see pages 362-367.

GSA SIN 33721

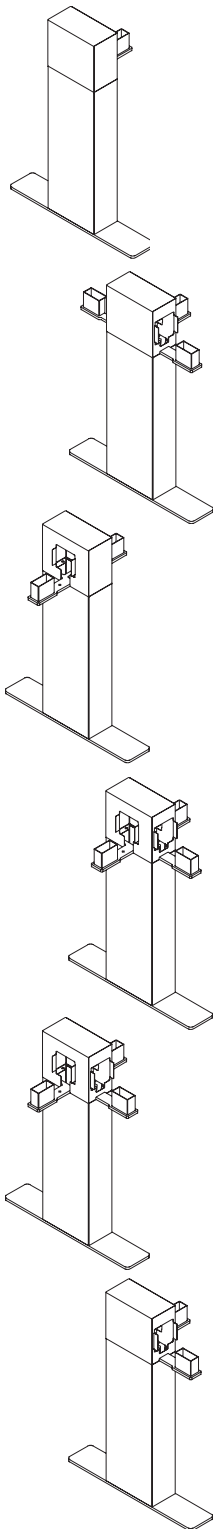

Description	Model	Ship Weight	Cubes	List Price		
				P1	P2	P3
Hubs						
End of Run Linear Configuration	RFDRWHUBEND	10	4	\$ 926	\$ 931	\$ 937
End of Run T-Configuration	RFDRWHUBENDT	10	4	\$ 926	\$ 931	\$ 937
Inline Linear Configuration	RFDRWHUBLIN	14	4	\$ 926	\$ 931	\$ 937
Inline X-Configuration	RFDRWHUBX	14	4	\$ 926	\$ 931	\$ 937
Inline T-Configuration	RFDRWHUBT	13	4	\$ 926	\$ 931	\$ 937
L-Configuration Hub	RFDRWHUBL	13	4	\$ 926	\$ 931	\$ 937

ALTITUDE

How to specify —
 Select the Model Number from above.

_____ .

1st Option:
Paint:
 P1 P2 P3
 See page 342 for selections and color codes.*

Examples:

For specification information see pages 362-367.

GSA SIN 33721

Description	Model	Ship Weight	Cubes	List Price		
				P1	P2	P3
Power Pole						
8' H Square Power Pole	UN2HPSQ	17	1	\$ 1012	\$ 1027	\$ 1039
Square Power Pole Splicer Kit	UN2HPSQSK	0.5	0.1	\$ 111	\$ 113	\$ 114
Power Pole Connector	RFDRWCNPP	1	0.1	\$ 199	\$ 200	\$ 202
Power Pole Connector - End Condition	RFDRWCNPPE	1	0.1	\$ 199	\$ 200	\$ 202
Power Pole Connector - Mid Condition	RFDRWCNPPM	1	0.1	\$ 199	\$ 200	\$ 202

UN2HPSQ



UN2HPSQSK

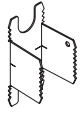

RFDRWCNPP

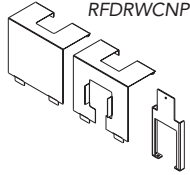

RFDRWCNPPE

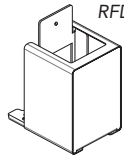

RFDRWCNPPM

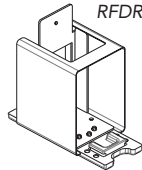

Wire Management

Description	Model	Ship Weight	Cubes	P1	P2	P3
Vertebrae Wire Manager	RFDRWWM	3	0.1	\$ 636	\$ 651	\$ 658

*Includes connector for Power Rail attachment

*Vertebrae available in black only, connector available in 32 standard paints.



Cord Management Snake (Black only) 58"	WKSWMC	2	0.3	\$ 380		
--	--------	---	-----	--------	--	--

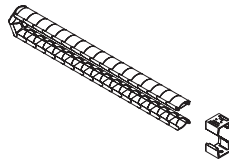

Cord Management Chain 36"	A9CLWMC	2	0.3	\$ 317		
---------------------------	---------	---	-----	--------	--	--

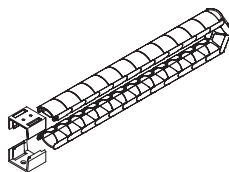

How to specify —

Select the Model Number from above.

Examples:

1st Option:

Paint:

P1 P2 P3

See page 342 for selections and color codes.*

For specification information see pages 362-367.

GSA SIN 33721

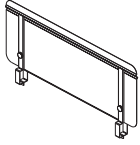

Description	Model	Ship Weight	Cubes	List Price		
				P1	P2	P3
Allsteel Metal Screen						
48"	RFDRWSC48	10	3.52	\$ 332	\$ 340	\$ 351
54"	RFDRWSC54	11	3.84	\$ 352	\$ 360	\$ 371
60"	RFDRWSC60	12	4.21	\$ 365	\$ 375	\$ 387
66"	RFDRWSC66	13	4.58	\$ 372	\$ 382	\$ 394
72"	RFDRWSC72	14	4.96	\$ 399	\$ 409	\$ 421

ALTITUDE

<p><i>How to specify —</i> Select the Model Number from above.</p>	<p><i>1st Option:</i> Paint: P1 P2 P3 See page 342 for selections and color codes.*</p>
--	--

Examples:

Height Adjustable Table Tie-In Brackets (Gallery Panels)

- Improves panel rigidity. Does not function as a panel stability solution.
- AGBKT to be specified for connection to a T leg HAT
- AGBKC to be specified for connection to a C leg HAT
- Reusable mounting template is required and must be ordered separately (AGBKTMP).
- Brackets telescope to account for 24" and 30" worksurface depths and screen attachments.
- A6 C legs with a 30"D worksurface and a screen must be specified with T leg brackets
- NOT compatible with Altitude MAX bases
- Height adjustable table brackets must be installed to both sides of the panel to substitute for a return panel in a dual-sided panel bench application. When a single bracket is connected to a wing panel as shown in the 4-pack image, the HAT bracket can substitute for a return panel.
- Freestanding panel can be connected to height adjustable table if it is supported by HAT brackets on both sides of the table and panel spine.

SINGLE BRACKET

Gallery Panel Application:

Max Height (with Glass): 65"H

Max Width: 75"W; No top size restrictions

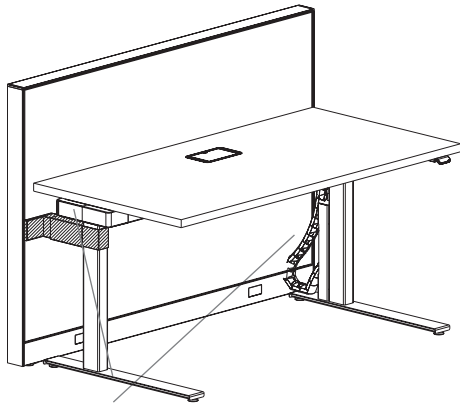
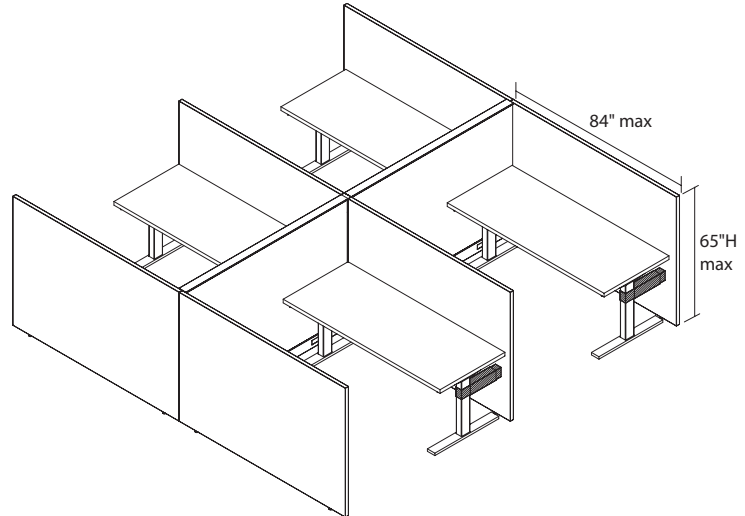

Note: Wire chain cannot be installed on the same leg as a HAT tie-in bracket.

DUAL SIDED PANEL BENCH

Gallery Panel Application:

Max Height (with Glass): 65"H

Bracket Needed: Single Panel (75" max) with Brackets on each leg (placed at the same height)

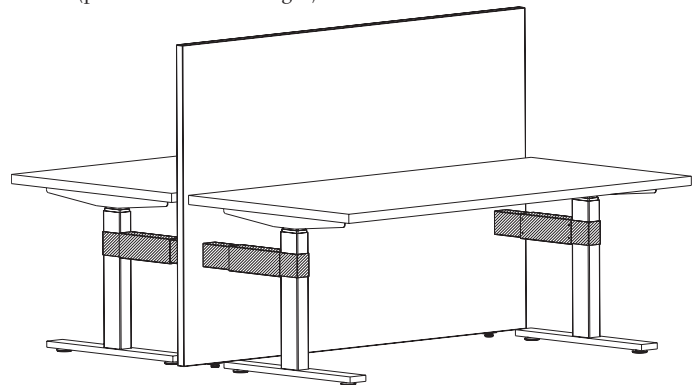

Freestanding Gallery Panel Application

Height Adjustable Table Tie-In Brackets (Optimize, Stride, and Terrace)

- Improves panel rigidity.
- ABKTL to be specified for connection to a LH T-leg HAT
- ABKTR to be specified for connection to a RH T-leg HAT
- ABKCL to be specified for connection to a LH C-leg HAT
- ABKCR to be specified for connection to a RH C-leg HAT
- Brackets mount into slotted standard.
- Brackets telescope to account for 24" and 30" worksurface depths and screen attachments.
- A6 C legs with a 30"D worksurface and a screen must be specified with T leg brackets
- NOT compatible with Altitude MAX bases
- Height adjustable table brackets must be installed to both sides of the panel to substitute for a return panel in a dual-sided panel bench application. When a single bracket is connected to a wing panel as shown in the 4-pack image, the HAT bracket can substitute for a return panel.
- Freestanding panel can be connected to height adjustable table if it is supported by HAT brackets on both sides of the table and panel spine for A8, A3, and A6.
- Dual sided A5 tables cannot support a freestanding panel. (A5 was discontinued on 12/31/2020)

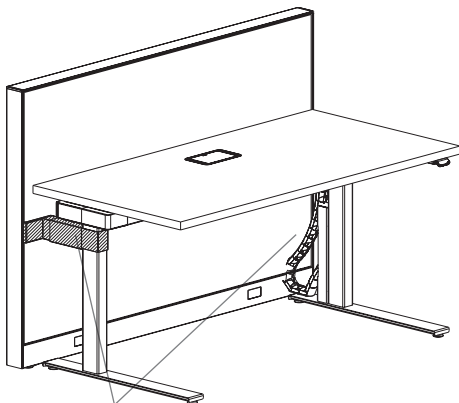

Note: Wire chain cannot be installed on the same leg as a HAT tie-in bracket.

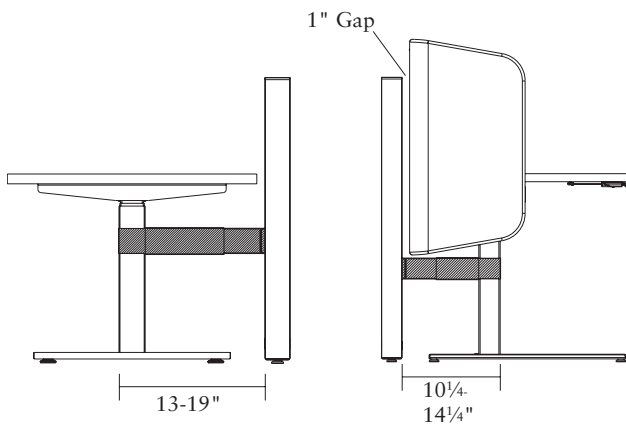

SINGLE BRACKET

Systems Application (not compatible with Concensys):

Max Height (with Glass): 65" H

Max Width: 96" W; Note: tops greater than 72" W will not align.

Overheads cannot be used without return panel

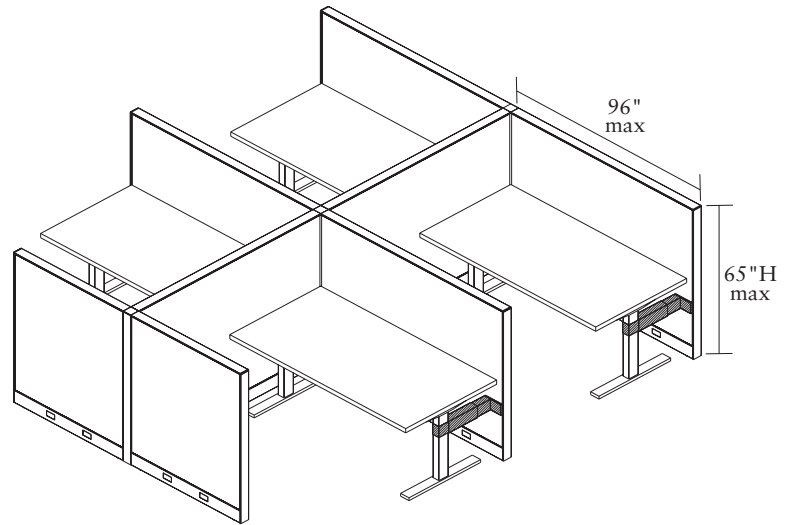

DUAL SIDED PANEL BENCH

Systems Application (not compatible with Concensys):

Max Height (with Glass): 65" H

Bracket Needed: Every 96" on both sides (placed at the same height).

Note: tops greater than 72" W will not align.

Overheads cannot be used without return panel

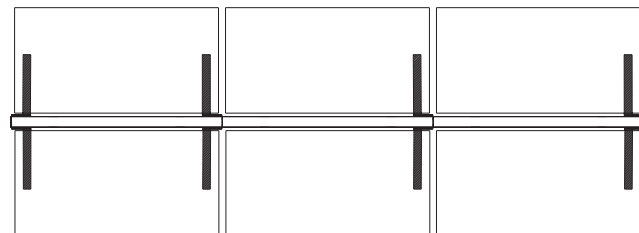
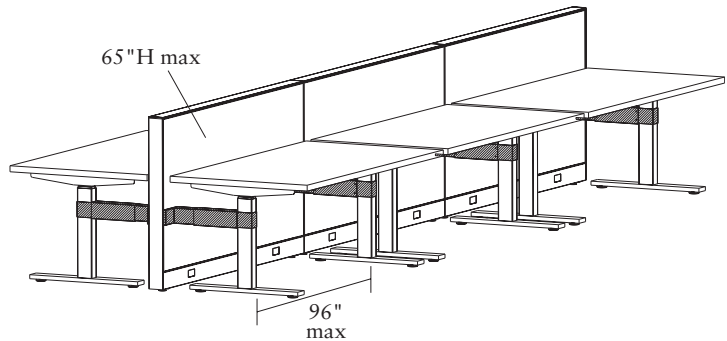

HAT to Panel Brackets

HAT to Panel Bracket Pricing

GSA SIN 33721

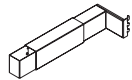

ABKTR

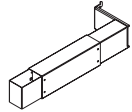

ABKTL

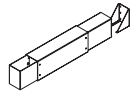

ABKCR

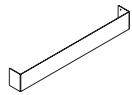

ABKCL

Description	Model	List Price
HAT to Panel Bracket T-leg RH	ABKTR	\$ 227
HAT to Panel Bracket T-leg LH	ABKTL	\$ 227
HAT to Panel Bracket C-leg RH	ABKCR	\$ 227
HAT to Panel Bracket C-leg LH	ABKCL	\$ 227
HAT to Gallery Panel Bracket T-leg	AGBKT	\$ 227
HAT to Gallery Panel Bracket C-leg	AGBKC	\$ 227
HAT to Gallery Panel Install Template <i>(Black only, code P)</i>	AGBKTMP	\$ 55

ALTITUDE

<p>How to specify — Select the Model Number from above.</p>	<p><i>1st Option:</i> Paint (if applicable):</p>
<p>A . </p>	

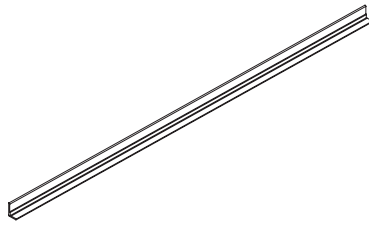

Rail Accessories

Side View



Top View

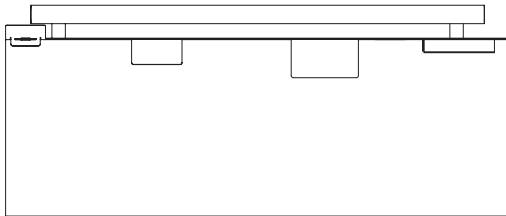

Phone/
Tablet
Stand Pencil
Holder Rail
Mounted
Shelf Vertical
Paper Tray

Front View

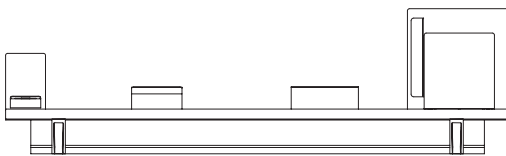

Worksurface Mounted Rail (page 388)

- Aluminum extrusion designed to mount to flat edge worksurfaces. Comes with rail and hardware for mounting.
- Mounted rail extends 3/4" on underside of worksurface which may interfere with the mounting of storage and screens.
- Widths available for Altitude tables 12" through 66" in 6" increments. Can pass across seams of ganged worksurfaces in tethered applications.
- Passes behind worksurface bracket on tethered applications.
- For freestanding applications rail should be 6" shorter than worksurface (i.e. 54" rail for 60" worksurface).

Rail Mounted Accessories

Not recommended for use on panel systems with attached worksurfaces due to fit up issues created with worksurface and panel. Adding accessory rail shifts worksurface — 3/8" away from panel along that edge. Forcing worksurface into place crushes fabric tile and with tiles of other material (steel, marker board, etc) is likely to scratch, dent, or otherwise damage tile during installation.

U9TM Phone/Tablet Stand (page 388)

- 6 1/2"H x 4 1/4"W and angles back 1 1/4".
- Has a 1/4" x 1" slot in bottom flange to allow for routing cables. Requires 1 1/4" space behind worksurface edge in order to be used.



U9TP Pencil Holder (page 388)

- 2 1/2"H x 6"W x 3"D.
- Holds approximately twenty #2 pencils.



U9TS Rail Mounted Shelf (page 388)

- 8"W x 4 1/2"D and sits 2 3/8" higher than top of worksurface.
- Holds up to 8 pounds.

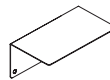

U9TF Vertical Paper Tray (page 388)

- Sits 12"H x 1 1/2"W x 12"D from back of worksurface.
- Folder front stands 9" high from worksurface top, 1/4" space holds about 280 sheets of copy paper.

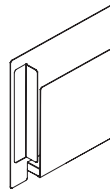

U9WTC Cord Organizer (page 388)

- Can attach to both bottom of worksurface or slides into rail.
- 4"W x 7/8"D, made from sheet metal.
- Top sits flush with worksurface if mounted to worksurface.
- 4 cable cut outs: 2 - .250" diameter and 2 - 0.147" diameter; .250" diameter cut outs are centered between the .147" diameter cut outs.



Universal Hook (page 388)

- Mounts to underside of worksurface and provides storage for bags, coats and purses. Can be used as a horizontal wire manager.



Privacy Screens available for Altitude Tables

















Altitude Table Top	Stride Landscape Surface Screen <i>Page 226</i>	Stride Painted Wood Screen <i>Page 226</i>	Involve Laminate End Screen <i>See Casegoods & Storage Price List Page 295</i>	Involve Glass End Screen <i>See Casegoods & Storage Price List Page 295</i>
48"W	—	—	36"W	—
54"W	48"W	48"W	36"W	48"W
60"W	30"W	30", 36"W	36", 42", 48"W	—
66"W	30", 36", 42"W	30", 36", 42"W	36", 42", 48", 54", 60"W	36", 42"W
72"W	30", 36", 42", 48"W	30", 36", 42", 48"W	36", 42", 48", 54", 60"W	36", 42", 48"W

Accessories

Worksurface Mounted Rail and Accessories



For specification information see page 387.

GSA SIN 33721

Description	Model	List Price		
		P1	P2	P3
Accessories Rail — Worksurface Mounted				
12"W	U912WTR 	\$ 106	\$ 112	\$ 116
18"W	U918WTR 	\$ 113	\$ 119	\$ 123
24"W	U924WTR 	\$ 130	\$ 136	\$ 140
30"W	U930WTR 	\$ 145	\$ 154	\$ 160
36"W	U936WTR 	\$ 165	\$ 174	\$ 180
42"W	U942WTR 	\$ 178	\$ 187	\$ 193
48"W	U948WTR 	\$ 188	\$ 200	\$ 205
54"W	U954WTR 	\$ 196	\$ 209	\$ 213
60"W	U960WTR 	\$ 206	\$ 220	\$ 226
66"W	U966WTR 	\$ 247	\$ 261	\$ 267
Rail Mounted Accessories				
Phone/Tablet Stand — 6½"H x 4¼"W	U9TM 	\$ 160	\$ 171	\$ 180
Pencil Holder — 2½"H x 6"W x 3"D	U9TP 	\$ 97	\$ 106	\$ 112
Shelf — 8"W x 4½"D; 2½" above top of worksurface	U9TS 	\$ 109	\$ 120	\$ 129
Vertical Paper Tray — 12"H x 1⅝"W x 12"D	U9TF 	\$ 176	\$ 187	\$ 196
Cord Organizer				
4"W x ⅞"D Metal with 4 cable cutouts	U9WTC 	\$ 174	\$ 181	\$ 187
Universal Hook (Black only)				
Package of 2	AGSAUHK 	\$ 117	—	—

How to specify —
Select the Model Number from above.

U | 9 | | | | | | | .

1st Option:
Paint:
  
See page 342 for selections and color codes.*

Examples: U912WTR.PR6 U9TF.P7G AGSAUHK.P27

 Shippable by small-package carrier.

ALTIITUDE

Extensions — Introduction

Extensions accessory line by Allsteel is designed to help you create your own space.

- **Create a unique space**

Each person is unique, no one person works exactly like another, and different tasks require different tools. Extensions work tools allow each person the ability to create a unique environment that is all their own. Lots of paper to manage? Need active files within arm's reach? Want to maximize your worksurface space? Need light somewhere other than below a cabinet? Whatever the task, we have the tools to accommodate your workstyle.

- **Create a comfortable space**

With a full line of organization, ergonomic, and illumination tools, Extensions allow you to create a comfortable, ergonomic work area. Organization tools keep important items visible and within your reach. Ergonomic tools help you stay comfortable while working. Illumination tools allow you to put your light where it suits you.

- **Create an organized space**

Tired of all the piles of paper building up on your worksurface? Organization tools house your materials and keep them in an orderly fashion. With a combination of hanging or freestanding organizational accessories, Extensions let you manage everything from binders to paper clips.

- **Organization tools**

Work tools are a durable metal construction. Extensions allow you to manage your workspace smartly with tools like the phone caddy to elevate the phone off the worksurface, landscaped mail box trays to minimize worksurface intrusion, folder holders and tool box pencil holders that hang off the slat rail and each other.

Increase your efficiency with organization!

- **Ergonomic tools**

Ergonomics is more than just comfort, it's flexibility and safety. The adjustable keyboard options allow users to maintain and vary comfortable wrist and arm positions throughout the day, whether typing or mousing. Monitor Arms offer versatile adjustability while providing optimum comfort for the eyes, neck, and shoulders.

- **Illumination tools**

Sleek and flexible, our lighting components offer you several choices. Recessed task lights conserve space and feature electronic ballast for longer bulb life and cooler operating temperature. LED tasklights' slim design blends in with its surrounding while utilizing energy-efficient LED technology. The Link light offers award-winning style to a highly versatile and energy efficient light.

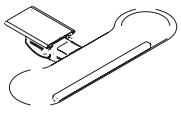
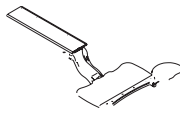
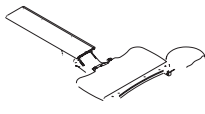
Articulating Keyboard Supports			
Features	Model AKTSHORT	Model AKTLONG	Model AKTMID
			
Keyboard Support	Platform style 28"W x 8"D	Platform Style 19"Wx11"D	Platform Style 19"Wx11"D
Keyboard Support Material	Phenolic	Phenolic	Phenolic
Suspension	<ul style="list-style-type: none"> Nylon glides on lubricated slide track Intuitive lift and lock one touch height adjustment 	Lubricated slide track system: spring assisted	Lubricated slide track system: spring assisted
Platform Rotation	360 degrees	360 degrees	360 degrees
Platform Tilt	+10/-20 degrees	+10/-20 degrees	+10/-20 degrees
Platform Tilt Adjustment	Soft touch lever for precise tilt adjustment	Convenient tilt wheel assists desired tilt angle	Convenient tilt wheel assists desired tilt angle
Platform Height Adjustment Range	6" (1½" above / 5¼" below)	12½" (7" above to 5½" below)	8" (3" above / 5" below)
Platform Height Adjustment	Lift platform to raise, lift slightly and tilt back to lower	Lift platform to raise, lift slightly and tilt back to lower	Lift platform to raise, lift slightly and tilt back to lower
Palm Rest	Detachable leatherette-covered gel palm rest	Fabric covered gel palm rest	Fabric covered gel palm rest
Mouse Pad	In-line to accommodate mouse on same level as keyboard.	Circular, swivel, tilt, LH/RH mounting, mouse catcher, gel rest	Circular, swivel, tilt, LH/RH mounting, mouse catcher, gel rest
Microsoft Natural Compatible	No	Yes — by removing palm rest	Yes — by removing palm rest
Track Depth	8"	23"	21"
Required Mounting Clearance	20"W x 8"D x ¼" Recess	19"W x 23"D + ¼" Recess	19"W x 23"D + ¼" Recess
Adjustable Wrist Rest	No	Fixed mounting and height	Fixed mounting and height
Ideal For	<ul style="list-style-type: none"> Straight worksurfaces ADA/HFES compliance Extensive adjustability with mouse in line, mouse over or mouse forward of keyboard Height-Adjustable Table 	<ul style="list-style-type: none"> Corner worksurface applications Sit to stand applications 	<ul style="list-style-type: none"> Shallow worksurfaces Corner worksurface (17" or 21") Radius worksurface (42" or 48")
Additional Information		<ul style="list-style-type: none"> Track can be cut in the field to shorten track depth — may affect ability to fully recess platform 	<ul style="list-style-type: none"> Track can be cut in the field to shorten track depth — may affect ability to fully recess platform

AKTSHORT Keyboard Support (page 391)

- Lift and lock intuitive height adjustment.
- Compatible with Altitude Height Adjustable Tables
- Positive and negative tilt for best ergonomic positioning.
- +10°/-20° tile adjustment and 360° rotation provides support of neutral position of shoulders, arms and wrists while accommodating multiple working postures.
- Surpasses ANSI/BIFMA standards.
- Black powder coat finish.
- Patented secondary slide and unique arm design provide minimal footprint.

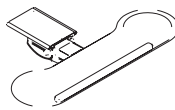

Keyboard Spacer Kit (page 391)

- Keyboard Spacer Kit required for mounting under Altitude worksurfaces.
- Kit provides ten spacers and hardware for mounting keyboard supports beneath an external worksurface support channel.
- Spacers are 2⅞" H providing more room beneath surface for mounting.

CPU Hammock (page 391)

- Features 360-degree swivel with an 11" track.
- Load capacity is 75 lbs.
- CPU must be minimum of ¾"W with maximum dimension of 64" in perimeter.
- Handy adjustment tool stores within unit.
- Safety feature prevents accidental release of straps and straps can be adjusted while CPU is installed.
- Can be used on Height Adjustable Tables as long as it is attached with spacer model AKMH. Take into account required leg room for users.







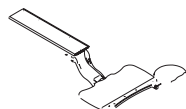
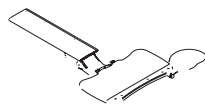



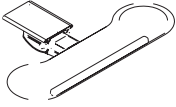

AKTMID and AKTLONG Keyboard Support (page 391)

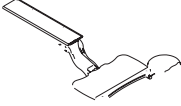
- Lift and lock intuitive height adjustment.
- Positive and negative tilt for the best ergonomic positioning.
- +10°/-20° tilt adjustment and 360° rotation provides support of neutral position of shoulders, arms, and wrists while accommodating multiple working postures.
- Non-handed mouse tray can be moved from right hand to left hand side.
- Surpasses ANSI/BIFMA standards.
- Black powder-coat finish.

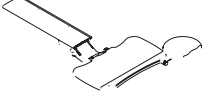

For specification information see page 390.

GSA SIN 33721

	Description	Model	List Price						
	Compact Keyboard Support with 8" Track 30"W x 13"D	AKTSHORT 	\$ 536						
	STS Keyboard Support with 23" Track 24"W x 12"D	AKTLONG 	\$ 657						
	Articulating Keyboard Support with 21" Track 24"W x 12"D	AKTMID 	\$ 565						
	Keyboard Spacer Kit 10 – 2½"H Spacers and Hardware	AKMH 	\$ 57						
	CPU Hammock™ (Silver only) 360° swivel CPU holder with adjustable straps	ACPU1 	\$ 383						
	Metal Corner Sleeve — for use with Optimize™, Concensys®, and Terrace® • Fits 1¼" thick square edge detail. (T-Mold worksurfaces) 22½"W leading edge x 18"D.	AWCS	<table border="1"> <thead> <tr> <th>P1 Paint List Price</th> <th>P2 Paint List Price</th> <th>P3 Paint List Price</th> </tr> </thead> <tbody> <tr> <td>\$ 134</td> <td>\$ 138</td> <td>\$ 143</td> </tr> </tbody> </table>	P1 Paint List Price	P2 Paint List Price	P3 Paint List Price	\$ 134	\$ 138	\$ 143
P1 Paint List Price	P2 Paint List Price	P3 Paint List Price							
\$ 134	\$ 138	\$ 143							

Edge Details

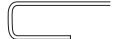

Model AWCS

How to specify —

Select the Model Number from above.



Examples: AKMH ACPU1

 Shippable by small-package carrier.

Allsteel's tool rail works in conjunction with a variety of accessories. Modular accessories free up worksurface space and provide orderly storage that is well within reach. Units can be arranged and rearranged to respond to changing workflow. The work tools that attach to the tool rail are:

- Mail Box
- Folder Holder
- Phone Caddy
- Binder Bin
- Tool Box
- Clip Caddy™
- Sidebar™ Personal Shelf
- Paper Wave™
- Gripper Clip

Additional accessories that work with the **tool rail work tools** aesthetically are:

- Bookends
- Freestanding Mail Box

Coat hooks, marker boards and center drawers round out the organization offering.

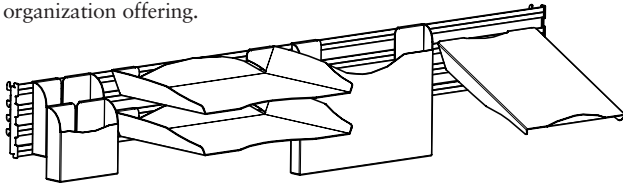

Tool rail, shown above, is height-adjustable in 1" increments using slots in panels or metal hutch. Tool rail shown with two tool boxes, two mail boxes, folder holder, and phone caddy. Folder holders and binder bins extend below a tool rail. Paper Wave and contents extend above a tool rail.

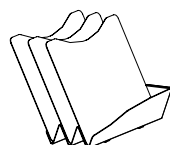
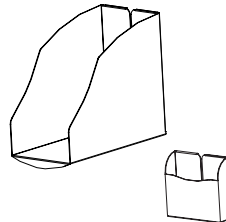
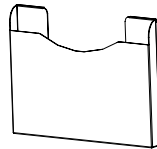

Tool Rails and Work Tools (page 395)

- Sturdy aluminum extrusion with steel support construction.
- Powder coated for durable finish.
- Use to hang Extensions tools. Cannot be used to support monitor arms.
- Suggested weight capacity not to exceed 80 lbs.
- Consideration needs to be given to height of tools and location of worksurfaces.
- For use with Terrace®, Concensys®, and Optimize™ systems.
- 5" high rail (widths coordinate with panels).
- Attachment via vertical reveals.
- Can be hung from wall track. Good solution for above copiers.
- Systems tool rail is off-modular — can be used on a panel of equal width or one size smaller.
- May span two panels of appropriate size, i.e., 60" W Tool Rail on two 30" W panels.

Tool Rail for Hutches (page 395)

- Will work on Universal, Terrace, Optimize, and Concensys system hutches produced after July 2, 2000 and Align™ metal hutches.
- Sturdy aluminum extrusion with steel support construction.
- Powder coated for durable finish.
- Use to hang Extensions tools. Cannot be used to support monitor arms.
- Suggested weight capacity not to exceed 80 lbs.
- Consideration needs to be given to height of tools and location of worksurfaces.

Mail Box (page 396)

- Holds standard letter-size paper and inter-office envelopes.
- Minimal horizontal intrusion.

Folder Holder (page 396)

- Holds manila envelopes.
- Is capable of hanging on other folder holders to maximize space.
- Stores vertically for easy access to files.

Phone Caddy (page 396)

- Holds telephone at optimum ergonomic angle.
- Wire management cut-outs.
- Accommodates standard phone sizes.

Binder Bin (page 396)

- Holds folders, binders, and manuals.

Tool Box (page 396)

- Holds pencils and other writing utensils, large post-it notes, and other desk top accessories.

Clip Caddy™ (page 396)

- Holds paper clips and other small objects.

Sidebar™ Personal Shelf (page 396)

- Holds office supplies and personal effects.

Paper Wave™ (page 396)

- Provides 3 fully divided slots for organizing files.
- Keeps papers from "bowing" at bottom.

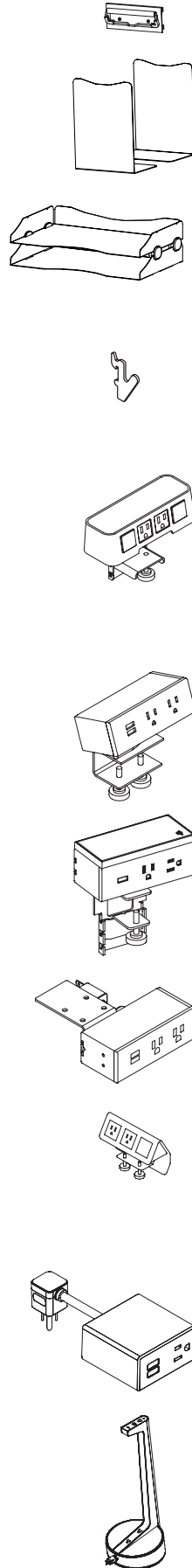

Gripper Clip (page 396)

- Binds project papers together.
- Mounts to tool rail or tool tile.

Bookends (page 396)

- Can be used on shelves or in cabinets.
- Used to hold books, binders, and catalogs upright.

Freestanding Mail Box (page 396)

- Incorporates similar aesthetic to mounted Mail Box.
- Mounting brackets allow for free access from front and back.
- Sold in pairs of two; will stack up to eight high.
- Individual mail box dimension = 1 3/4" H.
- Stacking brackets are black.

Coat Hook APMC6 (page 396)

- Hangs directly into slotted Terrace®, Optimize™, or Concensys® panel frame.
- Use for coat or bag.
- Package of six.
- Available in black only.

Power/Data Modules — Clamp On Worksurface (page 402)

- On-surface mounting option, fits on any worksurface with a 4" overhang.
- 6' Power cord. UL Listed.
- Includes adapters to allow use of commercially available data terminals or blanks to fill unused openings. Many of the AMP, AT&T, Krone, Leviton and most commercial data terminals can be used.

Power/Data Modules — Clamp On Worksurface (page 402)

- Worksurface clamp can be used on any surface with a 2 1/2" overhang.
- Must be installed at time of initial worksurface installation if installing between a worksurface and panel.
- 6' Power cord. UL Listed.
- The USB hub allows simultaneous powering of 2 USB-A devices. The USB hub is a charger only, no ability to connect to a PC. The charging capacity is limited and may not charge all devices.
- Qi compatible wireless charging available on select models.

Power/Data Modules — Under Worksurface (page 402)

- Under surface mounting can be used on any surface with a 5" clearance.
- 6' Power cord. UL Listed.
- Hardware not included.

Worksurface Power/Data Module (page 402)

- Provides easy access to technology at primary worksurface.
- Mounts to edge of a worksurface and requires 3/8" gap. Consider whether 3/8" gap will work with layout.
- Must be mounted at time of initial worksurface installation if mounting between a worksurface and a panel. Maintaining 3/8" gap may not be possible with worksurfaces that are panel wrapped.

Miki Power Modules (page 402)

- Table top and undermount units.
- Hardware not included on undermount.
- 6' Power cord, UL Listed.
- 1 AC power and 1 dual USB configuration.

Vesta Mobile Power (page 402)

- 3 AC power simplex, 1 dual USB-A, 1 USB-C configuration.
- 10' Retractable power cord, UL Listed.
- Unit weighs 13 lbs.

EXTENSIONS

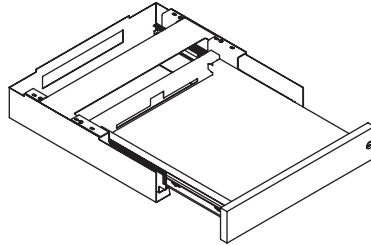
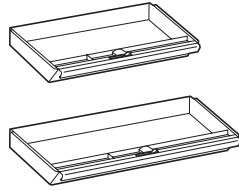

Flat Brackets

Front View

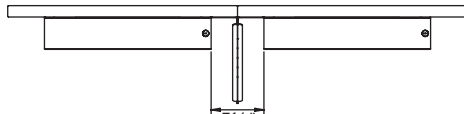

Top View

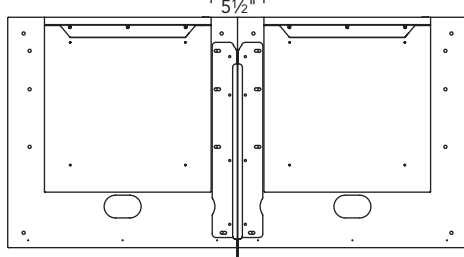

Metal Center Drawers (page 397)

- All metal center drawers feature pencil trays with three compartments for storage.
- Center drawers will not fit in center of 24" D worksurfaces which are wider than 60" due to location of center support bracket.
- For locking specifications, see pages 408-410.
- Ball-bearing slide suspension.

Laptop Drawer — U7WDA (page 397)

- Drawer body made of sheet metal.
- Drawer front made of 3/4" particleboard with laminate on both sides and fused laser edge banding.
- Core removable lock is located on right side drawer front
- 17 5/8" W x 18" D x 3 3/8" H Outside (interior 13" W x 16" D x 1 7/8" H)
- Minimum surface depth is 21" for surfaces not using an external stiffener; and 27" for surfaces using an external stiffener.
- Drawer extends 16"
- Maximum load: 45 lbs (functional BIFMA load)
- Drawer assembly and cover have cut out in back to allow for cables to exit drawer.
- Distance from floor to bottom of unit w/glides fully retracted is 24 3/4".
- Does not interfere with Further leg mounting plates so drawer can be placed directly next to either a system or table leg.
- When being placed next tower storage using the tower ell bracket (Z6LB) to support surface the drawer must be inset 3" to clear the ell bracket.
- Can be placed directly next to any support storage from any Allsteel product line (excluding towers).
- Flat brackets — drawer must be offset 3" from seam between surfaces to clear the bracket. See illustration at left.
- Can be used with rabbit edge worksurface models but there will be a larger reveal between surface and drawer.
- Can be used with knife edge worksurface models but reveal and depth need to be considered.

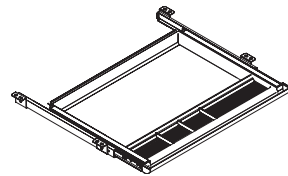

Polymer Center Drawer - ACD1 (page 397)

- 20 1/2" W x 17" D x 2" H
- Available in black only
- Made from ABS.
- Minimum clearance for mounting: 23" W x 16 1/4" D x 2" H.
- Retracts on 16" ball-bearing slides.
- Can be used on worksurfaces with Height Adjustable Bases as long as it is attached with spacer model AKMH.
- Can store up to 25 lbs.

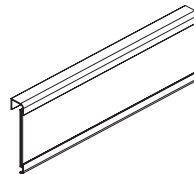





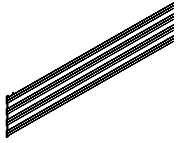

Name Plate (page 396)

- Comes in a 10-pack.
- Metal backer installs under a Terrace or Optimize top cap, can be used with frameless glass.
- Cover is a transparent polycarbonate insert.
- Full plate is 8 1/2" W x 2 5/8" H.





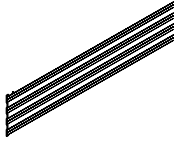

For specification information see pages 392-393.

GSA SIN 33721



Description	Model	P1 Paint List Price	P2 Paint List Price	P3 Paint List Price
5"H Tool Rails — for Panels				
24"W	EASR24 	\$ 237	\$ 270	\$ 301
30"W	EASR30 	\$ 251	\$ 284	\$ 315
36"W	EASR36 	\$ 262	\$ 295	\$ 326
42"W	EASR42 	\$ 274	\$ 307	\$ 338
48"W	EASR48 	\$ 281	\$ 314	\$ 345
60"W	EASR60 	\$ 332	\$ 365	\$ 396



5"H Tool Rails — for Metal Hutches				
36"W	EAHSR36 	\$ 262	\$ 294	\$ 324
42"W	EAHSR42 	\$ 274	\$ 306	\$ 336
48"W	EAHSR48 	\$ 281	\$ 313	\$ 343
60"W	EAHSR60 	\$ 332	\$ 364	\$ 394
66"W	EAHSR66 	\$ 342	\$ 374	\$ 404
72"W	EAHSR72 	\$ 368	\$ 400	\$ 430

How to specify —
Select the Model Number from above.

1st Option:

Paint:



See page 14 for finishes.









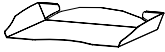
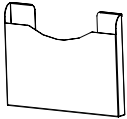

_____ . **P** _____

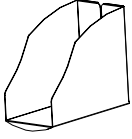
Example: EASR36.P02

 Shippable by small-package carrier.

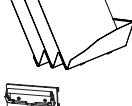
For specification information see pages 392-393.

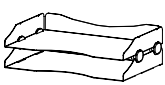
GSA SIN 33721

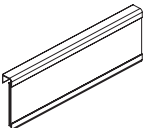
	Description	Model	P1 Paint List Price	P2 Paint List Price	P3 Paint List Price
	Mail Box 9"D x 15"W	EAPT S	\$ 117	\$ 134	\$ 148
	Folder Holder 9"H x 12"W	EAFS S	\$ 120	\$ 137	\$ 151
	Phone Caddy 9"W x 11"D	EATS S	\$ 146	\$ 163	\$ 177
	Binder Bin 8½"H x 5¼"W x 10"D	EABS S	\$ 117	\$ 134	\$ 148
	Tool Box 5"H x 5¼"W x 1½"D	EADH S	\$ 93	\$ 110	\$ 124
	Clip Caddy™ 2"H x 7"W x 3½"D	EAAC S	\$ 83	\$ 100	\$ 114
	Sidebar™ Personal Shelf 2"H x 21"W x 7"D	EAPS S	\$ 120	\$ 137	\$ 151
	Paper Wave™ Tray size: 2½"H x 6"W x 10"D Dividers: 9½"H x 9"W	EASS S	\$ 167	\$ 184	\$ 198
	Gripper Clip Package of 2 — 5"W x 2"H	EAPC S	\$ 120	\$ 137	\$ 151
	Freestanding Mail Box (specify paint color) Pair — 4⅞"H x 13¼"W x 9"D	EAFB S	\$ 241	\$ 258	\$ 272
	Coat Hooks (black only) Package of six	APMC6 S	\$ 117	N/A	N/A
	Panel Name Plate Package of 10	EACS S	\$ 320	\$ 337	\$ 351

Note: Not for use on tool tile or rail, name plate installs under top cap on Terrace and Optimize.

How to specify —
Select the Model Number from above.

1st Option:

Paint:

P1 P2 P3

See page 14 for finishes.

P | | | |





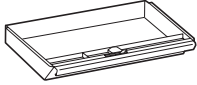
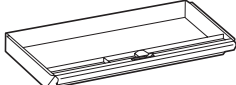
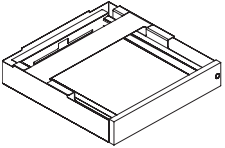
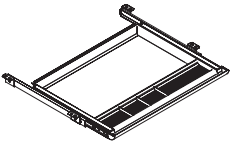

Examples: EAPT.P4J APMC6.P

S Shippable by small-package carrier.

For specification information see pages 393-394.

GSA SIN 33721

	Description	Model	List Price		
			P1	P2	P3
 <p>Angled front</p>	Metal Center Drawer w/Lock 19"W x 14¼"D x 3"H • 12" drawer extension (3/4). • Inside drawer dimension: 19"W x 13"D x 2⅝"H. • Minimum clearance for mounting: 21¼"W x 19¼"D.	CSDC19 S	\$ 271	\$ 290	\$ 306
 <p>Angled front</p>	24¼"W x 14¼"D x 3"H • 12" drawer extension (3/4). • Inside drawer dimension: 24½"W x 13½"D x 2⅝"H. • Minimum clearance for mounting: 27⅞"W x 19¼"D.	CSDC25 S	\$ 278	\$ 297	\$ 313
	Laptop Drawer — Locking, laminate front, metal case 17⅝"W x 18"D x 3⅜"H • 16" drawer extension • Inside drawer dimensions: 13"W x 16"D x 1⅞"H • Minimum clearance for mounting: 17⅞"W x 21"D x 3⅜"H (see illustration)	U7WDA S	\$ 1558	\$ 1578	\$ 1594
	Polymer Center Drawer 20½"W x 17"D x 2"H • 11½" extension • Minimum clearance for mounting: 23"W x 16¼"D x 2"H	ACD1	\$ 216	N/A	N/A

<p>How to specify — Select the Model Number from above.</p>	<p><i>1st Option:</i> Laminate Edge (Laptop drawer front if applicable): See page 20 for finishes.</p>	<p><i>2nd Option:</i> Edge (Laptop drawer edge if applicable): See page 20 for finishes.</p>	<p><i>3rd Option:</i> Paint (If laptop drawer, list exterior case color here): See page 14 for finishes. Power Data Module PR6 Silver.</p>	<p><i>4th Option:</i> Paint (Interior of laptop drawer if applicable): See page 14 for finishes.</p>	<p><i>5th Option:</i> Lock (if applicable): STD Standard OMT Omit (Deduct \$18)</p>	<p><i>6th Option:</i> Lock or Tech Module Color (if applicable): EL Silver (Lock)</p>
						

Example: U7WDA.LM11EV.P27.PR6.STDEL

S Shippable by small-package carrier.

Allsteel Extensions offers Illumination in three styles — Undercabinet LED Light, Wand Light, and **Splitly Light**.

Recessed Undercabinet LED Light

Recessed task lights conserve space and provide an efficient solution for illuminating the workplace. All models are equipped with LED strips.

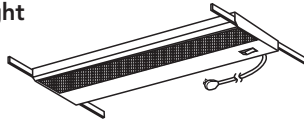

Recessed task light models mount under storage cabinets or shelves to provide optimal space utilization. Models are available in two styles and three sizes to correspond with the width of the cabinet or shelf. Task lights with a fused plug are available to meet Chicago electrical code.

Undercabinet LED Light

The Undercabinet LED Light is a low-profile, linear solution for overhead cabinets and shelves and is an ideal solution for painted wood storage. It utilizes energy-efficient LED technology which provides a long life. The Undercabinet LED Light provides the opportunity to mount the fixture where light is needed most.

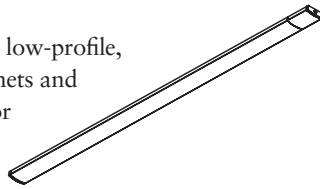

The Undercabinet LED Light features a metal trough reflector with diffuser lens. The light has a sleek 1/2" thick profile and provides two options for mounting, either magnetically or with hardware. Undercabinet LED Lights can be daisy-chained.

Optional undercabinet occupancy sensor is available which will automatically turn off the fixture after 30 minutes of no detection and back on immediately as the user re-enters the detection range using Passive Infrared (PIR) sensor technology. Unit features 360° lens with 90° outward detection angle, providing a 36" coverage diameter at 18". Occupancy sensor comes with connector and is required to be connected in the sequence shown below. Connect occupancy sensor to a light, or first light in daisy chain to control all linked lights.

CONNECTION SEQUENCE*

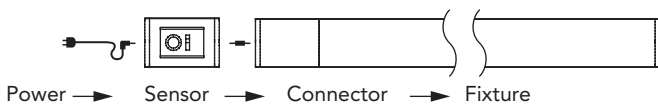

*Cannot deviate from this sequence

Recessed Task Lights (page 400)

- Black Metal Construction with 9' long black cord attached to right rear corner of the fixture.
- LED strip comes installed within light.
 - 50,000 hour life span
 - 120V-277V
 - CCT 4000K
 - CRI 80+
- Includes 4 cord retainer clips.
- Shorter width models can be used on wider overheads, shelves and hutches.
- On/Off switch provides individual control of tasklight within the workstation.
- Daisy chain models require a master control model — 10 fixtures maximum.
- RECOMMENDATION: Provide a separate circuit for task lights to ensure proper, long-term operation.

Undercabinet LED Lights (page 400)

- Low profile energy-efficient LED task light for use with overhead storage cabinets and shelves.
- 20W power supply for 10W 17" unit (.166 amps).
- 20W power supply for 20W 31" unit (.166 amps).
- 60W power supply for daisy-chain starter units (.5 amps). Must order one starter unit for each daisy-chain application.

LED Light Combinations Must Not Exceed 60W in Combination	Power Usage
6X 17"	60W
3X 31"	60W
1X 31" + 4X 17"	60W
2X 31" + 2X 17"	60W

- The combinations that could max out 60W are featured above. *Daisy chained units have a power limit of 60W from one power entry. 17W units use 10W and 31W units use 20W.*
- Specify up to 5 additional 17" interconnect units (ALED17UJMP30) to daisy-chain together with 17" daisy-chain starter fixture (ALED17U60).
Example: Daisy-chain 4-17" undercabinet LED lights:
Specify: 1 ALED17U60
Specify: 3 ALED17UJMP30 with 10" jumper cord
- Specify up to 2 additional 31" interconnect units (ALED31UJMP30) with 10" jumper cords to daisy-chain together with 31" tasklight (ALED31U60); or 17" daisy-chain starter fixture (ALED17U60).
- 3500K color temperature.
- 131 footcandles at 18" on ALED31U; 76 footcandles at 18" on ALED17U.
- Magnetic or screw-mount option — attachment hardware included.
- On 20 watt models, power drive is attached to plug: allow 1 1/8" D space at outlet.
- On 60 watt models, power drive brick is in center of cord.
- Includes 3 cord retainer clips.
- Meets California Title 24 Energy Efficiency Standards.
- "Instant On" switch with infinite dimming cycle from 100% to 15% with the last state memory, allowing the user to set their desired level of lighting.
- Fixture automatically turns off after 10 hours of use to reduce unwanted energy use.
- Optional occupancy sensor automatically turns off all interlinked fixtures after 30 minutes of no detection and back on immediately when detection is found.

Overhead Length	Suggested LED Sizes
24	17
30	17
36	17
42	31
48	17 + 17
60	31 + 17
72	31 + 31

Note: LED lights may need to be positioned along length properly to allow jumping to additional overheads. Suggested sizes above are recommendations for single overheads to provide as much light along length of overhead as possible.

The suggested sizes factor in 4 inches of room for the power inlet and occupancy sensor (optional).

Wand™ Task Light

Wand freestanding task light offers a clean, simple design along with powerful LED technology to illuminate the workspace. The swivel base and arm tilt allow users to position the light just where they need it. The 7.7 watt LED light offers efficiency and long life, providing up to 25 years of daily use. The slim, sleek design makes it easy to integrate into any workspace. Wand task light is 97% recyclable. Occupancy sensor and/or charging models available.

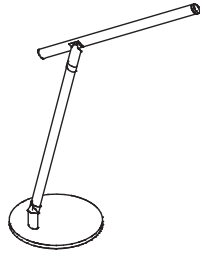

Wand LED Freestanding Task Light (page 401)

- Available in Silver or White. 9'4" cord is Silver.
- Full range dimming from 100% – 10% with last state memory.
- Uses 5W at highest setting and as low as 1 watt at its lowest setting, providing 75 to 12.7 footcandles of light, respectively (16" above worksurface).
- 7½" round swivel base and 16½"H tilt arm allow versatile positioning of the 13" lampshade.
- Designed for 50,000 hours of life.
- Color Temperature: 3500K. Color Rendering Index (CRI): 80.
- Materials: aluminum arm and lampshade, steel base.
- Weight: 4.4 lbs. 97% recyclable, 76% post-consumer.
- Certifications: UL and CUL. TAA compliant.
- Occupancy sensor available with automatic shut-off after 15 minutes if no motion is detected.
- USB model features USB-A (1), USB-C (1) charging within base of unit.
- USB model also features occupancy sensor. 7.5W (A) & 18W (C) power consumption.

Splitty Task Light

Splitty's organic and modern design compliments the workstation while also bringing rich features to the user. In addition to illuminating the space, Splitty can also be a teleconferencing tool through Splitty's 360-degree light head adjustment and soft touch, continuous dimming. Integrated charging allows for small personal device charging crucial to the modern worker's workplace toolkit while minimizing clutter within the station. Optional clamp or tool tile mounts available as accessories.

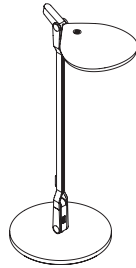

Splitty Task Light (page 401)

- Available in Silver, White, or Black (accessories available in silver only).
- Cord is 12' long.
- Cord is silver when black or silver finish specified, white when white light is specified.
- Soft touch on/off, dimming.
- Continuous dimming (100% – 3%) with last state memory.
- 5.8W of energy consumption. 7W at highest setting, 0.6W at lowest.
- 5" 360-degree swivel light head, 6.54" round swivel base and 17"H arm. Arm has full 180 degree rotation and 360 degree swivel.
- Designed for 60,000 hours of life.
- Color Temperature: 3500K, Color Rendering Index: 90.
- Materials: aluminum, plastic.
- USB-A has 5W of power consumption.
- USB-A (1) charging at bottom of light arm stem. Charging feature compatible for any mounting method.
- Clamp mount compatible with surfaces ¼" – 2¼" thick.
- Tool tile mount has 1½" adjustment range, minimum slot height of ⅝".

For specification information see pages 398-399.

Open Market / GSA SIN 33721 (as noted)



Open Market

Description	Watt Usage	Model	List Price
Recessed Task Lights (Black only) — Use recessed under overhead cabinets, storage shelves, or hutches, comes with cord retainer clips			
Task Light for 24"W	10	A870824 <input type="checkbox"/>	\$ 393
Task Light for 30"W and 36"W	14	A870830 <input type="checkbox"/>	\$ 397
Task Light for 42"W and 48"W	21	A870842 <input type="checkbox"/>	\$ 429
Task Light for 60"W, 66"W, and 72"W	28	A870860 <input type="checkbox"/>	\$ 464

Recessed Task Lights (Black only) — With fused plug (satisfies Chicago electrical code)

Task Light for 24"W	10	A870824CH <input type="checkbox"/>	\$ 507
Task Light for 30"W and 36"W	14	A870830CH <input type="checkbox"/>	\$ 517
Task Light for 42"W and 48"W	21	A870842CH <input type="checkbox"/>	\$ 550
Task Light for 60"W, 66"W, and 72"W	28	A870860CH <input type="checkbox"/>	\$ 581

Note: See below for GSA Approved Task Lights.

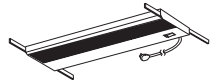

GSA SIN 33721

GSA Recessed Task Lights — Use recessed under overhead cabinets, storage shelves, or hutches

Base Models — Stand Alone

Task Light for 24"W	15	GS870924 <input type="checkbox"/>	\$ 502
Task Light for 30"W and 36"W	17	GS870930 <input type="checkbox"/>	\$ 519
Task Light for 42"W and 48"W	25	GS870948 <input type="checkbox"/>	\$ 557
Task Light for 60"W, 66"W, and 72"W	32	GS870960 <input type="checkbox"/>	\$ 597



GSA SIN 33721

Cord Retainer Clips (Black only)

Bag of 50 clips		AAPACM2 <input type="checkbox"/>	\$ 49
-----------------	--	----------------------------------	-------

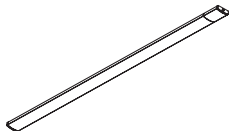

GSA SIN 33721

LED Undercabinet Light (white end caps)

17" Task Light w/20 watt power supply for 24"W or wider overhead	ALED17U <input type="checkbox"/>	\$ 930
17" Task Light w/60 watt power supply for daisy chain	ALED17U60 <input type="checkbox"/>	\$ 1018
17" 10 watt Interconnect Task Light w/10" Jumper Cord	ALED17UJMP30 <input type="checkbox"/>	\$ 718
31" Task Light w/20 watt power supply 36"W or wider overhead	ALED31U <input type="checkbox"/>	\$ 1396
31" Task Light w/60 watt power supply for daisy chain	ALED31U60 <input type="checkbox"/>	\$ 1471
31" 20 watt Interconnect Task Light w/10" Jumper Cord	ALED31UJMP30 <input type="checkbox"/>	\$ 838
Undercabinet Occupancy Sensor 2½"W + 1"W Connector	ALEDOCC*	\$ 566

*Undercabinet Occupancy Sensor works with LED Undercabinet lights shipped after 11/1/2013.

<p>How to specify — Select the Model Number from above.</p>	<p>1st Option: Cord Retainer Clip Color: Black only.</p>
--	---

P | 2 | 7

Examples: A870824 A870824CH GS870924 AAPACM2.P27

Shippable by small-package carrier.

For specification information see pages 398-399.

Open Market / GSA SIN 33721



GSA SIN 33721

Description	Model	List Price
Wand™ LED Task Light (Silver or White)		
Freestanding LED Task Light	WANDFS	\$ 453
Freestanding LED Task Light (Occupancy Sensor)	WANDFSOC S	\$ 644

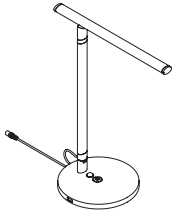

Freestanding LED Task light (Occupancy Sensor & Charging)	WANDFSUSB	\$ 671
---	-----------	--------



Splitty Task Light (Silver, White, or Black)		
Freestanding LED Task Light (Charging)	PRFTSKFS	\$ 613

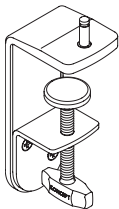

Clamp Mount (Silver only)	PRFTSKCL	\$ 70
---------------------------	----------	-------

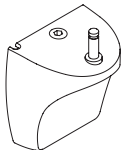

Tool Tile Mount (Silver only)	PRFTSKTR	\$ 70
-------------------------------	----------	-------

<p>How to specify — Select the Model Number from above.</p>	<p><i>1st Option:</i> Color (for Splitty): SVR Silver WHT White BLK Black</p> <p>(for Wand LED): SVR Silver WHT White</p>
--	--

Example: WANDFS.WHT

S Shippable by small-package carrier.

Extensions

For specification information see page 393.

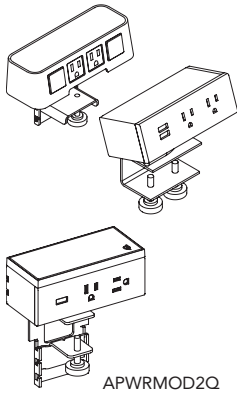

Description	Model	List Price
Power/Data Modules — Worksurface Clamp		
Dome — 2 Power, 2 Open Data with faceplate adapters (FOG Fog only)	ACOMDOME2	\$ 458
2 Power, 2 USB (SNW Snow or STRM Storm)	APWRMOD2WC	\$ 632
3 Power (SNW Snow or STRM Storm)	APWRMOD3WC	\$ 486
2 Power, 1 Dual USBA, Qi Power Module	APWRMOD2Q	\$ 697

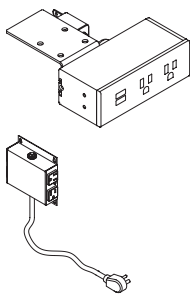

Power/Data Modules — Under Worksurface Mount		
2 Power, 2 USB (SNW Snow or STRM Storm)	APWRMOD2UWM	\$ 632
3 Power (SNW Snow or STRM Storm)	APWRMOD3UWM	\$ 486
4 Power Quad Tap (10' cord)	UNQTMP	\$ 405

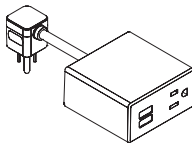

Miki		
1 Power, 1 USB Table Top	APWRMOD1TT	\$ 278
1 Power, 1 USB Under Worksurface Mount	APWRMOD1UWM	\$ 278

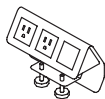

Worksurface Power/Data Module (PR6 Silver only)		
2 Simplex receptacles, 1 data position	A870302	\$ 351



Vesta		
3 Power Vesta – Corded	AVSTA3PWR	\$ 1780

EXTENSIONS

<p>How to specify — Select the Model Number from above.</p> <p>_____</p> <p>_____ .</p>	<p><i>1st Option:</i></p> <p>Color Option 1:</p> <p>FOG Fog</p> <p>SNW Snow</p> <p>STRM Storm</p> <p>BLK Black</p> <p>_____ .</p>	<p><i>2nd Option:</i></p> <p>Color Option 2 (if applicable):</p> <p>FOG Fog</p> <p>SNW Snow</p> <p>STRM Storm</p> <p>BLK Black</p> <p>_____</p>
--	--	--

Example: ACOMDOME2.FOG

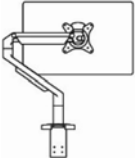
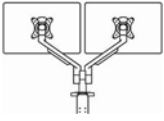
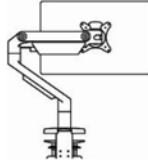
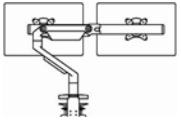
PIVOT MONITOR ARMS	Standard Dynamic Single	Standard Dynamic Dual	Heavy Duty Dynamic Single	Heavy Duty Dynamic Dual with Crossbar
Allsteel Model:	AMASTS	AMASD	AMASHD	AMADHD
				
Features:				
Price	\$425	\$858	\$732	\$1012
Colors	Black and Silver	Black and Silver	Black and Silver	Black and Silver
Monitor Rotation	180°	180°	180°	180°
Monitor Extension	18.75"	18.26"	20.75"	23"
Monitor Tilt Adjustment	+25°/-25°	+25°/-25°	+25°/-25°	+25°/-25°
Arm Height Adjustment	8.4" to 19"	9.6" to 20.1"	8.5" to 20"	8.5" to 20"
Weight Capacity	6.2 to 17 lbs.	6.2 to 17 lbs. per Arm	8 to 35 lbs.	17.5 lbs. per VESA Plate
Mounting Option	Grommet and Clamp Mounts	Grommet and Clamp Mounts	Grommet and Clamp Mounts	Grommet and Clamp Mounts
360° Lockout Feature	Yes	Yes	Yes	Yes
VESA Compatibility	75mm and 100mm	75mm and 100mm	75mm and 100mm	75mm and 100mm
Pole Height	N/A	N/A	N/A	N/A
Maximum Width per Monitor*	N/A	25"	N/A	25"
Worksurface Clamp Requirements	¾" to 2" Thick	¾" to 2" Thick	¾" to 2" Thick	¾" to 2" Thick
Worksurface Grommet Clamp Requirements	¾" to 2" Thick/Hole Diameter ⅜" to 2"	¾" to 2" Thick/Hole Diameter ⅜" to 2"	¾" to 2" Thick/Hole Diameter ⅜" to 2"	¾" to 2" Thick/Hole Diameter ⅜" to 2"
Environmental Info	94% Recycled Content	94% Recycled Content	94% Recycled Content	94% Recycled Content

*Use of APACSM Slider Model will allow for wider monitor capabilities

Pivot Standard Weight Monitor Arms

- Adaptable and adjustable to user preference the Pivot monitor arm offers a slim and refined design coupled with easy fingertip adjustment.
- Multiple points of adjustment including 360 degree swivel with optional 180 degree lockout, 18.75" extension, and 10" of height adjustment.
- Monitor tilts +25/-25 degrees.
- Standard weight arms utilize a tension spring that allows for effortless adjustment of monitors to proper ergonomic positions.
- Tension adjustment at multiple points allows for proper adjustment for monitors weight between 6-17 lbs.
- Model includes grommet and worksurface mounting options.
- Desk clamp mounts require ¾" – 2" thick surfaces; grommet mount requires hole diameter of ⅜" to 2" wide and accommodates up to 2" thick surfaces.
- Integrated cable management included with each model. Black models ship with all black cable management pieces, Silver models ship with grey wire management but optional white pieces ship in the box and can be installed on site.
- Dual monitor arm supports up to 25" wide monitors. Wider monitors may require use of optional slider mount model.
- Pivot arms are VESA 75mm and 100mm compatible.
- Quick release feature simplifies monitor installation and changes.

Pivot Slider Mount

- Provides 11.8" of horizontal movement.
- Allows for wider monitors to be used on dual monitor arms and sit flush side by side.
- Not compatible with Pivot Heavy Duty Series.

Pivot Heavy Duty Series

- Adaptable and adjustable to user preference the Pivot monitor arm offers a slim and refined design coupled with easy fingertip adjustment.
- Multiple points of adjustment including 360 degree swivel with optional 180 degree lockout, 20.75" extension, and 12" of height adjustment.
- Monitor tilts +25/-25 degrees.
- Tension adjustment at multiple points allows for proper adjustment for monitors weight between 8-35 lbs.
- Model includes grommet and worksurface mounting options.
- Desk clamp mounts require ¾" – 2" thick surfaces; grommet mount requires hole diameter of ⅜" to 2" wide and accommodates up to 2" thick surfaces.
- Integrated cable management included with each model. Black models ship with all black cable management pieces, Silver models ship with grey wire management but optional white pieces ship in the box and can be installed on site.
- Dual monitor arm supports up to 2 monitors weight 4-17.5 lbs each.
- Pivot arms are VESA 75mm and 100mm compatible.
- Quick release feature simplifies monitor installation and changes.

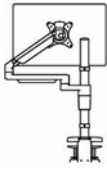
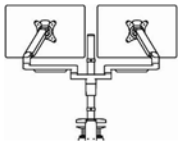
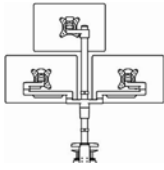
PIVOT MONITOR ARMS	Dynamic Single Post	Dynamic Dual Post	Triple Fixed Post
Allsteel Model:	APASD	APADD	APATF
			
Features:			
Price	\$628	\$879	\$1110
Colors	Silver	Silver	Silver
Monitor Rotation	180°	180°	180°
Monitor Extension	21"	21"	23"
Monitor Tilt Adjustment	+25°/-25°	+25°/-25°	+25°/-25°
Arm Height Adjustment	10.6"	10.6"	N/A
Weight Capacity	6.2 to 17 lbs.	6.2 to 17 lbs. per Arm	17 lbs. per arm
Mounting Option	Grommet and Clamp Mounts	Grommet and Clamp Mounts	Grommet and Clamp Mounts
360° Lockout Feature	Yes	Yes	Yes
VESA Compatibility	75mm and 100mm	75mm and 100mm	75mm and 100mm
Pole Height	17.7"	17.7"	27.5"
Maximum Width per Monitor*	25"	25"	25"
Worksurface Clamp Requirements	7/8" to 2" Thick	7/8" to 2" Thick	7/8" to 2" Thick
Worksurface Grommet Clamp Requirements	7/8" to 2" Thick/Hole Diameter 3/16" to 2"	7/8" to 2" Thick/Hole Diameter 3/16" to 2"	7/8" to 2" Thick/Hole Diameter 3/16" to 2"
Environmental Info	94% Recycled Content	94% Recycled Content	94% Recycled Content

*Use of APACSM Slider Model will allow for wider monitor capabilities

Pivot Post Series

- Adaptable and adjustable to user preference the Pivot monitor arm offers a slim and refined design coupled with easy fingertip adjustment.
- Multiple points of adjustment including 360 degree swivel with 21" extension and 10.6" of height adjustment.
- Monitor tilts +25/-25 degrees.
- Tension adjustment at multiple points allows for proper adjustment for monitors weight between 6.5-17 lbs per arm.
- Model includes grommet and worksurface mounting options.
- Desk clamp mounts require 7/8" – 2" thick surfaces; grommet mount requires hole diameter of 3/16" to 2" wide and accommodates up to 2" thick surfaces.
- Integrated cable management included with each model. Silver color option with grey wire management only.
- Dual monitor arm supports up to 25" wide monitors. Wider monitors may require use of optional slider mount model.
- Single and dual models have a post height of 17.7"; Triple monitor model has a post height of 27.5".
- Pivot arms are VESA 75mm and 100mm compatible.
- Quick release feature simplifies monitor installation and changes.

Pivot Counterweight Kit

- Counterweight Kit to be used with monitors weighing less than 6 lbs.
- Gray color only.
- Counterweight weighs 1 lb. 6 oz.

Pivot Conversion Kits

- Kit allows user to transform single monitor arm (Standard, Heavy Duty, or Post) into Dual Arm configuration
- Available in black and silver, Post arm only available in silver
- Required wire management included
- Once assembled, will aesthetically emulate dual configuration of chosen arm

Accessories — Pivot Monitor Arms

Pivot

For specification information see pages 404-405.

GSA SIN PENDING, GSA SIN 33721

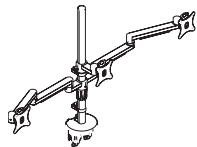
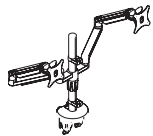
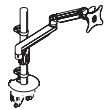
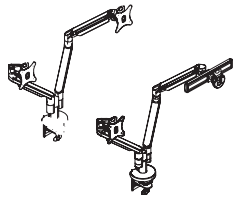
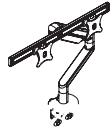

Description	Model	List Price
Pivot Monitor Arms		
Dynamic Single Monitor - Standard Weight	AMASTS <input type="checkbox"/>	\$ 425
Dynamic Single Monitor - Standard Weight for GSA *Silver Only Open for order Fall 2020 – GSA SIN 33721.	AMASTS-G	\$ 502
Dynamic Single Monitor - Heavy Weight	AMASHD <input type="checkbox"/>	\$ 732
Dynamic Dual Monitor with Crossbar	AMADHD <input type="checkbox"/>	\$ 1012
Dynamic Dual Monitor - Standard Weight	AMASD <input type="checkbox"/>	\$ 858
Dynamic Dual Monitor - Standard Weight for GSA *Silver Only **Slider Mount included. Open for order Fall 2020 – GSA SIN 33721.	AMASD-G	\$ 915
Single Dynamic Post Arm *Silver Only	APASD <input type="checkbox"/>	\$ 628
Double Dynamic Post Arm *Silver Only	APADD <input type="checkbox"/>	\$ 879
Triple Fixed Post Mount *Silver Only	APATF <input type="checkbox"/>	\$ 1110

How to specify —
Select the
Model Number
from above.

1st Option:
Select the Color:
SVR Silver
BLK Black

A | | | | | | | .

| | | |

Example: AMADHD.BLK

Shippable by small-package carrier.

Accessories — Pivot Monitor Arms

Pivot

For specification information see pages 404-405.

Open Market



Description	Model	List Price
Pivot Monitor Arms		
Monitor Arm Sliding Mount	APACSM <input type="checkbox"/>	\$ 202

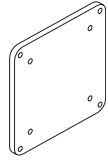

Monitor Arm Counterweight	APACW <input type="checkbox"/>	\$ 47
---------------------------	--------------------------------	-------

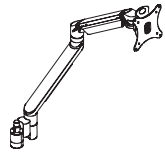

Pivot Monitor Arm Standard Single Conversion Kit	AMASTSCK	\$ 477
--	----------	--------

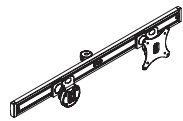

Pivot Monitor Arm Heavy Duty Single Conversion Kit	AMASHDCK	\$ 416
--	----------	--------

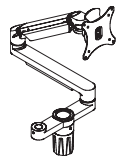

Pivot Single Post Arm Conversion Kit	APASDCK	\$ 606
* Silver Only		

How to specify —
Select the Model Number from above.

1st Option:
Select the Color:
SVR Silver
BLK Black

A | | | | | .

| | | |

Example:

Laterals, Pedestals and Storage, Painted Wood Storage

Standard Options

- Random Keying — The factory will assign key(s) arbitrarily using key numbers from chart below.
- Omit Lock Core — The factory will omit lock cores. Removable lock core kits with specific key number must be ordered to facilitate keying alike in the field.

Vertical Files

Standard Options

- Random Keying — The factory will assign key(s) arbitrarily (see below chart for key numbers).

Key Alike Process







- Order standard product which will be shipped with factory installed locks and random numbered cores.
- Order the appropriate quantity of like numbered cores required for each workstation or keyed area.
- Simply replace the factory installed core with the replacement cores after product has been installed.

Replacing Lock Cores

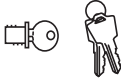
- Lock must be in the unlocked position.
- Insert core removal key and pull core straight out. (Reach units require rotating key 90° clockwise past unlocked position.)
- Insert new core with core removable key, hold core into lock and withdraw core removal key.
- Retain original core for future use.





	Random Keying	Omit Lock Core	Key Numbers	Lock Core Kit	Master Key
Align™ Laterals	X	X	101E-225E	ALKF23C*	AMKF22
Align New Low Credenzas, Towers, Pedestals (“YP” prefix models)	X	X	101E-225E	ALKF26EL	AMKF22
Align Old Pedestals (for New Pedestals after 11/2015 see above)	X	X	101E-225E	ALKF23C*	AMKF22
Align Old Towers (for New Towers after 2/2016 see above)	X	X	101E-225E	ALKF23C*	AMKF22
Align Metal Front Lockers	X	X	101E-225E	ALKF26EL	AMKF22
Align Laminate Front Lockers	X	X	101E-225E	ALKF23C*	AMKF22
Approach™ Desking and Storage	X	X	101E-225E	ALKF26EL	AMKF22
Center Drawer (CSDC19/25)	X	X	101E-225E	ALKF23C*	AMKF22
Essentials™ Laterals	X	X	101E-225E	ALKF23C	AMKF22
Essentials Overfile Cabinets	X	X	101E-225E	ALKF23C*	AMKF22
Essentials Pedestals	X	X	101E-225E	ALKF23C*	AMKF22
Essentials Personal Tower and Files	X	X	101E-225E	ALKF23C*	AMKF22
Further™ Laminate Storage	X	X	101E-225E	ALKF23C*	AMKF22
Hutches	X	X	101E-225E	ALKF23C*	AMKF22
Involve® Laminate Storage	X	X	101E-225E	ALKF23C*	AMKF22
Overheads (Flipper Door, including RTA)	X	X	101E-225E	ALKF23C*	AMKF22
Overheads (Receding Door)	X	X	101E-225E	ALKF23C*	AMKF22
Vertical Files A990/A940	X		101E-225E	ALKF23C*	AMKF22

*ALKF23C is chrome. Optional black core for wood casegoods is ALKF23CE4. Optional matte silver core is ALKF26EL.

	Description	Model	List Price
	Removable Lock Core Kits**	Key Numbers 101E-225E	
	Brushed Chrome used on metal and painted wood casegoods product produced after 2/3/97; A980, A990, and A940 Series vertical files; Persona™ pedestals produced after 8/22/09; Reach® Storage units produced after 10/5/09; and receding door overheads produced after 8/1/10. Includes one core, two keys, one core removal tool, adapter and instructions	ALKF23C 	\$ 27
	Black used on veneer casegoods product. Includes one core, two keys, one core removal tool, adapter and instructions. Core matches manufactured lock on metal casegoods but Black core can be used with veneer and laminate product.	ALKF23CE4 	\$ 27
	Matte Silver used on Approach and Align metal credenzas, new pedestals, and new towers. Includes one core, two keys, one core removal tool, adapter, and instructions.	ALKF26EL 	\$ 27
 Open Market	Master Key (One key) Available to authorized dealers only on faxed orders. Will open ALKF23C, LKF23C, ALKF23CE4, LKF23CE4, LKF24, LKF25EL, and LKF25E4 locks numbered 101E-225E.	AMKF22 	\$ 28

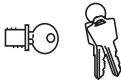
HOW TO ORDER:
Note: Numbers 101E-225E are available. Orders without numbers specified will be keyed at random.
SAMPLE ORDER:

Quantity	Model	Color
6	ALKF23C	X121E
1	AMKF22	X

	Brushed Chrome Removable Lock Core Kit* **	Key Numbers 101N-225N	
	Includes one core, two keys, one core removal tool, adapter, and instructions	ALKF23CN 	\$ 27
 Open Market	Master Key* (One key) Available to authorized dealers only on electronic orders. Will open ALKF23CN and LKF23CN locks numbered 101N-225N.	AMF22 	\$ 28

N series lock cores (ALKF23CN) are a replacement part for legacy Allsteel products. N series lock cores were used in all Persona pedestals produced between January 1996 and August 2009 as well as Receding Door Overheads produced between January 1996 and August 2010. N series lock cores are NOT used in current product and should not be ordered for product produced after these dates. E series lock cores are used in current product, see above.

*On existing Premium and Asset lateral, use N-Series locks.

** Removable Lock Core Kits are intended for use with Allsteel systems furniture and are approved under GSA SIN 33721. When purchased separately and used without Allsteel systems furniture, those Removable Lock Core Kits marked by (**) are considered Open Market.

 Shippable by small-package carrier.

Appendix

Locking Specifications — Easy Lock Program

SIN 33721

EASY LOCK PROGRAM

The Allsteel Easy Lock Program simplifies the lock-core ordering process when multiple cores are being specified. The Easy Lock cores can be used with Allsteel storage that currently uses the **ALKF23C** cores (all storage except Receding Door Overheads).

To ensure ease of ordering in different situations the Easy Lock cores can be specified in three different ways — Random, Specified or Sequential.

Random Keying

The Random Keying option is provided for instances where there are multiple orders or phases to a project and the offices need to be keyed alike but the key numbering is not required. With the random keying option key numbers are not specified, however, the core kits will be in sequential order from a random starting point.

Example: *There are 15 offices which each have 5 black locks that need to be keyed alike, but the actual key numbers are not important.*

This order would look like: **LKFE5BLK.X.15**

This specifies that 15 5-core kits are needed in black with random key numbers.

Specified Keying

The Specified Keying option is provided for the instances where there is a specific key number desired for all of the cores ordered.

Example: *There are 10 offices which each have 2 silver locks that need to be keyed-alike with key number 202.*

This order would look like: **LKFE2SLV.X202.10**

This specifies that 10 2-core kits are needed in silver with key number 202.

Sequential Keying

Allsteel Sequential Keying option is provided for the instances when there are multiple orders or phases to a project and it is imperative that key numbers are not duplicated.

Example: *A multiple phase project has 60 total offices — 40 offices in Phase I, and 20 offices in Phase II. The project manager has expressed a need to have keyed-alike offices but doesn't want any of the offices to use the same key numbers.*

The first 40 offices have 4 silver locks each that need to be keyed-alike.

This order would look like: **LKFE4SLV.SEQ/101.40**

This specifies that 40 4-core kits are needed in silver and the starting number is 101.

The second set of 20 offices only have 3 silver locks each that need to be keyed-alike; and it is important which key number starts off the sequence to ensure that no key number is duplicated. It is known that the first key range was key numbers 101-140.

The second order would look like: **LKFE3SLV.SEQ/141.20**

This specifies that 20 3-core kits are needed in silver and key sequence has to start at key number 141.

HOW TO ORDER:

Numbers 101-225 are available. Orders without key numbers specified will be keyed at random.

SAMPLE ORDER FOR EXAMPLES GIVEN:

Model	Key Type	Quantity
LKFE5BLK.	X.	15
LKFE2SLV.	X202.	10
LKFE4SLV.	SEQ/101.	40
LKFE3SLV.	SEQ/141.	20

NOTE: Quantity required is last number in model.option string.

Description	Model / Color	List Price
Easy Lock Lock-Core		
Lock Core Kit — 1 core, 2 keys	LKFE1 _____	\$ 27
Lock Core Kit — 2 cores, 2 keys	LKFE2 _____	\$ 56
Lock Core Kit — 3 cores, 2 keys	LKFE3 _____	\$ 83
Lock Core Kit — 4 cores, 2 keys	LKFE4 _____	\$ 111
Lock Core Kit — 5 cores, 2 keys	LKFE5 _____	\$ 139
Lock Core Kit — 6 cores, 2 keys	LKFE6 _____	\$ 167
Lock Core Kit — 7 cores, 2 keys	LKFE7 _____	\$ 195
Lock Core Kit — 8 cores, 2 keys	LKFE8 _____	\$ 223
Add color suffix to model: SLV Silver, BLK Black, MTS Matte Silver		
Note: One core removal key minimum per order. One additional core removal key per 25 lock-cores will be shipped.		
Master Key		
(One key) Available to authorized dealers only on faxed orders.		
	AMKF22	\$ 28

How to specify using Easy Lock Program:

Step 1 — Count the number of lock cores and color required in each workstation that need to be keyed alike.

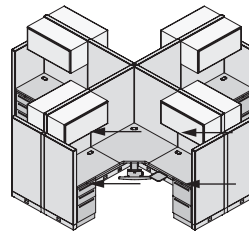

2 overheads with 1 lock-core each = 2
2 pedestals with 1 lock-core each = 2
Total silver lock-cores per station = 4

Step 2 — Count the total number of workstations needing 4 lock-cores.

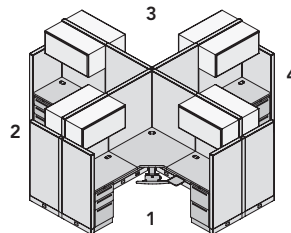

4 total workstations

Step 3 — Specify model number based on total number of lock-cores in a station and quantity of kits based on number of workstations.

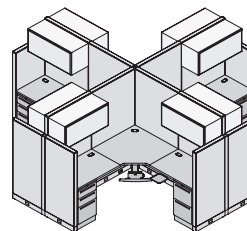

LKFE4SLV.X.4
Lock-Cores per station
Color of Core
Number of workstations

Description	Model	P1 Paint List Price	P2 Paint List Price	P3 Paint List Price
Touch-Up Paint — Brush				
Bottle of Touch-Up Paint with Brush — 0.5 oz.	APTK S	\$ 90	\$ 100	\$ 107
Touch-Up Paint — Spray				
Spray Can of Touch-Up Paint — 12 oz.	ARSLCC S	\$ 90	\$ 100	\$ 107

<p><i>How to specify —</i> Select the Model Number from above.</p> <p>A .</p>	<p><i>1st Option:</i> Paint Color: P1 P2 P3</p> <p>See page 14 for options. Some colors are limited to brush or spray.</p> <p> </p>
---	---

Examples: APTK.P02 ARSLCC.P02

S Shippable by small-package carrier.

Appendix

Fabric Grade Pricing

Model Number	Description	Grade G	Grade H	Grade J
Stride® Tackable Acoustical Tiles — see pages 161-162				
Z40724T	7½"H x 24"W Tile	\$ 120	\$ 126	\$ 132
Z40730T	7½"H x 30"W Tile	\$ 136	\$ 143	\$ 151
Z40736T	7½"H x 36"W Tile	\$ 150	\$ 159	\$ 168
Z40742T	7½"H x 42"W Tile	\$ 166	\$ 176	\$ 186
Z40748T	7½"H x 48"W Tile	\$ 177	\$ 188	\$ 200
Z40760T	7½"H x 60"W Tile	\$ 203	\$ 217	\$ 232
Z41524T	15"H x 24"W Tile	\$ 173	\$ 184	\$ 196
Z41530T	15"H x 30"W Tile	\$ 190	\$ 204	\$ 219
Z41536T	15"H x 36"W Tile	\$ 212	\$ 230	\$ 247
Z41542T	15"H x 42"W Tile	\$ 234	\$ 254	\$ 275
Z41548T	15"H x 48"W Tile	\$ 258	\$ 281	\$ 304
Z41560T	15"H x 60"W Tile	\$ 299	\$ 328	\$ 357
Z42224T	22½"H x 24"W Tile	\$ 218	\$ 236	\$ 253
Z42230T	22½"H x 30"W Tile	\$ 247	\$ 269	\$ 291
Z42236T	22½"H x 36"W Tile	\$ 274	\$ 301	\$ 327
Z42242T	22½"H x 42"W Tile	\$ 306	\$ 336	\$ 367
Z42248T	22½"H x 48"W Tile	\$ 340	\$ 374	\$ 409
Z42260T	22½"H x 60"W Tile	\$ 395	\$ 438	\$ 482
Z43024T	30"H x 24"W Tile	\$ 273	\$ 296	\$ 319
Z43030T	30"H x 30"W Tile	\$ 304	\$ 333	\$ 362
Z43036T	30"H x 36"W Tile	\$ 343	\$ 377	\$ 412
Z43042T	30"H x 42"W Tile	\$ 378	\$ 419	\$ 459
Z43048T	30"H x 48"W Tile	\$ 416	\$ 463	\$ 510
Z43060T	30"H x 60"W Tile	\$ 486	\$ 544	\$ 603
Z43724T	37½"H x 24"W Tile	\$ 334	\$ 363	\$ 392
Z43730T	37½"H x 30"W Tile	\$ 374	\$ 411	\$ 447
Z43736T	37½"H x 36"W Tile	\$ 423	\$ 466	\$ 510
Z43742T	37½"H x 42"W Tile	\$ 465	\$ 516	\$ 567
Z43748T	37½"H x 48"W Tile	\$ 511	\$ 569	\$ 628
Z43760T	37½"H x 60"W Tile	\$ 606	\$ 679	\$ 751
Z44524T	45"H x 24"W Tile	\$ 385	\$ 419	\$ 454
Z44530T	45"H x 30"W Tile	\$ 433	\$ 476	\$ 520
Z44536T	45"H x 36"W Tile	\$ 488	\$ 540	\$ 593
Z44542T	45"H x 42"W Tile	\$ 540	\$ 601	\$ 662
Z44548T	45"H x 48"W Tile	\$ 598	\$ 668	\$ 738
Z44560T	45"H x 60"W Tile	\$ 696	\$ 784	\$ 871
Z45224T	52½"H x 24"W Tile	\$ 432	\$ 473	\$ 513
Z45230T	52½"H x 30"W Tile	\$ 492	\$ 543	\$ 594
Z45236T	52½"H x 36"W Tile	\$ 553	\$ 614	\$ 675
Z45242T	52½"H x 42"W Tile	\$ 612	\$ 683	\$ 755
Z45248T	52½"H x 48"W Tile	\$ 677	\$ 758	\$ 840
Z45260T	52½"H x 60"W Tile	\$ 794	\$ 896	\$ 998
Z46024T	60"H x 24"W Tile	\$ 489	\$ 536	\$ 583
Z46030T	60"H x 30"W Tile	\$ 557	\$ 615	\$ 674
Z46036T	60"H x 36"W Tile	\$ 655	\$ 725	\$ 795
Z46042T	60"H x 42"W Tile	\$ 720	\$ 801	\$ 883
Z46048T	60"H x 48"W Tile	\$ 784	\$ 877	\$ 970
Z46060T	60"H x 60"W Tile	\$ 888	\$ 1005	\$ 1121

Model Number	Description	Grade G	Grade H	Grade J
Stride Tackable Acoustical Port Tiles — see pages 161-162				
Z40724E	7½"H x 24"W Tile	\$ 245	\$ 256	\$ 267
Z40730E	7½"H x 30"W Tile	\$ 260	\$ 274	\$ 288
Z40736E	7½"H x 36"W Tile	\$ 284	\$ 301	\$ 319
Z40742E	7½"H x 42"W Tile	\$ 299	\$ 319	\$ 339
Z40748E	7½"H x 48"W Tile	\$ 319	\$ 342	\$ 365
Z40760E	7½"H x 60"W Tile	\$ 357	\$ 385	\$ 414
Z41524E	15"H x 24"W Tile	\$ 315	\$ 338	\$ 361
Z41530E	15"H x 30"W Tile	\$ 346	\$ 374	\$ 403
Z41536E	15"H x 36"W Tile	\$ 374	\$ 408	\$ 442
Z41542E	15"H x 42"W Tile	\$ 404	\$ 444	\$ 484
Z41548E	15"H x 48"W Tile	\$ 436	\$ 481	\$ 527
Z41560E	15"H x 60"W Tile	\$ 498	\$ 554	\$ 611
Z42224E	22½"H x 24"W Tile	\$ 383	\$ 417	\$ 451
Z42230E	22½"H x 30"W Tile	\$ 423	\$ 465	\$ 507
Z42236E	22½"H x 36"W Tile	\$ 467	\$ 518	\$ 570
Z42242E	22½"H x 42"W Tile	\$ 509	\$ 568	\$ 628
Z42248E	22½"H x 48"W Tile	\$ 550	\$ 618	\$ 686
Z42260E	22½"H x 60"W Tile	\$ 639	\$ 725	\$ 810
Z43024E	30"H x 24"W Tile	\$ 450	\$ 495	\$ 541
Z43030E	30"H x 30"W Tile	\$ 503	\$ 559	\$ 616
Z43036E	30"H x 36"W Tile	\$ 560	\$ 628	\$ 696
Z43042E	30"H x 42"W Tile	\$ 613	\$ 692	\$ 772
Z43048E	30"H x 48"W Tile	\$ 670	\$ 761	\$ 851
Z43060E	30"H x 60"W Tile	\$ 776	\$ 890	\$ 1003
Z43724E	37½"H x 24"W Tile	\$ 538	\$ 594	\$ 651
Z43730E	37½"H x 30"W Tile	\$ 605	\$ 675	\$ 746
Z43736E	37½"H x 36"W Tile	\$ 670	\$ 756	\$ 841
Z43742E	37½"H x 42"W Tile	\$ 742	\$ 840	\$ 939
Z43748E	37½"H x 48"W Tile	\$ 806	\$ 920	\$ 1033
Z43760E	37½"H x 60"W Tile	\$ 946	\$ 1088	\$ 1230
Z44524E	45"H x 24"W Tile	\$ 601	\$ 669	\$ 737
Z44530E	45"H x 30"W Tile	\$ 685	\$ 771	\$ 856
Z44536E	45"H x 36"W Tile	\$ 762	\$ 864	\$ 965
Z44542E	45"H x 42"W Tile	\$ 846	\$ 965	\$ 1084
Z44548E	45"H x 48"W Tile	\$ 928	\$ 1064	\$ 1200
Z44560E	45"H x 60"W Tile	\$ 1081	\$ 1251	\$ 1421
Z45224E	52½"H x 24"W Tile	\$ 679	\$ 758	\$ 838
Z45230E	52½"H x 30"W Tile	\$ 763	\$ 861	\$ 960
Z45236E	52½"H x 36"W Tile	\$ 861	\$ 980	\$ 1099
Z45242E	52½"H x 42"W Tile	\$ 952	\$ 1091	\$ 1230
Z45248E	52½"H x 48"W Tile	\$ 1043	\$ 1202	\$ 1360
Z45260E	52½"H x 60"W Tile	\$ 1230	\$ 1428	\$ 1627
Z46024E	60"H x 24"W Tile	\$ 739	\$ 830	\$ 920
Z46030E	60"H x 30"W Tile	\$ 850	\$ 964	\$ 1077
Z46036E	60"H x 36"W Tile	\$ 989	\$ 1125	\$ 1261
Z46042E	60"H x 42"W Tile	\$ 1089	\$ 1248	\$ 1406
Z46048E	60"H x 48"W Tile	\$ 1186	\$ 1367	\$ 1548
Z46060E	60"H x 60"W Tile	\$ 1372	\$ 1598	\$ 1825

Model Number	Description	Grade G	Grade H	Grade J
Stride® Tackable Acoustical Tiles to-the-Floor — see page 165				
Z42224TF	22½"H x 24"W Tile	\$ 339	\$ 373	\$ 408
Z42230TF	22½"H x 30"W Tile	\$ 380	\$ 423	\$ 467
Z42236TF	22½"H x 36"W Tile	\$ 426	\$ 478	\$ 530
Z42242TF	22½"H x 42"W Tile	\$ 477	\$ 538	\$ 599
Z42248TF	22½"H x 48"W Tile	\$ 519	\$ 588	\$ 657
Z42260TF	22½"H x 60"W Tile	\$ 606	\$ 692	\$ 779

Z43024TF	30"H x 24"W Tile	\$ 406	\$ 452	\$ 498
Z43030TF	30"H x 30"W Tile	\$ 462	\$ 520	\$ 577
Z43036TF	30"H x 36"W Tile	\$ 522	\$ 591	\$ 660
Z43042TF	30"H x 42"W Tile	\$ 579	\$ 659	\$ 740
Z43048TF	30"H x 48"W Tile	\$ 638	\$ 730	\$ 822
Z43060TF	30"H x 60"W Tile	\$ 748	\$ 863	\$ 978

Z43724TF	37½"H x 24"W Tile	\$ 488	\$ 546	\$ 603
Z43730TF	37½"H x 30"W Tile	\$ 559	\$ 631	\$ 703
Z43736TF	37½"H x 36"W Tile	\$ 627	\$ 713	\$ 800
Z43742TF	37½"H x 42"W Tile	\$ 701	\$ 802	\$ 903
Z43748TF	37½"H x 48"W Tile	\$ 772	\$ 887	\$ 1002
Z43760TF	37½"H x 60"W Tile	\$ 908	\$ 1051	\$ 1195

Z44524TF	45"H x 24"W Tile	\$ 560	\$ 629	\$ 698
Z44530TF	45"H x 30"W Tile	\$ 637	\$ 723	\$ 810
Z44536TF	45"H x 36"W Tile	\$ 727	\$ 830	\$ 933
Z44542TF	45"H x 42"W Tile	\$ 810	\$ 931	\$ 1051
Z44548TF	45"H x 48"W Tile	\$ 890	\$ 1027	\$ 1165
Z44560TF	45"H x 60"W Tile	\$ 1053	\$ 1226	\$ 1398

Z45224TF	52½"H x 24"W Tile	\$ 629	\$ 709	\$ 790
Z45230TF	52½"H x 30"W Tile	\$ 721	\$ 822	\$ 923
Z45236TF	52½"H x 36"W Tile	\$ 838	\$ 959	\$ 1079
Z45242TF	52½"H x 42"W Tile	\$ 933	\$ 1075	\$ 1216
Z45248TF	52½"H x 48"W Tile	\$ 1020	\$ 1181	\$ 1342
Z45260TF	52½"H x 60"W Tile	\$ 1200	\$ 1401	\$ 1602

Z46024TF	60"H x 24"W Tile	\$ 700	\$ 792	\$ 884
Z46030TF	60"H x 30"W Tile	\$ 802	\$ 917	\$ 1032
Z46036TF	60"H x 36"W Tile	\$ 934	\$ 1071	\$ 1209
Z46042TF	60"H x 42"W Tile	\$ 1039	\$ 1200	\$ 1361
Z46048TF	60"H x 48"W Tile	\$ 1144	\$ 1328	\$ 1511
Z46060TF	60"H x 60"W Tile	\$ 1345	\$ 1575	\$ 1804

Model Number	Description	Grade G	Grade H	Grade J
Stride Full Desk Screens with Fabric Insert — see page 226				
Z6DF2830F	28"H x 30"W Desk Screen	\$ 913	\$ 941	\$ 969
Z6DF2836F	28"H x 36"W Desk Screen	\$ 944	\$ 978	\$ 1011
Z6DF2842F	28"H x 42"W Desk Screen	\$ 1016	\$ 1055	\$ 1095
Z6DF2848F	28"H x 48"W Desk Screen	\$ 1094	\$ 1140	\$ 1185
Z6DF2854F	28"H x 54"W Desk Screen	\$ 1203	\$ 1254	\$ 1305
Z6DF2860F	28"H x 60"W Desk Screen	\$ 1291	\$ 1347	\$ 1404

Model Number	Description	Grade G	Grade H	Grade J
Stride Wall-Mounted Tackboards — see page 274				
ZWMTB1530	15"H x 30"W Tackboard	\$ 1034	\$ 1091	\$ 1147
ZWMTB1536	15"H x 36"W Tackboard	\$ 1082	\$ 1150	\$ 1218
ZWMTB1542	15"H x 42"W Tackboard	\$ 1137	\$ 1216	\$ 1295
ZWMTB1548	15"H x 48"W Tackboard	\$ 1187	\$ 1278	\$ 1368
ZWMTB1560	15"H x 60"W Tackboard	\$ 1284	\$ 1397	\$ 1510

ZWMTB2024	20"H x 24"W Tackboard	\$ 1075	\$ 1135	\$ 1196
ZWMTB2030	20"H x 30"W Tackboard	\$ 1139	\$ 1215	\$ 1290
ZWMTB2036	20"H x 36"W Tackboard	\$ 1199	\$ 1290	\$ 1380
ZWMTB2042	20"H x 42"W Tackboard	\$ 1268	\$ 1373	\$ 1479
ZWMTB2048	20"H x 48"W Tackboard	\$ 1324	\$ 1445	\$ 1565
ZWMTB2060	20"H x 60"W Tackboard	\$ 1445	\$ 1596	\$ 1747

Model Number	Description	Grade G	Grade H	Grade J
Stride Tackable Fabric Accessory for Cantilever Storage — see page 277				
ZS42SF	for use w/ 42½"H unit	\$ 695	\$ 772	\$ 849
ZS50SF	for use w/ 50"H unit	\$ 915	\$ 1034	\$ 1152

Model Number	Description	Grade G	Grade H	Grade J
Altitude® A8 Screen Kits — see page 377				
FDSC48U	48"W	\$ 2009	\$ 2031	\$ 2086
FDSC54U	54"W	\$ 2078	\$ 2101	\$ 2159
FDSC60U	60"W	\$ 2140	\$ 2164	\$ 2223
FDSC66U	66"W	\$ 2267	\$ 2292	\$ 2356
FDSC72U	72"W	\$ 2440	\$ 2467	\$ 2536

FDSC48LL	48"W	\$ 1293	\$ 1306	\$ 1338
FDSC48LR	48"W	\$ 1293	\$ 1306	\$ 1338
FDSC54LL	54"W	\$ 1517	\$ 1533	\$ 1571
FDSC54LR	54"W	\$ 1517	\$ 1533	\$ 1571
FDSC60LL	60"W	\$ 1588	\$ 1604	\$ 1645
FDSC60LR	60"W	\$ 1588	\$ 1604	\$ 1645
FDSC66LL	66"W	\$ 1904	\$ 1925	\$ 1978
FDSC66LR	66"W	\$ 1904	\$ 1925	\$ 1978
FDSC72LL	72"W	\$ 2006	\$ 2029	\$ 2084
FDSC72LR	72"W	\$ 2006	\$ 2029	\$ 2084

FDSC48R	48"W	\$ 1249	\$ 1262	\$ 1293
FDSC54R	54"W	\$ 1280	\$ 1293	\$ 1325
FDSC60R	60"W	\$ 1378	\$ 1392	\$ 1426
FDSC66R	66"W	\$ 1593	\$ 1611	\$ 1654
FDSC72R	72"W	\$ 1698	\$ 1716	\$ 1762

Model Number	Grade 9	Grade 10	Grade 11	Grade 12	Grade 13	Grade 14	Grade 15	Grade 16	Grade 17	Grade 18	Grade 19	Grade 20	Grade 21	Grade 22
Stride® Seat Cushions for Painted Wood Storage — see page 263														
K5CT1815SC	\$ 569	\$ 604	\$ 639	\$ 674	\$ 717	\$ 761	\$ 804	\$ 848	\$ 891	\$ 935	\$ 978	\$ 1022	\$ 1065	\$ 1109
K5CT1818SC	\$ 589	\$ 624	\$ 659	\$ 694	\$ 737	\$ 781	\$ 824	\$ 868	\$ 911	\$ 955	\$ 998	\$ 1042	\$ 1085	\$ 1129
K5CT1824SC	\$ 615	\$ 650	\$ 685	\$ 720	\$ 763	\$ 807	\$ 850	\$ 894	\$ 937	\$ 981	\$ 1024	\$ 1068	\$ 1111	\$ 1155
K5CT1830SC	\$ 643	\$ 678	\$ 713	\$ 748	\$ 791	\$ 835	\$ 878	\$ 922	\$ 965	\$ 1009	\$ 1052	\$ 1096	\$ 1139	\$ 1183
K5CT1836SC	\$ 693	\$ 728	\$ 763	\$ 798	\$ 841	\$ 885	\$ 928	\$ 972	\$ 1015	\$ 1059	\$ 1102	\$ 1146	\$ 1189	\$ 1233
K5CT1848SC	\$ 707	\$ 742	\$ 777	\$ 812	\$ 855	\$ 899	\$ 942	\$ 986	\$ 1029	\$ 1073	\$ 1116	\$ 1160	\$ 1203	\$ 1247

Appendix

Fabric Grade Pricing

Model Number	Description	Grade G	Grade H	Grade J
Terrace® Tackable Acoustical Tiles — see pages 49-50				
TKG40724T	7½"H x 24"W Tile	\$ 136	\$ 146	\$ 157
TKG40730T	7½"H x 30"W Tile	\$ 149	\$ 161	\$ 174
TKG40736T	7½"H x 36"W Tile	\$ 164	\$ 179	\$ 194
TKG40742T	7½"H x 42"W Tile	\$ 180	\$ 197	\$ 214
TKG40748T	7½"H x 48"W Tile	\$ 197	\$ 217	\$ 237
TKG40760T	7½"H x 60"W Tile	\$ 232	\$ 257	\$ 281
TKG41524T	15"H x 24"W Tile	\$ 170	\$ 190	\$ 210
TKG41530T	15"H x 30"W Tile	\$ 193	\$ 218	\$ 242
TKG41536T	15"H x 36"W Tile	\$ 221	\$ 251	\$ 282
TKG41542T	15"H x 42"W Tile	\$ 245	\$ 280	\$ 315
TKG41548T	15"H x 48"W Tile	\$ 267	\$ 306	\$ 346
TKG41560T	15"H x 60"W Tile	\$ 320	\$ 371	\$ 421
TKG42224T	22½"H x 24"W Tile	\$ 232	\$ 262	\$ 293
TKG42230T	22½"H x 30"W Tile	\$ 266	\$ 303	\$ 340
TKG42236T	22½"H x 36"W Tile	\$ 310	\$ 355	\$ 400
TKG42242T	22½"H x 42"W Tile	\$ 352	\$ 404	\$ 456
TKG42248T	22½"H x 48"W Tile	\$ 394	\$ 454	\$ 513
TKG42260T	22½"H x 60"W Tile	\$ 462	\$ 536	\$ 611
TKG43024T	30"H x 24"W Tile	\$ 274	\$ 313	\$ 353
TKG43030T	30"H x 30"W Tile	\$ 319	\$ 370	\$ 420
TKG43036T	30"H x 36"W Tile	\$ 369	\$ 429	\$ 488
TKG43042T	30"H x 42"W Tile	\$ 429	\$ 499	\$ 569
TKG43048T	30"H x 48"W Tile	\$ 468	\$ 548	\$ 628
TKG43060T	30"H x 60"W Tile	\$ 553	\$ 652	\$ 752
TKG44224T	42"H x 24"W Tile	\$ 370	\$ 426	\$ 482
TKG44230T	42"H x 30"W Tile	\$ 443	\$ 513	\$ 583
TKG44236T	42"H x 36"W Tile	\$ 509	\$ 592	\$ 676
TKG44242T	42"H x 42"W Tile	\$ 581	\$ 679	\$ 777
TKG44248T	42"H x 48"W Tile	\$ 656	\$ 768	\$ 879
TKG44260T	42"H x 60"W Tile	\$ 794	\$ 934	\$ 1073
TKG45024T	50"H x 24"W Tile	\$ 430	\$ 496	\$ 563
TKG45030T	50"H x 30"W Tile	\$ 517	\$ 600	\$ 684
TKG45036T	50"H x 36"W Tile	\$ 613	\$ 712	\$ 812
TKG45042T	50"H x 42"W Tile	\$ 703	\$ 819	\$ 936
TKG45048T	50"H x 48"W Tile	\$ 795	\$ 928	\$ 1061
TKG45060T	50"H x 60"W Tile	\$ 948	\$ 1114	\$ 1279
TKG45724T	57½"H x 24"W Tile	\$ 506	\$ 583	\$ 659
TKG45730T	57½"H x 30"W Tile	\$ 600	\$ 696	\$ 791
TKG45736T	57½"H x 36"W Tile	\$ 702	\$ 818	\$ 934
TKG45742T	57½"H x 42"W Tile	\$ 806	\$ 940	\$ 1075
TKG45748T	57½"H x 48"W Tile	\$ 908	\$ 1061	\$ 1215
TKG45760T	57½"H x 60"W Tile	\$ 1075	\$ 1268	\$ 1460
TKG46524T	65"H x 24"W Tile	\$ 557	\$ 644	\$ 731
TKG46530T	65"H x 30"W Tile	\$ 664	\$ 772	\$ 880
TKG46536T	65"H x 36"W Tile	\$ 775	\$ 905	\$ 1034
TKG46542T	65"H x 42"W Tile	\$ 885	\$ 1037	\$ 1189
TKG46548T	65"H x 48"W Tile	\$ 994	\$ 1167	\$ 1341
TKG46560T	65"H x 60"W Tile	\$ 1172	\$ 1389	\$ 1606

Model Number	Description	Grade G	Grade H	Grade J
Terrace® Tackable Acoustical Ported Tiles — see pages 51-52				
TKG41524E	15"H x 24"W Tile	\$ 256	\$ 274	\$ 291
TKG41530E	15"H x 30"W Tile	\$ 276	\$ 298	\$ 320
TKG41536E	15"H x 36"W Tile	\$ 295	\$ 321	\$ 347
TKG41542E	15"H x 42"W Tile	\$ 318	\$ 349	\$ 379
TKG41548E	15"H x 48"W Tile	\$ 341	\$ 375	\$ 410
TKG41560E	15"H x 60"W Tile	\$ 391	\$ 434	\$ 477
TKG42224E	22½"H x 24"W Tile	\$ 307	\$ 333	\$ 359
TKG42230E	22½"H x 30"W Tile	\$ 342	\$ 375	\$ 408
TKG42236E	22½"H x 36"W Tile	\$ 384	\$ 423	\$ 462
TKG42242E	22½"H x 42"W Tile	\$ 425	\$ 471	\$ 517
TKG42248E	22½"H x 48"W Tile	\$ 455	\$ 507	\$ 559
TKG42260E	22½"H x 60"W Tile	\$ 522	\$ 587	\$ 652
TKG43024E	30"H x 24"W Tile	\$ 346	\$ 380	\$ 415
TKG43030E	30"H x 30"W Tile	\$ 386	\$ 429	\$ 472
TKG43036E	30"H x 36"W Tile	\$ 436	\$ 488	\$ 540
TKG43042E	30"H x 42"W Tile	\$ 486	\$ 547	\$ 609
TKG43048E	30"H x 48"W Tile	\$ 526	\$ 596	\$ 666
TKG43060E	30"H x 60"W Tile	\$ 600	\$ 687	\$ 774
TKG44224E	42"H x 24"W Tile	\$ 473	\$ 530	\$ 586
TKG44230E	42"H x 30"W Tile	\$ 540	\$ 611	\$ 682
TKG44236E	42"H x 36"W Tile	\$ 619	\$ 704	\$ 789
TKG44242E	42"H x 42"W Tile	\$ 686	\$ 784	\$ 883
TKG44248E	42"H x 48"W Tile	\$ 756	\$ 869	\$ 982
TKG44260E	42"H x 60"W Tile	\$ 895	\$ 1037	\$ 1178
TKG45024E	50"H x 24"W Tile	\$ 527	\$ 594	\$ 661
TKG45030E	50"H x 30"W Tile	\$ 618	\$ 702	\$ 786
TKG45036E	50"H x 36"W Tile	\$ 709	\$ 809	\$ 910
TKG45042E	50"H x 42"W Tile	\$ 805	\$ 923	\$ 1041
TKG45048E	50"H x 48"W Tile	\$ 896	\$ 1030	\$ 1163
TKG45060E	50"H x 60"W Tile	\$ 1052	\$ 1221	\$ 1389
TKG45724E	57½"H x 24"W Tile	\$ 605	\$ 683	\$ 760
TKG45730E	57½"H x 30"W Tile	\$ 669	\$ 766	\$ 862
TKG45736E	57½"H x 36"W Tile	\$ 764	\$ 881	\$ 998
TKG45742E	57½"H x 42"W Tile	\$ 871	\$ 1007	\$ 1143
TKG45748E	57½"H x 48"W Tile	\$ 970	\$ 1125	\$ 1280
TKG45760E	57½"H x 60"W Tile	\$ 1144	\$ 1338	\$ 1532
TKG46524E	65"H x 24"W Tile	\$ 654	\$ 741	\$ 828
TKG46530E	65"H x 30"W Tile	\$ 766	\$ 875	\$ 984
TKG46536E	65"H x 36"W Tile	\$ 879	\$ 1010	\$ 1141
TKG46542E	65"H x 42"W Tile	\$ 988	\$ 1140	\$ 1292
TKG46548E	65"H x 48"W Tile	\$ 1092	\$ 1266	\$ 1440
TKG46560E	65"H x 60"W Tile	\$ 1273	\$ 1491	\$ 1710

Model Number	Grade 9	Grade 10	Grade 11	Grade 12	Grade 13	Grade 14	Grade 15	Grade 16	Grade 17	Grade 18	Grade 19	Grade 20	Grade 21	Grade 22
Involve® Ped/Credenza Cushions – 18"D — see page 263														
K5CT1815SC	\$ 569	\$ 604	\$ 639	\$ 674	\$ 717	\$ 761	\$ 804	\$ 848	\$ 891	\$ 935	\$ 978	\$ 1022	\$ 1065	\$ 1109
K5CT1818SC	\$ 589	\$ 624	\$ 659	\$ 694	\$ 737	\$ 781	\$ 824	\$ 868	\$ 911	\$ 955	\$ 998	\$ 1042	\$ 1085	\$ 1129
K5CT1824SC	\$ 615	\$ 650	\$ 685	\$ 720	\$ 763	\$ 807	\$ 850	\$ 894	\$ 937	\$ 981	\$ 1024	\$ 1068	\$ 1111	\$ 1155
K5CT1830SC	\$ 643	\$ 678	\$ 713	\$ 748	\$ 791	\$ 835	\$ 878	\$ 922	\$ 965	\$ 1009	\$ 1052	\$ 1096	\$ 1139	\$ 1183
K5CT1836SC	\$ 693	\$ 728	\$ 763	\$ 798	\$ 841	\$ 885	\$ 928	\$ 972	\$ 1015	\$ 1059	\$ 1102	\$ 1146	\$ 1189	\$ 1233
K5CT1848SC	\$ 707	\$ 742	\$ 777	\$ 812	\$ 855	\$ 899	\$ 942	\$ 986	\$ 1029	\$ 1073	\$ 1116	\$ 1160	\$ 1203	\$ 1247

Cross Reference Index

by Model Number

Model	Page	Model	Page	Model	Page	Model	Page	Model	Page
8988EBZ	197	A9CLWMC	382	A871501A	78, 375	AE4-DJ108S	266	AF5RS7224UD	352
8988EBZ3	197	A5622ELS	353	A871502A	78, 375	AE4-DJ114S	266	AF5RS7230D	351
8988EBZS	197	A5622ERS	353	A871503A	78, 375	AE4-DJ126S	266	AF5RS7230UD	352
8989BW	79	A5722ELS	353	A871601	78, 375	AE4-DJ132S	266	AF5RS7824D	351
8989EB	79	A5722ERS	353	A871601A	78, 375	AE4-DJ138S	266	AF5RS7824UD	352
9120 Program	106, 219	A5822ELS	353	A871912	78, 195, 375	AE4-DJ144S	266	AF5RS7830D	351
87750Z	266	A5822ERS	353	A871912A	78, 195, 375	AE4-HW	266	AF5RS7830UD	352
831124	109	A5922ELS	353	A871918	78, 195, 375	AE4-PS72	266	AF5RS8424D	351
831130	109	A5922ERS	353	A871918A	78, 195, 375	AE4-PS144	266	AF5RS8424UD	352
831212M	97	A870302	266, 402	A871972	78, 195, 375	AECH	18.16, 379	AF5RS8430D	351
851524M	337	A870824	400	A871972A	78, 195, 375	AEHF	18.16, 379	AF5RS8430UD	352
851530M	337	A870824CH	400	A873501	78, 375	AESS	18.16, 379	AF5RS9024D	351
851536M	337	A870830	400	A873502	78, 375	AEV920	79, 197, 356	AF5RS9024UD	352
851542M	337	A870830CH	400	A873503	78, 375	AF5CCS5424	352	AF5RS9030D	351
851548M	337	A870842	400	A873504	78, 375	AF5CCS5430	352	AF5RS9030UD	352
851554M	337	A870842CH	400	A873506	78, 375	AF5CCS603624LD	353	AF5RS9624D	351
851560M	337	A870860	400	A876072	78, 375	AF5CCS603624RD	353	AF5RS9624UD	352
851566M	337	A870860CH	400	A876072A	78, 375	AF5CCS604824LD	353	AF5RS9630D	351
851572M	337	A871024	77, 196	A877010	79, 197	AF5CCS604824RD	353	AF5RS9630UD	352
852424M	337	A871024A	77, 196	A877012	78, 195, 375	AF5CCS604830LD	353	AF5120S4224D	352
853030M	337	A871030	77, 196	A877072	195	AF5CCS604830RD	353	AF5120S4230D	352
853636M	337	A871030A	77, 196	A877072A	195	AF5CCS723624LD	353	AF5120S4824D	352
854242M	337	A871036	77, 196	A877501	197	AF5CCS723624RD	353	AF5120S4830D	352
870224N	78	A871036A	77, 196	A877501A	197	AF5CCS724824LD	353	AF5120S5424D	352
870224NF	78	A871042	77, 196	A877502	197	AF5CCS724824RD	353	AF5120S5430D	352
870230N	78	A871042A	77, 196	A877502A	197	AF5CCS724830LD	353	AGBKC	337, 386
870230NF	78	A871048	77, 196	A877503	197	AF5CCS724830RD	353	AGBKT	337, 386
870236N	78	A871048A	77, 196	A877503A	197	AF5RND4824	351	AGBKTMP	337, 386
870236NFK	78	A871060	77, 196	A877504	197	AF5RND4830	351	AGSAUHK	388
870242N	78	A871060A	77, 196	A877506	197	AF5RND5424	351	AKMH	391
870242NFK	78	A871124	77, 196, 374	A8713108	77, 196	AF5RND5430	351	AKTLONG	391
870248N	78	A871124A	77, 196, 374	A8713108A	77, 196	AF5RND6024D	351	AKTMID	391
870248NFK	78	A871130	77, 196	AAPACM2	79, 197, 400	AF5RND6030D	351	AKTSHORT	391
870260N	78	A871130A	77, 196	AAS1520	379	AF5RND6624D	351	ALED17U	274, 400
870260NFK	78	A871136	77, 196	AAS1548	379	AF5RND6630D	351	ALED17U60	400
870535	78	A871136A	77, 196	AAS1554	379	AF5RND7224D	351	ALED17UJMP30	400
870565	78	A871142	77, 196	AAS1560	379	AF5RND7230D	351	ALED31U	274, 400
873550	79	A871142A	77, 196	AAS1566	379	AF5RND7824D	351	ALED31U60	400
873600	79, 376	A871148	77, 196, 374	AAS1572	379	AF5RND7830D	351	ALED31UJMP30	400
877550	197	A871148A	77, 196, 374	ABKCL	386	AF5RND8424D	351	ALEDODC	400
877600	197	A871160	77, 196, 374	ABKCR	386	AF5RND8430D	351	ALKF23C	409
899900	41, 151	A871160A	77, 196, 374	ABKTL	386	AF5RND9024D	351	ALKF23CE4	409
899910	41, 151	A871172	77, 196, 374	ABKTR	386	AF5RND9030D	351	ALKF23CN	409
A2-8CIR24	77, 196	A871172A	77, 196, 374	ACD1	397	AF5RND9624D	351	ALKF26EL	409
A2-8CIR30	77, 196	A871224	77, 196	ACOMDOME2	402	AF5RND9630D	351	AMADHD	406
A2-8CIR36	77, 196	A871224A	77, 196	ACPU1	391	AF5RS3624U	352	AMASD	406
A2-8CIR42	77, 196	A871230	77, 196	AE4-DD1	266	AF5RS3630U	352	AMASD-G	406
A2-8CIR48	77, 196	A871230A	77, 196	AE4-DD2	266	AF5RS4224U	352	AMASHD	406
A2-8CIR60	77, 196	A871236	77, 196	AE4-DJ0S	266	AF5RS4230U	352	AMASHDCK	407
A2REC2S2L	350	A871236A	77, 196	AE4-DJ6S	266	AF5RS4824	351	AMASTS	406
A6BLUETOOTH	349	A871242	77, 196	AE4-DJ12S	266	AF5RS4824U	352	AMASTSCK	407
A6CASTER	349	A871242A	77, 196	AE4-DJ18S	266	AF5RS4830	351	AMASTS-G	406
A6FOOTNTL	349	A871248	77, 196, 374	AE4-DJ24S	266	AF5RS4830U	352	AMF22	409
A6MREC3S2LCF	348	A871248A	77, 196, 374	AE4-DJ30S	266	AF5RS5424	351	AMKF22	409
A6MREC3S2LTF	348	A871254	374	AE4-DJ36S	266	AF5RS5424U	352	AMS2048LH	378
A6MREC3S3LCF	349	A871254A	374	AE4-DJ42S	266	AF5RS5430	351	AMS2048RH	378
A6MREC3S3LTF	349	A871260	77, 196, 374	AE4-DJ48S	266	AF5RS5430U	352	AMS2048SS	379
A6REC2S2LCF	348	A871260A	77, 196, 374	AE4-DJ54S	266	AF5RS6024D	351	AMS2048US	378
A6REC2S2LTF	348	A871266	374	AE4-DJ60S	266	AF5RS6024UD	352	AMS2054LH	378
A6REC2S3LCF	349	A871266A	374	AE4-DJ66S	266	AF5RS6030D	351	AMS2054RH	378
A6REC2S3LTF	349	A871272	374	AE4-DJ72S	266	AF5RS6030UD	352	AMS2054SS	379
A6REC3S2LCF	348	A871272A	374	AE4-DJ78S	266	AF5RS6624D	351	AMS2054US	378
A6REC3S2LTF	348	A871366	77, 196	AE4-DJ84S	266	AF5RS6624UD	352	AMS2060LH	378
A6REC3S3LCF	349	A871366A	77, 196	AE4-DJ90S	266	AF5RS6630D	351	AMS2060RH	378
A6REC3S3LTF	349	A871400	78, 195, 375	AE4-DJ96S	266	AF5RS6630UD	352	AMS2060SS	379
A6SLDGLIDE	349	A871400A	78, 195, 375	AE4-DJ102S	266	AF5RS7224D	351	AMS2060US	378

INDEX

Cross Reference Index

by Model Number

INDEX

Model	Page	Model	Page	Model	Page	Model	Page	Model	Page
AMS2066LH.....	378	CBK29.....	109	FDEPC2.....	380	G3018G.....	327	G3548G.....	328
AMS2066RH.....	378	CDG.....	110	FDEPC12.....	380	G3021.....	322	G3551.....	323
AMS2066SS.....	379	CDL29.....	109	FDNYE3CIRK.....	374	G3021G.....	327	G3551G.....	328
AMS2066US.....	378	CEP1129F.....	109	FDNYE4CIRK.....	374	G3024.....	322	G3554.....	323
AMS2072LH.....	378	CEP2429F.....	109	FDNYM3CIRK48K.....	374	G3024G.....	327	G3554G.....	328
AMS2072RH.....	378	CEP3029F.....	109	FDNYM3CIRK54K.....	374	G3027.....	322	G3557.....	323
AMS2072SS.....	379	CFDPWRC.....	380	FDNYM3CIRK60K.....	374	G3027G.....	327	G3557G.....	328
AMS2072US.....	378	CFDPWRSC.....	380	FDNYM3CIRK66K.....	374	G3030.....	322	G3560.....	323
AMS3248LH.....	378	CMT24.....	79, 197, 356	FDNYM3CIRK72K.....	374	G3030G.....	327	G3560G.....	328
AMS3248RH.....	378	CMT36.....	79, 197, 356	FDNYM4CIRK48K.....	374	G3033.....	322	G3563.....	323
AMS3248SS.....	379	CRK29.....	109	FDNYM4CIRK54K.....	374	G3033G.....	327	G3563G.....	328
AMS3248US.....	378	CS244.....	110	FDNYM4CIRK60K.....	374	G3036.....	322	G3566.....	323
AMS3254LH.....	378	CS249.....	110	FDNYM4CIRK66K.....	374	G3036G.....	327	G3566G.....	328
AMS3254RH.....	378	CS304.....	110	FDNYM4CIRK72K.....	374	G3039.....	322	G3569.....	323
AMS3254SS.....	379	CS309.....	110	FDPWRC.....	380	G3039G.....	327	G3569G.....	328
AMS3254US.....	378	CS364.....	110	FDPWRSC.....	380	G3042.....	322	G3572.....	323
AMS3260LH.....	378	CS369.....	110	FDRWEC.....	380	G3042G.....	327	G3572G.....	328
AMS3260RH.....	378	CS424.....	110	FDRWLEG.....	380	G3045.....	322	G3575.....	323
AMS3260SS.....	379	CS429.....	110	FDRWUC.....	380	G3045G.....	327	G3575G.....	328
AMS3260US.....	378	CS484.....	110	FDSC48LL.....	377	G3048.....	322	G3578.....	323
AMS3266LH.....	378	CS489.....	110	FDSC48LR.....	377	G3048G.....	327	G3578G.....	328
AMS3266RH.....	378	CS544.....	110	FDSC48R.....	377	G3051.....	322	G3581.....	323
AMS3266SS.....	379	CS549.....	110	FDSC48U.....	377	G3051G.....	327	G3581G.....	328
AMS3266US.....	378	CS604.....	110	FDSC54LL.....	377	G3054.....	322	G3584.....	323
AMS3272LH.....	378	CS609.....	110	FDSC54LR.....	377	G3054G.....	327	G3584G.....	328
AMS3272RH.....	378	CS664.....	110	FDSC54R.....	377	G3057.....	322	G4218.....	324
AMS3272SS.....	379	CS669.....	110	FDSC54U.....	377	G3057G.....	327	G4218G.....	329
AMS3272US.....	378	CS724.....	110	FDSC60LL.....	377	G3060.....	322	G4221.....	324
APACSM.....	407	CS729.....	110	FDSC60LR.....	377	G3060G.....	327	G4221G.....	329
APACW.....	407	CSCMP3614.....	110	FDSC60R.....	377	G3063.....	322	G4224.....	324
APADD.....	406	CSCMP3629.....	110	FDSC60U.....	377	G3063G.....	327	G4224G.....	329
APASD.....	406	CSCMP4214.....	110	FDSC66LL.....	377	G3066.....	322	G4227.....	324
APASDCK.....	407	CSCMP4229.....	110	FDSC66LR.....	377	G3066G.....	327	G4227G.....	329
APATF.....	406	CSCMP4814.....	110	FDSC66R.....	377	G3069.....	322	G4230.....	324
APMC6.....	396	CSCMP4829.....	110	FDSC66U.....	377	G3069G.....	327	G4230G.....	329
APOLG0512.....	225	CSCMP6014.....	110	FDSC72LL.....	377	G3072.....	322	G4233.....	324
APOLG0518.....	225	CSCMP6029.....	110	FDSC72LR.....	377	G3072G.....	327	G4233G.....	329
APTK.....	411	CSCMP7214.....	110	FDSC72R.....	377	G3075.....	322	G4236.....	324
APWRMOD1TT.....	402	CSCMP7229.....	110	FDSC72U.....	377	G3075G.....	327	G4236G.....	329
APWRMOD1UWM.....	402	CSDC19.....	397	FDSC72U.....	377	G3078.....	322	G4239.....	324
APWRMOD2Q.....	402	CSDC25.....	397	FDSC72U.....	377	G3078G.....	327	G4239G.....	329
APWRMOD2UWM.....	402	CSL2429F.....	109	FDSC72U.....	377	G3081.....	322	G4242.....	324
APWRMOD2WC.....	402	CSL3029F.....	109	FDSC72U.....	377	G3081G.....	327	G4242G.....	329
APWRMOD3UWM.....	402	EAAC.....	396	FDSC72U.....	377	G3084.....	322	G4245.....	324
APWRMOD3WC.....	402	EABS.....	396	FDSC72U.....	377	G3084G.....	327	G4245G.....	329
ARSLCC.....	411	EACS.....	396	FDSC72U.....	377	G3518.....	323	G4248.....	324
ATADF3.....	80, 198, 376	EADH.....	396	FDSC72U.....	377	G3518G.....	328	G4248G.....	329
ATADF4.....	80, 198, 376	EAFS.....	396	FDSC72U.....	377	G3521.....	323	G4251.....	324
ATADJ5.....	80, 198, 376	EAFT.....	396	FDSC72U.....	377	G3521G.....	328	G4251G.....	329
ATADJ6.....	80, 198, 376	EAHSR36.....	395	FDSC72U.....	377	G3524.....	323	G4254.....	324
AVF5RS4824.....	351	EAHSR42.....	395	FDSC72U.....	377	G3524G.....	328	G4254G.....	329
AVF5RS4830.....	351	EAHSR48.....	395	FDSC72U.....	377	G3527.....	323	G4257.....	324
AVF5RS5424.....	351	EAHSR60.....	395	FDSC72U.....	377	G3527G.....	328	G4257G.....	329
AVF5RS5430.....	351	EAHSR66.....	395	FDSC72U.....	377	G3530.....	323	G4260.....	324
AVF5RS6024D.....	351	EAHSR72.....	395	FDSC72U.....	377	G3530G.....	328	G4260G.....	329
AVF5RS6030D.....	351	EAPC.....	396	FDSC72U.....	377	G3533.....	323	G4263.....	324
AVF5RS6624D.....	351	EAPS.....	396	FDSC72U.....	377	G3533G.....	328	G4263G.....	329
AVF5RS6630D.....	351	EAPT.....	396	FDSC72U.....	377	G3536.....	323	G4266.....	324
AVF5RS7224D.....	351	EASR24.....	395	FDSC72U.....	377	G3536G.....	328	G4266G.....	329
AVF5RS7230D.....	351	EASR30.....	395	FDSC72U.....	377	G3539.....	323	G4269.....	324
AVSTA3PWR.....	402	EASR36.....	395	G1AGF.....	339	G3539G.....	328	G4269G.....	329
AWCS.....	391	EASR42.....	395	G1PTR.....	339	G3542.....	323	G4272.....	324
AYBHEP1229.....	108, 222	EASR48.....	395	G2AGF.....	339	G3542G.....	328	G4272G.....	329
AYBHEP1829.....	108, 222	EASR60.....	395	G2PTR.....	339	G3545.....	323	G4275.....	324
AYBHEP2429.....	108, 222	EASS.....	396	G3AGF.....	339	G3545G.....	328	G4275G.....	329
AYBHEP3029.....	108, 222	EATS.....	396	G3PTR.....	339	G3548.....	323	G4278.....	324

Cross Reference Index

by Model Number

Model	Page	Model	Page	Model	Page	Model	Page	Model	Page
G4278G.....	329	G5739G.....	331	G41360GS.....	335	GL3036LG.....	317	GL3554RG.....	318
G4281.....	324	G5742.....	326	G41363GS.....	335	GL3036R.....	312	GL3560L.....	313
G4281G.....	329	G5742G.....	331	G41366GS.....	335	GL3036RG.....	317	GL3560LG.....	318
G4284.....	324	G5745.....	326	G41369GS.....	335	GL3042L.....	312	GL3560R.....	313
G4284G.....	329	G5745G.....	331	G41372GS.....	335	GL3042LG.....	317	GL3560RG.....	318
G5018.....	325	G5748.....	326	G41375GS.....	335	GL3042R.....	312	GL3566L.....	313
G5018G.....	330	G5748G.....	331	G41378GS.....	335	GL3042RG.....	317	GL3566LG.....	318
G5021.....	325	G5751.....	326	G41381GS.....	335	GL3048L.....	312	GL3566R.....	313
G5021G.....	330	G5751G.....	331	G41515GS.....	336	GL3048LG.....	317	GL3566RG.....	318
G5024.....	325	G5754.....	326	G41518GS.....	336	GL3048R.....	312	GL3572L.....	313
G5024G.....	330	G5754G.....	331	G41521GS.....	336	GL3048RG.....	317	GL3572LG.....	318
G5027.....	325	G5757.....	326	G41524GS.....	336	GL3054L.....	312	GL3572R.....	313
G5027G.....	330	G5757G.....	331	G41527GS.....	336	GL3054LG.....	317	GL3572RG.....	318
G5030.....	325	G5760.....	326	G41530GS.....	336	GL3054R.....	312	GL3578L.....	313
G5030G.....	330	G5760G.....	331	G41533GS.....	336	GL3054RG.....	317	GL3578LG.....	318
G5033.....	325	G5763.....	326	G41536GS.....	336	GL3060L.....	312	GL3578R.....	313
G5033G.....	330	G5763G.....	331	G41539GS.....	336	GL3060LG.....	317	GL3578RG.....	318
G5036.....	325	G5766.....	326	G41542GS.....	336	GL3060R.....	312	GL4218L.....	314
G5036G.....	330	G5766G.....	331	G41545GS.....	336	GL3060RG.....	317	GL4218LG.....	319
G5039.....	325	G5769.....	326	G41548GS.....	336	GL3066L.....	312	GL4218R.....	314
G5039G.....	330	G5769G.....	331	G41551GS.....	336	GL3066LG.....	317	GL4218RG.....	319
G5042.....	325	G5772.....	326	G41554GS.....	336	GL3066R.....	312	GL4221L.....	314
G5042G.....	330	G5772G.....	331	G41557GS.....	336	GL3066RG.....	317	GL4221LG.....	319
G5045.....	325	G5775.....	326	G41560GS.....	336	GL3072L.....	312	GL4221R.....	314
G5045G.....	330	G5775G.....	331	G41563GS.....	336	GL3072LG.....	317	GL4221RG.....	319
G5048.....	325	G5778.....	326	G41566GS.....	336	GL3072R.....	312	GL4224L.....	314
G5048G.....	330	G5778G.....	331	G41569GS.....	336	GL3072RG.....	317	GL4224LG.....	319
G5051.....	325	G5781.....	326	G41572GS.....	336	GL3078L.....	312	GL4224R.....	314
G5051G.....	330	G5781G.....	331	G41575GS.....	336	GL3078LG.....	317	GL4224RG.....	319
G5054.....	325	G5784.....	326	G41578GS.....	336	GL3078R.....	312	GL4227L.....	314
G5054G.....	330	G5784G.....	331	G41581GS.....	336	GL3078RG.....	317	GL4227LG.....	319
G5057.....	325	G40715GS.....	334	GACRL12.....	339	GL3518L.....	313	GL4227R.....	314
G5057G.....	330	G40718GS.....	334	GACRL18.....	339	GL3518LG.....	318	GL4227RG.....	319
G5060.....	325	G40721GS.....	334	GACRL24.....	339	GL3518R.....	313	GL4230L.....	314
G5060G.....	330	G40724GS.....	334	GACRL30.....	339	GL3518RG.....	318	GL4230LG.....	319
G5063.....	325	G40727GS.....	334	GACRL36.....	339	GL3521L.....	313	GL4230R.....	314
G5063G.....	330	G40730GS.....	334	GBRSF.....	339	GL3521LG.....	318	GL4230RG.....	319
G5066.....	325	G40733GS.....	334	GCHMT.....	339	GL3521R.....	313	GL4236L.....	314
G5066G.....	330	G40736GS.....	334	GCHRB.....	339	GL3521RG.....	318	GL4236LG.....	319
G5069.....	325	G40739GS.....	334	GCKPM.....	332, 333	GL3524L.....	313	GL4236R.....	314
G5069G.....	330	G40742GS.....	334	GCTKS.....	337	GL3524LG.....	318	GL4236RG.....	319
G5072.....	325	G40745GS.....	334	GFT1.....	338	GL3524R.....	313	GL4242L.....	314
G5072G.....	330	G40748GS.....	334	GFT2.....	338	GL3524RG.....	318	GL4242LG.....	319
G5075.....	325	G40751GS.....	334	GHMB2030.....	338	GL3527L.....	313	GL4242R.....	314
G5075G.....	330	G40754GS.....	334	GHMB2630.....	338	GL3527LG.....	318	GL4242RG.....	319
G5078.....	325	G40757GS.....	334	GL3018L.....	312	GL3527R.....	313	GL4248L.....	314
G5078G.....	330	G40760GS.....	334	GL3018LG.....	317	GL3527RG.....	318	GL4248LG.....	319
G5081.....	325	G40763GS.....	334	GL3018R.....	312	GL3530L.....	313	GL4248R.....	314
G5081G.....	330	G40766GS.....	334	GL3018RG.....	317	GL3530LG.....	318	GL4248RG.....	319
G5084.....	325	G40769GS.....	334	GL3021L.....	312	GL3530R.....	313	GL4254L.....	314
G5084G.....	330	G40772GS.....	334	GL3021LG.....	317	GL3530RG.....	318	GL4254LG.....	319
G5718.....	326	G40775GS.....	334	GL3021R.....	312	GL3536L.....	313	GL4254R.....	314
G5718G.....	331	G40778GS.....	334	GL3021RG.....	317	GL3536LG.....	318	GL4254RG.....	319
G5721.....	326	G40781GS.....	334	GL3024L.....	312	GL3536R.....	313	GL4260L.....	314
G5721G.....	331	G41324GS.....	335	GL3024LG.....	317	GL3536RG.....	318	GL4260LG.....	319
G5724.....	326	G41327GS.....	335	GL3024R.....	312	GL3542L.....	313	GL4260R.....	314
G5724G.....	331	G41330GS.....	335	GL3024RG.....	317	GL3542LG.....	318	GL4260RG.....	319
G5727.....	326	G41333GS.....	335	GL3027L.....	312	GL3542R.....	313	GL4266L.....	314
G5727G.....	331	G41336GS.....	335	GL3027LG.....	317	GL3542RG.....	318	GL4266LG.....	319
G5730.....	326	G41339GS.....	335	GL3027R.....	312	GL3548L.....	313	GL4266R.....	314
G5730G.....	331	G41342GS.....	335	GL3027RG.....	317	GL3548LG.....	318	GL4266RG.....	319
G5733.....	326	G41345GS.....	335	GL3030L.....	312	GL3548R.....	313	GL4272L.....	314
G5733G.....	331	G41348GS.....	335	GL3030LG.....	317	GL3548RG.....	318	GL4272LG.....	319
G5736.....	326	G41351GS.....	335	GL3030R.....	312	GL3554L.....	313	GL4272R.....	314
G5736G.....	331	G41354GS.....	335	GL3030RG.....	317	GL3554LG.....	318	GL4272RG.....	319
G5739.....	326	G41357GS.....	335	GL3036L.....	312	GL3554R.....	313	GL4278L.....	314

INDEX

Cross Reference Index

by Model Number

INDEX

Model	Page	Model	Page	Model	Page	Model	Page	Model	Page
GL4278LG	319	GL5724RG	321	GS3587G	328	GS42117G	329	GT3021G	317
GL4278R	314	GL5727L	316	GS3593	323	GS42123	324	GT3024	312
GL4278RG	319	GL5727LG	321	GS3593G	328	GS42123G	329	GT3024G	317
GL5018L	315	GL5727R	316	GS3599	323	GS42129	324	GT3027	312
GL5018LG	320	GL5727RG	321	GS3599G	328	GS42129G	329	GT3027G	317
GL5018R	315	GL5730L	316	GS4281	324	GS42135	324	GT3030	312
GL5018RG	320	GL5730LG	321	GS4281G	329	GS42135G	329	GT3030G	317
GL5021L	315	GL5730R	316	GS4287	324	GS42141	324	GT3036	312
GL5021LG	320	GL5730RG	321	GS4287G	329	GS42141G	329	GT3036G	317
GL5021R	315	GL5736L	316	GS4293	324	GS42147	324	GT3042	312
GL5021RG	320	GL5736LG	321	GS4293G	329	GS42147G	329	GT3042G	317
GL5024L	315	GL5736R	316	GS4299	324	GS50105	325	GT3048	312
GL5024LG	320	GL5736RG	321	GS4299G	329	GS50105G	330	GT3048G	317
GL5024R	315	GL5742L	316	GS5081	325	GS50111	325	GT3054	312
GL5024RG	320	GL5742LG	321	GS5081G	330	GS50111G	330	GT3054G	317
GL5027L	315	GL5742R	316	GS5087	325	GS50117	325	GT3060	312
GL5027LG	320	GL5742RG	321	GS5087G	330	GS50117G	330	GT3060G	317
GL5027R	315	GL5748L	316	GS5093	325	GS50123	325	GT3066	312
GL5027RG	320	GL5748LG	321	GS5093G	330	GS50123G	330	GT3066G	317
GL5030L	315	GL5748R	316	GS5099	325	GS50129	325	GT3072	312
GL5030LG	320	GL5748RG	321	GS5099G	330	GS50129G	330	GT3072G	317
GL5030R	315	GL5754L	316	GS5781	326	GS50135	325	GT3078	312
GL5030RG	320	GL5754LG	321	GS5781G	331	GS50135G	330	GT3078G	317
GL5036L	315	GL5754R	316	GS5787	326	GS50141	325	GT3518	313
GL5036LG	320	GL5754RG	321	GS5787G	331	GS50141G	330	GT3518G	318
GL5036R	315	GL5760L	316	GS5793	326	GS50147	325	GT3521	313
GL5036RG	320	GL5760LG	321	GS5793G	331	GS50147G	330	GT3521G	318
GL5042L	315	GL5760R	316	GS5799	326	GS57105	326	GT3524	313
GL5042LG	320	GL5760RG	321	GS5799G	331	GS57105G	331	GT3524G	318
GL5042R	315	GL5766L	316	GS30105	322	GS57111	326	GT3527	313
GL5042RG	320	GL5766LG	321	GS30105G	327	GS57111G	331	GT3527G	318
GL5048L	315	GL5766R	316	GS30111	322	GS57117	326	GT3530	313
GL5048LG	320	GL5766RG	321	GS30111G	327	GS57117G	331	GT3530G	318
GL5048R	315	GL5772L	316	GS30117	322	GS57123	326	GT3536	313
GL5048RG	320	GL5772LG	321	GS30117G	327	GS57123G	331	GT3536G	318
GL5054L	315	GL5772R	316	GS30123	322	GS57129	326	GT3542	313
GL5054LG	320	GL5772RG	321	GS30123G	327	GS57129G	331	GT3542G	318
GL5054R	315	GL5778L	316	GS30129	322	GS57135	326	GT3548	313
GL5054RG	320	GL5778LG	321	GS30129G	327	GS57135G	331	GT3548G	318
GL5060L	315	GL5778R	316	GS30135	322	GS57141	326	GT3554	313
GL5060LG	320	GL5778RG	321	GS30135G	327	GS57141G	331	GT3554G	318
GL5060R	315	GMB1524	338	GS30141	322	GS57147	326	GT3560	313
GL5060RG	320	GMB1530	338	GS30141G	327	GS57147G	331	GT3560G	318
GL5066L	315	GMB1536	338	GS30147	322	GS870924	400	GT3566	313
GL5066LG	320	GMB1542	338	GS30147G	327	GS870930	400	GT3566G	318
GL5066R	315	GMB1548	338	GS35105	323	GS870948	400	GT3572	313
GL5066RG	320	GMB1554	338	GS35105G	328	GS870960	400	GT3572G	318
GL5072L	315	GMB1560	338	GS35111	323	GSGKL	332, 333	GT3578	313
GL5072LG	320	GMB2224	338	GS35111G	328	GSGKM	332, 333	GT3578G	318
GL5072R	315	GMB2230	338	GS35117	323	GSTF12	339	GT4218	314
GL5072RG	320	GMB2236	338	GS35117G	328	GSTF18	339	GT4218G	319
GL5078L	315	GMB2242	338	GS35123	323	GSTF24	339	GT4221	314
GL5078LG	320	GMB2248	338	GS35123G	328	GSTF30	339	GT4221G	319
GL5078R	315	GMB2254	338	GS35129	323	GSTF36	339	GT4224	314
GL5078RG	320	GMB2260	338	GS35129G	328	GSTF42	339	GT4224G	319
GL5718L	316	GS3081	322	GS35135	323	GSTF48	339	GT4227	314
GL5718LG	321	GS3081G	327	GS35135G	328	GSTF54	339	GT4227G	319
GL5718R	316	GS3087	322	GS35141	323	GSTF60	339	GT4230	314
GL5718RG	321	GS3087G	327	GS35141G	328	GSTF66	339	GT4230G	319
GL5721L	316	GS3093	322	GS35147	323	GSTF72	339	GT4236	314
GL5721LG	321	GS3093G	327	GS35147G	328	GSTF78	339	GT4236G	319
GL5721R	316	GS3099	322	GS42105	324	GSTFN7578	332, 333	GT4242	314
GL5721RG	321	GS3099G	327	GS42105G	329	GSTFN8184	332, 333	GT4242G	319
GL5724L	316	GS3581	323	GS42111	324	GT3018	312	GT4248	314
GL5724LG	321	GS3581G	328	GS42111G	329	GT3018G	317	GT4248G	319
GL5724R	316	GS3587	323	GS42117	324	GT3021	312	GT4254	314

Cross Reference Index

by Model Number

Model	Page	Model	Page	Model	Page	Model	Page	Model	Page
GT4254G	319	GT302418G	317	GTB2248	338	NHBRHDTBIFB	18.12	T6CB18L	108, 225
GT4260	314	GT302430	312	GTB2254	338	NHBRHDTBIFF	18.12	T6CB18R	108, 225
GT4260G	319	GT302430G	317	GTB2260	338	NHBRHDTBILB	18.9	T6CB24L	108, 225
GT4266	314	GT303018	312	GTEMP	312, 313, 314, 315, 316, 317, 318, 319, 320, 321	NHBRHDTBILF	18.9	T6CB24R	108, 225
GT4266G	319	GT303018G	317			NHBRHDTBIMB	18.10	T6SB	108, 225
GT4272	314	GT303024	312	GTK3CON30F	333	NHBRHDTBIMF	18.10	T7DV	115, 117, 281
GT4272G	319	GT303024G	317	GTK3CON30R	333	NHBRHDTBIPMB	18.11	T612FB	108, 225
GT4278	314	GT351824	313	GTK3CON35F	333	NHBRHDTBIPMF	18.11	T624CB	108, 225
GT4278G	319	GT351824G	318	GTK3CON35R	333	OH1524FD	115, 281	T624FB	108, 225
GT5018	315	GT351830	313	GTK3CON42F	333	OH1524HD	115, 281	T630FB	108, 225
GT5018G	320	GT351830G	318	GTK3CON42R	333	OH1524SD	115, 281	T5622EL	100, 216
GT5021	315	GT352418	313	GTK3CON50F	333	OH1530FD	115, 281	T5622ER	100, 216
GT5021G	320	GT352418G	318	GTK3CON50R	333	OH1530HD	115, 281	T5623EL	100, 216
GT5024	315	GT352430	313	GTK3CON57F	333	OH1530RD	116, 282	T5623ER	100, 216
GT5024G	320	GT352430G	318	GTK3CON57R	333	OH1530SD	115, 281	T5632EL	100, 216
GT5027	315	GT353018	313	GTK3CON65F	333	OH1536FD	115, 281	T5632ER	100, 216
GT5027G	320	GT353018G	318	GTK3CON65R	333	OH1536HD	115, 281	T5633EL	100, 216
GT5030	315	GT353024	313	GTK3CON72F	333	OH1536RD	116, 282	T5633ER	100, 216
GT5030G	320	GT353024G	318	GTK3CON72R	333	OH1536SD	115, 281	T5722EL	100, 216
GT5036	315	GT421824	314	GTK3CON80F	333	OH1542FD	115, 281	T5722ER	100, 216
GT5036G	320	GT421824G	319	GTK3CON80R	333	OH1542HD	115, 281	T5723EL	100, 216
GT5042	315	GT421830	314	GTK3CON87F	333	OH1542RD	116, 282	T5723ER	100, 216
GT5042G	320	GT421830G	319	GTK3CON87R	333	OH1542SD	115, 281	T5732EL	100, 216
GT5048	315	GT422418	314	GTKCKP	333	OH1548FD	115, 281	T5732ER	100, 216
GT5048G	320	GT422418G	319	GTKGK30	333	OH1548HD	115, 281	T5733EL	100, 216
GT5054	315	GT422430	314	GTSKCKP	333	OH1548RD	116, 282	T5733ER	100, 216
GT5054G	320	GT422430G	319	GWPSF	339	OH1548SD	115, 281	T5822EL	100, 216
GT5060	315	GT423018	314	GWS30	337	OH1560FD	115, 281	T5822ER	100, 216
GT5060G	320	GT423018G	319	GWS35	337	OH1560RD	116, 282	T5832EL	100, 216
GT5066	315	GT423024	314	GWS42	337	OH1560SD	115, 281	T5832ER	100, 216
GT5066G	320	GT423024G	319	GWS50	337	PMP41	110	T5922EL	100, 216
GT5072	315	GT501824	315	GWS57	337	PMP47	110	T5922ER	100, 216
GT5072G	320	GT501824G	320	GWSBK	337	PMP53	110	T5932EL	100, 216
GT5078	315	GT501830	315	GZ3CON30	332	POHRTA36S	116, 282	T5932ER	100, 216
GT5078G	320	GT501830G	320	GZ3CON35	332	POHRTA48S	116, 282	T52024S	211
GT5718	316	GT502418	315	GZ3CON42	332	POHRTA1536FD	116, 282	T52030S	211
GT5718G	321	GT502418G	320	GZ3CON50	332	POHRTA1542FD	116, 282	T52036S	211
GT5721	316	GT502430	315	GZ3CON57	332	POHRTA1548FD	116, 282	T52042S	211
GT5721G	321	GT502430G	320	GZ3CON65	332	PRFTSKCL	401	T52048S	211
GT5724	316	GT503018	315	GZ3CON72	332	PRFTSKFS	401	T52054S	211
GT5724G	321	GT503018G	320	GZ3CON80	332	PRFTSKTR	401	T52060S	211
GT5727	316	GT503024	315	GZ3CON87	332	RFDWR48	380	T52066S	211
GT5727G	321	GT503024G	320	GZCKP	332	RFDRW54	380	T52072S	211
GT5730	316	GT571824	316	K5CT1524SC	277	RFDRW60	380	T52078S	211
GT5730G	321	GT571824G	321	K5CT1815SC	263, 277	RFDRW66	380	T52084S	211
GT5736	316	GT571830	316	K5CT1818SC	263	RFDRW72	380	T52090S	211
GT5736G	321	GT571830G	321	K5CT1824SC	263	RFDRWAB	380	T52096S	211
GT5742	316	GT572418	316	K5CT1830SC	263	RFDRWCNPP	382	T52424S	97, 211
GT5742G	321	GT572418G	321	K5CT1836SC	263	RFDRWCNPPPE	382	T52430S	97, 211
GT5748	316	GT572430	316	K5CT1842SC	263	RFDRWCNPPM	382	T52436S	97, 211
GT5748G	321	GT572430G	321	K5CT1848SC	263	RFDRWHUBEND	381	T52442S	97, 211
GT5754	316	GT573018	316	LKFE	410	RFDRWHUBENDT	381	T52448S	97, 211
GT5754G	321	GT573018G	321	NHBRHDBKCE	18.14	RFDRWHUBL	381	T52454S	97, 211
GT5760	316	GT573024	316	NHBRHDFRM	18.8	RFDRWHUBLIN	381	T52460S	97, 211
GT5760G	321	GT573024G	321	NHBRHDFRMEXT	18.8	RFDRWHUBT	381	T52466S	97, 211
GT5766	316	GTB1524	338	NHBRHDMIFB	18.12	RFDRWHUBX	381	T52472S	97, 211
GT5766G	321	GTB1530	338	NHBRHDMIFF	18.12	RFDRWLEG	380	T52478S	97, 211
GT5772	316	GTB1542	338	NHBRHDMIGMBB	18.13	RFDRWSC48	383	T52484S	97, 211
GT5772G	321	GTB1548	338	NHBRHDMIGMBF	18.13	RFDRWSC54	383	T52490S	97, 211
GT5778	316	GTB1554	338	NHBRHDMIMB	18.10	RFDRWSC60	383	T52496S	97, 211
GT5778G	321	GTB1560	338	NHBRHDMIMF	18.10	RFDRWSC66	383	T53024S	97, 212
GT301824	312	GTB2224	338	NHBRHDMIPMB	18.11	RFDRWSC72	383	T53030S	97, 212
GT301824G	317	GTB2230	338	NHBRHDMIPMF	18.11	RFDRWWM	382	T53036S	97, 212
GT301830	312	GTB2236	338	NHBRHDPMB	18.15	T6BK	108, 225	T53042S	97, 212
GT301830G	317	GTB2242	338	NHBRHDSHELF	18.14	T6CB12L	108, 225	T53048S	97, 212
GT302418	312					T6CB12R	108, 225	T53054S	97, 212

INDEX

Cross Reference Index

by Model Number

INDEX

Model	Page	Model	Page	Model	Page	Model	Page	Model	Page
T53060B.....	101, 217	TK312H.....	46	TK327L.....	44	TK342E.....	46	TK365X.....	44
T53060S.....	97, 212	TK312HF.....	46	TK327LF.....	44	TK342EF.....	46	TK365XF.....	44
T53066B.....	101, 217	TK312L.....	44	TK327S.....	45	TK342L.....	44	TK365YEB.....	48, 109
T53066S.....	97, 212	TK312LF.....	44	TK327SF.....	45	TK342LF.....	44	TK365YM.....	48, 109
T53072B.....	101, 217	TK312S.....	45	TK327T.....	44	TK342PT.....	42	TK366PT.....	42
T53072PL.....	101, 217	TK312SF.....	45	TK327TF.....	44	TK342PTFK.....	42	TK366PTFK.....	42
T53072PR.....	101, 217	TK312T.....	44	TK327X.....	44	TK342S.....	45	TK368PT.....	42
T53072S.....	97, 212	TK312TF.....	44	TK327XF.....	44	TK342SF.....	45	TK368PTFK.....	42
T53078S.....	97, 212	TK312X.....	44	TK330B.....	45	TK342T.....	44	TK372PT.....	42
T53084S.....	97, 212	TK312XF.....	44	TK330BF.....	45	TK342TF.....	44	TK372PTFK.....	42
T53090S.....	97, 212	TK315B.....	45	TK330C.....	45	TK342W.....	46	TK378PT.....	42
T53096S.....	97, 212	TK315BF.....	45	TK330CF.....	45	TK342WF.....	46	TK378PTFK.....	42
T53624CR.....	99, 215	TK315C.....	45	TK330E.....	46	TK342X.....	44	TK380E.....	46
T53624SC.....	99, 215	TK315CF.....	45	TK330EF.....	46	TK342XF.....	44	TK380EF.....	46
T53660B.....	101, 217	TK315E.....	46	TK330H.....	46	TK348PT.....	42	TK380L.....	44
T53660S.....	212	TK315EF.....	46	TK330HF.....	46	TK348PTFK.....	42	TK380LF.....	44
T53666B.....	101, 217	TK315H.....	46	TK330L.....	44	TK350B.....	45	TK380S.....	45
T53666S.....	212	TK315HF.....	46	TK330LF.....	44	TK350BF.....	45	TK380SF.....	45
T53672B.....	101, 217	TK315HG.....	46	TK330PT.....	42	TK350C.....	45	TK380T.....	44
T53672S.....	212	TK315HGF.....	46	TK330PTFK.....	42	TK350CF.....	45	TK380TF.....	44
T54224CR.....	99, 215	TK315L.....	44	TK330S.....	45	TK350E.....	46	TK380X.....	44
T54224SC.....	99, 215	TK315LF.....	44	TK330SF.....	45	TK350EF.....	46	TK380XF.....	44
T54230CR.....	99, 215	TK315S.....	45	TK330T.....	44	TK350L.....	44	TK384PT.....	42
T54230SC.....	99, 215	TK315SF.....	45	TK330TF.....	44	TK350LF.....	44	TK384PTFK.....	42
T54662JL.....	101, 217	TK315T.....	44	TK330W.....	46	TK350S.....	45	TK387E.....	46
T54662JR.....	101, 217	TK315TF.....	44	TK330WF.....	46	TK350SF.....	45	TK387EF.....	46
T54663JL.....	101, 217	TK315W.....	46	TK330X.....	44	TK350T.....	44	TK387L.....	44
T54663JR.....	101, 217	TK315WF.....	46	TK330XF.....	44	TK350TF.....	44	TK387LF.....	44
T54722JL.....	101, 217	TK315X.....	44	TK332B.....	45	TK350W.....	46	TK387S.....	45
T54722JR.....	101, 217	TK315XF.....	44	TK332BF.....	45	TK350WF.....	46	TK387SF.....	45
T54723JL.....	101, 217	TK320B.....	45	TK332C.....	45	TK350X.....	44	TK387T.....	44
T54723JR.....	101, 217	TK320BF.....	45	TK332CF.....	45	TK350XF.....	44	TK387TF.....	44
T54824CR.....	99, 215	TK320C.....	45	TK332E.....	46	TK354PT.....	42	TK387W.....	46
T54824SC.....	99, 215	TK320CF.....	45	TK332EF.....	46	TK354PTFK.....	42	TK387WF.....	46
T54830CR.....	99, 215	TK320H.....	46	TK332L.....	44	TK357B.....	45	TK387X.....	44
T54830SC.....	99, 215	TK320HF.....	46	TK332LF.....	44	TK357BF.....	45	TK387XF.....	44
TAWG.....	79, 197, 264	TK320L.....	44	TK332S.....	45	TK357C.....	45	TK390PT.....	42
TBPLATE3-36.....	80, 198	TK320LF.....	44	TK332SF.....	45	TK357CF.....	45	TK390PTFK.....	42
TBPLATE3-42.....	80, 198	TK320S.....	45	TK332T.....	44	TK357E.....	46	TK396PT.....	42
TBPLATE3-48.....	80, 198	TK320SF.....	45	TK332TF.....	44	TK357EF.....	46	TK396PTFK.....	42
TBPLATE3-60.....	80, 198	TK320T.....	44	TK332W.....	46	TK357L.....	44	TK01524.....	40
TK4TRAYMS.....	62, 169	TK320TF.....	44	TK332WF.....	46	TK357LF.....	44	TK01530.....	40
TK24FR.....	41	TK320X.....	44	TK332X.....	44	TK357S.....	45	TK01536.....	40
TK30FR.....	41	TK320XF.....	44	TK332XF.....	44	TK357SF.....	45	TK01542.....	40
TK36FR.....	41	TK322E.....	46	TK335B.....	45	TK357T.....	44	TK01548.....	40
TK42FR.....	41	TK322EF.....	46	TK335BF.....	45	TK357TF.....	44	TK01560.....	40
TK48FR.....	41	TK322H.....	46	TK335C.....	45	TK357W.....	46	TK02224.....	40
TK60FR.....	41	TK322HF.....	46	TK335CF.....	45	TK357WF.....	46	TK02230.....	40
TK305H.....	46	TK322L.....	44	TK335E.....	46	TK357X.....	44	TK02236.....	40
TK305HF.....	46	TK322LF.....	44	TK335EF.....	46	TK357XF.....	44	TK02242.....	40
TK307H.....	46	TK322S.....	45	TK335L.....	44	TK360PT.....	42	TK02248.....	40
TK307HF.....	46	TK322SF.....	45	TK335LF.....	44	TK360PTFK.....	42	TK02260.....	40
TK307HGF.....	46	TK322T.....	44	TK335S.....	45	TK365B.....	45	TK03024.....	40
TK307HGF.....	46	TK322TF.....	44	TK335SF.....	45	TK365BF.....	45	TK03030.....	40
TK307L.....	44	TK322W.....	46	TK335T.....	44	TK365C.....	45	TK03036.....	40
TK307LF.....	44	TK322WF.....	46	TK335TF.....	44	TK365CF.....	45	TK03042.....	40
TK307S.....	45	TK322X.....	44	TK335W.....	46	TK365E.....	46	TK03048.....	40
TK307SF.....	45	TK322XF.....	44	TK335WF.....	46	TK365EF.....	46	TK03060.....	40
TK307T.....	44	TK324PT.....	42	TK335X.....	44	TK365L.....	44	TK03224WF.....	39
TK307TF.....	44	TK324PTFK.....	42	TK335XF.....	44	TK365LF.....	44	TK03224WR.....	39
TK307X.....	44	TK327B.....	45	TK336PT.....	42	TK365S.....	45	TK03230WF.....	39
TK307XF.....	44	TK327BF.....	45	TK336PTFK.....	42	TK365SF.....	45	TK03230WR.....	39
TK312B.....	45	TK327C.....	45	TK342B.....	45	TK365T.....	44	TK03236WF.....	39
TK312BF.....	45	TK327CF.....	45	TK342BF.....	45	TK365TF.....	44	TK03236WR.....	39
TK312C.....	45	TK327H.....	46	TK342C.....	45	TK365W.....	46	TK03242WF.....	39
TK312CF.....	45	TK327HF.....	46	TK342CF.....	45	TK365WF.....	46	TK03242WR.....	39

Cross Reference Index

by Model Number

Model	Page	Model	Page	Model	Page	Model	Page	Model	Page
TK03248WF.....	39	TK40724CTK.....	64	TK41542FD.....	63	TK43030GK.....	61	TKG40724FS.....	53
TK03248WR.....	39	TK40724FD.....	63	TK41542GK.....	61	TK43030PS.....	63	TKG40724LFD.....	63
TK03260WF.....	39	TK40724PS.....	63	TK41542PS.....	63	TK43030SP.....	63	TKG40724LM.....	56
TK03260WR.....	39	TK40724SP.....	63	TK41542SP.....	63	TK43030V.....	65	TKG40724MS.....	62
TK03524WF.....	39	TK40724SW.....	53	TK41542SW.....	53	TK43036CTK.....	64	TKG40724SH.....	54
TK03524WR.....	39	TK40724TGSF.....	43	TK41542TGSF.....	43	TK43036FD.....	63	TKG40724T.....	49
TK03530WF.....	39	TK40730CTK.....	64	TK41548CTK.....	64	TK43036GK.....	61	TKG40724TGSR.....	43
TK03530WR.....	39	TK40730FD.....	63	TK41548FD.....	63	TK43036PS.....	63	TKG40730FS.....	53
TK03536WF.....	39	TK40730PS.....	63	TK41548GK.....	61	TK43036SP.....	63	TKG40730LFD.....	63
TK03536WR.....	39	TK40730SP.....	63	TK41548PS.....	63	TK43036V.....	65	TKG40730LM.....	56
TK03542WF.....	39	TK40730SW.....	53	TK41548SP.....	63	TK43042CTK.....	64	TKG40730MS.....	62
TK03542WR.....	39	TK40730TGSF.....	43	TK41548SW.....	53	TK43042FD.....	63	TKG40730SH.....	54
TK03548WF.....	39	TK40736CTK.....	64	TK41548TGSF.....	43	TK43042GK.....	61	TKG40730T.....	49
TK03548WR.....	39	TK40736FD.....	63	TK41548V.....	65	TK43042PS.....	63	TKG40730TGSR.....	43
TK03560WF.....	39	TK40736PS.....	63	TK41554TGSF.....	43	TK43042SP.....	63	TKG40736FS.....	53
TK03560WR.....	39	TK40736SP.....	63	TK41560CTK.....	64	TK43048CTK.....	64	TKG40736LFD.....	63
TK04224WF.....	39	TK40736SW.....	53	TK41560FD.....	63	TK43048FD.....	63	TKG40736LM.....	56
TK04224WR.....	39	TK40736TGSF.....	43	TK41560GK.....	61	TK43048GK.....	61	TKG40736MS.....	62
TK04230WF.....	39	TK40742CTK.....	64	TK41560PS.....	63	TK43048PS.....	63	TKG40736SH.....	54
TK04230WR.....	39	TK40742FD.....	63	TK41560SP.....	63	TK43048SP.....	63	TKG40736T.....	49
TK04236WF.....	39	TK40742PS.....	63	TK41560SW.....	53	TK43048V.....	65	TKG40736TGSR.....	43
TK04236WR.....	39	TK40742SP.....	63	TK41560TGSF.....	43	TK43060CTK.....	64	TKG40742FS.....	53
TK04242WF.....	39	TK40742SW.....	53	TK41566TGSF.....	43	TK43060FD.....	63	TKG40742LFD.....	63
TK04242WR.....	39	TK40742TGSF.....	43	TK41572TGSF.....	43	TK43060GK.....	61	TKG40742LM.....	56
TK04248WF.....	39	TK40748CTK.....	64	TK41578TGSF.....	43	TK43060PS.....	63	TKG40742MS.....	62
TK04248WR.....	39	TK40748FD.....	63	TK41584TGSF.....	43	TK43060SP.....	63	TKG40742SH.....	54
TK04260WF.....	39	TK40748PS.....	63	TK41590TGSF.....	43	TK44230V.....	65	TKG40742T.....	49
TK04260WR.....	39	TK40748SP.....	63	TK41596TGSF.....	43	TK44242V.....	65	TKG40742TGSR.....	43
TK05024WF.....	39	TK40748SW.....	53	TK42224CTK.....	64	TK44248V.....	65	TKG40748FD.....	63
TK05024WR.....	39	TK40748TGSF.....	43	TK42224FD.....	63	TK851524CP.....	103	TKG40748FS.....	53
TK05030WF.....	39	TK40754TGSF.....	43	TK42224GK.....	61	TK851524P.....	103	TKG40748LM.....	56
TK05030WR.....	39	TK40760CTK.....	64	TK42224PS.....	63	TK851524PF.....	103	TKG40748MS.....	62
TK05036WF.....	39	TK40760FD.....	63	TK42224SP.....	63	TK851530CP.....	103	TKG40748SH.....	54
TK05036WR.....	39	TK40760PS.....	63	TK42230CTK.....	64	TK851530P.....	103	TKG40748T.....	49
TK05042WF.....	39	TK40760SP.....	63	TK42230FD.....	63	TK851530PF.....	103	TKG40748TGSR.....	43
TK05042WR.....	39	TK40760SW.....	53	TK42230GK.....	61	TK851536CP.....	103	TKG40754TGSR.....	43
TK05048WF.....	39	TK40760TGSF.....	43	TK42230PS.....	63	TK851536P.....	103	TKG40760FS.....	53
TK05048WR.....	39	TK40766TGSF.....	43	TK42230SP.....	63	TK851536PF.....	103	TKG40760LFD.....	63
TK05060WF.....	39	TK40772TGSF.....	43	TK42236CTK.....	64	TK851542P.....	103	TKG40760LM.....	56
TK05060WR.....	39	TK40778TGSF.....	43	TK42236FD.....	63	TK851542PF.....	103	TKG40760MS.....	62
TK05724WF.....	39	TK40784TGSF.....	43	TK42236GK.....	61	TK851548P.....	103	TKG40760SH.....	54
TK05724WR.....	39	TK40790TGSF.....	43	TK42236PS.....	63	TK851548PF.....	103	TKG40760T.....	49
TK05730WF.....	39	TK40796TGSF.....	43	TK42236SP.....	63	TK851554P.....	103	TKG40760TGSR.....	43
TK05730WR.....	39	TK41524CTK.....	64	TK42242CTK.....	64	TK851554PF.....	103	TKG40766TGSR.....	43
TK05736WF.....	39	TK41524FD.....	63	TK42242FD.....	63	TK851560P.....	103	TKG40772TGSR.....	43
TK05736WR.....	39	TK41524GK.....	61	TK42242GK.....	61	TK851560PF.....	103	TKG40778TGSR.....	43
TK05742WF.....	39	TK41524PS.....	63	TK42242PS.....	63	TK851566P.....	103	TKG40784TGSR.....	43
TK05742WR.....	39	TK41524SP.....	63	TK42242SP.....	63	TK851566PF.....	103	TKG40790TGSR.....	43
TK05748WF.....	39	TK41524SW.....	53	TK42248CTK.....	64	TK851572P.....	103	TKG40796TGSR.....	43
TK05748WR.....	39	TK41524TGSF.....	43	TK42248FD.....	63	TK851572PF.....	103	TKG41524E.....	51
TK05760WF.....	39	TK41530CTK.....	64	TK42248GK.....	61	TKCWD29L.....	109	TKG41524FS.....	53
TK05760WR.....	39	TK41530FD.....	63	TK42248PS.....	63	TKCWD29R.....	109	TKG41524LFD.....	63
TK06524WF.....	39	TK41530GK.....	61	TK42248SP.....	63	TKDKM30.....	41	TKG41524LM.....	56
TK06524WR.....	39	TK41530PS.....	63	TK42248V.....	65	TKDKM36.....	41	TKG41524LS.....	55
TK06530WF.....	39	TK41530SP.....	63	TK42260CTK.....	64	TKDKM42.....	41	TKG41524MS.....	62
TK06530WR.....	39	TK41530SW.....	53	TK42260FD.....	63	TKDKM48.....	41	TKG41524SH.....	54
TK06536WF.....	39	TK41530TGSF.....	43	TK42260GK.....	61	TKDPA29L.....	109	TKG41524T.....	49
TK06536WR.....	39	TK41530V.....	65	TK42260PS.....	63	TKDPA29R.....	109	TKG41524TGSR.....	43
TK06542WF.....	39	TK41536CTK.....	64	TK42260SP.....	63	TKEB29L.....	109	TKG41530E.....	51
TK06542WR.....	39	TK41536FD.....	63	TK43024CTK.....	64	TKEB29R.....	109	TKG41530FS.....	53
TK06548WF.....	39	TK41536GK.....	61	TK43024FD.....	63	TKEP1129PL.....	108, 109	TKG41530LFD.....	63
TK06548WR.....	39	TK41536PS.....	63	TK43024GK.....	61	TKEP1129PR.....	108, 109	TKG41530LM.....	56
TK06560WF.....	39	TK41536SP.....	63	TK43024PS.....	63	TKEP2429L.....	108, 109	TKG41530LS.....	55
TK06560WR.....	39	TK41536SW.....	53	TK43024SP.....	63	TKEP2429R.....	108, 109	TKG41530MS.....	62
TK18742D.....	41	TK41536TGSF.....	43	TK43030CTK.....	64	TKEP3029PL.....	108, 109	TKG41530SH.....	54
TK18742DF.....	41	TK41542CTK.....	64	TK43030FD.....	63	TKEP3029PR.....	108, 109	TKG41530T.....	49

INDEX

Cross Reference Index

by Model Number

INDEX

Model	Page	Model	Page	Model	Page	Model	Page	Model	Page
TKG41530TGRS.....	43	TKG42236SH	54	TKG43030LM	56	TKG43236E	51	TKG44536LM	57
TKG41536E	51	TKG42236T	49	TKG43030LS	55	TKG43236FS.....	53	TKG44536LTF	58
TKG41536FS.....	53	TKG42242E	51	TKG43030LTF	58	TKG43236LS	55	TKG44542LM	57
TKG41536LFD.....	63	TKG42242FS.....	53	TKG43030MS.....	62	TKG43236T	49	TKG44542LTF	58
TKG41536LM	56	TKG42242LFD	63	TKG43030SH	54	TKG43242E	51	TKG44548LM	57
TKG41536LS	55	TKG42242LM	56	TKG43030T	49	TKG43242FS.....	53	TKG44548LTF	58
TKG41536MS.....	62	TKG42242LTF	58	TKG43036E.....	51	TKG43242LS	55	TKG44560LM	57
TKG41536SH	54	TKG42242MS.....	62	TKG43036FS.....	53	TKG43242T	49	TKG44560LTF	58
TKG41536T	49	TKG42242SH	54	TKG43036LFD	63	TKG43248E	51	TKG45024E	52
TKG41536TGRS.....	43	TKG42242T	49	TKG43036LM	56	TKG43248FS.....	53	TKG45024T	50
TKG41542E	51	TKG42248E.....	51	TKG43036LS	55	TKG43248LS	55	TKG45030E.....	52
TKG41542FD	63	TKG42248FS.....	53	TKG43036LTF	58	TKG43248T	49	TKG45030T	50
TKG41542FS	53	TKG42248LFD	63	TKG43036MS.....	62	TKG43260E	51	TKG45036E	52
TKG41542LM	56	TKG42248LM	56	TKG43036SH	54	TKG43260FS.....	53	TKG45036T	50
TKG41542LS	55	TKG42248LTF	58	TKG43036T	49	TKG43260LS	55	TKG45042E	52
TKG41542MS.....	62	TKG42248MS.....	62	TKG43042E.....	51	TKG43260T	49	TKG45042T	50
TKG41542SH	54	TKG42248SH	54	TKG43042FS.....	53	TKG43724LM	57	TKG45048E.....	52
TKG41542T	49	TKG42248T	49	TKG43042LFD	63	TKG43724LTF	58	TKG45048T	50
TKG41542TGRS.....	43	TKG42260E.....	51	TKG43042LM	56	TKG43730LM	57	TKG45054SLS	59
TKG41548E.....	51	TKG42260FS.....	53	TKG43042LS	55	TKG43730LTF	58	TKG45054SLSTF	60
TKG41548FS.....	53	TKG42260LFD	63	TKG43042LTF	58	TKG43736LM	57	TKG45060E	52
TKG41548LFD.....	63	TKG42260LM	56	TKG43042MS.....	62	TKG43736LTF	58	TKG45060SLS	59
TKG41548LM	56	TKG42260LTF	58	TKG43042SH	54	TKG43742LM	57	TKG45060SLSTF	60
TKG41548LS	55	TKG42260MS.....	62	TKG43042T	49	TKG43742LTF	58	TKG45060T	50
TKG41548MS.....	62	TKG42260SH	54	TKG43048E.....	51	TKG43748LM	57	TKG45066SLS	59
TKG41548SH	54	TKG42260T	49	TKG43048FS.....	53	TKG43748LTF	58	TKG45066SLSTF	60
TKG41548T	49	TKG42524LM	56	TKG43048LFD	63	TKG43760LM	57	TKG45072SLS	59
TKG41548TGRS.....	43	TKG42524LTF	58	TKG43048LM	56	TKG43760LTF	58	TKG45072SLSTF	60
TKG41554TGRS.....	43	TKG42530LM	56	TKG43048LS	55	TKG44224E	52	TKG45078SLS	59
TKG41560E.....	51	TKG42530LTF	58	TKG43048LTF	58	TKG44224LS	55	TKG45078SLSTF	60
TKG41560FS	53	TKG42536LM	56	TKG43048MS.....	62	TKG44224T	50	TKG45084SLS	59
TKG41560LFD	63	TKG42536LTF	58	TKG43048SH	54	TKG44230E	52	TKG45084SLSTF	60
TKG41560LM	56	TKG42542LM	56	TKG43048T	49	TKG44230LS	55	TKG45090SLS	59
TKG41560LS	55	TKG42542LTF	58	TKG43054SLS	59	TKG44230T	50	TKG45090SLSTF	60
TKG41560MS.....	62	TKG42548LM	56	TKG43054SLSTF	60	TKG44236E	52	TKG45096SLS	59
TKG41560SH	54	TKG42548LTF	58	TKG43060E.....	51	TKG44236LS	55	TKG45096SLSTF	60
TKG41560T	49	TKG42554SLS	59	TKG43060FS.....	53	TKG44236T	50	TKG45724E	52
TKG41560TGRS.....	43	TKG42554SLSTF	60	TKG43060LFD	63	TKG44242E	52	TKG45724LM	57
TKG41566TGRS.....	43	TKG42560LM	56	TKG43060LM	56	TKG44242LS	55	TKG45724LTF	58
TKG41572TGRS.....	43	TKG42560LTF	58	TKG43060LS	55	TKG44242T	50	TKG45724T	50
TKG41578TGRS.....	43	TKG42560SLS	59	TKG43060LTF	58	TKG44248E	52	TKG45730E.....	52
TKG41584TGRS.....	43	TKG42560SLSTF	60	TKG43060MS.....	62	TKG44248LS	55	TKG45730LM	57
TKG41590TGRS.....	43	TKG42566SLS	59	TKG43060SH	54	TKG44248T	50	TKG45730LTF	58
TKG41596TGRS.....	43	TKG42566SLSTF	60	TKG43060SLS	59	TKG44254SLS	59	TKG45730T	50
TKG42224E	51	TKG42572SLS	59	TKG43060SLSTF	60	TKG44254SLSTF	60	TKG45736E	52
TKG42224FS.....	53	TKG42572SLSTF	60	TKG43060T	49	TKG44260E	52	TKG45736LM	57
TKG42224LFD	63	TKG42578SLS	59	TKG43066SLS	59	TKG44260LS	55	TKG45736LTF	58
TKG42224LM	56	TKG42578SLSTF	60	TKG43066SLSTF	60	TKG44260SLS	59	TKG45736T	50
TKG42224LTF	58	TKG42584SLS	59	TKG43072SLS	59	TKG44260SLSTF	60	TKG45742E	52
TKG42224MS.....	62	TKG42584SLSTF	60	TKG43072SLSTF	60	TKG44260T	50	TKG45742LM	57
TKG42224SH	54	TKG42590SLS	59	TKG43078SLS	59	TKG44266SLS	59	TKG45742LTF	58
TKG42224T	49	TKG42590SLSTF	60	TKG43078SLSTF	60	TKG44266SLSTF	60	TKG45742T	50
TKG42230E.....	51	TKG42596SLS	59	TKG43084SLS	59	TKG44272SLS	59	TKG45748E.....	52
TKG42230FS.....	53	TKG42596SLSTF	60	TKG43084SLSTF	60	TKG44272SLSTF	60	TKG45748LM	57
TKG42230LFD.....	63	TKG43024E.....	51	TKG43090SLS	59	TKG44278SLS	59	TKG45748LTF	58
TKG42230LM	56	TKG43024FS.....	53	TKG43090SLSTF	60	TKG44278SLSTF	60	TKG45748T	50
TKG42230LTF	58	TKG43024LFD	63	TKG43096SLS	59	TKG44284SLS	59	TKG45760E	52
TKG42230MS.....	62	TKG43024LM	56	TKG43096SLSTF	60	TKG44284SLSTF	60	TKG45760T	50
TKG42230SH	54	TKG43024LS	55	TKG43224E.....	51	TKG44290SLS	59	TKG46024LM	57
TKG42230T	49	TKG43024LTF	58	TKG43224FS.....	53	TKG44290SLSTF	60	TKG46024LTF	58
TKG42236E	51	TKG43024MS.....	62	TKG43224LS	55	TKG44296SLS	59	TKG46030LM	57
TKG42236FS.....	53	TKG43024SH	54	TKG43224T	49	TKG44296SLSTF	60	TKG46030LTF	58
TKG42236LFD.....	63	TKG43024T	49	TKG43230E.....	51	TKG44524LM	57	TKG46036LM	57
TKG42236LM	56	TKG43030E.....	51	TKG43230FS.....	53	TKG44524LTF	58	TKG46036LTF	58
TKG42236LTF	58	TKG43030FS.....	53	TKG43230LS	55	TKG44530LM	57	TKG46042LM	57
TKG42236MS.....	62	TKG43030LFD	63	TKG43230T	49	TKG44530LTF	58	TKG46042LTF	58

Cross Reference Index

by Model Number

Model	Page	Model	Page	Model	Page	Model	Page	Model	Page
TKG46048LM	57	TN52424SD	99	Y629NLK	224	Z5CT1542	260	Z5CT2448	260
TKG46048LTF	58	TN53030C	104	Y51524S	103	Z5CT1548	260	Z5CT2454	260
TKG46524E	52	TN53030CF	104	Y51530S	103	Z5CT1554	260	Z5CT2460	260
TKG46524T	50	TN53030Q	102	Y51536S	103	Z5CT1560	260	Z5CT2466	260
TKG46530E	52	TN53636C	104	Y51542S	103	Z5CT1566	260	Z5CT2472	260
TKG46530T	50	TN53636CF	104	Y51548S	103	Z5CT1572	260	Z5CT2478	260
TKG46536E	52	TNV52424Q	107, 220	Y51554S	103	Z5CT1578	260	Z5CT2484	260
TKG46536T	50	TNV53030Q	107, 220	Y51560S	103	Z5CT1584	260	Z5CT2490	260
TKG46542E	52	TT629SC	108, 224	Y51566S	103	Z5CT1590	260	Z5CT2496	260
TKG46542T	50	TT53024CB	99, 215	Y51572S	103	Z5CT1596	260	Z5SC42	97, 225
TKG46548E	52	TT53624CB	99, 215	Y52424C	103	Z5CT1724	260	Z5SC48	97, 225
TKG46548T	50	TT53660BT	98	Y53030C	103	Z5CT1730	260	Z5SC54	97, 225
TKG46560E	52	TT53666BT	98	Y53636C	103	Z5CT1736	260	Z5SC60	97, 225
TKG46560T	50	TT53672BT	98	Y62610SLPP	222	Z5CT1742	260	Z5SC66	97, 225
TKMP60	110	TT54224CB	99, 215	Y62620PENP	222	Z5CT1748	260	Z5SC72	97, 225
TKMP66	110	TT54824CB	99, 215	Y62624PENP	222	Z5CT1754	260	Z5SC78	97, 225
TKMP72	110	TWTH	115, 281	Y62910FENP	222	Z5CT1760	260	Z5SC84	97, 225
TKOM	41	U7WDA	397	Y62910PENP	222	Z5CT1766	260	Z5WM48	225
TKPPBL	108	U9TF	388	Y62910SLFP	222	Z5CT1772	260	Z5WM54	225
TKPPBR	108	U9TM	388	Y62910SLPP	222	Z5CT1778	260	Z5WM60	225
TKRF	41	U9TP	388	Y62920PENP	222	Z5CT1784	260	Z5WM66	225
TKSB29	109	U9TS	388	Y62924FENP	222	Z5CT1790	260	Z5WM72	225
TKSK24	40, 48	U9WTC	80, 388	Y62924PENP	222	Z5CT1796	260	Z5WM78	225
TKSK30	40, 48	U912WTR	388	Y62924SLFP	222	Z5CT1824	260	Z5WM84	225
TKSK36	40, 48	U918WTR	388	Y62924SLPP	222	Z5CT1830	260	Z6C3BK	182, 225
TKSK42	40, 48	U924WTR	388	Y62930FENP	222	Z5CT1836	260	Z6CE	264
TKSK48	40, 48	U930WTR	388	Y62930PENP	222	Z5CT1842	260	Z6CFC24	264
TKSK60	40, 48	U936WTR	388	YWC24Z	274	Z5CT1848	260	Z6CFC30	264
TKSL2429P	108, 109	U942WTR	388	YWC30Z	274	Z5CT1854	260	Z6CFN24	264
TKSL3029P	108, 109	U948WTR	388	YWC36Z	274	Z5CT1860	260	Z6CFN30	264
TN3LB	47	U954WTR	388	YWC42Z	274	Z5CT1866	260	Z6CFN36	264
TN3NB	47	U960WTR	388	YWC48Z	274	Z5CT1872	260	Z6CFN42	264
TN3SB	47	U966WTR	388	YWC60Z	274	Z5CT1878	260	Z6CFN48	264
TN3TB	47	UH6536FD	117	Z2NM	182, 281	Z5CT1884	260	Z6CFN54	264
TN3VB	47	UH6542FD	117	Z2RF	147	Z5CT1890	260	Z6CFN60	264
TN3VLB	47	UH6548FD	117	Z2UP24	115, 281	Z5CT1896	260	Z6CFN66	264
TN3XB	47	UH6560FD	117	Z2UP30	115, 281	Z5CT2124	260	Z6CFN72	264
TN24MS	40, 80	UH6566FD	117	Z2UP36	115, 281	Z5CT2130	260	Z6CFN78	264
TN30MS	40, 80	UH6572FD	117	Z2UP42	115, 281	Z5CT2136	260	Z6CFN84	264
TN36MS	40, 80	UHTB36	117	Z2UP48	115, 281	Z5CT2142	260	Z6CFN90	264
TN42MS	40, 80	UHTB42	117	Z2UP60	115, 281	Z5CT2148	260	Z6CFN96	264
TN48MS	40, 80	UHTB48	117	Z3CONB	153	Z5CT2154	260	Z6CFP24	264
TN60MS	40, 80	UHTB60	117	Z3CONC	153	Z5CT2160	260	Z6CFP30	264
TN524D	102	UHTB66	117	Z3MP	182	Z5CT2166	260	Z6CFP36	264
TN530D	102	UHTB72	117	Z3SS	154	Z5CT2172	260	Z6CFP42	264
TN51524S	104	UN2HPSQ	382	Z3SSV	154	Z5CT2178	260	Z6CFP48	264
TN51524SF	104	UN2HPSQSK	382	Z3TBGB	148	Z5CT2184	260	Z6CFP60	264
TN51530S	104	UN924HT	356	Z3TBGC	148	Z5CT2190	260	Z6CLFL	224
TN51530SF	104	UN936HT	356	Z3TBGI	148	Z5CT2196	260	Z6CLFR	224
TN51536S	104	UN948HT	356	Z3TBGL	148	Z5CT2324	260	Z6CLHL	224
TN51536SF	104	UNQTMP	356, 402	Z3TBGS	148	Z5CT2330	260	Z6CLHR	224
TN51542S	104	UTP	79, 197	Z3TBGT	148	Z5CT2336	260	Z6CRF24	264
TN51542SF	104	WANDFS	401	Z3TBGX	148	Z5CT2342	260	Z6CRF30	264
TN51548S	104	WANDFSOC	401	Z3UCON	153	Z5CT2348	260	Z6CRF36	264
TN51548SF	104	WANDFSUSB	401	Z3UCON10P	153	Z5CT2354	260	Z6CRF42	264
TN51554S	104	WKSWMC	356, 382	Z4STBRKT1	60, 174	Z5CT2360	260	Z6CRF48	264
TN51554SF	104	Y6EPKP	224	Z4STBRKT2	60, 174	Z5CT2366	260	Z6CRF54	264
TN51560S	104	Y6PPK	222	Z4UP24	115, 281	Z5CT2372	260	Z6CRF60	264
TN51560SF	104	Y324YS	48, 109	Z4UP30	115, 281	Z5CT2378	260	Z6CRF66	264
TN51566S	104	Y330YS	48, 109	Z4UP36	115, 281	Z5CT2384	260	Z6CRF72	264
TN51566SF	104	Y336YS	48, 109	Z4UP42	115, 281	Z5CT2390	260	Z6CRF78	264
TN51572S	104	Y342YS	48, 109	Z4UP48	115, 281	Z5CT2396	260	Z6CRF84	264
TN51572SF	104	Y348YS	48, 109	Z4UP60	115, 281	Z5CT2424	260	Z6CRF90	264
TN52424C	104	Y360YS	48, 109	Z5CT1524	260	Z5CT2430	260	Z6CRF96	264
TN52424CF	104	Y629LKNP	224	Z5CT1530	260	Z5CT2436	260	Z6CT2N24	265
TN52424Q	102	Y629LKNP	224	Z5CT1536	260	Z5CT2442	260	Z6CT2N30	265

INDEX

Cross Reference Index

by Model Number

INDEX

Model	Page	Model	Page	Model	Page	Model	Page	Model	Page
Z6CT2N36.....	265	Z6PL29FR.....	223	Z322PEV.....	159	Z335XTV.....	156	Z350PFV.....	154, 155, 157
Z6CT2N42.....	265	Z6PL29HP.....	223	Z322PF.....	154, 155, 157	Z335XX.....	156	Z350PL.....	154
Z6CT2N48.....	265	Z6PL40FL.....	223	Z322PFV.....	154, 155, 157	Z335XXV.....	156	Z350PLV.....	154
Z6CT2N54.....	265	Z6PL40FP.....	223	Z322PL.....	154, 155, 157	Z336PP.....	195	Z350PW.....	160
Z6CT2N60.....	265	Z6PL40FR.....	223	Z322PLV.....	154, 155, 157	Z336PPV.....	195	Z350PWV.....	160
Z6CT2N66.....	265	Z6PL40HL.....	223	Z322PVH.....	154, 155, 157, 158	Z336PT.....	152	Z350T.....	159
Z6CT2N72.....	265	Z6PL40HP.....	223	Z322PVHV.....	154, 155, 157, 158	Z336VT.....	152	Z350TL.....	155
Z6CT2N78.....	265	Z6PL40HR.....	223	Z322PW.....	160	Z342BB.....	158	Z350TLV.....	155
Z6CT2N84.....	265	Z6PTLFPC.....	223	Z322PWV.....	160	Z342BBV.....	158	Z350TS.....	155
Z6CT2N90.....	265	Z6PTLFPG.....	223	Z324PP.....	195	Z342CB.....	158	Z350TSV.....	155
Z6CT2N96.....	265	Z6PTLHPC.....	223	Z324PPV.....	195	Z342CBV.....	158	Z350TT.....	155
Z6CTSS124.....	265	Z6PTLHPG.....	223	Z324PT.....	152	Z342CC.....	158	Z350TTV.....	155
Z6CTSS130.....	265	Z6SCF.....	224	Z324PTV.....	152	Z342CCV.....	158	Z350X.....	159
Z6CTSS136.....	265	Z6SCH.....	224	Z330PB.....	158	Z342LL.....	154	Z350XL.....	156
Z6CTSS142.....	265	Z6Z3MK.....	182, 225	Z330PBV.....	158	Z342LLV.....	154	Z350XLV.....	156
Z6CTSS148.....	265	Z130DMK.....	151	Z330PE.....	159	Z342PB.....	158	Z350XS.....	156
Z6CTSS154.....	265	Z136DMK.....	151	Z330PEV.....	159	Z342PBV.....	158	Z350XSV.....	156
Z6CTSS160.....	265	Z142DMK.....	151	Z330PF.....	154, 155, 157	Z342PE.....	159	Z350XT.....	156
Z6CTSS166.....	265	Z148DMK.....	151	Z330PFV.....	154, 155, 157	Z342PEF.....	159	Z350XTV.....	156
Z6CTSS172.....	265	Z224FR.....	147	Z330PFV.....	154, 155, 157	Z342PEFV.....	159	Z350XX.....	156
Z6CTSS178.....	265	Z224SK.....	147	Z330PL.....	154, 155, 157	Z342PEV.....	159	Z350XXV.....	156
Z6CTSS184.....	265	Z230FR.....	147	Z330PLV.....	154, 155, 157	Z342PF.....	154, 155, 157	Z351PT.....	152
Z6CTSS190.....	265	Z230SK.....	147	Z330PP.....	195	Z342PFV.....	154, 155, 157	Z351VT.....	152
Z6CTSS196.....	265	Z235PP.....	195	Z330PPV.....	195	Z342PL.....	154	Z354PP.....	195
Z6DF2830D.....	226	Z236FR.....	147	Z330OPT.....	152	Z342PLV.....	154	Z354PPV.....	195
Z6DF2830F.....	226	Z242FR.....	147	Z330PVH.....	154, 155, 157, 158	Z342PP.....	195	Z354PT.....	152
Z6DF2830L.....	226	Z242SK.....	147	Z330PVHV.....	154, 155, 157, 158	Z342PPV.....	195	Z354VT.....	152
Z6DF2836D.....	226	Z248FR.....	147	Z330PW.....	160	Z342PT.....	152	Z357BB.....	158
Z6DF2836F.....	226	Z248SK.....	147	Z330PWV.....	160	Z342PW.....	160	Z357BBV.....	158
Z6DF2836L.....	226	Z260FR.....	147	Z330VT.....	152	Z342PWV.....	160	Z357CB.....	158
Z6DF2842D.....	226	Z260SK.....	147	Z335BB.....	158	Z342T.....	159	Z357CBV.....	158
Z6DF2842F.....	226	Z265PP.....	195	Z335BBV.....	158	Z342TL.....	155	Z357CC.....	158
Z6DF2842L.....	226	Z307PB.....	158	Z335CB.....	158	Z342TLV.....	155	Z357CCV.....	158
Z6DF2848D.....	226	Z307PBV.....	158	Z335CBV.....	158	Z342TS.....	155	Z357LL.....	154
Z6DF2848F.....	226	Z307PE.....	159	Z335CC.....	158	Z342TSV.....	155	Z357LLV.....	154
Z6DF2848L.....	226	Z307PEV.....	159	Z335CCV.....	158	Z342TT.....	155	Z357PB.....	158
Z6DF2854D.....	226	Z307PF.....	154, 155, 157	Z335LL.....	154	Z342TTV.....	155	Z357PBV.....	158
Z6DF2854F.....	226	Z307PFV.....	154, 155, 157	Z335LLV.....	154	Z342TV.....	152	Z357PE.....	159
Z6DF2854L.....	226	Z307PL.....	154, 155, 157	Z335LLV.....	154	Z342X.....	159	Z357PEF.....	159
Z6DF2860D.....	226	Z307PLV.....	154, 155, 157	Z335PB.....	158	Z342XL.....	156	Z357PEFV.....	159
Z6DF2860F.....	226	Z307PTG.....	159	Z335PBV.....	158	Z342XLV.....	156	Z357PEV.....	159
Z6DF2860L.....	226	Z307PTGV.....	159	Z335PE.....	159	Z342XS.....	156	Z357PF.....	154, 155, 157
Z6DM1430D.....	227	Z307PVH.....	154, 155, 157, 158	Z335PEV.....	159	Z342XSV.....	156	Z357PFV.....	154, 155, 157
Z6DM1430L.....	227	Z315PB.....	158	Z335PEV.....	159	Z342XT.....	156	Z357PL.....	154
Z6DM1436D.....	227	Z315PBV.....	158	Z335PF.....	154, 155, 157	Z342XTV.....	156	Z357PLV.....	154
Z6DM1442D.....	227	Z315PE.....	159	Z335PFV.....	154, 155, 157	Z342XX.....	156	Z357PW.....	160
Z6DM1442L.....	227	Z315PEV.....	159	Z335PL.....	154	Z342XXV.....	156	Z357PWV.....	160
Z6DM1448D.....	227	Z315PF.....	154, 155, 157	Z335PLV.....	154	Z348PP.....	195	Z357T.....	159
Z6DM1448L.....	227	Z315PFV.....	154, 155, 157	Z335P.....	155	Z348PPV.....	195	Z357TL.....	155
Z6DM1454D.....	227	Z315PL.....	154, 155, 157	Z335PFV.....	154, 155, 157	Z348PT.....	152	Z357TLV.....	155
Z6DM1454L.....	227	Z315PLV.....	154, 155, 157	Z335P.....	155	Z348PTV.....	152	Z357TS.....	155
Z6DM1460D.....	227	Z315PTG.....	159	Z335P.....	155	Z350BB.....	158	Z357TSV.....	155
Z6DM1460L.....	227	Z315PTGV.....	159	Z335P.....	155	Z350BBV.....	158	Z357TT.....	155
Z6DS1324TG.....	226	Z315PVH.....	154, 155, 157, 158	Z335P.....	155	Z350CB.....	158	Z357TTV.....	155
Z6DS1330TG.....	226	Z315PW.....	160	Z335P.....	155	Z350CBV.....	158	Z357X.....	159
Z6DS1336TG.....	226	Z315PWV.....	160	Z335P.....	155	Z350CC.....	158	Z357XL.....	156
Z6DS1342TG.....	226	Z322PB.....	158	Z335P.....	155	Z350CCV.....	158	Z357XLV.....	156
Z6DS1348TG.....	226	Z322PBV.....	158	Z335P.....	155	Z350LL.....	154	Z357XS.....	156
Z6DS1354TG.....	226	Z322PE.....	159	Z335P.....	155	Z350LLV.....	154	Z357XSV.....	156
Z6DS1360TG.....	226	Z315PVHV.....	154, 155, 157, 158	Z335P.....	155	Z350PB.....	158	Z357XT.....	156
Z6EPK.....	182, 225	Z315PW.....	160	Z335P.....	155	Z350PBV.....	158	Z357XTV.....	156
Z6LB.....	271	Z315PWV.....	160	Z335P.....	155	Z350PE.....	159	Z357XX.....	156
Z6MK.....	182, 225	Z322PB.....	158	Z335P.....	155	Z350PEF.....	159	Z357XXV.....	156
Z6PL29FL.....	223	Z322PBV.....	158	Z335P.....	155	Z350PEFV.....	159	Z360PP.....	195
Z6PL29FP.....	223	Z322PE.....	159	Z335P.....	155	Z350PEV.....	159	Z360PPV.....	195
				Z335XT.....	156	Z350PF.....	154, 155, 157	Z360PT.....	152

Cross Reference Index

by Model Number

Model	Page	Model	Page	Model	Page	Model	Page	Model	Page
Z360VT	152	Z372XSV	156	Z387PWV	160	Z03060P	147	Z04224WN	146
Z363PT	152	Z372XT	156	Z387T	159	Z3102BB	158	Z04224WR	146
Z363VT	152	Z372XTV	156	Z387TL	155	Z3102BBV	158	Z04230AIF	183
Z365BB	158	Z372XX	156	Z387TLV	155	Z3102CB	158	Z04230AIU	183
Z365BBV	158	Z372XXV	156	Z387TTS	155	Z3102CBV	158	Z04230WF	146
Z365CB	158	Z375PT	152	Z387TTSV	155	Z3102CC	158	Z04230WN	146
Z365CBV	158	Z375VT	152	Z387TT	155	Z3102CCV	158	Z04230WR	146
Z365CC	158	Z378PP	195	Z387TTV	155	Z3102LL	154	Z04236AIF	183
Z365CCV	158	Z378PPV	195	Z387X	159	Z3102LLV	154	Z04236AIU	183
Z365LL	154	Z378PT	152	Z387XL	156	Z3102TL	155	Z04236WF	146
Z365LLV	154	Z378VT	152	Z387XLV	156	Z3102TLV	155	Z04236WN	146
Z365PB	158	Z380BB	158	Z387XS	156	Z3102TS	155	Z04236WR	146
Z365PBV	158	Z380BBV	158	Z387XSV	156	Z3102TSV	155	Z04242AIF	183
Z365PE	159	Z380CB	158	Z387XT	156	Z3102TT	155	Z04242AIU	183
Z365PEF	159	Z380CBV	158	Z387XTV	156	Z3102TTV	155	Z04242WF	146
Z365PEFV	159	Z380CC	158	Z387XX	156	Z3102XL	156	Z04242WN	146
Z365PEV	159	Z380CCV	158	Z387XXV	156	Z3102XLV	156	Z04242WR	146
Z365PF	154, 155, 157	Z380LL	154	Z390PP	195	Z3102XS	156	Z04248AIF	183
Z365PFV	154, 155, 157	Z380LLV	154	Z390PPV	195	Z3102XSV	156	Z04248AIU	183
Z365PL	154	Z380PB	158	Z390PT	152	Z3102XT	156	Z04248WF	146
Z365PLV	154	Z380PBV	158	Z390VT	152	Z3102XTV	156	Z04248WN	146
Z365PW	160	Z380PE	159	Z395BB	158	Z3102XX	156	Z04248WR	146
Z365PWV	160	Z380PEF	159	Z395BBV	158	Z3102XXV	156	Z04260AIF	183
Z365T	159	Z380PEFV	159	Z395CB	158	Z3110BB	158	Z04260AIU	183
Z365TL	155	Z380PEV	159	Z395CBV	158	Z3110BBV	158	Z04260WF	146
Z365TLV	155	Z380PF	154, 155, 157	Z395CC	158	Z3110CB	158	Z04260WN	146
Z365TS	155	Z380PFV	154, 155, 157	Z395CCV	158	Z3110CBV	158	Z04260WR	146
Z365TSV	155	Z380PL	154	Z395LL	154	Z3110CC	158	Z05024AIF	183
Z365TT	155	Z380PLV	154	Z395LLV	154	Z3110CCV	158	Z05024AIU	183
Z365TTV	155	Z380PW	160	Z395TL	155	Z3110LL	154	Z05024WF	146
Z365X	159	Z380PWV	160	Z395TLV	155	Z3110LLV	154	Z05024WN	146
Z365XL	156	Z380T	159	Z395TS	155	Z3110TL	155	Z05024WR	146
Z365XLV	156	Z380TL	155	Z395TTSV	155	Z3110TLV	155	Z05030AIF	183
Z365XS	156	Z380TLV	155	Z395TT	155	Z3110TS	155	Z05030AIU	183
Z365XSV	156	Z380TTS	155	Z395TTV	155	Z3110TSV	155	Z05030WF	146
Z365XT	156	Z380TTSV	155	Z395XL	156	Z3110TT	155	Z05030WN	146
Z365XTV	156	Z380TT	155	Z395XLV	156	Z3110TTV	155	Z05030WR	146
Z365XX	156	Z380TTV	155	Z395XS	156	Z3110XL	156	Z05036AIF	183
Z365XXV	156	Z380X	159	Z395XSV	156	Z3110XLV	156	Z05036AIU	183
Z366PT	152	Z380XL	156	Z395XT	156	Z3110XS	156	Z05036WF	146
Z366VT	152	Z380XLV	156	Z395XTV	156	Z3110XSV	156	Z05036WN	146
Z368PP	195	Z380XS	156	Z395XX	156	Z3110XT	156	Z05036WR	146
Z368PPV	195	Z380XSV	156	Z395XXV	156	Z3110XTV	156	Z05042AIF	183
Z368PT	152	Z380XT	156	Z396PP	195	Z3110XX	156	Z05042AIU	183
Z368VT	152	Z380XTV	156	Z396PPV	195	Z3110XXV	156	Z05042WF	146
Z372BB	158	Z380XX	156	Z396PT	152	Z03524WF	146	Z05042WN	146
Z372BBV	158	Z380XXV	156	Z396VT	152	Z03524WN	146	Z05042WR	146
Z372CB	158	Z384PP	195	Z617UWTRGH	356	Z03524WR	146	Z05048AIF	183
Z372CBV	158	Z384PPV	195	Z636UWTRGH	356	Z03530WF	146	Z05048AIU	183
Z372CC	158	Z384PT	152	Z01524P	147	Z03530WN	146	Z05048WF	146
Z372CCV	158	Z384PTV	152	Z01530P	147	Z03530WR	146	Z05048WN	146
Z372LL	154	Z387BB	158	Z01536P	147	Z03536WF	146	Z05048WR	146
Z372LLV	154	Z387BBV	158	Z01542P	147	Z03536WN	146	Z05060AIF	183
Z372PP	195	Z387CB	158	Z01548P	147	Z03536WR	146	Z05060AIU	183
Z372PPV	195	Z387CBV	158	Z01560P	147	Z03542WF	146	Z05060WF	146
Z372PT	152	Z387CC	158	Z02224P	147	Z03542WN	146	Z05060WN	146
Z372TL	155	Z387CCV	158	Z02230P	147	Z03542WR	146	Z05060WR	146
Z372TLV	155	Z387LL	154	Z02236P	147	Z03548WF	146	Z05724AIF	183
Z372TS	155	Z387LLV	154	Z02242P	147	Z03548WN	146	Z05724AIU	183
Z372TSV	155	Z387PE	159	Z02248P	147	Z03548WR	146	Z05724WF	146
Z372TT	155	Z387PEV	159	Z02260P	147	Z03560WF	146	Z05724WN	146
Z372TTV	155	Z387PF	154, 155, 157	Z03024P	147	Z03560WN	146	Z05724WR	146
Z372VT	152	Z387PFV	154, 155, 157	Z03030P	147	Z03560WR	146	Z05730AIF	183
Z372XL	156	Z387PL	154	Z03036P	147	Z04224AIF	183	Z05730AIU	183
Z372XLV	156	Z387PLV	154	Z03042P	147	Z04224AIU	183	Z05730WF	146
Z372XS	156	Z387PW	160	Z03048P	147	Z04224WF	146	Z05730WN	146

INDEX

Cross Reference Index

by Model Number

INDEX

Model	Page	Model	Page	Model	Page	Model	Page	Model	Page
Z05730WR	146	Z40730L	170	Z41524L	170	Z41548V	177	Z42236LM	171
Z05736AIF	183	Z40730LM	171	Z41524LM	171	Z41554TGS	149	Z42236LTF	173
Z05736AIU	183	Z40730S	166	Z41524MB	169	Z41554TGSV	150	Z42236MB	169
Z05736WF	146	Z40730SH	167	Z41524MBS	169	Z41560E	163	Z42236MBS	169
Z05736WN	146	Z40730SW	168	Z41524S	166	Z41560G	176	Z42236PT	176
Z05736WR	146	Z40730T	161	Z41524SH	167	Z41560GL	148	Z42236S	166
Z05742AIF	183	Z40730TGS	149	Z41524SW	168	Z41560L	170	Z42236SF	166
Z05742AIU	183	Z40730TGSV	150	Z41524T	161	Z41560LM	171	Z42236SH	167
Z05742WF	146	Z40730V	177	Z41524TGS	149	Z41560MB	169	Z42236T	161
Z05742WN	146	Z40736E	163	Z41524TGSV	150	Z41560MBS	169	Z42236TF	165
Z05742WR	146	Z40736L	170	Z41524V	177	Z41560S	166	Z42236V	177
Z05748AIF	183	Z40736LM	171	Z41530E	163	Z41560SH	167	Z42236VTF	178
Z05748AIU	183	Z40736S	166	Z41530G	176	Z41560SW	168	Z42242E	163
Z05748WF	146	Z40736SH	167	Z41530GL	148	Z41560T	161	Z42242G	176
Z05748WR	146	Z40736SW	168	Z41530L	170	Z41560TGS	149	Z42242L	170
Z05748WN	146	Z40736T	161	Z41530LM	171	Z41560TGSV	150	Z42242LM	171
Z05760AIF	183	Z40736TGS	149	Z41530MB	169	Z41560V	177	Z42242LTF	173
Z05760AIU	183	Z40736TGSV	150	Z41530MBS	169	Z41566TGS	149	Z42242MB	169
Z05760WF	146	Z40736V	177	Z41530S	166	Z41566TGSV	150	Z42242MBS	169
Z05760WN	146	Z40742E	163	Z41530SH	167	Z41572GL	148	Z42242PT	176
Z05760WR	146	Z40742L	170	Z41530SW	168	Z41572TGS	149	Z42242S	166
Z06524AIF	183	Z40742LM	171	Z41530T	161	Z41572TGSV	150	Z42242SF	166
Z06524AIU	183	Z40742S	166	Z41530TGS	149	Z41578TGS	149	Z42242SH	167
Z06524WF	146	Z40742SH	167	Z41530TGSV	150	Z41578TGSV	150	Z42242T	161
Z06524WN	146	Z40742SW	168	Z41530V	177	Z41584GL	148	Z42242TF	165
Z06524WR	146	Z40742T	161	Z41536E	163	Z41584TGS	149	Z42242V	177
Z06530AIF	183	Z40742TGS	149	Z41536G	176	Z41584TGSV	150	Z42242VTF	178
Z06530AIU	183	Z40742TGSV	150	Z41536GL	148	Z41590GL	148	Z42248E	163
Z06530WF	146	Z40742V	177	Z41536L	170	Z41590TGS	149	Z42248G	176
Z06530WN	146	Z40748E	163	Z41536LM	171	Z41590TGSV	150	Z42248L	170
Z06530WR	146	Z40748L	170	Z41536MB	169	Z41596GL	148	Z42248LM	171
Z06536AIF	183	Z40748LM	171	Z41536MBS	169	Z41596TGS	149	Z42248LTF	173
Z06536AIU	183	Z40748S	166	Z41536S	166	Z41596TGSV	150	Z42248MB	169
Z06536WF	146	Z40748SH	167	Z41536SH	167	Z42224E	163	Z42248MBS	169
Z06536WN	146	Z40748SW	168	Z41536SW	168	Z42224G	176	Z42248PT	176
Z06536WR	146	Z40748T	161	Z41536T	161	Z42224L	170	Z42248S	166
Z06542AIF	183	Z40748TGS	149	Z41536TGS	149	Z42224LM	171	Z42248SF	166
Z06542AIU	183	Z40748TGSV	150	Z41536TGSV	150	Z42224LTF	173	Z42248SH	167
Z06542WF	146	Z40748V	177	Z41536V	177	Z42224MB	169	Z42248T	161
Z06542WN	146	Z40754TGS	149	Z41542E	163	Z42224MBS	169	Z42248TF	165
Z06542WR	146	Z40754TGSV	150	Z41542G	176	Z42224PT	176	Z42248V	177
Z06548AIF	183	Z40760E	163	Z41542GL	148	Z42224S	166	Z42248VTF	178
Z06548AIU	183	Z40760L	170	Z41542L	170	Z42224SF	166	Z42260E	163
Z06548WF	146	Z40760LM	171	Z41542LM	171	Z42224SH	167	Z42260G	176
Z06548WR	146	Z40760S	166	Z41542MB	169	Z42224T	161	Z42260L	170
Z06548WN	146	Z40760SH	167	Z41542MBS	169	Z42224TF	165	Z42260LM	171
Z06560AIF	183	Z40760SW	168	Z41542S	166	Z42224V	177	Z42260LTF	173
Z06560AIU	183	Z40760T	161	Z41542SH	167	Z42224VTF	178	Z42260MB	169
Z06560WF	146	Z40760TGS	149	Z41542SW	168	Z42230E	163	Z42260MBS	169
Z06560WN	146	Z40760TGSV	150	Z41542T	161	Z42230G	176	Z42260PT	176
Z06560WR	146	Z40760V	177	Z41542TGS	149	Z42230L	170	Z42260S	166
Z15042SD	41, 151	Z40766TGS	149	Z41542TGSV	150	Z42230LM	171	Z42260SF	166
Z16542SD	41, 151	Z40766TGSV	150	Z41542V	177	Z42230LTF	173	Z42260SH	167
Z18042SD	41, 151	Z40772TGS	149	Z41548E	163	Z42230MB	169	Z42260T	161
Z18742PDL	151	Z40772TGSV	150	Z41548G	176	Z42230MBS	169	Z42260TF	165
Z40724E	163	Z40778TGS	149	Z41548GL	148	Z42230PT	176	Z42260V	177
Z40724L	170	Z40778TGSV	150	Z41548L	170	Z42230S	166	Z42260VTF	178
Z40724LM	171	Z40784TGS	149	Z41548LM	171	Z42230SF	166	Z42554SHS	174
Z40724S	166	Z40784TGSV	150	Z41548MB	169	Z42230SH	167	Z42554SHTF	175
Z40724SH	167	Z40790TGS	149	Z41548MBS	169	Z42230T	161	Z42560SHS	174
Z40724SW	168	Z40790TGSV	150	Z41548S	166	Z42230TF	165	Z42560SHTF	175
Z40724T	161	Z40796TGS	149	Z41548SH	167	Z42230V	177	Z42566SHS	174
Z40724TGS	149	Z40796TGSV	150	Z41548SW	168	Z42230VTF	178	Z42566SHTF	175
Z40724TGSV	150	Z41524E	163	Z41548T	161	Z42236E	163	Z42572SHS	174
Z40724V	177	Z41524G	176	Z41548TGS	149	Z42236G	176	Z42572SHTF	175
Z40730E	163	Z41524GL	148	Z41548TGSV	150	Z42236L	170	Z42578SHS	174

Cross Reference Index

by Model Number

Model	Page	Model	Page	Model	Page	Model	Page	Model	Page
Z42578SHTF	175	Z43042VTF	178	Z43736V	177	Z44536NVS-SP	179	Z45230TF	165
Z42584SHS	174	Z43048E	163	Z43736VTF	178	Z44536NVS-ZP	181	Z45236E	164
Z42584SHTF	175	Z43048G	176	Z43742E	164	Z44536T	162	Z45236NVS-Q2P	180
Z42590SHS	174	Z43048L	170	Z43742LTF	173	Z44536TF	165	Z45236NVS-SQ	180
Z42590SHTF	175	Z43048LM	171	Z43742NVS-QP	179	Z44536V	177	Z45236NVS-ZQ	181
Z42596SHS	174	Z43048LTF	173	Z43742T	162	Z44536VTF	178	Z45236T	162
Z42596SHTF	175	Z43048MB	169	Z43742TF	165	Z44542E	164	Z45236TF	165
Z43024E	163	Z43048MBS	169	Z43742V	177	Z44542LTF	173	Z45242E	164
Z43024G	176	Z43048NVS-2P	179	Z43742VTF	178	Z44542NVS-3P	179	Z45242NVS-Q2P	180
Z43024L	170	Z43048S	166	Z43748E	164	Z44542NVS-SP	179	Z45242NVS-SQ	180
Z43024LM	171	Z43048SF	166	Z43748LTF	173	Z44542NVS-ZP	181	Z45242NVS-ZQ	181
Z43024LTF	173	Z43048SH	167	Z43748NVS-QP	179	Z44542T	162	Z45242T	162
Z43024MB	169	Z43048T	161	Z43748T	162	Z44542TF	165	Z45242TF	165
Z43024MBS	169	Z43048TF	165	Z43748TF	165	Z44542V	177	Z45248E	164
Z43024NVS-2P	179	Z43048V	177	Z43748V	177	Z44542VTF	178	Z45248NVS-Q2P	180
Z43024S	166	Z43048VTF	178	Z43748VTF	178	Z44548E	164	Z45248NVS-SQ	180
Z43024SF	166	Z43054SHS	174	Z43754SHS	174	Z44548LTF	173	Z45248NVS-ZQ	181
Z43024SH	167	Z43054SHTF	175	Z43754SHTF	175	Z44548NVS-3P	179	Z45248T	162
Z43024T	161	Z43060E	163	Z43760E	164	Z44548NVS-SP	179	Z45248TF	165
Z43024TF	165	Z43060G	176	Z43760LTF	173	Z44548NVS-ZP	181	Z45260E	164
Z43024V	177	Z43060L	170	Z43760NVS-QP	179	Z44548T	162	Z45260NVS-Q2P	180
Z43024VTF	178	Z43060LM	171	Z43760SHS	174	Z44548TF	165	Z45260NVS-SQ	180
Z43030E	163	Z43060LTF	173	Z43760SHTF	175	Z44548V	177	Z45260NVS-ZQ	181
Z43030G	176	Z43060MB	169	Z43760T	162	Z44548VTF	178	Z45260T	162
Z43030L	170	Z43060MBS	169	Z43760TF	165	Z44554SHS	174	Z45260TF	165
Z43030LM	171	Z43060NVS-2P	179	Z43760V	177	Z44554SHTF	175	Z45724LM	172
Z43030LTF	173	Z43060S	166	Z43760VTF	178	Z44560E	164	Z45724LTF	173
Z43030MB	169	Z43060SF	166	Z43766SHS	174	Z44560LTF	173	Z45730LM	172
Z43030MBS	169	Z43060SH	167	Z43766SHTF	175	Z44560NVS-3P	179	Z45730LTF	173
Z43030NVS-2P	179	Z43060SHS	174	Z43772SHS	174	Z44560NVS-SP	179	Z45736LM	172
Z43030S	166	Z43060SHTF	175	Z43772SHTF	175	Z44560NVS-ZP	181	Z45736LTF	173
Z43030SF	166	Z43060T	161	Z43778SHS	174	Z44560SHS	174	Z45742LM	172
Z43030SH	167	Z43060TF	165	Z43778SHTF	175	Z44560SHTF	175	Z45742LTF	173
Z43030T	161	Z43060V	177	Z43784SHS	174	Z44560T	162	Z45748LM	172
Z43030TF	165	Z43060VTF	178	Z43784SHTF	175	Z44560TF	165	Z45748LTF	173
Z43030V	177	Z43066SHS	174	Z43790SHS	174	Z44560V	177	Z46024E	164
Z43030VTF	178	Z43066SHTF	175	Z43790SHTF	175	Z44560VTF	178	Z46024LTF	173
Z43036E	163	Z43072SHS	174	Z43796SHS	174	Z44566SHS	174	Z46024NVS-4P	180
Z43036G	176	Z43072SHTF	175	Z43796SHTF	175	Z44566SHTF	175	Z46024NVS-S2P	180
Z43036L	170	Z43078SHS	174	Z44224LM	171	Z44572SHS	174	Z46024NVS-Z2P	181
Z43036LM	171	Z43078SHTF	175	Z44230LM	171	Z44572SHTF	175	Z46024T	162
Z43036LTF	173	Z43084SHS	174	Z44236LM	171	Z44578SHS	174	Z46024TF	165
Z43036MB	169	Z43084SHTF	175	Z44242LM	171	Z44578SHTF	175	Z46030E	164
Z43036MBS	169	Z43090SHS	174	Z44248LM	171	Z44584SHS	174	Z46030LTF	173
Z43036NVS-2P	179	Z43090SHTF	175	Z44260LM	171	Z44584SHTF	175	Z46030NVS-4P	180
Z43036S	166	Z43096SHS	174	Z44524E	164	Z44590SHS	174	Z46030NVS-S2P	180
Z43036SF	166	Z43096SHTF	175	Z44524LTF	173	Z44590SHTF	175	Z46030NVS-Z2P	181
Z43036SH	167	Z43724E	164	Z44524NVS-3P	179	Z44596SHS	174	Z46030T	162
Z43036T	161	Z43724LTF	173	Z44524NVS-SP	179	Z44596SHTF	175	Z46030TF	165
Z43036TF	165	Z43724NVS-QP	179	Z44524NVS-ZP	181	Z45024LM	171	Z46036E	164
Z43036V	177	Z43724T	162	Z44524T	162	Z45030LM	171	Z46036LTF	173
Z43036VTF	178	Z43724TF	165	Z44524TF	165	Z45036LM	171	Z46036NVS-4P	180
Z43042E	163	Z43724V	177	Z44524V	177	Z45042LM	171	Z46036NVS-S2P	180
Z43042G	176	Z43724VTF	178	Z44524VTF	178	Z45048LM	171	Z46036NVS-Z2P	181
Z43042L	170	Z43730E	164	Z44530E	164	Z45060LM	171	Z46036T	162
Z43042LM	171	Z43730LTF	173	Z44530LTF	173	Z45224E	164	Z46036TF	165
Z43042LTF	173	Z43730NVS-QP	179	Z44530NVS-3P	179	Z45224NVS-Q2P	180	Z46042E	164
Z43042MB	169	Z43730T	162	Z44530NVS-SP	179	Z45224NVS-SQ	180	Z46042LTF	173
Z43042MBS	169	Z43730TF	165	Z44530NVS-ZP	181	Z45224NVS-ZQ	181	Z46042NVS-4P	180
Z43042NVS-2P	179	Z43730V	177	Z44530T	162	Z45224T	162	Z46042NVS-S2P	180
Z43042S	166	Z43730VTF	178	Z44530TF	165	Z45224TF	165	Z46042NVS-Z2P	181
Z43042SF	166	Z43736E	164	Z44530V	177	Z45230E	164	Z46042T	162
Z43042SH	167	Z43736LTF	173	Z44530VTF	178	Z45230NVS-Q2P	180	Z46042TF	165
Z43042T	161	Z43736NVS-QP	179	Z44536E	164	Z45230NVS-SQ	180	Z46048E	164
Z43042TF	165	Z43736T	162	Z44536LTF	173	Z45230NVS-ZQ	181	Z46048LTF	173
Z43042V	177	Z43736TF	165	Z44536NVS-3P	179	Z45230T	162	Z46048NVS-4P	180

INDEX

Cross Reference Index

by Model Number

INDEX

Model	Page	Model	Page	Model	Page	Model	Page	Model	Page
Z46048NVS-S2P.....	180	ZDHC6024BL.....	258	ZDLCBN36.....	262	ZDST501524RGL.....	268	ZDT652418LFSL.....	269
Z46048NVS-Z2P.....	181	ZDHC6024FL.....	258	ZDLCBN42.....	262	ZDST502418LFL.....	268	ZDT652418LGL.....	269
Z46048TF.....	162	ZDHCBN24.....	262	ZDLCBN48.....	262	ZDST502418LFSL.....	268	ZDT652418LGL.....	269
Z46048TF.....	165	ZDHCBN30.....	262	ZDLCBN60.....	262	ZDST502418LGL.....	268	ZDT652418RFL.....	269
Z46060E.....	164	ZDHCBN36.....	262	ZDLCBR24.....	262	ZDST502418LGL.....	268	ZDT652418RFL.....	269
Z46060NVS-4P.....	180	ZDHCBN42.....	262	ZDLCBR30.....	262	ZDST502418RFL.....	268	ZDT652418RGL.....	269
Z46060NVS-S2P.....	180	ZDHCBN48.....	262	ZDLCBR36.....	262	ZDST502418RFL.....	268	ZDT652418RGL.....	269
Z46060NVS-Z2P.....	181	ZDHCBN60.....	262	ZDLCBR42.....	262	ZDST502418RGL.....	268	ZDT652424LFL.....	269
Z46060T.....	162	ZDHCBR24.....	262	ZDLCBR48.....	262	ZDST502418RGL.....	268	ZDT652424LFL.....	269
Z46060TF.....	165	ZDHCBR30.....	262	ZDLCBR60.....	262	ZDST502424LFL.....	268	ZDT652424LGL.....	269
Z46524LM.....	172	ZDHCBR36.....	262	ZDOC24ML.....	272	ZDST502424LFL.....	268	ZDT652424LGL.....	269
Z46530LM.....	172	ZDHCBR42.....	262	ZDOC24MLD.....	273	ZDST502424LGL.....	268	ZDT652424RFL.....	269
Z46536LM.....	172	ZDHCBR48.....	262	ZDOC24NL.....	272	ZDST502424LGL.....	268	ZDT652424RFL.....	269
Z46542LM.....	172	ZDHCBR60.....	262	ZDOC24NLD.....	273	ZDST502424RFL.....	268	ZDT652424RGL.....	269
Z46548LM.....	172	ZDHF24LS.....	275	ZDOC24P.....	272	ZDST502424RFL.....	268	ZDT652424RGL.....	269
Z51524S.....	214	ZDHF24RS.....	275	ZDOC24QL.....	272	ZDST502424RGL.....	268	ZHFPMK.....	275
Z51530S.....	214	ZDHF30S.....	275	ZDOC24QLD.....	273	ZDST502424RGL.....	268	ZHSPMK30.....	275
Z51536S.....	214	ZDHF36LS.....	275	ZDOC24U.....	272	ZDST502424RGL.....	268	ZHSPMK36.....	275
Z51542S.....	214	ZDHF36RS.....	275	ZDOC30ML.....	272	ZDST502424RGL.....	268	ZHSPMK42.....	275
Z51548S.....	214	ZDHF42S.....	275	ZDOC30MLD.....	273	ZDST502424RGL.....	268	ZHSPMK48.....	275
Z51554S.....	214	ZDHF48S.....	275	ZDOC30NL.....	272	ZDST502424RGL.....	268	ZHSPMK60.....	275
Z51560S.....	214	ZDHF60S.....	275	ZDOC30NLD.....	273	ZDST502424RGL.....	268	ZHSRMK.....	275
Z51566S.....	214	ZDHS30LS.....	275	ZDOC30P.....	272	ZDST502424RGL.....	268	ZR5CT1524.....	260
Z51572S.....	214	ZDHS30RS.....	275	ZDOC30QL.....	272	ZDST502424RGL.....	268	ZR5CT1530.....	260
Z52043LD.....	213	ZDHS36LS.....	275	ZDOC30QLD.....	273	ZDST502424RGL.....	268	ZR5CT1536.....	260
Z52051LD.....	213	ZDHS36RS.....	275	ZDOC30U.....	272	ZDST502424RGL.....	268	ZR5CT1542.....	260
Z52424C.....	214	ZDHS42LS.....	275	ZDOC36ML.....	272	ZDST502424RGL.....	268	ZR5CT1548.....	260
Z52443LD.....	213	ZDHS42RS.....	275	ZDOC36MLD.....	273	ZDST502424RGL.....	268	ZR5CT1554.....	260
Z52451LD.....	213	ZDHS48LS.....	275	ZDOC36NL.....	272	ZDST502424RGL.....	268	ZR5CT1560.....	260
Z53030C.....	214	ZDHS48RS.....	275	ZDOC36NLD.....	273	ZDST502424RGL.....	268	ZR5CT1566.....	260
Z53636C.....	214	ZDHS60LS.....	275	ZDOC36P.....	272	ZDST502424RGL.....	268	ZR5CT1572.....	260
Z61710UWTRGH.....	356	ZDHS60RS.....	275	ZDOC36QL.....	272	ZDST502424RGL.....	268	ZR5CT1578.....	260
Z63610UWTRGH.....	356	ZDLC1518LEML.....	259	ZDOC36QLD.....	273	ZDST502424RGL.....	268	ZR5CT1584.....	260
ZBS18.....	263	ZDLC1518REML.....	259	ZDOC36U.....	272	ZDST502424RGL.....	268	ZR5CT1590.....	260
ZBT15.....	263, 271	ZDLC2418A.....	257	ZDOC42ML.....	272	ZDT421524LGL.....	267	ZR5CT1596.....	260
ZBT24.....	263, 271	ZDLC2418BL.....	257	ZDOC42MLD.....	273	ZDT421524RFL.....	267	ZR5CT1724.....	260
ZD62429FEN.....	221	ZDLC2418D.....	257	ZDOC42NL.....	272	ZDT421524RGL.....	267	ZR5CT1730.....	260
ZD63029FEN.....	221	ZDLC3018A.....	257	ZDOC42NLD.....	273	ZDT422418LFL.....	267	ZR5CT1736.....	260
ZDCF653018FL.....	270	ZDLC3018BL.....	257	ZDOC42P.....	272	ZDT422418LGL.....	267	ZR5CT1742.....	260
ZDCF653024FL.....	270	ZDLC3018CL.....	257	ZDOC42QL.....	272	ZDT422418RFL.....	267	ZR5CT1748.....	260
ZDCLC2418LKL.....	257	ZDLC3018D.....	257	ZDOC42QLD.....	273	ZDT422418RGL.....	267	ZR5CT1754.....	260
ZDCLC2418RKL.....	257	ZDLC3018EL.....	257	ZDOC42U.....	272	ZDT422424LFL.....	267	ZR5CT1760.....	260
ZDCLC3018LKL.....	257	ZDLC3018FL.....	257	ZDOC48ML.....	272	ZDT422424LGL.....	267	ZR5CT1766.....	260
ZDCLC3018RKL.....	257	ZDLC3618A.....	257	ZDOC48MLD.....	273	ZDT422424RFL.....	267	ZR5CT1772.....	260
ZDCWK.....	263	ZDLC3618BL.....	257	ZDOC48NL.....	272	ZDT422424RGL.....	267	ZR5CT1778.....	260
ZDHC1524LFL.....	259	ZDLC3618CL.....	257	ZDOC48NLD.....	273	ZDT501524LFL.....	267	ZR5CT1784.....	260
ZDHC1524LGL.....	259	ZDLC3618D.....	257	ZDOC48P.....	272	ZDT501524LGL.....	267	ZR5CT1790.....	260
ZDHC1524RFL.....	259	ZDLC3618FL.....	257	ZDOC48QL.....	272	ZDT501524RFL.....	267	ZR5CT1796.....	260
ZDHC1524RGL.....	259	ZDLC4218A.....	257	ZDOC48QLD.....	273	ZDT501524RGL.....	267	ZR5CT1824.....	260
ZDHC2424A.....	258	ZDLC4218BL.....	257	ZDOC48U.....	272	ZDT502418LFL.....	267	ZR5CT1830.....	260
ZDHC2424BL.....	258	ZDLC4218CL.....	257	ZDOC60ML.....	272	ZDT502418LFL.....	267	ZR5CT1836.....	260
ZDHC3024A.....	258	ZDLC4218LFL.....	257	ZDOC60MLD.....	273	ZDT502418LGL.....	267	ZR5CT1842.....	260
ZDHC3024BL.....	258	ZDLC4218RCL.....	257	ZDOC60NL.....	272	ZDT502418LGL.....	267	ZR5CT1848.....	260
ZDHC3024FL.....	258	ZDLC4218RFL.....	257	ZDOC60NLD.....	273	ZDT502418RFL.....	267	ZR5CT1854.....	260
ZDHC3624A.....	258	ZDLC4818A.....	257	ZDOC60P.....	272	ZDT502418RFL.....	267	ZR5CT1860.....	260
ZDHC3624BL.....	258	ZDLC4818BL.....	257	ZDOC60QL.....	272	ZDT502418RGL.....	267	ZR5CT1866.....	260
ZDHC3624FL.....	258	ZDLC4818CL.....	257	ZDOC60QLD.....	273	ZDT502418RGL.....	267	ZR5CT1872.....	260
ZDHC4224A.....	258	ZDLC4818LFL.....	257	ZDOC60U.....	272	ZDT502424LFL.....	267	ZR5CT1878.....	260
ZDHC4224BL.....	258	ZDLC4818RCL.....	257	ZDPC30QL.....	276	ZDT502424LFL.....	267	ZR5CT1884.....	260
ZDHC4224LFL.....	258	ZDLC4818RFL.....	257	ZDPC30QLD.....	276	ZDT502424LGL.....	267	ZR5CT1890.....	260
ZDHC4224RFL.....	258	ZDLC6018A.....	257	ZDPC30TL.....	276	ZDT502424LGL.....	267	ZR5CT1896.....	260
ZDHC4824A.....	258	ZDLC6018BL.....	257	ZDPC30TLDL.....	276	ZDT502424LGL.....	267	ZS24.....	115, 282
ZDHC4824BL.....	258	ZDLC6018CL.....	257	ZDPC30TWL.....	276	ZDT502424LGL.....	267	ZS30.....	115, 282
ZDHC4824LFL.....	258	ZDLC6018FL.....	257	ZDST501524LFL.....	268	ZDT502424RFL.....	267	ZS36.....	115, 282
ZDHC4824RFL.....	258	ZDLC6018RFL.....	257	ZDST501524LGL.....	268	ZDT502424RGL.....	267	ZS42.....	115, 282
ZDHC6024A.....	258	ZDLCBN24.....	262	ZDST501524LGL.....	268	ZDT652418LFL.....	269	ZS42SF.....	277
		ZDLCBN30.....	262	ZDST501524RFL.....	268				

Model	Page	Model	Page
ZS48.....	115, 282	ZWTAK36S.....	160
ZS50SF.....	277	ZWTAK42.....	160
ZS60.....	115, 282	ZWTAK42S.....	160
ZST18.....	263, 271	ZWTAK48.....	160
ZST24.....	263, 271	ZWTAK48S.....	160
ZV5CT1724.....	261	ZWTAK60.....	160
ZV5CT1730.....	261	ZWTAK60S.....	160
ZV5CT1736.....	261	ZWTS.....	160
ZV5CT1742.....	261		
ZV5CT1748.....	261		
ZV5CT1754.....	261		
ZV5CT1760.....	261		
ZV5CT1766.....	261		
ZV5CT1772.....	261		
ZV5CT1778.....	261		
ZV5CT1784.....	261		
ZV5CT1790.....	261		
ZV5CT1796.....	261		
ZV5CT1824.....	261		
ZV5CT1830.....	261		
ZV5CT1836.....	261		
ZV5CT1842.....	261		
ZV5CT1848.....	261		
ZV5CT1854.....	261		
ZV5CT1860.....	261		
ZV5CT1866.....	261		
ZV5CT1872.....	261		
ZV5CT1878.....	261		
ZV5CT1884.....	261		
ZV5CT1890.....	261		
ZV5CT1896.....	261		
ZV5CT2424.....	261		
ZV5CT2430.....	261		
ZV5CT2436.....	261		
ZV5CT2442.....	261		
ZV5CT2448.....	261		
ZV5CT2454.....	261		
ZV5CT2460.....	261		
ZV5CT2466.....	261		
ZV5CT2472.....	261		
ZV5CT2478.....	261		
ZV5CT2484.....	261		
ZV5CT2490.....	261		
ZV5CT2496.....	261		
ZWMTB1530.....	274		
ZWMTB1536.....	274		
ZWMTB1542.....	274		
ZWMTB1548.....	274		
ZWMTB1560.....	274		
ZWMTB2024.....	274		
ZWMTB2030.....	274		
ZWMTB2036.....	274		
ZWMTB2042.....	274		
ZWMTB2048.....	274		
ZWMTB2060.....	274		
ZWN24Z.....	274		
ZWN30Z.....	274		
ZWN36Z.....	274		
ZWN42Z.....	274		
ZWN48Z.....	274		
ZWN60Z.....	274		
ZWTAK24.....	160		
ZWTAK24S.....	160		
ZWTAK30.....	160		
ZWTAK30S.....	160		
ZWTAK36.....	160		



Allsteel®

Allsteel Inc.
Muscatine, Iowa 52761

allsteeloffice.com

Form #A8686.A9 (12/22)