

# Seating, Social Collaborative & Tables

## Price & Specification Guide 2023

Prices effective March 1, 2023

PDF updated December 14, 2023

All content marked in red signifies an update to the previous version of this price guide published on November 1, 2023.

# Limited Lifetime Warranty

Our unwavering commitment to our customers compels us to care, and our dedication to quality is just one of the ways we show our customers how much they mean to us.

We recognize that keeping up with the pace of change requires having products that work as hard as the people who use them. That's why each of our products is rigorously tested and certified to meet the highest industry standards.

In the unlikely event that any Allsteel product or component covered by the Allsteel Warranty should fail under normal workplace use because of defective material or workmanship, Allsteel promises to fix it. Because taking care of *people* is how Allsteel takes care of business.

For information on Allsteel's warranty coverage, visit [AllsteelOffice.com](http://AllsteelOffice.com).

Government Support – [GovernmentSupport@hniworkplacefurnishings.com](mailto:GovernmentSupport@hniworkplacefurnishings.com)  
Product, Parts, Non-Warranty Parts Orders – [ProductSupport@hniworkplacefurnishings.com](mailto:ProductSupport@hniworkplacefurnishings.com)  
Quick Ship Orders – [QuickShip@hniworkplacefurnishings.com](mailto:QuickShip@hniworkplacefurnishings.com)  
Order Status – [OrderStatus@hniworkplacefurnishings.com](mailto:OrderStatus@hniworkplacefurnishings.com)  
General Inquiries – [GeneralSupport@hniworkplacefurnishings.com](mailto:GeneralSupport@hniworkplacefurnishings.com)

- Software support packages furnished to the customer, either by Allsteel® or by another source, which support the sale of Allsteel products are superseded by printed price lists.
- Prices are subject to change without notice. All orders are subject to prices in effect at the time of order.
- Please refer to your Allsteel Dealer Sales and Discount Policies for order placement information, terms and conditions.
- Additional copies of this Specification and Price List are available upon request from Allsteel Literature at 1-866-255-7833.

- Ordering information appears at the bottom of each product page complete with examples on how to specify. Fabric and finish pages are referenced at the bottom of product pages.

This publication is available as an interactive or downloadable PDF at [www.allsteeloffice.com](http://www.allsteeloffice.com).

### Questions or Comments?

Please call us at: **888-ALLSTEEL**  
**888-255-7833**

Limited Lifetime Warranty .....	Inside Front Cover
Table of Contents .....	3-4

### INTRODUCTION/SPECIFICATION

New, Revised, and Discontinued Products .....	5
COM Policy .....	6-8
Everyday Advantage® .....	9
Upholstery and Finishes .....	10-42

### SEATING

Seating Statement of Line .....	43-44
Seating BIFMA Guidelines .....	45
Definitions and Acronyms.....	46
Acuity® .....	54-61
Clarity®.....	62-65
Evo™ .....	66-71
Inspire®.....	73-91
Lyric™ .....	92-107
Mimeo™.....	108-111
Nimble®.....	112-113
O6.....	114-117
Pli.....	118-121
Quip™.....	122-123
Relate®.....	124-139
Seek® .....	140-143
Svelte.....	145-147
Vicinity™ .....	150-153
Upholstery Grades 9-22 Pricing .....	154-158

### SOCIAL COLLABORATIVE

Social Collaborative Statement of Line .....	159-162
ASI Social Collab Matrix .....	164-171

#### Seating Collections

Jetty:Mod.....	173-208
Townhall .....	209-224
Park.....	225-236
Recharge .....	237-253
Rise™ .....	254-266
Retreat™.....	267-273
Parallel™ .....	274-282
Two Thirds.....	284-295
Vicinity Lounge.....	296-299
ColHo .....	300-301
Linger™ .....	302-305
Reflect™ .....	306-309
Clubhouse™ .....	310-323
Upholstery Grades 9-22 Pricing .....	324-330

### Social Collaborative Accent Tables

Statement of Line .....	331
Finishes .....	332
Belong®.....	333-334
Parallel .....	335
Rise .....	336-337
Two Thirds.....	338-341
Park.....	342-344

### Social Collaborative Laptop Tables

Statement of Line .....	345
Finishes .....	346
Recharge .....	347
Rise .....	348

### Social Collaborative Meeting Tables

Statement of Line .....	349
Finishes .....	350
Park.....	351-352
Townhall .....	353-357
Recharge .....	358

### Social Collaborative Conferencing

Statement of Line .....	359
Finishes .....	360
Park.....	361-363

### TABLES

#### Admix™

Overview.....	364.1
Grain Direction and Alignment.....	364.2
Paint, Finishes, Laminates, and Veneers.....	364.3-364.4
Statement of Line .....	364.5-364.6
Electrical Overview .....	364.7
Wire Management.....	364.8-364.9
Reconfigurable Telescoping Tables .....	364.10
Reconfigurable Tables .....	364.11-364.12
Fixed Tables .....	364.13
Personal Tables.....	364.14-364.15
Reconfigurable and Personal Table Bases.....	364.16
Modesty Panels .....	364.17
Meeting Tables .....	364.18-364.23
Small Meeting Tables .....	364.24-364.26
V Media Tables .....	364.27
Full Rounds — Open Center.....	364.28
Media Tables.....	364.29-364.30
Media Walls .....	364.31-364.32
Perch Tables .....	364.33-364.34
Console Tables .....	364.35
Project Carts .....	364.36
Satellite Tables.....	364.37
Accessories .....	364.38-364.41

# Seating, Collaborative, & Tables

## Specification and Price List

Effective Date March 1, 2023

### Altitude®

Tables Overview.....	365
Paint Finishes, Laminates, Eased Edge .....	366
Fabrics.....	367
Working with Height-Adjustable Tables .....	368-373
Screens and Power Module .....	374
Altitude - Metal Screens .....	375-376
Power Rail Specifications .....	377-383
Working with Electrical and Data .....	384-388
Working with Organization Rail & Accessories & Screens.....	389
Altitude Height-Adjustable Tops, Bases, & Accessories.....	390-395
Altitude – A6.....	390-391
Worksurfaces for Height-Adjustable Bases .....	392-394
Cable Management.....	395
Power Rail – Electrical Components.....	396-398
A8 Screen Kits.....	399
Metal Screens and Tackboard Accessories.....	400-401
Power Rails and Accessories .....	402-405
Worksurface Mounted Rail and Accessories .....	406

### EXTENSIONS™

Introduction .....	411
Working with Ergonomic Accessories .....	412-413
Working with Organization Tools.....	414-419
Working with Illumination.....	420-423
Power/Data Modules .....	424

### ACCESSORIES

Working with Pivot Monitor Arms .....	426-429
---------------------------------------	---------

### AWARE®

Finishes .....	430
Aware Overview.....	431-434
Aware Electrical .....	435-436
Aware Tops and Bases.....	437-438
18"D Tops and Fixed or Nesting Legs .....	439-440
24"D Tops and Fixed or Nesting Legs .....	441-444
30"D Tops and Fixed or Nesting Legs .....	445-448
36"D Tops and Fixed or Nesting Legs .....	449-450
Trapezoid / Half-Round Tops and Legs.....	451-452
Polygon / Crescent / Connector Tops and Legs .....	453-454
Modesty Panels and Accessories.....	455-456
Electrical and Data.....	457-458
Buffet Credenza / Recycle Credenza.....	459-460
Mobile Marker and Tack Boards .....	461
Wall-Hung Marker Boards.....	462
Lectern .....	463
Aware Typicals.....	464

### HARVEST™

Paint Finishes, Laminates and Veneers .....	465
Working with Harvest Classic.....	466-468
Table Tops.....	469
End Table Bases.....	470
Electrical & Data .....	471
Working with Harvest Rustic.....	472
Rustic Powered .....	473
Rustic Non-Powered .....	474
Working with Harvest Metal .....	475
Metal Powered.....	476
Metal Non-Powered.....	477

### STRUCTURE

Overview Table Tops.....	478
Grain Direction and Alignment.....	479
Paint Finishes and Laminates .....	480
Bases Overview .....	481
Working with Adaptive Tables .....	482
Electrical and Wire Management Overview .....	483
Structure Product .....	484-491
Structure Product Matrix .....	492-499
Round Tops.....	500
Square Tops.....	501
Soft Square Tops .....	502
Diamond Tops.....	503-504
Boat Tops .....	505
Racetrack Tops.....	506-508
Rectangle Tops .....	509-511
Media Tops .....	512-513
Panel Bases.....	514
Cube Bases.....	515
Cylinder Bases.....	516
X-Bases .....	517
Freestanding Media Base Kits .....	518
Round / Square Pedestal Bases .....	519-520
T-Leg / Post-Leg / Community Bases.....	521
Adjustable Tables / Adaptive Tables .....	522
Cable / Wire Management.....	523
Electrical .....	524-526

### APPENDIX

Touch-Up Paint .....	527
Fabric Care and Sustainability Information .....	528-529
Cross Reference Index by Model Number .....	530-541

### NEW FINISHES

Wilsonart Solid Surface  
 Designer White – SDW4  
 Frosty White – SFW3  
 Night Stars – SNS5  
 Masoned Concrete – SMC2  
 Monte Amiata – SMA1  
 Studio Paints  
 Ochre – P093  
 Sienna – P092  
 Cove – P096  
 Harbor – P097  
 Sage – P095  
 Dune – P094  
 Stratawood Beigewood Maple SE878  
 Stratawood Field Elm Maple SE599  
 Stratawood Belair Maple SE934  
 Stratawood Florence Walnut ST579  
 Natural Florence Walnut NT579  
 Quarter Florence Walnut QT579  
 Fawn Cypress RF108  
 Belair LWBA  
 Field Elm LWFE

### NEW TEXTILES

Taylor  
 Livi with Supreen  
 Oxford with Supreen  
 Hamilton  
 Rush  
 Balance  
 Beaux  
 Belmont  
 Bradbury  
 Caspian  
 Centric  
 Connect  
 Constance with Supreen  
 Curator  
 Editor  
 Essence  
 Fedora  
 Loop  
 Lugano with Supreen  
 Mira  
 Moxie (new colors): Bermuda, Brigade, Butterscotch, Cozumel,  
 Dover, Forsythia, Grenache, Midnight, Muslin, Pacifica, Phantom,  
 Whirlwind  
 Noble Seating  
 Notion  
 Saxony  
 Shift  
 Sonnet  
 Sydney  
 Tango  
 Truss  
 Vibe  
 Zip

### DE-EMPHASIZED FINISHES

Amethyst — P091  
 Cobalt Mica — P090  
 Clarity & Relate Mesh Colors — Clay, Lime, Navy, Poppy, Sky —  
 12/31/2023

### DE-EMPHASIZED PRODUCTS

Corian Cameo White— SAW — 10/1/2023  
 Corian Designer White— SDW — 10/1/2023  
 Corian Deep Night Sky— SES — 10/1/2023  
 Clarity Armless Work, Polymer Base Work, Guest, and Lounge Chairs -  
 12/31/2023  
 Nimble Plastic Shells and Cart - 6/30/2024  
 Townhall Picnic Counter Height, Seated Height, and Work From Home  
 Picnic tables, Picnic Bench, and Low Stool - 12/31/2023  
 Park Meeting, Work From Home, and Counter Pill Tables and Park  
 Easel - 12/31/2023  
 Clubhouse Electrical Module Kits - 12/31/2023  
 Cable Management Trays: 24" and 36" - 12/31/2023  
 Gripper Clip - 12/31/2023

### DISCONTINUED FINISHES

Charcoal Walnut laminate — LWCW Disco 6/30/2022  
 Columbian Walnut laminate — LWZ Disco 6/30/2022  
 Amber Cherry laminate — LWAC Disco 6/30/2022  
 Charcoal Walnut edge — DC Disco 6/30/2022  
 Columbian Walnut edge — DZ Disco 6/30/2022  
 Amber Cherry edge — DA Disco 6/30/2022  
 Canyon Zephyr laminate — LT5B Disco 6/30/2022  
 Desert Zephyr laminate — LT5A Disco 6/30/2022  
 Ebony laminate — LT3E Disco 6/30/2022  
 Grey Mesh laminate — LT8A Disco 6/30/2022  
 Parchment laminate — TM20 Disco 6/30/2022  
 Pewter Mesh laminate — LT8C Disco 6/30/2022  
 Sheer Mesh laminate — LT8B Disco 6/30/2022  
 White Tigris laminate — LT2A Disco 6/30/2022  
 Shadow Edge — SHDW — 12/31/2022

### DISCONTINUED TEXTILES

Seed — 12/31/2022  
 Dapper — Azalea, Emerald, Peony, Pool, Rose, Spice — 12/31/2022  
 Analog — 12/31/2023  
 Whisper Vinyl — Brick Red, Carotene, Cucumber, Forest, Gravel,  
 Merlot, Ochre, Sangre, Zest — 12/31/2023

### DISCONTINUED PRODUCTS

Legacy Vicinity Stool discontinued 6/30/21. For new projects we  
 recommend purchasing the new Vicinity stool which is stackable and  
 offers the option of a seat pad.

Model Description	Discontinuing Model	Recommended Replacement
Counter Stool	CBS-PGANO	CUBS-PGANO
Bar Stool	CCS-PGANO	CUCS-PGANO

## COM Program

Allsteel understands that customers may at times want to specify fabrics outside of Allsteel's standard fabric offering. Our COM program was designed to make specifying COMs on Allsteel products a simpler, friendlier, and hassle-free process. This process is simple and easy to use, and is described below under "Allsteel to Supply (ATS)." If a Dealer wishes to manage the COM process themselves, they can do so by following guidelines under "Dealer to Supply (DTS)". **ATS is the preferred method for all COM fabrics.** With ATS, Company will provide acknowledgment based upon planned date of receipt of COM fabric and manage the entire process. DTS is allowed if it is not a partnership fabric or if Company does not have access to the supplier. **DTS may cause order delays and is strongly discouraged.** Find out more about Allsteel's COM process by emailing our COM Department at [allsteelcomteam@allsteeloffice.com](mailto:allsteelcomteam@allsteeloffice.com).

### Allsteel to Supply (ATS):

1. Select the fabric you wish to use and check the COM Search on Synergy at: [Allsteelsynergy/Design Resources/Textiles & Finishes/COM Search](#) or [COM Search quick link](#). You will need to have the COM supplier's name, fabric pattern name, and color name to search for approved fabrics.
2. If your fabric is listed as an approved fabric, you may place your order directly with Allsteel Customer Support. Please use the fabric code (e.g., S216426XP) from the COM Test Request on your order in the place of the standard fabric code.  
  
If your fabric is not listed as approved, you will need to select the "Request COM Test" link on the COM Search website. If your fabric is not listed as approved, and it is not a Partnership fabric you may request a "Dealer to Supply" code. Select the "Request COM Test" link on the COM Search website. Your name, company name and email will be prepopulated fields. The secondary email, project name, and bid/contract number are optional information. The supplier, pattern, and color will show a list by clicking in the box and entering the first letter of the name and these are free form text boxes. Once that information is entered click add. (Multiple series can be added to the same request if they are the same supplier, pattern, and color.) Then click submit.
3. An email will be sent to the to the requestor stating the COM Request was successfully submitted. Up to four emails could be received: Testing materials requested, in testing, and final approval/denial with price grade and fabric code. It's rare actual test yardage is required. Testing is mainly done by reviewing the attributes of the fabric. The testing process takes approximately 48 hours. Written COM price quotes hold pricing for 90 days after issue date.
4. Once the fabric has been approved by Allsteel, enter your order directly with Allsteel Customer Support. Allsteel will purchase all COM fabric directly from the COM suppliers and schedule for production.

In the event that the Dealer decides to cancel a COM fabric order, the Dealer is responsible for the cost of the fabric plus a handling charge that is equal to 10% of the fabric cost.

### Dealer to Supply (DTS):

1. Select the fabric you wish to use and check the COM Search on Synergy at: [Allsteelsynergy/Design Resources/Textiles & Finishes/COM Search](#) or [COM Search quick link](#). Or call Allsteel Customer Support to see if the fabric you have chosen has already been tested and approved on the product you are interested in.  
  
You will need to have the COM supplier's name, fabric pattern name, and color name for this inquiry.
2. If your fabric is not listed as approved, and it is not a Partnership fabric you may request a "Dealer to Supply" code. Select the "Request COM Test" link on the COM Search website. Your name, company name and email will be prepopulated fields. The secondary email, project name, and bid/contract number are optional information. The supplier, pattern, and color will show a list by clicking in the box and entering the first letter of the name and these are free form text boxes. Once that information is entered click add. (Multiple series can be added to the same request if they are the same supplier, pattern, and color.) Then click submit.
3. An email will be sent to the to the requestor stating the COM Request was successfully submitted. Up to four emails could be received: Testing materials requested, in testing, and final approval/denial with price grade and fabric code. It's rare actual test yardage is required. Testing is mainly done by reviewing the attributes of the fabric. The testing process takes approximately 48 hours.
4. Make sure to use a "Dealer to Supply" COM code (e.g., S216426ZP) and place your order directly with Allsteel Customer Support.
5. All "Dealer to Supply" orders will be charged Grade 4 pricing for seating, Grade 4 for Social Collaborative, and Grade D pricing for panels. Dealers will pay for the COM fabric separately.
6. All "Dealer to Supply" fabric must be sent on a fabric roll. Estimate the yardage required by using the yardage requirements listed in the price list by model. For questions please contact Allsteel Customer Support.
7. Place your fabric order directly with the COM Supplier with instructions for the fabric to be sent on a fabric roll to:

#### HNI Textile Distribution Center

**COM Production Yardage** — PO Number  
Docks 20-22  
301 Mulberry Avenue  
Muscatine, IA 52761

### Special Paint & Stain Policy

Allsteel at its own discretion may modify its standard products with non-standard paint and stain colors to meet specific needs. Dealer is required to submit a special paint or stain request via the COM Search on Synergy. A sample of the non-standard paint or stain color desired will be required for matching. Pricing, lead time, and order information will be provided at the time of approval.

- For each new requested stain or paint, there will be a \$500 net fee to cover supplier costs to match the special item.
- For existing, previously-approved stains or paints, there is no \$500 matching fee, however, there is a sample chip fee of \$175 net for stains and \$100 net for paints.
- Samples, preferably at least 3" x 5" chips, of the exact color desired should be sent to the Allsteel Tailored Products Group. Paint matches require (3) sample chips and stain matches require (3) sample chips. Please mail these sample chips to the address below and reference the Special Item Request Number from Tailored Solutions.

#### Allsteel Inc.

Attn: COM Team  
200 Oak St.  
Muscatine, IA 52761

- Allsteel will color match the sample and send control samples to the address provided in the request. Dealer will review Allsteel's color match and approve by signing the back of the sample chip. Send the signed sample back to the Allsteel Tailored Products Group.
- Special paints will be assigned a paint price grade.
- Orders will not be accepted until Allsteel receives the Dealer's written approval on the color match.
- Extended lead times will apply on orders containing special paints or stains.
- Due to manufacturing techniques, materials, and quality issues, some exclusions will apply and some matches may be declined.

### Important Notes

- Natural veneer is subject to nature's quality control. Differences in grain and color are naturally occurring variations and cannot be controlled by the manufacturer and cannot be considered as product defects. Natural veneer has the characteristics and beauty of a living organism; with its own variations of grain, growth, and color patterns. For these reasons, Natural veneer is preferred by many for its warmth and personal characteristics.
- Color changes will occur over time when wood is exposed to light. For this reason, when new product is ordered as an addition to existing product, there will be color variances between the old and new product. Please remember when specifying new product that although the species of veneer will be the same, additional product is being manufactured from a different tree. It may take several months for the new furniture to mature to the color level of existing product. Even with this maturation process the additional product will not be an exact match.

### Special Laminate Policy

The Company at its own discretion may modify its standard products with non-standard laminates to meet specific needs. Contact the Allsteel Tailored Products Group for pre-approved Wilsonart, Formica, Nevamar and Pionite laminates and pricing for special laminates. When requesting a special laminate please supply manufacturer, along with name and pattern number of laminate.

- Extended lead times will apply on orders containing special laminates.
- Due to manufacturing techniques, materials, and quality issues, some product exclusions will apply and some requests may be declined.

Information that **MUST** be included in the packing slip attached to the DTS fabric:

1. Dealer's Purchase Order number to Allsteel
2. Allsteel's Tracking number for the COM fabric
3. Dealer Name
4. Yards of Fabric

If the fabric shipment does not match the correct fabric and yardage, Allsteel will notify the Dealer for resolution.

If Allsteel receives fabric with incorrect labeling or fabric yardage that cannot be linked to an Allsteel furniture order, Allsteel will hold the fabric for up to 4 weeks. After 4 weeks Allsteel will dispose of the fabric. There are no exceptions to this policy.

Specific to DTS orders - The customer should send only the amount needed for the order. Excess yardage, or yardage not attached to an order will be disposed of at Allsteel's discretion.

Any canceled orders are subject to cancellation charges up to the full value of the Allsteel product canceled. Allsteel will determine the actual cancellation charge at the time the cancellation is requested.

8. For additional details on "Dealer to Supply" fabric refer to your Allsteel terms and conditions.

#### Additional Policy Information:

The company assumes no responsibility for the overall appearance, flammability, normal durability, colorfastness, or any other quality standards. The company reserves the right to reject a COM if the quality of the COM is not satisfactory for the product. Should this occur, the customer will be notified with an explanation when the issue is found.

The company is not responsible for fabric that has become obsolete at the COM supplier, that is of poor quality, or that is delivered late to the manufacturer from the COM supplier.

All cancellations or changes to COM orders are subject to Company approval. Because of the nature of COM, special fabrics, finishes, and structural modifications, products ordered as specials and then canceled prior to shipment are subject to cancellation costs up to the full value of the product canceled. The company determines the actual cancellation charge at the time the cancellation is requested. Upon approval, a cancellation number is issued to the Customer.

Purchase orders will not be accepted or entered unless the testing process is complete with positive results.

If all testing has been previously completed, re-testing is only necessary if fabric is to be used on a different product, or pattern direction has changed from that previously approved.

Previous test results can be obtained by a customer on the COM Search on Synergy or by calling Allsteel Customer Support.

All COM fabric will be applied to seating and panel systems Pattern Cut unless Railroad Cut is requested and approved on the COM Test Request. Any fabrics approved as a width pass, the dealer is responsible for clarifying Railroad Cut on orders containing items that are too large to support the Pattern Cut of a fabric application (any items larger than 48" high or wide).

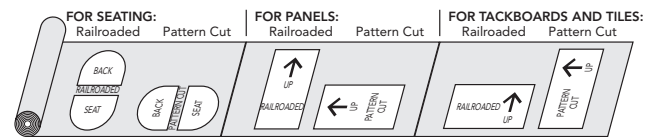

#### Fire Retardant

The Dealer is responsible for ensuring that the COM fabric is certified to meet all flame retardant requirements.

*For more information, please contact Allsteel Customer Support.*

#### YARDAGE REQUIREMENTS FOR FABRIC WITH REPEATS — FOR USE ON SOCIAL COLLABORATIVE PRODUCTS

Fabric Width	Plain Fabric	2"– 14" Repeat	15"– 19" Repeat	20"– 27" Repeat	28"– 36" Repeat
54"	0	+15%	+20%	+25%	+30%
53"	+6%	+19%	+24%	+28%	+36%
52"	+13%	+23%	+28%	+33%	+38%
51"	+19%	+26%	+31%	+36%	+41%
50"	+25%	+30%	+35%	+40%	+45%
49"	+30%	+35%	+40%	+45%	+50%
48"	+35%	+40%	+45%	+50%	+55%
47"	+45%	+50%	+55%	+58%	+65%

Depending upon the pattern repeat, it may be necessary to pattern cut the fabric. This will require 10% additional fabric.

To calculate multiple repeats (vertical and horizontal), add each repeat for total yardage required. For example for a fabric width of 54": 7" vertical requires 15%, 15" horizontal requires 20% total additional yardage required equals 35% (15% + 20%). Therefore, if your chair requires 2 yards of fabric, multiply 2 by 35%. Then 2.7 yards will be yardage required.



# Everyday Advantage®

## New terms and conditions for EDA:

1. Orders must clearly state “Everyday Advantage Order” and include the appropriate Everyday Advantage contract number:
  - Everyday Advantage Std-0125, Everyday Advantage Canada-0127
2. Everyday Advantage orders are not eligible for bid pricing.
3. Program discounting includes the complete Optimize, Further, and Terrace systems lines, private office solution, Approach and Involve storage. This program also includes Acuity, Evo, Inspire, Lyric, Mimeo, Nimble, Quip, Relate, Seek, and Svelte, seating. Altitude, Aware, and Structure tables are also available, along with Align pedestals, lockers and metal storage and Essentials pedestals, and Radii storage lines. In addition, Extensions ergonomic accessories and lighting are part of the standard offering. All other product not called out is available for order on the contract but will receive standard discounting of 55%–65%.
4. All textiles and finishes except for veneer and some wood finishes are available, depending on quantity and selection, and may have extended lead times.
5. Everyday Advantage orders are not limited to a minimum or maximum.
6. All orders ship based on standard lead times. Large-quantity orders of like products may be subject to longer lead times.
7. Standard freight terms apply.
8. If driver assistance is needed, standard driver assist charges will be added at time of order entry.

*Allsteel Inc. reserves the right to amend or terminate this program at anytime with 30 days written notice. Allsteel is not liable for service delays caused by force majeure (circumstances beyond Allsteel's control).*





Refer to pages 13-16 for current upholstery availability by model/series.

GSA Reference Page

ALLSTEEL MATERIALS PARTNERSHIP PROGRAM — SEE PROGRAM EXPLANATION AT BOTTOM OF PAGE 10.

UPHOLSTERY

### GRADE 6 — continued

<b>Mayer Fabrics LOOP</b>	
Admiral.....	637-004
Citron.....	637-003
Cobalt.....	637-034
Driftwood.....	637-000
Earth.....	637-010
Grass.....	637-013
Indigo.....	637-044
Marine.....	637-024
Mineral.....	637-007
Ocean.....	637-014
Plum.....	637-005
Shadow.....	637-016
Smoke.....	637-006
Tangelo.....	637-009
Tomato.....	637-001
<b>HBF Textiles POPPY</b>	
Flame.....	1047-44
Graphite.....	1047-85
Ink.....	1047-89
Khaki.....	1047-35
Limelight.....	1047-63
Natural.....	1047-16
Neutral.....	1047-83
Night.....	1047-59
Pool.....	1047-56
Punch.....	1047-45

### GRADE 7

<b>Mayer Fabrics CASPIAN</b>	
Almond.....	329-007
Cinder.....	329-016
Earth.....	329-010
Grotto.....	329-014
Ink.....	329-004
Jungle.....	329-013
Marine.....	329-024
Mineral.....	329-006
Mushroom.....	329-000
Sangria.....	329-021
Spring.....	329-003
Sunset.....	329-011
Tangelo.....	329-009
Watermelon.....	329-001

<b>Mayer Fabrics CURATOR</b>	
Cloud.....	WC921-006
Ink.....	WC921-004
Juniper.....	WC921-013
Metal.....	WC921-016
Mulberry.....	WC921-005
Onyx.....	WC921-026
Rhubarb.....	WC921-008
Ruby.....	WC921-001
Spearmint.....	WC921-003
Umber.....	WC921-002

<b>Camira SILK</b>	
Arabia.....	SCAMSLK02
Assam.....	SCAMSLK11
Brunei.....	SCAMSLK08
Byzantine.....	SCAMSLK03
Chancellor.....	SCAMSLK19
Divine.....	SCAMSLK13
Dynasty.....	SCAMSLK17
Emperor.....	SCAMSLK16
Empress.....	SCAMSLK05
Forbidden.....	SCAMSLK07
Imeon.....	SCAMSLK20
Incense.....	SCAMSLK06
Kingdom.....	SCAMSLK10
Monarch.....	SCAMSLK15
Oriental.....	SCAMSLK12
Pamir.....	SCAMSLK14
Parthian.....	SCAMSLK09
Persia.....	SCAMSLK04
Sahara.....	SCAMSLK01
Sovereign.....	SCAMSLK18
Tussah.....	SCAMSLK21

### GRADE 7 — continued

<b>Mayer Fabrics SONNET</b>	
Amber.....	ST-002
Beach.....	ST-027
Chambray.....	ST-024
Cherry.....	ST-001
Cocoa.....	ST-010
Driftwood.....	ST-017
Ink.....	ST-044
Latte.....	ST-007
Laurel.....	ST-043
Mango.....	ST-009
Moss.....	ST-023
Ocean.....	ST-014
Pear.....	ST-013
Powder.....	ST-004
Rain.....	ST-034
Sage.....	ST-003
Silver.....	ST-016
Slate.....	ST-046
Smoke.....	ST-006
Taupe.....	ST-000
Terra.....	ST-019
Titanium.....	ST-036
Willow.....	ST-033
Zinc.....	ST-026

### GRADE 8

<b>Maharam APT (100% Silicone Face)</b>	
Bengal.....	SMHMAPT25
Bloom.....	SMHMAPT29
Botanic.....	SMHMAPT20
Castle.....	SMHMAPT33
Charm.....	SMHMAPT36
Chartreuse.....	SMHMAPT21
Cobblestone.....	SMHMAPT11
Coconut.....	SMHMAPT01
Constellation.....	SMHMAPT07
Core.....	SMHMAPT26
Crepe.....	SMHMAPT22
Descend.....	SMHMAPT37
Eden.....	SMHMAPT15
Elixir.....	SMHMAPT35
Fluid.....	SMHMAPT14
Follow.....	SMHMAPT34
Fortress.....	SMHMAPT31
Galactic.....	SMHMAPT16
Garden.....	SMHMAPT19
Gingerbread.....	SMHMAPT05
Glacier.....	SMHMAPT10
Hickory.....	SMHMAPT06
Iris.....	SMHMAPT12
Jade.....	SMHMAPT18
Labyrinth.....	SMHMAPT08
Lotus.....	SMHMAPT30
Lumber.....	SMHMAPT04
Lyric.....	SMHMAPT23
Mantle.....	SMHMAPT17
Nocturnal.....	SMHMAPT27
Oak.....	SMHMAPT32
Shoreline.....	SMHMAPT17
Sketch.....	SMHMAPT09
Sorbet.....	SMHMAPT28
Stampede.....	SMHMAPT03
Turmeric.....	SMHMAPT24
Vibe.....	SMHMAPT02

<b>Mayer Fabrics CENTRIC</b>	
Blossom.....	WC979-001
Cinnamon.....	WC979-009
Denim.....	WC979-004
Dew.....	WC979-007
Grotto.....	WC979-013
Ink.....	WC979-014
Meadow.....	WC979-003
Mocha.....	WC979-000
Punch.....	WC979-011
Ruby.....	WC979-021
Saffron.....	WC979-002
Shale.....	WC979-006

<b>Mayer Fabrics EDITOR</b>	
Blush.....	WC920-001
Cinder.....	WC920-026
Evergreen.....	WC920-003
Firebrick.....	WC920-011
Grotto.....	WC920-013
Ink.....	WC920-014
Marble.....	WC920-007
Midnight.....	WC920-024
Mineral.....	WC920-006
Mushroom.....	WC920-000
Oatmeal.....	WC920-017
Plumberry.....	WC920-005
Pumice.....	WC920-027
Sandstone.....	WC920-009
Slate.....	WC920-016
Topaz.....	WC920-002
Water.....	WC920-004

### GRADE 8 — continued

<b>Ultrafabrics BRISA® — continued</b>	
Cabernet.....	RS99
Cambridge Blue.....	RS17
Canyon*.....	RS07
Caramel.....	RS91
Celery.....	RS87
Cinnabar*.....	RS36
Coffee Bean*.....	RS33
Cookie Dough*.....	RS234
Cream*.....	RS63
Desert Clay*.....	RS19
Esmeralda.....	RS302
Evening Blue.....	RS620
Flamingo.....	RS203
French Vanilla.....	RS66
Ginger*.....	RS51
Golden*.....	RS67
Gravel*.....	RS275
Hazy Lilac*.....	RS310
Honeycomb*.....	RS233
Iceberg.....	RS272
Indigo.....	RS14
Koi.....	RS202
Mineral*.....	RS97
Moon.....	RS277
New Sand*.....	RS20
Night Navy*.....	RS94
Olive*.....	RS02
Peat*.....	RS00
Pompeian Red.....	RS83
Putty.....	RS08
Quicksilver.....	RS30
Rose Red*.....	RS43
Sage.....	RS10
Salsa.....	RS15
Seaweed.....	RS303
Shiitake*.....	RS22
Skyway*.....	RS96
Sterling Blue.....	RS98
Strawberry.....	RS359
Truffle.....	RS12
Turq.....	RS23
White.....	RS47
Wishbone*.....	RS276
Wrought Iron*.....	RS27

### GRADE 8 — continued

<b>Camira ZAP</b>	
Argh.....	SCAMZAP11
Awesome.....	SCAMZAP14
Boing.....	SCAMZAP21
Bonza.....	SCAMZAP25
Clang.....	SCAMZAP19
Clobber.....	SCAMZAP12
Cool.....	SCAMZAP30
Crackle.....	SCAMZAP05
Crash.....	SCAMZAP16
Flump.....	SCAMZAP17
Gasp.....	SCAMZAP15
Hahaha.....	SCAMZAP09
Kapow.....	SCAMZAP06
Omg.....	SCAMZAP13
Power.....	SCAMZAP18
Puff.....	SCAMZAP26
Screech.....	SCAMZAP08
Snap.....	SCAMZAP01
Splash.....	SCAMZAP27
Splat.....	SCAMZAP20
Thud.....	SCAMZAP29
Wham.....	SCAMZAP23
Whirr.....	SCAMZAP03
Whomp.....	SCAMZAP28
Whoosh.....	SCAMZAP02
Wowzers.....	SCAMZAP07
Yeah.....	SCAMZAP04
Yikes.....	SCAMZAP10
Zoink.....	SCAMZAP24
Zoom.....	SCAMZAP22

### GRADE 9

<b>Mayer Fabrics BELMONT</b>	
Citrus.....	BL-002
Clementine.....	BL-009
Dune.....	BL-017
Gravel.....	BL-000
Opal.....	BL-004
Patina.....	BL-027
Raintree.....	BL-003
Reef.....	BL-014
Sisal.....	BL-007
Stone.....	BL-016
Tidal.....	BL-024
Tundra.....	BL-006

<b>Mayer Fabrics SHIFT</b>	
Almond.....	SH-007
Apricot.....	SH-009
Camel.....	SH-017
Charcoal.....	SH-016
Cranberry.....	SH-008
Cypress.....	SH-003
Metal.....	SH-000
Ocean.....	SH-024
Sapphire.....	SH-034
Silver.....	SH-006
Sky.....	SH-014
Spa.....	SH-004

<b>Mayer Fabrics TRUSS</b>	
Aluminum.....	TS-006
Cadet.....	TS-004
Currant.....	TS-001
Ocean.....	TS-003
Persimmon.....	TS-009
Sesame.....	TS-007
Storm.....	TS-016

### GRADE 9 — continued

<b>Ultrafabrics ULTRALEATHER PRO</b>	
Aubergine.....	SUF554336
Blue Bird.....	SUF554661
Blueberry.....	SUF554711
Blush.....	SUF554200
Butterfly.....	SUF554216
Butternut*.....	SUF554241
Campfire.....	SUF554229
Capri*.....	SUF554522
Char.....	SUF554626
Chestnut.....	SUF554214
Cloud.....	SUF554648
Coastal.....	SUF554450
Cork.....	SUF554595
Cougar*.....	SUF554209
Cranberry.....	SUF554357
Dark Chocolate.....	SUF554376
Dark Knight.....	SUF554618
Ember.....	SUF554649
Laurel.....	SUF554443
Mortar.....	SUF554733
Parfait.....	SUF554803
Persian Green.....	SUF554453
Rhubarb.....	SUF554329
Sailor.....	SUF554547
Sea Mist.....	SUF554478
Shore.....	SUF554352
Sky.....	SUF554530
Swan.....	SUF554811
Toasted Bagel*.....	SUF554444
Tundra.....	SUF554353
Violet.....	SUF554395
White Wash.....	SUF554008
Woodcres.....	SUF554087

<b>Camira YOREDALE</b>	
Askrigg.....	SCAMYDL03
Buckden.....	SCAMYDL01
Burnsall.....	SCAMYDL22
Carperby.....	SCAMYDL07
Cracoe.....	SCAMYDL23
Cray.....	SCAMYDL10
Dacre.....	SCAMYDL21
Darley.....	SCAMYDL20
Fossdale.....	SCAMYDL11
Gayle.....	SCAMYDL08
Hardraw.....	SCAMYDL04
Kidstone.....	SCAMYDL02
Leyburn.....	SCAMYDL25
Litton.....	SCAMYDL15
Nidd.....	SCAMYDL16
Ribble.....	SCAMYDL17
Ripley.....	SCAMYDL19
Sedbusk.....	SCAMYDL14
Simonstone.....	SCAMYDL05
Thoralby.....	SCAMYDL06
Thornton.....	SCAMYDL09
Walden.....	SCAMYDL13
Warfe.....	SCAMYDL18
Woden.....	SCAMYDL24
Woodale.....	SCAMYDL12

### GRADE 10

<b>Mayer Fabrics CONNECT</b>	
Admiral.....	635-024
Charcoal.....	635-006
Cobalt.....	635-004
Latte.....	635-007
Marine.....	635-014
Meadow.....	635-013
Plum.....	635-005
Spice.....	635-009
Spring.....	635-003

▲ Acuity Jacket Upholstery.

\* Colorway not shown on Textiles card; all Partnership Program memo samples are available from supplier. See contact information on page 10.

Allsteel Seating Upholstery Selections by Model/Series, for Social Collaborative see pages 15-16.

		Acuity Jockey	Acuity Seat (for Side see Relate)	Evo Seat	Evo Upholstered Back	Inspire Back and Seat Pad	Lyric Mesh & Upholstered Seat	Lyric MPP	Mimeo Seat	O6	Pji	Ped ASPT/ZSC Seat Cushions	Involve Approach Ped Ypp2 & Cradanza KVC Seat Cushions	Relate Upholstered Work	Relate Mesh Back Work	Relate Upholstered Side	Seek	Svelte	Svelte Channel Stitch
<b>LEATHER L1</b>																			
Davenport	DAV	•	•	•	•	• <sup>s</sup>	•	•	•	•	•	•	•	•	•	•	•	•	•
Florence	FLOR	•	•	•	•	•	•	•	•	•	•	•	•	•	•	•	•	•	•
Strasburg	STB		•						•	•								•	•
<b>GRADE 1</b>																			
Apex	APX		•	•	•	•	•	•	•	•	•	•	•	•	•	•	•	•	•
Centurion	CU		•	•	•	•	• <sup>U</sup>	•	•	•	•	•	•	•	•	•	•	•	•
Contourett	UR		•	•	•	•	• <sup>s</sup>	•	•	•	•	•	•	•	•	•	•	•	•
Dapper	DAPR		•	•	•	•	• <sup>s</sup>	•	•	•	•	•	•	•	•	•	•	•	•
Ensemble	ENSB		•	•		•	•	•	•	•	•	•	•	•	•	•	•	•	•
Hamilton	HAML		•	•	•	•	• <sup>s</sup>	•	•	•	•	•	•	•	•	•	•	•	•
Inertia	NR		•	•	•	•	• <sup>s</sup>	•	•	•	•	•	•	•	•	•	•	•	•
Optic	OP		•	•		•	• <sup>s</sup>	•	•	•	•	• <sup>s</sup>	•	• <sup>s</sup>	•	•	•	•	•
<b>GRADE 2</b>																			
Appoint Seating	PNS		•	•	•	•	• <sup>s</sup>	•	•	•	•	•	•	•	•	•	•	•	•
Blume	BLME		•	•	•	•	•	•	•	•	•	•	•	•	•	•	•	•	•
Clyde	CLYD		•	•	•	•	• <sup>s</sup>	•	•	•	•	•	•	•	•	•	•	•	•
Dotty	DOT		•	•		•	• <sup>s</sup>	•	•	•	•	•	•	•	•	•	•	•	•
Meld	SMHMMLD		•	•	•	•	• <sup>s</sup>	• <sup>s</sup>	•	•	•	•	•	•	•	•	•	•	•
Rush	RUSH		•	•	•	•	• <sup>s</sup>	•	•	•	•	•	•	•	•	•	•	•	•
Spin Seating	SPNN		•	•		•	• <sup>s</sup>	•	•	•	•	•	•	•	•	•	•	•	•
Taylor	TAY		•	•		•	•	•	•	•	•	•	•	•	•	•	•	•	•
Whisper Vinyl	WP		•	•	•	•	• <sup>s</sup>	•	•	•	•	•	•	•	•	•	•	•	•
<b>GRADE 3</b>																			
Lateral	SCFSLAT		•	•		•	• <sup>s</sup>	•	•	•	•	•	• <sup>s</sup>	•	• <sup>s</sup>	•	•	•	•
Moxie	SX		•	•	•	•	• <sup>s</sup>	•	•	•	•	•	•	•	•	•	•	•	•
Parker	PRKR		•	•		•	•	•	•	•	•	•	•	•	•	•	•	•	•
Purl	PURL		•	•	•	•	• <sup>s</sup>	•	•	•	•	•	• <sup>s</sup>	•	• <sup>s</sup>	•	•	•	•
Quill	QUL		•	•		•	•	•	•	•	•	•	•	•	•	•	•	•	•
Sydney	456		•	•	•	•	•	•	•	•	•	•	•	•	•	•	•	•	•
<b>GRADE 4</b>																			
Blink	1048		•	•		•	•	•	•	•	•	•	•	•	•	•	•	•	•
Caper	SMHMCAP		•	•	•	•	•	•	•	•	•	•	•	•	•	•	•	•	•
Look-See	1044							•	•										
Manner	SMHMAN		•	•	•	•	• <sup>s</sup>	•	•	•	•	•	•	•	•	•	•	•	•
Messenger	SMHMGRM		•	•	•	•	• <sup>s</sup>	•	•	•	•	•	•	•	•	•	•	•	•
Metric	SMHMMET		•	•	•	•	• <sup>s</sup>	•	•	•	•	•	•	•	•	•	•	•	•
Mira	330		•	•	•	•	•	•	•	•	•	•	•	•	•	•	•	•	•
Mode	SMHMMOD		•	•	•	•	• <sup>s</sup>	•	•	•	•	•	•	•	•	•	•	•	•
Multiply	SMHMMLT		•	•		•	•	•	•	•	•	•	•	•	•	•	•	•	•

<sup>P</sup>Ped Only

<sup>S</sup>Seat Only

<sup>B</sup>Available only on Banquet

<sup>U</sup>Available on Upholstered Back

<sup>X</sup>Not available on Involve Banquet

⊕ Partnership Program — See page 10 for details.

~ Available upholstery option only on select colorways.

• Available upholstery option

- Allsteel fabrics and foam meet requirements for CTB117.
- Blank spaces indicate that a product has not yet been tested or that it failed.
- Contact Allsteel Customer Support for other flammability code approvals.

Allsteel Seating Upholstery Selections by Model/Series, for Social Collaborative see pages 15-16.

UPHOLSTERY

		Acuity Jacket	Acuity Seat (for Side see Relate)	Evo Seat	Evo Upholstered Back	Inspire Back and Seat Pad	Lyric Mesh & Upholstered Seat	Lyric MP	Mimeo Seat	O6	Pji	Ped ASPT/ZSC Seat Cushions	Inspire Approach Ped Ypp2 & Gradana KACT Seat Cushions	Relate Upholstered Work	Relate Mesh Back Work	Relate Upholstered Side	Seek	Svelte	Svelte Channel Stitch	
<b>GRADE 4 — continued</b>																				
Murmur ☺	SMHMMUR		•	•		•	•	•	•	•	•	•		•			•	•	•	
Muse ☺	SMHMMUS		•	•		•	•	•	•	•	•	•		•			•	•	•	
Tango	460		•	•	•	•	•	•	•	•	•	•		•			•	•	•	
Trundle ☺	SMHMTRN		•	•		•	•	•	•	•	•	•		•			•	•	•	
Walkabout	1046								•	•								•	•	
<b>GRADE 5</b>																				
Checkmate	1043								•	•									•	•
Fedora	621		• <sup>s</sup>	•	•	•	• <sup>s</sup>	• <sup>s</sup>	•	•	•	•	•	•	•	•	•	•	•	•
Main Line Flax ☺	SCAMMLF		•	•	•	•	• <sup>s</sup>	•	•	•	•	•	•	•	•	•	•	•	•	•
Zip	ZP		•	•	•	•	•	•	•	•	•	•		•			•	•	•	•
Zippy	1045								•	•									•	•
<b>GRADE 6</b>																				
Arris	ARR		•	•			•	•	•	•	•	•		•			•	•	•	•
Balance	BA		•	•	•	•	•	•	•	•	•	•		•			•	•	•	•
Beaux	366		•	•	•	•	• <sup>s</sup>	• <sup>s</sup>	•	•	•	•		•			•	•	•	•
Blazer ☺	SCAMBLZ		•	•	•	• <sup>s</sup>	• <sup>s</sup>	•	•	•	•	•	• <sup>s</sup>	•			•	•	•	•
Essence	ES		•	•	•	•	• <sup>s</sup>	• <sup>s</sup>	•	•	•	•		•			•	•	•	•
Hemp	SCAMHMP		•	•	•	•	•	•	•	•	•	•		•			•	•	•	•
Loop	637		•	•	•	•	•	•	•	•	•	•		•			•	•	•	•
Poppy	1047		•	•	•	•	•	•	•	•	•	•		•			•	•	•	•
<b>GRADE 7</b>																				
Caspian	329		•	•	•	•	•	•	•	•	•	•		•			•	•	•	•
Curator	WC921		•	•	•	•	•	•	•	•	•	•		•			•	•	•	•
Silk	SCAMSLK		•	•	•	• <sup>s</sup>	•	•	•	•	•	•	•	•			•	•	•	•
Sonnet	ST		•	•	•	•	• <sup>s</sup>	• <sup>s</sup>	•	•	•	•		•			•	•	•	•
<b>GRADE 8</b>																				
Apt ☺	SMHMAPT		•	•			• <sup>s</sup>		•	•	•		• <sup>s</sup>	• <sup>s</sup>	•	•	•	•	•	•
Brisa ☺	RS	•	•	•	•	•	• <sup>s</sup>	•	•	•	•	•		•			•	•	•	•
Centric	WC979		•	•	•	•	•	•	•	•	•	•		•			•	•	•	•
Editor	WC920		•	•	•	•	•	•	•	•	•	•		•			•	•	•	•
Zap	SCAMZAP		•	•	•	•	•	•	•	•	•	•		•			•	•	•	•
<b>GRADE 9</b>																				
Belmont	BL		•	•	•	•	• <sup>s</sup>	• <sup>s</sup>	•	•	•	•		•			•	•	•	•
Shift	SH		•	•	•	•	•	•	•	•	•	•		•			•	•	•	•
Truss	TS		•	•	•	•	•	•	•	•	•	•		•			•	•	•	•
Ultraleather Pro ☺	SUF554		•	•	•	•	• <sup>s</sup>		•	•	•	•		•			•	•	•	•
Yoredale	SCAMYDL	•	•	•	•	•	•	•	•	•	•	•		•			•	•	•	•
<b>GRADE 10</b>																				
Connect	635		•	•	•	•	•	•	•	•	•	•		•			•	•	•	•

<sup>B</sup>Available only on Banquet

<sup>P</sup>Ped Only

<sup>S</sup>Seat Only

☺ Partnership Program — See page 10 for details.

~ Available upholstery option only on select colorways.

• Available upholstery option

Social Collaborative Standard Upholstery Selections by Model/Series, for all other seating see pages 13-14.

		Clubhouse – Front & Back Bed/Storage	Clubhouse – Seating / Consoles	Hedge	Linger Seat	Linger Side	Parallel	Reflect Shell ≠	Reflect Seat & Back	Retreat Exec/Conf Seat	Retreat Exec/Conf Body	Retreat Wing Back Seat	Retreat Wing Back Body	Retreat Hi/Low/Ottoman Seat-Top	Rise Seat	Rise Side	Vicinity Lounge
<b>LEATHER L1</b>																	
Allsteel Leather	WTH																
Florence Leather	FLOR																
Strasburg Leather	STB																
<b>GRADE 1</b>																	
Apex	APX																
Centurion	CU																
Contourett	UR																
Dapper	DAPR																
Hamilton	HAM																
Inertia	NR																
Noble Seating	SNBLE																
Optic	OP																
Vibe	VIBE																
<b>GRADE 2</b>																	
Appoint Seating	PNS																
Blume	BLME																
Clyde	CLYD																
Dotty	DOT																
Meld ⊕	SMHMLD																
Rush	RUSH																
Spin Seating	SPNN																
Taylor	TAY																
Whisper Vinyl	WP																
<b>GRADE 3</b>																	
Bradbury	BDY																
Lateral ⊕	SCFSLAT																
Notion	NTN																
Parker	PRKR																
Purl	PURL																
Quill	QUL																
Moxie	SX																
Saxony	SXNY																
<b>GRADE 4</b>																	
Blink	1048																
Caper ⊕	SMHMCAP																
Constance w/ Supreen	CNST																
Look-See	1044																
Lugano w/ Supreen	LUG																
Manner ⊕	SMHMMAN																
Messenger ⊕	SMHMGRM																
Metric ⊕	SMHMMET																
Mode ⊕	SMHMMOD																
Multiply ⊕	SMHMMLT																

⊕ Partnership Program — See page 10 for details.

≠ Upholstery will be Railroad cut.

• Available upholstery option

Social Collaborative Standard Upholstery Selections by Model/Series, for all other seating see pages 13-14.

UPHOLSTERY

		Clubhouse - Front & Back Bed/Storage	Clubhouse - Seating / Consoles	Hedge	Linger Seat	Linger Side	Parallel	Reflect Shell ≠	Reflect Seat & Back	Retreat Exec/Conf Seat	Retreat Exec/Conf Body	Retreat Wing Back Seat	Retreat Wing Back Body	Retreat Hi/Low/Ottoman Seat-Top	Rise Seat	Rise Side	Vicinity Lounge
<b>GRADE 4 — continued</b>																	
Murmur ⊕	SMHMMUR				•			•	•	•	•	•	•		•	•	
Muse ⊕	SMHMMUS	•	•	•	•	•	•	•	•	•	•	•	•		•	•	
Trundle ⊕	SMHMTRN	•	•	•	•	•	•	•		•		•			•	•	
Walkabout	1046	•	•		•	•	•								•		
<b>GRADE 5</b>																	
Checkmate	1043	•	•		•	•	•	•							•	•	
Main Line Flax ⊕	SCAMMLF	•	•	•	•	•	•	•		•		•	•		•	•	
Zippy	1045	•	•		•	•	•								•	•	
<b>GRADE 6</b>																	
Arris	ARR		•	•	•	•	•	•	•	•	•	•	•	•	•	•	•
Blazer	SCAMBLZ	•	•	•	•	•	•	•	•	•	•	•	•	•		•	•
Poppy	1047	•	•		•	•	•	•							•	•	
<b>GRADE 8</b>																	
Apt ⊕	SMHMAPT	•	•	•	•	•	•	•		•		•		•	•	•	•
Brisa ⊕	RS	•	•	•	•	•	•	•	•	•	•	•	•	•	•	•	•
<b>GRADE 9</b>																	
Ultraleather Pro ⊕	SUF554	•	•	•	•	•	•	•	•	•	•	•	•	•	•	•	•

⊕ Partnership Program — See page 10 for details.

≠ Upholstery will be Railroad cut.

• Available upholstery option



Refer to pages 13-16 for current upholstery availability by model/series.

GSA Reference Page

LEATHER L1	GRADE 1 – continued	GRADE 1 – continued	GRADE 1 – continued	GRADE 2 – continued
<b>DAVENPORT</b>	<b>CONTOURETT</b>	<b>INERTIA</b>	<b>VIBE</b>	<b>KAI</b>
Atlantis ..... DAV02	Baltic ..... UR94	Amethyst ..... NR61	Bliss ..... VIBE03	Algae ..... KAI07
Bittersweet ..... DAV03	Beach ..... UR23	Calypso ..... NR98	Calm ..... VIBE06	Barnacle ..... KAI19
Black ..... DAV01	Black ..... UR10	Cherry ..... NR66	Carefree ..... VIBE08	Clownfish ..... KAI04
Brown ..... DAV14	Bordeaux ..... UR63	Cobalt ..... NR91	Cheerful ..... VIBE17	Coastal ..... KAI13
Camel ..... DAV13	Buff ..... UR22	Coffee ..... NR49	Compassion ..... VIBE01	Conch ..... KAI02
Cream ..... DAV11	Cloud ..... UR18	Fog ..... NR19	Connected ..... VIBE13	Coral Reef ..... KAI16
Fog ..... DAV05	Coffee Bean ..... UR49	Fuchsia ..... NR63	Content ..... VIBE19	Crab ..... KAI01
Olive ..... DAV09	Crater ..... UR51	Gecko ..... NR76	Courage ..... VIBE12	Ebb ..... KAI12
Porcellana ..... DAV12	Flame ..... UR62	Glow ..... NR27	Dazed ..... VIBE21	Flow ..... KAI11
Red ..... DAV16	Graphite ..... UR19	Leaf ..... NR75	Delight ..... VIBE18	Inlet ..... KAI03
Rosewood ..... DAV10	Iron ..... UR20	Lime ..... NR82	Euphoria ..... VIBE15	Jellyfish ..... KAI18
Saddle ..... DAV07	Luggage ..... UR26	Loft ..... NR22	Gleeful ..... VIBE04	Kelp ..... KAI08
Smoke ..... DAV06	Marine ..... UR92	Mandarin ..... NR47	Gloomy ..... VIBE22	Orca ..... KAI26
Storm ..... DAV08	Navy ..... UR95	Meteor ..... NR30	Hope ..... VIBE07	Otter ..... KAI22
Wet Sand ..... DAV15	Nimbus ..... UR93	Mustard ..... NR49	Moody ..... VIBE05	Puffer ..... KAI06
<b>FLORENCE</b>	Ocean ..... UR96	Nickel ..... NR23	Nostalgia ..... VIBE09	Salty ..... KAI23
Almond Biscotti ..... FLOR01	Pumpkin ..... UR42	Onyx ..... NR10	Perplexed ..... VIBE10	Seahorse ..... KAI05
Basilica ..... FLOR12	Quarry ..... UR24	Regatta ..... NR90	Pride ..... VIBE02	Seashell ..... KAI20
Duomo ..... FLOR10	Red ..... UR64	Shadow ..... NR20	Relaxed ..... VIBE20	Seaweed ..... KAI09
Espresso ..... FLOR03	Safari ..... UR27	Surf ..... NR96	Secure ..... VIBE16	Shark ..... KAI24
Loggia ..... FLOR11	Sage ..... UR82	Tangelo ..... NR46	Serenity ..... VIBE11	Shoreline ..... KAI21
Lorenzo ..... FLOR13	Steel ..... UR21	<b>NOBLE SEATING</b>	Trust ..... VIBE14	Stringray ..... KAI25
Mezza Luna ..... FLOR08	Storm ..... UR17	Aegean ..... SNBLE18		Tide ..... KAI14
Struzzo ..... FLOR09	Taupe ..... UR28	Amethyst ..... SNBLE19		Turtle ..... KAI10
Terra ..... FLOR02	Trunk ..... UR50	Aspen ..... SNBLE14		Urchin ..... KAI17
		Aster ..... SNBLE20	<b>GRADE 2</b>	Wave ..... KAI15
<b>STRASBURG</b>	<b>DAPPER B<sup>w</sup>, F<sup>w</sup>, S<sup>w</sup>, T<sup>w</sup></b>	Blossom ..... SNBLE21	<b>APPOINT SEATING</b>	<b>RUSH</b>
Acorn ..... STB06	(100% Polyester)	Bluebell ..... SNBLE22	Artichoke ..... PNS014	(100% Polyester)
Almond ..... STB03	Ash ..... DAPR20	Bordeaux ..... SNBLE01	Blackberry ..... PNS012	Anchor ..... RUSH07
Anthraxite ..... STB21	Breeze ..... DAPR06	Brick ..... SNBLE02	Bronze ..... PNS002	Basil ..... RUSH16
Atlantic ..... STB19	Canvas ..... DAPR25	Chambray ..... SNBLE10	Carbon ..... PNS008	Blueberry ..... RUSH10
Aubergine ..... STB08	Charcoal ..... DAPR01	Chamomile ..... SNBLE23	Chai ..... PNS013	Flamingo ..... RUSH21
Bark ..... STB10	Clover ..... DAPR22	Clementine ..... SNBLE04	Cherry ..... PNS010	Greenery ..... RUSH15
Black ..... STB23	Currant ..... DAPR00	Conifer ..... SNBLE24	Dark Pewter ..... PNS017	Greyhound ..... RUSH06
Bordeaux ..... STB15	Fawn ..... DAPR35	Cottage ..... SNBLE25	Dune ..... PNS015	Marina ..... RUSH13
Cappuccino ..... STB05	Fern ..... DAPR85	Darkness ..... SNBLE26	Espresso ..... PNS003	Merlot ..... RUSH19
Chestnut ..... STB07	Gerbera ..... DAPR16	Dawn ..... SNBLE13	Framboise ..... PNS011	Midnight ..... RUSH11
Cream ..... STB02	Grape ..... DAPR33	Denim ..... SNBLE09	Frost ..... PNS034	Mint ..... RUSH09
Fir ..... STB17	Jewel ..... DAPR08	Desert Sand ..... SNBLE27	Jet ..... PNS007	Mulberry ..... RUSH18
Fog ..... STB20	Marigold ..... DAPR65	Dewfall ..... SNBLE28	Lawn ..... PNS005	Pumice ..... RUSH01
Fudge ..... STB11	Onyx ..... DAPR10	Dusted Sage ..... SNBLE29	Mandarin ..... PNS009	Punch ..... RUSH20
Graphite ..... STB22	Orchid ..... DAPR90	Flax ..... SNBLE30	Morel ..... PNS001	Sage ..... RUSH14
Ivory ..... STB01	Parrot ..... DAPR59	Grass ..... SNBLE07	Nimbus ..... PNS016	Salsa ..... RUSH24
Olive ..... STB09	Poppy ..... DAPR19	Gunmetal ..... SNBLE15	Platinum ..... PNS004	Sand ..... RUSH05
Sesame ..... STB04	Sapphire ..... DAPR07	Harmony ..... SNBLE31	Turquoise ..... PNS006	Seal ..... RUSH08
	Scarlet ..... DAPR45	Harvest ..... SNBLE12		Soot ..... RUSH02
<b>GRADE 1</b>	Sepia ..... DAPR30	Char ..... SNBLE00	<b>BLUME</b>	Stout ..... RUSH03
<b>APEX</b>	Sky ..... DAPR44	Ice Caves ..... SNBLE32	Chalk ..... BLME03	Sunshine ..... RUSH23
Basalt ..... APX25	Slate ..... DAPR15	Icicle ..... SNBLE33	Char ..... BLME00	Tapestry ..... RUSH04
Beet ..... APX12	Sorbet ..... DAPR55	Inky ..... SNBLE34	Coin ..... BLME02	Tiger ..... RUSH22
Blackberry ..... APX20	Spring ..... DAPR80	Iris ..... SNBLE35	Driftwood ..... BLME05	Vintage ..... RUSH17
Chive ..... APX05	Terracotta ..... DAPR13	Jade ..... SNBLE06	Emerald City ..... BLME07	Wave ..... RUSH12
Iris ..... APX03	Titanium ..... DAPR17	Knight ..... SNBLE17	Fir ..... BLME09	
Kiwi ..... APX06	Varsity ..... DAPR09	Mesa ..... SNBLE03	Harvest ..... BLME04	<b>SPIN SEATING</b>
Lemonade ..... APX08	Zest ..... DAPR70	Monarch ..... SNBLE36	Haze ..... BLME08	(51% Polyester, 49% Recycled Polyester)
Navy ..... APX13	<b>ENSEMBLE</b>	Pacific ..... SNBLE08	Hyacinth ..... BLME14	Alabaster ..... SPNN02
Papaya ..... APX09	Aquamarine ..... ENSB30	Pitch ..... SNBLE37	Jasper ..... BLME13	Cavern ..... SPNN03
Pumice ..... APX23	Ash ..... ENSB39	Queen Bee ..... SNBLE38	Merlot ..... BLME10	Cobblestone ..... SPNN04
Rain ..... APX19	Greige ..... ENSB36	Rainforest ..... SNBLE05	Moonstone ..... BLME01	Ember ..... SPNN06
Resort ..... APX15	Harbor ..... ENSB34	Regal ..... SNBLE11	Opal ..... BLME06	Flame ..... SPNN07
Royal ..... APX14	Navy ..... ENSB35	Sandcastle ..... SNBLE39	Scarlet ..... BLME11	Heron ..... SPNN13
Tiki ..... APX29	Oat ..... ENSB37	Sedona ..... SNBLE40	Slate ..... BLME12	Oat ..... SPNN01
Tomato ..... APX11	Pear ..... ENSB33	Stormy ..... SNBLE16		Ocean ..... SPNN12
<b>CENTURION B, C, F, O, S, T</b>	Sand ..... ENSB38	Subbeam ..... SNBLE41	<b>CLYDE</b>	Plum ..... SPNN15
(Nanotex™ Stain-Resistant finish)	Scarlet ..... ENSB32	Voyager ..... SNBLE42	Antique ..... CLYD04	Pool ..... SPNN11
Apricot ..... CU47	Slate ..... ENSB31	Windy Day ..... SNBLE43	Artifact ..... CLYD01	Raven ..... SPNN10
Bark ..... CU25	Stone ..... ENSB40	<b>OPTIC</b>	Blacksmith ..... CLYD10	Rhubarb ..... SPNN14
Black ..... CU10		Aurora ..... OP72	Claret ..... CLYD13	Tropic ..... SPNN08
Espresso ..... CU49	<b>HAMILTON</b>	Bark ..... OP24	Craftsman ..... CLYD08	Willow ..... SPNN05
Fog ..... CU03	(100% Polyester)	Canopy ..... OP84	Crate ..... CLYD12	
Frost ..... CU22	Azure ..... HAML10	Char ..... OP49	Fossil ..... CLYD02	
Goldenrod ..... CU27	Biscotti ..... HAML11	Ruby ..... OP42	Heirloom ..... CLYD05	
Indigo ..... CU06	Cabernet ..... HAML08	Sand ..... OP17	Iron ..... CLYD11	
Iris ..... CU50	Carolina ..... HAML21	Sky ..... OP83	Keepsake ..... CLYD15	
Iron Ore ..... CU19	Charcoal ..... HAML17	Slate ..... OP19	Linen ..... CLYD14	
Jade ..... CU83	Chocolate ..... HAML13	Sprout ..... OP74	Relic ..... CLYD06	
Marsala ..... CU63	Cloud ..... HAML18	Starry Night ..... OP11	Seasoned ..... CLYD03	
Morel ..... CU24	Dane ..... HAML16	Storm ..... OP56	Trestle ..... CLYD07	
Navy ..... CU98	Dusty Rose ..... HAML07	Wildfire ..... OP66		
Peacock ..... CU97	Esmeralda ..... HAML06		<b>DOTTY</b>	
Pear ..... CU84	Fern ..... HAML04		(100% Polyester)	
Ruby ..... CU67	Fresh ..... HAML03		Candy ..... DOT63	
Sapphire ..... CU09	Granola ..... HAML19		Gelato! ..... DOT34	
	Lilac ..... HAML14		Indigo ..... DOT31	
	Lime ..... HAML05		Onyx ..... DOT35	
	Lipstick ..... HAML09		Park ..... DOT83	
	Oxford ..... HAML20		Peat ..... DOT24	
	Passion Fruit ..... HAML02		Peony ..... DOT32	
	Pepper ..... HAML15		Suit ..... DOT20	
	Powder ..... HAML12		Sunflower ..... DOT33	
	Sunrise ..... HAML01		Tailor ..... DOT21	
			Tide ..... DOT90	
			Velum ..... DOT29	
			Violet ..... DOT30	

Note: See pages 10-12 for listing and explanation of Partnership Program upholstery.

▲ Acuity Jacket Upholstery  
Multi-use fabrics are noted with the following designators:  
B – Tackboards S – Stride®  
C – Concensys® T – Terrace®  
O – Optimize™ F – Further™  
\* limited to 48" W or less

UPHOLSTERY

Refer to pages 13-16 for current upholstery availability by model/series.

GSA Reference Page

UPHOLSTERY

## GRADE 2 – continued

### TAYLOR

(74% Post-Consumer Recycled Polyester, 26% Polyester)

Autumn	TAY43
Daffodil	TAY20
Deep Lilac	TAY75
Dreamy	TAY80
Envious	TAY58
Handkerchief	TAY90
Luxe	TAY50
Malbec	TAY40
Martini	TAY60
Mink	TAY30
Pearl	TAY15
Spritz	TAY45
Tungsten	TAY85

### WAVELENGTH

Base	WVL21
Crest	WVL14
Cycle	WVL20
Energy	WVL03
Frequency	WVL04
Infrared	WVL01
Motion	WVL13
Movement	WVL05
Peak	WVL11
Pressure	WVL06
Shallow	WVL02
Still	WVL07
Surface	WVL18
Surge	WVL10
Swell	WVL08
Tide	WVL16
Transition	WVL15
Trough	WVL19
Tsunami	WVL09
Ultraviolet	WVL12
White Caps	WVL17

### WHISPER VINYL

Antelope	WP20
Black	WP40
Bone	WP17
Brick Red	
(De-emphasized)	WP99
Camel	WP18
Cappuccino	WP21
Cashew	WP29
Cerulean	WP36
Charcoal	WP39
Cinnamon	WP25
Cognac	WP62
Cucumber	
(De-emphasized)	WP88
Elephant	WP38
Espresso	WP49
Fawn	WP91
Indigo	WP86
Mahogany	WP93
Mallard	WP90
Navy	WP37
Patina	WP34
Pewter	WP83
Putty (De-emphasized)	WP84
Salsa	WP42
Sangre (De-emphasized)	WP28
Storm	WP92
Truffle	WP95

## GRADE 3

### BRADBURY

Acorn	BDY01
Alabaster	BDY02
Aspire	BDY03
Blueberry	BDY04
Carbon	BDY05
Concord	BDY06
Cozumel	BDY07
Dolphin	BDY08
Gala	BDY09
Honey	BDY10
Mushroom	BDY11
Mystic	BDY12
Oat	BDY13
Rhino	BDY14
Scallion	BDY15
Sidewalk	BDY16
Terrazzo	BDY17
Vellum	BDY18
Walnut	BDY19

### GETAWAY

Brig	GTWY15
Canoe	GTWY03
Catamaran	GTWY08
Cruise Ship	GTWY10
Cuddy	GTWY01
Ferry	GTWY11
Gondola	GTWY02
Jet Ski	GTWY09
Kayak	GTWY05
Pontoon	GTWY13
Runabout	GTWY14
Sailboat	GTWY07
Speedboat	GTWY12
Wakeboard	GTWY06
Yacht	GTWY04

### NOTION

Agave	NTN01
Bark	NTN02
Beeswax	NTN03
Carbon	NTN04
Cassis	NTN05
Cement	NTN06
Char	NTN07
Chroma	NTN08
Dockside	NTN09
Drifter	NTN10
Fog	NTN11
Fountain	NTN12
Fox	NTN13
Grassland	NTN14
Henna	NTN15
Horizon	NTN16
Ivy	NTN17
Linen	NTN18
Mykonos	NTN19
Peat	NTN20
Poppy	NTN21
Rockfall	NTN22
Sandwash	NTN23
Stoneware	NTN24
Sumac	NTN25
Twilight	NTN26

### PARKER

Aloe	PRKR01
Cumulus	PRKR05
Cyan	PRKR06
Domino	PRKR07
Fossil	PRKR10
Graphite	PRKR11
Grass	PRKR12
Grenadine	PRKR13
Griffin	PRKR14
Kiln	PRKR16
Magnesium	PRKR18
Magnet	PRKR19
Mica	PRKR20
Mink	PRKR21
Nightfall	PRKR22
Paprika	PRKR24
Pine	PRKR25
Rapids	PRKR28
Rioja	PRKR30

## GRADE 3 – continued

### PURL

(80% Polyester, 20% Acrylic)

Alpaca	PURL08
Braid	PURL10
Deep	PURL12
Graze	PURL05
Loom	PURL06
Needle	PURL07
Pasture	PURL02
Ranch	PURL04
Shuttle	PURL09
Skein	PURL01
Thisle	PURL11
Yearling	PURL03

### QUILL

Aviary	QUL03
Feather	QUL02
Fountain	QUL06
Ink	QUL05
Metal	QUL04
Reed	QUL08
Scroll	QUL01
Well	QUL07

### MOXIE

Barnwood	SX09
Basalt	SX23
Bayou	SX02
Bermuda	SX52
Biscotti	SX08
Blackberry	SX48
Blarney	SX49
Blueberry	SX05
Bonsai	SX20
Brigade	SX53
Butterscotch	SX54
Carob	SX24
Chalk	SX50
Chartreuse	SX34
Cherry	SX38
Cinnamon	SX13
Cobalt	SX01
Coconut	SX06
Concrete	SX43
Cozumel	SX55
Cumin	SX32
Dragonfly	SX44
Dover	SX56
Earl Grey	SX40
Elysian	SX04
Evergreen	SX21
Fatigue	SX18
Fawn	SX30
Flint	SX39
Forsythia	SX57
Grenache	SX58
Hazel	SX31
Hemp	SX45
Hickory	SX25
Holly	SX51
Jam	SX16
Kelly	SX33
Lemongrass	SX19
Lime	SX41
Macintosh	SX12
Midnight	SX59
Mulberry	SX15
Muslin	SX60
Pacifica	SX61
Parchment	SX07
Peacock	SX03
Phantom	SX62
Pineapple	SX42
Plum	SX17
Punch	SX46
Riverstone	SX47
Russet	SX14
Smokestack	SX22
Tangerine	SX37
Terracotta	SX11
Thicket	SX35
Walnut	SX10
Whirlwind	SX63

## GRADE 3 – continued

### SAXONY

Arctic	SXNY14
Azure	SXNY11
Black	SXNY21
Clover	SXNY06
Cobalt	SXNY12
Emerald	SXNY08
Flare	SXNY02
Fog	SXNY18
Grass	SXNY05
Iron	SXNY20
Lagoon	SXNY07
Lipstick	SXNY01
Mandarin	SXNY03
Navy	SXNY13
Sand	SXNY16
Sea	SXNY10
Shell	SXNY15
Sky	SXNY09
Storm Cloud	SXNY19
Taupe	SXNY17
Zest	SXNY04

## GRADE 4

### CONSTANCE WITH SUPREEN

Airy	CNST01
Aztec	CNST02
Cassis	CNST03
Copperplate	CNST04
Cornerstone	CNST05
Envy	CNST06
Flagstone	CNST07
Flax	CNST08
Frost	CNST09
Gateway	CNST10
Grounds	CNST11
Hayfield	CNST12
Inkpad	CNST13
Pewter	CNST14
Pistachio	CNST15
Pompeii	CNST16
Poseidon	CNST17
Reflection	CNST18
Scuba	CNST19
Stoic	CNST20
Stonington	CNST21
Thunder	CNST22
Waterfall	CNST23

### LIVI

Asphalt	LIV101
Atlantis	LIV102
Bouquet	LIV103
Branch	LIV104
Coastal	LIV105
Cowboy	LIV106
Dawn	LIV107
Earth	LIV109
Evergreen	LIV110
Fennel	LIV111
Fog	LIV112
Honeycomb	LIV113
Jade	LIV114
Limestone	LIV115
Monochrome	LIV116
Night	LIV117
Overcast	LIV118
Pebble	LIV119
Pillow	LIV108
Plum	LIV120
Pumpkin	LIV121
Rhubarb	LIV122
Saxon	LIV123
Seaside	LIV124
Twine	LIV125

## GRADE 4 – continued

### LUGANO WITH SUPREEN

Andromeda	LUG01
Aquarelle	LUG02
Bayou	LUG03
Caviar	LUG04
Cloud	LUG05
Cobblestone	LUG06
Dutch	LUG07
Flirt	LUG08
Florence	LUG09
Frost	LUG10
Ganache	LUG11
Gravel	LUG12
Juniper	LUG13
Lapis	LUG14
Moonstone	LUG15
Mustard Seed	LUG16
Sandstone	LUG17
Sconce	LUG18
Semolina	LUG19
Spice Market	LUG20
Sterling	LUG21

### OXFORD

Armor	OXFD01
Azurite	OXFD02
Cadet	OXFD03
Cider	OXFD04
Clover	OXFD05
Coal	OXFD16
Coin	OXFD06
Crema	OXFD07
Currant	OXFD08
Deluge	OXFD09
Dewberry	OXFD10
Falcon	OXFD11
Gingerbread	OXFD12
Laurel	OXFD13
Odyssey	OXFD14
Pavement	OXFD15
Redvine	OXFD17
Seadrift	OXFD18
Shoji	OXFD19
Tourmaline	OXFD20
Vignette	OXFD21

## GRADE 6

### ARRIS

Artisan	ARR01
Baroque	ARR02
Noble	ARR02
Rattan	ARR05
Rich	ARR04
Tapestry	ARR03
Weft	ARR06

### ▲ Acuity Jacket Upholstery

Multi-use fabrics are noted with the following designators:

- B – Tackboards      S – Stride®
- C – Concensys®      T – Terrace®
- O – Optimize™      F – Further™

**Note:** See pages 10-12 for listing and explanation of Partnership Program upholstery.

Refer to pages 13-16 for current upholstery availability by model/series.

### MESH

#### ACUITY® MESH

Clay .....	C
Mist .....	M
Dusk .....	D
Navy .....	N
Lustre .....	L

#### CLARITY® & RELATE® MESH

Carbon** .....	LKM01
Navy ( <i>De-emphasized</i> ) .....	CM28
Clay ( <i>De-emphasized</i> ) .....	CM21
Platinum .....	CM23
Flint* .....	CM20
Poppy* ( <i>De-emphasized</i> ) .....	CM25
Graphite* .....	CM22
Sky* ( <i>De-emphasized</i> ) .....	CM26
Lime ( <i>De-emphasized</i> ) .....	CM30
Taupe ( <i>De-emphasized</i> ) .....	CM29

\*Not available on Relate

\*\*Not available on Clarity

#### MIMEO™ MESH

Amethyst .....	NM61
Cobalt .....	NM91
Fog .....	NM19
Glow .....	NM27
Leaf .....	NM75
Loft .....	NM22
Onyx .....	NM10
Shadow .....	NM20

#### QUIP™ MESH

Carbon .....	SBM01
Graphite .....	SBM22
Lime .....	SBM30
Loft .....	SBM03
Navy .....	SBM28
Poppy .....	SBM25

SEEK® MESH ..... Dusk Only

#### SPECTRUM\* MESH

Beacon .....	RM27
Blueberry .....	RM20
Brick .....	RM16
Bullseye .....	RM17
Carbon .....	RM10
Chalk .....	RM28
Cobalt .....	RM14
Espresso .....	RM15
Gold Dust .....	RM31
Kermit .....	RM23
Key Lime .....	RM32
Leaf .....	RM21
Linen .....	RM30
Loft .....	RM12
Midnight .....	RM24
Onyx .....	RM13
Pear .....	RM29
Quicksand .....	RM33
Salamander .....	RM25
Sky .....	RM19
Steel .....	RM26
Titanium .....	RM11

\*Only available on O6.

### INSPIRE, SEEK

#### and NIMBLE

#### POLYMER COLORS

Black (formerly Onyx) .....	BLK
Brownstone .....	BW
Cayenne .....	RD
Sprout .....	GN
Summit .....	GY
Surf .....	BU
Tangelo .....	RG
White (formerly Frost) .....	WT

#### VICINITY

#### POLYMER COLORS

Brownstone .....	BW
Calypso .....	CP
Cherry .....	CR
Lava .....	LA
Regatta .....	RE
Titanium .....	TI
White .....	WT
Zest .....	ZE

**Note:** See pages 10-12 for listing and explanation of Partnership Program upholstery.

#### ▲ Acuity Jacket Upholstery

Multi-use fabrics are noted with the following designators:

<b>B</b> – Tackboards	<b>S</b> – Stride®
<b>C</b> – Concensys®	<b>T</b> – Terrace®
<b>O</b> – Optimize™	<b>F</b> – Further™

# Seating

- Available upholstery option
- RR: railroaded, F/FR: Fire compliant model

Pattern Name	Code	Supplier	Grade	Acuity Arms	Acuity Back Jacket	Acuity Seat	Acuity Side (Mesh)	CoHo (MDS 10280)	Evo Seat (MDS 10259)	Evo Upholstered Back (MDS 10259)	Inspire Back
Parker	1054	HBF Textiles	3			•	•		•	•	
Blink	1048	HBF Textiles	4			•	•		•		•
Look-See	1044	HBF Textiles	4			•	•	•	•	•	
Walkabout	1046	HBF Textiles	4			•	•		•		
Against the Grain	AGG	HBF Textiles	5		F	F	•	•			F
Caddy Corner	1016	HBF Textiles	5			•	•	•	•	•	•
Checkmate	1043	HBF Textiles	5			•	•	•	•	•	•
Pebbled	SHBFPEB	HBF Textiles	5			•	•		•	•	
Picnic Plaid	1029	HBF Textiles	5			•	•		•		
Upbeat	1036	HBF Textiles	5			•	•		•		•
Zippy	1045	HBF Textiles	5			•	•	•	•	•	•
Poppy	1047	HBF Textiles	6			•	•	•	•	•	•
Crew Cut	SHBFCRW	HBF Textiles	7			•	•		•		
Happy Camper	1028	HBF Textiles	7			•	•	•	•	•	•
Honest	SHBFHON	HBF Textiles	7			•	•	•	•	•	
Roundabout	1005	HBF Textiles	7			•	•		•		•
Beetle	SHBFBEE	HBF Textiles	8			•	•		•	•	•
Dashing	1008	HBF Textiles	8			•	•		•		•
Fourfold	SHBFFOU	HBF Textiles	8			•	•		•		•
Modern Tweed	SHBFMOD	HBF Textiles	8			•	•	•	•		
Sherpa	1031	HBF Textiles	8			•	•	•	•	•	•
All Terrain	1027	HBF Textiles	9			•	•	•	•	•	•
Comfort Zone	905	HBF Textiles	9			•	•		•		
Crafted Felt	1017	HBF Textiles	9			•	•	•	•	•	•
Curtain Wall	1023	HBF Textiles	9			•	•		•		•
High Rise	SHBFHIG	HBF Textiles	9			•	•		•		
Madam Dottie	1001	HBF Textiles	9			•	•	•	•	•	•
Scribble XS	982	HBF Textiles	9			•	•		•	•	•
Uptown	1039	HBF Textiles	9			•	•	•	•	•	•
Wabi Sabi	SHBFWAB	HBF Textiles	9			•	•	•	•	•	•
Color Code	998	HBF Textiles	10			•	•		•		
Digital Bloom 2.0	1050	HBF Textiles	10			•	•	•	•	•	•
Equation	SHBFQU	HBF Textiles	10		F	F	•	•	•	•	F
Folded Lines	973	HBF Textiles	10			•	•	•	•		•
Remember	SHBFREM	HBF Textiles	10								
Roy's Cords	1025	HBF Textiles	10			•	•				
Soft Angles 2.0	1051	HBF Textiles	10			•	•	•	•		
Upscale	1040	HBF Textiles	10			•	•		•	•	•
Air Mail	1006	HBF Textiles	11			•	•		•		•
Argyle Boucle	978	HBF Textiles	11			•	•	•	•	•	•
Brushed Canvas	SHBFBCV	HBF Textiles	11			•	•		•	•	
Cloud	SHBFCLD	HBF Textiles	11			•	•		•		
Abito	ABI	HBF Textiles	12			•	•	•	•	•	•
Belgian Meadow	SHBFBLM	HBF Textiles	12			•	•	•	•	•	•
Complex	964	HBF Textiles	12			•	•	•	•	•	•
Crosstweed	991	HBF Textiles	12			•	•	•	•	•	•
Cutout	SHBFCUT	HBF Textiles	12			•	•		•		•
Dot Grid	975	HBF Textiles	12			•	•		•		•
Dot Structure	SHBFDOT	HBF Textiles	12			•	•	•	•	•	•
Glint	SHBFGLT	HBF Textiles	12			•	•		•		•
Grateful Grid	1015	HBF Textiles	12			•	•	•	•	•	•
Heartfelt	SHBFHTF	HBF Textiles	12		F	F	•	•	•	•	F
Lava Rock	993	HBF Textiles	12			•	•	•	•	•	•
Merci Boucle	SHBFMER	HBF Textiles	12			•	•	•	•	•	•
Moving Blanket	SHBFMOV	HBF Textiles	12			•	•		•		
Sable Island	SHBFSAB	HBF Textiles	12			•	•		•		
Sir Stripe A Lot	1004	HBF Textiles	12			•	•		•		•

UPHOLSTERY

# Seating

- Available upholstery option
- RR: railroaded, F/FR: Fire compliant model

UPHOLSTERY

Pattern Name	Code	Supplier	Grade	Acuity Arms	Acuity Back Jacket	Acuity Seat	Acuity Side (Mesh)	CoHo (MDS 10280)	Evo Seat (MDS 10259)	Evo Upholstered Back (MDS 10259)	Inspire Back
Sweater Weather	1030	HBF Textiles	12			•	•	•	•		•
Twist	SHBFTWS	HBF Textiles	12			•	•				•
Upstart	1042	HBF Textiles	12			•	•		•		•
Cherished Knit	954	HBF Textiles	13			•	•	•	•	•	•
Enriched Boucle	1021	HBF Textiles	13			•	•	•	•	•	•
Foundation	SHBFFND	HBF Textiles	13								
Moving Forward	1014	HBF Textiles	13			•	•	•	•		•
Night Earth	1013	HBF Textiles	13			•	•	•	•		•
Pepper Blend	995	HBF Textiles	13			•	•	•	•		•
Quill	1011	HBF Textiles	13			•	•	•	•		•
Scribble XL	983	HBF Textiles	13			•	•		•		•
Sister Solid	1003	HBF Textiles	13			•	•	•	•		•
Afghan	AFG	HBF Textiles	14			F	•		•		
Smart	SHBFSMT	HBF Textiles	14			•	•	•	•		
Velvet Mix	977	HBF Textiles	14			•	•		•		•
Hipster	SHBFHPT	HBF Textiles	15			F	F	•	•		F
Landscape Blur	1024	HBF Textiles	15			•	•	•	•		•
Poodle	1009	HBF Textiles	16			•	•	•	•		•
Sweater	SHBFSWE	HBF Textiles	16					•	•	•	
Woven Memory	1019	HBF Textiles	16			•	•		•		•
Crafted Cloud	1018	HBF Textiles	19			•	•	•	•		
Knitwork	SHBFKNI	HBF Textiles	21			•	•		•	•	F
Bunny	1012	HBF Textiles	23			•	•	•	•	•	•
Eccentric	966	HBF Textiles	23			•	•		•		
Eccentric	SHBFEC	HBF Textiles	23			•	•		•		
Wild West	717	HBF Textiles	L2			•	•		•		•
Aviator	SHBFAVI	HBF Textiles	L3			•					
Free Way	SHBFFRE	HBF Textiles	L3			•	•		•		•
Modern Patina	716	HBF Textiles	L3			•	•		•		•
Persuede	718	HBF Textiles	L3			•	•		•		•
Vivace II	709	HBF Textiles	L3			•	•	•	•		F
Upper Crust	708	HBF Textiles	L5			•	•	•	•		F
Voyage	713	HBF Textiles	L5			•	•	•	•		F

# Seating

- Available upholstery option
- RR: railroaded, F/FR: Fire compliant model

Pattern Name	Code	Supplier	Grade	Inspire Seat	Involve Soft Seating	Involve Approach, K5CT Ped Topper	Lyric Uph. Seat (CWW-, CLL-, CSC-, CSS-)	Lyric Upholstered Back (CWW-, CLL-, CWS30U-)	Mimeo	Radii Ped Topper	Relate Mesh Task	Relate Mesh Side	Relate Uph Task
Parker	1054	HBF Textiles	3										
Blink	1048	HBF Textiles	4	•	•	•	•	•	•	•	•	•	•
Look-See	1044	HBF Textiles	4		•	•	•	•	•	•	•	•	•
Walkabout	1046	HBF Textiles	4		•	•	•	•	•	•	•	•	•
Against the Grain	AGG	HBF Textiles	5	F	•	•	F	F	•	F	F	F	F
Caddy Corner	1016	HBF Textiles	5	•	•	•	•	•	•	•	•	•	•
Checkmate	1043	HBF Textiles	5	•	•	•	•	•	•	•	•	•	•
Pebbled	SHBFPEB	HBF Textiles	5				•				•	•	•
Picnic Plaid	1029	HBF Textiles	5		•	•	•	•	•	•	•	•	•
Upbeat	1036	HBF Textiles	5	•	•	•	•	•	•	•	•	•	•
Zippy	1045	HBF Textiles	5	•	•	•	•	•	•	•	•	•	•
Poppy	1047	HBF Textiles	6	•	•	•	•	•	•	•	•	•	•
Crew Cut	SHBFCRW	HBF Textiles	7		•	•	•	•	•	•	•	•	•
Happy Camper	1028	HBF Textiles	7	•	•	•	•	•	•	•	•	•	•
Honest	SHBFHON	HBF Textiles	7		•	•	•	•	•	•	•	•	•
Roundabout	1005	HBF Textiles	7	•	•	•	•	•	•	•	•	•	•
Beetle	SHBFBEE	HBF Textiles	8	•	•	•	•	•	•	•	•	•	•
Dashing	1008	HBF Textiles	8	•	•	•	•	•	•	•	•	•	•
Fourfold	SHBFFOU	HBF Textiles	8	•			•				•	•	•
Modern Tweed	SHBFMOD	HBF Textiles	8		•	•	•	•	•	•	•	•	•
Sherpa	1031	HBF Textiles	8	•	•	•	•	•	•	•	•	•	•
All Terrain	1027	HBF Textiles	9	•	•	•	•	•	•	•	•	•	•
Comfort Zone	905	HBF Textiles	9		•	•	•	•	•	•	•	•	•
Crafted Felt	1017	HBF Textiles	9	•	•	•	•	•	•	•	•	•	•
Curtain Wall	1023	HBF Textiles	9	•	•	•	•	•	•	•	•	•	•
High Rise	SHBFHIG	HBF Textiles	9		•	•	•	•	•	•	•	•	•
Madam Dottie	1001	HBF Textiles	9	•	•	•	•	•	•	•	•	•	•
Scribble XS	982	HBF Textiles	9	•	•	•	•	•	•	•	•	•	•
Uptown	1039	HBF Textiles	9	•	•	•	•	•	•	•	•	•	•
Wabi Sabi	SHBFWAB	HBF Textiles	9		•	•	•	•	•	•	•	•	•
Color Code	998	HBF Textiles	10		•	•	•	•	•	•	•	•	•
Digital Bloom 2.0	1050	HBF Textiles	10	•	•	•	•	•	•	•	•	•	•
Equation	SHBFEQU	HBF Textiles	10	F	F	F	F	F	•	F	F	F	F
Folded Lines	973	HBF Textiles	10	•	•	•	•	•	•	•	•	•	•
Remember	SHBFREM	HBF Textiles	10			•				•			
Roy's Cords	1025	HBF Textiles	10		•	•	•	•	•	•	•	•	•
Soft Angles 2.0	1051	HBF Textiles	10		•	•	•	•	•	•	•	•	•
Upscale	1040	HBF Textiles	10	•	•	•	•	•	•	•	•	•	•
Air Mail	1006	HBF Textiles	11	•	•	•	•	•	•	•	•	•	•
Argyle Boucle	978	HBF Textiles	11	•	•	•	•	•	•	•	•	•	•
Brushed Canvas	SHBFBCV	HBF Textiles	11		•	•	•	•	•	•	•	•	•
Cloud	SHBFCLD	HBF Textiles	11		•					•	•		
Abito	ABI	HBF Textiles	12	•	•	•	•	•	•	•	•	•	•
Belgian Meadow	SHBFBLM	HBF Textiles	12	•	•	•	•	•	•	•	•	•	•
Complex	964	HBF Textiles	12	•	•	•	•	•	•	•	•	•	•
Crosstweed	991	HBF Textiles	12	•	•	•	•	•	•	•	•	•	•
Cutout	SHBFCUT	HBF Textiles	12	•	•	•	•	•	•	•	•	•	•
Dot Grid	975	HBF Textiles	12	•	•	•	•	•	•	•	•	•	•
Dot Structure	SHBFDOT	HBF Textiles	12	•	•	•	•	•	•	•	•	•	•
Glint	SHBFGLT	HBF Textiles	12	•	•	•	•	•	•	•	•	•	•
Grateful Grid	1015	HBF Textiles	12	•	•	•	•	•	•	•	•	•	•
Heartfelt	SHBFHTF	HBF Textiles	12	F	F	F	F	F	•	F	F	F	F
Lava Rock	993	HBF Textiles	12	•	•	•	•	•	•	•	•	•	•
Merci Boucle	SHBFMER	HBF Textiles	12		•	•	•	•	•	•	•	•	•
Moving Blanket	SHBFMOV	HBF Textiles	12		•	•	•	•	•	•	•	•	•
Sable Island	SHBFSAB	HBF Textiles	12		•	•	•	•	•	•	•	•	•
Sir Stripe A Lot	1004	HBF Textiles	12	•	•	•	•	•	•	•	•	•	•

UPHOLSTERY

# Seating

- Available upholstery option
- RR: railroaded, F/FR: Fire compliant model

UPHOLSTERY

Pattern Name	Code	Supplier	Grade	Inspire Seat	Involve Soft Seating	Involve Approach, K5CT Ped Toppers	Lyric Uph. Seat (CWW, CLL, CSC, CSS,)	Lyric Upholstered Back	Lyric MP (CMPNU, CMPWU, CSWU, CWSS30U,)	Mimeo	Radii Ped Topper	Relate Mesh Task	Relate Mesh Side	Relate Uph Task
Sweater Weather	1030	HBF Textiles	12	•	•	•	•	•	•	•	•	•	•	•
Twist	SHBFTWS	HBF Textiles	12	•	•	•	•	•	•	•	•	•	•	•
Upstart	1042	HBF Textiles	12	•	•	•	•	•	•	•	•	•	•	•
Cherished Knit	954	HBF Textiles	13	•	•	•	•	•	•	•	•	•	•	•
Enriched Boucle	1021	HBF Textiles	13	•	•	•	•	•	•	•	•	•	•	•
Foundation	SHBFFND	HBF Textiles	13											
Moving Forward	1014	HBF Textiles	13	•	•	•	•	•	•	•	•	•	•	•
Night Earth	1013	HBF Textiles	13	•	•	•	•	•	•	•	•	•	•	•
Pepper Blend	995	HBF Textiles	13	•	•	•	•	•	•	•	•	•	•	•
Quill	1011	HBF Textiles	13	•	•	•	•	•	•	•	•	•	•	•
Scribble XL	983	HBF Textiles	13	•	•	•	•	•	•	•	•	•	•	•
Sister Solid	1003	HBF Textiles	13	•	•	•	•	•	•	•	•	•	•	•
Afghan	AFG	HBF Textiles	14		•	•	•			•	•	•	•	•
Smart	SHBFSMT	HBF Textiles	14		•	•	•			•	•	•	•	•
Velvet Mix	977	HBF Textiles	14	•	•	•	•	•	•	•	•	•	•	•
Hipster	SHBFHPT	HBF Textiles	15	F	F	F	F	F		•	F	F	F	F
Landscape Blur	1024	HBF Textiles	15	•	•	•	•	•	•	•	•	•	•	•
Poodle	1009	HBF Textiles	16	•	•	•	•	•	•	•	•	•	•	•
Sweater	SHBFSWE	HBF Textiles	16											
Woven Memory	1019	HBF Textiles	16	•	•	•	•	•	•	•	•	•	•	•
Crafted Cloud	1018	HBF Textiles	19		•	•	•	•	•	•	•	•	•	•
Knitwork	SHBFKNI	HBF Textiles	21	F	•	•	•	F		•	•	•	•	•
Bunny	1012	HBF Textiles	23	•	•	•	•	•	•	•	•	•	•	•
Eccentric	966	HBF Textiles	23		•	•	•			•	•	•		
Eccentric	SHBFEC	HBF Textiles	23		•	•	•			•	•	•		
Wild West	717	HBF Textiles	L2	•			•	•			•	•		
Aviator	SHBFAVI	HBF Textiles	L3											
Free Way	SHBFFRE	HBF Textiles	L3	•		•		•			•	•	•	•
Modern Patina	716	HBF Textiles	L3	•		•		•			•	•		
Persuede	718	HBF Textiles	L3	•		•		•			•	•		
Vivace II	709	HBF Textiles	L3	F		•		F			F	F		
Upper Crust	708	HBF Textiles	L5	F		•		F			F	F		
Voyage	713	HBF Textiles	L5	F		•		F			F	F		

# Seating

- Available upholstery option
- RR: railroaded, F/FR: Fire compliant model

Pattern Name	Code	Supplier	Grade	Relate Uph Side	Seek	Soothe Back/ Single Fabric	Soothe Seat	Soothe High Back Back/ Single Fabric	Soothe High Back Seat	Stride and ASP7/ZSC Ped Toppers	Svelte	Svelte Channel Stitch
Parker	1054	HBF Textiles	3	•	•	•	•			•	•	•
Blink	1048	HBF Textiles	4	•	•	•	•		•	•	•	•
Look-See	1044	HBF Textiles	4	•	•	•	•		•	•	•	•
Walkabout	1046	HBF Textiles	4	•	•	•	•		•	•	•	
Against the Grain	AGG	HBF Textiles	5	F	•					F		
Caddy Corner	1016	HBF Textiles	5	•	•		•			•	•	•
Checkmate	1043	HBF Textiles	5	•	•	•	•		•	•	•	•
Pebbled	SHBFPEB	HBF Textiles	5	•	•					•	•	•
Picnic Plaid	1029	HBF Textiles	5	•	•					•	•	
Upbeat	1036	HBF Textiles	5	•	•					•	•	•
Zippy	1045	HBF Textiles	5	•	•	•	•		•	•	•	•
Poppy	1047	HBF Textiles	6	•	•	•	•		•	•	•	•
Crew Cut	SHBFCRW	HBF Textiles	7		•					•	•	
Happy Camper	1028	HBF Textiles	7	•	•		•			•	•	•
Honest	SHBFHON	HBF Textiles	7		•							
Roundabout	1005	HBF Textiles	7	•	•		•			•	•	•
Beetle	SHBFBEE	HBF Textiles	8		•							
Dashing	1008	HBF Textiles	8	•	•		•			•	•	
Fourfold	SHBFFOU	HBF Textiles	8	•	•					•	•	
Modern Tweed	SHBFMOD	HBF Textiles	8	•	•					•	•	•
Sherpa	1031	HBF Textiles	8	•	•					•	•	•
All Terrain	1027	HBF Textiles	9	•	•		•			•	•	•
Comfort Zone	905	HBF Textiles	9							•	•	
Crafted Felt	1017	HBF Textiles	9	•	•		•			•	•	•
Curtain Wall	1023	HBF Textiles	9	•	•					•	•	
High Rise	SHBFHIG	HBF Textiles	9	•	•					•	•	
Madam Dottie	1001	HBF Textiles	9	•	•		•			•	•	•
Scribble XS	982	HBF Textiles	9	•	•					•	•	•
Uptown	1039	HBF Textiles	9	•	•		•			•	•	•
Wabi Sabi	SHBFWAB	HBF Textiles	9		•					•	•	•
Color Code	998	HBF Textiles	10	•	•					•	•	
Digital Bloom 2.0	1050	HBF Textiles	10		•					•		
Equation	SHBFEQU	HBF Textiles	10	F	•					F	•	•
Folded Lines	973	HBF Textiles	10	•	•		•			•	•	•
Remember	SHBFREM	HBF Textiles	10							•	•	
Roy's Cords	1025	HBF Textiles	10							•		
Soft Angles 2.0	1051	HBF Textiles	10		•					•	•	•
Upscale	1040	HBF Textiles	10	•	•		•			•	•	
Air Mail	1006	HBF Textiles	11	•	•		•			•	•	
Argyle Boucle	978	HBF Textiles	11	•	•		•			•	•	•
Brushed Canvas	SHBFBCV	HBF Textiles	11	•	•					•	•	•
Cloud	SHBFCLD	HBF Textiles	11		•						•	
Abito	ABI	HBF Textiles	12	•	•					•	•	•
Belgian Meadow	SHBFBLM	HBF Textiles	12	•	•					•	•	•
Complex	964	HBF Textiles	12	•	•		•			•	•	
Crosstweed	991	HBF Textiles	12	•	•					•	•	•
Cutout	SHBFCUT	HBF Textiles	12		•					•	•	•
Dot Grid	975	HBF Textiles	12		•						•	
Dot Structure	SHBFDOT	HBF Textiles	12	•	•					•	•	
Glint	SHBFGLT	HBF Textiles	12	•	•					ped only		
Grateful Grid	1015	HBF Textiles	12	•	•		•			•	•	
Heartfelt	SHBFHTF	HBF Textiles	12	F	•					F	•	•
Lava Rock	993	HBF Textiles	12	•	•		•			•	•	•
Merci Boucle	SHBFMER	HBF Textiles	12		•					•	•	•
Moving Blanket	SHBFMOV	HBF Textiles	12		•					•	•	
Sable Island	SHBFSAB	HBF Textiles	12	•	•					•	•	•
Sir Stripe A Lot	1004	HBF Textiles	12	•	•					•	•	•

UPHOLSTERY



# Seating

- Available upholstery option
- RR: railroaded, F/FR: Fire compliant model

UPHOLSTERY

Pattern Name	Code	Supplier	Grade	Relate Uph Side	Seek	Soothe Back/ Single Fabric	Soothe Seat	Soothe High Back Back/ Single Fabric	Soothe High Back Seat	Stride and ASP7/ZSC Ped Toppers	Svelte	Svelte Channel Stitch
Sweater Weather	1030	HBF Textiles	12	•	•	•			•	•		
Twist	SHBFTWS	HBF Textiles	12	•	•					•	•	•
Upstart	1042	HBF Textiles	12	•	•	•				•	•	•
Cherished Knit	954	HBF Textiles	13	•	•	•				•	•	•
Enriched Boucle	1021	HBF Textiles	13	•	•					•	•	•
Foundation	SHBFFND	HBF Textiles	13								•	•
Moving Forward	1014	HBF Textiles	13	•	•					•	•	•
Night Earth	1013	HBF Textiles	13	•	•	•				•	•	•
Pepper Blend	995	HBF Textiles	13	•	•	•				•	•	•
Quill	1011	HBF Textiles	13	•	•	•				•	•	•
Scribble XL	983	HBF Textiles	13	•	•					•	•	•
Sister Solid	1003	HBF Textiles	13	•	•					•	•	•
Afghan	AFG	HBF Textiles	14	•	•					•	•	•
Smart	SHBFSMT	HBF Textiles	14		•					•	•	
Velvet Mix	977	HBF Textiles	14	•	•	•				•	•	
Hipster	SHBFHPT	HBF Textiles	15	F	•					F	•	
Landscape Blur	1024	HBF Textiles	15	•	•					•	•	•
Poodle	1009	HBF Textiles	16	•	•					•	•	•
Sweater	SHBFSWE	HBF Textiles	16								•	•
Woven Memory	1019	HBF Textiles	16	•	•					•	•	
Crafted Cloud	1018	HBF Textiles	19							•	•	
Knitwork	SHBFKNI	HBF Textiles	21	•	•							
Bunny	1012	HBF Textiles	23	•	•					•	•	•
Eccentric	966	HBF Textiles	23		•					•	•	•
Eccentric	SHBFEC	HBF Textiles	23		•							
Wild West	717	HBF Textiles	L2		•	•						
Aviator	SHBFAVI	HBF Textiles	L3									
Free Way	SHBFFRE	HBF Textiles	L3	•	•							
Modern Patina	716	HBF Textiles	L3		•	•						
Persuede	718	HBF Textiles	L3		•	•						
Vivace II	709	HBF Textiles	L3		•							
Upper Crust	708	HBF Textiles	L5		•							
Voyage	713	HBF Textiles	L5		•							

# Seating

- Available upholstery option
- RR: railroaded, F/FR: Fire compliant model

Pattern Name	Code	Supplier	Grade			
				Versant	Vicinity Lounge	Vicinity Upholstered Seat
Parker	1054	HBF Textiles	3	•	•	•
Blink	1048	HBF Textiles	4	•	•	•
Look-See	1044	HBF Textiles	4	•	•	•
Walkabout	1046	HBF Textiles	4	•	•	•
Against the Grain	AGG	HBF Textiles	5			•
Caddy Corner	1016	HBF Textiles	5		•	•
Checkmate	1043	HBF Textiles	5	•	•	•
Pebbled	SHBFPEB	HBF Textiles	5		•	•
Picnic Plaid	1029	HBF Textiles	5		•	•
Upbeat	1036	HBF Textiles	5		•	•
Zippy	1045	HBF Textiles	5	•	•	•
Poppy	1047	HBF Textiles	6	•	•	•
Crew Cut	SHBFCRW	HBF Textiles	7	•	•	•
Happy Camper	1028	HBF Textiles	7		•	•
Honest	SHBFHON	HBF Textiles	7		•	•
Roundabout	1005	HBF Textiles	7		•	•
Beetle	SHBFBEE	HBF Textiles	8		•	•
Dashing	1008	HBF Textiles	8		•	•
Fourfold	SHBFFOU	HBF Textiles	8		•	•
Modern Tweed	SHBFMOD	HBF Textiles	8		•	•
Sherpa	1031	HBF Textiles	8		•	•
All Terrain	1027	HBF Textiles	9		•	•
Comfort Zone	905	HBF Textiles	9			•
Crafted Felt	1017	HBF Textiles	9		•	•
Curtain Wall	1023	HBF Textiles	9		•	•
High Rise	SHBFHIG	HBF Textiles	9		•	•
Madam Dottie	1001	HBF Textiles	9		•	•
Scribble XS	982	HBF Textiles	9		•	•
Uptown	1039	HBF Textiles	9		•	•
Wabi Sabi	SHBFWAB	HBF Textiles	9		•	•
Color Code	998	HBF Textiles	10		•	•
Digital Bloom 2.0	1050	HBF Textiles	10	•	•	•
Equation	SHBFEQU	HBF Textiles	10		•	•
Folded Lines	973	HBF Textiles	10		•	•
Remember	SHBFREM	HBF Textiles	10		•	•
Roy's Cords	1025	HBF Textiles	10			•
Soft Angles 2.0	1051	HBF Textiles	10	•	•	•
Upscale	1040	HBF Textiles	10		•	•
Air Mail	1006	HBF Textiles	11		•	•
Argyle Boucle	978	HBF Textiles	11		•	•
Brushed Canvas	SHBFBCV	HBF Textiles	11		•	•
Cloud	SHBFCLD	HBF Textiles	11			•
Abito	ABI	HBF Textiles	12		•	•
Belgian Meadow	SHBFBLM	HBF Textiles	12		•	•
Complex	964	HBF Textiles	12		•	•
Crosstweed	991	HBF Textiles	12		•	•
Cutout	SHBFCUT	HBF Textiles	12		•	•
Dot Grid	975	HBF Textiles	12		•	•
Dot Structure	SHBFDOT	HBF Textiles	12		•	•
Glint	SHBFGLT	HBF Textiles	12		•	•
Grateful Grid	1015	HBF Textiles	12		•	•
Heartfelt	SHBFHTF	HBF Textiles	12		•	•
Lava Rock	993	HBF Textiles	12		•	•
Merci Boucle	SHBFMER	HBF Textiles	12		•	•
Moving Blanket	SHBFMOV	HBF Textiles	12			•
Sable Island	SHBFSAB	HBF Textiles	12			•
Sir Stripe A Lot	1004	HBF Textiles	12		•	•

UPHOLSTERY

# Seating

- Available upholstery option
- RR: railroaded, F/FR: Fire compliant model

UPHOLSTERY

Pattern Name	Code	Supplier	Grade	Versant	Vicinity Lounge	Vicinity Upholstered Seat
Sweater Weather	1030	HBF Textiles	12		•	•
Twist	SHBFTWS	HBF Textiles	12		•	•
Upstart	1042	HBF Textiles	12		•	•
Cherished Knit	954	HBF Textiles	13		•	•
Enriched Boucle	1021	HBF Textiles	13		•	•
Foundation	SHBFFND	HBF Textiles	13			•
Moving Forward	1014	HBF Textiles	13		•	•
Night Earth	1013	HBF Textiles	13		•	•
Pepper Blend	995	HBF Textiles	13		•	•
Quill	1011	HBF Textiles	13		•	•
Scribble XL	983	HBF Textiles	13		•	•
Sister Solid	1003	HBF Textiles	13		•	•
Afghan	AFG	HBF Textiles	14		•	•
Smart	SHBFSMT	HBF Textiles	14			•
Velvet Mix	977	HBF Textiles	14			•
Hipster	SHBFHPT	HBF Textiles	15		•	•
Landscape Blur	1024	HBF Textiles	15		•	•
Poodle	1009	HBF Textiles	16		•	•
Sweater	SHBFSWE	HBF Textiles	16		•	•
Woven Memory	1019	HBF Textiles	16		•	•
Crafted Cloud	1018	HBF Textiles	19			•
Knitwork	SHBFKNI	HBF Textiles	21			•
Bunny	1012	HBF Textiles	23			•
Eccentric	966	HBF Textiles	23			
Eccentric	SHBFEC	HBF Textiles	23			•
Wild West	717	HBF Textiles	L2		•	•
Aviator	SHBFAVI	HBF Textiles	L3		•	
Free Way	SHBFFRE	HBF Textiles	L3		•	
Modern Patina	716	HBF Textiles	L3		•	•
Persuede	718	HBF Textiles	L3		•	•
Vivace II	709	HBF Textiles	L3		•	•
Upper Crust	708	HBF Textiles	L5		•	•
Voyage	713	HBF Textiles	L5		•	•



Paint Name	Allsteel Code	Grade	Clubhouse	Clubhouse Tile	Clubhouse Table Extension	Vicinity Seating	Acuity Work / Conference	Acuity Multi-Purpose Side	Relate Work/Conference, Aluminum Work/Conference, Work Stool Mesh Back	Relate Work/Conference, Aluminum Work/Conference Upholstered Back	Aluminum Relate Work / Conference Stool Mesh Back	Relate Multi-Purpose Side, 4-Legged
Black	P71	1				•	•					
Carbon	P4Q	1										
Charblack	CBK	1						•	•			•
Charblack Metallic*	P80	1										
Designer White	PJW	1		•	•							
Flint	P02	1		•	•							
Salt	P8C	1										
Black Mica Texture	P6P	1										
Textured Designer White	PK7	1	•	•								
Textured Flint	P7A	1	•	•								
Titanium	P8T / T	1				•	•	•				•
Graphite Metallic Texture	P85	2				•	•					
Night Bronze	P8B	2				•						
Pyrite	PJE	2				•						
Silver	PR6	2		•	•	•	•					•
Silver Generic	SVR	2										
Silver Texture	PR8	2	•	•								
Solar Black	P8X	2				•	•					•
Bullseye	PJF	3				•						
Polished Aluminum	PAL / P	4				•				•		
Polished Chrome	POL	4				•						

FINISHES

	Relate Multi-Purpose Side Stool Upholstered and Wood Back	Svelte	Lyric Work / Conference & Stool Base	Lyric MP 4 Leg, Lyric MP Stool	Lyric Side Chair & Lyric MP Stacker, Frame Finish	Mineo Task Base	Clarity Task, Clarity Guest, Clarity Lounge	Clarity Value Task	Clarity Value Task	Inspire	Nimble	Evo Task Fixed Arms, Evo Conference Fixed Arms, Evo Stool, Fixed Arms	Evo Task, Evo Conference, Evo Side Chair	Seek
	•		•	•	•	•	•	•		•		•	•	•
•									•					
			•				•							
			•									•	•	
					•							•	•	
			•	•		•	•		•	•		•	•	•
•			•	•			•		•	•		•	•	•
•			•	•		•			•	•		•	•	•
			•											
	•	•			•	•					•	•		

FINISHES

Paint Name	Allsteel Code	Grade	Parallel Frames & Table Bases	Parallel Arm Sleeve	Linger Base	Rise Tray	Take 5	Vicinity Lounge	Recharge Tables
Black	P27	1				•	•		
Black	P71	1		•		•	•	•	
Brownstone	P7D	1		•		•			
Bungalow	P7C	1				•			
Carbon	P4Q	1	•	•					
Charblack	CBK	1							
Cinder	P7Q	1		•		•			
Designer White	PJW	1	•	•		•	•	•	
Flint	P02	1		•		•		•	
Fossil	P28	1		•		•			
Loft	P7B	1		•		•			
Muslin	P4J	1		•		•			
Parchment	P93	1		•		•			
Pebble	P8R	1		•		•			
Pewter	P8D	1		•		•			
Salt	P8C	1		•		•			
Textured Brownstone	P7J	1							
Textured Designer White	PK7	1							•
Textured Flint	P7A	1							•
Textured Loft	P7L	1							
Textured Muslin	P7M	1							
Textured Pebble	P8Y	1							
Textured Salt	P8Z	1							
Textured Titanium	P8V	1							
Titanium	P8T / T	1		•		•	•		
Champagne Metallic	PR5	2		•		•			
Designer White High Gloss 65	P8W	2				•			
Gunmetal Metallic	PR3	2		•		•			
Night Bronze	P8B	2		•		•			
Pyrite	PJE	2	•	•		•		•	
Silver	PR6	2	•	•	•	•	•	•	
Silver Texture	PR8	2							•
Solar Black	P8X	2		•		•	•		
Atom	P8S	3		•		•			
Blossom	P8K	3		•		•			
Bullseye	PJF	3		•		•		•	
Ember	P8P	3		•		•			
Ion	P8N	3		•		•			
Iris	P8J	3		•		•			
Krypton	P8F	3		•		•			
Regatta	P8M	3		•		•			
Succulent	P8A	3		•		•			
Polished Aluminum	PAL / P	4			•				
Polished Chrome	POL	4	•				•	•	





Paint Name	Allsteel Code	Grade	Harvest Classic Tables	Belong Glass Top and Bases	Recharge Tables	Aware Credenza Inserts	Aware Credenzas	Aware Lectern
Black	P27	1	•	•	•			
Black	P71	1	•	•	•			
Brownstone	P7D	1	•	•	•			
Bungalow	P7C	1	•	•	•			
Carbon	P4Q	1						
Charblack	CBK	1						
Charblack Metallic*	P80	1						
Cinder	P7Q	1	•	•	•			
Designer White	PJW	1	•	•	•	•	•	•
Flint	P02	1	•	•	•	•	•	•
Fog	FOG	1						
Fossil	P28	1	•	•	•			
Greige		1						
Light Grey	P06	1						
Loft	P7B	1	•	•	•			
Muslin	P4J	1	•	•	•			
Nickel	P8L	1						
Parchment	P93	1			•			
Pebble	P8R	1	•	•	•			
Pewter	P8D	1	•	•	•			
Platinum Metallic Texture	P6H	1						
Putty	PJS	1						
Salt	P8C	1	•	•	•			
Shadow	P4K	1						
Textured Brownstone	P7J	1						
Textured Designer White	PK7	1						
Textured Flint	P7A	1						
Textured Loft	P7L	1						
Textured Muslin	P7M	1						
Textured Pebble	P8Y	1						
Textured Salt	P8Z	1						
Textured Titanium	P8V	1						
Titanium	P8T / T	1	•	•	•			
White	PD8	1						
Anodized Silver	PR0	2						
Bronze		2						
Champagne Metallic	PR5	2	•	•	•			
Designer White High Gloss 65	P8W	2	•	•	•			
Graphite Metallic Texture	P85	2						
Gunmetal Metallic	PR3	2	•	•	•			
Matte Gold	P8G	2						
Night Bronze	P8B	2	•	•	•			
Platinum Metallic	PR2	2	•	•	•			
Pyrite	PJE	2	•	•	•			
Silver	PR6	2	•	•	•	•	•	•
Silver Generic	SVR	2						
Silver Texture	PR8	2						
Solar Black	P8X	2	•	•	•			
Atom	P8S	3	•	•	•	•		
Blossom	P8K	3	•	•	•			



Paint Name	Allsteel Code	Grade	Harvest Classic Tables	Belong Glass Top and Bases	Aware	Aware Credenza Inserts	Aware Credenzas	Aware Lectern
Bullseye	PJF	3	•	•	•			
Ember	P8P	3	•	•	•			
Ion	P8N	3	•	•	•			
Iris	P8J	3	•	•	•			
Krypton	P8F	3	•	•	•	•		
Regatta	P8M	3	•	•	•			
Succulent	P8A	3	•	•	•			
Anodized Aluminum	AAL	1						
Black Anodized Aluminum	BKAL	1						
Satin Anodized Aluminum	SAL	1						
Brushed Stainless / Brushed Chrome Steel		4						
Polished Aluminum	PAL / P	4						
Polished Chrome	POL	4						
Markerboard White	MKP	6						

FINISHES

# Seating / Social Collaborative

Aware Mobile Boards	Aware Polished Only	Merge Adaptative Table Base	Merge Polished Adaptative Table Base	Structure Tables Painted Foot	Structure Tables Pedestal Base	Structure Table Wall Mount Bracket & Table Media Bracket	Structure Tables Polished Foot Option X Base, T-Leg Base, Adaptive Table & Adjustable Table
				•			•
				•			•
				•			•
				•			•
				•			•
				•			•
				•			•
	•		•				•

FINISHES

Pattern Name	Code	Grade	Harvest Classic Tables & Bases	Harvest Rustic Surfaces	Structure Table Tops	Structure Table Tops Solid Laminate Only (Panel, Cube, Cylinder)	Tables (Aware, Belong, Merge, Vicinity)	Townhall	Parallel Tables	Park by Norm Architects	Park Planter Cap	Recharge Tables	Rise	Two Thirds
Ash	LT3B	1												
Handspun Dove	LAHD	1	•											
Handspun Pearl	LAHP	1	•											
Handspun Chestnut	LAHC	1	•											
Handspun Slate	LAHS	1	•											
Silver Mesh	LT8D	1	•											
Black	P	1	•	•	•	•	•	•	•	•	•	•	•	•
Brownstone	LM13	1	•	•	•	•	•	•	•	•	•	•	•	•
Bungalow	LM12	1	•	•	•	•	•	•	•	•	•	•	•	•
Designer White 15051	LDW1	1	•	•	•	•	•	•	•	•	•	•	•	•
Flint	LM16	1	•	•	•	•	•	•	•	•	•	•	•	•
Fossil Shale	LEH1	1	•	•	•	•	•	•	•	•	•	•	•	•
Loft	LM11	1	•	•	•	•	•	•	•	•	•	•	•	•
Muslin	LM15	1	•	•	•	•	•	•	•	•	•	•	•	•
Titanium	LT11	1	•	•	•	•	•	•	•	•	•	•	•	•
Belair	LWBA	1	•	•	•	•	•	•	•	•	•	•	•	•
Bourbon Cherry	H	1	•	•	•	•	•	•	•	•	•	•	•	•
Field Elm	LWFE	1	•	•	•	•	•	•	•	•	•	•	•	•
Florence Walnut	LFW1	1	•	•	•	•	•	•	•	•	•	•	•	•
Kingswood Walnut	LK11	1	•	•	•	•	•	•	•	•	•	•	•	•
Natural Maple	LWD	1	•	•	•	•	•	•	•	•	•	•	•	•
NeoWalnut	LNU1	1	•	•	•	•	•	•	•	•	•	•	•	•
Pinnacle	PINC	1	•	•	•	•	•	•	•	•	•	•	•	•
Shaker Cherry	LW7C	1	•	•	•	•	•	•	•	•	•	•	•	•
Beigewood	LWBE	2	•	•	•	•	•	•	•	•	•	•	•	•
Fawn Cypress	LFC1	2	•	•	•	•	•	•	•	•	•	•	•	•
Lowell Ash	LLA1	2	•	•	•	•	•	•	•	•	•	•	•	•
Mangalore Mango	LMM1	2	•	•	•	•	•	•	•	•	•	•	•	•
Natural Recon	LNR1	2	•	•	•	•	•	•	•	•	•	•	•	•
Phantom Charcoal	LPC1	2	•	•	•	•	•	•	•	•	•	•	•	•
Phantom Ecrú	LPE1	2	•	•	•	•	•	•	•	•	•	•	•	•
Portico Teak	LPT1	2	•	•	•	•	•	•	•	•	•	•	•	•
Skyline Walnut	LSW1	2	•	•	•	•	•	•	•	•	•	•	•	•
Veranda Teak	LVT1	2	•	•	•	•	•	•	•	•	•	•	•	•
Natural Walnut	LWNW	3	•	•	•	•	•	•	•	•	•	•	•	•
Open Line Laminate Program	N/A	Variable		•	•		•	•	•		•			

Pattern Name	Code	Grade	Inspire Tablet	Clubhouse
Ash	LT3B	1		•
Handspun Chestnut	LAHC	1	•	•
Handspun Dove	LAHD	1	•	•
Handspun Pearl	LAHP	1	•	•
Handspun Slate	LAHS	1	•	•
Silver Mesh	LT8D	1	•	•
Black	P	1		•
Designer White 15051	LDW1	1		•
Flint	LM16	1		•
Fossil Shale	LEH1	1		•
Loft	LM11	1		•
Muslin	LM15	1		•
Titanium	LT11	1		•
Belair	LWBA	1		•
Bourbon Cherry	H	1		•
Field Elm	LWFE	1		•
Florence Walnut	LFW1	1		•
Kingswood Walnut	LK11	1		•
Natural Maple	LWD	1	•	•
NeoWalnut	LNU1	1		•
Pinnacle	PINC	1		•
Shaker Cherry	LW7C	1		•
Beigewood	LWBE	2		•
Fawn Cypress	LFC1	2		•
Lowell Ash	LLA1	2		•
Mangalore Mango	LMM1	2		•
Natural Recon	LNR1	2		•
Phantom Charcoal	LPC1	2		•
Phantom Ecrú	LPE1	2		•
Portico Teak	LPT1	2		•
Skyline Walnut	LSW1	2		•
Veranda Teak	LVT1	2		•
Natural Walnut	LWNW	3		•
Open Line Laminate Program	N/A	Variable		

FINISHES

Veneer Type	Stain Name	Code	Grade	Parallel Tables	Two Thirds
FSC Stratawood Cherry	Cinnamon Cherry	FSCSC260	1	•	
FSC Stratawood Cherry	Lowell Ash	FSCSC394	1	•	
FSC Stratawood Cherry	Clear Cherry	FSCSC700	1	•	
FSC Stratawood Cherry	Light Cherry	FSCSC701	1	•	
FSC Stratawood Cherry	Burnished Cherry	FSCSC777	1	•	
FSC Stratawood Cherry	Shaker Cherry	FSCSC774	1	•	
FSC Stratawood Maple	Field Elm	FSCSE599	1	•	
FSC Stratawood Maple	Clear Maple	FSCSE800	1	•	
FSC Stratawood Maple	Harvest Maple	FSCSE856	1	•	
FSC Stratawood Maple	Beigewood	FSCSE878	1	•	
FSC Stratawood Maple	Phantom Ecu	FSCSE912	1	•	
FSC Stratawood Maple	Belair	FSCSE934	1	•	
FSC Stratawood Oak	Clear Oak	FSCSF300	1	•	
FSC Stratawood Oak	Dark Rift Cut Oak	FSCSF331	1	•	
FSC Stratawood Walnut	Florence Walnut	FSCST579	1	•	
FSC Stratawood Walnut	Light Walnut	FSCST601	1	•	
FSC Stratawood Walnut	Skyline Walnut	FSCST625	1	•	
FSC Stratawood Walnut	Pinnacle Walnut	FSCST679	1	•	
FSC Stratawood Walnut	Sumatra Walnut	FSCST693	1	•	
FSC Natural Cherry	Cinnamon Cherry	FSCNC260	1	•	
FSC Natural Cherry	Light Cherry	FSCNC701	1	•	
FSC Natural Cherry	Burnished Cherry	FSCNC777	1	•	
FSC Natural Cherry	Lowell Ash	FSCNC394	1	•	
FSC Natural Cherry	Medium Red Cherry	FSCNC512	1	•	
FSC Natural Cherry	Shaker Cherry	FSCNC774	1	•	
FSC Natural Maple	Clear Maple	FSCNE800	1	•	
FSC Natural Maple	Harvest Maple	FSCNE856	1	•	
FSC Natural Walnut	Ebony Walnut	FSCNT509	1	•	
FSC Natural Walnut	Florence Walnut	FSCNT579	1	•	
FSC Natural Walnut	Light Walnut	FSCNT601	1	•	
FSC Natural Walnut	Skyline Walnut	FSCNT625	1	•	
FSC Natural Walnut	Nutmeg Walnut	FSCNT629	1	•	
FSC Natural Walnut	Pinnacle Walnut	FSCNT679	1	•	
FSC Natural Walnut	Sumatra Walnut	FSCNT693	1	•	
FSC Natural Rift Cut Oak	Fawn Cypress	FSCRF108	2	•	
FSC Natural Rift Cut Oak	Light Rift Cut Oak	FSCRF301	2	•	
FSC Natural Rift Cut Oak	Dark Rift Cut Oak	FSCRF331	2	•	
FSC Natural Rift Cut Oak	Phantom Ecu	FSCRF912	2	•	
Natural Cherry	Cinnamon Cherry	NC260	1	•	•
Natural Cherry	Lowell Ash	NC394	1	•	
Natural Cherry	Medium Red Cherry	NC512	1	•	•
Natural Cherry	Light Cherry	NC701	1	•	•
Natural Cherry	Shaker Cherry	NC774	1	•	
Natural Cherry	Burnished Cherry	NC777	1	•	•
Natural Maple	Clear Maple	NE800	1	•	•
Natural Maple	Harvest Maple	NE856	1	•	•
Natural Rift Cut Oak	Fawn Cypress	RF108	2	•	•
Natural Rift Cut Oak	Light Rift Cut Oak	RF301	2	•	•
Natural Rift Cut Oak	Dark Rift Cut Oak	RF331	2	•	•
Natural Rift Cut Oak	Phantom Ecu	RF912	2	•	•
Natural Walnut	Ebony Walnut	NT509	1	•	•
Natural Walnut	Florence Walnut	NT579	1	•	•
Natural Walnut	Light Walnut	NT601	2	•	•
Natural Walnut	Skyline Walnut	NT625	1	•	•
Natural Walnut	Nutmeg Walnut	NT629	1	•	•
Natural Walnut	Pinnacle Walnut	NT679	1	•	•
Natural Walnut	Sumatra Walnut	NT693	1	•	•

Veneer Type	Stain Name	Code	Grade	Parallel Tables	Two Thirds
Stratawood Cherry	Cinnamon Cherry	SC260	1	•	•
Stratawood Cherry	Lowell Ash	SC394	1	•	•
Stratawood Cherry	Clear Cherry	SC700	1	•	•
Stratawood Cherry	Light Cherry	SC701	1	•	•
Stratawood Cherry	Shaker Cherry	SC774	1	•	•
Stratawood Cherry	Burnished Cherry	SC777	1	•	•
Stratawood Maple	Field Elm	SE599	1	•	•
Stratawood Maple	Clear Maple	SE800	1	•	•
Stratawood Maple	Harvest Maple	SE856	1	•	•
Stratawood Maple	Beigewood	SE878	1	•	•
Stratawood Maple	Phantom Ecu	SE912	1	•	•
Stratawood Maple	Belair	SE934	1	•	•
Stratawood Silver Oak	Clear	SB100	1	•	•
Stratawood Silver Oak	Portico Teak	SB150	1	•	•
Stratawood Oak	Clear Oak	SF300	1	•	•
Stratawood Oak	Dark Rift Cut Oak	SF331	1	•	•
Stratawood Walnut	Florence Walnut	ST579	1	•	•
Stratawood Walnut	Light Walnut	ST601	1	•	•
Stratawood Walnut	Skyline Walnut	ST625	1	•	•
Stratawood Walnut	Pinnacle Walnut	ST679	1	•	•
Stratawood Walnut	Sumatra Walnut	ST693	1	•	•



Veneer Type	Stain Name	Code	Grade	Relate MP Side	Reflect	Vicinity Lounge
Natural Cherry	Light Cherry	NC701	1	•		
Natural Cherry	Burnished Cherry	NC777	1	•		
Natural Maple	Clear Maple	NE800	1	•		
Stratawood Cherry	Light Cherry	SC701	1		•	
Stratawood Cherry	Burnished Cherry	SC777	1		•	
Stratawood Maple	Field Elm	SE599	1		•	
Stratawood Maple	Clear Maple	SE800	1		•	
Stratawood Maple	Harvest Maple	SE856	1		•	
Stratawood Maple	Phantom Ecu	SE912	1		•	
Stratawood Maple	Belair	SE934	1		•	
Stratawood Oak	Clear Oak	SF300	1		•	
Stratawood Oak	Dark Rift Cut Oak	SF331	1		•	
Vicinity Veneer	Natural Oak	NF302				•
Vicinity Veneer	Warm Brown Oak	NF394				•
Vicinity Veneer	Black Wash Beech	RB997				•
Vicinity Veneer	Grey Wash Oak	NF314				•
Vicinity Veneer	Natural Walnut	QT500				•
Vicinity Veneer	Natural Beech	RB900				•
Vicinity Veneer	White Wash Beech	RB912				•

Veneer Type	Stain Name	Code	Grade	Aware Tables	Belong Tables	Harvest Classic Tables & Bases	Harvest Metal Veneer Surfaces (Tops)	Harvest Rustic Tables
FSC Stratawood Cherry	Cinnamon Cherry	FSCSC260	1	•	•	•	•	
FSC Stratawood Cherry	Lowell Ash	FSCSC394	1	•	•	•	•	
FSC Stratawood Cherry	Clear Cherry	FSCSC700	1	•	•	•	•	
FSC Stratawood Cherry	Light Cherry	FSCSC701	1	•	•	•	•	
FSC Stratawood Cherry	Shaker Cherry	FSCSC774	1	•	•	•	•	
FSC Stratawood Cherry	Burnished Cherry	FSCSC777	1	•	•	•	•	
FSC Stratawood Maple	Field Elm	FSCSE599	1	•	•	•	•	
FSC Stratawood Maple	Clear Maple	FSCSE800	1	•	•	•	•	
FSC Stratawood Maple	Harvest Maple	FSCSE856	1	•	•	•	•	
FSC Stratawood Maple	Beigewood	FSCSE878	1	•	•	•	•	
FSC Stratawood Maple	Phantom Ecu	FSCSE912	1	•	•	•	•	
FSC Stratawood Maple	Belair	FSCSE934	1	•	•	•	•	
FSC Stratawood Oak	Clear Oak	FSCSF300	1	•	•	•	•	
FSC Stratawood Oak	Dark Rift Cut Oak	FSCSF331	1	•	•	•	•	
FSC Stratawood Walnut	Florence Walnut	FSCST579	1	•	•	•	•	
FSC Stratawood Walnut	Light Walnut	FSCST601	1	•	•	•	•	
FSC Stratawood Walnut	Skyline Walnut	FSCST625	1	•	•	•	•	
FSC Stratawood Walnut	Pinnacle Walnut	FSCST679	1	•	•	•	•	
FSC Stratawood Walnut	Sumatra Walnut	FSCST693	1	•	•	•	•	
FSC Natural Cherry	Cinnamon Cherry	FSCNC260	1	•	•	•	•	
FSC Natural Cherry	Lowell Ash	FSCNC394	1	•	•	•	•	
FSC Natural Cherry	Medium Red Cherry	FSCNC512	1	•	•	•	•	
FSC Natural Cherry	Light Cherry	FSCNC701	1	•	•	•	•	
FSC Natural Cherry	Shaker Cherry	FSCNC774	1	•	•	•	•	
FSC Natural Cherry	Burnished Cherry	FSCNC777	1	•	•	•	•	
FSC Natural Maple	Clear Maple	FSCNE800	1	•	•	•	•	
FSC Natural Maple	Harvest Maple	FSCNE856	1	•	•	•	•	
FSC Natural Walnut	Ebony Walnut	FSCNT509	1	•	•	•	•	
FSC Natural Walnut	Florence Walnut	FSCNT579	1	•	•	•	•	
FSC Natural Walnut	Light Walnut	FSCNT601	1	•	•	•	•	
FSC Natural Walnut	Skyline Walnut	FSCNT625	1	•	•	•	•	
FSC Natural Walnut	Nutmeg Walnut	FSCNT629	1	•	•	•	•	
FSC Natural Walnut	Pinnacle Walnut	FSCNT679	1	•	•	•	•	
FSC Natural Walnut	Sumatra Walnut	FSCNT693	1	•	•	•	•	
FSC Natural Rift Cut Oak	Fawn Cypress	FSCRF108	2	•	•	•	•	
FSC Natural Rift Cut Oak	Light Rift Cut Oak	FSCRF301	2	•	•	•	•	
FSC Natural Rift Cut Oak	Dark Rift Cut Oak	FSCRF331	2	•	•	•	•	
FSC Natural Rift Cut Oak	Phantom Ecu	FSCRF912	2	•	•	•	•	
Natural Cherry	Cinnamon Cherry	NC260	1	•	•	•	•	
Natural Cherry	Lowell Ash	NC394	1	•	•	•	•	
Natural Cherry	Medium Red Cherry	NC512	1	•	•	•	•	
Natural Cherry	Light Cherry	NC701	1	•	•	•	•	
Natural Cherry	Shaker Cherry	NC774	1	•	•	•	•	
Natural Cherry	Burnished Cherry	NC777	1	•	•	•	•	
Natural Maple	Clear Maple	NE800	1	•	•	•	•	
Natural Maple	Harvest Maple	NE856	1	•	•	•	•	
Natural Rift Cut Oak	Fawn Cypress	RF108	2	•	•	•	•	
Natural Rift Cut Oak	Light Rift Cut Oak	RF301	2	•	•	•	•	
Natural Rift Cut Oak	Dark Rift Cut Oak	RF331	2	•	•	•	•	
Natural Rift Cut Oak	Phantom Ecu	RF912	2	•	•	•	•	
Natural Walnut	Ebony Walnut	NT509	1	•	•	•	•	
Natural Walnut	Florence Walnut	NT579	1	•	•	•	•	
Natural Walnut	Light Walnut	NT601	1	•	•	•	•	
Natural Walnut	Skyline Walnut	NT625	1	•	•	•	•	
Natural Walnut	Nutmeg Walnut	NT629	1	•	•	•	•	
Natural Walnut	Pinnacle Walnut	NT679	1	•	•	•	•	
Natural Walnut	Sumatra Walnut	NT693	1	•	•	•	•	

FINISHES

Veneer Type	Stain Name	Code	Grade	Aware Tables	Belong Tables	Harvest Classic Tables & Bases	Harvest Metal Veneer Surfaces (Tops)	Harvest Rustic Tables
Solid Plank Maple	Medium Grey	LL814						•
Solid Plank Maple	Light Neutral	LL815						•
Solid Plank Maple	Dark Brown	LL897						•
Stratawood Cherry	Cinnamon Cherry	SC260	1	•	•	•	•	
Stratawood Cherry	Lowell Ash	SC394	1	•	•	•	•	
Stratawood Cherry	Clear Cherry	SC700	1	•	•	•	•	
Stratawood Cherry	Light Cherry	SC701	1	•	•	•	•	
Stratawood Cherry	Shaker Cherry	SC774	1	•	•	•	•	
Stratawood Cherry	Burnished Cherry	SC777	1	•	•	•	•	
Stratawood Maple	Field Elm	SE599	1	•	•	•	•	
Stratawood Maple	Clear Maple	SE800	1	•	•	•	•	
Stratawood Maple	Harvest Maple	SE856	1	•	•	•	•	
Stratawood Maple	Beigewood	SE878	1	•	•	•	•	
Stratawood Maple	Phantom Ecu	SE912	1	•	•	•	•	
Stratawood Maple	Belair	SE934	1	•	•	•	•	
Stratawood Silver Oak	Clear	SB100	1	•	•	•	•	
Stratawood Silver Oak	Portico Teak	SB150	1	•	•	•	•	
Stratawood Oak	Clear Oak	SF300	1	•	•	•	•	
Stratawood Oak	Dark Rift Cut Oak	SF331	1	•	•	•	•	
Stratawood Walnut	Florence Walnut	ST579	1	•	•	•	•	
Stratawood Walnut	Light Walnut	ST601	1	•	•	•	•	
Stratawood Walnut	Skyline Walnut	ST625	1	•	•	•	•	
Stratawood Walnut	Pinnacle Walnut	ST679	1	•	•	•	•	
Stratawood Walnut	Sumatra Walnut	ST693	1	•	•	•	•	

**Seating** (Arm and armless versions available for most models.)

**Acuity®** pages 54-61



High-Back Work Chair



Side Chair

**Clarity®** pages 62-65



Work Chair



Guest Chair



Lounge Chair

**Evo™** pages 66-71



High-Back Work Chair



Mid-Back Conference



High-Back Work Stool

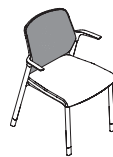

Side Chair

**Inspire®** pages 73-91



4-Leg Multi-Purpose



Sled Base Multi-Purpose



4-Leg Tablet Arm



Multi-Purpose Work Chair



Multi-Purpose Work Stool



4-Leg Stool

**Lyric™** pages 92-107



High-Back Work Chair



High-Back Work Stool



Large & Tall Work Chair



Side Chair



4-Leg Multi-Purpose



Multi-Purpose Work Chair



Wire Stool



Wire Stacker Multi-Purpose

**Mimeo™** pages 108-111



Work Chair



Work Stool

**Nimble®** pages 112-113



High Density Stacking Chair

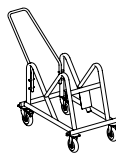

Chair Cart

**O6™** pages 114-117



High-Back Work Chair



High-Back Work Stool

#### Seating (Arm and armless versions available for most models.)

##### Pli™ pages 118-121

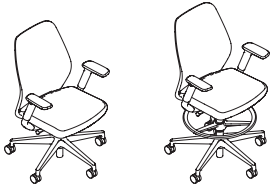

Work Chair

Work Stool

##### Quip™ pages 122-123



Work Chair

##### Relate® pages 124-139



High-Back  
Work Chair



High-Back  
Work Stool



Side Chair



4-Leg Stool

##### Seek® pages 140-143



Multi-Purpose  
Stacking and  
Nesting Chair

##### Svelte pages 145-147



High Back Chair



Mid Back Chair

##### Vicinity™ pages 150-153

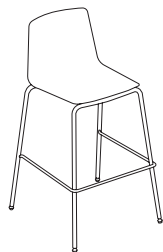

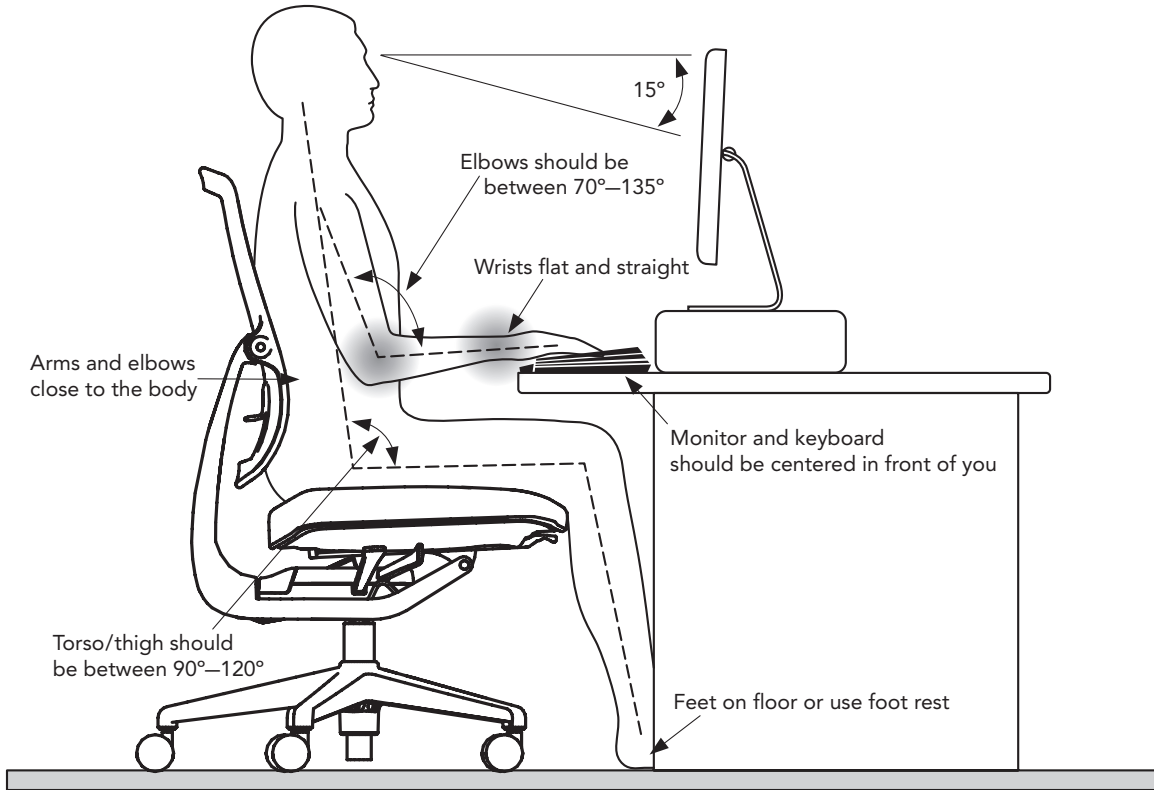

Measurements based on BIFMA G1-2013 guidelines. Many of the measurements are taken from the compressed seat (dotted horizontal line) and the tangent lumbar apex (dotted vertical line).

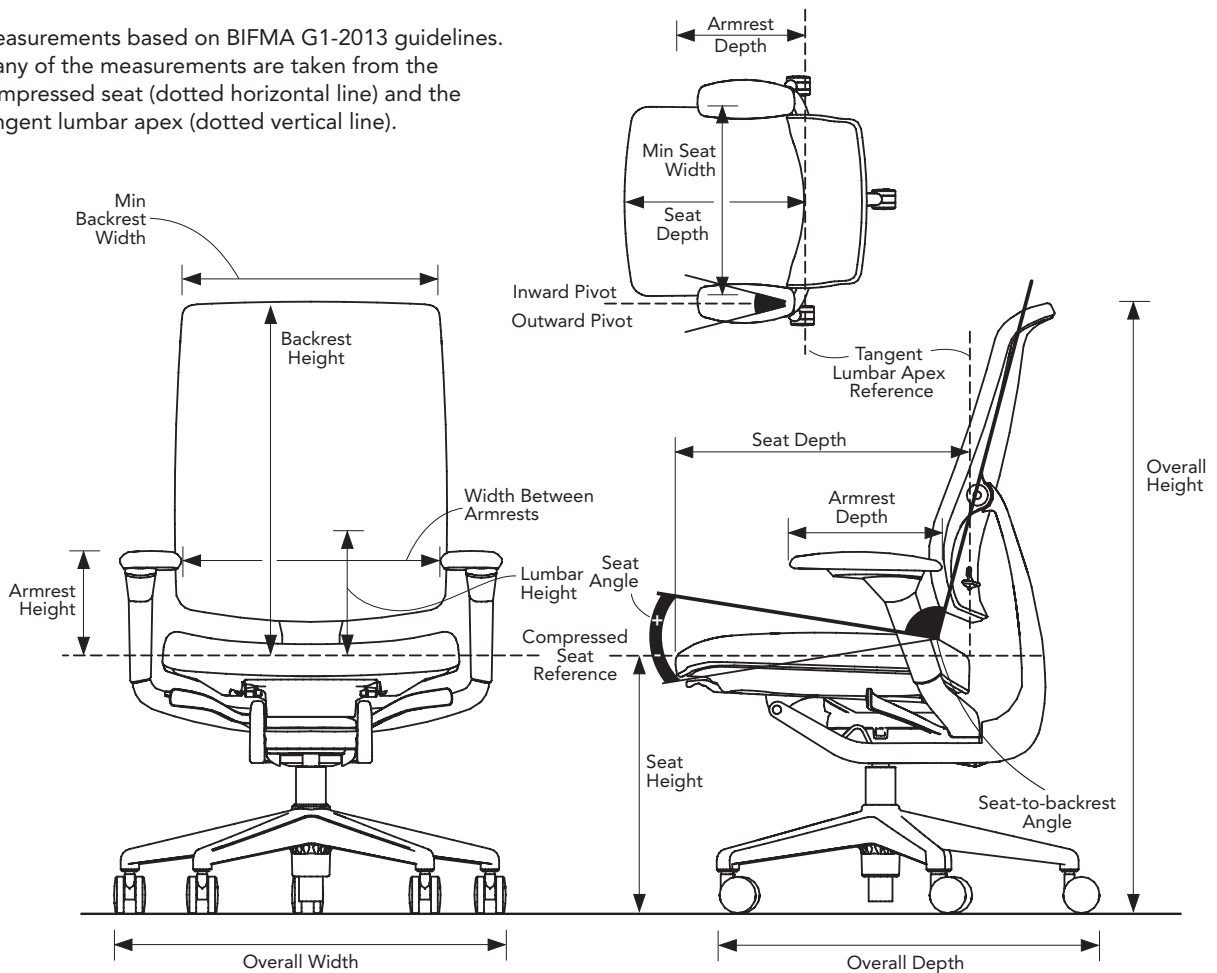

SEATING OVERVIEW

**ANSI** — (American National Standards Institute) ANSI is a private, non-profit organization (501(c)3) that administers and coordinates the U.S. voluntary standardization and conformity assessment system.

**Asynchronous** — High-performance seating control system with three levers to modify adjustments on the chair for a more customized fit:

- Angle of back relative to seat
- Tilt (free float or infinite locking)
- Forward tilt of seat

**ASTM Standards** — (American Society for Testing and Materials) is an international standards group that develops and publishes technical standards for many products, materials, and services.

**BIFMA** — (Business and Institutional Furniture Manufacturer's Association) Produces voluntary standards for manufacturers of office furnishings. These standards are intended to provide a common basis for the evaluation of safety, durability, dimensions, ergonomics, and the structural adequacy of the specified furniture.

**CAL TB117-2013** — Method used to test open flame resistance of components of upholstered furniture. This test is done with a lighted cigarette placed in crevices of mock-up components.

**CFC** — (Chlorofluorocarbons) CFCs are broken down by strong ultraviolet light in the stratosphere and release chlorine atoms that then deplete the ozone layer. CFCs are commonly used as refrigerants, solvents, and foam blowing agents.

**COL** — (Customer's Own Leather)

**COM** — (Customer's Own Material) See pages 6-8.

**Ergonomic** — The coordination of the design of a product with the capacities and requirements of the user.

**HFES** — (Human Factors and Ergonomics Society) A membership-based organization whose mission is to promote the discovery and exchange of knowledge concerning the characteristics of human beings that are applicable to the design of systems and devices of all kinds.

**Knee Tilt** — A seating control that pivots about a point underneath the knee (towards the front of the seat) to reduce pressure on the back of the legs when reclining.

**Memory Foam** — Viscoelastic foam developed by NASA that retains the shape impressed upon it to reduce pressure points and distribute the load on the seat more evenly.

**NFPA261** — Method of test for determining resistance of mock-up upholstered furniture material assemblies to ignition by a smoldering cigarette. This test is done with a lighted cigarette placed in crevices of mock-up components.

**NFPA266** — Method of test for fire characteristics of upholstered furniture exposed to flaming ignition source. This is a full-scale test of mock up. Equivalent to CAL133

**Pneumatic** — Operated by compressed air in a tool or machine

**Powder Coat** — Dry paint electrostatically charged for better adhesion to parts and baked on for a durable finish.

**Recyclable** — Able to be reclaimed and re-used into another value-added product.

**Recycled** — Made from post-industrial or post-consumer waste products.

**Synchro-Tilt** — A seating control where the chair back reclines at a prescribed ratio in relation to seat angle. Allows user to recline while keeping seat cushion relatively level to the floor.

**Urethane** — Synthetic plastic; any of a group of thermoplastic polymers that are used in resins, coatings, insulation, adhesives, foams, and fibers.

**Weight-Activated** — A seating control that has the recline tension engineered into the chair so that the chair recline tension will automatically vary depending on the weight of the user reclining the chair.

**Wyzenbeck Testing** — Method of testing the abrasion resistance of a fabric utilizing a cotton duck or wire mesh that is rubbed, back and forth (a double rub), over the fabric.

















*Acuity is a chair that enhances any environment, any body. Designed in collaboration with Bruce Fifield of Milan-based Design Continuum Italia, Acuity is designed with Italian sensibility and Allsteel ingenuity. Its design and ergonomics work seamlessly while the controls are intuitive. Acuity is elegant and pleasing to the eye, as anything inessential has been stripped away, leaving behind only a purity of form.*

*Acuity is level®2 certified and has achieved SCS Indoor Advantage™ Gold Certification. Acuity is designed and manufactured to have minimal impact on both the physical and social environment, made with no PVC components and has a recycled content of 28%-37%, depending on chair base selected.*

## KEY FEATURES

### AcuFit®

Acuity provides ideal ergonomics, instantly. We used the latest anthropometric databases, high-tech modeling, and intense observation to understand just what a body needs. You'll feel it the minute you sit – snug support and contoured cushioning that conforms to your body and stays with you throughout the day. No matter what size you are or how you work, Acuity adapts, automatically.

### Weight-activated mechanism

A ground-breaking, weight-activated mechanism built into the chair's structure does two things critical to effective ergonomics: automatically adjusts recline tension in response to the user's weight; and, keeps the seat and back moving smoothly together during recline, thereby maintaining perfect balance, body angle, and focus.

### Hybrid seat cushion

A unique combination of materials provides properties critical to comfort. A molded foam base with additional memory foam offers softness when you first sit along with greater support over time. This translates into instant comfort, the elimination of pressure points, and a healthy sitting experience over every hour of the day.

### Conforming mesh back

Form creates function with a back designed to provide ideal ergonomics for bodies of every shape and size. The mesh carrier mirrors the shape of the human spine, offering snug support to the shoulders, lumbar area, and everywhere in between, simultaneously and continuously. In addition, the structure and materials of the yoke have inherent dynamic properties that promote healthy posture by allowing just the right amount of flex and body movement.

## Intuitive Controls

Fine-tuning the fit is critical to optimizing ergonomics and improving personal comfort. Acuity's controls are well-marked, easy-to-find tabs, located along the sides of the seat so they're simple to see, use, and understand. Now you'll never have to get out of your seat or fuss with paddles and knobs to adjust your chair.

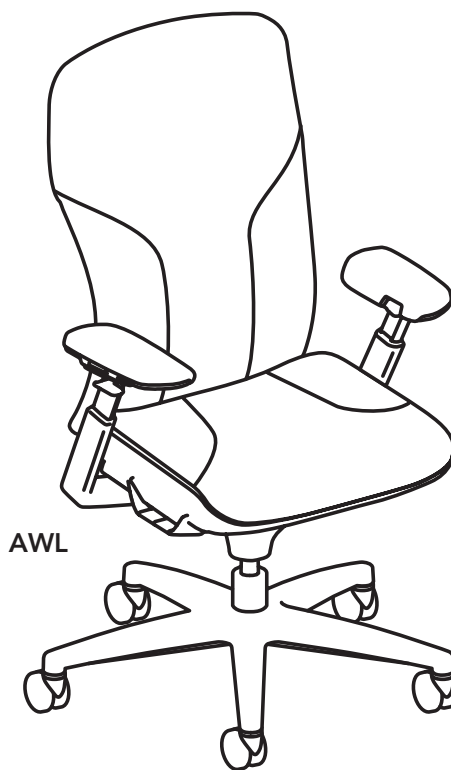
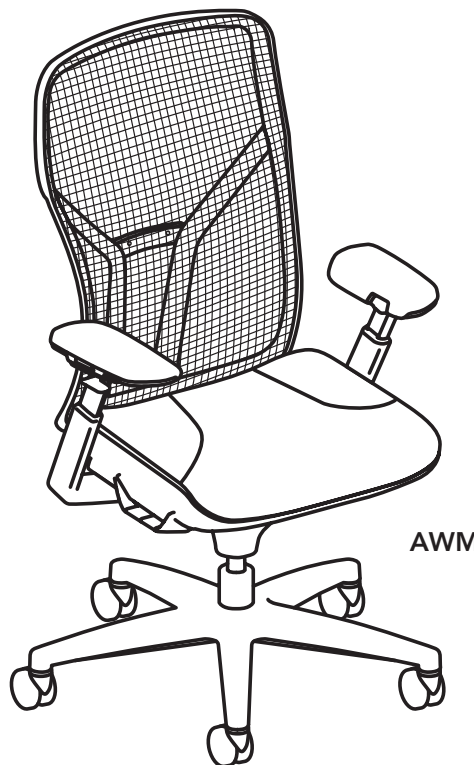

**Materials and Finishes**

Acuity has been designed to complement any interior design, any organizational aesthetic. Purity of form, sensual lines, and a slender profile let it make a supportive statement to every environment, every body. Choose from several classic colors for chassis, base, caster, mesh carrier, and mesh and a wide variety of standard and partnership upholstery options.

**Optional Upholstered Jacket**

Dress for success with a slip on jacket that offers premium appeal in conference areas, private offices, or the boardroom. Elegantly tailored with a simple snap closure and seven stitches per inch, architects and interior designers can choose from jackets in leather options. Remove the jacket and you're back to mesh for everyday flexibility, anywhere in the office.

**Casters**

Black dual-wheel hard tread casters for carpet are standard.

Optional multi-surface casters provide smooth functioning on any surface, from a carpeted conference room to polished concrete. Finishes that match bases in standard black, graphite, or polished aluminum give Acuity head-to-toe elegance.

**Fully Adjustable Arms**

Intuitive controls let you find any of the eight arm positions. A single lever releases the arms to slide up or down; a button right where the thumb naturally lands lets you move the arm pad inward or outward, forward or backward. You can also pivot the front of the arm pads inward to move in closer to your desk and offer support while working.

**Fixed Arms**

Provide basic support for people who face a varied work day. Fixed arms limit adjustability and maintain aesthetics in conference room settings. Acuity's Fixed T Arms are 100% cast aluminum.

**Materials**

- All upholstery foams are CFC-free.
- All COMs/COLs must be approved for upholsterability or applicable fire code compliance prior to order entry. See pages 6-8 for COM ordering information.
- Flammability code compliance of Allsteel textiles and seating is listed on pages 17-18.1. COM/COL manufacturers supply certificates of compliance for fabric-only tests such as CAL TB117-2013. Allsteel must test a complete chair to supply a certificate with CTB 133.

Acuity meets the requirements set forth in ANSI/BIFMA X5.1-2011 and BIFMA G1-2013. Acuity is warranted for multiple shifts and users up to 300 lbs.

**OPTIONS — ACUITY:****Armrests:**

- W** Fully Adjustable Arms      **A** Armless  
**F** Fixed Arms

**Jacket:**

- M** (None)

**Chassis:**

- G** Graphite Chassis  
**S** Silver Chassis  
**W** Brilliant White (limited to Titanium frames)  
**P** Polished Aluminum Chassis

**Back Frame/Mesh:**

- GC** Graphite Carrier/Clay Mesh  
**GD** Graphite Carrier/Dusk Mesh  
**TL** Titanium Carrier/Lustre Mesh  
**TM** Titanium Carrier/Mist Mesh

**Fire Code:**

- NO** Standard Upholstery, No Fire Code

**Base:**

- P71** Black Polymer Base  
**P85** Graphite Painted Aluminum Base (\$156 extra)  
**PR6** Silver Painted Aluminum Base (\$156 extra)  
**PQ8** Brilliant White Painted Aluminum Base (\$156 extra)  
**PAL** Polished Aluminum Base (\$233 extra)

**Pneumatic Cylinder:**

- 2** Standard; allows 5" of travel  
**3** Short; non-standard 3½" of travel to meet BIFMA G1-2002

**Casters:**

- H** Black Dual-Wheel Hard Tread for carpet  
**B** Black Multi-Surface (\$105 extra)  
**T** Titanium Multi-Surface (\$105 extra)  
**P** Polished Aluminum Multi-Surface (\$142 extra)

**Upholstery:**

See pages 56-57 for Centurion model.

See pages 13-14 for other upholstery selections.

See pages 17-18.1 for colors and codes

▲ Indicates upholstery available for Acuity jacket

**Armpads**

- S** Standard Polyurethane Armpad

Jacket — Acuity jacket models are subject to creases and gathers. Selection includes a subset of the Standard Options to optimize customer satisfaction.

**NOTE:** Not all options listed above are available on all models. See pages 56-57 for options by model.









# Seating — Work

• Features and adjustments on all Acuity models: Conforming Mesh Back, AcuFit® Tilt Lock with Recline Tension, Seat Depth, and Pneumatic Adjustment

GSA SIN 33721

(See page 154 for COM pricing on Grades 9-22)

Armrest	Jacket Material	Chassis Finish	Model Number <i>Add options below</i>									Leather				
				1	2	3	4	5	6	7	8	1*	2*			
<b>Fully Adjustable Arms</b>  	Leather	Graphite	AWLG	—	—	—	—	—	—	—	—	—	—	\$ 4473	\$ 5078	
		Silver	AWLS	—	—	—	—	—	—	—	—	—	—	—	\$ 4473	\$ 5078
		Brilliant White*	AWLW	—	—	—	—	—	—	—	—	—	—	—	\$ 4473	\$ 5078
		Polished Aluminum	AWLP	—	—	—	—	—	—	—	—	—	—	—	\$ 5045	\$ 5650
	(None)	Graphite	AWMG	\$ 2685	\$ 2732	\$ 2776	\$ 2821	\$ 2866	\$ 2910	\$ 2956	\$ 2999	\$ 3244	\$ 3517	\$ 3244	\$ 3517	
		Silver	AWMS	\$ 2685	\$ 2732	\$ 2776	\$ 2821	\$ 2866	\$ 2910	\$ 2956	\$ 2999	\$ 3244	\$ 3517	\$ 3244	\$ 3517	
		Brilliant White*	AWMW	\$ 2685	\$ 2732	\$ 2776	\$ 2821	\$ 2866	\$ 2910	\$ 2956	\$ 2999	\$ 3244	\$ 3517	\$ 3244	\$ 3517	
		Polished Aluminum	AWMP	\$ 3259	\$ 3306	\$ 3350	\$ 3395	\$ 3440	\$ 3484	\$ 3530	\$ 3573	\$ 3818	\$ 4091	\$ 3818	\$ 4091	
		Graphite with Centurion	VATWVG	\$ 2497	—	—	—	—	—	—	—	—	—	—	—	
<b>Fixed Arms</b>  	Leather	Graphite	AFLG	—	—	—	—	—	—	—	—	—	—	\$ 4582	\$ 5187	
		Silver	AFLS	—	—	—	—	—	—	—	—	—	—	—	\$ 4582	\$ 5187
		Brilliant White*	AFLW	—	—	—	—	—	—	—	—	—	—	—	\$ 4582	\$ 5187
		Polished Aluminum	AFLP	—	—	—	—	—	—	—	—	—	—	—	\$ 5155	\$ 5760
	(None)	Graphite	AFMG	\$ 2794	\$ 2841	\$ 2885	\$ 2930	\$ 2975	\$ 3019	\$ 3065	\$ 3108	\$ 3353	\$ 3626	\$ 3353	\$ 3626	
		Silver	AFMS	\$ 2794	\$ 2841	\$ 2885	\$ 2930	\$ 2975	\$ 3019	\$ 3065	\$ 3108	\$ 3353	\$ 3626	\$ 3353	\$ 3626	
		Brilliant White*	AFMW	\$ 2794	\$ 2841	\$ 2885	\$ 2930	\$ 2975	\$ 3019	\$ 3065	\$ 3108	\$ 3353	\$ 3626	\$ 3353	\$ 3626	
		Polished Aluminum	AFMP	\$ 3366	\$ 3413	\$ 3457	\$ 3502	\$ 3547	\$ 3591	\$ 3637	\$ 3680	\$ 3925	\$ 4198	\$ 3925	\$ 4198	
<b>Armless</b>  	Leather	Graphite	AALG	—	—	—	—	—	—	—	—	—	—	\$ 4266	\$ 4871	
		Silver	AALS	—	—	—	—	—	—	—	—	—	—	—	\$ 4266	\$ 4871
		Brilliant White*	AALW	—	—	—	—	—	—	—	—	—	—	—	\$ 4266	\$ 4871
		Polished Aluminum	AALP	—	—	—	—	—	—	—	—	—	—	—	\$ 4837	\$ 5442
	(None)	Graphite	AAMG	\$ 2477	\$ 2524	\$ 2568	\$ 2613	\$ 2658	\$ 2702	\$ 2748	\$ 2791	\$ 3036	\$ 3309	\$ 3036	\$ 3309	
		Silver	AAMS	\$ 2477	\$ 2524	\$ 2568	\$ 2613	\$ 2658	\$ 2702	\$ 2748	\$ 2791	\$ 3036	\$ 3309	\$ 3036	\$ 3309	
		Brilliant White*	AAMW	\$ 2477	\$ 2524	\$ 2568	\$ 2613	\$ 2658	\$ 2702	\$ 2748	\$ 2791	\$ 3036	\$ 3309	\$ 3036	\$ 3309	
		Polished Aluminum	AAMP	\$ 3050	\$ 3097	\$ 3141	\$ 3186	\$ 3231	\$ 3275	\$ 3321	\$ 3364	\$ 3609	\$ 3882	\$ 3609	\$ 3882	

\*Brilliant White models limited to Titanium frame finish.

Continued on next page ►

<p><b>How to specify —</b> Select the Model Number from above.</p>	<p><b>1st Option:</b> Select the Frame/Mesh Color:</p> <p>GC Graphite/Clay Mesh GD Graphite/Dusk Mesh TL Titanium/Lustre Mesh TM Titanium/Mist Mesh</p> <p>(Brilliant White models limited to Titanium frame finish. VATWVG model limited to Graphite/Dusk.)</p>	<p><b>2nd Option:</b> Select the Fire Code:</p> <p>NO</p>	<p><b>3rd Option:</b> Select the Base Color:</p> <p>P71 Black Polymer P85 Graphite Painted Aluminum (\$156 extra) PR6 Silver Painted Aluminum (\$156 extra) PQ8 Brilliant White Painted Aluminum (\$156 extra) PAL Polished Aluminum (\$233 extra)</p> <p>(VATWVG model limited to P71 Black Polymer)</p>
--	--	---	---

Examples: VATWVGGDNO.P71.2.H.CU10

GSA SIN 33721

Model Number	COM Yandage				Overall				Seat				Armrests				Backrest					
	COL Sp.	COL Sp.	COL Sp.	COL Sp.	Width	Depth	Height Standard (Range)	Height Standard (Range)	Width	Depth	Pan Angle (Range)	Height Standard (Range)	Width Between Armrests (Range)	Depth (Range)	Pivot Inwards	Pivot Outwards	Height	Width	Lumbar Height (Initial)	Backrest Height (Range)	Backrest Angle	Ship Weight
AWLG	—	11.2	14	4	41-46½"	26½"	25"	16½-21¼"	19"	15½-18½"	2.5°-9.5°	7-11"	12½-20½"	8¼-13¼"	25°	—	25½"	16"	8¼"	93.5°-111°	64.0	21.7
AWLS	—	11.2	14	4	41-46½"	26½"	25"	16½-21¼"	19"	15½-18½"	2.5°-9.5°	7-11"	12½-20½"	8¼-13¼"	25°	—	25½"	16"	8¼"	93.5°-111°	64.0	21.7
AWLW	—	11.2	14	4	41-46½"	26½"	25"	16½-21¼"	19"	15½-18½"	2.5°-9.5°	7-11"	12½-20½"	8¼-13¼"	25°	—	25½"	16"	8¼"	93.5°-111°	64.0	21.7
AWLP	—	11.2	14	4	41-46½"	26½"	25"	16½-21¼"	19"	15½-18½"	2.5°-9.5°	7-11"	12½-20½"	8¼-13¼"	25°	—	25½"	16"	8¼"	93.5°-111°	64.0	21.7
AWMG	1.0	11.2	—	4	41-46½"	26½"	25"	16½-21¼"	19"	15½-18½"	2.5°-9.5°	7-11"	12½-20½"	8¼-13¼"	25°	—	25½"	16"	8¼"	93.5°-111°	64.0	21.7
AWMS	1.0	11.2	—	4	41-46½"	26½"	25"	16½-21¼"	19"	15½-18½"	2.5°-9.5°	7-11"	12½-20½"	8¼-13¼"	25°	—	25½"	16"	8¼"	93.5°-111°	64.0	21.7
AWMW	1.0	11.2	—	4	41-46½"	26½"	25"	16½-21¼"	19"	15½-18½"	2.5°-9.5°	7-11"	12½-20½"	8¼-13¼"	25°	—	25½"	16"	8¼"	93.5°-111°	64.0	21.7
AWMP	1.0	11.2	—	4	41-46½"	26½"	25"	16½-21¼"	19"	15½-18½"	2.5°-9.5°	7-11"	12½-20½"	8¼-13¼"	25°	—	25½"	16"	8¼"	93.5°-111°	64.0	21.7
VATWVG	—	—	—	—	41-46½"	26½"	25"	16½-21¼"	19"	15½-18½"	2.5°-9.5°	7-11"	12½-20½"	8¼-13¼"	25°	—	25½"	16"	8¼"	93.5°-111°	64.0	21.7
AFLG	—	11.2	14	4	41-46½"	26½"	25"	16½-21¼"	19"	15½-18½"	2.5°-9.5°	9"	19¼"	11½"	—	—	25½"	16"	8¼"	93.5°-111°	64.0	21.7
AFLS	—	11.2	14	4	41-46½"	26½"	25"	16½-21¼"	19"	15½-18½"	2.5°-9.5°	9"	19¼"	11½"	—	—	25½"	16"	8¼"	93.5°-111°	64.0	21.7
AFLW	—	11.2	14	4	41-46½"	26½"	25"	16½-21¼"	19"	15½-18½"	2.5°-9.5°	9"	19¼"	11½"	—	—	25½"	16"	8¼"	93.5°-111°	64.0	21.7
AFLP	—	11.2	14	4	41-46½"	26½"	25"	16½-21¼"	19"	15½-18½"	2.5°-9.5°	9"	19¼"	11½"	—	—	25½"	16"	8¼"	93.5°-111°	64.0	21.7
AFMG	1.0	11.2	—	4	41-46½"	26½"	25"	16½-21¼"	19"	15½-18½"	2.5°-9.5°	9"	19¼"	11½"	—	—	25½"	16"	8¼"	93.5°-111°	64.0	21.7
AFMS	1.0	11.2	—	4	41-46½"	26½"	25"	16½-21¼"	19"	15½-18½"	2.5°-9.5°	9"	19¼"	11½"	—	—	25½"	16"	8¼"	93.5°-111°	64.0	21.7
AFMW	1.0	11.2	—	4	41-46½"	26½"	25"	16½-21¼"	19"	15½-18½"	2.5°-9.5°	9"	19¼"	11½"	—	—	25½"	16"	8¼"	93.5°-111°	64.0	21.7
AFMP	1.0	11.2	—	4	41-46½"	26½"	25"	16½-21¼"	19"	15½-18½"	2.5°-9.5°	9"	19¼"	11½"	—	—	25½"	16"	8¼"	93.5°-111°	64.0	21.7
AALG	—	11.2	14	—	41-46½"	26½"	25"	16½-21¼"	19"	15½-18½"	2.5°-9.5°	—	—	—	—	—	25½"	16"	8¼"	93.5°-111°	55.0	21.7
AALS	—	11.2	14	—	41-46½"	26½"	25"	16½-21¼"	19"	15½-18½"	2.5°-9.5°	—	—	—	—	—	25½"	16"	8¼"	93.5°-111°	55.0	21.7
AALW	—	11.2	14	—	41-46½"	26½"	25"	16½-21¼"	19"	15½-18½"	2.5°-9.5°	—	—	—	—	—	25½"	16"	8¼"	93.5°-111°	55.0	21.7
AALP	—	11.2	14	—	41-46½"	26½"	25"	16½-21¼"	19"	15½-18½"	2.5°-9.5°	—	—	—	—	—	25½"	16"	8¼"	93.5°-111°	55.0	21.7
AAMG	1.0	11.2	—	—	41-46½"	26½"	25"	16½-21¼"	19"	15½-18½"	2.5°-9.5°	—	—	—	—	—	25½"	16"	8¼"	93.5°-111°	55.0	21.7
AAMS	1.0	11.2	—	—	41-46½"	26½"	25"	16½-21¼"	19"	15½-18½"	2.5°-9.5°	—	—	—	—	—	25½"	16"	8¼"	93.5°-111°	55.0	21.7
AAMW	1.0	11.2	—	—	41-46½"	26½"	25"	16½-21¼"	19"	15½-18½"	2.5°-9.5°	—	—	—	—	—	25½"	16"	8¼"	93.5°-111°	55.0	21.7
AAMP	1.0	11.2	—	—	41-46½"	26½"	25"	16½-21¼"	19"	15½-18½"	2.5°-9.5°	—	—	—	—	—	25½"	16"	8¼"	93.5°-111°	55.0	21.7

Dimensions are in accordance with BIFMA G1-2013 guidelines — see illustration of guidelines on page 45.

◀ Continued from previous page

<p><b>4th Option:</b> Select the Cylinder:</p> <p>2 Standard, allows 5" of travel</p> <p>3 Short, allows 3½" of travel</p> <p>(VATWVG model limited to 2 standard cylinders)</p>	<p><b>5th Option:</b> Select the Casters:</p> <p>H Black Dual-Wheel Hard Tread for carpet</p> <p>B Black Multi-Surface (\$105 extra)</p> <p>T Titanium Multi-Surface (\$105 extra)</p> <p>P Polished Aluminum Multi-Surface (\$142 extra)</p> <p>(VATWVG model limited to H Black Dual-Wheel Hard Tread for carpet)</p>	<p><b>6th Option:</b> Select the Upholstery:</p> <p>See pages 13-14 for selections.</p> <p>See pages 6-8 for COM guidelines.</p> <p>(VATWVG model limited to CU Centurion upholstery)</p>	<p><b>7th Option:</b> Select the Armpad:</p> <p>S Standard Poly Armpads</p>
--	---	---	---

Acuity side chairs provide an ideal solution for busy work areas such as training rooms, gathering areas, informal conferencing, cafés, and more. With a stackable design and pivoting back, Acuity side chairs provide the perfect combination of versatility and unexpected comfort.

## MODELS AND OPTIONS

Acuity offers side chair models with mesh backs in two frame colors.

Side chairs feature **arm and armless models** with casters or glides.

**Glides** are available in nylon, nickel-plated, or felt options. Nylon glides are recommended for hard surfaces, commercial carpet, and damp environments. Nickel-plated glides are recommended for carpet. Felt glides are recommended for wood, tile, or high-shine floor surfaces.

**Multi-surface casters** are also available.

**Chairs ship up to two per carton to minimize waste.**

## CONSTRUCTION

**Steel frames and structural moldings** create a durable design that performs in a variety of environments.

**Seat upholstery** is easily field replaceable allowing users to extend the lifecycle of the chairs.

Multi-purpose side chairs **stack up to 4-high** on the floor.

Acuity mesh chairs feature Acuity Mesh. This construction provides responsive, conforming back support and an open, airy aesthetic.

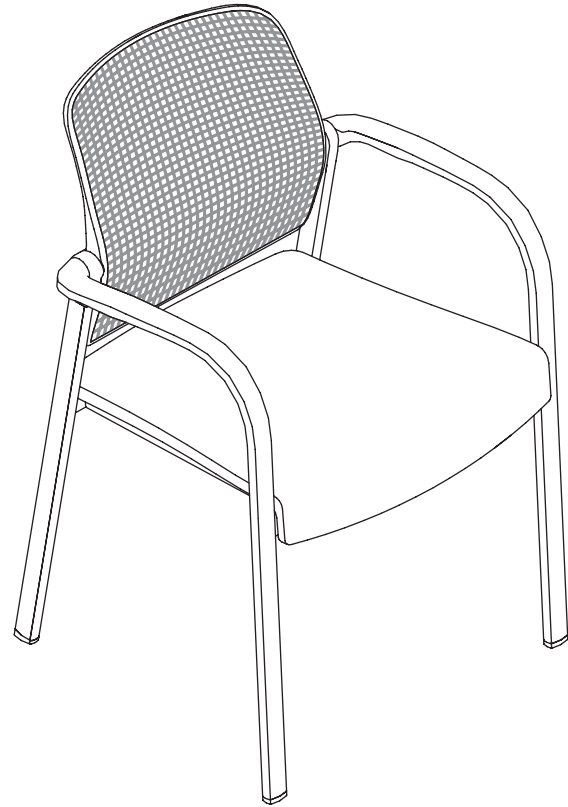

**ACM-MUGO — Mesh Back and Upholstered Seat**

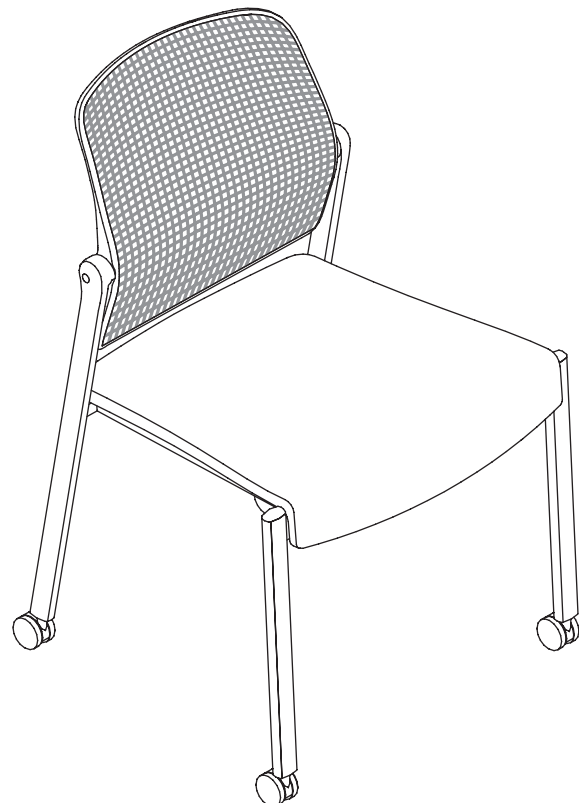

**ACM-MUCA — Mesh Back and Upholstered Seat**

**UPHOLSTERY AND CONTOURING**

Acuity side chairs feature a pivoting back that provides unexpected comfort in any application. The **pivoting back** provides support while encouraging movement that makes for healthy sitting. The **backrest** features a contoured lumbar support to help relieve stress on the back. Added movement and support allow the Acuity multi-purpose side chair to go from project conference rooms to teaming areas to training rooms with ease.

The upholstered seat features a generous 2" of high-resiliency molded foam padding for comfort and long-term support.

All upholstery foams are **CFC-free**.

All **COMs/COLs** must be approved for upholsterability or applicable fire code compliance prior to order entry. See COM ordering instructions on pages 6-8.

**Flammability** code compliance of Allsteel textiles and seating is listed on pages 13-14. COM/COL manufacturers supply certificates of compliance for fabric-only tests such as CAL TB117-2013.

Acuity meets the requirements set forth in ANSI/BIFMA X5.1-2011. Acuity side chairs are warranted for users up to 300 lbs.

**OPTIONS — ACUITY MULTI-PURPOSE SIDE:**

Versions include arm and armless models with glides or casters with an upholstered seat and mesh back.

Back Type:

**M** Mesh

Seat Type:

**U** Upholstered

Frame Type:

**C** Casters

**G** Glides

Arm Option:

**O** Arms (Arm color will match carrier color — black or titanium)

**A** Armless

Glides/Casters:

**0** Nylon Glides for hard surfaces and commercial carpet

**1** Nickel-plated Glides for carpet (\$18 extra)

**2** Felt Glides for wood, tile, or high-sheen surfaces. (\$18 extra)

**3** Multi-surface Casters

Frame Color:

**P85** Graphite

**PR6** Silver

**P8X** Solar Black

**P8T** Titanium

Carrier/Mesh Color:

**BC** Charblack Carrier/Clay Mesh

**BD** Charblack Carrier/Dusk Mesh



**TL** Titanium Carrier/Lustre Mesh

**TM** Titanium Carrier/Mist Mesh

Select the Upholstery:

See pages 13-14 for selections and see pages 17-18.1 for colors and codes.

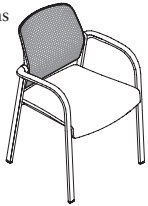
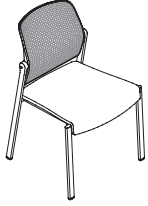
(See page 154 for COM pricing on Grades 9-22)

Overall Size Armrest	Adjustments and Features	Back Type	Model Number <i>Add options below</i>									Leather	
				1	2	3	4	5	6	7	8	1	2
GLIDES Arms	Pivot Back	Mesh	ACM-MUGO	\$ 1137	\$ 1169	\$ 1201	\$ 1241	\$ 1281	\$ 1322	\$ 1361	\$ 1402	\$ 1838	\$ 3028
													
Armless	Pivot Back	Mesh	ACM-MUGA	\$ 1071	\$ 1103	\$ 1135	\$ 1175	\$ 1215	\$ 1256	\$ 1295	\$ 1336	\$ 1772	\$ 2962
													
CASTERS Arms	Pivot Back	Mesh	ACM-MUCO	\$ 1226	\$ 1258	\$ 1290	\$ 1330	\$ 1370	\$ 1411	\$ 1450	\$ 1491	\$ 1927	\$ 3117
													
Armless	Pivot Back	Mesh	ACM-MUCA	\$ 1160	\$ 1192	\$ 1224	\$ 1264	\$ 1304	\$ 1345	\$ 1384	\$ 1425	\$ 1861	\$ 3051
													

**NOTE:** Acuity side chairs ship two per carton to minimize waste. Model numbers and prices are per chair.

<p><b>How to specify —</b> Select the Model Number from above.</p>	<p><b>1st Option:</b> Select the Glides/Casters:</p> <ul style="list-style-type: none"> <li>0 Nylon Glides</li> <li>1 Nickel-plated Glides for carpet (\$18 extra)</li> <li>2 Felt Glides (\$18 extra)</li> <li>3 Multi-surface Casters</li> </ul>	<p><b>2nd Option:</b> Select the Frame Color:</p> <ul style="list-style-type: none"> <li>P85 Graphite</li> <li>PR6 Silver</li> <li>P8X Solar Black</li> <li>P8T Titanium</li> </ul>	<p><b>3rd Option:</b> Select the Mesh Frame / Mesh Color:</p> <ul style="list-style-type: none"> <li>BC Charblack Carrier/Clay Mesh</li> <li>BD Charblack Carrier/Dusk Mesh</li> <li>TL Titanium Carrier/Lustre Mesh</li> <li>TM Titanium Carrier/Mist Mesh</li> </ul>	<p><b>4th Option:</b> Select the Upholstery:</p> <p>See pages 13-14 for selections and pages 17-18.1 for colors and codes. See pages 6-8 for COM guidelines.</p>
<p>ACM - MU . . . . .</p>				

Examples: ACM-MUCA.3.P85.BD.PNS012    ACM-MUGA.2.P85.BM.STX13



Model Number	COM Yachage			Overall			Seat			Armrests				Backrest						
	COL Sp. Feet	Height	Width	Depth	Height	Width	Depth	Pan Angle	Armrest Height	Width Between Armrests	Armrest Length	Arm Height to the Floor	Height	Width	Lumbar Height	Backrest/Seat Angle (Range)	Ship Weight	Ship Weight Per Carton	Cubes	
ACM-MUGO	1.0	11.5	33½"	24½"	21½"	18½"	18"	16"	8°	9¼"	20½"	7½"	26½"	18½"	16½"	9¼"	96°-99°	24	—	13.2
ACM-MUGA	1.0	11.5	33½"	22½"	21½"	18½"	18"	16"	8°	—	—	—	—	18½"	16½"	9¼"	96°-99°	24	—	13.2
ACM-MUCO	1.0	11.5	33½"	24½"	21½"	18½"	18"	16"	8°	9¼"	20½"	7½"	26½"	18½"	16½"	9¼"	96°-99°	24	—	13.2
ACM-MUCA	1.0	11.5	33½"	22½"	21½"	18½"	18"	16"	8°	—	—	—	—	18½"	16½"	9¼"	96°-99°	24	—	13.2

NOTE: Acuity side chairs ship two per carton to minimize waste. Model numbers and prices are per chair.

*Clarity offers a clean, simple design that preserves only the essential elements of form and function. Designed in collaboration with BMW Group DesignworksUSA, Clarity combines a pure, honest aesthetic that transcends the floor plan with an unexpected comfort that anticipates your every posture.*

### Form

The streamlined design creates a unique visual interest that inspires your imagination without distracting your focus. Clarity's frame and base are constructed of aluminum, offering superior quality and durability. Choose from several chair styles, nine mesh colors, and a variety of frame finishes to complement spaces from formal to casual. Wherever you work, it goes.

### Function

The continuous mesh seat and back offer instant comfort and support with minimal adjustment. You can sit upright. Side sit. Turn around. Or lean over the back. With no fussing and less fine-tuning. Anywhere you go, and any way you sit, it works.

### Versatility

Because form and function are simplified, Clarity adapts to any space you're in, as well as any type of work you're doing. From focused heads-down work to engaged collaboration to active lounging. It's always a reflection of the space it's in and the people who use it.



C50MFC



C40MFC (De-emphasized)



C10MFC (De-emphasized)

**DESIGN FEATURES**

Clarity seating is engineered to support a variety of work, conference, and lounge applications that share a simple, intuitive, and active design.

**Fixed Arms**

Provide basic support for users engaging in a variety of tasks throughout the day. Arms come with protective urethane arm pads. Fixed arms limit adjustability but provide consistent aesthetics in conference room settings.

**Arm Covers**

Optional soft arm pad sleeves are available as a set, one left and one right. Pad sleeves slip over existing arms on a Clarity work, guest, or lounge chair. Sleeves are made of 1/8" thick santoprene and are available in G Graphite or T Titanium.

**Pneumatic Seat Height Adjustment**

Regulates height of work chair relative to the floor. Standard 5" of travel accommodates average to tall users.

**Base/Casters/Glides**

Work chair bases are a five-star design, C5 models are aluminum and polymer base work models are composite. Dual-wheel casters are available in hard tread for carpet, or multi-surface for any floor surface.

Glides on guest and lounge chairs provide stability as user changes position. Cylinders return chairs to center position.

**Materials**

- All models meet CAL133.
- All COLs must be approved for upholsterability or applicable fire code compliance prior to order entry. See pages 6-8 for COM ordering instructions.
- Allsteel fabrics meet requirements for CAL TB117-2013. COM/COL manufacturers supply certificates of compliance for fabric-only tests such as CAL TB117-2013.
- Clarity is warranted for multiple shifts and users up to 300 lbs.

**OPTIONS — CLARITY**

Chair Type:

- C5** Work
- CV** Polymer Base Work
- C4** Guest
- CL** Lounge

Armrests:

- O** Fixed Arms
- A** Armless

Jacket:

- M** None (mesh chair)

Fire Code:

- NO** No Fire Code

Mesh Color:

- CM21** Clay (*De-emphasized*)
- CM20** Flint
- CM22** Graphite
- CM30** Lime (*De-emphasized*)
- CM28** Navy (*De-emphasized*)
- CM23** Platinum
- CM25** Poppy (*De-emphasized*)
- CM26** Sky (*De-emphasized*)
- CM29** Taupe (*De-emphasized*)

Frame Color:

- P4Q** Carbon
- PJW** Designer White (*De-emphasized*)
- P8B** Night Bronze (add \$36) (*De-emphasized*)
- PAL** Polished (add \$276) (*De-emphasized*)
- PJE** Pyrite (add \$36) (*De-emphasized*)
- PR6** Silver (add \$36)
- P8X** Solar Black (add \$36) (*De-emphasized*)
- P8T** Titanium (*De-emphasized*)

Mesh Carrier and Arm Pads:

- G** Graphite
- T** Titanium

Base:

- P71** Black
- P4Q** Carbon
- PJW** Designer White (*De-emphasized*)
- P8B** Night Bronze (add \$24) (*De-emphasized*)
- PAL** Polished (add \$145) (*De-emphasized*)
- PJE** Pyrite (add \$24) (*De-emphasized*)
- PR6** Silver (add \$24)
- P8X** Solar Black (add \$24) (*De-emphasized*)
- P8T** Titanium (*De-emphasized*)









Pneumatic Cylinder:

- 2** Work, allows 5" of travel
- 5** Guest, returns to center
- 6** Lounge, returns to center

Casters or Glides:

- GLD** Glides (Guest and Lounge)
- BHT** Black Hard Tread Casters for carpets
- P4Q** Carbon Multi-surface Casters (add \$66) (*De-emphasized*)
- PR6** Silver Multi-surface Casters (add \$66) (*De-emphasized*)
- PAL** Polished Multi-surface Casters (add \$142) (*De-emphasized*)



Model	Armrest	Jacket	Model Number <i>Add options below</i>	List Price
 	Arms	None	<b>C5OMFC</b>	<b>\$ 1437</b>
	Armless	None	<b>C5AMFC</b> <i>(De-emphasized)</i>	<b>\$ 1362</b>
 	Arms	None	<b>CVOMFC</b> <i>(De-emphasized)</i>	<b>\$ 1344</b>
	Armless	None	<b>CVAMFC</b> <i>(De-emphasized)</i>	<b>\$ 1268</b>
 	Arms	None	<b>C4OMFC</b> <i>(De-emphasized)</i>	<b>\$ 1355</b>
	Armless	None	<b>C4AMFC</b> <i>(De-emphasized)</i>	<b>\$ 1282</b>
 	Arms	None	<b>CLOMFC</b> <i>(De-emphasized)</i>	<b>\$ 2195</b>
	Armless	None	<b>CLAMFC</b> <i>(De-emphasized)</i>	<b>\$ 2080</b>
Soft Arm Pad Sleeve Set			<b>CZSAP</b> <i>(De-emphasized)</i>	<b>\$ 73</b>

Continued on next page ►

How to specify — Select the Model Number from above.	1st Option Select the Mesh Color (if applicable):	2nd Option: Select the Frame Color (if applicable): <i>(Polymer Base Work P4Q Carbon only):</i>	3rd Option: Select the Mesh Carrier Frame and Arm Pads Color (if applicable): <i>(Polymer Base Work G Graphite only)</i>	4th Option: Select the Base Color (if applicable): <i>(Polymer Base Work P71 Black only):</i>
C                     .	<b>CM21</b> Clay* <b>CM20</b> Flint <b>CM22</b> Graphite <b>CM30</b> Lime* <b>CM28</b> Navy* <b>CM23</b> Platinum <b>CM25</b> Poppy* <b>CM26</b> Sky* <b>CM29</b> Taupe* *De-emphasized	<b>P4Q</b> Carbon <b>PJW</b> Designer White* <b>P8B</b> Night Bronze (add \$36)* <b>PAL</b> Polished (\$276 extra)* <b>PJE</b> Pyrite (add \$36)* <b>PR6</b> Silver (\$36 extra) <b>P8X</b> Solar Black (add \$36)* <b>P8T</b> Titanium* *De-emphasized	<b>G</b> Graphite <b>T</b> Titanium	<b>P4Q</b> Carbon <b>PJW</b> Designer White* <b>P8B</b> Night Bronze (add \$24)* <b>PAL</b> Polished (\$145 extra)* <b>PJE</b> Pyrite (add \$24)* <b>PR6</b> Silver (\$24 extra) <b>P8X</b> Solar Black (add \$24)* <b>P8T</b> Titanium* *De-emphasized
Examples: C5OMFC.CM21.PR6.G.PR6.2.PR6 CZSAP.G				

Model Number	COM Yachage*		Overall			Seat			Armrests			Backrest				Ship Weight	Ship Weight Per Carton	Cubes		
	COL Sp. Fee**	Height (Range)	Width	Depth	Height (Range)	Width	Depth	Pan Angle (Range)	Armrest Height	Width Between Armrests	Armrest Length	Arm Height to the Floor	Height	Width	Lumbar Height				Backrest/Seat Angle (Range)	
C5OMFC	—	—	32½-37½"	25"	26"	15½-20½"	19"	16½"	4.7°-5.3°	9½"	21"	11½"	25-30"	19½"	19"	9½"	98°-110°	41	—	11.1
C5AMFC*	—	—	32½-37½"	25"	26"	15½-20½"	19"	16½"	4.7°-5.3°	—	—	—	—	—	—	9½"	98°-110°	38	—	11.1
CVOMFC*	—	—	32½-37½"	25"	26"	15½-20½"	19"	16½"	4.7°-5.3°	9½"	21"	11½"	25-30"	19½"	19"	9½"	98°-110°	39	—	11.1
CVAMFC*	—	—	32½-37½"	25"	26"	15½-20½"	19"	16½"	4.7°-5.3°	—	—	—	—	—	—	9½"	98°-110°	36	—	11.1
C4OMFC*	—	—	34¼"	28"	28"	17½"	19"	16½"	4.5°-6.4°	9½"	21"	11½"	26½"	19½"	19"	9½"	98°-110°	38	—	11.1
C4AMFC*	—	—	34¼"	28"	28"	17½"	19"	16½"	4.5°-6.4°	—	—	—	—	—	—	9½"	98°-110°	34	—	11.1
CLOMFC*	—	—	31¼"	29¼"	28¾"	16½"	22"	17½"	11.1°-13.0°	8½"	24"	12½"	24"	20½"	21½"	9½"	98°-110°	40	—	11.1
CLAMFC*	—	—	31¼"	28"	28¾"	16½"	22"	17½"	11.1°-13.0°	—	—	—	—	—	—	9½"	98°-110°	37	—	11.1
CZSAP*										+ ½"	- ¼"	+ ½"	+ ½"					5	—	0.2

NOTE:

\*De-emphasized

\*\*For COL quantities greater than one contact Allsteel Customer Support for guidance — less leather may be adequate.

◀ Continued from previous page

<p>5th Option: Select the Cylinder (if applicable):</p> <p>2 Work 5 Guest 6 Lounge</p>	<p>6th Option: Select the Glides/Casters (if applicable):</p> <p>GLD Glide (Guest and Lounge)</p> <p>Casters (Polymer Base Work BHT only)</p> <p>BHT Black Hard Tread for carpet P4Q Carbon Multi-surface (\$66 extra)* PR6 Silver Multi-surface (\$66 extra)* PAL Polished Multi-surface (\$142 extra)* *De-emphasized</p>
--	---

People are moving around the workspace to get work done, and the conference room or shared bench is the home away from home. The Evo collection is adaptable and interchangeable across multiple spaces to provide consistent comfort while maintaining a cohesive design.

## KEY FEATURES

Evo chairs feature weight-activated recline so there's no additional tension adjustment. Intuitive controls, along with specially sculpted and formulated seat foam, create a comfortable sitting experience for wherever and however people work.

### Arms

Open arms allow for multiple sitting postures and remain lateral when reclining for maximum support. Options for work and conference models: 4D adjustable arms, height-adjustable arms, fixed polished aluminum arms, or armless.

### Accent stitching

Accent stitching, available in nine colors, offers a way to make a design statement on work and conference models.

### Back support

Contoured frame provides upright back support. Optional user-adjustable lumbar can be added at any time.

### Up-front controls

Integrated, up-front controls are easy to access and use and contribute to an overall clean aesthetic.

### Height-Adjustable Footring

Travels 8" to ensure users have comfortable support of their feet and legs. The footring has a 20" diameter.

## MATERIALS

All COMs/COLs must be approved for upholsterability or applicable fire code compliance prior to order entry. See pages 6-8 for COM ordering instructions.

Allsteel fabrics meet requirements for CTB117. COM/COL manufacturers supply certificates of compliance for fabric-only tests such as CTB117.

Evo meets the requirements set forth in ANSI/BIFMA X5.1-2011 and BIFMA G1-2013. Evo is warranted for multiple shifts and users up to 300 lbs.

Evo Side Chair is warranted for users up to 300 lbs.

### 4D adjustable arms

Evo's 4D arms are fully adjustable in height, width, depth, and can pivot to provide optimal support. Pivot the front of the arm pads inward to move in closer to your desk and offer support while working.

### Height-adjustable arms

Provides height adjustments for optimal support of elbows and shoulders while keyboarding or conferencing while providing ease of entry/exit.

### Fixed polished aluminum arms

Provide basic support for users engaging in a variety of tasks throughout the day. Arms come with protective black, flint, titanium or salt urethane arm pads to match the specified frame finish. Fixed arms limit adjustability but provide consistent aesthetics in conference room settings.

### Optional adjustable lumbar support

To accommodate personal preference, an optional external lumbar support can be added at any time with 4" range of adjustment.

### Base and casters

Work chair bases are a five-star design. Dual-wheel casters are available in hard tread for carpet, or multi-surface for any floor surface.



DWW-MHWNO  
Work



DWC-UMWNO  
Conference

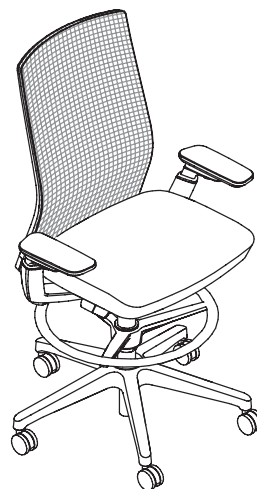

DWS-MHWNO  
Stool

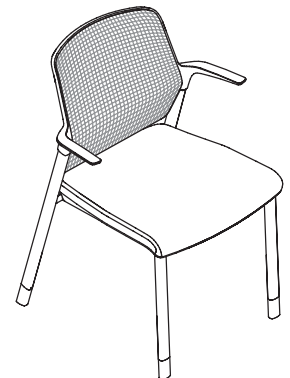

DSC-MUGONO  
Side Chair

## SIDE CHAIR MODELS AND OPTIONS

Evo offers side chair models in four frame colors with mesh backs in five colors. Side chairs feature arms with casters or glides. Glides are available in nylon, nickel-plated, or felt options. Nylon glides are recommended for hard surfaces, commercial carpet, and damp environments. Nickel-plated glides are recommended for carpet. Felt glides are recommended for wood, tile, or high-sheen floor surfaces. Multi-surface casters are also available. Chairs ship up to three per carton to minimize waste. Evo Side chair can be stacked up to four high.

## OPTIONS — WORK/CONFERENCE/STOOL

Chair Type:

- DWW** Work
- DWC** Conference
- DWS** Stool

Back Type:

- M** Mesh (Work/Stool)
- U** Upholstered (Conference)

Overall Size:

- H** High-Back (Work/Stool)
- M** Mid-Back (Conference)

Arms:

- W** 4D Adjustable Arms
- H** Height Adjustable Arms
- F** Fixed Polished Aluminum Arms
- A** No Arms

Fire Code:

- NO** No Fire Code

Frame Color (Work/Conference/Stool):

- BLK** Black
- E9** Flint (add \$88)
- ST** Salt (add \$88)
- TI** Titanium (add \$44)

Mesh Color (Work, Stool, Side):

- C** Clay            **M** Mist
- D** Dusk            **N** Navy
- L** Lustre

Lumbar (Work, Stool):

- L** Yes (\$55 extra)    **N** No

Cylinder:

- 2** Standard, allows 5" of Travel
- 3** Short, allows 2½" of Travel
- 4** Stool, allows 10" of Travel

Base Color:

- BLK** Black
- E9** Flint
- ST** Salt
- TI** Titanium
- PAL** Polished Aluminum (\$159 extra)

Casters:

- H** Black Hard Tread
- B** Black Multi-Surface (\$66 extra)
- E9** Flint Multi-Surface (\$66 extra)
- ST** Salt Multi-Surface (\$66 extra)
- T** Titanium Multi-Surface (\$66 extra)
- PAL** Polished Aluminum Multi-Surface (\$142 extra)

Upholstery:

See pages 13-14 for selections, colors, and codes.

Accent Stitching:

Accent stitching for seat (\$34 extra) and for Conference back (\$34 extra). See thread color/code options on page 69. Variance in accent stitch consistency in linearity should be expected based on material specifications.

Pad Color for Lumbar is **TGR** Translucent Graphite.

## OPTIONS — SIDE CHAIR

Chair Type:

- DSC** Side Chair

Back Type:

- M** Mesh

Seat Type:

- U** Upholstered

Casters/Glides:

- C** Casters
- G** Glides

Arm Option:

- O** Fixed Arms

Fire Code:

- NO** No Fire Code

Frame Color:

- P8X** Solar Black (side)
- P8T** Titanium (side)
- P71** Black (side)
- P02** Flint (side)
- P8C** Salt (side)
- PR6** Silver (side)

Mesh Color:

- C** Clay            **M** Mist
- D** Dusk            **N** Navy
- L** Lustre





Glides/Casters:

- 0** Nylon Glides
- 1** Nickel Glides (\$18 extra)
- 2** Felt Glides (\$18 extra)
- 3** Multi-Surface Casters

Seat Upholstery:

See pages 13-14 for selections, colors, and codes.

Upcharges listed for Grades 2 and above, add to Base Price. Grades 9-22 on pages 154-155.

Armrest	Back	Model Number	Base Price	Upholstery	Upcharge								Leather	
					2	3	4	5	6	7	8	1	2	
	Work Mesh High-Back	DWW-MHWNO	\$ 1602	Seat	\$ 23	\$ 42	\$ 64	\$ 87	\$ 112	\$ 132	\$ 159	\$ 344	\$ 556	
	Conference Upholstered Mid-Back	DWC-UMWNO	\$ 1809	Seat	\$ 23	\$ 42	\$ 64	\$ 87	\$ 112	\$ 132	\$ 159	\$ 344	\$ 556	
				Back	\$ 35	\$ 63	\$ 95	\$ 130	\$ 167	\$ 199	\$ 238			
	Work Mesh High-Back	DWW-MHHNO	\$ 1529	Seat	\$ 23	\$ 42	\$ 64	\$ 87	\$ 112	\$ 132	\$ 159	\$ 344	\$ 556	
	Conference Upholstered Mid-Back	DWC-UMHNO	\$ 1736	Seat	\$ 23	\$ 42	\$ 64	\$ 87	\$ 112	\$ 132	\$ 159	\$ 344	\$ 556	
				Back	\$ 35	\$ 63	\$ 95	\$ 130	\$ 167	\$ 199	\$ 238			
	Work Mesh High-Back	DWW-MHFNO	\$ 1579	Seat	\$ 23	\$ 42	\$ 64	\$ 87	\$ 112	\$ 132	\$ 159	\$ 344	\$ 556	
	Conference Upholstered Mid-Back	DWC-UMFNO	\$ 1785	Seat	\$ 23	\$ 42	\$ 64	\$ 87	\$ 112	\$ 132	\$ 159	\$ 344	\$ 556	
				Back	\$ 35	\$ 63	\$ 95	\$ 130	\$ 167	\$ 199	\$ 238			
	Work Mesh High-Back	DWW-MHANO	\$ 1409	Seat	\$ 23	\$ 42	\$ 64	\$ 87	\$ 112	\$ 132	\$ 159	\$ 344	\$ 556	
	Conference Upholstered Mid-Back	DWC-UMANO	\$ 1615	Seat	\$ 23	\$ 42	\$ 64	\$ 87	\$ 112	\$ 132	\$ 159	\$ 344	\$ 556	
				Back	\$ 35	\$ 63	\$ 95	\$ 130	\$ 167	\$ 199	\$ 238			
		DW-LUK	\$ 95											

Example of upcharges: Conference Upholstered Mid-Back Model **DWC-UMWNO** with Grade 2 Seat and Grade 5 Back = \$1809 + \$23 + \$130 = \$1962 Total (Plus any additional for options with upcharges selected below.)

Continued on next page ▶

How to specify — Select the Model Number from above.	1st Option: Select the Frame Color:	2nd Option: Select the Mesh Color for Work Chairs (if applicable):	3rd Option: Lumbar for Work Chairs (if applicable):	4th Option: Select the Cylinder (if applicable):	5th Option: Select the Base Color (if applicable):	6th Option: Select the Casters (if applicable):
	<b>BLK</b> Black <b>E9</b> Flint (add \$88) <b>ST</b> Salt (add \$88) <b>TI</b> Titanium (add \$44)	<b>C</b> Clay <b>D</b> Dusk <b>L</b> Lustre <b>M</b> Mist <b>N</b> Navy	<b>L</b> Yes (\$55 extra) <b>N</b> No	<b>2</b> Standard, 5" of Travel <b>3</b> Short, 2½" of Travel	<b>BLK</b> Black <b>E9</b> Flint <b>ST</b> Salt <b>TI</b> Titanium <b>PAL</b> Polished Aluminum (\$159 extra)	<b>H</b> Black Hard Tread <b>B</b> Black Multi-Surface (\$66 extra) <b>E9</b> Flint Multi-Surface (\$66 extra) <b>ST</b> Salt Multi-Surface (\$66 extra) <b>T</b> Titanium Multi-Surface (\$66 extra) <b>PAL</b> Polished Aluminum Multi-Surface (\$142 extra)
DW - NO . . . . .	. . . . .	. . . . .	. . . . .	. . . . .	. . . . .	. . . . .

Examples: DWW-MHWNO.BLK.D.L.2.BLK.B.CU10.TC01 DW-LUK.BLK.TGR

DWC-UMWNO.TI.2.TI.T.CU10.TC09.CU50.TC09

Model Number	COM Package			Overall			Seat			Armrests			Backrest			Ship Weight	Ship Weight Per Carton	Cubes		
	COL Sq. Feet	Height (Range)	Width	Depth	Height (Range)	Width	Depth (Range)	Pan Angle (Range)	Armrest Height	Width Between Arms	Depth (Range)	Pivot Inwards	Pivot Outwards	Height	Width				Lumbar Height*	Backrest/Seat Angle (Range)
DWW-MHWNO	0.75	38½"-43½"	26"	26"	16¼"-21¼" (Short 15½"-18")	20"	15½"-18¼"	3°- 10°	6¼"-11¼"	12½" - 21"	9¼"	30°	30°	24"	16½"	10"	97°- 113°	39	39	11.8
DWC-UMWNO	0.9 0.75	35"-40"	26"	26"	16¼"-21¼" (Short 15½"-18")	20"	16"-18¼"	3°- 10°	6¼"-11¼"	12½" - 21"	9¼"	30°	30°	20¼"	17"	10"	97°- 113°	39	39	11.8
DWW-MHHNO	0.75	38½"-43½"	26"	26"	16¼"-21¼" (Short 15½"-18")	20"	15½"-18¼"	3°- 10°	6¼"-10½"	21½"	9¼"	Arms to Floor 22¼"-31¼"		24"	16½"	10"	97°- 113°	39	39	11.8
DWC-UMHNO	0.9 0.75	35"-40"	26"	26"	16¼"-21¼" (Short 15½"-18")	20"	16"-18¼"	3°- 10°	6¼"-10½"	21½"	9¼"	22¼"-31¼"		20¼"	17"	10"	97°- 113°	39	39	11.8
DWW-MHFNO	0.75	38½"-43½"	26"	26"	16¼"-21¼" (Short 15½"-18")	20"	15½"-18¼"	3°- 10°	8"	21½"	9¼"	24¼"-29¼"		24"	16½"	10"	97°- 113°	39	39	11.8
DWC-UMFNO	0.9 0.75	35"-40"	26"	26"	16¼"-21¼" (Short 15½"-18")	20"	16"-18¼"	3°- 10°	8"	21½"	9¼"	24¼"-29¼"		20¼"	17"	10"	97°- 113°	39	39	11.8
DWW-MHANO	0.75	38½"-43½"	26"	26"	16¼"-21¼" (Short 15½"-18")	20"	15½"-18¼"	3°- 10°						24"	16½"	10"	97°- 113°	37	37	11.1
DWC-UMANO	0.9 0.75	35"-40"	26"	26"	16¼"-21¼" (Short 15½"-18")	20"	16"-18¼"	3°- 10°						20¼"	17"	10"	97°- 113°	37	37	11.1





**NOTE:** Dimensions are in accordance with BIFMA G1-2013 guidelines - see illustration of guidelines on page 45.

\*Optional external lumbar support can be added at any time.

◀ Continued from previous page

<p><b>7th Option:</b> Select the <b>Seat Upholstery</b> (if applicable): See pages 13-14 for selections and color codes. See pages 6-8 for COM Guidelines.</p>	<p><b>8th Option:</b> Select the <b>Accent Stitch for Seat</b> (if applicable): (Coordinating no upcharge, all other colors listed \$34 extra) <b>TC00</b> Coordinating      <b>TC05</b> Light Red <b>TC01</b> Yellow              <b>TC06</b> Orange <b>TC02</b> Tan                 <b>TC07</b> Medium Green <b>TC03</b> Natural            <b>TC08</b> Blue <b>TC04</b> Black              <b>TC09</b> Light Gray  See pages 6-8 for COM Guidelines.</p>	<p><b>9th Option:</b> Select the <b>Back Upholstery for Conference Chairs</b> (if applicable): See pages 13-14 for selections and color codes. See pages 6-8 for COM Guidelines.</p>	<p><b>10th Option:</b> Select the <b>Accent Stitch for Conference Back</b> (if applicable): (Coordinating no upcharge, all other colors listed \$34 extra) See 8th Option for accent stitch for seat for thread colors and codes.</p>	<p><b>11th Option:</b> <b>Pad Color for Lumbar</b> only required if ordered separately (if applicable): <b>TGR</b> Translucent Graphite</p>
--	---	--	---	---

(See pages 154-155. for COM pricing on Grades 9-22)

Armrest	Back	Model									Leather	
			1	2	3	4	5	6	7	8	1	2
 4D Arms	Work Stool Mesh	DWS-MHWNO	\$ 1981	\$ 2004	\$ 2023	\$ 2045	\$ 2068	\$ 2093	\$ 2113	\$ 2140	\$ 2325	\$ 2537
	High-Back											
 Height-Adjustable Arms	Work Stool Mesh	DWS-MHHNO	\$ 1907	\$ 1930	\$ 1949	\$ 1971	\$ 1994	\$ 2019	\$ 2039	\$ 2066	\$ 2251	\$ 2463
	High-Back											
 Fixed Arms	Work Stool Mesh	DWS-MHFNO	\$ 1956	\$ 1979	\$ 1998	\$ 2020	\$ 2043	\$ 2068	\$ 2088	\$ 2115	\$ 2300	\$ 2512
	High-Back											
 Armless	Work Stool Mesh	DWS-MHANO	\$ 1788	\$ 1811	\$ 1830	\$ 1852	\$ 1875	\$ 1900	\$ 1920	\$ 1947	\$ 2132	\$ 2344
	High-Back											

Model Number	Overall			Seat			Armrests				Backrest										
	COM Package	COL. Sp. Feet	Height (Range)	Width	Depth	Height (Range)	Width	Depth (Range)	Pan Angle (Range)	Armrest Height	Width Between Arms	Armrest Length	Pivot Inwards	Pivot Outwards	Height	Width	Lumbar Height	Backrest/Seat Angle (Range)	Slip Weight	Slip Weight Per Carton	Cubes
DWS-MHWNO	0.75		46"-55 1/2"	26"	26"	22 1/4"-33 3/4"	20"	15 1/2"-18 1/4"	3°-10°	6 1/4"-11 1/4"	12 1/2"-21"	9 1/4"	30"	30"	24"	16 1/2"	10"	97°-113°	45	45	11.8
DWS-MHHNO	0.75		46"-55 1/2"	26"	26"	22 1/4"-33 3/4"	20"	15 1/2"-18 1/4"	3°-10°	6 1/4"-10 1/2"	21 1/2"	9 1/4"			24"	16 1/2"	10"	97°-113°	45	45	11.8
DWS-MHFNO	0.75		46"-55 1/2"	26"	26"	22 1/4"-33 3/4"	20"	15 1/2"-18 1/4"	3°-10°	8"	21 1/2"	9 1/4"			24"	16 1/2"	10"	97°-113°	45	45	11.8
DWS-MHANO	0.75		46"-55 1/2"	26"	26"	22 1/4"-33 3/4"	20"	15 1/2"-18 1/4"	3°-10°			9 1/4"			24"	16 1/2"	10"	97°-113°	44	44	11.1



<b>How to specify —</b> Select the Model Number from above.	<b>1st Option:</b> Select the Frame Color: BLK Black E9 Flint (add \$88) ST Salt (add \$88) TI Titanium (add \$44)	<b>2nd Option:</b> Select the Mesh Color for Work Stools: C Clay D Dusk L Lustre M Mist N Navy	<b>3rd Option:</b> Select the Lumbar: Y Yes (\$55 extra) N No	<b>4th Option:</b> Select the Cylinder: 4 Stool, allows 10" of travel	<b>5th Option:</b> Select the Base Color: BLK Black E9 Flint ST Salt TI Titanium PAL Polished Aluminum (\$159 extra)	<b>6th Option:</b> Select the Casters: H Black Hard Tread B Black Multi-Surface (\$66 extra) E9 Flint Multi-Surface (\$66 extra) \ ST Salt Multi-Surface (\$66 extra) T Titanium Multi-Surface (\$66 extra) PAL Polished Aluminum (Multi-Surface \$142 extra)
	DWS   —   MH   NO   .         .         .         .         .         .         .         .					

<b>7th Option:</b> Select the Seat Upholstery: See pages 13-14 for selections and color codes. See pages 6-8 for COM Guidelines.	<b>8th Option:</b> Select the Accent Stitch for Seat (if applicable): (Coordinating no upcharge; all other colors listed \$34 extra) TC00 Coordinating      TC05 Light Red TC01 Yellow              TC06 Orange TC02 Tan                    TC07 Medium Green TC03 Natural              TC08 Blue TC04 Black                 TC09 Light Gray See pages 6-8 for COM Guidelines.
.                 .	.                 .

Examples: DWS-MHWNO.BLK.D.L.4.BLK.B.CU10.TC01  
 DWS-MHANO.TI.C.N.4.TI.T.CU50.TC00

EVO

(See page 155 for COM pricing on Grades 9-22)

Armrest	Back	Model	1	2	3	4	5	6	7	8	Leather	
											1	2
<b>CASTERS</b> 	4-Leg Side Chair Mesh Back	DSC-MUCONO	\$ 887	\$ 910	\$ 929	\$ 951	\$ 974	\$ 999	\$1019	\$1046	\$1116	\$ 1258
<b>GLIDES</b> 	4-Leg Side Chair Mesh Back	DSC-MUGONO	\$ 842	\$ 865	\$ 884	\$ 906	\$ 929	\$ 954	\$ 974	\$1001	\$1071	\$ 1213

Model Number	Overall			Seat			Armrests				Backrest									
	COM Yardage	COL Sq. Feet	Height	Width	Depth	Height	Width	Depth	Pan Angle (Range)	Armrest Height	Width Between Arms	Armrest Length	Armrest Height From Floor	Height	Width	Lumbar Height	Backrest/Seat Angle (Range)	Ship Weight	Ship Weight Per Carton	Cubes
DSC-MUCONO	1.0	11.50	33½"	22¼"	21½"	18¼"	18"	16"	8°	9¼"	19½"	7½"	26¼"	18½"	16½"	9¼"	96°-99°	28	—	13.2
DSC-MUGONO	1.0	11.50	33½"	22¼"	21½"	18¼"	18"	16"	8°	9¼"	19½"	7½"	26¼"	18½"	16½"	9¼"	96°-99°	28	—	13.2

<p><b>How to specify —</b> Select the Model Number from above.</p>	<p><b>1st Option:</b> Select the Frame Color for Side Chairs:</p> <p>P71 Black P02 Flint P8C Salt PR6 Silver P8X Solar Black P8T Titanium</p>	<p><b>2nd Option:</b> Select the Mesh Color for Side Chairs:</p> <p>C Clay D Dusk L Lustre M Mist N Navy</p>	<p><b>3rd Option:</b> Select the Glides or Casters:</p> <p>0 Nylon Glides 1 Nickel Glides (\$18 extra) 2 Felt Glides (\$18 extra) 3 Multi-Surface Casters</p>	<p><b>4th Option:</b> Select the Upholstery:</p> <p>See pages 13-14 for selections and color codes. See pages 6-8 for COM Guidelines.</p>
--	---	--	---	---

D | S | C | - | M | U | O | N | O | . | | | | . | | | | . | | | | . | | | | | | | | | |

Examples: DSC-MUCONO.P71.D.3.CU10 DSC-MUGONO.P71.D.1.CU50







*Inspire is designed to support a multitude of higher education environments. In Allsteel's second collaboration with Bruce Fifield of Milan-based Design Continuum Italia, Inspire responds to the specific needs of today's dynamic learning environments. Incorporating automatic comfort technologies, students can now stay comfortable longer promoting active, engaged learning.*

*Inspire has achieved SCS Indoor Advantage Gold Certification and level® 2 certification. Inspire is designed and manufactured to have minimal impact on both the physical and social environment, made with no PVC components, and ranges in percent recyclable from 59% to 98%.*

## KEY FEATURES

### TriFit™ Comfort Technologies

Inspire encourages interaction and involvement through unrestricted freedom of movement. The TriFit technology incorporates seat suspension, back recline, and seat flexure in a non-mechanical system that allows users to move freely and learn comfortably.

### Breadth of Line

Today's learning environments are extending beyond the classroom. Spaces are needed that invite interaction and support collaboration. With Inspire's broad statement of line, versatile spaces are created not only in classrooms, but also in active learning environments – cafés, libraries, labs, and team project rooms – throughout campus.

### Lasting Performance

Higher education environments mandate lasting performance. With Inspire's 4-sided welded steel frame construction, it creates a durable design that withstands active environments. The back recline and seat movement technologies are robust and non-mechanical to provide long-lasting, quiet use.

## MODELS AND OPTIONS

Inspire models are available with arms or armless. Arm models feature two arm cap options: non-flexible for high-use environments and flexible for enhanced comfort.

Seat and back upholstery options are available on all models. Upholstery can be field-installed and is field-replaceable.

## MATERIALS AND FINISHES

Polymer shells are offered in eight energizing colors and are made from recyclable material.

Trisect seating upholstery provides a high performance, sustainable fabric option to complement the eight polymer shell colors. This EIP antimony-free fabric incorporates Greenshield finish. Additional upholstery options also available.

- All upholstery foams are CFC-free.
- All COMs/COLs must be approved for upholsterability and applicable fire code compliance prior to order entry. See COM ordering instructions on pages 6-8.
- Allsteel fabrics and foam meet requirements for CAL TB117-2013. COM/COL manufacturers supply certificates of compliance for fabric-only tests such as CAL TB117-2013.
- Flammability code compliance of Allsteel textiles and seating is listed on pages 13-14. COM/COL manufacturers supply certificates of compliance for fabric-only tests such as CAL TB117-2013.

Inspire meets the requirements set forth in ANSI/BIFMA X5.1-2017. Inspire is warranted for multiple shifts and users up to 300 pounds. Inspire four-leg stack and sled base chairs ship two per carton. All other models ship one per carton. Work chairs and work stools ship fully assembled. Model numbers and pricing are per chair.

**4-Leg Multi-Purpose**

4-Leg Multi-Purpose chairs can stack five high.

Glides are available in nylon, nickel-plated steel, or nylon with felt options. Nylon glides are recommended for hard surfaces, commercial carpet, and damp environments. Nickel-plated steel glides are recommended for carpet. Nylon with felt glides are recommended for wood, tile, or high-sheen floor surfaces.

Multi-surface casters are also available.

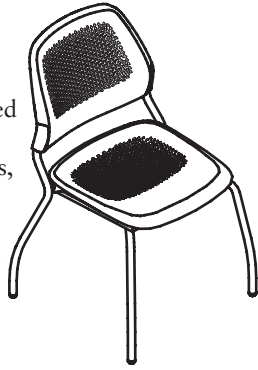

**OPTIONS — 4-LEG MULTI-PURPOSE**

Upholstery Option:

- N** None (Polymer seat and back)
- S** Upholstered Seat Pad
- U** Upholstered Seat and Back Pad

Glides/Casters:

- G** Glides
- C** Casters

Armrests:

- O** Fixed Arms
- A** Armless

Fire Code:

- NO** Standard Upholstery, No Fire Code

Type of Glides/Casters:

- 0** Nylon Glides
- 1** Nickel-plated Steel Glides (\$18 extra)
- 2** Nylon with Felt Glides (\$18 extra)
- 3** Multi-surface Casters

Arm Cap:

- N** No Arm
- H** Non-Flexible
- F** Flexible (\$22 extra)

Frame Finish:

- P8X** Solar Black
- P8T** Titanium
- PR6** Silver
- CBK** Charblack

Polymer Shell Color:

- |   |                                     |
|---|-------------------------------------|
| <b>BLK</b> Black<br>(formerly <b>CB</b> Onyx) | <b>GY</b> Summit                    |
| <b>BU</b> Surf                                | <b>RD</b> Cayenne                   |
| <b>BW</b> Brownstone                          | <b>RG</b> Tangelo                   |
| <b>GN</b> Sprout                              | <b>WT</b> White<br>(formerly Frost) |

Upholstery

See pages 13-14 for selections and pages 17-18.1 for color codes.

**Sled Base Multi-Purpose**

Sled Base Multi-Purpose chairs can stack five high.

Glides are available in polycarbonate, polycarbonate with felt or no glide options. Polycarbonate glides are recommended for hard surfaces, commercial carpet, and damp environments. Felt glides are recommended for wood, tile, or high-sheen floor surfaces.

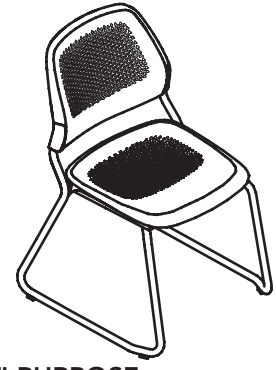

**OPTIONS — SLED BASE MULTI-PURPOSE**

Upholstery Option:

- N** None (Polymer seat and back)
- S** Upholstered Seat Pad
- U** Upholstered Seat and Back Pad

Armrests:

- O** Fixed Arms
- A** Armless

Fire Code:

- NO** Standard Upholstery, No Fire Code

Type of Glides:

- 0** Polycarbonate Glides
- 2** Felt Covered Polycarbonate Glides (\$18 extra)
- 4** No Glides

Arm Cap:

- N** No Arm
- H** Non-Flexible
- F** Flexible (\$22 extra)

Frame Finish:

- |                         |  |
|-------------------------|--|
| <b>CBK</b> Black        | <b>P8M</b> Regatta                             |
| <b>P8T</b> Titanium     | <b>P091</b> Amethyst<br><i>(De-emphasized)</i> |
| <b>P8B</b> Night Bronze | <b>P096</b> Cove                               |
| <b>PJE</b> Pyrite       | <b>P090</b> Cobalt<br><i>(De-emphasized)</i>   |
| <b>PR6</b> Silver       | <b>P094</b> Dune                               |
| <b>P8X</b> Solar Black  | <b>P097</b> Harbor                             |
| <b>P8S</b> Atom         | <b>P093</b> Ochre                              |
| <b>PJF</b> Bullseye     | <b>P095</b> Sage                               |
| <b>P8P</b> Ember        | <b>P092</b> Sienna                             |
| <b>P8N</b> Ion          |  |
| <b>P8J</b> Iris         |  |
| <b>P8F</b> Krypton      |  |

Polymer Shell Color:

- |   |                                     |
|---|-------------------------------------|
| <b>BLK</b> Black<br>(formerly <b>CB</b> Onyx) | <b>GY</b> Summit                    |
| <b>BU</b> Surf                                | <b>RD</b> Cayenne                   |
| <b>BW</b> Brownstone                          | <b>RG</b> Tangelo                   |
| <b>GN</b> Sprout                              | <b>WT</b> White<br>(formerly Frost) |

Upholstery

See pages 13-14 for selections and pages 17-18.1 for color codes.

**4-Leg Tablet Arm**

4-Leg Tablet Arm chairs can stack three high.

Tablets are field-installed to the chairs.

Tablet material consists of 3/4" thick 11-ply laminated Baltic Birch plywood.

Flip-and-fold tablet option provides 6 degrees of lateral rotation in the use position to accommodate a wider range of user types. It also flips up 90 degrees and rotates back 180 degrees to store when a tablet is not needed.

Glides are available in nylon, nickel-plated steel, or nylon with felt options. Nylon glides are recommended for hard surfaces, commercial carpet, and damp environments.

Nickel-plated glides are recommended for carpet. Felt glides are recommended for wood, tile, or high-shine floor surfaces.

Multi-surface casters are also available.

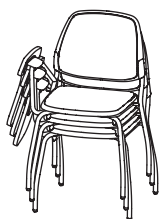
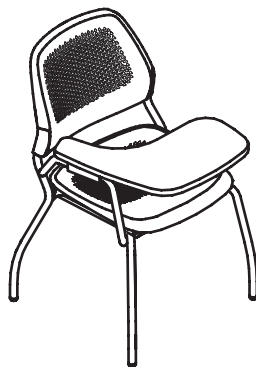

**Flip & Fold  
Right Hand 4-Leg  
Tablet Arm**

**OPTIONS — 4-LEG TABLET ARM**

Upholstery Option:

- N** None (Polymer seat and back)
- S** Upholstered Seat Pad
- U** Upholstered Seat and Back Pad

Glides/Casters:

- G** Glides
- C** Casters

Armrests:

- A** Armless

Tablet Arm:

- FR** Flip & Fold Right Hand
- FL** Flip & Fold Left Hand

Tablet Size:

- S** Standard

Fire Code:

- NO** Standard Upholstery, No Fire Code

Type of Glides/Casters:

- 0** Nylon Glides
- 1** Nickel-plated Steel Glides (\$18 extra)
- 2** Nylon with Felt Glides (\$18 extra)
- 3** Multi-surface Casters

Arm Cap:

- N** No Arm

Frame Finish:

- |                         |  |
|-------------------------|--|
| <b>CBK</b> Black        | <b>P8M</b> Regatta                             |
| <b>P8T</b> Titanium     | <b>P091</b> Amethyst<br><i>(De-emphasized)</i> |
| <b>P8B</b> Night Bronze | <b>P096</b> Cove                               |
| <b>PJE</b> Pyrite       | <b>P090</b> Cobalt<br><i>(De-emphasized)</i>   |
| <b>PR6</b> Silver       | <b>P094</b> Dune                               |
| <b>P8X</b> Solar Black  | <b>P097</b> Harbor                             |
| <b>P8S</b> Atom         | <b>P093</b> Ochre                              |
| <b>PJF</b> Bullseye     | <b>P095</b> Sage                               |
| <b>P8P</b> Ember        | <b>P092</b> Sienna                             |
| <b>P8N</b> Ion          |  |
| <b>P8J</b> Iris         |  |
| <b>P8F</b> Krypton      |  |

Polymer Shell Color:

- |   |                                     |
|---|-------------------------------------|
| <b>BLK</b> Black<br>(formerly <b>CB</b> Onyx) | <b>GY</b> Summit                    |
| <b>BU</b> Surf                                | <b>RD</b> Cayenne                   |
| <b>BW</b> Brownstone                          | <b>RG</b> Tangelo                   |
| <b>GN</b> Sprout                              | <b>WT</b> White<br>(formerly Frost) |

Tablet Laminate:

- LWD** Natural Maple

Upholstery

See pages 13-14 for selections and pages 17-18.1 for color codes.

**TABLET ARM DIMENSIONS**

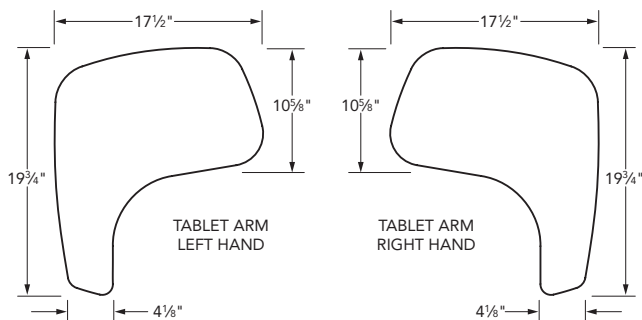

**MULTI-PURPOSE WORK CHAIR**

**Base/Casters**

Base is a black colored composite five-star structure. Dual-wheel casters feature hard tread for carpeted floors or soft tread for smooth floors.



**Pneumatic Seat Height Adjustment**

Regulates height of chair relative to the floor.

- Standard cylinder with 5" of travel accommodates average or tall users.
- Optional short cylinder with 3½" of travel keeps chair closer to the floor for shorter users.

**OPTIONS — MULTI-PURPOSE WORK CHAIR**

Upholstery Option:

- N** None (Polymer seat and back)
- S** Upholstered Seat Pad
- U** Upholstered Seat and Back Pad

Armrests:

- O** Fixed Arms
- A** Armless

Fire Code:

- NO** Standard Upholstery, No Fire Code

Pneumatic Cylinder:

- 2** Standard; allows 5" of travel
- 3** Short; non-standard 3½" of travel to meet BIFMA G1-2002

Type Casters:

- 0** 2½" Black Dual-wheel Hard Tread for Carpet
- 1** 2½" Black Dual-wheel Soft Tread for Smooth Surfaces

Arm Cap:

- N** No Arm
- H** Non-Flexible
- F** Flexible (\$22 extra)

Frame Finish with Charblack base:

<b>CBK</b> Black	<b>P8M</b> Regatta
<b>P8T</b> Titanium	<b>P091</b> Amethyst <i>(De-emphasized)</i>
<b>P8B</b> Night Bronze	<b>P096</b> Cove
<b>PJE</b> Pyrite	<b>P090</b> Cobalt <i>(De-emphasized)</i>
<b>PR6</b> Silver	<b>P094</b> Dune
<b>P8X</b> Solar Black	<b>P097</b> Harbor
<b>P8S</b> Atom	<b>P093</b> Ochre
<b>PJF</b> Bullseye	<b>P095</b> Sage
<b>P8P</b> Ember	<b>P092</b> Sienna
<b>P8N</b> Ion	
<b>P8J</b> Iris	
<b>P8F</b> Krypton	

Polymer Shell Color:

<b>BLK</b> Black (formerly <b>CB</b> Onyx)	<b>GY</b> Summit
<b>BU</b> Surf	<b>RD</b> Cayenne
<b>BW</b> Brownstone	<b>RG</b> Tangelo
<b>GN</b> Sprout	<b>WT</b> White (formerly Frost)

Upholstery

See pages 13-14 for selections and pages 17-18.1 for color codes.

**MULTI-PURPOSE WORK STOOL**

**Base/Casters**

Base is a black colored composite five-star structure. Dual-wheel casters feature hard tread for carpeted floors or soft tread for smooth floors.



**Height-Adjustable Footring**

Travels 8" to ensure users have comfortable support of their feet and legs. The footring has a 20" diameter.

**Pneumatic Seat Height Adjustment**

Regulates height of stool relative to the floor.

Includes extended-range height pneumatic cylinder with 10" of vertical travel.

**OPTIONS — MULTI-PURPOSE WORK STOOL**

Upholstery Option:

- N** None (Polymer seat and back)
- S** Upholstered Seat Pad
- U** Upholstered Seat and Back Pad

Armrests:

- O** Fixed Arms
- A** Armless

Fire Code:

- NO** Standard Upholstery, No Fire Code

Pneumatic Cylinder:

- 4** Extended Range Cylinder; allows 10" of travel

Type Casters:

- 0** 2½" Black Dual-wheel Hard Tread for Carpet
- 1** 2½" Black Dual-wheel Soft Tread for Smooth Surfaces
- 2** Glides

Arm Cap:

- N** No Arm
- H** Non-Flexible
- F** Flexible (\$22 extra)

Frame Finish with Charblack base:

<b>CBK</b> Black	<b>P8M</b> Regatta
<b>P8T</b> Titanium	<b>P091</b> Amethyst <i>(De-emphasized)</i>
<b>P8B</b> Night Bronze	<b>P096</b> Cove
<b>PJE</b> Pyrite	<b>P090</b> Cobalt <i>(De-emphasized)</i>
<b>PR6</b> Silver	<b>P094</b> Dune
<b>P8X</b> Solar Black	<b>P097</b> Harbor
<b>P8S</b> Atom	<b>P093</b> Ochre
<b>PJF</b> Bullseye	<b>P095</b> Sage
<b>P8P</b> Ember	<b>P092</b> Sienna
<b>P8N</b> Ion	
<b>P8J</b> Iris	
<b>P8F</b> Krypton	

Polymer Shell Color:

<b>BLK</b> Black (formerly <b>CB</b> Onyx)	<b>GY</b> Summit
<b>BU</b> Surf	<b>RD</b> Cayenne
<b>BW</b> Brownstone	<b>RG</b> Tangelo
<b>GN</b> Sprout	<b>WT</b> White (formerly Frost)

Upholstery

See pages 13-14 for selections and pages 17-18.1 for color codes.

**4-LEG STOOL**

4-Leg stools do not stack.

Glides are available in nylon, nickel-plated steel, or nylon with felt options. Nylon glides are recommended for hard surfaces, commercial carpet, and damp environments. Nickel-plated steel glides are recommended for carpet. Nylon with felt glides are recommended for wood, tile, or high-shine floor surfaces.

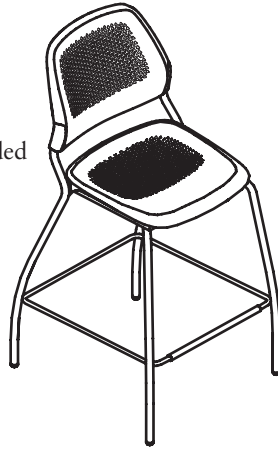

**OPTIONS — 4-LEG STOOL**

Upholstery Option:

- N** None (Polymer Seat and Back)
- S** Upholstered Seat Pad
- U** Upholstered Seat and Back Pad

Glides:

- G** Glides

Armrests:

- O** Fixed Arms
- A** Armless

Fire Code:

- NO** Standard Upholstery, No Fire Code

Type of Glides:

- 0** Nylon Glides
- 1** Nickel-plated Steel Glides (\$18 extra)
- 2** Nylon with Felt Glides (\$18 extra)

Arm Cap:

- N** No Arm
- H** Non-Flexible
- F** Flexible (\$22 extra)

Frame Finish:

- |                         |  |
|-------------------------|--|
| <b>CBK</b> Black        | <b>P8J</b> Iris                                |
| <b>P8T</b> Titanium     | <b>P8F</b> Krypton                             |
| <b>P8B</b> Night Bronze | <b>P8M</b> Regatta                             |
| <b>PJE</b> Pyrite       | <b>P091</b> Amethyst<br><i>(De-emphasized)</i> |
| <b>PR6</b> Silver       | <b>P090</b> Cobalt<br><i>(De-emphasized)</i>   |
| <b>P8X</b> Solar Black  | <b>P093</b> Ochre                              |
| <b>P8S</b> Atom         | <b>P092</b> Sienna                             |
| <b>PJF</b> Bullseye     |  |
| <b>P8P</b> Ember        |  |
| <b>P8N</b> Ion          |  |

Polymer Shell Color:

- |   |                                     |
|---|-------------------------------------|
| <b>BLK</b> Black<br>(formerly <b>CB</b> Onyx) | <b>GY</b> Summit                    |
| <b>BU</b> Surf                                | <b>RD</b> Cayenne                   |
| <b>BW</b> Brownstone                          | <b>RG</b> Tangelo                   |
| <b>GN</b> Sprout                              | <b>WT</b> White<br>(formerly Frost) |

Upholstery

See pages 13-14 for selections and pages 17-18.1 for color codes.

FLOOR COVERING	TYPE OF GLIDE			
	Polycarbonate/Nylon	Felt	Steel	Rubber
Carpet	Best	Not Recommended	Good	Not Recommended
Polished Concrete	Best	Good	Not Recommended	Not Recommended
Hardwood	Not Recommended	Best	Not Recommended	Good
Vinyl (Includes LVT)	Best	Better	Good	Good
VCT	Best	Good	Not Recommended	Good
Tile (Porcelain/Ceramic)	Best	Good	Not Recommended	Good
<b>Attention</b>	Particles can become lodged in nylon and mar floor surface.	Particles can become lodged in felt and mar floor surface.	Cleaning chemicals and water can cause rusting.	Resists moving/sliding. Could lead to chairs tipping back.



## Inspire Room Typicals

*These eight typicals show various arrangements featuring Inspire.*

### CLASSROOM

Collaborative areas feature Inspire four-leg stack chairs with casters around Merge® Power Bay™ tables. Instructor has an Inspire work stool at a variable height table.

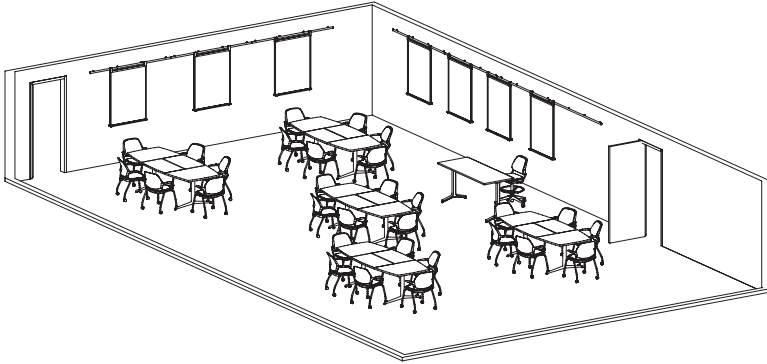

### TEAM ROOM

Inspire 4-Leg Multi-Purpose with casters around a Merge Power Bay table. Stride high credenza along wall.

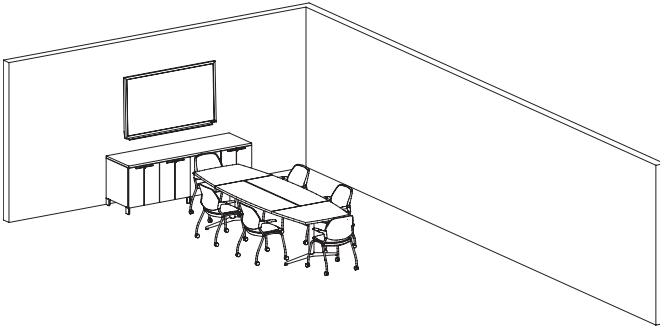

### U SHAPE CLASSROOM

Inspire 4-Leg Multi-Purpose with glides around tables. Instructor has an Inspire Multi-Purpose Work Stool with a variable height table.

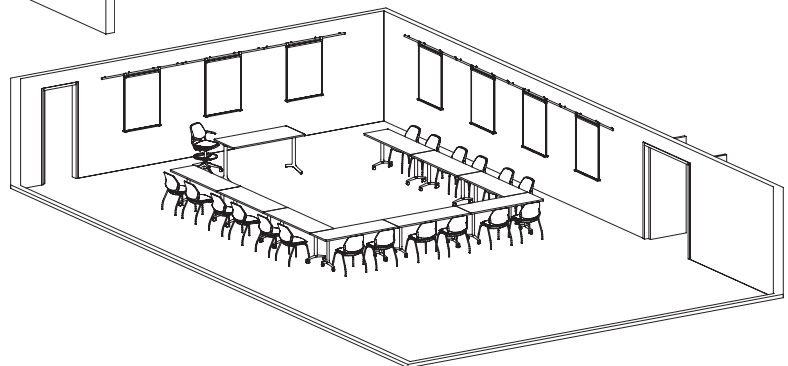

**CAFÉ/ATRIUM**

Inspire 4-Leg Multi-Purpose with glides around Merge tables. Inspire four-leg stools with Merge standing height tables occupy the perimeter.

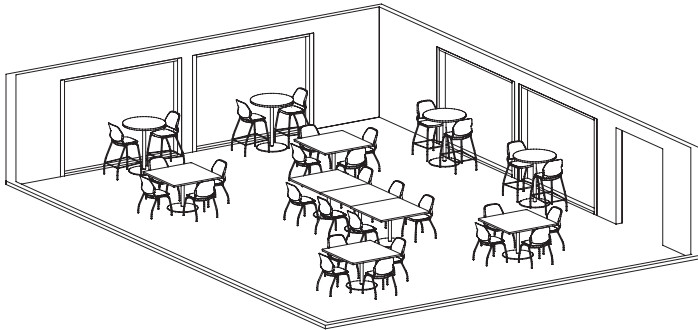

**COMPUTER LAB**

Inspire Multi-Purpose Work Chair with tables. Instructor has an Inspire Multi-Purpose Work Stool at a variable height table.

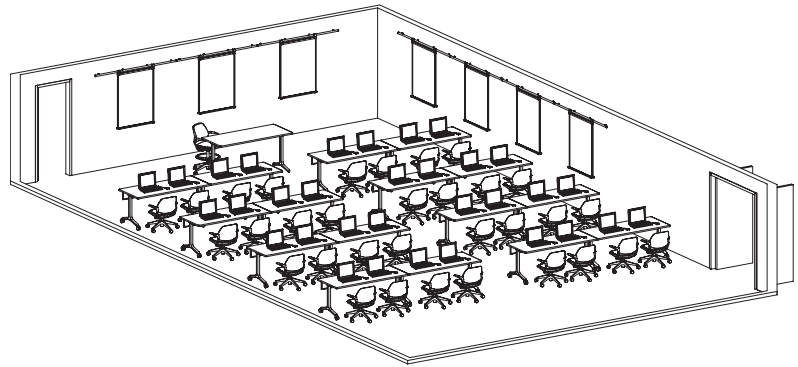

INSPIRE

**FACULTY OFFICE**

Inspire 4-Leg Multi-Purpose with casters around a Merge table create a teaming area in a Stride office with an Acuity® chair.

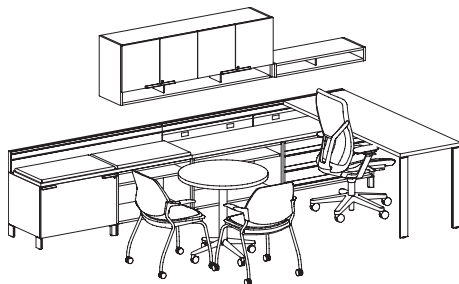





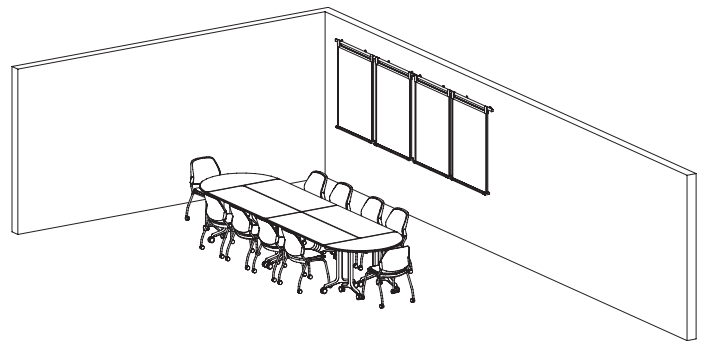

**SEMINAR**

Inspire 4-Leg Multi-Purpose with casters around a Merge Power Bay table.





(See page 155 for COM pricing on Grades 9-22)

Backrest Style Arm Style	Seat Construction	Glide or Caster	Model Number Add options below	Model Number								Leather*	
				1	2	3	4	5	6	7	8	1	2
Polymer Back Arms 	Polymer Seat	Glide	INST-NGO	\$ 808	—	—	—	—	—	—	—	—	—
		Caster	INST-NCO	\$ 853	—	—	—	—	—	—	—	—	—
Polymer Back Armless 	Polymer Seat	Glide	INST-NGA	\$ 675	—	—	—	—	—	—	—	—	—
		Caster	INST-NCA	\$ 721	—	—	—	—	—	—	—	—	—
Polymer Back Arms 	Upholstered Seat Pad	Glide	INST-SGO	\$ 986	\$ 1012	\$ 1030	\$ 1053	\$ 1077	\$ 1104	\$ 1126	\$ 1154	\$ 1230	\$ 1381
		Caster	INST-SCO	\$ 1028	\$ 1054	\$ 1072	\$ 1095	\$ 1119	\$ 1146	\$ 1168	\$ 1196	\$ 1272	\$ 1423
Polymer Back Armless 	Upholstered Seat Pad	Glide	INST-SGA	\$ 852	\$ 878	\$ 896	\$ 919	\$ 943	\$ 970	\$ 992	\$ 1020	\$ 1096	\$ 1247
		Caster	INST-SCA	\$ 896	\$ 922	\$ 940	\$ 963	\$ 987	\$ 1014	\$ 1036	\$ 1064	\$ 1140	\$ 1291
Upholstered Back Pad Arms 	Upholstered Seat Pad	Glide	INST-UGO	\$ 1145	\$ 1183	\$ 1216	\$ 1263	\$ 1308	\$ 1350	\$ 1396	\$ 1441	\$ 1576	\$ 1843
		Caster	INST-UCO	\$ 1190	\$ 1228	\$ 1261	\$ 1308	\$ 1353	\$ 1395	\$ 1441	\$ 1486	\$ 1621	\$ 1888
Upholstered Back Pad Armless 	Upholstered Seat Pad	Glide	INST-UGA	\$ 1012	\$ 1050	\$ 1083	\$ 1130	\$ 1175	\$ 1217	\$ 1263	\$ 1308	\$ 1443	\$ 1710
		Caster	INST-UCA	\$ 1058	\$ 1096	\$ 1129	\$ 1176	\$ 1221	\$ 1263	\$ 1309	\$ 1354	\$ 1489	\$ 1756

INSPIRE

Continued on next page ►

<p><b>How to specify —</b> Select the Model Number from above.</p> <p>INST-                    </p>	<p><b>1st Option:</b> Select the Fire Code (if applicable):</p> <p>NO</p>	<p><b>2nd Option:</b> Select the Glide or Caster Option:</p> <p>0 Nylon Glides 1 Nickel-plated Glides (\$18 extra) 2 Felt Glides (\$18 extra) 3 Multi-surface Casters</p>	<p><b>3rd Option:</b> Select the Arm Cap:</p> <p>N No Arm H Non-Flexible F Flexible (\$22 extra)</p>	<p><b>4th Option:</b> Select the Frame Color:</p> <table border="0"> <tr> <td>CBK Black</td> <td>P8J Iris</td> </tr> <tr> <td>P8T Titanium</td> <td>P8F Krypton</td> </tr> <tr> <td>P8B Night Bronze</td> <td>P8M Regatta</td> </tr> <tr> <td>PJE Pyrite</td> <td>P091 Amethyst <i>(De-emphasized)</i></td> </tr> <tr> <td>PR6 Silver</td> <td>P090 Cobalt <i>(De-emphasized)</i></td> </tr> <tr> <td>P8X Solar Black</td> <td>P093 Ochre</td> </tr> <tr> <td>P8S Atom</td> <td>P092 Sienna</td> </tr> <tr> <td>PJF Bullseye</td> <td></td> </tr> <tr> <td>P8P Ember</td> <td></td> </tr> <tr> <td>P8N Ion</td> <td></td> </tr> </table>	CBK Black	P8J Iris	P8T Titanium	P8F Krypton	P8B Night Bronze	P8M Regatta	PJE Pyrite	P091 Amethyst <i>(De-emphasized)</i>	PR6 Silver	P090 Cobalt <i>(De-emphasized)</i>	P8X Solar Black	P093 Ochre	P8S Atom	P092 Sienna	PJF Bullseye		P8P Ember		P8N Ion	
CBK Black	P8J Iris																							
P8T Titanium	P8F Krypton																							
P8B Night Bronze	P8M Regatta																							
PJE Pyrite	P091 Amethyst <i>(De-emphasized)</i>																							
PR6 Silver	P090 Cobalt <i>(De-emphasized)</i>																							
P8X Solar Black	P093 Ochre																							
P8S Atom	P092 Sienna																							
PJF Bullseye																								
P8P Ember																								
P8N Ion																								

Example: INST-NCONO.3.H.CBK.CB

Model Number	Overall						Seat				Armrests				Backrest			One Pack Ship Weight	Two Pack Ship Weight	Cubes	
	COM Yandage	COL Sp. Feet	Height (Range)	Width	Depth	Height	Width	Depth (Range)	Pan Angle (Range)	Height (Range)	Width Between Arms (Range)	Depth (Range)	Pivot Inwards	Pivot Outwards	Height (Range)	Width	Lumbar Height (Range)				Backrest/Seat Angle (Range)
INST-NGO	—	—	34"	24¼"	22¼"	18¼"	18¼"	18"	4	8¼"	20¼"	11"	—	—	18¼"	18¼"	8¼"	96 - 103°	23.8	39.0	15.4
INST-NCO	—	—	34"	24¼"	22¼"	18¼"	18¼"	18"	4	8¼"	20¼"	11"	—	—	18¼"	18¼"	8¼"	96 - 103°	24.0	39.4	15.4
INST-NGA	—	—	34"	21¼"	22¼"	18¼"	18¼"	18"	4	—	—	—	—	—	18¼"	18¼"	8¼"	96 - 103°	22.0	35.4	15.4
INST-NCA	—	—	34"	21¼"	22¼"	18¼"	18¼"	18"	4	—	—	—	—	—	18¼"	18¼"	8¼"	96 - 103°	22.2	35.8	15.4
INST-SGO	.6	6	34"	24¼"	22¼"	18¼"	18¼"	18"	4	8¼"	20¼"	11"	—	—	18¼"	18¼"	8¼"	96 - 103°	25.6	42.5	15.4
INST-SCO	.6	6	34"	24¼"	22¼"	18¼"	18¼"	18"	4	8¼"	20¼"	11"	—	—	18¼"	18¼"	8¼"	96 - 103°	25.8	42.9	15.4
INST-SGA	.6	6	34"	21¼"	22¼"	18¼"	18¼"	18"	4	—	—	—	—	—	18¼"	18¼"	8¼"	96 - 103°	23.8	38.9	15.4
INST-SCA	.6	6	34"	21¼"	22¼"	18¼"	18¼"	18"	4	—	—	—	—	—	18¼"	18¼"	8¼"	96 - 103°	24.0	39.3	15.4
INST-UGO	1.0	9.5	34"	24¼"	22¼"	18¼"	18¼"	17¼"	4	8¼"	20¼"	11"	—	—	18¼"	18¼"	8¼"	96 - 103°	27.1	45.6	15.4
INST-UCO	1.0	9.5	34"	24¼"	22¼"	18¼"	18¼"	17¼"	4	8¼"	20¼"	11"	—	—	18¼"	18¼"	8¼"	96 - 103°	27.3	46.0	15.4
INST-UGA	1.0	9.5	34"	21¼"	22¼"	18¼"	18¼"	17¼"	4	—	—	—	—	—	18¼"	18¼"	8¼"	96 - 103°	25.3	42.0	15.4
INST-UCA	1.0	9.5	34"	21¼"	22¼"	18¼"	18¼"	17¼"	4	—	—	—	—	—	18¼"	18¼"	8¼"	96 - 103°	25.5	42.4	15.4





Four-leg stack chairs ship in cartons containing 2 chairs. Model numbers and prices are per chair.

◀ Continued from previous page

<p><b>5th Option:</b> Select the Polymer Shell Color:</p> <table border="0"> <tr> <td><b>BLK</b> Black (formerly</td> <td><b>GY</b> Summit</td> </tr> <tr> <td><b>CB</b> - Onyx)</td> <td><b>RD</b> Cayenne</td> </tr> <tr> <td><b>BU</b> Surf</td> <td><b>RG</b> Tangelo</td> </tr> <tr> <td><b>BW</b> Brownstone</td> <td><b>WT</b> White (formerly Frost)</td> </tr> <tr> <td><b>GN</b> Sprout</td> <td></td> </tr> </table>	<b>BLK</b> Black (formerly	<b>GY</b> Summit	<b>CB</b> - Onyx)	<b>RD</b> Cayenne	<b>BU</b> Surf	<b>RG</b> Tangelo	<b>BW</b> Brownstone	<b>WT</b> White (formerly Frost)	<b>GN</b> Sprout		<p><b>6th Option:</b> Select the Upholstery (if applicable):</p> <p>See pages 13-14 for selections. See pages 17-18.1 for colors and codes. See pages 6-8 for COM guidelines.</p>
<b>BLK</b> Black (formerly	<b>GY</b> Summit										
<b>CB</b> - Onyx)	<b>RD</b> Cayenne										
<b>BU</b> Surf	<b>RG</b> Tangelo										
<b>BW</b> Brownstone	<b>WT</b> White (formerly Frost)										
<b>GN</b> Sprout											

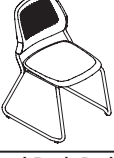

(See page 155 for COM pricing on Grades 9-22)

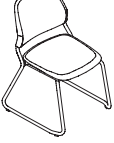
Backrest Style Arm Style	Seat Construction	Model Number Add options below									Leather*		
			1	2	3	4	5	6	7	8	1	2	
Polymer Back Arms 	Polymer Seat	INSL-NO	\$ 807	—	—	—	—	—	—	—	—	—	—
Polymer Back Armless 	Polymer Seat	INSL-NA	\$ 675	—	—	—	—	—	—	—	—	—	—
Polymer Back Arms 	Upholstered Seat Pad	INSL-SO	\$ 981	\$ 1007	\$ 1025	\$ 1048	\$ 1072	\$ 1099	\$ 1121	\$ 1149	\$ 1225	\$ 1376	
Polymer Back Armless 	Upholstered Seat Pad	INSL-SA	\$ 852	\$ 878	\$ 896	\$ 919	\$ 943	\$ 970	\$ 992	\$ 1020	\$ 1096	\$ 1247	
Upholstered Back Pad Arms 	Upholstered Seat Pad	INSL-UO	\$ 1142	\$ 1180	\$ 1213	\$ 1260	\$ 1305	\$ 1347	\$ 1393	\$ 1438	\$ 1573	\$ 1840	
Upholstered Back Pad Armless 	Upholstered Seat Pad	INSL-UA	\$ 1012	\$ 1050	\$ 1083	\$ 1130	\$ 1175	\$ 1217	\$ 1263	\$ 1308	\$ 1443	\$ 1710	

INSPIRE

Continued on next page ►

<p><b>How to specify —</b> Select the Model Number from above.</p> <p>INS L - [ ] [ ]</p>	<p><b>1st Option:</b> Select the Fire Code (if applicable): NO</p>	<p><b>2nd Option:</b> Select the Glide Option: 0 Polycarbonate Glides 2 Felt Covered Polycarbonate Glides (\$18 extra) 4 No Glides</p>	<p><b>3rd Option:</b> Select the Arm Cap: N No Arm H Non-Flexible F Flexible (\$22 extra)</p>	<p><b>4th Option:</b> Select the Frame Color:</p> <table border="0"> <tr> <td>CBK Black</td> <td>P8J Iris</td> </tr> <tr> <td>P8T Titanium</td> <td>P8F Krypton</td> </tr> <tr> <td>P8B Night Bronze</td> <td>P8M Regatta</td> </tr> <tr> <td>PJE Pyrite</td> <td>P091 Amethyst <i>(De-emphasized)</i></td> </tr> <tr> <td>PR6 Silver</td> <td>P090 Cobalt <i>(De-emphasized)</i></td> </tr> <tr> <td>P8X Solar Black</td> <td>P093 Ochre</td> </tr> <tr> <td>P8S Atom</td> <td>P092 Sienna</td> </tr> <tr> <td>PJF Bullseye</td> <td></td> </tr> <tr> <td>P8P Ember</td> <td></td> </tr> <tr> <td>P8N Ion</td> <td></td> </tr> </table>	CBK Black	P8J Iris	P8T Titanium	P8F Krypton	P8B Night Bronze	P8M Regatta	PJE Pyrite	P091 Amethyst <i>(De-emphasized)</i>	PR6 Silver	P090 Cobalt <i>(De-emphasized)</i>	P8X Solar Black	P093 Ochre	P8S Atom	P092 Sienna	PJF Bullseye		P8P Ember		P8N Ion	
CBK Black	P8J Iris																							
P8T Titanium	P8F Krypton																							
P8B Night Bronze	P8M Regatta																							
PJE Pyrite	P091 Amethyst <i>(De-emphasized)</i>																							
PR6 Silver	P090 Cobalt <i>(De-emphasized)</i>																							
P8X Solar Black	P093 Ochre																							
P8S Atom	P092 Sienna																							
PJF Bullseye																								
P8P Ember																								
P8N Ion																								

Example: INSL-SANO.2.N.PR6.BU.TSC96

Model Number	Overall						Seat			Armrests				Backrest			One Pack Ship Weight	Two Pack Ship Weight	Cubes		
	COM Yardage	COL Sp. Feet	Height (Range)	Width	Depth	Height	Width	Depth (Range)	Pan Angle (Range)	Height (Range)	Width Between Arms (Range)	Depth (Range)	Pivot Inwards	Pivot Outwards	Height (Range)	Width				Lumbar Height (Range)	Backrest/Seat Angle (Range)
INSL-NO	—	—	34"	24¼"	22¼"	18¼"	18¼"	18"	4°	8¼"	20¼"	11"	—	—	18¼"	18¼"	8¼"	96 - 103°	25.2	41.8	15.4
INSL-NA	—	—	34"	21¼"	22¼"	18¼"	18¼"	18"	4°	—	—	—	—	—	18¼"	18¼"	8¼"	96 - 103°	23.4	38.2	15.4
INSL-SO	.6	6	34"	24¼"	22¼"	18¼"	18¼"	18"	4°	8¼"	20¼"	11"	—	—	18¼"	18¼"	8¼"	96 - 103°	27.0	45.3	15.4
INSL-SA	.6	6	34"	21¼"	22¼"	18¼"	18¼"	18"	4°	—	—	—	—	—	18¼"	18¼"	8¼"	96 - 103°	25.2	41.7	15.4
INSL-UO	1.0	9.5	34"	24¼"	22¼"	18¼"	18¼"	17¼"	4°	8¼"	20¼"	11"	—	—	18¼"	18¼"	8¼"	96 - 103°	28.5	48.4	15.4
INSL-UA	1.0	9.5	34"	21¼"	22¼"	18¼"	18¼"	17¼"	4°	—	—	—	—	—	18¼"	18¼"	8¼"	96 - 103°	26.7	44.8	15.4

Sled base stack chairs ship in cartons containing 2 chairs. Model numbers and prices are per chair.

◀ Continued from previous page

<p><b>5th Option:</b> Select the Polymer Shell Color:</p> <table border="0"> <tr> <td><b>BLK</b> Black (formerly</td> <td><b>GY</b> Summit</td> </tr> <tr> <td><b>CB</b> - Onyx)</td> <td><b>RD</b> Cayenne</td> </tr> <tr> <td><b>BU</b> Surf</td> <td><b>RG</b> Tangelo</td> </tr> <tr> <td><b>BW</b> Brownstone</td> <td><b>WT</b> White (formerly Frost)</td> </tr> <tr> <td><b>GN</b> Sprout</td> <td></td> </tr> </table>	<b>BLK</b> Black (formerly	<b>GY</b> Summit	<b>CB</b> - Onyx)	<b>RD</b> Cayenne	<b>BU</b> Surf	<b>RG</b> Tangelo	<b>BW</b> Brownstone	<b>WT</b> White (formerly Frost)	<b>GN</b> Sprout		<p><b>6th Option:</b> Select the Upholstery (if applicable):</p> <p>See pages 13-14 for selections. See pages 17-18.1 for colors and codes. See pages 6-8 for COM guidelines.</p>
<b>BLK</b> Black (formerly	<b>GY</b> Summit										
<b>CB</b> - Onyx)	<b>RD</b> Cayenne										
<b>BU</b> Surf	<b>RG</b> Tangelo										
<b>BW</b> Brownstone	<b>WT</b> White (formerly Frost)										
<b>GN</b> Sprout											





# Seating — 4-Leg Tablet Arm

Inspire®

GSA SIN 33721

(See page 155 for COM pricing on Grades 9-22)

Backrest Style	Seat Construction	Tablet Style	Glide or Caster	Model Number Add options below									Leather*	
					1	2	3	4	5	6	7	8	1	2
<b>FLIP &amp; FOLD TABLET — 4 LEG</b>														
	Polymer Seat	Flip & Fold Right	Glide	INSTT-NGAFRS	\$ 1111	—	—	—	—	—	—	—	—	—
		Flip & Fold Right	Caster	INSTT-NCAFRS	\$ 1156	—	—	—	—	—	—	—	—	—
		Flip & Fold Left	Glide	INSTT-NGAFLS	\$ 1111	—	—	—	—	—	—	—	—	—
		Flip & Fold Left	Caster	INSTT-NCAFLS	\$ 1156	—	—	—	—	—	—	—	—	—
	Upholstered Seat Pad	Flip & Fold Right	Glide	INSTT-SGAFRS	\$ 1273	\$ 1299	\$ 1317	\$ 1340	\$ 1365	\$ 1393	\$ 1415	\$ 1444	\$ 1520	\$ 1675
		Flip & Fold Right	Caster	INSTT-SCAFRS	\$ 1316	\$ 1342	\$ 1360	\$ 1383	\$ 1408	\$ 1436	\$ 1458	\$ 1487	\$ 1563	\$ 1718
		Flip & Fold Left	Glide	INSTT-SGAFLS	\$ 1273	\$ 1299	\$ 1317	\$ 1340	\$ 1365	\$ 1393	\$ 1415	\$ 1444	\$ 1520	\$ 1675
		Flip & Fold Left	Caster	INSTT-SCAFLS	\$ 1316	\$ 1342	\$ 1360	\$ 1383	\$ 1408	\$ 1436	\$ 1458	\$ 1487	\$ 1563	\$ 1718
	Upholstered Seat Pad	Flip & Fold Right	Glide	INSTT-UGAFRS	\$ 1452	\$ 1490	\$ 1523	\$ 1572	\$ 1617	\$ 1661	\$ 1706	\$ 1753	\$ 1890	\$ 2163
		Flip & Fold Right	Caster	INSTT-UCAFRS	\$ 1497	\$ 1535	\$ 1568	\$ 1617	\$ 1662	\$ 1706	\$ 1751	\$ 1798	\$ 1935	\$ 2208
		Flip & Fold Left	Glide	INSTT-UGAFLS	\$ 1452	\$ 1490	\$ 1523	\$ 1572	\$ 1617	\$ 1661	\$ 1706	\$ 1753	\$ 1890	\$ 2163
		Flip & Fold Left	Caster	INSTT-UCAFLS	\$ 1497	\$ 1535	\$ 1568	\$ 1617	\$ 1662	\$ 1706	\$ 1751	\$ 1798	\$ 1935	\$ 2208

INSPIRE

Continued on next page ►

<p><b>How to specify —</b> Select the Model Number from above.</p> <p style="font-family: monospace; font-size: 1.2em; letter-spacing: 0.5em;">I N S T _</p>	<p><b>1st Option:</b> Select the Fire Code (if applicable):</p> <p><b>NO</b></p>	<p><b>2nd Option:</b> Select the Glide or Caster Option:</p> <p><b>0</b> Nylon Glides  <b>1</b> Nickel-plated Glides for Four-Leg only (\$18 extra)  <b>2</b> Felt Glides (\$18 extra)  <b>3</b> Multi-surface Casters for Four-Leg only  <b>4</b> No Glides for Sled Base only</p>	<p><b>3rd Option:</b> Select the Arm Cap:</p> <p><b>N</b> No Arm</p>	<p><b>4th Option:</b> Select the Frame Color:</p> <table style="width: 100%;"> <tr> <td><b>CBK</b> Black</td> <td><b>P8J</b> Iris</td> </tr> <tr> <td><b>P8T</b> Titanium</td> <td><b>P8F</b> Krypton</td> </tr> <tr> <td><b>P8B</b> Night Bronze</td> <td><b>P8M</b> Regatta</td> </tr> <tr> <td><b>PJE</b> Pyrite</td> <td><b>P091</b> Amethyst <i>(De-emphasized)</i></td> </tr> <tr> <td><b>PR6</b> Silver</td> <td><b>P090</b> Cobalt <i>(De-emphasized)</i></td> </tr> <tr> <td><b>P8X</b> Solar Black</td> <td><b>P093</b> Ochre</td> </tr> <tr> <td><b>P8S</b> Atom</td> <td><b>P092</b> Sienna</td> </tr> <tr> <td><b>PJF</b> Bullseye</td> <td></td> </tr> <tr> <td><b>P8P</b> Ember</td> <td></td> </tr> <tr> <td><b>P8N</b> Ion</td> <td></td> </tr> </table>	<b>CBK</b> Black	<b>P8J</b> Iris	<b>P8T</b> Titanium	<b>P8F</b> Krypton	<b>P8B</b> Night Bronze	<b>P8M</b> Regatta	<b>PJE</b> Pyrite	<b>P091</b> Amethyst <i>(De-emphasized)</i>	<b>PR6</b> Silver	<b>P090</b> Cobalt <i>(De-emphasized)</i>	<b>P8X</b> Solar Black	<b>P093</b> Ochre	<b>P8S</b> Atom	<b>P092</b> Sienna	<b>PJF</b> Bullseye		<b>P8P</b> Ember		<b>P8N</b> Ion	
<b>CBK</b> Black	<b>P8J</b> Iris																							
<b>P8T</b> Titanium	<b>P8F</b> Krypton																							
<b>P8B</b> Night Bronze	<b>P8M</b> Regatta																							
<b>PJE</b> Pyrite	<b>P091</b> Amethyst <i>(De-emphasized)</i>																							
<b>PR6</b> Silver	<b>P090</b> Cobalt <i>(De-emphasized)</i>																							
<b>P8X</b> Solar Black	<b>P093</b> Ochre																							
<b>P8S</b> Atom	<b>P092</b> Sienna																							
<b>PJF</b> Bullseye																								
<b>P8P</b> Ember																								
<b>P8N</b> Ion																								

Example: INSTT-NGAFRSNO.2.N.CBK.RD.LWD







Model Number	COM Yantage			Overall			Seat			Armrests			Backrest			One Back Ship Weight	Cubes		
	COL Sp. Feet	Height (Range)	Width	Depth	Height	Width	Depth (Range)	Pan Angle (Range)	Height (Range)	Width Between Arms (Range)	Depth (Range)	Pivot Inwards	Pivot Outwards	Height (Range)	Width			Lumbar Height (Range)	Backrest Seat Angle (Range)
<b>4 LEG</b>																			
INSTT-NGAFRS	—	—	34"	25½"		18¼"	18¼"	18"	4°	—	—	—	—	18¼"	18¼"	8¼"	96-103°	32.8	15.4
INSTT-NCAFRS	—	—	34"	25½"	22¼"	18¼"	18¼"	18"	4°	—	—	—	—	18¼"	18¼"	8¼"	96-103°	33.0	15.4
INSTT-NGAFLS	—	—	34"	25½"	22¼"	18¼"	18¼"	18"	4°	—	—	—	—	18¼"	18¼"	8¼"	96-103°	32.8	15.4
INSTT-NCAFLS	—	—	34"	25½"	22¼"	18¼"	18¼"	18"	4°	—	—	—	—	18¼"	18¼"	8¼"	96-103°	33.0	15.4
INSTT-SGAFRS	.6	6	34"	25½"		18¼"	18¼"	18"	4°	—	—	—	—	18¼"	18¼"	8¼"	96-103°	34.6	15.4
INSTT-SCAFRS	.6	6	34"	25½"	22¼"	18¼"	18¼"	18"	4°	—	—	—	—	18¼"	18¼"	8¼"	96-103°	34.8	15.4
INSTT-SGAFLS	.6	6	34"	25½"	22¼"	18¼"	18¼"	18"	4°	—	—	—	—	18¼"	18¼"	8¼"	96-103°	34.6	15.4
INSTT-SCAFLS	.6	6	34"	25½"	22¼"	18¼"	18¼"	18"	4°	—	—	—	—	18¼"	18¼"	8¼"	96-103°	34.8	15.4
INSTT-UGAFRS	1.0	9.5	34"	25½"		18¼"	18¼"	17¼"	4°	—	—	—	—	18¼"	18¼"	8¼"	96-103°	36.1	15.4
INSTT-UCAFRS	1.0	9.5	34"	25½"	22¼"	18¼"	18¼"	17¼"	4°	—	—	—	—	18¼"	18¼"	8¼"	96-103°	36.3	15.4
INSTT-UGAFLS	1.0	9.5	34"	25½"	22¼"	18¼"	18¼"	17¼"	4°	—	—	—	—	18¼"	18¼"	8¼"	96-103°	36.1	15.4
INSTT-UCAFLS	1.0	9.5	34"	25½"	22¼"	18¼"	18¼"	17¼"	4°	—	—	—	—	18¼"	18¼"	8¼"	96-103°	36.3	15.4



◀ Continued from previous page

<p><i>5th Option:</i>  <b>Select the Polymer Shell Color:</b>                  BLK Black (formerly CB – Onyx)                  BU Surf                  BW Brownstone                  GN Sprout                  GY Summit                  RD Cayenne                  RG Tangelo                  WT White (formerly Frost)</p>	<p><i>6th Option:</i>  <b>Select the Tablet Laminate Color:</b>                  LWD Natural Maple</p>	<p><i>7th Option:</i>  <b>Select the Upholstery (if applicable):</b>                  See pages 13-14 for selections.                  See pages 17-18.1 for colors and codes.                  See pages 6-8 for COM guidelines.</p>
--	--	---

(See page 155 for COM pricing on Grades 9-22)

Backrest Style Arm Style	Seat Construction	Model Number Add options below									Leather*		
			1	2	3	4	5	6	7	8	1	2	
Polymer Back Arms 	Polymer Seat	INTK-NO	\$ 1086	—	—	—	—	—	—	—	—	—	—
Polymer Back Armless 	Polymer Seat	INTK-NA	\$ 954	—	—	—	—	—	—	—	—	—	—
Polymer Back Arms 	Upholstered Seat Pad	INTK-SO	\$ 1261	\$ 1287	\$ 1305	\$ 1328	\$ 1352	\$ 1379	\$ 1401	\$ 1429	\$ 1505	\$ 1656	
Polymer Back Armless 	Upholstered Seat Pad	INTK-SA	\$ 1130	\$ 1156	\$ 1174	\$ 1197	\$ 1221	\$ 1248	\$ 1270	\$ 1298	\$ 1374	\$ 1525	
Upholstered Back Pad Arms 	Upholstered Seat Pad	INTK-UO	\$ 1421	\$ 1459	\$ 1492	\$ 1539	\$ 1584	\$ 1626	\$ 1672	\$ 1717	\$ 1852	\$ 2119	
Upholstered Back Pad Armless 	Upholstered Seat Pad	INTK-UA	\$ 1290	\$ 1328	\$ 1361	\$ 1408	\$ 1453	\$ 1495	\$ 1541	\$ 1586	\$ 1721	\$ 1988	

INSPIRE

Continued on next page ►

<p><b>How to specify —</b> Select the Model Number from above.</p> <p>INTK-□□</p>	<p><b>1st Option:</b> Select the Fire Code (if applicable): NO</p> <p>□□.</p>	<p><b>2nd Option:</b> Select the Cylinder Option: 2 Standard, allows 5" of travel 3 Short, allows 3½" of travel</p> <p>□.</p>	<p><b>3rd Option:</b> Select the Caster Option: 0 2½" Black Dual-wheel Hard Tread for carpet 1 2½" Black Dual-wheel Soft Tread for smooth surfaces (add \$33)</p> <p>□.</p>	<p><b>4th Option:</b> Select the Arm Cap: N No Arm H Non-Flexible F Flexible (\$22 extra)</p> <p>□.</p>
---	---	---	---	---

Example: INTK-UANO.2.0.N.PR6.CB.TSC94

Model Number	Overall			Seat				Armrests				Backrest			Ship Weight	Ship Weight Per Carton	Cubes				
	COM Package	COL Sp. Feet	Height (Range)	Width	Depth	Height	Width	Depth (Range)	Pan Angle (Range)	Height (Range)	Width Between Arms (Range)	Depth (Range)	Pivot Inwards	Pivot Outwards				Height (Range)	Width	Lumbar Height (Range)	Backrest/Seat Angle (Range)
INTK-NO	—	—	34-39"	24½"	25"	17¼-22¼"	18½"	18"	4°	8½"	20½"	11"	—	—	18½"	18½"	8½"	96-103°	28.9	—	15.4
INTK-NA	—	—	34-39"	24½"	25"	17¼-22¼"	18½"	18"	4°	—	—	—	—	—	18½"	18½"	8½"	96-103°	27.1	—	15.4
INTK-SO	.6	6	34-39"	24½"	25"	17¼-22¼"	18½"	18"	4°	8½"	20½"	11"	—	—	18½"	18½"	8½"	96-103°	30.7	—	15.4
INTK-SA	.6	6	34-39"	24½"	25"	17¼-22¼"	18½"	18"	4°	—	—	—	—	—	18½"	18½"	8½"	96-103°	28.9	—	15.4
INTK-UO	1.0	9.5	34-39"	24½"	25"	17¼-22¼"	18½"	17½"	4°	8½"	20½"	11"	—	—	18½"	18½"	8½"	96-103°	32.2	—	15.4
INTK-UA	1.0	9.5	34-39"	24½"	25"	17¼-22¼"	18½"	17½"	4°	—	—	—	—	—	18½"	18½"	8½"	96-103°	30.4	—	15.4









◀ Continued from previous page

<p><i>5th Option:</i></p> <p><b>Select the Frame Color with Charblack base:</b></p> <p><b>CBK</b> Black  <b>P8T</b> Titanium  <b>P8B</b> Night Bronze  <b>PJE</b> Pyrite  <b>PR6</b> Silver  <b>P8X</b> Solar Black  <b>P8S</b> Atom  <b>PJF</b> Bullseye  <b>P8P</b> Ember  <b>P8N</b> Ion</p> <p><b>P8J</b> Iris  <b>P8F</b> Krypton  <b>P8M</b> Regatta  <b>P091</b> Amethyst  <i>(De-emphasized)</i>  <b>P090</b> Cobalt  <i>(De-emphasized)</i>  <b>P093</b> Ochre  <b>P092</b> Sienna</p>	<p><i>6th Option:</i></p> <p><b>Select the Polymer Shell Color:</b></p> <p><b>BLK</b> Black (formerly  <b>CB</b> – Onyx)  <b>BU</b> Surf  <b>BW</b> Brownstone  <b>GN</b> Sprout</p> <p><b>GY</b> Summit  <b>RD</b> Cayenne  <b>RG</b> Tangelo  <b>WT</b> White (formerly  Frost)</p>	<p><i>7th Option:</i></p> <p><b>Select the Upholstery (if applicable):</b></p> <p>See pages 13-14 for selections.  See pages 17-18.1 for colors and codes.  See pages 6-8 for COM guidelines.</p>
---	---	---



(See page 155 for COM pricing on Grades 9-22)

Backrest Style Arm Style	Seat Construction	Model Number <i>Add options below</i>									Leather*		
			1	2	3	4	5	6	7	8	1	2	
Polymer Back Arms 	Polymer Seat	INWS-NO	\$ 1343	—	—	—	—	—	—	—	—	—	—
Polymer Back Armless 	Polymer Seat	INWS-NA	\$ 1213	—	—	—	—	—	—	—	—	—	—
Polymer Back Arms 	Upholstered Seat Pad	INWS-SO	\$ 1518	\$ 1544	\$ 1562	\$ 1585	\$ 1609	\$ 1636	\$ 1658	\$ 1686	\$ 1762	\$ 1913	
Polymer Back Armless 	Upholstered Seat Pad	INWS-SA	\$ 1388	\$ 1414	\$ 1432	\$ 1455	\$ 1479	\$ 1506	\$ 1528	\$ 1556	\$ 1632	\$ 1783	
Upholstered Back Pad Arms 	Upholstered Seat Pad	INWS-UO	\$ 1679	\$ 1717	\$ 1750	\$ 1797	\$ 1842	\$ 1884	\$ 1930	\$ 1975	\$ 2110	\$ 2377	
Upholstered Back Pad Armless 	Upholstered Seat Pad	INWS-UA	\$ 1549	\$ 1587	\$ 1620	\$ 1667	\$ 1712	\$ 1754	\$ 1800	\$ 1845	\$ 1980	\$ 2247	

INSPIRE

Continued on next page ►

<p><b>How to specify —</b> Select the Model Number from above.</p>	<p><b>1st Option:</b> Select the Fire Code (if applicable): NO</p>	<p><b>2nd Option:</b> Select the Cylinder Option: 4 Extended Range Work Stool Cylinder, allows 10" of travel</p>	<p><b>3rd Option:</b> Select the Caster Option: 0 2½" Black Dual-wheel Hard Tread for carpet 1 2½" Black Dual-wheel Soft Tread for smooth surfaces (add \$33) 2 Glides</p>	<p><b>4th Option:</b> Select the Arm Cap: N No Arm H Non-Flexible F Flexible (\$22 extra)</p>
INWS-□□□	□□.	4.	□.	□.

Example: INWS-NANO.4.0.N.CBK.WT







Model Number	COM Yandage			Overall			Seat				Armrests				Backrest				Ship Weight	Ship Weight Per Carton	Cubes
	COL Sp. Feet	Height (Range)	Width	Depth	Height (Range)	Width	Depth (Range)	Pan Angle (Range)	Height (Range)	Width Between Arms (Range)	Depth (Range)	Pivot Inwards	Pivot Outwards	Height (Range)	Width	Lumbar Height (Range)	Backrest/Seat Angle (Range)				
INWS-NO	—	—	37"-47"	24½"	25"	21½-31½"	18"	18"	4°	8"	20"	11"	—	—	18"	18"	8"	96-103°	35.1	—	22.9
INWS-NA	—	—	37"-47"	24½"	25"	21½-31½"	18"	18"	4°	—	—	—	—	—	18"	18"	8"	96-103°	33.3	—	22.9
INWS-SO	.6	6	37"-47"	24½"	25"	21½-31½"	18"	18"	4°	8"	20"	11"	—	—	18"	18"	8"	96-103°	36.9	—	22.9
INWS-SA	.6	6	37"-47"	24½"	25"	21½-31½"	18"	18"	4°	—	—	—	—	—	18"	18"	8"	96-103°	35.1	—	22.9
INWS-UO	1.0	9.5	37"-47"	24½"	25"	21½-31½"	18"	17"	4°	8"	20"	11"	—	—	18"	18"	8"	96-103°	38.4	—	22.9
INWS-UA	1.0	9.5	37"-47"	24½"	25"	21½-31½"	18"	17"	4°	—	—	—	—	—	18"	18"	8"	96-103°	36.6	—	22.9



◀ Continued from previous page

<p><b>5th Option:</b> Select the Frame Color with Charblack base:</p> <p>CBK Black P8T Titanium P8B Night Bronze PJE Pyrite PR6 Silver P8X Solar Black P8S Atom PJF Bullseye P8P Ember P8N Ion P8J Iris P8F Krypton</p> <p>P8M Regatta P091 Amethyst <i>(De-emphasized)</i> P090 Cobalt <i>(De-emphasized)</i> P093 Ochre P092 Sienna</p>	<p><b>6th Option:</b> Select the Polymer Shell Color:</p> <p>BLK Black (formerly CB – Onyx) BU Surf BW Brownstone GN Sprout</p> <p>GY Summit RD Cayenne RG Tangelo WT White (formerly Frost)</p>	<p><b>7th Option:</b> Select the Upholstery (if applicable):</p> <p>See pages 13-14 for selections. See pages 17-18.1 for colors and codes. See pages 6-8 for COM guidelines.</p>
---	--	---

(See page 155 for COM pricing on Grades 9-22)

Backrest Style Arm Style	Seat Construction	Model Number Add options below									Leather*		
			1	2	3	4	5	6	7	8	1	2	
Polymer Back Arms 	Polymer Seat	INFS-NGO	\$ 1338	—	—	—	—	—	—	—	—	—	—
Polymer Back Armless 	Polymer Seat	INFS-NGA	\$ 1213	—	—	—	—	—	—	—	—	—	—
Polymer Back Arms 	Upholstered Seat Pad	INFS-SGO	\$ 1512	\$ 1538	\$ 1556	\$ 1579	\$ 1603	\$ 1630	\$ 1652	\$ 1680	\$ 1756	\$ 1907	
Polymer Back Armless 	Upholstered Seat Pad	INFS-SGA	\$ 1388	\$ 1414	\$ 1432	\$ 1455	\$ 1479	\$ 1506	\$ 1528	\$ 1556	\$ 1632	\$ 1783	
Upholstered Back Pad Arms 	Upholstered Seat Pad	INFS-UGO	\$ 1673	\$ 1711	\$ 1744	\$ 1791	\$ 1836	\$ 1878	\$ 1924	\$ 1969	\$ 2104	\$ 2371	
Upholstered Back Pad Armless 	Upholstered Seat Pad	INFS-UGA	\$ 1549	\$ 1587	\$ 1620	\$ 1667	\$ 1712	\$ 1754	\$ 1800	\$ 1845	\$ 1980	\$ 2247	

INSPIRE

Continued on next page ►

<p><b>How to specify —</b> Select the Model Number from above.</p>	<p><b>1st Option:</b> Select the Fire Code (if applicable): NO</p>	<p><b>2nd Option:</b> Select the Glide Option: 0 Nylon Glides 1 Nickel-plated Glides (\$18 extra) 2 Felt Glides (\$18 extra)</p>	<p><b>3rd Option:</b> Select the Arm Cap: N No Arm H Non-Flexible F Flexible (\$22 extra)</p>	<p><b>4th Option:</b> Select the Frame Color: CBK Black P8T Titanium P8B Night Bronze PJE Pyrite PR6 Silver P8X Solar Black P8S Atom PJF Bullseye P8P Ember P8N Ion P8J Iris P8F Krypton P8M Regatta P091 Amethyst (De-emphasized) P090 Cobalt (De-emphasized) P093 Ochre P092 Sienna</p>
<p>INFS-          </p>	<p>      .</p>	<p>  .</p>	<p>  .</p>	<p>        .</p>

Example: INSF-UGANO.0.F.PR6.GY.TSC89

Model Number	COM			Overall				Seat			Armrests			Backrest		Ship Weight	Ship Weight Per Carton	Cubes	
	Yards	Sq. Feet	Height (Range)	Width	Depth	Height	Width	Depth (Range)	Pan Angle (Range)	Height (Range)	Width Between Arms (Range)	Depth (Range)	Height (Range)	Width	Lumbar Height (Range)				Backrest/Seat Angle (Range)
INFS-NGO	—	—	45 1/4"	24 1/4"	24 1/4"	30"	18 1/4"	18"	4°	8 1/4"	20 1/4"	11"	18 1/4"	18 1/4"	8 1/4"	96-103°	29.6	—	22.9
INFS-NGA	—	—	45 1/4"	22"	24 1/4"	30"	18 1/4"	18"	4°	—	—	—	18 1/4"	18 1/4"	8 1/4"	96-103°	27.8	—	22.9
INFS-SGO	.6	6	45 1/4"	24 1/4"	24 1/4"	30 1/4"	18 1/4"	18"	4°	8 1/4"	20 1/4"	11"	18 1/4"	18 1/4"	8 1/4"	96-103°	31.4	—	22.9
INFS-SGA	.6	6	45 1/4"	22"	24 1/4"	30 1/4"	18 1/4"	18"	4°	—	—	—	18 1/4"	18 1/4"	8 1/4"	96-103°	29.6	—	22.9
INFS-UGO	1.0	9.5	45 1/4"	24 1/4"	24 1/4"	30 1/4"	18 1/4"	17 1/4"	4°	8 1/4"	20 1/4"	11"	18 1/4"	18 1/4"	8 1/4"	96-103°	32.9	—	22.9
INFS-UGA	1.0	9.5	45 1/4"	22"	24 1/4"	30 1/4"	18 1/4"	17 1/4"	4°	—	—	—	18 1/4"	18 1/4"	8 1/4"	96-103°	31.1	—	22.9



◀ Continued from previous page

<p><i>5th Option:</i></p> <p><b>Select the Polymer Shell Color:</b></p> <p><b>BLK</b> Black (formerly CB – Onyx)</p> <p><b>BU</b> Surf</p> <p><b>BW</b> Brownstone</p> <p><b>GN</b> Sprout</p> <p><b>GY</b> Summit</p> <p><b>RD</b> Cayenne</p> <p><b>RG</b> Tangelo</p> <p><b>WT</b> White (formerly Frost)</p>	<p><i>6th Option:</i></p> <p><b>Select the Upholstery (if applicable):</b></p> <p>See pages 13-14 for selections.</p> <p>See pages 17-18.1 for colors and codes.</p> <p>See pages 6-8 for COM guidelines.</p>
--	---

The Lyric family of seating provides a multitude of choices. Make a serious statement with subdued colors or create a fun and playful vibe with a bold mix of mesh and upholstery. Lyric's comfort and intuitive functionality, paired with its simple but striking lines, make it perfect from the workstation to the training room to the conference room.

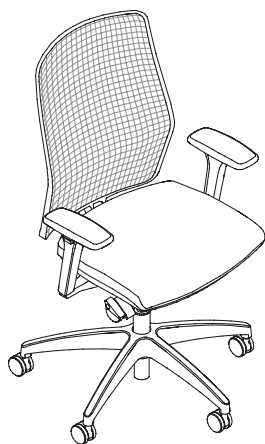

Lyric Work  
CWW-MHHNO

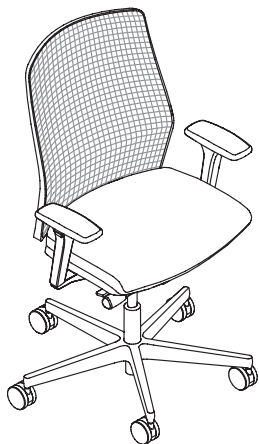

Lyric Large & Tall  
CLL-MLHNO

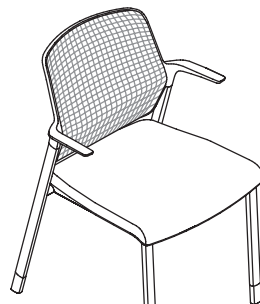

Lyric Side  
CSC-MUGONO

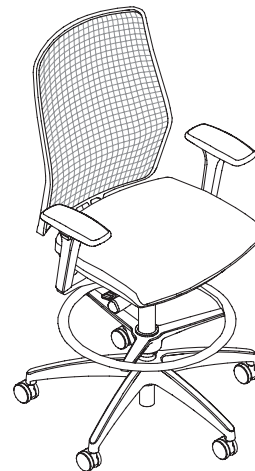

Lyric Stool  
CSS-MHHNO

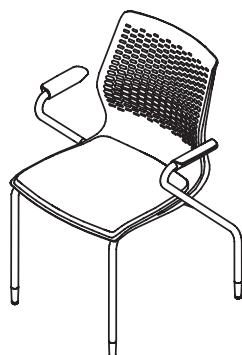

Lyric Multi-Purpose  
Chair  
CMPNU-PPGONO

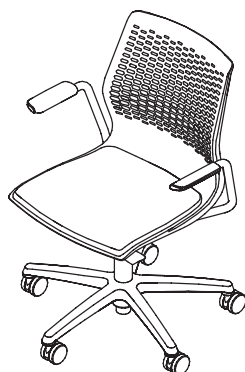

Lyric Multi-Purpose  
Work Chair  
CMPWU-PPCONO

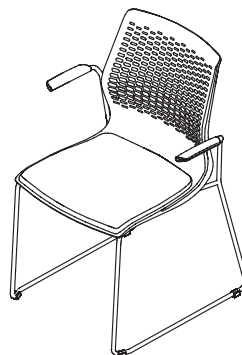

Lyric Wire Stacker  
CWSU-PPGONO

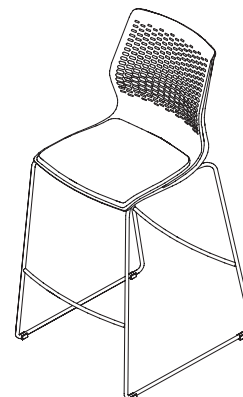

Lyric Wire Stool  
CWSS30U-PPGANO

## DESIGN FEATURES

*Choose the options specific to your needs.*

### Basic synchro control adjustment

Manual crank tension with knob and an upright lock.

### Enhanced synchro-tilt control

Manual crank tension adjustment with easily reached lever and three locking positions for the back.

### Weight activated control

Automatic tension control with an upright lock and tilt limiter.

### Mesh Backs

Mesh back chairs are available in six mesh colors.

### Optional adjustable lumbar support

Lyric provides automatic lumbar support. To accommodate personal preference, an optional external lumbar support can be added at any time with 4" range of adjustment.

### 4D fully adjustable arms

Lyric's 4D arms are fully adjustable in height, width, depth, and can pivot to provide optimal support. Pivot the front of the arm pads inward to move in closer to your desk and offer support while working.

### 2D adjustable arms

Provides height and width adjustments for optimal support of elbows and shoulders while keyboarding or conferencing while providing ease of entry/exit.

### Fixed arms

Provide basic support for users engaging in a variety of tasks throughout the day. Fixed arms limit adjustability but provide consistent aesthetics in conference room settings.

### Pneumatic seat height adjustment

Regulates height of work chair relative to the floor. Standard 5" of travel accommodates average to tall users. Stools offer 10" of travel.

### Seat depth adjustment

Allows seat cushion to manually adjust front to back.

### Base and casters

Work chair and stool bases are a five-star design. Dual-wheel casters are available in hard tread for carpet, or multi-surface for any floor surface.

### Materials

- All COMs/COLs must be approved for upholsterability or applicable fire code compliance prior to order entry. See pages 6-8 for COM ordering instructions. All steel fabrics meet requirements for CTB117. COM/COL manufacturers supply certificates of compliance for fabric only tests such as CTB117.
- Lyric meets the requirements set forth in ANSI/BIFMA X5.1-2011 and BIFMA G1-2013. Lyric is warranted for multiple shifts and users up to 300 lbs.

### Height-Adjustable Footring

Travels 8" to ensure users have comfortable support of their feet and legs. The footring has a 20" diameter.

## OPTIONS - WORK/CONFERENCE OR STOOL

### Chair Types:

<b>CWW</b>	Weight Activated Work Chair
<b>CSW</b>	Synchro-Tilt Work Chair
<b>CBW</b>	Basic Synchro Work Chair
<b>CSS</b>	Synchro-Tilt Stool

### Back:

<b>MH</b>	Mesh High-Back
<b>MM</b>	Mesh Mid-Back

### Arms:

<b>W</b>	4D Fully Adjustable
<b>H</b>	2D Adjustable
<b>F</b>	Fixed
<b>A</b>	Armless

### Frame Color:

<b>BLK</b>	Black
<b>T</b>	Titanium (add \$44)
<b>P096</b>	Cove
<b>P094</b>	Dune
<b>P097</b>	Harbor
<b>P095</b>	Sage

### Base Color:

<b>BLK</b>	Black
<b>T</b>	Titanium
<b>PAL</b>	Polished Aluminum (add \$159)

### Lumbar:

<b>N</b>	No Lumbar
<b>L</b>	Lumbar (add \$33)

### Lumbar Color:

<b>BLK</b>	Black
<b>T</b>	Titanium

### Cylinder:

<b>2</b>	Standard
<b>3</b>	Short
<b>4</b>	Extended (stool only)

### Casters:

<b>H</b>	Black Hard Tread
<b>B</b>	Black Multi-Surface (add \$66)
<b>T</b>	Titanium Multi-Surface (add \$66)
<b>PAL</b>	Polished Aluminum (add \$142)

### Mesh Back Material:

<b>FWM55</b>	Black
<b>FWM75</b>	Charcoal
<b>FWM80</b>	Titanium
<b>FWM85</b>	Salt
<b>FWM65</b>	Brownstone
<b>FWM60</b>	Regatta









### Seat Upholstery:

See pages 13-14 for selections, colors, and codes.

### Headrest:

<b>N</b>	No Headrest
<b>HR</b>	Headrest (add \$131)

(See page 156 for COM pricing on Grades 9-22)

Armrest	Control	Back	Model Number Add options below									Leather	
				1	2	3	4	5	6	7	8	1	2
 	Weight	Mesh High-Back	CWW-MHW	\$1438	\$1452	\$1462	\$1484	\$1507	\$1529	\$1553	\$1576	\$1598	\$2197
	Activated	Mesh Mid-Back	CWW-MMW	\$1403	\$1417	\$1427	\$1449	\$1472	\$1494	\$1518	\$1541	\$1563	\$2162
	Synchro	Mesh High-Back	CSW-MHW	\$1318	\$1332	\$1342	\$1364	\$1387	\$1409	\$1433	\$1456	\$1478	\$2077
		Mesh Mid-Back	CSW-MMW	\$1283	\$1297	\$1307	\$1329	\$1352	\$1374	\$1398	\$1421	\$1443	\$2042
	Basic	Mesh High-Back	CBW-MHW	\$1258	\$1272	\$1282	\$1304	\$1327	\$1349	\$1373	\$1396	\$1418	\$2017
	Synchro	Mesh Mid-Back	CBW-MMW	\$1225	\$1239	\$1249	\$1271	\$1294	\$1316	\$1340	\$1363	\$1385	\$1984
 	Weight	Mesh High-Back	CWW-MHH	\$1365	\$1379	\$1389	\$1411	\$1434	\$1456	\$1480	\$1503	\$1525	\$2124
	Activated	Mesh Mid-Back	CWW-MMH	\$1330	\$1344	\$1354	\$1376	\$1399	\$1421	\$1445	\$1468	\$1490	\$2089
	Synchro	Mesh High-Back	CSW-MHH	\$1245	\$1259	\$1269	\$1291	\$1314	\$1336	\$1360	\$1383	\$1405	\$2004
		Mesh Mid-Back	CSW-MMH	\$1210	\$1224	\$1234	\$1256	\$1279	\$1301	\$1325	\$1348	\$1370	\$1969
	Basic	Mesh High-Back	CBW-MHH	\$1186	\$1200	\$1210	\$1232	\$1255	\$1277	\$1301	\$1324	\$1346	\$1945
	Synchro	Mesh Mid-Back	CBW-MMH	\$1152	\$1166	\$1176	\$1198	\$1221	\$1243	\$1267	\$1290	\$1312	\$1911
 	Weight	Mesh High-Back	CWW-MHF	\$1375	\$1389	\$1399	\$1421	\$1444	\$1466	\$1490	\$1513	\$1535	\$2134
	Activated	Mesh Mid-Back	CWW-MMF	\$1341	\$1355	\$1365	\$1387	\$1410	\$1432	\$1456	\$1479	\$1501	\$2100
	Synchro	Mesh High-Back	CSW-MHF	\$1256	\$1270	\$1280	\$1302	\$1325	\$1347	\$1371	\$1394	\$1416	\$2015
		Mesh Mid-Back	CSW-MMF	\$1222	\$1236	\$1246	\$1268	\$1291	\$1313	\$1337	\$1360	\$1382	\$1981
	Basic	Mesh High-Back	CBW-MHF	\$1196	\$1210	\$1220	\$1242	\$1265	\$1287	\$1311	\$1334	\$1356	\$1955
	Synchro	Mesh Mid-Back	CBW-MMF	\$1161	\$1175	\$1185	\$1207	\$1230	\$1252	\$1276	\$1299	\$1321	\$1920
 	Weight	Mesh High-Back	CWW-MHA	\$1246	\$1260	\$1270	\$1292	\$1315	\$1337	\$1361	\$1384	\$1406	\$2005
	Activated	Mesh Mid-Back	CWW-MMA	\$1211	\$1225	\$1235	\$1257	\$1280	\$1302	\$1326	\$1349	\$1371	\$1970
	Synchro	Mesh High-Back	CSW-MHA	\$1128	\$1142	\$1152	\$1174	\$1197	\$1219	\$1243	\$1266	\$1288	\$1887
		Mesh Mid-Back	CSW-MMA	\$1093	\$1107	\$1117	\$1139	\$1162	\$1184	\$1208	\$1231	\$1253	\$1852
	Basic	Mesh High-Back	CBW-MHA	\$1068	\$1082	\$1092	\$1114	\$1137	\$1159	\$1183	\$1206	\$1228	\$1827
	Synchro	Mesh Mid-Back	CBW-MMA	\$1033	\$1047	\$1057	\$1079	\$1102	\$1124	\$1148	\$1171	\$1193	\$1792
Lumbar Kit			LLUK	\$ 59									
Headrest Kit			C-HDRK	\$ 248									

Continued on next page ►

<p><b>How to specify —</b> Select the Model Number from above. Add <b>NO</b> to the end of the model</p>	<p><b>1st Option:</b> Select the Frame Color: BLK Black T Titanium (add \$44)</p>	<p><b>2nd Option:</b> Select the Base Color: BLK Black T Titanium PAL Polished Aluminum (\$159 extra)</p>	<p><b>3rd Option:</b> Select the Lumbar: N No Lumbar L Lumbar (\$33 extra)</p>	<p><b>4th Option:</b> Select the Lumbar Color (if applicable): BLK Black T Titanium</p>
_____ .	_____ .	_____ .	_____ .	_____ .

Examples: CWW-MHWNO.T.T.LT.2.T.FWM55.AI26 LLUK.BLK

Model Number	COM Yandage			Overall				Seat			Armrests				Backrest							
	COL Sq. Feet	Height (Range)		Width	Depth	Height Std (Range)	Short Range (15-18 1/2")	Width	Depth	Pan Angle (Range)	Armrest Height	Width Between Arms	Depth (Range)	Pivot Inwards	Pivot Outwards	Height	Width	Lumbar Height*	Backrest/Seat Angle (Range)	Ship Weight	Ship Weight Per Carton	Cubes
CWW-MHW	0.80	20	38 1/2" - 43 1/2"	26"	26"	16 1/2" - 21 1/2"	19 1/2"	15 1/2" - 18 1/2"	6.4"	7 1/4" - 11 1/2"	13" - 20"	11" - 14"	30°	30°	24"	19"	9 1/2"	94° - 116°	37	48	11.3	
CWW-MMW	0.80	20	35 1/2" - 40"	26"	26"	16 1/2" - 21 1/2"	19 1/2"	15 1/2" - 18 1/2"	6.4"	7 1/4" - 11 1/2"	13" - 20"	11" - 14"	30°	30°	21"	19"	9 1/2"	94° - 116°	37	48	11.3	
CSW-MHW	0.80	20	38" - 43"	26"	26"	16" - 21"	19 1/2"	16 1/4" - 18 1/2"	11.7"	7 1/4" - 11 1/2"	13" - 20"	11" - 14"	30°	30°	24"	19"	9 1/2"	94 1/2° - 110°	38	48	11.3	
CSW-MMW	0.80	20	35" - 40"	26"	26"	16" - 21"	19 1/2"	16 1/4" - 18 1/2"	11.7"	7 1/4" - 11 1/2"	13" - 20"	11" - 14"	30°	30°	21"	19"	9 1/2"	94 1/2° - 110°	38	48	11.3	
CBW-MHW	0.80	20	38" - 43"	26"	26"	16" - 21"	19 1/2"	15 1/4" - 17 1/2"	9.7"	7 1/4" - 11 1/2"	13" - 20"	11" - 14"	30°	30°	24"	19"	9 1/2"	95 1/2° - 104°	37	45	11.3	
CBW-MMW	0.80	20	35" - 40"	26"	26"	16" - 21"	19 1/2"	15 1/4" - 17 1/2"	9.7"	7 1/4" - 11 1/2"	13" - 20"	11" - 14"	30°	30°	21"	19"	9 1/2"	95 1/2° - 104°	37	45	11.3	
														Arm to Floor								
CWW-MHH	0.80	20	38 1/2" - 43 1/2"	26"	26"	16 1/2" - 21 1/2"	19 1/2"	15 1/2" - 18 1/2"	6.4"	7 1/2" - 11 1/2"	17 1/4" - 20 1/2"	14 1/4" - 14 1/4"	24 1/2" - 32 1/2"	24"	19"	9 1/2"	94° - 116°	37	48	11.3		
CWW-MMH	0.80	20	35 1/2" - 40"	26"	26"	16 1/2" - 21 1/2"	19 1/2"	15 1/2" - 18 1/2"	6.4"	7 1/2" - 11 1/2"	17 1/4" - 20 1/2"	14 1/4" - 14 1/4"	24 1/2" - 32 1/2"	21"	19"	9 1/2"	94° - 116°	37	48	11.3		
CSW-MHH	0.80	20	38" - 43"	26"	26"	16" - 21"	19 1/2"	16 1/4" - 18 1/2"	11.7"	7 1/2" - 11 1/2"	17 1/4" - 20 1/2"	14 1/4" - 14 1/4"	23 1/2" - 32 1/2"	24"	19"	9 1/2"	94 1/2° - 110°	38	48	11.3		
CSW-MMH	0.80	20	35" - 40"	26"	26"	16" - 21"	19 1/2"	16 1/4" - 18 1/2"	11.7"	7 1/2" - 11 1/2"	17 1/4" - 20 1/2"	14 1/4" - 14 1/4"	23 1/2" - 32 1/2"	21"	19"	9 1/2"	94 1/2° - 110°	38	48	11.3		
CBW-MHH	0.80	20	38" - 43"	26"	26"	16" - 21"	19 1/2"	15 1/4" - 17 1/2"	9.7"	7 1/2" - 11 1/2"	17 1/4" - 20 1/2"	14 1/4" - 14 1/4"	23 1/2" - 32 1/2"	24"	19"	9 1/2"	95 1/2° - 104°	37	45	11.3		
CBW-MMH	0.80	20	35" - 40"	26"	26"	16" - 21"	19 1/2"	15 1/4" - 17 1/2"	9.7"	7 1/2" - 11 1/2"	17 1/4" - 20 1/2"	14 1/4" - 14 1/4"	23 1/2" - 32 1/2"	21"	19"	9 1/2"	95 1/2° - 104°	37	45	11.3		
CWW-MHF	0.80	20	38 1/2" - 43 1/2"	26"	26"	16 1/2" - 21 1/2"	19 1/2"	15 1/2" - 18 1/2"	6.4"	9 1/2"	20 1/2"	14"	25 1/2" - 30 1/2"	24"	19"	9 1/2"	94° - 116°	37	48	11.3		
CWW-MMF	0.80	20	35 1/2" - 40"	26"	26"	16 1/2" - 21 1/2"	19 1/2"	15 1/2" - 18 1/2"	6.4"	9 1/2"	20 1/2"	14"	25 1/2" - 30 1/2"	21"	19"	9 1/2"	94° - 116°	37	48	11.3		
CSW-MHF	0.80	20	38" - 43"	26"	26"	16" - 21"	19 1/2"	16 1/4" - 18 1/2"	11.7"	9 1/2"	20 1/2"	14"	25 1/2" - 30 1/2"	24"	19"	9 1/2"	94 1/2° - 110°	38	48	11.3		
CSW-MMF	0.80	20	35" - 40"	26"	26"	16" - 21"	19 1/2"	16 1/4" - 18 1/2"	11.7"	9 1/2"	20 1/2"	14"	25 1/2" - 30 1/2"	21"	19"	9 1/2"	94 1/2° - 110°	38	48	11.3		
CBW-MHF	0.80	20	38" - 43"	26"	26"	16" - 21"	19 1/2"	15 1/4" - 17 1/2"	9.7"	9 1/2"	20 1/2"	14"	25 1/2" - 30 1/2"	24"	19"	9 1/2"	95 1/2° - 104°	37	45	11.3		
CBW-MMF	0.80	20	35" - 40"	26"	26"	16" - 21"	19 1/2"	15 1/4" - 17 1/2"	9.7"	9 1/2"	20 1/2"	14"	25 1/2" - 30 1/2"	21"	19"	9 1/2"	95 1/2° - 104°	37	45	11.3		
CWW-MHA	0.80	20	38 1/2" - 43 1/2"	26"	26"	16 1/2" - 21 1/2"	19 1/2"	15 1/2" - 18 1/2"	6.4"						24"	19"	9 1/2"	94° - 116°	37	48	11.3	
CWW-MMA	0.80	20	35 1/2" - 40"	26"	26"	16 1/2" - 21 1/2"	19 1/2"	15 1/2" - 18 1/2"	6.4"						21"	19"	9 1/2"	94° - 116°	37	48	11.3	
CSW-MHA	0.80	20	38" - 43"	26"	26"	16" - 21"	19 1/2"	16 1/4" - 18 1/2"	11.7"						24"	19"	9 1/2"	94 1/2° - 110°	38	48	11.3	
CSW-MMA	0.80	20	35" - 40"	26"	26"	16" - 21"	19 1/2"	16 1/4" - 18 1/2"	11.7"						21"	19"	9 1/2"	94 1/2° - 110°	38	48	11.3	
CBW-MHA	0.80	20	38" - 43"	26"	26"	16" - 21"	19 1/2"	15 1/4" - 17 1/2"	9.7"						24"	19"	9 1/2"	95 1/2° - 104°	37	45	11.3	
CBW-MMA	0.80	20	35" - 40"	26"	26"	16" - 21"	19 1/2"	15 1/4" - 17 1/2"	9.7"						21"	19"	9 1/2"	95 1/2° - 104°	37	45	11.3	
C-HDRK			10" - 12 1/4"	11 1/4"	3 1/4"																	

**Note:** Dimensions are in accordance with BIFMA G1-2013 guidelines — see illustration of guidelines on page 45.





\*Optional external lumbar support can be added at any time with a 4" range of adjustment.

◀ Continued from previous page

<p><i>5th Option:</i> <b>Select the Cylinder:</b></p> <p>2 Standard 3 Short</p>	<p><i>6th Option:</i> <b>Select the Casters:</b></p> <p><b>H</b> Black Hard Tread <b>B</b> Black Multi-Surface (\$66 extra) <b>T</b> Titanium Multi-Surface (\$66 extra) <b>PAL</b> Polished Aluminum Multi-Surface (\$142 extra)</p>	<p><i>7th Option:</i> <b>Select the Mesh:</b></p> <p><b>FWM55</b> Black <b>FWM75</b> Charcoal <b>FWM80</b> Titanium <b>FWM85</b> Salt <b>FWM65</b> Brownstone <b>FWM60</b> Regatta</p>	<p><i>8th Option:</i> <b>Select the Upholstery:</b></p> <p>See pages 13-14 for selection, colors, and codes.</p>	<p><i>9th Option:</i> <b>Select the Headrest (if applicable):</b></p> <p><b>N</b> No Headrest <b>HR</b> Headrest (+\$131 extra)</p>
---	---	--	--	---



(See page 156 for COM pricing on Grades 9-22)

Armrest	Control	Back	Model Number	1	2	3	4	5	6	7	8	Leather	
												1	2
4D Arms 	Synchro	Mesh Mid-Back	CSS-MMW	\$ 1725	\$ 1735	\$ 1744	\$ 1761	\$ 1779	\$ 1797	\$ 1815	\$ 1833	\$ 1851	\$ 2321
2D Arms 		Mesh Mid-Back	CSS-MMH	\$ 1667	\$ 1677	\$ 1686	\$ 1703	\$ 1721	\$ 1739	\$ 1757	\$ 1775	\$ 1793	\$ 2263
Fixed Arms 		Mesh Mid-Back	CSS-MMF	\$ 1676	\$ 1686	\$ 1695	\$ 1712	\$ 1730	\$ 1748	\$ 1766	\$ 1784	\$ 1802	\$ 2272
Armless 		Mesh Mid-Back	CSS-MMA	\$ 1573	\$ 1583	\$ 1592	\$ 1609	\$ 1627	\$ 1645	\$ 1663	\$ 1681	\$ 1699	\$ 2169
Headrest Kit 			C-HDRK	\$ 248									

LYRIC

Continued on next page ►

<p><b>How to specify —</b> Select the Model Number from above. Add <b>NO</b> to the end of the model</p>	<p><b>1st Option:</b> Select the Frame Color: <b>BLK</b> Black (<i>Black Mesh</i>) <b>T</b> Titanium (<i>Titanium Mesh</i>) (add \$44)</p>	<p><b>2nd Option:</b> Select the Base Color: <b>BLK</b> Black <b>T</b> Titanium <b>PAL</b> Polished Aluminum (\$159 extra)</p>	<p><b>3rd Option:</b> Select the Lumbar: <b>N</b> No Lumbar <b>L</b> Lumbar (\$33 extra)</p>	<p><b>4th Option:</b> Select the Lumbar Color (if applicable): <b>BLK</b> Black <b>T</b> Titanium</p>	<p><b>5th Option:</b> Select the Cylinder: <b>4</b> Extended range work stool cylinder allows 10" of travel</p>
C   S   S   -                 .           .					4   .

Examples: CSS-MHHNO.T.T.LT.4.T.FWM55.AI26

Model Number	COM			Overall				Seat			Armrests				Backrest						
	Yardage	Sq. Feet	Height (Range)	Width	Depth	Height Std (Range)	Height Short (Range)	Width	Depth	Pan Angle (Range)	Armrest Height	Width Between Arms	Depth (Range)	Pivot Inwards	Pivot Outwards	Height	Width	Lumbar Height*	Backrest/Seat Angle (Range)	Ship Weight	Ship Weight Per Carton
CSS-MMW	0.80	20	43" - 53"	26"	26"	22½" - 32¼"	19½"	16½" - 18½"	11.7"	7½" - 11½"	17¼" - 20½"	14½" - 14½"	30¼" - 44¼"	21"	19"	9"	94½° - 110°	43	53	11.3	
CSS-MMH	0.80	20	43" - 53"	26"	26"	22½" - 32¼"	19½"	16½" - 18½"	11.7"	7½" - 11½"	17¼" - 20½"	14½" - 14½"	30¼" - 44¼"	21"	19"	9"	94½° - 110°	43	53	11.3	
CSS-MMF	0.80	20	43" - 53"	26"	26"	22½" - 32¼"	19½"	16½" - 18½"	11.7"	9"	20½"	14"	30¼" - 44¼"	21"	19"	9"	94½° - 110°	43	53	11.3	
CSS-MMA	0.80	20	43" - 53"	26"	26"	22½" - 32¼"	19½"	16½" - 18½"	11.7"					21"	19"	9"	94½° - 110°	43	53	11.3	
C-HDRK			10" - 12¼"	11½"	3¼"																

**Note:** Dimensions are in accordance with BIFMA G1-2013 guidelines — see illustration of guidelines on page 45.

\*Optional external lumbar support can be added at any time with a 4" range of adjustment.

◀ Continued from previous page

<p><b>6th Option:</b> Select the Casters:</p> <p><b>H</b> Black Hard Tread <b>B</b> Black Multi-Surface (\$66 extra) <b>T</b> Titanium Multi-Surface (\$66 extra) <b>PAL</b> Polished Aluminum Multi-Surface (\$142 extra)</p>	<p><b>7th Option:</b> Select the Mesh (if applicable):</p> <p><b>FWM55</b> Black <b>FWM75</b> Charcoal <b>FWM80</b> Titanium <b>FWM85</b> Salt <b>FWM65</b> Brownstone <b>FWM60</b> Regatta</p>	<p><b>8th Option:</b> Select the Seat Upholstery:</p> <p>See pages 13-14 for selection, colors, and codes.</p>	<p><b>9th Option:</b> Select the Headrest (if applicable):</p> <p><b>N</b> No Headrest <b>HR</b> Headrest (+\$131 extra)</p>
--	---	--	--

## DESIGN FEATURES

An economical solution, suited for larger and taller people who perform a variety of tasks. Lyric Large & Tall is warranted for multiple shifts and users up to 400 lbs.

### Enhanced synchro-tilt control

Manual crank tension adjustment with easily reached lever and three locking positions for the back.

### Mesh Backs

Mesh back Large & Tall chairs are available in Black mesh.

### 2D adjustable arms

Provides height and width adjustments for optimal support of elbows and shoulders while keyboarding or conferencing while providing ease of entry/exit.

### Fixed arms

Provide basic support for users engaging in a variety of tasks throughout the day. Fixed arms limit adjustability but provide consistent aesthetics in conference room settings.

### Pneumatic seat height adjustment

Regulates height of work chair relative to the floor. Standard 5" of travel accommodates average to tall users.

### Base and casters

Bases are a five-star design. Dual-wheel casters in multi-surface for any floor surface.

### Materials

- All COMs/COLs must be approved for upholsterability or applicable fire code compliance prior to order entry. See pages 6-8 for COM ordering instructions.
- Allsteel fabrics meet requirements for CTB117. COM/COL manufacturers supply certificates of compliance for fabric only tests such as CTB117.
- Lyric LT meets the requirements set forth in ANSI/BIFMA X5.1-2011 and BIFMA G1-2013. Lyric LT is warranted for multiple shifts and users up to 400 lbs.

## OPTIONS — LARGE & TALL

Chair Types:

**CLL** Large & Tall

Back:

**ML** Mesh Large & Tall

Arms:

**H** 2D Adjustable

**F** Fixed

**A** Armless

Frame Color:

**BLK** Black

**T** Titanium (add \$44)

Base Color:

**BLK** Black

**T** Titanium

Lumbar:

**N** No Lumbar

**L** Lumbar (add \$33)

Lumbar Color:

**BLK** Black

**T** Titanium

Cylinder:

**2** Standard

Casters:

**B** Black Multi-Surface

Mesh Back Material:

**FWM55** Black



Seat Upholstery:

See pages 13-14 for selections, colors, and codes.



CLL-MLHNO — Large & Tall

(See page 156 for COM pricing on Grades 9-22)

Armrest	Control	Back	Model Number									Leather	
				1	2	3	4	5	6	7	8	1	2
2D Arms 	Synchro	Mesh High-Back	CLL-MLH	\$ 1858	\$ 1872	\$ 1882	\$ 1904	\$ 1927	\$ 1949	\$ 1973	\$ 1996	\$ 2018	\$ 2617
Fixed Arms 	Synchro	Mesh High-Back	CLL-MLF	\$ 1868	\$ 1882	\$ 1892	\$ 1914	\$ 1937	\$ 1959	\$ 1983	\$ 2006	\$ 2028	\$ 2627
Armless 	Synchro	Mesh High-Back	CLL-MLA	\$ 1740	\$ 1754	\$ 1764	\$ 1786	\$ 1809	\$ 1831	\$ 1855	\$ 1878	\$ 1900	\$ 2499
L & T Lumbar Kit			LLUK-LT	\$ 65									

Model Number	Overall			Seat			Armrests			Backrest			Ctbs					
	COM Yards	COL Sq. Feet	Height (Range)	Width	Depth	Height Std (Range)	Width	Depth	Pan Angle (Range)	Armrest Height	Width Between Arms	Depth (Range)		Height	Width	Lumbar Height	Backrest/Seat Angle (Range)	Ship Weight
CLL-MLH			41" - 46"	28"	28"	19"-24"	22"	16 1/4" - 18 1/2"	15.8°	7 1/2" - 11 1/2"	19 1/4" - 22 1/4"	14 1/2" - 15 1/2"	25 1/2"	21 1/2"	11"	93°-105°	42	7.3
CLL-MLF			41" - 46"	28"	28"	19"-24"	22"	16 1/4" - 18 1/2"	15.8°	7 1/2" - 11 1/2"	19 1/4" - 22 1/4"	14 1/2" - 15 1/2"	25 1/2"	21 1/2"	11"	93°-105°	42	7.3
CLL-MLA			41" - 46"	28"	28"	19"-24"	22"	16 1/4" - 18 1/2"	15.8°	—	—	—	25 1/2"	21 1/2"	11"	93°-105°	41	7.3

Note: Dimensions are in accordance with BIFMA G1-2013 guidelines — see illustration of guidelines on page 45.

<p><b>How to specify —</b> Select the Model Number from above. Add <b>NO</b> to the end of the model</p> <p>_____ .</p>	<p><b>1st Option:</b> Select the Frame Color: <b>BLK</b> Black (<i>Black Mesh</i>) <b>T</b> Titanium (<i>Black Mesh</i>) (add \$44)</p> <p>_____ .</p>	<p><b>2nd Option:</b> Select the Base Color: <b>BLK</b> Black <b>T</b> Titanium</p> <p>_____ .</p>	<p><b>3rd Option:</b> Select the Lumbar: <b>N</b> No Lumbar <b>L</b> Lumbar (\$33 extra)</p> <p>_____ .</p>	<p><b>4th Option:</b> Select the Lumbar Color (if applicable): <b>BLK</b> Black <b>T</b> Titanium</p> <p>_____ .</p>
<p><b>5th Option:</b> Select the Cylinder: <b>2</b> Standard</p> <p><b>2</b> .</p>	<p><b>6th Option:</b> Select the Casters: <b>B</b> Black <b>M</b> Multi-Surface</p> <p><b>B</b> .</p>	<p><b>7th Option:</b> Select the Mesh (if applicable): <b>FWM55</b> Black</p> <p><b>FWM55</b> .</p>	<p><b>8th Option:</b> Select the Seat Upholstery: See pages 13-14 for selection, colors, and codes.</p> <p>_____ .</p>	

Example: LLUK-LT.BLK

Wherever they are, invite visitors to sit in style with options like an upholstered or mesh back, adding comfort and style to any location.

## KEY FEATURES

The waterfall seat front reduces pressure points and the intuitive back design offers built-in lumbar support. Lyric side chairs can be stacked up to four high.

## MODELS AND OPTIONS

Lyric side chair models with back types in mesh or upholstered mesh, and in two frame colors. Side chairs feature arm models with casters or glides.

Glides are available in nylon, nickel-plated, or felt options. Nylon glides are recommended for hard surfaces, commercial carpet, and damp environments. Nickel-plated glides are recommended for carpet. Felt glides are recommended for wood, tile, or high-shen floor surfaces. The versatile multi-surface casters are designed for use on hard or soft surfaces.

Chairs ship up to three per carton to minimize waste.

## MATERIALS

- All COMs/COLs must be approved for upholsterability or applicable fire code compliance prior to order entry. See pages 6-8 for COM ordering instructions.
- Allsteel fabrics meet requirements for CTB117. COM/COL manufacturers supply certificates of compliance for fabric only tests such as CTB117.
- Lyric side chairs are warranted for users up to 300 lbs.

## OPTIONS — SIDE CHAIR

Chair Types:

**CSC** Four Leg Side Chair

Back/Seat Material:

**MU** Mesh Back / Upholstered Seat

**UU** Upholstered Mesh Back / Upholstered Seat

Casters/Glides:

**C** Casters

**G** Glides

Arms:

**O** Fixed Arm

Fire code:

**NO** No Fire Code

Type of Caster or Glide:

**0** Nylon Glides for hard surfaces and commercial carpet

**1** Nickel Glides for carpet (\$18 extra)

**2** Felt Glides for wood, tile, or high sheen surfaces (\$18 extra)

**3** Multi-Surface Caster

Frame Color (Predetermines Mesh Color on Upholstered Models):

**P71** Black (Black Mesh on Upholstered Models)

**PR6** Silver (Titanium Mesh on Upholstered Models)

**P8X** Solar Black (Black Mesh on Upholstered Models)

**P8T** Titanium (Titanium Mesh on Upholstered Models)

Mesh Back Material for Upholstered Models, Centurion Fabric Code (see page 17):

Mesh Back Material

**FWM55** Black

**FWM75** Charcoal

**FWM80** Titanium

**FWM85** Salt

**FWM65** Brownstone

**FWM60** Regatta

Seat Upholstery:

See pages 13-14 for selections, colors, and codes.

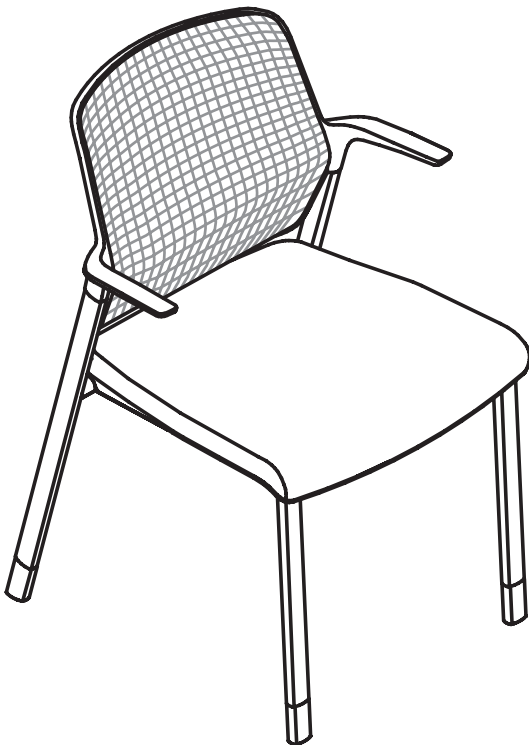



**CSC-MUGO — Mesh Back with Glides**

# Seating — Side

Lyric™

GSA SIN 33721

(See page 156 for COM pricing on Grades 9-22)

Description	Back	Model Number	1	2	3	4	5	6	7	8	Leather	
											1	2
<b>GLIDES</b> Arms 	Mesh Back	CSC-MUGONO	\$ 777	\$ 807	\$ 834	\$ 877	\$ 919	\$ 963	\$ 1006	\$ 1049	\$ 1091	\$ 1879
	Upholstered Mesh Back	CSC-UUGONO	\$ 895	\$ 925	\$ 952	\$ 995	\$ 1037	\$ 1081	\$ 1124	\$ 1167	\$ 1209	\$ 1997
<b>CASTERS</b> Arms 	Mesh Back	CSC-MUCONO	\$ 821	\$ 851	\$ 878	\$ 921	\$ 963	\$ 1007	\$ 1050	\$ 1093	\$ 1135	\$ 1923
	Upholstered Mesh Back	CSC-UUCONO	\$ 939	\$ 969	\$ 996	\$ 1039	\$ 1081	\$ 1125	\$ 1168	\$ 1211	\$ 1253	\$ 2041

**NOTE:** Lyric side chairs ship up to three per carton to minimize waste. Model numbers and prices are per chair.

Model Number	Overall			Seat				Armrests			Backrest							
	COM Yardage (seat only)	Height	Width	Depth	Height	Width	Depth	Pan Angle	Height	Width Between Arms	Arm Pad Width	Height	Width	Lumbar Height	Backrest/Seat Angle (Range)	Ship Weight Per Chair	Ship Weight Per Carton	Cubes
CSC-MUGONO	1.0	32 1/4"	22 1/4"	23 3/4"	18 1/4"	18 1/2"	16 1/2"	6.5°	9"	19 1/2"	1 1/2"	17 1/8"	16 1/4"	10"	96.3°	28	—	20
CSC-UUGONO	1.0	32 1/4"	22 1/4"	23 3/4"	18 1/4"	18 1/2"	16 1/2"	6.5°	9"	19 1/2"	1 1/2"	17 1/8"	16 1/4"	10"	96.3°	28	—	20
CSC-MUCONO	1.0	32 1/4"	22 1/4"	23 3/4"	18 1/4"	18 1/2"	16 1/2"	6.5°	9"	19 1/2"	1 1/2"	17 1/8"	16 1/4"	10"	96.3°	28	—	20
CSC-UUCONO	1.0	32 1/4"	22 1/4"	23 3/4"	18 1/4"	18 1/2"	16 1/2"	6.5°	9"	19 1/2"	1 1/2"	17 1/8"	16 1/4"	10"	96.3°	28	—	20

LYRIC

<p><b>How to specify —</b> Select the Model Number from above.</p> <p>C   S   C   -</p>	<p><b>1st Option:</b> Select the Glide or Caster:</p> <p>0 Nylon 1 Nickel (add \$18) 2 Felt (add \$18) 3 Multi-surface Casters</p>	<p><b>2nd Option:</b> Select the Frame Finish:</p> <p>P71 Black PR6 Silver P8X Solar Black P8T Titanium</p>	<p><b>7th Option:</b> Select the Mesh:</p> <p>FWM55 Black FWM75 Charcoal FWM80 Titanium FWM85 Salt FWM65 Brownstone FWM60 Regatta</p>	<p><b>4th Option:</b> Select the Centurion Upholstery Color Code from page 17 for Upholstered Mesh Models (if applicable):</p> <p>C   U         .</p>	<p><b>5th Option:</b> Select the Seat Upholstery:</p> <p>See pages 13-14 for for selections, colors, and codes.</p>
---	--	---	---	---	---

Examples: CSC-UUCONO.3.P71.CU22.CU22 CSC-MUGONO.0.P71.FWM55.AI42

Lyric multi-purpose chairs go with the flow of your business. They're light, yet durable, so you can easily shift from one meeting to the next. Choose a bright shell color to create a bold look, or play it safe with a neutral color that blends seamlessly with your space. For whatever awaits, write the next line with Lyric, the family of chairs that fit everywhere.

## MODELS AND OPTIONS

Lyric multi-purpose work chairs are constructed of a poly back and seat. Upholstered seat pad models available. Choose either arm or armless models.

The versatile multi-surface casters are designed for use on hard or soft surfaces.

## MATERIALS

- All COMs/COLs must be approved for upholsterability or applicable fire code compliance prior to order entry. See pages 6-8 for COM ordering instructions.
- Allsteel fabrics meet requirements for CTB117. COM/COL manufacturers supply certificates of compliance for fabric only tests such as CTB117.
- Lyric multi-purpose work chairs are warranted for users up to 300 lbs.

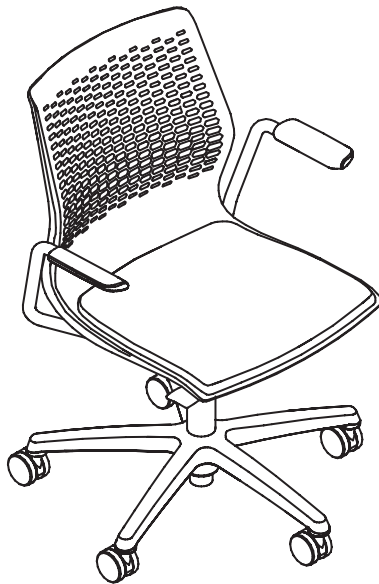

CMPWU-PPCONO — Poly Back with Upholstered Seat Pad and Casters

## OPTIONS - MULTI-PURPOSE WORK CHAIR

Chair Types:

- CMPW** Multi-Purpose Work Chair
- CMPWU** Multi-Purpose Work Chair w/Upholstered Seat Pad

Back Material:

- PP** Polymer Back

Casters:

- C** Casters

Arms:

- O** Fixed Arm
- A** Armless

Fire code:

- NO** No Fire Code

Type of Caster:

- B** Black Dual-Wheel Multi-Surface Caster
- T** Titanium Multi-Surface Caster (add \$62)

Arm Cap:

- H** Non-flexible

Frame Color:

- P71** Black
- PR6** Silver
- P8X** Solar Black
- P8T** Titanium

Base Color:

- BLK** Black
- TI** Titanium

Polymer Colors:

- BW** Brownstone
- CP** Calypso
- CR** Cherry
- LA** Lava
- RE** Regatta
- TI** Titanium
- WT** White
- ZE** Zest

Cylinder:





- 2** Standard, allows 5¼" of travel
- 3** Short, allows 4½" of travel

Seat Upholstery:

See pages 13-14 for selections, colors, and codes.

FLOOR COVERING	TYPE OF GLIDE			
	Polycarbonate/Nylon	Felt	Steel	Rubber
Carpet	Best	Not Recommended	Good	Not Recommended
Polished Concrete	Best	Good	Not Recommended	Not Recommended
Hardwood	Not Recommended	Best	Not Recommended	Good
Vinyl (Includes LVT)	Best	Better	Good	Good
VCT	Best	Good	Not Recommended	Good
Tile (Porcelain/Ceramic)	Best	Good	Not Recommended	Good
<b>Attention</b>	Particles can become lodged in nylon and mar floor surface.	Particles can become lodged in felt and mar floor surface.	Cleaning chemicals and water can cause rusting.	Resists moving/sliding. Could lead to chairs tipping back.

(See page 156 for COM pricing on Grades 9-22)

Description	Back and Seat	Number	1	2	3	4	5	6	7	8	L1	L2
Arms 	Poly	CMPW-PPCONO	\$ 845									
Arms 	Poly w/Upholstered Seat Pad	CMPWU-PPCONO	\$ 998	\$ 1022	\$ 1041	\$ 1063	\$ 1087	\$ 1113	\$ 1134	\$ 1161	\$ 1234	\$ 1380
Armless 	Poly	CMPW-PPCANO	\$ 713									
Armless 	Poly w/Upholstered Seat Pad	CMPWU-PPCANO	\$ 865	\$ 889	\$ 908	\$ 930	\$ 954	\$ 980	\$ 1001	\$ 1028	\$ 1101	\$ 1247

Model Number	Overall			Seat		Armrests			Backrest									
	COM Yardage (seat only)	Height	Width	Depth	Height	Width	Depth	Pan Angle	Height	Width Between Arms	Arm Pad Width	Height	Width	Lumbar Height	Backrest/Seat Angle (Range)	Ship Weight Per Chair	Ship Weight Per Carton	Cubes
CMPW-PPCONO		36½"	24½"	23"	19 - 24¼"	18"	16¼"	5°	8¾"	20¼"	2"	18"	17½"	7¼"	95°	29	—	18.3
CMPWU-PPCONO	0.60	36½"	24½"	23"	19 - 24¼"	18"	16¼"	5°	8¾"	20¼"	2"	18"	17½"	7¼"	95°	31	—	18.3
CMPW-PPCANO		36½"	24½"	23"	19 - 24¼"	18"	16¼"	5°	8¾"	20¼"	2"	18"	17½"	7¼"	95°	26	—	18.3
CMPWU-PPCANO	0.60	36½"	24½"	23"	19 - 24¼"	18"	16¼"	5°	8¾"	20¼"	2"	18"	17½"	7¼"	95°	28	—	18.3

<b>How to specify —</b> Select the Model Number from above.  <b>CMPW-</b>         .	<b>1st Option:</b> Select the Caster: <b>B</b> Black Dual-Wheel Multi-surface Casters <b>T</b> Titanium Dual-Wheel Multi-surface Casters (\$62 extra)	<b>2nd Option:</b> Select the Arm Cap (if applicable): <b>H</b> Non-flexible	<b>3rd Option:</b> Select the Frame Finish: <b>P71</b> Black <b>PR6</b> Silver <b>P8X</b> Solar Black <b>P8T</b> Titanium	<b>4th Option:</b> Select the Base Color: <b>BLK</b> Black <b>TI</b> Titanium	<b>5th Option:</b> Select the Polymer Color: <b>BW</b> Brownstone <b>CP</b> Calypso <b>CR</b> Cherry <b>LA</b> Lava <b>RE</b> Regatta <b>TI</b> Titanium <b>WT</b> White <b>ZE</b> Zest	<b>6th Option:</b> Select the Cylinder: <b>2</b> Standard, allows 5¼" of travel <b>3</b> Short, allows 4½" of travel	<b>7th Option:</b> Select the Seat Pad Upholstery (if applicable): See pages 13-14 for selections, colors, and codes.
	.	.	<b>H</b> .	<b>P</b>       .	.	.	.

Examples: CSC-UUCONO.0.P71.CU22.CU22 CSC-MUCONO.0.P71.AM01.AI42



*Lyric multi-purpose chairs go with the flow of your business. They're light, yet durable, so you can easily shift from one meeting to the next. Stow some away for the department lunch and learn. Then pull more off a stack to set up for the all-company awards celebration. Choose a bright shell color to create a bold look, or play it safe with a neutral color that blends seamlessly with your space. For whatever awaits, write the next line with Lyric, the family of chairs that fit everywhere.*

Chairs ship up to four per carton to minimize waste. Model numbers and prices are per chair.

Lyric multi-purpose chairs are warranted for users up to 300 lbs.

## KEY FEATURES

The perforated back on Lyric multi-purpose chair provides ventilation and distributed support. The waterfall seat front reduces pressure points and the intuitive back design offers built-in lumbar support.

## MODELS AND OPTIONS

Arm and armless models available. Shell color options from sophisticated to playful and leg options from sled-base to four-legged with casters or glides.

Glide options include nylon, polycarbonate, nickel-plated, or felt. Nylon glides are recommended for hard surfaces, commercial carpet, and damp environments. Nickel-plated glides are recommended for carpet. Felt glides are recommended for wood, tile, or high-sheen floor surfaces.

Multi-surface casters are also available on four leg models and are designed for use on hard or soft surfaces.

Lyric 4-Leg Multi-Purpose chairs offer the ability to stack up to four chairs high on the floor.

Lyric Wire Stacker Multi-Purpose chairs offer the ability to stack up to ten high on the floor.

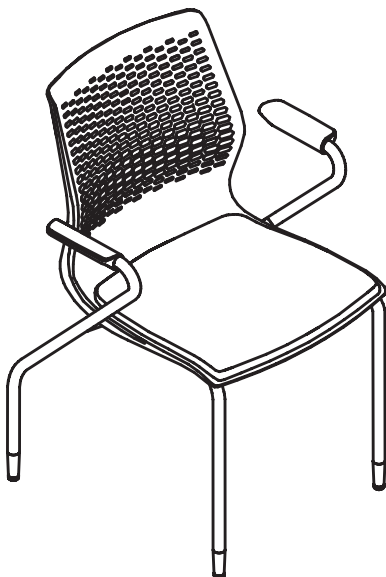

CMPNU-PPGO  
4 Leg w/Seat Pad

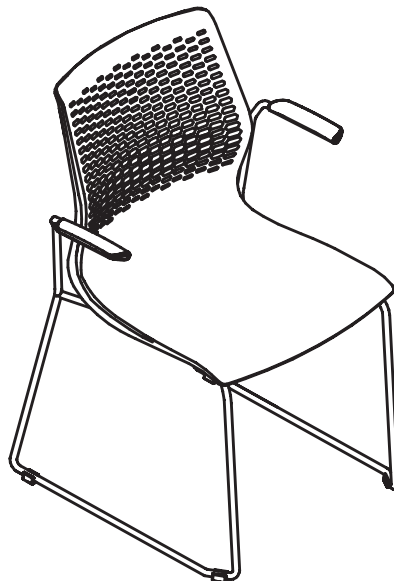

CWS-PPGO  
Wire Stacker

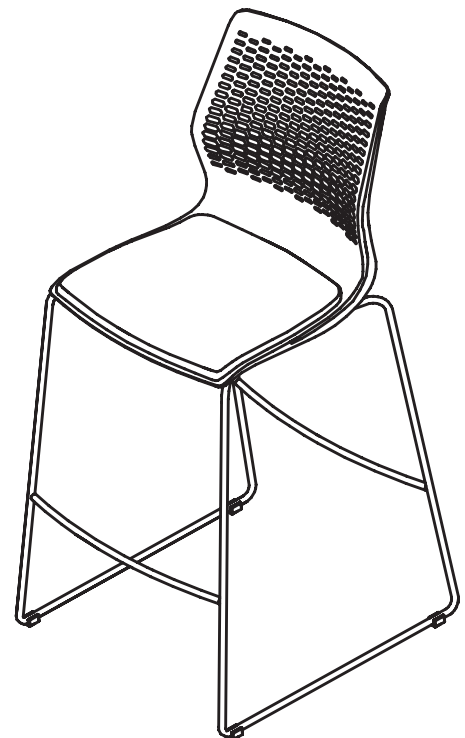

CWSS30U-PPGA  
Wire Stool  
w/Seat Pad

## OPTIONS — MULTI-PURPOSE

### Chair Types:

- CMPN** Four Leg Multi-Purpose Polymer Chair
- CMPNU** Four Leg Multi-Purpose Polymer Chair with Upholstered Seat Pad
- CWS** Wire Stacker Multi-Purpose Polymer Chair
- CWSU** Wire Stacker Multi-Purpose Polymer Chair with Upholstered Seat Pad
- CMSS30** Wire Multi-Purpose Polymer Stool
- CMSS30U** Wire Multi-Purpose Polymer Stool with Upholstered Seat Pad

### Back Material:

- PP** Polymer Back

### Casters/Glides:

- C** Casters
- G** Glides

### Arms:

- O** Fixed
- A** Armless

### Fire code:

- NO** No Fire Code

### Type of Glide or Caster:

- 0** Nylon Glide (four leg models only)
- 0** Polycarbonate (wire stacker and stool models only)
- 1** Nickel Glide (\$18 extra)
- 2** Felt Glide (\$18 extra)
- 5** Rubber Glide (four leg models only, \$18 extra)
- 3** Multi-Surface Caster (four leg models only)

### Arm Cap:

- H** Non-flexible (color predetermined based on finish selection, wire stacker arm caps are always black)

### Frame Finish (Arm Cap color):

- P71** Black (Black)
- PJF** Bullseye (Titanium)
- PJW** Designer White (Titanium)
- P02** Flint (Black)
- PJE** Pyrite (Black)
- PR6** Silver (Titanium)
- P8X** Solar Black (Black)
- P8T** Titanium (Titanium)

### Polymer Colors:



- BW** Brownstone
- CP** Calypso
- CR** Cherry
- LA** Lava
- RE** Regatta
- TI** Titanium
- WT** White
- ZE** Zest

### Upholstery Pad:

See pages [13-14](#) for selections.

See pages [17-18.1](#) for colors and codes

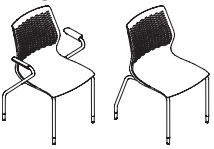
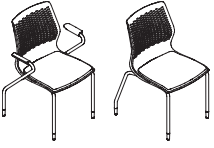
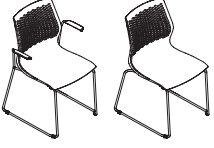
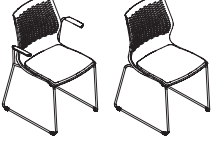
(See page 156 for COM pricing on Grades 9-22)

Base and Arms	Arms and Glides or Casters	Model Number	1	2	3	4	5	6	7	8	Leather*	
											1	2
<b>4 Leg</b> 	Arms with Glides	CMPN-PPGO	\$ 553									
	Arms with Casters	CMPN-PPCO	\$ 597									
	Armless with Glides	CMPN-PPGA	\$ 420									
	Armless with Casters	CMPN-PPCA	\$ 425									
<b>4 Leg w/Seat Pad</b> 	Arms with Glides	CMPNU-PPGO	\$ 678	\$ 701	\$ 720	\$ 742	\$ 765	\$ 790	\$ 810	\$ 837	\$ 907	\$ 1049
	Arms with Casters	CMPNU-PPCO	\$ 723	\$ 746	\$ 765	\$ 787	\$ 810	\$ 835	\$ 855	\$ 882	\$ 952	\$ 1094
	Armless with Glides	CMPNU-PPGA	\$ 547	\$ 570	\$ 589	\$ 611	\$ 634	\$ 659	\$ 679	\$ 706	\$ 776	\$ 918
	Armless with Caster	CMPNU-PPCA	\$ 591	\$ 614	\$ 633	\$ 655	\$ 678	\$ 703	\$ 723	\$ 750	\$ 820	\$ 962
<b>Wire Stacker</b> 	Arms with Glides	CWS-PPGO	\$ 635									
	Armless with Glides	CWS-PPGA	\$ 502									
<b>Wire Stacker w/Seat Pad</b> 	Arms with Glides	CWSU-PPGO	\$ 775	\$ 799	\$ 818	\$ 840	\$ 864	\$ 890	\$ 911	\$ 938	\$ 1011	\$ 1157
	Armless with Glides	CWSU-PPGA	\$ 641	\$ 665	\$ 684	\$ 706	\$ 730	\$ 756	\$ 777	\$ 804	\$ 877	\$ 1023
<b>Wire Stool</b> 	Armless with Glides	CWSS30-PPGA	\$ 635									
<b>Wire Stool w/Seat Pad</b> 	Armless with Glides	CWSS30U-PPGA	\$ 783	\$ 807	\$ 826	\$ 848	\$ 872	\$ 898	\$ 919	\$ 946	\$ 1019	\$ 1165

Continued on next page ►

<p><b>How to specify —</b> Select the Model Number from above.</p>	<p><b>1st Option:</b> Select the Glide or Caster:</p> <ul style="list-style-type: none"> <li>0 Nylon Glide (4 leg models only)</li> <li>0 Polycarbonate (wire stacker models only)</li> <li>1 Nickel Glide (\$18 extra)</li> <li>2 Felt Glide (\$18 extra)</li> <li>5 Rubber Glide (4 leg models only, \$18 extra)</li> <li>3 Multi-Surface Caster (4 leg models only)</li> </ul>	<p><b>2nd Option:</b> Arm Cap (if applicable):</p> <ul style="list-style-type: none"> <li>H Non-flexible</li> </ul> <p>Color predetermined based on finish selection, see page 105.</p>	<p><b>3rd Option:</b> Frame Finish:</p> <ul style="list-style-type: none"> <li>P71 Black</li> <li>PJF Bullseye</li> <li>PJW Designer White</li> <li>P02 Flint</li> <li>PJE Pyrite</li> <li>PR6 Silver</li> <li>P8X Solar Black</li> <li>P8T Titanium</li> </ul>	<p><b>4th Option:</b> Polymer Color:</p> <ul style="list-style-type: none"> <li>BW Brownstone</li> <li>CP Calypso</li> <li>CR Cherry</li> <li>LA Lava</li> <li>RE Regatta</li> <li>TI Titanium</li> <li>WT White</li> <li>ZE Zest</li> </ul>
<p>C       -   P   P     NO   .   .</p>	<p>H   .</p>	<p>      .</p>	<p>     </p>	

Examples: CMPN-PPGONO.1.H.PR6.CR CWSU-PPGANO.0.H.P8X.WT.CU22

Model Number	COM Yardage			Overall			Seat			Armrests			Backrest			Ship Weight	Ship Weight Per Carton	Cubes		
	COL Sq. Feet	Height (Range)	Width	Depth	Height Std (Range)	Width	Depth	Pan Angle (Range)	Armrest Height	Width Between Arms	Depth	Height	Width	Lumbar Height	Backrest/Seat Angle (Range)					
CMPN-PPGO		34"	24"	20½"	17¼"	18"	16¼"	6.6°	9"	20¼"	6½"	18¼"	17"	9¼"	93½°-99¼°	14	62	20	4 per carton	
CMPN-PPCO		34"	24"	20½"	17¼"	18"	16¼"	6.6°	9"	20¼"	6½"	18¼"	17"	9¼"	93½°-99¼°	14	62	20	4 per carton	
CMPN-PPGA		34"	24"	20½"	17¼"	18"	16¼"	6.6°				18¼"	17"	9¼"	93½°-99¼°	12	54	20	4 per carton	
CMPN-PPCA		34"	24"	20½"	17¼"	18"	16¼"	6.6°				18¼"	17"	9¼"	93½°-99¼°	12	54	20	4 per carton	
CMPNU-PPGO	0.6	6	34"	24"	20½"	17¼"	18"	16¼"	6.6°	9"	20¼"	6½"	18¼"	17"	9¼"	93½°-99¼°	14	62	20	4 per carton
CMPNU-PPCO	0.6	6	34"	24"	20½"	17¼"	18"	16¼"	6.6°	9"	20¼"	6½"	18¼"	17"	9¼"	93½°-99¼°	14	62	20	4 per carton
CMPNU-PPGA	0.6	6	34"	24"	20½"	17¼"	18"	16¼"	6.6°				18¼"	17"	9¼"	93½°-99¼°	12	54	20	4 per carton
CMPNU-PPCA	0.6	6	34"	24"	20½"	17¼"	18"	16¼"	6.6°				18¼"	17"	9¼"	93½°-99¼°	12	54	20	4 per carton
CWS-PPGO		34"	23¾"	22¼"	17¼"	18"	16¼"	6.6°	9"	20¼"	6½"	18¼"	17"	9¼"	93½°-99¼°	16	70	20	4 per carton	
CWS-PPGA		34"	19"	22¼"	17¼"	18"	16¼"	6.6°	9"	20¼"	6½"	18¼"	17"	9¼"	93½°-99¼°	15	66	20	4 per carton	
CWSU-PPGO	0.60		34"	21"	21½"	17¼"	18"	16¼"	6.6°	9"	20¼"	6½"	18¼"	17"	9¼"	93½°-99¼°	16	70	20	4 per carton
CWSU-PPGA	0.60		34"	21"	21½"	17¼"	18"	16¼"	6.6°	9"	20¼"	6½"	18¼"	17"	9¼"	93½°-99¼°	15	66	20	4 per carton
CWSS30-PPGA			46"	21½"	26"	33"	18"	16½"	5°				18"	17½"	7¼"	95°-101°	26		20	
CWSS30U-PPGA	0.60		46"	21½"	26"	33"	18"	16½"	5°	—	—	—	18"	17½"	7¼"	95°-101°	28		20	

**Note:** Lyric Multi-Purpose chairs ship up to four per carton to minimize waste. Chairs stack on floor up to 10-high. Model numbers and prices are per chair.

◀ Continued from previous page

5th Option:

Select the  
Seat Pad Upholstery  
(if applicable):

See pages 13-14 for selections, colors,  
and codes.

--	--	--	--	--	--	--	--	--	--	--	--	--	--	--	--	--	--	--	--	--

*Mimeo seating from Allsteel is designed to move with you. Created for today's active workplace, active workstyles, and active sitting, Mimeo is responsive and supportive of your every move. It hugs you. Embraces you. Envelops you. No matter your task. No matter your size or shape. Mimeo becomes one with you.*

*Designed in partnership with Bruce Fifield of Studio Fifield, Milan, Italy*

### Visually moving.

Mimeo's distinctive design and smart use of materials make a strong visual impact. It's appropriately scaled to impress and inspire across an open floorplan without overwhelming the environment. Comfortably moving from one space to the next, it brings style and character wherever it's used.

### Always the right fit.

Mimeo's lightweight and intuitive design adapts to any type of work you're doing. Experience immediate and lasting comfort for focused work, as well as in project rooms and open desk areas where activities change day to day or hour to hour. Mimeo is ideal for highly active and collaborative workstyles and enhances every space.

### Uncompromised comfort and support.

Mimeo's enveloping shape and dynamic back maintain constant contact with you, reducing and evenly distributing pressure points across the entire frame. No matter how you sit or move, the weight-activated motion adjusts automatically. Your whole body is supported. And each user, regardless of size, shape, or posture, has the same supportive experience.

### A new standard in weight activation

Mimeo's recline tension has been engineered to automatically adjust to the specific needs and body weight of each user without the need for manual adjustment.

The innovative weight-activated chair motion delivers the appropriate amount of tension for full recline, upright sitting, and every posture in between. As you effortlessly recline, the seat lifts your bodyweight, which modifies the amount of tension accordingly. The result is a personalized, balanced recline that allows for comfortable and healthy movement for any body, in any posture.



MIW-KWNO



MIS-KWNO

**DESIGN FEATURES**

Mimeo's innovative back-pattern design provides integrated lumbar support while accommodating every movement. The generous seat width and slightly curved arms invite unrestricted movement and comfort for all postures and body types. Mimeo is lightweight and easy to transport with an integrated back handle, bringing function to any space, effortlessly.

**IntelliForm™ back technology**

Exclusive technology combines the benefits of the compliant, polymer back with flex wings, supportive uprights, and the soft, breathable Mimeo mesh material. The innovative back design and carefully selected materials have been engineered to deliver personalized comfort for each user, even as they move and change postures. The polymer back is highly pliable, allowing the material to flex and move along with the user.

**Optional adjustable lumbar support**

Mimeo provides automatic lumbar support. To accommodate personal preference, an optional external lumbar support can be added at any time with 4" range of adjustment.

**4D adjustable arms**

Mimeo's open arm design moves with you as you recline to support your arms in a variety of postures. Adjustments in four directions allow support during work tasks, and the ability to position arms close to the body.

**Pneumatic seat height adjustment**

Regulates height of work chair relative to the floor. Standard 5" of travel accommodates average to tall users. Stools offer 10" of travel.

**Base and casters**

Work chair bases are a five-star design. Dual-wheel casters are available in hard tread for carpet, or multi-surface for any floor surface.

**Materials**

- All COMs/COLs must be approved for upholsterability or applicable fire code compliance prior to order entry. See pages 6-8 for COM ordering instructions.
- Allsteel fabrics meet requirements for CTB117. COM/COL manufacturers supply certificates of compliance for fabric-only tests such as CTB117.
- Mimeo meets the requirements set forth in ANSI/BIFMA X5.1-2011 and BIFMA G1-2013. Mimeo is warranted for multiple shifts and users up to 300 lbs.

**Height-Adjustable Footring**

Travels 8" to ensure users have comfortable support of their feet and legs. The footring has a 20" diameter.

**OPTIONS — WORK/CONFERENCE****Chair Type:**

- MIW** Work Chair
- MIS** Work Stool

**Back:**

- K** Knit

**Armrests:**

- W** 4D Adjustable Arms
- A** Armless

**Fire Code:**

- NO** No Fire Code

**Frame Color:**

- BLK** Black
- T** Titanium (add \$77)

**Base Color:**

- BLK** Black
- T** Titanium
- PAL** Polished Aluminum (add \$159)

**Back Carrier Color Option**

- BLK** Black
- G** Graphite
- T** Titanium
- WT** White

**Lumbar (color matches back carrier):**

- N** No Lumbar Adjustment
- L** Lumbar Adjustment (add \$71)

**Cylinder:**

- 2** Standard
- 3** Short
- 4** Extended (Stool Only)

**Casters:**

- H** Black Hard Tread
- B** Black Multi-surface (add \$66)
- T** Titanium Multi-surface (add \$66)



**Mimeo Mesh Back Material:**

- NM61** Amethyst
- NM91** Cobalt
- NM19** Fog
- NM27** Glow
- NM75** Leaf
- NM22** Loft
- NM10** Onyx
- NM20** Shadow

**Upholstery:**

See pages 13-14 for selections, colors, and codes.

(See page 157 for COM pricing on Grades 9-22)

Arm Style	Type	Model Number <i>Add options below</i>									Leather*	
			1	2	3	4	5	6	7	8	1	2
<b>Fully Adjustable Arms</b> 	Work	MIW-KWNO	\$ 1943	\$ 1962	\$ 1978	\$ 1999	\$ 2023	\$ 2046	\$ 2068	\$ 2091	\$ 2256	\$ 3090
	Stool	MIS-KWNO	\$ 2349	\$ 2368	\$ 2384	\$ 2405	\$ 2429	\$ 2452	\$ 2474	\$ 2497	\$ 2662	\$ 3496
<b>Armless</b> 	Work	MIW-KANO	\$ 1674	\$ 1693	\$ 1709	\$ 1730	\$ 1754	\$ 1777	\$ 1799	\$ 1822	\$ 1987	\$ 2821
	Stool	MIS-KANO	\$ 2080	\$ 2099	\$ 2115	\$ 2136	\$ 2160	\$ 2183	\$ 2205	\$ 2228	\$ 2393	\$ 3227
<b>Lumbar Kit</b>		MLUK	\$ 139									

Continued on next page ►

<p><b>How to specify —</b> Select the Model Number from above.</p>	<p><b>1st Option</b> Select the Frame Color (if applicable):</p> <p><b>BLK</b> Black <b>T</b> Titanium (\$77 extra)</p>	<p><b>2nd Option:</b> Select the Base Color (if applicable):</p> <p><b>BLK</b> Black <b>T</b> Titanium <b>PAL</b> Polished Aluminum (\$159 extra)</p>	<p><b>3rd Option:</b> Select the Back Carrier Color:</p> <p><b>BLK</b> Black <b>G</b> Graphite <b>T</b> Titanium <b>WT</b> White</p>	<p><b>4th Option:</b> Select the Lumbar (color matches back carrier):</p> <p><b>N</b> No Lumbar <b>L</b> Lumbar (\$71 extra)</p>	<p><b>5th Option:</b> Select the Cylinder:</p> <p><b>2</b> Standard <b>3</b> Short <b>4</b> Extended (stool only)</p>
MI     -   K         .         .         .         .         .         .					

Examples: MIW-KWNO.BLK.BLK.BLK.N.2.H.NM10.NR66 MLUK.WT  
MIS-KWNO.T.T.WT.L.4.T.NM22.PNS012

Model Number	COM Landage	COL Sq. Feet	Height (Range)	Width	Depth	Height	Width	Depth	Pan Angle (Range)	Armrest Height	Width Between Arms	Armrest Length	Arm Height to the Floor	Height	Width	Lumbar Height	Backrest/Seat Angle (Range)	Ship Weight	Ship Weight Per Carton	Cubes
<b>MIW-KWNO</b>	1.0	20	36" - 41"	23"	23"	16"-21"	20"	15" - 18"	4°	6" - 11"	13" - 21"	11"	22" - 32"	23"	18"	9"	95°-113°	31½	41	11.1
<i>Short Cylinder</i>			34" - 38"			14"-18"							21" - 29"							
<b>MIS-KWNO</b>	1.0	20	42" - 52"	23"	23"	22"-32"	20"	15" - 18"	4°	6" - 11"	13" - 21"	11"	28" - 43"	23"	18"	9"	95°-113°	41.5	45	12.6
<b>MIW-KANO</b>	1.0	20	36" - 41"	23"	23"	16"-21"	20"	15" - 18"	4°					23"	18"	9"	95°-113°	31½	41	11.1
<i>Short Cylinder</i>			34" - 38"			14"-18"														
<b>MIS-KANO</b>	1.0	20	42" - 52"	23"	23"	22"-32"	20"	15" - 18"	4°					23"	18"	9"	95°-113°	41.5	45	12.6

**Note:** Dimensions are in accordance with BIFMA G1-2013 guidelines — see illustration of guidelines on page 45.

◀ Continued from previous page

<p><i>6th Option:</i>  <b>Select the Casters:</b>  <b>H</b> Black Hard Tread  <b>B</b> Black Multi-surface (\$66 extra)  <b>T</b> Titanium Multi-surface (\$66 extra)</p>	<p><i>7th Option:</i>  <b>Select the Knit Color:</b>  <b>NM61</b> Amethyst  <b>NM91</b> Cobalt  <b>NM19</b> Fog  <b>NM27</b> Glow  <b>NM75</b> Leaf  <b>NM22</b> Loft  <b>NM10</b> Onyx  <b>NM20</b> Shadow</p>	<p><i>8th Option:</i>  <b>Select the Seat Upholstery:</b>                  See pages 13-14 for selection.                  See pages 17-18.1 for colors and codes.                  See pages 6-8 for COM guidelines.</p>
---	---	---





*Nimble is a high density stacking solution that is both extremely durable and surprisingly comfortable. Durable because we use the thickest wire frame in the industry. Comfortable because of the hidden front support bar, the contoured polypropylene back and seat along with the flexibility of the frame. The clean design will appeal to designers and facility managers alike.*

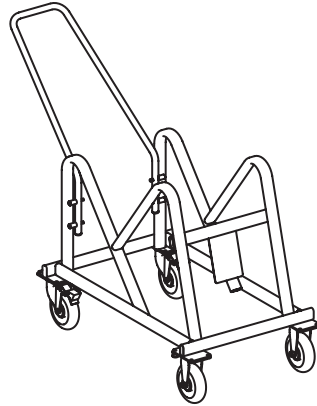
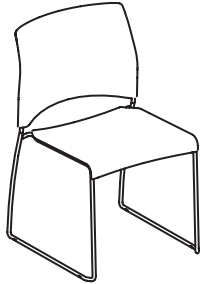

## MODELS AND OPTIONS

The Nimble chair is suited for team conference, cafeterias, auditoriums, or visitor's chair applications.

Nimble **stacks 36 chairs high** in 66"H by 50"D by 22"W (on a cart). A maximum of 12 chairs can be stacked without a cart with a dimension of 40"H by 33"D by 19½"W.

The **cart** is available in black epoxy paint finish with black casters. The cart angles chairs in a neat vertical arrangement that fits through doorways and can be moved by one person. Carts are shipped one per carton.

## SEATS AND BACKS

The seat features a **waterfall** edge to *enhance circulation* and *reduce fatigue*. The backrest features contoured **lumbar** support to help *relieve stress in the spine*.

The **seat and backrest shells** are color-impregnated, washable polypropylene with U.V. inhibitors.

The polypropylene shells are easily **field replaceable** with simple hand tools for long life.

## GLIDES

Nimble offers glide options for different types of flooring.

**Polycarbonate glide** is standard and well-suited for carpet and vinyl flooring.

**Stainless steel glide** can provide extra protection when used on rough, gritty, or hard surfaces (concrete).

**Felt-covered polycarbonate glide** is recommended for wood, tile, or high-sheen gloss floor surfaces to protect the finish longer.

## GANGING BRACKETS

Brackets securely connect Nimble chairs together for a neat, aligned row. The brackets are snapped in place over the chair glide (two brackets per chair). To connect the chairs, snap the bracket from one chair leg to the adjacent chair leg. To disconnect, unsnap the bracket. The chairs stack with the brackets in place.

Brackets are sold in packages of eight (for four chairs). The brackets can be added to Nimble chairs at any time.

[GSA Reference Page](#)

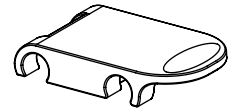

## FRAMES

The sturdy, **12mm wire frame** provides clean lines and excellent strength, ideal for high-density stacking.

The **chrome, black or silver epoxy powder-coated frame** is durable and scuff-resistant and complements any environment.

**Powder coating** is a non-hazardous and solvent-free process which provides an environmentally friendly, baked-on, durable finish. **Chrome** is recommended for high-intensity stacking applications due to its chip-resistant properties.

## SHIPPING

Nimble chairs **ship in cartons containing 4 chairs** to reduce packaging waste.

## STANDARDS

Nimble meets the requirements set forth in ANSI/BIFMA X5.1-2011. Nimble is warranted for users up to 300 lbs.

## OPTIONS — NIMBLE SEATING:

Description:

- Stacking Chair
- Ganging Brackets (Black only)
- Cart for Stacking and Transportation

Upholstery Options:

- Polypropylene Shells

Glide Options:

- 0 Polycarbonate Glides
- 1 Stainless Steel Glides (\$29 extra per chair)
- 2 Felt Covered Polycarbonate Glides (\$18 extra per chair)

Frame Colors:

<b>CBK</b> Black	<b>P8J</b> Iris
<b>P8T</b> Titanium	<b>P8F</b> Krypton
<b>P8B</b> Night Bronze	<b>P8M</b> Regatta
<b>PJE</b> Pyrite	<b>P091</b> Amethyst <i>(De-emphasized)</i>
<b>PR6</b> Silver	<b>P090</b> Cobalt <i>(De-emphasized)</i>
<b>P8X</b> Solar Black	<b>P093</b> Ochre
<b>P8S</b> Atom	<b>P092</b> Sienna
<b>PJF</b> Bullseye	
<b>P8P</b> Ember	
<b>P8N</b> Ion	

Carts are always Black.

Plastic Shell Colors:

Opaque Colors —	
<b>BLK</b> Black (formerly <b>CB</b> Onyx)	
<b>BU</b> Surf	
<b>BW</b> Brownstone	
<b>GN</b> Sprout	
<b>GY</b> Summit	
<b>RD</b> Cayenne	
<b>RG</b> Tangelo	
<b>WT</b> White (formerly Frost)	

Description	Frame Finish	Model Number	List Price
Plastic Shells	Chrome	Open Market NMBL-1FC (De-emphasized)	\$ 325
	Powder Coat	Open Market NMBL-2FC (De-emphasized)	\$ 325
	Ganging Brackets	NMBL-GANG (Package of 8 brackets for 4 chairs – Black only) (De-emphasized)	\$ 86



Nimble chairs ship in cartons containing 4 chairs. Model numbers and price are per chair.

Model Number	Overall					Seat			Armrests				Backrest				Unit Weight	Ship Weight Per Carton	Cubes			
	COM Yardage	COL Sq. Feet	Height (Range)	Width	Depth	Height (Range)	Width	Depth (Range)	Pan Angle (Range)	Height (Range)	Width Between Armrests (Range)	Depth (Range)	Pivot Inwards	Pivot Outwards	Height (Range)	Width				Lumbar Height (Range)	Backrest/Seat Angle (Range)	
NMBL-1FC*	-	-	31 1/8"	19 1/4"	21 1/2"	18"	18"	17 1/2"	4°	-	-	-	-	-	16 1/2"	19"	6"	96°	15.0	65.0	11.9	4 per carton
NMBL-2FC*	-	-	31 1/8"	19 1/4"	21 1/2"	18"	18"	17 1/2"	4°	-	-	-	-	-	16 1/2"	19"	6"	96°	15.0	65.0	11.9	4 per carton
NMBL-GANG*	-	-	1/2"	3"	1 1/4"		**													0.6	0.1	package of 8

\*De-emphasized

\*\*Calculate 21"W per chair with ganging bracket.

Description	Dimensions	Model Number	List Price
Cart	29"H x 21"W x 34"D*	NMBL-CART (De-emphasized)	\$ 1012

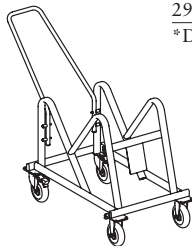

\*Depth dimension above does not include the handle

<p><b>How to specify —</b> Select the Model Number from above.</p>	<p><b>1st Option:</b> Select the Glide (if applicable):</p> <p>0 Polycarbonate Glides 1 Stainless Steel Glide Caps (\$29 per chair extra) 2 Felt Covered Polycarbonate Glides (\$18 per chair extra)</p>	<p><b>2nd Option:</b> Select the Frame Color (for NMBL-2FC only):</p> <table border="0"> <tr> <td>CBK Black</td> <td>P8J Iris</td> </tr> <tr> <td>P8T Titanium</td> <td>P8F Krypton</td> </tr> <tr> <td>P8B Night Bronze</td> <td>P8M Regatta</td> </tr> <tr> <td>PJE Pyrite</td> <td>P091 Amethyst (De-emphasized)</td> </tr> <tr> <td>PR6 Silver</td> <td>P090 Cobalt (De-emphasized)</td> </tr> <tr> <td>P8X Solar Black</td> <td>P093 Ochre</td> </tr> <tr> <td>P8S Atom</td> <td>P092 Sienna</td> </tr> <tr> <td>PJF Bullseye</td> <td></td> </tr> <tr> <td>P8P Ember</td> <td></td> </tr> <tr> <td>P8N Ion</td> <td></td> </tr> </table>	CBK Black	P8J Iris	P8T Titanium	P8F Krypton	P8B Night Bronze	P8M Regatta	PJE Pyrite	P091 Amethyst (De-emphasized)	PR6 Silver	P090 Cobalt (De-emphasized)	P8X Solar Black	P093 Ochre	P8S Atom	P092 Sienna	PJF Bullseye		P8P Ember		P8N Ion		<p><b>3rd Option:</b> Select the Shell (seat and back) Color (if applicable):</p> <p><b>Opaque:</b> BLK Black (formerly CB – Onyx) BU Surf BW Brownstone GN Sprout GY Summit RD Cayenne RG Tangelo WT White (formerly Frost)</p>
CBK Black	P8J Iris																						
P8T Titanium	P8F Krypton																						
P8B Night Bronze	P8M Regatta																						
PJE Pyrite	P091 Amethyst (De-emphasized)																						
PR6 Silver	P090 Cobalt (De-emphasized)																						
P8X Solar Black	P093 Ochre																						
P8S Atom	P092 Sienna																						
PJF Bullseye																							
P8P Ember																							
P8N Ion																							
<p>Examples: NMBL-1FC.0.WT NMBL-2FC.2.P71.RD NMBL-CART</p>																							

O6 is a task chair that answers the ergonomic demands and needs put forth by the user while addressing the mental well-being that is usually left behind in today's seating world. The workplace is about people and the furniture should be an extension of those individuals, not the other way around. O6 is the culmination of research that has deemed comfort, ergonomics, and fresh design language as keys to win.

## KEY FEATURES

O6 chairs feature weight-activated recline so there's no additional tension adjustment. Intuitive controls, along with specially sculpted and formulated seat foam, create a comfortable sitting experience for wherever and however people work.

### Customization

O6 allows for a wide range of color optionality. The O6 family is offered in two different meshes, totaling 29 distinct mesh colors. Coupled with 4 frame colors to choose from, O6 offers users the chance to make a design statement throughout their workspace.

### 4D Fully Adjustable Arms

O6's 4D arms are fully adjustable in height, width, depth, and can pivot to provide optimal support. Pivot the front of the arm pads inward to move in closer to your desk and offer support while working.

### 2D Adjustable Arms

Provides height and width adjustments for optimal support of elbows and shoulders while keyboarding or conferencing while providing ease of entry/exit.

### Pneumatic Seat Height Adjustment

Regulates height of work chair relative to the floor. Standard 5" of travel accommodates average to tall users. Stools offer 10" of travel.

### Seat Depth Adjustment

Allows seat cushion to manually adjust front to back.

### Height-Adjustable Footring

Travels 8" to ensure users have comfortable support of their feet and legs. The footring has a 20" diameter.

### Optional Adjustable Lumbar Support

To accommodate personal preference, an optional external lumbar support can be added at any time with 4" range of adjustment.

### Base and Casters

Work chair bases are a five-star design. Dual-wheel casters are available in hard tread for carpet, or multi-surface for any floor surface.

## Materials

- All COMs/COLs must be approved for upholsterability or applicable fire code compliance prior to order entry. See pages 6-8 for COM ordering instructions.
- Allsteel fabrics meet requirements for CTB117. COM/COL manufacturers supply certificates of compliance for fabric-only tests such as CTB117.
- O6 meets the requirements set forth on ANSI/BIFMA X5.1-2017 and BIFMA G1-2013. O6 is warranted for multiple shifts and users up to 300 lbs.

## OPTIONS — WORK / STOOL

Chair Type:

**MNL** Work

**MNLS** Stool

Arms:

**MHW** 4D Fully Adjustable

**MHH** 2D Adjustable

**MHA** Armless

Frame Color:

**BLK** Black

**TI** Titanium (add \$44)

**E9** Flint (add \$88)

**STX** Salt (add \$88)

Mesh Color:

**FWM55** Black

**FWM75** Charcoal

**FWM80** Titanium

**FWM85** Salt

**FWM65** Brownstone

**FWM60** Regatta

**FWM90** Breeze

**RM10** Carbon (add \$109)

**RM11** Titanium (add \$109)

**RM12** Loft (add \$109)

**RM13** Onyx (add \$109)

**RM14** Cobalt (add \$109)

**RM15** Espresso (add \$109)

**RM16** Brick (add \$109)

**RM17** Bullseye (add \$109)

**RM19** Sky (add \$109)

**RM20** Blueberry (add \$109)

**RM21** Leaf (add \$109)

**RM23** Kermit (add \$109)

**RM24** Midnight (add \$109)

**RM25** Salamander (add \$109)

**RM26** Steel (add \$109)

**RM27** Beacon (add \$109)

**RM28** Chalk (add \$109 Available on back only)

**RM29** Pear (add \$109)

**RM30** Linen (add \$109)

**RM31** Gold Dust (add \$109)

**RM32** Key Lime (add \$109)

**RM33** Quicksand (add \$109)

Lumbar:

- L** Yes (add \$60)
- N** No

Cylinder:

- 2** Standard
- 3** Short
- 4** Stool

Base Color:

- BLK** Black
- TI** Titanium
- E9** Flint
- ST** Salt

Casters:

- H** Black Hard Tread
- B** Black Multi-Surface (add \$66)
- T** Titanium Multi-Surface (add \$66)
- E9** Flint Multi-Surface (add \$66)
- ST** Salt Multi-Surface (add \$66)

(See page 157 for COM pricing on Grades 9-22)

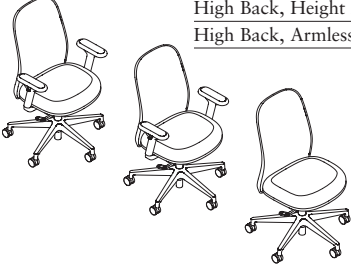
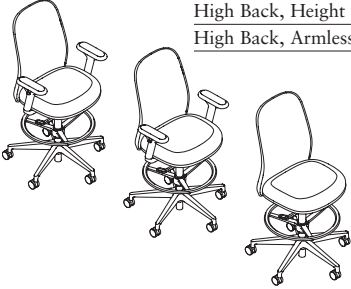
Back	Type	Model Number Add options below	Options								Leather	
			1	2	3	4	5	6	7	8	1	2
	High Back, 4D Adj Arms	MNL-MHW	\$ 1133	\$ 1153	\$ 1173	\$ 1191	\$ 1217	\$ 1244	\$ 1269	\$ 1295	\$ 1413	\$ 1613
	High Back, Height Adj Arms	MNL-MHH	\$ 1068	\$ 1088	\$ 1108	\$ 1126	\$ 1152	\$ 1179	\$ 1204	\$ 1230	\$ 1348	\$ 1548
	High Back, Armless	MNL-MHA	\$ 959	\$ 979	\$ 999	\$ 1017	\$ 1043	\$ 1070	\$ 1095	\$ 1121	\$ 1239	\$ 1439
	High Back, 4D Adj Arms	MNLS-MHW	\$ 1307	\$ 1327	\$ 1347	\$ 1365	\$ 1391	\$ 1418	\$ 1443	\$ 1469	\$ 1587	\$ 1787
	High Back, Height Adj Arms	MNLS-MHH	\$ 1242	\$ 1262	\$ 1282	\$ 1300	\$ 1326	\$ 1353	\$ 1378	\$ 1404	\$ 1522	\$ 1722
	High Back, Armless	MNLS-MHA	\$ 1133	\$ 1153	\$ 1173	\$ 1191	\$ 1217	\$ 1244	\$ 1269	\$ 1295	\$ 1413	\$ 1613
O6 Lumbar Kit		MNL-LUK	\$ 65									

<p><b>How to specify —</b> Select the Model Number from above.</p>	<p><b>1st Option:</b> Select the Frame Color: BLK Black TI Titanium (add \$44) E9 Flint (add \$88) STX Salt (add \$88)</p>	<p><b>2nd Option:</b> Select the Mesh (if applicable): See page 114 for selection.</p>	<p><b>3rd Option:</b> Select the Lumbar (if applicable): N No Lumbar L Lumbar (add \$60)</p>	<p><b>4th Option:</b> Select the Cylinder (if applicable): 2 Standard 3 Short 4 Stool</p>
--	--	--	--	---

<p><b>5th Option:</b> Select the Base (if applicable): BLK Black TI Titanium E9 Flint ST Salt</p>	<p><b>5th Option:</b> Select the Casters (if applicable): H Black Hard Tread B Black Multi-Surface (add \$66) T Titanium Multi-Surface (add \$66) E9 Flint Multi-Surface (add \$66) ST Salt Multi-Surface (add \$66)</p>	<p><b>7th Option:</b> Select the Upholstery (if applicable):</p>	<p><b>8th Option:</b> Select Headrest (if applicable): N No Headrest</p>
---	--	--	--

Examples: MNL-MHW.BLK.RM10.N.2.BLK.H.CU10.N

Model Number	COM Landage			Overall			Seat				Armrests				Backrest						
	COL Sq. Feet	Height (Range)	Height (Range)	Width	Depth	Height (Range)	Width	Depth (Range)	Pan Angle (Range)	Armrest Height	Width Between Arms	Depth (Range)	Pivot Inwards	Pivot Outwards	Height	Width	Lumbar Height*	Backrest/Seat Angle (Range)	Ship Weight	Ship Weight Per Carton	Curbs
MNL-MHW	0.81	37¼"-43"	26¼"	25½"	17"-22"	20½"	17½"-19½"	3°-8°	7½"-11½"	21"	10"	35"	35"	23"	17½"	4½"-9"	98°-111°	46	46	10.7	
MNL-MHH	0.81	37¼"-43"	26¼"	25½"	17"-22"	20½"	17½"-19½"	3°-8°	7½"-11¼"	21"	10"	-	-	23"	17½"	4½"-9"	98°-111°	46	46	10.7	
MNL-MHA	0.81	37¼"-43"	25½"	25½"	17"-22"	20½"	17½"-19½"	3°-8°	-	-	-	-	-	23"	17½"	4½"-9"	98°-111°	44	44	10.7	
MNLS-MHW	0.81	45¼"-55¼"	26¼"	25½"	24½"-34½"	20½"	17½"-19½"	3°-8°	7½"-11½"	21"	10"	35"	35"	23"	17½"	4½"-9"	98°-111°	52	52	10.7	
MNLS-MHH	0.81	45¼"-55¼"	26¼"	25½"	24½"-34½"	20½"	17½"-19½"	3°-8°	7¼"-11¼"	21"	10"	-	-	23"	17½"	4½"-9"	98°-111°	52	52	10.7	
MNLS-MHA	0.81	45¼"-55¼"	25½"	25½"	24½"-34½"	20½"	17½"-19½"	3°-8°	-	-	-	-	-	23"	17½"	4½"-9"	98°-111°	50	50	10.7	
MNL-LUK																					

Note: Dimensions are in accordance with BIFMA G1-2013 guidelines — see illustration of guidelines on page 45.

The Pli task seating portfolio provides distinctive performance and exceptional simplicity of movement. The innovative auto-fitting design enables each user to experience maximum ergonomic support for extended use without performing a series of multiple, complex adjustments. Sit, move, reach, work, and Pli adjusts to the movements and contours of each user.

## KEY FEATURES

The crucial criterion for wellness is a seating portfolio that combines the ergonomic support you need with the comfort you should never be without. Every one of the Pli chair models adapts to dynamic user movements with simplicity and responsiveness, ensuring a seated posture that is both healthful and comfortable.

### Minimal Adjustments

The distinctive 4-point seat suspension system ensures that Pli creates multi-position support without painstaking manual adjustments. Sit, and Pli conforms to you. The intuitive and easy height-adjustment control enables Pli to accommodate nearly every user stature. One adjustment is all you need to make.

### Back Support

Each Pli seating model offers flexible and responsive edgeless back support that transcends rigid perimeters, moving with the movements of the user. The conforming mesh back offers support to the lumbar area throughout the sit.

### 2D Adjustable Arms

Provides height and width adjustments for optimal support of elbows and shoulders while keyboarding or conferencing while providing ease of entry/exit.

### Fixed Arms

Provide basic support for users engaging in a variety of tasks throughout the day. Arms come with protective black, flint, titanium or salt urethane arm pads to match the specified frame finish. Fixed arms limit adjustability but provide consistent aesthetics in conference room settings.

### Pneumatic Seat Height Adjustment

Regulates height of work chair relative to the floor. Standard 5" of travel accommodates average to tall users. Stools offer 10" of travel.

### Height-Adjustable Footring

Travels 8" to ensure users have comfortable support of their feet and legs. The footring has a 20" diameter.

### Base and Casters

Work chair bases are a five-star design. Dual-wheel casters are available in hard tread for carpet, or multi-surface for any floor surface.

## Materials

- All COMs/COLs must be approved for upholsterability or applicable fire code compliance prior to order entry. See pages 6-8 for COM ordering instructions.
- Allsteel fabrics meet requirements for CTB117. COM/COL manufacturers supply certificates of compliance for fabric-only tests such as CTB117.
- Pli is warranted for multiple shifts and users up to 300 lbs.
- Pli meets the requirements set forth in ANSI/BIFMA X5.1-2011.

## OPTIONS — WORK / STOOL

Chair Type:

- FWW** Work
- FWS** Stool

Arms:

- MHH** Height-Adjustable
- MHF** Fixed Arm
- MHA** Armless

Frame Color:

- BLK** Black
- TI** Titanium (add \$44)
- E9** Flint (add \$88)
- ST** Salt (add \$88)

Mesh Color:

- D** Dusk
- M** Mist
- L** Lustre
- N** Navy
- C** Clay

Cylinder:

- 2** Standard
- 3** Short
- 4** Stool

Base Color:

- BLK** Black
- TI** Titanium
- E9** Flint
- ST** Salt



Castors:

- H** Black Hard Tread
- B** Black Multi-Surface (add \$66)
- T** Titanium Multi-Surface (add \$66)
- E9** Flint Multi-Surface (add \$66)
- ST** Salt Multi-Surface (add \$66)





(See page 157 for COM pricing on Grades 9-22)

Back	Type	Model Number <i>Add options below</i>									Leather	
			1	2	3	4	5	6	7	8	1	2
	Height Adj. Arms, No FC	FWW-MHHNO	\$ 1355	\$ 1376	\$ 1397	\$ 1418	\$ 1445	\$ 1472	\$ 1499	\$ 1527	\$ 1652	\$ 1865
	Fixed Arms, No FC	FWW-MHFNO	\$ 1320	\$ 1341	\$ 1362	\$ 1383	\$ 1410	\$ 1437	\$ 1464	\$ 1492	\$ 1617	\$ 1830
	Armless, No FC	FWW-MHANO	\$ 1181	\$ 1202	\$ 1223	\$ 1244	\$ 1271	\$ 1298	\$ 1325	\$ 1353	\$ 1478	\$ 1691
	Height Adj. Arms, No FC	FWS-MHHNO	\$ 1702	\$ 1723	\$ 1744	\$ 1765	\$ 1792	\$ 1819	\$ 1846	\$ 1874	\$ 1999	\$ 2212
	Fixed Arms, No FC	FWS-MHFNO	\$ 1667	\$ 1688	\$ 1709	\$ 1730	\$ 1757	\$ 1784	\$ 1811	\$ 1839	\$ 1964	\$ 2177
	Armless, No FC	FWS-MHANO	\$ 1529	\$ 1550	\$ 1571	\$ 1592	\$ 1619	\$ 1646	\$ 1673	\$ 1701	\$ 1826	\$ 2039

<p><b>How to specify —</b> Select the Model Number from above.</p> <p>_____ .</p>	<p><b>1st Option:</b> Select the Frame Color:</p> <p>BLK Black TI Titanium (add \$44) E9 Flint (add \$88) ST Salt (add \$88)</p> <p>_____ .</p>	<p><b>2nd Option:</b> Select the Mesh (if applicable):</p> <p>D Dusk M Mist L Lustre N Navy C Clay</p> <p>_____ .</p>	<p><b>3rd Option:</b> Select the Cylinder (if applicable):</p> <p>2 Standard 3 Short 4 Stool</p> <p>_____ .</p>	<p><b>4th Option:</b> Select the Base (if applicable):</p> <p>BLK Black TI Titanium E9 Flint ST Salt</p> <p>_____ .</p>
---	---	---	---	---

<p><b>5th Option:</b> Select the Casters (if applicable):</p> <p>H Black Hard Tread B Black Multi-Surface (add \$66) T Titanium Multi-Surface (add \$66) E9 Flint Multi-Surface (add \$66) ST Salt Multi-Surface (add \$66)</p> <p>_____ .</p>	<p><b>7th Option:</b> Select the Upholstery (if applicable):</p> <p>_____ .</p>
--	---

Examples: FWW-MHHNO.BLK.D.2.BLK.H.CU10

Model Number	COM			Overall			Seat			Armrests			Backrest			Ship Weight	Ship Weight Per Carton	Cubes	
	Yardage	Sq. Feet	Height (Range)	Width	Depth	Height (Range)	Width	Depth (Range)	Pan Angle (Range)	Armrest Height	Width Between Arms	Depth (Range)	Height	Width	Lumbar Height				Backrest/Seat Angle (Range)
FWW-MHHNO	0.77		37"-42"	27½"	25"	15"-20"	19"	17¼"	1½°-11°	7¼"-11½"	21"	8½"	22¼"	18¾"	10¼"	96°-122°	36	36	12.1
FWW-MHFNO	0.77		37"-42"	27½"	25"	15"-20"	19"	17¼"	1½°-11°	9¼"	21"	8½"	22¼"	18¾"	10¼"	96°-122°	35	35	12.1
FWW-MHANO	0.77		37"-42"	25"	25"	15"-20"	19"	17¼"	1½°-11°	-	-	-	22¼"	18¾"	10¼"	96°-122°	30	30	12.1
FWS-MHHNO	0.77		44"-54"	28"	26"	22"-31¼"	19"	17¼"	1½°-11°	7¼"-11½"	21"	8½"	22¼"	18¾"	10¼"	96°-122°	41	41	12.1
FWS-MHFNO	0.77		44"-54"	28"	26"	22"-31¼"	19"	17¼"	1½°-11°	9¼"	21"	8½"	22¼"	18¾"	10¼"	96°-122°	40	40	12.1
FWS-MHANO	0.77		44"-54"	26"	26"	22"-31¼"	19"	17¼"	1½°-11°	-	-	-	22¼"	18¾"	10¼"	96°-122°	35	35	12.1

Note: Dimensions are in accordance with BIFMA G1-2013 guidelines — see illustration of guidelines on page 45.



Pli

*With two frame finishes and six mesh color options that allow you to create your own aesthetic, Quip acts as a clever commentary on your company's personality.*

### Exceed expectations, not your budget.

Quip is the prize fighter of work chairs and work stools. This is a hard-working, no-nonsense chair that supports you through heads-down work, lunch breaks, and whatever else the day brings.

### All comfort. No fuss.

Easy-to-use adjustments, including seat depth, make Quip a comfortable sit.

1. Height-adjustable arms adjust side-to-side and front-to-back. Fixed arms and armless options are also available.
2. Intuitive standard controls include height adjustment, tilt tension, tilt lock, and seat depth, an adjustment that customizes the chair to your body.
3. Lumbar support has been engineered into the back. Optional lumbar support allows users to adapt the chair to their needs with minimal effort.

## DESIGN FEATURES

The jack-of-all-trades functionality you need. The attention-commanding look everyone loves. Quip wraps it all up in one smart investment.

### Frame finishes

A Black or White finish pairs with any of the mesh and upholstery color options for a stylish chair.

### Mesh and upholstery colors

From playful to traditional and every stop in between, there's a color combination that fits your space. You can even mix and match mesh and upholstery colors to get the exact look you want.

### 3D Adjustable arms

3D adjustable arms adjust up and down with armpads that adjust side-to-side and front-to-back to allow support during work tasks.

### Fixed arms

Provide basic support for users engaging in a variety of tasks throughout the day. Fixed arms limit adjustability but provide consistent aesthetics in conference room settings.

### Optional adjustable lumbar support

Adjustable lumbar support to accommodate personal preference. An optional external lumbar support can be added at any time.

### Pneumatic seat height adjustment

Regulates height of work chair relative to the floor. Standard 5" of travel accommodates average to tall users. Stools offer 10" of travel.

### Base and Casters

Work chair and stool bases are a five-star design. Dual-wheel casters are available in hard tread for carpet, or multi-surface for any floor surface.

### Materials

- All COMs/COLs must be approved for upholsterability or applicable fire code compliance prior to order entry. See pages 6-8 for COM ordering instructions.
- Allsteel fabrics meet requirements for CTB117. COM/COL manufacturers supply certificates of compliance for fabric-only tests such as CTB117.
- Quip meets the requirements set forth in ANSI/BIFMA X5.1-2011 and BIFMA G1-2013. Quip is warranted for multiple shifts and users up to 300 lbs.

### Height-Adjustable Footring

Travels 8" to ensure users have comfortable support of their feet and legs. The footring has a 20" diameter.

## OPTIONS — WORK / VALUE WORK / STOOL

**LST** Basic Work

Fire Code:

**NO** No Fire Code

Frame Color:

**BLK** Black

**WT** White (add \$40)

Lumbar:

**N** No Lumbar Adjustment

**L** Lumbar Adjustment

Cylinder:

**2** Standard

**3** Short (ST only)

**4** Extended (Stool Only)

Casters: (Value H only)

**H** Black Hard Tread

**S** Black Multi-surface (add \$60)

Quip Mesh:

**SBM01** Carbon

**SBM03** Loft

**SBM22** Graphite

**SBM28** Navy

**SBM30** Lime

**SBM25** Poppy

Upholstery:

See pages 13-14 for selections, colors, and codes.

(See page 157 for COM pricing on Grades 9-22)

Back	Type	Model Number Add options below									Leather				
			1	2	3	4	5	6	7	8	1	2			
	Mesh	Basic Work	LSTNO	\$ 831											
		Quip Lumbar Kit	STLUK	\$ 77											

Model Number	COL Sp. Feet		Overall			Seat		Armrests			Backrest			Cubox			
	Height (Range)	Width	Depth	Height	Width	Depth	Pan Angle (Range)	Armrest Height	Width Between Arms	Armrest Length	Arm Height to the Floor	Height	Width	Lumbar Height	Backrest/Seat Angle (Range)	Ship Weight Per Carton	
LST	20	38" - 43 1/2"	26"	26"	16" - 21"	19 1/2"	15 1/4" - 17 1/2"	10°	8 1/2"	20 1/2"	6"	24 1/4" - 29 1/8"	24"	17"	96° - 110°	46	11.1

Note: Dimensions are in accordance with BIFMA G1-2013 guidelines — see illustration of guidelines on page 45.

<p><b>How to specify —</b> Select the Model Number from above.</p>	<p><b>1st Option:</b> Select the Frame Color: BLK Black</p> <p>(Basic Work BLK only)</p>	<p><b>2nd Option:</b> Select the Arms (if applicable): W Fully Adjustable (\$103 extra)</p> <p>(Basic Work H Fully Adj. Arms only)</p>	<p><b>3rd Option:</b> Select the Lumbar (if applicable): L Lumbar</p> <p>(Basic Work L only)</p>	<p><b>4th Option:</b> Select the Cylinder (if applicable): 2 Standard</p> <p>(Basic Work 2 only)</p>
--	--	--	--	--

<p><b>5th Option:</b> Select the Casters (if applicable): H Black Hard Tread</p> <p>(Basic Work H only)</p>	<p><b>6th Option:</b> Select the Mesh (if applicable): SBM01 Carbon (Black)</p> <p>(Basic Work SBM01 only)</p>	<p><b>7th Option:</b> Select the Upholstery (if applicable):</p> <p>QLB10</p>
---	--	---

Examples: LSTNO.BLK.W.L.2.H.SBM01.QLB10 STLUK.WT

QUIP

Relate combines everything you want into a single collection of seating. A synchronous mechanism and a unique pivoting back provide exceptional ergonomics for more people at more tasks. Active adjustments allow you to control and customize your seating tension and support relative to any task. Replaceable high-wear parts encourage you to repair rather than replace your chairs. And, the full line of models makes coordinating office seating simple.

## KEY FEATURES

Relate's Body Adaptive Control™ combines a weight-sensing synchronized tilt mechanism with a pivoting back, resulting in improved pressure distribution, superior back support, and movement for healthy sitting.

### Synchronized Tilt

The synchronized tilt motion keeps the user's head level when reclining to improve mental focus and productivity, while reducing neck and eyestrain.

### Pivoting Back

The position of the pivoting back aligns with the natural position of the spine. This alignment keeps the spine supported in its proper curvature, which increases comfort. The adaptive, pivoting motion provides continuous back support while encouraging movement. Movement while sitting replenishes the spinal discs with nutrients, which reduces fatigue and keeps discs healthy.

### Quick Tension™ Lever

Features 5 settings to quickly adjust from low to high tension. Allows for frequent adjustment throughout the workday to provide custom support for different tasks.

### Height-Adjustable Lumbar Support

Allows users to adjust lumbar support anywhere within a 4" range on upholstered and mesh work/conference chairs. Lumbar support on mesh chairs can be adjusted asynchronously.

### Pneumatic Seat Height Adjustment

Regulates height of chair relative to the floor.

- Standard cylinder with 5" of travel accommodates average or tall users.
- Optional short cylinder with 3½" of travel keeps chair closer to the floor for shorter users, allowing all models to meet BIFMA G1-2002 solutions for VDT users.

### Seat Depth Adjustment

Adjusts from front-to-back, within a 3" range, to accommodate different leg lengths.

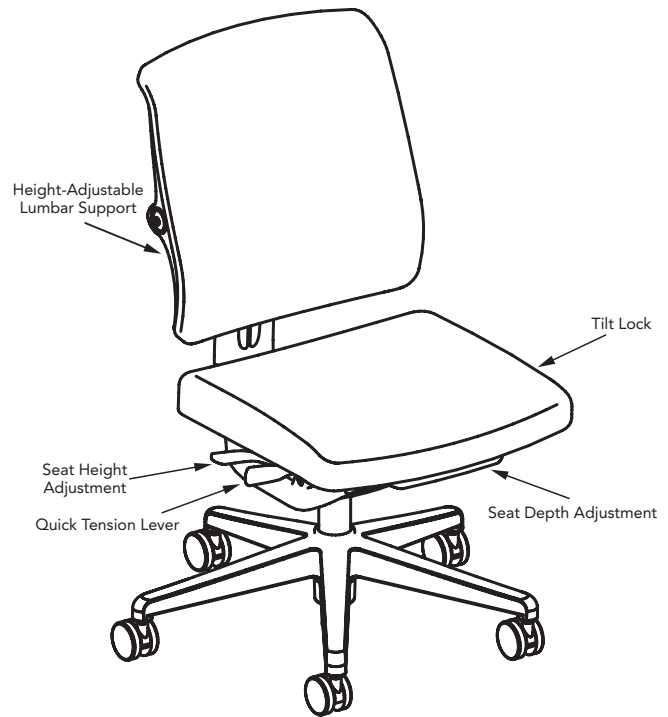

RL-UHA — Upholstered High-Back

**Fully Adjustable Arms**

Arms are fully adjustable in height, width, depth, and can pivot to provide optimal support. Pivot the front of the arm pads inward to move in closer to your desk and offer support while working.

**DESIGN FEATURES**

Relate seating is engineered to last a lifetime, simplify maintenance, and reduce costs.

**Base/Casters**

Base is composite five-star structure. Specific models are available in polished aluminum. Dual-wheel casters feature hard tread for carpeted floors or soft tread for smooth floors.

**Link Mesh**

Relate's Link Mesh is a leno weave with a polyester elastomeric and a polyester fill yarn. This construction provides responsive, conforming back support and an open, airy aesthetic. Link Mesh is 100% recyclable.

**Materials**

- All upholstery foams are **CFC-free**.
- All **COMs/COLs** must be approved for upholsterability or applicable fire code compliance prior to order entry. See COM ordering instructions on pages 6-8.
- **Flammability** code compliance of Allsteel textiles and seating is listed on pages 13-14. COM/COL manufacturers supply certificates of compliance for fabric-only tests such as CAL TB117-2013.

Relate meets the requirements set forth in ANSI/BIFMA X5.1-2011 and BIFMA G1-2013. Relate is warranted for multiple shifts and users up to 300 lbs.

Relate work chairs with adjustable arms ship knocked down.

**OPTIONS — RELATE WORK/CONFERENCE:**

Versions include High-Back models in mesh or upholstery with adjustable arms, fixed C arms, or without arms.

**Back Type:**

- M** Mesh (only available in High-Back)
- U** Upholstered

**Overall Size:**

- H** High-Back

**Armrests:**

- P** Fully Adjustable Arms
- A** Armless

**Pneumatic Cylinder:**

- 2** Standard, allows 5" of travel
- 3** Short, 3½" of travel to meet BIFMA G1-2002

**Casters:**

- 0** 2½" Black Dual-wheel Hard Tread for carpet
- 1** 2½" Black Dual-wheel Soft Tread for smooth surfaces (\$66 extra)

**Lumbar:**

- L** Height-Adjustable

Aluminum Option: (Aluminum models only — see pages 128-129)

- A1** Aluminum Base

**Fixed C arm Option:**

- A3** Aluminum Base and Aluminum Fixed C Arm (add \$167)

**Aluminum Finish:**

- PAL** Polished Aluminum (Aluminum models only)

**Frame Color:**

- CBK** Charblack

Mesh Color: (for Mesh Backs Only)

*Available on Charblack (CBK) frames*

- LKM01** Carbon
- CM21** Clay (*De-emphasized*)

**Upholstery:**

- See pages 13-14 for other upholstery selections.
- See pages 17-18.1 for colors and codes

**NOTE:** Mesh and upholstery work/conference chairs feature upholstered seats.

• Features and adjustments on Relate models:  
Synchro-Tilt, Pivot Back, Seat Depth, and Pneumatic Adjustment.

GSA SIN 33721

(See page 158 for COM pricing on Grades 9-22)

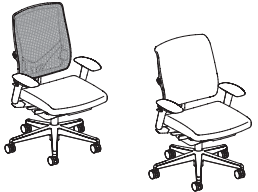
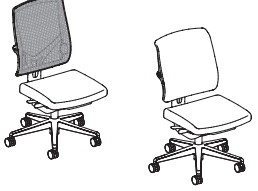
Armrest	Back Type	Model Number <i>Add options below</i>									Leather	
			1	2	3	4	5	6	7	8	1	2
Fully Adjustable Arms 	Mesh	RL-MHP	\$ 2158	\$ 2184	\$ 2206	\$ 2240	\$ 2270	\$ 2301	\$ 2334	\$ 2366	\$ 2857	\$ 4035
	High-Back Upholstered High-Back	RL-UHP	\$ 2135	\$ 2178	\$ 2217	\$ 2271	\$ 2325	\$ 2384	\$ 2439	\$ 2495	\$ 3521	\$ 5368
Armless 	Mesh	RL-MHA	\$ 1872	\$ 1898	\$ 1920	\$ 1954	\$ 1984	\$ 2015	\$ 2048	\$ 2080	\$ 2571	\$ 3749
	High-Back Upholstered High-Back	RL-UHA	\$ 1849	\$ 1892	\$ 1931	\$ 1985	\$ 2039	\$ 2098	\$ 2153	\$ 2209	\$ 3235	\$ 5082

NOTE: See pages 128-129 for polished aluminum Work/Conference models.

Continued on next page ►

<p><b>How to specify —</b> Select the Model Number from above.</p>	<p><b>1st Option:</b> <b>Select the Cylinder:</b> 2 Standard, allows 5" of travel 3 Short, allows 3½" of travel</p>	<p><b>2nd Option:</b> <b>Select the Casters:</b> 0 2½" Black Dual-Wheel Hard Tread for carpet 1 2½" Black Dual-Wheel Soft Tread for smooth surfaces (\$66 extra)</p>	<p><b>3rd Option:</b> <b>Select the Lumbar:</b> L Height-Adjustable</p>
--	---	--	---

Example: RL-UHCFC.2.0.L.CBK.BOX15

Model Number	COM Yardage			Overall			Seat				Armrests				Backrest			Ship Weight	Ship Weight Per Carton	Cubes	
	COL Sq. Feet	Height (Range)	Width	Depth	Height (Range)	Width	Depth (Range)	Pan Angle (Range)	Height (Range)	Width Between Armrests (Range)	Depth (Range)	Pivot Inwards	Pivot Outwards	Height (Range)	Width	Lumbar Height (Range)	Backrest/Seat Angle (Range)				
RL-MHP	1.3	11	39-44"	26"	24"	16-21" 14½-18"	19"	15-18"	3.5° to 8.5°	7½-11½"	14½-20¼"	6¼-10¼"	25°	15°	23"	17½"	5¼-9¼"	94.5°-109°	47.0	—	11.0
RL-UHP	2.0	22	40¼-45¼"	26"	24"	16-21" 14½-18"	19"	15-18"	3.5° to 8.5°	7½-11½"	14½-20¼"	6¼-10¼"	25°	15°	24¼"	17¼"	5¼-9¼"	94.5°-109°	48.0	—	11.0
RL-MHA	1.3	11	39-44"	26"	24"	16-21" 14½-18"	19"	15-18"	3.5° to 8.5°	—	—	—	—	—	23"	17½"	5¼-9¼"	94.5°-109°	40.0	—	16.7
RL-UHA	2.0	22	40¼-45¼"	26"	24"	16-21" 14½-18"	19"	15-18"	3.5° to 8.5°	—	—	—	—	—	24¼"	17¼"	5¼-9¼"	94.5°-109°	41.0	—	16.7

Dimensions are in accordance with BIFMA G1-2013 guidelines — see illustration of guidelines on page 45.

◀ Continued from previous page

<p><b>4th Option:</b> Select the Frame Color: CBK Charblack</p>	<p><b>5th Option:</b> Select the Mesh Color: For Mesh Back only. Available on Charblack (CBK) frames LKM01 Carbon CM21 Clay (De-emphasized)</p>	<p><b>6th Option:</b> Select the Upholstery: See pages 13-14 for selection. See pages 17-18.1 for colors and codes. See pages 6-8 for COM guidelines.</p>
---	---	---



# Seating — Work

Relate®

- Features and adjustments on Relate models: Synchro-Tilt, Pivot Back, Seat Depth, Pneumatic Adjustment, and Polished Aluminum Base.

GSA SIN 33721

(See page 158 for COM pricing on Grades 9-22)

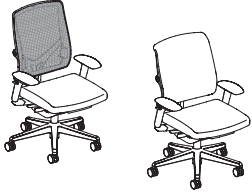
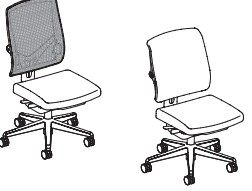
Armrest	Back Type	Model Number <i>Add options below</i>	1	2	3	4	5	6	7	8	Leather	
											1	2
Fully Adjustable Arms 	Mesh High-Back	RLA-MHP	\$ 2549	\$ 2575	\$ 2597	\$ 2631	\$ 2661	\$ 2692	\$ 2725	\$ 2757	\$ 3248	\$ 4426
	Upholstered High-Back	RLA-UHP	\$ 2527	\$ 2570	\$ 2609	\$ 2663	\$ 2717	\$ 2776	\$ 2831	\$ 2887	\$ 3913	\$ 5760
Armless 	Mesh High-Back	RLA-MHA	\$ 2263	\$ 2289	\$ 2311	\$ 2345	\$ 2375	\$ 2406	\$ 2439	\$ 2471	\$ 2962	\$ 4140
	Upholstered High-Back	RLA-UHA	\$ 2242	\$ 2285	\$ 2324	\$ 2378	\$ 2432	\$ 2491	\$ 2546	\$ 2602	\$ 3628	\$ 5475

RELATE

Continued on next page ►

<p><b>How to specify —</b> Select the Model Number from above.</p>	<p><b>1st Option:</b> Select the Cylinder:</p> <p>2 Standard, allows 5" of travel 3 Short, allows 3½" of travel</p>	<p><b>2nd Option:</b> Select the Casters:</p> <p>0 2½" Black Dual-Wheel Hard Tread for carpet 1 2½" Black Dual-Wheel Soft Tread for smooth surfaces (\$66 extra)</p>	<p><b>3rd Option:</b> Select the Lumbar:</p> <p>L Height-Adjustable</p>	<p><b>4th Option:</b> Select the Aluminum Option:</p> <p>A1 Aluminum Base</p>
<p>R   L     -               .     .</p>		<p>  .</p>	<p>  .</p>	<p>A     .</p>

Example: RLA-UHPFC.2.0.N.A3.PAL.CBK.BOX15

	COM Yardage			Overall			Seat				Armrests				Backrest			Ship Weight	Ship Weight Per Carton	Cubes	
	COL Sq. Feet	Height (Range)	Width	Depth	Height (Range)	Width	Depth (Range)	Pan Angle (Range)	Height (Range)	Width Between Armrests (Range)	Depth (Range)	Pivot Inwards	Pivot Outwards	Height (Range)	Width	Lumbar Height (Range)	Backrest/Seat Angle (Range)				
RLA-MHP	1.3	11	39-44"	26"	24"	17½-22½" 14½-18"	19"	15-18"	3.5° to 8.5°	7½-11½"	14½-20½"	6¼-10¼"	25°	15°	23"	17½"	5¼-9¼"	94.5°-109°	47.0	—	11.0
RLA-UHP	2.0	22	40¼-45¼"	26"	24"	17½-22½" 14½-18"	19"	15-18"	3.5° to 8.5°	7½-11½"	14½-20½"	6¼-10¼"	25°	15°	24¼"	17½"	5¼-9¼"	94.5°-109°	48.0	—	11.0
RLA-MHA	1.3	11	39-44"	26"	24"	17½-22½" 14½-18"	19"	15-18"	3.5° to 8.5°	—	—	—	—	—	23"	17½"	5¼-9¼"	94.5°-109°	40.0	—	16.7
RLA-UHA	2.0	22	40¼-45¼"	26"	24"	17½-22½" 14½-18"	19"	15-18"	3.5° to 8.5°	—	—	—	—	—	24¼"	17½"	5¼-9¼"	94.5°-109°	41.0	—	16.7

Dimensions are in accordance with BIFMA G1-2002 guidelines — see illustration of guidelines on page 45.

◀ Continued from previous page

<p>5th Option: <b>Select the Aluminum Finish:</b> PAL Polished Aluminum</p>	<p>6th Option: <b>Select the Frame Color:</b> CBK Charblack</p>	<p>7th Option: <b>Select the Mesh Color:</b> For Mesh Back only. Available on Charblack (CBK) frames LKM01 Carbon CM21 Clay (<i>De-emphasized</i>)</p>	<p>8th Option: <b>Select the Upholstery:</b> See pages 13-14 for selection. See pages 17-18.1 for colors and codes. See pages 6-8 for COM guidelines.</p>
<p>P   A   L   .</p>	<p>       </p>	<p>            .</p>	<p>               </p>

*Relate offers a full line of seating in complementary finishes making it simple to coordinate seating for the entire office. The Relate work stool is the perfect solution for anyplace where work happens at a standing height position. Relate work stools feature all of the same intuitive, ergonomic adjustments as the Relate work/conference chair.*

## KEY FEATURES

Relate's Body Adaptive Control™ combines a weight-sensing synchronized tilt mechanism with a pivoting back, resulting in improved pressure distribution, superior back support, and movement for healthy sitting.

### Synchronized Tilt

The synchronized tilt motion keeps the user's head level when reclining to improve mental focus and productivity, while reducing neck and eyestrain.

### Pivoting Back

The position of the pivoting back aligns with the natural position of the spine. This alignment keeps the spine supported in its proper curvature, which increases comfort. The adaptive, pivoting motion provides continuous back support while encouraging movement. Movement while sitting replenishes the spinal discs with nutrients, which reduces fatigue and keeps discs healthy.

### Quick Tension™ Lever

Features 5 settings to quickly adjust from low to high tension. Allows for frequent adjustment throughout the workday to provide custom support for different tasks.

### Height-Adjustable Lumbar Support

Allows users to adjust lumbar support anywhere within a 4" range on upholstered and mesh work stools. Lumbar support on mesh work stools can be adjusted asynchronously.

### Pneumatic Seat Height Adjustment

Regulates height of stool relative to the floor. Includes extended range height pneumatic cylinder with 10" of vertical travel.

### Seat Depth Adjustment

Adjusts from front-to-back, within a 3" range, to accommodate different leg lengths.

### Height-Adjustable Footring

Travels 8" to ensure users have comfortable support of their feet and legs. The footring has a 20" diameter.

**Fully Adjustable Arms**

Arms are fully adjustable in height, width, depth, and can pivot to provide optimal support. Pivot the front of the arm pads inward to move in closer to your desk and offer support while working.

**DESIGN FEATURES**

Relate seating is engineered to last a lifetime, simplify maintenance, and reduce costs.

**Base/Casters**

Base is composite five-star structure. Dual-wheel casters feature hard tread for carpeted floors or soft tread for smooth floors.

**Link Mesh**

Relate's Link Mesh is a leno weave with a polyester elastomeric and a polyester fill yarn. This construction provides responsive, conforming back support and an open, airy aesthetic. Link Mesh is 100% recyclable.

**Materials**

- All upholstery foams are **CFC-free**.
- All **COMs/COLs** must be approved for upholsterability or applicable fire code compliance prior to order entry. See COM ordering instructions on pages 6-8.
- **Flammability** code compliance of Allsteel textiles and seating is listed on pages 13-14. COM/COL manufacturers supply certificates of compliance for fabric-only tests such as CAL TB117-2013.

Relate meets the requirements set forth in ANSI/BIFMA X5.1-2011 and BIFMA G1-2013. Relate Work Stools are warranted for multiple shifts and users up to 300 lbs.

**OPTIONS — RELATE WORK STOOL:**

Versions include High-Back models in mesh or upholstery with adjustable arms, fixed C arms, or without arms.

Back Type:

**M** Mesh

Overall Size:

**H** High-Back

Armrests:

**P** Fully Adjustable Arms

**A** Armless

Pneumatic Cylinder:

**4** Extended Range, allows 10" of travel

Casters/Glides:

**0** 2½" Black Dual-Wheel Hard Tread Casters for carpet

**1** 2½" Black Dual-Wheel Soft Tread Casters for smooth surfaces (\$66 extra)

**2** Glides

Lumbar:

**L** Height-adjustable

Frame Color:

**CBK** Charblack

Mesh Color: (for Mesh Backs Only)

*Available on Charblack (CBK) frames*

**LKM01** Carbon

**CM21** Clay (*De-emphasized*)

Upholstery:

See pages 13-14 for other upholstery selections.

See pages 17-18.1 for colors and codes

**NOTE:** Mesh and upholstery work stools feature upholstered seats.



Model Number	COM Yardage		Overall				Seat			Armrests				Backrest			Ship Weight	Ship Weight Per Carton	Cubes		
	COL Sq. Feet	Height (Range)	Width	Depth	Height (Range)	Width	Depth (Range)	Pan Angle (Range)	Height (Range)	Width Between Armrests (Range)	Depth (Range)	Pivot Inwards	Pivot Outwards	Height (Range)	Width	Lumbar Height (Range)				Backrest Seat Angle (Range)	
RLS-MHP	1.3	11	46-56"	27½"	25½"	24-34"	19"	15-18"	3.5° to 8.5°	7½-11½"	14½-20¼"	6½-10¼"	25°	15°	23"	17½"	5½-9¼"	94.5°-109°	57.0	—	12.6
RLS-MHA	1.3	11	46-56"	27½"	25½"	24-34"	19"	15-18"	3.5° to 8.5°	—	—	—	—	—	23"	17½"	5½-9¼"	94.5°-109°	50.0	—	12.6

Dimensions are in accordance with BIFMA G1-2013 guidelines — see illustration of guidelines on page 45.

◀ Continued from previous page

<p><i>4th Option:</i>  <b>Select the Frame Color:</b>                  CBK Charblack</p>	<p><i>5th Option:</i>  <b>Select the Mesh Color:</b>                  For Mesh Back only.  <i>Available on Charblack (CBK) frames</i>                  LKM01 Carbon                  CM21 Clay (<i>De-emphasized</i>)</p>	<p><i>6th Option:</i>  <b>Select the Upholstery:</b>                  See pages 13-14 for selection.                  See pages 17-18.1 for colors and codes.                  See pages 6-8 for COM guidelines.</p>
--	---	--

*Relate multi-purpose side chairs provide an ideal solution for busy work areas such as training rooms, gathering areas, informal conferencing, cafés, and more. With a stackable design and pivoting back, Relate side chairs provide the perfect combination of versatility and unexpected comfort.*

### MODELS AND OPTIONS

Relate offers side chair models with **back types** in mesh, upholstery, and wood in three frame colors.

Side chairs feature **arm and armless models** with casters or glides.

**Glides** are available in nylon, nickel-plated, or felt options. Nylon glides are recommended for hard surfaces, commercial carpet, and damp environments. Nickel-plated glides are recommended for carpet. Felt glides are recommended for wood, tile, or high-shine floor surfaces.

**Multi-surface casters** are also available.

**Chairs ship up to two per carton to minimize waste.**

### CONSTRUCTION

**Steel frames and structural moldings** create a durable design that performs in a variety of environments.

**Seat and back upholstery** are easily field replaceable allowing users to extend the lifecycle of the chairs.

Multi-purpose side chairs **stack up to 4-high** on the floor.

Mesh chairs feature Link™ Mesh. **Link Mesh** is a leno weave with a polyester elastomeric and a polyester fill yarn. This construction provides responsive, conforming back support and an open, airy aesthetic. Link Mesh is 100% recyclable.

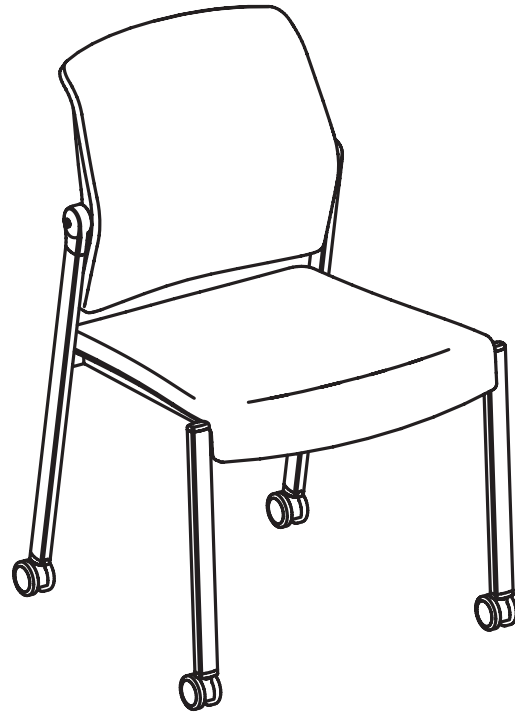

**RLM-UUCA — Upholstered Back and Upholstered Seat**

**UPHOLSTERY AND CONTOURING**

Relate multi-purpose side chairs feature a pivoting back that provides unexpected comfort in any application. The **pivoting back** provides support while encouraging movement that makes for healthy sitting. The **backrest** features a contoured lumbar support to help relieve stress on the back. Added movement and support allow the Relate multi-purpose side chair to go from project conference rooms to teaming areas to training rooms with ease.

The upholstered seat features a generous 2" of high-resiliency molded foam padding for comfort and long-term support.

All upholstery foams are **CFC-free**.

All **COMs/COLs** must be approved for upholsterability or applicable fire code compliance prior to order entry. See COM ordering instructions on pages 6-8.

**Flammability** code compliance of Allsteel textiles and seating is listed on pages 13-14. COM/COL manufacturers supply certificates of compliance for fabric-only tests such as CAL TB117-2013.

Relate meets the requirements set forth in ANSI/BIFMA X5.1-2011. Relate side chairs are warranted for users up to 300 lbs.

**OPTIONS — RELATE MULTI-PURPOSE SIDE:**

Versions include arm and armless models with glides or casters in an upholstered seat and mesh, upholstered, or wood back.

Back Type:

- M** Mesh
- U** Upholstered

Seat Type:

- U** Upholstered

Frame Type:

- C** Casters
- G** Glides

Arm Option:

- O** Arms
- A** Armless

Glides/Casters:

- 0** Nylon Glides for hard surfaces and commercial carpet
- 1** Nickel-plated Glides for carpet (\$18 extra)
- 2** Felt Glides for wood, tile, or high sheen surfaces. (\$18 extra)
- 3** Multi-surface Casters

Frame Color: (mesh frame black for all but Titanium)

- CBK** Charblack
- P8T** Titanium
- P8X** Solar Black
- PR6** Silver (arms are Charblack)

Mesh Color: (for Mesh Backs Only)

*Available on Charblack (CBK) mesh frames (CBK, PR6, and P8X frame color choices)*

- LKM01** Carbon
- CM21** Clay (*De-emphasized*)

*Available on Titanium (P8T) mesh frames (P8T frame color choice)*

- LKM01** Carbon
- CM23** Platinum
- CM29** Taupe (*De-emphasized*)





Select the Upholstery: (for upholstered seats or upholstered backs)

See pages 13-14 for selections.

See pages 17-18.1 for colors and codes.



(See page 158 for COM pricing on Grades 9-22)

Overall Size Armrest	Adjustments and Features	Back Type	Model Number <i>Add options below</i>	1	2	3	4	5	6	7	8	Leather	
											1	2	
<b>GLIDES</b> Arms 	Pivot Back	Mesh	<b>RLM-MUGO</b>	\$ 1003	\$ 1034	\$ 1066	\$ 1105	\$ 1145	\$ 1184	\$ 1224	\$ 1262	\$ 1690	\$ 2852
		Upholstered*	<b>RLM-UUGO</b>	\$ 993	\$ 1040	\$ 1084	\$ 1133	\$ 1189	\$ 1240	\$ 1291	\$ 1348	\$ 2518	\$ 3941
Armless 	Pivot Back	Mesh	<b>RLM-MUGA</b>	\$ 939	\$ 970	\$ 1002	\$ 1041	\$ 1081	\$ 1120	\$ 1160	\$ 1198	\$ 1626	\$ 2788
		Upholstered*	<b>RLM-UUGA</b>	\$ 929	\$ 976	\$ 1020	\$ 1071	\$ 1126	\$ 1178	\$ 1229	\$ 1286	\$ 2465	\$ 3899
		Wood	<b>RLM-WUGA</b>	\$ 981	\$ 1012	\$ 1044	\$ 1083	\$ 1123	\$ 1162	\$ 1202	\$ 1240	\$ 1668	\$ 2830
<b>CASTERS</b> Arms 	Pivot Back	Mesh	<b>RLM-MUCO</b>	\$ 1093	\$ 1124	\$ 1156	\$ 1195	\$ 1235	\$ 1274	\$ 1314	\$ 1352	\$ 1780	\$ 2942
		Upholstered*	<b>RLM-UUCO</b>	\$ 1082	\$ 1128	\$ 1171	\$ 1221	\$ 1274	\$ 1328	\$ 1378	\$ 1433	\$ 2597	\$ 4008
Armless 	Pivot Back	Mesh	<b>RLM-MUCA</b>	\$ 1027	\$ 1058	\$ 1090	\$ 1129	\$ 1169	\$ 1208	\$ 1248	\$ 1286	\$ 1714	\$ 2876
		Upholstered*	<b>RLM-UUCA</b>	\$ 1017	\$ 1064	\$ 1106	\$ 1157	\$ 1212	\$ 1264	\$ 1314	\$ 1371	\$ 2540	\$ 3959

**NOTE:** Relate side chairs ship two per carton to minimize waste. Model numbers and prices are per chair.

Continued on next page ►

<p><b>How to specify —</b> Select the Model Number from above.</p>	<p><b>1st Option:</b> Select the Glides/Casters:</p> <ul style="list-style-type: none"> <li>0 Nylon Glides</li> <li>1 Nickel-plated Glides (\$18 extra)</li> <li>2 Felt Glides (\$18 extra)</li> <li>3 Multi-surface Casters</li> </ul>	<p><b>2nd Option:</b> Select the Frame Color*:</p> <ul style="list-style-type: none"> <li><b>CBK</b> Charblack</li> <li><b>P8T</b> Titanium (wood and upholstered back models are not available with Titanium frame color)</li> <li><b>PR6</b> Silver (arms, mesh carrier, and upholstered outer back are Charblack)</li> <li><b>P8X</b> Solar Black</li> </ul>
<p><b>R   L M   -   U           .     .</b></p>		<p><b>       </b></p>

Examples: RLM-MUGO.0.CBKLM01.BOX15      RLM-PUCA.3.CBK.BOX15

RELATE

Model Number	COM			Overall				Seat			Armrests				Backrest			Ship Weight	Ship Weight Per Carton	Cubes
	Yardage	COL Sp. Feet	Height (Range)	Width	Depth	Height (Range)	Width	Depth (Range)	Pan Angle (Range)	Height (Range)	Width Between Armrests (Range)	Depth (Range)	Arm Height to the Floor	Height (Range)	Width	Lumbar Height (Range)	Backrest/Seat Angle (Range)			
RLM-MUGO	1.0	11.5	33½"	24½"	21½"	18½"	17½"	16"	7°	9¼"	20½"	15"	26¼"	18½"	16¼"	9¼"	95°-100°	24.0	-	13.2
RLM-UUGO	1.8	19.5	33½"	24½"	21½"	18½"	17½"	16¼"	7°	9¼"	20½"	15"	26¼"	18½"	16¼"	8"	95°-100°	24.0	-	13.2
RLM-MUGA	1.0	11.5	33½"	22½"	21½"	18½"	17½"	16"	7°	-	-	-	-	18½"	16¼"	9¼"	95°-100°	21.0	-	13.2
RLM-UUGA	1.8	19.5	33½"	22½"	21½"	18½"	17½"	16¼"	7°	-	-	-	-	18½"	16¼"	8"	95°-100°	21.0	-	13.2
RLM-WUGA	1.0	11.5	33"	22½"	21½"	18½"	17½"	17"	7°	-	-	-	-	17½"	16½"	8"	95°-100°	22.0	-	13.2
RLM-MUCO	1.0	11.5	33½"	24½"	21½"	18½"	17½"	16"	7°	9¼"	20½"	15"	26¼"	18½"	16¼"	9¼"	95°-100°	24.0	-	13.2
RLM-UUCO	1.8	19.5	33½"	24½"	21½"	18½"	17½"	16¼"	7°	9¼"	20½"	15"	26¼"	18½"	16¼"	8"	95°-100°	24.0	-	13.2
RLM-MUCA	1.0	11.5	33½"	22½"	21½"	18½"	17½"	16"	7°	-	-	-	-	18½"	16¼"	9¼"	95°-100°	21.0	-	13.2
RLM-UUCA	1.8	19.5	33½"	22½"	21½"	18½"	17½"	16¼"	7°	-	-	-	-	18½"	16¼"	8"	95°-100°	21.0	-	13.2

RELATE

◀ Continued from previous page

<p><b>3rd Option:</b>  <b>Select the Mesh Color:</b>                  For Mesh Back only.</p> <p>Available on Charblack <b>CBK</b> and Silver <b>PR6</b> frames</p> <p><b>LKM01</b> Carbon  <b>CM21</b> Clay (De-emphasized)</p> <p>Available on Titanium <b>P8T</b> frames</p> <p><b>LKM01</b> Carbon  <b>CM23</b> Platinum  <b>CM29</b> Taupe (De-emphasized)</p>	<p><b>4th Option:</b>  <b>Select the Upholstery:</b></p> <p>See pages 13-14 for selection.                  See pages 17-18.1 for colors and codes.                  See pages 6-8 for COM guidelines.</p>
---	--

Relate 4-Leg Stools are the perfect solution for any application where people prefer a standing height position such as cafés, standing height workstations, touchdown areas, and coffee bars. Similar to the side chair, Relate 4-Leg Stools feature a pivoting back for exceptional comfort and support.

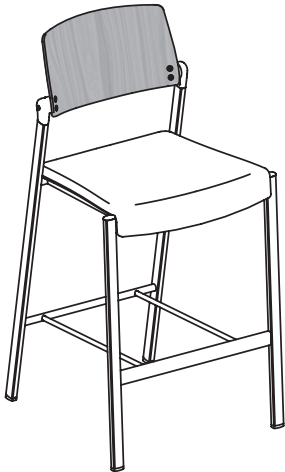

**RLC-WUGA —  
Wood Back**

## MODELS AND OPTIONS

Relate 4-Leg Stools are available with mesh, upholstered or wood backs. Four-legged stools feature arm and armless models with glides.

**Glides** are available in nylon, nickel-plated, or felt options. Nylon glides are recommended for hard surfaces, commercial carpet, and damp environments. Nickel-plated glides are recommended for carpet. Felt glides are recommended for wood, tile, or high-sheen floor surfaces.

## CONSTRUCTION

**Steel frames and structural moldings** create a durable design that performs in a variety of environments.

**Seat upholstery** is easily field replaceable allowing users to extend the lifecycle of the chairs.

## UPHOLSTERY AND CONTOURING

Relate 4-Leg Stools feature a pivoting back that provides unexpected comfort in any application. The **pivoting back** provides support while encouraging movement that makes for healthy sitting. The **backrest** features a contoured lumbar support to help relieve stress on the back.

The upholstered seat features a generous 2" of high-resiliency molded foam padding for comfort and long-term support.

All upholstery foams are **CFC-free**.

All **COMs/COLs** must be approved for upholsterability or applicable fire code compliance prior to order entry. See COM ordering instructions on pages 6-8.

**Flammability** code compliance of Allsteel textiles and seating is listed on pages 13-14. COM/COL manufacturers supply certificates of compliance for fabric-only tests such as CAL TB117-2013.

Relate meets the requirements set forth in ANSI/BIFMA X5.1-2011. Relate four-legged stools are warranted for users up to 300 lbs.

## OPTIONS — 4-LEG STOOL:

4-Leg Stools are available in arm or armless models with glides, an upholstered seat and wood back.

Back Type:

- M** Mesh
- U** Upholstered
- W** Wood (Wood, as a natural material, is subject to nature's quality control with variations in grain pattern and tone.)

Seat Type:

- U** Upholstered

Frame Type:

- G** Glides

Arm Option:

- O** Arms
- A** Armless

Glides:

- 0** Nylon Glides for hard surfaces and commercial carpet
- 1** Nickel-plated Glides for carpet (\$18 extra)
- 2** Felt Glides for wood, tile, or high sheen surfaces. (\$18 extra)

Frame Color: (mesh frame black for all but Titanium)

- CBK** Charblack
- P8T** Titanium
- P8X** Solar Black
- PR6** Silver (arms are Charblack)

Mesh Color (for Mesh Backs only):

Available on Charblack (**CBK**) mesh frames (**CBK, PR6, and P8X** frame color choices)

- LKM01** Carbon
- CM21** Clay (*De-emphasized*)

Available on Titanium (**P8T**) mesh frames (**P8T** frame color choice)

- LKM01** Carbon
- CM23** Platinum
- CM29** Taupe (*De-emphasized*)

Wood Finishes (for Wood Backs only):

- NE800** Natural Maple
- NC777** Burnished Cherry
- NC701** Light Cherry

Select the Seat Upholstery:

See pages 13-14 for selections.

See pages 17-18.1 for colors and codes.



*Seek is a multi-purpose chair designed for today's ever-changing corporate environments that require durability, versatility, and beauty. Its light-weight mobile design is ideal for multi-purpose settings such as adjunct teaming areas, conference rooms, classrooms, training rooms, and cafés.*

*The idea has always been to provide seating that one can sit in...not on. Seek achieves this with a deceptively simple design that conforms to the shape and movement of each user's body. Its pivoting back allows for natural shifts in posture while intuitively distributing lumbar support. The contoured seat reduces pressure points and evenly distributes weight for long-term comfort. So sit back, relax, and let Seek do all the work.*

## MODELS AND OPTIONS

With Seek, extended periods of sitting are refreshingly comfortable. Designed to move with the body and minimize pressure points, Seek conforms to each user's body movement, so no matter how they sit — or how long they stay — they stay comfortable.

**Weight-assisted pivot back** technology intuitively provides balance and lumbar support for ergonomic recline.

**Contoured seat design** distributes weight evenly, stabilizing the sitting bones during forward and reclined comfort. Universal fitting, Seek comfortably accommodates 95% of users.

**Arm and armless** models available. The curved shape of the arms accommodates differences in elbow height. The downward curve helps when approaching worksurfaces.

**Casters or glides** are available. Glide options include nylon, nickel-plated, or felt. The versatile multi-surface casters are designed for use on hard or soft surfaces.

**Seek offers the ability to stack, to nest, and to nest the stacks** for optimum space efficiency. The seat folds up so multiple chairs nest together like grocery carts. Four nested chairs can move or store together in a discrete 37-inches of space. Each additional nested chair adds 5 $\frac{1}{8}$ " of depth. Multiple chairs can stack up to four high in a space of 53"H x 28"W x 22"D. Each additional stack of nested chairs adds 15" of depth.

A Seek stack height of 4 chairs is recommended for storage density that allows the stacks to nest together. A maximum stack height of 6 chairs should not be exceeded when transporting the stacks of chairs.

**Chairs ship two per carton to minimize waste.** Model numbers and prices are per chair.

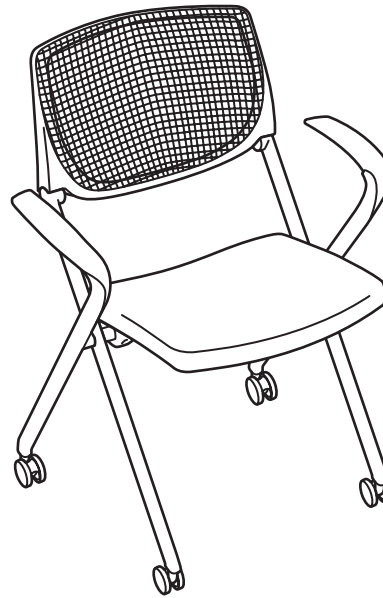

K-MUCO

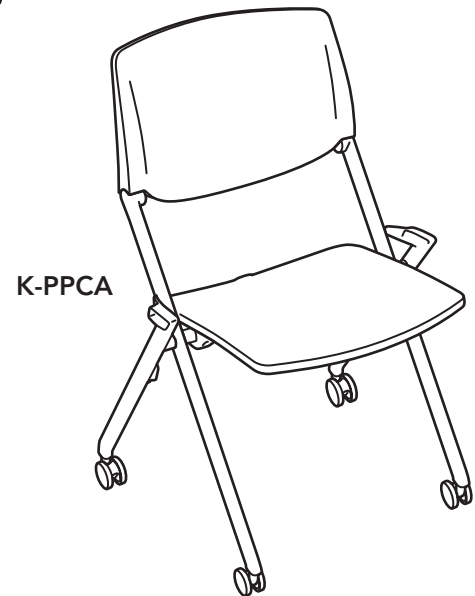

K-PPCA

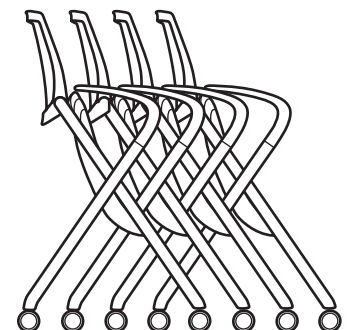
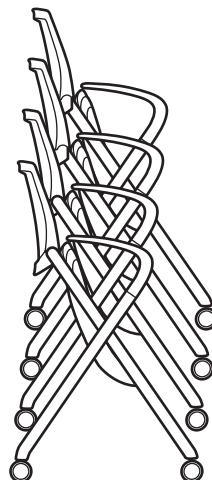

**CONSTRUCTION**

The solid construction meets or exceeds industry standards for performance. Seek’s flexible molded-polymer backrest facilitates heat-reducing airflow. Optional mesh back lets light and air through for added comfort.

Seek’s polymer shells are made from recyclable color-matched polymers with UV resistance to preserve colorfastness and ensure long-term durability. Allsteel paint finishes (for frames) are formulated for optimum hardness and chip resistance.

Seek meets the requirements set forth in ANSI/BIFMA X5.1-2011. Seek is level®2 certified. Seek is warranted for multiple shifts and users up to 300 lbs. Its lightweight construction makes it easy to move.

Allsteel fabrics and foam meet requirements for CAL TB117-2013. COM/COL manufacturers supply certificates of compliance for fabric-only tests such as CAL TB117-2013.

**OPTIONS — SEEK:**

Backrest Style:

- M** Mesh Back (Dusk Mesh only)
- P** Polymer Back

Seat Style:

- U** Upholstered Seat
- P** Polymer Seat

Casters/Glides:

- C** Casters
- G** Glides

Armrests:

- O** Arm Chair
- A** Armless

Frame Finish:

- P8X** Solar Black
- P8T** Titanium
- B** Black
- S** Silver

Fire Code:

- NO** Standard Upholstery, No Fire Code

Polymer Color:

- BLK** Black (formerly Onyx)
  - BU** Surf
  - BW** Brownstone
  - GN** Sprout\*
  - GY** Summit
  - RD** Cayenne\*
  - RG** Tangelo\*
  - WT** White (formerly Frost)
- \*Only available for polymer back models

Type of Glides/Casters:

- 0** Nylon Glides
- 1** Nickel-plated Glides (\$18 extra)
- 2** Felt Glides (\$18 extra)
- 3** Multi-surface Casters

Upholstery:





See pages 13-14 for Selections and pages 17-18.1 for Color Codes.

Seat (polymer seat models):

- POLYST** Polymer Seat

FLOOR COVERING	TYPE OF GLIDE			
	Polycarbonate/Nylon	Felt	Steel	Rubber
Carpet	Best	Not Recommended	Good	Not Recommended
Polished Concrete	Best	Good	Not Recommended	Not Recommended
Hardwood	Not Recommended	Best	Not Recommended	Good
Vinyl (Includes LVT)	Best	Better	Good	Good
VCT	Best	Good	Not Recommended	Good
Tile (Porcelain/Ceramic)	Best	Good	Not Recommended	Good
<b>Attention</b>	Particles can become lodged in nylon and mar floor surface.	Particles can become lodged in felt and mar floor surface.	Cleaning chemicals and water can cause rusting.	Resists moving/sliding. Could lead to chairs tipping back.

(See page 158 for COM pricing on Grades 9-22)

Backrest Style Arm Style	Seat Construction	Glides or Casters	Model Number <i>Add options below</i>	1	2	3	4	5	6	7	8	Leather		
												L1	L2	
<b>Mesh Back Arms</b> 	Upholstered Seat	Glides	K-MUGO	\$ 1234	\$ 1257	\$ 1272	\$ 1296	\$ 1317	\$ 1339	\$ 1364	\$ 1385	\$ 1455	\$ 1573	
		Casters	K-MUCO	\$ 1257	\$ 1280	\$ 1295	\$ 1319	\$ 1340	\$ 1362	\$ 1387	\$ 1408	\$ 1478	\$ 1596	
	Polymer Seat	Glides	K-MPGO	\$ 1131	—	—	—	—	—	—	—	—	—	—
		Casters	K-MPCO	\$ 1154	—	—	—	—	—	—	—	—	—	—
<b>Mesh Back Armless</b> 	Upholstered Seat	Glides	K-MUGA	\$ 1179	\$ 1202	\$ 1217	\$ 1241	\$ 1262	\$ 1284	\$ 1309	\$ 1330	\$ 1400	\$ 1518	
		Casters	K-MUCA	\$ 1204	\$ 1227	\$ 1242	\$ 1266	\$ 1287	\$ 1309	\$ 1334	\$ 1355	\$ 1425	\$ 1543	
	Polymer Seat	Glides	K-MPGA	\$ 1076	—	—	—	—	—	—	—	—	—	—
		Casters	K-MPCA	\$ 1076	—	—	—	—	—	—	—	—	—	—
<b>Polymer Back Arms</b> 	Upholstered Seat	Glides	K-PUGO	\$ 1024	\$ 1047	\$ 1062	\$ 1086	\$ 1107	\$ 1129	\$ 1154	\$ 1175	\$ 1245	\$ 1363	
		Casters	K-PUCO	\$ 1047	\$ 1070	\$ 1085	\$ 1109	\$ 1130	\$ 1152	\$ 1177	\$ 1198	\$ 1268	\$ 1386	
	Polymer Seat	Glides	K-PPGO	\$ 924	—	—	—	—	—	—	—	—	—	—
		Casters	K-PPCO	\$ 946	—	—	—	—	—	—	—	—	—	—
<b>Polymer Back Armless</b> 	Upholstered Seat	Glides	K-PUGA	\$ 971	\$ 994	\$ 1009	\$ 1033	\$ 1054	\$ 1076	\$ 1101	\$ 1122	\$ 1192	\$ 1310	
		Casters	K-PUCA	\$ 993	\$ 1016	\$ 1031	\$ 1055	\$ 1076	\$ 1098	\$ 1123	\$ 1144	\$ 1214	\$ 1332	
	Polymer Seat	Glides	K-PPGA	\$ 870	—	—	—	—	—	—	—	—	—	—
		Casters	K-PPCA	\$ 895	—	—	—	—	—	—	—	—	—	—

Continued on next page ►

<p><b>How to specify —</b> Select the Model Number from above.</p> <p><b>K</b> - [ ] [ ] [ ] [ ] [ ] [ ]</p>	<p><b>1st Option:</b> Select the Frame Finish:</p> <p><b>B</b> for Black frame finish <b>S</b> for Silver frame finish <b>P8X</b> Solar Black <b>P8T</b> Titanium</p>	<p><b>2nd Option:</b> Select the Fire Code:</p> <p><b>NO</b></p>	<p><b>3rd Option:</b> Select the Polymer Color:</p> <p><b>BLK</b> Black (formerly <b>CB</b> – Onyx) <b>BU</b> Surf <b>BW</b> Brownstone <b>GN</b> Sprout* <b>GY</b> Summit <b>RD</b> Cayenne* <b>RG</b> Tangelo* <b>WT</b> White (formerly Frost)</p> <p><i>*Only available for Polymer Back models.</i></p>
--	---	--	--

Examples: K-MUGOBNO.CB.1.BOX15 K-PUCASNO.BU.3.DOD10

K-MPGOBNO.CB.0.POLYST

SEEK

Model Number	COM Yandage		COL Sp. Feet Seat		COL Sp. Feet Back		COL Sp. Feet Arms		Overall			Seat			Armrests			Backrest			Ship Weight per Carton	Cubes
	COL Sp. Feet Seat	COL Sp. Feet Back	COL Sp. Feet Arms	Height (Range)	Width	Depth	Height	Width	Depth	Pan Angle	Height	Width	Depth	Pivot Inwards	Pivot Outwards	Height	Width	Lumbar Height (Initial)	Backrest/Seat Angle (Range)			
K-MUGO	0.7	4	—	—	35½"	28"	22"	19"	18"	17¼"	4°	8½"	23"	12¼"	—	—	19"	19½"	9½"	95°-103°	41	19.0 (2 per carton)
K-MUCO	0.7	4	—	—	35½"	28"	22"	19"	18"	17¼"	4°	8½"	23"	12¼"	—	—	19"	19½"	9½"	95°-103°	41.6	19.0 (2 per carton)
K-MPGO	—	—	—	—	35½"	28"	22"	18½"	17¾"	17¼"	6°	9½"	23"	12¼"	—	—	19½"	19½"	8½"	92°-100°	39.4	19.0 (2 per carton)
K-MPCO	—	—	—	—	35½"	28"	22"	18½"	17¾"	17¼"	6°	9½"	23"	12¼"	—	—	19½"	19½"	8½"	92°-100°	40	19.0 (2 per carton)
K-MUGA	0.7	4	—	—	35½"	23¼"	22"	19"	18"	17¼"	4°	—	—	—	—	19"	19½"	9½"	95°-103°	37.4	19.0 (2 per carton)	
K-MUCA	0.7	4	—	—	35½"	23¼"	22"	19"	18"	17¼"	4°	—	—	—	—	19"	19½"	9½"	95°-103°	38	19.0 (2 per carton)	
K-MPGA	—	—	—	—	35½"	23¼"	22"	18½"	17¾"	17¼"	6°	—	—	—	—	19½"	19½"	8½"	92°-100°	35.8	19.0 (2 per carton)	
K-MPCA	—	—	—	—	35½"	23¼"	22"	18½"	17¾"	17¼"	6°	—	—	—	—	19½"	19½"	8½"	92°-100°	36.4	19.0 (2 per carton)	
K-PUGO	0.7	4	—	—	35½"	28"	22"	19"	18"	17¼"	4°	8½"	23"	12¼"	—	—	19"	19½"	9½"	95°-103°	41	19.0 (2 per carton)
K-PUCO	0.7	4	—	—	35½"	28"	22"	19"	18"	17¼"	4°	8½"	23"	12¼"	—	—	19"	19½"	9½"	95°-103°	41.6	19.0 (2 per carton)
K-PPGO	—	—	—	—	35½"	28"	22"	18½"	17¾"	17¼"	6°	9½"	23"	12¼"	—	—	19½"	19½"	8½"	92°-100°	37.4	19.0 (2 per carton)
K-PPCO	—	—	—	—	35½"	28"	22"	18½"	17¾"	17¼"	6°	9½"	23"	12¼"	—	—	19½"	19½"	8½"	92°-100°	38	19.0 (2 per carton)
K-PUGA	0.7	4	—	—	35½"	23¼"	22"	19"	18"	17¼"	4°	—	—	—	—	19"	19½"	9½"	95°-103°	39.4	19.0 (2 per carton)	
K-PUCA	0.7	4	—	—	35½"	23¼"	22"	19"	18"	17¼"	4°	—	—	—	—	19"	19½"	9½"	95°-103°	40	19.0 (2 per carton)	
K-PPGA	—	—	—	—	35½"	23¼"	22"	18½"	17¾"	17¼"	6°	—	—	—	—	19½"	19½"	8½"	92°-100°	35.8	19.0 (2 per carton)	
K-PPCA	—	—	—	—	35½"	23¼"	22"	18½"	17¾"	17¼"	6°	—	—	—	—	19½"	19½"	8½"	92°-100°	36.4	19.0 (2 per carton)	

Seek chairs ship in cartons containing 2 chairs. Model numbers and prices are per chair.

◀ Continued from previous page





<p><i>4th Option:</i>  <b>Select the Glide/Casters:</b>                  0 Nylon Glides                  1 Nickel-plated Glides (\$18 extra)                  2 Felt Glides (\$18 extra)                  3 Multi-surface Casters</p>	<p><i>5th Option:</i>  <b>Select the Upholstery (if applicable):</b>                  See pages 13-14 for selection.                  See pages 17-18.1 for colors and codes.                  See pages 6-8 for COM guidelines.</p>	<p><i>5th Option:</i>  <b>Select the Seat Option (if applicable):</b>                  POLYST Polymer Seat</p>
<p><b>POLYST</b></p>		





Svelte is a modern, multi-functional office chair that brings refined, yet affordable, sophistication across a variety of applications. Sophistication shouldn't have to be expensive, and quality can be affordable. Svelte gracefully alleviates the disparity between low-cost and luxury with an elegant design that possesses an aesthetic as slender as the stack of cash to afford it. Combine that with its ability to consistently perform across almost any office setting, and it only adds to its value. Svelte meets the requirements set forth in ANSI/BIFMA X5.1-2013. Svelte is warranted for multiple shifts and users up to 300 lbs.

(See page 158 for COM pricing on Grades 9-22)

Description	Model Number <i>Add options below</i>	Base Price	Upholstery	2	3	4	5	6	7	8	Leather	
											1	2
<b>Svelte Seating</b>												
Svelte Uph High Back Chair, Plain Back, No Firecode	SV2HPNO	\$ 1280	High-Back	\$ 1319	\$ 1357	\$ 1395	\$ 1442	\$ 1489	\$ 1536	\$ 1582	\$ 1896	\$ 2399
												
Svelte Uph High Back Chair, Channel Stitch, No Firecode	SV2HCNO	\$ 1506	High-Back	\$ 1545	\$ 1583	\$ 1621	\$ 1668	\$ 1715	\$ 1762	\$ 1808	\$ 2122	\$ 2625
												
Svelte Uph Mid Back Chair, Plain Back, No Firecode	SV2MPNO	\$ 1243	Mid-Back	\$ 1282	\$ 1320	\$ 1358	\$ 1405	\$ 1452	\$ 1499	\$ 1545	\$ 1859	\$ 2362
												
Svelte Uph Mid Back Chair, Channel Stitch, No Firecode	SV2MCNO	\$ 1469	Mid-Back	\$ 1508	\$ 1546	\$ 1584	\$ 1631	\$ 1678	\$ 1725	\$ 1771	\$ 2085	\$ 2588
												

<b>Pricing Example:</b>	<b>Model/Options</b>	<b>Base Price/Upcharges</b>
Step 1: Select Model	SV2MPNO	\$ 1243
Step 2: Select Base	Polished Aluminum	\$ 109 upcharge
Step 3: Select Control	Synchro Seat Slider	\$ 109 upcharge
Step 4: Select Arm	Armless	\$ 0 upcharge
Step 5: Select Upholstery	Grade 8	\$ 302 upcharge
<b>Add Base + applicable Upcharges for Total List Price =</b>		<b>\$ 1763</b>

<b>How to specify —</b> Select the Model Number from above.	<b>1st Option:</b> Select the FSC Option: F FSC Wood	<b>2nd Option:</b> Select the Base Option: BLK Black PAL Polished Aluminum (add \$109 upcharge)	<b>3rd Option:</b> Select the Control Option: B Basic Synchro S Synchro Seat Slider (add \$109 upcharge)	<b>4th Option:</b> Select the Arm Option: A Armless H Height-Adjustable Arms (add \$109 upcharge) F Polished Loop Arms (add \$164 upcharge)	<b>5th Option:</b> Select the Upholstery: See pages 13-14 for selections and pages 17-18.1 for Color Codes.
SV2MPNO . F .			S .		

Example: SV2MPNO.F.PAL.S.B.HAML18

Model Number	COM Yardage*			Overall			Seat			Arms				Backrest							
	Ship Weight	Cubes	Height	Width	Depth	Height	Width	Depth	Pan Angle (Range)	Armrest Height	Arm Pad Length	Arm Pad Width	Width Between Armrest Uprights	Armrest Pivot	Height	Width	Lumbar Height	Backrest Inclination from Vertical	Backrest/Seat Angle (Range)		
SV2HPNO	57	15.9	2.5	42-45½"	26"	26"	16-19½"	17½-23"	20"	16¼"	7°-48°	7½"	11"	1½"	21½"	0°	29"	21½"	8¼"	12°-90°	95°-132°
SV2HCNO	57	15.9	2.5	42-45½"	26"	26"	16-19½"	17½-23"	20"	16¼"	7°-48°	7½"	11"	1½"	21½"	0°	29"	21½"	8¼"	12°-90°	95°-132°
SV2MPNO	53.5	11.3	1.9	35-39½"	26"	26"	18½"-23"	17½-23"	20"	14"-19"	4°-48°	7½"	11"	1½"	21½"	0°	20¾"	18½"	8¼"	12°-90°	98°-132°
SV2MCNO	53.5	11.3	1.9	35-39½"	26"	26"	18½"-23"	17½-23"	20"	14"-19"	4°-48°	7½"	11"	1½"	21½"	0°	20¾"	18½"	8¼"	12°-90°	98°-132°

\*COM Yardage is listed for total yardage/feet required for a model, with applicable yardage/feet for individual components listed.





*Introducing Vicinity, the newest addition to Allsteel's Social Collaborative collection of furniture.*

**Your next great idea happens here.**

*The cafeteria has evolved from a small, back-of-office nook to a vibrant, front-and-center space for planned and impromptu meetings, or for giving guests a taste of your company's culture. Vicinity meets these needs with the flexibility to fit more spaces around your office and a style that's distinctively yours. It's perfect for creative breaks, standing meetings, relaxed eating, or heads-down work.*

*The best ideas are born from connection. Vicinity gives you the space you need to discover what's possible.*

Choose from multiple color and finish combinations to fit the style of your office.

Simple, clean lines serve as the calling card for your company's personality.

Lightweight pieces are easy to move and utilize for whatever your office needs.

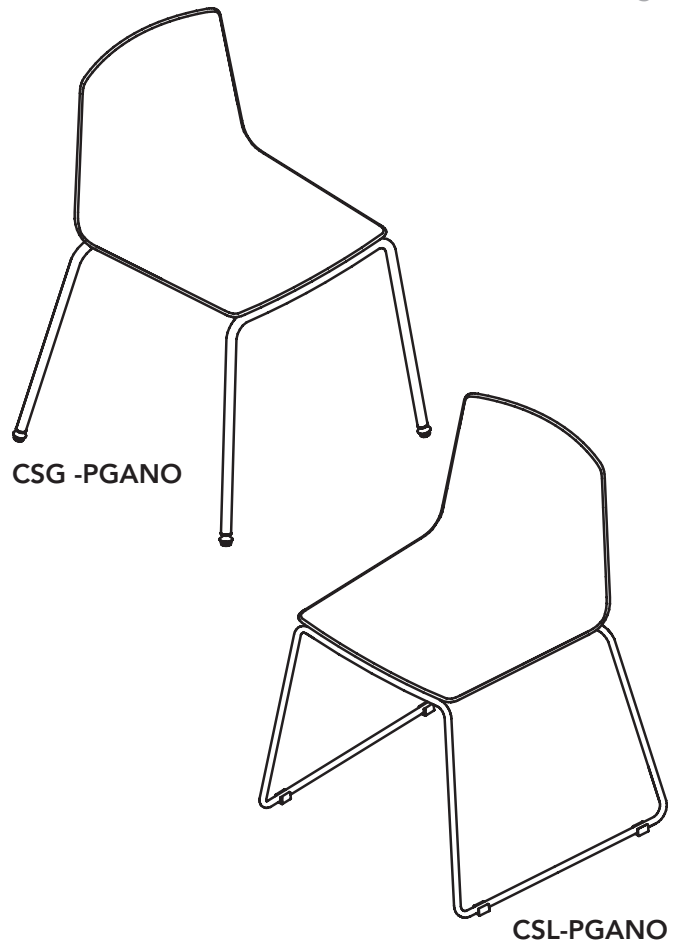

CSG-PGANO

CSL-PGANO

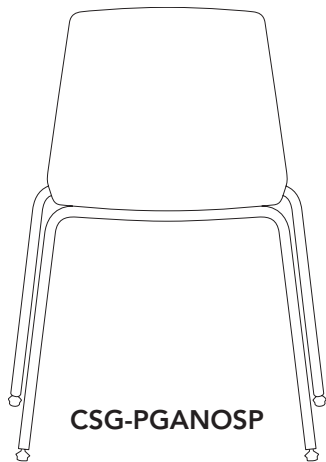

CSG-PGANOSP

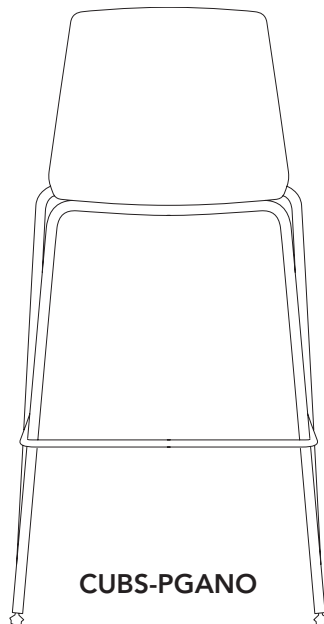

CUBS-PGANO

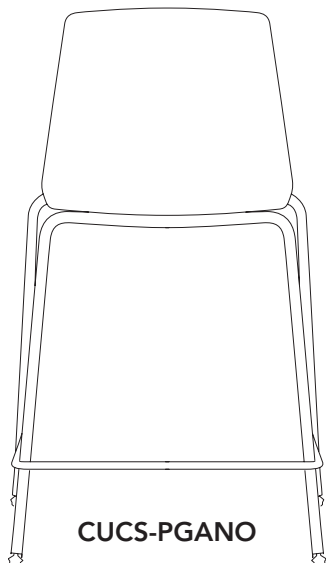

CUCS-PGANO

**MODELS AND OPTIONS**

Vicinity seating is available as seated, counter, or standing heights, with formed wire-frame or tube legs. Vicinity seating is produced using material-efficient processes; little waste is generated during the manufacture of these chairs and what is generated can be recycled into new components. The seating bases all contain at least 25% post-consumer recycled content.

Glides are available in nylon or polycarbonate, nickel-plated or steel, and felt or rubber. Nylon glides or polycarbonate are recommended for hard surfaces, commercial carpet, and damp environments. Nickel-plated and steel glides are recommended for carpet. Felt glides are recommended for wood, tile, or high-sheen floor surfaces.

Vicinity offers 8 different polymer shell colors and nine frame finish colors. 4-Leg and sled base chairs stack up to 10 chairs high in 44"H. Chairs ship up to four per carton to minimize waste. Model number and prices are per chair.

Vicinity meets the requirements set forth in ANSI/BIFMA X5.1-2017. Vicinity is warranted for multiple shifts and users up to 300 lbs.

**OPTIONS — CHAIRS / STOOLS**

- SG** 4-Leg Chair
- SL** Sled Base Chair
- CS** Counter Stool
- BS** Bar Stool
- UCS** Stacking Counter Stool
- UBS** Stacking Bar Stool

Glides 4-Leg / Stool:

- 0** Nylon for hard surfaces
- 1** Nickel for carpets (add \$18)
- 2** Felt (add \$18)
- 5** Rubber (add \$18)

Glides Sled Base:

- 0** Polycarbonate (only option for Lounge)
- 1** Steel (add \$18)
- 2** Felt (add \$18)

Frame Finish:

- P71** Black
- PJF** Bullseye
- PJW** Designer White
- POL** Chrome
- P096** Cove
- P094** Dune
- P02** Flint
- P097** Harbor
- P8B** Night Bronze
- PJE** Pyrite
- P095** Sage
- PR6** Silver
- P8X** Solar Black
- P8T** Titanium



Poly Shell Colors:

- BW** Brownstone
- CP** Calypso
- CR** Cherry
- LA** Lava
- RE** Regatta
- TI** Titanium
- WT** White
- ZE** Zest

VICINITY

FLOOR COVERING	TYPE OF GLIDE			
	Polycarbonate/Nylon	Felt	Steel	Rubber
Carpet	Best	Not Recommended	Good	Not Recommended
Polished Concrete	Best	Good	Not Recommended	Not Recommended
Hardwood	Not Recommended	Best	Not Recommended	Good
Vinyl (Includes LVT)	Best	Better	Good	Good
VCT	Best	Good	Not Recommended	Good
Tile (Porcelain/Ceramic)	Best	Good	Not Recommended	Good
<b>Attention</b>	Particles can become lodged in nylon and mar floor surface.	Particles can become lodged in felt and mar floor surface.	Cleaning chemicals and water can cause rusting.	Resists moving/sliding. Could lead to chairs tipping back.

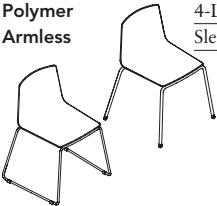

Description	Type	Model Number <i>Add options below</i>	List Price
Polymer Armless	4-Leg	CSG-PGANO	\$ 569
	Sled Base	CSL-PGANO	\$ 641
			
Stools Armless	Counter Stool	CUCS-PGANO	\$ 804
	Bar Stool	CUBS-PGANO	\$ 804
			
Seat Pads*	4-Leg Base with Seat Pad	CSG-PGANOSP	\$ 790
	Sled Base with Seat Pad	CSL-PGANOSP	\$ 861
	Counter Stool with Seat Pad	CUCS-PGANOSP	\$ 1023
	Bar Stool with Seat Pad	CUBS-PGANOSP	\$ 1023
			

\*List price is for Grade 1 fabric

<p><b>How to specify —</b> Select the Model Number from above.</p>	<p><b>1st Option:</b> <b>Select the Glide:</b> <b>4-Leg/Stool</b> 0 Nylon for hard surfaces 1 Nickel for carpets (add \$18) 2 Felt (add \$18) 5 Rubber (add \$18) <b>Sled Base</b> 0 Polycarbonate 1 Steel (add \$18) 2 Felt (add \$18)</p>	<p><b>2nd Option:</b> <b>Select the Frame Finish:</b> P71 Black PJF Bullseye PJW Designer White POL Chrome P02 Flint P8B Night Bronze (not available on Lounge) PJE Pyrite PR6 Silver P8X Solar Black P8T Titanium</p>	<p><b>3rd Option:</b> <b>Select the Poly Shell Color:</b> BW Brownstone CP Calypso CR Cherry LA Lava RE Regatta TI Titanium WT White ZE Zest</p>
<p>C       P   G   A   N   O   .     .</p>	<p>      .</p>	<p>      .</p>	<p>     </p>

Examples: CSG-PGANO.1.P71.CR CSL-PGANO.2.POL.WT

Model Number	Overall			Seat				Backrest							
	Height (Range)	Width	Depth	Height	Width	Depth	Pan Angle	Height	Width	Lumbar-Height	Backrest/Seat Angle (Range)	Ship Weight Per Chair	Ship Weight Per Carton	Cubes	COM Yardage
CSG-PGANO	31"	24"	21½"	17½"	17½"	16½"	2.4°	14"	17"	10"	100°-106°	24	66	16	
CSL-PGANO	30½"	23½"	21"	17½"	17½"	16½"	2.4°	14"	17"	10"	100°-106°	24	66	16	
CCS-PGANO	37½"	18"	18½"	24¼"	17½"	16½"	0.7°	14"	17"	10"	99°-105°	25	25	14	
CBS-PGANO	43½"	18½"	18½"	30¼"	17½"	16½"	0.7°	14"	17"	10"	99°-105°	25	25	14	
CUCS-PGANO	37½"	18"	18½"	24¼"	17½"	16½"	0.7°	14"	17"	10"	99°-105°	47	38	16	0.60
CUBS-PGANO	43½"	18½"	18½"	30¼"	17½"	16½"	0.7°	14"	17"	10"	99°-105°	52	40	19	0.60
CSG-PGANOSP	31"	24"	21½"	17½"	17½"	16½"	2.4°	14"	17"	10"	100°-106°	68	37	16	0.60
CSL-PGANOSP	30½"	23½"	21"	17½"	17½"	16½"	2.4°	14"	17"	10"	100°-106°	72	39	16	0.60
CUCS-PGANOSP	37½"	18"	18½"	24¼"	17½"	16½"	0.7°	14"	17"	10"	99°-105°	50	47	16	0.60
CUBS-PGANOSP	43½"	18½"	18½"	30¼"	17½"	16½"	0.7°	14"	17"	10"	99°-105°	55	52	19	0.60

Vicinity 4-Leg and Sled Base chairs ship up to four per carton to minimize waste. Model numbers and prices are per chair. Stools ship one per carton. Vicinity 4-Leg, Sled Base, and Stackable stools can be stacked up to 10-high and stacked up to 5-high with a seat pad.



Model Number		Grade 9	Grade 10	Grade 11	Grade 12	Grade 13	Grade 14	Grade 15	Grade 16	Grade 17	Grade 18	Grade 19	Grade 20	Grade 21	Grade 22
<b>ACUITY — Pages 54-57</b>															
AAMG		\$ 2835	\$ 2882	\$ 2928	\$ 2983	\$ 3037	\$ 3091	\$ 3146	\$ 3200	\$ 3255	\$ 3309	\$ 3363	\$ 3418	\$ 3473	\$ 3527
AAMS		\$ 2835	\$ 2882	\$ 2928	\$ 2983	\$ 3037	\$ 3091	\$ 3146	\$ 3200	\$ 3255	\$ 3309	\$ 3363	\$ 3418	\$ 3473	\$ 3527
AAMW		\$ 2835	\$ 2882	\$ 2928	\$ 2983	\$ 3037	\$ 3091	\$ 3146	\$ 3200	\$ 3255	\$ 3309	\$ 3363	\$ 3418	\$ 3473	\$ 3527
AAMP		\$ 3408	\$ 3455	\$ 3501	\$ 3556	\$ 3610	\$ 3664	\$ 3719	\$ 3773	\$ 3828	\$ 3882	\$ 3936	\$ 3991	\$ 4046	\$ 4100
AFMG		\$ 3152	\$ 3199	\$ 3245	\$ 3300	\$ 3354	\$ 3408	\$ 3463	\$ 3517	\$ 3572	\$ 3626	\$ 3680	\$ 3735	\$ 3790	\$ 3844
AFMS		\$ 3152	\$ 3199	\$ 3245	\$ 3300	\$ 3354	\$ 3408	\$ 3463	\$ 3517	\$ 3572	\$ 3626	\$ 3680	\$ 3735	\$ 3790	\$ 3844
AFMW		\$ 3152	\$ 3199	\$ 3245	\$ 3300	\$ 3354	\$ 3408	\$ 3463	\$ 3517	\$ 3572	\$ 3626	\$ 3680	\$ 3735	\$ 3790	\$ 3844
AFMP		\$ 3724	\$ 3771	\$ 3817	\$ 3872	\$ 3926	\$ 3980	\$ 4035	\$ 4089	\$ 4144	\$ 4198	\$ 4252	\$ 4307	\$ 4362	\$ 4416
AWMG		\$ 3043	\$ 3090	\$ 3136	\$ 3191	\$ 3245	\$ 3299	\$ 3354	\$ 3408	\$ 3463	\$ 3517	\$ 3571	\$ 3626	\$ 3681	\$ 3735
AWMS		\$ 3043	\$ 3090	\$ 3136	\$ 3191	\$ 3245	\$ 3299	\$ 3354	\$ 3408	\$ 3463	\$ 3517	\$ 3571	\$ 3626	\$ 3681	\$ 3735
AWMW		\$ 3043	\$ 3090	\$ 3136	\$ 3191	\$ 3245	\$ 3299	\$ 3354	\$ 3408	\$ 3463	\$ 3517	\$ 3571	\$ 3626	\$ 3681	\$ 3735
AWMP		\$ 3617	\$ 3664	\$ 3710	\$ 3765	\$ 3819	\$ 3873	\$ 3928	\$ 3982	\$ 4037	\$ 4091	\$ 4145	\$ 4200	\$ 4255	\$ 4309
<b>ACUITY SIDE — Pages 58-61</b>															
ACM-MUGO		\$ 1442	\$ 1483	\$ 1526	\$ 1583	\$ 1642	\$ 1701	\$ 1760	\$ 1820	\$ 1878	\$ 1936	\$ 1995	\$ 2055	\$ 2114	\$ 2173
ACM-MUGA		\$ 1376	\$ 1417	\$ 1460	\$ 1517	\$ 1576	\$ 1635	\$ 1694	\$ 1754	\$ 1812	\$ 1870	\$ 1929	\$ 1989	\$ 2048	\$ 2107
ACM-MUCO		\$ 1531	\$ 1572	\$ 1615	\$ 1672	\$ 1731	\$ 1790	\$ 1849	\$ 1909	\$ 1967	\$ 2025	\$ 2084	\$ 2144	\$ 2203	\$ 2262
ACM-MUCA		\$ 1465	\$ 1506	\$ 1549	\$ 1606	\$ 1665	\$ 1724	\$ 1783	\$ 1843	\$ 1901	\$ 1959	\$ 2018	\$ 2078	\$ 2137	\$ 2196
<b>EVO WORK — Pages 66-69 Upholstery upcharges below for Grades 9-22 need to be to added to Base Price listed on page 68.</b>															
DWW-MHWNO	Seat	\$ 181	\$ 205	\$ 229	\$ 258	\$ 287	\$ 316	\$ 345	\$ 373	\$ 403	\$ 431	\$ 460	\$ 489	\$ 518	\$ 547
DWW-MHHNO	Seat	\$ 181	\$ 205	\$ 229	\$ 258	\$ 287	\$ 316	\$ 345	\$ 373	\$ 403	\$ 431	\$ 460	\$ 489	\$ 518	\$ 547
DWW-MHFNO	Seat	\$ 181	\$ 205	\$ 229	\$ 258	\$ 287	\$ 316	\$ 345	\$ 373	\$ 403	\$ 431	\$ 460	\$ 489	\$ 518	\$ 547
DWW-MHANO	Seat	\$ 181	\$ 205	\$ 229	\$ 258	\$ 287	\$ 316	\$ 345	\$ 373	\$ 403	\$ 431	\$ 460	\$ 489	\$ 518	\$ 547
<b>EVO CONFERENCE — Pages 68-69 Upholstery upcharges below for Grades 9-22 need to be to added to Base Price listed on page 68.</b>															
DWC-UMWNO	Back	\$ 272	\$ 308	\$ 344	\$ 386	\$ 431	\$ 474	\$ 517	\$ 560	\$ 604	\$ 647	\$ 690	\$ 733	\$ 778	\$ 820
	Seat	\$ 181	\$ 205	\$ 229	\$ 258	\$ 287	\$ 316	\$ 345	\$ 373	\$ 403	\$ 431	\$ 460	\$ 489	\$ 518	\$ 547
DWC-UMHNO	Back	\$ 272	\$ 308	\$ 344	\$ 386	\$ 431	\$ 474	\$ 517	\$ 560	\$ 604	\$ 647	\$ 690	\$ 733	\$ 778	\$ 820
	Seat	\$ 181	\$ 205	\$ 229	\$ 258	\$ 287	\$ 316	\$ 345	\$ 373	\$ 403	\$ 431	\$ 460	\$ 489	\$ 518	\$ 547
DWC-UMFNO	Back	\$ 272	\$ 308	\$ 344	\$ 386	\$ 431	\$ 474	\$ 517	\$ 560	\$ 604	\$ 647	\$ 690	\$ 733	\$ 778	\$ 820
	Seat	\$ 181	\$ 205	\$ 229	\$ 258	\$ 287	\$ 316	\$ 345	\$ 373	\$ 403	\$ 431	\$ 460	\$ 489	\$ 518	\$ 547
DWC-UMANO	Back	\$ 272	\$ 308	\$ 344	\$ 386	\$ 431	\$ 474	\$ 517	\$ 560	\$ 604	\$ 647	\$ 690	\$ 733	\$ 778	\$ 820
	Seat	\$ 181	\$ 205	\$ 229	\$ 258	\$ 287	\$ 316	\$ 345	\$ 373	\$ 403	\$ 431	\$ 460	\$ 489	\$ 518	\$ 547
<b>EVO STOOL — Page 70</b>															
DWS-MHWNO		\$ 2162	\$ 2186	\$ 2210	\$ 2239	\$ 2268	\$ 2297	\$ 2326	\$ 2354	\$ 2384	\$ 2412	\$ 2441	\$ 2470	\$ 2499	\$ 2528
DWS-MHHNO		\$ 2088	\$ 2112	\$ 2136	\$ 2165	\$ 2194	\$ 2223	\$ 2252	\$ 2280	\$ 2310	\$ 2338	\$ 2367	\$ 2396	\$ 2425	\$ 2454
DWS-MHFNO		\$ 2137	\$ 2161	\$ 2185	\$ 2214	\$ 2243	\$ 2272	\$ 2301	\$ 2329	\$ 2359	\$ 2387	\$ 2416	\$ 2445	\$ 2474	\$ 2503
DWS-MHANO		\$ 1969	\$ 1993	\$ 2017	\$ 2046	\$ 2075	\$ 2104	\$ 2133	\$ 2161	\$ 2191	\$ 2219	\$ 2248	\$ 2277	\$ 2306	\$ 2335
<b>EVO SIDE — Page 71</b>															
DSC-MUCONO		\$ 1068	\$ 1092	\$ 1116	\$ 1145	\$ 1174	\$ 1203	\$ 1232	\$ 1260	\$ 1290	\$ 1318	\$ 1347	\$ 1376	\$ 1405	\$ 1434
DSC-MUGONO		\$ 1023	\$ 1047	\$ 1071	\$ 1100	\$ 1129	\$ 1158	\$ 1187	\$ 1215	\$ 1245	\$ 1273	\$ 1302	\$ 1331	\$ 1360	\$ 1389

# Seating

## Fabric Grades 9-22 Pricing

GSA SIN 33721

Model Number	Grade 9	Grade 10	Grade 11	Grade 12	Grade 13	Grade 14	Grade 15	Grade 16	Grade 17	Grade 18	Grade 19	Grade 20	Grade 21	Grade 22
INSPIRE — Pages 73-91														
INFS-SGO	\$ 1703	\$ 1729	\$ 1756	\$ 1786	\$ 1817	\$ 1847	\$ 1879	\$ 1909	\$ 1941	\$ 1970	\$ 2002	\$ 2032	\$ 2064	\$ 2095
INFS-SGA	\$ 1579	\$ 1605	\$ 1632	\$ 1662	\$ 1693	\$ 1723	\$ 1755	\$ 1785	\$ 1817	\$ 1846	\$ 1878	\$ 1908	\$ 1940	\$ 1971
INFS-UGO	\$ 2012	\$ 2057	\$ 2104	\$ 2157	\$ 2210	\$ 2263	\$ 2316	\$ 2370	\$ 2423	\$ 2476	\$ 2530	\$ 2584	\$ 2636	\$ 2690
INFS-UGA	\$ 1888	\$ 1933	\$ 1980	\$ 2033	\$ 2086	\$ 2139	\$ 2192	\$ 2246	\$ 2299	\$ 2352	\$ 2406	\$ 2460	\$ 2512	\$ 2566
INSL-SO	\$ 1172	\$ 1198	\$ 1225	\$ 1255	\$ 1286	\$ 1316	\$ 1348	\$ 1378	\$ 1410	\$ 1439	\$ 1471	\$ 1501	\$ 1533	\$ 1564
INSL-SA	\$ 1043	\$ 1069	\$ 1096	\$ 1126	\$ 1157	\$ 1187	\$ 1219	\$ 1249	\$ 1281	\$ 1310	\$ 1342	\$ 1372	\$ 1404	\$ 1435
INSL-UO	\$ 1481	\$ 1526	\$ 1573	\$ 1626	\$ 1679	\$ 1732	\$ 1785	\$ 1839	\$ 1892	\$ 1945	\$ 1999	\$ 2053	\$ 2105	\$ 2159
INSL-UA	\$ 1351	\$ 1396	\$ 1443	\$ 1496	\$ 1549	\$ 1602	\$ 1655	\$ 1709	\$ 1762	\$ 1815	\$ 1869	\$ 1923	\$ 1975	\$ 2029
INST-SGO	\$ 1177	\$ 1203	\$ 1230	\$ 1260	\$ 1291	\$ 1321	\$ 1353	\$ 1383	\$ 1415	\$ 1444	\$ 1476	\$ 1506	\$ 1538	\$ 1569
INST-SCO	\$ 1219	\$ 1245	\$ 1272	\$ 1302	\$ 1333	\$ 1363	\$ 1395	\$ 1425	\$ 1457	\$ 1486	\$ 1518	\$ 1548	\$ 1580	\$ 1611
INST-SGA	\$ 1043	\$ 1069	\$ 1096	\$ 1126	\$ 1157	\$ 1187	\$ 1219	\$ 1249	\$ 1281	\$ 1310	\$ 1342	\$ 1372	\$ 1404	\$ 1435
INST-SCA	\$ 1087	\$ 1113	\$ 1140	\$ 1170	\$ 1201	\$ 1231	\$ 1263	\$ 1293	\$ 1325	\$ 1354	\$ 1386	\$ 1416	\$ 1448	\$ 1479
INST-UGO	\$ 1484	\$ 1529	\$ 1576	\$ 1629	\$ 1682	\$ 1735	\$ 1788	\$ 1842	\$ 1895	\$ 1948	\$ 2002	\$ 2056	\$ 2108	\$ 2162
INST-UCO	\$ 1529	\$ 1574	\$ 1621	\$ 1674	\$ 1727	\$ 1780	\$ 1833	\$ 1887	\$ 1940	\$ 1993	\$ 2047	\$ 2101	\$ 2153	\$ 2207
INST-UGA	\$ 1351	\$ 1396	\$ 1443	\$ 1496	\$ 1549	\$ 1602	\$ 1655	\$ 1709	\$ 1762	\$ 1815	\$ 1869	\$ 1923	\$ 1975	\$ 2029
INST-UCA	\$ 1397	\$ 1442	\$ 1489	\$ 1542	\$ 1595	\$ 1648	\$ 1701	\$ 1755	\$ 1808	\$ 1861	\$ 1915	\$ 1969	\$ 2021	\$ 2075
INSTT-SGAFRS	\$ 1470	\$ 1494	\$ 1520	\$ 1550	\$ 1581	\$ 1611	\$ 1643	\$ 1674	\$ 1705	\$ 1735	\$ 1766	\$ 1797	\$ 1828	\$ 1859
INSTT-SCAFRS	\$ 1513	\$ 1537	\$ 1563	\$ 1593	\$ 1624	\$ 1654	\$ 1686	\$ 1717	\$ 1748	\$ 1778	\$ 1809	\$ 1840	\$ 1871	\$ 1902
INSTT-SGAFLS	\$ 1470	\$ 1494	\$ 1520	\$ 1550	\$ 1581	\$ 1611	\$ 1643	\$ 1674	\$ 1705	\$ 1735	\$ 1766	\$ 1797	\$ 1828	\$ 1859
INSTT-SCAFLS	\$ 1513	\$ 1537	\$ 1563	\$ 1593	\$ 1624	\$ 1654	\$ 1686	\$ 1717	\$ 1748	\$ 1778	\$ 1809	\$ 1840	\$ 1871	\$ 1902
INSTT-UGAFRS	\$ 1797	\$ 1845	\$ 1890	\$ 1944	\$ 1999	\$ 2053	\$ 2108	\$ 2163	\$ 2215	\$ 2271	\$ 2326	\$ 2379	\$ 2435	\$ 2489
INSTT-UCAFRS	\$ 1842	\$ 1890	\$ 1935	\$ 1989	\$ 2044	\$ 2098	\$ 2153	\$ 2208	\$ 2260	\$ 2316	\$ 2371	\$ 2424	\$ 2480	\$ 2534
INSTT-UGAFLS	\$ 1797	\$ 1845	\$ 1890	\$ 1944	\$ 1999	\$ 2053	\$ 2108	\$ 2163	\$ 2215	\$ 2271	\$ 2326	\$ 2379	\$ 2435	\$ 2489
INSTT-UCAFLS	\$ 1842	\$ 1890	\$ 1935	\$ 1989	\$ 2044	\$ 2098	\$ 2153	\$ 2208	\$ 2260	\$ 2316	\$ 2371	\$ 2424	\$ 2480	\$ 2534
INTK-SO	\$ 1452	\$ 1478	\$ 1505	\$ 1535	\$ 1566	\$ 1596	\$ 1628	\$ 1658	\$ 1690	\$ 1719	\$ 1751	\$ 1781	\$ 1813	\$ 1844
INTK-SA	\$ 1321	\$ 1347	\$ 1374	\$ 1404	\$ 1435	\$ 1465	\$ 1497	\$ 1527	\$ 1559	\$ 1588	\$ 1620	\$ 1650	\$ 1682	\$ 1713
INTK-UO	\$ 1760	\$ 1805	\$ 1852	\$ 1905	\$ 1958	\$ 2011	\$ 2064	\$ 2118	\$ 2171	\$ 2224	\$ 2278	\$ 2332	\$ 2384	\$ 2438
INTK-UA	\$ 1629	\$ 1674	\$ 1721	\$ 1774	\$ 1827	\$ 1880	\$ 1933	\$ 1987	\$ 2040	\$ 2093	\$ 2147	\$ 2201	\$ 2253	\$ 2307
INWS-SO	\$ 1709	\$ 1735	\$ 1762	\$ 1792	\$ 1823	\$ 1853	\$ 1885	\$ 1915	\$ 1947	\$ 1976	\$ 2008	\$ 2038	\$ 2070	\$ 2101
INWS-SA	\$ 1579	\$ 1605	\$ 1632	\$ 1662	\$ 1693	\$ 1723	\$ 1755	\$ 1785	\$ 1817	\$ 1846	\$ 1878	\$ 1908	\$ 1940	\$ 1971
INWS-UO	\$ 2018	\$ 2063	\$ 2110	\$ 2163	\$ 2216	\$ 2269	\$ 2322	\$ 2376	\$ 2429	\$ 2482	\$ 2536	\$ 2590	\$ 2642	\$ 2696
INWS-UA	\$ 1888	\$ 1933	\$ 1980	\$ 2033	\$ 2086	\$ 2139	\$ 2192	\$ 2246	\$ 2299	\$ 2352	\$ 2406	\$ 2460	\$ 2512	\$ 2566

GRADES 9-22 PRICING

# Seating

## Fabric Grades 9-22 Pricing

GSA SIN 33721

Model Number	Grade 9	Grade 10	Grade 11	Grade 12	Grade 13	Grade 14	Grade 15	Grade 16	Grade 17	Grade 18	Grade 19	Grade 20	Grade 21	Grade 22
<b>LYRIC WORK — Pages 92-95</b>														
CWW-MHW	\$ 1598	\$ 1622	\$ 1645	\$ 1679	\$ 1713	\$ 1748	\$ 1783	\$ 1817	\$ 1852	\$ 1885	\$ 1920	\$ 1956	\$ 1990	\$ 2059
CWW-MMW	\$ 1563	\$ 1587	\$ 1610	\$ 1644	\$ 1678	\$ 1713	\$ 1748	\$ 1782	\$ 1817	\$ 1850	\$ 1885	\$ 1921	\$ 1955	\$ 2024
CSW-MHW	\$ 1478	\$ 1502	\$ 1525	\$ 1559	\$ 1593	\$ 1628	\$ 1663	\$ 1697	\$ 1732	\$ 1765	\$ 1800	\$ 1836	\$ 1870	\$ 1939
CSW-MMW	\$ 1443	\$ 1467	\$ 1490	\$ 1524	\$ 1558	\$ 1593	\$ 1628	\$ 1662	\$ 1697	\$ 1730	\$ 1765	\$ 1801	\$ 1835	\$ 1904
CBW-MHW	\$ 1418	\$ 1442	\$ 1465	\$ 1499	\$ 1533	\$ 1568	\$ 1603	\$ 1637	\$ 1672	\$ 1705	\$ 1740	\$ 1776	\$ 1810	\$ 1879
CBW-MMW	\$ 1385	\$ 1409	\$ 1432	\$ 1466	\$ 1500	\$ 1535	\$ 1570	\$ 1604	\$ 1639	\$ 1672	\$ 1707	\$ 1743	\$ 1777	\$ 1846
CWW-MHH	\$ 1525	\$ 1549	\$ 1572	\$ 1606	\$ 1640	\$ 1675	\$ 1710	\$ 1744	\$ 1779	\$ 1812	\$ 1847	\$ 1883	\$ 1917	\$ 1986
CWW-MMH	\$ 1490	\$ 1514	\$ 1537	\$ 1571	\$ 1605	\$ 1640	\$ 1675	\$ 1709	\$ 1744	\$ 1777	\$ 1812	\$ 1848	\$ 1882	\$ 1951
CSW-MHH	\$ 1405	\$ 1429	\$ 1452	\$ 1486	\$ 1520	\$ 1555	\$ 1590	\$ 1624	\$ 1659	\$ 1692	\$ 1727	\$ 1763	\$ 1797	\$ 1866
CSW-MMH	\$ 1370	\$ 1394	\$ 1417	\$ 1451	\$ 1485	\$ 1520	\$ 1555	\$ 1589	\$ 1624	\$ 1657	\$ 1692	\$ 1728	\$ 1762	\$ 1831
CBW-MHH	\$ 1346	\$ 1370	\$ 1393	\$ 1427	\$ 1461	\$ 1496	\$ 1531	\$ 1565	\$ 1600	\$ 1633	\$ 1668	\$ 1704	\$ 1738	\$ 1807
CBW-MMH	\$ 1312	\$ 1336	\$ 1359	\$ 1393	\$ 1427	\$ 1462	\$ 1497	\$ 1531	\$ 1566	\$ 1599	\$ 1634	\$ 1670	\$ 1704	\$ 1773
CWW-MHF	\$ 1535	\$ 1559	\$ 1582	\$ 1616	\$ 1650	\$ 1685	\$ 1720	\$ 1754	\$ 1789	\$ 1822	\$ 1857	\$ 1893	\$ 1927	\$ 1996
CWW-MMF	\$ 1501	\$ 1525	\$ 1548	\$ 1582	\$ 1616	\$ 1651	\$ 1686	\$ 1720	\$ 1755	\$ 1788	\$ 1823	\$ 1859	\$ 1893	\$ 1962
CSW-MHF	\$ 1416	\$ 1440	\$ 1463	\$ 1497	\$ 1531	\$ 1566	\$ 1601	\$ 1635	\$ 1670	\$ 1703	\$ 1738	\$ 1774	\$ 1808	\$ 1877
CSW-MMF	\$ 1382	\$ 1406	\$ 1429	\$ 1463	\$ 1497	\$ 1532	\$ 1567	\$ 1601	\$ 1636	\$ 1669	\$ 1704	\$ 1740	\$ 1774	\$ 1843
CBW-MHF	\$ 1356	\$ 1380	\$ 1403	\$ 1437	\$ 1471	\$ 1506	\$ 1541	\$ 1575	\$ 1610	\$ 1643	\$ 1678	\$ 1714	\$ 1748	\$ 1817
CBW-MMF	\$ 1321	\$ 1345	\$ 1368	\$ 1402	\$ 1436	\$ 1471	\$ 1506	\$ 1540	\$ 1575	\$ 1608	\$ 1643	\$ 1679	\$ 1713	\$ 1782
CWW-MHA	\$ 1406	\$ 1430	\$ 1453	\$ 1487	\$ 1521	\$ 1556	\$ 1591	\$ 1625	\$ 1660	\$ 1693	\$ 1728	\$ 1764	\$ 1798	\$ 1867
CWW-MMA	\$ 1371	\$ 1395	\$ 1418	\$ 1452	\$ 1486	\$ 1521	\$ 1556	\$ 1590	\$ 1625	\$ 1658	\$ 1693	\$ 1729	\$ 1763	\$ 1832
CSW-MHA	\$ 1288	\$ 1312	\$ 1335	\$ 1369	\$ 1403	\$ 1438	\$ 1473	\$ 1507	\$ 1542	\$ 1575	\$ 1610	\$ 1646	\$ 1680	\$ 1749
CSW-MMA	\$ 1253	\$ 1277	\$ 1300	\$ 1334	\$ 1368	\$ 1403	\$ 1438	\$ 1472	\$ 1507	\$ 1540	\$ 1575	\$ 1611	\$ 1645	\$ 1714
CBW-MHA	\$ 1228	\$ 1252	\$ 1275	\$ 1309	\$ 1343	\$ 1378	\$ 1413	\$ 1447	\$ 1482	\$ 1515	\$ 1550	\$ 1586	\$ 1620	\$ 1689
CBW-MMA	\$ 1193	\$ 1217	\$ 1240	\$ 1274	\$ 1308	\$ 1343	\$ 1378	\$ 1412	\$ 1447	\$ 1480	\$ 1515	\$ 1551	\$ 1585	\$ 1654
<b>LYRIC STOOL — Pages 96-97 (upholstered on page 156)</b>														
CSS-MHW	\$ 1878	\$ 1896	\$ 1915	\$ 1941	\$ 1968	\$ 1996	\$ 2023	\$ 2050	\$ 2077	\$ 2103	\$ 2131	\$ 2158	\$ 2185	\$ 2240
CSS-MMW	\$ 1851	\$ 1869	\$ 1888	\$ 1914	\$ 1941	\$ 1969	\$ 1996	\$ 2023	\$ 2050	\$ 2076	\$ 2104	\$ 2131	\$ 2158	\$ 2213
CSS-MMH	\$ 1793	\$ 1811	\$ 1830	\$ 1856	\$ 1883	\$ 1911	\$ 1938	\$ 1965	\$ 1992	\$ 2018	\$ 2046	\$ 2073	\$ 2100	\$ 2155
CSS-MMF	\$ 1802	\$ 1820	\$ 1839	\$ 1865	\$ 1892	\$ 1920	\$ 1947	\$ 1974	\$ 2001	\$ 2027	\$ 2055	\$ 2082	\$ 2109	\$ 2164
CSS-MMA	\$ 1699	\$ 1717	\$ 1736	\$ 1762	\$ 1789	\$ 1817	\$ 1844	\$ 1871	\$ 1898	\$ 1924	\$ 1952	\$ 1979	\$ 2006	\$ 2061
<b>LYRIC L &amp; T — Pages 98-99 (upholstered on page 156)</b>														
CLL-MLH	\$ 2018	\$ 2042	\$ 2065	\$ 2099	\$ 2133	\$ 2168	\$ 2203	\$ 2237	\$ 2272	\$ 2305	\$ 2340	\$ 2376	\$ 2410	\$ 2479
CLL-MLF	\$ 2028	\$ 2052	\$ 2075	\$ 2109	\$ 2143	\$ 2178	\$ 2213	\$ 2247	\$ 2282	\$ 2315	\$ 2350	\$ 2386	\$ 2420	\$ 2489
CLL-MLA	\$ 1900	\$ 1924	\$ 1947	\$ 1981	\$ 2015	\$ 2050	\$ 2085	\$ 2119	\$ 2154	\$ 2187	\$ 2222	\$ 2258	\$ 2292	\$ 2361
<b>LYRIC SIDE — Pages 100-101</b>														
CSC-MUGO	\$ 1091	\$ 1135	\$ 1178	\$ 1235	\$ 1292	\$ 1350	\$ 1406	\$ 1464	\$ 1521	\$ 1579	\$ 1635	\$ 1693	\$ 1751	\$ 1793
CSC-UUGO	\$ 1209	\$ 1253	\$ 1296	\$ 1353	\$ 1410	\$ 1468	\$ 1524	\$ 1582	\$ 1639	\$ 1697	\$ 1753	\$ 1811	\$ 1869	\$ 1911
CSC-MUCO	\$ 1135	\$ 1179	\$ 1222	\$ 1279	\$ 1336	\$ 1394	\$ 1450	\$ 1508	\$ 1565	\$ 1623	\$ 1679	\$ 1737	\$ 1795	\$ 1837
CSC-UUCO	\$ 1253	\$ 1297	\$ 1340	\$ 1397	\$ 1454	\$ 1512	\$ 1568	\$ 1626	\$ 1683	\$ 1741	\$ 1797	\$ 1855	\$ 1913	\$ 1955
<b>Lyric Multi-Purpose Work Chair — Pages 102-103</b>														
CMPWU-PPCONO	\$ 1184	\$ 1209	\$ 1234	\$ 1263	\$ 1293	\$ 1322	\$ 1353	\$ 1382	\$ 1413	\$ 1441	\$ 1472	\$ 1501	\$ 1532	\$ 1561
CMPWU-PPCANO	\$ 1051	\$ 1076	\$ 1101	\$ 1130	\$ 1160	\$ 1189	\$ 1220	\$ 1249	\$ 1280	\$ 1308	\$ 1339	\$ 1368	\$ 1399	\$ 1428
<b>Lyric Multi-Purpose 4 Leg Stacker and Stools with Seat Pads — Pages 106-107</b>														
CMPNU-PPGO	\$ 859	\$ 883	\$ 907	\$ 936	\$ 965	\$ 994	\$ 1023	\$ 1051	\$ 1081	\$ 1109	\$ 1138	\$ 1167	\$ 1196	\$ 1225
CMPNU-PPCO	\$ 904	\$ 928	\$ 952	\$ 981	\$ 1010	\$ 1039	\$ 1068	\$ 1096	\$ 1126	\$ 1154	\$ 1183	\$ 1212	\$ 1241	\$ 1270
CMPNU-PPGA	\$ 728	\$ 752	\$ 776	\$ 805	\$ 834	\$ 863	\$ 892	\$ 920	\$ 950	\$ 978	\$ 1007	\$ 1036	\$ 1065	\$ 1094
CMPNU-PPCA	\$ 772	\$ 796	\$ 820	\$ 849	\$ 878	\$ 907	\$ 936	\$ 964	\$ 994	\$ 1022	\$ 1051	\$ 1080	\$ 1109	\$ 1138
CWSU-PPGO	\$ 961	\$ 986	\$ 1011	\$ 1040	\$ 1070	\$ 1099	\$ 1130	\$ 1159	\$ 1190	\$ 1218	\$ 1249	\$ 1278	\$ 1309	\$ 1338
CWSU-PPGA	\$ 827	\$ 852	\$ 877	\$ 906	\$ 936	\$ 965	\$ 996	\$ 1025	\$ 1056	\$ 1084	\$ 1115	\$ 1144	\$ 1175	\$ 1204
CWSS30U-PPGA	\$ 969	\$ 994	\$ 1019	\$ 1048	\$ 1078	\$ 1107	\$ 1138	\$ 1167	\$ 1198	\$ 1226	\$ 1257	\$ 1286	\$ 1317	\$ 1346

GRADES 9-22 PRICING

# Seating

## Fabric Grades 9-22 Pricing

GSA SIN 33721

Model Number	Grade 9	Grade 10	Grade 11	Grade 12	Grade 13	Grade 14	Grade 15	Grade 16	Grade 17	Grade 18	Grade 19	Grade 20	Grade 21	Grade 22
<b>MIMEO</b> — Pages <a href="#">108-111</a>														
MIW-KWNO	\$ 2114	\$ 2138	\$ 2159	\$ 2188	\$ 2215	\$ 2242	\$ 2269	\$ 2296	\$ 2324	\$ 2351	\$ 2379	\$ 2406	\$ 2434	\$ 2461
MIS-KWNO	\$ 2520	\$ 2544	\$ 2565	\$ 2594	\$ 2621	\$ 2648	\$ 2675	\$ 2702	\$ 2730	\$ 2757	\$ 2785	\$ 2812	\$ 2840	\$ 2867
MIW-KANO	\$ 1845	\$ 1869	\$ 1890	\$ 1919	\$ 1946	\$ 1973	\$ 2000	\$ 2027	\$ 2055	\$ 2082	\$ 2110	\$ 2137	\$ 2165	\$ 2192
MIS-KANO	\$ 2251	\$ 2275	\$ 2296	\$ 2325	\$ 2352	\$ 2379	\$ 2406	\$ 2433	\$ 2461	\$ 2488	\$ 2516	\$ 2543	\$ 2571	\$ 2598
<b>O6</b> — Pages <a href="#">114-117</a>														
MNL-MHW	\$ 1321	\$ 1347	\$ 1372	\$ 1398	\$ 1431	\$ 1463	\$ 1495	\$ 1527	\$ 1560	\$ 1592	\$ 1624	\$ 1657	\$ 1689	\$ 1721
MNL-MHH	\$ 1256	\$ 1282	\$ 1307	\$ 1333	\$ 1366	\$ 1398	\$ 1430	\$ 1462	\$ 1495	\$ 1527	\$ 1559	\$ 1592	\$ 1624	\$ 1656
MNL-MHA	\$ 1147	\$ 1173	\$ 1198	\$ 1224	\$ 1257	\$ 1289	\$ 1321	\$ 1353	\$ 1386	\$ 1418	\$ 1450	\$ 1483	\$ 1515	\$ 1547
MNLS-MHW	\$ 1495	\$ 1521	\$ 1546	\$ 1572	\$ 1605	\$ 1637	\$ 1669	\$ 1701	\$ 1734	\$ 1766	\$ 1798	\$ 1831	\$ 1863	\$ 1895
MNLS-MHH	\$ 1430	\$ 1456	\$ 1481	\$ 1507	\$ 1540	\$ 1572	\$ 1604	\$ 1636	\$ 1669	\$ 1701	\$ 1733	\$ 1766	\$ 1798	\$ 1830
MNLS-MHA	\$ 1321	\$ 1347	\$ 1372	\$ 1398	\$ 1431	\$ 1463	\$ 1495	\$ 1527	\$ 1560	\$ 1592	\$ 1624	\$ 1657	\$ 1689	\$ 1721
<b>PLI</b> — Pages <a href="#">118-121</a>														
FWW-MHHNO	\$ 1555	\$ 1582	\$ 1609	\$ 1637	\$ 1672	\$ 1705	\$ 1740	\$ 1774	\$ 1809	\$ 1843	\$ 1878	\$ 1911	\$ 1945	\$ 1980
FWW-MHFNO	\$ 1520	\$ 1547	\$ 1574	\$ 1602	\$ 1637	\$ 1670	\$ 1705	\$ 1739	\$ 1774	\$ 1808	\$ 1843	\$ 1876	\$ 1910	\$ 1945
FWW-MHANO	\$ 1381	\$ 1408	\$ 1435	\$ 1463	\$ 1498	\$ 1531	\$ 1566	\$ 1600	\$ 1635	\$ 1669	\$ 1704	\$ 1737	\$ 1771	\$ 1806
FWS-MHHNO	\$ 1902	\$ 1929	\$ 1956	\$ 1984	\$ 2019	\$ 2052	\$ 2087	\$ 2121	\$ 2156	\$ 2190	\$ 2225	\$ 2258	\$ 2292	\$ 2327
FWS-MHFNO	\$ 1867	\$ 1894	\$ 1921	\$ 1949	\$ 1984	\$ 2017	\$ 2052	\$ 2086	\$ 2121	\$ 2155	\$ 2190	\$ 2223	\$ 2257	\$ 2292
FWS-MHANO	\$ 1729	\$ 1756	\$ 1783	\$ 1811	\$ 1846	\$ 1879	\$ 1914	\$ 1948	\$ 1983	\$ 2017	\$ 2052	\$ 2085	\$ 2119	\$ 2154
<b>QUIP</b> — Pages <a href="#">122-123</a>														
ST	\$ 1070	\$ 1085	\$ 1101	\$ 1150	\$ 1198	\$ 1246	\$ 1294	\$ 1342	\$ 1390	\$ 1439	\$ 1486	\$ 1535	\$ 1583	\$ 1679
STS	\$ 1116	\$ 1131	\$ 1147	\$ 1196	\$ 1244	\$ 1292	\$ 1340	\$ 1388	\$ 1436	\$ 1485	\$ 1532	\$ 1581	\$ 1629	\$ 1725

GRADES 9-22 PRICING

# Seating

## Fabric Grades 9-22 Pricing

GSA SIN 33721

Model Number	Grade 9	Grade 10	Grade 11	Grade 12	Grade 13	Grade 14	Grade 15	Grade 16	Grade 17	Grade 18	Grade 19	Grade 20	Grade 21	Grade 22
<b>RELATE</b> — Pages <a href="#">124-129</a>														
RL-MHP	\$ 2402	\$ 2431	\$ 2462	\$ 2509	\$ 2559	\$ 2605	\$ 2654	\$ 2705	\$ 2751	\$ 2801	\$ 2847	\$ 2898	\$ 2947	\$ 2993
RL-UHP	\$ 2550	\$ 2606	\$ 2663	\$ 2742	\$ 2818	\$ 2896	\$ 2973	\$ 3051	\$ 3127	\$ 3206	\$ 3283	\$ 3361	\$ 3439	\$ 3515
RL-MHA	\$ 2116	\$ 2145	\$ 2176	\$ 2223	\$ 2273	\$ 2319	\$ 2368	\$ 2419	\$ 2465	\$ 2515	\$ 2561	\$ 2612	\$ 2661	\$ 2707
RL-UHA	\$ 2264	\$ 2320	\$ 2377	\$ 2456	\$ 2532	\$ 2610	\$ 2687	\$ 2765	\$ 2841	\$ 2920	\$ 2997	\$ 3075	\$ 3153	\$ 3229
<b>RELATE ALUMINUM</b> — Pages <a href="#">124-129</a>														
RLA-MHP	\$ 2793	\$ 2822	\$ 2853	\$ 2900	\$ 2950	\$ 2996	\$ 3045	\$ 3096	\$ 3142	\$ 3192	\$ 3238	\$ 3289	\$ 3338	\$ 3384
RLA-UHP	\$ 2942	\$ 2998	\$ 3055	\$ 3134	\$ 3210	\$ 3288	\$ 3365	\$ 3443	\$ 3519	\$ 3598	\$ 3675	\$ 3753	\$ 3831	\$ 3907
RLA-MHA	\$ 2507	\$ 2536	\$ 2567	\$ 2614	\$ 2664	\$ 2710	\$ 2759	\$ 2810	\$ 2856	\$ 2906	\$ 2952	\$ 3003	\$ 3052	\$ 3098
RLA-UHA	\$ 2657	\$ 2713	\$ 2770	\$ 2849	\$ 2925	\$ 3003	\$ 3080	\$ 3158	\$ 3234	\$ 3313	\$ 3390	\$ 3468	\$ 3546	\$ 3622
<b>RELATE WORK STOOL</b> — Pages <a href="#">130-133</a>														
RLS-MHP	\$ 3112	\$ 3141	\$ 3172	\$ 3219	\$ 3269	\$ 3315	\$ 3364	\$ 3415	\$ 3461	\$ 3511	\$ 3557	\$ 3608	\$ 3657	\$ 3703
RLS-MHA	\$ 2827	\$ 2856	\$ 2887	\$ 2934	\$ 2984	\$ 3030	\$ 3079	\$ 3130	\$ 3176	\$ 3226	\$ 3272	\$ 3323	\$ 3372	\$ 3418
<b>RELATE SIDE</b> — Pages <a href="#">134-137</a>														
RLM-MUGO	\$ 1301	\$ 1342	\$ 1382	\$ 1441	\$ 1497	\$ 1555	\$ 1612	\$ 1669	\$ 1727	\$ 1784	\$ 1841	\$ 1898	\$ 1955	\$ 2014
RLM-UUGO	\$ 1398	\$ 1450	\$ 1504	\$ 1589	\$ 1674	\$ 1759	\$ 1843	\$ 1929	\$ 2013	\$ 2098	\$ 2182	\$ 2267	\$ 2353	\$ 2437
RLM-MUGA	\$ 1237	\$ 1278	\$ 1318	\$ 1377	\$ 1433	\$ 1491	\$ 1548	\$ 1605	\$ 1663	\$ 1720	\$ 1777	\$ 1834	\$ 1891	\$ 1950
RLM-UUGA	\$ 1336	\$ 1388	\$ 1444	\$ 1529	\$ 1615	\$ 1701	\$ 1788	\$ 1873	\$ 1960	\$ 2046	\$ 2131	\$ 2218	\$ 2303	\$ 2389
RLM-MUCO	\$ 1391	\$ 1432	\$ 1472	\$ 1531	\$ 1587	\$ 1645	\$ 1702	\$ 1759	\$ 1817	\$ 1874	\$ 1931	\$ 1988	\$ 2045	\$ 2104
RLM-UUCO	\$ 1484	\$ 1536	\$ 1589	\$ 1674	\$ 1759	\$ 1843	\$ 1928	\$ 2013	\$ 2098	\$ 2183	\$ 2267	\$ 2352	\$ 2436	\$ 2522
RLM-MUCA	\$ 1325	\$ 1366	\$ 1406	\$ 1465	\$ 1521	\$ 1579	\$ 1636	\$ 1693	\$ 1751	\$ 1808	\$ 1865	\$ 1922	\$ 1979	\$ 2038
RLM-UUCA	\$ 1421	\$ 1473	\$ 1528	\$ 1613	\$ 1698	\$ 1783	\$ 1867	\$ 1953	\$ 2037	\$ 2122	\$ 2206	\$ 2291	\$ 2377	\$ 2461
<b>RELATE FOUR-LEGGED STOOL</b> — Pages <a href="#">138-139</a>														
RLC-MUGO	\$ 1793	\$ 1834	\$ 1874	\$ 1933	\$ 1989	\$ 2047	\$ 2104	\$ 2161	\$ 2219	\$ 2276	\$ 2333	\$ 2390	\$ 2447	\$ 2506
RLC-UUGO	\$ 1879	\$ 1928	\$ 1981	\$ 2064	\$ 2146	\$ 2229	\$ 2312	\$ 2394	\$ 2475	\$ 2558	\$ 2641	\$ 2721	\$ 2804	\$ 2888
RLC-MUGA	\$ 1730	\$ 1771	\$ 1811	\$ 1870	\$ 1926	\$ 1984	\$ 2041	\$ 2098	\$ 2156	\$ 2213	\$ 2270	\$ 2327	\$ 2384	\$ 2443
RLC-UUGA	\$ 1815	\$ 1865	\$ 1917	\$ 2000	\$ 2082	\$ 2165	\$ 2248	\$ 2331	\$ 2411	\$ 2494	\$ 2577	\$ 2659	\$ 2741	\$ 2824
RLC-WUGA	\$ 1772	\$ 1813	\$ 1853	\$ 1912	\$ 1968	\$ 2026	\$ 2083	\$ 2140	\$ 2198	\$ 2255	\$ 2312	\$ 2369	\$ 2426	\$ 2485
<b>SEEK</b> — Pages <a href="#">140-143</a>														
K-MUGO	\$ 1409	\$ 1432	\$ 1455	\$ 1484	\$ 1514	\$ 1543	\$ 1571	\$ 1601	\$ 1630	\$ 1659	\$ 1688	\$ 1717	\$ 1747	\$ 1776
K-MUCO	\$ 1432	\$ 1455	\$ 1478	\$ 1507	\$ 1537	\$ 1566	\$ 1594	\$ 1624	\$ 1653	\$ 1682	\$ 1711	\$ 1740	\$ 1770	\$ 1799
K-MUGA	\$ 1354	\$ 1377	\$ 1400	\$ 1429	\$ 1459	\$ 1488	\$ 1516	\$ 1546	\$ 1575	\$ 1604	\$ 1633	\$ 1662	\$ 1692	\$ 1721
K-MUCA	\$ 1379	\$ 1402	\$ 1425	\$ 1454	\$ 1484	\$ 1513	\$ 1541	\$ 1571	\$ 1600	\$ 1629	\$ 1658	\$ 1687	\$ 1717	\$ 1746
K-PUGO	\$ 1199	\$ 1222	\$ 1245	\$ 1274	\$ 1304	\$ 1333	\$ 1361	\$ 1391	\$ 1420	\$ 1449	\$ 1478	\$ 1507	\$ 1537	\$ 1566
K-PUCO	\$ 1222	\$ 1245	\$ 1268	\$ 1297	\$ 1327	\$ 1356	\$ 1384	\$ 1414	\$ 1443	\$ 1472	\$ 1501	\$ 1530	\$ 1560	\$ 1589
K-PUGA	\$ 1146	\$ 1169	\$ 1192	\$ 1221	\$ 1251	\$ 1280	\$ 1308	\$ 1338	\$ 1367	\$ 1396	\$ 1425	\$ 1454	\$ 1484	\$ 1513
K-PUCA	\$ 1168	\$ 1191	\$ 1214	\$ 1243	\$ 1273	\$ 1302	\$ 1330	\$ 1360	\$ 1389	\$ 1418	\$ 1447	\$ 1476	\$ 1506	\$ 1535
<b>SVELTE</b> — Pages <a href="#">145-147</a>														
SV2HPNO	\$ 1629	\$ 1676	\$ 1723	\$ 1770	\$ 1829	\$ 1888	\$ 1946	\$ 2005	\$ 2064	\$ 2123	\$ 2182	\$ 2241	\$ 2300	\$ 2359
SV2HCNO	\$ 1855	\$ 1902	\$ 1949	\$ 1996	\$ 2055	\$ 2114	\$ 2172	\$ 2231	\$ 2290	\$ 2349	\$ 2408	\$ 2467	\$ 2526	\$ 2585
SV2MPNO	\$ 1592	\$ 1639	\$ 1686	\$ 1733	\$ 1792	\$ 1851	\$ 1909	\$ 1968	\$ 2027	\$ 2086	\$ 2145	\$ 2204	\$ 2263	\$ 2322
SV2MCNO	\$ 1818	\$ 1865	\$ 1912	\$ 1959	\$ 2018	\$ 2077	\$ 2135	\$ 2194	\$ 2253	\$ 2312	\$ 2371	\$ 2430	\$ 2489	\$ 2548

GRADES 9-22 PRICING

Social Collaborative is Allsteel's answer for teaming spaces, areas outside of the primary workstation where workers can go to collaborate and be productive.

Jetty:Mod™ pages 173-208

## Seating & Ottomans

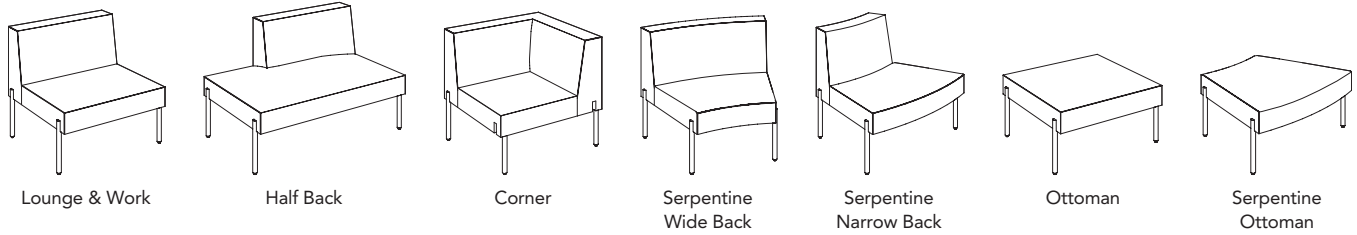

## Arms & Endcaps

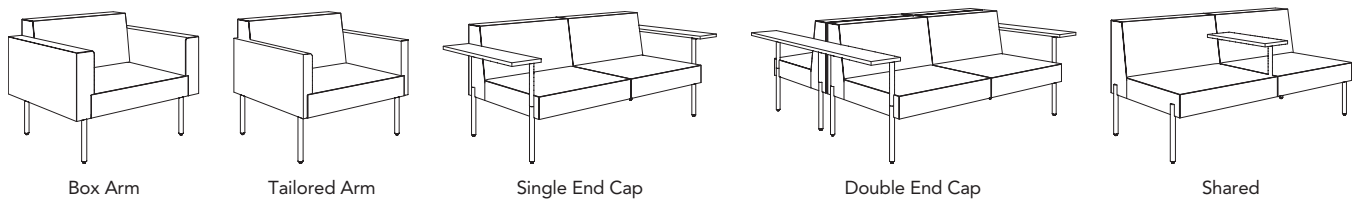

## Tables

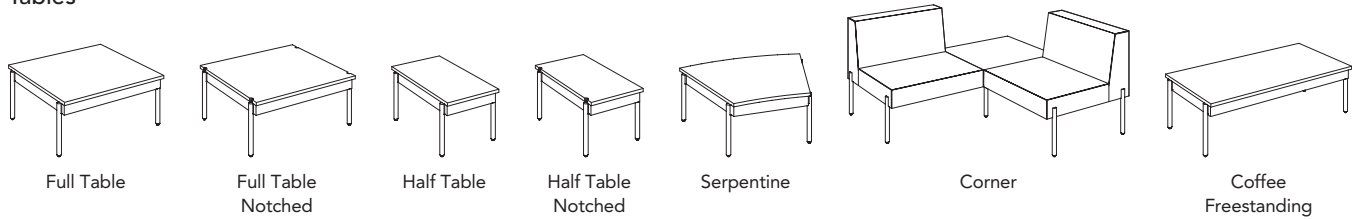

## Screens

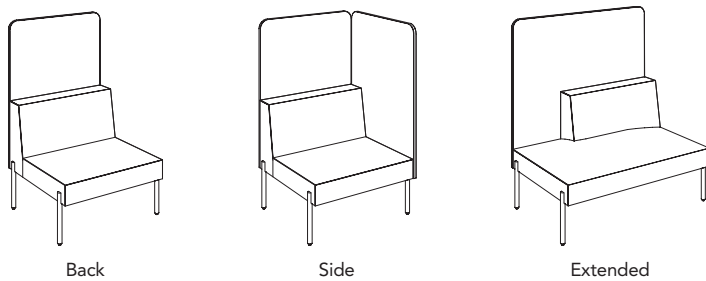

## Accessories

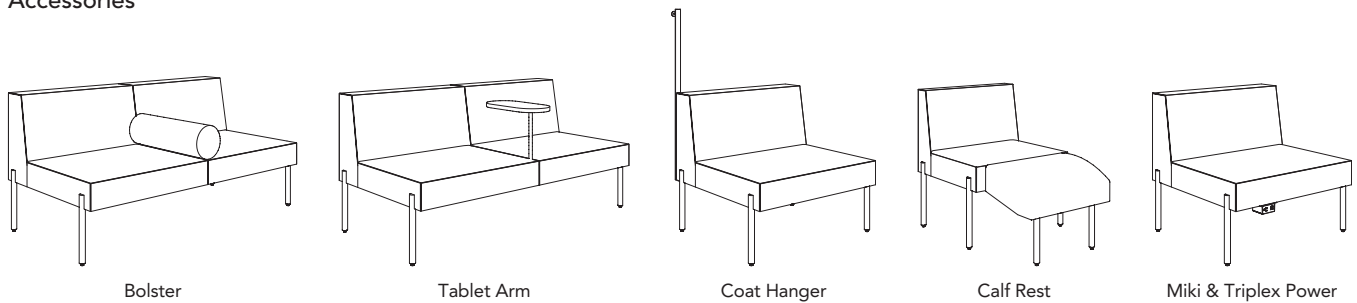

NOTE: All options shown in the statement of line are available on lounge (30 x 30) and work (24 x 24) models



Townhall™ Peak™ page 212

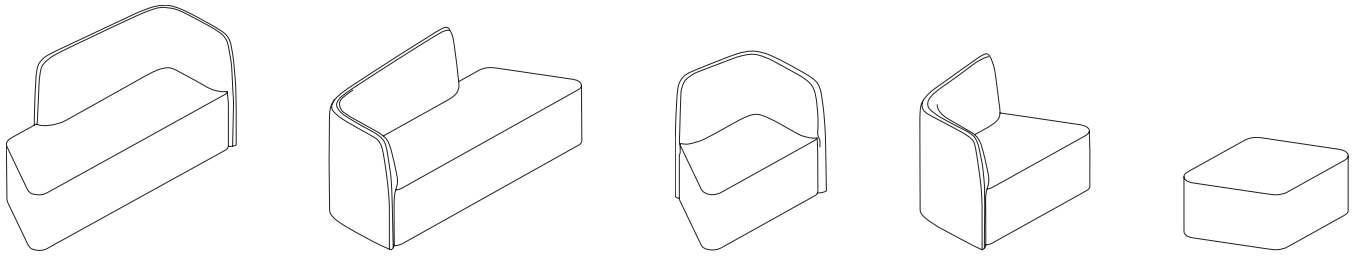

Townhall™ Cloud™ page 215

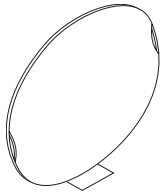

Townhall™ Rock™ pages 216-217

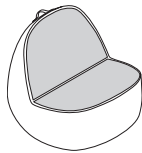

Townhall™ Wedge™ pages 218-219

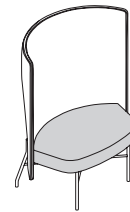

Townhall™ Picnic™ pages 220-221

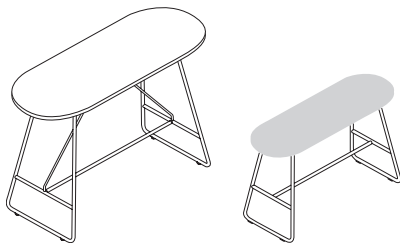

Townhall™ Summit™ page 224



**Park™** by Norm Architects pages 225-236

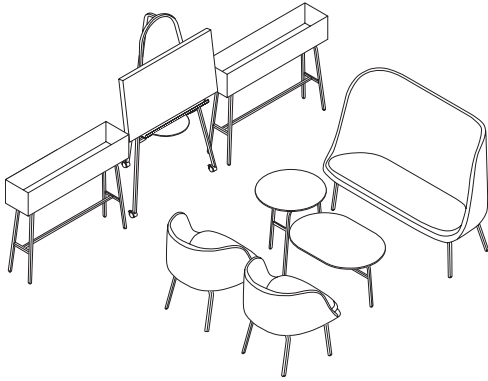

**Recharge** pages 237-253

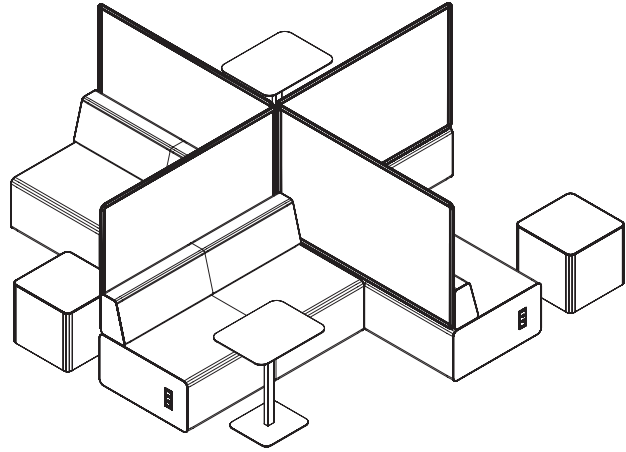

**Rise™** pages 254-265

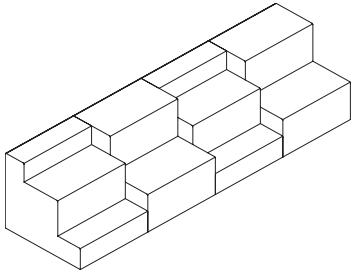

**Retreat™ Lounge** pages 268-271

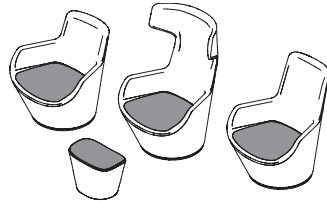

**Retreat™ Executive / Conference**  
pages 272-273



**Parallel™** pages 274-282

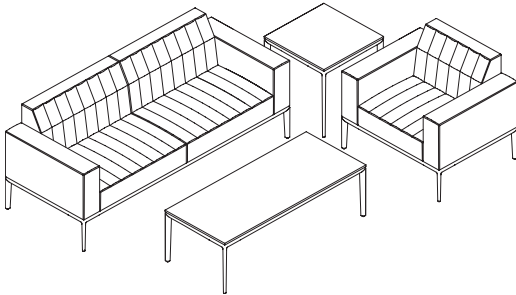

**Two Thirds** pages 284-295

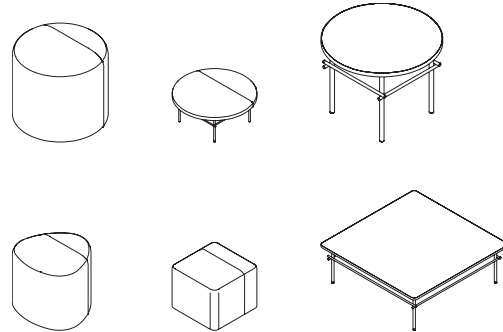

**Vicinity™ Lounge** pages [296-299](#)



**Co|Ho™** pages [300-301](#)



**Linger™** pages [302-305](#)



**Reflect™** pages [306-309](#)

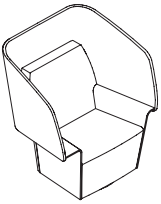

**Clubhouse™** pages [310-323](#)

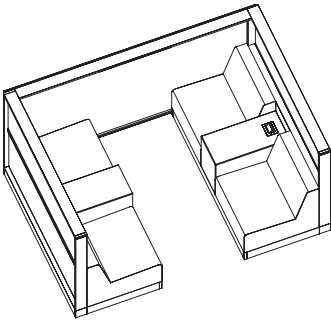

**Involve® for additional soft seating** —  
see Casegoods & Storage Price List pages [285-286](#)

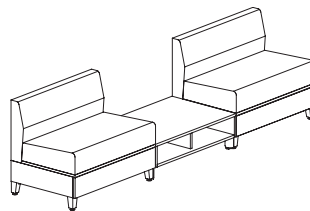



# Seating

- Available upholstery option
- RR: railroaded, F/FR: Fire compliant model

Pattern Name	Code	Supplier	Grade	Clubhouse - Front Board/Back Board/Storage	Clubhouse - Seating/ Consoles	Hedge - no CAL 133	Jetty/Mod	Linger Seat	Linger Side	Parallel	Park Collection Seat MDS 10272	Park Collection Shell MDS 10272
Parker	1054	HBF Textiles	3	•	•	•	•	•	•	•	•	•
Blink	1048	HBF Textiles	4	F	F	•	•	F	F	F	F	F
Look-See	1044	HBF Textiles	4	F	F	F	•	F	F	F	F	F
Walkabout	1046	HBF Textiles	4	F	F	•	•	F	F	F	•	•
Against the Grain	AGG	HBF Textiles	5	•	•	F	•	F	F	F	•	•
Caddy Corner	1016	HBF Textiles	5	•	•	•	•	•	•	•	•	•
Checkmate	1043	HBF Textiles	5	F	F	•	•	F	F	F	•	•
Pebbled	SHBFPEB	HBF Textiles	5	•	•	•	•	•	•	•	•	•
Picnic Plaid	1029	HBF Textiles	5	•	•	•	•	•	•	•	•	•
Upbeat	1036	HBF Textiles	5	•	•	•	•	•	•	•	•	•
Zippy	1045	HBF Textiles	5	F	F	•	•	F	F	F	•	•
Poppy	1047	HBF Textiles	6	F	F	•	•	F	F	F	•	•
Crew Cut	SHBFCRW	HBF Textiles	7	•	•	•	•	•	•	•	•	•
Happy Camper	1028	HBF Textiles	7	•	•	•	•	•	•	•	•	•
Honest	SHBFHON	HBF Textiles	7	•	•	•	•	•	•	•	•	•
Roundabout	1005	HBF Textiles	7	•	•	•	•	•	•	•	•	•
Beetle	SHBFBEE	HBF Textiles	8	•	•	•	•	•	•	•	•	•
Dashing	1008	HBF Textiles	8	•	•	•	•	•	•	•	•	•
Fourfold	SHBFFOU	HBF Textiles	8	•	•	•	•	•	•	•	•	•
Modern Tweed	SHBFMOD	HBF Textiles	8	•	•	•	•	•	•	•	•	•
Sherpa	1031	HBF Textiles	8	•	•	•	•	•	•	•	•	•
All Terrain	1027	HBF Textiles	9	•	•	•	•	•	•	•	•	•
Comfort Zone	905	HBF Textiles	9	•	•	•	•	•	•	•	•	•
Crafted Felt	1017	HBF Textiles	9	•	•	•	•	•	•	•	•	•
Curtain Wall	1023	HBF Textiles	9	•	•	•	•	•	•	•	•	•
High Rise	SHBFHIG	HBF Textiles	9	•	•	F	•	•	•	F	•	•
Madam Dottie	1001	HBF Textiles	9	•	•	•	•	•	•	•	•	•
Scribble XS	982	HBF Textiles	9	•	•	•	•	•	•	•	•	•
Uptown	1039	HBF Textiles	9	•	•	•	•	•	•	•	•	•
Wabi Sabi	SHBFWAB	HBF Textiles	9	•	•	•	•	•	•	•	•	•
Color Code	998	HBF Textiles	10	•	•	•	•	•	•	•	•	•
Digital Bloom 2.0	1050	HBF Textiles	10	•	•	•	•	•	•	•	•	•
Equation	SHBFEQU	HBF Textiles	10	•	•	F	•	F	F	F	•	•
Folded Lines	973	HBF Textiles	10	•	•	•	•	•	•	•	•	•
Remember	SHBFREM	HBF Textiles	10	•	•	•	•	•	•	•	•	•
Roy's Cords	1025	HBF Textiles	10	•	•	•	•	•	•	•	•	•
Soft Angles 2.0	1051	HBF Textiles	10	•	•	•	•	•	•	•	•	•
Upscale	1040	HBF Textiles	10	•	•	•	•	•	•	•	•	•
Air Mail	1006	HBF Textiles	11	•	•	•	•	•	•	•	•	•
Argyle Boucle	978	HBF Textiles	11	•	•	•	•	•	•	•	•	•
Brushed Canvas	SHBFBCV	HBF Textiles	11	•	•	•	•	•	•	•	•	•
Cloud	SHBFCLD	HBF Textiles	11	•	•	•	•	•	•	•	•	•
Abito	ABI	HBF Textiles	12	•	•	F	•	F	F	•	•	•
Belgian Meadow	SHBFBLM	HBF Textiles	12	•	•	•	•	•	•	•	•	•
Complex	964	HBF Textiles	12	•	•	•	•	•	•	•	•	•
Crosstweed	991	HBF Textiles	12	•	•	•	•	•	•	•	•	•
Cutout	SHBFCUT	HBF Textiles	12	•	•	•	•	•	•	•	•	•
Dot Grid	975	HBF Textiles	12	•	•	•	•	•	•	•	•	•
Dot Structure	SHBFDOT	HBF Textiles	12	•	•	•	•	•	•	•	•	•
Glint	SHBFGLT	HBF Textiles	12	•	•	•	•	•	•	•	•	•
Grateful Grid	1015	HBF Textiles	12	•	•	•	•	•	•	•	•	•
Heartfelt	SHBFHTF	HBF Textiles	12	F	F	•	•	F	F	F	•	•
Lava Rock	993	HBF Textiles	12	•	•	•	•	•	•	•	•	•
Merci Boucle	SHBFMER	HBF Textiles	12	•	•	•	•	•	•	•	•	•
Moving Blanket	SHBFMOV	HBF Textiles	12	•	•	•	•	•	•	•	•	•
Sable Island	SHBFSAB	HBF Textiles	12	•	•	•	•	•	•	•	•	•
Sir Stripe A Lot	1004	HBF Textiles	12	•	•	•	•	•	•	•	•	•

UPHOLSTERY

# Seating

- Available upholstery option
- RR: railroaded, F/FR: Fire compliant model

Pattern Name	Code	Supplier	Grade	Clubhouse - Front Board/Back Board/Storage	Clubhouse - Seating/ Consoles	Hedge - no CAL 133	Jetty/Mod	Linger Seat	Linger Side	Parallel	Park Collection Seat MDS 10272	Park Collection Shell MDS 10272
Sweater Weather	1030	HBF Textiles	12	•	•	•	•	•	•	•	•	•
Twist	SHBFTWS	HBF Textiles	12		•							•
Upstart	1042	HBF Textiles	12	•	•	•	•	•	•	•	•	•
Cherished Knit	954	HBF Textiles	13	•	•	•	•	•	•	•	•	•
Enriched Boucle	1021	HBF Textiles	13	•	•	•	•		•	•	•	•
Foundation	SHBFFND	HBF Textiles	13	•	•	•	•	•	•	•	•	•
Moving Forward	1014	HBF Textiles	13	•	•	•	•	•	•	•	•	
Night Earth	1013	HBF Textiles	13	•	•	•	•	•	•	•	•	•
Pepper Blend	995	HBF Textiles	13	•	•	•	•	•	•	•	•	•
Quill	1011	HBF Textiles	13	•	•	•	•	•	•	•	•	•
Scribble XL	983	HBF Textiles	13	•	•	•	•	•	•	•	•	•
Sister Solid	1003	HBF Textiles	13	•	•	•	•	•	•	•	•	•
Afghan	AFG	HBF Textiles	14	•	•	•	•		•	•	•	•
Smart	SHBFSMT	HBF Textiles	14	•	•	•	•	•	•	•	•	•
Velvet Mix	977	HBF Textiles	14	•	•	•	•	•	•	•	•	
Hipster	SHBFHPT	HBF Textiles	15		•	•	•	•	•	•		
Landscape Blur	1024	HBF Textiles	15	•	•	•	•		•		•	
Poodle	1009	HBF Textiles	16	•	•	•	•	•	•	•	•	•
Sweater	SHBFSWE	HBF Textiles	16	•	•	•	•		•	•	•	•
Woven Memory	1019	HBF Textiles	16	•	•	•	•		•		•	
Crafted Cloud	1018	HBF Textiles	19	•	•	•	•		•		•	
Knitwork	SHBFKNI	HBF Textiles	21			•					•	•
Bunny	1012	HBF Textiles	23	•	•	•	•	•	•	•	•	•
Eccentric	966	HBF Textiles	23	•	•	•	•	•	•	•	•	•
Eccentric	SHBFEC	HBF Textiles	23	•	•	•	•	•	•	•	•	•
Wild West	717	HBF Textiles	L2	•					•	•	•	
Aviator	SHBFAVI	HBF Textiles	L3		•			•	•	•		
Free Way	SHBFFRE	HBF Textiles	L3					F	F	•		
Modern Patina	716	HBF Textiles	L3	•				•		•	•	
Persuede	718	HBF Textiles	L3	•				•		•	•	
Vivace II	709	HBF Textiles	L3							•		
Upper Crust	708	HBF Textiles	L5							•		
Voyage	713	HBF Textiles	L5							•		

UPHOLSTERY

# Seating

- Available upholstery option
- RR: railroaded, F/FR: Fire compliant model

Pattern Name	Code	Supplier	Grade	Peak Back MDS 10269	Peak Seat MDS 10269	Peak Single Upholstery MDS 10269	Peak Welt MDS 10269	Peak Ottoman MDS 10269	Picnic Upholstered Seating MDS 10269	Recharge Pouf - Seat, Side, Welt	Recharge Bolster	Recharge Bolster Welt	Recharge Seat - NO RR	Reflect Seat (Seat and Back)
Parker	1054	HBF Textiles	3	•	•	•	•	•	•	•	•	•	•	•
Blink	1048	HBF Textiles	4		F		F	F	F	F	F	F	F	F
Look-See	1044	HBF Textiles	4	F	F	F	F	F	F	F	F	F	F	F
Walkabout	1046	HBF Textiles	4		•		•	•	•	•	•	•	•	•
Against the Grain	AGG	HBF Textiles	5		•		•	•	•	•	•	•	•	•
Caddy Corner	1016	HBF Textiles	5	•	•	•	•	•	•	•	•	•	•	•
Checkmate	1043	HBF Textiles	5	•	•	•	•	•	•	F	F	F	F	F
Pebbled	SHBFPEB	HBF Textiles	5	•	•	•	•	•	•	•	•	•	•	•
Picnic Plaid	1029	HBF Textiles	5	•	•	•	•	•	•	•	•	•	•	•
Upbeat	1036	HBF Textiles	5	•	•	•	•	•	•	•	•	•	•	•
Zippy	1045	HBF Textiles	5	•	•	•	•	•	•	•	•	•	•	•
Poppy	1047	HBF Textiles	6	•	•	•	•	•	•	F	F	F	F	F
Crew Cut	SHBFCRW	HBF Textiles	7	•	•	•	•	•	•	•	•	•	•	•
Happy Camper	1028	HBF Textiles	7	•	•	•	•	•	•	•	•	•	•	•
Honest	SHBFHON	HBF Textiles	7	•	•	•	•	•	•	•	•	•	•	•
Roundabout	1005	HBF Textiles	7		•		•	•	•	•	•	•	•	•
Beetle	SHBFBEE	HBF Textiles	8		•		•	•	•	•	•	•	•	•
Dashing	1008	HBF Textiles	8	•	•	•	•	•	•	•	•	•	•	•
Fourfold	SHBFFOU	HBF Textiles	8						•	•	•	•	•	•
Modern Tweed	SHBFMOD	HBF Textiles	8		•		•	•	•	•	•	•	•	•
Sherpa	1031	HBF Textiles	8	•	•	•	•	•	•	•	•	•	•	•
All Terrain	1027	HBF Textiles	9	•	•	•	•	•	•	•	•	•	•	•
Comfort Zone	905	HBF Textiles	9	•	•	•	•	•	•	•	•	•	•	•
Crafted Felt	1017	HBF Textiles	9	•	•	•	•	•	•	•	•	•	•	•
Curtain Wall	1023	HBF Textiles	9	•	•	•	•	•	•	•	•	•	•	•
High Rise	SHBFHIG	HBF Textiles	9		•		•	•	•	•	•	•	•	•
Madam Dottie	1001	HBF Textiles	9	•	•	•	•	•	•	•	•	•	•	•
Scribble XS	982	HBF Textiles	9	•	•	•	•	•	•	•	•	•	•	•
Uptown	1039	HBF Textiles	9	•	•	•	•	•	•	•	•	•	•	•
Wabi Sabi	SHBFWAB	HBF Textiles	9		•		•	•	•	•	•	•	•	•
Color Code	998	HBF Textiles	10	•	•	•	•	•	•	•	•	•	•	•
Digital Bloom 2.0	1050	HBF Textiles	10	•	•	•	•	•	•	•	•	•	•	•
Equation	SHBFQU	HBF Textiles	10		•		•	•	•	•	•	•	•	•
Folded Lines	973	HBF Textiles	10	•	•	•	•	•	•	•	•	•	•	•
Remember	SHBFREM	HBF Textiles	10		•		•	•	•	•	•	•	•	•
Roy's Cords	1025	HBF Textiles	10		•		•	•	•	•	•	•	•	•
Soft Angles 2.0	1051	HBF Textiles	10	•	•	•	•	•	•	•	•	•	•	•
Upscale	1040	HBF Textiles	10	•	•	•	•	•	•	•	•	•	•	•
Air Mail	1006	HBF Textiles	11	•	•	•	•	•	•	•	•	•	•	•
Argyle Boucle	978	HBF Textiles	11	•	•	•	•	•	•	•	•	•	•	•
Brushed Canvas	SHBFBCV	HBF Textiles	11	•	•	•	•	•	•	•	•	•	•	•
Cloud	SHBFCLD	HBF Textiles	11		•		•	•	•	•	•	•	•	•
Abito	ABI	HBF Textiles	12		•		•	•	•	•	•	•	•	•
Belgian Meadow	SHBFBLM	HBF Textiles	12	•	•	•	•	•	•	•	•	•	•	•
Complex	964	HBF Textiles	12	•	•	•	•	•	•	•	•	•	•	•
Crosstweed	991	HBF Textiles	12	•	•	•	•	•	•	•	•	•	•	•
Cutout	SHBFCUT	HBF Textiles	12		•		•	•	•	•	•	•	•	•
Dot Grid	975	HBF Textiles	12	•	•	•	•	•	•	•	•	•	•	•
Dot Structure	SHBFDOT	HBF Textiles	12	•	•	•	•	•	•	•	•	•	•	•
Glint	SHBFGLT	HBF Textiles	12		•		•	•	•	•	•	•	•	•
Grateful Grid	1015	HBF Textiles	12	•	•	•	•	•	•	•	•	•	•	•
Heartfelt	SHBFHTF	HBF Textiles	12	•	•	•	•	•	•	•	•	•	•	•
Lava Rock	993	HBF Textiles	12	•	•	•	•	•	•	•	•	•	•	•
Merci Boucle	SHBFMER	HBF Textiles	12	•	•	•	•	•	•	•	•	•	•	•
Moving Blanket	SHBFMOV	HBF Textiles	12		•		•	•	•	•	•	•	•	•
Sable Island	SHBFSAB	HBF Textiles	12		•		•	•	•	•	•	•	•	•
Sir Stripe A Lot	1004	HBF Textiles	12	•	•	•	•	•	•	•	•	•	•	•

UPHOLSTERY

# Seating

- Available upholstery option
- RR: railroaded, F/FR: Fire compliant model

Pattern Name	Code	Supplier	Grade	Peak Back MDS 10269	Peak Seat MDS 10269	Peak Single Upholstery MDS 10269	Peak Welt MDS 10269	Peak Ottoman MDS 10269	Picnic Upholstered Seating MDS 10269	Recharge Pouf - Seat, Side, Welt	Recharge Bolster	Recharge Bolster Welt	Recharge Seat - NO RR	Reflect Seat (Seat and Back)
Sweater Weather	1030	HBF Textiles	12	•	•	•	•	•	•	•	•	•	•	•
Twist	SHBFTWS	HBF Textiles	12											
Upstart	1042	HBF Textiles	12	•	•	•	•	•	•	•	•	•	•	•
Cherished Knit	954	HBF Textiles	13	•	•	•	•	•	•	•	•	•	•	•
Enriched Boucle	1021	HBF Textiles	13	•	•	•	•	•	•	•	•	•	•	•
Foundation	SHBFFND	HBF Textiles	13											
Moving Forward	1014	HBF Textiles	13	•	•	•	•	•	•	•	•	•	•	•
Night Earth	1013	HBF Textiles	13	•	•	•	•	•	•	•	•	•	•	•
Pepper Blend	995	HBF Textiles	13	•	•	•	•	•	•	•	•	•	•	•
Quill	1011	HBF Textiles	13	•	•	•	•	•	•	•	•	•	•	•
Scribble XL	983	HBF Textiles	13	•	•	•	•	•	•	•	•	•	•	•
Sister Solid	1003	HBF Textiles	13	•	•	•	•	•	•	•	•	•	•	•
Afghan	AFG	HBF Textiles	14		•		•		•		•		•	
Smart	SHBFSMT	HBF Textiles	14		•		•		•		•		•	
Velvet Mix	977	HBF Textiles	14	•	•	•	•	•	•	•	•	•	•	•
Hipster	SHBFHPT	HBF Textiles	15		•		•		•		•		•	
Landscape Blur	1024	HBF Textiles	15		•		•		•		•		•	
Poodle	1009	HBF Textiles	16	•	•	•	•	•	•	•	•	•	•	•
Sweater	SHBFSWE	HBF Textiles	16	•	•	•	•	•	•	•	•	•	•	•
Woven Memory	1019	HBF Textiles	16	•	•	•	•	•	•	•	•	•	•	•
Crafted Cloud	1018	HBF Textiles	19	•	•	•	•	•	•	•	•	•	•	•
Knitwork	SHBFKNI	HBF Textiles	21	•	•	•	•	•	•	•	•	•	•	•
Bunny	1012	HBF Textiles	23	•	•	•	•	•	•	•	•	•	•	•
Eccentric	966	HBF Textiles	23	•	•	•	•	•	•	•	•	•	•	•
Eccentric	SHBFEC	HBF Textiles	23	•	•	•	•	•	•	•	•	•	•	•
Wild West	717	HBF Textiles	L2	•	•	•	•	•	•	•	•	•	•	•
Aviator	SHBFAVI	HBF Textiles	L3											
Free Way	SHBFFRE	HBF Textiles	L3											
Modern Patina	716	HBF Textiles	L3	•	•	•	•	•	•	•	•	•	•	•
Persuede	718	HBF Textiles	L3	•	•	•	•	•	•	•	•	•	•	•
Vivace II	709	HBF Textiles	L3											
Upper Crust	708	HBF Textiles	L5											
Voyage	713	HBF Textiles	L5											

UPHOLSTERY



# Seating

- Available upholstery option
- RR: railroaded, F/FR: Fire compliant model

Pattern Name	Code	Supplier	Grade	Reflect Shell	Retreat Executive Conference Seat	Retreat Executive Conference Back Full Pass (10281)	Retreat Hi/Low/Ottoman Top/Seat	Retreat Hi/Low/Ottoman Side/Body	Retreat WingBack Seat	Retreat WingBack Body	Retreat Hi/Low/Ott LEATHER	Rise Seat	Rise Side	Rise Single Upholstery
Parker	1054	HBF Textiles	3		•	•	•	•						
Blink	1048	HBF Textiles	4	F		F		F					F	
Look-See	1044	HBF Textiles	4	F	F	F	F	F					F	
Walkabout	1046	HBF Textiles	4	•	•	•	•	•					F	
Against the Grain	AGG	HBF Textiles	5		•	•	•	•				F	F	•
Caddy Corner	1016	HBF Textiles	5	•	•	•	•	•	•				•	•
Checkmate	1043	HBF Textiles	5	F	•	•	•	•	•			F	F	•
Pebbled	SHBFPEB	HBF Textiles	5	•	•	•		•				•	•	•
Picnic Plaid	1029	HBF Textiles	5	•	•		•	•					•	
Upbeat	1036	HBF Textiles	5	•	•		•	•						
Zippy	1045	HBF Textiles	5		•	•	•	•				F	F	F
Poppy	1047	HBF Textiles	6		•	•	•	•	•			F	F	•
Crew Cut	SHBFCRW	HBF Textiles	7		•	•	•	•					•	
Happy Camper	1028	HBF Textiles	7	•	•	•	•	•	•				•	
Honest	SHBFHON	HBF Textiles	7		•	•	•	•				•	•	•
Roundabout	1005	HBF Textiles	7		•			•					•	
Beetle	SHBFBEE	HBF Textiles	8		•	•	•	•					•	
Dashing	1008	HBF Textiles	8		•			•					•	
Fourfold	SHBFFOU	HBF Textiles	8		•			•					•	
Modern Tweed	SHBFMOD	HBF Textiles	8		•			•				•	•	•
Sherpa	1031	HBF Textiles	8		•	•	•	•					•	
All Terrain	1027	HBF Textiles	9	•	•	•	•	•					•	•
Comfort Zone	905	HBF Textiles	9		•			•					•	
Crafted Felt	1017	HBF Textiles	9	•	•	•	•	•	•				•	•
Curtain Wall	1023	HBF Textiles	9		•			•					•	
High Rise	SHBFHIG	HBF Textiles	9		•			•				•	F	
Madam Dottie	1001	HBF Textiles	9	•	•			•				•	•	•
Scribble XS	982	HBF Textiles	9		•			•					•	•
Uptown	1039	HBF Textiles	9	•	•			•					•	
Wabi Sabi	SHBFWAB	HBF Textiles	9		•			•					•	
Color Code	998	HBF Textiles	10	•	•			•					•	
Digital Bloom 2.0	1050	HBF Textiles	10		•			•					•	
Equation	SHBFEQU	HBF Textiles	10		•			•				F	F	•
Folded Lines	973	HBF Textiles	10	•	•			•					•	
Remember	SHBFREM	HBF Textiles	10		•			•					•	
Roy's Cords	1025	HBF Textiles	10	•	•			•					•	
Soft Angles 2.0	1051	HBF Textiles	10	•	•	•	•	•	•				•	
Upscale	1040	HBF Textiles	10		•			•					•	
Air Mail	1006	HBF Textiles	11	•	•			•				•	•	•
Argyle Boucle	978	HBF Textiles	11	•	•	•	•	•	•				•	•
Brushed Canvas	SHBFBCV	HBF Textiles	11	•	•	•	•	•	•				•	•
Cloud	SHBFCLD	HBF Textiles	11		•			•					•	
Abito	ABI	HBF Textiles	12	•	•	•	•	•				F	F	•
Belgian Meadow	SHBFBLM	HBF Textiles	12	•	•	•	•	•	•			•	•	•
Complex	964	HBF Textiles	12	•	•	•	•	•					•	
Crosstweed	991	HBF Textiles	12	•	•	•	•	•	•				•	
Cutout	SHBFCUT	HBF Textiles	12		•			•					•	
Dot Grid	975	HBF Textiles	12		•			•					•	
Dot Structure	SHBFDOT	HBF Textiles	12	•	•	•	•	•	•			•	•	•
Glint	SHBFGLT	HBF Textiles	12		•			•						
Grateful Grid	1015	HBF Textiles	12	•	•	•	•	•					•	
Heartfelt	SHBFHTF	HBF Textiles	12	RR F	•	•	F	F	F	F		F	F	•
Lava Rock	993	HBF Textiles	12	•	•	•	•	•	•				•	•
Merci Boucle	SHBFMER	HBF Textiles	12	•	•	•	•	•	•				•	•
Moving Blanket	SHBFMOV	HBF Textiles	12		•			•					•	•
Sable Island	SHBFSAB	HBF Textiles	12		•			•					•	•
Sir Stripe A Lot	1004	HBF Textiles	12		•			•					•	•

UPHOLSTERY

# Seating

- Available upholstery option
- RR: railroaded, F/FR: Fire compliant model

Pattern Name	Code	Supplier	Grade	Reflect Shell	Retreat Executive Conference Seat	Retreat Executive Conference Seat Full Pass (10281)	Retreat Hi/Low/Ottoman Back	Retreat Hi/Low/Ottoman Top/Seat	Retreat WingBack Side/Body	Retreat WingBack Seat	Retreat WingBack Body	Retreat Hi/Low/Ott LEATHER	Rise Seat	Rise Side	Rise Single Upholstery
Sweater Weather	1030	HBF Textiles	12	•	•	•	•	•	•	•			•		
Twist	SHBFTWS	HBF Textiles	12	•	•	•	•	•	•	•			•		
Upstart	1042	HBF Textiles	12	•	•	•	•	•	•	•			•	•	•
Cherished Knit	954	HBF Textiles	13	•	•	•	•	•	•	•			•	•	•
Enriched Boucle	1021	HBF Textiles	13		•	•	•	•	•	•			•	•	•
Foundation	SHBFFND	HBF Textiles	13	•	•	•	•	•	•	•			•	•	•
Moving Forward	1014	HBF Textiles	13	•	•	•	•	•	•	•			•	•	•
Night Earth	1013	HBF Textiles	13	•	•	•	•	•	•	•			•	•	•
Pepper Blend	995	HBF Textiles	13	•	•	•	•	•	•	•			•	•	•
Quill	1011	HBF Textiles	13	•	•	•	•	•	•	•			•	•	•
Scribble XL	983	HBF Textiles	13		•	•	•	•	•	•			•	•	•
Sister Solid	1003	HBF Textiles	13	•	•	•	•	•	•	•			•	•	•
Afghan	AFG	HBF Textiles	14	•	•	•	•	•	•	•			•		
Smart	SHBFSMT	HBF Textiles	14		•	•	•	•	•	•			•	•	•
Velvet Mix	977	HBF Textiles	14		•	•	•	•	•	•			•		
Hipster	SHBFHPT	HBF Textiles	15		•	•	•	•	•	•			•		
Landscape Blur	1024	HBF Textiles	15		•	•	•	•	•	•			•		
Poodle	1009	HBF Textiles	16	•	•	•	•	•	•	•			•	•	•
Sweater	SHBFSWE	HBF Textiles	16	•	•	•	•	•	•	•			•		
Woven Memory	1019	HBF Textiles	16		•	•	•	•	•	•			•		
Crafted Cloud	1018	HBF Textiles	19		•	•	•	•	•	•			•		
Knitwork	SHBFKNI	HBF Textiles	21		•	•	•	•	•	•			•	•	•
Bunny	1012	HBF Textiles	23	•	•	•	•	•	•	•			•		
Eccentric	966	HBF Textiles	23		•	•	•	•	•	•			•	•	•
Eccentric	SHBFEC	HBF Textiles	23		•	•	•	•	•	•			•	•	•
Wild West	717	HBF Textiles	L2	•	•	•	•	•	•	•					
Aviator	SHBFAVI	HBF Textiles	L3												
Free Way	SHBFFRE	HBF Textiles	L3												
Modern Patina	716	HBF Textiles	L3	•	•	•	•	•	•	•					
Persuede	718	HBF Textiles	L3	•	•	•	•	•	•	•					
Vivace II	709	HBF Textiles	L3			•	•	•	•	•					
Upper Crust	708	HBF Textiles	L5			•	•	•	•	•					
Voyage	713	HBF Textiles	L5			•	•	•	•	•					

UPHOLSTERY

# Seating

- Available upholstery option
- RR: railroaded, F/FR: Fire compliant model

Pattern Name	Code	Supplier	Grade	Rock - Cushions MDS 10269	Rock - Shell/Body MDS 10269	Rock Single Upholstery MDS 10269	Summit	Take 5	Two Thirds Pouf	Wedge Seat MDS 10269	Wedge Back MDS 10270	Wedge Single Upholstery MDS 10269
Parker	1054	HBF Textiles	3	•	•	•						
Blink	1048	HBF Textiles	4	F					F	F	F	F
Look-See	1044	HBF Textiles	4	F	F	F	F		F	F	F	F
Walkabout	1046	HBF Textiles	4	•				F	•	•	•	•
Against the Grain	AGG	HBF Textiles	5	•	•	•	•	F		•	•	•
Caddy Corner	1016	HBF Textiles	5	•	•	•	•		•	•	•	•
Checkmate	1043	HBF Textiles	5	•	•	•		F	•	•	•	•
Pebbled	SHBFPEB	HBF Textiles	5	•	•	•	•		•			
Picnic Plaid	1029	HBF Textiles	5	•			•	•	•	•		
Upbeat	1036	HBF Textiles	5	•	•	•			•	•	•	•
Zippy	1045	HBF Textiles	5	•				F	•	•	•	•
Poppy	1047	HBF Textiles	6	•	•	•	F		•	•	•	•
Crew Cut	SHBFCRW	HBF Textiles	7	•					•	•	•	•
Happy Camper	1028	HBF Textiles	7	•	•	•	•	•	•	•	•	•
Honest	SHBFHON	HBF Textiles	7	•	•	•	•	•	•			
Roundabout	1005	HBF Textiles	7	•			•	•	•			
Beetle	SHBFBEE	HBF Textiles	8	•	•	•	•	•	•	•	•	•
Dashing	1008	HBF Textiles	8	•				•	•	•		
Fourfold	SHBFFOU	HBF Textiles	8	•				•	•	•		
Modern Tweed	SHBFMOD	HBF Textiles	8	•					•	•		
Sherpa	1031	HBF Textiles	8	•			•	•	•	•	•	•
All Terrain	1027	HBF Textiles	9	•	•	•		•	•	•		
Comfort Zone	905	HBF Textiles	9	•					•	•		
Crafted Felt	1017	HBF Textiles	9	•	•	•	•	•	•	•	•	•
Curtain Wall	1023	HBF Textiles	9	•				•	•	•		
High Rise	SHBFHIG	HBF Textiles	9					F	•			
Madam Dottie	1001	HBF Textiles	9	•	•	•	•	•	•	•		
Scribble XS	982	HBF Textiles	9	•					•	•	•	
Uptown	1039	HBF Textiles	9	•				•	•	•		
Wabi Sabi	SHBFWAB	HBF Textiles	9	•						•		
Color Code	998	HBF Textiles	10	•			•	•	•	•		
Digital Bloom 2.0	1050	HBF Textiles	10	•				•	•	•	•	
Equation	SHBFEQU	HBF Textiles	10	•	•	•		F	•	•	•	•
Folded Lines	973	HBF Textiles	10	•				•	•	•		
Remember	SHBFREM	HBF Textiles	10	•					•	•		
Roy's Cords	1025	HBF Textiles	10	•				•	•	•		
Soft Angles 2.0	1051	HBF Textiles	10	•				•	•	•	•	•
Upscale	1040	HBF Textiles	10	•			•	•	•	•		
Air Mail	1006	HBF Textiles	11	•			•	•	•	•		
Argyle Boucle	978	HBF Textiles	11	•	•	•	•	•	•	•		
Brushed Canvas	SHBFBCV	HBF Textiles	11	•	•	•			•	•		
Cloud	SHBFCLD	HBF Textiles	11	•					•	•	•	•
Abito	ABI	HBF Textiles	12	•			•	F	•	•		
Belgian Meadow	SHBFBLM	HBF Textiles	12	•			•	•	•	•	•	•
Complex	964	HBF Textiles	12	•			•	•	•	•	•	•
Crosstweed	991	HBF Textiles	12	•	•	•	•	•	•	•	•	•
Cutout	SHBFCUT	HBF Textiles	12	•				•	•	•		
Dot Grid	975	HBF Textiles	12	•				•	•	•		
Dot Structure	SHBFDOT	HBF Textiles	12	•				•	•	•	•	•
Glint	SHBFGLT	HBF Textiles	12	•					•	•		
Grateful Grid	1015	HBF Textiles	12	•			•	•	•	•	•	•
Heartfelt	SHBFHTF	HBF Textiles	12	•	•	•	•	F	•	•	•	•
Lava Rock	993	HBF Textiles	12	•	•	•	•	•	•	•	•	•
Merci Boucle	SHBFMER	HBF Textiles	12	•	•	•	•	•	•	•	•	•
Moving Blanket	SHBFMOV	HBF Textiles	12	•				•	•			
Sable Island	SHBFSAB	HBF Textiles	12	•								
Sir Stripe A Lot	1004	HBF Textiles	12	•				•	•	•		

UPHOLSTERY

# Seating

- Available upholstery option
- RR: railroaded, F/FR: Fire compliant model

Pattern Name	Code	Supplier	Grade	Rock - Cushions MDS 10269	Rock - Shell/Body MDS 10269	Rock Single Upholstery MDS 10269	Summit	Take 5	Two Thirds Pouf	Wedge Seat MDS 10269	Wedge Back MDS 10270	Wedge Single Upholstery MDS 10269
Sweater Weather	1030	HBF Textiles	12	•			•	•	•	•	•	•
Twist	SHBFTWS	HBF Textiles	12	•	•	•			•	•	•	•
Upstart	1042	HBF Textiles	12	•	•	•			•	•	•	•
Cherished Knit	954	HBF Textiles	13	•	•	•	•	•	•	•	•	•
Enriched Boucle	1021	HBF Textiles	13	•	•	•	•	•	•	•	•	•
Foundation	SHBFFND	HBF Textiles	13	•						•		
Moving Forward	1014	HBF Textiles	13	•			•	•	•	•		
Night Earth	1013	HBF Textiles	13	•	•	•	•	•	•	•	•	•
Pepper Blend	995	HBF Textiles	13	•	•	•	•	•	•	•	•	•
Quill	1011	HBF Textiles	13	•	•	•	•	•	•	•	•	•
Scribble XL	983	HBF Textiles	13	•					•	•		
Sister Solid	1003	HBF Textiles	13	•	•	•	•	•	•	•	•	•
Afghan	AFG	HBF Textiles	14	•	•	•		•	•	•	•	•
Smart	SHBFSMT	HBF Textiles	14	•				•	•	•		
Velvet Mix	977	HBF Textiles	14	•				•	•	•		
Hipster	SHBFHPT	HBF Textiles	15					•	•			
Landscape Blur	1024	HBF Textiles	15	•				•	•	•		
Poodle	1009	HBF Textiles	16	•	•	•	•	•	•	•	•	•
Sweater	SHBFSWE	HBF Textiles	16	•	•	•	•		•	•	•	•
Woven Memory	1019	HBF Textiles	16	•				•	•	•		
Crafted Cloud	1018	HBF Textiles	19	•				•	•	•		
Knitwork	SHBFKNI	HBF Textiles	21	•	•	•	•	•	•	•	•	•
Bunny	1012	HBF Textiles	23	•	•	•	•	•	•	•	•	•
Eccentric	966	HBF Textiles	23	•			•	•		•		
Eccentric	SHBFEC	HBF Textiles	23	•			•	•		•		
Wild West	717	HBF Textiles	L2	•				•	•	•		
Aviator	SHBFAVI	HBF Textiles	L3						•			
Free Way	SHBFFRE	HBF Textiles	L3						•			
Modern Patina	716	HBF Textiles	L3	•				•	•	•		
Persuede	718	HBF Textiles	L3	•				•	•	•		
Vivace II	709	HBF Textiles	L3					•	•			
Upper Crust	708	HBF Textiles	L5					•	•			
Voyage	713	HBF Textiles	L5					•	•			

UPHOLSTERY



**LAMINATES**

**GRADE L1 – SOLID**

Black .....	P
Flint .....	LM16
Loft .....	LM11
Designer White.....	LDW1

**GRADE L1 - WOODGRAIN**

Bourbon Cherry .....	H
Field Elm.....	LWFE
Florence Walnut.....	LFW1
Kingswood Walnut .....	LK11
Natural Maple .....	LWD
NeoWalnut .....	LNU1
Shaker Cherry .....	LW7C
Pinnacle.....	PINC

**GRADE L2 – WOODGRAIN**

Beigewood.....	LWBE
Lowell Ash .....	LLA1
Natural Recon .....	LNR1
Portico Teak .....	LPT1
Skyline Walnut.....	LSW1
Veranda Teak .....	LVT1
Fawn Cypress.....	LFC1
Phantom Ecrú .....	LPE1

**EDGE**

Beigewood.....	DE
Black .....	E4
Bourbon Cherry .....	H
Designer White.....	DW
Fawn Cypress.....	FC
Field Elm.....	FE
Flint .....	E9
Florence Walnut.....	FW
Kingswood Walnut .....	K1
Loft.....	EV
Lowell Ash.....	DL
Natural Maple .....	DD
Natural Recon.....	NR
NeoWalnut .....	NU
Phantom Ecrú .....	PE
Portico Teak.....	DP
Shaker Cherry .....	DF
Skyline Walnut.....	SW
Veranda Teak.....	VT
Pinnacle.....	PI

**PAINT**

**GRADE P1**

Textured Salt.....	P8Z
Textured Titanium.....	P8V

**GRADE P2**

Solar Black .....	P8X
-------------------	-----

**NOTE:** Refer to individual product pages for upcharges.

**FSC Certified Wood at Allsteel**  
See page 431 for more information.

Allsteel Seating Upholstery Selections by Model/Series.

Jetty:Mod

**GRADE 1**

Apex	APX	•
Centurion	CU	•
Contourett	UR	•
Dapper	DAPR	•
Ensemble	ENSB	•
Hamilton	HAML	•
Inertia	NR	•
Optic	OP	•

**GRADE 2**

Appoint Seating	PNS	•
Blume	BLME	•
Clyde	CLYD	•
Dotty	DOT	•
Meld	SMHMMLD	•
Rush	RUSH	•
Spin	SPNN	•
Whisper Vinyl	WP	•

**GRADE 3**

Lateral	SCFSLAT	•
Moxie	SX	•
Parker	PRKR	•
Purl	PURL	•
Quill	QUL	•

**GRADE 4**

Blink	1048	•
Caper	SMHMCAP	•
Look-See	1044	•
Manner	SMHMMAN	•
Merit	SMHMMER	•
Messenger	SMHMGRM	•
Metric	SMHMMET	•
Mode	SMHMMOD	•
Multiply	SMHMMLT	•
Murmur	SMHMMUR	•
Muse	SMHMMUS	•
Trundle	SMHMTRN	•
Walkabout	1046	•

Jetty:Mod

**GRADE 5**

Checkmate	1043	
Main Line Flax	SCAMMLF	•
Riddle	SCFSRID	•
Stinson Sequence	SCFSSEQ	•
Zippy	1045	

**GRADE 6**

Arris	ARR	•
Blazer	SCAMBLZ	•
Hemp	SCAMHMP	•
Poppy	1047	•

**GRADE 7**

Silk	SCAMSLK	•
------	---------	---

**GRADE 8**

Apt	SMHMAPT	•
Brisa	RS	•
Zap	SCAMZAP	•

**GRADE 9**

Ultraleather Pro	SUF554	•
Yoredale	SCAMYDL	•

**GRADE L1**

Davenport	DAV	
Florence	FLOR	
Strasburg Leather	STB	

⚡ Partnership Program — See page 10 for details.  
• Available upholstery option

- Allsteel fabrics and foam meet requirements for CTB117.
- Blank spaces indicate that a product has not yet been tested or that it failed.
- Contact Allsteel Customer Support for other flammability code approvals.

Jetty:Mod supports individual and group activities in cafes, atriums, and walkways while also influencing and directing circulation patterns. Its modern, modular, and can be modified to fit whatever the installation requires.

Jetty:Mod was designed to focus on work geometry and how to properly support you. Making sure to have proper sit depth and posture. There are two different versions or dimensions. The lounge version is 30" wide by 30" deep and you sit 18" off of the floor. This allows for more trust conversations to happen or to relax for the day. The work version is 24" wide by 24" deep and you sit 19.5" off of the floor. This will allow for a more upright position to do active work.



**Lounge**  
18"H x 30"D x 30"W



**Work**  
19.5"H x 24"D x 24"W

**WORK GEOMETRY**

It is important to determine whether the clearances between work mode/lounge mode and table are large enough to allow for an individual's legs to be positioned under the table and yet not too large as to result in awkward upper body positions when using the worksurface.

**WORK POSTURE & STANDARD HEIGHT TABLE**

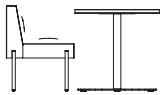

When specifying the work posture Jetty:Mod it is recommended to pair with standard height tables that provide 9"-10" of leg clearance.

Standard Table Height: 28"-29.75"

**LOUNGE POSTURE & CONTINENTAL HEIGHT TABLE**

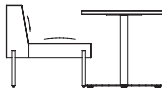

When specifying the lounge posture Jetty:Mod it is recommended to pair with continental height tables that provide 8.5"-10" of leg clearance.

Continental Table Height: 25"-27.75"

**MODELS AND OPTIONS**

Jetty:Mod is comprised of seating, arms, tables, screens, legs and connectors that allow you to create an array of configurations.

The seating includes Ottomans, Single Seats and Backs, Half-Backs, Serpentine Ottoman and Serpentine Seat and Back units.

Arms include Tailored Arms, Box Arms and Bolster Arm.

Tables are connected or an accessory to the overall configuration. These include Connecting Tables, both full and half, Serpentine Tables, End Caps, Shared Arm, Tablet Table and Coffee Table.

Screens provide privacy in any space. There are 4 different lengths of screens that can be attached to seating and tables.

Legs and connectors coincide with the work or lounge version.

**APPLICATIONS**

This sofa system supports applications for private offices, work islands, booths, individual workspaces and banquettes.

**MATERIALS**

All COMs/COLs must be approved for upholsterability. See pages 6-8 for COM ordering instructions.

**OPTIONS — SEATING**

Description:

Ottoman — Straight or Serpentine

Seat and Back — Straight, Serpentine, Half Back or Corner

FSC Certified Wood:

**FSC** FSC Certified Wood

Seat Upholstery:

See page 174 for upholstery selections.

Back Upholstery:

See page 174 for upholstery selections.

**OPTIONS — ARMS**

Description:

Tailored Arms - Left and Right

Box Arms - Left and Right

Bolster Arm

FSC Certified Wood:

**FSC** FSC Certified Wood

Upholstery:

See page 174 for upholstery selections.

**OPTIONS — TABLES**

Description:

Connecting Tables - Full, Half, Notched or Serpentine

Accessory Tables - End Caps, Shared Arm or Tablet Table

Tables - Coffee Table

FSC Certified Wood:

**FSC** FSC Certified Wood

Laminate Table Tops and Skirts:

See page 173 for laminate finishes and codes.

Painted Base:

See page 173 for paint finishes and codes.

**OPTIONS — LEGS AND CONNECTORS**

Description:

Legs and Connectors - Straight or Serpentine

Painted Legs and Connectors:

See page 173 for paint finishes and codes.

**OPTIONS — SCREENS**

Description:

24", 36", 30" and 45"

Screen Upholstery:

See page 174 for upholstery selections.

**OPTIONS — ELECTRICAL**

Description:

Electrical can be attached under seats and tables. Electrical includes Miki Undermount, hard wire and corded infeed wire options, and jumper kits that have 3 cord length options. See pages 206-207 for specifications and examples. See page 208 for electrical components.



A full gallery of typicals can be found on our website: <https://www.allsteeloffice.com/design-resources/idea-starters>. Each typical includes a complete BOM with current pricing, downloadable CAD files, and PDFs of each drawing.

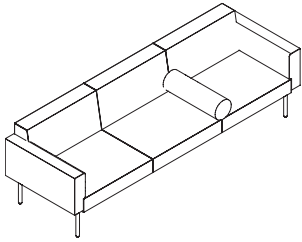

Reception

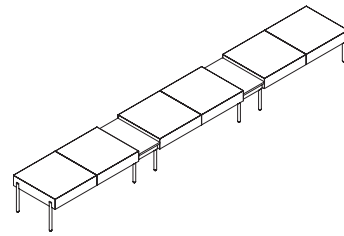

Meeting Overflow

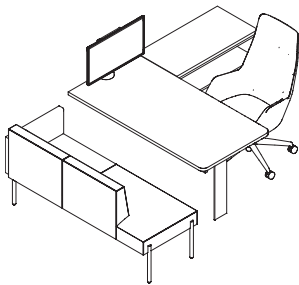

Micro Office

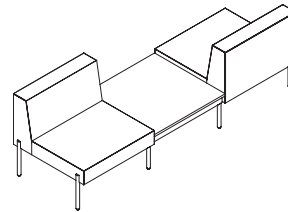

Yin Yang

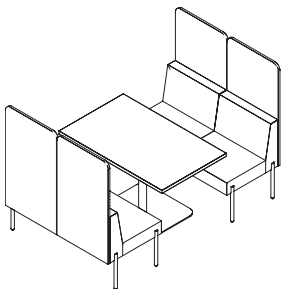

Booth

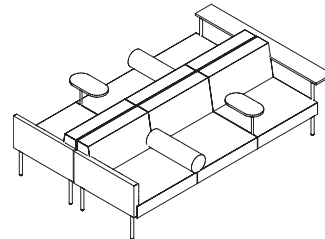

Back-to-Back

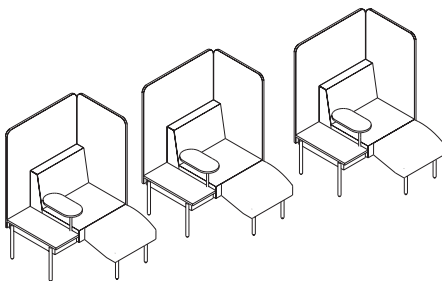

Focus Pod

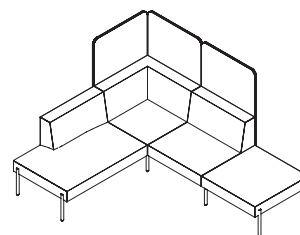

Small Gathering

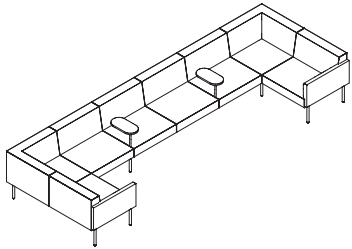

Usable U

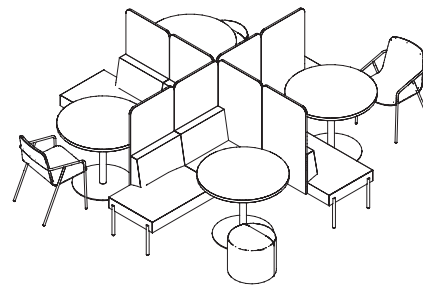

Meeting Pinwheel

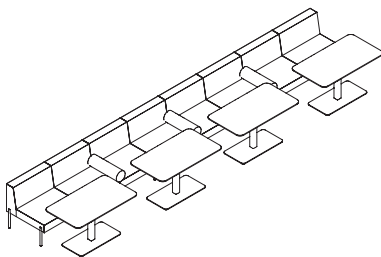

Banquette

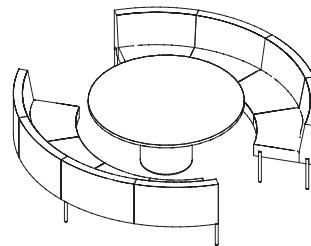

Firepit

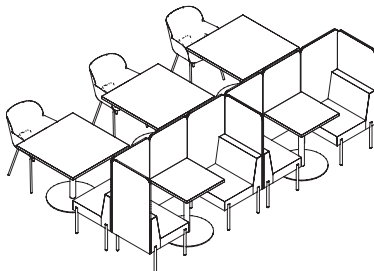

Booth Banquette

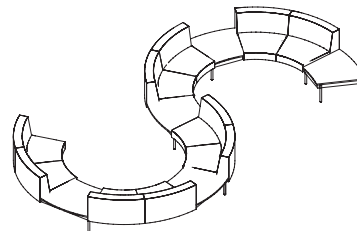

Organic

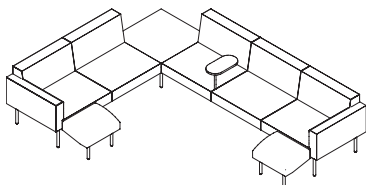

Usable L

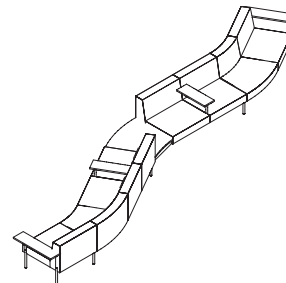

Serpentine

\*Rule: Serpentine units need to have a leg at each connection point wherever there is the biggest radius. At the smallest radius, you will need a leg every 2 units. Where there isn't a leg, you can use a serpentine in-line connector.

General Guidelines When Working With Jetty:Mod

**SEATING**

Corner Units - BPLCS, BPLCM, BPLWCS, BPWCM

- Corner unit is used to make an L-application and should not be used to end a run
- Corner unit needs to be specified with 1-Corner connecting leg and 1-Post leg. (BPLCRPL and BPWCRPL)

Calf Rest - BPLCR

- Calf Rest can only be used with the lounge version of Jetty:Mod
- It is recommended to placed at the front of the sofa unit it is being attached to, and should be placed either to the right or the left of the unit. This will depend on what the application is.
- Calf Rest is attached with 2 brackets to the bottom of the sofa unit, and then comes with 2 post legs that will go at the end to support

Serpentine Units - BPLSWS, BPLSWM, BPLSNS, BPLSNM, BPLSO, BPWSWS, BPWSWM, BPWSNS, BPWSNM, BPWSO

- Serpentine units need to have a leg at each connection point wherever there is the biggest radius. At the smallest radius, you will need a leg every 2 units. Where there isn't a leg, you can use a serpentine in-line connector.

See specifying examples below

What to Specify:

- 4 Serpentine Wide at Back (BPLSWS)
- 4 End Leg with Metal Cover (BPLELC)
- 4 Serpentine In-Line Leg 30 (BPLSIL30)
- 2 Serpentine In-Line Connector 30 (BPSIC30)

What to Specify:

- 4 Serpentine Wide at Back (BPLSNS)
- 4 End Leg with Metal Cover (BPLELC)
- 4 Serpentine In-Line Leg 30 (BPLSIL30)
- 2 Serpentine In-Line Connector 30 (BPSIC30)

What to Specify:

- 2 Serpentine Wide at Back (BPLSWS)
- 2 Single Seat and Back (BPLSS)
- 4 End Leg with Metal Cover (BPLELC)
- 2 Serpentine In-Line Leg 30 (BPLSIL30)
- 2 Serpentine In-Line Leg 15 (BPLSIL15)
- 2 Serpentine In-Line Connector 15 (BPSIC15)

What to Specify:

- 2 Serpentine Wide at Back (BPLSNS)
  - 2 Single Seat and Back (BPLSS)
  - 4 End Leg with Metal Cover (BPLELC)
  - 2 Serpentine In-Line Leg 30 (BPLSIL30)
  - 2 Serpentine In-Line Leg 15 (BPLSIL15)
  - 2 Serpentine In-Line Connector 15 (BPSIC15)
- Note: This can also be done using the work version

What to Specify:

- 4 Serpentine Wide at Back (BPLSWS)
- 1 Serpentine Connecting Table (BPCTO30)
- 4 End Leg with Metal Cover (BPLELC)
- 6 Serpentine In-Line Leg 30 (BPLSIL30)
- 2 Serpentine In-Line Connector 30 (BPSIC30)

What to Specify:

- 4 Serpentine Wide at Back (BPLSNS)
- 1 Serpentine Connecting Table (BPCTO30)
- 4 End Leg with Metal Cover (BPLELC)
- 6 Serpentine In-Line Leg 30 (BPLSIL30)
- 2 Serpentine In-Line Connector 30 (BPSIC30)

What to Specify:

- 2 Serpentine Wide at Back (BPLSNS)
- 2 Single Seat and Back (BPLSS)
- 1 Serpentine Connecting Table (BPCTO30)
- 4 End Leg with Metal Cover (BPLELC)
- 4 Serpentine In-Line Leg 30 (BPLSIL30)
- 2 Serpentine In-Line Connector 15 (BPSIC15)

What to Specify:

- 2 Serpentine Wide at Back (BPLSWS)
- 2 Single Seat and Back (BPLSS)
- 1 Serpentine Connecting Table (BPCTO30)
- 4 End Leg with Metal Cover (BPLELC)
- 4 Serpentine In-Line Leg 30 (BPLSIL30)
- 2 Serpentine In-Line Connector 15 (BPSIC15)

## HOW TO SPECIFY JETTY:MOD

### EXAMPLE #1

- (3) BPLSS - Lounge Single Seat and Back
- (1) BPLB - Lounge Bolster Arm
- (1) BPLBL - Lounge Box Arm Left
- (1) BPLBR - Lounge Box Arm Right
- (4) BPLEL - Lounge End Leg for Attaching
- (4) BPLSIC - Lounge Straight In-Line Connector

### EXAMPLE #2

- (1) BPLSS - Lounge Single Seat and Back
- (1) BPLCR - Lounge Calf Rest
- (1) BPBSCR30 - Lounge Screen 30"
- (1) BPBSCR45 - Lounge Screen 45"
- (1) BPCT15 - Half Connecting Table 15" x 30"
- (1) BPTT - Swivel Tablet
- (4) BPLELC - Lounge End Leg with Metal Cover
- (2) BSSICC - Short In-Line Connector

Note: One pod is specified, multiply by 3 for total

### EXAMPLE #3

- (10) BPLSWS - Lounge Serpentine Wide at Back
- (5) BPLCTO30 - Lounge Serpentine Connecting Table
- (4) BPLELC - Lounge End Leg with Metal Cover
- (23) BPLSIL30 - Lounge Serpentine In-Line Leg 30
- (5) BPSIC30 - Serpentine In-line Connector 30

### EXAMPLE #4

- (2) BPLSS - Lounge Single Seat and Back
- (1) BPCT30 - Connecting Table 30" x 30"
- (4) BPLELC - Lounge End Leg with Metal Cover
- (4) BPLSIL - Lounge Straight In-Line Leg

## EXAMPLE #5

- (6) BPLSS - Lounge Single Seat and Back
- (2) BPLB - Lounge Bolster Arm
- (1) BPLTL - Lounge Tailored Arm Left
- (1) BPLTR - Lounge Tailored Arm Right
- (2) BPTT - Swivel Tablet
- (1) BPT60 - Lounge End Cap 60"
- (8) BPLEL - Lounge End Leg for Attaching
- (8) BPLSIC - Lounge Straight In-Line Connector

## EXAMPLE #6

- (6) BPLSS - Lounge Single Seat and Back
- (1) BPLSWS - Lounge Serpentine Wide at Back
- (1) BPLSNS - Lounge Serpentine Wide at Back
- (1) BPLCTO30 - Lounge Serpentine Connecting Table
- (2) BPT30 - Lounge End Cap 30"
- (2) BPTS30 - Lounge Shared Arm
- (4) BPLEL - Lounge End Leg for Attaching
- (4) BPLSIC - Lounge Straight In-Line Connector
- (10) BPLSIL30 - Lounge Serpentine In-Line Leg 15
- (2) BPSIC15 - Serpentine In-line Connector 15

## ARMS

Tailored Arms - BPLTL, BPLTR, BPWTL, BPWTR

- Tailored Arms can only be used at the end of the run, not in between units

Box Arms - BPLBL, BPLBR, BPWBL, BPWBR

- Box Arms can only be used at the end of the run, not in between units

Bolster Arms - BPLB, BPWB

- Bolster Arms can only be used in between units that have a seat and back. It is recommended to not be used with an ottoman

## TABLES

Connecting Tables - BPCT30, BPCT24

- Connecting tables can go in between seating units and at the end of a run
- If a connecting table is in between 2 seat units, it will need 4 in-line legs (BPLSIL or BPWSIL) at each connection point between the units
- If a connecting table is placed at the end of a run, it will need 2 in-line legs (BPLSIL or BPWSIL) and then 2 end legs with a metal cover. You need a point of connection for the connecting tables

Half Connecting Tables - BPCT15, BPCT12

- Half connecting tables can go in between seating units and at the end of a run
- If a half connecting table is in between 2 seat units, it will need 2 in-line legs (BPLSIL or BPWSIL) at 2 of the connection points and the 2 short in-line (BSSICC) connectors at the other 2 connection points
- If a half connecting table is placed at the end of a run, it will need 2 short in-line connectors (BSSICC) and then 2 end legs with a metal cover. You need a point of connection for the half connecting tables

Serpentine Connecting Tables - BPCTO30, BPCTO24

- Serpentine connecting tables can go in between seating units and at the end of a run
- If a serpentine connecting table is in between 2 linear seat units, it will need 4 serpentine in-line legs (BPLSIL15 or BPWSIL15) at each of the connection points
- If a serpentine connecting table is in between 2 serpentine units, it will need 4 serpentine in-line legs (BPLSIL30 or BPWSIL30) at each of the connection points
- If a serpentine connecting table is in between 1 serpentine unit and 1 linear unit, the linear to serpentine will have a different leg compared to the serpentine to serpentine connection. You will need to specify 2 serpentine in-line legs (BPLSIL30 or BPWSIL30) and 2 serpentine in-line legs (BPLSIL15 or BPWSIL15)

Corner Connecting Tables - BPCCT30, BPCCT24

- Corner table is used to make an L-application and should not be used to end a run
- Corner unit needs to be specified with 1-Corner connecting leg and 1-Post leg. (BPLCRPL and BPWCRPL)

Notched Tables - BPNT30, BPNT15, BPNT24, BPNT12

- When pairing legs with notched tables, follow same guidelines that are used for connecting and half connecting tables
- It is recommended that you put a tablet arm within the notches. Items that we do not recommend are bolster arm, arms and the shared arm

End Caps - BPTE30, BPTE60, BPTE24, BPTE48

- End caps should be used at the end of a run, connecting into the end legs for attaching (BPTEL or BPWEL)
- The longer end caps are used to span across two units that are back-to-back

Shared Arms - BPTS30, BPTS24

- Shared arms are recommended to be used in between 2 seat and back units (serpentine or linear)

Swivel Tablet - BPTT

- Swivel tablet can go at the end of the run or in between units (serpentine or linear)

Coffee Table - BPCT2445

- Coffee table should be used on its own as a stand alone coffee table

## LEGS, CONNECTORS AND METAL PIECES

*You will need to specify two legs or connectors at each connection point. For example, if you have a two-seat sofa, you would need to specify two in-line connectors where the sofa units meet and then four end legs (two at one end and two at the other end of the sofa).*

Straight In-Line Connectors - BPLSIC, BPWSIC

- Straight in-line connectors are used to connect 2 linear units together, both seating and tables
- Swivel tablet, bolster arm and shared arm can be inserted into the in-line connectors

End Legs for Attaching - BPTEL, BPWEL

- End legs for attaching are used at the end of a run
- Tailored arms, box arms and tablet arm can be inserted into the end legs at the end of a run

End Legs with Metal Cover - BPLELC, BPWELC

- End legs with the metal cover are used at the end of a run where nothing will be inserted or attached to them

Corner Post Legs - BPLCRPL, BPWCRPL

- Corner post legs are to be used with corner seating and tables
- When corner units are used, 2 corner post legs will need to be specified

Serpentine In-Line Connector - BPSIC15, BPSIC30

- BPSIC15 should be used when connecting a linear unit to a serpentine unit
- BPSIC30 should be used when connecting a serpentine unit to a serpentine unit

Serpentine In-Line Leg - BPLSIL15, BPLSIL30, BPWSIL15, BPWSIL30

- BPLSIL15 and BPWSIL15 should be used when connecting a linear unit to a serpentine unit
- BPLSIL30 and BPWSIL30 should be used when connecting a serpentine unit to a serpentine unit

4 Unit Beam Connector - BP4UC

- The 4 unit beam connector can be used to connect 4 linear units together without having to put a leg in between
- This cannot be used with serpentine units

Short In-Line Connector - BSSICC

- Short in-line connector should be used when connecting a single seat and back unit to a half connecting table, and should be placed in between those units

Coat Hanger - BPCH





- The coat hanger can be placed on the back of seat and back, half back and serpentine units

## SCREENS

Screens - BPBSCR30, BPBSCR45, BPBSCR24, BPBSCR36

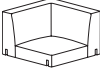
- The 30" and 45" screens should be paired with the lounge version, and the 24" and 36" should coincide with the work version
- Screens are attached to the bottom of the seat and tables
- Screens can go on the back and sides of seating units. Screens can be attached to the back of the tables, but cannot attach to the sides of them.
- They cannot be used in between units







Description	Model Number <i>Add options below</i>	Base Price	Upholstery	Upcharge							
				2	3	4	5	6	7	8	
 Single Seat and Back Single Upholstery	BPLSS	\$ 1976	Upholstery	\$ 60	\$ 120	\$ 180	\$ 260	\$ 341	\$ 420	\$ 500	
 Corner Single Upholstery	BPLCS	\$ 2398	Upholstery	\$ 87	\$ 172	\$ 258	\$ 371	\$ 486	\$ 600	\$ 714	
 Left Half Back Single Upholstery	BPLLS	\$ 2540	Upholstery	\$ 69	\$ 138	\$ 207	\$ 297	\$ 389	\$ 480	\$ 572	
 Right Half Back Single Upholstery	BPLRS	\$ 2540	Upholstery	\$ 69	\$ 138	\$ 207	\$ 297	\$ 389	\$ 480	\$ 572	
 Serpentine Wide at Back Single Upholstery	BPLSWS	\$ 2258	Upholstery	\$ 60	\$ 120	\$ 180	\$ 260	\$ 341	\$ 420	\$ 500	
 Serpentine Narrow at Back Single Upholstery	BPLSNS	\$ 2258	Upholstery	\$ 60	\$ 120	\$ 180	\$ 260	\$ 341	\$ 420	\$ 500	

<p><b>How to specify —</b> Select the Model Number from above.</p>	<p><b>1st Option:</b> FSC Certified Wood: FSC Select for FSC Certified Wood</p>	<p><b>2nd Option:</b> Select the Upholstery: See Allsteel Upholstery matrix on page 174.</p>
<p>B   P   L         .</p>	<p>F   S   C   .</p>	<p>         </p>

Example: BPLSS.FSC.PURL05

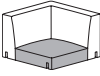
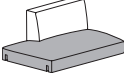
Model Number				Overall			Seat			Back			
	Ship Weight	Calves	COM Yardage*	Height	Width	Depth	Height	Width	Depth	Height	Width	Top Depth	Bottom Depth
<b>BPLSS</b>	41	14.5	3.4	18½"	30"	30"	7"	30"	21½"	18½"	30"	3.42"	7.69"
<b>BPLCS</b>	57	14.5	4.8	18½"	30"	30"	7"	21½"	21½"	18½"	30"	3.42"	7.69"
<b>BPLLS</b>	53	20	3.9	18½"	45"	30"	7"	45"	21½"	18½"	30"	3.42"	7.69"
<b>BPLRS</b>	53	20	3.9	18½"	45"	30"	7"	45"	21½"	18½"	30"	3.42"	7.69"
<b>BPLSWS</b>	42	15.2	3.4	18½"	Back: 35½" Front: 20"	30"	7"	Back: 35½" Front: 20"	21½"	18½"	35½"	3.42"	7.69"
<b>BPLSNS</b>	42	15.2	3.5	18½"	Back: 20" Front: 35½"	30"	7"	Back: 20" Front: 35½"	21½"	18½"	20"	3.42"	7.69"

\*COM Yardage is listed for total yardage/feet required for a model, with applicable yardage/feet for individual components listed.









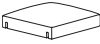

Description	Model Number <i>Add options below</i>	Base Price	Upholstery	Upcharge								
				2	3	4	5	6	7	8		
<b>Jetty:Mod Lounge</b>												
	Single Seat and Back	BPLSM	\$ 2116	Seat	\$ 28	\$ 55	\$ 82	\$ 119	\$ 155	\$ 192	\$ 229	
	Multi Upholstery			Back	\$ 33	\$ 66	\$ 99	\$ 141	\$ 185	\$ 228	\$ 272	
	Corner	BPLCM	\$ 2681	Seat	\$ 24	\$ 48	\$ 72	\$ 104	\$ 137	\$ 168	\$ 200	
	Multi Upholstery			Back	\$ 63	\$ 124	\$ 186	\$ 268	\$ 350	\$ 432	\$ 514	
	Left Half Back	BPLLM	\$ 2715	Seat	\$ 33	\$ 66	\$ 99	\$ 141	\$ 185	\$ 228	\$ 272	
	Multi Upholstery			Back	\$ 36	\$ 72	\$ 108	\$ 156	\$ 204	\$ 252	\$ 300	
	Right Half Back	BPLRM	\$ 2715	Seat	\$ 33	\$ 66	\$ 99	\$ 141	\$ 185	\$ 228	\$ 272	
	Multi Upholstery			Back	\$ 36	\$ 72	\$ 108	\$ 156	\$ 204	\$ 252	\$ 300	
	Serpentine Wide at Back	BPLSWM	\$ 2433	Seat	\$ 28	\$ 55	\$ 82	\$ 119	\$ 155	\$ 192	\$ 229	
	Multi Upholstery			Back	\$ 33	\$ 66	\$ 99	\$ 141	\$ 185	\$ 228	\$ 272	
	Serpentine Narrow at Back	BPLSNM	\$ 2433	Seat	\$ 30	\$ 58	\$ 88	\$ 127	\$ 165	\$ 204	\$ 244	
	Multi Upholstery			Back	\$ 31	\$ 63	\$ 93	\$ 135	\$ 175	\$ 216	\$ 258	

<p><b>How to specify —</b> Select the Model Number from above.</p>	<p><i>1st Option:</i> <b>FSC Certified Wood:</b> FSC Select for FSC Certified Wood</p>	<p><i>2nd Option:</i> <b>Select the Seat Upholstery:</b> See Allsteel Upholstery matrix on page 174.</p>	<p><i>3rd Option:</i> <b>Select the Back Upholstery:</b> See Allsteel Upholstery matrix on page 174.</p>
<p>B   P   L         .</p>	<p>F   S   C   .</p>	<p>          .</p>	<p>          .</p>

Example: BPLSM.FSC.BLME03.BLME09

Model Number	Overall					Seat				Back				
	Ship Weight	Calves	Height	Width	Depth	COM Yardage	Height	Width	Depth	COM Yardage	Height	Width	Top Depth	Bottom Depth
BPLSM	41	14.5	18½"	30"	30"	1.1	7"	30"	21½"	1.7	18½"	30"	3.42"	7.69"
BPLCM	57	14.5	18½"	30"	30"	1.1	7"	21½"	21½"	3.0	18½"	30"	3.42"	7.69"
BPLLM	53	20	18½"	45"	30"	1.7	7"	45"	21½"	1.7	18½"	30"	3.42"	7.69"
BPLRM	53	20	18½"	45"	30"	1.9	7"	45"	21½"	1.7	18½"	30"	3.42"	7.69"
BPLSWM	42	15.2	18½"	Back: 35½" Front: 20"	30"	1.1	7"	Back: 35½" Front: 20"	21½"	1.7	18½"	35½"	3.42"	7.69"
BPLSNM	42	15.2	18½"	Back: 20" Front: 35½"	30"	1.4	7"	Back: 20" Front: 35½"	21½"	1.5	18½"	20"	3.42"	7.69"

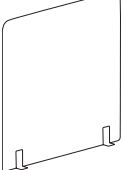
\*COM Yardage is listed for total yardage/feet required for a model, with applicable yardage/feet for individual components listed.





Description	Model Number <i>Add options below</i>	Base Price	Upholstery	Upcharge								P2 Paint
				2	3	4	5	6	7	8		
 Ottoman	BPLO	\$ 1552	Upholstery	\$ 40	\$ 79	\$ 118	\$ 172	\$ 224	\$ 276	\$ 329	N/A	
 Serpentine Ottoman	BPLSO	\$ 1763	Upholstery	\$ 40	\$ 79	\$ 118	\$ 172	\$ 224	\$ 276	\$ 329	N/A	
 Tailored Arm Left	BPLTL	\$ 847	Upholstery	\$ 24	\$ 48	\$ 72	\$ 104	\$ 137	\$ 168	\$ 200	N/A	
 Tailored Arm Right	BPLTR	\$ 847	Upholstery	\$ 24	\$ 48	\$ 72	\$ 104	\$ 137	\$ 168	\$ 200	N/A	
 Box Arm Left	BPLBL	\$ 988	Upholstery	\$ 24	\$ 48	\$ 72	\$ 104	\$ 137	\$ 168	\$ 200	N/A	
 Box Arm Right	BPLBR	\$ 988	Upholstery	\$ 24	\$ 48	\$ 72	\$ 104	\$ 137	\$ 168	\$ 200	N/A	
 Bolster Arm	BPLB	\$ 777	Upholstery	\$ 18	\$ 34	\$ 52	\$ 75	\$ 98	\$ 120	\$ 143	N/A	
 Screen 30"	BPBSCR30	\$ 1235	Upholstery	\$ 57	\$ 114	\$ 171	\$ 246	\$ 321	\$ 396	\$ 471	N/A	
 Screen 45"	BPBSCR45	\$ 1375	Upholstery	\$ 57	\$ 114	\$ 171	\$ 246	\$ 321	\$ 396	\$ 471	N/A	
 Calf Rest	BPLCR	\$ 1130	Upholstery	\$ 19	\$ 39	\$ 57	\$ 82	\$ 107	\$ 132	\$ 157	\$ 88	

<p><b>How to specify —</b> Select the Model Number from above.</p>	<p><i>1st Option:</i> <b>FSC Certified Wood:</b> FSC Select for FSC Certified Wood</p>	<p><i>2nd Option:</i> <b>Select the Upholstery:</b> See Allsteel Upholstery matrix on page 174.</p>	<p><i>3rd Option:</i> <b>Select the Paint Finish (if applicable):</b> See Paint Finishes on page 173.</p>
<p>B   P                     .</p>	<p>F   S   C   .</p>	<p>                .</p>	<p>        .</p>

*Example: BPLBR.FSC.PURL03*

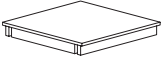
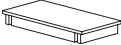
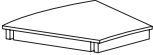
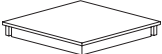
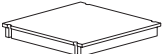
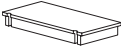
Model Number	Overall					
	Ship Weight	Calves	COM Yardage*	Height	Width	Depth
BPLO	32	4.9	2.2	7"	30"	30"
BPLSO	32	6	2.2	7"	Back: 35½" Front: 20"	30"
BPLTL	12	2.9	1.3	13¾"	30"	2¼"
BPLTR	12	2.9	1.3	13¾"	30"	2¼"
BPLBL	17	2.9	1.5	13¾"	30"	4¼"
BPLBR	17	2.9	1.5	13¾"	30"	4¼"
BPLB	6	1.5	1	7"	22½"	
BPBSCR30	20	5	3.3	41"	30"	1"
BPBSCR45	28	7.4	3.3	41"	45"	1"
BPLCR	12	1.6	1.2	14⅞"	20"	15"

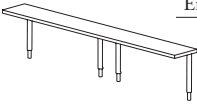
\*COM Yardage is listed for total yardage/feet required for a model, with applicable yardage/feet for individual components listed.

Description	Model Number <i>Add options below</i>	Base Price	Upcharge List Price — Add to Base Price		
			L2	P2 Paint	
<b>Jetty:Mod Lounge</b>					
 Connecting Table 30" x 30"	BPCT30	\$ 1341	\$ 0		N/A
 Half Connecting Table 15" x 30"	BPCT15	\$ 1059	\$ 0		N/A
 Serpentine Connecting Table	BPCTO30	\$ 1481	\$ 0		N/A
 Corner Connecting Table	BPCCT30	\$ 1341	\$ 0		N/A
 Notched Connecting Table 30" x 30"	BPNT30	\$ 1411	\$ 0		N/A
 Notched Half Connecting Table 15" x 30"	BPNT15	\$ 1130	\$ 0		N/A
 End Cap 30"	BPTE30	\$ 811	\$ 32		\$ 64
 End Cap 60"	BPTE60	\$ 953	\$ 38		\$ 75
 Shared Arm	BPTS30	\$ 811	\$ 32		\$ 64







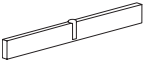
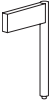
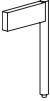

<p><b>How to specify —</b> Select the Model Number from above.</p>	<p><i>1st Option:</i> <b>FSC Certified Wood:</b> FSC Select for FSC Certified Wood</p>	<p><i>2nd Option:</i> <b>Select the Top Laminate:</b> See page 173 for options.</p>	<p><i>3rd Option:</i> <b>Select the Top Edge Band:</b> See page 173 for options.</p>	<p><i>4th Option:</i> <b>Select the Skirt Laminate (if applicable):</b> See page 173 for options. The skirt will come with a matching edgeband.</p>	<p><i>5th Option:</i> <b>Select the Paint Finish (if applicable):</b> See Paint Finishes on page 173.</p>
B   P               .	F   S   C   .	.	.	.	.

Examples: BPCT30.FSC.LDW1.DW.LDW1 BPTE30.FSC.LDW1.DW.P8X

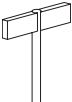
Model Number	Overall					
	Ship Weight	Calves	COM Yardage*	Height	Width	Depth
<b>BPCT30</b>	49	4.1	N/A	3.481"	30"	30"
<b>BPCT15</b>	32	2.2	N/A	3.481"	15"	30"
<b>BPCTO30</b>	48	5	N/A	3.481"	Back: 35½" Front: 20"	30"
<b>BPCCT30</b>	49	4.1	N/A	3.481"	30"	30"
<b>BPNT30</b>	49	4.1	N/A	3.481"	30"	30"
<b>BPNT15</b>	32	2.2	N/A	3.481"	15"	30"
<b>BPTE30</b>	20	0.8	N/A	12.981"	8"	30½"
<b>BPTE60</b>	26	1.5	N/A	12.981"	8"	60¼"
<b>BPTS30</b>	18	0.6	N/A	12.981"	8"	27.62"

\*COM Yardage is listed for total yardage/feet required for a model, with applicable yardage/feet for individual components listed.



Description	Model Number <i>Add options below</i>	Base Price	P2 Paint Upcharge
<b>Jetty:Mod Lounge</b>			
 Straight In-Line Connector *Only comes in Solar Black	<b>BPLSIC</b>	\$ 106	N/A
 End Leg for Attaching	<b>BPLEL</b>	\$ 120	\$ 10
 End Leg with Metal Cover *Metal Cover matches chosen paint color	<b>BPLELC</b>	\$ 127	\$ 10
 Corner Post Leg	<b>BPLCRPL</b>	\$ 135	\$ 11
 Straight In-Line Leg	<b>BPLSIL</b>	\$ 127	\$ 10
 Connecting Post Leg	<b>BPLCPL</b>	\$ 135	\$ 11
 Single Post Leg	<b>BPLSPL</b>	\$ 106	\$ 9
 Serpentine In-Line Leg 15	<b>BPLSIL15</b>	\$ 148	\$ 12
 Serpentine In-Line Leg 30	<b>BPLSIL30</b>	\$ 148	\$ 12
 4 Unit Beam Connector *Only comes in Solar Black (P8X)	<b>BP4UC</b>	\$ 676	N/A

**How to specify —**

Select the Model Number from above.

**1st Option:**

Select the Paint Finish (if applicable):



See Paint Finishes on page 173.

B | P | L | | | | | | | | . | | | | |

Example: BPLCPL.P8X

Model Number	Overall						
	Ship Weight	Calves	COM Yardage*	Height	Width	Depth	Leg Diameter
<b>BPLSIC</b>	4	1.7	N/A	2½"	25½"	1"	1½"
<b>BPLEL</b>	3	1.2	N/A	12½"	8.062"	1"	1½"
<b>BPLELC</b>	3	1.2	N/A	12½"	8.062"	1"	1½"
<b>BPLCRPL</b>	3	0.8	N/A	9¾"	8¼"	8¼"	1½"
<b>BPLSIL</b>	3	1.2	N/A	12½"	30"	1"	1½"
<b>BPLCPL</b>	3	0.5	N/A	3.481"	12"	30"	1½"
<b>BPLSPL</b>	2	0.5	N/A	9¾"	3"	3"	1½"
<b>BPLSIL15</b>	3	0.4	N/A	12½"	12"	1"	1½"
<b>BPLSIL30</b>	3	0.4	N/A	12½"	12"	1"	1½"
<b>BP4UC</b>	23	0.2	N/A	2½"	104"	1.13"	

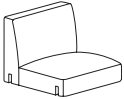
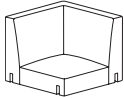
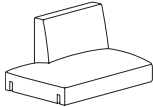
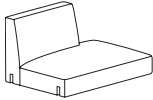
\*COM Yardage is listed for total yardage/feet required for a model, with applicable yardage/feet for individual components listed.



Description	Model Number <i>Add options below</i>	Base Price	Upholstery	Upcharge							
				2	3	4	5	6	7	8	
 Single Seat and Back Single Upholstery	BPWSS	\$ 1763	Upholstery	\$ 57	\$ 114	\$ 171	\$ 246	\$ 321	\$ 396	\$ 471	
 Corner Single Upholstery	BPWCS	\$ 2258	Upholstery	\$ 79	\$ 159	\$ 237	\$ 342	\$ 447	\$ 552	\$ 657	
 Left Half Back Single Upholstery	BPWLS	\$ 2258	Upholstery	\$ 66	\$ 130	\$ 196	\$ 283	\$ 369	\$ 456	\$ 543	
 Right Half Back Single Upholstery	BPWRS	\$ 2258	Upholstery	\$ 66	\$ 130	\$ 196	\$ 283	\$ 369	\$ 456	\$ 543	
 Serpentine Wide at Back Single Upholstery	BPWSWS	\$ 2045	Upholstery	\$ 58	\$ 117	\$ 175	\$ 253	\$ 331	\$ 408	\$ 486	
 Serpentine Narrow at Back Single Upholstery	BPWSNS	\$ 2045	Upholstery	\$ 58	\$ 117	\$ 175	\$ 253	\$ 331	\$ 408	\$ 486	

<p><b>How to specify —</b> Select the Model Number from above.</p>	<p><b>1st Option:</b> FSC Certified Wood: FSC Select for FSC Certified Wood</p>	<p><b>2nd Option:</b> Select the Upholstery: See Allsteel Upholstery matrix on page 174.</p>
<p>B   P   W         .</p>	<p>F   S   C   .</p>	<p>         </p>

*Example: BPWSS.FSC.BLME14*

Model Number				Overall			Seat			Back			
	Ship Weight	Calves	COM Yardage*	Height	Width	Depth	Height	Width	Depth	Height	Width	Top Depth	Bottom Depth
BPWSS	30	12.3	3.2	18"	24"	24"	7"	24"	17½"	18½"	24"	1.418"	5.689"
BPWCS	46	12.3	2.9	18"	24"	24"	7"	17½"	17½"	18½"	24"	1.418"	5.689"
BPWLS	42	15.2	3.7	18"	36"	24"	7"	36"	17½"	18½"	23¾"	1.418"	5.689"
BPWRS	42	15.2	3.7	18"	36"	24"	7"	36"	17½"	18½"	23¾"	1.418"	5.689"
BPWSWS	31	15.2	3.3	18"	Back: 32¾" Front: 19.7"	25½"	7"	Back: 32¾" Front: 19.7"	17½"	18½"	32¾"	1.418"	5.689"
BPWSNS	31	15.2	3.3	18"	Back: 22¾" Front: 32¾"	25½"	7"	Back: 22¾" Front: 32¾"	17½"	18½"	22¾"	1.418"	5.689"

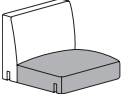
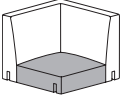
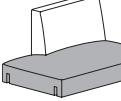
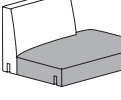
\*COM Yardage is listed for total yardage/feet required for a model, with applicable yardage/feet for individual components listed.

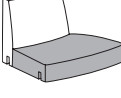







Description	Model Number <i>Add options below</i>	Base Price	Upholstery	Upcharge								
				2	3	4	5	6	7	8		
<b>Jetty:Mod Work</b>												
	Single Seat and Back	BPWSM	\$ 1905	Seat	\$ 27	\$ 52	\$ 78	\$ 112	\$ 147	\$ 180	\$ 214	
	Multi Upholstery			Back	\$ 31	\$ 63	\$ 93	\$ 135	\$ 175	\$ 216	\$ 258	
	Corner	BPWCM	\$ 2540	Seat	\$ 22	\$ 45	\$ 67	\$ 98	\$ 127	\$ 156	\$ 186	
	Multi Upholstery			Back	\$ 58	\$ 117	\$ 175	\$ 253	\$ 331	\$ 408	\$ 486	
	Left Half Back	BPWLM	\$ 2433	Seat	\$ 33	\$ 66	\$ 99	\$ 141	\$ 185	\$ 228	\$ 272	
	Multi Upholstery			Back	\$ 33	\$ 66	\$ 99	\$ 141	\$ 185	\$ 228	\$ 272	
	Right Half Back	BPWRM	\$ 2433	Seat	\$ 33	\$ 66	\$ 99	\$ 141	\$ 185	\$ 228	\$ 272	
	Multi Upholstery			Back	\$ 33	\$ 66	\$ 99	\$ 141	\$ 185	\$ 228	\$ 272	
	Serpentine Wide at Back	BPWSWM	\$ 2222	Seat	\$ 27	\$ 52	\$ 78	\$ 112	\$ 147	\$ 180	\$ 214	
	Multi Upholstery			Back	\$ 33	\$ 66	\$ 99	\$ 141	\$ 185	\$ 228	\$ 272	
	Serpentine Narrow at Back	BPWSNM	\$ 2222	Seat	\$ 28	\$ 55	\$ 82	\$ 119	\$ 155	\$ 192	\$ 229	
	Multi Upholstery			Back	\$ 31	\$ 63	\$ 93	\$ 135	\$ 175	\$ 216	\$ 258	

<p><b>How to specify —</b> Select the Model Number from above.</p>	<p><b>1st Option:</b> FSC Certified Wood: FSC Select for FSC Certified Wood</p>	<p><b>2nd Option:</b> Select the Seat Upholstery: See Allsteel Upholstery matrix on page 174.</p>	<p><b>3rd Option:</b> Select the Back Upholstery: See Allsteel Upholstery matrix on page 174.</p>
<p>B   P   W         .</p>	<p>F   S   C   .</p>	<p>          .</p>	<p>          .</p>

*Example: BPWSM.FSC.WP20.WP40*

Model Number	Overall					Seat					Back			
	Ship Weight	Calves	Height	Width	Depth	COM Yardage	Height	Width	Depth	COM Yardage	Height	Width	Top Depth	Bottom Depth
BPWSM	30	12.3	18½"	24"	24"	1.1	7"	24"	17½"	1.4	18½"	24"	1.418"	5.689"
BPWCM	46	12.3	18½"	24"	24"	1.1	7"	17½"	17½"	2.2	18½"	24"	1.418"	5.689"
BPWLM	42	15.2	18½"	36"	24"	1.7	7"	36"	17½"	1.4	18½"	23¾"	1.418"	5.689"
BPWRM	42	15.2	18½"	36"	24"	1.7	7"	36"	17½"	1.4	18½"	23¾"	1.418"	5.689"
BPWSWM	31	15.2	18½"	Back: 32¾" Front: 19.7"	25½"	1.1	7"	Back: 32¾" Front: 19.7"	17½"	1.4	18½"	32¾"	1.418"	5.689"
BPWSNM	31	15.2	18½"	Back: 22¾" Front: 32¾"	25½"	1.1	7"	Back: 22¾" Front: 32¾"	17½"	1.4	18½"	22¾"	1.418"	5.689"

\*COM Yardage is listed for total yardage/feet required for a model, with applicable yardage/feet for individual components listed.







Description	Model Number <i>Add options below</i>	Base Price	Upholstery	Upcharge							
				2	3	4	5	6	7	8	
<b>Jetty:Mod Work</b>											
 Ottoman	BPWO	\$ 1411	Upholstery	\$ 34	\$ 69	\$ 103	\$ 149	\$ 195	\$ 240	\$ 286	
 Serpentine Ottoman	BPWSO	\$ 1552	Upholstery	\$ 36	\$ 72	\$ 108	\$ 156	\$ 204	\$ 252	\$ 300	
 Tailored Arm Left	BPWTL	\$ 777	Upholstery	\$ 24	\$ 48	\$ 72	\$ 104	\$ 137	\$ 168	\$ 200	
 Tailored Arm Right	BPWTR	\$ 777	Upholstery	\$ 24	\$ 48	\$ 72	\$ 104	\$ 137	\$ 168	\$ 200	
 Box Arm Left	BPWBL	\$ 917	Upholstery	\$ 24	\$ 48	\$ 72	\$ 104	\$ 137	\$ 168	\$ 200	
 Box Arm Right	BPWBR	\$ 917	Upholstery	\$ 24	\$ 48	\$ 72	\$ 104	\$ 137	\$ 168	\$ 200	
 Bolster Arm	BPWB	\$ 706	Upholstery	\$ 18	\$ 34	\$ 52	\$ 75	\$ 98	\$ 120	\$ 143	
 Screen 24"	BPBSCR24	\$ 1165	Upholstery	\$ 57	\$ 114	\$ 171	\$ 246	\$ 321	\$ 396	\$ 471	
 Screen 36"	BPBSCR36	\$ 1304	Upholstery	\$ 57	\$ 114	\$ 171	\$ 246	\$ 321	\$ 396	\$ 471	

<p><b>How to specify —</b> Select the Model Number from above.</p>	<p><b>1st Option:</b> FSC Certified Wood: FSC Select for FSC Certified Wood</p>	<p><b>2nd Option:</b> Select the Upholstery: See Allsteel Upholstery matrix on page 174.</p>
<p>B   P               .</p>	<p>F   S   C   .</p>	<p>              .</p>
<p>Example: BPWBR.FSC.WP20</p>		

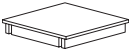
Model Number	Overall					
	Ship Weight	Calves	COM Yardage*	Height	Width	Depth
BPWO	21	4.9	1.9	7"	24"	24"
BPWSO	21	6	2	7" Back: 32½" Front: 19.7"	24"	24"
BPWTL	11	2.9	1.3	13½"	24"	2¼"
BPWTR	11	2.9	1.3	13½"	24"	2¼"
BPWBL	14	2.9	1.4	13½"	24"	4¼"
BPWBR	14	2.9	1.4	13½"	24"	4¼"
BPWB	6	1.5	1	7"	18½"	
BPBSCR24	17	5	1.8	41"	24"	1"
BPBSCR36	23	6	3.3	41"	36"	1"

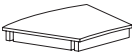
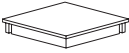
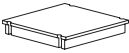
\*COM Yardage is listed for total yardage/feet required for a model, with applicable yardage/feet for individual components listed.

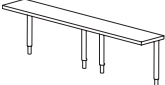





Description	Model Number <i>Add options below</i>	Base Price	Upcharge List Price — Add to Base Price		
			L2		P2 Paint
<b>Jetty:Mod Work</b>					
 Connecting Table 24" x 24"	BPCT24	\$ 1199	\$ 0		N/A
 Half Connecting Table 12" x 24"	BPCT12	\$ 917	\$ 0		N/A
 Serpentine Connecting Table	BPCTO24	\$ 1341	\$ 0		N/A
 Corner Connecting Table	BPCCT24	\$ 1199	\$ 0		N/A
 Notched Connecting Table 24" x 24"	BPNT24	\$ 1270	\$ 0		N/A
 Notched Half Connecting Table 12" x 24"	BPNT12	\$ 988	\$ 39		N/A
 End Cap 24"	BPTE24	\$ 741	\$ 29		\$ 58
 End Cap 48"	BPTE48	\$ 882	\$ 34		\$ 69
 Shared Arm	BPTS24	\$ 741	\$ 29		\$ 58

<p><b>How to specify —</b> Select the Model Number from above.</p>	<p><b>1st Option:</b> FSC Certified Wood: FSC Select for FSC Certified Wood</p>	<p><b>2nd Option:</b> Select the Top Laminate: See page 173 for options.</p>	<p><b>3rd Option:</b> Select the Top Edge Band: See page 173 for options.</p>	<p><b>4th Option:</b> Select the Skirt Laminate (if applicable): See page 173 for options. The skirt will come with a matching edgeband.</p>	<p><b>5th Option:</b> Select the Paint Finish (if applicable): See Paint Finishes on page 173.</p>
B   P             .	F   S   C   .	.	.	.	.

Examples: BPCT24.FSC.LDW1.DW.LDW1 BPTE48.FSC.LDW1.DW.P8X

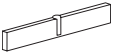
Model Number	Overall					
	Ship Weight	Calves	COM Yardage*	Height	Width	Depth
<b>BPCT24</b>	37	2.7	N/A	3.481"	24"	24"
<b>BPCT12</b>	25	1.5	N/A	3.481"	12"	24"
<b>BPCTO24</b>	41	3.8	N/A	3.481"	Back: 32.423" Front: 20"	24"
<b>BPCCT24</b>	37	2.7	N/A	3.481"	24"	24"
<b>BPNT24</b>	37	2.7	N/A	3.481"	24"	24"
<b>BPNT12</b>	25	1.5	N/A	3.481"	12"	24"
<b>BPTE24</b>	19	0.7	N/A	12.981"	8"	24½"
<b>BPTE48</b>	23½	1.2	N/A	12.981"	8"	48½"
<b>BPTS24</b>	16	0.4	N/A	12.981"	6"	21.62"

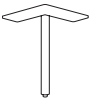
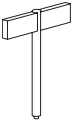
\*COM Yardage is listed for total yardage/feet required for a model, with applicable yardage/feet for individual components listed.

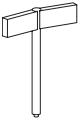
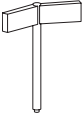
Description	Model Number <i>Add options below</i>	Base Price	P2 Paint Upcharge
<b>Jetty:Mod Work</b>			
 Straight In-Line Connector *Only comes in Solar Black	BPWSIC	\$ 84	N/A
 End Leg for Attaching	BPWEL	\$ 99	\$ 8
 End Leg with Metal Cover *Metal Cover matches chosen paint color	BPWELC	\$ 106	\$ 9
 Corner Post Leg	BPWCRPL	\$ 113	\$ 9
 Straight In-Line Leg	BPWSIL	\$ 106	\$ 9
 Connecting Post Leg	BPWCPL	\$ 113	\$ 9
 Single Post Leg	BPWSPL	\$ 84	\$ 7
 Serpentine In-Line Leg 15 15 degree turn	BPWSIL15	\$ 127	\$ 10
 Serpentine In-Line Leg 30 30 degree turn	BPWSIL30	\$ 127	\$ 10

<p><i>How to specify —</i> Select the Model Number from above.</p>	<p><i>1st Option:</i> Select the Paint Finish (if applicable): See Paint Finishes on page 173.</p>
--	--





**B | P | L | | | | | | | .**

| | | |

*Example: BPWSIL.P8V*

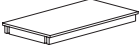
Model Number	Overall						
	Ship Weight	Calves	COM Yardage*	Height	Width	Depth	Leg Diameter
BPWSIC	3	1.7	N/A	2½"	19½"	1"	
BPWEL	3	1.2	N/A	13.953"	6.346"	1"	1½"
BPWELC	3	1.2	N/A	14"	6.346"	1"	1½"
BPWCRPL	3	0.8	N/A	11½"	8½"	8½"	1½"
BPWSIL	3	1.2	N/A	13½"	12"	1"	1½"
BPWCPL	3	0.5	N/A	11½"	7½"	3"	1½"
BPWSPL	3	0.5	N/A	11½"	3"	3"	1½"
BPWSIL15	3	0.4	N/A	13½"	12"	1"	1½"
BPWSIL30	3	0.4	N/A	13½"	12"	1"	1½"

\*COM Yardage is listed for total yardage/feet required for a model, with applicable yardage/feet for individual components listed.

Description	Model Number <i>Add options below</i>	Base Price	Upcharge List Price — Add to Base Price	
			L2	P2 Paint
<b>Jetty:Mod Lounge and Work (Used Across Both)</b>				
 Swivel Tablet	BPTT	\$ 600	\$ 23	\$ 47
 Coffee Table 24" x 45"	BPCT2445	\$ 1693	\$ 66	N/A
 Coat Hanger	BPCH	\$ 353	N/A	\$ 28
 Short In-Line Connector *Only comes in Solar Black (P8X)	BSSICC	\$ 78	N/A	N/A
 Serpentine In-Line Connector 15 *Only comes in Solar Black (P8X) *15 degree turn	BPSIC15	\$ 113	N/A	N/A
 Serpentine In-Line Connector 30 *Only comes in Solar Black (P8X) *30 degree turn	BPSIC30	\$ 113	N/A	N/A

<p><b>How to specify —</b> Select the Model Number from above.</p>	<p><b>1st Option:</b> FSC Certified Wood: FSC Select for FSC Certified Wood</p>	<p><b>2nd Option:</b> Select the Top Laminate: See page 173 for options.</p>	<p><b>3rd Option:</b> Select the Top Edge Band: See page 173 for options.</p>	<p><b>4th Option:</b> Select the Skirt Laminate (if applicable): See page 173 for options. The skirt will come with a matching edgeband.</p>	<p><b>5th Option:</b> Select the Paint Finish (if applicable): See Paint Finishes on page 173.</p>
B   P               .	F   S   C   .	.	.	.	.

Example: BPCH.P8Z

Model Number	Overall					
	Ship Weight	Calves	COM Yardage*	Height	Width	Depth
BPTT	14	0.5	N/A	15.93"	16"	8"
BPCT2445	58	5.2	N/A	3.481"	45"	24"
BPCH	4	0.6	N/A	36.688"	4.53"	1½"
BSSICC	2	0.2	N/A	2½"	12"	1"
BPSIC15	3	0.2	N/A	2½"	12"	1"
BPSIC30	3	0.2	N/A	2½"	12"	1"

\*COM Yardage is listed for total yardage/feet required for a model, with applicable yardage/feet for individual components listed.

Jetty:Mod electrical will be attached to the underside of the sofa. Electrical includes the Triplex system that has jumper kits, corded infeed, hardwire infeed and H-Connectors. Jumper kits, corded infeed and hardwire infeed are available at various lengths to support an array of configurations. Miki undermount units plugged into the Triplex system and placed at the front of the sofa. The Miki undermount power module has 1 simplex and 2 USB outlets.

It's the customer's responsibility to ensure that installation and use of the electrical system, the number of receptacles used on a given circuit, and connections to the building power supply meets all local and national electrical codes.

**GUIDELINES WHEN WORKING WITH ELECTRICAL FOR JETTY:MOD**

Miki Undermount - APWRMOD1UWM

- The Miki undermount consists of 1 simplex and 2 USB outlets
- Miki undermount power modules can be placed at the front of seat and table units. It cannot be placed where there is a support leg.
- 72" corded Miki undermount power modules can be specified on their own if the Jetty:Mod layout is placed along a wall with building power close enough to reach or within proximity of floor outlets.
- Miki can also be paired with the Triplex system to route a series of electrical components for larger Jetty:Mod configurations and/or if a hardwired in-feed is required/ desired.

Triplex Circuit 1 Jumper Kit - ATPKIT48, ATPKIT60, ATPKIT72

- Triplex Jumper Kits include 4-Trac Triplex Raceway available in lengths of 48", 60" and 72", conduit clamps and Triplex receptacle mounting bracket
- It is recommended to position the jumpers in the middle of the seat or table units that the electrical is going under

Triplex Circuit 2 Jumper Kit - ATPKIT482, ATPKIT602, ATPKIT722

- Triplex Jumper Kits include 4-Trac Triplex Raceway available in lengths of 48", 60" and 72", conduit clamps and Triplex receptacle mounting bracket
- It is recommended to position the jumpers in the middle of the seat or table units that the electrical is going under

Triplex Corded Infeed - ATPCIF48, ATPCIF72

- Triplex Corded Infeed includes a straight corded infeed with a straight 15 amp plug that is available in 48" and 72". Also available is an H-Connector with a mounting bracket.

Triplex Hardwire Infeed - ATPHWIF72

- Triplex Hardwire Infeed includes a straight hardwire infeed that is available in 72" and an H-Connector

Triplex H-Connector - ATPSPLIT

- H-Connectors are used to connector jumpers that will go in different directions whether that's a 90 degree turn or serpentine configurations

**ELECTRICAL EXAMPLE 1 — L-SHAPE**

- ATPCIF48 – 48” Triplex Corded Infeed (1)
- ATPKIT48 – 48” Triplex Circuit 1 Jumper Kit (2)
- APWRMOD1UWM – Miki Undermount (2)

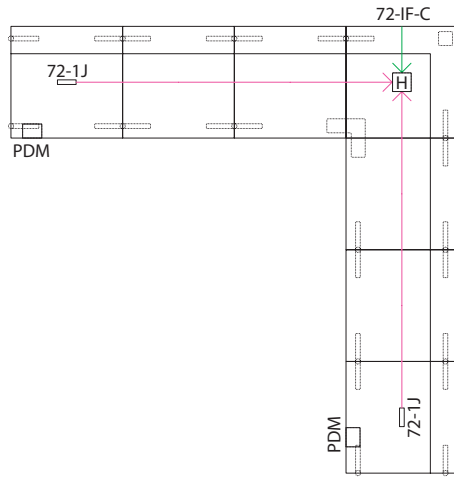

**ELECTRICAL EXAMPLE 3 — LINEAR**

- ATPCIF48 – 48” Triplex Corded Infeed (1)
- ATPKIT60 – 60” Triplex Circuit 1 Jumper Kit (1)
- ATPKIT72 – 72” Triplex Circuit 1 Jumper Kit (1)
- APWRMOD1UWM – Miki Undermount (3)

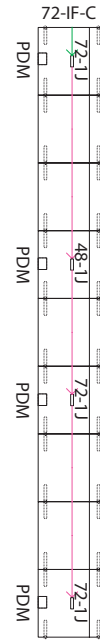

**ELECTRICAL EXAMPLE 2 — U-SHAPE**

- ATPCIF72 – 72” Triplex Corded Infeed (1)
- ATPKIT72 – 72” Triplex Circuit 1 Jumper Kit (2)
- APWRMOD1UWM – Miki Undermount (3)

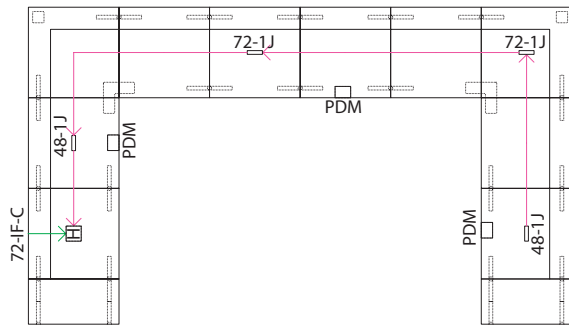

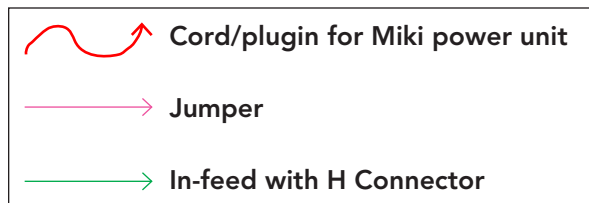
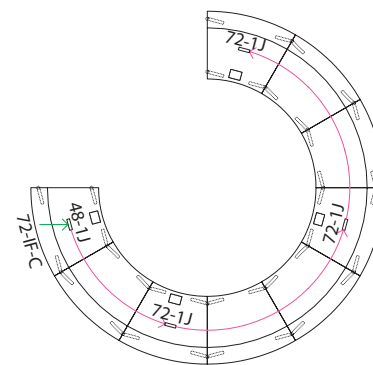

**ELECTRICAL EXAMPLE 4 — SERPENTINE**

- ATPCIF72 – 72” Triplex Corded Infeed (1)
- ATPKIT72 – 72” Triplex Circuit 1 Jumper Kit (2)
- APWRMOD1UWM – Miki Undermount (3)



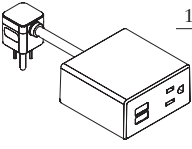
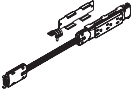

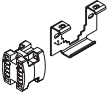
Description	Model Number <i>Add options below</i>	Base Price
<b>Jetty:Mod Electrical</b>		
 <p>Miki Undermount 1 Power, 1 USB</p>	APWRMOD1UWM	\$ 304
 <p>Triplex Circuit 1 Jumper Kit 48"</p>	ATPKIT48	\$ 155
<p>Triplex Circuit 1 Jumper Kit 60"</p>	ATPKIT60	\$ 169
<p>Triplex Circuit 1 Jumper Kit 72"</p>	ATPKIT72	\$ 184
<p>Triplex Circuit 2 Jumper Kit 48"</p>	ATPKIT482	\$ 155
<p>Triplex Circuit 2 Jumper Kit 60"</p>	ATPKIT602	\$ 169
<p>Triplex Circuit 2 Jumper Kit 72"</p>	ATPKIT722	\$ 184
 <p>Triplex Corded Infeed 48"</p>	ATPCIF48	\$ 212
<p>Triplex Corded Infeed 72"</p>	ATPCIF72	\$ 240
 <p>Triplex Hardwire Corded Infeed 72"</p>	ATPHWIF72	\$ 184
 <p>Triplex H-Connector</p>	ATPSPLIT	\$ 34

*How to specify —*  
Select the Model Number from above.

*1st Option:*  
**Miki Unit Color**  
*(if applicable):*  
SNW Snow  
STRM Storm

\_\_\_\_\_ . \_\_\_\_\_

Examples: ATPKIT48 APWRMOD1UWM.SNW

**SUMMIT / PICNIC  
PAINT FINISHES**

**GRADE P1**

Black .....	P7I
Brownstone .....	P7D
Charblack .....	CBK
Designer White .....	PJW
Flint .....	P02
Fossil .....	P28
Loft .....	P7B
Muslin .....	P4J
Salt .....	P8C
Textured Designer White .....	PK7
Textured Brownstone .....	P7J
Textured Flint .....	P7A
Textured Loft .....	P7L
Textured Muslin .....	P7M
Textured Pebble .....	P8Y
Textured Salt .....	P8Z
Textured Titanium .....	P8V

**GRADE P2**

Matte Gold .....	P8G
Night Bronze .....	P8B
Solar Black .....	P8X
Pyrite .....	PJE
Silver .....	PR6

**GRADE P3**

Amethyst ( <i>De-emphasized</i> ) .....	P091
Atom .....	P8S
Blossom*** .....	P8K
Bullseye .....	PJF
Cobalt Mica ( <i>De-emphasized</i> ) .....	P090
Ember .....	P8P
Ion .....	P8N
Iris .....	P8J
Krypton .....	P8F
Ochre .....	P093
Regatta .....	P8M
Sienna .....	P092
Succulent*** .....	P8A

**CLOUD  
PAINT FINISHES**

**GRADE P1**

Charblack .....	CBK
Textured Designer White .....	PK7
Textured Brownstone .....	P7J
Textured Flint .....	P7A
Textured Loft .....	P7L
Textured Muslin .....	P7M
Textured Pebble .....	P8Y
Textured Salt .....	P8Z
Textured Titanium .....	P8V

**GRADE P2**

Textured Silver .....	PR8
Solar Black .....	P8X

\*\*\*These colors are intended to be an inspirational option for the trending market. Production application is limited and color availability is approximately two years to coincide with evolving workplace trends.

**LAMINATES**

**GRADE L1**

**ABSTRACT**

Ash .....	LT3B
Handspun Pearl .....	LAHP
Handspun Dove .....	LAHD
Handspun Slate .....	LAHS
Handspun Chestnut .....	LAHC
Silver Mesh .....	LT8D

**SOLID**

Black .....	P
Brownstone .....	LM13
Bungalow .....	LM12
Designer White .....	LDW1
Flint .....	LM16
Fossil Shale .....	LEH1
Loft .....	LM11
Muslin .....	LM15
Titanium .....	LT11

**WOODGRAIN**

Belair .....	LWBA
Bourbon Cherry .....	H
Field Elm .....	LWFE
Florence Walnut .....	LFW1
Kingswood Walnut .....	LK11
Natural Maple .....	LWD
NeoWalnut .....	LNU1
Pinnacle .....	PINC
Shaker Cherry .....	LW7C

**GRADE L2**

**WOODGRAIN**

Beigewood .....	LWBE
Fawn Cypress .....	LFC1
Lowell Ash .....	LLA1
Mangalore Mango .....	LMM1
Natural Recon .....	LNR1
Phantom Charcoal .....	LPC1
Phantom Ecru .....	LPE1
Portico Teak .....	LPT1
Skyline Walnut .....	LSW1
Veranda Teak .....	LVT1

**GRADE L3**

**WOODGRAIN**

Natural Walnut .....	LWNW
----------------------	------

**LAMINATE EDGE COLORS**

Beigewood .....	DE
Belair .....	BA
Black .....	E4
Bourbon Cherry .....	H
Brownstone .....	EY
Bungalow .....	EX
Designer White .....	DW
Fawn Cypress .....	FC
Field Elm .....	FE
Flint .....	E9
Florence Walnut .....	FW
Fossil .....	EH
Kingswood Walnut .....	KI
Loft .....	EV
Lowell Ash .....	DL
Mangalore Mango .....	MM
Muslin .....	EU
Natural Maple .....	DD
Natural Recon .....	NR
Natural Walnut .....	DN
NeoWalnut .....	NU
Parchment .....	EN
Phantom Charcoal .....	PC
Phantom Ecru .....	PE
Pinnacle .....	PI
Platinum Metallic .....	EP
Portico Teak .....	DP
Shaker Cherry .....	DF
Skyline Walnut .....	SW
Titanium .....	TI
Veranda Teak .....	VT

NOTE: Refer to individual product pages for upcharges.

		Rock - Cushion	Rock - Shell/Body	Rock Single Upholstery	Peak Back	Peak Seat	Peak Single Upholstery	Peak Welt	Peak Ottoman	Wedge Seat	Wedge Back	Wedge Single Upholstery	Summit	Picnic Upholstered Seating
<b>GRADE 1</b>														
Apex	APX	•			•	•	•	•	•	•			•	•
Centurion	CU	•	•	•	•	•	•	•	•	•	•	•	•	•
Contourett	UR	•	•	•	•	•	•	•					•	•
Dapper	DAPR	•	•	•	•	•	•	•	•	•	•	•	•	•
Ensemble	ENSB	•	•	•	•	•	•	•	•	•	•	•	•	•
Hamilton	HAML	•	•	•	•	•	•	•	•	•	•	•	•	•
Inertia	NR	•	•	•	•	•	•	•	•	•	•	•	•	•
Optic	OP	•							•					
<b>GRADE 2</b>														
Appoint Seating	PNS	•	•	•	•	•	•	•	•	•	•	•	•	•
Blume	BLME	•	•	•	•	•	•	•	•	•	•	•	•	•
Clyde	CLYD	•	•	•	•	•	•	•	•	•	•	•	•	•
Dotty	DOT	•			•		•	•	•	•	•	•	•	•
Meld ⚡	SMHMLD	•	•	•	•	•	•	•	•	•	•	•	•	•
Rush	RUSH	•	•	•	•	•	•	•	•	•	•	•	•	•
Spin	SPNN	•			•				•				•	•
Whisper Vinyl	WP	•	•	•	•	•	•	•	•				•	•
<b>GRADE 3</b>														
Lateral ⚡	SCFSLAT	•				•		•	•					
Moxie	SX	•	•	•	•	•	•	•	•				•	•
Purl	PURL	•	•	•	•	•	•	•	•	•	•	•	•	•
Quill	QUL	•			•	•	•	•	•				•	•
<b>GRADE 4</b>														
Caper ⚡	SMHMCAP	•	•	•		•		•	•					•
Manner ⚡	SMHMMAN	•	•	•	•	•	•	•	•	•	•	•	•	•
Merit ⚡	SMHMMER	•	•	•	•	•	•	•	•	•	•	•	•	•
Messenger ⚡	SMHMGRM	•	•	•				•	•	•	•	•	•	•
Metric ⚡	SMHMMET	•	•	•	•	•	•	•	•	•	•	•	•	•
Mode ⚡	SMHMMOD	•	•	•	•	•	•	•	•	•	•	•	•	•
Multiply ⚡	SMHMMLT					•		•	•					
Murmur ⚡	SMHMMUR	•			•	•	•	•	•				•	•
Muse ⚡	SMHMMUS	•	•	•		•		•	•				•	•
Trundle ⚡	SMHMTRN	•			•				•					•

⚡ Partnership Program — See page 10 for details.  
 • Available upholstery option

- Allsteel fabrics and foam meet requirements for CTB117.
- Blank spaces indicate that a product has not yet been tested or that it failed.
- Contact Allsteel Customer Support for other flammability code approvals.

		Rock - Cushion	Rock - Shell/Body	Rock Single Upholstery	Peak Back	Peak Seat	Peak Single Upholstery	Peak Welt	Peak Ottoman	Wedge Seat	Wedge Back	Wedge Single Upholstery	Summit	Picnic Upholstered Seating
<b>GRADE 5</b>														
Main Line Flax ☎	SCAMMLF	•	•	•	•	•	•	•	•	•			•	•
Rove ☎	SMHMROV	•												
CF Stinson Sequence ☎	SCFSSEQ	•			•		•	•	•				•	•
<b>GRADE 6</b>														
Arris	ARR	•			•	•	•	•	•	•	•	•	•	•
Blazer ☎	SCAMBLZ	•	•	•	•	•	•	•	•	•	•	•	•	•
Chock ☎	SMHMCCK	•			•		•	•	•					
Hedge ☎	SMHMHED	•	•	•	•		•	•	•					•
Hemp ☎	SCAMHMP	•	•	•	•	•	•	•	•	•	•			•
Pocket ☎	SMHMPKT	•	•	•		•	•	•	•					•
Maharam Sequence ☎	SMHMSQN	•			•		•	•						•
Tandem ☎	SMHMTAN	•			•		•	•	•					•
<b>GRADE 7</b>														
Silk ☎	SCAMSLK	•	•	•	•	•	•	•	•	•	•			•
<b>GRADE 8</b>														
Apt ☎	SMHMAPT	•	•	•	•	•	•	•	•					•
Brisa ☎	RS	•	•	•	•	•	•	•	•				•	•
Zap ☎	SCAMZAP	•	•	•	•	•	•	•	•	•	•	•	•	•
<b>GRADE 9</b>														
Ultraleather Pro ☎	SUF554	•	•	•	•	•	•	•	•				•	•
Yoredale ☎	SCAMYDL	•	•	•	•	•	•	•	•	•	•	•	•	•

☎ Partnership Program — See page 10 for details.  
 • Available upholstery option

Upcharges listed for Grades 2 and above, add to Base Price. Grades 9-22 on page 324.

Style	Model Number <i>Add options below</i>	Base Price	Upholstery	Upcharge							
				2	3	4	5	6	7	8	
<b>Peak Single Upholstery</b>											
Peak Double Left Single Upholstery	ACVISDLS	\$ 4447	Seat/Back	\$ 144	\$ 286	\$ 428	\$ 616	\$ 806	\$ 996	\$ 1183	
Peak Double Right Single Upholstery	ACVISDRS	\$ 4447	Seat/Back	\$ 144	\$ 286	\$ 428	\$ 616	\$ 806	\$ 996	\$ 1183	
Peak Single Left Single Upholstery	ACVISSLS	\$ 2964	Seat/Back	\$ 72	\$ 143	\$ 213	\$ 307	\$ 402	\$ 495	\$ 590	
Peak Single Right Single Upholstery	ACVISSRS	\$ 2964	Seat/Back	\$ 72	\$ 143	\$ 213	\$ 307	\$ 402	\$ 495	\$ 590	
Peak Ottoman	ACVISOTS	\$ 1927	Body	\$ 62	\$ 120	\$ 179	\$ 259	\$ 337	\$ 418	\$ 496	
<b>Peak Multi Upholstery</b>											
Peak Double Left Multi Upholstery	ACVISDLM	\$ 4670	Seat	\$ 63	\$ 124	\$ 186	\$ 268	\$ 349	\$ 432	\$ 514	
			Back	\$ 54	\$ 107	\$ 160	\$ 230	\$ 300	\$ 371	\$ 442	
			Welt	\$ 35	\$ 70	\$ 105	\$ 151	\$ 197	\$ 242	\$ 289	
Peak Double Right Multi Upholstery	ACVISDRM	\$ 4670	Seat	\$ 63	\$ 124	\$ 186	\$ 268	\$ 349	\$ 432	\$ 514	
			Back	\$ 54	\$ 107	\$ 160	\$ 230	\$ 300	\$ 371	\$ 442	
			Welt	\$ 35	\$ 70	\$ 105	\$ 151	\$ 197	\$ 242	\$ 289	
Peak Single Left Multi Upholstery	ACVISSLM	\$ 3112	Seat	\$ 26	\$ 50	\$ 74	\$ 106	\$ 138	\$ 171	\$ 202	
			Back	\$ 30	\$ 59	\$ 89	\$ 128	\$ 167	\$ 207	\$ 245	
			Welt	\$ 21	\$ 42	\$ 63	\$ 90	\$ 117	\$ 145	\$ 173	
Peak Single Right Multi Upholstery	ACVISSRM	\$ 3112	Seat	\$ 26	\$ 50	\$ 74	\$ 106	\$ 138	\$ 171	\$ 202	
			Back	\$ 30	\$ 59	\$ 89	\$ 128	\$ 167	\$ 207	\$ 245	
			Welt	\$ 21	\$ 42	\$ 63	\$ 90	\$ 117	\$ 145	\$ 173	

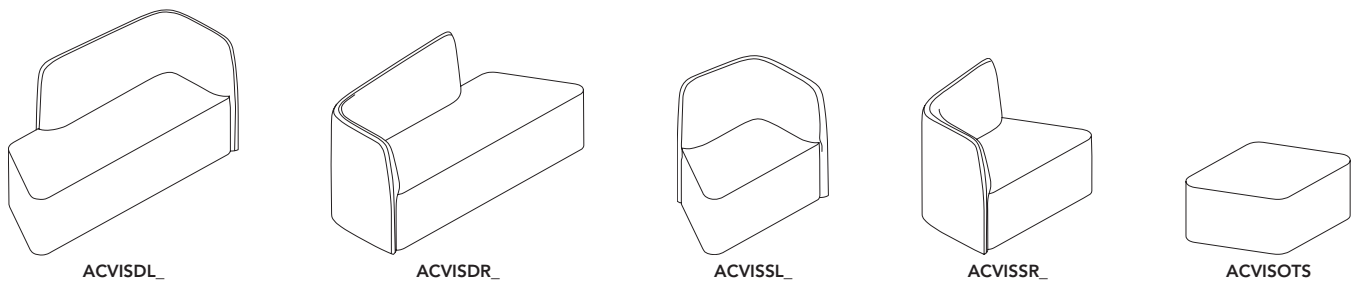

<b>Pricing Example:</b>	<b>Model/Options</b>	<b>Base Price/Upcharges</b>
Step 1: Select Model	ADVISDLM	\$ 4670
Step 2: Select Seat Upholstery	Grade 3	\$ 124 upcharge
Step 3: Select Back Upholstery	Grade 5	\$ 230 upcharge
Step 3: Select Welt Upholstery	Grade 1	\$ 0 upcharge
<b>Add Base + applicable Upcharges for Total List Price =</b>		<b>\$ 5024</b>

<p><b>How to specify —</b> Select the Model Number from above.</p> <p>ACVIS   S   .</p>	<p><i>1st Option:</i> Select the Upholstery for Single Upholstery Models: See Allsteel Upholstery matrix on pages 210-211.</p>
---	--

Example: ACVISSRS.HAML11

<p><b>How to specify —</b> Select the Model Number from above.</p> <p>ACVIS   M   .</p>	<p><i>1st Option:</i> Select the Seat Upholstery for Multi-Upholstery Models: See Allsteel Upholstery matrix on pages 210-211.</p>	<p><i>2nd Option:</i> Select the Back Upholstery for Multi-Upholstery Models: See Allsteel Upholstery matrix on pages 210-211.</p>	<p><i>3rd Option:</i> Select the Welt Upholstery for Multi-Upholstery Models: See Allsteel Upholstery matrix on pages 210-211.</p>
---	--	--	--

Example: ACVISDLM.CLYD13.RUSH18.HAML08

Model Number		Overall			Seat			Arms			Backrest							
		Ship Weight	Calves	COM Yardage*	Height	Width	Depth	Height	Width	Depth	Pan Angle (Range)	Armrest Height	Armrest Length	Arm Height to the Floor	Height	Width	Lumbar Height	Backrest angle (Range)
ACVISD_S	Seat/Back	220	55.6	8.6	38"	75½"	27½"											55.6
ACVISS_S	Seat/Back	160	31.3	4.5	38½"	43½"	27½"											31.3
ACVISOTS	Body	75	13.1	2.0	18¼"	40¼"	25½"											13.1
ACVISD_M	Seat	220	55.6	3.6	38"	75½"	27½"											55.6
	Back			3.1														
	Welt			2.0														
ACVISS_M	Seat	160	31.3	1.5	38½"	43½"	27½"											31.3
	Back			1.8														
	Welt			1.3														

\*COM Yardage is listed for total yardage/feet required for a model, with applicable yardage/feet for individual components listed.

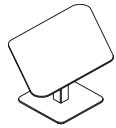

Description	Model <i>Add options below</i>	List Price with Upcharge			
		L1	L2	L3	
<b>Peak Tables</b>					
Peak Table	ACVISTBL	Table	\$ 1979	\$ 2025	\$ 2071
Peak Coffee Table	ACVISCTBL	Coffee Table	\$ 1827	\$ 1873	\$ 1919

Model Number	Overall				
	Ship Weight	Cutbs	Height	Width	Depth
ACVISTBL	50	8.7	27 1/2"	40 1/2"	25 1/2"
ACVISCTBL	45	6.1	17"	40 1/2"	25 1/2"

Peak Tables available in Knife Edge only.  
Peak Coffee Table has the same outer dimensions as the Peak Ottoman.

<p><b>How to specify —</b> Select the Model Number from above.</p>	<p><b>1st Option:</b> Select FSC (if applicable):</p>	<p><b>2nd Option:</b> Select the Laminate Color: See page 209 for selections and Color Codes.</p>	<p><b>3rd Option:</b> Select the Edge Color: See page 209 for selections and Color Codes.</p>	<p><b>4th Option:</b> Select the Paint Finish: P7A Textured Flint PR8 Textured Silver (Table) (Grade 2 upcharge \$52) PR8 Textured Silver (Coffee Table) (Grade 2 upcharge \$41) PK7 Textured Designer White</p>
<p>ACV I S           .</p>	<p>          .</p>	<p>          .</p>	<p>      .</p>	<p>       </p>

Example: ACVISTBL.LM15.EU.PK7

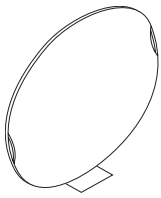

Description	Model <i>Add options below</i>	List Price with Upcharge	
		P1	P2
Cloud Screen			
Cloud Screen	ACDIV	\$ 2400	\$ 2565

Model Number	Cloud Screen	Ship Weight		COM Yardage*	Overall			Screen			Base Plate	
		Cuibs			Height	Width	Depth	Height	Width	Height	Width	Depth
ACDIV	Cloud Screen	66	8.8		72"	72"	22"	72"	72"	0.25"	17"	22"

<p><b>How to specify —</b> Select the Model Number from above.</p>	<p><b>1st Option:</b> <b>Select the Upholstery:</b> See Allsteel Upholstery matrix on pages <a href="#">210-211</a>.  Cloud only offers Noble fabric.</p>	<p><b>2nd Option:</b> <b>Select the Paint Finish:</b> See Paint Finishes on page <a href="#">209</a>.</p>
<p><b>A C D I V</b> .</p>	<p>                               .</p>	<p>                              </p>

Example:

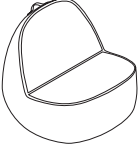
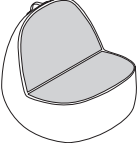

Upcharges listed for Grades 2 and above, add to Base Price. Grades 9-22 on page 324.

Style	Model Number <i>Add options below</i>	Base Price	Upholstery	Upcharge							
				2	3	4	5	6	7	8	
<b>Rock</b>											
Rock Single Upholstery	ACEGUS	\$ 2521	Cushion/Shell	\$ 79	\$ 157	\$ 236	\$ 342	\$ 446	\$ 552	\$ 657	
											
<b>Rock</b>											
Rock Multi Upholstery	ACEGUM	\$ 2646	Cushion Shell	\$ 40 \$ 55	\$ 79 \$ 111	\$ 118 \$ 165	\$ 171 \$ 239	\$ 223 \$ 312	\$ 276 \$ 386	\$ 329 \$ 459	
											

Note that handle is only available in single light gray leather.

Pricing Example:	Model/Options	Base Price/Upcharges
Step 1: Select Model	ACEGUM	\$ 2646
Step 2: Select Cushion Upholstery	Grade 4	\$ 118 upcharge
Step 3: Select Shell Upholstery	Grade 8	\$ 459 upcharge
Add Base + applicable Upcharges for Total List Price =		\$ 3223

<p><b>How to specify —</b> Select the Model Number from above.</p>	<p><i>1st Option:</i> Select the Upholstery for Single Upholstery Models: See Allsteel Upholstery matrix on pages 210-211.</p>
<p>A C E G U S .             </p>	<p>Example: ACEGUS.CLYD08</p>

<p><b>How to specify —</b> Select the Model Number from above.</p>	<p><i>1st Option:</i> Select the Seat/Cushion Upholstery for Multi-Upholstery Models: See Allsteel Upholstery matrix on pages 210-211.</p>	<p><i>2nd Option:</i> Select the Shell/Body Upholstery for Multi-Upholstery Models: See Allsteel Upholstery matrix on pages 210-211.</p>
<p>A C E G U M .             </p>	<p>Example: ACEGUM.DAPR10.PNS006</p>	

Model Number		Ship Weight		COM Yardage*		Overall			Seat			Backrest			
		Calbs	COM Yardage*	Height	Width	Depth	Height	Width	Depth	Pan Angle (Range)	Height	Width	Backrest Inclination from Vertical	Backrest Angle (Range)	
ACEGUS	Cushion/Shell	50	23.4	5.0	31"	31"	31"	14½"-19½"	29"	16½"	-1°-21°	21½"	29"	13°-33°	102°
ACEGUM	Cushion	50	23.4	3.5	31"	31"	31"	14½"-19½"	29"	16½"	-1°-21°	21½"	29"	13°-33°	102°
	Shell			2.5											

\*COM Yardage is listed for total yardage/feet required for a model, with applicable yardage/feet for individual components listed.

Upcharges listed for Grades 2 and above, add to Base Price. Grades 9-22 on page 324.

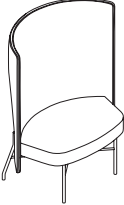
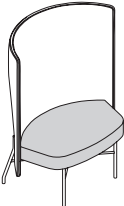
Style	Model Number <i>Add options below</i>	Base Price	Upholstery	Upcharge							
				2	3	4	5	6	7	8	
<b>Wedge</b>											
Wedge Single Upholstery	ACWEDS	\$ 3261	Seat/Back	\$ 63	\$ 126	\$ 189	\$ 273	\$ 357	\$ 441	\$ 525	
											
<b>Wedge</b>											
Wedge Multi Upholstery	ACWEDM	\$ 3424	Seat Back	\$ 16 \$ 47	\$ 31 \$ 94	\$ 47 \$ 142	\$ 68 \$ 204	\$ 89 \$ 268	\$ 111 \$ 331	\$ 131 \$ 394	
											

<b>Pricing Example:</b>	<b>Model/Options</b>	<b>Base Price/Upcharges</b>
Step 1: Select Model	ACWEDM	\$ 3424
Step 2: Select Seat Upholstery	Grade 4	\$ 47 upcharge
Step 3: Select Back Upholstery	Grade 1	\$ 0 upcharge
<b>Add Base + applicable Upcharges for Total List Price =</b>		<b>\$ 3471</b>

<b>How to specify —</b> Select the Model Number from above.	<b>1st Option:</b> Select the Upholstery for Single Upholstery Models: See Allsteel Upholstery matrix on pages 210-211.	<b>2nd Option:</b> Select the Paint Finish: P71 Black P JW Designer White P02 Flint PJE Pyrite (Grade 2 upcharge \$240) PR6 Silver (Grade 2 upcharge \$240) PJF Bullseye (Grade 3 upcharge \$600)
ACWEDS   .	.	.





Example: ACWEDS.DOT90.P02

<b>How to specify —</b> Select the Model Number from above.	<b>1st Option:</b> Select the Seat Upholstery for Multi-Upholstery Models: See Allsteel Upholstery matrix on pages 210-211.	<b>2nd Option:</b> Select the Back Upholstery for Multi-Upholstery Models: See Allsteel Upholstery matrix on pages 210-211.	<b>3rd Option:</b> Select the Paint Finish: P71 Black P JW Designer White P02 Flint PJE Pyrite (Grade 2 upcharge \$252) PR6 Silver (Grade 2 upcharge \$252) PJF Bullseye (Grade 3 upcharge \$631)
ACWEIDM   .	.	.	.

Example: ACWEDM.HAML18.NR66.PR6

Model Number		Ship Weight		COM Yardage*	Overall			Seat			Backrest			
		Culbs	Height		Width	Depth	Height	Width	Depth	Pan Angle (Range)	Width	Lumbar Height	Backrest/Seat Angle (Range)	
ACWEDS	Seat/Back	85	28.5	4.0	46 1/2"	48"	25 1/2"	17 1/4"	31"	19 1/4"	0°	15"	10"	0°
ACWEDM	Seat	85	28.5	1.0										
	Back			3.0										

\*COM Yardage is listed for total yardage/feet required for a model, with applicable yardage/feet for individual components listed.

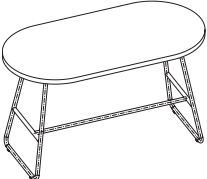
Description	Model <i>Add options below</i>	List Price			Paint Upcharge	
		L1	L2	L3	P2	P3
<b>Picnic Table</b>						
 Picnic Table, Bar Height	ACPICT	\$ 2283	\$ 2302	\$ 2318	\$ 129	\$ 321
<b>Picnic Table</b>						
 Picnic Table, Bar Height	ACPICT30	\$ 2359	\$ 2381	\$ 2402	\$ 129	\$ 321
<b>Picnic Table</b>						
 Picnic Table, Counter Height	ACPICTC24 <i>(De-emphasized)</i>	\$ 1634	\$ 1653	\$ 1669	\$ 87	\$ 172
<b>Picnic Table</b>						
 Picnic Table, Counter Height	ACPICTC30 <i>(De-emphasized)</i>	\$ 1710	\$ 1732	\$ 1753	\$ 87	\$ 172
<b>Picnic Table</b>						
 Picnic Table, Seated Height	ACPICBL <i>(De-emphasized)</i>	\$ 1502	\$ 1531	\$ 1559	\$ 54	\$ 135
<b>Picnic Table</b>						
 Work From Home Picnic Table	ACPICBL24 <i>(De-emphasized)</i>	\$ 1594	\$ 1608	\$ 1621	\$ 54	\$ 135

Picnic Table and Laminate Bench available in Flat Edge only.

<p><b>How to specify —</b> Select the Model Number from above.</p> <p>ACPICT     .                 .</p>	<p><b>1st Option:</b> Select FSC <i>(if applicable):</i></p> <p>          .</p>	<p><b>2nd Option:</b> Select the Laminate Finish: See page 350 for selections and Color Codes.</p> <p>                    .</p>	<p><b>3rd Option:</b> Select the Edge Color: See page 350 for selections and Color Codes.</p> <p>      .</p>	<p><b>4th Option:</b> Select the Paint Finish: See Paint Finishes on page 350.</p> <p><b>P1 P2 P3</b></p> <p><b>P2</b> add \$129 Table / \$54 Bench upcharge <b>P3</b> add \$321 Table/ \$135 Bench upcharge</p> <p>          .</p>
--	---	---	--	---



Example: ACPICT.LDW1.DW.P71

Model Number					Overall			Seat			
		Ship Weight	Cables	COM Yardage*	Height	Width	Depth	Height	Width	Depth	Pan Angle (Range)
ACPICT	Table	80	11.3		41"	64"	24"				
ACPICT30	Table	103	9.1		41"	64"	30"				
ACPICT24*	Table	67	8.5		36"	64"	24"				
ACPICT30*	Table	90	9.1		36"	64"	30"				
ACPICBL*	Table	60	16.5	1.0	28.19"	48"	16"	29½"	15"	47½"	
ACPICBL24*	Table	17	63		23.23"	48"	24"				

\*De-emphasized

\*\*COM Yardage is listed for total yardage/feet required for a model, with applicable yardage/feet for individual components listed.

Upcharges listed for Grades 2 and above, add to Base Price. Grades 9-22 on page 324.

Description	Model Number <i>Add options below</i>	List Price with Upcharge							
		1	2	3	4	5	6	7	8
<b>Picnic Bench</b>									
Picnic Bench Upholstered	ACPICBU <i>(De-emphasized)</i>	\$ 1481	\$ 1497	\$ 1512	\$ 1528	\$ 1549	\$ 1570	\$ 1592	\$ 1612
									
<b>Picnic Low Stool</b>									
Picnic Low Stool	ACPICLS <i>(De-emphasized)</i>	\$ 741	\$ 749	\$ 757	\$ 764	\$ 775	\$ 785	\$ 796	\$ 807
									

Picnic Low Stool stacks 6 high.

<p><b>How to specify —</b> Select the Model Number from above.</p> <p>ACPIC         .</p>	<p><b>1st Option:</b> Select the Upholstery: See Allsteel Upholstery matrix on pages 210-211.</p> <p>          .</p>	<p><b>2nd Option:</b> Select FSC (if applicable): X Non-FSC Wood</p> <p>X   .</p>	<p><b>3rd Option:</b> Select the Paint Finish: See Paint Finishes on page 209.</p> <p>P1 P2 P3</p> <p>P2 add \$55 Stool / \$54 Bench upcharge P3 add \$137 Stool / \$135 Bench upcharge</p> <p>     </p>
---	--	---	--

Example: ACPICLS.RUSH10.P02

Model Number					Overall			Seat			
		Ship Weight	Cubes	COM Yardage*	Height	Width	Depth	Height	Width	Depth	Pan Angle (Range)
ACPICBU*	Bench	60	16.5	1.0	29½"-47½"	15"	18¾"	29½"		15"	47½°
ACPICLS*	Stool	15	10.9	0.5	15"-19"	15"	22¾"	19"		15"	15°

\*De-emphasized

\*\*COM Yardage is listed for total yardage/feet required for a model, with applicable yardage/feet for individual components listed.



Upcharges listed for Grades 2 and above, add to Base Price. Grades 9-22 on page 324.

Description	Model Number <i>Add options below</i>	List Price with Upcharge							
		1	2	3	4	5	6	7	8
<b>Summit Stools</b>									
Summit Stool	ACPERU	\$ 963	\$ 971	\$ 979	\$ 986	\$ 997	\$ 1007	\$ 1018	\$ 1029



Summit Stool stacks 4 high.

Model Number	Stool	Ship Weight		COM Yardage*		Overall			Seat			Backrest			
		Cutbs	COM Yardage*	Height	Width	Depth	Height	Width	Depth	Pan Angle (Range)	Height	Width	Backrest Inclination from vertical	Backrest/Seat Angle (Range)	
ACPERU	Stool	0.5	0.5	0.5	33"	18"	17"	28"	0	13"	0°-3°	5 1/4"	0"	27°-30°	117°

\*COM Yardage is listed for total yardage/feet required for a model, with applicable yardage/feet for individual components listed.

<p><b>How to specify —</b> Select the Model Number from above.</p>	<p><b>1st Option:</b> Select the Upholstery: See Allsteel Upholstery matrix on pages 210-211.</p>	<p><b>2nd Option:</b> Select the Paint Finish: See Paint Finishes on page 209.</p> <p><b>P1</b> <b>P2</b> <b>P3</b>  <b>P2</b> add \$71 upcharge  <b>P3</b> add \$178 upcharge</p>
<p>ACPERU   .</p>	<p>        .</p>	<p>       </p>

Example: ACPERU.DOT24.P02

Alone-Together Solo

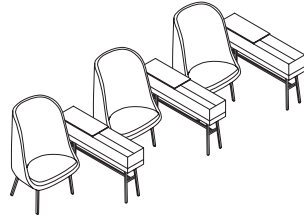

AIRPORT LOUNGE

Open Social Collaborative

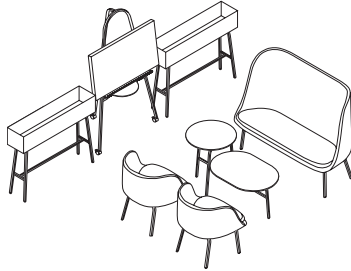

COLLABORATIVE WORK LOUNGE

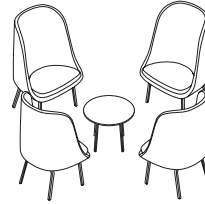

SPACE DEFINING LOUNGE  
(4 PERSON)

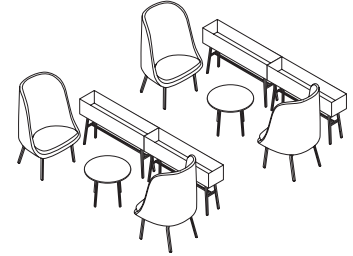

SPACE DEFINING LOUNGE  
(2 PERSON)

Kit-of-Parts

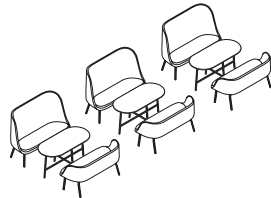

SPACE DEFINING BANQUETTE

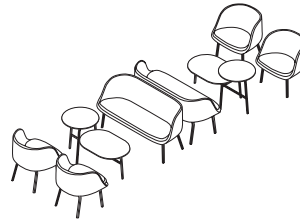

BACK-TO-BACK LOUNGE

Re-deployable Space Division

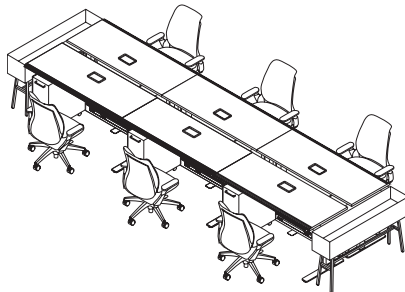

END-OF-RUN

**LAMINATES**

**GRADE L1-ABSTRACT**

Ash.....	LT3B
Handspun Pearl.....	LAHP
Handspun Dove.....	LAHD
Handspun Slate.....	LAHS
Handspun Chestnut.....	LAHC
Silver Mesh.....	LT8D

**GRADE L1-SOLID**

Black.....	P
Brownstone.....	LM13
Bungalow.....	LM12
Designer White.....	LDW1
Flint.....	LM16
Fossil Shale.....	LEH1
Loft.....	LM11
Muslin.....	LM15
Titanium.....	LT11

**GRADE L1-WOODGRAIN**

Belair.....	LWBA
Bourbon Cherry.....	H
Field Elm.....	LWFE
Florence Walnut.....	LFW1
Kingswood Walnut.....	LK11
Natural Maple.....	LWD
NeoWalnut.....	LNU1
Pinnacle.....	PINC
Shaker Cherry.....	LW7C

**GRADE L2-WOODGRAIN**

Beigewood.....	LWBE
Fawn Cypress.....	LFC1
Lowell Ash.....	LLA1
Mangalore Mango.....	LMM1
Natural Recon.....	LNRR1
Phantom Charcoal.....	LPC1
Phantom Ecru.....	LPE1
Portico Teak.....	LPT1
Skyline Walnut.....	LSW1
Veranda Teak.....	LVT1

**GRADE L3-WOODGRAIN**

Natural Walnut.....	LWNW
---------------------	------

**GRADE L4-MARKERBOARD**

White Markerboard.....	FMQ1
------------------------	------

**GRADE L7-SOLID (TRACELESS)\*†**

Black Velvet.....	LBV1
Charcoal Velvet.....	LCV1

\* Park Storage is available in all grades of laminate except Grades 4 and 7.

† LBV1 and LCV1 are warranted for 1 year.

**EDGES**

Beigewood.....	DE
Belair.....	BA
Black.....	E4
Bourbon Cherry.....	H
Brownstone.....	EY
Bungalow.....	EX
Designer White.....	DW
Fawn Cypress.....	FC
Field Elm.....	FE
Flint.....	E9
Florence Walnut.....	FW
Fossil.....	EH
Kingswood Walnut.....	KI
Loft.....	EV
Lowell Ash.....	DL
Mangalore Mango.....	MM
Muslin.....	EU
Natural Maple.....	DD
Natural Recon.....	NR
Natural Walnut.....	DN
NeoWalnut.....	NU
Parchment.....	EN
Phantom Charcoal.....	PC
Phantom Ecru.....	PE
Pinnacle.....	PI
Portico Teak.....	DP
Shaker Cherry.....	DF
Skyline Walnut.....	SW
Titanium.....	TI
Veranda Teak.....	VT

**NOTE:** \$33 upcharge on Woodgrain T-Mold.

**PAINT**

**GRADE P1**

Textured Brownstone.....	P7J
Textured Designer White.....	PK7
Textured Flint.....	P7A
Textured Loft.....	P7L
Textured Muslin.....	P7M
Textured Pebble.....	P8Y
Textured Salt.....	P8Z
Textured Titanium.....	P8V

**GRADE P2**

Textured Silver.....	PR8
Solar Black.....	P8X

**GRADE P3**

Amethyst ( <i>De-emphasized</i> ).....	P091
Atom.....	P85
Blossom***.....	P8K
Cobalt Mica ( <i>De-emphasized</i> ).....	P090
Ember.....	P8P
Ion.....	P8N
Iris.....	P8J
Krypton.....	P8F
Ochre.....	P093
Regatta.....	P8M
Sienna.....	P092
Succulent***.....	P8A

\*\*\*These colors are intended to be an inspirational option for the trending market. Production application is limited and color availability is approximately two years to coincide with evolving workplace trends.

**WOOD FINISH**

**WOOD SPECIES**

STAIN NAME	MAPLE
Beigewood.....	LE878
Belair.....	LE934
Burnished Cherry.....	LE777
Cinnamon Cherry.....	LE260
Clear Coat.....	LE100
Clear Oak.....	LE300
Clear/Natural Maple.....	LE800
Dark Rift Cut Oak.....	LE331
Ebony Maple.....	LE555
Field Elm.....	LE599
Florence Walnut.....	LE579
Harvest Maple.....	LE856
Light Cherry.....	LE701
Light Walnut.....	LE601
Lowell Ash.....	LE394
Medium Red Cherry.....	LE512
Natural Cherry.....	LE222
Nutmeg Walnut.....	LE629
Phantom Ecru.....	LE912
Pinnacle Walnut.....	LE679
Portico Teak.....	LE150
Shaker Cherry.....	LE774
Skyline Walnut.....	LE625
Sumatra Walnut.....	LE693

Natural variances in wood grains and color shades are expected in all wood finishes.

All of Allsteel's tables are level® – 2 certified to the ANSI/BIFMA e3 Furniture Sustainability Standard. See [www.levelcertified.org](http://www.levelcertified.org) for more information.

**NOTE:** Refer to individual product pages for upcharges.

**FSC Certified Wood at Allsteel**  
See page 431 for more information.

Allsteel Seating Upholstery Selections by Model/Series.

			Seat Upholstery	Seat & Back Upholstery
<b>GRADE 1</b>				
Apex	APX		•	
Centurion	CU		•	•
Contourett	UR		•	•
Dapper	DAPR		•	•
Ensemble	ENSB		•	•
Hamilton	HAML		•	•
Inertia	NR		•	•
Optic	OP		•	
<b>GRADE 2</b>				
Appoint Seating	PNS		•	•
Blume	BLME		•	•
Clyde	CLYD		•	•
Dotty	DOT		•	•
Meld	SMHMMLD		•	•
Rush	RUSH		•	•
Spin	SPNN		•	
Whisper Vinyl	WP		•	•
<b>GRADE 3</b>				
Lateral	SCFSLAT		•	
Moxie	SX		•	•
Purl	PURL		•	•
Quill	QUL		•	•
<b>GRADE 4</b>				
Caper	SMHMCAP		•	
Manner	SMHMMAN		•	•
Merit	SMHMMER		•	•
Messenger	SMHMGRM		•	•
Metric	SMHMMET		•	•
Mode	SMHMMOD		•	•
Trundle	SMHMTRN		•	

			Seat Upholstery	Seat & Back Upholstery
<b>GRADE 5</b>				
Main Line Flax	SCAMMLF		•	•
Riddle	SCFSRID		•	
Stinson Sequence	SCFSSEQ		•	
<b>GRADE 6</b>				
Arris	ARR		•	
Blazer	SCAMBLZ		•	•
Chock	SMHMCKK		•	
Hedge	SMHHMED		•	
Hemp	SCAMHMP		•	•
Pocket	SMHMPKT		•	
Tandem	SMHMTAN		•	
<b>GRADE 7</b>				
Silk	SCAMSLK		•	•
<b>GRADE 8</b>				
Brisa	RS		•	•
Zap	SCAMZAP		•	•
<b>GRADE 9</b>				
Ultraleather Pro	SUF554		•	•
Yoredale	SCAMYDL		•	•

⊕ Partnership Program — See page 10 for details.  
 • Available upholstery option

- Allsteel fabrics and foam meet requirements for CTB117.
- Blank spaces indicate that a product has not yet been tested or that it failed.
- Contact Allsteel Customer Support for other flammability code approvals.

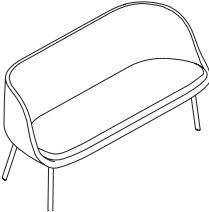
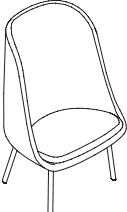
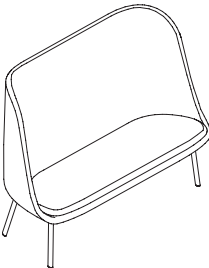

(See page 325 for COM pricing on Grades 9-22)

Description	Model Number <i>Add options below</i>	Base Price	Upholstery	Upcharge								
				2	3	4	5	6	7	8		
<b>Park Single Upholstery</b>												
	Park Lo Solo Lounge, Metal Leg	NALS	\$ 2822	Upholstery	\$ 40	\$ 79	\$ 118	\$ 171	\$ 223	\$ 276	\$ 329	
	Park Lo Solo Lounge, Wood Leg	NALSW	\$ 3375	Upholstery	\$ 40	\$ 79	\$ 118	\$ 171	\$ 223	\$ 276	\$ 329	
	Park Lo Settee Lounge, Metal Leg	NALD	\$ 4516	Upholstery	\$ 55	\$ 111	\$ 165	\$ 239	\$ 312	\$ 386	\$ 459	
	Park Lo Settee Lounge, Wood Leg	NALDW	\$ 5166	Upholstery	\$ 55	\$ 111	\$ 165	\$ 239	\$ 312	\$ 386	\$ 459	
	Park Hi Solo Lounge, Metal Leg	NAHS	\$ 3668	Upholstery	\$ 55	\$ 111	\$ 165	\$ 239	\$ 312	\$ 386	\$ 459	
	Park Hi Solo Lounge, Wood Leg	NAHSW	\$ 4221	Upholstery	\$ 55	\$ 111	\$ 165	\$ 239	\$ 312	\$ 386	\$ 459	
	Park Hi Settee Lounge, Metal Leg	NAHD	\$ 6068	Upholstery	\$ 79	\$ 157	\$ 236	\$ 342	\$ 446	\$ 552	\$ 657	
	Park Hi Settee Lounge, Wood Leg	NAHDW	\$ 6718	Upholstery	\$ 79	\$ 157	\$ 236	\$ 342	\$ 446	\$ 552	\$ 657	

PARK

<p><b>How to specify —</b> Select the Model Number from above.</p> <p>N   A   .</p>	<p><b>1st Option:</b> Select the Base Paint or Wood Finish:</p> <p>P1 P2</p> <p>Grade 2 upcharge: Solo \$24 / Settee \$26</p> <p>. . . . .</p>	<p><b>2nd Option:</b> Select the Upholstery:</p> <p>See Allsteel Upholstery matrix on page 13-14.</p> <p>. . . . .</p>
---	--	--

Example: NALS.P7L.SCAMBLZ24

Model Number	Ship Weight		COM Yardage*	Overall			Seat			Back				
	Calbs			Height	Width	Depth	Height	Width	Depth	Pan Angle (Range)	Height	Width	Lumbar Height	Backrest angle (Range)
<b>NALS</b>	50	39.4	2.5	31½"	32"	27½"	18¼"	21"	19½"	3"	17½"	15"	8¼"	107"
<b>NALSW</b>	52	39.4	2.5	31½"	32"	27½"	18¼"	21"	19½"	3"	17½"	15"	8¼"	107"
<b>NALD</b>	80	82.2	4.5	31½"	64"	27½"	18¼"	55¼"	19½"	3"	17½"	48"	8¼"	107"
<b>NALDW</b>	85	82.2	4.5	31½"	64"	27½"	18¼"	55¼"	19½"	3"	17½"	48"	8¼"	107"
<b>NAHS</b>	65	55.9	3.5	48½"	32"	27½"	18¼"	21"	19½"	3"	32"	15"	8¼"	107"
<b>NAHSW</b>	67	55.9	3.5	48½"	32"	27½"	18¼"	21"	19½"	3"	32"	15"	8¼"	107"
<b>NAHD</b>	105	116.1	5	48½"	64"	27½"	18¼"	55¼"	19½"	3"	32"	48"	8¼"	107"
<b>NAHDW</b>	110	116.1	5	48½"	64"	27½"	18¼"	55¼"	19½"	3"	32"	48"	8¼"	107"

\*COM Yardage is listed for total yardage/feet required for a model, with applicable yardage/feet for individual components listed.

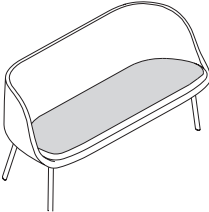
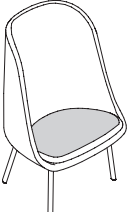
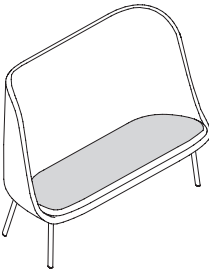

(See page 325 for COM pricing on Grades 9-22)

Description	Model Number <i>Add options below</i>	Base Price	Upholstery	Upcharge							
				2	3	4	5	6	7	8	
<b>Park Multi-Upholstery</b>											
	Park Lo Solo Lounge	NALSM	\$ 2964	Back	\$ 31	\$ 63	\$ 94	\$ 137	\$ 178	\$ 221	\$ 262
	Multi Upholstery, Metal Leg			Seat	\$ 8	\$ 16	\$ 23	\$ 34	\$ 44	\$ 55	\$ 66
	Park Lo Solo Lounge	NALSMW	\$ 3517	Back	\$ 31	\$ 63	\$ 94	\$ 137	\$ 178	\$ 221	\$ 262
	Multi Upholstery, Wood Leg			Seat	\$ 8	\$ 16	\$ 23	\$ 34	\$ 44	\$ 55	\$ 66
	Park Lo Settee Lounge	NALDM	\$ 4741	Back	\$ 45	\$ 91	\$ 137	\$ 198	\$ 259	\$ 320	\$ 381
	Multi Upholstery, Metal Leg			Seat	\$ 15	\$ 29	\$ 43	\$ 62	\$ 80	\$ 100	\$ 118
	Park Lo Settee Lounge	NALDMW	\$ 5391	Back	\$ 45	\$ 91	\$ 137	\$ 198	\$ 259	\$ 320	\$ 381
	Multi Upholstery, Wood Leg			Seat	\$ 15	\$ 29	\$ 43	\$ 62	\$ 80	\$ 100	\$ 118
	Park Hi Solo Lounge	NAHSM	\$ 3851	Back	\$ 45	\$ 91	\$ 137	\$ 198	\$ 259	\$ 320	\$ 381
	Multi Upholstery, Metal Leg			Seat	\$ 15	\$ 29	\$ 43	\$ 62	\$ 80	\$ 100	\$ 118
	Park Hi Solo Lounge	NAHSMW	\$ 4404	Back	\$ 45	\$ 91	\$ 137	\$ 198	\$ 259	\$ 320	\$ 381
	Multi Upholstery, Wood Leg			Seat	\$ 15	\$ 29	\$ 43	\$ 62	\$ 80	\$ 100	\$ 118
	Park High Settee Lounge	NAHDM	\$ 6371	Back	\$ 45	\$ 91	\$ 137	\$ 198	\$ 259	\$ 320	\$ 381
	Multi Upholstery, Metal Leg			Seat	\$ 33	\$ 66	\$ 100	\$ 143	\$ 188	\$ 232	\$ 276
	Park High Settee Lounge	NAHDMW	\$ 7021	Back	\$ 45	\$ 91	\$ 137	\$ 198	\$ 259	\$ 320	\$ 381
	Multi Upholstery, Wood Leg			Seat	\$ 33	\$ 66	\$ 100	\$ 143	\$ 188	\$ 232	\$ 276

<b>Pricing Example:</b>	<b>Model/Options</b>	<b>Base Price/Upcharges</b>
Step 1: Select Model	NALSM	\$ 2964
Step 2: Select Paint	P8X	\$ 24 upcharge
Step 3: Select Back Upholstery	Grade 5	\$ 137 upcharge
Step 4: Select Seat Upholstery	Grade 2	\$ 8 upcharge
<b>Add Base + applicable Upcharges for Total List Price =</b>		<b>\$ 3133</b>

<p><b>How to specify —</b> Select the Model Number from above.</p> <p>_____ .</p>	<p><b>1st Option:</b> Select the Base Paint or Wood Finish:</p> <p><b>P1 P2</b></p> <p>Grade 2 upcharge: Solo \$24 / Settee \$26</p> <p>_____ .</p>	<p><b>2nd Option:</b> Select the Back Upholstery for Multi-Upholstery Models:</p> <p>See Allsteel Upholstery matrix on page 13-14.</p> <p>_____ .</p>	<p><b>3rd Option:</b> Select the Seat Upholstery for Multi-Upholstery Models:</p> <p>See Allsteel Upholstery matrix on page 13-14.</p> <p>_____ .</p>
---	---	---	---

Examples: NALSM.P8X.HAML10.RUSH07

PARK

Model Number	Ship Weight		COM Yardage*	Overall			Back	Seat				Back			
	Calbs			Height	Width	Depth		Height	Width	Depth	Pan Angle (Range)	Height	Width	Lumbar Height	Backrest angle (Range)
NALSM	50	39.4	2	31½"	32"	27½"	Back					17½"	15"	8¼"	107"
			0.5				Seat	18¼"	21"	19½"	3"				
NALSMW	52	39.4	2	31½"	32"	27½"	Back					17½"	15"	8¼"	107"
			0.5				Seat	18¼"	21"	19½"	3"				
NALDM	80	82.2	3.5	31½"	64"	27½"	Back					17½"	48"	8¼"	107"
			1				Seat	18¼"	55¼"	19½"	3"				
NALDMW	85	82.2	3.5	31½"	64"	27½"	Back					17½"	48"	8¼"	107"
			1				Seat	18¼"	55¼"	19½"	3"				
NAHSM	65	55.9	3	48½"	32"	27½"	Back					32"	15"	8¼"	107"
			0.5				Seat	18¼"	21"	19½"	3"				
NAHSMW	67	55.9	3	48½"	32"	27½"	Back					32"	15"	8¼"	107"
			0.5				Seat	18¼"	21"	19½"	3"				
NAHDM	105	116.6	4	48½"	64"	27½"	Back					32"	48"	8¼"	107"
			1				Seat	18¼"	55¼"	19½"	3"				
NAHDMW	110	116.6	4	48½"	64"	27½"	Back					32"	48"	8¼"	107"
			1				Seat	18¼"	55¼"	19½"	3"				

\*COM Yardage is listed for total yardage/feet required for a model, with applicable yardage/feet for individual components listed.





Description	Model Number <i>below</i>	Cubes	Weight					Grade 2 Paint Upcharge
				L1	L2	L3	L7	
<b>Park Lo Side Table</b>								
19 1/4"H x 24"W x 24"D	NARC	10.0	20	\$1006	\$1029	\$1052	\$1144	\$ 29



<b>Park 48" Soft Square Meeting Table</b>								
28"H x 48"W x 48"D	NA48SS ( <i>De-emphasized</i> )	15.6	60	\$2081	\$2126	\$2170	\$2344	\$ 77

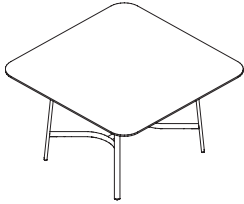

<b>Park 48" Round Meeting Table</b>								
28"H x 48"W x 48"D	NA48R ( <i>De-emphasized</i> )	15.6	60	\$2081	\$2126	\$2170	\$2344	\$ 77



PARK

Pricing Example:	Model/Options	Base Price/Upcharges
Step 1: Select Model	NARC	
Step 2: Select Laminate	w/Grade 3 Laminate	\$ 1052
Step 3: Select Paint	Grade 2 Paint	\$ 29 upcharge
Add Base + applicable Upcharges for Total List Price =		\$ 1081

How to specify — Select the Model Number from above.	1st Option: Select FSC (if applicable):	2nd Option: Select the Paint Finish: P1 P2	3rd Option: Select the Laminate Color: See page 226 for selections and color codes.	4th Option: Select the Edge Color: See page 226 for selections and color codes.
N A _ _	_ _ _	_ _ _	_ _ _ _	_

Example: NARC.FSC.P8Z.LFC1.FC



Description	Model Number <i>below</i>	Cubes	Weight					Grade 2 Paint Upcharge
				L1	L2	L3	L7	
<b>Park Lo Pill Table</b>								
20 1/2"H x 48"W x 15"D	NA4815RB	11.0	35	\$1030	\$1053	\$1076	\$1168	\$ 34



<b>Park Hi Pill Table</b>								
29 3/4"H x 48"W x 15"D	NA4828RB	14.6	50	\$1150	\$1173	\$1196	\$1288	\$ 43



<b>Work From Home Park Pill Table</b>								
29 3/4"H x 48"W x 20"D	NA482920RB (De-emphasized)	13.0	57	\$1118	\$1142	\$1166	\$1261	\$ 52



<b>Park Counter Pill Table</b>								
36"H x 48"W x 15"D	NA483615RB (De-emphasized)	15.5	60	\$1259	\$1282	\$1305	\$1397	\$ 41





<b>Park Counter Pill Table</b>								
36"H x 48"W x 20"D	NA483620RB (De-emphasized)	15.2	64	\$1262	\$1286	\$1310	\$1405	\$ 41



<p><b>How to specify —</b> Select the Model Number from above.</p>	<p><b>1st Option:</b> Select FSC (if applicable):</p>	<p><b>2nd Option:</b> Select the Paint Finish: P1 P2</p>	<p><b>3rd Option:</b> Select the Laminate Color: See page 226 for selections and color codes.</p>	<p><b>4th Option:</b> Select the Edge Color: See page 226 for selections and color codes.</p>
<p>NA        </p> <p>          .</p>	<p>          .</p>	<p>          .</p>	<p>          .</p>	<p>     </p>

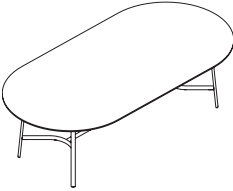

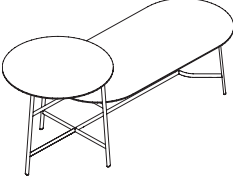
Example: NA483615RB.FSC.P8X.LWBA.BA

Description	Model Number <i>Add options below</i>	Cubes	Weight					Grade 2 Paint Upcharge
				L1	L2	L3	L7	
 <b>Park Pill Work Table</b> 28 3/4"H x 57"W x 27"D	NAPWT	18.9	45	\$2081	\$2137	\$2193	\$2415	\$ 54
 <b>Park 96" Pill Meeting Table</b> 28"H x 94"W x 48"D	NA96RCF <i>(De-emphasized)</i>	28.2	110	\$2777	\$2844	\$2910	\$3176	\$ 86
 <b>Park Hi Lo Casual Table</b> 28 3/4"H x 52 1/4"W x 24"D	NALC	25.7	52	\$2165	\$2227	\$2286	\$2528	\$ 42
 <b>Park Hi Lo Meeting Table</b> 41"H x 107 1/4"W x 42"D	NALCF	34.8	146	\$6248	\$6371	\$6490	\$6971	\$ 251

<b>Pricing Example:</b>	<b>Model/Options</b>	<b>Base Price/Upcharges</b>
Step 1: Select Model	NALC	
Step 2: Select Laminate	w/Grade 3 Laminate	\$ 2286
Step 3: Select Paint	Grade 2 Paint	\$ 42 upcharge
Add Base + applicable Upcharges for Total List Price =		\$ 2328

<p><b>How to specify —</b> Select the Model Number from above.</p> <p>N   A        </p>	<p><b>1st Option:</b> Select FSC (if applicable):</p> <p>          .</p>	<p><b>2nd Option:</b> Select the Paint Finish:</p> <p>P1 P2</p> <p>          .</p>	<p><b>3rd Option:</b> Select the Laminate Color:</p> <p>See page 226 for selections and color codes.</p> <p>          .</p>	<p><b>4th Option:</b> Select the Edge Color:</p> <p>See page 226 for selections and color codes.</p> <p>      .</p>	<p><b>5th Option:</b> Select whether Grommet (Park Hi Lo Meeting Table only):</p> <p>N No grommet G Grommet (\$12 upcharge)</p> <p>  .</p>	<p><b>6th Option:</b> Select the Grommet Color (Park Hi Lo Meeting Table only):</p> <p>E4 Black E9 Flint DW Designer White EV Loft EU Muslin TI Titanium</p> <p>     </p>
---	--	--	---	---	--	---

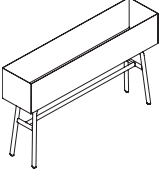
Example: NALCF.FSC.LWBA.BA.G.E9

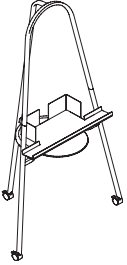
Description	Model Number	Cubes	Ship Weight	Base List Price	Grade 2 Paint Upcharge
	<i>Add options below</i>				
 <b>Park Planters — Lo Plant/Storage Pedestal</b> 28 3/4" H x 48 3/4" W x 11" D	NALP	6.5	53	\$ 1375	\$ 79
 <b>Park Planters — Hi Plant/Storage Pedestal</b> 38 3/4" H x 48 3/4" W x 11" D	NAHP	10.1	58	\$ 1530	\$ 88
 <b>Park Easel</b> 69" H x 39 3/4" W x 28" D	NAESL <i>(De-emphasized)</i>	0.4	60	\$ 2242	\$ 164

PARK

<p><b>How to specify —</b> Select the Model Number from above.</p>	<p><b>1st Option:</b> Select the Paint Finish:</p> <p>P1 P2</p>
<p>N   A         .</p>	<p>         </p>

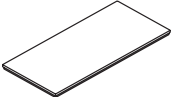

Example: NAESL.P8X

Description	Model	Cubes	Weight			
	<i>Add options below</i>			L1	L2	L3
 <b>Pedestal Planter</b> Park Laminate Plant/Storage Pedestal Top	NAPT	1.1	5	\$ 455	\$ 470	\$ 483

<p><b>How to specify —</b> Select the Model Number from above.</p>	<p><b>1st Option:</b> Select FSC (if applicable):</p>	<p><b>2nd Option:</b> Select the Laminate Color: See page 226 for selections and color codes.</p>	<p><b>3rd Option:</b> Select the Edge Color: See page 226 for selections and color codes.</p>
<p>N   A   P   T   .</p>	<p>          .</p>	<p>              .</p>	<p>     </p>

Example: NAPT.LWBA.EV

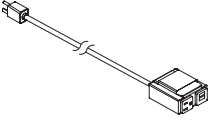
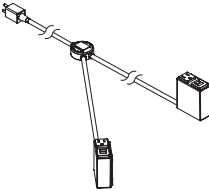
PARK

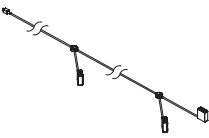
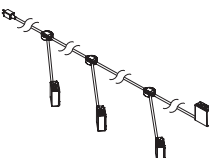
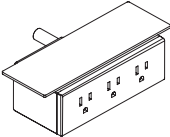
	Description	Model	List Price
	<b>Park Electrical</b> 1 MOD 2 SEMPLX *1 module including 1 A/C and Dual USB-A	NAE1	\$ 407
	2 MOD 4 SEMPLX *2 modules including 1 A/C and Dual USB-A	NAE2	\$ 671
	3 MOD 5 SEMPLX 1 USB	NAE3-1USB	\$ 896
	3 MOD 3 SEMPLX 3 USB	NAE3-3USB	\$ 1194
	4 MOD 8 SEMPLX	NAE4	\$ 1343
	EASEL ELECTRIC MODULE	NAEESL	\$ 448

<p><b>How to specify —</b> Select the Model Number from above.</p>	<p><i>1st Option:</i> <b>Select Braid Color:</b> BC0014 Black Storm BC0046 White/Fog</p>
--	--

N	A	E																	.
---	---	---	--	--	--	--	--	--	--	--	--	--	--	--	--	--	--	--	---

*Example: NAE3.BC0046*

**RECHARGE  
PAINT FINISHES**

**TABLE BASES**

- Textured Designer White .....PK7
- Textured Flint .....P7A
- Textured Silver.....PR8

**RECHARGE SCREEN  
FABRICS**

- Dark Grey ..... DRK
- Light Grey .....LGT
- Medium Grey ..... MDD

**RECHARGE CONNECTOR  
TABLE LAMINATES**

- Designer White.....LDW1
- Flint .....LM16

**RECHARGE  
TABLE LAMINATES**

**GRADE L1**

**SOLID COLOR**

- Black ..... P
- Brownstone.....LM13
- Bungalow .....LM12
- Designer White.....LDW1
- Flint .....LM16
- Fossil Shale.....LEH1
- Loft .....LM11
- Muslin.....LM15
- Titanium .....LTI1

**ABSTRACT**

- Ash.....LT3B
- Handspun Pearl.....LAHP
- Handspun Dove .....LAHD
- Handspun Slate .....LAHS
- Handspun Chestnut .....LAHC
- Silver Mesh .....LT8D

**WOODGRAIN**

- Belair.....LWBA
- Bourbon Cherry ..... H
- Field Elm.....LWFE
- Florence Walnut.....LFW1
- Kingswood Walnut .....LK11
- Natural Maple .....LWD
- NeoWalnut .....LNU1
- Pinnacle.....PINC
- Shaker Cherry .....LW7C

**GRADE L2**

**WOODGRAIN**

- Beigewood.....LWBE
- Fawn Cypress.....LFC1
- Lowell Ash .....LLA1
- Mangalore Mango .....LMM1
- Natural Recon.....LNR1
- Phantom Charcoal .....LPC1
- Phantom Ecu .....LPE1
- Portico Teak.....LPT1
- Skyline Walnut.....LSW1
- Veranda Teak.....LVT1

**GRADE L3**

**WOODGRAIN**

- Natural Walnut.....LWNW

**RECHARGE EDGE COLORS**

- Beigewood..... DE
- Belair.....BA
- Black ..... E4
- Bourbon Cherry ..... H
- Brownstone .....EY
- Bungalow ..... EX
- Designer White.....DW
- Fawn Cypress.....FC
- Field Elm..... FE
- Flint ..... E9
- Florence Walnut.....FW
- Fossil .....EH
- Kingswood Walnut .....KI
- Loft .....EV
- Lowell Ash .....DL
- Mangalore Mango .....MM
- Muslin.....EU
- Natural Maple .....DD
- Natural Recon.....NR
- Natural Walnut.....DN
- NeoWalnut .....NU
- Parchment.....EN
- Phantom Charcoal .....PC
- Phantom Ecu .....PE
- Pinnacle.....PI
- Plyband .....PL
- Portico Teak.....DP
- Shaker Cherry .....DF
- Skyline Walnut.....SW
- Titanium .....TI
- Veranda Teak.....VT

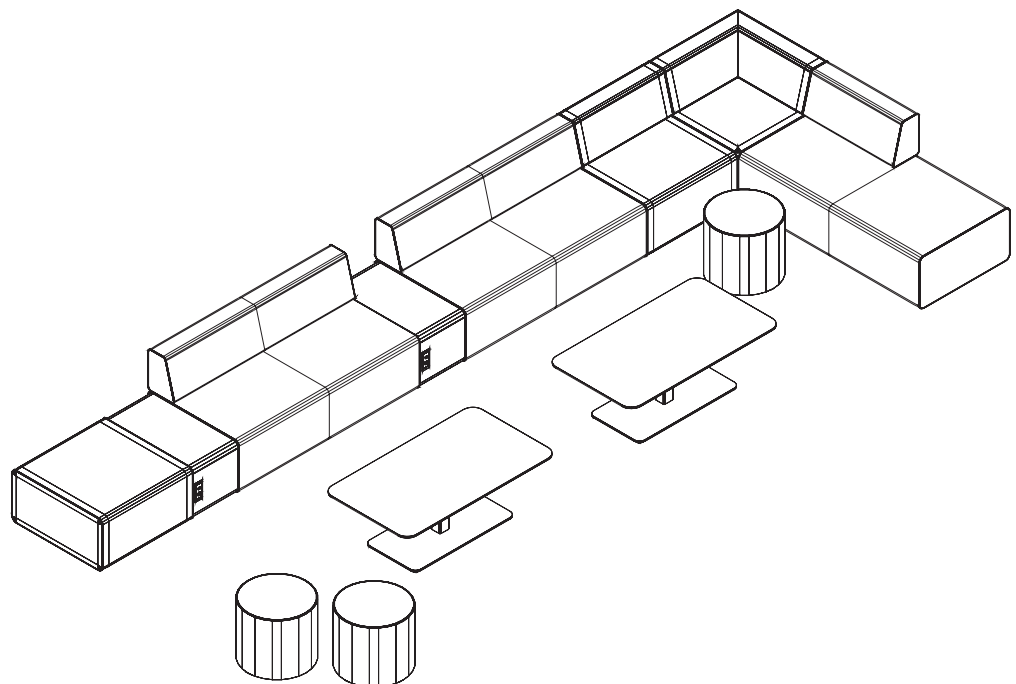

RECHARGE

Recharge Pouf - Seat, Side, Welt  
 Recharge Bolster  
 Recharge Bolster Welt  
 Recharge Seat  
 Recharge Seat Welt

Recharge Pouf - Seat, Side, Welt  
 Recharge Bolster  
 Recharge Bolster Welt  
 Recharge Seat  
 Recharge Seat Welt

RECHARGE

GRADE 1						
Apex	APX	•	•	•	•	•
Centurion	CU	•				
Contourett	UR	•	•	•	•	•
Dapper	DAPR	•	•	•	•	•
Ensemble	NSB	•	•	•	•	•
Hamilton	HAML	•	•	•	•	•
Inertia	NR	•	•	•	•	•
GRADE 2						
Appoint Seating	PNS	•	•	•	•	•
Blume	BLME	•	•	•	•	•
Clyde	CLYD	•	•	•	•	•
Dotty	DOT	•	•	•	•	•
Meld	SMHMMLD	•	•	•	•	•
Rush	RUSH	•	•	•	•	•
Spin Seating	SPNN	•	•	•	•	•
Whisper Vinyl	WP	•	•	•	•	•
GRADE 3						
Lateral	SCFSLAT	•	•	•	•	•
Moxie	SX	•	•	•	•	•
Parker	PRKR	•	•	•	•	•
Purl	PURL	•	•	•	•	•
Quill	QUL	•	•	•	•	•
GRADE 4						
Blink	1048	•	•	•	•	•
Caper	SMHMCAP	•				
Look-See	1044	•	•	•	•	•
Manner	SMHMMAN	•	•	•	•	•
Messenger	SMHMGRM	•	•	•	•	•
Metric	SMHMMET	•	•	•	•	•
Mode	SMHMMOD	•	•	•	•	•
Murmur	SMHMMUR	•				
Muse	SMHMMUS	•			•	
Trundle	SMHMTRN	•				
Walkabout	1046	•	•	•	•	•

GRADE 5						
Checkmate	1043	•	•	•	•	•
Main Line Flax	SCAMMLF	•	•	•	•	•
CF Stinson Sequence	SCFSSEQ	•	•	•	•	•
Zippy	1045	•	•	•	•	•
GRADE 6						
Arris	ARR	•	•		•	
Blazer	SCAMBLZ	•	•	•	•	•
Hemp	SCAMHMP	•	•	•	•	•
Poppy	1047	•	•	•	•	•
GRADE 7						
Silk	SCAMSLK	•	•	•	•	•
GRADE 8						
Apt	SMHMAPT	•	•	•	•	•
Brisa	RS	•	•	•	•	•
Zap	SCAMZAP	•	•	•	•	•
GRADE 9						
Ultraleather Pro	SUF554	•	•	•	•	•
Yoredale	SCAMYDL	•	•	•	•	•

- ⊕ Partnership Program — See page 10 for details.
- Available upholstery option
- Allsteel fabrics and foam meet requirements for CTB117.
- Blank spaces indicate that a product has not yet been tested or that it failed.
- Contact Allsteel Customer Support for other flammability code approvals.

*Designed in partnership with Chris Adamick, Recharge includes soft seating pieces and tables that can be integrated for private, public, or collaborative settings.*

## MODELS AND OPTIONS

Recharge seating is available in four different options: Pouf, Bench, Bench with Bolster, and Bench with Bolster and Screen. Bolsters are available as full width, half-width, and as corner units providing a large array of configurations.

Recharge Tables can stand alone or allow connection of seating components to create straight or 120-degree configurations. Power options are also available.

## APPLICATIONS

Use Recharge as booths, micro-environments or bench seating in café areas, lobbies, open plan, atrium spaces, or reception areas.

## KEY FEATURES

Recharge modular lounge seating is constructed of fabric covered foam with upholstery-grade FSC plywood core and box joints.

Each bench has glides that can be adjusted up to 2".

## MATERIALS

- All COMs/COLs must be approved for upholsterability. See pages 6-8 for COM ordering instructions.

## OPTIONS — MODULAR LOUNGE SEATING

### Description:

Bench — Single or Double width seats (no back bolster)

Bench with Bolsters — Single or Double width seats with full, half, or corner bolsters

Bench with Bolsters and Screens — Single or Double width seats with full, half, or corner bolsters and full width or full width and 3/4 side screens.

Poufs (mini ottomans) — Round or Square seat

### FSC Certified Wood:

**FSC** FSC Certified Wood

### Bench Seat Upholstery:

See page 238 for upholstery selections.

### Bench Seat Welt Cord Upholstery:

See page 238 for upholstery selections.

### Bolster Upholstery:

See page 238 for upholstery selections.

### Bolster Welt Cord Upholstery:

See page 238 for upholstery selections.

## OPTIONS — MODULAR LOUNGE CONNECTORS AND TABLES

### Description:

Connector Tables — Straight or 120-Degree

Tables — Coffee, Work, or Corner

Laptop Table

### Connector Tables

**L1** Designer White and Flint

### Laminate Table Tops

**L1** Solid Color, Abstract, and Woodgrain Laminate

**L2** Woodgrain Laminate

**L3** Woodgrain Laminate

See page 237 for laminate finishes and codes

### Painted Table Base

See page 237 for paint finishes and codes

## OPTIONS — ELECTRICAL

### Description:

Electrical ports are available on seat benches and connector tables with corded, 4-Wire Kits, or hard wire options. See pages 242-243 for specifications and examples. See page 253 for electrical components.



A full gallery of typicals can be found on our website: <https://www.allsteeloffice.com/design-resources/idea-starters>. Each typical includes a complete BOM with current pricing, downloadable CAD files, and PDFs of each drawing.

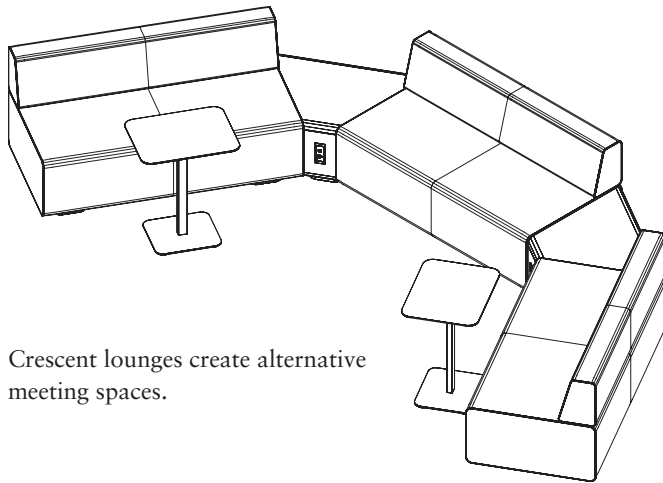

Crescent lounges create alternative meeting spaces.

Private booths are familiar, cafe-like work settings.

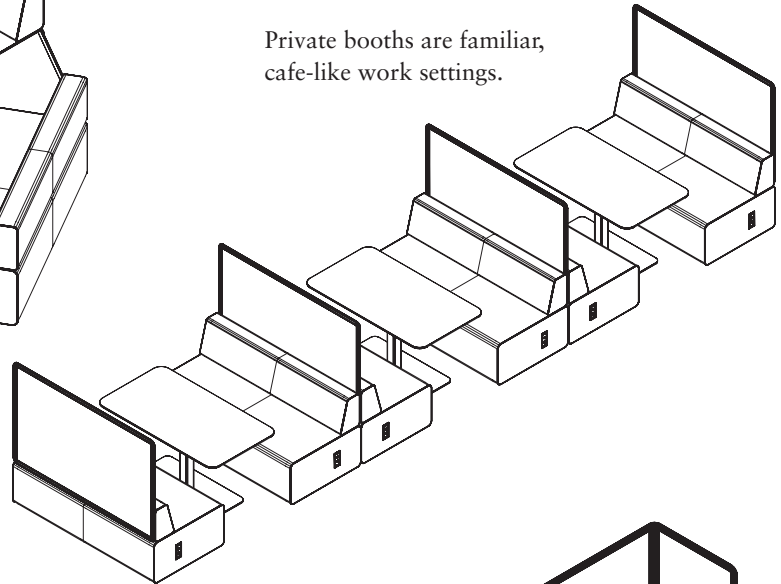

Clusters provide seating options and power for common spaces.

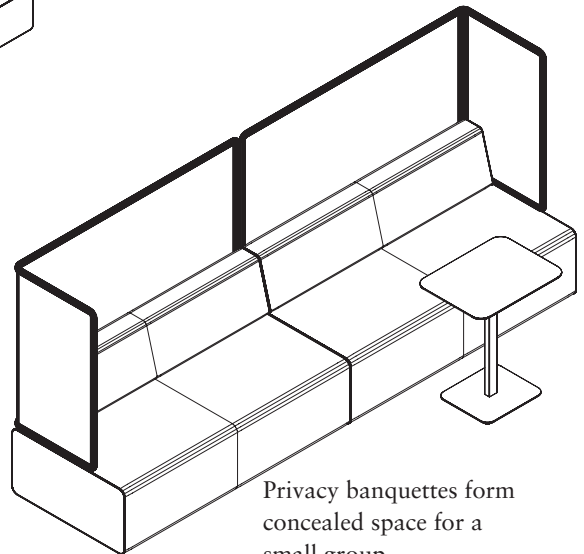
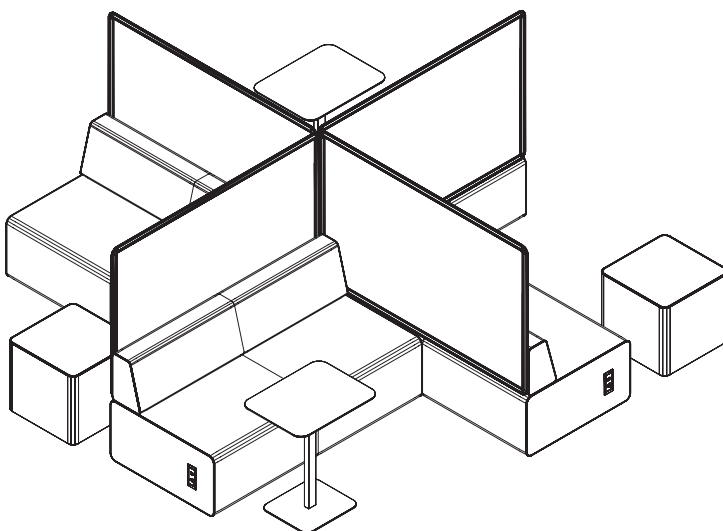

Privacy banquettes form concealed space for a small group.

Sofas offer space to think away from the desk.

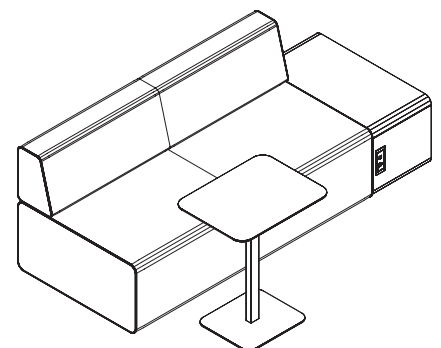

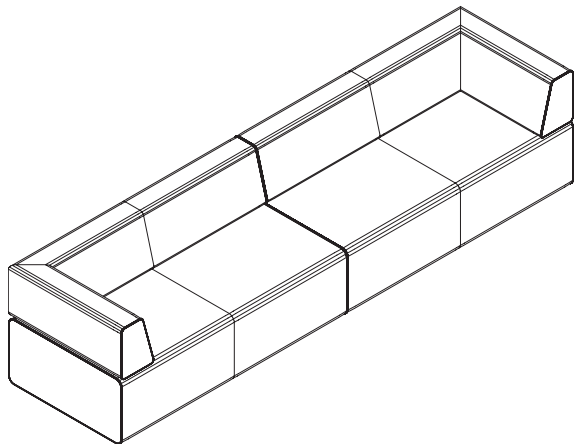

Sectional sofas easily scale up or down in length.

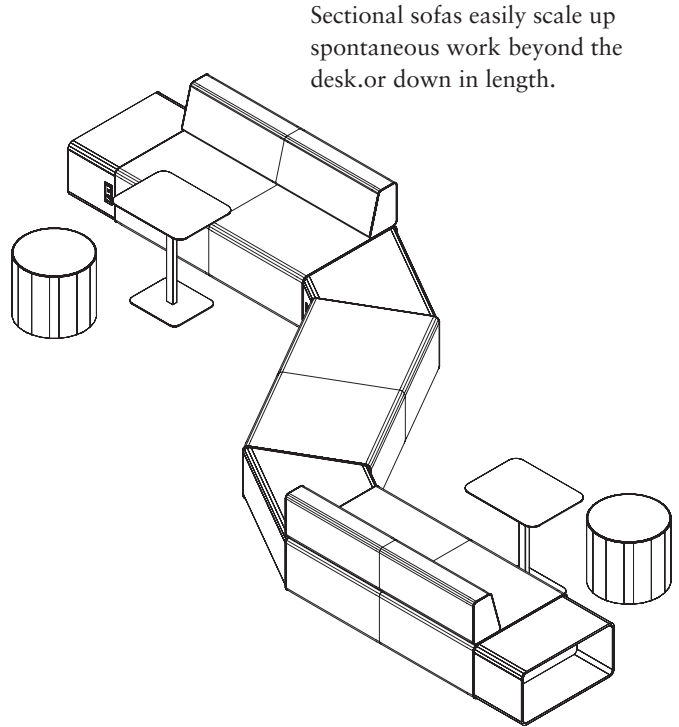

Sectional sofas easily scale up spontaneous work beyond the desk, or down in length.

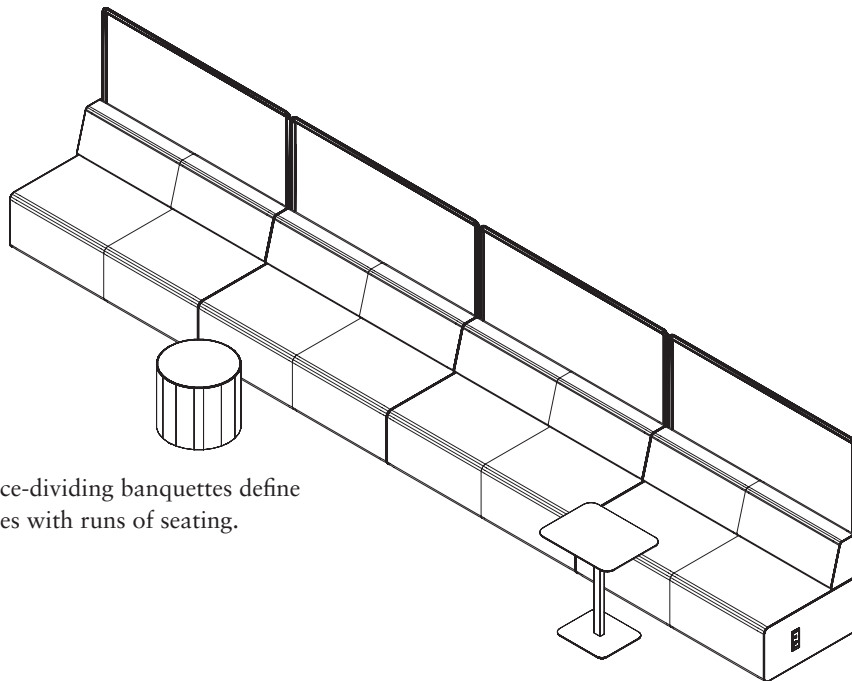

Space-dividing banquettes define zones with runs of seating.

Sectional return sofas turn 90 degree corners.

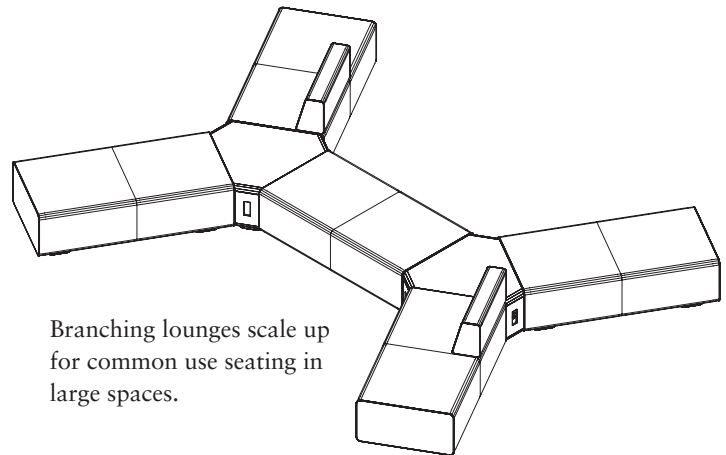
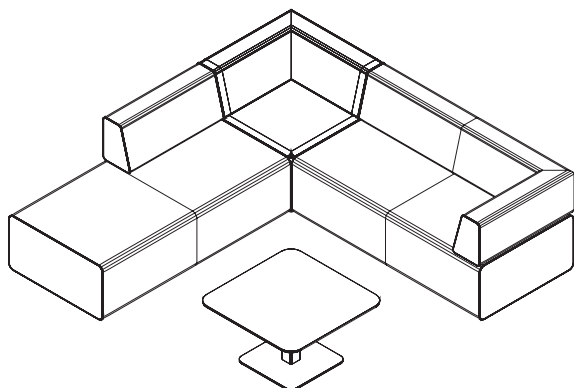

Branching lounges scale up for common use seating in large spaces.

RECHARGE

**POWER-READY MODELS**

Recharge power-ready Bench models and Connector Tables have cut-out(s) that will accept Recharge Power Ports (ordered separately).

Electrical cutout on the soft seating pieces is located on the side or in the front of the unit. The opening is 1.94"W x 6.25"H.

All Connector Tables come with or without an electrical cutout in them. The 120° x 3 Connector Table has three electrical cutouts, while the 120° x 2 and Straight Connector Tables have one electrical cutout. Electrical components need to be ordered separately from the units.

Recharge Power Ports are UL listed. All power modules have 2 simplex and 2 USB outlets. Three power options with cords are available:

- Corded – plugs a single unit into standard outlet
- Hardwire – connects a single unit to power source by a licensed electrician
- 4-Wire used for powering multiple units – requires 4-Wire Infeed Kit. 4-Wire Jumper Kit(s) may also be required when powering multiple units from the same Infeed. See examples.

It's the customer's responsibility to ensure that installation and use of the electrical system, the number of receptacles used on a given circuit, and connections to the building power supply meets all local and national electrical codes.

**STEPS FOR ORDERING RECHARGE 4-WIRE POWER KITS:**

1. Determine the number and location of powered ports in configuration. A maximum of thirteen Recharge ports can be connected on one Infeed.
2. Order one 4-Wire Power Port for each powered Recharge Unit.
3. Order one Infeed Kit. Each Infeed Kit includes H-Connector which can power either:
  - 3 Recharge units
  - 2 Recharge units and 1 Jumper
  - 1 Recharge unit and 2 Jumpers
  - 3 Jumpers
4. Determine if Jumper with H-Connector Kits are needed for connecting multiple powered Recharge units.
  - A Jumper Kit is required if the distance between the H-Connector on the end of Infeed or Jumper is greater than 72" to the Power Port cutout on the Recharge unit.
  - Jumper Kits are available in 42" and 72" lengths.
  - Infeeds and Jumpers can't plug directly into Power Port.

**ELECTRICAL EXAMPLE 1 — 2 variations**

- 2 – 4-Wire Power Ports
- 1 – Infeed Kit

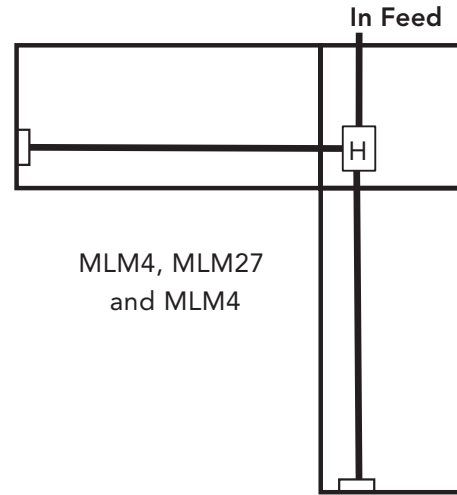
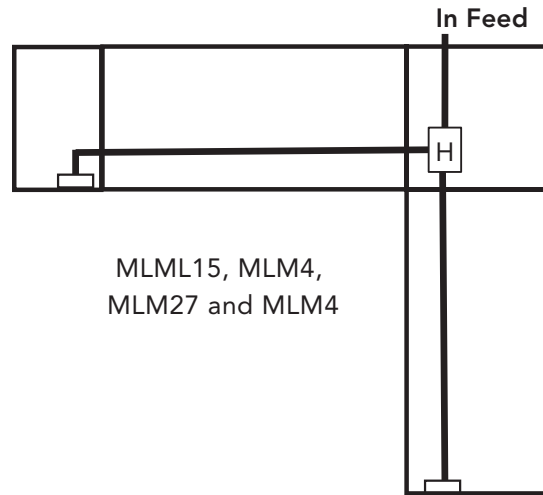

**ELECTRICAL EXAMPLE 2**

- Any soft seating with 2 MLM16's (120 x 2 connectors)
- 2 – 4-Wire Power Ports
- 1 – Infeed Kit

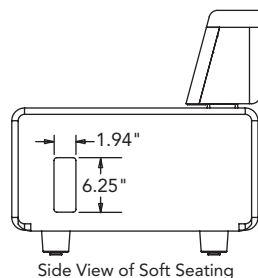
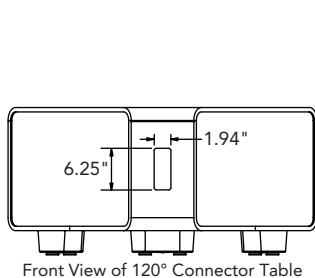
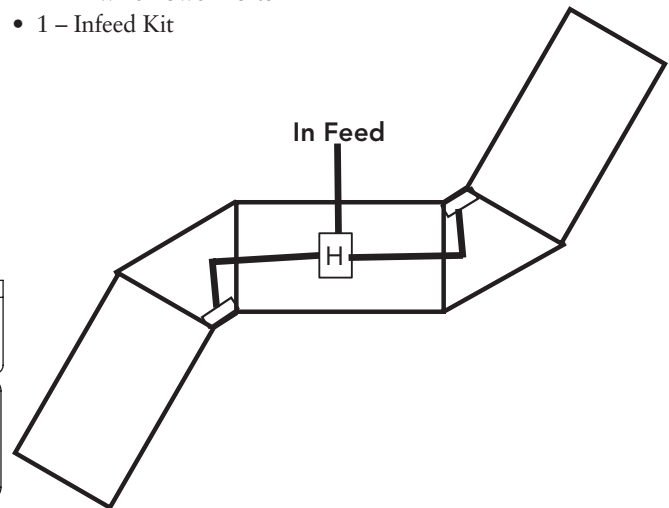

RECHARGE

**ELECTRICAL EXAMPLE 3**

- MLM1's and/or MLM2's with a MLM15 (straight connector table in the middle).
- 3 – 4-Wire Power Ports
- 1 – Infeed Kit
- 2 – 72" Jumper Kits

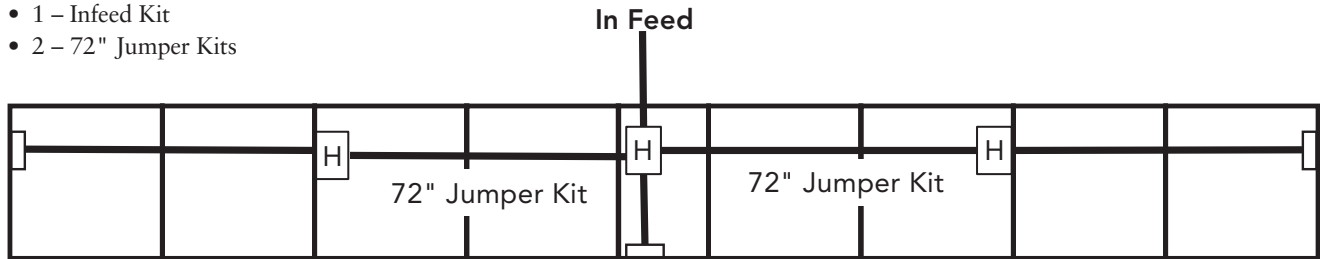

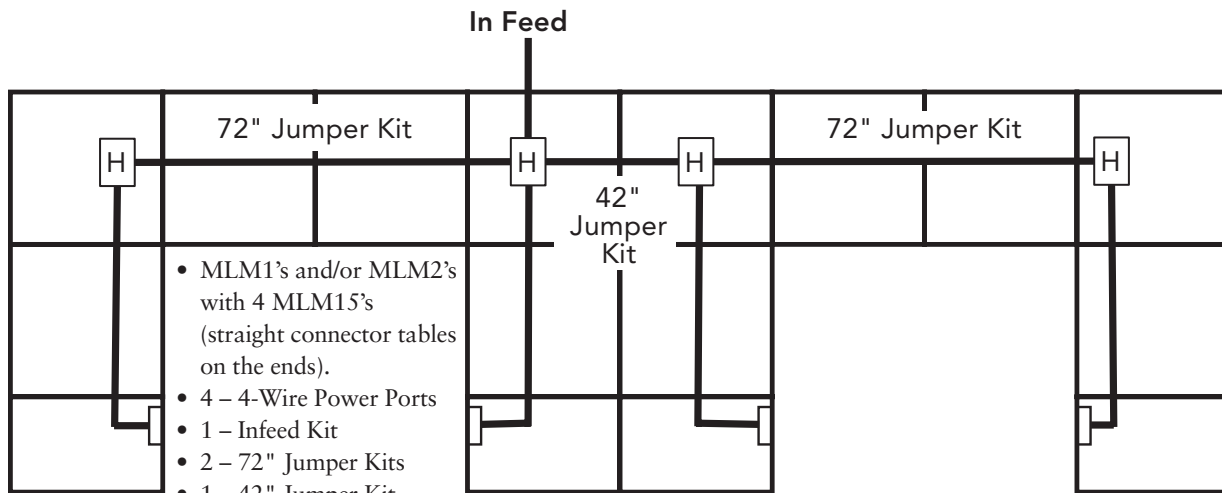

**ELECTRICAL EXAMPLE 4**

- MLM1's and/or MLM2's with 4 MLM15's (straight connector tables on the ends).
- 4 – 4-Wire Power Ports
- 1 – Infeed Kit
- 2 – 72" Jumper Kits
- 1 – 42" Jumper Kit

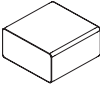
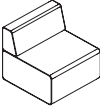
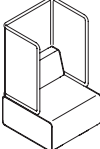
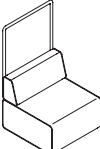

RECHARGE

Style	Description	Model Number <i>Add options below</i>	Base Price	Upholstery Upcharges	Upcharge							
					2	3	4	5	6	7	8	L1
<b>Poufs &amp; Single Seats</b>												
	Single Upholstery	MLM20S	\$ 719	Upholstery	\$ 43	\$ 87	\$ 131	\$ 190	\$ 248	\$ 307	\$ 366	\$ 845
	Multi Upholstery	MLM20	\$ 756	Seat	\$ 12	\$ 26	\$ 38	\$ 55	\$ 71	\$ 88	\$ 105	\$ 242
				Welt	\$ 16	\$ 31	\$ 47	\$ 68	\$ 89	\$ 111	\$ 131	\$ 304
				Side	\$ 20	\$ 41	\$ 62	\$ 89	\$ 116	\$ 143	\$ 171	\$ 394
	Single Upholstery	MLM21S	\$ 719	Upholstery	\$ 43	\$ 87	\$ 131	\$ 190	\$ 248	\$ 307	\$ 366	\$ 845
	Multi Upholstery	MLM21	\$ 756	Seat	\$ 12	\$ 26	\$ 38	\$ 55	\$ 71	\$ 88	\$ 105	\$ 242
				Welt	\$ 16	\$ 31	\$ 47	\$ 68	\$ 89	\$ 111	\$ 131	\$ 304
				Side	\$ 20	\$ 41	\$ 62	\$ 89	\$ 116	\$ 143	\$ 171	\$ 394
	Matching Welt	MLM1S	\$ 2030	Seat	\$ 65	\$ 130	\$ 196	\$ 282	\$ 369	\$ 456	\$ 543	\$ 1255
	Contrast Welt	MLM1	\$ 2137	Seat	\$ 52	\$ 104	\$ 156	\$ 225	\$ 295	\$ 363	\$ 433	\$ 1001
				Seat Welt	\$ 20	\$ 41	\$ 62	\$ 89	\$ 116	\$ 143	\$ 171	\$ 394
	Matching Welt	MLM2S	\$ 2587	Seat	\$ 65	\$ 130	\$ 196	\$ 282	\$ 369	\$ 456	\$ 543	\$ 1255
	Contrast Welt	MLM2	\$ 2724	Bolster	\$ 32	\$ 65	\$ 98	\$ 141	\$ 184	\$ 228	\$ 271	\$ 627
				Seat	\$ 52	\$ 104	\$ 156	\$ 225	\$ 295	\$ 363	\$ 433	\$ 1001
				Seat Welt	\$ 20	\$ 41	\$ 62	\$ 89	\$ 116	\$ 143	\$ 171	\$ 394
				Bolster	\$ 20	\$ 41	\$ 62	\$ 89	\$ 116	\$ 143	\$ 171	\$ 394
Bolster Welt	\$ 16	\$ 31	\$ 47	\$ 68	\$ 89	\$ 111	\$ 131	\$ 304				
	Matching Welt	MLM36S	\$ 4174	Seat	\$ 65	\$ 130	\$ 196	\$ 282	\$ 369	\$ 456	\$ 543	\$ 1255
	Contrast Welt	MLM36	\$ 4383	Bolster	\$ 32	\$ 65	\$ 98	\$ 141	\$ 184	\$ 228	\$ 271	\$ 627
				Seat	\$ 52	\$ 104	\$ 156	\$ 225	\$ 295	\$ 363	\$ 433	\$ 1001
				Seat Welt	\$ 20	\$ 41	\$ 62	\$ 89	\$ 116	\$ 143	\$ 171	\$ 394
				Bolster	\$ 20	\$ 41	\$ 62	\$ 89	\$ 116	\$ 143	\$ 171	\$ 394
Bolster Welt	\$ 16	\$ 31	\$ 47	\$ 68	\$ 89	\$ 111	\$ 131	\$ 304				
	Matching Welt	MLM37S	\$ 3701	Seat	\$ 65	\$ 130	\$ 196	\$ 282	\$ 369	\$ 456	\$ 543	\$ 1255
	Contrast Welt	MLM37	\$ 3885	Bolster	\$ 32	\$ 65	\$ 98	\$ 141	\$ 184	\$ 228	\$ 271	\$ 627
				Seat	\$ 52	\$ 104	\$ 156	\$ 225	\$ 295	\$ 363	\$ 433	\$ 1001
				Seat Welt	\$ 20	\$ 41	\$ 62	\$ 89	\$ 116	\$ 143	\$ 171	\$ 394
				Bolster	\$ 20	\$ 41	\$ 62	\$ 89	\$ 116	\$ 143	\$ 171	\$ 394
Bolster Welt	\$ 16	\$ 31	\$ 47	\$ 68	\$ 89	\$ 111	\$ 131	\$ 304				

Example of upcharges: Model MLM2 with Grade 5 Seat, Grade 2 Seat Welt, Grade 1 Bolster, and Grade 2 Bolster Welt = \$2724 + \$225 + \$20 + \$0 + \$16 = **\$2985 Total**

RECHARGE

Continued on next page ►

<p><b>How to specify —</b> Select the Model Number from above.</p>	<p><b>1st Option</b> FSC Certified Wood: FSC Select for FSC certified wood</p>	<p><b>2nd Option</b> Select the Power Cutout Option (if applicable): N No Power Cutout L Left Side (\$39 extra) R Right Side (\$39 extra) FL Front Left (\$39 extra) FR Front Right (\$39 extra)</p>	<p><b>3rd Option</b> Select the Seat Upholstery: See page 238 for selections and color codes. See Seating Price List for COM Guidelines.</p>	<p><b>4th Option</b> Select the Seat Welt Cord Upholstery (if applicable): See page 238 for selections and color codes.</p>	<p><b>5th Option:</b> Select the Bolster Upholstery (if applicable): See page 238 for selections and color codes.</p>
MLM           .	F   S   C   .	.	.	.	.

Examples: MLM20S.FSC.SCAMBLZ24 MLM36.FSC.FL.SHBFBCV90.PURL08.SHBFBCV80.PURL08.MDD

Model Number		Overall			Seat			Backrest								
		COM Yardage	COL Sq. Feet	Height	Width	Depth	Height	Width	Depth	Ran Angle	Height	Width	Lumbar Height	Backrest/Seat Angle	Slip Weight	Calbes
<b>MLM20S</b>	Full Unit	2.75	—	17¼"	19"	19"	17¼"	19"	19"	—					15	5.3
<b>MLM20</b>	Seat	0.5	—	17¼"	19"	19"	17¼"	19"	19"	—					15	5.3
	Welt	1.0	—													
	Side	1.25	—													
<b>MLM21S</b>	Full Unit	2.75	—	17¼"	19"	19"	17¼"	19"	19"	—					15	5.3
<b>MLM21</b>	Seat	0.5	—	17¼"	19"	19"	17¼"	19"	19"	—					15	5.3
	Welt	1.0	—													
	Side	1.25	—													
<b>MLM1S</b>	Full Unit	4.5	—	17¼"	29"	29"	17¼"	29"	29"	—					75	25.5
<b>MLM1</b>	Seat	3.25	—	17¼"	29"	29"	17¼"	29"	29"	—					75	25.5
	Seat Welt	1.25	—													
<b>MLM2S</b>	Seat	4.5	—	28¾"	29"	29"	17¼"	29"	20"	—	11½"	29"	8½"	101°	95	25.5
	Bolster	2.5	—													
<b>MLM2</b>	Seat	3.25	—	28¾"	29"	29"	17¼"	29"	20"	—	11½"	29"	8½"	101°	95	25.5
	Seat Welt	1.25	—													
	Bolster	1.5	—													
	Bolster Welt	1.0	—													
<b>MLM36S</b>	Seat	4.5	—	53¾"	29"	29"	17¼"	29"	20"	—	11½"	29"	8½"	101°	86	30.8
	Bolster	2.5	—													
<b>MLM36</b>	Seat	3.25	—	53¾"	29"	29"	17¼"	29"	20"	—	11½"	29"	8½"	101°	86	30.8
	Seat Welt	1.25	—													
	Bolster	1.5	—													
	Bolster Welt	1.0	—													
<b>MLM37S</b>	Seat	4.5	—	53¾"	29"	29"	17¼"	29"	20"	—	11½"	29"	8½"	101°	74	30.8
	Bolster	2.5	—													
<b>MLM37</b>	Seat	3.25	—	53¾"	29"	29"	17¼"	29"	20"	—	11½"	29"	8½"	101°	74	30.8
	Seat Welt	1.25	—													
	Bolster	1.5	—													
	Bolster Welt	1.0	—													

\*COM Yardage is listed for total yardage required for a model, with applicable yardage for individual components listed below each total: Seat, Seat Welt, Bolster, and Bolster Welt. If the same upholstery material is used for all components, use just the bold total yardage that aligns with the model number.

◀ Continued from previous page

<p>6th Option:  <b>Select the Bolster Welt Cord Upholstery</b>                  (if applicable):                  See page 238 for selections and color codes.</p>	<p>7th Option:  <b>Select the Screen Color</b>                  (if applicable):  <b>LGT</b> Light Gray  <b>MDD</b> Medium Gray  <b>DRK</b> Dark Gray</p>
--	---

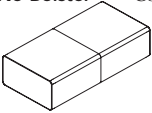
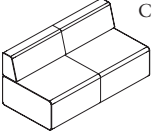
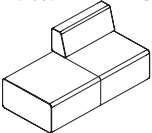
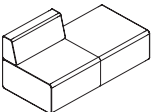
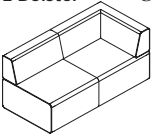
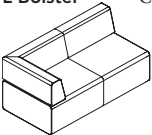
Style	Description	Model Number <i>Add options below</i>	Base Price	Upholstery Upcharges	Upcharge							
					2	3	4	5	6	7	8	L1
<b>Double Seats</b>												
Double	Matching Welt	MLM3S	\$ 2586	Seat	\$ 89	\$ 178	\$ 268	\$ 387	\$ 506	\$ 625	\$ 744	\$ 1719
No Bolster	Contrast Welt	MLM3	\$ 2748	Seat	\$ 79	\$ 157	\$ 236	\$ 342	\$ 446	\$ 552	\$ 657	\$ 1517
				Welt	\$ 20	\$ 41	\$ 62	\$ 89	\$ 116	\$ 143	\$ 171	\$ 394
Double With	Matching Welt	MLM4S	\$ 3845	Seat	\$ 89	\$ 178	\$ 268	\$ 387	\$ 506	\$ 625	\$ 744	\$ 1719
Double Bolster	Contrast Welt	MLM4	\$ 4047	Bolster	\$ 46	\$ 93	\$ 140	\$ 202	\$ 264	\$ 327	\$ 390	\$ 901
				Seat	\$ 79	\$ 157	\$ 236	\$ 342	\$ 446	\$ 552	\$ 657	\$ 1517
				Seat Welt	\$ 20	\$ 41	\$ 62	\$ 89	\$ 116	\$ 143	\$ 171	\$ 394
				Bolster	\$ 36	\$ 72	\$ 108	\$ 157	\$ 205	\$ 253	\$ 302	\$ 698
				Bolster Welt	\$ 16	\$ 31	\$ 47	\$ 68	\$ 89	\$ 111	\$ 131	\$ 304
Double With	Matching Welt	MLM9S	\$ 3700	Seat	\$ 89	\$ 178	\$ 268	\$ 387	\$ 506	\$ 625	\$ 744	\$ 1719
LH Half				Bolster	\$ 32	\$ 65	\$ 98	\$ 141	\$ 184	\$ 228	\$ 271	\$ 627
Bolster	Contrast Welt	MLM9	\$ 3895	Seat	\$ 79	\$ 157	\$ 236	\$ 342	\$ 446	\$ 552	\$ 657	\$ 1517
				Seat Welt	\$ 20	\$ 41	\$ 62	\$ 89	\$ 116	\$ 143	\$ 171	\$ 394
				Bolster	\$ 20	\$ 41	\$ 62	\$ 89	\$ 116	\$ 143	\$ 171	\$ 394
				Bolster Welt	\$ 16	\$ 31	\$ 47	\$ 68	\$ 89	\$ 111	\$ 131	\$ 304
Double With	Matching Welt	MLM10S	\$ 3700	Seat	\$ 89	\$ 178	\$ 268	\$ 387	\$ 506	\$ 625	\$ 744	\$ 1719
RH Half				Bolster	\$ 32	\$ 65	\$ 98	\$ 141	\$ 184	\$ 228	\$ 271	\$ 627
Bolster	Contrast Welt	MLM10	\$ 3895	Seat	\$ 79	\$ 157	\$ 236	\$ 342	\$ 446	\$ 552	\$ 657	\$ 1517
				Seat Welt	\$ 20	\$ 41	\$ 62	\$ 89	\$ 116	\$ 143	\$ 171	\$ 394
				Bolster	\$ 20	\$ 41	\$ 62	\$ 89	\$ 116	\$ 143	\$ 171	\$ 394
				Bolster Welt	\$ 16	\$ 31	\$ 47	\$ 68	\$ 89	\$ 111	\$ 131	\$ 304
Double With	Matching Welt	MLM11S	\$ 4177	Seat	\$ 89	\$ 178	\$ 268	\$ 387	\$ 506	\$ 625	\$ 744	\$ 1719
LH				Bolster	\$ 60	\$ 121	\$ 183	\$ 263	\$ 345	\$ 427	\$ 507	\$ 1173
L-Bolster	Contrast Welt	MLM11	\$ 4399	Seat	\$ 79	\$ 157	\$ 236	\$ 342	\$ 446	\$ 552	\$ 657	\$ 1517
				Seat Welt	\$ 20	\$ 41	\$ 62	\$ 89	\$ 116	\$ 143	\$ 171	\$ 394
				Bolster	\$ 52	\$ 104	\$ 156	\$ 225	\$ 295	\$ 363	\$ 433	\$ 1001
				Bolster Welt	\$ 16	\$ 31	\$ 47	\$ 68	\$ 89	\$ 111	\$ 131	\$ 304
Double With	Matching Welt	MLM13S	\$ 4177	Seat	\$ 89	\$ 178	\$ 268	\$ 387	\$ 506	\$ 625	\$ 744	\$ 1719
RH				Bolster	\$ 60	\$ 121	\$ 183	\$ 263	\$ 345	\$ 427	\$ 507	\$ 1173
L-Bolster	Contrast Welt	MLM13	\$ 4399	Seat	\$ 79	\$ 157	\$ 236	\$ 342	\$ 446	\$ 552	\$ 657	\$ 1517
				Seat Welt	\$ 20	\$ 41	\$ 62	\$ 89	\$ 116	\$ 143	\$ 171	\$ 394
				Bolster	\$ 52	\$ 104	\$ 156	\$ 225	\$ 295	\$ 363	\$ 433	\$ 1001
				Bolster Welt	\$ 16	\$ 31	\$ 47	\$ 68	\$ 89	\$ 111	\$ 131	\$ 304

**Example of upcharges:** Model MLM13 with Grade 5 Seat, Grade 2 Seat Welt, Grade 1 Bolster, and Grade 2 Bolster Welt = \$4399 + \$342 + \$20 + \$0 + \$16 = **\$4777 Total**

Continued on next page ►

<p><b>How to specify —</b> Select the Model Number from above.</p>	<p><i>1st Option</i> <b>FSC Certified Wood:</b> FSC Select for FSC certified wood</p>	<p><i>2nd Option</i> <b>Select the Power Cutout Option (if applicable):</b> N No Power Cutout L Left Side (\$39 extra) R Right Side (\$39 extra) B Both Sides (\$78 extra) FL Front Left (\$39 extra) FR Front Right (\$39 extra) FB Front Both (\$78 extra)</p>	<p><i>3rd Option</i> <b>Select the Seat Upholstery:</b> See page 238 for selections and color codes. See Seating Price List for COM Guidelines.</p>	<p><i>4th Option</i> <b>Select the Seat Welt Cord Upholstery (if applicable):</b> See page 238 for selections and color codes.</p>	<p><i>5th Option:</i> <b>Select the Bolster Upholstery (if applicable):</b> See page 238 for selections and color codes.</p>
<p>MLM           . F   S   C   .           .           .           .           .           .</p>					

Examples: MMLM9S.FSC.UR10.SCAMBLZ24 MLM11.FSC.B.SHBFCV90.PURL08.SHBFCV80.PURL08

Model Number		Overall			Seat			Backrest								
		COM Yardage	COL Sp. Feet	Height	Width	Depth	Height	Width	Depth	Ran Angle	Height	Width	Lumbar Height	Backrest/Seat Angle	Slip Weight	Calbes
<b>MLM3S</b>	Seat	7.5	—	17¼"	58"	29"	17¼"	58"	29"	—					125	41.8
<b>MLM3</b>	Seat	6.25	—	17¼"	58"	29"	17¼"	58"	29"	—					125	41.8
	Welt	1.25	—													
<b>MLM4S</b>	Seat	7.5	—	28¾"	58"	29"	17¼"	58"	20"	—	11½"	58"	8½"	101°	135	41.8
	Bolster	3.5	—													
<b>MLM4</b>	Seat	6.25	—	28¾"	58"	29"	17¼"	58"	20"	—	11½"	58"	8½"	101°	135	41.8
	Seat Welt	1.25	—													
	Bolster	2.5	—													
	Bolster Welt	1.0	—													
<b>MLM9S</b>	Seat	7.5	—	28¾"	58"	29"	17¼"	58"	20"	—	11½"	29"	8½"	101°	130	41.8
	Bolster	3.5	—													
<b>MLM9</b>	Seat	6.25	—	28¾"	58"	29"	17¼"	58"	20"	—	11½"	29"	8½"	101°	130	41.8
	Seat Welt	1.25	—													
	Bolster	2.5	—													
	Bolster Welt	1.0	—													
<b>MLM10S</b>	Seat	7.5	—	28¾"	58"	29"	17¼"	58"	20"	—	11½"	29"	8½"	101°	130	41.8
	Bolster	3.5	—													
<b>MLM10</b>	Seat	6.25	—	28¾"	58"	29"	17¼"	58"	20"	—	11½"	29"	8½"	101°	130	41.8
	Seat Welt	1.25	—													
	Bolster	2.5	—													
	Bolster Welt	1.0	—													
<b>MLM11S</b>	Seat	7.5	—	28¾"	58"	29"	17¼"	49"	20"	—	11½"	48½"	8½"	101°	140	41.8
	Bolster	4.0	—													
<b>MLM11</b>	Seat	6.25	—	28¾"	58"	29"	17¼"	49"	20"	—	11½"	48½"	8½"	101°	140	41.8
	Seat Welt	1.25	—													
	Bolster	3.0	—													
	Bolster Welt	1.0	—													
<b>MLM13S</b>	Seat	7.5	—	28¾"	58"	29"	17¼"	49"	20"	—	11½"	48½"	8½"	101°	140	41.8
	Bolster	4.0	—													
<b>MLM13</b>	Seat	6.25	—	28¾"	58"	29"	17¼"	49"	20"	—	11½"	48½"	8½"	101°	140	41.8
	Seat Welt	1.25	—													
	Bolster	3.0	—													
	Bolster Welt	1.0	—													

\*COM Yardage is listed for total yardage required for a model, with applicable yardage for individual components listed below each total: Seat, Seat Welt, Bolster, and Bolster Welt. If the same upholstery material is used for all components, use just the bold total yardage that aligns with the model number.

◀ Continued from previous page

6th Option:

**Select the Bolster Welt Cord Upholstery (if applicable):**

See page 238 for selections and color codes.



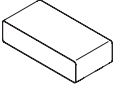
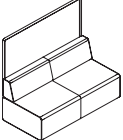
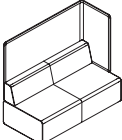
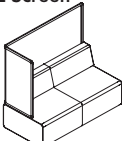
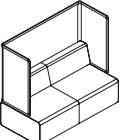
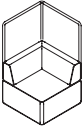

Style	Description	Model Number <i>Add options below</i>	Base Price	Upholstery Upcharges	Upcharge							
					2	3	4	5	6	7	8	L1
<b>Double Seats and Corner Seats</b>												
Double	Matching Welt	MLM44S	\$ 2918	Seat	\$ 104	\$ 209	\$ 312	\$ 451	\$ 590	\$ 728	\$ 866	\$ 1940
End Cap	Contrast Welt	MLM44	\$ 3063	Seat	\$ 103	\$ 204	\$ 307	\$ 443	\$ 579	\$ 714	\$ 851	\$ 1906
				Welt	\$ 14	\$ 28	\$ 41	\$ 58	\$ 77	\$ 94	\$ 112	\$ 250
Double With Straight Screen	Matching Welt	MLM5S	\$ 4861	Seat	\$ 89	\$ 178	\$ 268	\$ 387	\$ 506	\$ 625	\$ 744	\$ 1719
	Contrast Welt	MLM5	\$ 5116	Bolster	\$ 46	\$ 93	\$ 140	\$ 202	\$ 264	\$ 327	\$ 390	\$ 901
				Seat	\$ 79	\$ 157	\$ 236	\$ 342	\$ 446	\$ 552	\$ 657	\$ 1517
				Seat Welt	\$ 20	\$ 41	\$ 62	\$ 89	\$ 116	\$ 143	\$ 171	\$ 394
				Bolster	\$ 36	\$ 72	\$ 108	\$ 157	\$ 205	\$ 253	\$ 302	\$ 698
				Bolster Welt	\$ 16	\$ 31	\$ 47	\$ 68	\$ 89	\$ 111	\$ 131	\$ 304
Double With LH L-Screen	Matching Welt	MLM6S	\$ 5441	Seat	\$ 89	\$ 178	\$ 268	\$ 387	\$ 506	\$ 625	\$ 744	\$ 1719
	Contrast Welt	MLM6	\$ 5726	Bolster	\$ 46	\$ 93	\$ 140	\$ 202	\$ 264	\$ 327	\$ 390	\$ 901
				Seat	\$ 79	\$ 157	\$ 236	\$ 342	\$ 446	\$ 552	\$ 657	\$ 1517
				Seat Welt	\$ 20	\$ 41	\$ 62	\$ 89	\$ 116	\$ 143	\$ 171	\$ 394
				Bolster	\$ 36	\$ 72	\$ 108	\$ 157	\$ 205	\$ 253	\$ 302	\$ 698
				Bolster Welt	\$ 16	\$ 31	\$ 47	\$ 68	\$ 89	\$ 111	\$ 131	\$ 304
Double With RH L-Screen	Matching Welt	MLM7S	\$ 5441	Seat	\$ 89	\$ 178	\$ 268	\$ 387	\$ 506	\$ 625	\$ 744	\$ 1719
	Contrast Welt	MLM7	\$ 5726	Bolster	\$ 46	\$ 93	\$ 140	\$ 202	\$ 264	\$ 327	\$ 390	\$ 901
				Seat	\$ 79	\$ 157	\$ 236	\$ 342	\$ 446	\$ 552	\$ 657	\$ 1517
				Seat Welt	\$ 20	\$ 41	\$ 62	\$ 89	\$ 116	\$ 143	\$ 171	\$ 394
				Bolster	\$ 36	\$ 72	\$ 108	\$ 157	\$ 205	\$ 253	\$ 302	\$ 698
				Bolster Welt	\$ 16	\$ 31	\$ 47	\$ 68	\$ 89	\$ 111	\$ 131	\$ 304
Double With U-Screen	Matching Welt	MLM8S	\$ 5732	Seat	\$ 89	\$ 178	\$ 268	\$ 387	\$ 506	\$ 625	\$ 744	\$ 1719
	Contrast Welt	MLM8	\$ 6034	Bolster	\$ 46	\$ 93	\$ 140	\$ 202	\$ 264	\$ 327	\$ 390	\$ 901
				Seat	\$ 79	\$ 157	\$ 236	\$ 342	\$ 446	\$ 552	\$ 657	\$ 1517
				Seat Welt	\$ 20	\$ 41	\$ 62	\$ 89	\$ 116	\$ 143	\$ 171	\$ 394
				Bolster	\$ 36	\$ 72	\$ 108	\$ 157	\$ 205	\$ 253	\$ 302	\$ 698
				Bolster Welt	\$ 16	\$ 31	\$ 47	\$ 68	\$ 89	\$ 111	\$ 131	\$ 304
Square Corner With Screen	Matching Welt	MLM35S	\$ 4262	Seat	\$ 51	\$ 102	\$ 153	\$ 222	\$ 289	\$ 357	\$ 426	\$ 983
	Contrast Welt	MLM35	\$ 4476	Bolster	\$ 46	\$ 93	\$ 140	\$ 202	\$ 264	\$ 327	\$ 390	\$ 901
				Seat	\$ 44	\$ 88	\$ 132	\$ 191	\$ 250	\$ 309	\$ 368	\$ 850
				Seat Welt	\$ 12	\$ 26	\$ 38	\$ 55	\$ 71	\$ 88	\$ 105	\$ 242
				Bolster	\$ 36	\$ 72	\$ 108	\$ 157	\$ 205	\$ 253	\$ 302	\$ 698
				Bolster Welt	\$ 16	\$ 31	\$ 47	\$ 68	\$ 89	\$ 111	\$ 131	\$ 304

**Example of upcharges:** Model MLM8 with Grade 5 Seat, Grade 2 Seat Welt, Grade 1 Bolster, and Grade 2 Bolster Welt = \$6034 + \$342 + \$20 + \$0 + \$16 = **\$6412 Total**

Continued on next page ▶

<p><b>How to specify —</b> Select the Model Number from above.</p> <p><b>MLM</b>           . <b>FISC</b> .           .</p>	<p><b>1st Option</b> FSC Certified Wood: FSC Select for FSC certified wood</p>	<p><b>2nd Option</b> Select the Power Cutout Option (if applicable. End Cap only has N or Y): N No Power Cutout Y* End Cap Power (\$77 extra) L Left Side (\$39 extra) R Right Side (\$39 extra) B Both Sides (\$78 extra) FL Front Left (\$39 extra) FR Front Right (\$39 extra) FB Front Both (\$78 extra)</p>	<p><b>3rd Option</b> Select the Seat Upholstery: See page 238 for selections and color codes. See Seating Price List for COM Guidelines.</p>	<p><b>4th Option</b> Select the Seat Welt Cord Upholstery (if applicable): See page 238 for selections and color codes.</p>	<p><b>5th Option:</b> Select the Bolster Upholstery (if applicable): See page 238 for selections and color codes.</p>
--	--	--	--	---	---

Examples: MLM44S.FSC.Y.SCAMBLZ24 MLM6.FSC.FB.SHBFBCV90.PURL08.SHBFBCV80.PURL08.MDD

Model Number		Overall			Seat			Backrest				Ship Weight	Cubes			
		COM Yardage	COL Sp. Feet	Height	Width	Depth	Height	Width	Depth	Ran Angle	Height			Width	Lumbar Height	Backrest/Seat Angle
MLM4S	Seat	8.0	—	17¼"	29"	58"	17¼"	29"	58"	—					77	19.8
MLM4	Seat	6.25	—	17¼"	29"	58"	17¼"	29"	58"	—					77	19.8
	Welt	1.75	—													
MLM5S	Seat	7.5	—	53¾"	58"	29"	17¼"	58"	20"	—	11½"	58"	8½"	101°	157	43
	Bolster	3.5	—													
MLM5	Seat	6.25	—	53¾"	58"	29"	17¼"	58"	20"	—	11½"	58"	8½"	101°	157	43
	Seat Welt	1.25	—													
	Bolster	2.5	—													
	Bolster Welt	1.0	—													
MLM6S	Seat	7.5	—	53¾"	58"	29"	17¼"	57¼"	20"	—	11½"	57¼"	8½"	101°	165	44.3
	Bolster	3.5	—													
MLM6	Seat	6.25	—	53¾"	58"	29"	17¼"	57¼"	20"	—	11½"	57¼"	8½"	101°	165	44.3
	Seat Welt	1.25	—													
	Bolster	2.5	—													
	Bolster Welt	1.0	—													
MLM7S	Seat	7.5	—	53¾"	58"	29"	17¼"	57¼"	20"	—	11½"	57¼"	8½"	101°	165	44.3
	Bolster	3.5	—													
MLM7	Seat	6.25	—	53¾"	58"	29"	17¼"	57¼"	20"	—	11½"	57¼"	8½"	101°	165	44.3
	Seat Welt	1.25	—													
	Bolster	2.5	—													
	Bolster Welt	1.0	—													
MLM8S	Seat	7.5	—	53¾"	58"	29"	17¼"	56½"	20"	—	11½"	56½"	8½"	101°	175	44.3
	Bolster	3.5	—													
MLM8	Seat	6.25	—	53¾"	58"	29"	17¼"	56½"	20"	—	11½"	56½"	8½"	101°	175	44.3
	Seat Welt	1.25	—													
	Bolster	2.5	—													
	Bolster Welt	1.0	—													
MLM35S	Seat	3.75	—	53¾"	29"	29"	17¼"	20"	20"	—	11½"	20"	8½"	101°	95	30.8
	Bolster	3.0	—													
MLM35	Seat	2.5	—	53¾"	29"	29"	17¼"	20"	20"	—	11½"	20"	8½"	101°	95	30.8
	Seat Welt	1.25	—													
	Bolster	2.0	—													
	Bolster Welt	1.0	—													

\*COM Yardage is listed for total yardage required for a model, with applicable yardage for individual components listed below each total: Seat, Seat Welt, Bolster, and Bolster Welt. If the same upholstery material is used for all components, use just the bold total yardage that aligns with the model number.

◀ Continued from previous page

<p>6th Option:  <b>Select the Bolster Welt Cord Upholstery</b>                  (if applicable):                  See page 238 for selections and color codes.</p>	<p>7th Option:  <b>Select the Screen Color</b>                  (if applicable):  <b>LGT</b> Light Gray  <b>MDD</b> Medium Gray  <b>DRK</b> Dark Gray</p>
--	---

RECHARGE

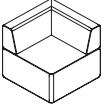
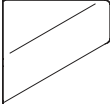
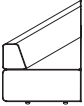
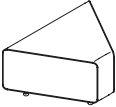
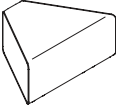
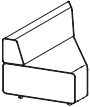
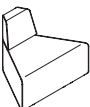
Style	Description	Model Number <i>Add options below</i>	Base Price	Upholstery Upcharges	Upcharge							
					2	3	4	5	6	7	8	L1
<b>Corner Seats (No Power)</b>												
	Matching Welt	MLM27S	\$ 2790	Seat	\$ 51	\$ 102	\$ 153	\$ 222	\$ 289	\$ 357	\$ 426	\$ 983
	Contrast Welt	MLM27	\$ 2936	Bolster	\$ 46	\$ 93	\$ 140	\$ 202	\$ 264	\$ 327	\$ 390	\$ 901
				Seat	\$ 44	\$ 88	\$ 132	\$ 191	\$ 250	\$ 309	\$ 368	\$ 850
				Seat Welt	\$ 12	\$ 26	\$ 38	\$ 55	\$ 71	\$ 88	\$ 105	\$ 242
				Bolster	\$ 36	\$ 72	\$ 108	\$ 157	\$ 205	\$ 253	\$ 302	\$ 698
Bolster Welt	\$ 16	\$ 31	\$ 47	\$ 68	\$ 89	\$ 111	\$ 131	\$ 304				
	Matching Welt	MLM41S	\$ 1724	Seat	\$ 55	\$ 109	\$ 163	\$ 235	\$ 309	\$ 380	\$ 452	\$ 1012
	Contrast Welt	MLM41	\$ 1809	Seat	\$ 47	\$ 94	\$ 141	\$ 203	\$ 266	\$ 329	\$ 391	\$ 875
				Seat Welt	\$ 14	\$ 28	\$ 41	\$ 58	\$ 77	\$ 94	\$ 112	\$ 250
*Ganging Kit Included												
	Matching Welt	MLM38S	\$ 2595	Seat	\$ 55	\$ 109	\$ 163	\$ 235	\$ 309	\$ 380	\$ 452	\$ 1012
	Contrast Welt	MLM38	\$ 2723	Bolster	\$ 32	\$ 65	\$ 95	\$ 137	\$ 180	\$ 222	\$ 263	\$ 590
				Seat	\$ 47	\$ 94	\$ 141	\$ 203	\$ 266	\$ 329	\$ 391	\$ 875
				Seat Welt	\$ 14	\$ 28	\$ 41	\$ 58	\$ 77	\$ 94	\$ 112	\$ 250
				Bolster	\$ 22	\$ 44	\$ 66	\$ 94	\$ 124	\$ 153	\$ 181	\$ 406
Bolster Welt	\$ 14	\$ 28	\$ 41	\$ 58	\$ 77	\$ 94	\$ 112	\$ 250				
*Ganging Kit Included												
	Matching Welt	MLM42S	\$ 1852	Seat	\$ 57	\$ 115	\$ 173	\$ 249	\$ 325	\$ 401	\$ 477	\$ 1069
	Contrast Welt	MLM42	\$ 1944	Seat	\$ 51	\$ 101	\$ 151	\$ 218	\$ 285	\$ 351	\$ 419	\$ 938
				Seat Welt	\$ 14	\$ 28	\$ 41	\$ 58	\$ 77	\$ 94	\$ 112	\$ 250
*Ganging Kit Included												
	Matching Welt	MLM43S	\$ 1852	Seat	\$ 57	\$ 115	\$ 173	\$ 249	\$ 325	\$ 401	\$ 477	\$ 1069
	Contrast Welt	MLM43	\$ 1944	Seat	\$ 51	\$ 101	\$ 151	\$ 218	\$ 285	\$ 351	\$ 419	\$ 938
				Seat Welt	\$ 14	\$ 28	\$ 41	\$ 58	\$ 77	\$ 94	\$ 112	\$ 250
*Ganging Kit Included												
	Matching Welt	MLM39S	\$ 2688	Seat	\$ 57	\$ 115	\$ 173	\$ 249	\$ 325	\$ 401	\$ 477	\$ 1069
	Contrast Welt	MLM39	\$ 2825	Bolster	\$ 32	\$ 65	\$ 95	\$ 137	\$ 180	\$ 222	\$ 263	\$ 590
				Seat	\$ 51	\$ 101	\$ 151	\$ 218	\$ 285	\$ 351	\$ 419	\$ 938
				Seat Welt	\$ 14	\$ 28	\$ 41	\$ 58	\$ 77	\$ 94	\$ 112	\$ 250
				Bolster	\$ 22	\$ 44	\$ 66	\$ 94	\$ 124	\$ 153	\$ 181	\$ 406
Bolster Welt	\$ 14	\$ 28	\$ 41	\$ 58	\$ 77	\$ 94	\$ 112	\$ 250				
*Ganging Kit Included												
	Matching Welt	MLM40S	\$ 2512	Seat	\$ 57	\$ 115	\$ 173	\$ 249	\$ 325	\$ 401	\$ 477	\$ 1069
	Contrast Welt	MLM40	\$ 2637	Bolster	\$ 33	\$ 67	\$ 100	\$ 143	\$ 189	\$ 232	\$ 276	\$ 619
				Seat	\$ 51	\$ 101	\$ 151	\$ 218	\$ 285	\$ 351	\$ 419	\$ 938
				Seat Welt	\$ 14	\$ 28	\$ 41	\$ 58	\$ 77	\$ 94	\$ 112	\$ 250
				Bolster	\$ 23	\$ 47	\$ 70	\$ 102	\$ 133	\$ 164	\$ 196	\$ 438
Bolster Welt	\$ 14	\$ 28	\$ 41	\$ 58	\$ 77	\$ 94	\$ 112	\$ 250				
*Ganging Kit Included												

Example of upcharges: Model MLM39 with Grade 5 Seat, Grade 2 Seat Welt, Grade 1 Bolster, and Grade 2 Bolster Welt = \$2825 + \$218 + \$14 + \$0 + \$14 = **\$3071 Total**

<p><b>How to specify —</b> Select the Model Number from above.</p>	<p><i>1st Option</i> FSC Certified Wood: FSC Select for FSC certified wood</p>	<p><i>2nd Option</i> Select the Seat Upholstery: See page 238 for selections and color codes. See Seating Price List for COM Guidelines.</p>	<p><i>3rd Option</i> Select the Seat Welt Cord Upholstery (if applicable): See page 238 for selections and color codes.</p>	<p><i>4th Option:</i> Select the Bolster Upholstery (if applicable): See page 238 for selections and color codes.</p>	<p><i>5th Option:</i> Select the Bolster Welt Cord Upholstery (if applicable): See page 238 for selections and color codes.</p>
MLM	FSC				

Examples: MLM42S.FSC.UR10 MLM39.FSC.SHBFBVC90.PURL08.SHBFBVC80.PURL08

Model Number		Overall			Seat			Backrest								
		COM Yardage	COL Sq. Feet	Height	Width	Depth	Height	Width	Depth	Ran Angle	Height	Width	Lumbar Height	Backrest/Seat Angle	Slip Weight	Calbes
MLM27S	Seat	3.75	—	28 1/4"	29"	29"	17 1/4"	20"	20"	—	11 1/2"	20"	8 1/2"	101°	90	26.3
	Bolster	3.0	—													
MLM27	Seat	2.5	—	28 1/4"	29"	29"	17 1/4"	20"	20"	—	11 1/2"	20"	8 1/2"	101°	90	26.3
	Seat Welt	1.25	—													
	Bolster	2.0	—													
	Bolster Welt	1.0	—													
MLM41S	Seat	4.0	—	17 1/4"	41"	20"	17 1/4"	41"	20"	—					34	10
MLM41	Seat	2.75	—	17 1/4"	41"	20"	17 1/4"	41"	20"	—					34	10
	Seat Welt	1.25	—													
MLM38S	Seat	4.0	—	28 1/4"	41"	20"	17 1/4"	20"	15"	—	11 1/2"	20"	8 1/2"	101°	50	17.8
	Bolster	2.5	—													
MLM38	Seat	2.75	—	28 1/4"	41"	20"	17 1/4"	20"	15"	—	11 1/2"	20"	8 1/2"	101°	50	17.8
	Seat Welt	1.25	—													
	Bolster	1.5	—													
	Bolster Welt	1.0	—													
MLM42S	Seat	4.25	—	17 1/4"	36"	25"	17 1/4"	36"	25"	—					38	11.4
MLM42	Seat	3.0	—	17 1/4"	36"	25"	17 1/4"	36"	25"	—					38	11.4
	Seat Welt	1.25	—													
MLM43S	Seat	4.25	—	17 1/4"	36"	25"	17 1/4"	36"	25"	—					38	11.4
MLM43	Seat	3.0	—	17 1/4"	36"	25"	17 1/4"	36"	25"	—					38	11.4
	Seat Welt	1.25	—													
MLM39S	Seat	4.25	—	28 1/4"	36"	25"	17 1/4"	18"	20"	—	11 1/2"	30"	8 1/2"	101°	54	19.4
	Bolster	2.5	—													
MLM39	Seat	3.0	—	28 1/4"	36"	25"	17 1/4"	18"	20"	—	11 1/2"	30"	8 1/2"	101°	54	19.4
	Seat Welt	1.25	—													
	Bolster	1.5	—													
	Bolster Welt	1.0	—													
MLM40S	Seat	4.25	—	28 1/4"	36"	25"	17 1/4"	18"	20"	—	11 1/2"	7"	8 1/2"	101°	48	19.4
	Bolster	2.0	—													
MLM40	Seat	3.0	—	28 1/4"	36"	25"	17 1/4"	18"	20"	—	11 1/2"	7"	8 1/2"	101°	48	19.4
	Seat Welt	1.25	—													
	Bolster	1.0	—													
	Bolster Welt	1.0	—													

\*COM Yardage is listed for total yardage required for a model, with applicable yardage for individual components listed below each total: Seat, Seat Welt, Bolster, and Bolster Welt. If the same upholstery material is used for all components, use just the bold total yardage that aligns with the model number.

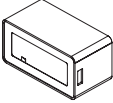
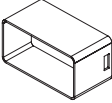
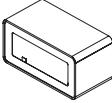
	Description	Model Number Power Location	Ship Weight	Cubes	L1	Laminate L2	L3
  	<b>Straight Connector Table 14½"W x 28½"D x 17"H</b>						
	Power Cutout Right	<b>MLMR15</b>	28	6.8	\$ 2589	\$ 2702	\$ 2777
	Power Cutout Left	<b>MLML15</b>	28	6.8	\$ 2589	\$ 2702	\$ 2777
	No Power Cutout	<b>MLM15N</b>	28	6.8	\$ 2589	\$ 2702	\$ 2777

MLMR15

MLML15

MLM15N

\*Ganging Kit Included

<b>120° x 2 Connector Table 35¾"W x 24¾"D x 17"H</b>							
	One Power Cutout	<b>MLM16</b>	30	12.3	\$ 3092	\$ 3227	\$ 3316
	No Power Cutout	<b>MLM16N</b>	30	12.3	\$ 3092	\$ 3227	\$ 3316

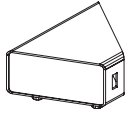

MLM16

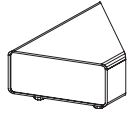

MLM16N

<b>120° x 3 Connector Table 35¾"W x 31"D x 17"H</b>							
	Three Power Cutouts	<b>MLM17</b>	35	14.1	\$ 4600	\$ 4800	\$ 4933
	No Power Cutouts	<b>MLM17N</b>	35	14.1	\$ 4600	\$ 4800	\$ 4933

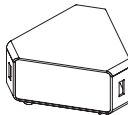

MLM17



MLM17N

<b>Coffee Table 48"L x 27"W x 17"H</b>							
	No Power	<b>MLM19</b>	145	24.9	\$ 1734	\$ 1798	\$ 1860

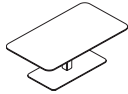

<b>Work Table 48"L x 27"W x 28"H</b>							
	No Power	<b>MLM22</b>	150	29.0	\$ 1893	\$ 1957	\$ 2019

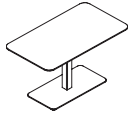

<b>Corner Table 29"L x 29"W x 17"H</b>							
	No Power	<b>MLM26</b>	73	14.7	\$ 1660	\$ 1720	\$ 1780

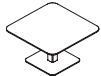

<b>Laptop Table 22"L x 17"W x 28"H</b>							
	No Power	<b>MLM18</b>	37	11.8	\$ 859	\$ 891	\$ 922



<p><b>How to specify —</b> Select the Model Number from above.</p> <p>MLM           .</p>	<p><b>1st Option:</b> Select the Laminate Color (if applicable): See page 237 for selections and color codes.</p> <p>Connector Tables limited to: <b>LDW1</b> Designer White <b>LM16</b> Flint</p> <p>          .</p>	<p><b>2nd Option:</b> Select the Laminate Edge Color (if applicable): See page 237 for selections and color codes. Connector Tables do not require an edge color.</p> <p>    .</p>	<p><b>3rd Option:</b> Select the Table Base Paint Color (if applicable): See page 237 for selections and color codes.</p> <p>          .</p>
---	---	--	--

Examples: MLMR15.LDW1    MLM22.LDW1.DW.PR8    MLM18.LM16.E9.P7A

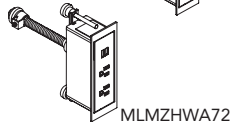
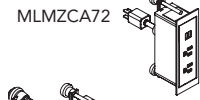
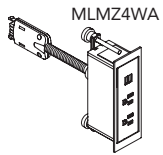

Description	Model Number	Ship Weight	Cubes	List Price
<b>Electrical 4-Wire Ports</b>				
Simplex/USB Port – 4-Wire 72"	MLMZ4WA	5	0.4	\$ 426

Simplex/USB Port – Corded 120"	MLMZCA72	5	0.4	\$ 381
--------------------------------	----------	---	-----	--------

Simplex/USB Port – Hardwire 72"	MLMZHWA72	5	0.4	\$ 409
---------------------------------	-----------	---	-----	--------

Simplex/USB Port – Hardwire for Chicago Code	MLMHWCC	8	0.4	\$ 426
--	---------	---	-----	--------

**Electrical 4-Wire Infeeds (black only)**

72" Sealtight Cable with H-Connector	S922P4S72K	2.1	0.7	\$ 309
New York Code version with H-Connector	S922P4NYK	4.5	0.7	\$ 454

**Electrical 4-Wire Jumpers**

42" Jumper with H-Connector	MLM42J	1.3	0.4	\$ 136
72" Jumper with H-Connector	MLM72J	2	0.8	\$ 183

**Ganging Kit**

Pack of 2	MLMGK	3.0	0.1	\$ 10
-----------	-------	-----	-----	-------

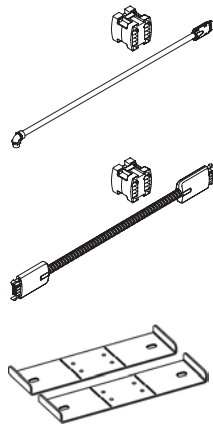

RECHARGE

<p><b>How to specify —</b> Select the Model Number from above.</p>	<p><i>1st Option:</i> <b>Faceplate Color</b> (if applicable): SNW Snow STRM Storm</p>
--	---

Examples: MLMZ4WA.SNW MLM1203EK.STRM MLM72J

**BASE PAINT FINISHES**

<b>GRADE P1</b>	
Charblack .....	CBK
Textured Designer White .....	PK7
Textured Brownstone .....	P7J
Textured Flint .....	P7A
Textured Titanium .....	P8V
Textured Loft .....	P7L
Textured Muslin .....	P7M
Textured Pebble .....	P8Y
Textured Salt .....	P8Z
<b>GRADE P2</b>	
Night Bronze .....	P8B
Pyrite .....	PJE
Solar Black .....	P8X
Textured Silver .....	PR8
<b>GRADE P3</b>	
Atom .....	P8S
Blossom*** .....	P8K
Bullseye .....	PJF
Cabernet*** .....	P7T
Conifer*** .....	P8H
Ember .....	P8P
Ion .....	P8N
Iris .....	P8J
Krypton .....	P8F
Regatta .....	P8M
Succulent*** .....	P8A

**LAMINATES**

<b>GRADE L1</b>	
<b>SOLID COLORS</b>	
Black .....	P
Brownstone .....	LM13
Bungalow .....	LM12
Designer White .....	LDW1
Flint .....	LM16
Fossil Shale .....	LEH1
Loft .....	LM11
Muslin .....	LM15
Titanium .....	LTI1
<b>ABSTRACT</b>	
Ash .....	LT3B
Handspun Pearl .....	LAHP
Handspun Dove .....	LAHD
Handspun Slate .....	LAHS
Handspun Chestnut .....	LAHC
Silver Mesh .....	LT8D
<b>WOODGRAIN</b>	
Belair .....	LWBA
Bourbon Cherry .....	H
Field Elm .....	LWFE
Florence Walnut .....	LFW1
Kingswood Walnut .....	LK11
Natural Maple .....	LWD
NeoWalnut .....	LNU1
Pinnacle .....	PINC
Shaker Cherry .....	LW7C
<b>GRADE L2</b>	
Beigewood .....	LWBE
Fawn Cypress .....	LFC1
Lowell Ash .....	LLA1
Mangalore Mango .....	LMM1
Natural Recon .....	LNR1
Phantom Charcoal .....	LPC1
Phantom Ecu .....	LPE1
Portico Teak .....	LPT1
Skyline Walnut .....	LSW1
Veranda Teak .....	LVT1
<b>GRADE L3</b>	
Natural Walnut .....	LWNW

**LAMINATE EDGE COLORS**

Beigewood .....	DE
Belair .....	BA
Black .....	E4
Bourbon Cherry .....	H
Brownstone .....	EY
Bungalow .....	EX
Designer White .....	DW
Fawn Cypress .....	FC
Field Elm .....	FE
Flint .....	E9
Florence Walnut .....	FW
Fossil .....	EH
Kingswood Walnut .....	KI
Loft .....	EV
Lowell Ash .....	DL
Mangalore Mango .....	MM
Muslin .....	EU
Natural Maple .....	DD
Natural Recon .....	NR
Natural Walnut .....	DN
NeoWalnut .....	NU
Parchment .....	EN
Phantom Charcoal .....	PC
Phantom Ecu .....	PE
Pinnacle .....	PI
Platinum Metallic .....	EP
Portico Teak .....	DP
Shaker Cherry .....	DF
Skyline Walnut .....	SW
Titanium .....	TI
Veranda Teak .....	VT

**VENEER**

<b>GRADE 1</b>	
Clear .....	RE800
Smoked Onyx .....	RE697
Nutmeg Walnut .....	RE629

RISE

**NOTE:** Refer to individual product pages for upcharges.

**FSC Certified Wood at Allsteel**

See page 431 for more information.

Rise Standard Upholstery Selections by Model/Series.

		Rise Seat	Rise Side	Rise 2.0 Seat	Rise 2.0 Side	Rise 2.0 Single Upholstery
<b>GRADE 1</b>						
Apex	APX		•		•	
Centurion	CU	•	•	•	•	•
Contourett	UR		•		•	
Dapper	DAPR		•		•	
Ensemble	ENSB	•	•	•	•	•
Hamilton	HAML	•	•	•	•	•
Inertia	NR	•	•	•	•	•
<b>GRADE 2</b>						
Appoint Seating	PNS	•	•	•	•	•
Blume	BLME	•	•	•	•	•
Clyde	CLYD	•	•	•	•	•
Dotty	DOT	•	•	•	•	•
Meld ⚡	SMHMMLD	•	•	•	•	•
Rush	RUSH	•	•	•	•	•
Spin	SPNN		•		•	
Whisper Vinyl	WP	•	•	•	•	•
<b>GRADE 3</b>						
Lateral ⚡	SCFSLAT		•		•	
Moxie	SX	•	•	•	•	•
Purl	PURL	•	•	•	•	•
Quill	QUL	•	•	•	•	•
<b>GRADE 4</b>						
Caper ⚡	SMHMCAP		•		•	
Manner ⚡	SMHMMAN	•	•	•	•	•
Merit ⚡	SMHMMER		•		•	
Messenger ⚡	SMHMGRM	•	•	•	•	•
Metric ⚡	SMHMMET	•	•	•	•	•
Mode ⚡	SMHMMOD	•	•	•	•	•
Multiply ⚡	SMHMMLT		•		•	
Murmur ⚡	SMHMMUR		•		•	
Muse ⚡	SMHMMUS		•		•	
Trundle ⚡	SMHMTRN		•		•	



⚡ Partnership Program — See page 10 for details.

- Available upholstery option



Rise Standard Upholstery Selections by Model/Series.

		Rise Seat	Rise Side	Rise 2.0 Seat	Rise 2.0 Side	Rise 2.0 Single Upholstery
<b>GRADE 5</b>						
Main Line Flax Ⓢ	SCAMMLF		•		•	
Rove Ⓢ	SMHMROV		•		•	
<b>GRADE 6</b>						
Arris	ARR	•	•	•	•	•
Blazer Ⓢ	SCAMBLZ		•		•	
Chock Ⓢ	SMHMCCK		•		•	
Hedge Ⓢ	SMHMHED		•		•	
Hemp Ⓢ	SCAMHMP		•		•	
Pocket Ⓢ	SMHMPKT		•		•	
Sequence Ⓢ	SMHMSQN		•		•	
Tandem Ⓢ	SMHMTAN	•	•	•	•	•
<b>GRADE 7</b>						
Silk Ⓢ	SCAMSLK		•		•	
<b>GRADE 8</b>						
Apt Ⓢ	SMHMAPT	•	•	•	•	•
Brisa Ⓢ	RS	•	•	•	•	•
<b>GRADE 9</b>						
Ultraleather Pro Ⓢ	SUF554	•	•	•	•	•
Yoredale Ⓢ	SCAMYDL	•	•	•	•	•

RISE

Ⓢ Partnership Program — See page 10 for details.

- Available upholstery option

Take collaboration to a new level.

Rise transforms any space into a meeting space. It is tiered and modular upholstered seating that allows a number of people to gather without taking over an entire room.

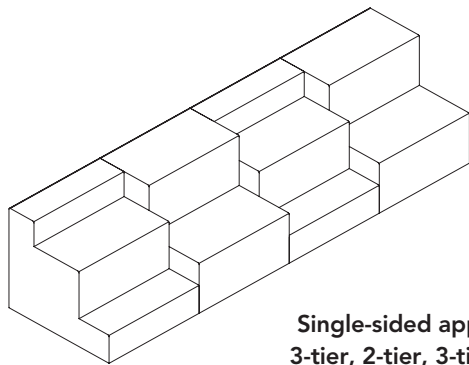

Single-sided application:  
3-tier, 2-tier, 3-tier, 2-tier

**MODELS AND OPTIONS**

Rise is designed as building blocks that can be combined into a variety of configurations. Rise is available as non-powered or power-ready. Rise is not intended for use as stairs.

**APPLICATION**

Use Rise back-to-back or side-by-side against a wall in atriums, open plan areas, brainstorming/huddle rooms, conference room, cafés, waiting areas, or lounges.

**KEY FEATURES**

Rise is constructed of fabric covered foam with upholstery-grade FSC plywood core, box joint, and corner block construction.

Rise has glides that are adjustable up to 2".

Ganging brackets with screws are included for connecting multiple units. Two brackets are required to connect two Rise units together. Soft Wall requires a special ganging bracket S922GB if it is not put between two units.

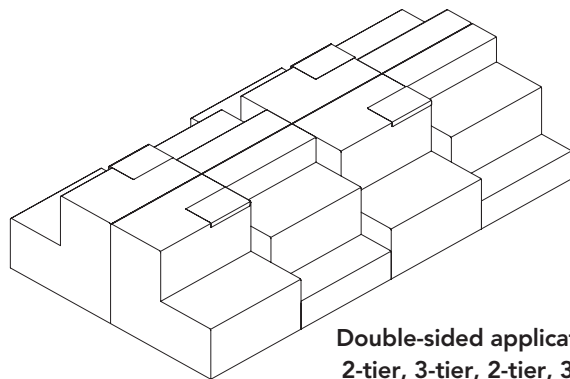

Double-sided application:  
2-tier, 3-tier, 2-tier, 3-tier

**DIMENSIONS**

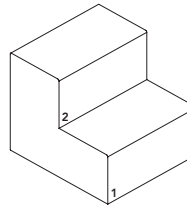

**RISE 2-TIER**

2-Tier — 34"H x 36"W x 40"D  
2-Tier Corner\* — 34"H x 40"W x 40"D  
Tiers 1 and 2 — 17"H x 20"D

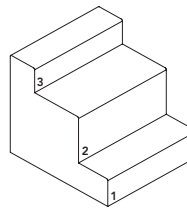

**RISE 3-TIER**

3-Tier — 34"H x 36"W x 40"D  
Tier 1 — 9½"H x 12"D  
Tier 2 — 16"H x 18"D  
Tier 3 — 8½"H x 10"D

\*NOTE: Dimension of unit may not fit through standard door, check installation site prior to ordering.

**MATERIALS**

The outside cover on Rise is fully upholstered. Rise can be specified in a solid color or two-tone on selected models.

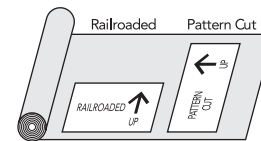

- Due to the dimension of the seat Rise fabric will be pattern cut.
- All upholstery foams are CFC-free.
- All COMs must be approved for upholsterability or applicable fire code compliance prior to order entry. See pages 6-8 for COM ordering instructions.
- **Flammability** code compliance of Allsteel textiles and seating is listed on pages 15-16. COM/COL manufacturers supply certificates of compliance for fabric-only tests such as CAL TB117-2013.

Rise is warranted up to 300 lbs per unit.

See pages 15-16 for upholstery selections.  
See pages 17-18.1 for colors and codes.

RISE

**CORNER MODELS**

Corner Rise models are available in two-tier models and are 40"W x 40"D. Units can be specified in a solid color or two-tone.

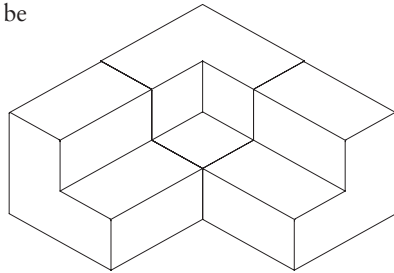

**Corner Application:**  
2-Tier, 2-Tier Inside Corner, 2-Tier

**POWER-READY MODELS**

Power-ready Rise models have a cut-out on the front right side of the lower tier (see below) that will accept a Rise Power Port (ordered separately). The opening is 6.25"W x 1.94"H.

Rise Power Ports are UL listed and constructed out of anodized aluminum with a painted, steel faceplate and two water-proof outlets and two USB ports. Three power options are available:

- Corded — plugs a single unit into standard outlet
- Hardwire — connects a single unit to power source by a licensed electrician
- 4-Wire used for powering multiple units — requires 4-Wire Infeed Kit. 4-wire Jumper Kit(s) may also be required when powering multiple units from the same infeed. See examples.

It's the customer's responsibility to ensure that installation and use of the electrical system, the number of receptacles used on a given circuit, and connections to the building power supply meets all local and national electrical codes.

**Front view of 3-Tier Rise Unit**

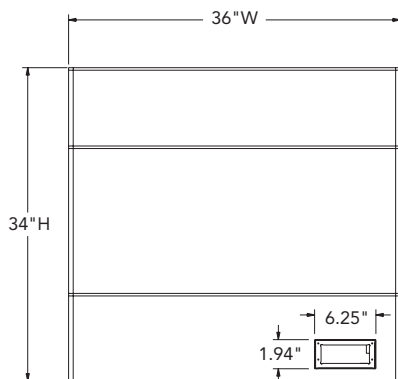

**STEPS FOR ORDERING RISE 4-WIRE POWER KITS:**

1. Determine the number and location of Powered Rise units in configuration. A maximum of thirteen Powered Rise units can be connected on one Infeed.
  2. Order one 4-Wire Power Port for each Powered Rise unit.
  3. Order one Infeed Kit. Each Infeed Kit includes H-Connector which can power either:
    - Three Rise units.
    - Two Rise units and one Jumper.
    - One Rise unit and two Jumpers.
    - Three Jumpers.
  4. Determine if Jumper with H-Connector Kits are needed for connecting multiple Powered Rise units.
    - A Jumper Kit is required if the distance between the H-Connector on the end of Infeed or Jumper is greater than 72" to the Power Port cut-out in Rise unit.
    - Jumper Kits are available in 36", 72", 108" and 144" lengths.
    - Infeeds and Jumpers can't plug directly into Power Port.
- See examples below. Electrical components listed on page 261.

**Example 1 — Double-sided Application (Top View)**

- 5 – 4-Wire Power Ports
- 1 – Infeed Kit
- 1 – 72" Jumper Kit

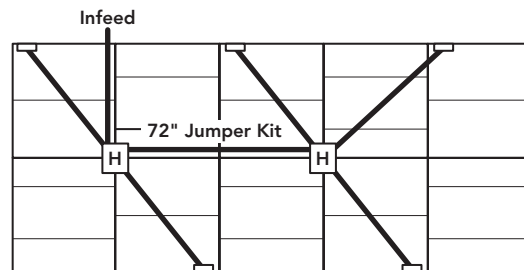



(See page 326 for COM pricing on Grades 9-22)

Description	Model Number	Base List Price	Upcharge List Price—Add to Base Price									
			2	3	4	5	6	7	8			
<b>2-Tier Rise</b>												
Non-Powered	S922S2	\$ 3299	\$ 83	\$ 167	\$ 250	\$ 362	\$ 474	\$ 585	\$ 696			
Power-Ready	S922S2P	\$ 3393	\$ 83	\$ 167	\$ 250	\$ 362	\$ 474	\$ 585	\$ 696			
<b>2-Tier Rise Non-Powered Corner</b>												
Inside Corner	S922S2IC	\$ 4504	\$ 102	\$ 204	\$ 307	\$ 444	\$ 580	\$ 717	\$ 854			
Outside Corner	S922S2OC	\$ 4504	\$ 102	\$ 204	\$ 307	\$ 444	\$ 580	\$ 717	\$ 854			
<b>3-Tier Rise</b>												
Non-Powered	S922S3	\$ 3665	\$ 83	\$ 167	\$ 250	\$ 362	\$ 474	\$ 585	\$ 696			
Power-Ready	S922S3P	\$ 3760	\$ 83	\$ 167	\$ 250	\$ 362	\$ 474	\$ 585	\$ 696			
Description	Model Number	Base List Price	Upcharge List Price — Add to Base Price									
			1	2	3	4	5	6	7	8		
<b>Two-tone 2-Tier Rise</b>												
Non-Powered	S922S2T	\$ 3575	Seat Upholstery	\$ 0	\$ 51	\$ 102	\$ 153	\$ 222	\$ 290	\$ 358	\$ 427	
Power-Ready	S922S2TP	\$ 3665	Side Upholstery	\$ 0	\$ 31	\$ 63	\$ 94	\$ 137	\$ 178	\$ 221	\$ 262	
<b>Two-tone 2-Tier Rise Non-Powered Corner</b>												
Inside Corner	S922S2TIC	\$ 4763	Seat Upholstery	\$ 0	\$ 67	\$ 133	\$ 201	\$ 290	\$ 380	\$ 469	\$ 559	
			Side Upholstery	\$ 0	\$ 35	\$ 71	\$ 106	\$ 153	\$ 201	\$ 248	\$ 296	
Outside Corner	S922S2TOC	\$ 4763	Seat Upholstery	\$ 0	\$ 67	\$ 133	\$ 201	\$ 290	\$ 380	\$ 469	\$ 559	
			Side Upholstery	\$ 0	\$ 35	\$ 71	\$ 106	\$ 153	\$ 201	\$ 248	\$ 296	
<b>Two-tone 3-Tier Rise</b>												
Non-Powered	S922S3T	\$ 3941	Seat Upholstery	\$ 0	\$ 51	\$ 102	\$ 153	\$ 222	\$ 290	\$ 358	\$ 427	
Power-Ready	S922S3TP	\$ 4033	Side Upholstery	\$ 0	\$ 31	\$ 63	\$ 94	\$ 137	\$ 178	\$ 221	\$ 262	
<b>Two-tone Pricing Example:</b>				Model/Options	Base Price/Upcharges							
Step 1: Select Model				S922S2T	\$ 3575							
Step 2: Select Seat Upholstery (if applicable):				Grade 5 Against the Grain	\$ 222 upcharge							
Step 3: Select Side Upholstery				Grade 1 Apex	\$ 0 upcharge							
				Add Base + applicable Upcharges for Total List Price = \$ 3797								

If sliding glides are needed for any of the above legacy models, please submit a replacement order with Allsteel Customer Support.

- For units ordered before October 1, 2019:
  - Corner Bracket Assembly 3700015600 (Qty 4)
  - Slide Guide 3130100100 (Qty 4)
- For units ordered after October 1, 2019:
  - Slide Glide 3130100100 (Qty 4)

 Shippable by small-package carrier.

<p><b>How to specify —</b> Select the Model Number from above.</p>	<p><i>1st Option:</i> FSC Certified Wood (if applicable): FSC Select for FSC Certified Wood</p>	<p><i>2nd Option:</i> Select the Upholstery (if applicable): See pages 255-256 for selections.</p>	<p><i>3rd Option:</i> Select the Side Upholstery for Two-tone models (if applicable): See pages 255-256 for selections.</p>
<p>S   9   2   2                     . F   S   C   .</p>			

Examples: S922S2.FSC.UR26 S922S3.FSC.UR26  
S922S2TP.FSC.ISN041.WP17





## RISE DIMENSIONS

GSA SIN 33721

Model Number	Overall			Tier 1			Tier 2			Tier 3			Ship Weight	Cubes	
	COM Yardage	Height	Width	Height	Width	Depth	Height	Width	Depth	Height	Width	Depth			
S922S2	5.5	34"	36"	40"	17"	36"	20"	17"	36"	20"	—	—	—	90	37.5
S922S2P	5.5	34"	36"	40"	17"	36"	20"	17"	36"	20"	—	—	—	90	37.5
S922S2IC	6.5	34"	40"	40"	17"	40"	20"	17"	40"	20"	—	—	—	99	37.5
S922S2OC	6.25*	34"	40"	40"	17"	40"	40"	17"	20"	20"	—	—	—	90	37.5
S922S3	4.75	34"	36"	40"	9½"	36"	12"	16"	36"	18"	8½"	36"	10"	90	37.5
S922S3P	4.75	34"	36"	40"	9½"	36"	12"	16"	36"	18"	8½"	36"	10"	90	37.5
<b>2-Tier</b>															
S922S2T	5.5	34"	36"	40"	17"	36"	20"	17"	36"	20"	—	—	—	90	37.5
S922S2TP	5.5	34"	36"	40"	17"	36"	20"	17"	36"	20"	—	—	—	90	37.5
Seat Side	3.25														
S922S2TIC	6.5*	34"	40"	40"	17"	40"	20"	17"	40"	20"	—	—	—	99	37.5
S922S2TOC	6.25*	34"	40"	40"	17"	40"	40"	17"	20"	20"	—	—	—	90	37.5
<b>3-Tier</b>															
Seat Side	3.25														
S922S3T	5.25	34"	36"	40"	9½"	36"	12"	16"	36"	18"	8½"	36"	10"	90	37.5
S922S3TP	5.25	34"	36"	40"	9½"	36"	12"	16"	36"	18"	8½"	36"	10"	90	37.5

\*Two-Tone Inside Corner — Seat 4.25 yds. + Side 2.25 yds. = 6.5 yards. Outside Corner — Seat 4.0 yds. + Side 2.25 yds. = 6.25 yards.

## RISE ELECTRICAL COMPONENTS\*

Description	Model Number	PVC Free Model	Ship Weight	Cubes	List Price	PVC Free List Price
<b>Rise Electrical Module</b>						
Power Port — Corded 120"	MLMZCA72	 N/A	5.0	0.4	\$ 381	N/A
Power Port — Hardwire 72"	MLMZHWA72	 N/A	5.0	0.4	\$ 409	N/A
Power Port — 4-Wire 72"	MLMZ4WA	 N/A	5.0	0.4	\$ 426	N/A
<b>Electrical, 4-Wire Infeed Kits (black only)</b>						
72" Sealtight Cable with H-Connector	S922P4S72K	 N/A	2.1	0.7	\$ 309	N/A
144" Sealtight Cable with H-Connector	S922P4S144K	 N/A	3.7	0.7	\$ 454	N/A
<b>Hardwire, 4-wire Infeed (New York Code)</b>						
4-Wire Infeed with H-Connector	S922P4NYK	N/A	4.5	0.4	\$ 454	N/A
<b>Electrical 4-Wire Jumpers</b>						
42" Jumper with H-Connector	MLM42J		1.3	0.4	\$ 136	
72" Jumper with H-Connector	MLM72J		2	0.8	\$ 183	

\*Applicable for both existing Rise and new power-ready models. Cutout size has changed; old electrical face plates will no longer fit.

 Shippable by small-package carrier.

**How to specify —**  
Select the Model Number from above.

**1st Option:**  
**Power Port Color**  
(if applicable):  
SNW Snow  
STRM Storm

Examples: MLMZCA72.SNW S922P4S72K.BLK

(See page 326 for COM pricing on Grades 9-22)

Description	Model Number	Base List Price	Upcharge List Price—Add to Base Price							
			2	3	4	5	6	7	8	
<b>Single-Tone Chaise</b>										
Non-Powered	S922S2LN	\$ 3563	\$ 126	\$ 252	\$ 378	\$ 547	\$ 714	\$ 882	\$ 1050	
Power-Ready	S922S2LP	\$ 3654	\$ 126	\$ 252	\$ 378	\$ 547	\$ 714	\$ 882	\$ 1050	
<b>Single-Tone Full Ottoman</b>										
Non-Powered	S922SON	\$ 2581	\$ 71	\$ 142	\$ 213	\$ 307	\$ 402	\$ 496	\$ 591	
Power-Ready	S922SOP	\$ 2672	\$ 71	\$ 142	\$ 213	\$ 307	\$ 402	\$ 496	\$ 591	
<b>Full Ottoman Wood Top</b>										
Non-Powered	S922SOWN	\$ 2591	\$ 67	\$ 134	\$ 203	\$ 292	\$ 385	\$ 508	\$ 605	
Power-Ready	S922SOWP	\$ 2682	\$ 67	\$ 134	\$ 203	\$ 292	\$ 385	\$ 508	\$ 605	
<b>Triangle</b>										
Non-Powered	S922SWDN	\$ 2618	\$ 79	\$ 157	\$ 236	\$ 342	\$ 446	\$ 552	\$ 657	
Power-Ready	S922SWDP	\$ 2709	\$ 79	\$ 157	\$ 236	\$ 342	\$ 446	\$ 552	\$ 657	
<b>Triangle Wood Top</b>										
Non-Powered	S922SWDWN	\$ 2628	\$ 61	\$ 122	\$ 159	\$ 238	\$ 318	\$ 400	\$ 481	
Power-Ready	S922SWDWP	\$ 2719	\$ 61	\$ 122	\$ 159	\$ 238	\$ 318	\$ 400	\$ 481	
<b>Half Ottoman</b>										
Non-Powered	S922SHON	\$ 2182	\$ 60	\$ 120	\$ 180	\$ 229	\$ 307	\$ 386	\$ 469	
<b>Rise Half Ottoman Wood Top</b>										
Non-Powered	S922SHOWN	\$ 2187	\$ 55	\$ 110	\$ 165	\$ 210	\$ 281	\$ 354	\$ 430	

<b>Single-tone Pricing Example:</b>	<b>Model/Options</b>	<b>Base Price/Upcharges</b>
Step 1: Select Non-Powered Full Ottoman	S922SON	
Step 2: Select Seat Upholstery	Grade 6 Blazer	\$ 2983 w/upcharge
Add Base + applicable Upcharges for Total List Price =		\$ 2983

<p><b>How to specify —</b> Select the Model Number from above.</p> <p>S   9   2   2           . F   S   C   .       .</p>	<p><b>1st Option:</b> FSC Certified Wood (if applicable): FSC Select for FSC Certified Wood</p>	<p><b>2nd Option:</b> Select Glides (if applicable): See page 254 for glides. G Standard Glides SG Sliding Glides (\$55 upcharge)</p>	<p><b>3rd Option:</b> Select the Upholstery (if applicable): See pages 255-256 for selections.</p>	<p><b>4th Option:</b> Select the Side Upholstery for Two-tone models (if applicable): See pages 255-256 for selections.</p>	<p><b>5th Option:</b> Select Veneer (if applicable): See page 254 for selections.</p>
---	---	---	--	---	---

Examples: S922S2LN.FSC.SG.ARR02  
S922SOP.FSC.SG.UR26



Model Number	Overall			Tier 1			Tier 2			Ship Weight	Cubes	
	COM Yardage	Height	Width	Depth	Height	Width	Depth	Height	Width			Depth
S922S2LN	7.5	34"	36"	60"	17"	36"	40"	17"	36"	20"	120	56.5
S922S2LP	7.5	34"	36"	60"	17"	36"	40"	17"	36"	20"	120	56.5
S922SON	3.5	17"	36"	40"	17"	36"	40"	-	-	-	60	18.9
S922SOP	3.5	17"	36"	40"	17"	36"	40"	-	-	-	60	18.9
S922SOWN	3.5	17¼"	36"	40"	17"	36"	40"	-	-	-	95	14.8
S922SOWP	3.5	17¼"	36"	40"	17"	36"	40"	-	-	-	95	14.8
S922SWDN	3.5	17"	10"/40"	40" Sides	17"	10"/40"	40" Sides	-	-	-	45	18.9
S922SWDP	3.5	17"	10"/40"	40" Sides	17"	10"/40"	40" Sides	-	-	-	45	18.9
S922SWDWN	3.5	17¼"	39½"	37"	17"	10"/40"	40" Sides	-	-	-	77	15.0
S922SWDWP	3.5	17¼"	39½"	37"	17"	10"/40"	40" Sides	-	-	-	77	15.0
S922SHON	2.5	17"	36"	20"	17"	36"	20"	-	-	-	40	10.1
S922SHOWN	2.5	17¼"	36"	20"	17"	36"	20"	-	-	-	52	7.4



(See page 326 for COM pricing on Grades 9-22)

Description	Model Number	Base List Price	Upcharge List Price—Add to Base Price							
			2	3	4	5	6	7	8	
<b>Arm Perch</b>										
Non-Powered	S922SAN	\$ 2618	\$ 82	\$ 164	\$ 246	\$ 346	\$ 450	\$ 554	\$ 660	
<b>Arm-Perch Wood Top</b>										
Non-Powered	S922SAWN	\$ 2623	\$ 75	\$ 150	\$ 225	\$ 317	\$ 412	\$ 508	\$ 605	
<b>Soft Wall</b>										
Non-Powered	S922SWN	\$ 2618	\$ 79	\$ 157	\$ 236	\$ 342	\$ 446	\$ 552	\$ 657	
<b>Lumbar Pillow</b>										
Non-Powered	S922LPN	\$ 290	\$ 31	\$ 63	\$ 94	\$ 137	\$ 178	\$ 221	\$ 262	

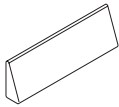
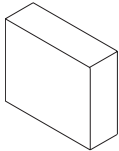
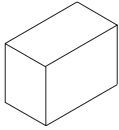

RISE

<b>Single-tone Pricing Example:</b>	<b>Model/Options</b>	<b>Base Price/Upcharges</b>
Step 1: Select Non-Powered Full Ottoman	S922SON	
Step 2: Select Seat Upholstery	Grade 6 Blazer	\$ 2983 w/upcharge
Add Base + applicable Upcharges for Total List Price =		\$ 2983

<p><b>How to specify —</b> Select the Model Number from above.</p>	<p><i>1st Option:</i> <b>FSC Certified Wood</b> (if applicable): FSC Select for FSC Certified Wood</p>	<p><i>2nd Option:</i> <b>Select Glides</b> (if applicable): See page 254 for glides. G Standard Glides SG Sliding Glides (\$55 upcharge)</p>	<p><i>3rd Option:</i> <b>Select the Upholstery</b> (if applicable): See pages 255-256 for selections.</p>	<p><i>4th Option:</i> <b>Select the Side Upholstery for Two-tone models</b> (if applicable): See pages 255-256 for selections.</p>	<p><i>5th Option:</i> <b>Select Veneer</b> (if applicable): See page 254 for selections.</p>
S   9   2   2           .   F   S   C   .					

Example:

Model Number	COM Yardage		Overall			Tier 1			Tier 2			Ship Weight	
	Height	Width	Depth	Height	Width	Depth	Height	Width	Depth	Ship Weight	Cubes		
S922SAN	3.5	26"	36"	40"	26"	36"	40"	-	-	-	45	14.9	
S922SAWN	3.5	26"	36"	20"	26"	36"	40"	-	-	-	60	10.8	
S922SWN	4.5	34"	13"	40"	-	-	-	-	-	-	45	13.8	
S922LPN	1.0	10"	36"	5"	-	-	-	-	-	-	5	1.8	



(See page 326 for COM pricing on Grades 9-22)

Description	Model Number	Base List Price		Upcharge List Price—Add to Base Price							
				2	3	4	5	6	7	8	
<b>Two-Tone Chaise</b>											
Non-Powered	S922S2LTN	\$ 3835	Seat Upholstery	\$ 79	\$ 159	\$ 238	\$ 342	\$ 447	\$ 553	\$ 660	
		\$ 3835	Side Upholstery	\$ 47	\$ 93	\$ 140	\$ 201	\$ 263	\$ 324	\$ 387	
Power-Ready	S922S2LTP	\$ 3927	Seat Upholstery	\$ 79	\$ 159	\$ 238	\$ 342	\$ 447	\$ 553	\$ 660	
		\$ 3927	Side Upholstery	\$ 47	\$ 93	\$ 140	\$ 201	\$ 263	\$ 324	\$ 387	
<b>Two-Tone Full Ottoman</b>											
Non-Powered	S922SOTN	\$ 2853	Seat Upholstery	\$ 55	\$ 111	\$ 167	\$ 239	\$ 312	\$ 386	\$ 462	
		\$ 2853	Side Upholstery	\$ 30	\$ 59	\$ 90	\$ 129	\$ 168	\$ 208	\$ 249	
Power-Ready	S922SOTP	\$ 2945	Seat Upholstery	\$ 55	\$ 111	\$ 167	\$ 239	\$ 312	\$ 386	\$ 462	
		\$ 2945	Side Upholstery	\$ 30	\$ 59	\$ 90	\$ 129	\$ 168	\$ 208	\$ 249	
<b>Two-Tone Full Ottoman Wood Top</b>											
Non-Powered	S922SOTWP	\$ 2955	Seat Upholstery	\$ 50	\$ 101	\$ 153	\$ 219	\$ 286	\$ 354	\$ 423	
		\$ 2955	Side Upholstery	\$ 27	\$ 54	\$ 82	\$ 118	\$ 154	\$ 190	\$ 228	
Power-Ready	S922SOTWN	\$ 2863	Seat Upholstery	\$ 50	\$ 101	\$ 153	\$ 219	\$ 286	\$ 354	\$ 423	
		\$ 2863	Side Upholstery	\$ 27	\$ 54	\$ 82	\$ 118	\$ 154	\$ 190	\$ 228	
<b>Two-Tone Half-Ottoman</b>											
Non-Powered	S922SHOTN	\$ 2454	Seat Upholstery	\$ 44	\$ 88	\$ 132	\$ 190	\$ 248	\$ 307	\$ 366	
		\$ 2454	Side Upholstery	\$ 17	\$ 34	\$ 52	\$ 74	\$ 96	\$ 119	\$ 142	
<b>Two-Tone Half Ottoman Wood Top</b>											
Non-Powered	S922SHOTWN	\$ 2459	Seat Upholstery	\$ 40	\$ 80	\$ 121	\$ 174	\$ 227	\$ 281	\$ 335	
		\$ 2459	Side Upholstery	\$ 15	\$ 31	\$ 47	\$ 67	\$ 88	\$ 109	\$ 130	
<b>Two-Tone Arm Perch</b>											
Non-Powered	S922SATN	\$ 2889	Seat Upholstery	\$ 64	\$ 128	\$ 192	\$ 268	\$ 353	\$ 438	\$ 525	
		\$ 2889	Side Upholstery	\$ 24	\$ 50	\$ 76	\$ 104	\$ 137	\$ 171	\$ 204	
<b>Two-Tone Arm Perch Wood Top</b>											
Non-Powered	S922SATWN	\$ 2894	Seat Upholstery	\$ 58	\$ 117	\$ 176	\$ 245	\$ 323	\$ 401	\$ 481	
		\$ 2894	Side Upholstery	\$ 22	\$ 45	\$ 69	\$ 95	\$ 125	\$ 156	\$ 187	
<b>Two-Tone Soft Wall</b>											
Non-Powered	S922SWTN	\$ 2889	Top/Front/Back	\$ 31	\$ 60	\$ 90	\$ 128	\$ 167	\$ 207	\$ 247	
		\$ 2889	Side Upholstery	\$ 52	\$ 102	\$ 153	\$ 218	\$ 285	\$ 353	\$ 419	

<b>How to specify —</b> Select the Model Number from above.	1st Option: FSC Certified Wood (if applicable): FSC Select for FSC Certified Wood	2nd Option: Select Glides (if applicable): See page 254 for glides G Standard Glides SG Sliding Glides (\$55 upcharge)	3rd Option: Select the Upholstery See pages 255-256 for selections.	4th Option: Select the Side Upholstery for Two-tone models (if applicable): See pages 255-256 for selections.	5th Option: Select Veneer (if applicable): See page 254 for selections.
S   9   2   2                     . F   S   C   .					

Example: S922S2LTN.FSC.SG.ARR02

Model Number		Overall				Tier 1			Tier 2			Ship Weight	Cubes
		COM Yardage	Height	Width	Depth	Height	Width	Depth	Height	Width	Depth		
S922S2LTN	Seat	4.0	34"	36"	60"	17"	36"	40"	17"	36"	20"	120	56.5
	Side	3.0											
S922S2LTP	Seat	4.0	34"	36"	60"	17"	36"	40"	17"	36"	20"	120	56.5
	Side	3.0											
S922SOTN	Seat	2.5	17"	36"	40"	17"	36"	40"	-	-	-	60	18.9
	Side	1.5											
S922SOTP	Seat	2.5	17"	36"	40"	17"	36"	40"	-	-	-	60	18.9
	Side	1.5											
S922SOTWP	Seat	2.5	17¼"	36"	40"	17"	36"	40"	-	-	-	95	14.8
	Side	1.5											
S922SOTWN	Seat	2.5	17¼"	36"	40"	17"	36"	40"	-	-	-	95	14.8
	Side	1.5											
S922SHOTN	Seat	2.0	17"	36"	20"	17"	36"	20"	-	-	-	40	10.1
	Side	1.0											
S922SHOTWN	Seat	2.0	17¼"	36"	20"	17"	36"	20"	-	-	-	52	7.4
	Side	1.0											
S922SATN	Seat	2.5	26"	36"	40"	26"	36"	40"	-	-	-	45	14.9
	Side	1.0											
S922SATWN	Seat	2.5	26"	36"	20"	26"	36"	40"	-	-	-	60	10.8
	Side	1.0											
S922SWTN	Seat	2.0	34"	13"	40"	-	-	-	-	-	-	4.5	13.8
	Side	2.5											

RISE

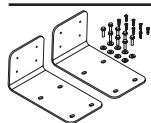

Description	Model Number	Base List Price	Ship Weight	Cubes
<b>Rise Accessories</b>				
Ganging Bracket	S922GB	\$ 247	25	0.8

RISE

<p><b>How to specify —</b> Select the Model Number from above.</p> <p>S   9                              </p>	<p><b>1st Option:</b> FSC Certified Wood (if applicable):</p> <p>FSC Select for FSC Certified Wood</p> <p>F   S   C   .</p>	<p><b>2nd Option:</b> Select the Laminate (if applicable):</p> <p>See page 254 for options.</p> <p>L      </p>	<p><b>3rd Option:</b> Select the Edge Color (if applicable):</p> <p>See page 254 for options.</p> <p>     </p>	<p><b>4th Option:</b> Select the Base Paint Color</p> <p>See page 254 for options.</p> <p>               </p>
---	---	--	--	---



**WOOD FINISH**

WOOD SPECIES	
PATTERN NAME	MAPLE
Beigewood.....	LE878
Belair.....	LE934
Burnished Cherry .....	LE777
Cinnamon Cherry .....	LE260
Clear Coat.....	LE100
Clear Oak .....	LE300
Clear/Natural Maple .....	LE800
Dark Rift Cut Oak .....	LE331
Ebony Maple.....	LE555
Field Elm.....	LE599
Florence Walnut.....	LE579
Harvest Maple .....	LE856
Light Cherry.....	LE701
Light Walnut.....	LE601
Lowell Ash .....	LE394
Medium Red Cherry .....	LE512
Natural Cherry.....	LE222
Nutmeg Walnut .....	LE629
Phantom Ecrú .....	LE912
Pinnacle Walnut .....	LE679
Portico Teak.....	LE150
Shaker Cherry .....	LE774
Skyline Walnut.....	LE625
Sumatra Walnut.....	LE693

RETREAT

**NOTE:** Refer to individual product pages for upcharges.

**FSC Certified Wood at Allsteel**  
See page [431](#) for more information.

Retreat Standard Upholstery Selections by Model/Series, for all other seating see *Seating, Collaboration, and Tables* pages 13-14.

		Executive/Conference Seat	Executive/Conference Seat	Wing Back Seat	Wing Back Body	Hi/Low/Ottoman Seat-Top	Hi/Low/Ottoman Side-Body
<b>GRADE 1</b>							
Apex	APX	•	•	•		•	
Centurion	CU	•	•	•	•	•	•
Contourett	UR	•	•	•		•	•
Dapper	DAPR	•	•	•		•	•
Ensemble	ENSB	•	•	•		•	•
Hamilton	HAML	•	•	•	•	•	•
Inertia	NR	•	•	•		•	•
<b>GRADE 2</b>							
Appoint Seating	PNS	•	•	•		•	•
Blume	BLME	•	•	•	•	•	•
Clyde	CLYD	•	•	•	•	•	•
Dotty	DOT	•	•	•		•	•
Meld	SMHMMLD	•	•	•	•	•	•
Rush	RUSH	•	•	•	•	•	•
Spin	SPNN	•					
Whisper Vinyl	WP	•	•				
<b>GRADE 3</b>							
Lateral	SCFSLAT	•		•		•	
Moxie	SX	•	•	•		•	•
Purl	PURL	•	•	•		•	•
Quill	QUL	•	•	•	•	•	•
<b>GRADE 4</b>							
Caper	SMHMCAP	•	•	•		•	•
Manner	SMHMMAN	•	•	•	•	•	•
Merit	SMHMMER	•	•	•	•	•	•
Messenger	SMHMGRM	•		•	•	•	•
Metric	SMHMMET	•		•	•	•	•
Mode	SMHMMOD	•	•	•	•	•	•
Multiply	SMHMMLT	•		•		•	
Murmur	SMHMMUR	•		•		•	
Muse	SMHMMUS	•		•		•	
Trundle	SMHMTRN	•		•		•	

		Executive/Conference Seat	Executive/Conference Seat	Wing Back Seat	Wing Back Body	Hi/Low/Ottoman Seat-Top	Hi/Low/Ottoman Side-Body
<b>GRADE 5</b>							
Main Line Flax	SCAMMLF	•	•	•		•	•
Rove	SMHMROV	•		•		•	
<b>GRADE 6</b>							
Arris	ARR	•	•	•	•	•	•
Blazer	SCAMBLZ	•	•	•	•	•	•
Chock	SMHMCCK	•		•		•	
Hedge	SMHMHED	•	•	•		•	•
Hemp	SCAMHMP	•	•	•		•	
Pocket	SMHMPPKT	•		•		•	
Maharam Sequence	SMHMSQN	•		•		•	
Tandem	SMHMTAN	•		•		•	
<b>GRADE 7</b>							
Silk	SCAMSLK	•	•	•	•	•	•
<b>GRADE 8</b>							
Apt	SMHMAPT	•		•		•	
Brisa	RS	•	•	•		•	•
Zap	SCAMZAP	•	•	•		•	•
<b>GRADE 9</b>							
Ultraleather Pro	SUF554	•	•	•		•	•
Yoredale	SCAMYDL	•	•	•	•	•	•
<b>GRADE L1</b>							
Florence	FLOR					•	•
Strasburg	STB	•	•			•	•

☞ Partnership Program — See page 10 for details.  
 • Available upholstery option

- Allsteel fabrics and foam meet requirements for CTB117.
- Blank spaces indicate that a product has not yet been tested or that it failed.
- Contact Allsteel Customer Support for other flammability code approvals.



*Retreat Lounge is a space-defining collection that supports real work in often underutilized spaces. It defines areas for small groups, provides privacy for individuals, and offers visual consistency in space planning. The lounge collection includes wing-back, high-back, and low-back chairs, and a matching ottoman.*

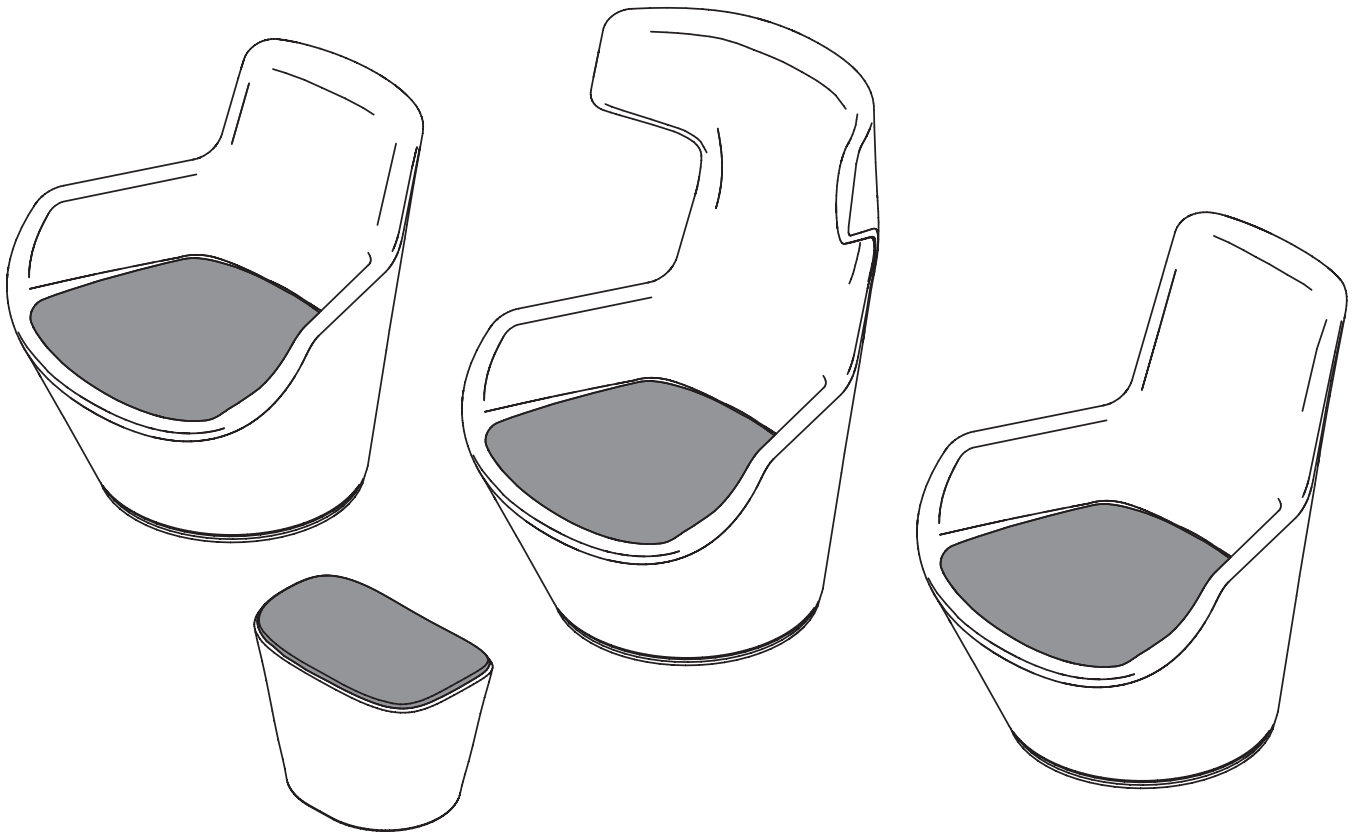

*Retreat Executive, Conference and Side seating extends premium comfort throughout meeting and private office spaces with its iconic design know from the Retreat lounge collection. The soft, organic shape of Retreat speaks to multiple generations of leaders, while creating a timeless and cohesive aesthetic that does not overwhelm the space or user.*



**DESIGN FEATURES**

Retreat is a space defining lounge collection that supports real work in often underutilized spaces. It defines space for small groups, provides privacy for individuals, and visual consistency in planning and varied elevations.

**Arms**

Arm height is specific for comfort or laptop placement.

**High-Back and Wing-Back**

High-back protects back of head and wing-back provides added visual privacy. Relaxed tailoring is normal and expected in the upper headrest of the wing back (see illustration below).

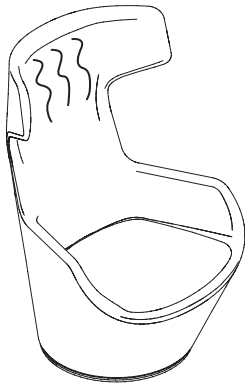

**Base Options for Chairs**

Select between fixed, swivel, or return-to-center base.

**Materials**

- All COMs/COLs must be approved for upholsterability or applicable fire code compliance prior to order entry. See pages 6-8 for COM ordering instructions.
- Allsteel fabrics meet requirements for CTB117. COM/COL manufacturers supply certificates of compliance for fabric-only tests such as CTB117.

**OPTIONS**

Chair Type:

- VERW** Wing-Back Upholstery
- VERH** High-Back Upholstery
- VERL** Low-Back Upholstery
- VERO** Ottoman Upholstery

Fire Code:

- NO** Standard Upholstery, No Fire Code

Base Type (if applicable):

- F** Fixed (Subtract \$327)
- S** Swivel
- R** Return-to-Center (\$289 extra)

Body Upholstery:

See page 267 for upholstery selection. Future “Non-stretch” fabrics will require dual zippers on wing back models (see illustration below).

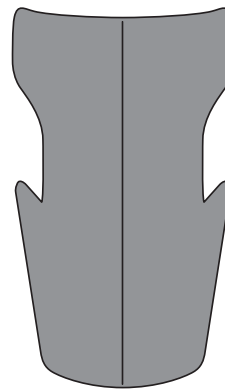

Single Zipper

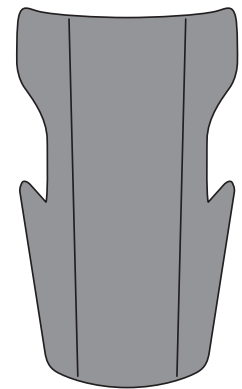





Dual Zipper

Seat Upholstery and Leather:

See page 267 for upholstery and leather selection.

Upcharges listed for Grades 2 and above, add to Base Price. Grades 9-22 on page 326.

Style	Model Number <i>Add options below</i>	Textiles	Base Price	Upholstery Upcharge								
					2	3	4	5	6	7	8	L1
	VERWNO	Upholstery	\$ 5569	Body	\$ 63	\$ 126	\$ 189	\$ 273	\$ 357	\$ 441	\$ 525	N/A
				Seat	\$ 16	\$ 31	\$ 47	\$ 68	\$ 89	\$ 111	\$ 131	N/A
	VERHNO	Upholstery	\$ 4800	Body	\$ 47	\$ 94	\$ 142	\$ 204	\$ 268	\$ 331	\$ 394	\$ 938
				Seat	\$ 16	\$ 31	\$ 47	\$ 68	\$ 89	\$ 111	\$ 131	\$ 313
	VERLNO	Upholstery	\$ 4416	Body	\$ 43	\$ 86	\$ 128	\$ 185	\$ 241	\$ 298	\$ 355	\$ 906
				Seat	\$ 15	\$ 29	\$ 43	\$ 62	\$ 80	\$ 100	\$ 118	\$ 313
	VERONO	Upholstery	\$ 1843	Body	\$ 23	\$ 47	\$ 71	\$ 102	\$ 133	\$ 165	\$ 197	\$ 469
				Seat	\$ 16	\$ 31	\$ 47	\$ 68	\$ 89	\$ 111	\$ 131	\$ 313

Example of upcharges: Model VERWNO with Grade 5 Body and Grade 2 Seat = \$5569 + \$273 + \$16 = \$5858 Total

RETREAT

<p><b>How to specify —</b> Select the Model Number from above.</p> <p>VER   NO .   .</p>	<p><b>1st Option</b> Select the Base Type (if applicable): F Fixed (Subtract \$327) S Swivel R Return to Center (\$289 extra)</p>	<p><b>2nd Option</b> Select the Body Upholstery: See page 267 for selections and Color Codes. See Seating Price List for COM Guidelines.</p>	<p><b>3rd Option</b> Select the Seat Upholstery: See page 267 for selections and Color Codes. See Seating Price List for COM Guidelines.</p>
--	---	--	--

Examples: VERWNO.F.CLYD04.CLYD04 VERLNO.R.CLYD13.RS10  
VERONO.CLYD01.CLYD10

Model Number	COM Yardage		Overall					Seat			Armrests			Backrest						
	COL Sp. Feet	Height (Range)	Width	Depth	Height	Width	Depth (Cushion)	Pan Angle (Range)	Armrest Height	Width Between Arms	Armrest Length	Armrest Serback	Height	Width	Lumbar Height	Backrest/Seat Angle	Ship Weight	Ship Weight Per Carton	Cubes	
VERWNO	4.0 1.0		46"	30½"	32½"	17½"	20"	19½"	5.8°	7½"	19½"	13"	6½"	32"	16½"	9"	102.4°	95	95	31.9
VERHNO	3.0 1.0		37"	30½"	32½"	17½"	20"	19½"	6.8°	7½"	19½"	13"	6½"	26½"	16½"	9"	102.4°	93	93	29.9
VERLNO	3.0 1.0		30½"	30½"	32½"	17½"	20"	19½"	6.8°	7½"	19½"	13"	6½"	20"	16½"	9"	102.4°	90	90	18.8
VERONO	1.5 1.0		16"	23"	15"													60	60	5.2

NOTE: Dimensions are in accordance with BIFMA G1-2002 guidelines — see illustration of guidelines on page 45.



Upcharges listed for Grades 2 and above, add to Base Price. Grades 9-22 on page 326.

Description	Model Number <i>Add options below</i>	Base Price	Upholstery	Upcharge								
				2	3	4	5	6	7	8	L1	
<b>Retreat Single Upholstery</b>												
Retreat Exec/Conf Mid-Back Single Upholstery	RETECMS	\$ 3347	Body/Seat	\$ 63	\$ 126	\$ 189	\$ 273	\$ 357	\$ 441	\$ 525	\$ 1214	
Retreat Exec/Conf Low-Back Single Upholstery	RETECLS	\$ 2893	Body/Seat	\$ 47	\$ 94	\$ 142	\$ 204	\$ 268	\$ 331	\$ 394	\$ 910	
Retreat Wood Side Mid-Back Single Upholstery	RETWMS	\$ 2980	Body/Seat	\$ 63	\$ 126	\$ 189	\$ 273	\$ 357	\$ 441	\$ 525	\$ 1214	
Retreat Wood Side Low-Back Single Upholstery	RETWLS	\$ 2844	Body/Seat	\$ 47	\$ 94	\$ 142	\$ 204	\$ 268	\$ 331	\$ 394	\$ 910	
<b>Retreat Multi Upholstery</b>												
Retreat Exec/Conf Mid-Back Multi Upholstery	RETECMM	\$ 3508	Body	\$ 47	\$ 94	\$ 142	\$ 204	\$ 268	\$ 331	\$ 394	\$ 910	
			Seat	\$ 16	\$ 31	\$ 47	\$ 68	\$ 89	\$ 111	\$ 131	\$ 304	
Retreat Exec/Conf Low-Back Multi Upholstery	RETECLM	\$ 3029	Body	\$ 31	\$ 63	\$ 94	\$ 137	\$ 178	\$ 221	\$ 262	\$ 607	
			Seat	\$ 16	\$ 31	\$ 47	\$ 68	\$ 89	\$ 111	\$ 131	\$ 304	
Retreat Wood Side Mid-Back Multi Upholstery	RETWMM	\$ 3101	Body	\$ 47	\$ 94	\$ 142	\$ 204	\$ 268	\$ 331	\$ 394	\$ 910	
			Seat	\$ 16	\$ 31	\$ 47	\$ 68	\$ 89	\$ 111	\$ 131	\$ 304	
Retreat Wood Side Low-Back Multi Upholstery	RETWLM	\$ 2947	Body	\$ 31	\$ 63	\$ 94	\$ 137	\$ 178	\$ 221	\$ 262	\$ 607	
			Seat	\$ 16	\$ 31	\$ 47	\$ 68	\$ 89	\$ 111	\$ 131	\$ 304	

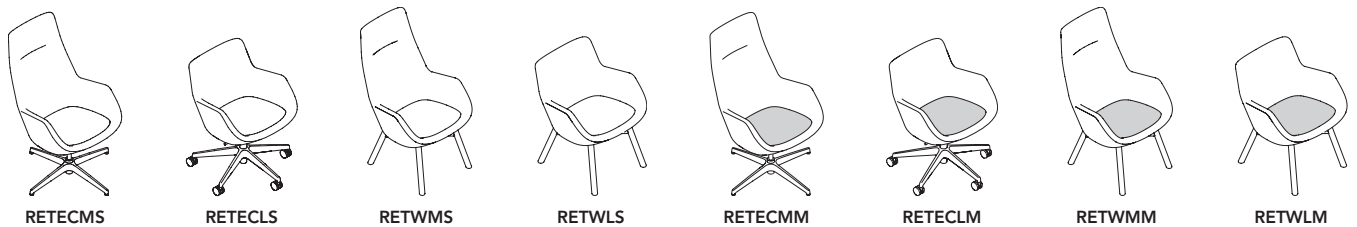

<b>Pricing Example:</b>	<b>Model/Options</b>	<b>Base Price/Upcharges</b>
Step 1: Select Model	RETECMM	\$ 3508
Step 2: Select Base Type	5	\$ 55 upcharge
Step 3: Select Paint Color	POL	\$ 55 upcharge
Step 4: Select Seat Upholstery	Grade 3	\$ 31 upcharge
Step 5: Select Body Upholstery	Grade 5	\$ 204 upcharge
Add Base + applicable Upcharges for Total List Price =		\$ 3853

Retreat Executive | Conference

<p><b>How to specify —</b> Select the Model Number from above.</p> <p>R   E   T   E   C       .     .</p>	<p><b>1st Option:</b> Select Base Type:</p> <p>5 5-Star (\$55 upcharge) 4 4-Star Return-to-Center</p>	<p><b>2nd Option:</b> Select Paint Color:</p> <p>P71 Black POL Polished (\$55 upcharge)</p>	<p><b>3rd Option:</b> Select the Upholstery for Single Upholstery Models:</p> <p>See Allsteel upholstery matrix on page 267.</p>
	<p>Example: RETECMS.4.P71.CLYD07</p>		

Retreat Executive | Conference

<p><b>How to specify —</b> Select the Model Number from above.</p> <p>R   E   T   E   C   M   .     .</p>	<p><b>1st Option:</b> Select Base Type:</p> <p>5 5-Star (\$55 upcharge) 4 4-Star Return-to-Center</p>	<p><b>2nd Option:</b> Select Paint Color:</p> <p>P71 Black POL Polished (\$55 upcharge)</p>	<p><b>3rd Option:</b> Select the Body Upholstery for Multi-Upholstery Models:</p> <p>See Allsteel upholstery matrix on page 267.</p>	<p><b>4th Option:</b> Select the Seat Upholstery for Multi-Upholstery Models:</p> <p>See Allsteel upholstery matrix on page 267.</p>
	<p>Example: RETECMM.5.POL.SCAMBLZ08.CLYD09</p>			

RETREAT

Model Number	Overall				Seat				Arms				Backrest								
	Ship Weight	Cubes	COM Yardage*	Height	Width	Depth	Height	Width	Depth	Pan Angle (Range)	Armrest Height	Armrest Length	Width Between Armrests Upholstered	Width Between Armrests Arm Pads	Armrest setback	Armrest Pivot	Height	Width	Lumbar Height	Backrest Inclination from Vertical	Backrest/Seat angle (Range)
RETECM_	60	29.9	4	43"-46½"	27"	27"	18½"-21"	15"	19"	3°-17°	7½"	10½"	15"	22"	7"	0	27"	15"	10"	15°-29°	102°
RETECL_	50	18.8	3	31¼"-34"	27"	27"	18½"-21"	15"	19"	3°-17°	7½"	10½"	15"	22"	7"	0	16½"	15"	10"	15°-29°	102°
RETWM_	55	37.7	4	43"	27"	27"	18½"	15"	19"	3°	7½"	10½"	15"	22"	7"	0	27"	15"	10"	15°	102°
RETWL_	45	26.6	3	31¼"	27"	27"	18½"	15"	19"	3°	7½"	10½"	15"	22"	7"	0	16½"	15"	10"	15°	102°

\*COM Yardage is listed for total yardage/feet required for a model, with applicable yardage/feet for individual components listed.

Retreat Wood Side

<p><b>How to specify —</b> Select the Model Number from above.</p>	<p><b>1st Option:</b> <b>Select Wood Finish:</b> See Allsteel wood finishes on page 266.</p>	<p><b>2nd Option:</b> <b>Select the Upholstery for Single Upholstery Models:</b> See Allsteel upholstery matrix on page 267.</p>
<p>R   E   T   W   S   .</p>	<p>          .</p>	<p>              .</p>

Example: RETELS.LE800.SCAMBLZ08

Retreat Executive | Conference

<p><b>How to specify —</b> Select the Model Number from above.</p>	<p><b>1st Option:</b> <b>Select Wood Finish:</b> See Allsteel wood finishes on page 266.</p>	<p><b>2nd Option:</b> <b>Select the Body Upholstery for Multi-Upholstery Models:</b> See Allsteel upholstery matrix on page 267.</p>	<p><b>3rd Option:</b> <b>Select the Seat Upholstery for Multi-Upholstery Models:</b> See Allsteel upholstery matrix on page 267.</p>
<p>R   E   T   W   S   .</p>	<p>          .</p>	<p>              .</p>	<p>            .</p>

Example: RETWMM.LA100.STB05.STB17



Social Collaborative Standard Upholstery Selections by Model/Series, for all other seating see pages 13-14.

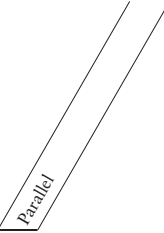
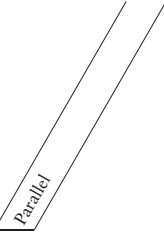

**LEATHER L1**

Allsteel Leather	WTH	•
Florence Leather	FLOR	•

**GRADE 1**

Apex	APX	
Centurion	CU	
Contourett	UR	•
Dapper	DAPR	•
Hamilton	HAM	•
Inertia	NR	•
Optic	OP	

**GRADE 2**

Appoint Seating	PNS	
Blume	BLME	•
Clyde	CLYD	•
Dotty	DOT	•
Meld	SMHMMLD	•
Rush	RUSH	•
Spin Seating	SPNN	•
Whisper Vinyl	WP	•

**GRADE 3**

Lateral	SCFSLAT	•
Moxie	SX	•
Purl	PURL	•
Quill	QUL	•

**GRADE 4**

Caper	SMHMCAP	•
Manner	SMHMMAN	•
Merit	SMHMMER	•
Messenger	SMHMGRM	•
Metric	SMHMMET	•
Mode	SMHMMOD	•
Multiply	SMHMMLT	•
Murmur	SMHMMUR	
Muse	SMHMMUS	
Trundle	SMHMTRN	•

**GRADE 5**

Main Line Flax	SCAMMLF	•
Rove	SMHMROV	•

**GRADE 6**

Arris	ARR	•
Blazer	SCAMBLZ	•
Chock	SMHMCCCK	
Hedge	SMHMHED	•
Pocket	SMHM PKT	•
Sequence	SMHMSQN	
Tandem	SMHMTAN	
Verse	SCARVRS	•

**GRADE 8**

Apt	SMHMAPT	•
Brisa	RS	•

**GRADE 9**

Ultraleather Pro	SUF554	•
------------------	--------	---

**GRADE 11**

Fusion	SCARFUS	•
--------	---------	---

**GRADE 13**

Maze	SCARMZE	•
------	---------	---

**GRADE 14**

Chroma	SCARCHR	•
--------	---------	---

PARALLEL

- ⊕ Partnership Program — See page 10 for details.
- ≠ Upholstery will be Railroad cut.
- Available upholstery option

**FRAMES & TABLE BASE  
PAINT FINISHES**

<b>GRADE P1</b>	
Carbon.....	P4Q
Designer White.....	PJW
<b>GRADE P2</b>	
Pyrite.....	PJE
Silver.....	PR6
<b>GRADE P4</b>	
Polished Chrome.....	POL

**ARM SLEEVES  
PAINT FINISHES**

<b>GRADE P1</b>	
Black.....	P71
Brownstone.....	P7D
Carbon.....	P4Q
Cinder.....	P7Q
Cove.....	P096
Designer White.....	PJW
Dune.....	P094
Flint.....	P02
Fossil.....	P28
Harbor.....	P097
Loft.....	P7B
Muslin.....	P4J
Parchment.....	P93
Pebble.....	P8R
Pewter.....	P8D
Sage.....	P095
Salt.....	P8C
Titanium.....	P8T/T
<b>GRADE P2</b>	
Champagne Metallic.....	PR5
Gunmetal Metallic.....	PR3
Night Bronze.....	P8B
Platinum Metallic.....	PR2
Pyrite.....	PJE
Silver.....	PR6
Solar Black.....	P8X
<b>GRADE P3</b>	
Atom.....	P8S
Blossom.....	P8K
Bullseye.....	PJF
Cabernet.....	P7T
Conifer.....	P8H
Ember.....	P8P
Ion.....	P8N
Iris.....	P8J
Krypton.....	P8F
Regatta.....	P8M
Succulent.....	P8A

**LAMINATES**

<b>GRADE L1</b>	
<b>SOLID COLORS</b>	
Black.....	P
Designer White.....	LDW1
Flint.....	LM16
Fossil Shale.....	LEH1
Loft.....	LM11
Muslin.....	LM15
Titanium.....	LTI1
<b>WOODGRAIN</b>	
Belair.....	LWBA
Bourbon Cherry.....	H
Field Elm.....	LWFE
Florence Walnut.....	LFW1
Kingswood Walnut.....	LK1
Natural Maple.....	LWD
NeoWalnut.....	LNU1
Pinnacle.....	PINC
Shaker Cherry.....	LW7C
<b>GRADE L2</b>	
Beigewood.....	LWBE
Fawn Cypress.....	LFC1
Lowell Ash.....	LLA1
Mangalore Mango.....	LMM1
Natural Recon.....	LNR1
Phantom Charcoal.....	LPC1
Phantom Ecu.....	LPE1
Portico Teak.....	LPT1
Skyline Walnut.....	LSW1
Veranda Teak.....	LVT1
<b>GRADE L3</b>	
Natural Walnut.....	LWNW

**SOLID SURFACE**

Designer White.....	SDW4
Frosty White.....	SFW3
Night Stars.....	SNS5
Masoned Concrete.....	SMC2
Monte Amiata.....	SMA1

**LAMINATE EDGE COLORS**

Beigewood.....	DE
Belair.....	BA
Black.....	E4
Bourbon Cherry.....	H
Brownstone.....	EY
Bungalow.....	EX
Designer White.....	DW
Fawn Cypress.....	FC
Field Elm.....	FE
Flint.....	E9
Florence Walnut.....	FW
Fossil.....	EH
Kingswood Walnut.....	KI
Loft.....	EV
Lowell Ash.....	DL
Mangalore Mango.....	MM
Muslin.....	EU
Natural Maple.....	DD
Natural Recon.....	NR
Natural Walnut.....	DN
NeoWalnut.....	NU
Parchment.....	EN
Phantom Charcoal.....	PC
Phantom Ecu.....	PE
Pinnacle.....	PI
Portico Teak.....	DP
Shaker Cherry.....	DF
Skyline Walnut.....	SW
Titanium.....	TI
Veranda Teak.....	VT

**STRATAWOOD  
VENEERS**

<b>GRADE V1</b>	
<b>CHERRY</b>	
Cinnamon/Biltmore Cherry.....	SC260
Lowell Ash.....	SC394
Clear Cherry.....	SC700
Light Cherry.....	SC701
Shaker Cherry.....	SC774
Burnished Cherry.....	SC777
<b>MAPLE</b>	
Field Elm.....	SE599
Clear Maple***.....	SE800
Harvest Maple.....	SE856
Beigewood.....	SE878
Phantom Ecu.....	SE912
Belair.....	SE934
<b>OAK</b>	
Clear Oak.....	SF300
Dark Rift Cut Oak.....	SF331
<b>SILVER OAK</b>	
Silver Oak Clear.....	SB100
Portico Teak.....	SB150
<b>WALNUT</b>	
Florence Walnut.....	ST579
Light Walnut.....	ST601
Skyline Walnut.....	ST625
Pinnacle Walnut.....	ST679
Sumatra Walnut.....	ST693

**NATURAL VENEERS —  
FLAT CUT**

<b>GRADE V1</b>	
<b>CHERRY</b>	
Cinnamon/Biltmore Cherry.....	NC260
Lowell Ash.....	NC394
Medium Red Cherry.....	NC512
Light Cherry.....	NC701
Shaker Cherry.....	NC774
Burnished Cherry.....	NC777
<b>MAPLE</b>	
Clear Maple.....	NE800
Harvest Maple.....	NE856
<b>WALNUT</b>	
Ebony Walnut.....	NT509
Florence Walnut.....	NT579
Light Walnut.....	NT601
Skyline Walnut.....	NT625
Nutmeg Walnut.....	NT629
Pinnacle Walnut.....	NT679
Sumatra Walnut.....	NT693

**NATURAL VENEERS —  
RIFT CUT**

<b>GRADE V2</b>	
Fawn Cypress Rift Cut Oak.....	RF108
Light Rift Cut Oak.....	RF301
Dark Rift Cut Oak.....	RF331
Phantom Ecu Rift Cut Oak.....	RF912

**NOTE:** Refer to individual product pages for upcharges.

**FSC Certified Wood at Allsteel**  
See page 431 for more information.



*Introducing Parallel, a collection of soft seating and coordinating tables that adapts to a variety of spaces. Parallel is at home in reception areas and collaborative workspaces, accommodating different functions while maintaining a consistent aesthetic. With HBF Textiles, Allsteel fabrics, or a designer's own material, Parallel provides a canvas to make a strong first impression anywhere it's used.*

*Designed in partnership with Chris Adamick.*

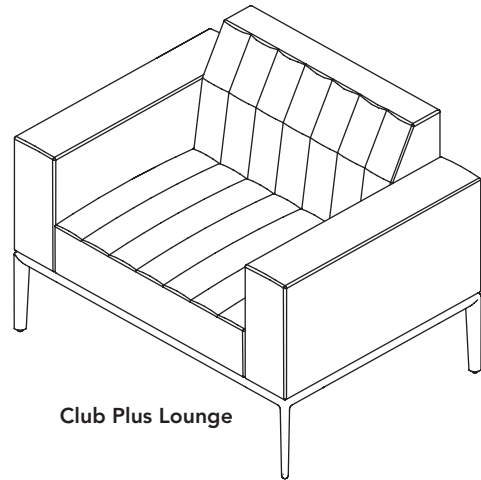

Club Plus Lounge

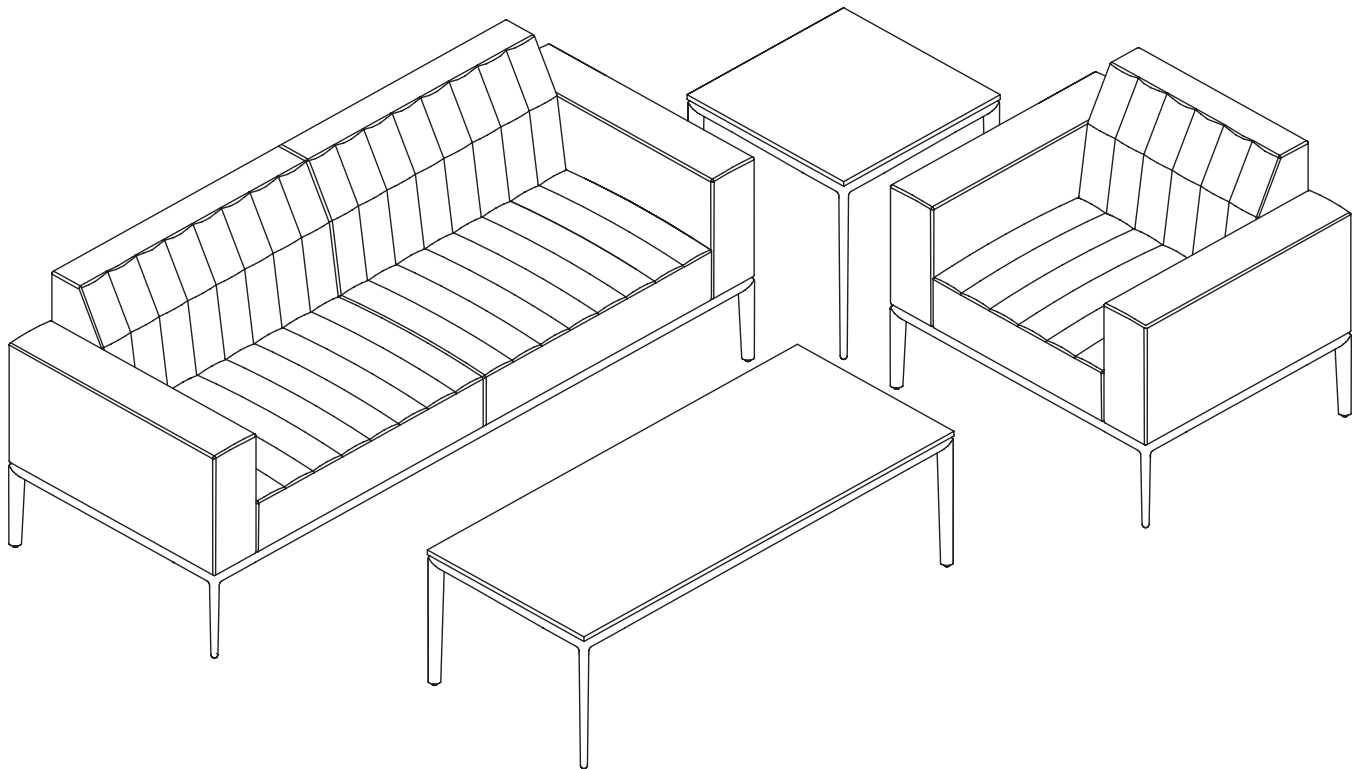

## DESIGN FEATURES

### Functional Versatility

*Flexible and functional, Parallel soft seating can be considered a workhorse in helping meet a company's workplace needs, whether it be casual conference areas, lobby and reception settings, or collaborative hubs.*

The variety of sizing and features allows Parallel to adapt from reception to collaborative areas throughout a workspace. The clean lines work well with current and future furniture settings. Generous sizing and thoughtful comfort considerations make the sit comfortable for five minutes or two hours.

### Design Versatility

*Cutting a sleek profile with tapered ellipse legs and a slim, stylistic reveal, Parallel is intended to work with your favorite Allsteel platforms without overpowering the space. The sharp tailoring of the upholstery paired with the dual-density foam means comfort without sacrificing aesthetics.*

The Parallel club chair, club plus lounge, and modular sofa options, as well as the coordinating side and coffee tables, enable a diverse array of setups, from structured stylized formal, to a warmer domesticated corporate vibe, to flexible collaborative in combination with other Allsteel products. A variety of upholstery materials and frame colors celebrates beautiful form while telling a strong design story.

### Wide Arms

6" wide arms with high-density foam allow for a comfortable surface for device usage, and the optional removable sleeve accessory, available in three finishes, makes a stable worksurface on the arm. Designed for comfort but also with the intent that all surfaces are sitting surfaces, Parallel is built to handle perching on the arms and back.

### Design Nuances

- Legs – Ellipse, tapered shape set to the very edge of the frame
- Reveal – Slim reveal around the entire perimeter
- Tailored upholstery – Available with a channeled design detail for a more refined aesthetic

### Materials

- All COMs/COLs must be approved for upholsterability or applicable fire code compliance prior to order entry. See pages 6-8 for COM ordering instructions.
- Allsteel fabrics meet requirements for CTB117. COM/COL manufacturers supply certificates of compliance for fabric-only tests such as CTB117.

### Tables (page 282)

- Available with laminate, veneer or solid surface tops.
- Leg finish option includes painted (color specified) or polished chrome.

## OPTIONS

### Seat and Back Upholstery:

**C** Channeled

### Base Colors:

**P4Q** Carbon

**PR6** Silver

**PJW** Designer White

**PJE** Pyrite

**POL** Polished Chrome

### FSC Certified Wood:

**FSC** FSC Certified Wood

### Seat and Back Upholstery:

See page 274 for colors and codes

### Optional Arm Sleeve Paint Colors:

**P1 P2 P3**

See page 275 for colors and codes

### Table Bases:

**P4Q** Carbon

**PR6** Silver

**PJW** Designer White

**PJE** Pyrite

**POL** Polished Chrome

### Laminate Tabletops:

**L1** Solid / Woodgrain

**L2** Woodgrain

**L3** Textured Woodgrain

See page 275 for finishes and codes

### Veneer Tabletops:

**V1** Stratawood

**V1** Natural – Flat Cut

**V2** Natural – Rift Cut

See page 275 for finishes and codes

### Solid Surface Tabletops:

**Grade A**

**SFW3** Frosty White

**Grade B**

**SDW4** Designer White

**Grade C**

**SNS5** Night Starts

**Grade D**

**SMC2** Masoned Concrete

**SMA1** Monte Amiata

More solid surface colors available as specials. Contact AllsteelFinishes@allsteeloffice.com for Corian and Wilsonart catalogs.

(See page 327 for COM pricing on Grades 9-22)

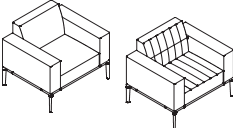
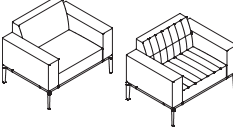
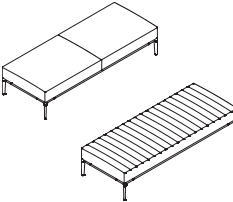
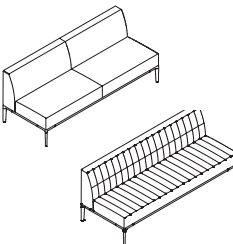
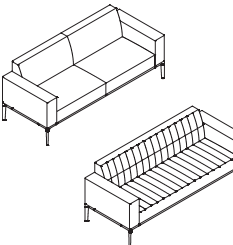
Description	Upholstery	Model Number		Base		Upcharge List Price – Add to Base Price						
		Old	New	List Price	2	3	4	5	6	7	8	L1 Leather
<b>Club Chair</b> 	Non-Channel	CLCNO	PSCN	\$ 4075	\$ 71	\$ 142	\$ 213	\$ 307	\$ 402	\$ 496	\$ 591	\$ 1365
	Channeled	CLCCNO	PSCC	\$ 4497	\$ 71	\$ 142	\$ 213	\$ 307	\$ 402	\$ 496	\$ 591	\$ 1365
<b>Club Plus Chair</b> 	Non-Channel	CLCPNO	PSCPN	\$ 4356	\$ 82	\$ 163	\$ 245	\$ 353	\$ 462	\$ 571	\$ 678	\$ 1614
	Channeled	CLCPCNO	PSCPC	\$ 4779	\$ 82	\$ 163	\$ 245	\$ 353	\$ 462	\$ 571	\$ 678	\$ 1614
<b>Bench</b> 	Non-Channel		PSBN	\$ 4356	\$ 103	\$ 207	\$ 309	\$ 446	\$ 583	\$ 720	\$ 857	\$ 2039
	Channeled		PSBC	\$ 4779	\$ 103	\$ 207	\$ 309	\$ 446	\$ 583	\$ 720	\$ 857	\$ 2039
<b>Armless Sofa</b> 	Non-Channel		PSASN	\$ 5626	\$ 120	\$ 240	\$ 360	\$ 520	\$ 680	\$ 840	\$ 1000	\$ 2379
	Channeled		PSASC	\$ 6191	\$ 120	\$ 240	\$ 360	\$ 520	\$ 680	\$ 840	\$ 1000	\$ 2379
<b>Double Arm Sofa</b> 	Non-Channel	CLSNO	PSDSN	\$ 6897	\$ 120	\$ 240	\$ 360	\$ 520	\$ 680	\$ 840	\$ 1000	\$ 2379
	Channeled	CLSCNO	PSDSC	\$ 7460	\$ 120	\$ 240	\$ 360	\$ 520	\$ 680	\$ 840	\$ 1000	\$ 2379

\*Old model numbers are no longer orderable. Please follow the new model numbers and the specification logic below.

\*Bench is not recommended to be used as a modular piece with others due to seat pan angle difference.

<p><b>How to specify —</b> Select the Model Number from above.</p> <p><b>P</b>   <b>S</b>           .</p>	<p><b>1st Option:</b> <b>FSC Certified Wood:</b> FSC Select for FSC Certified Wood</p> <p><b>F</b>   <b>S</b>   <b>C</b>   .</p>	<p><b>2nd Option:</b> <b>Select the Base Color:</b> See page 275 for selections and Color Codes.</p> <p><b>P2</b> Add \$109 Club Chair, \$137 Club Plus, \$164 all others  <b>P3</b> Add \$164 Club Chair, \$202 Club Plus, \$246 all others  <b>P4</b> Add \$218 Club Chair, \$273 Club Plus, \$327 all others</p> <p>        .</p>	<p><b>3rd Option:</b> <b>Select the Upholstery:</b> See page 274 for approved standard and partnership patterns.  See pages 6-8 for COM/COL Guidelines.</p> <p>               </p>
---	--	--	--

Example: PSDSN.FSC.PJW.AI19

Model Number	COM Package			Overall			Seat			Armrests			Backrest				Unit Weight	Ship Weight Per Carton	Cubes
	Height	Width	Depth	Height	Width	Depth	Pan Angle (Range)	Armrest Height	Width Between Arms	Armrest Length	Height	Width	Lumbar Height	Backrest Seat Angle (Range)					
PSCN	4.5	30"	36"	29¼"	17"	24"	20½"	4.2	8½"	6"	21"	14½"	24"	9½"	102	71	95	35.4	
PSCC	4.5	30"	36"	29¼"	17"	24"	20½"	4.2	8½"	6"	21"	14½"	24"	9½"	102	71	95	35.4	
PSCPN	5.5	30"	40"	29¼"	17"	28"	20½"	4.2	8½"	6"	21"	14½"	28"	9½"	102	75	96	35.4	
PSCPC	5.5	30"	40"	29¼"	17"	28"	20½"	4.2	8½"	6"	21"	14½"	28"	9½"	102	75	96	35.4	
PSBN	5.5	17"	76"	29¼"	17"	76"	29¼"	0								75	125	37.1	
PSBC	5.5	17"	76"	29¼"	17"	76"	29¼"	0								75	125	37.1	
PSASN	7	30"	76"	29¼"	17"	76"	20½"	4.2				14½"	76"	9½"	102	100	160	69.5	
PSASC	7	30"	76"	29¼"	17"	76"	20½"	4.2				14½"	76"	9½"	102	100	160	69.5	
PSDSN	7	30"	76"	29¼"	17"	64"	20½"	4.2	8½"	6"	21"	14½"	64"	9½"	102	109	170	69.5	
PSDSC	7	30"	76"	29¼"	17"	64"	20½"	4.2	8½"	6"	21"	14½"	64"	9½"	102	109	170	69.5	

(See page 327 for COM pricing on Grades 9-22)

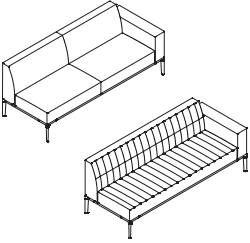
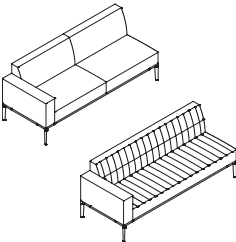
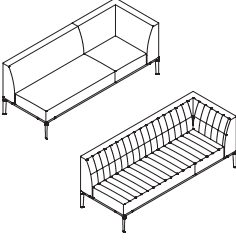
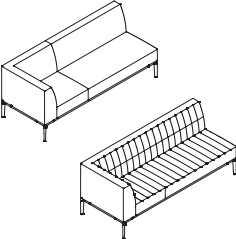
Description	Upholstery	Model Number		Base		Upcharge List Price – Add to Base Price						
		Old	New	List Price	2	3	4	5	6	7	8	L1 Leather
<b>Left Arm Sofa</b> *NOT for 90-degree turn 	Non-Channel		PSLSN	\$ 6050	\$ 120	\$ 240	\$ 360	\$ 520	\$ 680	\$ 840	\$ 1000	\$ 2379
	Channeled		PSLSC	\$ 6615	\$ 120	\$ 240	\$ 360	\$ 520	\$ 680	\$ 840	\$ 1000	\$ 2379
<b>Right Arm Sofa</b> *NOT for 90-degree turn 	Non-Channel		PSRSN	\$ 6050	\$ 120	\$ 240	\$ 360	\$ 520	\$ 680	\$ 840	\$ 1000	\$ 2379
	Channeled		PSRSC	\$ 6615	\$ 120	\$ 240	\$ 360	\$ 520	\$ 680	\$ 840	\$ 1000	\$ 2379
<b>Left Sectional</b> *Only for 90-degree turn 	Non-Channel		PSLCN	\$ 6615	\$ 120	\$ 240	\$ 360	\$ 520	\$ 680	\$ 840	\$ 1000	\$ 2379
	Channeled		PSLCC	\$ 7319	\$ 120	\$ 240	\$ 360	\$ 520	\$ 680	\$ 840	\$ 1000	\$ 2379
<b>Right Sectional</b> *Only for 90-degree turn 	Non-Channel		PSRCN	\$ 6615	\$ 120	\$ 240	\$ 360	\$ 520	\$ 680	\$ 840	\$ 1000	\$ 2379
	Channeled		PSRCC	\$ 7319	\$ 120	\$ 240	\$ 360	\$ 520	\$ 680	\$ 840	\$ 1000	\$ 2379

\*Old model numbers are no longer orderable. Please follow the new model numbers and the specification logic below.

\*Bench is not recommended to be used as a modular piece with others due to seat pan angle difference.

<p><b>How to specify —</b> Select the Model Number from above.</p> <p>P   S         .</p>	<p><b>1st Option:</b> FSC Certified Wood: FSC Select for FSC Certified Wood</p> <p>F   S   C   .</p>	<p><b>2nd Option:</b> Select the Base Color: See page 275 for selections and Color Codes.</p> <p>P2 Add \$109 Club Chair, \$137 Club Plus, \$164 all others P3 Add \$164 Club Chair, \$202 Club Plus, \$246 all others P4 Add \$218 Club Chair, \$273 Club Plus, \$327 all others</p> <p>        .</p>	<p><b>3rd Option:</b> Select the Upholstery: See page 274 for approved standard and partnership patterns. See pages 6-8 for COM/COL Guidelines.</p> <p>               </p>
---	--	--	--

Example: PLSLN.FSC.PJW.AI19

Model Number	Overall				Seat			Armrests			Backrest					Unit Weight	Ship Weight Per Carton	Cubes
	COM Package Height	Width	Depth	Height	Width	Depth	Pan Angle (Range)	Armrest Height	Width Between Arms	Armrest Length	Height	Width	Lumbar Height	Backrest/Seat Angle (Range)				
PSLSN	7	30"	76"	29¼"	17"	70"	20½"	4.2	8½"	6"	21"	14½"	70"	9½"	102	106	166	69.5
PSLSC	7	30"	76"	29¼"	17"	70"	20½"	4.2	8½"	6"	21"	14½"	70"	9½"	102	106	166	69.5
PSRSN	7	30"	76"	29¼"	17"	70"	20½"	4.2	8½"	6"	21"	14½"	70"	9½"	102	106	166	69.5
PSRSC	7	30"	76"	29¼"	17"	70"	20½"	4.2	8½"	6"	21"	14½"	70"	9½"	102	106	166	69.5
PSLCN	7	30"	76"	29¼"	17"	70"	20½"	4.2	8½"	6"	21"	14½"	70"	9½"	102	105	165	69.5
PSLCC	7	30"	76"	29¼"	17"	70"	20½"	4.2	8½"	6"	21"	14½"	70"	9½"	102	105	165	69.5
PSRCN	7	30"	76"	29¼"	17"	70"	20½"	4.2	8½"	6"	21"	14½"	70"	9½"	102	105	165	69.5
PSRCC	7	30"	76"	29¼"	17"	70"	20½"	4.2	8½"	6"	21"	14½"	70"	9½"	102	105	165	69.5

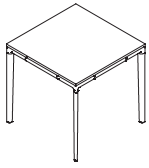

Description	Model Number		Unit Weight	Ship Weight	Cubes	Base		Upcharge List Price – Add to Base Price				
	Old	New				List Price	L2	L3	V3	V5	Corian B	Corian C
<b>Side Table — 22"W x 22"D x 21½"H</b>												
Laminate Flat Edge	CLSTL	PTSTL	39	49	13.7	\$ 1622	\$ 22	\$ 44				
Veneer Square Edge	CLSTV	PTSTV	37	47	13.7	\$ 2751			\$ 320	\$ 532		
Corian		PTSTS	42	52	13.7	\$ 3244					\$ 66	\$ 131

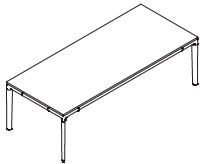

<b>Coffee Table — 52"W x 22"D x 16"H</b>												
Laminate Flat Edge	CLCTL	PTCTL	53	68	16.3	\$ 2081	\$ 33	\$ 66				
Veneer Square Edge	CLCTV	PTCTV	51	66	16.3	\$ 3104			\$ 360	\$ 600		
Corian		PTCTS	77	92	16.3	\$ 4092					\$ 153	\$ 306

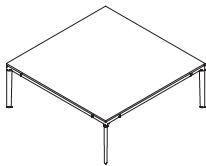

<b>Coffee Table — 42"W x 42"D x 16"H</b>												
Laminate Flat Edge		PTLTL	53	68	24.0	\$ 2187	\$ 39	\$ 77				
Veneer Square Edge		PTLTV	51	66	24.0	\$ 3387			\$ 393	\$ 654		
Corian		PTLTS	111	126	24.0	\$ 4515					\$ 218	\$ 436

\*Old model numbers are no longer orderable. Please follow the new model numbers and the specification logic below.

**How to specify —**  
Select the Model Number from above.

**1st Option:**  
**Select the Base Color:**  
See page 275 for selections and Color Codes.  
**P2 Add**  
\$88 Side Table 22"  
\$109 Coffee Table 52"  
\$120 Coffee Table 42"  
**P3 Add**  
\$131 Side Table 22"  
\$164 Coffee Table 52"  
\$180 Coffee Table 42"  
**P4 Add**  
\$175 Side Table 22"  
\$218 Coffee Table 52"  
\$240 Coffee Table 42"

**2nd Option:**  
**Select the Laminate (if applicable):**  
See page 275 for selections and Color Codes.

**2nd Option:**  
**Select the Veneer (if applicable):**  
See page 275 for selections and Finish Codes.

**2nd Option:**  
**Select Solid Surface (if applicable):**  
**Grade A**  
SFW3 Frosty White  
**Grade B**  
SDW4 Designer White  
**Grade C**  
SNS5 Night Stars  
**Grade D**  
SMC2 Masoned Concrete  
SMA1 Monte Amiata  
  
More Wilsonart and Corian colors available as specials

**3rd Option:**  
**Select the Edge Color (Laminate only):**  
See page 275 for selections and Color Codes.

**4th Option:**  
**Veneer Finish Method (Veneer only):**  
**OP** Open Pore Low Sheen  
**FF** Full-Fill Cleartech Add \$218 Side Table \$218 Coffee Tables

P | S | | | | . P | | | | . L | | | | | . | | | | | . S | | | | | | | | | |

Examples: PTSTL.P4Q.LDW1.DW PTCTV.PJW.SE800.OP PTLTS.POL.SDW4





## BASE PAINT FINISHES

GRADE P1	
Textured Salt.....	P8Z

GRADE P2	
Solar Black.....	P8X

## LAMINATES

GRADE L1	
<b>SOLID COLORS</b>	
Black.....	P
Brownstone.....	LM13
Bungalow.....	LM12
Designer White.....	LDW1
Flint.....	LM16
Fossil Shale.....	LEH1
Loft.....	LM11
Muslin.....	LM15
Titanium.....	LT11

<b>ABSTRACT</b>	
Ash.....	LT3B
Handspun Pearl.....	LAHP
Handspun Dove.....	LAHD
Handspun Slate.....	LAHS
Handspun Chestnut.....	LAHC
Silver Mesh.....	LT8D

<b>WOODGRAIN</b>	
Belair.....	LWBA
Bourbon Cherry.....	H
Field Elm.....	LWFE
Florence Walnut.....	LFW1
Kingswood Walnut.....	LK11
Natural Maple.....	LWD
NeoWalnut.....	LNU1
Pinnacle.....	PINC
Shaker Cherry.....	LW7C

GRADE L2	
Beigewood.....	LWBE
Fawn Cypress.....	LFC1
Lowell Ash.....	LLA1
Mangalore Mango.....	LMM1
Natural Recon.....	LNR1
Phantom Charcoal.....	LPC1
Phantom Ecu.....	LPE1
Portico Teak.....	LPT1
Skyline Walnut.....	LSW1
Veranda Teak.....	LVT1

GRADE L3	
Natural Walnut.....	LWNW

## LAMINATE EDGE COLORS

Beigewood.....	DE
Belair.....	BA
Black.....	E4
Bourbon Cherry.....	H
Brownstone.....	EY
Bungalow.....	EX
Designer White.....	DW
Fawn Cypress.....	FC
Field Elm.....	FE
Flint.....	E9
Florence Walnut.....	FW
Fossil.....	EH
Kingswood Walnut.....	KI
Loft.....	EV
Lowell Ash.....	DL
Mangalore Mango.....	MM
Muslin.....	EU
Natural Maple.....	DD
Natural Recon.....	NR
Natural Walnut.....	DN
NeoWalnut.....	NU
Parchment.....	EN
Phantom Charcoal.....	PC
Phantom Ecu.....	PE
Pinnacle.....	PI
Platinum Metallic.....	EP
Portico Teak.....	DP
Shaker Cherry.....	DF
Skyline Walnut.....	SW
Titanium.....	TI
Veranda Teak.....	VT

## STRATAWOOD VENEERS

GRADE V1	
<b>CHERRY</b>	
Cinnamon/Biltmore Cherry.....	SC260
Lowell Ash.....	SC394
Clear Cherry.....	SC700
Light Cherry.....	SC701
Shaker Cherry.....	SC774
Burnished Cherry.....	SC777

<b>MAPLE</b>	
Field Elm.....	SE599
Clear Maple***.....	SE800
Harvest Maple.....	SE856
Beigewood.....	SE878
Phantom Ecu.....	SE912
Belair.....	SE934

<b>OAK</b>	
Clear Oak.....	SF300
Dark Rift Cut Oak.....	SF331

<b>SILVER OAK</b>	
Silver Oak Clear.....	SB100
Portico Teak.....	SB150

<b>WALNUT</b>	
Florence Walnut.....	ST579
Light Walnut.....	ST601
Skyline Walnut.....	ST625
Pinnacle Walnut.....	ST679
Sumatra Walnut.....	ST693

## NATURAL VENEERS — FLAT CUT

GRADE V1	
<b>CHERRY</b>	
Cinnamon/Biltmore Cherry.....	NC260
Lowell Ash.....	NC394
Medium Red Cherry.....	NC512
Light Cherry.....	NC701
Shaker Cherry.....	NC774
Burnished Cherry.....	NC777

<b>MAPLE</b>	
Clear Maple.....	NE800
Harvest Maple.....	NE856

<b>WALNUT</b>	
Ebony Walnut.....	NT509
Florence Walnut.....	NT579
Light Walnut.....	NT601
Skyline Walnut.....	NT625
Nutmeg Walnut.....	NT629
Pinnacle Walnut.....	NT679
Sumatra Walnut.....	NT693

## NATURAL VENEERS — RIFT CUT

GRADE V2	
Fawn Cypress Rift Cut Oak.....	RF108
Light Rift Cut Oak.....	RF301
Dark Rift Cut Oak.....	RF331
Phantom Ecu Rift Cut Oak.....	RF912

**NOTE:** Refer to individual product pages for upcharges.

FSC Certified Wood at Allsteel

See page 431 for more information.

Two Thirds Standard Upholstery Selections by Model/Series.







Two Thirds

GRADE 1		
Apex	APX	•
Centurion	CU	•
Contourett	UR	•
Dapper	DAPR	•
Ensemble	ENSB	•
Hamilton	HAML	•
Inertia	NR	•
GRADE 2		
Appoint Seating	PNS	•
Blume	BLME	•
Clyde	CLYD	•
Dotty	DOT	•
Rush	RUSH	•
Spin	SPNN	•
Whisper Vinyl	WP	•
GRADE 3		
Lateral ⚡	SCFSLAT	•
Moxie	SX	•
Purl	PURL	•
Quill	QUL	•
GRADE 4		
Caper ⚡	SMHMCAP	•
Manner ⚡	SMHMMAN	•
Merit ⚡	SMHMMER	•
Messenger ⚡	SMHMGRM	•
Metric ⚡	SMHMMET	•
Mode ⚡	SMHMMOD	•
Murmur ⚡	SMHMMUR	•
Muse ⚡	SMHMMUS	•
Trundle ⚡	SMHMTRN	•
GRADE 5		
Main Line Flax ⚡	SCAMMLF	•

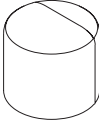
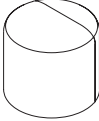
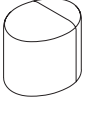
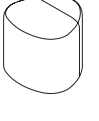
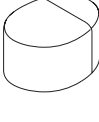
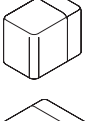
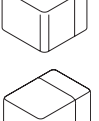
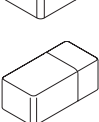
Two Thirds

GRADE 6		
Arris	ARR	•
Blazer ⚡	SCAMBLZ	•
Chock ⚡	SMHMCCK	•
Hemp ⚡	SCAMHMP	•
Pocket ⚡	SMHMPKT	•
Maharam Sequence ⚡	SMHMSQN	•
Tandem ⚡	SMHMTAN	•
GRADE 7		
Silk ⚡	SCAMSLK	•
GRADE 8		
Apt ⚡	SMHMAPT	•
Brisa ⚡	RS	•
Zap ⚡	SCAMZAP	•
GRADE 9		
Ultraleather Pro ⚡	SUF554	•
Yoredale ⚡	SCAMYDL	•
GRADE L1		
Davenport	DAV	•
Florence	FLOR	•
Strasburg	STB	•

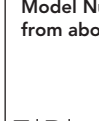
⚡ Partnership Program — See page 10 for details.  
 • Available upholstery option

Description	Model Number	Upcharge List Price — Add to Base Price									
		Base List Price	2	3	4	5	6	7	8	L1 Leather	
<b>Pouf Single Upholstery Models</b>											
 18" Round Pouf	EPR18S	\$ 798	\$ 27	\$ 52	\$ 78	\$ 112	\$ 147	\$ 180	\$ 214	\$ 249	\$ 480
 18" Round Pouf w/Handle	EPR18HS	\$ 907	\$ 27	\$ 52	\$ 78	\$ 112	\$ 147	\$ 180	\$ 214	\$ 249	\$ 480
 18" Round Wobble Pouf	EPW18S	\$ 871	\$ 27	\$ 52	\$ 78	\$ 112	\$ 147	\$ 180	\$ 214	\$ 249	\$ 480
 18" Round Wobble Pouf w/Handle	EPW18HS	\$ 980	\$ 27	\$ 52	\$ 78	\$ 112	\$ 147	\$ 180	\$ 214	\$ 249	\$ 480
 17" x 22" Pebble Pouf	EPP1722S	\$ 1016	\$ 30	\$ 58	\$ 88	\$ 127	\$ 165	\$ 204	\$ 244	\$ 244	\$ 544
 17" x 22" Pebble Pouf w/Handle	EPP1722HS	\$ 1125	\$ 30	\$ 58	\$ 88	\$ 127	\$ 165	\$ 204	\$ 244	\$ 244	\$ 544
 18" x 20" Pebble Pouf	EPP1820S	\$ 1092	\$ 28	\$ 55	\$ 82	\$ 119	\$ 155	\$ 192	\$ 229	\$ 229	\$ 512
 18" x 20" Pebble Pouf w/Handle	EPP1820HS	\$ 1201	\$ 28	\$ 55	\$ 82	\$ 119	\$ 155	\$ 192	\$ 229	\$ 229	\$ 512
 21" x 28" Pebble Pouf	EPP2128S	\$ 1164	\$ 33	\$ 66	\$ 99	\$ 141	\$ 185	\$ 228	\$ 272	\$ 272	\$ 608
 21" x 28" Pebble Pouf w/Handle	EPP2128HS	\$ 1273	\$ 33	\$ 66	\$ 99	\$ 141	\$ 185	\$ 228	\$ 272	\$ 272	\$ 608
 14" x 21" Block Pouf	EPB1421S	\$ 871	\$ 40	\$ 79	\$ 118	\$ 172	\$ 224	\$ 276	\$ 329	\$ 329	\$ 736
 14" x 21" Block Pouf w/Handle	EPB1421HS	\$ 980	\$ 40	\$ 79	\$ 118	\$ 172	\$ 224	\$ 276	\$ 329	\$ 329	\$ 736
 21" x 21" Block Pouf	EPB2121S	\$ 944	\$ 40	\$ 79	\$ 118	\$ 172	\$ 224	\$ 276	\$ 329	\$ 329	\$ 736
21" x 21" Block Pouf w/Handle	EPB2121HS	\$ 1053	\$ 40	\$ 79	\$ 118	\$ 172	\$ 224	\$ 276	\$ 329	\$ 329	\$ 736
21" x 28" Block Pouf	EPB2128S	\$ 1016	\$ 51	\$ 100	\$ 150	\$ 215	\$ 282	\$ 348	\$ 415	\$ 415	\$ 928
21" x 42" Block Pouf	EPB2142S	\$ 1382	\$ 51	\$ 100	\$ 150	\$ 215	\$ 282	\$ 348	\$ 415	\$ 415	\$ 928

**How to specify —**

Select the Model Number from above.

E | P | | | | | | | .

**1st Option:**

FSC Certified Wood  
FSC Select for FSC Certified Wood

F | S | C | .

**2nd Option:**

Select the Upholstery  
See page 285 for selections.

| | | | | .

**3rd Option:**

Select Handle (if applicable):



DAV01 Davenport Black  
DAV11 Davenport Cream  
DAV13 Davenport Camel

| | | | | .

Example: EPB2128S.FSC.ARR07

Model Number	Overall					
	Ship Weight	Cubes	COM Yardage*	Height	Width	Depth
EPR18S	11	5.4	1.6	17.25"	18.5"	18.5"
EPR18HS	15	5.4	1.6	17.25"	18.5"	18.5"
EPW18S	13	6.5	1.6	18.5"	18.5"	18.5"
EPW18HS	17	4.4	1.6	18.5"	18.5"	18.5"
EPP1722S	25	5.4	1.7	17.25"	22"	17"
EPP1722HS	25	5.4	1.7	17.25"	22"	17"
EPP1820S	28	6.0	1.7	19.5"	20"	18"
EPP1820HS	28	6.0	1.7	19.5"	20"	18"
EPP2128S	33	8.0	1.8	16.5"	28"	21"
EPP2128HS	33	8.0	1.8	16.5"	28"	21"
EPB1421S	21	5.4	1.7	17.25"	21"	14"
EPB1421HS	21	5.4	1.7	17.25"	21"	14"
EPB2121S	29	6.0	2.1	17.25"	21"	21"
EPB2121HS	29	6.0	2.1	17.25"	21"	21"
EPB2128S	37	8.0	2.3	17.25"	28"	21"
EPB2142S	50	12.0	2.9	17.25"	42"	21"

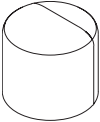
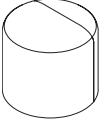
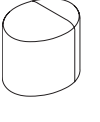
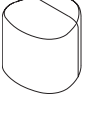
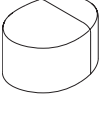
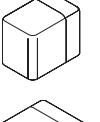
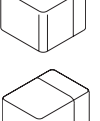
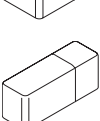
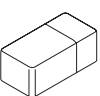
\*COM Yardage is listed for total yardage/feet required for a model, with applicable yardage/feet for individual components listed.

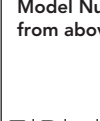
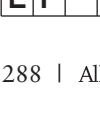
Description	Model Number	Base List Price	Upcharge List Price — Add to Base Price									
			2	3	4	5	6	7	8	L1 Leather		
<b>Pouf Multi-Upholstery Models</b>												
	18" Round Pouf	EPR18M	\$ 908	1/3 Upholstery	\$ 15	\$ 28	\$ 42	\$ 59	\$ 78	\$ 96	\$ 115	\$ 257
				2/3 Upholstery	\$ 22	\$ 45	\$ 67	\$ 98	\$ 127	\$ 156	\$ 186	\$ 416
	18" Round Pouf w/Handle	EPR18HM	\$ 1017									
	18" Round Wobble Pouf	EPW18M	\$ 980	1/3 Upholstery	\$ 15	\$ 28	\$ 42	\$ 59	\$ 78	\$ 96	\$ 115	\$ 257
				2/3 Upholstery	\$ 22	\$ 45	\$ 67	\$ 98	\$ 127	\$ 156	\$ 186	\$ 416
	18" Round Wobble Pouf w/Handle	EPW18HM	\$ 1089									
	17" x 22" Pebble Pouf	EPP1722M	\$ 1125	1/3 Upholstery	\$ 15	\$ 28	\$ 42	\$ 59	\$ 78	\$ 96	\$ 115	\$ 257
				2/3 Upholstery	\$ 27	\$ 52	\$ 78	\$ 112	\$ 147	\$ 180	\$ 214	\$ 480
	17" x 22" Pebble Pouf w/Handle	EPP1722HM	\$ 1234									
	18" x 20" Pebble Pouf	EPP1820M	\$ 1199	1/3 Upholstery	\$ 15	\$ 28	\$ 42	\$ 59	\$ 78	\$ 96	\$ 115	\$ 257
				2/3 Upholstery	\$ 27	\$ 52	\$ 78	\$ 112	\$ 147	\$ 180	\$ 214	\$ 480
	18" x 20" Pebble Pouf w/Handle	EPP1820HM	\$ 1308									
	21" x 28" Pebble Pouf	EPP2128M	\$ 1273	1/3 Upholstery	\$ 15	\$ 28	\$ 42	\$ 59	\$ 78	\$ 96	\$ 115	\$ 257
				2/3 Upholstery	\$ 27	\$ 52	\$ 78	\$ 112	\$ 147	\$ 180	\$ 214	\$ 480
	21" x 28" Pebble Pouf w/Handle	EPP2128HM	\$ 1382									
	14" x 21" Block Pouf	EPB1421M	\$ 980	1/3 Upholstery	\$ 18	\$ 34	\$ 52	\$ 75	\$ 98	\$ 120	\$ 143	\$ 320
				2/3 Upholstery	\$ 28	\$ 55	\$ 82	\$ 119	\$ 155	\$ 192	\$ 229	\$ 512
	14" x 21" Block Pouf w/Handle	EPB1421HM	\$ 1089									
	21" x 21" Block Pouf	EPB2121M	\$ 1052	1/3 Upholstery	\$ 18	\$ 34	\$ 52	\$ 75	\$ 98	\$ 120	\$ 143	\$ 320
				2/3 Upholstery	\$ 28	\$ 55	\$ 82	\$ 119	\$ 155	\$ 192	\$ 229	\$ 512
	21" x 21" Block Pouf w/Handle	EPB2121HM	\$ 1161									
	21" x 28" Block Pouf	EPB2128M	\$ 1125	1/3 Upholstery	\$ 18	\$ 34	\$ 52	\$ 75	\$ 98	\$ 120	\$ 143	\$ 320
				2/3 Upholstery	\$ 28	\$ 55	\$ 82	\$ 119	\$ 155	\$ 192	\$ 229	\$ 512
	14" x 42" Block Pouf	EPB1442M	\$ 1382	1/3 Upholstery	\$ 28	\$ 55	\$ 82	\$ 119	\$ 155	\$ 192	\$ 229	\$ 512
				2/3 Upholstery	\$ 40	\$ 79	\$ 118	\$ 172	\$ 224	\$ 276	\$ 329	\$ 736
	21" x 42" Block Pouf	EPB2142M	\$ 1491	1/3 Upholstery	\$ 28	\$ 55	\$ 82	\$ 119	\$ 155	\$ 192	\$ 229	\$ 512
				2/3 Upholstery	\$ 40	\$ 79	\$ 118	\$ 172	\$ 224	\$ 276	\$ 329	\$ 736



<b>Multi-upholstery Pricing Example:</b>	Model/Options	Base Price/Upcharges
Step 1: Select Model	EPB1421M	\$ 980
Step 2: Select 1/3 Upholstery	Grade 6 Arris	\$ 98 upcharge
Step 3: Select 2/3 Upholstery	Grade 3 Purl	\$ 55 upcharge
Add Base + applicable Upcharges for Total List Price =		\$ 1133

<p><b>How to specify —</b> Select the Model Number from above.</p> <p>E   P                     .</p>	<p><b>1st Option:</b> FSC Certified Wood (if applicable):</p> <p>FSC Select for FSC Certified Wood</p> <p>F   S   C   .</p>	<p><b>2nd Option:</b> Select the 1/3 Upholstery:</p> <p>See page 285 for selections.</p> <p>         </p>	<p><b>3rd Option:</b> Select the 2/3 Upholstery:</p> <p>See page 285 for selections.</p> <p>         </p>	<p><b>4th Option:</b> Select Handle (if applicable):</p> <p>DAV01 Davenport Black DAV11 Davenport Cream DAV13 Davenport Camel</p> <p>         </p>
---	---	---	---	--

Example: EPB2128M.FSC.QUL05.PURL11



Model Number					Overall		
		Ship Weight	Cubes	COM Yardage*	Height	Width	Depth
EPR18M		15	5.4		17.25"	18.5"	18.5"
EPR18HM		15	5.4		17.25"	18.5"	18.5"
	1/3 Upholstery			0.9			
	2/3 Upholstery			1.3			
EPW18M		17	6.5		18.5"	18.5"	18.5"
EPW18HM		17	6.5		18.5"	18.5"	18.5"
	1/3 Upholstery			0.9			
	2/3 Upholstery			1.3			
EPP1722M		25	5.4		17.25"	22"	17"
EPP1722HM		25	5.4		17.25"	22"	17"
	1/3 Upholstery			0.8			
	2/3 Upholstery			1.3			
EPP1820M		28	6.0		19.5"	20"	18"
EPP1820HM		28	6.0		19.5"	20"	18"
	1/3 Upholstery			0.9			
	2/3 Upholstery			1.4			
EPP2128M		33	8.0		16.5"	28"	21"
EPP2128HM		33	8.0		16.5"	28"	21"
	1/3 Upholstery			0.8			
	2/3 Upholstery			1.5			
EPB1421M		21	5.4		17.25"	21"	14"
EPB1421HM		21	5.4		17.25"	21"	14"
	1/3 Upholstery			0.9			
	2/3 Upholstery			1.4			
EPB2121M		33	6.0		17.25"	21"	21"
EPB2121HM		33	6.0		17.25"	21"	21"
	1/3 Upholstery			1.2			
	2/3 Upholstery			1.4			
EPB2128M		37	8.0		17.25"	28"	21"
	1/3 Upholstery			1.2			
	2/3 Upholstery			1.6			
EPB1442M		39	12.0		17.25"	42"	14"
	1/3 Upholstery			1.4			
	2/3 Upholstery			1.9			
EPB2142M		50	12.0		17.25"	42"	21"
	1/3 Upholstery			1.4			
	2/3 Upholstery			1.9			

\*COM Yardage is listed for total yardage/feet required for a model, with applicable yardage/feet for individual components listed.

Description	Model Number	Base List Price	Upcharge List Price — Add to Base Price								P2 Paint	L1 Leather
			2	3	4	5	6	7	8			
<b>Bench Single Upholstery Models</b>												
 39" Round Bench	EB39S	\$ 2210	\$ 40	\$ 79	\$ 118	\$ 172	\$ 224	\$ 276	\$ 329	\$ 88	\$ 736	
 21" x 42" Bench	EB2142S	\$ 1769	\$ 28	\$ 55	\$ 82	\$ 119	\$ 155	\$ 192	\$ 229	\$ 71	\$ 512	
 42" x 42" Bench	EB4242S	\$ 2210	\$ 48	\$ 96	\$ 144	\$ 209	\$ 272	\$ 336	\$ 401	\$ 88	\$ 895	

<p><b>How to specify —</b> Select the Model Number from above.</p> <p>EB                     .</p>	<p><b>1st Option:</b> FSC Certified Wood FSC Select for FSC Certified Wood</p> <p>F   S   C   .</p>	<p><b>2nd Option:</b> Select the Upholstery See page 285 for selections.</p> <p>                   </p>	<p><b>3rd Option:</b> Select the Paint P8Z Textured Salt P8X Solar Black (add P2 Paint upcharge)</p> <p>         </p>
--	---	---	---

*Example: EB39S.FSC.ARR.P8Z*

Description	Model Number	Base List Price	Upcharge List Price — Add to Base Price								P2 Paint	L1 Leather
			2	3	4	5	6	7	8			
<b>Bench Multi-Upholstery Models</b>												
 39" Round Bench	EB39M	\$ 2358	1/3 Upholstery	\$ 24	\$ 48	\$ 72	\$ 104	\$ 137	\$ 168	\$ 200	\$ 88	\$ 448
			2/3 Upholstery	\$ 31	\$ 63	\$ 93	\$ 135	\$ 175	\$ 216	\$ 258	\$ 576	
 21" x 42" Bench	EB2142M	\$ 1915	1/3 Upholstery	\$ 21	\$ 42	\$ 63	\$ 90	\$ 117	\$ 144	\$ 172	\$ 71	\$ 384
			2/3 Upholstery	\$ 24	\$ 48	\$ 72	\$ 104	\$ 137	\$ 168	\$ 200	\$ 448	
 42" x 42" Bench	EB4242M	\$ 2358	1/3 Upholstery	\$ 39	\$ 76	\$ 114	\$ 164	\$ 214	\$ 264	\$ 314	\$ 88	\$ 704
			2/3 Upholstery	\$ 42	\$ 82	\$ 124	\$ 178	\$ 234	\$ 288	\$ 343	\$ 768	

<b>Multi-upholstery Pricing Example:</b>	<b>Model/Options</b>	<b>Base Price/Upcharges</b>
Step 1: Select Model	EB4242M	\$ 2358
Step 2: Select 1/3 Upholstery	Grade 6 Arris	\$ 214 upcharge
Step 3: Select 2/3 Upholstery	Grade 4 Mode	\$ 124 upcharge
Step 4: Select Paint	Grade 2 P8X	\$ 88 upcharge
Add Base + applicable Upcharges for Total List Price =		\$ 2784

<p><b>How to specify —</b> Select the Model Number from above.</p> <p>EB                     .</p>	<p><b>1st Option:</b> FSC Certified Wood (if applicable): FSC Select for FSC Certified Wood</p> <p>F   S   C   .</p>	<p><b>2nd Option:</b> Select the 1/3 Upholstery See page 285 for selections.</p> <p>                   </p>	<p><b>3rd Option:</b> Select the 2/3 Upholstery See page 285 for selections.</p> <p>                   </p>	<p><b>4th Option:</b> Select the Paint P8Z Textured Salt P8X Solar Black (add P2 Paint upcharge)</p> <p>         </p>
--	--	---	---	---

*Example: EB4242M.FSC.ARR.MOD.P8X*

Model Number	Overall					
	Ship Weight	Cubes	COM Yardage*	Height	Width	Depth
EB39S	36	21.0	2.7	17.25"	39"	39"
EB2142S	33	10.3	1.9	17.25"	42"	21"
EB4242S	47	21.2	3.2	17.25"	42"	42"

\*COM Yardage is listed for total yardage/feet required for a model, with applicable yardage/feet for individual components listed.

Model Number	Overall					
	Ship Weight	Cubes	COM Yardage*	Height	Width	Depth
EB39M		36	21.0	17.25"	39"	39"
	1/3 Upholstery		1.5			
	2/3 Upholstery		1.8			
EB2142M		33	10.3	17.25"	42"	21"
	1/3 Upholstery		0.9			
	2/3 Upholstery		1.1			
EB4242M		47	21.2	17.25"	42"	42"
	1/3 Upholstery		1.7			
	2/3 Upholstery		1.7			

\*COM Yardage is listed for total yardage/feet required for a model, with applicable yardage/feet for individual components listed.

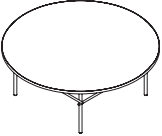
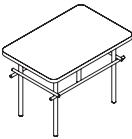
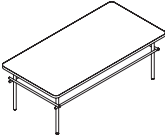
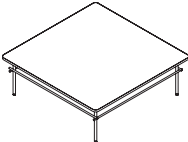

Description	Model Number	Base List Price	Upcharge List Price — Add to Base Price		P2 Paint
			L2	L3	
<b>Laminate Tables</b>					
 20" Round Side Table	ET20	\$ 895	\$ 11	\$ 22	\$ 44
 39" Round Table	ET39	\$ 2013	\$ 31	\$ 60	\$ 88
 14" x 21" Side Table	ET1421	\$ 1267	\$ 17	\$ 33	\$ 60
 21" x 42" Table	ET2142	\$ 1717	\$ 28	\$ 55	\$ 71
 42" x 42" Table	ET4242	\$ 2090	\$ 33	\$ 66	\$ 88

<b>Table Pricing Example:</b>	<b>Model/Options</b>	<b>Base Price/Upcharges</b>
Step 1: Select Model	ET1421	\$ 1267
Step 2: Select Laminate	LWBA Belair	\$ 0 upcharge
Step 3: Select Edgeband	BA Belair	\$ 0 upcharge
Step 4: Select Paint	P8X Solar Black	\$ 60 upcharge
<b>Add Base + applicable Upcharges for Total List Price =</b>		<b>\$ 1327</b>

<p><b>How to specify —</b> Select the Model Number from above.</p> <p>E   T             .</p>	<p><b>1st Option:</b> FSC Certified Wood (if applicable): FSC Select for FSC Certified Wood</p> <p>F   S   C   .</p>	<p><b>2nd Option:</b> Select the Laminate See page 284 for options.</p> <p>          .</p>	<p><b>3rd Option:</b> Select the Edge Band See page 284 for options.</p> <p>    .</p>	<p><b>4th Option:</b> Select the Paint P8Z Textured Salt P8X Solar Black (add P2 Paint upcharge)</p> <p>       </p>
---	--	--	---	---

Example: ET39.FSC.LWBA.BA.P8X

Model Number	Overall				
	Ship Weight	Cubes	Height	Width	Depth
ET20	14	3.4	17.25"	20"	20"
ET39	38	19.4	15"	39"	39"
ET1421	14	3.4	17.25"	21"	14"
ET2142	35	9.1	15"	42"	21"
ET4242	53	18.8	15"	42"	21"

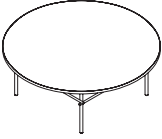
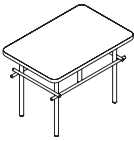
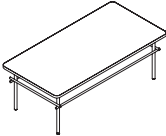
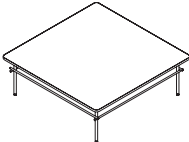
Description	Model Number	Base List Price	Upcharge List Price — Add to Base Price		P2 Paint
			V3	V5	
<b>Veneer Tables</b>					
 20" Round Side Table	EV20	\$ 1516	\$ 103	\$ 172	\$ 44
 39" Round Table	EV39	\$ 2440	\$ 140	\$ 233	\$ 88
 14" x 21" Veneer Side Table	EV1421	\$ 1715	\$ 101	\$ 167	\$ 60
 21" x 42" Veneer Table	EV2142	\$ 2063	\$ 123	\$ 203	\$ 71
 42" x 42" Veneer Table	EV4242	\$ 2537	\$ 151	\$ 251	\$ 88

<p><b>How to specify —</b> Select the Model Number from above.</p> <p>EV               .</p>	<p><b>1st Option:</b> FSC Certified Wood (if applicable): FSC Select for FSC Certified Wood</p> <p>F   S   C   .</p>	<p><b>2nd Option:</b> Select the Veneer See page 284 for options.</p> <p>              .</p>	<p><b>3rd Option:</b> Select the Veneer Finish OP Open Pore Low Sheen FF Full Fill Cleartech (add \$218)</p> <p>    .</p>	<p><b>4th Option:</b> Select the Paint P8Z Textured Salt P8X Solar Black (add P2 Paint upcharge)</p> <p>       </p>
--	--	--	---	---

Example: EV39.FSC.NC701.FF.P8X

Model Number	Overall				
	Ship Weight	Cubes	Height	Width	Depth
EV20	22	3.4	17.25"	20"	20"
EV39	53	19.4	15"	39"	39"
EV1421	22	3.4	17.25"	21"	14"
EV2142	45	9.1	15"	42"	21"
EV4242	65	18.8	15"	42"	21"

Social Collaborative Standard Upholstery Selections by Model/Series, for all other seating see pages 13-14.

Vicinity Lounge & Rocker

Vicinity Lounge & Rocker

LEATHER L1		
Allsteel Leather	WTH	•
Florence Leather	FLOR	•

GRADE 1		
Apex	APX	
Centurion	CU	•
Contourett	UR	•
Dapper	DAPR	
Hamilton	HAM	•
Inertia	NR	•
Optic	OP	

GRADE 2		
Appoint Seating	PNS	•
Blume	BLME	
Clyde	CLYD	•
Dotty	DOT	•
Meld	SMHMMLD	•
Rush	RUSH	•
Spin Seating	SPNN	
Whisper Vinyl	WP	•

GRADE 3		
Lateral	SCFSLAT	•
Moxie	SX	•
Purl	PURL	•
Quill	QUL	•

GRADE 4		
Caper	SMHMCAP	•
Manner	SMHMMAN	•
Merit	SMHMMER	•
Messenger	SMHMGRM	•
Metric	SMHMMET	•
Mode	SMHMMOD	•
Multiply	SMHMMLT	•
Murmur	SMHMMUR	•
Muse	SMHMMUS	•
Trundle	SMHMTRN	•

GRADE 5		
Main Line Flax	SCAMMLF	•
Rove	SMHMROV	•

GRADE 6		
Arris	ARR	•
Blazer	SCAMBLZ	•
Chock	SMHMCKK	
Hedge	SMHMHED	•
Pocket	SMHMCKT	•
Sequence	SMHMSQN	
Tandem	SMHMTAN	
Verse	SCARVRS	•

GRADE 8		
Apt	SMHMAPT	•
Brisa	RS	•

GRADE 9		
Ultraleather Pro	SUF554	•

GRADE 11		
Fusion	SCARFUS	•

GRADE 13		
Maze	SCARMZE	•

GRADE 14		
Chroma	SCARCHR	•

⊕ Partnership Program — See page 10 for details.

≠ Upholstery will be Railroad cut.

- Available upholstery option

**ROCKER PAINT FINISHES**

**GRADE P1**

Black ..... P71  
 Designer White..... PJW  
 Flint ..... P02

**GRADE P2**

Pyrite.....PJE  
 Silver.....PR6

**LOUNGE PAINT FINISHES**

**GRADE P1**

Black ..... P71  
 Designer White..... PJW  
 Flint ..... P02

**GRADE P2**

Pyrite.....PJE  
 Silver.....PR6

**GRADE P3**

Bullseye.....PJF

**GRADE P4**

Polished Chrome.....POL

**VENEER FINISHES**

**GRADE 1**

Black Wash Beech .....RB997  
 Natural Beech .....RB900  
 White Wash Beech .....RB912

**GRADE 2**

Natural Oak..... NF302  
 Warm Brown Oak..... NF394  
 Grey Wash Oak ..... NF314  
 Natural Walnut.....QT500

VICINITY LOUNGE

NOTE: Refer to individual product pages for upcharges.

(See page 327 for COM pricing on Grades 9-22)

Description	Type	Model Number	List Price									
			1	2	3	4	5	6	7	8	L1	
Lounge Armless Sled Base	Fully Upholstered Back	CLG-UGANO	\$ 2389	\$ 2436	\$ 2483	\$ 2531	\$ 2593	\$ 2657	\$ 2720	\$ 2783	\$ 3299	
	Fully Upholstered Back w/Contrasting Welts	CLG-CGANO	\$ 2543	\$ 2622	\$ 2700	\$ 2779	\$ 2885	\$ 2989	\$ 3095	\$ 3200	\$ 2543	
	Upholstered with Veneer Back	CLG-WGANO	\$ 3351	\$ 3382	\$ 3414	\$ 3445	\$ 3488	\$ 3529	\$ 3572	\$ 3613	\$ 3958	



VICINITY LOUNGE

Model Number	Overall			Seat				Backrest								
	COM Yardage	COL Sq. Feet	Height (Range)	Width	Depth	Height	Width	Depth	Pan Angle	Height	Width	Lumbar Height	Backrest/Seat Angle (Range)	Ship Weight Per Chair	Ship Weight Per Carton	Cubes
CLG-UGANO	3.0	50	27 1/2"	31 1/4"	28 3/4"	17 1/2"	26 1/2"	18 1/2"	13.9°	18 1/4"	21 1/4"	7"	97.7°	42	42	18.5
CLG-CGANO	5.0	50	27 1/2"	31 1/4"	28 3/4"	17 1/2"	26 1/2"	18 1/2"	13.9°	18 1/4"	21 1/4"	7"	97.7°	42	42	18.5
CLG-WGANO	2.0	45	27 1/2"	31 1/4"	28 3/4"	17 1/2"	26 1/2"	18 1/2"	13.9°	18 1/4"	21 1/4"	7"	97.7°	48	48	18.5

Note: Dimensions are in accordance with BIFMA G1-2002 guidelines — see illustration of guidelines on page 45.

<p><b>How to specify —</b> Select the Model Number from above.</p>	<p><b>1st Option:</b> Select the Glide: 0 Polycarbonate</p>	<p><b>2nd Option:</b> Select the Frame Finish: P71 Black PJF Bullseye PJW Designer White POL Chrome P02 Flint PJE Pyrite PR6 Silver</p>	<p><b>3rd Option:</b> Select the Veneer Shell Finish (if applicable): RB997 Black Wash Beech RB900 Natural Beech RB912 White Wash Beech NF314 Grey Wash Oak (add \$164) NF302 Natural Oak (add \$164) NF394 Warm Brown Oak (add \$164) QT500 Natural Walnut (add \$164)</p>
CLG          . 0   .	P       .		

Continued below ▼

<p><b>4th Option:</b> Select the Upholstery:</p>	<p><b>5th Option:</b> Select the Welt Cord Upholstery (if applicable):</p>
.	

Examples: CLG-UGANO.0.POL.CU63 CLG-CGANO.0.P71.CU27.CU10 CLG-WGANO.0.P71.RB997.CU27

(See page 327 for COM pricing on Grades 9-22)

Description	Type	Model Number	List Price								
			1	2	3	4	5	6	7	8	L1
Lounge Armless Rocker Base	Fully Upholstered Back	CLR-UGANO	\$ 2960	\$ 3007	\$ 3054	\$ 3102	\$ 3164	\$ 3228	\$ 3291	\$ 3354	\$ 3870
	Fully Upholstered Back w/Contrasting Welts	CLR-CGANO	\$ 3106	\$ 3185	\$ 3263	\$ 3342	\$ 3448	\$ 3552	\$ 3658	\$ 3763	\$ 4623
	Upholstered with Veneer Back	CLR-WGANO	\$ 3524	\$ 3555	\$ 3587	\$ 3618	\$ 3661	\$ 3702	\$ 3745	\$ 3786	\$ 4131

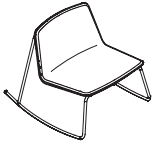

VICINITY LOUNGE

Model Number	COM Yardage		Overall			Seat			Backrest			Cubbs			
	COM Sq. Feet	Height (Range)	Width	Depth	Height	Width	Depth	Height	Width	Lumbar Height	Backrest/Seat Angle (Range)	Ship Weight Per Chair	Ship Weight Per Carton	Cubbs	
CLR-UGANO	3.0	50	27 1/2"	31 1/4"	34 1/4"	17 1/2"	26 1/2"	18 1/2"	18 1/4"	21 1/8"	7"	97.7°	44	44	22.7
CLR-CGANO	5.0	50	27 1/2"	31 1/4"	34 1/4"	17 1/2"	26 1/2"	18 1/2"	18 1/4"	21 1/8"	7"	97.7°	44	44	22.7
CLR-WGANO	2.0	45	27 1/2"	31 1/4"	34 1/4"	17 1/2"	26 1/2"	18 1/2"	18 1/4"	21 1/8"	7"	97.7°	50	50	22.7

Note: Dimensions are in accordance with BIFMA G1-2002 guidelines — see illustration of guidelines on page 45.

<p><b>How to specify —</b> Select the Model Number from above.</p>	<p><b>1st Option:</b> Select the Frame Finish:</p> <p>P71 Black P JW Designer White P02 Flint PJE Pyrite PR6 Silver</p>	<p><b>2nd Option:</b> Select the Veneer Shell Finish (if applicable):</p> <p>RB997 Black Wash Beech RB900 Natural Beech RB912 White Wash Beech NF314 Grey Wash Oak (add \$164) NF302 Natural Oak (add \$164) NF394 Warm Brown Oak (add \$164) QT500 Natural Walnut (add \$164)</p>
<p>CLR-           . P           .</p>		

Continued below ▼

<p><b>3rd Option:</b> Select the Upholstery:</p>	<p><b>4th Option:</b> Select the Welt Cord Upholstery (if applicable):</p>
<p>                      .</p>	<p>                      .</p>

Examples: CLR-UGANO.P71.CU63 CLR-CGANO.P JW.CU27.CU10 CLR-WGANO.P02.RB997.CU27



Allsteel Seating Upholstery Selections by Model/Series.

Co|Ho

GRADE 1		
Centurion	CU	•
Dapper	DAPR	•
Ensemble	ENSB	•
Hamilton	HAML	•
Inertia	NR	•
GRADE 2		
Appoint Seating	PNS	•
Blume	BLME	•
Clyde	CLYD	•
Dotty	DOT	•
Rush	RUSH	•
GRADE 3		
Purl	PURL	•
Quill	QUL	•
GRADE 4		
Manner ⚡	SMHMMAN	•
Messenger ⚡	SMHMGRM	•
GRADE 5		
Main Line Flax ⚡	SCAMMLF	•
GRADE 6		
Arris	ARR	•
Blazer ⚡	SCAMBLZ	•
Hemp ⚡	SCAMHMP	•
Pocket ⚡	SMHMPKT	•
Sequence ⚡	SMHMSQN	•
GRADE 7		
Silk ⚡	SCAMSLK	•
GRADE 8		
Nimble ⚡	SCFSNIM	•
Zap ⚡	SCAMZAP	•
GRADE 9		
Yoredale ⚡	SCAMYDL	•

Co|Ho

⚡ Partnership Program — See page 10 for details.  
 • Available upholstery option

- Allsteel fabrics and foam meet requirements for CTB117.
- Contact Allsteel Customer Support for other flammability code approvals.

(See page 327 for COM pricing on Grades 9-22)

Description	Model Number <i>Add options below</i>	Base Price	Upholstery	Upcharge									
				2	3	4	5	6	7	8	9	10	
Co Ho Seating Co Ho Uph Lounge Chair	CHULNO	\$ 1598	Seat/Body	\$ 22	\$ 44	\$ 66	\$ 95	\$ 125	\$ 154	\$ 184	\$ 213	\$ 242	



<b>Pricing Example:</b>	<b>Model/Options</b>	<b>Base Price/Upcharges</b>
Step 1: Select Model	CHULNO	\$ 1598
Step 2: Select Arm	Tablet Arm with Designer White Laminate	\$ 436 upcharge
Step 3: Select Upholstery	Grade 3	\$ 44 upcharge
<b>Add Base + applicable Upcharges for Total List Price =</b>		<b>\$ 2078</b>

Model Number	Overall			Seat				Arms			Backrest							
	Ship Weight	Cubes	COM Yardage* Height	Width	Depth	Height	Width	Depth	Pan Angle (Range)	Armrest Height	Arm Pad Length	Arm Pad Width	Height	Width	Lumbar Height	Backrest Inclination from Vertical	Backrest/Seat Angle (Range)	
CHULNO	30	13½"	1.4	32½"	23" w/o Tablet Arm 36" w/Tablet Arm	29"	16¼"	22"	18"	5°	11½"	19"	9½"	19½"	20"	N/A	17°	102°

\*COM Yardage is listed for total yardage/feet required for a model, with applicable yardage/feet for individual components listed.

<p><b>How to specify —</b> Select the Model Number from above.</p> <p>CHULNO .</p>	<p><b>1st Option:</b> <b>Select Arm Option:</b></p> <p>N None LDW1 Tablet Arm with Designer White Laminate (add \$436 upcharge) LM11 Tablet Arm with Loft Laminate (add \$436 upcharge)</p> <p> .</p>	<p><b>2nd Option:</b> <b>Select the Upholstery:</b></p> <p>See page 300 for selections and Color Codes.</p> <p> .</p>
--	---	---

Example: CHULNO.LDW1.ISN002



Social Collaborative Standard Upholstery Selections by Model/Series, for all other seating see pages 13-14.

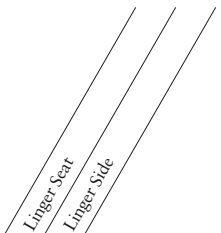
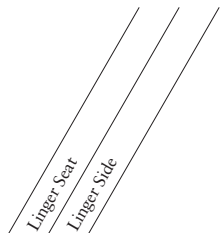

**LEATHER L1**

Allsteel Leather	WTH		
Florence Leather	FLOR		

**GRADE 1**

Apex	APX	•	•
Centurion	CU	•	•
Contourett	UR	•	•
Dapper	DAPR		•
Hamilton	HAM		•
Inertia	NR	•	•
Optic	OP		•

**GRADE 2**

Appoint Seating	PNS	•	•
Blume	BLME	•	•
Clyde	CLYD	•	•
Dotty	DOT	•	•
Meld	SMHMMLD	•	•
Rush	RUSH		•
Spin Seating	SPNN		•
Whisper Vinyl	WP	•	•

**GRADE 3**

Lateral	SCFSLAT		•
Moxie	SX	•	•
Purl	PURL	•	•
Quill	QUL	•	•

**GRADE 4**

Caper	SMHMCAP	•	•
Manner	SMHMMAN	•	•
Merit	SMHMMER		•
Messenger	SMHMGRM	•	•
Metric	SMHMMET	•	•
Mode	SMHMMOD	•	•
Multiply	SMHMMLT		•
Murmur	SMHMMUR		•
Muse	SMHMMUS		•
Trundle	SMHMTRN		•

**GRADE 5**

Main Line Flax	SCAMMLF		•
Rove	SMHMROV		•

**GRADE 6**

Arris	ARR	•	•
Blazer	SCAMBLZ		•
Chock	SMHMCKK		•
Hedge	SMHMHEd	•	•
Pocket	SMHMPKT		•
Sequence	SMHMSQN		•
Tandem	SMHMTAN		•
Verse	SCARVRS	•	•

**GRADE 8**

Apt	SMHMAPT	•	•
Brisa	RS	•	•

**GRADE 9**

Ultraleather Pro	SUF554	•	•
------------------	--------	---	---

**GRADE 11**

Fusion	SCARFUS	•	•
--------	---------	---	---

**GRADE 13**

Maze	SCARMZE	•	•
------	---------	---	---

**GRADE 14**

Chroma	SCARCHR		•
--------	---------	--	---

LINGER

⊕ Partnership Program — See page 10 for details.

≠ Upholstery will be Railroad cut.

• Available upholstery option

BASE PAINT FINISHES

GRADE 4

Polished Aluminum .....PAL/P

**NOTE:** Refer to individual product pages for upcharges.

**FSC Certified Wood at Allsteel**  
See page [431](#) for more information.

*Linger is a lounge chair that accommodates a variety of postures. Take a seat for longer meetings, sit upright, lounge, or swing your legs over the side. Perch on the back for shorter interactions when you don't want to commit to the sit.*

## MODELS AND OPTIONS

Linger is available in one size with an upholstered seat and a base that can be painted or polished aluminum. Linger is available in solid or two-tone upholstery options.

## APPLICATION

Place Linger in open areas, public or neighborhood spaces, small conference rooms, dedicated collaboration rooms, dormitory lounges, libraries, or hospitality waiting areas.

## KEY FEATURES

Linger is constructed of upholstery over frame and foam with either a painted or polished aluminum base. The core is upholstery-grade FSC plywood with box joint and corner block construction. The base swivels so you can engage the whole room. Plus it self-centers to its original position when not in use to keep spaces ready for the next meeting. Upholster the seat and sides in two different fabrics to create a unique aesthetic. Linger accommodates multiple postures, including the ability to sit on the back ledge.

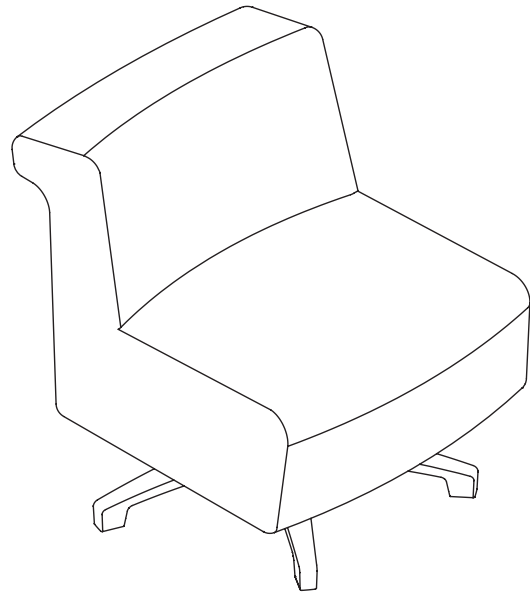

## MATERIALS AND FINISHES

Linger has a fully upholstered seat that can be specified as a single upholstery or two-tone.

- All upholstery foams are CFC-free.
- All COMs must be approved for upholsterability or applicable fire code compliance prior to order entry. See pages 6-8 for COM ordering instructions.
- **Flammability** code compliance of Allsteel textiles and seating is listed on pages 17-18.1. COM/COL manufacturers supply certificates of compliance for fabric-only tests such as CAL TB117-2013.

Linger is warranted for users up to 300 lbs.

## OPTIONS — LINGER

Base Color:

**PAL** Polished Aluminum

FSC Certified Wood:

**FSC** FSC Certified Wood

Upholstery:

See pages 17-18.1 for upholstery selections.

See page 302 for colors and codes.

(See page 327 for COM pricing on Grades 9-22)

Description	Base Option	Model Number	List Price							
			1	2	3	4	5	6	7	8
Linger	Polished	S924SS	\$ 3288	\$ 3347	\$ 3406	\$ 3465	\$ 3544	\$ 3623	\$ 3702	\$ 3780

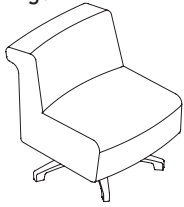

(See page 327 for COM upcharge pricing on Grades 9-22)

Description	Base Option	Model Number	Upcharge							
			1	2	3	4	5	6	7	8
Two-tone Linger	Polished	S924ST	\$ 3577	—	—	—	—	—	—	—
		Seat Upholstery – add to base price	\$ 0	\$ 40	\$ 79	\$ 118	\$ 171	\$ 223	\$ 276	\$ 329
		Side Upholstery – add to base price	\$ 0	\$ 20	\$ 40	\$ 59	\$ 86	\$ 112	\$ 138	\$ 164

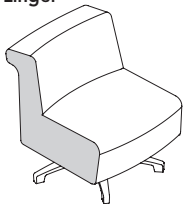

<b>Two-tone Pricing Example:</b>	<b>Model/Options</b>	<b>Base Price / Upcharges</b>
Step 1: Select Model	S924ST	\$ 3577
Step 2: Select Seat Upholstery	Grade 2 Trisect Marine	\$ 40 upcharge
Step 3: Select Side Upholstery	Grade 1 Whisper Vinyl Bone	\$ 0 upcharge
<b>Add Base + applicable Upcharges for Total List Price =</b>		<b>\$ 3617</b>

Model Number	Overall			Seat			Cubbs			
	COM Yachage	COL Sp. Feet	Height (Range)	Width	Depth	Height (Range)		Width	Depth (Range)	Ship Weight
S924SS	3.75	63¼	30½"	29"	27½"	17¼"	27"	23¼"	52	27.6
S924ST	3.75	63¼	30½"	29"	27½"	17¼"	27"	23¼"	52	27.6
Seat	2.5	42½"								
Side	1.25	21¼"								

LINGER

<p><b>How to specify —</b> Select the Model Number from above.</p> <p>S   9   2   4       .</p>	<p><b>1st Option:</b> Select the Base Finish: PAL Polished Aluminum</p> <p>P   A   L   .</p>	<p><b>2nd Option:</b> FSC Certified Wood: FSC Select for FSC Certified Wood</p> <p>F   S   C   .</p>	<p><b>3rd Option:</b> Select the Upholstery: See page 302 for selections and pages 17-18.1 for colors and codes.</p> <p>            .</p>	<p><b>4th Option:</b> Select the Side Upholstery for Two-tone models (if applicable): See page 302 for selections and pages 17-18.1 for colors and codes.</p> <p>            .</p>
---	--	--	---	--

Example: S924SS.PAL.FSC.STX17

Social Collaborative Standard Upholstery Selections by Model/Series, for all other seating see pages 13-14.

Reflect Shell ≠  
Reflect Seat & Back

<b>LEATHER L1</b>			
Allsteel Leather	WTH		
Florence Leather	FLOR		

<b>GRADE 1</b>			
Apex	APX		•
Centurion	CU	•	•
Contourett	UR		•
Dapper	DAPR	•	•
Hamilton	HAM	•	•
Inertia	NR	•	•
Optic	OP		

<b>GRADE 2</b>			
Appoint Seating	PNS		•
Blume	BLME		•
Clyde	CLYD	•	•
Dotty	DOT	•	•
Meld ⊕	SMHMMLD	•	•
Rush	RUSH	•	•
Spin Seating	SPNN		•
Whisper Vinyl	WP	•	•

<b>GRADE 3</b>			
Lateral ⊕	SCFSLAT		•
Moxie	SX	•	•
Purl	PURL	•	•
Quill	QUL		•

<b>GRADE 4</b>			
Caper ⊕	SMHMCAP	•	•
Manner ⊕	SMHMMAN	•	•
Merit ⊕	SMHMMER		•
Messenger ⊕	SMHMGRM	•	•
Metric ⊕	SMHMMET	•	•
Mode ⊕	SMHMMOD	•	•
Multiply ⊕	SMHMMLT		•
Murmur ⊕	SMHMMUR		
Muse ⊕	SMHMMUS		
Trundle ⊕	SMHMTRN		•

Reflect Shell ≠  
Reflect Seat & Back

<b>GRADE 5</b>			
Main Line Flax ⊕	SCAMMLF		•
Rove ⊕	SMHMROV		•

<b>GRADE 6</b>			
Arris	ARR		•
Blazer	SCAMBLZ	•	•
Chock ⊕	SMHMCKK		
Hedge ⊕	SMHMHED	•	•
Pocket ⊕	SMHMPKT	•	•
Sequence ⊕	SMHMSQN		
Tandem ⊕	SMHMTAN		
Verse ⊕	SCARVRS	•	•

<b>GRADE 8</b>			
Apt ⊕	SMHMAPT		•
Brisa ⊕	RS		•

<b>GRADE 9</b>			
Ultraleather Pro ⊕	SUF554	•	•

<b>GRADE 11</b>			
Fusion ⊕	SCARFUS	•	•

<b>GRADE 13</b>			
Maze ⊕	SCARMZE	•	•

<b>GRADE 14</b>			
Chroma ⊕	SCARCHR		•

REFLECT

⊕ Partnership Program — See page 10 for details.

≠ Upholstery will be Railroad cut.

• Available upholstery option

#### VENEER FINISH

Light Cherry.....	SC701
Burnished Cherry .....	SC777
Field Elm Maple.....	SE599
Clear Maple .....	SE800
Harvest Maple .....	SE856
Phantom Ecrú Maple .....	SE912
Belair Maple.....	SE943
Clear Oak .....	SF300
Dark Rift Cut Oak.....	SF331

**NOTE:** Refer to individual product pages for upcharges.

**FSC Certified Wood at Allsteel**  
See page [431](#) for more information.



Reflect creates personal refuges around the open office — in the hallway, adjacent to a row of workstations, or near a wall of windows. Enjoy the privacy of a large, sound-stifling back that reduces distractions and communicates unavailability. Or the generous space formed from wide armrests and an oversized seat, allowing room for your laptop, paperwork, and other tools of the trade. And the comfort of padded upholstery, which cushions you as you finish that email, report, or video call.

With Reflect, going solo doesn't always mean you have to go at it alone. Arrange multiple seats into pairs or pods to give team members a new space to collaborate. Use the concealed swivel to move towards or away from others as needed.

Some time away is good for everyone. Focus your attention in the right place with Reflect.

**MODELS AND OPTIONS**

Reflect is available with an upholstered seat/back and upper shell. Lower shells are veneer and each unit ships with a steel base plate for stationary placement.

**APPLICATION**

Place Reflect in open areas, public or neighborhood spaces, adjacent to workstations or in a cafe-type setting.

**KEY FEATURES**

*Surprising Functionality*

With an integrated swivel-based mechanism, Reflect enables multiple work modes — from 1:1 conversation to private office focus.

*Communicated Privacy*

Sight-blocking and sound dampening upper shell visually communicates unavailability and creates private seclusion.

*Comfortable Yet Active*

Ergonomically designed soft seating promotes upright postures and active working behaviors for the task at hand.

*Beautifully Designed*

Reflect's asymmetrical aesthetic is visually compelling and intuitively offers ancillary worksurface support for beverages and writing with its extended width armrest.

**CONSTRUCTION**

Reflect is constructed of fabric covered foam with an upholstery-grade FSC plywood core with box joint and corner block construction.

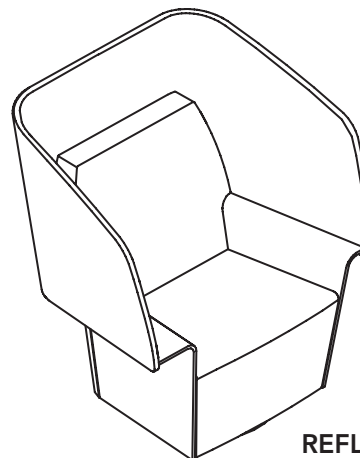

REFLECT GAWRP

**OPTIONS — REFLECT**

FSC Certified Wood:

**FSC** FSC Certified Wood

Lower Shell Veneer Finish:

**Stratawood Veneer**

**SE599** Field Elm Maple

**SE800** Clear Maple

**SE856** Harvest Maple

**SE912** Phantom Ecru Maple  
Oak

**SE943** Belair Maple

**SC701** Light Cherry

**SC777** Burnished Cherry

**SF300** Clear Oak

**SF331** Dark Rift Cut

Seat/Back Upholstery:

See page 306 for upholstery selections.

Upper Shell Upholstery:

See page 306 for upholstery selections.

**MATERIALS AND FINISHES**

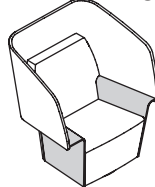

Lower Shell Veneer Finish

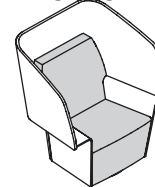

Seat/Back Upholstery Pattern Cut

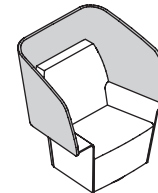

Upper Shell Upholstery Railroad Cut

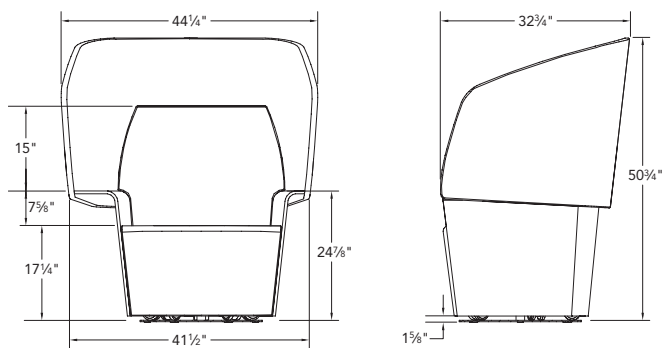
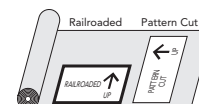
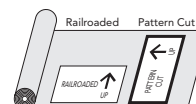

REFLECT

(See page 329 for COM upcharge pricing on Grades 9-18)

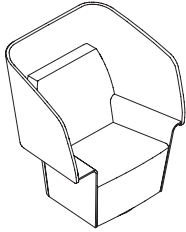

Model and Upholstery Option	Base List Price	Upcharge							
		1	2	3	4	5	6	7	8
Reflect									
GAWRP	\$ 8012	—	—	—	—	—	—	—	—
Seat/Back Upholstery – add to base price		\$ 0	\$ 51	\$ 102	\$ 153	\$ 222	\$ 290	\$ 358	\$ 427
Upper Shell Upholstery – add to base price		\$ 0	\$ 79	\$ 157	\$ 236	\$ 342	\$ 446	\$ 552	\$ 657

<b>Pricing Example:</b>	<b>Model/Options</b>	<b>Base Price/Upcharges</b>
Step 1: Select Model	GAWRP	\$ 8012
Step 2: Select Seat/Back Upholstery	Grade 2 Appoint Seating Carbon	\$ 51 upcharge
Step 3: Select Upper Shell Upholstery	Grade 4 Purl Deep	\$ 236 upcharge
Add Base + applicable Upcharges for Total List Price =		\$ 8299

Model Number	COM Yardage	COL Sq. Feet	Overall			Seat			Armrests			Backrest							
			Height	Width	Depth	Height	Width	Depth	Rear Angle	Armrest Height	Width Between Arms	Depth	Arm Height to Floor	Height	Width	Lumbar Height	Backrest/Seat Angle	Ship Weight	Cu Yds
GAWRP			50 1/2"	44 1/2"	32 1/2"	17 1/2"	25 1/2"	20"	5.3°	7 1/2"	25 1/2"	22 1/2"	24 1/2"	24"	26"	9"	97°	196	64.4
Seat/Back	3.25	—																	
Upper Shell	5	—																	

<p><b>How to specify —</b> Select the Model Number from above.</p> <p>GAWRP         .</p>	<p><b>1st Option:</b> FSC Certified Wood (if applicable): FSC Select for FSC Certified Wood</p> <p>F   S   C   .</p>	<p><b>2nd Option:</b> Select Lower Shell Veneer Finish: See page 307 for finishes.</p> <p>S           .</p>	<p><b>3rd Option:</b> Select the Seat/Back Upholstery: See page 306 for available colors and codes.</p> <p>          .</p>	<p><b>4th Option:</b> Select the Upper Shell Upholstery: See page 306 for available Upper Shell colors and codes. CU Centurion NR Inertia WP Whisper SX Moxie</p> <p>                .</p>
---	--	---	--	--

Example: GAWRP.FSC.SE800.SED08.WSP42



Social Collaborative Standard Upholstery Selections by Model/Series, for all other seating see pages 13-14.

Clubhouse – Front & Back Bag/Storage  
Clubhouse – Seating / Consoles

Clubhouse – Front & Back Bag/Storage  
Clubhouse – Seating / Consoles

**LEATHER L1**

Allsteel Leather	WTH		
Florence Leather	FLOR		

**GRADE 1**

Apex	APX		
Centurion	CU	•	•
Contourett	UR	•	•
Dapper	DAPR	•	•
Hamilton	HAM	•	•
Inertia	NR	•	•
Optic	OP		

**GRADE 2**

Appoint Seating	PNS	•	•
Blume	BLME	•	•
Clyde	CLYD	•	•
Dotty	DOT	•	•
Meld	SMHMMLD	•	•
Rush	RUSH	•	•
Spin Seating	SPNN	•	•
Whisper Vinyl	WP	•	•

**GRADE 3**

Lateral	SCFSLAT	•	•
Moxie	SX	•	•
Purl	PURL	•	•
Quill	QUL		•

**GRADE 4**

Caper	SMHMCAP	•	•
Manner	SMHMMAN	•	•
Merit	SMHMMER	•	•
Messenger	SMHMGRM	•	•
Metric	SMHMMET	•	•
Mode	SMHMMOD	•	•
Multiply	SMHMMLT	•	•
Murmur	SMHMMUR		
Muse	SMHMMUS		
Trundle	SMHMTRN	•	•

**GRADE 5**

Main Line Flax	SCAMMLF	•	•
Rove	SMHMROV	•	•

**GRADE 6**

Arris	ARR		•
Blazer	SCAMBLZ	•	•
Chock	SMHMCKK		
Hedge	SMHMHED	•	•
Pocket	SMHMPKT	•	•
Sequence	SMHMSQN		
Tandem	SMHMTAN		
Verse	SCARVRS	•	•

**GRADE 8**

Apt	SMHMAPT	•	•
Brisa	RS	•	•

**GRADE 9**

Ultraleather Pro	SUF554	•	•
------------------	--------	---	---

**GRADE 11**

Fusion	SCARFUS	•	•
--------	---------	---	---

**GRADE 13**

Maze	SCARMZE	•	•
------	---------	---	---

**GRADE 14**

Chroma	SCARCHR	•	•
--------	---------	---	---

- ⊕ Partnership Program — See page 10 for details.
- ≠ Upholstery will be Railroad cut.
- Available upholstery option

**TILE PAINT FINISHES**

<b>GRADE P1</b>	
Textured Designer White .....	PK7
Textured Flint .....	P7A
<b>GRADE P2</b>	
Silver Texture.....	PR8
<b>GRADE P4</b>	
Polished Aluminum .....	PAL/P

**TABLE EXTENSION PAINT FINISHES**

<b>GRADE P1</b>	
Designer White.....	PJW
Flint .....	P02
<b>GRADE P2</b>	
Silver .....	PR6

**LAMINATES**

<b>GRADE L1</b>	
<b>SOLID COLORS</b>	
Black .....	P
Designer White.....	LDW1
Flint .....	LM16
Fossil Shale.....	LEH1
Loft .....	LM11
Muslin.....	LM15
Titanium .....	LT11
<b>ABSTRACT</b>	
Handspun Pearl.....	LAHP
Handspun Dove .....	LAHD
Handspun Slate .....	LAHS
Handspun Chestnut .....	LAHC
<b>WOODGRAIN</b>	
Belair.....	LWBA
Bourbon Cherry .....	H
Field Elm.....	LWFE
Florence Walnut.....	LFW1
Kingswood Walnut .....	LK11
Natural Maple .....	LWD
NeoWalnut .....	LNU1
Pinnacle.....	PINC
Shaker Cherry .....	LW7C
<b>GRADE L2</b>	
Beigewood.....	LWBE
Fawn Cypress .....	LFC1
Lowell Ash .....	LLA1
Mangalore Mango .....	LMM1
Natural Recon.....	LNR1
Phantom Charcoal .....	LPC1
Phantom Ecu .....	LPE1
Portico Teak.....	LPT1
Skyline Walnut.....	LSW1
Veranda Teak.....	LVT1
<b>GRADE L3</b>	
Natural Walnut.....	LWNW

**LAMINATE EDGE COLORS**

Beigewood.....	DE
Belair.....	BA
Black .....	E4
Bourbon Cherry .....	H
Brownstone.....	EY
Bungalow .....	EX
Designer White.....	DW
Fawn Cypress.....	FC
Field Elm.....	FE
Flint .....	E9
Florence Walnut.....	FW
Fossil.....	EH
Kingswood Walnut .....	KI
Loft.....	EV
Lowell Ash .....	DL
Mangalore Mango .....	MM
Muslin.....	EU
Natural Maple .....	DD
Natural Recon.....	NR
Natural Walnut.....	DN
NeoWalnut .....	NU
Parchment.....	EN
Phantom Charcoal .....	PC
Phantom Ecu .....	PE
Pinnacle.....	PI
Platinum Metallic.....	EP
Portico Teak.....	DP
Shaker Cherry .....	DF
Skyline Walnut.....	SW
Titanium .....	TI
Veranda Teak.....	VT

NOTE: Refer to individual product pages for upcharges.

FSC Certified Wood at Allsteel  
See page 431 for more information.

*The best work happens when the right people come together in the right space. A space that facilitates uninterrupted thought and sets team members up for everyday office victories.*

*Meet Clubhouse, the newest addition to Allsteel's Social Collaborative collection of furniture.*

*It's where seating, surface and seclusion come together. Clubhouse is easy to set up in any space and fits however your team works. Its framed design serves a dual purpose: promoting collaboration while reducing outside distractions by communicating to others that work is happening inside.*

*Great things happen in your go-to place. That's the beauty of Clubhouse – the get-together getaway space.*

## AVAILABLE CONFIGURATIONS

Clubhouse is available in fourteen unique configurations that span between two different heights. Optional console and storage components provide ancillary worksurface support, media wall applications support technology and a wide array of fabrics and finishes allow for creative expression.

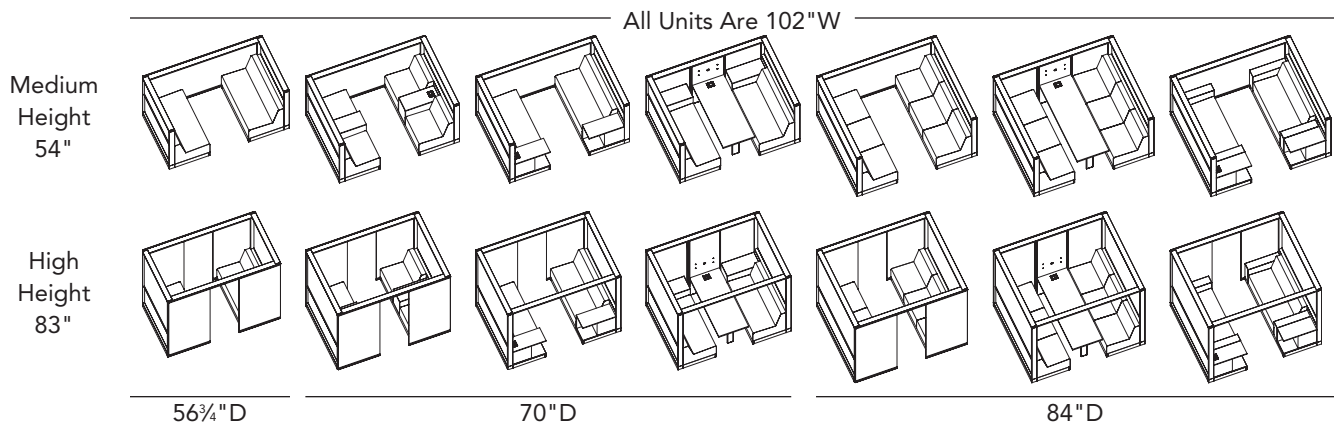

## APPLICATION

Like its sister products, Clubhouse addresses the modern workplace's need for flexibility in an open office design. By forming — not filling — a room, Clubhouse creates a secluded space within any place:

- The brainstorm retreat.
- A private area for the job interview.
- The temporary office for writing that memo to the boss.

## KEY FEATURES

### Spatial Delineation

- Microarchitectural-like frame forms a 3D boundary and creates a space within a space.
- Semi-translucent back and side screening elements visually establish privacy and communicate unavailability

### Extended Use Comfort

- Soft seating provides long-term comfort for small to mid-sized groups.
- Optional console and storage components provide ancillary work surface support.

### Support for Technology

- Optional media wall and table support digital content sharing and power distribution.
- Integrated power within console and storage pieces further enable the usage of technology.

## CONSTRUCTION

The construction of Clubhouse meets or exceeds industry standards for performance.

- Aluminum vertical uprights and horizontal extrusions are robust yet maintain a stream-line design.
- Back and side screens are made from durable polyester yarns. Screens are securely fastened across the top and a magnetic connection across the bottom allows the screen not to be damaged if impacted.
- Seating and console units are constructed of fabric covered foam with a plywood core.

## ELECTRICAL

Electrical is to be separately specified and can be integrated within media walls, consoles and storage components. Standard, Chicago and New York electrical-coded models are available for specification throughout each of the previously indicated items.

When a media wall electrical assembly is specified, table top power integration is automatically included.

Console and storage power integration is only available on a single side of a Clubhouse configuration and is to be called out during the specification process.

Please refer to page 322 for additional information on electrical and power for Clubhouse.

**NOTE:** Clubhouse Typical can be found at <https://www.allsteeloffice.com/design-resources/idea-starters>

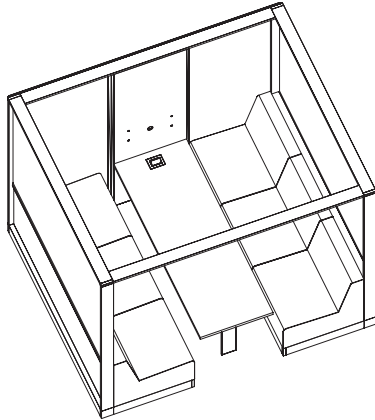

Clubhouse with Table and Media Wall, power ready.  
**GA84HMW**  
 84"D x 102"W x 83"H

**SPECIFICATION**

*Fabric Specification*

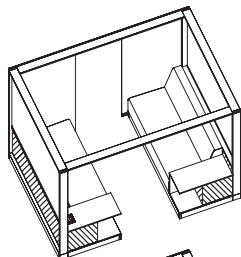

Frontboard, backboard and storage upholstery will match in specified fabric material.

Fabric is railroad cut.

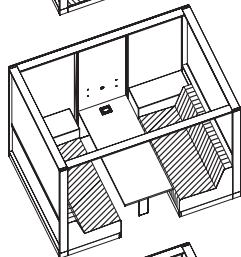
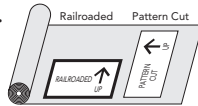

Seating top, back, seat and seat front upholstery will match in specified fabric material.

Fabric is pattern cut

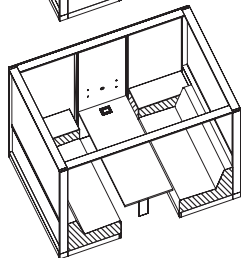
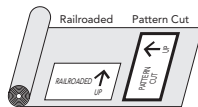

Seating side and console upholstery will match in specified fabric material.

Fabric is pattern cut

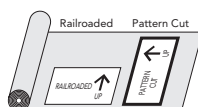

**OPTIONS**

Description:

**GAxxM** Medium Height (54"H x 102"W)

**GAxxH** High Height (83"H x 102"W)

Depth, Configuration, and Power:

- 56 3/4"D Seating – Non-powered
- 70"D Console (Upholstered or Laminate) – Powered or Non-Powered
- 70"D Storage – Powered L or R; or Non-Powered
- 70"D Table and Powered Media Wall
- 84"D Seating – Non-powered
- 84"D Storage – Powered L or R; or Non-Powered
- 84"D Table and Powered Media Wall

Frame Paint/Finish Color:

- P7A** Textured Flint
- PR8** Textured Silver
- PK7** Textured Designer White

Back and Sides Screen Material:

- CHK** Chalk
- GRS** Greystone
- PEW** Pewter

Table and Console Laminate with Matching Edge (if applicable):

**GRADE L1**

- L1** Abstract
- LT8D** Silver Mesh
- LAHPEH** Handspun Pearl/Fossil
- LAHDEH** Handspun Dove/Fossil
- LAHSE9** Handspun Slate/Flint
- LAHCEX** Handspun Chestnut/Bungalow

Solid Color

- LDW1DW** Designer White/Designer White
- LM15EU** Muslin/Muslin
- LM11EV** Loft/Loft
- LM16E9** Flint/Flint
- LEH1EH** Fossil Shale
- LT11TI** Titanium

Woodgrain

- LFW1FW** Florence Walnut
- LK11KI** Kingswood Walnut
- LWDDD** Natural Maple/Natural Maple
- LNU1NU** NeoWalnut
- LW7CDF** Shaker Cherry/Shaker Cherry

**GRADE L2**

- LWACDA** Amber Cherry/Amber Cherry
- LWBEDE** Beigewood/Beigewood
- LWBRDB** Brazilwood/Brazilwood
- LWZDZ** Columbian Walnut/Columbian Walnut
- LLA1DL** Lowell Ash
- LNR1NR** Natural Recon
- LPT1PT** Portico Teak
- LSW1SW** Skyline Walnut
- LVT1VT** Veranda Teak
- LBO1BO** Branded Oak
- LER1DR** Ebony Recon
- LFC1FC** Fawn Cypress
- LMM1MM** Mangalore Mango
- LPC1PC** Phantom Charcoal
- LPE1PE** Phantom Ecru

**GRADE L3**

- LWCDG** Cafelle/Cafelle
- LWCWDC** Charcoal Walnut/Charcoal Walnut
- LWNWDN** Natural Walnut/Natural Walnut

Frontboard, Backboard, and Storage Upholstery (if applicable):  
 See upholstery selection on page 310).

Seating Top, Back, Seat, and Seat Front Upholstery:  
 See upholstery selection on page 310).

Seating Side and Console Upholstery (if applicable):  
 See upholstery selection on page 310).

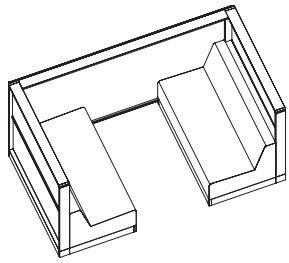

56¾"D x 102"W x 54"H with Seating – GA56MSE Units are non-powered.

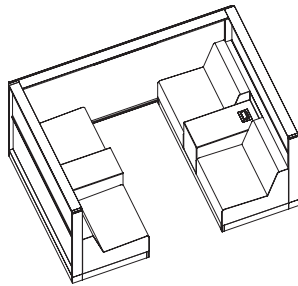
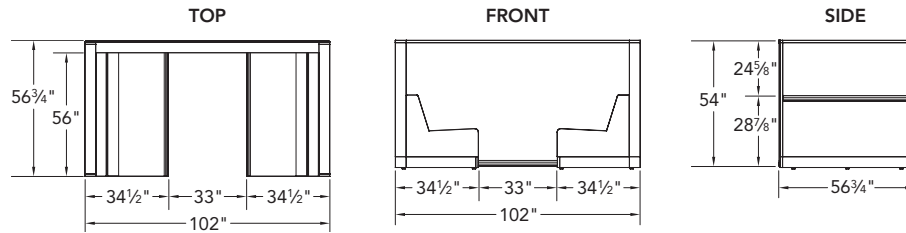

70"D x 102"W x 54"H with Console – GA70MCO Units available as power ready or as non-powered; center consoles are upholstered or laminate.

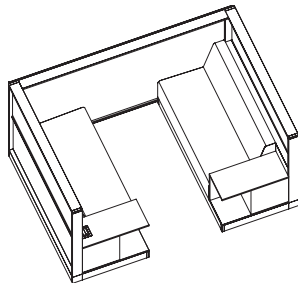
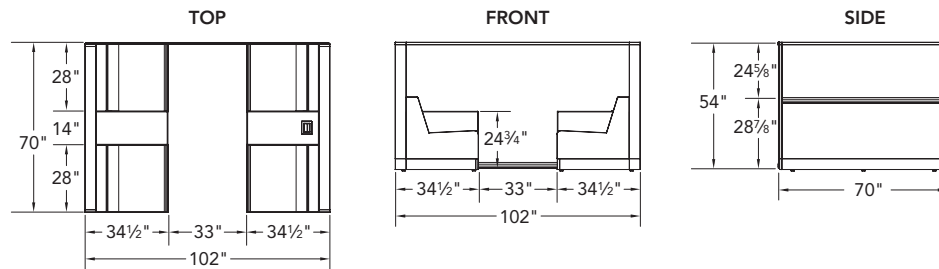

70"D x 102"W x 54"H with Storage – GA70MST Units available as power ready left or right, or as non-powered.

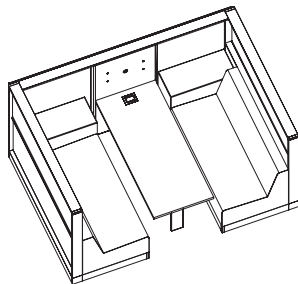
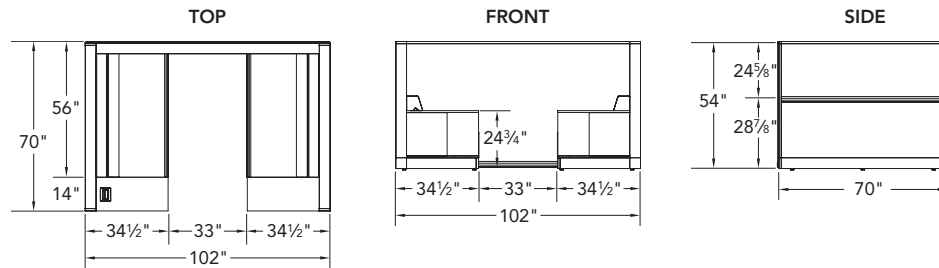

70"D x 102"W x 54"H with Table and Media Wall – GA70MM Units are power ready and available with or without end of bench consoles – either laminate or upholstered.

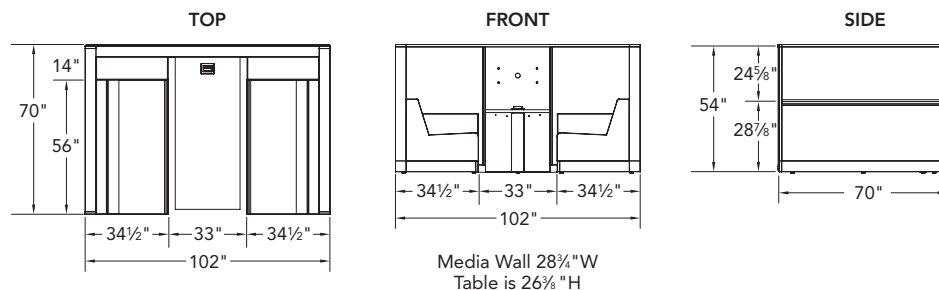

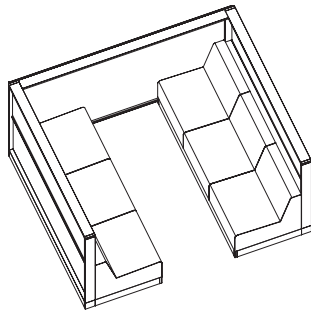

84"D x 102"W x 54"H with Seating – GA84MSE Units are non-powered.

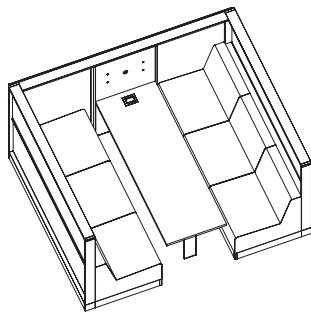
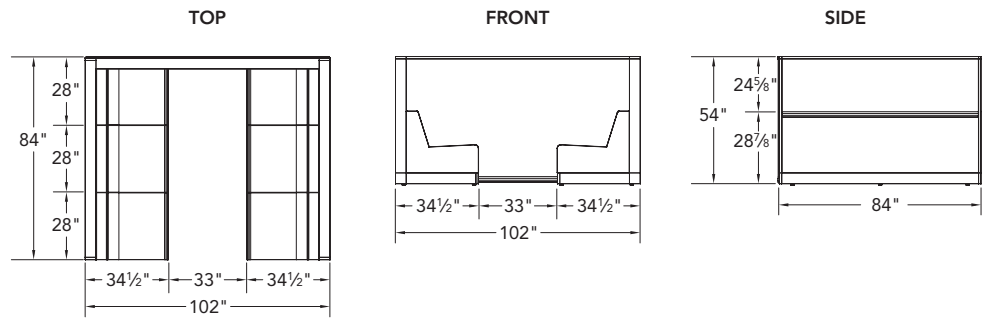

84"D x 102"W x 54"H with Table and Media Wall – GA84MMW Units are power ready.

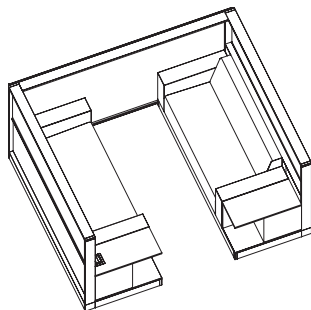
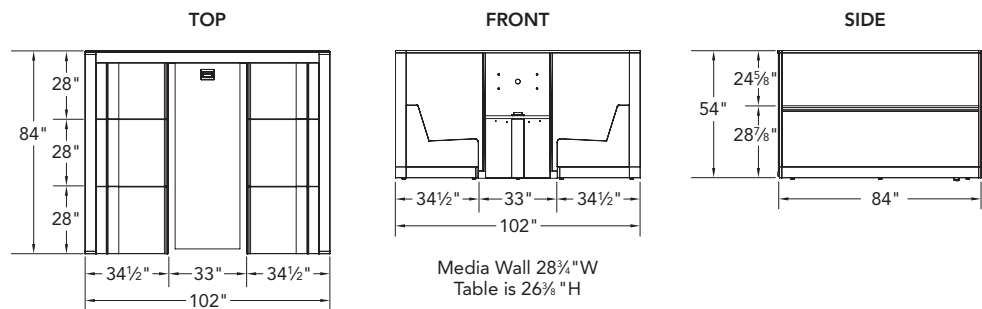

84"D x 102"W x 54"H with Table, Media Wall and Storage – GA84MST Units available as power ready left or right of seat; or as non-powered.

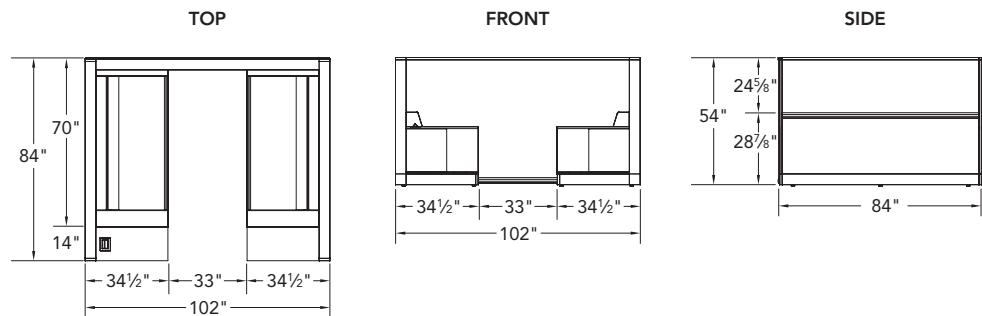

Above power is right of seat.



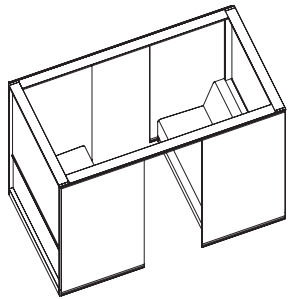

57½"D x 102"W x 83"H with Seating – GA56HSE Units are non-powered.

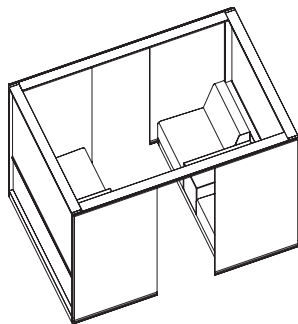
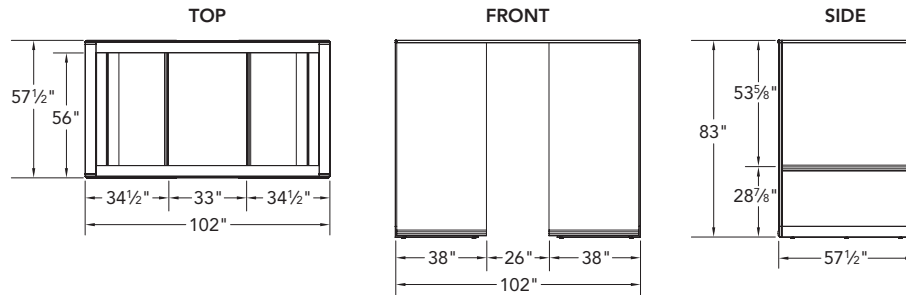

70"D x 102"W x 83"H with Console – GA70HCO Units available as power ready or as non-powered; center consoles are upholstered or laminate.

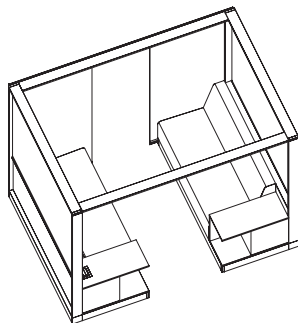
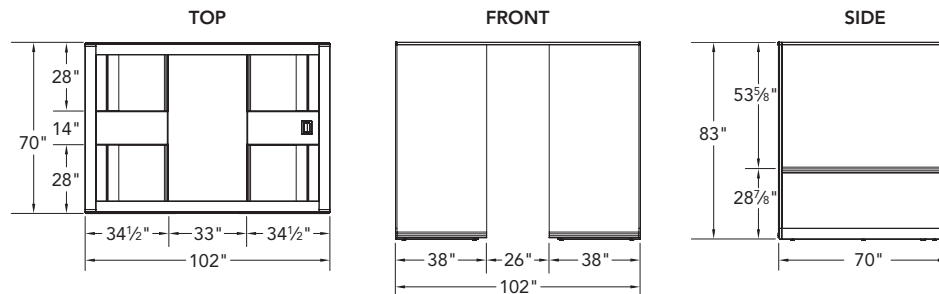

70"D x 102"W x 83"H with Storage – GA70HST Units available as powered left or right of seat, or as non-powered.

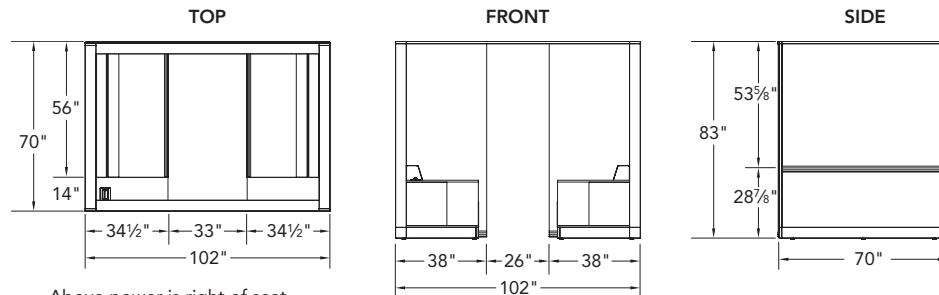

Above power is right of seat.

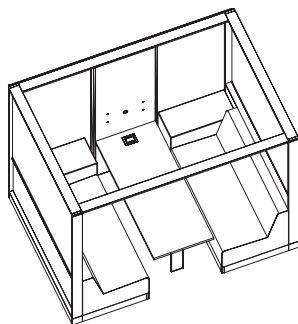

70"D x 102"W x 83"H with Table and Media Wall – GA70HM Units are power ready and available with or without end of bench consoles – either laminate or upholstered.

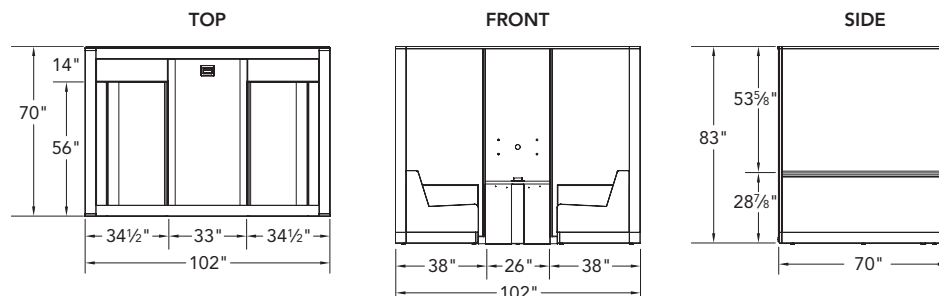

84"D x 102"W x 83"H with Seating – GA84HSE Units are non-powered.

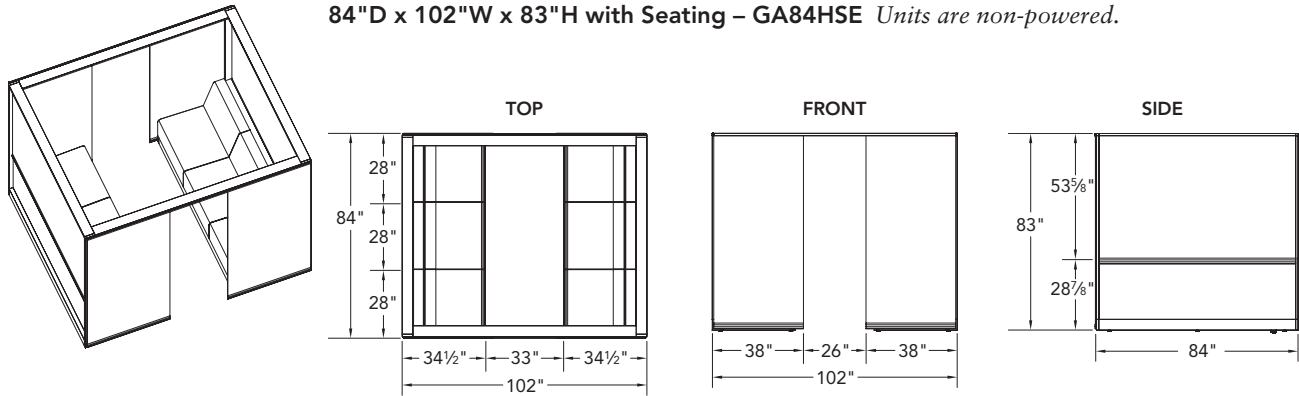

84"D x 102"W x 83"H with Table and Media Wall – GA84HMW Units are power ready.

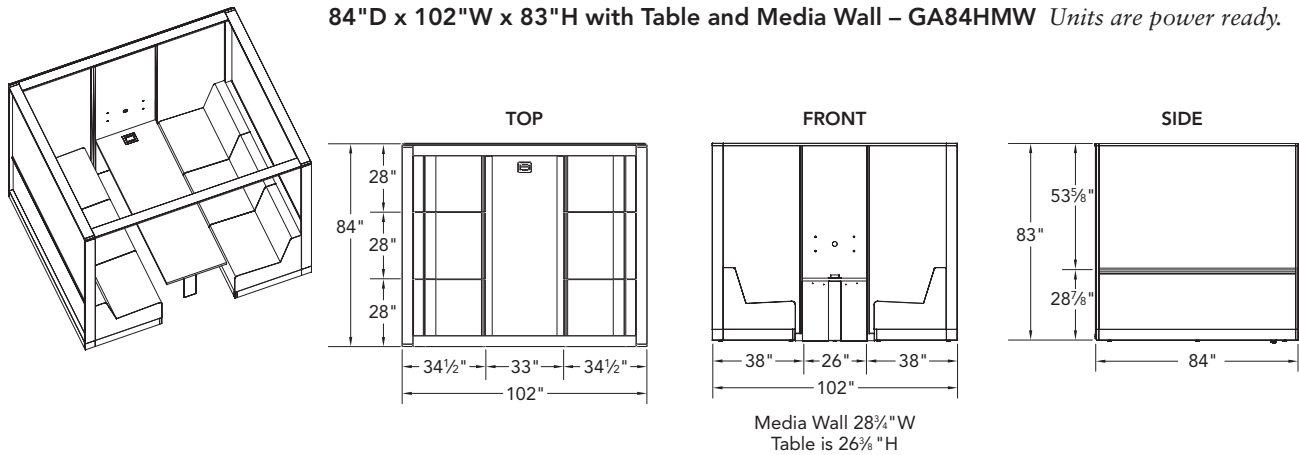

84"D x 102"W x 83"H with Table, Media Wall and Storage – GA84HST Units available as powered left or right of seat; or as non-powered.

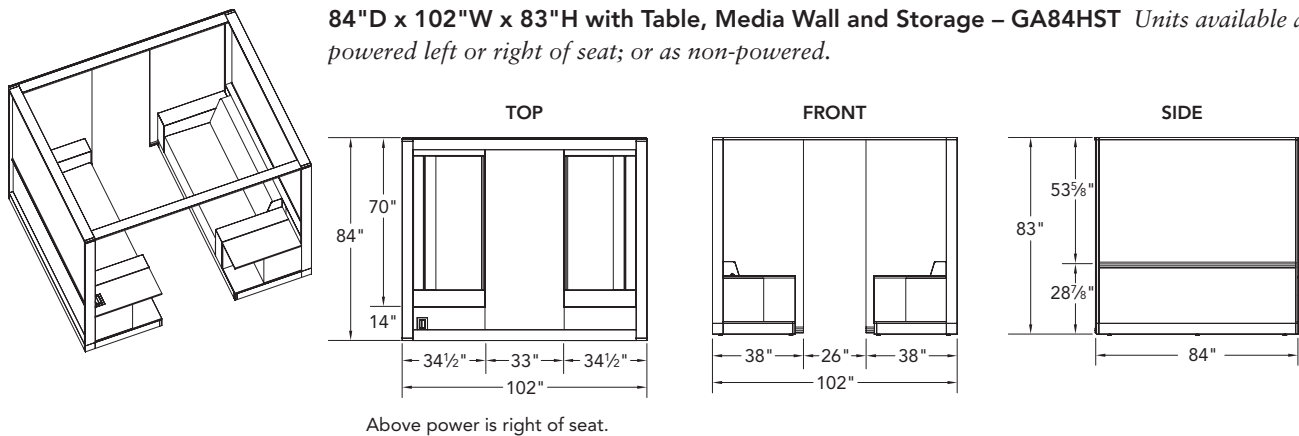

All units below are 54"H x 102"W

(See page 329 for COM pricing on 54"H Grades 7-18)

Table with columns: Description, Model Options, Model Number, Base List Price, Option Upcharges by Grade Selected (1-6). Rows are categorized by Seating, Consoles, Storage, Media Wall & Consoles, and Media Wall, with sub-sections for 56 1/2"D, 70"D, and 84"D.

\*Order TV or Monitor Wall Mount separately. See page 323.

Continued on next page ▶

How to specify —
Select the Model Number from above.

1st Option:

Select the Frame Paint/Finish Color:

- P7A Textured Flint
PR8 Textured Silver
PK7 Textured Designer White

2nd Option:

Select the Back and Side Screen Material:

- CHK Chalk
GRS Greystone
PEW Pewter

3rd Option:

Select the Laminate Finish and Edge for internal Table, Storage and Console Components (if applicable):

See page 311 for laminate and edge selections.

GA

M

Examples: GA56MSENO.P7A.GRS.CTU18.A119.CTU18 GA84MMWFC.P71.GRS.LWBEDE.CTU62.AI62.BOX10



Model Number	COM Yardage					Seat		Arms			Seat Back		Console or Storage		Table			
	Front/Backboard and Storage	Seat — Front, Seat, Back, Top	Seat Side and Console	Height from Floor (Plinth leveling glide variance)	Width	Depth to Bolster	Pan Angle	Height from Seat	Arm Pad Length	Arm Pad Width	Height	Inclination from Vertical	Depth	Width	Length	Width	Ship Weight	Cubbs
GA56MSE	4	8.5	2	16½"-18¼"	56"	20¼"	4°	—	—	—	16"	16.5	—	—	—	—	698	150
GA70MCOUHP	6.5	9	7.5	16½"-18¼"	28"	20¼"	4°	—	—	—	16"	16.5	18½"	14"	—	—	843	163
GA70MOUNP	6.5	9	7.5	16½"-18¼"	28"	20¼"	4°	—	—	—	16"	16.5	18½"	14"	—	—	843	163
GA70MCOUHP	6.5	9	7.5	16½"-18¼"	28"	20¼"	4°	—	—	—	16"	16.5	18½"	14"	—	—	843	163
GA70MCOUNP	6.5	9	7.5	16½"-18¼"	28"	20¼"	4°	—	—	—	16"	16.5	18½"	14"	—	—	843	163
GA70MCOUHP	6.5	9	6.5	16½"-18¼"	28"	20¼"	4°	—	—	—	16"	16.5	19½"	14"	—	—	853	166
GA70MCOUNP	6.5	9	6.5	16½"-18¼"	28"	20¼"	4°	—	—	—	16"	16.5	19½"	14"	—	—	853	166
GA70MSTHR	8.5	8.5	2	16½"-18¼"	56"	20¼"	4°	—	—	—	16"	16.5	19½"	14"	—	—	839	182
GA70MSTHL	8.5	8.5	2	16½"-18¼"	56"	20¼"	4°	—	—	—	16"	16.5	19½"	14"	—	—	839	182
GA70MSTNP	8.5	8.5	2	16½"-18¼"	56"	20¼"	4°	—	—	—	16"	16.5	19½"	14"	—	—	839	182
GA70MMCUCU	6.5	8.5	5.5	16½"-18¼"	56"	20¼"	4°	—	—	—	16"	16.5	18½"	14"	63½"	27"	1155	202
GA70MMCL	6.5	8.5	4.5	16½"-18¼"	56"	20¼"	4°	—	—	—	16"	16.5	19½"	14"	63½"	27"	1165	204
GA84MSE	5	13.5	6	16½"-18¼"	28"	20¼"	4°	—	—	—	16"	16.5	—	—	—	—	926	193
GA84MMW	5	13.5	6	16½"-18¼"	28"	20¼"	4°	—	—	—	16"	16.5	—	—	77½"	27"	1236	215
GA84MSTHR	10.5	8.5	8	16½"-18¼"	56"	20¼"	4°	9¾"	23"	7"	16"	16.5	19½"	14"	—	—	1020	215
GA84MSTHL	10.5	8.5	8	16½"-18¼"	56"	20¼"	4°	9¾"	23"	7"	16"	16.5	19½"	14"	—	—	1020	215
GA84MSTNP	10.5	8.5	8	16½"-18¼"	56"	20¼"	4°	9¾"	23"	7"	16"	16.5	19½"	14"	—	—	1020	215

◀ Continued from previous page

<p><i>4th Option:</i> <b>Select the Frontboard/Backboard and Storage Upholstery (if applicable):</b> See page 310 for upholstery selections.</p>	<p><i>5th Option:</i> <b>Select the Seating Upholstery:</b> See page 310 for upholstery selections.</p>	<p><i>6th Option:</i> <b>Select the Seating Side and Console Upholstery (if applicable):</b> See page 310 for upholstery selections.</p>
--	---	--

All units below are 83"H x 102"W

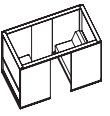
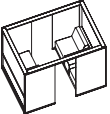
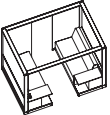
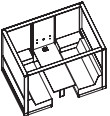
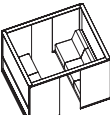
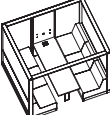
(See page 330 for COM pricing on 83"H Grades 7-18)

	Description	Model Options	Model Number	Base List Price	Option Upcharges by Grade Selected							
					1	2	3	4	5	6		
56 1/2" D Seating		56 1/4" D Seating, No Power	<b>GA56HSE</b>	\$ 24492	—	—	—	—	—	—		
		Frontboard/Backboard Upholstery			\$ 0	\$ 71	\$ 143	\$ 287	\$ 432	\$ 576		
		Seating Upholstery			\$ 0	\$ 175	\$ 350	\$ 701	\$ 1052	\$ 1402		
		Seating Side Upholstery			\$ 0	\$ 41	\$ 81	\$ 163	\$ 245	\$ 325		
70" D Consoles		70" D Upholstered Consoles, Power Ready	<b>GA70HCOUHP</b>	\$ 31630	—	—	—	—	—	—		
		70" D Upholstered Consoles, No Power	<b>GA70HCOUNP</b>	\$ 31628	—	—	—	—	—	—		
		Frontboard/Backboard Upholstery			\$ 0	\$ 71	\$ 143	\$ 287	\$ 432	\$ 576		
		Seating Upholstery			\$ 0	\$ 167	\$ 336	\$ 672	\$ 1009	\$ 1344		
		Seating Side/Console Upholstery			\$ 0	\$ 143	\$ 287	\$ 576	\$ 864	\$ 1153		
		70" D Laminate Consoles, Power Ready	<b>GA70HCOLHP</b>	\$ 32311	—	—	—	—	—	—		
		70" D Laminate Consoles, No Power	<b>GA70HCOLNP</b>	\$ 32308	—	—	—	—	—	—		
		Console Laminate/Laminate Edge			\$ 0	\$ 35	\$ 62	—	—	—		
70" D Storage		70" D Storage, Power Ready (Right of Seat — shown)	<b>GA70HSTHR</b>	\$ 29078	—	—	—	—	—	—		
		70" D Storage, Power Ready (Left of Seat)	<b>GA70HSTHL</b>	\$ 29078	—	—	—	—	—	—		
		70" D Storage, No Power	<b>GA70HSTNP</b>	\$ 29066	—	—	—	—	—	—		
		Storage Laminate/Laminate Edge			\$ 0	\$ 114	\$ 234	—	—	—		
		Frontboard/Backboard/Storage Upholstery			\$ 0	\$ 83	\$ 167	\$ 336	\$ 504	\$ 672		
		Seating Upholstery			\$ 0	\$ 175	\$ 350	\$ 701	\$ 1052	\$ 1402		
		Seating Side Upholstery			\$ 0	\$ 41	\$ 81	\$ 163	\$ 245	\$ 325		
		70" D Media Wall & Consoles		70" D Media Wall*, Uph. Consoles, Power Ready	<b>GA70HMCU</b>	\$ 34583	—	—	—	—	—	—
				Table/Media Wall Laminate/Laminate Edge			\$ 0	\$ 195	\$ 387	—	—	—
				Frontboard/Backboard Upholstery			\$ 0	\$ 71	\$ 143	\$ 287	\$ 432	\$ 576
				Seating Upholstery			\$ 0	\$ 175	\$ 350	\$ 701	\$ 1052	\$ 1402
				Seating Side/Console Upholstery			\$ 0	\$ 112	\$ 225	\$ 452	\$ 677	\$ 903
				70" D Media Wall*, Lam. Consoles, Power Ready	<b>GA70HMCL</b>	\$ 35263	—	—	—	—	—	—
				Table/Media Wall/Console Lam./Lam. Edge			\$ 0	\$ 195	\$ 387	—	—	—
				Frontboard/Backboard Upholstery			\$ 0	\$ 71	\$ 143	\$ 287	\$ 432	\$ 576
		84" D Seating		84" D Seating, No Power	<b>GA84HSE</b>	\$ 33024	—	—	—	—	—	—
Frontboard/Backboard Upholstery					\$ 0	\$ 71	\$ 143	\$ 287	\$ 432	\$ 576		
Seating Upholstery					\$ 0	\$ 252	\$ 504	\$ 1009	\$ 1513	\$ 2018		
Seating Side Upholstery					\$ 0	\$ 107	\$ 216	\$ 432	\$ 648	\$ 864		
84" D Media Wall				84" D Media Wall*, Power Ready	<b>GA84HMW</b>	\$ 37793	—	—	—	—	—	—
				Table/Media Wall Laminate/Laminate Edge			\$ 0	\$ 23	\$ 43	—	—	—
				Frontboard/Backboard Upholstery			\$ 0	\$ 71	\$ 143	\$ 287	\$ 432	\$ 576
				Seating Upholstery			\$ 0	\$ 252	\$ 504	\$ 1009	\$ 1513	\$ 2018
84" D Storage				Seating Side Upholstery			\$ 0	\$ 107	\$ 216	\$ 432	\$ 648	\$ 864
				84" D Storage, Power Ready (Right of Seat — shown)	<b>GA84HSTHR</b>	\$ 35038	—	—	—	—	—	—
				84" D Storage, Power Ready (Left of Seat)	<b>GA84HSTHL</b>	\$ 35038	—	—	—	—	—	—
				84" D Storage, No Power	<b>GA84HSTNP</b>	\$ 35036	—	—	—	—	—	—
				Storage Laminate/Laminate Edge			\$ 0	\$ 114	\$ 234	—	—	—
				Frontboard/Backboard/Storage Upholstery			\$ 0	\$ 83	\$ 167	\$ 336	\$ 504	\$ 672
				Seating Upholstery			\$ 0	\$ 161	\$ 321	\$ 644	\$ 966	\$ 1287
				Seating Side Upholstery			\$ 0	\$ 151	\$ 302	\$ 605	\$ 908	\$ 1210

\*Order TV or Monitor Wall Mount separately. See page 323.

Continued on next page ▶

<p><b>How to specify —</b> Select the Model Number from above.</p>	<p><i>1st Option:</i> Select the Frame Paint/Finish Color: <b>P7A</b> Textured Flint <b>PR8</b> Textured Silver <b>PK7</b> Textured Designer White</p>	<p><i>2nd Option:</i> Select the Back and Side Screen Material: <b>CHK</b> Chalk <b>GRS</b> Greystone <b>PEW</b> Pewter</p>	<p><i>3rd Option:</i> Select the Laminate Finish and Edge for internal Table, Storage and Console Components (if applicable): See page 311 for laminate and edge selections.</p>
GA       H           .	.	.	.

Examples: GA56HSENO.P7A.GRS.CTU18.AI19.CTU18 GA84HMWFC.P71.GRS.LWBEDE.CTU62. AI62.BOX10

Model Number	COM Yardage					Seat		Arms			Seat Back		Console or Storage		Table		Cubbs	
	Front/Backboard and Storage	Seat — Front, Seat, Back, Top	Seat Side and Console	Height from Floor (Plinth leveling glide variance)	Width	Depth to Bolster	Pan Angle	Height from Seat	Arm Pad Length	Arm Pad Width	Height	Inclination from Vertical	Depth	Width	Length	Width		Ship Weight
GA56HSE	4	8.5	2	16½"-18¼"	56"	20¼"	4°	—	—	—	16"	16.5	—	—	—	—	732	149
GA70HCOUHP	6.5	9	7.5	16½"-18¼"	28"	20¼"	4°	—	—	—	16"	16.5	18½"	14"	—	—	877	162
GA70HCOUNP	6.5	9	7.5	16½"-18¼"	28"	20¼"	4°	—	—	—	16"	16.5	18½"	14"	—	—	877	162
GA70HCOLHP	6.5	9	6.5	16½"-18¼"	28"	20¼"	4°	—	—	—	16"	16.5	19½"	14"	—	—	887	166
GA70HCOLNP	6.5	9	6.5	16½"-18¼"	28"	20¼"	4°	—	—	—	16"	16.5	19½"	14"	—	—	887	166
GA70HSTHR	8.5	8.5	2	16½"-18¼"	56"	20¼"	4°	—	—	—	16"	16.5	19½"	14"	—	—	863	181
GA70HSTHL	8.5	8.5	2	16½"-18¼"	56"	20¼"	4°	—	—	—	16"	16.5	19½"	14"	—	—	863	181
GA70HSTNP	8.5	8.5	2	16½"-18¼"	56"	20¼"	4°	—	—	—	16"	16.5	19½"	14"	—	—	863	181
GA70HMCU	6.5	8.5	5.5	16½"-18¼"	56"	20¼"	4°	—	—	—	16"	16.5	18½"	14"	63½"	27"	1209	208
GA70HMCL	6.5	8.5	4.5	16½"-18¼"	56"	20¼"	4°	—	—	—	16"	16.5	19½"	14"	63½"	27"	1219	212
GA84HSE	5	13.5	6	16½"-18¼"	28"	20¼"	4°	—	—	—	16"	16.5	—	—	—	—	960	192
GA84HMW	5	13.5	6	16½"-18¼"	28"	20¼"	4°	—	—	—	16"	16.5	—	—	77½"	27"	1290	221
GA84HSTHR	10.5	8.5	8	16½"-18¼"	56"	20¼"	4°	9½"	23"	7"	16"	16.5	19½"	14"	—	—	1044	214
GA84HSTHL	10.5	8.5	8	16½"-18¼"	56"	20¼"	4°	9½"	23"	7"	16"	16.5	19½"	14"	—	—	1044	214
GA84HSTNP	10.5	8.5	8	16½"-18¼"	56"	20¼"	4°	9½"	23"	7"	16"	16.5	19½"	14"	—	—	1044	214

◀ Continued from previous page

<p><b>4th Option:</b> Select the Frontboard/Backboard and Storage Upholstery (if applicable): See page 310 for upholstery selections.</p>	<p><b>5th Option:</b> Select the Seating Upholstery: See page 310 for upholstery selections.</p>	<p><b>6th Option:</b> Select the Seating Side and Console Upholstery (if applicable): See page 310 for upholstery selections.</p>
---	--	---

**CONSOLE AND STORAGE ELECTRICAL**

Console and storage Clubhouse units that are “power ready” require electrical module kits to be ordered separately based on local requirements. Select either Standard, Hardwire, or New York standard kits. Consult with your local electrician for the unit that is in compliance

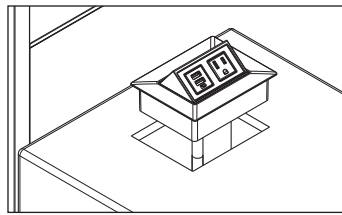

with local and national electrical codes. Verify code requirements before ordering. Chicago requires hardwiring. Exposed power module (shown) consists of one simplex receptacle and one USB hub for powering two devices.

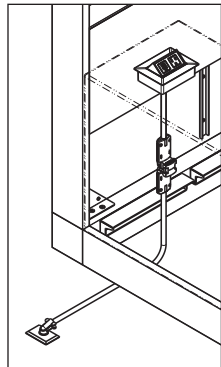

Standard Kit

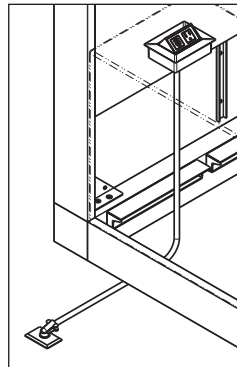

Hardwire Kit

**Standard Electrical Kit** for Clubhouse “power ready” console or storage units comes with one power module with 72" cord, H-connector, and a 72" sealtight infeed cable. The infeed cable can be connected to a power monument located within the plinth base on the side where the powered console or storage unit is located; or it can be routed under the plinth base to an external power monument as shown above.

**Hardwire Electrical Kit** for Clubhouse “power ready” console or storage units comes with one power module with a 110" of flex cable. The infeed cable can be connected to a power monument located within the plinth base on the side where the powered console or storage unit is located; or it can be routed under the plinth base to an external power monument as shown above.

**New York Electrical Kit** for Clubhouse “power ready” console or storage comes with one power module, H-connector, and cable to New York infeed box which can be attached to the inside surface of plinth base.

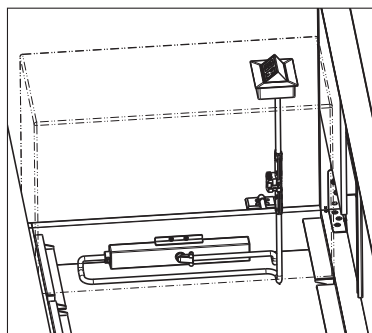

**MEDIA WALL ELECTRICAL**

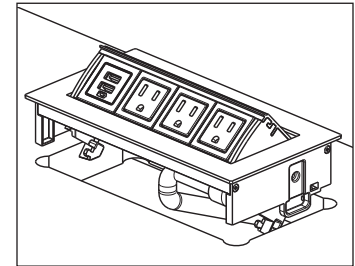
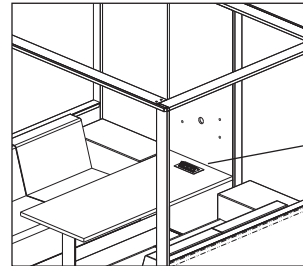

Media Wall Clubhouse units are “power ready” and require electrical module kits to be ordered separately based on local requirements. Select either Standard, Hardwire, or New York Standard kits. Consult with your local electrician for the unit that is in compliance with local and national electrical codes. Verify code requirements before ordering. Chicago requires hardwiring. Exposed power module (shown above) consists of three simplex receptacles and a USB hub for powering two devices.

**Standard Electrical Kit** for Clubhouse “power ready” media wall units comes with one external power module (described above), one internal power module with two simplex outlets to power monitor and accessory, H-connector, and a 72" sealtight infeed cable.

The infeed cable for Standard or Hardwire electrical can be connected to a power monument located within the plinth base on either side of unit; or it can be routed under the plinth base to an external power monument as shown above.

**Hardwire Electrical Kit** for Clubhouse media wall units comes with one external power module (described above), one internal power module with 72" cord and two simplex outlets to power monitor and accessory, H-connector, and a 72" flex infeed cable.

**New York Electrical Kit** for Clubhouse media wall units comes with one external power module (described above), one internal power module with 72" cord and two simplex outlets to power monitor and accessory, H-connector, and cable to New York infeed box which can be attached to the inside surface of plinth base (shown at right).

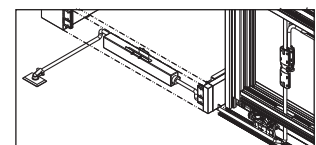
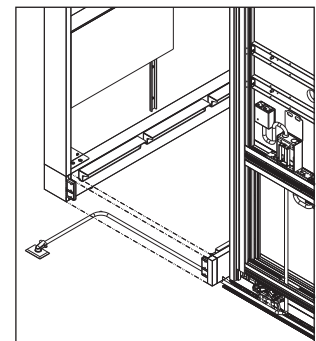
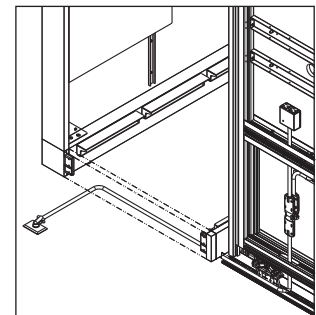

For specification information see page 322.

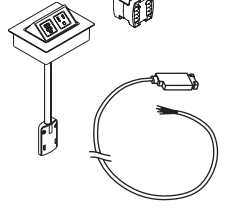
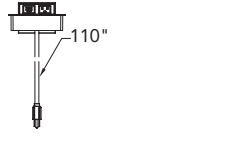
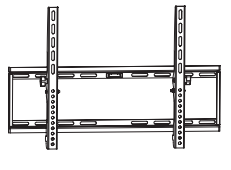
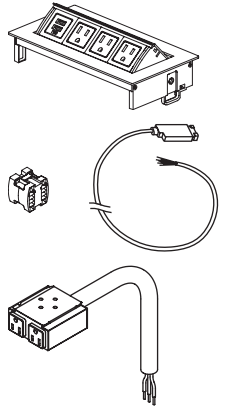
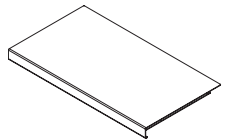
	Description	Model Number	List Price
	<b>Electrical Module Kits for "Power Ready" Models</b>		
	Standard Power Module Kit for Storage or Console Units	GAPWRSC <i>(De-emphasized)</i>	\$ 673
	Chicago (Hardwire) Power Module Kit for Storage or Console Units	GAPWRSCCN <i>(De-emphasized)</i>	\$ 584
	New York Power Module Kit for Storage or Console Units	GAPWRSCNY <i>(De-emphasized)</i>	\$ 762
	Standard Power Module with 3-prong plug; 110" cord	GAPWR <i>(De-emphasized)</i>	\$ 527
	<b>Tilt Wall Mount for 32" to 70" TVs or Monitors</b>		
	26½"W x 17½"H; -10° -0° Tilt	GATVMB	\$ 527
	Includes mounting hardware and conforms to VESA-compliant displays. Supports up to 165 lbs.		
	Standard Power Module Kit for Media Wall Units	GAPWRMW	\$ 942
	Chicago (Hardwire) Power Module Kit for Media Wall Units	GAPWRMWCH	\$ 1058
	New York Power Module Kit for Media Wall Units	GAPWRMWNY	\$ 1145
	<b>Table Extension — Specify Paint Color for Metal Tray</b>		
	24"W x 13¼"D x 1½" Thick	GATBLEXT	\$ 439
	Glides provide 7" extension toward user.		

<p><b>How to specify —</b> Select the Model Number from above.</p> <p>G A                     .                    </p>	<p><i>1st Option:</i> <b>Paint Colors for Table Extension:</b>  <b>P02</b> Flint  <b>PR6</b> Silver  <b>PJW</b> Designer White</p>
---	--

Examples: GAPWRSC GAPWRMWNY GATVMB GATBLEXT.PR6



Model Number	Grade 9	Grade 10	Grade 11	Grade 12	Grade 13	Grade 14	Grade 15	Grade 16	Grade 17	Grade 18	Grade 19	Grade 20	Grade 21	Grade 22	
<b>TOWNHALL ROCK SINGLE UPHOLSTERY</b> — Pages <a href="#">216-217</a>															
ACEGUS	\$ 2521	\$ 761	\$ 867	\$ 972	\$ 1076	\$ 1208	\$ 1339	\$ 1471	\$ 1602	\$ 1734	\$ 1864	\$ 1996	\$ 2127	\$ 2259	\$ 2390
<b>TOWNHALL ROCK MULTI UPHOLSTERY</b> — Pages <a href="#">216-217</a>															
ACEGUM	\$ 2646														
	Seat/Cushion	\$ 381	\$ 433	\$ 486	\$ 538	\$ 604	\$ 670	\$ 735	\$ 801	\$ 867	\$ 932	\$ 998	\$ 1063	\$ 1130	\$ 1195
	Back/Shell/Body	\$ 534	\$ 607	\$ 681	\$ 754	\$ 845	\$ 938	\$ 1029	\$ 1121	\$ 1214	\$ 1305	\$ 1397	\$ 1489	\$ 1581	\$ 1673
<b>TOWNHALL WEDGE MULTI UPHOLSTERY</b> — Pages <a href="#">218-219</a>															
ACWEDM	\$ 3424														
	Seat	\$ 152	\$ 174	\$ 195	\$ 215	\$ 241	\$ 268	\$ 294	\$ 320	\$ 347	\$ 373	\$ 399	\$ 426	\$ 452	\$ 478
	Back	\$ 457	\$ 520	\$ 583	\$ 646	\$ 725	\$ 804	\$ 882	\$ 961	\$ 1040	\$ 1119	\$ 1197	\$ 1277	\$ 1355	\$ 1434
<b>TOWNHALL WEDGE SINGLE UPHOLSTERY</b> — Pages <a href="#">218-219</a>															
ACWEDS	\$ 3261	\$ 610	\$ 694	\$ 778	\$ 862	\$ 966	\$ 1072	\$ 1177	\$ 1281	\$ 1387	\$ 1492	\$ 1597	\$ 1702	\$ 1807	\$ 1912
<b>TOWNHALL PEAK MULTI UPHOLSTERY</b> — Pages <a href="#">212-213</a>															
ACVISDLM	\$ 4670														
	Seat	\$ 549	\$ 624	\$ 699	\$ 775	\$ 870	\$ 964	\$ 1059	\$ 1154	\$ 1249	\$ 1342	\$ 1437	\$ 1532	\$ 1627	\$ 1721
	Back	\$ 472	\$ 538	\$ 602	\$ 668	\$ 749	\$ 830	\$ 912	\$ 993	\$ 1075	\$ 1156	\$ 1238	\$ 1319	\$ 1400	\$ 1482
	Welt	\$ 305	\$ 347	\$ 389	\$ 431	\$ 483	\$ 536	\$ 588	\$ 640	\$ 694	\$ 746	\$ 798	\$ 851	\$ 903	\$ 956
ACVISDRM	\$ 4670														
	Seat	\$ 549	\$ 624	\$ 699	\$ 775	\$ 870	\$ 964	\$ 1059	\$ 1154	\$ 1249	\$ 1342	\$ 1437	\$ 1532	\$ 1627	\$ 1721
	Back	\$ 472	\$ 538	\$ 602	\$ 668	\$ 749	\$ 830	\$ 912	\$ 993	\$ 1075	\$ 1156	\$ 1238	\$ 1319	\$ 1400	\$ 1482
	Welt	\$ 305	\$ 347	\$ 389	\$ 431	\$ 483	\$ 536	\$ 588	\$ 640	\$ 694	\$ 746	\$ 798	\$ 851	\$ 903	\$ 956
ACVISSLM	\$ 3112														
	Seat	\$ 228	\$ 260	\$ 292	\$ 323	\$ 362	\$ 402	\$ 441	\$ 480	\$ 520	\$ 560	\$ 599	\$ 638	\$ 677	\$ 717
	Back	\$ 274	\$ 312	\$ 349	\$ 387	\$ 435	\$ 482	\$ 529	\$ 577	\$ 624	\$ 671	\$ 719	\$ 766	\$ 814	\$ 861
	Welt	\$ 198	\$ 225	\$ 252	\$ 280	\$ 314	\$ 348	\$ 382	\$ 417	\$ 451	\$ 484	\$ 519	\$ 553	\$ 587	\$ 622
ACVISSRM	\$ 3112														
	Seat	\$ 228	\$ 260	\$ 292	\$ 323	\$ 362	\$ 402	\$ 441	\$ 480	\$ 520	\$ 560	\$ 599	\$ 638	\$ 677	\$ 717
	Back	\$ 274	\$ 312	\$ 349	\$ 387	\$ 435	\$ 482	\$ 529	\$ 577	\$ 624	\$ 671	\$ 719	\$ 766	\$ 814	\$ 861
	Welt	\$ 198	\$ 225	\$ 252	\$ 280	\$ 314	\$ 348	\$ 382	\$ 417	\$ 451	\$ 484	\$ 519	\$ 553	\$ 587	\$ 622
<b>TOWNHALL PEAK SINGLE UPHOLSTERY</b> — Pages <a href="#">212-213</a>															
ACVISDLS	\$ 4447	\$ 1325	\$ 1508	\$ 1691	\$ 1874	\$ 2102	\$ 2331	\$ 2559	\$ 2788	\$ 3017	\$ 3244	\$ 3473	\$ 3702	\$ 3930	\$ 4159
ACVISDRS	\$ 4447	\$ 1325	\$ 1508	\$ 1691	\$ 1874	\$ 2102	\$ 2331	\$ 2559	\$ 2788	\$ 3017	\$ 3244	\$ 3473	\$ 3702	\$ 3930	\$ 4159
ACVISSLS	\$ 2964	\$ 700	\$ 797	\$ 894	\$ 990	\$ 1111	\$ 1232	\$ 1353	\$ 1474	\$ 1595	\$ 1715	\$ 1836	\$ 1957	\$ 2078	\$ 2199
ACVISSRS	\$ 2964	\$ 700	\$ 797	\$ 894	\$ 990	\$ 1111	\$ 1232	\$ 1353	\$ 1474	\$ 1595	\$ 1715	\$ 1836	\$ 1957	\$ 2078	\$ 2199
ACVISOTS	\$ 1927	\$ 576	\$ 654	\$ 733	\$ 814	\$ 912	\$ 1011	\$ 1109	\$ 1209	\$ 1307	\$ 1407	\$ 1507	\$ 1605	\$ 1704	\$ 1802
<b>TOWNHALL SUMMIT STOOL</b> — Page <a href="#">224</a>															
ACPERU	\$ 963	\$ 76	\$ 87	\$ 98	\$ 107	\$ 120	\$ 133	\$ 147	\$ 160	\$ 174	\$ 187	\$ 200	\$ 213	\$ 226	\$ 239
<b>TOWNHALL PICNIC BENCH UPHOLSTERY</b> — Pages <a href="#">222-223</a>															
ACPICBU	\$ 1481	\$ 152	\$ 174	\$ 195	\$ 215	\$ 241	\$ 268	\$ 294	\$ 320	\$ 347	\$ 373	\$ 399	\$ 426	\$ 452	\$ 478
<i>(De-emphasized)</i>															
<b>TOWNHALL PICNIC LOW STOOL</b> — Pages <a href="#">222-223</a>															
ACPICLS	\$ 741	\$ 76	\$ 87	\$ 98	\$ 107	\$ 120	\$ 133	\$ 147	\$ 160	\$ 174	\$ 187	\$ 200	\$ 213	\$ 226	\$ 239
<i>(De-emphasized)</i>															
<b>PARK LOUNGE SINGLE UPHOLSTERY</b> — Pages <a href="#">228-229</a>															
NALS	\$ 2822	\$ 381	\$ 433	\$ 486	\$ 538	\$ 604	\$ 670	\$ 735	\$ 801	\$ 867	\$ 932	\$ 998	\$ 1063	\$ 1130	\$ 1195
NALD	\$ 4516	\$ 534	\$ 607	\$ 681	\$ 754	\$ 845	\$ 938	\$ 1029	\$ 1121	\$ 1214	\$ 1305	\$ 1397	\$ 1489	\$ 1581	\$ 1673
NAHS	\$ 3668	\$ 534	\$ 607	\$ 681	\$ 754	\$ 845	\$ 938	\$ 1029	\$ 1121	\$ 1214	\$ 1305	\$ 1397	\$ 1489	\$ 1581	\$ 1673
NAHD	\$ 6068	\$ 761	\$ 867	\$ 972	\$ 1076	\$ 1208	\$ 1339	\$ 1471	\$ 1602	\$ 1734	\$ 1864	\$ 1996	\$ 2127	\$ 2259	\$ 2390

Model Number		Grade 9	Grade 10	Grade 11	Grade 12	Grade 13	Grade 14	Grade 15	Grade 16	Grade 17	Grade 18	Grade 19	Grade 20	Grade 21	Grade 22
<b>PARK LOUNGE MULTI-UPHOLSTERY — Pages 230-231</b>															
NALSM	\$ 2964														
	Seat	\$ 76	\$ 87	\$ 98	\$ 107	\$ 120	\$ 133	\$ 147	\$ 160	\$ 174	\$ 187	\$ 200	\$ 213	\$ 226	\$ 239
	Back	\$ 305	\$ 347	\$ 389	\$ 431	\$ 483	\$ 536	\$ 588	\$ 640	\$ 694	\$ 746	\$ 798	\$ 851	\$ 903	\$ 956
NALDM	\$ 4741														
	Seat	\$ 137	\$ 156	\$ 175	\$ 193	\$ 217	\$ 241	\$ 264	\$ 288	\$ 312	\$ 335	\$ 359	\$ 383	\$ 407	\$ 430
	Back	\$ 442	\$ 503	\$ 564	\$ 625	\$ 700	\$ 777	\$ 853	\$ 929	\$ 1005	\$ 1082	\$ 1158	\$ 1234	\$ 1310	\$ 1386
NAHSM	\$ 3851														
	Seat	\$ 137	\$ 156	\$ 175	\$ 193	\$ 217	\$ 241	\$ 264	\$ 288	\$ 312	\$ 335	\$ 359	\$ 383	\$ 407	\$ 430
	Back	\$ 442	\$ 503	\$ 564	\$ 625	\$ 700	\$ 777	\$ 853	\$ 929	\$ 1005	\$ 1082	\$ 1158	\$ 1234	\$ 1310	\$ 1386
NAHDM	\$ 6371														
	Seat	\$ 320	\$ 363	\$ 408	\$ 452	\$ 507	\$ 563	\$ 617	\$ 673	\$ 728	\$ 783	\$ 839	\$ 893	\$ 949	\$ 1003
	Back	\$ 442	\$ 503	\$ 564	\$ 625	\$ 700	\$ 777	\$ 853	\$ 929	\$ 1005	\$ 1082	\$ 1158	\$ 1234	\$ 1310	\$ 1386
<b>Recharge Single Seats — Pages 244-245</b>															
MLM1	Seat	\$ 503	\$ 572	\$ 641	\$ 711	\$ 797	\$ 884	\$ 971	\$ 1058	\$ 1144	\$ 1231	\$ 1317	\$ 1404	\$ 1491	\$ 1578
	Seat Welt	\$ 198	\$ 225	\$ 252	\$ 280	\$ 314	\$ 348	\$ 382	\$ 417	\$ 451	\$ 484	\$ 519	\$ 553	\$ 587	\$ 622
MLM2	Seat	\$ 503	\$ 572	\$ 641	\$ 711	\$ 797	\$ 884	\$ 971	\$ 1058	\$ 1144	\$ 1231	\$ 1317	\$ 1404	\$ 1491	\$ 1578
	Seat Welt	\$ 198	\$ 225	\$ 252	\$ 280	\$ 314	\$ 348	\$ 382	\$ 417	\$ 451	\$ 484	\$ 519	\$ 553	\$ 587	\$ 622
	Bolster	\$ 198	\$ 225	\$ 252	\$ 280	\$ 314	\$ 348	\$ 382	\$ 417	\$ 451	\$ 484	\$ 519	\$ 553	\$ 587	\$ 622
	Bolster Welt	\$ 152	\$ 174	\$ 195	\$ 215	\$ 241	\$ 268	\$ 294	\$ 320	\$ 347	\$ 373	\$ 399	\$ 426	\$ 452	\$ 478
MLM27	Seat	\$ 427	\$ 486	\$ 544	\$ 603	\$ 676	\$ 750	\$ 823	\$ 898	\$ 971	\$ 1045	\$ 1118	\$ 1192	\$ 1265	\$ 1338
	Seat Welt	\$ 121	\$ 139	\$ 155	\$ 173	\$ 193	\$ 214	\$ 235	\$ 257	\$ 277	\$ 298	\$ 320	\$ 341	\$ 361	\$ 382
	Bolster	\$ 350	\$ 398	\$ 447	\$ 495	\$ 555	\$ 616	\$ 676	\$ 737	\$ 797	\$ 857	\$ 918	\$ 978	\$ 1039	\$ 1099
	Bolster Welt	\$ 152	\$ 174	\$ 195	\$ 215	\$ 241	\$ 268	\$ 294	\$ 320	\$ 347	\$ 373	\$ 399	\$ 426	\$ 452	\$ 478
<b>Recharge Double Seats — Pages 244-245</b>															
MLM3	Seat	\$ 761	\$ 867	\$ 972	\$ 1076	\$ 1208	\$ 1339	\$ 1471	\$ 1602	\$ 1734	\$ 1864	\$ 1996	\$ 2127	\$ 2259	\$ 2390
	Seat Welt	\$ 198	\$ 225	\$ 252	\$ 280	\$ 314	\$ 348	\$ 382	\$ 417	\$ 451	\$ 484	\$ 519	\$ 553	\$ 587	\$ 622
MLM4	Seat	\$ 761	\$ 867	\$ 972	\$ 1076	\$ 1208	\$ 1339	\$ 1471	\$ 1602	\$ 1734	\$ 1864	\$ 1996	\$ 2127	\$ 2259	\$ 2390
	Seat Welt	\$ 198	\$ 225	\$ 252	\$ 280	\$ 314	\$ 348	\$ 382	\$ 417	\$ 451	\$ 484	\$ 519	\$ 553	\$ 587	\$ 622
	Bolster	\$ 350	\$ 398	\$ 447	\$ 495	\$ 555	\$ 616	\$ 676	\$ 737	\$ 797	\$ 857	\$ 918	\$ 978	\$ 1039	\$ 1099
	Bolster Welt	\$ 152	\$ 174	\$ 195	\$ 215	\$ 241	\$ 268	\$ 294	\$ 320	\$ 347	\$ 373	\$ 399	\$ 426	\$ 452	\$ 478
MLM9	Seat	\$ 761	\$ 867	\$ 972	\$ 1076	\$ 1208	\$ 1339	\$ 1471	\$ 1602	\$ 1734	\$ 1864	\$ 1996	\$ 2127	\$ 2259	\$ 2390
	Seat Welt	\$ 198	\$ 225	\$ 252	\$ 280	\$ 314	\$ 348	\$ 382	\$ 417	\$ 451	\$ 484	\$ 519	\$ 553	\$ 587	\$ 622
	Bolster	\$ 198	\$ 225	\$ 252	\$ 280	\$ 314	\$ 348	\$ 382	\$ 417	\$ 451	\$ 484	\$ 519	\$ 553	\$ 587	\$ 622
	Bolster Welt	\$ 152	\$ 174	\$ 195	\$ 215	\$ 241	\$ 268	\$ 294	\$ 320	\$ 347	\$ 373	\$ 399	\$ 426	\$ 452	\$ 478
MLM10	Seat	\$ 761	\$ 867	\$ 972	\$ 1076	\$ 1208	\$ 1339	\$ 1471	\$ 1602	\$ 1734	\$ 1864	\$ 1996	\$ 2127	\$ 2259	\$ 2390
	Seat Welt	\$ 198	\$ 225	\$ 252	\$ 280	\$ 314	\$ 348	\$ 382	\$ 417	\$ 451	\$ 484	\$ 519	\$ 553	\$ 587	\$ 622
	Bolster	\$ 198	\$ 225	\$ 252	\$ 280	\$ 314	\$ 348	\$ 382	\$ 417	\$ 451	\$ 484	\$ 519	\$ 553	\$ 587	\$ 622
	Bolster Welt	\$ 152	\$ 174	\$ 195	\$ 215	\$ 241	\$ 268	\$ 294	\$ 320	\$ 347	\$ 373	\$ 399	\$ 426	\$ 452	\$ 478
<b>Recharge Double Seats — Pages 246-249</b>															
MLM11	Seat	\$ 761	\$ 867	\$ 972	\$ 1076	\$ 1208	\$ 1339	\$ 1471	\$ 1602	\$ 1734	\$ 1864	\$ 1996	\$ 2127	\$ 2259	\$ 2390
	Seat Welt	\$ 198	\$ 225	\$ 252	\$ 280	\$ 314	\$ 348	\$ 382	\$ 417	\$ 451	\$ 484	\$ 519	\$ 553	\$ 587	\$ 622
	Bolster	\$ 503	\$ 572	\$ 641	\$ 711	\$ 797	\$ 884	\$ 971	\$ 1058	\$ 1144	\$ 1231	\$ 1317	\$ 1404	\$ 1491	\$ 1578
	Bolster Welt	\$ 152	\$ 174	\$ 195	\$ 215	\$ 241	\$ 268	\$ 294	\$ 320	\$ 347	\$ 373	\$ 399	\$ 426	\$ 452	\$ 478
MLM13	Seat	\$ 761	\$ 867	\$ 972	\$ 1076	\$ 1208	\$ 1339	\$ 1471	\$ 1602	\$ 1734	\$ 1864	\$ 1996	\$ 2127	\$ 2259	\$ 2390
	Seat Welt	\$ 198	\$ 225	\$ 252	\$ 280	\$ 314	\$ 348	\$ 382	\$ 417	\$ 451	\$ 484	\$ 519	\$ 553	\$ 587	\$ 622
	Bolster	\$ 503	\$ 572	\$ 641	\$ 711	\$ 797	\$ 884	\$ 971	\$ 1058	\$ 1144	\$ 1231	\$ 1317	\$ 1404	\$ 1491	\$ 1578
	Bolster Welt	\$ 152	\$ 174	\$ 195	\$ 215	\$ 241	\$ 268	\$ 294	\$ 320	\$ 347	\$ 373	\$ 399	\$ 426	\$ 452	\$ 478
MLM5	Seat	\$ 761	\$ 867	\$ 972	\$ 1076	\$ 1208	\$ 1339	\$ 1471	\$ 1602	\$ 1734	\$ 1864	\$ 1996	\$ 2127	\$ 2259	\$ 2390
	Seat Welt	\$ 198	\$ 225	\$ 252	\$ 280	\$ 314	\$ 348	\$ 382	\$ 417	\$ 451	\$ 484	\$ 519	\$ 553	\$ 587	\$ 622
	Bolster	\$ 350	\$ 398	\$ 447	\$ 495	\$ 555	\$ 616	\$ 676	\$ 737	\$ 797	\$ 857	\$ 918	\$ 978	\$ 1039	\$ 1099
	Bolster Welt	\$ 152	\$ 174	\$ 195	\$ 215	\$ 241	\$ 268	\$ 294	\$ 320	\$ 347	\$ 373	\$ 399	\$ 426	\$ 452	\$ 478
MLM6 &	Seat	\$ 761	\$ 867	\$ 972	\$ 1076	\$ 1208	\$ 1339	\$ 1471	\$ 1602	\$ 1734	\$ 1864	\$ 1996	\$ 2127	\$ 2259	\$ 2390
MLM7	Seat Welt	\$ 198	\$ 225	\$ 252	\$ 280	\$ 314	\$ 348	\$ 382	\$ 417	\$ 451	\$ 484	\$ 519	\$ 553	\$ 587	\$ 622
	Bolster	\$ 350	\$ 398	\$ 447	\$ 495	\$ 555	\$ 616	\$ 676	\$ 737	\$ 797	\$ 857	\$ 918	\$ 978	\$ 1039	\$ 1099
	Bolster Welt	\$ 152	\$ 174	\$ 195	\$ 215	\$ 241	\$ 268	\$ 294	\$ 320	\$ 347	\$ 373	\$ 399	\$ 426	\$ 452	\$ 478
<b>Recharge Double Seats — Pages 246-249</b>															
MLM8	Seat	\$ 761	\$ 867	\$ 972	\$ 1076	\$ 1208	\$ 1339	\$ 1471	\$ 1602	\$ 1734	\$ 1864	\$ 1996	\$ 2127	\$ 2259	\$ 2390
	Seat Welt	\$ 198	\$ 225	\$ 252	\$ 280	\$ 314	\$ 348	\$ 382	\$ 417	\$ 451	\$ 484	\$ 519	\$ 553	\$ 587	\$ 622
	Bolster	\$ 350	\$ 398	\$ 447	\$ 495	\$ 555	\$ 616	\$ 676	\$ 737	\$ 797	\$ 857	\$ 918	\$ 978	\$ 1039	\$ 1099
	Bolster Welt	\$ 152	\$ 174	\$ 195	\$ 215	\$ 241	\$ 268	\$ 294	\$ 320	\$ 347	\$ 373	\$ 399	\$ 426	\$ 452	\$ 478

# Social Collaborative — Seating Collections

# Upholstery Grades 9 to 22 Pricing

Model Number	Grade 9	Grade 10	Grade 11	Grade 12	Grade 13	Grade 14	Grade 15	Grade 16	Grade 17	Grade 18	Grade 19	Grade 20	Grade 21	Grade 22
<b>Recharge™ Poufs — Pages 246-249</b>														
MLM20	Top	\$ 121	\$ 139	\$ 155	\$ 173	\$ 193	\$ 214	\$ 235	\$ 257	\$ 277	\$ 298	\$ 320	\$ 341	\$ 382
	Welt	\$ 152	\$ 174	\$ 195	\$ 215	\$ 241	\$ 268	\$ 294	\$ 320	\$ 347	\$ 373	\$ 399	\$ 426	\$ 478
	Side	\$ 198	\$ 225	\$ 252	\$ 280	\$ 314	\$ 348	\$ 382	\$ 417	\$ 451	\$ 484	\$ 519	\$ 553	\$ 622
MLM21	Top	\$ 121	\$ 139	\$ 155	\$ 173	\$ 193	\$ 214	\$ 235	\$ 257	\$ 277	\$ 298	\$ 320	\$ 341	\$ 382
	Welt	\$ 152	\$ 174	\$ 195	\$ 215	\$ 241	\$ 268	\$ 294	\$ 320	\$ 347	\$ 373	\$ 399	\$ 426	\$ 478
	Side	\$ 198	\$ 225	\$ 252	\$ 280	\$ 314	\$ 348	\$ 382	\$ 417	\$ 451	\$ 484	\$ 519	\$ 553	\$ 622
<b>Rise — Pages 260-265</b>														
S922S2	\$ 4106	\$ 4217	\$ 4330	\$ 4441	\$ 4579	\$ 4719	\$ 4858	\$ 4998	\$ 5136	\$ 5276	\$ 5415	\$ 5554	\$ 5693	\$ 5833
S922S2P	\$ 4200	\$ 4311	\$ 4424	\$ 4535	\$ 4673	\$ 4813	\$ 4952	\$ 5092	\$ 5230	\$ 5370	\$ 5509	\$ 5648	\$ 5787	\$ 5927
S922S2IC	\$ 5494	\$ 5630	\$ 5768	\$ 5904	\$ 6074	\$ 6245	\$ 6416	\$ 6586	\$ 6758	\$ 6929	\$ 7099	\$ 7270	\$ 7440	\$ 7611
S922S2OC	\$ 5494	\$ 5630	\$ 5768	\$ 5904	\$ 6074	\$ 6245	\$ 6416	\$ 6586	\$ 6758	\$ 6929	\$ 7099	\$ 7270	\$ 7440	\$ 7611
S922S3	\$ 4472	\$ 4583	\$ 4696	\$ 4807	\$ 4945	\$ 5085	\$ 5224	\$ 5364	\$ 5502	\$ 5642	\$ 5781	\$ 5920	\$ 6059	\$ 6199
S922S3P	\$ 4567	\$ 4678	\$ 4791	\$ 4902	\$ 5040	\$ 5180	\$ 5319	\$ 5459	\$ 5597	\$ 5737	\$ 5876	\$ 6015	\$ 6154	\$ 6294
<b>S922S2T, S922S2TP, S922S3T, and S922S3TP Upcharges</b>														
Seat	\$ 495	\$ 563	\$ 632	\$ 700	\$ 785	\$ 870	\$ 956	\$ 1041	\$ 1126	\$ 1213	\$ 1298	\$ 1383	\$ 1468	\$ 1554
Side	\$ 305	\$ 347	\$ 389	\$ 431	\$ 483	\$ 536	\$ 588	\$ 640	\$ 694	\$ 746	\$ 798	\$ 851	\$ 903	\$ 956
<b>S922S2TIC Upcharges</b>														
Seat	\$ 647	\$ 736	\$ 826	\$ 915	\$ 1027	\$ 1138	\$ 1250	\$ 1362	\$ 1473	\$ 1585	\$ 1697	\$ 1809	\$ 1920	\$ 2031
Side	\$ 343	\$ 390	\$ 438	\$ 484	\$ 543	\$ 603	\$ 662	\$ 721	\$ 780	\$ 839	\$ 899	\$ 958	\$ 1016	\$ 1075
<b>S922S2TOC Upcharges</b>														
Seat	\$ 647	\$ 736	\$ 826	\$ 915	\$ 1027	\$ 1138	\$ 1250	\$ 1362	\$ 1473	\$ 1585	\$ 1697	\$ 1809	\$ 1920	\$ 2031
Side	\$ 343	\$ 390	\$ 438	\$ 484	\$ 543	\$ 603	\$ 662	\$ 721	\$ 780	\$ 839	\$ 899	\$ 958	\$ 1016	\$ 1075
S922S2LN	\$ 4782	\$ 4950	\$ 5118	\$ 5286	\$ 5496	\$ 5706	\$ 5917	\$ 6126	\$ 6336	\$ 6547	\$ 6757	\$ 6966	\$ 7177	\$ 7387
S922S2LP	\$ 4873	\$ 5041	\$ 5209	\$ 5377	\$ 5587	\$ 5797	\$ 6008	\$ 6217	\$ 6427	\$ 6638	\$ 6848	\$ 7057	\$ 7268	\$ 7478
S922SON	\$ 3266	\$ 3361	\$ 3456	\$ 3551	\$ 3668	\$ 3787	\$ 3905	\$ 4022	\$ 4141	\$ 4259	\$ 4378	\$ 4496	\$ 4614	\$ 4732
S922SOP	\$ 3357	\$ 3452	\$ 3547	\$ 3642	\$ 3759	\$ 3878	\$ 3996	\$ 4113	\$ 4232	\$ 4350	\$ 4469	\$ 4587	\$ 4705	\$ 4823
S922SOWN	\$ 3385	\$ 3484	\$ 3583	\$ 3684	\$ 3807	\$ 3932	\$ 4060	\$ 4187	\$ 4316	\$ 4447	\$ 4572	\$ 4704	\$ 4837	\$ 4972
S922SOWP	\$ 3294	\$ 3393	\$ 3492	\$ 3593	\$ 3716	\$ 3841	\$ 3969	\$ 4096	\$ 4225	\$ 4356	\$ 4481	\$ 4613	\$ 4746	\$ 4881
S922SWDN	\$ 3379	\$ 3485	\$ 3590	\$ 3694	\$ 3826	\$ 3957	\$ 4089	\$ 4220	\$ 4352	\$ 4482	\$ 4614	\$ 4745	\$ 4877	\$ 5008
S922SWDP	\$ 3470	\$ 3576	\$ 3681	\$ 3785	\$ 3917	\$ 4048	\$ 4180	\$ 4311	\$ 4443	\$ 4573	\$ 4705	\$ 4836	\$ 4968	\$ 5099
S922SWDWN	\$ 3283	\$ 3367	\$ 3451	\$ 3537	\$ 3642	\$ 3749	\$ 3859	\$ 3967	\$ 4074	\$ 4184	\$ 4296	\$ 4410	\$ 4524	\$ 4639
S922SWDWP	\$ 3192	\$ 3276	\$ 3360	\$ 3446	\$ 3551	\$ 3658	\$ 3768	\$ 3876	\$ 3983	\$ 4093	\$ 4205	\$ 4319	\$ 4433	\$ 4548
S922SHON	\$ 2733	\$ 2815	\$ 2896	\$ 2978	\$ 3082	\$ 3185	\$ 3289	\$ 3392	\$ 3490	\$ 3599	\$ 3708	\$ 3817	\$ 3926	\$ 4035
S922SHOWN	\$ 2692	\$ 2767	\$ 2842	\$ 2917	\$ 3012	\$ 3107	\$ 3202	\$ 3297	\$ 3387	\$ 3487	\$ 3587	\$ 3687	\$ 3787	\$ 3887
S922SAN	\$ 3385	\$ 3493	\$ 3601	\$ 3711	\$ 3845	\$ 3981	\$ 4121	\$ 4259	\$ 4400	\$ 4542	\$ 4679	\$ 4822	\$ 4967	\$ 5115
S922SAWN	\$ 3326	\$ 3425	\$ 3524	\$ 3625	\$ 3748	\$ 3873	\$ 4001	\$ 4128	\$ 4257	\$ 4388	\$ 4513	\$ 4645	\$ 4778	\$ 4913
S922SWN	\$ 3379	\$ 3485	\$ 3590	\$ 3694	\$ 3826	\$ 3957	\$ 4089	\$ 4220	\$ 4352	\$ 4482	\$ 4614	\$ 4745	\$ 4877	\$ 5008
S922LPN	\$ 595	\$ 637	\$ 679	\$ 721	\$ 773	\$ 826	\$ 878	\$ 930	\$ 984	\$ 1036	\$ 1088	\$ 1141	\$ 1193	\$ 1246
S922S2LTN	\$ 4287	\$ 4351	\$ 4416	\$ 4483	\$ 4564	\$ 4646	\$ 4729	\$ 4813	\$ 4899	\$ 4985	\$ 5074	\$ 5162	\$ 5251	\$ 5342
S922S2LTP	\$ 4379	\$ 4443	\$ 4508	\$ 4575	\$ 4656	\$ 4738	\$ 4821	\$ 4905	\$ 4991	\$ 5077	\$ 5166	\$ 5254	\$ 5343	\$ 5434
S922SOTN	\$ 3122	\$ 3163	\$ 3203	\$ 3246	\$ 3296	\$ 3347	\$ 3400	\$ 3453	\$ 3506	\$ 3561	\$ 3615	\$ 3671	\$ 3728	\$ 3784
S922SOTP	\$ 3214	\$ 3255	\$ 3295	\$ 3338	\$ 3388	\$ 3439	\$ 3492	\$ 3545	\$ 3598	\$ 3653	\$ 3707	\$ 3763	\$ 3820	\$ 3876
<b>S922SOTWP Upcharges</b>														
Seat	\$ 457	\$ 527	\$ 597	\$ 668	\$ 754	\$ 841	\$ 930	\$ 1021	\$ 1112	\$ 1204	\$ 1298	\$ 1393	\$ 1489	\$ 1586
Side	\$ 246	\$ 284	\$ 321	\$ 360	\$ 406	\$ 453	\$ 501	\$ 550	\$ 599	\$ 649	\$ 699	\$ 750	\$ 802	\$ 854
<b>S922SOTWN Upcharges</b>														
Seat	\$ 457	\$ 527	\$ 597	\$ 668	\$ 754	\$ 841	\$ 930	\$ 1021	\$ 1112	\$ 1204	\$ 1298	\$ 1393	\$ 1489	\$ 1586
Side	\$ 246	\$ 284	\$ 321	\$ 360	\$ 406	\$ 453	\$ 501	\$ 550	\$ 599	\$ 649	\$ 699	\$ 750	\$ 802	\$ 854
S922SHOTN	\$ 2619	\$ 2643	\$ 2666	\$ 2691	\$ 2720	\$ 2749	\$ 2779	\$ 2810	\$ 2840	\$ 2872	\$ 2904	\$ 2936	\$ 2970	\$ 3003
<b>S922SHOTWN Upcharges</b>														
Seat	\$ 390	\$ 445	\$ 500	\$ 558	\$ 627	\$ 696	\$ 767	\$ 838	\$ 911	\$ 985	\$ 1058	\$ 1138	\$ 1215	\$ 1292
Side	\$ 151	\$ 173	\$ 194	\$ 217	\$ 244	\$ 270	\$ 298	\$ 326	\$ 354	\$ 383	\$ 412	\$ 442	\$ 473	\$ 503
S922SATN	\$ 3127	\$ 3163	\$ 3198	\$ 3256	\$ 3298	\$ 3344	\$ 3390	\$ 3437	\$ 3484	\$ 3530	\$ 3579	\$ 3630	\$ 3680	\$ 3730
S922SWTN	\$ 3377	\$ 3445	\$ 3445	\$ 3516	\$ 3674	\$ 3764	\$ 3852	\$ 3942	\$ 4033	\$ 4124	\$ 4217	\$ 4313	\$ 4409	\$ 4507
<b>S922SATWN Upcharges</b>														
Seat	\$ 562	\$ 644	\$ 727	\$ 864	\$ 965	\$ 1073	\$ 1181	\$ 1290	\$ 1402	\$ 1512	\$ 1627	\$ 1746	\$ 1865	\$ 1984
Side	\$ 218	\$ 251	\$ 283	\$ 336	\$ 375	\$ 417	\$ 459	\$ 502	\$ 545	\$ 588	\$ 633	\$ 679	\$ 725	\$ 771

Model Number		Grade 9	Grade 10	Grade 11	Grade 12	Grade 13	Grade 14	Grade 15	Grade 16	Grade 17	Grade 18	Grade 19	Grade 20	Grade 21	Grade 22
<b>Retreat — Pages 270-273</b>															
VERWNO	Body	\$ 610	\$ 694	\$ 778	\$ 862	\$ 966	\$ 1072	\$ 1177	\$ 1281	\$ 1387	\$ 1492	\$ 1597	\$ 1702	\$ 1807	\$ 1912
	Seat	\$ 152	\$ 174	\$ 195	\$ 215	\$ 241	\$ 268	\$ 294	\$ 320	\$ 347	\$ 373	\$ 399	\$ 426	\$ 452	\$ 478
VERHNO	Body	\$ 457	\$ 520	\$ 583	\$ 646	\$ 725	\$ 804	\$ 882	\$ 961	\$ 1040	\$ 1119	\$ 1197	\$ 1277	\$ 1355	\$ 1434
	Seat	\$ 152	\$ 174	\$ 195	\$ 215	\$ 241	\$ 268	\$ 294	\$ 320	\$ 347	\$ 373	\$ 399	\$ 426	\$ 452	\$ 478
VERLNO	Body	\$ 411	\$ 468	\$ 525	\$ 581	\$ 652	\$ 723	\$ 794	\$ 865	\$ 936	\$ 1007	\$ 1077	\$ 1148	\$ 1220	\$ 1291
	Seat	\$ 137	\$ 156	\$ 175	\$ 193	\$ 217	\$ 241	\$ 264	\$ 288	\$ 312	\$ 335	\$ 359	\$ 383	\$ 407	\$ 430
VERONO	Body	\$ 228	\$ 260	\$ 292	\$ 323	\$ 362	\$ 402	\$ 441	\$ 480	\$ 520	\$ 560	\$ 599	\$ 638	\$ 677	\$ 717
	Seat	\$ 152	\$ 174	\$ 195	\$ 215	\$ 241	\$ 268	\$ 294	\$ 320	\$ 347	\$ 373	\$ 399	\$ 426	\$ 452	\$ 478
RETECMS	Body/Seat	\$ 610	\$ 694	\$ 778	\$ 862	\$ 966	\$ 1072	\$ 1177	\$ 1281	\$ 1387	\$ 1492	\$ 1597	\$ 1702	\$ 1807	\$ 1912
RETECLS	Body/Seat	\$ 457	\$ 520	\$ 583	\$ 646	\$ 725	\$ 804	\$ 882	\$ 961	\$ 1040	\$ 1119	\$ 1197	\$ 1277	\$ 1355	\$ 1434
RETECMM	Body	\$ 457	\$ 520	\$ 583	\$ 646	\$ 725	\$ 804	\$ 882	\$ 961	\$ 1040	\$ 1119	\$ 1197	\$ 1277	\$ 1355	\$ 1434
	Seat	\$ 152	\$ 174	\$ 195	\$ 215	\$ 241	\$ 268	\$ 294	\$ 320	\$ 347	\$ 373	\$ 399	\$ 426	\$ 452	\$ 478
RETECLM	Body	\$ 305	\$ 347	\$ 389	\$ 431	\$ 483	\$ 536	\$ 588	\$ 640	\$ 694	\$ 746	\$ 798	\$ 851	\$ 903	\$ 956
	Seat	\$ 152	\$ 174	\$ 195	\$ 215	\$ 241	\$ 268	\$ 294	\$ 320	\$ 347	\$ 373	\$ 399	\$ 426	\$ 452	\$ 478
<b>PARALLEL CLUB CHAIR — Pages 276-279</b>															
PSCN		\$ 4760	\$ 4855	\$ 4950	\$ 5045	\$ 5162	\$ 5281	\$ 5399	\$ 5516	\$ 5635	\$ 5753	\$ 5872	\$ 5990	\$ 6108	\$ 6226
PSCC		\$ 5182	\$ 5277	\$ 5372	\$ 5467	\$ 5584	\$ 5703	\$ 5821	\$ 5938	\$ 6057	\$ 6175	\$ 6294	\$ 6412	\$ 6530	\$ 6648
<b>PARALLEL CLUB PLUS LOUNGE — Pages 276-279</b>															
PSCP		\$ 5143	\$ 5251	\$ 5360	\$ 5468	\$ 5605	\$ 5740	\$ 5875	\$ 6011	\$ 6146	\$ 6283	\$ 6418	\$ 6553	\$ 6689	\$ 6824
PSCPC		\$ 5566	\$ 5674	\$ 5783	\$ 5891	\$ 6028	\$ 6163	\$ 6298	\$ 6434	\$ 6569	\$ 6706	\$ 6841	\$ 6976	\$ 7112	\$ 7247
<b>PARALLEL SOFA — Pages 276-279</b>															
PSDSN		\$ 8056	\$ 8216	\$ 8377	\$ 8536	\$ 8736	\$ 8936	\$ 9135	\$ 9336	\$ 9535	\$ 9735	\$ 9935	\$ 10135	\$ 10334	\$ 10535
PSDSC		\$ 8619	\$ 8779	\$ 8940	\$ 9099	\$ 9299	\$ 9499	\$ 9698	\$ 9899	\$ 10098	\$ 10298	\$ 10498	\$ 10698	\$ 10897	\$ 11098
<b>Two-Thirds — Pages 286-291</b>															
EPR18S		\$ 1047	\$ 1081	\$ 1116	\$ 1149	\$ 1192	\$ 1236	\$ 1278	\$ 1321	\$ 1364	\$ 1407	\$ 1449	\$ 1492	\$ 1535	\$ 1578
EPW18S		\$ 1120	\$ 1154	\$ 1189	\$ 1222	\$ 1265	\$ 1309	\$ 1351	\$ 1394	\$ 1437	\$ 1480	\$ 1522	\$ 1565	\$ 1608	\$ 1651
EPP1722S		\$ 1298	\$ 1337	\$ 1375	\$ 1414	\$ 1463	\$ 1511	\$ 1560	\$ 1608	\$ 1657	\$ 1705	\$ 1754	\$ 1802	\$ 1851	\$ 1899
EPP1820S		\$ 1357	\$ 1394	\$ 1430	\$ 1467	\$ 1513	\$ 1558	\$ 1604	\$ 1649	\$ 1695	\$ 1741	\$ 1787	\$ 1833	\$ 1878	\$ 1924
EPP2128S		\$ 1480	\$ 1522	\$ 1566	\$ 1609	\$ 1664	\$ 1718	\$ 1772	\$ 1826	\$ 1881	\$ 1935	\$ 1989	\$ 2043	\$ 2098	\$ 2152
EPB1421S		\$ 1252	\$ 1305	\$ 1358	\$ 1410	\$ 1475	\$ 1541	\$ 1607	\$ 1673	\$ 1738	\$ 1803	\$ 1870	\$ 1935	\$ 2001	\$ 2066
EPB2121S		\$ 1325	\$ 1378	\$ 1431	\$ 1483	\$ 1548	\$ 1614	\$ 1680	\$ 1746	\$ 1811	\$ 1876	\$ 1943	\$ 2008	\$ 2074	\$ 2139
EPB2128S		\$ 1497	\$ 1563	\$ 1629	\$ 1696	\$ 1778	\$ 1861	\$ 1944	\$ 2027	\$ 2110	\$ 2193	\$ 2274	\$ 2357	\$ 2440	\$ 2523
EPB2142S		\$ 1863	\$ 1929	\$ 1995	\$ 2062	\$ 2144	\$ 2227	\$ 2310	\$ 2393	\$ 2476	\$ 2559	\$ 2640	\$ 2723	\$ 2806	\$ 2889
EPR18M	1/3 Upholstery	\$ 1041	\$ 1059	\$ 1077	\$ 1096	\$ 1119	\$ 1142	\$ 1165	\$ 1188	\$ 1210	\$ 1233	\$ 1255	\$ 1278	\$ 1301	\$ 1324
	2/3 Upholstery	\$ 1123	\$ 1154	\$ 1183	\$ 1213	\$ 1250	\$ 1287	\$ 1324	\$ 1361	\$ 1398	\$ 1435	\$ 1473	\$ 1510	\$ 1547	\$ 1584
EPW18M	1/3 Upholstery	\$ 1113	\$ 1131	\$ 1149	\$ 1168	\$ 1191	\$ 1214	\$ 1237	\$ 1260	\$ 1282	\$ 1305	\$ 1327	\$ 1350	\$ 1373	\$ 1396
	2/3 Upholstery	\$ 1195	\$ 1226	\$ 1255	\$ 1285	\$ 1322	\$ 1359	\$ 1396	\$ 1433	\$ 1470	\$ 1507	\$ 1545	\$ 1582	\$ 1619	\$ 1656
EPP1722M	1/3 Upholstery	\$ 1258	\$ 1276	\$ 1294	\$ 1313	\$ 1336	\$ 1359	\$ 1382	\$ 1405	\$ 1427	\$ 1450	\$ 1472	\$ 1495	\$ 1518	\$ 1541
	2/3 Upholstery	\$ 1374	\$ 1408	\$ 1443	\$ 1476	\$ 1519	\$ 1563	\$ 1605	\$ 1648	\$ 1691	\$ 1734	\$ 1776	\$ 1819	\$ 1862	\$ 1905
EPP1820M	1/3 Upholstery	\$ 1332	\$ 1350	\$ 1368	\$ 1387	\$ 1410	\$ 1433	\$ 1456	\$ 1479	\$ 1501	\$ 1524	\$ 1546	\$ 1569	\$ 1592	\$ 1615
	2/3 Upholstery	\$ 1448	\$ 1482	\$ 1517	\$ 1550	\$ 1593	\$ 1637	\$ 1679	\$ 1722	\$ 1765	\$ 1808	\$ 1850	\$ 1893	\$ 1936	\$ 1979
EPP2128M	1/3 Upholstery	\$ 1406	\$ 1424	\$ 1442	\$ 1461	\$ 1484	\$ 1507	\$ 1530	\$ 1553	\$ 1575	\$ 1598	\$ 1620	\$ 1643	\$ 1666	\$ 1689
	2/3 Upholstery	\$ 1522	\$ 1556	\$ 1591	\$ 1624	\$ 1667	\$ 1711	\$ 1753	\$ 1796	\$ 1839	\$ 1882	\$ 1924	\$ 1967	\$ 2010	\$ 2053
EPB1421M	1/3 Upholstery	\$ 1146	\$ 1169	\$ 1192	\$ 1215	\$ 1243	\$ 1272	\$ 1300	\$ 1329	\$ 1358	\$ 1386	\$ 1414	\$ 1443	\$ 1471	\$ 1500
	2/3 Upholstery	\$ 1245	\$ 1282	\$ 1318	\$ 1355	\$ 1401	\$ 1446	\$ 1492	\$ 1537	\$ 1583	\$ 1629	\$ 1675	\$ 1721	\$ 1766	\$ 1812
EPB2121M	1/3 Upholstery	\$ 1218	\$ 1241	\$ 1264	\$ 1287	\$ 1315	\$ 1344	\$ 1372	\$ 1401	\$ 1430	\$ 1458	\$ 1486	\$ 1515	\$ 1543	\$ 1572
	2/3 Upholstery	\$ 1317	\$ 1354	\$ 1390	\$ 1427	\$ 1473	\$ 1518	\$ 1564	\$ 1609	\$ 1655	\$ 1701	\$ 1747	\$ 1793	\$ 1838	\$ 1884
EPB2128M	1/3 Upholstery	\$ 1291	\$ 1314	\$ 1337	\$ 1360	\$ 1388	\$ 1417	\$ 1445	\$ 1474	\$ 1503	\$ 1531	\$ 1559	\$ 1588	\$ 1616	\$ 1645
	2/3 Upholstery	\$ 1390	\$ 1427	\$ 1463	\$ 1500	\$ 1546	\$ 1591	\$ 1637	\$ 1682	\$ 1728	\$ 1774	\$ 1820	\$ 1866	\$ 1911	\$ 1957
EPB1442M	1/3 Upholstery	\$ 1647	\$ 1684	\$ 1720	\$ 1757	\$ 1803	\$ 1848	\$ 1894	\$ 1939	\$ 1985	\$ 2031	\$ 2077	\$ 2123	\$ 2168	\$ 2214
	2/3 Upholstery	\$ 1763	\$ 1816	\$ 1869	\$ 1921	\$ 1986	\$ 2052	\$ 2118	\$ 2184	\$ 2249	\$ 2314	\$ 2381	\$ 2446	\$ 2512	\$ 2577
EPB2142M	1/3 Upholstery	\$ 1756	\$ 1793	\$ 1829	\$ 1866	\$ 1912	\$ 1957	\$ 2003	\$ 2048	\$ 2094	\$ 2140	\$ 2186	\$ 2232	\$ 2277	\$ 2323
	2/3 Upholstery	\$ 1872	\$ 1925	\$ 1978	\$ 2030	\$ 2095	\$ 2161	\$ 2227	\$ 2293	\$ 2358	\$ 2423	\$ 2490	\$ 2555	\$ 2621	\$ 2686

# Social Collaborative — Seating Collections

## Upholstery Grades 9 to 22 Pricing

Model Number	Grade 9	Grade 10	Grade 11	Grade 12	Grade 13	Grade 14	Grade 15	Grade 16	Grade 17	Grade 18	Grade 19	Grade 20	Grade 21	Grade 22
<b>VICINITY LOUNGE</b> — Pages <a href="#">298-299</a>														
CLG-UGANO	\$ 2846	\$ 2909	\$ 2972	\$ 3035	\$ 3114	\$ 3193	\$ 3271	\$ 3350	\$ 3429	\$ 3508	\$ 3586	\$ 3666	\$ 3744	\$ 3823
CLG-CGANO	\$ 3304	\$ 3410	\$ 3515	\$ 3619	\$ 3751	\$ 3882	\$ 4014	\$ 4145	\$ 4277	\$ 4407	\$ 4539	\$ 4670	\$ 4802	\$ 4933
CLG-WGANO	\$ 3656	\$ 3698	\$ 3740	\$ 3782	\$ 3834	\$ 3887	\$ 3939	\$ 3991	\$ 4045	\$ 4097	\$ 4149	\$ 4202	\$ 4254	\$ 4307
CLR-UGANO	\$ 3417	\$ 3480	\$ 3543	\$ 3606	\$ 3685	\$ 3764	\$ 3842	\$ 3921	\$ 4000	\$ 4079	\$ 4157	\$ 4237	\$ 4315	\$ 4394
CLR-CGANO	\$ 3867	\$ 3973	\$ 4078	\$ 4182	\$ 4314	\$ 4445	\$ 4577	\$ 4708	\$ 4840	\$ 4970	\$ 5102	\$ 5233	\$ 5365	\$ 5496
CLR-WGANO	\$ 3829	\$ 3871	\$ 3913	\$ 3955	\$ 4007	\$ 4060	\$ 4112	\$ 4164	\$ 4218	\$ 4270	\$ 4322	\$ 4375	\$ 4427	\$ 4480
<b>CO HO™</b> — Page <a href="#">301</a>														
CHULNO	\$ 1811	\$ 1840	\$ 1870	\$ 1899	\$ 1936	\$ 1973	\$ 2009	\$ 2046	\$ 2084	\$ 2121	\$ 2157	\$ 2194	\$ 2231	\$ 2267
<b>LINGER</b> — Pages <a href="#">304-305</a>														
S924SS	\$ 3860	\$ 3938	\$ 4017	\$ 4095	\$ 4194	\$ 4292	\$ 4392	\$ 4490	\$ 4588	\$ 4687	\$ 4785	\$ 4883	\$ 4982	\$ 5080
<b>S924ST Upcharges</b>														
Seat	\$ 381	\$ 433	\$ 486	\$ 538	\$ 604	\$ 670	\$ 735	\$ 801	\$ 867	\$ 932	\$ 998	\$ 1063	\$ 1130	\$ 1195
Side	\$ 190	\$ 216	\$ 242	\$ 269	\$ 302	\$ 335	\$ 368	\$ 401	\$ 433	\$ 466	\$ 499	\$ 531	\$ 565	\$ 598

Model Number	Base Model List Price	Option Upcharges — Add to Base Model Price											
		Grade 7	Grade 8	Grade 9	Grade 10	Grade 11	Grade 12	Grade 13	Grade 14	Grade 15	Grade 16	Grade 17	Grade 18
<b>Options</b>													
<b>Reflect — Page 309</b>													
<b>GAWRP</b>	<b>\$8012</b>												
Seat/Back Upholstery		\$ 358	\$ 427	\$ 495	\$ 563	\$ 632	\$ 700	\$ 785	\$ 870	\$ 956	\$ 1041	\$ 1126	\$ 1213
Upper Shell Upholstery		\$ 552	\$ 657	\$ 761	\$ 867	\$ 972	\$ 1076	\$ 1208	\$ 1339	\$ 1471	\$ 1602	\$ 1734	\$ 1864
<b>Clubhouse — Pages 318-321</b>													
<b>GA56MSE</b>	<b>\$21307</b>												
Frontboard/Backboard Upholstery		\$ 721	\$ 864	\$ 1009	\$ 1153	\$ 1298	\$ 1513	\$ 1729	\$ 1946	\$ 2163	\$ 2379	\$ 2595	\$ 2811
Seating Upholstery		\$ 1754	\$ 2105	\$ 2455	\$ 2806	\$ 3157	\$ 3684	\$ 4210	\$ 4735	\$ 5263	\$ 5788	\$ 6315	\$ 6841
Seating Side Upholstery		\$ 408	\$ 490	\$ 572	\$ 652	\$ 735	\$ 857	\$ 979	\$ 1102	\$ 1225	\$ 1347	\$ 1470	\$ 1593
<b>GA70MCOUHP</b>	<b>\$28384</b>												
<b>GA70MCOUNP</b>	<b>\$28382</b>												
Frontboard/Backboard Upholstery		\$ 721	\$ 864	\$ 1009	\$ 1153	\$ 1298	\$ 1513	\$ 1729	\$ 1946	\$ 2163	\$ 2379	\$ 2595	\$ 2811
Seating Upholstery		\$ 1682	\$ 2018	\$ 2355	\$ 2691	\$ 3027	\$ 3532	\$ 4037	\$ 4541	\$ 5047	\$ 5551	\$ 6055	\$ 6560
Seating Side Upholstery		\$ 1441	\$ 1729	\$ 2018	\$ 2306	\$ 2595	\$ 3027	\$ 3460	\$ 3893	\$ 4326	\$ 4758	\$ 5190	\$ 5624
<b>GA70MCOLHP</b>	<b>\$29065</b>												
<b>GA70MCOLNP</b>	<b>\$29062</b>												
Frontboard/Backboard Upholstery		\$ 721	\$ 864	\$ 1009	\$ 1153	\$ 1298	\$ 1513	\$ 1729	\$ 1946	\$ 2163	\$ 2379	\$ 2595	\$ 2811
Seating Upholstery		\$ 1682	\$ 2018	\$ 2355	\$ 2691	\$ 3027	\$ 3532	\$ 4037	\$ 4541	\$ 5047	\$ 5551	\$ 6055	\$ 6560
Seating Side Upholstery		\$ 1441	\$ 1729	\$ 2018	\$ 2306	\$ 2595	\$ 3027	\$ 3460	\$ 3893	\$ 4326	\$ 4758	\$ 5190	\$ 5624
<b>GA70MSTHR</b>	<b>\$27449</b>												
<b>GA70MSTHL</b>	<b>\$27449</b>												
<b>GA70MSTNP</b>	<b>\$27447</b>												
Frontboard/Backboard/Storage Upholstery		\$ 841	\$ 1009	\$ 1178	\$ 1344	\$ 1513	\$ 1765	\$ 2018	\$ 2270	\$ 2524	\$ 2776	\$ 3027	\$ 3280
Seating Upholstery		\$ 1754	\$ 2105	\$ 2455	\$ 2806	\$ 3157	\$ 3684	\$ 4210	\$ 4735	\$ 5263	\$ 5788	\$ 6315	\$ 6841
Seating Side Upholstery		\$ 408	\$ 490	\$ 572	\$ 652	\$ 735	\$ 857	\$ 979	\$ 1102	\$ 1225	\$ 1347	\$ 1470	\$ 1593
<b>GA70MMCU</b>	<b>\$31476</b>												
Frontboard/Backboard Upholstery		\$ 721	\$ 864	\$ 1009	\$ 1153	\$ 1298	\$ 1513	\$ 1729	\$ 1946	\$ 2163	\$ 2379	\$ 2595	\$ 2811
Seating Upholstery		\$ 1754	\$ 2105	\$ 2455	\$ 2806	\$ 3157	\$ 3684	\$ 4210	\$ 4735	\$ 5263	\$ 5788	\$ 6315	\$ 6841
Seating Side Upholstery		\$ 1129	\$ 1355	\$ 1581	\$ 1807	\$ 2032	\$ 2371	\$ 2710	\$ 3049	\$ 3387	\$ 3727	\$ 4066	\$ 4404
<b>GA70MMCL</b>	<b>\$32156</b>												
Frontboard/Backboard Upholstery		\$ 721	\$ 864	\$ 1009	\$ 1153	\$ 1298	\$ 1513	\$ 1729	\$ 1946	\$ 2163	\$ 2379	\$ 2595	\$ 2811
Seating Upholstery		\$ 1754	\$ 2105	\$ 2455	\$ 2806	\$ 3157	\$ 3684	\$ 4210	\$ 4735	\$ 5263	\$ 5788	\$ 6315	\$ 6841
Seating Side Upholstery		\$ 1129	\$ 1355	\$ 1581	\$ 1807	\$ 2032	\$ 2371	\$ 2710	\$ 3049	\$ 3387	\$ 3727	\$ 4066	\$ 4404
<b>GA84MSE</b>	<b>\$29626</b>												
Frontboard/Backboard Upholstery		\$ 721	\$ 864	\$ 1009	\$ 1153	\$ 1298	\$ 1513	\$ 1729	\$ 1946	\$ 2163	\$ 2379	\$ 2595	\$ 2811
Seating Upholstery		\$ 2524	\$ 3027	\$ 3532	\$ 4037	\$ 4541	\$ 5299	\$ 6055	\$ 6812	\$ 7571	\$ 8327	\$ 9083	\$ 9841
Seating Side Upholstery		\$ 1082	\$ 1298	\$ 1513	\$ 1729	\$ 1946	\$ 2270	\$ 2595	\$ 2920	\$ 3244	\$ 3568	\$ 3893	\$ 4218
<b>GA84MMW</b>	<b>\$34534</b>												
Frontboard/Backboard Upholstery		\$ 721	\$ 864	\$ 1009	\$ 1153	\$ 1298	\$ 1513	\$ 1729	\$ 1946	\$ 2163	\$ 2379	\$ 2595	\$ 2811
Seating Upholstery		\$ 2524	\$ 3027	\$ 3532	\$ 4037	\$ 4541	\$ 5299	\$ 6055	\$ 6812	\$ 7571	\$ 8327	\$ 9083	\$ 9841
Seating Side Upholstery		\$ 1082	\$ 1298	\$ 1513	\$ 1729	\$ 1946	\$ 2270	\$ 2595	\$ 2920	\$ 3244	\$ 3568	\$ 3893	\$ 4218
<b>GA84MSTHR</b>	<b>\$33257</b>												
<b>GA84MSTHL</b>	<b>\$33257</b>												
<b>GA84MSTNP</b>	<b>\$33255</b>												
Frontboard/Backboard/Storage Upholstery		\$ 841	\$ 1009	\$ 1178	\$ 1344	\$ 1513	\$ 1765	\$ 2018	\$ 2270	\$ 2524	\$ 2776	\$ 3027	\$ 3280
Seating Upholstery		\$ 1609	\$ 1932	\$ 2255	\$ 2575	\$ 2898	\$ 3381	\$ 3863	\$ 4346	\$ 4829	\$ 5312	\$ 5795	\$ 6280
Seating Side Upholstery		\$ 1513	\$ 1816	\$ 2119	\$ 2421	\$ 2724	\$ 3179	\$ 3632	\$ 4088	\$ 4541	\$ 4996	\$ 5450	\$ 5904

Model Number	Base Model List Price	Option Upcharges — Add to Base Model Price											
		Grade 7	Grade 8	Grade 9	Grade 10	Grade 11	Grade 12	Grade 13	Grade 14	Grade 15	Grade 16	Grade 17	Grade 18
<b>Options</b>													
<b>GA56HSE</b>	<b>\$24492</b>												
Frontboard/Backboard Upholstery		\$ 721	\$ 864	\$ 1009	\$ 1153	\$ 1298	\$ 1513	\$ 1729	\$ 1946	\$ 2163	\$ 2379	\$ 2595	\$ 2811
Seating Upholstery		\$ 1754	\$ 2105	\$ 2455	\$ 2806	\$ 3157	\$ 3684	\$ 4210	\$ 4735	\$ 5263	\$ 5788	\$ 6315	\$ 6841
Seating Side Upholstery		\$ 408	\$ 490	\$ 572	\$ 652	\$ 735	\$ 857	\$ 979	\$ 1102	\$ 1225	\$ 1347	\$ 1470	\$ 1593
<b>GA70HCOUHP</b>	<b>\$31630</b>												
<b>GA70HCOUNP</b>	<b>\$31628</b>												
Frontboard/Backboard Upholstery		\$ 721	\$ 864	\$ 1009	\$ 1153	\$ 1298	\$ 1513	\$ 1729	\$ 1946	\$ 2163	\$ 2379	\$ 2595	\$ 2811
Seating Upholstery		\$ 1682	\$ 2018	\$ 2355	\$ 2691	\$ 3027	\$ 3532	\$ 4037	\$ 4541	\$ 5047	\$ 5551	\$ 6055	\$ 6560
Seating Side Upholstery		\$ 1441	\$ 1729	\$ 2018	\$ 2306	\$ 2595	\$ 3027	\$ 3460	\$ 3893	\$ 4326	\$ 4758	\$ 5190	\$ 5624
<b>GA70HCOLHP</b>	<b>\$32311</b>												
<b>GA70HCOLNP</b>	<b>\$32308</b>												
Frontboard/Backboard Upholstery		\$ 721	\$ 864	\$ 1009	\$ 1153	\$ 1298	\$ 1513	\$ 1729	\$ 1946	\$ 2163	\$ 2379	\$ 2595	\$ 2811
Seating Upholstery		\$ 1682	\$ 2018	\$ 2355	\$ 2691	\$ 3027	\$ 3532	\$ 4037	\$ 4541	\$ 5047	\$ 5551	\$ 6055	\$ 6560
Seating Side Upholstery		\$ 1441	\$ 1729	\$ 2018	\$ 2306	\$ 2595	\$ 3027	\$ 3460	\$ 3893	\$ 4326	\$ 4758	\$ 5190	\$ 5624
<b>GA70HSTHR</b>	<b>\$29078</b>												
<b>GA70HSTHL</b>	<b>\$29078</b>												
<b>GA70HSTNP</b>	<b>\$29066</b>												
Frontboard/Backboard/Storage Upholstery		\$ 841	\$ 1009	\$ 1178	\$ 1344	\$ 1513	\$ 1765	\$ 2018	\$ 2270	\$ 2524	\$ 2776	\$ 3027	\$ 3280
Seating Upholstery		\$ 1754	\$ 2105	\$ 2455	\$ 2806	\$ 3157	\$ 3684	\$ 4210	\$ 4735	\$ 5263	\$ 5788	\$ 6315	\$ 6841
Seating Side Upholstery		\$ 408	\$ 490	\$ 572	\$ 652	\$ 735	\$ 857	\$ 979	\$ 1102	\$ 1225	\$ 1347	\$ 1470	\$ 1593
<b>GA70HMCU</b>	<b>\$34583</b>												
Frontboard/Backboard Upholstery		\$ 721	\$ 864	\$ 1009	\$ 1153	\$ 1298	\$ 1513	\$ 1729	\$ 1946	\$ 2163	\$ 2379	\$ 2595	\$ 2811
Seating Upholstery		\$ 1754	\$ 2105	\$ 2455	\$ 2806	\$ 3157	\$ 3684	\$ 4210	\$ 4735	\$ 5263	\$ 5788	\$ 6315	\$ 6841
Seating Side Upholstery		\$ 1129	\$ 1355	\$ 1581	\$ 1807	\$ 2032	\$ 2371	\$ 2710	\$ 3049	\$ 3387	\$ 3727	\$ 4066	\$ 4404
<b>GA70HMCL</b>	<b>\$35263</b>												
Frontboard/Backboard Upholstery		\$ 721	\$ 864	\$ 1009	\$ 1153	\$ 1298	\$ 1513	\$ 1729	\$ 1946	\$ 2163	\$ 2379	\$ 2595	\$ 2811
Seating Upholstery		\$ 1754	\$ 2105	\$ 2455	\$ 2806	\$ 3157	\$ 3684	\$ 4210	\$ 4735	\$ 5263	\$ 5788	\$ 6315	\$ 6841
Seating Side Upholstery		\$ 1129	\$ 1355	\$ 1581	\$ 1807	\$ 2032	\$ 2371	\$ 2710	\$ 3049	\$ 3387	\$ 3727	\$ 4066	\$ 4404
<b>GA84HSE</b>	<b>\$33024</b>												
Frontboard/Backboard Upholstery		\$ 721	\$ 864	\$ 1009	\$ 1153	\$ 1298	\$ 1513	\$ 1729	\$ 1946	\$ 2163	\$ 2379	\$ 2595	\$ 2811
Seating Upholstery		\$ 2524	\$ 3027	\$ 3532	\$ 4037	\$ 4541	\$ 5299	\$ 6055	\$ 6812	\$ 7571	\$ 8327	\$ 9083	\$ 9841
Seating Side Upholstery		\$ 1082	\$ 1298	\$ 1513	\$ 1729	\$ 1946	\$ 2270	\$ 2595	\$ 2920	\$ 3244	\$ 3568	\$ 3893	\$ 4218
<b>GA84HMW</b>	<b>\$37793</b>												
Frontboard/Backboard Upholstery		\$ 721	\$ 864	\$ 1009	\$ 1153	\$ 1298	\$ 1513	\$ 1729	\$ 1946	\$ 2163	\$ 2379	\$ 2595	\$ 2811
Seating Upholstery		\$ 2524	\$ 3027	\$ 3532	\$ 4037	\$ 4541	\$ 5299	\$ 6055	\$ 6812	\$ 7571	\$ 8327	\$ 9083	\$ 9841
Seating Side Upholstery		\$ 1082	\$ 1298	\$ 1513	\$ 1729	\$ 1946	\$ 2270	\$ 2595	\$ 2920	\$ 3244	\$ 3568	\$ 3893	\$ 4218
<b>GA84HSTHR</b>	<b>\$35038</b>												
<b>GA84HSTHL</b>	<b>\$35038</b>												
<b>GA84HSTNP</b>	<b>\$35036</b>												
Frontboard/Backboard/Storage Upholstery		\$ 841	\$ 1009	\$ 1178	\$ 1344	\$ 1513	\$ 1765	\$ 2018	\$ 2270	\$ 2524	\$ 2776	\$ 3027	\$ 3280
Seating Upholstery		\$ 1609	\$ 1932	\$ 2255	\$ 2575	\$ 2898	\$ 3381	\$ 3863	\$ 4346	\$ 4829	\$ 5312	\$ 5795	\$ 6280
Seating Side Upholstery		\$ 1513	\$ 1816	\$ 2119	\$ 2421	\$ 2724	\$ 3179	\$ 3632	\$ 4088	\$ 4541	\$ 4996	\$ 5450	\$ 5904

Belong™ page 333

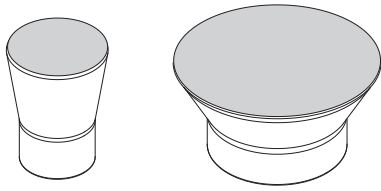

Parallel™ page 335

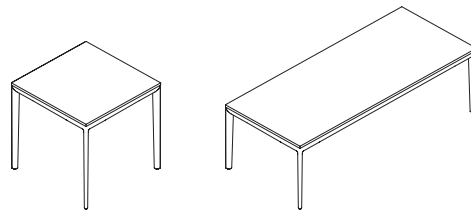

Rise™ pages 336-337

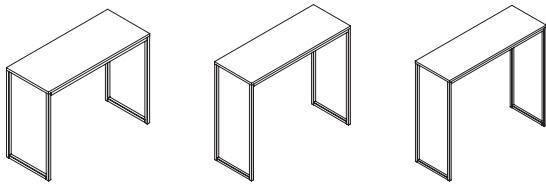

Two Thirds™ pages 338-341

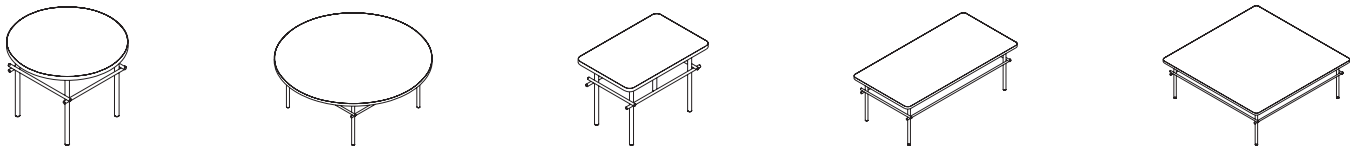

Park™ pages 342-343

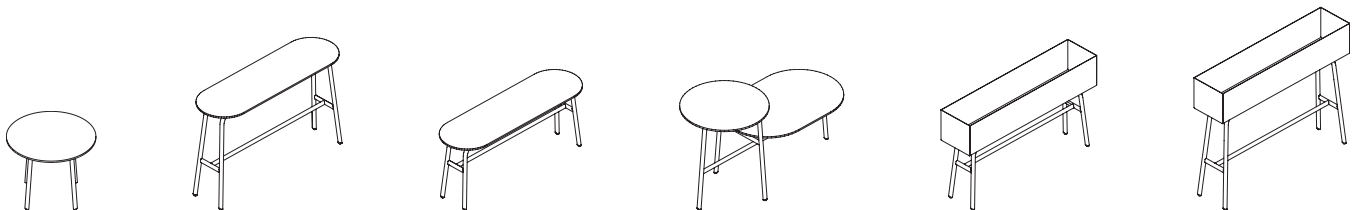



**TOP & BASE PAINT FINISHES**

GRADE P1	
Black	P27
Black	P71
Brownstone	P7D
Bungalow	P7C
Cinder	P7Q
Cove	P096
Designer White	PJW
Dune	P094
Flint	P02
Fossil	P28
Harbor	P097
Loft	P7B
Muslin	P4J
Pebble	P8R
Pewter	P8D
Sage	P095
Salt	P8C
Titanium	P8T/T
GRADE P2	
Champagne Metallic	PR5
Designer White High Gloss 65	P8W
Gunmetal Metallic	PR3
Matte Gold	P8G
Night Bronze	P8B
Platinum Metallic	PR2
Pyrite	PJE
Silver	PR6
Solar Black	P8X
GRADE P3	
Amethyst ( <i>De-emphasized</i> )	P091
Atom	P8S
Blossom	P8K
Bullseye	PJF
Cobalt Mica ( <i>De-emphasized</i> )	P090
Ember	P8P
Ion	P8N
Iris	P8J
Krypton	P8F
Ochre	P093
Regatta	P8M
Sienna	P092
Succulent	P8A
GRADE P4	
Polished Aluminum	PAL/P

**LAMINATES**

GRADE L1	
SOLID COLORS	
Black	P
Brownstone	LM13
Bungalow	LM12
Designer White 15051	LDW1
Flint	LM16
Fossil Shale	LEH1
Loft	LM11
Muslin	LM15
Titanium	LT11
ABSTRACT	
Ash	LT3B
Handspun Pearl	LAHP
Handspun Dove	LAHD
Handspun Slate	LAHS
Handspun Chestnut	LAHC
Silver Mesh	LT8D
WOODGRAIN	
Belair	LWBA
Bourbon Cherry	H
Field Elm	LWFE
Florence Walnut	LFW1
Kingswood Walnut	LK11
Natural Maple	LWD
NeoWalnut	LNU1
Pinnacle	PINC
Shaker Cherry	LW7C
GRADE L2	
Beigewood	LWBE
Fawn Cypress	LFC1
Lowell Ash	LLA1
Mangalore Mango	LMM1
Natural Recon	LNR1
Phantom Charcoal	LPC1
Phantom Ecru	LPE1
Portico Teak	LPT1
Skyline Walnut	LSW1
Veranda Teak	LVT1
GRADE L3	
Natural Walnut	LWNW

**LAMINATE EDGE COLORS**

Beigewood	DE
Belair	BA
Black	E4
Bourbon Cherry	H
Brownstone	EY
Bungalow	EX
Designer White	DW
Fawn Cypress	FC
Field Elm	FE
Flint	E9
Florence Walnut	FW
Fossil	EH
Kingswood Walnut	KI
Loft	EV
Lowell Ash	DL
Mangalore Mango	MM
Muslin	EU
Natural Maple	DD
Natural Recon	NR
Natural Walnut	DN
NeoWalnut	NU
Parchment	EN
Phantom Charcoal	PC
Phantom Ecru	PE
Pinnacle	PI
Platinum Metallic	EP
Portico Teak	DP
Shaker Cherry	DF
Skyline Walnut	SW
Titanium	TI
Veranda Teak	VT

**STRATAWOOD VENEERS**

GRADE V1	
CHERRY	
Cinnamon/Biltmore Cherry	SC260
Lowell Ash Cherry	SC394
Clear Cherry	SC700
Light Cherry	SC701
Shaker Cherry	SC774
Burnished Cherry	SC777
MAPLE	
Field Elm	SE599
Clear Maple	SE800
Harvest Maple	SE856
Beigewood	SE878
Phantom Ecru	SE912
Belair	SE934
OAK	
Clear Oak	SF300
Dark Rift Cut Oak	SF331
SILVER OAK	
Silver Oak Clear	SB100
Portico Teak Silver Oak	SB150
WALNUT	
Florence Walnut	ST579
Light Walnut	ST601
Skyline Walnut	ST625
Pinnacle Walnut	ST679
Sumatra Walnut	ST693
NATURAL VENEERS — FLAT CUT	
GRADE V1	
CHERRY	
Cinnamon/Biltmore Cherry	NC260
Lowell Ash	NC394
Medium Red Cherry	NC512
Light Cherry	NC701
Shaker Cherry	NC774
Burnished Cherry	NC777
MAPLE	
Clear Maple	NE800
Harvest Maple	NE856
WALNUT	
Ebony Walnut	NT509
Florence Walnut	NT579
Light Walnut	NT601
Skyline Walnut	NT625
Nutmeg Walnut	NT629
Pinnacle Walnut	NT679
Sumatra Walnut	NT693
NATURAL VENEERS — RIFT CUT	
GRADE V2	
Fawn Cypress Rift Cut Oak	RF108
Light Rift Cut Oak	RF301
Dark Rift Cut Oak	RF331
Phantom Ecru Rift Cut Oak	RF912

Note: Refer to individual product pages for upcharges.

FSC Certified Wood at Allsteel  
See page 431 for more information.

The spun aluminum Belong occasional tables offer needed horizontal surfaces for small group meeting areas while providing a pleasing aesthetic.

**MODELS AND OPTIONS**

The sculptural curved shape and lightweight design are available in two sizes — Coffee (16"H x 32" diameter) or Side (21"H x 16 diameter). The Belong tops are available in laminate, veneer, or glass with painted pan.

**APPLICATION**

Place in lounge and reception areas, small conference and huddle rooms, media and library areas, and cafés.

**KEY FEATURES**

Belong offers ample horizontal writing surface as a side table next to a chair or bench, or as a small coffee table surrounded by seating. Its organic hourglass shape provides legroom for users to sit up close when using laptops or tablets.

**Belong Side Table**

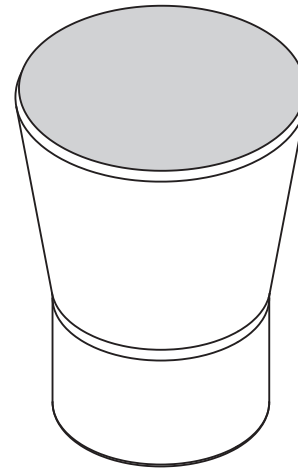

**Belong Coffee Table**

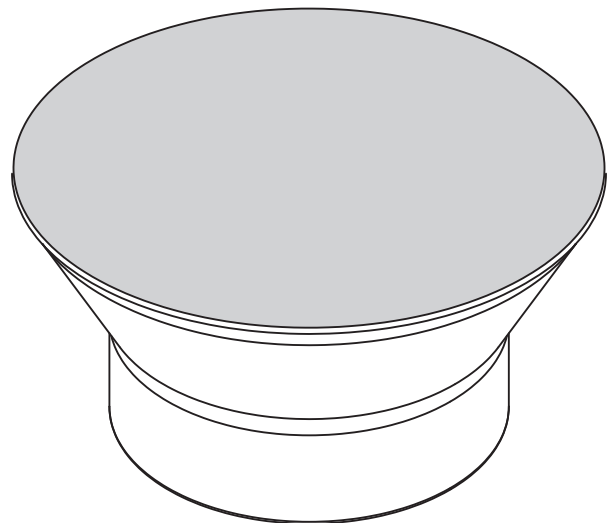



## Belong Side Tables

- Feature a 16" diameter top.
- Available in with four top finishes: laminate, glass, and veneer.
- Belong Side Table Base is 21"H.
- Specify top and base separately.



## Belong Coffee Tables

- Feature a 32" diameter top.
- Available in three top finishes: laminate, glass with painted pan, and veneer.
- Belong Coffee Table Base is 16"H.
- Specify top and base separately.

	Description	Model	Ship Weight	Cubes	L1 List Price	L2 List Price	L3 List Price
	<b>Belong Laminate Table Tops</b>						
	16" Diameter for Side Table	S912T16L	5.0	1.0	\$ 319	\$ 335	\$ 346
	32" Diameter for Coffee Table	S912T32L	19.0	2.5	\$ 442	\$ 461	\$ 477

	Description	Model	Ship Weight	Cubes	P1 Paint List Price	P2 Paint List Price	P3 Paint List Price
	<b>Belong Glass Table Tops with Painted Pan</b>						
	16" Diameter for Side Table	S912T16G	19.0	1.0	\$ 666	\$ 683	\$ 708
	32" Diameter for Coffee Table	S912T32G	38.0	2.5	\$ 864	\$ 895	\$ 946

	Description	Model	Ship Weight	Cubes	V1 List Price	V3 List Price	V5 List Price
	<b>Belong Veneer Table Tops</b>						
	16" Diameter for Side Table	S912T16V	10.0	1.0	\$ 1432	\$ 1593	\$ 1698
	32" Diameter for Coffee Table	S912T32V	25.0	2.5	\$ 1847	\$ 2054	\$ 2191

	Description	Model	Ship Weight	Cubes	P1 List Price	P2 List Price	P3 List Price
	<b>Belong Side Table Base</b>						
	21"H x 16" Diameter — Painted Aluminum	S912B2116	13.0	4.5	\$ 1141	\$ 1183	\$ 1184
	<b>Belong Coffee Table Base</b>						
	16"H x 32" Diameter — Painted Aluminum	S912B1632	16.0	12.7	\$ 1427	\$ 1493	\$ 1496

NOTE: Add FSC prefix to laminate code for FSC certified wood.

<p><b>How to specify —</b></p> <p>Select the Model Number from above.</p> <p><u>S</u>   <u>9</u>   <u>1</u>   <u>2</u>                                    </p>	<p><i>1st Option:</i></p> <p><b>Select the Top Material</b> <i>(if applicable):</i></p> <p>Laminate, Glass – C Clear, or Veneer.</p> <p>See page 332 for finishes.</p> <p>                                   </p>	<p><i>2nd Option:</i></p> <p><b>Edge Color for Laminate Tops</b> <i>(if applicable):</i></p> <p>See page 332 for finishes.</p> <p>                                   </p>	<p><i>2nd Option:</i></p> <p><b>Paint for Glass Top</b> <i>(if applicable):</i></p> <p><b>(P1) (P2) (P3)</b></p> <p>P1, P2, or P3 Paint.</p> <p>P                                  </p>	<p><i>1st Option:</i></p> <p><b>Paint for Base</b> <i>(if applicable):</i></p> <p><b>(P1) (P2) (P3)</b></p> <p>See page 332 for finishes.</p> <p>P                                  </p>
--	---	---	---	--

Examples: S912T16L.LWDEDD.BA    S912T16V.SC701    S912B2116.P4J    S912T32G.C.P7B

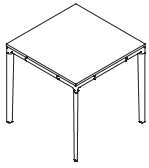

Description	Model Number	Unit Weight	Ship Weight	Cubes	Base		Upcharge List Price – Add to Base Price					
					List Price	L2	L3	V3	V5	Corian B	Corian C	
<b>Side Table — 22"W x 22"D x 21½"H</b>												
Laminate Flat Edge	PTSTL	39	49	13.7	\$ 1622	\$ 22	\$ 44					
Veneer Square Edge	PTSTV	37	47	13.7	\$ 2751			\$ 320	\$ 532			
Corian	PTSTS	42	52	13.7	\$ 3244					\$ 66	\$ 131	

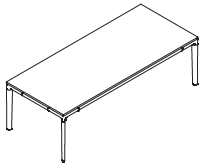

<b>Coffee Table — 52"W x 22"D x 16"H</b>												
Laminate Flat Edge	PTCTL	53	68	16.3	\$ 2081	\$ 33	\$ 66					
Veneer Square Edge	PTCTV	51	66	16.3	\$ 3104			\$ 360	\$ 600			
Corian	PTCTS	77	92	16.3	\$ 4092					\$ 153	\$ 306	

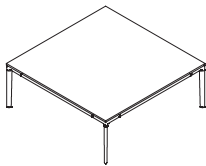

<b>Coffee Table — 42"W x 42"D x 16"H</b>												
Laminate Flat Edge	PTLTL	53	68	24.0	\$ 2187	\$ 39	\$ 77					
Veneer Square Edge	PTLTV	51	66	24.0	\$ 3387			\$ 393	\$ 654			
Corian	PTLTS	111	126	24.0	\$ 4515					\$ 218	\$ 436	

PARALLEL

<p><b>How to specify —</b> Select the Model Number from above.</p>	<p><b>1st Option:</b> <b>Select the Base Color:</b> See page 332 for selections and Color Codes. <b>P2 Add</b> \$88 Side Table 22" \$109 Coffee Table 52" \$120 Coffee Table 42" <b>P3 Add</b> \$131 Side Table 22" \$164 Coffee Table 52" \$180 Coffee Table 42" <b>P4 Add</b> \$175 Side Table 22" \$218 Coffee Table 52" \$240 Coffee Table 42"</p>	<p><b>2nd Option:</b> <b>Select the Laminate</b> (if applicable): See page 332 for selections and Color Codes.</p>	<p><b>2nd Option:</b> <b>Select the Veneer</b> (if applicable): See page 332 for selections and Finish Codes.</p>	<p><b>2nd Option:</b> <b>Select Corian</b> (if applicable): <b>Grade A</b> <b>SAW</b> Cameo White (De-emphasized) <b>Grade B</b> <b>SDW</b> Designer White (De-emphasized) <b>Grade C</b> <b>SES</b> Deep Night Sky (De-emphasized)  More Corian colors available as specials</p>	<p><b>3rd Option:</b> <b>Select the Edge Color</b> (Laminate only): See page 332 for selections and Color Codes.</p>	<p><b>4th Option:</b> <b>Veneer Finish Method</b> (Veneer only): <b>OP</b> Open Pore Low Shin <b>FF</b> Full-Fill Cleartech Add \$218 Side Table \$218 Coffee Tables</p>
P   S         .	P       .	L         .	.	S		

Examples: PTSTL.P4Q.LDW1.DW PTCTV.PJW.SE800.OP PTLTS.POL.SDW

Description	Model Number	Base List Price	Upcharge List Price — Add to Base Price		P2 Paint
			L2	L3	
<b>Laminate Tables</b>					
Low Work Table	S911NL	\$ 986	\$ 39	\$ 77	\$ 77
Mid Work Table	S911NM	\$ 1057	\$ 42	\$ 82	\$ 82
High Work Table	S911NH	\$ 1128	\$ 44	\$ 88	\$ 88

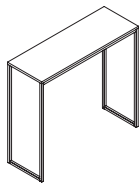
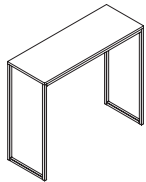
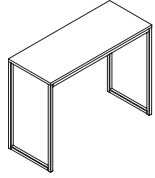

Table Pricing Example:	Model/Options	Base Price/Upcharges
Step 1: Select Model	S911NL	\$ 986
Step 2: Select Laminate	LDW1 Designer White	\$ 0 upcharge
Step 3: Select Edgeband	DW Designer White	\$ 0 upcharge
Step 4: Select Paint	P8X Solar Black	\$ 77 upcharge
Add Base + applicable Upcharges for Total List Price =		\$ 1063

RISE

<p><b>How to specify —</b> Select the Model Number from above.</p> <p>S   9   1   1   N   .</p>	<p><b>1st Option:</b> FSC Certified Wood (if applicable): FSC Select for FSC Certified Wood</p> <p>F   S   C   .</p>	<p><b>2nd Option:</b> Select the Laminate See page 332 for options.</p> <p>        .</p>	<p><b>3rd Option:</b> Select the Edge Band See page 332 for options.</p> <p>    .</p>	<p><b>4th Option:</b> Select the Paint See page 332 for options.</p> <p>       </p>
---	--	--	---	---

Example: S911NL.FSC.

Model Number	Overall				
	Ship Weight	Cubes	Height	Width	Depth
S911NL	35	53.3	28"	36"	15"
S911NM	39	72.6	34"	40"	15"
S911NH	43	87.4	38"	42½"	15"

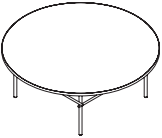
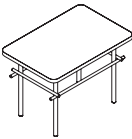
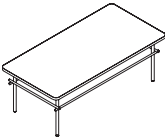
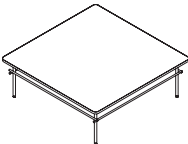

	Description	Model Number	Base List Price	Upcharge List Price — Add to Base Price		P2 Paint
				L2	L3	
	<b>Laminate Tables</b> 20" Round Side Table	ET20	\$ 895	\$ 11	\$ 22	\$ 44
	39" Round Table	ET39	\$ 2013	\$ 31	\$ 60	\$ 88
	14" x 21" Side Table	ET1421	\$ 1267	\$ 17	\$ 33	\$ 60
	21" x 42" Table	ET2142	\$ 1717	\$ 28	\$ 55	\$ 71
	42" x 42" Table	ET4242	\$ 2090	\$ 33	\$ 66	\$ 88

<b>Table Pricing Example:</b>	<b>Model/Options</b>	<b>Base Price/Upcharges</b>
Step 1: Select Model	ET1421	\$ 1267
Step 2: Select Laminate	LWBA Belair	\$ 0 upcharge
Step 3: Select Edgeband	BA Belair	\$ 0 upcharge
Step 4: Select Paint	P8X Solar Black	\$ 60 upcharge
Add Base + applicable Upcharges for Total List Price =		\$ 1327

<p><b>How to specify —</b> Select the Model Number from above.</p> <p>E   T             .</p>	<p><b>1st Option:</b> FSC Certified Wood (if applicable): FSC Select for FSC Certified Wood</p> <p>F   S   C   .</p>	<p><b>2nd Option:</b> Select the Laminate See page 332 for options.</p> <p>          .</p>	<p><b>3rd Option:</b> Select the Edge Band See page 332 for options.</p> <p>    .</p>	<p><b>4th Option:</b> Select the Paint P8Z Textured Salt P8X Solar Black (add P2 Paint upcharge)</p> <p>        .</p>
---	--	--	---	---

Example: ET39.FSC.LWBA.BA.P8X

Model Number	Overall				
	Ship Weight	Cubes	Height	Width	Depth
ET20	14	3.4	17.25"	20"	20"
ET39	38	19.4	15"	39"	39"
ET1421	14	3.4	17.25"	21"	14"
ET2142	35	9.1	15"	42"	21"
ET4242	53	18.8	15"	42"	21"

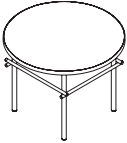
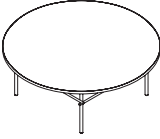
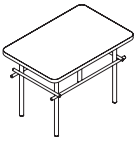
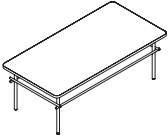
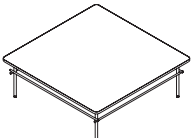

	Description	Model Number	Base List Price	Upcharge List Price — Add to Base Price		P2 Paint
				V3	V5	
	<b>Veneer Tables</b> 20" Round Side Table	<b>EV20</b>	<b>\$ 1516</b>	<b>\$ 103</b>	<b>\$ 172</b>	<b>\$ 44</b>
	39" Round Table	<b>EV39</b>	<b>\$ 2440</b>	<b>\$ 140</b>	<b>\$ 233</b>	<b>\$ 88</b>
	14" x 21" Veneer Side Table	<b>EV1421</b>	<b>\$ 1715</b>	<b>\$ 101</b>	<b>\$ 167</b>	<b>\$ 60</b>
	21" x 42" Veneer Table	<b>EV2142</b>	<b>\$ 2063</b>	<b>\$ 123</b>	<b>\$ 203</b>	<b>\$ 71</b>
	42" x 42" Veneer Table	<b>EV4242</b>	<b>\$ 2537</b>	<b>\$ 151</b>	<b>\$ 251</b>	<b>\$ 88</b>

**How to specify —**  
Select the Model Number from above.

**1st Option:**  
FSC Certified Wood (if applicable):  
FSC Select for FSC Certified Wood

**2nd Option:**  
Select the Veneer  
See page 332 for options.

**3rd Option:**  
Select the Veneer Finish  
OP Open Pore Low Sheen  
FF Full Fill Cleartech (add \$218)

**4th Option:**  
Select the Paint  
P8Z Textured Salt  
P8X Solar Black (add P2 Paint upcharge)

EV | | | | | | | .

FSC | .

| | | | | | | .

| | .

| | | |

Example: EV39.FSC.NC701.FF.P8X

Model Number	Overall				
	Ship Weight	Cubes	Height	Width	Depth
EV20	22	3.4	17.25"	20"	20"
EV39	53	19.4	15"	39"	39"
EV1421	22	3.4	17.25"	21"	14"
EV2142	45	9.1	15"	42"	21"
EV4242	65	18.8	15"	42"	21"



Description	Model Number <i>below</i>	Cubes	Weight					Grade 2 Paint Upcharge
				L1	L2	L3	L7	
<b>Park Lo Side Table</b> 19 1/4"H x 24"W x 24"D	<b>NARC</b>	10.0	20	\$1006	\$1029	\$1052	\$1144	\$ 29



<b>Park Hi Pill Table</b> 29 1/4"H x 48"W x 15"D	<b>NA4828RB</b>	14.6	50	\$1150	\$1173	\$1196	\$1288	\$ 43
---	-----------------	------	----	--------	--------	--------	--------	-------



<b>Park Lo Pill Table</b> 20 1/4"H x 48"W x 15"D	<b>NA4815RB</b>	11.0	35	\$1030	\$1053	\$1076	\$1168	\$ 34
---	-----------------	------	----	--------	--------	--------	--------	-------



<b>Work From Home Park Pill Table</b> 29 3/4"H x 48"W x 20"D	<b>NA482920RB</b> ( <i>De-emphasized</i> )	13.0	57	\$1118	\$1142	\$1166	\$1261	\$ 52
---	--	------	----	--------	--------	--------	--------	-------



<b>Park Counter Pill Table</b> 36"H x 48"W x 15"D	<b>NA483615RB</b> ( <i>De-emphasized</i> )	15.5	60	\$1259	\$1282	\$1305	\$1397	\$ 41
--	--	------	----	--------	--------	--------	--------	-------



<b>Park Counter Pill Table</b> 36"H x 48"W x 20"D	<b>NA483620RB</b> ( <i>De-emphasized</i> )	15.2	64	\$1262	\$1286	\$1310	\$1405	\$ 41
--	--	------	----	--------	--------	--------	--------	-------



<b>Park Hi Lo Casual Table</b> 28 1/2"H x 52 1/4"W x 24"D	<b>NALC</b>	25.7	52	\$2165	\$2227	\$2286	\$2528	\$ 42
--	-------------	------	----	--------	--------	--------	--------	-------

Pricing Example:	Model/Options	Base Price/Upcharges
Step 1: Select Model	NARC	
Step 2: Select Laminate	w/Grade 3 Laminate	\$ 1052
Step 3: Select Paint	Grade 2 Paint	\$ 29 upcharge
Add Base + applicable Upcharges for Total List Price =		\$ 1081

How to specify — Select the Model Number from above.	1st Option: Select FSC (if applicable):	2nd Option: Select the Paint Finish: P1 P2	3rd Option: Select the Laminate Color: See page 332 for selections and color codes.	4th Option: Select the Edge Color: See page 332 for selections and color codes.
N A _ _	_ _ _	_ _ _	_ _ _	_

Example: NARC.P8X.LWBA.PC

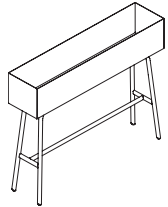
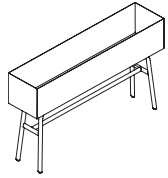

Description	Model	Cubes	Ship Weight	Base List Price	Grade 2 Paint Upcharge
<b>Park Planters — Lo Plant/Storage Pedestal</b>					
28 3/4" H x 48 3/4" W x 11" D	NALP	6.5	53	\$ 1375	\$ 79

<b>Park Planters — Hi Plant/Storage Pedestal</b>					
38 3/4" H x 48 3/4" W x 11" D	NAHP	10.1	58	\$ 1530	\$ 88

**How to specify —**  
Select the Model Number from above.

**1st Option:**  
Select the Paint Finish:  
P1 P2

**N|A| | | .**

*Example: NALP.P8X*

Description	Model <i>Add options below</i>	Cubes	Ship Weight	List Price with Upcharge		
				L1	L2	L3
<b>Pedestal Planter</b>						
Park Laminate Plant/Storage Pedestal Top	NAPT	1.1	5	\$ 455	\$ 470	\$ 483

**How to specify —**  
Select the Model Number from above.

**1st Option:**  
Select FSC (if applicable):

**2nd Option:**  
Select the Laminate Color:  
See page 332 for selections and color codes.

**3rd Option:**  
Select the Edge Color:  
See page 332 for selections and color codes.

**N|A|P|T| | | .**

*Example: NAPT.LWBA.EV*



Recharge™ page 347



Rise™ page 348



**RECHARGE PAINT FINISHES**

**TABLE BASES**

Textured Designer White .....	PK7
Textured Flint .....	P7A
Textured Silver .....	PR8

**RECHARGE SCREEN FABRICS**

Dark Grey .....	DRK
Light Grey .....	LGT
Medium Grey .....	MDD

**RECHARGE CONNECTOR TABLE LAMINATES**

Designer White .....	LDW1
Flint .....	LM16

**RECHARGE TABLE LAMINATES**

**GRADE L1**

**SOLID COLOR**

Black .....	P
Brownstone .....	LM13
Bungalow .....	LM12
Designer White .....	LDW1
Flint .....	LM16
Fossil Shale .....	LEH1
Loft .....	LM11
Muslin .....	LM15
Titanium .....	LT11

**ABSTRACT**

Ash .....	LT3B
Handspun Pearl .....	LAHP
Handspun Dove .....	LAHD
Handspun Slate .....	LAHS
Handspun Chestnut .....	LAHC
Silver Mesh .....	LT8D

**WOODGRAIN**

Belair .....	LWBA
Bourbon Cherry .....	H
Field Elm .....	LWFE
Florence Walnut .....	LFW1
Kingswood Walnut .....	LK11
Natural Maple .....	LWD
NeoWalnut .....	LNU1
Pinnacle .....	PINC
Shaker Cherry .....	LW7C

**GRADE L2**

**WOODGRAIN**

Beigewood .....	LWBE
Fawn Cypress .....	LFC1
Lowell Ash .....	LLA1
Mangalore Mango .....	LMM1
Natural Recon .....	LNR1
Phantom Charcoal .....	LPC1
Phantom Ecu .....	LPE1
Portico Teak .....	LPT1
Skyline Walnut .....	LSW1
Veranda Teak .....	LVT1

**GRADE L3**

**WOODGRAIN**

Natural Walnut .....	LWNW
----------------------	------

**RECHARGE EDGE COLORS**

Beigewood .....	DE
Belair .....	BA
Black .....	E4
Bourbon Cherry .....	H
Brownstone .....	EY
Bungalow .....	EX
Designer White .....	DW
Fawn Cypress .....	FC
Field Elm .....	FE
Flint .....	E9
Florence Walnut .....	FW
Fossil .....	EH
Kingswood Walnut .....	KI
Loft .....	EV
Lowell Ash .....	DL
Mangalore Mango .....	MM
Muslin .....	EU
Natural Maple .....	DD
Natural Recon .....	NR
Natural Walnut .....	DN
NeoWalnut .....	NU
Parchment .....	EN
Phantom Charcoal .....	PC
Phantom Ecu .....	PE
Pinnacle .....	PI
Plyband .....	PL
Portico Teak .....	DP
Shaker Cherry .....	DF
Skyline Walnut .....	SW
Titanium .....	TI
Veranda Teak .....	VT

**RISE PAINT FINISHES**

**GRADE P1**

Charblack .....	CBK
Textured Brownstone .....	P7J
Textured Designer White .....	PK7
Textured Flint .....	P7A
Textured Loft .....	P7L
Textured Muslin .....	P7M
Textured Pebble .....	P8Y
Textured Salt .....	P8Z
Textured Titanium .....	P8V

**GRADE P2**

Night Bronze .....	P8B
Pyrite .....	PJE
Silver Texture .....	PR8
Solar Black .....	P8X

**GRADE P3**

Atom .....	P8S
Blossom .....	P8K
Bullseye .....	PJF
Cabernet .....	P7T
Conifer .....	P8H
Ember .....	P8P
Ion .....	P8N
Iris .....	P8J
Krypton .....	P8F
Regatta .....	P8M
Succulent .....	P8A

	Description	Model Number Power Location	Ship Weight	Cubes	L1	Laminate L2	L3
Laptop Table 22"L x 17"W x 28"H	No Power	MLM18	37	11.8	\$ 859	\$ 891	\$ 922



RECHARGE

<p><b>How to specify —</b> Select the Model Number from above.</p> <p>MLM           .</p>	<p><b>1st Option:</b> Select the Laminate Color (if applicable): See page 346 for selections and color codes.</p> <p>Connector Tables limited to: LDW1 Designer White LM16 Flint</p> <p>          .</p>	<p><b>2nd Option:</b> Select the Laminate Edge Color (if applicable): See page 346 for selections and color codes. Connector Tables do not require an edge color.</p> <p>    .</p>	<p><b>3rd Option:</b> Select the Table Base Paint Color (if applicable): See page 346 for selections and color codes.</p> <p>          .</p>
---	---	--	--

Example: MLM18.LM16.E9.P7A



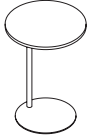

Description	Model Number	Base List Price	Laminate		Paint	
			L2	L3	P2	P3
<b>Rise Accessories</b>						
Laptop Table 28"H x 20"W x 20"D	S911RLTB	\$ 1015	\$ 1054	\$ 1092		\$ 1092 \$ 1130

RISE

<p><b>How to specify —</b> Select the Model Number from above.</p>	<p><b>1st Option:</b> FSC Certified Wood (if applicable): FSC Select for FSC Certified Wood</p>	<p><b>2nd Option:</b> Select the Laminate (if applicable): See page 346 for options.</p>	<p><b>3rd Option:</b> Select the Edge Color (if applicable): See page 346 for options.</p>	<p><b>4th Option:</b> Select the Base Paint Color See page 346 for options.</p>
S 9 _ _ _ _ _ _ _ _ _ _ _	. F S C .	L _ _	_ _	_ _ _ _ _ _ _

*Example:*

Park™ pages 351-352

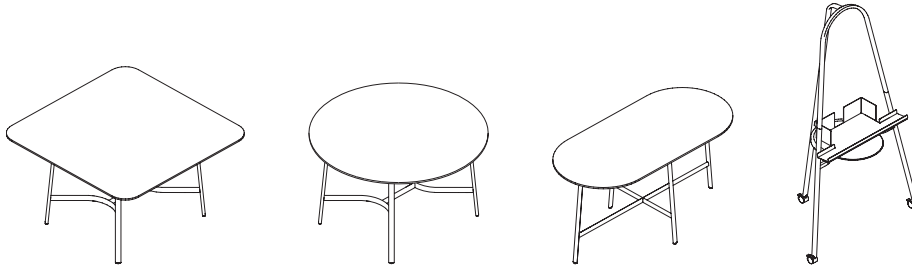

Townhall™ Peak™ page 353

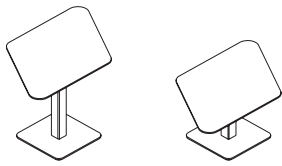

Townhall Picnic™ pages 354-357

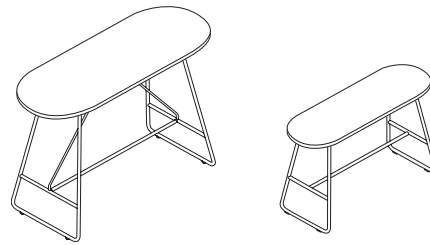

Recharge™ page 358

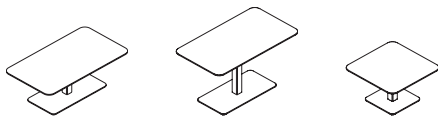

**PARK PAINT FINISHES**

<b>GRADE P1</b>	
Textured Brownstone.....	P7J
Textured Designer White.....	PK7
Textured Flint.....	P7A
Textured Loft.....	P7L
Textured Muslin.....	P7M
Textured Pebble.....	P8Y
Textured Salt.....	P8Z
Textured Titanium.....	P8V
<b>GRADE P2</b>	
Textured Silver.....	PR8
Solar Black.....	P8X
<b>GRADE P3</b>	
Amethyst ( <i>De-emphasized</i> ).....	P091
Atom.....	P85
Blossom***.....	P8K
Cobalt Mica ( <i>De-emphasized</i> ).....	P090
Ember.....	P8P
Ion.....	P8N
Iris.....	P8J
Krypton.....	P8F
Ochre.....	P093
Regatta.....	P8M
Sienna.....	P092
Succulent***.....	P8A

\*\*\*These colors are intended to be an inspirational option for the trending market. Product application is limited and color availability is approximately two years to coincide with evolving workplace trends.

**PARK TABLE LAMINATES**

<b>GRADE L1-ABSTRACT</b>	
Ash.....	LT3B
Handspun Pearl.....	LAHP
Handspun Dove.....	LAHD
Handspun Slate.....	LAHS
Handspun Chestnut.....	LAHC
Silver Mesh.....	LT8D
<b>GRADE L1-SOLID</b>	
Black.....	P
Brownstone.....	LM13
Bungalow.....	LM12
Designer White.....	LDW1
Flint.....	LM16
Fossil Shale.....	LEH1
Loft.....	LM11
Muslin.....	LM15
Titanium.....	LT11
<b>GRADE L1-WOODGRAIN</b>	
Belair.....	LWBA
Bourbon Cherry.....	H
Field Elm.....	LWFE
Florence Walnut.....	LFW1
Kingswood Walnut.....	LK11
Natural Maple.....	LWD
NeoWalnut.....	LNU1
Pinnacle.....	PINC
Shaker Cherry.....	LW7C
<b>GRADE L2-WOODGRAIN</b>	
Beigewood.....	LWBE
Fawn Cypress.....	LFC1
Lowell Ash.....	LLA1
Mangalore Mango.....	LMM1
Natural Recon.....	LNR1
Phantom Charcoal.....	LPC1
Phantom Ecu.....	LPE1
Portico Teak.....	LPT1
Skyline Walnut.....	LSW1
<b>GRADE L3-WOODGRAIN</b>	
Natural Walnut.....	LWNW
<b>GRADE L4-MARKERBOARD</b>	
White Markerboard.....	FMQ1
<b>GRADE L7-SOLID (TRACELESS)*†</b>	
Black Velvet.....	LBV1
Charcoal Velvet.....	LCV1

\*Park Storage is available in all grades of laminate except Grade 7.  
†LBV1 and LCV1 are warranted for 1 year.

**PARK, TOWNHALL & RECHARGE EDGE COLORS**

Beigewood.....	DE
Belair.....	BA
Black.....	E4
Bourbon Cherry.....	H
Brownstone.....	EY
Bungalow.....	EX
Designer White.....	DW
Fawn Cypress.....	FC
Field Elm.....	FE
Flint.....	E9
Florence Walnut.....	FW
Fossil.....	EH
Kingswood Walnut.....	KI
Loft.....	EV
Lowell Ash.....	DL
Mangalore Mango.....	MM
Muslin.....	EU
Natural Maple.....	DD
Natural Recon.....	NR
Natural Walnut.....	DN
NeoWalnut.....	NU
Parchment.....	EN
Phantom Charcoal.....	PC
Phantom Ecu.....	PE
Pinnacle.....	PI
Portico Teak.....	DP
Shaker Cherry.....	DF
Skyline Walnut.....	SW
Titanium.....	TI
Veranda Teak.....	VT

**NOTE:** \$33 upcharge on Woodgrain T-Mold.

**SUMMIT/PICNIC PAINT FINISHES**

<b>GRADE P1</b>	
Black.....	P71
Charblack.....	CBK
Designer White.....	PJW
Flint.....	P02
Textured Designer White.....	PK7
Textured Brownstone.....	P7J
Textured Flint.....	P7A
Textured Loft.....	P7L
Textured Muslin.....	P7M
Textured Pebble.....	P8Y
Textured Salt.....	P8Z
Textured Titanium.....	P8V
<b>GRADE P2</b>	
Night Bronze.....	P8B
Solar Black.....	P8X
Pyrite.....	PJE
Silver.....	PR6
Textured Silver.....	PR8
<b>GRADE P3</b>	
Atom.....	P8S
Blossom***.....	P8K
Bullseye.....	PJF
Cabernet***.....	P7T
Conifer***.....	P8H
Ember.....	P8P
Ion.....	P8N
Iris.....	P8J
Krypton.....	P8F
Regatta.....	P8M
Succulent***.....	P8A

**CLOUD PAINT FINISHES**

<b>GRADE P1</b>	
Charblack.....	CBK
Textured Designer White.....	PK7
Textured Brownstone.....	P7J
Textured Flint.....	P7A
Textured Loft.....	P7L
Textured Muslin.....	P7M
Textured Pebble.....	P8Y
Textured Salt.....	P8Z
Textured Titanium.....	P8V
<b>GRADE P2</b>	
Textured Silver.....	PR8
Solar Black.....	P8X

\*\*\*These colors are intended to be an inspirational option for the trending market. Product application is limited and color availability is approximately two years to coincide with evolving workplace trends.

**TOWNHALL LAMINATES**

<b>GRADE L1</b>	
<b>ABSTRACT</b>	
Ash.....	LT3B
Handspun Pearl.....	LAHP
Handspun Dove.....	LAHD
Handspun Slate.....	LAHS
Handspun Chestnut.....	LAHC
Silver Mesh.....	LT8D
<b>SOLID</b>	
Black.....	P
Brownstone.....	LM13
Bungalow.....	LM12
Designer White.....	LDW1
Flint.....	LM16
Fossil Shale.....	LEH1
Loft.....	LM11
Muslin.....	LM15
Titanium.....	LT11
<b>WOODGRAIN</b>	
Belair.....	LWBA
Bourbon Cherry.....	H
Field Elm.....	LWFE
Florence Walnut.....	LFW1
Kingswood Walnut.....	LK11
Natural Maple.....	LWD
NeoWalnut.....	LNU1
Pinnacle.....	PINC
Shaker Cherry.....	LW7C
<b>GRADE L2</b>	
<b>WOODGRAIN</b>	
Beigewood.....	LWBE
Fawn Cypress.....	LFC1
Lowell Ash.....	LLA1
Mangalore Mango.....	LMM1
Natural Recon.....	LNR1
Phantom Charcoal.....	LPC1
Phantom Ecu.....	LPE1
Portico Teak.....	LPT1
Skyline Walnut.....	LSW1
<b>GRADE L3</b>	
<b>WOODGRAIN</b>	
Natural Walnut.....	LWNW

**RECHARGE PAINT FINISHES**

<b>TABLE BASES</b>	
Textured Designer White.....	PK7
Textured Flint.....	P7A
Textured Silver.....	PR8

**RECHARGE CONNECTOR TABLE LAMINATES**

Designer White.....	LDW1
Flint.....	LM16



**RECHARGE TABLE LAMINATES**

<b>GRADE L1</b>	
<b>SOLID COLOR</b>	
Black.....	P
Brownstone.....	LM13
Bungalow.....	LM12
Designer White.....	LDW1
Flint.....	LM16
Fossil Shale.....	LEH1
Loft.....	LM11
Muslin.....	LM15
Titanium.....	LT11
<b>ABSTRACT</b>	
Ash.....	LT3B
Handspun Pearl.....	LAHP
Handspun Dove.....	LAHD
Handspun Slate.....	LAHS
Handspun Chestnut.....	LAHC
Silver Mesh.....	LT8D
<b>WOODGRAIN</b>	
Belair.....	LWBA
Bourbon Cherry.....	H
Field Elm.....	LWFE
Florence Walnut.....	LFW1
Kingswood Walnut.....	LK11
Natural Maple.....	LWD
NeoWalnut.....	LNU1
Pinnacle.....	PINC
Shaker Cherry.....	LW7C

<b>GRADE L2</b>	
<b>WOODGRAIN</b>	
Beigewood.....	LWBE
Fawn Cypress.....	LFC1
Lowell Ash.....	LLA1
Mangalore Mango.....	LMM1
Natural Recon.....	LNR1
Phantom Charcoal.....	LPC1
Phantom Ecu.....	LPE1
Portico Teak.....	LPT1
Skyline Walnut.....	LSW1
<b>GRADE L3</b>	
<b>WOODGRAIN</b>	
Natural Walnut.....	LWNW

Note: Refer to individual product pages for upcharges.

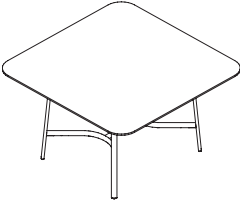
MEETING TABLES OVERVIEW

Description	Model Number <i>Add options below</i>	Cubes	Weight					Grade 2 Paint Upcharge
				L1	L2	L3	L7	
<b>Park 48" Soft Square Meeting Table</b>								
28"H x 48"W x 48"D	NA48SS ( <i>De-emphasized</i> )	15.6	60	\$2081	\$2126	\$2170	\$2344	\$ 77
								
<b>Park 48" Round Meeting Table</b>								
28"H x 48"W x 48"D	NA48R ( <i>De-emphasized</i> )	15.6	60	\$2081	\$2126	\$2170	\$2344	\$ 77
								
<b>Park Pill Work Table</b>								
28½"H x 57"W x 27"D	NAPWT	18.9	45	\$2081	\$2137	\$2193	\$2415	\$ 54
								

Pricing Example:	Model/Options	Base Price/Upcharges
Step 1: Select Model	NAPWT	
Step 2: Select Laminate	w/Grade 3 Laminate	\$ 2193
Step 3: Select Paint	Grade 2 Paint	\$ 54 upcharge
Add Base + applicable Upcharges for Total List Price =		\$ 2247

<p><b>How to specify —</b> Select the Model Number from above.</p>	<p><b>1st Option:</b> Select FSC (if applicable):</p>	<p><b>2nd Option:</b> Select the Paint Finish:</p> <p>P1 P2</p>	<p><b>3rd Option:</b> Select the Laminate Color:</p> <p>See page 350 for selections and color codes.</p>	<p><b>4th Option:</b> Select the Edge Color:</p> <p>See page 350 for selections and color codes.</p>
<p>NA        </p> <p>          .</p>	<p>          .</p>	<p>          .</p>	<p>          .</p>	<p>      .</p>

Example: NAPWT.FSC.P8X.LWBA.BA



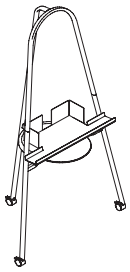

Description	Model Number <i>Add options below</i>	Cubes	Ship Weight	Base List Price	Grade 2 Paint Upcharge
<b>Park Easel</b>					
69"H x 39 1/4"W x 28"D	<b>NAESL</b> <i>(De-emphasized)</i>	0.4	60	\$ 2242	\$ 164

\*The maximum TV size that will fit on the Park Easel is 65" or 65 pounds.

**How to specify —**  
Select the Model Number from above.

**1st Option:**  
Select the Paint Finish:

P1 P2

N|A|E|S|L|. .

Example: NAESL.P8X

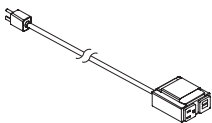

Description	Model	List Price
<b>Park Electrical</b>		
1 MOD 2 SMPLX	<b>NAE1</b>	\$ 407

\*1 module including 1 A/C and Dual USB-A

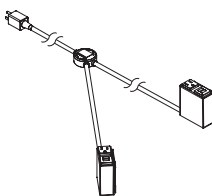

2 MOD 4 SMPLX	<b>NAE2</b>	\$ 671
---------------	-------------	--------

\*2 modules including 1 A/C and Dual USB-A

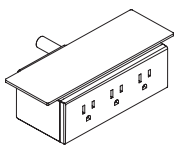

EASEL ELECTRIC MODULE	<b>NAEESL</b>	\$ 448
-----------------------	---------------	--------

**How to specify —**  
Select the Model Number from above.

**1st Option:**  
Select Braid Color:  
BC0014 Black Storm  
BC0046 White/Fog

N|A|E|. . . . .

Example: NAE1.BC0046

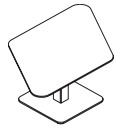

Description	Model <i>Add options below</i>	List Price with Upcharge			
		L1	L2	L3	
<b>Peak Tables</b>					
Peak Table	ACVISTBL	Table	\$ 1979	\$ 2025	\$ 2071
Peak Coffee Table	ACVISCTBL	Coffee Table	\$ 1827	\$ 1873	\$ 1919

Model Number	Overall				
	Ship Weight	Cutbs	Height	Width	Depth
ACVISTBL	50	8.7	27 1/2"	40 1/2"	25 1/2"
ACVISCTBL	45	6.1	17"	40 1/2"	25 1/2"

Peak Tables available in Knife Edge only.  
Peak Coffee Table has the same outer dimensions as the Peak Ottoman.



<p><b>How to specify —</b> Select the Model Number from above.</p>	<p><b>1st Option:</b> Select FSC (if applicable):</p>	<p><b>2nd Option:</b> Select the Laminate Color: See page 350 for selections and Color Codes.</p>	<p><b>3rd Option:</b> Select the Edge Color: See page 350 for selections and Color Codes.</p>	<p><b>4th Option:</b> Select the Paint Finish: P7A Textured Flint PR8 Textured Silver (Table) (Grade 2 upcharge \$52) PR8 Textured Silver (Coffee Table) (Grade 2 upcharge \$41) PK7 Textured Designer White</p>
<p>ACV I S           .           .</p>	<p>          .</p>	<p>          .</p>	<p>      .</p>	<p>         </p>

Example: ACVISTBL.LM15.EU.PK7

# Social Collaborative — Meeting Tables

Townhall Picnic™

GSA SIN 33721

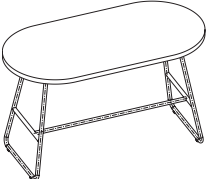
Description	Model <i>Add options below</i>	List Price			Paint Upcharge	
		L1	L2	L3	P2	P3
<b>Picnic Table</b>						
 Picnic Table, Bar Height	ACPICT	\$ 2283	\$ 2302	\$ 2318	\$ 129	\$ 321
<b>Picnic Table</b>						
 Picnic Table, Bar Height	ACPICT30	\$ 2359	\$ 2381	\$ 2402	\$ 129	\$ 321
<b>Picnic Table</b>						
 Picnic Table, Counter Height	ACPICTC24 <i>(De-emphasized)</i>	\$ 1634	\$ 1653	\$ 1669	\$ 87	\$ 172
<b>Picnic Table</b>						
 Picnic Table, Counter Height	ACPICTC30 <i>(De-emphasized)</i>	\$ 1710	\$ 1732	\$ 1753	\$ 87	\$ 172
<b>Picnic Table</b>						
 Picnic Table, Seated Height	ACPICBL <i>(De-emphasized)</i>	\$ 1502	\$ 1531	\$ 1559	\$ 54	\$ 135
<b>Picnic Table</b>						
 Work From Home Picnic Table	ACPICBL24 <i>(De-emphasized)</i>	\$ 1594	\$ 1608	\$ 1621	\$ 54	\$ 135

Picnic Table and Laminate Bench available in Flat Edge only.

<p><b>How to specify —</b> Select the Model Number from above.</p> <p>ACPICT     .</p>	<p><b>1st Option:</b> Select FSC <i>(if applicable):</i></p> <p>        .</p>	<p><b>2nd Option:</b> Select the Laminate Finish: See page 350 for selections and Color Codes.</p> <p>            .</p>	<p><b>3rd Option:</b> Select the Edge Color: See page 350 for selections and Color Codes.</p> <p>    .</p>	<p><b>4th Option:</b> Select the Paint Finish: See Paint Finishes on page 350.</p> <p>P1 P2 P3 P2 add \$129 Table / \$54 Bench upcharge P3 add \$321 Table/ \$135 Bench upcharge</p> <p>      .</p>
--	---	---	--	---

Example: ACPICT.LDW1.DW.P71



Model Number					Overall			Seat			
		Ship Weight	Cables	COM Yardage*	Height	Width	Depth	Height	Width	Depth	Pan Angle (Range)
ACPICT	Table	80	11.3		41"	64"	24"				
ACPICT30	Table	103	9.1		41"	64"	30"				
ACPICT24*	Table	67	8.5		36"	64"	24"				
ACPICT30*	Table	90	9.1		36"	64"	30"				
ACPICBL*	Table	60	16.5	1.0	28.19"	48"	16"	29½"		15"	47½°
ACPICBL24*	Table	17	63		23.23"	48"	24"				

\*De-emphasized

\*\*COM Yardage is listed for total yardage/feet required for a model, with applicable yardage/feet for individual components listed.



Upcharges listed for Grades 2 and above, add to Base Price. Grades 9-22 on page 324.

Description	Model Number <i>Add options below</i>	List Price with Upcharge							
		1	2	3	4	5	6	7	8
<b>Picnic Bench</b>									
Picnic Bench Upholstered	ACPICBU <i>(De-emphasized)</i>	\$ 1481	\$ 1497	\$ 1512	\$ 1528	\$ 1549	\$ 1570	\$ 1592	\$ 1612
									
<b>Picnic Low Stool</b>									
Picnic Low Stool	ACPICLS <i>(De-emphasized)</i>	\$ 741	\$ 749	\$ 757	\$ 764	\$ 775	\$ 785	\$ 796	\$ 807
									

Picnic Low Stool stacks 6 high.

<p><b>How to specify —</b> Select the Model Number from above.</p> <p>ACPIC           .</p>	<p><b>1st Option:</b> Select the Upholstery: See Allsteel Upholstery matrix on pages 210-211.</p> <p>          .</p>	<p><b>2nd Option:</b> Select FSC (if applicable): X Non-FSC Wood</p> <p>X   .</p>	<p><b>3rd Option:</b> Select the Paint Finish: See Paint Finishes on page 209.</p> <p>P1 P2 P3</p> <p>P2 add \$55 Stool / \$54 Bench upcharge P3 add \$137 Stool / \$135 Bench upcharge</p> <p>     </p>
---	--	---	--

Example: ACPICLS.RUSH10.P02

Model Number		Ship Weight	Cubes	COM Yardage*	Height	Width	Depth	Height	Width	Depth	Pan Angle (Range)
ACPICBU*	Bench	60	16.5	1.0	29½"-47½"	15"	18¾"	29½"		15"	47½°
ACPICLS*	Stool	15	10.9	0.5	15"-19"	15"	22¾"	19"		15"	15°

\*De-emphasized

\*\*COM Yardage is listed for total yardage/feet required for a model, with applicable yardage/feet for individual components listed.

GSA SIN 33721

	Description	Model Number Power Location	Ship Weight	Cubes	Laminate		
					L1	L2	L3
Coffee Table 48"L x 27"W x 17"H	No Power	<b>MLM19</b>	145	24.9	\$ 1734	\$ 1798	\$ 1860

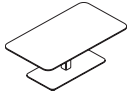

GSA SIN 33721

Work Table 48"L x 27"W x 28"H	No Power	<b>MLM22</b>	150	29.0	\$ 1893	\$ 1957	\$ 2019
-------------------------------	----------	--------------	-----	------	---------	---------	---------

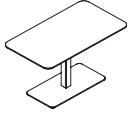

GSA SIN 33721

Corner Table 29"L x 29"W x 17"H	No Power	<b>MLM26</b>	73	14.7	\$ 1660	\$ 1720	\$ 1780
---------------------------------	----------	--------------	----	------	---------	---------	---------

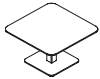

GSA SIN 33721

RECHARGE

<p><b>How to specify —</b> Select the Model Number from above.</p> <p>MLM           .</p>	<p><b>1st Option:</b> Select the Laminate Color (if applicable): See page 350 for selections and color codes.</p> <p>Connector Tables limited to: <b>LDW1</b> Designer White <b>LM16</b> Flint</p> <p>          .</p>	<p><b>2nd Option:</b> Select the Laminate Edge Color (if applicable): See page 350 for selections and color codes. Connector Tables do not require an edge color.</p> <p>      .</p>	<p><b>3rd Option:</b> Select the Table Base Paint Color (if applicable): See page 350 for selections and color codes.</p> <p>          .</p>
---	---	--	--

Example: MLM22.LWBA.BA.PR8

Park™ page [361-362](#)

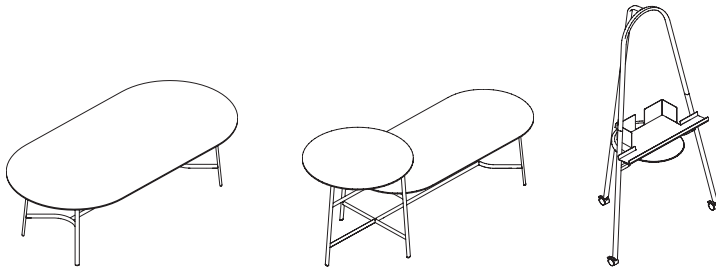

**PARK PAINT FINISHES**

**GRADE P1**

Textured Brownstone.....	P7J
Textured Designer White.....	PK7
Textured Flint.....	P7A
Textured Loft.....	P7L
Textured Muslin.....	P7M
Textured Pebble.....	P8Y
Textured Salt.....	P8Z
Textured Titanium.....	P8V

**GRADE P2**

Textured Silver.....	PR8
Solar Black.....	P8X

**GRADE P3**

Amethyst ( <i>De-emphasized</i> ).....	P091
Atom.....	P85
Blossom***.....	P8K
Cobalt Mica ( <i>De-emphasized</i> ).....	P090
Ember.....	P8P
Ion.....	P8N
Iris.....	P8J
Krypton.....	P8F
Ochre.....	P093
Regatta.....	P8M
Sienna.....	P092
Succulent***.....	P8A

\*\*\*These colors are intended to be an inspirational option for the trending market. Product application is limited and color availability is approximately two years to coincide with evolving workplace trends.

**PARK TABLES LAMINATES**

**GRADE L1-ABSTRACT**

Ash.....	LT3B
Handspun Pearl.....	LAHP
Handspun Dove.....	LAHD
Handspun Slate.....	LAHS
Handspun Chestnut.....	LAHC
Silver Mesh.....	LT8D

**GRADE L1-SOLID**

Black.....	P
Brownstone.....	LM13
Bungalow.....	LM12
Designer White.....	LDW1
Flint.....	LM16
Fossil Shale.....	LEH1
Loft.....	LM11
Muslin.....	LM15
Titanium.....	LT11

**GRADE L1-WOODGRAIN**

Belair.....	LWBA
Bourbon Cherry.....	H
Field Elm.....	LWFE
Florence Walnut.....	LFW1
Kingswood Walnut.....	LK11
Natural Maple.....	LWD
NeoWalnut.....	LNU1
Pinnacle.....	PINC
Shaker Cherry.....	LW7C

**GRADE L2-WOODGRAIN**

Beigewood.....	LWBE
Fawn Cypress.....	LFC1
Lowell Ash.....	LLA1
Mangalore Mango.....	LMM1
Natural Recon.....	LNR1
Phantom Charcoal.....	LPC1
Phantom Ecu.....	LPE1
Portico Teak.....	LPT1
Skyline Walnut.....	LSW1

**PARK TABLES LAMINATES — CONTINUED**

**GRADE L3-WOODGRAIN**

Natural Walnut.....	LWNW
---------------------	------

**GRADE L4-MARKERBOARD**

White Markerboard.....	FMQ1
------------------------	------

**GRADE L7-SOLID (TRACELESS)\*†**

Black Velvet.....	LBV1
Charcoal Velvet.....	LCV1

\*Park Storage is available in all grades of laminate except Grades 4 and 7.

†LBV1 and LCV1 are warranted for 1 year.

**PARK EDGE COLORS**

Beigewood.....	DE
Belair.....	BA
Black.....	E4
Bourbon Cherry.....	H
Brownstone.....	EY
Bungalow.....	EX
Designer White.....	DW
Fawn Cypress.....	FC
Field Elm.....	FE
Flint.....	E9
Florence Walnut.....	FW
Fossil.....	EH
Kingswood Walnut.....	KI
Loft.....	EV
Lowell Ash.....	DL
Mangalore Mango.....	MM
Muslin.....	EU
Natural Maple.....	DD
Natural Recon.....	NR
Natural Walnut.....	DN
NeoWalnut.....	NU
Parchment.....	EN
Phantom Charcoal.....	PC
Phantom Ecu.....	PE
Pinnacle.....	PI
Plyband.....	PL
Portico Teak.....	DP
Shaker Cherry.....	DF
Skyline Walnut.....	SW
Titanium.....	TI
Veranda Teak.....	VT

**NOTE:** \$33 upcharge on Woodgrain T-Mold.

CONFERENCING TABLES OVERVIEW

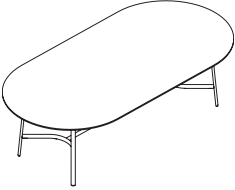
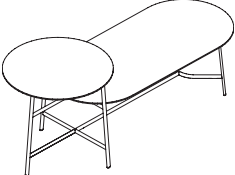
Description	Model Number <i>Add options below</i>	Cubes	Weight					Grade 2 Paint Upcharge
				L1	L2	L3	L7	
 <p><b>Park 96" Pill Meeting Table</b> 28"H x 94"W x 48"D</p>	<b>NA96RCF</b> <i>(De-emphasized)</i>	28.2	110	\$2777	\$2844	\$2910	\$3176	\$ 86
 <p><b>Park Hi Lo Meeting Table</b> 41"H x 107¼"W x 42"D</p>	<b>NALCF</b>	34.8	146	\$6248	\$6371	\$6490	\$6971	\$ 251

Pricing Example:	Model/Options	Base Price/Upcharges
Step 1: Select Model	NALCF	
Step 2: Select Laminate	w/Grade 3 Laminate	\$ 6490
Step 3: Select Paint	Grade 2 Paint	\$ 251 upcharge
Add Base + applicable Upcharges for Total List Price =		\$ 6741

How to specify — Select the Model Number from above.	1st Option: Select FSC (if applicable):	2nd Option: Select the Paint Finish: P1 P2	3rd Option: Select the Laminate Color: See page 360 for selections and color codes.	4th Option: Select the Edge Color: See page 360 for selections and color codes.	5th Option: Select whether Grommet (Park Hi Lo Meeting Table only): N No grommet G Grommet (\$12 upcharge)	6th Option: Select the Grommet Color (Park Hi Lo Meeting Table only): E4 Black E9 Flint DW Designer White EV Loft EU Muslin TI Titanium
N A _ _	_ _ _	_ _ _	_ _ _ _	_ _	_	_

Example: NALCF.FSC.LWBA.BA.G.E9

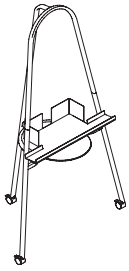





Description	Model Number <i>Add options below</i>	Cubes	Ship Weight	Base List Price	Grade 2 Paint Upcharge
<b>Park Easel</b> 69"H x 39¼"W x 28"D	<b>NAESL</b> ( <i>De-emphasized</i> )	0.4	60	\$ 2242	\$ 164

PARK

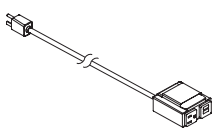
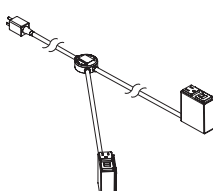
<p><i>How to specify —</i> Select the Model Number from above.</p>	<p><i>1st Option:</i> Select the Paint Finish:</p>
<p><b>NAESL</b> .</p>	<p><b>P1 P2</b></p>
<p>□ □ □ □</p>	

*Example: NAESL.P8X*

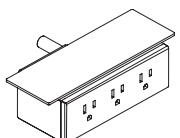
	Description	Model	List Price
	<p>Park Electrical 1 MOD 2 SMPLX *1 module including 1 A/C and Dual USB-A</p>	<p>NAE1</p>	<p>\$ 407</p>
	<p>2 MOD 4 SMPLX *2 modules including 1 A/C and Dual USB-A</p>	<p>NAE2</p>	<p>\$ 671</p>
	<p>3 MOD 5 SMPLX 1 USB</p>	<p>NAE3-1USB</p>	<p>\$ 896</p>
	<p>3 MOD 3 SMPLX 3 USB</p>	<p>NAE3-3USB</p>	<p>\$ 1194</p>
	<p>4 MOD 8 SMPLX</p>	<p>NAE4</p>	<p>\$ 1343</p>
	<p>EASEL ELECTRIC MODULE</p>	<p>NAEESL</p>	<p>\$ 448</p>

PARK

<p><i>How to specify —</i> Select the Model Number from above.</p> <p><b>N A E</b>                     .</p>	<p><i>1st Option:</i> <b>Select Braid Color:</b> BC0014 Black Storm BC0046 White/Fog</p> <p>                     </p>
--	---

Example: NAE3.BC0046





Admix™ is an innovative table system designed to be easily adaptable and flexible to meet the needs of collaborative teams and hybrid settings. Inspired by light-scale tables, this user-friendly table system provides the functionality and application range of a training table that is effortlessly reconfigurable. With teamwork being at the forefront of today's office environment, Admix™ offers ancillary components with thoughtfully executed technology support for collaborative work in the office and equitable hybrid meetings.

**APPLICATION**

Full collection that offers countless configuration options to support the various types of collaborative meetings.

- Collaborative Spaces
  - Conference
  - Project rooms
  - Makers space
  - Open Collaborative
- Learning Spaces
  - Reconfigurable tables
  - Training rooms
- Digital Meetings
  - Equitable for in person and view from camera
  - Proper viewing angles and viewing distance

**SPECIFICATION CHOICE**

Range of shapes, sizes, and configurations to meet the needs of any space available in an array of materials.

1. Choose your top
  - Shapes, sizes
2. Choose your base
  - 4 heights available: continental, standard, counter, bar
  - Footrests
  - Shelving options
  - Caster/glide/wheelbarrow
3. Choose your style
  - Veneer, laminate, metal finishes
4. Choose your technology
  - Power integrated into tables
  - Mobile powered satellite tables
  - Wire management under surface and vertically down leg
  - Braided cord wrapped around wire hook

**KEY FEATURES**

Feature rich product that supports user choice to adapt to the needs of highly collaborative teams and video conference settings.

- Interchangeable caster/glide
- Telescoping base
- In surface and under mount power
- Braided cord power units
- Footrest standard on counter and bar height
- Media tops and media walls
- Homebase accessories - bag hook, desk mat, tray
- PET wire manager
- Tables with shelving
- Organic top shapes

**OPTIONS**

All tops are available in veneer or laminate with a flat or knife edge.

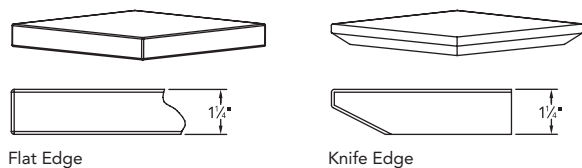

Tables can be specified with 4 casters, 4 glides, or a wheelbarrow setup (2 casters, 2 glides). Casters are available in silver or black. The caster and glide are integrated into a casting at bottom of leg to provide interchangeability over the life of the product.

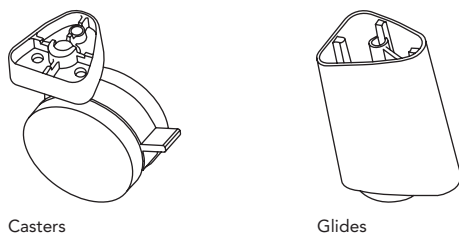

**LAMINATE TOPS**

**SINGLE-PIECE TOPS** – Woodgrain laminates as standard product are always oriented with the grain direction running parallel to the length of the table top.

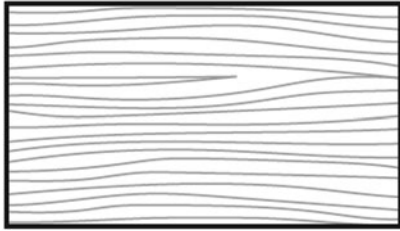

**TWO & THREE PIECE TOPS** – Tops longer than 96". Woodgrain laminates as standard product are always oriented with the grain direction running parallel to the length of the tabletop. Please note that 2-piece tops, in woodgrain colors, will not have exact grain alignment in the center where the two halves meet, a reasonable match can be expected. Allsteel cannot guarantee a grain match on tables that are 60"W. Woodgrain laminates will be aligned within 3/8" across seams unless otherwise noted in the price guide pages.

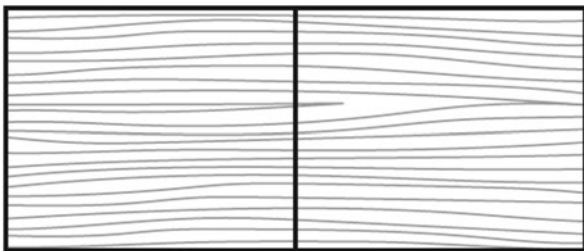

**SPECIAL TOPS** – Specials for wide tables. Woodgrain laminates as specials wider than 60" are always oriented with the grain direction running parallel to the seam of the tabletop. Allsteel will create best match grain alignment but cannot guarantee a perfect match along the seam between the pieces of laminate on two and three piece tops.

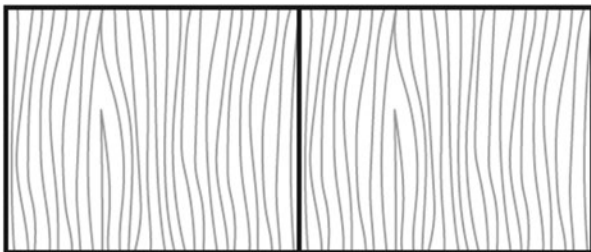

**VENEER TOPS**

**SINGLE-PIECE TOPS** – All veneer single piece tops are oriented with the grain direction running parallel to the length of the table top.

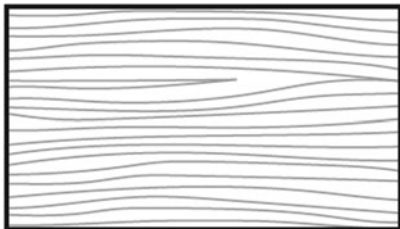

**MULTI-PIECE TOPS** – All veneer multi-piece tops are oriented with the grain direction running parallel to the seam of the table top.

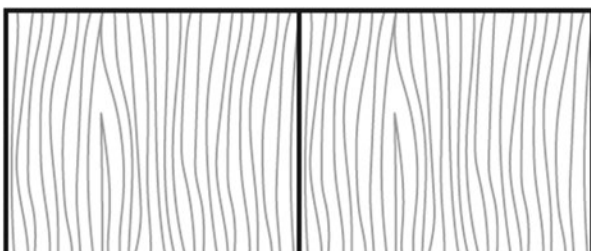

ADMIX

**PAINT FINISHES**

GRADE P1	
Black	P71
Brownstone	P7D
Bungalow	P7C
Charblack	CBK
Cinder	P7Q
Cove	P096
Designer White	PJW
Designer White Texture	PK7
Dune	P094
Flint	P02
Fossil	P28
Harbor	P097
Loft	P7B
Muslin	P4J
Pebble	P8R
Pewter	P8D
Sage	P095
Salt	P8C
Textured Brownstone	P7J
Textured Flint	P7A
Textured Loft	P7L
Textured Muslin	P7M
Textured Pebble	P8Y
Textured Salt	P8Z
Textured Titanium	P8V
Titanium	P8T

GRADE P2	
Champagne Metallic	PR5
Designer White 65 High Gloss	P8W
Gunmetal Metallic	PR3
Night Bronze	P8B
Platinum Metallic	PR2
Pyrite	PJE
Silver	PR6
Silver Texture	PR8
Solar Black	P8X

GRADE P3	
Atom	P8S
Blossom***	P8K
Bullseye	PJF
Ember	P8P
Ion	P8N
Iris	P8J
Krypton	P8F
Regatta	P8M
Succulent***	P8A

\*\*\*These colors are intended to be an inspirational option for the trending market. Product application is limited and color availability is approximately two years to coincide with evolving workplace trends.

**LAMINATES**

GRADE L1	
<b>SOLID</b>	
Black	P
Brownstone	LM13
Bungalow	LM12
Designer White	LDW1
Flint	LM16
Fossil Shale	LEH1
Loft	LM11
Muslin	LM15
Titanium	LTI1

<b>ABSTRACT</b>	
Ash	LT3B
Handspun Pearl	LAHP
Handspun Dove	LAHD
Handspun Slate	LAHS
Handspun Chestnut	LAHC
Silver Mesh	LT8D

<b>WOODGRAIN</b>	
Belair	LWBA
Bourbon Cherry	H
Field Elm	LWFE
Florence Walnut	LWF1
Kingswood Walnut	LK11
Natural Maple	LWD
Neo Walnut	LNU1
Pinnacle	PINC
Shaker Cherry	LW7C

GRADE L2	
<b>WOODGRAIN</b>	
Beigewood	LWBE
Fawn Cypress	LFC1
Lowell Ash	LLA1
Mangalore Mango	LMM1
Natural Recon	LNR1
Phantom Charcoal	LPC1
Phantom Ecu	LPE1
Portico Teak	LPT1
Skyline Walnut	LSW1
Veranda Teak	LVT1

GRADE L3	
Natural Walnut	LWNW

**LAMINATE EDGE COLORS**

Beigewood	DE
Belair	BA
Black	E4
Bourbon Cherry	H
Brownstone	EY
Bungalow	EX
Designer White	DW
Fawn Cypress	FC
Field Elm	FE
Flint	E9
Florence Walnut	FW
Fossil	EH
Kingswood Walnut	KI
Loft	EV
Lowell Ash	DL
Mangalore Mango	MM
Muslin	EU
Natural Maple	DD
Natural Recon	NR
Natural Walnut	DN
Neo Walnut	NU
Parchment	EN
Phantom Charcoal	PC
Phantom Ecu	PE
Pinnacle	PI
Platinum Metallic	EP
Plyband	PL
Portico Teak	DP
Shaker Cherry	DF
Skyline Walnut	SW
Titanium	TI
Veranda Teak	VT

**LAMINATE BASE FINISHES**

L1 – SOLID	
Black	P
Designer White	LDW1
Flint	LM16
Loft	LM11

L1 – WOODGRAIN	
Bourbon Cherry	H
Field Elm	LWFE
Florence Walnut	LWF1
Kingswood Walnut	LK11
Natural Maple	LWD
Neo Walnut	LNU1
Pinnacle	PINC
Shaker Cherry	LW7C

L2 – WOODGRAIN	
Beigewood	LWBE
Fawn Cypress	LFC1
Lowell Ash	LLA1
Mangalore Mango	LMM1
Natural Recon	LNR1
Phantom Charcoal	LPC1
Phantom Ecu	LPE1
Skyline Walnut	LSW1
Veranda Teak	LVT1

L3 – WOODGRAIN	
Natural Walnut	LWNW

**STRATAWOOD VENEERS**

GRADE V1	
----------	--

<b>CHERRY</b>	
Stratawood Cinnamon Cherry	SC260
Stratawood Lowell Ash	SC394
Stratawood Clear Cherry	SC700
Stratawood Light Cherry	SC701
Stratawood Shaker Cherry	SC774
Stratawood Burnished Cherry	SC777

<b>MAPLE</b>	
Field Elm*	SE599
Clear Maple	SE800
Harvest Maple	SE856
Beigewood*	SE878
Phantom Ecu*	SE912
Belair*	SE934

<b>OAK</b>	
Clear Silver Oak	SB100
Portico Teak Silver Oak	SB150

<b>RIFT OAK</b>	
Clear Oak	SF300
Dark Rift Cut Oak	SF331

<b>WALNUT</b>	
Florence Walnut	ST579
Light Walnut	ST601
Skyline Walnut	ST625
Pinnacle Walnut	ST679
Sumatra Walnut	ST693

<b>WASHED WALNUT</b>	
Clear	SW600
Smoked Gray*	SW612
Smoked Onyx*	SW697

\*Use OP Top Fin Only.

**NATURAL VENEERS — FLAT CUT**

GRADE V1	
<b>CHERRY</b>	
Cinnamon/Biltmore Cherry	NC260
Lowell Ash	NC394
Medium Red Cherry	NC512
Light Cherry	NC701
Shaker Cherry	NC774
Burnished Cherry	NC777

<b>MAPLE</b>	
Natural Maple-Clear	NE800
Harvest Maple	NE856

<b>WALNUT</b>	
Ebony Walnut*	NT509
Florence Walnut	NT579
Light Walnut	NT601
Skyline Walnut	NT625
Nutmeg Walnut	NT629
Pinnacle Walnut	NT679
Sumatra Walnut	NT693

\*Use OP Top Fin Only.

**NATURAL VENEERS — RIFT CUT & QUARTER CUT**

GRADE V2	
----------	--

<b>WHITE OAK</b>	
Fawn Cypress Rift Cut Oak*	RF108
Light Rift Cut Oak	RF301
Dark Rift Cut Oak	RF331
Phantom Ecu Rift Cut Oak*	RF912

<b>QUARTER CUT WALNUT</b>	
Ebony*	QT509
Florence	QT579
Light	QT601
Skyline	QT625
Nutmeg	QT629
Pinnacle	QT679
Sumatra	QT693

\*Use OP Top Fin Only.

All of Allsteel's tables are level® – 2 certified to the ANSI/BIFMA e3 Furniture Sustainability Standard. See [www.levelcertified.org](http://www.levelcertified.org) for more information.

NOTE: Refer to individual product pages for upcharges.

FABRICS

GRADE A

NOBLE

Onyx.....	NB-006
Thunder.....	NB-016
Charcoal.....	NB-046
Greige.....	NB-026
Dove.....	NB-036
Beach.....	NB-037
Java.....	NB-000
Slate Grey.....	NB-066
Stone.....	NB-067
Rattan.....	NB-057
Tundra.....	NB-076
Folkstone.....	NB-056
Sangria.....	NB-008
White.....	NB-047
Blue Fog.....	NB-024
Apricot.....	NB-009
Teal.....	NB-014
Buff.....	NB-007
Spice.....	NB-019
Mocha.....	NB-010
Paprika.....	NB-001
Camel.....	NB-017
Cream.....	NB-027
Basil.....	NB-003
Indigo.....	NB-004
Citrus.....	NB-013
Dijon.....	NB-002

ADMIX

All of Allsteel's tables are level® – 2 certified to the ANSI/BIFMA e3 Furniture Sustainability Standard. See [www.levelcertified.org](http://www.levelcertified.org) for more information.

NOTE: Refer to individual product pages for upcharges.

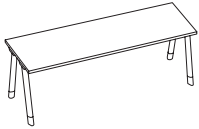

Telescoping Reconfigurable Tables

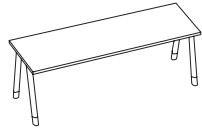

Fixed Reconfigurable Tables — Outset Legs Shown

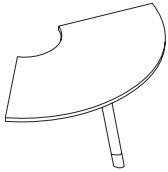

Corner Connector Tops

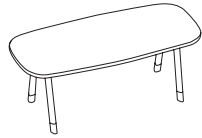

Personal Tables

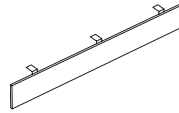

Modesty Panels

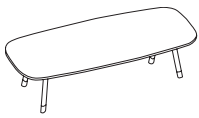

Meeting Tables — Continental Height

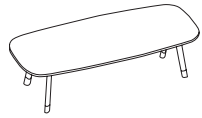

Standard Height

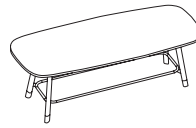

Counter Height

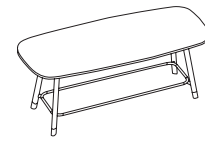

Bar Height

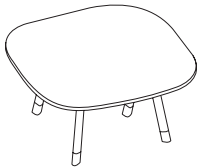

Small Meeting Tables — Continental Height

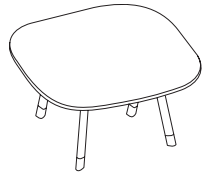

Standard Height



Counter Height



Bar Height



Small Meeting Tables w/ Shelf — Counter Height



Bar Height



V Shape Media Tables — Standard Height

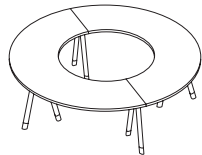

Full Rounds Open Center — Standard Height

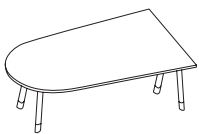

Freestanding Media Tables — Continental Height

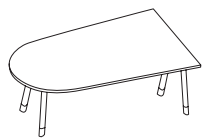

Standard Height



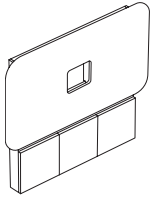

Wall Mounted Media Tables — Continental Height

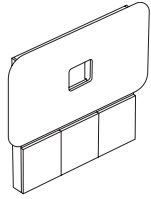

Standard Height

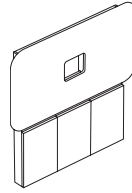

Counter Height

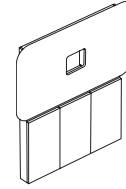

Bar Height

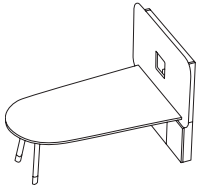

Media Wall Tables — Continental Height

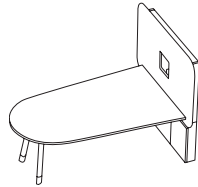

Standard Height

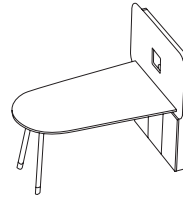

Bar Height

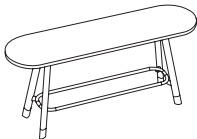

Perch Tables — Counter Height



Bar Height

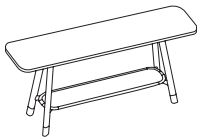

Console Tables w/ Low Shelf — Counter Height



Bar Height



Project Cart w/ 2 Shelves — Counter Height



Bar Height



Satellite Table — Counter Height

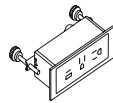

Under Mount Power

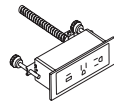

In Surface Bezel Mount Power

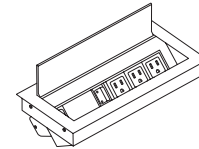

In Surface Tech Module

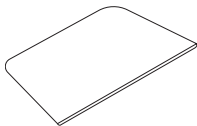

Accessory Deskpad

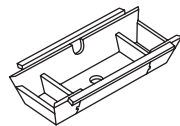

Accessory PET Undersurface Wire Manager

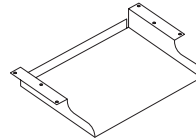

Accessory Tray



Accessory Dual-Purpose Bag Hook / Wire Hook

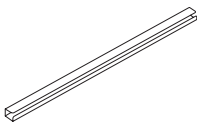

Accessory Vertical Wire Manager

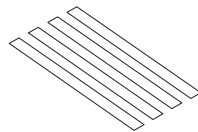

Accessory Vertical Wire Manager Strap

**UNDER MOUNT POWER & IN SURFACE BEZEL MOUNT POWER**

Power unit available in an under mount or in surface bezel mount installation. In surface requires cutout to be specified in worksurface. Cut out size is 1.938" x 6.313".

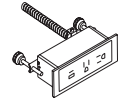

Units come standard with 2 power simplexes and a combo USB-A + USB-C. 1 power simplex is rotated 90 degrees to accommodate various plug styles.

Standard plug is 10ft cord length, Hardwire conduit is 6ft, and Braided cord is 10ft length. Interlink IQ option also available for daisy chain applications.

**IN SURFACE TECH MODULE**

Power unit requires cutout to be specified in worksurface. Units available with Extron plates or data plates to accommodate various Audio/Video requirements. Cut out size is 5.025" x 11.094".

**Corded**

Corded models plug directly into an outlet and cannot plug into other corded power modules. In order to plug into other units the units need to be hard-wired.

**Hardwire**

Hardwire models are provided with 10 feet of sealtight cable. Customers must furnish junction boxes, conduit, and additional wire to be in compliance with local and national codes.

Qi charging is available on Corded and Hardwire versions.

- Includes 3 Qi charging coils (5 watts each) for wireless charging.
- Units have LED indicator lights below the lid's surface.
- Units house power and charging USB inside. All units are Qi certified.

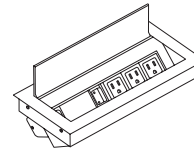
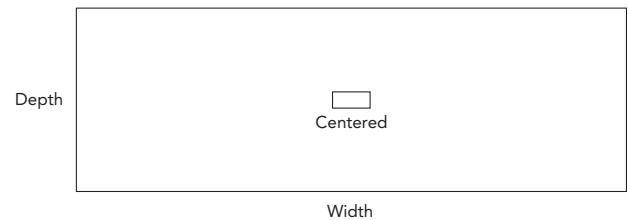
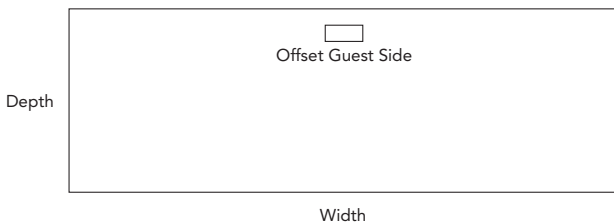

Table Type	C1 Cutout Option		C2 Cutout Option	
	Depth Location	Width Location	Depth Location	Width Location
24"D Reconfigurable Tables	5" to edge of cutout	Centered	n/a	n/a
30"D Reconfigurable Tables	8" to edge of cutout	Centered	n/a	n/a
24" Personal Tables	5" to edge of cutout	Centered	n/a	n/a
30" Personal Tables	8" to edge of cutout	Centered	n/a	n/a
Meeting Tables	Centered	Centered	Centered	Equally Spaced
Small Meeting Tables	Centered	Centered	n/a	n/a
30"D V Media (3 cutouts total)	8" to edge of cutout	Qty 1 Centered on Each Length, Qty 1 Centered on Corner Connector	n/a	n/a
24"D Full Round (4 cutouts total)	5" to edge of cutout	4 Equally Spaced	n/a	n/a
Media Tops	Centered	Centered	n/a	n/a
Perch Tables	Centered	Centered	n/a	n/a
Console Tables	Centered	Centered	n/a	n/a
Project Cart	Centered	Centered	n/a	n/a





### PET UNDERSURFACE WIRE MANAGER

Made from 100% PET and provides a warmer, softer feel for a wire manager solution. 12mm thickness in dark grey color. Ends open for easy wire management and to allow the wire manager to sit directly under an external stiffener bar.

Attaches to bottom of worksurface with screws through flanges. Access door opens for easy access to inside of unit. Interior height approx 4" and trapezoid shape allows for interior width from 4" at bottom to 6" at top of unit. Interior dimensions also allow for it to mount under an insurface bezel mount power unit.

Available in 18", 36", and 48" widths. Multiple units may be used in combination on larger tables — recommend 3-12" between units when placed end to end. Unit is optional and must be ordered separately.

Designed for the Environment

- Low VOC
- HPD
- Cal 01350 Emissions Compliant
- Rapidly renewable content
- Prop 65 Compliant
- Declare Compliant
- Red List Compliant
- No FR Additives
- No Conflict Minerals

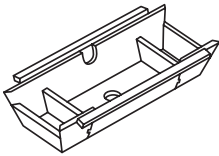

### DUAL PURPOSE WIRE HOOK / BAG HOOK

The dual purpose wire hook / bag hook is ideal for reconfigurable environments with mobile tables. Intended to be used with a braided cord where the cord can be easily wrapped up. Max load capacity is 20lbs. Unit is optional and must be ordered separately.

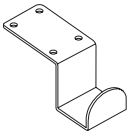

**METAL VERTICAL WIRE MANAGER**

The vertical wire manager is bent sheet metal and attaches to inside of leg with double stick tape. Unit is powder coated in all Admix™ metal colors to allow it to match the chosen leg color. Interior dimensions are approximately 1" x 1" with 1 side partially open for wires to be easily routed to inside of unit.

Unit is optional and must be ordered separately.

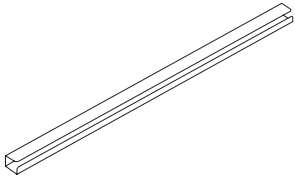

**VELCRO STRAP VERTICAL WIRE MANAGER**

Model ships with quantity 4 velcro straps. Ideal for light duty braided cord applications or standard plug units where cord is visible. Not recommended for hardwire conduit. Made from 11" long x 0.75" wide two-side hook and loop velcro. Unit is optional and must be ordered separately.

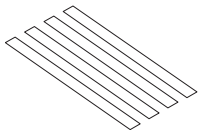

- Top and Base ordered separately. Telescoping tops intended to be used with telescoping bases.
- Option for cutout only, order power units separately.
- Reference page 364.7 for cutout locations.
- Available in veneer or laminate tops, flat edge only.
- Edgeband color option specified separately for laminate.
- Tops ship with pilot holes for locating base.
- Telescoping inset range per side: 60"W = 8.75", 66"W = 10.0", 72"W = 11.0", 78"W = 12.0", 84"W = 12.0"
- Base includes external stiffeners for tops, telescoping rail system and threaded knob to lock down by hand.
- Base ships knocked down.
- Telescoping tables not for use with accessory tray ATLADM-ACCTRAY due to rail system.

Description	Model Number add "L" for Laminate or "V" for Veneer	Ship Weight	Cubes	Laminate List Price			Veneer List Price	
				L1	L2	L3	V1	V2
<b>Rectangle Telescoping Tops Flat Edge</b>								
24"D x 60"W	ATLADM-TTREC □ 2460F	4	4.1	\$ 527	\$ 553	\$ 580	\$ 1402	\$ 1542
24"D x 66"W	ATLADM-TTREC □ 2466F	49	4.5	\$ 549	\$ 576	\$ 604	\$ 1488	\$ 1637
24"D x 72"W	ATLADM-TTREC □ 2472F	53	4.9	\$ 571	\$ 600	\$ 628	\$ 1665	\$ 1832
24"D x 78"W	ATLADM-TTREC □ 2478F	58	5.3	\$ 621	\$ 652	\$ 683	\$ 1731	\$ 1904
24"D x 84"W	ATLADM-TTREC □ 2484F	62	5.7	\$ 670	\$ 704	\$ 737	\$ 1800	\$ 1980
30"D x 60"W	ATLADM-TTREC □ 3060F	56	5.0	\$ 615	\$ 646	\$ 677	\$ 1543	\$ 1697
30"D x 66"W	ATLADM-TTREC □ 3066F	61	5.5	\$ 643	\$ 675	\$ 707	\$ 1615	\$ 1777
30"D x 72"W	ATLADM-TTREC □ 3072F	67	6.0	\$ 671	\$ 705	\$ 738	\$ 1699	\$ 1869
30"D x 78"W	ATLADM-TTREC □ 3078F	72	6.5	\$ 740	\$ 777	\$ 814	\$ 1819	\$ 2001
30"D x 84"W	ATLADM-TTREC □ 3084F	78	7.0	\$ 808	\$ 848	\$ 889	\$ 1948	\$ 2143

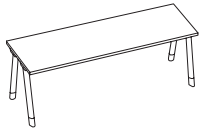
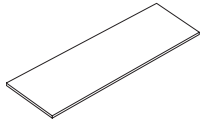

Example of Built-up Table

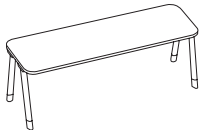
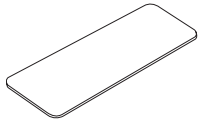

Example of Built-up Table

<b>Rounded Rectangle Telescoping Tops Flat Edge</b>								
24"D x 60"W	ATLADM-TTRREC □ 2460F	45	4.1	\$ 580	\$ 609	\$ 638	\$ 1542	\$ 1696
24"D x 66"W	ATLADM-TTRREC □ 2466F	49	4.5	\$ 604	\$ 634	\$ 664	\$ 1637	\$ 1801
24"D x 72"W	ATLADM-TTRREC □ 2472F	53	4.9	\$ 628	\$ 659	\$ 691	\$ 1832	\$ 2015
24"D x 78"W	ATLADM-TTRREC □ 2478F	58	5.3	\$ 683	\$ 717	\$ 751	\$ 1904	\$ 2094
24"D x 84"W	ATLADM-TTRREC □ 2484F	62	5.7	\$ 737	\$ 774	\$ 811	\$ 1980	\$ 2178
30"D x 60"W	ATLADM-TTRREC □ 3060F	56	5.0	\$ 677	\$ 711	\$ 745	\$ 1697	\$ 1867
30"D x 66"W	ATLADM-TTRREC □ 3066F	61	5.5	\$ 707	\$ 742	\$ 778	\$ 1777	\$ 1955
30"D x 72"W	ATLADM-TTRREC □ 3072F	67	6.0	\$ 738	\$ 775	\$ 812	\$ 1869	\$ 2056
30"D x 78"W	ATLADM-TTRREC □ 3078F	72	6.5	\$ 814	\$ 855	\$ 895	\$ 2001	\$ 2201
30"D x 84"W	ATLADM-TTRREC □ 3084F	78	7.0	\$ 889	\$ 933	\$ 978	\$ 2143	\$ 2357

<p><b>How to specify —</b> Select the Model Number from above.</p> <p>ATLADM -</p> <p>TTR</p>	<p><i>1st Option:</i> <b>FSC Certified Wood:</b> X Standard - No FSC F FSC Certified</p>	<p><i>2nd Option:</i> <b>Laminate/Veneer:</b> See page 364.3 for finishes.</p>	<p><i>3rd Option:</i> <b>Edge (Laminate):</b> See page 364.3 for finishes.</p>	<p><i>3rd Option:</i> <b>Top Finish (Veneer):</b> FF Full Fill +\$273 OP Open Pore Low Sheen</p>	<p><i>4th Option:</i> <b>Cutout:</b> GN No Grommet C1E 1 Bezel Mount Power</p>
	<p>Example: ATLADM-TTREC□2460F.X.LDW1.DW.GN</p>				

Description	Model	Ship Weight	Cubes	List Price	
				P1	P2
<b>Telescoping Bases — Standard Height</b>					
For 60"W Tops	ATLADM-BRTLM60S	61	4.0	\$ 3052	\$ 3336
For 66"W Tops	ATLADM-BRTLM66S	62	4.1	\$ 3088	\$ 3372
For 72"W Tops	ATLADM-BRTLM72S (shown)	63	4.2	\$ 3106	\$ 3390
For 78"W Tops	ATLADM-BRTLM78S	64	4.4	\$ 3130	\$ 3414
For 84"W Tops	ATLADM-BRTLM84S	66	4.5	\$ 3160	\$ 3444

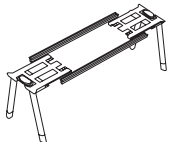

<p><b>How to specify —</b> Select the Model Number from above.</p> <p>ATLADM - BRTLM</p>	<p><i>1st Option:</i> <b>Paint Color:</b> P1 P2 P3 See page 364.3 for finishes.</p>	<p><i>2nd Option:</i> <b>Select the Foot:</b> CSB Casters Black CSS Casters Silver GLD Glides WHB Wheelbarrow Black (2 Glides + 2 Casters Black) WHS Wheelbarrow Silver (2 Glides + 2 Casters Silver)</p>
	<p>Example: ATLADM-BRTLM60S.P71.GLD</p>	

ADMIX

- Order base separately.
- Option for cutout only, order power units separately.
- Reference page 364.7 for cutout locations.
- Available in veneer or laminate tops, flat edge only.
- Edgeband color option specified separately for laminate.
- Tops ship with pilot holes for locating base.
- For use with bases on page 364.16.

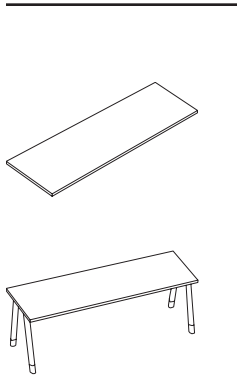

Example of Built-up Table

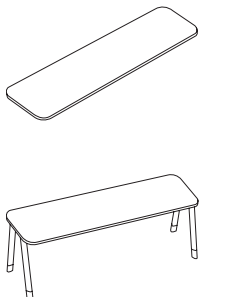

Example of Built-up Table

Description	Model Number add "L" for Laminate or "V" for Veneer	Ship Weight	Cubes	Laminate List Price			Veneer List Price		
				L1	L2	L3	V1	V2	
<b>Rectangle Fixed Tops Flat Edge</b>									
24"D x 48"W	ATLADM-TFREC □ 2448F	36	3.3	\$ 510	\$ 536	\$ 561	\$ 1225	\$ 1348	
24"D x 54"W	ATLADM-TFREC □ 2454F	40	3.7	\$ 519	\$ 545	\$ 571	\$ 1289	\$ 1418	
24"D x 60"W	ATLADM-TFREC □ 2460F	45	4.1	\$ 527	\$ 553	\$ 580	\$ 1402	\$ 1542	
24"D x 66"W	ATLADM-TFREC □ 2466F	49	4.5	\$ 549	\$ 576	\$ 604	\$ 1488	\$ 1637	
24"D x 72"W	ATLADM-TFREC □ 2472F	53	4.9	\$ 571	\$ 600	\$ 628	\$ 1665	\$ 1832	
24"D x 78"W	ATLADM-TFREC □ 2478F	58	5.3	\$ 621	\$ 652	\$ 683	\$ 1731	\$ 1904	
24"D x 84"W	ATLADM-TFREC □ 2484F	62	5.7	\$ 670	\$ 704	\$ 737	\$ 1800	\$ 1980	
30"D x 48"W	ATLADM-TFREC □ 3048F	45	4.1	\$ 565	\$ 593	\$ 622	\$ 1506	\$ 1657	
30"D x 54"W	ATLADM-TFREC □ 3054F	50	4.6	\$ 590	\$ 620	\$ 659	\$ 1526	\$ 1679	
30"D x 60"W	ATLADM-TFREC □ 3060F	56	5.0	\$ 615	\$ 646	\$ 677	\$ 1543	\$ 1697	
30"D x 66"W	ATLADM-TFREC □ 3066F	61	5.5	\$ 643	\$ 675	\$ 707	\$ 1615	\$ 1777	
30"D x 72"W	ATLADM-TFREC □ 3072F	67	6.0	\$ 671	\$ 705	\$ 738	\$ 1699	\$ 1869	
30"D x 78"W	ATLADM-TFREC □ 3078F	72	6.5	\$ 740	\$ 777	\$ 814	\$ 1819	\$ 2001	
30"D x 84"W	ATLADM-TFREC □ 3084F	78	7.0	\$ 808	\$ 848	\$ 889	\$ 1948	\$ 2143	
<b>Rounded Rectangle Fixed Tops Flat Edge</b>									
24"D x 48"W	ATLADM-TFRREC □ 2448F	36	3.3	\$ 561	\$ 589	\$ 617	\$ 1348	\$ 1483	
24"D x 54"W	ATLADM-TFRREC □ 2454F	40	3.7	\$ 571	\$ 600	\$ 628	\$ 1418	\$ 1560	
24"D x 60"W	ATLADM-TFRREC □ 2460F	45	4.1	\$ 580	\$ 609	\$ 638	\$ 1542	\$ 1696	
24"D x 66"W	ATLADM-TFRREC □ 2466F	49	4.5	\$ 604	\$ 634	\$ 664	\$ 1637	\$ 1801	
24"D x 72"W	ATLADM-TFRREC □ 2472F	53	4.9	\$ 628	\$ 659	\$ 691	\$ 1832	\$ 2015	
24"D x 78"W	ATLADM-TFRREC □ 2478F	58	5.3	\$ 683	\$ 717	\$ 751	\$ 1904	\$ 2094	
24"D x 84"W	ATLADM-TFRREC □ 2484F	62	5.7	\$ 737	\$ 774	\$ 811	\$ 1980	\$ 2178	
30"D x 48"W	ATLADM-TFRREC □ 3048F	45	4.1	\$ 622	\$ 653	\$ 684	\$ 1657	\$ 1823	
30"D x 54"W	ATLADM-TFRREC □ 3054F	50	4.6	\$ 649	\$ 681	\$ 714	\$ 1679	\$ 1847	
30"D x 60"W	ATLADM-TFRREC □ 3060F	56	5.0	\$ 677	\$ 711	\$ 745	\$ 1697	\$ 1867	
30"D x 66"W	ATLADM-TFRREC □ 3066F	61	5.5	\$ 707	\$ 742	\$ 778	\$ 1777	\$ 1955	
30"D x 72"W	ATLADM-TFRREC □ 3072F	67	6.0	\$ 738	\$ 775	\$ 812	\$ 1869	\$ 2056	
30"D x 78"W	ATLADM-TFRREC □ 3078F	72	6.5	\$ 814	\$ 855	\$ 895	\$ 2001	\$ 2201	
30"D x 84"W	ATLADM-TFRREC □ 3084F	78	7.0	\$ 889	\$ 993	\$ 978	\$ 2143	\$ 2357	

ADMIX

<p><b>How to specify —</b> Select the Model Number from above.</p> <p>ATLADM   -   TFR                    </p>	<p><b>1st Option:</b> FSC Certified Wood: X Standard - No FSC F FSC Certified</p>	<p><b>2nd Option:</b> Laminate/Veneer: See page 364.3 for finishes.</p>	<p><b>3rd Option:</b> Edge (Laminate): See page 364.3 for finishes.</p>	<p><b>3rd Option:</b> Top Finish (Veneer): FF Full Fill +\$273 OP Open Pore Low Sheen</p>	<p><b>4th Option:</b> Cutout: GN No Grommet C1E 1 Bezel Mount Power</p>
--	---	---	---	---	---

Example: ATLADM-TFRECL2472F.X.LDW1.DW.GN

- Order base separately.
- Option for cutout only, order power units separately.
- Reference page 364.7 for cutout locations.
- Available in veneer or laminate tops, flat edge only.
- Edgeband color option specified separately for laminate.
- Tops ship with pilot holes for locating base.
- For use with bases on page 364.16.

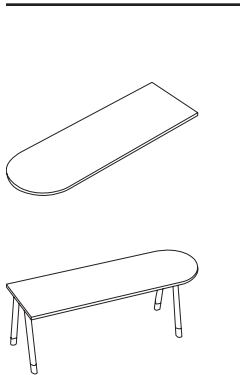

Example of Built-up Table

Description	Model Number add "L" for Laminate or "V" for Veneer	Ship Weight	Cubes	Laminate List Price			Veneer List Price		
				L1	L2	L3	V1	V2	
<b>Half Racetrack Fixed Tops Flat Edge</b>									
24"D x 48"W	ATLADM-TFHRAC □ 2448F	36	3.3	\$ 561	\$ 589	\$ 617	\$ 1348	\$ 1483	
24"D x 54"W	ATLADM-TFHRAC □ 2454F	40	3.7	\$ 571	\$ 600	\$ 628	\$ 1418	\$ 1560	
24"D x 60"W	ATLADM-TFHRAC □ 2460F	45	4.1	\$ 580	\$ 609	\$ 639	\$ 1542	\$ 1696	
24"D x 66"W	ATLADM-TFHRAC □ 2466F	49	4.5	\$ 604	\$ 634	\$ 664	\$ 1637	\$ 1801	
24"D x 72"W	ATLADM-TFHRAC □ 2472F	53	4.9	\$ 628	\$ 659	\$ 691	\$ 1832	\$ 2015	
24"D x 78"W	ATLADM-TFHRAC □ 2478F	58	5.3	\$ 683	\$ 717	\$ 751	\$ 1904	\$ 2094	
24"D x 84"W	ATLADM-TFHRAC □ 2484F	62	5.7	\$ 737	\$ 774	\$ 811	\$ 1980	\$ 2178	
30"D x 48"W	ATLADM-TFHRAC □ 3048F	45	4.1	\$ 622	\$ 653	\$ 684	\$ 1657	\$ 1823	
30"D x 54"W	ATLADM-TFHRAC □ 3054F	50	4.6	\$ 649	\$ 681	\$ 714	\$ 1679	\$ 1847	
30"D x 60"W	ATLADM-TFHRAC □ 3060F	56	5.0	\$ 677	\$ 711	\$ 745	\$ 1697	\$ 1867	
30"D x 66"W	ATLADM-TFHRAC □ 3066F	61	5.5	\$ 707	\$ 742	\$ 778	\$ 1777	\$ 1955	
30"D x 72"W	ATLADM-TFHRAC □ 3072F	67	6.0	\$ 738	\$ 775	\$ 812	\$ 1869	\$ 2056	
30"D x 78"W	ATLADM-TFHRAC □ 3078F	72	6.5	\$ 814	\$ 855	\$ 895	\$ 2001	\$ 2201	
30"D x 84"W	ATLADM-TFHRAC □ 3084F	78	7.0	\$ 889	\$ 933	\$ 978	\$ 2143	\$ 2357	

ADMIX

<p><b>How to specify —</b> Select the Model Number from above.</p>	<p><b>1st Option:</b> <b>FSC Certified Wood:</b> X Standard - No FSC F FSC Certified</p>	<p><b>2nd Option:</b> <b>Laminate/Veneer:</b> See page 364.3 for finishes.</p>	<p><b>3rd Option:</b> <b>Edge (Laminate):</b> See page 364.3 for finishes.</p>	<p><b>3rd Option:</b> <b>Top Finish (Veneer):</b> FF Full Fill +\$273 OP Open Pore Low Sheen</p>	<p><b>4th Option:</b> <b>Cutout:</b> GN No Grommet C1E 1 Bezel Mount Power</p>
<p>ATLADM -</p> <p>TFHRAC</p>					

Example: ATLADM-TFHRACL2472F.X.LDW1.DW.GN

- Connector tops available in 45, 90, and 120 degree angles.
- Flat brackets included to connect to adjoining tops.
- Intended to be used with flat end tops only — Ex: Rectangular and Half Racetrack on pages 364.11-364.12.
- 120 degree top includes qty 1 center leg.
- For use with Rectangular and Half Racetrack tops on pages 364.11-364.12.

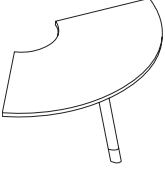

Description	Model Number add "L" for Laminate or "V" for Veneer	Ship Weight	Cubes	Laminate List Price			Veneer List Price		
				L1	L2	L3	V1	V2	
<b>Corner Connector Tops</b>									
45° Corner Top 24"D	ATLADM-TCNR45 □ 24F	18	1.8	\$ 672	\$ 706	\$ 739	\$ 1008	\$ 1109	
90° Corner Top 24"D	ATLADM-TCNR90 □ 24F	18	1.8	\$ 790	\$ 830	\$ 869	\$ 1185	\$ 1304	
120° Corner Top w/ Leg 24"D	ATLADM-TCNR120 □ 24FX	18	1.8	\$ 1334	\$ 1379	\$ 1425	\$ 1789	\$ 1925	
45° Corner Top 30"D	ATLADM-TCNR45 □ 30F	18	1.8	\$ 777	\$ 816	\$ 855	\$ 1166	\$ 1283	
90° Corner Top 30"D	ATLADM-TCNR90 □ 30F	18	1.8	\$ 914	\$ 960	\$ 1005	\$ 1371	\$ 1508	
120° Corner Top w/ Leg 30"D	ATLADM-TCNR120 □ 30FX (shown)	18	1.8	\$ 1476	\$ 1529	\$ 1581	\$ 2002	\$ 2160	

ADMIX

<p><b>How to specify —</b> Select the Model Number from above.</p> <p>AT   LADM   -   TCNR                   .</p>	<p><b>1st Option:</b> <b>FSC Certified Wood:</b> X Standard - No FSC F FSC Certified</p> <p>    .</p>	<p><b>2nd Option:</b> <b>Laminate/Veneer:</b> See page 364.3 for finishes.</p> <p>          .</p>	<p><b>3rd Option:</b> <b>Edge (Laminate):</b> See page 364.3 for finishes.</p> <p>          .</p>	<p><b>3rd Option:</b> <b>Top Finish (Veneer):</b> FF Full Fill +\$273 OP Open Pore Low Sheen</p> <p>     </p>
--	---	---	---	---

Example: ATLADM-TCNR45L24F.X.LDW1.DW

- Order base separately.
- Option for cutout only, order power units separately.
- Reference page 364.7 for cutout locations.
- Available in veneer or laminate tops, flat or knife edge.
- Edgeband color option specified separately for laminate.
- Tops ship with pilot holes for locating base.
- For use with bases on page 364.16.

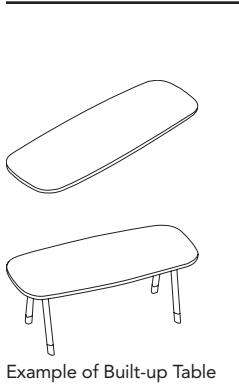

Example of Built-up Table

Description	Model Number add "L" for Laminate or "V" for Veneer	Ship Weight	Cubes	Laminate List Price			Veneer List Price	
				L1	L2	L3	V1	V2
<b>Boat Fixed Tops Flat Edge</b>								
24"D x 60"W	ATLADM-TFBOAT □ 2460F	45	4.1	\$ 580	\$ 609	\$ 638	\$ 1542	\$ 1696
24"D x 66"W	ATLADM-TFBOAT □ 2466F	49	4.5	\$ 604	\$ 634	\$ 664	\$ 1637	\$ 1801
24"D x 72"W	ATLADM-TFBOAT □ 2472F	53	4.9	\$ 628	\$ 659	\$ 691	\$ 1832	\$ 2015
24"D x 78"W	ATLADM-TFBOAT □ 2478F	58	5.3	\$ 683	\$ 717	\$ 751	\$ 1904	\$ 2094
24"D x 84"W	ATLADM-TFBOAT □ 2484F	62	5.7	\$ 737	\$ 774	\$ 811	\$ 1980	\$ 2178
30"D x 60"W	ATLADM-TFBOAT □ 3060F	56	5.0	\$ 677	\$ 711	\$ 745	\$ 1697	\$ 1867
30"D x 66"W	ATLADM-TFBOAT □ 3066F	61	5.5	\$ 707	\$ 742	\$ 778	\$ 1777	\$ 1955
30"D x 72"W	ATLADM-TFBOAT □ 3072F	67	6.0	\$ 738	\$ 775	\$ 812	\$ 1869	\$ 2056
30"D x 78"W	ATLADM-TFBOAT □ 3078F	72	6.5	\$ 814	\$ 855	\$ 895	\$ 2001	\$ 2201
30"D x 84"W	ATLADM-TFBOAT □ 3084F	78	7.0	\$ 889	\$ 933	\$ 978	\$ 2143	\$ 2357
<b>Boat Fixed Tops Knife Edge</b>								
24"D x 60"W	ATLADM-TFBOAT □ 2460K	45	4.1	\$ 1580	\$ 1659	\$ 1738	\$ 2542	\$ 2796
24"D x 66"W	ATLADM-TFBOAT □ 2466K	49	4.5	\$ 1604	\$ 1684	\$ 1764	\$ 2637	\$ 2901
24"D x 72"W	ATLADM-TFBOAT □ 2472K	53	4.9	\$ 1628	\$ 1709	\$ 1791	\$ 2832	\$ 3115
24"D x 78"W	ATLADM-TFBOAT □ 2478K	58	5.3	\$ 1683	\$ 1767	\$ 1851	\$ 2904	\$ 3194
24"D x 84"W	ATLADM-TFBOAT □ 2484K	62	5.7	\$ 1737	\$ 1824	\$ 1911	\$ 2980	\$ 3278
30"D x 60"W	ATLADM-TFBOAT □ 3060K	56	5.0	\$ 1677	\$ 1761	\$ 1845	\$ 2697	\$ 2967
30"D x 66"W	ATLADM-TFBOAT □ 3066K	61	5.5	\$ 1707	\$ 1792	\$ 1878	\$ 2777	\$ 3055
30"D x 72"W	ATLADM-TFBOAT □ 3072K	67	6.0	\$ 1738	\$ 1825	\$ 1912	\$ 2869	\$ 3156
30"D x 78"W	ATLADM-TFBOAT □ 3078K	72	6.5	\$ 1814	\$ 1905	\$ 1995	\$ 3001	\$ 3301
30"D x 84"W	ATLADM-TFBOAT □ 3084K	78	7.0	\$ 1889	\$ 1983	\$ 2078	\$ 3143	\$ 3457

ADMIX

<p><b>How to specify —</b> Select the Model Number from above.</p> <p>ATLADM - TFBOAT</p>	<p><b>1st Option:</b> FSC Certified Wood: X Standard - No FSC F FSC Certified</p>	<p><b>2nd Option:</b> Laminate/Veneer: See page 364.3 for finishes.</p>	<p><b>3rd Option:</b> Edge (Laminate): See page 364.3 for finishes.</p>	<p><b>3rd Option:</b> Top Finish (Veneer): FF Full Fill +\$273 OP Open Pore Low Sheen</p>	<p><b>4th Option:</b> Cutout: GN No Grommet C1E 1 Bezel Mount Power</p>
---	---	---	---	---	---

Example: ATLADM-TFBOATL2460F.LDW1.DW.GN

- Order base separately.
- Option for cutout only, order power units separately.
- Reference page 364.7 for cutout locations.
- Available in veneer or laminate tops, flat or knife edge.
- Edgeband color option specified separately for laminate.
- Tops ship with pilot holes for locating base.
- For use with bases on page 364.16.

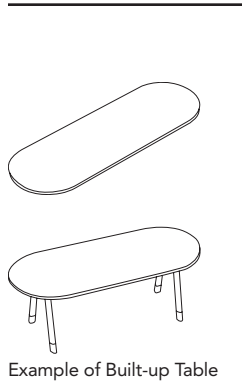

Example of Built-up Table

Description	Model Number add "L" for Laminate or "V" for Veneer	Ship Weight	Cubes	Laminate List Price			Veneer List Price	
				L1	L2	L3	V1	V2
<b>Racetrack Fixed Tops Flat Edge</b>								
24"D x 48"W	ATLADM-TFRACE □ 2448F	36	3.3	\$ 561	\$ 589	\$ 617	\$ 1348	\$ 1483
24"D x 54"W	ATLADM-TFRACE □ 2454F	40	3.7	\$ 571	\$ 600	\$ 628	\$ 1418	\$ 1560
24"D x 60"W	ATLADM-TFRACE □ 2460F	45	4.1	\$ 580	\$ 609	\$ 638	\$ 1542	\$ 1696
24"D x 66"W	ATLADM-TFRACE □ 2466F	49	4.5	\$ 604	\$ 634	\$ 664	\$ 1637	\$ 1801
24"D x 72"W	ATLADM-TFRACE □ 2472F	53	4.9	\$ 628	\$ 659	\$ 691	\$ 1837	\$ 2015
24"D x 78"W	ATLADM-TFRACE □ 2478F	58	5.3	\$ 683	\$ 717	\$ 751	\$ 1904	\$ 2094
24"D x 84"W	ATLADM-TFRACE □ 2484F	62	5.7	\$ 737	\$ 774	\$ 811	\$ 1980	\$ 2178
30"D x 48"W	ATLADM-TFRACE □ 3048F	45	4.1	\$ 622	\$ 653	\$ 684	\$ 1657	\$ 1823
30"D x 54"W	ATLADM-TFRACE □ 3054F	50	4.6	\$ 649	\$ 681	\$ 714	\$ 1679	\$ 1847
30"D x 60"W	ATLADM-TFRACE □ 3060F	56	5.0	\$ 677	\$ 711	\$ 745	\$ 1697	\$ 1867
30"D x 66"W	ATLADM-TFRACE □ 3066F	61	5.5	\$ 707	\$ 742	\$ 778	\$ 1777	\$ 1955
30"D x 72"W	ATLADM-TFRACE □ 3072F	67	6.0	\$ 738	\$ 775	\$ 812	\$ 1869	\$ 2056
30"D x 78"W	ATLADM-TFRACE □ 3078F	72	6.5	\$ 814	\$ 855	\$ 895	\$ 2001	\$ 2201
30"D x 84"W	ATLADM-TFRACE □ 3084F	78	7.0	\$ 889	\$ 933	\$ 978	\$ 2143	\$ 2357
<b>Racetrack Fixed Tops Knife Edge</b>								
24"D x 48"W	ATLADM-TFRACE □ 2448K	36	3.3	\$ 1561	\$ 1639	\$ 1717	\$ 2348	\$ 2583
24"D x 54"W	ATLADM-TFRACE □ 2454K	40	3.7	\$ 1571	\$ 1650	\$ 1728	\$ 2418	\$ 2660
24"D x 60"W	ATLADM-TFRACE □ 2460K	45	4.1	\$ 1580	\$ 1659	\$ 1738	\$ 2542	\$ 2796
24"D x 66"W	ATLADM-TFRACE □ 2466K	49	4.5	\$ 1604	\$ 1684	\$ 1764	\$ 2637	\$ 2901
24"D x 72"W	ATLADM-TFRACE □ 2472K	53	4.9	\$ 1628	\$ 1709	\$ 1791	\$ 2832	\$ 3115
24"D x 78"W	ATLADM-TFRACE □ 2478K	58	5.3	\$ 1683	\$ 1767	\$ 1851	\$ 2904	\$ 3194
24"D x 84"W	ATLADM-TFRACE □ 2484K	62	5.7	\$ 1737	\$ 1824	\$ 1911	\$ 2980	\$ 3278
30"D x 48"W	ATLADM-TFRACE □ 3048K	45	4.1	\$ 1622	\$ 1703	\$ 1784	\$ 2657	\$ 2923
30"D x 54"W	ATLADM-TFRACE □ 3054K	50	4.6	\$ 1649	\$ 1731	\$ 1814	\$ 2679	\$ 2947
30"D x 60"W	ATLADM-TFRACE □ 3060K	56	5.0	\$ 1677	\$ 1761	\$ 1845	\$ 2697	\$ 2967
30"D x 66"W	ATLADM-TFRACE □ 3066K	61	5.5	\$ 1707	\$ 1792	\$ 1878	\$ 2777	\$ 3055
30"D x 72"W	ATLADM-TFRACE □ 3072K	67	6.0	\$ 1738	\$ 1825	\$ 1912	\$ 2869	\$ 3156
30"D x 78"W	ATLADM-TFRACE □ 3078K	72	6.5	\$ 1814	\$ 1905	\$ 1995	\$ 3001	\$ 3301
30"D x 84"W	ATLADM-TFRACE □ 3084K	78	7.0	\$ 1889	\$ 1983	\$ 2078	\$ 3143	\$ 3457

ADMIX

<p><b>How to specify —</b> Select the Model Number from above.</p> <p>ATLADM - TFRACE</p>	<p><b>1st Option:</b> FSC Certified Wood: X Standard - No FSC F FSC Certified</p>	<p><b>2nd Option:</b> Laminate/Veneer: See page 364.3 for finishes.</p>	<p><b>3rd Option:</b> Edge (Laminate): See page 364.3 for finishes.</p>	<p><b>3rd Option:</b> Top Finish (Veneer): FF Full Fill +\$273 OP Open Pore Low Sheen</p>	<p><b>4th Option:</b> Cutout: GN No Grommet C1E 1 Bezel Mount Power</p>
---	---	---	---	---	---

Example: ATLADM-TFRACEL2460F.X.LDW1.DW.GN



- Base includes external stiffeners for tops (if required).
- Base ships knocked down.
- Outset bases to only be used for tops with flat side on both ends — Ex: Rectangular and Rounded Rectangular.
- Inset dimension for each top size: 48"W = 6.0", 54"W = 7.0", 60"W = 8.75", 66"W = 10.0", 72"W = 11.0", 78"W = 12.0", 84"W = 12.0"
- For use with tops on pages [364.11-364.15](#).

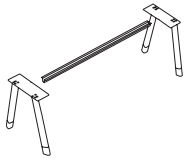

Description	Model	Ship Weight	Cubes	List Price	
				P1	P2
<b>Fixed Base Outset Legs — Standard Height</b>					
For 48" Table Tops	ATLADM-BRFXOUTM48S	38	2.6	\$ 1700	\$ 1870
For 54" Table Tops	ATLADM-BRFXOUTM54S	41	2.9	\$ 1786	\$ 1956
For 60" Table Tops	ATLADM-BRFXOUTM60S	42	3.0	\$ 1799	\$ 1969
For 66" Table Tops	ATLADM-BRFXOUTM66S	43	3.0	\$ 1806	\$ 1976
For 72" Table Tops	ATLADM-BRFXOUTM72S (shown)	43	3.1	\$ 1824	\$ 1994
For 78" Table Tops	ATLADM-BRFXOUTM78S	44	3.1	\$ 1833	\$ 2003
For 84" Table Tops	ATLADM-BRFXOUTM84S	44	3.2	\$ 1845	\$ 2015
<b>Fixed Base Inset Legs — Standard Height</b>					
For 48" Table Tops	ATLADM-BRFXINM48S	38	2.6	\$ 1700	\$ 1870
For 54" Table Tops	ATLADM-BRFXINM54S	38	2.6	\$ 1700	\$ 1870
For 60" Table Tops	ATLADM-BRFXINM60S	38	2.6	\$ 1700	\$ 1870
For 66" Table Tops	ATLADM-BRFXINM66S	38	2.6	\$ 1700	\$ 1870
For 72" Table Tops	ATLADM-BRFXINM72S (shown)	38	2.6	\$ 1700	\$ 1870
For 78" Table Tops	ATLADM-BRFXINM78S	41	2.9	\$ 1786	\$ 1956
For 84" Table Tops	ATLADM-BRFXINM84S	42	3.0	\$ 1799	\$ 1969

ADMIX

<p><i>How to specify —</i> Select the Model Number from above.</p>	<p><i>1st Option:</i> <b>Paint Color:</b> P1 P2 P3 See page <a href="#">364.3</a> for finishes.</p>	<p><i>2nd Option:</i> <b>Select the Foot:</b> CSB Casters Black CSS Casters Silver GLD Glides WHB Wheelbarrow Black (2 Glides + 2 Casters Black) WHS Wheelbarrow Silver (2 Glides + 2 Casters Silver)</p>
<p>A T L A D M   -   B R F X                   .</p>	<p>          .</p>	<p>       </p>

Example: ATLADM-BRFXOUTM48S.P11.GLD

- Modesty panels include angle brackets for top attachment.
- Order modesty to match top size. Non-Rectangular tops may require ordering one size smaller.
- Grain runs horizontal on all sizes.
- For use with standard height reconfigurable and personal tables.

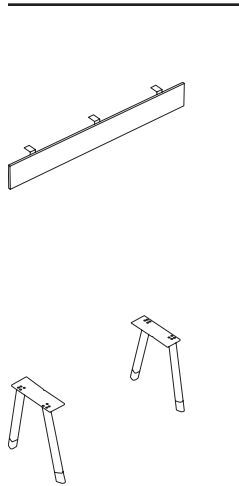

Description	Model Number add "L" for Laminate or "V" for Veneer	Ship Weight	Cubes	Laminate List Price			Veneer List Price	
				L1	L2	L3	V1	V2
<b>Modesty Panels</b>								
36"	ATLADM-MOD □ 36	7	1.1	\$ 426	\$ 448	\$ 469	\$ 553	\$ 608
42"	ATLADM-MOD □ 42	8	1.3	\$ 479	\$ 503	\$ 527	\$ 614	\$ 675
48"	ATLADM-MOD □ 48	9	1.4	\$ 541	\$ 568	\$ 595	\$ 705	\$ 776
54"	ATLADM-MOD □ 54	11	1.6	\$ 587	\$ 616	\$ 646	\$ 751	\$ 826
60"	ATLADM-MOD □ 60	12	1.8	\$ 613	\$ 644	\$ 674	\$ 832	\$ 915
66"	ATLADM-MOD □ 66	13	1.9	\$ 641	\$ 673	\$ 705	\$ 879	\$ 967
72"	ATLADM-MOD □ 72 (shown)	14	2.1	\$ 671	\$ 705	\$ 738	\$ 960	\$ 1056
78"	ATLADM-MOD □ 78	15	2.3	\$ 705	\$ 740	\$ 776	\$ 1008	\$ 1109
84"	ATLADM-MOD □ 84	16	2.5	\$ 740	\$ 777	\$ 814	\$ 1058	\$ 1164

ADMIX

<p><i>How to specify —</i> Select the Model Number from above.</p> <p>ATLADM - MOD         .</p>	<p><i>1st Option:</i> FSC Certified Wood: X Standard - No FSC F FSC Certified</p> <p>  .</p>	<p><i>2nd Option:</i> Laminate/Veneer: See page 364.3 for finishes.</p> <p>         </p>
--	--	--

Example: ATLADM-MODL36.X.LDW1

- Order base separately.
- Option for cutout only, order power units separately.
- Reference page 364.7 for cutout locations.
- Available in veneer or laminate tops, flat or knife edge.
- Edgeband color option specified separately for laminate.
- Tops ship with pilot holes for locating base.
- For use with bases on pages 364.22-364.23.
- Tops 120" or greater are 2 piece. Adjoining seams are not edgebanded.

Description	Model Number add "L" for Laminate or "V" for Veneer	Ship Weight	Cubes	Laminate List Price			Veneer List Price	
				L1	L2	L3	V1	V2
<b>Rectangle Tops Flat</b>								
36"D x 60"W	ATLADM-TMREC 3660F	67	6.0	\$ 675	\$ 709	\$ 743	\$ 2015	\$ 2217
36"D x 72"W	ATLADM-TMREC 3672F	80	7.1	\$ 783	\$ 822	\$ 861	\$ 2219	\$ 2441
36"D x 84"W	ATLADM-TMREC 3684F	94	8.2	\$ 992	\$ 1042	\$ 1091	\$ 2567	\$ 2824
36"D x 96"W	ATLADM-TMREC 3696F	107	9.4	\$ 1149	\$ 1206	\$ 1264	\$ 3047	\$ 3352
36"D x 108"W	ATLADM-TMREC 36108F	120	10.5	\$ 1443	\$ 1515	\$ 1587	\$ 3520	\$ 3872
36"D x 120"W	ATLADM-TMREC 36120F	134	11.6	\$ 1737	\$ 1824	\$ 1911	\$ 3992	\$ 4391
36"D x 144"W	ATLADM-TMREC 36144F	160	13.9	\$ 1974	\$ 2073	\$ 2171	\$ 4806	\$ 5287
42"D x 72"W	ATLADM-TMREC 4272F	94	8.2	\$ 1069	\$ 1122	\$ 1176	\$ 3371	\$ 3708
42"D x 84"W	ATLADM-TMREC 4284F	109	9.5	\$ 1201	\$ 1261	\$ 1321	\$ 4032	\$ 4435
42"D x 96"W	ATLADM-TMREC 4296F	125	10.8	\$ 1229	\$ 1290	\$ 1352	\$ 4217	\$ 4639
42"D x 108"W	ATLADM-TMREC 42108F	140	12.1	\$ 1593	\$ 1673	\$ 1752	\$ 5195	\$ 5715
42"D x 120"W	ATLADM-TMREC 42120F	156	8.8	\$ 1956	\$ 2054	\$ 2152	\$ 5610	\$ 6171
42"D x 144"W	ATLADM-TMREC 42144F	187	10.5	\$ 2221	\$ 2332	\$ 2443	\$ 7105	\$ 7816
48"D x 72"W	ATLADM-TMREC 4872F	107	9.3	\$ 1167	\$ 1225	\$ 1284	\$ 3700	\$ 4070
48"D x 84"W	ATLADM-TMREC 4884F	125	10.8	\$ 1387	\$ 1456	\$ 1526	\$ 4435	\$ 4879
48"D x 96"W	ATLADM-TMREC 4896F	143	12.2	\$ 1421	\$ 1492	\$ 1563	\$ 4774	\$ 5251
48"D x 108"W	ATLADM-TMREC 48108F	160	13.7	\$ 1689	\$ 1773	\$ 2038	\$ 5699	\$ 6269
48"D x 120"W	ATLADM-TMREC 48120F	178	10.0	\$ 1956	\$ 2054	\$ 2152	\$ 6518	\$ 7170
48"D x 144"W	ATLADM-TMREC 48144F	214	11.9	\$ 2221	\$ 2332	\$ 2443	\$ 8043	\$ 8847

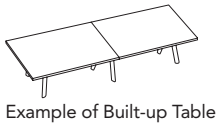
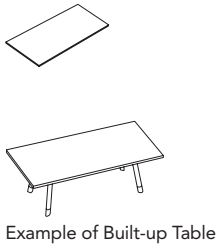

<b>Rectangle Tops Knife</b>								
36"D x 60"W	ATLADM-TMREC 3660K	67	6.0	\$ 1875	\$ 1969	\$ 2063	\$ 3215	\$ 3537
36"D x 72"W	ATLADM-TMREC 3672K	80	7.1	\$ 1983	\$ 2082	\$ 2181	\$ 3419	\$ 3761
36"D x 84"W	ATLADM-TMREC 3684K	94	8.2	\$ 2192	\$ 2302	\$ 2411	\$ 3767	\$ 4144
36"D x 96"W	ATLADM-TMREC 3696K	107	9.4	\$ 2349	\$ 2466	\$ 2584	\$ 4247	\$ 4672
36"D x 108"W	ATLADM-TMREC 36108K	120	10.5	\$ 2643	\$ 2775	\$ 2907	\$ 4720	\$ 5192
36"D x 120"W	ATLADM-TMREC 36120K	134	11.6	\$ 3137	\$ 3294	\$ 3451	\$ 5392	\$ 5931
36"D x 144"W	ATLADM-TMREC 36144K	160	13.9	\$ 3374	\$ 3543	\$ 3711	\$ 6206	\$ 6827
42"D x 72"W	ATLADM-TMREC 4272K	94	8.2	\$ 2369	\$ 2487	\$ 2606	\$ 4671	\$ 5138
42"D x 84"W	ATLADM-TMREC 4284K	109	9.5	\$ 2501	\$ 2626	\$ 2751	\$ 5332	\$ 5865
42"D x 96"W	ATLADM-TMREC 4296K	125	10.8	\$ 2529	\$ 2655	\$ 2782	\$ 5517	\$ 6069
42"D x 108"W	ATLADM-TMREC 42108K	140	12.1	\$ 2893	\$ 3038	\$ 3182	\$ 6495	\$ 7145
42"D x 120"W	ATLADM-TMREC 42120K	156	8.8	\$ 3456	\$ 3629	\$ 3802	\$ 7110	\$ 7821
42"D x 144"W	ATLADM-TMREC 42144K	187	10.5	\$ 3721	\$ 3907	\$ 4093	\$ 8605	\$ 9466
48"D x 72"W	ATLADM-TMREC 4872K	107	9.3	\$ 2567	\$ 2695	\$ 2824	\$ 5100	\$ 5610
48"D x 84"W	ATLADM-TMREC 4884K	125	10.8	\$ 2787	\$ 2926	\$ 3066	\$ 5835	\$ 6419
48"D x 96"W	ATLADM-TMREC 4896K	143	12.2	\$ 2821	\$ 2962	\$ 3103	\$ 6174	\$ 6791
48"D x 108"W	ATLADM-TMREC 48108K	160	13.7	\$ 3089	\$ 3243	\$ 3398	\$ 7099	\$ 7809
48"D x 120"W	ATLADM-TMREC 48120K	178	10.0	\$ 3556	\$ 3734	\$ 3912	\$ 8118	\$ 8930
48"D x 144"W	ATLADM-TMREC 48144K	214	11.9	\$ 3821	\$ 4012	\$ 4203	\$ 9643	\$ 10607

Note: Tops 120" or greater are two pieces.

How to specify — Select the Model Number from above.	1st Option: FSC Certified Wood: X Standard - No FSC F FSC Certified	2nd Option: Laminate/Veneer: See page 364.3 for finishes.	3rd Option: Edge (Laminate): See page 364.3 for finishes.	3rd Option: Top Finish (Veneer): FF Full Fill +\$273 (up to 120"W) +\$436 (for 144"W) OP Open Pore Low Sheen	4th Option: Cutout: GN No Grommet C1E 1 Bezel Mount Power C1TM 1 Tech Module C2E 2 Bezel Mount Power C2TM 2 Tech Module Note: C2 options for tables 108"W and greater.
ATLADM - TMREC					

Example: ATLADM-TMRECL3660F.X.LDW1.DW.GN

- Order base separately.
- Option for cutout only, order power units separately.
- Reference page 364.7 for cutout locations.
- Available in veneer or laminate tops, flat or knife edge.
- Edgeband color option specified separately for laminate.
- Tops ship with pilot holes for locating base.
- For use with bases on pages 364.22-364.23.
- Tops 120" or greater are 2 piece. Adjoining seams are not edgebanded.

Description	Model Number add "L" for Laminate or "V" for Veneer	Ship Weight	Cubes	Laminate List Price			Veneer List Price	
				L1	L2	L3	V1	V2
<b>Rounded Rectangle Tops Flat</b>								
36"D x 60"W	ATLADM-TMRREC □ 3660F	67	6.0	\$ 743	\$ 780	\$ 817	\$ 2217	\$ 2439
36"D x 72"W	ATLADM-TMRREC □ 3672F	80	7.1	\$ 861	\$ 904	\$ 947	\$ 2441	\$ 2685
36"D x 84"W	ATLADM-TMRREC □ 3684F	94	8.2	\$ 1091	\$ 1146	\$ 1200	\$ 2824	\$ 3106
36"D x 96"W	ATLADM-TMRREC □ 3696F	107	9.4	\$ 1264	\$ 1327	\$ 1390	\$ 3352	\$ 3687
36"D x 108"W	ATLADM-TMRREC □ 36108F	120	10.5	\$ 1587	\$ 1666	\$ 1746	\$ 3872	\$ 4259
36"D x 120"W	ATLADM-TMRREC □ 36120F	134	11.6	\$ 1911	\$ 2007	\$ 2102	\$ 4391	\$ 4830
36"D x 144"W	ATLADM-TMRREC □ 36144F	160	13.9	\$ 2171	\$ 2280	\$ 2388	\$ 5287	\$ 5816
42"D x 72"W	ATLADM-TMRREC □ 4272F	94	8.2	\$ 1176	\$ 1235	\$ 1294	\$ 3708	\$ 4079
42"D x 84"W	ATLADM-TMRREC □ 4284F	109	9.5	\$ 1321	\$ 1387	\$ 1453	\$ 4435	\$ 4879
42"D x 96"W	ATLADM-TMRREC □ 4296F	125	10.8	\$ 1352	\$ 1420	\$ 1487	\$ 4639	\$ 5103
42"D x 108"W	ATLADM-TMRREC □ 42108F	140	12.1	\$ 1752	\$ 1841	\$ 1927	\$ 5715	\$ 6287
42"D x 120"W	ATLADM-TMRREC □ 42120F	156	8.8	\$ 2152	\$ 2260	\$ 2367	\$ 6171	\$ 6788
42"D x 144"W	ATLADM-TMRREC □ 42144F	187	10.5	\$ 2443	\$ 2565	\$ 2687	\$ 7816	\$ 8598
48"D x 72"W	ATLADM-TMRREC □ 4872F	107	9.3	\$ 1284	\$ 1348	\$ 1412	\$ 4070	\$ 4477
48"D x 84"W	ATLADM-TMRREC □ 4884F	125	10.8	\$ 1526	\$ 1602	\$ 1679	\$ 4879	\$ 5367
48"D x 96"W	ATLADM-TMRREC □ 4896F	143	12.2	\$ 1563	\$ 1641	\$ 1719	\$ 5251	\$ 5776
48"D x 108"W	ATLADM-TMRREC □ 48108F	160	13.7	\$ 1858	\$ 1951	\$ 2044	\$ 6269	\$ 6896
48"D x 120"W	ATLADM-TMRREC □ 48120F	178	10.0	\$ 2152	\$ 2260	\$ 2367	\$ 7170	\$ 7887
48"D x 144"W	ATLADM-TMRREC □ 48144F	214	11.9	\$ 2443	\$ 2565	\$ 2687	\$ 8847	\$ 9732



Example of Built-up Table

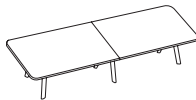

Example of Built-up Table

<b>Rounded Rectangle Tops Knife</b>								
36"D x 60"W	ATLADM-TMRREC □ 3660K	67	6.0	\$ 2063	\$ 2166	\$ 2269	\$ 3537	\$ 3891
36"D x 72"W	ATLADM-TMRREC □ 3672K	80	7.1	\$ 2181	\$ 2290	\$ 2399	\$ 3761	\$ 4137
36"D x 84"W	ATLADM-TMRREC □ 3684K	94	8.2	\$ 2411	\$ 2532	\$ 2652	\$ 4144	\$ 5448
36"D x 96"W	ATLADM-TMRREC □ 3696K	107	9.4	\$ 2584	\$ 2713	\$ 2842	\$ 4672	\$ 5139
36"D x 108"W	ATLADM-TMRREC □ 36108K	120	10.5	\$ 2907	\$ 3052	\$ 3198	\$ 5192	\$ 5711
36"D x 120"W	ATLADM-TMRREC □ 36120K	134	11.6	\$ 3451	\$ 3624	\$ 3796	\$ 5931	\$ 6524
36"D x 144"W	ATLADM-TMRREC □ 36144K	160	13.9	\$ 3711	\$ 3897	\$ 4082	\$ 6827	\$ 7510
42"D x 72"W	ATLADM-TMRREC □ 4272K	94	8.2	\$ 2606	\$ 2736	\$ 2867	\$ 5138	\$ 5652
42"D x 84"W	ATLADM-TMRREC □ 4284K	109	9.5	\$ 2751	\$ 2889	\$ 3026	\$ 5865	\$ 6452
42"D x 96"W	ATLADM-TMRREC □ 4296K	125	10.8	\$ 2782	\$ 2921	\$ 3060	\$ 6069	\$ 6676
42"D x 108"W	ATLADM-TMRREC □ 42108K	140	12.1	\$ 3182	\$ 3341	\$ 3500	\$ 7145	\$ 7860
42"D x 120"W	ATLADM-TMRREC □ 42120K	156	8.8	\$ 3802	\$ 3992	\$ 4182	\$ 7821	\$ 8603
42"D x 144"W	ATLADM-TMRREC □ 42144K	187	10.5	\$ 4093	\$ 4298	\$ 4502	\$ 9466	\$10413
48"D x 72"W	ATLADM-TMRREC □ 4872K	107	9.3	\$ 2824	\$ 2965	\$ 3106	\$ 5610	\$ 6171
48"D x 84"W	ATLADM-TMRREC □ 4884K	125	10.8	\$ 3066	\$ 3219	\$ 3373	\$ 6419	\$ 7061
48"D x 96"W	ATLADM-TMRREC □ 4896K	143	12.2	\$ 3103	\$ 3558	\$ 3713	\$ 6791	\$ 7470
48"D x 108"W	ATLADM-TMRREC □ 48108K	160	13.7	\$ 3398	\$ 3243	\$ 3398	\$ 7809	\$ 8590
48"D x 120"W	ATLADM-TMRREC □ 48120K	178	10.0	\$ 3912	\$ 4108	\$ 4303	\$ 8930	\$ 9823
48"D x 144"W	ATLADM-TMRREC □ 48144K	214	11.9	\$ 4203	\$ 4413	\$ 4623	\$10607	\$11668

Note: Tops 120" or greater are two pieces.

<p><b>How to specify —</b> Select the Model Number from above.</p> <p>ATLADM - TMRREC</p>	<p><b>1st Option:</b> FSC Certified Wood: X Standard - No FSC F FSC Certified</p>	<p><b>2nd Option:</b> Laminate/Veneer: See page 364.3 for finishes.</p>	<p><b>3rd Option:</b> Edge (Laminate): See page 364.3 for finishes.</p>	<p><b>3rd Option:</b> Top Finish (Veneer): FF Full Fill +\$273 (up to 120"W) +\$436 (for 144"W) OP Open Pore Low Sheen</p>	<p><b>4th Option:</b> Cutout: GN No Grommet C1E 1 Bezel Mount Power C1TM 1 Tech Module C2E 2 Bezel Mount Power C2TM 2 Tech Module Note: C2 options for tables 108"W and greater.</p>
---	---	---	---	--	--

Example: ATLADM-TMRRECL3660F.X.LDW1.DW.GN

- Order base separately.
- Option for cutout only, order power units separately.
- Reference page 364.7 for cutout locations.

- Available in veneer or laminate tops, flat or knife edge.
- Edgeband color option specified separately for laminate.
- Tops ship with pilot holes for locating base.

- For use with bases on pages 364.22-364.23.
- Tops 120" or greater are 2 piece. Adjoining seams are not edgebanded.

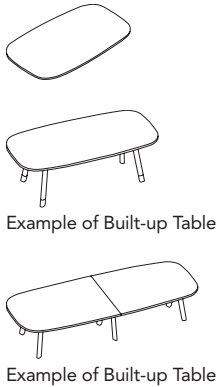

Description	Model Number add "L" for Laminate or "V" for Veneer	Ship Weight	Cubes	Laminate List Price			Veneer List Price	
				L1	L2	L3	V1	V2
<b>Boat Tops Flat</b>								
36"D x 60"W	ATLADM-TMBOAT □ 3660F	67	6.0	\$ 743	\$ 780	\$ 817	\$ 2217	\$ 2439
36"D x 72"W	ATLADM-TMBOAT □ 3672F	80	7.1	\$ 861	\$ 904	\$ 947	\$ 2441	\$ 2685
36"D x 84"W	ATLADM-TMBOAT □ 3684F	94	8.2	\$ 1091	\$ 1146	\$ 1200	\$ 2824	\$ 3106
36"D x 96"W	ATLADM-TMBOAT □ 3696F	107	9.4	\$ 1264	\$ 1327	\$ 1390	\$ 3352	\$ 3687
36"D x 108"W	ATLADM-TMBOAT □ 36108F	120	10.5	\$ 1587	\$ 1666	\$ 1746	\$ 3872	\$ 4259
36"D x 120"W	ATLADM-TMBOAT □ 36120F	134	11.6	\$ 1911	\$ 2007	\$ 2102	\$ 4391	\$ 4830
36"D x 144"W	ATLADM-TMBOAT □ 36144F	160	13.9	\$ 2171	\$ 2280	\$ 2388	\$ 5287	\$ 5816
42"D x 72"W	ATLADM-TMBOAT □ 4272F	94	8.2	\$ 1176	\$ 1235	\$ 1294	\$ 3708	\$ 4079
42"D x 84"W	ATLADM-TMBOAT □ 4284F	109	9.5	\$ 1321	\$ 1387	\$ 1453	\$ 4435	\$ 4879
42"D x 96"W	ATLADM-TMBOAT □ 4296F	125	10.8	\$ 1352	\$ 1420	\$ 1487	\$ 4639	\$ 5103
42"D x 108"W	ATLADM-TMBOAT □ 42108F	140	12.1	\$ 1752	\$ 1841	\$ 1927	\$ 5715	\$ 6287
42"D x 120"W	ATLADM-TMBOAT □ 42120F	156	8.8	\$ 2152	\$ 2260	\$ 2367	\$ 6171	\$ 6788
42"D x 144"W	ATLADM-TMBOAT □ 42144F	187	10.5	\$ 2443	\$ 2565	\$ 2687	\$ 7816	\$ 8598
48"D x 72"W	ATLADM-TMBOAT □ 4872F	107	9.3	\$ 1284	\$ 1348	\$ 1412	\$ 4070	\$ 4477
48"D x 84"W	ATLADM-TMBOAT □ 4884F	125	10.8	\$ 1526	\$ 1602	\$ 1679	\$ 4879	\$ 5367
48"D x 96"W	ATLADM-TMBOAT □ 4896F	143	12.2	\$ 1563	\$ 1641	\$ 1719	\$ 5251	\$ 5776
48"D x 108"W	ATLADM-TMBOAT □ 48108F	160	13.7	\$ 1858	\$ 1951	\$ 2044	\$ 6269	\$ 6896
48"D x 120"W	ATLADM-TMBOAT □ 48120F	178	10.0	\$ 2152	\$ 2260	\$ 2367	\$ 7170	\$ 7887
48"D x 144"W	ATLADM-TMBOAT □ 48144F	214	11.9	\$ 2443	\$ 2565	\$ 2687	\$ 8847	\$ 9732

<b>Boat Tops Knife</b>								
36"D x 60"W	ATLADM-TMBOAT □ 3660K	67	6.0	\$ 2063	\$ 2166	\$ 2269	\$ 3537	\$ 3891
36"D x 72"W	ATLADM-TMBOAT □ 3672K	80	7.1	\$ 2181	\$ 2290	\$ 2399	\$ 3761	\$ 4137
36"D x 84"W	ATLADM-TMBOAT □ 3684K	94	8.2	\$ 2411	\$ 2532	\$ 2652	\$ 4144	\$ 5448
36"D x 96"W	ATLADM-TMBOAT □ 3696K	107	9.4	\$ 2584	\$ 2713	\$ 2842	\$ 4672	\$ 5139
36"D x 108"W	ATLADM-TMBOAT □ 36108K	120	10.5	\$ 2907	\$ 3052	\$ 3198	\$ 5192	\$ 5711
36"D x 120"W	ATLADM-TMBOAT □ 36120K	134	11.6	\$ 3451	\$ 3624	\$ 3796	\$ 5931	\$ 6524
36"D x 144"W	ATLADM-TMBOAT □ 36144K	160	13.9	\$ 3711	\$ 3897	\$ 4082	\$ 6827	\$ 7510
42"D x 72"W	ATLADM-TMBOAT □ 4272K	94	8.2	\$ 2606	\$ 2736	\$ 2867	\$ 5138	\$ 5652
42"D x 84"W	ATLADM-TMBOAT □ 4284K	109	9.5	\$ 2751	\$ 2889	\$ 3026	\$ 5865	\$ 6452
42"D x 96"W	ATLADM-TMBOAT □ 4296K	125	10.8	\$ 2782	\$ 2921	\$ 3060	\$ 6069	\$ 6676
42"D x 108"W	ATLADM-TMBOAT □ 42108K	140	12.1	\$ 3182	\$ 3341	\$ 3500	\$ 7145	\$ 7860
42"D x 120"W	ATLADM-TMBOAT □ 42120K	156	8.8	\$ 3802	\$ 3992	\$ 4182	\$ 7821	\$ 8603
42"D x 144"W	ATLADM-TMBOAT □ 42144K	187	10.5	\$ 4093	\$ 4298	\$ 4502	\$ 9466	\$10413
48"D x 72"W	ATLADM-TMBOAT □ 4872K	107	9.3	\$ 2824	\$ 2965	\$ 3106	\$ 5610	\$ 6171
48"D x 84"W	ATLADM-TMBOAT □ 4884K	125	10.8	\$ 3066	\$ 3219	\$ 3373	\$ 6419	\$ 7061
48"D x 96"W	ATLADM-TMBOAT □ 4896K	143	12.2	\$ 3103	\$ 3558	\$ 3713	\$ 6791	\$ 7470
48"D x 108"W	ATLADM-TMBOAT □ 48108K	160	13.7	\$ 3398	\$ 3243	\$ 3398	\$ 7809	\$ 8590
48"D x 120"W	ATLADM-TMBOAT □ 48120K	178	10.0	\$ 3912	\$ 4108	\$ 4303	\$ 8930	\$ 9823
48"D x 144"W	ATLADM-TMBOAT □ 48144K	214	11.9	\$ 4203	\$ 4413	\$ 4623	\$10607	\$11668

Note: Tops 120" or greater are two pieces.

How to specify — Select the Model Number from above.	1st Option: FSC Certified Wood: X Standard - No FSC F FSC Certified	2nd Option: Laminate/Veneer: See page 364.3 for finishes.	3rd Option: Edge (Laminate): See page 364.3 for finishes.	3rd Option: Top Finish (Veneer): FF Full Fill +\$273 (up to 120"W) +\$436 (for 144"W) OP Open Pore Low Sheen	4th Option: Cutout: GN No Grommet C1E 1 Bezel Mount Power C1TM 1 Tech Module C2E 2 Bezel Mount Power C2TM 2 Tech Module Note: C2 options for tables 108"W and greater.
ATLADM - TMBOAT					

Example: ATLADM-TMBOATL3660F.X.LDW1.DW.GN

- Order base separately.
- Option for cutout only, order power units separately.
- Reference page 364.7 for cutout locations.
- Available in veneer or laminate tops, flat or knife edge.
- Edgeband color option specified separately for laminate.
- Tops ship with pilot holes for locating base.
- For use with bases on pages 364.22-364.23.
- Tops 120" or greater are 2 piece. Adjoining seams are not edgebanded.

Description	Model Number add "L" for Laminate or "V" for Veneer	Ship Weight	Cubes	Laminate List Price			Veneer List Price	
				L1	L2	L3	V1	V2
<b>Racetrack Tops Flat</b>								
36"D x 60"W	ATLADM-TMRACE □ 3660F	67	6.0	\$ 743	\$ 780	\$ 817	\$ 2217	\$ 2439
36"D x 72"W	ATLADM-TMRACE □ 3672F	80	7.1	\$ 861	\$ 904	\$ 947	\$ 2441	\$ 2685
36"D x 84"W	ATLADM-TMRACE □ 3684F	94	8.2	\$ 1091	\$ 1146	\$ 1200	\$ 2824	\$ 3106
36"D x 96"W	ATLADM-TMRACE □ 3696F	107	9.4	\$ 1264	\$ 1327	\$ 1390	\$ 3352	\$ 3687
36"D x 108"W	ATLADM-TMRACE □ 36108F	120	10.5	\$ 1587	\$ 1666	\$ 1746	\$ 3872	\$ 4259
36"D x 120"W	ATLADM-TMRACE □ 36120F	134	11.6	\$ 1911	\$ 2007	\$ 2102	\$ 4391	\$ 4830
36"D x 144"W	ATLADM-TMRACE □ 36144F	160	13.9	\$ 2171	\$ 2280	\$ 2388	\$ 5287	\$ 5816
42"D x 72"W	ATLADM-TMRACE □ 4272F	94	8.2	\$ 1176	\$ 1235	\$ 1294	\$ 3708	\$ 4079
42"D x 84"W	ATLADM-TMRACE □ 4284F	109	9.5	\$ 1321	\$ 1387	\$ 1453	\$ 4435	\$ 4879
42"D x 96"W	ATLADM-TMRACE □ 4296F	125	10.8	\$ 1352	\$ 1420	\$ 1487	\$ 4639	\$ 5103
42"D x 108"W	ATLADM-TMRACE □ 42108F	140	12.1	\$ 1752	\$ 1841	\$ 1927	\$ 5715	\$ 6287
42"D x 120"W	ATLADM-TMRACE □ 42120F	156	8.8	\$ 2152	\$ 2260	\$ 2367	\$ 6171	\$ 6788
42"D x 144"W	ATLADM-TMRACE □ 42144F	187	10.5	\$ 2443	\$ 2565	\$ 2687	\$ 7816	\$ 8598
48"D x 72"W	ATLADM-TMRACE □ 4872F	107	9.3	\$ 1284	\$ 1348	\$ 1412	\$ 4070	\$ 4477
48"D x 84"W	ATLADM-TMRACE □ 4884F	125	10.8	\$ 1526	\$ 1602	\$ 1679	\$ 4879	\$ 5367
48"D x 96"W	ATLADM-TMRACE □ 4896F	143	12.2	\$ 1563	\$ 1641	\$ 1719	\$ 5251	\$ 5776
48"D x 108"W	ATLADM-TMRACE □ 48108F	160	13.7	\$ 1858	\$ 1951	\$ 2044	\$ 6269	\$ 6896
48"D x 120"W	ATLADM-TMRACE □ 48120F	178	10.0	\$ 2152	\$ 2260	\$ 2367	\$ 7170	\$ 7887
48"D x 144"W	ATLADM-TMRACE □ 48144F	214	11.9	\$ 2443	\$ 2565	\$ 2687	\$ 8847	\$ 9732

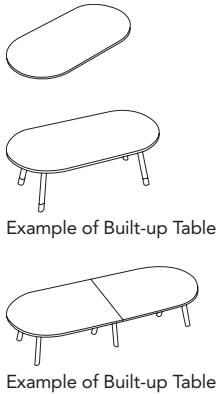

**Racetrack Tops Knife**

36"D x 60"W	ATLADM-TMRACE □ 3660K	67	6.0	\$ 2063	\$ 2166	\$ 2269	\$ 3537	\$ 3891
36"D x 72"W	ATLADM-TMRACE □ 3672K	80	7.1	\$ 2181	\$ 2290	\$ 2399	\$ 3761	\$ 4137
36"D x 84"W	ATLADM-TMRACE □ 3684K	94	8.2	\$ 2411	\$ 2532	\$ 2652	\$ 4144	\$ 5448
36"D x 96"W	ATLADM-TMRACE □ 3696K	107	9.4	\$ 2584	\$ 2713	\$ 2842	\$ 4672	\$ 5139
36"D x 108"W	ATLADM-TMRACE □ 36108K	120	10.5	\$ 2907	\$ 3052	\$ 3198	\$ 5192	\$ 5711
36"D x 120"W	ATLADM-TMRACE □ 36120K	134	11.6	\$ 3451	\$ 3624	\$ 3796	\$ 5931	\$ 6524
36"D x 144"W	ATLADM-TMRACE □ 36144K	160	13.9	\$ 3711	\$ 3897	\$ 4082	\$ 6827	\$ 7510
42"D x 72"W	ATLADM-TMRACE □ 4272K	94	8.2	\$ 2606	\$ 2736	\$ 2867	\$ 5138	\$ 5652
42"D x 84"W	ATLADM-TMRACE □ 4284K	109	9.5	\$ 2751	\$ 2889	\$ 3026	\$ 5865	\$ 6452
42"D x 96"W	ATLADM-TMRACE □ 4296K	125	10.8	\$ 2782	\$ 2921	\$ 3060	\$ 6069	\$ 6676
42"D x 108"W	ATLADM-TMRACE □ 42108K	140	12.1	\$ 3182	\$ 3341	\$ 3500	\$ 7145	\$ 7860
42"D x 120"W	ATLADM-TMRACE □ 42120K	156	8.8	\$ 3802	\$ 3992	\$ 4182	\$ 7821	\$ 8603
42"D x 144"W	ATLADM-TMRACE □ 42144K	187	10.5	\$ 4093	\$ 4298	\$ 4502	\$ 9466	\$10413
48"D x 72"W	ATLADM-TMRACE □ 4872K	107	9.3	\$ 2824	\$ 2965	\$ 3106	\$ 5610	\$ 6171
48"D x 84"W	ATLADM-TMRACE □ 4884K	125	10.8	\$ 3066	\$ 3219	\$ 3373	\$ 6419	\$ 7061
48"D x 96"W	ATLADM-TMRACE □ 4896K	143	12.2	\$ 3103	\$ 3558	\$ 3713	\$ 6791	\$ 7470
48"D x 108"W	ATLADM-TMRACE □ 48108K	160	13.7	\$ 3398	\$ 3243	\$ 3398	\$ 7809	\$ 8590
48"D x 120"W	ATLADM-TMRACE □ 48120K	178	10.0	\$ 3912	\$ 4108	\$ 4303	\$ 8930	\$ 9823
48"D x 144"W	ATLADM-TMRACE □ 48144K	214	11.9	\$ 4203	\$ 4413	\$ 4623	\$10607	\$11668

Note: Tops 120" or greater are two pieces.

How to specify — Select the Model Number from above.	1st Option: FSC Certified Wood: X Standard - No FSC F FSC Certified	2nd Option: Laminate/Veneer: See page 364.3 for finishes.	3rd Option: Edge (Laminate): See page 364.3 for finishes.	3rd Option: Top Finish (Veneer): FF Full Fill +\$273 (up to 120"W) +\$436 (for 144"W) OP Open Pore Low Sheen	4th Option: Cutout: GN No Grommet C1E 1 Bezel Mount Power C1TM 1 Tech Module C2E 2 Bezel Mount Power C2TM 2 Tech Module Note: C2 options for tables 108"W and greater.
ATLADM - TMRACE					

Example: ATLADM-TMRACEL3660F.X.LDW1.DW.GN

- Base includes external stiffeners for tops.
- 108", 120", and 144" models have 6 legs.
- For use with tops on pages 364.18-364.21.
- Base ships knocked down.

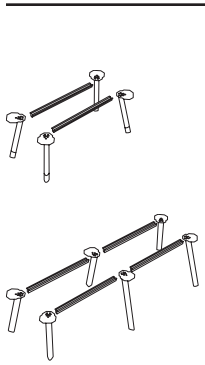

Description	Model	Ship Weight	Cubes	List Price	
				P1	P2
<b>Meeting Table Bases — Continental Height</b>					
For Tops 36"D x 60"W	ATLADM-BMTGM3660L	41	2.6	\$ 1650	\$ 1816
For Tops 36"D x 72"W	ATLADM-BMTGM3672L (shown)	48	3.3	\$ 1822	\$ 1988
For Tops 36"D x 84"W	ATLADM-BMTGM3684L	51	3.5	\$ 1862	\$ 2028
For Tops 36"D x 96"W	ATLADM-BMTGM3696L	54	3.7	\$ 2164	\$ 2354
For Tops 36"D x 108"W	ATLADM-BMTGM36108L	75	5.1	\$ 3179	\$ 3464
For Tops 36"D x 120"W	ATLADM-BMTGM36120L	77	5.3	\$ 3191	\$ 3476
For Tops 36"D x 144"W	ATLADM-BMTGM36144L	83	5.7	\$ 3271	\$ 3556
For Tops 42"D x 72"W	ATLADM-BMTGM4272L	49	3.3	\$ 1822	\$ 2260
For Tops 42"D x 84"W	ATLADM-BMTGM4284L	52	3.5	\$ 1862	\$ 2300
For Tops 42"D x 96"W	ATLADM-BMTGM4296L (shown)	54	3.7	\$ 2164	\$ 2354
For Tops 42"D x 108"W	ATLADM-BMTGM42108L	75	5.1	\$ 3179	\$ 3464
For Tops 42"D x 120"W	ATLADM-BMTGM42120L	77	5.3	\$ 3191	\$ 3476
For Tops 42"D x 144"W	ATLADM-BMTGM42144L	83	5.7	\$ 3271	\$ 3556
For Tops 48"D x 72"W	ATLADM-BMTGM4872L	42	3.3	\$ 2070	\$ 2260
For Tops 48"D x 84"W	ATLADM-BMTGM4884L	49	3.5	\$ 2110	\$ 2300
For Tops 48"D x 96"W	ATLADM-BMTGM4896L	52	3.7	\$ 2164	\$ 2354
For Tops 48"D x 108"W	ATLADM-BMTGM48108L	56	5.1	\$ 3179	\$ 3464
For Tops 48"D x 120"W	ATLADM-BMTGM48120L (shown)	77	5.3	\$ 3191	\$ 3476
For Tops 48"D x 144"W	ATLADM-BMTGM48144L	79	5.7	\$ 3271	\$ 3556

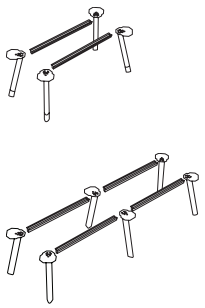

<b>Meeting Table Bases — Seated Height</b>					
For Tops 36"D x 60"W	ATLADM-BMTGM3660S	42	2.6	\$ 1700	\$ 1870
For Tops 36"D x 72"W	ATLADM-BMTGM3672S (shown)	49	3.3	\$ 1872	\$ 2042
For Tops 36"D x 84"W	ATLADM-BMTGM3684S	52	3.5	\$ 1912	\$ 2082
For Tops 36"D x 96"W	ATLADM-BMTGM3696S	56	3.7	\$ 2222	\$ 2418
For Tops 36"D x 108"W	ATLADM-BMTGM36108S	77	5.1	\$ 3266	\$ 3560
For Tops 36"D x 120"W	ATLADM-BMTGM36120S	79	5.3	\$ 3278	\$ 3572
For Tops 36"D x 144"W	ATLADM-BMTGM36144S	85	5.7	\$ 3358	\$ 3652
For Tops 42"D x 72"W	ATLADM-BMTGM4272S	49	3.3	\$ 1872	\$ 2042
For Tops 42"D x 84"W	ATLADM-BMTGM4284S	52	3.5	\$ 1912	\$ 2082
For Tops 42"D x 96"W	ATLADM-BMTGM4296S (shown)	56	3.7	\$ 2222	\$ 2418
For Tops 42"D x 108"W	ATLADM-BMTGM42108S	77	5.1	\$ 3266	\$ 3560
For Tops 42"D x 120"W	ATLADM-BMTGM42120S	79	5.3	\$ 3278	\$ 3572
For Tops 42"D x 144"W	ATLADM-BMTGM42144S	85	5.7	\$ 3358	\$ 3652
For Tops 48"D x 72"W	ATLADM-BMTGM4872S	51	3.3	\$ 2128	\$ 2324
For Tops 48"D x 84"W	ATLADM-BMTGM4884S	54	3.5	\$ 2168	\$ 2364
For Tops 48"D x 96"W	ATLADM-BMTGM4896S	56	3.7	\$ 2222	\$ 2418
For Tops 48"D x 108"W	ATLADM-BMTGM48108S	77	5.1	\$ 3266	\$ 2560
For Tops 48"D x 120"W	ATLADM-BMTGM48120S (shown)	79	5.3	\$ 3278	\$ 3572
For Tops 48"D x 144"W	ATLADM-BMTGM48144S	85	5.7	\$ 3358	\$ 3652

<p><b>How to specify —</b> Select the Model Number from above.</p>	<p><b>1st Option:</b> <b>Paint Color:</b>  <input type="radio"/> P1 <input type="radio"/> P2 <input type="radio"/> P3                  See page 364.3 for finishes.</p>	<p><b>2nd Option:</b> <b>Caster/Glide:</b>                  CSB Casters Black                  CSS Casters Silver                  GLD Glides                  WHB Wheelbarrow Black (2 Glides + 2 Casters Black)                  WHS Wheelbarrow Silver (2 Glides + 2 Casters Silver)</p>
<p>ATLADM - BMTGM                     .                     .          </p>		

Example: ATLADM-BMTGM3660L.P1.GLD

- Base includes external stiffeners for tops.
- Base ships knocked down.
- 108", 120", and 144" models have 6 legs.
- Footrest is standard on counter and bar height tables at 11" off floor.
- For use with tops on pages 364.18-364.21.

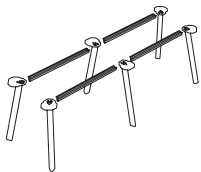
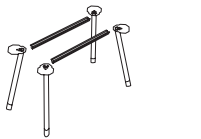
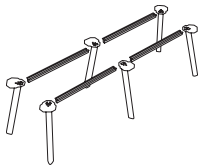
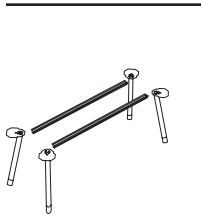

Description	Model	Ship Weight	Cubes	List Price	
				P1	P2
<b>Meeting Table Bases — Counter Height</b>					
For Tops 36"D x 60"W	ATLADM-BMTGM3660C	70	6.2	\$ 2700	\$ 2971
For Tops 36"D x 72"W	ATLADM-BMTGM3672C	79	7.0	\$ 2922	\$ 3198
For Tops 36"D x 84"W	ATLADM-BMTGM3684C	84	7.4	\$ 3062	\$ 3448
For Tops 36"D x 96"W	ATLADM-BMTGM3696C	91	7.7	\$ 3508	\$ 3832
For Tops 36"D x 108"W	ATLADM-BMTGM36108C	119	10.4	\$ 4895	\$ 5351
For Tops 36"D x 120"W	ATLADM-BMTGM36120C	123	10.7	\$ 5007	\$ 5473
For Tops 36"D x 144"W	ATLADM-BMTGM36144C	133	11.2	\$ 5187	\$ 5663
For Tops 42"D x 72"W	ATLADM-BMTGM4272C	79	7.0	\$ 2972	\$ 3253
For Tops 42"D x 84"W	ATLADM-BMTGM4284C	84	7.4	\$ 3112	\$ 3403
For Tops 42"D x 96"W	ATLADM-BMTGM4296C (shown)	91	7.7	\$ 3558	\$ 3441
For Tops 42"D x 108"W	ATLADM-BMTGM42108C	120	10.4	\$ 4945	\$ 5406
For Tops 42"D x 120"W	ATLADM-BMTGM42120C	124	10.7	\$ 5057	\$ 5528
For Tops 42"D x 144"W	ATLADM-BMTGM42144C	134	11.2	\$ 5237	\$ 5718
For Tops 48"D x 72"W	ATLADM-BMTGM4872C	83	7.0	\$ 3314	\$ 3628
For Tops 48"D x 84"W	ATLADM-BMTGM4884C	88	7.0	\$ 3454	\$ 3778
For Tops 48"D x 96"W	ATLADM-BMTGM4896C	92	7.4	\$ 3608	\$ 3942
For Tops 48"D x 108"W	ATLADM-BMTGM48108C	119	7.7	\$ 4995	\$ 5461
For Tops 48"D x 120"W	ATLADM-BMTGM48120C (shown)	123	5.3	\$ 5107	\$ 5583
For Tops 48"D x 144"W	ATLADM-BMTGM48144C	134	5.7	\$ 5287	\$ 5773

<b>Meeting Table Bases — Bar Height</b>					
For Tops 36"D x 60"W	ATLADM-BMTGM3660B	74	6.2	\$ 2800	\$ 3081
For Tops 36"D x 72"W	ATLADM-BMTGM3672B (shown)	83	7.0	\$ 3022	\$ 3308
For Tops 36"D x 84"W	ATLADM-BMTGM3684B	88	7.4	\$ 3162	\$ 3458
For Tops 36"D x 96"W	ATLADM-BMTGM3696B	96	7.7	\$ 3624	\$ 3960
For Tops 36"D x 108"W	ATLADM-BMTGM36108B	127	10.4	\$ 5069	\$ 5543
For Tops 36"D x 120"W	ATLADM-BMTGM36120B	131	10.7	\$ 5181	\$ 5665
For Tops 36"D x 144"W	ATLADM-BMTGM36144B	141	11.2	\$ 5361	\$ 5855
For Tops 42"D x 72"W	ATLADM-BMTGM4272B	83	6.7	\$ 3072	\$ 3363
For Tops 42"D x 84"W	ATLADM-BMTGM4284B	88	6.9	\$ 3212	\$ 3513
For Tops 42"D x 96"W	ATLADM-BMTGM4296B (shown)	96	7.1	\$ 3674	\$ 4015
For Tops 42"D x 108"W	ATLADM-BMTGM42108B	127	10.1	\$ 5119	\$ 5598
For Tops 42"D x 120"W	ATLADM-BMTGM42120B	131	10.3	\$ 5231	\$ 5720
For Tops 42"D x 144"W	ATLADM-BMTGM42144B	141	10.7	\$ 5411	\$ 5910
For Tops 48"D x 72"W	ATLADM-BMTGM4872B	88	6.7	\$ 3430	\$ 3756
For Tops 48"D x 84"W	ATLADM-BMTGM4884B	93	6.9	\$ 3570	\$ 3906
For Tops 48"D x 96"W	ATLADM-BMTGM4896B	97	7.1	\$ 3724	\$ 4070
For Tops 48"D x 108"W	ATLADM-BMTGM48108B	127	10.1	\$ 5169	\$ 5653
For Tops 48"D x 120"W	ATLADM-BMTGM48120B (shown)	131	10.3	\$ 5281	\$ 5775
For Tops 48"D x 144"W	ATLADM-BMTGM48144B	142	10.7	\$ 5461	\$ 5965

ADMIX

<p><b>How to specify —</b> Select the Model Number from above.</p>	<p><i>1st Option:</i> <b>Paint Color:</b>  <input type="radio"/> P1 <input type="radio"/> P2 <input type="radio"/> P3                  See page 364.3 for finishes.</p>	<p><i>2nd Option:</i> <b>Caster/Glide:</b>                  CSB Casters Black                  CSS Casters Silver                  GLD Glides                  WHB Wheelbarrow Black (2 Glides + 2 Casters Black)                  WHS Wheelbarrow Silver (2 Glides + 2 Casters Silver)</p>
<p>ATLADM - BMTGM                     .                     .          </p>		

Example: ATLADM-BMTGM3660C.P71.GLD



- Order base separately.
- Option for cutout only, order power units separately.
- Reference page 364.7 for cutout locations.
- Available in veneer or laminate tops, flat or knife edge.
- Edgeband color option specified separately for laminate.
- Tops ship with pilot holes for locating base.
- For use with bases on page 364.26.
- Laminate tops are 1 piece. Veneer tops 54" and greater are 2 piece.

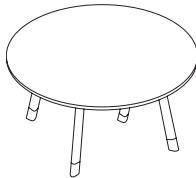
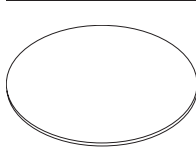

Example of Built-up Table

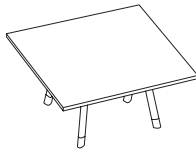
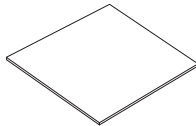

Example of Built-up Table

Description	Model Number add "L" for Laminate or "V" for Veneer	Ship Weight	Cubes	Laminate List Price			Veneer List Price		
				L1	L2	L3	V1	V2	
<b>Round Tops — Flat</b>									
36"Diameter	ATLADM-TMRND □ 36F	40	3.7	\$ 612	\$ 643	\$ 673	\$ 2586	\$ 2845	
42"Diameter	ATLADM-TMRND □ 42F	55	4.9	\$ 723	\$ 759	\$ 795	\$ 2808	\$ 3089	
48"Diameter	ATLADM-TMRND □ 48F	71	6.3	\$ 880	\$ 924	\$ 968	\$ 3673	\$ 4040	
54"Diameter	ATLADM-TMRND □ 54F	90	7.9	\$ 1273	\$ 1337	\$ 1400	\$ 4489	\$ 4937	
60"Diameter	ATLADM-TMRND □ 60F	111	9.6	\$ 1466	\$ 1539	\$ 1613	\$ 5463	\$ 6009	
<b>Round Tops — Knife</b>									
36"Diameter	ATLADM-TMRND □ 36K	40	3.7	\$ 1162	\$ 1220	\$ 1278	\$ 3136	\$ 3450	
42"Diameter	ATLADM-TMRND □ 42K	55	4.9	\$ 1273	\$ 1337	\$ 1400	\$ 3358	\$ 3694	
48"Diameter	ATLADM-TMRND □ 48K	71	6.3	\$ 1430	\$ 1502	\$ 1573	\$ 4223	\$ 4645	
54"Diameter	ATLADM-TMRND □ 54K	90	7.9	\$ 1823	\$ 1914	\$ 2005	\$ 5039	\$ 5543	
60"Diameter	ATLADM-TMRND □ 60K	111	9.6	\$ 2016	\$ 2117	\$ 2218	\$ 6013	\$ 6614	
<b>Square Tops — Flat</b>									
36"D x 36"W	ATLADM-TMSQR □ 36F	40	3.7	\$ 551	\$ 579	\$ 606	\$ 2327	\$ 2560	
42"D x 42"W	ATLADM-TMSQR □ 42F	55	4.9	\$ 651	\$ 684	\$ 716	\$ 2527	\$ 2780	
48"D x 48"W	ATLADM-TMSQR □ 48F	71	6.3	\$ 792	\$ 832	\$ 871	\$ 3306	\$ 3637	
54"D x 54"W	ATLADM-TMSQR □ 54F	90	7.9	\$ 1146	\$ 1203	\$ 1261	\$ 4040	\$ 4444	
60"D x 60"W	ATLADM-TMSQR □ 60F	111	9.6	\$ 1319	\$ 1385	\$ 1451	\$ 4917	\$ 5409	
<b>Square Tops — Knife</b>									
36"D x 36"W	ATLADM-TMSQR □ 36K	40	3.7	\$ 1046	\$ 1098	\$ 1151	\$ 2822	\$ 3055	
42"D x 42"W	ATLADM-TMSQR □ 42K	55	4.9	\$ 1146	\$ 1203	\$ 1261	\$ 3022	\$ 3324	
48"D x 48"W	ATLADM-TMSQR □ 48K	71	6.3	\$ 1287	\$ 1351	\$ 1416	\$ 3801	\$ 4181	
54"D x 54"W	ATLADM-TMSQR □ 54K	90	7.9	\$ 1641	\$ 1723	\$ 1805	\$ 4535	\$ 4989	
60"D x 60"W	ATLADM-TMSQR □ 60K	111	9.6	\$ 1814	\$ 1905	\$ 1995	\$ 5412	\$ 5953	

Note: Laminate tops are 1 piece. Veneer tops 54" and greater are 2 piece.

<b>How to specify —</b> Select the Model Number from above.	<b>1st Option:</b> FSC Certified Wood: X Standard - No FSC F FSC Certified	<b>2nd Option:</b> Laminate/Veneer: See page 364.3 for finishes.	<b>3rd Option:</b> Edge (Laminate): See page 364.3 for finishes.	<b>3rd Option:</b> Top Finish (Veneer): FF Full Fill +\$273 OP Open Pore Low Sheen	<b>4th Option:</b> Cutout: GN No Grommet C1E 1 Bezel Mount Power C1TM 1 Tech Module
ATLADM   -					
TM           .					

Example: ATLADM-TMRNDL36F.X.LDW1.DW.GN

- Order base separately.
- Option for cutout only, order power units separately.
- Reference page 364.7 for cutout locations.
- Available in veneer or laminate tops, flat or knife edge.
- Edgeband color option specified separately for laminate.
- Tops ship with pilot holes for locating base.
- For use with bases on page 364.26.
- Laminate tops are 1 piece. Veneer tops 54" and greater are 2 piece — adjoining seams are not edgebanded.

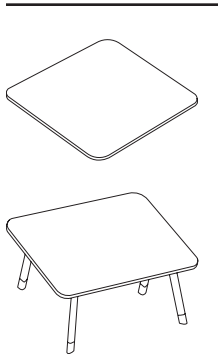

Example of Built-up Table

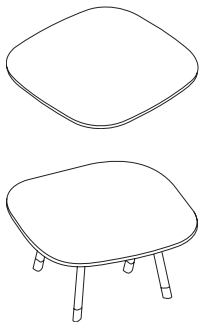

Example of Built-up Table

Description	Model Number add "L" for Laminate or "V" for Veneer	Ship Weight	Cubes	Laminate List Price			Veneer List Price	
				L1	L2	L3	V1	V2
<b>Rounded Square Tops — Flat</b>								
36" Diameter	ATLADM-TMRSQR □ 36F	40	3.7	\$ 612	\$ 643	\$ 673	\$ 2586	\$ 2845
42" Diameter	ATLADM-TMRSQR □ 42F	55	4.9	\$ 723	\$ 759	\$ 795	\$ 2808	\$ 3089
48" Diameter	ATLADM-TMRSQR □ 48F	71	6.3	\$ 880	\$ 924	\$ 968	\$ 3673	\$ 4040
54" Diameter	ATLADM-TMRSQR □ 54F	90	7.9	\$ 1273	\$ 1337	\$ 1400	\$ 4489	\$ 4937
60" Diameter	ATLADM-TMRSQR □ 60F	111	9.6	\$ 1466	\$ 1539	\$ 1613	\$ 5463	\$ 6009
<b>Rounded Square Tops — Knife</b>								
36" Diameter	ATLADM-TMRSQR □ 36K	40	3.7	\$ 1162	\$ 1220	\$ 1278	\$ 3136	\$ 3450
42" Diameter	ATLADM-TMRSQR □ 42K	55	4.9	\$ 1273	\$ 1337	\$ 1400	\$ 3358	\$ 3694
48" Diameter	ATLADM-TMRSQR □ 48K	71	6.3	\$ 1430	\$ 1502	\$ 1573	\$ 4223	\$ 4645
54" Diameter	ATLADM-TMRSQR □ 54K	90	7.9	\$ 1823	\$ 1914	\$ 2005	\$ 5039	\$ 5543
60" Diameter	ATLADM-TMRSQR □ 60K	111	9.6	\$ 2016	\$ 2117	\$ 2218	\$ 6013	\$ 6614
<b>Soft Square Tops — Flat</b>								
36" Diameter	ATLADM-TMSSQR □ 36F	40	3.7	\$ 612	\$ 643	\$ 673	\$ 2586	\$ 2845
42" Diameter	ATLADM-TMSSQR □ 42F	55	4.9	\$ 723	\$ 759	\$ 795	\$ 2808	\$ 3089
48" Diameter	ATLADM-TMSSQR □ 48F	71	6.3	\$ 880	\$ 924	\$ 968	\$ 3673	\$ 4040
54" Diameter	ATLADM-TMSSQR □ 54F	90	7.9	\$ 1273	\$ 1337	\$ 1400	\$ 4489	\$ 4937
60" Diameter	ATLADM-TMSSQR □ 60F	111	9.6	\$ 1466	\$ 1539	\$ 1613	\$ 5463	\$ 6009
<b>Soft Square Tops — Knife</b>								
36" Diameter	ATLADM-TMSSQR □ 36K	40	3.7	\$ 1162	\$ 1220	\$ 1278	\$ 3136	\$ 3450
42" Diameter	ATLADM-TMSSQR □ 42K	55	4.9	\$ 1273	\$ 1337	\$ 1400	\$ 3358	\$ 3694
48" Diameter	ATLADM-TMSSQR □ 48K	71	6.3	\$ 1430	\$ 1502	\$ 1573	\$ 4223	\$ 4645
54" Diameter	ATLADM-TMSSQR □ 54K	90	7.9	\$ 1823	\$ 1914	\$ 2005	\$ 5039	\$ 5543
60" Diameter	ATLADM-TMSSQR □ 60K	111	9.6	\$ 2016	\$ 2117	\$ 2218	\$ 6013	\$ 6614

**Note:** Laminate tops are 1 piece. Veneer tops 54" and greater are 2 piece.

ADMIX

<p><b>How to specify —</b> Select the Model Number from above.</p> <p>ATLADM -</p> <p>TM</p>	<p><b>1st Option:</b> FSC Certified Wood: X Standard - No FSC F FSC Certified</p>	<p><b>2nd Option:</b> Laminate/Veneer: See page 364.3 for finishes.</p>	<p><b>3rd Option:</b> Edge (Laminate): See page 364.3 for finishes.</p>	<p><b>3rd Option:</b> Top Finish (Veneer): FF Full Fill +\$273 OP Open Pore Low Sheen</p>	<p><b>4th Option:</b> Cutout: GN No Grommet C1E 1 Bezel Mount Power C1TM 1 Tech Module</p>
--	---	---	---	---	--

Example: ATLADM-TMRSQR□36F.X.LDW1.DW.GN

- Base ships knocked down.
- Footrest is standard on counter and bar height tables at 11" off floor. Shelf models do not have a footrest.
- Shelf models have a laminate or veneer shelf that is 14" below worksurface.
- For use with tops on pages 364.24-364.25.

Description	Model	Ship Weight	Cubes	List Price	
				P1	P2
<b>Table Base Legs — Qty 4</b>					
Continental Height	ATLADM-BMTGM4L (shown)	41	2.6	\$ 1650	\$ 1816
Standard Height	ATLADM-BMTGM4S	42	2.6	\$ 1700	\$ 1870
<b>Small Meeting Table Bases — Counter Height</b>					
For Tops 36"D x 36"W	ATLADM-BMTGM3636C	64	7.3	\$ 2550	\$ 2806
For Tops 42"D x 42"W	ATLADM-BMTGM4242C	65	7.6	\$ 2650	\$ 2916
For Tops 48"D x 48"W	ATLADM-BMTGM4848C (shown)	66	7.8	\$ 2750	\$ 3026
For Tops 54"D x 54"W	ATLADM-BMTGM5454C	67	8.1	\$ 2810	\$ 3092
For Tops 60"D x 60"W	ATLADM-BMTGM6060C	69	8.3	\$ 2850	\$ 3136
<b>Small Meeting Table Bases — Bar Height</b>					
For Tops 36"D x 36"W	ATLADM-BMTGM3636B	68	7.3	\$ 2650	\$ 2916
For Tops 42"D x 42"W	ATLADM-BMTGM4242B	69	7.6	\$ 2750	\$ 3026
For Tops 48"D x 48"W	ATLADM-BMTGM4848B (shown)	70	7.8	\$ 2850	\$ 3136
For Tops 54"D x 54"W	ATLADM-BMTGM5454B	72	8.1	\$ 2910	\$ 3202
For Tops 60"D x 60"W	ATLADM-BMTGM6060B	73	8.3	\$ 2950	\$ 3246

**How to specify —**  
Select the Model Number from above.

**1st Option:**  
**Paint Color:**  
P1 P2 P3  
See page 364.3 for finishes.

**2nd Option:**  
**Caster/Glide:**  
CSB Casters Black  
CSS Casters Silver  
GLD Glides  
WHB Wheelbarrow Black (2 Glides + 2 Casters Black)  
WHS Wheelbarrow Silver (2 Glides + 2 Casters Silver)

AT | LADM | - | BMTGM | | | | | . | | | | | .

*Example: ATLADM-BMTGM4L.P71.GLD*

Description	Model Number add "L" for Laminate or "V" for Veneer	Ship Weight	Cubes	Laminate List Price			Veneer List Price	
				L1	L2	L3	V1	V2
<b>Small Meeting Table Bases with High Shelf - Counter Height</b>								
For Tops 48"D x 48"W	ATLADM-BMTGM □ 4848C	76	14.3	\$ 3674	\$ 3720	\$ 3766	\$ 4071	\$ 4203
For Tops 54"D x 54"W	ATLADM-BMTGM □ 5454C	81	16.1	\$ 3848	\$ 3900	\$ 3952	\$ 4295	\$ 4443
For Tops 60"D x 60"W	ATLADM-BMTGM □ 6060C	88	18.1	\$ 4003	\$ 4061	\$ 4118	\$ 4498	\$ 4663
<b>Small Meeting Table Bases with High Shelf - Bar Height</b>								
For Tops 48"D x 48"W	ATLADM-BMTGM □ 4848B	80	14.3	\$ 3774	\$ 3820	\$ 3866	\$ 4171	\$ 4303
For Tops 54"D x 54"W	ATLADM-BMTGM □ 5454B	85	16.1	\$ 3948	\$ 4000	\$ 4052	\$ 4395	\$ 4543
For Tops 60"D x 60"W	ATLADM-BMTGM □ 6060B	92	18.1	\$ 4103	\$ 4161	\$ 4218	\$ 4598	\$ 4763

**How to specify —**  
Select the Model Number from above.

**1st Option:**  
**FSC Certified Wood:**  
X Standard - No FSC  
F FSC Certified

**2nd Option:**  
**Laminate/Veneer:**  
See page 364.3 for finishes.

**3rd Option:**  
**Paint Color:**  
P1 P2 P3  
See page 364.3 for finishes.

**3rd Option:**  
**Caster/Glide:**  
CSB Casters Black  
CSS Casters Silver  
GLD Glides  
WHB Wheelbarrow Black (2 Glides + 2 Casters Black)  
WHS Wheelbarrow Silver (2 Glides + 2 Casters Silver)

AT | LADM | - | BMTGM | | | | | . | | | | | . | | | | | . | | | | | .

*Example: ATLADM-BMTGML3636C.X.LDW1.DW.GLD*

ADMIX

- Top and Base ordered separately.
- Option for cutout only, order power units separately.
- Reference page 364.7 for cutout locations.
- Available in veneer or laminate tops, flat or knife edge.
- Edgeband color option specified separately for laminate.
- Tops ship with pilot holes for locating base.
- Tops are 3 piece — adjoining seams are not edgebanded.
- Base ships knocked down.
- Bases have 9 legs total.

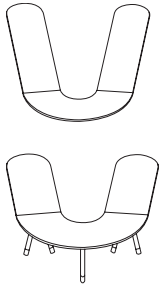

Example of Built-up Table

Description	Model Number add "L" for Laminate or "V" for Veneer	Ship Weight	Cubes	Laminate List Price			Veneer List Price	
				L1	L2	L3	V1	V2
<b>V Media Tops — Flat Edge</b>								
15° — 4-Person	ATLADM-TVM15 □ 4PF	45	6.5	\$ 3638	\$ 3820	\$ 4002	\$ 6434	\$ 7077
15° — 6-Person	ATLADM-TVM15 □ 6PF	62	8.9	\$ 4002	\$ 4202	\$ 4402	\$ 7077	\$ 7785
15° — 8-Person	ATLADM-TVM15 □ 8PF	80	11.4	\$ 4402	\$ 4622	\$ 4842	\$ 7785	\$ 8564
<b>V Media Tops — Knife Edge</b>								
15° — 4-Person	ATLADM-TVM15 □ 4PK	45	6.5	\$ 5238	\$ 5500	\$ 5762	\$ 8034	\$ 8837
15° — 6-Person	ATLADM-TVM15 □ 6PK	62	8.9	\$ 5602	\$ 5882	\$ 6162	\$ 8677	\$ 9545
15° — 8-Person	ATLADM-TVM15 □ 8PK	80	11.4	\$ 6002	\$ 6302	\$ 6602	\$ 9385	\$ 10324
30° — 4-Person	ATLADM-TVM30 □ 4PF	45	6.5	\$ 3638	\$ 3820	\$ 4002	\$ 6434	\$ 7077
30° — 6-Person	ATLADM-TVM30 □ 6PF	62	8.9	\$ 4002	\$ 4202	\$ 4402	\$ 7077	\$ 7785
30° — 8-Person	ATLADM-TVM30 □ 8PF	80	11.4	\$ 4402	\$ 4622	\$ 4842	\$ 7785	\$ 8564
55° — 4-Person	ATLADM-TVM55 □ 4PF	45	6.5	\$ 3636	\$ 3820	\$ 4002	\$ 6434	\$ 7077
55° — 6-Person	ATLADM-TVM55 □ 6PF	62	8.9	\$ 4002	\$ 4202	\$ 4402	\$ 7077	\$ 7785
55° — 8-Person	ATLADM-TVM55 □ 8PF	80	11.4	\$ 4402	\$ 4622	\$ 4842	\$ 7785	\$ 8564

**V Media Tops — Knife Edge**

15° — 4-Person	ATLADM-TVM15 □ 4PK	45	6.5	\$ 5238	\$ 5500	\$ 5762	\$ 8034	\$ 8837
15° — 6-Person	ATLADM-TVM15 □ 6PK	62	8.9	\$ 5602	\$ 5882	\$ 6162	\$ 8677	\$ 9545
15° — 8-Person	ATLADM-TVM15 □ 8PK	80	11.4	\$ 6002	\$ 6302	\$ 6602	\$ 9385	\$ 10324
30° — 4-Person	ATLADM-TVM30 □ 4PK	45	6.5	\$ 5238	\$ 5500	\$ 5762	\$ 8034	\$ 8837
30° — 6-Person	ATLADM-TVM30 □ 6PK	62	8.9	\$ 5602	\$ 5882	\$ 6162	\$ 8677	\$ 9545
30° — 8-Person	ATLADM-TVM30 □ 8PK	80	11.4	\$ 6002	\$ 6302	\$ 6602	\$ 9385	\$ 10324
55° — 4-Person	ATLADM-TVM55 □ 4PK	45	6.5	\$ 5238	\$ 5500	\$ 5762	\$ 8034	\$ 8837
55° — 6-Person	ATLADM-TVM55 □ 6PK	62	8.9	\$ 5602	\$ 5882	\$ 6162	\$ 8677	\$ 9545
55° — 8-Person	ATLADM-TVM55 □ 8PK	80	11.4	\$ 6002	\$ 6302	\$ 6602	\$ 9385	\$ 10324

Note: All V-Media tops 3 pieces.

<p><b>How to specify —</b> Select the Model Number from above.</p> <p>ATLADM   -  </p> <p>TVM                     .</p>	<p><b>1st Option:</b> FSC Certified Wood:</p> <p>X Standard - No FSC</p> <p>F FSC Certified</p>	<p><b>2nd Option:</b> Laminate/Veneer:</p> <p>See page 364.3 for finishes.</p>	<p><b>3rd Option:</b> Edge (Laminate):</p> <p>See page 364.3 for finishes.</p>	<p><b>3rd Option:</b> Top Finish (Veneer):</p> <p>FF Full Fill +\$273</p> <p>OP Open Pore Low Sheen</p>	<p><b>4th Option:</b> Cutout:</p> <p>GN No Grommet</p> <p>C1E 1 Bezel Mount Power</p> <p>Note: 1 Bezel Mount Power included on each section of top = 3 cutouts total.</p>
	<p>Example: ATLADM-TVM15L4PF.X.LDW1.DW.GN</p>				

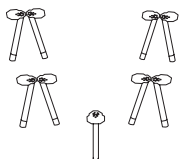

Description	Model	Ship Weight	Cubes	List Price	
				P1	P2
<b>V Media Bases — Standard Height</b>					
4-Person	ATLADM-BVM4PSM5S (shown)	96	6.4	\$ 3825	\$ 4208
6-Person	ATLADM-BVM6PSM5S	108	7.6	\$ 4091	\$ 4474
8-Person	ATLADM-BVM8PSM5S	125	9.2	\$ 4465	\$ 4848

<p><b>How to specify —</b> Select the Model Number from above.</p> <p>ATLADM   -   BVM                     .</p>	<p><b>1st Option:</b> Paint Color:</p> <p>P1 P2 P3</p> <p>See page 364.3 for finishes.</p>	<p><b>2nd Option:</b> Glide:</p> <p>GLD Glides</p>
	<p>Example: ATLADM-BVM4PSM5S.P71.GLD</p>	

- Top and Base ordered separately.
- Option for cutout only, order power units separately.
- Reference page 364.7 for cutout locations.
- Available in veneer or laminate tops, flat or knife edge.
- Edgeband color option specified separately for laminate.
- Tops ship with pilot holes for locating base.
- Tops are 2 piece — adjoining seams are not edgebanded.
- Base ships knocked down.
- Bases have 8 legs total.

Description	Model Number add "L" for Laminate or "V" for Veneer	Ship Weight	Cubes	Laminate List Price			Veneer List Price	
				L1	L2	L3	V1	V2
<b>Full Round Tops — Open Center</b>								
24"D x 96" Diameter — Flat Edge	ATLADM-TFRND □ 96F	143	6.5	\$ 2705	\$ 2840	\$ 2976	\$ 8445	\$ 9290
24"D x 96" Diameter — Knife Edge	ATLADM-TFRND □ 96K	143	6.5	\$ 3455	\$ 3628	\$ 3801	\$ 9195	\$ 10115

**Note:** Full round tops come in 2 pieces.

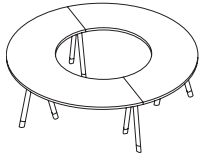

Example of Built-up Table

How to specify — Select the Model Number from above.	1st Option: FSC Certified Wood: X Standard - No FSC F FSC Certified	2nd Option: Laminate/Veneer: See page 364.3 for finishes.	3rd Option: Edge (Laminate): See page 364.3 for finishes.	3rd Option: Top Finish (Veneer): FF Full Fill +\$273 OP Open Pore Low Sheen	4th Option: Cutout: GN No Grommet C1E 1 Bezel Mount Power <b>Note:</b> 2 Bezel Mount Power included on each section of top = 4 cutouts total.
ATLADM - TFRND					

Example: ATLADM-TFRNDL96F.X.LDW1.DW.GN

Description	Model	Ship Weight	Cubes	List Price	
				P1	P2
<b>Full Round Table Bases — Standard Height</b>					
For 96" Diameter Tops	ATLADM-BFRNDM96S	101	6.8	\$ 3796	\$ 4136

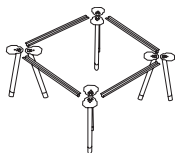

How to specify — Select the Model Number from above.	1st Option: Paint Color: P1 P2 P3 See page 364.3 for finishes.	2nd Option: Glide: GLD Glides
ATLADM - BFRNDM96S		GLD

Example: ATLADM-BFRNDM96S.P71.GLD

- Top and Base ordered separately.
- Option for cutout only, order power units separately.
- Reference page 364.7 for cutout locations.
- Available in veneer or laminate tops, flat or knife edge.
- Edgeband color option specified separately for laminate.
- Tops ship with pilot holes for locating base.
- Rounded Media — Laminate and veneer tops are 1 piece.
- Bulb Media — Laminate tops are 1 piece. Veneer tops 54" and greater are 2 piece — adjoining seams are not edgebanded.
- For use with bases on page 364.30 and media walls on page 364.31.

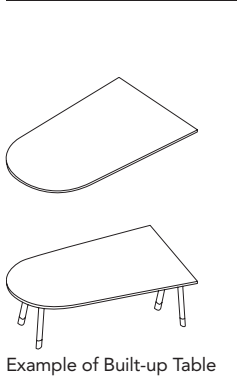

Description	Model Number add "L" for Laminate or "V" for Veneer	Ship Weight	Cubes	Laminate List Price			Veneer List Price		
				L1	L2	L3	V1	V2	
<b>Rounded Media Tops — Flat Edge</b>									
48/36"D x 48"W	ATLADM-TRMED □ 4848F	71	6.3	\$ 1159	\$ 1217	\$ 1275	\$ 3673	\$ 4040	
48/36"D x 60"W	ATLADM-TRMED □ 4860F	89	7.8	\$ 1220	\$ 1281	\$ 1342	\$ 3867	\$ 4254	
48/36"D x 72"W	ATLADM-TRMED □ 4872F	107	9.3	\$ 1284	\$ 1348	\$ 1412	\$ 4070	\$ 4477	
48/36"D x 84"W	ATLADM-TRMED □ 4884F	125	10.8	\$ 1526	\$ 1602	\$ 1679	\$ 4879	\$ 5367	
48/36"D x 96"W	ATLADM-TRMED □ 4896F	143	12.2	\$ 1563	\$ 1641	\$ 1719	\$ 5251	\$ 5776	
<b>Rounded Media Tops — Knife Edge</b>									
48/36"D x 48"W	ATLADM-TRMED □ 4848K	71	6.3	\$ 2559	\$ 2687	\$ 2815	\$ 5073	\$ 5580	
48/36"D x 60"W	ATLADM-TRMED □ 4860K	89	7.8	\$ 2620	\$ 2751	\$ 2882	\$ 5267	\$ 5794	
48/36"D x 72"W	ATLADM-TRMED □ 4872K	107	9.3	\$ 2684	\$ 2818	\$ 2952	\$ 5470	\$ 6017	
48/36"D x 84"W	ATLADM-TRMED □ 4884K	125	10.8	\$ 2926	\$ 3072	\$ 3219	\$ 6279	\$ 6907	
48/36"D x 96"W	ATLADM-TRMED □ 4896K	143	12.2	\$ 2963	\$ 3111	\$ 3259	\$ 6651	\$ 7316	

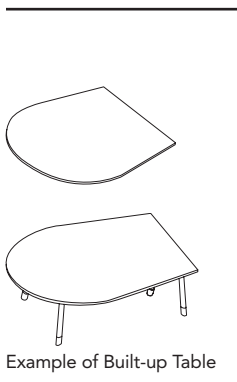

Description	Model Number add "L" for Laminate or "V" for Veneer	Ship Weight	Lam Cubes	Ven Cubes	Laminate List Price			Veneer List Price	
					L1	L2	L3	V1	V2
<b>Bulb Media Tops — Flat Edge</b>									
48/36"D x 48"W	ATLADM-TBMED □ 4848F	89	7.8	5.2	\$ 1159	\$ 1217	\$ 1275	\$ 3673	\$ 4040
48/36"D x 60"W	ATLADM-TBMED □ 4860F	111	9.6	6.5	\$ 1220	\$ 1281	\$ 1342	\$ 3867	\$ 4254
48/36"D x 72"W	ATLADM-TBMED □ 4872F	134	11.5	7.7	\$ 1284	\$ 1348	\$ 1412	\$ 4070	\$ 4477
48/36"D x 84"W	ATLADM-TBMED □ 4884F	156	13.3	8.9	\$ 1526	\$ 1602	\$ 1679	\$ 4879	\$ 5367
48/36"D x 96"W	ATLADM-TBMED □ 4896F	178	15.1	10.2	\$ 1563	\$ 1641	\$ 1719	\$ 5251	\$ 5776
<b>Bulb Media Tops — Knife Edge</b>									
48/36"D x 48"W	ATLADM-TBMED □ 4848K	71	6.3	5.2	\$ 2559	\$ 2687	\$ 2815	\$ 5073	\$ 5580
48/36"D x 60"W	ATLADM-TBMED □ 4860K	89	7.8	6.5	\$ 2620	\$ 2751	\$ 2882	\$ 5267	\$ 5794
48/36"D x 72"W	ATLADM-TBMED □ 4872K	107	9.3	7.7	\$ 2684	\$ 2818	\$ 2952	\$ 5470	\$ 6017
48/36"D x 84"W	ATLADM-TBMED □ 4884K	125	10.8	8.9	\$ 2926	\$ 3072	\$ 3219	\$ 6279	\$ 6907
48/36"D x 96"W	ATLADM-TBMED □ 4896K	143	12.2	10.2	\$ 2963	\$ 3111	\$ 3259	\$ 6651	\$ 7316

**Note:** Laminate tops are 1 piece. Veneer tops 54" and greater are 2 piece.

<p><b>How to specify —</b> Select the Model Number from above.</p> <p>ATLAD   TBMED</p>	<p><b>1st Option:</b> FSC Certified Wood: X Standard - No FSC F FSC Certified</p>	<p><b>2nd Option:</b> Laminate/Veneer: See page 364.3 for finishes.</p>	<p><b>3rd Option:</b> Edge (Laminate): See page 364.3 for finishes.</p>	<p><b>3rd Option:</b> Top Finish (Veneer): FF Full Fill +\$273 OP Open Pore Low Sheen</p>	<p><b>4th Option:</b> Cutout: GN No Grommet C1E 1 Bezel Mount Power C1TM 1 Tech Module</p>
---	---	---	---	---	--

Example: ATLADM-ACCWIREMGR18.eps-TRMEDL4848F.X.LDW1.DW.GN



- Must be attached to the wall. Not for freestanding applications. Z brackets included for wall mounting.
- Top and bottom are 2 piece and require field assembly. Fabric panel also ships unassembled.
- Center panel on lower cabinet is a hinged door for access to wires and outlets.
- A vertical cavity exists from the hinged door to the fabric panel cutout to manage wires. Wire cavity is 4.25"D x 15.0"W with a grommet pass through from top to bottom halves.
- Table attached models include an angle bracket to support end of table and a grommet cutout to manage cords from bottom of table top to inside of media wall.
- Floating media walls can be mounted at desired height in field.
- Fabric panel attaches to media wall with Z brackets. TV mount GATVMB can be attached directly to face of the fabric panel. A low profile non-articulating TV mount should be used.
- Fabric panel is 60"W x 40"H and intended for use with flat screen TV's 55" and smaller.
- Center cutout in fabric panel is 10"W x 10"H to manage wires into media wall.

Description	Model Number add "L" for Laminate or "V" for Veneer	Ship Weight	Cubes	Laminate List Price			Veneer List Price	
				L1	L2	L3	V1	V2
<b>Fabric Media Wall — No Table</b>								
For Cont'l Height	ATLADM-MNWALLF □ 60L (shown)	85	13.2	\$ 4778	\$ 4924	\$ 5071	\$ 6728	\$ 7216
For Standard Height	ATLADM-MNWALLF □ 60S	87	13.4	\$ 4853	\$ 5003	\$ 5153	\$ 6853	\$ 7353
For Counter Height	ATLADM-MNWALLF □ 60C	96	14.3	\$ 4928	\$ 5082	\$ 5236	\$ 6978	\$ 7491
For Bar Height	ATLADM-MNWALLF □ 60B	104	15.0	\$ 5007	\$ 5165	\$ 5322	\$ 7109	\$ 7635
<b>Fabric Media Wall — Table Attached</b>								
For Cont'l Height	ATLADM-MTWALLF □ 60L	93	13.6	\$ 4997	\$ 5143	\$ 5290	\$ 6947	\$ 7435
For Standard Height	ATLADM-MTWALLF □ 60S (shown)	96	13.8	\$ 5072	\$ 5222	\$ 5372	\$ 7072	\$ 7572
For Counter Height	ATLADM-MTWALLF □ 60C	105	14.6	\$ 5147	\$ 5301	\$ 5455	\$ 7197	\$ 7710
For Bar Height	ATLADM-MTWALLF □ 60B	113	15.3	\$ 5226	\$ 5384	\$ 5541	\$ 7328	\$ 7854
<b>Note:</b> Table attached models require table to be ordered separately.								
<b>Fabric Media Wall — Floating</b>								
No Table	ATLADM-MNWFLTF □ 6040	44	10.1	\$ 3353	\$ 3428	\$ 3503	\$ 4353	\$ 4603
Table Attached	ATLADM-MTWFLTF □ 6040 (shown)	52	10.4	\$ 3572	\$ 3647	\$ 3722	\$ 4572	\$ 4822
<b>Note:</b> Table attached models require table to be ordered separately.								

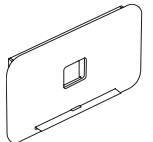
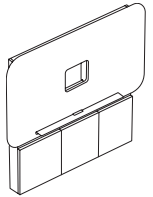
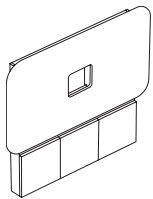

ADMIX

<p><b>How to specify —</b> Select the Model Number from above.</p> <p>ATLADM - IM</p>	<p><b>1st Option:</b> FSC Certified Wood: X Standard - No FSC F FSC Certified</p>	<p><b>2nd Option:</b> Laminate/Veneer: See page 364.3 for finishes.</p>	<p><b>3rd Option:</b> Fabric: See page 364.4 for fabrics.</p>
---	---	---	---

Example: ATLADM-MNWALLFL60L.X.LDW1.NBLE13



- Wall Mount Bracket is used to fasten one end of a table top to the wall. User to provide mounting hardware.
- Table Media Mount is used to mount a television to the end of a table top when not against a wall. Mounting hardware is provided for television sizes 32" to 50" with VESA Mounts of 100 x 100 to 200 x 200; for some televisions, additional hardware is required.

Description	Model	Ship Weight	Cubes	List Price	
				P1	P2
<b>Table Wall Mount Bracket</b>					
Wall Mount Bracket	AMPTWMB	4.0	0.4	\$ 152	N/A
<b>Note:</b> For applications with tables attached to drywall or building walls. Not required in media wall applications.					
<b>TV Bracket Clamp Mount</b>					
Table Media Mount	AMPTTMM	4.0	0.4	\$ 308	\$ 319
<b>Note:</b> For use with freestanding tables. Not for use in applications with media table attached to media walls.					
<b>TV Wall Mount Bracket</b>					
26½"W x 17½"H; -10° -0° Tilt	GATVMB			\$ 527	N/A
Includes mounting hardware and conforms to VESA-compliant displays. Supports up to 165 lbs.					
<b>Note:</b> Can be attached to Media Wall Fabric panel or directly to drywall/building walls.					

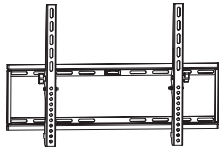
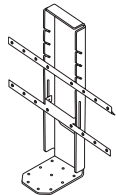
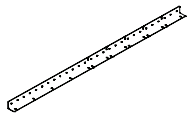

ADMIX

*How to specify —*

Select the Model Number from above.

--	--	--	--	--	--	--	--	--	--	--

Example: AMPTWMB

- Order base separately.
- Option for cutout only, order power units separately.
- Reference page 364.7 for cutout locations.

- Available in veneer or laminate tops, flat or knife edge.
- Edgeband color option specified separately for laminate.

- Tops ship with pilot holes for locating base.
- For use with bases on page 364.34.

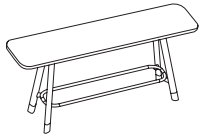
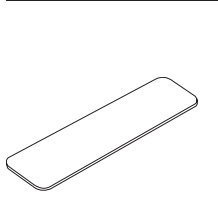

Example of Built-up Table

Description	Model Number add "L" for Laminate or "V" for Veneer	Ship Weight	Cubes	Laminate List Price			Veneer List Price	
				L1	L2	L3	V1	V2
<b>Perch Rounded Rectangular Tops — Flat Edge</b>								
20"D x 48"W	ATLADM-TPRREC L 2048F	30	2.8	\$ 536	\$ 563	\$ 590	\$ 1286	\$ 1415
20"D x 60"W	ATLADM-TPRREC L 2060F	37	3.5	\$ 553	\$ 581	\$ 608	\$ 1472	\$ 1619
20"D x 72"W	ATLADM-TPRREC L 2072F	45	4.2	\$ 600	\$ 630	\$ 660	\$ 1748	\$ 1923
20"D x 84"W	ATLADM-TPRREC L 2084F	52	4.8	\$ 704	\$ 739	\$ 774	\$ 1890	\$ 2079
20"D x 96"W	ATLADM-TPRREC L 2096F	59	5.5	\$ 739	\$ 776	\$ 813	\$ 2364	\$ 2600

**Perch Rounded Rectangular Tops — Knife Edge**

20"D x 48"W	ATLADM-TPRREC L 2048K	30	2.8	\$ 1086	\$ 1140	\$ 1195	\$ 1836	\$ 2020
20"D x 60"W	ATLADM-TPRREC L 2060K	37	3.5	\$ 1553	\$ 1631	\$ 1708	\$ 2472	\$ 2719
20"D x 72"W	ATLADM-TPRREC L 2072K	45	4.2	\$ 1600	\$ 1680	\$ 1760	\$ 2748	\$ 3023
20"D x 84"W	ATLADM-TPRREC L 2084K	52	4.8	\$ 1704	\$ 1789	\$ 1874	\$ 2890	\$ 3179
20"D x 96"W	ATLADM-TPRREC L 2096K	59	5.5	\$ 1739	\$ 1826	\$ 1913	\$ 3364	\$ 3700

**Perch Racetrack Tops — Flat Edge**

20"D x 48"W	ATLADM-TPRACE L 2048F	30	2.8	\$ 536	\$ 563	\$ 590	\$ 1286	\$ 1415
20"D x 60"W	ATLADM-TPRACE L 2060F	37	3.5	\$ 553	\$ 581	\$ 608	\$ 1472	\$ 1619
20"D x 72"W	ATLADM-TPRACE L 2072F	45	4.2	\$ 600	\$ 630	\$ 660	\$ 1748	\$ 1923
20"D x 84"W	ATLADM-TPRACE L 2084F	52	4.8	\$ 704	\$ 739	\$ 774	\$ 1890	\$ 2079
20"D x 96"W	ATLADM-TPRACE L 2096F	59	5.5	\$ 739	\$ 776	\$ 813	\$ 2364	\$ 2600

**Perch Racetrack Tops — Knife Edge**

20"D x 48"W	ATLADM-TPRACE L 2048K	30	2.8	\$ 1086	\$ 1140	\$ 1195	\$ 1836	\$ 2020
20"D x 60"W	ATLADM-TPRACE L 2060K	37	3.5	\$ 1553	\$ 1631	\$ 1708	\$ 2472	\$ 2719
20"D x 72"W	ATLADM-TPRACE L 2072K	45	4.2	\$ 1600	\$ 1680	\$ 1760	\$ 2748	\$ 3023
20"D x 84"W	ATLADM-TPRACE L 2084K	52	4.8	\$ 1704	\$ 1789	\$ 1874	\$ 2890	\$ 3179
20"D x 96"W	ATLADM-TPRACE L 2096K	59	5.5	\$ 1739	\$ 1826	\$ 1913	\$ 3364	\$ 3700

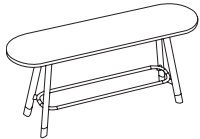
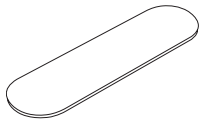

Example of Built-up Table

ADMIX

<b>How to specify —</b> Select the Model Number from above.	<b>1st Option:</b> <b>FSC Certified Wood:</b> X Standard - No FSC F FSC Certified	<b>2nd Option:</b> <b>Laminate/Veneer:</b> See page 364.3 for finishes.	<b>3rd Option:</b> <b>Edge (Laminate):</b> See page 364.3 for finishes.	<b>3rd Option:</b> <b>Top Finish (Veneer):</b> FF Full Fill +\$273 OP Open Pore Low Sheen	<b>4th Option:</b> <b>Cutout:</b> GN No Grommet C1E 1 Bezel Mount Power
ATLADM - TPR   .	.	.	.	.	.

*Example: ATLADM-TPRRECL2048F.X.LDW1.DW.GN*

- Base ships knocked down.
- Base includes external stiffeners for tops (if required).
- Footrest is standard on counter and bar height tables at 11" off floor.
- For use with tops on page 364.33.

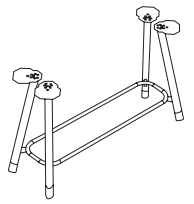
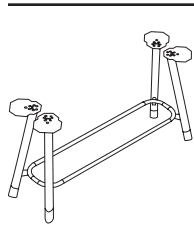

Description	Model	Ship Weight	Cubes	List Price	
				P1	P2
<b>Perch Table Bases — Counter Height</b>					
For Tops 20"D x 48"W	ATLADM-BPERM2048C	64	6.1	\$ 2550	\$ 2806
For Tops 20"D x 60"W	ATLADM-BPERM2060C	66	6.2	\$ 2600	\$ 2861
For Tops 20"D x 72"W	ATLADM-BPERM2072C (shown)	68	6.3	\$ 2650	\$ 2916
For Tops 20"D x 84"W	ATLADM-BPERM2084C	75	6.9	\$ 2856	\$ 3132
For Tops 20"D x 96"W	ATLADM-BPERM2096C	78	7.1	\$ 2983	\$ 3269
<b>Perch Table Bases — Bar Height</b>					
For Tops 20"D x 48"W	ATLADM-BPERM2048B	68	6.1	\$ 2650	\$ 2916
For Tops 20"D x 60"W	ATLADM-BPERM2060B	70	6.2	\$ 2700	\$ 2971
For Tops 20"D x 72"W	ATLADM-BPERM2072B (shown)	72	6.3	\$ 2750	\$ 3026
For Tops 20"D x 84"W	ATLADM-BPERM2084B	79	6.9	\$ 2956	\$ 3242
For Tops 20"D x 96"W	ATLADM-BPERM2096B	82	7.1	\$ 3083	\$ 3379

ADMIX

<p><b>How to specify —</b> Select the Model Number from above.</p> <p>ATLADM - BPERM20         .         .</p>	<p><b>1st Option:</b> <b>Paint Color:</b> P1 P2 P3 See page 364.3 for finishes.</p>	<p><b>2nd Option:</b> <b>Caster/Glide:</b> CSB Casters Black CSS Casters Silver GLD Glides (only 96"W) WHB Wheelbarrow Black (2 Glides + 2 Casters Black) WHS Wheelbarrow Silver (2 Glides + 2 Casters Silver)</p>
--	---	--

Example: ATLADM-BPERM2048C.P71.GLD

- Top and Base ordered separately.
- Option for cutout only, order power units separately.
- Reference page 364.7 for cutout locations.
- Available in veneer or laminate tops, flat or knife edge.
- Edgeband color option specified separately for laminate.
- Tops ship with pilot holes for locating base.
- Base includes external stiffeners for tops (if required).
- Shelf is standard on counter and bar height tables at 11" off floor.

Description	Model Number add "L" for Laminate or "V" for Veneer	Ship Weight	Cubes	Laminate List Price			Veneer List Price	
				L1	L2	L3	V1	V2
<b>Console Rounded Rectangular Table Tops — Flat Edge</b>								
20"D x 48"W	ATLADM-TCRREC □ 2048F	30	2.8	\$ 536	\$ 563	\$ 590	\$ 1286	\$ 1415
20"D x 60"W	ATLADM-TCRREC □ 2060F	37	3.5	\$ 553	\$ 581	\$ 608	\$ 1472	\$ 1619
20"D x 72"W	ATLADM-TCRREC □ 2072F	45	4.2	\$ 600	\$ 630	\$ 660	\$ 1748	\$ 1923
20"D x 84"W	ATLADM-TCRREC □ 2084F	52	4.8	\$ 704	\$ 739	\$ 774	\$ 1890	\$ 2079
20"D x 96"W	ATLADM-TCRREC □ 2096F	59	5.5	\$ 739	\$ 776	\$ 813	\$ 2364	\$ 2600
<b>Console Rounded Rectangular Table Tops — Knife Edge</b>								
20"D x 48"W	ATLADM-TCRREC □ 2048K	30	2.8	\$ 1086	\$ 1140	\$ 1195	\$ 1836	\$ 2020
20"D x 60"W	ATLADM-TCRREC □ 2060K	37	3.5	\$ 1553	\$ 1631	\$ 1708	\$ 2472	\$ 2719
20"D x 72"W	ATLADM-TCRREC □ 2072K	45	4.2	\$ 1600	\$ 1680	\$ 1760	\$ 2748	\$ 3023
20"D x 84"W	ATLADM-TCRREC □ 2084K	52	4.8	\$ 1704	\$ 1789	\$ 1874	\$ 2890	\$ 3179
20"D x 96"W	ATLADM-TCRREC □ 2096K	59	5.5	\$ 1739	\$ 1826	\$ 1913	\$ 3364	\$ 3700

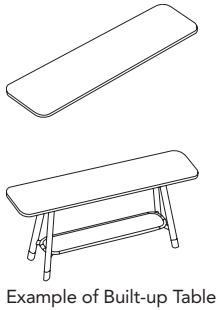

Example of Built-up Table

<p><b>How to specify —</b> Select the Model Number from above.</p> <p><b>ATLADM - TCR</b> <b>REC</b></p>	<p><b>1st Option:</b> FSC Certified Wood: X Standard - No FSC F FSC Certified</p>	<p><b>2nd Option:</b> Laminate/Veneer: See page 364.3 for finishes.</p>	<p><b>3rd Option:</b> Edge (Laminate): See page 364.3 for finishes.</p>	<p><b>3rd Option:</b> Top Finish (Veneer): FF Full Fill +\$273 OP Open Pore Low Sheen</p>	<p><b>4th Option:</b> Cutout: GN No Grommet C1E 1 Bezel Mount Power</p>
--	---	---	---	---	---

Example: ATLADM-TCRRECL2048F.X.LDW1.DW.GN

Description	Model Number add "L" for Laminate or "V" for Veneer	Ship Weight	Cubes	Laminate List Price			Veneer List Price	
				L1	L2	L3	V1	V2
<b>Console Table Base with Low Shelf — Counter Height</b>								
For Tops 20"D x 48"W	ATLADM-BCONM □ 2048C	69	6.9	\$ 3118	\$ 3146	\$ 3175	\$ 3363	\$ 3444
For Tops 20"D x 60"W	ATLADM-BCONM □ 2060C	73	7.3	\$ 3244	\$ 3276	\$ 3308	\$ 3520	\$ 3612
For Tops 20"D x 72"W	ATLADM-BCONM □ 2072C (shown)	77	7.7	\$ 3355	\$ 3390	\$ 3426	\$ 3659	\$ 3760
For Tops 20"D x 84"W	ATLADM-BCONM □ 2084C	86	8.6	\$ 3631	\$ 3670	\$ 3709	\$ 3965	\$ 4076
For Tops 20"D x 96"W	ATLADM-BCONM □ 2096C	92	9.1	\$ 3836	\$ 3879	\$ 3921	\$ 4202	\$ 4324
<b>Console Table Base with Low Shelf — Bar Height</b>								
For Tops 20"D x 48"W	ATLADM-BCONM □ 2048B	75	7.0	\$ 3218	\$ 3246	\$ 3275	\$ 3436	\$ 3544
For Tops 20"D x 60"W	ATLADM-BCONM □ 2060B	80	7.4	\$ 3344	\$ 3376	\$ 3408	\$ 3620	\$ 3712
For Tops 20"D x 72"W	ATLADM-BCONM □ 2072B (shown)	85	7.9	\$ 3455	\$ 3490	\$ 3526	\$ 3759	\$ 3860
For Tops 20"D x 84"W	ATLADM-BCONM □ 2084B	95	8.8	\$ 3731	\$ 3770	\$ 3809	\$ 4065	\$ 4176
For Tops 20"D x 96"W	ATLADM-BCONM □ 2096B	100	9.3	\$ 3936	\$ 3979	\$ 4021	\$ 4302	\$ 4424

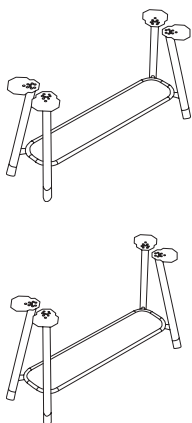

<p><b>How to specify —</b> Select the Model Number from above.</p> <p><b>ATLADM - BIC</b> <b>ONM</b></p>	<p><b>1st Option:</b> FSC Certified Wood: X Standard - No FSC F FSC Certified</p>	<p><b>2nd Option:</b> Laminate/Veneer: See page 364.3 for finishes.</p>	<p><b>3rd Option:</b> Paint Color: P1 P2 P3 See page 364.3 for finishes.</p>	<p><b>4th Option:</b> Caster/Glide: CSB Casters Black CSS Casters Silver GLD Glides (96" can only use Glides) WHB Wheelbarrow Black (2 Glides + 2 Casters Black) WHS Wheelbarrow Silver (2 Glides + 2 Casters Silver)</p>
--	---	---	--	---

Example: ATLADM-BCONML2048C.X.LDW1.P71.GLD

- Top and Base ordered separately.
- Option for cutout only, order power units separately.
- Reference page 364.7 for cutout locations.
- Available in veneer or laminate tops, flat or knife edge.
- Edgeband color option specified separately for laminate.
- Tops ship with pilot holes for locating base.
- An upper and lower shelf is standard on counter and bar height tables. The low shelf is 11" off floor and the upper shelf is 14" below worksurface.

Description	Model Number add "L" for Laminate or "V" for Veneer	Ship Weight	Cubes	Laminate List Price			Veneer List Price	
				L1	L2	L3	V1	V2
<b>Project Cart Tops — Flat Edge</b>								
24"D x 36"W	ATLADM-TJRREC □ 2436F	27	2.6	\$ 506	\$ 531	\$ 557	\$ 1081	\$ 1189
24"D x 42"W	ATLADM-TJRREC □ 2442F	31	2.9	\$ 542	\$ 569	\$ 596	\$ 1231	\$ 1354
24"D x 48"W	ATLADM-TJRREC □ 2448F	36	3.3	\$ 561	\$ 589	\$ 617	\$ 1348	\$ 1483
<b>Project Cart Tops — Knife Edge</b>								
24"D x 36"W	ATLADM-TJRREC □ 2436K	27	2.6	\$ 1056	\$ 1109	\$ 1162	\$ 1631	\$ 1794
24"D x 42"W	ATLADM-TJRREC □ 2442K	31	2.9	\$ 1092	\$ 1147	\$ 1201	\$ 1781	\$ 1959
24"D x 48"W	ATLADM-TJRREC □ 2448K	36	3.3	\$ 1111	\$ 1167	\$ 1222	\$ 1898	\$ 2088

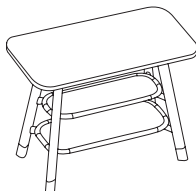
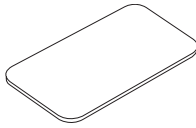

Example of Built-up Table

<b>How to specify —</b> Select the Model Number from above.  <b>ATLADM - TJR</b> <b>REC</b>	<b>1st Option:</b> <b>FSC Certified Wood:</b> X Standard - No FSC F FSC Certified	<b>2nd Option:</b> <b>Laminate/Veneer:</b> See page 364.3 for finishes.	<b>3rd Option:</b> <b>Edge (Laminate):</b> See page 364.3 for finishes.	<b>3rd Option:</b> <b>Top Finish (Veneer):</b> FF Full Fill +\$273 OP Open Pore Low Sheen	<b>4th Option:</b> <b>Cutout:</b> GN No Grommet C1E 1 Bezel Mount Power
	. . . . .	. . . . .	. . . . .	. . . . .	. . . . .

Example: ATLADM-TJRRECL2436F.X.LDW1.DW.GN

Description	Model Number add "L" for Laminate or "V" for Veneer	Ship Weight	Cubes	Laminate List Price			Veneer List Price	
				L1	L2	L3	V1	V2
<b>Project Cart Base with 2 Shelves — Counter Height</b>								
For Tops 24"D x 36"W	ATLADM-BPROJM □ 2436C	94	7.6	\$ 3689	\$ 3721	\$ 3753	\$ 4297	\$ 4422
For Tops 24"D x 42"W	ATLADM-BPROJM □ 2442C	98	7.9	\$ 3869	\$ 3905	\$ 3941	\$ 4553	\$ 4693
	(shown)							
For Tops 24"D x 48"W	ATLADM-BPROJM □ 2448C	103	8.2	\$ 4062	\$ 4103	\$ 4143	\$ 4833	\$ 4991
<b>Project Cart Base with 2 Shelves — Bar Height</b>								
For Tops 24"D x 36"W	ATLADM-BPROJM □ 2436B	100	7.8	\$ 3789	\$ 3821	\$ 3853	\$ 4397	\$ 4522
For Tops 24"D x 42"W	ATLADM-BPROJM □ 2442B	105	8.1	\$ 3969	\$ 4005	\$ 4041	\$ 4653	\$ 4793
	(shown)							
For Tops 24"D x 48"W	ATLADM-BPROJM □ 2448B	109	8.5	\$ 4162	\$ 4203	\$ 4243	\$ 4933	\$ 5091

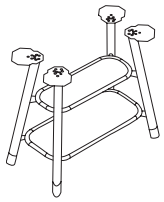
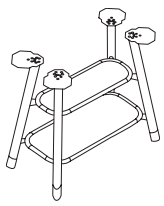

<b>How to specify —</b> Select the Model Number from above.  <b>ATLADM -</b> <b>BPROJM</b>	<b>1st Option:</b> <b>FSC Certified Wood:</b> X Standard - No FSC F FSC Certified	<b>2nd Option:</b> <b>Laminate/Veneer:</b> See page 364.3 for finishes.	<b>3rd Option:</b> <b>Paint Color:</b> P1 P2 P3 See page 364.3 for finishes.	<b>4th Option:</b> <b>Caster/Glide:</b> CSB Casters Black CSS Casters Silver GLD Glides (96" can only use Glides) WHB Wheelbarrow Black (2 Glides + 2 Casters Black) WHS Wheelbarrow Silver (2 Glides + 2 Casters Silver)
	. . . . .	. . . . .	. . . . .	. . . . .

Example: ATLADM-BPROJML2436C.X.LDW1.P71.GLD

ADMIX

- Top and Base ordered separately.
- Available in veneer or laminate tops, flat or knife edge.
- Edgeband color option specified separately for laminate.
- Tops ship with pilot holes for locating base.
- Base includes:
  - Qty 3 — undermount power units daisy chained together with 20ft braided standard plug cord.
  - Qty 1 — wire hook for braided cord.
  - Qty 1 — low metal shelf 11" off the floor.
- Specified paint color on base applies to table legs, metal shelf, and wire hook.

Description	Model Number add "L" for Laminate or "V" for Veneer	Ship Weight	Cubes	Laminate List Price			Veneer List Price	
				L1	L2	L3	V1	V2
<b>Satellite Table — 24" Diameter</b>								
Flat Edge	ATLADM-TSSQR □ 24F	18	0.8	\$ 413	\$ 434	\$ 454	\$ 1652	\$ 1817
Knife Edge	ATLADM-TSSQR □ 24K	18	0.8	\$ 713	\$ 749	\$ 784	\$ 1952	\$ 2147

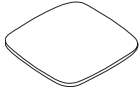

Example of Built-up Table

<p><b>How to specify —</b> Select the Model Number from above.</p> <p>ATLADM - TSSQR</p>	<p><b>1st Option:</b> <b>FSC Certified Wood:</b></p> <p>X Standard - No FSC F FSC Certified</p>	<p><b>2nd Option:</b> <b>Laminate/Veneer:</b></p> <p>See page 364.3 for finishes.</p>	<p><b>3rd Option:</b> <b>Edge (Laminate):</b></p> <p>See page 364.3 for finishes.</p>	<p><b>3rd Option:</b> <b>Top Finish (Veneer):</b></p> <p>FF Full Fill +\$273 OP Open Pore Low Sheen</p>
--	---	---	---	---

Example: ATLADM-TSSQRL24F.X.LDW1.DW

Description	Model	Ship Weight	Cubes	List Price	
				P1	P2
<b>Satellite Table Base — Counter Height</b>					
For 24" Diameter	ATLADM-BSATM2424C	58	6.5	\$ 3695	\$ 3921

**Note:** Base includes tray, 3 power units daisy chained with 20ft braided cord, and 1 wire hook.

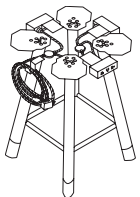

<p><b>How to specify —</b> Select the Model Number from above.</p> <p>ATLADM - BSATM2424C</p>	<p><b>1st Option:</b> <b>Paint Color:</b></p> <p>P1 P2 P3 See page 364.3 for finishes.</p>	<p><b>2nd Option:</b> <b>Caster/Glide:</b></p> <p>CSB Casters Black CSS Casters Silver GLD Glides</p>	<p><b>3rd Option:</b> <b>Power Color:</b></p> <p>BLK Black w/ Braided Cord SNW Snow w/ Braided Cord STRM Storm w/ Braided Cord</p>
---	--	---	--

Example: ATLADM-BSATM2424C.P71.GLD.BLK

- Desk pad is vinyl wrapped with a felt bottom to protect worksurface.
- See page 364.8 for PET wire manager specs and application matrix.

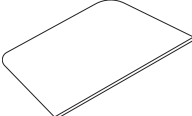

Description	Model	Ship Weight	Cubes	List Price
<b>Home Base Desk Pad — Vinyl Wrapped</b>				
20"W x 33"L x 3/4"H	ATLADM-ACCDSKPAD	8	1.3	\$ 950

**How to specify —**  
Select the Model Number from above.

ATLADM -  
ACCDSKPAD .

*1st Option:*  
**Deskpad Color:**  
VWH Vinyl – White  
VBL Vinyl – Black

Example: ATLADM-ACCDSKPAD.VWH

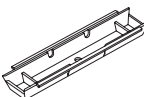

Description	Model	Ship Weight	Cubes	List Price
<b>Under Table PET Wire Tray</b>				
PET Wire Manager 18"W	ATLADM-ACCWIREMGR18	2	0.6	\$ 974
PET Wire Manager 36"W	ATLADM-ACCWIREMGR36 (shown)	3	1.1	\$ 1025
PET Wire Manager 48"W	ATLADM-ACCWIREMGR48	4	1.4	\$ 1076

**How to specify —**  
Select the Model Number from above.





ATLADM -  
ACCWIREMGR . DGY4

*1st Option:*  
**PET Color:**  
DGY4 Dark Grey

Example: ATLADM-ACCWIREMGR18.DGY4

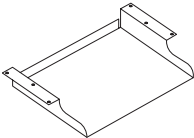
ADMIX

- See page 364.8 for vertical wire manager specs.

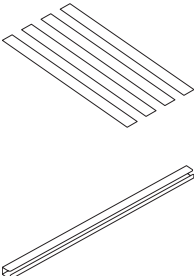
	Description	Model	Ship Weight	Cubes	List Price	
					P1	P2
	<b>Under Table Tray</b> 11"W x 13½"L x 5"H	ATLADM-ACCTRAY	5	0.4	\$ 150	\$ 165
	<b>Under Table Bag / Wire Hook</b> 4"W x 4"L x 4"H	ATLADM-ACCHOOK	2	0.0	\$ 90	\$ 99
	<b>Replacement Foot — Qty 1</b>					
	With Glide	ATLADM-ACCFOOTGLD	3\	0.1	\$ 120	\$ 132
	With Caster	ATLADM-ACCFOOTCST	2	0.1	\$ 120	\$ 132
	<b>Leg Velcro Wire Strap</b> Kit of 4 (for 1 leg)	ATLACC-LEGWIRESTP	3	0.1	\$ 85	N/A
	<b>Vertical Wire Manager — Leg</b>					
	20" for Continental and Counter Height	ATLACC-LEGWIREMGR20	3	0.1	\$ 120	\$ 132
	22" for Standard Height	ATLACC-LEGWIREMGR22	4	0.1	\$ 125	\$ 138
		(shown)				
	26" for Bar Height	ATLACC-LEGWIREMGR26	5	0.2	\$ 140	\$ 154

ADMIX



<p><i>How to specify —</i> Select the Model Number from above.</p> <div style="font-family: monospace; border: 1px solid black; padding: 2px; display: inline-block; margin-bottom: 5px;"> <span style="border-right: 1px solid black; padding-right: 5px;">A</span> <span style="border-right: 1px solid black; padding-right: 5px;">T</span> <span style="border-right: 1px solid black; padding-right: 5px;">L</span> <span style="border-right: 1px solid black; padding-right: 5px;">A</span> <span style="border-right: 1px solid black; padding-right: 5px;"> </span> <span style="border-right: 1px solid black; padding-right: 5px;"> </span> <span style="border-right: 1px solid black; padding-right: 5px;"> </span> <span style="border-right: 1px solid black; padding-right: 5px;">-</span> <span style="padding-left: 5px;"> </span> <span style="padding-left: 5px;"> </span> <span style="padding-left: 5px;"> </span> <span style="padding-left: 5px;"> </span> <span style="padding-left: 5px;"> </span> <span style="padding-left: 5px;"> </span> <span style="padding-left: 5px;"> </span> <span style="padding-left: 5px;"> </span> <span style="padding-left: 5px;"> </span> <span style="padding-left: 5px;"> </span> <span style="padding-left: 5px;"> </span> <span style="padding-left: 5px;"> </span> <span style="padding-left: 5px;"> </span> </div> <p style="font-size: small;">.....</p>	<p><i>1st Option:</i> <b>Paint Color</b> (if applicable):  <span style="border: 1px solid black; border-radius: 50%; padding: 2px;">P1</span> <span style="border: 1px solid black; border-radius: 50%; padding: 2px; margin-left: 5px;">P2</span> <span style="border: 1px solid black; border-radius: 50%; padding: 2px; margin-left: 5px;">P3</span> </p> <p>See page 364.3 for finishes.</p>
--	--

*Example: ATLADM-ACCTRAY.P71*

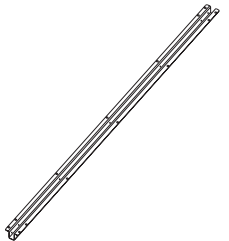

- External worksurface support stiffeners shown for replacement purposes only. Appropriate worksurface supports are included with bases.
- Tech module fits C1TM and C2TM worksurface cutouts only. See page 364.7 for spec info.



Description	Model	Ship Weight	Cubes	List Price P1
<b>Replacement External Worksurface Support Channel (no color option) — 1½"H</b>				
30"W External Support Channel	Z5SC42 			\$ 83
36"W External Support Channel	Z5SC48 			\$ 86
42"W External Support Channel	Z5SC54 			\$ 99
48"W External Support Channel	Z5SC60			\$ 106
54"W External Support Channel	Z5SC66			\$ 124
60"W External Support Channel	Z5SC72			\$ 133
66"W External Support Channel	Z5SC78			\$ 145
72"W External Support Channel	Z5SC84			\$ 160

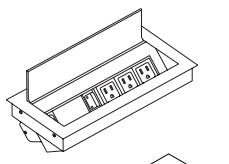

<b>Tech Module — Standard Plug Power Solutions (Surface Mounted)</b>				
10' corded power includes 4 power/2 data ports	AMPTP1	5.0	0.4	\$ 942
10' corded power includes 3 power/1 Extron cut-out	AMPTP2 (shown)	5.0	0.4	\$ 837
10' corded power includes 3 power/1 dual USB A+C/2 data ports	AMPTP3	5.0	0.4	\$ 1051
10' corded power includes 3 power/1 dual USB A+C/Wireless Charging	AMPTP4	5.0	0.4	\$ 1258

**Note:** For use with C1, C2, and C3 cutouts.

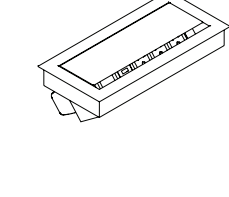

<b>Tech Module — Hardwire Power Solutions (Surface Mounted)</b>				
10' hardwire power includes 4 power/2 data ports	AMPTP1HW	5.0	0.4	\$ 1082
10' hardwire power includes 3 power/1 Extron cut-out	AMPTP2HW (shown)	5.0	0.4	\$ 976
10' hardwire power includes 3 power/1 dual USB A+C/2 data ports	AMPTP3HW	5.0	0.4	\$ 1189
10' hardwire power includes 3 power/1 dual USB A+C/Wireless Charging	AMPTP4HW	5.0	0.4	\$ 1387

**Note:** For use with C1, C2, and C3 cutouts.

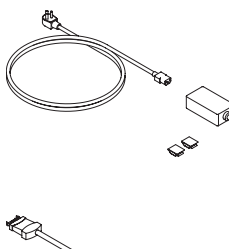



<b>InterLink IQ</b>				
Interlink IQ Starter with 72" Infeed cord	AW4QBI	2.0	0.2	\$ 828
Interlink IQ 36" Jumper	AW4QJ36	2.0	0.2	\$ 166



<b>Ganging Bracket</b>				
Bracket includes Hardware	AW4GANG	0.2	0.0	\$ 98

**Note:** For use on reconfigurable tables.

<p><b>How to specify —</b> Select the Model Number from above.</p>	<p><b>1st Option:</b> <b>Paint Color</b> (if applicable):</p> <p>  </p> <p>See page 364.3 for finishes.</p>
--	--

Example: Z5SC42

ADMIX

- Bezel mount power fits C1E and C2E worksurface cutouts only. See page 364.7 for spec info.
- See page 364.40 for Interlink IQ infeed and jumper.

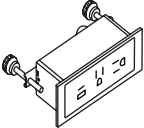
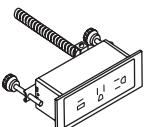
	Description	Model	Ship Weight	Cubes	List Price P1
	<b>Undermount Power Module</b> 5 <sup>3</sup> / <sub>16</sub> "H x 9 <sup>1</sup> / <sub>4</sub> "L x 7 <sup>3</sup> / <sub>8</sub> "W	AUPWRMOD	4.5	0.2	\$ 761
	<b>Bezel Mount Power Module</b> 5 <sup>3</sup> / <sub>16</sub> "H x 9 <sup>1</sup> / <sub>4</sub> "L x 7 <sup>3</sup> / <sub>8</sub> "W	ABPWRMOD	4.5	0.2	\$ 761

ADMIX

<p><i>How to specify —</i> Select the Model Number from above.</p> <p><b>A</b>   <b>P</b>   <b>W</b>   <b>R</b>   <b>M</b>   <b>O</b>   <b>D</b>   .</p>	<p><i>1st Option:</i> <b>Select Port:</b> AC USB-A/C</p> <p><b>A</b>   <b>C</b>   .</p>	<p><i>2nd Option:</i> <b>Select Cord:</b> S Straight B Braided (+\$91) I Interlink (+\$55) H Hardwire (+\$106)</p> <p>  .</p>	<p><i>3rd Option:</i> <b>Select Plastic:</b> SNW Snow STRM Storm BLK Black</p> <p>        .</p>
--	---	---	---

Example: AUPWRMOD.AC.B.SNW



**Effective Date March 1, 2023**

- Software support packages furnished to the customer, either by Allsteel® or by another source, which support the sale of Allsteel products are superseded by printed price lists.
- Prices are subject to change without notice. All orders are subject to prices in effect at the time of order.
- Please refer to your Allsteel Dealer Sales and Discount Policies for order placement information, terms and conditions.
- Additional copies of this Specification and Price List are available upon request from Allsteel Literature at 1-866-255-7833.

- Ordering information appears at the bottom of each product page complete with examples on how to specify. Fabric and finish pages are referenced at the bottom of product pages.

This publication is available as an interactive or downloadable PDF at [www.allsteeloffice.com](http://www.allsteeloffice.com).

**Questions or Comments?**

Please call us at: **888-ALLSTEEL**  
**888-255-7833**

Paint Finishes, Laminates, Eased Edge .....	366
Fabrics.....	367
Working with Height-Adjustable Tables .....	368-373
Screens and Power Module .....	374
Altitude - Metal Screens.....	375-376
Power Rail Specifications.....	377-383
General Overview .....	377
Power Rail Typical.....	378
Working with Altitude Power Rails .....	379
Low Rail with Floor Legs .....	379
Raised Rail.....	379
Screens .....	379
Working with Cable Management .....	380
Working with Power Rail Electricals .....	381
General Notes about Electrical and Circuitry .....	381
Electrical Infeeds.....	381
Routing Power.....	382-383
Working with Electrical and Data .....	384-388
Working with Organization Rail & Accessories & Screens.....	389
Altitude Height-Adjustable Tops, Bases, & Accessories.....	390-395
Altitude – A6.....	390-391
Worksurfaces for Height-Adjustable Bases .....	392-394
Cable Management.....	395
Power Rail – Electrical Components.....	396-398
A8 Screen Kits.....	399
Metal Screens and Tackboard Accessories.....	400-401
Power Rails and Accessories .....	402-405
Worksurface Mounted Rail and Accessories .....	406



### BASE COLORS

#### GRADE P1

Black.....	P71
Brownstone.....	P7D
Cinder.....	P7Q
Cove.....	P096
Designer White.....	PJW
Dune.....	P094
Flint.....	P02
Fossil.....	P28
Harbor.....	P097
Loft.....	P7B
Muslin.....	P4J
Nickel.....	P8L
Parchment.....	P93
Pebble.....	P8R
Pewter.....	P8D
Sage.....	P095
Salt.....	P8C
Titanium.....	P8T

#### GRADE P2

Champagne Metallic.....	PR5
Gunmetal Metallic.....	PR3
Night Bronze.....	P8B
Platinum Metallic.....	PR2
Silver.....	PR6

#### GRADE P3

Bullseye*.....	PJF
Regatta*.....	P8M

\*\*\*Altitude Basic is only offered in one finish, Silver (SVR)

### POWER RAIL PAINT COLORS

#### GRADE P1

Black.....	P71
Brownstone.....	P7D
Bungalow.....	P7C
Cinder.....	P7Q
Designer White.....	PJW
Flint.....	P02
Fossil.....	P28
Loft.....	P7B
Muslin.....	P4J
Pebble.....	P8R
Pewter.....	P8D
Salt.....	P8C
Titanium.....	P8T

#### GRADE P2

Champagne Metallic.....	PR5
Gunmetal Metallic.....	PR3
Night Bronze.....	P8B
Pyrite.....	PJE
Silver.....	PR6
Solar Black.....	P8X

#### GRADE P3

Amethyst ( <i>De-emphasized</i> ).....	P091
Atom.....	P8S
Blossom***.....	P8K
Cobalt Mica ( <i>De-emphasized</i> ).....	P090
Ember.....	P8P
Ion.....	P8N
Iris.....	P8J
Krypton.....	P8F
Ochre.....	P093
Regatta.....	P8M
Sienna.....	P092
Succulent***.....	P8A

\*\*\*These colors are intended to be an inspirational option for the trending market. Product application is limited and color availability is approximately two years to coincide with evolving workplace trends.

### A8 SCREEN BRACKET PAINT COLORS

#### GRADE P1

Black.....	P71
Designer White.....	PJW

#### GRADE P2

Silver.....	PR6
-------------	-----

### LAMINATES

#### GRADE L1

Black.....	P
Brownstone.....	LM13
Bungalow.....	LM12
Designer White.....	LDW1
Flint.....	LM16
Fossil Shale.....	LEH1
Loft.....	LM11
Muslin.....	LM15
Titanium.....	LTI1

#### ABSTRACT

Ash.....	LT3B
Handspun Pearl.....	LAHP
Handspun Dove.....	LAHD
Handspun Slate.....	LAHS
Handspun Chestnut.....	LAHC
Silver Mesh.....	LT8D

#### WOODGRAIN

Belair.....	LWBA
Bourbon Cherry.....	H
Field Elm.....	LWFE
Florence Walnut.....	LFW1
Kingswood Walnut.....	LK11
Natural Maple.....	LWD
NeoWalnut.....	LNU1
Pinnacle.....	PINC
Shaker Cherry.....	LW7C

#### GRADE L2

Beigewood.....	LWBE
Fawn Cypress.....	LFC1
Lowell Ash.....	LLA1
Mangalore Mango.....	LMM1
Natural Recon.....	LNR1
Phantom Charcoal.....	LPC1
Phantom Ecru.....	LPE1
Portico Teak.....	LPT1
Skyline Walnut.....	LSW1
Veranda Teak.....	LVT1

#### GRADE L3

Natural Walnut.....	LWNW
---------------------	------

### EASED EDGE LAMINATES

#### GRADE L1

Designer White.....	LDW1
Loft.....	LM11
Natural Maple.....	LWD

#### GRADE L2

Natural Recon.....	LNR1
--------------------	------

### STRAIGHT/ROUNDED EDGE COLORS

Beigewood.....	DE
Belair.....	BA
Black.....	E4
Bourbon Cherry.....	H
Brownstone.....	EY
Bungalow.....	EX
Designer White.....	DW
Fawn Cypress.....	FC
Field Elm.....	FE
Flint.....	E9
Florence Walnut.....	FW
Fossil.....	EH
Kingswood Walnut.....	KI
Loft.....	EV
Lowell Ash.....	DL
Mangalore Mango.....	MM
Muslin.....	EU
Natural Maple.....	DD
Natural Recon.....	NR
Natural Walnut.....	DN
NeoWalnut.....	NU
Parchment.....	EN
Phantom Charcoal.....	PC
Phantom Ecru.....	PE
Pinnacle.....	PI
Platinum Metallic.....	EP
Plyband.....	PL
Portico Teak.....	DP
Shaker Cherry.....	DF
Skyline Walnut.....	SW
Titanium.....	TI
Veranda Teak.....	VT

### ELECTRICAL & DATA COMPONENTS

Black.....	E4
Brownstone.....	EY
Designer White.....	DW
Flint.....	E9
Loft.....	EV
Muslin.....	EU
Silver.....	ES

All of Allsteel's tables are level® - 2 certified to the ANSI/BIFMA e3 Furniture Sustainability Standard. See [www.levelcertified.org](http://www.levelcertified.org) for more information.

**NOTE:** Refer to individual product pages for upcharges.

# Fabrics

For use with Screen Kits.

## GRADE A

**NOBLE**

Aegean .....	NBLE18
Amethyst.....	NBLE19
Aspen .....	NBLE14
Aster .....	NBLE20
Blossom.....	NBLE21
Bluebell .....	NBLE22
Bordeaux.....	NBLE01
Brick .....	NBLE02
Chambray .....	NBLE10
Chamomile.....	NBLE23
Clementine .....	NBLE04
Conifer.....	NBLE24
Cottage .....	NBLE25
Darkness .....	NBLE26
Dawn .....	NBLE13
Denim .....	NBLE09
Desert Sand.....	NBLE27
Dewfall .....	NBLE28
Dusted Sage.....	NBLE29
Flax.....	NBLE30
Grass.....	NBLE07
Gunmetal .....	NBLE15
Harmony.....	NBLE31
Harvest .....	NBLE12
Ice Caves .....	NBLE32
Icicle.....	NBLE33
Inky.....	NBLE34
Iris.....	NBLE35
Jade.....	NBLE06
Knight .....	NBLE17
Mesa .....	NBLE03
Monarch .....	NBLE36
Pacific .....	NBLE08
Pitch.....	NBLE37
Queen Bee .....	NBLE38
Rainforest .....	NBLE05
Regal.....	NBLE11
Sandcastle .....	NBLE39
Sedona .....	NBLE40
Stormy .....	NBLE16
Sunbeam .....	NBLE41
Voyager.....	NBLE42
Windy Day.....	NBLE43

## GRADE D

**BLAZER LITE**  
*(100% Pure New Wool)*

Haven .....	PCAMBLT40
Retreat .....	PCAMBLT39
Solace.....	PCAMBLT70

ALTITUDE

Altitude height-adjustable bases are available in five styles:

### A6

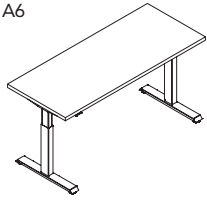

T-leg with  
Rectangular Worksurface

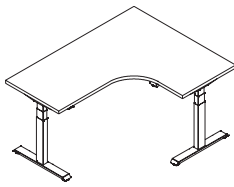

T-leg with  
Corner Cove Worksurface

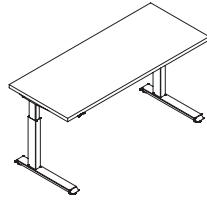

C-leg with  
Rectangular Worksurface

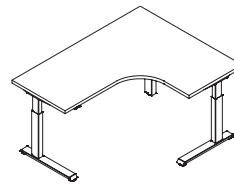

C-leg with  
Corner Cove Worksurface

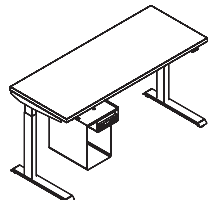

Altitude HAT  
with Undermount  
Radii Console

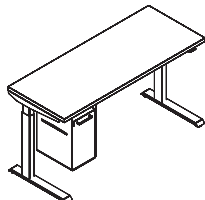

Altitude HAT  
with Flush Undermount  
Radii

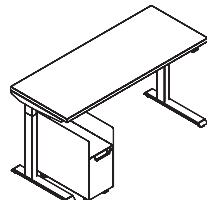

Altitude HAT  
with Freestanding Mobile  
Alcove Radii

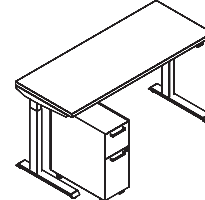

Altitude HAT  
with Freestanding Mobile  
Alcove Radii

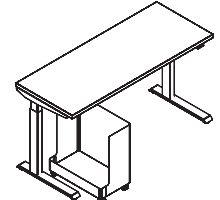

Altitude HAT with  
Freestanding Mobile  
Radii Caddy

### A8 Screens

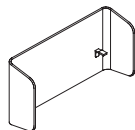

U Screen Kit

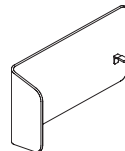

L Screen Kit (Left)

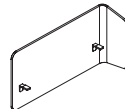

L Screen Kit (Right)

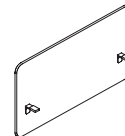

Rectangular Screen Kit

### Metal Screens



L Screen (Left)



L Screen (Right)



U Screen

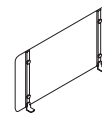

Straight

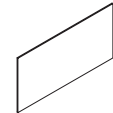

Tackboard Accessory

### Altitude Power Rail

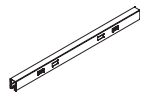

Altitude Power Rail

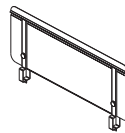

Altitude Rail Screen

A6 Clearance Dimensions

Rectangle

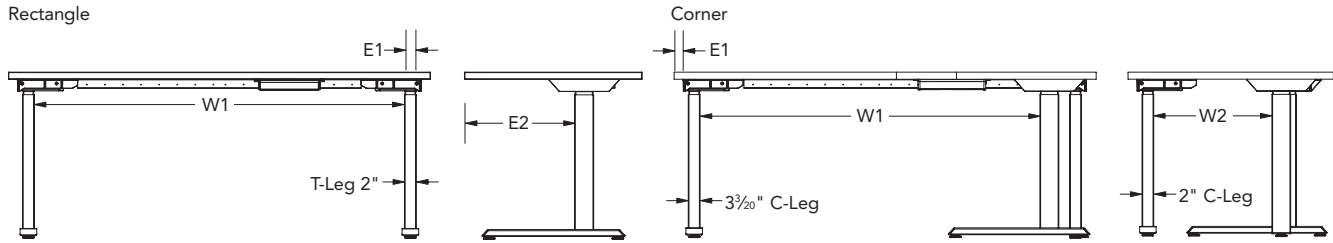

Base Style:	A6-T Base				A6-C Base				
	Dimension Location:	E1	W1	W2	E2	E1	W1	W2	E2
<b>Altitude Top:</b> (Surface dimensions are nominal. Actual widths are reduced by 2")	Edge of table to outside of leg	Between legs	Between legs	Edge of table to the outside of leg	Edge of table to outside of leg	Between legs	Between legs	Edge of table to the outside of leg	
24" x 48" Rectangle*	2½"	35¼"	—	10%"	2½"	35¼"	—	14%"	
24" x 54" Rectangle	2½"	41¼"	—	10%"	2½"	41¼"	—	14%"	
24" x 60" Rectangle	2½"	47¼"	—	10%"	2½"	47¼"	—	14%"	
24" x 66" Rectangle	2½"	53¼"	—	10%"	2½"	53¼"	—	14%"	
24" x 72" Rectangle	2½"	59¼"	—	10%"	2½"	59¼"	—	14%"	
30" x 48" Rectangle	2½"	35¼"	—	13%"	2½"	35¼"	—	17%"	
30" x 54" Rectangle	2½"	41¼"	—	13%"	2½"	41¼"	—	17%"	
30" x 60" Rectangle	2½"	47¼"	—	13%"	2½"	47¼"	—	17%"	
30" x 66" Rectangle	2½"	53¼"	—	13%"	2½"	53¼"	—	17%"	
30" x 72" Rectangle	2½"	59¼"	—	13%"	2½"	59¼"	—	17%"	
60" x 36" Corner Cove	2½"	43"	26"	10%"	2½"	43"	29½"	14%"	
60" x 48" Corner Cove	2½"	43"	32"	10%"	2½"	43"	35½"	14%"	
72" x 36" Corner Cove	2½"	55"	26"	10%"	2½"	55"	29½"	14%"	
72" x 48" Corner Cove	2½"	55"	32"	10%"	2½"	55"	35½"	14%"	

Bottom Views

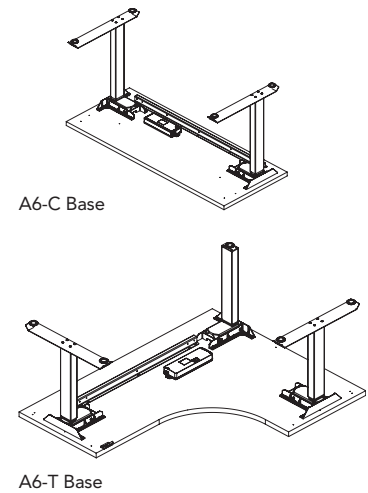

Feature	Altitude Basic	A6
Range Adjustment	26¼" – 43½"H + Adjustable Glide	2-Stage 26½" to 45¼" + ½" Adjustable Glide
Base Only, Without Work Surface		3-Stage 21¼" to 47½" + ½" Adjustable Glide
Range Adjustment	27¾" to 44"H + Adjustable Glide	2-Stage 27¾" to 46¾" + ½" Adjustable Glide
Includes Standard Allsteel 1½" Work Surface		3-Stage 22¾" to 48¾" + ½" Adjustable Glide
Foot Configuration	<ul style="list-style-type: none"> <li>T Foot</li> <li>Standard leveling glide</li> </ul>	<ul style="list-style-type: none"> <li>T Foot or C Foot</li> <li>Standard options include leveling glide, slide glides, and casters</li> </ul>
Leg Options	2 leg	2 and 3 leg
UL Certified Weight Rating	180 lbs	<ul style="list-style-type: none"> <li>250 lbs for 2-leg</li> <li>350 lbs for 2-leg Max</li> <li>375 lbs for 3-leg</li> <li>500 lbs for 3-leg Max</li> </ul>
Cross Bar Design	Yes	A6 models ordered prior to 4/5/2021 have cross bar understructure, A6 models ordered after 4/5/2021 do not
Colors	Silver Only	20 Allsteel Paint Finishes offered, see Altitude Tables Finishes page
Control Pad	Up/down only	Basic up/down, memory preset, paddle, foot pedal
Wire Management	Allsteel standard options available Hinged trough not recommended	Allsteel standard options available
Power Access	Desktop power modules available	Desktop power modules available
Warranty	5 years	If Purchased Before 3/1/2021: 10 Years Metal Base, 7 Years Electronics If Purchased After 3/1/2021: 10 Years for Entire Product



Height-Adjustable Worksurfaces, Bases, and Controls

Height-Adjustable Worksurfaces (page 392)

- Height-adjustable worksurfaces are available in laminate with flat edge and rectangular veneer with matching square edge.
- T-mold is used on the edge of curved worksurfaces. This will have a noticeable visual difference when directly adjacent to straight worksurfaces.
- Worksurface dimensions are nominal. Actual widths are reduced by 2" (1" each side) and worksurface depths are reduced by ¼". Corner cove depth is nominal, actual is 1" less.
- Rectangular undersized worksurface models' (model number ending in -U) actual widths and depths are reduced by 2".
- Corner Cove undersized worksurface models' (model number ending in -LD) actual dimensions are reduced by 2".
- Altitude worksurfaces are pre-drilled with mounting location for bases.
- Rectangular worksurface grommet location is limited to center location due to mounting of worksurface supports at each end of the worksurface.
- Certain two-piece top configurations may require two stiffeners depending on the footprint of your station.
- 2-leg standard bases can accommodate worksurface configurations from 24"D x 24"W to 30"D x 72"W.
- 2-leg Max bases can accommodate worksurface configurations from 24"D x 24"W to 30"D x 96"W.
- 3-Leg standard bases can accommodate worksurface configurations from 24"D x 48"W x 36"W to 30"D x 72"W x 48"W.
- 3-Leg Max bases can accommodate worksurface configurations from 24"D x 48"W x 36"W to 30"D x 72"W x 72"W.
- Altitude A6 bases specified with a work surface 60"W and greater require the use of an external stiffener. An external stiffener is included in Altitude work surface models 60"W and greater (all models ending with letter -D). If a non-Altitude work surface is being used, an external stiffener may need to be specified separately.

Height-Adjustable Bases (pages 390-391)

- Electronic height-adjustable base units are available in six styles: A6-T Base with 2 legs, A6-C Base with 2 legs, A6-T Base with 3 legs, A6-C Base with 3 legs, A6-T Max Base with 2 legs, A6-C Max Base with 2 legs, A6-T Max Base with 3 legs, and A6-C Max Base with 3 legs.
- A6 2-stage 1.2"/sec, A6 3-stage 1.4"/sec, A6 Max .8"/sec. Motor devices have a continuous cycle time of 2 minutes with an 18 minute rest period before it can be cycled again.
- Control box is powered by 110-120V/60Hz/4A. Standby power is < 0.1 Watts. Power cords on A6-T models are 10'.
- Pedestals taller than 24½" for 2-stage models and 19½" for 3-stage models when placed under table will limit range in lowest position.
- Mobile box/file pedestals will clear feet on height adjustable base but will extend past edge of worksurface in that position. See chart on page 369.
- Moving worksurfaces can collide with other components. It is important to ensure free range of motion prior to operating the table.
- All tables have adjustable glides providing ½" adjustment on A6.
- Slide glides offered as a .option and model level. Only available on 2-leg bases.
- Casters available on model level for retrofitting on 2-Leg Bases ONLY.
- Altitude A6 tables feature collision detection, a feature designed to stop table travel when the table detects an obstacle.
- A6 load capacity is 250 lbs for 2-leg models, 375 lbs for 3-leg models, 350 lbs for 2-leg Max models, and 500 lbs for 3-leg Max models. This includes the weight of the worksurface.
- G1 Glide enables the A63-stage height adjustable bases to reach the BIFMA G1 height requirements. Glides come in a pack of 4. Glide is always black.

A6 Control Options

- Memory Controls are now a .option.
- Up/Down: Basic Up/Down control.
- Memory Control: 4 memory pre-set options allow the user to adjust their height to their preferred heights.
- Paddle: Simple, aesthetic control with 1 memory pre-set option and reminder mode.
- Bluetooth Capability: A6 optional Bluetooth capability is sold as accessory model A6BLUETOOTH. Bluetooth is enabled through smartphone app AiDesk. Bluetooth control will only work with 2-leg A6 tables. Bluetooth control will **not** work with 3-leg A6 tables. No additional controls are required for use, but they can be used in addition to the bluetooth control (bluetooth plug in uses different port than other controls).

Note: HAT-to-Panel bracket does not work with the Max Base.

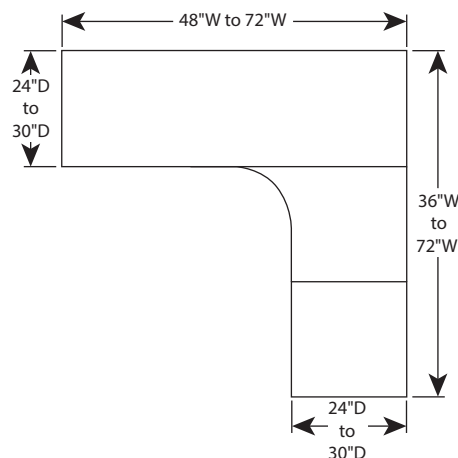
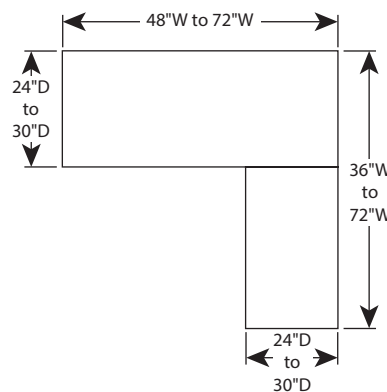
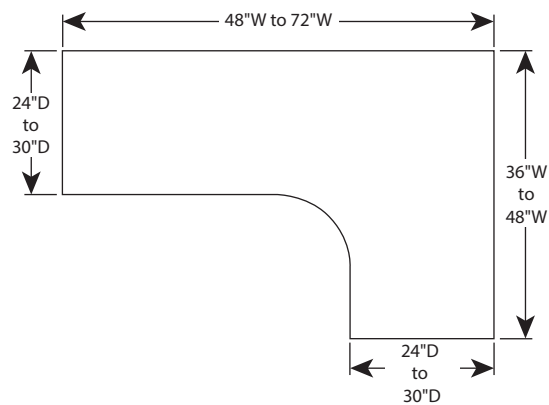

For specification information see page 370.

**Rectangular Laminate Tops – 24"D**

Base Model(s)	Actual Dimensions
AF5RS4824, AVF5RS4824	46"W x 23¼"D
AF5RS5424, AVF5RS5424	52"W x 23¼"D
AF5RS6024D, AVF5RS6024D	58"W x 23¼"D
AF5RS6624D, AVF5RS6624D	64"W x 23¼"D
AF5RS7224D, AVF5RS7224D	70"W x 23¼"D
AF5RS7824D	76"W x 23¼"D
AF5RS8424D	82"W x 23¼"D
AF5RS9024D	88"W x 23¼"D
AF5RS9624D	94"W x 23¼"D

**Rounded Corner Laminate Tops – 24"D**

Base Model(s)	Actual Dimensions
AF5RND4824	46"W x 23¼"D
AF5RND5424	52"W x 23¼"D
AF5RND6024D	58"W x 23¼"D
AF5RND6624D	64"W x 23¼"D
AF5RND7224D	70"W x 23¼"D
AF5RND7824D	76"W x 23¼"D
AF5RND8424D	82"W x 23¼"D
AF5RND9024D	88"W x 23¼"D
AF5RND9624D	94"W x 23¼"D

**Rectangular Laminate Tops – 30"D**

Base Model(s)	Actual Dimensions
AF5RS4830, AVF5RS4830	46"W x 29¼"D
AF5RS5430, AVF5RS5430	52"W x 29¼"D
AF5RS6030D, AVF5RS6030D	58"W x 29¼"D
AF5RS6630D, AVF5RS6630D	64"W x 29¼"D
AF5RS7230D, AVF5RS7230D	70"W x 29¼"D
AF5RS7830D	76"W x 29¼"D
AF5RS8430D	82"W x 29¼"D
AF5RS9030D	88"W x 29¼"D
AF5RS9630D	94"W x 29¼"D

**Rounded Corner Laminate Tops – 30"D**

Base Model(s)	Actual Dimensions
AF5RND4830	46"W x 29¼"D
AF5RND5430	52"W x 29¼"D
AF5RND6030D	58"W x 29¼"D
AF5RND6630D	64"W x 29¼"D
AF5RND7230D	70"W x 29¼"D
AF5RND7830D	76"W x 29¼"D
AF5RND8430D	82"W x 29¼"D
AF5RND9030D	88"W x 29¼"D
AF5RND9630D	94"W x 29¼"D

**Undersized Rectangular Worksurface – 24"D**

Base Model(s)	Actual Dimensions
AF5RS3624U	34"W x 22"D
AF5RS4224U	40"W x 22"D
AF5RS4824U	46"W x 22"D
AF5RS5424U	52"W x 22"D
AF5RS6024UD	58"W x 22"D
AF5RS6624UD	64"W x 22"D
AF5RS7224UD	70"W x 22"D
AF5RS7824UD	76"W x 22"D
AF5RS8424UD	82"W x 22"D
AF5RS9024UD	88"W x 22"D
AF5RS9624UD	94"W x 22"D

**Undersized Rectangular Worksurface – 30"D**

Base Model(s)	Actual Dimensions
AF5RS3630U	34"W x 28"D
AF5RS4230U	40"W x 28"D
AF5RS4830U	46"W x 28"D
AF5RS5430U	52"W x 28"D
AF5RS6030UD	58"W x 28"D
AF5RS6630UD	64"W x 28"D
AF5RS7230UD	70"W x 28"D
AF5RS7830UD	76"W x 28"D
AF5RS8430UD	82"W x 28"D
AF5RS9030UD	88"W x 28"D
AF5RS9630UD	94"W x 28"D

**120 Degree Corner Worksurface – 24"D**

Base Model(s)	Actual Dimensions
AF5120S4224D	22"A x 40"B x 40"C x 22"D
AF5120S4824D	22"A x 46"B x 46"C x 22"D
AF5120S5424D	22"A x 52"B x 52"C x 22"D

**120 Degree Corner Worksurface – 30"D**

Base Model(s)	Actual Dimensions
AF5120S4224D	28"A x 40"B x 40"C x 28"D
AF5120S4824D	28"A x 46"B x 46"C x 28"D
AF5120S5424D	28"A x 52"B x 52"C x 28"D

For specification information see page 370.

**Corner Cove Laminate Tops – 24"D Extended Left**

Base Model(s)	Actual Dimensions
A5822ELS	23¼"A x 58¼"B x 34½"C x 23¼"D
A5622ELS	23¼"A x 58¼"B x 46¼"C x 23¼"D
A5922ELS	23¼"A x 70¼"B x 34½"C x 23¼"D
A7222ELS	23¼"A x 70¼"B x 46¼"C x 23¼"D

**Undersized Corner Cove Worksurface, Left Hand – 24"D**

Base Model(s)	Actual Dimensions
AF5CCS603624LD	22"A x 58"B x 34"C x 22"D
AF5CCS604824LD	22"A x 58"B x 46"C x 22"D
AF5CCS723624LD	22"A x 70"B x 34"C x 22"D
AF6CCS724824LD	22"A x 70"B x 46"C x 22"D

**Undersized Corner Cove Worksurface, Left Hand – 30"D**

Base Model(s)	Actual Dimensions
AF5CCS604830LD	28"A x 58"B x 46"C x 28"D
AF5CCS724830LD	28"A x 70"B x 46"C x 28"D

**Corner Cove Laminate Tops – 24"D Extended Right**

Base Model(s)	Actual Dimensions
A5822ERS	23¼"A x 58¼"B x 34½"C x 23¼"D
A5622ERS	23¼"A x 58¼"B x 46¼"C x 23¼"D
A5922ERS	23¼"A x 70¼"B x 34½"C x 23¼"D
A7222ERS	23¼"A x 70¼"B x 46¼"C x 23¼"D

**Undersized Corner Cove Worksurface, Right Hand – 24"D**

Base Model(s)	Actual Dimensions
AF5CCS603624RD	22"A x 58"B x 34"C x 22"D
AF5CCS604824RD	22"A x 58"B x 46"C x 22"D
AF5CCS723624RD	22"A x 70"B x 34"C x 22"D
AF6CCS724824RD	22"A x 70"B x 46"C x 22"D

**Undersized Corner Cove Worksurface, Right Hand – 30"D**

Base Model(s)	Actual Dimensions
AF5CCS604830RD	28"A x 58"B x 46"C x 28"D
AF5CCS724830RD	28"A x 70"B x 46"C x 28"D

## Cable & Wire Management

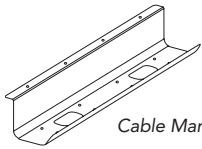

Cable Management Tray

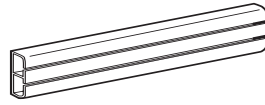

Wire Management Channel

### Cable Management Tray (page 395)

- Attaches under the worksurface to contain cables.
- Metal tray shelf is 4" deep. Can hold electrical power strip and/or surge protector.
- 24" and 36" lengths, use multiple units for larger worksurfaces.
- Attachment hardware included, paint option is black only.
- Zip tie attachment points located in base of tray. Zip ties not included.

### Wire Management Channel (page 395)

- Self adhesive backing to attach to panels and underside of worksurfaces.
- Flexible strips allow cabling to enter/exit and can be contained inside the 2-cavity profile.
- Each cavity provides space for a maximum of six .22" dia. cables. Total capacity = 1 sq. in.

### Cord Management Chain (page 395)

- Works with Approach and Altitude A6-units.
- Used to route and conceal power/data cables from control box and other devices. Includes all mounting hardware and a plate to secure to a leveling glide.
- Houses 6 cables @ 0.300" diameter.
- Made of plastic chain with plastic attachment brackets at each end. Only comes in Black finish.

### Under Worksurface Trough (page 395)

- Used to conceal wires and control box below worksurfaces. Trough can be configured at various height/width combinations to meet capacity needs — see illustrations below.
- On 48"W and 54"W worksurfaces use one 17"W trough. 54"W has space to use 2 – 17"W, if necessary.
- On 60"W, 66"W, and 72"W worksurfaces use the 36" trough.
- On 84"W worksurface use 2 – 17"W troughs.

### Quad Tap (page 395)

- Under surface mounting, used on any worksurface.
- 10' Power cord. UL Listed
- 4 Simplex receptacles.
- May be used in conjunction with hinged trough to reduce the number of cords routed from a worksurface to a beam.

### Power Module

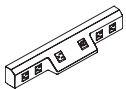

- Contains 5 simplex outlets and 1 dual USB.
- Available in plastic or metal. Metal power module is required for Chicago code.
- Cord options include straight and curly.
  - Straight cord is 144"
  - Curly cord is 120"
- MUST be specified with SPLA-ALT-BEAMA (see Standard Specials pricer for more information).
- Cannot be attached directly to the bottom of the worksurface.

### Screens

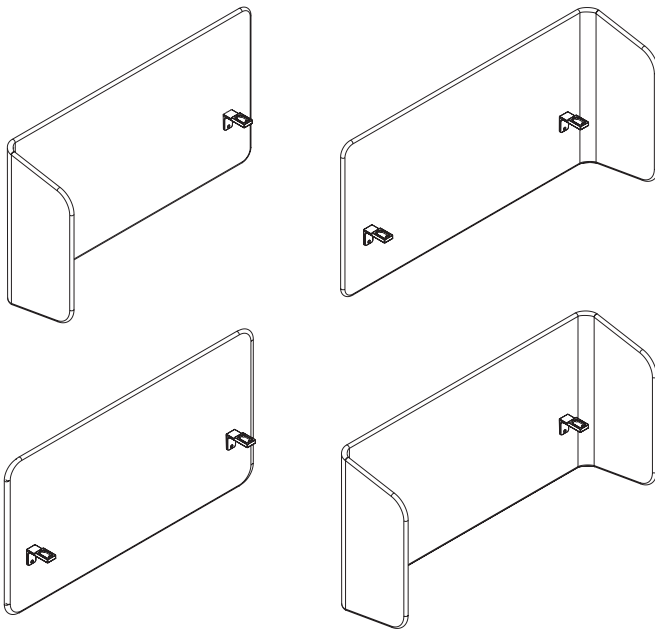

- See Table 1 for overall table width and depth for each screen shape.
- Adding a screen adds 3" to depth of the table.
- Adding a screen adds 1" to the width of the table per return wing.
- RH L-screens have return wing on user's right; LH opposite.
- When using a 24"D worksurface with Altitude screens, you must specify a T-foot.

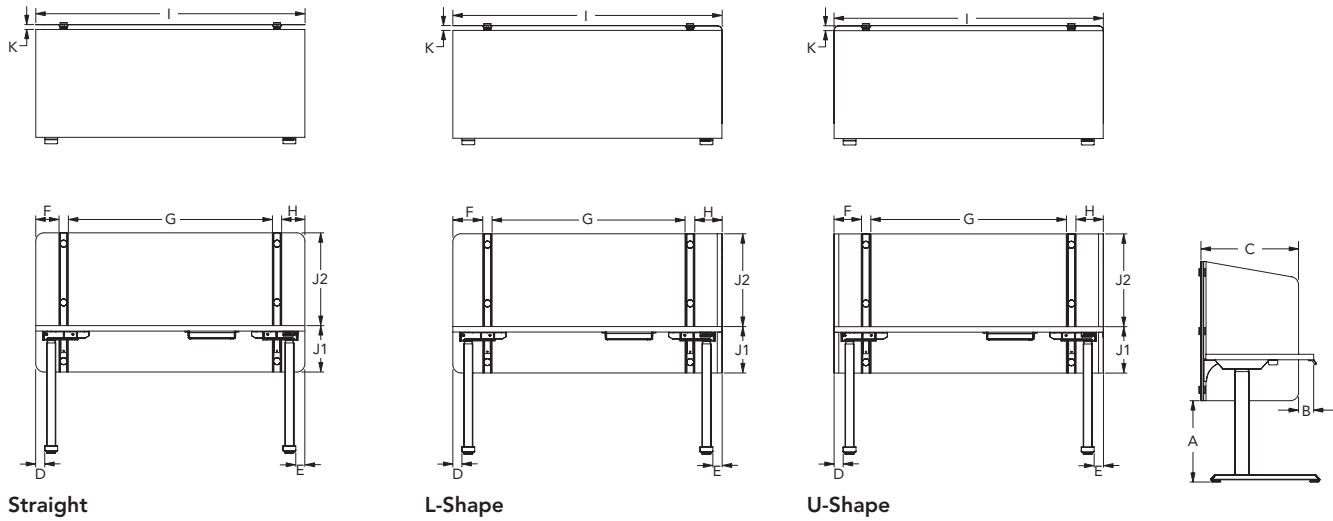

Size Reference Matrix

Models	A	B	C1	C2	D	E	F	G1	G2	H	I	J1	J2	K
	Under Desk Height	Wing to Front	Wing Width STD	Wing Width EXT	Left Leg to Edge	Right Leg to Edge	Left Side Panel to Support	Distance Between Supports	Distance Between Center/ Right Support	Right Side Panel to Support	Overall Width	Desktop To Base of Panel	Desktop To Top of Panel	Cable Drop Space
AMS2048LH	24.7	3.3	21.1	24.3	2.0	2.0	5.9	29.7	-	6.4	46.1	2.9	20.0	1.0
AMS2054LH	24.7	3.3	21.1	24.3	2.0	2.0	5.9	35.7	-	6.4	52.1	2.9	20.0	1.0
AMS2060LH	24.7	3.3	21.1	24.3	2.0	2.0	5.9	41.7	-	6.4	58.1	2.9	20.0	1.0
AMS2066LH	24.7	3.3	21.1	24.3	2.0	2.0	5.9	22.8	22.8	6.4	64.1	2.9	20.0	1.0
AMS2072LH	24.7	3.3	21.1	24.3	2.0	2.0	5.9	25.8	25.8	6.4	70.1	2.9	20.0	1.0
AMS2048RH	24.7	3.3	21.1	24.3	2.0	2.0	6.4	29.7	-	5.9	46.1	2.9	20.0	1.0
AMS2054RH	24.7	3.3	21.1	24.3	2.0	2.0	6.4	35.7	-	5.9	52.1	2.9	20.0	1.0
AMS2060RH	24.7	3.3	21.1	24.3	2.0	2.0	6.4	41.7	-	5.9	58.1	2.9	20.0	1.0
AMS2066RH	24.7	3.3	21.1	24.3	2.0	2.0	6.4	22.8	22.8	5.9	64.1	2.9	20.0	1.0
AMS2072RH	24.7	3.3	21.1	24.3	2.0	2.0	6.4	25.8	25.8	5.9	70.1	2.9	20.0	1.0
AMS3248LH	17.5	3.3	21.1	24.3	2.0	2.0	5.9	29.7	-	6.4	46.1	10.0	20.0	1.0
AMS3254LH	17.5	3.3	21.1	24.3	2.0	2.0	5.9	35.7	-	6.4	52.1	10.0	20.0	1.0
AMS3260LH	17.5	3.3	21.1	24.3	2.0	2.0	5.9	41.7	-	6.4	58.1	10.0	20.0	1.0
AMS3266LH	17.5	3.3	21.1	24.3	2.0	2.0	5.9	22.8	22.8	6.4	64.1	10.0	20.0	1.0
AMS3272LH	17.5	3.3	21.1	24.3	2.0	2.0	5.9	25.8	25.8	6.4	70.1	10.0	20.0	1.0
AMS3248RH	17.5	3.3	21.1	24.3	2.0	2.0	6.4	29.7	-	5.9	46.1	10.0	20.0	1.0
AMS3254RH	17.5	3.3	21.1	24.3	2.0	2.0	6.4	35.7	-	5.9	52.1	10.0	20.0	1.0
AMS3260RH	17.5	3.3	21.1	24.3	2.0	2.0	6.4	41.7	-	5.9	58.1	10.0	20.0	1.0
AMS3266RH	17.5	3.3	21.1	24.3	2.0	2.0	6.4	22.8	22.8	5.9	64.1	10.0	20.0	1.0
AMS3272RH	17.5	3.3	21.1	24.3	2.0	2.0	6.4	25.8	25.8	5.9	70.1	10.0	20.0	1.0
AMS2048US	24.7	3.3	21.1	24.3	2.0	2.0	5.9	30.3	-	5.9	46.1	2.9	20.0	1.0
AMS2054US	24.7	3.3	21.1	24.3	2.0	2.0	5.9	36.3	-	5.9	52.1	2.9	20.0	1.0
AMS2060US	24.7	3.3	21.1	24.3	2.0	2.0	5.9	42.3	-	5.9	58.1	2.9	20.0	1.0
AMS2066US	24.7	3.3	21.1	24.3	2.0	2.0	5.9	23.1	23.1	5.9	64.1	2.9	20.0	1.0
AMS2072US	24.7	3.3	21.1	24.3	2.0	2.0	5.9	26.1	26.1	5.9	70.1	2.9	20.0	1.0
AMS3248US	17.5	3.3	21.1	24.3	2.0	2.0	5.9	30.3	-	5.9	46.1	10.0	20.0	1.0
AMS3254US	17.5	3.3	21.1	24.3	2.0	2.0	5.9	36.3	-	5.9	52.1	10.0	20.0	1.0
AMS3260US	17.5	3.3	21.1	24.3	2.0	2.0	5.9	42.3	-	5.9	58.1	10.0	20.0	1.0
AMS3266US	17.5	3.3	21.1	24.3	2.0	2.0	5.9	23.1	23.1	5.9	64.1	10.0	20.0	1.0
AMS3272US	17.5	3.3	21.1	24.3	2.0	2.0	5.9	26.1	26.1	5.9	70.1	10.0	20.0	1.0
AMS2048SS	24.7	-	-	-	2.0	2.0	5.0	32.0	-	5.0	46.0	2.9	20.0	1.0
AMS2054SS	24.7	-	-	-	2.0	2.0	5.0	38.0	-	5.0	52.0	2.9	20.0	1.0
AMS2060SS	24.7	-	-	-	2.0	2.0	5.0	44.0	-	5.0	58.0	2.9	20.0	1.0
AMS2066SS	24.7	-	-	-	2.0	2.0	5.0	24.0	24.0	5.0	64.0	2.9	20.0	1.0
AMS2072SS	24.7	-	-	-	2.0	2.0	5.0	27.0	27.0	5.0	70.0	2.9	20.0	1.0
AMS3248SS	17.5	-	-	-	2.0	2.0	5.0	32.0	-	5.0	46.0	10.0	20.0	1.0
AMS3254SS	17.5	-	-	-	2.0	2.0	5.0	38.0	-	5.0	52.0	10.0	20.0	1.0
AMS3260SS	17.5	-	-	-	2.0	2.0	5.0	44.0	-	5.0	58.0	10.0	20.0	1.0
AMS3266SS	17.5	-	-	-	2.0	2.0	5.0	24.0	24.0	5.0	64.0	10.0	20.0	1.0
AMS3272SS	17.5	-	-	-	2.0	2.0	5.0	27.0	27.0	5.0	70.0	10.0	20.0	1.0

ALTITUDE

**Altitude — Metal Screens (page 400)**

- Powder coated magnetic metal privacy screen.
- Metal surfaces can be easily disinfected with cleaners. See cleaning guide for more details at AllsteelOffice.com.
- Available in all standard paint colors.
- Provides 1" gap along the back for accessory mount and cord drop.
- Available in 48"W, 54"W, 60"W, 66"W and 72"W.
- 66"W and 72"W screens include 3rd center bracket.
- Available in Straight, L- and U-shape configurations. Above and Above/Below desk applications.
- L- and U-Shape screens are not compatible with shrouded Height Adjustable Table legs.
- Optional tackable accessories specified separately.
- 66"W tackable accessory comes as a set of (2) 24"W.
- 72"W tackable accessory comes as a set of (2) 20"W.
- Available in standard and extended wings.
- Wings mount flush to the edge of the surface with an L-Bracket.
- 20"W tackable accessory must only be applied to both standard and extended wings without accessory slots.
- Wings are available with accessory slots that accept Radii Hot File, Side Saddle and Coat hook.
- Top slot can accept one Radii accessory.
- Bottom slot can accept a Coat hook and one other accessory.
- Accessories can hang on either side of the wing.
- TIP: If the Hot File is used in the top slot, it will block access for accessories in the bottom slot.
- Do not hang more than 5lbs of weight on wings.
- Screens are compatible with Radii undermount storage.
- Not compatible with standard 120-worksurfaces. Contact Allsteel TPG for custom sizes.
- When using a 24"D worksurface with Altitude screens, you must specify a T-foot.

**Size Reference Matrix**

Tackboards	Wing	48"W	54"W	60"W	66"W	72"W
Actual Dimensions	20"W	30"W	36"W	42"W	20"W	24"W
Set of Tackboards	1	1	1	1	2	2

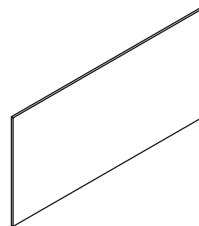

**Accessories — Tackboard (page 401)**

- Tackable accessories come with metal frame available in standard paint colors and fabric options.
- Attach to the screen using a dual lock tape (included in hardware).

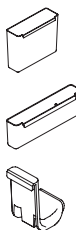

**Accessories — Radii (page 401)**

- Wings are available with accessory slots that accept Radii Hot File, Side Saddle and Coat hook.
- Top slot can accept one Radii accessory.
- Bottom slot can accept a Coat hook and one other accessory.
- Accessories can hang on either side of the wing.
- TIP: If the Hot File is used in the top slot, it will block access for accessories in the bottom slot.

**Accessories — Further Worksurface Rail Mount (page 406)**

- Accessory rail must be field cut to fit between the screen brackets.
- The following accessories are not compatible with screens: U9WTC and U9TM.

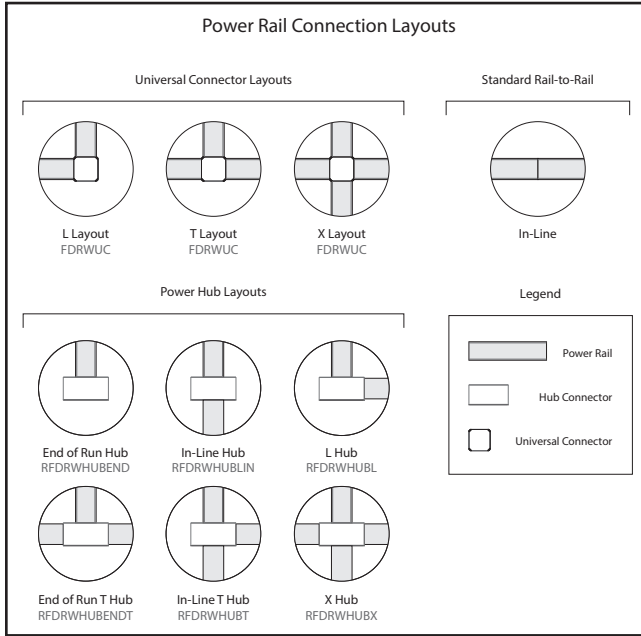

**GENERAL OVERVIEW**

- Accommodates power and lay-in capacity for data cables.
- Available in 48", 54", 60", 66", and 72" lengths.
- Maximum of 2 duplexes and 2 data ports per side of rail.
- Models come equipped with hardware for in-line connections.
- Fiber optic cables can follow 90 degree turns at the intersection of the power rails.
- Power harnesses snap into electrical brackets within the power rail and accept duplex receptacles.
- Electrical power harness accepts up to 2 duplex receptacles per side of rail.
- End caps are required at an end-of-run, unless connected to an end-of-run power pole or a hub.
- Power rail can be set low to the floor using the floor legs or raised off the floor at 20½" H with elevated legs.

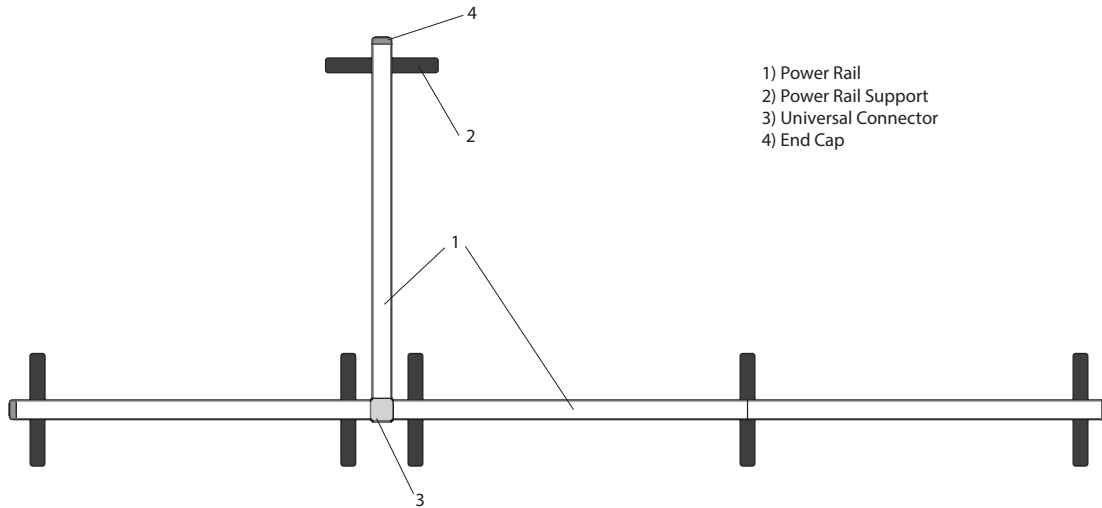

ALTITUDE



Power Rail Typicals

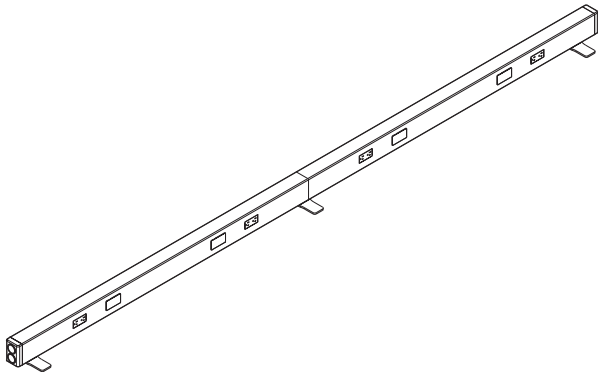

Low Rail, (2) 60"W Rail  
Linear Configuration

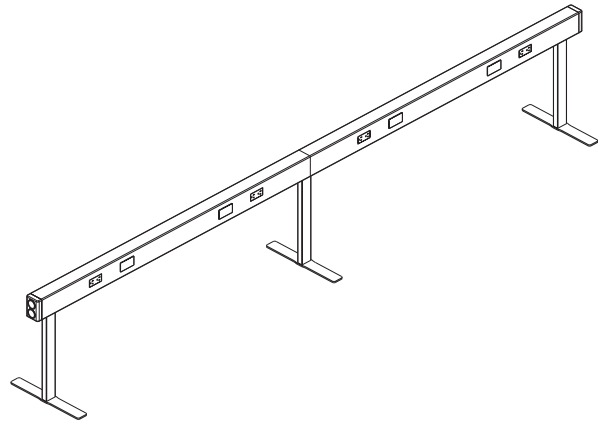

Raised Rail, (2) 60"W Rail  
Linear Configuration

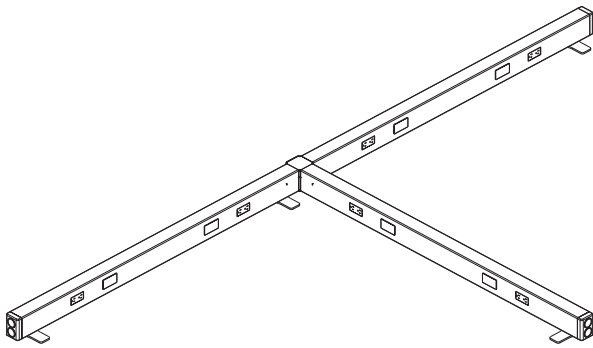

Low Rail, (3) 60"W Rail  
T-Configuration

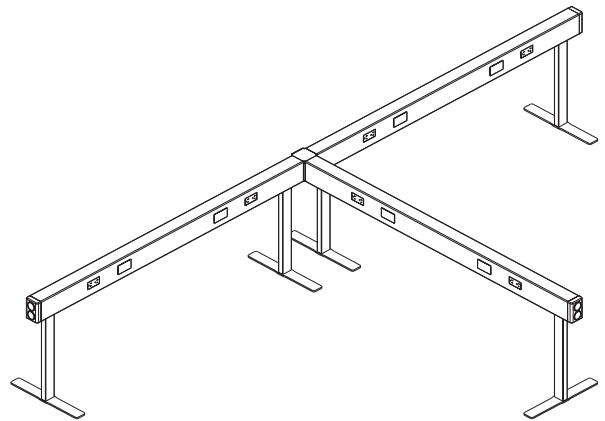

Raised Rail, (3) 60"W Rail  
T-Configuration

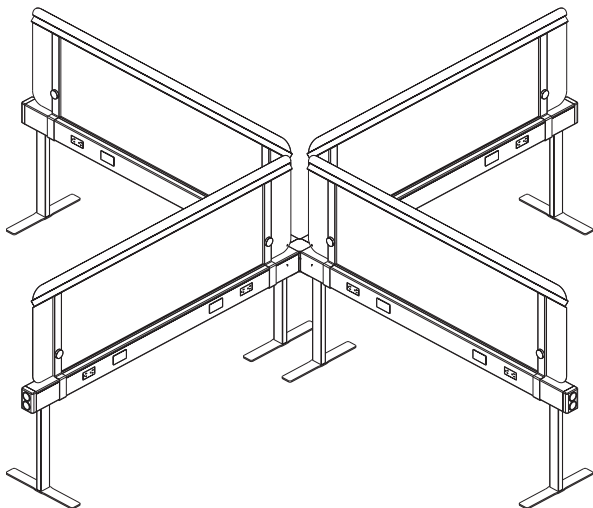

Raised Rail, (4) 60"W Rail  
X-Configuration with Screens

ALTITUDE

**WORKING WITH ALTITUDE POWER RAILS**

**Low Rail with Floor Legs:**

- Each power rail is supported by (2) floor legs.
- Floor legs have a leveling mechanism that can adjust up to 1¼"H.
- Legs are specified separately and come in qty of 1. Each leg is 7¼"D x 2¼"W.
- Leg is inset 2.8" from end of the power rail.
- Universal connector allows "L", "T" and "X" configurations.
- Can connect directly to another power rail in linear applications without use of the universal connector.
- Cannot mount screens on the low rail.
- Power infeed can access the power rail in multiple ways:
  - through a receptacle position on the power rail (side infeed).
  - through the end cap on to the first power block.
  - through power pole using a power pole connector kit.

**Raised Rail**

- Power rails can be raised up to 20½"H using Elevated Legs and/or Hubs.
- Elevated Legs and Hubs can be used in conjunction to create the desired capability and aesthetic.
- Can be in Linear, L-, T- or X-configurations using Elevated Legs, Hubs or Universal Connector.
- Supports screens. See screens section for more details.
- Elevated Legs
  - Inset 2.8" from end of the power rail.
  - Can be shared in between the two rails in linear configuration.
  - Cannot route power and/or data.
  - Specified separately and come in qty of 1. Foot is included.
  - Leg is 15¼"D x 2¼"W x 17¾"H.
  - Order RFDRAWAB separately to anchor to floor. Appropriate fasteners per floor type sourced locally.
- Support Hubs
  - Connect directly to the power rail.
  - Can be shared in between the two rails.
  - L-, T- and X-hubs can be shared in between power rails.
  - End of Run hub is only specified at end condition.
  - Can route power and/or data.
  - Can integrate power pole. Power Pole connector kit is specified separately and come in qty of 1. Foot is included.

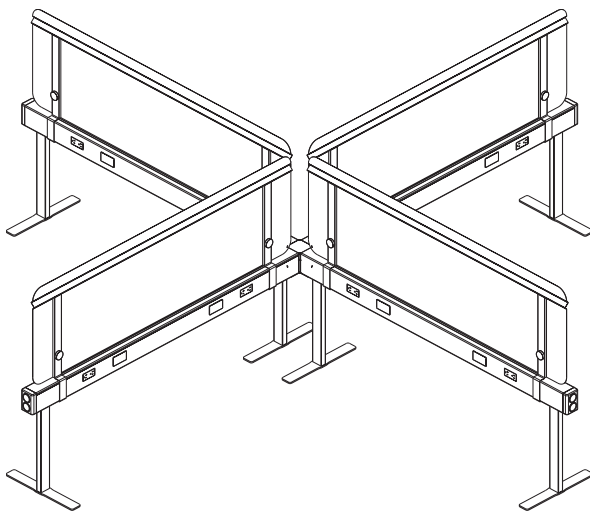

**Screens**

- Constructed of painted steel material.
- Standard Allsteel paint options can be applied.
- Screen height is 20"H, provides overall height of 42"H above fixed floor.
- Painted steel is magnetic and cleanable. Refer to cleaning solutions page at Allsteel Office website.
- Attachment hardware included.

ALTITUDE

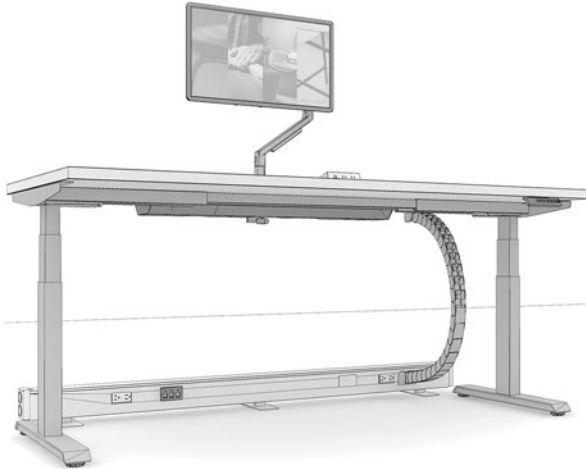

Altitude Desk + 60"W Low Rail + WKSWMC

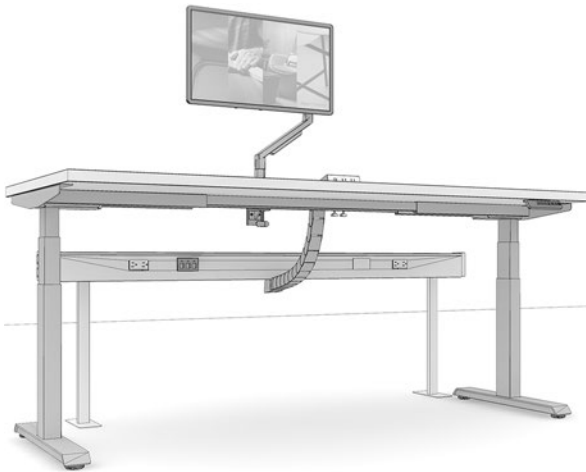

Altitude Desk + 60"W Raised Rail + A9CLWMC

**WORKING WITH CABLE MANAGEMENT**

- Used to route and conceal power/data cables from control box and other devices. Includes all mounting hardware.
- Houses 6 cables @ 0.300" diameter.
- Specify WKSWMC for 58" chain. Only comes in Black Finish. Recommended for use with Low Rail.
- Specify A9CLWMC for 36" chain. Comes in Black, White and Silver. Recommended for use with Raised Rail.
- Links the power rail to a height adjustable desk.
- Has two connecting points: Top section connects underneath the Height Adjustable Desk and the bottom section connects underneath the power rail using a double-sided tape. Hardware included.
- When mounting the chain to underneath the rail, an adapter link is required. Included in the hardware.

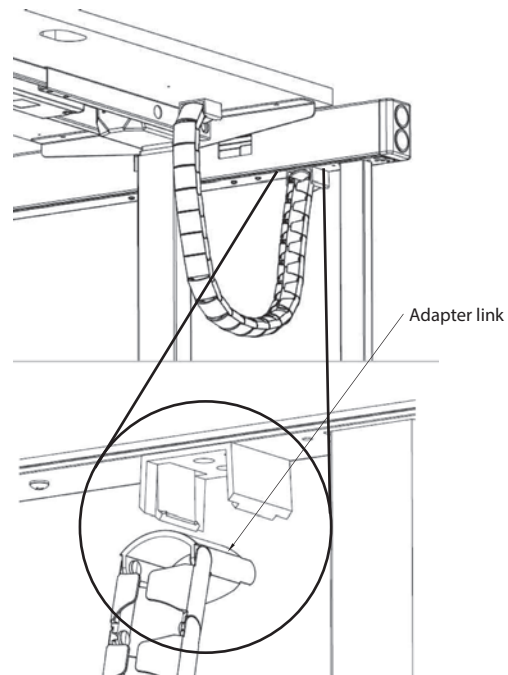

ALTITUDE

## WORKING WITH POWER RAIL ELECTRICALS

### General Notes about Electrical and Circuitry:

- Power Rail offers a choice of four electrical systems:
  - Four-circuit, 3 + 1
  - Four-circuit, 2 + 2
  - Three-circuit, separate neutrals
  - Eight circuits; two four-circuit systems provided back to back.
  - See Altitude Pricer section “Working with Electrical” for a detailed explanation of each electrical system.
  - All four systems utilize an 8-wire electrical system, rated at 20 amps.
- Per circuit (15 amps Canadian) — 16 amps plannable in U.S.
  - Power Rail and electrical components are UL Listed. Electrical
- Components are also CSA certified.
  - Installation and use of the electrical system, the number of receptacles.
- Used on a given circuit and connections to the building power supply.
- Should follow all local and national electrical codes.

### Electrical Infeeds

- Power infeed cables deliver power from building to panel's electrical system.
- Infeed cables are housed in conduit to separate electrical system from communications and data lines.
- Select quantity of base or ceiling infeed cables depending on individual power requirements.
- Refer to rail supports for infeed access points.

**Routing Power**

- Power infeed can access the raised power rail in multiple ways:
  - Through power pole using a power pole connector kit.
  - Through Support Hubs.
  - Through the infeed vertebrae.

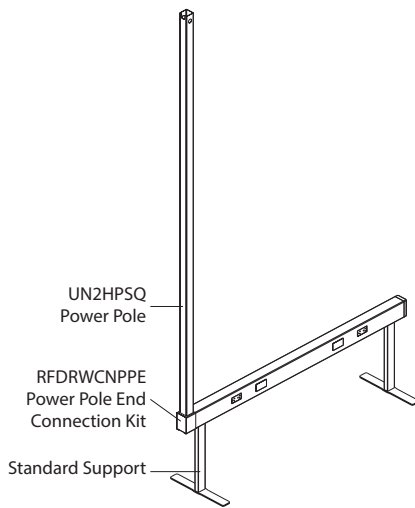
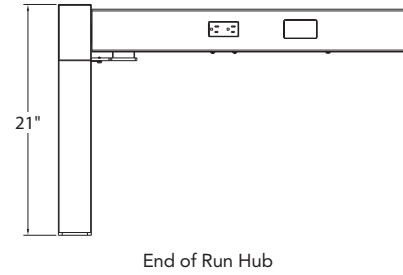
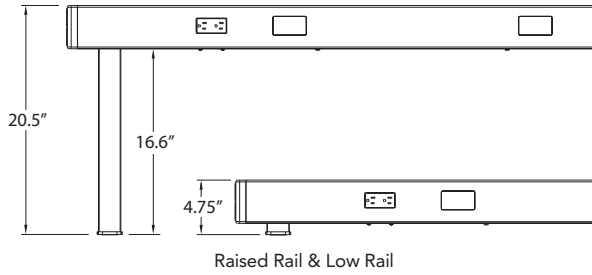

RFDRWCNPPE + UN2HPSQ  
Connected to 60" W Rail

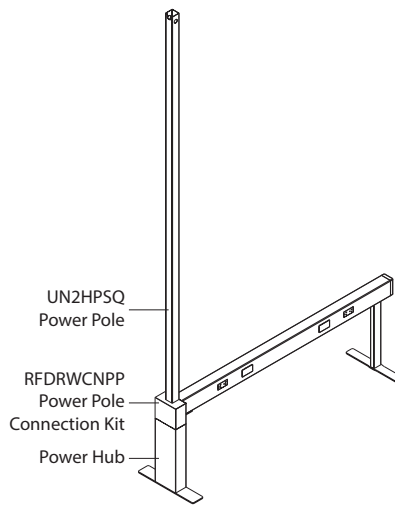

RFDRWHUBEND + RFDRWCNPP  
UN2HPSQ connected to 60" W Rail

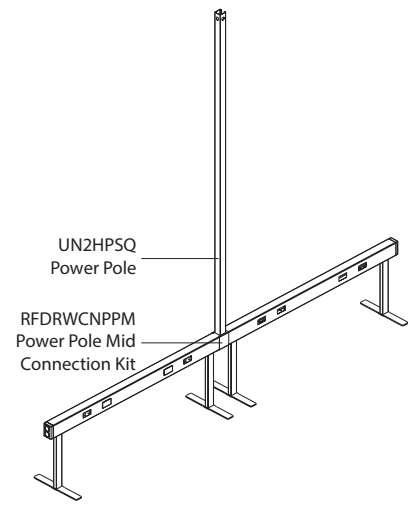

UN2HPSQ + RFDRWCNPPM  
Connected to 60" W Rail

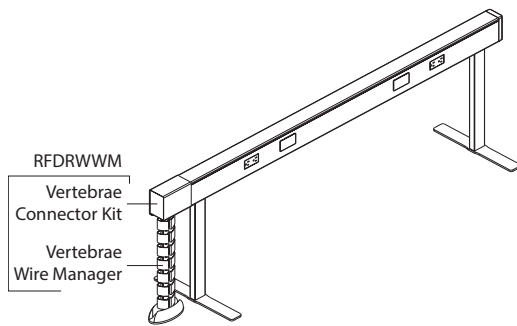

RFDRWWM  
Connected to 60" W Rail

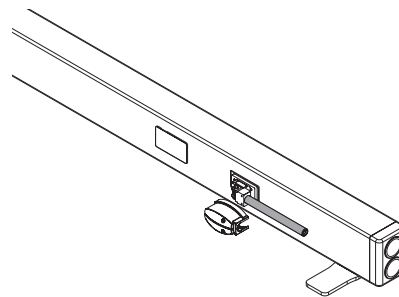

A876072 Infeed  
Connected to 60" W Rail through End Cap

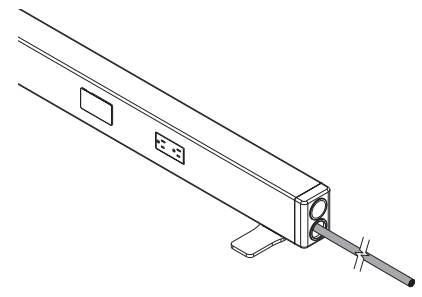

A877012 Infeed  
Connected to 60" W Rail through End Cap

**Electrical Systems**

**General Notes about Electric, Circuitry, and Chicago Code:**

- Power Rail offers a choice of four electrical systems:
  - Four-circuit, 3 + 1
  - Four-circuit, 2 + 2
  - Three-circuit, separate neutrals
  - Eight circuits; two four-circuit systems provided back to back.
- See pages 384-385 for a detailed explanation of each electrical system.
- All four systems utilize an 8-wire electrical system, rated at 20 amps per circuit (15 amps Canadian) — 16 amps plannable in U.S.
- Power Rail and electrical components are UL Listed. Electrical components are also CSA certified.
- Installation and use of the electrical system, the number of receptacles used on a given circuit and connections to the building power supply should be in compliance with all local and national electrical codes.

**Caution: Electrical equipment cords or extension cords MUST NOT BE ROUTED through cable openings in frame sides.**

**Note: No more than one conduit that is connected to a harness mounted to horizontal can be routed through the same cut out in the same horizontal at beltline. Attempting to use more will cause binding of conduit and may affect reveals on receptacles.**

**Hardwire New York Code (page 397)**

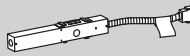
- Hardwire (New York Code) junction box (model A871400) is used when local electrical codes require hardwire entry. 
- For use in panels 48" W to 72" W.
- Unit must connect to a power harness.
- Customer to furnish all cabling and wiring from power entry to power source.
- Junction box can be positioned at any duplex receptacle location.
- For NY infeed through the end cap:
  - Order 24" pass-thru harness with power block A871124.
  - Will not have power at first cut-out from infeed.
- For NY infeed through a power rail cut-out:
  - Order 48"-72" pass-thru harness with power block. *Harness width must match power rail width.*
  - Will not have power at cut-out location used for infeed.
- For any power rail not used for infeed, order standard electrical power harness.

**Hardwire Chicago Code (page 398)**

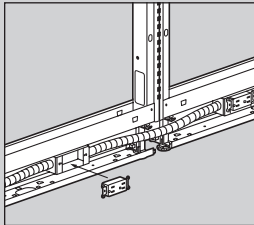
- Wiring harnesses and snap connectors are not allowed in Chicago — base pathways must be comprised of all-metallic components.
- The base pathway, junction box (model 873600) clips directly into receptacle locations and can be used both single- and double-sided.
- Customer must furnish conduit, wiring, and designer-type receptacles for the base pathway and conduit, wiring, designer-type receptacles, and receptacle covers for the beltline.
- Power entry can be routed from the floor into a junction box (model 873600). 

**Electrical Infeeds**

- Power infeed cables deliver power from building to panel's electrical system.
- Infeed cables are housed in conduit to separate electrical system from communications and data lines.
- Select quantity of base or ceiling infeed cables depending on individual power requirements.

**Base Infeed (page 397)**

- Sealtight base pathway power infeed mounts into any receptacle position in the base pathway area.
- A heavy rubber sheathing shields conduit, allowing infeed to be exposed.
- A jumper is required to connect base pathway power to beltline.

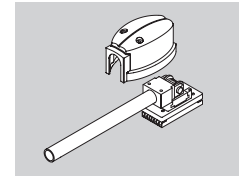

**Sealtight Electrical Infeed (page 397)**

- Sealtight electrical infeed cable is used with footed panels.
- Should not be ordered prior to installation to have pre-wired as infeed must be routed from inside of panel out to be connected to power.
- Cannot be connected to power harness in panel frame that infeed is brought into unless additional pass-thru harness without power block is used to feed from below beltline to above beltline.

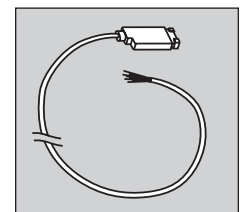

**Power Infeed (page 397)**

- Power infeed connects to a prewired electrical harness in the power rail.
- Most codes allow flex conduit to be exposed after installation. Verify code requirements before ordering for exposed application.

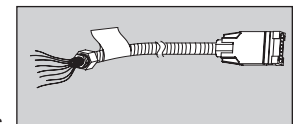

**To Order:**

- Determine which electrical system you will use after consulting your electrician and computer support personnel:
  - The Four-circuit system (4-Hot/2-Neutral/2-Ground)
    - 3 + 1 option
    - 2 + 2 option
  - The three-circuit system (3-Hot/3-Neutral/2-Ground)
  - The eight-circuit system (back-to-back four-circuit systems)
- Determine location, quantity, and circuit of duplexes.
- Determine the appropriate choice and use of isolated, isolated/dedicated, and separate neutrals circuits.
- Specify appropriate power harnesses\* and pass-thru cables.\*
- Determine the location, quantity, and type of power infeed needed.

\* Select power harness models (A8712XX), with the last two digits corresponding with the panel width into which the component is to be positioned.  
The initial cable length can be stretched approximately 3" to transverse "T", "X", "L", and extended straight connectors.

**Flexconnect™ Electrical System Options**

The four-circuit, eight-wire electrical system is widely specified and trusted by hundreds of thousands of end-users. This proven system delivers four circuits for every power infeed in either a 3 + 1 or 2 + 2 configuration. The isolated/dedicated circuits are ideal for sensitive computing equipment, while the common circuits are suitable for faxes, copiers, task lights and other peripherals. Both the 3 + 1 and 2 + 2 systems use the same pre-wired components, making it easy to adjust as electrical needs change.

You can also choose a three-circuit, eight-wire system that has a dedicated neutral for every hot circuit. The three-circuit components have model numbers with an "A" suffix and appear in a gray box in this price.

All three systems utilize an eight-wire electrical system rated at 20 amps per circuit (15 amps Canadian). Concensys panels and electrical components are UL listed and CSA certified.

**Four-circuit, 3 + 1 Receptacle Option**

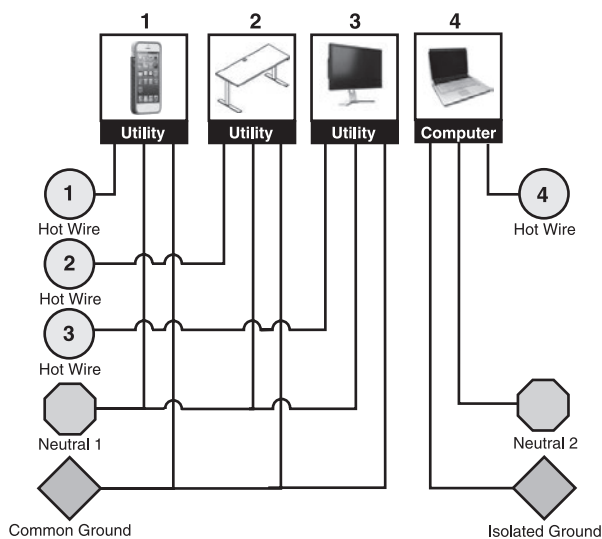

The 3 + 1 option is the electrical standard used on Allsteel systems for many years in most installations. This wiring option provides three utility circuits plus an isolated/dedicated circuit for more sensitive equipment. Circuit 2 (one of the 3 common circuits sharing a neutral wire) cannot be used with single-phase building electrical supply.

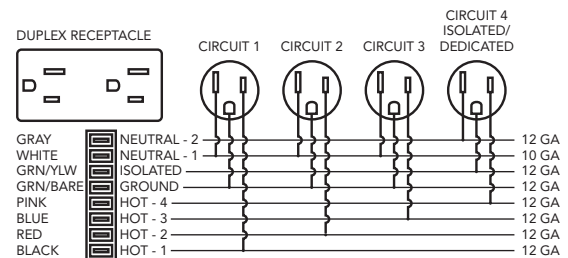

**Four-circuit, 2 + 2 Receptacle Option**

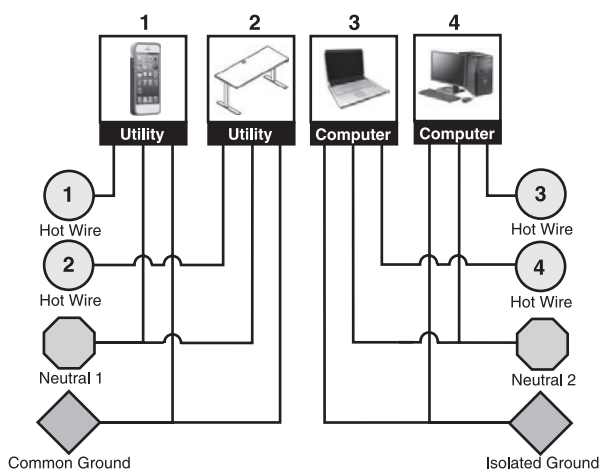

The 2 + 2 option is a wiring option that provides two utility circuits and two isolated circuits for more extensive computer usage applications.

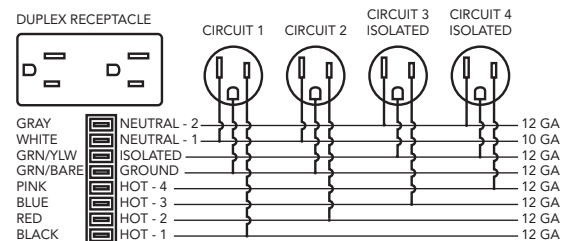

ALTITUDE

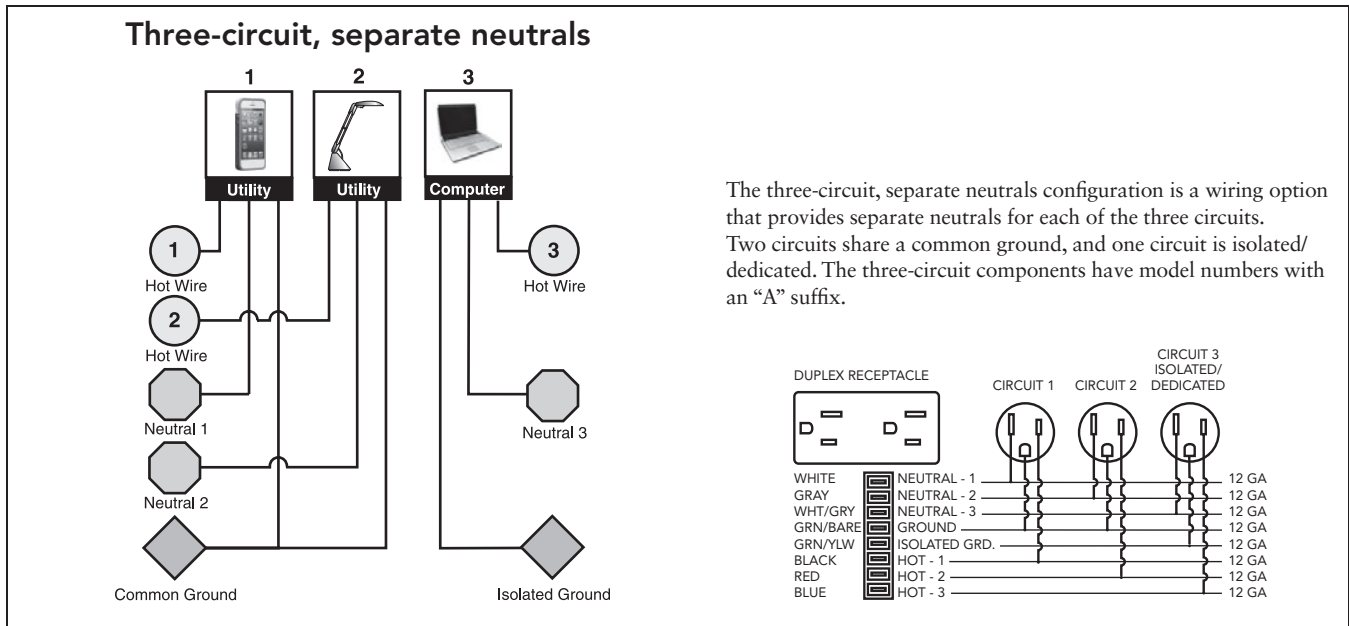

Altitude System Receptacle Usage					
Two 8-wire, 20 amp (15 amp Canadian) electrical systems are offered					
Electrical System	Circuitry	Receptacle Capacity			
Four-circuit 4-Hot/2-Neutral/2-Ground	3 + 1	Common Circuit-1 A873501	Common Circuit-2 <sup>(1)</sup> A873502	Common Circuit-3 A873503	Iso/Dedicated Circuit-4 A873504
	2 + 2	Common Circuit-1 A873501	Common Circuit-2 A873502	Isolated Circuit-3 A873506	Isolated Circuit-4 A873504
Three-circuit 3-Hot/3-Neutral/2-Ground	w/separate neutrals	Common Circuit-1 A871501A	Common Circuit-2 A871502A	Iso/Dedicated Circuit-3 A871503A	N/A

(1) Circuit 2 (one of the 3 common circuits sharing a neutral wire) cannot be used with a single-phase building electrical supply.

**Notes:**

- Four-circuit components and three-circuit components (with suffix "A") cannot be used together.
- Components of the two systems are keyed differently to prevent components of one system being connected to components of another system.
- Allsteel model numbers are printed on the UL labels, and components are color-coded to provide visual identification of the different components.
- Four-circuit components have black plastic parts.
- Three-circuit components have rust-colored terminal ends and receptacle backs are rust-colored.

**Duplex Receptacle**



15 amp receptacle



### Infeeds

- Power infeed cables deliver power from building to Power Rail's electrical system.
- Infeed cables are housed in conduit to separate electrical system from communications and data lines.
- Select quantity of infeed cables depending on individual power requirements.

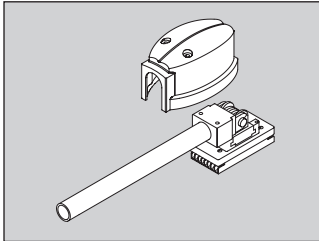

### Base Infeed:

- Sealtight base pathway power infeed mounts into any receptacle position in the power rail housing.
- A heavy rubber sheathing shields conduit, allowing infeed to be exposed.

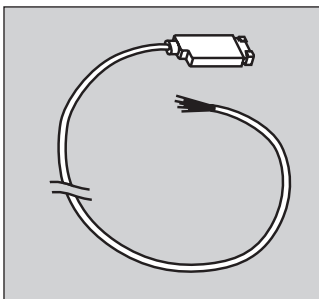

### Sealtight Electrical Infeed:

- Sealtight electrical infeed is used for power entering through the end cap.
- Should not be ordered prior to installation to have pre-wired as infeed must be routed from inside of the power rail out to be connected to power.

### Power Harness

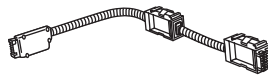

**Electrical power harnesses** are used to distribute power in the power rail. **Power blocks** on electrical power harness accept duplex receptacles.

- Electrical power harnesses are used to distribute power in Power Rails. Harnesses must be installed in each power rail housing.
- Specify harness length to match rail housing length. Each power harness accepts four duplex receptacles (two on each side of power rail housing).
- Connectors at both ends of power harnesses allow power distribution in either direction.
- Harness power blocks snap directly onto brackets in power rail housing.

### Power Blocks

- Power blocks snap directly onto brackets in the power rail and accept receptacles (sold separately) on each side of harness.

### Duplexes

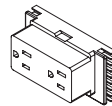

Duplex Receptacles

### Receptacle Color Recommended to Coordinate with Paint Color

Paint Color	Receptacle Color
Bungalow — P7C .....	Muslin — EU
Champagne Metallic — PR5 .....	Muslin — EU
Cinder — P7Q .....	Brownstone — EY
Fossil — P28 .....	Flint — E9
Gunmetal Metallic — PR3 .....	Brownstone — EY
Parchment — P93 .....	Muslin — EU
Pebble — P8R .....	Loft — EV
Pewter — P8D .....	Flint — E9
Platinum — PR2 .....	Loft — EV
Platinum Metallic — P42 .....	Silver — E5
Salt — P8C .....	Silver — E5
Titanium — P8T .....	Silver — E5

- Duplex receptacles snap into power blocks of power harnesses.
- Duplexes are available in multiple colors. See inside front cover for finishes.
- Each receptacle is labeled to indicate which circuit it will be connected to: 1, 2, 3 or 4.
- Duplexes are model specific to support either 3 + 1 and 2 + 2 electrical infeed; or have an "A" suffix and are designed to support a three-circuit separate neutral electrical infeed.
- At least one duplex must be installed in upper housing side of rail housing assembly (see page 388, "Working with Electrical and Data").

### Data

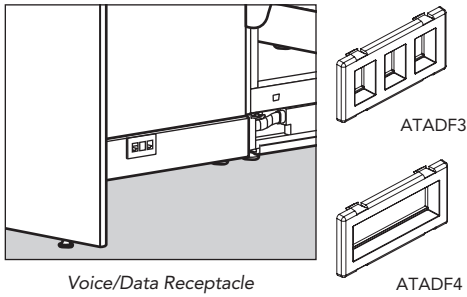

Voice/Data Receptacle

#### Data Faceplates:

- Fit into data port openings in Power Rail Housing.
- Due to rail housing depth, data modules should not be used back-to-back.

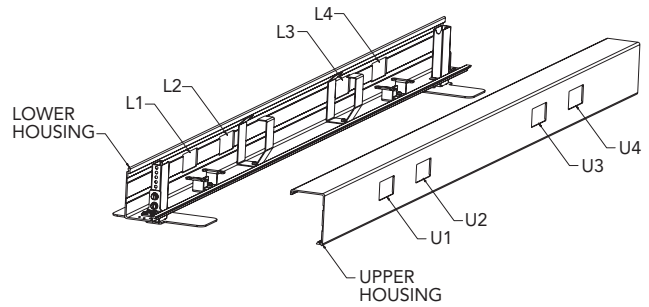

- Ports 1 and 4 accept duplexes, port covers and base infeeds.
- Ports 2 and 3 accept data and port covers.
- Either U1 or U4 must always contain a duplex.
- Data cannot be back-to-back (data in L2 + U2 or L3 + U3 combinations are not permitted).

### Port Cover

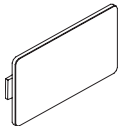

- Port covers must be used where no duplex or data faceplate is present.
- Fits into Power Rail port locations in place of duplex receptacles and data faceplates.
- Does not fit into port sizes of other product lines.

### Cable Capacity

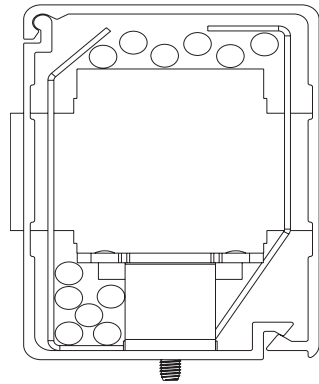

- The power rail housing allows continuous voice and data lines to run without interruption.
- Lay-in is provided for environments where systems furniture or cabling are subject to frequent change.
- Lower cavity allows 6 voice/data cables (1/4" dia).
- Upper cavity lay-in allows 6 voice/data cables (1/4" dia).

### Power Rail Receptacle Locations

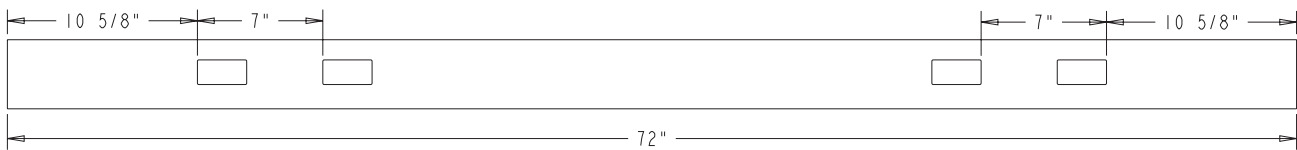
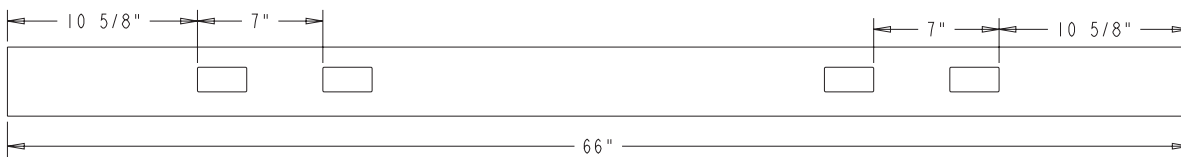
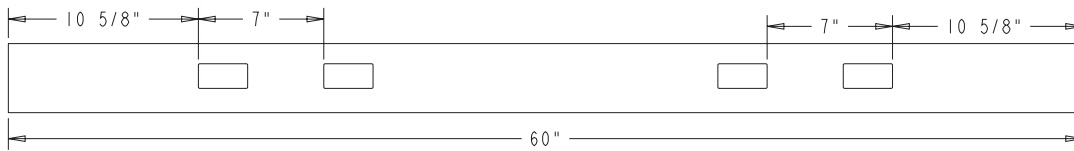
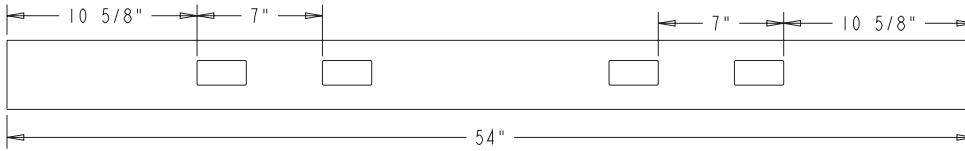
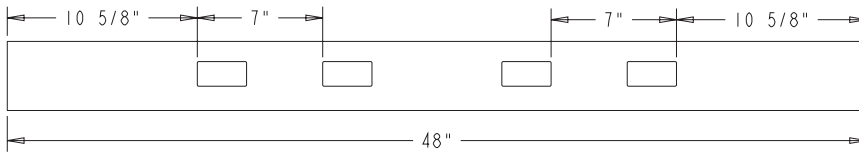

- For example, in a four-circuit system:
  - Circuit 1 — calculators, fans, etc.
  - Circuit 2 — task lights (could be wired to wall switch)
  - Circuit 3 — CRT or flat screen monitors
  - Circuit 4 — CPUs
- Use circuit 4 for power-sensitive electronic equipment.

**Placement of pedestals and lateral files** may render some duplex locations inaccessible. Pedestal placement may also affect compatibility with pull-up receptacles.

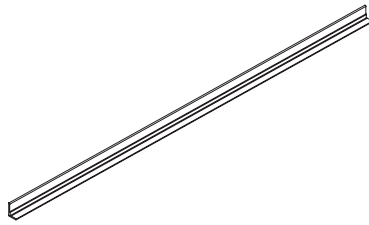

### Rail Accessories

Side View



Top View

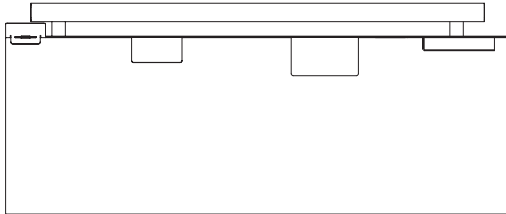

Phone/  
Tablet  
Stand

Pencil  
Holder

Rail  
Mounted  
Shelf

Vertical  
Paper Tray

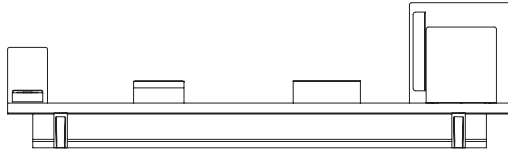

Front View

### Worksurface Mounted Rail (page 406)

- Aluminum extrusion designed to mount to flat edge worksurfaces. Comes with rail and hardware for mounting.
- Mounted rail extends  $\frac{3}{4}$ " on underside of worksurface which may interfere with the mounting of storage and screens.
- Widths available for Altitude tables 12" through 66" in 6" increments. Can pass across seams of ganged worksurfaces in tethered applications.
- Passes behind worksurface bracket on tethered applications.
- For freestanding applications rail should be 6" shorter than worksurface (i.e. 54" rail for 60" worksurface).

### Rail Mounted Accessories

Not recommended for use on panel systems with attached worksurfaces due to fit up issues created with worksurface and panel. Adding accessory rail shifts worksurface —  $\frac{3}{8}$ " away from panel along that edge. Forcing worksurface into place crushes fabric tile and with tiles of other material (steel, marker board, etc) is likely to scratch, dent, or otherwise damage tile during installation.

### U9TM Phone/Tablet Stand (page 406)

- 6 $\frac{1}{2}$ "H x 4 $\frac{3}{4}$ "W and angles back 1 $\frac{1}{4}$ ".
- Has a  $\frac{1}{4}$ " x 1" slot in bottom flange to allow for routing cables. Requires 1 $\frac{1}{4}$ " space behind worksurface edge in order to be used.



### U9TP Pencil Holder (page 406)

- 2 $\frac{3}{8}$ "H x 6"W x 3"D.
- Holds approximately twenty #2 pencils.



### U9TS Rail Mounted Shelf (page 406)

- 8"W x 4 $\frac{1}{2}$ "D and sits 2 $\frac{3}{8}$ " higher than top of worksurface.
- Holds up to 8 pounds.

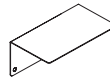

### U9TF Vertical Paper Tray (page 406)

- Sits 12"H x 1 $\frac{1}{2}$ "W x 12"D from back of worksurface.
- Folder front stands 9" high from worksurface top, 1 $\frac{1}{4}$ " space holds about 280 sheets of copy paper.

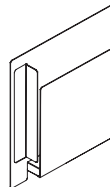

### U9WTC Cord Organizer (page 406)

- Can attach to both bottom of worksurface or slides into rail.
- 4"W x 7 $\frac{1}{8}$ "D, made from sheet metal.
- Top sits flush with worksurface if mounted to worksurface.
- 4 cable cut outs: 2 – .250" diameter and 2 – 0.147" diameter; .250" diameter cut outs are centered between the .147" diameter cut outs.



### Universal Hook (page 406)

- Mounts to underside of worksurface and provides storage for bags, coats and purses. Can be used as a horizontal wire manager.



For specification information see pages 369-370.

GSA SIN 33721

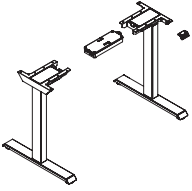
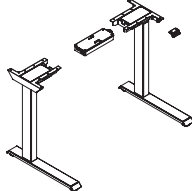
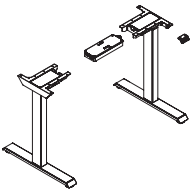
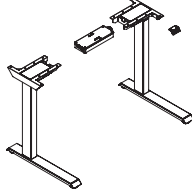
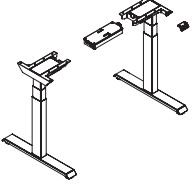
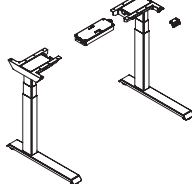
	Description	Model	List Price		
			P1	P2	P3
	<b>2-Stage</b>				
	2 Stage, 2 Leg Rectangle T Foot	A6REC2S2LTF	\$ 2088	\$ 2255	\$ 2506
	*Bases purchased in April 2021 or later accommodate 24"D-30"D Rectangular Worksurfaces 24"W-72"W, bases purchased prior to this date accommodate 24"D-30"D Rectangular Worksurfaces 48"W-72"W				
	2 Stage, 2 Leg Rectangle C Foot	A6REC2S2LCF	\$ 2088	\$ 2255	\$ 2506
	*Bases purchased in April 2021 or later accommodate 24"D-30"D Rectangular Worksurfaces 24"W-72"W, bases purchased prior to this date accommodate 24"D-30"D Rectangular Worksurfaces 48"W-72"W				
	<b>3-Stage</b>				
	A6 3 Stage, 2 Leg Rectangle T Foot	A6REC3S2LTF	\$ 2342	\$ 2530	\$ 2811
	*Bases purchased in April 2021 or later accommodate 24"D-30"D Rectangular Worksurfaces 24"W-72"W, bases purchased prior to this date accommodate 24"D-30"D Rectangular Worksurfaces 48"W-72"W				
	A6 3 Stage, 2 Leg Rectangle C Foot	A6REC3S2LCF	\$ 2342	\$ 2530	\$ 2811
	*Bases purchased in April 2021 or later accommodate 24"D-30"D Rectangular Worksurfaces 24"W-72"W, bases purchased prior to this date accommodate 24"D-30"D Rectangular Worksurfaces 48"W-72"W				
	A6 Max 3 Stage, 2 Leg T Foot	A6MREC3S2LTF	\$ 3251	\$ 3511	\$ 3902
	*Bases purchased in April 2021 or later accommodate 24"D-30"D Rectangular Worksurfaces 24"W-96"W, bases purchased prior to this date accommodate 24"D-30"D Rectangular Worksurfaces 48"W-96"W				
	*350 LB Max Lift Capacity				
	A6 Max 3 Stage, 2 Leg C Foot	A6MREC3S2LCF	\$ 3251	\$ 3511	\$ 3902
	*Bases purchased in April 2021 or later accommodate 24"D-30"D Rectangular Worksurfaces 24"W-96"W, bases purchased prior to this date accommodate 24"D-30"D Rectangular Worksurfaces 48"W-96"W				
	*350 LB Max Lift Capacity				

ALTITUDE

<p><b>How to specify —</b> Select the Model Number from above.</p>	<p><b>1st Option:</b> Select the Base Paint Color (if applicable):</p> <p><b>P1 P2 P3</b></p> <p>See page 366 for paint finishes.</p>	<p><b>2nd Option:</b> Select Feet Options (if applicable):</p> <p>X Standard Glides S Slide Glides (\$148 extra)</p>	<p><b>3rd Option:</b> Select the Keypad (if applicable):</p> <p>UD Basic Up/Down MEM Memory Preset PDL Paddle</p>
_____.	_____.	_____.	_____.

Example: A6RND3S2LCF.P8L.X.PDL

For specification information see pages 369-370.

GSA SIN 33721

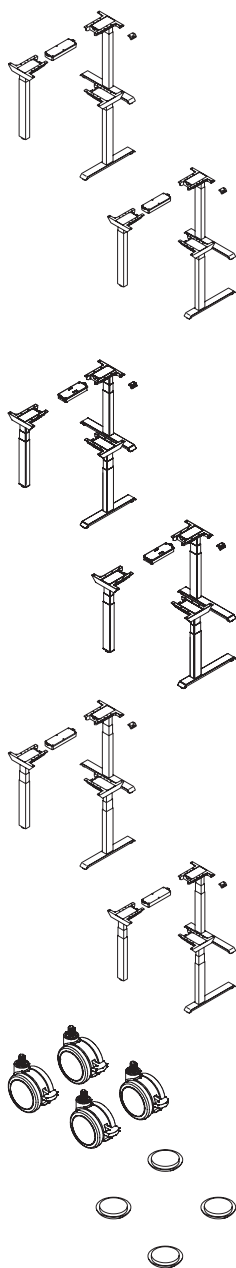

Description	Model	List Price		
		P1	P2	P3
<b>2-Stage</b>				
A6 2 Stage, 3 Leg Rectangle T Foot	A6REC2S3LTF	\$ 3378	\$ 3716	\$ 4223
A6 2 Stage, 3 Leg Rectangle C Foot	A6REC2S3LCF	\$ 3378	\$ 3716	\$ 4223
<b>3-Stage</b>				
A6 3 Stage, 3 Leg Rectangle T Foot	A6REC3S3LTF	\$ 3681	\$ 3976	\$ 4418
*3-leg standard bases can accommodate worksurface configurations from 24"D x 48"W x 36"W to 30"D x 72"W x 48"W.				
A6 3 Stage, 3 Leg Rectangle C Foot	A6REC3S3LCF	\$ 3681	\$ 3976	\$ 4418
*3-leg standard bases can accommodate worksurface configurations from 24"D x 48"W x 36"W to 30"D x 72"W x 48"W.				
A6 Max 3 Stage, 3 Leg Rectangle T Foot	A6MREC3S3LTF	\$ 4250	\$ 4676	\$ 5313
*3-Leg Max bases can accommodate worksurface configurations from 24"D x 48"W x 36"W to 30"D x 72"W x 72"W. *500 lb Max Lift Capacity				
A6 Max 3 Stage, 3 Leg Rectangle C Foot	A6MREC3S3LCF	\$ 4250	\$ 4676	\$ 5313
*3-Leg Max bases can accommodate worksurface configurations from 24"D x 48"W x 36"W to 30"D x 72"W x 72"W. *500 lb Max Lift Capacity				
<b>Foot Retrofit Options</b>				
Casters (Use on 2-leg bases ONLY)	A6CASTER*	\$ 268	N/A	N/A
* A6 casters are intended for use with Allsteel A6 height-adjustable tables. When purchased separately and used without Allsteel furniture, the A6 casters marked by (*) are considered Open Market.				
Slide Glides (Use on 2-leg bases ONLY)	A6SLDGLIDE	\$ 195	N/A	N/A
G1 Glide (4-Pack)	A6G1GLIDE	\$ 210	N/A	N/A
*Glide enables 3-stage base to reach G1 requirement heights.				
<b>Bluetooth Control</b>				
A6 Bluetooth Accessory	A6BLUETOOTH	\$ 137	N/A	N/A
* Bluetooth control will only work with 2-leg A6 tables. Bluetooth control will not work with 3-leg A6 tables.				

<p><b>How to specify —</b> Select the Model Number from above.</p>	<p><b>1st Option:</b> Select the Base Paint Color (if applicable): P1 P2 P3 See page 366 for paint finishes.</p>	<p><b>2nd Option:</b> Select Feet Options (if applicable): X Standard Glides</p>	<p><b>3rd Option:</b> Select the Keypad (if applicable): UD Basic Up/Down MEM Memory Preset PDL Paddle</p>
--	--	--	--

Example: A6RND3S3LCF.P8L.X.PDL

For specification information see page 370.

GSA SIN 33721

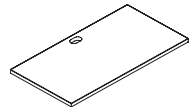

Description	Laminate w/Flat Edge Model	Veneer w/Square Edge Model	Ship Weight	List Price			List Price		
				L1	L2	L3	V1	V3	V5
<b>Rectangular Laminate Tops — 24"D (60" to 96" ships with stiffener)</b>									
78"W – 96"W Tops can ONLY be used with Altitude MAX Base									
48"W	AF5RS4824	AVF5RS4824	46	\$ 607	\$ 631	\$ 650	\$ 2024	\$ 2244	\$ 2390
54"W	AF5RS5424	AVF5RS5424	48	\$ 659	\$ 685	\$ 705	\$ 2121	\$ 2351	\$ 2504
60"W	AF5RS6024D	AVF5RS6024D	53	\$ 820	\$ 847	\$ 868	\$ 2346	\$ 2587	\$ 2748
66"W	AF5RS6624D	AVF5RS6624D	74	\$ 850	\$ 878	\$ 900	\$ 2352	\$ 2594	\$ 2755
72"W	AF5RS7224D	AVF5RS7224D	82	\$ 874	\$ 902	\$ 924	\$ 2462	\$ 2713	\$ 2881
78"W	AF5RS7824D		76	\$ 905	\$ 922	\$ 938	—	—	—
84"W	AF5RS8424D		81	\$ 813	\$ 830	\$ 846	—	—	—
90"W	AF5RS9024D		86	\$ 947	\$ 964	\$ 980	—	—	—
96"W	AF5RS9624D		91	\$ 969	\$ 986	\$ 1002	—	—	—

**Rounded Corner Laminate Tops — 24"D (60" to 96" ships with stiffener)**

78"W – 96"W Tops can ONLY be used with Altitude MAX Base

48"W	AF5RND4824		46	\$ 699	\$ 716	\$ 732	—	—	—
54"W	AF5RND5424		48	\$ 758	\$ 775	\$ 791	—	—	—
60"W	AF5RND6024D		53	\$ 924	\$ 941	\$ 957	—	—	—
66"W	AF5RND6624D		78	\$ 973	\$ 990	\$ 1006	—	—	—
72"W	AF5RND7224D		85	\$ 1004	\$ 1021	\$ 1037	—	—	—
78"W	AF5RND7824D		76	\$ 1038	\$ 1055	\$ 1071	—	—	—
84"W	AF5RND8424D		81	\$ 950	\$ 967	\$ 983	—	—	—
90"W	AF5RND9024D		86	\$ 1088	\$ 1105	\$ 1121	—	—	—
96"W	AF5RND9624D		91	\$ 1112	\$ 1129	\$ 1145	—	—	—

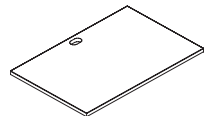

**Rectangular Laminate Tops — 30"D (60" to 96" ships with stiffener)**

78"W – 96"W Tops can ONLY be used with Altitude MAX Base

48"W	AF5RS4830	AVF5RS4830	52	\$ 683	\$ 709	\$ 730	\$ 2225	\$ 2466	\$ 2627
54"W	AF5RS5430	AVF5RS5430	59	\$ 774	\$ 802	\$ 827	\$ 2324	\$ 2576	\$ 2744
60"W	AF5RS6030D	AVF5RS6030D	63	\$ 917	\$ 947	\$ 970	\$ 2546	\$ 2809	\$ 2985
66"W	AF5RS6630D	AVF5RS6630D	78	\$ 972	\$ 1003	\$ 1028	\$ 2554	\$ 2818	\$ 2994
72"W	AF5RS7230D	AVF5RS7230D	87	\$ 997	\$ 1028	\$ 1054	\$ 2660	\$ 2933	\$ 3115
78"W	AF5RS7830D		92	\$ 1030	\$ 1047	\$ 1063	—	—	—
84"W	AF5RS8430D		98	\$ 943	\$ 960	\$ 976	—	—	—
90"W	AF5RS9030D		105	\$ 1081	\$ 1098	\$ 1114	—	—	—
96"W	AF5RS9630D		111	\$ 1108	\$ 1125	\$ 1141	—	—	—



**Rounded Corner Laminate Tops — 30"D (60" to 96" ships with stiffener)**

78"W – 96"W Tops can ONLY be used with Altitude MAX Base

48"W	AF5RND4830		52	\$ 784	\$ 801	\$ 817	—	—	—
54"W	AF5RND5430		59	\$ 889	\$ 906	\$ 922	—	—	—
60"W	AF5RND6030D		63	\$ 1039	\$ 1056	\$ 1072	—	—	—
66"W	AF5RND6630D		82	\$ 1096	\$ 1113	\$ 1129	—	—	—
72"W	AF5RND7230D		90	\$ 1146	\$ 1163	\$ 1179	—	—	—
78"W	AF5RND7830D		92	\$ 1182	\$ 1199	\$ 1215	—	—	—
84"W	AF5RND8430D		98	\$ 1102	\$ 1119	\$ 1135	—	—	—
90"W	AF5RND9030D		105	\$ 1243	\$ 1260	\$ 1276	—	—	—
96"W	AF5RND9630D		111	\$ 1274	\$ 1291	\$ 1307	—	—	—

**Note:** Height-adjustable worksurface dimensions are nominal. Actual widths are reduced by 2" (1" on each side, and worksurface depths are reduced by 3/4". Corner cove depth is nominal, actual is 1" less. This is to allow for pinch-points and unobstructed table movement.

How to specify — Select the Model Number from above.	1st Option: Laminate or Veneer Type and Finish (if applicable): See page 366 for finishes.	2nd Option: Paint (if applicable): See page 366 for finishes.	3rd Option: Laminate Edge Color (if applicable): See page 366 for finishes.	4th Option: Grommet Location (if applicable): GC Grommet Center GO No Grommet	5th Option: Grommet Type (if applicable): P Oval Plastic M Oval Metal S Square Metal (Add \$12 per grommet for metal.)	6th Option: Grommet Color (Metal only): EL Matte Silver Plastic grommet color determined by worksurface finish.
<input type="checkbox"/> <input type="checkbox"/> <input type="checkbox"/> <input type="checkbox"/> <input type="checkbox"/> <input type="checkbox"/> <input type="checkbox"/> <input type="checkbox"/> <input type="checkbox"/> <input type="checkbox"/> <input type="checkbox"/> <input type="checkbox"/> <input type="checkbox"/> <input type="checkbox"/> <input type="checkbox"/> <input type="checkbox"/> <input type="checkbox"/> <input type="checkbox"/> <input type="checkbox"/> <input type="checkbox"/>	<input type="checkbox"/> <input type="checkbox"/> <input type="checkbox"/> <input type="checkbox"/> <input type="checkbox"/> <input type="checkbox"/> <input type="checkbox"/> <input type="checkbox"/> <input type="checkbox"/> <input type="checkbox"/> <input type="checkbox"/> <input type="checkbox"/> <input type="checkbox"/> <input type="checkbox"/> <input type="checkbox"/> <input type="checkbox"/> <input type="checkbox"/> <input type="checkbox"/> <input type="checkbox"/> <input type="checkbox"/>	<input type="checkbox"/> <input type="checkbox"/> <input type="checkbox"/> <input type="checkbox"/> <input type="checkbox"/> <input type="checkbox"/> <input type="checkbox"/> <input type="checkbox"/> <input type="checkbox"/> <input type="checkbox"/> <input type="checkbox"/> <input type="checkbox"/> <input type="checkbox"/> <input type="checkbox"/> <input type="checkbox"/> <input type="checkbox"/> <input type="checkbox"/> <input type="checkbox"/> <input type="checkbox"/> <input type="checkbox"/>	<input type="checkbox"/> <input type="checkbox"/> <input type="checkbox"/> <input type="checkbox"/> <input type="checkbox"/> <input type="checkbox"/> <input type="checkbox"/> <input type="checkbox"/> <input type="checkbox"/> <input type="checkbox"/> <input type="checkbox"/> <input type="checkbox"/> <input type="checkbox"/> <input type="checkbox"/> <input type="checkbox"/> <input type="checkbox"/> <input type="checkbox"/> <input type="checkbox"/> <input type="checkbox"/> <input type="checkbox"/>	<input type="checkbox"/> <input type="checkbox"/> <input type="checkbox"/> <input type="checkbox"/> <input type="checkbox"/> <input type="checkbox"/> <input type="checkbox"/> <input type="checkbox"/> <input type="checkbox"/> <input type="checkbox"/> <input type="checkbox"/> <input type="checkbox"/> <input type="checkbox"/> <input type="checkbox"/> <input type="checkbox"/> <input type="checkbox"/> <input type="checkbox"/> <input type="checkbox"/> <input type="checkbox"/> <input type="checkbox"/>	<input type="checkbox"/> <input type="checkbox"/> <input type="checkbox"/> <input type="checkbox"/> <input type="checkbox"/> <input type="checkbox"/> <input type="checkbox"/> <input type="checkbox"/> <input type="checkbox"/> <input type="checkbox"/> <input type="checkbox"/> <input type="checkbox"/> <input type="checkbox"/> <input type="checkbox"/> <input type="checkbox"/> <input type="checkbox"/> <input type="checkbox"/> <input type="checkbox"/> <input type="checkbox"/> <input type="checkbox"/>	<input type="checkbox"/> <input type="checkbox"/> <input type="checkbox"/> <input type="checkbox"/> <input type="checkbox"/> <input type="checkbox"/> <input type="checkbox"/> <input type="checkbox"/> <input type="checkbox"/> <input type="checkbox"/> <input type="checkbox"/> <input type="checkbox"/> <input type="checkbox"/> <input type="checkbox"/> <input type="checkbox"/> <input type="checkbox"/> <input type="checkbox"/> <input type="checkbox"/> <input type="checkbox"/> <input type="checkbox"/>

Examples: AF5RS4824.LM14EW.GO AVF5RS4824.SC777.GC.SEL

For specification information see page 370.

GSA SIN PENDING

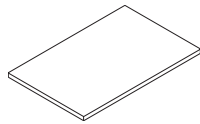

Description	Laminate w/Flat Edge Model	Ship Weight	List Price		
			L1	L2	L3
<b>Undersized Rectangular Worksurface - 24"D (60" to 96" ships with stiffener)</b>					
<b>78"W - 96"W Tops can ONLY be used with Altitude MAX base.</b>					
36"W	AF5RS3624U	23	\$ 496	\$ 520	\$ 543
42"W	AF5RS4224U	27	\$ 541	\$ 568	\$ 593
48"W	AF5RS4824U	31	\$ 607	\$ 637	\$ 665
54"W	AF5RS5424U	35	\$ 659	\$ 691	\$ 722
60"W	AF5RS6024UD	49	\$ 869	\$ 909	\$ 947
66"W	AF5RS6624UD	53	\$ 908	\$ 949	\$ 989
72"W	AF5RS7224UD	57	\$ 937	\$ 979	\$ 1020
78"W	AF5RS7824UD	62	\$ 978	\$ 1021	\$ 1064
84"W	AF5RS8424UD	66	\$ 890	\$ 929	\$ 967
90"W	AF5RS9024UD	70	\$ 1034	\$ 1079	\$ 1124
96"W	AF5RS9624UD	74	\$ 1066	\$ 1112	\$ 1158

**Undersized Rectangular Worksurface - 30"D (60" to 96" ships with stiffener)**

**78"W - 96"W Tops can ONLY be used with Altitude MAX base.**

36"W	AF5RS3630U	29	\$ 551	\$ 578	\$ 604
42"W	AF5RS4230U	35	\$ 586	\$ 615	\$ 642
48"W	AF5RS4830U	40	\$ 683	\$ 716	\$ 748
54"W	AF5RS5430U	45	\$ 774	\$ 812	\$ 848
60"W	AF5RS6030UD	60	\$ 967	\$ 1011	\$ 1054
66"W	AF5RS6630UD	65	\$ 1030	\$ 1076	\$ 1122
72"W	AF5RS7230UD	70	\$ 1062	\$ 1109	\$ 1156
78"W	AF5RS7830UD	76	\$ 1103	\$ 1153	\$ 1201
84"W	AF5RS8430UD	81	\$ 1020	\$ 1065	\$ 1110
90"W	AF5RS9030UD	86	\$ 1169	\$ 1221	\$ 1272
96"W	AF5RS9630UD	91	\$ 1204	\$ 1257	\$ 1309

**120 Degree Corner Worksurface - 24"D**

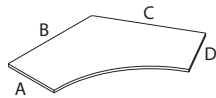

24" A x 42" B x 42" C x 24" D	AF5120S4224D	59	\$ 1041	\$ 1088	\$ 1135
24" A x 48" B x 48" C x 24" D	AF5120S4824D	69	\$ 1150	\$ 1202	\$ 1253
24" A x 54" B x 54" C x 24" D	AF5120S5424D	79	\$ 1358	\$ 1420	\$ 1479

**120 Degree Corner Worksurface - 30"D**

30" A x 42" B x 42" C x 30" D	AF5120S4230D	68	\$ 1041	\$ 1088	\$ 1135
30" A x 48" B x 48" C x 30" D	AF5120S4830D	79	\$ 1464	\$ 1531	\$ 1596
30" A x 54" B x 54" C x 30" D	AF5120S5430D	92	\$ 1672	\$ 1748	\$ 1823

**Symmetrical Corner Cove Worksurface — 24"D**

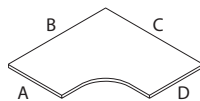

24" A x 54" B x 54" C x 24" D	AF5CCS5424	56	\$ 1155	\$ 1210	\$ 1264
-------------------------------	------------	----	---------	---------	---------

**Symmetrical Corner Cove Worksurface — 30"D**

30" A x 54" B x 54" C x 30" D	AF5CCS5430	66	\$ 1262	\$ 1322	\$ 1381
-------------------------------	------------	----	---------	---------	---------

How to specify — Select the Model Number from above.	1st Option: FSC Certified Wood:	2nd Option: Laminate:	3rd Option: Laminate Edge Color:	4th Option: Grommet Location (if applicable):	5th Option: Grommet Type (if applicable):	6th Option: Grommet Color (Metal only):
FSC FSC Mixed Credit X Standard Wood	See page 366 for finishes.	See page 366 for finishes.	GC Grommet Center GO No Grommet	P Oval Plastic M Oval Metal S Square Metal  (Add \$12 per grommet for metal.)	EL Matte Silver  Plastic grommet color determined by worksurface finish.	
_____ _____	_____	_____	_____	_____	_____	

Example:



For specification information see page 370.

GSA SIN 33721

Description	Laminate w/Flat Edge Model	Ship Weight	List Price		
			L1	L2	L3
<b>Corner Cove Laminate Tops — 24"D Extended Left</b>					
24" A x 60" B x 36" C x 24" D	A5822ELS	54	\$ 1017	\$ 1051	\$ 1084
24" A x 60" B x 48" C x 24" D	A5622ELS	75	\$ 1114	\$ 1152	\$ 1188
24" A x 72" B x 36" C x 24" D	A5922ELS	63	\$ 1134	\$ 1172	\$ 1208
24" A x 72" B x 48" C x 24" D	A5722ELS	86	\$ 1418	\$ 1465	\$ 1510
<b>Corner Cove Laminate Tops — 24"D Extended Right</b>					
24" A x 60" B x 36" C x 24" D	A5822ERS	54	\$ 1017	\$ 1051	\$ 1084
24" A x 60" B x 48" C x 24" D	A5622ERS	75	\$ 1114	\$ 1152	\$ 1188
24" A x 72" B x 36" C x 24" D	A5922ERS	63	\$ 1134	\$ 1172	\$ 1208
24" A x 72" B x 48" C x 24" D	A5722ERS	86	\$ 1418	\$ 1465	\$ 1510
<b>Note:</b> Height-adjustable worksurface dimensions are nominal. Actual widths are reduced by 2" (1" on each side" and worksurface depths are reduced by 3/4". Corner cove depth is nominal, actual is 1" less. This is to allow for pinch-points and unobstructed table movement.					
<b>Undersized Corner Cove Worksurface, Left Hand — 24"D</b>					
24" A x 60" B x 36" C x 24" D	AF5CCS603624LD	58	\$ 1065	\$ 1113	\$ 1161
24" A x 60" B x 48" C x 24" D	AF5CCS604824LD	67	\$ 1163	\$ 1216	\$ 1268
24" A x 72" B x 36" C x 24" D	AF5CCS723624LD	66	\$ 1199	\$ 1253	\$ 1306
24" A x 72" B x 48" C x 24" D	AF5CCS724824LD	75	\$ 1482	\$ 1549	\$ 1615
<b>Undersized Corner Cove Worksurface, Right Hand — 24"D</b>					
24" A x 60" B x 36" C x 24" D	AF5CCS603624RD	58	\$ 1065	\$ 1113	\$ 1161
24" A x 60" B x 48" C x 24" D	AF5CCS604824RD	67	\$ 1163	\$ 1216	\$ 1268
24" A x 72" B x 36" C x 24" D	AF5CCS723624RD	66	\$ 1199	\$ 1253	\$ 1306
24" A x 72" B x 48" C x 24" D	AF5CCS724824RD	75	\$ 1482	\$ 1549	\$ 1615
<b>Undersized Corner Cove Worksurface, Left Hand — 30"D</b>					
30" A x 60" B x 48" C x 30" D	AF5CCS604830LD	77	\$ 1244	\$ 1301	\$ 1357
30" A x 72" B x 48" C x 30" D	AF5CCS724830LD	88	\$ 1569	\$ 1640	\$ 1711
<b>Undersized Corner Cove Worksurface, Right Hand — 30"D</b>					
30" A x 60" B x 48" C x 30" D	AF5CCS604830RD	77	\$ 1244	\$ 1301	\$ 1357
30" A x 72" B x 48" C x 30" D	AF5CCS724830RD	88	\$ 1569	\$ 1640	\$ 1711

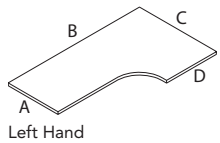
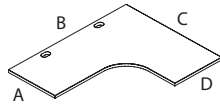
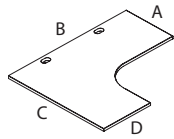

Left Hand

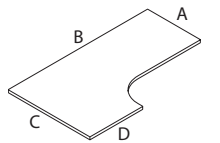

Right Hand

<p><b>How to specify —</b> Select the Model Number from above.</p>	<p><b>1st Option:</b> Laminate or Veneer Type and Finish (if applicable): See page 366 for finishes.</p>	<p><b>2nd Option:</b> Paint (if applicable): See page 366 for finishes.</p>	<p><b>3rd Option:</b> Laminate Edge Color (if applicable): See page 366 for finishes.</p>	<p><b>4th Option:</b> Grommet Location and Type: GC Center P Oval Plastic M Oval Metal GB Grommet LH/RH P Oval Plastic M Oval Metal S Square Metal GO No Grommet</p>
<p>Examples:</p>				

For specification information see page 373.

GSA SIN 33721

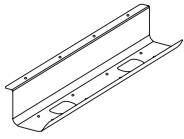

Description	Model	List Price
<b>Cable Management Tray</b>		
24" Tray	AJTRGH24 <input type="checkbox"/>	\$ 123
36" Tray	AJTRGH36 <input type="checkbox"/>	\$ 147

**Note:** Black only.

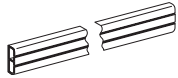

<b>Wire Management Channel (Black only)</b>		
92" Long	AEV920 <input type="checkbox"/>	\$ 208

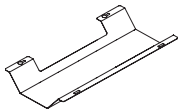

<b>Under Worksurface Trough (Black only)</b>		
17"W — Single Pack	Z617UWTRGH	\$ 104
17"W — Ten Pack	Z61710UWTRGH	\$ 1053
36"W — Single Pack	Z636UWTRGH	\$ 183
36"W — Ten Pack	Z63610UWTRGH	\$ 1785

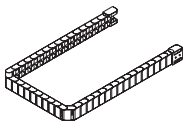

<b>Cord Management Chain (Black Only)</b>		
58"	WKSWMC	\$ 415

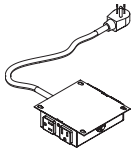

<b>Power/Data Modules — Under Worksurface Mount</b>		
4 Power Quad Tap	UNQTMP	\$ 442

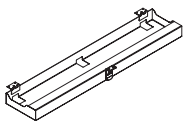

Description	Model	Ship Weight	Cubes	List Price		
				P1	P2	P3
<b>Hinged Wire Management Troughs for under Worksurfaces (Black only)</b>						
24"W	UN924HT			\$ 338	\$ 357	\$ 385
36"W	UN936HT			\$ 354	\$ 374	\$ 404
48"W	UN948HT			\$ 373	\$ 394	\$ 426

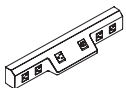

<b>Concealed Power Module</b>						
Corded	FDPWRC	5	0.3	\$ 743	N/A	N/A
Corded Chicago Code	CFDPWRC	6	0.3	\$ 1267	N/A	N/A
Spiral Cord	FDPWRSC	5	0.3	\$ 782	N/A	N/A
Spiral Cord Chicago Code	CFDPWRSC	6	0.3	\$ 1299	N/A	N/A

<p><b>How to specify —</b> Select the Model Number from above.</p>	<p><b>2nd Option:</b> <b>Paint</b> (if applicable): See page 366 for finishes.</p>
--	--

Examples: Z617UWTRGH AJTRGH24.P27 AEV920

Shippable by small-package carrier.

For specification information see page 386.

GSA SIN 33721

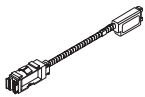
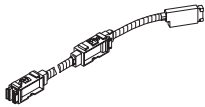

Description	Max. Recept. Cap. per Panel Side	Four-circuit 3 + 1 2 + 2	Three-circuit Separate Neutrals		List Price
<b>Electrical Power Harnesses</b>					
For 48" W Frames	2	A871248*	A871248A	<input type="checkbox"/>	\$ 403
For 54" W Frames	2	A871254*	A871254A	<input type="checkbox"/>	\$ 401
For 60" W Frames	2	A871260*	A871260A	<input type="checkbox"/>	\$ 403
For 66" W Frames	2	A871266*	A871266A	<input type="checkbox"/>	\$ 401
For 72" W Frames	2	A871272*	A871272A	<input type="checkbox"/>	\$ 404

**Note:** Four-circuit components and Three-circuit components (with an "A" suffix) cannot be connected together.

**Electrical Pass-Thru Harnesses with Power Block**

For 24" W Frames**	1	A871124	A871124A	<input type="checkbox"/>	\$ 232
For 48" W Frames†	1	A871148*	A871148A	<input type="checkbox"/>	\$ 247
For 60" W Frames†	1	A871160*	A871160A	<input type="checkbox"/>	\$ 247
For 72" W Frames†	1	A871172	A871172A	<input type="checkbox"/>	\$ 331

\*Electrical harnesses are intended for use with Allsteel systems furniture and are approved under GSA SIN 33721. When purchased separately and used without Allsteel systems furniture, those electrical harnesses marked by (\*) are considered Open Market.

\*\*Only used with NY Infeed through End Cap.

†48"-72" are only used with NY infeed through power rail cut-out.

<p><b>How to specify —</b> Select the Model Number from above.</p> <p>_____ .</p>	<p><i>1st Option:</i> <b>Color:</b> P Black</p>
---	---

Examples: A871248.P A871224.P A871224A.P A871124.P

Shippable by small-package carrier.

For specification information see page 386.

GSA SIN 33721

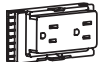

Duplex Receptacle

Description	Four-circuit 3 + 1 2 + 2	Three-circuit Separate Neutrals		List Price
<b>Duplex Receptacles for Beltline or Base Pathway — Altitude (specify color)</b>				
Circuit 1	A873501	A871501A	S	\$ 69
Circuit 2	A873502	A871502A	S	\$ 69
Circuit 3 (3+1)	A873503	A871503A	S	\$ 69
Circuit 3 (2+2)	A873506	N/A	S	\$ 69
Circuit 4 — iso/dedicated	A873504	N/A	S	\$ 69
Circuit 1, 20 AMP	A871601	A871601A	S	\$ 69

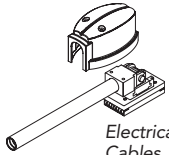

Electrical Infeed Cables

<b>Electrical Infeed Cables</b>				
6' Sealtight Cable for Terrace Receptacle	A876072	A8716072A	S	\$ 426
6' Flex Cable	A871972	A871972A	S	\$ 321

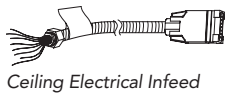

Ceiling Electrical Infeed

<b>Ceiling Electrical Infeed Cables</b>				
12' Flex Cable	A871912	A871912A	S	\$ 435
18' Flex Cable	A871918	A871918A	S	\$ 548

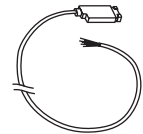

Electrical Infeed Cable

<b>Electrical Infeed Cables (for use with footed panels)</b>				
12' Sealtight Cable Power Infeed	A877012	N/A	S	\$ 531

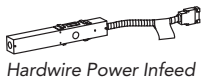

Hardwire Power Infeed

<b>Hardwire Power Infeed (New York Code)</b>				
For 48"-72" W rails	A871400	A871400A	S	\$ 418

**Note:** Four-circuit components and Three-circuit components (with an "A" suffix) cannot be connected together.

ALTITUDE

<p><b>How to specify —</b> Select the Model Number from above.</p> <p>_____ .</p>	<p><i>1st Option:</i> <b>Electrical Receptacle</b> <b>Color (if applicable):</b> See page 366 for finishes.</p> <p><b>E   S</b></p>
---	---

*Example:* A873501.E4

For specification information see page 386.

GSA SIN 33721



Description	Model	List Price
<b>Hardwire (Chicago Code)</b> (Black only)		
Altitude Base Pathway Junction Box (Pack of 6)	873600	\$ 1111

For specification information see page 387.

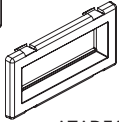
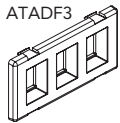

ATADF4

Description	Model	P1 Paint List Price
<b>Data Faceplates</b>		
Three-Port Flex-Mode Faceplate, Black (E4)	ATADF3	\$ 40
Four-Port Flex-Mode Faceplate, Black (E4)	ATADF4	\$ 40

**Notes:** ATADF3 can install up to 3 jacks (CAT 3, 5E, or 6). ATADF4 can install 4 jacks (CAT 3, 5E, or 6).

ATADF models are compatible with ports in Altitude tiles.

Allsteel's data faceplates are designed for use with the jacks listed below. We do not guarantee compatibility with other manufacturers' product.

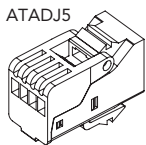

ATADJ5

<b>Jacks</b>		
RJ45 CAT 5E Jack — Black only Toolless	ATADJ5	\$ 71
RJ45 CAT 6 Jack — Black only Requires Tool	ATADJ6	\$ 95

**How to specify —**

Select the Model Number from above.



Example: 873600

**How to specify —**

Select the Model Number from above.

**1st Option:**

**Data Faceplate Color:**

E4 Black



Example: ATADF4.E4

Shippable by small-package carrier.

For specification information see page 374.

Open Market

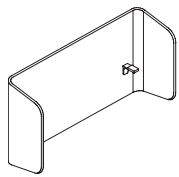

Description	Model	Old Model Numbers	Ship Weight	Cubes	List Price	
					A	D
<b>U Screen Kit</b>						
48"	FDSC48U	FDSCU48K	30.0	16.6	\$ 1972	\$ 2093
54"	FDSC54U	FDSCU54K	31.0	18.6	\$ 2040	\$ 2166
60"	FDSC60U (shown)	FDSCU60K	32.0	20.6	\$ 2100	\$ 2230
66"	FDSC66U	FDSCU66K	33.0	22.6	\$ 2223	\$ 2362
72"	FDSC72U	FDSCU72K	34.0	24.6	\$ 2391	\$ 2541

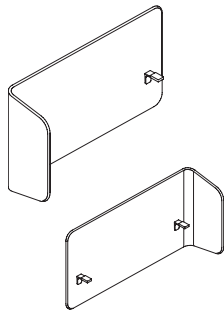

<b>L Screen Kit</b>						
Left Hand 48"	FDSC48LL	FDSC48LK	26.5	16.6	\$ 1283	\$ 1353
Right Hand 48"	FDSC48LR	FDSC48RK	26.5	16.6	\$ 1283	\$ 1353
Left Hand 54"	FDSC54LL	FDSC54LK	27.5	18.6	\$ 1503	\$ 1587
Right Hand 54"	FDSC54LR	FDSC54RK	27.5	18.6	\$ 1503	\$ 1587
Left Hand 60"	FDSC60LL (shown)	FDSC60LK	28.5	20.6	\$ 1571	\$ 1661
Right Hand 60"	FDSC60LR (shown)	FDSC60RK	28.5	20.6	\$ 1571	\$ 1661
Left Hand 66"	FDSC66LL	FDSC66LK	29.5	22.6	\$ 1871	\$ 1986
Right Hand 66"	FDSC66LR	FDSC66RK	29.5	22.6	\$ 1871	\$ 1986
Left Hand 72"	FDSC72LL	FDSC72LK	30.5	24.6	\$ 1970	\$ 2091
Right Hand 72"	FDSC72LR	FDSC72RK	30.5	24.6	\$ 1970	\$ 2091

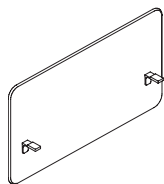

<b>Rectangular Screen Kit</b>						
48"	FDSC48R	FDSCR48K	23.0	3.7	\$ 1241	\$ 1309
54"	FDSC54R	FDSCR54K	24.0	4.1	\$ 1271	\$ 1341
60"	FDSC60R (shown)	FDSCR60K	25.0	4.6	\$ 1366	\$ 1442
66"	FDSC66R	FDSCR66K	26.0	5.0	\$ 1569	\$ 1663
72"	FDSC72R	FDSCR72K	27.0	5.6	\$ 1670	\$ 1771

Note: Installation brackets are now attached to the screen from the factory.

ALTITUDE

<p><b>How to specify —</b> Select the Model Number from above.</p>	<p><b>1st Option:</b> Select the Screen Fabric: See page 367 for selections and color codes.</p>	<p><b>2nd Option:</b> Select the Screen Bracket Paint: P1 P2 See page 366 for selections and color codes.* P2 (\$15 extra)</p>
--	--	--

Examples: FDSCU48K.PCAMBLT40.P71    FDSC48LK.PCAMBLT70.P71    FDSCR48K.PCAMBLT39.P71

For specification information see pages 375-376.

GSA SIN 33721

	Description	Model	P1 Paint List Price	P2 Paint Upcharge	P3 Paint Upcharge	
	<b>20"H Metal L-Screen</b>					
	48"W	AMS2048LH	\$ 833	\$ 865	\$ 897	
	54"W	AMS2054LH	\$ 906	\$ 940	\$ 975	
	60"W	AMS2060LH	\$ 1014	\$ 1053	\$ 1091	
	66"W	AMS2066LH	\$ 1109	\$ 1151	\$ 1193	
	72"W	AMS2072LH	\$ 1160	\$ 1204	\$ 1248	
	48"W	AMS2048RH (shown)	\$ 833	\$ 865	\$ 897	
	54"W	AMS2054RH	\$ 906	\$ 940	\$ 975	
	60"W	AMS2060RH	\$ 1014	\$ 1053	\$ 1091	
	66"W	AMS2066RH	\$ 1109	\$ 1151	\$ 1193	
72"W	AMS2072RH	\$ 1160	\$ 1204	\$ 1248		
	<b>30"H Metal L-Screen</b>					
	48"W	AMS3248LH	\$ 1081	\$ 1122	\$ 1163	
	54"W	AMS3254LH	\$ 1145	\$ 1189	\$ 1232	
	60"W	AMS3260LH	\$ 1196	\$ 1241	\$ 1287	
	66"W	AMS3266LH	\$ 1312	\$ 1362	\$ 1412	
	72"W	AMS3272LH	\$ 1363	\$ 1415	\$ 1466	
	48"W	AMS3248RH (shown)	\$ 1081	\$ 1122	\$ 1163	
	54"W	AMS3254RH	\$ 1145	\$ 1189	\$ 1232	
	60"W	AMS3260RH	\$ 1196	\$ 1241	\$ 1287	
	66"W	AMS3266RH	\$ 1312	\$ 1362	\$ 1412	
72"W	AMS3272RH	\$ 1363	\$ 1415	\$ 1466		
	<b>20"H Metal U-Screen</b>					
	48"W	AMS2048US (shown)	\$ 1086	\$ 1128	\$ 1168	
	54"W	AMS2054US	\$ 1145	\$ 1189	\$ 1232	
	60"W	AMS2060US	\$ 1196	\$ 1241	\$ 1287	
	66"W	AMS2066US	\$ 1312	\$ 1362	\$ 1412	
	72"W	AMS2072US	\$ 1377	\$ 1430	\$ 1481	
		<b>30"H Metal U-Screen</b>				
		48"W	AMS3248US (shown)	\$ 1304	\$ 1354	\$ 1403
		54"W	AMS3254US	\$ 1374	\$ 1426	\$ 1478
		60"W	AMS3260US	\$ 1435	\$ 1490	\$ 1543
66"W		AMS3266US	\$ 1574	\$ 1633	\$ 1693	
72"W		AMS3272US	\$ 1653	\$ 1716	\$ 1778	

<p><b>How to specify —</b> Select the Model Number from above.</p>	<p>1st Option: <b>Wing Type :</b> STD Standard EXT Extended</p>	<p>2nd Option: <b>Accessories Slots:</b> X No Accessory Cut Out SLT Accessory Cut Out</p>	<p>3rd Option: <b>Paint Option:</b> P1 P2 P3 See page 366 for finishes.</p>	<p>4th Option: <b>Paint Option:</b> NA Screen</p>
	<p>_____ . _____ . _____ . P ____ . NA</p>			



Examples: AMS2048LH.STD.SLT.PR6.NA    AMS2048SS.PR6.NA    Shippable by small-package carrier.

For specification information see pages 375-376.

GSA SIN 33721

Description	Model	P1 Paint List Price	P2 Paint Upcharge	P3 Paint Upcharge
<b>20"H Metal Rectangular Screen</b>				
48"W	AMS2048SS (shown)	\$ 710	\$ 738	\$ 764
54"W	AMS2054SS	\$ 746	\$ 775	\$ 803
60"W	AMS2060SS	\$ 796	\$ 827	\$ 856
66"W	AMS2066SS	\$ 906	\$ 940	\$ 975
72"W	AMS2072SS	\$ 978	\$ 1016	\$ 1053
<b>30"H Metal Rectangular Screen</b>				
48"W	AMS3248SS (shown)	\$ 870	\$ 903	\$ 936
54"W	AMS3254SS	\$ 906	\$ 940	\$ 975
60"W	AMS3260SS	\$ 964	\$ 1000	\$ 1038
66"W	AMS3266SS	\$ 1086	\$ 1128	\$ 1168
72"W	AMS3272SS	\$ 1145	\$ 1189	\$ 1232
<b>15"H Tackboard Accessories</b>				
20"W	AAS1520 <span style="border: 1px solid black; padding: 0 2px;">S</span>	\$ 309	\$ 321	\$ 332
48"W	AAS1548 <span style="border: 1px solid black; padding: 0 2px;">S</span> (shown)	\$ 367	\$ 382	\$ 395
54"W	AAS1554 <span style="border: 1px solid black; padding: 0 2px;">S</span>	\$ 406	\$ 422	\$ 437
60"W	AAS1560 <span style="border: 1px solid black; padding: 0 2px;">S</span>	\$ 423	\$ 440	\$ 455
66"W	AAS1566 <span style="border: 1px solid black; padding: 0 2px;">S</span>	\$ 617	\$ 640	\$ 664
72"W	AAS1572 <span style="border: 1px solid black; padding: 0 2px;">S</span>	\$ 675	\$ 701	\$ 727

<p><b>How to specify —</b> Select the Model Number from above.</p>	<p><b>1st Option:</b> <b>Wing Type :</b> STD Standard EXT Extended</p>	<p><b>2nd Option:</b> <b>Accessories Slots:</b> X No Accessory Cut Out SLT Accessory Cut Out</p>	<p><b>3rd Option:</b> <b>Paint Option:</b> <span style="border: 1px solid black; border-radius: 50%; padding: 2px;">P1</span> <span style="border: 1px solid black; border-radius: 50%; padding: 2px;">P2</span> <span style="border: 1px solid black; border-radius: 50%; padding: 2px;">P3</span> See page 366 for finishes.</p>	<p><b>4th Option:</b> <b>Paint Option:</b> NA Screen</p>	<p><b>5th Option:</b> <b>Accessories Color (if applicable):</b> DW Designer White E9 Flint</p>
<p>Examples: AAS1548.PR6.APN911 AFAMS2048LH.STD.SLT.PR6.NA AFAMS2048SS.PR6.NA</p>					

Work Tools	Description	Model	List Price
	<b>Hot File</b> (Designer White Only) 9½"H x 12¼"W x 3¾"D	AEHF	\$ 62
	<b>Side Saddle</b> (Designer White Only) 4"H x 12¼"W x 2½"D	AESS	\$ 51
	<b>Bag or Coat Hook</b> (Designer White Only) 3¼"H x 1½"W x 2¼"D	AECH	\$ 39

<p><b>How to specify —</b> Select the Model Number from above.</p>	<p><b>1st Option:</b> <b>Paint Option (if applicable):</b> <span style="border: 1px solid black; border-radius: 50%; padding: 2px;">P1</span> <span style="border: 1px solid black; border-radius: 50%; padding: 2px;">P2</span> <span style="border: 1px solid black; border-radius: 50%; padding: 2px;">P3</span> See page 366 for finishes.</p>	<p><b>2nd Option:</b> <b>Fabric Option (if applicable):</b> See page 367 for fabric options.</p>	<p><b>3rd Option:</b> <b>Paint Option:</b> NA Screen</p>	<p><b>4th Option:</b> <b>Accessories Color (if applicable):</b> DW Designer White E9 Flint</p>
<p>Example: AEHF.PJW</p>				

S Shippable by small-package carrier.



For specification information see pages 377-382.

GSA SIN 33721

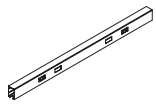

Description	Model	Ship Weight	Cubes	List Price		
				P1	P2	P3
<b>Power Rail</b>						
48"	RFDRW48	7	0.6	\$ 613	\$ 659	\$ 727
54"	RFDRW54	8	0.6	\$ 647	\$ 695	\$ 766
60"	RFDRW60 (shown)	9	0.7	\$ 745	\$ 799	\$ 881
66"	RFDRW66	10	0.8	\$ 795	\$ 853	\$ 938
72"	RFDRW72	11	0.9	\$ 897	\$ 962	\$ 1058

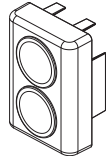

Power Rail End Cap	FDRWEC	1.5	0.1	\$ 228	\$ 245	\$ 269
--------------------	--------	-----	-----	--------	--------	--------

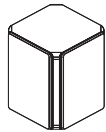

Power Rail Universal Connector	FDRWUC	3	0.1	\$ 415	\$ 444	\$ 487
--------------------------------	--------	---	-----	--------	--------	--------

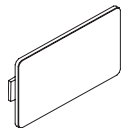

<b>Electrical Port Cover</b>						
2 Pack	FDEPC2	1	0.1	\$ 62	\$ 67	\$ 73
12 Pack	FDEPC12	2	0.1	\$ 213	\$ 229	\$ 251

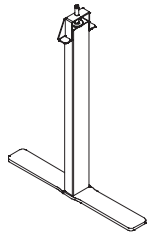

Elevated Power Rail Legs 20.5"H	RFDRWLEG	5	0.1	\$ 373	\$ 375	\$ 375
---------------------------------	----------	---	-----	--------	--------	--------

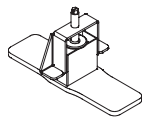

Floor Mount Legs	FDRWLEG	5	0.1	\$ 81	\$ 83	\$ 85
------------------	---------	---	-----	-------	-------	-------

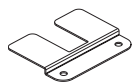

Altitude Power Rail Floor Anchor Bracket	RFDRWAB	2	0.1	\$ 53	\$ 70	\$ 77
--	---------	---	-----	-------	-------	-------

**How to specify —**

Select the Model Number from above.



**1st Option:**

**Paint:**



See page 366 for selections and color codes.\*



*Examples:*

For specification information see pages 377-382.

GSA SIN 33721

Description	Model	Ship Weight	Cubes	List Price		
				P1	P2	P3
<b>Hubs</b>						
End of Run Linear Configuration	RFDRWHUBEND	10	4	\$ 1065	\$ 1071	\$ 1077
End of Run T-Configuration	RFDRWHUBENDT	10	4	\$ 1065	\$ 1071	\$ 1077
Inline Linear Configuration	RFDRWHUBLIN	14	4	\$ 1065	\$ 1071	\$ 1077
Inline X-Configuration	RFDRWHUBX	14	4	\$ 1065	\$ 1071	\$ 1077
Inline T-Configuration	RFDRWHUBT	13	4	\$ 1065	\$ 1071	\$ 1077
L-Configuration Hub	RFDRWHUBL	13	4	\$ 1065	\$ 1071	\$ 1077

**How to specify —**

Select the Model Number from above.

**1st Option:**

**Paint:**

P1 P2 P3

See page 366 for selections and color codes.\*

\_\_\_\_\_ .

*Examples:*



For specification information see pages 377-382.

GSA SIN 33721

UN2HPSQ	Description	Model	Ship Weight	Cubes	List Price		
					P1	P2	P3
	<b>Power Pole</b>						
	8' H Square Power Pole	UN2HPSQ	17	1	\$ 1104	\$ 1121	\$ 1134
	Square Power Pole Splicer Kit	UN2HPSQSK	0.5	0.1	\$ 121	\$ 124	\$ 125
	Power Pole Connector	RFDRWCNPP	1	0.1	\$ 229	\$ 231	\$ 233
	Power Pole Connector - End Condition	RFDRWCNPPE	1	0.1	\$ 229	\$ 231	\$ 233
	Power Pole Connector - Mid Condition	RFDRWCNPPM	1	0.1	\$ 229	\$ 231	\$ 233

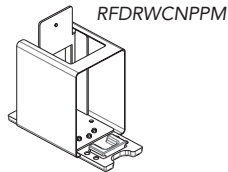
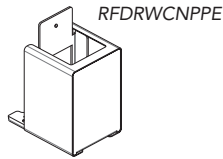
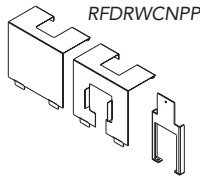
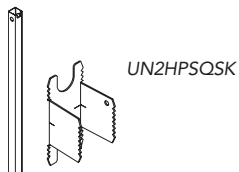

### Wire Management

Vertebrae Wire Manager	RFDRWWM	3	0.1	\$ 714	\$ 731	\$ 738
------------------------	---------	---	-----	--------	--------	--------

\*Includes connector for Power Rail attachment

\*Vertebrae available in black only, connector available in 32 standard paints.



Cord Management Snake (Black only) 58"	WKSWMC	2	0.3	\$ 415		
--	--------	---	-----	--------	--	--

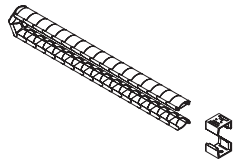

Cord Management Chain 36"	A9CLWMC	2	0.3	\$ 346		
---------------------------	---------	---	-----	--------	--	--

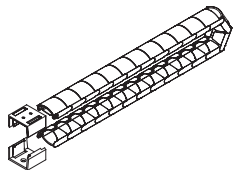

#### How to specify —

Select the Model Number from above.

#### 1st Option:

#### Paint:

**P1 P2 P3**

See page 366 for selections and color codes.\*

Examples:

For specification information see pages 377-382.

GSA SIN 33721

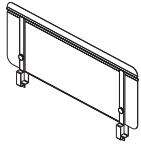

Description	Model	Ship Weight	Cubes	List Price		
				P1	P2	P3
<b>Allsteel Metal Screen</b>						
48"	RFDRWSC48	10	3.52	\$ 382	\$ 391	\$ 403
54"	RFDRWSC54	11	3.84	\$ 405	\$ 414	\$ 426
60"	RFDRWSC60	12	4.21	\$ 420	\$ 431	\$ 444
66"	RFDRWSC66	13	4.58	\$ 428	\$ 439	\$ 452
72"	RFDRWSC72	14	4.96	\$ 459	\$ 470	\$ 483

<p><b>How to specify —</b> Select the Model Number from above.</p> <p>_____ .</p>	<p><b>1st Option:</b> <b>Paint:</b>  <span style="border: 1px solid black; border-radius: 50%; padding: 2px;">P1</span> <span style="border: 1px solid black; border-radius: 50%; padding: 2px;">P2</span> <span style="border: 1px solid black; border-radius: 50%; padding: 2px;">P3</span>                      See page 366 for selections and color codes.*</p> <p>_____</p>
---	---

















*Examples:*

# Accessories

## Worksurface Mounted Rail and Accessories

For specification information see page 389.

GSA SIN 33721

Description	Model	List Price		
		P1	P2	P3
<b>Accessories Rail — Worksurface Mounted</b>				
12" W	U912WTR 	\$ 106	\$ 113	\$ 117
18" W	U918WTR 	\$ 113	\$ 120	\$ 124
24" W	U924WTR 	\$ 130	\$ 137	\$ 141
30" W	U930WTR 	\$ 145	\$ 155	\$ 162
36" W	U936WTR 	\$ 165	\$ 175	\$ 182
42" W	U942WTR 	\$ 178	\$ 188	\$ 195
48" W	U948WTR 	\$ 188	\$ 202	\$ 207
54" W	U954WTR 	\$ 196	\$ 211	\$ 215
60" W	U960WTR 	\$ 206	\$ 222	\$ 228
66" W	U966WTR 	\$ 247	\$ 263	\$ 269
<b>Rail Mounted Accessories</b>				
Phone/Tablet Stand — 6½"H x 4¼"W	U9TM 	\$ 160	\$ 172	\$ 182
Pencil Holder — 2½"H x 6"W x 3"D	U9TP 	\$ 106	\$ 107	\$ 114
Shelf — 8"W x 4½"D; 2½" above top of worksurface	U9TS 	\$ 109	\$ 121	\$ 131
Vertical Paper Tray — 12"H x 1⅞"W x 12"D	U9TF 	\$ 176	\$ 188	\$ 198
<b>Cord Organizer</b>				
4"W x ⅞"D Metal with 4 cable cutouts	U9WTC 	\$ 174	\$ 182	\$ 189
<b>Universal Hook (Black only)</b>				
Package of 2	AGSAUHK 	\$ 128	—	—

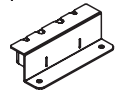
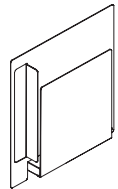
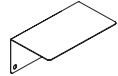
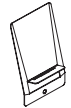
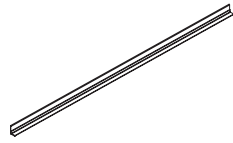

**How to specify —**  
Select the Model Number from above.

*1st Option:*

**Paint:**

See page 366 for selections and color codes.\*

U | 9 | | | | | | | .

| | | | |

Examples: U912WTR.PR6 U9TF.P7G AGSAUHK.P27

 Shippable by small-package carrier.











## Extensions — Introduction

Extensions accessory line by Allsteel is designed to help you create your own space.

- **Create a unique space**

Each person is unique, no one person works exactly like another, and different tasks require different tools. Extensions work tools allow each person the ability to create a unique environment that is all their own. Lots of paper to manage? Need active files within arm's reach? Want to maximize your worksurface space? Need light somewhere other than below a cabinet? Whatever the task, we have the tools to accommodate your workstyle.

- **Create a comfortable space**

With a full line of organization, ergonomic, and illumination tools, Extensions allow you to create a comfortable, ergonomic work area. Organization tools keep important items visible and within your reach. Ergonomic tools help you stay comfortable while working. Illumination tools allow you to put your light where it suits you.

- **Create an organized space**

Tired of all the piles of paper building up on your worksurface? Organization tools house your materials and keep them in an orderly fashion. With a combination of hanging or freestanding organizational accessories, Extensions let you manage everything from binders to paper clips.

- **Organization tools**

Work tools are a durable metal construction. Extensions allow you to manage your workspace smartly with tools like the phone caddy to elevate the phone off the worksurface, landscaped mail box trays to minimize worksurface intrusion, folder holders and tool box pencil holders that hang off the slat rail and each other.

Increase your efficiency with organization!

- **Ergonomic tools**

Ergonomics is more than just comfort, it's flexibility and safety. The adjustable keyboard options allow users to maintain and vary comfortable wrist and arm positions throughout the day, whether typing or mousing. Monitor Arms offer versatile adjustability while providing optimum comfort for the eyes, neck, and shoulders.

- **Illumination tools**

Sleek and flexible, our lighting components offer you several choices. Recessed task lights conserve space and feature electronic ballast for longer bulb life and cooler operating temperature. LED tasklights' slim design blends in with its surrounding while utilizing energy-efficient LED technology. The Link light offers award-winning style to a highly versatile and energy efficient light.

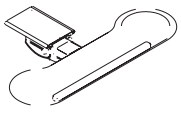
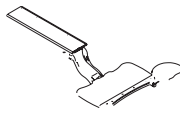
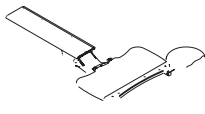
Articulating Keyboard Supports			
Features	Model AKTSHORT	Model AKTLONG	Model AKTMID
			
Keyboard Support	Platform style 28"W x 8"D	Platform Style 19"Wx11"D	Platform Style 19"Wx11"D
Keyboard Support Material	Phenolic	Phenolic	Phenolic
Suspension	<ul style="list-style-type: none"> <li>Nylon glides on lubricated slide track</li> <li>Intuitive lift and lock one touch height adjustment</li> </ul>	Lubricated slide track system: spring assisted	Lubricated slide track system: spring assisted
Platform Rotation	360 degrees	360 degrees	360 degrees
Platform Tilt	+10/-20 degrees	+10/-20 degrees	+10/-20 degrees
Platform Tilt Adjustment	Soft touch lever for precise tilt adjustment	Convenient tilt wheel assists desired tilt angle	Convenient tilt wheel assists desired tilt angle
Platform Height Adjustment Range	6½" (1½" above / 5¼" below)	12½" (7" above to 5½" below)	8" (3" above / 5" below)
Platform Height Adjustment	Lift platform to raise, lift slightly and tilt back to lower	Lift platform to raise, lift slightly and tilt back to lower	Lift platform to raise, lift slightly and tilt back to lower
Palm Rest	Detachable leatherette-covered gel palm rest	Fabric covered gel palm rest	Fabric covered gel palm rest
Mouse Pad	In-line to accommodate mouse on same level as keyboard.	Circular, swivel, tilt, LH/RH mounting, mouse catcher, gel rest	Circular, swivel, tilt, LH/RH mounting, mouse catcher, gel rest
Microsoft Natural Compatible	No	Yes — by removing palm rest	Yes — by removing palm rest
Track Depth	8"	23"	21"
Required Mounting Clearance	20"W x 8"D x ¼" Recess	19"W x 23"D + ¼" Recess	19"W x 23"D + ¼" Recess
Adjustable Wrist Rest	No	Fixed mounting and height	Fixed mounting and height
Ideal For	<ul style="list-style-type: none"> <li>Straight worksurfaces</li> <li>ADA/HFES compliance</li> <li>Extensive adjustability with mouse in line, mouse over or mouse forward of keyboard</li> <li>Height-Adjustable Table</li> </ul>	<ul style="list-style-type: none"> <li>Corner worksurface applications</li> <li>Sit to stand applications</li> </ul>	<ul style="list-style-type: none"> <li>Shallow worksurfaces</li> <li>Corner worksurface (17" or 21")</li> <li>Radius worksurface (42" or 48")</li> </ul>
Additional Information		<ul style="list-style-type: none"> <li>Track can be cut in the field to shorten track depth — may affect ability to fully recess platform</li> </ul>	<ul style="list-style-type: none"> <li>Track can be cut in the field to shorten track depth — may affect ability to fully recess platform</li> </ul>

**AKTSHORT Keyboard Support (page 413)**

- Lift and lock intuitive height adjustment.
- Compatible with Altitude Height Adjustable Tables
- Positive and negative tilt for best ergonomic positioning.
- +10°/-20° tilt adjustment and 360° rotation provides support of neutral position of shoulders, arms and wrists while accommodating multiple working postures.
- Surpasses ANSI/BIFMA standards.
- Black powder coat finish.
- Patented secondary slide and unique arm design provide minimal footprint.

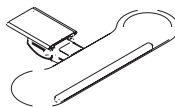

**Keyboard Spacer Kit (page 413)**

- Keyboard Spacer Kit required for mounting under Altitude worksurfaces.
- Kit provides ten spacers and hardware for mounting keyboard supports beneath an external worksurface support channel.
- Spacers are 2⅞"H providing more room beneath surface for mounting.

**CPU Hammock (page 413)**

- Features 360-degree swivel with an 11" track.
- Load capacity is 75 lbs.
- CPU must be minimum of ¾"W with maximum dimension of 64" in perimeter.
- Handy adjustment tool stores within unit.
- Safety feature prevents accidental release of straps and straps can be adjusted while CPU is installed.
- Can be used on Height Adjustable Tables as long as it is attached with spacer model AKMH. Take into account required leg room for users.







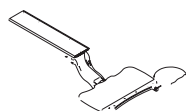
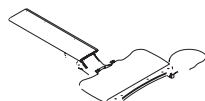



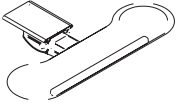

**AKTMID and AKTLONG Keyboard Support (page 413)**

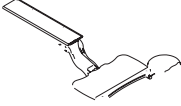
- Lift and lock intuitive height adjustment.
- Positive and negative tilt for the best ergonomic positioning.
- +10°/-20° tilt adjustment and 360° rotation provides support of neutral position of shoulders, arms, and wrists while accommodating multiple working postures.
- Non-handed mouse tray can be moved from right hand to left hand side.
- Surpasses ANSI/BIFMA standards.
- Black powder-coat finish.

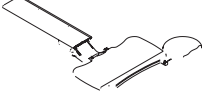

For specification information see page 412.

GSA SIN 33721

	Description	Model	List Price						
	<b>Compact Keyboard Support with 8" Track</b> 30"W x 13"D	AKTSHORT 	\$ 585						
	<b>STS Keyboard Support with 23" Track</b> 24"W x 12"D	AKTLONG 	\$ 717						
	<b>Articulating Keyboard Support with 21" Track</b> 24"W x 12"D	AKTMID 	\$ 616						
	<b>Keyboard Spacer Kit</b> 10 – 2½"H Spacers and Hardware	AKMH 	\$ 63						
	<b>CPU Hammock™ (Silver only)</b> 360° swivel CPU holder with adjustable straps	ACPU1 	\$ 418						
	<b>Metal Corner Sleeve</b> — for use with Optimize™, Concensys®, and Terrace® • Fits 1¼" thick square edge detail. (T-Mold worksurfaces) 22½"W leading edge x 18"D.	AWCS	<table border="1"> <thead> <tr> <th>P1 Paint List Price</th> <th>P2 Paint List Price</th> <th>P3 Paint List Price</th> </tr> </thead> <tbody> <tr> <td>\$ 147</td> <td>\$ 152</td> <td>\$ 157</td> </tr> </tbody> </table>	P1 Paint List Price	P2 Paint List Price	P3 Paint List Price	\$ 147	\$ 152	\$ 157
P1 Paint List Price	P2 Paint List Price	P3 Paint List Price							
\$ 147	\$ 152	\$ 157							

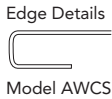

**How to specify —**  
Select the Model Number from above.



Examples: AKMH ACPU1

 Shippable by small-package carrier.

Allsteel's tool rail works in conjunction with a variety of accessories. Modular accessories free up worksurface space and provide orderly storage that is well within reach. Units can be arranged and rearranged to respond to changing workflow. The work tools that attach to the tool rail are:

- Mail Box
- Folder Holder
- Phone Caddy
- Binder Bin
- Tool Box
- Clip Caddy™
- Sidebar™ Personal Shelf
- Paper Wave™
- Gripper Clip

Additional accessories that work with the **tool rail work tools** aesthetically are:

- Bookends
- Freestanding Mail Box

Coat hooks, marker boards and center drawers round out the organization offering.

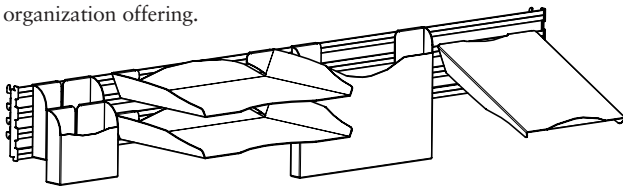

Tool rail, shown above, is height-adjustable in 1" increments using slots in panels or metal hutch. Tool rail shown with two tool boxes, two mail boxes, folder holder, and phone caddy. Folder holders and binder bins extend below a tool rail. Paper Wave and contents extend above a tool rail.

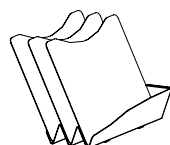
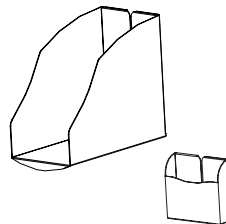
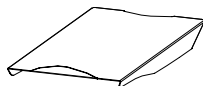
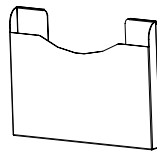

### Tool Rails and Work Tools (page 417)

- Sturdy aluminum extrusion with steel support construction.
- Powder coated for durable finish.
- Use to hang Extensions tools. Cannot be used to support monitor arms.
- Suggested weight capacity not to exceed 80 lbs.
- Consideration needs to be given to height of tools and location of worksurfaces.
- For use with Terrace®, Concensys®, and Optimize™ systems.
- 5" high rail (widths coordinate with panels).
- Attachment via vertical reveals.
- Can be hung from wall track. Good solution for above copiers.
- Systems tool rail is off-modular — can be used on a panel of equal width or one size smaller.
- May span two panels of appropriate size, i.e., 60" W Tool Rail on two 30" W panels.

### Tool Rail for Hutches (page 417)

- Will work on Universal, Terrace, Optimize, and Concensys system hutches produced after July 2, 2000 and Align™ metal hutches.
- Sturdy aluminum extrusion with steel support construction.
- Powder coated for durable finish.
- Use to hang Extensions tools. Cannot be used to support monitor arms.
- Suggested weight capacity not to exceed 80 lbs.
- Consideration needs to be given to height of tools and location of worksurfaces.

### Mail Box (page 418)

- Holds standard letter-size paper and inter-office envelopes.
- Minimal horizontal intrusion.

### Folder Holder (page 418)

- Holds manila envelopes.
- Is capable of hanging on other folder holders to maximize space.
- Stores vertically for easy access to files.

### Phone Caddy (page 418)

- Holds telephone at optimum ergonomic angle.
- Wire management cut-outs.
- Accommodates standard phone sizes.

### Binder Bin (page 418)

- Holds folders, binders, and manuals.

### Tool Box (page 418)

- Holds pencils and other writing utensils, large post-it notes, and other desk top accessories.

### Clip Caddy™ (page 418)

- Holds paper clips and other small objects.

### Sidebar™ Personal Shelf (page 418)

- Holds office supplies and personal effects.

### Paper Wave™ (page 418)

- Provides 3 fully divided slots for organizing files.
- Keeps papers from "bowing" at bottom.



**Gripper Clip (page 418)**

- Binds project papers together.
- Mounts to tool rail or tool tile.

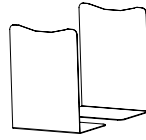

**Bookends (page 418)**

- Can be used on shelves or in cabinets.
- Used to hold books, binders, and catalogs upright.

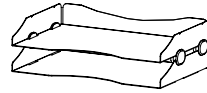

**Freestanding Mail Box (page 418)**

- Incorporates similar aesthetic to mounted Mail Box.
- Mounting brackets allow for free access from front and back.
- Sold in pairs of two; will stack up to eight high.
- Individual mail box dimension = 1 3/4" H.
- Stacking brackets are black.



**Coat Hook APMC6 (page 418)**

- Hangs directly into slotted Terrace®, Optimize™, or Concensys® panel frame.
- Use for coat or bag.
- Package of six.
- Available in black only.

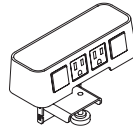

**Power/Data Modules — Clamp On Worksurface (page 424)**

- On-surface mounting option, fits on any worksurface with a 4" overhang.
- 6' Power cord. UL Listed.
- Includes adapters to allow use of commercially available data terminals or blanks to fill unused openings. Many of the AMP, AT&T, Krone, Leviton and most commercial data terminals can be used.

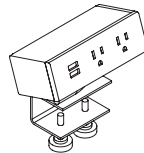

**Power/Data Modules — Clamp On Worksurface (page 424)**

- Worksurface clamp can be used on any surface with a 2 1/2" overhang.
- Must be installed at time of initial worksurface installation if installing between a worksurface and panel.
- 6' Power cord. UL Listed.
- The USB hub allows simultaneous powering of 2 USB-A devices. The USB hub is a charger only, no ability to connect to a PC. The charging capacity is limited and may not charge all devices.
- Qi compatible wireless charging available on select models.

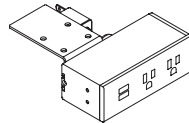
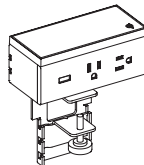

**Power/Data Modules — Under Worksurface (page 424)**

- Under surface mounting can be used on any surface with a 5" clearance.
- 6' Power cord. UL Listed.
- Hardware not included.



**Worksurface Power/Data Module (page 424)**

- Provides easy access to technology at primary worksurface.
- Mounts to edge of a worksurface and requires 3/8" gap. Consider whether 3/8" gap will work with layout.
- Must be mounted at time of initial worksurface installation if mounting between a worksurface and a panel. Maintaining 3/8" gap may not be possible with worksurfaces that are panel wrapped.

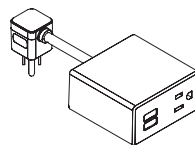

**Miki Power Modules (page 424)**

- Table top and undermount units.
- Hardware not included on undermount.
- 6' Power cord, UL Listed.
- 1 AC power and 1 dual USB configuration.



**Vesta Mobile Power (page 424)**

- 3 AC power simplex, 1 dual USB-A, 1 USB-C configuration.
- 10' Retractable power cord, UL Listed.
- Unit weighs 13 lbs.

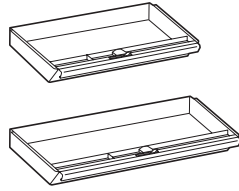

**Metal Center Drawers (page 419)**

- All metal center drawers feature pencil trays with three compartments for storage.
- Center drawers will not fit in center of 24" D worksurfaces which are wider than 60" due to location of center support bracket.
- For locking specifications, see pages 292-293 in the Desking and Benching Price & Specification Guide.
- Ball-bearing slide suspension.

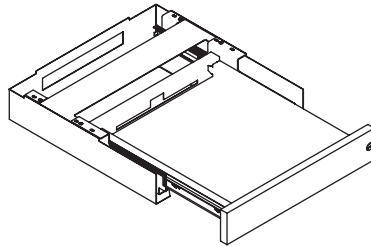

**Laptop Drawer — U7WDA (page 419)**

- Drawer body made of sheet metal.
- Drawer front made of 3/4" particleboard with laminate on both sides and fused laser edge banding.
- Core removable lock is located on right side drawer front
- 17 7/8" W x 18" D x 3 3/8" H Outside (interior 13" W x 16" D x 1 7/8" H)
- Minimum surface depth is 21" for surfaces not using an external stiffener; and 27" for surfaces using an external stiffener.
- Drawer extends 16"
- Maximum load: 45 lbs (functional BIFMA load)
- Drawer assembly and cover have cut out in back to allow for cables to exit drawer.
- Distance from floor to bottom of unit w/glides fully retracted is 24 3/4".
- Does not interfere with Further leg mounting plates so drawer can be placed directly next to either a system or table leg.
- When being placed next tower storage using the tower ell bracket (Z6LB) to support surface the drawer must be inset 3" to clear the ell bracket.
- Can be placed directly next to any support storage from any Allsteel product line (excluding towers).
- Flat brackets — drawer must be offset 3" from seam between surfaces to clear the bracket. See illustration at left.
- Can be used with rabbit edge worksurface models but there will be a larger reveal between surface and drawer.
- Can be used with knife edge worksurface models but reveal and depth need to be considered.

**Flat Brackets**

Front View



Top View

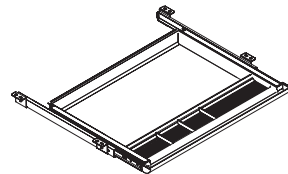
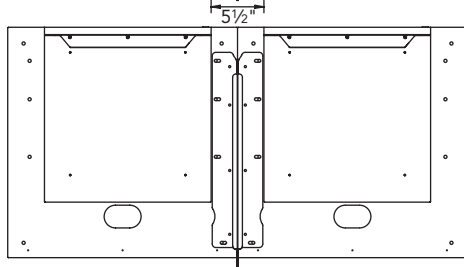

**Polymer Center Drawer - ACD1 (page 419)**

- 20 1/2" W x 17" D x 2" H
- Available in black only
- Made from ABS.
- Minimum clearance for mounting: 23" W x 16 1/4" D x 2" H.
- Retracts on 16" ball-bearing slides.
- Can be used on worksurfaces with Height Adjustable Bases as long as it is attached with spacer model AKMH.
- Can store up to 25 lbs.

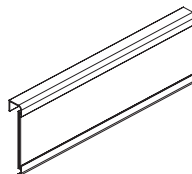

**Name Plate (page 418)**









- Comes in a 10-pack.
- Metal backer installs under a Terrace or Optimize top cap, can be used with frameless glass.
- Cover is a transparent polycarbonate insert.
- Full plate is 8 1/2" W x 2 5/8" H.

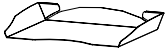
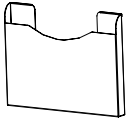

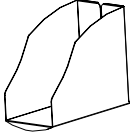
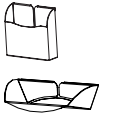

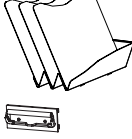
For specification information see pages 414-415.

GSA SIN 33721

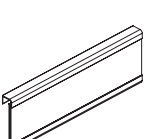
	Description	Model	P1 Paint List Price	P2 Paint List Price	P3 Paint List Price
	<b>Mail Box</b> 9"D x 15"W	EAPT <span style="border: 1px solid black; padding: 0 2px;">S</span>	\$ 128	\$ 147	\$ 162
	<b>Folder Holder</b> 9"H x 12"W	EAFS <span style="border: 1px solid black; padding: 0 2px;">S</span>	\$ 131	\$ 150	\$ 165
	<b>Phone Caddy</b> 9"W x 11"D	EATS <span style="border: 1px solid black; padding: 0 2px;">S</span>	\$ 160	\$ 179	\$ 194
	<b>Binder Bin</b> 8½"H x 5¼"W x 10"D	EABS <span style="border: 1px solid black; padding: 0 2px;">S</span>	\$ 128	\$ 147	\$ 162
	<b>Tool Box</b> 5"H x 5¼"W x 1½"D	EADH <span style="border: 1px solid black; padding: 0 2px;">S</span>	\$ 102	\$ 121	\$ 136
	<b>Clip Caddy™</b> 2"H x 7"W x 3½"D	EAAC <span style="border: 1px solid black; padding: 0 2px;">S</span>	\$ 91	\$ 110	\$ 125
	<b>Sidebar™ Personal Shelf</b> 2"H x 21"W x 7"D	EAPS <span style="border: 1px solid black; padding: 0 2px;">S</span>	\$ 131	\$ 150	\$ 165
	<b>Paper Wave™</b> Tray size: 2½"H x 6"W x 10"D Dividers: 9½"H x 9"W	EASS <span style="border: 1px solid black; padding: 0 2px;">S</span>	\$ 183	\$ 202	\$ 217
	<b>Gripper Clip</b> Package of 2 — 5"W x 2"H	EAPC ( <i>De-emphasized</i> ) <span style="border: 1px solid black; padding: 0 2px;">S</span>	\$ 131	\$ 150	\$ 165
	<b>Freestanding Mail Box</b> (specify paint color) Pair — 4⅞"H x 13¼"W x 9"D	EAFB <span style="border: 1px solid black; padding: 0 2px;">S</span>	\$ 263	\$ 282	\$ 297
	<b>Coat Hooks</b> (black only) Package of six	APMC6 <span style="border: 1px solid black; padding: 0 2px;">S</span>	\$ 128	N/A	N/A
	<b>Panel Name Plate</b> Package of 10	EACS	\$ 349	\$ 368	\$ 383

**Note:** Not for use on tool tile or rail, name plate installs under top cap on Terrace and Optimize.

**How to specify —**  
Select the Model Number from above.

*1st Option:*

**Paint:**

P1 P2 P3

See page 31 for finishes.

**P** | | | |

Examples: EAPT.P4J APMC6.P

S Shippable by small-package carrier.

For specification information see pages 415-416.

GSA SIN 33721

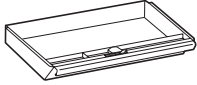
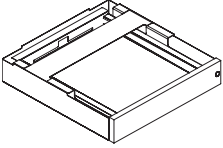
	Description	Model	List Price		
			P1	P2	P3
 Angled front	<b>Metal Center Drawer w/Lock</b> 19"W x 14¼"D x 3"H • 12" drawer extension (3/4). • Inside drawer dimension: 19"W x 13"D x 2⅝"H. • Minimum clearance for mounting: 21¼"W x 19¼"D.	CSDC19 <span style="border: 1px solid black; padding: 0 2px;">S</span>	\$ 296	\$ 317	\$ 335
	24½"W x 14¼"D x 3"H • 12" drawer extension (3/4). • Inside drawer dimension: 24½"W x 13½"D x 2⅝"H. • Minimum clearance for mounting: 27⅝"W x 19¼"D.	CSDC25 <span style="border: 1px solid black; padding: 0 2px;">S</span>	\$ 304	\$ 325	\$ 343
 Angled front	<b>Laptop Drawer — Locking, laminate front, metal case</b> 17⅝"W x 18"D x 3⅜"H • 16" drawer extension • Inside drawer dimensions: 13"W x 16"D x 1⅞"H • Minimum clearance for mounting: 17⅝"W x 21"D x 3⅜"H (see illustration)	U7WDA <span style="border: 1px solid black; padding: 0 2px;">S</span>	\$ 1699	\$ 1721	\$ 1739
	<b>Polymer Center Drawer</b> 20½"W x 17"D x 2"H • 11½" extension • Minimum clearance for mounting: 23"W x 16¼"D x 2"H	ACD1	\$ 236	N/A	N/A

<b>How to specify —</b> Select the Model Number from above.  _____ _____	<b>1st Option:</b> <b>Laminate</b> (Laptop drawer front if applicable): See page 366 for finishes.	<b>2nd Option:</b> <b>Edge</b> (Laptop drawer edge if applicable): See page 366 for finishes.	<b>3rd Option:</b> <b>Paint</b> (If laptop drawer, list exterior case color here): See page 31 for finishes.  Power Data Module PR6 Silver.	<b>4th Option:</b> <b>Paint</b> (Interior of laptop drawer if applicable): See page 31 for finishes.	<b>5th Option:</b> <b>Lock</b> (if applicable): <b>STD</b> Standard <b>OMT</b> Omit (Deduct \$20)	<b>6th Option:</b> <b>Lock or Tech Module Color</b> (if applicable): <b>EL</b> Silver (Lock)
--	---	--	---	---	---	---

Example: U7WDA.LM11EV.P27.PR6.STDEL

S Shippable by small-package carrier.

Allsteel Extensions offers Illumination in three styles — Undercabinet LED Light, Wand Light, and Splitty Light.

**Recessed Undercabinet LED Light**

Recessed task lights conserve space and provide an efficient solution for illuminating the workplace. All models are equipped with LED strips.

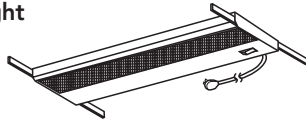

Recessed task light models mount under storage cabinets or shelves to provide optimal space utilization. Models are available in two styles and three sizes to correspond with the width of the cabinet or shelf. Task lights with a fused plug are available to meet Chicago electrical code.

**Undercabinet LED Light**

The Undercabinet LED Light is a low-profile, linear solution for overhead cabinets and shelves and is an ideal solution for painted wood storage. It utilizes energy-efficient LED technology which provides a long life. The Undercabinet LED Light provides the opportunity to mount the fixture where light is needed most.

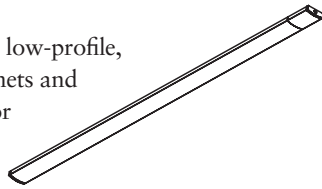

The Undercabinet LED Light features a metal trough reflector with diffuser lens. The light has a sleek 1/2" thick profile and provides two options for mounting, either magnetically or with hardware. Undercabinet LED Lights can be daisy-chained.

Optional undercabinet occupancy sensor is available which will automatically turn off the fixture after 30 minutes of no detection and back on immediately as the user re-enters the detection range using Passive Infrared (PIR) sensor technology. Unit features 360° lens with 90° outward detection angle, providing a 36" coverage diameter at 18". Occupancy sensor comes with connector and is required to be connected in the sequence shown below. Connect occupancy sensor to a light, or first light in daisy chain to control all linked lights.

**CONNECTION SEQUENCE\***

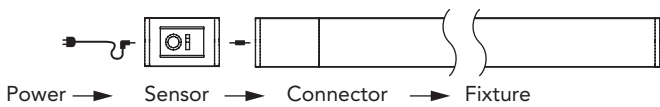

\*Cannot deviate from this sequence

**Recessed Task Lights (page 422)**

- Black Metal Construction with 9' long black cord attached to right rear corner of the fixture.
- LED strip comes installed within light.
  - 50,000 hour life span
  - 120V-277V
  - CCT 4000K
  - CRI 80+
- Includes 4 cord retainer clips.
- Shorter width models can be used on wider overheads, shelves and hutches.
- On/Off switch provides individual control of tasklight within the workstation.
- Daisy chain models require a master control model — 10 fixtures maximum.
- RECOMMENDATION: Provide a separate circuit for task lights to ensure proper, long-term operation.

**Undercabinet LED Lights (page 422)**

- Low profile energy-efficient LED task light for use with overhead storage cabinets and shelves.
- 20W power supply for 10W 17" unit (.166 amps).
- 20W power supply for 20W 31" unit (.166 amps).
- 60W power supply for daisy-chain starter units (.5 amps). Must order one starter unit for each daisy-chain application.

LED Light Combinations Must Not Exceed 60W in Combination	Power Usage
6X 17"	60W
3X 31"	60W
1X 31" + 4X 17"	60W
2X 31" + 2X 17"	60W

- The combinations that could max out 60W are featured above. *Daisy chained units have a power limit of 60W from one power entry. 17W units use 10W and 31W units use 20W.*
- Specify up to 5 additional 17" interconnect units (ALED17UJMP30) to daisy-chain together with 17" daisy-chain starter fixture (ALED17U60).  
*Example: Daisy-chain 4 – 17" undercabinet LED lights:*  
Specify: 1 ALED17U60  
Specify: 3 ALED17UJMP30 with 10" jumper cord
- Specify up to 2 additional 31" interconnect units (ALED31UJMP30) with 10" jumper cords to daisy-chain together with 31" tasklight (ALED31U60); or 17" daisy-chain starter fixture (ALED17U60).
- 3500K color temperature.
- 131 footcandles at 18" on ALED31U; 76 footcandles at 18" on ALED17U.
- Magnetic or screw-mount option — attachment hardware included.
- On 20 watt models, power drive is attached to plug: allow 1 1/8" D space at outlet.
- On 60 watt models, power drive brick is in center of cord.
- Includes 3 cord retainer clips.
- Meets California Title 24 Energy Efficiency Standards.
- "Instant On" switch with infinite dimming cycle from 100% to 15% with the last state memory, allowing the user to set their desired level of lighting.
- Fixture automatically turns off after 10 hours of use to reduce unwanted energy use.
- Optional occupancy sensor automatically turns off all interlinked fixtures after 30 minutes of no detection and back on immediately when detection is found.

Overhead Length	Suggested LED Sizes
24	17
30	17
36	17
42	31
48	17 + 17
60	31 + 17
72	31 + 31

Note: LED lights may need to be positioned along length properly to allow jumping to additional overheads. Suggested sizes above are recommendations for single overheads to provide as much light along length of overhead as possible.

The suggested sizes factor in 4 inches of room for the power inlet and occupancy sensor (optional).

**Wand™ Task Light**

Wand freestanding task light offers a clean, simple design along with powerful LED technology to illuminate the workspace. The swivel base and arm tilt allow users to position the light just where they need it. The 7.7 watt LED light offers efficiency and long life, providing up to 25 years of daily use. The slim, sleek design makes it easy to integrate into any workspace. Wand task light is 97% recyclable. Occupancy sensor and/or charging models available.

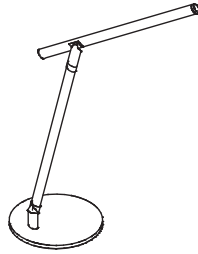
**Wand LED Freestanding Task Light (page 423)**

- Available in Silver or White. 9'4" cord is Silver.
- Full range dimming from 100% – 10% with last state memory.
- Uses 5W at highest setting and as low as 1 watt at its lowest setting, providing 75 to 12.7 footcandles of light, respectively (16" above worksurface).
- 7½" round swivel base and 16½"H tilt arm allow versatile positioning of the 13" lampshade.
- Designed for 50,000 hours of life.
- Color Temperature: 3500K. Color Rendering Index (CRI): 80.
- Materials: aluminum arm and lampshade, steel base.
- Weight: 4.4 lbs. 97% recyclable, 76% post-consumer.
- Certifications: UL and CUL. TAA compliant.
- Occupancy sensor available with automatic shut-off after 15 minutes if no motion is detected.
- USB model features USB-A (1), USB-C (1) charging within base of unit.
- USB model also features occupancy sensor. 7.5W (A) & 18W (C) power consumption.

**Splitty Task Light**

Splitty's organic and modern design compliments the workstation while also bringing rich features to the user. In addition to illuminating the space, Splitty can also be a teleconferencing tool through Splitty's 360-degree light head adjustment and soft touch, continuous dimming. Integrated charging allows for small personal device charging crucial to the modern worker's workplace toolkit while minimizing clutter within the station. Optional clamp or tool tile mounts available as accessories.

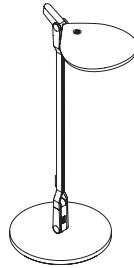
**Splitty Task Light (page 423)**

- Available in Silver, White, or Black (accessories available in silver only).
- Cord is 12' long.
- Cord is silver when black or silver finish specified, white when white light is specified.
- Soft touch on/off, dimming.
- Continuous dimming (100% – 3%) with last state memory.
- 5.8W of energy consumption. 7W at highest setting, 0.6W at lowest.
- 5" 360-degree swivel light head, 6.54" round swivel base and 17"H arm. Arm has full 180 degree rotation and 360 degree swivel.
- Designed for 60,000 hours of life.
- Color Temperature: 3500K, Color Rendering Index: 90.
- Materials: aluminum, plastic.
- USB-A has 5W of power consumption.
- USB-A (1) charging at bottom of light arm stem. Charging feature compatible for any mounting method.
- Clamp mount compatible with surfaces ¼" – 2¼" thick.
- Tool tile mount has 1½" adjustment range, minimum slot height of ⅜".

For specification information see pages 420-421.

Open Market / GSA SIN 33721 (as noted)

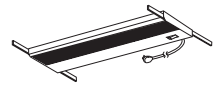

Open Market

Description	Watt Usage	Model	List Price
<b>Recessed Task Lights (Black only)</b> — Use recessed under overhead cabinets, storage shelves, or hutches, comes with cord retainer clips			
Task Light for 24"W	10	A870824 <span style="border: 1px solid black; padding: 0 2px;">S</span>	\$ 429
Task Light for 30"W and 36"W	14	A870830 <span style="border: 1px solid black; padding: 0 2px;">S</span>	\$ 433
Task Light for 42"W and 48"W	21	A870842 <span style="border: 1px solid black; padding: 0 2px;">S</span>	\$ 468
Task Light for 60"W, 66"W, and 72"W	28	A870860 <span style="border: 1px solid black; padding: 0 2px;">S</span>	\$ 506

**Recessed Task Lights (Black only)** — With fused plug (satisfies Chicago electrical code)

Task Light for 24"W	10	A870824CH <span style="border: 1px solid black; padding: 0 2px;">S</span>	\$ 553
Task Light for 30"W and 36"W	14	A870830CH <span style="border: 1px solid black; padding: 0 2px;">S</span>	\$ 564
Task Light for 42"W and 48"W	21	A870842CH <span style="border: 1px solid black; padding: 0 2px;">S</span>	\$ 600
Task Light for 60"W, 66"W, and 72"W	28	A870860CH <span style="border: 1px solid black; padding: 0 2px;">S</span>	\$ 634

**Note:** See below for GSA Approved Task Lights.

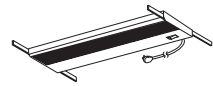

GSA SIN 33721

**GSA Recessed Task Lights** — Use recessed under overhead cabinets, storage shelves, or hutches

**Base Models** — Stand Alone

Task Light for 24"W	15	GS870924 <span style="border: 1px solid black; padding: 0 2px;">S</span>	\$ 548
Task Light for 30"W and 36"W	17	GS870930 <span style="border: 1px solid black; padding: 0 2px;">S</span>	\$ 566
Task Light for 42"W and 48"W	25	GS870948 <span style="border: 1px solid black; padding: 0 2px;">S</span>	\$ 608
Task Light for 60"W, 66"W, and 72"W	32	GS870960 <span style="border: 1px solid black; padding: 0 2px;">S</span>	\$ 651



GSA SIN 33721

**Cord Retainer Clips (Black only)**

Bag of 50 clips		AAPACM2 <span style="border: 1px solid black; padding: 0 2px;">S</span>	\$ 54
-----------------	--	---	-------

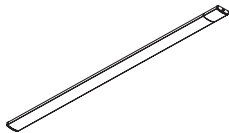

GSA SIN 33721

**LED Undercabinet Light** (white end caps)

17" Task Light w/20 watt power supply for 24"W or wider overhead	ALED17U	<span style="border: 1px solid black; padding: 0 2px;">S</span>	\$ 1014
17" Task Light w/60 watt power supply for daisy chain	ALED17U60	<span style="border: 1px solid black; padding: 0 2px;">S</span>	\$ 1110
17" 10 watt Interconnect Task Light w/10" Jumper Cord	ALED17UJMP30	<span style="border: 1px solid black; padding: 0 2px;">S</span>	\$ 783
31" Task Light w/20 watt power supply 36"W or wider overhead	ALED31U	<span style="border: 1px solid black; padding: 0 2px;">S</span>	\$ 1522
31" Task Light w/60 watt power supply for daisy chain	ALED31U60	<span style="border: 1px solid black; padding: 0 2px;">S</span>	\$ 1604
31" 20 watt Interconnect Task Light w/10" Jumper Cord	ALED31UJMP30	<span style="border: 1px solid black; padding: 0 2px;">S</span>	\$ 914
Undercabinet Occupancy Sensor 2 3/4"W + 1"W Connector	ALEDOCC*		\$ 617

\*Undercabinet Occupancy Sensor works with LED Undercabinet lights shipped after 11/1/2013.

**How to specify —**  
Select the Model Number from above.

**1st Option:**  
**Cord Retainer**  
**Clip Color:**  
Black only.

P | 2 | 7

Examples: A870824    A870824CH    GS870924    AAPACM2.P27

S Shippable by small-package carrier.

For specification information see pages 420-421.

Open Market / GSA SIN 33721



GSA SIN 33721

Description	Model	List Price
<b>Wand™ LED Task Light (Silver or White)</b>		
Freestanding LED Task Light	WANDFS <input type="checkbox"/>	\$ 494
Freestanding LED Task Light (Occupancy Sensor)	WANDFSOC <input type="checkbox"/>	\$ 702

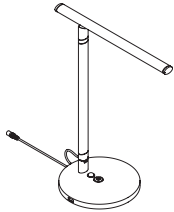

Freestanding LED Task light (Occupancy Sensor & Charging)	WANDFSUSB	\$ 732
---	-----------	--------



<b>Splitty Task Light (Silver, White, or Black)</b>		
Freestanding LED Task Light (Charging)	PRFTSKFS	\$ 669

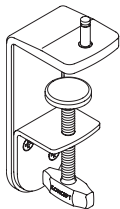

Clamp Mount (Silver only)	PRFTSKCL	\$ 77
---------------------------	----------	-------

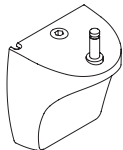

Tool Tile Mount (Silver only)	PRFTSKTR	\$ 77
-------------------------------	----------	-------

<p><b>How to specify —</b> Select the Model Number from above.</p>	<p><i>1st Option:</i> <b>Color</b> (for Splitty): SVR Silver WHT White BLK Black</p> <p>(for Wand LED): SVR Silver WHT White</p>
--	--

Example: WANDFS.WHT

Shippable by small-package carrier.

# Extensions

For specification information see page 415.

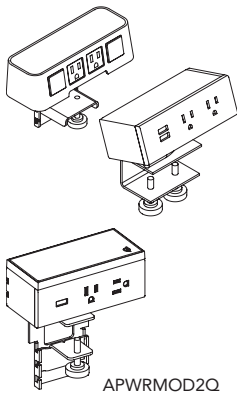

Description	Model	List Price
<b>Power/Data Modules — Worksurface Clamp</b>		
Dome — 2 Power, 2 Open Data with faceplate adapters (FOG Fog only)	ACOMDOME2	\$ 500
2 Power, 2 USB (SNW Snow or STRM Storm)	APWRMOD2WC	\$ 689
3 Power (SNW Snow or STRM Storm)	APWRMOD3WC	\$ 530
2 Power, 1 Dual USB, Qi Power Module	APWRMOD2Q	\$ 760

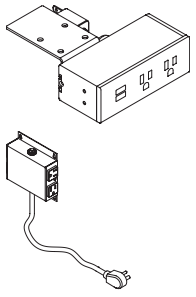

<b>Power/Data Modules — Under Worksurface Mount</b>		
2 Power, 2 USB (SNW Snow or STRM Storm)	APWRMOD2UWM	\$ 689
3 Power (SNW Snow or STRM Storm)	APWRMOD3UWM	\$ 530
4 Power Quad Tap (10' cord)	UNQTMP	\$ 442

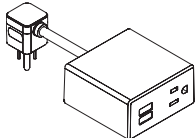

<b>Miki</b>		
1 Power, 1 USB Table Top	APWRMOD1TT	\$ 304
1 Power, 1 USB Under Worksurface Mount	APWRMOD1UWM	\$ 304

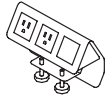

<b>Worksurface Power/Data Module (PR6 Silver only)</b>		
2 Simplex receptacles, 1 data position	A870302	\$ 383



<b>Vesta</b>		
3 Power Vesta – Corded	AVSTA3PWR	\$ 1941

<p><b>How to specify —</b> Select the Model Number from above.</p> <p>_____ .</p>	<p><i>1st Option:</i></p> <p><b>Color Option 1:</b></p> <p>FOG Fog SNW Snow STRM Storm BLK Black</p> <p>_____ .</p>	<p><i>2nd Option:</i></p> <p><b>Color Option 2</b> (if applicable):</p> <p>FOG Fog SNW Snow STRM Storm BLK Black</p> <p>_____ .</p>
---	---	---

*Example: ACOMDOME2.FOG*

EXTENSIONS



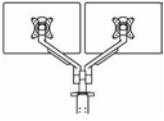
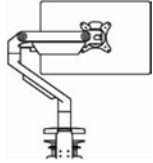
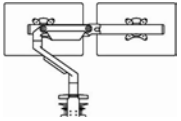

PIVOT MONITOR ARMS	Standard Dynamic Single	Standard Dynamic Dual	Heavy Duty Dynamic Single	Heavy Duty Dynamic Dual with Crossbar
Allsteel Model:	AMASTS	AMASD	AMASHD	AMADHD
				
Features:				
Price	\$464	\$936	\$798	\$1104
Colors	Black and Silver	Black and Silver	Black and Silver	Black and Silver
Monitor Rotation	180°	180°	180°	180°
Monitor Extension	18.75"	18.26"	20.75"	23"
Monitor Tilt Adjustment	+25°/-25°	+25°/-25°	+25°/-25°	+25°/-25°
Arm Height Adjustment	8.4" to 19"	9.6" to 20.1"	8.5" to 20"	8.5" to 20"
Weight Capacity	6.2 to 17 lbs.	6.2 to 17 lbs. per Arm	8 to 35 lbs.	17.5 lbs. per VESA Plate
Mounting Option	Grommet and Clamp Mounts	Grommet and Clamp Mounts	Grommet and Clamp Mounts	Grommet and Clamp Mounts
360° Lockout Feature	Yes	Yes	Yes	Yes
VESA Compatibility	75mm and 100mm	75mm and 100mm	75mm and 100mm	75mm and 100mm
Pole Height	N/A	N/A	N/A	N/A
Maximum Width per Monitor*	N/A	25"	N/A	25"
Worksurface Clamp Requirements	¾" to 2" Thick	¾" to 2" Thick	¾" to 2" Thick	¾" to 2" Thick
Worksurface Grommet Clamp Requirements	¾" to 2" Thick/Hole Diameter ⅜" to 2"	¾" to 2" Thick/Hole Diameter ⅜" to 2"	¾" to 2" Thick/Hole Diameter ⅜" to 2"	¾" to 2" Thick/Hole Diameter ⅜" to 2"
Environmental Info	94% Recycled Content	94% Recycled Content	94% Recycled Content	94% Recycled Content

\*Use of APACSM Slider Model will allow for wider monitor capabilities

#### Pivot Standard Weight Monitor Arms

- Adaptable and adjustable to user preference the Pivot monitor arm offers a slim and refined design coupled with easy fingertip adjustment.
- Multiple points of adjustment including 360 degree swivel with optional 180 degree lockout, 18.75" extension, and 10" of height adjustment.
- Monitor tilts +25/-25 degrees.
- Standard weight arms utilize a tension spring that allows for effortless adjustment of monitors to proper ergonomic positions.
- Tension adjustment at multiple points allows for proper adjustment for monitors weight between 6-17 lbs.
- Model includes grommet and worksurface mounting options.
- Desk clamp mounts require ¾" – 2" thick surfaces; grommet mount requires hole diameter of ⅜" to 2" wide and accommodates up to 2" thick surfaces.
- Integrated cable management included with each model. Black models ship with all black cable management pieces, Silver models ship with grey wire management but optional white pieces ship in the box and can be installed on site.
- Dual monitor arm supports up to 25" wide monitors. Wider monitors may require use of optional slider mount model.
- Pivot arms are VESA 75mm and 100mm compatible.
- Quick release feature simplifies monitor installation and changes.

#### Pivot Slider Mount

- Provides 11.8" of horizontal movement.
- Allows for wider monitors to be used on dual monitor arms and sit flush side by side.
- Not compatible with Pivot Heavy Duty Series.

#### Pivot Heavy Duty Series

- Adaptable and adjustable to user preference the Pivot monitor arm offers a slim and refined design coupled with easy fingertip adjustment.
- Multiple points of adjustment including 360 degree swivel with optional 180 degree lockout, 20.75" extension, and 12" of height adjustment.
- Monitor tilts +25/-25 degrees.
- Tension adjustment at multiple points allows for proper adjustment for monitors weight between 8-35 lbs.
- Model includes grommet and worksurface mounting options.
- Desk clamp mounts require ¾" – 2" thick surfaces; grommet mount requires hole diameter of ⅜" to 2" wide and accommodates up to 2" thick surfaces.
- Integrated cable management included with each model. Black models ship with all black cable management pieces, Silver models ship with grey wire management but optional white pieces ship in the box and can be installed on site.
- Dual monitor arm supports up to 2 monitors weight 4-17.5 lbs each.
- Pivot arms are VESA 75mm and 100mm compatible.
- Quick release feature simplifies monitor installation and changes.

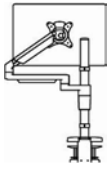
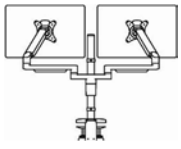
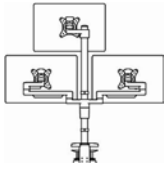
PIVOT MONITOR ARMS	Dynamic Single Post	Dynamic Dual Post	Triple Fixed Post
Allsteel Model:	APASD	APADD	APATF
			
Features:			
Price	\$628	\$879	\$1110
Colors	Silver	Silver	Silver
Monitor Rotation	180°	180°	180°
Monitor Extension	21"	21"	23"
Monitor Tilt Adjustment	+25°/-25°	+25°/-25°	+25°/-25°
Arm Height Adjustment	10.6"	10.6"	N/A
Weight Capacity	6.2 to 17 lbs.	6.2 to 17 lbs. per Arm	17 lbs. per arm
Mounting Option	Grommet and Clamp Mounts	Grommet and Clamp Mounts	Grommet and Clamp Mounts
360° Lockout Feature	Yes	Yes	Yes
VESA Compatibility	75mm and 100mm	75mm and 100mm	75mm and 100mm
Pole Height	17.7"	17.7"	27.5"
Maximum Width per Monitor*	25"	25"	25"
Worksurface Clamp Requirements	7/8" to 2" Thick	7/8" to 2" Thick	7/8" to 2" Thick
Worksurface Grommet Clamp Requirements	7/8" to 2" Thick/Hole Diameter 3/16" to 2"	7/8" to 2" Thick/Hole Diameter 3/16" to 2"	7/8" to 2" Thick/Hole Diameter 3/16" to 2"
Environmental Info	94% Recycled Content	94% Recycled Content	94% Recycled Content

\*Use of APACSM Slider Model will allow for wider monitor capabilities

### Pivot Post Series

- Adaptable and adjustable to user preference the Pivot monitor arm offers a slim and refined design coupled with easy fingertip adjustment.
- Multiple points of adjustment including 360 degree swivel with 21" extension and 10.6" of height adjustment.
- Monitor tilts +25/-25 degrees.
- Tension adjustment at multiple points allows for proper adjustment for monitors weight between 6.5-17 lbs per arm.
- Model includes grommet and worksurface mounting options.
- Desk clamp mounts require 7/8" - 2" thick surfaces; grommet mount requires hole diameter of 3/16" to 2" wide and accommodates up to 2" thick surfaces.
- Integrated cable management included with each model. Silver color option with grey wire management only.
- Dual monitor arm supports up to 25" wide monitors. Wider monitors may require use of optional slider mount model.
- Single and dual models have a post height of 17.7"; Triple monitor model has a post height of 27.5".
- Pivot arms are VESA 75mm and 100mm compatible.
- Quick release feature simplifies monitor installation and changes.

### Pivot Counterweight Kit

- Counterweight Kit to be used with monitors weighing less than 6 lbs.
- Gray color only.
- Counterweight weighs 1 lb. 6 oz.

### Pivot Conversion Kits



- Kit allows user to transform single monitor arm (Standard, Heavy Duty, or Post) into Dual Arm configuration
- Available in black and silver, Post arm only available in silver
- Required wire management included
- Once assembled, will aesthetically emulate dual configuration of chosen arm

# Accessories — Pivot Monitor Arms

Pivot

For specification information see pages 426-427.

GSA SIN PENDING, GSA SIN 33721

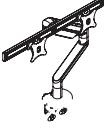
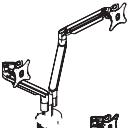
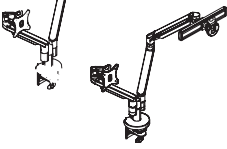
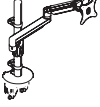
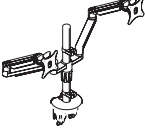
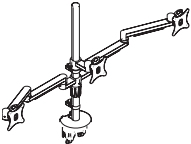
Description	Model	List Price
<b>Pivot Monitor Arms</b>		
 Dynamic Single Monitor - Standard Weight	AMASTS <span style="border: 1px solid black; padding: 0 2px;">S</span>	\$ 464
Dynamic Single Monitor - Standard Weight for GSA *Silver Only Open for order Fall 2020 – GSA SIN 33721.	AMASTS-G	\$ 548
 Dynamic Single Monitor - Heavy Weight	AMASHD <span style="border: 1px solid black; padding: 0 2px;">S</span>	\$ 798
 Dynamic Dual Monitor with Crossbar	AMADHD <span style="border: 1px solid black; padding: 0 2px;">S</span>	\$ 1104
 Dynamic Dual Monitor - Standard Weight	AMASD <span style="border: 1px solid black; padding: 0 2px;">S</span>	\$ 936
 Dynamic Dual Monitor - Standard Weight for GSA *Silver Only **Slider Mount included. Open for order Fall 2020 – GSA SIN 33721.	AMASD-G	\$ 998
 Single Dynamic Post Arm *Silver Only	APASD <span style="border: 1px solid black; padding: 0 2px;">S</span>	\$ 628
 Double Dynamic Post Arm *Silver Only	APADD <span style="border: 1px solid black; padding: 0 2px;">S</span>	\$ 879
 Triple Fixed Post Mount *Silver Only	APATF <span style="border: 1px solid black; padding: 0 2px;">S</span>	\$ 1110

<p><b>How to specify —</b> Select the Model Number from above.</p> <p><b>A</b>                     .</p>	<p><i>1st Option:</i> <b>Select the Color:</b> SVR Silver BLK Black</p> <p>         </p>
--	--

Example: AMADHD.BLK

S Shippable by small-package carrier.

# Accessories — Pivot Monitor Arms

Pivot

For specification information see pages 426-427.

Open Market

ACCESSORIES



Description	Model	List Price
<b>Pivot Monitor Arms</b>		
Monitor Arm Sliding Mount	APACSM <input type="checkbox"/>	\$ 221

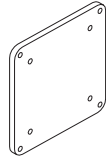

Monitor Arm Counterweight	APACW <input type="checkbox"/>	\$ 52
---------------------------	--------------------------------	-------

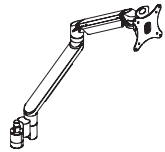

Pivot Monitor Arm Standard Single Conversion Kit	AMASTSCK	\$ 520
--	----------	--------

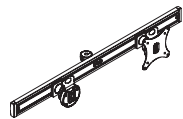

Pivot Monitor Arm Heavy Duty Single Conversion Kit	AMASHDCK	\$ 454
--	----------	--------

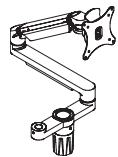

Pivot Single Post Arm Conversion Kit	APASDCK	\$ 661
* Silver Only		

<p><b>How to specify —</b> Select the Model Number from above.</p> <p>A           .</p>	<p><b>1st Option:</b> Select the Color: SVR Silver BLK Black</p> <p>       </p>
---	---

Example:

**TOP & BASE PAINT FINISHES**

**GRADE P1**

Black	P27
Black	P71
Brownstone	P7D
Bungalow	P7C
Cinder	P7Q
Cove	P096
Designer White	PJW
Dune	P094
Flint	P02
Fossil	P28
Harbor	P097
Loft	P7B
Muslin	P4J
Parchment	P93
Pebble	P8R
Pewter	P8D
Sage	P095
Salt	P8C
Titanium	P8T/T

**GRADE P2**

Champagne Metallic	PR5
Designer White High Gloss 65	P8W
Gunmetal Metallic	PR3
Night Bronze	P8B
Platinum Metallic	PR2
Pyrite	PJE
Silver	PR6
Solar Black	P8X

**GRADE P3**

Atom	P8S
Blossom	P8K
Bullseye	PJF
Cabernet	P7T
Conifer	P8H
Ember	P8P
Ion	P8N
Iris	P8J
Krypton	P8F
Regatta	P8M
Succulent	P8A

**GRADE P4**

Polished Aluminum	PAL/P
-------------------	-------

**LAMINATES**

**GRADE L1**

**SOLID COLORS**

Black	P
Brownstone	LM13
Bungalow	LM12
Designer White	LDW1
Flint	LM16
Fossil Shale	LEH1
Loft	LM11
Muslin	LM15
Titanium	LTI1

**ABSTRACT**

Ash	LT3B
Handspun Pearl	LAHP
Handspun Dove	LAHD
Handspun Slate	LAHS
Handspun Chestnut	LAHC
Silver Mesh	LT8D

**WOODGRAIN**

Belair	LWBA
Bourbon Cherry	H
Field Elm	LWFE
Florence Walnut	LFW1
Kingswood Walnut	LK11
Natural Maple	LWD
NeoWalnut	LNU1
Pinnacle	PINC
Shaker Cherry	LW7C

**GRADE L2**

Beigewood	LWBE
Fawn Cypress	LFC1
Lowell Ash	LLA1
Mangalore Mango	LMM1
Natural Recon	LNR1
Phantom Charcoal	LPC1
Phantom Ecu	LPE1
Portico Teak	LPT1
Skyline Walnut	LSW1
Veranda Teak	LVT1

**GRADE L3**

Natural Walnut	LWNW
----------------	------

**LAMINATE EDGE COLORS**

Beigewood	DE
Belair	BA
Black	E4
Bourbon Cherry	H
Brownstone	EY
Bungalow	EX
Designer White	DW
Fawn Cypress	FC
Field Elm	FE
Flint	E9
Florence Walnut	FW
Fossil	EH
Kingswood Walnut	KI
Loft	EV
Lowell Ash	DL
Mangalore Mango	MM
Muslin	EU
Natural Maple	DD
Natural Recon	NR
Natural Walnut	DN
NeoWalnut	NU
Parchment	EN
Phantom Charcoal	PC
Phantom Ecu	PE
Pinnacle	PI
Portico Teak	DP
Shaker Cherry	DF
Skyline Walnut	SW
Titanium	TI
Veranda Teak	VT

**STRATAWOOD VENEERS**

**GRADE V1**

**CHERRY**

Cinnamon/Biltmore Cherry	SC260
Lowell Ash	SC394
Clear Cherry	SC700
Light Cherry	SC701
Shaker Cherry	SC774
Burnished Cherry	SC777

**MAPLE**

Field Elm	SE599
Clear Maple	SE800
Harvest Maple	SE856
Beigewood	SE878
Phantom Ecu	SE912
Belair	SE934

**OAK**

Clear Oak	SEF300
Dark Rift Cut Oak	SEF331

**SILVER OAK**

Clear	SB100
Portico Teak	SB150

**WALNUT**

Florence Walnut	ST579
Light Walnut	ST601
Skyline Walnut	ST625
Pinnacle Walnut	ST679
Sumatra Walnut	ST693

**NATURAL VENEERS — FLAT CUT**

**GRADE V1**

**CHERRY**

Cinnamon/Biltmore Cherry	NC260
Lowell Ash	NC394
Medium Red Cherry	NC512
Light Cherry	NC701
Shaker Cherry	NC774
Burnished Cherry	NC777

**MAPLE**

Clear Maple	NE800
Harvest Maple	NE856

**WALNUT**

Ebony Walnut	NT509
Florence Walnut	NT579
Light Walnut	NT601
Skyline Walnut	NT625
Nutmeg Walnut	NT629
Pinnacle Walnut	NT679
Sumatra Walnut	NT693

**NATURAL VENEERS — RIFT CUT**

**GRADE V2**

Fawn Cypress Rift Cut Oak	RF108
Light Rift Cut Oak	RF301
Dark Rift Cut Oak	RF331
Phantom Ecu Rift Cut Oak	RF912

**Note:** Refer to individual product pages for upcharges.

**FSC Certified Wood at Allsteel**  
See page 431 for more information.

**Aware Collection**

Allsteel designed a flexible and comprehensive collection of active learning furniture. The Aware Collection consists of buffet and recycle credenzas, mobile and wall-hung marker boards, and unique shaped table tops that offer a timeless design. Look to the Aware Collection brochure for full details.

**Materials and Edge Treatments**

Aware tables offer functional flexibility and aesthetic versatility to provide one, simple solution for the entire office. The broad selection of materials and finishes ensure that the tables look beautiful in any application.

**Laminate Edges**

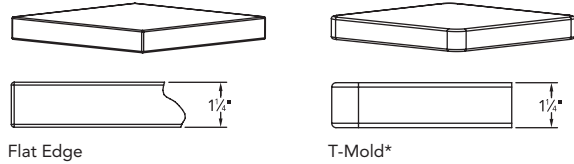

Flat Edge

T-Mold\*

**Fluid Form Edge**

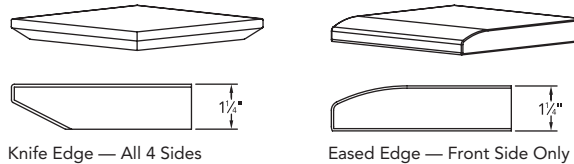

Knife Edge — All 4 Sides

Eased Edge — Front Side Only

**Veneer Edge**

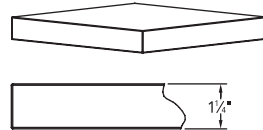

Square Edge

T-mold tops will have a 3/4" radius on all corners.

24" D or 30" D Knife edge rectangle tops feature a shaped edge on all four sides. Eased edge tops feature a shaped edge on one side.

Allsteel Fluid Form is an advanced surface material that offers a seamless solid base layer with protective coating. Its seamless 3-dimensional edge profile eliminates the need for edge banding or T-mold making it ideal for horizontal surfaces.

**FSC Certified Wood at Allsteel**

Forest Stewardship Council® (FSC) certification promotes the sustainable harvesting of forests worldwide. The FSC program sets requirements for the management of the forest and for everyone that handles the wood from forest to product. Allsteel has an FSC Chain of Custody and can provide FSC certified products to customers who choose to order them. FSC products can contribute to LEED projects. To order FSC products, the "FSC" option must be selected in the model code at time of order. For more information, please contact Customer Support at 888-255-7833.

**FSC Trademark License code FSC-C014704.**

Aware Table Options		Top Finish and Edge Options				
		Laminate				Veneer
Leg Options		Flat	T-Mold	Knife	Eased	Square
T-Leg	Fixed	X	X		X	X
	Nesting	X	X		X	X
	Folding	X	X		X	
V-Leg	Fixed	X	X	X	X	X
	Nesting	X	X		X	X

Aware Table Sizes	Table Top Sizes*			
Style of Legs	18"D	24"D	30"D	36"D
T-Leg – Folding	60"-72"W	60"-72"W	60"-72"W	
T-Leg – Fixed or Nesting	48"-72"W	36"-96"W	36"-96"W	48"-72"W
V-Leg – Fixed or Nesting		36"-96"W	36"-96"W	

\*Widths are available in 6" or 12" increments of range listed.

Aware Standing Height Table Sizes	Table Top Sizes*	
Style of Legs	24"D	30"D
T-Leg Fixed		54"-84"W
V-Leg Fixed	54"-84"W	

\*Widths are available in 6" or 12" increments of range listed.

**Table Capacities**

Table Tops	Seating Capacity	Table Tops	Seating Capacity
18" x 48" Rectangle	2	24" x 36" Rectangle	1
18" x 54" Rectangle	2	24" x 42" Rectangle	1
18" x 60" Rectangle	2	24" x 48" Rectangle	2
18" x 66" Rectangle	2	24" x 54" Rectangle	2
18" x 72" Rectangle	3	24" x 60" Rectangle	2
		24" x 66" Rectangle	2
		24" x 72" Rectangle	3

Table Tops	Seating Capacity	Table Tops	Seating Capacity
30" x 36" Rectangle	2	36" x 48" Rectangle	4
30" x 42" Rectangle	2	36" x 54" Rectangle	4
30" x 48" Rectangle	4	36" x 60" Rectangle	4
30" x 54" Rectangle	4	36" x 66" Rectangle	6
30" x 60" Rectangle	4	36" x 72" Rectangle	6
30" x 66" Rectangle	4		
30" x 72" Rectangle	6		
30" x 84" Rectangle	6		
30" x 96" Rectangle	8		

Fixed

Nesting

Folding

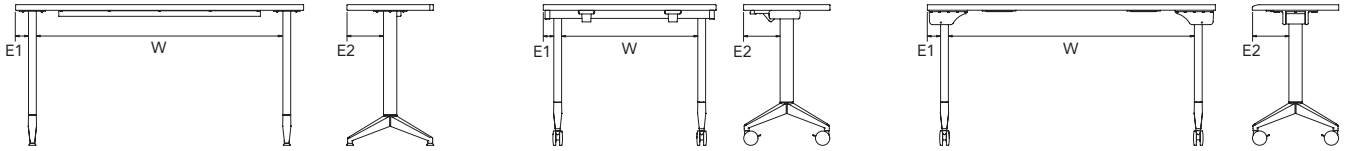

Leg Type:	T-Leg Fixed			T-Leg Nesting			V-Leg Fixed or Nesting			T-Leg Folding		
Dimension:	E1	W	E2	E1	W	E2	E1	W	E2	E1	W	E2
<b>Aware Table Rectangle Top Size:</b>	Edge of Table to outside of leg	Between Legs	Edge of table to the outside of leg	Edge of Table to outside of leg	Between Legs	Edge of table to the outside of leg	Edge of Table to outside of leg	Between Legs	Edge of table to the outside of leg	Edge of Table to outside of leg	Between Legs	Edge of table to the outside of leg
18" x 48"	2 5/8"	39 3/8"	7 7/8"	2 1/2"	40 3/8"	7 7/8"	-	-	-	-	-	-
18" x 54"	2 5/8"	45 3/8"	7 7/8"	2 1/2"	46 3/8"	7 7/8"	-	-	-	-	-	-
18" x 60"	2 5/8"	51 3/8"	7 7/8"	2 1/2"	52 3/8"	7 7/8"	-	-	-	2 3/4"	51 1/4"	7 7/8"
18" x 66"	2 5/8"	57 3/8"	7 7/8"	2 1/2"	58 3/8"	7 7/8"	-	-	-	2 3/4"	57 1/4"	7 7/8"
18" x 72"	2 5/8"	63 3/8"	7 7/8"	2 1/2"	64 3/8"	7 7/8"	-	-	-	2 3/4"	63 1/4"	7 7/8"
24" x 36"	2 5/8"	27 3/8"	10 5/8"	2 1/2"	28 3/8"	10 5/8"	5 1/8"	22 7/8"	10 5/8"	-	-	-
24" x 42"	2 5/8"	33 3/8"	10 5/8"	2 1/2"	34 3/8"	10 5/8"	5 1/8"	28 3/8"	10 5/8"	-	-	-
24" x 48"	2 5/8"	39 3/8"	10 5/8"	2 1/2"	40 3/8"	10 5/8"	5 1/8"	34 3/8"	10 5/8"	-	-	-
24" x 54"	2 5/8"	45 3/8"	10 5/8"	2 1/2"	46 3/8"	10 5/8"	5 1/8"	40 3/8"	10 5/8"	-	-	-
24" x 60"	2 5/8"	51 3/8"	10 5/8"	2 1/2"	52 3/8"	10 5/8"	5 1/8"	46 3/8"	10 5/8"	2 3/4"	51 1/4"	10 5/8"
24" x 66"	2 5/8"	57 3/8"	10 5/8"	2 1/2"	58 3/8"	10 5/8"	5 1/8"	52 3/8"	10 5/8"	2 3/4"	57 1/4"	10 5/8"
24" x 72"	2 5/8"	63 3/8"	10 5/8"	2 1/2"	64 3/8"	10 5/8"	5 1/8"	58 3/8"	10 5/8"	2 3/4"	63 1/4"	10 5/8"
24" x 84"	2 5/8"	75 3/8"	10 5/8"	2 1/2"	76 3/8"	10 5/8"	5 1/8"	70 3/8"	10 5/8"	-	-	-
24" x 96"	2 5/8"	87 3/8"	10 5/8"	2 1/2"	88 3/8"	10 5/8"	5 1/8"	82 3/8"	10 5/8"	-	-	-
30" x 36"	2 5/8"	27 3/8"	13 3/8"	2 1/2"	28 3/8"	13 3/8"	5 1/8"	22 7/8"	13 3/8"	-	-	-
30" x 42"	2 5/8"	33 3/8"	13 3/8"	2 1/2"	34 3/8"	13 3/8"	5 1/8"	28 3/8"	13 3/8"	-	-	-
30" x 48"	2 5/8"	39 3/8"	13 3/8"	2 1/2"	40 3/8"	13 3/8"	5 1/8"	34 3/8"	13 3/8"	-	-	-
30" x 54"	2 5/8"	45 3/8"	13 3/8"	2 1/2"	46 3/8"	13 3/8"	5 1/8"	40 3/8"	13 3/8"	-	-	-
30" x 60"	2 5/8"	51 3/8"	13 3/8"	2 1/2"	52 3/8"	13 3/8"	5 1/8"	46 3/8"	13 3/8"	2 3/4"	51 1/4"	13 3/8"
30" x 66"	2 5/8"	57 3/8"	13 3/8"	2 1/2"	58 3/8"	13 3/8"	5 1/8"	52 3/8"	13 3/8"	2 3/4"	57 1/4"	13 3/8"
30" x 72"	2 5/8"	63 3/8"	13 3/8"	2 1/2"	64 3/8"	13 3/8"	5 1/8"	58 3/8"	13 3/8"	2 3/4"	63 1/4"	13 3/8"
30" x 84"	2 5/8"	75 3/8"	13 3/8"	2 1/2"	76 3/8"	13 3/8"	5 1/8"	70 3/8"	13 3/8"	-	-	-
30" x 96"	2 5/8"	87 3/8"	13 3/8"	2 1/2"	88 3/8"	13 3/8"	5 1/8"	82 3/8"	13 3/8"	-	-	-
36" x 48"	2 5/8"	39 3/8"	16 3/8"	2 1/2"	40 3/8"	16 3/8"	-	-	-	-	-	-
36" x 54"	2 5/8"	45 3/8"	16 3/8"	2 1/2"	46 3/8"	16 3/8"	-	-	-	-	-	-
36" x 60"	2 5/8"	51 3/8"	16 3/8"	2 1/2"	52 3/8"	16 3/8"	-	-	-	-	-	-
36" x 66"	2 5/8"	57 3/8"	16 3/8"	2 1/2"	58 3/8"	16 3/8"	-	-	-	-	-	-
36" x 72"	2 5/8"	63 3/8"	16 3/8"	2 1/2"	64 3/8"	16 3/8"	-	-	-	-	-	-

**Space Requirement Guidelines**

Tables:

- 24"-30"W per person depending on materials
- 4' between tables
- Breakout Rooms 10-12 sq. ft. per person
- Computer Training 20 sq. ft. per person

**Aware Tables — Maximum Space Reduction**

Space reduction when storing:

- up to 71% by nesting
- up to 82% with table truck
- up to 86% by folding

Percentage will vary with quantity and size of tables.

**Space Savings With Nesting Tables**

1. Start with table size in nested position:  
 18"D table = 18"D  
 24"D table = 24"D  
 30"D table = 30"D  
 36"D table = 36"D
2. Add 7¼"D for each additional nested table (no additional required if modesty panel is attached).  
 Example: A 24"D table in nested position is 24"D.  
 Add 9 additional nested tables  
 (9 x = 69¾"D).  
 Depth requirement for ten nested tables is 93¾"D.
3. Add 1½"W for each additional nested T-Leg table to the width of the widest table. Maximum 6" additional width. (3"W for V-Leg; maximum 12" additional width)  
 Example: Ten 72"W tables are nested.  
 72" + 6" = 78"W
4. Total space for 10 nested tables above is 93¾"D x 78"W.
5. Space saved by nesting is over \_\_\_ square feet.
6. Table height of Aware nested tables:  
 18"D table = 37⅞"H nested  
 24"D table = 41⅞"H nested  
 30"D table = 44⅞"H nested  
 36"D table = 47⅞"H nested

**Folded Tables Standard — Side View**



**T-Leg Nested — Top View**

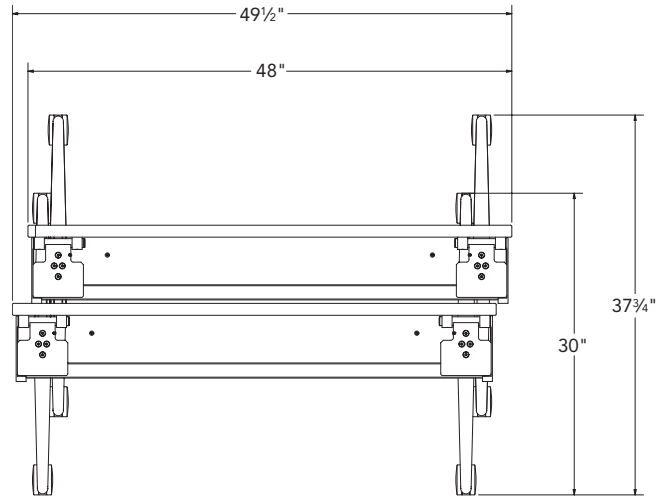

**V-Leg Nested — Top View**

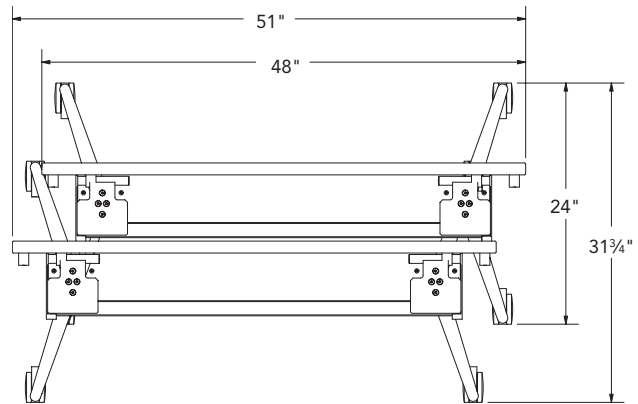



**POWER/DATA PORT CUTOUTS FOR AWARE TABLES**

When specifying Aware tables, grommets or power/data port cutouts may be specified for power/data. Grommets are available in plastic or oval (shown at right). If cutouts are specified, a pop-up power/data port must be specified for use in the cutout. Cutouts are unfinished and cannot be used as grommet openings. The chart below indicates which grommet or cutout options are available on Aware tables.

- | Code       | Position  |
|------------|---|
| <b>AGO</b> | No grommets or cutouts.   |
| <b>AG1</b> | Single grommet, centered left to right, 2" from back of surface.  |
| <b>AG2</b> | Pair of grommets, approximately 3" in from each side, 2" from back of surface.  |
| <b>ATC</b> | One cutout for Pop-up Power, centered left-to-right and front-to-back. Only on 30"D and 36"D tables. Do not specify on folding or nesting tables. |
| <b>ATE</b> | One cutout for Pop-up Power, centered left-to-right, 2" in from back of surface.  |

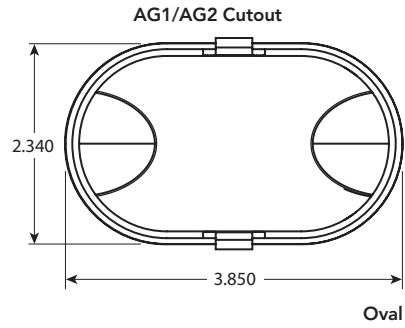

AG1 and AG2 Grommet Color Offering	
Designer White	DW
Black	E4
Flint	E9
Fossil	EH
Parchment	EN
Muslin	EU
Loft	EV
Brownstone	EY
Titanium	TI

Dimension	AGO	AG1	AG2	ATC	ATE
18"D x 48"W	•	•	•		•
18"D x 54"W	•	•	•		•
18"D x 60"W	•	•	•		•
18"D x 66"W	•	•	•		•
18"D x 72"W	•	•	•		•
24"D x 36"W	•	•	•		•
24"D x 42"W	•	•	•		•
24"D x 48"W	•	•	•		•
24"D x 54"W	•	•	•		•
24"D x 60"W	•	•	•		•
24"D x 66"W	•	•	•		•
24"D x 72"W	•	•	•		•
24"D x 84"W	•	•	•		•
24"D x 96"W	•	•	•		•
30"D x 36"W	•	•	•	•	•
30"D x 42"W	•	•	•	•	•
30"D x 48"W	•	•	•	•	•
30"D x 54"W	•	•	•	•	•
30"D x 60"W	•	•	•	•	•
30"D x 66"W	•	•	•	•	•
30"D x 72"W	•	•	•	•	•
30"D x 84"W	•	•	•	•	•
30"D x 96"W	•	•	•	•	•
36"D x 48"W	•	•	•	•	•
36"D x 54"W	•	•	•	•	•
36"D x 60"W	•	•	•	•	•
36"D x 66"W	•	•	•	•	•
36"D x 72"W	•	•	•	•	•

**Grommet Locations**

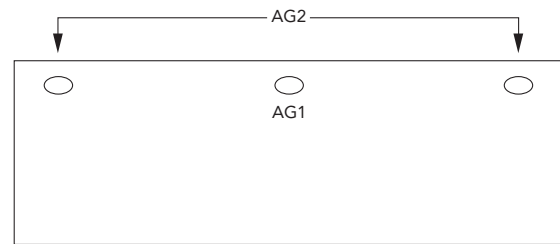

**Cutout Locations**

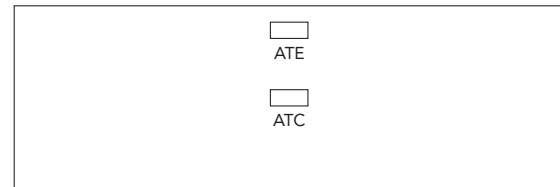

**WIRE MANAGER CABLE CAPACITY**

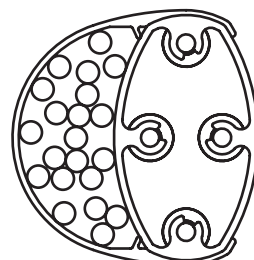

21 voice/data cables (.25" dia.) at 60% fill ratio

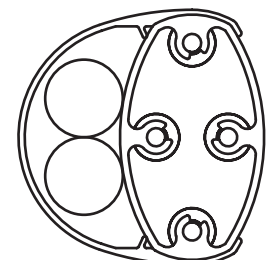

2 electrical infeed at 60% fill ratio

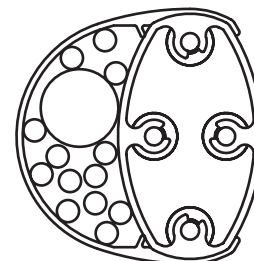

13 voice/data cables (.25" dia.) at 60% fill ratio

**ELECTRICAL OPTIONS**

Aware Tables offer three power options: Corded, Interlink IQ, or Hardwire. Installation and use of electrical systems, the number of receptacles used on a given circuit, and connections to the building power supply should be in compliance with all local and national electrical codes. Verify code requirements before ordering. Chicago requires hard wiring. Chicago and New York do not permit use of Interlink IQ components.

**Corded**

Corded models plug directly into an outlet. Corded modules cannot plug into other corded power modules. In order to plug into other units the unit would need to be hardwired. When routing corded models to a wall outlet, the maximum amount of cord that can be exposed outside of the furniture is 6 feet. (New York, check local code.)

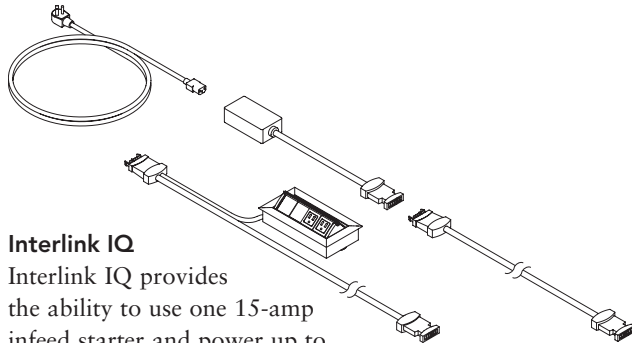
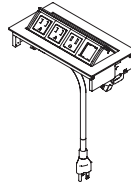

**Interlink IQ**

Interlink IQ provides the ability to use one 15-amp infeed starter and power up to 8 power modules (including jumpers) off of one infeed starter. Interlink IQ provides a visual indicator of system status. LED illuminates green when you are connected and ready to plug in. A red light indicates you have linked too many units. See page 434 for examples of multiple tables using Interlink IQ components.

**Hardwire**

Hardwire models are provided with 10' of sealtight cable. Customer must furnish junction boxes, conduit, and additional wire to be in compliance with local and national electrical codes.

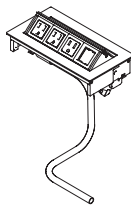

**Wire Trough**

Attach wire trough as needed to the underside of tables to support cords.

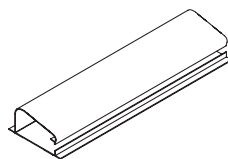

AWARE

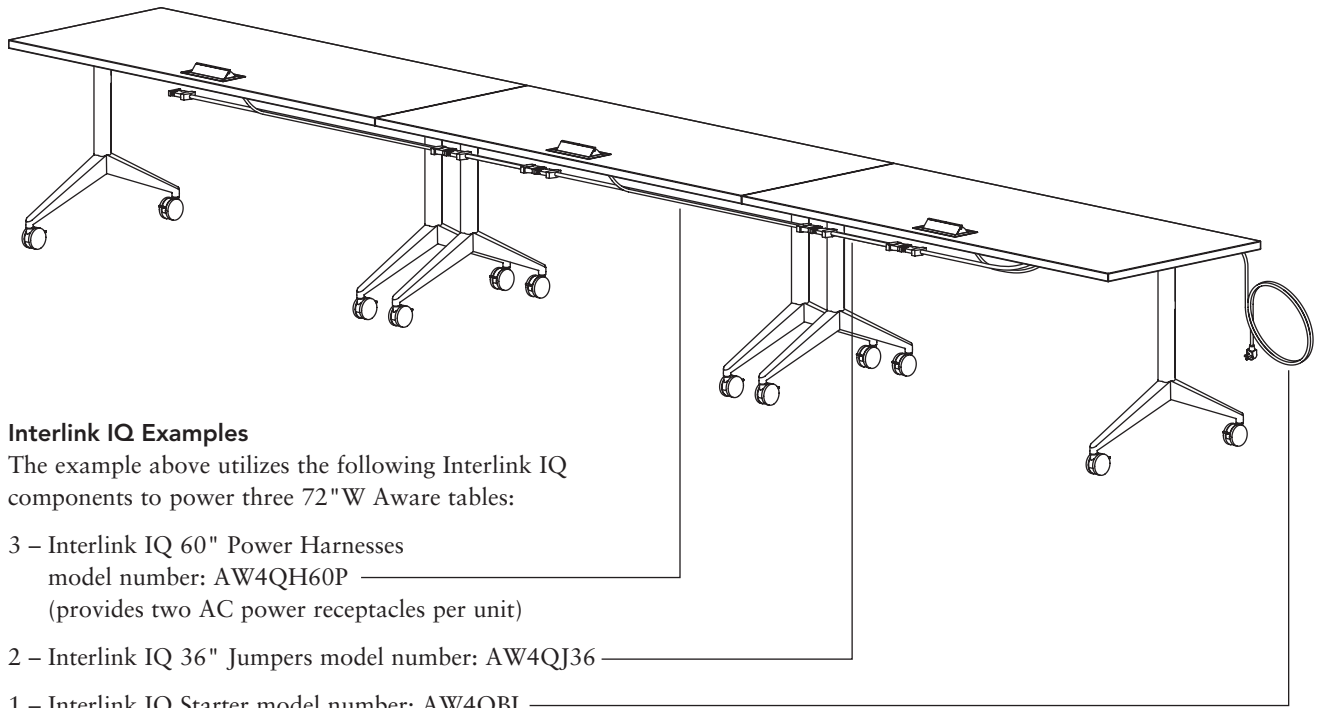

**Interlink IQ Examples**

The example above utilizes the following Interlink IQ components to power three 72" W Aware tables:

- 3 – Interlink IQ 60" Power Harnesses  
model number: AW4QH60P  
(provides two AC power receptacles per unit)
- 2 – Interlink IQ 36" Jumpers model number: AW4QJ36
- 1 – Interlink IQ Starter model number: AW4QBI

The example below utilizes the following Interlink IQ components to power five 72" W Aware tables:

- 5 – Interlink IQ 60" Power Harnesses model number:  
AW4QH60P  
(provides two AC power receptacles per unit)
- 2 – Interlink IQ 36" Jumpers model number: AW4QJ36
- 1 – Interlink IQ Starter model number: AW4QBI

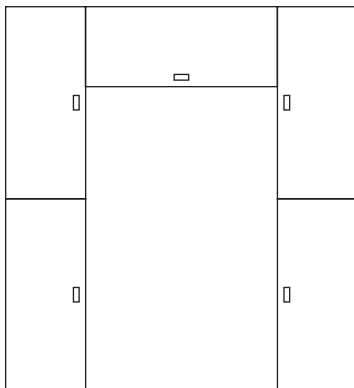

- Order folding legs separately — see options on page 438.
- Specify grommet location, type, and color — see page 434.
- Eased edge tops feature shaped edge on front side.
- Optional electrical components, wire trough, modesty panel, and ganging hardware ordered separately — see pages 455-458.

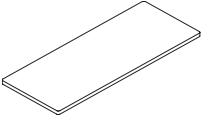

Description	Model	Ship Weight	Cubes	List Price			
				L1	L2	L3	FF
<b>18"D Folding Table Tops</b>							
60"W Laminate – Flat Edge	AW3LF1860F	52	4.6	\$ 636	\$ 660	\$ 681	—
60"W Laminate – T-Mold Edge	AW3LT1860F	36	4.6	\$ 636	\$ 660	\$ 681	—
60"W Fluid Form – Eased Edge	AW3FE1860F	52	4.6	—	—	—	\$ 838
66"W Laminate – Flat Edge	AW3LF1866F	57	5.0	\$ 718	\$ 746	\$ 768	—
66"W Laminate – T-Mold Edge	AW3LT1866F	44	5.0	\$ 718	\$ 746	\$ 768	—
66"W Fluid Form – Eased Edge	AW3FE1866F	57	5.0	—	—	—	\$ 953
72"W Laminate – Flat Edge	AW3LF1872F	62	5.5	\$ 744	\$ 772	\$ 796	—
72"W Laminate – T-Mold Edge	AW3LT1872F	52	5.5	\$ 744	\$ 772	\$ 796	—
72"W Fluid Form – Eased Edge	AW3FE1872F	62	5.5	—	—	—	\$ 1045
<b>24"D Folding Table Tops</b>							
60"W Laminate – Flat Edge	AW3LF2460F	53	5.9	\$ 696	\$ 723	\$ 744	—
60"W Laminate – T-Mold Edge	AW3LT2460F	53	5.9	\$ 696	\$ 723	\$ 744	—
60"W Fluid Form – Eased Edge	AW3FE2460F	53	5.9	—	—	—	\$ 852
66"W Laminate – Flat Edge	AW3LF2466F	64	6.4	\$ 744	\$ 772	\$ 796	—
66"W Laminate – T-Mold Edge	AW3LT2466F	64	6.4	\$ 744	\$ 772	\$ 796	—
66"W Fluid Form – Eased Edge	AW3FE2466F	64	6.4	—	—	—	\$ 1045
72"W Laminate – Flat Edge	AW3LF2472F	75	6.9	\$ 787	\$ 817	\$ 841	—
72"W Laminate – T-Mold Edge	AW3LT2472F	75	6.9	\$ 787	\$ 817	\$ 841	—
72"W Fluid Form – Eased Edge	AW3FE2472F	75	6.9	—	—	—	\$ 1235
<b>30"D Folding Table Tops</b>							
60"W Laminate – Flat Edge	AW3LF3060F	78	7.1	\$ 775	\$ 804	\$ 828	—
60"W Laminate – T-Mold Edge	AW3LT3060F	78	7.1	\$ 775	\$ 804	\$ 828	—
60"W Fluid Form – Eased Edge	AW3FE3060F	78	7.1	—	—	—	\$ 999
66"W Laminate – Flat Edge	AW3LF3066F	86	7.7	\$ 833	\$ 864	\$ 891	—
66"W Laminate – T-Mold Edge	AW3LT3066F	86	7.7	\$ 833	\$ 864	\$ 891	—
66"W Fluid Form – Eased Edge	AW3FE3066F	86	7.7	—	—	—	\$ 1120
72"W Laminate – Flat Edge	AW3LF3072F	93	8.4	\$ 889	\$ 921	\$ 951	—
72"W Laminate – T-Mold Edge	AW3LT3072F	93	8.4	\$ 889	\$ 921	\$ 951	—
72"W Fluid Form – Eased Edge	AW3FE3072F	93	8.4	—	—	—	\$ 1243

<p><b>How to specify —</b> Select the Model Number from above.</p> <p>Suffix: F for use with folding legs</p> <p>AW3          </p> <p>          F .</p>	<p><b>1st Option:</b> FSC Certified Wood:</p> <p>FSC Select for FSC Certified Wood X No FSC</p> <p>          .</p>	<p><b>2nd Option:</b> Laminate or Fluid Form:</p> <p>See inside front cover for finishes.</p> <p>          .</p>	<p><b>3rd Option:</b> Edge Color (Laminate only):</p> <p>See inside front cover for finishes.</p> <p>          .</p>	<p><b>4th Option:</b> Grommet or Cutout Location (see page 434):</p> <p>AG0 No Grommets AG1 Centered Oval (Add \$12) AG2 Pair Ovals (Add \$24) ATE Pop-up Power Cutout – Centered Side-to-Side, 2" from Back</p> <p>A          </p>	<p><b>5th Option:</b> Grommet Type (if applicable):</p> <p>P Oval Plastic</p> <p>         </p>	<p><b>6th Option:</b> Grommet Color:</p> <p>See page 434 for Oval grommet color offering.</p> <p>         </p>
---	--	--	--	---	--	--

Examples: AW3LT1860F.X.LM13EY.AG2PEY AW3FE3072F.FSC.TF33.AG0 [S] Shippable by small-package carrier.

- Order top for folding legs separately — see options on page 437.
- Legs are sold in pairs. Folding models do not include beam; order width to match width of top.
- Leg finish options include painted (color specified) or polished. Legs require some assembly.
- Legs below with top from previous page creates seated height 29"H table. Glides provide ½" of adjustment.
- All casters are urethane tread locking casters. Choice of Black or Silver.

AWARE

Description	Model + Suffix "B" Painted or "S" Polished	Ship Weight	Cubes	P1 Paint List Price	P2 Paint List Price	P3 Paint List Price	Polished List Price
<b>Folding 29"H T-Legs for 18"D – 24"D x 60"W – 72"W Tops</b>							
Pair, Seated Height w/Glides	AW2TSFG □ (shown)	17 <input checked="" type="checkbox"/>	2.7	\$ 1618	\$ 1644	\$ 1666	\$ 1825
Pair, Seated Height w/Casters	AW2TSFC □	17 <input checked="" type="checkbox"/>	2.4	\$ 1618	\$ 1644	\$ 1666	\$ 1825

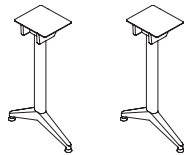

Description	Model + Suffix "B" Painted or "S" Polished	Ship Weight	Cubes	P1 Paint List Price	P2 Paint List Price	P3 Paint List Price	Polished List Price
<b>Folding 29"H T-Legs for 30"D x 60"W – 72"W Tops</b>							
Pair, Seated Height w/Glides	AW2TLFG □	17 <input checked="" type="checkbox"/>	4.3	\$ 1670	\$ 1696	\$ 1718	\$ 1877
Pair, Seated Height w/Casters	AW2TLFC □ (shown)	17 <input checked="" type="checkbox"/>	4.1	\$ 1670	\$ 1696	\$ 1718	\$ 1877

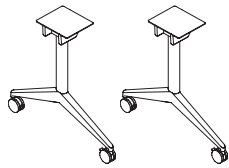

<p><b>How to specify —</b> Select the Model Number from above. Add suffix: <b>B</b> for Painted <b>S</b> for Polished</p>	<p><i>1st Option:</i> <b>Paint Color or PAL for Polished:</b> <input type="radio"/> P1 <input type="radio"/> P2 <input type="radio"/> P3 See page 430 for finishes.</p>	<p><i>2nd Option:</i> <b>Caster Color (if applicable):</b> <b>B</b> Black <b>S</b> Silver</p>
<p>AW2   .                                 .</p>		

Examples: AW2TSFGB.P7D AW2TSFCB.P7D.B AW2TLFCS.PAL.S  Shippable by small-package carrier.

- Order legs separately — see options on page 440. “T” suffix top for T-legs.
- Specify grommet location, type, and color — see page 434.
- Eased edge tops feature shaped edge on front side.
- Optional electrical components, wire trough, modesty panel, and ganging hardware ordered separately — see pages 455-458.

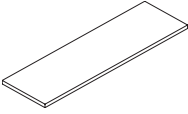

Description	Model	Ship Weight	Cubes	List Price			
				L1 or V1	L2 or V2	L3	FF
<b>18"D Table Tops</b>							
48"W Laminate – Flat Edge	AW3LF1848T	36 <input type="checkbox"/> S	3.8	\$ 545	\$ 567	\$ 584	—
48"W Laminate – T-Mold Edge	AW3LT1848T	36 <input type="checkbox"/> S	3.8	\$ 545	\$ 567	\$ 584	—
48"W Fluid Form – Eased Edge	AW3FE1848T	36 <input type="checkbox"/> S	3.8	—	—	—	\$ 813
48"W Veneer – Square Edge	AW3VF1848T	36 <input type="checkbox"/> S	3.8	\$ 2862	\$ 3075	—	—
<hr/>							
54"W Laminate – Flat Edge	AW3LF1854T	44 <input type="checkbox"/> S	4.2	\$ 578	\$ 601	\$ 620	—
54"W Laminate – T-Mold Edge	AW3LT1854T	44 <input type="checkbox"/> S	4.2	\$ 578	\$ 601	\$ 620	—
54"W Fluid Form – Eased Edge	AW3FE1854T	44 <input type="checkbox"/> S	4.2	—	—	—	\$ 821
54"W Veneer – Square Edge	AW3VF1854T	44 <input type="checkbox"/> S	4.2	\$ 2985	\$ 3208	—	—
<hr/>							
60"W Laminate – Flat Edge	AW3LF1860T (shown)	52 <input type="checkbox"/> S	4.6	\$ 636	\$ 660	\$ 681	—
60"W Laminate – T-Mold Edge	AW3LT1860T	52 <input type="checkbox"/> S	4.6	\$ 636	\$ 660	\$ 681	—
60"W Fluid Form – Eased Edge	AW3FE1860T	52 <input type="checkbox"/> S	4.6	—	—	—	\$ 838
60"W Veneer – Square Edge	AW3VF1860T	52 <input type="checkbox"/> S	4.6	\$ 3112	\$ 3345	—	—
<hr/>							
66"W Laminate – Flat Edge	AW3LF1866T	57 <input type="checkbox"/> S	5.0	\$ 718	\$ 746	\$ 768	—
66"W Laminate – T-Mold Edge	AW3LT1866T	57 <input type="checkbox"/> S	5.0	\$ 718	\$ 746	\$ 768	—
66"W Fluid Form – Eased Edge	AW3FE1866T	57 <input type="checkbox"/> S	5.0	—	—	—	\$ 953
66"W Veneer – Square Edge	AW3VF1866T	57 <input type="checkbox"/> S	5.0	\$ 3301	\$ 3548	—	—
<hr/>							
72"W Laminate – Flat Edge	AW3LF1872T	62 <input type="checkbox"/> S	5.5	\$ 744	\$ 772	\$ 796	—
72"W Laminate – T-Mold Edge	AW3LT1872T	62 <input type="checkbox"/> S	5.5	\$ 744	\$ 772	\$ 796	—
72"W Fluid Form – Eased Edge	AW3FE1872T	62 <input type="checkbox"/> S	5.5	—	—	—	\$ 1045
72"W Veneer – Square Edge	AW3VF1872T	62 <input type="checkbox"/> S	5.5	\$ 3361	\$ 3612	—	—

AWARE

<p><b>How to specify —</b> Select the Model Number from above.</p> <p>AW3          </p> <p>          T   .</p>	<p><b>1st Option:</b> FSC Certified Wood:</p> <p>FSC Select for FSC Certified Wood X No FSC</p>	<p><b>2nd Option:</b> Laminate or Fluid Form:</p> <p>See inside front cover for finishes.</p>	<p><b>3rd Option:</b> Edge Color (Laminate only):</p> <p>See inside front cover for finishes.</p>	<p><b>4th Option:</b> Grommet or Cutout Location (see page 434):</p> <p>AG0 No Grommets AG1 Centered Oval (Add \$12) AG2 Pair Ovals (Add \$24) ATE Pop-up Power Cutout – Centered Side-to-Side, 2" from Back</p> <p>A        </p>	<p><b>5th Option:</b> Grommet Type (if applicable):</p> <p>P Oval Plastic</p>	<p><b>6th Option:</b> Grommet Color:</p> <p>See page 434 for Oval grommet color offering.</p>
--	---	---	---	---	---	---

Examples: AW3LT1848T.X.LM13EY.AG2PEY

Shippable by small-package carrier.

- Order top separately — see options on page 439. "T" suffix top for T-legs.
- Legs are sold in pairs. Nesting models and T-legs 60"W and wider include beam, order width to match width of top.

- Leg finish options include painted (color specified) or polished. Legs require some assembly.
- Legs below with top from previous page creates seated height 29"H table. Glides provide ½" of adjustment.

- All casters are urethane tread locking casters. Choice of Black or Silver.

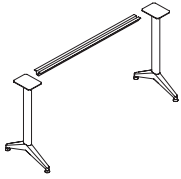

Description	Model + Suffix "B" Painted or "S" Polished	Ship Weight	Cubes	P1 Paint List Price	P2 Paint List Price	P3 Paint List Price	Polished List Price
<b>Fixed 29"H T-Legs for 18"D Tops (60"W and 72"W includes beam)</b>							
48"W or 54"W Pair, Seated Height w/Glides	AW2TSPG □	16	Ⓢ 2.8	\$ 888	\$ 912	\$ 934	\$ 1086
48"W or 54"W Pair, Seated Height w/Casters	AW2TSPC □	16	Ⓢ 2.4	\$ 888	\$ 912	\$ 934	\$ 1086
60"W or 66"W Pair, Seated Height w/Glides	AW2TSPG □ 60 (shown)	23	3.5	\$ 999	\$ 1023	\$ 1045	\$ 1197
60"W or 66"W Pair, Seated Height w/Casters	AW2TSPC □ 60	23	3.5	\$ 999	\$ 1023	\$ 1045	\$ 1197
72"W Pair, Seated Height w/Glides	AW2TSPG □ 72	25	3.8	\$ 1027	\$ 1051	\$ 1073	\$ 1225
72"W Pair, Seated Height w/Casters	AW2TSPC □ 72	25	3.8	\$ 1027	\$ 1051	\$ 1073	\$ 1225

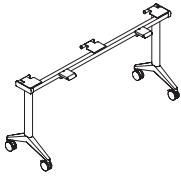

<b>Nesting 29"H T-Legs for 18"D Tops (includes beam)</b>							
48"W Kit, Seated Height w/Casters	AW2TS18N48C □	24	4.8	\$ 1411	\$ 1437	\$ 1459	\$ 1626
54"W Kit, Seated Height w/Casters	AW2TS18N54C □	24	5.1	\$ 1430	\$ 1456	\$ 1478	\$ 1649
60"W Kit, Seated Height w/Casters	AW2TS18N60C □ (shown)	32	5.4	\$ 1530	\$ 1556	\$ 1578	\$ 1769
66"W Kit, Seated Height w/Casters	AW2TS18N66C □	33	5.4	\$ 1575	\$ 1601	\$ 1623	\$ 1791
72"W Kit, Seated Height w/Casters	AW2TS18N72C □	35	5.6	\$ 1626	\$ 1652	\$ 1674	\$ 1845

<p><b>How to specify —</b> Select the Model Number from above. Add suffix: B for Painted S for Polished</p>	<p><b>1st Option:</b> <b>Paint Color or PAL for Polished:</b> P1 P2 P3 See page 430 for finishes.</p>	<p><b>2nd Option:</b> <b>Caster Color (if applicable):</b> B Black S Silver</p>	<p>AW2                 .         .</p>
---	---	---	--

Examples: AW2TSPGB.P7D AW2TSPCB60.P7D.B AW2TS18N48CS.PAL.S

Ⓢ Shippable by small-package carrier.

- Order legs separately — see options on page 442. “T” suffix top for T-legs and “V” suffix top for V-legs.
- Specify grommet location, type, and color — see page 434.
- Knife edge tops feature shaped edge on all sides. Eased edge tops feature shaped edge on front side.
- Optional electrical components, wire trough, modesty panel, and ganging hardware ordered separately — see pages 455-458.

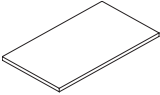

Description	Model + Suffix "T" T-leg / "V" V-leg	Ship Weight	Cubes	List Price			
				L1 or V1	L2 or V2	L3	FF
<b>24"D Table Tops</b>							
36"W Laminate – Flat Edge	AW3LF2436 □	36	3.7	\$ 512	\$ 532	\$ 548	—
36"W Laminate – T-Mold Edge	AW3LT2436 □	36	3.7	\$ 512	\$ 532	\$ 548	—
36"W Laminate – Knife Edge*	AW3LK2436V	36	3.7	\$ 1650	\$ 1706	\$ 1761	—
36"W Fluid Form – Eased Edge	AW3FE2436 □	36	3.7	—	—	—	\$ 804
36"W Veneer – Square Edge	AW3VF2436 □	36	3.7	\$ 2739	\$ 2943	—	—
<hr/>							
42"W Laminate – Flat Edge	AW3LF2442 □ (shown)	41	4.2	\$ 545	\$ 567	\$ 584	—
42"W Laminate – T-Mold Edge	AW3LT2442 □	41	4.2	\$ 545	\$ 567	\$ 584	—
42"W Laminate – Knife Edge	AW3LK2442V	41	4.2	\$ 1659	\$ 1715	\$ 1770	—
42"W Fluid Form – Eased Edge	AW3FE2442 □	41	4.2	—	—	—	\$ 813
42"W Veneer – Square Edge	AW3VF2442 □	41	4.2	\$ 2862	\$ 3075	—	—
<hr/>							
48"W Laminate – Flat Edge	AW3LF2448 □	46	4.8	\$ 578	\$ 601	\$ 620	—
48"W Laminate – T-Mold Edge	AW3LT2448 □	46	4.8	\$ 578	\$ 601	\$ 620	—
48"W Laminate – Knife Edge	AW3LK2448V	46	4.8	\$ 1666	\$ 1722	\$ 1778	—
48"W Fluid Form – Eased Edge	AW3FE2448 □	46	4.8	—	—	—	\$ 821
48"W Veneer – Square Edge	AW3VF2448 □	46	4.8	\$ 2985	\$ 3208	—	—
<hr/>							
54"W Laminate – Flat Edge	AW3LF2454 □	49	5.3	\$ 636	\$ 660	\$ 681	—
54"W Laminate – T-Mold Edge	AW3LT2454 □	49	5.3	\$ 636	\$ 660	\$ 681	—
54"W Laminate – Knife Edge	AW3LK2454V	49	5.3	\$ 1671	\$ 1728	\$ 1783	—
54"W Fluid Form – Eased Edge	AW3FE2454 □	49	5.3	—	—	—	\$ 838
54"W Veneer – Square Edge	AW3VF2454 □	49	5.3	\$ 3112	\$ 3345	—	—

\*V-legs are the only option offered for knife edge table tops.

<p><b>How to specify —</b> Select the Model Number from above.</p> <p>Suffix: T for use with T legs V for use with V legs (Knife “V” only)</p> <p>AW3          </p>	<p><b>1st Option:</b> FSC Certified Wood:</p> <p>FSC Select for FSC Certified Wood X No FSC</p> <p>          .</p>	<p><b>2nd Option:</b> Laminate or Fluid Form:</p> <p>See inside front cover for finishes.</p> <p>          .</p>	<p><b>3rd Option:</b> Edge Color (Laminate only):</p> <p>See inside front cover for finishes.</p> <p>          .</p>	<p><b>4th Option:</b> Grommet or Cutout Location (see page 434):</p> <p>AG0 No Grommets AG1 Centered Oval (Add \$12) AG2 Pair Ovals (Add \$24) ATE Pop-up Power Cutout – Centered Side-to-Side, 2" from Back</p> <p>A          </p>	<p><b>5th Option:</b> Grommet Type (if applicable):</p> <p>P Oval Plastic</p> <p>         </p>	<p><b>6th Option:</b> Grommet Color:</p> <p>See page 434 for Oval grommet color offering.</p> <p>         </p>
---	--	--	--	---	--	--

Examples: AW3LT2436T.X.LM13EY.AG2PEY

AW3VF2454V.FSC.NC777.P

Shippable by small-package carrier.



- Order top separately — see options on page 441. “T” suffix top for T-legs and “V” suffix top for V-legs.
- Legs are sold in pairs. Nesting models include beam, order width to match width of top.

- Leg finish options include painted (color specified) or polished. Legs require some assembly.
- Select legs below with top from previous page to create either a seated height 29"H table or a 42"H standing height table. Glides provide ½" of adjustment.

- All casters are urethane tread locking casters. Choice of Black or Silver.

AWARE

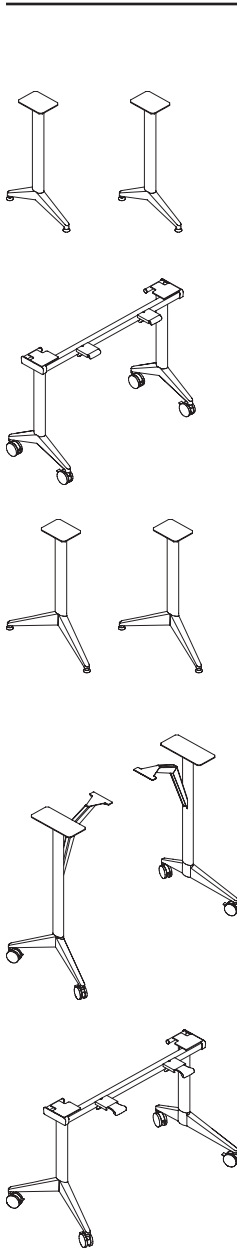

Description	Model + Suffix "B" Painted or "S" Polished	Ship Weight	Cubes	P1 Paint List Price	P2 Paint List Price	P3 Paint List Price	Polished List Price
<b>Fixed 29"H T-Legs for 24"D x 36"W – 54"W Tops</b>							
Pair, Seated Height w/Glides	AW2TSPG □ (shown)	16 <b>S</b>	2.8	\$ 888	\$ 912	\$ 934	\$ 1086
Pair, Seated Height w/Casters	AW2TSPC □	16 <b>S</b>	2.4	\$ 888	\$ 912	\$ 934	\$ 1086

<b>Nesting 29"H T-Legs for 24"D Tops (includes beam)</b>							
36"W Kit, Seated Height w/Casters	AW2TS24N36C □	22	4.5	\$ 1393	\$ 1419	\$ 1441	\$ 1607
42"W Kit, Seated Height w/Casters	AW2TS24N42C □ (shown)	23	4.5	\$ 1402	\$ 1428	\$ 1450	\$ 1617
48"W Kit, Seated Height w/Casters	AW2TS24N48C □	24	4.8	\$ 1411	\$ 1437	\$ 1459	\$ 1626
54"W Kit, Seated Height w/Casters	AW2TS24N54C □	24	5.1	\$ 1430	\$ 1456	\$ 1478	\$ 1649

<b>Fixed 29"H V-Legs for 24"D – 30"D x 36"W – 54"W Tops</b>							
Pair, Seated Height w/Glides	AW2VMPG □ (shown)	18 <b>S</b>	3.5	\$ 1035	\$ 1059	\$ 1081	\$ 1232
Pair, Seated Height w/Casters	AW2VMPC □	18 <b>S</b>	2.4	\$ 1035	\$ 1059	\$ 1081	\$ 1232

<b>Fixed 42"H V-Legs for 24"D x 54"W Tops</b>							
54"W Pair Standing Height w/Glides	AW2VMSHGB	5.8	28	\$ 1375	\$ 1399	\$ 1421	—
54"W Pair Standing Height w/Casters	AW2VMSHCB (shown)	5.8	28	\$ 1375	\$ 1399	\$ 1421	—

<b>Nesting 29"H V-Legs for 24"D Tops (includes beam)</b>							
36"W Kit, Seated Height w/Casters	AW2VM24N36C □	24	4.5	\$ 1540	\$ 1566	\$ 1588	\$ 1760
42"W Kit, Seated Height w/Casters	AW2VM24N42C □ (shown)	24	4.5	\$ 1551	\$ 1577	\$ 1599	\$ 1769
48"W Kit, Seated Height w/Casters	AW2VM24N48C □	25	4.5	\$ 1560	\$ 1586	\$ 1608	\$ 1779
54"W Kit, Seated Height w/Casters	AW2VM24N54C □	26	4.8	\$ 1569	\$ 1595	\$ 1617	\$ 1788

**NOTE:** T-legs only work with “T” suffix tops and V-legs only work with “V” suffix tops.

<p><b>How to specify —</b></p> <p>Select the Model Number from above.</p> <p>Add suffix:  <b>B</b> for Painted  <b>S</b> for Polished</p> <p><b>AW2</b>   .         .</p>	<p><b>1st Option:</b></p> <p><b>Paint Color or PAL for Polished:</b></p> <p><b>P1 P2 P3</b></p> <p>See page 430 for finishes.</p> <p>Standing height only available as painted.</p>	<p><b>2nd Option:</b></p> <p><b>Caster Color (if applicable):</b></p> <p><b>B</b> Black  <b>S</b> Silver</p>
---	---	--

- Order legs separately — see options on page 444. “T” suffix top for T-legs and “V” suffix top for V-legs.
- Specify grommet location, type, and color — see page 434.
- Knife edge tops feature shaped edge on all sides. Eased edge tops feature shaped edge on front side.
- Optional electrical components, wire trough, modesty panel, and ganging hardware ordered separately — see pages 455-458.

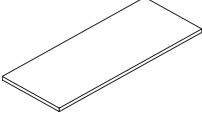

Description	Model + Suffix "T" T-leg / "V" V-leg	Ship Weight	Cubes	List Price			
				L1 or V1	L2 or V2	L3	FF
<b>24"D Table Tops</b>							
60"W Laminate – Flat Edge	AW3LF2460 □	53 [S]	5.9	\$ 696	\$ 723	\$ 744	—
60"W Laminate – T-Mold Edge	AW3LT2460 □	53 [S]	5.9	\$ 696	\$ 723	\$ 744	—
60"W Laminate – Knife Edge*	AW3LK2460V	53 [S]	5.9	\$ 1682	\$ 1739	\$ 1796	—
60"W Fluid Form – Eased Edge	AW3FE2460 □	53 [S]	5.9	—	—	—	\$ 852
60"W Veneer – Square Edge	AW3VF2460 □	53 [S]	5.9	\$ 3239	\$ 3480	—	—
<b>66"W Table Tops</b>							
66"W Laminate – Flat Edge	AW3LF2466 □	64 [S]	6.4	\$ 744	\$ 772	\$ 796	—
66"W Laminate – T-Mold Edge	AW3LT2466 □	64 [S]	6.4	\$ 744	\$ 772	\$ 796	—
66"W Laminate – Knife Edge*	AW3LK2466V	64 [S]	6.4	\$ 1755	\$ 1814	\$ 1874	—
66"W Fluid Form – Eased Edge	AW3FE2466 □	64 [S]	6.4	—	—	—	\$ 1045
66"W Veneer – Square Edge	AW3VF2466 □	64 [S]	6.4	\$ 3361	\$ 3612	—	—
<b>72"W Table Tops</b>							
72"W Laminate – Flat Edge	AW3LF2472 □	75 [S]	6.9	\$ 787	\$ 817	\$ 841	—
72"W Laminate – T-Mold Edge	AW3LT2472 □	75 [S]	6.9	\$ 787	\$ 817	\$ 841	—
72"W Laminate – Knife Edge*	AW3LK2472V	75 [S]	6.9	\$ 1835	\$ 1897	\$ 1959	—
72"W Fluid Form – Eased Edge	AW3FE2472 □	75 [S]	6.9	—	—	—	\$ 1235
72"W Veneer – Square Edge	AW3VF2472 □	75 [S]	6.9	\$ 3488	\$ 3748	—	—
<b>84"W Table Tops</b>							
84"W Laminate – Flat Edge	AW3LF2484 □	91 [S]	8.0	\$ 908	\$ 941	\$ 971	—
84"W Laminate – T-Mold Edge	AW3LT2484 □	91 [S]	8.0	\$ 908	\$ 941	\$ 971	—
84"W Laminate – Knife Edge*	AW3LK2484V	91 [S]	8.0	\$ 2021	\$ 2088	\$ 2156	—
84"W Fluid Form – Eased Edge	AW3FE2484 □	91 [S]	8.0	—	—	—	\$ 1721
84"W Veneer – Square Edge	AW3VF2484 □	91 [S]	8.0	\$ 3807	\$ 4091	—	—
<b>96"W Table Tops</b>							
96"W Laminate – Flat Edge	AW3LF2496 □	100	9.1	\$ 1095	\$ 1134	\$ 1169	—
96"W Laminate – T-Mold Edge	AW3LT2496 □	100	9.1	\$ 1095	\$ 1134	\$ 1169	—
96"W Laminate – Knife Edge*	AW3LK2496V	100	9.1	\$ 2322	\$ 2400	\$ 2479	—
96"W Fluid Form – Eased Edge	AW3FE2496 □	100	9.1	—	—	—	\$ 2482
96"W Veneer – Square Edge	AW3VF2496 □	100	9.1	\$ 4313	\$ 4635	—	—

\*V-legs are the only option offered for knife edge table tops.

<p><b>How to specify —</b> Select the Model Number from above.</p> <p>Suffix: T for use with T legs V for use with V legs (Knife “V” only)</p> <p><b>AW3</b>          </p>	<p><b>1st Option:</b> FSC Certified Wood:</p> <p>FSC Select for FSC Certified Wood X No FSC</p>	<p><b>2nd Option:</b> Laminate or Fluid Form:</p> <p>See inside front cover for finishes.</p>	<p><b>3rd Option:</b> Edge Color (Laminate only):</p> <p>See inside front cover for finishes.</p>	<p><b>4th Option:</b> Grommet or Cutout Location (see page 434):</p> <p>AG0 No Grommets AG1 Centered Oval (Add \$12) AG2 Pair Ovals (Add \$24) ATE Pop-up Power Cutout – Centered Side-to-Side, 2" from Back</p> <p><b>A</b>          </p>	<p><b>5th Option:</b> Grommet Type (if applicable):</p> <p>P Oval Plastic</p>	<p><b>6th Option:</b> Grommet Color:</p> <p>See page 434 for Oval grommet color offering.</p>
--	---	---	---	--	---	---

Examples: AW3LT2460T.X.LM13EY.AG2PEY

[S] Shippable by small-package carrier.

- Order Top separately — see options on page 443. “T” suffix top for T-legs and “V” suffix top for V-legs.
- Leg finish options include painted (color specified) or polished. Legs require some assembly. Standing height models come with external stiffener.
- Legs are sold in pairs. Nesting models include beam, order width to match width of top.
- Select legs below with top from previous page to create either a seated height 29"H table or a 42"H standing height table. Glides provide ½" of adjustment.
- All casters are urethane tread locking casters. Choice of Black or Silver.

AWARE

Description	Model + Suffix "B" Painted or "S" Polished	Ship Weight	Cubes	P1 Paint List Price	P2 Paint List Price	P3 Paint List Price	Polished List Price
<b>Fixed 29"H T-Legs for 24"D Tops (includes beam)</b>							
60"- 66"W Kit, Seated Height w/Glides	AW2TSPG □ 60 (shown)	23	3.5	\$ 999	\$ 1023	\$ 1045	\$ 1197
60"- 66"W Kit, Seated Height w/Casters	AW2TSPC □ 60	23	3.5	\$ 999	\$ 1023	\$ 1045	\$ 1197
72"W Kit, Seated Height w/Glides	AW2TSPG □ 72	25	3.8	\$ 1027	\$ 1051	\$ 1073	\$ 1225
72"W Kit, Seated Height w/Casters	AW2TSPC □ 72	25	3.8	\$ 1027	\$ 1051	\$ 1073	\$ 1225
84"W Kit, Seated Height w/Glides	AW2TSPG □ 84	27	4.2	\$ 1055	\$ 1079	\$ 1101	\$ 1253
84"W Kit, Seated Height w/Casters	AW2TSPC □ 84	27	4.2	\$ 1055	\$ 1079	\$ 1101	\$ 1253
96"W Kit, Seated Height w/Glides	AW2TSPG □ 96	28	4.2	\$ 1278	\$ 1302	\$ 1324	\$ 1476
96"W Kit, Seated Height w/Casters	AW2TSPC □ 96	28	4.2	\$ 1278	\$ 1302	\$ 1324	\$ 1476
<b>Nesting 29"H T-Legs for 24"D Tops (includes beam)</b>							
60"W Kit, Seated Height w/Casters	AW2TS24N60C □ (shown)	32	5.4	\$ 1530	\$ 1556	\$ 1578	\$ 1769
66"W Kit, Seated Height w/Casters	AW2TS24N66C □	33	5.4	\$ 1575	\$ 1601	\$ 1623	\$ 1791
72"W Kit, Seated Height w/Casters	AW2TS24N72C □	35	5.6	\$ 1626	\$ 1652	\$ 1674	\$ 1845
84"W Kit, Seated Height w/Casters	AW2TS24N84C □	40	6.1	\$ 1705	\$ 1731	\$ 1753	\$ 1920
96"W Kit, Seated Height w/Casters	AW2TS24N96C □	44	6.5	\$ 1781	\$ 1807	\$ 1829	\$ 1994
<b>Fixed 29"H V-Legs for 24"D Tops (includes beam)</b>							
60"- 66"W Kit, Seated Height w/Glides	AW2VMPG □ 60 (shown)	25	4.3	\$ 1146	\$ 1170	\$ 1192	\$ 1343
60"- 66"W Kit, Seated Height w/Casters	AW2VMPC □ 60	25	4.3	\$ 1146	\$ 1170	\$ 1192	\$ 1343
72"W Kit, Seated Height w/Glides	AW2VMPG □ 72	27	4.5	\$ 1174	\$ 1198	\$ 1220	\$ 1371
72"W Kit, Seated Height w/Casters	AW2VMPC □ 72	27	4.5	\$ 1174	\$ 1198	\$ 1220	\$ 1371
84"W Kit, Seated Height w/Glides	AW2VMPG □ 84	29	5.0	\$ 1202	\$ 1226	\$ 1248	\$ 1399
84"W Kit, Seated Height w/Casters	AW2VMPC □ 84	29	5.0	\$ 1202	\$ 1226	\$ 1248	\$ 1399
96"W Kit, Seated Height w/Glides	AW2VMPG □ 96	30	5.0	\$ 1425	\$ 1449	\$ 1471	\$ 1622
96"W Kit, Seated Height w/Casters	AW2VMPC □ 96	30	5.0	\$ 1425	\$ 1449	\$ 1471	\$ 1622
<b>Fixed 42"H V-Legs for 24"D Tops</b>							
60"-66" W Kit Standing Height w/Glides	AW2VMSHGB60	6.6	35	\$ 1486	\$ 1510	\$ 1532	—
60"-66" W Kit Standing Height w/Casters	AW2VMSHCB60 (shown)	6.6	35	\$ 1486	\$ 1510	\$ 1532	—
72" W Kit Standing Height w/Glides	AW2VMSHGB72	6.8	37	\$ 1514	\$ 1538	\$ 1560	—
72" W Kit Standing Height w/Casters	AW2VMSHCB72	6.8	37	\$ 1514	\$ 1538	\$ 1560	—
84" W Kit Standing Height w/Glides	AW2VMSHGB84	7.3	39	\$ 1542	\$ 1566	\$ 1588	—
84" W Kit Standing Height w/Casters	AW2VMSHCB84	7.3	39	\$ 1542	\$ 1566	\$ 1588	—
<b>Nesting 29"H V-Legs for 24"D Tops (includes beam)</b>							
60"W Kit, Seated Height w/Casters	AW2VM24N60C □ (shown)	33	5.1	\$ 1699	\$ 1725	\$ 1747	\$ 1922
66"W Kit, Seated Height w/Casters	AW2VM24N66C □	34	5.4	\$ 1688	\$ 1714	\$ 1736	\$ 1931
72"W Kit, Seated Height w/Casters	AW2VM24N72C □	37	5.4	\$ 1761	\$ 1787	\$ 1809	\$ 1981
84"W Kit, Seated Height w/Casters	AW2VM24N84C □	41	6.1	\$ 1840	\$ 1866	\$ 1888	\$ 2057
96"W Kit, Seated Height w/Casters	AW2VM24N96C □	45	6.5	\$ 1915	\$ 1941	\$ 1963	\$ 2134

**NOTE:** T-legs only work with “T” suffix tops and V-legs only work with “V” suffix tops.

<p><b>How to specify —</b>                  Select the Model Number from above.                  Add suffix:  <b>B</b> for Painted  <b>S</b> for Polished</p>	<p><b>1st Option:</b>                  Paint Color or PAL for Polished:                  P1 P2 P3                  See page 430 for finishes.                    Standing height only available as painted.</p>	<p><b>2nd Option:</b>                  Caster Color (if applicable):  <b>B</b> Black  <b>S</b> Silver (coming soon)</p>
<p>AW 2                     .                 .</p>		

Examples: AW2TSPGB60.P7D AW2TSPCB60.P7D.B AW2TS24N60CS.PAL.S [S] Shippable by small-package carrier.

- Order legs separately — see options on page 446. “T” suffix top for T-legs and “V” suffix top for V-legs.
- Specify grommet location, type, and color — see page 434.
- Knife edge tops feature shaped edge on all sides. Eased edge tops feature shaped edge on front side.
- Optional electrical components, wire trough, modesty panel, and ganging hardware ordered separately — see pages 455-458.

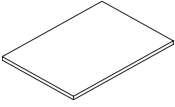

Description	Model + Suffix "T" T-leg / "V" V-leg	Ship Weight	Cubes	List Price			
				L1 or V1	L2 or V2	L3	FF
<b>30"D Table Tops</b>							
36"W Laminate – Flat Edge	AW3LF3036 □	43 [S]	4.4	\$ 545	\$ 567	\$ 584	—
36"W Laminate – T-Mold Edge	AW3LT3036 □	43 [S]	4.4	\$ 545	\$ 567	\$ 584	—
36"W Laminate – Knife Edge*	AW3LK3036V	43 [S]	4.4	\$ 1659	\$ 1715	\$ 1770	—
36"W Fluid Form – Eased Edge	AW3FE3036 □	43 [S]	4.4	—	—	—	\$ 813
36"W Veneer – Square Edge	AW3VF3036 □	43 [S]	4.4	\$ 2862	\$ 3075	—	—
<hr/>							
42"W Laminate – Flat Edge	AW3LF3042 □	51 [S]	5.1	\$ 578	\$ 601	\$ 620	—
42"W Laminate – T-Mold Edge	AW3LT3042 □	51 [S]	5.1	\$ 578	\$ 601	\$ 620	—
42"W Laminate – Knife Edge	AW3LK3042V	51 [S]	5.1	\$ 1666	\$ 1722	\$ 1778	—
42"W Fluid Form – Eased Edge	AW3FE3042 □	51 [S]	5.1	—	—	—	\$ 821
42"W Veneer – Square Edge	AW3VF3042 □	51 [S]	5.1	\$ 2985	\$ 3208	—	—
<hr/>							
48"W Laminate – Flat Edge	AW3LF3048 □	58 [S]	5.8	\$ 627	\$ 651	\$ 671	—
48"W Laminate – T-Mold Edge	AW3LT3048 □	58 [S]	5.8	\$ 627	\$ 651	\$ 671	—
48"W Laminate – Knife Edge	AW3LK3048V	58 [S]	5.8	\$ 1647	\$ 1703	\$ 1758	—
48"W Fluid Form – Eased Edge	AW3FE3048 □	58 [S]	5.8	—	—	—	\$ 850
48"W Veneer – Square Edge	AW3VF3048 □	58 [S]	5.8	\$ 3171	\$ 3408	—	—
<hr/>							
54"W Laminate – Flat Edge	AW3LF3054 □	65 [S]	6.4	\$ 701	\$ 728	\$ 749	—
54"W Laminate – T-Mold Edge	AW3LT3054 □	65 [S]	6.4	\$ 701	\$ 728	\$ 749	—
54"W Laminate – Knife Edge	AW3LK3054V	65 [S]	6.4	\$ 1741	\$ 1799	\$ 1859	—
54"W Fluid Form – Eased Edge	AW3FE3054 □	65 [S]	6.4	—	—	—	\$ 923
54"W Veneer – Square Edge	AW3VF3054 □	65 [S]	6.4	\$ 3286	\$ 3531	—	—

\*V-legs are the only option offered for knife edge table tops.

<p><b>How to specify —</b> Select the Model Number from above.</p> <p>Suffix: T for use with T legs V for use with V legs (Knife “V” only)</p>	<p><b>1st Option:</b> FSC Certified Wood:</p> <p>FSC Select for FSC Certified Wood X No FSC</p>	<p><b>2nd Option:</b> Laminate or Fluid Form:</p> <p>See inside front cover for finishes.</p>	<p><b>3rd Option:</b> Edge Color (Laminate only):</p> <p>See inside front cover for finishes.</p>	<p><b>4th Option:</b> Grommet or Cutout Location (see page 434):</p> <p>AG0 No Grommets AG1 Centered Oval (Add \$12) AG2 Pair Ovals (Add \$24) ATE Pop-up Power Cutout – Centered Side-to-Side, 2" from Back ATC Cutout – Centered Side-to-Side, Front-to-Back (Not for Nesting)</p>	<p><b>5th Option:</b> Grommet Type (if applicable):</p> <p>P Oval Plastic</p>	<p><b>6th Option:</b> Grommet Color:</p> <p>See page 434 for Oval grommet color offering.</p>
AW3				A		

Examples: AW3LT3036T.X.LM13EY.AG2PEY

[S] Shippable by small-package carrier.



- Order legs separately — see options on page 448. “T” suffix top for T-legs and “V” suffix top for V-legs.
- Specify grommet location, type, and color — see page 434.
- Knife edge tops feature shaped edge on all sides. Eased edge tops feature shaped edge on front side.
- Optional electrical components, wire trough, modesty panel, and ganging hardware ordered separately — see pages 455-458.

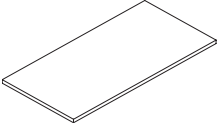

Description	Model + Suffix "T" T-leg / "V" V-leg	Ship Weight	Cubes	List Price				
				L1 or V1	L2 or V2	L3	FF	
<b>30"D Table Tops</b>								
60"W Laminate – Flat Edge	AW3LF3060 □	78	5	7.1	\$ 775	\$ 804	\$ 828	—
60"W Laminate – T-Mold Edge	AW3LT3060 □	78	5	7.1	\$ 775	\$ 804	\$ 828	—
60"W Laminate – Knife Edge*	AW3LK3060V	78	5	7.1	\$ 1833	\$ 1895	\$ 1957	—
60"W Fluid Form – Eased Edge	AW3FE3060 □	78	5	7.1	—	—	—	\$ 999
60"W Veneer – Square Edge	AW3VF3060 □	78	5	7.1	\$ 3400	\$ 3653	—	—
<hr/>								
66"W Laminate – Flat Edge	AW3LF3066 □	86	5	7.7	\$ 833	\$ 864	\$ 891	—
66"W Laminate – T-Mold Edge	AW3LT3066 □	86	5	7.7	\$ 833	\$ 864	\$ 891	—
66"W Laminate – Knife Edge	AW3LK3066V	86	5	7.7	\$ 1918	\$ 1982	\$ 2047	—
66"W Fluid Form – Eased Edge	AW3FE3066 □	86	5	7.7	—	—	—	\$ 1120
66"W Veneer – Square Edge	AW3VF3066 □	86	5	7.7	\$ 3516	\$ 3778	—	—
<hr/>								
72"W Laminate – Flat Edge	AW3LF3072 □	93	5	8.4	\$ 889	\$ 921	\$ 951	—
72"W Laminate – T-Mold Edge	AW3LT3072 □	93	5	8.4	\$ 889	\$ 921	\$ 951	—
72"W Laminate – Knife Edge	AW3LK3072V	93	5	8.4	\$ 2005	\$ 2071	\$ 2138	—
72"W Fluid Form – Eased Edge	AW3FE3072 □	93	5	8.4	—	—	—	\$ 1243
72"W Veneer – Square Edge	AW3VF3072 □	93	5	8.4	\$ 3625	\$ 3896	—	—
<hr/>								
84"W Laminate – Flat Edge	AW3LF3084 □	109	9.7	9.7	\$ 1094	\$ 1133	\$ 1168	—
84"W Laminate – T-Mold Edge	AW3LT3084 □	109	9.7	9.7	\$ 1094	\$ 1133	\$ 1168	—
84"W Laminate – Knife Edge	AW3LK3084V	109	9.7	9.7	\$ 2380	\$ 2461	\$ 2543	—
84"W Fluid Form – Eased Edge	AW3FE3084 □	109	9.7	9.7	—	—	—	\$ 1726
84"W Veneer – Square Edge	AW3VF3084 □	109	9.7	9.7	\$ 4031	\$ 4331	—	—
<hr/>								
96"W Laminate – Flat Edge	AW3LF3096 □	123	11.0	11.0	\$ 1487	\$ 1539	\$ 1588	—
96"W Laminate – T-Mold Edge	AW3LT3096 □	123	11.0	11.0	\$ 1487	\$ 1539	\$ 1588	—
96"W Laminate – Knife Edge	AW3LK3096V	123	11.0	11.0	\$ 3024	\$ 3127	\$ 3231	—
96"W Fluid Form – Eased Edge	AW3FE3096 □	123	11.0	11.0	—	—	—	\$ 2559
96"W Veneer – Square Edge	AW3VF3096 □	123	11.0	11.0	\$ 4806	\$ 5164	—	—

\*V-legs are the only option offered for knife edge table tops.

<p><b>How to specify —</b> Select the Model Number from above.</p> <p>Suffix: T for use with T legs V for use with V legs (Knife “V” only)</p>	<p><b>1st Option:</b> FSC Certified Wood:</p> <p>FSC Select for FSC Certified Wood X No FSC</p>	<p><b>2nd Option:</b> Laminate or Fluid Form:</p> <p>See inside front cover for finishes.</p>	<p><b>3rd Option:</b> Edge Color (Laminate only):</p> <p>See inside front cover for finishes.</p>	<p><b>4th Option:</b> Grommet or Cutout Location (see page 434):</p> <p>AG0 No Grommets AG1 Centered Oval (Add \$12) AG2 Pair Ovals (Add \$24) ATE Pop-up Power Cutout – Centered Side-to-Side, 2" from Back ATC Cutout – Centered Side-to-Side, Front-to-Back (Not for Nesting)</p>	<p><b>5th Option:</b> Grommet Type (if applicable):</p> <p>P Oval Plastic</p>	<p><b>6th Option:</b> Grommet Color:</p> <p>See page 434 for Oval grommet color offering.</p>
--	---	---	---	--	---	---

AW3 | | | | | | .

Examples: AW3LT3060T.X.LM13EY.AG2PEY

Shippable by small-package carrier.

- Order top separately — see options on page 447. “T” suffix top for T-legs and “V” suffix top for V-legs.
- Legs are sold in pairs. Nesting models include beam, order width to match width of top. Standing height models come with external stiffener.
- Leg finish options include painted (color specified) or polished. Legs require some assembly.
- Select legs below with top from previous page to create either a seated height 29"H table or a 42"H standing height table. Glides provide ½" of adjustment.
- All casters are urethane tread locking casters. Choice of Black or Silver.

AWARE

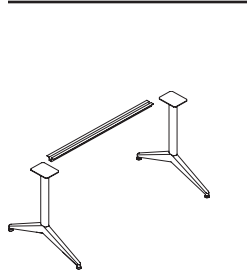

Description	Model + Suffix "B" Painted or "S" Polished	Ship Weight	Cubes	P1 Paint List Price	P2 Paint List Price	P3 Paint List Price	Polished List Price
<b>Fixed 29"H T-Legs for 30"D Tops (includes beam)</b>							
60" – 66" W Kit, Seated Height w/Glides	AW2TLPG □ 60	26	5.7	\$ 1047	\$ 1071	\$ 1093	\$ 1245
60" – 66" W Kit, Seated Height w/Casters	AW2TLPC □ 60	23	3.5	\$ 1047	\$ 1071	\$ 1093	\$ 1245
72" W Kit, Seated Height w/Glides	AW2TLPG □ 72	28	5.9	\$ 1075	\$ 1099	\$ 1121	\$ 1273
72" W Kit, Seated Height w/Casters	AW2TLPC □ 72	28	5.9	\$ 1075	\$ 1099	\$ 1121	\$ 1273
84" W Kit, Seated Height w/Glides	AW2TLPG □ 84	30	6.3	\$ 1103	\$ 1127	\$ 1149	\$ 1301
84" W Kit, Seated Height w/Casters	AW2TLPC □ 84	27	4.2	\$ 1103	\$ 1127	\$ 1149	\$ 1301
96" W Kit, Seated Height w/Glides	AW2TLPG □ 96	31	6.3	\$ 1326	\$ 1350	\$ 1372	\$ 1524
96" W Kit, Seated Height w/Casters	AW2TLPC □ 96	28	4.2	\$ 1326	\$ 1350	\$ 1372	\$ 1524



<b>Fixed 42"H T-Legs for 30"D Tops</b>							
60"–66" W Kit Standing Height w/Glides	AW2TLSHGB60	6.6	35	\$ 1292	\$ 1316	\$ 1338	—
60"–66" W Kit Standing Height w/Casters	AW2TLSHCB60	6.6	35	\$ 1292	\$ 1316	\$ 1338	—
(shown)							
72" W Kit Standing Height w/Glides	AW2TLSHGB72	6.8	37	\$ 1320	\$ 1344	\$ 1366	—
72" W Kit Standing Height w/Casters	AW2TLSHCB72	6.8	37	\$ 1320	\$ 1344	\$ 1366	—
84" W Kit Standing Height w/Glides	AW2TLSHGB84	7.3	39	\$ 1348	\$ 1372	\$ 1394	—
84" W Kit Standing Height w/Casters	AW2TLSHCB84	7.3	39	\$ 1348	\$ 1372	\$ 1394	—

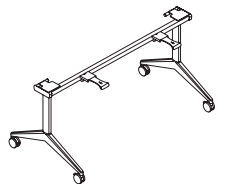

<b>Nesting 29"H T-Legs for 30"D Tops (includes beam)</b>							
60" W Kit, Seated Height w/Casters	AW2TL30N60C □	34	7.1	\$ 1581	\$ 1607	\$ 1629	\$ 1820
66" W Kit, Seated Height w/Casters	AW2TL30N66C □	35	7.1	\$ 1626	\$ 1652	\$ 1674	\$ 1842
72" W Kit, Seated Height w/Casters	AW2TL30N72C □	37	7.3	\$ 1677	\$ 1703	\$ 1725	\$ 1896
84" W Kit, Seated Height w/Casters	AW2TL30N84C □	42	7.9	\$ 1756	\$ 1782	\$ 1804	\$ 1971
96" W Kit, Seated Height w/Casters	AW2TL30N96C □	46	8.3	\$ 1832	\$ 1858	\$ 1880	\$ 2045

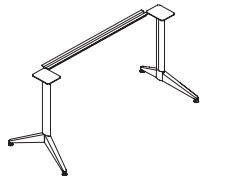

<b>Fixed 29"H V-Legs for 30"D Tops (includes beam)</b>							
60" - 66" W Kit, Seated Height w/Glides	AW2VMPC □ 60	25	4.3	\$ 1146	\$ 1170	\$ 1192	\$ 1343
(shown)							
60" - 66" W Kit, Seated Height w/Casters	AW2VMPC □ 60	25	4.3	\$ 1146	\$ 1170	\$ 1192	\$ 1343
72" W Kit, Seated Height w/Glides	AW2VMPC □ 72	27	4.5	\$ 1174	\$ 1198	\$ 1220	\$ 1371
72" W Kit, Seated Height w/Casters	AW2VMPC □ 72	27	4.5	\$ 1174	\$ 1198	\$ 1220	\$ 1371
84" W Kit, Seated Height w/Glides	AW2VMPC □ 84	29	5.0	\$ 1202	\$ 1226	\$ 1248	\$ 1399
84" W Kit, Seated Height w/Casters	AW2VMPC □ 84	29	5.0	\$ 1202	\$ 1226	\$ 1248	\$ 1399
96" W Kit, Seated Height w/Glides	AW2VMPC □ 96	30	5.0	\$ 1425	\$ 1449	\$ 1471	\$ 1622
96" W Kit, Seated Height w/Casters	AW2VMPC □ 96	30	5.0	\$ 1425	\$ 1449	\$ 1471	\$ 1622

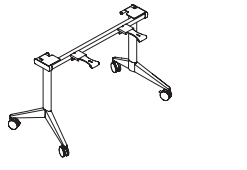

<b>Nesting 29"H V-Legs for 30"D Tops (includes beam)</b>							
60" W Kit, Seated Height w/Casters	AW2VM30N60C □	33	5.1	\$ 1699	\$ 1725	\$ 1747	\$ 1922
66" W Kit, Seated Height w/Casters	AW2VM30N66C □	34	5.4	\$ 1688	\$ 1714	\$ 1736	\$ 1931
72" W Kit, Seated Height w/Casters	AW2VM30N72C □	37	5.4	\$ 1761	\$ 1787	\$ 1809	\$ 1981
84" W Kit, Seated Height w/Casters	AW2VM30N84C □	41	6.1	\$ 1840	\$ 1866	\$ 1888	\$ 2057
96" W Kit, Seated Height w/Casters	AW2VM30N96C □	45	6.5	\$ 1915	\$ 1941	\$ 1963	\$ 2134

NOTE: T-legs only work with “T” suffix tops and V-legs only work with “V” suffix tops.

<p><b>How to specify —</b> Select the Model Number from above. Add suffix: B for Painted S for Polished</p>	<p><b>1st Option:</b> Paint Color or PAL for Polished: P1 P2 P3 See page 430 for finishes.  Standing height only available as painted.</p>	<p><b>2nd Option:</b> Caster Color (if applicable): B Black S Silver</p>
AW2		

Examples: AW2TLPGB.P7D    AW2TLPCB.P7D.B    AW2TL30N60CS.PAL.S

- Order "T" legs separately — see options on page 450.
- Specify grommet location, type, and color — see page 434.
- Eased edge tops feature shaped edge on front side.
- Optional electrical components, wire trough, modesty panel, and ganging hardware ordered separately — see pages 455-458.

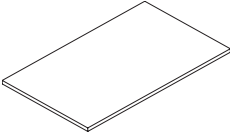

Description	Model	Ship Weight	Cubes	List Price			
				L1 or V1	L2 or V2	L3	FF
<b>36" D Table Tops</b>							
48"W Laminate – Flat Edge	AW3LF3648T	58 <input type="checkbox"/>	6.8	\$ 826	\$ 857	\$ 883	—
48"W Laminate – T-Mold Edge	AW3LT3648T	58 <input type="checkbox"/>	6.8	\$ 826	\$ 857	\$ 883	—
48"W Fluid Form – Eased Edge	AW3FE3648T	58 <input type="checkbox"/>	6.8	—	—	—	\$ 1035
48"W Veneer – Square Edge	AW3VF3648T	58 <input type="checkbox"/>	6.8	\$ 3798	\$ 4081	—	—
<hr/>							
54"W Laminate – Flat Edge	AW3LF3654T	65 <input type="checkbox"/>	7.5	\$ 887	\$ 919	\$ 949	—
54"W Laminate – T-Mold Edge	AW3LT3654T	65 <input type="checkbox"/>	7.5	\$ 887	\$ 919	\$ 949	—
54"W Fluid Form – Eased Edge	AW3FE3654T	65 <input type="checkbox"/>	7.5	—	—	—	\$ 1048
54"W Veneer – Square Edge	AW3VF3654T	65 <input type="checkbox"/>	7.5	\$ 3921	\$ 4214	—	—
<hr/>							
60"W Laminate – Flat Edge	AW3LF3660T (shown)	73 <input type="checkbox"/>	8.3	\$ 949	\$ 983	\$ 1014	—
60"W Laminate – T-Mold Edge	AW3LT3660T	73 <input type="checkbox"/>	8.3	\$ 949	\$ 983	\$ 1014	—
60"W Fluid Form – Eased Edge	AW3FE3660T	73 <input type="checkbox"/>	8.3	—	—	—	\$ 1061
60"W Veneer – Square Edge	AW3VF3660T	73 <input type="checkbox"/>	8.3	\$ 4045	\$ 4346	—	—
<hr/>							
66"W Laminate – Flat Edge	AW3LF3666T	86 <input type="checkbox"/>	9.1	\$ 1002	\$ 1037	\$ 1070	—
66"W Laminate – T-Mold Edge	AW3LT3666T	86 <input type="checkbox"/>	9.1	\$ 1002	\$ 1037	\$ 1070	—
66"W Fluid Form – Eased Edge	AW3FE3666T	86 <input type="checkbox"/>	9.1	—	—	—	\$ 1316
66"W Veneer – Square Edge	AW3VF3666T	86 <input type="checkbox"/>	9.1	\$ 4168	\$ 4479	—	—
<hr/>							
72"W Laminate – Flat Edge	AW3LF3672T	93 <input type="checkbox"/>	9.9	\$ 1057	\$ 1095	\$ 1128	—
72"W Laminate – T-Mold Edge	AW3LT3672T	93 <input type="checkbox"/>	9.9	\$ 1057	\$ 1095	\$ 1128	—
72"W Fluid Form – Eased Edge	AW3FE3672T	93 <input type="checkbox"/>	9.9	—	—	—	\$ 1568
72"W Veneer – Square Edge	AW3VF3672T	93 <input type="checkbox"/>	9.9	\$ 4282	\$ 4601	—	—

\*V-legs are the only option offered for knife edge table tops.

<p><b>How to specify —</b> Select the Model Number from above.</p> <p>AW3          </p>	<p><b>1st Option:</b> FSC Certified Wood:</p> <p>FSC Select for FSC Certified Wood X No FSC</p>	<p><b>2nd Option:</b> Laminate or Fluid Form:</p> <p>See inside front cover for finishes.</p>	<p><b>3rd Option:</b> Edge Color (Laminate only):</p> <p>See inside front cover for finishes.</p>	<p><b>4th Option:</b> Grommet or Cutout Location (see page 434):</p> <p>AG0 No Grommets AG1 Centered Oval (Add \$12) AG2 Pair Ovals (Add \$24) ATE Pop-up Power Cutout – Centered Side-to-Side, 2" from Back ATC Cutout – Centered Side-to-Side, Front-to-Back (Not for Nesting)</p> <p>A        </p>	<p><b>5th Option:</b> Grommet Type (if applicable):</p> <p>P Oval Plastic</p>	<p><b>6th Option:</b> Grommet Color:</p> <p>See page 434 for Oval grommet color offering.</p>
---	---	---	---	---	---	---

Examples: AW3LT2436T.X.LM13EY.AG2PEY

Shippable by small-package carrier.













**Modesty Panels:**

- 9¼"H x ½"D.
- Modesty panel must be removed from tables prior to folding.
- Tables may be nested with modesty panel attached to table. Nesting depth of additional tables does not increase.
- Modesty panel is undersized by 9¾" from width of table top.
- Nesting V-leg models require one size smaller modesty panel than T-leg. Example: 42"W Nesting V-leg table requires AW4HM36. See below.

**Universal Hook**

Mounts to underside of worksurface and provides storage for bags, coats and purses. Hooks can be used as a horizontal wire manager under worksurface.

**Ganging Bracket**

- One-step tool-free operation.
- Tables have pre-drilled holes for proper installation and alignment of ganging mechanism.
- Includes two ganging links and two screws. Recommend one package of 2 brackets per table.
- Ganging brackets will not work with knife edge surfaces.

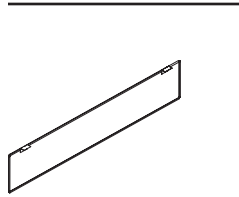

Description	Model	Ship Weight	Cubes	P1 Paint List Price	P2 Paint List Price	P3 Paint List Price
<b>Hinged Metal Modesty Panels for Aware Tables with T-Legs</b>						
26½"W — for 36"W table with T-Legs	AW4HM36	8	1.7	\$ 331	\$ 342	\$ 350
32½"W — for 42"W table with T-Legs	AW4HM42	9	1.9	\$ 346	\$ 357	\$ 365
38½"W — for 48"W table with T-Legs	AW4HM48	11	2.2	\$ 372	\$ 383	\$ 391
44½"W — for 54"W table with T-Legs	AW4HM54	12	2.5	\$ 391	\$ 402	\$ 410
50½"W — for 60"W table with T-Legs	AW4HM60	14	3.1	\$ 419	\$ 430	\$ 438
56½"W — for 66"W table with T-Legs	AW4HM66	16	3.1	\$ 459	\$ 470	\$ 478
62½"W — for 72"W table with T-Legs	AW4HM72	17	3.7	\$ 520	\$ 531	\$ 539
74½"W — for 84"W table with T-Legs	AW4HM84	20	4.4	\$ 581	\$ 592	\$ 600
86½"W — for 96"W table with T-Legs	AW4HM96	21	4.4	\$ 620	\$ 631	\$ 639

**Hinged Metal Modesty Panels for Aware Tables with V-Legs**

26½"W — for 42"W table with V-Legs	AW4HM36	8	1.7	\$ 331	\$ 342	\$ 350
32½"W — for 48"W table with V-Legs	AW4HM42	9	1.9	\$ 346	\$ 357	\$ 365
38½"W — for 54"W table with V-Legs	AW4HM48	11	2.2	\$ 372	\$ 383	\$ 391
44½"W — for 60"W table with V-Legs	AW4HM54	12	2.5	\$ 391	\$ 402	\$ 410
50½"W — for 66"W table with V-Legs	AW4HM60	14	3.1	\$ 419	\$ 430	\$ 438
56½"W — for 72"W table with V-Legs	AW4HM66	16	3.1	\$ 459	\$ 470	\$ 478
68½"W — for 84"W table with V-Legs	AW4HM78	20	4.4	\$ 561	\$ 572	\$ 580
80½"W — for 96"W table with V-Legs	AW4HM90	21	4.4	\$ 611	\$ 622	\$ 630

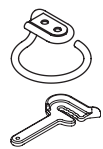

Description	Model	Ship Weight	Cubes	List Price
<b>Universal Hook (Black only)</b>				
Package of 2	AGSAUHK	3	0.2	\$ 128
<b>Ganging Bracket</b>				
Bracket includes Hardware	AW4GANG	0.2	0.0	\$ 98

**How to specify —**  
Select the Model Number from above.

**1st Option:**  
**Paint Color**  
(if applicable):  
P1
P2
P3

Examples: AW4HM60.P27 AW4HM42.PJW AW4GANG

S Shippable by small-package carrier.

**Laptop Drawer**

- Drawer body made of sheet metal.
- Drawer front made of 3/4" particleboard with laminate on both sides and fused laser edge banding.
- Core removable lock is located on right side drawer front
- 17 7/8" W x 18" D x 3 3/8" H Outside (interior 13" W x 16" D x 1 7/8" H)
- Minimum surface depth is 21" for surfaces not using an external stiffener; and 27" for surfaces using an external stiffener.
- Drawer extends 16"

- Maximum load: 45 lbs (functional BIFMA load)
- Drawer assembly and cover have cut out in back to allow for cables to exit drawer.
- Distance from floor to bottom of unit w/ glides fully retracted is 24 3/4".
- Can be used with rabbet edge worksurface models but there will be a larger reveal between surface and drawer.
- Can be used with knife edge worksurface models but reveal and depth need to be considered.

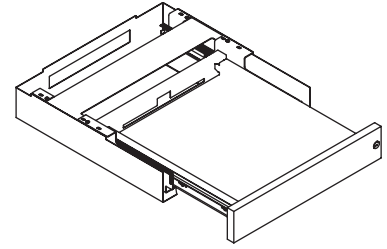

**Aware®**

Front View

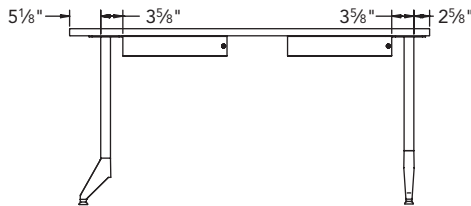

Top View

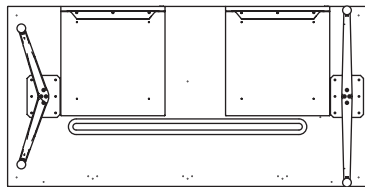

**Aware Tables**

- Can only be used on 30" deep surfaces due to interference with internal stiffener.
- Can only be used with fixed legs; no nesting or folding legs.
- Cannot be used with an external stiffener.
- T-legs- drawer must be offset from worksurface edge by edge to leg distance + 3 3/4" to clear leg mounting plate.
- V-legs- drawer must be offset from worksurface edge by edge to leg distance + 3 3/4" to clear leg mounting plate
- See illustrations at left.

**Not on Merge® or Altitude® Tables**

- Cannot be used with Merge tables due to interference with internal stiffener; and Altitude tables due to interference with external stiffener.

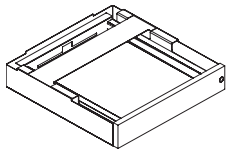

GSA SIN 33721

Description	Model	List Price		
		P1 Paint	P2 Paint	P3 Paint
<b>Laptop Drawer - Locking, laminate front, metal case</b>				
17 7/8" W x 18" D x 3 3/8" H (Interior 13" W x 16" D x 1 7/8" H)	U7WDA <span style="border: 1px solid black; padding: 0 2px;">5</span>	\$ 1699	\$ 1721	\$ 1739

<b>How to specify —</b> Select the Model Number from above.	1st Option: <b>Laminate</b> (Drawer front if applicable): See page 430 for finishes.	2nd Option: <b>Edge</b> (Drawer edge if applicable): See page 430 for finishes.	3rd Option: <b>Paint</b> (If drawer, list exterior case color here): See page 430 for finishes.	4th Option: <b>Paint</b> (Interior Drawer if applicable): See page 430 for finishes.	5th Option: <b>Lock</b> (if applicable): <b>STD</b> Standard <b>OMT</b> Omit Lock Core (Deduct \$20)	6th Option: <b>Lock Color</b> (if applicable): <b>EL</b> Silver
U           .	.	.	.	.	.	.

Example: U7WDA.LM11EV.P27.PR6.STDEL

5 Shippable by small-package carrier.

**Wire Trough**

- Accepts cords for routing
- Wire trough adheres and screws to underside of table surface

**Wire Manager Covers**

- Attaches to leg and conceals power, voice, and data cables.
- Will not work on large T folding legs.
- Cable capacity shown on page 434.



**Power/Data Ports**

- Corded has 10' cord and plug.
- Hardwire has 10' cord.

**Interlink IQ Electrical Modules**

- Pluggable, single circuit electrical system
- UL recognized as a powered table system and meets the requirements of UL 962
- Interlink IQ modules require a minimum of one Interlink IQ starter.
- A maximum of 8 Interlink IQ power modules (including jumpers) can be "daisy chained" together in any combination off of one 15-amp infeed starter.

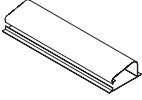
- System status indicator:
  - Red light indicates too many units connected
  - Green light indicates appropriate use
- All models include wire management clips and hardware
- Power harness includes 60" cord and 11" tail. Daisy chained tables in line over 60" will require 36" jumper between modules.

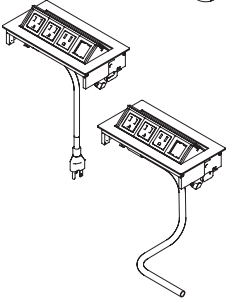
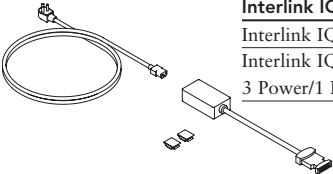
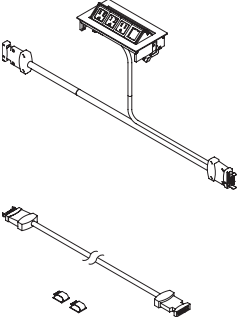
	Description	Model	Ship Weight	Cubes	List Price	
	<b>Wire Trough (Black only)</b>					
	17¼"W Trough for 48"W and shorter Tables	AW4W48	5			
	34"W Trough for 54"W or 60"W Tables	AW4W60	5			
	42¼"W Trough for 66"W or 72"W Tables	AW4W72	5			
	58"W Trough for 84"W or 96"W Tables	AW4W84	5			
	<b>Wire Manager Covers</b>					
	For small T (AW2TS prefix) and medium V (AW2VM prefix) leg models	AWCVRG	5			
	For large T (AW2TL prefix, except folding) and caster models	AWCVRC	5			
	<b>Power/Data Ports</b>					
	Power Harness Corded – 3 AC / 1 Open Data	AW4P2C	5			
	Power Harness Hardwired – 3 AC / 1 Open Data	AW4P2H	5			
	<b>Interlink IQ Electrical Modules</b>					
	Interlink IQ Starter with 72" Infeed cord	AW4QBI	5			
	Interlink IQ Power Harness — 3 Power/1 Dual USB A+C/2 OpenWindows	AM4QH3P1U2B				
	Interlink IQ 60" Power Harness with Pop-Up — 3 AC / 1 Open Data	AW4QH60P	5			
	<b>Interlink IQ 36" Jumper</b>					
	Interlink IQ 36" Jumper	AW4QJ36	5			
	Interlink IQ 36" Backward Compatible Jumper*	AW4QBCJ36	5			

\*Must order to connect new interlink IQ components to existing installs.

<p><b>How to specify —</b> Select the Model Number from above.</p>	<p>1st Option: <b>Paint Color</b> (if applicable):</p> <p>FOG Fog SVR Silver BLK Black</p>
<p>AW          </p>	<p>         </p>

Examples: AW4W48 AW4P2CF.FOG AW4QBI

 Shippable by small-package carrier.





**Technology Modules**



- Can be mounted by clamping to worksurface or mounting flush to the worksurface top.
- The USB hub allows simultaneous powering of four USB-A devices.
- Technology Modules have 10' cords.
- Opening size needed to flush mount in worksurface.

**Worksurface Power/Data Module**

- Provides easy access to technology at primary worksurface.
- Mounts to edge of a worksurface and requires 3/8" gap. Consider whether 3/8" gap will work with layout.

Model	Depth of Cut	Width of Cut
A87P2U1R	4"	8"

AWARE

	Description	Model	List Price
	<b>Technology Modules — Flush Mount (EL Silver only)</b>		
	2 Power, 2 dual USB Hubs	A87P2U1R <span style="border: 1px solid black; padding: 0 2px;">S</span>	\$ 1097
	<b>Worksurface Power/Data Module (PR6 Silver only)</b>		
	2 Simplex receptacles, 1 data position	A870302	\$ 383

<p><i>How to specify —</i> Select the Model Number from above.</p>	<p><i>1st Option:</i> <b>Technology Module Color:</b> EL Silver</p>				
<table border="1" style="width: 100%; height: 20px;"> <tr> <td style="width: 25%; text-align: center;">E   L</td> <td style="width: 25%;"></td> <td style="width: 25%;"></td> <td style="width: 25%;"></td> </tr> </table>	E   L				
E   L					

Examples: A87P2U1R.EL A870302

S Shippable by small-package carrier.

- 2- and 3-Bay credenzas ship fully assembled.
- Available in solid and woodgrain laminate colors. You can select one laminate for the case and a second laminate for the front doors and back panels. Credenza top including front edge is the same color as the case.
- Painted mesh in Designer White, Flint, or Silver at top and bottom of the front and back sides of unit provides passive ventilation.
- Edge guards on mesh and wire manager protects cords and fingers.
- Grommet models feature square Silver metal grommet.
- Six leveling glides on 72"W, four glides on 48"W. Leveling range is 1".
- Credenzas are constructed from ¾" thick high-pressure laminated particleboard with 1 mm edge banding and European cam-and-pin construction.
- Units are shipped with either lock cores removed or as non-locking. Core removable lock option allows key numbers to be easily changed in the field. Cores available in the Casegoods & Storage price list on page 65. Note: Middle cabinet on 3-Bay units do not lock.
- Shelves are painted metal. Base shelves are secured, except center shelf in 72"W credenza.
- Interior bay dimensions are 22"W x 28½"H x 22¾"D. Secured bottom shelves are 19"D to account for ventilation and wire management. Rated for 50 lbs.
- Removable back(s) snap on for easy component installation.
- Bottom wire management channel runs entire width of credenza.
- Optional top hung drawers (8½"H) use full extension slides; limit of one drawer per bay. Drawers cannot be used in same bay with AV rack, waste pullout, and will limit size of refrigerator.
- Slide out A/V storage rack features EIA spacing with twelve usable rack spaces.
- Units ship with one adjustable shelf per bay. Shelves are adjustable in 6" increments.
- Additional metal shelves are field-installed using supplied template, maximum of three per bay.

Description	Model	Ship Weight	Cubes	Solid Laminate List Price	UPCHARGES*			
					L2 Laminate Case Front/Back		L3 Laminate Case Front/Back	
<b>Buffet Credenza — 34"H x 24"D</b>								
72"W with Grommet / Removable Back Left and Right	AW4BC7224	336	56	\$ 9354	\$ 221	\$ 94	\$ 444	\$ 189
72"W no Grommet / Removable Back Left and Right	AW4BC7224NG	336	56	\$ 9343	\$ 221	\$ 94	\$ 444	\$ 189
<b>48"W with Grommet /</b>								
Removable Back Left (shown)	AW4BC4824L	235	38	\$ 6815	\$ 161	\$ 68	\$ 323	\$ 137
48"W no Grommet / Removable Back Left (shown)	AW4BC4824LNG	235	38	\$ 6803	\$ 161	\$ 68	\$ 323	\$ 137
<b>48"W with Grommet /</b>								
Removable Back Right	AW4BC4824R	235	38	\$ 6815	\$ 161	\$ 68	\$ 323	\$ 137
48"W no Grommet / Removable Back Right	AW4BC4824RNG	235	38	\$ 6803	\$ 161	\$ 68	\$ 323	\$ 137

Description	Model	Ship Weight	Cubes	List Price
<b>Credenza Storage Drawer</b> (Laminate front LM16 Flint only)				
Interior: 14½"W x 14¾"D x 2¾"H Particleboard body in a metal case	AW4DRAWER	30	4.1	\$ 888
<b>Slide Out Audio/Visual Storage Rack</b> (Black only, not specified) Weight capacity 125 lbs.				
19¾"W x 18¾"D x 22¾"H Metal frame with 10-32 threaded holes	AW4AVRACK	29	4.8	\$ 3217
<b>Trash/Recycling Slide Out</b> (Platinum only, not specified) Weight capacity 100 lbs.				
14¾"W x 22½"D x 18¾"H Comes with 2 – 35 qt bins	AW4TRASH	36	2.8	\$ 668
<b>Metal Interior Shelf</b> (Painted in Flint, Designer White, or Silver only)				
23"W x 21"D x 2"H Weight capacity 50 lbs.	AW4SHELF	5	1.6	\$ 238

How to specify — Select the Model Number from above.	1st Option: FSC Certified Wood (if applicable): FSC Certified X No FSC	2nd Option: Case Laminate (if applicable):	3rd Option: Matching Edge Color (if applicable):	4th Option: 2nd Laminate Color (Front) (if applicable):	5th Option: Matching Edge Color (if applicable):	6th Option: Paint Color (if applicable): PJW Designer White P02 Flint PR6 Silver (No upcharge for PR6)	7th Option: Lock (if applicable): OMT Omit Cores NL No Locks or Holes
AW4							

Examples: AW4BC7224.X.LM14EW.LWDDD.PR6.NL AW4DRAWER.LM16E9

- 2- and 3-Bay credenzas ship fully assembled.
- Available in solid and woodgrain laminate colors. You can select one laminate for the case and back, and a second laminate for the front doors. Credenza top including front edge is the same color as the case.
- Painted mesh in Designer White, Flint, or Silver at bottom of the front side of unit matches buffet credenza.
- Waste bins and inserts are not included with Recycle Credenzas. Recommend 25 gallon waste bins 17" x 17" x 28"H by Tough Guy, Rubbermaid, Continental, or Safco. Order inserts separately.
- Credenzas are constructed from ¾" thick high-pressure laminated particleboard with 1 mm edge banding and European cam-and-pin construction.
- Front plates and optional inserts are metal.
- Septums in 3-Bay units provide separation and support.
- Units come with 3 of each label with 57" W units; and 2 of each label with 36" W units. Silver and white units come with Black labels; Flint comes with White labels.
- Back is inset ⅞" for easy handling and flush fit against wall.
- Leveling glide range is 1".

AWARE

Description	Model	Ship Weight	Cubes	Solid Laminate List Price	UPCHARGES*			
					L2 Laminate Case/Back	L2 Laminate Front	L3 Laminate Case/Back	L3 Laminate Front
<b>Recycle Credenza — 40"H x 20"D</b> (Front plate and mesh in Designer White, Flint or Silver)								
57"W Three Bays – Interior each 17"W x 28"H x 17¼"D (Shown with paper and bottle/can inserts – order separately below)	AW4WC5720	275	43	\$ 8905	\$ 211	\$ 90	\$ 421	\$ 180
36"W Two Bays – Interior 34½"W x 28"H x 17¼"D (Shown with bottle/can and paper inserts – order separately below)	AW4WC3620	180	35	\$ 6695	\$ 157	\$ 67	\$ 316	\$ 135

Description	Model	Ship Weight	Cubes	List Price	
				P1 Paint	P3 Paint
<b>Paper Insert for Recycle Credenza</b> (Painted metal in Designer White, Flint, Silver, Atom or Krypton)					
For 57"W Recycle Credenza	AW4WCTIP57W	3	0.5	\$ 238	\$ 258
For 36"W Recycle Credenza	AW4WCTIP36W	3	0.5	\$ 238	\$ 258
<b>Bottle/Can Insert for Recycle Credenza</b> (Painted metal in Designer White, Flint, Silver, Atom or Krypton)					
For 57"W Recycle Credenza	AW4WCTIBC57W	3	0.5	\$ 238	\$ 258
For 36"W Recycle Credenza	AW4WCTIBC36W	3	0.5	\$ 238	\$ 258

Description	Model	Ship Weight	Cubes	List Price
<b>Waste Credenza Labels</b> (Bottle/Cans, Paper, Recycle, Trash – SPECIFY Black or White)				
12 Labels — 3 of each	AW4WC57LABEL	0.1	0.1	\$ 116
8 Labels — 2 of each	AW4WC36LABEL	0.1	0.1	\$ 79

**Note:** Recycle Credenzas come with 3 of each label with 57" W units; and 2 of each label with 36" W units.

How to specify — Select the Model Number from above.	1st Option: FSC Certified Wood (if applicable):  FSC Certified X No FSC	2nd Option: Case Laminate (if applicable):	3rd Option: Matching Edge Color (if applicable):	4th Option: 2nd Laminate Color (Front) (if applicable):	5th Option: Matching Edge Color (if applicable):	6th Option: Paint (if applicable):  P8S Atom (P3 upcharge) PJW Designer White P02 Flint P8F Krypton (P3 upcharge) PR6 Silver (no upcharge)	7th Option: Label Color (if applicable):  BLK Black WHT White
AW4							

Examples: AW4WC5720.X.LM14EW.LWDDD.PR6 AW4WCTIP57W.P7H

- Mobile marker boards are available in porcelain or laminated glass.
- Mobile tack boards are two-sided with platinum fabric and silver frames.
- Feet are 24"D x 3"H on 50"H and 30"D x 3"H on 72"H units. The low profile foot fits under most footed panels and storage.
- Foot design allows multiple boards to be nested.
- Mobile boards have two locking casters.
- Boards are shipped with feet unattached in same package.
- Porcelain boards are two-sided white, magnetic, and can be used for projection. Smooth, dry-erase porcelain surface for easy writing and clean erasing. Low odor markers are not recommended.
- Laminated glass boards are two-sided white, non-magnetic. For best results use bold marker colors. Low odor markers are not recommended.
- Marker and eraser holder comes with suction cups for attachment.
- Optional hooks are designed to hold large easel pads with slots.

Description	Model	Ship Weight	Cubes	List Price
<b>Mobile Marker Boards — Porcelain</b>				
72"H x 60"W with 30"D feet	AW4MB7260P	150	15	\$ 6210
72"H x 48"W with 30"D feet	AW4MB7248P	123	12.2	\$ 4746
72"H x 36"W with 30"D feet	AW4MB7236P	95	9.5	\$ 4438
50"H x 48"W with 24"D feet	AW4MB5048P	85	8.8	\$ 4318
50"H x 36"W with 24"D feet	AW4MB5036P	75	6.8	\$ 4150
<b>Mobile Marker Boards — Laminated Glass</b>				
72"H x 48"W with 30"D feet	AW4MB7248G	175	12.2	\$ 8632
72"H x 36"W with 30"D feet	AW4MB7236G	147	9.5	\$ 6965
50"H x 48"W with 24"D feet	AW4MB5048G	137	8.8	\$ 6427
50"H x 36"W with 24"D feet	AW4MB5036G	127	6.8	\$ 5338
<b>Mobile Tack Boards — Platinum Fabric</b>				
72"H x 60"W with 30"D feet	AW4TB7260	98	15	\$ 6210
72"H x 48"W with 30"D feet	AW4TB7248	80	12.2	\$ 4746
72"H x 36"W with 30"D feet	AW4TB7236	62	9.5	\$ 4438
50"H x 48"W with 24"D feet	AW4TB5048	55	8.8	\$ 4318
50"H x 36"W with 24"D feet	AW4TB5036	49	6.8	\$ 4150

Description	Model	Ship Weight	Cubes	P1 Paint	List Price P2 Paint	P3 Paint
<b>Marker and Eraser Holder (Specify Paint)</b>						
4½"H x 4¾"W x 2½"D	AW4BACC	0.8 <b>S</b>	0.1	\$ 224	\$ 233	\$ 239
<b>Marker and Tack Board Hooks (Specify Paint — PR6 Silver Only)</b>						
2 Hooks 1¼"W x 2⅝"D x 2¼"H	AW4BHOOK	0.8 <b>S</b>	0.1	N/A	\$ 139	N/A

<p><i>How to specify —</i> Select the Model Number from above.</p>	<p><i>1st Option :</i> <b>Paint:</b></p>	<p><i>1st Option Hooks:</i> <b>Paint:</b> PR6 Silver (No upcharge)</p>	<p><i>2nd Option :</i> <b>Panel Fabric</b> (if applicable):</p>
<p>AW4                         .             .</p>		<p>P   R   6                    </p>	

Examples: AW4MB7260P.PR6 AW4BACC.P7F AW4BHOOK.PR6

**S** Shippable by small-package carrier.

AWARE

- Wall-hung marker boards are available in porcelain or back painted glass.
- Porcelain boards are white, magnetic, and can be used for projection. Smooth, dry-erase porcelain surface for easy writing and clean erasing. Low odor markers are not recommended. Slim frame design, front of frame is 5/32". Frame is anodized aluminum with mitered corners and extends 3/4" from the wall.
- Porcelain boards can hang either vertical or horizontal. Galvanized steel Z-brackets are included. Wall fasteners not included.
- Glass boards are white, back painted glass that are easy to clean and erase. Constructed with 1/4" tempered safety glass with beveled corners, polished edges, and a steel back. Boards are magnetic. Frameless, floating mounted board extends 1/2" from wall. For best results use bold marker colors. Low odor markers are not recommended.
- Wall-hung boards are designed to easily attach to a solid wall without exposed hardware for an integrated appearance.
- Hanging instructions provided. See glass note below.
- Marker and eraser holder comes with suction cups for attachment.

AWARE

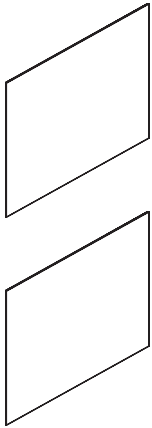

Description	Model	Ship Weight	Cubes	List Price
<b>Wall-Hung Marker Boards — Porcelain</b>				
48"H x 96"W	AW4WB4896P	90	7.6	\$ 2152
48"H x 72"W	AW4WB4872P	70	5.8	\$ 1741
48"H x 60"W	AW4WB4860P	50	4.9	\$ 1486
48"H x 48"W	AW4WB4848P	45	4	\$ 1239
36"H x 48"W	AW4WB3648P	35	3.1	\$ 1071
<b>Wall-Hung Marker Boards — Back Painted Glass</b>				
48"H x 96"W	AW4WB4896G	250	9	\$ 7410
48"H x 72"W	AW4WB4872G	190	6.9	\$ 6151
48"H x 60"W	AW4WB4860G	157	5.8	\$ 5375
48"H x 48"W	AW4WB4848G	126	4.7	\$ 4438
36"H x 48"W	AW4WB3648G	95	3.4	\$ 3580

**Note:** If multiple boards are being installed on the same wall, use caution when positioning glass panels next to each other. Due to the weakest point of tempered glass being along the edges, the edges should be protected as much as possible. To insure a successful installation, leave a gap of one quarter inch between boards to prevent damage to the glass. Allsteel will not be held responsible for damage caused by improper installation.



Description	Model	Ship Weight	Cubes	P1 Paint	List Price P2 Paint	P3 Paint
<b>Marker and Eraser Holder (Specify Paint)</b>						
4 1/8"H x 4 3/4"W x 2 1/2"D	AW4BACC	0.8	0.1	\$ 224	\$ 233	\$ 239

<p><b>How to specify —</b> Select the Model Number from above.</p>	<p><i>1st Option</i> Marker Boards: <b>Paint:</b> PR6 Silver (No upcharge)</p>	<p><i>1st Option</i> Marker and Eraser Holder: <b>Paint:</b> P1 P2 P3</p>
<p>AW4                     .   P   R   6  </p>		

Examples: AW4MB7260P.PR6 AW4MB5036P.PR6 AW4BACC.P7F

GSA SIN 33721

- Lectern features laminate construction with painted metal base and accents.
- Angled surface is 24"W x 11½"D with ⅜" lip at bottom.
- Removable back panel provides easy power and cord routing from bottom of unit to top.
- Recessed area at top right for water or beverage.

- Metal surface at top left, front for mounting microphone holder or light is 5"W x 7"D. Requires end-user to drill applicable holes for mounting.
- Recessed center area at top front provides room for cords and power supplies. Flip-up laminate door provides easy access and hides cords. Area has an Extron cut-out

- and two simplex cutouts for mounting two AW4LECTPWR power units below. Extron super plate unit purchased separately.
- Storage shelf below angled surface is 4"H x 24¼"W x 10"D. Cut-out at front of compartment for routing cords.
- Four 2¼" casters for mobility, all are locking for lectern to remain stationary when necessary.

Description	Model	Ship Weight	Cubes	List Price		
				L1	L2	L3
<b>Lectern — Laminate and Painted Metal</b>						
Technology Ready 26"W x 19"D x 43¾"H	AW4LECT	170	32	\$ 5158	\$ 5333	\$ 5508

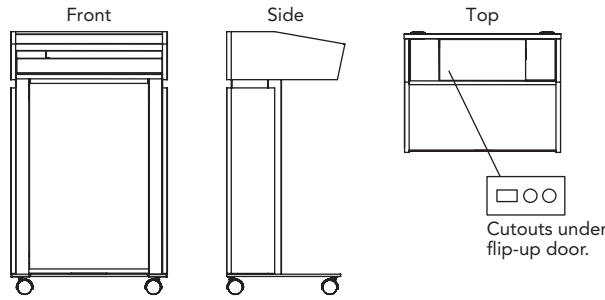
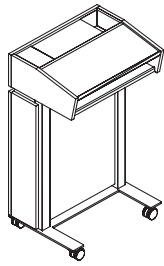

Description	Model	Ship Weight	Cubes	List Price
<b>Lectern Power Unit — White or Black</b>				
Single AC power unit, bracket, and 6' cord w/plug	AW4LECTPWR	0.9	1.6	\$ 163

<p><b>How to specify —</b> Select the Model Number from above.</p>	<p><b>1st Option:</b> FSC Certified Wood (if applicable): FSC Certified X No FSC</p>	<p><b>2nd Option:</b> Laminate (if applicable): See page 430 for finishes.</p>	<p><b>3rd Option:</b> Edge Color (if applicable): See page 430 for finishes.</p>	<p><b>4th Option:</b> Paint (if applicable): PJW Designer White P02 Flint PR6 Silver (No upcharges)</p>	<p><b>5th Option:</b> Electrical (if applicable): BLK Black WHT White</p>
<p>AW4LECT . . . . .</p>					

Examples: AW4LECT.X.LWDDD.PR6 AW4LECT.FSC.LM13EY.PR6 AW4LECTPWR.BLK

Setting the table for change.

Today's corporate training room can take many forms, including lectures, brainstorms, and breakouts – sometimes requiring multiple transformations in a single day. Whether you're planning for an hour-long meeting or an aggressive all-day agenda with various room changes, the Aware collection can easily create the space you need right now and adapt to create the space you'll need in a few hours.

Aware Kit-of-Parts in Typicals Below

Line	Qty	Model Number	Description
1	1	AW4WC5720	40"H x 57"W x 20"D Recycle Credenza
2	2	AW4BC7224NG	34"H x 72"W x 24"D Buffet Credenza – No Grommet
3	4	AW4WB4896P	48"H x 96"W Wall Hung Marker Board – Porcelain
4	8	AW4MB7236P	72"H x 36"W Mobile Marker Board – Porcelain
5	13	AW3LF2460V	24"D x 60"W Aware Top Lam Flat Edge
6	13	AW2VM24N60CS	Aware 24"D x 60"W Nesting V-Leg – Polished w/Caster
7	12	AW3LFT2460T	24"D x 60"W Aware Trapezoid Top Laminate Flat Edge
8	12	AW2TS24N42CB	Aware 24"D x 42"W Nesting T-Leg – Polished w/Caster
9	2	AW3LFH2448V	24"D x 48"W Aware Half-Round Top Laminate Flat Edge
10	2	AW2VM24N36CB	Aware 24"D x 36"W Nesting V-Leg – Polished w/Caster

Seating, Structure, and Social Collaborative Kit-of-Parts In Typicals Below

Line	Qty	Model Number	Description
11	50	K-MUCOSNO	Seek Work Fixed Arms Mesh Back Upholstered Seat
12	1	AMPTLF36RND	36" Dia. Round Top, Laminate, Flat Edge
13	1	S925B72	72"W Mind-Share Bench Seat
14	1	S925B72F72	72"W Mind-Share Bench with 72"W Screen
15	1	S914CWS	Counterweight for 23" dia. base All-Around
16	1	AMPTPR26M	Medium-Round Pedestal Base – Continental Height
17	2	EPR18S	Two Thirds Pouf
18	2	S921B2CL	Hedge w/Base 10" Laminate Tablet – Double
19	2	S922S2TOC	Two-Tone – 2 Tier Outside Corner Rise
20	2	S922S2	Rise – 2 Tier

AWARE

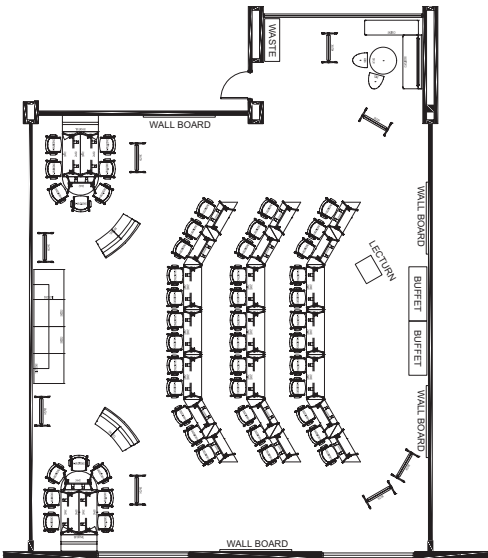

9:00 am

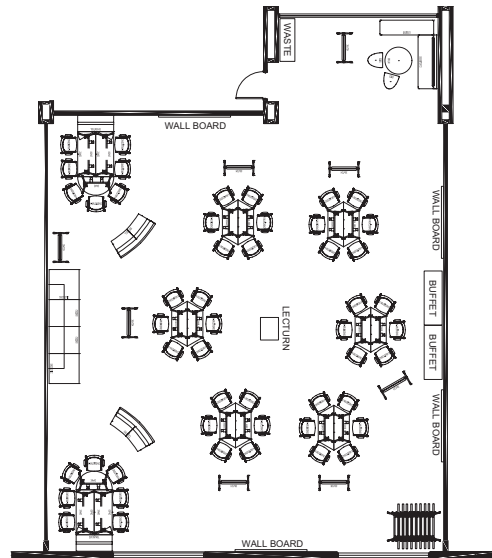

12:00 pm

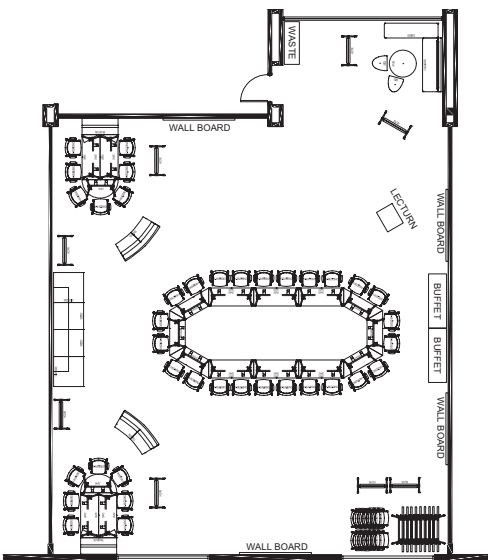

3:45 pm

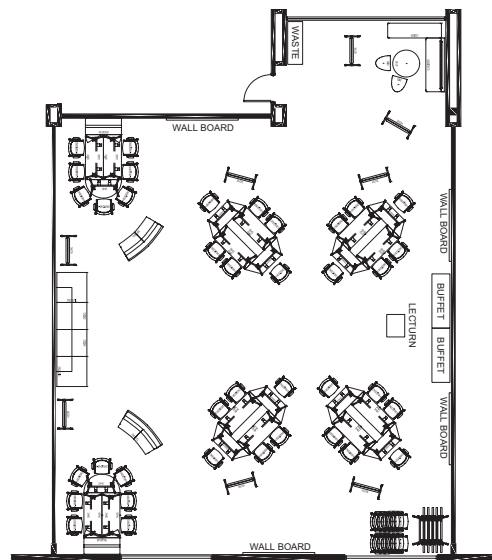

7:00 pm

## HARVEST PAINT FINISHES

GRADE P1	
Black.....	P27
Brownstone.....	P7D
Bungalow.....	P7C
Cinder.....	P7Q
Designer White.....	PJW
Flint.....	P02
Loft.....	P7B
Muslin.....	P4J
Pebble.....	P8R
Pewter.....	P8D
Salt.....	P8C
Titanium.....	P8T

GRADE P2	
Champagne Metallic.....	PR5
Designer White 65 High Gloss.....	P8W
Gunmetal Metallic.....	PR3
Night Bronze.....	P8B
Platinum Metallic.....	PR2
Pyrite.....	PJE
Silver.....	PR6
Solar Black.....	P8X

GRADE P3	
Atom.....	P8S
Blossom***.....	P8K
Bullseye.....	PJF
Cabernet***.....	P7T
Conifer***.....	P8H
Ember.....	P8P
Ion.....	P8N
Iris.....	P8J
Krypton.....	P8F
Regatta.....	P8M
Succulent***.....	P8A

These colors are intended to be an inspirational option for the trending market. Product application is limited and color availability is approximately two years to coincide with evolving workplace trends.

*Metallic paints, due to varying reflectance, may appear to have less visual color consistency than other paint finishes, even when L/A/B values are exactly the same. (L/A/B — measurable aspects of color — values are maintained within a specified range, to ensure consistent appearance of paint colors.)*

## HARVEST RUSTIC WOOD LEG & PLANK TOP FINISHES

Dark Brown.....	LL897
Light Neutral.....	LL815
Medium Grey.....	LL814

## HARVEST LAMINATES

GRADE L1	
<b>CORE SOLID COLORS**</b>	
Black.....	P
Brownstone.....	LM13
Bungalow.....	LM12
Designer White.....	LDW1
Flint.....	LM16
Loft.....	LM11
Muslin.....	LM15
<b>WOODGRAIN</b>	
Belair.....	LWBA
Bourbon Cherry.....	H
Field Elm.....	LWFE
Florence Walnut.....	LFW1
Kingswood Walnut.....	LK11
Natural Maple.....	LWD
NeoWalnut.....	LNU1
Pinnacle.....	PINC
Shaker Cherry.....	LW7C

GRADE L2	
Beigewood.....	LWBE
Fawn Cypress.....	LFC1
Lowell Ash.....	LLA1
Mangalore Mango.....	LMM1
Natural Recon.....	LNR1
Phantom Charcoal.....	LPC1
Phantom Ecu.....	LPE1
Portico Teak.....	LPT1
Skyline Walnut.....	LSW1
Veranda Teak.....	LVT1

GRADE L3	
Natural Walnut.....	LWNW

\*\*144"L and 168"L (2 piece) Tops are limited to solid color laminates and edge colors.

## HARVEST LAMINATE EDGE COLORS

Edge colors are predetermined based on matching laminate selection.

Beigewood.....	DE
Belair.....	BA
Black.....	E4
Bourbon Cherry.....	H
Brazilwood.....	DB
Brownstone.....	EY
Bungalow.....	EX
Designer White.....	DW
Fawn Cypress.....	LF
Field Elm.....	FE
Flint.....	E9
Florence Walnut.....	FW
Kingswood Walnut.....	KI
Loft.....	EV
Lowell Ash.....	DL
Mangalore Mango.....	MM
Muslin.....	EU
Natural Maple.....	DD
Natural Recon.....	NR
Natural Walnut.....	DN
NeoWalnut.....	NU
Phantom Charcoal.....	PC
Phantom Ecu.....	PE
Pinnacle.....	PI
Plyband ♦.....	PL
Portico Teak.....	DP
Shaker Cherry.....	DF
Skyline Walnut.....	SW
Veranda Teak.....	VT

♦ Edge is limited to flat edge surfaces: rectangle, square, trapezoid, polygon, or round. No curvilinear or combination curve and straight. No T-Mold.

## HARVEST VENEERS

### STRATAWOOD

**GRADE V1**  
Add FSC prefix to Stratawood and Natural veneer codes listed below for FSC finishes on Harvest.  
*Example: FSCSC777*

<b>CHERRY</b>	
Cinnamon/Biltmore Cherry.....	SC260
Lowell Ash Cherry.....	SC394
Clear Cherry.....	SC700
Light Cherry.....	SC701
Shaker Cherry.....	SC774
Burnished Cherry.....	SC777

<b>MAPLE</b>	
Field Elm.....	SE599
Clear Maple.....	SE800
Harvest Maple.....	SE856
Beigewood.....	SE878
Phantom Ecu.....	SE912
Belair.....	SE934

<b>OAK</b>	
Clear Oak.....	SEF300
Dark Rift Cut Oak.....	SEF331

<b>SILVER OAK</b>	
Clear.....	SB100
Portico Teak.....	SB150

<b>WALNUT</b>	
Florence Walnut.....	ST579
Light Walnut.....	ST601
Skyline Walnut.....	ST625
Pinnacle Walnut.....	ST679
Sumatra Walnut.....	ST693

### NATURAL — FLAT CUT

GRADE V1	
<b>CHERRY</b>	
Cinnamon/Biltmore Cherry.....	NC260
Lowell Ash.....	NC394
Medium Red Cherry.....	NC512
Light Cherry.....	NC701
Shaker Cherry.....	NC774
Burnished Cherry.....	NC777

<b>MAPLE</b>	
Clear/Natural Maple.....	NE800
Harvest Maple.....	NE856

<b>WALNUT</b>	
Ebony Walnut.....	NT509
Florence Walnut.....	NT579
Light Walnut.....	NT601
Skyline Walnut.....	NT625
Nutmeg Walnut.....	NT629
Pinnacle Walnut.....	NT679
Sumatra Walnut.....	NT693

### NATURAL — RIFT CUT

GRADE V2	
Fawn Cypress Rift Cut Oak.....	RF108
Light Rift Cut Oak.....	RF301
Dark Rift Cut Oak.....	RF331
Phantom Ecu Rift Cut Oak.....	RF912

Horizontal surfaces to be full-fill, ClearTech finish.

*The beauty of wood is the natural variation of grain patterns and colors that make each piece unique. This variation is also influenced by lighting conditions, orientation of mated parts, and varying acceptance of the finishing process. The varying colors and physical characteristics naturally occur in all wood species but are most pronounced in lighter colored woods, and are especially evident in natural finishes.*

**NOTE:** Refer to individual product pages for upcharges.

**FSC Certified Wood at Allsteel**

See page 431 for more information.

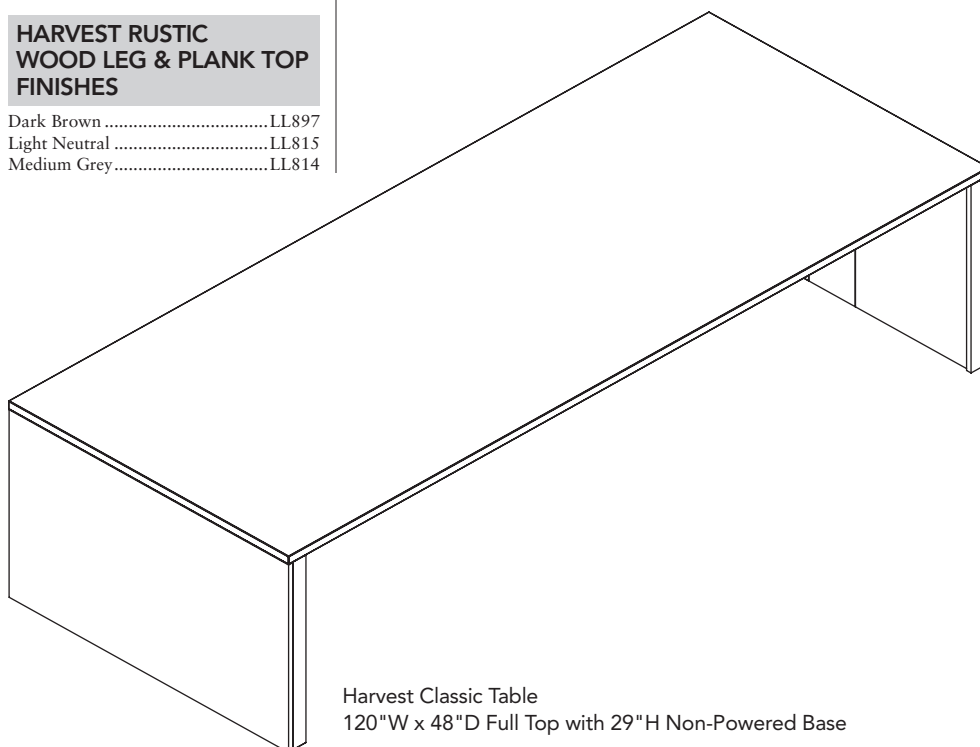

Harvest Classic Table  
120"W x 48"D Full Top with 29"H Non-Powered Base



Harvest brings all the collaborative potential of a multi-purpose table to the corporate environment. It's welcoming. Useful. It invites conversation and interaction whenever people meet up. So it's easy to Harvest the best ideas.

## MODELS AND OPTIONS

Select the seated table height models for meeting and conference rooms or touchdown areas. Or specify a standing-height version for project spaces or cafés. Harvest Classic includes an optional split top that facilitates cord management and power/data hubs that allow for easy access to technology. The sliding doors in the technology trough not only provide easy access to cords from below, but are painted to add an accent color to the space. A solid top can be specified when technology access isn't as critical. Harvest tables are available in laminate or veneer.

## APPLICATIONS

Place Harvest tables in cafés, atrium spaces, libraries, open-plan areas, and conference rooms.

## KEY FEATURES

Harvest Classic tables are offered in a variety of sizes with power and data capability. Inspired by gathering spaces where people like to talk and share, like the dining room table or coffee area in the office, it invites conversation and interaction whenever people meet up.

## TABLE CAPACITIES

Table Top	Seating Capacity
72"W x 36"D	4
72"W x 42"D	4
72"W x 48"D	4
96"W x 36"D	6
96"W x 42"D	6
96"W x 48"D	6
120"W x 36"D	8
120"W x 42"D	8
120"W x 48"D	8

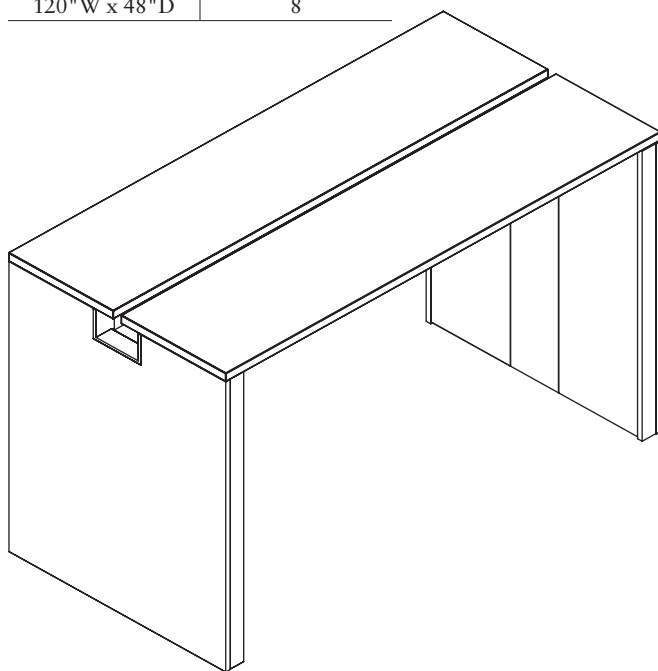

72"W x 36"D Split Top with 42"H Powered End Panel Base

## MATERIALS AND FINISHES

Laminate Edge



Flat Edge

Veneer Edge

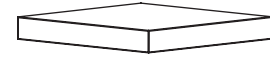

Square Edge

## CLEARANCE DIMENSIONS

### Between Bases

End panel bases are 3" D making clearance between bases 6" less than the width of top:

- 72"W top has 66" clearance
- 96"W top has 90" clearance
- 120"W top has 114" clearance

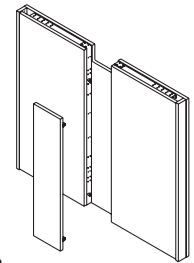

### End Panel Bases

All end panel bases have a hidden center channel 7"W x 1½" D for routing cables from floor to trough. The end panel access door can be mounted flush to bottom for a clean aesthetic or rotated to provide a one-half inch offset to allow for additional cord and cable clearance.

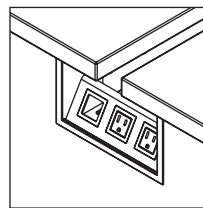

Powered end panel models feature cutouts for mounting a power/data hub and align with end panel center channel and the technology trough of top. Full tops (without split) can be used with powered end panels. Cutout is finished with a PR6 Silver bezel.

### Split Tops

Split tops provide a 1¼" gap for routing cords and power adapters. Inside technology trough dimensions are 7"W x 3¾"D.

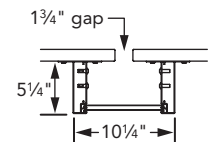

### Wire Trough and Beam

A recessed wire trough runs the length of all table tops. It is accessible through three sliding doors on the under side. Sliding doors can be easily removed for cleaning.

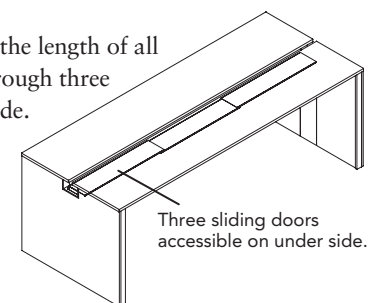

Three sliding doors accessible on under side.

Center trough with beam is 10¼" wide and extends 5¼" below top. Clearance under top and under trough:

- 29"H End Panels provide 28¾"H / 23"H
- 42"H End Panels provide 40¾"H / 35½"H

Distance from front edge of surface to trough:

- 36"D Top is 12⅞"D
- 42"D Top is 15⅞"D
- 48"D Top is 18⅞"D

### ELECTRICAL OPTIONS

Harvest Classic Tables offer three power options: Corded, Interlink IQ, or Hardwire. Installation and use of electrical systems, the number of receptacles used on a given circuit and connections to the building power supply should be in compliance with all local and national electrical codes. See matrix on page 468 for suggested cord length requirements. Verify code requirements before ordering. Chicago requires hard wiring. Chicago and New York do not permit use of Interlink IQ components.

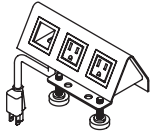

#### Corded

Corded models plug directly into an outlet and can be mounted back-to-back. Corded modules cannot plug into other corded power modules. In order to plug into other units the unit would need to be hardwired. When routing corded models to a wall outlet, the maximum amount of cord that can be exposed outside of the furniture is 6 feet. (New York, check local code.)

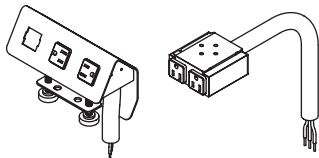

#### Hardwire

Hardwire models are provided with 20' of sealtight cable. Customer must furnish junction boxes, conduit, and additional wire to be in compliance with local and national electrical codes. Hardwire surface mounted modules cannot mount back-to-back and require units to be mounted side-by-side (see below).

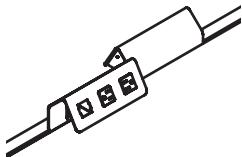

### Interlink IQ

Interlink IQ provides the ability to use one 12-amp infeed starter and power up to 8 power modules (including jumpers)

off of one infeed starter. Interlink IQ provides a visual indicator of system status. LED illuminates green when you are connected and ready to plug in. A red light indicates you have linked too many units.

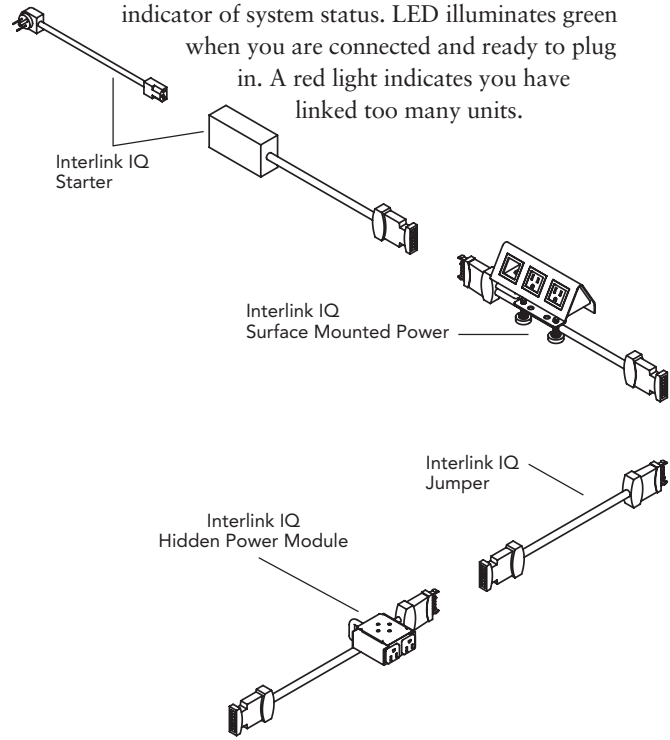

#### Interlink IQ Examples:

- Example #1** – 120" Harvest Classic table with full top, power needed in end panels
- (1) **S913P06LS** – 6' Interlink IQ starter
  - (2) **S913PLE** – Interlink IQ end panel power module
  - (1) **S913P05LJ** – Interlink IQ Jumper
- Example #2** – Two 120" Harvest Classic tables with split tops, power needed in end panels and throughout table
- (1) **S913P06LS** – 6' Interlink IQ starter
  - (2) **S913PLE** – Interlink IQ end panel power module
  - (4) **S913PLM** – Interlink IQ surface mounted power module
  - (2) **S913HPLE** – Interlink IQ Hidden power module

## Harvest Classic Electrical Routing

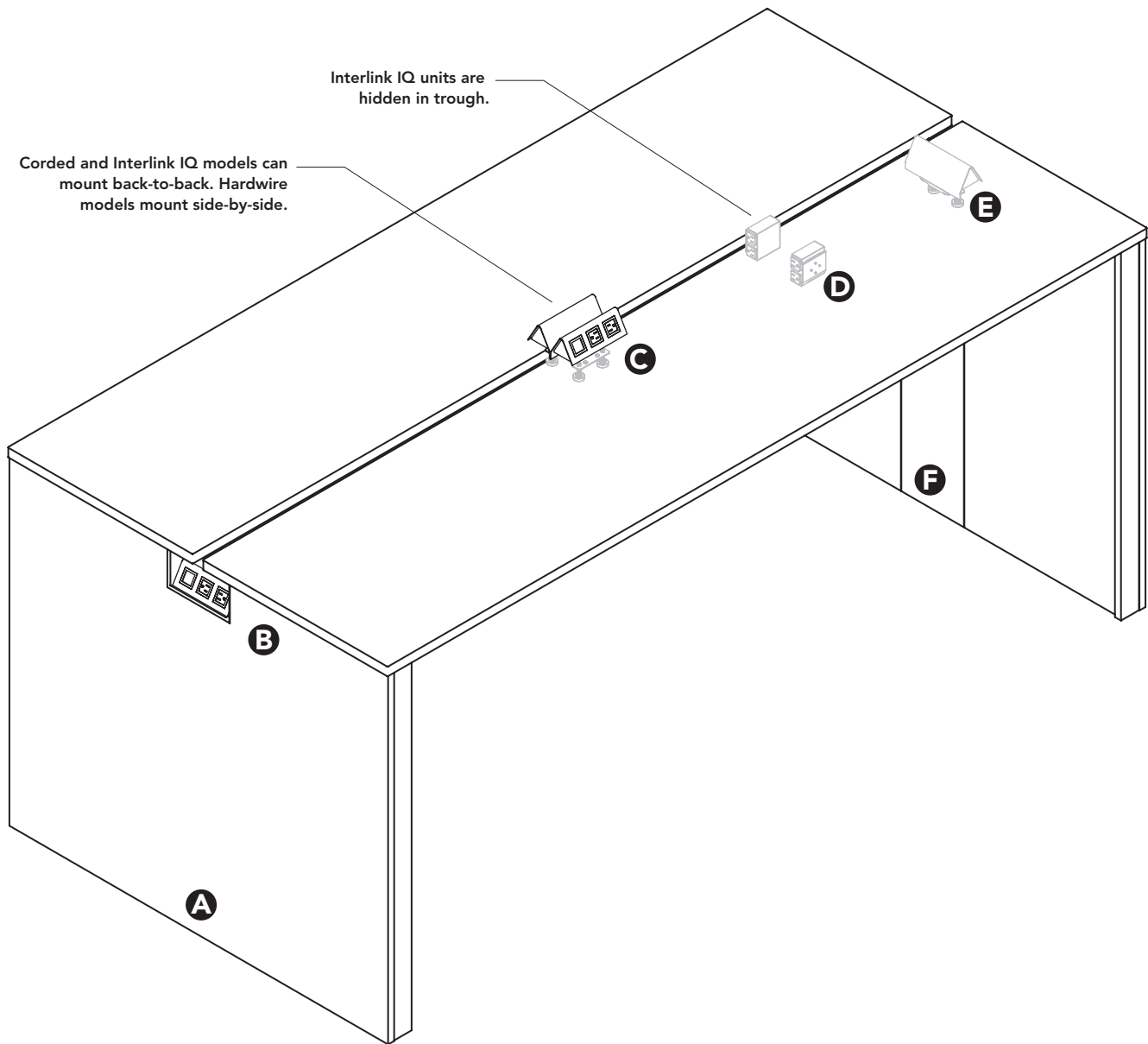

HARVEST

**Harvest Electrical Cable Length Routing Matrix** Add length from "A" or "F" to power source to dimension below.

Table Width:	Any	72" Wide Top				96" Wide Top				120" Wide Top			
Routing Paths: <i>(Reference illustration above)</i>	A to B	A to C	A to D	A to E	F to D	A to C	A to D	A to E	F to D	A to C	A to D	A to E	F to D
	F to E	F to C		F to B		F to C		F to B		F to C		F to B	
Table Height:	29½"H	66"	84"	102"	48"	78"	102"	126"	54"	90"	120"	150"	60"
	42"H	78"	96"	114"	60"	90"	114"	138"	66"	102"	132"	162"	72"

### General Rules

- Corded power modules cannot plug into other corded power modules. Corded modules can plug into hardwired modules.
- Corded power running to a wall outlet is limited to 6' of cord exposed outside of the furniture. (New York, check local code)
- An Interlink IQ Starter is required for Interlink IQ components and can support a maximum of 8 power modules (including jumpers) in any combination.
- Chicago requires hardwire. Interlink IQ can not be used in Chicago or New York.

- All models below include rectangle top and beams with bottom access sliding doors to create a technology trough. Order the same depth end panel bases separately on page 470.
- Laminate tops have a flat edge that is color coordinated. Veneer tops have a matching square edge.
- Beams with sliding doors are painted metal and available in P1, P2, or P3 paint colors.

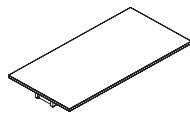

Full Top

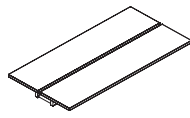

Split Top

Description	Model	Ship Weight	Cubes	List Price		
				L1 or V1	L2 or V2	L3
<b>36"D Harvest Classic Table Tops — includes Beams and Sliding Doors</b>						
72"W Laminate Top — Full	S913LTF3672	145	0.0	\$ 2039	\$ 2073	\$ 2102
72"W Laminate Top — Split	S913LTS3672	145	0.0	\$ 2432	\$ 2478	\$ 2523
72"W Veneer Top — Full	S913WTF3672	145	0.0	\$ 3002	\$ 3144	—
72"W Veneer Top — Split	S913WTS3672	145	0.0	\$ 3422	\$ 3595	—
96"W Laminate Top — Full	S913LTF3696	178	0.0	\$ 2461	\$ 2501	\$ 2537
96"W Laminate Top — Split	S913LTS3696	178	0.0	\$ 2857	\$ 2909	\$ 2961
96"W Veneer Top — Full	S913WTF3696	178	0.0	\$ 3491	\$ 3653	—
96"W Veneer Top — Split	S913WTS3696	178	0.0	\$ 3909	\$ 4101	—
120"W Laminate Top — Full	S913LTF3620	212	0.0	\$ 3228	\$ 3281	\$ 3337
120"W Laminate Top — Split	S913LTS3620	212	0.0	\$ 3620	\$ 3687	\$ 3759
120"W Veneer Top — Full	S913WTF3620	212	0.0	\$ 4753	\$ 4988	—
120"W Veneer Top — Split	S913WTS3620	212	0.0	\$ 5169	\$ 5435	—

<b>42"D Harvest Classic Table Tops — includes Beams and Sliding Doors</b>						
72"W Laminate Top — Full	S913LTF4272	158	0.0	\$ 2235	\$ 2275	\$ 2311
72"W Laminate Top — Split	S913LTS4272	158	0.0	\$ 2631	\$ 2683	\$ 2735
72"W Veneer Top — Full	S913WTF4272	158	0.0	\$ 3422	\$ 3595	—
72"W Veneer Top — Split	S913WTS4272	158	0.0	\$ 3842	\$ 4046	—
96"W Laminate Top — Full	S913LTF4296	195	0.0	\$ 2658	\$ 2703	\$ 2748
96"W Laminate Top — Split	S913LTS4296	195	0.0	\$ 3053	\$ 3111	\$ 3170
96"W Veneer Top — Full	S913WTF4296	195	0.0	\$ 3909	\$ 4101	—
96"W Veneer Top — Split	S913WTS4296	195	0.0	\$ 4326	\$ 4550	—
120"W Laminate Top — Full	S913LTF4220	234	0.0	\$ 3423	\$ 3483	\$ 3546
120"W Laminate Top — Split	S913LTS4220	234	0.0	\$ 4014	\$ 4089	\$ 4166
120"W Veneer Top — Full	S913WTF4220	234	0.0	\$ 5169	\$ 5435	—
120"W Veneer Top — Split	S913WTS4220	234	0.0	\$ 5590	\$ 5888	—

<b>48"D Harvest Classic Table Tops — includes Beams and Sliding Doors</b>						
72"W Laminate Top — Full	S913LTF4872	171	0.0	\$ 2432	\$ 2477	\$ 2522
72"W Laminate Top — Split	S913LTS4872	171	0.0	\$ 2827	\$ 2885	\$ 2944
72"W Veneer Top — Full	S913WTF4872	171	0.0	\$ 3842	\$ 4046	—
72"W Veneer Top — Split	S913WTS4872	171	0.0	\$ 4257	\$ 4492	—
96"W Laminate Top — Full	S913LTF4896	213	0.0	\$ 2857	\$ 2908	\$ 2960
96"W Laminate Top — Split	S913LTS4896	213	0.0	\$ 3250	\$ 3315	\$ 3380
96"W Veneer Top — Full	S913WTF4896	213	0.0	\$ 4326	\$ 4550	—
96"W Veneer Top — Split	S913WTS4896	213	0.0	\$ 4746	\$ 5000	—
120"W Laminate Top — Full	S913LTF4820	255	0.0	\$ 3620	\$ 3686	\$ 3756
120"W Laminate Top — Split	S913LTS4820	255	0.0	\$ 4014	\$ 4096	\$ 4178
120"W Veneer Top — Full	S913WTF4820	255	0.0	\$ 5590	\$ 5888	—
120"W Veneer Top — Split	S913WTS4820	255	0.0	\$ 6012	\$ 6342	—

<p><b>How to specify —</b> Select the Model Number from above.</p>	<p><b>1st Option:</b> <b>FSC Certified Wood</b> (if applicable):</p> <p><b>FSC</b> Select for FSC Certified Wood (72"W and 96"W only)</p> <p><b>X</b> No FSC</p>	<p><b>1st Option:</b> <b>Laminate:</b></p> <p>See page 465 for finishes.</p>	<p><b>1st Option:</b> <b>Veneer:</b></p> <p>See page 465 for finishes.</p>	<p><b>1st Option:</b> <b>Edge Color</b> (Laminate only):</p> <p>Matching edge color based on laminate selection.</p>	<p><b>1st Option:</b> <b>Beam and Door Paint Color:</b></p> <p><b>P1 P2 P3</b></p> <p>See page 465 for finishes.</p> <table border="1"> <thead> <tr> <th>Unit Width</th> <th>P2</th> <th>P3</th> </tr> </thead> <tbody> <tr> <td>72"W</td> <td>\$39</td> <td>\$80</td> </tr> <tr> <td>96"W</td> <td>\$44</td> <td>\$98</td> </tr> <tr> <td>120"W</td> <td>\$55</td> <td>\$120</td> </tr> </tbody> </table>	Unit Width	P2	P3	72"W	\$39	\$80	96"W	\$44	\$98	120"W	\$55	\$120
Unit Width	P2	P3															
72"W	\$39	\$80															
96"W	\$44	\$98															
120"W	\$55	\$120															
<p>S   9   1   3           .</p>	<p>        .</p>	<p>         </p>	<p>          .</p>	<p>      .</p>	<p><b>P</b>      </p>												

Examples: S913LTF4872.X.LM13EY.P7D S913WTS4872.FSC.SC777.P27

- Models below include two end panel bases and connecting hardware. Order matching depth tops that include beams and doors separately on page 469.
- Laminate end panel bases have a flat edge that is color coordinated. Veneer bases have a matching square edge.
- All end panel bases have a 7" W x 1½" D hidden center channel for routing cables from floor to trough.
- Powered end panel bases are power and data ready. Order electrical and data modules and cables separately. See page 471.
- Powered end panel base has cut-out for mounting end panel power/data module and space in the trough for routing cables.
- Non-Powered end panel bases do not have cut-outs.

Description	Model	Ship Weight	Cubes	List Price		
				L1 or V1	L2 or V2	L3
<b>36"D Harvest Classic Table End Panel Bases</b>						
29"H Laminate Base Pair — Non Powered	S913LNB3629	153	12.3	\$ 4237	\$ 4384	\$ 4526
29"H Laminate Base Pair — For Power	S913LPB3629	153	12.3	\$ 4633	\$ 4790	\$ 4951
29"H Veneer Base Pair — Non Powered	S913WNB3629	153	12.3	\$ 5347	\$ 5745	—
29"H Veneer Base Pair — For Power	S913WPB3629	153	12.3	\$ 5764	\$ 6194	—
42"H Laminate Base Pair — Non Powered	S913LNB3642	201	12.3	\$ 4633	\$ 4790	\$ 4951
42"H Laminate Base Pair — For Power	S913LPB3642	201	12.3	\$ 5026	\$ 5195	\$ 5371
42"H Veneer Base Pair — Non Powered	S913WNB3642	201	12.3	\$ 5764	\$ 6194	—
42"H Veneer Base Pair — For Power	S913WPB3642	201	12.3	\$ 6187	\$ 6649	—
<b>42"D Harvest Classic Table End Panel Bases</b>						
29"H Laminate Base Pair — Non Powered	S913LNB4229	172	15.9	\$ 4437	\$ 4589	\$ 4742
29"H Laminate Base Pair — For Power	S913LPB4229	172	15.9	\$ 4830	\$ 4994	\$ 5162
29"H Veneer Base Pair — Non Powered	S913WNB4229	172	15.9	\$ 5607	\$ 6025	—
29"H Veneer Base Pair — For Power	S913WPB4229	172	15.9	\$ 6026	\$ 6476	—
42"H Laminate Base Pair — Non Powered	S913LNB4242	227	15.9	\$ 4830	\$ 4994	\$ 5162
42"H Laminate Base Pair — For Power	S913LPB4242	227	15.9	\$ 5223	\$ 5401	\$ 5581
42"H Veneer Base Pair — Non Powered	S913WNB4242	227	15.9	\$ 6026	\$ 6476	—
42"H Veneer Base Pair — For Power	S913WPB4242	227	15.9	\$ 6446	\$ 6926	—
<b>48"D Harvest Classic Table End Panel Bases</b>						
29"H Laminate Base Pair — Non Powered	S913LNB4829	190	16.2	\$ 4633	\$ 4790	\$ 4951
29"H Laminate Base Pair — For Power	S913LPB4829	190	16.2	\$ 5026	\$ 5195	\$ 5371
29"H Veneer Base Pair — Non Powered	S913WNB4829	190	16.2	\$ 5870	\$ 6308	—
29"H Veneer Base Pair — For Power	S913WPB4829	190	16.2	\$ 6289	\$ 6757	—
42"H Laminate Base Pair — Non Powered	S913LNB4842	254	16.2	\$ 5026	\$ 5195	\$ 5371
42"H Laminate Base Pair — For Power	S913LPB4842	254	16.2	\$ 5419	\$ 5605	\$ 5792
42"H Veneer Base Pair — Non Powered	S913WNB4842	254	16.2	\$ 6446	\$ 6926	—
42"H Veneer Base Pair — For Power	S913WPB4842	254	16.2	\$ 6866	\$ 7378	—

<p><b>How to specify —</b> Select the Model Number from above.</p> <p>S   9   1   3                </p>	<p><b>1st Option:</b> FSC Certified Wood (if applicable):</p> <p>FSC Select for FSC Certified Wood X No FSC</p> <p>(NOTE: Laminate is limited to "X" no FSC at this time.)</p>	<p><b>2nd Option:</b> Laminate (if applicable):</p> <p>See page 465 for finishes.</p>	<p><b>2nd Option:</b> Veneer (if applicable):</p> <p>See page 465 for finishes.</p>	<p><b>3rd Option:</b> Edge Color (Laminate only):</p> <p>Matching edge color based on laminate selection.</p>
---	--	---	---	---

Examples: S913LNB3629.X.LM13EY S913WNB3629.FSC.SC777

HARVEST

- Harvest Classic tables offer three power options: Corded, Interlink IQ, or Hardwire.
- Corded models plug directly into an outlet. Corded modules cannot plug into other corded power modules.
- When routing corded models to a wall outlet, the maximum amount of cord that can be exposed outside of the furniture is 6'. (New York, check local code)
- In order to plug corded models into other units the unit would need to be hardwired.
- Interlink IQ modules require a minimum of one Interlink IQ Starter.
- A maximum of 8 Interlink IQ Power Modules (including jumpers) can be “daisy chained” together in any combination off of one 12-amp infeed starter.
- Interlink IQ provides a visual indicator of system status. LED illuminates green when you’re connected and ready to plug in.
- Hardwire models are provided with 20' of sealtight cable.
- In hardwire applications customer must furnish junction boxes, conduit, and additional wire to be in compliance with local and national electrical codes.

Description	Model	Ship Weight	Cubes	List Price	
<b>Corded Power/Data Solutions for Harvest Classic Tables</b>					
6' Corded for Mounting in End Panel Base – 2 Receptacles/1 Data	S913P06CE	<input type="checkbox"/>	6	0.3	\$ 408
12' Corded for Mounting in End Panel Base – 2 Receptacles/1 Data	S913P12CE	<input type="checkbox"/>	8	0.3	\$ 464
20' Corded for Mounting in End Panel Base – 2 Receptacles/1 Data	S913P20CE	<input type="checkbox"/>	11	0.3	\$ 506
6' Corded for Surface Mounting on Harvest Table – 2 Receptacles/1 Data	S913P06CM	<input type="checkbox"/>	6	0.3	\$ 408
12' Corded for Surface Mounting on Harvest Table – 2 Receptacles/1 Data	S913P12CM	<input type="checkbox"/>	8	0.3	\$ 464
20' Corded for Surface Mounting on Harvest Table – 2 Receptacles/1 Data	S913P20CM	<input type="checkbox"/>	11	0.3	\$ 506
<b>Interlink IQ Power/Data Modules for Harvest Classic Tables</b>					
6' Interlink IQ Starter	S913P06LS	<input type="checkbox"/>	8	0.4	\$ 861
10' Interlink IQ Starter	S913P10LS	<input type="checkbox"/>	11	0.4	\$ 903
5' Interlink IQ Jumper	S913P05LJ	<input type="checkbox"/>	8	0.4	\$ 204
Interlink IQ End Panel Base Power Module* w/5' Cord – 2 Receptacles/1 Data	S913PLE	<input type="checkbox"/>	8	0.4	\$ 514
Interlink IQ Surface Mounted Power Module* w/5' Cord – 2 Receptacles/1 Data	S913PLM	<input type="checkbox"/>	8	0.4	\$ 514
Interlink IQ Hidden Power Module* w/5' Cord – 2 Receptacles	S913PLHE	<input type="checkbox"/>	8	0.4	\$ 472
Interlink IQ Hidden Power Module* w/5' Cord – 1 Receptacle/1 Data	S913PLHED	<input type="checkbox"/>	8	0.4	\$ 472
* Interlink IQ Power Modules require a minimum of one Interlink IQ Starter within configuration.					
<b>Hardwire Power/Data Solutions for Harvest Classic Tables</b>					
20' Hard Wire for Mounting in End Panel Base – 2 Receptacles/1 Data	S913P20HE	<input type="checkbox"/>	14	0.4	\$ 723
20' Hard Wire for Surface Mounting on Harvest Table – 2 Receptacles/1 Data	S913P20HM	<input type="checkbox"/>	14	0.4	\$ 723

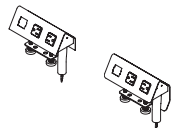
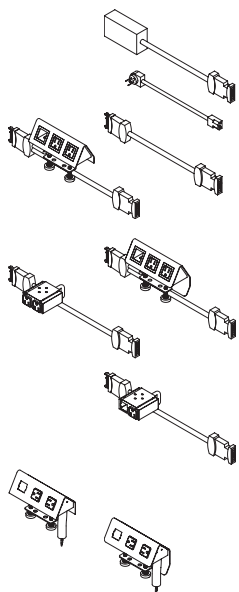

Shippable by small-package carrier.

HARVEST

How to specify —  
Select the Model Number from above.

S | 9 | 1 | 3 | | | | | | | | | | | | | | | | | | | | | |

Examples: S913P06CE S913P06LS S913P20HE

The Harvest Rustic table is designed to help you feel at ease hosting gatherings of all kinds. Seated- and standing-height tables are perfect for everything from the brainstorm to the weekly donut club. All the necessities of the office mixed with an appealing, familiar aesthetic. Bring your team together around the Harvest Rustic table.

### MODELS AND OPTIONS

Harvest Rustic offers three wood finish options for the legs to mix and match a wide selection of laminate top finishes or select a rustic plank top in matching finish. Perfect for cafés, atriums, open-plan areas, and collaboration spaces.

Choose between seated- and standing-height tables, square and rectangular shapes. Standing-height tables have a footrest for added comfort.

Harvest Rustic powered tables include built-in power and USB capabilities to power equipment.

### POWERED TABLES

Each table includes six simplex electrical outlets and six double USB ports (illustrated below) that are recessed at 6 locations within the 12" D x 3" H cubbies located just below table top on the two longest sides. Cubby area provides ample room for power supplies, excess cord, phone, and other paper, binders, or supplies — keeping the table top clear for the work at hand.

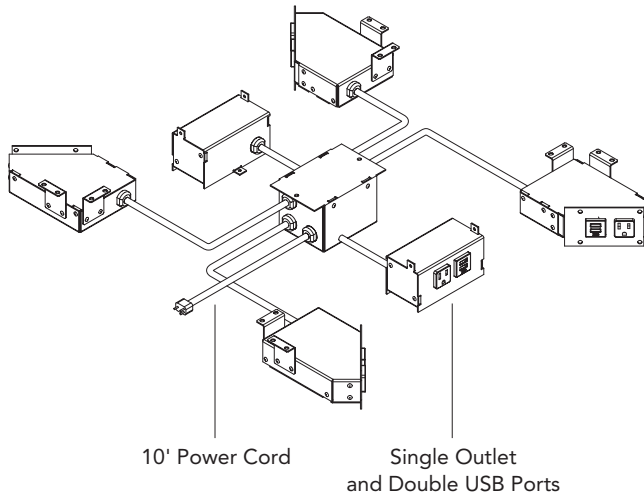

### NON-POWERED TABLES

Non-powered models feature a wooden apron on all four sides of the table (no cubbies). Without cubbies, non-powered tables cannot be easily converted to powered tables.

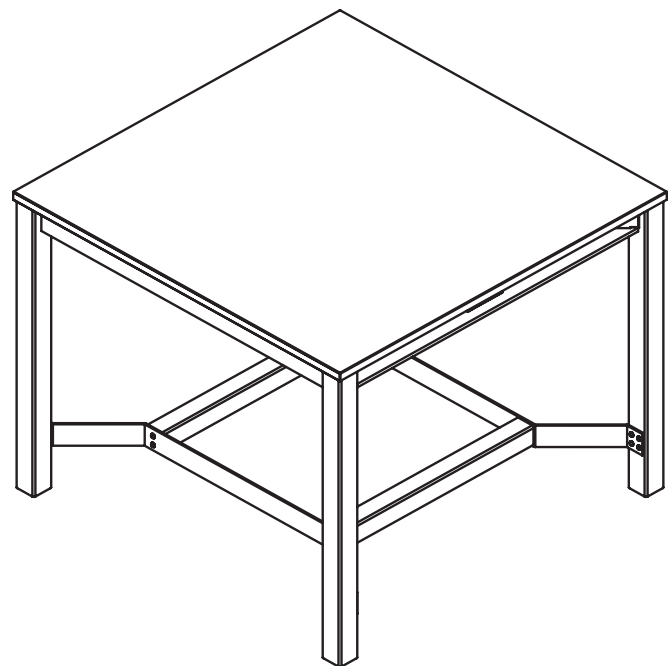
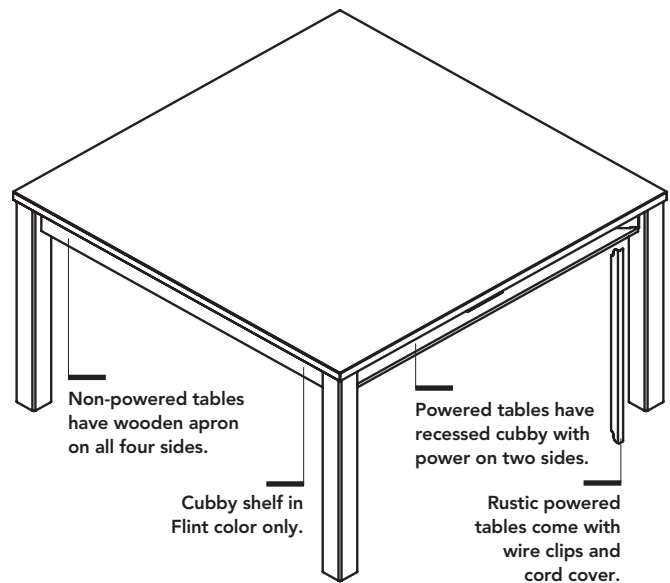

The beauty of wood is the natural variation of grain patterns and colors that make each piece unique. This variation is also influenced by lighting conditions, orientation of mated parts, and varying acceptance of the finishing process. The varying colors and physical characteristics naturally occur in all wood species but are most pronounced in lighter colored woods, and are especially evident in natural finishes.





- Table comes complete with laminate top with flat edges, solid wood legs — 29"H seated or 42"H standing height, and painted metal support structure — assembly required.
- Non-powered tables feature a wooden apron on all four sides and cannot be easily converted to powered tables.

• See page 473 for powered tables.

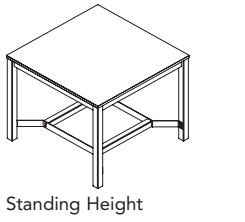
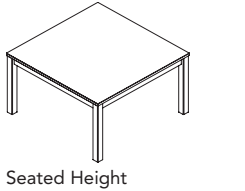
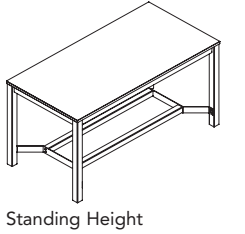
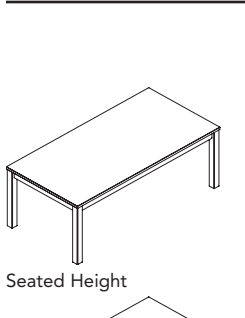

Description	Model Number Add "L" for Laminate or "P" for Plank	Ship Weight	Cubes	Laminate List Price			List Price Plank Top
				L1	L2	L3	
<b>36"D Harvest Rustic Non-Powered — includes top, legs, and metal under supports</b>							
72"W x 29"H	S942 □ TSE3672NP	209	19	\$ 5024	\$ 5054	\$ 5080	\$10388
84"W x 29"H	S942 □ TSE3684NP	259	24	\$ 5515	\$ 5550	\$ 5584	\$11446
96"W x 29"H **	S942 □ TSE3696NP	277	27	\$ 5829	\$ 5871	\$ 5913	\$12424
120"W x 29"H **	S942 □ TSE36120NP	305	29	\$ 5970	\$ 6018	\$ 6069	\$12962
72"W x 42"H	S942 □ TST3672NP	240	30	\$ 6291	\$ 6321	\$ 6347	\$11655
84"W x 42"H	S942 □ TST3684NP	293	36	\$ 6817	\$ 6852	\$ 6886	\$12748
96"W x 42"H **	S942 □ TST3696NP	313	40	\$ 7205	\$ 7247	\$ 7289	\$13800
120"W x 42"H **	S942 □ TST36120NP	343	44	\$ 7604	\$ 7652	\$ 7703	\$14596

<b>42"D Harvest Rustic Non-Powered — includes top, legs, and metal under supports</b>							
72"W x 29"H	S942 □ TSE4272NP	223	21	\$ 5782	\$ 5817	\$ 5851	\$10870
84"W x 29"H	S942 □ TSE4284NP	277	26	\$ 6196	\$ 6237	\$ 6277	\$12079
96"W x 29"H	S942 □ TSE4296NP	299	29	\$ 6509	\$ 6556	\$ 6605	\$12926
120"W x 29"H	S942 □ TSE42120NP	328	31	\$ 6653	\$ 6707	\$ 6765	\$13641
72"W x 42"H	S942 □ TST4272NP	270	32	\$ 7369	\$ 7404	\$ 7438	\$12457
84"W x 42"H	S942 □ TST4284NP	327	38	\$ 7818	\$ 7859	\$ 7899	\$13701
96"W x 42"H	S942 □ TST4296NP	351	42	\$ 8205	\$ 8252	\$ 8301	\$14622
120"W x 42"H	S942 □ TST42120NP	382	46	\$ 8607	\$ 8661	\$ 8719	\$15595

<b>48"D Harvest Rustic Non-Powered — includes top, legs, and metal under supports</b>							
72"W x 29"H	S942 □ TSE4872NP	237	22	\$ 6498	\$ 6539	\$ 6579	\$11623
84"W x 29"H	S942 □ TSE4884NP	296	28	\$ 6980	\$ 7026	\$ 7073	\$12512
96"W x 29"H	S942 □ TSE4896NP	322	31	\$ 7124	\$ 7177	\$ 7233	\$13224
120"W x 29"H	S942 □ TSE48120NP	350	33	\$ 7423	\$ 7483	\$ 7547	\$14392
72"W x 42"H	S942 □ TST4872NP	285	34	\$ 8328	\$ 8369	\$ 8409	\$13453
84"W x 42"H	S942 □ TST4884NP	347	40	\$ 8845	\$ 8891	\$ 8938	\$14377
96"W x 42"H	S942 □ TST4896NP	375	45	\$ 9063	\$ 9116	\$ 9172	\$15163
120"W x 42"H	S942 □ TST48120NP	405	49	\$ 9620	\$ 9680	\$ 9744	\$16589

<b>Square Harvest Rustic Non-Powered — includes top, legs, and metal under supports</b>							
54" Square x 29"H	S942 □ TSE54SQRNP	214	19	\$ 4524	\$ 4559	\$ 4593	\$10353
60" Square x 29"H	S942 □ TSE60SQRNP	241	22	\$ 4831	\$ 4873	\$ 4915	\$11427
54" Square x 42"H	S942 □ TST54SQRNP	242	30	\$ 5726	\$ 5761	\$ 5795	\$11555
60" Square x 42"H	S942 □ TST60SQRNP	273	34	\$ 6172	\$ 6214	\$ 6256	\$12768

<p><b>How to specify —</b> Select the Model Number from above.</p> <p>S   9   4   2                     .   X   .</p>	<p><i>1st Option:</i> <b>FSC Certified Wood:</b> X No FSC</p>	<p><i>2nd Option:</i> <b>Laminate:</b> See page 465 for Harvest Rustic laminate finishes.</p>	<p><i>3rd Option:</i> <b>Edge Color:</b> See page 465 for Harvest Rustic edge finishes.</p>	<p><i>4th Option:</i> <b>Harvest Rustic Wood Leg Color:</b> LL814 Medium Grey LL815 Light Neutral LL897 Dark Brown</p>	<p><i>4th Option:</i> <b>Paint Color for Metal Under Supports:</b> P1 P2 P3 See page 465 for paint colors and codes. P2 upcharge: \$35 on 29"H, \$105 on 42"H</p>
	<p>Examples: S942LTSE3672NP.X.LPE1.PE.LL814.P02 S942PTSE3672NP.X.LL814.PR6</p>				

The Harvest Metal table is designed to help you feel at ease hosting gatherings of all kinds. Seated- and standing-height tables are perfect for everything from the brainstorm to the weekly robotics club. All the necessities of the office mixed with an appealing, familiar aesthetic. Bring your team together around the Harvest Metal table.

### MODELS AND OPTIONS

Harvest Metal offers numerous painted options for the metal legs to mix and match a wide selection of laminate and veneer top finishes. Perfect for cafés, atriums, open-plan areas, and collaboration spaces.

Choose between seated- and standing-height tables, square and rectangular shapes. Standing-height table has a footrest for added comfort.

Harvest Metal powered tables include built-in power and USB capabilities to power equipment.

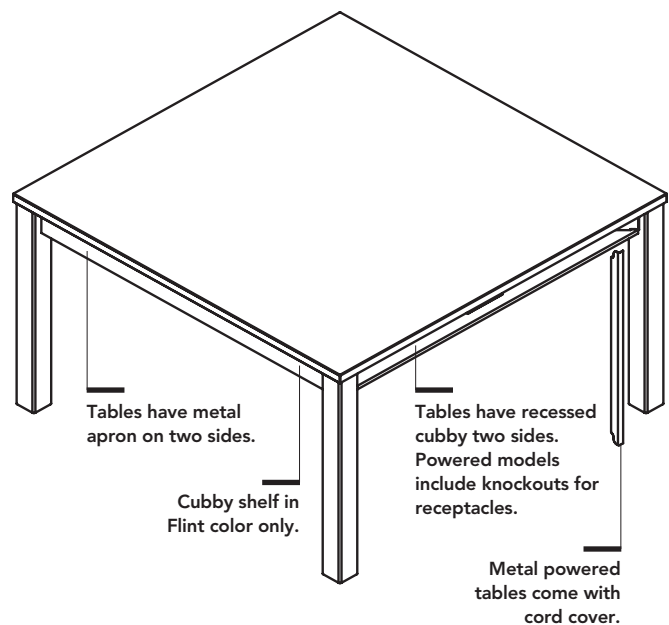

### POWERED TABLES

Each table includes six simplex electrical outlets and six double USB ports (illustrated below) that are recessed at 6 locations within the 12"D x 3"H cubbies located just below table top on the two longest sides. Cubby area provides ample room for power supplies, excess cord, phone, and other paper, binders, or supplies — keeping the table top clear for the work at hand.

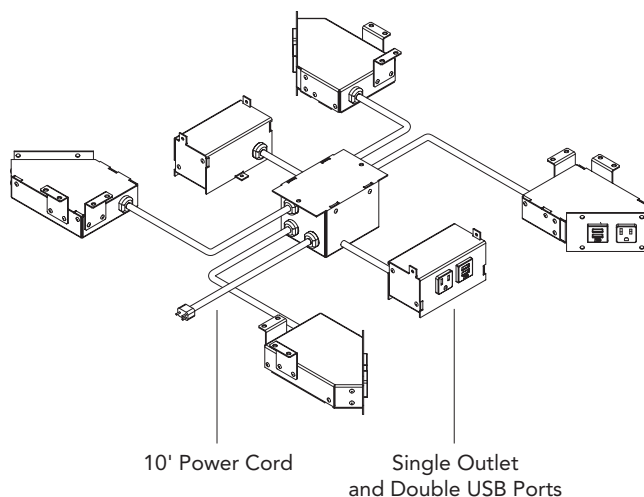

### NON-POWERED TABLES

Non-powered metal models feature cubbies, but without any knock-outs for receptacles. Non-powered tables cannot be easily converted to powered tables.

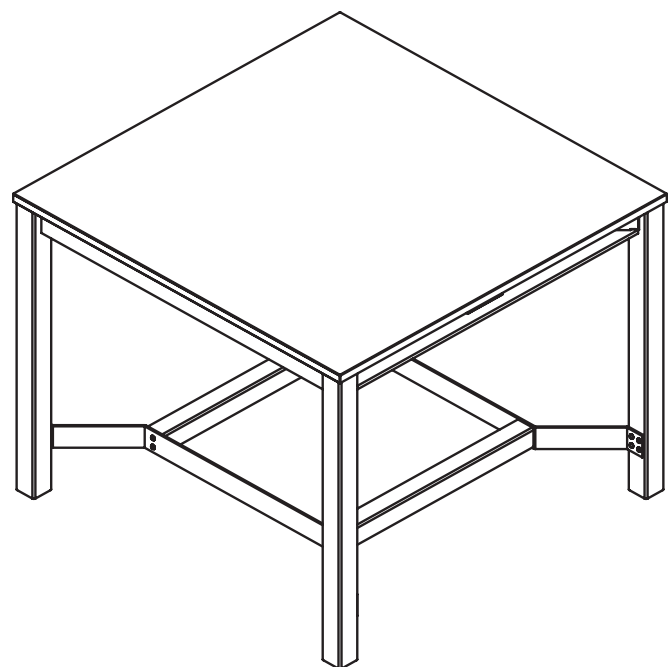

- Table comes complete with laminate or veneer top, painted metal legs — 29"H seated or 42"H standing height, support structure, and electrical — assembly required.
- Each powered table includes 6 simplex electrical outlets and 6 double USB ports recessed within the 12"D x 3"H cubbies located just below table top on the two longest sides. See page 475.
- See page 477 for non-powered tables.
- Cubby shelf color is not specified and comes in Flint.
- Electrical is corded with plug; for hardwired add "HW" suffix and \$176 upcharge. Cord to power is 10' long from center of table top.
- Tables come with painted metal wire management cover for routing cable down table leg. Cover attaches with double faced tape.

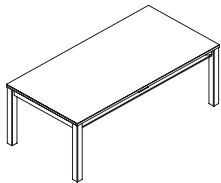

Seated Height

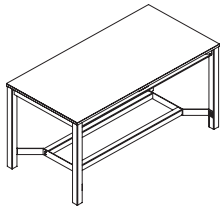

Standing Height

Description	Model Number add "L" for Laminate or "V" for Veneer	Ship Weight	Cubes	Laminate List Price			Veneer List Price	
				L1	L2	L3	V1	V2
<b>36"D Harvest Metal — includes top, legs, metal under supports, and electrical.</b>								
72"W x 29"H	S943 □ TSE3672	209	19	\$ 5775	\$ 5805	\$ 5831	\$ 9262	\$ 9572
84"W x 29"H	S943 □ TSE3684	259	24	\$ 6267	\$ 6302	\$ 6336	\$10181	\$10540
96"W x 29"H	S943 □ TSE3696	277	27	\$ 6582	\$ 6624	\$ 6666	\$10997	\$11411
120"W x 29"H	S943 □ TSE36120	305	29	\$ 6722	\$ 6770	\$ 6821	\$11433	\$11873
72"W x 42"H	S943 □ TST3672	240	30	\$ 7011	\$ 7041	\$ 7067	\$10498	\$10808
84"W x 42"H	S943 □ TST3684	293	36	\$ 7531	\$ 7566	\$ 7600	\$11445	\$11804
96"W x 42"H	S943 □ TST3696	313	40	\$ 7914	\$ 7956	\$ 7998	\$12329	\$12743
120"W x 42"H	S943 □ TST36120	343	44	\$ 8304	\$ 8352	\$ 8403	\$13015	\$13455

<b>42"D Harvest Metal — includes top, legs, metal under supports, and electrical.</b>								
72"W x 29"H	S943 □ TSE4272	223	21	\$ 6525	\$ 6560	\$ 6594	\$ 9433	\$ 9728
84"W x 29"H	S943 □ TSE4284	277	26	\$ 6940	\$ 6981	\$ 7021	\$10384	\$10741
96"W x 29"H	S943 □ TSE4296	299	29	\$ 7254	\$ 7301	\$ 7350	\$11094	\$11498
120"W x 29"H	S943 □ TSE42120	328	31	\$ 7397	\$ 7451	\$ 7509	\$11674	\$12115
72"W x 42"H	S943 □ TST4272	270	32	\$ 8075	\$ 8110	\$ 8144	\$10983	\$11278
84"W x 42"H	S943 □ TST4284	327	38	\$ 8518	\$ 8559	\$ 8599	\$11962	\$12319
96"W x 42"H	S943 □ TST4296	351	42	\$ 8900	\$ 8947	\$ 8996	\$12740	\$13144
120"W x 42"H	S943 □ TST42120	382	46	\$ 9293	\$ 9347	\$ 9405	\$13570	\$14011

<b>48"D Harvest Metal — includes top, legs, metal under supports, and electrical.</b>								
72"W x 29"H	S943 □ TSE4872	237	22	\$ 7221	\$ 7262	\$ 7302	\$10036	\$10341
84"W x 29"H	S943 □ TSE4884	296	28	\$ 7704	\$ 7750	\$ 7797	\$10873	\$11223
96"W x 29"H	S943 □ TSE4896	322	31	\$ 7849	\$ 7902	\$ 7958	\$11321	\$11707
120"W x 29"H	S943 □ TSE48120	350	33	\$ 8147	\$ 8207	\$ 8271	\$12284	\$12735
72"W x 42"H	S943 □ TST4872	385	34	\$ 9012	\$ 9053	\$ 9093	\$11827	\$12132
84"W x 42"H	S943 □ TST4884	347	40	\$ 9523	\$ 9569	\$ 9616	\$12579	\$12929
96"W x 42"H	S943 □ TST4896	375	45	\$ 9736	\$ 9789	\$ 9845	\$13208	\$13594
120"W x 42"H	S943 □ TST48120	405	49	\$10284	\$10344	\$10408	\$14421	\$14872

<b>Square Harvest Metal — includes top, legs, metal under supports, and electrical.</b>								
54" Square x 29"H**	S943 □ TSE54SQR	214	19	\$ 5486	\$ 5521	\$ 5555	\$ 9542	\$ 9883
60" Square x 29"H**	S943 □ TSE60SQR	241	22	\$ 5874	\$ 5916	\$ 5958	\$10561	\$10968
54" Square x 42"H**	S943 □ TST54SQR	242	30	\$ 6661	\$ 6696	\$ 6730	\$10717	\$11058
60" Square x 42"H**	S943 □ TST60SQR	273	34	\$ 7178	\$ 7220	\$ 7262	\$11865	\$12272

\*\* 54" and 60" square veneer tops ship in two pieces.

**Note:** Add suffix "HW" to model number for Hardwire, \$176 upcharge. *Example:* S943LTST3672HW

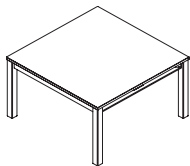

Seated Height

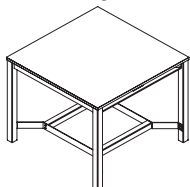

Standing Height

<p><b>How to specify —</b> Select the Model Number from above.</p> <p>S   9   4   3  </p>	<p><b>1st Option:</b> FSC Certified Wood: X No FSC</p>	<p><b>2nd Option:</b> Veneer Finish (Veneer only): FF Full Finish OP Open pore</p>	<p><b>3rd Option:</b> Laminate or Veneer: See page 465 for Harvest Metal finishes.</p>	<p><b>4th Option:</b> Edge Color (Laminate only): See page 465 for Harvest Metal finishes.</p>	<p><b>5th Option:</b> Paint Color for Metal Legs, Supports, and Wire Cover: P1 P2 P3 See page 465 for P1 and Select paint colors and codes. P2 upcharge: \$35 on 29"H, \$105 on 42"H</p>
	<p>Example: S943LTSE3672.X.LPE1.PE.P02 S943LTSE3672.X.FF.SC777.P02</p>				

- Table comes complete with laminate or veneer top, painted metal legs — 29"H seated or 42"H standing height, and support structure — assembly required.
- See page 476 for powered tables.
- Non-powered tables feature a metal apron on the two depth sides and cubby storage on the two width sides. Cubbies on non-powered tables do not have electrical or data ports and therefore cannot be easily converted to powered tables.
- Cubby shelf color is not specified and comes in Flint.

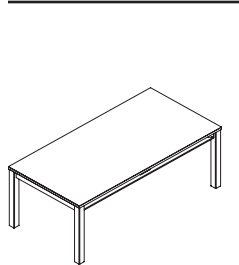

Seated Height

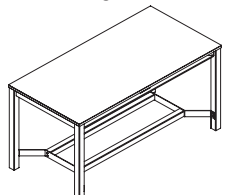

Standing Height

Description	Model Number add "L" for Laminate or "V" for Veneer	Ship Weight	Cubes	Laminate List Price			Veneer List Price	
				L1	L2	L3	V1	V2
<b>36"D Harvest Metal Non-Powered — includes top, legs, and metal under supports.</b>								
72"W x 29"H	S943 □ TSE3672NP	209	19	\$4982	\$5012	\$5038	\$8614	\$8924
84"W x 29"H	S943 □ TSE3684NP	259	24	\$5474	\$5509	\$5543	\$9533	\$9892
96"W x 29"H	S943 □ TSE3696NP	277	27	\$5789	\$5831	\$5873	\$10349	\$10763
120"W x 29"H	S943 □ TSE36120NP	305	29	\$5929	\$5977	\$6028	\$10785	\$11225
72"W x 42"H	S943 □ TST3672NP	209	19	\$6150	\$6180	\$6206	\$9782	\$10092
84"W x 42"H	S943 □ TST3684NP	259	24	\$6670	\$6705	\$6739	\$10729	\$11088
96"W x 42"H	S943 □ TST3696NP	277	27	\$7053	\$7095	\$7137	\$11613	\$12027
120"W x 42"H	S943 □ TST36120NP	305	29	\$7443	\$7491	\$7542	\$12299	\$12739

<b>42"D Harvest Metal Non-Powered — includes top, legs, and metal under supports.</b>								
72"W x 29"H	S943 □ TSE4272NP	209	19	\$5732	\$5767	\$5801	\$9039	\$9334
84"W x 29"H	S943 □ TSE4284NP	259	24	\$6147	\$6188	\$6228	\$10071	\$10428
96"W x 29"H	S943 □ TSE4296NP	277	27	\$6461	\$6508	\$6557	\$10781	\$11185
120"W x 29"H	S943 □ TSE42120NP	305	29	\$6604	\$6658	\$6716	\$11361	\$11802
72"W x 42"H	S943 □ TST4272NP	209	19	\$7211	\$7246	\$7280	\$10518	\$10813
84"W x 42"H	S943 □ TST4284NP	259	24	\$7654	\$7695	\$7735	\$11578	\$11935
96"W x 42"H	S943 □ TST4296NP	277	27	\$8036	\$8083	\$8132	\$12356	\$12760
120"W x 42"H	S943 □ TST42120NP	305	29	\$8429	\$8483	\$8541	\$13186	\$13627

<b>48"D Harvest Metal Non-Powered — includes top, legs, and metal under supports.</b>								
72"W x 29"H	S943 □ TSE4872NP	209	19	\$6428	\$6469	\$6509	\$9642	\$9947
84"W x 29"H	S943 □ TSE4884NP	259	24	\$6911	\$6957	\$7004	\$10447	\$10797
96"W x 29"H	S943 □ TSE4896NP	277	27	\$7056	\$7109	\$7165	\$11008	\$11394
120"W x 29"H	S943 □ TSE48120NP	305	29	\$7354	\$7414	\$7478	\$11971	\$12422
72"W x 42"H	S943 □ TST4872NP	209	19	\$8147	\$8188	\$8228	\$11361	\$11666
84"W x 42"H	S943 □ TST4884NP	259	24	\$8658	\$8704	\$8751	\$12194	\$12544
96"W x 42"H	S943 □ TST4896NP	277	27	\$8871	\$8924	\$8980	\$12823	\$13209
120"W x 42"H	S943 □ TST48120NP	305	29	\$9419	\$9479	\$9543	\$14036	\$14487

<b>Square Harvest Metal Non-Powered — includes top, legs, and metal under supports.</b>								
54" Square x 29"H**	S943 □ TSE54SQRNP	209	19	\$4693	\$4728	\$4762	\$8749	\$9090
60" Square x 29"H**	S943 □ TSE60SQRNP	259	24	\$5081	\$5123	\$5165	\$9768	\$10175
54" Square x 42"H**	S943 □ TST54SQRNP	209	19	\$5797	\$5832	\$5866	\$9853	\$10194
60" Square x 42"H**	S943 □ TST60SQRNP	259	24	\$6316	\$6358	\$6400	\$11003	\$11410

\*\* 54" and 60" square veneer tops ship in two pieces.

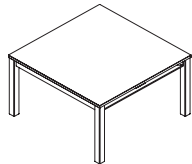

Seated Height

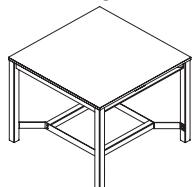

Standing Height

<p><b>How to specify —</b> Select the Model Number from above.</p> <p>S   9   4   3</p>	<p><b>1st Option:</b> FSC Certified Wood: X No FSC</p>	<p><b>2nd Option:</b> Veneer Finish (Veneer only): FF Full Finish OP Open pore</p>	<p><b>3rd Option:</b> Laminate or Veneer: See page 465 for Harvest Metal finishes.</p>	<p><b>4th Option:</b> Edge Color (Laminate only): See page 465 for Harvest Metal finishes.</p>	<p><b>5th Option:</b> Paint Color for Metal Legs and Under Supports: P1 P2 P3 See page 465 for P1 and P2 paint colors and codes. P2 upcharge: \$35 on 29"H, \$105 on 42"H</p>
<p>Example: S943LTSE3672NP.X.LPE1.PE.P02 S943LTSE3672NP.X.FF.SC777.P02</p>					

Structure rounds out the Allsteel table offering and supports a wide array of applications, from conference rooms to café settings and everything in between.

The tables are adaptable and interchangeable for use in multiple spaces. The combination of rich details and durable design creates an experience out of any activity at the office while elevating culture and brand. A variety of table top shapes, edges, bases, and finishes ensures a consistent aesthetic throughout the entire floorplan.

### MODELS AND OPTIONS

Structure is available in five heights and ten top shapes.

### APPLICATION

Use in open meeting areas, dedicated collaboration rooms, neighborhood spaces, cafés, large and smaller conference rooms, libraries, and lounge areas.

### KEY FEATURES

Range of shapes, sizes, and configurations to meet the needs of any space available in an array of materials.

### MATERIALS AND EDGE TREATMENTS

Woodgrain laminates will be aligned within  $\frac{3}{8}$ " across seams unless otherwise noted in the price guide pages.

#### Laminate Edges



Flat Edge

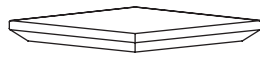

Knife Edge

### SINGLE-PIECE TOPS

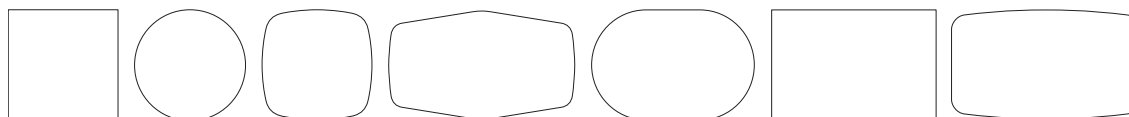

Size Ranges

Square  
24"-84"

Round  
24"-84"

Soft Square  
24"-84"

Diamond  
24"-54"W  
40"-96"L

Racetrack  
24"-54"W  
36"-96"L

Rectangle  
24"-54"W  
36"-96"L

Boat  
30", 36"W  
52", 60", 72"L

### TWO-PIECE TOPS



Size Ranges

Diamond  
48"-60"W  
120"-192"L

Racetrack  
42"-60"W  
120"-168"L

Rectangle  
36"-60"W  
120"-168"L

### MEDIA TOPS

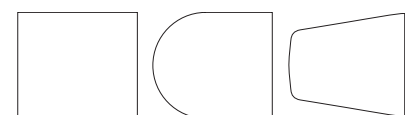

Rectangle

Racetrack  
48", 54" or 60"W  
54", 60" or 72"L

Diamond

### THREE-PIECE TOPS



Size Ranges

Racetrack  
54"-60"W  
192"-240"L

Rectangle  
54"-60"W  
192"-240"L

### GRAIN DIRECTION AND ALIGNMENT

**SINGLE-PIECE TOPS** – Woodgrain laminates as standard product are always oriented with the grain direction running parallel to the length of the table top.

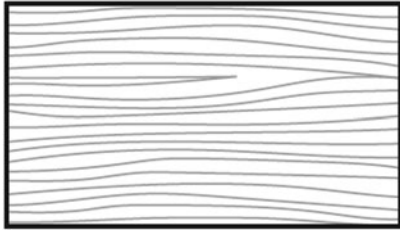

**TWO & THREE PIECE TOPS** – Tops longer than 96". Woodgrain laminates as standard product are always oriented with the grain direction running parallel to the length of the tabletop. Please note that 2-piece tops, in woodgrain colors, will not have exact grain alignment in the center where the two halves meet, a reasonable match can be expected. Allsteel cannot guarantee a grain match on tables that are 60"W.

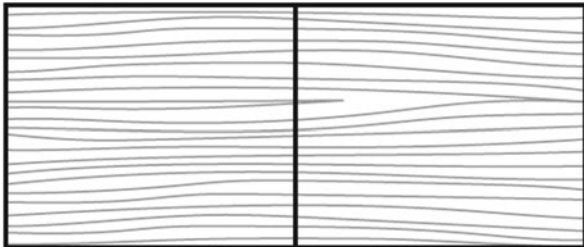

**SPECIAL TOPS** – Specials for wide tables. Woodgrain laminates as specials wider than 60" are always oriented with the grain direction running parallel to the seam of the tabletop. Allsteel will create best match grain alignment but cannot guarantee a perfect match along the seam between the pieces of laminate on two and three piece tops.

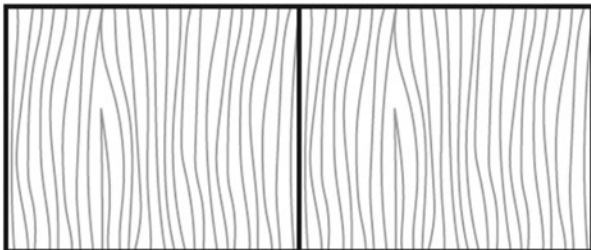

### PAINT FINISHES

GRADE P1	
Black	P71
Brownstone	P7D
Bungalow	P7C
Charblack	CBK
Cinder	P7Q
Cove	P096
Designer White	PJW
Designer White Texture	PK7
Dune	P094
Flint	P02
Fossil	P28
Harbor	P097
Loft	P7B
Muslin	P4J
Pebble	P8R
Pewter	P8D
Sage	P095
Salt	P8C
Textured Brownstone	P7J
Textured Flint	P7A
Textured Loft	P7L
Textured Muslin	P7M
Textured Pebble	P8Y
Textured Salt	P8Z
Textured Titanium	P8V
Titanium	P8T

GRADE P2	
Champagne Metallic	PR5
Designer White 65 High Gloss	P8W
Gunmetal Metallic	PR3
Night Bronze	P8B
Platinum Metallic	PR2
Pyrite	PJE
Silver	PR6
Silver Texture	PR8
Solar Black	P8X

GRADE P3	
Atom	P8S
Blossom***	P8K
Bullseye	PJF
Cabernet***	P7T
Conifer***	P8H
Ember	P8P
Ion	P8N
Iris	P8J
Krypton	P8F
Regatta	P8M
Succulent***	P8A

\*\*\*These colors are intended to be an inspirational option for the trending market. Product application is limited and color availability is approximately two years to coincide with evolving workplace trends.

### PEDESTAL BASE PAINT FINISHES

GRADE P1	
Charblack	CBK
Textured Designer White	PK7
Textured Brownstone	P7J
Textured Flint	P7A
Textured Loft	P7L
Textured Muslin	P7M
Textured Pebble	P8Y
Textured Salt	P8Z
Textured Titanium	P8V

GRADE P2	
Silver Texture	PR8

### LAMINATES

GRADE L1	
<b>SOLID</b>	
Black	P
Brownstone	LM13
Bungalow	LM12
Designer White 15051	LDW1
Flint	LM16
Fossil Shale	LEH1
Loft	LM11
Muslin	LM15
Titanium	LTI1

<b>ABSTRACT</b>	
Ash	LT3B
Handspun Pearl	LAHP
Handspun Dove	LAHD
Handspun Slate	LAHS
Handspun Chestnut	LAHC
Silver Mesh	LT8D

WOODGRAIN	
Belair	LWBA
Bourbon Cherry	H
Field Elm	LWFE
Florence Walnut	LFW1
Kingswood Walnut	LK11
Natural Maple	LWD
Neo Walnut	LNU1
Pinnacle	PINC
Shaker Cherry	LW7C

GRADE L2	
<b>WOODGRAIN</b>	
Beigewood	LWBE
Fawn Cypress	LFC1
Lowell Ash	LLA1
Mangalore Mango	LMM1
Natural Recon	LNR1
Phantom Charcoal	LPC1
Phantom Ecru	LPE1
Portico Teak	LPT1
Skyline Walnut	LSW1
Veranda Teak	LVT1

GRADE L3	
Natural Walnut	LWNW

### LAMINATE EDGE COLORS

Beigewood	DE
Belair	BA
Black	E4
Bourbon Cherry	H
Brownstone	EY
Bungalow	EX
Designer White	DW
Fawn Cypress	FC
Field Elm	FE
Flint	E9
Florence Walnut	FW
Fossil	EH
Kingswood Walnut	KI
Loft	EV
Lowell Ash	DL
Mangalore Mango	MM
Muslin	EU
Natural Maple	DD
Natural Recon	NR
Natural Walnut	DN
Neo Walnut	NU
Parchment	EN
Phantom Charcoal	PC
Phantom Ecru	PE
Pinnacle	PI
Platinum Metallic	EP
Plyband	PL
Portico Teak	DP
Shaker Cherry	DF
Skyline Walnut	SW
Titanium	TI
Veranda Teak	VT

### LAMINATE BASE FINISHES

L1 – SOLID	
Black	P
Designer White	LDW1
Flint	LM16
Loft	LM11

L1 – WOODGRAIN	
Bourbon Cherry	H
Field Elm	LWFE
Florence Walnut	LFW1
Kingswood Walnut	LK11
Natural Maple	LWD
Neo Walnut	LNU1
Pinnacle	PINC
Shaker Cherry	LW7C

L2 – WOODGRAIN	
Beigewood	LWBE
Fawn Cypress	LFC1
Lowell Ash	LLA1
Mangalore Mango	LMM1
Natural Recon	LNR1
Phantom Charcoal	LPC1
Phantom Ecru	LPE1
Skyline Walnut	LSW1
Veranda Teak	LVT1

L3 – WOODGRAIN	
Natural Walnut	LWNW

### PLASTIC GROMMETS

FOR TABLE TOPS	
Black	E4
Brownstone	EY
Bungalow	EX
Designer White	DW
Flint	E9
Fossil	EH
Loft	EV
Muslin	EU
Parchment	EN
Titanium	TI

### RECOMMENDED COORDINATE COLORS

For Plastic Grommets on Laminate specify the same color used for the edge color; or the following plastic grommet color based on edge selected:  
Natural Maple, Fawn Cypress, Natural Recon, Muslin EU  
Phantom Charcoal, Flint E9  
Phantom Ecru, Loft EV  
Portico Teak, Fossil EH  
Shaker Cherry, Black E4  
Skyline Walnut, Flint E9

For Plastic Grommets on Fluid Form specify either same color as painted legs/base; or the following plastic grommet color based on Fluid Form selected:  
Auburn Cherry, Black E4  
Natural Maple, Muslin EU

For Plastic Grommets on Veneer the color is predetermined based on finish selection.  
All Maple veneers, Muslin EU  
All Cherry, Walnut and Dark Rift Cut Oak veneers, Black E4

Forest Stewardship Council (FSC) is a non-profit organization devoted to encouraging the responsible management of the world's forests. FSC sets high standards that ensure forestry is practiced in an environmentally responsible, socially beneficial, and economically viable way. Allsteel received its FSC Chain of Custody certification in 2010 and can offer FSC Certified products. Select wood-based products can be ordered as FSC certified, either by choosing the FSC option or selecting an FSC laminate or veneer finish at the time of order. For more information, please contact Customer Support at 888-255-7833. (FSC Trademark license code: FSC-CO14704.)

All of Allsteel's tables are level® – 2 certified to the ANSI/BIFMA e3 Furniture Sustainability Standard. See [www.levelcertified.org](http://www.levelcertified.org) for more information.

**NOTE:** Refer to individual product pages for upcharges.

### Structure Bases

\*\*\*Indicates widest width to determine knee space

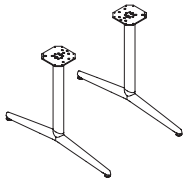

Large T Base — 29"H  
Available in glides or casters.  
\*\*\*36½"

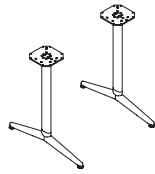

Medium T Base\* — 29"H  
Available in glides or casters.  
\*\*\*25½"

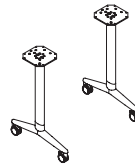

Small T Base\* — 29"H  
Available in glides or casters.  
\*\*\*19½"

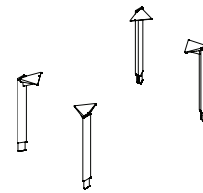

Post-Legs — Fixed or 6" Adjustable  
Height — 29"H  
Available in glides or casters.

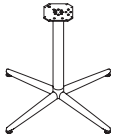

Large X Base — 18", 27", 29"H  
Glides only.  
\*\*\*36½"

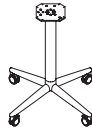

Medium X Base\* — 18", 27",  
29", 36", 42"H  
Available in glides or casters.  
\*\*\*28½"

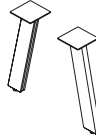

Community Legs — 29"H  
Glides only.

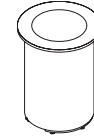

Small Cylinder — 29"H  
Glides only.  
\*\*\*18"

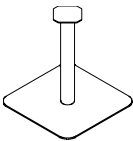

Large Square Pedestal —  
18", 27", 29", 36", 42"H  
Glides only.  
\*\*\*25"

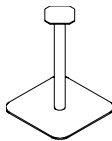

Medium Square Pedestal —  
18", 27", 29", 36", 42"H  
Glides only.  
\*\*\*20"

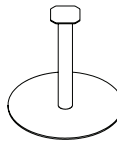

Large Round Pedestal —  
18", 27", 29", 36", 42"H  
Glides only.  
\*\*\*28"

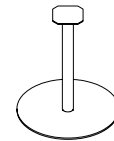

Medium Round Pedestal —  
18", 27", 29", 36", 42"H  
Glides only.  
\*\*\*24"

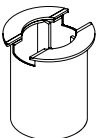

Large Cylinder — 29"H  
Glides only.  
\*\*\*20"

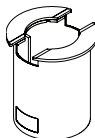

Large Cylinder w/Power  
Management — 29"H  
Glides only.  
\*\*\*20"

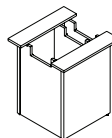

Cube — 29", 42"H  
Glides only.  
\*\*\*20"

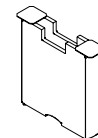

Hollow Panel — 29"  
Glides only.  
\*\*\*25½" x 5½"

### Power and Wire Management

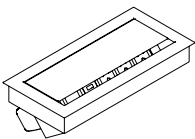

10' Corded Power

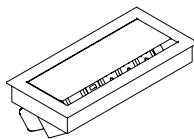

10' Hardwire Power

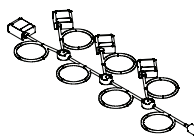

Large Undersurface  
Mount Power

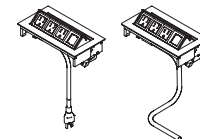

Power/Data Ports

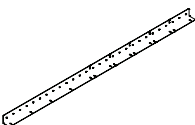

Wall Mount Bracket

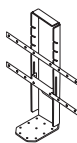

Table Media Mount



### Structure Adaptive Tables convert any space into a meeting space.

Adaptive Tables feature a self-centering drop leaf and height-adjustable table top to provide a solution that quickly lifts, lowers, and docks to adapt to spontaneous changes in work and space requirements.



#### Add Workspace to Existing Worksurfaces

Adaptive Tables feature a self-centering drop leaf and height-adjustable table top allowing the tables to effortlessly dock next to existing worksurfaces. Simply drop the leaf, adjust the height, and dock. The drop leaf is designed to tuck under the worksurface while docking to provide a seamless transition from worksurface to table.

Adaptive table tops are 36" W with the drop leaf up and 22¼" W with the drop leaf down. The bases are 28" in diameter.

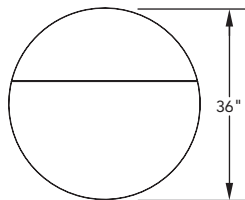

Round  
w/Drop Leaf Up

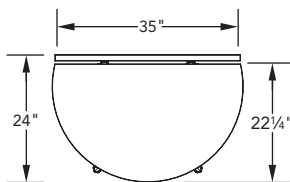

Round  
w/Drop Leaf Down

#### Store Tables Beneath Existing Worksurfaces

Adaptive Tables tuck beneath existing worksurfaces by adjusting the height. Adaptive Tables feature a gas cylinder to provide quiet, smooth movement. Simply pull the height-adjustment lever and push down on the center of the table top to lower the height of the table.

To raise the height of the table, simply pull the height-adjusting lever beneath the edge of the table top and the table will automatically rise. Release the height-adjustment lever to set the table height. Adaptive Tables adjust from 26" H to 33" H.

#### Convert Table Position from Docked to Freestanding

Adaptive tables quickly convert from a docked position to freestanding by simply pulling the drop leaf up. The self-centering mechanism ensures that the base remains in the center of the table top whether the drop leaf is up or down.

#### Combine Table Surfaces and Base Finishes

The wide variety of material options and base finishes allow Adaptive Tables to integrate seamlessly into any space. Table tops are available in laminate, with Flat Edge or Knife Edge treatments. Cast aluminum table bases are available with painted or polished aluminum finishes. Polished Aluminum models feature black vertical columns.

Structure tables exceed BIFMA Standards and are backed by the Allsteel lifetime warranty. Die-cast and extruded aluminum components are lightweight, yet highly durable. The self-centering drop leaf has a maximum load capacity of 125 pounds.

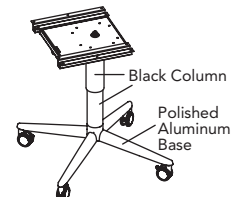

### IN-SURFACE POWER

#### Corded

Corded models plug directly into an outlet and cannot plug into other corded power modules. In order to plug into other units the units need to be hard-wired. When routing corded models to a wall outlet, the maximum amount of cord that can be exposed outside of the furniture is 6 feet.

#### Hardwire

Hardwire models are provided with 10 feet of sealtight cable. Customers must furnish junction boxes, conduit, and additional wire to be in compliance with local and national codes.

Qi charging is available on Corded and Hardwire versions.

- Includes 3 Qi charging coils (5 watts each) for wireless charging.
- Units have LED indicator lights below the lid's surface.
- Units house power and charging USB inside. All units are Qi certified.
- Cut-outs are centered on single-piece tops.
- Cut-outs are available for round, square, and soft square tops 54" or greater.
- Cut-outs are aligned with the shape of the table.

.C0 - No Cut Out  
 .ATE - Small Edge Cut Out, 4" x 8"  
 .C1 - 1 Large Center Cut Out, 5" x 11"  
 .C2 - 2 Large Center Cut Outs, 5" x 11"  
 .C3 - 3 Large Center Cut Outs, 5" x 11"  
 .G1 - 1 Small Center Cutout, 4" x 8"

Cutout	Shape	Total Table Length	Value (in)	Dimension			
.ATE	Rectangle	Single-piece tops	1.972	Distance from Edge			
.C2	Rectangle, Racetrack	120	24.45	Distance from Joining Edge			
		144	30.45				
		168	36.45				
		192	24.45				
		216	30.45				
		240	36.45				
	Diamond	Diamond	120	24.45	Distance from Joining Edge		
			144	30.45			
			168	36.45			
			192	42.45			
Square, Round, Soft Square	Square, Round, Soft Square	72	9.49	Distance from Joining Edge			
		84	12.49				
.C1	Media:	54	16.05	Distance from Wall			
	Rectangle, Racetrack, Diamond	60	18.45				
		72	23.25				

## LARGE PEDESTAL AND X-BASE

2 electrical infeed (0.55" dia.) and 18 voice/data cables (0.25" dia.) at 60% fill ratio. Note: 3.5" diameter column with wire manager.

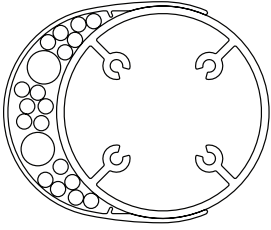

## LARGE PEDESTAL AND X-BASE

1 electrical infeed (0.55" dia.) and 23 voice/data cables (0.25" dia.) at 60% fill ratio. Note: 3.5" diameter column with wire manager.

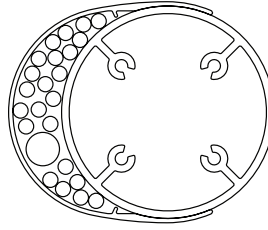

## LARGE T LEG

2 electrical infeed (0.55" dia.) and 11 voice/data cables (0.25" dia.) at 60% fill ratio.

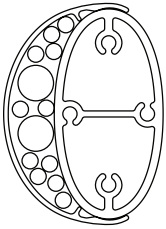

## LARGE T LEG

1 electrical infeed (0.55" dia.) and 16 voice/data cables (0.25" dia.) at 60% fill ratio.

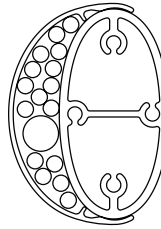

## SMALL AND MEDIUM T LEG

2 electrical infeed (0.55" dia.) and 9 voice/data cables (0.25" dia.) at 60% fill ratio.

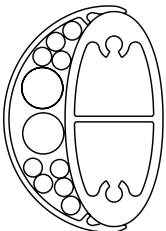

## SMALL AND MEDIUM T LEG

1 electrical infeed (0.55" dia.) and 14 voice/data cables (0.25" dia.) at 60% fill ratio.

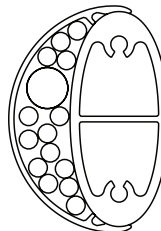

## MEDIUM PEDESTAL AND X BASE

2 electrical infeed (0.55" dia.) and 11 voice/data cables (0.25" dia.) at 60% fill ratio.

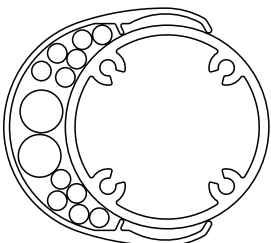

## MEDIUM PEDESTAL AND X BASE

1 electrical infeed (0.55" dia.) and 16 voice/data cables (0.25" dia.) at 60% fill ratio.

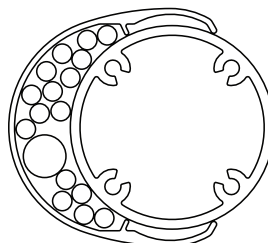

## WOOD BASE ELECTRIC CAVITY GUIDE

All wood bases can accommodate cables. The below diagrams document the narrowest opening to plan for when considering which base to order. For the cleanest look and access on a cylinder, consider using AMPTCYLBWM, which includes a larger bottom cavity with door access.

AMPTCYLSM

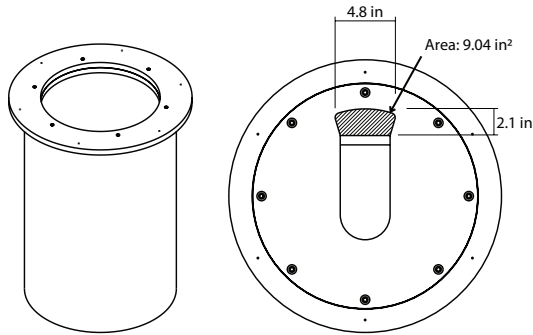

AMPTCYLB

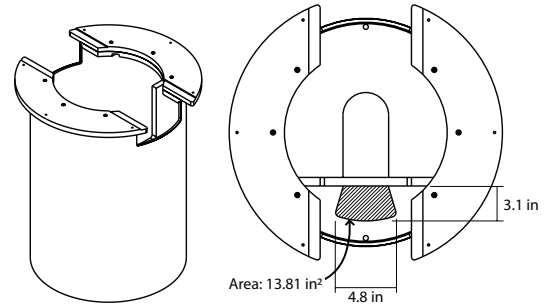

AMPTCYLBWM

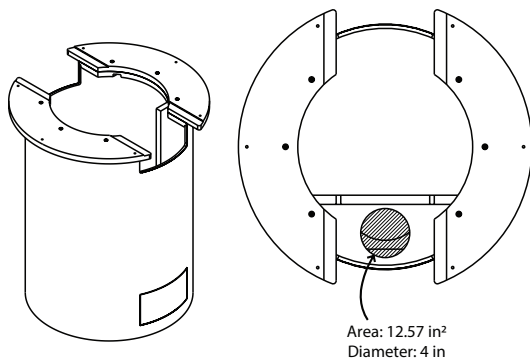

AMPTPANEL

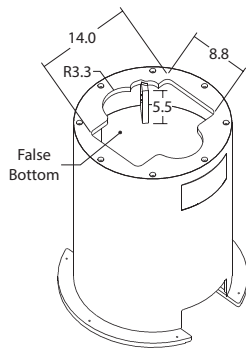
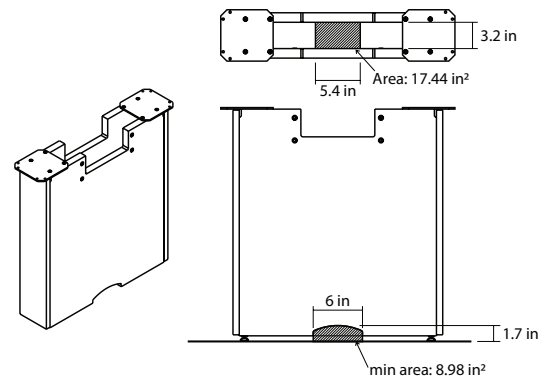

AMPTCUBE

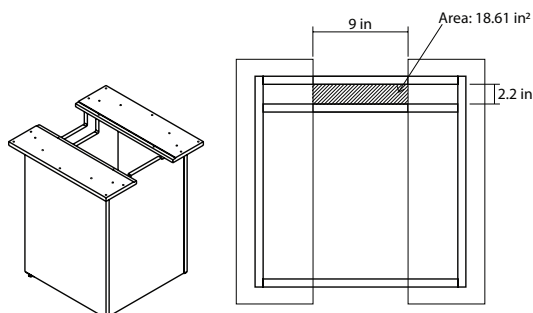

AMPTCUBEST

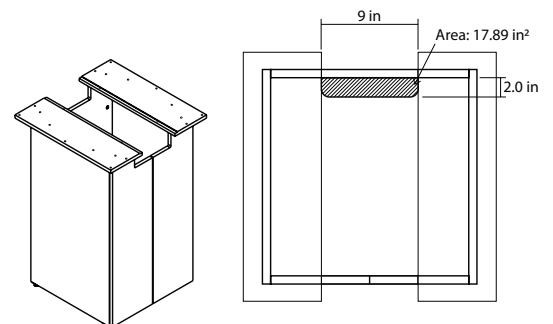

**Table Dimensions and Base Locations**

Base	Shape	36"	42"	48"	52"	54"	60"	72"	84"
Small Cylinder	Diamond					22.5	22.5	22.5	23.0
	Racetrack					18.0	18.0	18.0	18.0
	Rectangle					15.0	15.0	22.0	22.0
Cylinder	Diamond					21.5	21.5	21.5	25.0
	Racetrack					19.0	19.0	19.0	25.0
	Rectangle					19.0	19.0	19.0	25.0
Cube	Diamond					22.0	22.0	22.0	
	Racetrack					22.0	22.0	22.0	23.0
	Rectangle					22.0	22.0	22.0	23.0
Panel	Diamond					15.8	15.8	15.8	15.8
	Racetrack					15.8	15.8	15.8	15.8
	Rectangle					15.8	15.8	15.8	15.8
Community Legs	Diamond							6.2	6.2
	Racetrack 36"W-42"W			7.9			7.9	7.9	7.9
	Racetrack 48"W							7.9	7.9
	Racetrack 54"W								
	Racetrack 60"W								
	Rectangle 36"W			7.2			7.2	7.2	7.2
	Rectangle 42"W-60"W						9.4	9.4	9.4
	Square					14.5	14.5	14.5	14.5
	Soft Square					14.5	14.5	14.5	14.5
Round					14.5	14.5	14.5	14.5	
T-Legs	Boat				5.8		5.8	5.8	
	Diamond							5.8	14.3
	Racetrack 24"W & 36"W	5.8	5.8	5.8			5.8	5.8	14.3
	Racetrack 30"W		7.3	7.3			7.3	7.3	14.3
	Racetrack 42"W							10.7	14.3
	Racetrack 48"W								
Rectangle	5.8	5.8	5.8			5.8	5.8	15.0	
Pedestal/X-base	Boat				13.0		15.0	18.0	
	Diamond							18.3	20.6
	Racetrack						18.4	18.4	20.6
	Rectangle						15.0	18.3	20.6

Note: Dimensions are from edge of table to center of base.

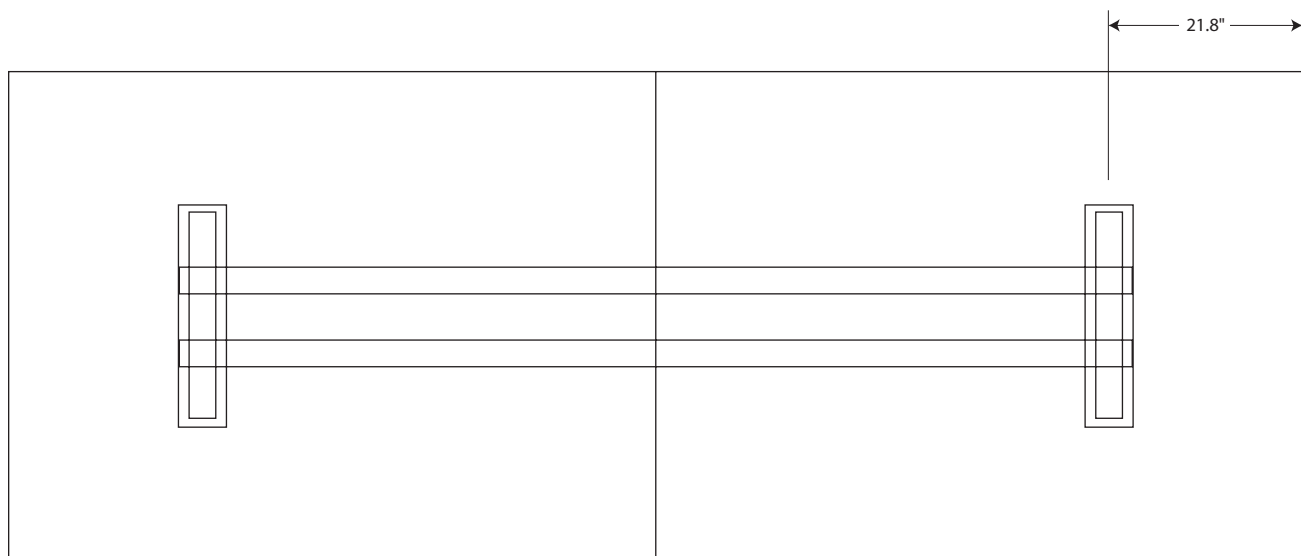

**Table Dimensions and Base Locations**

Base	Shape	96"	120"	144"	168"	192"	216"	240"
Small Cylinder	Diamond	29.0						
	Racetrack	18.0						
	Rectangle	22.0	29.0	29.0				
Cylinder	Diamond	28.0	28.5	28.5	28.5	28.0		
	Racetrack	28.0	28.5	28.5	28.5	28.0	28.0	28.0
	Rectangle	28.0	28.5	28.5	28.5	28.0	28.0	28.0
Cube	Diamond							
	Racetrack	29.0	29.0	29.0	29.0	29.0	29.0	29.0
	Rectangle	29.0	29.0	29.0	29.0	29.0	29.0	29.0
Panel	Diamond	21.8	21.8	21.8	21.8	21.8		
	Racetrack	21.8	21.8	21.8	21.8	21.8	21.8	21.8
	Rectangle	21.8	21.8	21.8	21.8	21.8	21.8	21.8
Community Legs	Diamond	6.2	22.5	22.5	22.5	22.5		
	Racetrack 36"W-42"W	7.9	8.0	8.0				
	Racetrack 48"W	7.9	11.0	11.0				
	Racetrack 54"W	7.9	14.0	14.0	14.0	14.0	14.0	14.0
	Racetrack 60"W		17.0	17.0	17.0	17.0	17.0	17.0
	Rectangle 36"W	7.2	7.2	7.2				
	Rectangle 42"W-60"W	9.4	9.4	9.4	9.4	9.4	9.4	9.4
	Square							
	Soft Square							
T-Legs	Boat							
	Diamond	18.0						
	Racetrack 24"W & 36"W	18.0						
	Racetrack 30"W							
	Racetrack 42"W	18.0						
	Racetrack 48"W							
Pedestal/X-base	Boat							
	Diamond	23.6	18.0	23.6				
	Racetrack	23.6	18.0	23.6				
	Rectangle	23.6	18.0	23.6				

Note: Dimensions are from edge of table to center of base.

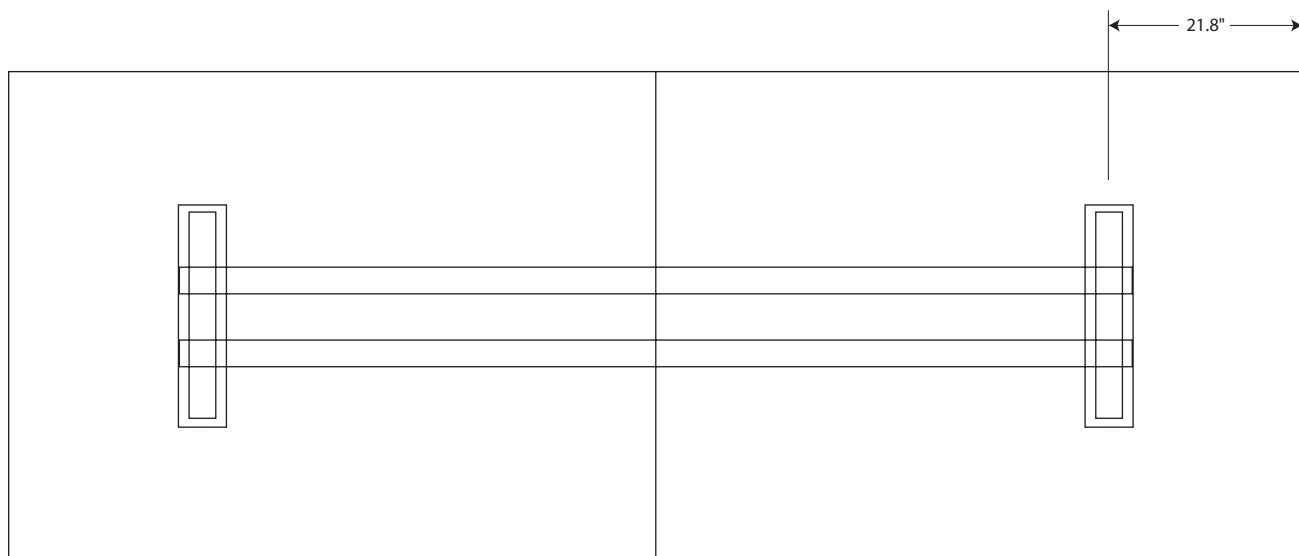

## Media Dimensions and Base Locations

Base	Shape	54"	60"	72"
Small Cylinder	Media Diamond	22.5	22.5	22.5
	Media Racetrack	18.0	18.0	18.0
	Media Rectangle	15.0	15.0	22.0
Cylinder	Media Diamond	21.5	21.5	21.5
	Media Racetrack	19.0	19.0	19.0
	Media Rectangle	19.0	19.0	19.0
Cube	Media Diamond	22.0	22.0	22.0
	Media Racetrack	22.0	22.0	22.0
	Media Rectangle	22.0	22.0	22.0
Panel	Media Diamond	15.8	15.8	15.8
	Media Racetrack	15.8	15.8	15.8
	Media Rectangle	15.8	15.8	15.8
Community Legs	Media Diamond	16.5	22.5	22.5
	Media Racetrack 48"W		11.0	
	Media Racetrack 54"W	14.0	14.0	14.0
	Media Racetrack 60"W		17.0	17.0
	Rectangle	9.4	9.4	9.4
Pedestal/X-base	Media Diamond 48"W-54"W	23.6	23.6	23.6
	Media Diamond 60"W		23.6	23.6
	Media Racetrack 48"W-54"W	18.0	18.0	22.0
	Media Racetrack 60"W		18.0	22.0
	Media Rectangle 48"W-54"W	12.0	18.0	22.0
	Media Rectangle 60"W		20.0	22.0

Note: Dimensions are from edge of table to center of base.

STRUCTURE

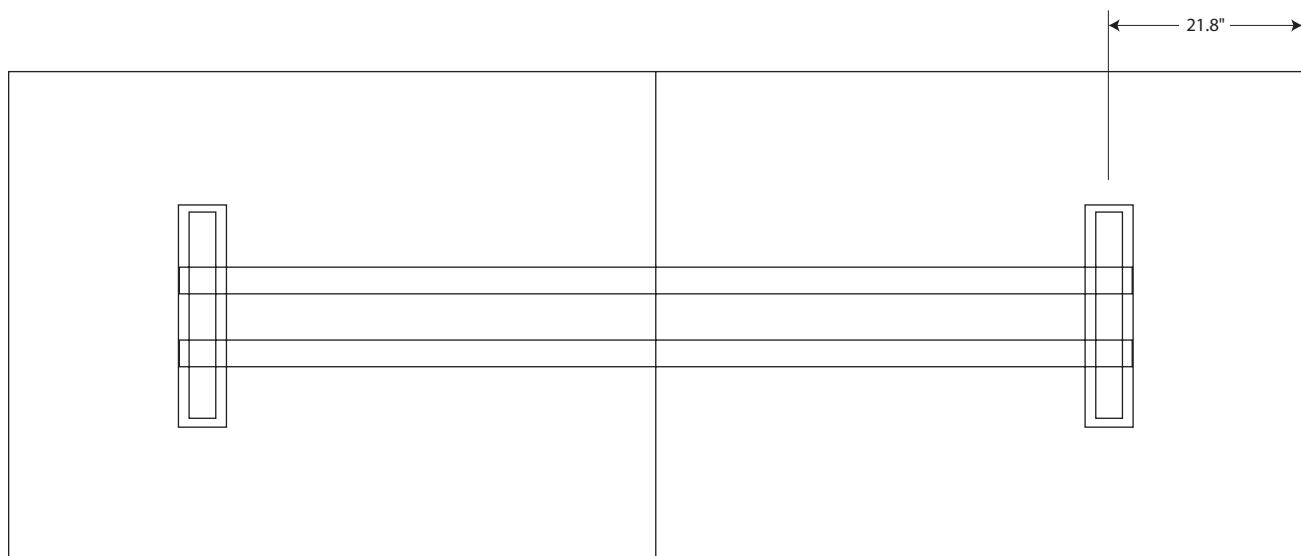

## Undersurface Mount Power Configuration Guide

■ = Mini Tap

● = Node

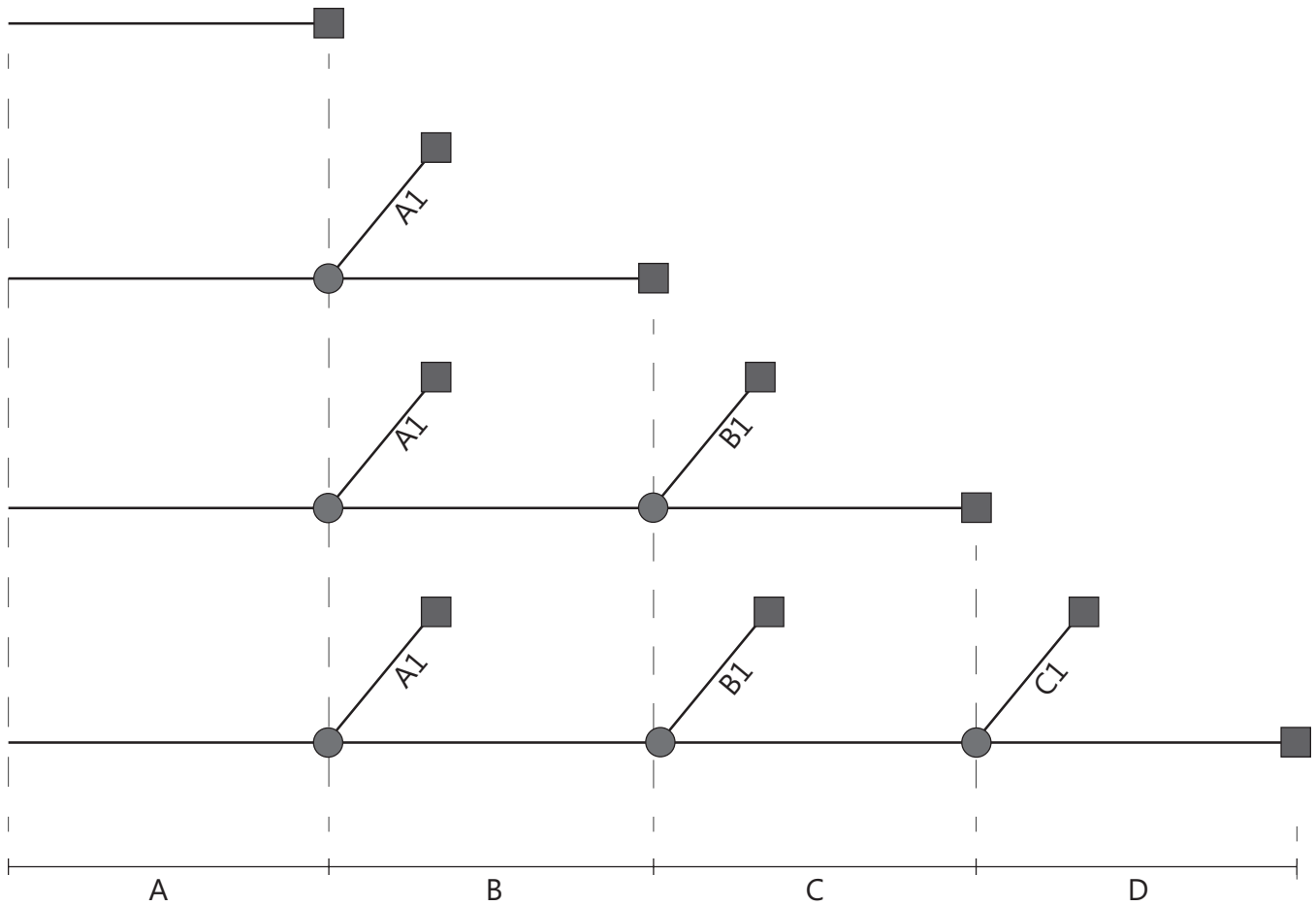

	Dimensions (inches)						
	A	A1	B	B1	C	C1	D
AMPTUSPS1A/U	72	-	-	-	-	-	-
AMPTUSPS2	72	36	36	-	-	-	-
AMPTUSPL3	136	43	54	20	72	-	-
AMPTUSPS4	72	20	40	20	40	20	60
AMPTUSPM4	92	20	33	20	24	20	54
AMPTUSPL4	108	23	63	23	28	23	72
AMPTUSPXL4	118	60	60	40	60	28	62



STRUCTURE

Shape	Worksurface Type	Size	Electrical Recommendation	Qty		
Diamond	Small	30x50	AMPTUSPS2	1		
		24x40				
	Single	42x72	AMPTUSPM4	1		
		48x72	AMPTUSPL4	1		
		42x84				
		42x96				
		48x84				
		48x96				
	54x96					
	Multi	48x120	AMPTUSPL3	2		
		48x144				
		54x120				
		54x144				
		54x168				
		60x120				
		60x144				
60x168						
54x192	AMPTUSPXL4	2				
Rectangle	Single	24x36	AMPTUSPS2	1		
		24x42				
		24x48				
		24x60				
		27x72				
		24x84				
		30x42				
		30x48				
		30x60				
		30x72				
		30x84				
		36x48			AMPTUSPM4	1
		36x60				
		36x72				
		42x60				
		42x72				
		48x72				
		36x84			AMPTUSPL4	1
	36x96					
	42x84					
	42x96					
	48x84					
	48x96					
	54x96	AMPTUSPL3	2			
42x120						
42x144						
48x120						
48x144						
54x120						
Multi	54x144	AMPTUSPXL4	2			
	54x168					
	60x120					
	60x144					
	60x168					
	54x192					
	54x216					
	54x240					
	60x192					
	60x216					
60x240						
Boat	Single	30x52	AMPTUSPS2	1		
		30x60				
		30x72				
		36x52	AMPTUSPM4	1		
		36x60				
		36x72				

Shape	Worksurface Type	Size	Electrical Recommendation	Qty		
Racetrack	Single	24x36	AMPTUSPS2	1		
		24x42				
		24x48				
		24x60				
		27x72				
		24x84				
		30x42				
		30x48				
		30x60				
		30x72				
		30x84				
		36x48			AMPTUSPM4	1
		36x60				
		36x72				
		42x60				
		42x72				
		48x72				
		36x84			AMPTUSPL4	1
	36x96					
	42x84					
	42x96					
	48x84					
	48x96					
	54x96	AMPTUSPL3	2			
	36x120					
	36x144					
	42x120					
	42x144					
	48x120					
	48x144					
	54x120					
	54x144					
	54x168					
	60x120					
	60x144					
	60x168					
54x192						
54x216						
54x240						
60x192						
60x216						
60x240						
Square, Round, Soft Square	Single	24x24	AMPTUSPS2	1		
		30x30				
		36x36				
	Multi	42x42	AMPTUSPS4	1		
		48x48				
		54x54				
Multi	60x60	AMPTUSPXL4	1			
	72x72					
	84x84					
Media: Rectangle/Racetrack/Diamond	Media	48x54	AMPTUSPS2 or AMPTUSPS4	1		
		48x60				
		54x54				
		54x60				
		54x72				
		60x60				
60x72						

## Undersurface Mount Power Configuration Guide

■ = Mini Tap

● = Node

AMPTUSPS1A/U  
1 Module

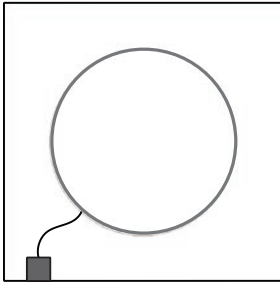

AMPTUSPS2  
2 Modules

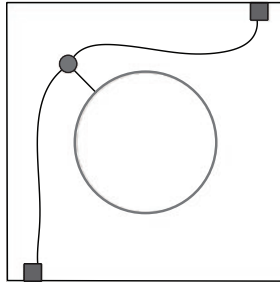

AMPTUSPS4  
4 Modules

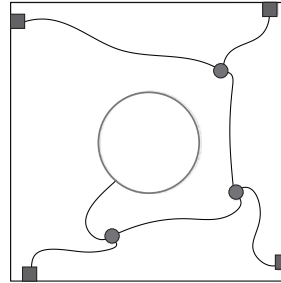

AMPTUSPL3  
3 Modules

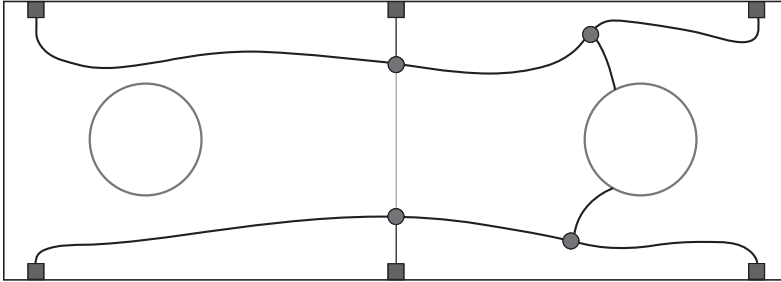

AMPTUSPM4  
4 Modules

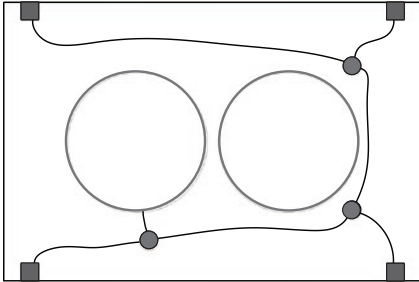

AMPTUSPL4  
4 Modules

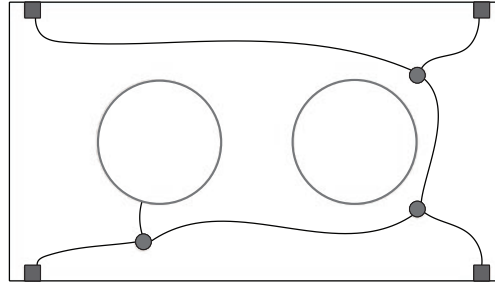

AMPTUSPXL4  
4 Modules

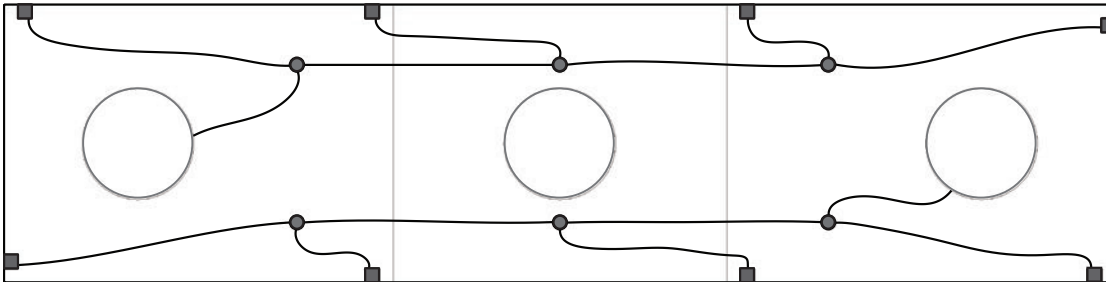

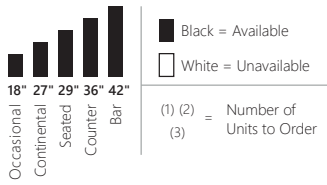







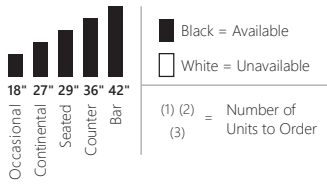























These top and base combinations are recommended and approved for optimal knee clearance, stability, and aesthetics. Required base and leg quantities are based on top size and shape. Please reference the Price and Specification Guide for more details.

TOPS	AVAILABLE WIDTHS	MEDIUM ROUND PEDESTAL	LARGE ROUND PEDESTAL	MEDIUM SQUARE PEDESTAL	LARGE SQUARE PEDESTAL	MEDIUM X BASE	LARGE X BASE	SMALL CYLINDER	CYLINDER (W/M)	CYLINDER (NO W/M)
SQUARE	24"	■ ■ ■ (1)	N/A	■ ■ ■ (1)	N/A	N/A	N/A	N/A	N/A	N/A
	30"	■ ■ ■ (1)	N/A	■ ■ ■ (1)	N/A	■ ■ ■ (1)	N/A	N/A	N/A	N/A
	36"	■ ■ ■ (1)	N/A	■ ■ ■ (1)	N/A	■ ■ ■ (1)	N/A	■ ■ ■ (1)	■ ■ ■ (1)	■ ■ ■ (1)
	42"	N/A	■ ■ ■ (1)	N/A	■ ■ ■ (1)	N/A	■ ■ ■ (1)	■ ■ ■ (1)	■ ■ ■ (1)	■ ■ ■ (1)
	48"	N/A	■ ■ ■ (1)	N/A	■ ■ ■ (1)	N/A	■ ■ ■ (1)	N/A	■ ■ ■ (1)	■ ■ ■ (1)
	54" 60"	N/A	N/A	N/A	N/A	N/A	N/A	N/A	N/A	N/A
	72" 84"	N/A	N/A	N/A	N/A	N/A	N/A	N/A	N/A	N/A
ROUND	24"	■ ■ ■ (1)	N/A	N/A	N/A	N/A	N/A	N/A	N/A	N/A
	30"	■ ■ ■ (1)	N/A	■ ■ ■ (1)	N/A	■ ■ ■ (1)	N/A	N/A	N/A	N/A
	36"	■ ■ ■ (1)	N/A	■ ■ ■ (1)	N/A	■ ■ ■ (1)	N/A	■ ■ ■ (1)	■ ■ ■ (1)	■ ■ ■ (1)
	42"	N/A	■ ■ ■ (1)	N/A	■ ■ ■ (1)	N/A	■ ■ ■ (1)	■ ■ ■ (1)	■ ■ ■ (1)	■ ■ ■ (1)
	48"	N/A	■ ■ ■ (1)	N/A	■ ■ ■ (1)	N/A	■ ■ ■ (1)	N/A	■ ■ ■ (1)	■ ■ ■ (1)
	54" 60"	N/A	N/A	N/A	N/A	N/A	N/A	N/A	■ ■ ■ (1)	■ ■ ■ (1)
	72" 84"	N/A	N/A	N/A	N/A	N/A	N/A	N/A	N/A	N/A
SOFT SQUARE	24"	■ ■ ■ (1)	N/A	■ ■ ■ (1)	N/A	N/A	N/A	N/A	N/A	N/A
	30"	■ ■ ■ (1)	N/A	■ ■ ■ (1)	N/A	■ ■ ■ (1)	N/A	N/A	N/A	N/A
	36"	■ ■ ■ (1)	N/A	■ ■ ■ (1)	N/A	■ ■ ■ (1)	N/A	■ ■ ■ (1)	■ ■ ■ (1)	■ ■ ■ (1)
	42"	N/A	■ ■ ■ (1)	N/A	■ ■ ■ (1)	N/A	■ ■ ■ (1)	■ ■ ■ (1)	■ ■ ■ (1)	■ ■ ■ (1)
	48"	N/A	■ ■ ■ (1)	N/A	■ ■ ■ (1)	N/A	■ ■ ■ (1)	N/A	■ ■ ■ (1)	■ ■ ■ (1)
	54" 60"	N/A	N/A	N/A	N/A	N/A	N/A	N/A	N/A	N/A
	72" 84"	N/A	N/A	N/A	N/A	N/A	N/A	N/A	N/A	N/A
BOAT	30"x52" 30"x60" 30"x72" 36"x52" 36"x60" 36"x72"	■ ■ ■ (2)	N/A	■ ■ ■ (2)	N/A	■ ■ ■ (2)	N/A	N/A	N/A	N/A

STRUCTURE



These top and base combinations are recommended and approved for optimal knee clearance, stability, and aesthetics. Required base and leg quantities are based on top size and shape. Please reference the Price and Specification Guide for more details.

TOPS		AVAILABLE WIDTHS	CUBE 	PANEL 	SMALL T LEGS 	MEDIUM T LEGS 	LARGE T LEGS 	FIXED POST-LEGS 	ADJUSTABLE POST-LEGS 	COMMUNITY LEGS 
SQUARE	□	24"	N/A	N/A	N/A	N/A	N/A	N/A	N/A	N/A
		30"	N/A	N/A	N/A	N/A	N/A	 (1 kit of 4)	 (1 kit of 4)	N/A
		36"	N/A	N/A	N/A	N/A	N/A	 (1 kit of 4)	 (1 kit of 4)	N/A
		42"	N/A	N/A	N/A	N/A	N/A	 (1 kit of 4)	 (1 kit of 4)	N/A
		48"	 (1)	N/A	N/A	N/A	N/A	 (1 kit of 4)	 (1 kit of 4)	N/A
		54" 60"	 (1)	N/A	N/A	N/A	N/A	N/A	N/A	 (1 kit of 4)
		72" 84"	N/A	N/A	N/A	N/A	N/A	N/A	N/A	 (1 kit of 4)
ROUND	○	24"	N/A	N/A	N/A	N/A	N/A	N/A	N/A	N/A
		30"	N/A	N/A	N/A	N/A	N/A	N/A	N/A	N/A
		36"	N/A	N/A	N/A	N/A	N/A	N/A	N/A	N/A
		42"	N/A	N/A	N/A	N/A	N/A	N/A	N/A	N/A
		48"	 (1)	N/A	N/A	N/A	N/A	N/A	N/A	N/A
		54" 60"	 (1)	N/A	N/A	N/A	N/A	N/A	N/A	 (1 kit of 4)
		72" 84"	N/A	N/A	N/A	N/A	N/A	N/A	N/A	 (1 kit of 4)
SOFT SQUARE	◻	24"	N/A	N/A	N/A	N/A	N/A	N/A	N/A	N/A
		30"	N/A	N/A	N/A	N/A	N/A	N/A	N/A	N/A
		36"	N/A	N/A	N/A	N/A	N/A	N/A	N/A	N/A
		42"	N/A	N/A	N/A	N/A	N/A	N/A	N/A	N/A
		48"	 (1)	N/A	N/A	N/A	N/A	N/A	N/A	N/A
		54" 60"	 (1)	N/A	N/A	N/A	N/A	N/A	N/A	 (1 kit of 4)
		72" 84"	N/A	N/A	N/A	N/A	N/A	N/A	N/A	 (1 kit of 4)
BOAT	30"x52" 30"x60" 30"x72" 36"x52" 36"x60" 36"x72"	N/A	N/A	N/A	 (1 kit of 2)	N/A	N/A	N/A	N/A	

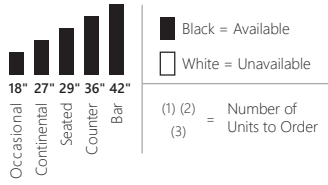

These top and base combinations are recommended and approved for optimal knee clearance, stability, and aesthetics. Required base and leg quantities are based on top size and shape. Please reference the Price and Specification Guide for more details.

TOPS	AVAILABLE WIDTHS	MEDIUM ROUND PEDESTAL	LARGE ROUND PEDESTAL	MEDIUM SQUARE PEDESTAL	LARGE SQUARE PEDESTAL	MEDIUM X BASE	LARGE X BASE	SMALL CYLINDER	CYLINDER (W/M)	CYLINDER (NO W/M)
MEDIA RECTANGLE	48"x54" 48"x60" 54"x54" 54"x60" 54"x72"	(1)	N/A	(1)	N/A	(1)	N/A	(1)	(1)	(1)
	60"x60" 60"x72"	N/A	(1)	N/A	(1)	N/A	(1)	(1)	(1)	(1)
MEDIA DIAMOND	48"x54" 48"x60" 54"x54" 54"x60" 54"x72"	(1)	N/A	(1)	N/A	(1)	N/A	(1)	(1)	(1)
	60"x60" 60"x72"	N/A	(1)	N/A	(1)	N/A	(1)	(1)	(1)	(1)
MEDIA RACETRACK	48"x54" 48"x60" 54"x54" 54"x60" 54"x72"	(1)	N/A	(1)	N/A	(1)	N/A	(1)	(1)	(1)
	60"x60" 60"x72"	N/A	(1)	N/A	(1)	N/A	(1)	(1)	(1)	(1)
DIAMOND	24"x40"	(1)	N/A	N/A	N/A	N/A	N/A	N/A	N/A	N/A
	30"x50"	N/A	(1)	N/A	(1)	N/A	N/A	N/A	N/A	N/A
	42"x72"	N/A	(2)	N/A	(2)	N/A	(2)	N/A	(2)	(2)
	42"x84" 42"x96"	N/A	(2)	N/A	(2)	N/A	(2)	(2)	(1 kit of 2)	(1 kit of 2)
	48"x72"	N/A	(2)	N/A	(2)	N/A	(2)	N/A	(2)	(2)
	48"x84" 48"x96"	N/A	(2)	N/A	(2)	N/A	(2)	N/A	(1 kit of 2)	(1 kit of 2)
	48"x120"	N/A	(2)	N/A	(2)	N/A	(2)	N/A	(1 kit of 2)	(1 kit of 2)
	48"x144"	N/A	(3)	N/A	(3)	N/A	(3)	N/A	(1 kit of 2)	(1 kit of 2)
	54"x96"	N/A	(2)	N/A	(2)	N/A	(2)	N/A	(1 kit of 2)	(1 kit of 2)
	54"x120" 54"x144"	N/A	N/A	N/A	N/A	N/A	N/A	N/A	(1 kit of 2)	(1 kit of 2)
	54"x168"	N/A	N/A	N/A	N/A	N/A	N/A	N/A	(1 kit of 2)	(1 kit of 2)
	54"x192"	N/A	N/A	N/A	N/A	N/A	N/A	N/A	(1 kit of 3)	(1 kit of 3)
	60"x120" 60"x144"	N/A	N/A	N/A	N/A	N/A	N/A	N/A	(1 kit of 2)	(1 kit of 2)
	60"x168"	N/A	N/A	N/A	N/A	N/A	N/A	N/A	(1 kit of 2)	(1 kit of 2)
60"x192"	N/A	N/A	N/A	N/A	N/A	N/A	N/A	(1 kit of 3)	(1 kit of 3)	

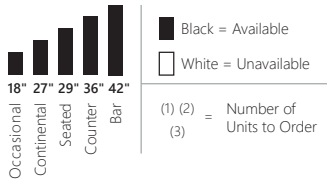

These top and base combinations are recommended and approved for optimal knee clearance, stability, and aesthetics. Required base and leg quantities are based on top size and shape. Please reference the Price and Specification Guide for more details.

TOPS		AVAILABLE WIDTHS	CUBE	PANEL	SMALL T LEGS	MEDIUM T LEGS	LARGE T LEGS	FIXED POST-LEGS	ADJUSTABLE POST-LEGS	COMMUNITY LEGS
MEDIA RECTANGLE	48"x54"									
	48"x60"									
MEDIA DIAMOND	54"x54"	(1)	(1)	N/A	N/A	N/A	N/A	N/A	N/A	(1 kit of 2)
	54"x60"									
MEDIA RACETRACK	54"x72"									
	60"x60"	(1)	(1)	N/A	N/A	N/A	N/A	N/A	N/A	(1 kit of 2)
DIAMOND	60"x72"									
	24"x40"	N/A	N/A	N/A	N/A	N/A	N/A	N/A	N/A	N/A
DIAMOND	30"x50"	N/A	N/A	N/A	N/A	N/A	N/A	N/A	N/A	N/A
	42"x72"	N/A	N/A	N/A	(1 kit of 2)	N/A	N/A	N/A	N/A	(1 kit of 4)
	42"x84"	N/A	N/A	N/A	(1 kit of 2)	N/A	N/A	N/A	N/A	(1 kit of 4)
	42"x96"	N/A	N/A	N/A	(1 kit of 2)	N/A	N/A	N/A	N/A	(1 kit of 4)
	48"x72"	N/A	(2)	N/A	N/A	(1 kit of 2)	N/A	N/A	N/A	(1 kit of 4)
	48"x84"	N/A	(1 kit of 2)	N/A	N/A	(1 kit of 2)	N/A	N/A	N/A	(1 kit of 4)
	48"x96"	N/A	(1 kit of 2)	N/A	N/A	N/A	N/A	N/A	N/A	(1 kit of 6)
	48"x120"	N/A	(1 kit of 2)	N/A	N/A	N/A	N/A	N/A	N/A	(1 kit of 6)
	48"x144"	N/A	(1 kit of 2)	N/A	N/A	N/A	N/A	N/A	N/A	(1 kit of 6)
	54"x96"	N/A	(1 kit of 2)	N/A	N/A	N/A	N/A	N/A	N/A	(1 kit of 4)
	54"x120"	N/A	(1 kit of 2)	N/A	N/A	N/A	N/A	N/A	N/A	(1 kit of 6)
	54"x144"	N/A	(1 kit of 2)	N/A	N/A	N/A	N/A	N/A	N/A	(1 kit of 6)
	54"x168"	N/A	(1 kit of 3)	N/A	N/A	N/A	N/A	N/A	N/A	(1 kit of 6)
	54"x192"	N/A	(1 kit of 3)	N/A	N/A	N/A	N/A	N/A	N/A	(1 kit of 6)
60"x120"	N/A	(1 kit of 2)	N/A	N/A	N/A	N/A	N/A	N/A	(1 kit of 6)	
60"x144"	N/A	(1 kit of 2)	N/A	N/A	N/A	N/A	N/A	N/A	(1 kit of 6)	
60"x168"	N/A	(1 kit of 3)	N/A	N/A	N/A	N/A	N/A	N/A	(1 kit of 6)	
60"x192"	N/A	(1 kit of 3)	N/A	N/A	N/A	N/A	N/A	N/A	(1 kit of 6)	

# Structure

## Top-Base Compatibility Matrix

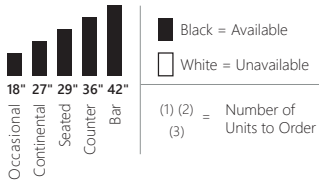





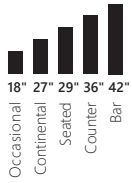















































































































These top and base combinations are recommended and approved for optimal knee clearance, stability, and aesthetics. Required base and leg quantities are based on top size and shape. Please reference the Price and Specification Guide for more details.

TOP	AVAILABLE WIDTHS	MEDIUM ROUND PEDESTAL	LARGE ROUND PEDESTAL	MEDIUM SQUARE PEDESTAL	LARGE SQUARE PEDESTAL	MEDIUM X BASE	LARGE X BASE	SMALL CYLINDER	CYLINDER (W/M)	CYLINDER (NO W/M)	
RECTANGLE	24"x36"	(1)	N/A	(1)	N/A	N/A	N/A	N/A	N/A	N/A	
	24"x42"	N/A	N/A	N/A	N/A	N/A	N/A	N/A	N/A	N/A	
	24"x48"	N/A	N/A	N/A	N/A	N/A	N/A	N/A	N/A	N/A	
	24"x60"	(2)	N/A	(2)	N/A	N/A	N/A	N/A	N/A	N/A	
	24"x72"	(2)	N/A	(2)	N/A	N/A	N/A	N/A	N/A	N/A	
	24"x84"	(2)	N/A	(2)	N/A	N/A	N/A	N/A	N/A	N/A	
	30"x42"	N/A	(1)	N/A	(1)	N/A	N/A	(1)	(1)	(1)	(1)
	30"x48"	N/A	(1)	N/A	(1)	N/A	N/A	(1)	N/A	(1)	(1)
	30"x60"	(2)	N/A	(2)	N/A	N/A	(2)	N/A	N/A	N/A	N/A
	30"x72"	(2)	N/A	(2)	N/A	N/A	(2)	N/A	N/A	N/A	N/A
	30"x84"	(2)	N/A	(2)	N/A	N/A	(2)	N/A	N/A	N/A	N/A
	36"x48"	N/A	(1)	N/A	(1)	N/A	N/A	(1)	N/A	(1)	(1)
	36"x60"	(2)	N/A	(2)	N/A	N/A	(2)	N/A	N/A	N/A	N/A
	36"x72"	(2)	N/A	(2)	N/A	N/A	(2)	N/A	(2)	(2)	(2)
	36"x84"	(2)	N/A	(2)	N/A	N/A	(2)	N/A	(2)	(1 kit of 2)	(1 kit of 2)
	36"x96"	(2)	N/A	(2)	N/A	N/A	(2)	N/A	(2)	(1 kit of 2)	(1 kit of 2)
	36"x120"	(2)	N/A	(2)	N/A	N/A	(2)	N/A	(2)	(1 kit of 2)	(1 kit of 2)
	36"x144"	(3)	N/A	(3)	N/A	N/A	(3)	N/A	(2)	(1 kit of 2)	(1 kit of 2)
	42"x60"	N/A	(2)	N/A	(2)	N/A	N/A	(2)	(2)	(2)	(2)
	42"x72"	N/A	(2)	N/A	(2)	N/A	N/A	(2)	(2)	(2)	(2)
	42"x84"	N/A	(2)	N/A	(2)	N/A	N/A	(2)	(2)	(1 kit of 2)	(1 kit of 2)
	42"x96"	N/A	(2)	N/A	(2)	N/A	N/A	(2)	(2)	(1 kit of 2)	(1 kit of 2)
	42"x120"	N/A	(2)	N/A	(2)	N/A	N/A	(2)	(2)	(1 kit of 2)	(1 kit of 2)
	42"x144"	N/A	(3)	N/A	(3)	N/A	N/A	(3)	(2)	(1 kit of 2)	(1 kit of 2)
	48"x72"	N/A	(2)	N/A	(2)	N/A	N/A	(2)	N/A	(2)	(2)
	48"x84"	N/A	(2)	N/A	(2)	N/A	N/A	(2)	N/A	(1 kit of 2)	(1 kit of 2)
	48"x96"	N/A	(2)	N/A	(2)	N/A	N/A	(2)	N/A	(1 kit of 2)	(1 kit of 2)
	48"x120"	N/A	(2)	N/A	(2)	N/A	N/A	(2)	N/A	(1 kit of 2)	(1 kit of 2)
	48"x144"	N/A	(3)	N/A	(3)	N/A	N/A	(3)	N/A	(1 kit of 2)	(1 kit of 2)
	54"x96"	N/A	N/A	N/A	N/A	N/A	N/A	N/A	N/A	(1 kit of 2)	(1 kit of 2)
54"x120"	N/A	N/A	N/A	N/A	N/A	N/A	N/A	N/A	(1 kit of 2)	(1 kit of 2)	
54"x144"	N/A	N/A	N/A	N/A	N/A	N/A	N/A	N/A	(1 kit of 2)	(1 kit of 2)	
54"x168"	N/A	N/A	N/A	N/A	N/A	N/A	N/A	N/A	(1 kit of 2)	(1 kit of 2)	
54"x192"	N/A	N/A	N/A	N/A	N/A	N/A	N/A	N/A	(1 kit of 3)	(1 kit of 3)	
54"x216"	N/A	N/A	N/A	N/A	N/A	N/A	N/A	N/A	(1 kit of 3)	(1 kit of 3)	
54"x240"	N/A	N/A	N/A	N/A	N/A	N/A	N/A	N/A	(1 kit of 3)	(1 kit of 3)	
60"x120"	N/A	N/A	N/A	N/A	N/A	N/A	N/A	N/A	(1 kit of 2)	(1 kit of 2)	
60"x144"	N/A	N/A	N/A	N/A	N/A	N/A	N/A	N/A	(1 kit of 2)	(1 kit of 2)	
60"x168"	N/A	N/A	N/A	N/A	N/A	N/A	N/A	N/A	(1 kit of 2)	(1 kit of 2)	
60"x192"	N/A	N/A	N/A	N/A	N/A	N/A	N/A	N/A	(1 kit of 3)	(1 kit of 3)	
60"x216"	N/A	N/A	N/A	N/A	N/A	N/A	N/A	N/A	(1 kit of 3)	(1 kit of 3)	
60"x240"	N/A	N/A	N/A	N/A	N/A	N/A	N/A	N/A	(1 kit of 3)	(1 kit of 3)	



Black = Available  
 White = Unavailable  
 (1) (2) = Number of Units to Order  
 (3) =

These top and base combinations are recommended and approved for optimal knee clearance, stability, and aesthetics. Required base and leg quantities are based on top size and shape. Please reference the Price and Specification Guide for more details.

TOP	AVAILABLE WIDTHS	CUBE	PANEL	SMALL T LEGS	MEDIUM T LEGS	LARGE T LEGS	FIXED POST-LEGS	ADJUSTABLE POST-LEGS	COMMUNITY LEGS	
										
RECTANGLE	24"x36"	N/A	N/A	 (1 kit of 2)	N/A	N/A	 (1 kit of 4)	 (1 kit of 4)	N/A	
	24"x42"	N/A	N/A	 (1 kit of 2)	N/A	N/A	 (1 kit of 4)	 (1 kit of 4)	N/A	
	24"x48"	N/A	N/A	 (1 kit of 2)	N/A	N/A	 (1 kit of 4)	 (1 kit of 4)	N/A	
	24"x60"	N/A	N/A	 (1 kit of 2)	N/A	N/A	 (1 kit of 4)	 (1 kit of 4)	N/A	
	24"x72"	N/A	N/A	 (1 kit of 2)	N/A	N/A	N/A	N/A	N/A	
	24"x84"	N/A	N/A	 (1 kit of 2)	N/A	N/A	N/A	N/A	N/A	
	30"x42"	N/A	N/A	N/A	 (1 kit of 2)	N/A	N/A	N/A	N/A	
	30"x48"	N/A	N/A	N/A	 (1 kit of 2)	N/A	 (1 kit of 4)	 (1 kit of 4)	N/A	
	30"x60"	N/A	N/A	N/A	 (1 kit of 2)	N/A	 (1 kit of 4)	 (1 kit of 4)	N/A	
	30"x72"	N/A	N/A	N/A	 (1 kit of 2)	N/A	N/A	N/A	N/A	
	30"x84"	N/A	N/A	N/A	 (1 kit of 2)	N/A	N/A	N/A	N/A	
	36"x48"	N/A	N/A	N/A	 (1 kit of 2)	N/A	 (1 kit of 4)	 (1 kit of 4)	 (1 kit of 4)	
	36"x60"	N/A	 (2)	N/A	 (1 kit of 2)	N/A	N/A	N/A	N/A	 (1 kit of 4)
	36"x72"	N/A	 (2)	N/A	 (1 kit of 2)	N/A	N/A	N/A	N/A	 (1 kit of 4)
	36"x84"	N/A	 (1 kit of 2)	N/A	 (1 kit of 2)	N/A	N/A	N/A	N/A	 (1 kit of 4)
	36"x96"	N/A	 (1 kit of 2)	N/A	N/A	N/A	N/A	N/A	N/A	 (1 kit of 6)
	36"x120"	N/A	 (1 kit of 2)	N/A	N/A	N/A	N/A	N/A	N/A	 (1 kit of 6)
	36"x144"	N/A	 (1 kit of 2)	N/A	N/A	N/A	N/A	N/A	N/A	 (1 kit of 6)
	42"x60"	N/A	 (2)	N/A	N/A	 (1 kit of 2)	N/A	N/A	N/A	 (1 kit of 4)
	42"x72"	N/A	 (2)	N/A	N/A	 (1 kit of 2)	N/A	N/A	N/A	 (1 kit of 4)
	42"x84"	N/A	 (1 kit of 2)	N/A	N/A	 (1 kit of 2)	N/A	N/A	N/A	 (1 kit of 4)
	42"x96"	N/A	 (1 kit of 2)	N/A	N/A	N/A	N/A	N/A	N/A	 (1 kit of 6)
	42"x120"	 (1 kit of 2)	 (1 kit of 2)	N/A	N/A	N/A	N/A	N/A	N/A	 (1 kit of 6)
	42"x144"	 (1 kit of 2)	 (1 kit of 2)	N/A	N/A	N/A	N/A	N/A	N/A	 (1 kit of 6)
	48"x72"	 (2)	 (2)	N/A	N/A	 (1 kit of 2)	N/A	N/A	N/A	 (1 kit of 4)
	48"x84"	 (1 kit of 2)	 (1 kit of 2)	N/A	N/A	 (1 kit of 2)	N/A	N/A	N/A	 (1 kit of 4)
	48"x96"	 (1 kit of 2)	 (1 kit of 2)	N/A	N/A	N/A	N/A	N/A	N/A	 (1 kit of 6)
	48"x120"	 (1 kit of 2)	 (1 kit of 2)	N/A	N/A	N/A	N/A	N/A	N/A	 (1 kit of 6)
	48"x144"	 (1 kit of 2)	 (1 kit of 2)	N/A	N/A	N/A	N/A	N/A	N/A	 (1 kit of 6)
	54"x96"	 (1 kit of 2)	 (1 kit of 2)	N/A	N/A	N/A	N/A	N/A	N/A	 (1 kit of 4)
54"x120"	 (1 kit of 2)	 (1 kit of 2)	N/A	N/A	N/A	N/A	N/A	N/A	 (1 kit of 6)	
54"x144"	 (1 kit of 2)	 (1 kit of 3)	N/A	N/A	N/A	N/A	N/A	N/A	 (1 kit of 6)	
54"x192"	 (1 kit of 3)	 (1 kit of 3)	N/A	N/A	N/A	N/A	N/A	N/A	 (1 kit of 8)	
54"x216"	 (1 kit of 3)	 (1 kit of 3)	N/A	N/A	N/A	N/A	N/A	N/A	 (1 kit of 8)	
54"x240"	 (1 kit of 3)	 (1 kit of 3)	N/A	N/A	N/A	N/A	N/A	N/A	 (1 kit of 8)	
60"x120"	 (1 kit of 2)	 (1 kit of 2)	N/A	N/A	N/A	N/A	N/A	N/A	 (1 kit of 6)	
60"x144"	 (1 kit of 3)	 (1 kit of 3)	N/A	N/A	N/A	N/A	N/A	N/A	 (1 kit of 6)	
60"x168"	 (1 kit of 3)	 (1 kit of 3)	N/A	N/A	N/A	N/A	N/A	N/A	 (1 kit of 8)	
60"x192"	 (1 kit of 3)	 (1 kit of 3)	N/A	N/A	N/A	N/A	N/A	N/A	 (1 kit of 8)	
60"x216"	 (1 kit of 3)	 (1 kit of 3)	N/A	N/A	N/A	N/A	N/A	N/A	 (1 kit of 8)	
60"x240"	(1 kit of 3)	(1 kit of 3)	N/A	N/A	N/A	N/A	N/A	N/A	(1 kit of 8)	



# Structure

## Top-Base Compatibility Matrix

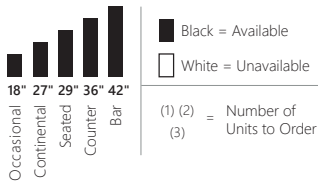

These top and base combinations are recommended and approved for optimal knee clearance, stability, and aesthetics. Required base and leg quantities are based on top size and shape. Please reference the Price and Specification Guide for more details.

TOP	AVAILABLE WIDTHS	MEDIUM ROUND PEDESTAL	LARGE ROUND PEDESTAL	MEDIUM SQUARE PEDESTAL	LARGE SQUARE PEDESTAL	MEDIUM X BASE	LARGE X BASE	SMALL CYLINDER	CYLINDER (W/M)	CYLINDER (NO W/M)	
RACETRACK	24"x36"	■ ■ ■ (1)	N/A	■ ■ ■ (1)	N/A	N/A	N/A	N/A	N/A	N/A	
	24"x42"	N/A	N/A	N/A	N/A	N/A	N/A	N/A	N/A	N/A	
	24"x48"	N/A	N/A	N/A	N/A	N/A	N/A	N/A	N/A	N/A	
	24"x60"	N/A	N/A	N/A	N/A	N/A	N/A	N/A	N/A	N/A	
	24"x72"	■ ■ ■ (2)	N/A	■ ■ ■ (2)	N/A	N/A	N/A	N/A	N/A	N/A	
	24"x84"	■ ■ ■ (2)	N/A	■ ■ ■ (2)	N/A	N/A	N/A	N/A	N/A	N/A	
	30"x42"	N/A	■ ■ ■ (1)	N/A	■ ■ ■ (1)	N/A	■ ■ ■ (1)	■ ■ ■ (1)	■ ■ ■ (1)	■ ■ ■ (1)	■ ■ ■ (1)
	30"x48"	N/A	■ ■ ■ (1)	N/A	■ ■ ■ (1)	N/A	■ ■ ■ (1)	■ ■ ■ (1)	N/A	■ ■ ■ (1)	■ ■ ■ (1)
	30"x60"	■ ■ ■ (2)	N/A	■ ■ ■ (2)	N/A	■ ■ ■ (2)	N/A	N/A	N/A	N/A	N/A
	30"x72"	■ ■ ■ (2)	N/A	■ ■ ■ (2)	N/A	■ ■ ■ (2)	N/A	N/A	N/A	N/A	N/A
	30"x84"	■ ■ ■ (2)	N/A	■ ■ ■ (2)	N/A	■ ■ ■ (2)	N/A	N/A	N/A	N/A	N/A
	36"x48"	N/A	■ ■ ■ (1)	N/A	■ ■ ■ (1)	N/A	■ ■ ■ (1)	■ ■ ■ (1)	■ ■ ■ (1)	■ ■ ■ (1)	■ ■ ■ (1)
	36"x60"	■ ■ ■ (2)	N/A	■ ■ ■ (2)	N/A	■ ■ ■ (2)	N/A	N/A	N/A	N/A	N/A
	36"x72"	■ ■ ■ (2)	N/A	■ ■ ■ (2)	N/A	■ ■ ■ (2)	N/A	N/A	■ ■ ■ (2)	■ ■ ■ (2)	■ ■ ■ (2)
	36"x84"	■ ■ ■ (2)	N/A	■ ■ ■ (2)	N/A	■ ■ ■ (2)	N/A	N/A	■ ■ ■ (2)	■ ■ ■ (1 kit of 2)	■ ■ ■ (1 kit of 2)
	36"x96"	■ ■ ■ (2)	N/A	■ ■ ■ (2)	N/A	■ ■ ■ (2)	N/A	N/A	■ ■ ■ (2)	■ ■ ■ (1 kit of 2)	■ ■ ■ (1 kit of 2)
	42"x72"	N/A	■ ■ ■ (2)	N/A	■ ■ ■ (2)	N/A	■ ■ ■ (2)	■ ■ ■ (2)	■ ■ ■ (2)	■ ■ ■ (2)	■ ■ ■ (2)
	42"x84"	N/A	■ ■ ■ (2)	N/A	■ ■ ■ (2)	N/A	■ ■ ■ (2)	■ ■ ■ (2)	■ ■ ■ (2)	■ ■ ■ (1 kit of 2)	■ ■ ■ (1 kit of 2)
	42"x96"	N/A	■ ■ ■ (2)	N/A	■ ■ ■ (2)	N/A	■ ■ ■ (2)	■ ■ ■ (2)	■ ■ ■ (2)	■ ■ ■ (1 kit of 2)	■ ■ ■ (1 kit of 2)
	42"x120"	N/A	■ ■ ■ (2)	N/A	■ ■ ■ (2)	N/A	■ ■ ■ (2)	■ ■ ■ (2)	■ ■ ■ (2)	■ ■ ■ (1 kit of 2)	■ ■ ■ (1 kit of 2)
	42"x144"	N/A	■ ■ ■ (3)	N/A	■ ■ ■ (3)	N/A	■ ■ ■ (3)	■ ■ ■ (3)	N/A	■ ■ ■ (1 kit of 2)	■ ■ ■ (1 kit of 2)
	48"x72"	N/A	■ ■ ■ (2)	N/A	■ ■ ■ (2)	N/A	■ ■ ■ (2)	■ ■ ■ (2)	N/A	■ ■ ■ (2)	■ ■ ■ (2)
	48"x84"	N/A	■ ■ ■ (2)	N/A	■ ■ ■ (2)	N/A	■ ■ ■ (2)	■ ■ ■ (2)	N/A	■ ■ ■ (1 kit of 2)	■ ■ ■ (1 kit of 2)
	48"x96"	N/A	■ ■ ■ (2)	N/A	■ ■ ■ (2)	N/A	■ ■ ■ (2)	■ ■ ■ (2)	N/A	■ ■ ■ (1 kit of 2)	■ ■ ■ (1 kit of 2)
	48"x120"	N/A	■ ■ ■ (2)	N/A	■ ■ ■ (2)	N/A	■ ■ ■ (2)	■ ■ ■ (2)	N/A	■ ■ ■ (1 kit of 2)	■ ■ ■ (1 kit of 2)
	48"x144"	N/A	■ ■ ■ (3)	N/A	■ ■ ■ (3)	N/A	■ ■ ■ (3)	■ ■ ■ (3)	N/A	■ ■ ■ (1 kit of 2)	■ ■ ■ (1 kit of 2)
	54"x96"	N/A	N/A	N/A	N/A	N/A	N/A	N/A	N/A	■ ■ ■ (1 kit of 2)	■ ■ ■ (1 kit of 2)
	54"x120"	N/A	N/A	N/A	N/A	N/A	N/A	N/A	N/A	■ ■ ■ (1 kit of 2)	■ ■ ■ (1 kit of 2)
	54"x144"	N/A	N/A	N/A	N/A	N/A	N/A	N/A	N/A	■ ■ ■ (1 kit of 2)	■ ■ ■ (1 kit of 2)
	54"x168"	N/A	N/A	N/A	N/A	N/A	N/A	N/A	N/A	■ ■ ■ (1 kit of 2)	■ ■ ■ (1 kit of 2)
54"x192"	N/A	N/A	N/A	N/A	N/A	N/A	N/A	N/A	■ ■ ■ (1 kit of 3)	■ ■ ■ (1 kit of 3)	
54"x216"	N/A	N/A	N/A	N/A	N/A	N/A	N/A	N/A	■ ■ ■ (1 kit of 3)	■ ■ ■ (1 kit of 3)	
54"x240"	N/A	N/A	N/A	N/A	N/A	N/A	N/A	N/A	■ ■ ■ (1 kit of 3)	■ ■ ■ (1 kit of 3)	
60"x120"	N/A	N/A	N/A	N/A	N/A	N/A	N/A	N/A	■ ■ ■ (1 kit of 2)	■ ■ ■ (1 kit of 2)	
60"x144"	N/A	N/A	N/A	N/A	N/A	N/A	N/A	N/A	■ ■ ■ (1 kit of 2)	■ ■ ■ (1 kit of 2)	
60"x168"	N/A	N/A	N/A	N/A	N/A	N/A	N/A	N/A	■ ■ ■ (1 kit of 2)	■ ■ ■ (1 kit of 2)	
60"x192"	N/A	N/A	N/A	N/A	N/A	N/A	N/A	N/A	■ ■ ■ (1 kit of 3)	■ ■ ■ (1 kit of 3)	
60"x216"	N/A	N/A	N/A	N/A	N/A	N/A	N/A	N/A	■ ■ ■ (1 kit of 3)	■ ■ ■ (1 kit of 3)	
60"x240"	N/A	N/A	N/A	N/A	N/A	N/A	N/A	N/A	■ ■ ■ (1 kit of 3)	■ ■ ■ (1 kit of 3)	

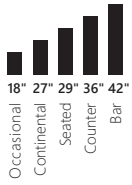

Black = Available  
White = Unavailable  
(1) (2) = Number of Units to Order  
(3) = Number of Units to Order

These top and base combinations are recommended and approved for optimal knee clearance, stability, and aesthetics. Required base and leg quantities are based on top size and shape. Please reference the Price and Specification Guide for more details.

TOP	AVAILABLE WIDTHS	CUBE	PANEL	SMALL T LEGS	MEDIUM T LEGS	LARGE T LEGS	FIXED POST-LEGS	ADJUSTABLE POST-LEGS	COMMUNITY LEGS	
RACETRACK	24"x36"	N/A	N/A	(1 kit of 2)	N/A	N/A	N/A	N/A	N/A	
	24"x42"	N/A	N/A	(1 kit of 2)	N/A	N/A	N/A	N/A	N/A	
	24"x48"	N/A	N/A	(1 kit of 2)	N/A	N/A	N/A	N/A	N/A	
	24"x60"	N/A	N/A	(1 kit of 2)	N/A	N/A	N/A	N/A	N/A	
	24"x72"	N/A	N/A	(1 kit of 2)	N/A	N/A	N/A	N/A	N/A	
	24"x84"	N/A	N/A	(1 kit of 2)	N/A	N/A	N/A	N/A	N/A	
	30"x42"	N/A	N/A	N/A	(1 kit of 2)	N/A	N/A	N/A	N/A	
	30"x48"	N/A	N/A	N/A	(1 kit of 2)	N/A	N/A	N/A	N/A	
	30"x60"	N/A	N/A	N/A	(1 kit of 2)	N/A	N/A	N/A	N/A	
	30"x72"	N/A	N/A	N/A	(1 kit of 2)	N/A	N/A	N/A	N/A	
	30"x84"	N/A	N/A	N/A	(1 kit of 2)	N/A	N/A	N/A	N/A	
	36"x48"	N/A	N/A	N/A	(1 kit of 2)	N/A	N/A	N/A	N/A	(1 kit of 4)
	36"x60"	N/A	N/A	N/A	(1 kit of 2)	N/A	N/A	N/A	N/A	(1 kit of 4)
	36"x72"	N/A	(2)	N/A	(1 kit of 2)	N/A	N/A	N/A	N/A	(1 kit of 4)
	36"x84"	N/A	(1 kit of 2)	N/A	(1 kit of 2)	N/A	N/A	N/A	N/A	(1 kit of 4)
	36"x96"	N/A	(1 kit of 2)	N/A	(1 kit of 2)	N/A	N/A	N/A	N/A	(1 kit of 4)
	42"x72"	N/A	(2)	N/A	N/A	N/A	(1 kit of 2)	N/A	N/A	(1 kit of 4)
	42"x84"	N/A	(1 kit of 2)	N/A	N/A	N/A	(1 kit of 2)	N/A	N/A	(1 kit of 4)
	42"x96"	N/A	(1 kit of 2)	N/A	N/A	N/A	(1 kit of 2)	N/A	N/A	(1 kit of 4)
	42"x120"	N/A	(1 kit of 2)	N/A	N/A	N/A	N/A	N/A	N/A	(1 kit of 6)
	42"x144"	(1 kit of 2)	(1 kit of 2)	N/A	N/A	N/A	N/A	N/A	N/A	(1 kit of 6)
	48"x72"	(2)	(2)	N/A	N/A	N/A	N/A	N/A	N/A	(1 kit of 4)
	48"x84"	(1 kit of 2)	(1 kit of 2)	N/A	N/A	N/A	N/A	N/A	N/A	(1 kit of 4)
	48"x96"	(1 kit of 2)	(1 kit of 2)	N/A	N/A	N/A	N/A	N/A	N/A	(1 kit of 4)
	48"x120"	(1 kit of 2)	(1 kit of 2)	N/A	N/A	N/A	N/A	N/A	N/A	(1 kit of 6)
	48"x144"	(1 kit of 2)	(1 kit of 2)	N/A	N/A	N/A	N/A	N/A	N/A	(1 kit of 6)
	54"x96"	(1 kit of 2)	(1 kit of 2)	N/A	N/A	N/A	N/A	N/A	N/A	(1 kit of 4)
	54"x120"	(1 kit of 2)	(1 kit of 2)	N/A	N/A	N/A	N/A	N/A	N/A	(1 kit of 6)
	54"x144"	(1 kit of 2)	(1 kit of 2)	N/A	N/A	N/A	N/A	N/A	N/A	(1 kit of 6)
	54"x168"	(1 kit of 2)	(1 kit of 3)	N/A	N/A	N/A	N/A	N/A	N/A	(1 kit of 6)
54"x192"	(1 kit of 3)	(1 kit of 3)	N/A	N/A	N/A	N/A	N/A	N/A	(1 kit of 8)	
54"x216"	(1 kit of 3)	(1 kit of 3)	N/A	N/A	N/A	N/A	N/A	N/A	(1 kit of 8)	
54"x240"	(1 kit of 3)	(1 kit of 3)	N/A	N/A	N/A	N/A	N/A	N/A	(1 kit of 8)	
60"x120"	(1 kit of 2)	(1 kit of 2)	N/A	N/A	N/A	N/A	N/A	N/A	(1 kit of 6)	
60"x144"	(1 kit of 2)	(1 kit of 2)	N/A	N/A	N/A	N/A	N/A	N/A	(1 kit of 6)	
60"x168"	(1 kit of 2)	(1 kit of 3)	N/A	N/A	N/A	N/A	N/A	N/A	(1 kit of 6)	
60"x192"	(1 kit of 3)	(1 kit of 3)	N/A	N/A	N/A	N/A	N/A	N/A	(1 kit of 8)	
60"x216"	(1 kit of 3)	(1 kit of 3)	N/A	N/A	N/A	N/A	N/A	N/A	(1 kit of 8)	
60"x240"	(1 kit of 3)	(1 kit of 3)	N/A	N/A	N/A	N/A	N/A	N/A	(1 kit of 8)	

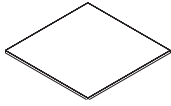
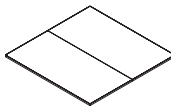

- Order Base Separately.
- Order power units separately.
- Tops ship with pilot holes for locating supports.
- Reference page [483](#) for cutout locations.
- Middle seams on multi-piece tops are not edgebanded.
- External stiffeners are included with top models when required.
- Available in laminate (flat or knife edges).
- For 72" to 84" tops, the woodgrain direction runs parallel with the seam and will have greater alignment variations.

Description	Model	Cutout	Ship Weight	Cubes	List Price			
					L1	L2	L3	
<b>Square Tops Laminate Square Edge</b>								
24" x 24" Square	AMPTLFPO24SQR	G1	24.0	1.8	\$ 403	\$ 418	\$ 432	
30" x 30" Square	AMPTLFPO30SQR	G1	34.0	2.4	\$ 464	\$ 481	\$ 497	
36" x 36" Square	AMPTLFPO36SQR	G1	47.0	3.3	\$ 542	\$ 561	\$ 581	
42" x 42" Square	AMPTLFPO42SQR	G1	62.0	4.5	\$ 705	\$ 731	\$ 755	
48" x 48" Square	AMPTLFPO48SQR	G1	80.0	5.8	\$ 828	\$ 858	\$ 886	
54" x 54" Square	AMPTLF54SQR	C1	99.0	7.5	\$ 1231	\$ 1275	\$ 1318	
60" x 60" Square	AMPTLF60SQR	C1	138.6	11.1	\$ 1419	\$ 1470	\$ 1519	
72" x 72" Square (2 pieces)	AMPTLF72SQR	C2	197.8	17.4	\$ 1978	\$ 2048	\$ 2116	
84" x 84" Square (2 pieces)	AMPTLF84SQR	C2	261.0	22.0	\$ 2534	\$ 2622	\$ 2711	
<b>Square Tops Laminate Knife Edge</b>								
24" x 24" Square	AMPTLKPO24SQR	G1	24.0	1.8	\$ 845	\$ 875	\$ 904	
30" x 30" Square	AMPTLKPO30SQR	G1	34.0	2.4	\$ 1023	\$ 1059	\$ 1095	
36" x 36" Square	AMPTLKPO36SQR	G1	47.0	3.3	\$ 1295	\$ 1341	\$ 1386	
42" x 42" Square	AMPTLKPO42SQR	G1	62.0	4.5	\$ 1556	\$ 1611	\$ 1665	
48" x 48" Square	AMPTLKPO48SQR	G1	80.0	5.8	\$ 1897	\$ 1964	\$ 2030	
54" x 54" Square	AMPTLK54SQR	C1	99.0	7.5	\$ 2709	\$ 2804	\$ 2899	
60" x 60" Square	AMPTLK60SQR	C1	138.6	11.1	\$ 3123	\$ 3232	\$ 3341	
72" x 72" Square (2 pieces)	AMPTLK72SQR	C2	197.8	17.4	\$ 4344	\$ 4497	\$ 4648	
84" x 84" Square (2 pieces)	AMPTLK84SQR	C2	261.0	22.0	\$ 5578	\$ 5773	\$ 5969	

<b>How to specify —</b> Select the Model Number from above.	<b>1st Option:</b> <b>FSC Certified Wood:</b> FSC    Enter for FSC wood X        Enter for non-FSC wood	<b>2nd Option:</b> <b>Laminate:</b> See page <a href="#">480</a> for finishes.	<b>3rd Option:</b> <b>Edge:</b> See page <a href="#">480</a> for finishes.	<b>4th Option:</b> <b>Cutout (if applicable):</b> Upcharge of \$17 per cutout. C0 No cutout C1 Large center cutout C2 Two large center cutouts G1 One small center cutout
--	--	--	--	---

A M P T L | | | | | | | | . | | | | . | | | | | . | | | | | . C | |

Examples: AMPTLK36SQR.X.LT11.LM13.C1    AMPTLF64SQR.FSC.LLA1.LWNW.C0



- Order Base Separately.
- Order power units separately.
- Tops ship with pilot holes for locating supports.
- Reference page 483 for cutout locations.
- External stiffeners are included with top models when required.
- Available in laminate (flat or knife edges).

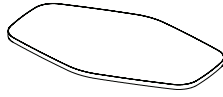

Description	Model	Cutout	Ship Weight	Cubes	List Price			
					L1	L2	L3	
<b>Diamond Tops Laminate Square Edge</b>								
24" x 40" Small Diamond	AMPTLF2440DIA	C0	36.0	2.9	\$ 732	\$ 758	\$ 784	
30" x 50" Small Diamond	AMPTLF3050DIA	C0	54.0	4.4	\$ 842	\$ 872	\$ 901	
42" x 72" Diamond	AMPTLF4272DIA	C1	122.8	10.0	\$ 1491	\$ 1544	\$ 1595	
42" x 84" Diamond	AMPTLF4284DIA	C1	143.0	12.5	\$ 1693	\$ 1752	\$ 1811	
42" x 96" Diamond	AMPTLF4296DIA	C1	162.2	13.8	\$ 1752	\$ 1815	\$ 1876	
48" x 72" Diamond	AMPTLF4872DIA	C1	136.8	11.1	\$ 1732	\$ 1792	\$ 1853	
48" x 84" Diamond	AMPTLF4884DIA	C1	159.0	13.8	\$ 1926	\$ 1994	\$ 2061	
48" x 96" Diamond	AMPTLF4896DIA	C1	181.2	15.2	\$ 1988	\$ 2058	\$ 2129	
54" x 96" Diamond	AMPTLF5496DIA	C1	199.2	16.6	\$ 2150	\$ 2226	\$ 2302	

### Diamond Tops Laminate Knife Edge

24" x 40" Small Diamond	AMPTLK2440DIA	C0	36.0	2.9	\$ 1614	\$ 1671	\$ 1727
30" x 50" Small Diamond	AMPTLK3050DIA	C0	54.0	4.4	\$ 1856	\$ 1921	\$ 1986
42" x 72" Diamond	AMPTLK4272DIA	C1	24.0	1.6	\$ 2737	\$ 2832	\$ 2928
42" x 84" Diamond	AMPTLK4284DIA	C1	34.0	2.4	\$ 3106	\$ 3214	\$ 3322
42" x 96" Diamond	AMPTLK4296DIA	C1	47.0	3.6	\$ 3230	\$ 3344	\$ 3457
48" x 72" Diamond	AMPTLK4872DIA	C1	62.0	4.9	\$ 3178	\$ 3290	\$ 3400
48" x 84" Diamond	AMPTLK4884DIA	C1	80.0	5.8	\$ 3536	\$ 3660	\$ 3783
48" x 96" Diamond	AMPTLK4896DIA	C1	99.0	7.5	\$ 3664	\$ 3793	\$ 3922
54" x 96" Diamond	AMPTLK5496DIA	C1	138.6	11.1	\$ 3965	\$ 4104	\$ 4243

<p><i>How to specify —</i> Select the Model Number from above.</p>	<p><i>1st Option:</i> <b>FSC Certified Wood:</b> FSC Enter for FSC wood X Enter for non-FSC wood</p>	<p><i>2nd Option:</i> <b>Laminate:</b> See page 480 for finishes.</p>	<p><i>3rd Option:</i> <b>Edge:</b> See page 480 for finishes.</p>	<p><i>4th Option:</i> <b>Cutout</b> (if applicable): Upcharge of \$17 per cutout. C0 No cutout C1 Large center cutout</p>
AMPTL	.	.	.	C

Examples: AMPTLK4272DIA.X.LTI1.LM13.C1 AMPTLF3050DIA.FSC.LLA1.LWNW.CO



- Order Base Separately.
- Order power units separately.
- Tops ship with pilot holes for locating supports.
- External stiffeners are included with top models when required.
- Available in laminate (flat or knife edges).



Description	Model	Cutout	Ship Weight	Cubes	List Price			
					L1	L2	L3	
<b>Boat Tops Laminate Square Edge</b>								
30" x 52" Boat	AMPTLF3052BT	C0	48.0	4.2	\$ 1294	\$ 1340	\$ 1385	
30" x 60" Boat	AMPTLF3060BT	C0	71.6	6.6	\$ 1397	\$ 1447	\$ 1496	
30" x 72" Boat	AMPTLF3072BT	C0	85.8	7.7	\$ 1502	\$ 1555	\$ 1608	
36" x 52" Boat	AMPTLF3652BT	C0	58.0	4.8	\$ 1398	\$ 1448	\$ 1497	
36" x 60" Boat	AMPTLF3660BT	C0	83.6	7.3	\$ 1501	\$ 1554	\$ 1607	
36" x 72" Boat	AMPTLF3672BT	C0	100.8	8.6	\$ 1600	\$ 1656	\$ 1713	
<b>Boat Tops Laminate Knife Edge</b>								
30" x 52" Boat	AMPTLK3052BT	C0	48.0	4.2	\$ 2591	\$ 2682	\$ 2772	
30" x 60" Boat	AMPTLK3060BT	C0	71.6	6.6	\$ 2796	\$ 2895	\$ 2993	
30" x 72" Boat	AMPTLK3072BT	C0	85.8	7.7	\$ 3007	\$ 3113	\$ 3218	
36" x 52" Boat	AMPTLK3652BT	C0	58.0	4.8	\$ 2796	\$ 2895	\$ 2993	
36" x 60" Boat	AMPTLK3660BT	C0	83.6	7.3	\$ 3006	\$ 3112	\$ 3217	
36" x 72" Boat	AMPTLK3672BT	C0	100.8	8.6	\$ 3205	\$ 3318	\$ 3430	

<p><b>How to specify —</b> Select the Model Number from above.</p>	<p><i>1st Option:</i> <b>FSC Certified Wood:</b> FSC Enter for FSC wood X Enter for non-FSC wood</p>	<p><i>2nd Option:</i> <b>Laminate:</b> See page 480 for finishes.</p>	<p><i>3rd Option:</i> <b>Edge:</b> See page 480 for finishes.</p>
<p>AMPTL                     .                     .</p>			

Examples: AMPTLK3052BT.X.LT11.LM13 AMPTLF3052BT.FSC.LLA1.LWNW







- Order Base Separately.
- Order power units separately.
- Tops ship with pilot holes for locating supports.
- Reference page 483 for cutout locations.
- Middle seams on multi-piece tops are not edgebanded.
- External stiffeners are included with top models when required.
- Available in laminate (flat or knife edges).
- 192" to 240" tops are 3 pieces.
- 60"D tops may have greater woodgrain alignment variation across the seams.

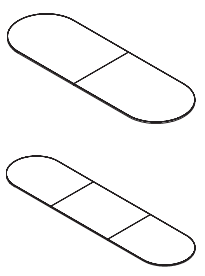

Description	Model	Cutout	Ship Weight	Cubes	List Price		
					L1	L2	L3
<b>Racetrack Multi-Piece Tops Laminate Square Edge (model number includes two or three units)</b>							
42" x 120" Racetrack	AMPTLF42120RT	C2	192.2	20.4	\$ 2187	\$ 2264	\$ 2341
42" x 144" Racetrack	AMPTLF42144RT	C2	224.2	23.6	\$ 2453	\$ 2540	\$ 2626
48" x 120" Racetrack	AMPTLF48120RT	C2	216.2	22.6	\$ 2187	\$ 2264	\$ 2341
48" x 144" Racetrack	AMPTLF48144RT	C2	252.2	26.2	\$ 2453	\$ 2540	\$ 2626
54" x 120" Racetrack	AMPTLF54120RT	C2	238.2	24.8	\$ 2728	\$ 2824	\$ 2920
54" x 144" Racetrack	AMPTLF54144RT	C2	280.2	28.9	\$ 3064	\$ 3172	\$ 3279
54" x 168" Racetrack	AMPTLF54168RT	C2	322.2	33.0	\$ 3776	\$ 3908	\$ 4041
54" x 192" Racetrack	AMPTLF54192RT	C3	378.2	44.8	\$ 4548	\$ 4708	\$ 4868
54" x 216" Racetrack	AMPTLF54216RT	C3	420.2	44.8	\$ 4884	\$ 5056	\$ 5227
54" x 240" Racetrack	AMPTLF54240RT	C3	462.2	50.9	\$ 5599	\$ 5796	\$ 5992
60" x 120" Racetrack	AMPTLF60120RT	C2	262.2	27.1	\$ 2863	\$ 2964	\$ 3064
60" x 144" Racetrack	AMPTLF60144RT	C2	308.2	31.6	\$ 3218	\$ 3331	\$ 3444
60" x 168" Racetrack	AMPTLF60168RT	C2	356.2	36.0	\$ 3963	\$ 4102	\$ 4241
60" x 192" Racetrack	AMPTLF60192RT	C3	416.2	48.8	\$ 4776	\$ 4944	\$ 5111
60" x 216" Racetrack	AMPTLF60216RT	C3	462.2	48.8	\$ 5129	\$ 5309	\$ 5489
60" x 240" Racetrack	AMPTLF60240RT	C3	510.2	55.6	\$ 5881	\$ 6088	\$ 6294

**Racetrack Multi-Piece Tops Laminate Knife Edge (model number includes two or three units)**

42" x 120" Racetrack	AMPTLK42120RT	C2	192.2	20.4	\$ 3428	\$ 3548	\$ 3668
42" x 144" Racetrack	AMPTLK42144RT	C2	224.2	23.6	\$ 3754	\$ 3886	\$ 4017
48" x 120" Racetrack	AMPTLK48120RT	C2	216.2	22.6	\$ 3428	\$ 3548	\$ 3668
48" x 144" Racetrack	AMPTLK48144RT	C2	252.2	26.2	\$ 3754	\$ 3886	\$ 4017
54" x 120" Racetrack	AMPTLK54120RT	C2	238.2	24.8	\$ 4281	\$ 4432	\$ 4581
54" x 144" Racetrack	AMPTLK54144RT	C2	280.2	28.9	\$ 4687	\$ 4852	\$ 5016
54" x 168" Racetrack	AMPTLK54168RT	C2	322.2	33.0	\$ 6076	\$ 6289	\$ 6503
54" x 192" Racetrack	AMPTLK54192RT	C3	378.2	44.8	\$ 7512	\$ 7775	\$ 8039
54" x 216" Racetrack	AMPTLK54216RT	C3	420.2	44.8	\$ 7916	\$ 8193	\$ 8471
54" x 240" Racetrack	AMPTLK54240RT	C3	462.2	50.9	\$ 9311	\$ 9637	\$ 9963
60" x 120" Racetrack	AMPTLK60120RT	C2	262.2	27.1	\$ 4495	\$ 4652	\$ 4811
60" x 144" Racetrack	AMPTLK60144RT	C2	308.2	31.6	\$ 4921	\$ 5094	\$ 5266
60" x 168" Racetrack	AMPTLK60168RT	C2	356.2	36.0	\$ 6379	\$ 6603	\$ 6826
60" x 192" Racetrack	AMPTLK60192RT	C3	416.2	48.8	\$ 7887	\$ 8164	\$ 8440
60" x 216" Racetrack	AMPTLK60216RT	C3	462.2	48.8	\$ 8309	\$ 8601	\$ 8892
60" x 240" Racetrack	AMPTLK60240RT	C3	510.2	55.6	\$ 9776	\$10119	\$10461

STRUCTURE

<p><b>How to specify —</b> Select the Model Number from above.</p>	<p><b>1st Option:</b> FSC Certified Wood: FSC Enter for FSC wood X Enter for non-FSC wood</p>	<p><b>2nd Option:</b> Laminate: See page 480 for finishes.</p>	<p><b>3rd Option:</b> Edge: See page 480 for finishes.</p>	<p><b>4th Option:</b> Cutout (if applicable): Upcharge of \$17 per cutout. C0 No cutout C2 Two large center cutouts C3 Three large center cutouts</p>
AMPTL				C

Examples: AMPTLK42120RT.X.LT11.LM13.C2 AMPTLF42120RT.FSC.LLA1.LWNW.C0

- Order Base Separately.
- Order power units separately.
- Tops ship with pilot holes for locating supports.
- Reference page 483 for cutout locations.
- External stiffeners are included with top models when required.
- Available in laminate (flat or knife edges).
- Grommet cutout G1 cannot be specified with pedestal or X-base.

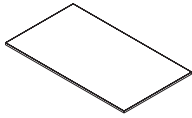

Description	Model	Cutout	Ship Weight	Cubes	List Price		
					L1	L2	L3
<b>Rectangle Tops Laminate Square Edge</b>							
24" x 36" Rectangle	AMPTLF2436RE	G1 ATE	31.0	2.7	\$ 460	\$ 477	\$ 493
24" x 42" Rectangle	AMPTLF2442RE	G1 ATE	36.0	3.1	\$ 493	\$ 511	\$ 528
24" x 48" Rectangle	AMPTLF2448RE	G1 ATE	41.0	3.5	\$ 526	\$ 545	\$ 564
24" x 60" Rectangle	AMPTLF2460RE	C1 ATE	66.6	6.1	\$ 627	\$ 649	\$ 671
24" x 72" Rectangle	AMPTLF2472RE	C1 ATE	79.8	6.8	\$ 701	\$ 727	\$ 751
24" x 84" Rectangle	AMPTLF2484RE	C1 ATE	93.0	8.8	\$ 828	\$ 858	\$ 887
30" x 42" Rectangle	AMPTLF3042RE	G1 ATE	46.0	3.7	\$ 520	\$ 539	\$ 558
30" x 48" Rectangle	AMPTLF3048RE	G1 ATE	52.0	4.2	\$ 565	\$ 585	\$ 605
30" x 60" Rectangle	AMPTLF3060RE	C1 ATE	79.6	7.0	\$ 715	\$ 741	\$ 766
30" x 72" Rectangle	AMPTLF3072RE	C1 ATE	94.8	7.9	\$ 801	\$ 830	\$ 858
30" x 84" Rectangle	AMPTLF3084RE	C1 ATE	110.0	10.1	\$ 966	\$ 1000	\$ 1034
36" x 48" Rectangle	AMPTLF3648RE	G1	61.0	4.9	\$ 640	\$ 663	\$ 685
36" x 60" Rectangle	AMPTLF3660RE	C1	91.6	7.8	\$ 775	\$ 803	\$ 830
36" x 72" Rectangle	AMPTLF3672RE	C1	108.8	9.0	\$ 913	\$ 945	\$ 978
36" x 84" Rectangle	AMPTLF3684RE	C1	126.0	11.3	\$ 1150	\$ 1191	\$ 1231
36" x 96" Rectangle	AMPTLF3696RE	C1	143.2	12.4	\$ 1345	\$ 1392	\$ 1439
42" x 60" Rectangle	AMPTLF4260RE	C1	103.6	8.7	\$ 1090	\$ 1129	\$ 1167
42" x 72" Rectangle	AMPTLF4272RE	C1	122.8	10.0	\$ 1199	\$ 1242	\$ 1283
42" x 84" Rectangle	AMPTLF4284RE	C1	143.0	12.5	\$ 1359	\$ 1407	\$ 1455
42" x 96" Rectangle	AMPTLF4296RE	C1	162.2	13.8	\$ 1425	\$ 1476	\$ 1526
48" x 72" Rectangle	AMPTLF4872RE	C1	136.8	11.1	\$ 1297	\$ 1343	\$ 1388
48" x 84" Rectangle	AMPTLF4884RE	C1	159.0	13.8	\$ 1545	\$ 1600	\$ 1654
48" x 96" Rectangle	AMPTLF4896RE	C1	181.2	15.2	\$ 1617	\$ 1674	\$ 1731
54" x 96" Rectangle	AMPTLF5496RE	C1	199.2	16.6	\$ 1809	\$ 1873	\$ 1936

<p><b>How to specify —</b> Select the Model Number from above.</p>	<p><b>1st Option:</b> <b>FSC Certified Wood:</b> FSC Enter for FSC wood X Enter for non-FSC wood</p>	<p><b>2nd Option:</b> <b>Laminate:</b> See page 480 for finishes.</p>	<p><b>3rd Option:</b> <b>Edge:</b> See page 480 for finishes.</p>	<p><b>4th Option:</b> <b>Cutout</b> (if applicable): Upcharge of \$17 per cutout. C0 No cutout C1 Large center cutout G1 One small center cutout ATE One small edge cutout</p>
AMPTL                     .	.	.	.	.

Example: AMPTLF2436RE.X.LT11.LM13.C1





- Wall Mount Bracket is used to fasten one end of a table top to the wall. User to provide mounting hardware.
- Order Base Separately.
- Order power units separately.
- Tops ship with pilot holes for locating supports.
- Reference page 483 for cutout locations.
- External stiffeners are included with top models when required.
- Available in laminate (flat or knife edges).

Description	Model	Ship Weight	Cubes	List Price		
				P1	P2	P3
<b>Accessories</b>						
Wall Mount Bracket	AMPTWMB	4.0	0.4	\$ 152	N/A	N/A
<b>Tilt Wall Mount for 32" to 70" TVs or Monitors</b>						
26 1/8" W x 17 3/8" H; -10° -0° Tilt		GATVMB		\$ 527		
Includes mounting hardware and conforms to VESA-compliant displays. Supports up to 165 lbs.						

Description	Model	Cutout	Ship Weight	Cubes	List Price		
					L1	L2	L3
<b>Media Rectangle Tops Laminate Square Edge</b>							
48" x 54" Media Rectangle	AMPTLF4854MRE	C1	89.0	7.1	\$ 1283	\$ 1328	\$ 1374
48" x 60" Media Rectangle	AMPTLF4860MRE	C1	115.6	9.6	\$ 1398	\$ 1448	\$ 1497
54" x 54" Media Rectangle	AMPTLF5454MRE	C1	110	8.7	\$ 1827	\$ 1892	\$ 1956
54" x 60" Media Rectangle	AMPTLF5460MRE	C1	126.6	10.5	\$ 1973	\$ 2042	\$ 2112
54" x 72" Media Rectangle	AMPTLF5472MRE	C1	150.8	12.2	\$ 2162	\$ 2238	\$ 2314
60" x 60" Media Rectangle	AMPTLF6060MRE	C1	159.8	13.2	\$ 2141	\$ 2213	\$ 2285
60" x 72" Media Rectangle	AMPTLF6072MRE	C1	159.8	13.2	\$ 2165	\$ 2242	\$ 2317
<b>Media Rectangle Tops Laminate Knife Edge</b>							
48" x 54" Media Rectangle	AMPTLK4854MRE	C1	89.0	7.1	\$ 1928	\$ 1996	\$ 2064
48" x 60" Media Rectangle	AMPTLK4860MRE	C1	115.6	9.6	\$ 2100	\$ 2175	\$ 2248
54" x 54" Media Rectangle	AMPTLK5454MRE	C1	110	8.7	\$ 2744	\$ 2840	\$ 2936
54" x 60" Media Rectangle	AMPTLK5460MRE	C1	126.6	10.5	\$ 2958	\$ 3062	\$ 3166
54" x 72" Media Rectangle	AMPTLK5472MRE	C1	150.8	12.2	\$ 3243	\$ 3357	\$ 3470
60" x 60" Media Rectangle	AMPTLK6060MRE	C1	159.8	13.2	\$ 3043	\$ 3151	\$ 3260
60" x 72" Media Rectangle	AMPTLK6072MRE	C1	159.8	13.2	\$ 3248	\$ 3362	\$ 3476

<p><b>How to specify —</b> Select the Model Number from above.</p>	<p><b>1st Option:</b> FSC Certified Wood: FSC Enter for FSC wood X Enter for non-FSC wood</p>	<p><b>2nd Option:</b> Laminate: See page 480 for finishes.</p>	<p><b>3rd Option:</b> Edge: See page 480 for finishes.</p>	<p><b>4th Option:</b> Cutout (if applicable): Upcharge of \$17 per cutout. C0 No cutout C1 Large center cutout</p>
AMPTL				C

Examples: AMPTLK4854MRE.X.LT11.LM13.C1 AMPTLF4854MRE.FSC.LLA1.LWNW.CO

- For wall mounted tops, not freestanding, a wall-mount bracket is used to fasten one end of the top to the wall (user to provide mounting hardware). See page 512.
- Order Base Separately.
- Order power units separately.
- Tops ship with pilot holes for locating supports.
- Reference page 483 for cutout locations.
- External stiffeners are included with top models when required.
- Available in laminate (flat or knife edges).

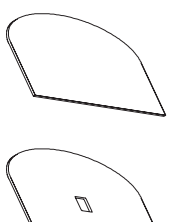

Description	Model	Cutout	Ship Weight	Cubes	List Price		
					L1	L2	L3
<b>Media Half-Racetrack Tops Laminate Square Edge</b>							
48" x 54" Media Half-Racetrack	AMPTLF4854MRT	C1	89.0	7.1	\$ 1283	\$ 1328	\$ 1374
48" x 60" Media Half-Racetrack	AMPTLF4860MRT	C1	115.6	9.6	\$ 1400	\$ 1450	\$ 1499
54" x 54" Media Half-Racetrack	AMPTLF5454MRT	C1	100.0	9.7	\$ 1827	\$ 1892	\$ 1956
54" x 60" Media Half-Racetrack	AMPTLF5460MRT	C1	126.6	10.5	\$ 1972	\$ 2041	\$ 2111
54" x 72" Media Half-Racetrack	AMPTLF5472MRT	C1	150.8	12.2	\$ 2160	\$ 2236	\$ 2312
60" x 60" Media Half-Racetrack	AMPTLF6060MRT	C1	138.6	11.4	\$ 2061	\$ 2133	\$ 2205
60" x 72" Media Half-Racetrack	AMPTLF6072MRT	C1	159.8	13.2	\$ 2162	\$ 2239	\$ 2314

Description	Model	Cutout	Ship Weight	Cubes	List Price		
					L1	L2	L3
<b>Media Half-Racetrack Tops Laminate Knife Edge</b>							
48" x 54" Media Half-Racetrack	AMPTLK4854MRT	C1	89.0	7.1	\$ 1928	\$ 1996	\$ 2064
48" x 60" Media Half-Racetrack	AMPTLK4860MRT	C1	115.6	9.6	\$ 2101	\$ 2176	\$ 2249
54" x 54" Media Half-Racetrack	AMPTLK5454MRT	C1	100.0	9.7	\$ 2744	\$ 2840	\$ 2936
54" x 60" Media Half-Racetrack	AMPTLK5460MRT	C1	126.6	10.5	\$ 2957	\$ 3061	\$ 3165
54" x 72" Media Half-Racetrack	AMPTLK5472MRT	C1	150.8	12.2	\$ 3240	\$ 3354	\$ 3467
60" x 60" Media Half-Racetrack	AMPTLK6060MRT	C1	138.6	11.4	\$ 3093	\$ 3201	\$ 3310
60" x 72" Media Half-Racetrack	AMPTLK6072MRT	C1	159.8	13.2	\$ 3245	\$ 3359	\$ 3473

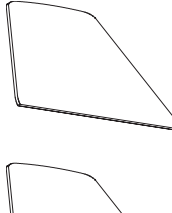

Description	Model	Cutout	Ship Weight	Cubes	List Price		
					L1	L2	L3
<b>Media Half-Diamond Tops Laminate Square Edge</b>							
48" x 54" Media Half-Diamond	AMPTLF4854MDIA	C1	89.0	7.1	\$ 1291	\$ 1336	\$ 1382
48" x 60" Media Half-Diamond	AMPTLF4860MDIA	C1	115.6	9.6	\$ 1406	\$ 1456	\$ 1505
54" x 54" Media Half-Diamond	AMPTLF5454MDIA	C1	100.0	9.7	\$ 1836	\$ 1901	\$ 1965
54" x 60" Media Half-Diamond	AMPTLF5460MDIA	C1	126.6	10.5	\$ 1980	\$ 2049	\$ 2119
54" x 72" Media Half-Diamond	AMPTLF5472MDIA	C1	150.8	12.2	\$ 2137	\$ 2213	\$ 2289
60" x 60" Media Half-Diamond	AMPTLF6060MDIA	C1	138.6	11.4	\$ 2072	\$ 2144	\$ 2216
60" x 72" Media Half-Diamond	AMPTLF6072MDIA	C1	159.8	13.2	\$ 2140	\$ 2217	\$ 2292

Description	Model	Cutout	Ship Weight	Cubes	List Price		
					L1	L2	L3
<b>Media Half-Diamond Tops Laminate Knife Edge</b>							
48" x 54" Media Half-Diamond	AMPTLK4854MDIA	C1	89.0	7.1	\$ 1937	\$ 2005	\$ 2073
48" x 60" Media Half-Diamond	AMPTLK4860MDIA	C1	115.6	9.6	\$ 2110	\$ 2185	\$ 2258
54" x 54" Media Half-Diamond	AMPTLK5454MDIA	C1	100.0	9.7	\$ 2758	\$ 2854	\$ 2950
54" x 60" Media Half-Diamond	AMPTLK5460MDIA	C1	126.6	10.5	\$ 2973	\$ 3077	\$ 3181
54" x 72" Media Half-Diamond	AMPTLK5472MDIA	C1	150.8	12.2	\$ 3222	\$ 3336	\$ 3449
60" x 60" Media Half-Diamond	AMPTLK6060MDIA	C1	138.6	11.4	\$ 3106	\$ 3214	\$ 3323
60" x 72" Media Half-Diamond	AMPTLK6072MDIA	C1	159.8	13.2	\$ 3227	\$ 3341	\$ 3455

<p><b>How to specify —</b> Select the Model Number from above.</p> <p>AMPT L                                    .           .</p>	<p><b>1st Option:</b> FSC Certified Wood: FSC Enter for FSC wood X Enter for non-FSC wood</p>	<p><b>2nd Option:</b> Laminate: See page 480 for finishes.</p>	<p><b>3rd Option:</b> Edge: See page 480 for finishes.</p>	<p><b>4th Option:</b> Cutout (if applicable): Upcharge of \$17 per cutout. C0 No cutout C1 Large center cutout</p> <p>C  </p>
---	---	--	--	---

Examples: AMPTLK4854MDIA.X.LT11.LM13.C1 AMPTLF4854MRT.FSC.LLA1.LWNW.C0

STRUCTURE



- External support stiffeners that ship with tops will not be used with panel base models that include beams.
- Removable end caps allow access to route power and data wires from the floor to undersurface.
- See page 485 for wire routing capacity from floor to undersurface.
- Panel base glides provide 3/4" adjustment.
- Power modules are ordered separately.
- 72" W top requires 2 single bases
- For tables 120" or greater, a set of beams is provided.



Description	Model	Ship Weight	Cubes	List Price		
				L1	L2	L3
<b>Hollow Panel Bases — Laminate</b>						
Single	AMPTPL	58.0	5.2	\$ 1667	\$ 1725	\$ 1784
for 84" Wide	AMPTPL84	125.0	10.9	\$ 3687	\$ 3803	\$ 3921
for 96" Wide	AMPTPL96	125.0	10.9	\$ 3687	\$ 3803	\$ 3921
for 120" Wide	AMPTPL120	131.0	11.2	\$ 3810	\$ 3926	\$ 4044
for 144" Wide	AMPTPL144	133.0	11.4	\$ 3937	\$ 4053	\$ 4171
for 168" Wide	AMPTPL168	135.0	16.9	\$ 5757	\$ 5931	\$ 6107
for 192" Wide	AMPTPL192	202.0	17.1	\$ 5925	\$ 6099	\$ 6275
for 216" Wide	AMPTPL216	204.0	17.3	\$ 6052	\$ 6226	\$ 6402
for 240" Wide	AMPTPL240	206.0	17.6	\$ 6205	\$ 6379	\$ 6555

<p><b>How to specify —</b> Select the Model Number from above.</p>	<p><b>1st Option:</b> <b>FSC Certified Wood:</b> FSC Enter for FSC wood X Enter for non-FSC wood</p>	<p><b>2nd Option:</b> <b>Laminate:</b> See page 480 for finishes.</p>	<p><b>3rd Option:</b> <b>Endcap:</b> See page 480 for finishes.</p>
<p>AMPTPL           .           .</p>		<p>          .</p>	<p>         </p>

Example: AMPTPL120.X.LT11.LM16









- ¼" tall, non-adjustable, slide glides on all bases.
- Some assembly required.

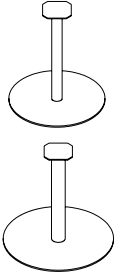

Description	Model	Ship Weight	Cubes	List Price	
				P1	P2
<b>Round Pedestal Bases</b>					
Medium Occasional Height	AMTPR18M	60.0	4.0	\$ 874	\$ 905
Medium Continental Height	AMTPR26M	60.0	4.0	\$ 897	\$ 928
Medium Seated Height	AMTPR29M	60.0	4.0	\$ 901	\$ 932
Medium Counter Height	AMTPR36M	62.0	4.6	\$ 1035	\$ 1071
Medium Bar Height	AMTPR42M	66.0	5.1	\$ 1063	\$ 1099
Large Occasional Height	AMTPR18L	95.0	4.5	\$ 1247	\$ 1290
Large Continental Height	AMTPR26L	95.0	4.5	\$ 1268	\$ 1311
Large Seated Height	AMTPR29L	95.0	4.5	\$ 1274	\$ 1317
Large Counter Height	AMTPR36L	98.0	5.1	\$ 1408	\$ 1456
Large Bar Height	AMTPR42L	101.0	5.6	\$ 1433	\$ 1481

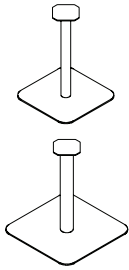

Description	Model	Ship Weight	Cubes	List Price	
				P1	P2
<b>Square Pedestal Bases</b>					
Medium Occasional Height	AMTPS18M	60.0	3.6	\$ 980	\$ 1011
Medium Continental Height	AMTPS26M	60.0	3.6	\$ 1003	\$ 1034
Medium Seated Height	AMTPS29M	60.0	3.6	\$ 1007	\$ 1038
Medium Counter Height	AMTPS36M	62.0	4.2	\$ 1141	\$ 1177
Medium Bar Height	AMTPS42M	66.0	4.7	\$ 1169	\$ 1205
Large Occasional Height	AMTPS18L	95.0	4.2	\$ 1296	\$ 1339
Large Continental Height	AMTPS26L	95.0	4.2	\$ 1317	\$ 1360
Large Seated Height	AMTPS29L	95.0	4.2	\$ 1323	\$ 1366
Large Counter Height	AMTPS36L	98.0	4.8	\$ 1457	\$ 1505
Large Bar Height	AMTPS42L	101.0	5.3	\$ 1482	\$ 1530

**How to specify —**  
Select the Model Number from above.

**1st Option:**  
**Paint Finishes:**  
P1 P2  
See page 480 for finishes.

AMPT | P | | | | | | . | | | |

Examples: AMTPR18M.P27 AMTPS18L.P27



# Structure

## T-Leg / Post-Leg / Community Bases

- T-leg table bases are available in painted or polished aluminum.
- T-leg available with glides or casters.
- T-leg casters are locking with urethane tread.
- T-leg glides provide ½" adjustment.
- T-leg bases require some assembly.
- AMPTGST support gussets are needed when ordering 60"W or greater tops with T-Legs.
- Height-adjustable post-legs adjust from 26½"H to 32½".
- Post-leg models contain four legs and ship two per carton.
- Post-legs require some assembly.
- Post-leg glides provide 1¼" adjustment.
- Community table legs come in kits of 2, 4, 6, or 8.
- Community legs provide a recessed channel with cover to route cords from floor to undersurface.
- Community leg glides provide 3" adjustment.

Description	Model	Ship Weight	Cubes	List Price		
				P1	P2	P3
<b>T-Leg Bases</b>						
Small, Pair, Seated Height w/Casters	AMPTTSSC	15.0	2.0	\$ 772	\$ 800	\$ 827
Small, Pair, Seated Height w/Glides	AMPTTSSG	15.0	2.0	\$ 772	\$ 800	\$ 827
Medium, Pair, Seated Height w/Casters	AMPTTMSC	17.0	2.0	\$ 839	\$ 869	\$ 898
Medium, Pair, Seated Height w/Glides	AMPTTMSG	17.0	2.0	\$ 839	\$ 869	\$ 898
Large, Pair, Seated Height w/Glides	AMPTTLSG	25.0	3.4	\$ 1071	\$ 1109	\$ 1147
Support Gusset for large tops — Pair	AMPTGST	5.0	0.2	\$ 184	\$ 191	\$ 198

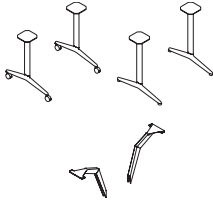

<b>T-Leg Bases — Polished</b>						
Description	Model	Ship Weight	Cubes	P1	P2	P3
Small, Pair, Seated Height w/Casters	AMPTTSSCP	15.0	2.0	\$ 931	\$ 964	\$ 997
Small, Pair, Seated Height w/Glides	AMPTTSSGP	15.0	2.0	\$ 931	\$ 964	\$ 997
Medium, Pair, Seated Height w/Casters	AMPTTMSCP	17.0	2.0	\$ 1022	\$ 1058	\$ 1094
Medium, Pair, Seated Height w/Glides	AMPTTMSGP	17.0	2.0	\$ 1022	\$ 1058	\$ 1094
Large, Pair, Seated Height w/Glides	AMPTTLSGP	25.0	3.4	\$ 1262	\$ 1306	\$ 1350

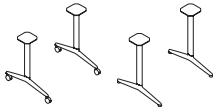

<b>Post-Leg Bases</b>						
Description	Model	Ship Weight	Cubes	P1	P2	P3
Kit of 4, Fixed Height w/Casters	AMPTPLC	13.0	1.2	\$ 771	\$ 792	\$ 812
Adjustable, Kit of 4 w/Casters	AMPTAPLC	13.0	1.2	\$ 949	\$ 972	\$ 995
Kit of 4, Fixed Height w/Glides	AMPTPLG	13.0	1.2	\$ 771	\$ 792	\$ 812
Adjustable, Kit of 4 w/Glides	AMPTAPLG	13.0	1.2	\$ 949	\$ 972	\$ 995

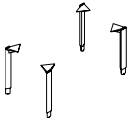

<b>Community Bases</b>						
Description	Model	Ship Weight	Cubes	P1	P2	P3
2-Leg Base	AMPTCL2	29.0	2.2	\$ 1120	\$ 1160	\$ 1199
2-Leg Base for hardwired use	AMPTCL2HW	29.0	2.2	\$ 1145	\$ 1186	\$ 1226
4-Leg Base	AMPTCL4	58.0	4.4	\$ 2240	\$ 2319	\$ 2397
4-Leg Base for hardwired use	AMPTCL4HW	58.0	4.4	\$ 2290	\$ 2371	\$ 2452
6-Leg Base	AMPTCL6	87.0	6.6	\$ 3360	\$ 3478	\$ 3596
6-Leg Base for hardwired use	AMPTCL6HW	87.0	6.6	\$ 3435	\$ 3556	\$ 3677
8-Leg Base	AMPTCL8	116	8.8	\$ 4480	\$ 4637	\$ 4794
8-Leg Base for hardwired use	AMPTCL8HW	116	8.8	\$ 4580	\$ 4742	\$ 4903

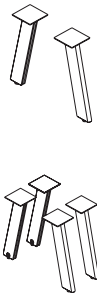

Hardwire Version

STRUCTURE

<p><b>How to specify —</b> Select the Model Number from above.</p>	<p><b>1st Option:</b> <b>Paint Finishes:</b>  <span>P1</span> <span>P2</span> <span>P3</span>            See page 480 for finishes.</p>
<p>AMPT                     .                    </p>	

Examples: AMPTTSSC.P27 AMPTAPLG.P27 AMPTCL4HW.P27







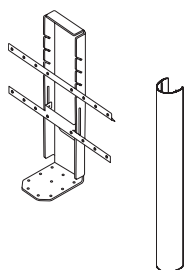



- Table Media Mount is used to mount a television to the end of a table top when not against a wall. Mounting hardware is provided for television sizes 32 to 50 with VESA Mounts of 100x100 to 200x200; for some televisions, additional hardware is required.
- The Wire Management Covers snap on to legs. See wire capacity on page 484.
- The Cable Management Tray attaches under the surface and is 4" deep to contain cables, a power strip and/or surge protector.
- Wire management channel has self adhesive backing to attach to panels or underside of surface.
- Each wire-management channel has 2 cavities that can hold six .22" dia. cables
- Wire basket models include basket and two vertical hanging supports made of .148" dia. steel wire.
- Verticals must be placed 18" or more apart from one another and must be within 15" from each end of the basket. Can hold a maximum load of 25 lbs.
- A cord management snake is used to route and conceal power/data cables from outlet to undersurface. Includes all mounting hardware and a plate to secure to leveling glide. Can house six .300" dia. cables.
- Table media mount, AMPTTMM, can only be used with the Structure Media Round/Square Pedestal Base Kit found on page 518.

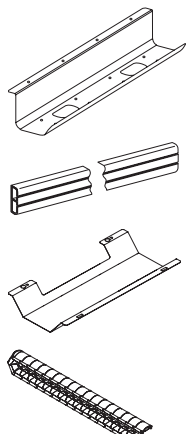

Description	Model	Ship Weight	Cubes	List Price		
				P1	P2	P3
<b>Accessories</b>						
Table Media Mount	AMPTTMM	4.0	0.4	\$ 308	\$ 319	\$ 330
Wire Manager Cover for T-Leg - Medium	AMPTWMCOM	4.0	0.4	\$ 121	\$ 126	\$ 130
Wire Manager Cover for T-Leg - Large	AMPTWMCOL	4.0	0.4	\$ 136	\$ 141	\$ 146
Wire Manager Cover for Medium Column - Short	AMPTWMCRSRS	4.0	0.4	\$ 121	\$ 126	\$ 130
Wire Manager Cover for Medium Column - Long	AMPTWMCURL	4.0	0.4	\$ 152	\$ 158	\$ 163
Wire Manager Cover for Large Column - Short	AMPTWMCLRS	4.0	0.4	\$ 168	\$ 174	\$ 180
Wire Manager Cover for Large Column - Long	AMPTWMCLRL	4.0	0.4	\$ 201	\$ 208	\$ 216
Wire Manager Cover for X Base - Short	AMPTWMCXBS	4.0	0.4	\$ 121	\$ 126	\$ 130
Wire Manager Cover for X Base - Long	AMPTWMCXBL	4.0	0.4	\$ 152	\$ 158	\$ 163

Wire Manager Model	Description	Actual Length	Target Bases
AMPTWMCOM	Wire Manager Cover for T-Leg Medium	21"	All Small & Medium T-Legs
AMPTWMCOL	Wire Manager Cover for T-Leg Large	21"	All Large T-Legs
AMPTWMCRSRS	Wire Manager Cover for Medium Column - Short	22"	Medium Pedestal Bases, Continental & Seated Heights
AMPTWMCURL	Wire Manager Cover for Medium Column - Long	33"	Medium Pedestal Bases, Counter & Bar Heights
AMPTWMCLRS	Wire Manager Cover for Large Column - Short	22"	Large Pedestal Bases, Continental & Seated Heights
AMPTWMCLRL	Wire Manager Cover for Large Column - Long	32"	Large Pedestal Base, Counter & Bar Heights
AMPTWMCXBS	Wire Manager Cover for X Base - Short	16"	Medium & Large X Base, Continental & Seated Heights
AMPTWMCXBL	Wire Manager Cover for X Base - Long	25"	Medium and Large X base, Counter & Bar Heights



Description	Model	List Price
<b>Cable Management Tray</b>		
24" Tray	AJTRGH24 	\$ 123
36" Tray	AJTRGH36 	\$ 147
<b>Note: Black only.</b>		
<b>Wire Management Channel (Black only)</b>		
92" Long	AEV920 	\$ 227
<b>Under Worksurface Trough (Black only)</b>		
17" W — Single Pack	Z617UWTRGH 	\$ 104
17" W — Ten Pack	Z61710UWTRGH 	\$ 1053
36" W — Single Pack	Z636UWTRGH 	\$ 183
36" W — Ten Pack	Z63610UWTRGH	\$ 1785
<b>Cord Management Snake (Black Only)</b>		
58"	WKSWMC	\$ 415

 Shippable by small-package carrier.

**How to specify —**  
Select the Model Number from above.

**1st Option:**  
**Paint Finish**  
(if applicable):  
    
See page 480 for finishes.

Examples: AMPTWMB.FOG AJTRGH24 Z617UWTRGH

- 10' corded power models used in C1, C2, and C3 cutouts.
- Power/data ports used in G1 or ATE cutouts.
- HDMI and VGA Kits to be used in data ports on electrical models.

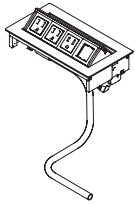
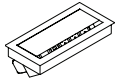

Description	Model	Ship Weight	Cubes	List Price P1
<b>Hardwire Power Solutions (Surface Mounted)</b>				
10' hardwire power includes 4 power/2 data ports	AMPTP1HW	5.0	0.4	\$ 1082
10' hardwire power includes 3 power/1 Extron cut-out	AMPTP2HW	5.0	0.4	\$ 976
10' hardwire power includes 3 power/1 dual USB A+C/2 data ports	AMPTP3HW	5.0	0.4	\$ 1189
10' hardwire power includes 3 power/1 dual USB A+C/Wireless Charging	AMPTP4HW	5.0	0.4	\$ 1387

**Note:** For use with C1, C2, and C3 cutouts.

**Power/Data Ports**

Power Harness Hardwired – 3 AC / 1 Open Data	AW4P2H <b>S</b>	3	1.9	\$ 607
--	-----------------	---	-----	--------

**Note:** For use with G1 or ATE cutouts.

<p><b>How to specify —</b> Select the Model Number from above.</p>	<p><i>1st Option:</i> <b>Paint Finish</b> (if applicable): <b>P1 P2</b> See page 480 for finishes.</p>
<p>Examples:</p>	

- 10' corded power models used in C1, C2, and C3 cutouts.
- Power/data ports used in G1 or ATE cutouts.
- HDMI and VGA Kits to be used in data ports on electrical models.

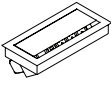
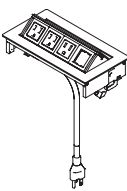
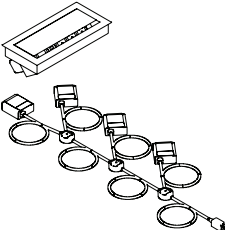
	Description	Model	Ship Weight	Cubes	List Price P1
	<b>Corded Power Solutions (Surface Mounted)</b>				
	10' corded power includes 4 power/2 data ports	AMPTP1	5.0	0.4	\$ 942
	10' corded power includes 3 power/1 Extron cut-out	AMPTP2	5.0	0.4	\$ 837
	10' corded power includes 3 power/1 dual USB A+C/2 data ports	AMPTP3	5.0	0.4	\$ 1051
	10' corded power includes 3 power/1 dual USB A+C/Wireless Charging	AMPTP4	5.0	0.4	\$ 1258
	<b>Note:</b> For use with C1, C2, and C3 cutouts.				
	<b>Power/Data Ports</b>				
	Power Harness Corded – 3 AC / 1 Open Data	AW4P2C <span style="border: 1px solid black; padding: 0 2px;">S</span>	3	1.9	\$ 607
	<b>Note:</b> For use with G1 or ATE cutouts.				
	<b>Under Surface Power Solutions</b>				
	Small Undersurface mount power — 2 modules including 1 A/C and Dual USB	AMPTUSPS2	5.0	0.1	\$ 830
	Small Undersurface mount power — 1 module including 2 A/C - Corded	AMPTUSPS1A	5.0	0.1	\$ 195
	Small Undersurface mount power — 1 module including 1 A/C and Dual USB - Corded	AMPTUSPS1U	5.0	0.1	\$ 455
	Small Undersurface mount power — 4 modules including 1 A/C and Dual USB	AMPTUSPS4	5.0	0.1	\$ 1748
	Medium Undersurface mount power — 4 modules including 1 A/C and Dual USB	AMPTUSPM4	5.0	0.1	\$ 1759
	Large Undersurface mount power — 3 modules including 1 AC and Dual USB	AMPTUSPL3	5.0	0.1	\$ 1328
	Large Undersurface mount power — 4 modules including 1 A/C and Dual USB	AMPTUSPL4	5.0	0.1	\$ 1764
Structure XL Under Top Power 4-Modules with AC/Dual USB	AMPTUSPXL4	5.0	0.1	\$ 1772	

<p><b>How to specify —</b> Select the Model Number from above.</p>	<p><i>1st Option:</i> <b>Paint Finish</b> (if applicable): <span style="border: 1px solid black; border-radius: 50%; padding: 2px;">P1</span> <span style="border: 1px solid black; border-radius: 50%; padding: 2px;">P2</span> See page 480 for finishes.</p>
--	---

Examples: AMPTP1.FOG AMPTUSPM4 AMPTUSPS1U

- 10' corded power models used in C1, C2, and C3 cutouts.
- Power/data ports used in G1 or ATE cutouts.
- HDMI and VGA Kits to be used in data ports on electrical models.

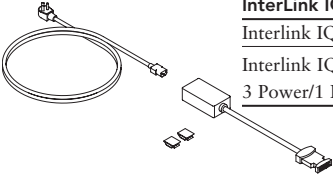

Description	Model	Ship Weight	Cubes	List Price P1
<b>InterLink IQ</b>				
Interlink IQ Starter with 72" Infeed cord	AW4QBI <span>S</span>	2.0	0.2	\$ 828
Interlink IQ Power Harness — 3 Power/1 Dual USB A+C/2 OpenWindows	AM4QH3P1U2B	5.0	0.2	\$ 1308
<b>Extron Plate (Double Space) — VGA, HDMI, HDMI, Audio</b>				
VGA Kit	AMPTPVG	5.0	0.1	\$ 318
HDMI Kit	AMPTPHI	5.0	0.1	\$ 227



Description	Model	Ship Weight	Cubes	List Price
<b>Universal Hook (Black only)</b>				
Package of 2	AGSAUHK <span>S</span>	3	0.2	\$ 128
<b>Ganging Bracket</b>				
Bracket includes Hardware	AW4GANG <span>S</span>	0.2	0.0	\$ 98

STRUCTURE

**How to specify —**  
Select the Model Number from above.

**1st Option:**  
**Paint Finish**  
(if applicable):  
P1 P2  
See page 480 for finishes.

Examples: AMPTPLATE AMPTPVG

GSA SIN 33721

Description	Model	P1 Paint List Price	P2 Paint List Price
<b>Touch-Up Paint — Brush</b>			
Bottle of Touch-Up Paint with Brush — 0.5 oz.	APTK <span style="border: 1px solid black; padding: 0 2px;">S</span>	\$ 94	\$ 104
<b>Touch-Up Paint — Spray</b>			
Spray Can of Touch-Up Paint — 12 oz.	ARSLCC <span style="border: 1px solid black; padding: 0 2px;">S</span>	\$ 94	\$ 104

<p><i>How to specify —</i> Select the Model Number from above.</p> <p>A               .</p>	<p><i>1st Option:</i> <b>Paint Color:</b> <span style="border: 1px solid black; border-radius: 50%; padding: 2px;">P1</span> <span style="border: 1px solid black; border-radius: 50%; padding: 2px;">P2</span> <span style="border: 1px solid black; border-radius: 50%; padding: 2px;">P3</span></p> <p>See available Touch-Up Paint colors listed above. Some colors are limited to brush or spray.</p> <p>               </p>
---	---

Examples: APTK.P02 ARSLCC.P02

S Shippable by small-package carrier.

Cleaning instructions are listed on the back of our fabric cards and are available in written form upon request.

### CLEANING CODES

- D** Dry clean only.
- L** Clean with warm water and mild soap, using clean cloth, as soon as possible.
- P** Clean with detergent and water or perchlorethylene.
- R** Detailed recommended cleaning and/or disinfecting procedures are available upon request.
- S** Only pure, water-free solvents may be used. CAUTION: Use of water-based or detergent-based solvents may cause shrinking and/or permanent water stains.
- SM** Same as S. Do not brush.
- SW** Clean with water-based cleaning agents, foam or pure water-free solvents (Energine, Carbona, Renuzit, or other similar products). Vacuuming or light brushing is recommended to prevent dust and soil buildup.
- W** Water-based cleaning agents or foam may be used.
- WS** See SW.
- X** Brush or vacuum only.
- XS** Brush and vacuum only, NO liquid cleaners.

### CLEANING VINYL

Vinyl-coated fabrics are perhaps the most maintenance-free fabrics ever produced and certainly will provide exceptional service life if given proper care. Almost all vinyl manufacturers now provide information concerning the necessary cleaning procedures for their products. In reality, all care and maintenance instructions are the same for all coated fabrics regardless of their manufacturing origin.

**Everyday soil** — A gentle mixture of any mild soap and warm water will generally dissipate most common soil from the surface. Using a soft cloth, wash the area to be cleaned and rinse. If stubborn dirt remains, such as a stain embedded in the grain of the vinyl, use a soft brush, and if necessary, a touch of cleaning powder. In both situations, rinse and dry with a soft cloth.

**Gum** — Remove as much chewing gum as possible prior to the application of Naptha or Kerosene, worked in with a soft cloth. If gum cannot be removed, ice may be used to harden the gum so that it separates itself from the vinyl surface. (This same method is also useful in removing wax.)

**Ink Spots** — You must work quickly! Magic Marker, India ink, and ballpoint pen immediately will affect pigments, and, for the most part, are difficult to remove. It is recommended that a solution of water and rubbing alcohol be applied and gently rubbed on the spot as soon as possible. Hair sprays containing alcohol are sometimes effective in emergencies for removing ink.

**Nail Polish and Polish Remover** — These products will immediately damage vinyl surfaces and, to retard further damage, should be carefully wiped clean.

**Paint** — Try to remove as soon as possible. It is not recommended that any paint removers or brush cleaners be used. Clean oil-based paints with a soft clean cloth and Naptha. To clean latex-based paints, use the same method as recommended for everyday soil.

**Tar, Asphalt, Etc.** — Petroleum-based products will stain all vinyl if allowed to stand too long. Clean as soon as possible with a cloth followed by the immediate application of Kerosene or Naptha.

Products are now on the market that are manufactured to enhance the beauty and service life of all vinyl. However, by using the methods described above with sensible care and attention, the consumer should enjoy years of satisfaction and pride with any vinyl-coated fabrics.

### CLEANING LEATHER

Because leather is a natural product, it needs very little or no care during normal usage.

**Spots and Spills** — Wipe excess liquid up immediately with a clean, absorbent cloth or sponge. If necessary, use clean lukewarm water only and let dry naturally. If water is used, clean the entire area where the spot occurred. An example would be the entire seat cushion or the entire arm. Do not dry wet areas with hair dryers, etc.

**Stubborn Spots and Stains** — Use a mild, non-detergent cleaner such as bar or Ivory soap. Apply the soap to a clean, wet sponge and wash, then rinse well. Allow to dry naturally.

**Butter, Oil, or Grease** — Wipe excess butter, oil or grease off of the leather with a clean dry cloth, then leave it alone as the spot should dissipate into the leather in a short period of time. Do not apply water or try to wash a butter, oil, or grease spot.

**DO NOT USE** saddle soap, cleaning solvent, furniture polish, oils, varnish, abrasive cleaners, soaps, window cleaner, or ammonia water.

Allsteel, as an HNI company, adheres to the HNI Enterprise Sustainability Policy of 2008 and its related procedures. The Design for the Environment Procedure directs the product design process to consider potential environmental impacts of the product; including materials selection, packaging and transport, product use, and design for disassembly at the end of the product's useful life. The Manufacture for the Environment Procedure sets goals related to energy efficiency, waste recycling, air emissions reductions, worker safety, water efficiency, increased renewable energy, and chemical reductions.

The Enterprise Sustainability Policy sets goals and measures results, driven by the ANSI/BIFMA e3 Furniture Sustainability Standard and evaluated in the 3rd party certification called level®. Rigorous quantitative evaluation criteria cover four categories: materials, energy and atmosphere, human and ecosystem health, and social responsibility. The audit process evaluates the individual products, the manufacturing site(s), and the corporation. Allsteel's furniture is level 2 and level 3 certified to the standard. (ANSI is the American National Standards Institute, an organization that directs the transparent development process of national standards.)

In addition, Allsteel's products support requirements of LEED (Leadership in Energy and Environmental Design), the green building rating system. Whether a customer seeks to achieve LEED certification or just obtain the benefits without certification, Allsteel's products meet the standards set forth in LEED. Allsteel is proud to support sustainability initiatives in the building industry as a member of the U.S. Green Building Council (USGBC).

Allsteel complies with the Federal Trade Commission Part 260 Guide for the Use of Environmental Marketing Claims. Our third-party certifications support our environmental statements and our credibility. Third-party certification involves an independent assessment declaring that specified requirements pertaining to a product, process or management system have been met. Allsteel's third party certifications include BIFMA level® 2, SCS Indoor Advantage™ Gold, and FSC®. Select products are Cradle to Cradle Certified™ Bronze and/or have third party certified Environmental Product Declarations.

Nearly all of Allsteel's products are level 2 or level 3 and Indoor Advantage Gold certified. FSC® certified products are available; check price lists for details.

**Visit our website for the latest Allsteel sustainability information: [allsteeloffice.com](http://allsteeloffice.com).**



# Cross Reference Index

by Model Number

Model	Page	Model	Page	Model	Page	Model	Page
831124	453	A876072	397	AF5RND6030D	392	ALED17U	422
831130	453	A876072A	397	AF5RND6624D	392	ALED17U60	422
873600	398	A877012	397	AF5RND6630D	392	ALED17UJMP30	422
A6BLUETOOTH	391	AALG	56	AF5RND7224D	392	ALED31U	422
A6CASTER	391	AALP	56	AF5RND7230D	392	ALED31U60	422
A6G1GLIDE	391	AALS	56	AF5RND7824D	392	ALED31UJMP30	422
A6MREC3S2LCF	390	AALW	56	AF5RND7830D	392	ALEDOCC	422
A6MREC3S2LTF	390	AAMG	56	AF5RND8424D	392	AM4QH3P1U2B	457, 526
A6MREC3S3LCF	391	AAMP	56	AF5RND8430D	392	AMADHD	428
A6MREC3S3LTF	391	AAMS	56	AF5RND9024D	392	AMASD	428
A6REC2S2LCF	390	AAMW	56	AF5RND9030D	392	AMASD-G	428
A6REC2S2LTF	390	AAPACM2	422	AF5RND9624D	392	AMASHD	428
A6REC2S3LCF	391	AAS1520	401	AF5RND9630D	392	AMASHDCK	429
A6REC2S3LTF	391	AAS1548	401	AF5RS3624U	393	AMASTS	428
A6REC3S2LCF	390	AAS1554	401	AF5RS3630U	393	AMASTSCK	429
A6REC3S2LTF	390	AAS1560	401	AF5RS4224U	393	AMASTS-G	428
A6REC3S3LCF	391	AAS1566	401	AF5RS4230U	393	AMPTAPLC	521
A6REC3S3LTF	391	AAS1572	401	AF5RS4824	392	AMPTAPLG	521
A6SLDGLIDE	391	ABPWVMOD	364, 41	AF5RS4824U	393	AMPTCB	515
A9CLWMC	404	ACD1	419	AF5RS4830	392	AMPTCB84	515
A87P2U1R	458	ACDIV	215	AF5RS4830U	393	AMPTCB96	515
A5622ELS	394	ACEGUM	216	AF5RS5424	392	AMPTCB120	515
A5622ERS	394	ACEGUS	216	AF5RS5424U	393	AMPTCB144	515
A5722ELS	394	ACM-MUCA	60	AF5RS5430	392	AMPTCB168	515
A5722ERS	394	ACM-MUCO	60	AF5RS5430U	393	AMPTCB192	515
A5822ELS	394	ACM-MUGA	60	AF5RS6024D	392	AMPTCB216	515
A5822ERS	394	ACM-MUGO	60	AF5RS6024UD	393	AMPTCB240	515
A5922ELS	394	ACOMDOME2	424	AF5RS6030D	392	AMPTCBST	515
A5922ERS	394	ACPERU	224	AF5RS6030UD	393	AMPTCBST84	515
A870302	424, 458	ACPICBL	220, 354	AF5RS6624D	392	AMPTCBST96	515
A870824	422	ACPICBL24	220, 354	AF5RS6624UD	393	AMPTCBST120	515
A870824CH	422	ACPICBU	222, 356	AF5RS6630D	392	AMPTCBST144	515
A870830	422	ACPICLS	222, 356	AF5RS6630UD	393	AMPTCBST168	515
A870830CH	422	ACPICCT	220, 354	AF5RS7224D	392	AMPTCBST192	515
A870842	422	ACPICCT30	220, 354	AF5RS7224UD	393	AMPTCBST216	515
A870842CH	422	ACPICCTC24	220, 354	AF5RS7230D	392	AMPTCBST240	515
A870860	422	ACPICCTC30	220, 354	AF5RS7230UD	393	AMPTCL2	521
A870860CH	422	ACPU1	413	AF5RS7824D	392	AMPTCL2HW	521
A871124	396	ACVISCTBL	214, 353	AF5RS7824UD	393	AMPTCL4	521
A871124A	396	ACVISDLM	212	AF5RS7830D	392	AMPTCL4HW	521
A871148	396	ACVISDLS	212	AF5RS7830UD	393	AMPTCL6	521
A871148A	396	ACVISDRM	212	AF5RS8424D	392	AMPTCL6HW	521
A871160	396	ACVISDRS	212	AF5RS8424UD	393	AMPTCL8	521
A871160A	396	ACVISOTS	212	AF5RS8430D	392	AMPTCL8HW	521
A871172	396	ACVISSLM	212	AF5RS8430UD	393	AMPTCYL	516
A871172A	396	ACVISSLS	212	AF5RS9024D	392	AMPTCYL84	516
A871248	396	ACVISSRM	212	AF5RS9024UD	393	AMPTCYL96	516
A871248A	396	ACVISSRS	212	AF5RS9030D	392	AMPTCYL120	516
A871254	396	ACVISTBL	214, 353	AF5RS9030UD	393	AMPTCYL144	516
A871254A	396	ACWEDM	218	AF5RS9624D	392	AMPTCYL168	516
A871260	396	ACWEDS	218	AF5RS9624UD	393	AMPTCYL192	516
A871260A	396	AECH	401	AF5RS9630D	392	AMPTCYL216	516
A871266	396	AEHF	401	AF5RS9630UD	393	AMPTCYL240	516
A871266A	396	AESS	401	AF5120S4224D	393	AMPTCYLSM	516
A871272	396	AEV920	395, 523	AF5120S4230D	393	AMPTCYLWM	516
A871272A	396	AF5CCS5424	393	AF5120S4824D	393	AMPTCYLWM84	516
A871400	397	AF5CCS5430	393	AF5120S4830D	393	AMPTCYLWM96	516
A871400A	397	AF5CCS603624LD	394	AF5120S5424D	393	AMPTCYLWM120	516
A871501A	397	AF5CCS603624RD	394	AF5120S5430D	393	AMPTCYLWM144	516
A871502A	397	AF5CCS604824LD	394	AFLG	56	AMPTCYLWM168	516
A871503A	397	AF5CCS604824RD	394	AFLP	56	AMPTCYLWM192	516
A871601	397	AF5CCS604830LD	394	AFLS	56	AMPTCYLWM216	516
A871601A	397	AF5CCS604830RD	394	AFLW	56	AMPTCYLWM240	516
A871912	397	AF5CCS723624LD	394	AFMG	56	AMPTGST	521
A871912A	397	AF5CCS723624RD	394	AFMP	56	AMPTLF30HRND	522
A871918	397	AF5CCS724824LD	394	AFMS	56	AMPTLF30HRNDP	522
A871918A	397	AF5CCS724824RD	394	AFMW	56	AMPTLF30HSQR	522
A871972	397	AF5CCS724830LD	394	AGSAUHK	406, 455, 526	AMPTLF30HSQR	522
A871972A	397	AF5CCS724830RD	394	AJTRGH24	395, 523	AMPTLF36ARNND	522
A873501	397	AF5RND4824	392	AJTRGH36	395, 523	AMPTLF36ARNNDP	522
A873502	397	AF5RND4830	392	AKMH	413	AMPTLF36HRND	522
A873503	397	AF5RND5424	392	AKTLONG	413	AMPTLF36HRNDP	522
A873504	397	AF5RND5430	392	AKTMID	413	AMPTLF36HSQR	522
A873506	397	AF5RND6024D	392	AKTSHORT	413	AMPTLF36HSQR	522

# Cross Reference Index

by Model Number

Model	Page	Model	Page	Model	Page	Model	Page
AMPTLF54RND	500	AMPTLF4896DIA	503	AMPTLFPO42RND	500	AMPTLK4284RT	507
AMPTLF54SQR	501	AMPTLF4896RE	509	AMPTLFPO42SSQR	501	AMPTLK4296DIA	503
AMPTLF54SSQR	502	AMPTLF4896RT	506	AMPTLFPO42SSQR	502	AMPTLK4296RE	510
AMPTLF60RND	500	AMPTLF5454MDIA	513	AMPTLFPO48RND	500	AMPTLK4296RT	507
AMPTLF60SQR	501	AMPTLF5454MRE	512	AMPTLFPO48SQR	501	AMPTLK4854MDIA	513
AMPTLF60SSQR	502	AMPTLF5454MRT	513	AMPTLFPO48SSQR	502	AMPTLK4854MRE	512
AMPTLF72RND	500	AMPTLF5460MDIA	513	AMPTLK30HRND	522	AMPTLK4854MRT	513
AMPTLF72SQR	501	AMPTLF5460MRE	512	AMPTLK30HRNDP	522	AMPTLK4860MDIA	513
AMPTLF72SSQR	502	AMPTLF5460MRT	513	AMPTLK30HSQR	522	AMPTLK4860MRE	512
AMPTLF84RND	500	AMPTLF5472MDIA	513	AMPTLK30HSQRP	522	AMPTLK4860MRT	513
AMPTLF84SQR	501	AMPTLF5472MRE	512	AMPTLK36ARND	522	AMPTLK4872DIA	503
AMPTLF84SSQR	502	AMPTLF5472MRT	513	AMPTLK36ARNDP	522	AMPTLK4872RE	510
AMPTLF2436RE	509	AMPTLF5496DIA	503	AMPTLK36HRND	522	AMPTLK4872RT	507
AMPTLF2436RT	506	AMPTLF5496RE	509	AMPTLK36HRNDP	522	AMPTLK4884DIA	503
AMPTLF2440DIA	503	AMPTLF5496RT	506	AMPTLK36HSQR	522	AMPTLK4884RE	510
AMPTLF2442RE	509	AMPTLF6060MDIA	513	AMPTLK36HSQRP	522	AMPTLK4884RT	507
AMPTLF2442RT	506	AMPTLF6060MRE	512	AMPTLK54RND	500	AMPTLK4896DIA	503
AMPTLF2448RE	509	AMPTLF6060MRT	513	AMPTLK54SQR	501	AMPTLK4896RE	510
AMPTLF2448RT	506	AMPTLF6072MDIA	513	AMPTLK54SSQR	502	AMPTLK4896RT	507
AMPTLF2460RE	509	AMPTLF6072MRE	512	AMPTLK60RND	500	AMPTLK5460MDIA	513
AMPTLF2460RT	506	AMPTLF6072MRT	513	AMPTLK60SQR	501	AMPTLK5454MRE	512
AMPTLF2472RE	509	AMPTLF36120RE	511	AMPTLK60SSQR	502	AMPTLK5454MRT	513
AMPTLF2472RT	506	AMPTLF36144RE	511	AMPTLK72RND	500	AMPTLK5460MDIA	513
AMPTLF2484RE	509	AMPTLF42120RE	511	AMPTLK72SQR	501	AMPTLK5460MRE	512
AMPTLF2484RT	506	AMPTLF42120RT	508	AMPTLK72SSQR	502	AMPTLK5460MRT	513
AMPTLF3042RE	509	AMPTLF42144RE	511	AMPTLK84RND	500	AMPTLK5472MDIA	513
AMPTLF3042RT	506	AMPTLF42144RT	508	AMPTLK84SQR	501	AMPTLK5472MRE	512
AMPTLF3048RE	509	AMPTLF48120DIA	504	AMPTLK84SSQR	502	AMPTLK5472MRT	513
AMPTLF3048RT	506	AMPTLF48120RE	511	AMPTLK2436RE	510	AMPTLK5496DIA	503
AMPTLF3050DIA	503	AMPTLF48120RT	508	AMPTLK2436RT	507	AMPTLK5496RE	510
AMPTLF3052BT	505	AMPTLF48144DIA	504	AMPTLK2440DIA	503	AMPTLK5496RT	507
AMPTLF3060BT	505	AMPTLF48144RE	511	AMPTLK2442RE	510	AMPTLK6060MDIA	513
AMPTLF3060RE	509	AMPTLF48144RT	508	AMPTLK2442RT	507	AMPTLK6060MRE	512
AMPTLF3060RT	506	AMPTLF54120DIA	504	AMPTLK2448RE	510	AMPTLK6060MRT	513
AMPTLF3072BT	505	AMPTLF54120RE	511	AMPTLK2448RT	507	AMPTLK6072MDIA	513
AMPTLF3072RE	509	AMPTLF54120RT	508	AMPTLK2460RE	510	AMPTLK6072MRE	512
AMPTLF3072RT	506	AMPTLF54144DIA	504	AMPTLK2460RT	507	AMPTLK6072MRT	513
AMPTLF3084RE	509	AMPTLF54144RE	511	AMPTLK2472RE	510	AMPTLK36120RE	511
AMPTLF3084RT	506	AMPTLF54144RT	508	AMPTLK2472RT	507	AMPTLK36144RE	511
AMPTLF3648RE	509	AMPTLF54168DIA	504	AMPTLK2484RE	510	AMPTLK42120RE	511
AMPTLF3648RT	506	AMPTLF54168RE	511	AMPTLK2484RT	507	AMPTLK42120RT	508
AMPTLF3652BT	505	AMPTLF54168RT	508	AMPTLK3042RE	510	AMPTLK42144RE	511
AMPTLF3660BT	505	AMPTLF54192DIA	504	AMPTLK3042RT	507	AMPTLK42144RT	508
AMPTLF3660RE	509	AMPTLF54192RE	511	AMPTLK3048RE	510	AMPTLK42120DIA	504
AMPTLF3660RT	506	AMPTLF54192RT	508	AMPTLK3048RT	507	AMPTLK48120RE	511
AMPTLF3672BT	505	AMPTLF54216RE	511	AMPTLK3050DIA	503	AMPTLK48120RT	508
AMPTLF3672RE	509	AMPTLF54216RT	508	AMPTLK3052BT	505	AMPTLK48144DIA	504
AMPTLF3672RT	506	AMPTLF54240RE	511	AMPTLK3060BT	505	AMPTLK48144RE	511
AMPTLF3684RE	509	AMPTLF54240RT	508	AMPTLK3060RE	510	AMPTLK48144RT	508
AMPTLF3684RT	506	AMPTLF60120DIA	504	AMPTLK3060RT	507	AMPTLK54120DIA	504
AMPTLF3696RE	509	AMPTLF60120RE	511	AMPTLK3072BT	505	AMPTLK54120RE	511
AMPTLF3696RT	506	AMPTLF60120RT	508	AMPTLK3072RE	510	AMPTLK54120RT	508
AMPTLF4260RE	509	AMPTLF60144DIA	504	AMPTLK3072RT	507	AMPTLK54144DIA	504
AMPTLF4272DIA	503	AMPTLF60144RE	511	AMPTLK3084RE	510	AMPTLK54144RE	511
AMPTLF4272RE	509	AMPTLF60144RT	508	AMPTLK3084RT	507	AMPTLK54144RT	508
AMPTLF4272RT	506	AMPTLF60168DIA	504	AMPTLK3648RE	510	AMPTLK54168DIA	504
AMPTLF4284DIA	503	AMPTLF60168RE	511	AMPTLK3648RT	507	AMPTLK54168RE	511
AMPTLF4284RE	509	AMPTLF60168RT	508	AMPTLK3652BT	505	AMPTLK54168RT	508
AMPTLF4284RT	506	AMPTLF60192DIA	504	AMPTLK3660BT	505	AMPTLK54192DIA	504
AMPTLF4296DIA	503	AMPTLF60192RE	511	AMPTLK3660RE	510	AMPTLK54192RE	511
AMPTLF4296RE	509	AMPTLF60192RT	508	AMPTLK3660RT	507	AMPTLK54192RT	508
AMPTLF4296RT	506	AMPTLF60216RE	511	AMPTLK3672BT	505	AMPTLK54216RE	511
AMPTLF4854MDIA	513	AMPTLF60216RT	508	AMPTLK3672RE	510	AMPTLK54216RT	508
AMPTLF4854MRE	512	AMPTLF60240RE	511	AMPTLK3672RT	507	AMPTLK54240RE	511
AMPTLF4854MRT	513	AMPTLF60240RT	508	AMPTLK3684RE	510	AMPTLK54240RT	508
AMPTLF4860MDIA	513	AMPTLFPO24RND	500	AMPTLK3684RT	507	AMPTLK60120DIA	504
AMPTLF4860MRE	512	AMPTLFPO24SQR	501	AMPTLK3696RE	510	AMPTLK60120RE	511
AMPTLF4860MRT	513	AMPTLFPO24SSQR	502	AMPTLK3696RT	507	AMPTLK60120RT	508
AMPTLF4872DIA	503	AMPTLFPO30RND	500	AMPTLK4260RE	510	AMPTLK60144DIA	504
AMPTLF4872RE	509	AMPTLFPO30SQR	501	AMPTLK4272DIA	503	AMPTLK60144RE	511
AMPTLF4872RT	506	AMPTLFPO30SSQR	502	AMPTLK4272RE	510	AMPTLK60144RT	508
AMPTLF4884DIA	503	AMPTLFPO36RND	500	AMPTLK4272RT	507	AMPTLK60168DIA	504
AMPTLF4884RE	509	AMPTLFPO36SQR	501	AMPTLK4284DIA	503	AMPTLK60168RE	511
AMPTLF4884RT	506	AMPTLFPO36SSQR	502	AMPTLK4284RE	510	AMPTLK60168RT	508

# Cross Reference Index

by Model Number

Model	Page	Model	Page	Model	Page	Model	Page
AMPTLK60192DIA	504	AMPTPS26M	519	AMS2054LH	400	ATLADM-BAMEDIAM4860L	364.30
AMPTLK60192RE	511	AMPTPS26MPWR	520	AMS2054RH	400	ATLADM-BAMEDIAM4860S	364.30
AMPTLK60192RT	508	AMPTPS29L	519	AMS2054SS	401	ATLADM-BAMEDIAM4872B	364.30
AMPTLK60216RE	511	AMPTPS29LPWR	520	AMS2054US	400	ATLADM-BAMEDIAM4872C	364.30
AMPTLK60216RT	508	AMPTPS29M	519	AMS2060LH	400	ATLADM-BAMEDIAM4872L	364.30
AMPTLK60240RE	511	AMPTPS29MPWR	520	AMS2060RH	400	ATLADM-BAMEDIAM4872S	364.30
AMPTLK60240RT	508	AMPTPS36L	519	AMS2060SS	401	ATLADM-BAMEDIAM4884B	364.30
AMPTLKPO24RND	500	AMPTPS36LPWR	520	AMS2060US	400	ATLADM-BAMEDIAM4884C	364.30
AMPTLKPO24SQR	501	AMPTPS36M	519	AMS2066LH	400	ATLADM-BAMEDIAM4884L	364.30
AMPTLKPO24SSQR	502	AMPTPS36MPWR	520	AMS2066RH	400	ATLADM-BAMEDIAM4884S	364.30
AMPTLKPO30RND	500	AMPTPS42L	519	AMS2066SS	401	ATLADM-BAMEDIAM4896B	364.30
AMPTLKPO30SQR	501	AMPTPS42LPWR	520	AMS2066US	400	ATLADM-BAMEDIAM4896C	364.30
AMPTLKPO30SSQR	502	AMPTPS42M	519	AMS2072LH	400	ATLADM-BAMEDIAM4896L	364.30
AMPTLKPO36RND	500	AMPTPS42MPWR	520	AMS2072RH	400	ATLADM-BAMEDIAM4896S	364.30
AMPTLKPO36SQR	501	AMPTPSMEDIA18M	518	AMS2072SS	401	ATLADM-BCONML2048B	364.35
AMPTLKPO36SSQR	502	AMPTPSMEDIA26M	518	AMS2072US	400	ATLADM-BCONML2048C	364.35
AMPTLKPO42RND	500	AMPTPSMEDIA29M	518	AMS3248LH	400	ATLADM-BCONML2060B	364.35
AMPTLKPO42SQR	501	AMPTPSMEDIA36M	518	AMS3248RH	400	ATLADM-BCONML2060C	364.35
AMPTLKPO42SSQR	502	AMPTPSMEDIA42M	518	AMS3248SS	401	ATLADM-BCONML2072B	364.35
AMPTLKPO48RND	500	AMPTPVG	526	AMS3248US	400	ATLADM-BCONML2072C	364.35
AMPTLKPO48SQR	501	AMPTTSLG	521	AMS3254LH	400	ATLADM-BCONML2084B	364.35
AMPTLKPO48SSQR	502	AMPTTSLGP	521	AMS3254RH	400	ATLADM-BCONML2084C	364.35
AMPTP1	364.40, 525	AMPTTMM	364.32, 523	AMS3254SS	401	ATLADM-BCONML2096B	364.35
AMPTP1HW	364.40, 524	AMPTTMSC	521	AMS3254US	400	ATLADM-BCONML2096C	364.35
AMPTP2	364.40, 525	AMPTTMSCP	521	AMS3260LH	400	ATLADM-BCONMV2048B	364.35
AMPTP2HW	364.40, 524	AMPTTMSG	521	AMS3260RH	400	ATLADM-BCONMV2048C	364.35
AMPTP3	364.40, 525	AMPTTMSGP	521	AMS3260SS	401	ATLADM-BCONMV2060B	364.35
AMPTP3HW	364.40, 524	AMPTTSSC	521	AMS3260US	400	ATLADM-BCONMV2072B	364.35
AMPTP4	364.40, 525	AMPTTSSCP	521	AMS3266LH	400	ATLADM-BCONMV2072C	364.35
AMPTP4HW	364.40, 524	AMPTTSSG	521	AMS3266RH	400	ATLADM-BCONMV2084B	364.35
AMPTPHI	526	AMPTTSSGP	521	AMS3266SS	401	ATLADM-BCONMV2084C	364.35
AMPTPL	514	AMPTUSPL3	525	AMS3266US	400	ATLADM-BCONMV2096B	364.35
AMPTPL84	514	AMPTUSPL4	525	AMS3272LH	400	ATLADM-BCONMV2096C	364.35
AMPTPL96	514	AMPTUSPM4	525	AMS3272RH	400	ATLADM-BFMEDIAM4848L	364.30
AMPTPL120	514	AMPTUSPS1A	525	AMS3272SS	401	ATLADM-BFMEDIAM4848S	364.30
AMPTPL144	514	AMPTUSPS1U	525	AMS3272US	400	ATLADM-BFMEDIAM4860L	364.30
AMPTPL168	514	AMPTUSPS2	525	APACSM	429	ATLADM-BFMEDIAM4860S	364.30
AMPTPL192	514	AMPTUSPS4	525	APACW	429	ATLADM-BFMEDIAM4872L	364.30
AMPTPL216	514	AMPTUSPXL4	525	APADD	428	ATLADM-BFMEDIAM4872S	364.30
AMPTPL240	514	AMPTWMB	364.32, 512	APASD	428	ATLADM-BFMEDIAM4884L	364.30
AMPTPLATE	526	AMPTWMCLRL	523	APASDCK	429	ATLADM-BFMEDIAM4884S	364.30
AMPTPLC	521	AMPTWMCLRS	523	APATF	428	ATLADM-BFMEDIAM4896L	364.30
AMPTPLG	521	AMPTWMCOL	523	APMC6	418	ATLADM-BFMEDIAM4896S	364.30
AMPTPR18L	519	AMPTWMCOM	523	APTK	527	ATLADM-BFRNDM96S	364.28
AMPTPR18LPWR	520	AMPTWMC SRL	523	APWRMOD1TT	424	ATLADM-BMTGM4L	364.26
AMPTPR18M	519	AMPTWMC SRS	523	APWRMOD1UWM	208, 424	ATLADM-BMTGM4S	364.26
AMPTPR18MPWR	520	AMPTWMCXBL	523	APWRMOD2Q	424	ATLADM-BMTGM3636B	364.26
AMPTPR26L	519	AMPTWMCXBS	523	APWRMOD2UWM	424	ATLADM-BMTGM3636C	364.26
AMPTPR26LPWR	520	AMPTXL18G	517	APWRMOD2WC	424	ATLADM-BMTGM3660B	364.23
AMPTPR26M	519	AMPTXL18GP	517	APWRMOD3UWM	424	ATLADM-BMTGM3660C	364.23
AMPTPR26MPWR	520	AMPTXL26G	517	APWRMOD3WC	424	ATLADM-BMTGM3660L	364.22
AMPTPR29L	519	AMPTXL26GP	517	ARSLCC	527	ATLADM-BMTGM3660S	364.22
AMPTPR29LPWR	520	AMPTXL29G	517	ATADF3	398	ATLADM-BMTGM3672B	364.23
AMPTPR29M	519	AMPTXL29GP	517	ATADF4	398	ATLADM-BMTGM3672C	364.23
AMPTPR29MPWR	520	AMPTXM18C	517	ATADJ5	398	ATLADM-BMTGM3672L	364.22
AMPTPR36L	519	AMPTXM18CP	517	ATADJ6	398	ATLADM-BMTGM3672S	364.22
AMPTPR36LPWR	520	AMPTXM18G	517	ATLACC-LEGWIREMGR20	364.39	ATLADM-BMTGM3684B	364.23
AMPTPR36M	519	AMPTXM18GP	517	ATLACC-LEGWIREMGR22	364.39	ATLADM-BMTGM3684C	364.23
AMPTPR36MPWR	520	AMPTXM26C	517	ATLACC-LEGWIREMGR26	364.39	ATLADM-BMTGM3684L	364.22
AMPTPR42L	519	AMPTXM26CP	517	ATLACC-LEGWIRESTP	364.39	ATLADM-BMTGM3684S	364.22
AMPTPR42LPWR	520	AMPTXM26G	517	ATLADM-ACCDSKPAD	364.38	ATLADM-BMTGM3696B	364.23
AMPTPR42M	519	AMPTXM26GP	517	ATLADM-ACCFOOTCST	364.39	ATLADM-BMTGM3696C	364.23
AMPTPR42MPWR	520	AMPTXM29C	517	ATLADM-ACCFOOTGLD	364.39	ATLADM-BMTGM3696L	364.22
AMPTPRMEDIA18M	518	AMPTXM29CP	517	ATLADM-ACCHOOK	364.39	ATLADM-BMTGM3696S	364.22
AMPTPRMEDIA26M	518	AMPTXM29G	517	ATLADM-ACCTRAY	364.39	ATLADM-BMTGM4242B	364.26
AMPTPRMEDIA29M	518	AMPTXM29GP	517	ATLADM-ACCWIREMGR18	364.38	ATLADM-BMTGM4242C	364.26
AMPTPRMEDIA36M	518	AMPTXM36G	517	ATLADM-ACCWIREMGR36	364.38	ATLADM-BMTGM4272B	364.23
AMPTPRMEDIA42M	518	AMPTXM36GP	517	ATLADM-ACCWIREMGR48	364.38	ATLADM-BMTGM4272C	364.23
AMPTPS18L	519	AMPTXM42G	517	ATLADM-BAMEDIAM4848B	364.30	ATLADM-BMTGM4272L	364.22
AMPTPS18LPWR	520	AMPTXM42GP	517	ATLADM-BAMEDIAM4848C	364.30	ATLADM-BMTGM4272S	364.22
AMPTPS18M	519	AMS2048LH	400	ATLADM-BAMEDIAM4848L	364.30	ATLADM-BMTGM4284B	364.23
AMPTPS18MPWR	520	AMS2048RH	400	ATLADM-BAMEDIAM4848S	364.30	ATLADM-BMTGM4284C	364.23
AMPTPS26L	519	AMS2048SS	401	ATLADM-BAMEDIAM4860B	364.30	ATLADM-BMTGM4284L	364.22
AMPTPS26LPWR	520	AMS2048US	400	ATLADM-BAMEDIAM4860C	364.30	ATLADM-BMTGM4284S	364.22

# Cross Reference Index

by Model Number

Model	Page	Model	Page	Model	Page	Model	Page
ATLADM-BMTGM4296B.....	364.23	ATLADM-BPERM2072B.....	364.34	ATLADM-MTWALLFV60C.....	364.31	ATLADM-TFBOATL3078K.....	364.14
ATLADM-BMTGM4296C.....	364.23	ATLADM-BPERM2072C.....	364.34	ATLADM-MTWALLFV60L.....	364.31	ATLADM-TFBOATL3084F.....	364.14
ATLADM-BMTGM4296L.....	364.22	ATLADM-BPERM2084B.....	364.34	ATLADM-MTWALLFV60S.....	364.31	ATLADM-TFBOATL3084K.....	364.14
ATLADM-BMTGM4296S.....	364.22	ATLADM-BPERM2084C.....	364.34	ATLADM-MTWFLTFV6040.....	364.31	ATLADM-TFBOATV2460F.....	364.14
ATLADM-BMTGM4488B.....	364.26	ATLADM-BPERM2096B.....	364.34	ATLADM-MTWFLTFV6040.....	364.31	ATLADM-TFBOATV2460K.....	364.14
ATLADM-BMTGM4488C.....	364.26	ATLADM-BPERM2096C.....	364.34	ATLADM-TBMEDL4848F.....	364.29	ATLADM-TFBOATV2466K.....	364.14
ATLADM-BMTGM4488E.....	364.23	ATLADM-BPROJML2436B.....	364.36	ATLADM-TBMEDL4848H.....	364.29	ATLADM-TFBOATV2472F.....	364.14
ATLADM-BMTGM4488F.....	364.23	ATLADM-BPROJML2436C.....	364.36	ATLADM-TBMEDL4848K.....	364.29	ATLADM-TFBOATV2478F.....	364.14
ATLADM-BMTGM4488G.....	364.22	ATLADM-BPROJML2442B.....	364.36	ATLADM-TBMEDL4860K.....	364.29	ATLADM-TFBOATV2478K.....	364.14
ATLADM-BMTGM4488H.....	364.22	ATLADM-BPROJML2442C.....	364.36	ATLADM-TBMEDL4872F.....	364.29	ATLADM-TFBOATV2484F.....	364.14
ATLADM-BMTGM4488I.....	364.23	ATLADM-BPROJML2448B.....	364.36	ATLADM-TBMEDL4872K.....	364.29	ATLADM-TFBOATV2484K.....	364.14
ATLADM-BMTGM4488J.....	364.23	ATLADM-BPROJML2448C.....	364.36	ATLADM-TBMEDL4884F.....	364.29	ATLADM-TFBOATV2484L.....	364.14
ATLADM-BMTGM4488K.....	364.22	ATLADM-BPROJMV2436B.....	364.36	ATLADM-TBMEDL4884K.....	364.29	ATLADM-TFBOATV3060K.....	364.14
ATLADM-BMTGM4488L.....	364.22	ATLADM-BPROJMV2436C.....	364.36	ATLADM-TBMEDL4896F.....	364.29	ATLADM-TFBOATV3066F.....	364.14
ATLADM-BMTGM4488M.....	364.22	ATLADM-BPROJMV2442B.....	364.36	ATLADM-TBMEDL4896K.....	364.29	ATLADM-TFBOATV3066K.....	364.14
ATLADM-BMTGM4488N.....	364.23	ATLADM-BPROJMV2442C.....	364.36	ATLADM-TBMEDV4884F.....	364.29	ATLADM-TFBOATV3072F.....	364.14
ATLADM-BMTGM4488O.....	364.22	ATLADM-BPROJMV2448B.....	364.36	ATLADM-TBMEDV4884K.....	364.29	ATLADM-TFBOATV3072K.....	364.14
ATLADM-BMTGM4488P.....	364.22	ATLADM-BPROJMV2448C.....	364.36	ATLADM-TBMEDV4860F.....	364.29	ATLADM-TFBOATV3078F.....	364.14
ATLADM-BMTGM4488Q.....	364.26	ATLADM-BRFXINM48S.....	364.16	ATLADM-TBMEDV4860K.....	364.29	ATLADM-TFBOATV3078K.....	364.14
ATLADM-BMTGM4488R.....	364.26	ATLADM-BRFXINM54S.....	364.16	ATLADM-TBMEDV4872F.....	364.29	ATLADM-TFBOATV3084F.....	364.14
ATLADM-BMTGM4488S.....	364.26	ATLADM-BRFXINM60S.....	364.16	ATLADM-TBMEDV4872K.....	364.29	ATLADM-TFBOATV3084K.....	364.14
ATLADM-BMTGM4488T.....	364.26	ATLADM-BRFXINM66S.....	364.16	ATLADM-TBMEDV4884F.....	364.29	ATLADM-TFHRACL2448F.....	364.12
ATLADM-BMTGM4488U.....	364.23	ATLADM-BRFXINM72S.....	364.16	ATLADM-TBMEDV4884K.....	364.29	ATLADM-TFHRACL2454F.....	364.12
ATLADM-BMTGM4488V.....	364.23	ATLADM-BRFXINM78S.....	364.16	ATLADM-TBMEDV4896F.....	364.29	ATLADM-TFHRACL2460F.....	364.12
ATLADM-BMTGM4488W.....	364.22	ATLADM-BRFXINM84S.....	364.16	ATLADM-TBMEDV4896K.....	364.29	ATLADM-TFHRACL2466F.....	364.12
ATLADM-BMTGM4488X.....	364.22	ATLADM-BRFXOUTM48S.....	364.16	ATLADM-TCNR45L24F.....	364.13	ATLADM-TFHRACL2472F.....	364.12
ATLADM-BMTGM4488Y.....	364.23	ATLADM-BRFXOUTM54S.....	364.16	ATLADM-TCNR45L30F.....	364.13	ATLADM-TFHRACL2478F.....	364.12
ATLADM-BMTGM4488Z.....	364.23	ATLADM-BRFXOUTM60S.....	364.16	ATLADM-TCNR45V24F.....	364.13	ATLADM-TFHRACL2484F.....	364.12
ATLADM-BMTGM4606B.....	364.26	ATLADM-BRFXOUTM66S.....	364.16	ATLADM-TCNR45V30F.....	364.13	ATLADM-TFHRACL3048F.....	364.12
ATLADM-BMTGM4606C.....	364.26	ATLADM-BRFXOUTM72S.....	364.16	ATLADM-TCNR90L24F.....	364.13	ATLADM-TFHRACL3054F.....	364.12
ATLADM-BMTGM4606D.....	364.23	ATLADM-BRFXOUTM78S.....	364.16	ATLADM-TCNR90L30F.....	364.13	ATLADM-TFHRACL3060F.....	364.12
ATLADM-BMTGM4606E.....	364.23	ATLADM-BRFXOUTM84S.....	364.16	ATLADM-TCNR90V24F.....	364.13	ATLADM-TFHRACL3066F.....	364.12
ATLADM-BMTGM4606F.....	364.22	ATLADM-BRFXOUTM84S.....	364.16	ATLADM-TCNR90V30F.....	364.13	ATLADM-TFHRACL3072F.....	364.12
ATLADM-BMTGM4606G.....	364.22	ATLADM-BRFXOUTM84S.....	364.16	ATLADM-TCNR120L24FX.....	364.13	ATLADM-TFHRACL3078F.....	364.12
ATLADM-BMTGM4606H.....	364.23	ATLADM-BRFXOUTM84S.....	364.16	ATLADM-TCNR120L30FX.....	364.13	ATLADM-TFHRACL3084F.....	364.12
ATLADM-BMTGM4606I.....	364.23	ATLADM-BRFXOUTM84S.....	364.16	ATLADM-TCNR120V24FX.....	364.13	ATLADM-TFHRACV2448F.....	364.12
ATLADM-BMTGM4606J.....	364.22	ATLADM-BRFXOUTM84S.....	364.16	ATLADM-TCNR120V30FX.....	364.13	ATLADM-TFHRACV2454F.....	364.12
ATLADM-BMTGM4606K.....	364.22	ATLADM-BSATM2424C.....	364.37	ATLADM-TCRRECL2048F.....	364.35	ATLADM-TFHRACV2460F.....	364.12
ATLADM-BMTGM4606L.....	364.23	ATLADM-BVM4PSM5S.....	364.27	ATLADM-TCRRECL2048K.....	364.35	ATLADM-TFHRACV2466F.....	364.12
ATLADM-BMTGM4606M.....	364.23	ATLADM-BVM6PSM5S.....	364.27	ATLADM-TCRRECL2060F.....	364.35	ATLADM-TFHRACV2472F.....	364.12
ATLADM-BMTGM4606N.....	364.22	ATLADM-BVM8PSM5S.....	364.27	ATLADM-TCRRECL2060K.....	364.35	ATLADM-TFHRACV2478F.....	364.12
ATLADM-BMTGM4606O.....	364.22	ATLADM-MNWALLFL60B.....	364.31	ATLADM-TCRRECL2072F.....	364.35	ATLADM-TFHRACV2484F.....	364.12
ATLADM-BMTGM4606P.....	364.22	ATLADM-MNWALLFL60C.....	364.31	ATLADM-TCRRECL2072K.....	364.35	ATLADM-TFHRACV3048F.....	364.12
ATLADM-BMTGM4606Q.....	364.23	ATLADM-MNWALLFL60L.....	364.31	ATLADM-TCRRECL2084F.....	364.35	ATLADM-TFHRACV3054F.....	364.12
ATLADM-BMTGM4606R.....	364.22	ATLADM-MNWALLFL60S.....	364.31	ATLADM-TCRRECL2084K.....	364.35	ATLADM-TFHRACV3060F.....	364.12
ATLADM-BMTGM4606S.....	364.22	ATLADM-MNWALLFV60B.....	364.31	ATLADM-TCRRECL2096F.....	364.35	ATLADM-TFHRACV3066F.....	364.12
ATLADM-BMTGM4606T.....	364.23	ATLADM-MNWALLFV60C.....	364.31	ATLADM-TCRRECL2096K.....	364.35	ATLADM-TFHRACV3072F.....	364.12
ATLADM-BMTGM4606U.....	364.23	ATLADM-MNWALLFV60L.....	364.31	ATLADM-TCRRECV2048F.....	364.35	ATLADM-TFHRACV3078F.....	364.12
ATLADM-BMTGM4606V.....	364.22	ATLADM-MNWALLFV60S.....	364.31	ATLADM-TCRRECV2048K.....	364.35	ATLADM-TFHRACV3084F.....	364.12
ATLADM-BMTGM4606W.....	364.22	ATLADM-MNWFLTFV6040.....	364.31	ATLADM-TCRRECV2060F.....	364.35	ATLADM-TFRACEL2448F.....	364.15
ATLADM-BMTGM4606X.....	364.23	ATLADM-MNWFLTFV6040.....	364.31	ATLADM-TCRRECV2060K.....	364.35	ATLADM-TFRACEL2448K.....	364.15
ATLADM-BMTGM4606Y.....	364.23	ATLADM-MODL36.....	364.17	ATLADM-TCRRECV2072F.....	364.35	ATLADM-TFRACEL2454F.....	364.15
ATLADM-BMTGM4606Z.....	364.22	ATLADM-MODL42.....	364.17	ATLADM-TCRRECV2072K.....	364.35	ATLADM-TFRACEL2454K.....	364.15
ATLADM-BMTGM48108B.....	364.23	ATLADM-MODL48.....	364.17	ATLADM-TCRRECV2084F.....	364.35	ATLADM-TFRACEL2460F.....	364.15
ATLADM-BMTGM48108C.....	364.23	ATLADM-MODL54.....	364.17	ATLADM-TCRRECV2084K.....	364.35	ATLADM-TFRACEL2460K.....	364.15
ATLADM-BMTGM48108D.....	364.22	ATLADM-MODL60.....	364.17	ATLADM-TCRRECV2096F.....	364.35	ATLADM-TFRACEL2466F.....	364.15
ATLADM-BMTGM48108E.....	364.22	ATLADM-MODL66.....	364.17	ATLADM-TCRRECV2096K.....	364.35	ATLADM-TFRACEL2466K.....	364.15
ATLADM-BMTGM48108F.....	364.22	ATLADM-MODL72.....	364.17	ATLADM-TFBOATL2460F.....	364.14	ATLADM-TFRACEL2472F.....	364.15
ATLADM-BMTGM48108G.....	364.23	ATLADM-MODL78.....	364.17	ATLADM-TFBOATL2460K.....	364.14	ATLADM-TFRACEL2472K.....	364.15
ATLADM-BMTGM48108H.....	364.22	ATLADM-MODL84.....	364.17	ATLADM-TFBOATL2466F.....	364.14	ATLADM-TFRACEL2478F.....	364.15
ATLADM-BMTGM48108I.....	364.22	ATLADM-MODV36.....	364.17	ATLADM-TFBOATL2466K.....	364.14	ATLADM-TFRACEL2478K.....	364.15
ATLADM-BMTGM48108J.....	364.22	ATLADM-MODV42.....	364.17	ATLADM-TFBOATL2472F.....	364.14	ATLADM-TFRACEL2484F.....	364.15
ATLADM-BMTGM48108K.....	364.23	ATLADM-MODV48.....	364.17	ATLADM-TFBOATL2472K.....	364.14	ATLADM-TFRACEL2484K.....	364.15
ATLADM-BMTGM48108L.....	364.23	ATLADM-MODV54.....	364.17	ATLADM-TFBOATL2478F.....	364.14	ATLADM-TFRACEL3048F.....	364.15
ATLADM-BMTGM48108M.....	364.22	ATLADM-MODV60.....	364.17	ATLADM-TFBOATL2478K.....	364.14	ATLADM-TFRACEL3048K.....	364.15
ATLADM-BMTGM48108N.....	364.22	ATLADM-MODV66.....	364.17	ATLADM-TFBOATL2484F.....	364.14	ATLADM-TFRACEL3054F.....	364.15
ATLADM-BMTGM48108O.....	364.26	ATLADM-MODV72.....	364.17	ATLADM-TFBOATL2484K.....	364.14	ATLADM-TFRACEL3054K.....	364.15
ATLADM-BMTGM48108P.....	364.26	ATLADM-MODV78.....	364.17	ATLADM-TFBOATL3060F.....	364.14	ATLADM-TFRACEL3060F.....	364.15
ATLADM-BMTGM48108Q.....	364.26	ATLADM-MODV84.....	364.17	ATLADM-TFBOATL3060K.....	364.14	ATLADM-TFRACEL3060K.....	364.15
ATLADM-BMTGM48108R.....	364.26	ATLADM-MTWALLFL60B.....	364.31	ATLADM-TFBOATL3066F.....	364.14	ATLADM-TFRACEL3066F.....	364.15
ATLADM-BMTGM48108S.....	364.26	ATLADM-MTWALLFL60C.....	364.31	ATLADM-TFBOATL3066K.....	364.14	ATLADM-TFRACEL3066K.....	364.15
ATLADM-BMTGM48108T.....	364.26	ATLADM-MTWALLFL60L.....	364.31	ATLADM-TFBOATL3072F.....	364.14	ATLADM-TFRACEL3072F.....	364.15
ATLADM-BMTGM48108U.....	364.26	ATLADM-MTWALLFL60S.....	364.31	ATLADM-TFBOATL3072K.....	364.14	ATLADM-TFRACEL3072K.....	364.15
ATLADM-BMTGM48108V.....	364.26	ATLADM-MTWALLFV60B.....	364.31	ATLADM-TFBOATL3078F.....	364.14	ATLADM-TFRACEL3078F.....	364.15

Model	Page	Model	Page	Model	Page	Model	Page
ATLADM-TFRACEL3078K	364.15	ATLADM-TFRRECL3072F	364.11	ATLADM-TMBOATV4272F	364.20	ATLADM-TMRACEV3696F	364.21
ATLADM-TFRACEL3084F	364.15	ATLADM-TFRRECL3078F	364.11	ATLADM-TMBOATV4272K	364.20	ATLADM-TMRACEV3696K	364.21
ATLADM-TFRACEL3084K	364.15	ATLADM-TFRRECL3084F	364.11	ATLADM-TMBOATV4284F	364.20	ATLADM-TMRACEV4272F	364.21
ATLADM-TFRACEV2448F	364.15	ATLADM-TFRRECV2448F	364.11	ATLADM-TMBOATV4284K	364.20	ATLADM-TMRACEV4272K	364.21
ATLADM-TFRACEV2448K	364.15	ATLADM-TFRRECV2454F	364.11	ATLADM-TMBOATV4296F	364.20	ATLADM-TMRACEV4284F	364.21
ATLADM-TFRACEV2454F	364.15	ATLADM-TFRRECV2460F	364.11	ATLADM-TMBOATV4296K	364.20	ATLADM-TMRACEV4284K	364.21
ATLADM-TFRACEV2454K	364.15	ATLADM-TFRRECV2466F	364.11	ATLADM-TMBOATV4872F	364.20	ATLADM-TMRACEV4296F	364.21
ATLADM-TFRACEV2460F	364.15	ATLADM-TFRRECV2472F	364.11	ATLADM-TMBOATV4872K	364.20	ATLADM-TMRACEV4296K	364.21
ATLADM-TFRACEV2460K	364.15	ATLADM-TFRRECV2478F	364.11	ATLADM-TMBOATV4884F	364.20	ATLADM-TMRACEV4872F	364.21
ATLADM-TFRACEV2466F	364.15	ATLADM-TFRRECV2484F	364.11	ATLADM-TMBOATV4884K	364.20	ATLADM-TMRACEV4872K	364.21
ATLADM-TFRACEV2466K	364.15	ATLADM-TFRRECV3048F	364.11	ATLADM-TMBOATV4896F	364.20	ATLADM-TMRACEV4884F	364.21
ATLADM-TFRACEV2472F	364.15	ATLADM-TFRRECV3054F	364.11	ATLADM-TMBOATV4896K	364.20	ATLADM-TMRACEV4884K	364.21
ATLADM-TFRACEV2472K	364.15	ATLADM-TFRRECV3060F	364.11	ATLADM-TMBOATV36108F	364.20	ATLADM-TMRACEV4896F	364.21
ATLADM-TFRACEV2478F	364.15	ATLADM-TFRRECV3066F	364.11	ATLADM-TMBOATV36108K	364.20	ATLADM-TMRACEV4896K	364.21
ATLADM-TFRACEV2478K	364.15	ATLADM-TFRRECV3072F	364.11	ATLADM-TMBOATV36120F	364.20	ATLADM-TMRACEV36108F	364.21
ATLADM-TFRACEV2484F	364.15	ATLADM-TFRRECV3078F	364.11	ATLADM-TMBOATV36120K	364.20	ATLADM-TMRACEV36120K	364.21
ATLADM-TFRACEV2484K	364.15	ATLADM-TFRRECV3084F	364.11	ATLADM-TMBOATV36144F	364.20	ATLADM-TMRACEV36120F	364.21
ATLADM-TFRACEV3048F	364.15	ATLADM-TJRRECL2436F	364.36	ATLADM-TMBOATV36144K	364.20	ATLADM-TMRACEV36120K	364.21
ATLADM-TFRACEV3048K	364.15	ATLADM-TJRRECL2436K	364.36	ATLADM-TMBOATV42108F	364.20	ATLADM-TMRACEV36144F	364.21
ATLADM-TFRACEV3054F	364.15	ATLADM-TJRRECL2442F	364.36	ATLADM-TMBOATV42108K	364.20	ATLADM-TMRACEV36144K	364.21
ATLADM-TFRACEV3054K	364.15	ATLADM-TJRRECL2442K	364.36	ATLADM-TMBOATV42120F	364.20	ATLADM-TMRACEV42108F	364.21
ATLADM-TFRACEV3060F	364.15	ATLADM-TJRRECL2448F	364.36	ATLADM-TMBOATV42120K	364.20	ATLADM-TMRACEV42108K	364.21
ATLADM-TFRACEV3060K	364.15	ATLADM-TJRRECL2448K	364.36	ATLADM-TMBOATV42144F	364.20	ATLADM-TMRACEV42120F	364.21
ATLADM-TFRACEV3066F	364.15	ATLADM-TJRRECV2436F	364.36	ATLADM-TMBOATV42144K	364.20	ATLADM-TMRACEV42120K	364.21
ATLADM-TFRACEV3066K	364.15	ATLADM-TJRRECV2436K	364.36	ATLADM-TMBOATV48108F	364.20	ATLADM-TMRACEV42144F	364.21
ATLADM-TFRACEV3072F	364.15	ATLADM-TJRRECV2442F	364.36	ATLADM-TMBOATV48108K	364.20	ATLADM-TMRACEV42144K	364.21
ATLADM-TFRACEV3072K	364.15	ATLADM-TJRRECV2442K	364.36	ATLADM-TMBOATV48120F	364.20	ATLADM-TMRACEV48108F	364.21
ATLADM-TFRACEV3078F	364.15	ATLADM-TJRRECV2448F	364.36	ATLADM-TMBOATV48120K	364.20	ATLADM-TMRACEV48108K	364.21
ATLADM-TFRACEV3078K	364.15	ATLADM-TJRRECV2448K	364.36	ATLADM-TMBOATV48144F	364.20	ATLADM-TMRACEV48120F	364.21
ATLADM-TFRACEV3084F	364.15	ATLADM-TMBOATL3660F	364.20	ATLADM-TMBOATV48144K	364.20	ATLADM-TMRACEV48120K	364.21
ATLADM-TFRACEV3084K	364.15	ATLADM-TMBOATL3660K	364.20	ATLADM-TMRACEL3660F	364.21	ATLADM-TMRACEV48144F	364.21
ATLADM-TFRECL2448F	364.11	ATLADM-TMBOATL3672F	364.20	ATLADM-TMRACEL3660K	364.21	ATLADM-TMRACEV48144K	364.21
ATLADM-TFRECL2454F	364.11	ATLADM-TMBOATL3672K	364.20	ATLADM-TMRACEL3672F	364.21	ATLADM-TMRECL3660F	364.18
ATLADM-TFRECL2460F	364.11	ATLADM-TMBOATL3684F	364.20	ATLADM-TMRACEL3672K	364.21	ATLADM-TMRECL3660K	364.18
ATLADM-TFRECL2466F	364.11	ATLADM-TMBOATL3684K	364.20	ATLADM-TMRACEL3684F	364.21	ATLADM-TMRECL3672F	364.18
ATLADM-TFRECL2472F	364.11	ATLADM-TMBOATL3696F	364.20	ATLADM-TMRACEL3684K	364.21	ATLADM-TMRECL3672K	364.18
ATLADM-TFRECL2478F	364.11	ATLADM-TMBOATL3696K	364.20	ATLADM-TMRACEL3696F	364.21	ATLADM-TMRECL3684F	364.18
ATLADM-TFRECL2484F	364.11	ATLADM-TMBOATL4272F	364.20	ATLADM-TMRACEL3696K	364.21	ATLADM-TMRECL3684K	364.18
ATLADM-TFRECL3048F	364.11	ATLADM-TMBOATL4272K	364.20	ATLADM-TMRACEL4272F	364.21	ATLADM-TMRECL3696F	364.18
ATLADM-TFRECL3054F	364.11	ATLADM-TMBOATL4284F	364.20	ATLADM-TMRACEL4272K	364.21	ATLADM-TMRECL3696K	364.18
ATLADM-TFRECL3060F	364.11	ATLADM-TMBOATL4284K	364.20	ATLADM-TMRACEL4284F	364.21	ATLADM-TMRECL4272F	364.18
ATLADM-TFRECL3066F	364.11	ATLADM-TMBOATL4296F	364.20	ATLADM-TMRACEL4284K	364.21	ATLADM-TMRECL4272K	364.18
ATLADM-TFRECL3072F	364.11	ATLADM-TMBOATL4296K	364.20	ATLADM-TMRACEL4296F	364.21	ATLADM-TMRECL4284F	364.18
ATLADM-TFRECL3078F	364.11	ATLADM-TMBOATL4872F	364.20	ATLADM-TMRACEL4296K	364.21	ATLADM-TMRECL4284K	364.18
ATLADM-TFRECL3084F	364.11	ATLADM-TMBOATL4872K	364.20	ATLADM-TMRACEL4872F	364.21	ATLADM-TMRECL4296F	364.18
ATLADM-TFRECV2448F	364.11	ATLADM-TMBOATL4884F	364.20	ATLADM-TMRACEL4872K	364.21	ATLADM-TMRECL4296K	364.18
ATLADM-TFRECV2454F	364.11	ATLADM-TMBOATL4884K	364.20	ATLADM-TMRACEL4884F	364.21	ATLADM-TMRECL4872F	364.18
ATLADM-TFRECV2460F	364.11	ATLADM-TMBOATL4896F	364.20	ATLADM-TMRACEL4884K	364.21	ATLADM-TMRECL4872K	364.18
ATLADM-TFRECV2466F	364.11	ATLADM-TMBOATL4896K	364.20	ATLADM-TMRACEL4896F	364.21	ATLADM-TMRECL4884F	364.18
ATLADM-TFRECV2472F	364.11	ATLADM-TMBOATL36108F	364.20	ATLADM-TMRACEL4896K	364.21	ATLADM-TMRECL4884K	364.18
ATLADM-TFRECV2478F	364.11	ATLADM-TMBOATL36108K	364.20	ATLADM-TMRACEL36108F	364.21	ATLADM-TMRECL4896F	364.18
ATLADM-TFRECV2484F	364.11	ATLADM-TMBOATL36120F	364.20	ATLADM-TMRACEL36108K	364.21	ATLADM-TMRECL4896K	364.18
ATLADM-TFRECV3048F	364.11	ATLADM-TMBOATL36120K	364.20	ATLADM-TMRACEL36120F	364.21	ATLADM-TMRECL36108F	364.18
ATLADM-TFRECV3054F	364.11	ATLADM-TMBOATL36144F	364.20	ATLADM-TMRACEL36120K	364.21	ATLADM-TMRECL36108K	364.18
ATLADM-TFRECV3060F	364.11	ATLADM-TMBOATL36144K	364.20	ATLADM-TMRACEL36144F	364.21	ATLADM-TMRECL36120F	364.18
ATLADM-TFRECV3066F	364.11	ATLADM-TMBOATL42108F	364.20	ATLADM-TMRACEL36144K	364.21	ATLADM-TMRECL36120K	364.18
ATLADM-TFRECV3072F	364.11	ATLADM-TMBOATL42108K	364.20	ATLADM-TMRACEL42108F	364.21	ATLADM-TMRECL36144F	364.18
ATLADM-TFRECV3078F	364.11	ATLADM-TMBOATL42120F	364.20	ATLADM-TMRACEL42108K	364.21	ATLADM-TMRECL36144K	364.18
ATLADM-TFRECV3084F	364.11	ATLADM-TMBOATL42120K	364.20	ATLADM-TMRACEL42120F	364.21	ATLADM-TMRECL42108F	364.18
ATLADM-TFRNDL96F	364.28	ATLADM-TMBOATL42144F	364.20	ATLADM-TMRACEL42120K	364.21	ATLADM-TMRECL42108K	364.18
ATLADM-TFRNDL96K	364.28	ATLADM-TMBOATL42144K	364.20	ATLADM-TMRACEL42144F	364.21	ATLADM-TMRECL42120F	364.18
ATLADM-TFRNDV96F	364.28	ATLADM-TMBOATL48108F	364.20	ATLADM-TMRACEL42144K	364.21	ATLADM-TMRECL42120K	364.18
ATLADM-TFRNDV96K	364.28	ATLADM-TMBOATL48108K	364.20	ATLADM-TMRACEL48108F	364.21	ATLADM-TMRECL42144F	364.18
ATLADM-TFRRECL2448F	364.11	ATLADM-TMBOATL48120F	364.20	ATLADM-TMRACEL48108K	364.21	ATLADM-TMRECL42144K	364.18
ATLADM-TFRRECL2454F	364.11	ATLADM-TMBOATL48120K	364.20	ATLADM-TMRACEL48120F	364.21	ATLADM-TMRECL48108F	364.18
ATLADM-TFRRECL2460F	364.11	ATLADM-TMBOATL48144F	364.20	ATLADM-TMRACEL48120K	364.21	ATLADM-TMRECL48108K	364.18
ATLADM-TFRRECL2466F	364.11	ATLADM-TMBOATL48144K	364.20	ATLADM-TMRACEL48144F	364.21	ATLADM-TMRECL48120F	364.18
ATLADM-TFRRECL2472F	364.11	ATLADM-TMBOATV3660F	364.20	ATLADM-TMRACEL48144K	364.21	ATLADM-TMRECL48120K	364.18
ATLADM-TFRRECL2478F	364.11	ATLADM-TMBOATV3672F	364.20	ATLADM-TMRACEV3660F	364.21	ATLADM-TMRECL48144F	364.18
ATLADM-TFRRECL2484F	364.11	ATLADM-TMBOATV3672K	364.20	ATLADM-TMRACEV3660K	364.21	ATLADM-TMRECL48144K	364.18
ATLADM-TFRRECL3048F	364.11	ATLADM-TMBOATV3684F	364.20	ATLADM-TMRACEV3672F	364.21	ATLADM-TMRECV3660F	364.18
ATLADM-TFRRECL3054F	364.11	ATLADM-TMBOATV3684K	364.20	ATLADM-TMRACEV3672K	364.21	ATLADM-TMRECV3660K	364.18
ATLADM-TFRRECL3060F	364.11	ATLADM-TMBOATV3696F	364.20	ATLADM-TMRACEV3684F	364.21	ATLADM-TMRECV3672F	364.18
ATLADM-TFRRECL3066F	364.11	ATLADM-TMBOATV3696K	364.20	ATLADM-TMRACEV3684K	364.21	ATLADM-TMRECV3672K	364.18

Model	Page	Model	Page	Model	Page	Model	Page
ATLADM-TMRECV3684F.....	364.18	ATLADM-TMRRECL4896K.....	364.19	ATLADM-TMRSQRV60F.....	364.25	ATLADM-TPRRECV2060F.....	364.33
ATLADM-TMRECV3684K.....	364.18	ATLADM-TMRRECL36108F.....	364.19	ATLADM-TMRSQRV60K.....	364.25	ATLADM-TPRRECV2060K.....	364.33
ATLADM-TMRECV3696F.....	364.18	ATLADM-TMRRECL36108K.....	364.19	ATLADM-TMSQRL36F.....	364.24	ATLADM-TPRRECV2072F.....	364.33
ATLADM-TMRECV3696K.....	364.18	ATLADM-TMRRECL36120F.....	364.19	ATLADM-TMSQRL36K.....	364.24	ATLADM-TPRRECV2072K.....	364.33
ATLADM-TMRECV4272F.....	364.18	ATLADM-TMRRECL36120K.....	364.19	ATLADM-TMSQRL42F.....	364.24	ATLADM-TPRRECV2084F.....	364.33
ATLADM-TMRECV4272K.....	364.18	ATLADM-TMRRECL36144F.....	364.19	ATLADM-TMSQRL42K.....	364.24	ATLADM-TPRRECV2084K.....	364.33
ATLADM-TMRECV4284F.....	364.18	ATLADM-TMRRECL36144K.....	364.19	ATLADM-TMSQRL48F.....	364.24	ATLADM-TPRRECV2096F.....	364.33
ATLADM-TMRECV4284K.....	364.18	ATLADM-TMRRECL42108F.....	364.19	ATLADM-TMSQRL48K.....	364.24	ATLADM-TPRRECV2096K.....	364.33
ATLADM-TMRECV4296F.....	364.18	ATLADM-TMRRECL42108K.....	364.19	ATLADM-TMSQRL54F.....	364.24	ATLADM-TRMEDL4848F.....	364.29
ATLADM-TMRECV4296K.....	364.18	ATLADM-TMRRECL42120F.....	364.19	ATLADM-TMSQRL54K.....	364.24	ATLADM-TRMEDL4848K.....	364.29
ATLADM-TMRECV4872F.....	364.18	ATLADM-TMRRECL42120K.....	364.19	ATLADM-TMSQRL60F.....	364.24	ATLADM-TRMEDL4860F.....	364.29
ATLADM-TMRECV4872K.....	364.18	ATLADM-TMRRECL42144F.....	364.19	ATLADM-TMSQRL60K.....	364.24	ATLADM-TRMEDL4860K.....	364.29
ATLADM-TMRECV4884F.....	364.18	ATLADM-TMRRECL42144K.....	364.19	ATLADM-TMSQRV36F.....	364.24	ATLADM-TRMEDL4872F.....	364.29
ATLADM-TMRECV4884K.....	364.18	ATLADM-TMRRECL48108F.....	364.19	ATLADM-TMSQRV36K.....	364.24	ATLADM-TRMEDL4872K.....	364.29
ATLADM-TMRECV4896F.....	364.18	ATLADM-TMRRECL48108K.....	364.19	ATLADM-TMSQRV42F.....	364.24	ATLADM-TRMEDL4884F.....	364.29
ATLADM-TMRECV4896K.....	364.18	ATLADM-TMRRECL48120F.....	364.19	ATLADM-TMSQRV42K.....	364.24	ATLADM-TRMEDL4884K.....	364.29
ATLADM-TMRECV36108F.....	364.18	ATLADM-TMRRECL48120K.....	364.19	ATLADM-TMSQRV48F.....	364.24	ATLADM-TRMEDL4896F.....	364.29
ATLADM-TMRECV36108K.....	364.18	ATLADM-TMRRECL48144F.....	364.19	ATLADM-TMSQRV48K.....	364.24	ATLADM-TRMEDL4896K.....	364.29
ATLADM-TMRECV36120F.....	364.18	ATLADM-TMRRECL48144K.....	364.19	ATLADM-TMSQRV54F.....	364.24	ATLADM-TRMEDV4848F.....	364.29
ATLADM-TMRECV36120K.....	364.18	ATLADM-TMRRECL3660F.....	364.19	ATLADM-TMSQRV54K.....	364.24	ATLADM-TRMEDV4860K.....	364.29
ATLADM-TMRECV36144F.....	364.18	ATLADM-TMRRECV3660K.....	364.19	ATLADM-TMSQRV60F.....	364.24	ATLADM-TRMEDV4860F.....	364.29
ATLADM-TMRECV36144K.....	364.18	ATLADM-TMRRECV3672F.....	364.19	ATLADM-TMSQRV60K.....	364.24	ATLADM-TRMEDV4860K.....	364.29
ATLADM-TMRECV42108F.....	364.18	ATLADM-TMRRECV3684F.....	364.19	ATLADM-TMSQRV60K.....	364.24	ATLADM-TRMEDV4872F.....	364.29
ATLADM-TMRECV42108K.....	364.18	ATLADM-TMRRECV3684K.....	364.19	ATLADM-TMSSQRL36F.....	364.25	ATLADM-TRMEDV4872K.....	364.29
ATLADM-TMRECV42120F.....	364.18	ATLADM-TMRRECV3696F.....	364.19	ATLADM-TMSSQRL36K.....	364.25	ATLADM-TRMEDV4884F.....	364.29
ATLADM-TMRECV42120K.....	364.18	ATLADM-TMRRECV3696K.....	364.19	ATLADM-TMSSQRL42F.....	364.25	ATLADM-TRMEDV4884K.....	364.29
ATLADM-TMRECV42144F.....	364.18	ATLADM-TMRRECV4272F.....	364.19	ATLADM-TMSSQRL42K.....	364.25	ATLADM-TRMEDV4896F.....	364.29
ATLADM-TMRECV42144K.....	364.18	ATLADM-TMRRECV4272K.....	364.19	ATLADM-TMSSQRL48F.....	364.25	ATLADM-TRMEDV4896K.....	364.29
ATLADM-TMRECV48108F.....	364.18	ATLADM-TMRRECV4284F.....	364.19	ATLADM-TMSSQRL48K.....	364.25	ATLADM-TSSQRL24F.....	364.37
ATLADM-TMRECV48108K.....	364.18	ATLADM-TMRRECV4284K.....	364.19	ATLADM-TMSSQRL54F.....	364.25	ATLADM-TSSQRL24K.....	364.37
ATLADM-TMRECV48120F.....	364.18	ATLADM-TMRRECV4296F.....	364.19	ATLADM-TMSSQRL54K.....	364.25	ATLADM-TSSQRV24F.....	364.37
ATLADM-TMRECV48120K.....	364.18	ATLADM-TMRRECV4296K.....	364.19	ATLADM-TMSSQRL60F.....	364.25	ATLADM-TSSQRV24K.....	364.37
ATLADM-TMRECV48144F.....	364.18	ATLADM-TMRRECV4872F.....	364.19	ATLADM-TMSSQRL60K.....	364.25	ATLADM-TTRECL2460F.....	364.10
ATLADM-TMRECV48144K.....	364.18	ATLADM-TMRRECV4872K.....	364.19	ATLADM-TMSSQRV36F.....	364.25	ATLADM-TTRECL2466F.....	364.10
ATLADM-TMRECL3672K.....	364.19	ATLADM-TMRRECV4884F.....	364.19	ATLADM-TMSSQRV36K.....	364.25	ATLADM-TTRECL2472F.....	364.10
ATLADM-TMRECL3672K.....	364.19	ATLADM-TMRRECV4884K.....	364.19	ATLADM-TMSSQRV42F.....	364.25	ATLADM-TTRECL2478F.....	364.10
ATLADM-TMRNDL36F.....	364.24	ATLADM-TMRRECV4896F.....	364.19	ATLADM-TMSSQRV48F.....	364.25	ATLADM-TTRECL2484F.....	364.10
ATLADM-TMRNDL36K.....	364.24	ATLADM-TMRRECV4896K.....	364.19	ATLADM-TMSSQRV48K.....	364.25	ATLADM-TTRECL3060F.....	364.10
ATLADM-TMRNDL42F.....	364.24	ATLADM-TMRRECV36108F.....	364.19	ATLADM-TMSSQRV54F.....	364.25	ATLADM-TTRECL3066F.....	364.10
ATLADM-TMRNDL42K.....	364.24	ATLADM-TMRRECV36108K.....	364.19	ATLADM-TMSSQRV54K.....	364.25	ATLADM-TTRECL3072F.....	364.10
ATLADM-TMRNDL48F.....	364.24	ATLADM-TMRRECV36120F.....	364.19	ATLADM-TMSSQRV60F.....	364.25	ATLADM-TTRECL3078F.....	364.10
ATLADM-TMRNDL48K.....	364.24	ATLADM-TMRRECV36120K.....	364.19	ATLADM-TMSSQRV60K.....	364.25	ATLADM-TTRECL3084F.....	364.10
ATLADM-TMRNDL54F.....	364.24	ATLADM-TMRRECV36144F.....	364.19	ATLADM-TPRACEL2048F.....	364.33	ATLADM-TTREC2460F.....	364.10
ATLADM-TMRNDL54K.....	364.24	ATLADM-TMRRECV36144K.....	364.19	ATLADM-TPRACEL2048K.....	364.33	ATLADM-TTREC2466F.....	364.10
ATLADM-TMRNDL60F.....	364.24	ATLADM-TMRRECV42108F.....	364.19	ATLADM-TPRACEL2060F.....	364.33	ATLADM-TTREC2472F.....	364.10
ATLADM-TMRNDL60K.....	364.24	ATLADM-TMRRECV42108K.....	364.19	ATLADM-TPRACEL2060K.....	364.33	ATLADM-TTREC2478F.....	364.10
ATLADM-TMRNDV36F.....	364.24	ATLADM-TMRRECV42120F.....	364.19	ATLADM-TPRACEL2072F.....	364.33	ATLADM-TTREC2484F.....	364.10
ATLADM-TMRNDV36K.....	364.24	ATLADM-TMRRECV42120K.....	364.19	ATLADM-TPRACEL2072K.....	364.33	ATLADM-TTREC2484K.....	364.10
ATLADM-TMRNDV42F.....	364.24	ATLADM-TMRRECV42144F.....	364.19	ATLADM-TPRACEL2084F.....	364.33	ATLADM-TTREC2484F.....	364.10
ATLADM-TMRNDV42K.....	364.24	ATLADM-TMRRECV42144K.....	364.19	ATLADM-TPRACEL2084K.....	364.33	ATLADM-TTREC2484K.....	364.10
ATLADM-TMRNDV48F.....	364.24	ATLADM-TMRRECV48108F.....	364.19	ATLADM-TPRACEL2096F.....	364.33	ATLADM-TTREC2484F.....	364.10
ATLADM-TMRNDV48K.....	364.24	ATLADM-TMRRECV48108K.....	364.19	ATLADM-TPRACEL2096K.....	364.33	ATLADM-TTREC2484K.....	364.10
ATLADM-TMRNDV54F.....	364.24	ATLADM-TMRRECV48120F.....	364.19	ATLADM-TPRACEV2048F.....	364.33	ATLADM-TTREC2460F.....	364.10
ATLADM-TMRNDV54K.....	364.24	ATLADM-TMRRECV48120K.....	364.19	ATLADM-TPRACEV2048K.....	364.33	ATLADM-TTREC2466F.....	364.10
ATLADM-TMRNDV60F.....	364.24	ATLADM-TMRRECV48144F.....	364.19	ATLADM-TPRACEV2060F.....	364.33	ATLADM-TTREC2472F.....	364.10
ATLADM-TMRNDV60K.....	364.24	ATLADM-TMRRECV48144K.....	364.19	ATLADM-TPRACEV2060K.....	364.33	ATLADM-TTREC2478F.....	364.10
ATLADM-TMRRECL3660F.....	364.19	ATLADM-TMRSQRL36F.....	364.25	ATLADM-TPRACEV2072F.....	364.33	ATLADM-TTREC2484F.....	364.10
ATLADM-TMRRECL3660K.....	364.19	ATLADM-TMRSQRL36K.....	364.25	ATLADM-TPRACEV2072K.....	364.33	ATLADM-TTREC2484K.....	364.10
ATLADM-TMRRECL3672F.....	364.19	ATLADM-TMRSQRL42F.....	364.25	ATLADM-TPRACEV2084F.....	364.33	ATLADM-TTREC2460F.....	364.10
ATLADM-TMRRECL3684F.....	364.19	ATLADM-TMRSQRL42K.....	364.25	ATLADM-TPRACEV2084K.....	364.33	ATLADM-TTREC2466F.....	364.10
ATLADM-TMRRECL3684K.....	364.19	ATLADM-TMRSQRL48F.....	364.25	ATLADM-TPRACEV2096F.....	364.33	ATLADM-TTREC2472F.....	364.10
ATLADM-TMRRECL3696K.....	364.19	ATLADM-TMRSQRL48K.....	364.25	ATLADM-TPRACEV2096K.....	364.33	ATLADM-TTREC2478F.....	364.10
ATLADM-TMRRECL3696K.....	364.19	ATLADM-TMRSQRL54F.....	364.25	ATLADM-TPRACEV2096F.....	364.33	ATLADM-TTREC2484F.....	364.10
ATLADM-TMRRECL4272F.....	364.19	ATLADM-TMRSQRL54K.....	364.25	ATLADM-TPRRECL2048F.....	364.33	ATLADM-TTREC2484K.....	364.10
ATLADM-TMRRECL4272K.....	364.19	ATLADM-TMRSQRL60F.....	364.25	ATLADM-TPRRECL2048K.....	364.33	ATLADM-TTREC2460F.....	364.10
ATLADM-TMRRECL4284F.....	364.19	ATLADM-TMRSQRL60K.....	364.25	ATLADM-TPRRECL2060F.....	364.33	ATLADM-TTREC2472F.....	364.10
ATLADM-TMRRECL4284K.....	364.19	ATLADM-TMRSQRL60K.....	364.25	ATLADM-TPRRECL2060K.....	364.33	ATLADM-TTREC2478F.....	364.10
ATLADM-TMRRECL4296F.....	364.19	ATLADM-TMRSQRV36F.....	364.25	ATLADM-TPRRECL2072K.....	364.33	ATLADM-TTREC2484F.....	364.10
ATLADM-TMRRECL4296K.....	364.19	ATLADM-TMRSQRV36K.....	364.25	ATLADM-TPRRECL2084F.....	364.33	ATLADM-TTREC2484K.....	364.10
ATLADM-TMRRECL4872F.....	364.19	ATLADM-TMRSQRV42F.....	364.25	ATLADM-TPRRECL2084K.....	364.33	ATLADM-TTREC2460F.....	364.10
ATLADM-TMRRECL4872K.....	364.19	ATLADM-TMRSQRV42K.....	364.25	ATLADM-TPRRECL2096F.....	364.33	ATLADM-TTREC2466F.....	364.10
ATLADM-TMRRECL4884F.....	364.19	ATLADM-TMRSQRV48F.....	364.25	ATLADM-TPRRECL2096K.....	364.33	ATLADM-TTREC2472F.....	364.10
ATLADM-TMRRECL4884K.....	364.19	ATLADM-TMRSQRV48K.....	364.25	ATLADM-TPRRECL2096K.....	364.33	ATLADM-TTREC2478F.....	364.10
ATLADM-TMRRECL4884K.....	364.19	ATLADM-TMRSQRV54F.....	364.25	ATLADM-TPRRECV2048F.....	364.33	ATLADM-TTREC2484F.....	364.10
ATLADM-TMRRECL4896F.....	364.19	ATLADM-TMRSQRV54K.....	364.25	ATLADM-TPRRECV2048K.....	364.33	ATLADM-TTREC2460F.....	364.10

# Cross Reference Index

by Model Number

Model	Page	Model	Page	Model	Page	Model	Page
ATLADM-TVM15L6PF	364.27	AW2TL36N48CB	450, 454	AW2TSPCB	440, 442, 452	AW2VMPGS60	444, 448
ATLADM-TVM15L6PK	364.27	AW2TL36N48CS	450, 454	AW2TSPCB60	440, 444	AW2VMPGS72	444, 448
ATLADM-TVM15L8PF	364.27	AW2TL36N54CB	450	AW2TSPCB72	440, 444	AW2VMPGS84	444, 448
ATLADM-TVM15L8PK	364.27	AW2TL36N54CS	450	AW2TSPCB84	444	AW2VMPGS96	444, 448
ATLADM-TVM15V4PF	364.27	AW2TL36N60CB	450	AW2TSPCB96	444	AW2VMSHCB	442
ATLADM-TVM15V4PK	364.27	AW2TL36N60CS	450	AW2TSPCS	440, 442, 452	AW2VMSHCB60	444
ATLADM-TVM15V6PF	364.27	AW2TL36N66CB	450	AW2TSPCS60	440, 444	AW2VMSHCB72	444
ATLADM-TVM15L8PK	364.27	AW2TL36N66CS	450	AW2TSPCS72	440, 444	AW2VMSHCB84	444
ATLADM-TVM15V8PF	364.27	AW2TL36N72CB	450	AW2TSPCS84	444	AW2VMSHGB	442
ATLADM-TVM15V8PK	364.27	AW2TL36N72CS	450	AW2TSPCS96	444	AW2VMSHGB60	444
ATLADM-TVM30L4PF	364.27	AW2TLFCB	438	AW2TSPGB	440, 442, 452	AW2VMSHGB72	444
ATLADM-TVM30L4PK	364.27	AW2TLFCS	438	AW2TSPGB60	440, 444	AW2VMSHGB84	444
ATLADM-TVM30L6PF	364.27	AW2TLFGB	438	AW2TSPGB72	440, 444	AW3FE1848T	439
ATLADM-TVM30L6PK	364.27	AW2TLFGS	438	AW2TSPGB84	444	AW3FE1854T	439
ATLADM-TVM30L8PF	364.27	AW2TLPCB	446, 450, 452, 454	AW2TSPGB96	444	AW3FE1860F	437
ATLADM-TVM30L8PK	364.27	AW2TLPCB60	448, 450	AW2TSPGS	440, 442, 452	AW3FE1860T	439
ATLADM-TVM30V4PF	364.27	AW2TLPCB72	448, 450	AW2TSPGS60	440, 444	AW3FE1866F	437
ATLADM-TVM30V4PK	364.27	AW2TLPCB84	448	AW2TSPGS72	440, 444	AW3FE1866T	439
ATLADM-TVM30V6PF	364.27	AW2TLPCB96	448	AW2TSPGS84	444	AW3FE1872F	437
ATLADM-TVM30V6PK	364.27	AW2TLPCS	446, 450, 452, 454	AW2TSPGS96	444	AW3FE1872T	439
ATLADM-TVM30V8PF	364.27	AW2TLPCS60	448, 450	AW2VM18N42CB	454	AW3FE2436T	441
ATLADM-TVM30V8PK	364.27	AW2TLPCS72	448, 450	AW2VM18N42CS	454	AW3FE2436V	441
ATLADM-TVM55L4PF	364.27	AW2TLPCS84	448	AW2VM24N36CB	442	AW3FE2442T	441
ATLADM-TVM55L4PK	364.27	AW2TLPCS96	448	AW2VM24N36CS	442	AW3FE2442V	441
ATLADM-TVM55L6PF	364.27	AW2TLPGB	446, 450, 452, 454	AW2VM24N42CB	442, 452	AW3FE2448T	441
ATLADM-TVM55L6PK	364.27	AW2TLPGB60	448, 450	AW2VM24N42CS	442, 452	AW3FE2448V	441
ATLADM-TVM55L8PF	364.27	AW2TLPGB72	448, 450	AW2VM24N48CB	442	AW3FE2454T	441
ATLADM-TVM55L8PK	364.27	AW2TLPGB84	448	AW2VM24N48CS	442	AW3FE2454V	441
ATLADM-TVM55V4PF	364.27	AW2TLPGB96	448	AW2VM24N54CB	442	AW3FE2460F	437
ATLADM-TVM55V4PK	364.27	AW2TLPGS	446, 450, 452, 454	AW2VM24N54CS	442	AW3FE2460T	443
ATLADM-TVM55V6PF	364.27	AW2TLPGS60	448, 450	AW2VM24N60CB	444	AW3FE2460V	443
ATLADM-TVM55V6PK	364.27	AW2TLPGS72	448, 450	AW2VM24N60CS	444	AW3FE2466F	437
ATLADM-TVM55V8PF	364.27	AW2TLPGS84	448	AW2VM24N66CB	444	AW3FE2466T	443
ATLADM-TVM55V8PK	364.27	AW2TLPGS96	448	AW2VM24N66CS	444	AW3FE2466V	443
ATPCIF48	208	AW2TLSHCB	446	AW2VM24N72CB	444	AW3FE2472F	437
ATPCIF72	208	AW2TLSHCB60	448	AW2VM24N72CS	444	AW3FE2472T	443
ATPHWIF72	208	AW2TLSHCB72	448	AW2VM24N84CB	444	AW3FE2472V	443
ATPKIT48	208	AW2TLSHCB84	448	AW2VM24N84CS	444	AW3FE2484T	443
ATPKIT60	208	AW2TLSHGB	446	AW2VM24N96CB	444	AW3FE2484V	443
ATPKIT72	208	AW2TLSHGB60	448	AW2VM24N96CS	444	AW3FE2496T	443
ATPKIT482	208	AW2TLSHGB72	448	AW2VM30N36CB	446	AW3FE2496V	443
ATPKIT602	208	AW2TLSHGB84	448	AW2VM30N36CS	446	AW3FE3036T	445
ATPKIT722	208	AW2TS18N48CB	440	AW2VM30N42CB	446, 454	AW3FE3036V	445
ATPSPLIT	208	AW2TS18N48CS	440	AW2VM30N42CS	446, 454	AW3FE3042T	445
AUPWRMOD	364.41	AW2TS18N54CB	440	AW2VM30N48CB	446, 452	AW3FE3042V	445
AVF5RS4824	392	AW2TS18N54CS	440	AW2VM30N48CS	446, 452	AW3FE3048T	445
AVF5RS4830	392	AW2TS18N60CB	440	AW2VM30N54CB	446	AW3FE3048V	445
AVF5RS5424	392	AW2TS18N60CS	440	AW2VM30N54CS	446	AW3FE3054T	445
AVF5RS5430	392	AW2TS18N66CB	440	AW2VM30N60CB	448	AW3FE3054V	445
AVF5RS6024D	392	AW2TS18N66CS	440	AW2VM30N60CS	448	AW3FE3060F	437
AVF5RS6030D	392	AW2TS18N72CB	440	AW2VM30N66CB	448	AW3FE3060T	447
AVF5RS6624D	392	AW2TS18N72CS	440	AW2VM30N66CS	448	AW3FE3060V	447
AVF5RS6630D	392	AW2TS24N36CB	442, 452	AW2VM30N72CB	448	AW3FE3066F	437
AVF5RS7224D	392	AW2TS24N36CS	442, 452	AW2VM30N72CS	448	AW3FE3066T	447
AVF5RS7230D	392	AW2TS24N42CB	442, 452	AW2VM30N84CB	448	AW3FE3066V	447
AVSTA3PWR	424	AW2TS24N42CS	442, 452	AW2VM30N84CS	448	AW3FE3072F	437
AW2TL30N36CB	446	AW2TS24N48CB	442	AW2VM30N96CB	448	AW3FE3072T	447
AW2TL30N36CS	446	AW2TS24N48CS	442	AW2VM30N96CS	448	AW3FE3072V	447
AW2TL30N42CB	446	AW2TS24N54CB	442	AW2VMPCB	442, 446, 452, 454	AW3FE3084T	447
AW2TL30N42CS	446	AW2TS24N54CS	442	AW2VMPCB60	444, 448	AW3FE3084V	447
AW2TL30N48CB	446	AW2TS24N60CB	444	AW2VMPCB72	444, 448	AW3FE3096T	447
AW2TL30N48CS	446	AW2TS24N60CS	444	AW2VMPCB84	444, 448	AW3FE3096V	447
AW2TL30N54CB	446, 452, 454	AW2TS24N66CB	444	AW2VMPCB96	444, 448	AW3FE3648T	449
AW2TL30N54CS	446, 452, 454	AW2TS24N66CS	444	AW2VMPCS	442, 446, 452, 454	AW3FE3654T	449
AW2TL30N60CB	448	AW2TS24N72CB	444	AW2VMPCS60	444, 448	AW3FE3660T	449
AW2TL30N60CS	448	AW2TS24N72CS	444	AW2VMPCS72	444, 448	AW3FE3666F	449
AW2TL30N66CB	448	AW2TS24N84CB	444	AW2VMPCS84	444, 448	AW3FE3672T	449
AW2TL30N66CS	448	AW2TS24N84CS	444	AW2VMPCS96	444, 448	AW3LF1848T	439
AW2TL30N72CB	448	AW2TS24N96CB	444	AW2VMPCB	442, 446, 452, 454	AW3LF1854T	439
AW2TL30N72CS	448	AW2TS24N96CS	444	AW2VMPCB60	444, 448	AW3LF1860F	437
AW2TL30N84CB	448	AW2TSFCB	438	AW2VMPCB72	444, 448	AW3LF1860T	439
AW2TL30N84CS	448	AW2TSFCS	438	AW2VMPCB84	444, 448	AW3LF1866F	437
AW2TL30N96CB	448	AW2TSFGB	438	AW2VMPCB96	444, 448	AW3LF1866T	439
AW2TL30N96CS	448	AW2TSFGS	438	AW2VMPCB	442, 446, 452, 454	AW3LF1872F	437

# Cross Reference Index

by Model Number

Model	Page	Model	Page	Model	Page	Model	Page
AW3LF1872T	439	AW3LK3060V	447	AW3VF1854T	439	AW4MB7236P	461
AW3LF2436T	441	AW3LK3066V	447	AW3VF1860T	439	AW4MB7248G	461
AW3LF2436V	441	AW3LK3072V	447	AW3VF1866T	439	AW4MB7248P	461
AW3LF2442T	441	AW3LK3084V	447	AW3VF1872T	439	AW4MB7260P	461
AW3LF2442V	441	AW3LK3096V	447	AW3VF2436T	441	AW4P2C	457, 525
AW3LF2448T	441	AW3LT1848T	439	AW3VF2436V	441	AW4P2H	457, 524
AW3LF2448V	441	AW3LT1854T	439	AW3VF2442T	441	AW4QBCJ36	457
AW3LF2454T	441	AW3LT1860F	437	AW3VF2442V	441	AW4QBI	364.40, 457, 526
AW3LF2454V	441	AW3LT1860T	439	AW3VF2448T	441	AW4QH60P	457
AW3LF2460F	437	AW3LT1866F	437	AW3VF2448V	441	AW4QJ36	364.40, 457
AW3LF2460T	443	AW3LT1866T	439	AW3VF2454T	441	AW4SHELF	459
AW3LF2460V	443	AW3LT1872F	437	AW3VF2454V	441	AW4TB5036	461
AW3LF2466F	437	AW3LT1872T	439	AW3VF2460T	443	AW4TB5048	461
AW3LF2466T	443	AW3LT2436T	441	AW3VF2460V	443	AW4TB7236	461
AW3LF2466V	443	AW3LT2436V	441	AW3VF2466T	443	AW4TB7248	461
AW3LF2472F	437	AW3LT2442T	441	AW3VF2466V	443	AW4TB7260	461
AW3LF2472T	443	AW3LT2442V	441	AW3VF2472T	443	AW4TRASH	459
AW3LF2472V	443	AW3LT2448T	441	AW3VF2472V	443	AW4W48	457
AW3LF2484T	443	AW3LT2448V	441	AW3VF2484T	443	AW4W60	457
AW3LF2484V	443	AW3LT2454T	441	AW3VF2484V	443	AW4W72	457
AW3LF2496T	443	AW3LT2454V	441	AW3VF2496T	443	AW4W84	457
AW3LF2496V	443	AW3LT2460F	437	AW3VF2496V	443	AW4WB3648G	462
AW3LF3036T	445	AW3LT2460T	443	AW3VF3036T	445	AW4WB3648P	462
AW3LF3036V	445	AW3LT2460V	443	AW3VF3036V	445	AW4WB4848G	462
AW3LF3042T	445	AW3LT2466F	437	AW3VF3042T	445	AW4WB4848P	462
AW3LF3042V	445	AW3LT2466T	443	AW3VF3042V	445	AW4WB4860G	462
AW3LF3048T	445	AW3LT2466V	443	AW3VF3048T	445	AW4WB4860P	462
AW3LF3048V	445	AW3LT2472F	437	AW3VF3048V	445	AW4WB4872G	462
AW3LF3054T	445	AW3LT2472T	443	AW3VF3054T	445	AW4WB4872P	462
AW3LF3054V	445	AW3LT2472V	443	AW3VF3054V	445	AW4WB4896G	462
AW3LF3060F	437	AW3LT2484T	443	AW3VF3060T	447	AW4WB4896P	462
AW3LF3060T	447	AW3LT2484V	443	AW3VF3060V	447	AW4WCT36L LABEL	460
AW3LF3060V	447	AW3LT2496T	443	AW3VF3066T	447	AW4WCS57 LABEL	460
AW3LF3066F	437	AW3LT2496V	443	AW3VF3066V	447	AW4WC3620	460
AW3LF3066T	447	AW3LT3036T	445	AW3VF3072T	447	AW4WCS5720	460
AW3LF3066V	447	AW3LT3036V	445	AW3VF3072V	447	AW4WCTIBC36W	460
AW3LF3072F	437	AW3LT3042T	445	AW3VF3084T	447	AW4WCTIBC57W	460
AW3LF3072T	447	AW3LT3042V	445	AW3VF3084V	447	AW4WCTIP36W	460
AW3LF3072V	447	AW3LT3048T	445	AW3VF3096T	447	AW4WCTIP57W	460
AW3LF3084T	447	AW3LT3048V	445	AW3VF3096V	447	AWCS	413
AW3LF3084V	447	AW3LT3054T	445	AW3VF3648T	449	AWCVRC	457
AW3LF3096T	447	AW3LT3054V	445	AW3VF3654T	449	AWCVRG	457
AW3LF3096V	447	AW3LT3060F	437	AW3VF3660T	449	AWLG	56
AW3LF3648T	449	AW3LT3060T	447	AW3VF3666T	449	AWLP	56
AW3LF3654T	449	AW3LT3060V	447	AW3VF3672T	449	AWLS	56
AW3LF3660T	449	AW3LT3066F	437	AW4AVRACK	459	AWLW	56
AW3LF3666T	449	AW3LT3066T	447	AW4BACC	461, 462	AWMG	56
AW3LF3672T	449	AW3LT3066V	447	AW4BC4824L	459	AWMP	56
AW3LFC2470V	453	AW3LT3072F	437	AW4BC4824LNG	459	AWMS	56
AW3LFC3085T	453	AW3LT3072T	447	AW4BC4824R	459	AWMW	56
AW3LFH2448T	451	AW3LT3072V	447	AW4BC4824RNG	459	BP4UC	192
AW3LFH2448V	451	AW3LT3084T	447	AW4BC7224	459	BPBSCR24	198
AW3LFH3060T	451	AW3LT3084V	447	AW4BC7224NG	459	BPBSCR30	188
AW3LFH3060V	451	AW3LT3096T	447	AW4BHOOK	461	BPBSCR36	198
AW3LFH3672T	451	AW3LT3096V	447	AW4DRAWER	459	BPBSCR45	188
AW3LFP2455V	453	AW3LT3648T	449	AW4GANG	364.40, 455, 526	BPCCT24	200
AW3LFP3066T	453	AW3LT3654T	449	AW4HM36	455	BPCCT30	190
AW3LFPQ2490	453	AW3LT3660T	449	AW4HM42	455	BPCH	204
AW3LFPQ3090	453	AW3LT3666T	449	AW4HM48	455	BPCT12	200
AW3LFT2460T	451	AW3LT3672T	449	AW4HM54	455	BPCT15	190
AW3LFT3072V	451	AW3LTC2470V	453	AW4HM60	455	BPCT24	200
AW3LK2436V	441	AW3LTC3085T	453	AW4HM66	455	BPCT30	190
AW3LK2442V	441	AW3LTH2448T	451	AW4HM72	455	BPCT2445	204
AW3LK2448V	441	AW3LTH2448V	451	AW4HM78	455	BPCTO24	200
AW3LK2454V	441	AW3LTH3060T	451	AW4HM84	455	BPCTO30	190
AW3LK2460V	443	AW3LTH3060V	451	AW4HM90	455	BPLB	188
AW3LK2466V	443	AW3LTH3672T	451	AW4HM96	455	BPLBL	188
AW3LK2472V	443	AW3LTP2455V	453	AW4LECT	463	BPLBR	188
AW3LK2484V	443	AW3LTP3066T	453	AW4LECTPWR	463	BPLCM	186
AW3LK2496V	443	AW3LTQ2490	453	AW4MB5036G	461	BPLCPL	192
AW3LK3036V	445	AW3LTQ3090	453	AW4MB5036P	461	BPLCR	188
AW3LK3042V	445	AW3LTT2460T	451	AW4MB5048G	461	BPLCRPL	192
AW3LK3048V	445	AW3LTT3072V	451	AW4MB5048P	461	BPLCS	184
AW3LK3054V	445	AW3VF1848T	439	AW4MB7236G	461	BPLEL	192



# Cross Reference Index

by Model Number

Model	Page	Model	Page	Model	Page	Model	Page
BPLELC.....	192	CFDPWRC.....	395	CWW-MHW.....	94	EPP2128S.....	286
BPLLM.....	186	CFDPWRSC.....	395	CWW-MMA.....	94	EPR18HM.....	288
BPLLS.....	184	C-HDRK.....	94, 96	CWW-MMF.....	94	EPR18HS.....	286
BPLO.....	188	CHULNO.....	301	CWW-MMH.....	94	EPR18M.....	288
BPLRM.....	186	CLAMFC.....	64	CWW-MMW.....	94	EPR18S.....	286
BPLRS.....	184	CLCCNO.....	278	CZSAP.....	64	EPW18HM.....	288
BPLSIC.....	192	CLCNO.....	278	DSC-MUCONO.....	71	EPW18HS.....	286
BPLSIL.....	192	CLCPCNO.....	278	DSC-MUGONO.....	71	EPW18M.....	288
BPLSIL15.....	192	CLCPNO.....	278	DWC-UMANO.....	68	EPW18S.....	286
BPLSIL30.....	192	CLCTL.....	282	DWC-UMFNO.....	68	ET20.....	292, 338
BPLSM.....	186	CLCTV.....	282	DWC-UMHNO.....	68	ET39.....	292, 338
BPLSNM.....	186	CLG-CGANO.....	298	DWC-UMWNO.....	68	ET1421.....	292, 338
BPLSNS.....	184	CLG-UGANO.....	298	DW-LUK.....	68	ET2142.....	292, 338
BPLSO.....	188	CLG-WGANO.....	298	DWS-MHANO.....	70	ET4242.....	292, 338
BPLSPL.....	192	CLL-MLA.....	99	DWS-MHFNO.....	70	EV20.....	294, 340
BPLSS.....	184	CLL-MLF.....	99	DWS-MHHNO.....	70	EV39.....	294, 340
BPLSWM.....	186	CLL-MLH.....	99	DWS-MHWNO.....	70	EV1421.....	294, 340
BPLSWS.....	184	CLOMFC.....	64	DWW-MHANO.....	68	EV2142.....	294, 340
BPLTL.....	188	CLR-CGANO.....	299	DWW-MHFNO.....	68	EV4242.....	294, 340
BPLTR.....	188	CLR-UGANO.....	299	DWW-MHHNO.....	68	FDEPC2.....	402
BPNT12.....	200	CLR-WGANO.....	299	DWW-MHWNO.....	68	FDEPC12.....	402
BPNT15.....	190	CLSCNO.....	278	EAAC.....	418	FDPWRC.....	395
BPNT24.....	200	CLSNO.....	278	EABS.....	418	FDPWRSC.....	395
BPNT30.....	190	CLSTL.....	282	EACS.....	418	FDRWEC.....	402
BPSIC15.....	204	CLSTV.....	282	EADH.....	418	FDRWLEG.....	402
BPSIC30.....	204	CMPN-PPCA.....	106	EAFS.....	418	FDRWUC.....	402
BPTE24.....	200	CMPN-PPCO.....	106	EAFST.....	418	FDSC48LL.....	399
BPTE30.....	190	CMPN-PPGA.....	106	EAHSR36.....	417	FDSC48LR.....	399
BPTE48.....	200	CMPN-PPGO.....	106	EAHSR42.....	417	FDSC48R.....	399
BPTE60.....	190	CMPNU-PPCA.....	106	EAHSR48.....	417	FDSC48U.....	399
BPTS24.....	200	CMPNU-PPCO.....	106	EAHSR60.....	417	FDSC54LL.....	399
BPTS30.....	190	CMPNU-PPGA.....	106	EAHSR66.....	417	FDSC54LR.....	399
BPTT.....	204	CMPNU-PPGO.....	106	EAHSR72.....	417	FDSC54R.....	399
BPWB.....	198	CMPW-PPCANO.....	103	EAPC.....	418	FDSC54U.....	399
BPWBL.....	198	CMPW-PPCONO.....	103	EAPS.....	418	FDSC60LL.....	399
BPWBR.....	198	CMPWU-PPCANO.....	103	EAPT.....	418	FDSC60LR.....	399
BPWCM.....	196	CMPWU-PPCONO.....	103	EASR24.....	417	FDSC60R.....	399
BPWCPL.....	202	CSC-MUCONO.....	101	EASR30.....	417	FDSC60U.....	399
BPWCRPL.....	202	CSC-MUGONO.....	101	EASR36.....	417	FDSC66LL.....	399
BPWSC.....	194	CSC-UUCONO.....	101	EASR42.....	417	FDSC66LR.....	399
BPWEL.....	202	CSC-UUGONO.....	101	EASR48.....	417	FDSC66R.....	399
BPWELC.....	202	CSDC19.....	419	EASR60.....	417	FDSC66U.....	399
BPWLM.....	196	CSDC25.....	419	EASS.....	418	FDSC72LL.....	399
BPWLS.....	194	CSG-PGANO.....	152	EATS.....	418	FDSC72LR.....	399
BPWO.....	198	CSG-PGANOSP.....	152	EB39M.....	290	FDSC72R.....	399
BPWRM.....	196	CSL-PGANO.....	152	EB39S.....	290	FDSC72U.....	399
BPWRS.....	194	CSL-PGANOSP.....	152	EB2142M.....	290	FDSC148LK.....	399
BPWSIC.....	202	CSS-MMA.....	96	EB2142S.....	290	FDSC148RK.....	399
BPWSIL.....	202	CSS-MMF.....	96	EB4242M.....	290	FDSC154LK.....	399
BPWSIL15.....	202	CSS-MMH.....	96	EB4242S.....	290	FDSC154RK.....	399
BPWSIL30.....	202	CSS-MMW.....	96	EPB1421HM.....	288	FDSC160LK.....	399
BPWSM.....	196	CSW-MHA.....	94	EPB1421HS.....	286	FDSC160RK.....	399
BPWSNM.....	196	CSW-MHF.....	94	EPB1421M.....	288	FDSC166LK.....	399
BPWSNS.....	194	CSW-MHH.....	94	EPB1421S.....	286	FDSC166RK.....	399
BPWSO.....	198	CSW-MHW.....	94	EPB1442M.....	288	FDSC172LK.....	399
BPWSPL.....	202	CSW-MMA.....	94	EPB2121HM.....	288	FDSC172RK.....	399
BPWSS.....	194	CSW-MMF.....	94	EPB2121HS.....	286	FDSCR48K.....	399
BPWSWM.....	196	CSW-MMH.....	94	EPB2121M.....	288	FDSCR54K.....	399
BPWSWS.....	194	CSW-MMW.....	94	EPB2121S.....	286	FDSCR60K.....	399
BPWTL.....	198	CUBS-PGANO.....	152	EPB2128M.....	288	FDSCR66K.....	399
BPWTR.....	198	CUBS-PGANOSP.....	152	EPB2128S.....	286	FDSCR72K.....	399
BSSICC.....	204	CUCS-PGANO.....	152	EPB2142M.....	288	FDSCU48K.....	399
C4AMFC.....	64	CUCS-PGANOSP.....	152	EPB2142S.....	286	FDSCU54K.....	399
C4OMFC.....	64	CVAMFC.....	64	EPP1722HM.....	288	FDSCU60K.....	399
C5AMFC.....	64	CVOMFC.....	64	EPP1722HS.....	286	FDSCU66K.....	399
C5OMFC.....	64	CWS-PPGA.....	106	EPP1722M.....	288	FDSCU72K.....	399
CBW-MHA.....	94	CWS-PPGO.....	106	EPP1722S.....	286	FWS-MHANO.....	120
CBW-MHF.....	94	CWSS30-PPGA.....	106	EPP1820HM.....	288	FWS-MHFNO.....	120
CBW-MHH.....	94	CWSS30U-PPGA.....	106	EPP1820HS.....	286	FWS-MHHNO.....	120
CBW-MHW.....	94	CWSU-PPGA.....	106	EPP1820M.....	288	FWW-MHANO.....	120
CBW-MMA.....	94	CWSU-PPGO.....	106	EPP1820S.....	286	FWW-MHFNO.....	120
CBW-MMF.....	94	CW'W-MHA.....	94	EPP2128HM.....	288	FWW-MHHNO.....	120
CBW-MMH.....	94	CW'W-MHF.....	94	EPP2128HS.....	286	GA56HSE.....	320
CBW-MMW.....	94	CW'W-MHH.....	94	EPP2128M.....	288	GA56MSE.....	318

# Cross Reference Index

by Model Number

Model	Page	Model	Page	Model	Page	Model	Page
GA70HCOLHP	320	INST-UCA	80	MLM22	252, 358	NALSMW	230
GA70HCOLNP	320	INST-UCO	80	MLM26	252, 358	NALSWS	228
GA70HCOUHP	320	INST-UGA	80	MLM27	250	NAPT	235, 343
GA70HCOUNP	320	INST-UGO	80	MLM27S	250	NAPWT	234, 351
GA70HMCL	320	INTK-NA	86	MLM35	248	NARC	232, 342
GA70HMCU	320	INTK-NO	86	MLM35S	248	NMBL-1FC	113
GA70HSTHL	320	INTK-SA	86	MLM36	244	NMBL-2FC	113
GA70HSTHR	320	INTK-SO	86	MLM36S	244	NMBL-CART	113
GA70HSTNP	320	INTK-UA	86	MLM37	244	NMBL-GANG	113
GA70MCOLHP	318	INTK-UO	86	MLM37S	244	PRFTSKCL	423
GA70MCOLNP	318	INWS-NA	88	MLM38	250	PRFTSKFS	423
GA70MCOUHP	318	INWS-NO	88	MLM38S	250	PRFTSKTR	423
GA70MCOUNP	318	INWS-SA	88	MLM39	250	PSASC	278
GA70MMCL	318	INWS-SO	88	MLM39S	250	PSASN	278
GA70MMCU	318	INWS-UA	88	MLM40	250	PSBC	278
GA70MSTHL	318	INWS-UO	88	MLM40S	250	PSBN	278
GA70MSTHR	318	K-MPCA	142	MLM41	250	PSCC	278
GA70MSTNP	318	K-MPCO	142	MLM41S	250	PSCN	278
GA84HMW	320	K-MPGA	142	MLM42	250	PSCPC	278
GA84HSE	320	K-MPGO	142	MLM42J	253, 261	PSCPN	278
GA84HSTHL	320	K-MUCA	142	MLM42S	250	PSDSC	278
GA84HSTHR	320	K-MUCO	142	MLM43	250	PSDSN	278
GA84HSTNP	320	K-MUGA	142	MLM43S	250	PSLCC	280
GA84MMW	318	K-MUGO	142	MLM44	248	PSLCN	280
GA84MSE	318	K-PPCA	142	MLM44S	248	PSLSC	280
GA84MSTHL	318	K-PPCO	142	MLM72J	253, 261	PSLSN	280
GA84MSTHR	318	K-PPGA	142	MLMGK	253	PSRCC	280
GA84MSTNP	318	K-PPGO	142	MLMHWC	253	PSRCN	280
GAPWR	323	K-PUCA	142	MLML15	252	PSRSC	280
GAPWRMW	323	K-PUCO	142	MLMR15	252	PSRSN	280
GAPWRMWCH	323	K-PUGA	142	MLMZ4WA	253, 261	PTCTL	282, 335
GAPWRMWNY	323	K-PUGO	142	MLMZCA72	253, 261	PTCTS	282, 335
GAPWRSC	323	LLUK	94	MLMZHWA72	253, 261	PTCTV	282, 335
GAPWRSCCN	323	LLUK-LT	99	MLUK	110	PTLTL	282, 335
GAPWRSCNY	323	LSTNO	123	MNL-LUK	116	PTLTS	282, 335
GATBLEXT	323	MIS-KANO	110	MNL-MHA	116	PTLTV	282, 335
GATVMB	323, 364, 32, 512	MIS-KWNO	110	MNL-MHH	116	PTSTL	282, 335
GAWRP	309	MIW-KANO	110	MNL-MHW	116	PTSTS	282, 335
GS870924	422	MIW-KWNO	110	MNLS-MHA	116	PTSTV	282, 335
GS870930	422	MLM1	244	MNLS-MHH	116	RETECLM	272
GS870948	422	MLM1S	244	MNLS-MHW	116	RETECLS	272
GS870960	422	MLM2	244	NA48R	232, 351	RETECMM	272
INFS-NGA	90	MLM2S	244	NA48SS	232, 351	RETECMS	272
INFS-NGO	90	MLM3	246	NA96RCF	234, 361	RETWLM	272
INFS-SGA	90	MLM3S	246	NA4815RB	233, 342	RETWLS	272
INFS-SGO	90	MLM4	246	NA4828RB	233, 342	RETWMM	272
INFS-UGA	90	MLM4S	246	NA482920RB	233, 342	RETWMS	272
INFS-UGO	90	MLM5	248	NA483615RB	233, 342	RFDRW48	402
INSL-NA	82	MLM5S	248	NA483620RB	233, 342	RFDRW54	402
INSL-NO	82	MLM6	248	NAE1	236, 344, 352, 363	RFDRW60	402
INSL-SA	82	MLM6S	248	NAE2	236, 344, 352, 363	RFDRW66	402
INSL-SO	82	MLM7	248	NAE3-IUSB	236, 363	RFDRW72	402
INSL-UA	82	MLM7S	248	NAE3-3USB	236, 363	RFDRWAB	402
INSL-UO	82	MLM8	248	NAE4	236, 363	RFDRWCNPP	404
INST-NCA	80	MLM8S	248	NAEESL	236, 352, 363	RFDRWCNPPPE	404
INST-NCO	80	MLM9	246	NAESL	235, 352, 362	RFDRWCNPPM	404
INST-NGA	80	MLM9S	246	NAHD	228	RFDRWHUBEND	403
INST-NGO	80	MLM10	246	NAHDM	230	RFDRWHUBENDT	403
INST-SCA	80	MLM10S	246	NAHDMW	230	RFDRWHUBL	403
INST-SO	80	MLM11	246	NAHDW	228	RFDRWHUBLIN	403
INST-SGA	80	MLM11S	246	NAHP	235, 343	RFDRWHUBT	403
INST-SGO	80	MLM13	246	NAHS	228	RFDRWHUBX	403
INST-NCAFLS	84	MLM13S	246	NAHSM	230	RFDRWLEG	402
INST-NCAFRS	84	MLM15N	252	NAHSMW	230	RFDRWSC48	405
INST-NGAFLS	84	MLM16	252	NAHSW	228	RFDRWSC54	405
INST-NGAFRS	84	MLM16N	252	NALC	234, 342	RFDRWSC60	405
INST-SCAFLS	84	MLM17	252	NALCF	234, 361	RFDRWSC66	405
INST-SCAFRS	84	MLM17N	252	NALD	228	RFDRWSC72	405
INST-SGAFLS	84	MLM18	252, 347	NALDM	230	RFDRWWM	404
INST-SGAFRS	84	MLM19	252, 358	NALDMW	230	RLA-MHA	128
INST-UCAFLS	84	MLM20	244	NALDW	228	RLA-MHP	128
INST-UCAFRS	84	MLM20S	244	NALP	235, 343	RLA-UHA	128
INST-UGAFLS	84	MLM21	244	NALS	228	RLA-UHP	128
INST-UGAFRS	84	MLM21S	244	NALSM	230	RLC-MUGA	139

# Cross Reference Index

by Model Number

Model	Page	Model	Page	Model	Page	Model	Page
RLC-MUGO	139	S913PLHED	471	S922SWTN	264	S942PTSE4296NP	474
RLC-UUGA	139	S913PLM	471	S924SS	305	S942PTSE4872	473
RLC-UUGO	139	S913WNB3629	470	S924ST	305	S942PTSE4872NP	474
RLC-WUGA	139	S913WNB3642	470	S942LTSE545QR	473	S942PTSE4884	473
RL-MHA	126	S913WNB4229	470	S942LTSE545QRNP	474	S942PTSE4884NP	474
RL-MHP	126	S913WNB4242	470	S942LTSE605QR	473	S942PTSE4896	473
RLM-MUCA	136	S913WNB4829	470	S942LTSE605QRNP	474	S942PTSE4896NP	474
RLM-MUCO	136	S913WNB4842	470	S942LTSE3672	473	S942PTSE36120	473
RLM-MUGA	136	S913WPB3629	470	S942LTSE3672NP	474	S942PTSE36120NP	474
RLM-MUGO	136	S913WPB3642	470	S942LTSE3684	473	S942PTSE42120	473
RLM-UUCA	136	S913WPB4229	470	S942LTSE3684NP	474	S942PTSE42120NP	474
RLM-UUCO	136	S913WPB4242	470	S942LTSE3696	473	S942PTSE48120	473
RLM-UUGA	136	S913WPB4829	470	S942LTSE3696NP	474	S942PTSE48120NP	474
RLM-UUGO	136	S913WPB4842	470	S942LTSE4272	473	S942PTST545QR	473
RLM-WUGA	136	S913WTF3620	469	S942LTSE4272NP	474	S942PTST545QRNP	474
RLS-MHA	132	S913WTF3672	469	S942LTSE4284	473	S942PTST605QR	473
RLS-MHP	132	S913WTF3696	469	S942LTSE4284NP	474	S942PTST605QRNP	474
RL-UHA	126	S913WTF4220	469	S942LTSE4296	473	S942PTST3672	473
RL-UHP	126	S913WTF4272	469	S942LTSE4296NP	474	S942PTST3672NP	474
S911NH	336	S913WTF4296	469	S942LTSE4872	473	S942PTST3684	473
S911NL	336	S913WTF4820	469	S942LTSE4872NP	474	S942PTST3684NP	474
S911NM	336	S913WTF4872	469	S942LTSE4884	473	S942PTST3696	473
S911RLTB	348	S913WTF4896	469	S942LTSE4884NP	474	S942PTST3696NP	474
S912B1632	334	S913WTS3620	469	S942LTSE4896	473	S942PTST4272	473
S912B2116	334	S913WTS3672	469	S942LTSE4896NP	474	S942PTST4272NP	474
S912T16G	334	S913WTS3696	469	S942LTSE36120	473	S942PTST4284	473
S912T16L	334	S913WTS4220	469	S942LTSE36120NP	474	S942PTST4284NP	474
S912T16V	334	S913WTS4272	469	S942LTSE42120	473	S942PTST4296	473
S912T32G	334	S913WTS4296	469	S942LTSE42120NP	474	S942PTST4296NP	474
S912T32L	334	S913WTS4820	469	S942LTSE48120	473	S942PTST4872	473
S912T32V	334	S913WTS4872	469	S942LTSE48120NP	474	S942PTST4872NP	474
S913LNB3629	470	S913WTS4896	469	S942LTST545QR	473	S942PTST4884	473
S913LNB3642	470	S922GB	266	S942LTST545QRNP	474	S942PTST4884NP	474
S913LNB4229	470	S922LPN	263.1	S942LTST605QR	473	S942PTST4896	473
S913LNB4242	470	S922P4NYK	253, 261	S942LTST605QRNP	474	S942PTST4896NP	474
S913LNB4829	470	S922P4S72K	253, 261	S942LTST3672	473	S942PTST36120	473
S913LNB4842	470	S922P4S144K	261	S942LTST3672NP	474	S942PTST36120NP	474
S913LPB3629	470	S922S2	260	S942LTST3684	473	S942PTST42120	473
S913LPB3642	470	S922S2IC	260	S942LTST3684NP	474	S942PTST42120NP	474
S913LPB4229	470	S922S2LN	262	S942LTST3696	473	S942PTST48120	473
S913LPB4242	470	S922S2LP	262	S942LTST3696NP	474	S942PTST48120NP	474
S913LPB4829	470	S922S2LTN	264	S942LTST4272	473	S943LTSE545QR	476
S913LPB4842	470	S922S2LTP	264	S942LTST4272NP	474	S943LTSE545QRNP	477
S913LTF3620	469	S922S2OC	260	S942LTST4284	473	S943LTSE605QR	476
S913LTF3672	469	S922S2P	260	S942LTST4284NP	474	S943LTSE605QRNP	477
S913LTF3696	469	S922S2T	260	S942LTST4296	473	S943LTSE3672	476
S913LTF4220	469	S922S2TIC	260	S942LTST4296NP	474	S943LTSE3672NP	477
S913LTF4272	469	S922S2TOC	260	S942LTST4872	473	S943LTSE3684	476
S913LTF4296	469	S922S2TP	260	S942LTST4872NP	474	S943LTSE3684NP	477
S913LTF4820	469	S922S3	260	S942LTST4884	473	S943LTSE3696	476
S913LTF4872	469	S922S3P	260	S942LTST4884NP	474	S943LTSE3696NP	477
S913LTF4896	469	S922S3T	260	S942LTST4896	473	S943LTSE4272	476
S913LTS3620	469	S922S3TP	260	S942LTST4896NP	474	S943LTSE4272NP	477
S913LTS3672	469	S922SAN	263.1	S942LTST36120	473	S943LTSE4284	476
S913LTS3696	469	S922SATN	264	S942LTST36120NP	474	S943LTSE4284NP	477
S913LTS4220	469	S922SATWN	264	S942LTST42120	473	S943LTSE4296	476
S913LTS4272	469	S922SAWN	263.1	S942LTST42120NP	474	S943LTSE4296NP	477
S913LTS4296	469	S922SHON	262	S942LTST48120	473	S943LTSE4872	476
S913LTS4820	469	S922SHOTN	264	S942LTST48120NP	474	S943LTSE4872NP	477
S913LTS4872	469	S922SHOTWN	264	S942PTSE545QR	473	S943LTSE4884	476
S913LTS4896	469	S922SHOWN	262	S942PTSE545QRNP	474	S943LTSE4884NP	477
S913P05LJ	471	S922SON	262	S942PTSE605QR	473	S943LTSE4896	476
S913P06CE	471	S922SOP	262	S942PTSE605QRNP	474	S943LTSE4896NP	477
S913P06CM	471	S922SOTN	264	S942PTSE3672	473	S943LTSE36120	476
S913P06LS	471	S922SOTP	264	S942PTSE3672NP	474	S943LTSE36120NP	477
S913P10LS	471	S922SOTWN	264	S942PTSE3684	473	S943LTSE42120	476
S913P12CE	471	S922SOTWP	264	S942PTSE3684NP	474	S943LTSE42120NP	477
S913P12CM	471	S922SOWN	262	S942PTSE3696	473	S943LTSE48120	476
S913P20CE	471	S922SOWP	262	S942PTSE3696NP	474	S943LTSE48120NP	477
S913P20CM	471	S922SWDN	262	S942PTSE4272	473	S943LTST545QR	476
S913P20HE	471	S922SWDP	262	S942PTSE4272NP	474	S943LTST545QRNP	477
S913P20HM	471	S922SWDWN	262	S942PTSE4284	473	S943LTST605QR	476
S913PLE	471	S922SWDWP	262	S942PTSE4284NP	474	S943LTST605QRNP	477
S913PLHE	471	S922SWN	263.1	S942PTSE4296	473	S943LTST3672	476

# Cross Reference Index

by Model Number

Model	Page	Model	Page
S943LTST3672NP	477	S943VTST36120NP	477
S943LTST3684	476	S943VTST42120	476
S943LTST3684NP	477	S943VTST42120NP	477
S943LTST3696	476	S943VTST48120	476
S943LTST3696NP	477	S943VTST48120NP	477
S943LTST4272	476	STLUK	123
S943LTST4272NP	477	SV2HCNO	146
S943LTST4284	476	SV2HPNO	146
S943LTST4284NP	477	SV2MCNO	146
S943LTST4296	476	SV2MPNO	146
S943LTST4296NP	477	U7WDA	419, 456
S943LTST4872	476	U9TF	406
S943LTST4872NP	477	U9TM	406
S943LTST4884	476	U9TP	406
S943LTST4884NP	477	U9TS	406
S943LTST4896	476	U9WTC	406
S943LTST4896NP	477	U912WTR	406
S943LTST36120	476	U918WTR	406
S943LTST36120NP	477	U924WTR	406
S943LTST42120	476	U930WTR	406
S943LTST42120NP	477	U936WTR	406
S943LTST48120	476	U942WTR	406
S943LTST48120NP	477	U948WTR	406
S943VTSE54SQR	476	U954WTR	406
S943VTSE54SQRNP	477	U960WTR	406
S943VTSE60SQR	476	U966WTR	406
S943VTSE60SQRNP	477	UN2HPSQ	404
S943VTSE3672	476	UN2HPSQSK	404
S943VTSE3672NP	477	UN924HT	395
S943VTSE3684	476	UN936HT	395
S943VTSE3684NP	477	UN948HT	395
S943VTSE3696	476	UNQTMP	395, 424
S943VTSE3696NP	477	VATWMG	56
S943VTSE4272	476	VERHNO	270
S943VTSE4272NP	477	VERLNO	270
S943VTSE4284	476	VERONO	270
S943VTSE4284NP	477	VERWNO	270
S943VTSE4296	476	WANDFS	423
S943VTSE4296NP	477	WANDFSOC	423
S943VTSE4872	476	WANDFSUSB	423
S943VTSE4872NP	477	WKSWMC	395, 404, 523
S943VTSE4884	476	Z5SC42	364.40
S943VTSE4884NP	477	Z5SC48	364.40
S943VTSE4896	476	Z5SC54	364.40
S943VTSE4896NP	477	Z5SC60	364.40
S943VTSE36120	476	Z5SC66	364.40
S943VTSE36120NP	477	Z5SC72	364.40
S943VTSE42120	476	Z5SC78	364.40
S943VTSE42120NP	477	Z5SC84	364.40
S943VTSE48120	476	Z617UWTRGH	395, 523
S943VTSE48120NP	477	Z636UWTRGH	395, 523
S943VTST54SQR	476	Z61710UWTRGH	395, 523
S943VTST54SQRNP	477	Z63610UWTRGH	395, 523
S943VTST60SQR	476		
S943VTST60SQRNP	477		
S943VTST3672	476		
S943VTST3672NP	477		
S943VTST3684	476		
S943VTST3684NP	477		
S943VTST3696	476		
S943VTST3696NP	477		
S943VTST4272	476		
S943VTST4272NP	477		
S943VTST4284	476		
S943VTST4284NP	477		
S943VTST4296	476		
S943VTST4296NP	477		
S943VTST4872	476		
S943VTST4872NP	477		
S943VTST4884	476		
S943VTST4884NP	477		
S943VTST4896	476		
S943VTST4896NP	477		
S943VTST36120	476		



Allsteel®

Allsteel Inc.  
Muscatine, Iowa 52761

[allsteeloffice.com](http://allsteeloffice.com)

Form #A8712.A10 (12/23)