

Standard Specials

Price & Specification Guide 2023

Prices effective March 1, 2023

PAINTED METAL FINISHES

GRADE P1

Black	P27
Brownstone	P7D
Bungalow	P7C
Cinder	P7Q
Designer White	PJW
Flint	P02
Fossil	P28
Loft	P7B
Muslin	P4J
Parchment	P93
Pebble	P8R
Pewter	P8D
Salt	P8C
Titanium	P8T

GRADE P2

Champagne Metallic	PR5
Gunmetal Metallic	PR3
Platinum Metallic	PR2
Silver**	PR6
Solar Black	P8X

**PR6 no upcharge on Involve; available as a Grade P2 color on stanchions; is not available on Concensys, Essentials, and vertical files. PQ8 is not available on vertical files.

GRADE P3

Atom	P8S
Blossom***	P8K
Bullseye	PJF
Cabernet***	P7T
Conifer***	P8H
Ember	P8P
Ion	P8N
Iris	P8J
Krypton	P8F
Regatta	P8M
Succulent***	P8A

*** These colors are intended to be an inspirational option for the trending market. Product application is limited and color availability is approximately two years to coincide with evolving workplace trends.

Metallic paints, due to varying reflectance, may appear to have less visual color consistency than other paint finishes, even when L/A/B values are exactly the same. (L/A/B — measurable aspects of color — values are maintained within a specified range, to ensure consistent appearance of paint colors.)

METAL STORAGE PULLS

Black	E4
Bronze (for veneer only)	EZ
Matte Silver	EL

PAINTED WOOD FINISHES

Brownstone	M13
Bungalow	M12
Designer White	M17
Flint	M16
Loft	M11
Muslin	M15

ELECTRICAL AND DATA COMPONENTS

Black	E4
Brownstone	EY
Designer White	DW
Flint	E9
Loft	EV
Muslin	EU
Silver	ES

Recommended Coordinate Colors:
 Bungalow use Muslin EU
 Carob use Black E4
 Champagne Metallic use Muslin EU
 Cinder use Brownstone EY
 Fossil use Flint E9
 Gunmetal Metallic use Brownstone EY
 Parchment use Muslin EU
 Pebble use Loft EV
 Pewter use Flint E9
 Platinum Metallic use Loft EV
 Salt use Silver ES
 Titanium use Silver ES

LAMINATES

GRADE L1

CORE	
Ash	LT3B
Brownstone*	LM13
Bungalow*	LM12
Camelstone	LT6A
Canyon Zephyr	LT5B
Desert Zephyr	LT5A
Designer White	LDW1
Flint*	LM16
Fossil Shale*	LEH1
Grey Mesh	LT8A
Greystone	TM65
Loft*	LM11
Muslin*	LM15
Parchment	TM20
Pewter Mesh	LT8C
Sheer Mesh	LT8B
Silver Mesh	LT8D
Titanium	LT11
White Tigris	LT2A
Whitestone	TM33

WOODGRAIN

Florence Walnut*	LFW1
Kingswood Walnut*	LK11
Natural Maple*	LWD
NeoWalnut*	LNU1
Shaker Cherry*	LW7C

GRADE L2

Amber Cherry*	LWAC
Beigewood*	LWBE
Branded Oak*	LBO1
Brazilwood*	LWBR
Columbian Walnut*	LWZ
Ebony Recon*	LER1
Fawn Cypress*	LFC1
Lowell Ash*	LLA1
Mangalore Mango*	LMM1
Natural Recon*	LNR1
Phantom Charcoal*	LPC1
Phantom Ecru*	LPE1
Portico Teak*	LPT1
Skyline Walnut*	LSW1

GRADE L3

Cafelle*	LWC
Charcoal Walnut*	LWCW
Natural Walnut*	LWNW

* Storage available in these 29 laminates.

LAMINATE AND PAINTED WOOD STORAGE PULLS

Silver	PR6
--------	-----

LAMINATE EDGE COLORS

Amber Cherry	DA
Beigewood	DE
Black	E4
Branded Oak	BO
Brazilwood	DB
Brownstone	EY
Bungalow	EX
Cafelle	DG
Charcoal Walnut	DC
Columbian Walnut	DZ
Designer White	DW
Ebony Recon	DR
Fawn Cypress	FC
Flint	E9
Florence Walnut	FW
Fossil	EH
Kingswood Walnut	KI
Loft	EV
Lowell Ash	DL
Mangalore Mango	MM
Muslin	EU
Natural Maple	DD
Natural Recon	NR
Natural Walnut	DN
NeoWalnut	NU
Parchment	EN
Phantom Charcoal	PC
Phantom Ecru	PE
Platinum Metallic	EP
Plyband ♦	PL
Portico Teak	DP
Shaker Cherry	DF
Skyline Walnut	SW
Titanium	TI

♦ Edge is limited to flat edge surfaces: rectangle, square, trapezoid, polygon, or round. No curvilinear or combination curve and straight.

METAL GROMMETS

FOR LAMINATE WORKSURFACES

Oval/Square:	
Matte Silver	EL

FOR VENEER WORKSURFACES

Oval:	
Black	E4
Bronze	EZ
Matte Silver	EL
Square:	
Matte Silver	EL

PLASTIC GROMMETS

FOR WORKSURFACES

Black	E4
Brownstone	EY
Bungalow	EX
Designer White	DW
Flint	E9
Fossil	EH
Loft	EV
Muslin	EU
Parchment	EN

PLASTIC GROMMETS WITH WOODGRAIN EDGE

If woodgrain edge is specified, the plastic grommet color is predetermined, based on finish selection.

Beigewood, Fawn Cypress, Natural Maple, and Natural Recon	Muslin EU
Branded Oak	Brownstone EY
Phantom Charcoal	Flint E9
Phantom Ecru	Loft EV
Portico Teak	Fossil EH
Skyline Walnut	Flint E9
All other woodgrain options	Black E4

STRATAWOOD VENEERS

GRADE V1

Add FSC prefix to Stratawood codes listed below for Stratawood veneer trim on Stride and Terrace.
 Example: **FSCSC777**

CHERRY

Burnished Cherry	SC777
Light Cherry	SC701
Wheat Cherry	SC706

MAPLE

Clear Maple***	SE800
----------------	-------

OAK

Clear Oak	SF300
Dark Rift Oak	SF331

WALNUT

Coffee Walnut	ST615
Dark Roast Walnut	ST684
Light Walnut	ST601

NATURAL VENEERS — NATURAL-1

GRADE V3

CHERRY

Burnished Cherry	NC777
Light Cherry	NC701
Medium Wheat Cherry	NC706

MAPLE

Natural Maple***	NE800
------------------	-------

WALNUT

Coffee Walnut	NT615
Dark Roast Walnut	NT684
Light Walnut	NT601

NATURAL VENEERS — NATURAL-2

GRADE V5

Dark Rift Oak	RF331
---------------	-------

***SE800 and NE800 are not available on Stride trim.

The beauty of wood is the natural variation of grain patterns and colors that make each piece unique. This variation is also influenced by lighting conditions, orientation of mated parts, and varying acceptance of the finishing process. The varying colors and physical characteristics naturally occur in all wood species but are most pronounced in lighter colored woods, and are especially evident in natural finishes.

GROMMETS ON VENEER WORKSURFACES

Wire management grommets come standard on most veneer worksurfaces. Choose between metal or plastic grommet option. Note: Plastic grommet color is predetermined based on finish selection. All Maple veneers.....Muslin EU
 All other veneersBlack E4

LOCKS

Black	E4
Chrome	ordered by base model
Matte Silver	EL

NOTE: Refer to individual product pages for upcharges.

- Software support packages furnished to the customer, either by Allsteel® or by another source, which support the sale of Allsteel products are superseded by printed price lists.
- Prices are subject to change without notice. All orders are subject to prices in effect at the time of order.
- Please refer to your Allsteel Dealer Sales and Discount Policies for order placement information, terms and conditions.
- Additional copies of this Specification and Price List are available to Allsteel Dealers on Synergy as a PDF.

- Ordering information appears at the bottom of each product page complete with examples on how to specify. Fabric and finish pages are referenced at the bottom of product pages.

This publication is available as an interactive or downloadable PDF at www.allsteeloffice.com/pricers.

Questions or Comments?

Please call us at: **888-ALLSTEEL**
888-255-7833

Standard Finishes	2
Table of Contents	3
WORKSURFACES	
Primary Rectangle	4-5
Stride Linear Corner Asymmetrical	6
Stride Linear Corner Cove.....	6
Wave.....	7
Reef	7
Peninsula	8
Boomerang	9
Stride 120 Degree Countertop.....	9
Corner Cove.....	10
Countertops - T-Mold Edge.....	11
Full Depth Lateral Divider Screens.....	12-14
20"H Stride Benching Lateral Divider Screens	15
Corner	16
STRIDE®	
Stride 30"H Panels	17
Stride Feet.....	18
Stride Power Pole Splice	18
Stride Trim	19
Stride 25"H Fabric, Steel, and Laminate Tiles	20
22½"H Frameless Glass Specification Rules.....	21
Frameless Glass Alignment Brackets.....	22
Stride 22½"H Frameless Glass with Top Cap.....	23
Stride COM Insert Spec.....	24
Grooved Top Cap For Frameless COM Insert.....	25
22½"H & 30"H Low Profile Glass Stackers.....	26
Stride Tackable Acoustical Ported-Below-Worksurface Tiles	27
Stride Steel Ported Tiles	28
Stride Electrical Components	29-30
TERRACE®	
Terrace Feet	31
Terrace Power Pole Splice.....	31
Steel to-the-Floor Tiles.....	31
Terrace 22½"H Frameless Glass with Flat Top Cap	32
Terrace 22½"H Frameless Glass with Radius Top Cap	32
Terrace Flat & Radius Trim COM Insert Specs.....	33
Grooved Top Cap for Frameless COM Insert.....	34
Terrace Fabric Tiles to-the-Floor	35
Terrace Fabric Below-Worksurface Tiles — Ported	36
Terrace Steel Ported Tiles.....	37
Terrace Pass Thru Kits.....	38
Terrace Electrical Components.....	39

FURTHER®	
Further 28"H Triangle Base Beam Mounted Glass Screens.....	40
28"H Triangle Base Beam Mounted Fabric Screens	41
Further Electrical	42
APPROACH™	
Approach End Cap.....	43
OPTIMIZE®	
Optimize 22½"H Frameless Glass with Top Cap	44
Optimize Trim COM Insert Spec.....	45
Top Cap For Frameless COM Insert	46
Optimize Electrical	47
ALTITUDE®	
Wire Manager Chain.....	48
HAT Base & Worksurface Spec Rules	49
Height-Adjustable Bases.....	50-59
Screen Kits in Contourett	60
Altitude A8 Screen Kits - Extended Wing Specification Notes....	61
Altitude A8 Screen Kits - Extended Wing	62
INVOLVE®	
Involve® Desk Mount Screens, Glass	63
Involve® Towers.....	64-65
Involve® Credenzas	66-67
Involve® Two-Tone Banquette Cushion	68
ENERGY MANAGEMENT SYSTEM	
EMS.....	69-70
ELECTRICAL TITLE 24	
Electrical — Title 24	71-72
ACCESSORIES	
Panel / Wall Mount Hand Sanitizer Bottle Holder.....	73
Tool Tile / Tool Rail Mount Hand Sanitizer Bottle Holder.....	73
Aware Mobile Markerboards.....	73
Panel Fabrics	74



Description	Laminate Model w/T-Mold Edge	Laminate w/T-Mold Edge		
		L1 List Price	L2 Upcharge	L3 Upcharge
24"D Primary Worksurfaces				
24"W	832424A	\$ 418	\$ 23	\$ 40
30"W	832430A	\$ 440	\$ 24	\$ 42
36"W	832436A	\$ 498	\$ 25	\$ 47
42"W	832442A	\$ 556	\$ 26	\$ 50
48"W	832448A	\$ 604	\$ 28	\$ 53
54"W	832454A	\$ 650	\$ 35	\$ 59
60"W	832460A	\$ 738	\$ 37	\$ 64
66"W	832466A	\$ 804	\$ 39	\$ 70
72"W	832472A	\$ 838	\$ 40	\$ 71



30"D Primary Worksurfaces				
24"W	833024A	\$ 440	\$ 24	\$ 42
30"W	833030A	\$ 530	\$ 26	\$ 49
36"W	833036A	\$ 570	\$ 27	\$ 51
42"W	833042A	\$ 619	\$ 28	\$ 56
48"W	833048A	\$ 650	\$ 35	\$ 59
54"W	833054A	\$ 726	\$ 37	\$ 64
60"W	833060A	\$ 810	\$ 39	\$ 70
66"W	833066A	\$ 873	\$ 42	\$ 77
72"W	833072A	\$ 946	\$ 46	\$ 81



Note: Add Suffix "N" to model number for no grommet, no upcharge. Example: 832424AN

<p>How to specify — Select the Model Number from above. Suffix N No Grommets</p>	<p>1st Option: Laminate: See inside front cover for finishes.</p>	<p>2nd Option: Edge Trim Color: See inside front cover for finishes.</p>	<p>3rd Option: Grommet Type: P Oval Plastic (will match edge trim) M Oval Metal (Add \$12 per grommet) S Square Metal (Add \$12 per grommet)</p>	<p>4th Option: Grommet Color (Metal only): Oval: EL Matte Silver Square: EL Matte Silver</p>
--	---	--	--	--

Example: 832424A.LT3B.E9.P

For specification information see applicable system's specification book.

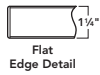

Arrows indicate grain direction for woodgrain laminates

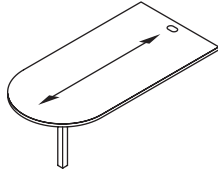

Support column ordered separately.

Description	Model with Grommet	Model without Grommet	Laminate w/Flat Edge		
			L1 List Price	L2 Upcharge	L3 Upcharge
Peninsula Worksurface with Grommet					
24"W x 30"L	SPLA-WSMG.M375728	SPLA-WSMN.M375756	\$ 1199	\$ 45	\$ 85
24"W x 36"L	SPLA-WSMG.M375729	SPLA-WSMN.M375757	\$ 1199	\$ 45	\$ 85
24"W x 42"L	SPLA-WSMG.M375730	SPLA-WSMN.M375758	\$ 1199	\$ 45	\$ 85
24"W x 48"L	SPLA-WSMG.M375732	SPLA-WSMN.M375759	\$ 1199	\$ 45	\$ 85
24"W x 54"L	SPLA-WSMG.M375733	SPLA-WSMN.M375760	\$ 1199	\$ 45	\$ 85
24"W x 60"L	SPLA-WSMG.M380424	SPLA-WSMN.M380427	\$ 1199	\$ 45	\$ 85
24"W x 66"L	SPLA-WSMG.M380425	SPLA-WSMN.M380428	\$ 1317	\$ 45	\$ 85
24"W x 72"L	SPLA-WSMG.M380426	SPLA-WSMN.M380429	\$ 1436	\$ 45	\$ 85
24"W x 78"L	SPLA-WSMG.M375734	SPLA-WSMN.M375761	\$ 1829	\$ 45	\$ 85
24"W x 84"L	SPLA-WSMG.M375735	SPLA-WSMN.M375762	\$ 1917	\$ 45	\$ 85
24"W x 90"L	SPLA-WSMG.M375736	SPLA-WSMN.M375763	\$ 2138	\$ 45	\$ 85
24"W x 96"L	SPLA-WSMG.M375737	SPLA-WSMN.M375764	\$ 2226	\$ 45	\$ 85
30"W x 30"L	SPLA-WSMG.M375738	SPLA-WSMN.M375765	\$ 1199	\$ 45	\$ 85
30"W x 36"L	SPLA-WSMG.M375739	SPLA-WSMN.M375766	\$ 1199	\$ 45	\$ 85
30"W x 42"L	SPLA-WSMG.M375740	SPLA-WSMN.M375767	\$ 1199	\$ 45	\$ 85
30"W x 48"L	SPLA-WSMG.M375741	SPLA-WSMN.M375768	\$ 1199	\$ 45	\$ 85
30"W x 54"L	SPLA-WSMG.M375742	SPLA-WSMN.M375769	\$ 1199	\$ 45	\$ 85
30"W x 78"L	SPLA-WSMG.M375743	SPLA-WSMN.M375770	\$ 1829	\$ 45	\$ 85
30"W x 84"L	SPLA-WSMG.M375744	SPLA-WSMN.M375771	\$ 1917	\$ 45	\$ 85
30"W x 90"L	SPLA-WSMG.M375745	SPLA-WSMN.M375772	\$ 2138	\$ 45	\$ 85
30"W x 96"L	SPLA-WSMG.M375746	SPLA-WSMN.M375773	\$ 2226	\$ 45	\$ 85
36"W x 30"L	SPLA-WSMG.M375747	SPLA-WSMN.M375775	\$ 1436	\$ 45	\$ 85
36"W x 36"L	SPLA-WSMG.M375748	SPLA-WSMN.M375776	\$ 1436	\$ 45	\$ 85
36"W x 42"L	SPLA-WSMG.M375749	SPLA-WSMN.M375778	\$ 1436	\$ 45	\$ 85
36"W x 48"L	SPLA-WSMG.M375750	SPLA-WSMN.M375779	\$ 1436	\$ 45	\$ 85
36"W x 54"L	SPLA-WSMG.M375751	SPLA-WSMN.M375780	\$ 1436	\$ 45	\$ 85
36"W x 78"L	SPLA-WSMG.M375752	SPLA-WSMN.M375781	\$ 2130	\$ 45	\$ 85
36"W x 84"L	SPLA-WSMG.M375753	SPLA-WSMN.M375782	\$ 2216	\$ 45	\$ 85
36"W x 90"L	SPLA-WSMG.M375754	SPLA-WSMN.M375783	\$ 2439	\$ 45	\$ 85
36"W x 96"L	SPLA-WSMG.M375755	SPLA-WSMN.M375785	\$ 2527	\$ 45	\$ 85

<p>How to specify — Select the Model Number from above. Add suffix if applicable:</p>	<p><i>1st Option:</i> Laminate: See inside front cover for finishes.</p>	<p><i>2nd Option:</i> Edge Trim Color: See inside front cover for finishes.</p>	<p><i>3rd Option:</i> Grommet Type (if applicable): P Oval Plastic M Oval Metal (Add \$24) S Square Metal (Add \$24)</p>	<p><i>4th Option:</i> Grommet Color (if applicable): See inside front cover for finishes.</p>
<p>S P L A - W S M .</p> <p> .</p>	<p> .</p>	<p> .</p>	<p> </p>	<p>E </p>

Examples: SPLA-WSMG.M375728.LT3B.E9.PE4 SPLA-WSMN.M375756.LT3B.E4

Worksurfaces

Boomerang and 120° Countertops

For specification information see applicable system's specification book.

Laminate

Description	Laminate w/Flat Edge Model	Laminate w/Flat Edge		
		L1 List Price	L2 Upcharge	L3 Upcharge
Boomerang Worksurfaces — Left Hand 90°				
48" A x 72" B x 24" C	T547229BL	\$ 1718	\$ 77	\$ 154
48" A x 72" B x 30" C	T547239BL	\$ 1791	\$ 79	\$ 161
Boomerang Worksurfaces — Left Hand 110°				
36" A x 72" B x 24" C	T547221BL	\$ 1718	\$ 77	\$ 154
36" A x 72" B x 30" C	T547231BL	\$ 1791	\$ 79	\$ 161
Boomerang Worksurfaces — Right Hand 90°				
48" A x 72" B x 24" C	T547229BR	\$ 1718	\$ 77	\$ 154
48" A x 72" B x 30" C	T547239BR	\$ 1791	\$ 79	\$ 161
Boomerang Worksurface — Right Hand 110°				
36" A x 72" B x 24" C	T547221BR	\$ 1718	\$ 77	\$ 154
36" A x 72" B x 30" C	T547231BR	\$ 1791	\$ 79	\$ 161

Note: Add Suffix "N" to model number for no grommets, no upcharge. *Example:* T547239BLN

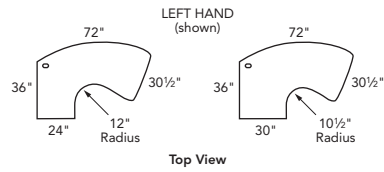
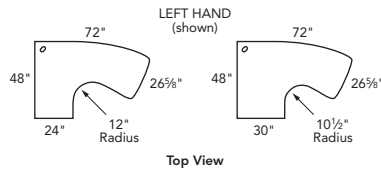
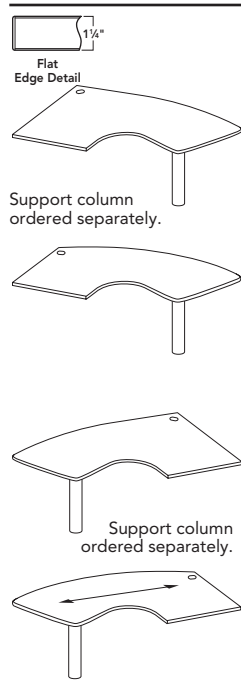

Arrows indicate grain direction for woodgrain laminates

15"D 120° Corner Countertops				
30" W x 30" W	Z53030CSB	\$ 1088	\$ 46	\$ 83
36" W x 36" W	Z53636CSB	\$ 1204	\$ 50	\$ 96
42" W x 42" W	Z54242CSB	\$ 1297	\$ 53	\$ 103
48" W x 48" W	Z54848CSB	\$ 1413	\$ 57	\$ 113

<p>How to specify —</p> <p>Select the Model Number from above. Add suffix if applicable:</p> <p>"N" for No Grommets — no upcharge</p>	<p>1st Option:</p> <p>Laminate:</p> <p>See inside front cover for finishes.</p>	<p>2nd Option:</p> <p>Edge Trim Color (Laminate worksurfaces only):</p> <p>See inside front cover for finishes.</p>	<p>3rd Option:</p> <p>Grommet Type:</p> <p>P Oval Plastic (will match edge trim on laminate)</p> <p>M Oval Metal (Add \$12 per grommet)</p> <p>S Square Metal (Add \$12 per grommet)</p>	<p>4th Option:</p> <p>Grommet Color (if applicable):</p> <p>See inside front cover for finishes.</p>
<p>_____ .</p>	<p>_____ .</p>	<p>_____ .</p>	<p>_____</p>	<p>E _____</p>

Examples: T547221BR.LT3B.E9.P 5303030CSB.TM33.EV

For specification information see applicable System's Price & Specification Guide.

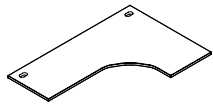

Description	Laminate w/Flat Edge Model	Old Model For Reference	Laminate w/Flat Edge		
			L1 List Price	L2 Upcharge	L3 Upcharge
Corner Cove Worksurfaces — Extended Left					
60" x 36" — 24"L / 24"R	T5822EL	83122ELM	\$ 901	\$ 36	\$ 68
60" x 36" — 24"L / 30"R	T5832EL	83132ELM	\$ 940	\$ 38	\$ 70
60" x 48" — 24"L / 24"R	T5622EL	83622ELM	\$ 1001	\$ 40	\$ 74
60" x 48" — 30"L / 24"R	T5623EL	83623ELM	\$ 1044	\$ 41	\$ 78
60" x 48" — 24"L / 30"R	T5632EL	83632ELM	\$ 1044	\$ 41	\$ 78
60" x 48" — 30"L / 30"R	T5633EL	83633ELM	\$ 1080	\$ 42	\$ 81
72" x 36" — 24"L / 24"R	T5922EL	83222ELM	\$ 1001	\$ 40	\$ 74
72" x 36" — 24"L / 30"R	T5932EL	83232ELM	\$ 1044	\$ 41	\$ 78
72" x 48" — 24"L / 24"R	T5722EL	83722ELM	\$ 1276	\$ 47	\$ 93
72" x 48" — 30"L / 24"R	T5723EL	83723ELM	\$ 1320	\$ 48	\$ 99
72" x 48" — 24"L / 30"R	T5732EL	83732ELM	\$ 1320	\$ 48	\$ 99
72" x 48" — 30"L / 30"R	T5733EL	83733ELM	\$ 1357	\$ 51	\$ 102

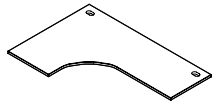

Corner Cove Worksurfaces — Extended Right					
36" x 60" — 24"L / 24"R	T5822ER	83122ERM	\$ 901	\$ 36	\$ 68
36" x 60" — 30"L / 24"R	T5832ER	83132ERM	\$ 940	\$ 38	\$ 70
48" x 60" — 24"L / 24"R	T5622ER	83622ERM	\$ 1001	\$ 40	\$ 74
48" x 60" — 24"L / 30"R	T5623ER	83623ERM	\$ 1044	\$ 41	\$ 78
48" x 60" — 30"L / 24"R	T5632ER	83632ERM	\$ 1044	\$ 41	\$ 78
48" x 60" — 30"L / 30"R	T5633ER	83633ERM	\$ 1080	\$ 42	\$ 81
36" x 72" — 24"L / 24"R	T5922ER	83222ERM	\$ 1001	\$ 40	\$ 74
36" x 72" — 30"L / 24"R	T5932ER	83232ERM	\$ 1044	\$ 41	\$ 78
48" x 72" — 24"L / 24"R	T5722ER	83722ERM	\$ 1276	\$ 47	\$ 93
48" x 72" — 24"L / 30"R	T5723ER	83723ERM	\$ 1320	\$ 48	\$ 99
48" x 72" — 30"L / 24"R	T5732ER	83732ERM	\$ 1320	\$ 48	\$ 99
48" x 72" — 30"L / 30"R	T5733ER	83733ERM	\$ 1357	\$ 51	\$ 102

Notes:

- Add Suffix "N" to model number for no grommet, no upcharge.
- Corner cove worksurfaces do NOT include rear support bracket. Order brackets separately, T6BK for Terrace, Stride and Optimize, 831099 for Concensys.



<p>How to specify — Select the Model Number from above.</p>	<p>1st Option: Laminate: See inside front cover for finishes.</p>	<p>2nd Option: Edge Trim Color: See inside front cover for finishes.</p>	<p>3rd Option: Grommet Type: P Oval Plastic (will match edge trim) M Oval Metal (Add \$24 per grommet) S Square Metal (Add \$24 per grommet)</p>	<p>4th Option: Grommet Color (Metal only): EL Matte Silver Note: Plastic grommet color matches trim selection.</p>
<p>Examples: T5822EL.LT3B.EY.MEL T5822EL.LT3B.EV.P</p>				

E | L

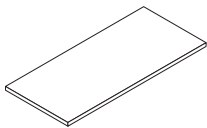

Description	Model	L1 List Price	L2 Upcharge	L3 Upcharge
Straight Countertops				
24"W x 15"D	851524	\$ 366	\$ 21	\$ 37
30"W x 15"D	851530	\$ 408	\$ 23	\$ 39
36"W x 15"D	851536	\$ 455	\$ 24	\$ 45
42"W x 15"D	851542	\$ 471	\$ 24	\$ 46
48"W x 15"D	851548	\$ 499	\$ 25	\$ 47
54"W x 15"D	851554	\$ 564	\$ 27	\$ 50
60"W x 15"D	851560	\$ 630	\$ 24	\$ 45
66"W x 15"D	851566	\$ 654	\$ 35	\$ 59
72"W x 15"D	851572	\$ 680	\$ 36	\$ 60

Note: Order mounting brackets separately; see Concensys Price & Spec Guide.



Description	Model	L1 List Price	L2 Upcharge	L3 Upcharge
Corner Countertops				
15"D x 24"W x 24"W	852424	\$ 714	\$ 37	\$ 62
15"D x 30"W x 30"W	853030	\$ 830	\$ 40	\$ 71
15"D x 36"W x 36"W	853636	\$ 922	\$ 45	\$ 80
15"D x 42"W x 42"W	854242	\$ 999	\$ 47	\$ 90

Note: Order mounting brackets separately; see Concensys Price & Spec Guide.

OPTIONS:

SUFFIX	OPTION — Routed to fit Painted Variable Height Trim	UPCHARGE
RS	For routing one end of a straight countertop, when used in variable height panel applications.	None
RR*	For routing right end of corner countertops, when used in variable height panel applications.	None
RL*	For routing left end of corner countertops, when used in variable height panel applications.	None
RB*	For routing both ends of a straight or corner countertop when used in variable height panel applications.	None

***Note:** "Right end" and "left end" are determined by facing the inside radius of the corner countertop.

<p>How to specify — Select the Concensys Model Number from above.</p> <p>8 5 .</p>	<p>1st Option: Laminate: See inside front cover for finishes.</p> <p> .</p>	<p>2nd Option: Edge Trim Color: See inside front cover for finishes.</p> <p> </p>
---	--	---

Example: 851524.LT3B.E4

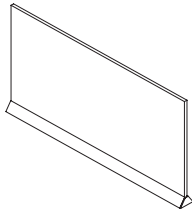
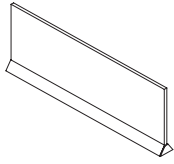

Description	Model		P1 List Price	P2 Upcharge	P3 Upcharge	Frosted Glass Upcharge	Smoked Glass Upcharge
8"H Lateral Divider Screen — 3/8" Thick Glass							
18"D	SPLA-SS-STR08HGDS1.M490854		\$ 820	\$ 27	\$ 53	\$ 40	\$ 107
20"D	SPLA-SS-STR08HGDS1.M490855		\$ 837	\$ 27	\$ 53	\$ 40	\$ 107
21"D	SPLA-SS-STR08HGDS1.M490856		\$ 854	\$ 27	\$ 53	\$ 40	\$ 107
24"D	SPLA-SS-STR08HGDS2.M490857		\$ 871	\$ 36	\$ 70	\$ 55	\$ 142
27"D	SPLA-SS-STR08HGDS2.M490858		\$ 889	\$ 36	\$ 70	\$ 55	\$ 142
30"D	SPLA-SS-STR08HGDS3.M490859		\$ 934	\$ 38	\$ 78	\$ 70	\$ 157
36"D	SPLA-SS-STR08HGDS3.M490860		\$ 980	\$ 38	\$ 78	\$ 70	\$ 157

13"H Lateral Divider Screen — 3/8" Thick Glass							
18"D	SPLA-SS-STR13HGDS1.M490861		\$ 860	\$ 27	\$ 55	\$ 45	\$ 111
20"D	SPLA-SS-STR13HGDS1.M490862		\$ 878	\$ 27	\$ 55	\$ 45	\$ 111
21"D	SPLA-SS-STR13HGDS1.M490863		\$ 897	\$ 27	\$ 55	\$ 45	\$ 111
24"D	SPLA-SS-STR13HGDS2.M490864		\$ 913	\$ 37	\$ 73	\$ 57	\$ 150
27"D	SPLA-SS-STR13HGDS2.M490865		\$ 934	\$ 37	\$ 73	\$ 57	\$ 150
30"D	SPLA-SS-STR13HGDS3.M490866		\$ 980	\$ 40	\$ 81	\$ 73	\$ 164
36"D	SPLA-SS-STR13HGDS3.M490867		\$ 1020	\$ 40	\$ 81	\$ 73	\$ 164

20"H Lateral Divider Screen — 3/8" Thick Glass							
18"D	SPLA-SS-STR20HGDS1.M490868		\$ 1067	\$ 42	\$ 83	\$ 68	\$ 171
20"D	SPLA-SS-STR20HGDS1.M490869		\$ 1088	\$ 42	\$ 83	\$ 68	\$ 171
21"D	SPLA-SS-STR20HGDS1.M490870		\$ 1111	\$ 42	\$ 83	\$ 68	\$ 171
24"D	SPLA-SS-STR20HGDS2.M490872		\$ 1133	\$ 57	\$ 114	\$ 89	\$ 231
27"D	SPLA-SS-STR20HGDS2.M490873		\$ 1157	\$ 57	\$ 114	\$ 89	\$ 231
30"D	SPLA-SS-STR20HGDS3.M490874		\$ 1181	\$ 64	\$ 126	\$ 114	\$ 253
36"D	SPLA-SS-STR20HGDS3.M490875		\$ 1240	\$ 64	\$ 126	\$ 114	\$ 253

Notes:

- Screen depths nominal sizes match actual sizes. *Not for use with Stride Benching. See page 15.
- 13H screens are 12.6"H (to match standard Stride Lateral Screens).
- 8H screen nominal height matches actual.
- 20H screen nominal height matches actual, intending to align with 50H panels. These will not align with Stride Benching 20H Beam Mounted Screens or 20H Elevated table mounted screens.
- Screens used on Systems applications must be placed 3" from a seam with a cantilever or center support bracket. If necessary the alternative attachment kit, VHB Tape and End Cap, may be used. Order separately.
- Screens used on Further applications can be placed anywhere, however support brackets may need to be repositioned.

<p>How to specify — Select the Model Number from above.</p> <p>_____</p> <p>_____</p>	<p>1st Option: Glass (if applicable):</p> <p>LC Clear LF Frosted GSM1 Smoked</p>	<p>2nd Option: Paint (if applicable):</p> <p> </p> <p>See inside front cover for finishes.</p>
<p>Example: SPLA-SS-STR08HGDS1.M490854.LC.P02</p>		

Shippable by small-package carrier.

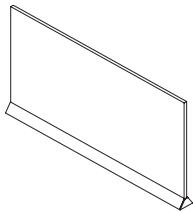
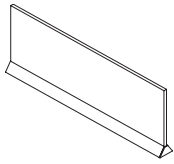

Description	Model	P1 List Price	P2 Upcharge	P3 Upcharge	Frosted Glass Upcharge	Smoked Glass Upcharge
8"H Lateral Divider Screen — 3/8" Thick Glass						
42"W	SPLA-SS-STR08HGDS4.M505525	\$ 1026	\$ 46	\$ 91	\$ 83	\$ 186
48"W	SPLA-SS-STR08HGDS4.M505526	\$ 1073	\$ 46	\$ 91	\$ 83	\$ 186
54"W	SPLA-SS-STR08HGDS5.M505527	\$ 1125	\$ 59	\$ 118	\$ 107	\$ 240
60"W	SPLA-SS-STR08HGDS5.M505528	\$ 1180	\$ 59	\$ 118	\$ 107	\$ 240
66"W	SPLA-SS-STR08HGDS6.M505529	\$ 1237	\$ 68	\$ 136	\$ 124	\$ 279
72"W	SPLA-SS-STR08HGDS7.M505530	\$ 1295	\$ 75	\$ 150	\$ 136	\$ 306

13"H Lateral Divider Screen — 3/8" Thick Glass						
42"W	SPLA-SS-STR13HGDS4.M505531	\$ 1068	\$ 60	\$ 121	\$ 109	\$ 240
48"W	SPLA-SS-STR13HGDS4.M505532	\$ 1119	\$ 60	\$ 121	\$ 109	\$ 240
54"W	SPLA-SS-STR13HGDS5.M505533	\$ 1171	\$ 75	\$ 151	\$ 135	\$ 298
60"W	SPLA-SS-STR13HGDS5.M505534	\$ 1227	\$ 75	\$ 151	\$ 135	\$ 298
66"W	SPLA-SS-STR13HGDS6.M505535	\$ 1286	\$ 82	\$ 166	\$ 148	\$ 328
72"W	SPLA-SS-STR13HGDS7.M505536	\$ 1346	\$ 91	\$ 180	\$ 164	\$ 360

Notes:

- Screen depths nominal sizes match actual sizes and not for use with Stride Benching. See page 15.
- 13H screens are 12.6"H (to match standard Stride Lateral Screens).
- 8H screen nominal height matches actual.
- 20H screen nominal height matches actual, intending to align with 50H panels. These will not align with Stride Benching 20H Beam Mounted Screens or 20H Elevated table mounted screens.
- Screens used on Systems applications must be placed 3" from a seam with a cantilever or center support bracket. If necessary the alternative attachment kit, VHB Tape and End Cap, may be used. Order separately.
- Screens used on Further applications can be placed anywhere, however support brackets may need to be repositioned.

Bracket-less Alternative Attachment Kit

SPLA-STR-SPLSCRNGLAS.M505831	\$ 64	\$ 17
SPLA-STR-SPLSCRNGLAS.M506260	\$ 71	\$ 17

Notes:

- Bracket-less alternative attachment kit for Stride Lateral Divider Screens up to 36"W SPLA-STR-SPLSCRNGLAS.M505831.
- Bracket-less alternative attachment kit for Stride Lateral Divider Screens 42"W–72"W SPLA-STR-SPLSCRNGLAS.M506260.

<p>How to specify — Select the Model Number from above.</p> <p>_____</p> <p>_____</p>	<p>1st Option: Glass (if applicable): LC Clear LF Frosted GSM1 Smoked</p>	<p>2nd Option: Paint (if applicable): P1 P2 See inside front cover for finishes.</p>
<p>Example:</p> <p>SPLA-SS-STR08HGDS4.M505525</p>	<p>L</p>	<p>P</p>

Shippable by small-package carrier.

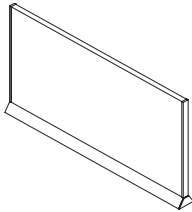
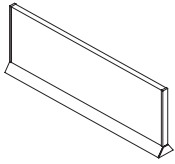

Description	Model	P1 List Price	P2 Upcharge	P3 Upcharge	Upholstery Upcharge				
					Grade A	Grade B	Grade C	Grade D	
8"H Lateral Divider Screen — 3/4" Thick Tackable Fabric									
18"D	SPLA-SS-STR08HFDS1.M490833	\$ 732	\$ 25	\$ 48	\$ 0	\$ 9	\$ 18	\$ 32	
20"D	SPLA-SS-STR08HFDS1.M490834	\$ 749	\$ 25	\$ 48	\$ 0	\$ 9	\$ 18	\$ 32	
21"D	SPLA-SS-STR08HFDS1.M490835	\$ 763	\$ 25	\$ 48	\$ 0	\$ 9	\$ 18	\$ 32	
24"D	SPLA-SS-STR08HFDS2.M490836	\$ 780	\$ 32	\$ 62	\$ 0	\$ 12	\$ 24	\$ 42	
27"D	SPLA-SS-STR08HFDS2.M490837	\$ 797	\$ 32	\$ 62	\$ 0	\$ 12	\$ 24	\$ 42	
30"D	SPLA-SS-STR08HFDS3.M490838	\$ 821	\$ 36	\$ 71	\$ 0	\$ 14	\$ 28	\$ 56	
36"D	SPLA-SS-STR08HFDS3.M490839	\$ 909	\$ 36	\$ 71	\$ 0	\$ 14	\$ 28	\$ 56	
42"W	SPLA-SS-STR08HFDS4.M506668	\$ 927	\$ 36	\$ 71	\$ 0	\$ 14	\$ 28	\$ 56	
48"W	SPLA-SS-STR08HFDS4.M506670	\$ 945	\$ 36	\$ 71	\$ 0	\$ 14	\$ 28	\$ 56	
54"W	SPLA-SS-STR08HFDS4.M506672	\$ 964	\$ 36	\$ 71	\$ 0	\$ 14	\$ 28	\$ 56	
60"W	SPLA-SS-STR08HFDS4.M506673	\$ 982	\$ 36	\$ 71	\$ 0	\$ 14	\$ 28	\$ 56	
66"W	SPLA-SS-STR08HFDSRR.M506674	\$ 1002	\$ 17	\$ 28	\$ 0	\$ 66	\$ 134	\$ 202	
72"W	SPLA-SS-STR08HFDSRR.M506774	\$ 1022	\$ 17	\$ 28	\$ 0	\$ 66	\$ 134	\$ 202	

13"H Lateral Divider Screen — 3/4" Thick Tackable Fabric									
18"D	SPLA-SS-STR13HFDS1.M490840	\$ 774	\$ 25	\$ 50	\$ 0	\$ 14	\$ 26	\$ 48	
20"D	SPLA-SS-STR13HFDS1.M490841	\$ 793	\$ 25	\$ 50	\$ 0	\$ 14	\$ 26	\$ 48	
21"D	SPLA-SS-STR13HFDS1.M490842	\$ 808	\$ 25	\$ 50	\$ 0	\$ 14	\$ 26	\$ 48	
24"D	SPLA-SS-STR13HFDS2.M490843	\$ 824	\$ 34	\$ 67	\$ 0	\$ 18	\$ 35	\$ 62	
27"D	SPLA-SS-STR13HFDS2.M490844	\$ 889	\$ 34	\$ 67	\$ 0	\$ 18	\$ 35	\$ 62	
30"D	SPLA-SS-STR13HFDS3.M490845	\$ 866	\$ 38	\$ 77	\$ 0	\$ 24	\$ 47	\$ 83	
36"D	SPLA-SS-STR13HFDS3.M490846	\$ 957	\$ 38	\$ 77	\$ 0	\$ 24	\$ 47	\$ 83	
42"W	SPLA-SS-STR13HFDS4.M506775	\$ 975	\$ 36	\$ 71	\$ 0	\$ 14	\$ 28	\$ 56	
48"W	SPLA-SS-STR13HFDS4.M506776	\$ 996	\$ 36	\$ 71	\$ 0	\$ 14	\$ 28	\$ 56	
54"W	SPLA-SS-STR13HFDS4.M506777	\$ 1015	\$ 36	\$ 71	\$ 0	\$ 14	\$ 28	\$ 56	
60"W	SPLA-SS-STR13HFDS4.M506786	\$ 1036	\$ 36	\$ 71	\$ 0	\$ 14	\$ 28	\$ 56	
66"W	SPLA-SS-STR13HFDSRR.M506778	\$ 1055	\$ 17	\$ 28	\$ 0	\$ 66	\$ 134	\$ 202	
72"W	SPLA-SS-STR13HFDSRR.M506779	\$ 1078	\$ 17	\$ 28	\$ 0	\$ 66	\$ 134	\$ 202	

20"H Lateral Divider Screen — 3/4" Thick Tackable Fabric									
18"D	SPLA-SS-STR20HFDS1.M490847	\$ 929	\$ 38	\$ 78	\$ 0	\$ 23	\$ 40	\$ 73	
20"D	SPLA-SS-STR20HFDS1.M490848	\$ 946	\$ 38	\$ 78	\$ 0	\$ 23	\$ 40	\$ 73	
21"D	SPLA-SS-STR20HFDS1.M490849	\$ 965	\$ 38	\$ 78	\$ 0	\$ 23	\$ 40	\$ 73	
24"D	SPLA-SS-STR20HFDS2.M490850	\$ 985	\$ 50	\$ 104	\$ 0	\$ 27	\$ 53	\$ 96	
27"D	SPLA-SS-STR20HFDS2.M490851	\$ 1004	\$ 50	\$ 104	\$ 0	\$ 27	\$ 53	\$ 96	
30"D	SPLA-SS-STR20HFDS3.M490852	\$ 1028	\$ 60	\$ 120	\$ 0	\$ 37	\$ 71	\$ 132	
36"D	SPLA-SS-STR20HFDS3.M490853	\$ 1063	\$ 60	\$ 120	\$ 0	\$ 37	\$ 71	\$ 132	

Notes:

- Screen depths nominal sizes match actual sizes.*Not for use with Stride Benching. See page 15.
- 13H screens are 12.6"H (to match standard Stride Lateral Screens).
- 8H screen nominal height matches actual.
- 20H screen nominal height matches actual, intending to align with 50H panels. These will not align with Stride Benching 20H Beam Mounted Screens or 20H Elevated table mounted screens.
- Screens used on Systems applications must be placed 3" from a seam with a cantilever or center support bracket. If necessary the alternative attachment kit, VHB Tape and End Cap, may be used. Order separately.
- Screens used on Further applications can be placed anywhere, however support brackets may need to be repositioned.
- Bracket-less alternative attachment kit for Stride Lateral Divider Screens up to 36"W SPLA-STR-SPLSCRNGLAS.M505831.
- Bracket-less alternative attachment kit for Stride Lateral Divider Screens 42"W-72"W SPLA-STR-SPLSCRNGLAS.M506260.

How to specify —
Select the Model Number from above.

1st Option:
Fabric
(if applicable):
See [inside back cover](#) for fabrics.

2nd Option:
Paint
(if applicable):
P1 P2
See [inside front cover](#) for finishes.

Example: P

S Shippable by small-package carrier.

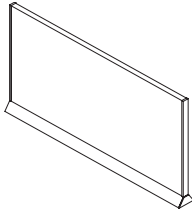

Description	Model	P1 List Price	P2 Upcharge	P3 Upcharge	Frosted Glass Upcharge	Smoked Glass Upcharge
20"H Lateral Divider Screen — Glass						
27"D	SPLA-SS-STR20HGDS2.M518445	\$ 1157	\$ 57	\$ 114	\$ 89	\$ 231
30"D	SPLA-SS-STR20HGDS3.M518446	\$ 1181	\$ 64	\$ 126	\$ 114	\$ 253
36"D	SPLA-SS-STR20HGDS3.M518447	\$ 1240	\$ 64	\$ 126	\$ 114	\$ 253

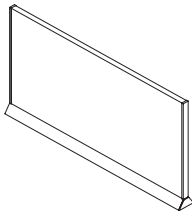

Description	Model	P1 List Price	P2 Upcharge	P3 Upcharge	Upholstery Upcharge			
					Grade A	Grade B	Grade C	Grade D
20"H Lateral Divider Screen — Fabric								
27"D	SPLA-SS-STR20HFDS2.M518448	\$ 1004	\$ 50	\$ 104	\$ 0	\$ 27	\$ 53	\$ 96
30"D	SPLA-SS-STR20HFDS3.M518449	\$ 1028	\$ 60	\$ 120	\$ 0	\$ 37	\$ 71	\$ 132
36"D	SPLA-SS-STR20HFDS3.M518450	\$ 1063	\$ 60	\$ 120	\$ 0	\$ 37	\$ 71	\$ 132

Notes:

- Screen depths nominal sizes match Stride Benching surface depth.
- Nominal depths are 27", 30", and 36".
- Actual depths are 22¾", 25¾", and 31¾".
- 20"H screen nominal height matches actual, intending to align with 50"H panels. These will not align with Stride Benching 20"H Beam Mounted Screens or 20"H Elevated table mounted screens.

<p>How to specify — Select the Model Number from above.</p> <div style="border: 1px solid black; height: 20px; width: 100%;"></div>	<p>1st Option: Fabric/Glass (if applicable): See inside back cover for fabrics.</p> <div style="border: 1px solid black; height: 20px; width: 100%;"></div>	<p>2nd Option: Paint (if applicable): P1 P2 See inside front cover for finishes.</p> <div style="border: 1px solid black; height: 20px; width: 100%;"></div>
<p>Example: P</p>		

For specification information see applicable System's Price & Specification Guide.



Flat Edge

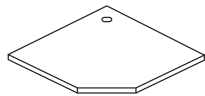
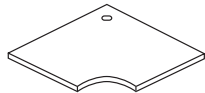
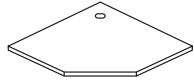
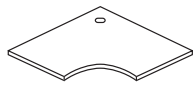

Description	Laminate w/Flat Edge Model	Old Model For Reference	Laminate w/Flat Edge		
			L1 List Price	L2 Upcharge	L3 Upcharge
24"D Corner Worksurfaces w/Radial Leading Edge					
36"W x 24"D	T53624CR	833624RM	\$ 790	\$ 33	\$ 58
42"W x 24"D	T54224CR	834224RM	\$ 842	\$ 34	\$ 63
48"W x 24"D	T54824CR	834824RM	\$ 958	\$ 39	\$ 71
24"D Corner Worksurfaces w/Straight Leading Edge					
36"W	T53624SC		\$ 764	\$ 30	\$ 58
42"W	T54224SC		\$ 802	\$ 31	\$ 60
48"W	T54824SC		\$ 898	\$ 34	\$ 69
30"D Corner Worksurfaces w/Radial Leading Edge					
42"W x 30"D	T54230CR	834230RM	\$ 1018	\$ 40	\$ 75
48"W x 30"D	T54830CR	834830RM	\$ 1099	\$ 42	\$ 82
30"D Corner Worksurfaces w/Straight Leading Edge					
42"W	T54230SC		\$ 974	\$ 38	\$ 75
48"W	T54830SC		\$ 1005	\$ 39	\$ 77

Notes:

- Add Suffix "N" to model number for no grommet, no upcharge.
- Corner cove worksurfaces do NOT include rear support bracket. Order brackets separately, T6BK for Terrace, Stride and Optimize, 831099 for Concensus.

Corner Worksurfaces with Radial Leading Edge

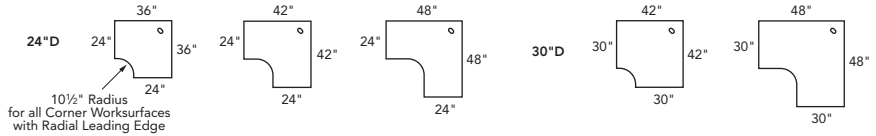

Corner Worksurfaces with Straight Leading Edge

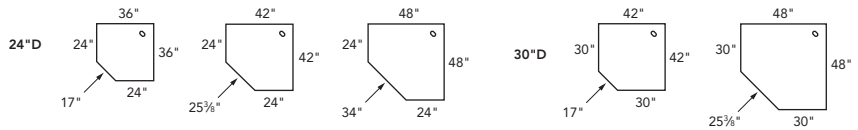

<p>How to specify — Select the Model Number from above.</p>	<p>1st Option: Laminate: See inside front cover for finishes.</p>	<p>2nd Option: Paint (Corner Shelves only): P1 P2 See inside front cover for finishes.</p>	<p>2nd Option: Edge Trim Color: See inside front cover for finishes.</p>	<p>3rd Option: Grommet Type: P Plastic M Metal (Add \$12 per grommet) S Square Metal (Add \$12 per grommet)</p>	<p>4th Option: Grommet Color (Metal only): EL Matte Silver Note: Plastic grommet color matches trim selection.</p>
<p>_____ . _____ . P _____</p>					<p>E L </p>

Examples: T53624CR.LT3B.EV.MEL T53624SCN.LT3B.EV

For specification information see Stride system specification book.

Description	Model	List Price P1	Upcharge P2
2-Way 90° Light Block Kit with Top Cap Transition Piece			
L-90 Light Block Kit with "L" Top Cap (for 30"H Panel)	Z330LLSS.M376721	\$ 845	\$ 17
"L" 90° Vertical Filler Trim			
30"H L-90 Degree Trim (for 30"H Panel)	Z330PLSS.M376714	\$ 958	\$ 28
5"H L-90 Degree Trim (for 30"H to 35"H Panel)	SPLA-STR-TRIM.M430113	\$ 106	\$ 17
12½"H L-90 Degree Trim (for 30"H to 42½"H Panel)	SPLA-STR-TRIM.M430114	\$ 113	\$ 17
20"H L-90 Degree Trim (for 30"H to 50"H Panel)	SPLA-STR-TRIM.M430115	\$ 121	\$ 17
27½"H L-90 Degree Trim (for 30"H to 57½"H Panel)	SPLA-STR-TRIM.M523058	\$ 130	\$ 17
"F" Flat Vertical Filler Trim			
5"H Filler Trim (for 30"H to 35"H Panel)	SPLA-STR-TRIM.M430107	\$ 83	\$ 17
12½"H Filler Trim (for 30"H to 42½"H Panel)	SPLA-STR-TRIM.M430108	\$ 91	\$ 17
20"H Filler Trim (for 30"H to 50"H Panel)	SPLA-STR-TRIM.M430109	\$ 101	\$ 17
27½"H Filler Trim (for 30"H to 57½"H Panel)	SPLA-STR-TRIM.M523060	\$ 113	\$ 17
30"H Filler Trim (for 30"H Panel)	Z330PFSS.M376713	\$ 937	\$ 28
"VH" Variable Height Vertical End Trim			
5"H "E" Variable Height Trim (for 30"H to 35"H Panel)	SPLA-STR-TRIM.M430110	\$ 83	\$ 17
12½"H "E" Variable Height Trim (for 30"H to 42½"H Panel)	SPLA-STR-TRIM.M430111	\$ 91	\$ 17
20"H "E" Variable Height Trim (for 30"H to 50"H Panel)	SPLA-STR-TRIM.M430112	\$ 101	\$ 17
27½"H "E" Variable Height Trim (for 30"H to 57½"H Panel)	SPLA-STR-TRIM.M523059	\$ 113	\$ 17
3-Way Light Block Kit with Top Cap Transition Piece			
3-Way Light Block Kit for "S" Top Cap (for 30"H Panel)	Z330TSSS.M376722	\$ 925	\$ 17
3-Way Light Block Kit for "L" Top Cap (for 30"H Panel)	Z330TLSS.M376719	\$ 934	\$ 17
3-Way Light Block Kit for "T" Top Cap (for 30"H Panel)	Z330TTSS.M376720	\$ 934	\$ 17
4-Way Light Block Kit with Top Cap Transition Piece			
4-Way Light Block Kit for "S" Top Cap (for 30"H Panel)	Z330XSSS.M376715	\$ 940	\$ 17
4-Way Light Block Kit for "L" Top Cap (for 30"H Panel)	Z330XLSS.M376716	\$ 940	\$ 17
4-Way Light Block Kit for "T" Top Cap (for 30"H Panel)	Z330XTSS.M376717	\$ 940	\$ 17
4-Way Light Block Kit for "X" Top Cap (for 30"H Panel)	Z330XXSS.M376718	\$ 940	\$ 17
Vertical End Trim			
30"H "E" End Trim for 30"H Raceway Panel	Z330PESS.M376712	\$ 937	\$ 28
30"H "EF" End Trim for 30"H Footed Panel	SPLA-STR-TRIM.M430106	\$ 118	\$ 17
Light Block Kits without Top Cap Transition Piece			
30"H 3-Way Light Block Kit w/o Top Cap	SPLA-STR-TRIM.M430116	\$ 84	\$ 17
30"H 4-Way Light Block Kit w/o Top Cap	SPLA-STR-TRIM.M430117	\$ 97	\$ 17
"W" Wall Mount Kit			
30"H Wall Mount (for 30"H Panel)	SPLA-STR-TRIM.M430118	\$ 193	\$ 17

How to specify —
Select the Model Number from above.

1st Option:
Paint Color
(if applicable):
P1 P2
See inside front cover for finishes.

Examples: Z330LLSS.M376721.P52 SPLA-STR-TRIM.M430110.P02

For specification information see *Stride system specification book*.

FINISHES

TABLE OF CONTENTS

WORKSURFACES

STRIDE

TERRACE

FURTHER

APPROACH

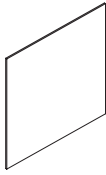

Description	Model	List Price		Upcharge		
		Grade A	Grade B	Grade C	Grade D	Grade E
25"H Tackable Acoustical Tiles (monolithic tiles for 30"H Stride frames) — specify fabric						
18"W	Z42518TSS.M376723	\$ 1177	\$ 19	\$ 48	\$ 77	\$ 125
20"W	Z42520TSS.M376724	\$ 1177	\$ 19	\$ 46	\$ 70	\$ 120
24"W	Z42524TSS.M376725	\$ 1195	\$ 19	\$ 46	\$ 71	\$ 122
30"W	Z42530TSS.M376726	\$ 1206	\$ 27	\$ 50	\$ 79	\$ 125
36"W	Z42536TSS.M376727	\$ 296	\$ 28	\$ 53	\$ 85	\$ 129
42"W	Z42542TSS.M376728	\$ 315	\$ 35	\$ 59	\$ 90	\$ 133
48"W	Z42548TSS.M376729	\$ 334	\$ 37	\$ 62	\$ 96	\$ 137
60"W	Z42560TSS.M376730	\$ 368	\$ 46	\$ 70	\$ 105	\$ 146

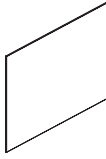

Description	Model	List Price	Upcharge	Upcharge
		P1	P2	P3
25"H Steel Tiles (monolithic tiles for 30"H Stride frames) — specify paint				
18"W	Z42518SSS.M376731	\$ 1360	\$ 32	\$ 60
20"W	Z42520SSS.M376732	\$ 1485	\$ 32	\$ 60
24"W	Z42524SSS.M376733	\$ 1506	\$ 32	\$ 60
30"W	Z42530SSS.M376734	\$ 1540	\$ 32	\$ 60
36"W	Z42536SSS.M376735	\$ 1595	\$ 32	\$ 60
42"W	Z42542SSS.M376736	\$ 708	\$ 32	\$ 60
48"W	Z42548SSS.M376737	\$ 751	\$ 32	\$ 60
60"W	Z42560SSS.M376738	\$ 841	\$ 32	\$ 60

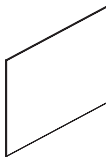

Description	Model	List Price	Upcharge	Upcharge
		L1	L2	L3
25"H Laminate Tiles (monolithic tiles for 30"H Stride frames) — specify laminate & edge				
18"W	SPLA-STR-LMTILE30.M430119	\$ 677	\$ 51	\$ 120
20"W	SPLA-STR-LMTILE30.M430120	\$ 677	\$ 51	\$ 120
24"W	SPLA-STR-LMTILE30.M430121	\$ 677	\$ 51	\$ 120
30"W	SPLA-STR-LMTILE30.M430122	\$ 728	\$ 51	\$ 120
36"W	SPLA-STR-LMTILE30.M430123	\$ 782	\$ 51	\$ 120
42"W	SPLA-STR-LMTILE30.M430124	\$ 851	\$ 51	\$ 120
48"W	SPLA-STR-LMTILE30.M430125	\$ 920	\$ 51	\$ 120
60"W	SPLA-STR-LMTILE30.M430126	\$ 1051	\$ 51	\$ 120

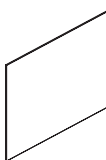

25"H Laminate Tiles to-the-Floor (monolithic tiles for 30"H Stride frames) — specify laminate & edge				
18"W	SPLA-STR-LMTILE30.M430127	\$ 942	\$ 51	\$ 120
20"W	SPLA-STR-LMTILE30.M430128	\$ 942	\$ 51	\$ 120
24"W	SPLA-STR-LMTILE30.M430129	\$ 942	\$ 51	\$ 120
30"W	SPLA-STR-LMTILE30.M430130	\$ 1032	\$ 51	\$ 120
36"W	SPLA-STR-LMTILE30.M430131	\$ 1092	\$ 51	\$ 120
42"W	SPLA-STR-LMTILE30.M430132	\$ 1170	\$ 51	\$ 120
48"W	SPLA-STR-LMTILE30.M430133	\$ 1243	\$ 51	\$ 120
60"W	SPLA-STR-LMTILE30.M430134	\$ 1436	\$ 51	\$ 120

Note: For to-the-Floor models please order the to-the-Floor Bracket Kit Z4TFB separately.

<p>How to specify — Select the Model Number from above.</p>	<p><i>1st Option:</i> Fabric (if applicable): See <i>inside back cover</i> for fabrics.</p>	<p><i>2nd Option:</i> Paint Color (if applicable): P1 P2 See <i>inside front cover</i> for finishes.</p>	<p><i>3rd Option:</i> Laminate Color (if applicable): See <i>inside front cover</i> for finishes.</p>	<p><i>4th Option:</i> Edge Color (if applicable): See <i>inside front cover</i> for finishes.</p>
<p>_____ .</p>	<p>_____</p>	<p>_____</p>	<p>_____ .</p>	<p>_____</p>

Example: Z42518TSS.M376723.APN911

22¹/₂"H Frameless Glass Specification Rules

Connector brackets are required to connect all glass screens together.

Every run of glass must have perpendicular support. Must use an L, T, or X connector brackets.

See page 22 for models.

Models are universal and are to be used for Stride, Terrace and Optimize.

Brackets connect to top corners of the glass.

Inline

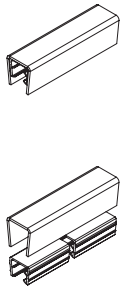

"S" Ext. Straight

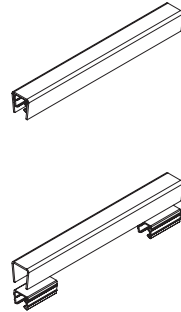

"T"

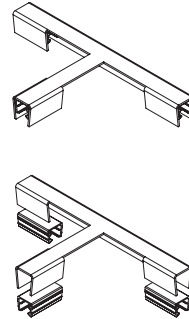

"L"

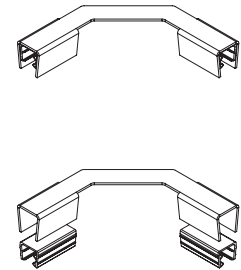

120° — 2 Way

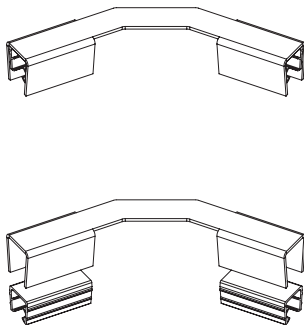

120° — 3 Way

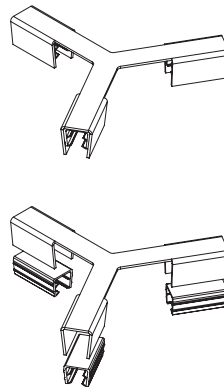

"X"

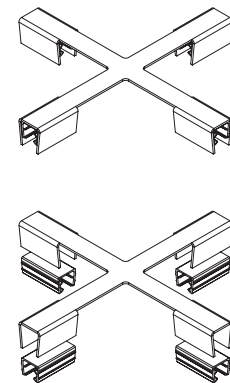

For specification information please see page 21.

Model	P1 List Price	P2 Upcharge	P3 Upcharge
Panel Mounted Frameless Glass Screen Alignment Bracket for an In-Line application SPLA-ACC-BRACKET.M508476	\$ 87	\$ 17	\$ 28
Panel Mounted Frameless Glass Screen Alignment Bracket for an "L" application SPLA-ACC-BRACKET.M508479	\$ 87	\$ 17	\$ 28
Panel Mounted Frameless Glass Screen Alignment Bracket for a "T" application SPLA-ACC-BRACKET.M508480	\$ 87	\$ 17	\$ 28
Panel Mounted Frameless Glass Screen Alignment Bracket for a 120° — 2 Way application SPLA-ACC-BRACKET.M508481	\$ 87	\$ 17	\$ 28
Panel Mounted Frameless Glass Screen Alignment Bracket for a 120° — 3 Way application SPLA-ACC-BRACKET.M508482	\$ 87	\$ 17	\$ 28
Panel Mounted Frameless Glass Screen Alignment Bracket for an "X" application SPLA-ACC-BRACKET.M508484	\$ 87	\$ 17	\$ 28
Panel Mounted Frameless Glass Screen Alignment Bracket for an "S" application SPLA-ACC-BRACKET.M508485	\$ 87	\$ 17	\$ 28

How to specify —
Select the Model Number from above.



Example:

1st Option:

Paint
(if applicable):



See [inside front cover](#) for finishes.



For specification information please see page 21.

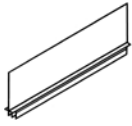

Description	Model	P1 List Price	P2 Upcharge	Frosted Glass Upcharge	Smoked Glass Upcharge
22½"H Frameless Glass with Top Cap					
42"W	SPLA-STR-SCRNGLSSM.M511269	\$ 1022	\$ 17	\$ 110	\$ 166
48"W	SPLA-STR-SCRNGLSSM.M511270	\$ 1106	\$ 17	\$ 110	\$ 166
54"W	SPLA-STR-SCRNGLSSM.M511271	\$ 1223	\$ 17	\$ 110	\$ 166
60"W	SPLA-STR-SCRNGLSSM.M511272	\$ 1345	\$ 17	\$ 110	\$ 166
66"W	SPLA-STR-SCRNGLSSM.M511273	\$ 1476	\$ 17	\$ 110	\$ 166
72"W	SPLA-STR-SCRNGLSSL.M511274	\$ 1609	\$ 17	\$ 165	\$ 249
78"W	SPLA-STR-SCRNGLSSL.M511275	\$ 1818	\$ 17	\$ 165	\$ 249
84"W	SPLA-STR-SCRNGLSSL.M511276	\$ 2030	\$ 17	\$ 165	\$ 249
90"W	SPLA-STR-SCRNGLSSL.M511278	\$ 2096	\$ 17	\$ 165	\$ 249
96"W	SPLA-STR-SCRNGLSSL.M511279	\$ 2165	\$ 17	\$ 165	\$ 249

Note: Due to increased height of the glass, there will be noticeable side-to-side movement on the screen.
Please contact TPG prior to placing your order to review your layout if you have questions.
Alignment brackets are required. See page 22.



22½"H Grooved End Trim for ⅜" Glass Panel Mounted Screens					
	SPLA-STR-TRIM.M507357	\$ 134	\$ 17		

<p>How to specify — Select the Model Number from above.</p>	<p>1st Option: Glass (if applicable): LC Clear LF Frosted GSM1 Smoked</p>	<p>2nd Option: Paint (if applicable): P1 P2 See inside front cover for finishes.</p>
<p>_____ . _____ .</p>	<p>_____ .</p>	<p>P _____</p>

Example: SPLA-SS-STR08HGDS1.M490854.LC.P02

S Shippable by small-package carrier.

Stride COM Insert Spec

Custom material used in grooved top cap trim should be sized according to these dimensions:

Standard Height	Actual Dimensions	Standard Width	Actual Dimensions
7½"H	8.460"H	24"W	23.866"W
15"H	15.960"H	30"W	29.866"W
22½"H	23.460"H	36"W	35.866"W
		42"W	41.866"W
		48"W	47.866"W
		54"W	53.866"W
		60"W	59.866"W
		66"W	65.866"W
		72"W	71.866"W
		78"W	77.866"W
		84"W	83.866"W
		90"W	89.866"W
		96"W	95.866"W

Height tolerance should be +0.000" / -0.188"

Width tolerance should be +/- 0.094"

Thickness of custom material must be 10MM thick -0.120MM / +0.890MM

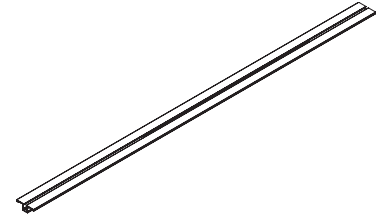

For COM material heights taller than 15"H.

Connector brackets are required to connect all screens together.

Every run of glass must have perpendicular support. Must use an L, T, or X connector brackets.

See page [22](#) for models

For specification information please see page 24.



Description	Model	P1	P2	P3
		List Price	Upcharge	Upcharge
Grooved Top Cap for Frameless COM Insert				
24"W	SPLA-STR-TRIM.M508411	\$ 296	\$ 17	\$ 28
30"W	SPLA-STR-TRIM.M508412	\$ 310	\$ 17	\$ 28
36"W	SPLA-STR-TRIM.M508413	\$ 322	\$ 17	\$ 28
42"W	SPLA-STR-TRIM.M508414	\$ 338	\$ 17	\$ 28
48"W	SPLA-STR-TRIM.M508416	\$ 342	\$ 17	\$ 28
54"W	SPLA-STR-TRIM.M508417	\$ 344	\$ 17	\$ 28
60"W	SPLA-STR-TRIM.M508418	\$ 363	\$ 17	\$ 28
66"W	SPLA-STR-TRIM.M508419	\$ 384	\$ 17	\$ 28
72"W	SPLA-STR-TRIM.M508420	\$ 411	\$ 17	\$ 28
78"W	SPLA-STR-TRIM.M508421	\$ 439	\$ 17	\$ 28
84"W	SPLA-STR-TRIM.M508422	\$ 485	\$ 17	\$ 28
90"W	SPLA-STR-TRIM.M508423	\$ 519	\$ 17	\$ 28
96"W	SPLA-STR-TRIM.M508424	\$ 574	\$ 17	\$ 28

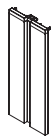

22½"H Grooved End Trim for Variable Height				
	SPLA-STR-TRIM.M507357	\$ 134	\$ 17	\$ 28

How to specify —
Select the Model Number from above.

Example:

1st Option:
Paint
(if applicable):

P1 P2

See [inside front cover](#) for finishes.

P | | |

For specification information please see page 24.

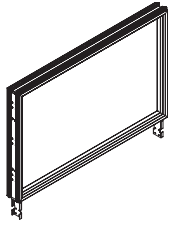

Description	Model	P1 List Price	P2 Upcharge	P3 Upcharge	Frosted Glass Upcharge
22½"H Low Profile Glass Stacker					
24"W	SPLA-SS-STR022GDS1.M506787	\$ 1002	\$ 77	\$ 150	\$ 102
30"W	SPLA-SS-STR022GDS1.M506788	\$ 1092	\$ 77	\$ 150	\$ 102
36"W	SPLA-SS-STR022GDS1.M506789	\$ 1192	\$ 77	\$ 150	\$ 102
42"W	SPLA-SS-STR022GDS2.M506790	\$ 1298	\$ 77	\$ 150	\$ 185
48"W	SPLA-SS-STR022GDS2.M506791	\$ 1417	\$ 77	\$ 150	\$ 185

22½"H x 60"W Low Profile Glass Stacker For 30+30 or 24+36 Frames

60"W	SPLA-SS-STR022GDS2.M506792	\$ 1573	\$ 77	\$ 150	\$ 185
------	----------------------------	---------	-------	--------	--------

22½"H x 72"W Low Profile Glass Stacker For 36+36 or 24+48 Frames

72"W	SPLA-SS-STR022GDS3.M506793	\$ 1747	\$ 77	\$ 150	\$ 285
------	----------------------------	---------	-------	--------	--------

22½"H x 84"W Low Profile Glass Stacker For 36+48 Frames

84"W	SPLA-SS-STR022GDS3.M506794	\$ 1939	\$ 77	\$ 150	\$ 285
------	----------------------------	---------	-------	--------	--------

22½"H x 90"W Low Profile Glass Stacker For 42+48 or 30+30+30 Frames

90"W	SPLA-SS-STR022GDS3.M506795	\$ 2154	\$ 77	\$ 150	\$ 285
------	----------------------------	---------	-------	--------	--------

22½"H x 96"W Low Profile Glass Stacker For 48+48 or 30+30+36 Frames

96"W	SPLA-SS-STR022GDS3.M506796	\$ 2391	\$ 77	\$ 150	\$ 285
------	----------------------------	---------	-------	--------	--------

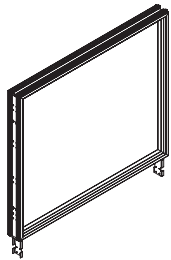

30"H Low Profile Glass Stacker

24"W	SPLA-SS-STR030GDS1.M506797	\$ 1061	\$ 77	\$ 150	\$ 175
30"W	SPLA-SS-STR030GDS1.M506798	\$ 1158	\$ 77	\$ 150	\$ 175
36"W	SPLA-SS-STR030GDS1.M506799	\$ 1261	\$ 77	\$ 150	\$ 175
42"W	SPLA-SS-STR030GDS2.M506800	\$ 1374	\$ 77	\$ 150	\$ 245
48"W	SPLA-SS-STR030GDS2.M506801	\$ 1500	\$ 77	\$ 150	\$ 245

30"H x 60"W Low Profile Glass Stacker For 30+30 or 24+36 Frames

60"W	SPLA-SS-STR030GDS2.M506802	\$ 1663	\$ 77	\$ 150	\$ 245
------	----------------------------	---------	-------	--------	--------

30"H x 72"W Low Profile Glass Stacker For 36+36 or 24+48 Frames

72"W	SPLA-SS-STR030GDS3.M506803	\$ 1846	\$ 77	\$ 150	\$ 381
------	----------------------------	---------	-------	--------	--------

30"H x 84"W Low Profile Glass Stacker For 36+48 Frames

84"W	SPLA-SS-STR030GDS3.M506804	\$ 2049	\$ 77	\$ 150	\$ 381
------	----------------------------	---------	-------	--------	--------

30"H x 90"W Low Profile Glass Stacker For 42+48 or 30+30+30 Frames

90"W	SPLA-SS-STR030GDS3.M506805	\$ 2277	\$ 77	\$ 150	\$ 381
------	----------------------------	---------	-------	--------	--------

30"H x 96"W Low Profile Glass Stacker For 48+48 or 30+30+36 Frames

96"W	SPLA-SS-STR030GDS3.M506806	\$ 2527	\$ 77	\$ 150	\$ 381
------	----------------------------	---------	-------	--------	--------

How to specify —
Select the Model Number from above.

1st Option:
Glass
(if applicable):
LC Clear
LF Frosted

2nd Option:
Paint
(if applicable):
P1 P2
See inside front cover for finishes.

_____ .

_____ .

Example:

_____ .

P _____

For specification information see current Stride Price & Specification Guide.

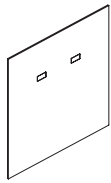

Description	Model		List Price		Upcharge		
			Grade A	Grade B	Grade C	Grade D	Grade E
37 1/2"H Tackable Acoustical Port Tiles (Monolithic tile for 42 1/2"H frame)							
18"W	SPLA-SS-STRETILE38HS.M425572		\$ 421	\$ 26	\$ 51	\$ 93	\$ 137
20"W	SPLA-SS-STRETILE38HS.M425573		\$ 421	\$ 26	\$ 51	\$ 93	\$ 137
24"W	SPLA-SS-STRETILE38HS.M425574		\$ 421	\$ 26	\$ 51	\$ 93	\$ 137
30"W	SPLA-SS-STRETILE38HM.M425575		\$ 443	\$ 38	\$ 78	\$ 142	\$ 208
36"W	SPLA-SS-STRETILE38HM.M425576		\$ 465	\$ 38	\$ 78	\$ 142	\$ 208
42"W	SPLA-SS-STRETILE38HM.M425577		\$ 494	\$ 38	\$ 78	\$ 142	\$ 208
48"W	SPLA-SS-STRETILE38HL.M425578		\$ 519	\$ 64	\$ 129	\$ 237	\$ 346
60"W	SPLA-SS-STRETILE38HL.M425579		\$ 569	\$ 64	\$ 129	\$ 237	\$ 346

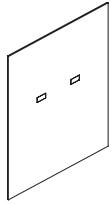

45"H Tackable Acoustical Port Tiles (Monolithic tile for 50"H frame)							
18"W	SPLA-SS-STRETILE45HS.M425580		\$ 454	\$ 32	\$ 61	\$ 113	\$ 165
20"W	SPLA-SS-STRETILE45HS.M425581		\$ 454	\$ 32	\$ 61	\$ 113	\$ 165
24"W	SPLA-SS-STRETILE45HS.M425582		\$ 454	\$ 32	\$ 61	\$ 113	\$ 165
30"W	SPLA-SS-STRETILE45HM.M425583		\$ 484	\$ 47	\$ 92	\$ 171	\$ 248
36"W	SPLA-SS-STRETILE45HM.M425584		\$ 508	\$ 47	\$ 92	\$ 171	\$ 248
42"W	SPLA-SS-STRETILE45HM.M425585		\$ 537	\$ 47	\$ 92	\$ 171	\$ 248
48"W	SPLA-SS-STRETILE45HL.M425586		\$ 574	\$ 78	\$ 154	\$ 285	\$ 414
60"W	SPLA-SS-STRETILE45HL.M425587		\$ 622	\$ 78	\$ 154	\$ 285	\$ 414

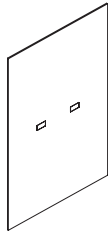

52 1/2"H Tackable Acoustical Port Tiles (Monolithic tile for 57 1/2"H frame)							
18"W	SPLA-SS-STRETILE53HS.M425588		\$ 496	\$ 36	\$ 71	\$ 133	\$ 193
20"W	SPLA-SS-STRETILE53HS.M425589		\$ 496	\$ 36	\$ 71	\$ 133	\$ 193
24"W	SPLA-SS-STRETILE53HS.M425590		\$ 496	\$ 36	\$ 71	\$ 133	\$ 193
30"W	SPLA-SS-STRETILE53HM.M425591		\$ 523	\$ 55	\$ 109	\$ 199	\$ 291
36"W	SPLA-SS-STRETILE53HM.M425592		\$ 557	\$ 55	\$ 109	\$ 199	\$ 291
42"W	SPLA-SS-STRETILE53HM.M425593		\$ 588	\$ 55	\$ 109	\$ 199	\$ 291
48"W	SPLA-SS-STRETILE53HL.M425594		\$ 622	\$ 90	\$ 180	\$ 333	\$ 484
60"W	SPLA-SS-STRETILE53HL.M425595		\$ 684	\$ 90	\$ 180	\$ 333	\$ 484

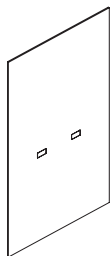

60"H Tackable Acoustical Port Tiles (Monolithic tile for 65"H frame)							
18"W	SPLA-SS-STRETILE60HS.M425596		\$ 531	\$ 40	\$ 81	\$ 151	\$ 220
20"W	SPLA-SS-STRETILE60HS.M425597		\$ 531	\$ 40	\$ 81	\$ 151	\$ 220
24"W	SPLA-SS-STRETILE60HS.M425598		\$ 531	\$ 40	\$ 81	\$ 151	\$ 220
30"W	SPLA-SS-STRETILE60HM.M425599		\$ 569	\$ 61	\$ 124	\$ 228	\$ 331
36"W	SPLA-SS-STRETILE60HM.M425600		\$ 644	\$ 61	\$ 124	\$ 228	\$ 331
42"W	SPLA-SS-STRETILE60HM.M425601		\$ 677	\$ 61	\$ 124	\$ 228	\$ 331
48"W	SPLA-SS-STRETILE60HL.M425602		\$ 702	\$ 102	\$ 207	\$ 379	\$ 552
60"W	SPLA-SS-STRETILE60HL.M425603		\$ 741	\$ 102	\$ 207	\$ 379	\$ 552

Note: Electrical mounts with 8988EBZ (ordered separately) mounted to underside of beltline horizontal (segment bar not required).

Note: Should not be used with low storage as port access will be blocked.

<p>How to specify — Select the Model Number from above.</p>	<p>1st Option: Fabric: See inside back cover for fabrics.</p>	<p>2nd Option: Electrical Grommet Color: See inside front cover for finishes.</p>
<p>S P L A - S S - S T R E T I L E </p>		
<p>Example: SPLA-SS-STRETILE38HS.M425572.APN927.E4</p>		

Shippable by small-package carrier.

For specification information see *Stride Price & Specification Guide*.

Description	Model	P1 Paint List Price	P2 Paint Upcharge	P3 Paint Upcharge
7"H Steel Tiles				
24"W	SPLA-SS-STRSTILE7HSM.M516892 S	\$ 165	\$ 26	\$ 48
30"W	SPLA-SS-STRSTILE7HSM.M516891 S	\$ 170	\$ 26	\$ 48
36"W	SPLA-SS-STRSTILE7HSM.M516890 S	\$ 184	\$ 26	\$ 48
42"W	SPLA-SS-STRSTILE7HLG.M516889 S	\$ 204	\$ 26	\$ 48
48"W	SPLA-SS-STRSTILE7HLG.M516888 S	\$ 216	\$ 26	\$ 48
60"W	SPLA-SS-STRSTILE7HLG.M516887 S	\$ 244	\$ 26	\$ 48
15"H Steel Tiles				
24"W	SPLA-SS-STRSTILE15HS.M516886 S	\$ 191	\$ 26	\$ 48
30"W	SPLA-SS-STRSTILE15HS.M516885 S	\$ 203	\$ 26	\$ 48
36"W	SPLA-SS-STRSTILE15HS.M516884 S	\$ 222	\$ 26	\$ 48
42"W	SPLA-SS-STRSTILE15HL.M516883 S	\$ 239	\$ 26	\$ 48
48"W	SPLA-SS-STRSTILE15HL.M516882 S	\$ 264	\$ 26	\$ 48
60"W	SPLA-SS-STRSTILE15HL.M516881 S	\$ 295	\$ 26	\$ 48
22½"H Steel Tiles				
24"W	SPLA-SS-STRSTILE22HS.M516880 S	\$ 282	\$ 26	\$ 48
30"W	SPLA-SS-STRSTILE22HS.M516879 S	\$ 306	\$ 26	\$ 48
36"W	SPLA-SS-STRSTILE22HS.M516878 S	\$ 328	\$ 26	\$ 48
42"W	SPLA-SS-STRSTILE22HL.M516877 S	\$ 356	\$ 26	\$ 48
48"W	SPLA-SS-STRSTILE22HL.M516876 S	\$ 381	\$ 26	\$ 48
60"W	SPLA-SS-STRSTILE22HL.M516875 S	\$ 444	\$ 26	\$ 48
30"H Steel Tiles				
24"W	SPLA-SS-STRSTILE30HS.M516874 S	\$ 339	\$ 26	\$ 48
30"W	SPLA-SS-STRSTILE30HS.M516873 S	\$ 367	\$ 26	\$ 48
36"W	SPLA-SS-STRSTILE30HS.M516872 S	\$ 397	\$ 26	\$ 48
42"W	SPLA-SS-STRSTILE30HL.M516871 S	\$ 431	\$ 26	\$ 48
48"W	SPLA-SS-STRSTILE30HL.M516870 S	\$ 463	\$ 26	\$ 48
60"W	SPLA-SS-STRSTILE30HL.M516869 S	\$ 531	\$ 26	\$ 48

Note: Order special UTP KIT separately below.

Note: 24"W tiles require 1 UTP kit.

30"W - 60"W tiles require 2 UTP kits.

Description	Model	List Price
Data/Electrical Port Kit (specify color)		
Tile Port Kit for Steel Tiles	SPLA-UTP.M456004 S	\$ 40

How to specify —
Select the Model Number from above.

1st Option:
Paint Color:
P1 P2
See [inside front cover](#) for finishes.

_____ . P _____

Example: SPLA-SS-STRSTILE7HSM.M455956.P4J

S Shippable by small-package carrier.

For specification information see *Stride Price & Specification Guide*.

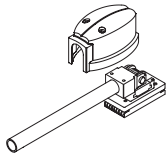

Description	Four-circuit 3 + 1 2 + 2		Three-circuit Separate Neutrals	
		List Price		List Price
Base Electrical In-feed Cable (Black only)				
12' Sealtight	SPLA-TP-ELEC-BYR.M489306	\$ 533	SPLA-TP-ELEC-BYR.M489309	\$ 769
18' Sealtight	SPLA-TP-ELEC-BYR.M489307	\$ 1014	SPLA-TP-ELEC-BYR.M489310	\$ 1043
24' Sealtight	SPLA-TP-ELEC-BYR.M489308	\$ 1354	SPLA-TP-ELEC-BYR.M489311	\$ 1389

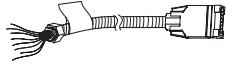

Ceiling Electrical In-Feed Cables				
6' Flex Cable	SPLA-TP-ELEC-BYR.M489324	\$ 485	N/A	
24' Flex Cable	SPLA-TP-ELEC-BYR.M489325	\$ 738	N/A	

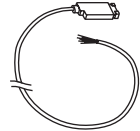

Electrical Base In-Feed Cable				
6' Sealtight Cable Power In-Feed	SPLA-TP-ELEC-BYR.M489326	\$ 588	N/A	
18' Sealtight Cable Power In-Feed	SPLA-TP-ELEC-BYR.M489327	\$ 811	N/A	
24' Sealtight Cable Power In-Feed	SPLA-TP-ELEC-BYR.M489328	\$ 1012	N/A	

How to specify —
Select the
Model Number
from above.

Example: SPLA-TP-ELEC-BYR.M489306

Shippable by small-package carrier.

For specification information see Terrace system specification book.

Description	Model	List Price	Upcharge
		P1	P2
Terrace Blade Feet and Glide Cover Kits — specify paint color			
End Blade Foot* — Dual Sided	SPLA-ACC-SUPPORT.M375836	\$ 665	\$ 17
Mid Blade Foot* — Dual-Sided	SPLA-ACC-SUPPORT.M375837	\$ 665	\$ 17
Glide Tower Cover Kit for Blade Foot** — Single	SPLA-ACC-SUPPORT.M375840	\$ 75	\$ 17
Glide Tower Cover Kit for Blade Feet** — Pair	SPLA-ACC-SUPPORT.M375841	\$ 151	\$ 17

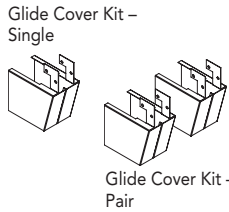
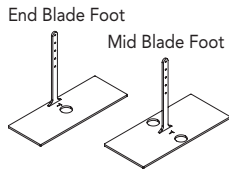

***Blade Feet**

- Blade Feet to be used with Raceway panels only – not compatible with Footed panels
- Glide tower cover kit includes parts to hide glide tower and give “footed” appearance. Will not exactly match standard footed aesthetic.
- Terrace panels must be ordered separately
- Blade feet are intended to be used to create free-standing panel runs
- Panels supported by Blade feet cannot contain hanging elements (shelves; overheads; shared storage)
- Panels supported by Blade feet cannot support worksurfaces
- Maximum height panels: Panels supported by blade bases can be no taller than 50”H (including stackers).
- Minimum quantity of supports: A blade base is required AT LEAST every 96” (8 feet), or every other panel connection, whichever condition happens first. A blade foot must be used at the ends of the panel run.
- Maximum length of run: A freestanding panel run supported by blade bases cannot be longer than 192” (16 feet).
- Note on Leveling: The special bases are designed to screw directly to the panel frame verticals. Therefore, there is no height adjustability once installed.
- Contact TPG to review layouts for potential exceptions or applications outside of free-standing panel runs

****Glide Tower**

- Includes parts to hide glide tower(s) and give “footed” appearance. Will not exactly match standard footed aesthetic.

Terrace Power Pole Accessories — specify paint color

Power Pole Splice Kit — use with 2 Standard			
Power Poles (order Terrace Power Poles separately)	SPLA-DNA-TRIM.M375864	\$ 323	\$ 17



Description	Model	List Price	Upcharge	Upcharge
		P1	P2	P3
22½”H Steel Base Tiles to-the-Floor — specify paint color				
24”W	TKG42224FSF	\$ 466	\$ 29	\$ 55
30”W	TKG42230FSF	\$ 504	\$ 29	\$ 55
36”W	TKG42236FSF	\$ 541	\$ 29	\$ 55
42”W	TKG42242FSF	\$ 577	\$ 29	\$ 55
48”W	TKG42248FSF	\$ 621	\$ 29	\$ 55
60”W	TKG42260FSF	\$ 704	\$ 29	\$ 55

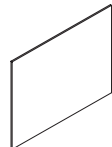

30”H Steel Base Tiles to-the-Floor — specify paint color

24”W	TKG43024FSF	\$ 625	\$ 29	\$ 55
30”W	TKG43030FSF	\$ 681	\$ 29	\$ 55
36”W	TKG43036FSF	\$ 726	\$ 29	\$ 55
42”W	TKG43042FSF	\$ 776	\$ 29	\$ 55
48”W	TKG43048FSF	\$ 825	\$ 29	\$ 55
60”W	TKG43060FSF	\$ 954	\$ 29	\$ 55

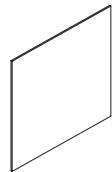

How to specify —

Select the Model Number from above.

1st Option:

Select the Paint Color:



See inside front cover for paints.

_____ . P _____

Examples: SPLA-ACC-SUPPORT.M375836.P7C TKG42224FSF.PR5

For specification information please see page 21.

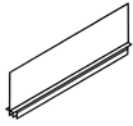

Description	Model	P1 List Price	P2 Upcharge	Frosted Glass Upcharge	Smoked Glass Upcharge
22½"H Frameless Glass with Flat Top Cap					
24"W	SPLA-DNA-SCRNGLSSFA.M511280	\$ 751	\$ 38	\$ 70	\$ 107
30"W	SPLA-DNA-SCRNGLSSFA.M511281	\$ 803	\$ 38	\$ 70	\$ 107
36"W	SPLA-DNA-SCRNGLSSFA.M511282	\$ 928	\$ 38	\$ 70	\$ 107
42"W	SPLA-DNA-SCRNGLSSFB.M511283	\$ 990	\$ 46	\$ 110	\$ 166
48"W	SPLA-DNA-SCRNGLSSFB.M511284	\$ 1060	\$ 46	\$ 110	\$ 166
54"W	SPLA-DNA-SCRNGLSSFC.M511285	\$ 1174	\$ 46	\$ 165	\$ 249
60"W	SPLA-DNA-SCRNGLSSFC.M511286	\$ 1295	\$ 46	\$ 165	\$ 249
66"W	SPLA-DNA-SCRNGLSSFC.M511287	\$ 1415	\$ 46	\$ 165	\$ 249
72"W	SPLA-DNA-SCRNGLSSFC.M511288	\$ 1541	\$ 46	\$ 165	\$ 249
78"W	SPLA-DNA-SCRNGLSSFC.M511289	\$ 1735	\$ 46	\$ 165	\$ 249
84"W	SPLA-DNA-SCRNGLSSFC.M511290	\$ 1961	\$ 46	\$ 165	\$ 249
90"W	SPLA-DNA-SCRNGLSSFC.M511291	\$ 2013	\$ 46	\$ 165	\$ 249
96"W	SPLA-DNA-SCRNGLSSFC.M511292	\$ 2075	\$ 46	\$ 165	\$ 249



22½"H Grooved High/Low Flat Connector Kit					
	SPLA-DNA-TRIM.M507358	\$ 124	\$ 17		

22½"H Frameless Glass with Radius Top Cap					
24"W	SPLA-DNA-SCRNGLSSRA.M511293	\$ 751	\$ 38	\$ 70	\$ 107
30"W	SPLA-DNA-SCRNGLSSRA.M511294	\$ 803	\$ 38	\$ 70	\$ 107
36"W	SPLA-DNA-SCRNGLSSRA.M511295	\$ 928	\$ 38	\$ 70	\$ 107
42"W	SPLA-DNA-SCRNGLSSRB.M511296	\$ 990	\$ 46	\$ 110	\$ 166
48"W	SPLA-DNA-SCRNGLSSRB.M511297	\$ 1060	\$ 46	\$ 110	\$ 166
54"W	SPLA-DNA-SCRNGLSSRC.M511298	\$ 1174	\$ 46	\$ 165	\$ 249
60"W	SPLA-DNA-SCRNGLSSRC.M511299	\$ 1295	\$ 46	\$ 165	\$ 249
66"W	SPLA-DNA-SCRNGLSSRC.M511300	\$ 1415	\$ 46	\$ 165	\$ 249
72"W	SPLA-DNA-SCRNGLSSRC.M511301	\$ 1541	\$ 46	\$ 165	\$ 249
78"W	SPLA-DNA-SCRNGLSSRC.M511302	\$ 1735	\$ 46	\$ 165	\$ 249
84"W	SPLA-DNA-SCRNGLSSRC.M511303	\$ 1961	\$ 46	\$ 165	\$ 249
90"W	SPLA-DNA-SCRNGLSSRC.M511304	\$ 2013	\$ 46	\$ 165	\$ 249
96"W	SPLA-DNA-SCRNGLSSRC.M511305	\$ 2075	\$ 46	\$ 165	\$ 249



22½"H Grooved Painted High/Low Radius Connector Kit					
	SPLA-DNA-TRIM.M507359	\$ 124	\$ 17		

Note: Due to increased height of the glass, there will be noticeable side-to-side movement on the screen.
Please contact TPG prior to placing your order to review your layout if you have questions.
Alignment brackets are required. See page 22.

<p>How to specify — Select the Model Number from above.</p>	<p>1st Option: Glass (if applicable): LC Clear LF Frosted GSM1 Smoked</p>	<p>2nd Option: Paint (if applicable): P1 P2 See inside front cover for finishes.</p>
<p>Example: _____ .</p>	<p>_____ .</p>	<p>P _____</p>

S Shippable by small-package carrier.

Terrace Flat Trim COM Insert Spec

Custom material used in grooved top cap trim should be sized according to these dimensions:

Standard Height	Actual Dimensions	Standard Width	Actual Dimensions
7½"H	8.460"H	24"W	23.866"W
15"H	15.960"H	30"W	29.866"W
22½"H	23.460"H	36"W	35.866"W
		42"W	41.866"W
		48"W	47.866"W
Height tolerance should be +0.000" / -0.188"		54"W	53.866"W
		60"W	59.866"W
Width tolerance should be +/- 0.094"		66"W	65.866"W
		72"W	71.866"W
Thickness of custom material must be 10MM thick -0.120MM / +0.890MM		78"W	77.866"W
		84"W	83.866"W
		90"W	89.866"W
		96"W	95.866"W

For COM material heights taller than 15"H.

Connector brackets are required to connect all screens together.

Every run of glass must have perpendicular support. Must use an L, T, or X connector brackets.

See page 22 for models

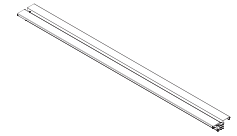

Terrace Radius Trim COM Insert Spec

Custom material used in grooved top cap trim should be sized according to these dimensions:

Standard Height	Actual Dimensions	Standard Width	Actual Dimensions
7½"H	8.460"H	24"W	23.866"W
15"H	15.960"H	30"W	29.866"W
22½"H	23.460"H	36"W	35.866"W
		42"W	41.866"W
		48"W	47.866"W
Height tolerance should be +0.000" / -0.188"		54"W	53.866"W
		60"W	59.866"W
Width tolerance should be +/- 0.094"		66"W	65.866"W
		72"W	71.866"W
Thickness of custom material must be 10MM thick -0.120MM / +0.890MM		78"W	77.866"W
		84"W	83.866"W
		90"W	89.866"W
		96"W	95.866"W

For COM material heights taller than 15"H.

Connector brackets are required to connect all screens together.

Every run of glass must have perpendicular support. Must use an L, T, or X connector brackets.

See page 22 for models

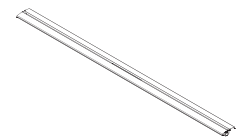

For specification information please see page 33.

FINISHES

TABLE OF CONTENTS

WORKSURFACES

STRIDE

TERRACE

FURTHER

APPROACH

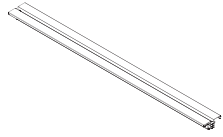

Description	Model	P1 List Price	P2 Upcharge
Grooved Flat Trim For Frameless COM Insert			
24"W	SPLA-DNA-TRIM.M508426	\$ 295	\$ 17
30"W	SPLA-DNA-TRIM.M508427	\$ 300	\$ 17
36"W	SPLA-DNA-TRIM.M508428	\$ 315	\$ 17
42"W	SPLA-DNA-TRIM.M508429	\$ 322	\$ 17
48"W	SPLA-DNA-TRIM.M508431	\$ 327	\$ 17
54"W	SPLA-DNA-TRIM.M508432	\$ 341	\$ 17
60"W	SPLA-DNA-TRIM.M508433	\$ 356	\$ 17
66"W	SPLA-DNA-TRIM.M508434	\$ 383	\$ 17
72"W	SPLA-DNA-TRIM.M508435	\$ 409	\$ 17
78"W	SPLA-DNA-TRIM.M508503	\$ 431	\$ 17
84"W	SPLA-DNA-TRIM.M508436	\$ 472	\$ 17
90"W	SPLA-DNA-TRIM.M508437	\$ 496	\$ 17
96"W	SPLA-DNA-TRIM.M508438	\$ 557	\$ 17

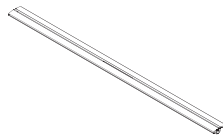

Grooved Radius Trim For Frameless COM Insert			
24"W	SPLA-DNA-TRIM.M508439	\$ 295	\$ 17
30"W	SPLA-DNA-TRIM.M508440	\$ 300	\$ 17
36"W	SPLA-DNA-TRIM.M508441	\$ 315	\$ 17
42"W	SPLA-DNA-TRIM.M508442	\$ 322	\$ 17
48"W	SPLA-DNA-TRIM.M508443	\$ 327	\$ 17
54"W	SPLA-DNA-TRIM.M508444	\$ 341	\$ 17
60"W	SPLA-DNA-TRIM.M508445	\$ 356	\$ 17
66"W	SPLA-DNA-TRIM.M508446	\$ 383	\$ 17
72"W	SPLA-DNA-TRIM.M508449	\$ 409	\$ 17
78"W	SPLA-DNA-TRIM.M508505	\$ 431	\$ 17
84"W	SPLA-DNA-TRIM.M508450	\$ 472	\$ 17
90"W	SPLA-DNA-TRIM.M508451	\$ 496	\$ 17
96"W	SPLA-DNA-TRIM.M508452	\$ 557	\$ 17

How to specify —
Select the Model Number from above.



Example:

1st Option:

Paint (if applicable):

P1 P2

See inside front cover for finishes.

P | | |

For specification information see current Terrace Price & Specification Guide.

FINISHES

TABLE OF CONTENTS

WORKSURFACES

STRIDE

TERRACE

FURTHER

APPROACH

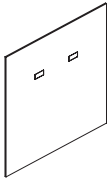

Description	Model	List Price		Upcharge		
		Grade A	Grade B	Grade C	Grade D	Grade E
30"H Tackable Acoustical Port Tiles						
18"W	SPLA-SS-TER30HFT1.M425613	\$ 277	\$ 14	\$ 32	\$ 57	\$ 82
20"W	SPLA-SS-TER30HFT1.M425614	\$ 277	\$ 14	\$ 32	\$ 57	\$ 82
24"W	SPLA-SS-TER30HFT1.M425615	\$ 277	\$ 14	\$ 32	\$ 57	\$ 82
30"W	SPLA-SS-TER30HFT2.M425616	\$ 290	\$ 24	\$ 47	\$ 85	\$ 125
36"W	SPLA-SS-TER30HFT2.M425617	\$ 320	\$ 24	\$ 47	\$ 85	\$ 125
42"W	SPLA-SS-TER30HFT2.M425618	\$ 335	\$ 24	\$ 47	\$ 85	\$ 125
48"W	SPLA-SS-TER30HFT3.M425619	\$ 352	\$ 39	\$ 79	\$ 145	\$ 211
60"W	SPLA-SS-TER30HFT3.M425620	\$ 371	\$ 39	\$ 79	\$ 145	\$ 211

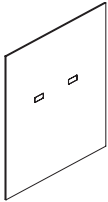

42½"H Tackable Acoustical Port Tiles						
18"W	SPLA-SS-TER42HFT1.M425621	\$ 344	\$ 26	\$ 51	\$ 93	\$ 136
20"W	SPLA-SS-TER42HFT1.M425622	\$ 344	\$ 26	\$ 51	\$ 93	\$ 136
24"W	SPLA-SS-TER42HFT1.M425623	\$ 344	\$ 26	\$ 51	\$ 93	\$ 136
30"W	SPLA-SS-TER42HFT2.M425624	\$ 364	\$ 38	\$ 78	\$ 142	\$ 207
36"W	SPLA-SS-TER42HFT2.M425625	\$ 401	\$ 38	\$ 78	\$ 142	\$ 207
42"W	SPLA-SS-TER42HFT2.M425626	\$ 428	\$ 38	\$ 78	\$ 142	\$ 207
48"W	SPLA-SS-TER42HFT3.M425627	\$ 458	\$ 64	\$ 128	\$ 237	\$ 346
60"W	SPLA-SS-TER42HFT3.M425628	\$ 507	\$ 64	\$ 128	\$ 237	\$ 346

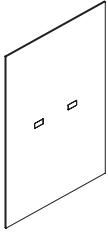

50"H Tackable Acoustical Port Tiles						
18"W	SPLA-SS-TER50HFT1.M425629	\$ 364	\$ 28	\$ 61	\$ 112	\$ 162
20"W	SPLA-SS-TER50HFT1.M425630	\$ 364	\$ 28	\$ 61	\$ 112	\$ 162
24"W	SPLA-SS-TER50HFT1.M425631	\$ 364	\$ 28	\$ 61	\$ 112	\$ 162
30"W	SPLA-SS-TER50HFT2.M425632	\$ 404	\$ 46	\$ 91	\$ 168	\$ 245
36"W	SPLA-SS-TER50HFT2.M425633	\$ 450	\$ 46	\$ 91	\$ 168	\$ 245
42"W	SPLA-SS-TER50HFT2.M425634	\$ 496	\$ 46	\$ 91	\$ 168	\$ 245
48"W	SPLA-SS-TER50HFT3.M425635	\$ 539	\$ 77	\$ 153	\$ 283	\$ 410
60"W	SPLA-SS-TER50HFT3.M425636	\$ 590	\$ 77	\$ 153	\$ 283	\$ 410

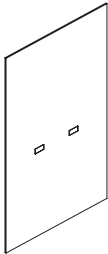

57½"H Tackable Acoustical Port Tiles						
18"W	SPLA-SS-TER57HFT1.M425637	\$ 419	\$ 36	\$ 70	\$ 129	\$ 189
20"W	SPLA-SS-TER57HFT1.M425638	\$ 419	\$ 36	\$ 70	\$ 129	\$ 189
24"W	SPLA-SS-TER57HFT1.M425639	\$ 419	\$ 36	\$ 70	\$ 129	\$ 189
30"W	SPLA-SS-TER57HFT2.M425640	\$ 419	\$ 53	\$ 105	\$ 196	\$ 285
36"W	SPLA-SS-TER57HFT2.M425641	\$ 451	\$ 53	\$ 105	\$ 196	\$ 285
42"W	SPLA-SS-TER57HFT2.M425642	\$ 501	\$ 53	\$ 105	\$ 196	\$ 285
48"W	SPLA-SS-TER57HFT3.M425643	\$ 542	\$ 89	\$ 178	\$ 324	\$ 473
60"W	SPLA-SS-TER57HFT3.M425644	\$ 594	\$ 89	\$ 178	\$ 324	\$ 473

65"H Tackable Acoustical Port Tiles						
18"W	SPLA-SS-TER65HFT1.M425645	\$ 434	\$ 39	\$ 79	\$ 145	\$ 211
20"W	SPLA-SS-TER65HFT1.M425646	\$ 434	\$ 39	\$ 79	\$ 145	\$ 211
24"W	SPLA-SS-TER65HFT1.M425647	\$ 434	\$ 39	\$ 79	\$ 145	\$ 211
30"W	SPLA-SS-TER65HFT2.M425648	\$ 483	\$ 60	\$ 120	\$ 219	\$ 319
36"W	SPLA-SS-TER65HFT2.M425649	\$ 529	\$ 60	\$ 120	\$ 219	\$ 319
42"W	SPLA-SS-TER65HFT2.M425650	\$ 576	\$ 60	\$ 120	\$ 219	\$ 319
48"W	SPLA-SS-TER65HFT3.M425651	\$ 612	\$ 99	\$ 198	\$ 366	\$ 533
60"W	SPLA-SS-TER65HFT3.M425652	\$ 657	\$ 99	\$ 198	\$ 366	\$ 533

Note: Electrical mounts with 8989EB (ordered separately) mounted to the underside of the beltline horizontal (segment bar not required.)
Note: Should not be used with low storage because port access will be blocked.

<p>How to specify — Select the Model Number from above.</p>	<p><i>1st Option:</i> Fabric: See inside back cover for fabrics.</p>	<p><i>2nd Option:</i> Electrical Grommet Color: See inside front cover for finishes.</p>
---	---	---

Example: SPLA-SS-TER30HFT1.M425613.ECH901.E9 [S] Shippable by small-package carrier.

For specification information see *Terrace Price & Specification Guide*.

Description	Model	P1 Paint List Price	P2 Paint Upcharge	P3 Paint Upcharge
7½"H Steel Tiles				
24"W	SPLA-SS-TER07HST1.M455980 S	\$ 163	\$ 36	\$ 68
30"W	SPLA-SS-TER07HST1.M455981 S	\$ 170	\$ 36	\$ 68
36"W	SPLA-SS-TER07HST1.M455982 S	\$ 184	\$ 36	\$ 68
42"W	SPLA-SS-TER07HST2.M455983 S	\$ 207	\$ 36	\$ 68
48"W	SPLA-SS-TER07HST2.M455984 S	\$ 222	\$ 36	\$ 68
60"W	SPLA-SS-TER07HST2.M455985 S	\$ 248	\$ 36	\$ 68
15"H Steel Tiles				
24"W	SPLA-SS-TER15HST1.M455986 S	\$ 169	\$ 36	\$ 68
30"W	SPLA-SS-TER15HST1.M455987 S	\$ 177	\$ 36	\$ 68
36"W	SPLA-SS-TER15HST1.M455988 S	\$ 193	\$ 36	\$ 68
42"W	SPLA-SS-TER15HST2.M455989 S	\$ 212	\$ 36	\$ 68
48"W	SPLA-SS-TER15HST2.M455990 S	\$ 229	\$ 36	\$ 68
60"W	SPLA-SS-TER15HST2.M455991 S	\$ 258	\$ 36	\$ 68
22½"H Steel Tiles				
24"W	SPLA-SS-TER22HST1.M455992 S	\$ 215	\$ 36	\$ 68
30"W	SPLA-SS-TER22HST1.M455993 S	\$ 223	\$ 36	\$ 68
36"W	SPLA-SS-TER22HST1.M455994 S	\$ 238	\$ 36	\$ 68
42"W	SPLA-SS-TER22HST2.M455995 S	\$ 258	\$ 36	\$ 68
48"W	SPLA-SS-TER22HST2.M455996 S	\$ 276	\$ 36	\$ 68
60"W	SPLA-SS-TER22HST2.M455997 S	\$ 305	\$ 36	\$ 68
30"H Steel Tiles				
24"W	SPLA-SS-TER30HST1.M455998 S	\$ 248	\$ 51	\$ 104
30"W	SPLA-SS-TER30HST1.M455999 S	\$ 272	\$ 51	\$ 104
36"W	SPLA-SS-TER30HST1.M456000 S	\$ 307	\$ 51	\$ 104
42"W	SPLA-SS-TER30HST2.M456001 S	\$ 327	\$ 51	\$ 104
48"W	SPLA-SS-TER30HST2.M456002 S	\$ 365	\$ 51	\$ 104
60"W	SPLA-SS-TER30HST2.M456003 S	\$ 414	\$ 51	\$ 104

Note: Order special UTP KIT separately below.

Note: 24"W tiles require 1 UTP kit.

30"W - 60"W tiles require 2 UTP kits.

Description	Model	List Price
Data/Electrical Port Kit (specify color)		
Tile Port Kit for Steel Tiles	SPLA-UTP.M456004 S	\$ 40

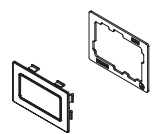

How to specify —
Select the Model Number from above.

1st Option:

Paint Color:

P1 P2

See [inside front cover](#) for finishes.

_____ . **P** _____

Example: SPLA-SS-STRSTILE7HSM.M455956.P4J

S Shippable by small-package carrier.

For specification information see current Terrace Price & Specification Guide.

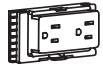

Duplex Receptacle

Description	Four-circuit 3 + 1 2 + 2	List Price	Three-circuit Separate Neutrals	List Price
Duplex Receptacle				
Circuit 2 - 20 AMP	SPLA-TP-PELEC-BYR.M487355	\$ 84	SPLA-TP-PELEC-BYR.M487372	\$ 84
Circuit 3 - 20 AMP (3 + 1)	SPLA-TP-PELEC-BYR.M487356	\$ 84	SPLA-TP-PELEC-BYR.M487373	\$ 84
Circuit 3 - 20 AMP (2 + 2)	SPLA-TP-PELEC-BYR.M487358	\$ 84	N/A	
Circuit 4 - 20 AMP (Four Circuit - ISO/DEDICATED)	SPLA-TP-PELEC-BYR.M487359	\$ 84	N/A	

Note: Duplex receptacles are 1 1/8"D and will sit proud of the panel frame.

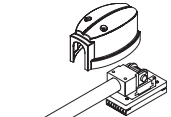

Base Electrical Infeed

Base Electrical In-Feed Cable: Sealtight cable for Terrace receptacle				
12' Sealtight	SPLA-TP-ELEC-BYR.M489312	\$ 727	SPLA-TP-ELEC-BYR.M489315	\$ 701
18' Sealtight	SPLA-TP-ELEC-BYR.M489313	\$ 982	SPLA-TP-ELEC-BYR.M489316	\$ 982
24' Sealtight	SPLA-TP-ELEC-BYR.M489314	\$ 1312	SPLA-TP-ELEC-BYR.M489317	\$ 1166

Base Electrical In-Feed Cable: Flex Cable				
12' Flex Cable	SPLA-TP-ELEC-BYR.M489318	\$ 463	SPLA-TP-ELEC-BYR.M489321	\$ 559
18' Flex Cable	SPLA-TP-ELEC-BYR.M489319	\$ 1014	SPLA-TP-ELEC-BYR.M489322	\$ 951
24' Flex Cable	SPLA-TP-ELEC-BYR.M489320	\$ 1078	SPLA-TP-ELEC-BYR.M489323	\$ 1172



Ceiling Electrical Infeed

Ceiling Electrical In-Feed Cables				
6' Flex Cable	SPLA-TP-ELEC-BYR.M489324	\$ 485	N/A	
24' Flex Cable	SPLA-TP-ELEC-BYR.M489325	\$ 738	N/A	

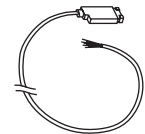

Electrical Infeed Cable

Electrical Base In-Feed Cables (for use with footed panels)				
6' Sealtight Ceiling	SPLA-TP-ELEC-BYR.M489326	\$ 588	N/A	
18' Sealtight Ceiling	SPLA-TP-ELEC-BYR.M489327	\$ 811	N/A	
24' Sealtight Ceiling	SPLA-TP-ELEC-BYR.M489328	\$ 1012	N/A	

How to specify —
Select the Model Number from above.

1st Option:
Electrical Receptacle Color (if applicable):
See [inside front cover](#) for finishes.

1st Option:
Color (if applicable):
P Black

_____ . **E**

Example: SPLA-TP-PELEC-BYR.M487355.E4

S Shippable by small-package carrier.

For specification information see current Further Price & Specification Guide.

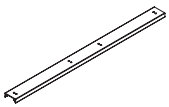
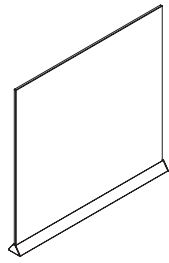

Description	Model	P1 List Price	P2 Upcharge	P3 Upcharge	Frosted Glass Upcharge	Smoked Glass Upcharge
28"H Triangle Base Beam Mounted Glass Screens						
24"W	SPLA-FTR-GSCRN2040.M511316	\$ 946	\$ 17	\$ 28	\$ 147	\$ 298
30"W	SPLA-FTR-GSCRN2040.M511317	\$ 1103	\$ 17	\$ 28	\$ 116	\$ 234
36"W	SPLA-FTR-GSCRN2040.M511319	\$ 1232	\$ 17	\$ 28	\$ 116	\$ 234
42"W	SPLA-FTR-GSCRN2040.M511321	\$ 1398	\$ 17	\$ 28	\$ 116	\$ 234
48"W	SPLA-FTR-GSCRN4060.M511322	\$ 1512	\$ 17	\$ 28	\$ 147	\$ 298
54"W	SPLA-FTR-GSCRN4060.M511323	\$ 1637	\$ 17	\$ 28	\$ 147	\$ 298
60"W	SPLA-FTR-GSCRN4060.M511325	\$ 1749	\$ 17	\$ 28	\$ 147	\$ 298
66"W	SPLA-FTR-GSCRN4060.M511326	\$ 2072	\$ 17	\$ 28	\$ 147	\$ 298
72"W	SPLA-FTR-GSCRN6080.M511327	\$ 2229	\$ 17	\$ 28	\$ 202	\$ 411
78"W	SPLA-FTR-GSCRN6080.M511328	\$ 2420	\$ 17	\$ 28	\$ 202	\$ 411
84"W	SPLA-FTR-GSCRN6080.M511329	\$ 2621	\$ 17	\$ 28	\$ 202	\$ 411
90"W	SPLA-FTR-GSCRN6080.M511331	\$ 2759	\$ 17	\$ 28	\$ 202	\$ 411
96"W	SPLA-FTR-GSCRN6080.M511332	\$ 2962	\$ 17	\$ 28	\$ 202	\$ 411

Beam Trim For Triangle Base Screens

24"W	SPLA-FTR-CAP2040.M511333	\$ 335	\$ 13	\$ 21
30"W	SPLA-FTR-CAP2040.M511334	\$ 347	\$ 13	\$ 21
36"W	SPLA-FTR-CAP2040.M511335	\$ 357	\$ 13	\$ 21
42"W	SPLA-FTR-CAP2040.M511336	\$ 377	\$ 13	\$ 21
48"W	SPLA-FTR-CAP2040.M511337	\$ 426	\$ 13	\$ 21
54"W	SPLA-FTR-CAP4060.M511338	\$ 470	\$ 18	\$ 32
60"W	SPLA-FTR-CAP4060.M511339	\$ 490	\$ 18	\$ 32
66"W	SPLA-FTR-CAP4060.M511340	\$ 512	\$ 18	\$ 32
72"W	SPLA-FTR-CAP4060.M511341	\$ 525	\$ 18	\$ 32
78"W	SPLA-FTR-CAP6080.M511342	\$ 542	\$ 26	\$ 48
84"W	SPLA-FTR-CAP6080.M511343	\$ 578	\$ 26	\$ 48
90"W	SPLA-FTR-CAP6080.M511344	\$ 611	\$ 26	\$ 48
96"W	SPLA-FTR-CAP6080.M511345	\$ 680	\$ 26	\$ 48

Notes:

- 28"H Beam Mounted Screens will align with 57½"H Storage when used with 28"H Further Beams.
- Beam Mount component must be ordered separately.
- Beam Mount models will not be visible in specifying software, but are visible on Allsteel Synergy quoting and ordering tools.

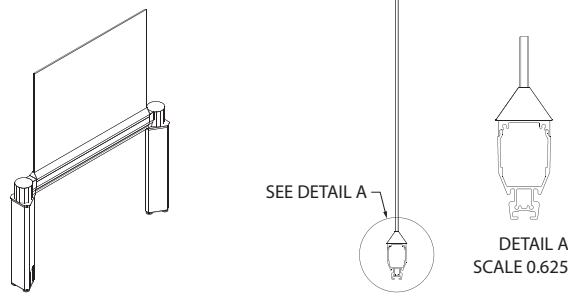

Specification Rules:

- This solution is for New Further Beams only.
- Triangle Base will slightly overhang the beam.
- Special Beam trim to be ordered separately. See detail A.
- Installation requires clamping of the top cap to get it to "snap" on.
- Top cap pressure fit will be tight so the data or electrical in the beam will be more difficult to access after special top cap and screen is installed.

<p>How to specify — Select the Model Number from above.</p>	<p>1st Option: Glass (if applicable): LC Clear LF Frosted GSM1 Smoked</p>	<p>2nd Option: Paint (if applicable): P1 P2 P3 See inside front cover for finishes.</p>
<p>Example:</p>		

5 Shippable by small-package carrier.

For specification information see current Further Price & Specification Guide.

Description	Model	P1 List Price	P2 Upcharge	P3 Upcharge	Upholstery Upcharge			
					Grade A	Grade B	Grade C	Grade D
28"H Triangle Base Beam Mounted Fabric Screens								
24"W	SPLA-FTR-MOD0520.M514118	\$ 909	\$17	\$28	\$0	\$28	\$80	\$136
30"W	SPLA-FTR-MOD2040.M514119	\$1078	\$17	\$28	\$0	\$51	\$107	\$162
36"W	SPLA-FTR-MOD2040.M514120	\$1188	\$17	\$28	\$0	\$51	\$107	\$162
42"W	SPLA-FTR-MOD2040.M514121	\$1239	\$17	\$28	\$0	\$51	\$107	\$162
48"W	SPLA-FTR-MOD2040.M514123	\$1294	\$17	\$28	\$0	\$51	\$107	\$162
54"W	SPLA-FTR-MOD4060.M514124	\$1426	\$17	\$28	\$0	\$62	\$129	\$197
60"W	SPLA-FTR-MOD4060.M514125	\$1519	\$17	\$28	\$0	\$62	\$129	\$197
66"W	SPLA-FTR-MODRR.M514127	\$1597	\$17	\$28	\$0	\$62	\$129	\$197
72"W	SPLA-FTR-MODRR.M514128	\$1672	\$17	\$28	\$0	\$62	\$129	\$197

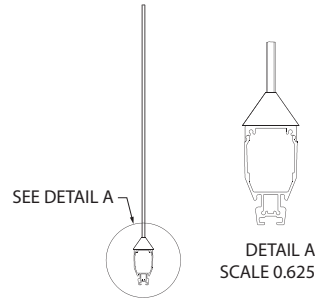
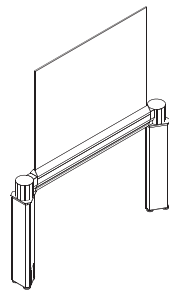

Specification Rules:

- This solution is for New Further Beams only.
- Triangle Base will slightly overhang the beam.
- Special Beam trim to be ordered separately. See detail A.
- Installation requires clamping of the top cap to get it to snap on.
- Top cap pressure fit will be tight so the data or electrical in the beam will be more difficult to access after special top cap and screen is installed.

<p>How to specify — Select the Model Number from above.</p> <p>_____</p> <p>_____ .</p>	<p>1st Option: Fabric (if applicable): See <i>inside back cover</i> for fabrics.</p> <p>_____ .</p>	<p>2nd Option: Paint (if applicable): P1 P2 See <i>inside front cover</i> for finishes.</p> <p>_____ . P _____</p>
--	---	--

Example:

For specification information see current Further Price & Specification Guide.



Description	Max. Receptacles Per Side	Model	List Price
Duplex Receptacles for Further Dual-Sided Power Kits			
Receptacle - 20 AMP Circuit 2 - Further		SPLA-TP-PELEC-BYR.M487360 S	\$ 84
Receptacle - 20 AMP Circuit 1 - Further		SPLA-TP-PELEC-BYR.M496568 S	\$ 84
Receptacle - 20 AMP Circuit 3 - Further (2+2)		SPLA-TP-PELEC-BYR.M487362 S	\$ 84
Receptacle - 20 AMP Circuit 3 - Further (3+1)		SPLA-TP-PELEC-BYR.M487361 S	\$ 84
Receptacle - 20 AMP Circuit 4 - Further (ISOLATED/DEDICATED)		SPLA-TP-PELEC-BYR.M487363 S	\$ 84

Note: 20 AMP receptacles not compatible with old style beams.

Note: Further 20 AMP receptacles extend from beam 1/8" more than standard Further receptacles.

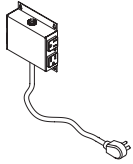

Description	Max. Receptacles Per Side	Model	List Price
Power/Data Modules — Under Worksurface Mount			
FURTHER QUAD TAP POWER MODULE with 6' cord		SPLA-TP-ELEC-BYR.M454877 S	\$ 525

FINISHES

TABLE OF CONTENTS

WORKSURFACES

STRIDE

TERRACE

FURTHER

APPROACH

How to specify —
Select the Model Number from above.

1st Option:
Electrical Receptacle Color
(if applicable):
See [inside front cover](#) for finishes.



Examples: SPLA-TP-ELEC-BYR.M454877
SPLA-TP-PELEC-BYR.M496568.E4

S Shippable by small-package carrier.

For specification information please see page 21.

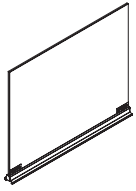

Description	Model	P1 List Price	P2 Upcharge	P3 Upcharge	Frosted Glass Upcharge	Smoked Glass Upcharge
22½"H Frameless Glass with Top Cap						
24"W	SPLA-SS-OPTSCRGLSS.M511306	\$ 831	\$ 17	\$ 28	\$ 70	\$ 107
30"W	SPLA-SS-OPTSCRGLSS.M511307	\$ 917	\$ 17	\$ 28	\$ 70	\$ 107
36"W	SPLA-SS-OPTSCRGLSS.M511308	\$ 1036	\$ 17	\$ 28	\$ 70	\$ 107
42"W	SPLA-SS-OPTSCRGLSM.M511309	\$ 1102	\$ 17	\$ 28	\$ 110	\$ 166
48"W	SPLA-SS-OPTSCRGLSM.M511310	\$ 1213	\$ 17	\$ 28	\$ 110	\$ 166
54"W	SPLA-SS-OPTSCRGLSM.M511311	\$ 1326	\$ 17	\$ 28	\$ 110	\$ 166
60"W	SPLA-SS-OPTSCRGLSM.M511312	\$ 1424	\$ 17	\$ 28	\$ 110	\$ 166
66"W	SPLA-SS-OPTSCRGLSM.M511313	\$ 1537	\$ 17	\$ 28	\$ 110	\$ 166
72"W	SPLA-SS-OPTSCRGLSL.M511314	\$ 1622	\$ 17	\$ 28	\$ 165	\$ 249

Note: Due to increased height of the glass, there will be noticeable side-to-side movement on the screen.

Please contact TPG prior to placing your order to review your layout if you have questions.

Note: The height of these models are NOT compatible with new frameless glass models (ie: P21536FGS) launched 7/1/21. If 22½"H frameless glass is needed for NEW model design, please contact TPG as product modification requests will be needed.

<p>How to specify — Select the Model Number from above.</p>	<p>1st Option: Glass (if applicable): LC Clear LF Frosted GSM1 Smoked</p>	<p>2nd Option: Paint (if applicable): P1 P2 See inside front cover for finishes.</p>
<p>_____ .</p>	<p>_____ .</p>	<p>P _____</p>

Example:

S Shippable by small-package carrier.

Optimize Trim COM Insert Spec

Custom material used in grooved top cap trim should be sized according to these dimensions:



Standard Height	Actual Dimensions	Standard Width	Actual Dimensions
7½"H	8.460"H	24"W	23.866"W
15"H	15.960"H	30"W	29.866"W
22½"H	23.460"H	36"W	35.866"W
		42"W	41.866"W
		48"W	47.866"W
		54"W	53.866"W
		60"W	59.866"W
		66"W	65.866"W
		72"W	71.866"W

Height tolerance should be +0.000" / -0.188"

Width tolerance should be +/- 0.094"

Thickness of custom material must be 10MM thick -0.120MM / +0.890MM

For COM material heights taller than 15"H.
 Connector brackets are required to connect all screens together.
 Every run of glass must have perpendicular support. Must use an L, T, or X connector brackets.
 See page [22](#) for models

Note: The dimensions referenced are NOT compatible with new frameless glass models (ie: P21536FGS) launched 7/1/21.

For specification information see current Optimize Price & Specification Guide.

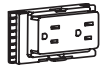

Description	Four-circuit 3 + 1 2 + 2	List Price	Three-circuit Separate Neutrals	List Price
Duplex Receptacle				
Circuit 2 - 20 AMP	SPLA-TP-PELEC-BYR.M487364	\$ 84	SPLA-TP-PELEC-BYR.M487368	\$ 84
Circuit 3 - 20 AMP (3 + 1)	SPLA-TP-PELEC-BYR.M487365	\$ 84	SPLA-TP-PELEC-BYR.M487369	\$ 84
Circuit 3 - 20 AMP (2 + 2)	SPLA-TP-PELEC-BYR.M487366	\$ 84		
Circuit 4 - 20 AMP (Four Circuit - ISO/DEDICATED)	SPLA-TP-PELEC-BYR.M487367	\$ 84		

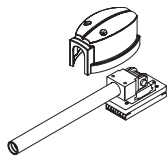

Base Electrical In-Feed Cable: Sealight Cable for Optimize Receptacle				
12' Sealight	SPLA-TP-ELEC-BYR.M489329	\$ 727	SPLA-TP-ELEC-BYR.M489332	\$ 745
18' Sealight	SPLA-TP-ELEC-BYR.M489330	\$ 982	SPLA-TP-ELEC-BYR.M489333	\$ 1011
24' Sealight	SPLA-TP-ELEC-BYR.M489331	\$ 1287	SPLA-TP-ELEC-BYR.M489334	\$ 1346

Base Electrical In-Feed Cable: Flex Cable				
12' Flex Cable	SPLA-TP-ELEC-BYR.M489318	\$ 463	SPLA-TP-ELEC-BYR.M489321	\$ 559
18' Flex Cable	SPLA-TP-ELEC-BYR.M489319	\$ 1014	SPLA-TP-ELEC-BYR.M489322	\$ 951
24' Flex Cable	SPLA-TP-ELEC-BYR.M489320	\$ 1078	SPLA-TP-ELEC-BYR.M489323	\$ 1172

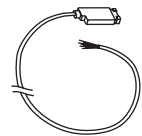

Ceiling Electrical In-Feed Cables				
6' Flex Cable	SPLA-TP-ELEC-BYR.M489324	\$ 485		
24' Flex Cable	SPLA-TP-ELEC-BYR.M489325	\$ 738		

<p>How to specify — Select the Model Number from above.</p>	<p><i>1st Option:</i> Electrical Receptacle Color (if applicable): See inside front cover for finishes.</p>	<p><i>1st Option:</i> Color (if applicable): P Black</p>	<p>_____ . E _____</p>
--	--	---	-------------------------------

Example: SPLA-TP-PELEC-BYR.M487364.E4

Shippable by small-package carrier.

120 Degree Surfaces

Base Type	Depth	36	42	48	54
	Width				
A6 T- or C-Base	36				
	42				
	48				
	54				

Corner Covers

Base Type	Depth	36	42	48	54	60
	Width					
A6 T- or C-Base	54	A6REC3S3LTF or A6REC3S3LCF				
	60					
	66					
	72					
	78	For A6 T- or C-Base to support these size corner covers, please submit a modification request on the Tailored Solutions App on Allsteel Synergy.				
	84					
	90					
	96					

Rectangular Tops

Base Type	Depth	24	27	30	36		
	Width						
A6 T- or C-Base NOTE: Bases for 36D tops are "old style" T-Base only. If New Style A6 T- or C-Bases is needed please submit a modification request through the Tailored Solutions App.	36						
	42	A6REC3S2LTF or A6REC3S2LCF			BLACK-M490245	Standard Special SILVER-M490243	WHITE-M490247
	78	A6MREC3S2LTF or A6MREC3S2LCF			BLACK-M490245	Standard Special SILVER-M490243	WHITE-M490247
	84	A6MREC3S2LTF or A6MREC3S2LCF			BLACK-M490245	Standard Special SILVER-M490243	WHITE-M490247
	90	A6MREC3S2LTF or A6MREC3S2LCF			BLACK-M490245	Standard Special SILVER-M490243	WHITE-M490247
	96				BLACK-M490245	Special Stretcher Bar M501803	WHITE-M490247

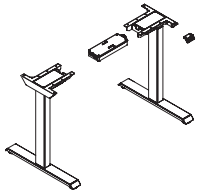

Open Market

Description	Model	List Price
T-Base Height-Adjustable		
Adjustable 2 leg - black paint - 800mm feet	SPLA-ALT-TLEGBASE.M490245	\$ 2633
Adjustable 2 leg - silver paint - 800mm feet	SPLA-ALT-TLEGBASE.M490243	\$ 2633
Adjustable 2 leg - white paint - 800mm feet	SPLA-ALT-TLEGBASE.M490247	\$ 2633

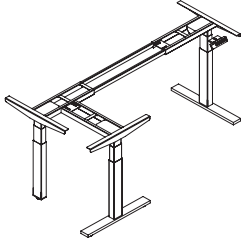

Open Market

Adjustable 3 leg - black paint - 800mm feet	SPLA-ALT-TLEGBASE.M490246	\$ 4372
Adjustable 3 leg - silver paint - 800mm feet	SPLA-ALT-TLEGBASE.M490244	\$ 4372
Adjustable 3 leg - white paint - 800mm feet	SPLA-ALT-TLEGBASE.M490248	\$ 4372

T-leg Stretcher Bars		
Two 51" stretcher bars to support surfaces 85"-96"	SPLA-ALT-TLEGBASE.M501803	\$ 71

How to specify —
 Select the
 Model Number
 from above.

Example: SPLA-ALT-TLEGBASE.M490245

Note: For specification rules see page 49.

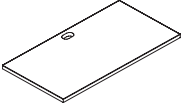

Description	Model	L1	L2	L3
		List Price	Upcharge	Upcharge
Rectangular Laminate Tops — 24"D				
36"W	SPLA-ALT-2436EOSLEG.M490249	\$ 610	\$ 24	\$ 42
42"W	SPLA-ALT-2442EOSLEG.M490250	\$ 665	\$ 28	\$ 55
78"W	SPLA-ALT-3684EOSLEG.M490251	\$ 1452	\$ 67	\$ 132
84"W	SPLA-ALT-3684EOSLEG.M490252	\$ 1452	\$ 67	\$ 132
90"W	SPLA-ALT-4997EOSLEG.M490253	\$ 1500	\$ 79	\$ 155
96"W	SPLA-ALT-4997EOSLEG.M490254	\$ 1500	\$ 79	\$ 155



Description	Model	L1	L2	L3
		List Price	Upcharge	Upcharge
Rectangular Laminate Tops — 27"D				
36"W	SPLA-ALT-3048EOSLEG.M490256	\$ 678	\$ 34	\$ 62
42"W	SPLA-ALT-3048EOSLEG.M490257	\$ 720	\$ 34	\$ 62
48"W	SPLA-ALT-3048EOSLEG.M490258	\$ 782	\$ 34	\$ 62
54"W	SPLA-ALT-3060EOSLEG.M490259	\$ 1025	\$ 42	\$ 80
60"W	SPLA-ALT-3060EOSLEG.M490260	\$ 1025	\$ 42	\$ 80
66"W	SPLA-ALT-3066EOSLEG.M490261	\$ 1171	\$ 47	\$ 88
72"W	SPLA-ALT-3072EOSLEG.M490262	\$ 1171	\$ 49	\$ 96
78"W	SPLA-ALT-3684EOSLEG.M490263	\$ 1776	\$ 67	\$ 132
84"W	SPLA-ALT-3684EOSLEG.M490264	\$ 1776	\$ 67	\$ 132
90"W	SPLA-ALT-4997EOSLEG.M490265	\$ 1820	\$ 79	\$ 155
96"W	SPLA-ALT-4997EOSLEG.M490266	\$ 1820	\$ 79	\$ 155

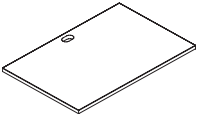

Description	Model	L1	L2	L3
		List Price	Upcharge	Upcharge
Rectangular Laminate Tops — 30"D				
36"W	SPLA-ALT-3048EOSLEG.M490267	\$ 678	\$ 34	\$ 62
42"W	SPLA-ALT-3048EOSLEG.M490268	\$ 720	\$ 34	\$ 62
78"W	SPLA-ALT-3684EOSLEG.M490269	\$ 1776	\$ 67	\$ 132
84"W	SPLA-ALT-3684EOSLEG.M490270	\$ 1776	\$ 67	\$ 132
90"W	SPLA-ALT-4997EOSLEG.M490271	\$ 1820	\$ 79	\$ 155
96"W	SPLA-ALT-4997EOSLEG.M490272	\$ 1820	\$ 79	\$ 155

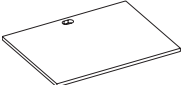

Description	Model	L1	L2	L3
		List Price	Upcharge	Upcharge
Rectangular Laminate Tops — 36"D				
36"W	SPLA-ALT-3636EOSLEG.M490273	\$ 917	\$ 36	\$ 61
42"W	SPLA-ALT-3660EOSLEG.M490274	\$ 1044	\$ 49	\$ 91
48"W	SPLA-ALT-3660EOSLEG.M490275	\$ 1172	\$ 49	\$ 91
54"W	SPLA-ALT-3660EOSLEG.M490276	\$ 1437	\$ 49	\$ 91
60"W	SPLA-ALT-3660EOSLEG.M490277	\$ 1437	\$ 49	\$ 91
66"W	SPLA-ALT-3672EOSLEG.M490278	\$ 1691	\$ 57	\$ 114
72"W	SPLA-ALT-3672EOSLEG.M490279	\$ 1628	\$ 57	\$ 114
78"W	SPLA-ALT-3684EOSLEG.M490280	\$ 2050	\$ 67	\$ 132
84"W	SPLA-ALT-3684EOSLEG.M490281	\$ 2050	\$ 67	\$ 132
90"W	SPLA-ALT-4997EOSLEG.M490282	\$ 2099	\$ 79	\$ 155
96"W	SPLA-ALT-4997EOSLEG.M490283	\$ 2099	\$ 79	\$ 155

Notes:

Actual width is undersized by 2". Actual depth undersized by 0.75".

Worksurfaces over 72"W require heavy-duty base (standard special).

Worksurfaces over 60"W require external stiffener (order separately): Z5SC48 for 66", S5SC54 for 72"W, Z5SC60 for 78"W, Z5SC66 for 84"W, Z5SC72 for 90"W and 96"W.

<p>How to specify — Select the Model Number from above.</p> <p>_____</p> <p>_____</p> <p>_____</p>	<p>1st Option: Laminate: See inside front cover for finishes.</p> <p>_____</p>	<p>2nd Option: Laminate Edge Color (if applicable): See inside front cover for finishes.</p> <p>_____</p>	<p>3rd Option: Grommet Location: GC Grommet Center (Rectangular only) GO No Grommet</p> <p>_____</p>	<p>4th Option: Grommet Type (if applicable): P Oval Plastic M Oval Metal S Square Metal</p> <p>(Add \$24 per grommet for metal.)</p> <p>_____</p>	<p>5th Option: Grommet Color (if applicable):</p> <p>_____</p>
---	--	---	--	---	--

Example: SPLA-ALT-2436EOSLEG.M490249.LDW1.DW.GO

Note: For specification rules see page 49.

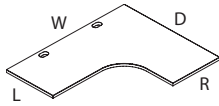

Description	Model	L1	L2	L3
		List Price	Upcharge	Upcharge
Corner Cove Worksurfaces — Extended Left				
54"W x 36"D - 24"L x 24"R	SPLA-ALT-3660MIXLEG.M490284	\$ 967	\$ 49	\$ 91
54"W x 36"D - 24"L x 30"R	SPLA-ALT-3660MIXLEG.M490479	\$ 967	\$ 49	\$ 91
54"W x 36"D - 30"L x 24"R	SPLA-ALT-3660MIXLEG.M490562	\$ 967	\$ 49	\$ 91
54"W x 36"D - 30"L x 30"R	SPLA-ALT-3660MIXLEG.M490387	\$ 967	\$ 49	\$ 91
54"W x 42"D - 24"L x 24"R	SPLA-ALT-4860MIXLEG.M490285	\$ 1061	\$ 64	\$ 125
54"W x 42"D - 24"L x 30"R	SPLA-ALT-4860MIXLEG.M490480	\$ 1061	\$ 64	\$ 125
54"W x 42"D - 30"L x 24"R	SPLA-ALT-4860MIXLEG.M490563	\$ 1061	\$ 64	\$ 125
54"W x 42"D - 30"L x 30"R	SPLA-ALT-4860MIXLEG.M490388	\$ 1061	\$ 64	\$ 125
54"W x 48"D - 24"L x 24"R	SPLA-ALT-4860MIXLEG.M490286	\$ 1061	\$ 64	\$ 125
54"W x 48"D - 24"L x 30"R	SPLA-ALT-4860MIXLEG.M490481	\$ 1061	\$ 64	\$ 125
54"W x 48"D - 30"L x 24"R	SPLA-ALT-4860MIXLEG.M490564	\$ 1061	\$ 64	\$ 125
54"W x 48"D - 30"L x 30"R	SPLA-ALT-4860MIXLEG.M490389	\$ 1061	\$ 64	\$ 125
54"W x 54"D - 24"L x 24"R	SPLA-ALT-6197MIXLEG.M490287	\$ 1485	\$ 94	\$ 189
54"W x 54"D - 24"L x 30"R	SPLA-ALT-6197MIXLEG.M490482	\$ 1485	\$ 94	\$ 189
54"W x 54"D - 30"L x 24"R	SPLA-ALT-6197MIXLEG.M490565	\$ 1485	\$ 94	\$ 189
54"W x 54"D - 30"L x 30"R	SPLA-ALT-6197MIXLEG.M490390	\$ 1485	\$ 94	\$ 189
60"W x 36"D - 24"L x 30"R	SPLA-ALT-3660MIXLEG.M490483	\$ 967	\$ 49	\$ 91
60"W x 36"D - 30"L x 24"R	SPLA-ALT-3660MIXLEG.M490566	\$ 967	\$ 49	\$ 91
60"W x 36"D - 30"L x 30"R	SPLA-ALT-3660MIXLEG.M490391	\$ 967	\$ 49	\$ 91
60"W x 42"D - 24"L x 24"R	SPLA-ALT-4860MIXLEG.M490289	\$ 1061	\$ 64	\$ 125
60"W x 42"D - 24"L x 30"R	SPLA-ALT-4860MIXLEG.M490484	\$ 1061	\$ 64	\$ 125
60"W x 42"D - 30"L x 24"R	SPLA-ALT-4860MIXLEG.M490567	\$ 1061	\$ 64	\$ 125
60"W x 42"D - 30"L x 30"R	SPLA-ALT-4860MIXLEG.M490392	\$ 1061	\$ 64	\$ 125
60"W x 48"D - 24"L x 30"R	SPLA-ALT-4860MIXLEG.M490486	\$ 1061	\$ 64	\$ 125
60"W x 48"D - 30"L x 24"R	SPLA-ALT-4860MIXLEG.M490568	\$ 1061	\$ 64	\$ 125
60"W x 48"D - 30"L x 30"R	SPLA-ALT-4860MIXLEG.M490393	\$ 1061	\$ 64	\$ 125
60"W x 54"D - 24"L x 24"R	SPLA-ALT-6197MIXLEG.M490291	\$ 1485	\$ 94	\$ 189
60"W x 54"D - 24"L x 30"R	SPLA-ALT-6197MIXLEG.M490488	\$ 1485	\$ 94	\$ 189
60"W x 54"D - 30"L x 24"R	SPLA-ALT-6197MIXLEG.M490569	\$ 1485	\$ 94	\$ 189
60"W x 54"D - 30"L x 30"R	SPLA-ALT-6197MIXLEG.M490394	\$ 1485	\$ 94	\$ 189
60"W x 60"D - 24"L x 24"R	SPLA-ALT-6197MIXLEG.M490292	\$ 1485	\$ 94	\$ 189
60"W x 60"D - 24"L x 30"R	SPLA-ALT-6197MIXLEG.M490489	\$ 1485	\$ 94	\$ 189
60"W x 60"D - 30"L x 24"R	SPLA-ALT-6197MIXLEG.M490570	\$ 1485	\$ 94	\$ 189
60"W x 60"D - 30"L x 30"R	SPLA-ALT-6197MIXLEG.M490395	\$ 1485	\$ 94	\$ 189
66"W x 36"D - 24"L x 24"R	SPLA-ALT-3672MIXLEG.M490293	\$ 1061	\$ 57	\$ 114
66"W x 36"D - 24"L x 30"R	SPLA-ALT-3672MIXLEG.M490490	\$ 1061	\$ 57	\$ 114
66"W x 36"D - 30"L x 24"R	SPLA-ALT-3672MIXLEG.M490571	\$ 1061	\$ 57	\$ 114
66"W x 36"D - 30"L x 30"R	SPLA-ALT-3672MIXLEG.M490396	\$ 1061	\$ 57	\$ 114
66"W x 42"D - 24"L x 24"R	SPLA-ALT-4872MIXLEG.M490294	\$ 1181	\$ 79	\$ 126
66"W x 42"D - 24"L x 30"R	SPLA-ALT-4872MIXLEG.M490492	\$ 1181	\$ 79	\$ 126
66"W x 42"D - 30"L x 24"R	SPLA-ALT-4872MIXLEG.M490572	\$ 1181	\$ 79	\$ 126
66"W x 42"D - 30"L x 30"R	SPLA-ALT-4872MIXLEG.M490397	\$ 1181	\$ 79	\$ 126
66"W x 48"D - 24"L x 24"R	SPLA-ALT-4872MIXLEG.M490295	\$ 1334	\$ 79	\$ 126
66"W x 48"D - 24"L x 30"R	SPLA-ALT-4872MIXLEG.M490493	\$ 1334	\$ 79	\$ 126
66"W x 48"D - 30"L x 24"R	SPLA-ALT-4872MIXLEG.M490573	\$ 1334	\$ 79	\$ 126
66"W x 48"D - 30"L x 30"R	SPLA-ALT-4872MIXLEG.M490398	\$ 1334	\$ 79	\$ 126
66"W x 54"D - 24"L x 24"R	SPLA-ALT-6197MIXLEG.M490301	\$ 1759	\$ 94	\$ 189
66"W x 54"D - 24"L x 30"R	SPLA-ALT-6197MIXLEG.M490494	\$ 1759	\$ 94	\$ 189
66"W x 54"D - 30"L x 24"R	SPLA-ALT-6197MIXLEG.M490574	\$ 1759	\$ 94	\$ 189
66"W x 54"D - 30"L x 30"R	SPLA-ALT-6197MIXLEG.M490399	\$ 1759	\$ 94	\$ 189
66"W x 60"D - 24"L x 24"R	SPLA-ALT-6197MIXLEG.M490313	\$ 1759	\$ 94	\$ 189

Note: Dimensions are nominal. "W" and "D" are undersized by 2" for all sizes except 36" which is undersized by 1½" due to base limitations. "L" and "R" are undersized by ¾".

<p>How to specify — Select the Model Number from above.</p>	<p>1st Option: Laminate: See inside front cover for finishes.</p>	<p>2nd Option: Laminate Edge Color (if applicable): See inside front cover for finishes.</p>	<p>3rd Option: Grommet Location (if applicable): GB Grommet LH and RH GO No Grommet</p>	<p>4th Option: Grommet Type (if applicable): P Oval Plastic M Oval Metal S Square Metal (Add \$24 per grommet for metal.)</p>	<p>5th Option: Grommet Color (if applicable):</p>
--	---	--	---	--	---

Example: SPLA-ALT-3660MIXLEG.M490284.LDW1.DW.GO

Note: For specification rules see page 49.

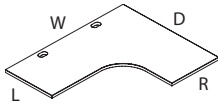

Description	Model	L1	L2	L3
		List Price	Upcharge	Upcharge
Corner Cove Worksurfaces — Extended Left				
66"W x 60"D - 24"L x 30"R	SPLA-ALT-6197MIXLEG.M490495	\$ 1759	\$ 94	\$ 189
66"W x 60"D - 30"L x 24"R	SPLA-ALT-6197MIXLEG.M490575	\$ 1759	\$ 94	\$ 189
66"W x 60"D - 30"L x 30"R	SPLA-ALT-6197MIXLEG.M490400	\$ 1759	\$ 94	\$ 189
72"W x 36"D - 24"L x 30"R	SPLA-ALT-3672MIXLEG.M490496	\$ 1061	\$ 57	\$ 114
72"W x 36"D - 30"L x 24"R	SPLA-ALT-3672MIXLEG.M490576	\$ 1061	\$ 57	\$ 114
72"W x 36"D - 30"L x 30"R	SPLA-ALT-3672MIXLEG.M490401	\$ 1061	\$ 57	\$ 114
72"W x 42"D - 24"L x 24"R	SPLA-ALT-4872MIXLEG.M490315	\$ 1334	\$ 79	\$ 126
72"W x 42"D - 24"L x 30"R	SPLA-ALT-4872MIXLEG.M490497	\$ 1334	\$ 79	\$ 126
72"W x 42"D - 30"L x 24"R	SPLA-ALT-4872MIXLEG.M490577	\$ 1334	\$ 79	\$ 126
72"W x 42"D - 30"L x 30"R	SPLA-ALT-4872MIXLEG.M490402	\$ 1334	\$ 79	\$ 126
72"W x 48"D - 24"L x 30"R	SPLA-ALT-4872MIXLEG.M490498	\$ 1334	\$ 79	\$ 126
72"W x 48"D - 30"L x 24"R	SPLA-ALT-4872MIXLEG.M490578	\$ 1334	\$ 79	\$ 126
72"W x 48"D - 30"L x 30"R	SPLA-ALT-4872MIXLEG.M490404	\$ 1334	\$ 79	\$ 126
72"W x 54"D - 24"L x 24"R	SPLA-ALT-6197MIXLEG.M490317	\$ 1759	\$ 94	\$ 189
72"W x 54"D - 24"L x 30"R	SPLA-ALT-6197MIXLEG.M490499	\$ 1759	\$ 94	\$ 189
72"W x 54"D - 30"L x 24"R	SPLA-ALT-6197MIXLEG.M490579	\$ 1759	\$ 94	\$ 189
72"W x 54"D - 30"L x 30"R	SPLA-ALT-6197MIXLEG.M490405	\$ 1759	\$ 94	\$ 189
72"W x 60"D - 24"L x 24"R	SPLA-ALT-6197MIXLEG.M490318	\$ 1759	\$ 94	\$ 189
72"W x 60"D - 24"L x 30"R	SPLA-ALT-6197MIXLEG.M490500	\$ 1759	\$ 94	\$ 189
72"W x 60"D - 30"L x 24"R	SPLA-ALT-6197MIXLEG.M490580	\$ 1759	\$ 94	\$ 189
72"W x 60"D - 30"L x 30"R	SPLA-ALT-6197MIXLEG.M490406	\$ 1759	\$ 94	\$ 189
78"W x 36"D - 24"L x 24"R	SPLA-ALT-3684MIXLEG.M490319	\$ 1397	\$ 67	\$ 132
78"W x 36"D - 24"L x 30"R	SPLA-ALT-3684MIXLEG.M490501	\$ 1397	\$ 67	\$ 132
78"W x 36"D - 30"L x 24"R	SPLA-ALT-3684MIXLEG.M490582	\$ 1397	\$ 67	\$ 132
78"W x 36"D - 30"L x 30"R	SPLA-ALT-3684MIXLEG.M490408	\$ 1397	\$ 67	\$ 132
78"W x 42"D - 24"L x 24"R	SPLA-ALT-4985MIXLEG.M490320	\$ 1669	\$ 67	\$ 133
78"W x 42"D - 24"L x 30"R	SPLA-ALT-4985MIXLEG.M490502	\$ 1669	\$ 67	\$ 133
78"W x 42"D - 30"L x 24"R	SPLA-ALT-4985MIXLEG.M490583	\$ 1669	\$ 67	\$ 133
78"W x 42"D - 30"L x 30"R	SPLA-ALT-4985MIXLEG.M490409	\$ 1669	\$ 67	\$ 133
78"W x 48"D - 24"L x 24"R	SPLA-ALT-4985MIXLEG.M490321	\$ 1669	\$ 67	\$ 133
78"W x 48"D - 24"L x 30"R	SPLA-ALT-4985MIXLEG.M490503	\$ 1669	\$ 67	\$ 133
78"W x 48"D - 30"L x 24"R	SPLA-ALT-4985MIXLEG.M490584	\$ 1669	\$ 67	\$ 133
78"W x 48"D - 30"L x 30"R	SPLA-ALT-4985MIXLEG.M490410	\$ 1669	\$ 67	\$ 133
78"W x 54"D - 24"L x 24"R	SPLA-ALT-6197MIXLEG.M490322	\$ 2095	\$ 94	\$ 189
78"W x 54"D - 24"L x 30"R	SPLA-ALT-6197MIXLEG.M490504	\$ 2095	\$ 94	\$ 189
78"W x 54"D - 30"L x 24"R	SPLA-ALT-6197MIXLEG.M490585	\$ 2095	\$ 94	\$ 189
78"W x 54"D - 30"L x 30"R	SPLA-ALT-6197MIXLEG.M490411	\$ 2095	\$ 94	\$ 189
78"W x 60"D - 24"L x 24"R	SPLA-ALT-6197MIXLEG.M490323	\$ 2095	\$ 94	\$ 189
78"W x 60"D - 24"L x 30"R	SPLA-ALT-6197MIXLEG.M490505	\$ 2095	\$ 94	\$ 189
78"W x 60"D - 30"L x 24"R	SPLA-ALT-6197MIXLEG.M490586	\$ 2095	\$ 94	\$ 189
78"W x 60"D - 30"L x 30"R	SPLA-ALT-6197MIXLEG.M490412	\$ 2095	\$ 94	\$ 189
84"W x 36"D - 24"L x 24"R	SPLA-ALT-3684MIXLEG.M490324	\$ 1471	\$ 67	\$ 132
84"W x 36"D - 24"L x 30"R	SPLA-ALT-3684MIXLEG.M490506	\$ 1471	\$ 67	\$ 132
84"W x 36"D - 30"L x 24"R	SPLA-ALT-3684MIXLEG.M490587	\$ 1471	\$ 67	\$ 132
84"W x 36"D - 30"L x 30"R	SPLA-ALT-3684MIXLEG.M490413	\$ 1471	\$ 67	\$ 132
84"W x 42"D - 24"L x 24"R	SPLA-ALT-4985MIXLEG.M490325	\$ 1743	\$ 67	\$ 133
84"W x 42"D - 24"L x 30"R	SPLA-ALT-4985MIXLEG.M490507	\$ 1743	\$ 67	\$ 133
84"W x 42"D - 30"L x 24"R	SPLA-ALT-4985MIXLEG.M490588	\$ 1743	\$ 67	\$ 133
84"W x 42"D - 30"L x 30"R	SPLA-ALT-4985MIXLEG.M490414	\$ 1743	\$ 67	\$ 133
84"W x 48"D - 24"L x 24"R	SPLA-ALT-4985MIXLEG.M490326	\$ 1743	\$ 67	\$ 133
84"W x 48"D - 24"L x 30"R	SPLA-ALT-4985MIXLEG.M490508	\$ 1743	\$ 67	\$ 133

Note: Dimensions are nominal. "W" and "D" are undersized by 2" for all sizes except 36" which is undersized by 1½" due to base limitations. "L" and "R" are undersized by ¾".

<p>How to specify — Select the Model Number from above.</p> <p>_____</p> <p>_____</p> <p>_____</p>	<p>1st Option: Laminate: See inside front cover for finishes.</p> <p>_____</p>	<p>2nd Option: Laminate Edge Color: See inside front cover for finishes.</p> <p>_____</p>	<p>3rd Option: Grommet Location (if applicable): GB Grommet LH and RH GO No Grommet</p> <p>_____</p>	<p>4th Option: Grommet Type (if applicable): P Oval Plastic M Oval Metal S Square Metal (Add \$24 per grommet for metal.)</p> <p>_____</p>	<p>5th Option: Grommet Color (if applicable):</p> <p>_____</p>
---	--	---	--	---	--

Example: SPLA-ALT-6197MIXLEG.M490495.LDW1.DW.GO

Note: For specification rules see page 49.

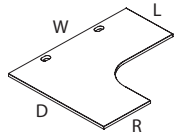

Description	Model	L1	L2	L3
		List Price	Upcharge	Upcharge
Corner Cove Worksurfaces — Extended Right				
54"W x 36"D - 24"L x 24"R	SPLA-ALT-3660MIXLEG.M490339	\$ 967	\$ 49	\$ 91
54"W x 36"D - 24"L x 30"R	SPLA-ALT-3660MIXLEG.M490522	\$ 967	\$ 49	\$ 91
54"W x 36"D - 30"L x 24"R	SPLA-ALT-3660MIXLEG.M490604	\$ 967	\$ 49	\$ 91
54"W x 36"D - 30"L x 30"R	SPLA-ALT-3660MIXLEG.M490438	\$ 967	\$ 49	\$ 91
54"W x 42"D - 24"L x 24"R	SPLA-ALT-4860MIXLEG.M490340	\$ 1061	\$ 64	\$ 125
54"W x 42"D - 24"L x 30"R	SPLA-ALT-4860MIXLEG.M490523	\$ 1061	\$ 64	\$ 125
54"W x 42"D - 30"L x 24"R	SPLA-ALT-4860MIXLEG.M490605	\$ 1061	\$ 64	\$ 125
54"W x 42"D - 30"L x 30"R	SPLA-ALT-4860MIXLEG.M490439	\$ 1061	\$ 64	\$ 125
54"W x 48"D - 24"L x 24"R	SPLA-ALT-4860MIXLEG.M490341	\$ 1061	\$ 64	\$ 125
54"W x 48"D - 24"L x 30"R	SPLA-ALT-4860MIXLEG.M490524	\$ 1061	\$ 64	\$ 125
54"W x 48"D - 30"L x 24"R	SPLA-ALT-4860MIXLEG.M490606	\$ 1061	\$ 64	\$ 125
54"W x 48"D - 30"L x 30"R	SPLA-ALT-4860MIXLEG.M490440	\$ 1061	\$ 64	\$ 125
54"W x 54"D - 24"L x 24"R	SPLA-ALT-6197MIXLEG.M490342	\$ 1485	\$ 94	\$ 189
54"W x 54"D - 24"L x 30"R	SPLA-ALT-6197MIXLEG.M490525	\$ 1485	\$ 94	\$ 189
54"W x 54"D - 30"L x 24"R	SPLA-ALT-6197MIXLEG.M490608	\$ 1485	\$ 94	\$ 189
54"W x 54"D - 30"L x 30"R	SPLA-ALT-6197MIXLEG.M490441	\$ 1485	\$ 94	\$ 189
60"W x 36"D - 24"L x 30"R	SPLA-ALT-3660MIXLEG.M490526	\$ 967	\$ 49	\$ 91
60"W x 36"D - 30"L x 24"R	SPLA-ALT-3660MIXLEG.M490610	\$ 967	\$ 49	\$ 91
60"W x 36"D - 30"L x 30"R	SPLA-ALT-3660MIXLEG.M490442	\$ 967	\$ 49	\$ 91
60"W x 42"D - 24"L x 24"R	SPLA-ALT-4860MIXLEG.M490344	\$ 1061	\$ 64	\$ 125
60"W x 42"D - 24"L x 30"R	SPLA-ALT-4860MIXLEG.M490527	\$ 1061	\$ 64	\$ 125
60"W x 42"D - 30"L x 24"R	SPLA-ALT-4860MIXLEG.M490611	\$ 1061	\$ 64	\$ 125
60"W x 42"D - 30"L x 30"R	SPLA-ALT-4860MIXLEG.M490443	\$ 1061	\$ 64	\$ 125
60"W x 48"D - 24"L x 30"R	SPLA-ALT-4860MIXLEG.M490528	\$ 1061	\$ 64	\$ 125
60"W x 48"D - 30"L x 24"R	SPLA-ALT-4860MIXLEG.M490612	\$ 1061	\$ 64	\$ 125
60"W x 48"D - 30"L x 30"R	SPLA-ALT-4860MIXLEG.M490444	\$ 1061	\$ 64	\$ 125
60"W x 54"D - 24"L x 24"R	SPLA-ALT-6197MIXLEG.M490346	\$ 1485	\$ 94	\$ 189
60"W x 54"D - 24"L x 30"R	SPLA-ALT-6197MIXLEG.M490529	\$ 1485	\$ 94	\$ 189
60"W x 54"D - 30"L x 24"R	SPLA-ALT-6197MIXLEG.M490613	\$ 1485	\$ 94	\$ 189
60"W x 54"D - 30"L x 30"R	SPLA-ALT-6197MIXLEG.M490445	\$ 1485	\$ 94	\$ 189
60"W x 60"D - 24"L x 24"R	SPLA-ALT-6197MIXLEG.M490347	\$ 1485	\$ 94	\$ 189
60"W x 60"D - 24"L x 30"R	SPLA-ALT-6197MIXLEG.M490530	\$ 1485	\$ 94	\$ 189
60"W x 60"D - 30"L x 24"R	SPLA-ALT-6197MIXLEG.M490614	\$ 1485	\$ 94	\$ 189
60"W x 60"D - 30"L x 30"R	SPLA-ALT-6197MIXLEG.M490446	\$ 1485	\$ 94	\$ 189
66"W x 36"D - 24"L x 24"R	SPLA-ALT-3672MIXLEG.M490348	\$ 1061	\$ 57	\$ 114
66"W x 36"D - 24"L x 30"R	SPLA-ALT-3672MIXLEG.M490531	\$ 1061	\$ 57	\$ 114
66"W x 36"D - 30"L x 24"R	SPLA-ALT-3672MIXLEG.M490615	\$ 1061	\$ 57	\$ 114
66"W x 36"D - 30"L x 30"R	SPLA-ALT-3672MIXLEG.M490447	\$ 1061	\$ 57	\$ 114
66"W x 42"D - 24"L x 24"R	SPLA-ALT-4872MIXLEG.M490349	\$ 1181	\$ 79	\$ 126
66"W x 42"D - 24"L x 30"R	SPLA-ALT-4872MIXLEG.M490532	\$ 1181	\$ 79	\$ 126
66"W x 42"D - 30"L x 24"R	SPLA-ALT-4872MIXLEG.M490616	\$ 1181	\$ 79	\$ 126
66"W x 42"D - 30"L x 30"R	SPLA-ALT-4872MIXLEG.M490448	\$ 1181	\$ 79	\$ 126
66"W x 48"D - 24"L x 24"R	SPLA-ALT-4872MIXLEG.M490350	\$ 1334	\$ 79	\$ 126
66"W x 48"D - 24"L x 30"R	SPLA-ALT-4872MIXLEG.M490533	\$ 1334	\$ 79	\$ 126
66"W x 48"D - 30"L x 24"R	SPLA-ALT-4872MIXLEG.M490617	\$ 1334	\$ 79	\$ 126
66"W x 48"D - 30"L x 30"R	SPLA-ALT-4872MIXLEG.M490449	\$ 1334	\$ 79	\$ 126
66"W x 54"D - 24"L x 24"R	SPLA-ALT-6197MIXLEG.M490351	\$ 1759	\$ 94	\$ 189
66"W x 54"D - 24"L x 30"R	SPLA-ALT-6197MIXLEG.M490534	\$ 1759	\$ 94	\$ 189
66"W x 54"D - 30"L x 24"R	SPLA-ALT-6197MIXLEG.M490618	\$ 1759	\$ 94	\$ 189
66"W x 54"D - 30"L x 30"R	SPLA-ALT-6197MIXLEG.M490450	\$ 1759	\$ 94	\$ 189
66"W x 60"D - 24"L x 24"R	SPLA-ALT-6197MIXLEG.M490353	\$ 1759	\$ 94	\$ 189

Note: Dimensions are nominal. "W" and "D" are undersized by 2" for all sizes except 36" which is undersized by 1½" due to base limitations. "L" and "R" are undersized by ¾".

<p>How to specify — Select the Model Number from above.</p> <div style="border: 1px solid black; height: 20px; width: 100%;"></div> <div style="border: 1px solid black; height: 20px; width: 100%;"></div> <div style="border: 1px solid black; height: 20px; width: 100%;"></div>	<p>1st Option: Laminate: See inside front cover for finishes.</p> <div style="border: 1px solid black; height: 20px; width: 100%;"></div>	<p>2nd Option: Laminate Edge Color: See inside front cover for finishes.</p> <div style="border: 1px solid black; height: 20px; width: 100%;"></div>	<p>3rd Option: Grommet Location (if applicable): GB Grommet LH and RH GO No Grommet</p> <div style="border: 1px solid black; height: 20px; width: 100%;"></div>	<p>4th Option: Grommet Type (if applicable): P Oval Plastic M Oval Metal S Square Metal (Add \$24 per grommet for metal.)</p> <div style="border: 1px solid black; height: 20px; width: 100%;"></div>	<p>5th Option: Grommet Color (if applicable):</p> <div style="border: 1px solid black; height: 20px; width: 100%;"></div>
--	---	--	---	--	---

Example: SPLA-ALT-3660MIXLEG.M490339.LDW1.DW.GO

Note: For specification rules see page 49.

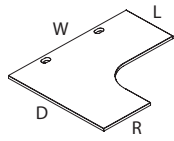

Description	Model	L1	L2	L3
		List Price	Upcharge	Upcharge
Corner Cove Worksurfaces — Extended Right				
84"W x 48"D - 30"L x 24"R	SPLA-ALT-4985MIXLEG.M490636	\$ 1743	\$ 67	\$ 133
84"W x 48"D - 30"L x 30"R	SPLA-ALT-4985MIXLEG.M490466	\$ 1743	\$ 67	\$ 133
84"W x 54"D - 24"L x 24"R	SPLA-ALT-6197MIXLEG.M490369	\$ 2168	\$ 94	\$ 189
84"W x 54"D - 24"L x 30"R	SPLA-ALT-6197MIXLEG.M490549	\$ 2168	\$ 94	\$ 189
84"W x 54"D - 30"L x 24"R	SPLA-ALT-6197MIXLEG.M490637	\$ 2168	\$ 94	\$ 189
84"W x 54"D - 30"L x 30"R	SPLA-ALT-6197MIXLEG.M490467	\$ 2168	\$ 94	\$ 189
84"W x 60"D - 24"L x 24"R	SPLA-ALT-6197MIXLEG.M490370	\$ 2168	\$ 94	\$ 189
84"W x 60"D - 24"L x 30"R	SPLA-ALT-6197MIXLEG.M490550	\$ 2168	\$ 94	\$ 189
84"W x 60"D - 30"L x 24"R	SPLA-ALT-6197MIXLEG.M490638	\$ 2168	\$ 94	\$ 189
84"W x 60"D - 30"L x 30"R	SPLA-ALT-6197MIXLEG.M490468	\$ 2168	\$ 94	\$ 189
90"W x 36"D - 24"L x 24"R	SPLA-ALT-4997MIXLEG.M490371	\$ 1656	\$ 78	\$ 153
90"W x 36"D - 24"L x 30"R	SPLA-ALT-4997MIXLEG.M490551	\$ 1656	\$ 78	\$ 153
90"W x 36"D - 30"L x 24"R	SPLA-ALT-4997MIXLEG.M490639	\$ 1656	\$ 78	\$ 153
90"W x 36"D - 30"L x 30"R	SPLA-ALT-4997MIXLEG.M490469	\$ 1656	\$ 78	\$ 153
90"W x 42"D - 24"L x 24"R	SPLA-ALT-4997MIXLEG.M490372	\$ 1929	\$ 78	\$ 153
90"W x 42"D - 24"L x 30"R	SPLA-ALT-4997MIXLEG.M490552	\$ 1929	\$ 78	\$ 153
90"W x 42"D - 30"L x 24"R	SPLA-ALT-4997MIXLEG.M490641	\$ 1929	\$ 78	\$ 153
90"W x 42"D - 30"L x 30"R	SPLA-ALT-4997MIXLEG.M490470	\$ 1929	\$ 78	\$ 153
90"W x 48"D - 24"L x 24"R	SPLA-ALT-4997MIXLEG.M490373	\$ 1929	\$ 78	\$ 153
90"W x 48"D - 24"L x 30"R	SPLA-ALT-4997MIXLEG.M490553	\$ 1929	\$ 78	\$ 153
90"W x 48"D - 30"L x 24"R	SPLA-ALT-4997MIXLEG.M490642	\$ 1929	\$ 78	\$ 153
90"W x 48"D - 30"L x 30"R	SPLA-ALT-4997MIXLEG.M490471	\$ 1929	\$ 78	\$ 153
90"W x 54"D - 24"L x 24"R	SPLA-ALT-6197MIXLEG.M490374	\$ 2354	\$ 94	\$ 189
90"W x 54"D - 24"L x 30"R	SPLA-ALT-6197MIXLEG.M490554	\$ 2354	\$ 94	\$ 189
90"W x 54"D - 30"L x 24"R	SPLA-ALT-6197MIXLEG.M490643	\$ 2354	\$ 94	\$ 189
90"W x 54"D - 30"L x 30"R	SPLA-ALT-6197MIXLEG.M490472	\$ 2354	\$ 94	\$ 189
90"W x 60"D - 24"L x 24"R	SPLA-ALT-6197MIXLEG.M490375	\$ 2354	\$ 94	\$ 189
90"W x 60"D - 24"L x 30"R	SPLA-ALT-6197MIXLEG.M490555	\$ 2354	\$ 94	\$ 189
90"W x 60"D - 30"L x 24"R	SPLA-ALT-6197MIXLEG.M490646	\$ 2354	\$ 94	\$ 189
90"W x 60"D - 30"L x 30"R	SPLA-ALT-6197MIXLEG.M490473	\$ 2354	\$ 94	\$ 189
96"W x 36"D - 24"L x 24"R	SPLA-ALT-4997MIXLEG.M490376	\$ 1731	\$ 78	\$ 153
96"W x 36"D - 24"L x 30"R	SPLA-ALT-4997MIXLEG.M490556	\$ 1731	\$ 78	\$ 153
96"W x 36"D - 30"L x 24"R	SPLA-ALT-4997MIXLEG.M490647	\$ 1731	\$ 78	\$ 153
96"W x 36"D - 30"L x 30"R	SPLA-ALT-4997MIXLEG.M490474	\$ 1731	\$ 78	\$ 153
96"W x 42"D - 24"L x 24"R	SPLA-ALT-4997MIXLEG.M490377	\$ 2004	\$ 78	\$ 153
96"W x 42"D - 24"L x 30"R	SPLA-ALT-4997MIXLEG.M490557	\$ 2004	\$ 78	\$ 153
96"W x 42"D - 30"L x 24"R	SPLA-ALT-4997MIXLEG.M490648	\$ 2004	\$ 78	\$ 153
96"W x 42"D - 30"L x 30"R	SPLA-ALT-4997MIXLEG.M490475	\$ 2004	\$ 78	\$ 153
96"W x 48"D - 24"L x 24"R	SPLA-ALT-4997MIXLEG.M490378	\$ 2004	\$ 78	\$ 153
96"W x 48"D - 24"L x 30"R	SPLA-ALT-4997MIXLEG.M490558	\$ 2004	\$ 78	\$ 153
96"W x 48"D - 30"L x 24"R	SPLA-ALT-4997MIXLEG.M490649	\$ 2004	\$ 78	\$ 153
96"W x 48"D - 30"L x 30"R	SPLA-ALT-4997MIXLEG.M490476	\$ 2004	\$ 78	\$ 153
96"W x 54"D - 24"L x 24"R	SPLA-ALT-6197MIXLEG.M490379	\$ 2429	\$ 94	\$ 189
96"W x 54"D - 24"L x 30"R	SPLA-ALT-6197MIXLEG.M490559	\$ 2429	\$ 94	\$ 189
96"W x 54"D - 30"L x 24"R	SPLA-ALT-6197MIXLEG.M490650	\$ 2429	\$ 94	\$ 189
96"W x 54"D - 30"L x 30"R	SPLA-ALT-6197MIXLEG.M490477	\$ 2429	\$ 94	\$ 189
96"W x 60"D - 24"L x 24"R	SPLA-ALT-6197MIXLEG.M490385	\$ 2429	\$ 94	\$ 189
96"W x 60"D - 24"L x 30"R	SPLA-ALT-6197MIXLEG.M490560	\$ 2429	\$ 94	\$ 189
96"W x 60"D - 30"L x 24"R	SPLA-ALT-6197MIXLEG.M490652	\$ 2429	\$ 94	\$ 189
96"W x 60"D - 30"L x 30"R	SPLA-ALT-6197MIXLEG.M490478	\$ 2429	\$ 94	\$ 189

Note: Dimensions are nominal. "W" and "D" are undersized by 2" for all sizes except 36" which is undersized by 1½" due to base limitations. "L" and "R" are undersized by ¾".

<p>How to specify — Select the Model Number from above.</p>	<p>1st Option: Laminate: See inside front cover for finishes.</p>	<p>2nd Option: Laminate Edge Color: See inside front cover for finishes.</p>	<p>3rd Option: Grommet Location (if applicable): GB Grommet LH and RH GO No Grommet</p>	<p>4th Option: Grommet Type (if applicable): P Oval Plastic M Oval Metal S Square Metal (Add \$24 per grommet for metal.)</p>	<p>5th Option: Grommet Color (if applicable):</p>
<p>_____ . _____ . _____ . _____</p>	<p>_____ . _____ . _____ . _____</p>	<p>_____ . _____ . _____ . _____</p>	<p>_____ . _____ . _____ . _____</p>	<p>_____ . _____ . _____ . _____</p>	<p>_____ . _____ . _____ . _____</p>

Example: SPLA-ALT-4985MIXLEG.M490636.LDW1.DW.GO

Note: For specification rules see page 49.



Description	Model	L1	L2	L3
		List Price	Upcharge	Upcharge
36"W x 24"L x 24"R	SPLA-ALT-36CNRMIXLEG.M490665	\$ 874	\$ 35	\$ 61
36"W x 24"L x 30"R	SPLA-ALT-36CNRMIXLEG.M490675	\$ 874	\$ 35	\$ 61
36"W x 30"L x 24"R	SPLA-ALT-36CNRMIXLEG.M490679	\$ 874	\$ 35	\$ 61
36"W x 30"L x 30"R	SPLA-ALT-36CNRMIXLEG.M490671	\$ 899	\$ 35	\$ 61
42"W x 24"L x 24"R	SPLA-ALT-42CNRMIXLEG.M490666	\$ 928	\$ 40	\$ 78
42"W x 24"L x 30"R	SPLA-ALT-42CNRMIXLEG.M490676	\$ 1107	\$ 40	\$ 78
42"W x 30"L x 24"R	SPLA-ALT-42CNRMIXLEG.M490680	\$ 1107	\$ 40	\$ 78
42"W x 30"L x 30"R	SPLA-ALT-42CNRMIXLEG.M490672	\$ 1107	\$ 40	\$ 78
48"W x 24"L x 24"R	SPLA-ALT-48CNRMIXLEG.M490668	\$ 1046	\$ 49	\$ 93
48"W x 24"L x 30"R	SPLA-ALT-48CNRMIXLEG.M490677	\$ 1188	\$ 49	\$ 93
48"W x 30"L x 24"R	SPLA-ALT-48CNRMIXLEG.M490681	\$ 1188	\$ 49	\$ 93
48"W x 30"L x 30"R	SPLA-ALT-48CNRMIXLEG.M490673	\$ 1188	\$ 49	\$ 93
54"W x 24"L x 24"R	SPLA-ALT-54CNRMIXLEG.M490669	\$ 1538	\$ 94	\$ 189
54"W x 24"L x 30"R	SPLA-ALT-54CNRMIXLEG.M490678	\$ 1680	\$ 94	\$ 189
54"W x 30"L x 24"R	SPLA-ALT-54CNRMIXLEG.M490682	\$ 1680	\$ 94	\$ 189
54"W x 30"L x 30"R	SPLA-ALT-54CNRMIXLEG.M490674	\$ 1680	\$ 94	\$ 189
60"W x 24"L x 24"R	SPLA-ALT-60CNRMIXLEG.M490670	\$ 1753	\$ 94	\$ 189
60"W x 24"L x 30"R	SPLA-ALT-60CNRMIXLEG.M501497	\$ 1753	\$ 94	\$ 189
60"W x 30"L x 24"R	SPLA-ALT-60CNRMIXLEG.M501498	\$ 1753	\$ 94	\$ 189
60"W x 30"L x 30"R	SPLA-ALT-60CNRMIXLEG.M501499	\$ 1753	\$ 94	\$ 189

Note: Dimensions are nominal. "W" and "D" are undersized by 2" for all sizes except 36" which is undersized by 1½" due to base limitations. "L" and "R" are undersized by ¾".

OPTIMIZE

ALTITUDE

INVOLVE

TITLE 24

ACCESSORIES

PANEL FABRICS

<p>How to specify — Select the Model Number from above.</p>	<p>1st Option: Laminate: See inside front cover for finishes.</p>	<p>2nd Option: Laminate Edge Color: See inside front cover for finishes.</p>	<p>3rd Option: Grommet Type (if applicable): P Oval Plastic M Oval Metal S Square Metal (Add \$12 per grommet for metal.)</p>	<p>4th Option: Grommet Color (if applicable):</p>
<p>_____ .</p>	<p>_____ .</p>	<p>_____ .</p>	<p>_____</p>	<p>_____</p>

Example: SPLA-ALT-36CNRMIXLEG.M490665.LDW1.DW.PDW

Note: For specification rules see page 49.

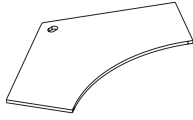

Description	Model	L1	L2	L3
		List Price	Upcharge	Upcharge
Corner Worksurfaces				
36"W x 24"L x 24"R	SPLA-ALT-4872CNR120G.M490683	\$ 1237	\$ 79	\$ 126
36"W x 24"L x 30"R	SPLA-ALT-4872CNR120G.M490705	\$ 1319	\$ 79	\$ 126
36"W x 27"L x 27"R	SPLA-ALT-4872CNR120G.M490688	\$ 1319	\$ 79	\$ 126
36"W x 30"L x 24"R	SPLA-ALT-4872CNR120G.M490699	\$ 1319	\$ 79	\$ 126
36"W x 30"L x 30"R	SPLA-ALT-4872CNR120G.M490694	\$ 1319	\$ 79	\$ 126
42"W x 24"L x 24"R	SPLA-ALT-4985CNR120G.M490684	\$ 1319	\$ 67	\$ 133
42"W x 24"L x 30"R	SPLA-ALT-4985CNR120G.M490706	\$ 1319	\$ 67	\$ 133
42"W x 27"L x 27"R	SPLA-ALT-4985CNR120G.M490689	\$ 1319	\$ 67	\$ 133
42"W x 30"L x 24"R	SPLA-ALT-4985CNR120G.M490700	\$ 1319	\$ 67	\$ 133
42"W x 30"L x 30"R	SPLA-ALT-4985CNR120G.M490695	\$ 1319	\$ 67	\$ 133
48"W x 24"L x 24"R	SPLA-ALT-4985CNR120G.M490685	\$ 1444	\$ 67	\$ 133
48"W x 24"L x 30"R	SPLA-ALT-6197CNR120G.M490707	\$ 1862	\$ 94	\$ 189
48"W x 27"L x 27"R	SPLA-ALT-4985CNR120G.M490690	\$ 1862	\$ 67	\$ 133
48"W x 30"L x 24"R	SPLA-ALT-6197CNR120G.M490701	\$ 1862	\$ 94	\$ 189
48"W x 30"L x 30"R	SPLA-ALT-6197CNR120G.M490696	\$ 1862	\$ 94	\$ 189
54"W x 24"L x 24"R	SPLA-ALT-4997CNR120G.M490686	\$ 1702	\$ 78	\$ 153
54"W x 24"L x 30"R	SPLA-ALT-6197CNR120G.M490708	\$ 2120	\$ 94	\$ 189
54"W x 27"L x 27"R	SPLA-ALT-4997CNR120G.M490692	\$ 2120	\$ 78	\$ 153
54"W x 30"L x 24"R	SPLA-ALT-6197CNR120G.M490702	\$ 2120	\$ 94	\$ 189
54"W x 30"L x 30"R	SPLA-ALT-6197CNR120G.M490697	\$ 2120	\$ 94	\$ 189

Note: 120 Tops must be supported with A5 bases. Order model ATBC2S3L separately.

Note: Dimensions are nominal. Actual dimensions provide a 1" gap on the ends and a 3/4" gap at the back.

<p>How to specify — Select the Model Number from above.</p>	<p>1st Option: Laminate: See inside front cover for finishes.</p>	<p>2nd Option: Laminate Edge Color: See inside front cover for finishes.</p>	<p>3rd Option: Grommet Type (if applicable): P Oval Plastic M Oval Metal S Square Metal (Add \$12 per grommet for metal.)</p>	<p>4th Option: Grommet Color (if applicable):</p>
<div style="border-bottom: 1px solid black; height: 15px; width: 100%;"></div>	<div style="border-bottom: 1px solid black; height: 15px; width: 100%;"></div>	<div style="border-bottom: 1px solid black; height: 15px; width: 100%;"></div>	<div style="border-bottom: 1px solid black; height: 15px; width: 100%;"></div>	<div style="border-bottom: 1px solid black; height: 15px; width: 100%;"></div>

Example: SPLA-ALT-4872CNR120G.M490683.LDW1.DW.PDW

For specification information see standard Altitude pricer and specification guide.

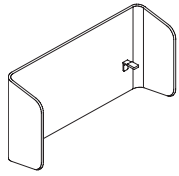

Description	Model	P1 Clear List Price	P2 Upcharge
U Screen Kit			
48"	SPLA-A8-FABSCRNPNTA.M505257	\$ 1982	\$ 17
54"	SPLA-A8-FABSCRNPNTA.M505258	\$ 2049	\$ 17
60"	SPLA-A8-FABSCRNPNTB.M505259	\$ 2108	\$ 17
66"	SPLA-A8-FABSCRNPNTB.M505260	\$ 2234	\$ 17
72"	SPLA-A8-FABSCRNPNTB.M505261	\$ 2401	\$ 17

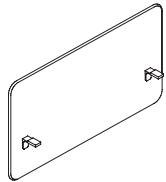

Rectangular Screen Kit			
48"	SPLA-A8-FABSCRNPNTA.M505262	\$ 1391	\$ 17
54"	SPLA-A8-FABSCRNPNTA.M505263	\$ 1426	\$ 17
60"	SPLA-A8-FABSCRNPNTB.M505264	\$ 1472	\$ 17
66"	SPLA-A8-FABSCRNPNTB.M505265	\$ 1576	\$ 17
72"	SPLA-A8-FABSCRNPNTB.M505266	\$ 1678	\$ 17

Note: These screens ARE NOT TACKABLE. The properties of Contourett fabric do not allow this feature.

Note: Installation brackets are now attached to the screen from the factory.

<p>How to specify — Select the Model Number from above.</p>	<p>1st Option: Select the Screen Fabric: See inside back cover for selections and color codes.</p>	<p>2nd Option: Select the Screen Bracket Paint: P1 P2 See inside front cover for selections and color codes.* P2 (\$15 extra)</p>
<p>Examples:</p>		

Specification Notes:

- Interior wing dimension is 27.825"
- On a 30"D Altitude work surface (true depth is 29.25") the extended wing screen will not extend to the front edge of the work surface, the screen will end 1.5" before the front edge of the work surface.

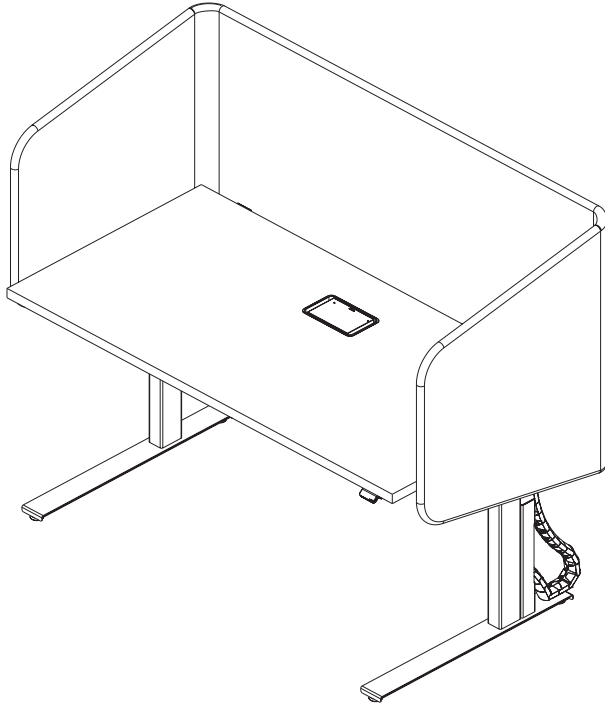

- On a 24"D Altitude work surface (true depth is 23.25") the extended wing screen will extend 4.5" past the front edge of the work surface.

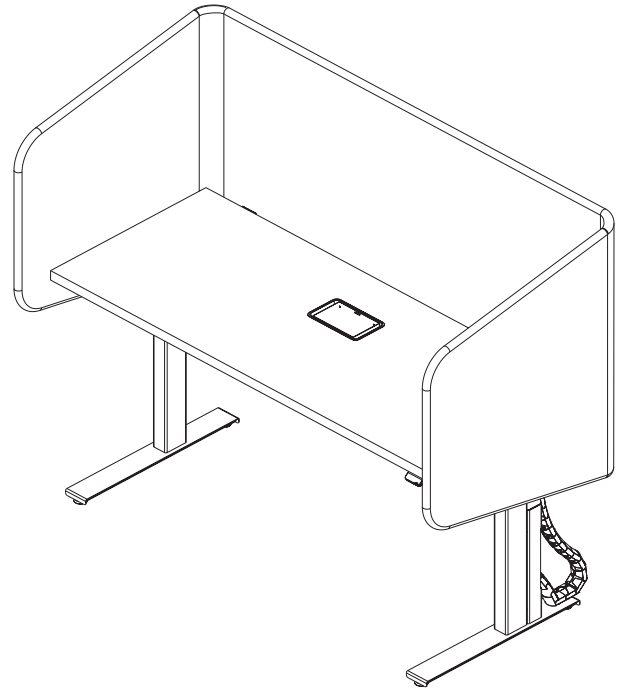

- Adding a screen adds 1" to the width of the table per return wing.
- All Altitude worksurfaces are 2" under nominal width to accommodate screens.
- RH L-screens have return wing on user's right; LH opposite.
- Textile offering is limited to Nobel.

For specification information see page 61.

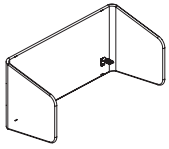

Description	Model	P1 Paint List Price	P2 Paint Upcharge	P3 Paint Upcharge
Extended Wing U Screen				
48"W	SPLA-A8-EXTSCRNPNTA.M519714	\$ 2283	\$ 17	\$ 40
54"W	SPLA-A8-EXTSCRNPNTA.M519715	\$ 2389	\$ 17	\$ 40
60"W	SPLA-A8-EXTSCRNPNTB.M519716	\$ 2431	\$ 17	\$ 40
66"W	SPLA-A8-EXTSCRNPNTB.M519717	\$ 2576	\$ 17	\$ 40
72"W	SPLA-A8-EXTSCRNPNTB.M519718	\$ 2771	\$ 17	\$ 40

OPTIMIZE

ALTITUDE

INVOLVE

TITLE 24

ACCESSORIES

PANEL FABRICS

<p>How to specify — Select the Model Number from above.</p> <div style="border-bottom: 1px solid black; height: 20px; width: 100%;"></div>	<p>1st Option: Fabric (if applicable): See inside back cover for fabrics.</p> <div style="border-bottom: 1px solid black; height: 20px; width: 100%;"></div>	<p>2nd Option: Paint (if applicable): P1 P2 See inside front cover for finishes.</p> <div style="border-bottom: 1px solid black; height: 20px; width: 100%;"></div>
---	--	--

Example:

For specification information see current Involvement Price & Specification Guide.

Description	Model	P1 Clear List Price	P2 Upcharge	Frosted Glass Upcharge	Smoked Glass Upcharge
32"H					
36"W	SPLA-IN-SCRNGLSS.M505543	\$ 1225	\$ 17	\$ 305	\$ 464
42"W	SPLA-IN-SCRNGLSS.M505544	\$ 1373	\$ 17	\$ 305	\$ 464
48"W	SPLA-IN-SCRNGLSS.M505545	\$ 1518	\$ 17	\$ 305	\$ 464
54"W	SPLA-IN-SCRNGLSS.M505546	\$ 1685	\$ 17	\$ 305	\$ 464
60"W	SPLA-IN-SCRNGLSS.M505547	\$ 1846	\$ 17	\$ 305	\$ 464

Note: 32"H Involvement Desk Mount Screens will align with 50"H Storage.

Note: Not for use with Height Adjustable Tables.

<p>How to specify — Select the Model Number from above.</p> <p>Example:</p>	<p>1st Option: Glass (if applicable): LC Clear LF Frosted GSM1 Smoked</p>	<p>2nd Option: Paint (if applicable): P1 P2 See inside front cover for finishes.</p>
---	---	--

S Shippable by small-package carrier.

For specification information see below and the Involve section of the Casegoods & Storage Price and Specification Guide.

THESE MODELS ARE NEW (HAVING NEW MODEL NUMBERS) AND HAVE A FLUSH TOP DESIGN (TOP CAPS OVER THE SIDES). PREVIOUS STANDARD SPECIALS WITH AN INSET TOP (SIDES WERE FULL HEIGHT) ARE STILL AVAILABLE WITH THE OLD MODEL NUMBER. CONTACT TPG FOR ASSISTANCE.

Description	Model	L1 List Price	L2 Upcharge		L3 Upcharge	
			Case	Front	Case	Front
42½"H Pull Out Tower — 12"W						
24"D LH	SPLA-IN-PLSTG12A.M475881	\$ 4260	\$ 85	\$ 40	\$ 172	\$ 75
24"D RH	SPLA-IN-PLSTG12A.M475880	\$ 4260	\$ 85	\$ 40	\$ 172	\$ 75
27"D LH	SPLA-IN-PLSTG12A.M488732	\$ 4648	\$ 85	\$ 40	\$ 172	\$ 75
27"D RH	SPLA-IN-PLSTG12A.M488731	\$ 4648	\$ 85	\$ 40	\$ 172	\$ 75

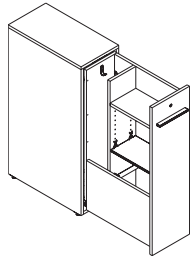

RH

Note: Towers are freestanding.

Contains:

- Removable file bar
- 1 – Adjustable shelf
- 1 – Fixed shelf
- 2 – Coat hooks

Wardrobe on 24"D model is 6"D

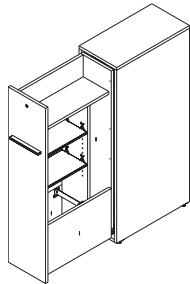

LH

50"H Pull Out Tower — 12"W

24"D LH	SPLA-IN-PLSTG12A.M475886	\$ 4881	\$ 85	\$ 40	\$ 172	\$ 75
24"D RH	SPLA-IN-PLSTG12A.M475885	\$ 4881	\$ 85	\$ 40	\$ 172	\$ 75
27"D LH	SPLA-IN-PLSTG12A.M488734	\$ 5345	\$ 85	\$ 40	\$ 172	\$ 75
27"D RH	SPLA-IN-PLSTG12A.M488733	\$ 5345	\$ 85	\$ 40	\$ 172	\$ 75

Note: Towers are freestanding.

Contains:

- Removable file bar
- 2 – Adjustable shelves
- 1 – Fixed shelf
- 2 – Coat hooks

Wardrobe on 24"D model is 6"D

<p>How to specify — Select the Model Number from above.</p> <p>S P L A - I N - P L S T G 1 2 A . M 4 . .</p>	<p>1st Option: Pull Type (if applicable): MP Beam OP Halo SP Square AP Arch</p>	<p>2nd Option: Pull Color (if applicable): MP Beam / OP Halo PJW Designer White PR6 Silver PJE Pyrite P8X Solar Black P2 upcharge +\$17/pull</p>	<p>3rd Option: Metal Shelf Color: See inside front cover for finishes. Add \$38 for P2 or \$73 for P3 Paints.</p> <p>P .</p>
---	---	--	---

Continued below ▼

<p>4th Option: FSC Certified Wood: FSC Select for FSC Certified Wood X No FSC</p> <p> .</p>	<p>5th Option: Laminate Color (Case): See inside front cover for finishes.</p> <p> .</p>	<p>6th Option: Matching Edge: See inside front cover for finishes.</p> <p> .</p>	<p>7th Option: 2nd Laminate Color (Front): See inside front cover for finishes.</p> <p> .</p>	<p>8th Option: Matching Edge: See inside front cover for finishes.</p> <p> .</p>	<p>9th Option: Lock Option: STD Standard OMT Omit Lock Core (deduct \$18 per lock)</p> <p> .</p>	<p>10th Option: Lock Color (if applicable): EL Silver</p> <p>E L .</p>
--	---	---	--	---	---	---

Example: SPLA-IN-PLSTG12A.M475881.APPR6.P7D.X.LWCWEDCW.LWCWEDCW.STDEL

Description	Model	L1		L2 Upcharge		L3 Upcharge	
		List Price	Case	Front	Case	Front	
42½"H Wardrobe Tower — 12"W							
30"D LH Footed 2-Tone	SPLA-SS-IN42H2TTFB.M490878	\$ 3677	\$ 85	\$ 40	\$ 172	\$ 75	
30"D LH Plinth 2-Tone	SPLA-SS-IN42H2TTPB.M490880	\$ 3677	\$ 85	\$ 40	\$ 172	\$ 75	
30"D RH Footed 2-Tone	SPLA-SS-IN42H2TTFB.M490877	\$ 3677	\$ 85	\$ 40	\$ 172	\$ 75	
30"D RH Plinth 2-Tone	SPLA-SS-IN42H2TTPB.M490879	\$ 3677	\$ 85	\$ 40	\$ 172	\$ 75	
50"H Wardrobe Tower — 12"W							
30"D LH Footed 2-Tone	SPLA-SS-IN50H2TTFB.M490882	\$ 3816	\$ 91	\$ 42	\$ 185	\$ 77	
30"D LH Plinth 2-Tone	SPLA-SS-IN50H2TTPB.M490884	\$ 3816	\$ 91	\$ 42	\$ 185	\$ 77	
30"D RH Footed 2-Tone	SPLA-SS-IN50H2TTFB.M490881	\$ 3816	\$ 91	\$ 42	\$ 185	\$ 77	
30"D RH Plinth 2-Tone	SPLA-SS-IN50H2TTPB.M490883	\$ 3816	\$ 91	\$ 42	\$ 185	\$ 77	
57½"H Wardrobe Tower — 12"W							
30"D LH Footed 2-Tone	SPLA-SS-IN57H2TTFB.M490886	\$ 3925	\$ 92	\$ 42	\$ 188	\$ 79	
30"D LH Plinth 2-Tone	SPLA-SS-IN57H2TTPB.M490888	\$ 3925	\$ 92	\$ 42	\$ 188	\$ 79	
30"D RH Footed 2-Tone	SPLA-SS-IN57H2TTFB.M490885	\$ 3925	\$ 92	\$ 42	\$ 188	\$ 79	
30"D RH Plinth 2-Tone	SPLA-SS-IN57H2TTPB.M490887	\$ 3925	\$ 92	\$ 42	\$ 188	\$ 79	
65"H Wardrobe Tower — 12"W							
30"D LH Footed 2-Tone	SPLA-SS-IN65H2TTFB.M490890	\$ 3968	\$ 93	\$ 42	\$ 191	\$ 79	
30"D LH Plinth 2-Tone	SPLA-SS-IN65H2TTPB.M490892	\$ 3968	\$ 93	\$ 42	\$ 191	\$ 79	
30"D RH Footed 2-Tone	SPLA-SS-IN65H2TTFB.M490889	\$ 3968	\$ 93	\$ 42	\$ 191	\$ 79	
30"D RH Plinth 2-Tone	SPLA-SS-IN65H2TTPB.M490891	\$ 3968	\$ 93	\$ 42	\$ 191	\$ 79	

Note: Wardrobe includes coat rod and adjustable shelf.
 *Upcharges are added to solid laminate list price depending on woodgrain laminate selection.

How to specify — Select the Model Number from above. S P L A - S S - I N .	1st Option: Foot Type (if applicable): TF Terrace Foot ZF Stride Foot (Add \$92)	2nd Option: Foot Paint Color (if applicable): P1 P2 See inside front cover for finishes. Stride is limited to PR6 Silver.	3rd Option: Pull Type (if applicable): MP Beam OP Halo SP Square AP Arch	4th Option: Pull Color (if applicable): MP Beam / OP Halo PJW Designer White PR6 Silver PJE Pyrite P8X Solar Black P2 upcharge +\$17/pull SP Square PJW Designer White EL Matte Silver P02 Flint P7B Loft PJE Pyrite P8X Solar Black AP Arch PRO Anodized Silver P2 upcharge +\$17/pull
	Continued below ▼			

5th Option: Metal Shelf Color: P1 P2 P3 See inside front cover for finishes. Add \$17 for P2 (except PR6) or \$28 for P3 Paints.	6th Option: FSC Certified Wood (if applicable): FSC Select for FSC Certified Wood X No FSC	7th Option: Laminate Color (if applicable): See inside front cover for finishes. (If two-tone list case color here.)	8th Option: Matching Edge (if applicable): See inside front cover for finishes.	9th Option: 2nd Laminate Color (Front) (if applicable): See inside front cover for finishes.	10th Option: Matching Edge (if applicable): See inside front cover for finishes.	11th Option: Lock (if applicable): STD Standard Core (Deduct \$18) OMT Omit Lock Core	12th Option: Lock Color (if applicable): EL Silver
							E L

Example: SPLA-SS-IN42H2TTFB.M490878.APPR6.P7D.X.LM13EY.LM15EU.STDEL

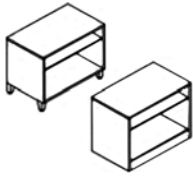

Description	Model	L1	L2	L3
		List Price	Upcharge	Upcharge
24"H x 12"D Credenza — Open Cubby with Metal Shelf for Use with Height-Adjustable Tables				
24"W Footed	SPLA-SS-IN2TOCFB.M487936	\$ 2087	\$ 69	\$ 137
30"W Footed	SPLA-SS-IN2TOCFB.M487937	\$ 2198	\$ 69	\$ 137
30"W Plinth Base	SPLA-SS-IN2TOCPB.M487939	\$ 2198	\$ 69	\$ 137
36"W Footed	SPLA-SS-IN2TOCFB.M487938	\$ 2300	\$ 69	\$ 137
36"W Plinth Base	SPLA-SS-IN2TOCPB.M487940	\$ 2300	\$ 69	\$ 137

*Upcharges are added to laminate list price depending on woodgrain laminate selection.

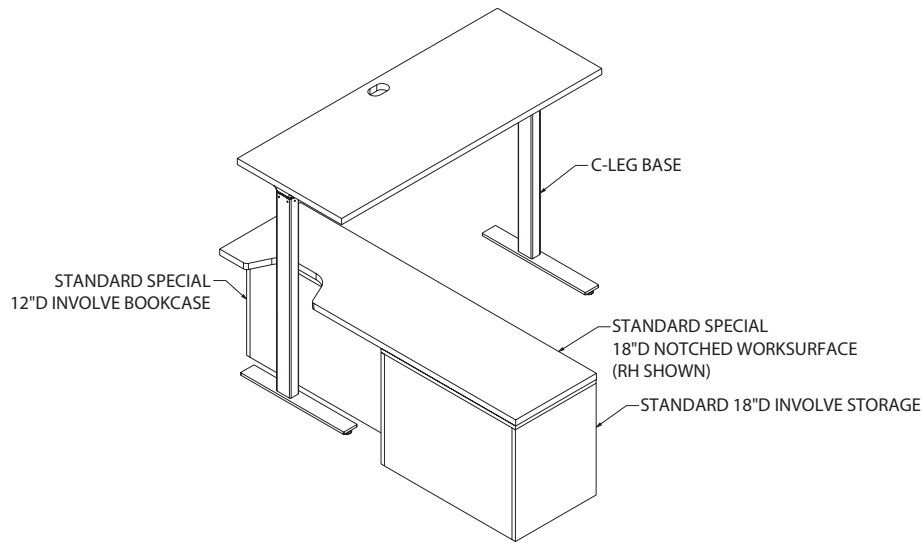

<p>How to specify — Select the Model Number from above.</p>	<p><i>1st Option:</i> Foot Type (if applicable): TF Terrace Foot ZF Stride Foot (Add \$92)</p>	<p><i>2nd Option:</i> Foot Paint Color (if applicable): P1 P2 See inside front cover for finishes. Stride is limited to PR6 Silver.</p>	<p><i>3rd Option:</i> Metal Shelf Color (if applicable): P1 P2 P3 Add \$17 for P2 (except PR6) or \$28 for P3 Paints on shelf.</p>
	<p>S P L A - S S - I N 2 T O C F B . M 4 8 7 9</p>	<p>P</p>	<p>.</p>

Continued below ▼

<p><i>4th Option:</i> FSC Certified Wood: FSC Select for FSC Certified Wood X No FSC</p>	<p><i>5th Option:</i> Laminate Color: See inside front cover for finishes. (If two-tone list case color here.)</p>	<p><i>6th Option:</i> Matching Edge: See inside front cover for finishes.</p>
<p>.</p>	<p>.</p>	<p>.</p>

Example: SPLA-SS-IN2TOCFB.M487936.TFPQ8.PR6.X.LWCWEDCW

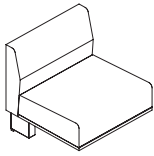

Description	Model Number	Base List Price	Upcharge List Price — Add to Base Price								
			1	2	3	4	5	6	7	8	
Two-Tone Banquette Cushion — 24"D x 19"H Back for use on 11"H seat bases											
24"W	SPLA-IN-BANCUSH.										
	M490800	\$ 1439	Back Fabric	\$ 0	\$ 18	\$ 26	\$ 39	\$ 56	\$ 73	\$ 90	\$ 107
			Seat Fabric	\$ 0	\$ 18	\$ 26	\$ 39	\$ 56	\$ 73	\$ 90	\$ 107
24"W	SPLA-IN-BANCUSHFC.										
Fire Code	M490802	\$ 1639	Back Fabric	\$ 0	\$ 18	\$ 26	\$ 39	\$ 56	\$ 73	\$ 90	\$ 107
			Seat Fabric	\$ 0	\$ 18	\$ 26	\$ 39	\$ 56	\$ 73	\$ 90	\$ 107
36"W	SPLA-IN-BANCUSH36.										
	M490801	\$ 1848	Back Fabric	\$ 0	\$ 31	\$ 63	\$ 105	\$ 147	\$ 191	\$ 236	\$ 279
			Seat Fabric	\$ 0	\$ 31	\$ 63	\$ 105	\$ 147	\$ 191	\$ 236	\$ 279
36"W	SPLA-IN-BANCUSHFC36.										
Fire Code	M490803	\$ 2053	Back Fabric	\$ 0	\$ 31	\$ 63	\$ 105	\$ 147	\$ 191	\$ 236	\$ 279
			Seat Fabric	\$ 0	\$ 31	\$ 63	\$ 105	\$ 147	\$ 191	\$ 236	\$ 279

Note: Due to the design of the cushion, pattern matching is not possible on Involve cushion backs. Large scale patterns and stripes are to be avoided, unless approved by the customer.

	24"W Models	36"W Models
COM Yardage (Back)	1.6 yards	1.6 yards
COM Yardage (Seat)	1.3 yards	1.3 yards

How to specify Cushions —

Select the Model Number from above.

1st Option:

Back Upholstery:

Specify back upholstery — see Casegoods & Storage price list pages 9-13.

2nd Option:

Seat Upholstery:

Specify seating upholstery — see Casegoods & Storage price list pages 9-13.

Example: SPLA-IN-BANCUSH.M490800.CU40.CU98

S Shippable by small-package carrier.

EMS ENERGY MANAGEMENT SYSTEM

Summary of Title 24

The 2014 California Title 24, addresses building energy efficiency standards with an objective to reduce energy use in California. The owner or tenant is responsible to meet these specific requirements. This impacts:

- All building permits, new or renovation
- Office improvements, including moving or reconfiguring existing furniture

Office Furniture Impact

In Subchapter 4, Section 130.5(d), controlled duplex receptacles are required and non-controlled duplex receptacles are allowed. A factory-marked controlled duplex receptacle is required within 6 feet of any non-controlled receptacle. Circuit controls for 120 volt duplex receptacles will run on timers, sensors, or both. A power strip or surge bar does not meet the standard. These requirements are for new spaces and retrofits, with all building permits, and any time furniture with electrical is moved. A post-installation inspection is also required. Controlling duplex receptacles can be accomplished at the building power controls or within the furniture power system.

FAQ

Q. What should I discuss with customers now?

A. Ask if Title 24 compliance will be necessary on the project, and how they intend to comply. Be ready to discuss options.

Q. How will this affect planning and specification?

A. Plan for the 6' rule when placing controlled and non-controlled duplex receptacles. The Allsteel IDS team is versed in Title 24 and ready to help you with your planning needs.

Q. Does this work with existing Allsteel electrical?

A. Yes, the infeed must be the EMS version but the other electrical components downstream from the infeed will remain Allsteel standard electrical components. Please see notes below for more information.

Q. When will the EMS (Energy Management System) be orderable?

A. Components are available now through Tailored Solutions.

Q. Can you sync more than 1 occupancy sensor to a Monitor Controlled Device (MCD)?

A. Yes, you can sync multiple occupancy sensors to each MCD.

Q. How do I know whether to specify the base/ceiling infeed or power harness MCD?

A. The MCD needs to be as close to the power input as possible. If your last panel in a run needs to have powered duplex receptacles, the base/ceiling in-feed version must be used. If not, it is recommended to use the power harness MCD. (Context: The power harness MCD is concealed within the panel kickplate. The base/ceiling in-feed is mounted to the outside of the kickplate on the panel.)

Furniture Controls

Specify Allsteel EMS Base/ceiling in-feed or power harness. Each Monitor/ Controlled Device (MCD) includes programming instructions. Controlled labels for duplex receptacles are available as well as duplex receptacles marked with 'controlled'. Occupancy sensor is specified separately.

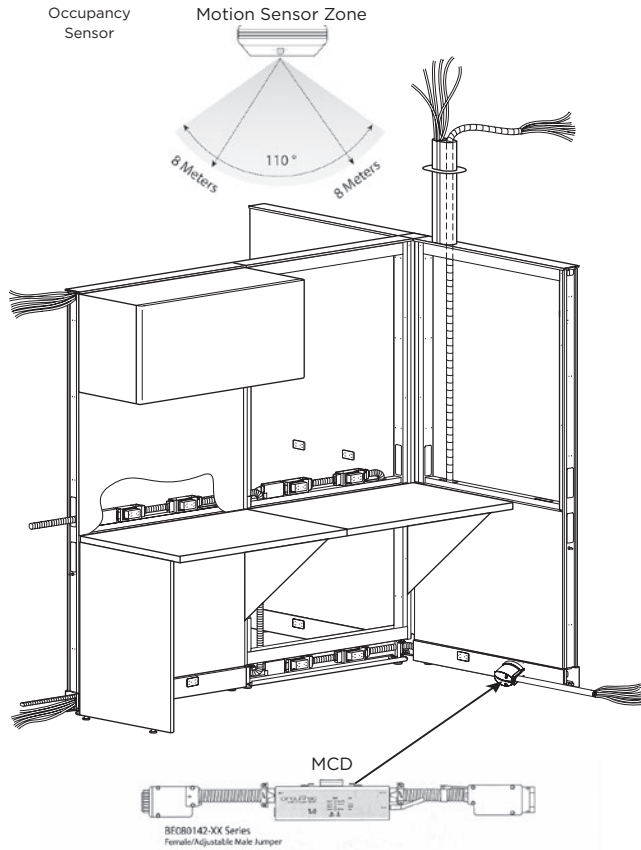

- Follow 6' rule when placing controlled receptacles
- Label controlled receptacles

Allsteel EMS, features "CircuiTrac™ by Byrne" energy management system. EMS is compatible with new installations or can easily retrofit to existing Allsteel electrical systems. Simply program the circuits at the time of installation and sync to the occupancy sensor(s).

Key components:

- Monitor/Control Device (MCD) (Base/ceiling in-feed or power harness)
- Occupancy Sensor
- Label controlled duplex receptacles with stickers or order pre-marked, "controlled", duplex receptacles

Building Controls

A certified electrician wires in-feeds for select circuits to be controlled using an occupancy sensor or timer. All controlled duplex receptacles must be labeled as such.

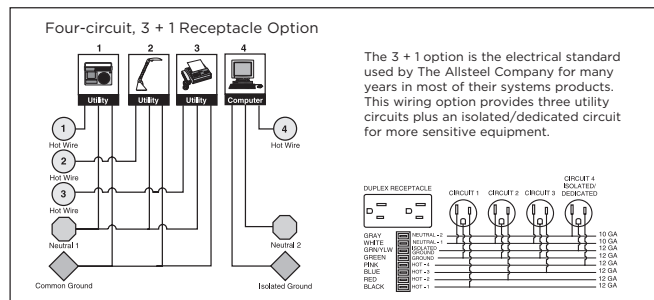
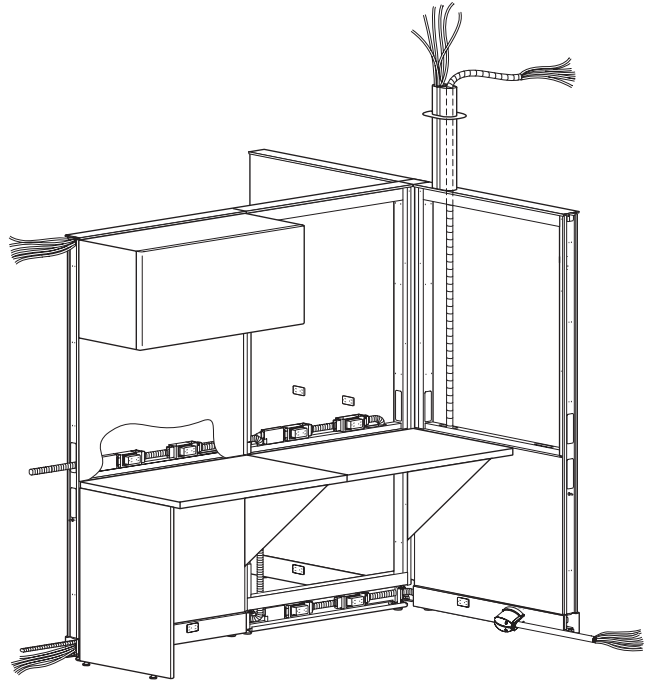

- Follow 6' rule when placing controlled duplex receptacles
- Label controlled duplex receptacles
- Use standard electrical components
- Coordinate with electrician on which circuit(s) to control
- Electrician provides controlled circuits

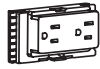

Description	Model	List Price
Title 24 Electrical — Further		
Receptacle - CONTROLLED STAMP Circuit 1 - Further	SPLA-TP-PELEC-BYR.M490934	\$ 84
Receptacle - CONTROLLED STAMP Circuit 2 - Further	SPLA-TP-PELEC-BYR.M490935	\$ 84
Receptacle - CONTROLLED STAMP Circuit 3 - Further (2+2)	SPLA-TP-PELEC-BYR.M490937	\$ 84
Receptacle - CONTROLLED STAMP Circuit 3 - Further (3+1)	SPLA-TP-PELEC-BYR.M490936	\$ 84
Receptacle - CONTROLLED STAMP Circuit 4 - Further (Four-Circuit - ISO/DEDICATED)	SPLA-TP-PELEC-BYR.M490938	\$ 84

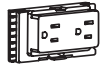

Title 24 Electrical — Optimize		
BASE ELEC IN-FEED 6FT SEALTIGHT CABLE w/ screw mount MDC, SN/Ap fit to power block out (Four Circuit)	SPLA-TP-ELEC-BYR.M490914	\$ 4598
BASE ELEC IN-FEED 6FT SEALTIGHT CABLE w/ screw mount MDC, SN/Ap fit to power block out (Three Circuit)	SPLA-TP-ELEC-BYR.M490923	\$ 4598
Receptacle - CONTROLLED STAMP Circuit 1 - Optimize (Four Circuit)	SPLA-TP-PELEC-BYR.M490939	\$ 84
Receptacle - CONTROLLED STAMP Circuit 1 - Optimize (Three Circuit)	SPLA-TP-PELEC-BYR.M490950	\$ 84
Receptacle - CONTROLLED STAMP Circuit 2 - Optimize (Four Circuit)	SPLA-TP-PELEC-BYR.M490940	\$ 84
Receptacle - CONTROLLED STAMP Circuit 2 - Optimize (Three Circuit)	SPLA-TP-PELEC-BYR.M490951	\$ 84
Receptacle - CONTROLLED STAMP Circuit 3 - Optimize (Four Circuit 2+2)	SPLA-TP-PELEC-BYR.M490942	\$ 84
Receptacle - CONTROLLED STAMP Circuit 3 - Optimize (Four Circuit 3+1)	SPLA-TP-PELEC-BYR.M490941	\$ 84
Receptacle - CONTROLLED STAMP Circuit 3 - Optimize (Three Circuit 3+1)	SPLA-TP-PELEC-BYR.M490952	\$ 84
Receptacle - CONTROLLED STAMP Circuit 4 - Optimize (Four Circuit ISO/DEDICATED)	SPLA-TP-PELEC-BYR.M490943	\$ 84

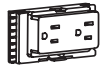

Title 24 Electrical — Stride		
BASE ELEC IN-FEED 6FT SEALTIGHT CABLE w/ screw mount MDC, SN/Ap fit to power block out (Four Circuit)	SPLA-TP-ELEC-BYR.M490912	\$ 4598
BASE ELEC IN-FEED 6FT SEALTIGHT CABLE w/ screw mount MDC, SN/Ap fit to power block out (Three Circuit)	SPLA-TP-ELEC-BYR.M490921	\$ 4598
Receptacle - CONTROLLED STAMP Circuit 1 - Stride (Four Circuit)	SPLA-TP-PELEC-BYR.M490924	\$ 84
Receptacle - CONTROLLED STAMP Circuit 1 - Stride (Three Circuit)	SPLA-TP-PELEC-BYR.M490944	\$ 84
Receptacle - CONTROLLED STAMP Circuit 2 - Stride (Four Circuit)	SPLA-TP-PELEC-BYR.M490925	\$ 84
Receptacle - CONTROLLED STAMP Circuit 2 - Stride (Three Circuit)	SPLA-TP-PELEC-BYR.M490945	\$ 84
Receptacle - CONTROLLED STAMP Circuit 3 - Stride (Four Circuit 2+2)	SPLA-TP-PELEC-BYR.M490927	\$ 84
Receptacle - CONTROLLED STAMP Circuit 3 - Stride (Four Circuit 3+1)	SPLA-TP-PELEC-BYR.M490926	\$ 84
Receptacle - CONTROLLED STAMP Circuit 3 - Stride (Three Circuit)	SPLA-TP-PELEC-BYR.M490946	\$ 84
Receptacle - CONTROLLED STAMP Circuit 4 - Stride (Four Circuit - ISO/DEDICATED)	SPLA-TP-PELEC-BYR.M490928	\$ 84

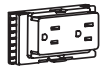

Title 24 Electrical — Terrace		
BASE ELEC IN-FEED 6FT SEALTIGHT CABLE w/ screw mount MDC, SN/Ap fit to power block out (Four Circuit)	SPLA-TP-ELEC-BYR.M490913	\$ 4598
BASE ELEC IN-FEED 6FT SEALTIGHT CABLE w/ screw mount MDC, SN/Ap fit to power block out (Three Circuit)	SPLA-TP-ELEC-BYR.M490922	\$ 4598
Receptacle - CONTROLLED STAMP Circuit 1 - Terrace (Four Circuit)	SPLA-TP-PELEC-BYR.M490929	\$ 84
Receptacle - CONTROLLED STAMP Circuit 1 - Terrace (Three Circuit)	SPLA-TP-PELEC-BYR.M490947	\$ 84
Receptacle - CONTROLLED STAMP Circuit 2 - Terrace (Four Circuit)	SPLA-TP-PELEC-BYR.M490930	\$ 84
Receptacle - CONTROLLED STAMP Circuit 2 - Terrace (Three Circuit)	SPLA-TP-PELEC-BYR.M490948	\$ 84
Receptacle - CONTROLLED STAMP Circuit 3 - Terrace (Four Circuit 2+2)	SPLA-TP-PELEC-BYR.M490932	\$ 84
Receptacle - CONTROLLED STAMP Circuit 3 - Terrace (Four Circuit 3+1)	SPLA-TP-PELEC-BYR.M490931	\$ 84
Receptacle - CONTROLLED STAMP Circuit 3 - Terrace (Three Circuit)	SPLA-TP-PELEC-BYR.M490949	\$ 84
Receptacle - CONTROLLED STAMP Circuit 4 - Terrace (Four Circuit - ISO/DEDICATED)	SPLA-TP-PELEC-BYR.M490933	\$ 84

<p>How to specify — Select the Model Number from above.</p>	<p><i>1st Option:</i> Electrical Receptacle Color (if applicable): See inside front cover for finishes.</p>	<p><i>1st Option:</i> Color (if applicable): P Black</p>
<p>Example: SPLA-TP-ELEC-BYR.M490929.E4</p>		

[S] Shippable by small-package carrier.

GRADE A

APPOINT PANEL

100% Polyester

Artichoke.....	APN911
Blackberry.....	APN932
Bronze.....	APN922
Carbon.....	APN928
Chai.....	APN912
Cherry.....	APN930
Dark Pewter.....	APN917
Dune.....	APN915
Espresso.....	APN923
Framboise.....	APN931
Frost.....	APN934
Jet.....	APN927
Lawn.....	APN925
Mandarin.....	APN929
Morel.....	APN909
Nimbus.....	APN916
Platinum.....	APN924
Turquoise.....	APN926

BINARY

Blush.....	BNRY12
Coal.....	BNRY06
Cream.....	BNRY01
Denim.....	BNRY08
Diamond.....	BNRY03
Graphite.....	BNRY05
Juniper.....	BNRY10
Lagoon.....	BNRY07
Lavendar.....	BNRY11
Mineral.....	BNRY04
Reef.....	BNRY09
Sand Dollar.....	BNRY02

CENTURION*

(Nanotex™ Stain-Resistant finish)

Apricot.....	CU47
Bark.....	CU25
Black.....	CU10
Espresso.....	CU49
Fog.....	CU03
Frost.....	CU22
Goldenrod.....	CU27
Indigo.....	CU06
Iris.....	CU50
Iron Ore.....	CU19
Jade.....	CU83
Marsala.....	CU63
Morel.....	CU24
Navy.....	CU98
Peacock.....	CU97
Pear.....	CU84
Ruby.....	CU67
Sapphire.....	CU09

CIRCUIT

Atlas.....	CIRC35
Dolphin.....	CIRC63
Island White.....	CIRC14
Moon.....	CIRC07
Night.....	CIRC49
Pacific.....	CIRC28
Quartz.....	CIRC01
Sienna.....	CIRC56
Silk.....	CIRC21
Snap Pea.....	CIRC42

ETCH

100% Polyester

Axis.....	ECH913
Blend.....	ECH914
Cast.....	ECH912
Highlight.....	ECH910
Midtone.....	ECH911
Outline.....	ECH908
Shade.....	ECH909
Tonal.....	ECH916
Vanish.....	ECH915

GRADE A – continued

EXCHANGE

100% Polyester

Iron.....	EXG916
Nickel.....	EXG914
Pistachio.....	EXG910
Root.....	EXG913
Rupee.....	EXG903
Shadow.....	EXG911
Silver.....	EXG915
Sisal.....	EXG917
Stone.....	EXG912

LANDSCAPE

100% Polyester

Corn silk.....	LN15
Drift.....	LN05
Khaki.....	LN20
Sheen.....	LN10
Slate.....	LN35
Umber.....	LN25
Urban.....	LN30

LUCY

100% Recycled Polyester

Aspen.....	LC932
Corn silk.....	LC930
Dusk.....	LC922
Fawn.....	LC933
Graphite.....	LC934
Mist.....	LC920
Neutra.....	LC924
Pewter.....	LC935
Snowdrop.....	LC928

REFLECTIONS

100% Recycled Polyester

Galvanized.....	REF929
Ice.....	REF920
Loggia.....	REF921
Mistral.....	REF928
Moonstone.....	REF923
Pewter.....	REF922
Stainless.....	REF924
Vanilla.....	REF925
Winter.....	REF927

REFUGE

64% Recycled Polyester
36% Polyester

Artesian.....	RFG996
Dune.....	RFG992
Eclipse.....	RFG990
Frost †.....	RFG993
Glacier †.....	RFG991
Mineral.....	RFG994
Tidal.....	RFG994

SARTO

100% Polyester (45% Recycled)

Ash.....	SRT988
Fog.....	SRT914
Lemongrass.....	SRT949
Mist.....	SRT945
Mushroom.....	SRT976
Oyster.....	SRT918
Reef.....	SRT964
Sesame.....	SRT993
Shale.....	SRT952

TEMPEST

100% Recycled Polyester

Dragonfly.....	TP930
Frost.....	TP915
Full Stream.....	TP980
Gold Rush.....	TP910
Slate.....	TP945
Tumbleweed.....	TP970
Wind Chill.....	TP940
Zebra.....	TP935

GRADE B

*ANALOG

Album.....	ANLG06
Cartridge.....	ANLG04
Cassette.....	ANLG09
Dial.....	ANLG02
Media.....	ANLG08
Reel.....	ANLG07
Signal.....	ANLG03
Stereo.....	ANLG01
Track.....	ANLG05

COAST

100% Antimony-Free Polyester

Channel.....	COA914
Dune.....	COA903
Headlands.....	COA910
Marsh.....	COA902
Pebble.....	COA912
Pier.....	COA913
Shoal.....	COA901
Silt.....	COA906
Tide.....	COA908

DISPERSE

100% Polyester

Autumn.....	DISP03
Branch.....	DISP10
Coffee Bean.....	DISP13
Dusk.....	DISP09
Emerald City.....	DISP08
Gold Rush.....	DISP02
Igloo.....	DISP11
Ink.....	DISP06
Mist.....	DISP12
Oatmeal.....	DISP15
Prince.....	DISP07
Reservoir.....	DISP01
Rose.....	DISP04
Spring.....	DISP05
Steel.....	DISP16
Taupe.....	DISP14

MICA

100% Recycled Polyester

Anthracite.....	MCA911
Breeze.....	MCA918
Bronze.....	MCA913
Buff.....	MCA914
Cremini.....	MCA917
Crystal †.....	MCAWIT
Dew.....	MCA920
Dove.....	MCA912
Fresh.....	MCA916
Mineral.....	MCA915
Nectar.....	MCA919
Shale.....	MCA910

SPIN PANEL

46% Recycled Polyester,
56% Polyester

Alabaster.....	SPIN02
Cavern.....	SPIN03
Cobblestone.....	SPIN04
Ember.....	SPIN06
Flame.....	SPIN07
Heron.....	SPIN13
Oat.....	SPIN01
Ocean.....	SPIN12
Plum.....	SPIN15
Pool.....	SPIN11
Raven.....	SPIN10
Rhubarb.....	SPIN14
Tropic.....	SPIN08
Willow.....	SPIN05

GRADE B – continued

TERRAIN

52% Recycled Polyester,
48% Polyester

Bay.....	TRRN05
Bayou.....	TRRN35
Canyon.....	TRRN30
Cliff.....	TRRN45
Crest.....	TRRN25
Delta.....	TRRN10
Plateau.....	TRRN15
Ridge.....	TRRN20
Valley.....	TRRN40

ALLSTEEL PARTNERSHIP PROGRAM

Allsteel understands that customers may want to specify panel and seating textiles outside of Allsteel's standard offering. Allsteel's **Partnership Program** consists of on-trend and design-forward patterns that have been tested and approved by Allsteel for use on Allsteel products. A subset of these approved patterns is available on cards in the textile binder, while numerous others are available on our website, allsteeloffice.com.

For memo samples, please contact our partners:

- Camira, memos@camirafabrics.com
1.616.288.0655
- Carnegie, carnegiefabrics.com
1.800.727.6770
- CF Stinson, cfstinson.com
1.800.841.6279
- HBF Textiles, hbftextiles.com
1.877.494.5727
- Maharam, maharam.com
1.800.645.3943
- Ultrafabrics, ultrafabricsllc.com
1.877.309.6648

The intent of the **Partnership Program** is to offer a wide variety of on-trend textiles to meet your varied needs, but since these textiles are not part of our standard offering they may be subject to extended lead times. Because new materials will be introduced regularly, Allsteel reserves the right to change the offering at any time.

PARTNERSHIP – GRADE D

Camira BLAZER LITE

(100% Pure New Wool)

Angel.....	PCAMBLT49
Aspire.....	PCAMBLT52
Balance.....	PCAMBLT41
Bliss.....	PCAMBLT48
Buddha.....	PCAMBLT56
Cuddle.....	PCAMBLT62
Dainty.....	PCAMBLT64
Daydream.....	PCAMBLT46
Devoted.....	PCAMBLT58
Faith.....	PCAMBLT68
Freedom.....	PCAMBLT69
Graceful.....	PCAMBLT59
Happy.....	PCAMBLT55
Harmony.....	PCAMBLT63
Haven.....	PCAMBLT40
Hope.....	PCAMBLT50
Hush.....	PCAMBLT42
Love.....	PCAMBLT47
Mood.....	PCAMBLT44
Pamper.....	PCAMBLT66
Pastel.....	PCAMBLT65
Pillow.....	PCAMBLT43
Praise.....	PCAMBLT54
Retreat.....	PCAMBLT39
Shelter.....	PCAMBLT60
Solace.....	PCAMBLT70
Tender.....	PCAMBLT53
True.....	PCAMBLT61
Verity.....	PCAMBLT57
Wish.....	PCAMBLT67
Worship.....	PCAMBLT59

* Limited to product 48" W or less.

Multi-use fabrics are seating fabrics that can be used on specific Allsteel panels systems, providing more color and pattern options. The applicable Allsteel multi-use fabrics are noted with System designators in the Seating, Collaboration, and Tables Price List.



Allsteel®

Allsteel Inc.
Muscatine, Iowa 52761

allsteeloffice.com

Form # A8722 (04/23)