

Standard Specials

Price & Specification Guide 2022

Prices effective May 13, 2022

PAINTED METAL FINISHES

GRADE P1

Black	P27
Brownstone	P7D
Bungalow	P7C
Cinder	P7Q
Designer White	PJW
Flint	P02
Fossil	P28
Loft	P7B
Muslin	P4J
Parchment	P93
Pebble	P8R
Pewter	P8D
Salt	P8C
Titanium	P8T

GRADE P2

Champagne Metallic	PR5
Gunmetal Metallic	PR3
Platinum Metallic	PR2
Silver**	PR6
Solar Black	P8X

**PR6 no upcharge on Involve; available as a Grade P2 color on stanchions; is not available on Concensus, Essentials, and vertical files. PQ8 is not available on vertical files.

GRADE P3

Atom	P8S
Blossom***	P8K
Bullseye	PJF
Cabernet***	P7T
Conifer***	P8H
Ember	P8P
Ion	P8N
Iris	P8J
Krypton	P8F
Regatta	P8M
Succulent***	P8A

*** These colors are intended to be an inspirational option for the trending market. Product application is limited and color availability is approximately two years to coincide with evolving workplace trends.

Metallic paints, due to varying reflectance, may appear to have less visual color consistency than other paint finishes, even when L/A/B values are exactly the same. (L/A/B — measurable aspects of color — values are maintained within a specified range, to ensure consistent appearance of paint colors.)

METAL STORAGE PULLS

Black	E4
Bronze (for veneer only)	EZ
Matte Silver	EL

PAINTED WOOD FINISHES

Brownstone	M13
Bungalow	M12
Designer White	M17
Flint	M16
Loft	M11
Muslin	M15

ELECTRICAL AND DATA COMPONENTS

Black	E4
Brownstone	EY
Designer White	DW
Flint	E9
Loft	EV
Muslin	EU
Silver	ES

Recommended Coordinate Colors:
 Bungalow use Muslin EU
 Carob use Black E4
 Champagne Metallic use Muslin EU
 Cinder use Brownstone EY
 Fossil use Flint E9
 Gunmetal Metallic use Brownstone EY
 Parchment use Muslin EU
 Pebble use Loft EV
 Pewter use Flint E9
 Platinum Metallic use Loft EV
 Salt use Silver ES
 Titanium use Silver ES

LAMINATES

GRADE L1

CORE	
Ash	LT3B
Brownstone*	LM13
Bungalow*	LM12
Camelstone	LT6A
Canyon Zephyr	LT5B
Desert Zephyr	LT5A
Designer White	LDW1
Flint*	LM16
Fossil Shale*	LEH1
Grey Mesh	LT8A
Greystone	TM65
Loft*	LM11
Muslin*	LM15
Parchment	TM20
Pewter Mesh	LT8C
Sheer Mesh	LT8B
Silver Mesh	LT8D
Titanium	LT11
White Tigris	LT2A
Whitestone	TM33

WOODGRAIN

Florence Walnut*	LFW1
Kingswood Walnut*	LK11
Natural Maple*	LWD
NeoWalnut*	LNU1
Shaker Cherry*	LW7C

GRADE L2

Amber Cherry*	LWAC
Beigewood*	LWBE
Branded Oak*	LBO1
Brazilwood*	LWBR
Columbian Walnut*	LWZ
Ebony Recon*	LER1
Fawn Cypress*	LFC1
Lowell Ash*	LLA1
Mangalore Mango*	LMM1
Natural Recon*	LNR1
Phantom Charcoal*	LPC1
Phantom Ecru*	LPE1
Portico Teak*	LPT1
Skyline Walnut*	LSW1

GRADE L3

Cafelle*	LWC
Charcoal Walnut*	LWCW
Natural Walnut*	LWNW

* Storage available in these 29 laminates.

LAMINATE AND PAINTED WOOD STORAGE PULLS

Silver	PR6
--------	-----

LAMINATE EDGE COLORS

Amber Cherry	DA
Beigewood	DE
Black	E4
Branded Oak	BO
Brazilwood	DB
Brownstone	EY
Bungalow	EX
Cafelle	DG
Charcoal Walnut	DC
Columbian Walnut	DZ
Designer White	DW
Ebony Recon	DR
Fawn Cypress	FC
Flint	E9
Florence Walnut	FW
Fossil	EH
Kingswood Walnut	KI
Loft	EV
Lowell Ash	DL
Mangalore Mango	MM
Muslin	EU
Natural Maple	DD
Natural Recon	NR
Natural Walnut	DN
NeoWalnut	NU
Parchment	EN
Phantom Charcoal	PC
Phantom Ecru	PE
Platinum Metallic	EP
Plyband ♦	PL
Portico Teak	DP
Shaker Cherry	DF
Skyline Walnut	SW
Titanium	TI

♦ Edge is limited to flat edge surfaces: rectangle, square, trapezoid, polygon, or round. No curvilinear or combination curve and straight.

METAL GROMMETS

FOR LAMINATE WORKSURFACES

Oval/Square:	
Matte Silver	EL

FOR VENEER WORKSURFACES

Oval:	
Black	E4
Bronze	EZ
Matte Silver	EL
Square:	
Matte Silver	EL

PLASTIC GROMMETS

FOR WORKSURFACES

Black	E4
Brownstone	EY
Bungalow	EX
Designer White	DW
Flint	E9
Fossil	EH
Loft	EV
Muslin	EU
Parchment	EN

PLASTIC GROMMETS WITH WOODGRAIN EDGE

If woodgrain edge is specified, the plastic grommet color is predetermined, based on finish selection.

Beigewood, Fawn Cypress, Natural Maple, and Natural Recon	Muslin EU
Branded Oak	Brownstone EY
Phantom Charcoal	Flint E9
Phantom Ecru	Loft EV
Portico Teak	Fossil EH
Skyline Walnut	Flint E9
All other woodgrain options	Black E4

STRATAWOOD VENEERS

GRADE V1

Add FSC prefix to Stratawood codes listed below for Stratawood veneer trim on Stride and Terrace.
 Example: **FSCSC777**

CHERRY

Burnished Cherry	SC777
Light Cherry	SC701
Wheat Cherry	SC706

MAPLE

Clear Maple***	SE800
----------------	-------

OAK

Clear Oak	SF300
Dark Rift Oak	SF331

WALNUT

Coffee Walnut	ST615
Dark Roast Walnut	ST684
Light Walnut	ST601

NATURAL VENEERS — NATURAL-1

GRADE V3

CHERRY

Burnished Cherry	NC777
Light Cherry	NC701
Medium Wheat Cherry	NC706

MAPLE

Natural Maple***	NE800
------------------	-------

WALNUT

Coffee Walnut	NT615
Dark Roast Walnut	NT684
Light Walnut	NT601

NATURAL VENEERS — NATURAL-2

GRADE V5

Dark Rift Oak	RF331
---------------	-------

***SE800 and NE800 are not available on Stride trim.

The beauty of wood is the natural variation of grain patterns and colors that make each piece unique. This variation is also influenced by lighting conditions, orientation of mated parts, and varying acceptance of the finishing process. The varying colors and physical characteristics naturally occur in all wood species but are most pronounced in lighter colored woods, and are especially evident in natural finishes.

GROMMETS ON VENEER WORKSURFACES

Wire management grommets come standard on most veneer worksurfaces. Choose between metal or plastic grommet option. Note: Plastic grommet color is predetermined based on finish selection. All Maple veneers.....Muslin EU
 All other veneersBlack E4

LOCKS

Black	E4
Chrome	ordered by base model
Matte Silver	EL

NOTE: Refer to individual product pages for upcharges.

- Software support packages furnished to the customer, either by Allsteel® or by another source, which support the sale of Allsteel products are superseded by printed price lists.
- Prices are subject to change without notice. All orders are subject to prices in effect at the time of order.
- Please refer to your Allsteel Dealer Sales and Discount Policies for order placement information, terms and conditions.
- Additional copies of this Specification and Price List are available to Allsteel Dealers on Synergy as a PDF.

- Ordering information appears at the bottom of each product page complete with examples on how to specify. Fabric and finish pages are referenced at the bottom of product pages.

This publication is available as an interactive or downloadable PDF at www.allsteeloffice.com/pricers.

Questions or Comments?

Please call us at: **888-ALLSTEEL**
888-255-7833

Standard Finishes	2	Terrace Steel Ported Tiles.....	39
Table of Contents	3	Terrace Laminate Tiles.....	40-41
WORKSURFACES		Terrace Laminate Tiles — Ported.....	42-43
Primary Rectangle	4-5	Terrace Pass Thru Kits.....	44
Stride Linear Corner Asymmetrical	6	Terrace Electrical Components.....	45
Stride Linear Corner Cove.....	6	FURTHER®	
Wave.....	7	Further 28"H Triangle Base Beam Mounted Glass Screens.....	46
Reef	7	28"H Triangle Base Beam Mounted Fabric Screens	47
Peninsula	8	Further Electrical	48
Boomerang	9	APPROACH™	
Stride 120 Degree Countertop.....	9	Approach End Cap.....	49
Corner Cove.....	10	OPTIMIZE®	
Countertops - T-Mold Edge.....	11	Optimize 22½"H Frameless Glass with Top Cap	50
Full Depth Lateral Divider Screens.....	12-14	Optimize Trim COM Insert Spec.....	51
20"H Stride Benching Lateral Divider Screens	15	Top Cap For Frameless COM Insert	52
Corner	16	Optimize Electrical	53
STRIDE®		ALTITUDE®	
Stride 30"H Panels	17	Wire Manager Chain.....	54
Stride Feet.....	18	HAT Base & Worksurface Spec Rules	55
Stride Power Pole Splice	18	Height-Adjustable Bases.....	56-65
Stride Trim	19	Screen Kits in Contourett	66
Stride 25"H Fabric, Steel, and Laminate Tiles	20	Altitude A8 Screen Kits - Extended Wing Specification Notes....	67
22½"H Frameless Glass Specification Rules.....	21	Altitude A8 Screen Kits - Extended Wing	68
Frameless Glass Alignment Brackets.....	22	INVOLVE®	
Stride 22½"H Frameless Glass with Top Cap.....	23	Involve® Desk Mount Screens, Glass	69
Stride COM Insert Spec.....	24	Involve® Towers.....	70-71
Grooved Top Cap For Frameless COM Insert.....	25	Involve® Credenzas	72-73
22½"H & 30"H Low Profile Glass Stackers.....	26	Involve® Two-Tone Banquette Cushion	74
Stride Tackable Acoustical Ported-Below-Worksurface Tiles	27	ENERGY MANAGEMENT SYSTEM	
Stride Steel Ported Tiles	28	EMS.....	75-76
Stride Laminate Tiles and Segment Kits.....	29	ELECTRICAL TITLE 24	
Stride Laminate Tiles to-the-Floor	30	Electrical — Title 24	77-78
Stride Electrical Components	31-32	ACCESSORIES	
TERRACE®		Panel / Wall Mount Hand Sanitizer Bottle Holder.....	79
Terrace Feet	33	Tool Tile / Tool Rail Mount Hand Sanitizer Bottle Holder.....	79
Terrace Power Pole Splice.....	33	Aware Mobile Markerboards.....	79
Steel to-the-Floor Tiles.....	33	Panel Fabrics	80
Terrace 22½"H Frameless Glass with Flat Top Cap	34		
Terrace 22½"H Frameless Glass with Radius Top Cap	34		
Terrace Flat & Radius Trim COM Insert Specs.....	35		
Grooved Top Cap for Frameless COM Insert.....	36		
Terrace Fabric Tiles to-the-Floor	37		
Terrace Fabric Below-Worksurface Tiles — Ported	38		



Description	Laminate Model w/T-Mold Edge	Laminate w/T-Mold Edge		
		L1 List Price	L2 List Price	L3 List Price
24"D Primary Worksurfaces				
24"W	832424A	\$ 388	\$ 409	\$ 425
30"W	832430A	\$ 409	\$ 431	\$ 448
36"W	832436A	\$ 463	\$ 486	\$ 506
42"W	832442A	\$ 517	\$ 541	\$ 563
48"W	832448A	\$ 561	\$ 587	\$ 610
54"W	832454A	\$ 604	\$ 636	\$ 658
60"W	832460A	\$ 686	\$ 720	\$ 745
66"W	832466A	\$ 747	\$ 783	\$ 812
72"W	832472A	\$ 779	\$ 816	\$ 845



30"D Primary Worksurfaces				
24"W	833024A	\$ 409	\$ 431	\$ 448
30"W	833030A	\$ 493	\$ 517	\$ 538
36"W	833036A	\$ 530	\$ 555	\$ 577
42"W	833042A	\$ 575	\$ 601	\$ 627
48"W	833048A	\$ 604	\$ 636	\$ 658
54"W	833054A	\$ 675	\$ 709	\$ 734
60"W	833060A	\$ 753	\$ 789	\$ 818
66"W	833066A	\$ 812	\$ 851	\$ 883
72"W	833072A	\$ 880	\$ 922	\$ 955



Note: Add Suffix "N" to model number for no grommet, no upcharge. Example: 832424AN

<p>How to specify — Select the Model Number from above. Suffix N No Grommets</p>	<p>1st Option: Laminate: See inside front cover for finishes.</p>	<p>2nd Option: Edge Trim Color: See inside front cover for finishes.</p>	<p>3rd Option: Grommet Type: P Oval Plastic (will match edge trim) M Oval Metal (Add \$11 per grommet) S Square Metal (Add \$11 per grommet)</p>	<p>4th Option: Grommet Color (Metal only): Oval: EL Matte Silver Square: EL Matte Silver</p>
--	---	--	--	--

Example: 832424A.LT3B.E9.P

Description	Laminate Model w/Flat Edge & Scallop	Laminate w/Flat Edge & Scallop		
		L1 List Price	L2 List Price	L3 List Price
24"D Primary Worksurfaces				
24"W	T52424SS	\$ 514	\$ 533	\$ 550
30"W	T52430SS	\$ 535	\$ 556	\$ 572
36"W	T52436SS	\$ 587	\$ 609	\$ 629
42"W	T52442SS	\$ 643	\$ 666	\$ 688
48"W	T52448SS	\$ 688	\$ 714	\$ 735
54"W	T52454SS	\$ 734	\$ 765	\$ 786
60"W	T52460SS	\$ 819	\$ 852	\$ 875
66"W	T52466SS	\$ 877	\$ 912	\$ 939
72"W	T52472SS	\$ 911	\$ 947	\$ 974
78"W	T52478SS	\$ 1143	\$ 1187	\$ 1226
84"W	T52484SS	\$ 1191	\$ 1237	\$ 1280
90"W	T52490SS	\$ 1390	\$ 1443	\$ 1494
96"W	T52496SS	\$ 1447	\$ 1502	\$ 1558
30"D Primary Worksurfaces				
24"W	T53024SS	\$ 535	\$ 556	\$ 572
30"W	T53030SS	\$ 620	\$ 643	\$ 664
36"W	T53036SS	\$ 657	\$ 681	\$ 703
42"W	T53042SS	\$ 699	\$ 725	\$ 748
48"W	T53048SS	\$ 734	\$ 765	\$ 786
54"W	T53054SS	\$ 804	\$ 837	\$ 860
60"W	T53060SS	\$ 883	\$ 918	\$ 945
66"W	T53066SS	\$ 942	\$ 979	\$ 1008
72"W	T53072SS	\$ 1013	\$ 1054	\$ 1085
78"W	T53078SS	\$ 1280	\$ 1329	\$ 1376
84"W	T53084SS	\$ 1332	\$ 1383	\$ 1433
90"W	T53090SS	\$ 1566	\$ 1625	\$ 1685
96"W	T53096SS	\$ 1613	\$ 1674	\$ 1736

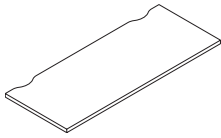

<p>How to specify — Select the Model Number from above.</p>	<p>1st Option: Laminate: See inside front cover for finishes.</p>	<p>2nd Option: Edge Trim Color: See inside front cover for finishes.</p>
<input type="text"/>	<input type="text"/>	<input type="text"/>

Example: T52424SS.LT3B.E9

For specification information see applicable system's specification book.

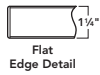

Arrows indicate grain direction for woodgrain laminates

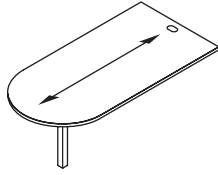

Support column ordered separately.

Description	Model with Grommet	Model without Grommet	Laminate w/Flat Edge		
			L1 List Price	L2 List Price	L3 List Price
Peninsula Worksurface with Grommet					
24"W x 30"L	SPLA-WSMG.M375728	SPLA-WSMN.M375756	\$ 1115	\$ 1156	\$ 1194
24"W x 36"L	SPLA-WSMG.M375729	SPLA-WSMN.M375757	\$ 1115	\$ 1156	\$ 1194
24"W x 42"L	SPLA-WSMG.M375730	SPLA-WSMN.M375758	\$ 1115	\$ 1156	\$ 1194
24"W x 48"L	SPLA-WSMG.M375732	SPLA-WSMN.M375759	\$ 1115	\$ 1156	\$ 1194
24"W x 54"L	SPLA-WSMG.M375733	SPLA-WSMN.M375760	\$ 1115	\$ 1156	\$ 1194
24"W x 60"L	SPLA-WSMG.M380424	SPLA-WSMN.M380427	\$ 1115	\$ 1156	\$ 1194
24"W x 66"L	SPLA-WSMG.M380425	SPLA-WSMN.M380428	\$ 1225	\$ 1266	\$ 1304
24"W x 72"L	SPLA-WSMG.M380426	SPLA-WSMN.M380429	\$ 1335	\$ 1376	\$ 1414
24"W x 78"L	SPLA-WSMG.M375734	SPLA-WSMN.M375761	\$ 1701	\$ 1742	\$ 1780
24"W x 84"L	SPLA-WSMG.M375735	SPLA-WSMN.M375762	\$ 1783	\$ 1824	\$ 1862
24"W x 90"L	SPLA-WSMG.M375736	SPLA-WSMN.M375763	\$ 1988	\$ 2029	\$ 2067
24"W x 96"L	SPLA-WSMG.M375737	SPLA-WSMN.M375764	\$ 2070	\$ 2111	\$ 2149
30"W x 30"L	SPLA-WSMG.M375738	SPLA-WSMN.M375765	\$ 1115	\$ 1156	\$ 1194
30"W x 36"L	SPLA-WSMG.M375739	SPLA-WSMN.M375766	\$ 1115	\$ 1156	\$ 1194
30"W x 42"L	SPLA-WSMG.M375740	SPLA-WSMN.M375767	\$ 1115	\$ 1156	\$ 1194
30"W x 48"L	SPLA-WSMG.M375741	SPLA-WSMN.M375768	\$ 1115	\$ 1156	\$ 1194
30"W x 54"L	SPLA-WSMG.M375742	SPLA-WSMN.M375769	\$ 1115	\$ 1156	\$ 1194
30"W x 78"L	SPLA-WSMG.M375743	SPLA-WSMN.M375770	\$ 1701	\$ 1742	\$ 1780
30"W x 84"L	SPLA-WSMG.M375744	SPLA-WSMN.M375771	\$ 1783	\$ 1824	\$ 1862
30"W x 90"L	SPLA-WSMG.M375745	SPLA-WSMN.M375772	\$ 1988	\$ 2029	\$ 2067
30"W x 96"L	SPLA-WSMG.M375746	SPLA-WSMN.M375773	\$ 2070	\$ 2111	\$ 2149
36"W x 30"L	SPLA-WSMG.M375747	SPLA-WSMN.M375775	\$ 1335	\$ 1376	\$ 1414
36"W x 36"L	SPLA-WSMG.M375748	SPLA-WSMN.M375776	\$ 1335	\$ 1376	\$ 1414
36"W x 42"L	SPLA-WSMG.M375749	SPLA-WSMN.M375778	\$ 1335	\$ 1376	\$ 1414
36"W x 48"L	SPLA-WSMG.M375750	SPLA-WSMN.M375779	\$ 1335	\$ 1376	\$ 1414
36"W x 54"L	SPLA-WSMG.M375751	SPLA-WSMN.M375780	\$ 1335	\$ 1376	\$ 1414
36"W x 78"L	SPLA-WSMG.M375752	SPLA-WSMN.M375781	\$ 1981	\$ 2022	\$ 2060
36"W x 84"L	SPLA-WSMG.M375753	SPLA-WSMN.M375782	\$ 2061	\$ 2102	\$ 2140
36"W x 90"L	SPLA-WSMG.M375754	SPLA-WSMN.M375783	\$ 2268	\$ 2309	\$ 2347
36"W x 96"L	SPLA-WSMG.M375755	SPLA-WSMN.M375785	\$ 2350	\$ 2391	\$ 2429

<p>How to specify — Select the Model Number from above. Add suffix if applicable:</p>	<p><i>1st Option:</i> Laminate: See inside front cover for finishes.</p>	<p><i>2nd Option:</i> Edge Trim Color: See inside front cover for finishes.</p>	<p><i>3rd Option:</i> Grommet Type (if applicable): P Oval Plastic M Oval Metal (Add \$22) S Square Metal (Add \$22)</p>	<p><i>4th Option:</i> Grommet Color (if applicable): See inside front cover for finishes.</p>
<p>S P L A - W S M .</p>				<p>E </p>

Examples: SPLA-WSMG.M375728.LT3B.E9.PE4 SPLA-WSMN.M375756.LT3B.E4

Worksurfaces

Boomerang and 120° Countertops

For specification information see applicable system's specification book.

Laminate

Description	Laminate w/Flat Edge Model	Laminate w/Flat Edge		
		L1 List Price	L2 List Price	L3 List Price
Boomerang Worksurfaces — Left Hand 90°				
48" A x 72" B x 24" C	T547229BL	\$ 1663	\$ 1734	\$ 1806
48" A x 72" B x 30" C	T547239BL	\$ 1731	\$ 1804	\$ 1880
Boomerang Worksurfaces — Left Hand 110°				
36" A x 72" B x 24" C	T547221BL	\$ 1663	\$ 1734	\$ 1806
36" A x 72" B x 30" C	T547231BL	\$ 1731	\$ 1804	\$ 1880
Boomerang Worksurfaces — Right Hand 90°				
48" A x 72" B x 24" C	T547229BR	\$ 1663	\$ 1734	\$ 1806
48" A x 72" B x 30" C	T547239BR	\$ 1731	\$ 1804	\$ 1880
Boomerang Worksurface — Right Hand 110°				
36" A x 72" B x 24" C	T547221BR	\$ 1663	\$ 1734	\$ 1806
36" A x 72" B x 30" C	T547231BR	\$ 1731	\$ 1804	\$ 1880

Note: Add Suffix "N" to model number for no grommets, no upcharge. *Example: T547239BLN*

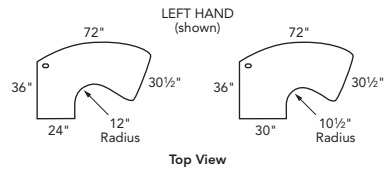
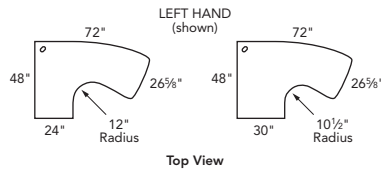
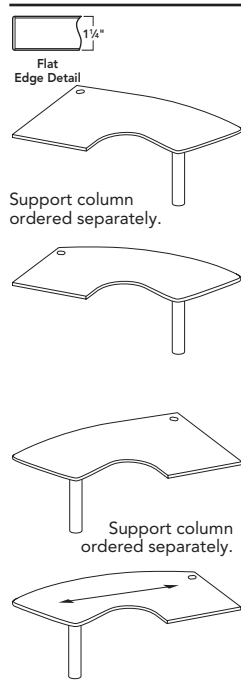

Arrows indicate grain direction for woodgrain laminates



15"D 120° Corner Countertops

30" W x 30" W	Z53030CSB	\$ 1012	\$ 1054	\$ 1089
36" W x 36" W	Z53636CSB	\$ 1120	\$ 1166	\$ 1209
42" W x 42" W	Z54242CSB	\$ 1206	\$ 1255	\$ 1301
48" W x 48" W	Z54848CSB	\$ 1314	\$ 1367	\$ 1419

<p>How to specify —</p> <p>Select the Model Number from above. Add suffix if applicable:</p> <p>"N" for No Grommets — no upcharge</p>	<p>1st Option:</p> <p>Laminate:</p> <p>See inside front cover for finishes.</p>	<p>2nd Option:</p> <p>Edge Trim Color (Laminate worksurfaces only):</p> <p>See inside front cover for finishes.</p>	<p>3rd Option:</p> <p>Grommet Type:</p> <p>P Oval Plastic (will match edge trim on laminate)</p> <p>M Oval Metal (Add \$11 per grommet)</p> <p>S Square Metal (Add \$11 per grommet)</p>	<p>4th Option:</p> <p>Grommet Color (if applicable):</p> <p>See inside front cover for finishes.</p>
<p>_____ .</p>	<p>_____ .</p>	<p>_____ .</p>	<p>_____</p>	<p>E _____</p>

Examples: T547221BR.LT3B.E9.P 5303030CSB.TM33.EV

For specification information see applicable System's Price & Specification Guide.

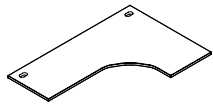

Description	Laminate w/Flat Edge Model	Old Model For Reference	Laminate w/Flat Edge		
			L1 List Price	L2 List Price	L3 List Price
Corner Cove Worksurfaces — Extended Left					
60" x 36" — 24"L / 24"R	T5822EL	83122ELM	\$ 901	\$ 934	\$ 963
60" x 36" — 24"L / 30"R	T5832EL	83132ELM	\$ 940	\$ 974	\$ 1004
60" x 48" — 24"L / 24"R	T5622EL	83622ELM	\$ 1001	\$ 1037	\$ 1068
60" x 48" — 30"L / 24"R	T5623EL	83623ELM	\$ 1044	\$ 1081	\$ 1115
60" x 48" — 24"L / 30"R	T5632EL	83632ELM	\$ 1044	\$ 1081	\$ 1115
60" x 48" — 30"L / 30"R	T5633EL	83633ELM	\$ 1080	\$ 1118	\$ 1154
72" x 36" — 24"L / 24"R	T5922EL	83222ELM	\$ 1001	\$ 1037	\$ 1068
72" x 36" — 24"L / 30"R	T5932EL	83232ELM	\$ 1044	\$ 1081	\$ 1115
72" x 48" — 24"L / 24"R	T5722EL	83722ELM	\$ 1276	\$ 1319	\$ 1361
72" x 48" — 30"L / 24"R	T5723EL	83723ELM	\$ 1320	\$ 1363	\$ 1405
72" x 48" — 24"L / 30"R	T5732EL	83732ELM	\$ 1320	\$ 1364	\$ 1403
72" x 48" — 30"L / 30"R	T5733EL	83733ELM	\$ 1357	\$ 1403	\$ 1450

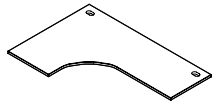

Corner Cove Worksurfaces — Extended Right					
36" x 60" — 24"L / 24"R	T5822ER	83122ERM	\$ 901	\$ 934	\$ 963
36" x 60" — 30"L / 24"R	T5832ER	83132ERM	\$ 940	\$ 974	\$ 1004
48" x 60" — 24"L / 24"R	T5622ER	83622ERM	\$ 1001	\$ 1037	\$ 1068
48" x 60" — 24"L / 30"R	T5623ER	83623ERM	\$ 1044	\$ 1081	\$ 1115
48" x 60" — 30"L / 24"R	T5632ER	83632ERM	\$ 1044	\$ 1081	\$ 1115
48" x 60" — 30"L / 30"R	T5633ER	83633ERM	\$ 1080	\$ 1118	\$ 1154
36" x 72" — 24"L / 24"R	T5922ER	83222ERM	\$ 1001	\$ 1037	\$ 1068
36" x 72" — 30"L / 24"R	T5932ER	83232ERM	\$ 1044	\$ 1081	\$ 1115
48" x 72" — 24"L / 24"R	T5722ER	83722ERM	\$ 1276	\$ 1319	\$ 1361
48" x 72" — 24"L / 30"R	T5723ER	83723ERM	\$ 1320	\$ 1363	\$ 1405
48" x 72" — 30"L / 24"R	T5732ER	83732ERM	\$ 1320	\$ 1364	\$ 1403
48" x 72" — 30"L / 30"R	T5733ER	83733ERM	\$ 1357	\$ 1403	\$ 1450

Note: Add Suffix "N" to model number for no grommet, no upcharge.

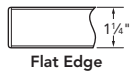

<p>How to specify — Select the Model Number from above.</p>	<p>1st Option: Laminate: See inside front cover for finishes.</p>	<p>2nd Option: Edge Trim Color: See inside front cover for finishes.</p>	<p>3rd Option: Grommet Type: P Oval Plastic (will match edge trim) M Oval Metal (Add \$22 per grommet) S Square Metal (Add \$22 per grommet)</p>	<p>4th Option: Grommet Color (Metal only): EL Matte Silver Note: Plastic grommet color matches trim selection.</p>

Examples: T5822EL.LT3B.EY.MEL T5822EL.LT3B.EV.P

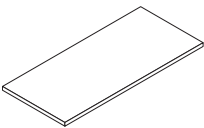

Description	Model	List Price		
		L1	L2	L3
Straight Countertops				
24"W x 15"D	851524	\$ 340	\$ 359	\$ 374
30"W x 15"D	851530	\$ 379	\$ 400	\$ 415
36"W x 15"D	851536	\$ 423	\$ 445	\$ 464
42"W x 15"D	851542	\$ 438	\$ 460	\$ 480
48"W x 15"D	851548	\$ 464	\$ 487	\$ 507
54"W x 15"D	851554	\$ 524	\$ 549	\$ 570
60"W x 15"D	851560	\$ 586	\$ 608	\$ 627
66"W x 15"D	851566	\$ 608	\$ 640	\$ 662
72"W x 15"D	851572	\$ 632	\$ 665	\$ 687

Note: Order mounting brackets separately; see Concensys Price & Spec Guide.



Description	Model	List Price		
		L1	L2	L3
Corner Countertops				
15"D x 24"W x 24"W	852424	\$ 664	\$ 698	\$ 721
15"D x 30"W x 30"W	853030	\$ 772	\$ 809	\$ 838
15"D x 36"W x 36"W	853636	\$ 857	\$ 898	\$ 931
15"D x 42"W x 42"W	854242	\$ 929	\$ 972	\$ 1012

Note: Order mounting brackets separately; see Concensys Price & Spec Guide.

OPTIONS:

SUFFIX	OPTION — Routed to fit Painted Variable Height Trim	UPCHARGE
RS	For routing one end of a straight countertop, when used in variable height panel applications.	None
RR*	For routing right end of corner countertops, when used in variable height panel applications.	None
RL*	For routing left end of corner countertops, when used in variable height panel applications.	None
RB*	For routing both ends of a straight or corner countertop when used in variable height panel applications.	None

***Note:** "Right end" and "left end" are determined by facing the inside radius of the corner countertop.

<p>How to specify — Select the Concensys Model Number from above.</p> <p>8 5 .</p>	<p>1st Option: Laminate: See inside front cover for finishes.</p> <p> .</p>	<p>2nd Option: Edge Trim Color: See inside front cover for finishes.</p> <p> </p>
---	--	---

Example: 851524.LT3B.E4

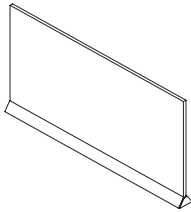
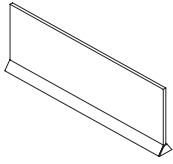

Description	Model		P1 List Price	P2 List Upcharge	P3 List Upcharge	Frosted Glass Upcharge	Smoked Glass Upcharge
8"H Lateral Divider Screen — 3/8" Thick Glass							
18"D	SPLA-SS-STR08HGDS1.M490854		\$ 762	\$ 25	\$ 49	\$ 37	\$ 99
20"D	SPLA-SS-STR08HGDS1.M490855		\$ 778	\$ 25	\$ 49	\$ 37	\$ 99
21"D	SPLA-SS-STR08HGDS1.M490856		\$ 794	\$ 25	\$ 49	\$ 37	\$ 99
24"D	SPLA-SS-STR08HGDS2.M490857		\$ 810	\$ 33	\$ 65	\$ 51	\$ 132
27"D	SPLA-SS-STR08HGDS2.M490858		\$ 827	\$ 33	\$ 65	\$ 51	\$ 132
30"D	SPLA-SS-STR08HGDS3.M490859		\$ 868	\$ 35	\$ 72	\$ 65	\$ 146
36"D	SPLA-SS-STR08HGDS3.M490860		\$ 911	\$ 35	\$ 72	\$ 65	\$ 146

13"H Lateral Divider Screen — 3/8" Thick Glass							
18"D	SPLA-SS-STR13HGDS1.M490861		\$ 800	\$ 25	\$ 51	\$ 41	\$ 103
20"D	SPLA-SS-STR13HGDS1.M490862		\$ 816	\$ 25	\$ 51	\$ 41	\$ 103
21"D	SPLA-SS-STR13HGDS1.M490863		\$ 834	\$ 25	\$ 51	\$ 41	\$ 103
24"D	SPLA-SS-STR13HGDS2.M490864		\$ 849	\$ 34	\$ 67	\$ 53	\$ 139
27"D	SPLA-SS-STR13HGDS2.M490865		\$ 868	\$ 34	\$ 67	\$ 53	\$ 139
30"D	SPLA-SS-STR13HGDS3.M490866		\$ 911	\$ 37	\$ 75	\$ 67	\$ 152
36"D	SPLA-SS-STR13HGDS3.M490867		\$ 948	\$ 37	\$ 75	\$ 67	\$ 152

20"H Lateral Divider Screen — 3/8" Thick Glass							
18"D	SPLA-SS-STR20HGDS1.M490868		\$ 992	\$ 39	\$ 77	\$ 63	\$ 159
20"D	SPLA-SS-STR20HGDS1.M490869		\$ 1012	\$ 39	\$ 77	\$ 63	\$ 159
21"D	SPLA-SS-STR20HGDS1.M490870		\$ 1033	\$ 39	\$ 77	\$ 63	\$ 159
24"D	SPLA-SS-STR20HGDS2.M490872		\$ 1054	\$ 53	\$ 106	\$ 82	\$ 214
27"D	SPLA-SS-STR20HGDS2.M490873		\$ 1076	\$ 53	\$ 106	\$ 82	\$ 214
30"D	SPLA-SS-STR20HGDS3.M490874		\$ 1098	\$ 59	\$ 117	\$ 106	\$ 235
36"D	SPLA-SS-STR20HGDS3.M490875		\$ 1153	\$ 59	\$ 117	\$ 106	\$ 235

Notes:

- Screen depths nominal sizes match actual sizes. *Not for use with Stride Benching. See page 15.
- 13H screens are 12.6"H (to match standard Stride Lateral Screens).
- 8H screen nominal height matches actual.
- 20H screen nominal height matches actual, intending to align with 50H panels. These will not align with Stride Benching 20H Beam Mounted Screens or 20H Elevated table mounted screens.
- Screens used on Systems applications must be placed 3" from a seam with a cantilever or center support bracket. If necessary the alternative attachment kit, VHB Tape and End Cap, may be used. Order separately.
- Screens used on Further applications can be placed anywhere, however support brackets may need to be repositioned.

<p>How to specify — Select the Model Number from above.</p> <div style="border: 1px solid black; height: 20px; width: 100%;"></div> <div style="border: 1px solid black; height: 20px; width: 100%;"></div>	<p><i>1st Option:</i> Glass (if applicable): LC Clear LF Frosted GSM1 Smoked</p>	<p><i>2nd Option:</i> Paint (if applicable): See inside front cover for finishes.</p>
<p>Example: SPLA-SS-STR08HGDS1.M490854.LC.P02</p>		

Shippable by small-package carrier.

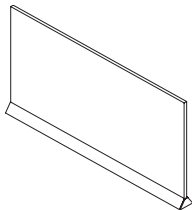
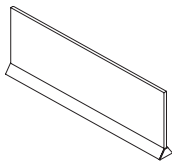

Description	Model	P1 List Price	P2 List Upcharge	P3 List Upcharge	Frosted Glass Upcharge	Smoked Glass Upcharge
8"H Lateral Divider Screen — 3/8" Thick Glass						
42"W	SPLA-SS-STR08HGDS4.M505525	\$ 954	\$ 42	\$ 84	\$ 77	\$ 173
48"W	SPLA-SS-STR08HGDS4.M505526	\$ 998	\$ 42	\$ 84	\$ 77	\$ 173
54"W	SPLA-SS-STR08HGDS5.M505527	\$ 1046	\$ 54	\$ 109	\$ 99	\$ 223
60"W	SPLA-SS-STR08HGDS5.M505528	\$ 1097	\$ 54	\$ 109	\$ 99	\$ 223
66"W	SPLA-SS-STR08HGDS6.M505529	\$ 1150	\$ 63	\$ 126	\$ 115	\$ 259
72"W	SPLA-SS-STR08HGDS7.M505530	\$ 1204	\$ 69	\$ 139	\$ 126	\$ 284

13"H Lateral Divider Screen — 3/8" Thick Glass						
42"W	SPLA-SS-STR13HGDS4.M505531	\$ 993	\$ 55	\$ 112	\$ 101	\$ 223
48"W	SPLA-SS-STR13HGDS4.M505532	\$ 1041	\$ 55	\$ 112	\$ 101	\$ 223
54"W	SPLA-SS-STR13HGDS5.M505533	\$ 1089	\$ 69	\$ 140	\$ 125	\$ 277
60"W	SPLA-SS-STR13HGDS5.M505534	\$ 1141	\$ 69	\$ 140	\$ 125	\$ 277
66"W	SPLA-SS-STR13HGDS6.M505535	\$ 1196	\$ 76	\$ 154	\$ 137	\$ 305
72"W	SPLA-SS-STR13HGDS7.M505536	\$ 1252	\$ 84	\$ 167	\$ 152	\$ 334

Notes:

- Screen depths nominal sizes match actual sizes and not for use with Stride Benching. See page 15.
- 13H screens are 12.6"H (to match standard Stride Lateral Screens).
- 8H screen nominal height matches actual.
- 20H screen nominal height matches actual, intending to align with 50H panels. These will not align with Stride Benching 20H Beam Mounted Screens or 20H Elevated table mounted screens.
- Screens used on Systems applications must be placed 3" from a seam with a cantilever or center support bracket. If necessary the alternative attachment kit, VHB Tape and End Cap, may be used. Order separately.
- Screens used on Further applications can be placed anywhere, however support brackets may need to be repositioned.

Bracket-less Alternative Attachment Kit

SPLA-STR-SPLSCRNGLAS.M505831	\$ 59	\$ 15
SPLA-STR-SPLSCRNGLAS.M506260	\$ 66	\$ 15

Notes:

- Bracket-less alternative attachment kit for Stride Lateral Divider Screens up to 36"W SPLA-STR-SPLSCRNGLAS.M505831.
- Bracket-less alternative attachment kit for Stride Lateral Divider Screens 42"W–72"W SPLA-STR-SPLSCRNGLAS.M506260.

<p>How to specify — Select the Model Number from above.</p> <p>_____</p> <p>_____</p>	<p>1st Option: Glass (if applicable): LC Clear LF Frosted GSM1 Smoked</p> <p>L .</p>	<p>2nd Option: Paint (if applicable): P1 P2 See inside front cover for finishes.</p> <p>P </p>
--	---	--

Example:

S Shippable by small-package carrier.

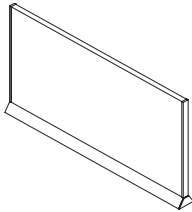
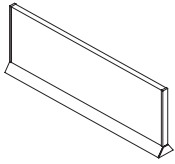

Description	Model	P1 List Price	P2 List Upcharge	P3 List Upcharge	Upholstery Upcharge				
					Grade A	Grade B	Grade C	Grade D	
8"H Lateral Divider Screen — ¾" Thick Tackable Fabric									
18"D	SPLA-SS-STR08HFDS1.M490833	\$ 681	\$ 23	\$ 44	\$ 0	\$ 8	\$ 16	\$ 29	
20"D	SPLA-SS-STR08HFDS1.M490834	\$ 696	\$ 23	\$ 44	\$ 0	\$ 8	\$ 16	\$ 29	
21"D	SPLA-SS-STR08HFDS1.M490835	\$ 709	\$ 23	\$ 44	\$ 0	\$ 8	\$ 16	\$ 29	
24"D	SPLA-SS-STR08HFDS2.M490836	\$ 725	\$ 29	\$ 57	\$ 0	\$ 11	\$ 22	\$ 39	
27"D	SPLA-SS-STR08HFDS2.M490837	\$ 741	\$ 29	\$ 57	\$ 0	\$ 11	\$ 22	\$ 39	
30"D	SPLA-SS-STR08HFDS3.M490838	\$ 763	\$ 33	\$ 66	\$ 0	\$ 13	\$ 26	\$ 52	
36"D	SPLA-SS-STR08HFDS3.M490839	\$ 845	\$ 33	\$ 66	\$ 0	\$ 13	\$ 26	\$ 52	
42"W	SPLA-SS-STR08HFDS4.M506668	\$ 862	\$ 33	\$ 66	\$ 0	\$ 13	\$ 26	\$ 52	
48"W	SPLA-SS-STR08HFDS4.M506670	\$ 879	\$ 33	\$ 66	\$ 0	\$ 13	\$ 26	\$ 52	
54"W	SPLA-SS-STR08HFDS4.M506672	\$ 896	\$ 33	\$ 66	\$ 0	\$ 13	\$ 26	\$ 52	
60"W	SPLA-SS-STR08HFDS4.M506673	\$ 913	\$ 33	\$ 66	\$ 0	\$ 13	\$ 26	\$ 52	
66"W	SPLA-SS-STR08HFDSRR.M506674	\$ 932	\$ 15	\$ 26	\$ 0	\$ 61	\$ 124	\$ 187	
72"W	SPLA-SS-STR08HFDSRR.M506774	\$ 950	\$ 15	\$ 26	\$ 0	\$ 61	\$ 124	\$ 187	

13"H Lateral Divider Screen — ¾" Thick Tackable Fabric									
18"D	SPLA-SS-STR13HFDS1.M490840	\$ 720	\$ 23	\$ 46	\$ 0	\$ 13	\$ 24	\$ 44	
20"D	SPLA-SS-STR13HFDS1.M490841	\$ 737	\$ 23	\$ 46	\$ 0	\$ 13	\$ 24	\$ 44	
21"D	SPLA-SS-STR13HFDS1.M490842	\$ 751	\$ 23	\$ 46	\$ 0	\$ 13	\$ 24	\$ 44	
24"D	SPLA-SS-STR13HFDS2.M490843	\$ 766	\$ 31	\$ 62	\$ 0	\$ 16	\$ 32	\$ 57	
27"D	SPLA-SS-STR13HFDS2.M490844	\$ 782	\$ 31	\$ 62	\$ 0	\$ 16	\$ 32	\$ 57	
30"D	SPLA-SS-STR13HFDS3.M490845	\$ 805	\$ 35	\$ 71	\$ 0	\$ 22	\$ 43	\$ 77	
36"D	SPLA-SS-STR13HFDS3.M490846	\$ 890	\$ 35	\$ 71	\$ 0	\$ 22	\$ 43	\$ 77	
42"W	SPLA-SS-STR13HFDS4.M506775	\$ 907	\$ 33	\$ 66	\$ 0	\$ 13	\$ 26	\$ 52	
48"W	SPLA-SS-STR13HFDS4.M506776	\$ 926	\$ 33	\$ 66	\$ 0	\$ 13	\$ 26	\$ 52	
54"W	SPLA-SS-STR13HFDS4.M506777	\$ 944	\$ 33	\$ 66	\$ 0	\$ 13	\$ 26	\$ 52	
60"W	SPLA-SS-STR13HFDS4.M506786	\$ 963	\$ 33	\$ 66	\$ 0	\$ 13	\$ 26	\$ 52	
66"W	SPLA-SS-STR13HFDSRR.M506778	\$ 981	\$ 15	\$ 26	\$ 0	\$ 61	\$ 124	\$ 187	
72"W	SPLA-SS-STR13HFDSRR.M506779	\$ 1002	\$ 15	\$ 26	\$ 0	\$ 61	\$ 124	\$ 187	

20"H Lateral Divider Screen — ¾" Thick Tackable Fabric									
18"D	SPLA-SS-STR20HFDS1.M490847	\$ 864	\$ 35	\$ 72	\$ 0	\$ 21	\$ 37	\$ 67	
20"D	SPLA-SS-STR20HFDS1.M490848	\$ 880	\$ 35	\$ 72	\$ 0	\$ 21	\$ 37	\$ 67	
21"D	SPLA-SS-STR20HFDS1.M490849	\$ 897	\$ 35	\$ 72	\$ 0	\$ 21	\$ 37	\$ 67	
24"D	SPLA-SS-STR20HFDS2.M490850	\$ 916	\$ 46	\$ 96	\$ 0	\$ 25	\$ 49	\$ 89	
27"D	SPLA-SS-STR20HFDS2.M490851	\$ 934	\$ 46	\$ 96	\$ 0	\$ 25	\$ 49	\$ 89	
30"D	SPLA-SS-STR20HFDS3.M490852	\$ 956	\$ 55	\$ 111	\$ 0	\$ 34	\$ 66	\$ 122	
36"D	SPLA-SS-STR20HFDS3.M490853	\$ 988	\$ 55	\$ 111	\$ 0	\$ 34	\$ 66	\$ 122	

Notes:

- Screen depths nominal sizes match actual sizes.*Not for use with Stride Benching. See page 15.
- 13H screens are 12.6"H (to match standard Stride Lateral Screens).
- 8H screen nominal height matches actual.
- 20H screen nominal height matches actual, intending to align with 50H panels. These will not align with Stride Benching 20H Beam Mounted Screens or 20H Elevated table mounted screens.
- Screens used on Systems applications must be placed 3" from a seam with a cantilever or center support bracket. If necessary the alternative attachment kit, VHB Tape and End Cap, may be used. Order separately.
- Screens used on Further applications can be placed anywhere, however support brackets may need to be repositioned.
- Bracket-less alternative attachment kit for Stride Lateral Divider Screens up to 36"W SPLA-STR-SPLSCRNGLAS.M505831.
- Bracket-less alternative attachment kit for Stride Lateral Divider Screens 42"W-72"W SPLA-STR-SPLSCRNGLAS.M506260.

<p>How to specify — Select the Model Number from above.</p> <div style="border: 1px solid black; height: 20px; width: 100%;"></div>	<p><i>1st Option:</i> Fabric (if applicable): See inside back cover for fabrics.</p>	<p><i>2nd Option:</i> Paint (if applicable): P1 P2 See inside front cover for finishes.</p>
<p><i>Example:</i></p> <div style="border: 1px solid black; padding: 5px;"> <div style="display: flex; justify-content: space-between; border-bottom: 1px solid black;"> 18"D SPLA-SS-STR08HFDS1.M490833 S </div> <div style="display: flex; justify-content: space-between; border-bottom: 1px solid black;"> 20"D SPLA-SS-STR08HFDS1.M490834 S </div> <div style="display: flex; justify-content: space-between; border-bottom: 1px solid black;"> 21"D SPLA-SS-STR08HFDS1.M490835 S </div> <div style="display: flex; justify-content: space-between; border-bottom: 1px solid black;"> 24"D SPLA-SS-STR08HFDS2.M490836 S </div> <div style="display: flex; justify-content: space-between; border-bottom: 1px solid black;"> 27"D SPLA-SS-STR08HFDS2.M490837 S </div> <div style="display: flex; justify-content: space-between; border-bottom: 1px solid black;"> 30"D SPLA-SS-STR08HFDS3.M490838 S </div> <div style="display: flex; justify-content: space-between; border-bottom: 1px solid black;"> 36"D SPLA-SS-STR08HFDS3.M490839 S </div> <div style="display: flex; justify-content: space-between; border-bottom: 1px solid black;"> 42"W SPLA-SS-STR08HFDS4.M506668 S </div> <div style="display: flex; justify-content: space-between; border-bottom: 1px solid black;"> 48"W SPLA-SS-STR08HFDS4.M506670 S </div> <div style="display: flex; justify-content: space-between; border-bottom: 1px solid black;"> 54"W SPLA-SS-STR08HFDS4.M506672 S </div> <div style="display: flex; justify-content: space-between; border-bottom: 1px solid black;"> 60"W SPLA-SS-STR08HFDS4.M506673 S </div> <div style="display: flex; justify-content: space-between; border-bottom: 1px solid black;"> 66"W SPLA-SS-STR08HFDSRR.M506674 S </div> <div style="display: flex; justify-content: space-between; border-bottom: 1px solid black;"> 72"W SPLA-SS-STR08HFDSRR.M506774 S </div> </div>	<p>P</p>	

S Shippable by small-package carrier.

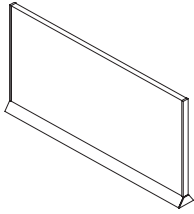

Description	Model	P1	P2	P3	Frosted Glass	Smoked Glass
		List Price	List Upcharge	List Upcharge	Upcharge	Upcharge
20"H Lateral Divider Screen — Glass						
27"D	SPLA-SS-STR20HGDS2.M518445	\$ 1076	\$ 53	\$ 106	\$ 82	\$ 214
30"D	SPLA-SS-STR20HGDS3.M518446	\$ 1098	\$ 59	\$ 117	\$ 106	\$ 235
36"D	SPLA-SS-STR20HGDS3.M518447	\$ 1153	\$ 59	\$ 117	\$ 106	\$ 235

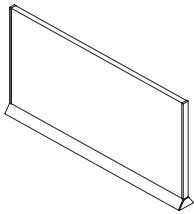

Description	Model	P1 List Price	P2 List Upcharge	P3 List Upcharge	Upholstery Upcharge			
					Grade A	Grade B	Grade C	Grade D
					20"H Lateral Divider Screen — Fabric			
27"D	SPLA-SS-STR20HFDS2.M518448	\$ 934	\$ 46	\$ 96	\$ 0	\$ 25	\$ 49	\$ 89
30"D	SPLA-SS-STR20HFDS3.M518449	\$ 956	\$ 55	\$ 111	\$ 0	\$ 34	\$ 66	\$ 122
36"D	SPLA-SS-STR20HFDS3.M518450	\$ 988	\$ 55	\$ 111	\$ 0	\$ 34	\$ 66	\$ 122

Notes:

- Screen depths nominal sizes match Stride Benching surface depth.
- Nominal depths are 27", 30", and 36".
- Actual depths are 22¾", 25¾", and 31¾".
- 20"H screen nominal height matches actual, intending to align with 50"H panels. These will not align with Stride Benching 20"H Beam Mounted Screens or 20"H Elevated table mounted screens.

<p>How to specify — Select the Model Number from above.</p> <div style="border: 1px solid black; height: 20px; width: 100%;"></div>	<p>1st Option: Fabric/Glass (if applicable): See inside back cover for fabrics.</p> <div style="border: 1px solid black; height: 20px; width: 100%;"></div>	<p>2nd Option: Paint (if applicable): P1 P2 See inside front cover for finishes.</p> <div style="border: 1px solid black; height: 20px; width: 100%;"></div>
--	---	--

Example:

S Shippable by small-package carrier.

Worksurfaces

Corner — Flat Edge

For specification information see applicable System's Price & Specification Guide.



Flat Edge

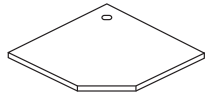
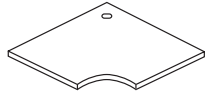
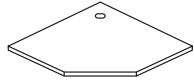

Description	Laminate w/Flat Edge Model	Old Model For Reference	Laminate w/Flat Edge		
			L1 List Price	L2 List Price	L3 List Price
24"D Corner Worksurfaces w/Radial Leading Edge					
36"W x 24"D	T53624CR	833624RM	\$ 790	\$ 820	\$ 843
42"W x 24"D	T54224CR	834224RM	\$ 842	\$ 873	\$ 899
48"W x 24"D	T54824CR	834824RM	\$ 958	\$ 993	\$ 1023
24"D Corner Worksurfaces w/Straight Leading Edge					
36"W	T53624SC		\$ 764	\$ 791	\$ 817
42"W	T54224SC		\$ 802	\$ 830	\$ 857
48"W	T54824SC		\$ 898	\$ 929	\$ 961
30"D Corner Worksurfaces w/Radial Leading Edge					
42"W x 30"D	T54230CR	834230RM	\$ 1018	\$ 1054	\$ 1086
48"W x 30"D	T54830CR	834830RM	\$ 1099	\$ 1137	\$ 1174
30"D Corner Worksurfaces w/Straight Leading Edge					
42"W	T54230SC		\$ 974	\$ 1008	\$ 1042
48"W	T54830SC		\$ 1005	\$ 1040	\$ 1075

Note: Add Suffix "N" to model number for no grommet, no upcharge.

Corner Worksurfaces with Radial Leading Edge

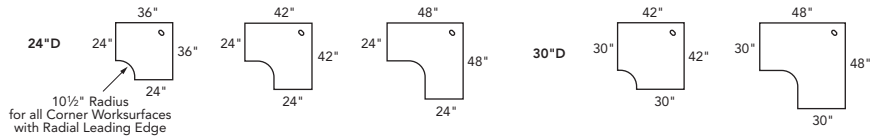

Corner Worksurfaces with Straight Leading Edge

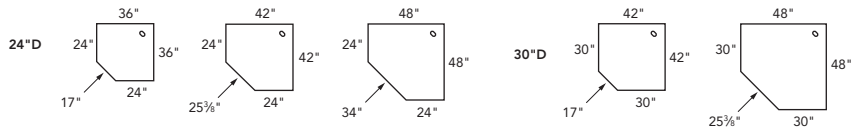

How to specify —
Select the Model Number from above.

1st Option: Laminate:
See inside front cover for finishes.

2nd Option: Paint (Corner Shelves only):
P1 P2
See inside front cover for finishes.

2nd Option: Edge Trim Color:
See inside front cover for finishes.

3rd Option: Grommet Type:
P Plastic
M Metal (add \$11 per grommet)
S Square Metal (Add \$11 per grommet)

4th Option: Grommet Color (Metal only):
EL Matte Silver
Note: Plastic grommet color matches trim selection.

_____ .

_____ .

P | | |

_____ .

|

E | L |

Examples: T53624CR.LT3B.EV.MEL T53624SCN.LT3B.EV

For specification information see Stride system specification book.

Description	Model	List Price P1	List Price P2
2-Way 90° Light Block Kit with Top Cap Transition Piece			
L-90 Light Block Kit with "L" Top Cap (for 30"H Panel)	Z330LLSS.M376721	\$ 93	\$ 108
"L" 90° Vertical Filler Trim			
30"H L-90 Degree Trim (for 30"H Panel)	Z330PLSS.M376714	\$ 142	\$ 168
5"H L-90 Degree Trim (for 30"H to 35"H Panel)	SPLA-STR-TRIM.M430113	\$ 98	\$ 113
12½"H L-90 Degree Trim (for 30"H to 42½"H Panel)	SPLA-STR-TRIM.M430114	\$ 105	\$ 120
20"H L-90 Degree Trim (for 30"H to 50"H Panel)	SPLA-STR-TRIM.M430115	\$ 112	\$ 127
27½"H L-90 Degree Trim (for 30"H to 57½"H Panel)	SPLA-STR-TRIM.M523058	\$ 121	\$ 136
"F" Flat Vertical Filler Trim			
5"H Filler Trim (for 30"H to 35"H Panel)	SPLA-STR-TRIM.M430107	\$ 77	\$ 92
12½"H Filler Trim (for 30"H to 42½"H Panel)	SPLA-STR-TRIM.M430108	\$ 84	\$ 99
20"H Filler Trim (for 30"H to 50"H Panel)	SPLA-STR-TRIM.M430109	\$ 94	\$ 109
27½"H Filler Trim (for 30"H to 57½"H Panel)	SPLA-STR-TRIM.M523060	\$ 105	\$ 120
30"H Filler Trim (for 30"H Panel)	Z330PFSS.M376713	\$ 122	\$ 148
"VH" Variable Height Vertical End Trim			
5"H "E" Variable Height Trim (for 30"H to 35"H Panel)	SPLA-STR-TRIM.M430110	\$ 77	\$ 92
12½"H "E" Variable Height Trim (for 30"H to 42½"H Panel)	SPLA-STR-TRIM.M430111	\$ 84	\$ 99
20"H "E" Variable Height Trim (for 30"H to 50"H Panel)	SPLA-STR-TRIM.M430112	\$ 94	\$ 109
27½"H "E" Variable Height Trim (for 30"H to 57½"H Panel)	SPLA-STR-TRIM.M523059	\$ 105	\$ 120
3-Way Light Block Kit with Top Cap Transition Piece			
3-Way Light Block Kit for "S" Top Cap (for 30"H Panel)	Z330TSSS.M376722	\$ 111	\$ 126
3-Way Light Block Kit for "L" Top Cap (for 30"H Panel)	Z330TLSS.M376719	\$ 120	\$ 135
3-Way Light Block Kit for "T" Top Cap (for 30"H Panel)	Z330TTSS.M376720	\$ 120	\$ 135
4-Way Light Block Kit with Top Cap Transition Piece			
4-Way Light Block Kit for "S" Top Cap (for 30"H Panel)	Z330XSSS.M376715	\$ 125	\$ 140
4-Way Light Block Kit for "L" Top Cap (for 30"H Panel)	Z330XLSS.M376716	\$ 125	\$ 140
4-Way Light Block Kit for "T" Top Cap (for 30"H Panel)	Z330XTSS.M376717	\$ 125	\$ 140
4-Way Light Block Kit for "X" Top Cap (for 30"H Panel)	Z330XXSS.M376718	\$ 125	\$ 140
Vertical End Trim			
30"H "E" End Trim for 30"H Raceway Panel	Z330PESS.M376712	\$ 122	\$ 148
30"H "EF" End Trim for 30"H Footed Panel	SPLA-STR-TRIM.M430106	\$ 109	\$ 124
Light Block Kits without Top Cap Transition Piece			
30"H 3-Way Light Block Kit w/o Top Cap	SPLA-STR-TRIM.M430116	\$ 78	\$ 93
30"H 4-Way Light Block Kit w/o Top Cap	SPLA-STR-TRIM.M430117	\$ 90	\$ 105
"W" Wall Mount Kit			
30"H Wall Mount (for 30"H Panel)	SPLA-STR-TRIM.M430118	\$ 179	\$ 194

How to specify —
 Select the Model Number from above.

1st Option:
Paint Color
 (if applicable):
 P1 P2
 See inside front cover for finishes.

Examples: Z330LLSS.M376721.P52 SPLA-STR-TRIM.M430110.P02

For specification information see *Stride system specification book*.

FINISHES

TABLE OF CONTENTS

WORKSURFACES

STRIDE

TERRACE

FURTHER

APPROACH

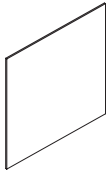

Description	Model	List Price				
		Grade A	Grade B	Grade C	Grade D	Grade E
25"H Tackable Acoustical Tiles (monolithic tiles for 30"H Stride frames) — specify fabric						
18"W	Z42518TSS.M376723	\$ 229	\$ 246	\$ 273	\$ 300	\$ 345
20"W	Z42520TSS.M376724	\$ 229	\$ 246	\$ 273	\$ 300	\$ 345
24"W	Z42524TSS.M376725	\$ 246	\$ 263	\$ 288	\$ 312	\$ 359
30"W	Z42530TSS.M376726	\$ 256	\$ 281	\$ 302	\$ 329	\$ 372
36"W	Z42536TSS.M376727	\$ 275	\$ 301	\$ 324	\$ 354	\$ 395
42"W	Z42542TSS.M376728	\$ 293	\$ 325	\$ 347	\$ 376	\$ 416
48"W	Z42548TSS.M376729	\$ 310	\$ 344	\$ 367	\$ 399	\$ 437
60"W	Z42560TSS.M376730	\$ 342	\$ 384	\$ 407	\$ 439	\$ 477

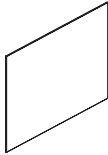

Description	Model	List Price	List Price	List Price
		P1	P2	P3
25"H Steel Tiles (monolithic tiles for 30"H Stride frames) — specify paint				
18"W	Z42518SSS.M376731	\$ 516	\$ 545	\$ 571
20"W	Z42520SSS.M376732	\$ 516	\$ 545	\$ 571
24"W	Z42524SSS.M376733	\$ 535	\$ 564	\$ 590
30"W	Z42530SSS.M376734	\$ 567	\$ 596	\$ 622
36"W	Z42536SSS.M376735	\$ 618	\$ 647	\$ 673
42"W	Z42542SSS.M376736	\$ 658	\$ 687	\$ 713
48"W	Z42548SSS.M376737	\$ 698	\$ 727	\$ 753
60"W	Z42560SSS.M376738	\$ 782	\$ 811	\$ 837

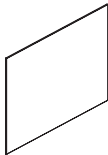

Description	Model	List Price	List Price	List Price
		L1	L2	L3
25"H Laminate Tiles (monolithic tiles for 30"H Stride frames) — specify laminate & edge				
18"W	SPLA-STR-LMTILE30.M430119	\$ 629	\$ 676	\$ 740
20"W	SPLA-STR-LMTILE30.M430120	\$ 629	\$ 676	\$ 740
24"W	SPLA-STR-LMTILE30.M430121	\$ 629	\$ 676	\$ 740
30"W	SPLA-STR-LMTILE30.M430122	\$ 677	\$ 724	\$ 788
36"W	SPLA-STR-LMTILE30.M430123	\$ 727	\$ 774	\$ 838
42"W	SPLA-STR-LMTILE30.M430124	\$ 791	\$ 838	\$ 902
48"W	SPLA-STR-LMTILE30.M430125	\$ 855	\$ 902	\$ 966
60"W	SPLA-STR-LMTILE30.M430126	\$ 977	\$ 1024	\$ 1088

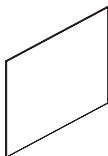

25"H Laminate Tiles to-the-Floor (monolithic tiles for 30"H Stride frames) — specify laminate & edge				
18"W	SPLA-STR-LMTILE30.M430127	\$ 876	\$ 923	\$ 987
20"W	SPLA-STR-LMTILE30.M430128	\$ 876	\$ 923	\$ 987
24"W	SPLA-STR-LMTILE30.M430129	\$ 876	\$ 923	\$ 987
30"W	SPLA-STR-LMTILE30.M430130	\$ 960	\$ 1007	\$ 1071
36"W	SPLA-STR-LMTILE30.M430131	\$ 1015	\$ 1062	\$ 1126
42"W	SPLA-STR-LMTILE30.M430132	\$ 1088	\$ 1135	\$ 1199
48"W	SPLA-STR-LMTILE30.M430133	\$ 1156	\$ 1203	\$ 1267
60"W	SPLA-STR-LMTILE30.M430134	\$ 1335	\$ 1382	\$ 1446

Note: For to-the-Floor models please order the to-the-Floor Bracket Kit Z4TFB separately.

<p>How to specify — Select the Model Number from above.</p>	<p><i>1st Option:</i> Fabric (if applicable): See <i>inside back cover</i> for fabrics.</p>	<p><i>2nd Option:</i> Paint Color (if applicable): P1 P2 See <i>inside front cover</i> for finishes.</p>	<p><i>3rd Option:</i> Laminate Color (if applicable): See <i>inside front cover</i> for finishes.</p>	<p><i>4th Option:</i> Edge Color (if applicable): See <i>inside front cover</i> for finishes.</p>
<p>_____ .</p>	<p>_____</p>	<p>_____</p>	<p>_____ .</p>	<p>_____</p>

Example: Z42518TSS.M376723.APN911

22 1/2"H Frameless Glass Specification Rules

Connector brackets are required to connect all glass screens together.

Every run of glass must have perpendicular support. Must use an L, T, or X connector brackets.

See page 22 for models.

Models are universal and are to be used for Stride, Terrace and Optimize.

Brackets connect to top corners of the glass.

Inline

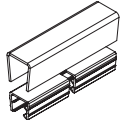
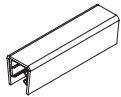

“S” Ext. Straight

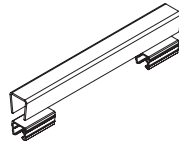
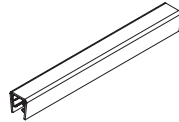

“T”

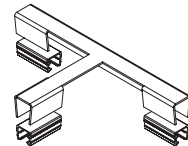
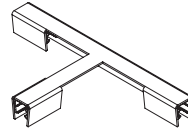

“L”

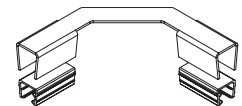
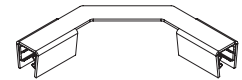

120° — 2 Way

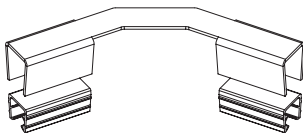
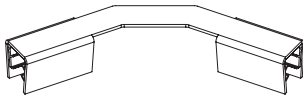

120° — 3 Way

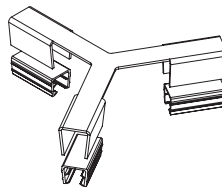
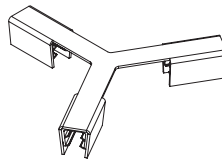

“X”

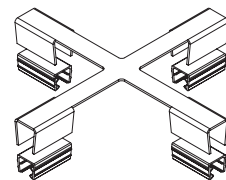
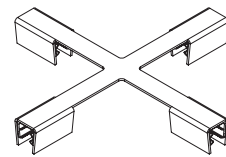

For specification information please see page 21.

Model	P1 List Price	P2 Upcharge	P3 Upcharge
Panel Mounted Frameless Glass Screen Alignment Bracket for an In-Line application SPLA-ACC-BRACKET.M508476	\$ 81	\$ 15	\$ 26
Panel Mounted Frameless Glass Screen Alignment Bracket for an "L" application SPLA-ACC-BRACKET.M508479	\$ 81	\$ 15	\$ 26
Panel Mounted Frameless Glass Screen Alignment Bracket for a "T" application SPLA-ACC-BRACKET.M508480	\$ 81	\$ 15	\$ 26
Panel Mounted Frameless Glass Screen Alignment Bracket for a 120° — 2 Way application SPLA-ACC-BRACKET.M508481	\$ 81	\$ 15	\$ 26
Panel Mounted Frameless Glass Screen Alignment Bracket for a 120° — 3 Way application SPLA-ACC-BRACKET.M508482	\$ 81	\$ 15	\$ 26
Panel Mounted Frameless Glass Screen Alignment Bracket for an "X" application SPLA-ACC-BRACKET.M508484	\$ 81	\$ 15	\$ 26
Panel Mounted Frameless Glass Screen Alignment Bracket for an "S" application SPLA-ACC-BRACKET.M508485	\$ 81	\$ 15	\$ 26

How to specify —
Select the Model Number from above.



Example:

1st Option:

Paint
(if applicable):

P1 P2

See inside front cover for finishes.



For specification information please see page 21.



Description	Model	P1 List Price	P2 List Upcharge	Frosted Glass Upcharge	Smoked Glass Upcharge
22½"H Frameless Glass with Top Cap					
24"W	SPLA-STR-SCRNGLSSS.M511266	\$ 716	\$ 15	\$ 65	\$ 99
30"W	SPLA-STR-SCRNGLSSS.M511267	\$ 773	\$ 15	\$ 65	\$ 99
36"W	SPLA-STR-SCRNGLSSS.M511268	\$ 889	\$ 15	\$ 65	\$ 99
42"W	SPLA-STR-SCRNGLSSM.M511269	\$ 950	\$ 15	\$ 102	\$ 154
48"W	SPLA-STR-SCRNGLSSM.M511270	\$ 1028	\$ 15	\$ 102	\$ 154
54"W	SPLA-STR-SCRNGLSSM.M511271	\$ 1137	\$ 15	\$ 102	\$ 154
60"W	SPLA-STR-SCRNGLSSM.M511272	\$ 1251	\$ 15	\$ 102	\$ 154
66"W	SPLA-STR-SCRNGLSSM.M511273	\$ 1373	\$ 15	\$ 102	\$ 154
72"W	SPLA-STR-SCRNGLSSL.M511274	\$ 1496	\$ 15	\$ 153	\$ 180
78"W	SPLA-STR-SCRNGLSSL.M511275	\$ 1691	\$ 15	\$ 153	\$ 180
84"W	SPLA-STR-SCRNGLSSL.M511276	\$ 1888	\$ 15	\$ 153	\$ 180
90"W	SPLA-STR-SCRNGLSSL.M511278	\$ 1949	\$ 15	\$ 153	\$ 180
96"W	SPLA-STR-SCRNGLSSL.M511279	\$ 2014	\$ 15	\$ 153	\$ 180

Note: Due to increased height of the glass, there will be noticeable side-to-side movement on the screen.
Please contact TPG prior to placing your order to review your layout if you have questions.
Alignment brackets are required. See page 22.

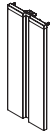

22½"H Grooved End Trim for ⅜" Glass Panel Mounted Screens		P1	P2
SPLA-STR-TRIM.M507357		\$ 124	\$ 15

<p>How to specify — Select the Model Number from above.</p> <p>_____ . _____ .</p>	<p>1st Option: Glass (if applicable): LC Clear LF Frosted GSM1 Smoked</p> <p>_____ .</p>	<p>2nd Option: Paint (if applicable): P1 P2 See inside front cover for finishes.</p> <p>P _____</p>
---	--	---

Example: SPLA-SS-STR08HGDS1.M490854.LC.P02

Shippable by small-package carrier.

Stride COM Insert Spec

Custom material used in grooved top cap trim should be sized according to these dimensions:

Standard Height	Actual Dimensions	Standard Width	Actual Dimensions
7½"H	8.460"H	24"W	23.866"W
15"H	15.960"H	30"W	29.866"W
22½"H	23.460"H	36"W	35.866"W
		42"W	41.866"W
		48"W	47.866"W
		54"W	53.866"W
		60"W	59.866"W
		66"W	65.866"W
		72"W	71.866"W
		78"W	77.866"W
		84"W	83.866"W
		90"W	89.866"W
		96"W	95.866"W

Height tolerance should be +0.000" / -0.188"

Width tolerance should be +/- 0.094"

Thickness of custom material must be 10MM thick -0.120MM / +0.890MM

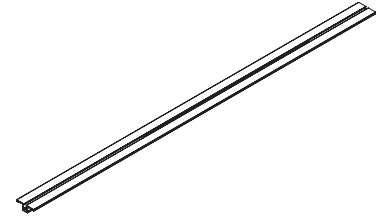

For COM material heights taller than 15"H.

Connector brackets are required to connect all screens together.

Every run of glass must have perpendicular support. Must use an L, T, or X connector brackets.

See page [22](#) for models

For specification information please see page 24.



Description	Model	P1	P2	P3
		List Price	Upcharge	Upcharge
Grooved Top Cap for Frameless COM Insert				
24"W	SPLA-STR-TRIM.M508411	\$ 275	\$ 15	\$ 26
30"W	SPLA-STR-TRIM.M508412	\$ 288	\$ 15	\$ 26
36"W	SPLA-STR-TRIM.M508413	\$ 299	\$ 15	\$ 26
42"W	SPLA-STR-TRIM.M508414	\$ 314	\$ 15	\$ 26
48"W	SPLA-STR-TRIM.M508416	\$ 318	\$ 15	\$ 26
54"W	SPLA-STR-TRIM.M508417	\$ 320	\$ 15	\$ 26
60"W	SPLA-STR-TRIM.M508418	\$ 337	\$ 15	\$ 26
66"W	SPLA-STR-TRIM.M508419	\$ 357	\$ 15	\$ 26
72"W	SPLA-STR-TRIM.M508420	\$ 382	\$ 15	\$ 26
78"W	SPLA-STR-TRIM.M508421	\$ 408	\$ 15	\$ 26
84"W	SPLA-STR-TRIM.M508422	\$ 451	\$ 15	\$ 26
90"W	SPLA-STR-TRIM.M508423	\$ 482	\$ 15	\$ 26
96"W	SPLA-STR-TRIM.M508424	\$ 534	\$ 15	\$ 26

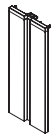

22½"H Grooved End Trim for Variable Height				
	SPLA-STR-TRIM.M507357	\$ 124	\$ 15	\$ 26

How to specify —
Select the Model Number from above.

Example:

1st Option:
Paint
(if applicable):

P1 P2

See inside front cover for finishes.

P

For specification information please see page 24.

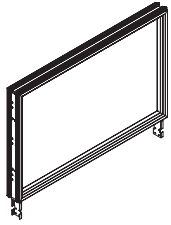

Description	Model	P1 List Price	P2 List Upcharge	P3 List Upcharge	Frosted Glass Upcharge
22½"H Low Profile Glass Stacker					
24"W	SPLA-SS-STR022GDS1.M506787	\$ 932	\$ 71	\$ 139	\$ 94
30"W	SPLA-SS-STR022GDS1.M506788	\$ 1015	\$ 71	\$ 139	\$ 94
36"W	SPLA-SS-STR022GDS1.M506789	\$ 1108	\$ 71	\$ 139	\$ 94
42"W	SPLA-SS-STR022GDS2.M506790	\$ 1207	\$ 71	\$ 139	\$ 172
48"W	SPLA-SS-STR022GDS2.M506791	\$ 1318	\$ 71	\$ 139	\$ 172

22½ "H x 60"W Low Profile Glass Stacker For 30+30 or 24+36 Frames

60"W	SPLA-SS-STR022GDS2.M506792	\$ 1463	\$ 71	\$ 139	\$ 172
------	----------------------------	---------	-------	--------	--------

22½ "H x 72"W Low Profile Glass Stacker For 36+36 or 24+48 Frames

72"W	SPLA-SS-STR022GDS3.M506793	\$ 1625	\$ 71	\$ 139	\$ 265
------	----------------------------	---------	-------	--------	--------

22½ "H x 84"W Low Profile Glass Stacker For 36+48 Frames

84"W	SPLA-SS-STR022GDS3.M506794	\$ 1803	\$ 71	\$ 139	\$ 265
------	----------------------------	---------	-------	--------	--------

22½ "H x 90"W Low Profile Glass Stacker For 42+48 or 30+30+30 Frames

90"W	SPLA-SS-STR022GDS3.M506795	\$ 2003	\$ 71	\$ 139	\$ 265
------	----------------------------	---------	-------	--------	--------

22½ "H x 96"W Low Profile Glass Stacker For 48+48 or 30+30+36 Frames

96"W	SPLA-SS-STR022GDS3.M506796	\$ 2224	\$ 71	\$ 139	\$ 265
------	----------------------------	---------	-------	--------	--------

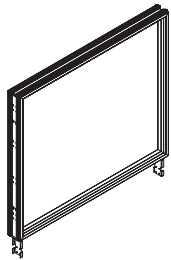

30 "H Low Profile Glass Stacker

24"W	SPLA-SS-STR030GDS1.M506797	\$ 987	\$ 71	\$ 139	\$ 162
30"W	SPLA-SS-STR030GDS1.M506798	\$ 1077	\$ 71	\$ 139	\$ 162
36"W	SPLA-SS-STR030GDS1.M506799	\$ 1173	\$ 71	\$ 139	\$ 162
42"W	SPLA-SS-STR030GDS2.M506800	\$ 1278	\$ 71	\$ 139	\$ 227
48"W	SPLA-SS-STR030GDS2.M506801	\$ 1395	\$ 71	\$ 139	\$ 227

30 "H x 60"W Low Profile Glass Stacker For 30+30 or 24+36 Frames

60"W	SPLA-SS-STR030GDS2.M506802	\$ 1547	\$ 71	\$ 139	\$ 227
------	----------------------------	---------	-------	--------	--------

30 "H x 72"W Low Profile Glass Stacker For 36+36 or 24+48 Frames

72"W	SPLA-SS-STR030GDS3.M506803	\$ 1717	\$ 71	\$ 139	\$ 354
------	----------------------------	---------	-------	--------	--------

30 "H x 84"W Low Profile Glass Stacker For 36+48 Frames

84"W	SPLA-SS-STR030GDS3.M506804	\$ 1906	\$ 71	\$ 139	\$ 354
------	----------------------------	---------	-------	--------	--------

30 "H x 90"W Low Profile Glass Stacker For 42+48 or 30+30+30 Frames

90"W	SPLA-SS-STR030GDS3.M506805	\$ 2118	\$ 71	\$ 139	\$ 354
------	----------------------------	---------	-------	--------	--------

30 "H x 96"W Low Profile Glass Stacker For 48+48 or 30+30+36 Frames

96"W	SPLA-SS-STR030GDS3.M506806	\$ 2350	\$ 71	\$ 139	\$ 354
------	----------------------------	---------	-------	--------	--------

How to specify —
Select the Model Number from above.

1st Option:
Glass
(if applicable):
LC Clear
LF Frosted

2nd Option:
Paint
(if applicable):
P1 P2
See inside front cover for finishes.

_____ .

_____ .

Example:

_____ .

P _____

For specification information see current Stride Price & Specification Guide.

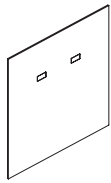

Description	Model	List Price				
		Grade A	Grade B	Grade C	Grade D	Grade E
37 1/2" H Tackable Acoustical Port Tiles (Monolithic tile for 42 1/2" H frame)						
18" W	SPLA-SS-STRETILE38HS.M425572	\$ 391	\$ 415	\$ 438	\$ 477	\$ 518
20" W	SPLA-SS-STRETILE38HS.M425573	\$ 391	\$ 415	\$ 438	\$ 477	\$ 518
24" W	SPLA-SS-STRETILE38HS.M425574	\$ 391	\$ 415	\$ 438	\$ 477	\$ 518
30" W	SPLA-SS-STRETILE38HM.M425575	\$ 412	\$ 447	\$ 484	\$ 544	\$ 605
36" W	SPLA-SS-STRETILE38HM.M425576	\$ 432	\$ 467	\$ 504	\$ 564	\$ 625
42" W	SPLA-SS-STRETILE38HM.M425577	\$ 459	\$ 494	\$ 531	\$ 591	\$ 652
48" W	SPLA-SS-STRETILE38HL.M425578	\$ 482	\$ 541	\$ 602	\$ 702	\$ 803
60" W	SPLA-SS-STRETILE38HL.M425579	\$ 529	\$ 588	\$ 649	\$ 749	\$ 850

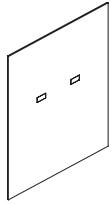

45" H Tackable Acoustical Port Tiles (Monolithic tile for 50" H frame)						
18" W	SPLA-SS-STRETILE45HS.M425580	\$ 422	\$ 451	\$ 478	\$ 527	\$ 575
20" W	SPLA-SS-STRETILE45HS.M425581	\$ 422	\$ 451	\$ 478	\$ 527	\$ 575
24" W	SPLA-SS-STRETILE45HS.M425582	\$ 422	\$ 451	\$ 478	\$ 527	\$ 575
30" W	SPLA-SS-STRETILE45HM.M425583	\$ 450	\$ 493	\$ 535	\$ 609	\$ 680
36" W	SPLA-SS-STRETILE45HM.M425584	\$ 472	\$ 515	\$ 557	\$ 631	\$ 702
42" W	SPLA-SS-STRETILE45HM.M425585	\$ 499	\$ 542	\$ 584	\$ 658	\$ 729
48" W	SPLA-SS-STRETILE45HL.M425586	\$ 534	\$ 606	\$ 677	\$ 799	\$ 919
60" W	SPLA-SS-STRETILE45HL.M425587	\$ 578	\$ 650	\$ 721	\$ 843	\$ 963

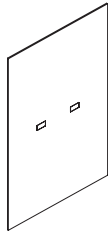

52 1/2" H Tackable Acoustical Port Tiles (Monolithic tile for 57 1/2" H frame)						
18" W	SPLA-SS-STRETILE53HS.M425588	\$ 461	\$ 494	\$ 527	\$ 584	\$ 640
20" W	SPLA-SS-STRETILE53HS.M425589	\$ 461	\$ 494	\$ 527	\$ 584	\$ 640
24" W	SPLA-SS-STRETILE53HS.M425590	\$ 461	\$ 494	\$ 527	\$ 584	\$ 640
30" W	SPLA-SS-STRETILE53HM.M425591	\$ 486	\$ 537	\$ 587	\$ 671	\$ 756
36" W	SPLA-SS-STRETILE53HM.M425592	\$ 518	\$ 569	\$ 619	\$ 703	\$ 788
42" W	SPLA-SS-STRETILE53HM.M425593	\$ 547	\$ 598	\$ 648	\$ 732	\$ 817
48" W	SPLA-SS-STRETILE53HL.M425594	\$ 578	\$ 661	\$ 745	\$ 887	\$ 1028
60" W	SPLA-SS-STRETILE53HL.M425595	\$ 636	\$ 719	\$ 803	\$ 945	\$ 1086

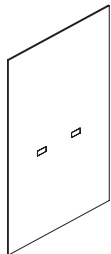

60" H Tackable Acoustical Port Tiles (Monolithic tile for 65" H frame)						
18" W	SPLA-SS-STRETILE60HS.M425596	\$ 494	\$ 531	\$ 569	\$ 634	\$ 698
20" W	SPLA-SS-STRETILE60HS.M425597	\$ 494	\$ 531	\$ 569	\$ 634	\$ 698
24" W	SPLA-SS-STRETILE60HS.M425598	\$ 494	\$ 531	\$ 569	\$ 634	\$ 698
30" W	SPLA-SS-STRETILE60HM.M425599	\$ 529	\$ 585	\$ 644	\$ 741	\$ 836
36" W	SPLA-SS-STRETILE60HM.M425600	\$ 599	\$ 655	\$ 714	\$ 811	\$ 906
42" W	SPLA-SS-STRETILE60HM.M425601	\$ 629	\$ 685	\$ 744	\$ 841	\$ 936
48" W	SPLA-SS-STRETILE60HL.M425602	\$ 653	\$ 747	\$ 845	\$ 1005	\$ 1166
60" W	SPLA-SS-STRETILE60HL.M425603	\$ 689	\$ 783	\$ 881	\$ 1041	\$ 1202

Note: Electrical mounts with 8988EBZ (ordered separately) mounted to underside of beltline horizontal (segment bar not required).

























Note: Should not be used with low storage as port access will be blocked.

<p>How to specify — Select the Model Number from above.</p>	<p>1st Option: Fabric: See inside back cover for fabrics.</p>	<p>2nd Option: Electrical Grommet Color: See inside front cover for finishes.</p>
<p>S P L A - S S - S T R E T I L E</p> <p>_____ .</p>	<p>_____ .</p>	<p>_____ .</p>

Example: SPLA-SS-STRETILE38HS.M425572.APN927.E4

Shippable by small-package carrier.

For specification information see *Stride Price & Specification Guide*.

Description	Model	P1 Paint List Price	P2 Paint Upcharge	P3 Paint Upcharge
7"H Steel Tiles				
24"W	SPLA-SS-STRSTILE7HSM.M516892 	\$ 153	\$ 24	\$ 44
30"W	SPLA-SS-STRSTILE7HSM.M516891 	\$ 158	\$ 24	\$ 44
36"W	SPLA-SS-STRSTILE7HSM.M516890 	\$ 171	\$ 24	\$ 44
42"W	SPLA-SS-STRSTILE7HLG.M516889 	\$ 189	\$ 24	\$ 44
48"W	SPLA-SS-STRSTILE7HLG.M516888 	\$ 201	\$ 24	\$ 44
60"W	SPLA-SS-STRSTILE7HLG.M516887 	\$ 227	\$ 24	\$ 44
15"H Steel Tiles				
24"W	SPLA-SS-STRSTILE15HS.M516886 	\$ 177	\$ 24	\$ 44
30"W	SPLA-SS-STRSTILE15HS.M516885 	\$ 188	\$ 24	\$ 44
36"W	SPLA-SS-STRSTILE15HS.M516884 	\$ 206	\$ 24	\$ 44
42"W	SPLA-SS-STRSTILE15HL.M516883 	\$ 222	\$ 24	\$ 44
48"W	SPLA-SS-STRSTILE15HL.M516882 	\$ 245	\$ 24	\$ 44
60"W	SPLA-SS-STRSTILE15HL.M516881 	\$ 274	\$ 24	\$ 44
22½"H Steel Tiles				
24"W	SPLA-SS-STRSTILE22HS.M516880 	\$ 262	\$ 24	\$ 44
30"W	SPLA-SS-STRSTILE22HS.M516879 	\$ 284	\$ 24	\$ 44
36"W	SPLA-SS-STRSTILE22HS.M516878 	\$ 305	\$ 24	\$ 44
42"W	SPLA-SS-STRSTILE22HL.M516877 	\$ 331	\$ 24	\$ 44
48"W	SPLA-SS-STRSTILE22HL.M516876 	\$ 354	\$ 24	\$ 44
60"W	SPLA-SS-STRSTILE22HL.M516875 	\$ 413	\$ 24	\$ 44
30"H Steel Tiles				
24"W	SPLA-SS-STRSTILE30HS.M516874 	\$ 315	\$ 24	\$ 44
30"W	SPLA-SS-STRSTILE30HS.M516873 	\$ 341	\$ 24	\$ 44
36"W	SPLA-SS-STRSTILE30HS.M516872 	\$ 369	\$ 24	\$ 44
42"W	SPLA-SS-STRSTILE30HL.M516871 	\$ 401	\$ 24	\$ 44
48"W	SPLA-SS-STRSTILE30HL.M516870 	\$ 430	\$ 24	\$ 44
60"W	SPLA-SS-STRSTILE30HL.M516869 	\$ 494	\$ 24	\$ 44



Note: Order special UTP KIT separately below.

Note: 24"W tiles require 1 UTP kit.

30"W - 60"W tiles require 2 UTP kits.

Description	Model	List Price
Data/Electrical Port Kit (specify color)		
Tile Port Kit for Steel Tiles	SPLA-UTP.M456004 	\$ 37

How to specify —
Select the Model Number from above.

1st Option:
Paint Color:
 
See inside front cover for finishes.

_____ . **P** _____

Example: SPLA-SS-STRSTILE7HSM.M455956.P4J

 Shippable by small-package carrier.

For specification information see *Stride Price & Specification Guide*.

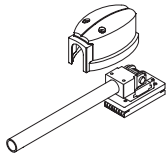

Description	Four-circuit 3 + 1 2 + 2		Three-circuit Separate Neutrals	
		List Price		List Price
Base Electrical In-feed Cable (Black only)				
12' Sealtight	SPLA-TP-ELEC-BYR.M489306	\$ 495	SPLA-TP-ELEC-BYR.M489309	\$ 715
18' Sealtight	SPLA-TP-ELEC-BYR.M489307	\$ 943	SPLA-TP-ELEC-BYR.M489310	\$ 970
24' Sealtight	SPLA-TP-ELEC-BYR.M489308	\$ 1259	SPLA-TP-ELEC-BYR.M489311	\$ 1292



Ceiling Electrical In-Feed Cables				
6' Flex Cable	SPLA-TP-ELEC-BYR.M489324	\$ 451	N/A	
24' Flex Cable	SPLA-TP-ELEC-BYR.M489325	\$ 686	N/A	

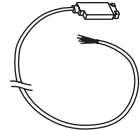

Electrical Base In-Feed Cable				
6' Sealtight Cable Power In-Feed	SPLA-TP-ELEC-BYR.M489326	\$ 547	N/A	
18' Sealtight Cable Power In-Feed	SPLA-TP-ELEC-BYR.M489327	\$ 754	N/A	
24' Sealtight Cable Power In-Feed	SPLA-TP-ELEC-BYR.M489328	\$ 941	N/A	

How to specify —
Select the
Model Number
from above.

Example: SPLA-TP-ELEC-BYR.M489306

Shippable by small-package carrier.

Standard Specials – 12/2022

For specification information see Terrace system specification book.

Description	Model	List Price	List Price
		P1	P2
Terrace Blade Feet and Glide Cover Kits — specify paint color			
End Blade Foot* — Dual Sided	SPLA-ACC-SUPPORT.M375836	\$ 618	\$ 633
Mid Blade Foot* — Dual-Sided	SPLA-ACC-SUPPORT.M375837	\$ 618	\$ 633
Glide Tower Cover Kit for Blade Foot** — Single	SPLA-ACC-SUPPORT.M375840	\$ 69	\$ 84
Glide Tower Cover Kit for Blade Feet** — Pair	SPLA-ACC-SUPPORT.M375841	\$ 140	\$ 155

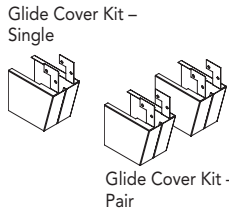
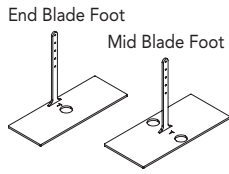

***Blade Feet**

- Blade Feet to be used with Raceway panels only – not compatible with Footed panels
- Glide tower cover kit includes parts to hide glide tower and give “footed” appearance. Will not exactly match standard footed aesthetic.
- Terrace panels must be ordered separately
- Blade feet are intended to be used to create free-standing panel runs
- Panels supported by Blade feet cannot contain hanging elements (shelves; overheads; shared storage)
- Panels supported by Blade feet cannot support worksurfaces
- Maximum height panels: Panels supported by blade bases can be no taller than 50”H (including stackers).
- Minimum quantity of supports: A blade base is required AT LEAST every 96” (8 feet), or every other panel connection, whichever condition happens first. A blade foot must be used at the ends of the panel run.
- Maximum length of run: A freestanding panel run supported by blade bases cannot be longer than 192” (16 feet).
- Note on Leveling: The special bases are designed to screw directly to the panel frame verticals. Therefore, there is no height adjustability once installed.
- Contact TPG to review layouts for potential exceptions or applications outside of free-standing panel runs

****Glide Tower**

- Includes parts to hide glide tower(s) and give “footed” appearance. Will not exactly match standard footed aesthetic.

Terrace Power Pole Accessories — specify paint color

Power Pole Splice Kit — use with 2 Standard			
Power Poles (order Terrace Power Poles separately)	SPLA-DNA-TRIM.M375864	\$ 300	\$ 315



Description	Model	List Price	List Price	List Price
		P1	P2	P3
22½”H Steel Base Tiles to-the-Floor — specify paint color				
24”W	TKG42224FSF	\$ 427	\$ 453	\$ 477
30”W	TKG42230FSF	\$ 462	\$ 488	\$ 512
36”W	TKG42236FSF	\$ 496	\$ 522	\$ 546
42”W	TKG42242FSF	\$ 529	\$ 555	\$ 579
48”W	TKG42248FSF	\$ 569	\$ 595	\$ 619
60”W	TKG42260FSF	\$ 645	\$ 671	\$ 695

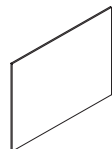

30”H Steel Base Tiles to-the-Floor — specify paint color

24”W	TKG43024FSF	\$ 573	\$ 599	\$ 623
30”W	TKG43030FSF	\$ 624	\$ 650	\$ 674
36”W	TKG43036FSF	\$ 665	\$ 691	\$ 715
42”W	TKG43042FSF	\$ 711	\$ 737	\$ 761
48”W	TKG43048FSF	\$ 756	\$ 782	\$ 806
60”W	TKG43060FSF	\$ 875	\$ 901	\$ 925

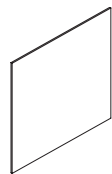

How to specify —

Select the Model Number from above.

1st Option:

Select the Paint Color:



See inside front cover for paints.

_____ . P _____

Examples: SPLA-ACC-SUPPORT.M375836.P7C TKG42224FSF.PR5

For specification information please see page 21.



Description	Model	P1 List Price	P2 List Upcharge	Frosted Glass Upcharge	Smoked Glass Upcharge
22½"H Frameless Glass with Flat Top Cap					
24"W	SPLA-DNA-SCRNGLSSFA.M511280	\$ 698	\$ 35	\$ 65	\$ 99
30"W	SPLA-DNA-SCRNGLSSFA.M511281	\$ 747	\$ 35	\$ 65	\$ 99
36"W	SPLA-DNA-SCRNGLSSFA.M511282	\$ 863	\$ 35	\$ 65	\$ 99
42"W	SPLA-DNA-SCRNGLSSFB.M511283	\$ 921	\$ 42	\$ 102	\$ 154
48"W	SPLA-DNA-SCRNGLSSFB.M511284	\$ 986	\$ 42	\$ 102	\$ 154
54"W	SPLA-DNA-SCRNGLSSFC.M511285	\$ 1092	\$ 42	\$ 153	\$ 231
60"W	SPLA-DNA-SCRNGLSSFC.M511286	\$ 1204	\$ 42	\$ 153	\$ 231
66"W	SPLA-DNA-SCRNGLSSFC.M511287	\$ 1316	\$ 42	\$ 153	\$ 231
72"W	SPLA-DNA-SCRNGLSSFC.M511288	\$ 1433	\$ 42	\$ 153	\$ 231
78"W	SPLA-DNA-SCRNGLSSFC.M511289	\$ 1614	\$ 42	\$ 153	\$ 231
84"W	SPLA-DNA-SCRNGLSSFC.M511290	\$ 1824	\$ 42	\$ 153	\$ 231
90"W	SPLA-DNA-SCRNGLSSFC.M511291	\$ 1872	\$ 42	\$ 153	\$ 231
96"W	SPLA-DNA-SCRNGLSSFC.M511292	\$ 1930	\$ 42	\$ 153	\$ 231



22½"H Grooved High/Low Flat Connector Kit					
	SPLA-DNA-TRIM.M507358	\$ 115	\$ 15		

22½"H Frameless Glass with Radius Top Cap					
24"W	SPLA-DNA-SCRNGLSSRA.M511293	\$ 698	\$ 35	\$ 65	\$ 99
30"W	SPLA-DNA-SCRNGLSSRA.M511294	\$ 747	\$ 35	\$ 65	\$ 99
36"W	SPLA-DNA-SCRNGLSSRA.M511295	\$ 863	\$ 35	\$ 65	\$ 99
42"W	SPLA-DNA-SCRNGLSSRB.M511296	\$ 921	\$ 42	\$ 102	\$ 154
48"W	SPLA-DNA-SCRNGLSSRB.M511297	\$ 986	\$ 42	\$ 102	\$ 154
54"W	SPLA-DNA-SCRNGLSSRC.M511298	\$ 1092	\$ 42	\$ 153	\$ 231
60"W	SPLA-DNA-SCRNGLSSRC.M511299	\$ 1204	\$ 42	\$ 153	\$ 231
66"W	SPLA-DNA-SCRNGLSSRC.M511300	\$ 1316	\$ 42	\$ 153	\$ 231
72"W	SPLA-DNA-SCRNGLSSRC.M511301	\$ 1433	\$ 42	\$ 153	\$ 231
78"W	SPLA-DNA-SCRNGLSSRC.M511302	\$ 1614	\$ 42	\$ 153	\$ 231
84"W	SPLA-DNA-SCRNGLSSRC.M511303	\$ 1824	\$ 42	\$ 153	\$ 231
90"W	SPLA-DNA-SCRNGLSSRC.M511304	\$ 1872	\$ 42	\$ 153	\$ 231
96"W	SPLA-DNA-SCRNGLSSRC.M511305	\$ 1930	\$ 42	\$ 153	\$ 231



22½"H Grooved Painted High/Low Radius Connector Kit					
	SPLA-DNA-TRIM.M507359	\$ 115	\$ 15		

Note: Due to increased height of the glass, there will be noticeable side-to-side movement on the screen.
Please contact TPG prior to placing your order to review your layout if you have questions.
Alignment brackets are required. See page 22.

<p>How to specify — Select the Model Number from above.</p>	<p>1st Option: Glass (if applicable): LC Clear LF Frosted GSM1 Smoked</p>	<p>2nd Option: Paint (if applicable): P1 P2 See inside front cover for finishes.</p>
<p>Example: _____ .</p>	<p>_____ .</p>	<p>P _____</p>

[5] Shippable by small-package carrier.

Terrace Flat Trim COM Insert Spec

Custom material used in grooved top cap trim should be sized according to these dimensions:

Standard Height	Actual Dimensions	Standard Width	Actual Dimensions
7½"H	8.460"H	24"W	23.866"W
15"H	15.960"H	30"W	29.866"W
22½"H	23.460"H	36"W	35.866"W
		42"W	41.866"W
		48"W	47.866"W
Height tolerance should be +0.000" / -0.188"		54"W	53.866"W
		60"W	59.866"W
Width tolerance should be +/- 0.094"		66"W	65.866"W
		72"W	71.866"W
Thickness of custom material must be 10MM thick -0.120MM / +0.890MM		78"W	77.866"W
		84"W	83.866"W
		90"W	89.866"W
		96"W	95.866"W

For COM material heights taller than 15"H.

Connector brackets are required to connect all screens together.

Every run of glass must have perpendicular support. Must use an L, T, or X connector brackets.

See page 22 for models

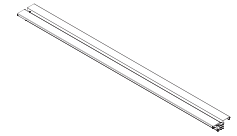

Terrace Radius Trim COM Insert Spec

Custom material used in grooved top cap trim should be sized according to these dimensions:

Standard Height	Actual Dimensions	Standard Width	Actual Dimensions
7½"H	8.460"H	24"W	23.866"W
15"H	15.960"H	30"W	29.866"W
22½"H	23.460"H	36"W	35.866"W
		42"W	41.866"W
		48"W	47.866"W
Height tolerance should be +0.000" / -0.188"		54"W	53.866"W
		60"W	59.866"W
Width tolerance should be +/- 0.094"		66"W	65.866"W
		72"W	71.866"W
Thickness of custom material must be 10MM thick -0.120MM / +0.890MM		78"W	77.866"W
		84"W	83.866"W
		90"W	89.866"W
		96"W	95.866"W

For COM material heights taller than 15"H.

Connector brackets are required to connect all screens together.

Every run of glass must have perpendicular support. Must use an L, T, or X connector brackets.

See page 22 for models

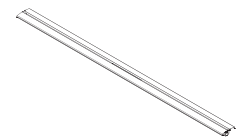

For specification information please see page 35.

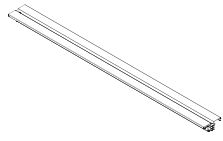

Description	Model	P1 List Price	P2 Upcharge
Grooved Flat Trim For Frameless COM Insert			
24"W	SPLA-DNA-TRIM.M508426	\$ 274	\$ 15
30"W	SPLA-DNA-TRIM.M508427	\$ 279	\$ 15
36"W	SPLA-DNA-TRIM.M508428	\$ 292	\$ 15
42"W	SPLA-DNA-TRIM.M508429	\$ 299	\$ 15
48"W	SPLA-DNA-TRIM.M508431	\$ 304	\$ 15
54"W	SPLA-DNA-TRIM.M508432	\$ 317	\$ 15
60"W	SPLA-DNA-TRIM.M508433	\$ 331	\$ 15
66"W	SPLA-DNA-TRIM.M508434	\$ 356	\$ 15
72"W	SPLA-DNA-TRIM.M508435	\$ 380	\$ 15
78"W	SPLA-DNA-TRIM.M508503	\$ 401	\$ 15
84"W	SPLA-DNA-TRIM.M508436	\$ 439	\$ 15
90"W	SPLA-DNA-TRIM.M508437	\$ 461	\$ 15
96"W	SPLA-DNA-TRIM.M508438	\$ 518	\$ 15

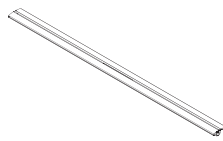

Grooved Radius Trim For Frameless COM Insert			
24"W	SPLA-DNA-TRIM.M508439	\$ 274	\$ 15
30"W	SPLA-DNA-TRIM.M508440	\$ 279	\$ 15
36"W	SPLA-DNA-TRIM.M508441	\$ 292	\$ 15
42"W	SPLA-DNA-TRIM.M508442	\$ 299	\$ 15
48"W	SPLA-DNA-TRIM.M508443	\$ 304	\$ 15
54"W	SPLA-DNA-TRIM.M508444	\$ 317	\$ 15
60"W	SPLA-DNA-TRIM.M508445	\$ 331	\$ 15
66"W	SPLA-DNA-TRIM.M508446	\$ 356	\$ 15
72"W	SPLA-DNA-TRIM.M508449	\$ 380	\$ 15
78"W	SPLA-DNA-TRIM.M508505	\$ 401	\$ 15
84"W	SPLA-DNA-TRIM.M508450	\$ 439	\$ 15
90"W	SPLA-DNA-TRIM.M508451	\$ 461	\$ 15
96"W	SPLA-DNA-TRIM.M508452	\$ 518	\$ 15

How to specify —
Select the Model Number from above.

_____ .

Example:

1st Option:

Paint
(if applicable):

P1 P2

See inside front cover for finishes.

P | | |

For specification information see current Terrace Price & Specification Guide.

FINISHES

TABLE OF CONTENTS

WORKSURFACES

STRIDE

TERRACE

FURTHER

APPROACH

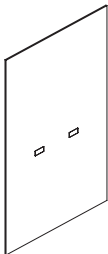
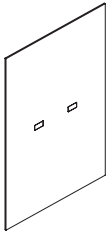
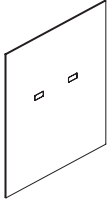
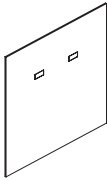

Description	Model	List Price				
		Grade A	Grade B	Grade C	Grade D	Grade E
30"H Tackable Acoustical Port Tiles						
18"W	SPLA-SS-TER30HFT1.M425613	\$ 257	\$ 270	\$ 286	\$ 310	\$ 333
20"W	SPLA-SS-TER30HFT1.M425614	\$ 257	\$ 270	\$ 286	\$ 310	\$ 333
24"W	SPLA-SS-TER30HFT1.M425615	\$ 257	\$ 270	\$ 286	\$ 310	\$ 333
30"W	SPLA-SS-TER30HFT2.M425616	\$ 269	\$ 291	\$ 312	\$ 348	\$ 385
36"W	SPLA-SS-TER30HFT2.M425617	\$ 297	\$ 319	\$ 340	\$ 376	\$ 413
42"W	SPLA-SS-TER30HFT2.M425618	\$ 311	\$ 333	\$ 354	\$ 390	\$ 427
48"W	SPLA-SS-TER30HFT3.M425619	\$ 327	\$ 363	\$ 400	\$ 461	\$ 523
60"W	SPLA-SS-TER30HFT3.M425620	\$ 345	\$ 381	\$ 418	\$ 479	\$ 541

42½"H Tackable Acoustical Port Tiles						
18"W	SPLA-SS-TER42HFT1.M425621	\$ 320	\$ 344	\$ 367	\$ 406	\$ 446
20"W	SPLA-SS-TER42HFT1.M425622	\$ 320	\$ 344	\$ 367	\$ 406	\$ 446
24"W	SPLA-SS-TER42HFT1.M425623	\$ 320	\$ 344	\$ 367	\$ 406	\$ 446
30"W	SPLA-SS-TER42HFT2.M425624	\$ 338	\$ 373	\$ 410	\$ 470	\$ 530
36"W	SPLA-SS-TER42HFT2.M425625	\$ 373	\$ 408	\$ 445	\$ 505	\$ 565
42"W	SPLA-SS-TER42HFT2.M425626	\$ 398	\$ 433	\$ 470	\$ 530	\$ 590
48"W	SPLA-SS-TER42HFT3.M425627	\$ 426	\$ 485	\$ 545	\$ 646	\$ 747
60"W	SPLA-SS-TER42HFT3.M425628	\$ 471	\$ 530	\$ 590	\$ 691	\$ 792

50"H Tackable Acoustical Port Tiles						
18"W	SPLA-SS-TER50HFT1.M425629	\$ 338	\$ 364	\$ 394	\$ 442	\$ 488
20"W	SPLA-SS-TER50HFT1.M425630	\$ 338	\$ 364	\$ 394	\$ 442	\$ 488
24"W	SPLA-SS-TER50HFT1.M425631	\$ 338	\$ 364	\$ 394	\$ 442	\$ 488
30"W	SPLA-SS-TER50HFT2.M425632	\$ 375	\$ 417	\$ 459	\$ 531	\$ 602
36"W	SPLA-SS-TER50HFT2.M425633	\$ 418	\$ 460	\$ 502	\$ 574	\$ 645
42"W	SPLA-SS-TER50HFT2.M425634	\$ 461	\$ 503	\$ 545	\$ 617	\$ 688
48"W	SPLA-SS-TER50HFT3.M425635	\$ 501	\$ 572	\$ 643	\$ 764	\$ 882
60"W	SPLA-SS-TER50HFT3.M425636	\$ 548	\$ 619	\$ 690	\$ 811	\$ 929

57½"H Tackable Acoustical Port Tiles						
18"W	SPLA-SS-TER57HFT1.M425637	\$ 389	\$ 422	\$ 454	\$ 509	\$ 564
20"W	SPLA-SS-TER57HFT1.M425638	\$ 389	\$ 422	\$ 454	\$ 509	\$ 564
24"W	SPLA-SS-TER57HFT1.M425639	\$ 389	\$ 422	\$ 454	\$ 509	\$ 564
30"W	SPLA-SS-TER57HFT2.M425640	\$ 389	\$ 438	\$ 486	\$ 571	\$ 654
36"W	SPLA-SS-TER57HFT2.M425641	\$ 419	\$ 468	\$ 516	\$ 601	\$ 684
42"W	SPLA-SS-TER57HFT2.M425642	\$ 466	\$ 515	\$ 563	\$ 648	\$ 731
48"W	SPLA-SS-TER57HFT3.M425643	\$ 504	\$ 586	\$ 669	\$ 805	\$ 944
60"W	SPLA-SS-TER57HFT3.M425644	\$ 552	\$ 634	\$ 717	\$ 853	\$ 992

65"H Tackable Acoustical Port Tiles						
18"W	SPLA-SS-TER65HFT1.M425645	\$ 403	\$ 439	\$ 476	\$ 537	\$ 599
20"W	SPLA-SS-TER65HFT1.M425646	\$ 403	\$ 439	\$ 476	\$ 537	\$ 599
24"W	SPLA-SS-TER65HFT1.M425647	\$ 403	\$ 439	\$ 476	\$ 537	\$ 599
30"W	SPLA-SS-TER65HFT2.M425648	\$ 449	\$ 504	\$ 560	\$ 652	\$ 745
36"W	SPLA-SS-TER65HFT2.M425649	\$ 492	\$ 547	\$ 603	\$ 695	\$ 788
42"W	SPLA-SS-TER65HFT2.M425650	\$ 535	\$ 590	\$ 646	\$ 738	\$ 831
48"W	SPLA-SS-TER65HFT3.M425651	\$ 569	\$ 661	\$ 753	\$ 909	\$ 1064
60"W	SPLA-SS-TER65HFT3.M425652	\$ 611	\$ 703	\$ 795	\$ 951	\$ 1106

Note: Electrical mounts with 8989EB (ordered separately) mounted to the underside of the beltline horizontal (segment bar not required.)

Note: Should not be used with low storage because port access will be blocked.

<p>How to specify — Select the Model Number from above.</p>	<p><i>1st Option:</i> Fabric: See inside back cover for fabrics.</p>	<p><i>2nd Option:</i> Electrical Grommet Color: See inside front cover for finishes.</p>
--	---	---

Example: SPLA-SS-TER30HFT1.M425613.ECH901.E9

Shippable by small-package carrier.

For specification information see *Terrace Price & Specification Guide*.

Description	Model	P1 Paint List Price	P2 Paint List Price	P3 Paint List Price
7½"H Steel Tiles				
24"W	SPLA-SS-TER07HST1.M455980 S	\$ 151	\$ 184	\$ 214
30"W	SPLA-SS-TER07HST1.M455981 S	\$ 158	\$ 191	\$ 221
36"W	SPLA-SS-TER07HST1.M455982 S	\$ 171	\$ 204	\$ 234
42"W	SPLA-SS-TER07HST2.M455983 S	\$ 192	\$ 225	\$ 255
48"W	SPLA-SS-TER07HST2.M455984 S	\$ 206	\$ 239	\$ 269
60"W	SPLA-SS-TER07HST2.M455985 S	\$ 230	\$ 263	\$ 293
15"H Steel Tiles				
24"W	SPLA-SS-TER15HST1.M455986 S	\$ 157	\$ 190	\$ 220
30"W	SPLA-SS-TER15HST1.M455987 S	\$ 164	\$ 197	\$ 227
36"W	SPLA-SS-TER15HST1.M455988 S	\$ 179	\$ 212	\$ 242
42"W	SPLA-SS-TER15HST2.M455989 S	\$ 197	\$ 230	\$ 260
48"W	SPLA-SS-TER15HST2.M455990 S	\$ 213	\$ 246	\$ 276
60"W	SPLA-SS-TER15HST2.M455991 S	\$ 240	\$ 273	\$ 303
22½"H Steel Tiles				
24"W	SPLA-SS-TER22HST1.M455992 S	\$ 200	\$ 233	\$ 263
30"W	SPLA-SS-TER22HST1.M455993 S	\$ 207	\$ 240	\$ 270
36"W	SPLA-SS-TER22HST1.M455994 S	\$ 221	\$ 254	\$ 284
42"W	SPLA-SS-TER22HST2.M455995 S	\$ 240	\$ 273	\$ 303
48"W	SPLA-SS-TER22HST2.M455996 S	\$ 256	\$ 289	\$ 319
60"W	SPLA-SS-TER22HST2.M455997 S	\$ 283	\$ 316	\$ 346
30"H Steel Tiles				
24"W	SPLA-SS-TER30HST1.M455998 S	\$ 230	\$ 277	\$ 326
30"W	SPLA-SS-TER30HST1.M455999 S	\$ 253	\$ 300	\$ 349
36"W	SPLA-SS-TER30HST1.M456000 S	\$ 285	\$ 332	\$ 381
42"W	SPLA-SS-TER30HST2.M456001 S	\$ 304	\$ 351	\$ 400
48"W	SPLA-SS-TER30HST2.M456002 S	\$ 339	\$ 386	\$ 435
60"W	SPLA-SS-TER30HST2.M456003 S	\$ 385	\$ 432	\$ 481

Note: Order special UTP KIT separately below.

Note: 24"W tiles require 1 UTP kit.

30"W - 60"W tiles require 2 UTP kits.

Description	Model	List Price
Data/Electrical Port Kit (specify color)		
Tile Port Kit for Steel Tiles	SPLA-UTP.M456004 S	\$ 37

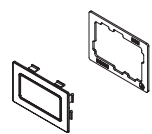

How to specify —
Select the Model Number from above.

1st Option:

Paint Color:

P1 P2

See inside front cover for finishes.

P

Example: SPLA-SS-STRSTILE7HSM.M455956.P4J

S Shippable by small-package carrier.

For specification information see current Terrace Price & Specification Guide.



Duplex Receptacle

Description	Four-circuit 3 + 1 2 + 2	List Price	Three-circuit Separate Neutrals	List Price
Duplex Receptacle				
Circuit 2 - 20 AMP	SPLA-TP-PELEC-BYR.M487355	\$ 78	SPLA-TP-PELEC-BYR.M487372	\$ 78
Circuit 3 - 20 AMP (3 + 1)	SPLA-TP-PELEC-BYR.M487356	\$ 78	SPLA-TP-PELEC-BYR.M487373	\$ 78
Circuit 3 - 20 AMP (2 + 2)	SPLA-TP-PELEC-BYR.M487358	\$ 78	N/A	
Circuit 4 - 20 AMP (Four Circuit - ISO/DEDICATED)	SPLA-TP-PELEC-BYR.M487359	\$ 78	N/A	

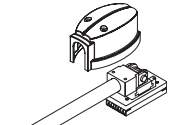

Base Electrical Infeed

Base Electrical In-Feed Cable: Sealtight cable for Terrace receptacle				
12' Sealtight	SPLA-TP-ELEC-BYR.M489312	\$ 676	SPLA-TP-ELEC-BYR.M489315	\$ 652
18' Sealtight	SPLA-TP-ELEC-BYR.M489313	\$ 913	SPLA-TP-ELEC-BYR.M489316	\$ 913
24' Sealtight	SPLA-TP-ELEC-BYR.M489314	\$ 1220	SPLA-TP-ELEC-BYR.M489317	\$ 1084

Base Electrical In-Feed Cable: Flex Cable				
12' Flex Cable	SPLA-TP-ELEC-BYR.M489318	\$ 430	SPLA-TP-ELEC-BYR.M489321	\$ 520
18' Flex Cable	SPLA-TP-ELEC-BYR.M489319	\$ 943	SPLA-TP-ELEC-BYR.M489322	\$ 884
24' Flex Cable	SPLA-TP-ELEC-BYR.M489320	\$ 1002	SPLA-TP-ELEC-BYR.M489323	\$ 1090

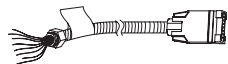

Ceiling Electrical Infeed

Ceiling Electrical In-Feed Cables				
6' Flex Cable	SPLA-TP-ELEC-BYR.M489324	\$ 451	N/A	
24' Flex Cable	SPLA-TP-ELEC-BYR.M489325	\$ 686	N/A	

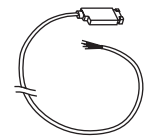

Electrical Infeed Cable

Electrical Base In-Feed Cables (for use with footed panels)				
6' Sealtight Ceiling	SPLA-TP-ELEC-BYR.M489326	\$ 547	N/A	
18' Sealtight Ceiling	SPLA-TP-ELEC-BYR.M489327	\$ 754	N/A	
24' Sealtight Ceiling	SPLA-TP-ELEC-BYR.M489328	\$ 941	N/A	

How to specify —
Select the Model Number from above.

1st Option:
Electrical Receptacle Color (if applicable):
See inside front cover for finishes.

1st Option:
Color (if applicable):
P Black

_____ . **E**

Example: SPLA-TP-PELEC-BYR.M487355.E4

S Shippable by small-package carrier.

For specification information see current Further Price & Specification Guide.

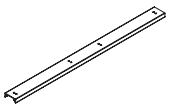
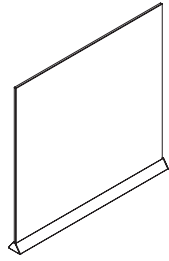

Description	Model	P1 List Price	P2 List Upcharge	P3 List Upcharge	Frosted Glass Upcharge	Smoked Glass Upcharge
28"H Triangle Base Beam Mounted Glass Screens						
24"W	SPLA-FTR-GSCRN4060.M511316	\$ 880	\$ 15	\$ 26	\$ 136	\$ 277
30"W	SPLA-FTR-GSCRN2040.M511317	\$ 1026	\$ 15	\$ 26	\$ 107	\$ 217
36"W	SPLA-FTR-GSCRN2040.M511319	\$ 1146	\$ 15	\$ 26	\$ 107	\$ 217
42"W	SPLA-FTR-GSCRN2040.M511321	\$ 1300	\$ 15	\$ 26	\$ 107	\$ 217
48"W	SPLA-FTR-GSCRN4060.M511322	\$ 1406	\$ 15	\$ 26	\$ 136	\$ 277
54"W	SPLA-FTR-GSCRN4060.M511323	\$ 1522	\$ 15	\$ 26	\$ 136	\$ 277
60"W	SPLA-FTR-GSCRN4060.M511325	\$ 1627	\$ 15	\$ 26	\$ 136	\$ 277
66"W	SPLA-FTR-GSCRN4060.M511326	\$ 1927	\$ 15	\$ 26	\$ 136	\$ 277
72"W	SPLA-FTR-GSCRN6080.M511327	\$ 2073	\$ 15	\$ 26	\$ 187	\$ 382
78"W	SPLA-FTR-GSCRN6080.M511328	\$ 2251	\$ 15	\$ 26	\$ 187	\$ 382
84"W	SPLA-FTR-GSCRN6080.M511329	\$ 2438	\$ 15	\$ 26	\$ 187	\$ 382
90"W	SPLA-FTR-GSCRN6080.M511331	\$ 2566	\$ 15	\$ 26	\$ 187	\$ 382
96"W	SPLA-FTR-GSCRN6080.M511332	\$ 2755	\$ 15	\$ 26	\$ 187	\$ 382

Beam Trim For Triangle Base Screens

24"W	SPLA-FTR-CAP2040.M511333	\$ 311	\$ 12	\$ 19
30"W	SPLA-FTR-CAP2040.M511334	\$ 322	\$ 12	\$ 19
36"W	SPLA-FTR-CAP2040.M511335	\$ 332	\$ 12	\$ 19
42"W	SPLA-FTR-CAP2040.M511336	\$ 350	\$ 12	\$ 19
48"W	SPLA-FTR-CAP2040.M511337	\$ 396	\$ 12	\$ 19
54"W	SPLA-FTR-CAP4060.M511338	\$ 437	\$ 16	\$ 29
60"W	SPLA-FTR-CAP4060.M511339	\$ 455	\$ 16	\$ 29
66"W	SPLA-FTR-CAP4060.M511340	\$ 476	\$ 16	\$ 29
72"W	SPLA-FTR-CAP4060.M511341	\$ 488	\$ 16	\$ 29
78"W	SPLA-FTR-CAP6080.M511342	\$ 504	\$ 24	\$ 44
84"W	SPLA-FTR-CAP6080.M511343	\$ 537	\$ 24	\$ 44
90"W	SPLA-FTR-CAP6080.M511344	\$ 568	\$ 24	\$ 44
96"W	SPLA-FTR-CAP6080.M511345	\$ 632	\$ 24	\$ 44

Notes:

- 28"H Beam Mounted Screens will align with 57½"H Storage when used with 28"H Further Beams.
- Beam Mount component must be ordered separately.
- Beam Mount models will not be visible in specifying software, but are visible on Allsteel Synergy quoting and ordering tools.

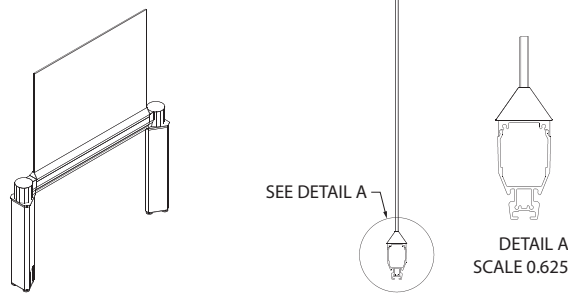

Specification Rules:

- This solution is for New Further Beams only.
- Triangle Base will slightly overhang the beam.
- Special Beam trim to be ordered separately. See detail A.
- Installation requires clamping of the top cap to get it to "snap" on.
- Top cap pressure fit will be tight so the data or electrical in the beam will be more difficult to access after special top cap and screen is installed.

<p>How to specify — Select the Model Number from above.</p>	<p>1st Option: Glass (if applicable): LC Clear LF Frosted GSM1 Smoked</p>	<p>2nd Option: Paint (if applicable): P1 P2 P3 See inside front cover for finishes.</p>
<p>Example:</p>		

5 Shippable by small-package carrier.

For specification information see current Further Price & Specification Guide.

Description	Model	P1 List Price	P2 List Upcharge	P3 List Upcharge	Upholstery Upcharge			
					Grade A	Grade B	Grade C	Grade D
28"H Triangle Base Beam Mounted Fabric Screens								
24"W	SPLA-FTR-MOD0520.M514118	\$ 845	\$15	\$26	\$0	\$26	\$74	\$126
30"W	SPLA-FTR-MOD2040.M514119	\$1002	\$15	\$26	\$0	\$47	\$99	\$150
36"W	SPLA-FTR-MOD2040.M514120	\$1105	\$15	\$26	\$0	\$47	\$99	\$150
42"W	SPLA-FTR-MOD2040.M514121	\$1152	\$15	\$26	\$0	\$47	\$99	\$150
48"W	SPLA-FTR-MOD2040.M514123	\$1203	\$15	\$26	\$0	\$47	\$99	\$150
54"W	SPLA-FTR-MOD4060.M514124	\$1326	\$15	\$26	\$0	\$57	\$120	\$183
60"W	SPLA-FTR-MOD4060.M514125	\$1413	\$15	\$26	\$0	\$57	\$120	\$183
66"W	SPLA-FTR-MODRR.M514127	\$1485	\$15	\$26	\$0	\$57	\$120	\$183
72"W	SPLA-FTR-MODRR.M514128	\$1555	\$15	\$26	\$0	\$57	\$120	\$183

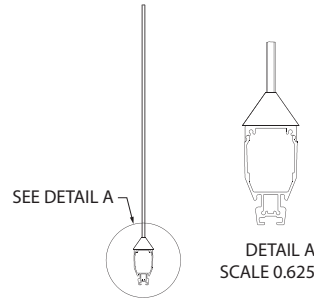
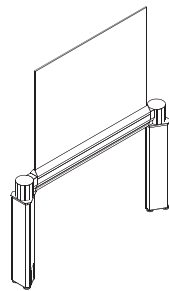

Specification Rules:

- This solution is for New Further Beams only.
- Triangle Base will slightly overhang the beam.
- Special Beam trim to be ordered separately. See detail A.
- Installation requires clamping of the top cap to get it to snap on.
- Top cap pressure fit will be tight so the data or electrical in the beam will be more difficult to access after special top cap and screen is installed.

<p>How to specify — Select the Model Number from above.</p> <p>_____</p> <p>_____</p>	<p>1st Option: Fabric (if applicable): See inside back cover for fabrics.</p> <p>_____</p>	<p>2nd Option: Paint (if applicable): P1 P2 See inside front cover for finishes.</p> <p>_____ P _____</p>
--	--	---

Example:

For specification information see current Further Price & Specification Guide.



Description	Max. Receptacles Per Side	Model	List Price
Duplex Receptacles for Further Dual-Sided Power Kits			
Receptacle - 20 AMP Circuit 2 - Further		SPLA-TP-PELEC-BYR.M487360 S	\$ 78
Receptacle - 20 AMP Circuit 1 - Further		SPLA-TP-PELEC-BYR.M496568 S	\$ 78
Receptacle - 20 AMP Circuit 3 - Further (2+2)		SPLA-TP-PELEC-BYR.M487362 S	\$ 78
Receptacle - 20 AMP Circuit 3 - Further (3+1)		SPLA-TP-PELEC-BYR.M487361 S	\$ 78
Receptacle - 20 AMP Circuit 4 - Further (ISOLATED/DEDICATED)		SPLA-TP-PELEC-BYR.M487363 S	\$ 78

Note: 20 AMP receptacles not compatible with old style beams.

Note: Further 20 AMP receptacles extend from beam 1/8" more than standard Further receptacles.

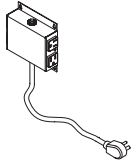

Description	Max. Receptacles Per Side	Model	List Price
Power/Data Modules — Under Worksurface Mount			
FURTHER QUAD TAP POWER MODULE with 6' cord		SPLA-TP-ELEC-BYR.M454877 S	\$ 488

How to specify —
Select the Model Number from above.

1st Option:

Electrical Receptacle Color
(if applicable):

See inside front cover for finishes.



Examples: SPLA-TP-ELEC-BYR.M454877
SPLA-TP-PELEC-BYR.M496568.E4

S Shippable by small-package carrier.

For specification information please see page 21.

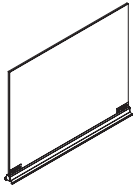

Description	Model	P1 List Price	P2 List Upcharge	P3 List Upcharge	Frosted Glass Upcharge	Smoked Glass Upcharge
22½"H Frameless Glass with Top Cap						
24"W	SPLA-SS-OPTSCRGLSS.M511306	\$ 773	\$ 15	\$ 26	\$ 65	\$ 99
30"W	SPLA-SS-OPTSCRGLSS.M511307	\$ 853	\$ 15	\$ 26	\$ 65	\$ 99
36"W	SPLA-SS-OPTSCRGLSS.M511308	\$ 963	\$ 15	\$ 26	\$ 65	\$ 99
42"W	SPLA-SS-OPTSCRGLSM.M511309	\$ 1025	\$ 15	\$ 26	\$ 102	\$ 154
48"W	SPLA-SS-OPTSCRGLSM.M511310	\$ 1128	\$ 15	\$ 26	\$ 102	\$ 154
54"W	SPLA-SS-OPTSCRGLSM.M511311	\$ 1233	\$ 15	\$ 26	\$ 102	\$ 154
60"W	SPLA-SS-OPTSCRGLSM.M511312	\$ 1324	\$ 15	\$ 26	\$ 102	\$ 154
66"W	SPLA-SS-OPTSCRGLSM.M511313	\$ 1429	\$ 15	\$ 26	\$ 102	\$ 154
72"W	SPLA-SS-OPTSCRGLSL.M511314	\$ 1508	\$ 15	\$ 26	\$ 153	\$ 231

Note: Due to increased height of the glass, there will be noticeable side-to-side movement on the screen.

Please contact TPG prior to placing your order to review your layout if you have questions.

Note: The height of these models are NOT compatible with new frameless glass models (ie: P21536FGS) launched 7/1/21. If 22½"H frameless glass is needed for NEW model design, please contact TPG as product modification requests will be needed.

<p>How to specify — Select the Model Number from above.</p>	<p>1st Option: Glass (if applicable): LC Clear LF Frosted GSM1 Smoked</p>	<p>2nd Option: Paint (if applicable): P1 P2 See inside front cover for finishes.</p>
<p>Example: _____ .</p>	<p>_____ .</p>	<p>P _____</p>

S Shippable by small-package carrier.

Optimize Trim COM Insert Spec

Custom material used in grooved top cap trim should be sized according to these dimensions:



Standard Height	Actual Dimensions	Standard Width	Actual Dimensions
7½"H	8.460"H	24"W	23.866"W
15"H	15.960"H	30"W	29.866"W
22½"H	23.460"H	36"W	35.866"W
		42"W	41.866"W
		48"W	47.866"W
		54"W	53.866"W
		60"W	59.866"W
		66"W	65.866"W
		72"W	71.866"W

Height tolerance should be +0.000" / -0.188"

Width tolerance should be +/- 0.094"

Thickness of custom material must be 10MM thick -0.120MM / +0.890MM

For COM material heights taller than 15"H.

Connector brackets are required to connect all screens together.

Every run of glass must have perpendicular support. Must use an L, T, or X connector brackets.

See page [22](#) for models

Note: The dimensions referenced are NOT compatible with new frameless glass models (ie: P21536FGS) launched 7/1/21.

For specification information see current Optimize Price & Specification Guide.

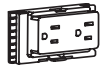

Description	Four-circuit 3 + 1 2 + 2	List Price	Three-circuit Separate Neutrals	List Price
Duplex Receptacle				
Circuit 2 - 20 AMP	SPLA-TP-PELEC-BYR.M487364	\$ 78	SPLA-TP-PELEC-BYR.M487368	\$ 78
Circuit 3 - 20 AMP (3 + 1)	SPLA-TP-PELEC-BYR.M487365	\$ 78	SPLA-TP-PELEC-BYR.M487369	\$ 78
Circuit 3 - 20 AMP (2 + 2)	SPLA-TP-PELEC-BYR.M487366	\$ 78		
Circuit 4 - 20 AMP (Four Circuit - ISO/DEDICATED)	SPLA-TP-PELEC-BYR.M487367	\$ 78		

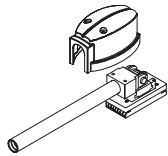

Base Electrical In-Feed Cable: Seal-tight Cable for Optimize Receptacle				
12' Seal-tight	SPLA-TP-ELEC-BYR.M489329	\$ 676	SPLA-TP-ELEC-BYR.M489332	\$ 693
18' Seal-tight	SPLA-TP-ELEC-BYR.M489330	\$ 913	SPLA-TP-ELEC-BYR.M489333	\$ 940
24' Seal-tight	SPLA-TP-ELEC-BYR.M489331	\$ 1197	SPLA-TP-ELEC-BYR.M489334	\$ 1252

Base Electrical In-Feed Cable: Flex Cable				
12' Flex Cable	SPLA-TP-ELEC-BYR.M489318	\$ 430	SPLA-TP-ELEC-BYR.M489321	\$ 520
18' Flex Cable	SPLA-TP-ELEC-BYR.M489319	\$ 943	SPLA-TP-ELEC-BYR.M489322	\$ 884
24' Flex Cable	SPLA-TP-ELEC-BYR.M489320	\$ 1002	SPLA-TP-ELEC-BYR.M489323	\$ 1090

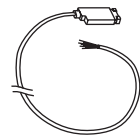

Ceiling Electrical In-Feed Cables				
6' Flex Cable	SPLA-TP-ELEC-BYR.M489324	\$ 451		
24' Flex Cable	SPLA-TP-ELEC-BYR.M489325	\$ 686		

<p>How to specify — Select the Model Number from above.</p>	<p><i>1st Option:</i> Electrical Receptacle Color (if applicable): See inside front cover for finishes.</p>	<p><i>1st Option:</i> Color (if applicable): P Black</p>	<p>_____ . E _____</p>
--	--	---	-------------------------------

Example: SPLA-TP-PELEC-BYR.M487364.E4

Shippable by small-package carrier.

120 Degree Surfaces

Base Type	Depth	36	42	48	54
	Width				
A6 T- or C-Base	36				
	42				
	48				
	54				

Corner Covers

Base Type	Depth	36	42	48	54	60
	Width					
A6 T- or C-Base	54	A6REC3S3LTF or A6REC3S3LCF				
	60					
	66					
	72					
	78	For A6 T- or C-Base to support these size corner covers, please submit a modification request on the Tailored Solutions App on Allsteel Synergy.				
	84					
	90					
	96					

Rectangular Tops

Base Type	Depth	24	27	30	36		
	Width						
A6 T- or C-Base NOTE: Bases for 36D tops are "old style" T-Base only. If New Style A6 T- or C-Bases is needed please submit a modification request through the Tailored Solutions App.	36						
	42	A6REC3S2LTF or A6REC3S2LCF			BLACK-M490245	Standard Special SILVER-M490243	WHITE-M490247
	78	A6MREC3S2LTF or A6MREC3S2LCF			BLACK-M490245	Standard Special SILVER-M490243	WHITE-M490247
	84	A6MREC3S2LTF or A6MREC3S2LCF			BLACK-M490245	Standard Special SILVER-M490243	WHITE-M490247
	90	A6MREC3S2LTF or A6MREC3S2LCF			BLACK-M490245	Standard Special SILVER-M490243	WHITE-M490247
	96				BLACK-M490245	Special Stretcher Bar M501803	WHITE-M490247

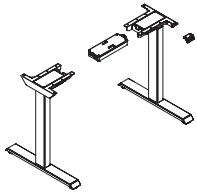

Open Market

Description	Model	List Price
T-Base Height-Adjustable		
Adjustable 2 leg - black paint - 800mm feet	SPLA-ALT-TLEGBASE.M490245	\$ 2449
Adjustable 2 leg - silver paint - 800mm feet	SPLA-ALT-TLEGBASE.M490243	\$ 2449
Adjustable 2 leg - white paint - 800mm feet	SPLA-ALT-TLEGBASE.M490247	\$ 2449

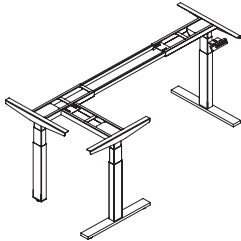

Open Market

Adjustable 3 leg - black paint - 800mm feet	SPLA-ALT-TLEGBASE.M490246	\$ 4067
Adjustable 3 leg - silver paint - 800mm feet	SPLA-ALT-TLEGBASE.M490244	\$ 4067
Adjustable 3 leg - white paint - 800mm feet	SPLA-ALT-TLEGBASE.M490248	\$ 4067

T-leg Stretcher Bars		
Two 51" stretcher bars to support surfaces 85"-96"	SPLA-ALT-TLEGBASE.M501803	\$ 66

How to specify —
 Select the
 Model Number
 from above.

Example: SPLA-ALT-TLEGBASE.M490245

Note: For specification rules see page 55.

Description	Model	L1	L2	L3
		List Price	List Price	List Price
Rectangular Laminate Tops — 24"D				
36"W	SPLA-ALT-2436EOSLEG.M490249	\$ 567	\$ 589	\$ 606
42"W	SPLA-ALT-2442EOSLEG.M490250	\$ 618	\$ 644	\$ 669
78"W	SPLA-ALT-3684EOSLEG.M490251	\$ 1350	\$ 1412	\$ 1472
84"W	SPLA-ALT-3684EOSLEG.M490252	\$ 1350	\$ 1412	\$ 1472
90"W	SPLA-ALT-4997EOSLEG.M490253	\$ 1395	\$ 1468	\$ 1539
96"W	SPLA-ALT-4997EOSLEG.M490254	\$ 1395	\$ 1468	\$ 1539
Rectangular Laminate Tops — 27"D				
36"W	SPLA-ALT-3048EOSLEG.M490256	\$ 630	\$ 661	\$ 687
42"W	SPLA-ALT-3048EOSLEG.M490257	\$ 669	\$ 700	\$ 726
48"W	SPLA-ALT-3048EOSLEG.M490258	\$ 727	\$ 758	\$ 784
54"W	SPLA-ALT-3060EOSLEG.M490259	\$ 953	\$ 992	\$ 1027
60"W	SPLA-ALT-3060EOSLEG.M490260	\$ 953	\$ 992	\$ 1027
66"W	SPLA-ALT-3066EOSLEG.M490261	\$ 1089	\$ 1131	\$ 1170
72"W	SPLA-ALT-3072EOSLEG.M490262	\$ 1089	\$ 1134	\$ 1178
78"W	SPLA-ALT-3684EOSLEG.M490263	\$ 1652	\$ 1714	\$ 1774
84"W	SPLA-ALT-3684EOSLEG.M490264	\$ 1652	\$ 1714	\$ 1774
90"W	SPLA-ALT-4997EOSLEG.M490265	\$ 1693	\$ 1766	\$ 1837
96"W	SPLA-ALT-4997EOSLEG.M490266	\$ 1693	\$ 1766	\$ 1837
Rectangular Laminate Tops — 30"D				
36"W	SPLA-ALT-3048EOSLEG.M490267	\$ 630	\$ 661	\$ 687
42"W	SPLA-ALT-3048EOSLEG.M490268	\$ 669	\$ 700	\$ 726
78"W	SPLA-ALT-3684EOSLEG.M490269	\$ 1652	\$ 1714	\$ 1774
84"W	SPLA-ALT-3684EOSLEG.M490270	\$ 1652	\$ 1714	\$ 1774
90"W	SPLA-ALT-4997EOSLEG.M490271	\$ 1693	\$ 1766	\$ 1837
96"W	SPLA-ALT-4997EOSLEG.M490272	\$ 1693	\$ 1766	\$ 1837
Rectangular Laminate Tops — 36"D				
36"W	SPLA-ALT-3636EOSLEG.M490273	\$ 853	\$ 886	\$ 909
42"W	SPLA-ALT-3660EOSLEG.M490274	\$ 971	\$ 1016	\$ 1055
48"W	SPLA-ALT-3660EOSLEG.M490275	\$ 1090	\$ 1135	\$ 1174
54"W	SPLA-ALT-3660EOSLEG.M490276	\$ 1336	\$ 1381	\$ 1420
60"W	SPLA-ALT-3660EOSLEG.M490277	\$ 1336	\$ 1381	\$ 1420
66"W	SPLA-ALT-3672EOSLEG.M490278	\$ 1573	\$ 1626	\$ 1679
72"W	SPLA-ALT-3672EOSLEG.M490279	\$ 1573	\$ 1626	\$ 1679
78"W	SPLA-ALT-3684EOSLEG.M490280	\$ 1907	\$ 1969	\$ 2029
84"W	SPLA-ALT-3684EOSLEG.M490281	\$ 1907	\$ 1969	\$ 2029
90"W	SPLA-ALT-4997EOSLEG.M490282	\$ 1952	\$ 2025	\$ 2096
96"W	SPLA-ALT-4997EOSLEG.M490283	\$ 1952	\$ 2025	\$ 2096

Notes:

Actual width is undersized by 2". Actual depth undersized by 0.75".

Worksurfaces over 72"W require heavy-duty base (standard special).

Worksurfaces over 60"W require external stiffener (order separately): Z5SC48 for 66", S5SC54 for 72"W, Z5SC60 for 78"W, Z5SC66 for 84"W, Z5SC72 for 90"W and 96"W.

<p>How to specify — Select the Model Number from above.</p> <div style="border: 1px solid black; height: 40px; width: 100%;"></div> <div style="border: 1px solid black; height: 40px; width: 100%;"></div> <div style="border: 1px solid black; height: 40px; width: 100%;"></div>	<p>1st Option: Laminate: See inside front cover for finishes.</p> <div style="border: 1px solid black; height: 40px; width: 100%;"></div>	<p>2nd Option: Laminate Edge Color (if applicable): See inside front cover for finishes.</p> <div style="border: 1px solid black; height: 40px; width: 100%;"></div>	<p>3rd Option: Grommet Location: GC Grommet Center (Rectangular only) GO No Grommet</p> <div style="border: 1px solid black; height: 40px; width: 100%;"></div>	<p>4th Option: Grommet Type (if applicable): P Oval Plastic M Oval Metal S Square Metal (Add \$22 per grommet for metal.)</p> <div style="border: 1px solid black; height: 40px; width: 100%;"></div>	<p>5th Option: Grommet Color (if applicable):</p> <div style="border: 1px solid black; height: 40px; width: 100%;"></div>
--	---	--	---	--	---

Example: SPLA-ALT-2436EOSLEG.M490249.LDW1.DW.GO

Note: For specification rules see page 55.

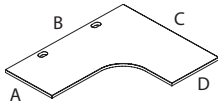

Description	Model	L1	L2	L3
		List Price	List Price	List Price
Corner Cove Worksurfaces — Extended Left				
54"W x 36"D - 24"L x 24"R	SPLA-ALT-3660MIXLEG.M490284	\$ 899	\$ 944	\$ 983
54"W x 36"D - 24"L x 30"R	SPLA-ALT-3660MIXLEG.M490479	\$ 899	\$ 944	\$ 983
54"W x 36"D - 30"L x 24"R	SPLA-ALT-3660MIXLEG.M490562	\$ 899	\$ 944	\$ 983
54"W x 36"D - 30"L x 30"R	SPLA-ALT-3660MIXLEG.M490387	\$ 899	\$ 944	\$ 983
54"W x 42"D - 24"L x 24"R	SPLA-ALT-4860MIXLEG.M490285	\$ 987	\$ 1046	\$ 1103
54"W x 42"D - 24"L x 30"R	SPLA-ALT-4860MIXLEG.M490480	\$ 987	\$ 1046	\$ 1103
54"W x 42"D - 30"L x 24"R	SPLA-ALT-4860MIXLEG.M490563	\$ 987	\$ 1046	\$ 1103
54"W x 42"D - 30"L x 30"R	SPLA-ALT-4860MIXLEG.M490388	\$ 987	\$ 1046	\$ 1103
54"W x 48"D - 24"L x 24"R	SPLA-ALT-4860MIXLEG.M490286	\$ 987	\$ 1046	\$ 1103
54"W x 48"D - 24"L x 30"R	SPLA-ALT-4860MIXLEG.M490481	\$ 987	\$ 1046	\$ 1103
54"W x 48"D - 30"L x 24"R	SPLA-ALT-4860MIXLEG.M490564	\$ 987	\$ 1046	\$ 1103
54"W x 48"D - 30"L x 30"R	SPLA-ALT-4860MIXLEG.M490389	\$ 987	\$ 1046	\$ 1103
54"W x 54"D - 24"L x 24"R	SPLA-ALT-6197MIXLEG.M490287	\$ 1381	\$ 1468	\$ 1556
54"W x 54"D - 24"L x 30"R	SPLA-ALT-6197MIXLEG.M490482	\$ 1381	\$ 1468	\$ 1556
54"W x 54"D - 30"L x 24"R	SPLA-ALT-6197MIXLEG.M490565	\$ 1381	\$ 1468	\$ 1556
54"W x 54"D - 30"L x 30"R	SPLA-ALT-6197MIXLEG.M490390	\$ 1381	\$ 1468	\$ 1556
60"W x 36"D - 24"L x 30"R	SPLA-ALT-3660MIXLEG.M490483	\$ 899	\$ 944	\$ 983
60"W x 36"D - 30"L x 24"R	SPLA-ALT-3660MIXLEG.M490566	\$ 899	\$ 944	\$ 983
60"W x 36"D - 30"L x 30"R	SPLA-ALT-3660MIXLEG.M490391	\$ 899	\$ 944	\$ 983
60"W x 42"D - 24"L x 24"R	SPLA-ALT-4860MIXLEG.M490289	\$ 987	\$ 1046	\$ 1103
60"W x 42"D - 24"L x 30"R	SPLA-ALT-4860MIXLEG.M490484	\$ 987	\$ 1046	\$ 1103
60"W x 42"D - 30"L x 24"R	SPLA-ALT-4860MIXLEG.M490567	\$ 987	\$ 1046	\$ 1103
60"W x 42"D - 30"L x 30"R	SPLA-ALT-4860MIXLEG.M490392	\$ 987	\$ 1046	\$ 1103
60"W x 48"D - 24"L x 30"R	SPLA-ALT-4860MIXLEG.M490486	\$ 987	\$ 1046	\$ 1103
60"W x 48"D - 30"L x 24"R	SPLA-ALT-4860MIXLEG.M490568	\$ 987	\$ 1046	\$ 1103
60"W x 48"D - 30"L x 30"R	SPLA-ALT-4860MIXLEG.M490393	\$ 987	\$ 1046	\$ 1103
60"W x 54"D - 24"L x 24"R	SPLA-ALT-6197MIXLEG.M490291	\$ 1381	\$ 1468	\$ 1556
60"W x 54"D - 24"L x 30"R	SPLA-ALT-6197MIXLEG.M490488	\$ 1381	\$ 1468	\$ 1556
60"W x 54"D - 30"L x 24"R	SPLA-ALT-6197MIXLEG.M490569	\$ 1381	\$ 1468	\$ 1556
60"W x 54"D - 30"L x 30"R	SPLA-ALT-6197MIXLEG.M490394	\$ 1381	\$ 1468	\$ 1556
60"W x 60"D - 24"L x 24"R	SPLA-ALT-6197MIXLEG.M490292	\$ 1381	\$ 1468	\$ 1556
60"W x 60"D - 24"L x 30"R	SPLA-ALT-6197MIXLEG.M490489	\$ 1381	\$ 1468	\$ 1556
60"W x 60"D - 30"L x 24"R	SPLA-ALT-6197MIXLEG.M490570	\$ 1381	\$ 1468	\$ 1556
60"W x 60"D - 30"L x 30"R	SPLA-ALT-6197MIXLEG.M490395	\$ 1381	\$ 1468	\$ 1556
66"W x 36"D - 24"L x 24"R	SPLA-ALT-3672MIXLEG.M490293	\$ 987	\$ 1040	\$ 1093
66"W x 36"D - 24"L x 30"R	SPLA-ALT-3672MIXLEG.M490490	\$ 987	\$ 1040	\$ 1093
66"W x 36"D - 30"L x 24"R	SPLA-ALT-3672MIXLEG.M490571	\$ 987	\$ 1040	\$ 1093
66"W x 36"D - 30"L x 30"R	SPLA-ALT-3672MIXLEG.M490396	\$ 987	\$ 1040	\$ 1093
66"W x 42"D - 24"L x 24"R	SPLA-ALT-4872MIXLEG.M490294	\$ 1098	\$ 1171	\$ 1215
66"W x 42"D - 24"L x 30"R	SPLA-ALT-4872MIXLEG.M490492	\$ 1098	\$ 1171	\$ 1215
66"W x 42"D - 30"L x 24"R	SPLA-ALT-4872MIXLEG.M490572	\$ 1098	\$ 1171	\$ 1215
66"W x 42"D - 30"L x 30"R	SPLA-ALT-4872MIXLEG.M490397	\$ 1098	\$ 1171	\$ 1215
66"W x 48"D - 24"L x 24"R	SPLA-ALT-4872MIXLEG.M490295	\$ 1241	\$ 1314	\$ 1358
66"W x 48"D - 24"L x 30"R	SPLA-ALT-4872MIXLEG.M490493	\$ 1241	\$ 1314	\$ 1358
66"W x 48"D - 30"L x 24"R	SPLA-ALT-4872MIXLEG.M490573	\$ 1241	\$ 1314	\$ 1358
66"W x 48"D - 30"L x 30"R	SPLA-ALT-4872MIXLEG.M490398	\$ 1241	\$ 1314	\$ 1358
66"W x 54"D - 24"L x 24"R	SPLA-ALT-6197MIXLEG.M490301	\$ 1636	\$ 1723	\$ 1811
66"W x 54"D - 24"L x 30"R	SPLA-ALT-6197MIXLEG.M490494	\$ 1636	\$ 1723	\$ 1811
66"W x 54"D - 30"L x 24"R	SPLA-ALT-6197MIXLEG.M490574	\$ 1636	\$ 1723	\$ 1811
66"W x 54"D - 30"L x 30"R	SPLA-ALT-6197MIXLEG.M490399	\$ 1636	\$ 1723	\$ 1811
66"W x 60"D - 24"L x 24"R	SPLA-ALT-6197MIXLEG.M490313	\$ 1636	\$ 1723	\$ 1811

Note: Dimensions are nominal. "W" and "D" are undersized by 2" for all sizes except 36" which is undersized by 1½" due to base limitations. "L" and "R" are undersized by ¾".

<p>How to specify — Select the Model Number from above.</p>	<p>1st Option: Laminate: See inside front cover for finishes.</p>	<p>2nd Option: Laminate Edge Color (if applicable): See inside front cover for finishes.</p>	<p>3rd Option: Grommet Location (if applicable): GB Grommet LH and RH GO No Grommet</p>	<p>4th Option: Grommet Type (if applicable): P Oval Plastic M Oval Metal S Square Metal (Add \$22 per grommet for metal.)</p>	<p>5th Option: Grommet Color (if applicable):</p>
--	---	--	---	--	---

Example: SPLA-ALT-3660MIXLEG.M490284.LDW1.DW.GO

Note: For specification rules see page 55.

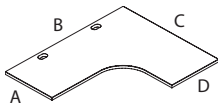

Description	Model	L1	L2	L3
		List Price	List Price	List Price
Corner Cove Worksurfaces — Extended Left				
66"W x 60"D - 24"L x 30"R	SPLA-ALT-6197MIXLEG.M490495	\$ 1636	\$ 1723	\$ 1811
66"W x 60"D - 30"L x 24"R	SPLA-ALT-6197MIXLEG.M490575	\$ 1636	\$ 1723	\$ 1811
66"W x 60"D - 30"L x 30"R	SPLA-ALT-6197MIXLEG.M490400	\$ 1636	\$ 1723	\$ 1811
72"W x 36"D - 24"L x 30"R	SPLA-ALT-3672MIXLEG.M490496	\$ 987	\$ 1040	\$ 1093
72"W x 36"D - 30"L x 24"R	SPLA-ALT-3672MIXLEG.M490576	\$ 987	\$ 1040	\$ 1093
72"W x 36"D - 30"L x 30"R	SPLA-ALT-3672MIXLEG.M490401	\$ 987	\$ 1040	\$ 1093
72"W x 42"D - 24"L x 24"R	SPLA-ALT-4872MIXLEG.M490315	\$ 1241	\$ 1314	\$ 1358
72"W x 42"D - 24"L x 30"R	SPLA-ALT-4872MIXLEG.M490497	\$ 1241	\$ 1314	\$ 1358
72"W x 42"D - 30"L x 24"R	SPLA-ALT-4872MIXLEG.M490577	\$ 1241	\$ 1314	\$ 1358
72"W x 42"D - 30"L x 30"R	SPLA-ALT-4872MIXLEG.M490402	\$ 1241	\$ 1314	\$ 1358
72"W x 48"D - 24"L x 30"R	SPLA-ALT-4872MIXLEG.M490498	\$ 1241	\$ 1314	\$ 1358
72"W x 48"D - 30"L x 24"R	SPLA-ALT-4872MIXLEG.M490578	\$ 1241	\$ 1314	\$ 1358
72"W x 48"D - 30"L x 30"R	SPLA-ALT-4872MIXLEG.M490404	\$ 1241	\$ 1314	\$ 1358
72"W x 54"D - 24"L x 24"R	SPLA-ALT-6197MIXLEG.M490317	\$ 1636	\$ 1723	\$ 1811
72"W x 54"D - 24"L x 30"R	SPLA-ALT-6197MIXLEG.M490499	\$ 1636	\$ 1723	\$ 1811
72"W x 54"D - 30"L x 24"R	SPLA-ALT-6197MIXLEG.M490579	\$ 1636	\$ 1723	\$ 1811
72"W x 54"D - 30"L x 30"R	SPLA-ALT-6197MIXLEG.M490405	\$ 1636	\$ 1723	\$ 1811
72"W x 60"D - 24"L x 24"R	SPLA-ALT-6197MIXLEG.M490318	\$ 1636	\$ 1723	\$ 1811
72"W x 60"D - 24"L x 30"R	SPLA-ALT-6197MIXLEG.M490500	\$ 1636	\$ 1723	\$ 1811
72"W x 60"D - 30"L x 24"R	SPLA-ALT-6197MIXLEG.M490580	\$ 1636	\$ 1723	\$ 1811
72"W x 60"D - 30"L x 30"R	SPLA-ALT-6197MIXLEG.M490406	\$ 1636	\$ 1723	\$ 1811
78"W x 36"D - 24"L x 24"R	SPLA-ALT-3684MIXLEG.M490319	\$ 1299	\$ 1361	\$ 1421
78"W x 36"D - 24"L x 30"R	SPLA-ALT-3684MIXLEG.M490501	\$ 1299	\$ 1361	\$ 1421
78"W x 36"D - 30"L x 24"R	SPLA-ALT-3684MIXLEG.M490582	\$ 1299	\$ 1361	\$ 1421
78"W x 36"D - 30"L x 30"R	SPLA-ALT-3684MIXLEG.M490408	\$ 1299	\$ 1361	\$ 1421
78"W x 42"D - 24"L x 24"R	SPLA-ALT-4985MIXLEG.M490320	\$ 1552	\$ 1614	\$ 1675
78"W x 42"D - 24"L x 30"R	SPLA-ALT-4985MIXLEG.M490502	\$ 1552	\$ 1614	\$ 1675
78"W x 42"D - 30"L x 24"R	SPLA-ALT-4985MIXLEG.M490583	\$ 1552	\$ 1614	\$ 1675
78"W x 42"D - 30"L x 30"R	SPLA-ALT-4985MIXLEG.M490409	\$ 1552	\$ 1614	\$ 1675
78"W x 48"D - 24"L x 24"R	SPLA-ALT-4985MIXLEG.M490321	\$ 1552	\$ 1614	\$ 1675
78"W x 48"D - 24"L x 30"R	SPLA-ALT-4985MIXLEG.M490503	\$ 1552	\$ 1614	\$ 1675
78"W x 48"D - 30"L x 24"R	SPLA-ALT-4985MIXLEG.M490584	\$ 1552	\$ 1614	\$ 1675
78"W x 48"D - 30"L x 30"R	SPLA-ALT-4985MIXLEG.M490410	\$ 1552	\$ 1614	\$ 1675
78"W x 54"D - 24"L x 24"R	SPLA-ALT-6197MIXLEG.M490322	\$ 1948	\$ 2035	\$ 2123
78"W x 54"D - 24"L x 30"R	SPLA-ALT-6197MIXLEG.M490504	\$ 1948	\$ 2035	\$ 2123
78"W x 54"D - 30"L x 24"R	SPLA-ALT-6197MIXLEG.M490585	\$ 1948	\$ 2035	\$ 2123
78"W x 54"D - 30"L x 30"R	SPLA-ALT-6197MIXLEG.M490411	\$ 1948	\$ 2035	\$ 2123
78"W x 60"D - 24"L x 24"R	SPLA-ALT-6197MIXLEG.M490323	\$ 1948	\$ 2035	\$ 2123
78"W x 60"D - 24"L x 30"R	SPLA-ALT-6197MIXLEG.M490505	\$ 1948	\$ 2035	\$ 2123
78"W x 60"D - 30"L x 24"R	SPLA-ALT-6197MIXLEG.M490586	\$ 1948	\$ 2035	\$ 2123
78"W x 60"D - 30"L x 30"R	SPLA-ALT-6197MIXLEG.M490412	\$ 1948	\$ 2035	\$ 2123
84"W x 36"D - 24"L x 24"R	SPLA-ALT-3684MIXLEG.M490324	\$ 1368	\$ 1430	\$ 1490
84"W x 36"D - 24"L x 30"R	SPLA-ALT-3684MIXLEG.M490506	\$ 1368	\$ 1430	\$ 1490
84"W x 36"D - 30"L x 24"R	SPLA-ALT-3684MIXLEG.M490587	\$ 1368	\$ 1430	\$ 1490
84"W x 36"D - 30"L x 30"R	SPLA-ALT-3684MIXLEG.M490413	\$ 1368	\$ 1430	\$ 1490
84"W x 42"D - 24"L x 24"R	SPLA-ALT-4985MIXLEG.M490325	\$ 1621	\$ 1683	\$ 1744
84"W x 42"D - 24"L x 30"R	SPLA-ALT-4985MIXLEG.M490507	\$ 1621	\$ 1683	\$ 1744
84"W x 42"D - 30"L x 24"R	SPLA-ALT-4985MIXLEG.M490588	\$ 1621	\$ 1683	\$ 1744
84"W x 42"D - 30"L x 30"R	SPLA-ALT-4985MIXLEG.M490414	\$ 1621	\$ 1683	\$ 1744
84"W x 48"D - 24"L x 24"R	SPLA-ALT-4985MIXLEG.M490326	\$ 1621	\$ 1683	\$ 1744
84"W x 48"D - 24"L x 30"R	SPLA-ALT-4985MIXLEG.M490508	\$ 1621	\$ 1683	\$ 1744

Note: Dimensions are nominal. "W" and "D" are undersized by 2" for all sizes except 36" which is undersized by 1½" due to base limitations. "L" and "R" are undersized by ¾".

<p>How to specify — Select the Model Number from above.</p>	<p>1st Option: Laminate: See inside front cover for finishes.</p>	<p>2nd Option: Laminate Edge Color: See inside front cover for finishes.</p>	<p>3rd Option: Grommet Location (if applicable): GB Grommet LH and RH GO No Grommet</p>	<p>4th Option: Grommet Type (if applicable): P Oval Plastic M Oval Metal S Square Metal (Add \$22 per grommet for metal.)</p>	<p>5th Option: Grommet Color (if applicable):</p>
--	---	--	---	--	---

Example: SPLA-ALT-6197MIXLEG.M490495.LDW1.DW.GO

Note: For specification rules see page 55.

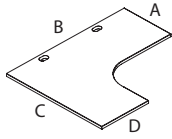

Description	Model	L1 List Price	L2 List Price	L3 List Price
Corner Cove Worksurfaces — Extended Right				
84"W x 48"D - 30"L x 24"R	SPLA-ALT-4985MIXLEG.M490636	\$ 1621	\$ 1683	\$ 1744
84"W x 48"D - 30"L x 30"R	SPLA-ALT-4985MIXLEG.M490466	\$ 1621	\$ 1683	\$ 1744
84"W x 54"D - 24"L x 24"R	SPLA-ALT-6197MIXLEG.M490369	\$ 2016	\$ 2103	\$ 2191
84"W x 54"D - 24"L x 30"R	SPLA-ALT-6197MIXLEG.M490549	\$ 2016	\$ 2103	\$ 2191
84"W x 54"D - 30"L x 24"R	SPLA-ALT-6197MIXLEG.M490637	\$ 2016	\$ 2103	\$ 2191
84"W x 54"D - 30"L x 30"R	SPLA-ALT-6197MIXLEG.M490467	\$ 2016	\$ 2103	\$ 2191
84"W x 60"D - 24"L x 24"R	SPLA-ALT-6197MIXLEG.M490370	\$ 2016	\$ 2103	\$ 2191
84"W x 60"D - 24"L x 30"R	SPLA-ALT-6197MIXLEG.M490550	\$ 2016	\$ 2103	\$ 2191
84"W x 60"D - 30"L x 24"R	SPLA-ALT-6197MIXLEG.M490638	\$ 2016	\$ 2103	\$ 2191
84"W x 60"D - 30"L x 30"R	SPLA-ALT-6197MIXLEG.M490468	\$ 2016	\$ 2103	\$ 2191
90"W x 36"D - 24"L x 24"R	SPLA-ALT-4997MIXLEG.M490371	\$ 1540	\$ 1612	\$ 1682
90"W x 36"D - 24"L x 30"R	SPLA-ALT-4997MIXLEG.M490551	\$ 1540	\$ 1612	\$ 1682
90"W x 36"D - 30"L x 24"R	SPLA-ALT-4997MIXLEG.M490639	\$ 1540	\$ 1612	\$ 1682
90"W x 36"D - 30"L x 30"R	SPLA-ALT-4997MIXLEG.M490469	\$ 1540	\$ 1612	\$ 1682
90"W x 42"D - 24"L x 24"R	SPLA-ALT-4997MIXLEG.M490372	\$ 1794	\$ 1866	\$ 1936
90"W x 42"D - 24"L x 30"R	SPLA-ALT-4997MIXLEG.M490552	\$ 1794	\$ 1866	\$ 1936
90"W x 42"D - 30"L x 24"R	SPLA-ALT-4997MIXLEG.M490641	\$ 1794	\$ 1866	\$ 1936
90"W x 42"D - 30"L x 30"R	SPLA-ALT-4997MIXLEG.M490470	\$ 1794	\$ 1866	\$ 1936
90"W x 48"D - 24"L x 24"R	SPLA-ALT-4997MIXLEG.M490373	\$ 1794	\$ 1866	\$ 1936
90"W x 48"D - 24"L x 30"R	SPLA-ALT-4997MIXLEG.M490553	\$ 1794	\$ 1866	\$ 1936
90"W x 48"D - 30"L x 24"R	SPLA-ALT-4997MIXLEG.M490642	\$ 1794	\$ 1866	\$ 1936
90"W x 48"D - 30"L x 30"R	SPLA-ALT-4997MIXLEG.M490471	\$ 1794	\$ 1866	\$ 1936
90"W x 54"D - 24"L x 24"R	SPLA-ALT-6197MIXLEG.M490374	\$ 2189	\$ 2276	\$ 2364
90"W x 54"D - 24"L x 30"R	SPLA-ALT-6197MIXLEG.M490554	\$ 2189	\$ 2276	\$ 2364
90"W x 54"D - 30"L x 24"R	SPLA-ALT-6197MIXLEG.M490643	\$ 2189	\$ 2276	\$ 2364
90"W x 54"D - 30"L x 30"R	SPLA-ALT-6197MIXLEG.M490472	\$ 2189	\$ 2276	\$ 2364
90"W x 60"D - 24"L x 24"R	SPLA-ALT-6197MIXLEG.M490375	\$ 2189	\$ 2276	\$ 2364
90"W x 60"D - 24"L x 30"R	SPLA-ALT-6197MIXLEG.M490555	\$ 2189	\$ 2276	\$ 2364
90"W x 60"D - 30"L x 24"R	SPLA-ALT-6197MIXLEG.M490646	\$ 2189	\$ 2276	\$ 2364
90"W x 60"D - 30"L x 30"R	SPLA-ALT-6197MIXLEG.M490473	\$ 2189	\$ 2276	\$ 2364
96"W x 36"D - 24"L x 24"R	SPLA-ALT-4997MIXLEG.M490376	\$ 1610	\$ 1682	\$ 1752
96"W x 36"D - 24"L x 30"R	SPLA-ALT-4997MIXLEG.M490556	\$ 1610	\$ 1682	\$ 1752
96"W x 36"D - 30"L x 24"R	SPLA-ALT-4997MIXLEG.M490647	\$ 1610	\$ 1682	\$ 1752
96"W x 36"D - 30"L x 30"R	SPLA-ALT-4997MIXLEG.M490474	\$ 1610	\$ 1682	\$ 1752
96"W x 42"D - 24"L x 24"R	SPLA-ALT-4997MIXLEG.M490377	\$ 1864	\$ 1936	\$ 2006
96"W x 42"D - 24"L x 30"R	SPLA-ALT-4997MIXLEG.M490557	\$ 1864	\$ 1936	\$ 2006
96"W x 42"D - 30"L x 24"R	SPLA-ALT-4997MIXLEG.M490648	\$ 1864	\$ 1936	\$ 2006
96"W x 42"D - 30"L x 30"R	SPLA-ALT-4997MIXLEG.M490475	\$ 1864	\$ 1936	\$ 2006
96"W x 48"D - 24"L x 24"R	SPLA-ALT-4997MIXLEG.M490378	\$ 1864	\$ 1936	\$ 2006
96"W x 48"D - 24"L x 30"R	SPLA-ALT-4997MIXLEG.M490558	\$ 1864	\$ 1936	\$ 2006
96"W x 48"D - 30"L x 24"R	SPLA-ALT-4997MIXLEG.M490649	\$ 1864	\$ 1936	\$ 2006
96"W x 48"D - 30"L x 30"R	SPLA-ALT-4997MIXLEG.M490476	\$ 1864	\$ 1936	\$ 2006
96"W x 54"D - 24"L x 24"R	SPLA-ALT-6197MIXLEG.M490379	\$ 2259	\$ 2346	\$ 2434
96"W x 54"D - 24"L x 30"R	SPLA-ALT-6197MIXLEG.M490559	\$ 2259	\$ 2346	\$ 2434
96"W x 54"D - 30"L x 24"R	SPLA-ALT-6197MIXLEG.M490650	\$ 2259	\$ 2346	\$ 2434
96"W x 54"D - 30"L x 30"R	SPLA-ALT-6197MIXLEG.M490477	\$ 2259	\$ 2346	\$ 2434
96"W x 60"D - 24"L x 24"R	SPLA-ALT-6197MIXLEG.M490385	\$ 2259	\$ 2346	\$ 2434
96"W x 60"D - 24"L x 30"R	SPLA-ALT-6197MIXLEG.M490560	\$ 2259	\$ 2346	\$ 2434
96"W x 60"D - 30"L x 24"R	SPLA-ALT-6197MIXLEG.M490652	\$ 2259	\$ 2346	\$ 2434
96"W x 60"D - 30"L x 30"R	SPLA-ALT-6197MIXLEG.M490478	\$ 2259	\$ 2346	\$ 2434

Note: Dimensions are nominal. "W" and "D" are undersized by 2" for all sizes except 36" which is undersized by 1½" due to base limitations. "L" and "R" are undersized by ¾".

<p>How to specify — Select the Model Number from above.</p>	<p>1st Option: Laminate: See inside front cover for finishes.</p>	<p>2nd Option: Laminate Edge Color: See inside front cover for finishes.</p>	<p>3rd Option: Grommet Location (if applicable): GB Grommet LH and RH GO No Grommet</p>	<p>4th Option: Grommet Type (if applicable): P Oval Plastic M Oval Metal S Square Metal (Add \$22 per grommet for metal.)</p>	<p>5th Option: Grommet Color (if applicable):</p>
<p>_____ . _____ . _____ . _____ . _____</p>	<p>_____ . _____ . _____ . _____ . _____</p>	<p>_____ . _____ . _____ . _____ . _____</p>	<p>_____ . _____ . _____ . _____ . _____</p>	<p>_____ . _____ . _____ . _____ . _____</p>	<p>_____ . _____ . _____ . _____ . _____</p>

Example: SPLA-ALT-4985MIXLEG.M490636.LDW1.DW.GO

Note: For specification rules see page 55.



Description	Model	L1	L2	L3
		List Price	List Price	List Price
36"W x 24"L x 24"R	SPLA-ALT-36CNRMIXLEG.M490665	\$ 813	\$ 845	\$ 869
36"W x 24"L x 30"R	SPLA-ALT-36CNRMIXLEG.M490675	\$ 813	\$ 845	\$ 869
36"W x 30"L x 24"R	SPLA-ALT-36CNRMIXLEG.M490679	\$ 813	\$ 845	\$ 869
36"W x 30"L x 30"R	SPLA-ALT-36CNRMIXLEG.M490671	\$ 899	\$ 931	\$ 955
42"W x 24"L x 24"R	SPLA-ALT-42CNRMIXLEG.M490666	\$ 863	\$ 900	\$ 935
42"W x 24"L x 30"R	SPLA-ALT-42CNRMIXLEG.M490676	\$ 1029	\$ 1066	\$ 1101
42"W x 30"L x 24"R	SPLA-ALT-42CNRMIXLEG.M490680	\$ 1009	\$ 1046	\$ 1081
42"W x 30"L x 30"R	SPLA-ALT-42CNRMIXLEG.M490672	\$ 1029	\$ 1066	\$ 1101
48"W x 24"L x 24"R	SPLA-ALT-48CNRMIXLEG.M490668	\$ 973	\$ 1018	\$ 1059
48"W x 24"L x 30"R	SPLA-ALT-48CNRMIXLEG.M490677	\$ 1105	\$ 1150	\$ 1191
48"W x 30"L x 24"R	SPLA-ALT-48CNRMIXLEG.M490681	\$ 1105	\$ 1150	\$ 1191
48"W x 30"L x 30"R	SPLA-ALT-48CNRMIXLEG.M490673	\$ 1105	\$ 1150	\$ 1191
54"W x 24"L x 24"R	SPLA-ALT-54CNRMIXLEG.M490669	\$ 1430	\$ 1517	\$ 1605
54"W x 24"L x 30"R	SPLA-ALT-54CNRMIXLEG.M490678	\$ 1562	\$ 1649	\$ 1737
54"W x 30"L x 24"R	SPLA-ALT-54CNRMIXLEG.M490682	\$ 1562	\$ 1649	\$ 1737
54"W x 30"L x 30"R	SPLA-ALT-54CNRMIXLEG.M490674	\$ 1562	\$ 1649	\$ 1737
60"W x 24"L x 24"R	SPLA-ALT-60CNRMIXLEG.M490670	\$ 1630	\$ 1717	\$ 1805
60"W x 24"L x 30"R	SPLA-ALT-60CNRMIXLEG.M501497	\$ 1630	\$ 1717	\$ 1805
60"W x 30"L x 24"R	SPLA-ALT-60CNRMIXLEG.M501498	\$ 1630	\$ 1717	\$ 1805
60"W x 30"L x 30"R	SPLA-ALT-60CNRMIXLEG.M501499	\$ 1630	\$ 1717	\$ 1805

Note: Dimensions are nominal. "W" and "D" are undersized by 2" for all sizes except 36" which is undersized by 1½" due to base limitations. "L" and "R" are undersized by ¾".

OPTIMIZE

ALTITUDE

INVOLVE

TITLE 24

ACCESSORIES

PANEL FABRICS

<p>How to specify — Select the Model Number from above.</p>	<p>1st Option: Laminate: See inside front cover for finishes.</p>	<p>2nd Option: Laminate Edge Color: See inside front cover for finishes.</p>	<p>3rd Option: Grommet Type (if applicable): P Oval Plastic M Oval Metal S Square Metal (Add \$11 per grommet for metal.)</p>	<p>4th Option: Grommet Color (if applicable):</p>
<p>_____ .</p>	<p>_____ .</p>	<p>_____ .</p>	<p>_____</p>	<p>_____</p>

Example: SPLA-ALT-36CNRMIXLEG.M490665.LDW1.DW.PDW

Note: For specification rules see page 55.

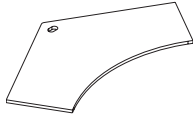

Description	Model	L1	L2	L3
		List Price	List Price	List Price
Corner Worksurfaces				
36"W x 24"L x 24"R	SPLA-ALT-4872CNR120G.M490683	\$ 1150	\$ 1223	\$ 1267
36"W x 24"L x 30"R	SPLA-ALT-4872CNR120G.M490705	\$ 1227	\$ 1300	\$ 1344
36"W x 27"L x 27"R	SPLA-ALT-4872CNR120G.M490688	\$ 1227	\$ 1300	\$ 1344
36"W x 30"L x 24"R	SPLA-ALT-4872CNR120G.M490699	\$ 1227	\$ 1300	\$ 1344
36"W x 30"L x 30"R	SPLA-ALT-4872CNR120G.M490694	\$ 1227	\$ 1300	\$ 1344
42"W x 24"L x 24"R	SPLA-ALT-4985CNR120G.M490684	\$ 1227	\$ 1289	\$ 1350
42"W x 24"L x 30"R	SPLA-ALT-4985CNR120G.M490706	\$ 1227	\$ 1289	\$ 1350
42"W x 27"L x 27"R	SPLA-ALT-4985CNR120G.M490689	\$ 1227	\$ 1289	\$ 1350
42"W x 30"L x 24"R	SPLA-ALT-4985CNR120G.M490700	\$ 1227	\$ 1289	\$ 1350
42"W x 30"L x 30"R	SPLA-ALT-4985CNR120G.M490695	\$ 1227	\$ 1289	\$ 1350
48"W x 24"L x 24"R	SPLA-ALT-4985CNR120G.M490685	\$ 1343	\$ 1405	\$ 1466
48"W x 24"L x 30"R	SPLA-ALT-6197CNR120G.M490707	\$ 1732	\$ 1819	\$ 1907
48"W x 27"L x 27"R	SPLA-ALT-4985CNR120G.M490690	\$ 1732	\$ 1794	\$ 1855
48"W x 30"L x 24"R	SPLA-ALT-6197CNR120G.M490701	\$ 1732	\$ 1819	\$ 1907
48"W x 30"L x 30"R	SPLA-ALT-6197CNR120G.M490696	\$ 1732	\$ 1819	\$ 1907
54"W x 24"L x 24"R	SPLA-ALT-4997CNR120G.M490686	\$ 1583	\$ 1655	\$ 1725
54"W x 24"L x 30"R	SPLA-ALT-6197CNR120G.M490708	\$ 1972	\$ 2059	\$ 2147
54"W x 27"L x 27"R	SPLA-ALT-4997CNR120G.M490692	\$ 1972	\$ 2044	\$ 2114
54"W x 30"L x 24"R	SPLA-ALT-6197CNR120G.M490702	\$ 1972	\$ 2059	\$ 2147
54"W x 30"L x 30"R	SPLA-ALT-6197CNR120G.M490697	\$ 1972	\$ 2059	\$ 2147

Note: 120 Tops must be supported with A5 bases. Order model ATBC2S3L separately.

Note: Dimensions are nominal. Actual dimensions provide a 1" gap on the ends and a 3/4" gap at the back.

<p>How to specify — Select the Model Number from above.</p>	<p>1st Option: Laminate: See inside front cover for finishes.</p>	<p>2nd Option: Laminate Edge Color: See inside front cover for finishes.</p>	<p>3rd Option: Grommet Type (if applicable): P Oval Plastic M Oval Metal S Square Metal (Add \$11 per grommet for metal.)</p>	<p>4th Option: Grommet Color (if applicable):</p>
<div style="border-bottom: 1px solid black; height: 15px; width: 100%;"></div>	<div style="border-bottom: 1px solid black; height: 15px; width: 100%;"></div>	<div style="border-bottom: 1px solid black; height: 15px; width: 100%;"></div>	<div style="border-bottom: 1px solid black; height: 15px; width: 100%;"></div>	<div style="border-bottom: 1px solid black; height: 15px; width: 100%;"></div>

Example: SPLA-ALT-4872CNR120G.M490683.LDW1.DW.PDW

For specification information see standard Altitude pricer and specification guide.

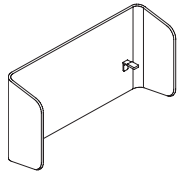

Description	Model	P1 Clear List Price	P2 List Upcharge
U Screen Kit			
48"	SPLA-A8-FABSCRNPNTA.M505257	\$ 1843	\$ 15
54"	SPLA-A8-FABSCRNPNTA.M505258	\$ 1906	\$ 15
60"	SPLA-A8-FABSCRNPNTB.M505259	\$ 1961	\$ 15
66"	SPLA-A8-FABSCRNPNTB.M505260	\$ 2078	\$ 15
72"	SPLA-A8-FABSCRNPNTB.M505261	\$ 2233	\$ 15

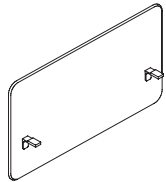

Rectangular Screen Kit			
48"	SPLA-A8-FABSCRNPNTA.M505262	\$ 1294	\$ 15
54"	SPLA-A8-FABSCRNPNTA.M505263	\$ 1326	\$ 15
60"	SPLA-A8-FABSCRNPNTB.M505264	\$ 1369	\$ 15
66"	SPLA-A8-FABSCRNPNTB.M505265	\$ 1466	\$ 15
72"	SPLA-A8-FABSCRNPNTB.M505266	\$ 1561	\$ 15

Note: These screens ARE NOT TACKABLE. The properties of Contourett fabric do not allow this feature.

Note: Installation brackets are now attached to the screen from the factory.

<p>How to specify — Select the Model Number from above.</p>	<p>1st Option: Select the Screen Fabric: See inside back cover for selections and color codes.</p>	<p>2nd Option: Select the Screen Bracket Paint: P1 P2 See inside front cover for selections and color codes.* P2 (\$13 extra)</p>
<p>Examples:</p>		

Specification Notes:

- Interior wing dimension is 27.825"
- On a 30"D Altitude work surface (true depth is 29.25") the extended wing screen will not extend to the front edge of the work surface, the screen will end 1.5" before the front edge of the work surface.

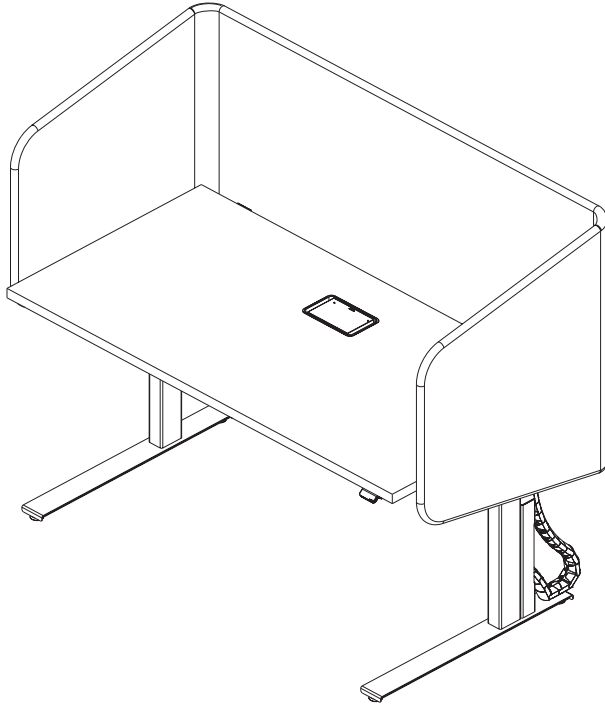

- On a 24"D Altitude work surface (true depth is 23.25") the extended wing screen will extend 4.5" past the front edge of the work surface.

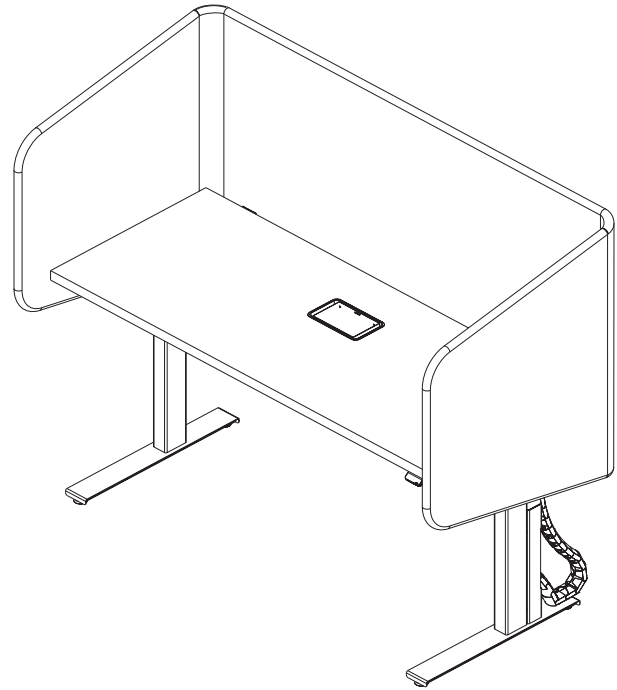

- Adding a screen adds 1" to the width of the table per return wing.
- All Altitude worksurfaces are 2" under nominal width to accommodate screens.
- RH L-screens have return wing on user's right; LH opposite.
- Textile offering is limited to Nobel.

For specification information see page 67.

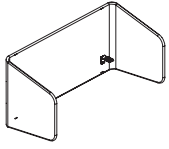

Description	Model	P1 Paint List Price	P2 Paint Upcharge	P3 Paint Upcharge
Extended Wing U Screen				
48"W	SPLA-A8-EXTSCRNPNTA.M519714	\$ 2123	\$ 15	\$ 37
54"W	SPLA-A8-EXTSCRNPNTA.M519715	\$ 2222	\$ 15	\$ 37
60"W	SPLA-A8-EXTSCRNPNTB.M519716	\$ 2261	\$ 15	\$ 37
66"W	SPLA-A8-EXTSCRNPNTB.M519717	\$ 2396	\$ 15	\$ 37
72"W	SPLA-A8-EXTSCRNPNTB.M519718	\$ 2577	\$ 15	\$ 37

<p>How to specify — Select the Model Number from above.</p> <div style="border-bottom: 1px solid black; height: 15px; width: 100%;"></div> <div style="border-bottom: 1px solid black; height: 15px; width: 100%;"></div>	<p>1st Option: Fabric (if applicable): See inside back cover for fabrics.</p> <div style="border-bottom: 1px solid black; height: 15px; width: 100%;"></div>	<p>2nd Option: Paint (if applicable): P1 P2 See inside front cover for finishes.</p> <div style="border-bottom: 1px solid black; height: 15px; width: 100%;"></div>
--	--	--

Example:

For specification information see current Involvement Price & Specification Guide.

Description	Model	P1 Clear List Price	P2 List Upcharge	Frosted Glass Upcharge	Smoked Glass Upcharge
32"H					
36"W	SPLA-IN-SCRNGLSS.M505543	\$ 1139	\$ 15	\$ 283	\$ 431
42"W	SPLA-IN-SCRNGLSS.M505544	\$ 1277	\$ 15	\$ 283	\$ 431
48"W	SPLA-IN-SCRNGLSS.M505545	\$ 1412	\$ 15	\$ 283	\$ 431
54"W	SPLA-IN-SCRNGLSS.M505546	\$ 1567	\$ 15	\$ 283	\$ 431
60"W	SPLA-IN-SCRNGLSS.M505547	\$ 1717	\$ 15	\$ 283	\$ 431

Note: 32"H Involvement Desk Mount Screens will align with 50"H Storage.

Note: Not for use with Height Adjustable Tables.

<p>How to specify — Select the Model Number from above.</p> <p>Example: _____ .</p>	<p>1st Option: Glass (if applicable): LC Clear LF Frosted GSM1 Smoked</p> <p>_____ .</p>	<p>2nd Option: Paint (if applicable): P1 P2 See inside front cover for finishes.</p> <p>P _____</p>
---	---	--

S Shippable by small-package carrier.

For specification information see below and the Involve section of the Caseloads & Storage Price and Specification Guide.

THESE MODELS ARE NEW (HAVING NEW MODEL NUMBERS) AND HAVE A FLUSH TOP DESIGN (TOP CAPS OVER THE SIDES). PREVIOUS STANDARD SPECIALS WITH AN INSET TOP (SIDES WERE FULL HEIGHT) ARE STILL AVAILABLE WITH THE OLD MODEL NUMBER. CONTACT TPG FOR ASSISTANCE.

Description	Model	L1 List Price	L2 Upcharge		L3 Upcharge	
			Case	Front	Case	Front
42½"H Pull Out Tower — 12"W						
24"D LH	SPLA-IN-PLSTG12A.M475881	\$ 3587	\$ 79	\$ 37	\$ 160	\$ 69
24"D RH	SPLA-IN-PLSTG12A.M475880	\$ 3587	\$ 79	\$ 37	\$ 160	\$ 69
27"D LH	SPLA-IN-PLSTG12A.M488732	\$ 3800	\$ 79	\$ 37	\$ 160	\$ 69
27"D RH	SPLA-IN-PLSTG12A.M488731	\$ 3800	\$ 79	\$ 37	\$ 160	\$ 69
30"D LH	SPLA-IN-PLSTG12A.M475883	\$ 4014	\$ 79	\$ 37	\$ 160	\$ 69
30"D RH	SPLA-IN-PLSTG12A.M475882	\$ 4014	\$ 79	\$ 37	\$ 160	\$ 69

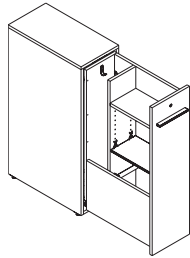

RH

Note: Towers are freestanding.

Contains:

- Removable file bar
- 1 – Adjustable shelf
- 1 – Fixed shelf
- 2 – Coat hooks

Wardrobe on 24"D model is 6"D

Wardrobe on 30"D model is 8"D

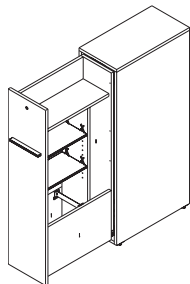

LH

50"H Pull Out Tower — 12"W

24"D LH	SPLA-IN-PLSTG12A.M475886	\$ 4271	\$ 79	\$ 37	\$ 160	\$ 69
24"D RH	SPLA-IN-PLSTG12A.M475885	\$ 4271	\$ 79	\$ 37	\$ 160	\$ 69
27"D LH	SPLA-IN-PLSTG12A.M488734	\$ 4528	\$ 79	\$ 37	\$ 160	\$ 69
27"D RH	SPLA-IN-PLSTG12A.M488733	\$ 4528	\$ 79	\$ 37	\$ 160	\$ 69
30"D LH	SPLA-IN-PLSTG12A.M475889	\$ 4782	\$ 79	\$ 37	\$ 160	\$ 69
30"D RH	SPLA-IN-PLSTG12A.M475887	\$ 4782	\$ 79	\$ 37	\$ 160	\$ 69

Note: Towers are freestanding.

Contains:

- Removable file bar
- 2 – Adjustable shelves
- 1 – Fixed shelf
- 2 – Coat hooks

Wardrobe on 24"D model is 6"D

Wardrobe on 30"D model is 8"D

<p>How to specify — Select the Model Number from above.</p>	<p>1st Option: Pull Type (if applicable): MP Beam OP Halo SP Square AP Arch</p>	<p>2nd Option: Pull Color (if applicable): MP Beam / OP Halo PJV Designer White PR6 Silver PJE Pyrite P8X Solar Black P2 upcharge +\$15/pull</p>	<p>3rd Option: Metal Shelf Color: See inside front cover for finishes. Add \$35 for P2 or \$67 for P3 Paints.</p>
<p>SPLA-IN-</p>		<p>PLSTG12A.M4</p>	
<p>P</p>		<p>P</p>	

Continued below ▼

<p>4th Option: FSC Certified Wood: FSC Select for FSC Certified Wood X No FSC</p>	<p>5th Option: Laminate Color (Case): See inside front cover for finishes.</p>	<p>6th Option: Matching Edge: See inside front cover for finishes.</p>	<p>7th Option: 2nd Laminate Color (Front): See inside front cover for finishes.</p>	<p>8th Option: Matching Edge: See inside front cover for finishes.</p>	<p>9th Option: Lock Option: STD Standard OMT Omit Lock Core (deduct \$18 per lock)</p>	<p>10th Option: Lock Color (if applicable): EL Silver</p>
<p>E/L</p>		<p>E/L</p>		<p>E/L</p>		<p>E/L</p>

Example: SPLA-IN-PLSTG12A.M475881.APPR6.P7D.X.LWCWEDCW.LWCWEDCW.STDEL

Description	Model	L1		L2 Upcharge		L3 Upcharge	
		List Price	Case	Front	Case	Front	
42½"H Wardrobe Tower — 12"W							
30"D LH Footed 2-Tone	SPLA-SS-IN42H2TTFB.M490878	\$ 3420	\$ 79	\$ 37	\$ 160	\$ 69	
30"D LH Plinth 2-Tone	SPLA-SS-IN42H2TTPB.M490880	\$ 3420	\$ 79	\$ 37	\$ 160	\$ 69	
30"D RH Footed 2-Tone	SPLA-SS-IN42H2TTFB.M490877	\$ 3420	\$ 79	\$ 37	\$ 160	\$ 69	
30"D RH Plinth 2-Tone	SPLA-SS-IN42H2TTPB.M490879	\$ 3420	\$ 79	\$ 37	\$ 160	\$ 69	
50"H Wardrobe Tower — 12"W							
30"D LH Footed 2-Tone	SPLA-SS-IN50H2TTFB.M490882	\$ 3549	\$ 84	\$ 39	\$ 172	\$ 71	
30"D LH Plinth 2-Tone	SPLA-SS-IN50H2TTPB.M490884	\$ 3549	\$ 84	\$ 39	\$ 172	\$ 71	
30"D RH Footed 2-Tone	SPLA-SS-IN50H2TTFB.M490881	\$ 3549	\$ 84	\$ 39	\$ 172	\$ 71	
30"D RH Plinth 2-Tone	SPLA-SS-IN50H2TTPB.M490883	\$ 3549	\$ 84	\$ 39	\$ 172	\$ 71	
57½"H Wardrobe Tower — 12"W							
30"D LH Footed 2-Tone	SPLA-SS-IN57H2TTFB.M490886	\$ 3651	\$ 85	\$ 39	\$ 174	\$ 73	
30"D LH Plinth 2-Tone	SPLA-SS-IN57H2TTPB.M490888	\$ 3651	\$ 85	\$ 39	\$ 174	\$ 73	
30"D RH Footed 2-Tone	SPLA-SS-IN57H2TTFB.M490885	\$ 3651	\$ 85	\$ 39	\$ 174	\$ 73	
30"D RH Plinth 2-Tone	SPLA-SS-IN57H2TTPB.M490887	\$ 3651	\$ 85	\$ 39	\$ 174	\$ 73	
65"H Wardrobe Tower — 12"W							
30"D LH Footed 2-Tone	SPLA-SS-IN65H2TTFB.M490890	\$ 3691	\$ 86	\$ 39	\$ 177	\$ 73	
30"D LH Plinth 2-Tone	SPLA-SS-IN65H2TTPB.M490892	\$ 3691	\$ 86	\$ 39	\$ 177	\$ 73	
30"D RH Footed 2-Tone	SPLA-SS-IN65H2TTFB.M490889	\$ 3691	\$ 86	\$ 39	\$ 177	\$ 73	
30"D RH Plinth 2-Tone	SPLA-SS-IN65H2TTPB.M490891	\$ 3691	\$ 86	\$ 39	\$ 177	\$ 73	

Note: Wardrobe includes coat rod and adjustable shelf.
 *Upcharges are added to solid laminate list price depending on woodgrain laminate selection.

How to specify — Select the Model Number from above. S P L A - S S - I N .	1st Option: Foot Type (if applicable): TF Terrace Foot ZF Stride Foot (Add \$83)	2nd Option: Foot Paint Color (if applicable): P1 P2 See inside front cover for finishes. Stride is limited to PR6 Silver.	3rd Option: Pull Type (if applicable): MP Beam OP Halo SP Square AP Arch	4th Option: Pull Color (if applicable): MP Beam / OP Halo PJW Designer White PR6 Silver PJE Pyrite P8X Solar Black P2 upcharge +\$15/pull SP Square PJW Designer White EL Matte Silver P02 Flint P7B Loft PJE Pyrite P8X Solar Black AP Arch PRO Anodized Silver P2 upcharge +\$15/pull

Continued below ▼

5th Option: Metal Shelf Color: P1 P2 P3 See inside front cover for finishes. Add \$15 for P2 (except PR6) or \$26 for P3 Paints.	6th Option: FSC Certified Wood (if applicable): FSC Select for FSC Certified Wood X No FSC	7th Option: Laminate Color (if applicable): See inside front cover for finishes. (If two-tone list case color here.)	8th Option: Matching Edge (if applicable): See inside front cover for finishes.	9th Option: 2nd Laminate Color (Front) (if applicable): See inside front cover for finishes.	10th Option: Matching Edge (if applicable): See inside front cover for finishes.	11th Option: Lock (if applicable): STD Standard Core (Deduct \$18) OMT Omit Lock Core (Deduct \$18)	12th Option: Lock Color (if applicable): EL Silver
.	E L

Example: SPLA-SS-IN42H2TTFB.M490878.APPR6.P7D.X.LM13EY.LM15EU.STDEL

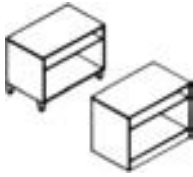

Description	Model	L1	L2	L3
		List Price	List Price	List Price
24"H x 12"D Credenza — Open Cubby with Metal Shelf for Use with Height-Adjustable Tables				
24"W Footed	SPLA-SS-IN2TOCFB.M487936	\$ 1941	\$ 2005	\$ 2068
30"W Footed	SPLA-SS-IN2TOCFB.M487937	\$ 2044	\$ 2108	\$ 2171
30"W Plinth Base	SPLA-SS-IN2TOCPB.M487939	\$ 2044	\$ 2108	\$ 2171
36"W Footed	SPLA-SS-IN2TOCFB.M487938	\$ 2139	\$ 2203	\$ 2266
36"W Plinth Base	SPLA-SS-IN2TOCPB.M487940	\$ 2139	\$ 2203	\$ 2266

*Upcharges are added to laminate list price depending on woodgrain laminate selection.

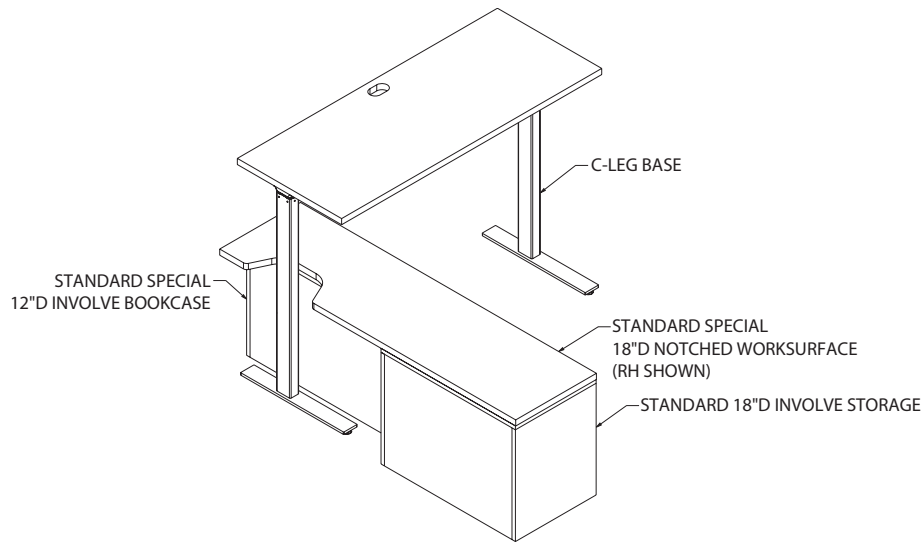

<p>How to specify — Select the Model Number from above.</p>	<p><i>1st Option:</i> Foot Type (if applicable): TF Terrace Foot ZF Stride Foot (Add \$83)</p>	<p><i>2nd Option:</i> Foot Paint Color (if applicable): P1 P2 See inside front cover for finishes. Stride is limited to PR6 Silver.</p>	<p><i>3rd Option:</i> Metal Shelf Color (if applicable): P1 P2 P3 Add \$15 for P2 (except PR6) or \$26 for P3 Paints on shelf.</p>
	<p>S P L A - S S - I N 2 T O C F B . M 4 8 7 9</p>	<p>P</p>	<p>.</p>

Continued below ▼

<p><i>4th Option:</i> FSC Certified Wood: FSC Select for FSC Certified Wood X No FSC</p>	<p><i>5th Option:</i> Laminate Color: See inside front cover for finishes. (If two-tone list case color here.)</p>	<p><i>6th Option:</i> Matching Edge: See inside front cover for finishes.</p>
<p>.</p>	<p>.</p>	<p>.</p>

Example: SPLA-SS-IN2TOCFB.M487936.TFPQ8.PR6.X.LWCWEDCW

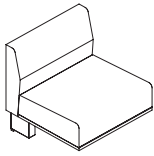

Description	Model Number	Base List Price	Upcharge List Price — Add to Base Price								
			1	2	3	4	5	6	7	8	
Two-Tone Banquette Cushion — 24"D x 19"H Back for use on 11"H seat bases											
24"W	SPLA-IN-BANCUSH.										
	M490800	\$ 1338	Back Fabric	\$ 0	\$ 16	\$ 24	\$ 36	\$ 52	\$ 67	\$ 83	\$ 99
			Seat Fabric	\$ 0	\$ 16	\$ 24	\$ 36	\$ 52	\$ 67	\$ 83	\$ 99
24"W	SPLA-IN-BANCUSHFC.										
Fire Code	M490802	\$ 1524	Back Fabric	\$ 0	\$ 16	\$ 24	\$ 36	\$ 52	\$ 67	\$ 83	\$ 99
			Seat Fabric	\$ 0	\$ 16	\$ 24	\$ 36	\$ 52	\$ 67	\$ 83	\$ 99
36"W	SPLA-IN-BANCUSH36.										
	M490801	\$ 1719	Back Fabric	\$ 0	\$ 28	\$ 58	\$ 97	\$ 136	\$ 177	\$ 219	\$ 259
			Seat Fabric	\$ 0	\$ 28	\$ 58	\$ 97	\$ 136	\$ 177	\$ 219	\$ 259
36"W	SPLA-IN-BANCUSHFC36.										
Fire Code	M490803	\$ 1909	Back Fabric	\$ 0	\$ 23	\$ 48	\$ 80	\$ 111	\$ 145	\$ 178	\$ 210
			Seat Fabric	\$ 0	\$ 23	\$ 48	\$ 80	\$ 111	\$ 145	\$ 178	\$ 210

Note: Due to the design of the cushion, pattern matching is not possible on Involve cushion backs. Large scale patterns and stripes are to be avoided, unless approved by the customer.

	24"W Models	36"W Models
COM Yardage (Back)	1.6 yards	1.6 yards
COM Yardage (Seat)	1.3 yards	1.3 yards

<p>How to specify Cushions — Select the Model Number from above.</p>	<p><i>1st Option:</i> Back Upholstery: Specify back upholstery — see Casegoods & Storage price list pages 9-13.</p>	<p><i>2nd Option:</i> Seat Upholstery: Specify seating upholstery — see Casegoods & Storage price list pages 9-13.</p>
---	--	---

Example: SPLA-IN-BANCUSH.M490800.CU40.CU98

S Shippable by small-package carrier.

EMS ENERGY MANAGEMENT SYSTEM

Summary of Title 24

The 2014 California Title 24, addresses building energy efficiency standards with an objective to reduce energy use in California. The owner or tenant is responsible to meet these specific requirements. This impacts:

- All building permits, new or renovation
- Office improvements, including moving or reconfiguring existing furniture

Office Furniture Impact

In Subchapter 4, Section 130.5(d), controlled duplex receptacles are required and non-controlled duplex receptacles are allowed. A factory-marked controlled duplex receptacle is required within 6 feet of any non-controlled receptacle. Circuit controls for 120 volt duplex receptacles will run on timers, sensors, or both. A power strip or surge bar does not meet the standard. These requirements are for new spaces and retrofits, with all building permits, and any time furniture with electrical is moved. A post-installation inspection is also required. Controlling duplex receptacles can be accomplished at the building power controls or within the furniture power system.

FAQ

Q. What should I discuss with customers now?

A. Ask if Title 24 compliance will be necessary on the project, and how they intend to comply. Be ready to discuss options.

Q. How will this affect planning and specification?

A. Plan for the 6' rule when placing controlled and non-controlled duplex receptacles. The Allsteel IDS team is versed in Title 24 and ready to help you with your planning needs.

Q. Does this work with existing Allsteel electrical?

A. Yes, the infeed must be the EMS version but the other electrical components downstream from the infeed will remain Allsteel standard electrical components. Please see notes below for more information.

Q. When will the EMS (Energy Management System) be orderable?

A. Components are available now through Tailored Solutions.

Q. Can you sync more than 1 occupancy sensor to a Monitor Controlled Device (MCD)?

A. Yes, you can sync multiple occupancy sensors to each MCD.

Q. How do I know whether to specify the base/ceiling infeed or power harness MCD?

A. The MCD needs to be as close to the power input as possible. If your last panel in a run needs to have powered duplex receptacles, the base/ceiling in-feed version must be used. If not, it is recommended to use the power harness MCD. (Context: The power harness MCD is concealed within the panel kickplate. The base/ceiling in-feed is mounted to the outside of the kickplate on the panel.)

Furniture Controls

Specify Allsteel EMS Base/ceiling in-feed or power harness. Each Monitor/ Controlled Device (MCD) includes programming instructions. Controlled labels for duplex receptacles are available as well as duplex receptacles marked with 'controlled'. Occupancy sensor is specified separately.

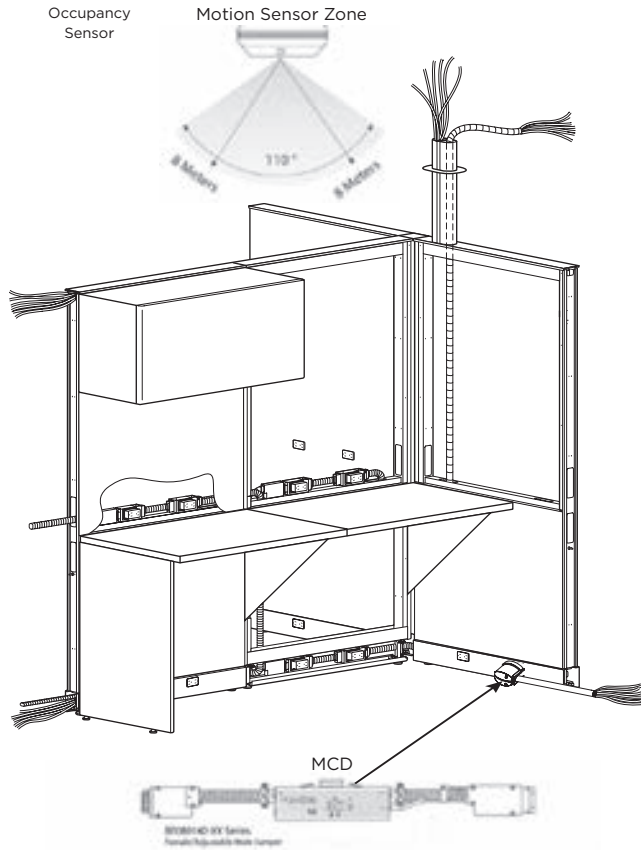

- Follow 6' rule when placing controlled receptacles
- Label controlled receptacles

Allsteel EMS, features "CircuiTrac™ by Byrne" energy management system. EMS is compatible with new installations or can easily retrofit to existing Allsteel electrical systems. Simply program the circuits at the time of installation and sync to the occupancy sensor(s).

Key components:

- Monitor/Control Device (MCD) (Base/ceiling in-feed or power harness)
- Occupancy Sensor
- Label controlled duplex receptacles with stickers or order pre-marked, "controlled", duplex receptacles

Building Controls

A certified electrician wires in-feeds for select circuits to be controlled using an occupancy sensor or timer. All controlled duplex receptacles must be labeled as such.

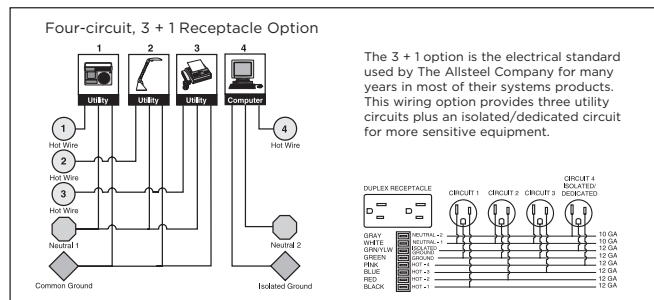
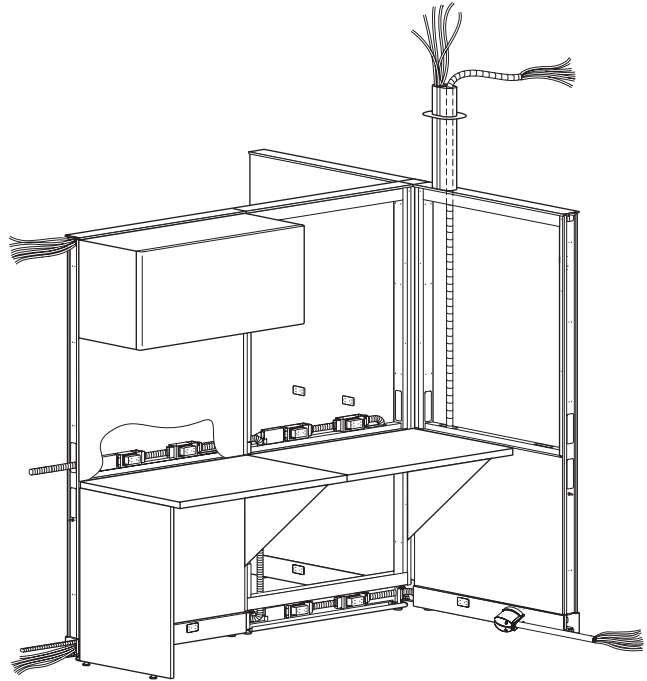

- Follow 6' rule when placing controlled duplex receptacles
- Label controlled duplex receptacles
- Use standard electrical components
- Coordinate with electrician on which circuit(s) to control
- Electrician provides controlled circuits

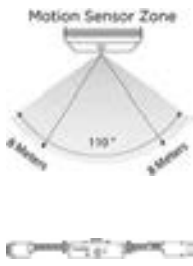

Description	Four-circuit 3 + 1 2 + 2	List Price	Three-circuit Separate Neutrals	List Price
Title 24 Electrical				
30"W Pass-through w/ MCD, No Power Block (Four Circuit) (no duplexes with 30"W frame)	SPLA-TP-ELEC-BYR.M490906	\$ 4900	N/A	
30"W Pass-through w/ MCD, No Power Block (no duplexes with 30"W frame)	SPLA-TP-ELEC-BYR.M490916	\$ 4900	N/A	
36"W Power Harness w/ MDC, One Power Block	SPLA-TP-ELEC-BYR.M490908	\$ 5189	SPLA-TP-ELEC-BYR.M490917	\$ 5189
42"W Power Harness w/ MDC, One Power Block	SPLA-TP-ELEC-BYR.M490909	\$ 5204	SPLA-TP-ELEC-BYR.M490918	\$ 5204
48"W Power Harness w/ MDC, One Power Block	SPLA-TP-ELEC-BYR.M490910	\$ 5217	SPLA-TP-ELEC-BYR.M490919	\$ 5217
60"W Power Harness w/ MDC, One Power Block	SPLA-TP-ELEC-BYR.M490911	\$ 5243	SPLA-TP-ELEC-BYR.M490920	\$ 5243
Occupancy Sensor for Energy Management System	SPLA-TP-ELEC-BYR.M490915	\$ 733	N/A	

How to specify —
Select the
Model Number
from above.

1st Option:
**Electrical Receptacle
Color (if applicable):**
See inside front
cover for finishes.

1st Option:
**Color
(if applicable):**
P Black

_____ . **E**

Example: SPLA-TP-ELEC-BYR.M490906.P

S Shippable by small-package carrier.

OPTIMIZE

ALTITUDE

INVOLVE

TITLE 24

ACCESSORIES

PANEL FABRICS

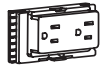

Description	Model	List Price
Title 24 Electrical — Further		
Receptacle - CONTROLLED STAMP Circuit 1 - Further	SPLA-TP-PELEC-BYR.M490934	\$ 78
Receptacle - CONTROLLED STAMP Circuit 2 - Further	SPLA-TP-PELEC-BYR.M490935	\$ 78
Receptacle - CONTROLLED STAMP Circuit 3 - Further (2+2)	SPLA-TP-PELEC-BYR.M490937	\$ 78
Receptacle - CONTROLLED STAMP Circuit 3 - Further (3+1)	SPLA-TP-PELEC-BYR.M490936	\$ 78
Receptacle - CONTROLLED STAMP Circuit 4 - Further (Four-Circuit - ISO/DEDICATED)	SPLA-TP-PELEC-BYR.M490938	\$ 78

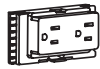

Title 24 Electrical — Optimize		
BASE ELEC IN-FEED 6FT SEALTIGHT CABLE w/ screw mount MDC, SN/Ap fit to power block out (Four Circuit)	SPLA-TP-ELEC-BYR.M490914	\$ 4277
BASE ELEC IN-FEED 6FT SEALTIGHT CABLE w/ screw mount MDC, SN/Ap fit to power block out (Three Circuit)	SPLA-TP-ELEC-BYR.M490923	\$ 4277
Receptacle - CONTROLLED STAMP Circuit 1 - Optimize (Four Circuit)	SPLA-TP-PELEC-BYR.M490939	\$ 78
Receptacle - CONTROLLED STAMP Circuit 1 - Optimize (Three Circuit)	SPLA-TP-PELEC-BYR.M490950	\$ 78
Receptacle - CONTROLLED STAMP Circuit 2 - Optimize (Four Circuit)	SPLA-TP-PELEC-BYR.M490940	\$ 78
Receptacle - CONTROLLED STAMP Circuit 2 - Optimize (Three Circuit)	SPLA-TP-PELEC-BYR.M490951	\$ 78
Receptacle - CONTROLLED STAMP Circuit 3 - Optimize (Four Circuit 2+2)	SPLA-TP-PELEC-BYR.M490942	\$ 78
Receptacle - CONTROLLED STAMP Circuit 3 - Optimize (Four Circuit 3+1)	SPLA-TP-PELEC-BYR.M490941	\$ 78
Receptacle - CONTROLLED STAMP Circuit 3 - Optimize (Three Circuit 3+1)	SPLA-TP-PELEC-BYR.M490952	\$ 78
Receptacle - CONTROLLED STAMP Circuit 4 - Optimize (Four Circuit ISO/DEDICATED)	SPLA-TP-PELEC-BYR.M490943	\$ 78

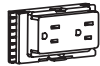

Title 24 Electrical — Stride		
BASE ELEC IN-FEED 6FT SEALTIGHT CABLE w/ screw mount MDC, SN/Ap fit to power block out (Four Circuit)	SPLA-TP-ELEC-BYR.M490912	\$ 4277
BASE ELEC IN-FEED 6FT SEALTIGHT CABLE w/ screw mount MDC, SN/Ap fit to power block out (Three Circuit)	SPLA-TP-ELEC-BYR.M490921	\$ 4277
Receptacle - CONTROLLED STAMP Circuit 1 - Stride (Four Circuit)	SPLA-TP-PELEC-BYR.M490924	\$ 78
Receptacle - CONTROLLED STAMP Circuit 1 - Stride (Three Circuit)	SPLA-TP-PELEC-BYR.M490944	\$ 78
Receptacle - CONTROLLED STAMP Circuit 2 - Stride (Four Circuit)	SPLA-TP-PELEC-BYR.M490925	\$ 78
Receptacle - CONTROLLED STAMP Circuit 2 - Stride (Three Circuit)	SPLA-TP-PELEC-BYR.M490945	\$ 78
Receptacle - CONTROLLED STAMP Circuit 3 - Stride (Four Circuit 2+2)	SPLA-TP-PELEC-BYR.M490927	\$ 78
Receptacle - CONTROLLED STAMP Circuit 3 - Stride (Four Circuit 3+1)	SPLA-TP-PELEC-BYR.M490926	\$ 78
Receptacle - CONTROLLED STAMP Circuit 3 - Stride (Three Circuit)	SPLA-TP-PELEC-BYR.M490946	\$ 78
Receptacle - CONTROLLED STAMP Circuit 4 - Stride (Four Circuit - ISO/DEDICATED)	SPLA-TP-PELEC-BYR.M490928	\$ 78

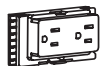

Title 24 Electrical — Terrace		
BASE ELEC IN-FEED 6FT SEALTIGHT CABLE w/ screw mount MDC, SN/Ap fit to power block out (Four Circuit)	SPLA-TP-ELEC-BYR.M490913	\$ 4277
BASE ELEC IN-FEED 6FT SEALTIGHT CABLE w/ screw mount MDC, SN/Ap fit to power block out (Three Circuit)	SPLA-TP-ELEC-BYR.M490922	\$ 4277
Receptacle - CONTROLLED STAMP Circuit 1 - Terrace (Four Circuit)	SPLA-TP-PELEC-BYR.M490929	\$ 78
Receptacle - CONTROLLED STAMP Circuit 1 - Terrace (Three Circuit)	SPLA-TP-PELEC-BYR.M490947	\$ 78
Receptacle - CONTROLLED STAMP Circuit 2 - Terrace (Four Circuit)	SPLA-TP-PELEC-BYR.M490930	\$ 78
Receptacle - CONTROLLED STAMP Circuit 2 - Terrace (Three Circuit)	SPLA-TP-PELEC-BYR.M490948	\$ 78
Receptacle - CONTROLLED STAMP Circuit 3 - Terrace (Four Circuit 2+2)	SPLA-TP-PELEC-BYR.M490932	\$ 78
Receptacle - CONTROLLED STAMP Circuit 3 - Terrace (Four Circuit 3+1)	SPLA-TP-PELEC-BYR.M490931	\$ 78
Receptacle - CONTROLLED STAMP Circuit 3 - Terrace (Three Circuit)	SPLA-TP-PELEC-BYR.M490949	\$ 78
Receptacle - CONTROLLED STAMP Circuit 4 - Terrace (Four Circuit - ISO/DEDICATED)	SPLA-TP-PELEC-BYR.M490933	\$ 78

How to specify —
Select the Model Number from above.

1st Option:
Electrical Receptacle Color (if applicable):
See inside front cover for finishes.

1st Option:
Color (if applicable):
P Black

Example: SPLA-TP-ELEC-BYR.M490929.E4

[S] Shippable by small-package carrier.

GRADE A

APPOINT PANEL

100% Polyester

Artichoke.....	APN911
Blackberry.....	APN932
Bronze.....	APN922
Carbon.....	APN928
Chai.....	APN912
Cherry.....	APN930
Dark Pewter.....	APN917
Dune.....	APN915
Espresso.....	APN923
Framboise.....	APN931
Frost.....	APN934
Jet.....	APN927
Lawn.....	APN925
Mandarin.....	APN929
Morel.....	APN909
Nimbus.....	APN916
Platinum.....	APN924
Turquoise.....	APN926

BINARY

Blush.....	BNRY12
Coal.....	BNRY06
Cream.....	BNRY01
Denim.....	BNRY08
Diamond.....	BNRY03
Graphite.....	BNRY05
Juniper.....	BNRY10
Lagoon.....	BNRY07
Lavendar.....	BNRY11
Mineral.....	BNRY04
Reef.....	BNRY09
Sand Dollar.....	BNRY02

CENTURION*

(Nanotex™ Stain-Resistant finish)

Apricot.....	CU47
Bark.....	CU25
Black.....	CU10
Espresso.....	CU49
Fog.....	CU03
Frost.....	CU22
Goldenrod.....	CU27
Indigo.....	CU06
Iris.....	CU50
Iron Ore.....	CU19
Jade.....	CU83
Marsala.....	CU63
Morel.....	CU24
Navy.....	CU98
Peacock.....	CU97
Pear.....	CU84
Ruby.....	CU67
Sapphire.....	CU09

CIRCUIT

Atlas.....	CIRC35
Dolphin.....	CIRC63
Island White.....	CIRC14
Moon.....	CIRC07
Night.....	CIRC49
Pacific.....	CIRC28
Quartz.....	CIRC01
Sienna.....	CIRC56
Silk.....	CIRC21
Snap Pea.....	CIRC42

ETCH

100% Polyester

Axis.....	ECH913
Blend.....	ECH914
Cast.....	ECH912
Highlight.....	ECH910
Midtone.....	ECH911
Outline.....	ECH908
Shade.....	ECH909
Tonal.....	ECH916
Vanish.....	ECH915

GRADE A – continued

EXCHANGE

100% Polyester

Iron.....	EXG916
Nickel.....	EXG914
Pistachio.....	EXG910
Root.....	EXG913
Rupee.....	EXG903
Shadow.....	EXG911
Silver.....	EXG915
Sisal.....	EXG917
Stone.....	EXG912

LANDSCAPE

100% Polyester

Corn silk.....	LN15
Drift.....	LN05
Khaki.....	LN20
Sheen.....	LN10
Slate.....	LN35
Umber.....	LN25
Urban.....	LN30

LUCY

100% Recycled Polyester

Aspen.....	LC932
Corn silk.....	LC930
Dusk.....	LC922
Fawn.....	LC933
Graphite.....	LC934
Mist.....	LC920
Neutra.....	LC924
Pewter.....	LC935
Snowdrop.....	LC928

REFLECTIONS

100% Recycled Polyester

Galvanized.....	REF929
Ice.....	REF920
Loggia.....	REF921
Mistral.....	REF928
Moonstone.....	REF923
Pewter.....	REF922
Stainless.....	REF924
Vanilla.....	REF925
Winter.....	REF927

REFUGE

64% Recycled Polyester
36% Polyester

Artesian.....	RFG996
Dune.....	RFG992
Eclipse.....	RFG990
Frost †.....	RFG993
Glacier †.....	RFG991
Mineral.....	RFG998
Tidal.....	RFG994

SARTO

100% Polyester (45% Recycled)

Ash.....	SRT988
Fog.....	SRT914
Lemongrass.....	SRT949
Mist.....	SRT945
Mushroom.....	SRT976
Oyster.....	SRT918
Reef.....	SRT964
Sesame.....	SRT993
Shale.....	SRT952

TEMPEST

100% Recycled Polyester

Dragonfly.....	TP930
Frost.....	TP915
Full Stream.....	TP980
Gold Rush.....	TP910
Slate.....	TP945
Tumbleweed.....	TP970
Wind Chill.....	TP940
Zebra.....	TP935

GRADE B

*ANALOG

Album.....	ANLG06
Cartridge.....	ANLG04
Cassette.....	ANLG09
Dial.....	ANLG02
Media.....	ANLG08
Reel.....	ANLG07
Signal.....	ANLG03
Stereo.....	ANLG01
Track.....	ANLG05

COAST

100% Antimony-Free Polyester

Channel.....	COA914
Dune.....	COA903
Headlands.....	COA910
Marsh.....	COA902
Pebble.....	COA912
Pier.....	COA913
Shoal.....	COA901
Silt.....	COA906
Tide.....	COA908

DISPERSE

100% Polyester

Autumn.....	DISP03
Branch.....	DISP10
Coffee Bean.....	DISP13
Dusk.....	DISP09
Emerald City.....	DISP08
Gold Rush.....	DISP02
Igloo.....	DISP11
Ink.....	DISP06
Mist.....	DISP12
Oatmeal.....	DISP15
Prince.....	DISP07
Reservoir.....	DISP01
Rose.....	DISP04
Spring.....	DISP05
Steel.....	DISP16
Taupe.....	DISP14

MICA

100% Recycled Polyester

Anthracite.....	MCA911
Breeze.....	MCA918
Bronze.....	MCA913
Buff.....	MCA914
Cremini.....	MCA917
Crystal †.....	MCAWIT
Dew.....	MCA920
Dove.....	MCA912
Fresh.....	MCA916
Mineral.....	MCA915
Nectar.....	MCA919
Shale.....	MCA910

SPIN PANEL

46% Recycled Polyester,
56% Polyester

Alabaster.....	SPIN02
Cavern.....	SPIN03
Cobblestone.....	SPIN04
Ember.....	SPIN06
Flame.....	SPIN07
Heron.....	SPIN13
Oat.....	SPIN01
Ocean.....	SPIN12
Plum.....	SPIN15
Pool.....	SPIN11
Raven.....	SPIN10
Rhubarb.....	SPIN14
Tropic.....	SPIN08
Willow.....	SPIN05

GRADE B – continued

TERRAIN

52% Recycled Polyester,
48% Polyester

Bay.....	TRRN05
Bayou.....	TRRN35
Canyon.....	TRRN30
Cliff.....	TRRN45
Crest.....	TRRN25
Delta.....	TRRN10
Plateau.....	TRRN15
Ridge.....	TRRN20
Valley.....	TRRN40

ALLSTEEL PARTNERSHIP PROGRAM

Allsteel understands that customers may want to specify panel and seating textiles outside of Allsteel's standard offering. Allsteel's **Partnership Program** consists of on-trend and design-forward patterns that have been tested and approved by Allsteel for use on Allsteel products. A subset of these approved patterns is available on cards in the textile binder, while numerous others are available on our website, allsteeloffice.com.

For memo samples, please contact our partners:

- Camira, memos@camirafabrics.com
1.616.288.0655
- Carnegie, carnegiefabrics.com
1.800.727.6770
- CF Stinson, cfstinson.com
1.800.841.6279
- HBF Textiles, hbftextiles.com
1.877.494.5727
- Maharam, maharam.com
1.800.645.3943
- Ultrafabrics, ultrafabricsllc.com
1.877.309.6648

The intent of the **Partnership Program** is to offer a wide variety of on-trend textiles to meet your varied needs, but since these textiles are not part of our standard offering they may be subject to extended lead times. Because new materials will be introduced regularly, Allsteel reserves the right to change the offering at any time.

PARTNERSHIP – GRADE D

Camira BLAZER LITE

(100% Pure New Wool)

Angel.....	PCAMBLT49
Aspire.....	PCAMBLT52
Balance.....	PCAMBLT41
Bliss.....	PCAMBLT48
Buddha.....	PCAMBLT56
Cuddle.....	PCAMBLT62
Dainty.....	PCAMBLT64
Daydream.....	PCAMBLT46
Devoted.....	PCAMBLT58
Faith.....	PCAMBLT68
Freedom.....	PCAMBLT69
Graceful.....	PCAMBLT59
Happy.....	PCAMBLT55
Harmony.....	PCAMBLT63
Haven.....	PCAMBLT40
Hope.....	PCAMBLT50
Hush.....	PCAMBLT42
Love.....	PCAMBLT47
Mood.....	PCAMBLT44
Pamper.....	PCAMBLT66
Pastel.....	PCAMBLT65
Pillow.....	PCAMBLT43
Praise.....	PCAMBLT54
Retreat.....	PCAMBLT39
Shelter.....	PCAMBLT60
Solace.....	PCAMBLT70
Tender.....	PCAMBLT53
True.....	PCAMBLT61
Verity.....	PCAMBLT57
Wish.....	PCAMBLT67
Worship.....	PCAMBLT59

* Limited to product 48" W or less.

Multi-use fabrics are seating fabrics that can be used on specific Allsteel panels systems, providing more color and pattern options. The applicable Allsteel multi-use fabrics are noted with System designators in the Seating, Collaboration, and Tables Price List.



Allsteel®

Allsteel Inc.
Muscatine, Iowa 52761

allsteeloffice.com

Form # A8706 (11/22)