

PRICING EFFECTIVE FEBRUARY 2024

# CREDENTIALS™

*Price & Specification Guide*

PDF updated May 6, 2024

Gunlocke®

## VENEER 2 (SELECT)

### NATURAL FC CHERRY

|                      |       |
|----------------------|-------|
| A. Cinnamon/Biltmore | NC260 |
| B. Lowell Ash        | NC394 |
| C. Medium Red        | NC512 |
| D. Light             | NC701 |
| E. Shaker            | NC774 |
| F. Burnished         | NC777 |

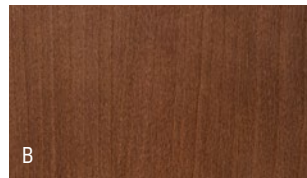

### NATURAL FC MAPLE

|            |       |
|------------|-------|
| G. Natural | NE800 |
| H. Harvest | NE856 |



### NATURAL FC WALNUT

|                      |       |
|----------------------|-------|
| I. Florence          | NT579 |
| J. Light             | NT601 |
| K. Skyline           | NT625 |
| L. Nutmeg            | NT629 |
| M. Pinnacle          | NT679 |
| N. Sumatra           | NT693 |
| O. Ebony             | NT509 |
| (Use OP TopFin Only) |       |

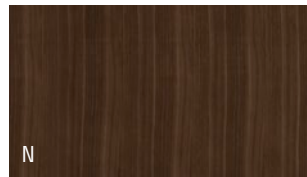
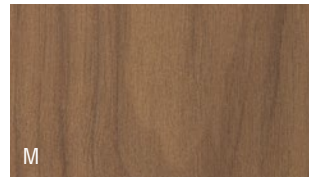
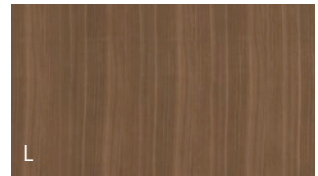
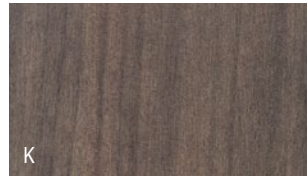
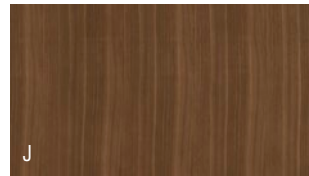
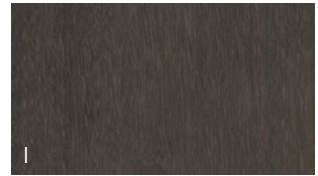

## VENEER 3 (PREMIUM)

### NATURAL QC WALNUT

|                      |       |
|----------------------|-------|
| A. Florence          | QT579 |
| B. Light             | QT601 |
| C. Skyline           | QT625 |
| D. Nutmeg            | QT629 |
| E. Pinnacle          | QT679 |
| F. Sumatra           | QT693 |
| G. Ebony             | QT509 |
| (Use OP TopFin Only) |       |

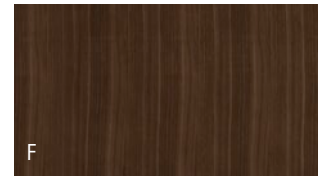
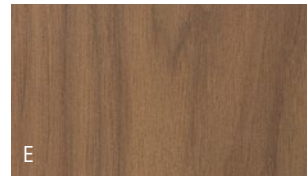
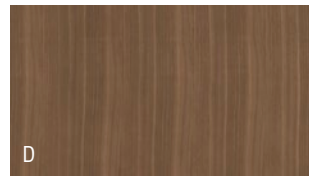
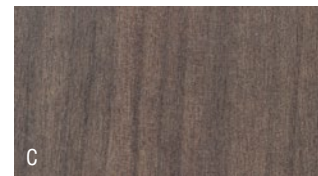
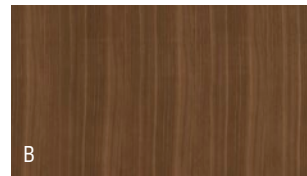
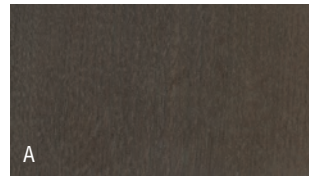

### NATURAL RIFT CUT OAK

|                      |       |
|----------------------|-------|
| H. Light             | RF301 |
| I. Dark              | RF331 |
| J. Phantom Ecu       | RF912 |
| (Use OP TopFin Only) |       |
| K. Fawn Cypress      | RF108 |

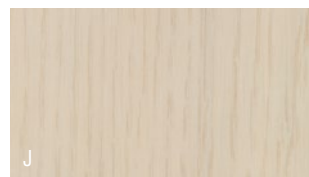

# ORDERING OPTION CODES

Credentials  
02/24

## TOP FINISH

|                                     |    |
|-------------------------------------|----|
| Open Pore Low Sheen                 | OP |
| Full Fill ClearTech™                | FF |
| Full Fill Top ≤ 120" Length(+\$282) |    |
| Full Fill Top > 120" Length(+\$450) |    |

## PULLS

|                               |     |
|-------------------------------|-----|
| Metal Pull - Champagne Silver | MPS |
| Metal Pull - Dark Bronze      | MPZ |
| Integral Wood Pull            | FPW |

## PENCIL LIP COLOR

|                               |     |
|-------------------------------|-----|
| Pencil Lip - Champagne Silver | PLS |
| Pencil Lip - Dark Bronze      | PLZ |

## BACK PAINTED GLASS DOORS/TACKZONE

|           |    |
|-----------|----|
| Ice White | WH |
| Black     | BK |
| Muslin    | ML |

## BACK PAINTED GLASS TOPS

|                        |     |
|------------------------|-----|
| Ice White, Acid Etched | TWH |
| Black, Acid Etched     | TBK |
| Muslin, Acid Etched    | TML |

## DESKTOP OPTION

|                           |     |
|---------------------------|-----|
| Standard Veneer           | TVN |
| <b>Faux Leather Inlay</b> |     |
| White (+\$1,703)          | TLW |
| Black (+\$1,703)          | TLB |
| Chocolate (+\$1,703)      | TLC |

## Back Painted Glass Insert

|                                   |     |
|-----------------------------------|-----|
| Ice White, Acid Etched (+\$2,383) | TGW |
| Black, Acid Etched (+\$2,383)     | TGB |
| Muslin, Acid Etched (+\$2,383)    | TGM |

## PERSONAL CORNER

### LEATHER

|           |     |
|-----------|-----|
| White     | CWH |
| Black     | CBL |
| Chocolate | CCH |

### VINYL

|           |     |
|-----------|-----|
| White     | VWH |
| Black     | VBL |
| Chocolate | VCH |

## MODESTY PANEL SET #1

|                                 |    |
|---------------------------------|----|
| No Mod Required (deduct \$-867) | MN |
| Finished Modesty Panel          | MY |

## MODESTY PANEL SET #2 TROUGH BRIDGES

|                                   |    |
|-----------------------------------|----|
| No Mod Required (deduct \$-1,422) | MN |
| Wall Access Panel                 | AP |

## LOCKS

|           |    |
|-----------|----|
| Locks Yes | LY |
| Locks No  | LN |

## KEYING

|                       |    |
|-----------------------|----|
| Field Installed Locks | FL |
|-----------------------|----|

## FACTORY-INSTALLED

|                    |     |
|--------------------|-----|
| Random Key Numbers |     |
| Silver             | RMS |
| Black              | RMB |

## Designated Key Numbers

|                           |                     |
|---------------------------|---------------------|
| Specify a number between: |                     |
| Silver                    | FT100TAS - FT150TAS |
| Black                     | FT100TA - FT150TA   |

## GRAIN DIRECTION

|                              |     |
|------------------------------|-----|
| Standard Veneer Direction    | VLG |
| Cross/Short Veneer Direction | VST |

## MAGNETIC ACCESSORIES PAINT COLOR

|        |     |
|--------|-----|
| White  | AWH |
| Black  | ABK |
| Muslin | AML |

## OFFICE NUMBER

|  |             |
|--|-------------|
| Specify a number to identify each office | OFC1-OFC199 |
|--|-------------|

## PULLS

Metal Pull - Champagne Silver



Metal Pull - Dark Bronze



Integral Wood Pull



## LEATHER DETAILS

Leather Desk Inlay



Leather Tray for Overhead Cubby



Leather Box Drawer Insert



## MISC. DETAILS

Grommet

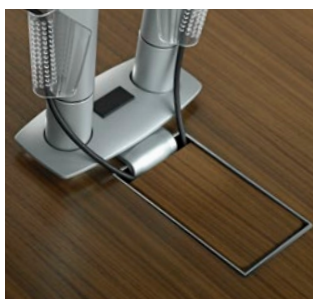

Printer Pedestal



Height Adjustable Desk



|  |         |  |         |
|--|---------|--|---------|
| General Information . . . . .                              | 2-6     | Overheads . . . . .                        | 116-136 |
| Conditions of Sale . . . . .                               | 2       | Single Wall Mount Overheads . . . . .      | 116-121 |
| GSA Terms & Conditions . . . . .                           | 3       | Double High Wall Mount Overheads . . . . . | 122-125 |
| Warranty . . . . .   | 5       | Tackboards . . . . .                       | 126-129 |
| Delivery Information . . . . .                             | 6       | Back Painted Glass Whiteboards . . . . .   | 130-132 |
| Veneers & Finishes . . . . .                               | 7       | Wood Magnetic Tackzone . . . . .           | 133-135 |
| Edge Detail & Pull Options . . . . .                       | 8       | Shelves for Segmented Tackzone . . . . .   | 136     |
| Pedestal Legend . . . . .                                  | 9       | Miscellaneous                              |         |
| Filing . . . . .   | 10-11   | Round Tables & Bases . . . . .             | 137     |
| Product Reference . . . . .                                | 13-30   | Accessories . . . . .                      | 138-147 |
| Features + Advantages . . . . .                            | 14-15   | Fabric Grade Pricing . . . . .             | 148-151 |
| Technical Specifications . . . . .                         | 16-18   | Weights + Cubes . . . . .                  | 152-160 |
| Height Reference . . . . .                                 | 19      |  |         |
| Desktop Leather Inlay and Glass Insert Locations . . . . . | 20      |  |         |
| Worksurface Veneer Grain Directions . . . . .              | 21-22   |  |         |
| Grommets & Trough Locations . . . . .                      | 23-24   |  |         |
| Metal Pull Locations . . . . .                             | 25      |  |         |
| Integral Wood Pull Locations . . . . .                     | 26      |  |         |
| Specification Tips . . . . .                               | 27      |  |         |
| Wire Management . . . . .                                  | 28-29   |  |         |
| Product Specifications . . . . .                           | 30      |  |         |
| Unitized Casegoods . . . . .                               | 31-103  |  |         |
| Freestanding Table Desks . . . . .                         | 32-38   |  |         |
| Double Pedestal Desks . . . . .                            | 39      |  |         |
| Single Pedestal Desks . . . . .                            | 40-41   |  |         |
| Extensions . . . . .                                       | 42-49   |  |         |
| Runoff Desks . . . . .                                     | 50-55   |  |         |
| Bridges . . . . .  | 56-57   |  |         |
| Credenza & Return Components . . . . .                     | 58-61   |  |         |
| Pedestals . . . . .  | 62-73   |  |         |
| Layers Pedestals . . . . .                                 | 74-85   |  |         |
| Modesty / Access / Support Panels . . . . .                | 86-91   |  |         |
| Brackets / Storage . . . . .                               | 92-96   |  |         |
| Mobile Pedestals . . . . .                                 | 97      |  |         |
| Cushions . . . . .   | 98      |  |         |
| Trough Inserts . . . . .                                   | 99      |  |         |
| Height Adjustable Desks . . . . .                          | 100-103 |  |         |
| Storage . . . . .  | 105-115 |  |         |
| Lateral Files . . . . .                                    | 106-107 |  |         |
| Bookcases . . . . .  | 108     |  |         |
| Hinged Door Cabinets . . . . .                             | 109     |  |         |
| Closets . . . . .  | 110-113 |  |         |
| Storage Box . . . . .                                      | 114     |  |         |
| Utility Cabinets . . . . .                                 | 115     |  |         |

**INTRODUCTION**

The Gunlocke Company is dedicated to providing the finest products and service possible. This price list reflects that commitment. Included is a current listing of our casegood models.

Seating and Lounge are presented in a separate price list. Contact your Gunlocke Customer Services Representative for more information, (800) 828-6300.

Designed for easy use, each page of this price list, and the inside front cover fold out provide all information required to order a product correctly. Should additional information be needed, contact your Gunlocke customer service representative.

**PRICING**

Prices shown cover standard product specifications. Any changes or alterations, other than those listed, will be subject to an additional charge. Prices include cartoning and freight. Authorization and pricing must be secured in advance for orders or contracts calling for large quantities, indefinite quantities, or extended delivery dates. Prices are subject to change without notice; the most current prices are published on <http://www.gunlocke.com>.

**ORDERING**

To expedite order entry and to assure proper service, email or fax all orders directly to:

**The Gunlocke Company**

Attn: Order Entry  
One Gunlocke Drive  
Wayland, New York 14572  
585-728-5111  
585-728-8350 FAX  
800-828-6300  
[www.gunlocke.com](http://www.gunlocke.com)

Gunlocke will not be responsible for duplicate orders if purchase orders are left unmarked.

**ACKNOWLEDGMENT**

Each order will be acknowledged by Gunlocke. Customers should check each acknowledgment for accuracy and immediately notify Gunlocke of any discrepancies. The printed acknowledgment is the final agreement between The Gunlocke Company and the customer, superseding all previous communications regarding the order.

**SPECIFICATION CHANGES**

Gunlocke reserves the right to change specifications for the improvement of products at any time, without notice.

**ORDER CHANGES**

Gunlocke is not required to accept changes in orders after confirmation. Reasonable changes are subject to additional charges for labor, material and administrative costs.

Order changes of acknowledgment may result in re-scheduling of product.

**RETURNED MERCHANDISE**

No merchandise may be returned without prior authorization.

**SHOWROOMS**

For all showroom locations and tour information, please reference the showrooms page online at: [www.gunlocke.com/inspiration/showrooms](http://www.gunlocke.com/inspiration/showrooms)

**CANCELLATIONS**

Cancellation of orders cannot be accepted since every order is manufactured according to customer specifications.

**STORAGE**

If delivery cannot be made and products are ready, Gunlocke will transfer products to a storage facility and products will be invoiced at that time. The customer is responsible for storage charges and assumes and bears all risks associated with the storage of that product.

**TERMS**

Net 30 days from date of invoice. A service charge of eighteen percent (18%) per year or .0004931% per day, compounded monthly, will be added to balance due beyond the thirtieth day. Products are shipped FOB factory, freight prepaid and allowed. Title passes to purchaser and Gunlocke's responsibility ceases when shipment is accepted for transportation by a carrier. A full explanation of all payment terms is found on order and invoice forms.

**ORDERING INFORMATION**

**1a.** Intended use: The furniture on this schedule is intended for use by Government executives (or equivalent military rank) in the Executive, Judicial and Legislative Branches of the Federal Government. To help customers make a good purchasing decision based on their needs and budget, GSA has established four grades of furniture. Grade (1) includes furniture that tends to be the most expensive on this schedule, grade (2) furniture tends to be more moderately priced and grades (3) and (4) furniture tend to be affordably priced when compared to grades (1) and (2). Some pieces of furniture on this schedule may be significantly higher in price than GSA Traditional and Contemporary Executive Special Order Program furniture. The ordering agency or service is responsible for determining furniture appropriate for use in its offices which will fit within its budget and comply with applicable Federal or internal agency procurement regulations. Please see reverse for GSA terms and conditions.

**GSA/FEDERAL CONTRACT INFORMATION:**

Model numbers identified with the following verbiage "When purchased separately without a configurable TAA compliant end product, not on GSA contract" is to mean that these configurable parts or components:

- Have no functionality or capability without being integrated into an end product; and
- Are considered Open Market if purchased without a configurable TAA compliant end product.

**Grade 1** All exposed solid parts such as top rims, base rails etc. (except decorative accents, inlays and painted parts) shall be the same species as the face veneer. Top and bottom edges of drawer fronts shall be solid wood in the same species as the face veneers. Drawer sides and backs shall be solid wood.

**Grade 2** Exposed wood panel trim and trim on tops shall be the same wood species as the face veneer on the top. Some or all other exposed solid parts, such as base rails can be an alternative wood species (such as poplar or gum) different from the face veneers. Exposed, finished engineered wood core material such as MDF is acceptable only for the edges of drawer fronts. Drawer sides shall be solid wood or veneer core plywood/laminated construction. Silea is grade 2.

**Grade 3** Most or all exposed solid parts can be an alternative wood species (such as poplar or gum), different from the face veneers. Exposed, finished engineered wood core material such as MDF is acceptable only for the edges of drawer fronts. Drawer sides shall be solid wood or veneer core plywood/laminated construction. Medley, Kennsington, Credentials, and all tables are grade 3.

**Grade 4** Most or all exposed solid parts can be an alternative wood species (such as poplar or gum), different from the face veneers. Exposed, finished engineered wood core material such as MDF is acceptable only for the edges of drawer fronts. Drawer sides shall be composite wood material construction such as MDF. Trio is grade 4.

**ITEMS ON GSA CONTRACT**

Please note, in order to verify if an item is on GSA Contract or is "Open Market," please use Compass quoting which is updated in real time with all GSA contract changes. If you need additional assistance, please contact your local sales representative.





## 12 YEAR WARRANTY

Subject to the limitations set forth below. The Gunlocke Company warrants to the original purchaser all product in this price list to be free from defects in material and workmanship for a twelve year period from the date of shipment. This 12-year warranty applies to all products sold and installed by a Gunlocke authorized agent for normal commercial single shift service. Gunlocke will repair, or at its option, replace defective merchandise, free of charge. The following components not manufactured by Gunlocke have the following warranties:

- **High wear components** such as casters and glides are warranted for five years after date of shipment to original owner.
- **Electrical components** warranted 10 years from date of manufacture with exception of lamps and ballasts which are not warranted. This includes Fluorescent Tasklights.
- **LED tasklights** are warranted for 3 years from date of shipment to original owner.
- **Drawer suspensions** are warranted for lifetime of product after shipment to original owner.
- **Personal corners** including covering (leather) are warranted for three years of single shift and normal use after shipment to original owner.
- **Height adjustable electrical components** are warranted for five years of single shift and normal use after shipment to original owner.

Any non-standard material selected by the customer is not warranted. Neither does this warranty apply to damage resulting from accident, alteration, or misuse, as well as damage from normal wear and tear such as dents, nicks, scratches, fading and improper maintenance. That is, Gunlocke's warranty is only valid if products are given proper use and care. Gunlocke assumes no responsibility for product damages resulting from improper installation or user modification.

## WOOD FURNITURE

Wood owes its inherent beauty to variations in color, grain, and texture, and therefore, these variations are not considered defects. There may be minor variations from one piece of furniture to the next even though they are finished at the same time. Exposure to light and the aging process will cause a darkening of natural wood products. Light finishes on wood products do not mask the natural characteristics of wood. The Gunlocke Company does not guarantee the exact matching of grain, pattern, and color.

These finishes do not cover any of the natural characteristics of the wood, including nature's colorations, pitch pockets, and the variations of steambent wood. Merchandise will not be replaced because of these natural variations.

It is expressly understood and agreed that the buyer's sole and exclusive remedy for any and all losses or damages resulting from nonconforming goods, or from any other cause, shall be repair or replacement of defective parts, and that Gunlocke shall not be liable for damages or injury to persons or property, nor for replacement of the entire commercial unit, if repair or replacement of defective parts can reasonably render the unit conforming.

All warranty claims must be made in writing by the original owner. Owner may be required to produce the invoice or other evidence to establish that a claim is within the warranty period. Warranty claims may be submitted on the Gunlocke website.

As stated and illustrated on the website, serial numbers are required to process a warranty claim. No person, firm or corporation is authorized to assume for Gunlocke any liability in connection with the sale or installation of Gunlocke products except as stated above.

All other warranties, expressed or implied, are excluded. Gunlocke shall not be liable for incidental or consequential damages of any sort.

Within the Continental USA, all orders above \$20,000 list are shipped FOB factory, freight prepaid and allowed. All orders less than \$20,000 list will be subject to a \$200 net freight charge. Products shipped to Alaska and Hawaii FOB factory, freight prepaid and allowed to port of embarkation. Customer is responsible for freight charges from port of embarkation to final destination.

An anticipated shipping date is indicated on the order acknowledgment. Gunlocke cannot accept responsibility for shipping delays caused by outside sources or unforeseen problems. Delay of shipments requested by customers must be approved by Gunlocke. Any resultant storage charges will be charged to the customer.

Gunlocke may await completion of the entire order and ship all at once or may make partial shipments from time to time at its sole discretion unless the customer requests in writing that partial shipments are needed and Gunlocke approves the specific shipping schedule. Additional charges may apply.

Gunlocke is not liable for any delay or failure to deliver or perform due to strikes, lock-outs, or other labor or transportation difficulties, delay of sources or supply, accidents, fires, acts of God, or any other causes of like or unlike nature beyond the control of Gunlocke.

**LIABILITY**

Gunlocke products and their packaging are tendered to a transportation company only after passing rigid quality control inspection. At that time, title to the product is passed to the purchaser. However the transportation company assumes all liability from acceptance of shipment through its delivery. That is, Gunlocke's liability ceases at the time of shipment.

**FILING OF CLAIMS**

All claims for damage or loss must be submitted via our website within 15 days after receipt of merchandise. Do not return freight damaged merchandise to Gunlocke. Follow the steps below to expedite processing and resolution of claims.

**For Visible Damage**

1. Make damage notation on delivery receipt and have driver sign. Do not reject or refuse the shipment.
2. Immediately contact Gunlocke Traffic Department at 585-728-8268.
3. Hold damaged carton and all interior packing for carrier's inspection. These materials will be needed to substantiate the claim.

**For Concealed Damage**

1. Open cartons within 15 days of receipt and inspect.
2. Follow steps 2, and 3 as listed under Visible Damage.
3. Do not remove product from delivered destination.

**For Loss**

1. Be sure loss notation is made on delivery receipt and have driver sign.
2. Contact Gunlocke Traffic Department at 585-728-8268.

Should transportation company seek to limit its liability on concealed, loss, or damage claims, please contact Gunlocke's traffic department. After a thorough investigation of the claim, the traffic department will provide you with guidance in corresponding with the carrier.

Returned merchandise, regardless of delivery method, will not be accepted unless specifically authorized by Gunlocke.

**For Damage or Loss of Parcel Post or UPS Shipment**

Notify the Gunlocke traffic department immediately at 585-728-8268.

**NORMAL DELIVERY**

All normal ground transportation by Gunlocke will be made on a dock-to-dock basis. The Gunlocke traffic department will determine the recommended method of shipment according to the ship to destination. If the delivery on a shipment takes longer than 2 hours to be unloaded, an additional charge will be billed at \$60/hour at 15 minute increments. Gunlocke reserves the absolute right to determine the method of shipping unless special delivery instructions have been previously approved.

**Gunlocke will make every effort in honoring delivery requests as stated on orders. However, the Company shall have no liability for failure to deliver, perform or delay in delivery due to any cause outside the control of Gunlocke. The Company assumes no liability for costs incurred due to delayed or late deliveries.**

If a guaranteed delivery time is needed please call Gunlocke Traffic Department at 585-728-8268 for a quote as additional charges will apply. Weekend or after hours deliveries are subject to additional charges.

**WEEKEND DELIVERY**

A \$500 charge will apply on weekend delivery after 3:00 PM Friday through Sunday evenings.

**DROP SHIP / JOB SITE DELIVERY**

Orders under \$50,000 list will incur a \$125 charge for ship to locations other than a designated dealer warehouse.

**INSIDE DELIVERY**

Inside delivery must be noted on order. A minimum \$100 charge will apply.

**SPECIAL DELIVERY**

Please contact the Gunlocke traffic department for special delivery services such as inside delivery, weekend or after hour deliveries, reconsignment or other special needs. These are billable services.

**Gunlocke will make every effort in honoring delivery requests as stated on orders. However, the Company shall have no liability for failure to deliver, perform or delay in delivery due to any cause outside the control of Gunlocke. The Company assumes no liability for costs incurred due to delayed or late deliveries.**

**DOCK RESTRICTIONS**

Gunlocke trailers are 53' x 102"; when attached to truck cab the total length is 75'. If delivery dock will not accommodate trucks of this sizes, the Gunlocke traffic department must be contacted prior to shipping. Alternate arrangements can be made; additional charges may apply.

**CREDENTIALS CASEGOODS**

Credentials is offered in three select veneers and two premium veneers. All exposed surfaces utilize select plain sliced Cherry, Maple or Walnut veneers or premium Quarter Cut Walnut or Rift Cut Oak veneers.

Specialty Finishes:

- Gunlocke so that a finish formulation can be developed to match the special finish and color.
- Review the approval sample provided by Gunlocke.
- Written approval and sign off is required for Gunlocke customer service.
- Once written approval and sign off is received, the special finish order will be acknowledged.

**Note:** See our Website at Gunlocke.com for special finish request forms.

**All Casegoods & Tables Purchase Orders:**

- 10% list upcharge per wood unit to base veneer option receiving special finish.
- \$250 net formulation fee for special finish.

**Note:** This procedure and related costs apply to new and previously formulated special finishes. Special finish orders may receive additional lead time.

**CREDENTIALS VENEERS**

veneer 2 (select)

---

|                            |
|----------------------------|
| <b>Plain Sliced Cherry</b> |
| <b>Plain Sliced Maple</b>  |
| <b>Plain Sliced Walnut</b> |

---

veneer 3 (premium)

---

|                           |
|---------------------------|
| <b>Quarter Cut Walnut</b> |
| <b>Rift Cut Oak</b>       |

---

**NOTE:** For FSC Certified Product add "FSC" to beginning of finish option code. Example: FSCNC260. A 5% list upcharge will be applied per unit ordered with FSC option.

**EDGE DETAILS – square**

profiles/cope



**PULL OPTIONS**

Credentials is available in a metal pull and an integral wood finger pull.  
The metal pull is available in an anodized silver and dark bronze finish.

**METAL PULL**

Top Mount  
-Top of pedestal fronts

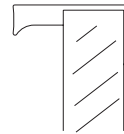
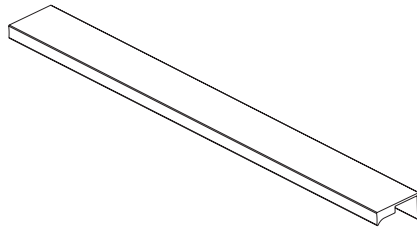

Face Mount  
-Face of closet/storage doors

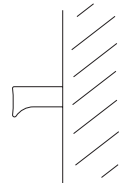
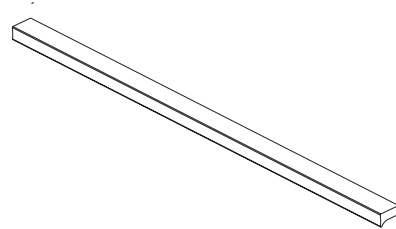

**INTEGRAL WOOD PULL**

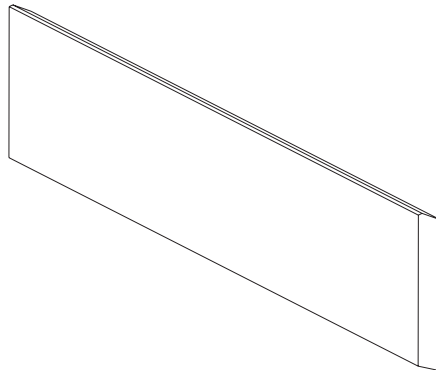

**PEDESTAL LEGEND**

NOTE: Left hand pedestals shown below.

**FULL HEIGHT**

[---]= (HIDDEN BOX DRAWER)

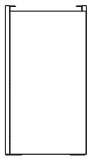

-X  
FALSE



-2  
FILE



-3  
(BOX)  
BOX  
FILE

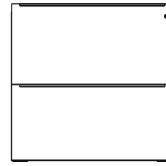

-4  
LATERAL  
LATERAL

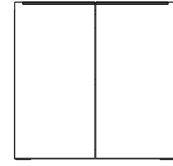

-5  
HINGED DOOR

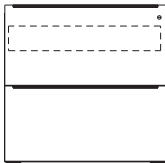

-7  
(BOX)  
BOX  
LATERAL

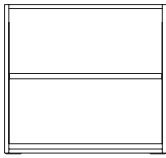

-SH  
OPEN SHELF

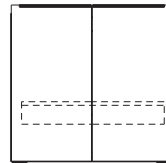

-P  
PRINTER PED

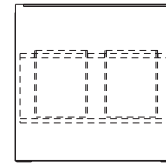

-T  
TRASH RECEPTACLE  
INCLUDES 2 TRASH CANS

**LAYERS HEIGHT**

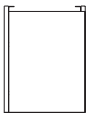

-X  
FALSE



-A  
(BOX)  
FILE

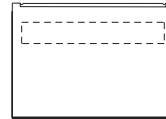

-B  
(BOX)



-5  
HINGED DOOR

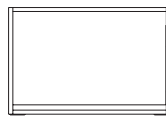

-SH  
OPEN SHELF

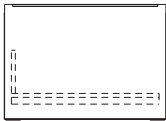

-P  
PRINTER PED

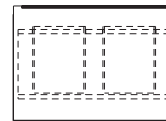

-T  
TRASH RECEPTACLE  
INCLUDES 2 TRASH CANS

**MOBILE PEDESTAL**

-Optional Face Lock

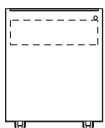

NOTE: LEATHER BOX DRAWER INSERTS MUST BE ORDERED SEPARATELY.

**STANDARD FILING OPTIONS**  
**WOOD PEDESTALS**

**15 wide file drawers**

- A. Letter – side to side
- B. Legal – side to side

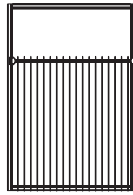

A

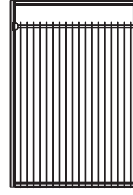

B

**18 wide file drawers**

- C. Letter – side to side
- D. Legal – side to side
- E. Letter – front to back

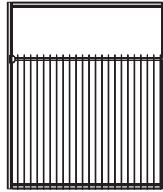

C

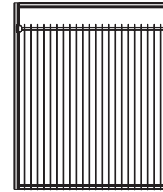

D

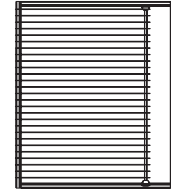

E

**30 wide file drawers**

- F. Letter – side to side
- G. Legal – side to side
- H. Letter – front to back

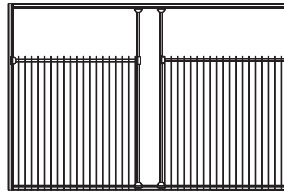

F

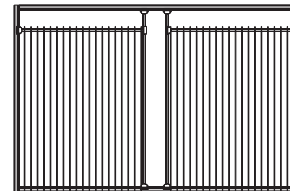

G

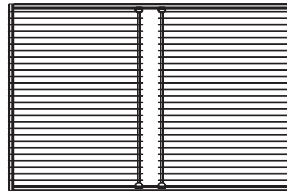

H

**36 wide file drawers**

- I. Letter – side to side
- J. Legal – side to side
- K. Letter – front to back
- L. Legal – front to back

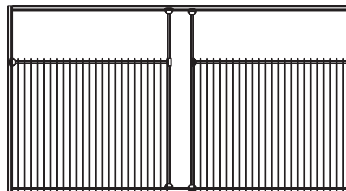

I

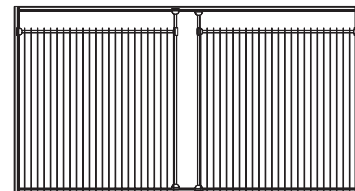

J

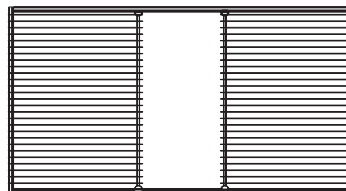

K

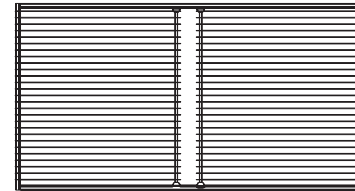

L

**INSIDE DRAWER DIMENSIONS**

**WOOD DRAWERS**

| Pedestal width  | Drawer type | D       | W      | H     |
|-----------------|-------------|---------|--------|-------|
| 15 letter width | 24 box      | 14 1/16 | 11 3/8 | 3 1/4 |
|                 | 24 file     | 17 1/16 | 11 3/8 | 9 1/8 |
| 18 letter width | 30 box      | 14 1/16 | 14 3/8 | 3 1/4 |
|                 | 30 file     | 17 1/16 | 14 3/8 | 9 1/8 |
| 30 width        | box         | 14 1/16 | 26 3/8 | 3 1/4 |
|                 | lateral     | 17 1/16 | 26 3/8 | 9 1/8 |
| 36 width        | box         | 14 1/16 | 32 3/8 | 3 1/4 |
|                 | lateral     | 17 1/16 | 32 3/8 | 9 1/8 |

**LOCKS & KEYING**

Locks are standard on all below worksurface storage units. Two lock options are available. When the factory installed lock option is selected lock cores are installed at the factory. Note: when the random option is selected some units may be shipped with the same key number. When the field installed lock option is selected each unit is shipped with an empty lock cylinder. Locks are Silver or Black.

factory installed locks option code

Option 1

|                           |            |
|---------------------------|------------|
| <b>silver random keys</b> | <b>RMS</b> |
| <b>black random keys</b>  | <b>RMB</b> |

Option 2 Specify a number between

|                               |                        |
|-------------------------------|------------------------|
| <b>SILVER Designated Keys</b> | <b>100TAS - 150TAS</b> |
| <b>BLACK Designated Keys</b>  | <b>100TA - 150TA</b>   |

Field installed locks are also available. When field installed locks are specified each unit is shipped with an empty lock cylinder. A separate line item must be ordered to receive the numbered lock cores for field installation. Field installed locks are available at an additional charge of \$10 list per lock core.

Field installed lock core set, specify model # and key number (add \$10 list per core):

|                               | model number    | Specify a number between |
|-------------------------------|-----------------|--------------------------|
| <b>SILVER Designated Keys</b> | <b>ACLCKFLD</b> | <b>100TAS - 200TAS</b>   |
| <b>BLACK Designated Keys</b>  | <b>ACLCKFLD</b> | <b>100TA - 200TA</b>     |

**Note:** Add \$10 list per lock core.

---



---



---



---



---



---



---



---



---



---



---



---



---



---



---



---



---



---



---



---



---



---



---



---



---



---



---



Product Reference . . . . . 13-30

- Features + Advantages . . . . . 14-15
- Technical Specifications . . . . . 16-18
- Height Reference . . . . . 19
- Desktop Leather Inlay and Glass Insert Locations . . . . . 20
- Worksurface Veneer Grain Directions . . . . . 21-22
- Grommets & Trough Locations . . . . . 23-24
- Metal Pull Locations . . . . . 25
- Integral Wood Pull Locations . . . . . 26
- Specification Tips . . . . . 27
- Wire Management . . . . . 28-29
- Product Specifications . . . . . 30

| ATTRIBUTE                   | FEATURE                       | ADVANTAGE  |
|-----------------------------|-------------------------------|--|
| <b>STYLE/DESIGN</b>         | Hand selected veneer          | <ul style="list-style-type: none"> <li>• Quarter cut walnut and plain sliced cherry, maple, and walnut</li> <li>• Rift cut oak</li> </ul>  |
|                             | Refined aesthetic             | <ul style="list-style-type: none"> <li>• Clean, modern design</li> <li>• Layering and various planes</li> <li>• Refined details</li> <li>• Integral wood pull or metal pull</li> <li>• Mitered worksurfaces with waterfall veneer</li> <li>• Optional locking on all units</li> </ul>                              |
|                             | High end material selection   | <ul style="list-style-type: none"> <li>• Stone</li> <li>• Leather</li> <li>• Back painted glass</li> <li>• Stainless steel desk base</li> <li>• Dark bronze and champagne silver hardware</li> </ul>   |
| <b>PLANNING FLEXIBILITY</b> | Large breadth of line         | <ul style="list-style-type: none"> <li>• Numerous components can be used together to create a variety of planning requirements for size and storage</li> </ul>   |
| <b>FUNCTIONALITY</b>        | Accessory track/trough system | <ul style="list-style-type: none"> <li>• Provides sit-to-stand solution in office</li> <li>• Electric driven system with three preset heights</li> <li>• Height range of 29.5"-42"</li> <li>• Integrated in mitered wood base</li> <li>• Charcoal black metal shroud for clean aesthetic in up position</li> </ul> |
| <b>STORAGE</b>              | Soft close hardware           | <ul style="list-style-type: none"> <li>• Hidden bottom mount suspension on soft close drawers</li> <li>• Soft close hinges on all doors</li> </ul>   |
|                             | Cantilevered worksurfaces     | <ul style="list-style-type: none"> <li>• Provides unique aesthetic and conferencing end</li> </ul>   |
|                             | Magnetic tackzone             | <ul style="list-style-type: none"> <li>• Backpainted glass and wood tackzone provide magnetic surface for posting papers and magnetic accessories</li> </ul>   |
|                             | Hidden box drawers            | <ul style="list-style-type: none"> <li>• Provides clean lines and fewer fronts</li> <li>• Includes veneered front</li> <li>• Optional leather inserts</li> </ul>   |
|                             | Overhead door options         | <ul style="list-style-type: none"> <li>• Hinged, soft lift, or sliding door overheads</li> </ul>   |
|                             | Various pedestal options      | <ul style="list-style-type: none"> <li>• Drawers, doors, open shelves, printer storage, and trash can</li> </ul>   |

| ATTRIBUTE                     | FEATURE                    | ADVANTAGE   |
|-------------------------------|----------------------------|---|
| <b>TECHNOLOGY INTEGRATION</b> | Wire management            | <ul style="list-style-type: none"> <li>• Worksurface trough with pencil lip</li> <li>• Flush grommet with door options</li> </ul>   |
|                               | Wall access                | <ul style="list-style-type: none"> <li>• Optional hinged wall access panels provide simple, clean wire management</li> </ul>  |
|                               | Lighting                   | <ul style="list-style-type: none"> <li>• Standard high efficiency LED tasklighting</li> <li>• Recessed into bottom of overhead for clean aesthetic</li> </ul>   |
|                               | Worksurface power          | <ul style="list-style-type: none"> <li>• Power unit can be installed beneath grommet, in worksurface trough or in kneespace for easy access</li> </ul>  |
| <b>SUSTAINABILITY</b>         | Design for the environment | <ul style="list-style-type: none"> <li>• FSC certified products available</li> <li>• LEED IEQ 4.5 compliant finish</li> <li>• High percentage of recycled content: 66% post industrial and 9% post consumer yielding an RC value factor of 42%</li> <li>• Energy Efficient LED task lighting</li> </ul>       |
| <b>DURABILITY</b>             | Drawer system              | <ul style="list-style-type: none"> <li>• Dowel construction—strength</li> <li>• Superior filing capability—extruded file rail integral to drawer</li> <li>• UV finish on drawers—scratch and chemical resistant</li> <li>• 5-sided drawers—can adjust or remove in field without unloading drawers</li> </ul> |
|                               | 12-year warranty           | <ul style="list-style-type: none"> <li>• Backed by Gunlocke's 12-year warranty</li> </ul>   |

## veneers

All exposed wood surfaces utilize select Plain Sliced Cherry, Maple, Walnut veneers or premium Quarter Cut Walnut, or Rift Cut Oak veneers. These veneers are carefully selected and slip matched to assure balance and consistency.

## WOOD TOPS

Wood veneer tops feature a balanced 3-ply construction and are 1 1/2" thick. Each top has a 3/32" thick external solid-wood band on all sides.

Standard tops are constructed of 45 lb particleboard.

Tops connect to the chassis with wood screws through the inset top panel of the pedestals and steel angle brackets.

## CHASSIS/PEDESTAL CONSTRUCTION

All wood pedestals are made with veneer end panels and fronts which are constructed with 3/4" thick balanced 3-ply panels. End panels are connected with an inset top, back, and bottom panel which is made of 3/4" thick 3-ply particle board. Panels are securely fastened together with cam fasteners in conjunction with solid wood dowels that are securely adhered with PVA (white polyvinyl acetate) glue. A 1 1/16"H x 2 7/16"W 3-ply particle board is mounted to the underside of the inset bottom panel. A threaded steel glide plate is attached to the hardwood stretcher to provide a durable connection between the glide and the bottom of pedestal. The glide plate is 10-gauge or 0.134" thick steel.

Steel glide plates are attached to single end panels with screws. End panels are pre-bored to accept the stem of the glide. The threaded steel glide plate provides a durable connection from glide to bottom of unit end panel.

Each unit is equipped with a minimum of four adjustable glides.

## OVERHEAD/STORAGE CONSTRUCTION

All wood panels are constructed with 1" thick balanced 3-ply panels. The top, end, and bottom panels are securely fastened together with wooden dowels that are adhered with PVA (white polyvinyl acetate) glue. This construction method eliminates any visible assembly fasteners.

Wall mount cabinets are mounted to the wall with a spade and "Z" bracket attachment method. Steel barrel nuts and spade brackets are securely mounted through the back of wall mount cabinets. All units ship with a steel Z bracket. This bracket is mounted to the wall by field installers. Installers are responsible for selecting and supplying appropriate fasteners for wall conditions.

Units with hinged doors include 95° soft close hinges. Hinges are fully adjustable.

## LAYERS UNITS

All layers runoffs and bridges include a wood box to sit on the low height credenza unit. Layers box includes a protective non-skid strip on bottom edge to protect lower worksurface. Layers units provide 7 3/4" of height difference.

## GLIDES

Glides provide 1 1/8" of vertical leveling adjustment. Glide bottom is durable nonrust nylon.

## DRAWERS

All drawers are constructed of four sides and a bottom, which are attached to a drawer front with screws for easy removal. Drawer fronts feature matched veneer within each pedestal set.

The drawer side material is vinyl-clad particleboard, finished with a roll-coated 7-level UV cured polyester/acrylic finish that provides a high level of chemical and scratch resistance. The drawers are fastened together at each corner with dowel joinery for maximum drawer

strength. The bottom material is a 3-ply substrate consisting of medium density fiberboard core with a melamine face and backer.

Optional leather organization trays are available for all box drawers.

## PULLS

Units are available in a continuous metal pull or an integral wood pull.

The drawer front on credenza and return pedestals overlay the worksurface for an uninterrupted appearance. The drawer front on the desk pedestals are below the worksurface to keep main worksurface clean.

Integral wood pull is on a 35° bevel and provides a seamless wood look to the station.

Continuous metal pull is an anodized aluminum pull available in a dark bronze or champagne silver finish. The metal pull on pedestal fronts aligns with metal pull on 24D closets. The metal pull on overhead doors aligns with metal pull on 18D closets.

## SUSPENSIONS

Credentials casegoods utilizes zinc-coated steel, high-grade drawer suspensions which feature an integrated soft close mechanism. The suspensions are bottom mount and are concealed under the drawer body for a cleaner appearance when opening/closing drawers. Box drawer suspensions are 15" depth full extension and are load rated for 100 lb static load, 90 lb dynamic load. File and lateral file drawers are 18" depth full extension and are load rated for 150 lb static load, 135 lb dynamic load. Lateral files include an anti-tip mechanism that prevents more than one drawer from being opened at the same time.

**HINGES**

Units with hinged doors include 95° soft close hinges. Hinges are fully adjustable.

**FILING**

The file hanging system is an integral part of the drawer. A highly durable black plastic extrusion is securely fastened into a route on the top of the drawer. The plastic extrusion and steel folder rails allow side to side and front to back filing in file and lateral file drawers. The plastic extrusion was designed to promote optimum filing capacity within the drawer while providing a durable, reliable and maintenance free filing system. (See filing capability section for technical information on drawer dimensions.)

**LOCKS**

Silver or black face locks are optional on all desks, credenzas, returns, modular pedestals, and storage units. Each pedestal is independently locked. Lock plugs are either factory or field installed.

**KEYING**

Keying is available either factory or field installed. Factory installed keying offers two options: random or designated. When the random keying option is selected an arbitrary key number will be assigned to the unit. Note: some furniture units may have like key numbers when random keying is selected. When the designated keying option is selected a key number must be specified between 100TAS-150TAS for silver lock core and 100TA-150TA for black lock cores. All keys are solid brass. When the field installed keying option is selected, a lock cylinder will not be included in the furniture unit.

**WIRE MANAGEMENT**

Wire management capabilities include optional worksurface grommets and worksurface troughs. Chassis include wire cutouts in kneewell for seamless wire management between pedestals and adjoining units.

Trough worksurfaces provide a 1" wire management gap on the back edge of the worksurface. An anodized aluminum pencil lip is included with each trough worksurface. The tackzone sits below the worksurface on the top edge of the pedestal end panels. A trough worksurface is REQUIRED for all tackzone applications.

Under worksurface wire managers (Model #ACWM) are sold separately to conceal wires between pedestals. These units house and manage wire horizontally around a station.

Wall access is accommodated in credenza, bridge and return units. Two options are available. (1) No modesty panel provides direct access to wall. (2) The hinged access panel option provides access to the wall as needed, creates a cavity behind the panel to mount a power strip (not provided) and houses cords behind panel. The panel hinges and clips on and off to provide occasional access as needed.

**POWER UNIT**

A power unit may be ordered separately to add integrated power to the station. The unit includes 3 power outlets – 2 power outlets on top surface and 1 power outlet on the end. Ships with 6 ft power cord with standard plug. UL listed.

The unit can be mounted in various applications: 1) to bottom of worksurface beneath grommets, 2) to bottom of worksurface in trough opening, 3) as power strip inside wall access panels or kneespace.

**TECHNICAL SPECIFICATIONS****GROMMET**

3.250" x 5.875" rectangular grommet. Grommet bezel is inset flush to top of worksurface. Includes a hinged door that is on a dampening hinge for smooth open/close. Door material may be specified as wood veneer or back painted glass.

**LIGHTING**

Recessed low-profile LED overhead lighting is standard and INCLUDED in all overhead cabinets. They do NOT need to be purchased separately. LED lighting provides high efficiency, low energy lighting with a long life. All LED light strips are encased in a silver aluminum extrusion and include a built-in microswitch to turn the light on/off. Lights are field installed. All units include a 10' cord with a standard plug. Light temperature is 3200K.

**MONITOR ARM**

Monitor arm is EVO2. Monitor arm is silver finish. Monitor arm can be mounted inside grommet hole, desktop trough, or clamped to edge of desk.

Product specs are listed below:

Vertical range: +/- 5.2" from horizontal

Horizontal range: 18.6"

Rotation: 360° at two joints, 180° from center

Monitor tilt: 90° up, 20° down from center

Monitor pivot: Landscape to portrait

Monitor compatibility: VESA monitor compatible - 75mm & 100mm VESA adapters included

Cable management: Cables are managed beneath arm

Mounting options: Desk clamp, grommet mount, or trough mount

Monitor weight: 7-20lbs

## ACCESSORIES

All accessories include imbedded magnets and can be positioned anywhere on wood tackzone and back painted glass tackzone. The accessories provide quick access to files, pencils, and other work utensils. Units are painted standard white, muslin, and black to match glass colors.

## PERSONAL CORNER + DESKPADS

Personal corners can be used between two perpendicular worksurfaces to create an ergonomic corner for user. Deskpads are used in-line. All units are wrapped in leather or vinyl. The bottom surface has a felt lining to protect the worksurface. The chassis is made from 10-gauge aluminum. Personal corners are 36"W x 12 1/2"D. Deskpads are 36"W x 18"D. Units are designed to fit over 1 1/2" thick worksurfaces. Desk inlays are Dolce faux leather and are available in three colors.

## ORGANIZATIONAL TRAYS

Leather organization trays can be used in box drawers and in cubby of 1H overheads. All units are wrapped in leather. The bottom surface has a protective felt lining.

## STAINLESS STEEL BASE

Stainless steel base units include a brushed stainless base. Unit is constructed of 1 1/2" square stainless steel tubing. Units are fully welded for seamless construction.

Three top options are available – 1) wood top, 2) stone top, 3) back painted glass top. Units with a wood top are rabbetted into base with a 1/2" top exposed on all sides. Back painted glass tops and stone tops include a recessed plywood subtop for glass/stone. Stone tops include a template for stone so it can be purchased locally.

## TACKBOARDS

Tackboards are constructed of 7/8" thick material comprised of a 1/8" thick hardboard glued in between a layer of 3/8" thick pressboard on each side. The fabric is precisely aligned and fitted to the tackboard and adhered to the rigid hardboard with staples.

A trough worksurface is REQUIRED for all tackzone applications.

## BACK PAINTED GLASS

Doors and tackzone back painted glass units are captured by an extruded aluminum mitered frame which is powder coated to match. Frame is 3/4" thick and 1 3/4" high. The frame is low profile allowing only 1/16" visible frame around the perimeter of the glass from the front view. Back painted glass is 4mm thick and is available on doors, and in the "tackzone" of overhead storage. Tackzone glass units are magnetized with a steel backer. These units can also act as a whiteboard with use of dry-erase markers. 6 magnets are included with each magnetized whiteboard.

Worksurfaces and desktop inserts in back painted glass are frameless and are acid etched to eliminate fingerprinting.

A trough worksurface is REQUIRED for all tackzone applications.

## CLEANING BACK PAINTED GLASS

All back painted glass should be cleaned with a soft lint free cloth and non-ammonia based cleaner only.

## FINISH

Natural veneer is subject to nature's quality control. Each species will exhibit differences in grain pattern and tone. This is to be expected and, in fact, contributes to the beauty and individuality of each product. Flat Cut veneers emphasize the variations of wood by exhibiting cathedrals in the grain pattern. Quarter Cut and Rift Cut veneers are a premium cut that maintains variations in the grain but without cathedral patterns. Stratawood is a natural, FSC®-certified reconstituted veneer that is designed to exhibit a consistent grain pattern and is available in either a straight grain or cathedral pattern.

Our proprietary wood finish system utilizes a combination of topcoats engineered for the various applications found in the furniture industry. It is exceptionally clear and durable, and allows the beauty of wood to show through. The durability, depth, clarity, and beauty of our wood finishes meet the high expectations of our customers, and meet or exceed indoor air quality (IAQ) standards. All colors and species are not available on all products. Please refer to front cover of price lists for availability of finishes.

## CLEANING FINISH

Regular dusting and occasional cleaning are recommended to maintain your wood finish. To clean, dampen a soft cloth with luke warm water and gently wipe the wood in the direction of the grain. A mild solution of Murphy's oil soap and water may also be used. Avoid cleaners with oil, waxes, or silicones as they may create a hazy look.

**STANDARD UNIT HEIGHTS FOR CREDENTIALS:**

| unit                          | height   |
|-------------------------------|----------|
| Worksurface                   | 1 1/2    |
| Layers Pedestal               | 20 3/16  |
| Layers Pedestal + Worksurface | 21 11/16 |
| 2H Pedestal                   | 27 15/16 |
| 2H Pedestal + Worksurface     | 29 7/16  |

| unit        | height   |
|-------------|----------|
| 3H Storage  | 43 7/16  |
| 4H Storage  | 57 7/16  |
| 5H Storage  | 75 15/16 |
| 6H Storage  | 84 7/16  |
| 1H Overhead | 19 1/2   |
| 2H Overhead | 28       |

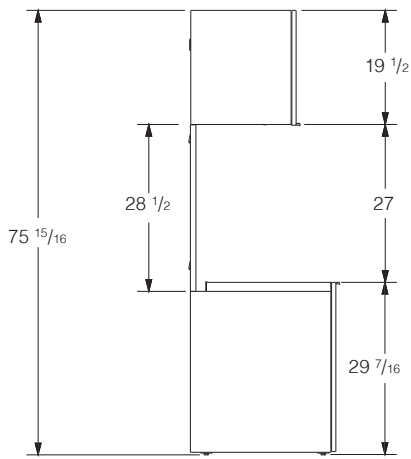

Standard Height Credenza  
1 High Overhead

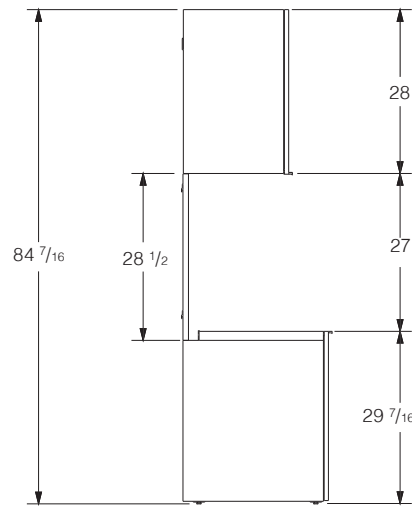

Standard Height Credenza  
2 High Overhead

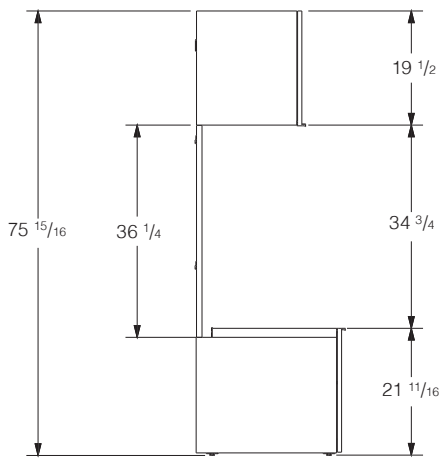

Layers Height Credenza  
1 High Overhead

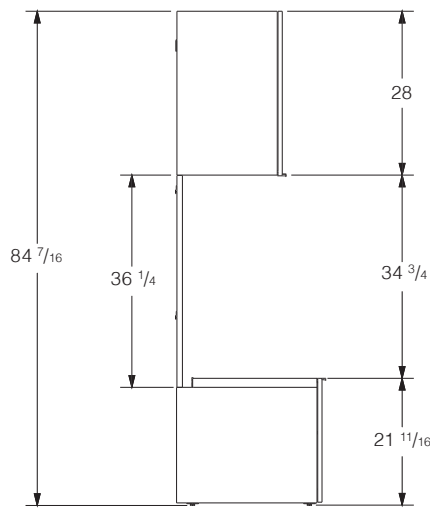

Layers Height Credenza  
2 High Overhead

# DESKTOP LEATHER INLAY AND GLASS INSERT LOCATIONS

Desks and Extensions are available with a Faux Leather inlay or a back painted glass insert.

option picks

|   |            |
|---|------------|
| Standard Veneer                         | <b>TVN</b> |
| Faux Leather Inlay                      |            |
| White (+\$1,703)                        | <b>TLW</b> |
| Black (+\$1,703)                        | <b>TLB</b> |
| Chocolate (+\$1,703)                    | <b>TLC</b> |
| Back Painted Glass Insert (Acid Etched) |            |
| Ice White (+\$2,383)                    | <b>TGW</b> |
| Black (+\$2,383)                        | <b>TGB</b> |
| Muslin (+\$2,383)                       | <b>TGM</b> |

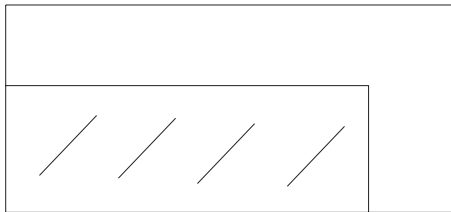

Freestanding Desk with Modesty Panel Base  
(LH desk shown)  
Ex. GA2DTRM3672L-3WW

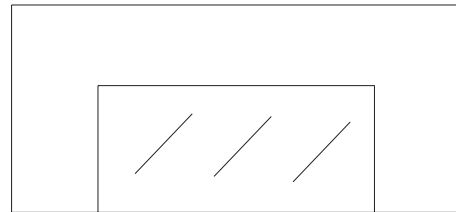

Freestanding Double Pedestal Desks &  
Freestanding Miter Base Desk  
Ex. GA2DRO3672-32WW  
GA2DTRR3672-WW

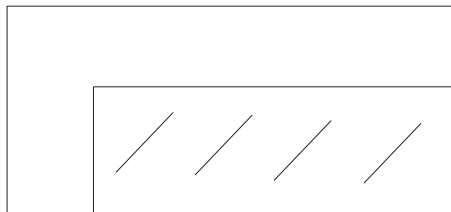

Freestanding Desk with Height Adjustable Base  
(LH desk shown)  
Ex. GA2DTRA3672L-WW

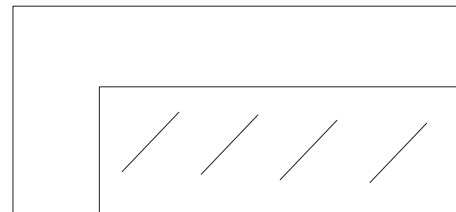

Single Pedestal Desks & All Extension Desks  
(LH desk shown)  
Ex. GA2DRO3672L-3WW



**WORKSURFACE VENEER GRAIN DIRECTIONS:**

Note: All vertical faces on chassis and storage are vertical grain.

**FREESTANDING DESK**

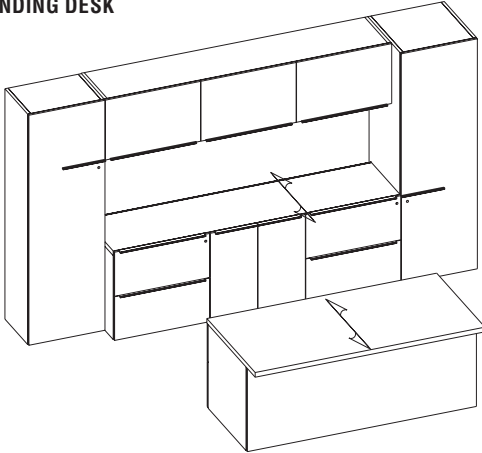

Freestanding Desk – short grain  
Full Base Credenza – short grain

**L STATION**

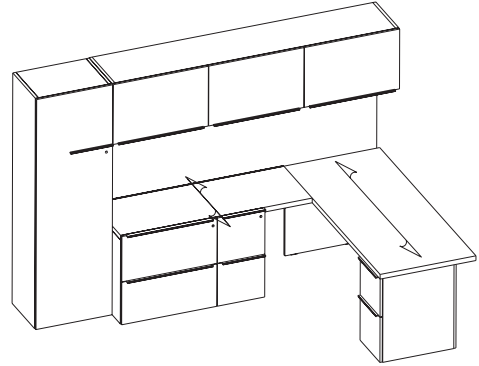

Single Pedestal Desk / Extension – long grain  
Modular Return – short grain

**U STATION**

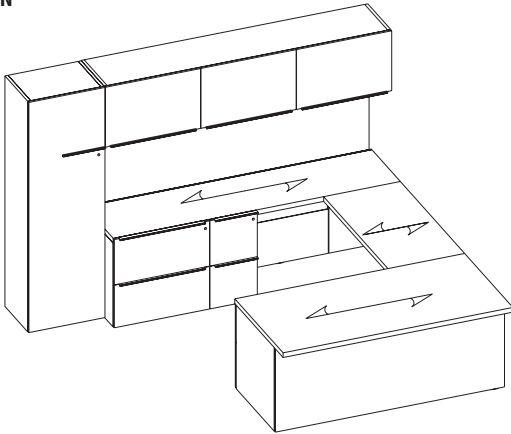

Single Pedestal Desk / Extension – long grain  
Bridge –short grain  
Modular Credenza –long grain

## WORKSURFACE VENEER GRAIN DIRECTIONS:

Note: All vertical faces on chassis and storage are vertical grain.

### LAYERS WORKWALL L STATION

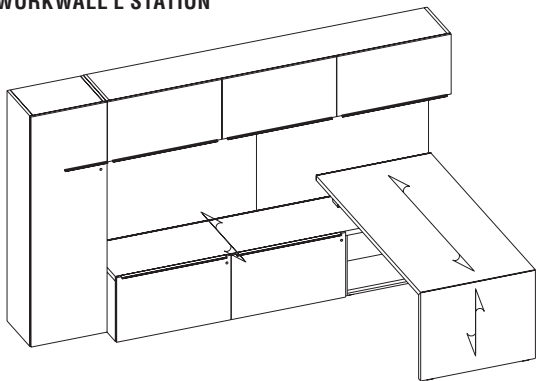

Layers Mitered Runoff Desk – long grain  
Layers Full Bank Credenza – short grain

### WORKWALL L STATION

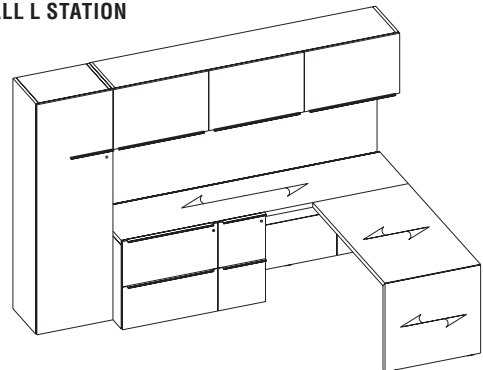

Mitered Runoff Desk – short grain  
Modular Credenza – long grain

### WORKWALL U STATION

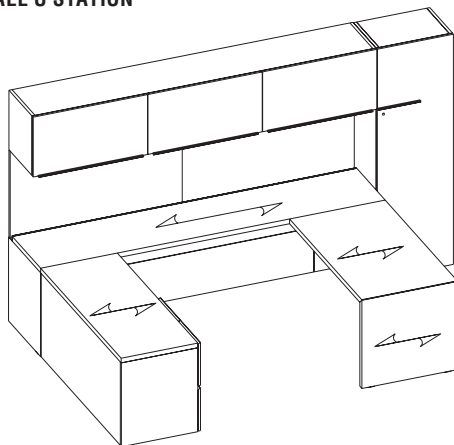

Mitered Runoff Desk –short grain  
Modular Credenza – long grain  
Modular Return – short grain

**Credentials worksurfaces are available with an optional grommet.**

- Grommet is recessed into worksurface and includes a dampening mechanism for smooth open / close.
- Grommet door cover is available in veneer or back painted glass.
- A 1" slot is included for cords and/or monitor arm clamps.

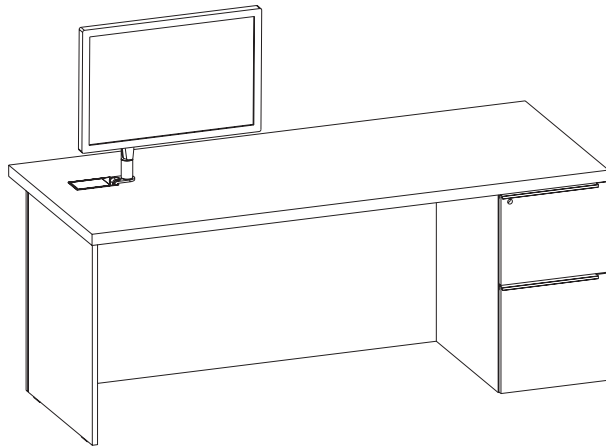

Grommet shown in Single Pedestal Desk with Monitor Arm

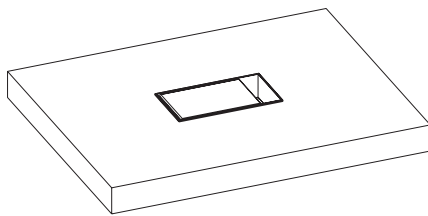

Grommet door closed

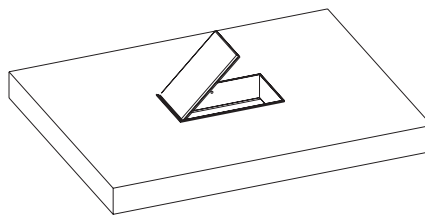

Grommet door open

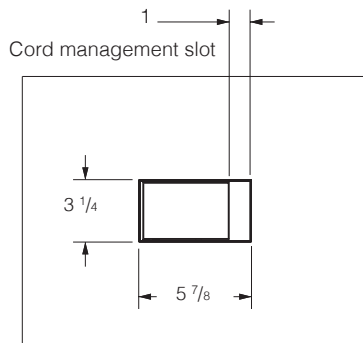

Grommet dimensions

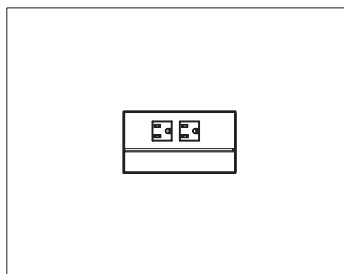

Top view shown with power unit – ACPWRT. (*De-emphasized*)  
ACPWRT must be ordered separately  
(shown without door)

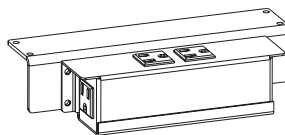

**The worksurface trough is integral to the design and configuration of the product.**

- The trough provides a 1 11/16" gap for cords, power access, and monitor arm clamping.
- All trough worksurfaces include a metal pencil lip.
- The tackzone is recessed into trough area – below worksurface level and sits on end panel of pedestal/chassis.
- Plastic Trough Insert is required and must be ordered separately across entire length of trough (see page 99 to order).

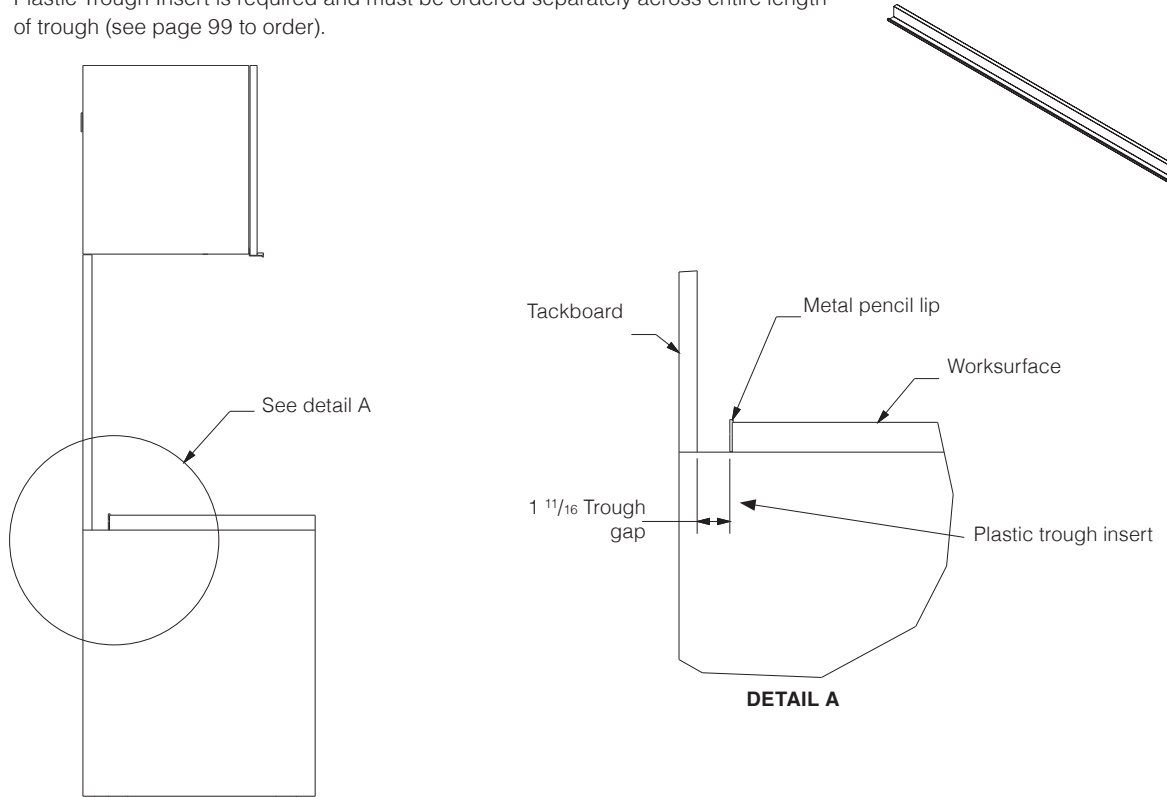

**A trough worksurface is REQUIRED in ALL tackzone applications.**

- The trough can be on a single worksurface or span across multiple units.
- In situations where the trough spans multiple units, each individual unit MUST be specified with a trough worksurface.

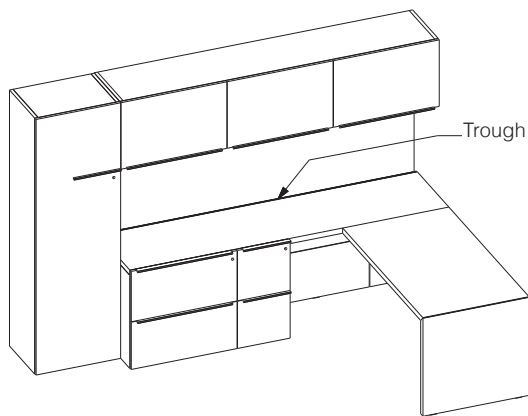

**EXAMPLE 1:**  
Back edge of credenza

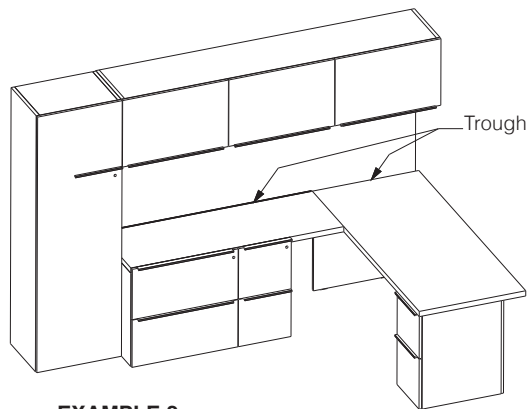

**EXAMPLE 2:**  
Back edge of return  
and  
Left hand end of desk

**Metal pull locations are shown below.**

Left hand units shown where applicable.

DESK PEDESTALS

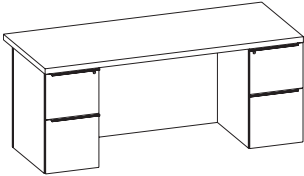

MODULAR PEDESTALS

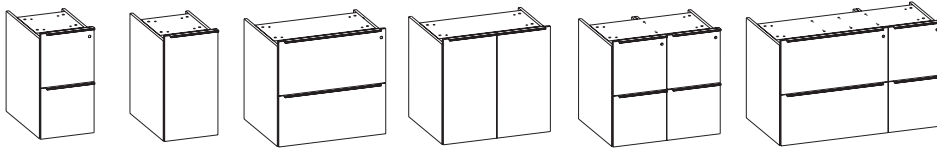

STORAGE

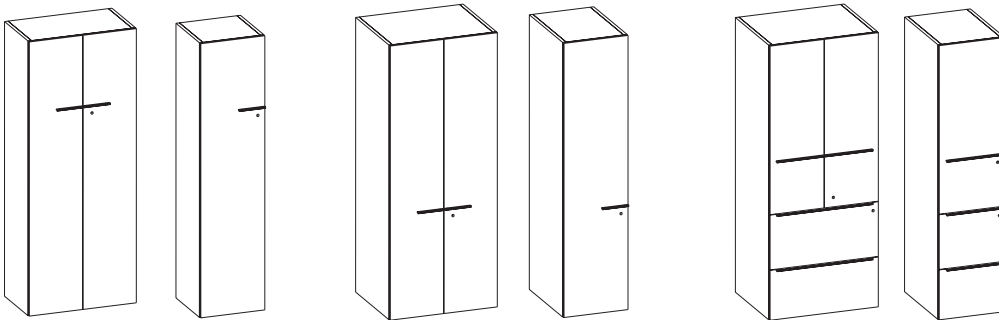

18D CLOSETS

24D CLOSETS

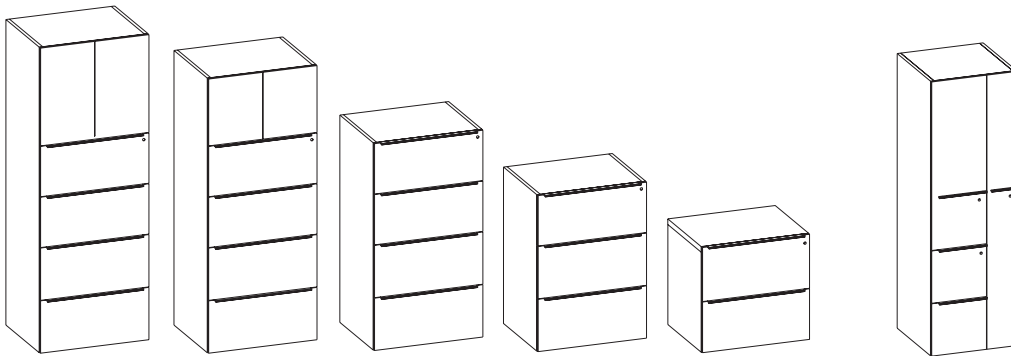

OVERHEADS

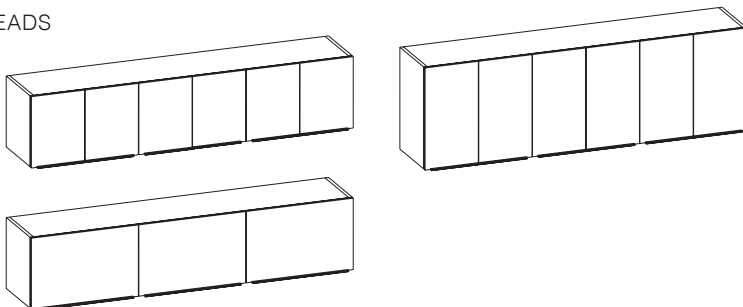

# INTEGRAL WOOD PULL LOCATIONS

## Integral wood pull locations are shown below.

Left hand units shown where applicable.

### DESK PEDESTALS

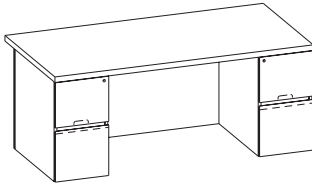

--- dashed line indicates bevel / hidden finger pull

### MODULAR PEDESTALS

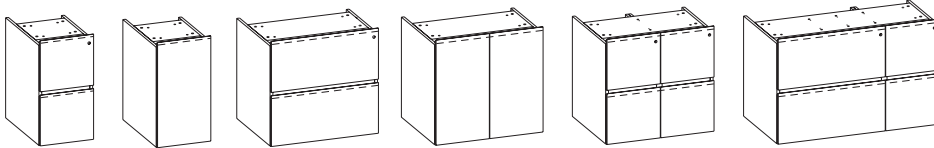

### STORAGE

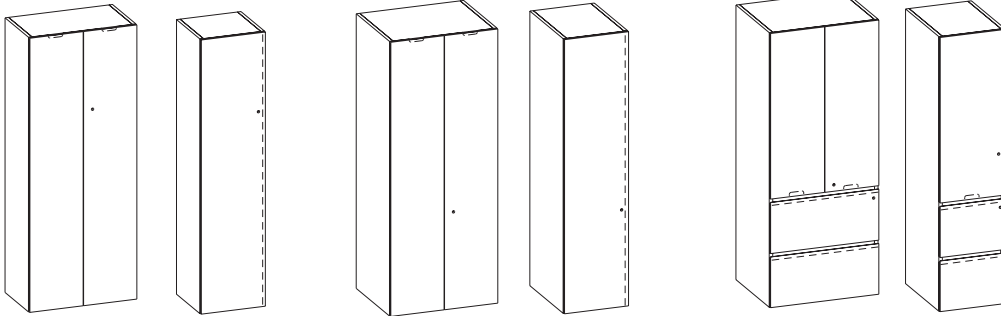

18D CLOSETS

24D CLOSETS

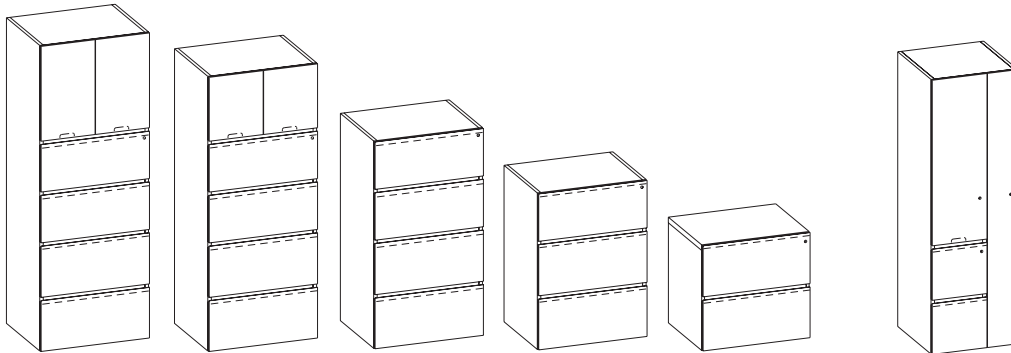

### OVERHEADS

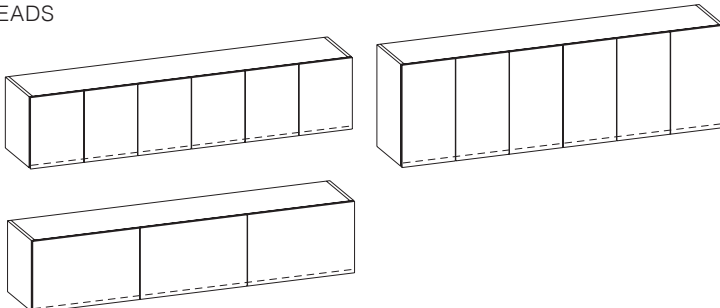

**STEP 1: SELECT CONFIGURATION**

FREESTANDING DESK

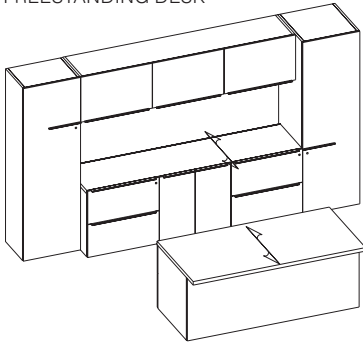

U STATION

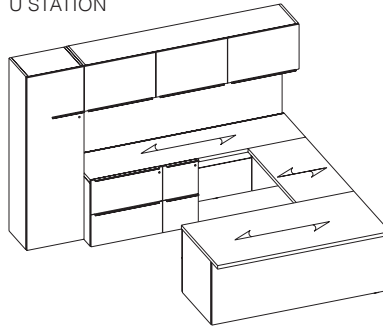

WORKWALL U STATION

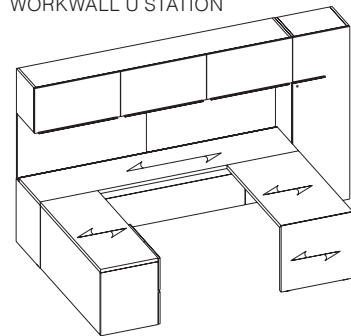

L STATION

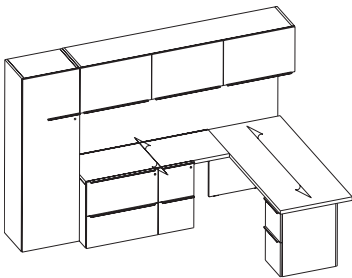

WORKWALL L STATION

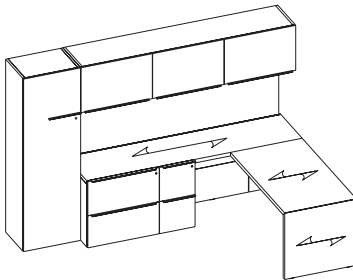

LAYERS WORKWALL L STATION

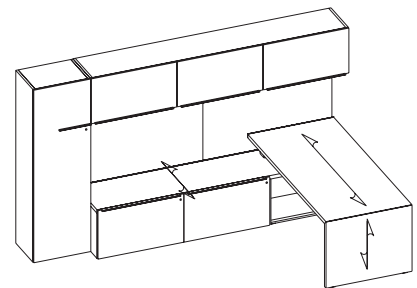

**STEP 2: BEGIN WITH DESKING COMPONENTS**

- Desk, extensions, runoffs, and full bank credenzas are unitized
- Credenzas and returns are built from modular components which must be specified separately

**STEP 3: BE SURE TO SPECIFY TROUGH LOCATIONS ALONG ENTIRE LENGTH OF TACKZONE**

- Plastic Trough Insert is REQUIRED and must be ordered separately across entire length of trough

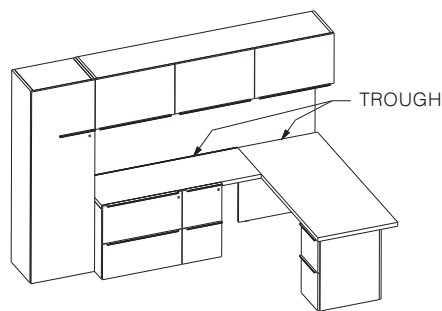
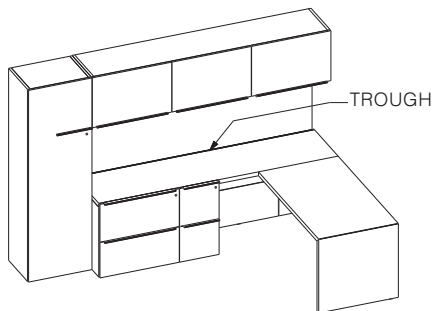

**STEP 4: ADD FREESTANDING STORAGE**

- Lateral files, bookcases, closets, storage box, and utility cabinets

**STEP 5: ADD OVERHEADS AND TACKZONE**

- Fabric tackboard, magnetic glass whiteboards, and wood tackzones are available
- Recessed tasklights are INCLUDED with all overhead cabinets

**STEP 6: INSERT ACCESSORIES**

- Leather box drawer inserts, power units, magnetic accessories, monitor arms, etc.

**STEP 7: OFFICE # OPTION**

- An office # option is included on all models ("OFC1" through "OFC199")
- Each individual office must be specified with its own unique office #
- All components for each office must be specified with the same office # option

## GROMMET SPECIFICATIONS

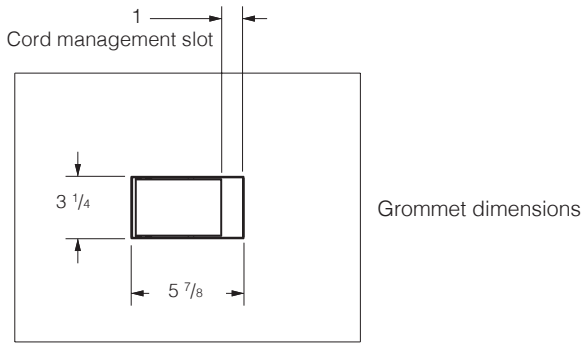

## GROMMET LOCATIONS

Credenzas, Returns, Bridges

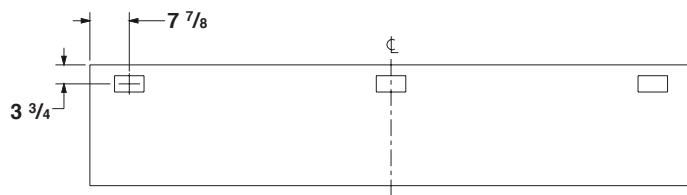

Pedestal Desks and Run-offs; Miter Desks, Extensions, and Run-offs; Slab Base Extensions and Run-offs

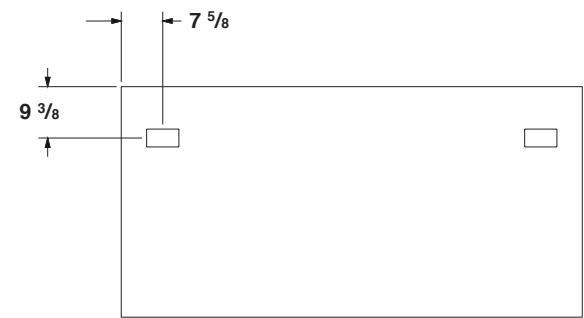

Stainless Metal Base Desks, Extensions, and Runoffs

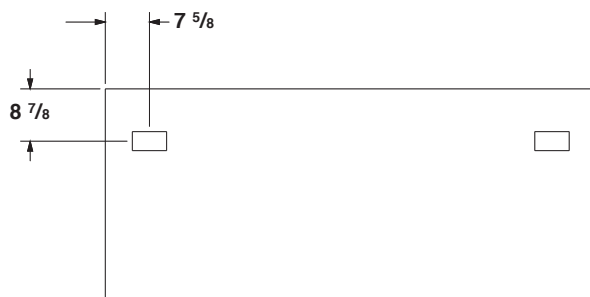

Layers Run-off Tops

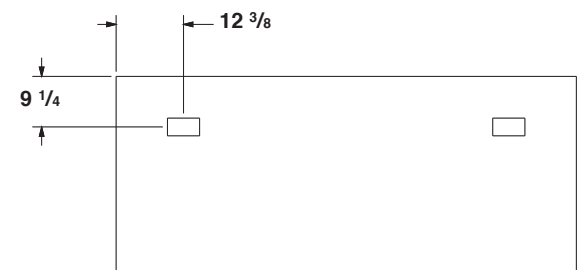

Height Adjustable Desks

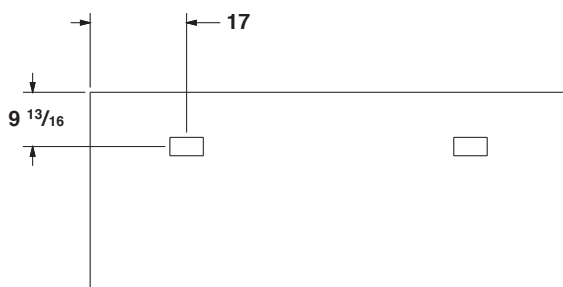

Height Adjustable Extensions

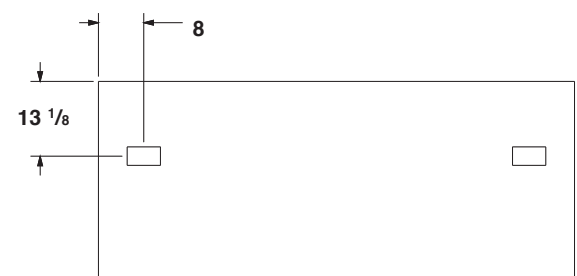



**GROMMET LOCATIONS**

**Modesty Panel Base Desks**

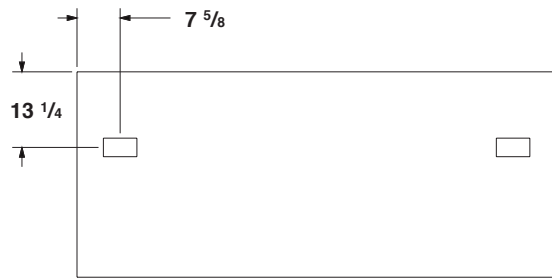

**Modesty Panel Base Extensions (No Trough)**

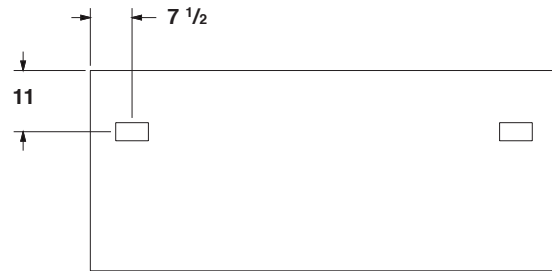

**Modesty Panel Base Extensions (Trough End)**

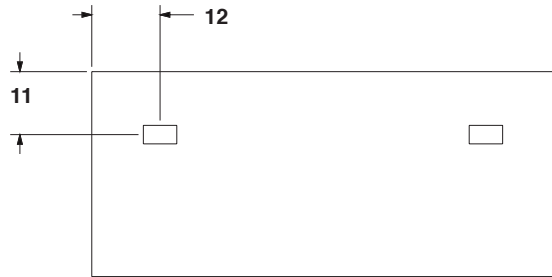

**HEIGHT ADJUSTABLE WORKSURFACES**

Worksurfaces are actual widths. A 1" clearance gap is required for any height adjustable top on all sides. Moving worksurfaces can collide with other components. It is important to ensure free range of motion prior to operating the table. Please contact Gunlocke's Tailored Solutions department (GUNTS) for special worksurface size requirements if standard models do not provide 1" gaps. Adjacent worksurfaces need to be self supporting. A wall mount bracket may be used.

**HEIGHT ADJUSTABLE BASE**

Electric height adjustable base unit is available in a 2-Stage lifting column with an offset C-Leg design. The height adjustable base is a compact 2-part lifting column. A lifting column is an electric linear actuator integrated into a stable guide. The sophisticated motor system is completely hidden inside the column. The control box is powered by 110-120V /60Hz. Standby power is 0.1 Watts. Height range is 29" to 45". Lifting columns are rated for 225 lbs. dynamic load per column and are connected to tops using steel support brackets. Pedestals taller than 24 H" when placed under the height adjustable table will limit range in lowest position.

**HEIGHT ADJUSTABLE COMPONENTS**

Height adjustable components include:

- Qty (2) height adjustable lifting columns
- Qty (1) control box
- Qty (5) keypad options from basic to premium
- Qty (2) cables connecting lifting columns to control box
- Qty (1) standard plug power cable to connect control box to power source

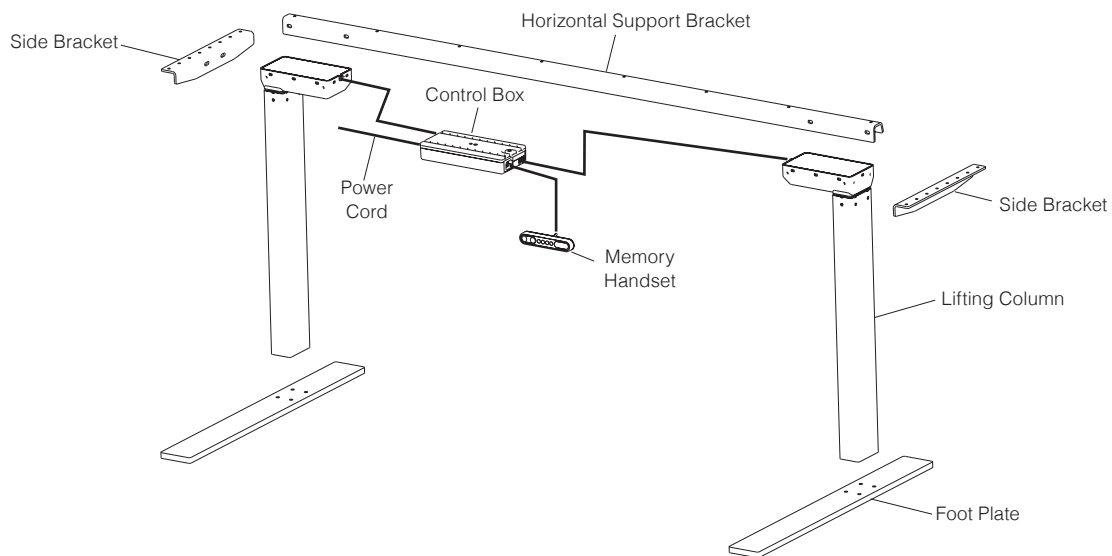

|   |         |
|---|---------|
| Unitized Casegoods . . . . .                | 31-103  |
| Freestanding Table Desks . . . . .          | 32-38   |
| Double Pedestal Desks . . . . .             | 39      |
| Single Pedestal Desks . . . . .             | 40-41   |
| Extensions . . . . .                        | 42-49   |
| Runoff Desks . . . . .                      | 50-55   |
| Bridges . . . . .                           | 56-57   |
| Credenza & Return Components . . . . .      | 58-61   |
| Pedestals . . . . .                         | 62-73   |
| Layers Pedestals . . . . .                  | 74-85   |
| Modesty / Access / Support Panels . . . . . | 86-91   |
| Brackets / Storage . . . . .                | 92-96   |
| Mobile Pedestals . . . . .                  | 97      |
| Cushions . . . . .                          | 98      |
| Trough Inserts . . . . .                    | 99      |
| Height Adjustable Desks . . . . .           | 100-103 |

# FREESTANDING TABLE DESKS

Stainless metal base

**Credentials**

02/24

|                 | D  | W  | H       | model number         | veneer 2 | veneer 3 |
|-----------------|----|----|---------|----------------------|----------|----------|
| <b>WOOD TOP</b> | 30 | 72 | 29 7/16 | <b>GA2DTRL3072-W</b> | 10,053   | 10,967   |
|                 | 36 | 72 | 29 7/16 | <b>GA2DTRL3672-W</b> | 10,362   | 11,304   |
|                 | 36 | 78 | 29 7/16 | <b>GA2DTRL3678-W</b> | 10,674   | 11,644   |
|                 | 36 | 84 | 29 7/16 | <b>GA2DTRL3684-W</b> | 10,994   | 11,993   |

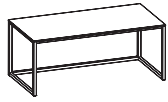

User Side

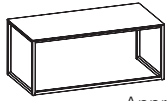

Approach Side

- Optional 10" height modesty panel with 6" overhang

## PRODUCT INFO

Stainless base is 1.5" square stainless tube with brushed finish

Fully welded seamless assembly

1.5" worksurface is rabbeted into stainless base assembly - H" top thickness is visible on all sides

short grain veneer on worksurface

## TO ORDER PLEASE SPECIFY THE FOLLOWING:

|    |  |                        |
|----|--|------------------------|
| 1. |  | <b>MODEL NUMBER</b>    |
| 2. |  | <b>FINISH</b>          |
| 3. |  | <b>TOP FINISH TYPE</b> |
| 4. |  | <b>MODESTY</b>         |
| 5. |  | <b>GROMMET</b>         |
| 6. |  | <b>OFFICE #</b>        |

See set 1 below for grommet option codes

No Grommet    **GN**  
 Left            **GL** \_\_\_ (Add +\$197)  
 Right          **GR** \_\_\_ (Add +\$197)  
 Left & Right   **GB** \_\_\_ (Add +\$394)

\_\_\_ = add grommet bezel color and door finish to complete option pick.

**SV** = silver bezel, veneer door  
**BV** = black bezel, veneer door  
**WG** = silver bezel, white glass door  
**MG** = silver bezel, muslin glass door  
**BG** = black bezel, black glass door

See inside front cover for required option codes

Example: **GLSV** = left grommet, silver bezel, veneer door

Example

**GA2DTRL3072-W.NC215.FF.MY.GN.OFC1**

|               |        |            |         |         |          |
|---------------|--------|------------|---------|---------|----------|
| GA2DTRL3072-W | NC215  | FF         | MY      | GN      | OFC1     |
| MODEL NUMBER  | FINISH | TOP FINISH | MODESTY | GROMMET | OFFICE # |

|                  | D  | W  | H       | model number         | list   |
|------------------|----|----|---------|----------------------|--------|
| <b>GLASS TOP</b> | 30 | 72 | 29 7/16 | <b>GA2DTRL3072-G</b> | 17,180 |
|                  | 36 | 72 | 29 7/16 | <b>GA2DTRL3672-G</b> | 17,710 |
|                  | 36 | 78 | 29 7/16 | <b>GA2DTRL3678-G</b> | 18,243 |
|                  | 36 | 84 | 29 7/16 | <b>GA2DTRL3684-G</b> | 18,791 |

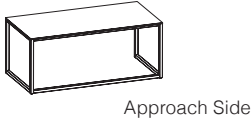
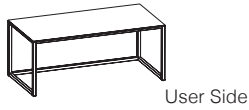

• Back painted glass is 1/2" thick.

**STONE TOP**  
(stone top ordered separately)

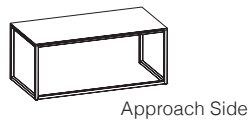

|    |    |         |                      |       |
|----|----|---------|----------------------|-------|
| 30 | 72 | 29 7/16 | <b>GA2DTRL3072-S</b> | 8,380 |
| 36 | 72 | 29 7/16 | <b>GA2DTRL3672-S</b> | 8,641 |
| 36 | 78 | 29 7/16 | <b>GA2DTRL3678-S</b> | 8,900 |
| 36 | 84 | 29 7/16 | <b>GA2DTRL3684-S</b> | 9,167 |

- Gunlocke will provide a template for the stone to be sourced locally. Contact GUNCS for template.
- Template is for 2cm (3/4") thick stone top.

**PRODUCT INFO**

Stainless base is 1.5" square stainless tube with brushed finish

Fully welded seamless assembly

Includes a 1" plywood subtop

**TO ORDER PLEASE SPECIFY THE FOLLOWING:**

- MODEL NUMBER**
- BACK PAINTED GLASS COLOR (ONLY FOR GLASS TOPS)**
- OFFICE #**

**See inside front cover for required option codes**

Example

GA2DTRL3072-G.TWH.OFC1  
 GA2DTRL3072-G      TWH      OFC1  
 MODEL NUMBER      BACK PAINTED GLASS COLOR      OFFICE #

# FREESTANDING TABLE DESKS

**Credentials**  
02/24

Modesty panel base

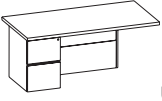
|   | D  | W  | H       | model number            | veneer 2 | veneer 3 |
|---|----|----|---------|-------------------------|----------|----------|
| <b>PEDESTAL LEFT</b>  |    |    |         |                         |          |          |
|  | 36 | 72 | 29 7/16 | <b>GA2DTRM3672L-3WW</b> | 9,027    | 9,848    |
| User Side   | 36 | 78 | 29 7/16 | <b>GA2DTRM3678L-3WW</b> | 9,297    | 10,142   |
|   | 36 | 84 | 29 7/16 | <b>GA2DTRM3684L-3WW</b> | 9,577    | 10,448   |

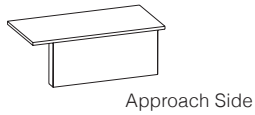

- 10" overhang approach side
- 15" overhang on conference end
- Pedestal is 18" width w/ hidden upper box drawer

## PRODUCT INFO

Short grain veneer on worksurface

## TO ORDER PLEASE SPECIFY THE FOLLOWING:

|    |  |                        |
|----|--|------------------------|
| 1. |  | <b>MODEL NUMBER</b>    |
| 2. |  | <b>FINISH</b>          |
| 3. |  | <b>TOP FINISH TYPE</b> |
| 4. |  | <b>DESKTOP INSERT</b>  |
| 5. |  | <b>PULL</b>            |
| 6. |  | <b>GROMMET</b>         |
| 7. |  | <b>LOCKING</b>         |
| 8. |  | <b>KEYING</b>          |
| 9. |  | <b>OFFICE #</b>        |

See inside front cover for required option codes

Example

| MODEL NUMBER     | FINISH | TOP FINISH | DESKTOP INSERT | PULL | GROMMET | LOCKING | KEYING | OFFICE # |
|------------------|--------|------------|----------------|------|---------|---------|--------|----------|
| GA2DTRM3672L-3WW | NC215  | FF         | TVN            | MPS  | GN      | LY      | RMS    | OFC1     |

### See set 2 below for grommet option codes

No Grommet **GN**  
Left **GL** \_\_\_ (Add +\$197)

\_\_\_ = add grommet bezel color and door finish to complete option pick.

**SV** = silver bezel, veneer door  
**BV** = black bezel, veneer door  
**WG** = silver bezel, white glass door  
**MG** = silver bezel, muslin glass door  
**BG** = black bezel, black glass door

Example: **GLSV** = left grommet, silver bezel, veneer door

|                       | D  | W  | H       | model number            | veneer 2 | veneer 3 |
|-----------------------|----|----|---------|-------------------------|----------|----------|
| <b>PEDESTAL RIGHT</b> | 36 | 72 | 29 7/16 | <b>GA2DTRM3672R-3WW</b> | 9,027    | 9,848    |
|                       | 36 | 78 | 29 7/16 | <b>GA2DTRM3678R-3WW</b> | 9,297    | 10,142   |
|                       | 36 | 84 | 29 7/16 | <b>GA2DTRM3684R-3WW</b> | 9,577    | 10,448   |

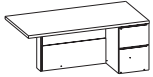

User Side

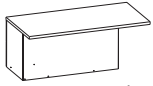

Approach Side

- 10" overhang approach side
- 15" overhang on conference end
- Pedestal is 18" width w/ hidden upper box drawer

**PRODUCT INFO**

Short grain veneer on worksurface

**TO ORDER PLEASE SPECIFY THE FOLLOWING:**

1.  **MODEL NUMBER**
2.  **FINISH**
3.  **TOP FINISH TYPE**
4.  **DESKTOP INSERT**
5.  **PULL**
6.  **GROMMET**
7.  **LOCKING**
8.  **KEYING**
9.  **OFFICE #**

**See inside front cover for required option codes**

Example

GA2DTRM3672R-3WW.NC215.FF.TVN.MPS.GN.LY.RMS.OFC1

|                     |               |                   |                       |             |                |                |               |                 |
|---------------------|---------------|-------------------|-----------------------|-------------|----------------|----------------|---------------|-----------------|
| GA2DTRM3672R-3WW    | NC215         | FF                | TVN                   | MPS         | GN             | LY             | RMS           | OFC1            |
| <b>MODEL NUMBER</b> | <b>FINISH</b> | <b>TOP FINISH</b> | <b>DESKTOP INSERT</b> | <b>PULL</b> | <b>GROMMET</b> | <b>LOCKING</b> | <b>KEYING</b> | <b>OFFICE #</b> |

**See set 3 below for grommet option codes**

No Grommet Right **GN**  
Right **GR** \_\_\_ (Add +\$197)

\_\_\_ = add grommet bezel color and door finish to complete option pick.

- SV** = silver bezel, veneer door
- BV** = black bezel, veneer door
- WG** = silver bezel, white glass door
- MG** = silver bezel, muslin glass door
- BG** = black bezel, black glass door

Example: **GRSV** = right grommet, silver bezel, veneer door

# FREESTANDING TABLE DESKS

**Credentials**  
02/24

Height adjustable base

|                            | D  | W  | H       | model number            | veneer 2 | veneer 3 |
|----------------------------|----|----|---------|-------------------------|----------|----------|
| <b>CONFERENCE END LEFT</b> | 36 | 72 | 29 7/16 | <b>GA2DTRAK3672L-WW</b> | 14,376   | 15,683   |
|                            | 36 | 78 | 29 7/16 | <b>GA2DTRAK3678L-WW</b> | 14,867   | 16,218   |
|                            | 36 | 84 | 29 7/16 | <b>GA2DTRAK3684L-WW</b> | 15,369   | 16,766   |

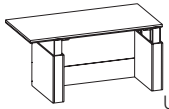

User Side

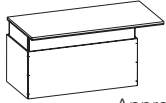

Approach Side

- 6" overhang approach side
- 12" overhang on conference end
- Provides sit-to-stand electric height adjustment
- Height adjustable mechanism is integrated into a wood base
- Includes black metal shroud to conceal height adjustable hardware when in raised position
- 29" to 45" height adjustment range

## PRODUCT INFO

Short grain veneer on worksurface

## TO ORDER PLEASE SPECIFY THE FOLLOWING:

|    |                      |                        |
|----|----------------------|------------------------|
| 1. | <input type="text"/> | <b>MODEL NUMBER</b>    |
| 2. | <input type="text"/> | <b>FINISH</b>          |
| 3. | <input type="text"/> | <b>TOP FINISH TYPE</b> |
| 4. | <input type="text"/> | <b>DESKTOP INSERT</b>  |
| 5. | <input type="text"/> | <b>GROMMET</b>         |
| 6. | <input type="text"/> | <b>OFFICE #</b>        |

### See set 3 below for grommet option codes

No Grommet **GN**  
Right **GR** \_\_\_ (Add +\$197)

\_\_\_ = add grommet bezel color and door finish to complete option pick.

**SV** = silver bezel, veneer door  
**BV** = black bezel, veneer door  
**WG** = silver bezel, white glass door  
**MG** = silver bezel, muslin glass door  
**BG** = black bezel, black glass door

Example: **GRSV** = right grommet, silver bezel, veneer door

See inside front cover for required option codes

Example

**GA2DTRAK3672L-WW.NC215.FF.TVN.GN.OFC1**

|                  |        |            |                |         |          |
|------------------|--------|------------|----------------|---------|----------|
| GA2DTRAK3672L-WW | NC215  | FF         | TVN            | GN      | OFC1     |
| MODEL NUMBER     | FINISH | TOP FINISH | DESKTOP INSERT | GROMMET | OFFICE # |



|                             | D  | W  | H       | model number            | veneer 2 | veneer 3 |
|-----------------------------|----|----|---------|-------------------------|----------|----------|
| <b>CONFERENCE END RIGHT</b> | 36 | 72 | 29 7/16 | <b>GA2DTRAK3672R-WW</b> | 14,376   | 15,683   |
|                             | 36 | 78 | 29 7/16 | <b>GA2DTRAK3678R-WW</b> | 14,867   | 16,218   |
|                             | 36 | 84 | 29 7/16 | <b>GA2DTRAK3684R-WW</b> | 15,369   | 16,766   |

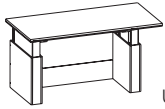

User Side

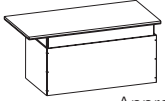

Approach Side

- 6" overhang approach side
- 12" overhang on conference end
- Provides sit-to-stand electric height adjustment
- Height adjustable mechanism is integrated into a wood base
- Includes black metal shroud to conceal height adjustable hardware when in raised position
- 29" to 45" height adjustment range

**PRODUCT INFO**

Short grain veneer on worksurface

**TO ORDER PLEASE SPECIFY THE FOLLOWING:**

1.  **MODEL NUMBER**
2.  **FINISH**
3.  **TOP FINISH TYPE**
4.  **DESKTOP INSERT**
5.  **GROMMET**
6.  **OFFICE #**

**See set 2 below for grommet option codes**

No Grommet **GN**  
Left **GL** \_\_\_ (Add +\$197)

\_\_\_ = add grommet bezel color and door finish to complete option pick.

- SV** = silver bezel, veneer door
- BV** = black bezel, veneer door
- WG** = silver bezel, white glass door
- MG** = silver bezel, muslin glass door
- BG** = black bezel, black glass door

Example: **GLSV** = left grommet, silver bezel, veneer door

**See inside front cover for required option codes**

Example

**GA2DTRAK3672R-WW.NC215.FF.TVN.GN.OFC1**  
 GA2DTRAK3672R-WW    NC215    FF    TVN    GN    OFC1  
 MODEL NUMBER    FINISH    TOP FINISH    DESKTOP INSERT    GROMMET    OFFICE #

# FREESTANDING TABLE DESKS

Credentials

02/24

Miter end panel base

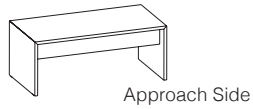
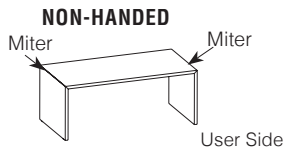

| D  | W  | H       | model number          | veneer 2 | veneer 3 |
|----|----|---------|-----------------------|----------|----------|
| 36 | 72 | 29 7/16 | <b>GA2DTRR3672-WW</b> | 7,210    | 7,865    |
| 36 | 78 | 29 7/16 | <b>GA2DTRR3678-WW</b> | 7,429    | 8,104    |
| 36 | 84 | 29 7/16 | <b>GA2DTRR3684-WW</b> | 7,652    | 8,348    |

- 10" height modesty panel standard with 6" overhang

## PRODUCT INFO

Short grain veneer on worksurface

## TO ORDER PLEASE SPECIFY THE FOLLOWING:

1.  **MODEL NUMBER**
2.  **FINISH**
3.  **TOP FINISH TYPE**
4.  **DESKTOP INSERT**
5.  **GROMMET**
6.  **OFFICE #**

See set 1 below for grommet option codes

No Grommet **GN**  
 Left **GL** \_\_\_ (Add +\$197)  
 Right **GR** \_\_\_ (Add +\$197)  
 Left & Right **GB** \_\_\_ (Add +\$394)

\_\_\_ = add grommet bezel color and door finish to complete option pick.

**SV** = silver bezel, veneer door  
**BV** = black bezel, veneer door  
**WG** = silver bezel, white glass door  
**MG** = silver bezel, muslin glass door  
**BG** = black bezel, black glass door

See inside front cover for required option codes

Example: **GLSV** = left grommet, silver bezel,

### Example

GA2DTRR3672-WW.NC215.FF.TVN.GN.OFC1

|                |        |            |                |         |         |
|----------------|--------|------------|----------------|---------|---------|
| GA2DTRR3672-WW | NC215  | FF         | TVN            | GN      | OFC1    |
| MODEL NUMBER   | FINISH | TOP FINISH | DESKTOP INSERT | GROMMET | OFFICE# |

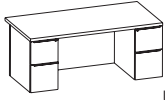
|  | D  | W  | H       | model number           | veneer 2 | veneer 3 |
|--|----|----|---------|------------------------|----------|----------|
|  <p>User Side</p> | 36 | 72 | 29 7/16 | <b>GA2DRO3672-32WW</b> | 10,057   | 10,971   |
|  | 36 | 78 | 29 7/16 | <b>GA2DRO3678-32WW</b> | 10,358   | 11,300   |
|  | 36 | 84 | 29 7/16 | <b>GA2DRO3684-32WW</b> | 10,668   | 11,638   |

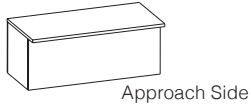

- Full modesty panel with 6" overhang
- -3 pedestals include hidden upper box drawer
- 72" and 78" width units include 15" width pedestal
- 84" width units include 18" width pedestal

**PRODUCT INFO**

Short grain veneer on worksurface

**TO ORDER PLEASE SPECIFY THE FOLLOWING:**

1.  **MODEL NUMBER**
2.  **FINISH**
3.  **TOP FINISH TYPE**
4.  **DESKTOP INSERT**
5.  **PULL**
6.  **GROMMET**
7.  **LOCKING**
8.  **KEYING**
9.  **OFFICE #**

**See inside front cover for required option codes**

Example

**GA2DRO3672-32WW.NC215.FF.TVN.MPS.GN.LY.RMS.OFC1**

|                     |               |                   |                       |             |                |                |               |                 |
|---------------------|---------------|-------------------|-----------------------|-------------|----------------|----------------|---------------|-----------------|
| GA2DRO3672-32WW     | NC215         | FF                | TVN                   | MPS         | GN             | LY             | RMS           | OFC1            |
| <b>MODEL NUMBER</b> | <b>FINISH</b> | <b>TOP FINISH</b> | <b>DESKTOP INSERT</b> | <b>PULL</b> | <b>GROMMET</b> | <b>LOCKING</b> | <b>KEYING</b> | <b>OFFICE #</b> |

See set 1 below for grommet option codes

- No Grommet **GN**
- Left **GL** \_\_\_ (Add +\$197)
- Right **GR** \_\_\_ (Add +\$197)
- Left & Right **GB** \_\_\_ (Add +\$394)

\_\_\_ = add grommet bezel color and door finish to complete option pick.

- SV** = silver bezel, veneer door
- BV** = black bezel, veneer door
- WG** = silver bezel, white glass door
- MG** = silver bezel, muslin glass door
- BG** = black bezel, black glass door

Example: **GLSV** = left grommet, silver bezel, veneer door

# SINGLE PEDESTAL DESKS

Credentials  
02/24

Left hand

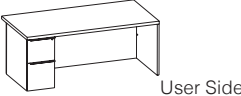
|   | D  | W  | H       | model number           | veneer 2 | veneer 3 |
|---|----|----|---------|------------------------|----------|----------|
| <b>PEDESTAL LEFT<br/>NO TROUGH</b><br> | 30 | 72 | 29 7/16 | <b>GA2DRO3072L-3WW</b> | 8,158    | 8,900    |
|   | 36 | 72 | 29 7/16 | <b>GA2DRO3672L-3WW</b> | 8,410    | 9,174    |
|   | 36 | 78 | 29 7/16 | <b>GA2DRO3678L-3WW</b> | 8,661    | 9,448    |
|   | 36 | 84 | 29 7/16 | <b>GA2DRO3684L-3WW</b> | 8,924    | 9,735    |

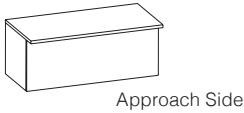

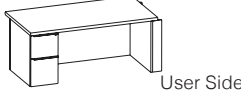
|  | D  | W  | H       | model number            | veneer 2 | veneer 3 |
|--|----|----|---------|-------------------------|----------|----------|
| <b>PEDESTAL LEFT<br/>TROUGH RIGHT END</b><br> | 30 | 72 | 29 7/16 | <b>GA2DRO3072TL-3WW</b> | 8,158    | 8,900    |
|  | 36 | 72 | 29 7/16 | <b>GA2DRO3672TL-3WW</b> | 8,410    | 9,174    |
|  | 36 | 78 | 29 7/16 | <b>GA2DRO3678TL-3WW</b> | 8,661    | 9,448    |
|  | 36 | 84 | 29 7/16 | <b>GA2DRO3684TL-3WW</b> | 8,924    | 9,735    |

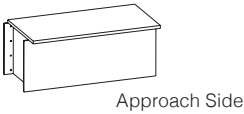

- Full modesty panel with 6" overhang
- -3 pedestals include hidden upper box drawer
- 72" and 78" width units include 15" width pedestal
- 84" width units include 18" width pedestal
- Trough end units are required when a tackzone spans over the end of the desk worksurface
- Trough units include a metal pencil lip

**NOTE:** Plastic Trough Insert is REQUIRED and must be ordered separately across entire length of trough. Single Pedestal desks have 6" overhang, deducting 6" from the overall trough insert length.

## PRODUCT INFO

Long grain veneer on worksurface

## TO ORDER PLEASE SPECIFY THE FOLLOWING:

- - 
  - 
  - 
  - 
  - 
  - 
  - 
  - 
  -
- MODEL NUMBER**  
**FINISH**  
**TOP FINISH TYPE**  
**DESKTOP INSERT**  
**PULL**  
**GROMMET**  
**LOCKING**  
**KEYING**  
**PENCIL LIP COLOR (TROUGH ONLY)**  
**OFFICE #**

See set 1 below for grommet option codes

No Grommet **GN**  
Left **GL** \_\_\_ (Add +\$197)  
Right **GR** \_\_\_ (Add +\$197)  
Left & Right **GB** \_\_\_ (Add +\$394)

\_\_\_ = add grommet bezel color and door finish to complete option pick.

**SV** = silver bezel, veneer door  
**BV** = black bezel, veneer door  
**WG** = silver bezel, white glass door  
**MG** = silver bezel, muslin glass door  
**BG** = black bezel, black glass door

Example: **GLSV** = left grommet, silver bezel, veneer door

See inside front cover for required option codes

Example

GA2DRO3072L-3WW.NC215.FF.TVN.MPS.GN.LY.RMS.OFC1

| MODEL NUMBER    | FINISH | TOP FINISH | DESKTOP INSERT | PULL | GROMMET | LOCKING | KEYING | OFFICE # |
|-----------------|--------|------------|----------------|------|---------|---------|--------|----------|
| GA2DRO3072L-3WW | NC215  | FF         | TVN            | MPS  | GN      | LY      | RMS    | OFC1     |

|                                 | D  | W  | H       | model number           | veneer 2 | veneer 3 |
|---------------------------------|----|----|---------|------------------------|----------|----------|
| <b>PEDESTAL RIGHT NO TROUGH</b> | 30 | 72 | 29 7/16 | <b>GA2DRO3072R-3WW</b> | 8,158    | 8,900    |
|                                 | 36 | 72 | 29 7/16 | <b>GA2DRO3672R-3WW</b> | 8,410    | 9,174    |
|                                 | 36 | 78 | 29 7/16 | <b>GA2DRO3678R-3WW</b> | 8,661    | 9,448    |
|                                 | 36 | 84 | 29 7/16 | <b>GA2DRO3684R-3WW</b> | 8,924    | 9,735    |

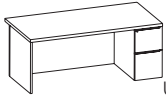

User Side



Approach Side

**PEDESTAL RIGHT TROUGH LEFT END**

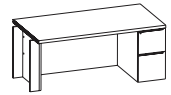

User Side



Approach Side

|    |    |         |                         |       |       |
|----|----|---------|-------------------------|-------|-------|
| 30 | 72 | 29 7/16 | <b>GA2DRO3072TR-3WW</b> | 8,158 | 8,900 |
| 36 | 72 | 29 7/16 | <b>GA2DRO3672TR-3WW</b> | 8,410 | 9,174 |
| 36 | 78 | 29 7/16 | <b>GA2DRO3678TR-3WW</b> | 8,661 | 9,448 |
| 36 | 84 | 29 7/16 | <b>GA2DRO3684TR-3WW</b> | 8,924 | 9,735 |

- Full modesty panel with 6" overhang
- -3 pedestals include hidden upper box drawer
- 72" and 78" width units include 15" width pedestal
- 84" width units include 18" width pedestal
- Trough end units are required when a tackzone spans over the end of the desk worksurface
- Trough units include a metal pencil lip

**NOTE:** Plastic Trough Insert is REQUIRED and must be ordered separately across entire length of trough. Single Pedestal desks have 6" overhang, deducting 6" from the overall trough insert length.

**PRODUCT INFO**

Long grain veneer on worksurface

**TO ORDER PLEASE SPECIFY THE FOLLOWING:**

- MODEL NUMBER
- FINISH
- TOP FINISH TYPE
- DESKTOP INSERT
- PULL
- GROMMET
- LOCKING
- KEYING
- PENCIL LIP COLOR (TROUGH ONLY)
- OFFICE #

See set 1 below for grommet option codes

No Grommet **GN**  
 Left **GL** \_\_\_ (Add +\$197)  
 Right **GR** \_\_\_ (Add +\$197)  
 Left & Right **GB** \_\_\_ (Add +\$394)

\_\_\_ = add grommet bezel color and door finish to complete option pick.

**SV** = silver bezel, veneer door  
**BV** = black bezel, veneer door  
**WG** = silver bezel, white glass door  
**MG** = silver bezel, muslin glass door  
**BG** = black bezel, black glass door

Example: **GLSV** = left grommet, silver bezel, veneer door

See inside front cover for required option codes

Example

GA2DRO3072R-3WW.NC215.FF.TVN.MPS.GN.LY.RMS.OFC1

| MODEL NUMBER    | FINISH | TOP FINISH | DESKTOP INSERT | PULL | GROMMET | LOCKING | KEYING | OFFICE # |
|-----------------|--------|------------|----------------|------|---------|---------|--------|----------|
| GA2DRO3072R-3WW | NC215  | FF         | TVN            | MPS  | GN      | LY      | RMS    | OFC1     |

# EXTENSIONS

Left hand | stainless metal base

**Credentials**  
02/24

|  | D  | W  | H       | model number         | veneer 2 | veneer 3 |
|--|----|----|---------|----------------------|----------|----------|
| <b>BASE LEFT<br/>NO TROUGH</b><br> <p>User Side</p> | 30 | 72 | 29 7/16 | <b>GA2XRL3072L-W</b> | 9,049    | 9,872    |
|  | 36 | 72 | 29 7/16 | <b>GA2XRL3672L-W</b> | 9,326    | 10,174   |
|  | 36 | 78 | 29 7/16 | <b>GA2XRL3678L-W</b> | 9,607    | 10,480   |
|  | 36 | 84 | 29 7/16 | <b>GA2XRL3684L-W</b> | 9,895    | 10,794   |

|   | D  | W  | H       | model number          | veneer 2 | veneer 3 |
|---|----|----|---------|-----------------------|----------|----------|
| <b>BASE LEFT<br/>TROUGH RIGHT END</b><br> <p>User Side</p> | 30 | 72 | 29 7/16 | <b>GA2XRL3072TL-W</b> | 9,049    | 9,872    |
|   | 36 | 72 | 29 7/16 | <b>GA2XRL3672TL-W</b> | 9,326    | 10,174   |
|   | 36 | 78 | 29 7/16 | <b>GA2XRL3678TL-W</b> | 9,607    | 10,480   |
|   | 36 | 84 | 29 7/16 | <b>GA2XRL3684TL-W</b> | 9,895    | 10,794   |

- Optional 10" height modesty panel with 6" overhang
- Trough end units are required when a tackzone spans over the end of the desk worksurface.
- Trough units include a metal pencil lip

**NOTE:** Plastic Trough Insert is REQUIRED and must be ordered separately across entire length of trough.

## PRODUCT INFO

Stainless base is 1.5" square stainless tube with brushed finish

1.5" worksurface is rabbeted into stainless base assembly. 1/2" top thickness is visible on all sides

Long grain veneer on worksurface

## TO ORDER PLEASE SPECIFY THE FOLLOWING:

- |    |                      |                                       |
|----|----------------------|---------------------------------------|
| 1. | <input type="text"/> | <b>MODEL NUMBER</b>                   |
| 2. | <input type="text"/> | <b>FINISH</b>                         |
| 3. | <input type="text"/> | <b>TOP FINISH TYPE</b>                |
| 4. | <input type="text"/> | <b>DESKTOP INSERT</b>                 |
| 5. | <input type="text"/> | <b>MODESTY</b>                        |
| 6. | <input type="text"/> | <b>GROMMET</b>                        |
| 7. | <input type="text"/> | <b>PENCIL LIP COLOR (TROUGH ONLY)</b> |
| 8. | <input type="text"/> | <b>OFFICE #</b>                       |

### See set 3 below for grommet option codes

No Grommet **GN**  
Right **GR** \_\_\_ (Add +\$197)

\_\_\_ = add grommet bezel color and door finish to complete option pick.

**SV** = silver bezel, veneer door  
**BV** = black bezel, veneer door  
**WG** = silver bezel, white glass door  
**MG** = silver bezel, muslin glass door  
**BG** = black bezel, black glass door

Example: **GRSV** = right grommet, silver bezel, veneer door

**See inside front cover for required option codes**

Example

GA2XRL3072L-W.NC215.FF.TVN.MY.GN.OFC1

|                     |               |                   |                       |                |                |                 |
|---------------------|---------------|-------------------|-----------------------|----------------|----------------|-----------------|
| GA2XRL3072L-W       | NC215         | FF                | TVN                   | MY             | GN             | OFC1            |
| <b>MODEL NUMBER</b> | <b>FINISH</b> | <b>TOP FINISH</b> | <b>DESKTOP INSERT</b> | <b>MODESTY</b> | <b>GROMMET</b> | <b>OFFICE #</b> |

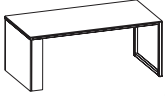
|   | D  | W  | H       | model number         | veneer 2 | veneer 3 |
|---|----|----|---------|----------------------|----------|----------|
| <b>BASE RIGHT<br/>NO TROUGH</b><br><br>User Side | 30 | 72 | 29 7/16 | <b>GA2XRL3072R-W</b> | 9,049    | 9,872    |
|   | 36 | 72 | 29 7/16 | <b>GA2XRL3672R-W</b> | 9,326    | 10,174   |
|   | 36 | 78 | 29 7/16 | <b>GA2XRL3678R-W</b> | 9,607    | 10,480   |
|   | 36 | 84 | 29 7/16 | <b>GA2XRL3684R-W</b> | 9,895    | 10,794   |

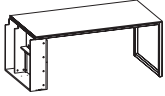
|   | D  | W  | H       | model number          | veneer 2 | veneer 3 |
|---|----|----|---------|-----------------------|----------|----------|
| <b>BASE RIGHT<br/>TROUGH LEFT END</b><br><br>User Side | 30 | 72 | 29 7/16 | <b>GA2XRL3072TR-W</b> | 9,049    | 9,872    |
|   | 36 | 72 | 29 7/16 | <b>GA2XRL3672TR-W</b> | 9,326    | 10,174   |
|   | 36 | 78 | 29 7/16 | <b>GA2XRL3678TR-W</b> | 9,607    | 10,480   |
|   | 36 | 84 | 29 7/16 | <b>GA2XRL3684TR-W</b> | 9,895    | 10,794   |

- Optional 10" height modesty panel with 6" overhang
- Trough end units are required when a tackzone spans over the end of the desk worksurface.
- Trough units include a metal pencil lip

**NOTE:** Plastic Trough Insert is REQUIRED and must be ordered separately across entire length of trough.

**PRODUCT INFO**

Stainless base is 1.5" square stainless tube with brushed finish

1.5" worksurface is rabbeted into stainless base assembly. 1/2" top thickness is visible on all sides

Long grain veneer on worksurface

**TO ORDER PLEASE SPECIFY THE FOLLOWING:**

1.  **MODEL NUMBER**
2.  **FINISH**
3.  **TOP FINISH TYPE**
4.  **DESKTOP INSERT**
5.  **MODESTY**
6.  **GROMMET**
7.  **PENCIL LIP COLOR (TROUGH ONLY)**
8.  **OFFICE #**

**See set 2 below for grommet option codes**

No Grommet      **GN**  
Left                **GL** \_\_\_\_ (Add +\$197)

\_\_\_\_ = add grommet bezel color and door finish to complete option pick.

**SV** = silver bezel, veneer door  
**BV** = black bezel, veneer door  
**WG** = silver bezel, white glass door  
**MG** = silver bezel, muslin glass door  
**BG** = black bezel, black glass door

Example: **GLSV** = left grommet, silver bezel, veneer door

**See inside front cover for required option codes**

Example

**GA2XRL3072R-W.NC215.FF.TVN.MY.GN.OFC1**

|                     |               |                   |                       |                |                |                 |
|---------------------|---------------|-------------------|-----------------------|----------------|----------------|-----------------|
| GA2XRL3072R-W       | NC215         | FF                | TVN                   | MY             | GN             | OFC1            |
| <b>MODEL NUMBER</b> | <b>FINISH</b> | <b>TOP FINISH</b> | <b>DESKTOP INSERT</b> | <b>MODESTY</b> | <b>GROMMET</b> | <b>OFFICE #</b> |

# EXTENSIONS

Left hand | modesty panel base

**Credentials**  
02/24

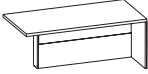
|  | D  | W  | H       | model number         | veneer 2 | veneer 3 |
|--|----|----|---------|----------------------|----------|----------|
| <b>BASE LEFT<br/>NO TROUGH</b><br><br>User Side | 30 | 72 | 29 7/16 | <b>GA2XRM3072L-W</b> | 7,443    | 8,120    |
|  | 36 | 72 | 29 7/16 | <b>GA2XRM3672L-W</b> | 7,673    | 8,370    |
|  | 36 | 78 | 29 7/16 | <b>GA2XRM3678L-W</b> | 7,902    | 8,620    |
|  | 36 | 84 | 29 7/16 | <b>GA2XRM3684L-W</b> | 8,140    | 8,880    |

## BASE LEFT TROUGH RIGHT END



User Side

|    |    |         |                       |       |       |
|----|----|---------|-----------------------|-------|-------|
| 30 | 72 | 29 7/16 | <b>GA2XRM3072TL-W</b> | 7,443 | 8,120 |
| 36 | 72 | 29 7/16 | <b>GA2XRM3672TL-W</b> | 7,673 | 8,370 |
| 36 | 78 | 29 7/16 | <b>GA2XRM3678TL-W</b> | 7,902 | 8,620 |
| 36 | 84 | 29 7/16 | <b>GA2XRM3684TL-W</b> | 8,140 | 8,880 |

- 10" overhang approach side
- 15" overhang on conference end
- Trough end units are required when a tackzone spans over the end of the desk worksurface.
- Trough units include a metal pencil lip

**NOTE:** Plastic Trough Insert is REQUIRED and must be ordered separately across entire length of trough.

### PRODUCT INFO

Long grain veneer on worksurface

### TO ORDER PLEASE SPECIFY THE FOLLOWING:

1.  **MODEL NUMBER**
2.  **FINISH**
3.  **TOP FINISH TYPE**
4.  **DESKTOP INSERT**
5.  **GROMMET**
6.  **PENCIL LIP COLOR (TROUGH ONLY)**
7.  **OFFICE #**

#### See set 3 below for grommet option codes

No Grommet **GN**  
Right **GR** \_\_\_ (Add +\$197)

\_\_\_ = add grommet bezel color and door finish to complete option pick.

**SV** = silver bezel, veneer door  
**BV** = black bezel, veneer door  
**WG** = silver bezel, white glass door  
**MG** = silver bezel, muslin glass door  
**BG** = black bezel, black glass door

Example: **GRSV** = right grommet, silver bezel, veneer door

See inside front cover for required option codes

Example

**GA2XRM3072L-W.NC215.FF.TVN.GN.OFC1**

|                     |               |                   |                       |                |                 |
|---------------------|---------------|-------------------|-----------------------|----------------|-----------------|
| GA2XRM3072L-W       | NC215         | FF                | TVN                   | GN             | OFC1            |
| <b>MODEL NUMBER</b> | <b>FINISH</b> | <b>TOP FINISH</b> | <b>DESKTOP INSERT</b> | <b>GROMMET</b> | <b>OFFICE #</b> |



|   | D  | W  | H       | model number         | veneer 2 | veneer 3 |
|---|----|----|---------|----------------------|----------|----------|
| <b>BASE RIGHT<br/>NO TROUGH</b><br><br> <p>User Side</p> | 30 | 72 | 29 7/16 | <b>GA2XRM3072R-W</b> | 7,443    | 8,120    |
|   | 36 | 72 | 29 7/16 | <b>GA2XRM3672R-W</b> | 7,673    | 8,370    |
|   | 36 | 78 | 29 7/16 | <b>GA2XRM3678R-W</b> | 7,902    | 8,620    |
|   | 36 | 84 | 29 7/16 | <b>GA2XRM3684R-W</b> | 8,140    | 8,880    |

**BASE RIGHT  
TROUGH LEFT END**

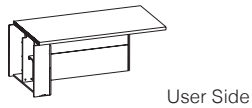

|    |    |         |                       |       |       |
|----|----|---------|-----------------------|-------|-------|
| 30 | 72 | 29 7/16 | <b>GA2XRM3072TR-W</b> | 7,443 | 8,120 |
| 36 | 72 | 29 7/16 | <b>GA2XRM3672TR-W</b> | 7,673 | 8,370 |
| 36 | 78 | 29 7/16 | <b>GA2XRM3678TR-W</b> | 7,902 | 8,620 |
| 36 | 84 | 29 7/16 | <b>GA2XRM3684TR-W</b> | 8,140 | 8,880 |

- 10" overhang approach side
- 15" overhang on conference end
- Trough end units are required when a tackzone spans over the end of the desk worksurface.
- Trough units include a metal pencil lip

**NOTE:** Plastic Trough Insert is REQUIRED and must be ordered separately across entire length of trough.

**PRODUCT INFO**

Long grain veneer on worksurface

TO ORDER PLEASE SPECIFY THE FOLLOWING:

1.  **MODEL NUMBER**
2.  **FINISH**
3.  **TOP FINISH TYPE**
4.  **DESKTOP INSERT**
5.  **GROMMET**
6.  **PENCIL LIP COLOR (TROUGH ONLY)**
7.  **OFFICE #**

**See set 2 below for grommet option codes**

No Grommet **GN**  
Left **GL** \_\_\_ (Add +\$197)

\_\_\_ = add grommet bezel color and door finish to complete option pick.

**SV** = silver bezel, veneer door  
**BV** = black bezel, veneer door  
**WG** = silver bezel, white glass door  
**MG** = silver bezel, muslin glass door  
**BG** = black bezel, black glass door

Example: **GLSV** = left grommet, silver bezel, veneer door

**See inside front cover for required option codes**

Example

**GA2XRM3072R-W.NC215.FF.TVN.GN.OFC1**  
 GA2XRM3072R-W    NC215    FF    TVN    GN    OFC1  
**MODEL NUMBER**    **FINISH**    **TOP FINISH**    **DESKTOP INSERT**    **GROMMET**    **OFFICE #**

# EXTENSIONS

Left hand | height adjustable base

**Credentials**  
02/24

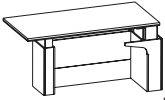
|  | D  | W  | H       | model number          | veneer 2 | veneer 3 |
|--|----|----|---------|-----------------------|----------|----------|
| <b>CONFERENCE END LEFT<br/>NO TROUGH</b><br> <p>User Side</p> | 30 | 72 | 29 7/16 | <b>GA2XRAK3072L-W</b> | 13,467   | 14,691   |
|  | 36 | 72 | 29 7/16 | <b>GA2XRAK3672L-W</b> | 13,940   | 15,207   |
|  | 36 | 78 | 29 7/16 | <b>GA2XRAK3678L-W</b> | 14,415   | 15,725   |
|  | 36 | 84 | 29 7/16 | <b>GA2XRAK3684L-W</b> | 14,903   | 16,258   |

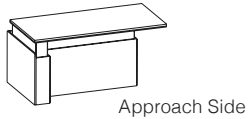

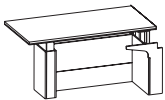
|   |    |    |         |                        |        |        |
|---|----|----|---------|------------------------|--------|--------|
| <b>CONFERENCE END LEFT<br/>TROUGH RIGHT END</b><br> <p>User Side</p> | 30 | 72 | 29 7/16 | <b>GA2XRAK3072TL-W</b> | 13,467 | 14,691 |
|   | 36 | 72 | 29 7/16 | <b>GA2XRAK3672TL-W</b> | 13,940 | 15,207 |
|   | 36 | 78 | 29 7/16 | <b>GA2XRAK3678TL-W</b> | 14,415 | 15,725 |
|   | 36 | 84 | 29 7/16 | <b>GA2XRAK3684TL-W</b> | 14,903 | 16,258 |

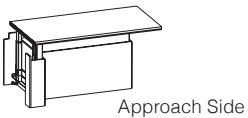

- 10" overhang approach side
- 15" overhang on conference end
- Trough end units are required when a tackzone spans over the end of the desk worksurface.
- Trough units include a metal pencil lip
- Provides sit-to-stand electric height adjustment
- Height adjustable mechanism is integrated into a wood base
- Includes black metal shroud to conceal height adjustable hardware when in raised position
- 29" to 45" height adjustment range
- If attaching to a bridge, specify bridge model for use with height adjustable extensions
- If attaching to a return, a 3" shorter width modesty or wall access panel must be used on return

**NOTE:** Plastic Trough Insert is REQUIRED and must be ordered separately across entire length of trough.

## PRODUCT INFO

Long grain veneer on worksurface

## TO ORDER PLEASE SPECIFY THE FOLLOWING:

|    |  |                                       |
|----|--|---------------------------------------|
| 1. |  | <b>MODEL NUMBER</b>                   |
| 2. |  | <b>FINISH</b>                         |
| 3. |  | <b>TOP FINISH TYPE</b>                |
| 4. |  | <b>DESKTOP INSERT</b>                 |
| 5. |  | <b>GROMMET</b>                        |
| 6. |  | <b>PENCIL LIP COLOR (TROUGH ONLY)</b> |
| 7. |  | <b>OFFICE #</b>                       |

### See set 3 below for grommet option codes

No Grommet **GN**  
Right **GR** \_\_\_ (Add +\$197)

\_\_\_ = add grommet bezel color and door finish to complete option pick.

**SV** = silver bezel, veneer door  
**BV** = black bezel, veneer door  
**WG** = silver bezel, white glass door  
**MG** = silver bezel, muslin glass door  
**BG** = black bezel, black glass door

Example: **GRSV** = right grommet, silver bezel, veneer door

### See inside front cover for required option codes

Example

|  |               |                   |                       |                |                 |
|--|---------------|-------------------|-----------------------|----------------|-----------------|
| <b>GA2XRAK3072L-W.NC215.FF.TVN.GN.OFC1</b> |               |                   |                       |                |                 |
| GA2XRAK3072L-W                             | NC215         | FF                | TVN                   | GN             | OFC1            |
| <b>MODEL NUMBER</b>                        | <b>FINISH</b> | <b>TOP FINISH</b> | <b>DESKTOP INSERT</b> | <b>GROMMET</b> | <b>OFFICE #</b> |

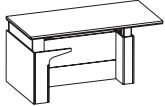
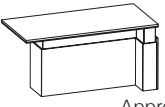
|  | D  | W  | H       | model number          | veneer 2 | veneer 3 |
|--|----|----|---------|-----------------------|----------|----------|
| <b>CONFERENCE END RIGHT NO TROUGH</b><br> <p>User Side</p>  <p>Approach Side</p> | 30 | 72 | 29 7/16 | <b>GA2XRAK3072R-W</b> | 13,467   | 14,691   |
|  | 36 | 72 | 29 7/16 | <b>GA2XRAK3672R-W</b> | 13,940   | 15,207   |
|  | 36 | 78 | 29 7/16 | <b>GA2XRAK3678R-W</b> | 14,415   | 15,725   |
|  | 36 | 84 | 29 7/16 | <b>GA2XRAK3684R-W</b> | 14,903   | 16,258   |

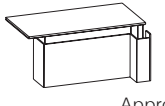
|   | D  | W  | H       | model number           | veneer 2 | veneer 3 |
|---|----|----|---------|------------------------|----------|----------|
| <b>CONFERENCE END RIGHT TROUGH LEFT END</b><br> <p>User Side</p>  <p>Approach Side</p> | 30 | 72 | 29 7/16 | <b>GA2XRAK3072TR-W</b> | 13,467   | 14,691   |
|   | 36 | 72 | 29 7/16 | <b>GA2XRAK3672TR-W</b> | 13,940   | 15,207   |
|   | 36 | 78 | 29 7/16 | <b>GA2XRAK3678TR-W</b> | 14,415   | 15,725   |
|   | 36 | 84 | 29 7/16 | <b>GA2XRAK3684TR-W</b> | 14,903   | 16,258   |

- 10" overhang approach side
- 15" overhang on conference end
- Trough end units are required when a tackzone spans over the end of the desk worksurface.
- Trough units include a metal pencil lip
- Provides sit-to-stand electric height adjustment
- Height adjustable mechanism is integrated into a wood base
- Includes black metal shroud to conceal height adjustable hardware when in raised position
- 29" to 45" height adjustment range
- If attaching to a bridge, specify bridge model for use with height adjustable extensions
- If attaching to a return, a 3" shorter width modesty or wall access panel must be used on return

**NOTE:** Plastic Trough Insert is REQUIRED and must be ordered separately across entire length of trough.

**PRODUCT INFO**

Long grain veneer on worksurface

**TO ORDER PLEASE SPECIFY THE FOLLOWING:**

1.  **MODEL NUMBER**
2.  **FINISH**
3.  **TOP FINISH TYPE**
4.  **DESKTOP INSERT**
5.  **GROMMET**
6.  **PENCIL LIP COLOR (TROUGH ONLY)**
7.  **OFFICE #**

**See set 2 below for grommet option codes**

No Grommet **GN**  
 Left **GL** \_\_\_ (Add +\$197)  
 \_\_\_ = add grommet bezel color and door finish to complete option pick.  
**SV** = silver bezel, veneer door  
**BV** = black bezel, veneer door  
**WG** = silver bezel, white glass door  
**MG** = silver bezel, muslin glass door  
**BG** = black bezel, black glass door

Example: **GLSV** = left grommet, silver bezel, veneer door

**See inside front cover for required option codes**

Example

**GA2XRAK3072R-W.NC215.FF.TVN.GN.OFC1**  
 GA2XRAK3072R-W    NC215    FF    TVN    GN    OFC1  
**MODEL NUMBER**    **FINISH**    **TOP FINISH**    **DESKTOP INSERT**    **GROMMET**    **OFFICE #**

# EXTENSIONS

Left hand | miter end panel base

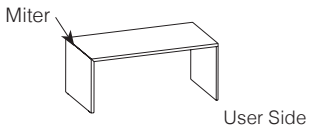
|   | D  | W  | H       | model number         | veneer 2 | veneer 3 |
|---|----|----|---------|----------------------|----------|----------|
| <b>BASE LEFT<br/>NO TROUGH</b><br> | 30 | 72 | 29 7/16 | <b>GA2XRR3072L-W</b> | 6,804    | 7,422    |
|   | 36 | 72 | 29 7/16 | <b>GA2XRR3672L-W</b> | 7,013    | 7,650    |
|   | 36 | 78 | 29 7/16 | <b>GA2XRR3678L-W</b> | 7,225    | 7,882    |
|   | 36 | 84 | 29 7/16 | <b>GA2XRR3684L-W</b> | 7,442    | 8,118    |

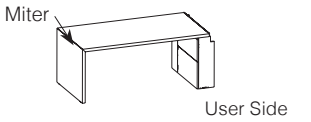
|  | D  | W  | H       | model number          | veneer 2 | veneer 3 |
|--|----|----|---------|-----------------------|----------|----------|
| <b>BASE LEFT<br/>TROUGH RIGHT END</b><br> | 30 | 72 | 29 7/16 | <b>GA2XRR3072TL-W</b> | 6,804    | 7,422    |
|  | 36 | 72 | 29 7/16 | <b>GA2XRR3672TL-W</b> | 7,013    | 7,650    |
|  | 36 | 78 | 29 7/16 | <b>GA2XRR3678TL-W</b> | 7,225    | 7,882    |
|  | 36 | 84 | 29 7/16 | <b>GA2XRR3684TL-W</b> | 7,442    | 8,118    |

- 6" overhang approach side
- Trough end units are required when a tackzone spans over the end of the desk worksurface.
- Trough units include a metal pencil lip

**NOTE:** Plastic Trough Insert is REQUIRED and must be ordered separately across entire length of trough.

## PRODUCT INFO

Long grain veneer on worksurface

## TO ORDER PLEASE SPECIFY THE FOLLOWING:

1.  **MODEL NUMBER**
2.  **FINISH**
3.  **TOP FINISH TYPE**
4.  **DESKTOP INSERT**
5.  **GROMMET**
6.  **PENCIL LIP COLOR (TROUGH ONLY)**
7.  **OFFICE #**

### See set 3 below for grommet option codes

No Grommet **GN**  
Right **GR** \_\_\_ (Add +\$197)

\_\_\_ = add grommet bezel color and door finish to complete option pick.

**SV** = silver bezel, veneer door  
**BV** = black bezel, veneer door  
**WG** = silver bezel, white glass door  
**MG** = silver bezel, muslin glass door  
**BG** = black bezel, black glass door

Example: **GRSV** = right grommet, silver bezel, veneer door

### See inside front cover for required option codes

Example

**GA2XRR3072L-W.NC215.FF.TVN.GN.OFC1**

|                     |               |                   |                       |                |                 |
|---------------------|---------------|-------------------|-----------------------|----------------|-----------------|
| GA2XRR3072L-W       | NC215         | FF                | TVN                   | GN             | OFC1            |
| <b>MODEL NUMBER</b> | <b>FINISH</b> | <b>TOP FINISH</b> | <b>DESKTOP INSERT</b> | <b>GROMMET</b> | <b>OFFICE #</b> |

**BASE RIGHT  
NO TROUGH**

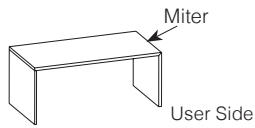

| D  | W  | H       | model number         | veneer 2 | veneer 3 |
|----|----|---------|----------------------|----------|----------|
| 30 | 72 | 29 7/16 | <b>GA2XRR3072R-W</b> | 6,804    | 7,422    |
| 36 | 72 | 29 7/16 | <b>GA2XRR3672R-W</b> | 7,013    | 7,650    |
| 36 | 78 | 29 7/16 | <b>GA2XRR3678R-W</b> | 7,225    | 7,882    |
| 36 | 84 | 29 7/16 | <b>GA2XRR3684R-W</b> | 7,442    | 8,118    |

**BASE RIGHT  
TROUGH LEFT END**

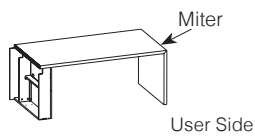

|    |    |         |                       |       |       |
|----|----|---------|-----------------------|-------|-------|
| 30 | 72 | 29 7/16 | <b>GA2XRR3072TR-W</b> | 6,804 | 7,422 |
| 36 | 72 | 29 7/16 | <b>GA2XRR3672TR-W</b> | 7,013 | 7,650 |
| 36 | 78 | 29 7/16 | <b>GA2XRR3678TR-W</b> | 7,225 | 7,882 |
| 36 | 84 | 29 7/16 | <b>GA2XRR3684TR-W</b> | 7,442 | 8,118 |

- 6" overhang approach side
- Trough end units are required when a tackzone spans over the end of the desk worksurface.
- Trough units include a metal pencil lip

**NOTE:** Plastic Trough Insert is REQUIRED and must be ordered separately across entire length of trough

**PRODUCT INFO**

Long grain veneer on worksurface

**TO ORDER PLEASE SPECIFY THE FOLLOWING:**

1.  **MODEL NUMBER**
2.  **FINISH**
3.  **TOP FINISH TYPE**
4.  **DESKTOP INSERT**
5.  **GROMMET**
6.  **PENCIL LIP COLOR (TROUGH ONLY)**
7.  **OFFICE #**

**See set 2 below for grommet option codes**

No Grommet **GN**  
Left **GL** \_\_\_ (Add +\$197)

\_\_\_ = add grommet bezel color and door finish to complete option pick.

**SV** = silver bezel, veneer door  
**BV** = black bezel, veneer door  
**WG** = silver bezel, white glass door  
**MG** = silver bezel, muslin glass door  
**BG** = black bezel, black glass door

Example: **GLSV** = left grommet, silver bezel, veneer door

**See inside front cover for required option codes**

Example

|   |               |                   |                       |                |                 |
|---|---------------|-------------------|-----------------------|----------------|-----------------|
| <b>GA2XRR3072R-W.NC215.FF.TVN.GN.OFC1</b> |               |                   |                       |                |                 |
| GA2XRR3072R-W                             | NC215         | FF                | TVN                   | GN             | OFC1            |
| <b>MODEL NUMBER</b>                       | <b>FINISH</b> | <b>TOP FINISH</b> | <b>DESKTOP INSERT</b> | <b>GROMMET</b> | <b>OFFICE #</b> |

# RUNOFF DESKS

Left hand | stainless metal base

**Credentials**  
02/24

|   | D  | W  | H       | model number         | veneer 2 | veneer 3 |
|---|----|----|---------|----------------------|----------|----------|
| <b>STANDARD<br/>BASE LEFT</b><br><br> <p>User Side</p> | 30 | 48 | 29 7/16 | <b>GA2RRL3048L-W</b> | 7,689    | 8,388    |
|   | 30 | 54 | 29 7/16 | <b>GA2RRL3054L-W</b> | 7,919    | 8,639    |
|   | 36 | 54 | 29 7/16 | <b>GA2RRL3654L-W</b> | 8,158    | 8,900    |
|   | 36 | 60 | 29 7/16 | <b>GA2RRL3660L-W</b> | 8,403    | 9,167    |

- Optional 10" height modesty panel with 6" overhang

## LAYERS OVERLAPPING BASE LEFT



|    |    |         |                       |       |        |
|----|----|---------|-----------------------|-------|--------|
| 30 | 72 | 29 7/16 | <b>GA2RLRL3072L-W</b> | 8,074 | 8,808  |
| 30 | 78 | 29 7/16 | <b>GA2RLRL3078L-W</b> | 8,480 | 9,251  |
| 36 | 78 | 29 7/16 | <b>GA2RLRL3678L-W</b> | 8,903 | 9,712  |
| 36 | 84 | 29 7/16 | <b>GA2RLRL3684L-W</b> | 9,346 | 10,196 |

- Optional 10" height modesty panel with 6" overhang
- Layers units overlap low height credenza worksurfaces
- Includes layers box
- Unit is free-floating on lower credenza worksurface
- Includes pencil lip on end of unit

## PRODUCT INFO

Stainless base is 1.5" square stainless tube with brushed finish

1.5" worksurface is rabbeted into stainless base assembly - H" top thickness is visible on all sides

Short grain veneer on worksurface

## TO ORDER PLEASE SPECIFY THE FOLLOWING:

|    |                      |                                       |
|----|----------------------|---------------------------------------|
| 1. | <input type="text"/> | <b>MODEL NUMBER</b>                   |
| 2. | <input type="text"/> | <b>FINISH</b>                         |
| 3. | <input type="text"/> | <b>TOP FINISH TYPE</b>                |
| 4. | <input type="text"/> | <b>MODESTY</b>                        |
| 5. | <input type="text"/> | <b>GROMMET</b>                        |
| 6. | <input type="text"/> | <b>PENCIL LIP COLOR (LAYERS ONLY)</b> |
| 7. | <input type="text"/> | <b>OFFICE #</b>                       |

### See set 3 below for grommet option codes

No Grommet **GN**  
Right **GR** \_\_\_ (Add +\$197)

\_\_\_ = add grommet bezel color and door finish to complete option pick.

**SV** = silver bezel, veneer door  
**BV** = black bezel, veneer door  
**WG** = silver bezel, white glass door  
**MG** = silver bezel, muslin glass door  
**BG** = black bezel, black glass door

Example: **GRSV** = right grommet, silver bezel, veneer door

### See inside front cover for required option codes

Example

GA2RRL3048L-W.NC215.FF.TVN.MY.GN.PLS.OFC1

|                     |               |                   |                       |                |                |                         |                 |
|---------------------|---------------|-------------------|-----------------------|----------------|----------------|-------------------------|-----------------|
| GA2RRL3048L-W       | NC215         | FF                | TVN                   | MY             | GN             | PLS                     | OFC1            |
| <b>MODEL NUMBER</b> | <b>FINISH</b> | <b>TOP FINISH</b> | <b>DESKTOP INSERT</b> | <b>MODESTY</b> | <b>GROMMET</b> | <b>PENCIL LIP COLOR</b> | <b>OFFICE #</b> |

|                                | D  | W  | H       | model number         | veneer 2 | veneer 3 |
|--------------------------------|----|----|---------|----------------------|----------|----------|
| <b>STANDARD<br/>BASE RIGHT</b> | 30 | 48 | 29 7/16 | <b>GA2RRL3048R-W</b> | 7,689    | 8,388    |
|                                | 30 | 54 | 29 7/16 | <b>GA2RRL3054R-W</b> | 7,919    | 8,639    |
|                                | 36 | 54 | 29 7/16 | <b>GA2RRL3654R-W</b> | 8,158    | 8,900    |
|                                | 36 | 60 | 29 7/16 | <b>GA2RRL3660R-W</b> | 8,403    | 9,167    |



- Optional 10" height modesty panel with 6" overhang

**LAYERS OVERLAPPING  
BASE RIGHT**



|    |    |         |                       |       |        |
|----|----|---------|-----------------------|-------|--------|
| 30 | 72 | 29 7/16 | <b>GA2RLRL3072R-W</b> | 8,074 | 8,808  |
| 30 | 78 | 29 7/16 | <b>GA2RLRL3078R-W</b> | 8,480 | 9,251  |
| 36 | 78 | 29 7/16 | <b>GA2RLRL3678R-W</b> | 8,903 | 9,712  |
| 36 | 84 | 29 7/16 | <b>GA2RLRL3684R-W</b> | 9,346 | 10,196 |

- Optional 10" height modesty panel with 6" overhang
- Layers units overlap low height credenza worksurfaces
- Includes layers box
- Unit is free-floating on lower credenza worksurface
- Includes pencil lip on end of unit

**PRODUCT INFO**

Stainless base is 1.5" square stainless tube with brushed finish

1.5" worksurface is rabbeted into stainless base assembly - H" top thickness is visible on all sides

Short grain veneer on worksurface

**TO ORDER PLEASE SPECIFY THE FOLLOWING:**

- MODEL NUMBER**
- FINISH**
- TOP FINISH TYPE**
- MODESTY**
- GROMMET**
- PENCIL LIP COLOR (LAYERS ONLY)**
- OFFICE #**

**See set 2 below for grommet option codes**

No Grommet **GN**  
Left **GL** \_\_\_\_ (Add +\$197)

\_\_\_\_ = add grommet bezel color and door finish to complete option pick.

**SV** = silver bezel, veneer door  
**BV** = black bezel, veneer door  
**WG** = silver bezel, white glass door  
**MG** = silver bezel, muslin glass door  
**BG** = black bezel, black glass door

Example: **GLSV** = left grommet, silver bezel, veneer door

**See inside front cover for required option codes**

Example

GA2RRL3048R-W.NC215.FF.TVN.MY.GN.PLS.OFC1

|                     |               |                   |                       |                |                |                         |                |
|---------------------|---------------|-------------------|-----------------------|----------------|----------------|-------------------------|----------------|
| GA2RRL3048R-W       | NC215         | FF                | TVN                   | MY             | GN             | PLS                     | OFC1           |
| <b>MODEL NUMBER</b> | <b>FINISH</b> | <b>TOP FINISH</b> | <b>DESKTOP INSERT</b> | <b>MODESTY</b> | <b>GROMMET</b> | <b>PENCIL LIP COLOR</b> | <b>OFFICE#</b> |

# RUNOFF DESKS

Left hand | miter panel base

**Credentials**  
02/24

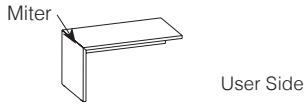
|  | D  | W  | H       | model number         | veneer 2 | veneer 3 |
|--|----|----|---------|----------------------|----------|----------|
| <b>STANDARD<br/>BASE LEFT</b><br> | 30 | 48 | 29 7/16 | <b>GA2RRR3048L-W</b> | 5,782    | 6,308    |
|  | 30 | 54 | 29 7/16 | <b>GA2RRR3054L-W</b> | 5,956    | 6,497    |
|  | 36 | 54 | 29 7/16 | <b>GA2RRR3654L-W</b> | 6,135    | 6,693    |
|  | 36 | 60 | 29 7/16 | <b>GA2RRR3660L-W</b> | 6,318    | 6,892    |

- 6" overhang approach side

## LAYERS OVERLAPPING BASE LEFT

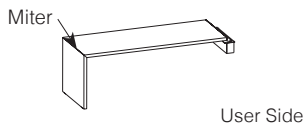

|    |    |         |                       |       |       |
|----|----|---------|-----------------------|-------|-------|
| 30 | 72 | 29 7/16 | <b>GA2RLRR3072L-W</b> | 6,074 | 6,626 |
| 30 | 78 | 29 7/16 | <b>GA2RLRR3078L-W</b> | 6,376 | 6,956 |
| 36 | 78 | 29 7/16 | <b>GA2RLRR3678L-W</b> | 6,692 | 7,300 |
| 36 | 84 | 29 7/16 | <b>GA2RLRR3684L-W</b> | 7,029 | 7,668 |

- 6" overhang approach side
- Layers units overlap low height credenza worksurfaces
- Includes layers box
- Unit is free-floating on lower credenza worksurface
- Includes pencil lip on end of unit

### PRODUCT INFO

Short grain veneer on worksurface

### TO ORDER PLEASE SPECIFY THE FOLLOWING:

|    |                      |                                       |
|----|----------------------|---------------------------------------|
| 1. | <input type="text"/> | <b>MODEL NUMBER</b>                   |
| 2. | <input type="text"/> | <b>FINISH</b>                         |
| 3. | <input type="text"/> | <b>TOP FINISH TYPE</b>                |
| 4. | <input type="text"/> | <b>GROMMET</b>                        |
| 5. | <input type="text"/> | <b>PENCIL LIP COLOR (LAYERS ONLY)</b> |
| 6. | <input type="text"/> | <b>OFFICE #</b>                       |

#### See set 3 below for grommet option codes

No Grommet **GN**  
Right **GR** \_\_\_ (Add +\$197)

\_\_\_ = add grommet bezel color and door finish to complete option pick.

**SV** = silver bezel, veneer door  
**BV** = black bezel, veneer door  
**WG** = silver bezel, white glass door  
**MG** = silver bezel, muslin glass door  
**BG** = black bezel, black glass door

Example: **GRSV** = right grommet, silver bezel, veneer door

#### See inside front cover for required option codes

Example

| MODEL NUMBER  | FINISH | TOP FINISH | DESKTOP INSERT | GROMMET | PENCIL LIP COLOR | OFFICE # |
|---------------|--------|------------|----------------|---------|------------------|----------|
| GA2RRR3048L-W | NC215  | FF         | TVN            | GN      | PLS              | OFC1     |



**STANDARD  
BASE RIGHT**

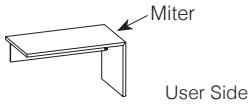

| D  | W  | H       | model number         | veneer 2 | veneer 3 |
|----|----|---------|----------------------|----------|----------|
| 30 | 48 | 29 7/16 | <b>GA2RRR3048R-W</b> | 5,782    | 6,308    |
| 30 | 54 | 29 7/16 | <b>GA2RRR3054R-W</b> | 5,956    | 6,497    |
| 36 | 54 | 29 7/16 | <b>GA2RRR3654R-W</b> | 6,135    | 6,693    |
| 36 | 60 | 29 7/16 | <b>GA2RRR3660R-W</b> | 6,318    | 6,892    |

- 6" overhang approach side

**LAYERS OVERLAPPING  
BASE RIGHT**

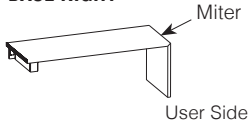

|    |    |         |                       |       |       |
|----|----|---------|-----------------------|-------|-------|
| 30 | 72 | 29 7/16 | <b>GA2RLRR3072R-W</b> | 6,074 | 6,626 |
| 30 | 78 | 29 7/16 | <b>GA2RLRR3078R-W</b> | 6,376 | 6,956 |
| 36 | 78 | 29 7/16 | <b>GA2RLRR3678R-W</b> | 6,692 | 7,300 |
| 36 | 84 | 29 7/16 | <b>GA2RLRR3684R-W</b> | 7,029 | 7,668 |

- 6" overhang approach side
- Layers units overlap low height credenza worksurfaces
- Includes layers box
- Unit is free-floating on lower credenza worksurface
- Includes pencil lip on end of unit

**PRODUCT INFO**

Short grain veneer on worksurface

**TO ORDER PLEASE SPECIFY THE FOLLOWING:**

- MODEL NUMBER**
- FINISH**
- TOP FINISH TYPE**
- GROMMET**
- PENCIL LIP COLOR (LAYERS ONLY)**
- OFFICE #**

**See set 2 below for grommet option codes**

No Grommet **GN**  
Left **GL** \_\_\_ (Add +\$197)

\_\_\_ = add grommet bezel color and door finish to complete option pick.

**SV** = silver bezel, veneer door  
**BV** = black bezel, veneer door  
**WG** = silver bezel, white glass door  
**MG** = silver bezel, muslin glass door  
**BG** = black bezel, black glass door

Example: **GLSV** = left grommet, silver bezel, veneer door

**See inside front cover for required option codes**

Example

|   |               |                   |                       |                |                         |                 |
|---|---------------|-------------------|-----------------------|----------------|-------------------------|-----------------|
| <b>GA2RRR3048R-W.NC215.FF.TVN.GN.PLS.OFC1</b> |               |                   |                       |                |                         |                 |
| GA2RRR3048R-W                                 | NC215         | FF                | TVN                   | GN             | PLS                     | OFC1            |
| <b>MODEL NUMBER</b>                           | <b>FINISH</b> | <b>TOP FINISH</b> | <b>DESKTOP INSERT</b> | <b>GROMMET</b> | <b>PENCIL LIP COLOR</b> | <b>OFFICE #</b> |

# RUNOFF DESKS

Left hand | pedestal

Credentials

02/24

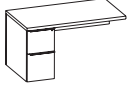
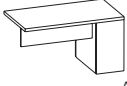
|  | D  | W  | H       | model number          | veneer 2 | veneer 3 |
|--|----|----|---------|-----------------------|----------|----------|
| <b>STANDARD PEDESTAL LEFT</b><br> <p>User Side</p>  <p>Approach Side</p> | 30 | 48 | 29 7/16 | <b>GA2RRO3048L-3W</b> | 6,934    | 7,564    |
|  | 30 | 54 | 29 7/16 | <b>GA2RRO3054L-3W</b> | 7,139    | 7,788    |
|  | 36 | 54 | 29 7/16 | <b>GA2RRO3654L-3W</b> | 7,353    | 8,021    |
|  | 36 | 60 | 29 7/16 | <b>GA2RRO3660L-3W</b> | 7,576    | 8,265    |

- 6" overhang approach side
- -3 pedestals include hidden upper box drawer
- All units include 15" width pedestal

## LAYERS OVERLAPPING PEDESTAL LEFT

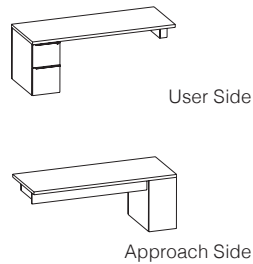

|    |    |         |                        |       |       |
|----|----|---------|------------------------|-------|-------|
| 30 | 72 | 29 7/16 | <b>GA2RLRO3072L-3W</b> | 7,282 | 7,944 |
| 30 | 78 | 29 7/16 | <b>GA2RLRO3078L-3W</b> | 7,645 | 8,340 |
| 36 | 78 | 29 7/16 | <b>GA2RLRO3678L-3W</b> | 8,024 | 8,753 |
| 36 | 84 | 29 7/16 | <b>GA2RLRO3684L-3W</b> | 8,428 | 9,194 |

- 6" overhang approach side
- -3 pedestals include hidden upper box drawer
- All units include 15" width pedestal
- Layers units overlap low height credenza worksurfaces
- Includes layers box
- Unit is free-floating on lower credenza worksurface
- Includes pencil lip on end of unit

## PRODUCT INFO

Short grain veneer on worksurface

## TO ORDER PLEASE SPECIFY THE FOLLOWING:

|     |  |                                       |
|-----|--|---------------------------------------|
| 1.  |  | <b>MODEL NUMBER</b>                   |
| 2.  |  | <b>FINISH</b>                         |
| 3.  |  | <b>TOP FINISH TYPE</b>                |
| 4.  |  | <b>PULL</b>                           |
| 5.  |  | <b>MODESTY</b>                        |
| 6.  |  | <b>GROMMET</b>                        |
| 7.  |  | <b>PENCIL LIP COLOR (LAYERS ONLY)</b> |
| 8.  |  | <b>LOCKING</b>                        |
| 9.  |  | <b>KEYING</b>                         |
| 10. |  | <b>OFFICE #</b>                       |

See inside front cover for required option codes

Example

GA2RRO3048L-3W.NC215.FF.TVN.MPS.MY.GN.PLS.LY.RMS.OFC1

|                |        |            |                |      |         |         |                  |         |        |          |
|----------------|--------|------------|----------------|------|---------|---------|------------------|---------|--------|----------|
| GA2RRO3048L-3W | NC215  | FF         | TVN            | MPS  | MY      | GN      | PLS              | LY      | RMS    | OFC1     |
| MODEL NUMBER   | FINISH | TOP FINISH | DESKTOP INSERT | PULL | MODESTY | GROMMET | PENCIL LIP COLOR | LOCKING | KEYING | OFFICE # |

### See set 3 below for grommet option codes

No Grommet **GN**  
Right **GR** \_\_\_ (Add +\$197)

\_\_\_ = add grommet bezel color and door finish to complete option pick.

**SV** = silver bezel, veneer door  
**BV** = black bezel, veneer door  
**WG** = silver bezel, white glass door  
**MG** = silver bezel, muslin glass door  
**BG** = black bezel, black glass door

Example: **GRSV** = right grommet, silver bezel, veneer door

|                                | D  | W  | H       | model number          | veneer 2 | veneer 3 |
|--------------------------------|----|----|---------|-----------------------|----------|----------|
| <b>STANDARD PEDESTAL RIGHT</b> | 30 | 48 | 29 7/16 | <b>GA2RRO3048R-3W</b> | 6,934    | 7,564    |
|                                | 30 | 54 | 29 7/16 | <b>GA2RRO3054R-3W</b> | 7,139    | 7,788    |
|                                | 36 | 54 | 29 7/16 | <b>GA2RRO3654R-3W</b> | 7,353    | 8,021    |
|                                | 36 | 60 | 29 7/16 | <b>GA2RRO3660R-3W</b> | 7,576    | 8,265    |

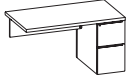

User Side

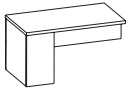

Approach Side

- 6" overhang approach side
- -3 pedestals include hidden upper box drawer
- All units include 15" width pedestal

**LAYERS OVERLAPPING PEDESTAL RIGHT**

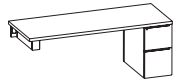

User Side

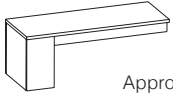

Approach Side

|    |    |         |                        |       |       |
|----|----|---------|------------------------|-------|-------|
| 30 | 72 | 29 7/16 | <b>GA2RLRO3072R-3W</b> | 7,282 | 7,944 |
| 30 | 78 | 29 7/16 | <b>GA2RLRO3078R-3W</b> | 7,645 | 8,340 |
| 36 | 78 | 29 7/16 | <b>GA2RLRO3678R-3W</b> | 8,024 | 8,753 |
| 36 | 84 | 29 7/16 | <b>GA2RLRO3684R-3W</b> | 8,428 | 9,194 |

- 6" overhang approach side
- -3 pedestals include hidden upper box drawer
- All units include 15" width pedestal
- Layers units overlap low height credenza worksurfaces
- Includes layers box
- Unit is free-floating on lower credenza worksurface

**PRODUCT INFO**

Short grain veneer on worksurface

**TO ORDER PLEASE SPECIFY THE FOLLOWING:**

- MODEL NUMBER
- FINISH
- TOP FINISH TYPE
- PULL
- MODESTY
- GROMMET
- PENCIL LIP COLOR (LAYERS ONLY)
- LOCKING
- KEYING
- OFFICE #

**See set 2 below for grommet option codes**

No Grommet **GN**  
Left **GL** \_\_\_ (Add +\$197)

\_\_\_ = add grommet bezel color and door finish to complete option pick.

**SV** = silver bezel, veneer door  
**BV** = black bezel, veneer door  
**WG** = silver bezel, white glass door  
**MG** = silver bezel, muslin glass door  
**BG** = black bezel, black glass door

Example: **GLSV** = left grommet, silver bezel, veneer door

**See inside front cover for required option codes**

Example

GA2RRO3048R-3W.NC215.FF.TVN.MPS.GN.PLS.LY.RMS.OFC1  
GA2RRO3048R-3W NC215 FF TVN MPS MY GN PLS LY RMS OFC1  
MODEL NUMBER FINISH TOP FINISH DESKTOP INSERT PULL MODESTY GROMMET PENCIL LIP COLOR LOCKING KEYING OFFICE #

# BRIDGES

Standard

Credentials

02/24

|  | D  | W  | H       | model number         | veneer 2 | veneer 3 |
|--|----|----|---------|----------------------|----------|----------|
| <b>STANDARD</b><br> | 24 | 42 | 29 7/16 | <b>GA2BRG2442-WW</b> | 3,151    | 3,437    |
|  | 24 | 48 | 29 7/16 | <b>GA2BRG2448-WW</b> | 3,241    | 3,536    |
|  | 24 | 54 | 29 7/16 | <b>GA2BRG2454-WW</b> | 3,333    | 3,636    |

- Optional no modesty panel (deduct -\$-867) or full height modesty panel

## FOR USE WITH HEIGHT ADJUSTABLE EXTENSIONS

|   |    |    |         |                       |       |       |
|---|----|----|---------|-----------------------|-------|-------|
|  | 24 | 42 | 29 7/16 | <b>GA2BRG2442A-WW</b> | 3,151 | 3,437 |
|   | 24 | 48 | 29 7/16 | <b>GA2BRG2448A-WW</b> | 3,241 | 3,536 |
|   | 24 | 54 | 29 7/16 | <b>GA2BRG2454A-WW</b> | 3,333 | 3,636 |

- Optional no modesty panel (deduct -\$-867) or full height modesty panel

## LAYERS FOR USE WITH STANDARD OR HEIGHT ADJUSTABLE DESKS/EXTENSIONS

|   |    |    |         |                      |       |       |
|---|----|----|---------|----------------------|-------|-------|
|  | 24 | 66 | 29 7/16 | <b>GA2BLRG2466-W</b> | 3,313 | 3,614 |
|   | 24 | 72 | 29 7/16 | <b>GA2BLRG2472-W</b> | 3,403 | 3,712 |
|   | 24 | 78 | 29 7/16 | <b>GA2BLRG2478-W</b> | 3,501 | 3,819 |

- No modesty panel
- Layers units overlap low height credenza worksurfaces
- Includes layers box
- Unit is free-floating on lower credenza worksurface

## PRODUCT INFO

Short grain veneer on worksurface

## TO ORDER PLEASE SPECIFY THE FOLLOWING:

|    |                      |                        |
|----|----------------------|------------------------|
| 1. | <input type="text"/> | <b>MODEL NUMBER</b>    |
| 2. | <input type="text"/> | <b>FINISH</b>          |
| 3. | <input type="text"/> | <b>TOP FINISH TYPE</b> |
| 4. | <input type="text"/> | <b>MODESTY</b>         |
| 5. | <input type="text"/> | <b>GROMMET</b>         |
| 6. | <input type="text"/> | <b>OFFICE #</b>        |

### See set 4 below for grommet option codes

No Grommet **GN**  
Center **GC** \_\_\_ (Add +\$197)

\_\_\_ = add grommet bezel color and door finish to complete option pick.

**SV** = silver bezel, veneer door  
**BV** = black bezel, veneer door  
**WG** = silver bezel, white glass door  
**MG** = silver bezel, muslin glass door  
**BG** = black bezel, black glass door

Example: **GCSV** = center grommet, silver bezel, veneer door

### See inside front cover for required option codes

Example

|                                   |               |                   |                |                |                 |
|-----------------------------------|---------------|-------------------|----------------|----------------|-----------------|
| GA2BRG2442-WW.NC215.FF.MY.GN.OFC1 |               |                   |                |                |                 |
| GA2BRG2442-WW                     | NC215         | FF                | MY             | GN             | OFC1            |
| <b>MODEL NUMBER</b>               | <b>FINISH</b> | <b>TOP FINISH</b> | <b>MODESTY</b> | <b>GROMMET</b> | <b>OFFICE #</b> |

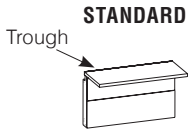

**STANDARD**

| D      | W  | H       | model number          | veneer 2 | veneer 3 |
|--------|----|---------|-----------------------|----------|----------|
| 21 1/4 | 42 | 29 7/16 | <b>GA2BRG2442T-WW</b> | 4,089    | 4,461    |
| 21 1/4 | 48 | 29 7/16 | <b>GA2BRG2448T-WW</b> | 4,178    | 4,558    |
| 21 1/4 | 54 | 29 7/16 | <b>GA2BRG2454T-WW</b> | 4,274    | 4,662    |

- Optional no modesty panel (deduct -\$1,422) or wall access panel
- Trough back units are required when a tackzone spans over the back of the worksurface
- Trough units include a metal pencil lip

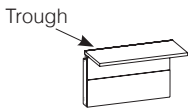

**FOR USE WITH HEIGHT  
ADJUSTABLE EXTENSIONS**

|        |    |         |                        |       |       |
|--------|----|---------|------------------------|-------|-------|
| 21 1/4 | 42 | 29 7/16 | <b>GA2BRG2442TA-WW</b> | 4,089 | 4,461 |
| 21 1/4 | 48 | 29 7/16 | <b>GA2BRG2448TA-WW</b> | 4,178 | 4,558 |
| 21 1/4 | 54 | 29 7/16 | <b>GA2BRG2454TA-WW</b> | 4,274 | 4,662 |

- Optional no modesty panel (deduct -\$1,422) or wall access panel
- Trough back units are required when a tackzone spans over the back of the worksurface
- Trough units include a metal pencil lip

**NOTE:** Plastic Trough Insert is REQUIRED and must be ordered separately across entire length of trough.

**PRODUCT INFO**

Short grain veneer on worksurface

**TO ORDER PLEASE SPECIFY THE FOLLOWING:**

1.  **MODEL NUMBER**
2.  **FINISH**
3.  **TOP FINISH TYPE**
4.  **MODESTY**
5.  **PENCIL LIP COLOR (TROUGH ONLY)**
6.  **OFFICE #**

**See inside front cover for required option codes**

Example

**GA2BRG2442T-WW.NC215.FF.MY.PLS.OFC1**  
 GA2BRG2442T-WW    NC215    FF    MY    PLS    OFC1  
MODEL NUMBER    FINISH    TOP FINISH    MODESTY    PENCIL LIP COLOR    OFFICE #

# CREDENZA WORKSURFACES

Standard & trough back

**Credentials**

02/24

|  | D  | W   | H     | model number         | veneer 2 | veneer 3 |
|--|----|-----|-------|----------------------|----------|----------|
| <b>STANDARD</b><br> | 24 | 60  | 1 1/2 | <b>GA2CWR2460-W</b>  | 1,975    | 2,154    |
|  | 24 | 66  | 1 1/2 | <b>GA2CWR2466-W</b>  | 2,079    | 2,268    |
|  | 24 | 72  | 1 1/2 | <b>GA2CWR2472-W</b>  | 2,191    | 2,390    |
|  | 24 | 78  | 1 1/2 | <b>GA2CWR2478-W</b>  | 2,298    | 2,507    |
|  | 24 | 84  | 1 1/2 | <b>GA2CWR2484-W</b>  | 2,413    | 2,632    |
|  | 24 | 90  | 1 1/2 | <b>GA2CWR2490-W</b>  | 2,536    | 2,766    |
|  | 24 | 96  | 1 1/2 | <b>GA2CWR2496-W</b>  | 2,659    | 2,901    |
|  | 24 | 102 | 1 1/2 | <b>GA2CWR24102-W</b> | 2,849    | 3,108    |
|  | 24 | 108 | 1 1/2 | <b>GA2CWR24108-W</b> | 3,104    | 3,386    |
|  | 24 | 114 | 1 1/2 | <b>GA2CWR24114-W</b> | 3,382    | 3,689    |
|  | 24 | 120 | 1 1/2 | <b>GA2CWR24120-W</b> | 3,690    | 4,025    |

## TROUGH BACK

Trough



|    |     |       |                       |       |       |
|----|-----|-------|-----------------------|-------|-------|
| 24 | 60  | 1 1/2 | <b>GA2CWR2460T-W</b>  | 1,975 | 2,154 |
| 24 | 66  | 1 1/2 | <b>GA2CWR2466T-W</b>  | 2,079 | 2,268 |
| 24 | 72  | 1 1/2 | <b>GA2CWR2472T-W</b>  | 2,191 | 2,390 |
| 24 | 78  | 1 1/2 | <b>GA2CWR2478T-W</b>  | 2,298 | 2,507 |
| 24 | 84  | 1 1/2 | <b>GA2CWR2484T-W</b>  | 2,413 | 2,632 |
| 24 | 90  | 1 1/2 | <b>GA2CWR2490T-W</b>  | 2,536 | 2,766 |
| 24 | 96  | 1 1/2 | <b>GA2CWR2496T-W</b>  | 2,659 | 2,901 |
| 24 | 102 | 1 1/2 | <b>GA2CWR24102T-W</b> | 2,849 | 3,108 |
| 24 | 108 | 1 1/2 | <b>GA2CWR24108T-W</b> | 3,104 | 3,386 |
| 24 | 114 | 1 1/2 | <b>GA2CWR24114T-W</b> | 3,382 | 3,689 |
| 24 | 120 | 1 1/2 | <b>GA2CWR24120T-W</b> | 3,690 | 4,025 |

- Trough back units are required when a tackzone spans over the back of the worksurface
- Trough units include a metal pencil lip

**NOTE:** Plastic Trough Insert is REQUIRED and must be ordered separately across entire length of trough.

## PRODUCT INFO

Long grain veneer on worksurface

## TO ORDER PLEASE SPECIFY THE FOLLOWING:

|    |                      |                                       |
|----|----------------------|---------------------------------------|
| 1. | <input type="text"/> | <b>MODEL NUMBER</b>                   |
| 2. | <input type="text"/> | <b>FINISH</b>                         |
| 3. | <input type="text"/> | <b>TOP FINISH TYPE</b>                |
| 4. | <input type="text"/> | <b>GROMMET (STANDARD TOP ONLY)</b>    |
| 5. | <input type="text"/> | <b>PENCIL LIP COLOR (TROUGH ONLY)</b> |
| 6. | <input type="text"/> | <b>OFFICE #</b>                       |

### See set 5 below for grommet option codes

No Grommet **GN**  
 Left **GL** \_\_\_ (Add +\$197)  
 Right **GR** \_\_\_ (Add +\$197)  
 Left & Right **GB** \_\_\_ (Add +\$394)

\_\_\_ = add grommet bezel color and door finish to complete option pick.

**SV** = silver bezel, veneer door  
**BV** = black bezel, veneer door  
**WG** = silver bezel, white glass door  
**MG** = silver bezel, muslin glass door  
**BG** = black bezel, black glass door

Example: **GCSV** = center grommet, silver bezel, veneer door

See inside front cover for required option codes

Example

|                                   |               |                   |                |                         |                 |
|-----------------------------------|---------------|-------------------|----------------|-------------------------|-----------------|
| GA2CWR2460-W.NC215.FF.GN.PLS.OFC1 |               |                   |                |                         |                 |
| GA2CWR2460-W                      | NC215         | FF                | GN             | PLS                     | OFC1            |
| <b>MODEL NUMBER</b>               | <b>FINISH</b> | <b>TOP FINISH</b> | <b>GROMMET</b> | <b>PENCIL LIP COLOR</b> | <b>OFFICE #</b> |

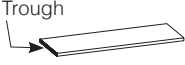
|   | D  | W   | H     | model number           | veneer 2 | veneer 3 |
|---|----|-----|-------|------------------------|----------|----------|
| <b>TROUGH LEFT END</b><br> | 24 | 60  | 1 1/2 | <b>GA2CWR2460TL-W</b>  | 1,975    | 2,154    |
|   | 24 | 66  | 1 1/2 | <b>GA2CWR2466TL-W</b>  | 2,079    | 2,268    |
|   | 24 | 72  | 1 1/2 | <b>GA2CWR2472TL-W</b>  | 2,191    | 2,390    |
|   | 24 | 78  | 1 1/2 | <b>GA2CWR2478TL-W</b>  | 2,298    | 2,507    |
|   | 24 | 84  | 1 1/2 | <b>GA2CWR2484TL-W</b>  | 2,413    | 2,632    |
|   | 24 | 90  | 1 1/2 | <b>GA2CWR2490TL-W</b>  | 2,536    | 2,766    |
|   | 24 | 96  | 1 1/2 | <b>GA2CWR2496TL-W</b>  | 2,659    | 2,901    |
|   | 24 | 102 | 1 1/2 | <b>GA2CWR24102TL-W</b> | 2,849    | 3,108    |
|   | 24 | 108 | 1 1/2 | <b>GA2CWR24108TL-W</b> | 3,104    | 3,386    |
|   | 24 | 114 | 1 1/2 | <b>GA2CWR24114TL-W</b> | 3,382    | 3,689    |
|   | 24 | 120 | 1 1/2 | <b>GA2CWR24120TL-W</b> | 3,690    | 4,025    |

- Trough left end units are required when a tack zone spans over the left end of the worksurface.
- Trough units include a metal pencil lip

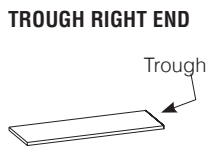

|    |     |       |                        |       |       |
|----|-----|-------|------------------------|-------|-------|
| 24 | 60  | 1 1/2 | <b>GA2CWR2460TR-W</b>  | 1,975 | 2,154 |
| 24 | 66  | 1 1/2 | <b>GA2CWR2466TR-W</b>  | 2,079 | 2,268 |
| 24 | 72  | 1 1/2 | <b>GA2CWR2472TR-W</b>  | 2,191 | 2,390 |
| 24 | 78  | 1 1/2 | <b>GA2CWR2478TR-W</b>  | 2,298 | 2,507 |
| 24 | 84  | 1 1/2 | <b>GA2CWR2484TR-W</b>  | 2,413 | 2,632 |
| 24 | 90  | 1 1/2 | <b>GA2CWR2490TR-W</b>  | 2,536 | 2,766 |
| 24 | 96  | 1 1/2 | <b>GA2CWR2496TR-W</b>  | 2,659 | 2,901 |
| 24 | 102 | 1 1/2 | <b>GA2CWR24102TR-W</b> | 2,849 | 3,108 |
| 24 | 108 | 1 1/2 | <b>GA2CWR24108TR-W</b> | 3,104 | 3,386 |
| 24 | 114 | 1 1/2 | <b>GA2CWR24114TR-W</b> | 3,382 | 3,689 |
| 24 | 120 | 1 1/2 | <b>GA2CWR24120TR-W</b> | 3,690 | 4,025 |

- Trough back units are required when a tackzone spans over the back of the worksurface
- Trough units include a metal pencil lip

**NOTE:** Plastic Trough Insert is REQUIRED and must be ordered separately across entire length of trough.

**PRODUCT INFO**

Long grain veneer on worksurface

**TO ORDER PLEASE SPECIFY THE FOLLOWING:**

- |    |                      |                                       |
|----|----------------------|---------------------------------------|
| 1. | <input type="text"/> | <b>MODEL NUMBER</b>                   |
| 2. | <input type="text"/> | <b>FINISH</b>                         |
| 3. | <input type="text"/> | <b>TOP FINISH TYPE</b>                |
| 4. | <input type="text"/> | <b>GROMMET</b>                        |
| 5. | <input type="text"/> | <b>PENCIL LIP COLOR (TROUGH ONLY)</b> |
| 6. | <input type="text"/> | <b>OFFICE #</b>                       |

**See set 5 below for grommet option codes**

|              |                            |
|--------------|----------------------------|
| No Grommet   | <b>GN</b>                  |
| Left         | <b>GL</b> ___ (Add +\$197) |
| Right        | <b>GR</b> ___ (Add +\$197) |
| Left & Right | <b>GB</b> ___ (Add +\$394) |

\_\_\_ = add grommet bezel color and door finish to complete option pick.

**SV** = silver bezel, veneer door  
**BV** = black bezel, veneer door  
**WG** = silver bezel, white glass door  
**MG** = silver bezel, muslin glass door  
**BG** = black bezel, black glass door

**See inside front cover for required option codes**

Example: **GCSV** = center grommet, silver bezel, veneer door

Example

**GA2CWR2460TL-W.NC215.FF.GN.PLS.OFC1**

|                     |               |                   |                |                         |                 |
|---------------------|---------------|-------------------|----------------|-------------------------|-----------------|
| GA2CWR2460TL-W      | NC215         | FF                | GN             | PLS                     | OFC1            |
| <b>MODEL NUMBER</b> | <b>FINISH</b> | <b>TOP FINISH</b> | <b>GROMMET</b> | <b>PENCIL LIP COLOR</b> | <b>OFFICE #</b> |

# RETURN WORKSURFACES

Standard

**Credentials**

02/24

|   | D  | W  | H     | model number        | veneer 2 | veneer 3 |
|---|----|----|-------|---------------------|----------|----------|
| <b>STANDARD</b>   |    |    |       |                     |          |          |
|  | 24 | 42 | 1 1/2 | <b>GA2RWR2442-W</b> | 1,693    | 1,847    |
|   | 24 | 48 | 1 1/2 | <b>GA2RWR2448-W</b> | 1,781    | 1,943    |
|   | 24 | 54 | 1 1/2 | <b>GA2RWR2454-W</b> | 1,875    | 2,045    |
|   | 24 | 60 | 1 1/2 | <b>GA2RWR2460-W</b> | 1,975    | 2,154    |
|   | 24 | 66 | 1 1/2 | <b>GA2RWR2466-W</b> | 2,079    | 2,268    |
|   | 24 | 72 | 1 1/2 | <b>GA2RWR2472-W</b> | 2,191    | 2,390    |

## PRODUCT INFO

Short grain veneer on worksurface

## TO ORDER PLEASE SPECIFY THE FOLLOWING:

1.  **MODEL NUMBER**
2.  **FINISH**
3.  **TOP FINISH TYPE**
4.  **GROMMET**
5.  **OFFICE #**

### See set 5 below for grommet option codes

No Grommet **GN**  
 Left **GL** \_\_\_ (Add +\$197)  
 Right **GR** \_\_\_ (Add +\$197)  
 Left & Right **GB** \_\_\_ (Add +\$394)

\_\_\_ = add grommet bezel color and door finish to complete option pick.

**SV** = silver bezel, veneer door  
**BV** = black bezel, veneer door  
**WG** = silver bezel, white glass door  
**MG** = silver bezel, muslin glass door  
**BG** = black bezel, black glass door

### See inside front cover for required option codes

Example: **GCSV** = center grommet, silver bezel, veneer door

### Example

**GA2RWR2442-W.NC215.FF.GN.OFC1**

|                     |               |                   |                |                 |
|---------------------|---------------|-------------------|----------------|-----------------|
| GA2RWR2442-W        | NC215         | FF                | GN             | OFC1            |
| <b>MODEL NUMBER</b> | <b>FINISH</b> | <b>TOP FINISH</b> | <b>GROMMET</b> | <b>OFFICE #</b> |



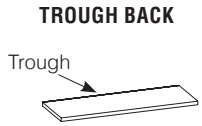

| D  | W  | H     | model number         | veneer 2 | veneer 3 |
|----|----|-------|----------------------|----------|----------|
| 24 | 42 | 1 1/2 | <b>GA2RWR2442T-W</b> | 1,693    | 1,847    |
| 24 | 48 | 1 1/2 | <b>GA2RWR2448T-W</b> | 1,781    | 1,943    |
| 24 | 54 | 1 1/2 | <b>GA2RWR2454T-W</b> | 1,875    | 2,045    |
| 24 | 60 | 1 1/2 | <b>GA2RWR2460T-W</b> | 1,975    | 2,154    |
| 24 | 66 | 1 1/2 | <b>GA2RWR2466T-W</b> | 2,079    | 2,268    |
| 24 | 72 | 1 1/2 | <b>GA2RWR2472T-W</b> | 2,191    | 2,390    |

- Trough back units are required when a tackzone spans over the back of the worksurface
- Trough units include a metal pencil lip

**NOTE:** Plastic Trough Insert is REQUIRED and must be ordered separately across entire length of trough.

**PRODUCT INFO**

short grain veneer on worksurface

**TO ORDER PLEASE SPECIFY THE FOLLOWING:**

1.  **MODEL NUMBER**
2.  **FINISH**
3.  **TOP FINISH TYPE**
4.  **PENCIL LIP COLOR**
5.  **OFFICE #**

**See inside front cover for required option codes**

Example

GA2RWR2442T-W.NC215.FF.PLS.OFC1

|                             |                       |                           |                                 |                         |
|-----------------------------|-----------------------|---------------------------|---------------------------------|-------------------------|
| GA2RWR2442T-W               | NC215                 | FF                        | PLS                             | OFC1                    |
| <small>MODEL NUMBER</small> | <small>FINISH</small> | <small>TOP FINISH</small> | <small>PENCIL LIP COLOR</small> | <small>OFFICE #</small> |

# PEDESTALS

Full height | left hand

**Credentials**

02/24

|                                      | D  | W  | H                                | model number          | veneer 2 | veneer 3 |
|--------------------------------------|----|----|----------------------------------|-----------------------|----------|----------|
| <b>15" WIDTH<br/>FALSE PEDESTALS</b> | 24 | 15 | 27 <sup>15</sup> / <sub>16</sub> | <b>GA2MPW2415L-LW</b> | 1,406    | 1,534    |



- For use with: standard or trough back worksurfaces  
no modesty panel applications



|  |    |    |                                  |                        |       |       |
|--|----|----|----------------------------------|------------------------|-------|-------|
|  | 24 | 15 | 27 <sup>15</sup> / <sub>16</sub> | <b>GA2MPW2415L-XBW</b> | 1,470 | 1,604 |
|--|----|----|----------------------------------|------------------------|-------|-------|

- For use with: standard or trough back worksurfaces  
wall access panel or full back panel applications



|  |    |                               |                                  |                        |       |       |
|--|----|-------------------------------|----------------------------------|------------------------|-------|-------|
|  | 24 | 6 <sup>1</sup> / <sub>2</sub> | 27 <sup>15</sup> / <sub>16</sub> | <b>GA2MPW2415L-XEW</b> | 1,470 | 1,604 |
|--|----|-------------------------------|----------------------------------|------------------------|-------|-------|

- For use with: standard or trough left end worksurfaces  
no modesty or full back panel applications
- Aligns with wall access panel on adjoining bridge or return

## PRODUCT INFO



TO ORDER PLEASE SPECIFY THE FOLLOWING:

- MODEL NUMBER**
- FINISH**
- OFFICE #**

**See inside front cover for required option codes**

Example

**GA2MPW2415L-LW.NC215.OFC1**  
 GA2MPW2415L-LW      NC215      OFC1  
 MODEL NUMBER      FINISH      OFFICE #

|  | D      | W  | H        | model number          | veneer 2 | veneer 3 |
|--|--------|----|----------|-----------------------|----------|----------|
| <b>15" WIDTH</b>   |        |    |          |                       |          |          |
| FILE   FILE  | 24 7/8 | 15 | 27 15/16 | <b>GA2MPW2415L-2W</b> | 3,700    | 4,036    |
|   |        |    |          |                       |          |          |
| BOX   BOX   FILE   | 24 7/8 | 15 | 27 15/16 | <b>GA2MPW2415L-3W</b> | 3,700    | 4,036    |
|   |        |    |          |                       |          |          |
| <b>18" WIDTH</b>   |        |    |          |                       |          |          |
| FILE   FILE  | 24 7/8 | 18 | 27 15/16 | <b>GA2MPW2418L-2W</b> | 3,888    | 4,241    |
|   |        |    |          |                       |          |          |
| BOX   BOX   FILE   | 24 7/8 | 18 | 27 15/16 | <b>GA2MPW2418L-3W</b> | 3,888    | 4,241    |
|  |        |    |          |                       |          |          |

**PRODUCT INFO**

All pedestals have optional face locks

Hinged door cabinets do not lock

-3 and -7 pedestals include hidden upper box drawer

**TO ORDER PLEASE SPECIFY THE FOLLOWING:**

- 1.  **MODEL NUMBER**
- 2.  **FINISH**
- 3.  **PULL**
- 4.  **LOCKING**
- 5.  **KEYING**
- 6.  **OFFICE #**

**See inside front cover for required option codes**

Example









GA2MPW2415L-2W.NC215.MPS.LY.RMS.OFC1  
 GA2MPW2415L-2W    NC215    MPS    LY    RMS    OFC1  
 MODEL NUMBER    FINISH    PULL    LOCKING    KEYING    OFFICE #

# PEDESTALS

Full height | left hand

Credentials

02/24

|  | D      | W  | H        | model number  | veneer 2 | veneer 3 |
|--|--------|----|----------|---|----------|----------|
| <b>30" WIDTH</b>   |        |    |          |   |          |          |
| LATERAL FILE<br>                      | 24 7/8 | 30 | 27 15/16 | <b>GA2MPW2430L-4W</b>                                     | 4,218    | 4,601    |
|  |        |    |          | • Optional face lock                                      |          |          |
| BOX   BOX   LATERAL FILE<br>          | 24 7/8 | 30 | 27 15/16 | <b>GA2MPW2430L-7W</b>                                     | 4,218    | 4,601    |
|  |        |    |          | • Optional face lock                                      |          |          |
| HINGED DOOR<br>                       | 24 7/8 | 30 | 27 15/16 | <b>GA2MPW2430L-5W</b>                                     | 3,700    | 4,036    |
| OPEN SHELF<br>                        | 24 7/8 | 30 | 27 15/16 | <b>GA2MPW2430L-SHW</b>                                    | 3,315    | 3,616    |
|  |        |    |          | • Optional face lock                                      |          |          |
| PRINTER<br>                           | 24 7/8 | 30 | 27 15/16 | <b>GA2MPW2430L-PW</b>                                     | 3,907    | 4,262    |
| TRASH RECEPTACLE<br>                  | 24 7/8 | 30 | 27 15/16 | <b>GA2MPW2430L-TW</b>                                     | 3,907    | 4,262    |
|  |        |    |          | • Includes quantity (2) brushed satin aluminum trash cans |          |          |
| FILE   FILE + BOX   BOX   FILE<br>  | 24 7/8 | 30 | 27 15/16 | <b>GA2MPW2430L-23W</b>                                    | 6,660    | 7,265    |
|  |        |    |          | • Optional face lock                                      |          |          |
| OPEN CUBBY   BOX   LATERAL FILE<br> | 24 7/8 | 30 | 27 15/16 | <b>GA2MPW2430L-BW</b>                                     | 4,095    | 4,467    |
|  |        |    |          | • Optional face lock                                      |          |          |

## PRODUCT INFO

Hinged door cabinets do not lock

-B pedestals include hidden upper box drawer

## TO ORDER PLEASE SPECIFY THE FOLLOWING:

1.  **MODEL NUMBER**
2.  **FINISH**
3.  **PULL**
4.  **LOCKING**
5.  **KEYING**
6.  **OFFICE #**

See inside front cover for required option codes

Example

GA2MPW2430L-4W.NC215.MPS.LY.RMS.OFC1  
 GA2MPW2430L-4W    NC215    MPS    LY    RMS    OFC1  
 MODEL NUMBER    FINISH    PULL    LOCKING    KEYING    OFFICE #

|   | D   | W  | H        | model number           | veneer 2 | veneer 3 |
|---|---|----|----------|------------------------|----------|----------|
| <b>36" WIDTH</b>  |   |    |          |                        |          |          |
| LATERAL FILE<br>                         | 24 7/8  | 36 | 27 15/16 | <b>GA2MPW2436L-4W</b>  | 4,729    | 5,159    |
|   | • Optional face lock                                      |    |          |                        |          |          |
| BOX   BOX   LATERAL FILE<br>             | 24 7/8  | 36 | 27 15/16 | <b>GA2MPW2436L-7W</b>  | 4,729    | 5,159    |
|   | • Optional face lock                                      |    |          |                        |          |          |
| HINGED DOOR<br>                          | 24 7/8  | 36 | 27 15/16 | <b>GA2MPW2436L-5W</b>  | 4,146    | 4,523    |
| OPEN SHELF<br>                           | 24 7/8  | 36 | 27 15/16 | <b>GA2MPW2436L-SHW</b> | 3,711    | 4,048    |
|   | • Optional face lock                                      |    |          |                        |          |          |
| PRINTER<br>                              | 24 7/8  | 36 | 27 15/16 | <b>GA2MPW2436L-PW</b>  | 4,376    | 4,774    |
| TRASH RECEPTACLE<br>                     | 24 7/8  | 36 | 27 15/16 | <b>GA2MPW2436L-TW</b>  | 4,376    | 4,774    |
|   | • Includes quantity (2) brushed satin aluminum trash cans |    |          |                        |          |          |
| FILE   FILE +<br>BOX   BOX   FILE<br>  | 24 7/8  | 36 | 27 15/16 | <b>GA2MPW2436L-23W</b> | 6,995    | 7,631    |
|   | • Optional face lock                                      |    |          |                        |          |          |
| OPEN CUBBY   BOX  <br>LATERAL FILE<br> | 24 7/8  | 36 | 27 15/16 | <b>GA2MPW2436L-BW</b>  | 4,585    | 5,002    |
|   | • Optional face lock                                      |    |          |                        |          |          |

**PRODUCT INFO**

Hinged door cabinets do not lock

-B pedestals include hidden upper box drawer

**TO ORDER PLEASE SPECIFY THE FOLLOWING:**

- |    |                      |                     |
|----|----------------------|---------------------|
| 1. | <input type="text"/> | <b>MODEL NUMBER</b> |
| 2. | <input type="text"/> | <b>FINISH</b>       |
| 3. | <input type="text"/> | <b>PULL</b>         |
| 4. | <input type="text"/> | <b>LOCKING</b>      |
| 5. | <input type="text"/> | <b>KEYING</b>       |
| 6. | <input type="text"/> | <b>OFFICE #</b>     |

**See inside front cover for required option codes**

Example





GA2MPW2436L-4W.NC215.MPS.LY.RMS.OFC1  
 GA2MPW2436L-4W    NC215    MPS    LY    RMS    OFC1  
 MODEL NUMBER    FINISH    PULL    LOCKING    KEYING    OFFICE #

# PEDESTALS

Full height | left hand

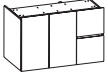
Credentials

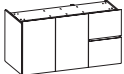
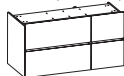
02/24

|  | D      | W  | H        | model number           | veneer 2 | veneer 3 |
|--|--------|----|----------|------------------------|----------|----------|
| <b>45" WIDTH</b>   |        |    |          |                        |          |          |
| HINGED DOOR +<br>FILE   FILE<br>                | 24 7/8 | 45 | 27 15/16 | <b>GA2MPW2445L-52W</b> | 6,660    | 7,265    |
| LATERAL FILE +<br>BOX   BOX   FILE<br>          | 24 7/8 | 45 | 27 15/16 | <b>GA2MPW2445L-43W</b> | 7,128    | 7,776    |
| BOX   BOX   LATERAL FILE +<br>FILE   FILE<br>   | 24 7/8 | 45 | 27 15/16 | <b>GA2MPW2445L-72W</b> | 7,128    | 7,776    |
| <b>54" WIDTH</b>   |        |    |          |                        |          |          |
| HINGED DOOR +<br>FILE   FILE<br>                | 24 7/8 | 54 | 27 15/16 | <b>GA2MPW2454L-52W</b> | 7,227    | 7,884    |
| LATERAL FILE +<br>BOX   BOX   FILE<br>        | 24 7/8 | 54 | 27 15/16 | <b>GA2MPW2454L-43W</b> | 7,752    | 8,457    |
| BOX   BOX   LATERAL FILE +<br>FILE   FILE<br> | 24 7/8 | 54 | 27 15/16 | <b>GA2MPW2454L-72W</b> | 7,752    | 8,457    |

## PRODUCT INFO

All pedestals have optional face locks

Hinged door cabinets do not lock

-3 and -7 pedestals include hidden upper box drawer

## TO ORDER PLEASE SPECIFY THE FOLLOWING:

1.  **MODEL NUMBER**
2.  **FINISH**
3.  **PULL**
4.  **LOCKING**
5.  **KEYING**
6.  **OFFICE #**

See inside front cover for required option codes

Example

GA2MPW2445L-52W.NC215.MPS.LY.RMS.OFC1

|                     |               |             |                |               |                 |
|---------------------|---------------|-------------|----------------|---------------|-----------------|
| GA2MPW2445L-52W     | NC215         | MPS         | LY             | RMS           | OFC1            |
| <b>MODEL NUMBER</b> | <b>FINISH</b> | <b>PULL</b> | <b>LOCKING</b> | <b>KEYING</b> | <b>OFFICE #</b> |

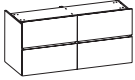
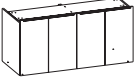
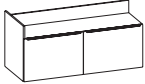
|   | D      | W  | H        | model number           | veneer 2 | veneer 3 |
|---|--------|----|----------|------------------------|----------|----------|
| <b>60" WIDTH</b><br>LATERAL FILE<br>   | 24 7/8 | 60 | 27 15/16 | <b>GA2MPW2460L-44W</b> | 7,598    | 8,289    |
| HINGED DOOR<br>                        | 24 7/8 | 60 | 27 15/16 | <b>GA2MPW2460L-55W</b> | 6,660    | 7,265    |
| OPEN CUBBY   BOX  <br>LATERAL FILE<br> | 24 7/8 | 60 | 27 15/16 | <b>GA2MPW2460L-BBW</b> | 7,369    | 8,039    |

**PRODUCT INFO**

All pedestals have optional face locks

Hinged door cabinets do not lock

-B pedestals include hidden upper box drawer

**TO ORDER PLEASE SPECIFY THE FOLLOWING:**

- 1.  **MODEL NUMBER**
- 2.  **FINISH**
- 3.  **PULL**
- 4.  **LOCKING**
- 5.  **KEYING**
- 6.  **OFFICE #**

**See inside front cover for required option codes**

Example

GA2MPW2460L-44W.NC215.MPS.LY.RMS.OFC1  
 GA2MPW2460L-44W    NC215    MPS    LY    RMS    OFC1  
 MODEL NUMBER    FINISH    PULL    LOCKING    KEYING    OFFICE #

# PEDESTALS

Full height | right hand

**Credentials**  
02/24

|  | D | W | H | model number | veneer 2 | veneer 3 |
|--|---|---|---|--------------|----------|----------|
|--|---|---|---|--------------|----------|----------|

**15" WIDTH  
FALSE PEDESTALS**

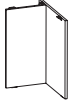

|    |    |          |                       |       |       |
|----|----|----------|-----------------------|-------|-------|
| 24 | 15 | 27 15/16 | <b>GA2MPW2415R-LW</b> | 1,406 | 1,534 |
|----|----|----------|-----------------------|-------|-------|

- For use with: standard or trough back worksurfaces  
no modesty panel applications



|    |    |          |                        |       |       |
|----|----|----------|------------------------|-------|-------|
| 24 | 15 | 27 15/16 | <b>GA2MPW2415R-XBW</b> | 1,470 | 1,604 |
|----|----|----------|------------------------|-------|-------|

- For use with: standard or trough back worksurfaces  
wall access or full back panel applications

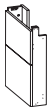

|    |       |          |                        |       |       |
|----|-------|----------|------------------------|-------|-------|
| 24 | 6 1/2 | 27 15/16 | <b>GA2MPW2415R-XEW</b> | 1,470 | 1,604 |
|----|-------|----------|------------------------|-------|-------|

- For use with: standard or trough left end worksurfaces  
no modesty or full back panel applications
- Aligns with wall access panel on adjoining bridge or return

**PRODUCT INFO**

TO ORDER PLEASE SPECIFY THE FOLLOWING:





1.  **MODEL NUMBER**
2.  **FINISH**
3.  **OFFICE #**

See inside front cover for required option codes

Example

**GA2MPW2415R-LW.NC215.OFC1**  
 GA2MPW2415R-LW    NC215    OFC1  
 MODEL NUMBER    FINISH    OFFICE #



|   | D      | W  | H        | model number          | veneer 2 | veneer 3 |
|---|--------|----|----------|-----------------------|----------|----------|
| <b>15" WIDTH</b>  |        |    |          |                       |          |          |
| FILE   FILE   | 24 7/8 | 15 | 27 15/16 | <b>GA2MPW2415R-2W</b> | 3,700    | 4,036    |
|  |        |    |          |                       |          |          |
| BOX   BOX   FILE  | 24 7/8 | 15 | 27 15/16 | <b>GA2MPW2415R-3W</b> | 3,700    | 4,036    |
|  |        |    |          |                       |          |          |
| <b>18" WIDTH</b>  |        |    |          |                       |          |          |
| FILE   FILE   | 24 7/8 | 18 | 27 15/16 | <b>GA2MPW2418R-2W</b> | 3,888    | 4,241    |
|  |        |    |          |                       |          |          |
| BOX   BOX   FILE  | 24 7/8 | 18 | 27 15/16 | <b>GA2MPW2418R-3W</b> | 3,888    | 4,241    |
|  |        |    |          |                       |          |          |

**PRODUCT INFO**

All pedestals have optional face locks

Hinged door cabinets do not lock

-3 and -7 pedestals include hidden upper box drawer

**TO ORDER PLEASE SPECIFY THE FOLLOWING:**

- 1.  **MODEL NUMBER**
- 2.  **FINISH**
- 3.  **PULL**
- 4.  **LOCKING**
- 5.  **KEYING**
- 6.  **OFFICE #**

**See inside front cover for required option codes**

Example









GA2MPW2415R-2W.NC215.MPS.LY.RMS.OFC1  
 GA2MPW2415R-2W    NC215    MPS    LY    RMS    OFC1  
 MODEL NUMBER    FINISH    PULL    LOCKING    KEYING    OFFICE #

# PEDESTALS

Full height | right hand

Credentials

02/24

|   | D      | W  | H        | model number  | veneer 2 | veneer 3 |
|---|--------|----|----------|---|----------|----------|
| <b>30" WIDTH</b>  |        |    |          |   |          |          |
| LATERAL FILE<br>                         | 24 7/8 | 30 | 27 15/16 | <b>GA2MPW2430R-4W</b>                                     | 4,218    | 4,601    |
| BOX   BOX   LATERAL FILE<br>             | 24 7/8 | 30 | 27 15/16 | <b>GA2MPW2430R-7W</b>                                     | 4,218    | 4,601    |
| HINGED DOOR<br>                          | 24 7/8 | 30 | 27 15/16 | <b>GA2MPW2430R-5W</b>                                     | 3,700    | 4,036    |
| OPEN SHELF<br>                           | 24 7/8 | 30 | 27 15/16 | <b>GA2MPW2430R-SHW</b>                                    | 3,315    | 3,616    |
| PRINTER<br>                              | 24 7/8 | 30 | 27 15/16 | <b>GA2MPW2430R-PW</b>                                     | 3,907    | 4,262    |
| TRASH RECEPTACLE<br>                     | 24 7/8 | 30 | 27 15/16 | <b>GA2MPW2430R-TW</b>                                     | 3,907    | 4,262    |
|   |        |    |          | • Includes quantity (2) brushed satin aluminum trash cans |          |          |
| FILE   FILE +<br>BOX   BOX   FILE<br>  | 24 7/8 | 30 | 27 15/16 | <b>GA2MPW2430R-32W</b>                                    | 6,660    | 7,265    |
| OPEN CUBBY   BOX  <br>LATERAL FILE<br> | 24 7/8 | 30 | 27 15/16 | <b>GA2MPW2430R-BW</b>                                     | 4,095    | 4,467    |

## PRODUCT INFO

All pedestals have optional face locks

Hinged door cabinets do not lock

-B pedestals include hidden upper box drawer

## TO ORDER PLEASE SPECIFY THE FOLLOWING:









- |    |                      |                     |
|----|----------------------|---------------------|
| 1. | <input type="text"/> | <b>MODEL NUMBER</b> |
| 2. | <input type="text"/> | <b>FINISH</b>       |
| 3. | <input type="text"/> | <b>PULL</b>         |
| 4. | <input type="text"/> | <b>LOCKING</b>      |
| 5. | <input type="text"/> | <b>KEYING</b>       |
| 6. | <input type="text"/> | <b>OFFICE #</b>     |

See inside front cover for required option codes

Example

GA2MPW2430R-4W.NC215.MPS.LY.RMS.OFC1

|                     |               |             |                |               |                 |
|---------------------|---------------|-------------|----------------|---------------|-----------------|
| GA2MPW2430R-4W      | NC215         | MPS         | LY             | RMS           | OFC1            |
| <b>MODEL NUMBER</b> | <b>FINISH</b> | <b>PULL</b> | <b>LOCKING</b> | <b>KEYING</b> | <b>OFFICE #</b> |

|   | D      | W  | H        | model number  | veneer 2 | veneer 3 |
|---|--------|----|----------|---|----------|----------|
| <b>36" WIDTH</b>  |        |    |          |   |          |          |
| LATERAL FILE<br>                         | 24 7/8 | 36 | 27 15/16 | <b>GA2MPW2436R-4W</b>                                     | 4,729    | 5,159    |
| BOX   BOX   LATERAL FILE<br>             | 24 7/8 | 36 | 27 15/16 | <b>GA2MPW2436R-7W</b>                                     | 4,729    | 5,159    |
| HINGED DOOR<br>                          | 24 7/8 | 36 | 27 15/16 | <b>GA2MPW2436R-5W</b>                                     | 4,146    | 4,523    |
| OPEN SHELF<br>                           | 24 7/8 | 36 | 27 15/16 | <b>GA2MPW2436R-SHW</b>                                    | 3,711    | 4,048    |
| PRINTER<br>                              | 24 7/8 | 36 | 27 15/16 | <b>GA2MPW2436R-PW</b>                                     | 4,376    | 4,774    |
| TRASH RECEPTACLE<br>                     | 24 7/8 | 36 | 27 15/16 | <b>GA2MPW2436R-TW</b>                                     | 4,376    | 4,774    |
|   |        |    |          | • Includes quantity (2) brushed satin aluminum trash cans |          |          |
| BOX   BOX   FILE+<br>FILE   FILE<br>   | 24 7/8 | 36 | 27 15/16 | <b>GA2MPW2436R-32W</b>                                    | 6,995    | 7,631    |
| OPEN CUBBY   BOX  <br>LATERAL FILE<br> | 24 7/8 | 36 | 27 15/16 | <b>GA2MPW2436R-BW</b>                                     | 4,585    | 5,002    |

**PRODUCT INFO**

All pedestals have optional face locks

Hinged door cabinets do not lock

-B pedestals include hidden upper box drawer

**TO ORDER PLEASE SPECIFY THE FOLLOWING:**

1.  **MODEL NUMBER**
2.  **FINISH**
3.  **PULL**
4.  **LOCKING**
5.  **KEYING**
6.  **OFFICE #**

**See inside front cover for required option codes**

Example





GA2MPW2436R-4W.NC215.MPS.LY.RMS.OFC1  
 GA2MPW2436R-4W    NC215    MPS    LY    RMS    OFC1  
 MODEL NUMBER    FINISH    PULL    LOCKING    KEYING    OFFICE #

# PEDESTALS

Full height | right hand

Credentials

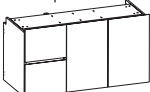
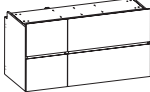
02/24

|   | D      | W  | H        | model number           | veneer 2 | veneer 3 |
|---|--------|----|----------|------------------------|----------|----------|
| <b>45" WIDTH</b>  |        |    |          |                        |          |          |
| HINGED DOOR +<br>FILE   FILE  | 24 7/8 | 45 | 27 15/16 | <b>GA2MPW2445R-25W</b> | 6,660    | 7,265    |
|    |        |    |          |                        |          |          |
| LATERAL FILE +<br>BOX   BOX   FILE  | 24 7/8 | 45 | 27 15/16 | <b>GA2MPW2445R-34W</b> | 7,128    | 7,776    |
|    |        |    |          |                        |          |          |
| BOX   BOX   LATERAL FILE +<br>FILE   FILE   | 24 7/8 | 45 | 27 15/16 | <b>GA2MPW2445R-27W</b> | 7,128    | 7,776    |
|    |        |    |          |                        |          |          |
| <b>54" WIDTH</b>  |        |    |          |                        |          |          |
| HINGED DOOR +<br>FILE   FILE  | 24 7/8 | 54 | 27 15/16 | <b>GA2MPW2454R-25W</b> | 7,227    | 7,884    |
|    |        |    |          |                        |          |          |
| LATERAL FILE +<br>BOX   BOX   FILE  | 24 7/8 | 54 | 27 15/16 | <b>GA2MPW2454R-34W</b> | 7,752    | 8,457    |
|  |        |    |          |                        |          |          |
| BOX   BOX   LATERAL FILE +<br>FILE   FILE   | 24 7/8 | 54 | 27 15/16 | <b>GA2MPW2454R-27W</b> | 7,752    | 8,457    |
|  |        |    |          |                        |          |          |

## PRODUCT INFO

All pedestals have optional face locks

Hinged door cabinets do not lock

-3 and -7 pedestals include hidden upper box drawer

## TO ORDER PLEASE SPECIFY THE FOLLOWING:

- |    |                      |                     |
|----|----------------------|---------------------|
| 1. | <input type="text"/> | <b>MODEL NUMBER</b> |
| 2. | <input type="text"/> | <b>FINISH</b>       |
| 3. | <input type="text"/> | <b>PULL</b>         |
| 4. | <input type="text"/> | <b>LOCKING</b>      |
| 5. | <input type="text"/> | <b>KEYING</b>       |
| 6. | <input type="text"/> | <b>OFFICE #</b>     |

See inside front cover for required option codes

Example

GA2MPW2445R-25W.NC215.MPS.LY.RMS.OFC1  
 GA2MPW2445R-25W    NC215    MPS    LY    RMS    OFC1  
 MODEL NUMBER    FINISH    PULL    LOCKING    KEYING    OFFICE #

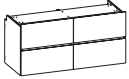
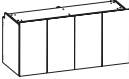
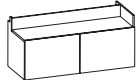
|   | D      | W  | H        | model number           | veneer 2 | veneer 3 |
|---|--------|----|----------|------------------------|----------|----------|
| <b>60" WIDTH</b><br>LATERAL FILE<br>   | 24 7/8 | 60 | 27 15/16 | <b>GA2MPW2460R-44W</b> | 7,598    | 8,289    |
| HINGED DOOR<br>                        | 24 7/8 | 60 | 27 15/16 | <b>GA2MPW2460R-55W</b> | 6,660    | 7,265    |
| OPEN CUBBY   BOX  <br>LATERAL FILE<br> | 24 7/8 | 60 | 27 15/16 | <b>GA2MPW2460R-BBW</b> | 7,369    | 8,039    |

**PRODUCT INFO**

All pedestals have optional face locks

Hinged door cabinets do not lock

-BB pedestals include hidden upper box drawer

**TO ORDER PLEASE SPECIFY THE FOLLOWING:**

1.  **MODEL NUMBER**
2.  **FINISH**
3.  **PULL**
4.  **LOCKING**
5.  **KEYING**
6.  **OFFICE #**

**See inside front cover for required option codes**

Example

GA2MPW2460R-44W.NC215.MPS.LY.RMS.OFC1  
 GA2MPW2460R-44W    NC215    MPS    LY    RMS    OFC1  
**MODEL NUMBER**    **FINISH**    **PULL**    **LOCKING**    **KEYING**    **OFFICE #**

# LAYERS PEDESTALS

Low height | left hand

**Credentials**

02/24

|  | D | W | H | model number | veneer 2 | veneer 3 |
|--|---|---|---|--------------|----------|----------|
|--|---|---|---|--------------|----------|----------|

**15" WIDTH**

FALSE PEDESTALS



|    |    |                                 |                        |       |       |
|----|----|---------------------------------|------------------------|-------|-------|
| 24 | 15 | 20 <sup>3</sup> / <sub>16</sub> | <b>GA2MLPW2415L-LW</b> | 1,337 | 1,458 |
|----|----|---------------------------------|------------------------|-------|-------|

- For use with: standard or trough back worksurfaces  
no modesty panel applications



|    |    |                                 |                         |       |       |
|----|----|---------------------------------|-------------------------|-------|-------|
| 24 | 15 | 20 <sup>3</sup> / <sub>16</sub> | <b>GA2MLPW2415L-XBW</b> | 1,396 | 1,523 |
|----|----|---------------------------------|-------------------------|-------|-------|

- For use with: standard or trough back worksurfaces  
wall access panel or full back panel applications

**PRODUCT INFO**

TO ORDER PLEASE SPECIFY THE FOLLOWING:

1.  **MODEL NUMBER**
2.  **FINISH**
3.  **OFFICE #**

See inside front cover for required option codes

Example

**GA2MLPW2415L-LW.NC215.OFC1**

|                     |               |                 |
|---------------------|---------------|-----------------|
| GA2MLPW2415L-LW     | NC215         | OFC1            |
| <b>MODEL NUMBER</b> | <b>FINISH</b> | <b>OFFICE #</b> |

|                                | D      | W  | H       | model number           | veneer 2 | veneer 3 |
|--------------------------------|--------|----|---------|------------------------|----------|----------|
| <b>15" WIDTH</b><br>BOX   FILE | 24 7/8 | 15 | 20 3/16 | <b>GA2MLPW2415L-AW</b> | 3,514    | 3,833    |



|                                |        |    |         |                        |       |       |
|--------------------------------|--------|----|---------|------------------------|-------|-------|
| <b>18" WIDTH</b><br>BOX   FILE | 24 7/8 | 18 | 20 3/16 | <b>GA2MLPW2418L-AW</b> | 3,693 | 4,029 |
|--------------------------------|--------|----|---------|------------------------|-------|-------|



**PRODUCT INFO**

All pedestals have optional face locks

Hinged door cabinets do not lock

-A and -B pedestals include hidden upper box drawer

**TO ORDER PLEASE SPECIFY THE FOLLOWING:**

- 1.  **MODEL NUMBER**
- 2.  **FINISH**
- 3.  **PULL**
- 4.  **LOCKING**
- 5.  **KEYING**
- 6.  **OFFICE #**

**See inside front cover for required option codes**

Example





GA2MLPW2415L-AW.NC215.MPS.LY.RMS.OFC1  
 GA2MLPW2415L-AW    NC215    MPS    LY    RMS    OFC1  
 MODEL NUMBER    FINISH    PULL    LOCKING    KEYING    OFFICE #

# LAYERS PEDESTALS

Low height | left hand

Credentials

02/24

|  | D      | W  | H       | model number  | veneer 2 | veneer 3 |
|--|--------|----|---------|---|----------|----------|
| <b>30" WIDTH</b>   |        |    |         |   |          |          |
| BOX   LATERAL FILE   | 24 7/8 | 30 | 20 3/16 | <b>GA2MLPW2430L-BW</b>                                    | 4,010    | 4,374    |
|   |        |    |         | • Optional face lock                                      |          |          |
| HINGED DOOR  | 24 7/8 | 30 | 20 3/16 | <b>GA2MLPW2430L-5W</b>                                    | 3,514    | 3,833    |
|   |        |    |         |   |          |          |
| OPEN SHELF   | 24 7/8 | 30 | 20 3/16 | <b>GA2MLPW2430L-SHW</b>                                   | 3,149    | 3,435    |
|   |        |    |         |   |          |          |
| PRINTER  | 24 7/8 | 30 | 20 3/16 | <b>GA2MLPW2430L-PW</b>                                    | 3,711    | 4,048    |
|   |        |    |         |   |          |          |
| TRASH RECEPTACLE   | 24 7/8 | 30 | 20 3/16 | <b>GA2MLPW2430L-TW</b>                                    | 5,759    | 6,282    |
|  |        |    |         | • Includes quantity (2) brushed satin aluminum trash cans |          |          |

## PRODUCT INFO

Hinged door cabinets do not lock

-A and -B pedestals include hidden upper box drawer

## TO ORDER PLEASE SPECIFY THE FOLLOWING:

1.  **MODEL NUMBER**
2.  **FINISH**
3.  **PULL**
4.  **LOCKING**
5.  **KEYING**
6.  **OFFICE #**



See inside front cover for required option codes

Example

GA2MLPW2430L-BW.NC215.MPS.LY.RMS.OFC1

|                     |               |             |                |               |                 |
|---------------------|---------------|-------------|----------------|---------------|-----------------|
| GA2MLPW2430L-BW     | NC215         | MPS         | LY             | RMS           | OFC1            |
| <b>MODEL NUMBER</b> | <b>FINISH</b> | <b>PULL</b> | <b>LOCKING</b> | <b>KEYING</b> | <b>OFFICE #</b> |

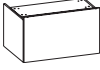
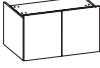

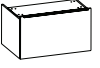
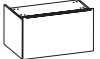
|   | D      | W  | H       | model number  | veneer 2 | veneer 3 |
|---|--------|----|---------|---|----------|----------|
| <b>36" WIDTH</b>  |        |    |         |   |          |          |
| BOX   LATERAL FILE<br> | 24 7/8 | 36 | 20 3/16 | <b>GA2MLPW2436L-BW</b>                                    | 4,488    | 4,896    |
|   |        |    |         | • Optional face lock                                      |          |          |
| HINGED DOOR<br>        | 24 7/8 | 36 | 20 3/16 | <b>GA2MLPW2436L-5W</b>                                    | 3,938    | 4,296    |
| OPEN SHELF<br>         | 24 7/8 | 36 | 20 3/16 | <b>GA2MLPW2436L-SHW</b>                                   | 3,529    | 3,850    |
| PRINTER<br>            | 24 7/8 | 36 | 20 3/16 | <b>GA2MLPW2436L-PW</b>                                    | 4,161    | 4,539    |
| TRASH RECEPTACLE<br>  | 24 7/8 | 36 | 20 3/16 | <b>GA2MLPW2436L-TW</b>                                    | 4,161    | 4,539    |
|   |        |    |         | • Includes quantity (2) brushed satin aluminum trash cans |          |          |

**PRODUCT INFO**

Hinged door cabinets do not lock

-A and -B pedestals include hidden upper box drawer

**TO ORDER PLEASE SPECIFY THE FOLLOWING:**

- 1.  **MODEL NUMBER**
- 2.  **FINISH**
- 3.  **PULL**
- 4.  **LOCKING**
- 5.  **KEYING**
- 6.  **OFFICE #**

**See inside front cover for required option codes**

Example

**GA2MLPW2436L-BW.NC215.MPS.LY.RMS.OFC1**  
 GA2MLPW2436L-BW    NC215    MPS    LY    RMS    OFC1  
 MODEL NUMBER    FINISH    PULL    LOCKING    KEYING    OFFICE #

# LAYERS PEDESTALS

Low height | left hand

**Credentials**  
02/24

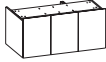
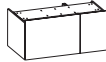
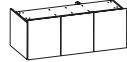
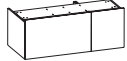
|   | D      | W  | H       | model number            | veneer 2 | veneer 3 |
|---|--------|----|---------|-------------------------|----------|----------|
| <b>45" WIDTH</b>  |        |    |         |                         |          |          |
| HINGED DOOR +<br>BOX   FILE   | 24 7/8 | 45 | 20 3/16 | <b>GA2MLPW2445L-5AW</b> | 6,325    | 6,900    |
|    |        |    |         |                         |          |          |
| BOX   LATERAL FILE +<br>BOX   FILE  | 24 7/8 | 45 | 20 3/16 | <b>GA2MLPW2445L-BAW</b> | 6,771    | 7,386    |
|    |        |    |         |                         |          |          |
| <b>54" WIDTH</b>  |        |    |         |                         |          |          |
| HINGED DOOR +<br>BOX   FILE   | 24 7/8 | 54 | 20 3/16 | <b>GA2MLPW2454L-5AW</b> | 6,864    | 7,488    |
|    |        |    |         |                         |          |          |
| BOX   LATERAL FILE +<br>BOX   FILE  | 24 7/8 | 54 | 20 3/16 | <b>GA2MLPW2454L-BAW</b> | 7,363    | 8,032    |
|  |        |    |         |                         |          |          |

## PRODUCT INFO

All pedestals have optional face locks

Hinged door cabinets do not lock

-A and -B pedestals include hidden upper box drawer

## TO ORDER PLEASE SPECIFY THE FOLLOWING:

1.  **MODEL NUMBER**
2.  **FINISH**
3.  **PULL**
4.  **LOCKING**
5.  **KEYING**
6.  **OFFICE #**

See inside front cover for required option codes

Example

GA2MLPW2445L-5AW.NC215.MPS.LY.RMS.OFC1

|                     |               |             |                |               |                 |
|---------------------|---------------|-------------|----------------|---------------|-----------------|
| GA2MLPW2445L-5AW    | NC215         | MPS         | LY             | RMS           | OFC1            |
| <b>MODEL NUMBER</b> | <b>FINISH</b> | <b>PULL</b> | <b>LOCKING</b> | <b>KEYING</b> | <b>OFFICE #</b> |

|  | D | W | H | model number | veneer 2 | veneer 3 |
|--|---|---|---|--------------|----------|----------|
|--|---|---|---|--------------|----------|----------|

**60" WIDTH**

BOX | LATERAL FILE +  
BOX | LATERAL FILE

|        |    |         |                         |       |       |
|--------|----|---------|-------------------------|-------|-------|
| 24 7/8 | 60 | 20 3/16 | <b>GA2MLPW2460L-BBW</b> | 7,221 | 7,877 |
|--------|----|---------|-------------------------|-------|-------|

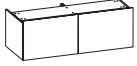

HINGED DOOR +  
HINGED DOOR

|        |    |         |                         |       |       |
|--------|----|---------|-------------------------|-------|-------|
| 24 7/8 | 60 | 20 3/16 | <b>GA2MLPW2460L-55W</b> | 6,325 | 6,900 |
|--------|----|---------|-------------------------|-------|-------|

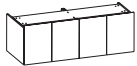

**PRODUCT INFO**

Hinged door cabinets do not lock

-A and -B pedestals include hidden upper box drawer

**TO ORDER PLEASE SPECIFY THE FOLLOWING:**

1.  **MODEL NUMBER**
2.  **FINISH**
3.  **PULL**
4.  **LOCKING**
5.  **KEYING**
6.  **OFFICE #**

**See inside front cover for required option codes**

Example

GA2MLPW2460L-BBW.NC215.MPS.LY.RMS.OFC1  
 GA2MLPW2460L-BBW    NC215    MPS    LY    RMS    OFC1  
 MODEL NUMBER    FINISH    PULL    LOCKING    KEYING    OFFICE #

# LAYERS PEDESTALS

Low height | right hand

**Credentials**

02/24

|                  | D  | W  | H                               | model number           | veneer 2 | veneer 3 |
|------------------|----|----|---------------------------------|------------------------|----------|----------|
| <b>15" WIDTH</b> |    |    |                                 |                        |          |          |
| FALSE PEDESTALS  | 24 | 15 | 20 <sup>3</sup> / <sub>16</sub> | <b>GA2MLPW2415R-LW</b> | 1,337    | 1,458    |

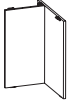

- For use with: standard or trough back worksurfaces  
no modesty panel applications



|  |    |    |                                 |                         |       |       |
|--|----|----|---------------------------------|-------------------------|-------|-------|
|  | 24 | 15 | 20 <sup>3</sup> / <sub>16</sub> | <b>GA2MLPW2415R-XBW</b> | 1,396 | 1,523 |
|--|----|----|---------------------------------|-------------------------|-------|-------|

- For use with: standard or trough back worksurfaces  
wall access panel or full back panel applications

## PRODUCT INFO

TO ORDER PLEASE SPECIFY THE FOLLOWING:

1.  **MODEL NUMBER**
2.  **FINISH**
3.  **OFFICE #**

See inside front cover for required option codes

Example

GA2MLPW2415R-LW.NC215.OFC1  
 GA2MLPW2415R-LW    NC215    OFC1  
 MODEL NUMBER    FINISH    OFFICE #

|                  | D      | W  | H       | model number           | veneer 2 | veneer 3 |
|------------------|--------|----|---------|------------------------|----------|----------|
| <b>15" WIDTH</b> |        |    |         |                        |          |          |
| BOX   FILE       | 24 7/8 | 15 | 20 3/16 | <b>GA2MLPW2415R-AW</b> | 3,514    | 3,833    |



|                  |        |    |         |                        |       |       |
|------------------|--------|----|---------|------------------------|-------|-------|
| <b>18" WIDTH</b> |        |    |         |                        |       |       |
| BOX   FILE       | 24 7/8 | 18 | 20 3/16 | <b>GA2MLPW2418R-AW</b> | 3,693 | 4,029 |



**PRODUCT INFO**

All pedestals have optional face locks

Hinged door cabinets do not lock

-A and -B pedestals include hidden upper box drawer

**TO ORDER PLEASE SPECIFY THE FOLLOWING:**

- 1.  **MODEL NUMBER**
- 2.  **FINISH**
- 3.  **PULL**
- 4.  **LOCKING**
- 5.  **KEYING**
- 6.  **OFFICE #**

**See inside front cover for required option codes**

Example



GA2MLPW2415R-AW.NC215.MPS.LY.RMS.OFC1  
 GA2MLPW2415R-AW    NC215    MPS    LY    RMS    OFC1  
 MODEL NUMBER    FINISH    PULL    LOCKING    KEYING    OFFICE #

# LAYERS PEDESTALS

Low height | right hand

**Credentials**

02/24

|   | D      | W  | H       | model number  | veneer 2 | veneer 3 |
|---|--------|----|---------|---|----------|----------|
| <b>30" WIDTH</b>  |        |    |         |   |          |          |
| BOX   LATERAL FILE<br> | 24 7/8 | 30 | 20 3/16 | <b>GA2MLPW2430R-BW</b>                                    | 4,010    | 4,374    |
|   |        |    |         | • Optional face lock                                      |          |          |
| HINGED DOOR<br>        | 24 7/8 | 30 | 20 3/16 | <b>GA2MLPW2430R-5W</b>                                    | 3,514    | 3,833    |
| OPEN SHELF<br>         | 24 7/8 | 30 | 20 3/16 | <b>GA2MLPW2430R-SHW</b>                                   | 3,149    | 3,435    |
| PRINTER<br>            | 24 7/8 | 30 | 20 3/16 | <b>GA2MLPW2430R-PW</b>                                    | 3,711    | 4,048    |
| TRASH RECEPTACLE<br>  | 24 7/8 | 30 | 20 3/16 | <b>GA2MLPW2430R-TW</b>                                    | 5,759    | 6,282    |
|   |        |    |         | • Includes quantity (2) brushed satin aluminum trash cans |          |          |

## PRODUCT INFO

Hinged door cabinets do not lock

-A and -B pedestals include hidden upper box drawer

## TO ORDER PLEASE SPECIFY THE FOLLOWING:

- |    |                      |                     |
|----|----------------------|---------------------|
| 1. | <input type="text"/> | <b>MODEL NUMBER</b> |
| 2. | <input type="text"/> | <b>FINISH</b>       |
| 3. | <input type="text"/> | <b>PULL</b>         |
| 4. | <input type="text"/> | <b>LOCKING</b>      |
| 5. | <input type="text"/> | <b>KEYING</b>       |
| 6. | <input type="text"/> | <b>OFFICE #</b>     |

See inside front cover for required option codes

Example

GA2MLPW2430R-BW.NC215.MPS.LY.RMS.OFC1

|                     |               |             |                |               |                 |
|---------------------|---------------|-------------|----------------|---------------|-----------------|
| GA2MLPW2430R-BW     | NC215         | MPS         | LY             | RMS           | OFC1            |
| <b>MODEL NUMBER</b> | <b>FINISH</b> | <b>PULL</b> | <b>LOCKING</b> | <b>KEYING</b> | <b>OFFICE #</b> |

|   | D      | W  | H       | model number  | veneer 2 | veneer 3 |
|---|--------|----|---------|---|----------|----------|
| <b>36" WIDTH</b>  |        |    |         |   |          |          |
| BOX   LATERAL FILE<br> | 24 7/8 | 36 | 20 3/16 | <b>GA2MLPW2436R-BW</b>                                    | 4,488    | 4,896    |
|   |        |    |         | • Optional face lock                                      |          |          |
| HINGED DOOR<br>        | 24 7/8 | 36 | 20 3/16 | <b>GA2MLPW2436R-5W</b>                                    | 3,938    | 4,296    |
| OPEN SHELF<br>         | 24 7/8 | 36 | 20 3/16 | <b>GA2MLPW2436R-SHW</b>                                   | 3,529    | 3,850    |
| PRINTER<br>            | 24 7/8 | 36 | 20 3/16 | <b>GA2MLPW2436R-PW</b>                                    | 4,161    | 4,539    |
| TRASH RECEPTACLE<br>  | 24 7/8 | 36 | 20 3/16 | <b>GA2MLPW2436R-TW</b>                                    | 4,161    | 4,539    |
|   |        |    |         | • Includes quantity (2) brushed satin aluminum trash cans |          |          |

**PRODUCT INFO**

Hinged door cabinets do not lock

-A and -B pedestals include hidden upper box drawer

**TO ORDER PLEASE SPECIFY THE FOLLOWING:**

- 1.  **MODEL NUMBER**
- 2.  **FINISH**
- 3.  **PULL**
- 4.  **LOCKING**
- 5.  **KEYING**
- 6.  **OFFICE #**

See inside front cover for required option codes

Example

GA2MLPW2436R-BW.NC215.MPS.LY.RMS.OFC1  
 GA2MLPW2436R-BW    NC215    MPS    LY    RMS    OFC1  
 MODEL NUMBER    FINISH    PULL    LOCKING    KEYING    OFFICE #

# LAYERS PEDESTALS

Low height | right hand

**Credentials**

02/24

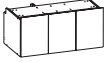
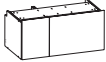
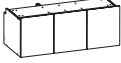
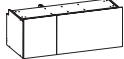
|   | D      | W  | H       | model number            | veneer 2 | veneer 3 |
|---|--------|----|---------|-------------------------|----------|----------|
| <b>45" WIDTH</b>  |        |    |         |                         |          |          |
| HINGED DOOR +<br>BOX   FILE   | 24 7/8 | 45 | 20 3/16 | <b>GA2MLPW2445R-A5W</b> | 6,325    | 6,900    |
|    |        |    |         |                         |          |          |
| BOX   LATERAL FILE +<br>BOX   FILE  | 24 7/8 | 45 | 20 3/16 | <b>GA2MLPW2445R-ABW</b> | 6,771    | 7,386    |
|    |        |    |         |                         |          |          |
| <b>54" WIDTH</b>  |        |    |         |                         |          |          |
| HINGED DOOR +<br>BOX   FILE   | 24 7/8 | 54 | 20 3/16 | <b>GA2MLPW2454R-A5W</b> | 6,864    | 7,488    |
|    |        |    |         |                         |          |          |
| BOX   LATERAL FILE +<br>BOX   FILE  | 24 7/8 | 54 | 20 3/16 | <b>GA2MLPW2454R-ABW</b> | 7,363    | 8,032    |
|  |        |    |         |                         |          |          |

## PRODUCT INFO

All pedestals have optional face locks

Hinged door cabinets do not lock

-A and -B pedestals include hidden upper box drawer

## TO ORDER PLEASE SPECIFY THE FOLLOWING:

- |    |                      |                     |
|----|----------------------|---------------------|
| 1. | <input type="text"/> | <b>MODEL NUMBER</b> |
| 2. | <input type="text"/> | <b>FINISH</b>       |
| 3. | <input type="text"/> | <b>PULL</b>         |
| 4. | <input type="text"/> | <b>LOCKING</b>      |
| 5. | <input type="text"/> | <b>KEYING</b>       |
| 6. | <input type="text"/> | <b>OFFICE #</b>     |

See inside front cover for required option codes

Example

GA2MLPW2445R-A5W.NC215.MPS.LY.RMS.OFC1

|                     |               |             |                |               |                 |
|---------------------|---------------|-------------|----------------|---------------|-----------------|
| GA2MLPW2445R-A5W    | NC215         | MPS         | LY             | RMS           | OFC1            |
| <b>MODEL NUMBER</b> | <b>FINISH</b> | <b>PULL</b> | <b>LOCKING</b> | <b>KEYING</b> | <b>OFFICE #</b> |



|  | D | W | H | model number | veneer 2 | veneer 3 |
|--|---|---|---|--------------|----------|----------|
|--|---|---|---|--------------|----------|----------|

**60" WIDTH**

BOX | LATERAL FILE +  
BOX | LATERAL FILE

|        |    |         |                         |       |       |
|--------|----|---------|-------------------------|-------|-------|
| 24 7/8 | 60 | 20 3/16 | <b>GA2MLPW2460R-BBW</b> | 7,221 | 7,877 |
|--------|----|---------|-------------------------|-------|-------|

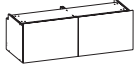

HINGED DOOR +  
HINGED DOOR

|        |    |         |                         |       |       |
|--------|----|---------|-------------------------|-------|-------|
| 24 7/8 | 60 | 20 3/16 | <b>GA2MLPW2460R-55W</b> | 6,325 | 6,900 |
|--------|----|---------|-------------------------|-------|-------|

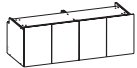

**PRODUCT INFO**

All pedestals have optional face locks

Hinged door cabinets do not lock

-A and -B pedestals include hidden upper box drawer

**TO ORDER PLEASE SPECIFY THE FOLLOWING:**

1.  **MODEL NUMBER**
2.  **FINISH**
3.  **PULL**
4.  **LOCKING**
5.  **KEYING**
6.  **OFFICE #**

**See inside front cover for required option codes**

Example

**GA2MLPW2460R-BBW.NC215.MPS.LY.RMS.OFC1**

|                     |               |             |                |               |                 |
|---------------------|---------------|-------------|----------------|---------------|-----------------|
| GA2MLPW2460R-BBW    | NC215         | MPS         | LY             | RMS           | OFC1            |
| <b>MODEL NUMBER</b> | <b>FINISH</b> | <b>PULL</b> | <b>LOCKING</b> | <b>KEYING</b> | <b>OFFICE #</b> |

# CREDENZA MODESTY PANELS

Full height

**Credentials**

02/24

|   | D             | W                 | H                  | model number       | veneer 2 | veneer 3 |
|---|---------------|-------------------|--------------------|--------------------|----------|----------|
| <b>FINISHED BACK PANEL</b><br> | $\frac{3}{4}$ | 58 $\frac{1}{2}$  | 27 $\frac{15}{16}$ | <b>GA2MCF60-W</b>  | 1,531    | 1,670    |
|   | $\frac{3}{4}$ | 64 $\frac{1}{2}$  | 27 $\frac{15}{16}$ | <b>GA2MCF66-W</b>  | 1,614    | 1,761    |
|   | $\frac{3}{4}$ | 70 $\frac{1}{2}$  | 27 $\frac{15}{16}$ | <b>GA2MCF72-W</b>  | 1,701    | 1,856    |
|   | $\frac{3}{4}$ | 76 $\frac{1}{2}$  | 27 $\frac{15}{16}$ | <b>GA2MCF78-W</b>  | 1,782    | 1,944    |
|   | $\frac{3}{4}$ | 82 $\frac{1}{2}$  | 27 $\frac{15}{16}$ | <b>GA2MCF84-W</b>  | 1,873    | 2,043    |
|   | $\frac{3}{4}$ | 88 $\frac{1}{2}$  | 27 $\frac{15}{16}$ | <b>GA2MCF90-W</b>  | 1,967    | 2,146    |
|   | $\frac{3}{4}$ | 94 $\frac{1}{2}$  | 27 $\frac{15}{16}$ | <b>GA2MCF96-W</b>  | 2,070    | 2,258    |
|   | $\frac{3}{4}$ | 100 $\frac{1}{2}$ | 27 $\frac{15}{16}$ | <b>GA2MCF102-W</b> | 2,208    | 2,409    |
|   | $\frac{3}{4}$ | 106 $\frac{1}{2}$ | 27 $\frac{15}{16}$ | <b>GA2MCF108-W</b> | 2,364    | 2,579    |
|   | $\frac{3}{4}$ | 112 $\frac{1}{2}$ | 27 $\frac{15}{16}$ | <b>GA2MCF114-W</b> | 2,535    | 2,765    |
|   | $\frac{3}{4}$ | 118 $\frac{1}{2}$ | 27 $\frac{15}{16}$ | <b>GA2MCF120-W</b> | 2,709    | 2,955    |

- Specify width to match worksurface width
- Example: 90" worksurface = 90" finished back panel

## PRODUCT INFO

TO ORDER PLEASE SPECIFY THE FOLLOWING:

1.  **MODEL NUMBER**
2.  **FINISH**
3.  **OFFICE #**

See inside front cover for required option codes

Example

**GA2MCF60-W.NC215.OFC1**

|                             |                       |                         |
|-----------------------------|-----------------------|-------------------------|
| GA2MCF60-W                  | NC215                 | OFC1                    |
| <small>MODEL NUMBER</small> | <small>FINISH</small> | <small>OFFICE #</small> |

**FINISHED BACK PANEL**



| D             | W       | H       | model number        | veneer 2 | veneer 3 |
|---------------|---------|---------|---------------------|----------|----------|
| $\frac{3}{4}$ | 58 1/2  | 20 3/16 | <b>GA2MLCF60-W</b>  | 1,458    | 1,590    |
| $\frac{3}{4}$ | 64 1/2  | 20 3/16 | <b>GA2MLCF66-W</b>  | 1,531    | 1,670    |
| $\frac{3}{4}$ | 70 1/2  | 20 3/16 | <b>GA2MLCF72-W</b>  | 1,614    | 1,761    |
| $\frac{3}{4}$ | 76 1/2  | 20 3/16 | <b>GA2MLCF78-W</b>  | 1,697    | 1,851    |
| $\frac{3}{4}$ | 82 1/2  | 20 3/16 | <b>GA2MLCF84-W</b>  | 1,780    | 1,942    |
| $\frac{3}{4}$ | 88 1/2  | 20 3/16 | <b>GA2MLCF90-W</b>  | 1,869    | 2,039    |
| $\frac{3}{4}$ | 94 1/2  | 20 3/16 | <b>GA2MLCF96-W</b>  | 1,962    | 2,140    |
| $\frac{3}{4}$ | 100 1/2 | 20 3/16 | <b>GA2MLCF102-W</b> | 2,097    | 2,288    |
| $\frac{3}{4}$ | 106 1/2 | 20 3/16 | <b>GA2MLCF108-W</b> | 2,246    | 2,450    |
| $\frac{3}{4}$ | 112 1/2 | 20 3/16 | <b>GA2MLCF114-W</b> | 2,404    | 2,622    |
| $\frac{3}{4}$ | 118 1/2 | 20 3/16 | <b>GA2MLCF120-W</b> | 2,572    | 2,806    |

- Specify width to match worksurface width
- Example: 90" worksurface = 90" finished back panel

**PRODUCT INFO**

TO ORDER PLEASE SPECIFY THE FOLLOWING:

1.  **MODEL NUMBER**
2.  **FINISH**
3.  **OFFICE #**

See inside front cover for required option codes

Example

GA2MLCF60-W.NC215.OFC1  
 GA2MLCF60-W      NC215      OFC1  
 MODEL NUMBER      FINISH      OFFICE #

# CREDENZA WALL ACCESS PANELS

**Credentials**  
02/24

Full height

## WALL ACCESS PANEL



| D       | W  | H      | model number      | veneer 2 | veneer 3 |
|---------|----|--------|-------------------|----------|----------|
| 5 11/16 | 24 | 26 1/2 | <b>GA2MCA24-W</b> | 1,891    | 2,063    |
| 5 11/16 | 27 | 26 1/2 | <b>GA2MCA27-W</b> | 1,952    | 2,129    |
| 5 11/16 | 30 | 26 1/2 | <b>GA2MCA30-W</b> | 2,012    | 2,195    |
| 5 11/16 | 33 | 26 1/2 | <b>GA2MCA33-W</b> | 2,075    | 2,264    |
| 5 11/16 | 36 | 26 1/2 | <b>GA2MCA36-W</b> | 2,140    | 2,334    |
| 5 11/16 | 39 | 26 1/2 | <b>GA2MCA39-W</b> | 2,207    | 2,408    |
| 5 11/16 | 42 | 26 1/2 | <b>GA2MCA42-W</b> | 2,250    | 2,454    |
| 5 11/16 | 45 | 26 1/2 | <b>GA2MCA45-W</b> | 2,298    | 2,507    |
| 5 11/16 | 48 | 26 1/2 | <b>GA2MCA48-W</b> | 2,346    | 2,559    |
| 5 11/16 | 51 | 26 1/2 | <b>GA2MCA51-W</b> | 2,394    | 2,612    |
| 5 11/16 | 54 | 26 1/2 | <b>GA2MCA54-W</b> | 2,439    | 2,661    |
| 5 11/16 | 57 | 26 1/2 | <b>GA2MCA57-W</b> | 2,490    | 2,716    |
| 5 11/16 | 60 | 26 1/2 | <b>GA2MCA60-W</b> | 2,539    | 2,770    |
| 5 11/16 | 63 | 26 1/2 | <b>GA2MCA63-W</b> | 2,591    | 2,826    |
| 5 11/16 | 66 | 26 1/2 | <b>GA2MCA66-W</b> | 2,643    | 2,883    |
| 5 11/16 | 69 | 26 1/2 | <b>GA2MCA69-W</b> | 2,695    | 2,940    |
| 5 11/16 | 72 | 26 1/2 | <b>GA2MCA72-W</b> | 2,748    | 2,998    |

- Specify width to match kneewell space between pedestals
- Example: (90" worksurface) - (15" LH pedestal) - (15" RH pedestal) = 60" wall access panel

## PRODUCT INFO

TO ORDER PLEASE SPECIFY THE FOLLOWING:

1.  **MODEL NUMBER**
2.  **FINISH**
3.  **OFFICE #**

See inside front cover for required option codes

Example

GA2MCA24-W.NC215.OFC1  
 GA2MCA24-W      NC215      OFC1  
 MODEL NUMBER      FINISH      OFFICE #

**FINISHED BACK PANEL**



| D   | W      | H        | model number      | veneer 2 | veneer 3 |
|-----|--------|----------|-------------------|----------|----------|
| 3/4 | 38 1/4 | 27 15/16 | <b>GA2MRF39-W</b> | 1,276    | 1,392    |
| 3/4 | 41 1/4 | 27 15/16 | <b>GA2MRF42-W</b> | 1,315    | 1,434    |
| 3/4 | 44 1/4 | 27 15/16 | <b>GA2MRF45-W</b> | 1,353    | 1,476    |
| 3/4 | 47 1/4 | 27 15/16 | <b>GA2MRF48-W</b> | 1,386    | 1,512    |
| 3/4 | 50 1/4 | 27 15/16 | <b>GA2MRF51-W</b> | 1,422    | 1,551    |
| 3/4 | 53 1/4 | 27 15/16 | <b>GA2MRF54-W</b> | 1,458    | 1,590    |
| 3/4 | 56 1/4 | 27 15/16 | <b>GA2MRF57-W</b> | 1,495    | 1,631    |
| 3/4 | 59 1/4 | 27 15/16 | <b>GA2MRF60-W</b> | 1,531    | 1,670    |
| 3/4 | 62 1/4 | 27 15/16 | <b>GA2MRF63-W</b> | 1,573    | 1,716    |
| 3/4 | 65 1/4 | 27 15/16 | <b>GA2MRF66-W</b> | 1,614    | 1,761    |
| 3/4 | 68 1/4 | 27 15/16 | <b>GA2MRF69-W</b> | 1,658    | 1,809    |
| 3/4 | 71 1/4 | 27 15/16 | <b>GA2MRF72-W</b> | 1,701    | 1,856    |

- Specify width to match worksurface width
- Example: 60" worksurface = 60" finished back panel

**NOTE:** A 3" shorter width modesty is required when used with a height adjustable desk.

**PRODUCT INFO**

TO ORDER PLEASE SPECIFY THE FOLLOWING:

1.  **MODEL NUMBER**
2.  **FINISH**
3.  **OFFICE #**

See inside front cover for required option codes

Example

**GA2MRF39-W.NC215.OFC1**

|                             |                       |                         |
|-----------------------------|-----------------------|-------------------------|
| GA2MRF39-W                  | NC215                 | OFC1                    |
| <small>MODEL NUMBER</small> | <small>FINISH</small> | <small>OFFICE #</small> |

# RETURN WALL ACCESS PANELS

Full height

**Credentials**

02/24

## WALL ACCESS PANEL

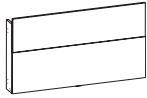

| D       | W  | H      | model number      | veneer 2 | veneer 3 |
|---------|----|--------|-------------------|----------|----------|
| 5 11/16 | 21 | 26 1/2 | <b>GA2MRA21-W</b> | 1,837    | 2,004    |
| 5 11/16 | 24 | 26 1/2 | <b>GA2MRA24-W</b> | 1,891    | 2,063    |
| 5 11/16 | 27 | 26 1/2 | <b>GA2MRA27-W</b> | 1,952    | 2,129    |
| 5 11/16 | 30 | 26 1/2 | <b>GA2MRA30-W</b> | 2,012    | 2,195    |
| 5 11/16 | 33 | 26 1/2 | <b>GA2MRA33-W</b> | 2,075    | 2,264    |
| 5 11/16 | 36 | 26 1/2 | <b>GA2MRA36-W</b> | 2,140    | 2,334    |
| 5 11/16 | 39 | 26 1/2 | <b>GA2MRA39-W</b> | 2,207    | 2,408    |
| 5 11/16 | 42 | 26 1/2 | <b>GA2MRA42-W</b> | 2,250    | 2,454    |
| 5 11/16 | 45 | 26 1/2 | <b>GA2MRA45-W</b> | 2,298    | 2,507    |
| 5 11/16 | 48 | 26 1/2 | <b>GA2MRA48-W</b> | 2,346    | 2,559    |
| 5 11/16 | 51 | 26 1/2 | <b>GA2MRA51-W</b> | 2,394    | 2,612    |
| 5 11/16 | 54 | 26 1/2 | <b>GA2MRA54-W</b> | 2,439    | 2,661    |
| 5 11/16 | 57 | 26 1/2 | <b>GA2MRA57-W</b> | 2,490    | 2,716    |
| 5 11/16 | 60 | 26 1/2 | <b>GA2MRA60-W</b> | 2,539    | 2,770    |

- Specify width to match kneewell space between pedestals
- Example: (60" worksurface) - (15" LH pedestal) = 45" wall access panel

**NOTE:** A 3" shorter width wall access panel is required when used with a height adjustable desk.

## PRODUCT INFO

TO ORDER PLEASE SPECIFY THE FOLLOWING:

1.  **MODEL NUMBER**
2.  **FINISH**
3.  **OFFICE #**

**See inside front cover for required option codes**

Example

GA2MRA21-W.NC215.OFC1  
 GA2MRA21-W      NC215      OFC1  
 MODEL NUMBER      FINISH      OFFICE #

|  | D | W | H | model number | veneer 2 | veneer 3 |
|--|---|---|---|--------------|----------|----------|
|--|---|---|---|--------------|----------|----------|

**FULL HEIGHT**

INTERMEDIATE SUPPORT  
FOR USE WITH  
MODESTY PANEL

|               |    |        |                   |     |     |
|---------------|----|--------|-------------------|-----|-----|
| $\frac{3}{4}$ | 14 | 27 1/2 | <b>GA2MSP12-W</b> | 843 | 920 |
|---------------|----|--------|-------------------|-----|-----|



T-SUPPORT FOR USE WITH  
NO MODESTY PANEL

|   |    |        |                    |     |     |
|---|----|--------|--------------------|-----|-----|
| 8 | 12 | 27 1/2 | <b>GA2MSPT12-W</b> | 719 | 784 |
|---|----|--------|--------------------|-----|-----|



**LAYERS LOW HEIGHT**

INTERMEDIATE SUPPORT  
FOR USE WITH  
MODESTY PANEL

|               |        |         |                    |     |     |
|---------------|--------|---------|--------------------|-----|-----|
| $\frac{3}{4}$ | 5 1/16 | 20 3/16 | <b>GA2MLSP12-W</b> | 377 | 411 |
|---------------|--------|---------|--------------------|-----|-----|



T-SUPPORT FOR USE WITH  
NO MODESTY PANEL

|   |        |         |                     |     |     |
|---|--------|---------|---------------------|-----|-----|
| 8 | 5 1/16 | 20 3/16 | <b>GA2MLSPT12-W</b> | 682 | 744 |
|---|--------|---------|---------------------|-----|-----|



**PRODUCT INFO**

TO ORDER PLEASE SPECIFY THE FOLLOWING:

1.  **MODEL NUMBER**
2.  **FINISH**
3.  **OFFICE #**

See inside front cover for required option codes

Example

|                              |               |                 |
|------------------------------|---------------|-----------------|
| <b>GA2MSP12-W.NC215.OFC1</b> |               |                 |
| GA2MSP12-W                   | NC215         | OFC1            |
| <b>MODEL NUMBER</b>          | <b>FINISH</b> | <b>OFFICE #</b> |

# WORKSURFACE WALL MOUNT BRACKETS

Credentials  
02/24

## WALL MOUNT BRACKET

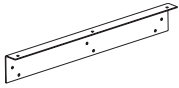

| D     | W  | H     | model number    | list |
|-------|----|-------|-----------------|------|
| 2 1/2 | 19 | 1 1/4 | <b>MDWLBK24</b> | 134  |
| 2 1/2 | 25 | 1 1/4 | <b>MDWLBK30</b> | 145  |

## WALL MOUNT BRACKET

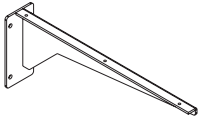

|       |         |       |                |     |
|-------|---------|-------|----------------|-----|
| 3 1/8 | 20 3/16 | 7 1/8 | <b>ACWCB20</b> | 252 |
| 3 1/8 | 15 3/16 | 7 1/8 | <b>ACWCB15</b> | 235 |

- For use with 24" tops to provide support on an end condition

- For use with 24" tops to provide support on center as an alternative to a T-bracket

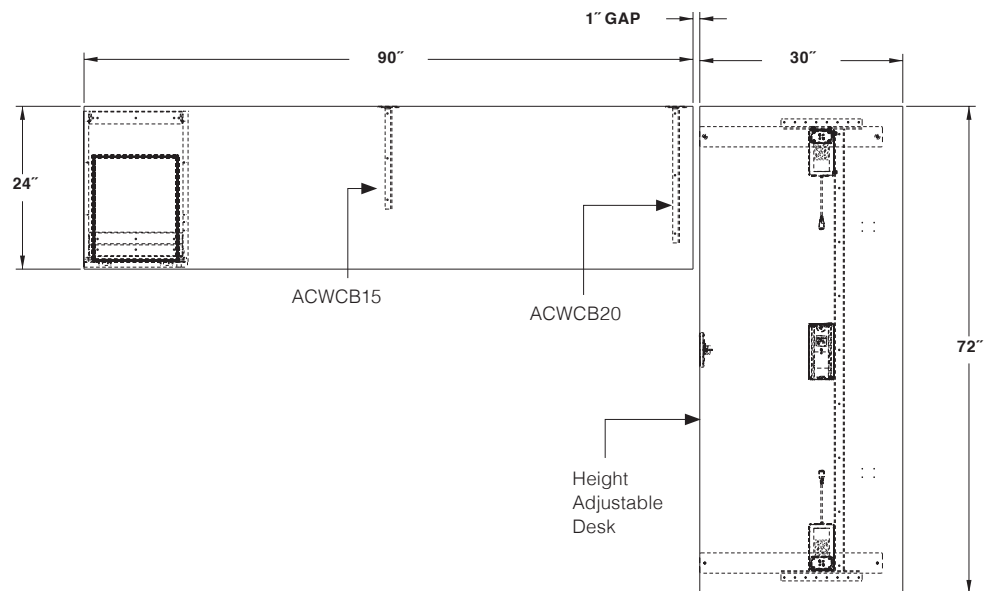

## PRODUCT INFO

TO ORDER PLEASE SPECIFY THE FOLLOWING:

1.  MODEL NUMBER



**NOTE: Office # option not required**

**See inside front cover for required option codes**

Example

MDWLBK24  
MDWLBK24  
MODEL NUMBER

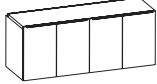

|  | D      | W  | H        | model number            | veneer 2 | veneer 3 |
|--|--------|----|----------|-------------------------|----------|----------|
| <b>60" WIDTH</b>   |        |    |          |                         |          |          |
| -44  | 24 7/8 | 60 | 27 15/16 | <b>GA2CFS2460T-44WW</b> | 9,633    | 10,509   |
|   |        |    |          |                         |          |          |
| -55  | 24 7/8 | 60 | 27 15/16 | <b>GA2CFS2460T-55WW</b> | 8,673    | 9,461    |
|   |        |    |          |                         |          |          |
| <b>72" WIDTH</b>   |        |    |          |                         |          |          |
| -44  | 24 7/8 | 72 | 27 15/16 | <b>GA2CFS2472T-44WW</b> | 10,772   | 11,751   |
|   |        |    |          |                         |          |          |
| -55  | 24 7/8 | 72 | 27 15/16 | <b>GA2CFS2472T-55WW</b> | 9,690    | 10,571   |
|  |        |    |          |                         |          |          |

- Trough back units are required when a tackzone spans over the back of the worksurface
- Trough units include a metal pencil lip

**NOTE:** Plastic Trough Insert is REQUIRED and must be ordered separately across entire length of trough.

**PRODUCT INFO**

Short grain veneer on worksurface

Doors do not lock

**TO ORDER PLEASE SPECIFY THE FOLLOWING:**

- |    |                      |                                       |
|----|----------------------|---------------------------------------|
| 1. | <input type="text"/> | <b>MODEL NUMBER</b>                   |
| 2. | <input type="text"/> | <b>FINISH</b>                         |
| 3. | <input type="text"/> | <b>TOP FINISH TYPE</b>                |
| 4. | <input type="text"/> | <b>PULL</b>                           |
| 5. | <input type="text"/> | <b>MODESTY</b>                        |
| 6. | <input type="text"/> | <b>LOCKING</b>                        |
| 7. | <input type="text"/> | <b>KEYING</b>                         |
| 8. | <input type="text"/> | <b>PENCIL LIP COLOR (TROUGH ONLY)</b> |
| 9. | <input type="text"/> | <b>OFFICE #</b>                       |

See inside front cover for required option codes

Example

GA2CFS2460T-44WW.NC215.FF.MPS.MY.LY.RMS.PLS.OFC1  
 GA2CFS2460T-44WW    NC215    FF    MPS    MY    LY    RMS    PLS    OFC1  
 MODEL NUMBER    FINISH    TOP FINISH    PULL    MODESTY    LOCKING    KEYING    PENCIL LIP COLOR    OFFICE #

# FULL BANK STORAGE CREDENZAS

Credentials  
02/24

Trough back

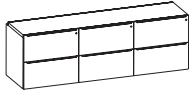
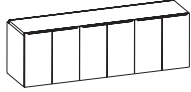
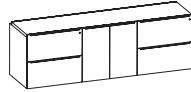
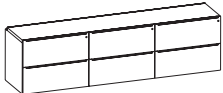
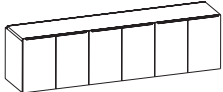
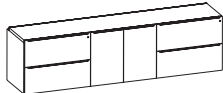
|   | D      | W   | H        | model number              | veneer 2 | veneer 3 |
|---|--------|-----|----------|---------------------------|----------|----------|
| <b>90" WIDTH</b>  |        |     |          |                           |          |          |
| -444  | 24 7/8 | 90  | 27 15/16 | <b>GA2CFS2490T-444WW</b>  | 14,056   | 15,334   |
|    |        |     |          |                           |          |          |
| -555  | 24 7/8 | 90  | 27 15/16 | <b>GA2CFS2490T-555WW</b>  | 12,612   | 13,758   |
|    |        |     |          |                           |          |          |
| -454  | 24 7/8 | 90  | 27 15/16 | <b>GA2CFS2490T-454WW</b>  | 13,572   | 14,806   |
|    |        |     |          |                           |          |          |
| <b>108" WIDTH</b>   |        |     |          |                           |          |          |
| -444  | 24 7/8 | 108 | 27 15/16 | <b>GA2CFS24108T-444WW</b> | 15,990   | 17,444   |
|    |        |     |          |                           |          |          |
| -555  | 24 7/8 | 108 | 27 15/16 | <b>GA2CFS24108T-555WW</b> | 14,369   | 15,675   |
|  |        |     |          |                           |          |          |
| -454  | 24 7/8 | 108 | 27 15/16 | <b>GA2CFS24108T-454WW</b> | 15,444   | 16,848   |
|  |        |     |          |                           |          |          |

- Trough back units are required when a tackzone spans over the back of the worksurface
- Trough units include a metal pencil lip

**NOTE:** Plastic Trough Insert is **REQUIRED** and must be ordered separately across entire length of trough.

## PRODUCT INFO

Short grain veneer on worksurface

Doors do not lock

## TO ORDER PLEASE SPECIFY THE FOLLOWING:

1.  **MODEL NUMBER**
2.  **FINISH**
3.  **TOP FINISH TYPE**
4.  **PULL**
5.  **MODESTY**
6.  **LOCKING**
7.  **KEYING**
8.  **PENCIL LIP COLOR (TROUGH ONLY)**
9.  **OFFICE #**

See inside front cover for required option codes

Example

GA2CFS2490T-444WW.NC125.FF.MPS.MY.LY.RMS.PLS.OFC1

|                             |                       |                           |                     |                        |                        |                       |                                 |                         |
|-----------------------------|-----------------------|---------------------------|---------------------|------------------------|------------------------|-----------------------|---------------------------------|-------------------------|
| GA2CFS2490T-444WW           | NC125                 | FF                        | MPS                 | MY                     | LY                     | RMS                   | PLS                             | OFC1                    |
| <small>MODEL NUMBER</small> | <small>FINISH</small> | <small>TOP FINISH</small> | <small>PULL</small> | <small>MODESTY</small> | <small>LOCKING</small> | <small>KEYING</small> | <small>PENCIL LIP COLOR</small> | <small>OFFICE #</small> |

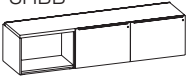
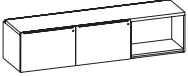
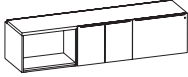
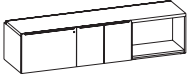
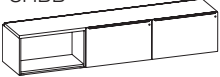
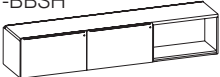
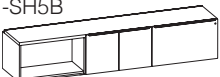
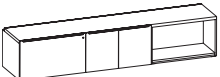
|  | D      | W   | H       | model number               | veneer 2 | veneer 3 |
|--|--------|-----|---------|----------------------------|----------|----------|
| <b>90" WIDTH</b>   |        |     |         |                            |          |          |
| -SHBB<br>   | 24 7/8 | 90  | 20 3/16 | <b>GA2CLFS2490T-SHBBW</b>  | 12,671   | 13,823   |
| -BBSH<br>   | 24 7/8 | 90  | 20 3/16 | <b>GA2CLFS2490T-BBSHW</b>  | 12,671   | 13,823   |
| -SH5B<br>   | 24 7/8 | 90  | 20 3/16 | <b>GA2CLFS2490T-SH5BW</b>  | 12,216   | 13,326   |
| -B5SH<br>   | 24 7/8 | 90  | 20 3/16 | <b>GA2CLFS2490T-B5SHW</b>  | 12,216   | 13,326   |
| <b>108" WIDTH</b>  |        |     |         |                            |          |          |
| -SHBB<br>   | 24 7/8 | 108 | 20 3/16 | <b>GA2CLFS24108T-SHBBW</b> | 14,441   | 15,754   |
| -BBSH<br>   | 24 7/8 | 108 | 20 3/16 | <b>GA2CLFS24108T-BBSHW</b> | 14,441   | 15,754   |
| -SH5B<br> | 24 7/8 | 108 | 20 3/16 | <b>GA2CLFS24108T-SH5BW</b> | 13,926   | 15,192   |
| -B5SH<br> | 24 7/8 | 108 | 20 3/16 | <b>GA2CLFS24108T-B5SHW</b> | 13,926   | 15,192   |

- Trough back units are required when a tackzone spans over the back of the worksurface
- Trough units include a metal pencil lip

**NOTE:** Plastic Trough Insert is REQUIRED and must be ordered separately across entire length of trough.

**PRODUCT INFO**

Short grain veneer on worksurface

Doors do not lock

**TO ORDER PLEASE SPECIFY THE FOLLOWING:**

- |    |  |                                       |
|----|--|---------------------------------------|
| 1. |  | <b>MODEL NUMBER</b>                   |
| 2. |  | <b>FINISH</b>                         |
| 3. |  | <b>TOP FINISH TYPE</b>                |
| 4. |  | <b>PULL</b>                           |
| 5. |  | <b>MODESTY</b>                        |
| 6. |  | <b>LOCKING</b>                        |
| 7. |  | <b>KEYING</b>                         |
| 8. |  | <b>PENCIL LIP COLOR (TROUGH ONLY)</b> |
| 9. |  | <b>OFFICE #</b>                       |

See inside front cover for required option codes

Example

GA2CLFS2490T-SHBBW.NC215.FF.MPS.MY.LY.RMS.PLS.OFC1  
 GA2CLFS2490T-SHBBW NC215 FF MPS MY LY RMS PLS OFC1  
 MODEL NUMBER FINISH TOP FINISH PULL MODESTY LOCKING KEYING PENCIL LIP COLOR OFFICE #

# LAYERS FULL BANK STORAGE CREDENZAS

**Credentials**  
02/24

Trough back

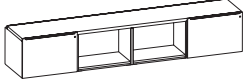
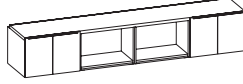
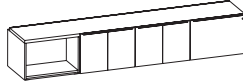
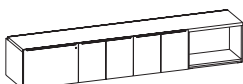
|   | D      | W   | H       | model number                | veneer 2 | veneer 3 |
|---|--------|-----|---------|-----------------------------|----------|----------|
| <b>120" WIDTH</b>   |        |     |         |                             |          |          |
| -BSHB   | 24 7/8 | 120 | 20 3/16 | <b>GA2CLFS24120T-BSHBW</b>  | 16,651   | 18,165   |
|  |        |     |         |                             |          |          |
| -5SH5   | 24 7/8 | 120 | 20 3/16 | <b>GA2CLFS24120T-5SH5W</b>  | 16,651   | 18,165   |
|  |        |     |         |                             |          |          |
| -SH55B  | 24 7/8 | 120 | 20 3/16 | <b>GA2CLFS24120T-SH55BW</b> | 16,530   | 18,033   |
|  |        |     |         |                             |          |          |
| -B55SH  | 24 7/8 | 120 | 20 3/16 | <b>GA2CLFS24120T-B55SHW</b> | 16,530   | 18,033   |
|  |        |     |         |                             |          |          |

- Trough back units are required when a tackzone spans over the back of the worksurface
- Trough units include a metal pencil lip

**NOTE:** Plastic Trough Insert is REQUIRED and must be ordered separately across entire length of trough.

## PRODUCT INFO

Short grain veneer on worksurface

Doors do not lock

## TO ORDER PLEASE SPECIFY THE FOLLOWING:

1.  **MODEL NUMBER**
2.  **FINISH**
3.  **TOP FINISH TYPE**
4.  **PULL**
5.  **MODESTY**
6.  **LOCKING**
7.  **KEYING**
8.  **PENCIL LIP COLOR (TROUGH ONLY)**
9.  **OFFICE #**

See inside front cover for required option codes

Example

GA2CLFS24120T-BSHBW.NC215.FF.MPS.MY.LY.RMS.PLS.OFC1

|                     |        |            |      |         |         |        |                  |          |
|---------------------|--------|------------|------|---------|---------|--------|------------------|----------|
| GA2CLFS24120T-BSHBW | NC215  | FF         | MPS  | MY      | LY      | RMS    | PLS              | OFC1     |
| MODEL NUMBER        | FINISH | TOP FINISH | PULL | MODESTY | LOCKING | KEYING | PENCIL LIP COLOR | OFFICE # |

|                                | D      | W  | H        | model number         | veneer 2 | veneer 3 |
|--------------------------------|--------|----|----------|----------------------|----------|----------|
| <b>18" WIDTH</b><br>BOX   FILE | 21 3/8 | 18 | 21 15/16 | <b>GA2MPD1818-AW</b> | 4,061    | 4,430    |



**PRODUCT INFO**

Includes 2 locking casters and 2 non-locking casters

Includes inset top panel

Includes hidden box drawer

**TO ORDER PLEASE SPECIFY THE FOLLOWING:**

- 1.  **MODEL NUMBER**
- 2.  **FINISH**
- 3.  **PULL**
- 4.  **LOCKING**
- 5.  **KEYING**
- 6.  **OFFICE #**

**See inside front cover for required option codes**

Example

**GA2MPD1818-AW.NC215.MPS.LY.RMS.OFC1**

|                     |               |             |                |               |                 |
|---------------------|---------------|-------------|----------------|---------------|-----------------|
| GA2MPD1818-AW       | NC215         | CPM         | LY             | RMS           | OFC1            |
| <b>MODEL NUMBER</b> | <b>FINISH</b> | <b>PULL</b> | <b>LOCKING</b> | <b>KEYING</b> | <b>OFFICE #</b> |

# CUSHIONS

**Credentials**  
02/24

|   | D      | W      | H     | model number           | fabric grades |     |     | COM/4 |
|---|--------|--------|-------|------------------------|---------------|-----|-----|-------|
|   |        |        |       |                        | 1             | 2   | 3   |       |
| <b>MOBILE PEDESTAL CUSHIONS</b>   |        |        |       |                        |               |     |     |       |
|  | 19 3/4 | 17 3/4 | 1 1/2 | <b>GAAMPD-CUSH1818</b> | 646           | 665 | 690 | 710   |

**LAYERS CREENZA CUSHIONS FOR STANDARD WORKSURFACE**



|        |    |       |                         |     |     |     |     |
|--------|----|-------|-------------------------|-----|-----|-----|-----|
| 23 3/4 | 30 | 1 1/2 | <b>GAACLPD-CUSH2430</b> | 728 | 756 | 784 | 814 |
| 23 3/4 | 36 | 1 1/2 | <b>GAACLPD-CUSH2436</b> | 785 | 821 | 857 | 894 |

**LAYERS CREENZA CUSHIONS FOR TROUGH BACK WORKSURFACES**

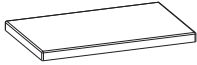

|    |    |       |                          |     |     |     |     |
|----|----|-------|--------------------------|-----|-----|-----|-----|
| 21 | 30 | 1 1/2 | <b>GAACLPD-CUSH2130T</b> | 728 | 756 | 784 | 814 |
| 21 | 36 | 1 1/2 | <b>GAACLPD-CUSH2136T</b> | 785 | 821 | 857 | 894 |

**PRODUCT INFO**

|            |       |
|------------|-------|
| COM Fabric | (yds) |
| CUSH1818   | 0.75  |
| CUSH2430   | 1.00  |
| CUSH2436   | 1.25  |
| CUSH2430T  | 1.00  |
| CUSH2436T  | 1.25  |

|             |         |
|-------------|---------|
| COM Leather | (sq ft) |
| CUSH1818    | 12.75   |
| CUSH2430    | 17.00   |
| CUSH2436    | 21.25   |
| CUSH2430T   | 17.00   |
| CUSH2436T   | 21.25   |

**TO ORDER PLEASE SPECIFY THE FOLLOWING:**

- MODEL NUMBER**
- FABRIC**
- FLAMMABILITY**
- OFFICE #**

For standard flammability rating, please specify CTB117, for California 133 and Boston fire-code treatment, please specify CTB113

**Option Codes:**  
U = CTB117

**See inside front cover for required option codes**

**Example**

|                                      |               |                     |                 |
|--------------------------------------|---------------|---------------------|-----------------|
| <b>GAAMPD-CUSH1818.FABRIC.U.OFC1</b> |               |                     |                 |
| GAAMPD-CUSH1818                      | FABRIC        | U                   | OFC1            |
| <b>MODEL NUMBER</b>                  | <b>FABRIC</b> | <b>FLAMMABILITY</b> | <b>OFFICE #</b> |

|                      | D       | W       | H                   | model number        | list |
|----------------------|---------|---------|---------------------|---------------------|------|
| <b>TROUGH INSERT</b> | 3       | 28 1/4  | 3                   | <b>GAATROUGH30</b>  | 178  |
|                      | 3       | 34 1/4  | 3                   | <b>GAATROUGH36</b>  | 181  |
|                      | 3       | 40 1/4  | 3                   | <b>GAATROUGH42</b>  | 184  |
|                      | 3       | 46 1/4  | 3                   | <b>GAATROUGH48</b>  | 190  |
|                      | 3       | 52 1/4  | 3                   | <b>GAATROUGH54</b>  | 193  |
|                      | 3       | 58 1/4  | 3                   | <b>GAATROUGH60</b>  | 196  |
|                      | 3       | 64 1/4  | 3                   | <b>GAATROUGH66</b>  | 279  |
|                      | 3       | 70 1/4  | 3                   | <b>GAATROUGH72</b>  | 282  |
|                      | 3       | 76 1/4  | 3                   | <b>GAATROUGH78</b>  | 287  |
|                      | 3       | 82 1/4  | 3                   | <b>GAATROUGH84</b>  | 290  |
|                      | 3       | 88 1/4  | 3                   | <b>GAATROUGH90</b>  | 295  |
|                      | 3       | 94 1/4  | 3                   | <b>GAATROUGH96</b>  | 299  |
|                      | 3       | 100 1/4 | 3                   | <b>GAATROUGH102</b> | 304  |
|                      | 3       | 106 1/4 | 3                   | <b>GAATROUGH108</b> | 307  |
|                      | 3       | 112 1/4 | 3                   | <b>GAATROUGH114</b> | 309  |
| 3                    | 118 1/4 | 3       | <b>GAATROUGH120</b> | 317                 |      |

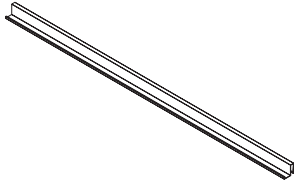

Profile:

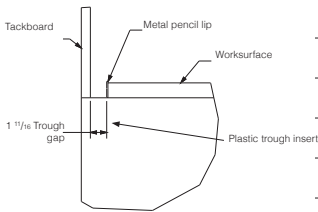

**EXAMPLE A**

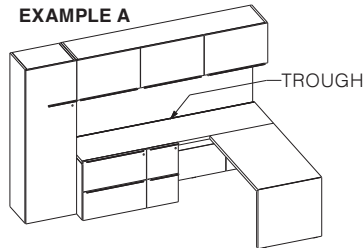

**EXAMPLE B**

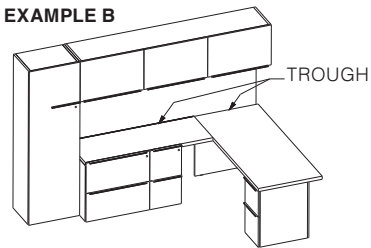

Trough insert is required across the entire length of trough.

**EXAMPLE A:** 108" back edge of credenza = 108" Trough Insert

**EXAMPLE B:** (72" back edge of return) + (36" LH end of desk) - (6" Desk overhang) = 102" Trough Insert

**NOTE:** overhang only needs to be deducted from overall length for single pedestal desks

**PRODUCT INFO**

Trough insert is black plastic

**TO ORDER PLEASE SPECIFY THE FOLLOWING:**

1.  **MODEL NUMBER**
2.  **OFFICE #**

**See inside front cover for required option codes**

Example

|                         |                 |
|-------------------------|-----------------|
| <b>GAATROUGH30.OFC1</b> |                 |
| GAATROUGH30             | OFC1            |
| <b>MODEL NUMBER</b>     | <b>OFFICE #</b> |

|              | for use with top sizes | D  | W  | H      | model number     | list  |
|--------------|------------------------|----|----|--------|------------------|-------|
| <b>BASES</b> | 24 x 42                | 21 | 42 | 26 5/8 | <b>BSHAT2142</b> | 3,171 |
|              | 24 x 48                | 21 | 48 | 26 5/8 | <b>BSHAT2148</b> | 3,185 |
|              | 24 x 54                | 21 | 54 | 26 5/8 | <b>BSHAT2154</b> | 3,204 |
|              | 24 x 60                | 21 | 60 | 26 5/8 | <b>BSHAT2160</b> | 3,218 |
|              | 24 x 66                | 21 | 66 | 26 5/8 | <b>BSHAT2166</b> | 3,237 |
|              | 24 x 72                | 21 | 72 | 26 5/8 | <b>BSHAT2172</b> | 3,252 |

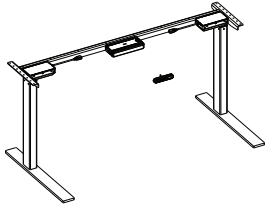

|            |    |    |        |                  |       |
|------------|----|----|--------|------------------|-------|
| 30/36 x 48 | 27 | 48 | 26 5/8 | <b>BSHAT2748</b> | 3,218 |
| 30/36 x 54 | 27 | 54 | 26 5/8 | <b>BSHAT2754</b> | 3,237 |
| 30/36 x 60 | 27 | 60 | 26 5/8 | <b>BSHAT2760</b> | 3,252 |
| 30/36 x 66 | 27 | 66 | 26 5/8 | <b>BSHAT2766</b> | 3,272 |
| 30/36 x 72 | 27 | 72 | 26 5/8 | <b>BSHAT2772</b> | 3,287 |



Base at lowest height setting

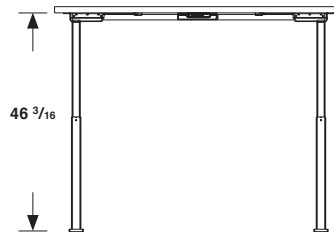

Base at tallest height setting

## PRODUCT INFO

TO ORDER PLEASE SPECIFY THE FOLLOWING:

1.  **MODEL NUMBER**
2.  **BASE COLOR**

**BASE COLOR OPTIONS:**

- BK** Black
- SV** Silver

See inside front cover for required option codes

Example

BSHAT2760.BK  
 BSHAT2760 BK  
 MODEL NUMBER BASE COLOR



|  | D  | W  | H     | model number         | veneer 2 | veneer 3 |
|--|----|----|-------|----------------------|----------|----------|
| <b>24" TOPS</b><br> | 24 | 42 | 1 1/2 | <b>GA2DWRA2442-W</b> | 1,693    | 1,847    |
|  | 24 | 48 | 1 1/2 | <b>GA2DWRA2448-W</b> | 1,781    | 1,943    |
|  | 24 | 54 | 1 1/2 | <b>GA2DWRA2454-W</b> | 1,875    | 2,045    |
|  | 24 | 60 | 1 1/2 | <b>GA2DWRA2460-W</b> | 1,975    | 2,154    |
|  | 24 | 66 | 1 1/2 | <b>GA2DWRA2466-W</b> | 2,079    | 2,268    |
|  | 24 | 72 | 1 1/2 | <b>GA2DWRA2472-W</b> | 2,191    | 2,390    |

**PRODUCT INFO**

**TO ORDER PLEASE SPECIFY THE FOLLOWING:**

1.
2.
3.
4.
5.
6.

**MODEL NUMBER**  
**FINISH**  
**TOP FINISH TYPE**  
**GRAIN DIRECTION**  
**GROMMET**  
**OFFICE #**

**See set 1 below for grommet option codes**

**No Grommet**    **GN**  
 Left            **GL (Add +\$197)**  
 Center         **GC (Add +\$197)**  
 Right          **GR (Add +\$197)**  
 Both            **GB (Add +\$394)**

**Add grommet bezel color and door finish to complete option pick.**

**SV** = silver bezel, veneer door  
**BV** = black bezel, veneer door  
**WG** = silver bezel, white glass door  
**BG** = black bezel, black glass door  
**MG** = silver bezel, muslin glass door

**See inside front cover for required option codes**

**Example: GLSV = left grommet, silver bezel, veneer door**

Example

**GA2DWRA2442-W.NC215.FF.VLG.GN.OFC1**

|                             |                       |                           |                                |                        |                         |
|-----------------------------|-----------------------|---------------------------|--------------------------------|------------------------|-------------------------|
| GA2DWRA2442-W               | NC215                 | FF                        | VLG                            | GN                     | OFC1                    |
| <small>MODEL NUMBER</small> | <small>FINISH</small> | <small>TOP FINISH</small> | <small>GRAIN DIRECTION</small> | <small>GROMMET</small> | <small>OFFICE #</small> |

# HEIGHT ADJUSTABLE TOPS

**Credentials**  
02/24

|  | D  | W  | H     | model number         | veneer 2 | veneer 3 |
|--|----|----|-------|----------------------|----------|----------|
| <b>30" TOPS</b><br> | 30 | 48 | 1 1/2 | <b>GA2DWRA3048-W</b> | 2,072    | 2,260    |
|  | 30 | 54 | 1 1/2 | <b>GA2DWRA3054-W</b> | 2,195    | 2,394    |
|  | 30 | 60 | 1 1/2 | <b>GA2DWRA3060-W</b> | 2,369    | 2,584    |
|  | 30 | 66 | 1 1/2 | <b>GA2DWRA3066-W</b> | 2,521    | 2,750    |
|  | 30 | 72 | 1 1/2 | <b>GA2DWRA3072-W</b> | 2,591    | 2,826    |

|  |    |    |       |                      |       |       |
|--|----|----|-------|----------------------|-------|-------|
| <b>36" TOPS</b><br> | 36 | 48 | 1 1/2 | <b>GA2DWRA3648-W</b> | 2,422 | 2,642 |
|  | 36 | 54 | 1 1/2 | <b>GA2DWRA3654-W</b> | 2,561 | 2,794 |
|  | 36 | 60 | 1 1/2 | <b>GA2DWRA3660-W</b> | 2,710 | 2,956 |
|  | 36 | 66 | 1 1/2 | <b>GA2DWRA3666-W</b> | 2,917 | 3,182 |
|  | 36 | 72 | 1 1/2 | <b>GA2DWRA3672-W</b> | 2,980 | 3,251 |

## PRODUCT INFO

TO ORDER PLEASE SPECIFY THE FOLLOWING:

1.  **MODEL NUMBER**
2.  **FINISH**
3.  **TOP FINISH TYPE**
4.  **GRAIN DIRECTION**
5.  **GROMMET**
6.  **OFFICE #**

See set 1 below for grommet option codes

**No Grommet GN**  
 Left **GL (Add +\$197)**  
 Right **GR (Add +\$197)**  
 Both **GB (Add +\$394)**

**Add grommet bezel color and door finish to complete option pick.**

**SV** = silver bezel, veneer door  
**BV** = black bezel, veneer door  
**WG** = silver bezel, white glass door  
**BG** = black bezel, black glass door  
**MG** = silver bezel, muslin glass door

See inside front cover for required option codes

**Example: GLSV = left grommet, silver bezel, veneer door**

Example

GA2DWRA3048-W.NC215.FF.VLG.GN.OFC1

|                     |               |                   |                        |                |                 |
|---------------------|---------------|-------------------|------------------------|----------------|-----------------|
| GA2DWRA3048-W       | NC215         | FF                | VLG                    | GN             | OFC1            |
| <b>MODEL NUMBER</b> | <b>FINISH</b> | <b>TOP FINISH</b> | <b>GRAIN DIRECTION</b> | <b>GROMMET</b> | <b>OFFICE #</b> |

# HEIGHT ADJUSTABLE MODESTY PANEL

Optional | for use with 30" and 36" Tops

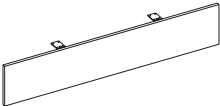
|  | D   | W  | H  | model number       | veneer 2 | veneer 3 |
|--|-----|----|----|--------------------|----------|----------|
| <b>MODESTY PANELS</b><br> | 3/4 | 48 | 10 | <b>GA2DMHA48-W</b> | 943      | 1,029    |
|  | 3/4 | 54 | 10 | <b>GA2DMHA54-W</b> | 995      | 1,085    |
|  | 3/4 | 60 | 10 | <b>GA2DMHA60-W</b> | 1,050    | 1,145    |
|  | 3/4 | 66 | 10 | <b>GA2DMHA66-W</b> | 1,109    | 1,210    |
|  | 3/4 | 72 | 10 | <b>GA2DMHA72-W</b> | 1,153    | 1,258    |

- Optional 10" height modesty panel with 6" overhang

**PRODUCT INFO**

TO ORDER PLEASE SPECIFY THE FOLLOWING:

1.  **MODEL NUMBER**
2.  **FINISH**
3.  **OFFICE #**

**See inside front cover for required option codes**

Example

**GA2DMHA48-W.NC215.OFC1**  
 GA2DMHA48-W      NC215      OFC1  
 MODEL NUMBER      FINISH      OFFICE #



|  |         |
|--|---------|
| Storage . . . . .                          | 105-115 |
| Lateral Files . . . . .                    | 106-107 |
| Bookcases . . . . .                        | 108     |
| Hinged Door Cabinets . . . . .             | 109     |
| Closets . . . . .                          | 110-113 |
| Storage Box . . . . .                      | 114     |
| Utility Cabinets . . . . .                 | 115     |
| Overheads . . . . .                        | 116-136 |
| Single Wall Mount Overheads . . . . .      | 116-121 |
| Double High Wall Mount Overheads . . . . . | 122-125 |
| Tackboards . . . . .                       | 126-129 |
| Back Painted Glass Whiteboards . . . . .   | 130-132 |
| Wood Magnetic Tackzone . . . . .           | 133-135 |
| Shelves for Segmented Tackzone . . . . .   | 136     |
| Miscellaneous                              |         |
| Round Tables & Bases . . . . .             | 137     |
| Accessories . . . . .                      | 138-147 |
| Fabric Grade Pricing . . . . .             | 148-151 |
| Weights + Cubes . . . . .                  | 152-160 |

# LATERAL FILES

Layers & 2 high

**Credentials**

02/24

|  | D | W | H | model number | veneer 2 | veneer 3 |
|--|---|---|---|--------------|----------|----------|
|--|---|---|---|--------------|----------|----------|

### 30" WIDTH LAYERS

STANDARD



|        |    |          |                         |       |       |
|--------|----|----------|-------------------------|-------|-------|
| 24 7/8 | 30 | 21 11/16 | <b>GA2LFS LH2430-WW</b> | 5,198 | 5,670 |
|--------|----|----------|-------------------------|-------|-------|

### 36" WIDTH LAYERS

STANDARD



|        |    |          |                         |       |       |
|--------|----|----------|-------------------------|-------|-------|
| 24 7/8 | 36 | 21 11/16 | <b>GA2LFS LH2436-WW</b> | 5,455 | 5,951 |
|--------|----|----------|-------------------------|-------|-------|

### 30" WIDTH 2 HIGH

STANDARD



|        |    |         |                         |       |       |
|--------|----|---------|-------------------------|-------|-------|
| 24 7/8 | 30 | 29 7/16 | <b>GA2LFS 2H2430-WW</b> | 5,472 | 5,969 |
|--------|----|---------|-------------------------|-------|-------|

W/ TROUGH BACK



|        |    |         |                          |       |       |
|--------|----|---------|--------------------------|-------|-------|
| 24 7/8 | 30 | 29 7/16 | <b>GA2LFS 2H2430T-WW</b> | 5,472 | 5,969 |
|--------|----|---------|--------------------------|-------|-------|

### 36" WIDTH 2 HIGH

STANDARD



|        |    |         |                         |       |       |
|--------|----|---------|-------------------------|-------|-------|
| 24 7/8 | 36 | 29 7/16 | <b>GA2LFS 2H2436-WW</b> | 5,742 | 6,264 |
|--------|----|---------|-------------------------|-------|-------|

W/ TROUGH BACK



|        |    |         |                          |       |       |
|--------|----|---------|--------------------------|-------|-------|
| 24 7/8 | 36 | 29 7/16 | <b>GA2LFS 2H2436T-WW</b> | 5,742 | 6,264 |
|--------|----|---------|--------------------------|-------|-------|

- Trough back units are required when a tackzone spans over the back of the worksurface
- Trough units include a metal pencil lip

**NOTE:** Plastic Trough Insert is REQUIRED and must be ordered separately. Freestanding Lateral Files and Hinged Door Cabinets require their own trough insert.

## PRODUCT INFO

All units have a finished back

All pedestals have optional face locks

Layers height includes hidden upper box drawer

## TO ORDER PLEASE SPECIFY THE FOLLOWING:

- |    |                      |                                       |
|----|----------------------|---------------------------------------|
| 1. | <input type="text"/> | <b>MODEL NUMBER</b>                   |
| 2. | <input type="text"/> | <b>FINISH</b>                         |
| 3. | <input type="text"/> | <b>TOP FINISH TYPE</b>                |
| 4. | <input type="text"/> | <b>GRAIN DIRECTION</b>                |
| 5. | <input type="text"/> | <b>PULL</b>                           |
| 6. | <input type="text"/> | <b>LOCKING</b>                        |
| 7. | <input type="text"/> | <b>KEYING</b>                         |
| 8. | <input type="text"/> | <b>PENCIL LIP COLOR (TROUGH ONLY)</b> |
| 9. | <input type="text"/> | <b>OFFICE #</b>                       |

**Grain Direction:** specify grain direction to match that of adjoining unit.

**Example:**  
Specify "VST" short grain if next to:  
-Unitized Full Bank Credenza, Desk, or Extension





Specify "VLG" long grain if next to:  
-Modular Single Pedestal Credenza, or Return



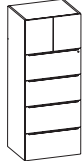

See inside front cover for required option codes

Example

GA2LFS LH2430-WW.NC215.VLG.MPS.LY.RMS.PLS.OFC1

|                     |               |                   |                        |             |                |               |                         |                 |
|---------------------|---------------|-------------------|------------------------|-------------|----------------|---------------|-------------------------|-----------------|
| GA2LFS LH2430-WW    | NC215         | FF                | VLG                    | MPS         | LY             | RMS           | PLS                     | OFC1            |
| <b>MODEL NUMBER</b> | <b>FINISH</b> | <b>TOP FINISH</b> | <b>GRAIN DIRECTION</b> | <b>PULL</b> | <b>LOCKING</b> | <b>KEYING</b> | <b>PENCIL LIP COLOR</b> | <b>OFFICE #</b> |

|   | D      | W  | H        | model number           | veneer 2 | veneer 3 |
|---|--------|----|----------|------------------------|----------|----------|
| <b>30" WIDTH</b>  |        |    |          |                        |          |          |
|  | 24 7/8 | 30 | 43 7/16  | <b>GA2LFS3H2430-WW</b> | 7,554    | 8,241    |
|  | 24 7/8 | 30 | 57 7/16  | <b>GA2LFS4H2430-WW</b> | 9,276    | 10,119   |
|  | 24 7/8 | 30 | 75 15/16 | <b>GA2LFS5H2430-WW</b> | 12,493   | 13,629   |
|  | 24 7/8 | 30 | 84 7/16  | <b>GA2LFS6H2430-WW</b> | 13,445   | 14,667   |

|   |        |    |          |                        |        |        |
|---|--------|----|----------|------------------------|--------|--------|
| <b>36" WIDTH</b>  |        |    |          |                        |        |        |
|    | 24 7/8 | 36 | 43 7/16  | <b>GA2LFS3H2436-WW</b> | 7,930  | 8,651  |
|   | 24 7/8 | 36 | 57 7/16  | <b>GA2LFS4H2436-WW</b> | 9,740  | 10,625 |
|  | 24 7/8 | 36 | 75 15/16 | <b>GA2LFS5H2436-WW</b> | 13,119 | 14,312 |
|  | 24 7/8 | 36 | 84 7/16  | <b>GA2LFS6H2436-WW</b> | 14,118 | 15,401 |

**NOTE:** 5 High and 6 High Lateral Files do not have locks on top doors. These doors are equipped with touch latches and free swing hinges.

**PRODUCT INFO**

All units have a finished back

All pedestals have optional face locks

5H and 6H Lateral Files do not lock on top doors.

**TO ORDER PLEASE SPECIFY THE FOLLOWING:**

1.  **MODEL NUMBER**
2.  **FINISH**
3.  **PULL**
4.  **LOCKING**
5.  **KEYING**
6.  **OFFICE #**

**See inside front cover for required option codes**

Example









GA2LFS3H2430-WW.NC215.MPS.LY.RM.OFC1  
 GA2LFS3H2430-WW    NC215    MPS    LY    RMS    OFC1  
 MODEL NUMBER    FINISH    PULL    LOCKING    KEYING    OFFICE #

# BOOKCASES

2 High | 6 high

Credentials

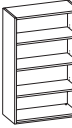
02/24

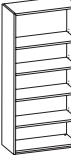
|   |        | D      | W  | H        | model number          | veneer 2 | veneer 3 |
|---|--------|--------|----|----------|-----------------------|----------|----------|
| <b>30" WIDTH</b>  |        |        |    |          |                       |          |          |
|    | 2 HIGH | 16 7/8 | 30 | 29 7/16  | <b>GA2BKN2H1830-W</b> | 3,176    | 3,465    |
|    | 3 HIGH | 16 7/8 | 30 | 43 7/16  | <b>GA2BKN3H1830-W</b> | 3,812    | 4,158    |
|    | 4 HIGH | 16 7/8 | 30 | 57 7/16  | <b>GA2BKN4H1830-W</b> | 4,578    | 4,994    |
|    | 5 HIGH | 16 7/8 | 30 | 75 15/16 | <b>GA2BKN5H1830-W</b> | 5,489    | 5,988    |
|    | 6 HIGH | 16 7/8 | 30 | 84 7/16  | <b>GA2BKN6H1830-W</b> | 6,589    | 7,188    |
| <b>36" WIDTH</b>  |        |        |    |          |                       |          |          |
|    | 2 HIGH | 16 7/8 | 36 | 29 7/16  | <b>GA2BKN2H1836-W</b> | 3,559    | 3,882    |
|   | 3 HIGH | 16 7/8 | 36 | 43 7/16  | <b>GA2BKN3H1836-W</b> | 4,274    | 4,662    |
|  | 4 HIGH | 16 7/8 | 36 | 57 7/16  | <b>GA2BKN4H1836-W</b> | 5,125    | 5,591    |
|  | 5 HIGH | 16 7/8 | 36 | 75 15/16 | <b>GA2BKN5H1836-W</b> | 6,152    | 6,711    |
|  | 6 HIGH | 16 7/8 | 36 | 84 7/16  | <b>GA2BKN6H1836-W</b> | 7,383    | 8,054    |

## PRODUCT INFO

All units have a finished back

6-high bookcases must be attached to wall

## TO ORDER PLEASE SPECIFY THE FOLLOWING:

1.  **MODEL NUMBER**
2.  **FINISH**
3.  **OFFICE #**

See inside front cover for required option codes

Example

GA2BKN2H1830-W.NC215.OFC1  
 GA2BKN2H1830-W    NC215    OFC1  
 MODEL NUMBER    FINISH    OFFICE #



|                         | D      | W  | H        | model number           | veneer 2 | veneer 3 |
|-------------------------|--------|----|----------|------------------------|----------|----------|
| <b>30" WIDTH LAYERS</b> |        |    |          |                        |          |          |
| STANDARD                | 24 7/8 | 30 | 21 11/16 | <b>GA2HDCLH2430-WW</b> | 3,951    | 4,310    |



|                         |        |    |          |                        |       |       |
|-------------------------|--------|----|----------|------------------------|-------|-------|
| <b>36" WIDTH LAYERS</b> |        |    |          |                        |       |       |
| STANDARD                | 24 7/8 | 36 | 21 11/16 | <b>GA2HDCLH2436-WW</b> | 4,367 | 4,764 |



|                         |        |    |         |                        |       |       |
|-------------------------|--------|----|---------|------------------------|-------|-------|
| <b>30" WIDTH 2 HIGH</b> |        |    |         |                        |       |       |
| STANDARD                | 24 7/8 | 30 | 29 7/16 | <b>GA2HDC2H2430-WW</b> | 4,161 | 4,539 |



|                |        |    |         |                         |       |       |
|----------------|--------|----|---------|-------------------------|-------|-------|
| W/ TROUGH BACK | 24 7/8 | 30 | 29 7/16 | <b>GA2HDC2H2430T-WW</b> | 4,161 | 4,539 |
|----------------|--------|----|---------|-------------------------|-------|-------|



|                         |        |    |         |                        |       |       |
|-------------------------|--------|----|---------|------------------------|-------|-------|
| <b>36" WIDTH 2 HIGH</b> |        |    |         |                        |       |       |
| STANDARD                | 24 7/8 | 36 | 29 7/16 | <b>GA2HDC2H2436-WW</b> | 4,595 | 5,013 |



|                |        |    |         |                         |       |       |
|----------------|--------|----|---------|-------------------------|-------|-------|
| W/ TROUGH BACK | 24 7/8 | 36 | 29 7/16 | <b>GA2HDC2H2436T-WW</b> | 4,595 | 5,013 |
|----------------|--------|----|---------|-------------------------|-------|-------|



- Trough back units are required when a tackzone spans over the back of the worksurface
- Trough units include a metal pencil lip

**NOTE:** Plastic Trough Insert is REQUIRED and must be ordered separately. Freestanding Lateral Files and Hinged Door Cabinets require their own trough insert.

**PRODUCT INFO**

All units have a finished back

Units do not lock

**TO ORDER PLEASE SPECIFY THE FOLLOWING:**

- |    |                      |                                      |
|----|----------------------|--------------------------------------|
| 1. | <input type="text"/> | <b>MODEL NUMBER</b>                  |
| 2. | <input type="text"/> | <b>FINISH</b>                        |
| 3. | <input type="text"/> | <b>TOP FINISH</b>                    |
| 4. | <input type="text"/> | <b>GRAIN DIRECTION</b>               |
| 5. | <input type="text"/> | <b>PULL</b>                          |
| 6. | <input type="text"/> | <b>PENCIL LIP COLOR(TROUGH ONLY)</b> |
| 7. | <input type="text"/> | <b>OFFICE #</b>                      |

**Grain Direction:** specify grain direction to match that of adjoining unit.

**Example:**  
Specify "VST" short grain if next to:  
-Unitized Full Bank Credenza, Desk, or Extension

Specify "VLG" long grain if next to:  
-Modular Single Pedestal Credenza, or Return

**See inside front cover for required option codes**

Example

GA2HDCLH2430-WW.NC215.OP.VLG.MPS.PLS.OFC1  
 GA2HDCLH2430-WW    NC215    OP    VLG    MPS    PLS    OFC1  
 MODEL NUMBER    FINISH    TOP FINISH    GRAIN DIRECTION    PULL    PENCIL LIP COLOR    OFFICE #

# CLOSETS – 18D

5 High

Credentials

02/24

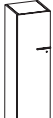
|   | D      | W  | H        | model number            | veneer 2 | veneer 3 |
|---|--------|----|----------|-------------------------|----------|----------|
| <b>18" WIDTH LEFT HAND</b><br> | 17 3/4 | 18 | 75 15/16 | <b>GA2CLC5H1818L-WW</b> | 5,645    | 6,158    |
|   | 17 3/4 | 18 | 75 15/16 | <b>GA2CLS5H1818L-WW</b> | 6,289    | 6,861    |
|   | 17 3/4 | 18 | 75 15/16 | <b>GA2CLD5H1818L-WW</b> | 7,031    | 7,670    |

- CLC = Coat hook with (1) adjustable shelf
- CLS = (4) adjustable shelves
- CLD = Coat hook with (1) adjustable shelf | Divider | (4) adjustable shelves

## 18" WIDTH RIGHT HAND

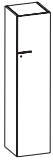

|        |    |          |                         |       |       |
|--------|----|----------|-------------------------|-------|-------|
| 17 3/4 | 18 | 75 15/16 | <b>GA2CLC5H1818R-WW</b> | 5,645 | 6,158 |
| 17 3/4 | 18 | 75 15/16 | <b>GA2CLS5H1818R-WW</b> | 6,289 | 6,861 |
| 17 3/4 | 18 | 75 15/16 | <b>GA2CLD5H1818R-WW</b> | 7,031 | 7,670 |

- CLC = Coat hook with (1) adjustable shelf
- CLS = (4) adjustable shelves
- CLD = Coat hook with (1) adjustable shelf | Divider | (4) adjustable shelves

## 24" WIDTH LEFT HAND

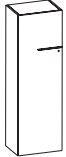

|        |    |          |                         |       |       |
|--------|----|----------|-------------------------|-------|-------|
| 17 3/4 | 24 | 75 15/16 | <b>GA2CLD5H1824L-WW</b> | 8,080 | 8,814 |
|--------|----|----------|-------------------------|-------|-------|

- CLD = Coat hook with (1) adjustable shelf | Divider | (4) adjustable shelves

## 24" WIDTH RIGHT HAND

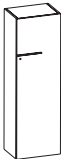

|        |    |          |                         |       |       |
|--------|----|----------|-------------------------|-------|-------|
| 17 3/4 | 24 | 75 15/16 | <b>GA2CLD5H1824R-WW</b> | 8,080 | 8,814 |
|--------|----|----------|-------------------------|-------|-------|

- CLD = Coat hook with (1) adjustable shelf | Divider | (4) adjustable shelves

## 30" WIDTH

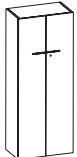

|        |    |          |                        |       |        |
|--------|----|----------|------------------------|-------|--------|
| 17 3/4 | 30 | 75 15/16 | <b>GA2CLS5H1830-WW</b> | 9,118 | 9,947  |
| 17 3/4 | 30 | 75 15/16 | <b>GA2CLD5H1830-WW</b> | 9,841 | 10,736 |

- CLS = (4) adjustable shelves
- CLD = Coat hook with (1) adjustable shelf | Divider | (4) adjustable shelves

### PRODUCT INFO

All units have a finished back

All units have optional face locks

### TO ORDER PLEASE SPECIFY THE FOLLOWING:

|    |                      |                     |
|----|----------------------|---------------------|
| 1. | <input type="text"/> | <b>MODEL NUMBER</b> |
| 2. | <input type="text"/> | <b>FINISH</b>       |
| 3. | <input type="text"/> | <b>PULL</b>         |
| 4. | <input type="text"/> | <b>LOCKING</b>      |
| 5. | <input type="text"/> | <b>KEYING</b>       |
| 6. | <input type="text"/> | <b>OFFICE #</b>     |

See inside front cover for required option codes

Example

GA2CLC5H1818L-WW.NC215.MPS.LY.RMS.OFC1

|                     |               |             |                |               |                 |
|---------------------|---------------|-------------|----------------|---------------|-----------------|
| GA2CLC5H1818L-WW    | NC215         | MPS         | LY             | RMS           | OFC1            |
| <b>MODEL NUMBER</b> | <b>FINISH</b> | <b>PULL</b> | <b>LOCKING</b> | <b>KEYING</b> | <b>OFFICE #</b> |

|                            | D      | W  | H       | model number            | veneer 2 | veneer 3 |
|----------------------------|--------|----|---------|-------------------------|----------|----------|
| <b>18" WIDTH LEFT HAND</b> | 17 3/4 | 18 | 84 7/16 | <b>GA2CLC6H1818L-WW</b> | 6,318    | 6,892    |
|                            | 17 3/4 | 18 | 84 7/16 | <b>GA2CLS6H1818L-WW</b> | 7,043    | 7,683    |
|                            | 17 3/4 | 18 | 84 7/16 | <b>GA2CLD6H1818L-WW</b> | 7,872    | 8,588    |



- CLC = Coat hook with (2) adjustable shelves
- CLS = (5) adjustable shelves
- CLD = Coat hook with (2) adjustable adjustable shelf | Divider | (5) adjustable shelves

**18" WIDTH RIGHT HAND**



|        |    |         |                         |       |       |
|--------|----|---------|-------------------------|-------|-------|
| 17 3/4 | 18 | 84 7/16 | <b>GA2CLC6H1818R-WW</b> | 6,318 | 6,892 |
| 17 3/4 | 18 | 84 7/16 | <b>GA2CLS6H1818R-WW</b> | 7,043 | 7,683 |
| 17 3/4 | 18 | 84 7/16 | <b>GA2CLD6H1818R-WW</b> | 7,872 | 8,588 |

- CLC = Coat hook with (2) adjustable shelves
- CLS = (5) adjustable shelves
- CLD = Coat hook with (2) adjustable adjustable shelf | Divider | (5) adjustable shelves

**24" WIDTH LEFT HAND**

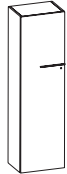

|        |    |         |                         |       |       |
|--------|----|---------|-------------------------|-------|-------|
| 17 3/4 | 24 | 84 7/16 | <b>GA2CLD6H1824L-WW</b> | 9,056 | 9,879 |
|--------|----|---------|-------------------------|-------|-------|

- CLD = Coat hook with (2) adjustable shelves | Divider | (5) adjustable shelves

**24" WIDTH RIGHT HAND**



|        |    |         |                         |       |       |
|--------|----|---------|-------------------------|-------|-------|
| 17 3/4 | 24 | 84 7/16 | <b>GA2CLD6H1824R-WW</b> | 9,056 | 9,879 |
|--------|----|---------|-------------------------|-------|-------|

- CLD = Coat hook with (2) adjustable shelves | Divider | (5) adjustable shelves

**PRODUCT INFO**

All units have a finished back

All units have optional face locks

**TO ORDER PLEASE SPECIFY THE FOLLOWING:**

- |    |                      |                     |
|----|----------------------|---------------------|
| 1. | <input type="text"/> | <b>MODEL NUMBER</b> |
| 2. | <input type="text"/> | <b>FINISH</b>       |
| 3. | <input type="text"/> | <b>PULL</b>         |
| 4. | <input type="text"/> | <b>LOCKING</b>      |
| 5. | <input type="text"/> | <b>KEYING</b>       |
| 6. | <input type="text"/> | <b>OFFICE #</b>     |

**See inside front cover for required option codes**

Example

GA2CLC6H1818L-WW.NC215.MPS.LY.RMS.OFC1  
 GA2CLC6H1818L-WW    NC215    MPS    LY    RMS    OFC1  
 MODEL NUMBER    FINISH    PULL    LOCKING    KEYING    OFFICE #

# CLOSETS – 24D

5 High

**Credentials**  
02/24

| D                          | W  | H        | model number            | veneer 2 | veneer 3 |
|----------------------------|----|----------|-------------------------|----------|----------|
| <b>18" WIDTH LEFT HAND</b> |    |          |                         |          |          |
| 24 7/8                     | 18 | 75 15/16 | <b>GA2CLC5H2418L-WW</b> | 5,940    | 6,480    |
| 24 7/8                     | 18 | 75 15/16 | <b>GA2CLS5H2418L-WW</b> | 6,617    | 7,218    |
| 24 7/8                     | 18 | 75 15/16 | <b>GA2CLD5H2418L-WW</b> | 7,397    | 8,069    |



- CLC = Closet rod with (1) adjustable shelf
- CLS = (4) adjustable shelves
- CLD = Closet rod with (1) adjustable shelf | Divider | (4) adjustable shelves

## 18" WIDTH RIGHT HAND



|        |    |          |                         |       |       |
|--------|----|----------|-------------------------|-------|-------|
| 24 7/8 | 18 | 75 15/16 | <b>GA2CLC5H2418R-WW</b> | 5,940 | 6,480 |
| 24 7/8 | 18 | 75 15/16 | <b>GA2CLS5H2418R-WW</b> | 6,617 | 7,218 |
| 24 7/8 | 18 | 75 15/16 | <b>GA2CLD5H2418R-WW</b> | 7,397 | 8,069 |

- CLC = Closet rod with (1) adjustable shelf
- CLD = Closet rod with (1) adjustable shelf | Divider | (4) adjustable shelves

## 24" WIDTH LEFT HAND

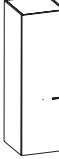

|        |    |          |                         |       |       |
|--------|----|----------|-------------------------|-------|-------|
| 24 7/8 | 24 | 75 15/16 | <b>GA2CLD5H2424L-WW</b> | 8,511 | 9,285 |
|--------|----|----------|-------------------------|-------|-------|

- CLD = Closet rod with (1) adjustable shelf | Divider | (4) adjustable shelves

## 24" WIDTH RIGHT HAND



|        |    |          |                         |       |       |
|--------|----|----------|-------------------------|-------|-------|
| 24 7/8 | 24 | 75 15/16 | <b>GA2CLD5H2424R-WW</b> | 8,511 | 9,285 |
|--------|----|----------|-------------------------|-------|-------|

- CLD = Closet rod with (1) adjustable shelf | Divider | (4) adjustable shelves

## 30" WIDTH



|        |    |          |                        |        |        |
|--------|----|----------|------------------------|--------|--------|
| 24 7/8 | 30 | 75 15/16 | <b>GA2CLS5H2430-WW</b> | 9,596  | 10,468 |
| 24 7/8 | 30 | 75 15/16 | <b>GA2CLD5H2430-WW</b> | 10,358 | 11,300 |

- CLS = (4) adjustable shelves
- CLD = Closet rod with (1) adjustable shelf | Divider | (4) adjustable shelves

### PRODUCT INFO

All units have a finished back

All units have optional face locks

Metal pull height matches 29H pedestal pulls

### TO ORDER PLEASE SPECIFY THE FOLLOWING:

|    |                      |                     |
|----|----------------------|---------------------|
| 1. | <input type="text"/> | <b>MODEL NUMBER</b> |
| 2. | <input type="text"/> | <b>FINISH</b>       |
| 3. | <input type="text"/> | <b>PULL</b>         |
| 4. | <input type="text"/> | <b>LOCKING</b>      |
| 5. | <input type="text"/> | <b>KEYING</b>       |
| 6. | <input type="text"/> | <b>OFFICE #</b>     |

See inside front cover for required option codes

Example

GA2CLC5H2418L-WW.NC215.MPS.LY.RMS.OFC1

|                     |               |             |                |               |                 |
|---------------------|---------------|-------------|----------------|---------------|-----------------|
| GA2CLC5H2418L-WW    | NC215         | MPS         | LY             | RMS           | OFC1            |
| <b>MODEL NUMBER</b> | <b>FINISH</b> | <b>PULL</b> | <b>LOCKING</b> | <b>KEYING</b> | <b>OFFICE #</b> |

| D      | W  | H       | model number            | veneer 2 | veneer 3 |
|--------|----|---------|-------------------------|----------|----------|
| 24 7/8 | 18 | 84 7/16 | <b>GA2CLC6H2418L-WW</b> | 6,654    | 7,259    |
| 24 7/8 | 18 | 84 7/16 | <b>GA2CLS6H2418L-WW</b> | 7,414    | 8,088    |
| 24 7/8 | 18 | 84 7/16 | <b>GA2CLD6H2418L-WW</b> | 8,286    | 9,039    |

**18" WIDTH LEFT HAND**



- CLC = Closet rod with (2) adjustable shelves
- CLS = (5) adjustable shelves
- CLD = Closet rod with (2) adjustable adjustable shelf | Divider | (5) adjustable shelves

**18" WIDTH RIGHT HAND**



|        |    |         |                         |       |       |
|--------|----|---------|-------------------------|-------|-------|
| 24 7/8 | 18 | 84 7/16 | <b>GA2CLC6H2418R-WW</b> | 6,654 | 7,259 |
| 24 7/8 | 18 | 84 7/16 | <b>GA2CLS6H2418R-WW</b> | 7,414 | 8,088 |
| 24 7/8 | 18 | 84 7/16 | <b>GA2CLD6H2418R-WW</b> | 8,286 | 9,039 |

- CLC = Closet rod with (2) adjustable shelf
- CLS = (5) adjustable shelves
- CLD = Closet rod with (2) adjustable shelf | Divider | (5) adjustable shelves

**24" WIDTH LEFT HAND**



|        |    |         |                         |       |        |
|--------|----|---------|-------------------------|-------|--------|
| 24 7/8 | 24 | 84 7/16 | <b>GA2CLD6H2424L-WW</b> | 9,526 | 10,392 |
|--------|----|---------|-------------------------|-------|--------|

- CLD = Closet rod with (2) adjustable shelf | Divider | (5) adjustable shelves

**24" WIDTH RIGHT HAND**



|        |    |         |                         |       |        |
|--------|----|---------|-------------------------|-------|--------|
| 24 7/8 | 24 | 84 7/16 | <b>GA2CLD6H2424R-WW</b> | 9,526 | 10,392 |
|--------|----|---------|-------------------------|-------|--------|

- CLD = Closet rod with (2) adjustable shelf | Divider | (5) adjustable shelves

**PRODUCT INFO**

All units have a finished back

All units have optional face locks

Metal pull height matches 29H pedestal pulls

**TO ORDER PLEASE SPECIFY THE FOLLOWING:**

- |    |                      |                     |
|----|----------------------|---------------------|
| 1. | <input type="text"/> | <b>MODEL NUMBER</b> |
| 2. | <input type="text"/> | <b>FINISH</b>       |
| 3. | <input type="text"/> | <b>PULL</b>         |
| 4. | <input type="text"/> | <b>LOCKING</b>      |
| 5. | <input type="text"/> | <b>KEYING</b>       |
| 6. | <input type="text"/> | <b>OFFICE #</b>     |

**See inside front cover for required option codes**

Example

GA2CLC6H2418L-WW.NC215.MPS.LY.RMS.OFC1  
 GA2CLC6H2418L-WW    NC215    MPS    LY    RMS    OFC1  
 MODEL NUMBER    FINISH    PULL    LOCKING    KEYING    OFFICE #

# STORAGE BOX

5 High | 6 high

Credentials

02/24

|   | D   | W      | H  | model number | veneer 2                | veneer 3      |
|---|---|--------|----|--------------|-------------------------|---------------|
| <b>5 HIGH</b>   |   |        |    |              |                         |               |
|   | 18" WIDTH LEFT HAND   | 24 7/8 | 18 | 75 15/16     | <b>GA2SBH5H2418L-WW</b> | 7,346 8,014   |
|   | <ul style="list-style-type: none"> <li>Includes (2) adjustable shelves behind doors</li> <li>(2) file drawers bottom, door upper</li> </ul> |        |    |              |                         |               |
|   | 18" WIDTH RIGHT HAND  | 24 7/8 | 18 | 75 15/16     | <b>GA2SBH5H2418R-WW</b> | 7,346 8,014   |
| <ul style="list-style-type: none"> <li>Includes (2) adjustable shelves behind doors</li> <li>(2) file drawers bottom, door upper</li> </ul> |   |        |    |              |                         |               |
|   | 30" WIDTH   | 24 7/8 | 30 | 75 15/16     | <b>GA2SBH5H2430-WW</b>  | 10,943 11,938 |
|   | <ul style="list-style-type: none"> <li>Includes (2) adjustable shelves behind doors</li> <li>(2) file drawers bottom, door upper</li> </ul> |        |    |              |                         |               |
|   | <b>6 HIGH</b>   |        |    |              |                         |               |
|   | 18" WIDTH LEFT HAND   | 24 7/8 | 18 | 84 7/16      | <b>GA2SBH6H2418L-WW</b> | 8,743 9,538   |
|   | <ul style="list-style-type: none"> <li>Includes (3) adjustable shelves behind door</li> <li>(2) file drawers bottom, door upper</li> </ul>  |        |    |              |                         |               |
|   | 18" WIDTH RIGHT HAND  | 24 7/8 | 18 | 84 7/16      | <b>GA2SBH6H2418R-WW</b> | 8,743 9,538   |
| <ul style="list-style-type: none"> <li>Includes (3) adjustable shelves behind door</li> <li>(2) file drawers bottom, door upper</li> </ul>  |   |        |    |              |                         |               |
|   | 30" WIDTH   | 24 7/8 | 30 | 84 7/16      | <b>GA2SBH6H2430-WW</b>  | 12,612 13,758 |
|   | <ul style="list-style-type: none"> <li>Includes (3) adjustable shelves behind door</li> <li>(2) file drawers bottom, door upper</li> </ul>  |        |    |              |                         |               |

## PRODUCT INFO

All units have a finished back

All units have optional face locks

## TO ORDER PLEASE SPECIFY THE FOLLOWING:

- |    |                      |                     |
|----|----------------------|---------------------|
| 1. | <input type="text"/> | <b>MODEL NUMBER</b> |
| 2. | <input type="text"/> | <b>FINISH</b>       |
| 3. | <input type="text"/> | <b>PULL</b>         |
| 4. | <input type="text"/> | <b>LOCKING</b>      |
| 5. | <input type="text"/> | <b>KEYING</b>       |
| 6. | <input type="text"/> | <b>OFFICE #</b>     |

See inside front cover for required option codes

Example

**GA2SBH5H2418L-WW.NC215.MPS.LY.RMS.OFC1**

|                     |               |             |                |               |                 |
|---------------------|---------------|-------------|----------------|---------------|-----------------|
| GA2SBH5H2418L-WW    | NC215         | MPS         | LY             | RMS           | OFC1            |
| <b>MODEL NUMBER</b> | <b>FINISH</b> | <b>PULL</b> | <b>LOCKING</b> | <b>KEYING</b> | <b>OFFICE #</b> |

|  | D          | W      | H  | model number | veneer 2                | veneer 3      |
|--|------------|--------|----|--------------|-------------------------|---------------|
| <b>5 HIGH</b>  |            |        |    |              |                         |               |
|   | LEFT HAND  | 24 7/8 | 24 | 75 15/16     | <b>GA2UTC5H2424L-WW</b> | 11,475 12,518 |
|   | RIGHT HAND | 24 7/8 | 24 | 75 15/16     | <b>GA2UTC5H2424R-WW</b> | 11,475 12,518 |
| <b>6 HIGH</b>  |            |        |    |              |                         |               |
|   | LEFT HAND  | 24 7/8 | 24 | 84 7/16      | <b>GA2UTC6H2424L-WW</b> | 13,162 14,358 |
|  | RIGHT HAND | 24 7/8 | 24 | 84 7/16      | <b>GA2UTC6H2424R-WW</b> | 13,162 14,358 |

**Note:** Tall door hinges off center divider on utility cabinets for side access to integral wood pulls.

**PRODUCT INFO**

All units have a finished back

All units have optional face locks

**TO ORDER PLEASE SPECIFY THE FOLLOWING:**

- 1.  **MODEL NUMBER**
- 2.  **FINISH**
- 3.  **PULL**
- 4.  **LOCKING**
- 5.  **KEYING**
- 6.  **OFFICE #**

**See inside front cover for required option codes**

Example

GA2UTC5H2424L-WW.NC215.MPS.LY.RMS.OFC1  
 GA2UTC5H2424L-WW    NC215    MPS    LY    RMS    OFC1  
 MODEL NUMBER    FINISH    PULL    LOCKING    KEYING    OFFICE #

# WALL MOUNT OVERHEADS

Hinged | wood doors

Credentials

02/24

## 1 HIGH

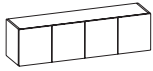

| D  | W   | H      | model number          | veneer 2 | veneer 3 |
|----|-----|--------|-----------------------|----------|----------|
| 18 | 30  | 19 1/2 | <b>GA2WCH1H30-WW</b>  | 4,486    | 4,894    |
| 18 | 36  | 19 1/2 | <b>GA2WCH1H36-WW</b>  | 4,689    | 5,115    |
| 18 | 60  | 19 1/2 | <b>GA2WCH1H60-WW</b>  | 7,862    | 8,577    |
| 18 | 66  | 19 1/2 | <b>GA2WCH1H66-WW</b>  | 8,210    | 8,956    |
| 18 | 72  | 19 1/2 | <b>GA2WCH1H72-WW</b>  | 8,578    | 9,358    |
| 18 | 78  | 19 1/2 | <b>GA2WCH1H78-WW</b>  | 9,293    | 10,138   |
| 18 | 84  | 19 1/2 | <b>GA2WCH1H84-WW</b>  | 9,702    | 10,584   |
| 18 | 90  | 19 1/2 | <b>GA2WCH1H90-WW</b>  | 10,128   | 11,049   |
| 18 | 96  | 19 1/2 | <b>GA2WCH1H96-WW</b>  | 10,560   | 11,520   |
| 18 | 102 | 19 1/2 | <b>GA2WCH1H102-WW</b> | 11,006   | 12,006   |
| 18 | 108 | 19 1/2 | <b>GA2WCH1H108-WW</b> | 11,478   | 12,521   |

- Units are available in wood integral pull only
- Recessed LED tasklights included

## PRODUCT INFO

Doors do not lock

Door widths:

30" = (2) doors

36" = (2) doors

60" = (4) doors

66" = (4) doors

72" = (4) doors

78" = (4) doors

84" = (6) doors

90" = (6) doors

96" = (6) doors

102" = (6) doors

108" = (6) doors

Hidden cubbies behind doors

TO ORDER PLEASE SPECIFY THE FOLLOWING:

|    |                      |                     |
|----|----------------------|---------------------|
| 1. | <input type="text"/> | <b>MODEL NUMBER</b> |
| 2. | <input type="text"/> | <b>FINISH</b>       |
| 3. | <input type="text"/> | <b>PULL</b>         |
| 4. | <input type="text"/> | <b>OFFICE #</b>     |

See inside front cover for required option codes

Example

|                                     |               |             |                 |
|-------------------------------------|---------------|-------------|-----------------|
| <b>GA2WCH1H30-WW.NC215.MPS.OFC1</b> |               |             |                 |
| GA2WCH1H30-WW                       | NC215         | MPS         | OFC1            |
| <b>MODEL NUMBER</b>                 | <b>FINISH</b> | <b>PULL</b> | <b>OFFICE #</b> |



**1 HIGH**

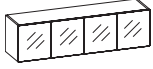

| D  | W   | H      | model number          | veneer 2 | veneer 3 |
|----|-----|--------|-----------------------|----------|----------|
| 18 | 30  | 19 1/2 | <b>GA2WCH1H30-WG</b>  | 5,065    | 5,525    |
| 18 | 36  | 19 1/2 | <b>GA2WCH1H36-WG</b>  | 5,299    | 5,781    |
| 18 | 60  | 19 1/2 | <b>GA2WCH1H60-WG</b>  | 8,853    | 9,658    |
| 18 | 72  | 19 1/2 | <b>GA2WCH1H72-WG</b>  | 9,678    | 10,558   |
| 18 | 90  | 19 1/2 | <b>GA2WCH1H90-WG</b>  | 11,412   | 12,449   |
| 18 | 108 | 19 1/2 | <b>GA2WCH1H108-WG</b> | 12,960   | 14,138   |

- Recessed LED tasklights included

**PRODUCT INFO**

Doors do not lock

Door widths:

30" = (2) doors

36" = (2) doors

60" = (4) doors

72" = (4) doors

90" = (6) doors

108" = (6) doors

Hidden cubbies behind doors

**TO ORDER PLEASE SPECIFY THE FOLLOWING:**

1.  **MODEL NUMBER**
2.  **FINISH**
3.  **GLASS COLOR**
4.  **OFFICE #**

**See inside front cover for required option codes**

Example

**GA2WCH1H30-WG.NC215.WH.OFC1**  
 GA2WCH1H30-WG    NC215    WH    OFC1  
 MODEL NUMBER    FINISH    GLASS COLOR    OFFICE #

# WALL MOUNT OVERHEADS

Soft lift | wood doors

**Credentials**

02/24

## 1 HIGH

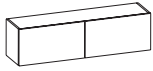

| D  | W   | H      | model number          | veneer 2 | veneer 3 |
|----|-----|--------|-----------------------|----------|----------|
| 18 | 60  | 19 1/2 | <b>GA2WCF1H60-WW</b>  | 8,193    | 8,938    |
| 18 | 72  | 19 1/2 | <b>GA2WCF1H72-WW</b>  | 8,943    | 9,756    |
| 18 | 90  | 19 1/2 | <b>GA2WCF1H90-WW</b>  | 10,560   | 11,520   |
| 18 | 108 | 19 1/2 | <b>GA2WCF1H108-WW</b> | 11,973   | 13,061   |

- Units are available in wood integral pull only
- Recessed LED tasklights included

### PRODUCT INFO

Doors do not lock

Door widths:

60" = (2) doors

72" = (2) doors

90" = (3) doors

108" = (3) doors

Hidden cubbies behind doors

TO ORDER PLEASE SPECIFY THE FOLLOWING:

|    |                      |                     |
|----|----------------------|---------------------|
| 1. | <input type="text"/> | <b>MODEL NUMBER</b> |
| 2. | <input type="text"/> | <b>FINISH</b>       |
| 3. | <input type="text"/> | <b>PULL</b>         |
| 4. | <input type="text"/> | <b>OFFICE #</b>     |

See inside front cover for required option codes

Example

GA2WCF1H60-WW.NC215.MPS.OFC1

|                     |               |             |                 |
|---------------------|---------------|-------------|-----------------|
| GA2WCF1H60-WW       | NC215         | MPS         | OFC1            |
| <b>MODEL NUMBER</b> | <b>FINISH</b> | <b>PULL</b> | <b>OFFICE #</b> |

**1 HIGH**

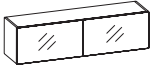

| D  | W   | H      | model number          | veneer 2 | veneer 3 |
|----|-----|--------|-----------------------|----------|----------|
| 18 | 60  | 19 1/2 | <b>GA2WCF1H60-WG</b>  | 9,236    | 10,076   |
| 18 | 72  | 19 1/2 | <b>GA2WCF1H72-WG</b>  | 10,098   | 11,016   |
| 18 | 90  | 19 1/2 | <b>GA2WCF1H90-WG</b>  | 11,904   | 12,986   |
| 18 | 108 | 19 1/2 | <b>GA2WCF1H108-WG</b> | 13,530   | 14,760   |

- Recessed LED tasklights included

**PRODUCT INFO**

Doors do not lock

Door widths:

60" = (2) doors

72" = (2) doors

90" = (3) doors

108" = (3) doors

Hidden cubbies behind doors

**TO ORDER PLEASE SPECIFY THE FOLLOWING:**

1.  **MODEL NUMBER**
2.  **FINISH**
3.  **GLASS COLOR**
4.  **OFFICE #**

**See inside front cover for required option codes**

Example

**GA2WCF1H60-WG.NC215.WH.OFC1**

|                             |                       |                            |                         |
|-----------------------------|-----------------------|----------------------------|-------------------------|
| GA2WCF1H60-WG               | NC215                 | WH                         | OFC1                    |
| <small>MODEL NUMBER</small> | <small>FINISH</small> | <small>GLASS COLOR</small> | <small>OFFICE #</small> |

# WALL MOUNT OVERHEADS

Sliding | wood doors

**Credentials**

02/24

## 1 HIGH

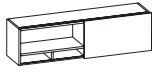

| D  | W   | H      | model number          | veneer 2 | veneer 3 |
|----|-----|--------|-----------------------|----------|----------|
| 18 | 60  | 19 1/2 | <b>GA2WCS1H60-WW</b>  | 8,193    | 8,938    |
| 18 | 72  | 19 1/2 | <b>GA2WCS1H72-WW</b>  | 8,943    | 9,756    |
| 18 | 90  | 19 1/2 | <b>GA2WCS1H90-WW</b>  | 10,560   | 11,520   |
| 18 | 108 | 19 1/2 | <b>GA2WCS1H108-WW</b> | 11,973   | 13,061   |

- No pulls required
- Recessed LED tasklights included

### PRODUCT INFO

Doors do not lock

Door widths:

60" = (1) doors

72" = (1) doors

90" = (2) doors

108" = (2) doors

Hidden cubbies behind doors

TO ORDER PLEASE SPECIFY THE FOLLOWING:

1.  **MODEL NUMBER**
2.  **FINISH**
3.  **OFFICE #**

**See inside front cover for required option codes**

Example

**GA2WCS1H60-WW.NC215.OFC1**  
 GA2WCS1H60-WW    NC215    OFC1  
 MODEL NUMBER    FINISH    OFFICE #

**1 HIGH**

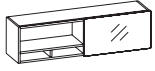

| D  | W   | H      | model number          | veneer 2 | veneer 3 |
|----|-----|--------|-----------------------|----------|----------|
| 18 | 60  | 19 1/2 | <b>GA2WCS1H60-WG</b>  | 9,236    | 10,076   |
| 18 | 72  | 19 1/2 | <b>GA2WCS1H72-WG</b>  | 10,098   | 11,016   |
| 18 | 90  | 19 1/2 | <b>GA2WCS1H90-WG</b>  | 11,904   | 12,986   |
| 18 | 108 | 19 1/2 | <b>GA2WCS1H108-WG</b> | 13,530   | 14,760   |

- Recessed LED tasklights included

**PRODUCT INFO**

Doors do not lock

Door widths:  
60" = (1) doors  
72" = (1) doors  
90" = (2) doors  
108" = (2) doors

Hidden cubbies behind doors

**TO ORDER PLEASE SPECIFY THE FOLLOWING:**

1.  **MODEL NUMBER**
2.  **FINISH**
3.  **GLASS COLOR**
4.  **OFFICE #**

**See inside front cover for required option codes**

Example

**GA2WCS1H60-WG.NC215.WH.OFC1**  
 GA2WCS1H60-WG    NC215    WH    OFC1  
 MODEL NUMBER    FINISH    GLASS COLOR    OFFICE #

# WALL MOUNT OVERHEADS

Hinged | wood doors

Credentials

02/24

## 2 HIGH

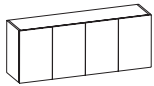

| D  | W  | H  | model number         | veneer 2 | veneer 3 |
|----|----|----|----------------------|----------|----------|
| 18 | 30 | 28 | <b>GA2WCH2H30-WW</b> | 6,417    | 7,000    |
| 18 | 36 | 28 | <b>GA2WCH2H36-WW</b> | 6,723    | 7,334    |
| 18 | 60 | 28 | <b>GA2WCH2H60-WW</b> | 9,554    | 10,422   |
| 18 | 66 | 28 | <b>GA2WCH2H66-WW</b> | 9,995    | 10,904   |
| 18 | 72 | 28 | <b>GA2WCH2H72-WW</b> | 10,454   | 11,404   |
| 18 | 78 | 28 | <b>GA2WCH2H78-WW</b> | 11,270   | 12,294   |
| 18 | 84 | 28 | <b>GA2WCH2H84-WW</b> | 11,783   | 12,854   |
| 18 | 90 | 28 | <b>GA2WCH2H90-WW</b> | 12,318   | 13,438   |

- Units are available in wood integral pull only
- Recessed LED tasklights included

## PRODUCT INFO

Doors do not lock

Door widths:

30" = (2) doors

36" = (2) doors

60" = (4) doors

66" = (4) doors

72" = (4) doors

78" = (4) doors

84" = (6) doors

90" = (6) doors

TO ORDER PLEASE SPECIFY THE FOLLOWING:

- MODEL NUMBER**
- FINISH**
- PULL**
- OFFICE #**

See inside front cover for required option codes

Example

GA2WCH2H30-WW.NC215.MPS.OFC1  

|               |        |      |          |
|---------------|--------|------|----------|
| GA2WCH2H30-WW | NC215  | MPS  | OFC1     |
| MODEL NUMBER  | FINISH | PULL | OFFICE # |

**2 HIGH**

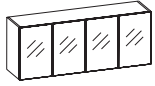

| D  | W  | H  | model number         | veneer 2 | veneer 3 |
|----|----|----|----------------------|----------|----------|
| 18 | 30 | 28 | <b>GA2WCH2H30-WG</b> | 7,288    | 7,950    |
| 18 | 36 | 28 | <b>GA2WCH2H36-WG</b> | 7,637    | 8,331    |
| 18 | 60 | 28 | <b>GA2WCH2H60-WG</b> | 10,801   | 11,783   |
| 18 | 72 | 28 | <b>GA2WCH2H72-WG</b> | 11,834   | 12,910   |
| 18 | 90 | 28 | <b>GA2WCH2H90-WG</b> | 13,928   | 15,194   |

- Recessed LED tasklights included

**PRODUCT INFO**

Doors do not lock

Door widths:

30" = (2) doors

36" = (2) doors

60" = (4) doors

72" = (4) doors

90" = (6) doors

**TO ORDER PLEASE SPECIFY THE FOLLOWING:**

1.  **MODEL NUMBER**
2.  **FINISH**
3.  **GLASS COLOR**
4.  **OFFICE #**

**See inside front cover for required option codes**

Example

**GA2WCH2H30-WG.NC215.WH.OFC1**  
 GA2WCH2H30-WG    NC215    WH    OFC1  
 MODEL NUMBER    FINISH    GLASS COLOR    OFFICE #

# WALL MOUNT OVERHEADS

Sliding | wood doors

Credentials

02/24

## 2 HIGH

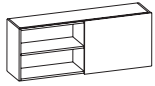

| D  | W  | H  | model number         | veneer 2 | veneer 3 |
|----|----|----|----------------------|----------|----------|
| 18 | 60 | 28 | <b>GA2WCS2H60-WW</b> | 9,970    | 10,876   |
| 18 | 72 | 28 | <b>GA2WCS2H72-WW</b> | 10,911   | 11,903   |
| 18 | 90 | 28 | <b>GA2WCS2H90-WW</b> | 12,854   | 14,022   |

- No pulls required
- Recessed LED tasklights included

### PRODUCT INFO

Doors do not lock

Door widths:  
 60" = (1) doors  
 72" = (1) doors  
 90" = (2) doors

TO ORDER PLEASE SPECIFY THE FOLLOWING:

1.  **MODEL NUMBER**
2.  **FINISH**
3.  **OFFICE #**

See inside front cover for required option codes

Example

**GA2WCS2H60-WW.NC215.OFC1**

|                     |               |                 |
|---------------------|---------------|-----------------|
| GA2WCS2H60-WW       | NC215         | OFC1            |
| <b>MODEL NUMBER</b> | <b>FINISH</b> | <b>OFFICE #</b> |



**2 HIGH**

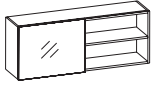

| D  | W  | H  | model number         | veneer 2 | veneer 3 |
|----|----|----|----------------------|----------|----------|
| 18 | 60 | 28 | <b>GA2WCS2H60-WG</b> | 11,279   | 12,304   |
| 18 | 72 | 28 | <b>GA2WCS2H72-WG</b> | 12,362   | 13,486   |
| 18 | 90 | 28 | <b>GA2WCS2H90-WG</b> | 14,547   | 15,869   |

- Recessed LED tasklights included

**PRODUCT INFO**

Doors do not lock

Door widths:  
60" = (1) doors  
72" = (1) doors  
90" = (2) doors

**TO ORDER PLEASE SPECIFY THE FOLLOWING:**

1.  **MODEL NUMBER**
2.  **FINISH**
3.  **GLASS COLOR**
4.  **OFFICE #**

**See inside front cover for required option codes**

Example

**GA2WCS2H60-WG.NC215.WH.OFC1**

|                             |                       |                            |                         |
|-----------------------------|-----------------------|----------------------------|-------------------------|
| GA2WCS2H60-WG               | NC215                 | WH                         | OFC1                    |
| <small>MODEL NUMBER</small> | <small>FINISH</small> | <small>GLASS COLOR</small> | <small>OFFICE #</small> |

# TACKBOARDS

Standard

**Credentials**  
02/24

|   | D       | W   | H      | yards  | model number    | fabric grades    |       |       | COM/4 |       |
|---|---------|-----|--------|--------|-----------------|------------------|-------|-------|-------|-------|
|   |         |     |        |        |                 | 1                | 2     | 3     |       |       |
| <b>STANDARD</b>   |         |     |        |        |                 |                  |       |       |       |       |
| <br>FABRIC | 7/8     | 30  | 28 1/2 | 1.25   | <b>GAATKW30</b> | 1,028            | 1,055 | 1,083 | 1,111 |       |
|   | 7/8     | 36  | 28 1/2 | 1.25   | <b>GAATKW36</b> | 1,078            | 1,111 | 1,149 | 1,184 |       |
|   | 7/8     | 60  | 28 1/2 | 2.00   | <b>GAATKW60</b> | 1,252            | 1,306 | 1,361 | 1,418 |       |
|   | 7/8     | 66  | 28 1/2 | 2.25   | <b>GAATKW66</b> | 1,278            | 1,332 | 1,387 | 1,444 |       |
|   | 7/8     | 72  | 28 1/2 | 2.50   | <b>GAATKW72</b> | 1,327            | 1,386 | 1,450 | 1,517 |       |
|   | 7/8     | 78  | 28 1/2 | 2.50   | <b>GAATKW78</b> | 1,366            | 1,436 | 1,506 | 1,577 |       |
|   | 7/8     | 84  | 28 1/2 | 2.75   | <b>GAATKW84</b> | 1,402            | 1,472 | 1,542 | 1,613 |       |
|   | 7/8     | 90  | 28 1/2 | 3.00   | <b>GAATKW90</b> | 1,463            | 1,536 | 1,616 | 1,694 |       |
|   | 7/8     | 96  | 28 1/2 | 3.00   | <b>GAATKW96</b> | 1,525            | 1,604 | 1,690 | 1,775 |       |
|   | 2-PIECE | 7/8 | 102    | 28 1/2 | 3.50            | <b>GAATKW102</b> | 2,104 | 2,191 | 2,284 | 2,375 |
|   | 2-PIECE | 7/8 | 108    | 28 1/2 | 4.00            | <b>GAATKW108</b> | 2,177 | 2,273 | 2,371 | 2,471 |
|   | 2-PIECE | 7/8 | 120    | 28 1/2 | 4.00            | <b>GAATKW120</b> | 2,505 | 2,606 | 2,711 | 2,819 |

- Dimensioned from full height trough worksurface to bottom of overhead.
- A trough worksurface is required for ALL tackzone.
- Tackboards listed on this page are all standard "railroad".

**PRODUCT SPECIFICATIONS:**

**STANDARD**

The fabric on all Gunlocke tackboards is applied in a railroad fashion.

- Tackboard widths less than or equal to 96" are one piece
- Tackboards greater than 96" are two piece and the fabric is pattern matched
- When ordering individual wall mount tackboards to be placed side by side, the fabric pattern will be random matched. If a fabric pattern match is required, contact Gunlocke Bid/Quote for a special quote.

**SPECIAL**

Fabric applied "up the roll" is a special application. Please see guidelines below and contact Gunlocke Bid/Quote for a special quote.

- Fabrics used on tackboard 48" and under in width can be applied "up the roll"
- Tackboards greater than 48" in width can only be applied railroaded, due to fabric height limitations

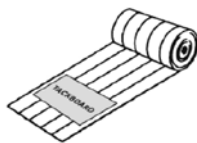
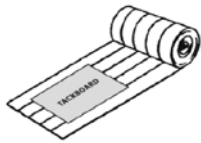

**PRODUCT INFO**

See yards listed above for COM fabric requirement

102, 108, and 120 wide tackboards are 2-piece

**TO ORDER PLEASE SPECIFY THE FOLLOWING:**

|    |                      |                      |
|----|----------------------|----------------------|
| 1. | <input type="text"/> | <b>MODEL NUMBER</b>  |
| 2. | <input type="text"/> | <b>FABRIC</b>        |
| 3. | <input type="text"/> | <b>FSC TACKBOARD</b> |
| 4. | <input type="text"/> | <b>OFFICE #</b>      |

**FSC Tackboard Options:**

**FSC** = FSC Required (+5% COM upcharge)  
**NR** = FSC Not Required

**COM FABRIC REQUIREMENT**

All COM must be shipped prepaid to Gunlocke with package side marked with:

- Dealer Name
- Dealer Purchase Order Number
- Gunlocke Pattern Number

See inside front cover for required option codes

Example

**GAATKW30.FABRIC.FSC.OFC1**

|              |        |               |          |
|--------------|--------|---------------|----------|
| GAATKW30     | FABRIC | FSC           | OFC1     |
| MODEL NUMBER | FABRIC | FSC TACKBOARD | OFFICE # |

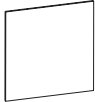
|   | D   | W  | H  | yards | model number      | fabric grades |       |       | COM/4 |
|---|-----|----|----|-------|-------------------|---------------|-------|-------|-------|
|   |     |    |    |       |                   | 1             | 2     | 3     |       |
| <br>FABRIC | 7/8 | 30 | 48 | 1.25  | <b>GAATKW1H30</b> | 1,252         | 1,279 | 1,307 | 1,335 |
|   | 7/8 | 36 | 48 | 1.25  | <b>GAATKW1H36</b> | 1,278         | 1,311 | 1,349 | 1,384 |
|   | 7/8 | 42 | 48 | 1.50  | <b>GAATKW1H42</b> | 1,327         | 1,370 | 1,410 | 1,454 |
|   | 7/8 | 48 | 48 | 1.50  | <b>GAATKW1H48</b> | 1,366         | 1,409 | 1,449 | 1,493 |

- Dimensioned from trough worksurface to top of 1 high overhead (or 5 high storage)
- A trough worksurface is required for ALL tackzone.

**TOP OF 2 HIGH OVERHEAD**

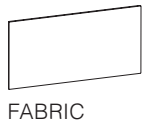

|     |    |        |      |                   |       |       |       |       |
|-----|----|--------|------|-------------------|-------|-------|-------|-------|
| 7/8 | 30 | 56 1/2 | 1.75 | <b>GAATKW2H30</b> | 1,278 | 1,305 | 1,333 | 1,361 |
| 7/8 | 36 | 56 1/2 | 1.75 | <b>GAATKW2H36</b> | 1,327 | 1,360 | 1,398 | 1,433 |
| 7/8 | 42 | 56 1/2 | 1.75 | <b>GAATKW2H42</b> | 1,366 | 1,409 | 1,449 | 1,493 |
| 7/8 | 48 | 56 1/2 | 1.75 | <b>GAATKW2H48</b> | 1,402 | 1,445 | 1,485 | 1,529 |

- Dimensioned from trough worksurface to top of 2 high overhead (or 6 high storage)
- A trough worksurface is required for ALL tackzone.
- Tackboards to top of 1H overheads are standard "railroad". Tackboards to top of 2H overheads are "up the roll".

**PRODUCT SPECIFICATIONS:**

**STANDARD**

The fabric on all Gunlocke tackboards is applied in a railroad fashion.

- Tackboard widths less than or equal to 96" are one piece
- Tackboards greater than 96" are two piece and the fabric is pattern matched
- When ordering individual wall mount tackboards to be placed side by side, the fabric pattern will be random matched. If a fabric pattern match is required, contact Gunlocke Bid/Quote for a special quote.

**SPECIAL**

Fabric applied "up the roll" is a special application. Please see guidelines below and contact Gunlocke Bid/Quote for a special quote.

- Fabrics used on tackboard 48" and under in width can be applied "up the roll"
- Tackboards greater than 48" in width can only be applied railroaded, due to fabric height limitations

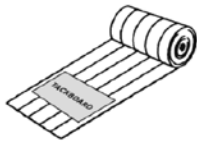
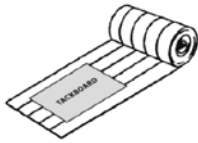

**PRODUCT INFO**

See yards listed above for COM fabric requirement

**TO ORDER PLEASE SPECIFY THE FOLLOWING:**

1.  **MODEL NUMBER**
2.  **FABRIC**
3.  **FSC TACKBOARD**
4.  **OFFICE #**

**FSC Tackboard Options:**

**FSC** = FSC Required (+5% COM upcharge)  
**NR** = FSC Not Required

**COM FABRIC REQUIREMENT**

All COM must be shipped prepaid to Gunlocke with package side marked with:

- Dealer Name
- Dealer Purchase Order Number
- Gunlocke Pattern Number

**See inside front cover for required option codes**

Example

**GAATKW1H30. FABRIC.FSC.OFC1**  
 GAATKW1H30      FABRIC      FSC      OFC1  
 MODEL NUMBER      FABRIC      FSC TACKBOARD      OFFICE #

# LAYERS TACKBOARDS

Standard

## STANDARD



FABRIC

|         | D   | W   | H      | yards | model number      | fabric grades |       |       | COM/4 |
|---------|-----|-----|--------|-------|-------------------|---------------|-------|-------|-------|
|         |     |     |        |       |                   | 1             | 2     | 3     |       |
|         | 7/8 | 30  | 36 1/4 | 1.25  | <b>GAATLKW30</b>  | 1,078         | 1,105 | 1,133 | 1,161 |
|         | 7/8 | 36  | 36 1/4 | 1.25  | <b>GAATLKW36</b>  | 1,252         | 1,285 | 1,323 | 1,358 |
|         | 7/8 | 60  | 36 1/4 | 2.00  | <b>GAATLKW60</b>  | 1,278         | 1,332 | 1,387 | 1,444 |
|         | 7/8 | 66  | 36 1/4 | 2.25  | <b>GAATLKW66</b>  | 1,327         | 1,381 | 1,436 | 1,493 |
|         | 7/8 | 72  | 36 1/4 | 2.50  | <b>GAATLKW72</b>  | 1,366         | 1,425 | 1,489 | 1,556 |
|         | 7/8 | 78  | 36 1/4 | 2.50  | <b>GAATLKW78</b>  | 1,402         | 1,472 | 1,542 | 1,613 |
|         | 7/8 | 84  | 36 1/4 | 2.75  | <b>GAATLKW84</b>  | 1,463         | 1,533 | 1,603 | 1,674 |
|         | 7/8 | 90  | 36 1/4 | 3.00  | <b>GAATLKW90</b>  | 1,525         | 1,598 | 1,678 | 1,756 |
|         | 7/8 | 96  | 36 1/4 | 3.00  | <b>GAATLKW96</b>  | 2,104         | 2,183 | 2,269 | 2,354 |
| 2-PIECE | 7/8 | 102 | 36 1/4 | 3.50  | <b>GAATLKW102</b> | 2,177         | 2,264 | 2,357 | 2,448 |
| 2-PIECE | 7/8 | 108 | 36 1/4 | 4.00  | <b>GAATLKW108</b> | 2,287         | 2,383 | 2,481 | 2,581 |
| 2-PIECE | 7/8 | 120 | 36 1/4 | 4.00  | <b>GAATLKW120</b> | 2,552         | 2,653 | 2,758 | 2,866 |

- Dimensioned from full height trough worksurface to bottom of overhead.
- A trough worksurface is required for ALL tackzone.
- Tackboards listed on this page are all standard "railroad".

### PRODUCT SPECIFICATIONS:

#### STANDARD

The fabric on all Gunlocke tackboards is applied in a railroad fashion.

- Tackboard widths less than or equal to 96" are one piece
- Tackboards greater than 96" are two piece and the fabric is pattern matched
- When ordering individual wall mount tackboards to be placed side by side, the fabric pattern will be random matched. If a fabric pattern match is required, contact Gunlocke Bid/Quote for a special quote.

#### SPECIAL

Fabric applied "up the roll" is a special application. Please see guidelines below and contact Gunlocke Bid/Quote for a special quote.

- Fabrics used on tackboard 48" and under in width can be applied "up the roll"
- Tackboards greater than 48" in width can only be applied railroaded, due to fabric height limitations

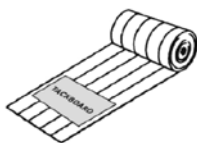
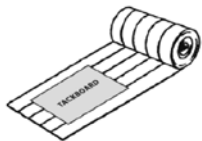

### PRODUCT INFO

See yards listed above for COM fabric requirement

102, 108, and 120 wide tackboards are 2-piece

### TO ORDER PLEASE SPECIFY THE FOLLOWING:

1.  **MODEL NUMBER**
2.  **FABRIC**
3.  **FSC TACKBOARD**
4.  **OFFICE #**

#### FSC Tackboard Options:

**FSC** = FSC Required (+5% COM upcharge)  
**NR** = FSC Not Required

#### COM FABRIC REQUIREMENT

All COM must be shipped prepaid to Gunlocke with package side marked with:

- Dealer Name
- Dealer Purchase Order Number
- Gunlocke Pattern Number

See inside front cover for required option codes

Example

GAATLKW30.FABRIC.FSC.OFC1  
 GAATLKW30      FABRIC      FSC      OFC1  
 MODEL NUMBER      FABRIC      FSC TACKBOARD      OFFICE #

|                               | D   | W  | H      | yards | model number       | fabric grades |       |       | COM/4 |
|-------------------------------|-----|----|--------|-------|--------------------|---------------|-------|-------|-------|
|                               |     |    |        |       |                    | 1             | 2     | 3     |       |
| <b>TOP OF 1 HIGH OVERHEAD</b> | 7/8 | 30 | 55 3/4 | 1.75  | <b>GAATLKW1H30</b> | 1,278         | 1,305 | 1,333 | 1,361 |
|                               | 7/8 | 36 | 55 3/4 | 1.75  | <b>GAATLKW1H36</b> | 1,327         | 1,360 | 1,398 | 1,433 |
|                               | 7/8 | 42 | 55 3/4 | 1.75  | <b>GAATLKW1H42</b> | 1,366         | 1,409 | 1,449 | 1,493 |
|                               | 7/8 | 48 | 55 3/4 | 1.75  | <b>GAATLKW1H48</b> | 1,402         | 1,445 | 1,485 | 1,529 |



FABRIC

- Dimensioned from trough worksurface to top of 1 high overhead (or 5 high storage)
- A trough worksurface is required for ALL tackzone.

**TOP OF 2 HIGH OVERHEAD**

|                               |     |    |        |      |                    |       |       |       |       |
|-------------------------------|-----|----|--------|------|--------------------|-------|-------|-------|-------|
| <b>TOP OF 2 HIGH OVERHEAD</b> | 7/8 | 30 | 64 1/4 | 2.00 | <b>GAATLKW2H30</b> | 1,327 | 1,354 | 1,382 | 1,410 |
|                               | 7/8 | 36 | 64 1/4 | 2.00 | <b>GAATLKW2H36</b> | 1,366 | 1,399 | 1,437 | 1,472 |
|                               | 7/8 | 42 | 64 1/4 | 2.00 | <b>GAATLKW2H42</b> | 1,402 | 1,445 | 1,485 | 1,529 |
|                               | 7/8 | 48 | 64 1/4 | 2.00 | <b>GAATLKW2H48</b> | 1,463 | 1,506 | 1,546 | 1,590 |



FABRIC

- Dimensioned from trough worksurface to top of 2 high overhead (or 6 high storage)
- A trough worksurface is required for ALL tackzone.
- Layers tackboards to top of 1H and 2H overheads are "up the roll".

**PRODUCT SPECIFICATIONS:**

**STANDARD**

The fabric on all Gunlocke tackboards is applied in a railroad fashion.

- Tackboard widths less than or equal to 96" are one piece
- Tackboards greater than 96" are two piece and the fabric is pattern matched
- When ordering individual wall mount tackboards to be placed side by side, the fabric pattern will be random matched. If a fabric pattern match is required, contact Gunlocke Bid/Quote for a special quote.

**SPECIAL**

Fabric applied "up the roll" is a special application. Please see guidelines below and contact Gunlocke Bid/Quote for a special quote.

- Fabrics used on tackboard 48" and under in width can be applied "up the roll"
- Tackboards greater than 48" in width can only be applied railroaded, due to fabric height limitations

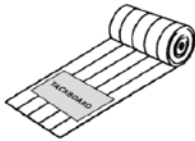
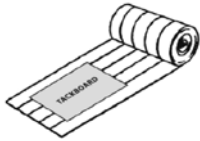

**PRODUCT INFO**

See yards listed above for COM fabric requirement

**TO ORDER PLEASE SPECIFY THE FOLLOWING:**

1.  **MODEL NUMBER**
2.  **FABRIC**
3.  **FSC TACKBOARD**
4.  **OFFICE #**

**FSC Tackboard Options:**

**FSC** = FSC Required (+5% COM upcharge)  
**NR** = FSC Not Required

**COM FABRIC REQUIREMENT**

All COM must be shipped prepaid to Gunlocke with package side marked with:

- Dealer Name
- Dealer Purchase Order Number
- Gunlocke Pattern Number

**See inside front cover for required option codes**

Example

**GAATLKW30.FABRIC.FSC.OFC1**

|                     |               |                      |                 |
|---------------------|---------------|----------------------|-----------------|
| GAATLKW30           | FABRIC        | FSC                  | OFC1            |
| <b>MODEL NUMBER</b> | <b>FABRIC</b> | <b>FSC TACKBOARD</b> | <b>OFFICE #</b> |

# WHITEBOARDS

Standard

Credentials

02/24

|                 | D   | W   | H      | model number         | list  |
|-----------------|-----|-----|--------|----------------------|-------|
| <b>STANDARD</b> | 3/4 | 30  | 28 1/2 | <b>GAATGW30-GSA</b>  | 1,938 |
|                 | 3/4 | 36  | 28 1/2 | <b>GAATGW36-GSA</b>  | 2,202 |
|                 | 3/4 | 60  | 28 1/2 | <b>GAATGW60-GSA</b>  | 3,609 |
| <b>MAGNETIC</b> | 3/4 | 66  | 28 1/2 | <b>GAATGW66-GSA</b>  | 4,129 |
|                 | 3/4 | 72  | 28 1/2 | <b>GAATGW72-GSA</b>  | 4,401 |
|                 | 3/4 | 78  | 28 1/2 | <b>GAATGW78-GSA</b>  | 4,880 |
|                 | 3/4 | 84  | 28 1/2 | <b>GAATGW84-GSA</b>  | 5,543 |
| 2-PIECE         | 3/4 | 90  | 28 1/2 | <b>GAATGW90-GSA</b>  | 5,798 |
| 2-PIECE         | 3/4 | 96  | 28 1/2 | <b>GAATGW96-GSA</b>  | 6,077 |
| 2-PIECE         | 3/4 | 102 | 28 1/2 | <b>GAATGW102-GSA</b> | 6,334 |
|                 | 3/4 | 108 | 28 1/2 | <b>GAATGW108-GSA</b> | 6,604 |

- **NOTE:** Quantity 6 magnets are included with each unit 72"W and less. Quantity 12 magnets are included with each unit 84"W and greater. Magnets can also be ordered separately.

## PRODUCT INFO

TO ORDER PLEASE SPECIFY THE FOLLOWING:

1.  **MODEL NUMBER**
2.  **GLASS COLOR**
3.  **OFFICE #**

**NOTE:** Whiteboards are GSA (TAA) compliant standard.

**See inside front cover for required option codes**

Example

GAATGW30-GSA.WH.OFC1  
 GAATGW30-GSA      WH      OFC1  
 MODEL NUMBER      GLASS COLOR      OFFICE #

**TOP OF 1 HIGH OVERHEAD**



MAGNETIC

| D   | W  | H  | model number          | select |
|-----|----|----|-----------------------|--------|
| 3/4 | 30 | 48 | <b>GAATGW1H30-GSA</b> | 3,609  |
| 3/4 | 36 | 48 | <b>GAATGW1H36-GSA</b> | 4,129  |
| 3/4 | 42 | 48 | <b>GAATGW1H42-GSA</b> | 4,401  |
| 3/4 | 48 | 48 | <b>GAATGW1H48-GSA</b> | 4,880  |

- Dimensioned from trough worksurface to top of 1 high overhead (or 5 high storage)
- A trough worksurface is required for ALL tackzone.

**TOP OF 2 HIGH OVERHEAD**

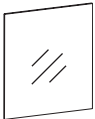

MAGNETIC

|     |    |        |                       |       |
|-----|----|--------|-----------------------|-------|
| 3/4 | 30 | 56 1/2 | <b>GAATGW2H30-GSA</b> | 4,129 |
| 3/4 | 36 | 56 1/2 | <b>GAATGW2H36-GSA</b> | 4,401 |
| 3/4 | 42 | 56 1/2 | <b>GAATGW2H42-GSA</b> | 4,880 |
| 3/4 | 48 | 56 1/2 | <b>GAATGW2H48-GSA</b> | 5,543 |

- Dimensioned from trough worksurface to top of 2 high overhead (or 6 high storage)
- A trough worksurface is required for ALL tackzone.
- **NOTE:** Quantity 6 magnets are included with each unit 72"W and less. Quantity 12 magnets are included with each unit 84"W and greater. Magnets can also be ordered separately.

**PRODUCT INFO**

**TO ORDER PLEASE SPECIFY THE FOLLOWING:**

1.  **MODEL NUMBER**
2.  **GLASS COLOR**
3.  **OFFICE #**

**NOTE:** Whiteboards are GSA (TAA) compliant standard.

**See inside front cover for required option codes**

Example

**GAATGW1H30-GSA.WH.OFC1**  
 GAATGW1H30-GSA      WH      OFC1  
 MODEL NUMBER      GLASS COLOR      OFFICE #

# SEGMENTED WHITEBOARDS

**Credentials**  
02/24  
Top of Overhead

|  | D   | W  | H  | model number           | list  |
|--|-----|----|----|------------------------|-------|
| <b>TOP OF 1 HIGH OVERHEAD</b><br><br>MAGNETIC | 3/4 | 30 | 48 | <b>GAATGW1H30-XGSA</b> | 4,149 |
|  | 3/4 | 36 | 48 | <b>GAATGW1H36-XGSA</b> | 4,751 |
|  | 3/4 | 42 | 48 | <b>GAATGW1H42-XGSA</b> | 5,064 |
|  | 3/4 | 48 | 48 | <b>GAATGW1H48-XGSA</b> | 5,618 |

- Dimensioned from trough worksurface to top of 1 high overhead (or 5 high storage)
- A trough worksurface is required for ALL tackzone.

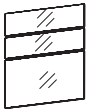
|  |     |    |        |                        |       |
|--|-----|----|--------|------------------------|-------|
| <b>TOP OF 2 HIGH OVERHEAD</b><br><br>MAGNETIC | 3/4 | 30 | 56 1/2 | <b>GAATGW2H30-XGSA</b> | 4,751 |
|  | 3/4 | 36 | 56 1/2 | <b>GAATGW2H36-XGSA</b> | 5,064 |
|  | 3/4 | 42 | 56 1/2 | <b>GAATGW2H42-XGSA</b> | 5,618 |
|  | 3/4 | 48 | 56 1/2 | <b>GAATGW2H48-XGSA</b> | 6,373 |

- Dimensioned from trough worksurface to top of 2 high overhead (or 6 high storage)
- A trough worksurface is required for ALL tackzone.
- **NOTE:** Quantity 6 magnets are included with each unit 72"W and less. Quantity 12 magnets are included with each unit 84"W and greater. Magnets can also be ordered separately.
- Shelves must be ordered separately.

|                     |   |                 |    |      |              |             |          |
|---------------------|---|-----------------|----|------|--------------|-------------|----------|
| <b>PRODUCT INFO</b> | <p>TO ORDER PLEASE SPECIFY THE FOLLOWING:</p> <p>1. <input type="text"/> <b>MODEL NUMBER</b></p> <p>2. <input type="text"/> <b>GLASS COLOR</b></p> <p>3. <input type="text"/> <b>OFFICE #</b></p> <p><b>NOTE:</b> Whiteboards are GSA (TAA) compliant standard.</p> <p><b>See inside front cover for required option codes</b></p> <p>Example</p> <hr/> <p>GAATGW1H30-XGSA.WH.OFC1</p> <table style="width: 100%; border-collapse: collapse;"> <tr> <td style="border-bottom: 1px solid black; width: 33%;">GAATGW1H30-XGSA</td> <td style="border-bottom: 1px solid black; width: 33%;">WH</td> <td style="border-bottom: 1px solid black; width: 33%;">OFC1</td> </tr> <tr> <td style="font-size: small;">MODEL NUMBER</td> <td style="font-size: small;">GLASS COLOR</td> <td style="font-size: small;">OFFICE #</td> </tr> </table> | GAATGW1H30-XGSA | WH | OFC1 | MODEL NUMBER | GLASS COLOR | OFFICE # |
| GAATGW1H30-XGSA     | WH  | OFC1            |    |      |              |             |          |
| MODEL NUMBER        | GLASS COLOR   | OFFICE #        |    |      |              |             |          |

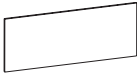

|   | D       | W   | H      | model number    | veneer 2         | veneer 3 |       |
|---|---------|-----|--------|-----------------|------------------|----------|-------|
| <b>STANDARD</b><br><br><br><br><b>MAGNETIC</b> | 7/8     | 30  | 28 1/2 | <b>GAATWD30</b> | 2,138            | 2,333    |       |
|   | 7/8     | 36  | 28 1/2 | <b>GAATWD36</b> | 2,270            | 2,477    |       |
|   | 7/8     | 60  | 28 1/2 | <b>GAATWD60</b> | 3,068            | 3,347    |       |
|   | 7/8     | 66  | 28 1/2 | <b>GAATWD66</b> | 3,246            | 3,541    |       |
|   | 7/8     | 72  | 28 1/2 | <b>GAATWD72</b> | 3,524            | 3,845    |       |
|   | 7/8     | 78  | 28 1/2 | <b>GAATWD78</b> | 3,634            | 3,965    |       |
|   | 7/8     | 84  | 28 1/2 | <b>GAATWD84</b> | 3,832            | 4,181    |       |
|   | 7/8     | 90  | 28 1/2 | <b>GAATWD90</b> | 4,340            | 4,734    |       |
|   | 2-PIECE | 7/8 | 96     | 28 1/2          | <b>GAATWD96</b>  | 4,468    | 4,874 |
|   | 2-PIECE | 7/8 | 102    | 28 1/2          | <b>GAATWD102</b> | 4,599    | 5,017 |
|   | 2-PIECE | 7/8 | 108    | 28 1/2          | <b>GAATWD108</b> | 4,851    | 5,292 |
|   | 2-PIECE | 7/8 | 120    | 28 1/2          | <b>GAATWD120</b> | 5,008    | 5,464 |

• **NOTE:** Quantity 6 magnets are included with each unit 72"W and less. Quantity 12 magnets are included with each unit 84"W and greater. Magnets can also be ordered separately.

**PRODUCT INFO**

TO ORDER PLEASE SPECIFY THE FOLLOWING:

- 1.  **MODEL NUMBER**
- 2.  **FINISH**
- 3.  **OFFICE #**

See inside front cover for required option codes

Example

GAATWD30.NC215.OFC1  
 GAATWD30      NC215      OFC1  
 MODEL NUMBER      FINISH      OFFICE #

# WOOD MAGNETIC TACKZONE

**Credentials**  
02/24

Top of Overhead

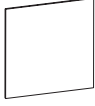
|  | D   | W  | H  | model number      | veneer 2 | veneer 3 |
|--|-----|----|----|-------------------|----------|----------|
| <b>TOP OF 1 HIGH OVERHEAD</b><br><br>MAGNETIC | 7/8 | 30 | 48 | <b>GAATWD1H30</b> | 3,068    | 3,347    |
|  | 7/8 | 36 | 48 | <b>GAATWD1H36</b> | 3,246    | 3,541    |
|  | 7/8 | 42 | 48 | <b>GAATWD1H42</b> | 3,524    | 3,845    |
|  | 7/8 | 48 | 48 | <b>GAATWD1H48</b> | 3,634    | 3,965    |

- Dimensioned from trough worksurface to top of 1 high overhead (or 5 high storage)
- A trough worksurface is required for ALL tackzone.

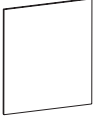
|  | D   | W  | H      | model number      | veneer 2 | veneer 3 |
|--|-----|----|--------|-------------------|----------|----------|
| <b>TOP OF 2 HIGH OVERHEAD</b><br><br>MAGNETIC | 7/8 | 30 | 56 1/2 | <b>GAATWD2H30</b> | 3,246    | 3,541    |
|  | 7/8 | 36 | 56 1/2 | <b>GAATWD2H36</b> | 3,524    | 3,845    |
|  | 7/8 | 42 | 56 1/2 | <b>GAATWD2H42</b> | 3,634    | 3,965    |
|  | 7/8 | 48 | 56 1/2 | <b>GAATWD2H48</b> | 3,832    | 4,181    |

- Dimensioned from trough worksurface to top of 2 high overhead (or 6 high storage)
- A trough worksurface is required for ALL tackzone.

- **NOTE:** Quantity 6 magnets are included with each unit 72"W and less. Quantity 12 magnets are included with each unit 84"W and greater. Magnets can also be ordered separately.

## PRODUCT INFO

TO ORDER PLEASE SPECIFY THE FOLLOWING:

1.  **MODEL NUMBER**
2.  **FINISH**
3.  **OFFICE #**

See inside front cover for required option codes

Example

GAATWD1H30.NC215.OFC1  
 GAATWD1H30      NC215      OFC1  
 MODEL NUMBER      FINISH      OFFICE #

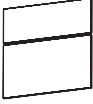
|  | D   | W  | H  | model number        | veneer 2 | veneer 3 |
|--|-----|----|----|---------------------|----------|----------|
| <b>TOP OF 1 HIGH OVERHEAD</b><br><br>MAGNETIC | 7/8 | 30 | 48 | <b>GAATWD1H30-X</b> | 3,527    | 3847     |
|  | 7/8 | 36 | 48 | <b>GAATWD1H36-X</b> | 3,737    | 4076     |
|  | 7/8 | 42 | 48 | <b>GAATWD1H42-X</b> | 4,055    | 4423     |
|  | 7/8 | 48 | 48 | <b>GAATWD1H48-X</b> | 4,180    | 4560     |

- Dimensioned from trough worksurface to top of 1 high overhead (or 5 high storage)
- A trough worksurface is required for ALL tackzone

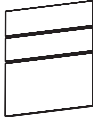
|  |     |    |        |                     |       |       |
|--|-----|----|--------|---------------------|-------|-------|
| <b>TOP OF 2 HIGH OVERHEAD</b><br><br>MAGNETIC | 7/8 | 30 | 56 1/2 | <b>GAATWD2H30-X</b> | 3,737 | 4,076 |
|  | 7/8 | 36 | 56 1/2 | <b>GAATWD2H36-X</b> | 4,055 | 4,423 |
|  | 7/8 | 42 | 56 1/2 | <b>GAATWD2H42-X</b> | 4,180 | 4,560 |
|  | 7/8 | 48 | 56 1/2 | <b>GAATWD2H48-X</b> | 4,409 | 4,810 |

- Dimensioned from trough worksurface to top of 2 high overhead (or 6 high storage)
- A trough worksurface is required for ALL tackzone.
- **NOTE:** Quantity 6 magnets are included with each unit 72"W and less. Quantity 12 magnets are included with each unit 84"W and greater. Magnets can also be ordered separately.
- Shelves must be ordered separately.

|                             |   |                         |       |      |                             |                       |                         |
|-----------------------------|---|-------------------------|-------|------|-----------------------------|-----------------------|-------------------------|
| <p><b>PRODUCT INFO</b></p>  | <p>TO ORDER PLEASE SPECIFY THE FOLLOWING:</p> <p>1. <input type="text"/> <b>MODEL NUMBER</b></p> <p>2. <input type="text"/> <b>FINISH</b></p> <p>3. <input type="text"/> <b>OFFICE #</b></p> <p><b>See inside front cover for required option codes</b></p> <p>Example</p> <hr/> <p>GAATWD1H30-X.NC215.OFC1</p> <table border="0"> <tr> <td>GAATWD1H30-X</td> <td>NC215</td> <td>OFC1</td> </tr> <tr> <td><small>MODEL NUMBER</small></td> <td><small>FINISH</small></td> <td><small>OFFICE #</small></td> </tr> </table> | GAATWD1H30-X            | NC215 | OFC1 | <small>MODEL NUMBER</small> | <small>FINISH</small> | <small>OFFICE #</small> |
| GAATWD1H30-X                | NC215   | OFC1                    |       |      |                             |                       |                         |
| <small>MODEL NUMBER</small> | <small>FINISH</small>   | <small>OFFICE #</small> |       |      |                             |                       |                         |

|   | D | W   | H | model number        | veneer 2 | veneer 3 |
|---|---|-----|---|---------------------|----------|----------|
| WOOD<br> | 8 | 30  | 1 | <b>GA2ASF830-W</b>  | 926      | 1,010    |
|   | 8 | 36  | 1 | <b>GA2ASF836-W</b>  | 996      | 1,086    |
|   | 8 | 42  | 1 | <b>GA2ASF842-W</b>  | 1,135    | 1,238    |
|   | 8 | 48  | 1 | <b>GA2ASF848-W</b>  | 1,267    | 1,382    |
|   | 8 | 60  | 1 | <b>GA2ASF860-W</b>  | 1,444    | 1,575    |
|   | 8 | 66  | 1 | <b>GA2ASF866-W</b>  | 1,543    | 1,683    |
|   | 8 | 72  | 1 | <b>GA2ASF872-W</b>  | 1,630    | 1,778    |
|   | 8 | 78  | 1 | <b>GA2ASF878-W</b>  | 1,710    | 1,865    |
|   | 8 | 84  | 1 | <b>GA2ASF884-W</b>  | 1,807    | 1,971    |
|   | 8 | 90  | 1 | <b>GA2ASF890-W</b>  | 2,021    | 2,205    |
| 2-PIECE   | 8 | 96  | 1 | <b>GA2ASF896-W</b>  | 2,092    | 2,282    |
| 2-PIECE   | 8 | 102 | 1 | <b>GA2ASF8102-W</b> | 2,165    | 2,362    |
| 2-PIECE   | 8 | 108 | 1 | <b>GA2ASF8108-W</b> | 2,235    | 2,438    |
| 2-PIECE   | 8 | 120 | 1 | <b>GA2ASF8120-W</b> | 2,886    | 3,148    |
| 2-PIECE   | 8 | 144 | 1 | <b>GA2ASF8144-W</b> | 3,262    | 3,558    |

- WHEN PLACING MULTIPLE SHELVES END TO END, PLEASE CONTACT GUNTS FOR A SPECIAL SET OF SHELVES WITH A DOWEL PIN FOR ALIGNMENT SHELF TO SHELF
- STANDARD 2-PIECE SHELVES INCLUDE DOWEL PIN

PRODUCT INFO

TO ORDER PLEASE SPECIFY THE FOLLOWING:

1.  MODEL NUMBER
2.  FINISH
3.  OFFICE #

See inside front cover for required option codes

Example

GA2ASF830-W.NC215.OFC1  
 GA2ASF830-W      NC215      OFC1  
 MODEL NUMBER      FINISH      OFFICE #

|   | D               | W | H     | model number      | veneer 2 | veneer 3 |
|---|-----------------|---|-------|-------------------|----------|----------|
|  | 42 dia.         |   | 1 1/2 | <b>GA2TRD42-W</b> | 4,811    | 5,248    |
|   | 48 dia.         |   | 1 1/2 | <b>GA2TRD48-W</b> | 5,671    | 6,186    |
|   | 2-PIECE 54 dia. |   | 1 1/2 | <b>GA2TRD54-W</b> | 6,790    | 7,407    |
|   | 2-PIECE 60 dia. |   | 1 1/2 | <b>GA2TRD60-W</b> | 7,086    | 7,730    |

**PRODUCT INFO**

TO ORDER PLEASE SPECIFY THE FOLLOWING:

- 1.  **MODEL NUMBER**
- 2.  **FINISH**
- 3.  **TOP FINISH TYPE**
- 4.  **OFFICE #**

**See inside front cover for required option codes**

Example

**GA2TRD42-W.NC215.FF.OFC1**

|                     |               |                   |                 |
|---------------------|---------------|-------------------|-----------------|
| GA2TRD42-W          | NC215         | FF                | OFC1            |
| <b>MODEL NUMBER</b> | <b>FINISH</b> | <b>TOP FINISH</b> | <b>OFFICE #</b> |

# RECESSED LED TASKLIGHTS

Replacements

Credentials

02/24

|                                | D   | W  | H   | model number      | list  |
|--------------------------------|-----|----|-----|-------------------|-------|
| <b>RECESSED LED TASKLIGHTS</b> |     |    |     |                   |       |
|                                | 5/8 | 24 | 5/8 | <b>ACLEDD24-R</b> | 811   |
|                                | 5/8 | 54 | 5/8 | <b>ACLEDD54-R</b> | 1,132 |
|                                | 5/8 | 72 | 5/8 | <b>ACLEDD72-R</b> | 1,713 |

Tasklights are INCLUDED with all overhead cabinets.  
They do NOT need to be purchased separately.

- LED lighting provides high efficiency, low energy lighting with a long life.
- All LED light strips are encased in a silver aluminum extrusion and include a built-in microswitch to turn the light on/off.
- Lights are field installed.
- All units include a 10' cord with a standard plug.
- Tasklights are recessed into bottom panel of overhead cabinet.
- Light temperature 3200K

## PRODUCT INFO

See product specs above

TO ORDER PLEASE SPECIFY THE FOLLOWING:

1.  **MODEL NUMBER**

**NOTE: Office # option not required**

**See inside front cover for required option codes**

Example

ACLEDD24-R  
ACLEDD24-R  
MODEL NUMBER

|                | D                  | W | H             | model number    | list |
|----------------|--------------------|---|---------------|-----------------|------|
| <b>MAGNETS</b> | $\frac{3}{8}$ dia. |   | $\frac{1}{2}$ | <b>SAMAGNET</b> | 102  |



- **NOTE:** Quantity 6 magnets are included with each unit 72"W and less. Quantity 12 magnets are included with each unit 84"W and greater.
- Magnets are silver

**PRODUCT INFO**

TO ORDER PLEASE SPECIFY THE FOLLOWING:

1.  **MODEL NUMBER**

**See inside front cover for required option codes**

Example

SAMAGNET  
SAMAGNET  
MODEL NUMBER

|   | D     | W  | H | model number | list |
|---|-------|----|---|--------------|------|
| <b>BENEATH WORKSURFACE<br/>WIRE MANAGER</b> | 3 1/4 | 30 | 1 | <b>ACWM</b>  | 115  |

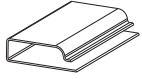

**PRODUCT INFO**

TO ORDER PLEASE SPECIFY THE FOLLOWING:

1.  **MODEL NUMBER**

**NOTE: Office # option not required**

**See inside front cover for required option codes**

Example

---

ACWM  
ACWM  
MODEL NUMBER



|   | D      | W  | H     | model number     | list  |
|---|--------|----|-------|------------------|-------|
| <b>PERSONAL CORNER</b>  |        |    |       |                  |       |
|  | 12 1/2 | 36 | 1 7/8 | <b>GAACORNER</b> | 1,169 |

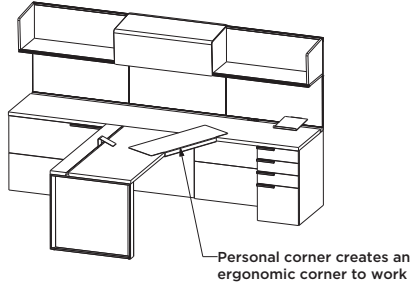

|   |    |    |       |                  |       |
|---|----|----|-------|------------------|-------|
| <b>DESKPAD</b>  |    |    |       |                  |       |
|  | 18 | 36 | 1 7/8 | <b>GAADSKPAD</b> | 1,653 |

**PRODUCT INFO**

Designed for 1.5" thick worksurfaces.

**TO ORDER PLEASE SPECIFY THE FOLLOWING:**

1.  **MODEL NUMBER**
2.  **LEATHER/VINYL COLOR**
3.  **OFFICE #**

**Leather Color:**  
**CBL** = Black  
**CWH** = White  
**CCH** = Chocolate

**Vinyl Color:**  
**VBL** = Black  
**VWH** = White  
**VCH** = Chocolate

**See inside front cover for required option codes**







Example

GAACORNER.CWH.OFC1  
 GAACORNER                    CWH                    OFC1  
 MODEL NUMBER                LEATHER COLOR                OFFICE #

# ORGANIZATION TRAYS

Credentials  
02/24

Leather

|  | D  | W        | H | model number        | list  |
|--|--|----------|---|---------------------|-------|
| <b>15" BOX DRAWER INSERT</b><br>  | 13 15/16   | 11 11/16 | 3 | <b>GAATRAYBOX15</b> | 916   |
|  | <ul style="list-style-type: none"> <li>For use in 15" wide box drawers</li> </ul>  |          |   |                     |       |
| <b>18" BOX DRAWER INSERT</b><br>  | 13 15/16   | 14 11/16 | 3 | <b>GAATRAYBOX18</b> | 1,006 |
|  | <ul style="list-style-type: none"> <li>For use in 18" wide box drawers</li> </ul>  |          |   |                     |       |
| <b>30" BOX DRAWER INSERT</b><br>  | 13 15/16   | 26 11/16 | 3 | <b>GAATRAYBOX30</b> | 1,713 |
|  | <ul style="list-style-type: none"> <li>For use in 30" wide box drawers</li> </ul>  |          |   |                     |       |
| <b>36" BOX DRAWER INSERT</b><br>  | 13 15/16   | 32 11/16 | 3 | <b>GAATRAYBOX36</b> | 1,875 |
|  | <ul style="list-style-type: none"> <li>For use in 36" wide box drawers</li> </ul>  |          |   |                     |       |
| <b>15" TRAY FOR OVERHEADS WITH CUBBY</b><br> (Sliding & soft lift doors ONLY)  | 13 15/16   | 13 1/4   | 3 | <b>GAATRAYLTR15</b> | 799   |
|  | <ul style="list-style-type: none"> <li>Letter tray for use in 1 high overheads with 15" wide cubbies.</li> <li>For sliding door and soft lift door overhead, with width dimension in 15" increments = 60"w, 90"w, 120"w</li> <li>Not for use with hinged doors. Hinge location prevents leather tray from fitting in opening.</li> </ul> |          |   |                     |       |
| <b>18" TRAY FOR OVERHEADS WITH CUBBY</b><br> (Sliding & soft lift doors ONLY) | 13 15/16   | 16 1/4   | 3 | <b>GAATRAYLTR18</b> | 873   |
|  | <ul style="list-style-type: none"> <li>Letter tray for use in 1 high overheads with 18" wide cubbies</li> <li>For sliding door and soft lift door overhead, with width dimension in 18" increments = 72"w, 108"w</li> <li>Not for use with hinged doors. Hinge location prevents leather tray from fitting in opening.</li> </ul>        |          |   |                     |       |

## PRODUCT INFO

### TO ORDER PLEASE SPECIFY THE FOLLOWING:

- MODEL NUMBER**
- LEATHER COLOR**
- OFFICE #**

**Leather Color:**

**CBL** = Black  
**CWH** = White  
**CCH** = Chocolate

See inside front cover for required option codes

Example

GAATRAYBOX15.CWH.OFC1  
 GAATRAYBOX15      CWH      OFC1  
 MODEL NUMBER      LEATHER COLOR      OFFICE #

|                        | D | W       | H     | model number      | list |
|------------------------|---|---------|-------|-------------------|------|
| <b>15" PENCIL TRAY</b> | 3 | 11 5/16 | 1 1/4 | <b>ACPT15-GAA</b> | 117  |

**18" PENCIL TRAY**

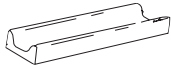

|  |   |         |       |                   |     |
|--|---|---------|-------|-------------------|-----|
|  | 3 | 14 5/16 | 1 1/4 | <b>ACPT18-GAA</b> | 124 |
|--|---|---------|-------|-------------------|-----|

[W] [W]  
vener 2 vener 3

**CENTER DRAWER**

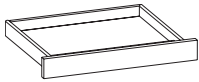

|  |        |        |         |                      |         |
|--|--------|--------|---------|----------------------|---------|
|  | 17 5/8 | 21 3/4 | 2 15/16 | <b>GS2CDWSD-</b> [ ] | 788 860 |
|--|--------|--------|---------|----------------------|---------|

**INTERIOR DIMENSIONS**

D = 15 1/2  
W = 18 1/4  
H = 1 3/8

**PRODUCT INFO**

Center drawer includes pencil tray

**TO ORDER PLEASE SPECIFY THE FOLLOWING:**

1.  **MODEL NUMBER**
2.  **FINISH** • Finish option not required for pencil trays

**NOTE: Office # option not required**

**See inside front cover for required option codes**

Example

|                     |               |
|---------------------|---------------|
| <b>ACCD19.NC215</b> |               |
| ACCD19              | NC215         |
| <b>MODEL NUMBER</b> | <b>FINISH</b> |

POWER UNIT

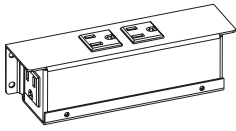

| D     | W | H     | model number                         | list |
|-------|---|-------|--------------------------------------|------|
| 1 3/4 | 3 | 1 3/4 | <b>ACPWRT</b> <i>(De-emphasized)</i> | 758  |

- Includes 3 power outlets - 2 power outlets on top surface and 1 power outlet on end of unit.
- Ships with 6 ft power cord with standard plug
- UL listed
- Mounting bracket included for use installation in the following applications:
  - To bottom of worksurface beneath grommets
  - To bottom of worksurface in trough opening of trough worksurfaces
  - As power strip inside wall access panels or beneath desks

PRODUCT INFO

TO ORDER PLEASE SPECIFY THE FOLLOWING:





1.  **MODEL NUMBER**

**NOTE: Office # option not required**

**See inside front cover for required option codes**

Example

ACPWRT  
ACPWRT  
MODEL NUMBER

|   | D   | W  | H | model number      | list |
|---|-----|----|---|-------------------|------|
| <b>FOR USE WITH<br/>15" W FILE DRAWERS</b><br>   | 1/8 | 15 | 1 | <b>ACFLR15-AA</b> | 43   |
| <b>FOR USE WITH<br/>18" W FILE DRAWERS</b><br>   | 1/8 | 18 | 1 | <b>ACFLR18-AA</b> | 44   |
| <b>FOR USE WITH<br/>30" W LATERAL FILES</b><br>  | 1/8 | 30 | 1 | <b>ACFLR30-AA</b> | 48   |
| <b>FOR USE WITH<br/>36" W LATERAL FILES</b><br> | 1/8 | 36 | 1 | <b>ACFLR36-AA</b> | 53   |

**PRODUCT INFO**

TO ORDER PLEASE SPECIFY THE FOLLOWING:

1.  **MODEL NUMBER**

**NOTE: Office # option not required**

**See inside front cover for required option codes**

Example

ACFLR15-AA  
ACFLR15-AA  
MODEL NUMBER

TRASH CAN

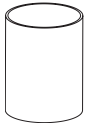

| D     | W     | H  | model number   | list |
|-------|-------|----|----------------|------|
| 9 3/4 | 9 3/4 | 12 | <b>ACTRASH</b> | 925  |

Quantity 2 trash cans are included with all (-T) pedestals.  
They do not need to be purchased separately.

- Satin brushed aluminum finish

PRODUCT INFO

TO ORDER PLEASE SPECIFY THE FOLLOWING:

1.  **MODEL NUMBER**

**NOTE: Office # option not required**

**See inside front cover for required option codes**

Example

---

**ACTRASH**  
ACTRASH  
MODEL NUMBER

|                   | D  | W  | H     | model number        | veneer 2 | veneer 3 |
|-------------------|----|----|-------|---------------------|----------|----------|
| <b>SAMPLE TOP</b> | 18 | 18 | 1 1/2 | <b>GAATOP1818-W</b> | 1,410    | 1,541    |

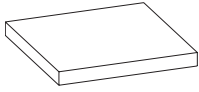

**PRODUCT INFO**

TO ORDER PLEASE SPECIFY THE FOLLOWING:

- 1.  **MODEL NUMBER**
- 2.  **FINISH**
- 3.  **TOP FINISH TYPE**
- 4.  **OFFICE #**

**See inside front cover for required option codes**

Example

GAATOP1818-W.NC215.FF.OFC1  
 GAATOP1818-W      NC215      FF      OFC1  
 MODEL NUMBER      FINISH      TOP FINISH      OFFICE #

# FABRIC GRADE PRICING

Credentials  
02/24

| model number             | 1     | 2     | 3     | COM/4 | 5     | 6     | 7     | 8     | 9     | 10    | 11    | 12    | 13    | 14    | 15    | 16    |
|--------------------------|-------|-------|-------|-------|-------|-------|-------|-------|-------|-------|-------|-------|-------|-------|-------|-------|
| <b>GAAMPD-CUSH1818</b>   | 646   | 665   | 690   | 710   | 742   | 768   | 795   | 826   | 852   | 882   | 911   | 940   | 977   | 1,004 | 1,039 | 1,076 |
| <b>GAACLPD-CUSH2430</b>  | 728   | 756   | 784   | 814   | 855   | 892   | 925   | 964   | 999   | 1,040 | 1,081 | 1,117 | 1,166 | 1,200 | 1,246 | 1,294 |
| <b>GAACLPD-CUSH2436</b>  | 785   | 821   | 857   | 894   | 942   | 990   | 1,033 | 1,082 | 1,127 | 1,175 | 1,224 | 1,270 | 1,331 | 1,378 | 1,435 | 1,495 |
| <b>GAACLPD-CUSH2130T</b> | 728   | 756   | 784   | 814   | 855   | 892   | 925   | 964   | 999   | 1,040 | 1,081 | 1,117 | 1,166 | 1,200 | 1,246 | 1,294 |
| <b>GAACLPD-CUSH2136T</b> | 785   | 821   | 857   | 894   | 942   | 990   | 1,033 | 1,082 | 1,127 | 1,175 | 1,224 | 1,270 | 1,331 | 1,378 | 1,435 | 1,495 |
| <b>GAATKW30</b>          | 1,028 | 1,055 | 1,083 | 1,111 | 1,149 | 1,186 | 1,219 | 1,253 | 1,292 | 1,327 | 1,369 | 1,400 | 1,447 | 1,485 | 1,529 | 1,574 |
| <b>GAATKW36</b>          | 1,078 | 1,111 | 1,149 | 1,184 | 1,231 | 1,274 | 1,318 | 1,365 | 1,406 | 1,452 | 1,501 | 1,545 | 1,605 | 1,648 | 1,704 | 1,761 |
| <b>GAATKW60</b>          | 1,252 | 1,306 | 1,361 | 1,418 | 1,495 | 1,568 | 1,632 | 1,709 | 1,780 | 1,854 | 1,928 | 2,002 | 2,094 | 2,165 | 2,255 | 2,346 |
| <b>GAATKW66</b>          | 1,278 | 1,332 | 1,387 | 1,444 | 1,521 | 1,594 | 1,658 | 1,735 | 1,806 | 1,880 | 1,954 | 2,028 | 2,120 | 2,191 | 2,281 | 2,372 |
| <b>GAATKW72</b>          | 1,327 | 1,386 | 1,450 | 1,517 | 1,598 | 1,683 | 1,755 | 1,841 | 1,921 | 2,003 | 2,088 | 2,169 | 2,273 | 2,352 | 2,453 | 2,558 |
| <b>GAATKW78</b>          | 1,366 | 1,436 | 1,506 | 1,577 | 1,670 | 1,765 | 1,844 | 1,939 | 2,030 | 2,124 | 2,218 | 2,309 | 2,422 | 2,510 | 2,623 | 2,741 |
| <b>GAATKW84</b>          | 1,402 | 1,472 | 1,542 | 1,613 | 1,706 | 1,801 | 1,880 | 1,975 | 2,066 | 2,160 | 2,254 | 2,345 | 2,458 | 2,546 | 2,659 | 2,777 |
| <b>GAATKW90</b>          | 1,463 | 1,536 | 1,616 | 1,694 | 1,797 | 1,901 | 1,990 | 2,091 | 2,190 | 2,294 | 2,397 | 2,493 | 2,622 | 2,720 | 2,843 | 2,971 |
| <b>GAATKW96</b>          | 1,525 | 1,604 | 1,690 | 1,775 | 1,890 | 1,999 | 2,097 | 2,208 | 2,314 | 2,429 | 2,541 | 2,647 | 2,785 | 2,892 | 3,028 | 3,165 |
| <b>GAATKW102</b>         | 2,104 | 2,191 | 2,284 | 2,375 | 2,499 | 2,619 | 2,722 | 2,845 | 2,960 | 3,082 | 3,206 | 3,319 | 3,470 | 3,586 | 3,730 | 3,881 |
| <b>GAATKW108</b>         | 2,177 | 2,273 | 2,371 | 2,471 | 2,603 | 2,736 | 2,845 | 2,979 | 3,104 | 3,235 | 3,365 | 3,493 | 3,655 | 3,779 | 3,936 | 4,097 |
| <b>GAATKW120</b>         | 2,505 | 2,606 | 2,711 | 2,819 | 2,961 | 3,100 | 3,221 | 3,361 | 3,496 | 3,635 | 3,775 | 3,911 | 4,087 | 4,219 | 4,385 | 4,560 |
| <b>GAATKW1H30</b>        | 1,252 | 1,279 | 1,307 | 1,335 | 1,373 | 1,410 | 1,443 | 1,477 | 1,516 | 1,551 | 1,593 | 1,624 | 1,671 | 1,709 | 1,753 | 1,798 |
| <b>GAATKW1H36</b>        | 1,278 | 1,311 | 1,349 | 1,384 | 1,431 | 1,474 | 1,518 | 1,565 | 1,606 | 1,652 | 1,701 | 1,745 | 1,805 | 1,848 | 1,904 | 1,961 |
| <b>GAATKW1H42</b>        | 1,327 | 1,370 | 1,410 | 1,454 | 1,510 | 1,569 | 1,618 | 1,673 | 1,726 | 1,784 | 1,841 | 1,893 | 1,965 | 2,020 | 2,085 | 2,154 |
| <b>GAATKW1H48</b>        | 1,366 | 1,409 | 1,449 | 1,493 | 1,549 | 1,608 | 1,657 | 1,712 | 1,765 | 1,823 | 1,880 | 1,932 | 2,004 | 2,059 | 2,124 | 2,193 |
| <b>GAATKW2H30</b>        | 1,278 | 1,305 | 1,333 | 1,361 | 1,399 | 1,436 | 1,469 | 1,503 | 1,542 | 1,577 | 1,619 | 1,650 | 1,697 | 1,735 | 1,779 | 1,824 |
| <b>GAATKW2H36</b>        | 1,327 | 1,360 | 1,398 | 1,433 | 1,480 | 1,523 | 1,567 | 1,614 | 1,655 | 1,701 | 1,750 | 1,794 | 1,854 | 1,897 | 1,953 | 2,010 |
| <b>GAATKW2H42</b>        | 1,366 | 1,409 | 1,449 | 1,493 | 1,549 | 1,608 | 1,657 | 1,712 | 1,765 | 1,823 | 1,880 | 1,932 | 2,004 | 2,059 | 2,124 | 2,193 |
| <b>GAATKW2H48</b>        | 1,402 | 1,445 | 1,485 | 1,529 | 1,585 | 1,644 | 1,693 | 1,748 | 1,801 | 1,859 | 1,916 | 1,968 | 2,040 | 2,095 | 2,160 | 2,229 |
| <b>GAATLKW30</b>         | 1,078 | 1,105 | 1,133 | 1,161 | 1,199 | 1,236 | 1,269 | 1,303 | 1,342 | 1,377 | 1,419 | 1,450 | 1,497 | 1,535 | 1,579 | 1,624 |
| <b>GAATLKW36</b>         | 1,252 | 1,285 | 1,323 | 1,358 | 1,405 | 1,448 | 1,492 | 1,539 | 1,580 | 1,626 | 1,675 | 1,719 | 1,779 | 1,822 | 1,878 | 1,935 |
| <b>GAATLKW60</b>         | 1,278 | 1,332 | 1,387 | 1,444 | 1,521 | 1,594 | 1,658 | 1,735 | 1,806 | 1,880 | 1,954 | 2,028 | 2,120 | 2,191 | 2,281 | 2,372 |
| <b>GAATLKW66</b>         | 1,327 | 1,381 | 1,436 | 1,493 | 1,570 | 1,643 | 1,707 | 1,784 | 1,855 | 1,929 | 2,003 | 2,077 | 2,169 | 2,240 | 2,330 | 2,421 |
| <b>GAATLKW72</b>         | 1,366 | 1,425 | 1,489 | 1,556 | 1,637 | 1,722 | 1,794 | 1,880 | 1,960 | 2,042 | 2,127 | 2,208 | 2,312 | 2,391 | 2,492 | 2,597 |
| <b>GAATLKW78</b>         | 1,402 | 1,472 | 1,542 | 1,613 | 1,706 | 1,801 | 1,880 | 1,975 | 2,066 | 2,160 | 2,254 | 2,345 | 2,458 | 2,546 | 2,659 | 2,777 |
| <b>GAATLKW84</b>         | 1,463 | 1,533 | 1,603 | 1,674 | 1,767 | 1,862 | 1,941 | 2,036 | 2,127 | 2,221 | 2,315 | 2,406 | 2,519 | 2,607 | 2,720 | 2,838 |
| <b>GAATLKW90</b>         | 1,525 | 1,598 | 1,678 | 1,756 | 1,859 | 1,963 | 2,052 | 2,153 | 2,252 | 2,356 | 2,459 | 2,555 | 2,684 | 2,782 | 2,905 | 3,033 |
| <b>GAATLKW96</b>         | 2,104 | 2,183 | 2,269 | 2,354 | 2,469 | 2,578 | 2,676 | 2,787 | 2,893 | 3,008 | 3,120 | 3,226 | 3,364 | 3,471 | 3,607 | 3,744 |
| <b>GAATLKW102</b>        | 2,177 | 2,264 | 2,357 | 2,448 | 2,572 | 2,692 | 2,795 | 2,918 | 3,033 | 3,155 | 3,279 | 3,392 | 3,543 | 3,659 | 3,803 | 3,954 |
| <b>GAATLKW108</b>        | 2,287 | 2,383 | 2,481 | 2,581 | 2,713 | 2,846 | 2,955 | 3,089 | 3,214 | 3,345 | 3,475 | 3,603 | 3,765 | 3,889 | 4,046 | 4,207 |
| <b>GAATLKW120</b>        | 2,552 | 2,653 | 2,758 | 2,866 | 3,008 | 3,147 | 3,268 | 3,408 | 3,543 | 3,682 | 3,822 | 3,958 | 4,134 | 4,266 | 4,432 | 4,607 |



| model number             | 17    | 18    | 19    | 20    | 21    | 22    | 23    | 24    | 25    | 26    | 27    | col | L1    | L2    | L3    | L4    | L5    |
|--------------------------|-------|-------|-------|-------|-------|-------|-------|-------|-------|-------|-------|-----|-------|-------|-------|-------|-------|
| <b>GAAMPD-CUSH1818</b>   | 1,113 | 1,138 | 1,175 | 1,206 | 1,242 | 1,277 | 1,345 | 1,414 | 1,488 | 1,555 | 1,624 | 710 | 929   | 1,164 | 1,399 | 1,637 | 1,850 |
| <b>GAACLPD-CUSH2430</b>  | 1,343 | 1,376 | 1,422 | 1,467 | 1,512 | 1,557 | 1,649 | 1,739 | 1,834 | 1,925 | 2,016 | 814 | 1,107 | 1,421 | 1,733 | 2,047 | 2,332 |
| <b>GAACLPD-CUSH2436</b>  | 1,552 | 1,595 | 1,653 | 1,706 | 1,764 | 1,821 | 1,939 | 2,052 | 2,166 | 2,281 | 2,397 | 894 | 1,256 | 1,652 | 2,041 | 2,435 | 2,789 |
| <b>GAACLPD-CUSH2130T</b> | 1,343 | 1,376 | 1,422 | 1,467 | 1,512 | 1,557 | 1,649 | 1,739 | 1,834 | 1,925 | 2,016 | 814 | 1,107 | 1,421 | 1,733 | 2,047 | 2,332 |
| <b>GAACLPD-CUSH2136T</b> | 1,552 | 1,595 | 1,653 | 1,706 | 1,764 | 1,821 | 1,939 | 2,052 | 2,166 | 2,281 | 2,397 | 894 | 1,256 | 1,652 | 2,041 | 2,435 | 2,789 |
| <b>GAATKW30</b>          | 1,621 | 1,652 | 1,695 | 1,738 | 1,783 | 1,827 | 1,916 | 2,001 | 2,095 | 2,182 | 2,269 |     |       |       |       |       |       |
| <b>GAATKW36</b>          | 1,817 | 1,858 | 1,912 | 1,966 | 2,023 | 2,079 | 2,191 | 2,297 | 2,409 | 2,522 | 2,633 |     |       |       |       |       |       |
| <b>GAATKW60</b>          | 2,435 | 2,499 | 2,588 | 2,674 | 2,761 | 2,852 | 3,029 | 3,204 | 3,382 | 3,560 | 3,737 |     |       |       |       |       |       |
| <b>GAATKW66</b>          | 2,461 | 2,525 | 2,614 | 2,700 | 2,787 | 2,878 | 3,055 | 3,230 | 3,408 | 3,586 | 3,763 |     |       |       |       |       |       |
| <b>GAATKW72</b>          | 2,657 | 2,731 | 2,831 | 2,927 | 3,028 | 3,126 | 3,327 | 3,522 | 3,724 | 3,926 | 4,123 |     |       |       |       |       |       |
| <b>GAATKW78</b>          | 2,851 | 2,932 | 3,042 | 3,151 | 3,262 | 3,377 | 3,599 | 3,817 | 4,039 | 4,264 | 4,480 |     |       |       |       |       |       |
| <b>GAATKW84</b>          | 2,887 | 2,968 | 3,078 | 3,187 | 3,298 | 3,413 | 3,635 | 3,853 | 4,075 | 4,300 | 4,516 |     |       |       |       |       |       |
| <b>GAATKW90</b>          | 3,093 | 3,184 | 3,306 | 3,426 | 3,545 | 3,669 | 3,915 | 4,156 | 4,403 | 4,649 | 4,888 |     |       |       |       |       |       |
| <b>GAATKW96</b>          | 3,300 | 3,396 | 3,528 | 3,657 | 3,790 | 3,923 | 4,191 | 4,455 | 4,723 | 4,987 | 5,250 |     |       |       |       |       |       |
| <b>GAATKW102</b>         | 4,025 | 4,131 | 4,278 | 4,415 | 4,557 | 4,703 | 4,993 | 5,275 | 5,566 | 5,858 | 6,140 |     |       |       |       |       |       |
| <b>GAATKW108</b>         | 4,254 | 4,367 | 4,525 | 4,674 | 4,828 | 4,984 | 5,298 | 5,604 | 5,917 | 6,227 | 6,533 |     |       |       |       |       |       |
| <b>GAATKW120</b>         | 4,729 | 4,848 | 5,017 | 5,177 | 5,344 | 5,513 | 5,846 | 6,175 | 6,511 | 6,843 | 7,172 |     |       |       |       |       |       |
| <b>GAATKW1H30</b>        | 1,845 | 1,876 | 1,919 | 1,962 | 2,007 | 2,051 | 2,140 | 2,225 | 2,319 | 2,406 | 2,493 |     |       |       |       |       |       |
| <b>GAATKW1H36</b>        | 2,017 | 2,058 | 2,112 | 2,166 | 2,223 | 2,279 | 2,391 | 2,497 | 2,609 | 2,722 | 2,833 |     |       |       |       |       |       |
| <b>GAATKW1H42</b>        | 2,221 | 2,271 | 2,338 | 2,400 | 2,467 | 2,536 | 2,670 | 2,803 | 2,936 | 3,068 | 3,203 |     |       |       |       |       |       |
| <b>GAATKW1H48</b>        | 2,260 | 2,310 | 2,377 | 2,439 | 2,506 | 2,575 | 2,709 | 2,842 | 2,975 | 3,107 | 3,242 |     |       |       |       |       |       |
| <b>GAATKW2H30</b>        | 1,871 | 1,902 | 1,945 | 1,988 | 2,033 | 2,077 | 2,166 | 2,251 | 2,345 | 2,432 | 2,519 |     |       |       |       |       |       |
| <b>GAATKW2H36</b>        | 2,066 | 2,107 | 2,161 | 2,215 | 2,272 | 2,328 | 2,440 | 2,546 | 2,658 | 2,771 | 2,882 |     |       |       |       |       |       |
| <b>GAATKW2H42</b>        | 2,260 | 2,310 | 2,377 | 2,439 | 2,506 | 2,575 | 2,709 | 2,842 | 2,975 | 3,107 | 3,242 |     |       |       |       |       |       |
| <b>GAATKW2H48</b>        | 2,296 | 2,346 | 2,413 | 2,475 | 2,542 | 2,611 | 2,745 | 2,878 | 3,011 | 3,143 | 3,278 |     |       |       |       |       |       |
| <b>GAATLKW30</b>         | 1,671 | 1,702 | 1,745 | 1,788 | 1,833 | 1,877 | 1,966 | 2,051 | 2,145 | 2,232 | 2,319 |     |       |       |       |       |       |
| <b>GAATLKW36</b>         | 1,991 | 2,032 | 2,086 | 2,140 | 2,197 | 2,253 | 2,365 | 2,471 | 2,583 | 2,696 | 2,807 |     |       |       |       |       |       |
| <b>GAATLKW60</b>         | 2,461 | 2,525 | 2,614 | 2,700 | 2,787 | 2,878 | 3,055 | 3,230 | 3,408 | 3,586 | 3,763 |     |       |       |       |       |       |
| <b>GAATLKW66</b>         | 2,510 | 2,574 | 2,663 | 2,749 | 2,836 | 2,927 | 3,104 | 3,279 | 3,457 | 3,635 | 3,812 |     |       |       |       |       |       |
| <b>GAATLKW72</b>         | 2,696 | 2,770 | 2,870 | 2,966 | 3,067 | 3,165 | 3,366 | 3,561 | 3,763 | 3,965 | 4,162 |     |       |       |       |       |       |
| <b>GAATLKW78</b>         | 2,887 | 2,968 | 3,078 | 3,187 | 3,298 | 3,413 | 3,635 | 3,853 | 4,075 | 4,300 | 4,516 |     |       |       |       |       |       |
| <b>GAATLKW84</b>         | 2,948 | 3,029 | 3,139 | 3,248 | 3,359 | 3,474 | 3,696 | 3,914 | 4,136 | 4,361 | 4,577 |     |       |       |       |       |       |
| <b>GAATLKW90</b>         | 3,155 | 3,246 | 3,368 | 3,488 | 3,607 | 3,731 | 3,977 | 4,218 | 4,465 | 4,711 | 4,950 |     |       |       |       |       |       |
| <b>GAATLKW96</b>         | 3,879 | 3,975 | 4,107 | 4,236 | 4,369 | 4,502 | 4,770 | 5,034 | 5,302 | 5,566 | 5,829 |     |       |       |       |       |       |
| <b>GAATLKW102</b>        | 4,098 | 4,204 | 4,351 | 4,488 | 4,630 | 4,776 | 5,066 | 5,348 | 5,639 | 5,931 | 6,213 |     |       |       |       |       |       |
| <b>GAATLKW108</b>        | 4,364 | 4,477 | 4,635 | 4,784 | 4,938 | 5,094 | 5,408 | 5,714 | 6,027 | 6,337 | 6,643 |     |       |       |       |       |       |
| <b>GAATLKW120</b>        | 4,776 | 4,895 | 5,064 | 5,224 | 5,391 | 5,560 | 5,893 | 6,222 | 6,558 | 6,890 | 7,219 |     |       |       |       |       |       |

# FABRIC GRADE PRICING

**Credentials**  
02/24

| model number       | 1     | 2     | 3     | COM/4 | 5     | 6     | 7     | 8     | 9     | 10    | 11    | 12    | 13    | 14    | 15    | 16    |
|--------------------|-------|-------|-------|-------|-------|-------|-------|-------|-------|-------|-------|-------|-------|-------|-------|-------|
| <b>GAATLKW1H30</b> | 1,278 | 1,305 | 1,333 | 1,361 | 1,399 | 1,436 | 1,469 | 1,503 | 1,542 | 1,577 | 1,619 | 1,650 | 1,697 | 1,735 | 1,779 | 1,824 |
| <b>GAATLKW1H36</b> | 1,327 | 1,360 | 1,398 | 1,433 | 1,480 | 1,523 | 1,567 | 1,614 | 1,655 | 1,701 | 1,750 | 1,794 | 1,854 | 1,897 | 1,953 | 2,010 |
| <b>GAATLKW1H42</b> | 1,366 | 1,409 | 1,449 | 1,493 | 1,549 | 1,608 | 1,657 | 1,712 | 1,765 | 1,823 | 1,880 | 1,932 | 2,004 | 2,059 | 2,124 | 2,193 |
| <b>GAATLKW1H48</b> | 1,402 | 1,445 | 1,485 | 1,529 | 1,585 | 1,644 | 1,693 | 1,748 | 1,801 | 1,859 | 1,916 | 1,968 | 2,040 | 2,095 | 2,160 | 2,229 |
| <b>GAATLKW2H30</b> | 1,327 | 1,354 | 1,382 | 1,410 | 1,448 | 1,485 | 1,518 | 1,552 | 1,591 | 1,626 | 1,668 | 1,699 | 1,746 | 1,784 | 1,828 | 1,873 |
| <b>GAATLKW2H36</b> | 1,366 | 1,399 | 1,437 | 1,472 | 1,519 | 1,562 | 1,606 | 1,653 | 1,694 | 1,740 | 1,789 | 1,833 | 1,893 | 1,936 | 1,992 | 2,049 |
| <b>GAATLKW2H42</b> | 1,402 | 1,445 | 1,485 | 1,529 | 1,585 | 1,644 | 1,693 | 1,748 | 1,801 | 1,859 | 1,916 | 1,968 | 2,040 | 2,095 | 2,160 | 2,229 |
| <b>GAATLKW2H48</b> | 1,463 | 1,506 | 1,546 | 1,590 | 1,646 | 1,705 | 1,754 | 1,809 | 1,862 | 1,920 | 1,977 | 2,029 | 2,101 | 2,156 | 2,221 | 2,290 |

| model number       | 17    | 18    | 19    | 20    | 21    | 22    | 23    | 24    | 25    | 26    | 27    | col | L1 | L2 | L3 | L4 | L5 |
|--------------------|-------|-------|-------|-------|-------|-------|-------|-------|-------|-------|-------|-----|----|----|----|----|----|
| <b>GAATLKW1H30</b> | 1,871 | 1,902 | 1,945 | 1,988 | 2,033 | 2,077 | 2,166 | 2,251 | 2,345 | 2,432 | 2,519 |     |    |    |    |    |    |
| <b>GAATLKW1H36</b> | 2,066 | 2,107 | 2,161 | 2,215 | 2,272 | 2,328 | 2,440 | 2,546 | 2,658 | 2,771 | 2,882 |     |    |    |    |    |    |
| <b>GAATLKW1H42</b> | 2,260 | 2,310 | 2,377 | 2,439 | 2,506 | 2,575 | 2,709 | 2,842 | 2,975 | 3,107 | 3,242 |     |    |    |    |    |    |
| <b>GAATLKW1H48</b> | 2,296 | 2,346 | 2,413 | 2,475 | 2,542 | 2,611 | 2,745 | 2,878 | 3,011 | 3,143 | 3,278 |     |    |    |    |    |    |
| <b>GAATLKW2H30</b> | 1,920 | 1,951 | 1,994 | 2,037 | 2,082 | 2,126 | 2,215 | 2,300 | 2,394 | 2,481 | 2,568 |     |    |    |    |    |    |
| <b>GAATLKW2H36</b> | 2,105 | 2,146 | 2,200 | 2,254 | 2,311 | 2,367 | 2,479 | 2,585 | 2,697 | 2,810 | 2,921 |     |    |    |    |    |    |
| <b>GAATLKW2H42</b> | 2,296 | 2,346 | 2,413 | 2,475 | 2,542 | 2,611 | 2,745 | 2,878 | 3,011 | 3,143 | 3,278 |     |    |    |    |    |    |
| <b>GAATLKW2H48</b> | 2,357 | 2,407 | 2,474 | 2,536 | 2,603 | 2,672 | 2,806 | 2,939 | 3,072 | 3,204 | 3,339 |     |    |    |    |    |    |

# WEIGHTS + CUBES

| model number   | weight   | cubes | #locks | page |
|----------------|----------|-------|--------|------|
| ACFLR15-AA     | 1 lbs.   | 0.1   | -      | 145  |
| ACFLR18-AA     | 1 lbs.   | 0.2   | -      | 145  |
| ACFLR30-AA     | 1 lbs.   | 0.2   | -      | 145  |
| ACFLR36-AA     | 1 lbs.   | 0.3   | -      | 145  |
| ACLED24-R      | 1 lbs.   | 0.2   | -      | 138  |
| ACLED54-R      | 4 lbs.   | 0.4   | -      | 138  |
| ACLED72-R      | 5 lbs.   | 0.6   | -      | 138  |
| ACPT15-GAA     | 2 lbs.   | 0.5   | -      | 143  |
| ACPT18-GAA     | 2 lbs.   | 0.5   | -      | 143  |
| ACPWRT         | 1 lbs.   | 0.1   | -      | 144  |
| ACTRASH        | 1 lbs.   | 1.4   | -      | 146  |
| ACWCB15        | 6 lbs.   | 0.7   | -      | 92   |
| ACWCB20        | 8 lbs.   | 0.8   | -      | 92   |
| ACWM           | 1 lbs.   | 0.6   | -      | 140  |
| BSHAT2142      | 53 lbs.  | 5.4   | -      | 100  |
| BSHAT2148      | 55 lbs.  | 6.3   | -      | 100  |
| BSHAT2154      | 57 lbs.  | 7.1   | -      | 100  |
| BSHAT2160      | 59 lbs.  | 7.9   | -      | 100  |
| BSHAT2166      | 61 lbs.  | 8.8   | -      | 100  |
| BSHAT2172      | 63 lbs.  | 9.6   | -      | 100  |
| BSHAT2748      | 59 lbs.  | 7.8   | -      | 100  |
| BSHAT2754      | 61 lbs.  | 8.9   | -      | 100  |
| BSHAT2760      | 63 lbs.  | 9.9   | -      | 100  |
| BSHAT2766      | 65 lbs.  | 10.9  | -      | 100  |
| BSHAT2772      | 67 lbs.  | 12.0  | -      | 100  |
| GA2ASF830-W    | 16 lbs.  | 0.8   | -      | 136  |
| GA2ASF836-W    | 17 lbs.  | 1.0   | -      | 136  |
| GA2ASF842-W    | 19 lbs.  | 1.1   | -      | 136  |
| GA2ASF848-W    | 20 lbs.  | 1.3   | -      | 136  |
| GA2ASF860-W    | 22 lbs.  | 1.6   | -      | 136  |
| GA2ASF866-W    | 24 lbs.  | 1.8   | -      | 136  |
| GA2ASF872-W    | 25 lbs.  | 1.9   | -      | 136  |
| GA2ASF878-W    | 26 lbs.  | 2.1   | -      | 136  |
| GA2ASF884-W    | 27 lbs.  | 2.2   | -      | 136  |
| GA2ASF890-W    | 29 lbs.  | 2.4   | -      | 136  |
| GA2ASF896-W    | 30 lbs.  | 2.5   | -      | 136  |
| GA2ASF8102-W   | 31 lbs.  | 2.7   | -      | 136  |
| GA2ASF8108-W   | 32 lbs.  | 2.8   | -      | 136  |
| GA2ASF8120-W   | 35 lbs.  | 3.1   | -      | 136  |
| GA2ASF8144-W   | 40 lbs.  | 3.7   | -      | 136  |
| GA2BKN2H1830-W | 126 lbs. | 12.3  | -      | 108  |
| GA2BKN2H1836-W | 144 lbs. | 14.6  | -      | 108  |
| GA2BKN3H1830-W | 141 lbs. | 17.6  | -      | 108  |

| model number       | weight   | cubes | #locks | page |
|--------------------|----------|-------|--------|------|
| GA2BKN3H1836-W     | 159 lbs. | 20.8  | -      | 108  |
| GA2BKN4H1830-W     | 178 lbs. | 22.9  | -      | 108  |
| GA2BKN4H1836-W     | 201 lbs. | 27.1  | -      | 108  |
| GA2BKN5H1830-W     | 223 lbs. | 30.0  | -      | 108  |
| GA2BKN5H1836-W     | 251 lbs. | 35.4  | -      | 108  |
| GA2BKN6H1830-W     | 251 lbs. | 33.2  | -      | 108  |
| GA2BKN6H1836-W     | 283 lbs. | 39.2  | -      | 108  |
| GA2BLRG2466-W      | 83 lbs.  | 35.0  | -      | 56   |
| GA2BLRG2472-W      | 90 lbs.  | 38.0  | -      | 56   |
| GA2BLRG2478-W      | 97 lbs.  | 41.1  | -      | 56   |
| GA2BRG2442A-WW     | 54 lbs.  | 22.8  | -      | 56   |
| GA2BRG2442TA-WW    | 49 lbs.  | 20.5  | -      | 57   |
| GA2BRG2442T-WW     | 49 lbs.  | 20.5  | -      | 57   |
| GA2BRG2442-WW      | 54 lbs.  | 22.8  | -      | 56   |
| GA2BRG2448A-WW     | 60 lbs.  | 25.8  | -      | 56   |
| GA2BRG2448TA-WW    | 55 lbs.  | 23.2  | -      | 57   |
| GA2BRG2448T-WW     | 55 lbs.  | 23.2  | -      | 57   |
| GA2BRG2448-WW      | 60 lbs.  | 25.8  | -      | 56   |
| GA2BRG2454A-WW     | 69 lbs.  | 28.9  | -      | 56   |
| GA2BRG2454TA-WW    | 61 lbs.  | 25.9  | -      | 57   |
| GA2BRG2454T-WW     | 61 lbs.  | 25.9  | -      | 57   |
| GA2BRG2454-WW      | 69 lbs.  | 28.9  | -      | 56   |
| GA2CFS2460T-44WW   | 335 lbs. | 31.4  | 2      | 93   |
| GA2CFS2460T-55WW   | 326 lbs. | 31.4  | -      | 93   |
| GA2CFS2472T-44WW   | 388 lbs. | 37.4  | 2      | 93   |
| GA2CFS2472T-55WW   | 380 lbs. | 37.4  | -      | 93   |
| GA2CFS2490T-444WW  | 510 lbs. | 46.4  | 3      | 94   |
| GA2CFS2490T-454WW  | 504 lbs. | 46.4  | 2      | 94   |
| GA2CFS2490T-555WW  | 492 lbs. | 46.4  | -      | 94   |
| GA2CFS24108T-444WW | 584 lbs. | 55.4  | 3      | 94   |
| GA2CFS24108T-454WW | 580 lbs. | 55.4  | 2      | 94   |
| GA2CFS24108T-555WW | 572 lbs. | 55.4  | -      | 94   |
| GA2CLC5H1818L-WW   | 174 lbs. | 19.9  | 1      | 110  |
| GA2CLC5H1818R-WW   | 174 lbs. | 19.9  | 1      | 110  |
| GA2CLC5H2418L-WW   | 217 lbs. | 26.7  | 1      | 112  |
| GA2CLC5H2418R-WW   | 217 lbs. | 26.7  | 1      | 112  |
| GA2CLC6H1818L-WW   | 207 lbs. | 22.0  | 1      | 111  |
| GA2CLC6H1818R-WW   | 197 lbs. | 22.0  | 1      | 111  |
| GA2CLC6H2418L-WW   | 248 lbs. | 29.6  | 1      | 113  |
| GA2CLC6H2418R-WW   | 248 lbs. | 29.6  | 1      | 113  |
| GA2CLD5H1818L-WW   | 220 lbs. | 19.9  | 1      | 110  |
| GA2CLD5H1818R-WW   | 220 lbs. | 19.9  | 1      | 110  |
| GA2CLD5H1824L-WW   | 254 lbs. | 25.6  | 1      | 110  |

**Credentials**

02/24

**WEIGHTS + CUBES**

| model number         | weight   | cubes | #locks | page |
|----------------------|----------|-------|--------|------|
| GA2CLD5H1824R-WW     | 254 lbs. | 25.6  | 1      | 110  |
| GA2CLD5H1830-WW      | 299 lbs. | 31.3  | 1      | 110  |
| GA2CLD5H2418L-WW     | 294 lbs. | 26.7  | 1      | 112  |
| GA2CLD5H2418R-WW     | 294 lbs. | 26.7  | 1      | 112  |
| GA2CLD5H2424L-WW     | 335 lbs. | 34.4  | 1      | 112  |
| GA2CLD5H2424R-WW     | 335 lbs. | 34.4  | 1      | 112  |
| GA2CLD5H2430-WW      | 375 lbs. | 42.0  | 1      | 112  |
| GA2CLD6H1818L-WW     | 256 lbs. | 22.0  | 1      | 111  |
| GA2CLD6H1818R-WW     | 256 lbs. | 22.0  | 1      | 111  |
| GA2CLD6H1824L-WW     | 296 lbs. | 28.3  | 1      | 111  |
| GA2CLD6H1824R-WW     | 296 lbs. | 28.3  | 1      | 111  |
| GA2CLD6H2418L-WW     | 330 lbs. | 29.6  | 1      | 113  |
| GA2CLD6H2418R-WW     | 330 lbs. | 29.6  | 1      | 113  |
| GA2CLD6H2424L-WW     | 378 lbs. | 38.1  | 1      | 113  |
| GA2CLD6H2424R-WW     | 379 lbs. | 38.1  | 1      | 113  |
| GA2CLFS2490T-B5SHW   | 398 lbs. | 34.8  | 1      | 95   |
| GA2CLFS2490T-BBSHW   | 448 lbs. | 34.8  | 2      | 95   |
| GA2CLFS2490T-SH5BW   | 422 lbs. | 34.8  | 1      | 95   |
| GA2CLFS2490T-SHBBW   | 471 lbs. | 34.8  | 2      | 95   |
| GA2CLFS24108T-B5SHW  | 485 lbs. | 41.5  | 1      | 95   |
| GA2CLFS24108T-BBSHW  | 539 lbs. | 41.5  | 2      | 95   |
| GA2CLFS24108T-SH5BW  | 485 lbs. | 41.5  | 1      | 95   |
| GA2CLFS24108T-SHBBW  | 539 lbs. | 41.5  | 2      | 95   |
| GA2CLFS24120T-5SH5W  | 481 lbs. | 46.0  | -      | 96   |
| GA2CLFS24120T-B55SHW | 542 lbs. | 46.0  | 1      | 96   |
| GA2CLFS24120T-BSHBW  | 579 lbs. | 46.0  | 2      | 96   |
| GA2CLFS24120T-SH55BW | 542 lbs. | 46.0  | 1      | 96   |
| GA2CLS5H1818L-WW     | 197 lbs. | 19.9  | 1      | 110  |
| GA2CLS5H1818R-WW     | 197 lbs. | 19.9  | 1      | 110  |
| GA2CLS5H1830-WW      | 285 lbs. | 31.3  | 1      | 110  |
| GA2CLS5H2418L-WW     | 251 lbs. | 26.7  | 1      | 112  |
| GA2CLS5H2418R-WW     | 251 lbs. | 26.7  | 1      | 112  |
| GA2CLS5H2430-WW      | 346 lbs. | 42.0  | 1      | 112  |
| GA2CLS6H1818L-WW     | 230 lbs. | 22.0  | 1      | 111  |
| GA2CLS6H1818R-WW     | 220 lbs. | 22.0  | 1      | 111  |
| GA2CLS6H2418L-WW     | 282 lbs. | 29.6  | 1      | 113  |
| GA2CLS6H2418R-WW     | 282 lbs. | 29.6  | 1      | 113  |
| GA2CWR2460TL-W       | 72 lbs.  | 4.4   | -      | 59   |
| GA2CWR2460TR-W       | 73 lbs.  | 4.4   | -      | 59   |
| GA2CWR2460T-W        | 68 lbs.  | 4.0   | -      | 58   |
| GA2CWR2460-W         | 76 lbs.  | 4.4   | -      | 58   |
| GA2CWR2466TL-W       | 80 lbs.  | 4.9   | -      | 59   |
| GA2CWR2466TR-W       | 80 lbs.  | 4.9   | -      | 59   |

| model number    | weight   | cubes | #locks | page |
|-----------------|----------|-------|--------|------|
| GA2CWR2466T-W   | 74 lbs.  | 4.4   | -      | 58   |
| GA2CWR2466-W    | 83 lbs.  | 4.9   | -      | 58   |
| GA2CWR2472TL-W  | 87 lbs.  | 5.3   | -      | 59   |
| GA2CWR2472TR-W  | 87 lbs.  | 5.3   | -      | 59   |
| GA2CWR2472T-W   | 81 lbs.  | 4.7   | -      | 58   |
| GA2CWR2472-W    | 90 lbs.  | 5.3   | -      | 58   |
| GA2CWR2478TL-W  | 94 lbs.  | 5.7   | -      | 59   |
| GA2CWR2478TR-W  | 94 lbs.  | 5.7   | -      | 59   |
| GA2CWR2478T-W   | 87 lbs.  | 5.1   | -      | 58   |
| GA2CWR2478-W    | 97 lbs.  | 5.7   | -      | 58   |
| GA2CWR2484TL-W  | 101 lbs. | 6.1   | -      | 59   |
| GA2CWR2484TR-W  | 101 lbs. | 6.1   | -      | 59   |
| GA2CWR2484T-W   | 93 lbs.  | 5.5   | -      | 58   |
| GA2CWR2484-W    | 104 lbs. | 6.1   | -      | 58   |
| GA2CWR2490TL-W  | 108 lbs. | 6.5   | -      | 59   |
| GA2CWR2490TR-W  | 108 lbs. | 6.5   | -      | 59   |
| GA2CWR2490T-W   | 99 lbs.  | 5.9   | -      | 58   |
| GA2CWR2490-W    | 111 lbs. | 6.5   | -      | 58   |
| GA2CWR2496TL-W  | 115 lbs. | 7.0   | -      | 59   |
| GA2CWR2496TR-W  | 115 lbs. | 7.0   | -      | 59   |
| GA2CWR2496T-W   | 107 lbs. | 6.3   | -      | 58   |
| GA2CWR2496-W    | 118 lbs. | 7.0   | -      | 58   |
| GA2CWR24102TL-W | 122 lbs. | 7.4   | -      | 59   |
| GA2CWR24102TR-W | 122 lbs. | 7.4   | -      | 59   |
| GA2CWR24102T-W  | 112 lbs. | 6.6   | -      | 58   |
| GA2CWR24102-W   | 125 lbs. | 7.4   | -      | 58   |
| GA2CWR24108TL-W | 129 lbs. | 7.8   | -      | 59   |
| GA2CWR24108TR-W | 129 lbs. | 7.8   | -      | 59   |
| GA2CWR24108T-W  | 118 lbs. | 7.0   | -      | 58   |
| GA2CWR24108-W   | 132 lbs. | 7.8   | -      | 58   |
| GA2CWR24114TL-W | 136 lbs. | 8.2   | -      | 59   |
| GA2CWR24114TR-W | 136 lbs. | 8.2   | -      | 59   |
| GA2CWR24114T-W  | 125 lbs. | 7.4   | -      | 58   |
| GA2CWR24114-W   | 139 lbs. | 8.2   | -      | 58   |
| GA2CWR24120TL-W | 143 lbs. | 8.6   | -      | 59   |
| GA2CWR24120TR-W | 143 lbs. | 8.6   | -      | 59   |
| GA2CWR24120T-W  | 131 lbs. | 7.8   | -      | 58   |
| GA2CWR24120-W   | 146 lbs. | 8.6   | -      | 58   |
| GA2DMHA48-W     | 8 lbs.   | 1.3   | -      | 103  |
| GA2DMHA54-W     | 9 lbs.   | 1.4   | -      | 103  |
| GA2DMHA60-W     | 11 lbs.  | 1.6   | -      | 103  |
| GA2DMHA66-W     | 12 lbs.  | 1.8   | -      | 103  |
| GA2DMHA72-W     | 13 lbs.  | 1.9   | -      | 103  |

# WEIGHTS + CUBES

Credentials

02/24

| model number     | weight   | cubes | #locks | page |
|------------------|----------|-------|--------|------|
| GA2DRO3072L-3WW  | 251 lbs. | 46.5  | 1      | 40   |
| GA2DRO3072R-3WW  | 251 lbs. | 46.5  | 1      | 41   |
| GA2DRO3072TL-3WW | 247 lbs. | 46.5  | 1      | 40   |
| GA2DRO3072TR-3WW | 247 lbs. | 46.5  | 1      | 41   |
| GA2DRO3672-32WW  | 355 lbs. | 54.9  | 2      | 39   |
| GA2DRO3672L-3WW  | 276 lbs. | 54.9  | 1      | 40   |
| GA2DRO3672R-3WW  | 276 lbs. | 54.9  | 1      | 41   |
| GA2DRO3672TL-3WW | 267 lbs. | 54.9  | 1      | 40   |
| GA2DRO3672TR-3WW | 267 lbs. | 54.9  | 1      | 41   |
| GA2DRO3678-32WW  | 380 lbs. | 59.3  | 2      | 39   |
| GA2DRO3678L-3WW  | 286 lbs. | 59.3  | 1      | 40   |
| GA2DRO3678R-3WW  | 286 lbs. | 59.3  | 1      | 41   |
| GA2DRO3678TL-3WW | 276 lbs. | 59.3  | 1      | 40   |
| GA2DRO3678TR-3WW | 276 lbs. | 59.3  | 1      | 41   |
| GA2DRO3684-32WW  | 405 lbs. | 63.7  | 2      | 39   |
| GA2DRO3684L-3WW  | 306 lbs. | 63.7  | 1      | 40   |
| GA2DRO3684R-3WW  | 306 lbs. | 63.7  | 1      | 41   |
| GA2DRO3684TL-3WW | 301 lbs. | 63.7  | 1      | 40   |
| GA2DRO3684TR-3WW | 301 lbs. | 63.7  | 1      | 41   |
| GA2DTRAK3672L-WW | 500 lbs. | 54.9  | -      | 36   |
| GA2DTRAK3672R-WW | 500 lbs. | 54.9  | -      | 37   |
| GA2DTRAK3678L-WW | 525 lbs. | 59.3  | -      | 36   |
| GA2DTRAK3678R-WW | 525 lbs. | 59.3  | -      | 37   |
| GA2DTRAK3684L-WW | 550 lbs. | 63.7  | -      | 36   |
| GA2DTRAK3684R-WW | 550 lbs. | 63.7  | -      | 37   |
| GA2DTRL3072-G    | 101 lbs. | 46.5  | -      | 33   |
| GA2DTRL3072-S    | 75 lbs.  | 46.5  | -      | 33   |
| GA2DTRL3072-W    | 111 lbs. | 46.5  | -      | 32   |
| GA2DTRL3672-G    | 125 lbs. | 54.9  | -      | 33   |
| GA2DTRL3672-S    | 85 lbs.  | 54.9  | -      | 33   |
| GA2DTRL3672-W    | 131 lbs. | 54.9  | -      | 32   |
| GA2DTRL3678-G    | 135 lbs. | 59.3  | -      | 33   |
| GA2DTRL3678-S    | 95 lbs.  | 59.3  | -      | 33   |
| GA2DTRL3678-W    | 142 lbs. | 59.3  | -      | 32   |
| GA2DTRL3684-G    | 145 lbs. | 63.7  | -      | 33   |
| GA2DTRL3684-S    | 105 lbs. | 63.7  | -      | 33   |
| GA2DTRL3684-W    | 152 lbs. | 63.7  | -      | 32   |
| GA2DTRM3672L-3WW | 350 lbs. | 54.9  | 1      | 34   |
| GA2DTRM3672R-3WW | 350 lbs. | 54.9  | 1      | 35   |
| GA2DTRM3678L-3WW | 375 lbs. | 59.3  | 1      | 34   |
| GA2DTRM3678R-3WW | 375 lbs. | 59.3  | 1      | 35   |
| GA2DTRM3684L-3WW | 400 lbs. | 63.7  | 1      | 34   |
| GA2DTRM3684R-3WW | 400 lbs. | 63.7  | 1      | 35   |
| GA2DTRR3672-WW   | 239 lbs. | 54.9  | -      | 38   |

| model number     | weight   | cubes | #locks | page |
|------------------|----------|-------|--------|------|
| GA2DTRR3678-WW   | 264 lbs. | 59.3  | -      | 38   |
| GA2DTRR3684-WW   | 289 lbs. | 63.7  | -      | 38   |
| GA2DWRA2442-W    | 39 lbs.  | 3.2   | -      | 101  |
| GA2DWRA2448-W    | 45 lbs.  | 3.6   | -      | 101  |
| GA2DWRA2454-W    | 51 lbs.  | 4.0   | -      | 101  |
| GA2DWRA2460-W    | 56 lbs.  | 4.4   | -      | 101  |
| GA2DWRA2466-W    | 62 lbs.  | 4.9   | -      | 101  |
| GA2DWRA2472-W    | 67 lbs.  | 5.3   | -      | 101  |
| GA2DWRA3048-W    | 56 lbs.  | 4.4   | -      | 102  |
| GA2DWRA3054-W    | 63 lbs.  | 4.9   | -      | 102  |
| GA2DWRA3060-W    | 70 lbs.  | 5.4   | -      | 102  |
| GA2DWRA3066-W    | 77 lbs.  | 5.9   | -      | 102  |
| GA2DWRA3072-W    | 84 lbs.  | 6.4   | -      | 102  |
| GA2DWRA3648-W    | 67 lbs.  | 5.2   | -      | 102  |
| GA2DWRA3654-W    | 76 lbs.  | 5.8   | -      | 102  |
| GA2DWRA3660-W    | 84 lbs.  | 6.4   | -      | 102  |
| GA2DWRA3666-W    | 93 lbs.  | 7.0   | -      | 102  |
| GA2DWRA3672-W    | 101 lbs. | 7.6   | -      | 102  |
| GA2HDC2H2430T-WW | 169 lbs. | 17.3  | -      | 109  |
| GA2HDC2H2430-WW  | 169 lbs. | 17.3  | -      | 109  |
| GA2HDC2H2436T-WW | 195 lbs. | 20.4  | -      | 109  |
| GA2HDC2H2436-WW  | 195 lbs. | 20.4  | -      | 109  |
| GA2HDCLH2430-WW  | 132 lbs. | 13.1  | -      | 109  |
| GA2HDCLH2436-WW  | 152 lbs. | 15.5  | -      | 109  |
| GA2LFS2H2430T-WW | 177 lbs. | 17.3  | 1      | 106  |
| GA2LFS2H2430-WW  | 188 lbs. | 17.3  | 1      | 106  |
| GA2LFS2H2436T-WW | 196 lbs. | 20.4  | 1      | 106  |
| GA2LFS2H2436-WW  | 212 lbs. | 20.4  | 1      | 106  |
| GA2LFS3H2430-WW  | 259 lbs. | 24.7  | 1      | 107  |
| GA2LFS3H2436-WW  | 297 lbs. | 29.2  | 1      | 107  |
| GA2LFS4H2430-WW  | 325 lbs. | 32.2  | 1      | 107  |
| GA2LFS4H2436-WW  | 364 lbs. | 38.0  | 1      | 107  |
| GA2LFS5H2430-WW  | 410 lbs. | 42.0  | 1      | 107  |
| GA2LFS5H2436-WW  | 461 lbs. | 49.7  | 1      | 107  |
| GA2LFS6H2430-WW  | 454 lbs. | 46.5  | 1      | 107  |
| GA2LFS6H2436-WW  | 512 lbs. | 55.0  | 1      | 107  |
| GA2LFSLH2430-WW  | 162 lbs. | 13.1  | 1      | 106  |
| GA2LFSLH2436-WW  | 172 lbs. | 15.5  | 1      | 106  |
| GA2MCA24-W       | 30 lbs.  | 4.0   | -      | 88   |
| GA2MCA27-W       | 32 lbs.  | 4.4   | -      | 88   |
| GA2MCA30-W       | 34 lbs.  | 4.9   | -      | 88   |
| GA2MCA33-W       | 35 lbs.  | 5.3   | -      | 88   |
| GA2MCA36-W       | 37 lbs.  | 5.8   | -      | 88   |
| GA2MCA39-W       | 39 lbs.  | 6.2   | -      | 88   |

**Credentials**

02/24

**WEIGHTS + CUBES**

| model number     | weight   | cubes | #locks | page |
|------------------|----------|-------|--------|------|
| GA2MCA42-W       | 41 lbs.  | 6.7   | -      | 88   |
| GA2MCA45-W       | 43 lbs.  | 7.1   | -      | 88   |
| GA2MCA48-W       | 45 lbs.  | 7.6   | -      | 88   |
| GA2MCA51-W       | 46 lbs.  | 8.0   | -      | 88   |
| GA2MCA54-W       | 48 lbs.  | 8.5   | -      | 88   |
| GA2MCA57-W       | 53 lbs.  | 8.9   | -      | 88   |
| GA2MCA60-W       | 54 lbs.  | 9.3   | -      | 88   |
| GA2MCA63-W       | 56 lbs.  | 9.8   | -      | 88   |
| GA2MCA66-W       | 58 lbs.  | 10.2  | -      | 88   |
| GA2MCA69-W       | 60 lbs.  | 10.7  | -      | 88   |
| GA2MCA72-W       | 62 lbs.  | 11.1  | -      | 88   |
| GA2MCF60-W       | 41 lbs.  | 4.1   | -      | 86   |
| GA2MCF66-W       | 45 lbs.  | 4.5   | -      | 86   |
| GA2MCF72-W       | 48 lbs.  | 4.9   | -      | 86   |
| GA2MCF78-W       | 51 lbs.  | 5.3   | -      | 86   |
| GA2MCF84-W       | 54 lbs.  | 5.7   | -      | 86   |
| GA2MCF90-W       | 58 lbs.  | 6.1   | -      | 86   |
| GA2MCF96-W       | 61 lbs.  | 6.5   | -      | 86   |
| GA2MCF102-W      | 64 lbs.  | 6.9   | -      | 86   |
| GA2MCF108-W      | 67 lbs.  | 7.4   | -      | 86   |
| GA2MCF114-W      | 70 lbs.  | 7.8   | -      | 86   |
| GA2MCF120-W      | 73 lbs.  | 8.2   | -      | 86   |
| GA2MLCF60-W      | 33 lbs.  | 3.1   | -      | 87   |
| GA2MLCF66-W      | 35 lbs.  | 3.4   | -      | 87   |
| GA2MLCF72-W      | 37 lbs.  | 3.7   | -      | 87   |
| GA2MLCF78-W      | 40 lbs.  | 4.0   | -      | 87   |
| GA2MLCF84-W      | 42 lbs.  | 4.3   | -      | 87   |
| GA2MLCF90-W      | 44 lbs.  | 4.6   | -      | 87   |
| GA2MLCF96-W      | 46 lbs.  | 4.9   | -      | 87   |
| GA2MLCF102-W     | 49 lbs.  | 5.2   | -      | 87   |
| GA2MLCF108-W     | 51 lbs.  | 5.5   | -      | 87   |
| GA2MLCF114-W     | 53 lbs.  | 5.8   | -      | 87   |
| GA2MLCF120-W     | 57 lbs.  | 6.1   | -      | 87   |
| GA2MLPW2415L-AW  | 75 lbs.  | 6.7   | 1      | 75   |
| GA2MLPW2415L-LW  | 55 lbs.  | 6.5   | -      | 74   |
| GA2MLPW2415L-XBW | 65 lbs.  | 6.5   | -      | 74   |
| GA2MLPW2415R-AW  | 75 lbs.  | 6.7   | 1      | 81   |
| GA2MLPW2415R-LW  | 55 lbs.  | 6.5   | -      | 80   |
| GA2MLPW2415R-XBW | 65 lbs.  | 6.5   | -      | 80   |
| GA2MLPW2418L-AW  | 81 lbs.  | 7.9   | 1      | 75   |
| GA2MLPW2418R-AW  | 81 lbs.  | 7.9   | 1      | 81   |
| GA2MLPW2430L-5W  | 89 lbs.  | 12.3  | -      | 76   |
| GA2MLPW2430L-BW  | 139 lbs. | 12.3  | 1      | 76   |
| GA2MLPW2430L-PW  | 120 lbs. | 12.3  | 1      | 76   |

| model number     | weight   | cubes | #locks | page |
|------------------|----------|-------|--------|------|
| GA2MLPW2430L-SHW | 77 lbs.  | 12.3  | -      | 76   |
| GA2MLPW2430L-TW  | 122 lbs. | 12.3  | 1      | 76   |
| GA2MLPW2430R-5W  | 89 lbs.  | 12.3  | -      | 82   |
| GA2MLPW2430R-BW  | 139 lbs. | 12.3  | 1      | 82   |
| GA2MLPW2430R-PW  | 120 lbs. | 12.3  | 1      | 82   |
| GA2MLPW2430R-SHW | 77 lbs.  | 12.3  | -      | 82   |
| GA2MLPW2430R-TW  | 122 lbs. | 12.3  | 1      | 82   |
| GA2MLPW2436L-5W  | 98 lbs.  | 14.6  | -      | 77   |
| GA2MLPW2436L-BW  | 151 lbs. | 14.6  | 1      | 77   |
| GA2MLPW2436L-PW  | 130 lbs. | 12.3  | 1      | 77   |
| GA2MLPW2436L-SHW | 87 lbs.  | 14.6  | -      | 77   |
| GA2MLPW2436L-TW  | 132 lbs. | 12.3  | 1      | 77   |
| GA2MLPW2436R-5W  | 98 lbs.  | 14.6  | -      | 83   |
| GA2MLPW2436R-BW  | 151 lbs. | 14.6  | 1      | 83   |
| GA2MLPW2436R-PW  | 130 lbs. | 12.3  | 1      | 83   |
| GA2MLPW2436R-SHW | 87 lbs.  | 14.6  | -      | 83   |
| GA2MLPW2436R-TW  | 132 lbs. | 12.3  | 1      | 83   |
| GA2MLPW2445L-5AW | 157 lbs. | 18.0  | 1      | 78   |
| GA2MLPW2445L-BAW | 175 lbs. | 18.0  | 2      | 78   |
| GA2MLPW2445R-A5W | 157 lbs. | 18.0  | 1      | 84   |
| GA2MLPW2445R-ABW | 175 lbs. | 18.0  | 2      | 84   |
| GA2MLPW2454L-5AW | 176 lbs. | 21.3  | 1      | 78   |
| GA2MLPW2454L-BAW | 196 lbs. | 21.3  | 2      | 78   |
| GA2MLPW2454R-A5W | 176 lbs. | 21.3  | 1      | 84   |
| GA2MLPW2454R-ABW | 196 lbs. | 21.3  | 2      | 84   |
| GA2MLPW2460L-55W | 173 lbs. | 23.6  | -      | 79   |
| GA2MLPW2460L-BBW | 209 lbs. | 23.6  | 2      | 79   |
| GA2MLPW2460R-55W | 173 lbs. | 23.6  | -      | 85   |
| GA2MLPW2460R-BBW | 209 lbs. | 23.6  | 2      | 85   |
| GA2MLSPT12-W     | 7 lbs.   | 0.4   | -      | 91   |
| GA2MLSPT12-W     | 11 lbs.  | 1.3   | -      | 91   |
| GA2MPD1818-AW    | 99 lbs.  | 7.2   | 1      | 97   |
| GA2MPW2415L-2W   | 90 lbs.  | 9.0   | 1      | 63   |
| GA2MPW2415L-3W   | 93 lbs.  | 9.0   | 1      | 63   |
| GA2MPW2415L-LW   | 50 lbs.  | 8.7   | -      | 62   |
| GA2MPW2415L-XBW  | 71 lbs.  | 8.7   | -      | 62   |
| GA2MPW2415L-XEW  | 71 lbs.  | 8.7   | -      | 62   |
| GA2MPW2415R-2W   | 90 lbs.  | 9.0   | 1      | 69   |
| GA2MPW2415R-3W   | 93 lbs.  | 9.0   | 1      | 69   |
| GA2MPW2415R-LW   | 50 lbs.  | 8.7   | -      | 68   |
| GA2MPW2415R-XBW  | 71 lbs.  | 8.7   | -      | 68   |
| GA2MPW2415R-XEW  | 71 lbs.  | 8.7   | -      | 68   |
| GA2MPW2418L-2W   | 97 lbs.  | 10.5  | 1      | 63   |
| GA2MPW2418L-3W   | 101 lbs. | 10.5  | 1      | 63   |

# WEIGHTS + CUBES

Credentials

02/24

| model number    | weight   | cubes | #locks | page |
|-----------------|----------|-------|--------|------|
| GA2MPW2418R-2W  | 97 lbs.  | 10.5  | 1      | 69   |
| GA2MPW2418R-3W  | 101 lbs. | 10.5  | 1      | 69   |
| GA2MPW2430L-4W  | 135 lbs. | 16.5  | 1      | 64   |
| GA2MPW2430L-5W  | 121 lbs. | 16.5  | -      | 64   |
| GA2MPW2430L-7W  | 136 lbs. | 16.5  | 1      | 64   |
| GA2MPW2430L-23W | 172 lbs. | 16.5  | 2      | 64   |
| GA2MPW2430L-BW  | 165 lbs. | 16.5  | 1      | 64   |
| GA2MPW2430L-PW  | 130 lbs. | 16.5  | 1      | 64   |
| GA2MPW2430L-SHW | 105 lbs. | 16.5  | -      | 64   |
| GA2MPW2430L-TW  | 132 lbs. | 16.5  | 1      | 64   |
| GA2MPW2430R-4W  | 135 lbs. | 16.5  | 1      | 70   |
| GA2MPW2430R-5W  | 121 lbs. | 16.5  | -      | 70   |
| GA2MPW2430R-7W  | 136 lbs. | 16.5  | 1      | 70   |
| GA2MPW2430R-32W | 172 lbs. | 16.5  | 2      | 70   |
| GA2MPW2430R-BW  | 165 lbs. | 16.5  | 1      | 70   |
| GA2MPW2430R-PW  | 130 lbs. | 16.5  | 1      | 70   |
| GA2MPW2430R-SHW | 105 lbs. | 16.5  | -      | 70   |
| GA2MPW2430R-TW  | 132 lbs. | 16.5  | 1      | 70   |
| GA2MPW2436L-4W  | 142 lbs. | 19.5  | 1      | 65   |
| GA2MPW2436L-5W  | 138 lbs. | 19.5  | -      | 65   |
| GA2MPW2436L-7W  | 147 lbs. | 19.5  | 1      | 65   |
| GA2MPW2436L-23W | 187 lbs. | 19.5  | 2      | 65   |
| GA2MPW2436L-BW  | 183 lbs. | 19.5  | 1      | 65   |
| GA2MPW2436L-PW  | 140 lbs. | 19.5  | 1      | 65   |
| GA2MPW2436L-SHW | 118 lbs. | 19.5  | -      | 65   |
| GA2MPW2436L-TW  | 142 lbs. | 19.5  | 1      | 65   |
| GA2MPW2436R-4W  | 142 lbs. | 19.5  | 1      | 71   |
| GA2MPW2436R-5W  | 138 lbs. | 19.5  | -      | 71   |
| GA2MPW2436R-7W  | 147 lbs. | 19.5  | 1      | 71   |
| GA2MPW2436R-32W | 187 lbs. | 19.5  | 2      | 71   |
| GA2MPW2436R-BW  | 183 lbs. | 19.5  | 1      | 71   |
| GA2MPW2436R-PW  | 140 lbs. | 19.5  | 1      | 71   |
| GA2MPW2436R-SHW | 118 lbs. | 19.5  | -      | 71   |
| GA2MPW2436R-TW  | 142 lbs. | 19.5  | 1      | 71   |
| GA2MPW2445L-43W | 203 lbs. | 24.0  | 2      | 66   |
| GA2MPW2445L-52W | 200 lbs. | 24.0  | 1      | 66   |
| GA2MPW2445L-72W | 216 lbs. | 24.0  | 2      | 66   |
| GA2MPW2445R-25W | 200 lbs. | 24.0  | 1      | 72   |
| GA2MPW2445R-27W | 216 lbs. | 24.0  | 2      | 72   |
| GA2MPW2445R-34W | 203 lbs. | 24.0  | 2      | 72   |
| GA2MPW2454L-43W | 232 lbs. | 28.4  | 2      | 66   |
| GA2MPW2454L-52W | 224 lbs. | 28.4  | 1      | 66   |
| GA2MPW2454L-72W | 234 lbs. | 28.4  | 2      | 66   |
| GA2MPW2454R-25W | 224 lbs. | 28.4  | 1      | 72   |

| model number    | weight   | cubes | #locks | page |
|-----------------|----------|-------|--------|------|
| GA2MPW2454R-27W | 234 lbs. | 28.4  | 2      | 72   |
| GA2MPW2454R-34W | 232 lbs. | 28.4  | 2      | 72   |
| GA2MPW2460L-44W | 244 lbs. | 31.4  | 2      | 67   |
| GA2MPW2460L-55W | 231 lbs. | 31.4  | -      | 67   |
| GA2MPW2460L-BBW | 322 lbs. | 31.4  | 2      | 67   |
| GA2MPW2460R-44W | 244 lbs. | 31.4  | 2      | 73   |
| GA2MPW2460R-55W | 231 lbs. | 31.4  | -      | 73   |
| GA2MPW2460R-BBW | 322 lbs. | 31.4  | 2      | 73   |
| GA2MRA21-W      | 28 lbs.  | 3.6   | -      | 90   |
| GA2MRA24-W      | 30 lbs.  | 4.0   | -      | 90   |
| GA2MRA27-W      | 32 lbs.  | 4.4   | -      | 90   |
| GA2MRA30-W      | 34 lbs.  | 4.9   | -      | 90   |
| GA2MRA33-W      | 36 lbs.  | 5.3   | -      | 90   |
| GA2MRA36-W      | 37 lbs.  | 5.8   | -      | 90   |
| GA2MRA39-W      | 39 lbs.  | 6.2   | -      | 90   |
| GA2MRA42-W      | 41 lbs.  | 6.7   | -      | 90   |
| GA2MRA45-W      | 43 lbs.  | 7.1   | -      | 90   |
| GA2MRA48-W      | 45 lbs.  | 7.6   | -      | 90   |
| GA2MRA51-W      | 47 lbs.  | 8.0   | -      | 90   |
| GA2MRA54-W      | 49 lbs.  | 8.5   | -      | 90   |
| GA2MRA57-W      | 51 lbs.  | 8.9   | -      | 90   |
| GA2MRA60-W      | 53 lbs.  | 9.3   | -      | 90   |
| GA2MRF39-W      | 20 lbs.  | 2.8   | -      | 89   |
| GA2MRF42-W      | 22 lbs.  | 3.0   | -      | 89   |
| GA2MRF45-W      | 23 lbs.  | 3.2   | -      | 89   |
| GA2MRF48-W      | 25 lbs.  | 3.4   | -      | 89   |
| GA2MRF51-W      | 26 lbs.  | 3.6   | -      | 89   |
| GA2MRF54-W      | 28 lbs.  | 3.8   | -      | 89   |
| GA2MRF57-W      | 30 lbs.  | 4.0   | -      | 89   |
| GA2MRF60-W      | 32 lbs.  | 4.2   | -      | 89   |
| GA2MRF63-W      | 33 lbs.  | 4.4   | -      | 89   |
| GA2MRF66-W      | 35 lbs.  | 4.6   | -      | 89   |
| GA2MRF69-W      | 36 lbs.  | 4.8   | -      | 89   |
| GA2MRF72-W      | 38 lbs.  | 5.0   | -      | 89   |
| GA2MSP12-W      | 7 lbs.   | 0.6   | -      | 91   |
| GA2MSPT12-W     | 11 lbs.  | 1.7   | -      | 91   |
| GA2RLRL3072L-W  | 126 lbs. | 46.5  | -      | 50   |
| GA2RLRL3072R-W  | 126 lbs. | 46.5  | -      | 51   |
| GA2RLRL3078L-W  | 135 lbs. | 50.2  | -      | 50   |
| GA2RLRL3078R-W  | 135 lbs. | 50.2  | -      | 51   |
| GA2RLRL3678L-W  | 160 lbs. | 59.3  | -      | 50   |
| GA2RLRL3678R-W  | 160 lbs. | 59.3  | -      | 51   |
| GA2RLRL3684L-W  | 170 lbs. | 63.7  | -      | 50   |
| GA2RLRL3684R-W  | 170 lbs. | 63.7  | -      | 51   |



**Credentials**

02/24

**WEIGHTS + CUBES**

| model number    | weight   | cubes | #locks | page |
|-----------------|----------|-------|--------|------|
| GA2RLRO3072L-3W | 231 lbs. | 46.5  | 1      | 54   |
| GA2RLRO3072R-3W | 231 lbs. | 46.5  | 1      | 55   |
| GA2RLRO3078L-3W | 241 lbs. | 50.2  | 1      | 54   |
| GA2RLRO3078R-3W | 241 lbs. | 50.2  | 1      | 55   |
| GA2RLRO3678L-3W | 276 lbs. | 59.3  | 1      | 54   |
| GA2RLRO3678R-3W | 276 lbs. | 59.3  | 1      | 55   |
| GA2RLRO3684L-3W | 287 lbs. | 63.7  | 1      | 54   |
| GA2RLRO3684R-3W | 287 lbs. | 63.7  | 1      | 55   |
| GA2RLRR3072L-W  | 126 lbs. | 46.5  | -      | 52   |
| GA2RLRR3072R-W  | 126 lbs. | 46.5  | -      | 53   |
| GA2RLRR3078L-W  | 135 lbs. | 50.2  | -      | 52   |
| GA2RLRR3078R-W  | 135 lbs. | 50.2  | -      | 53   |
| GA2RLRR3678L-W  | 160 lbs. | 59.3  | -      | 52   |
| GA2RLRR3678R-W  | 160 lbs. | 59.3  | -      | 53   |
| GA2RLRR3684L-W  | 170 lbs. | 63.7  | -      | 52   |
| GA2RLRR3684R-W  | 170 lbs. | 63.7  | -      | 53   |
| GA2RRL3048L-W   | 76 lbs.  | 31.6  | -      | 50   |
| GA2RRL3048R-W   | 76 lbs.  | 31.6  | -      | 51   |
| GA2RRL3054L-W   | 85 lbs.  | 35.3  | -      | 50   |
| GA2RRL3054R-W   | 85 lbs.  | 35.3  | -      | 51   |
| GA2RRL3654L-W   | 101 lbs. | 41.7  | -      | 50   |
| GA2RRL3654R-W   | 101 lbs. | 41.7  | -      | 51   |
| GA2RRL3660L-W   | 110 lbs. | 46.1  | -      | 50   |
| GA2RRL3660R-W   | 110 lbs. | 46.1  | -      | 51   |
| GA2RRO3048L-3W  | 188 lbs. | 31.6  | 1      | 54   |
| GA2RRO3048R-3W  | 188 lbs. | 31.6  | 1      | 55   |
| GA2RRO3054L-3W  | 198 lbs. | 35.3  | 1      | 54   |
| GA2RRO3054R-3W  | 198 lbs. | 35.3  | 1      | 55   |
| GA2RRO3654L-3W  | 225 lbs. | 41.7  | 1      | 54   |
| GA2RRO3654R-3W  | 225 lbs. | 41.7  | 1      | 55   |
| GA2RRO3660L-3W  | 237 lbs. | 46.1  | 1      | 54   |
| GA2RRO3660R-3W  | 237 lbs. | 46.1  | 1      | 55   |
| GA2RRR3048L-W   | 133 lbs. | 31.6  | -      | 52   |
| GA2RRR3048R-W   | 133 lbs. | 31.6  | -      | 53   |
| GA2RRR3054L-W   | 143 lbs. | 35.3  | -      | 52   |
| GA2RRR3054R-W   | 143 lbs. | 35.3  | -      | 53   |
| GA2RRR3654L-W   | 167 lbs. | 41.7  | -      | 52   |
| GA2RRR3654R-W   | 167 lbs. | 41.7  | -      | 53   |
| GA2RRR3660L-W   | 179 lbs. | 46.1  | -      | 52   |
| GA2RRR3660R-W   | 179 lbs. | 46.1  | -      | 53   |
| GA2RWR2442T-W   | 49 lbs.  | 2.8   | -      | 61   |
| GA2RWR2442-W    | 55 lbs.  | 3.2   | -      | 60   |
| GA2RWR2448T-W   | 56 lbs.  | 3.2   | -      | 61   |
| GA2RWR2448-W    | 62 lbs.  | 3.6   | -      | 60   |

| model number     | weight   | cubes | #locks | page |
|------------------|----------|-------|--------|------|
| GA2RWR2454T-W    | 62 lbs.  | 3.6   | -      | 61   |
| GA2RWR2454-W     | 69 lbs.  | 4.0   | -      | 60   |
| GA2RWR2460T-W    | 68 lbs.  | 4.0   | -      | 61   |
| GA2RWR2460-W     | 76 lbs.  | 4.4   | -      | 60   |
| GA2RWR2466T-W    | 75 lbs.  | 4.4   | -      | 61   |
| GA2RWR2466-W     | 83 lbs.  | 4.9   | -      | 60   |
| GA2RWR2472T-W    | 81 lbs.  | 4.7   | -      | 61   |
| GA2RWR2472-W     | 90 lbs.  | 5.3   | -      | 60   |
| GA2SBH5H2418L-WW | 284 lbs. | 26.7  | 2      | 114  |
| GA2SBH5H2418R-WW | 284 lbs. | 26.7  | 2      | 114  |
| GA2SBH5H2430-WW  | 384 lbs. | 42.0  | 2      | 114  |
| GA2SBH6H2418L-WW | 315 lbs. | 29.6  | 2      | 114  |
| GA2SBH6H2418R-WW | 315 lbs. | 29.6  | 2      | 114  |
| GA2SBH6H2430-WW  | 436 lbs. | 46.5  | 2      | 114  |
| GA2TRD42-W       | 79 lbs.  | 5.3   | -      | 137  |
| GA2TRD48-W       | 100 lbs. | 6.8   | -      | 137  |
| GA2TRD54-W       | 124 lbs. | 8.5   | -      | 137  |
| GA2TRD60-W       | 150 lbs. | 10.3  | -      | 137  |
| GA2UTC5H2424L-WW | 413 lbs. | 34.4  | 3      | 115  |
| GA2UTC5H2424R-WW | 413 lbs. | 34.4  | 3      | 115  |
| GA2UTC6H2424L-WW | 461 lbs. | 38.1  | 3      | 115  |
| GA2UTC6H2424R-WW | 461 lbs. | 38.1  | 3      | 115  |
| GA2WCF1H60-WG    | 212 lbs. | 17.2  | -      | 119  |
| GA2WCF1H60-WW    | 195 lbs. | 17.2  | -      | 118  |
| GA2WCF1H72-WG    | 246 lbs. | 20.5  | -      | 119  |
| GA2WCF1H72-WW    | 225 lbs. | 20.5  | -      | 118  |
| GA2WCF1H90-WG    | 311 lbs. | 25.4  | -      | 119  |
| GA2WCF1H90-WW    | 286 lbs. | 25.4  | -      | 118  |
| GA2WCF1H108-WG   | 360 lbs. | 30.4  | -      | 119  |
| GA2WCF1H108-WW   | 329 lbs. | 30.4  | -      | 118  |
| GA2WCH1H30-WG    | 117 lbs. | 9.0   | -      | 117  |
| GA2WCH1H30-WW    | 104 lbs. | 9.0   | -      | 116  |
| GA2WCH1H36-WG    | 133 lbs. | 10.7  | -      | 117  |
| GA2WCH1H36-WW    | 119 lbs. | 10.7  | -      | 116  |
| GA2WCH1H60-WG    | 219 lbs. | 17.2  | -      | 117  |
| GA2WCH1H60-WW    | 194 lbs. | 17.2  | -      | 116  |
| GA2WCH1H66-WW    | 209 lbs. | 18.9  | -      | 116  |
| GA2WCH1H72-WG    | 251 lbs. | 20.5  | -      | 117  |
| GA2WCH1H72-WW    | 225 lbs. | 20.5  | -      | 116  |
| GA2WCH1H78-WW    | 239 lbs. | 22.1  | -      | 116  |
| GA2WCH1H84-WW    | 270 lbs. | 23.8  | -      | 116  |
| GA2WCH1H90-WG    | 322 lbs. | 25.4  | -      | 117  |
| GA2WCH1H90-WW    | 285 lbs. | 25.4  | -      | 116  |
| GA2WCH1H96-WW    | 301 lbs. | 27.1  | -      | 116  |

# WEIGHTS + CUBES

| model number    | weight   | cubes | #locks | page |
|-----------------|----------|-------|--------|------|
| GA2WCH1H102-WW  | 315 lbs. | 28.7  | -      | 116  |
| GA2WCH1H108-WG  | 371 lbs. | 30.4  | -      | 117  |
| GA2WCH1H108-WW  | 330 lbs. | 30.4  | -      | 116  |
| GA2WCH2H30-WG   | 138 lbs. | 12.4  | -      | 123  |
| GA2WCH2H30-WW   | 123 lbs. | 12.4  | -      | 122  |
| GA2WCH2H36-WG   | 156 lbs. | 14.7  | -      | 123  |
| GA2WCH2H36-WW   | 141 lbs. | 14.7  | -      | 122  |
| GA2WCH2H60-WG   | 261 lbs. | 23.7  | -      | 123  |
| GA2WCH2H60-WW   | 231 lbs. | 23.7  | -      | 122  |
| GA2WCH2H66-WW   | 248 lbs. | 26.0  | -      | 122  |
| GA2WCH2H72-WG   | 297 lbs. | 28.3  | -      | 123  |
| GA2WCH2H72-WW   | 266 lbs. | 28.3  | -      | 122  |
| GA2WCH2H78-WW   | 283 lbs. | 30.5  | -      | 122  |
| GA2WCH2H84-WW   | 322 lbs. | 32.8  | -      | 122  |
| GA2WCH2H90-WG   | 385 lbs. | 35.0  | -      | 123  |
| GA2WCH2H90-WW   | 339 lbs. | 35.0  | -      | 122  |
| GA2WCS1H60-WG   | 159 lbs. | 17.2  | -      | 121  |
| GA2WCS1H60-WW   | 164 lbs. | 17.2  | -      | 120  |
| GA2WCS1H72-WG   | 183 lbs. | 20.5  | -      | 121  |
| GA2WCS1H72-WW   | 181 lbs. | 20.5  | -      | 120  |
| GA2WCS1H90-WG   | 223 lbs. | 25.4  | -      | 121  |
| GA2WCS1H90-WW   | 244 lbs. | 25.4  | -      | 120  |
| GA2WCS1H108-WG  | 271 lbs. | 30.4  | -      | 121  |
| GA2WCS1H108-WW  | 275 lbs. | 30.4  | -      | 120  |
| GA2WCS2H60-WG   | 166 lbs. | 23.7  | -      | 125  |
| GA2WCS2H60-WW   | 164 lbs. | 23.7  | -      | 124  |
| GA2WCS2H72-WG   | 190 lbs. | 28.3  | -      | 125  |
| GA2WCS2H72-WW   | 201 lbs. | 28.3  | -      | 124  |
| GA2WCS2H90-WG   | 243 lbs. | 35.0  | -      | 125  |
| GA2WCS2H90-WW   | 259 lbs. | 35.0  | -      | 124  |
| GA2XRAK3072L-W  | 550 lbs. | 46.5  | -      | 46   |
| GA2XRAK3072R-W  | 550 lbs. | 46.5  | -      | 47   |
| GA2XRAK3072TL-W | 552 lbs. | 46.5  | -      | 46   |
| GA2XRAK3072TR-W | 552 lbs. | 46.5  | -      | 47   |
| GA2XRAK3672L-W  | 571 lbs. | 54.9  | -      | 46   |
| GA2XRAK3672R-W  | 571 lbs. | 54.9  | -      | 47   |
| GA2XRAK3672TL-W | 560 lbs. | 54.9  | -      | 46   |
| GA2XRAK3672TR-W | 560 lbs. | 54.9  | -      | 47   |
| GA2XRAK3678L-W  | 568 lbs. | 59.3  | -      | 46   |
| GA2XRAK3678R-W  | 568 lbs. | 59.3  | -      | 47   |
| GA2XRAK3678TL-W | 570 lbs. | 59.3  | -      | 46   |
| GA2XRAK3678TR-W | 570 lbs. | 59.3  | -      | 47   |
| GA2XRAK3684L-W  | 578 lbs. | 63.7  | -      | 46   |
| GA2XRAK3684R-W  | 578 lbs. | 63.7  | -      | 47   |

| model number    | weight   | cubes | #locks | page |
|-----------------|----------|-------|--------|------|
| GA2XRAK3684TL-W | 578 lbs. | 63.7  | -      | 46   |
| GA2XRAK3684TR-W | 578 lbs. | 63.7  | -      | 47   |
| GA2XRL3072L-W   | 152 lbs. | 46.5  | -      | 42   |
| GA2XRL3072R-W   | 152 lbs. | 46.5  | -      | 43   |
| GA2XRL3072TL-W  | 145 lbs. | 46.5  | -      | 42   |
| GA2XRL3072TR-W  | 145 lbs. | 46.5  | -      | 43   |
| GA2XRL3672L-W   | 181 lbs. | 54.9  | -      | 42   |
| GA2XRL3672R-W   | 181 lbs. | 54.9  | -      | 43   |
| GA2XRL3672TL-W  | 168 lbs. | 54.9  | -      | 42   |
| GA2XRL3672TR-W  | 168 lbs. | 54.9  | -      | 43   |
| GA2XRL3678L-W   | 191 lbs. | 59.3  | -      | 42   |
| GA2XRL3678R-W   | 191 lbs. | 59.3  | -      | 43   |
| GA2XRL3678TL-W  | 178 lbs. | 59.3  | -      | 42   |
| GA2XRL3678TR-W  | 178 lbs. | 59.3  | -      | 43   |
| GA2XRL3684L-W   | 200 lbs. | 63.7  | -      | 42   |
| GA2XRL3684R-W   | 200 lbs. | 63.7  | -      | 43   |
| GA2XRL3684TL-W  | 189 lbs. | 63.7  | -      | 42   |
| GA2XRL3684TR-W  | 189 lbs. | 63.7  | -      | 43   |
| GA2XRM3072L-W   | 220 lbs. | 46.5  | -      | 44   |
| GA2XRM3072R-W   | 220 lbs. | 46.5  | -      | 45   |
| GA2XRM3072TL-W  | 220 lbs. | 46.5  | -      | 44   |
| GA2XRM3072TR-W  | 220 lbs. | 46.5  | -      | 45   |
| GA2XRM3672L-W   | 245 lbs. | 54.9  | -      | 44   |
| GA2XRM3672R-W   | 245 lbs. | 54.9  | -      | 45   |
| GA2XRM3672TL-W  | 245 lbs. | 54.9  | -      | 44   |
| GA2XRM3672TR-W  | 245 lbs. | 54.9  | -      | 45   |
| GA2XRM3678L-W   | 265 lbs. | 59.3  | -      | 44   |
| GA2XRM3678R-W   | 265 lbs. | 59.3  | -      | 45   |
| GA2XRM3678TL-W  | 265 lbs. | 59.3  | -      | 44   |
| GA2XRM3678TR-W  | 265 lbs. | 59.3  | -      | 45   |
| GA2XRM3684L-W   | 285 lbs. | 63.7  | -      | 44   |
| GA2XRM3684R-W   | 285 lbs. | 63.7  | -      | 45   |
| GA2XRM3684TL-W  | 284 lbs. | 63.7  | -      | 44   |
| GA2XRM3684TR-W  | 284 lbs. | 63.7  | -      | 45   |
| GA2XRR3072L-W   | 190 lbs. | 46.5  | -      | 48   |
| GA2XRR3072R-W   | 190 lbs. | 46.5  | -      | 49   |
| GA2XRR3072TL-W  | 196 lbs. | 46.5  | -      | 48   |
| GA2XRR3072TR-W  | 196 lbs. | 46.5  | -      | 49   |
| GA2XRR3672L-W   | 215 lbs. | 54.9  | -      | 48   |
| GA2XRR3672R-W   | 215 lbs. | 54.9  | -      | 49   |
| GA2XRR3672TL-W  | 230 lbs. | 54.9  | -      | 48   |
| GA2XRR3672TR-W  | 230 lbs. | 54.9  | -      | 49   |
| GA2XRR3678L-W   | 235 lbs. | 59.3  | -      | 48   |
| GA2XRR3678R-W   | 235 lbs. | 59.3  | -      | 49   |

**Credentials**

02/24

**WEIGHTS + CUBES**

| model number      | weight   | cubes | #locks | page |
|-------------------|----------|-------|--------|------|
| GA2XRR3678TL-W    | 242 lbs. | 59.3  | -      | 48   |
| GA2XRR3678TR-W    | 242 lbs. | 59.3  | -      | 49   |
| GA2XRR3684L-W     | 255 lbs. | 63.7  | -      | 48   |
| GA2XRR3684R-W     | 255 lbs. | 63.7  | -      | 49   |
| GA2XRR3684TL-W    | 254 lbs. | 63.7  | -      | 48   |
| GA2XRR3684TR-W    | 254 lbs. | 63.7  | -      | 49   |
| GAACLPD-CUSH2130T | 10 lbs.  | 2.1   | -      | 98   |
| GAACLPD-CUSH2136T | 10 lbs.  | 2.4   | -      | 98   |
| GAACLPD-CUSH2430  | 9 lbs.   | 2.3   | -      | 98   |
| GAACLPD-CUSH2436  | 9 lbs.   | 2.7   | -      | 98   |
| GAACORNER         | 8 lbs.   | 1.7   | -      | 141  |
| GAADSKPAD         | 10 lbs.  | 2.3   | -      | 141  |
| GAAMPD-CUSH1818   | 6 lbs.   | 1.2   | -      | 98   |
| GAATGW1H30-GSA    | 43 lbs.  | 3.7   | -      | 131  |
| GAATGW1H30-XGSA   | 48 lbs.  | 3.7   | -      | 132  |
| GAATGW1H36-GSA    | 50 lbs.  | 4.3   | -      | 131  |
| GAATGW1H36-XGSA   | 55 lbs.  | 4.3   | -      | 132  |
| GAATGW1H42-GSA    | 58 lbs.  | 5.0   | -      | 131  |
| GAATGW1H42-XGSA   | 63 lbs.  | 5.0   | -      | 132  |
| GAATGW1H48-GSA    | 66 lbs.  | 5.6   | -      | 131  |
| GAATGW1H48-XGSA   | 71 lbs.  | 5.6   | -      | 132  |
| GAATGW2H30-GSA    | 50 lbs.  | 4.3   | -      | 131  |
| GAATGW2H30-XGSA   | 55 lbs.  | 4.3   | -      | 132  |
| GAATGW2H36-GSA    | 59 lbs.  | 5.0   | -      | 131  |
| GAATGW2H36-XGSA   | 64 lbs.  | 5.0   | -      | 132  |
| GAATGW2H42-GSA    | 67 lbs.  | 5.8   | -      | 131  |
| GAATGW2H42-XGSA   | 72 lbs.  | 5.8   | -      | 132  |
| GAATGW2H48-GSA    | 76 lbs.  | 6.6   | -      | 131  |
| GAATGW2H48-XGSA   | 81 lbs.  | 6.6   | -      | 132  |
| GAATGW30-GSA      | 28 lbs.  | 2.3   | -      | 130  |
| GAATGW36-GSA      | 32 lbs.  | 2.7   | -      | 130  |
| GAATGW60-GSA      | 50 lbs.  | 4.3   | -      | 130  |
| GAATGW66-GSA      | 55 lbs.  | 4.7   | -      | 130  |
| GAATGW72-GSA      | 59 lbs.  | 5.1   | -      | 130  |
| GAATGW78-GSA      | 64 lbs.  | 5.5   | -      | 130  |
| GAATGW84-GSA      | 68 lbs.  | 5.9   | -      | 130  |
| GAATGW90-GSA      | 73 lbs.  | 6.4   | -      | 130  |
| GAATGW96-GSA      | 77 lbs.  | 6.8   | -      | 130  |
| GAATGW102-GSA     | 82 lbs.  | 7.2   | -      | 130  |
| GAATGW108-GSA     | 86 lbs.  | 7.6   | -      | 130  |
| GAATKW1H30        | 24 lbs.  | 3.8   | -      | 127  |
| GAATKW1H36        | 27 lbs.  | 4.5   | -      | 127  |
| GAATKW1H42        | 29 lbs.  | 5.1   | -      | 127  |
| GAATKW1H48        | 32 lbs.  | 5.8   | -      | 127  |

| model number | weight  | cubes | #locks | page |
|--------------|---------|-------|--------|------|
| GAATKW2H30   | 26 lbs. | 4.4   | -      | 127  |
| GAATKW2H36   | 29 lbs. | 5.2   | -      | 127  |
| GAATKW2H42   | 33 lbs. | 6.0   | -      | 127  |
| GAATKW2H48   | 36 lbs. | 6.8   | -      | 127  |
| GAATKW30     | 18 lbs. | 2.3   | -      | 126  |
| GAATKW36     | 20 lbs. | 2.8   | -      | 126  |
| GAATKW60     | 26 lbs. | 4.5   | -      | 126  |
| GAATKW66     | 28 lbs. | 4.9   | -      | 126  |
| GAATKW72     | 29 lbs. | 5.3   | -      | 126  |
| GAATKW78     | 31 lbs. | 5.7   | -      | 126  |
| GAATKW84     | 33 lbs. | 6.1   | -      | 126  |
| GAATKW90     | 34 lbs. | 6.6   | -      | 126  |
| GAATKW96     | 36 lbs. | 7.0   | -      | 126  |
| GAATKW102    | 37 lbs. | 7.4   | -      | 126  |
| GAATKW108    | 39 lbs. | 7.8   | -      | 126  |
| GAATKW120    | 42 lbs. | 8.7   | -      | 126  |
| GAATLKW1H30  | 26 lbs. | 4.3   | -      | 129  |
| GAATLKW1H36  | 29 lbs. | 5.1   | -      | 129  |
| GAATLKW1H42  | 33 lbs. | 5.9   | -      | 129  |
| GAATLKW1H48  | 36 lbs. | 6.7   | -      | 129  |
| GAATLKW2H30  | 28 lbs. | 5.0   | -      | 129  |
| GAATLKW2H36  | 32 lbs. | 5.9   | -      | 129  |
| GAATLKW2H42  | 36 lbs. | 6.8   | -      | 129  |
| GAATLKW2H48  | 40 lbs. | 7.7   | -      | 129  |
| GAATLKW30    | 20 lbs. | 2.9   | -      | 128  |
| GAATLKW36    | 22 lbs. | 3.4   | -      | 128  |
| GAATLKW60    | 31 lbs. | 5.5   | -      | 128  |
| GAATLKW66    | 33 lbs. | 6.1   | -      | 128  |
| GAATLKW72    | 35 lbs. | 6.6   | -      | 128  |
| GAATLKW78    | 37 lbs. | 7.1   | -      | 128  |
| GAATLKW84    | 39 lbs. | 7.7   | -      | 128  |
| GAATLKW90    | 41 lbs. | 8.2   | -      | 128  |
| GAATLKW96    | 43 lbs. | 8.7   | -      | 128  |
| GAATLKW102   | 45 lbs. | 9.2   | -      | 128  |
| GAATLKW108   | 47 lbs. | 9.8   | -      | 128  |
| GAATLKW120   | 52 lbs. | 10.8  | -      | 128  |
| GAATOP1818-W | 20 lbs. | 1.0   | -      | 147  |
| GAATRAYBOX15 | 3 lbs.  | 0.9   | -      | 142  |
| GAATRAYBOX18 | 4 lbs.  | 1.0   | -      | 142  |
| GAATRAYBOX30 | 7 lbs.  | 1.7   | -      | 142  |
| GAATRAYBOX36 | 8 lbs.  | 2.1   | -      | 142  |
| GAATRAYLTR15 | 3 lbs.  | 1.0   | -      | 142  |
| GAATRAYLTR18 | 4 lbs.  | 1.1   | -      | 142  |
| GAATROUGH30  | 3 lbs.  | 0.6   | -      | 99   |

# WEIGHTS + CUBES

| model number | weight   | cubes | #locks | page |
|--------------|----------|-------|--------|------|
| GAATROUGH36  | 3 lbs.   | 0.7   | -      | 99   |
| GAATROUGH42  | 4 lbs.   | 0.9   | -      | 99   |
| GAATROUGH48  | 4 lbs.   | 1.0   | -      | 99   |
| GAATROUGH54  | 5 lbs.   | 1.1   | -      | 99   |
| GAATROUGH60  | 5 lbs.   | 1.2   | -      | 99   |
| GAATROUGH66  | 6 lbs.   | 1.4   | -      | 99   |
| GAATROUGH72  | 6 lbs.   | 1.5   | -      | 99   |
| GAATROUGH78  | 7 lbs.   | 1.6   | -      | 99   |
| GAATROUGH84  | 7 lbs.   | 1.7   | -      | 99   |
| GAATROUGH90  | 8 lbs.   | 1.9   | -      | 99   |
| GAATROUGH96  | 9 lbs.   | 2.0   | -      | 99   |
| GAATROUGH102 | 9 lbs.   | 2.1   | -      | 99   |
| GAATROUGH108 | 10 lbs.  | 2.2   | -      | 99   |
| GAATROUGH114 | 10 lbs.  | 2.4   | -      | 99   |
| GAATROUGH120 | 11 lbs.  | 2.5   | -      | 99   |
| GAATWD1H30   | 68 lbs.  | 3.8   | -      | 134  |
| GAATWD1H30-X | 68 lbs.  | 3.8   | -      | 135  |
| GAATWD1H36   | 80 lbs.  | 4.5   | -      | 134  |
| GAATWD1H36-X | 80 lbs.  | 4.5   | -      | 135  |
| GAATWD1H42   | 91 lbs.  | 5.1   | -      | 134  |
| GAATWD1H42-X | 91 lbs.  | 5.1   | -      | 135  |
| GAATWD1H48   | 103 lbs. | 5.8   | -      | 134  |
| GAATWD1H48-X | 103 lbs. | 5.8   | -      | 135  |
| GAATWD2H30   | 78 lbs.  | 4.4   | -      | 134  |
| GAATWD2H30-X | 78 lbs.  | 4.4   | -      | 135  |
| GAATWD2H36   | 92 lbs.  | 5.2   | -      | 134  |
| GAATWD2H36-X | 92 lbs.  | 5.2   | -      | 135  |
| GAATWD2H42   | 106 lbs. | 6.0   | -      | 134  |
| GAATWD2H42-X | 106 lbs. | 6.0   | -      | 135  |
| GAATWD2H48   | 120 lbs. | 6.8   | -      | 134  |
| GAATWD2H48-X | 120 lbs. | 6.8   | -      | 135  |
| GAATWD30     | 45 lbs.  | 2.3   | -      | 133  |
| GAATWD36     | 51 lbs.  | 2.8   | -      | 133  |
| GAATWD60     | 79 lbs.  | 4.5   | -      | 133  |
| GAATWD66     | 86 lbs.  | 4.9   | -      | 133  |
| GAATWD72     | 93 lbs.  | 5.3   | -      | 133  |
| GAATWD78     | 100 lbs. | 5.7   | -      | 133  |
| GAATWD84     | 107 lbs. | 6.1   | -      | 133  |
| GAATWD90     | 114 lbs. | 6.6   | -      | 133  |
| GAATWD96     | 121 lbs. | 7.0   | -      | 133  |
| GAATWD102    | 127 lbs. | 7.4   | -      | 133  |
| GAATWD108    | 134 lbs. | 7.8   | -      | 133  |
| GAATWD120    | 148 lbs. | 8.7   | -      | 133  |
| GS2CDWSD-W   | 2 lbs.   | 13.0  | -      | 143  |

| model number | weight | cubes | #locks | page |
|--------------|--------|-------|--------|------|
| MDWLBK24     | 2 lbs. | 1.2   | -      | 92   |
| MDWLBK30     | 2 lbs. | 1.2   | -      | 92   |
| SAMAGNET     | 1 lbs. | 0.1   | -      | 139  |



---

---

# Gunlocke®

One Gunlocke Drive  
Wayland, NY 14572  
800 828 6300

[GUNLOCKE.COM](http://GUNLOCKE.COM)

FORM #G1063.A3 (5/24)