

PRICING EFFECTIVE FEBRUARY 2024

# SEATING & OCCASIONAL TABLES

*Price & Specification Guide*

PDF updated June 21, 2024

Gunlocke®

# ORDERING OPTION CODES

## MAPLE WOOD FINISHES

- A. Natural/Clear Maple 800
- B. Ebony Maple 555
- C. Harvest Maple 856
- D. Beigewood 878
- E. Field Elm 599
- F. Belair 934

\*All Finish options are also available with FSC

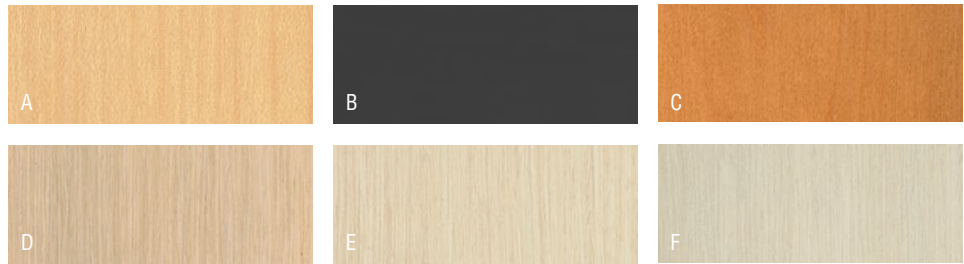

## CHERRY WOOD FINISHES

- A. Natural Cherry 222
- B. Light Cherry 701
- C. Cinnamon Cherry 260
- D. Burnished Cherry 777
- E. Medium Red Cherry 512
- F. Lowell Ash 394
- G. Shaker Cherry 774

\*All Finish options are also available with FSC



## WALNUT WOOD FINISHES

- A. Nutmeg Walnut 629
- B. Light Walnut 601
- C. Sumatra Walnut 693
- D. Skyline Walnut 625
- E. Pinnacle Walnut 679
- F. Florence Walnut 579

\*All Finish options are also available with FSC

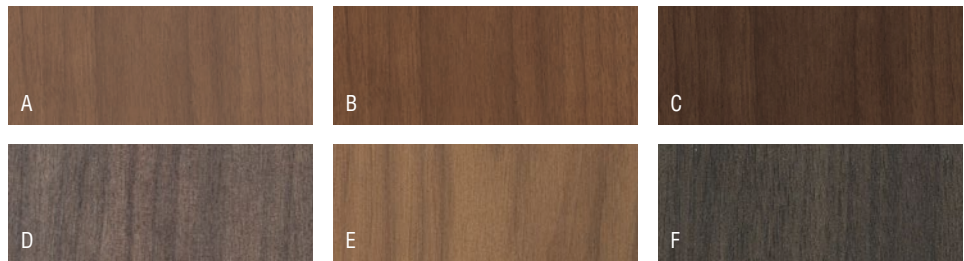

## OAK WOOD FINISHES

- A. Natural/Clear Oak 300
- B. Light Rift Oak 301
- C. Dark Rift Oak 331
- D. Phantom Ecu 912
- E. Portico Teak 150
- F. Silver Oak 100
- G. Fawn Cypress 108

\*All Finish options are also available with FSC



LAMINATES (AVAILABLE ON LIV SEATING AND CALM OCCASIONAL TABLES)

WOODGRAIN

- |                     |      |
|---------------------|------|
| A. Lowell Ash       | LLA1 |
| B. Natural Recon    | LNR1 |
| C. Phantom Ecru     | LPE1 |
| D. Portico Teak     | LPT1 |
| E. Skyline Walnut   | LSW1 |
| F. Beigewood        | LWBE |
| G. Field Elm        | LWFE |
| H. Pinnacle Walnut  | PINC |
| I. Fawn Cypress     | LFC1 |
| J. Natural Maple    | LWD  |
| K. Harvest Maple    | C    |
| L. Shaker Cherry    | LW7C |
| M. Biltmore Cherry  | COGN |
| N. Florence Walnut  | LFW1 |
| O. Kingswood Walnut | LK11 |
| P. NeoWalnut        | LNU1 |
| Q. Veranda Teak     | LVT1 |

SOLID

- |                         |      |
|-------------------------|------|
| R. Designer White 15051 | LDW1 |
| S. Loft                 | LM11 |
| T. Flint                | LM16 |
| U. Black                | P    |



## PAINT FINISHES

---

- |                   |     |
|-------------------|-----|
| A. Designer White | PJW |
| B. Chrome         | PC  |
| C. Silver         | PR6 |
| D. Titanium       | P8T |
| E. Solar Black    | P8X |
| F. Black          | P71 |
| G. Pyrite         | PJE |
| H. Matte Gold     | P8G |
| I. Bullseye       | PJF |
| J. Regatta        | P8M |

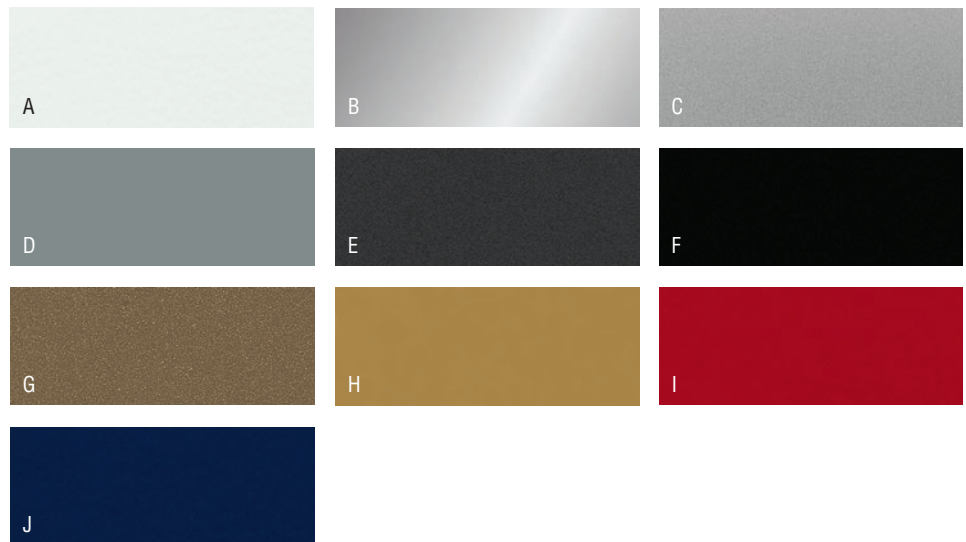



Product Reference  
 Products in Numerical Order . . . . . 2-3  
 Abridged Picture Index . . . . . 4-5

General Information  
 GSA Terms And Conditions . . . . . 6  
 Conditions of Sale . . . . . 7  
 Warranty . . . . . 8  
 Shipping Instructions . . . . . 9

Special Finish and Laser Backs . . . . . 10

Standard Textile and COM Overview . . . . . 11-12

COM | COL Guidelines / Ordering . . . . . 13-14

Cut Yardage | Requirements . . . . . 15

Flammability | ACT Performance . . . . . 16

Fabric Matrix . . . . . 18-21

**PRODUCTS**

Guest Seating . . . . . 23-39  
 Product Specifications . . . . . 24-25  
 Bank of England™ . . . . . 26  
 Calia . . . . . 27-28  
 Camille . . . . . 29-30  
 Genesee Guest . . . . . 31-32  
 Lily™ . . . . . 33  
 Metta . . . . . 34-35  
 Savor™ . . . . . 36-37  
 Tia™ Guest . . . . . 38-39

Multipurpose Seating . . . . . 41-61  
 Product Specifications . . . . . 42  
 Convo® Barstool . . . . . 43-46  
 LIV Guest . . . . . 47-48  
 LIV Stool . . . . . 49-50  
 Multi® . . . . . 51-54  
 Multi® Stool . . . . . 55  
 Multi® Bariatric . . . . . 56-57  
 Tia™ Barstool . . . . . 58-59  
 Trillia™ Barstool . . . . . 60-61

Swivel Seating . . . . . 63-79  
 Swivel Seating Product Specifications . . . . . 64-67  
 Avoca™ . . . . . 68-69  
 Genesee . . . . . 70-72  
 Geneva . . . . . 73-74  
 Olla Executive . . . . . 75-78  
 Washington Series . . . . . 79

Lounge Seating . . . . . 81-171  
 Product Specifications . . . . . 82  
 Calm Lounge Ordering Option Codes . . . . . 84-85  
 Calm . . . . . 86-104  
 Ciji . . . . . 105-165  
 Iris . . . . . 166-171

Occasional Tables . . . . . 173-180  
 Briefing . . . . . 174  
 Calm . . . . . 175-177  
 Cylinder . . . . . 178  
 Cube . . . . . 179  
 Letchworth . . . . . 180



# PRODUCTS IN NUMERICAL ORDER

**Seating**  
02/24

product	page	product	page	product	page
ACPUNDER-EU Calm	104	GK1105-1W Ciji	109	GK1133 Ciji	163
ACPUNDER-EU-HW Calm	104	GK1105-2A Ciji	118	GK1137 Ciji	163
GABTRT17H2454-WW Letchworth	180	GK1105-2W Ciji	117	GK1139 Ciji	164
GABTRT17H3636-WW Letchworth	180	GK1105-3A Ciji	126	GK1143 Ciji	164
GABTRT17H4242-WW Letchworth	180	GK1105-3W Ciji	125	GK1145R Ciji	164
GABTRT21H2424-WW Letchworth	180	GK1107-1A Ciji	112	GK1155 Ciji	165
GAGB17-198 Calm	104	GK1107-1W Ciji	111	GK1157 Ciji	165
GBGB17-131 Calm	100	GK1107-2A Ciji	120	GK1159 Ciji	165
GBGB17-142 Calm	101	GK1107-2W Ciji	119	GK1161 Ciji	165
GBGB17-153 Calm	102	GK1107-3A Ciji	128	GK1163 Ciji	165
GGCA14-011 Lily	33	GK1107-3W Ciji	127	GK2800 Olla	75
GGCAL17-011 Calia	27	GK1109A Ciji	154	GK2802 Olla	76
GGCAL17-021 Calia	28	GK1109W Ciji	153	GK2804 Olla	75
GGHB17-071 Tia	38	GK1111-1A Ciji	130	GK2806 Olla	76
GGHB17-081 Tia	39	GK1111-1W Ciji	129	GK2808 Olla	77
GGJA14-011 Savor	36	GK1111-2A Ciji	138	GK2810 Olla	78
GGJA14-021 Savor	36	GK1111-2W Ciji	137	GK2812 Olla	77
GGJA14-031 Savor	37	GK1111-3A Ciji	146	GK2814 Olla	78
GGLIV19-011 Liv	47	GK1111-3W Ciji	145	GK3006N Washington	79
GGLIV19-012 Liv	47	GK1113-1A Ciji	132	GK8907 Molti	51
GGLIV19-013 Liv	47	GK1113-1W Ciji	131	GK9901P Molti	52
GGLIV19-014 Liv	47	GK1113-2A Ciji	140	GK9901W Molti	53
GGLIV19-021 Liv	48	GK1113-2W Ciji	139	GK9903N Molti	51
GGLIV19-022 Liv	48	GK1113-3A Ciji	148	GK9905P Molti	54
GGLIV19-023 Liv	48	GK1113-3W Ciji	147	GK9905W Molti	54
GGLIV19-024 Liv	48	GK1115-1A Ciji	134	GK9907N Molti	54
GGLIV19-SVL1 Liv	42	GK1115-1W Ciji	133	GK9923N Molti	55
GGLIV19-SVL2 Liv	42	GK1115-2A Ciji	142	GK9947 BOE	26
GGRA16-111 Genesee	31	GK1115-2W Ciji	141	GK9947US BOE	26
GGRA16-121 Genesee	31	GK1115-3A Ciji	150	GK9961P Molti	56
GGRA16-141 Genesee	32	GK1115-3W Ciji	149	GK9961W Molti	57
GGWA16-011 Metta	34	GK1117-1A Ciji	136	GK21001 Camille	29
GGWA16-021 Metta	35	GK1117-1W Ciji	135	GK21003 Camille	29
GK1101-1A Ciji	106	GK1117-2A Ciji	144	GK21003-021 Camille	30
GK1101-1W Ciji	105	GK1117-2W Ciji	143	GLGB17-011 Calm	86
GK1101-2A Ciji	114	GK1117-3A Ciji	152	GLGB17-021 Calm	87
GK1101-2W Ciji	113	GK1117-3W Ciji	151	GLGB17-031 Calm	88
GK1101-3A Ciji	122	GK1119A Ciji	156	GLGB17-041 Calm	89
GK1101-3W Ciji	121	GK1119W Ciji	155	GLGB17-052 Calm	90
GK1103-1A Ciji	108	GK1121-1A Ciji	158	GLGB17-062 Calm	91
GK1103-1W Ciji	107	GK1121-1W Ciji	157	GLGB17-072 Calm	92
GK1103-2A Ciji	116	GK1121-2A Ciji	160	GLGB17-082 Calm	93
GK1103-2W Ciji	115	GK1121-2W Ciji	159	GLGB17-093 Calm	94
GK1103-3A Ciji	124	GK1121-3A Ciji	162	GLGB17-103 Calm	95
GK1103-3W Ciji	123	GK1121-3W Ciji	161	GLGB17-113 Calm	96
GK1105-1A Ciji	110	GK1131 Ciji	163	GLGB17-123 Calm	97

product	page	product	page	product	page
GLGB17-161 Calm	98	GMQA16-021 Trillia	61	GTGB17-2424H24-S Calm	177
GLGB17-171 Calm	99	GMQA16-041 Trillia	60	GTGB17-2424H24-W Calm	177
GLGB17-181 Calm	103	GMQA16-051 Trillia	61	GTGB17-3225H17-F Calm	175
GLIRS17-011 Iris	166	GMQA16-071 Trillia	60	GTGB17-3225H17-G Calm	175
GLIRS17-021 Iris	167	GMQA16-081 Trillia	61	GTGB17-3225H17-L Calm	175
GLIRS17-031 Iris	166	GNTOCB1824 Tables	179	GTGB17-3225H17-S Calm	175
GLIRS17-041 Iris	168	GNTOCB2420 Tables	179	GTGB17-3225H17-W Calm	175
GLIRS17-051 Iris	169	GNTOCB2424 Tables	179	GTGB17-3232H17-F Calm	175
GLIRS17-061 Iris	170	GNTOCB3616 Tables	179	GTGB17-3232H17-G Calm	175
GLIRS17-071 Iris	169	GNTOCY1820 Tables	178	GTGB17-3232H17-L Calm	175
GLIRS17-081 Iris	171	GNTOCY1824 Tables	178	GTGB17-3232H17-S Calm	175
GM2ETRD18H24-L Briefing	174	GNTOCY2420 Tables	178	GTGB17-3232H17-W Calm	175
GM2ETRD18H24-S Briefing	174	GNTOCY2424 Tables	178	GTGB17-3250H17-F Calm	175
GM2ETRD18H24-W Briefing	174	GNTOCY3616 Tables	178	GTGB17-3250H17-G Calm	175
GM2LTRD18H24-L Briefing	174	GSGNV17-011 Geneva	73	GTGB17-3250H17-L Calm	175
GM2LTRD18H24-S Briefing	174	GSGNV17-031 Geneva	74	GTGB17-3250H17-S Calm	175
GM2LTRD18H24-W Briefing	174	GSGNV17-051 Geneva	73	GTGB17-3250H17-W Calm	175
GM2NTRD18H19-L Briefing	174	GSGNV17-071 Geneva	74		
GM2NTRD18H19-S Briefing	174	GSHA15-011 Avoca	68		
GM2NTRD18H19-W Briefing	174	GSHA15-021 Avoca	68		
GM2NTRD30H15-L Briefing	174	GSHA15-031 Avoca	69		
GM2NTRD30H15-S Briefing	174	GSHA15-041 Avoca	69		
GM2NTRD30H15-W Briefing	174	GSRA16-011 Genesee	70		
GM2NTRS1824H17-L Briefing	174	GSRA16-021 Genesee	70		
GM2NTRS1824H17-S Briefing	174	GSRA16-031 Genesee	71		
GM2NTRS1824H17-W Briefing	174	GSRA16-041 Genesee	71		
GMBTRT17H2454-WW Letchworth	180	GSRA16-051 Genesee	72		
GMBTRT17H3636-WW Letchworth	180	GSRA16-061 Genesee	72		
GMBTRT17H4242-WW Letchworth	180	GTGB17-1218H26-F Calm	177		
GMBTRT21H2424-WW Letchworth	180	GTGB17-1218H26-G Calm	177		
GMBTRT36H2060-WW Letchworth	180	GTGB17-1218H26-L Calm	177		
GMHB17-011 Tia	58	GTGB17-1218H26-S Calm	177		
GMHB17-041 Tia	59	GTGB17-1218H26-W Calm	177		
GMLA15-011 Convo	43	GTGB17-1632H17-F Calm	176		
GMLA15-021 Convo	45	GTGB17-1632H17-G Calm	176		
GMLA15-041 Convo	44	GTGB17-1632H17-L Calm	176		
GMLA15-051 Convo	46	GTGB17-1632H17-S Calm	176		
GMLIV19-031 Liv	49	GTGB17-1632H17-W Calm	176		
GMLIV19-032 Liv	49	GTGB17-1650H17-F Calm	176		
GMLIV19-033 Liv	49	GTGB17-1650H17-G Calm	176		
GMLIV19-034 Liv	49	GTGB17-1650H17-L Calm	176		
GMLIV19-041 Liv	50	GTGB17-1650H17-S Calm	176		
GMLIV19-042 Liv	50	GTGB17-1650H17-W Calm	176		
GMLIV19-043 Liv	50	GTGB17-2424H24-F Calm	177		
GMLIV19-044 Liv	50	GTGB17-2424H24-G Calm	177		
GMQA16-011 Trillia	60	GTGB17-2424H24-L Calm	177		

**GUEST SEATING**

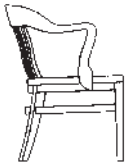

**GK9947**  
Bank of England (pg. 26)

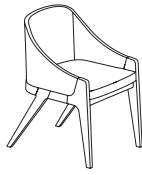

**GGCAL17-011**  
Calia (pg. 27)



**GK21001**  
Camille (pg. 29)



**GGRA16-141**  
Genesee (pg. 32)

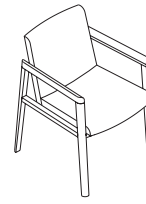

**GGCA14-011**  
Lily (pg. 33)



**GGLIV19-023**  
LIV (pg. 48)



**GGWA16-011**  
Metta (pg. 34)

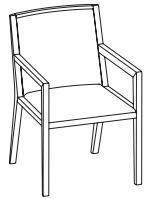

**GGJA14-011**  
Savor (pg. 36)



**GGHB17-071**  
Tia (pg. 38)

**MULTIPURPOSE SEATING**



**GMLA15-011**  
Convo Barstool  
(pg. 43)



**GGLIV19-013**  
LIV Stacker  
(pg. 47)



**GGLIV19-043**  
LIV Stool  
(pg. 50)



**GK9901P**  
Molti (pg. 52)

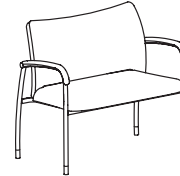

**GK9961P**  
Molti Bariatric  
(pg. 56)



**GK9923N**  
Molti Stool (pg. 55)

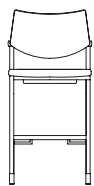

**GMHB17-011**  
Tia Barstool (pg. 58)



**GMQA16-011**  
Trillia Barstool (pg. 60)

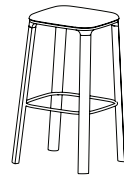

**SWIVEL SEATING**



**GSHA15-031**  
Avoca (pg. 69)



**GSR16-031**  
Genesee (pg. 71)



**GSGNV17-011**  
Geneva (pg. 73)



**GK2800**  
Olla (pg. 75)



**GK3006N**  
Washington (pg. 79)

**LOUNGE SEATING**

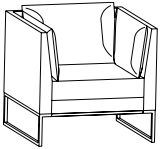

**GLGB17-011**  
Calm (pg. 86)

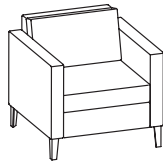

**GK1111-1W**  
Ciji (pg. 129)



**GLIRS17-011**  
Iris (pg. 166)

**OCCASIONAL TABLES**

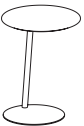

**GM2LTRD18H24**  
Briefing (pg. 174)



**GTGB17-3225H17**  
Calm (pg. 175)

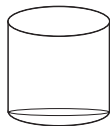

**GNTOCY1820**  
Cylinder (pg. 178)

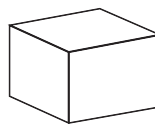

**GNTOCB1824**  
Cube (pg. 179)

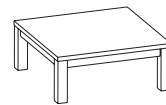

**GABTRT21H2424-WW**  
Letchworth (pg. 180)

## **GSA/FEDERAL CONTRACT INFORMATION:**

Model numbers identified with the following verbiage “When purchased separately without a configurable TAA compliant end product, not on GSA contract” is to mean that these configurable parts or components:

- Have no functionality or capability without being integrated into an end product; and
- Are considered Open Market if purchased without a configurable TAA compliant end product.

## **ITEMS ON GSA CONTRACT**

Please note, in order to verify if an item is on GSA Contract or is “Open Market,” please use Compass quoting which is updated in real time with all GSA contract changes. If you need additional assistance, please contact your local sales representative.

### INTRODUCTION

The Gunlocke Company is dedicated to providing the finest possible products and service. This price list reflects that commitment. Included is a current listing of our seating models.

**Casegoods are presented in a separate price lists. Contact your Gunlocke Customer Services Representative for more information. (800) 828-6300**

Designed for easy use, each page of this price list provides all information required to order a product correctly. Should additional information be needed, contact your Gunlocke Customer Service representative.

### PRICING

Prices shown covers standard products. Any changes or alterations, other than those listed, will be subject to an additional charge. Prices include cartoning and freight. Contact the Gunlocke Tailored Solutions at [gunts@gunlocke.com](mailto:gunts@gunlocke.com) to request custom quotes. Authorization and pricing must be secured in advance for orders or contracts calling for large quantities, indefinite quantities, or extended delivery dates.

### ORDERING

Orders submitted electronically will receive priority service and shorter overall lead times. You can submit your orders electronically via traditional EDI (Electronic Data Interchange), by e-commerce at [Gunlocke.com](http://Gunlocke.com) using your XML and SIF files.

Orders in the amount of \$75,000 list or larger will require a XML or SIF file to be e-mailed to our order entry department at [gunlockeoe@gunlocke.com](mailto:gunlockeoe@gunlocke.com).

Orders under \$75,000 list do not require an XML or SIF file and can be e-mailed to our order entry department at [gunlockeoe@gunlocke.com](mailto:gunlockeoe@gunlocke.com), faxed to 585-728-8350, or mailed to:

The Gunlocke Company  
Attn: Order Entry  
One Gunlocke Drive  
Wayland, New York 14572

### ORDER CHANGES

Gunlocke is not required to accept changes in orders after confirmation. Reasonable changes are subject to additional charges for labor, material and administrative costs.

**Order changes of acknowledgment may result in re-scheduling of product.**

### ACKNOWLEDGMENT

Each order will be acknowledged by Gunlocke. Customers should check each acknowledgment for accuracy and immediately notify Gunlocke of any discrepancies.

**This printed acknowledgment is the final agreement between The Gunlocke Company and the customer, superseding all previous communications regarding the order.**

### SPECIFICATION CHANGES

Gunlocke reserves the right to change specifications for the improvement of products at any time, without notice.

### RETURNED MERCHANDISE

No merchandise may be returned without prior authorization.

### SHOWROOMS

For all showroom locations and tour information, please reference the showrooms page online at: [www.gunlocke.com/inspiration/showrooms](http://www.gunlocke.com/inspiration/showrooms)

### CANCELLATIONS

Cancellations of orders cannot be accepted since every order is manufactured according to customer's specifications.

### STORAGE

If delivery cannot be made and products are ready, Gunlocke will transfer products to a storage facility of the customers choice and products will be invoiced at this time. The customer is responsible for storage charges as well and assumes and bears all risks associated with the storage of that product.

### TERMS

**Net 30 days from date of invoice.** A service charge of eighteen percent (18%) per year or .0004931 per day, compounded monthly, will be added to balance due beyond the thirtieth day. Products are shipped **FOB factory, freight prepaid and allowed.**

Title passes to purchaser and Gunlocke's responsibility ceases when shipment is accepted for transportation by a carrier. A full explanation of all payment terms is found on order and invoice forms.

## 12 YEAR WARRANTY

Subject to the limitations set forth below. The Gunlocke Company warrants to the original purchaser all product in this price list to be free from defects in material and workmanship for a twelve year period from the date of shipment.

This **12-year warranty** applies to all products sold and installed by a Gunlocke authorized agent for normal commercial single shift service. Gunlocke will repair, or at its option, replace defective merchandise, free of charge. The following components not manufactured by Gunlocke have the following warranties:

- **High wear components** Such as casters and glides are warranted for five years after date of shipment to original owner.
- **Seating control mechanisms** are warranted for five years after date of shipment to original owner.
- **Fabric and leather** are warranted for three years if single-shift and normal use after shipment to original owner.

Any non-standard material selected by the customer is not warranted. Neither does this warranty apply to damage resulting from accident, alteration, or misuse, as well as damage from normal wear and tear such as dents, nicks, scratches, fading and improper maintenance. That is, Gunlocke's warranty is only valid if products are given proper use and care. Gunlocke assumes no responsibility for product damages resulting from improper installation or user modification.

## WOOD FURNITURE

Wood owes its inherent beauty to variations in color, grain, and texture, and therefore, these variations are not considered defects. There may be minor variations from one piece of furniture to the next even though they are finished at the same time. Exposure to light and the aging process will cause a darkening of natural wood products. Light finishes on wood products do not mask the natural characteristics of wood.

The Gunlocke Company does not guarantee the exact matching of grain, pattern, and color. Gunlocke offers 800 a natural maple finish on maple, 222 a natural cherry on maple, 701 a light cherry finish on cherry or maple, 629 nutmeg walnut on walnut or maple, and 601 light walnut on walnut or maple. These finishes do not cover any of the natural characteristics of the wood, including nature's colorations, pitch pockets, and the variations of steambent wood. Merchandise will not be replaced because of these natural variations.

It is expressly understood and agreed that the buyer's sole and exclusive remedy for any and all losses or damages resulting from nonconforming goods, or from any other cause, shall be repair or replacement of defective parts, and that Gunlocke shall not be liable for damages or injury to persons or property, nor for replacement of the entire commercial unit, if repair or replacement of defective parts can reasonably render the unit conforming.

All warranty claims must be submitted in writing by the original owner via our website.

Owner may be required to produce the invoice or other evidence to establish that a claim is within the warranty period.

As stated and illustrated on the website, serial numbers are required to process a warranty claim. No person, firm, or corporation is authorized to assume for Gunlocke any liability in connection with the sale or installation of Gunlocke products except as stated above.

All other warranties, expressed or implied, are excluded. Gunlocke shall not be liable for incidental or consequential damages of any sort.



Within the Continental USA, all orders above \$20,000 list are shipped FOB factory, freight prepaid and allowed. All orders less than \$20,000 list will be subject to a \$200 net freight charge. Products shipped to Alaska and Hawaii FOB factory, freight prepaid and allowed to port of embarkation. Customer is responsible for freight charges from port of embarkation to final destination.

An anticipated shipping date is indicated on the order acknowledgment. Gunlocke cannot accept responsibility for shipping delays caused by outside sources or unforeseen problems. Delay of shipments requested by customers must be approved by Gunlocke. Any resultant storage charges will be charged to the customer.

Gunlocke may await completion of the entire order and ship all at once or may make partial shipments from time to time at its sole discretion unless the customer requests in writing that partial shipments are needed and Gunlocke approves the specific shipping schedule. Additional charges may apply.

Gunlocke is not liable for any delay or failure to deliver or perform due to strikes, lock-outs, or other labor or transportation difficulties, delay of sources or supply, accidents, fires, acts of God, or any other causes of like or unlike nature beyond the control of Gunlocke.

### LIABILITY

Gunlocke products and their packaging are tendered to a transportation company only after passing rigid quality control inspection. At that time, title to the product is passed to the purchaser. However the transportation company assumes all liability from acceptance of shipment through its delivery. That is, Gunlocke's liability ceases at the time of shipment.

### FILING OF CLAIMS

All claims for damage or loss must be submitted via our website within 15 days after receipt of merchandise. Do not return freight damaged merchandise to Gunlocke. Follow the steps below to expedite processing and resolution of claims.

### For Visible Damage

1. Make damage notation on delivery receipt and have driver sign. Do not reject or refuse the shipment.
2. Immediately contact Gunlocke Traffic Department at 585-728-8268.
3. Hold damaged carton and all interior packing for carrier's inspection. These materials will be needed to substantiate the claim.

### For Concealed Damage

1. Open cartons within 15 days of receipt and inspect.
2. Follow steps 2, and 3 as listed under Visible Damage.
3. Do not remove product from delivered destination.

### For Loss

1. Be sure loss notation is made on delivery receipt and have driver sign.
2. Contact Gunlocke Traffic Department at 585-728-8268.

Should transportation company seek to limit its liability on concealed, loss, or damage claims, please contact Gunlocke's traffic department. After a thorough investigation of the claim, the traffic department will provide you with guidance in corresponding with the carrier.

Returned merchandise, regardless of delivery method, will not be accepted unless specifically authorized by Gunlocke.

### For Damage or Loss of Parcel Post or UPS Shipment

Notify the Gunlocke traffic department immediately at 585-728-8268.

### NORMAL DELIVERY

All normal ground transportation by Gunlocke will be made on a dock-to-dock basis. The Gunlocke traffic department will determine the recommended method of shipment according to the ship to destination. If the delivery on a shipment takes longer than 3 hours to be unloaded, an additional charge will be billed at \$100/hour. Gunlocke reserves the absolute right to determine the method of shipping unless special delivery instructions have been previously approved.

## SHIPPING INSTRUCTIONS

Gunlocke will make every effort in honoring delivery requests as stated on orders. However, the Company shall have no liability for failure to deliver, perform or delay in delivery due to any cause outside the control of Gunlocke. The Company assumes no liability for costs incurred due to delayed or late deliveries.

If a guaranteed delivery time is needed please call Gunlocke Traffic Department at 585-728-8268 for a quote as additional charges will apply. Weekend or after hours deliveries are subject to additional charges.

### WEEKEND DELIVERY

A \$500 charge will apply on weekend delivery after 3:00 PM Friday through Sunday evenings.

### DROP SHIP / JOB SITE DELIVERY

Orders under \$50,000 list will incur a \$125 charge for ship to locations other than a designated dealer warehouse.

### INSIDE DELIVERY

Inside delivery must be noted on order. A minimum \$100 charge will apply.

### SPECIAL DELIVERY

Please contact the Gunlocke traffic department for special delivery services such as inside delivery, weekend or after hour deliveries, reconsignment or other special needs. These are billable services.

**Gunlocke will make every effort in honoring delivery requests as stated on orders. However, the Company shall have no liability for failure to deliver, perform or delay in delivery due to any cause outside the control of Gunlocke. The Company assumes no liability for costs incurred due to delayed or late deliveries.**

### DOCK RESTRICTIONS

Gunlocke trailers are 53' x 102"; when attached to truck cab the total length is 75'. If delivery dock will not accommodate trucks of this sizes, the Gunlocke traffic department must be contacted prior to shipping. Alternate arrangements can be made; additional charges may apply.

## SPECIAL FINISHES

- Submit a color sample block (minimum size 3" x 3") to Gunlocke Order Entry so that a finish formulation can be developed to match the special finish and color.
- Review the approval sample provided by Gunlocke.
- Written approval and sign off is required for Gunlocke Customer Service.
- Once written approval and sign off is received, the special finish order will be acknowledged.

## All seating purchase orders:

- **10% list** upcharge per unit to base model receiving special finish.
- **\$250 net formulation fee** for special finish.

This procedure and cost apply to new and previously formulated special finishes. Special finish orders may receive additional lead time.

## FSC OPTION

For FSC Certified Product add "FSC" to beginning of wood finish option code.

### Example: FSC260.

Only models that have wood finish option can be ordered as FSC Certified Product.

## UPCHARGES

- 5% list upcharge per unit to base model

## MULTIPLE FABRICS PRICING

When multiple fabrics per chair are requested, the chair is priced at the highest grade price.

---

## ETCHED AND LASER CUT BACKS

Eligible Models:

### All Multi Seating with Wood Backs

Minimum order quantity: 5 Units

There shall be an initial setup fee of **\$250 (NET)** with a **\$100** List up-charge per unit. All standard finishes may be specified with backs. For new designs please submit artwork\* to Customer Service for review and approval. Once the artwork is accepted, an actual sample will be produced and sent for approval.

\*Please allow 3-5 business days upon receipt of the artwork for the sample to be completed.

All artwork must be clean and sharp image. Gunlocke can only accept mailed original artwork. Artwork must be black and white, bold and have crisp lines to be processed. Contact Order Entry for complete order and approval process. (800) 828-6300.

## GUNLOCKE STANDARD TEXTILE OFFERING AND COM PROGRAM OVERVIEW

Customers purchasing Gunlocke seating can choose coverings from the standard fabric/leather offering or fabrics can be specified outside of the Gunlocke standard fabric offering through a simpler, hassle-free COM process.

**Standard Fabric/Leather Partnership Program** – select from any one of the Gunlocke standard fabrics or leather offerings listed on the website from the following textile partners: HBF, Maharam, Momentum, Ultrafabrics or Camira. For the most current standard fabric and leather offering, please visit the website at Gunlocke.com.

HBF  
TEXTILES

maharam

Ultrafabrics

camira

**COM Program** – COM coverings can easily be specified and applied your seating products. Gunlocke offers two different processes for the COM program which are outlined below. The Gunlocke To Supply COM process is managed by Gunlocke and Dealer to Supply COM process is managed by the dealer.

- **Gunlocke To Supply (GTS) COM Program** – this is a process for fabrics that are not included in the standard Gunlocke offering. Gunlocke will manage the COM process with the textile supplier and will coordinate with the dealer to approve, grade/price and procure the fabric.

### GTS Guidelines:

1. Select the fabric you wish to use and check the Gunlocke COM Tool on Gunlocke.com to determine if the fabric you have chosen has already been tested and approved on the product you are interested in. The COM supplier's name, fabric pattern name, and color name will be needed to search for approved fabrics.
  - 2a. If your fabric is listed as an approved fabric, you may place your order directly with Gunlocke Customer Service. Please use the fabric code (e.g., S216426XP) noted in the COM Tool on your order in the place of the standard fabric code.
  - 2b. If the fabric has not previously been tested, you must enter a COM request. Your name, company name and email will be prepopulated fields. The secondary email, project name, and bid/contract number are optional information. However, it's best to include any bid/contract information to ensure the code is set up correctly. The supplier, pattern, and color will show a list by clicking in the box and entering the first letter of the name and these are free form text boxes. Once that information is entered click add. (Multiple series can be added to the same request if they are the same supplier, pattern, and color.) Then click submit. An email will be sent to the to the requestor stating the COM Request was successfully submitted. Up to four emails could be received: Testing materials requested, in testing, and final approval/denial. It's rare actual test yardage is required. Testing is mainly done by reviewing the attributes of the fabric. The testing process takes 24-48 hours.
  3. If approved, the final email will include the GTS fabric option code and price grade. Written COM price quotes hold pricing for 90 days after issue date.
- **Dealer to Supply – COM or COL Program** – this is also a process for fabrics/leathers that are not included in the standard Gunlocke offering. The main difference is that the dealer will manage the COM process themselves and will procure the fabric from textile supplier and send to Gunlocke to upholster on the product.

**COM/COL Guidelines:**

1. Select the fabric you wish to use and check the Gunlocke COM Tool on Gunlocke.com to determine if the fabric you have chosen has already been tested and approved on the product you are interested in. The COM supplier's name, fabric pattern name, and color name will be needed to search for approved fabrics.
2. If your fabric is listed as approved, please reference the upholstery requirements listed in the pricer.
3. If the fabric has not previously been tested, you must enter a COM request. Your name, company name and email will be prepopulated fields. The secondary email, project name, and bid/contract number are optional information. However, it's best to include any bid/contract information to ensure the code is set up correctly. The supplier, pattern, and color will show a list by clicking in the box and entering the first letter of the name and these are free form text boxes. Once that information is entered click add. (Multiple series can be added to the same request if they are the same supplier, pattern, and color.) Then click submit. An email will be sent to the to the requestor stating the COM Request was successfully submitted. Up to four emails could be received: Testing materials requested, in testing, and final approval/denial. It's rare actual test yardage is required. Testing is mainly done by reviewing the attributes of the fabric. The testing process takes 24-48 hours.
4. If approved, the final email will include the Dealer to Supply fabric option code and the COM or COL price grade. Written COM price quotes hold pricing for 90 days after issue date.
5. The dealer is responsible for sending the COM fabric to Gunlocke. Fabric must be marked with "COM – Dealer to Supply", dealer name, order number and seating model #. COM textile should be shipped to the address below the same time as the order submission and reference tracking information on order, to prevent production delays.

HNI Textile Distribution Center - Dealer PO Number  
Attn: COM Production Yardage  
301 Mulberry Ave.  
Dock Doors 20-22  
Muscatine, IA 52761
6. All COM "Dealer to Supply" orders will be charged grade 4 pricing. Dealers will pay for the COM fabric separately.
7. All COM fabric must be sent on a fabric roll.
8. Once the COM fabric is received, the order will be scheduled in production and acknowledged with a ship date.

Specific to DTS orders - the customer should send only the amount needed for the order. Fabric should arrive no sooner than 4 weeks in advance of order placement. Excess yardage, or yardage not attached to an order will be disposed of at Gunlocke's discretion.

Any canceled orders are subject to cancellation charges up to the full value of the Gunlocke product canceled. Gunlocke will determine the actual cancellation charge at the time the cancellation is requested.

**COM | CUSTOMER'S OWN MATERIAL**

1. Gunlocke cannot be held responsible for performance, color accuracy, or weaving of COM materials. All responsibility for COM shipments is between the purchaser and the textile source.
2. Gunlocke assumes no responsibility for the flame retardance of any COM. Customers are solely responsible for making sure that COM shipments comply with all applicable codes and regulations.
3. Gunlocke reserves the right to reject fabrics or leathers we deem unsuitable for upholstery. When this occurs, the customer will be notified in writing with an explanation of the problem. Gunlocke cannot be held responsible for any unsatisfactory results in the application of a COM/COL, and a written release from the customer will be required before the order is processed.
4. Please contact Gunlocke Customer Service if you are planning on having any fabric applied in a non-standard technique. (I.E. using the back side as the face), or have special requirements.
5. Fabric alterations such as laminated backing or fire coding may result in differences in upholstery appearance or stiffness.

**YARDAGE REQUIREMENTS**

Yardages shown in price list are for non-directional fabric based on 54" wide plain fabric (no repeat pattern). A chart is provided on page 14 to assist in determining the additional COM yardage requirements. Please add the indicated percentage to the yardage shown beside the style number in the price list. This guide will accurately cover most COM orders, but there will be instances due to unusual repeats or designs that additional yardage may be required. **Gunlocke will not be held responsible for any additional COM that may be required. Please contact Customer Service for quotations on fabric requirements.**

**SELF-DECK PLATFORMS**

Self-covered platforms in COM are available at no upcharge. Allow additional yardage in the following amounts for 54" material:

One seat sofa	1 yd.
Two seat sofa	1.5 yds.
Three seat sofa	2 yds.

**FABRIC APPLICATION**

Cutting direction is based on the fabric width and the way the fabric is cut from the roll and applied to Gunlocke products. There are two cutting directions: Vertical (cut-right) or Horizontal (railroaded). Gunlocke reserves the right to railroad (or apply the fabric according to the weave) whenever possible to avoid seams in large upholstered areas and/or single cushions units. If a fabric is questionable, a cutting of adequate size allowing full repeats must be sent to Customer Service for approval.

**COL | CUSTOMER'S OWN LEATHER**

Customer's leather must meet standards set by Gunlocke. All hides must be #1 quality, bear no greater than three defects, and yield a minimum of 45 usable square feet per hide. Imperfections that penetrate the hide, brands, large marks, burns, excessive healed over scars and scratches, and excessive fat wrinkles are considered defects.

**COL SPECIFICATIONS**

Leather footage requirements listed in the price list refer to usable leather square footage that meet the standards described above. Calf hides must be at least 30 square feet of clean and usable matching hides. When specifying calf hides, add 30% to footage requirements. **Gunlocke will not be held responsible for any additional COL that may be required.**

**LEATHER SEAT PUDDLING**

Leather is a natural material which has elasticity and will form according to usage. For example as a leather seat "breaks in" (similar to leather shoes) stretching may occur. This is an inherent quality of natural leather and is not considered a defect.

**LEATHER LOGOS**

Leather is a natural material which has elasticity. The degree of stretching occurring in the upholstery process varies by model and may reduce the visual depth of the logo detail.

**EMBROIDERED LOGOS**

Certain logo geometry may limit threads per inch on embroidered logos. **Logos on Fabric and Leather have a three year warranty see page 8.**

**FOR SAMPLE CONTACT:**

gunts@gunlocke.com

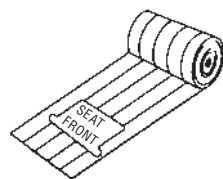

Vertical or Cut-Right

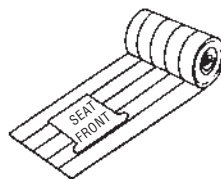

Horizontal or Railroaded

**COM | COL ORDERING PROCESS**

**1. COM material must be approved by Gunlocke for applicability and yardage requirements before acceptance of an order.**

**Please send large memo sample to COM for approval.**

Additional yardage may be required to determine acceptance for upholstery.

**2. COM | COL sample must reference the supplier's company name, pattern, color and number order.**

**3. Application instructions must accompany order.** In absence of these instructions, Gunlocke will determine best method of upholstery.

**4. All COM | COL must be shipped pre-paid to Gunlocke with package side marked with:**

- Dealer Name
- Dealer purchase order number
- Gunlocke seating pattern number

**HNI Textile Distribution Center -  
Dealer PO Number  
Attn: COM Production Yardage  
301 Mulberry Ave.  
Dock Doors 20-22  
Muscatine, IA 52761**

**NOTE**

COM and COL orders cannot be scheduled for production or acknowledged as to ship date until COM has been received and approved by Gunlocke. Gunlocke will not warrant application and upholstery technique

**PLEASE REFER TO YOUR FABRIC SWATCH CARD FOR HORIZONTAL AND VERTICAL REPEAT REQUIREMENTS.**

Fabric Width	Plain Fabric	2"-10" Repeat	11"-20" Repeat	21"-25" Repeat	26"-30" Repeat	31"-37" Repeat	38"-45" Repeat	46"-52" Repeat
54"	0%	10%	15%	20%	25%	30%	35%	40%
52"	15%	20%	25%	30%	35%	40%	45%	50%
50"	25%	30%	35%	40%	45%	50%	55%	60%
48"	35%	40%	45%	50%	55%	60%	65%	70%
45"	45%	50%	55%	60%	65%	70%	75%	80%

Fabric Width	Plain Fabric	2"-10" Repeat	11"-20" Repeat	21"-25" Repeat	26"-30" Repeat	31"-37" Repeat	38"-45" Repeat	46"-52" Repeat
36"	60%	65%	70%	75%	80%	85%	90%	95%

**Depending upon the pattern repeat, it may be necessary to cut the fabric vertical (cut-right). This will require 15% additional fabric.**

To calculate the correct yardage with repeats (horizontal and vertical), add the horizontal repeat to the vertical repeat for total yardage required.

When calculating repeat, round up to nearest .5 yard.

**For example:**

**A fabric width of 54" with a 8" vertical repeat (requires 10%) + a 20" horizontal repeat (requires 15%) = total additional yardage equals 25%.**

**Therefore, if the chair requires 2 yards of fabric, multiply 2 by 125% (or 2 x 1.25). Then 2.5 yards will be yardage required.**

**CUT YARDAGE PROGRAM**

All Gunlocke Branded textiles and leathers are available on a cut yardage basis.

**PRICING**

For pricing information, please contact customer support at [guncks@gunlocke.com](mailto:guncks@gunlocke.com) or call 800-828-6300. Please have fabric pattern and color available. Pricing provided will not include shipping charges, storage or insurance charges, sales and other taxes.

**ORDERING**

Order all fabrics by name and pattern number. All cut-yardage orders will be cut and shipped to the nearest one-eighth yard. Minimum order quantity is one yard. Leathers are sold by the square foot to the closest whole or half hide. When an exact match is necessary, please submit a cutting with order; slight variations in shade cannot be avoided.

**ACKNOWLEDGMENT**

All orders will be confirmed by Gunlocke in writing. The order acknowledgment is the final expression of the agreement between the customer and Gunlocke and supersedes all prior verbal and written statements regarding the order. The acknowledgment can be modified only in writing with reconfirmation signed by Gunlocke.

**CANCELLATIONS**

Orders may not be canceled or returned by the customer without the written consent of The Gunlocke Company and are subject to a cancellation or restocking charge of 35% of the total amount of the order.

**CREDIT TERMS FOR CUT YARDAGE PROGRAM**

Credit may be established upon Gunlocke's written acceptance of satisfactory references. Gunlocke may cancel or change credit terms at its discretion and may request advance payment at any time. All prepaid orders must include shipping and handling charges and tax where applicable. If local taxes are not applied on prepaid orders, customer must complete a resale certificate indicating their tax I.D. number.



**FLAMMABILITY GUIDELINES  
UPHOLSTERY COVERS**

Gunlocke makes every effort to ship high quality product, free of defects in material and workmanship. Great care is taken in selecting only first quality upholstery materials from reputable suppliers.

**Upholstery material is warranted for 3 years against unusual wear or deterioration; there is no warranty against fading, normal wear, or customer-induced cuts and tears.**

Leather is a natural material. There may be minor variation in markings such as growth wrinkles, healed scars, and grain patterns. Also, subtle variations in the tanning and dyeing process can be seen from one hide to another.

**Combinations of Upholstery Covers**

Contact Tailored Solutions (gunts@gunlocke.com) for assistance with pricing of fabric, vinyl, leather or upholstery combinations.

**SPECIAL TREATMENT/ FLAMMABILITY**

Technical Bulletin #133 is a flammability regulation that may be required or requested for certain areas or applications. Most standard Gunlocke fabrics, when used in combination with proper components, can meet the requirements of the composite test for California technical bulletin #133. The composite test requires the use of a full-scale mock-up/sample that in all respects (including fabrics, filling materials, combustible decorative parts and furniture style) reflects the construction of the actual furniture required for a specific area or application.

While Gunlocke has tested several model/upholstery combinations for TB133, not all possible combinations have been tested or certified. Please contact Customer Service to determine if the specific model/upholstery combination you are working with has been tested or if a new test is required. In addition, all COM fabrics must be evaluated on an individual basis and may also require testing. Testing is available as follows:

**Specific model & upholstery**

- Fire barrier is available as a special treatment. If required, please contact Gunlocke Tailored Solutions to quote as a special: gunts@gunlocke.com.
- Please check with Customer Service to verify testing has been completed with your model and fabric selection.
- Cost of testing a chair is \$850 NET, plus the cost of chair and fabric.
- Additional lead-time for testing for CAL 133.
- Additional lead-time for fire barrier cloth is 3-4 weeks.

\*Note that specification of the fire barrier cloth does not in itself provide certification. Testing must be completed and pass for the specific model/upholstery combination to obtain a certificate. Once testing is completed, Gunlocke will provide a certification letter specific to the sample tested for CAL 133.

**Special Flammability Code Requirements**

Please inquire for pricing and lead time.

**ACT PERFORMANCE GUIDELINES**

**Explanation of ACT Icons**

All Gunlocke fabrics conform to the Association of Contract Fabrics Guidelines.

**FIRE RETARDANCY**



Flammability testing determines a fabric's resistance to burning.

Application	Passes
Upholstery	California 117-2013
Panels and Upholstered Walls	ASTM E 84 (unadhered method)

**COLORFASTNESS TO WET AND DRY CROCKING**



Colorfastness to wet and dry crocking refers to the rubbing off of color from the fabric onto clothing, hands or other materials and can occur under wet or dry conditions.

Application	Passes
Upholstery AATCC 8-1974	Dry Crocking, Class 4 minimum Wet Crocking, Class 3 minimum
Panels and Upholstered Walls	AATCC 8-1974 Class 3 minimum

**COLORFASTNESS TO LIGHT**



Colorfastness to light is the degree to which fabric will retain its color when exposed to light.

Application	Passes
Upholstery	AATCC 16-A-1974 or AATCC 16-E-1976 Class 4 minimum at 40 hours
Panels and Upholstered Walls	AATCC 16-A-1974 or AATCC 16-E-1976 Class 4 minimum at 40 hours

**PHYSICAL PROPERTIES**



Three physical property tests include: brush pill test to determine a fabric's pilling. Breaking/tensile strength is the ability of a fabric to withstand tension without breaking or tearing. Seam slippage is the pulling apart of fabrics at the seams.

Application	Passes
Upholstery	Brush pill ASTM D3511, 3-4 minimum Breaking strength ASTM DF-D1682-64 (1975) 50 lbs. minimum in warp and weft Seam slippage ASTM D3597-D434-75 25 lbs. minimum in warp and weft

**ABRASION**



Abrasion is the ability of a fabric to withstand damage from wear and rubbing. There is a general contract specification as well as a heavy duty specification.

Application	Passes
General Contract Upholstery	ASTM 3597 modified #10 cotton duck) 15,000 double rubs Wyzenbeek Method
Heavy Duty Upholstery	ASTM 3597 modified (#10 cotton duck) 30,000 double rubs Wyzenbeek method or ASTM D4966 (with 21 oz.weight) 40,000 rubs Martindale method







# FABRIC MATRIX

Seating  
02/24

FABRIC TABLES  
Silea Tackboards

• Available upholstery option  
RR: railroaded, F/FR: Fire compliant model

Supplier	Pattern Name	Pattern Code	New Grade	FABRIC TABLES Silea Tackboards						
				Tack	Tack A	Tack B	Tack C	Tack D	Tack E	Tack F
HBF Textiles	Blink	1048	4							
HBF Textiles	Look-See	1044	4							
HBF Textiles	Walkabout	1046	4							
HBF Textiles	Against the Grain	SHBFAGG	5	•			•	•	•	
HBF Textiles	Caddy Corner	1016	5							
HBF Textiles	Checkmate	1043	5							
HBF Textiles	Pebbled	SHBFPEB	5							
HBF Textiles	Picnic Plaid	1029	5							
HBF Textiles	Upbeat	1036	5							
HBF Textiles	Zippy	1045	5							
HBF Textiles	Poppy	1047	6							
HBF Textiles	Crew Cut	SHBFCRW	7	•			•	•	•	
HBF Textiles	Happy Camper	1028	7							
HBF Textiles	Honest	SHBFHON	7							
HBF Textiles	Roundabout	1005	7							
HBF Textiles	Dashing	1008	8							
HBF Textiles	Fourfold	SHBFFOU	8	•			•	•	•	
HBF Textiles	Modern Tweed	SHBFMOD	8							
HBF Textiles	Sherpa	1031	8							
HBF Textiles	All Terrain	1027	9							
HBF Textiles	Comfort Zone	905	9							
HBF Textiles	Crafted Felt	1017	9							
HBF Textiles	Curtain Wall	1023	9							
HBF Textiles	Madam Dottie	1001	9							
HBF Textiles	Scribble XS	982	9							
HBF Textiles	Uptown	1039	9							
HBF Textiles	Wabi Sabi	SHBFWAB	9							
HBF Textiles	Color Code	998	10							
HBF Textiles	Digital Bloom 2.0	1050	10							
HBF Textiles	Equation	SHBFEQU	10	•			•	•	•	
HBF Textiles	Folded Lines	973	10							
HBF Textiles	Remember	SHBFREM	10							
HBF Textiles	Roy's Cords	1025	10							
HBF Textiles	Soft Angles 2.0	1051	10							
HBF Textiles	Upscale	1040	10							
HBF Textiles	Air Mail	1006	11							
HBF Textiles	Argyle Boucle	978	11							
HBF Textiles	Brushed Canvas	SHBFBCV	11							
HBF Textiles	Cloud	SHBFCLD	11							
HBF Textiles	Complex	964	12							
HBF Textiles	Abito	SHBFABI	12							
HBF Textiles	Beetle	SHBFABI	12	•			•	•	•	
HBF Textiles	Belgian Meadow	SHBFBLM	12	•			•	•	•	
HBF Textiles	Crosstweed	991	12							
HBF Textiles	Cutout	SHBFCUT	12							
HBF Textiles	Dot Grid	975	12							
HBF Textiles	Dot Structure	SHBFDOT	12							
HBF Textiles	Glint	SHBFGLT	12	•			•	•	•	
HBF Textiles	Grateful Grid	1015	12							
HBF Textiles	Heartfelt	SHBFHTF	12	•	•	•	•	•	•	•
HBF Textiles	Lava Rock	993	12							
HBF Textiles	Merci Boucle	SHBFMER	12							
HBF Textiles	Moving Blanket	SHBFMOV	12							
HBF Textiles	Sable Island	SHBFSAB	12							

FABRIC TABLES  
Silea Tackboards

• Available upholstery option  
RR: railroaded, F/FR: Fire compliant model

Supplier	Pattern Name	Pattern Code	New Grade	FABRIC TABLES Silea Tackboards						
				Tack	Tack A	Tack B	Tack C	Tack D	Tack E	Tack F
				No Restriction	66"W & 77"W Railroad Cut Only	77"W Railroad Cut Only	66"W & 77"W Pattern Cut Only	77"W Pattern Cut Only	No Pattern Cut	No Railroad Cut
HBF Textiles	Sir Stripe A Lot	1004	12							
HBF Textiles	Sweater Weather	1030	12							
HBF Textiles	Twist	SHBFTWS	12							
HBF Textiles	Upstart	1042	12							
HBF Textiles	Cherished Knit	954	13							
HBF Textiles	Enriched Boucle	1021	13							
HBF Textiles	Foundation	SHBFFND	13							
HBF Textiles	Moving Forward	1014	13							
HBF Textiles	Night Earth	1013	13							
HBF Textiles	Pepper Blend	995	13							
HBF Textiles	Quill	1011	13							
HBF Textiles	Scribble XL	983	13							
HBF Textiles	Sister Solid	1003	13							
HBF Textiles	Afghan	SHBFAFG	14	•	•	•	•	•	•	•
HBF Textiles	Smart	SHBFSMT	14							
HBF Textiles	Velvet Mix	977	14							
HBF Textiles	Hipster	SHBFHPT	15	•			•	•	•	
HBF Textiles	Landscape Blur	1024	15							
HBF Textiles	Poodle	1009	16							
HBF Textiles	Sweater	SHBFSWE	16							
HBF Textiles	Woven Memory	1019	16							
HBF Textiles	Crafted Cloud	1018	19							
HBF Textiles	Knitwork	SHBFKNI	21							
HBF Textiles	Bunny	1012	23							
HBF Textiles	Eccentric	966	23							
HBF Textiles	Eccentric	SHBFECC	23							
HBF Textiles	Wild West	717	L2							
HBF Textiles	Aviator	K08	L3							
HBF Textiles	Freeway	K03	L3							
HBF Textiles	Modern Patina	716	L3							
HBF Textiles	Persuede	718	L3							
HBF Textiles	Vivace II	K07	L3							
HBF Textiles	Upper Crust	K05	L5							
HBF Textiles	Voyage	K09	L5							

# FABRIC MATRIX

## FABRIC TABLES

• Available upholstery option

RR: railroaded, F/FR: Fire compliant model

Supplier	Pattern Name	Pattern Code	New Grade	FABRIC TABLES							Callia
				Liv	Iris	Swivel 2	Lounge 2	Side 1	Side 2		
HBF Textiles	Blink	1048	4			•	•	•	•	•	
HBF Textiles	Look-See	1044	4	•	•	•	•	•	•	•	
HBF Textiles	Walkabout	1046	4	•	•	•	•	•	•	•	
HBF Textiles	Against the Grain	SHBFAGG	5	•	•	•	•	•	•	•	
HBF Textiles	Caddy Corner	1016	5	•	•	•	•	•	•	•	
HBF Textiles	Checkmate	1043	5	•	•	•	•	•	•	•	
HBF Textiles	Pebbled	SHBFPEB	5	•		•	•	•	•		
HBF Textiles	Picnic Plaid	1029	5	•		•	•	•	•		
HBF Textiles	Upbeat	1036	5	•		•	•	•	•	•	
HBF Textiles	Zippy	1045	5	•	•	•	•	•	•	•	
HBF Textiles	Poppy	1047	6	•	•	•	•	•	•	•	
HBF Textiles	Crew Cut	SHBFCRW	7		•	•	•	•	•	•	
HBF Textiles	Happy Camper	1028	7	•	•	•	•	•	•	•	
HBF Textiles	Honest	SHBFHON	7	•	•	•	•	•	•	•	
HBF Textiles	Roundabout	1005	7	•		•	•	•	•		
HBF Textiles	Dashing	1008	8	•	•	•	•	•	•	•	
HBF Textiles	Fourfold	SHBFFOU	8	•		•	•	•	•		
HBF Textiles	Modern Tweed	SHBFMOD	8			•	•	•	•		
HBF Textiles	Sherpa	1031	8		•	•	•	•	•	•	
HBF Textiles	All Terrain	1027	9	•		•	•	•	•	•	
HBF Textiles	Comfort Zone	905	9		•	•	•	•	•	•	
HBF Textiles	Crafted Felt	1017	9	•	•	•	•	•	•	•	
HBF Textiles	Curtain Wall	1023	9	•		•	•	•	•	•	
HBF Textiles	Madam Dottie	1001	9	•	•	•	•	•	•	•	
HBF Textiles	Scribble XS	982	9	•		•	•	•	•		
HBF Textiles	Uptown	1039	9	•		•	•	•	•	•	
HBF Textiles	Wabi Sabi	SHBFWAB	9	•		•	•	•	•		
HBF Textiles	Color Code	998	10	•		•	•	•	•		
HBF Textiles	Digital Bloom 2.0	1050	10	•		•	•	•	•	•	
HBF Textiles	Equation	SHBFEQU	10	•	•	•	•	•	•	•	
HBF Textiles	Folded Lines	973	10	•	•	•	•	•	•	•	
HBF Textiles	Remember	SHBFREM	10	•		•	•	•	•		
HBF Textiles	Roy's Cords	1025	10		•	•	•	•	•		
HBF Textiles	Soft Angles 2.0	1051	10	•	•	•	•	•	•	•	
HBF Textiles	Upscale	1040	10	•	•	•	•	•	•	•	
HBF Textiles	Air Mail	1006	11	•	•	•	•	•	•	•	
HBF Textiles	Argyle Boucle	978	11	•	•	•	•	•	•	•	
HBF Textiles	Brushed Canvas	SHBFBCV	11	•	•	•	•	•	•	•	
HBF Textiles	Cloud	SHBFCLD	11	•		•	•	•	•		
HBF Textiles	Complex	964	12	•	•	•	•	•	•	•	
HBF Textiles	Abito	SHBFABI	12	•	•	•	•	•	•	•	
HBF Textiles	Beetle	SHBFABI	12	•	•	•	•	•	•	•	
HBF Textiles	Belgian Meadow	SHBFBLM	12	•	•	•	•	•	•	•	
HBF Textiles	Crosstweed	991	12	•	•	•	•	•	•	•	
HBF Textiles	Cutout	SHBFCUT	12	•		•	•	•	•		
HBF Textiles	Dot Grid	975	12	•		•	•	•	•		
HBF Textiles	Dot Structure	SHBFDOT	12	•	•	•	•	•	•	•	
HBF Textiles	Glint	SHBFGLT	12	•	•	•	•	•	•	•	
HBF Textiles	Grateful Grid	1015	12	•	•	•	•	•	•	•	
HBF Textiles	Heartfelt	SHBFHTF	12	•	•	•	•	•	•	•	
HBF Textiles	Lava Rock	993	12	•	•	•	•	•	•	•	
HBF Textiles	Merci Boucle	SHBFMER	12		•	•	•	•	•	•	
HBF Textiles	Moving Blanket	SHBFMOV	12	•		•	•	•	•	•	

FABRIC TABLES

- Available upholstery option
- RR: railroaded, F/FR: Fire compliant model

Supplier	Pattern Name	Pattern Code	New Grade	Liv	Iris	Swivel 2	Lounge 2	Side 1	Side 2	Callia
HBF Textiles	Sable Island	SHBFSAB	12	•		•	•	•	•	
HBF Textiles	Sir Stripe A Lot	1004	12	•		•	•	•	•	
HBF Textiles	Sweater Weather	1030	12	•	•	•	•	•	•	•
HBF Textiles	Twist	SHBFTWS	12		•	•	•	•	•	•
HBF Textiles	Upstart	1042	12	•	•	•	•	•	•	•
HBF Textiles	Cherished Knit	954	13	•	•	•	•	•	•	•
HBF Textiles	Enriched Boucle	1021	13	•	•	•	•	•	•	•
HBF Textiles	Foundation	SHBFFND	13			•	•		•	
HBF Textiles	Moving Forward	1014	13	•	•	•	•	•	•	•
HBF Textiles	Night Earth	1013	13	•	•	•	•	•	•	•
HBF Textiles	Pepper Blend	995	13	•	•	•	•	•	•	•
HBF Textiles	Quill	1011	13	•	•	•	•	•	•	•
HBF Textiles	Scribble XL	983	13	•		•	•	•	•	
HBF Textiles	Sister Solid	1003	13	•	•	•	•	•	•	•
HBF Textiles	Afghan	SHBFAFG	14			•	•	•	•	•
HBF Textiles	Smart	SHBFSMT	14			•	•	•	•	
HBF Textiles	Velvet Mix	977	14	•		•	•	•	•	•
HBF Textiles	Hipster	SHBFHPT	15	•	•	•	•	•	•	•
HBF Textiles	Landscape Blur	1024	15	•		•	•	•	•	
HBF Textiles	Poodle	1009	16	•	•	•	•	•	•	•
HBF Textiles	Sweater	SHBFSWE	16			•	•	•	•	•
HBF Textiles	Woven Memory	1019	16	•		•	•	•	•	•
HBF Textiles	Crafted Cloud	1018	19			•	•	•	•	•
HBF Textiles	Knitwork	SHBFKNI	21		•	•	•	•	•	•
HBF Textiles	Bunny	1012	23		•	•	•	•	•	•
HBF Textiles	Eccentric	966	23		•	•	•	•	•	•
HBF Textiles	Eccentric	SHBFEC	23							
HNI Textiles	Strasburg	STB	L1	•	•	•	•	•	•	•
HBF Textiles	Wild West	717	L2	•		•	•	•	•	
HBF Textiles	Aviator	K08	L3	•	•	•	•	•	•	•
HBF Textiles	Freeway	K03	L3	•	•	•	•	•	•	•
HBF Textiles	Modern Patina	716	L3	•		•	•	•	•	
HBF Textiles	Persuede	718	L3	•		•	•	•	•	
HBF Textiles	Vivace II	K07	L3	•	•	•	•	•	•	•
HBF Textiles	Upper Crust	K05	L5		•	•	•	•	•	•
HBF Textiles	Voyage	K09	L5	•	•	•	•	•	•	•



Guest Seating . . . . .	23-39
Product Specifications . . . . .	24-25
Bank of England™ . . . . .	26
Calia . . . . .	27-28
Camille . . . . .	29-30
Genesee Guest . . . . .	31-32
Lily™ . . . . .	33
Metta . . . . .	34-35
Savor™ . . . . .	36-37
Tia™ Guest . . . . .	38-39

# GUEST SEATING

## Product Specifications

### BANK OF ENGLAND™

---

**Frame:**

**Construction:** Hardwood frame joined by double dowels, corner blocks.

**Available hardwoods:** Maple

**Seat:** Foam filled over sheet webbed frame, upholstered.

**Back:** Steambent hardwood back.

**Arm:** Steambent hardwood arms.

**Glides:** Nickel-plated steel.

**BIFMA Rating:**

**Chairs:** ANSI/BIFMA X5.1 2011  
(253lb Weight Rating)

### CALIA

---

**Frame:**

**Construction:** Hardwood frame joined by mortise and tenon, corner blocks. Steambent back rail

**Available hardwoods:** Maple, Ash

**Seat:** Foam filled over sheet-webbed seat foundation, upholstered.

**Back:** High resiliency foam overmolded onto rigid urethane bucket, wrapped in 1/2" foam on inside back.

**Glides:** Nickel-plated steel

**BIFMA Rating:**

ANSI/BIFMA X5.1 2017  
(275lb Weight Rating)

### CAMILLE

---

**Frame:**

**Construction:** Hardwood frame joined by double dowels, mortise and tenon, and corner blocks.

**Available hardwoods:** Maple

**Seat:** Foam filled over strip-webbed seat foundation, upholstered.

**Back:** Foam filled over flexible foundation, upholstered.

**Glides:** Nickel-plated steel.

**BIFMA Rating:**

ANSI/BIFMA X5.1 2017  
(275lb Weight Rating)

### GENESEE

---

**Seat:** High resiliency foam overmolded onto rigid urethane bucket, wrapped in 1/2" foam with additional 1/2" high resiliency foam topper.

**Back:** High resiliency foam overmolded onto rigid urethane bucket, wrapped in 1/2" foam.

**Arm:**

**Polished aluminum:** Polished cast aluminum.

**Control:**

**Swivel tilt:** Swivel tilt with tilt lockout, polished low-profile control.

**Base:** Four star, die cast polished aluminum.

**Glides:** 1 3/4" nylon cap glides.

**Upholstery:** Top-stitch around edges of bucket.

**BIFMA Rating:**

ANSI/BIFMA X5.1 2017  
(300lb Weight Rating)

### LILY™

---

**Frame:**

**Construction:** Hardwood frame joined by mortise and tenon, corner blocks.

**Available hardwoods:** Maple, Ash

**Seat:** Foam filled over sheet webbed vent plywood foundation, upholstered.

**Back:** Foam filled over strip-webbed seat foundation, upholstered.

**Glides:** Nickel-plated steel.

**BIFMA Rating:**

ANSI/BIFMA X5.1 2011  
(253lb Weight Rating)

### METTA

---

**Frame:** 3/4" polished chrome steel tubing, with 1/2" solid rod cross members.

**Seat & Back:**

**Fully Upholstered:** Rigid fiberglass reinforced urethane with overmolded foam, wrapped in 1/4" dacron. 1/4" upholstery grade plywood outer.

**Wood Outers:** Rigid fiberglass reinforced urethane with overmolded foam, wrapped in 1/4" dacron. 1/4" qtr cut or rift cut plywood outer.

**Arm Cap:** 13" flexible vinyl molded piece, undermounted with double-sided tape. Wrapped in J" high density foam.

**Glides:** Push-fit low density polyethylene; heavy-duty round plastic inserts

**Shipping:** Product ships 1 to a box.

Does not stack.

**BIFMA Rating:**

ANSI/BIFMA X5.1 2011  
(253lb Weight Rating)

### SAVOR™

---

**Frame:**

**Construction:** Steambent back posts, hardwood frame joined by mortise and tenon, corner blocks.

**Available hardwoods:** Maple, Ash

**Seat:** Foam filled over sheet-webbed plywood seat foundation, upholstered.

**Back:** Foam filled over strip-webbed seat foundation, upholstered.

**Glides:** Nickel-plated steel.

**BIFMA Rating:**

ANSI/BIFMA X5.1 2017  
(275lb Weight Rating)



## TIA™ GUEST

---

### Frame:

**Construction:** Hardwood frame joined by mortise and tenon, and corner blocks.

**Available hardwoods:** Maple, Ash

**Seat & Back:** <sup>13</sup>/<sub>16</sub>" thick plywood bucket, consisting of 13 cross-plyies of <sup>1</sup>/<sub>16</sub>" thick #3 grade southern hardwood.

**Glides:** Nickel-plated steel.

### BIFMA Rating:

ANSI/BIFMA X5.1 2017  
(275lb Weight Rating)

model number	fabric grades								dimensions	W	D	H
<b>GK9947US</b> Arm, upholstered seat	<b>1</b>	5,267	<b>10</b>	5,419	<b>19</b>	5,614	<b>L1</b>	5,428	Overall	23 1/2"	22 3/4"	31 3/8"
	<b>2</b>	5,282	<b>11</b>	5,436	<b>20</b>	5,636	<b>L2</b>	5,569	Seat		16 3/4"	17 3/8"
	<b>3</b>	5,295	<b>12</b>	5,454	<b>21</b>	5,660	<b>L3</b>	5,738	Arm			27 3/4"
	<b>COM/4</b>	5,309	<b>13</b>	5,477	<b>22</b>	5,683	<b>L4</b>	5,878	Between arms	19"		
	<b>5</b>	5,327	<b>14</b>	5,500	<b>23</b>	5,727	<b>L5</b>	6,019				
	<b>6</b>	5,346	<b>15</b>	5,523	<b>24</b>	5,773						
	<b>7</b>	5,363	<b>16</b>	5,546	<b>25</b>	5,819						
	<b>8</b>	5,382	<b>17</b>	5,568	<b>26</b>	5,864						
	<b>9</b>	5,400	<b>18</b>	5,591	<b>27</b>	5,909						
	<b>GK9947</b> Wood seat	5,084 All Wood										

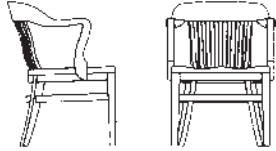

**Upholstery Requirements: GK9947US**

Fabric yards	0.7
Leather feet <sup>2</sup>	11.9
Shipping weight	32 lbs.
Cube	13.9

TO ORDER PLEASE SPECIFY THE FOLLOWING:

<input type="text"/>	<input type="text"/>	<input type="text"/>	<input type="text"/>
<b>MODEL NUMBER</b>	<b>FINISH</b>	<b>FLAMMABILITY RATING</b>	<b>UPHOLSTERY (model GK9947US only)</b>
	Cherry finishes on Maple Walnut finishes on Maple Maple finishes on Maple Oak finishes on Maple Light Rift Oak 301 not available on Maple. Please refer to the Bank of England™ product page on www.gunlocke.com for standard finish options.	U CTB117	Please refer to list of available upholstery and leather selections on www.gunlocke.com

Example

GK9947US.215.U.DOL728

GK9947US	215	U	DOL728
MODEL NUMBER	FINISH	FLAMMABILITY	UPHOLSTERY

model number	fabric grades								dimensions	W	D	H
<b>GGCAL17-011</b> Single Upholstery	<b>1</b>	2,973	<b>10</b>	3,490	<b>19</b>	4,160	<b>L1</b>	3,525	Overall	21"	24"	31 3/8"
	<b>2</b>	3,021	<b>11</b>	3,551	<b>20</b>	4,237	<b>L2</b>	4,007	Seat	19"	18 3/8"	18"
	<b>3</b>	3,067	<b>12</b>	3,614	<b>21</b>	4,316	<b>L3</b>	4,585	<b>Upholstery Requirements: GGCAL17-011</b>			
	<b>COM/4</b>	3,115	<b>13</b>	3,691	<b>22</b>	4,393	<b>L4</b>	5,066	Fabric yards	2.4		
	<b>5</b>	3,177	<b>14</b>	3,770	<b>23</b>	4,549	<b>L5</b>	5,550	Leather feet <sup>2</sup>	40.8		
	<b>6</b>	3,239	<b>15</b>	3,848	<b>24</b>	4,705			Shipping weight	27 lbs.		
	<b>7</b>	3,302	<b>16</b>	3,926	<b>25</b>	4,861			Cube	13.2		
	<b>8</b>	3,364	<b>17</b>	4,003	<b>26</b>	5,017						
	<b>9</b>	3,427	<b>18</b>	4,082	<b>27</b>	5,174						

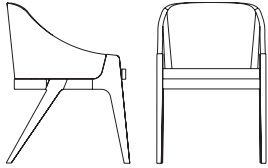

TO ORDER PLEASE SPECIFY THE FOLLOWING:

<input type="text"/>	<input type="text"/>	<input type="text"/>	<input type="text"/>
<b>MODEL NUMBER</b>	<b>SPECIES &amp; FINISH</b>	<b>FLAMMABILITY RATING</b>	<b>UPHOLSTERY</b>

These seating models are available in the following hardwoods:

Maple **NE**  
Ash **QA**

Please refer to the Calia product page on [www.gunlocke.com](http://www.gunlocke.com) for standard finish options.

**Cherry finishes on Maple or Ash**  
**Maple finishes on Maple or Ash**  
**Walnut finishes on Maple or Ash**  
**Oak finishes on Maple or Ash**

*Natural Cherry 222, Clear Maple 800, Clear Oak 300 and Fawn Cypress 108 not available on Ash.*

*Light Rift Oak 301 not available on Maple.*

**U CTB117**

**Please refer to list of available upholstery and leather selections on [www.gunlocke.com](http://www.gunlocke.com)**

Example

GGCAL17-011.NE.U.DOL728  
 GGCAL17-011 NE U DOL728  
 MODEL NUMBER SPECIES & FINISH FLAMMABILITY UPHOLSTERY

# CALIA

Guest | Dual Upholstery

Seating  
02/24

model number                      fabric grades

**GGCAL17-021**                      **1** 3,026

Dual upholstery

dimensions	W	D	H
Overall	21"	24"	31 <sup>3</sup> / <sub>8</sub> "
Seat	19"	18 <sup>3</sup> / <sub>8</sub> "	18"

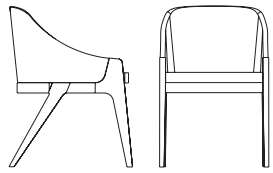

**Upholstery Requirements: GGCAL17-021**

	Dual Upholstery	
Fabric yards	Inner 1.7	Outer 1.0
Leather feet <sup>2</sup>	Inner 28.9	Outer 17.0
Shipping weight	27 lbs.	
Cube	13.2	

Inner	1		10		19		841		L1		391	
		2	34	11	409	20	896	L2	732			
	3	67	12	455	21	951	L3	1,142				
	COM/4	101	13	509	22	1,007	L4	1,484				
	5	145	14	565	23	1,117	L5	1,826				
	6	189	15	620	24	1,227						
	7	233	16	674	25	1,338						
	8	278	17	731	26	1,449						
	9	321	18	785	27	1,559						

To calculate price of chair with different fabric for Seat and Back; start with Grade 1 price, add appropriate grade price located in second row for Seat, and last add appropriate grade price located in third row for Back to the sum of the Grade 1 and Seat price.

**Example: Grade 1 \$3,026 + grade 4 fabric seat \$101 + grade 2 fabric back \$20 = \$3,147**

Outer	1		10		19		495		L1		230	
		2	20	11	242	20	528	L2	431			
	3	41	12	267	21	560	L3	672				
	COM/4	59	13	299	22	593	L4	873				
	5	85	14	332	23	658	L5	1,075				
	6	111	15	365	24	723						
	7	137	16	397	25	788						
	8	164	17	430	26	852						
	9	190	18	462	27	917						

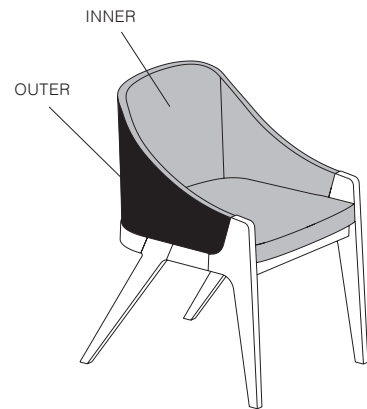

**TO ORDER PLEASE SPECIFY THE FOLLOWING:**

<input type="text"/>	<input type="text"/>	<input type="text"/>	<input type="text"/>	<input type="text"/>
<b>MODEL NUMBER</b>	<b>SPECIES &amp; FINISH</b>	<b>FLAMMABILITY RATING</b>	<b>INNER UPHOLSTERY</b>	<b>OUTER UPHOLSTERY</b>

These seating models are available in the following hardwoods:

Maple      **NE**  
Ash         **QA**

Please refer to the Calia product page on [www.gunlocke.com](http://www.gunlocke.com) for standard finish options.

**Cherry finishes on Maple or Ash**  
**Maple finishes on Maple or Ash**  
**Walnut finishes on Maple or Ash**  
**Oak finishes on Maple or Ash**

*Natural Cherry 222, Clear Maple 800, Clear Oak 300 and Fawn Cypress 108 not available on Ash.*

*Light Rift Oak 301 not available on Maple.*

**U** CTB117

Please refer to list of available upholstery and leather selections on [www.gunlocke.com](http://www.gunlocke.com)

Please refer to list of available upholstery and leather selections on [www.gunlocke.com](http://www.gunlocke.com)

**Example**

<b>GGCAL17-021.U.DOL728.DOL728</b>				
GGCAL17-021	NE	U	DOL728	SPNN04
<b>MODEL NUMBER</b>	<b>SPECIES &amp; FINISH</b>	<b>FLAMMABILITY UPHOLSTERY</b>	<b>INNER UPHOLSTERY</b>	<b>OUTER UPHOLSTERY</b>

model number	fabric grades								dimensions	W	D	H
<b>GK21001</b> Open arm, upholstered seat and full back, curved leg	<b>1</b>	1,507	<b>10</b>	1,852	<b>19</b>	2,299	<b>L1</b>	1,875	Overall	22 1/2"	24"	32"
	<b>2</b>	1,539	<b>11</b>	1,893	<b>20</b>	2,350	<b>L2</b>	2,197	Seat		18 1/2"	18 3/4"
	<b>3</b>	1,571	<b>12</b>	1,935	<b>21</b>	2,403	<b>L3</b>	2,583	Arm			25 3/4"
	<b>COM/4</b>	1,601	<b>13</b>	1,986	<b>22</b>	2,454	<b>L4</b>	2,903	Between arms	20"		
	<b>5</b>	1,642	<b>14</b>	2,038	<b>23</b>	2,559	<b>L5</b>	3,225	<b>Upholstery Requirements: GK21001</b>			
	<b>6</b>	1,685	<b>15</b>	2,090	<b>24</b>	2,662			Fabric yards		1.6	
	<b>7</b>	1,727	<b>16</b>	2,142	<b>25</b>	2,766			Leather feet <sup>2</sup>		27.2	
	<b>8</b>	1,768	<b>17</b>	2,193	<b>26</b>	2,870			Shipping weight		23.5 lbs.	
	<b>9</b>	1,810	<b>18</b>	2,247	<b>27</b>	2,974			Cube		13.9	

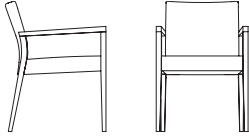

<b>GK21003</b> Open arm, upholstered seat and half upholstered back, straight leg	<b>1</b>	1,549	<b>10</b>	1,850	<b>19</b>	2,242	<b>L1</b>	1,871	Overall	22 1/2"	25"	30 1/2"
	<b>2</b>	1,577	<b>11</b>	1,886	<b>20</b>	2,288	<b>L2</b>	2,152	Seat		17 3/4"	18 1/2"
	<b>3</b>	1,605	<b>12</b>	1,922	<b>21</b>	2,332	<b>L3</b>	2,490	Arm			25 3/4"
	<b>COM/4</b>	1,632	<b>13</b>	1,969	<b>22</b>	2,379	<b>L4</b>	2,771	Between arms	20"		
	<b>5</b>	1,668	<b>14</b>	2,014	<b>23</b>	2,469	<b>L5</b>	3,052	<b>Upholstery Requirements: GK21003</b>			
	<b>6</b>	1,705	<b>15</b>	2,059	<b>24</b>	2,560			Fabric yards		1.4	
	<b>7</b>	1,741	<b>16</b>	2,105	<b>25</b>	2,652			Leather feet <sup>2</sup>		23.8	
	<b>8</b>	1,778	<b>17</b>	2,151	<b>26</b>	2,742			Shipping weight		23.6 lbs.	
	<b>9</b>	1,814	<b>18</b>	2,195	<b>27</b>	2,833			Cube		13.0	

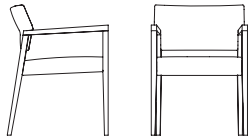

TO ORDER PLEASE SPECIFY THE FOLLOWING:

.  .  .

<b>MODEL NUMBER</b>	<b>FINISH</b>	<b>FLAMMABILITY RATING</b>	<b>UPHOLSTERY</b>
	Cherry finishes on Maple Walnut finishes on Maple Maple finishes on Maple Oak finishes on Maple Light Rift Oak 301 not available on Maple. Please refer to the Camille product page on <a href="http://www.gunlocke.com">www.gunlocke.com</a> for standard finish options.	U CTB117	Please refer to list of available upholstery and leather selections on <a href="http://www.gunlocke.com">www.gunlocke.com</a>

Example

GK21001.215.U.DOL728  
 GK21001      215      U      DOL728  
 MODEL NUMBER      FINISH      FLAMMABILITY      UPHOLSTERY

# CAMILLE

Guest | Dual Upholstery

Seating  
02/24

model number                      fabric grades                      dimensions                      W                      D                      H

**GK21003-021**  
Open arm, upholstered seat and half upholstered back, straight leg

**1** 1,579

Overall	22 1/2"	25"	30 1/2"
Seat		17 3/4"	18 1/2"
Arm			25 3/4"
Between arms	20"		

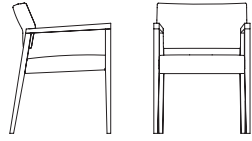

**Upholstery Requirements: GK21003-021**

	Dual Upholstery	
Fabric yards	Seat 0.9	Back .5
Leather feet <sup>2</sup>	Seat 15.3	Back 8.5
Shipping weight	23.6 lbs.	
Cube	13.0	

Seat	<b>1</b>	<b>10</b>	216	<b>19</b>	495	<b>L1</b>	230	
	<b>2</b>	20	<b>11</b>	242	<b>20</b>	528	<b>L2</b>	431
	<b>3</b>	41	<b>12</b>	267	<b>21</b>	560	<b>L3</b>	672
	<b>COM/4</b>	59	<b>13</b>	299	<b>22</b>	593	<b>L4</b>	873
	<b>5</b>	85	<b>14</b>	332	<b>23</b>	658	<b>L5</b>	1,075
	<b>6</b>	111	<b>15</b>	365	<b>24</b>	723		
	<b>7</b>	137	<b>16</b>	397	<b>25</b>	788		
	<b>8</b>	164	<b>17</b>	430	<b>26</b>	852		
	<b>9</b>	190	<b>18</b>	462	<b>27</b>	917		

To calculate price of chair with different fabric for Seat and Back; start with Grade 1 price, add appropriate grade price located in second row for Seat, and last add appropriate grade price located in third row for Back to the sum of the Grade 1 and Seat price.

**Example: Grade 1 \$1,579 + grade 4 fabric seat \$59 + grade 2 fabric back \$11 = \$1,649**

Back	<b>1</b>	<b>10</b>	109	<b>19</b>	248	<b>L1</b>	116	
	<b>2</b>	11	<b>11</b>	121	<b>20</b>	264	<b>L2</b>	217
	<b>3</b>	20	<b>12</b>	134	<b>21</b>	281	<b>L3</b>	336
	<b>COM/4</b>	30	<b>13</b>	150	<b>22</b>	296	<b>L4</b>	436
	<b>5</b>	44	<b>14</b>	167	<b>23</b>	329	<b>L5</b>	538
	<b>6</b>	56	<b>15</b>	183	<b>24</b>	361		
	<b>7</b>	70	<b>16</b>	199	<b>25</b>	394		
	<b>8</b>	82	<b>17</b>	216	<b>26</b>	427		
	<b>9</b>	95	<b>18</b>	232	<b>27</b>	459		

TO ORDER PLEASE SPECIFY THE FOLLOWING:

<input type="text"/>	<input type="text"/>	<input type="text"/>	<input type="text"/>	<input type="text"/>
<b>MODEL NUMBER</b>	<b>FINISH</b>	<b>FLAMMABILITY RATING</b>	<b>SEAT UPHOLSTERY</b>	<b>BACK UPHOLSTERY</b>
	Cherry finishes on Maple Walnut finishes on Maple Maple finishes on Maple Oak finishes on Maple Please refer to the Camille product page on <a href="http://www.gunlocke.com">www.gunlocke.com</a> for standard finish options.	U CTB117	Please refer to list of available upholstery and leather selections on <a href="http://www.gunlocke.com">www.gunlocke.com</a>	Please refer to list of available upholstery and leather selections on <a href="http://www.gunlocke.com">www.gunlocke.com</a>

Example

GK21003-021.215.U.DOL728.SPNN04  
 GK21003-021    215    U    DOL728    SPNN04  
 MODEL NUMBER    FINISH    FLAMMABILITY    SEAT UPHOLSTERY    BACK UPHOLSTERY

model number	fabric grades								dimensions	W	D	H
<b>GGRA16-111</b> Guest, High Back Armless	<b>1</b>	2,605	<b>10</b>	3,057	<b>19</b>	3,644	<b>L1</b>	3,088	Overall	21 3/4"	28"	39 1/8"
	<b>2</b>	2,647	<b>11</b>	3,111	<b>20</b>	3,712	<b>L2</b>	3,510	Seat	21"	19 1/2"	18"
	<b>3</b>	2,688	<b>12</b>	3,165	<b>21</b>	3,781	<b>L3</b>	4,017	<b>Upholstery Requirements: GGRA16-111</b>			
	<b>COM/4</b>	2,728	<b>13</b>	3,234	<b>22</b>	3,848	<b>L4</b>	4,437	Fabric yards	1.6		
	<b>5</b>	2,784	<b>14</b>	3,302	<b>23</b>	3,985	<b>L5</b>	4,859	Leather feet <sup>2</sup>	27.2		
	<b>6</b>	2,838	<b>15</b>	3,371	<b>24</b>	4,122			Shipping weight	44 lbs.		
	<b>7</b>	2,892	<b>16</b>	3,439	<b>25</b>	4,258			Cube	18.3		
	<b>8</b>	2,947	<b>17</b>	3,507	<b>26</b>	4,395						
	<b>9</b>	3,002	<b>18</b>	3,575	<b>27</b>	4,531						

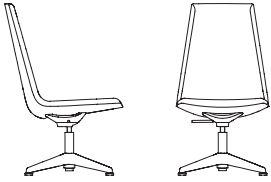

<b>GGRA16-121</b> Guest, Mid Back Armless	<b>1</b>	2,450	<b>10</b>	2,816	<b>19</b>	3,291	<b>L1</b>	2,841	Overall	21 3/4"	26 1/2"	32 3/8"
	<b>2</b>	2,484	<b>11</b>	2,859	<b>20</b>	3,346	<b>L2</b>	3,182	Seat		18 5/8"	18"
	<b>3</b>	2,517	<b>12</b>	2,905	<b>21</b>	3,401	<b>L3</b>	3,592	<b>Upholstery Requirements: GGRA16-121</b>			
	<b>COM/4</b>	2,551	<b>13</b>	2,959	<b>22</b>	3,457	<b>L4</b>	3,934	Fabric yards	1.5		
	<b>5</b>	2,595	<b>14</b>	3,015	<b>23</b>	3,567	<b>L5</b>	4,276	Leather feet <sup>2</sup>	25.5		
	<b>6</b>	2,639	<b>15</b>	3,070	<b>24</b>	3,677			Shipping weight	42 lbs.		
	<b>7</b>	2,683	<b>16</b>	3,124	<b>25</b>	3,788			Cube	14.5		
	<b>8</b>	2,728	<b>17</b>	3,181	<b>26</b>	3,899						
	<b>9</b>	2,771	<b>18</b>	3,235	<b>27</b>	4,009						

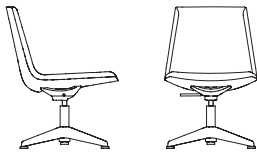

TO ORDER PLEASE SPECIFY THE FOLLOWING:

.  .

MODEL NUMBER

FLAMMABILITY RATING

UPHOLSTERY

U CTB117

Please refer to list of available upholstery and leather selections on [www.gunlocke.com](http://www.gunlocke.com)

**NOTE:** Genesee Guest comes standard with a 4-star polished aluminum base, return-to-center cylinder, at a fixed seat height of 18", and with 1 3/4" nylon cap glides.

Example

GGRA16-111.U.DOL728

GGRA16-111 U DOL728  
MODEL NUMBER FLAMMABILITY UPHOLSTERY

# GENESEE GUEST

Polished Arms

Seating  
02/24

model number                      fabric grades                      dimensions      W      D      H

**GGRA16-141**  
Guest, Mid Back  
Polished Arms

<b>1</b>	2,538	<b>10</b>	2,904	<b>19</b>	3,379	<b>L1</b>	2,929
<b>2</b>	2,572	<b>11</b>	2,947	<b>20</b>	3,434	<b>L2</b>	3,270
<b>3</b>	2,605	<b>12</b>	2,993	<b>21</b>	3,489	<b>L3</b>	3,680
<b>COM/4</b>	2,639	<b>13</b>	3,047	<b>22</b>	3,545	<b>L4</b>	4,022
<b>5</b>	2,683	<b>14</b>	3,103	<b>23</b>	3,655	<b>L5</b>	4,364
<b>6</b>	2,727	<b>15</b>	3,158	<b>24</b>	3,765		
<b>7</b>	2,771	<b>16</b>	3,212	<b>25</b>	3,876		
<b>8</b>	2,816	<b>17</b>	3,269	<b>26</b>	3,987		
<b>9</b>	2,859	<b>18</b>	3,323	<b>27</b>	4,097		



Overall	23 1/2"	26 1/2"	32 3/8"
Seat		19 1/4"	18"
Arm			24 1/2"
Between arms	21"		

**Upholstery Requirements: GGRA16-141**

Fabric yards	1.5
Leather feet <sup>2</sup>	25.5
Shipping weight	47 lbs.
Cube	15.6

TO ORDER PLEASE SPECIFY THE FOLLOWING:

.  .

MODEL NUMBER

FLAMMABILITY  
RATING

UPHOLSTERY

U CTB117

Please refer to list of  
available upholstery  
and leather selections  
on [www.gunlocke.com](http://www.gunlocke.com)

**NOTE:** Genesee Guest comes standard with a 4-star polished aluminum base, return-to-center cylinder, at a fixed seat height of 18", and with 1 3/4" nylon cap glides.

Example

GGRA16-141.U.DOL728

GGRA16-141      U      DOL728  
MODEL NUMBER      FLAMMABILITY      UPHOLSTERY



model number	fabric grades								dimensions	W	D	H
<b>GGCA14-011</b> Open arm, upholstered seat and back	<b>1</b>	2,026	<b>10</b>	2,371	<b>19</b>	2,818	<b>L1</b>	2,394	Overall	21 1/2"	23 1/2"	33"
	<b>2</b>	2,058	<b>11</b>	2,412	<b>20</b>	2,869	<b>L2</b>	2,716	Seat		18 1/2"	17"
	<b>3</b>	2,090	<b>12</b>	2,454	<b>21</b>	2,922	<b>L3</b>	3,102	Arm			25 3/4"
	<b>COM/4</b>	2,120	<b>13</b>	2,505	<b>22</b>	2,973	<b>L4</b>	3,422	Between arms	19 1/4"		
	<b>5</b>	2,161	<b>14</b>	2,557	<b>23</b>	3,078	<b>L5</b>	3,744	<b>Upholstery Requirements: GGCA14-011</b>			
	<b>6</b>	2,204	<b>15</b>	2,609	<b>24</b>	3,181			Fabric yards			1.6
	<b>7</b>	2,246	<b>16</b>	2,661	<b>25</b>	3,285			Leather feet <sup>2</sup>			27.2
	<b>8</b>	2,287	<b>17</b>	2,712	<b>26</b>	3,389			Shipping weight			25 lbs.
	<b>9</b>	2,329	<b>18</b>	2,766	<b>27</b>	3,493			Cube			14.6

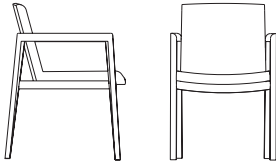

TO ORDER PLEASE SPECIFY THE FOLLOWING:

--	--	--	--	--

**MODEL NUMBER**    **SPECIES & FINISH**    **STITCH DETAIL**    **FLAMMABILITY RATING**    **UPHOLSTERY**

These seating models are available in the following hardwoods:

Maple    **NE**  
Ash        **QA**

Please refer to the Lily™ product page on [www.gunlocke.com](http://www.gunlocke.com) for standard finish options.

**Cherry finishes on Maple**  
**Maple finishes on Maple**  
**Cherry finishes on Ash**  
**Walnut finishes on Ash**  
**Oak finishes on Ash**

*Natural Cherry 222, Ebony Maple 555, Clear Oak 300 and Fawn Cypress 108 not available on Ash.*

*Sumatra Walnut 629 and Light Rift Oak 301 not available on Maple.*

Not required **NR**  
Stitch detail  
**SD +\$91**

**U** CTB117

**Please refer to list of available upholstery and leather selections on [www.gunlocke.com](http://www.gunlocke.com)**

Example

<b>GGCA14-011.NE800.SD.U.DOL728</b>				
GGCA14-011	NE800	SD	U	DOL728
<b>MODEL NUMBER</b>	<b>SPECIES &amp; FINISH</b>	<b>STITCH DETAIL</b>	<b>FLAMMABILITY</b>	<b>UPHOLSTERY</b>

# METTA

Fully Upholstered

Seating  
02/24

model number	fabric grades	dimensions	W	D	H
--------------	---------------	------------	---	---	---

**GGWA16-011**  
Fully upholstered

**1** 2,069

Overall	21 1/8"	25 7/16"	33 9/16"
Seat		18 5/8"	18 11/16"
Arm			25 3/4"
Between arms	18 7/8"		

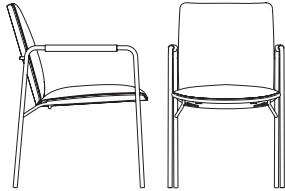

### Upholstery Requirements: GGWA16-011

	Dual Upholstery	
Fabric yards	Inners 1.3	Outers 0.1
Leather feet <sup>2</sup>	Inners 22.1	Outers 1.4
Shipping weight	30 lbs.	
Cube	14.4	

#### Inners and Arms

<b>1</b>	<b>10</b>	280	<b>19</b>	643	<b>L1</b>	298
<b>2</b>	27	<b>11</b>	314	<b>20</b>	<b>L2</b>	560
<b>3</b>	52	<b>12</b>	348	<b>21</b>	<b>L3</b>	873
<b>COM/4</b>	78	<b>13</b>	390	<b>22</b>	<b>L4</b>	1,135
<b>5</b>	111	<b>14</b>	432	<b>23</b>	<b>L5</b>	1,396
<b>6</b>	145	<b>15</b>	473	<b>24</b>		
<b>7</b>	179	<b>16</b>	517	<b>25</b>		
<b>8</b>	212	<b>17</b>	559	<b>26</b>		
<b>9</b>	246	<b>18</b>	601	<b>27</b>		

To calculate price of chair with different fabric for Seat and Back; start with Grade 1 price, add appropriate grade price located in second row for Seat, and last add appropriate grade price located in third row for Back to the sum of the Grade 1 and Seat price.

**Example: Grade 1 \$2,069 + grade 4 fabric seat \$78 + grade 2 fabric back \$17 = \$2,164**

#### Outers

<b>1</b>	<b>10</b>	173	<b>19</b>	396	<b>L1</b>	184
<b>2</b>	17	<b>11</b>	193	<b>20</b>	<b>L2</b>	346
<b>3</b>	32	<b>12</b>	215	<b>21</b>	<b>L3</b>	538
<b>COM/4</b>	48	<b>13</b>	240	<b>22</b>	<b>L4</b>	698
<b>5</b>	68	<b>14</b>	266	<b>23</b>	<b>L5</b>	860
<b>6</b>	90	<b>15</b>	292	<b>24</b>		
<b>7</b>	110	<b>16</b>	319	<b>25</b>		
<b>8</b>	131	<b>17</b>	345	<b>26</b>		
<b>9</b>	152	<b>18</b>	370	<b>27</b>		

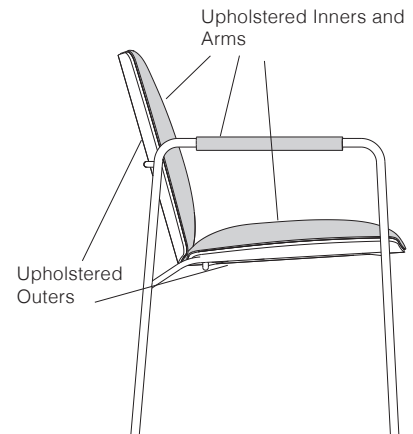

TO ORDER PLEASE SPECIFY THE FOLLOWING:

<input type="text"/>	<input type="text"/>	<input type="text"/>	<input type="text"/>
----------------------	----------------------	----------------------	----------------------

MODEL NUMBER

FLAMMABILITY RATING

INNERS & ARMS UPHOLSTERY

OUTERS UPHOLSTERY

U CTB117

Please refer to list of available upholstery and leather selections on [www.gunlocke.com](http://www.gunlocke.com)

Please refer to list of available upholstery and leather selections on [www.gunlocke.com](http://www.gunlocke.com)

#### Example

GGWA16-011.U.DOL728.SPNN04

GGWA16-011	U	DOL728	SPNN04
MODEL NUMBER	FLAMMABILITY	INNERS & ARMS UPHOLSTERY	OUTERS UPHOLSTERY

model number	fabric grades								dimensions	W	D	H
<b>GGWA16-021</b> Wood shell	<b>1</b>	2,358	<b>10</b>	2,638	<b>19</b>	3,001	<b>L1</b>	2,656	Overall	21 1/8"	25 3/4"	33 9/16"
	<b>2</b>	2,385	<b>11</b>	2,672	<b>20</b>	3,043	<b>L2</b>	2,918	Seat		18 5/8"	18 11/16"
	<b>3</b>	2,410	<b>12</b>	2,706	<b>21</b>	3,086	<b>L3</b>	3,231	Arm			25 3/4"
	<b>COM/4</b>	2,436	<b>13</b>	2,748	<b>22</b>	3,128	<b>L4</b>	3,493	Between arms	18 7/8"		
	<b>5</b>	2,469	<b>14</b>	2,790	<b>23</b>	3,212	<b>L5</b>	3,754				
	<b>6</b>	2,503	<b>15</b>	2,831	<b>24</b>	3,297						
	<b>7</b>	2,537	<b>16</b>	2,875	<b>25</b>	3,381						
	<b>8</b>	2,570	<b>17</b>	2,917	<b>26</b>	3,466						
	<b>9</b>	2,604	<b>18</b>	2,959	<b>27</b>	3,550						
										<b>Upholstery Requirements: GGWA16-021</b>		
									Fabric yards		1.3	
									Leather feet <sup>2</sup>		22.1	
									Shipping weight		13 lbs.	
									Cube		14.4	

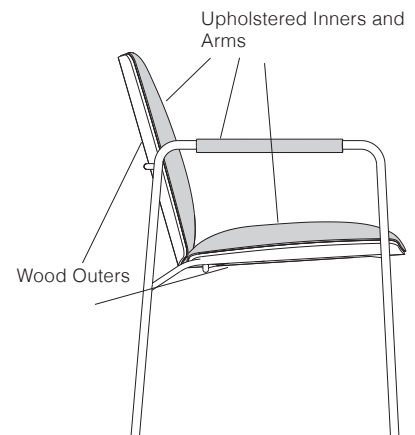
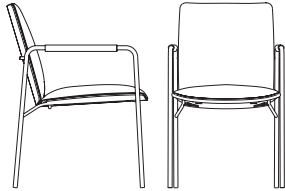

TO ORDER PLEASE SPECIFY THE FOLLOWING:

<input type="text"/>	<input type="text"/>	<input type="text"/>	<input type="text"/>
<b>MODEL NUMBER</b>	<b>OUTERS FINISH</b>	<b>FLAMMABILITY RATING</b>	<b>INNERS &amp; ARMS UPHOLSTERY</b>
	Walnut finishes on Walnut Cherry finishes on Cherry Maple finishes on Maple Oak finishes on Oak Walnut, Cherry, and Maple shells are quarter cut; Oak shells are rift cut. Please refer to the Metta product page on <a href="http://www.gunlocke.com">www.gunlocke.com</a> for standard finish options.	U CTB117	Please refer to list of available upholstery and leather selections on <a href="http://www.gunlocke.com">www.gunlocke.com</a>

Example

GGWA16-021.215.U.DOL728  
GGWA16-021    215    U    DOL728  
**MODEL NUMBER**    **OUTERS FINISH**    **FLAMMABILITY**    **INNERS & ARMS UPHOLSTERY**

model number	fabric grades								dimensions	W	D	H
<b>GGJA14-011</b> Open arm, upholstered seat and back wood top rail	<b>1</b>	1,850	<b>10</b>	2,151	<b>19</b>	2,543	<b>L1</b>	2,172	Overall	22 1/2"	23 1/2"	33"
	<b>2</b>	1,878	<b>11</b>	2,187	<b>20</b>	2,589	<b>L2</b>	2,453	Seat	19 1/2"	18"	18 1/2"
	<b>3</b>	1,906	<b>12</b>	2,223	<b>21</b>	2,633	<b>L3</b>	2,791	Arm	25 1/2"		
	<b>COM/4</b>	1,933	<b>13</b>	2,270	<b>22</b>	2,680	<b>L4</b>	3,072	Between arms	19 1/2"		
	<b>5</b>	1,969	<b>14</b>	2,315	<b>23</b>	2,770	<b>L5</b>	3,353	<b>Upholstery Requirements: GGJA14-011</b>			
	<b>6</b>	2,006	<b>15</b>	2,360	<b>24</b>	2,861			Fabric yards	1.4		
	<b>7</b>	2,042	<b>16</b>	2,406	<b>25</b>	2,953			Leather feet <sup>2</sup>	23.8		
	<b>8</b>	2,079	<b>17</b>	2,452	<b>26</b>	3,043			Shipping weight	25 lbs.		
	<b>9</b>	2,115	<b>18</b>	2,496	<b>27</b>	3,134			Cube	14.6		

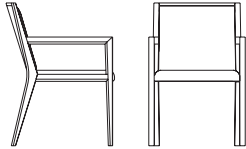

<b>GGJA14-021</b> Open arm, upholstered seat and back upholstered top rail	<b>1</b>	1,816	<b>10</b>	2,117	<b>19</b>	2,509	<b>L1</b>	2,138
	<b>2</b>	1,844	<b>11</b>	2,153	<b>20</b>	2,555	<b>L2</b>	2,419
	<b>3</b>	1,872	<b>12</b>	2,189	<b>21</b>	2,599	<b>L3</b>	2,757
	<b>COM/4</b>	1,899	<b>13</b>	2,236	<b>22</b>	2,646	<b>L4</b>	3,038
	<b>5</b>	1,935	<b>14</b>	2,281	<b>23</b>	2,736	<b>L5</b>	3,319
	<b>6</b>	1,972	<b>15</b>	2,326	<b>24</b>	2,827		
	<b>7</b>	2,008	<b>16</b>	2,372	<b>25</b>	2,919		
	<b>8</b>	2,045	<b>17</b>	2,418	<b>26</b>	3,009		
	<b>9</b>	2,081	<b>18</b>	2,462	<b>27</b>	3,100		

Overall	22 1/2"	23 1/2"	33"
Seat	19 1/2"	18"	18 1/2"
Arm	26"		
Between arms	19 1/2"		
<b>Upholstery Requirements: GGJA14-021</b>			
Fabric yards	1.4		
Leather feet <sup>2</sup>	23.8		
Shipping weight	25 lbs.		
Cube	14.6		

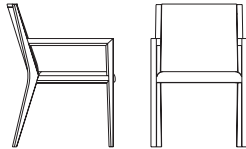

TO ORDER PLEASE SPECIFY THE FOLLOWING:

.  .  .

**MODEL NUMBER**    **SPECIES & FINISH**    **FLAMMABILITY RATING**    **UPHOLSTERY**

These seating models are available in the following hardwoods:

Maple    **NE**  
Ash        **QA**

Please refer to the Savor™ product page on [www.gunlocke.com](http://www.gunlocke.com) for standard finish options.

**Cherry finishes on Maple**  
**Maple finishes on Maple**  
**Cherry finishes on Ash**  
**Walnut finishes on Ash**  
**Oak finishes on Ash**

*Natural Cherry 222, Ebony Maple 555, Clear Oak 300 and Fawn Cypress 108 not available on Ash.*

*Sumatra Walnut 629 and Light Rift Oak 301 not available on Maple.*

**U**    **CTB117**

Please refer to list of available upholstery and leather selections on [www.gunlocke.com](http://www.gunlocke.com)

Example

GGJA14-011	NE800	U	DOL728
<b>MODEL NUMBER</b>	<b>SPECIES &amp; FINISH</b>	<b>FLAMMABILITY</b>	<b>UPHOLSTERY</b>

model number fabric grades dimensions W D H

**GGJA14-031** 1 1,884  
Open arm,  
upholstered seat and back,  
wood top rail

Overall	22 1/2"	23 1/2"	33"
Seat	19"	18"	18 1/2"
Arm			25 1/2"
Between arms	19 1/2"		

**Upholstery Requirements: GGJA14-031**

	Dual Upholstery	
Fabric yards	Seat 0.8	Back 0.8
Leather feet <sup>2</sup>	Seat 13.6	Back 13.6
Shipping weight		25 lbs.
Cube		14.6

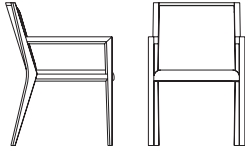

Seat	1	10	216	19	495	L1	230	
	2	20	11	242	20	528	L2	431
	3	41	12	267	21	560	L3	672
	COM/4	59	13	299	22	593	L4	873
	5	85	14	332	23	658	L5	1,075
	6	111	15	365	24	723		
	7	137	16	397	25	788		
	8	164	17	430	26	852		
	9	190	18	462	27	917		

To calculate price of chair with different fabric for Seat and Back; start with Grade 1 price, add appropriate grade price located in second row for Seat, and last add appropriate grade price located in third row for Back to the sum of the Grade 1 and Seat price.

**Example: Grade 1 \$1,884 + grade 4 fabric seat \$59 + grade 2 fabric back \$17 = \$1,960**

Back	1	10	173	19	396	L1	184	
	2	17	11	193	20	422	L2	346
	3	32	12	215	21	448	L3	538
	COM/4	48	13	240	22	473	L4	698
	5	68	14	266	23	527	L5	860
	6	90	15	292	24	578		
	7	110	16	319	25	630		
	8	131	17	345	26	682		
	9	152	18	370	27	734		

TO ORDER PLEASE SPECIFY THE FOLLOWING:

.  .  .  .

MODEL NUMBER SPECIES & FINISH FLAMMABILITY RATING SEAT UPHOLSTERY BACK UPHOLSTERY

These seating models are available in the following hardwoods:

Maple NE  
Ash QA

Please refer to the Savor product page on [www.gunlocke.com](http://www.gunlocke.com) for standard finish options.

**Cherry finishes on Maple**  
**Maple finishes on Maple**  
**Cherry finishes on Ash**  
**Walnut finishes on Ash**  
**Oak finishes on Ash**

*Natural Cherry 222, Ebony Maple 555, Clear Oak 300 and Fawn Cypress 108 not available on Ash.*

*Sumatra Walnut 629 and Light Rift Oak 301 not available on Maple.*

U CTB117

Please refer to list of available upholstery and leather selections on [www.gunlocke.com](http://www.gunlocke.com)

Please refer to list of available upholstery and leather selections on [www.gunlocke.com](http://www.gunlocke.com)

Example

GGJA14-031	NE800	U	DOL728	SPNN04
MODEL NUMBER	SPECIES & FINISH	FLAMMABILITY UPHOLSTERY	INNER UPHOLSTERY	OUTER UPHOLSTERY

# TIA™ GUEST

## Single Upholstery

Seating  
02/24

model number	fabric grades								dimensions	W	D	H
<b>GGHB17-071</b> Single upholstery, armless	<b>1</b>	1,422	<b>10</b>	1,680	<b>19</b>	2,016	<b>L1</b>	1,699	Overall	19"	21 1/2"	32 1/8"
	<b>2</b>	1,446	<b>11</b>	1,712	<b>20</b>	2,055	<b>L2</b>	1,940	Seat	18 1/2"	16 3/4"	18 3/8"
	<b>3</b>	1,470	<b>12</b>	1,743	<b>21</b>	2,093	<b>L3</b>	2,228	<b>Upholstery Requirements: GGH17-071</b>			
	<b>COM/4</b>	1,494	<b>13</b>	1,782	<b>22</b>	2,132	<b>L4</b>	2,469	Fabric yards	1.2		
	<b>5</b>	1,524	<b>14</b>	1,820	<b>23</b>	2,211	<b>L5</b>	2,711	Leather feet <sup>2</sup>	20.4		
	<b>6</b>	1,555	<b>15</b>	1,860	<b>24</b>	2,289			Shipping weight	23 lbs.		
	<b>7</b>	1,587	<b>16</b>	1,899	<b>25</b>	2,367			Cube	10.9		
	<b>8</b>	1,618	<b>17</b>	1,939	<b>26</b>	2,444						
	<b>9</b>	1,649	<b>18</b>	1,977	<b>27</b>	2,524						

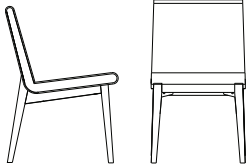

### TO ORDER PLEASE SPECIFY THE FOLLOWING:

<b>MODEL NUMBER</b>	<b>FINISH</b>	<b>FLAMMABILITY RATING</b>	<b>UPHOLSTERY</b>

These seating models are available in the following hardwoods:

Maple **NE**  
Ash **QA**

Please refer to the Tia product page on [www.gunlocke.com](http://www.gunlocke.com) for standard finish options.

**Cherry finishes on Maple or Ash**  
**Walnut finishes on Maple or Ash**  
**Maple finishes on Maple or Ash**  
**Oak finishes on Maple or Ash**

*Natural Cherry 222, Clear Maple 800, Clear Oak 300 and Fawn Cypress 108 not available on Ash.  
 Light Rift Oak 301 not available on Maple.*

**U CTB117**

**Please refer to list of available upholstery and leather selections on [www.gunlocke.com](http://www.gunlocke.com)**

### Example

**GGHB17-071.QA629.U.DOL728**

GGHB17-071	QA629	U	DOL728
<b>MODEL NUMBER</b>	<b>FINISH</b>	<b>FLAMMABILITY</b>	<b>UPHOLSTERY</b>

model number fabric grades dimensions W D H

**GGHB17-081**  
Dual upholstery,  
armless

Overall	19"	21 1/2"	32 1/8"
Seat	18 1/2"	16 3/4"	18 3/8"

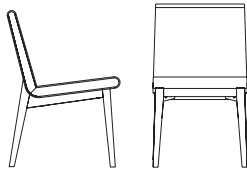

**Upholstery Requirements: GGHB17-081**

	Dual Upholstery	
Fabric yards	Seat 1.1	Back 1.2
Leather feet <sup>2</sup>	Seat 18.7	Back 20.4
Shipping weight	23 lbs.	
Cube	10.9	

Seat	1	10	236	19	544	L1	254	
	2	22	11	266	20	580	L2	473
	3	44	12	294	21	616	L3	740
	COM/4	65	13	330	22	652	L4	960
	5	94	14	366	23	723	L5	1,181
	6	122	15	402	24	795		
	7	152	16	436	25	867		
	8	180	17	472	26	938		
	9	209	18	508	27	1,009		

To calculate price of chair with different fabric for Seat and Back; start with Grade 1 price, add appropriate grade price located in second row for Seat, and last add appropriate grade price located in third row for Back to the sum of the Grade 1 and Seat price.

**Example: Grade 1 \$1,448 + grade 4 fabric seat \$65 + grade 2 fabric back \$24 = \$1,537**

Back	1	10	258	19	594	L1	277	
	2	24	11	290	20	633	L2	518
	3	48	12	321	21	671	L3	806
	COM/4	72	13	360	22	710	L4	1,047
	5	102	14	398	23	789	L5	1,289
	6	133	15	438	24	867		
	7	165	16	477	25	945		
	8	196	17	517	26	1,022		
	9	227	18	555	27	1,102		

**Note: When Tia Guest chair is upholstered in multiple fabrics, there is an added angled seam along the side boxings to accommodate seat and back as two choices of upholstery.**

TO ORDER PLEASE SPECIFY THE FOLLOWING:

.  .  .  .

**MODEL NUMBER** . **FINISH** . **FLAMMABILITY RATING** . **SEAT UPHOLSTERY** . **BACK UPHOLSTERY**

These seating models are available in the following hardwoods:  
Maple **NE**  
Ash **QA**  
Please refer to the Tia product page on [www.gunlocke.com](http://www.gunlocke.com) for standard finish options.

**Cherry finishes on Maple or Ash**  
**Walnut finishes on Maple or Ash**  
**Maple finishes on Maple or Ash**  
**Oak finishes on Maple or Ash**  
*Natural Cherry 222, Clear Maple 800, Clear Oak 300 and Fawn Cypress 108 not available on Ash.*  
*Light Rift Oak 301 not available on Maple.*

**U** CTB117

Please refer to list of available upholstery and leather selections on [www.gunlocke.com](http://www.gunlocke.com)

Please refer to list of available upholstery and leather selections on [www.gunlocke.com](http://www.gunlocke.com)

Example

GGHB17-081.QA629.U.DOL728.SPNN04  
GGHB17-081 QA629 U DOL728 SPNN04  
MODEL NUMBER FINISH FLAMMABILITY SEAT UPHOLSTERY BACK UPHOLSTERY





Multipurpose Seating . . . . . 41-61  
Product Specifications. . . . . 42  
Convo® Barstool . . . . . 43-46  
LIV Guest. . . . . 47-48  
LIV Stool. . . . . 49-50  
Multi®. . . . . 51-54  
Multi® Stool . . . . . 55  
Multi® Bariatric. . . . . 56-57  
Tia™ Barstool. . . . . 58-59  
Trillia™ Barstool . . . . . 60-61

# MULTIPURPOSE SEATING

## Product Specifications

### CONVO™

**Frame:**

Round tubular steel offered in Polished Stainless as well as powder-coats Silver, Black, and Bronze.

**Upholstered Seat:**

**Seat Pan:** Rigid fiberglass reinforced urethane pan provides structure to support user load, wrapped in 1/4" dacron.

**Top Cushion:** High resilient foam overmolded onto rigid fiberglass reinforced urethane pan, wrapped in 1/4" dacron.

**Wood Seat:**

Consists of 2"x2" solid ash hardwood blocks, glued and contoured to shape.

**Glides:** Push-fit low density polyethylene; heavy-duty round plastic inserts.

**Shipping:** Product ships 1 to a box.

**BIFMA Rating:**

ANSI/BIFMA X5.1 2011  
(253lb Weight Rating)

### LIV GUEST & STOOL

**Frame:** Round tubular steel available in 9 powder coat colors (Silver, Black, Designer White, Matte Gold, Pyrite Bronze, Titanium, Solar Black, Regatta Blue, Bullseye Red) or polished chrome.

**Laminate Seat:** Bent plywood with laminate layer inside and out

**Wood Bucket:** Bent plywood with quartered cut ash inside and out

**Glides:** Black Domed Nylon Glide or polished Toggle glide with white nylon and option to purchase nickel or felt caps.

Toggle Glide Caps - 4 pack

Nickel: GGLIV19-SVL1 \$71.00

Felt: GGLIV19-SVL2 \$72.00

Nylon glides are recommended for hard surfaces, commercial carpet and damp environments. Nickel-plated glides are recommended for carpet. Felt glides are recommended for wood, tile or high-sheen floor surfaces.

**Stacking:** 5 chairs high limit.

See GK8907. Page 51

**Shipping:** Product ships 1 to a box except armless versions which stacks 2 to a box.

**BIFMA Rating:**

ANSI/BIFMA X5.1 2017  
(275lb Weight Rating)

### MULTI GUEST, STOOL & TANDEM

**Frame:** Round tubular steel.

**Seat:** Foam filled over contoured plastic, upholstered.

**Upholstered Back:** PVC Foam filled over plywood, upholstered. Triple stitched.

**Wood Back:** Bent plywood.

**Laser Backs:** A laser cut logo or insignia is available on wood back.

**LSR:** Laser Back Chair. See pg. 10 for directions.

**Moderne Arm:** Textured polypropylene or RF bent plywood.

**Glides:** Plastic.

**Boot:** Flexible textured polyvinyl chloride 2 1/2" high. (glide models only) Black boot on black frame. Grey boot on silver frame.

**Casters:** 1 1/2" dual wheel hooded; black. Optional.

**Shipping:** Product ships 2 to a box.

**Stacking:** 5 chairs high limit or 4 chairs with casters. See GK8907. Page 51

**BIFMA Rating:**

ANSI/BIFMA X5.1 2017 w/ additional requirements (300lb Weight Rating)

**NOTE:**

Space required for a stack of chairs 5-high with cart.

<b>W</b>	<b>D</b>	<b>H</b>
26"	38"	51"

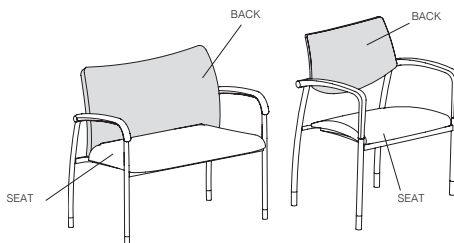

### MULTI BARIATRIC

**Frame:** Round tubular steel.

**Seat:** Foam filled over reinforced upholstery-grade hardwood seat frame. Sheet webbing Interior for added user comfort. 3 degree seat angle.

**Upholstered Back:** Foam filled over plywood, upholstered. Triple stitched.

**Modern Arms:** Textured polypropylene or RF bent plywood.

**Glides:** Plastic.

**Boot:** Flexible textured polyvinyl chloride 2 1/2" high (glide models only). Black boot on black frame. Grey boot on silver frame.

**Gore Protection:** Waterproof moisture barrier, anti-microbial, and stain resistant.

**Shipping:** Product ships 1 to a box.

**BIFMA Rating:**

ANSI/BIFMA X5.1 2011 w/ additional requirements (600lb Weight Rating)

### TRILLIA™ BARSTOOLS

**Wood Seat:** Consists of 2" wide solid ash hardwood blocks, glued and contoured to shape.

**Upholstered Seat:** High resilient foam overmolded onto vacuum-formed ABS plastic. Double needle stitch detail optional.

**Legs:** Solid ash hardwood.

**Footrest:** 1/2" solid bar footrest, polished stainless steel.

**Glides:** Nickel-plated steel.

**Shipping:** Product ships 1 to a box.

**BIFMA Rating:**

ANSI/BIFMA X5.1 2011  
(253lb Weight Rating)

### TIA™ BARSTOOLS

**Frame:**

**Construction:** Hardwood frame joined by mortise and tenon, and corner blocks.

**Available hardwoods:** Maple, Ash

**Seat & Back:** 13/16" thick plywood bucket, consisting of 13 cross-plyies of 1/16" thick #3 grade southern hardwood.

**Footrest:** 16 ga steel footrest, available in: polished, brushed, black or white.

**Glides:** Nickel-plated steel.

**Shipping:** Product ships 1 to a box.

**BIFMA Rating:**

ANSI/BIFMA X5.1 2017  
(275lb Weight Rating)

model number	fabric grades	dimensions	W	D	H
<b>GMLA15-011</b> Upholstered	<b>1</b> 1,404	Overall	16 1/4"	16"	30 1/2"
		Seat	16 1/4"	16"	

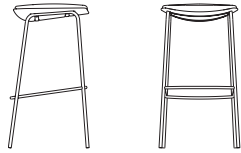

**Upholstery Requirements: GMLA15-011**

Dual Upholstery	
Fabric yards	Cushion 0.7 Bottom 0.7
Leather feet <sup>2</sup>	Cushion 11.9 Bottom 11.9
Shipping weight	28 lbs.
Cube	7.1

**Top Cushion**

<b>1</b>	<b>10</b>	152	<b>19</b>	347	<b>L1</b>	161	
<b>2</b>	15	<b>11</b>	169	<b>20</b>	369	<b>L2</b>	302
<b>3</b>	28	<b>12</b>	187	<b>21</b>	393	<b>L3</b>	471
<b>COM/4</b>	42	<b>13</b>	210	<b>22</b>	416	<b>L4</b>	611
<b>5</b>	60	<b>14</b>	233	<b>23</b>	460	<b>L5</b>	752
<b>6</b>	79	<b>15</b>	256	<b>24</b>	506		
<b>7</b>	96	<b>16</b>	279	<b>25</b>	552		
<b>8</b>	115	<b>17</b>	301	<b>26</b>	597		
<b>9</b>	133	<b>18</b>	324	<b>27</b>	642		

To calculate price of stool with different fabric for Top Cushion and Bottom Seat Pan, start with Grade 1 price, add appropriate grade price located in second row for Top Cushion, and last add appropriate grade price located in third row for Bottom Seat Pan to the sum of the Grade 1 and Top Cushion price.

**Example: Grade 1 \$1,404 + grade 4 fabric Top Cushion \$42 + grade 2 fabric Bottom Seat Pan \$15 = \$1,461**

**Bottom Seat Pan**

<b>1</b>	<b>10</b>	152	<b>19</b>	347	<b>L1</b>	161	
<b>2</b>	15	<b>11</b>	169	<b>20</b>	369	<b>L2</b>	302
<b>3</b>	28	<b>12</b>	187	<b>21</b>	393	<b>L3</b>	471
<b>COM/4</b>	42	<b>13</b>	210	<b>22</b>	416	<b>L4</b>	611
<b>5</b>	60	<b>14</b>	233	<b>23</b>	460	<b>L5</b>	752
<b>6</b>	79	<b>15</b>	256	<b>24</b>	506		
<b>7</b>	96	<b>16</b>	279	<b>25</b>	552		
<b>8</b>	115	<b>17</b>	301	<b>26</b>	597		
<b>9</b>	133	<b>18</b>	324	<b>27</b>	642		



**TO ORDER PLEASE SPECIFY THE FOLLOWING:**

<input type="text"/>	<input type="text"/>	<input type="text"/>	<input type="text"/>	<input type="text"/>
<b>MODEL NUMBER</b>	<b>FRAME</b>	<b>FLAMMABILITY RATING</b>	<b>TOP CUSHION UPHOLSTERY</b>	<b>BOTTOM SEAT PAN UPHOLSTERY</b>
	This seating model is available with the following frame options. Please specify by adding suffix to model number. <b>P71</b> Black <b>PR6</b> Silver <b>PJE</b> Pyrite	<b>U CTB117</b>	Select upholstery for the top cushion. <b>Please refer to list of available upholstery and leather selections on www.gunlocke.com</b>	Select upholstery for the bottom seat pan. <b>Please refer to list of available upholstery and leather selections on www.gunlocke.com</b>

**Example**

<b>GMLA15-011.P71.U.DOL728.SPNN04</b>				
GMLA15-011	P71	U	DOL728	SPNN04
<b>MODEL NUMBER</b>	<b>FRAME</b>	<b>FLAMMABILITY RATING</b>	<b>TOP CUSHION UPHOLSTERY</b>	<b>BOTTOM SEAT PAN UPHOLSTERY</b>

# CONVO® BARSTOOL

Seating

02/24

Counter Height | Upholstered

model number	fabric grades	dimensions	W	D	H
<b>GMLA15-041</b> Upholstered	<b>1</b> 1,404	Overall	16 1/4"	16"	26 1/4"
		Seat	16 1/4"	16"	

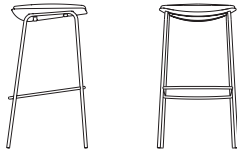

### Upholstery Requirements: GMLA15-041

	Dual Upholstery
Fabric yards	Cushion 0.7 Bottom 0.7
Leather feet <sup>2</sup>	Cushion 11.9 Bottom 11.9
Shipping weight	28 lbs.
Cube	7.1

### Top Cushion

<b>1</b>	<b>10</b>	152	<b>19</b>	347	<b>L1</b>	161	
<b>2</b>	15	<b>11</b>	169	<b>20</b>	369	<b>L2</b>	302
<b>3</b>	28	<b>12</b>	187	<b>21</b>	393	<b>L3</b>	471
<b>COM/4</b>	42	<b>13</b>	210	<b>22</b>	416	<b>L4</b>	611
<b>5</b>	60	<b>14</b>	233	<b>23</b>	460	<b>L5</b>	752
<b>6</b>	79	<b>15</b>	256	<b>24</b>	506		
<b>7</b>	96	<b>16</b>	279	<b>25</b>	552		
<b>8</b>	115	<b>17</b>	301	<b>26</b>	597		
<b>9</b>	133	<b>18</b>	324	<b>27</b>	642		

To calculate price of stool with different fabric for Top Cushion and Bottom Seat Pan, start with Grade 1 price, add appropriate grade price located in second row for Top Cushion, and last add appropriate grade price located in third row for Bottom Seat Pan to the sum of the Grade 1 and Top Cushion price.

**Example: Grade 1 \$1,404 + grade 4 fabric Top Cushion \$42 + grade 2 fabric Bottom Seat Pan \$15 = \$1,461**

### Bottom Seat Pan

<b>1</b>	<b>10</b>	152	<b>19</b>	347	<b>L1</b>	161	
<b>2</b>	15	<b>11</b>	169	<b>20</b>	369	<b>L2</b>	302
<b>3</b>	28	<b>12</b>	187	<b>21</b>	393	<b>L3</b>	471
<b>COM/4</b>	42	<b>13</b>	210	<b>22</b>	416	<b>L4</b>	611
<b>5</b>	60	<b>14</b>	233	<b>23</b>	460	<b>L5</b>	752
<b>6</b>	79	<b>15</b>	256	<b>24</b>	506		
<b>7</b>	96	<b>16</b>	279	<b>25</b>	552		
<b>8</b>	115	<b>17</b>	301	<b>26</b>	597		
<b>9</b>	133	<b>18</b>	324	<b>27</b>	642		



**Note: Footrest for Counter Height Convo is 8 1/2" high off the floor.**

### TO ORDER PLEASE SPECIFY THE FOLLOWING:

<input type="text"/>	<input type="text"/>	<input type="text"/>	<input type="text"/>	<input type="text"/>
<b>MODEL NUMBER</b>	<b>FRAME</b>	<b>FLAMMABILITY RATING</b>	<b>TOP CUSHION UPHOLSTERY</b>	<b>BOTTOM SEAT PAN UPHOLSTERY</b>
	This seating model is available with the following frame options. Please specify by adding suffix to model number. <b>P71</b> Black <b>PR6</b> Silver <b>PJE</b> Pyrite	<b>U CTB117</b>	Select upholstery for the top cushion. <b>Please refer to list of available upholstery and leather selections on www.gunlocke.com</b>	Select upholstery for the bottom seat pan. <b>Please refer to list of available upholstery and leather selections on www.gunlocke.com</b>

### Example

<b>GMLA15-041.P71.U.DOL728.SPNN04</b>				
GMLA15-041	P71	U	DOL728	SPNN04
<b>MODEL NUMBER</b>	<b>FRAME</b>	<b>FLAMMABILITY RATING</b>	<b>TOP CUSHION UPHOLSTERY</b>	<b>BOTTOM SEAT PAN UPHOLSTERY</b>

model number	list		dimensions	W	D	H
<b>GMLA15-021</b> Solid Ash Wood Seat	2,195	All Wood	Overall	16 1/4"	16"	30 1/2"
			Seat	16 1/4"	16"	

Shipping weight	28 lbs.
Cube	7.1

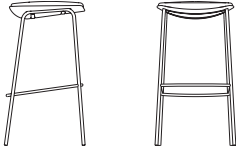

**Note:** Footrest for Bar Height Convo is 12 3/4" high off the floor.

TO ORDER PLEASE SPECIFY THE FOLLOWING:

<b>MODEL NUMBER</b>	<b>FRAME</b>	<b>SPECIES &amp; FINISH</b>	

This seating model is available with the following frame options.  
Please specify by adding suffix to model number.  
**P71** Black  
**PR6** Silver  
**PJE** Pyrite

This seating model is available with the following hardwood option:  
**Ash QA**  
Please refer to the Convo™ product page on [www.gunlocke.com](http://www.gunlocke.com) for standard finish options.  
**Cherry finishes on Ash**  
**Walnut finishes on Ash**  
**Oak finishes on Ash**  
*Natural Oak 300 not available on Ash.*

Example

<b>GMLA15-021.P71.QA601</b>		
GMLA15-021	P71	QA601
<b>MODEL NUMBER</b>	<b>FRAME</b>	<b>SPECIES &amp; FINISH</b>

# CONVO® BARSTOOL

Counter Height | Wood Seat

**Seating**  
02/24

model number	list		dimensions	W	D	H
<b>GMLA15-051</b>	2,195	All Wood	Overall	16 1/4"	16"	26 1/8"
Solid Ash Wood Seat			Seat	16 1/4"	16"	

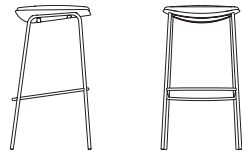

Shipping weight	28 lbs.
Cube	7.1

**Note:** Footrest for Counter Height Convo is 8 1/2" high off the floor.

## TO ORDER PLEASE SPECIFY THE FOLLOWING:

<b>MODEL NUMBER</b>	<b>FRAME</b>	<b>SPECIES &amp; FINISH</b>		

This seating model is available with the following frame options.  
Please specify by adding suffix to model number.  
**P71** Black  
**PR6** Silver  
**PJE** Pyrite

This seating model is available with the following hardwood option:  
**Ash QA**  
Please refer to the Convo™ product page on [www.gunlocke.com](http://www.gunlocke.com) for standard finish options.  
**Cherry finishes on Ash**  
**Walnut finishes on Ash**  
**Oak finishes on Ash**  
*Natural Oak 300 not available on Ash.*

### Example

<b>GMLA15-051.P71.QA601</b>		
GMLA15-051	P71	QA601
<b>MODEL NUMBER</b>	<b>FRAME</b>	<b>SPECIES &amp; FINISH</b>

model number	list	dimensions	W	D	H
<b>GGLIV19-011</b> Wood Seat	1,384	Overall	21"	22.5"	32.5"
		Seat	19"	17"	17.25"
		Shipping weight			18.5 lbs.
		Cube			12.8

**GGLIV19-012**  
Laminate Seat

967



model number	fabric grades	dimensions	W	D	H
<b>GGLIV19-013</b> Upholstered Seat	<b>1</b> 1,262 <b>10</b> 1,478 <b>19</b> 1,757 <b>L1</b> 1,492	Overall	21"	22.5"	32.5"
	<b>2</b> 1,282 <b>11</b> 1,504 <b>20</b> 1,790 <b>L2</b> 1,693	Seat	19"	17"	17.25"



**Upholstery Requirements: GGLIV19-013**

Fabric yards	1
Leather feet <sup>2</sup>	17
Shipping weight	19.3 lbs.
Cube	12.8

**GGLIV19-014**  
Upholstered Seat  
w/Channel Stitch

<b>1</b> 1,455 <b>10</b> 1,713 <b>19</b> 2,049 <b>L1</b> 1,732
<b>2</b> 1,479 <b>11</b> 1,745 <b>20</b> 2,088 <b>L2</b> 1,973
<b>3</b> 1,503 <b>12</b> 1,776 <b>21</b> 2,126 <b>L3</b> 2,261
<b>COM/4</b> 1,527 <b>13</b> 1,815 <b>22</b> 2,165 <b>L4</b> 2,502
<b>5</b> 1,557 <b>14</b> 1,853 <b>23</b> 2,244 <b>L5</b> 2,744
<b>6</b> 1,588 <b>15</b> 1,893 <b>24</b> 2,322
<b>7</b> 1,620 <b>16</b> 1,932 <b>25</b> 2,400
<b>8</b> 1,651 <b>17</b> 1,972 <b>26</b> 2,477
<b>9</b> 1,682 <b>18</b> 2,010 <b>27</b> 2,557



Overall	21"	22.5"	32.5"
Seat	19"	17"	17.25"

**Upholstery Requirements: GGLIV19-014**

Fabric yards	1
Leather feet <sup>2</sup>	17
Shipping weight	19.3 lbs.
Cube	12.8

TO ORDER PLEASE SPECIFY THE FOLLOWING:

MODEL NUMBER	FSC	FRAME	GLIDE	GLWOOD	LAMINATE	FABRIC	FLAMMABILITY RATING
	No FSC <b>X</b> FSC Certified <b>F +86</b>	Polished Chrome <b>PC</b> <b>+113</b> Black <b>P71</b> Designer White <b>PJW</b> Matte Gold <b>P8G</b> Silver <b>PR6</b> Pyrite <b>PJE</b> Solar Black <b>P8X</b> Titanium <b>P8T</b> Bullseye <b>PJF</b> Regatta <b>P8M</b>	Standard Black Nylon <b>STD</b> Swivel Glide w/ Nylon <b>SVL0 +19</b> <i>Toggle Glide Option Pack page 42.</i>	Only on model GGLIV19-011 <b>Cherry finishes on Quartered Ash</b> <b>Walnut finishes on Quartered Ash</b> <b>Maple finishes on Quartered Ash</b> <b>Oak finishes on Quartered Ash</b>	Only on model GGLIV19-012 <b>L1 and L2 Woodgrain Laminates +113</b>	Only on models GGLIV19-013 and GGLIV19-014 <b>Please refer to list of available upholstery and leather selections on www.gunlocke.com</b>	<b>U CTB117</b>

Example

GGLIV19-013.X.PC.STD.DOL728.U

MODEL NUMBER	FSC	FRAME	GLIDE	FABRIC	FLAMMABILITY
GGLIV19-013	X	PC	STD	DOL728	U

LIV  
Armed Guest

model number	list	dimensions	W	D	H
<b>GGLIV19-021</b> Wood Seat	1,603	Overall	20.5"	22.5"	32.5"
		Seat	19"	17"	17.25"
<b>GGLIV19-022</b> Laminate Seat	1,183	Shipping weight	23.5 lbs.		
		Cube	12.5		

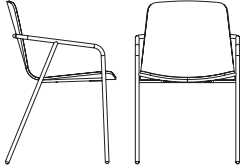

model number	fabric grades					dimensions	W	D	H
<b>GGLIV19-023</b> Upholstered Seat	<b>1</b>	1,511	<b>10</b>	1,727	<b>19</b>	2,006	<b>L1</b>	1,741	
	<b>2</b>	1,531	<b>11</b>	1,753	<b>20</b>	2,039	<b>L2</b>	1,942	
	<b>3</b>	1,552	<b>12</b>	1,778	<b>21</b>	2,071	<b>L3</b>	2,183	
	<b>COM/4</b>	1,570	<b>13</b>	1,810	<b>22</b>	2,104	<b>L4</b>	2,384	
	<b>5</b>	1,596	<b>14</b>	1,843	<b>23</b>	2,169	<b>L5</b>	2,586	
	<b>6</b>	1,622	<b>15</b>	1,876	<b>24</b>	2,234			
	<b>7</b>	1,648	<b>16</b>	1,908	<b>25</b>	2,299			
	<b>8</b>	1,675	<b>17</b>	1,941	<b>26</b>	2,363			
	<b>9</b>	1,701	<b>18</b>	1,973	<b>27</b>	2,428			



Overall	21"	22.5"	32.5"
Seat	19"	17"	17.25"

**Upholstery Requirements: GGLIV19-023**

Fabric yards	1
Leather feet <sup>2</sup>	17
Shipping weight	24.3 lbs.
Cube	12.5

<b>GGLIV19-024</b> Upholstered Seat w/Channel Stitch	<b>1</b>	1,705	<b>10</b>	1,963	<b>19</b>	2,299	<b>L1</b>	1,982
	<b>2</b>	1,729	<b>11</b>	1,995	<b>20</b>	2,338	<b>L2</b>	2,223
	<b>3</b>	1,753	<b>12</b>	2,026	<b>21</b>	2,376	<b>L3</b>	2,511
	<b>COM/4</b>	1,777	<b>13</b>	2,065	<b>22</b>	2,415	<b>L4</b>	2,752
	<b>5</b>	1,807	<b>14</b>	2,103	<b>23</b>	2,494	<b>L5</b>	2,994
	<b>6</b>	1,838	<b>15</b>	2,143	<b>24</b>	2,572		
	<b>7</b>	1,870	<b>16</b>	2,182	<b>25</b>	2,650		
	<b>8</b>	1,901	<b>17</b>	2,222	<b>26</b>	2,727		
	<b>9</b>	1,932	<b>18</b>	2,260	<b>27</b>	2,807		



Overall	21"	22.5"	32.5"
Seat	19"	17"	17.25"

**Upholstery Requirements: GGLIV19-024**

Fabric yards	1
Leather feet <sup>2</sup>	17
Shipping weight	24.3 lbs.
Cube	12.5

TO ORDER PLEASE SPECIFY THE FOLLOWING:

MODEL NUMBER	FSC	FRAME	GLIDE	GLWOOD	LAMINATE	FABRIC	FLAMMABILITY RATING
	No FSC <b>X</b> FSC Certified <b>F +86</b>	Polished Chrome <b>PC</b> <b>+113</b> Black <b>P71</b> Designer White <b>PJW</b> Matte Gold <b>P8G</b> Silver <b>PR6</b> Pyrite <b>PJE</b> Solar Black <b>P8X</b> Titanium <b>P8T</b> Bullseye <b>PJF</b> Regatta <b>P8M</b>	Standard Black Nylon <b>STD</b> Swivel Glide w/ Nylon <b>SVL0 +19</b> <i>Toggle Glide Option Pack page 42.</i>	Only on model GGLIV19-021 <b>Cherry finishes on Quartered Ash</b> <b>Walnut finishes on Quartered Ash</b> <b>Maple finishes on Quartered Ash</b> <b>Oak finishes on Quartered Ash</b>	Only on model GGLIV19-022 <b>L1 and L2 Woodgrain Laminates +113</b>	Only on models GGLIV19-023 and GGLIV19-024 <b>Please refer to list of available upholstery and leather selections on www.gunlocke.com</b>	<b>U CTB117</b>

Example

GGLIV19-023.X.PC.STD.DOL728.U

MODEL NUMBER	FSC	FRAME	GLIDE	FABRIC	FLAMMABILITY
GGLIV19-023	X	PC	STD	DOL728	U



model number	list	dimensions	W	D	HM
<b>GMLIV19-031</b> Wood Seat	1,718	Overall	19"	20.5"	32.5"
		Seat	18"	16"	24.5"
<b>GMLIV19-032</b> Laminate Seat	1,301	Shipping weight	23.6 lbs.		
		Cube	12.5		

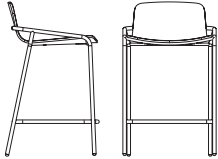

model number	fabric grades					dimensions	W	D	H			
<b>GMLIV19-033</b> Upholstered Seat	<b>1</b>	1,627	<b>10</b>	1,843	<b>19</b>	2,122	<b>L1</b>	1,857	Overall	19"	20.5"	32.5"
	<b>2</b>	1,647	<b>11</b>	1,869	<b>20</b>	2,155	<b>L2</b>	2,058	Seat	18"	16"	24.5"
	<b>3</b>	1,668	<b>12</b>	1,894	<b>21</b>	2,187	<b>L3</b>	2,299	<b>Upholstery Requirements: GMLIV19-033</b>			
	<b>COM/4</b>	1,686	<b>13</b>	1,926	<b>22</b>	2,220	<b>L4</b>	2,500	Fabric yards	1		
	<b>5</b>	1,712	<b>14</b>	1,959	<b>23</b>	2,285	<b>L5</b>	2,702	Leather feet <sup>2</sup>	17		
	<b>6</b>	1,738	<b>15</b>	1,992	<b>24</b>	2,350			Shipping weight	24.4 lbs.		
	<b>7</b>	1,764	<b>16</b>	2,024	<b>25</b>	2,415			Cube	12.5		
	<b>8</b>	1,791	<b>17</b>	2,057	<b>26</b>	2,479						
	<b>9</b>	1,817	<b>18</b>	2,089	<b>27</b>	2,544						

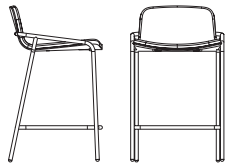

<b>GMLIV19-034</b> Upholstered Seat w/Channel Stitch	<b>1</b>	1,820	<b>10</b>	2,078	<b>19</b>	2,414	<b>L1</b>	2,097	Overall	19"	20.5"	32.5"
	<b>2</b>	1,844	<b>11</b>	2,110	<b>20</b>	2,453	<b>L2</b>	2,338	Seat	18"	16"	24.5"
	<b>3</b>	1,868	<b>12</b>	2,141	<b>21</b>	2,491	<b>L3</b>	2,626	<b>Upholstery Requirements: GMLIV19-034</b>			
	<b>COM/4</b>	1,892	<b>13</b>	2,180	<b>22</b>	2,530	<b>L4</b>	2,867	Fabric yards	1		
	<b>5</b>	1,922	<b>14</b>	2,218	<b>23</b>	2,609	<b>L5</b>	3,109	Leather feet <sup>2</sup>	17		
	<b>6</b>	1,953	<b>15</b>	2,258	<b>24</b>	2,687			Shipping weight	24.4 lbs.		
	<b>7</b>	1,985	<b>16</b>	2,297	<b>25</b>	2,765			Cube	12.5		
	<b>8</b>	2,016	<b>17</b>	2,337	<b>26</b>	2,842						
	<b>9</b>	2,047	<b>18</b>	2,375	<b>27</b>	2,922						

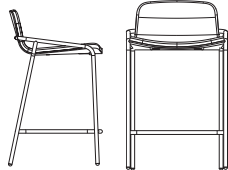

TO ORDER PLEASE SPECIFY THE FOLLOWING:

MODEL NUMBER	FSC	FRAME	GLIDE	GLWOOD	LAMINATE	FABRIC	FLAMMABILITY RATING
	No FSC <b>X</b> FSC Certified <b>F +86</b>	Polished Chrome <b>PC</b> <b>+113</b> Black <b>P71</b> Designer White <b>PJW</b> Matte Gold <b>P8G</b> Silver <b>PR6</b> Pyrite <b>PJE</b> Solar Black <b>P8X</b> Titanium <b>P8T</b> Bullseye <b>PJF</b> Regatta <b>P8M</b>	Standard Black Nylon <b>STD</b> Swivel Glide w/ Nylon <b>SVL0 +19</b> <i>Toggle Glide Option Pack page 42.</i>	Only on model GGLIV19-031 <b>Cherry finishes on Quartered Ash</b> <b>Walnut finishes on Quartered Ash</b> <b>Maple finishes on Quartered Ash</b> <b>Oak finishes on Quartered Ash</b>	Only on model GGLIV19-032 <b>L1 and L2 Woodgrain Laminates +113</b>	Only on models GGLIV19-033 and GGLIV19-034 <b>Please refer to list of available upholstery and leather selections on www.gunlocke.com</b>	<b>U CTB117</b>

Example

GGLIV19-033.X.PC.STD.DOL728.U

MODEL NUMBER	FSC	FRAME	GLIDE	FABRIC	FLAMMABILITY
GGLIV19-033	X	PC	STD	DOL728	U

# LIV

## Bar Height Stool

Seating  
02/24

model number	list	dimensions	W	D	H
<b>GMLIV19-041</b> Wood Seat	1,764	Overall	19"	20.5"	37.5"
		Seat	18"	16"	28.5"
<b>GMLIV19-042</b> Laminate Seat	1,346	Shipping weight	24.6 lbs.		
		Cube	14		

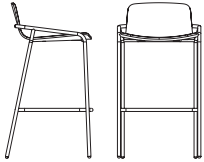

model number	fabric grades					dimensions	W	D	H			
<b>GMLIV19-043</b> Upholstered Seat	<b>1</b>	1,673	<b>10</b>	1,889	<b>19</b>	2,168	<b>L1</b>	1,903	Overall	19"	20.5"	37.5"
	<b>2</b>	1,693	<b>11</b>	1,915	<b>20</b>	2,201	<b>L2</b>	2,104	Seat	18"	16"	28.5"
	<b>3</b>	1,714	<b>12</b>	1,940	<b>21</b>	2,233	<b>L3</b>	2,345	<b>Upholstery Requirements: GMLIV19-043</b>			
	<b>COM/4</b>	1,732	<b>13</b>	1,972	<b>22</b>	2,266	<b>L4</b>	2,546	Fabric yards	1		
	<b>5</b>	1,758	<b>14</b>	2,005	<b>23</b>	2,331	<b>L5</b>	2,748	Leather feet <sup>2</sup>	17		
	<b>6</b>	1,784	<b>15</b>	2,038	<b>24</b>	2,396			Shipping weight	25.4 lbs.		
	<b>7</b>	1,810	<b>16</b>	2,070	<b>25</b>	2,461			Cube	14		
	<b>8</b>	1,837	<b>17</b>	2,103	<b>26</b>	2,525						
	<b>9</b>	1,863	<b>18</b>	2,135	<b>27</b>	2,590						

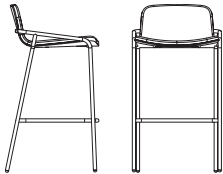

<b>GMLIV19-044</b> Upholstered Seat w/Channel Stitch	<b>1</b>	1,867	<b>10</b>	2,125	<b>19</b>	2,461	<b>L1</b>	2,144	Overall	19"	20.5"	37.5"
	<b>2</b>	1,891	<b>11</b>	2,157	<b>20</b>	2,500	<b>L2</b>	2,385	Seat	18"	16"	28.5"
	<b>3</b>	1,915	<b>12</b>	2,188	<b>21</b>	2,538	<b>L3</b>	2,673	<b>Upholstery Requirements: GMLIV19-044</b>			
	<b>COM/4</b>	1,939	<b>13</b>	2,227	<b>22</b>	2,577	<b>L4</b>	2,914	Fabric yards	1		
	<b>5</b>	1,969	<b>14</b>	2,265	<b>23</b>	2,656	<b>L5</b>	3,156	Leather feet <sup>2</sup>	17		
	<b>6</b>	2,000	<b>15</b>	2,305	<b>24</b>	2,734			Shipping weight	25.4 lbs.		
	<b>7</b>	2,032	<b>16</b>	2,344	<b>25</b>	2,812			Cube	14		
	<b>8</b>	2,063	<b>17</b>	2,384	<b>26</b>	2,889						
	<b>9</b>	2,094	<b>18</b>	2,422	<b>27</b>	2,969						

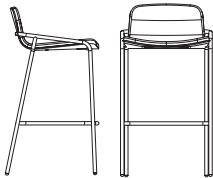

### TO ORDER PLEASE SPECIFY THE FOLLOWING:

MODEL NUMBER	FSC	FRAME	GLIDE	GLWOOD	LAMINATE	FABRIC	FLAMMABILITY RATING
	No FSC <b>X</b> FSC Certified <b>F +86</b>	Polished Chrome <b>PC</b> <b>+113</b> Black <b>P71</b> Designer White <b>PJW</b> Matte Gold <b>P8G</b> Silver <b>PR6</b> Pyrite <b>PJE</b> Solar Black <b>P8X</b> Titanium <b>P8T</b> Bullseye <b>PJF</b> Regatta <b>P8M</b>	Standard Black Nylon <b>STD</b> Swivel Glide w/ Nylon <b>SVL0 +19</b> <i>Toggle Glide Option Pack page 42.</i>	Only on model GGLIV19-041 <b>Cherry finishes on Quartered Ash</b> <b>Walnut finishes on Quartered Ash</b> <b>Maple finishes on Quartered Ash</b> <b>Oak finishes on Quartered Ash</b>	Only on model GGLIV19-042 <b>L1 and L2 Woodgrain Laminates +113</b>	Only on models GGLIV19-043 and GGLIV19-044 <b>Please refer to list of available upholstery and leather selections on www.gunlocke.com</b>	<b>U CTB117</b>

### Example

GGLIV19-043.X.PC.STD.DOL728.U							
GGLIV19-043	X	PC	STD	DOL728	U		
MODEL NUMBER	FSC	FRAME	GLIDE	FABRIC	FLAMMABILITY		

model number                      fabric grades                      dimensions      W      D      H

**GK9903N**  
Armless,  
upholstered

**1** 946

Overall	20 3/4"	23"	33"
Seat		18"	18"
Arm			
Between Arms			

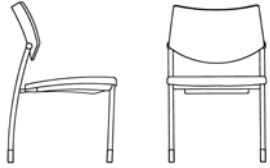

**Upholstery Requirements: GK9903N**

	Dual Upholstery	
Fabric yards	Seat 0.8	Back 0.5
Leather feet <sup>2</sup>	Seat 13.6	Back 8.5
Shipping weight	35 lbs.	
Cube	17.8	

Seat

<b>1</b>	<b>10</b>	173	<b>19</b>	396	<b>L1</b>	184	
<b>2</b>	17	<b>11</b>	193	<b>20</b>	422	<b>L2</b>	346
<b>3</b>	32	<b>12</b>	215	<b>21</b>	448	<b>L3</b>	538
<b>COM/4</b>	48	<b>13</b>	240	<b>22</b>	473	<b>L4</b>	698
<b>5</b>	68	<b>14</b>	266	<b>23</b>	527	<b>L5</b>	860
<b>6</b>	90	<b>15</b>	292	<b>24</b>	578		
<b>7</b>	110	<b>16</b>	319	<b>25</b>	630		
<b>8</b>	131	<b>17</b>	345	<b>26</b>	682		
<b>9</b>	152	<b>18</b>	370	<b>27</b>	734		

To calculate price of chair with different fabric for Seat and Back; start with Grade 1 price, add appropriate grade price located in second row for Seat, and last add appropriate grade price located in third row for Back to the sum of the Grade 1 and Seat price.

**Example: Grade 1 \$946 + grade 4 fabric Seat/Back \$48 + grade 2 fabric Arms \$11 = \$1,005**

Back

<b>1</b>	<b>10</b>	109	<b>19</b>	248	<b>L1</b>	116	
<b>2</b>	11	<b>11</b>	121	<b>20</b>	264	<b>L2</b>	217
<b>3</b>	20	<b>12</b>	134	<b>21</b>	281	<b>L3</b>	336
<b>COM/4</b>	30	<b>13</b>	150	<b>22</b>	296	<b>L4</b>	436
<b>5</b>	44	<b>14</b>	167	<b>23</b>	329	<b>L5</b>	538
<b>6</b>	56	<b>15</b>	183	<b>24</b>	361		
<b>7</b>	70	<b>16</b>	199	<b>25</b>	394		
<b>8</b>	82	<b>17</b>	216	<b>26</b>	427		
<b>9</b>	95	<b>18</b>	232	<b>27</b>	459		

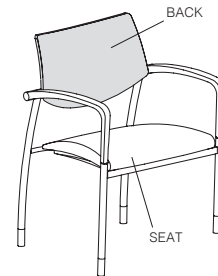

**GK8907**  
Cart



655  
Holds 5 stacked chairs. Metal cart available in black finish only. (Use with Multi or LIV chairs)

Overall	25 3/4"	25 7/8"	7 1/2"
Shipping weight	16 lbs.		
Cube	20.6		

**TO ORDER PLEASE SPECIFY THE FOLLOWING:**

<input type="text"/>	<input type="text"/>	<input type="text"/>	<input type="text"/>	<input type="text"/>	<input type="text"/>
<b>MODEL NUMBER</b>	<b>FRAME</b>	<b>GANGING</b>	<b>FLAMMABILITY RATING</b>	<b>SEAT UPHOLSTERY</b>	<b>BACK UPHOLSTERY</b>

This seating model is available with the following frame options. Please specify by adding suffix to model number.

**NEW FINISHES**

- P71** Black
- PR6** Silver
- P71C** Black with Casters (+\$186)
- PR6C** Silver with Casters (+\$186)

Ganging device on leg available. Please specify by adding suffix to model number.

- G** Ganging device +\$34
- GN** No Ganging

**U CTB117**

Select upholstery for the seat.  
**Please refer to list of available upholstery and leather selections on www.gunlocke.com**

Select upholstery for the back.  
**Please refer to list of available upholstery and leather selections on www.gunlocke.com**

**Example**

GK9903N.P71.GN.U.DOL728.SPNN04  
 GK9903N      P71      GN      U      DOL728      SPNN04  
 MODEL NUMBER      FRAME      GANGING      FLAMMABILITY RATING      SEAT UPHOLSTERY      BACK UPHOLSTERY

model number	fabric grades
<b>GK9901P</b> Plastic Moderne Arm, upholstered	<b>1</b> 1,104

dimensions	W	D	H
Overall	24 1/2"	23"	33"
Seat		18"	18"
Arm			26 1/4"
Between Arms	20 3/4"		

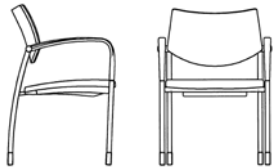

**Upholstery Requirements: GK9901P**

	Dual Upholstery	
Fabric yards	Seat 0.8	Back 0.5
Leather feet <sup>2</sup>	Seat 13.6	Back 8.5
Shipping weight	36 lbs.	
Cube	17.8	

Seat	1	10	173	19	396	L1	184	
	2	17	11	193	20	422	L2	346
	3	32	12	215	21	448	L3	538
	COM/4	48	13	240	22	473	L4	698
	5	68	14	266	23	527	L5	860
	6	90	15	292	24	578		
	7	110	16	319	25	630		
	8	131	17	345	26	682		
	9	152	18	370	27	734		

To calculate price of chair with different fabric for Seat and Back; start with Grade 1 price, add appropriate grade price located in second row for Seat, and last add appropriate grade price located in third row for Back to the sum of the Grade 1 and Seat price.

**Example: Grade 1 \$1,104 + grade 4 fabric Seat/Back \$48 + grade 2 fabric Arms \$11 = \$1,163**

Back	1	10	109	19	248	L1	116	
	2	11	11	121	20	264	L2	217
	3	20	12	134	21	281	L3	336
	COM/4	30	13	150	22	296	L4	436
	5	44	14	167	23	329	L5	538
	6	56	15	183	24	361		
	7	70	16	199	25	394		
	8	82	17	216	26	427		
	9	95	18	232	27	459		

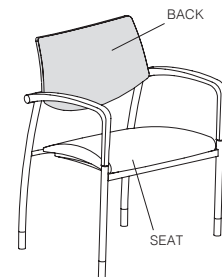

TO ORDER PLEASE SPECIFY THE FOLLOWING:

<input type="text"/>	<input type="text"/>	<input type="text"/>	<input type="text"/>	<input type="text"/>	<input type="text"/>
<b>MODEL NUMBER</b>	<b>FRAME</b>	<b>GANGING</b>	<b>FLAMMABILITY RATING</b>	<b>SEAT UPHOLSTERY</b>	<b>BACK UPHOLSTERY</b>
	This seating model is available with the following frame options. Please specify by adding suffix to model number. <b>NEW FINISHES</b> P71 Black PR6 Silver P71C Black with Casters (+\$186) PR6C Silver with Casters (+\$186)	Ganging device on leg available. Please specify by adding suffix to model number. G Ganging device +\$34 GN No Ganging	U CTB117	Select upholstery for the seat. <b>Please refer to list of available upholstery and leather selections on www.gunlocke.com</b>	Select upholstery for the back. <b>Please refer to list of available upholstery and leather selections on www.gunlocke.com</b>

Example

GK9901P.P71.GN.U.DOL728.SPNN04					
GK9901P	P71	GN	U	DOL728	SPNN04
MODEL NUMBER	FRAME	GANGING	FLAMMABILITY RATING	SEAT UPHOLSTERY	BACK UPHOLSTERY

Wood Moderne Arm, Upholstered

model number fabric grades

**GK9901W** 1 1,405  
Wood Moderne Arm,  
upholstered

dimensions W D H

Overall	24 1/2"	23"	33"
Seat		18"	18"
Arm			26 1/4"
Between Arms	20 3/4"		

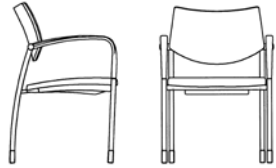

**Upholstery Requirements: GK9901W**

	Dual Upholstery	
Fabric yards	Seat 0.8	Back 0.5
Leather feet <sup>2</sup>	Seat 13.6	Back 8.5
Shipping weight		36 lbs.
Cube		17.8

Seat

<b>1</b>	<b>10</b>	173	<b>19</b>	396	<b>L1</b>	184
<b>2</b>	17	<b>11</b>	193	<b>20</b>	<b>L2</b>	346
<b>3</b>	32	<b>12</b>	215	<b>21</b>	<b>L3</b>	538
<b>COM/4</b>	48	<b>13</b>	240	<b>22</b>	<b>L4</b>	698
<b>5</b>	68	<b>14</b>	266	<b>23</b>	<b>L5</b>	860
<b>6</b>	90	<b>15</b>	292	<b>24</b>		
<b>7</b>	110	<b>16</b>	319	<b>25</b>		
<b>8</b>	131	<b>17</b>	345	<b>26</b>		
<b>9</b>	152	<b>18</b>	370	<b>27</b>		

To calculate price of chair with different fabric for Seat and Back; start with Grade 1 price, add appropriate grade price located in second row for Seat, and last add appropriate grade price located in third row for Back to the sum of the Grade 1 and Seat price.

**Example: Grade 1 \$1,405 + grade 4 fabric Seat/Back \$48 + grade 2 fabric Arms \$11 = \$1,464**

Back

<b>1</b>	<b>10</b>	109	<b>19</b>	248	<b>L1</b>	116
<b>2</b>	11	<b>11</b>	121	<b>20</b>	<b>L2</b>	217
<b>3</b>	20	<b>12</b>	134	<b>21</b>	<b>L3</b>	336
<b>COM/4</b>	30	<b>13</b>	150	<b>22</b>	<b>L4</b>	436
<b>5</b>	44	<b>14</b>	167	<b>23</b>	<b>L5</b>	538
<b>6</b>	56	<b>15</b>	183	<b>24</b>		
<b>7</b>	70	<b>16</b>	199	<b>25</b>		
<b>8</b>	82	<b>17</b>	216	<b>26</b>		
<b>9</b>	95	<b>18</b>	232	<b>27</b>		

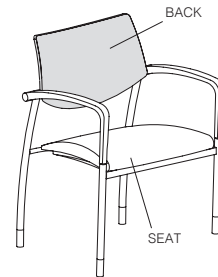

TO ORDER PLEASE SPECIFY THE FOLLOWING:

<input type="text"/>	<input type="text"/>	<input type="text"/>	<input type="text"/>	<input type="text"/>	<input type="text"/>	<input type="text"/>
<b>MODEL NUMBER</b>	<b>FRAME</b>	<b>FINISH</b>	<b>GANGING</b>	<b>FLAMMABILITY RATING</b>	<b>SEAT UPHOLSTERY</b>	<b>BACK UPHOLSTERY</b>

This seating model is available with the following frame options. Please specify by adding suffix to model number.

**NEW FINISHES**

- P71** Black
- PR6** Silver
- P71C** Black with Casters (+\$186)
- PR6C** Silver with Casters (+\$186)

- Cherry finishes on Maple**
- Walnut finishes on Maple**
- Maple finishes on Maple**
- Oak finishes on Maple**

Please refer to the Multi® product page on [www.gunlocke.com](http://www.gunlocke.com) for standard finish options.

- Ganging device on leg available. Please specify by adding suffix to model number.
- G** Ganging device +\$34
- GN** No Ganging

**U CTB117**

Select upholstery for the seat.  
**Please refer to list of available upholstery and leather selections on [www.gunlocke.com](http://www.gunlocke.com)**

Select upholstery for the back.  
**Please refer to list of available upholstery and leather selections on [www.gunlocke.com](http://www.gunlocke.com)**

Example

**GK9901W.P71.GN.U.DOL728.SPNN04**

GK9901W	P71	215	GN	U	DOL728	SPNN04
<b>MODEL NUMBER</b>	<b>FRAME</b>	<b>FINISH</b>	<b>GANGING RATING</b>	<b>FLAMMABILITY UPHOLSTERY</b>	<b>SEAT UPHOLSTERY</b>	<b>BACK</b>

# MULTI®

## Wood Back

model number	fabric grades								dimensions	W	D	H
<b>GK9907N</b> Armless, upholstered seat, wood back	<b>1</b>	1,180	<b>10</b>	1,353	<b>19</b>	1,576	<b>L1</b>	1,364	Overall	20 3/4"	23"	33"
	<b>2</b>	1,197	<b>11</b>	1,373	<b>20</b>	1,602	<b>L2</b>	1,526	Seat		18"	18"
	<b>3</b>	1,212	<b>12</b>	1,395	<b>21</b>	1,628	<b>L3</b>	1,718	<b>Upholstery Requirements: GK9907N</b>			
	<b>COM/4</b>	1,228	<b>13</b>	1,420	<b>22</b>	1,653	<b>L4</b>	1,878	Fabric yards	0.8		
	<b>5</b>	1,248	<b>14</b>	1,446	<b>23</b>	1,707	<b>L5</b>	2,040	Leather feet <sup>2</sup>	13.6		
	<b>6</b>	1,270	<b>15</b>	1,472	<b>24</b>	1,758			Shipping weight	35 lbs.		
	<b>7</b>	1,290	<b>16</b>	1,499	<b>25</b>	1,810			Cube	17.8		
	<b>8</b>	1,311	<b>17</b>	1,525	<b>26</b>	1,862						
	<b>9</b>	1,332	<b>18</b>	1,550	<b>27</b>	1,914						

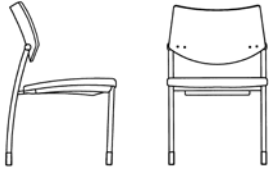

<b>GK9905P</b> Plastic Moderne Arm, upholstered seat, wood back	<b>1</b>	1,338	<b>10</b>	1,511	<b>19</b>	1,734	<b>L1</b>	1,522
	<b>2</b>	1,355	<b>11</b>	1,531	<b>20</b>	1,760	<b>L2</b>	1,684
	<b>3</b>	1,370	<b>12</b>	1,553	<b>21</b>	1,786	<b>L3</b>	1,876
	<b>COM/4</b>	1,386	<b>13</b>	1,578	<b>22</b>	1,811	<b>L4</b>	2,036
	<b>5</b>	1,406	<b>14</b>	1,604	<b>23</b>	1,865	<b>L5</b>	2,198
	<b>6</b>	1,428	<b>15</b>	1,630	<b>24</b>	1,916		
	<b>7</b>	1,448	<b>16</b>	1,657	<b>25</b>	1,968		
	<b>8</b>	1,469	<b>17</b>	1,683	<b>26</b>	2,020		
	<b>9</b>	1,490	<b>18</b>	1,708	<b>27</b>	2,072		

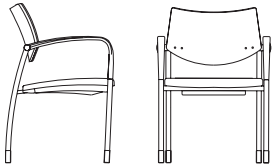

Overall	24 1/2"	23"	33"
Seat		18"	18"
Arm			26 1/4"
Between arms	20 3/4"		

**Upholstery Requirements: GK9905P**

Fabric yards	0.8
Leather feet <sup>2</sup>	13.6
Shipping weight	36 lbs.
Cube	17.8

<b>GK9905W</b> Wood Moderne Arm, upholstered seat, wood back	<b>1</b>	1,626	<b>10</b>	1,799	<b>19</b>	2,022	<b>L1</b>	1,810
	<b>2</b>	1,643	<b>11</b>	1,819	<b>20</b>	2,048	<b>L2</b>	1,972
	<b>3</b>	1,658	<b>12</b>	1,841	<b>21</b>	2,074	<b>L3</b>	2,164
	<b>COM/4</b>	1,674	<b>13</b>	1,866	<b>22</b>	2,099	<b>L4</b>	2,324
	<b>5</b>	1,694	<b>14</b>	1,892	<b>23</b>	2,153	<b>L5</b>	2,486
	<b>6</b>	1,716	<b>15</b>	1,918	<b>24</b>	2,204		
	<b>7</b>	1,736	<b>16</b>	1,945	<b>25</b>	2,256		
	<b>8</b>	1,757	<b>17</b>	1,971	<b>26</b>	2,308		
	<b>9</b>	1,778	<b>18</b>	1,996	<b>27</b>	2,360		

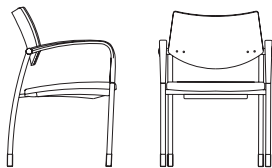

Overall	24 1/2"	23"	33"
Seat		18"	18"
Arm			26 1/4"
Between arms	20 3/4"		

**Upholstery Requirements: GK9905W**

Fabric yards	0.8
Leather feet <sup>2</sup>	13.6
Shipping weight	36 lbs.
Cube	17.8

### TO ORDER PLEASE SPECIFY THE FOLLOWING:

<input type="text"/>	<input type="text"/>	<input type="text"/>	<input type="text"/>	<input type="text"/>	<input type="text"/>	<input type="text"/>
<b>MODEL NUMBER</b>	<b>FRAME</b>	<b>FINISH</b>	<b>BACK</b>	<b>GANGING</b>	<b>FLAMMABILITY RATING</b>	<b>SEAT UPHOLSTERY</b>
<p>This seating model is available with the following frame options. Please specify by adding suffix to model number.</p> <p><b>NEW FINISHES</b></p> <p><b>P71</b> Black</p> <p><b>PR6</b> Silver</p> <p><b>P71C</b> Black with Casters (+\$186)</p> <p><b>PR6C</b> Silver with Casters (+\$186)</p>		<p><b>Cherry finishes on Maple</b></p> <p><b>Walnut finishes on Maple</b></p> <p><b>Maple finishes on Maple</b></p> <p><b>Oak finishes on Maple</b></p> <p>Please refer to the Multi® product page on <a href="http://www.gunlocke.com">www.gunlocke.com</a> for standard finish options.</p>	<p>Back is formed of molded plywood with face veneer in maple.</p> <p><b>PLN</b> Plain</p> <p><b>TDP</b> Teardrop +\$113</p>	<p>Ganging device on leg available. Please specify by adding suffix to model number.</p> <p><b>G</b> Ganging device +\$34</p> <p><b>GN</b> No Ganging</p>	<p><b>U</b> CTB117</p>	<p>Select upholstery for the back.</p> <p><b>Please refer to list of available upholstery and leather selections on <a href="http://www.gunlocke.com">www.gunlocke.com</a></b></p>

### Example

**GK9905N.P71.215.PLN.GN.U.DOL728**

GK9905N	P71	215	PLN	U	DOL728
MODEL NUMBER	FRAME	FINISH	BACK	FLAMMABILITY RATING	SEAT UPHOLSTERY

model number	fabric grades	dimensions	W	D	H
<b>GK9923N</b> Armless, upholstered	<b>1</b> 1,279	Overall	24 1/2"	23"	43"
		Seat		18"	28"
		Arm			37"
		Between arms			
		Seat to Foot Rung			17"

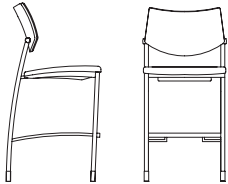

**Upholstery Requirements: GK9923N**

	Dual Upholstery	
Fabric yards	Seat 0.8	Back 0.5
Leather feet <sup>2</sup>	Seat 13.6	Back 8.5
Shipping weight	40 lbs.	
Cube	19.1	

Seat	1	10	173	19	396	L1	184	
	2	17	11	193	20	422	L2	346
	3	32	12	215	21	448	L3	538
	COM/4	48	13	240	22	473	L4	698
	5	68	14	266	23	527	L5	860
	6	90	15	292	24	578		
	7	110	16	319	25	630		
	8	131	17	345	26	682		
	9	152	18	370	27	734		

To calculate price of chair with different fabric for Seat and Back; start with Grade 1 price, add appropriate grade price located in second row for Seat, and last add appropriate grade price located in third row for Back to the sum of the Grade 1 and Seat price.

**Example: Grade 1 \$1,279 + grade 4 fabric Seat/back \$48 + grade 2 fabric Arms \$11 = \$1,338**

Back	1	10	109	19	248	L1	116	
	2	11	11	121	20	264	L2	217
	3	20	12	134	21	281	L3	336
	COM/4	30	13	150	22	296	L4	436
	5	44	14	167	23	329	L5	538
	6	56	15	183	24	361		
	7	70	16	199	25	394		
	8	82	17	216	26	427		
	9	95	18	232	27	459		

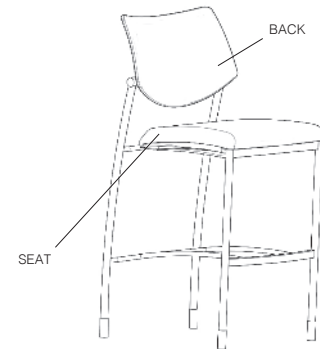

**TO ORDER PLEASE SPECIFY THE FOLLOWING:**

<input type="text"/>	<input type="text"/>	<input type="text"/>	<input type="text"/>	<input type="text"/>
<b>MODEL NUMBER</b>	<b>FRAME</b>	<b>FLAMMABILITY RATING</b>	<b>SEAT UPHOLSTERY</b>	<b>BACK UPHOLSTERY</b>
	This seating models are available with the following frame options. Please specify by adding suffix to model number. <b>P71</b> Black <b>PR6</b> Silver	<b>U</b> CTB117	Select upholstery for the seat. <b>Please refer to list of available upholstery and leather selections on www.gunlocke.com</b>	Select upholstery for the back. <b>Please refer to list of available upholstery and leather selections on www.gunlocke.com</b>

**Example**

<b>GK9923N.P71.U.DOL728.SPNN04</b>				
GK9923N	P71	U	DOL728	SPNN04
<b>MODEL NUMBER</b>	<b>FRAME</b>	<b>FLAMMABILITY RATING</b>	<b>SEAT UPHOLSTERY</b>	<b>BACK UPHOLSTERY</b>

model number                      fabric grades                      dimensions                      W                      D                      H

**GK9961P**  
Plastic Moderne Arm,  
upholstered

**1** 3,462

Overall	36 1/2"	26 1/4"	33 1/2"
Seat		19"	19"
Arm			27 1/4"
Between arms	33 1/4"		

**Upholstery Requirements: GK9961P**

	Dual Upholstery	
Fabric yards	Seat 0.9	Back 1.3
Leather feet <sup>2</sup>	Seat 15.3	Back 22.1
Shipping weight	60 lbs.	
Cube	32.6	

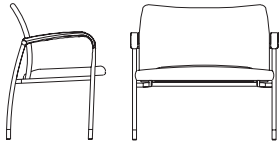

Seat	<b>1</b>	<b>10</b>	194	<b>19</b>	445	<b>L1</b>	208	
	<b>2</b>	19	<b>11</b>	218	<b>20</b>	474	<b>L2</b>	389
	<b>3</b>	36	<b>12</b>	242	<b>21</b>	504	<b>L3</b>	605
	<b>COM/4</b>	54	<b>13</b>	270	<b>22</b>	533	<b>L4</b>	785
	<b>5</b>	78	<b>14</b>	299	<b>23</b>	592	<b>L5</b>	967
	<b>6</b>	101	<b>15</b>	329	<b>24</b>	650		
	<b>7</b>	123	<b>16</b>	358	<b>25</b>	708		
	<b>8</b>	147	<b>17</b>	387	<b>26</b>	768		
	<b>9</b>	170	<b>18</b>	417	<b>27</b>	827		

To calculate price of chair with different fabric for Seat and Back; start with Grade 1 price, add appropriate grade price located in second row for Seat, and last add appropriate grade price located in third row for Back to the sum of the Grade 1 and Seat price.

**Example: Grade 1 \$3,462 + grade 4 fabric Seat/back \$54 + grade 2 fabric Arms \$27 = \$3,543**

Back	<b>1</b>	<b>10</b>	280	<b>19</b>	643	<b>L1</b>	298	
	<b>2</b>	27	<b>11</b>	314	<b>20</b>	685	<b>L2</b>	560
	<b>3</b>	52	<b>12</b>	348	<b>21</b>	728	<b>L3</b>	873
	<b>COM/4</b>	78	<b>13</b>	390	<b>22</b>	770	<b>L4</b>	1,135
	<b>5</b>	111	<b>14</b>	432	<b>23</b>	854	<b>L5</b>	1,396
	<b>6</b>	145	<b>15</b>	473	<b>24</b>	939		
	<b>7</b>	179	<b>16</b>	517	<b>25</b>	1,023		
	<b>8</b>	212	<b>17</b>	559	<b>26</b>	1,108		
	<b>9</b>	246	<b>18</b>	601	<b>27</b>	1,192		

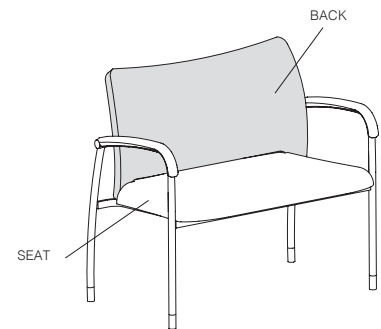

TO ORDER PLEASE SPECIFY THE FOLLOWING:

<input type="text"/>	<input type="text"/>	<input type="text"/>	<input type="text"/>	<input type="text"/>	<input type="text"/>	<input type="text"/>
<b>MODEL NUMBER</b>	<b>FRAME</b>	<b>GANGING</b>	<b>FLAMMABILITY RATING</b>	<b>GORE BARRIER</b>	<b>SEAT UPHOLSTERY</b>	<b>BACK UPHOLSTERY</b>
	<b>P71</b> Black <b>PR6</b> Silver	Ganging device on leg available. Please specify by adding suffix to model number. <b>G</b> Ganging device +\$34 <b>GN</b> No Ganging	<b>U</b> CTB117	<b>GBN</b> No Gore	Select upholstery for the seat. <b>Please refer to list of available upholstery and leather selections on www.gunlocke.com</b>	Select upholstery for the back. <b>Please refer to list of available upholstery and leather selections on www.gunlocke.com</b>

Example

GK9961P.P71.GN.U.GBN.DOL728.SPNN04

GK9961P	P71	GN	U	GBN	DOL728	SPNN04
<b>MODEL NUMBER</b>	<b>FRAME</b>	<b>GANGING</b>	<b>FLAMMABILITY RATING</b>	<b>GORE BARRIER</b>	<b>SEAT UPHOLSTERY</b>	<b>BACK UPHOLSTERY</b>



model number fabric grades

**GK9961W** 1 3,763  
Wood Moderne Arm,  
upholstered

dimensions W D H

Overall	36 1/2"	26 1/4"	33 1/2"
Seat		19"	19"
Arm			27 1/4"
Between arms	33 1/4"		

**Upholstery Requirements: GK9961W**

	Dual Upholstery	
Fabric yards	Seat 0.9	Back 1.3
Leather feet <sup>2</sup>	Seat 15.3	Back 22.1
Shipping weight	60 lbs.	
Cube	32.6	

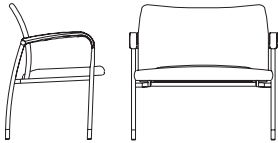

Seat

<b>1</b>	<b>10</b>	194	<b>19</b>	445	<b>L1</b>	208
<b>2</b>	19	<b>11</b>	218	<b>20</b>	<b>L2</b>	389
<b>3</b>	36	<b>12</b>	242	<b>21</b>	<b>L3</b>	605
<b>COM/4</b>	54	<b>13</b>	270	<b>22</b>	<b>L4</b>	785
<b>5</b>	78	<b>14</b>	299	<b>23</b>	<b>L5</b>	967
<b>6</b>	101	<b>15</b>	329	<b>24</b>		
<b>7</b>	123	<b>16</b>	358	<b>25</b>		
<b>8</b>	147	<b>17</b>	387	<b>26</b>		
<b>9</b>	170	<b>18</b>	417	<b>27</b>		

To calculate price of chair with different fabric for Seat and Back; start with Grade 1 price, add appropriate grade price located in second row for Seat, and last add appropriate grade price located in third row for Back to the sum of the Grade 1 and Seat price.

**Example: Grade 1 \$3,763 + grade 4 fabric Seat/back \$54 + grade 2 fabric Arms \$27 = \$3,844**

Back

<b>1</b>	<b>10</b>	280	<b>19</b>	643	<b>L1</b>	298
<b>2</b>	27	<b>11</b>	314	<b>20</b>	<b>L2</b>	560
<b>3</b>	52	<b>12</b>	348	<b>21</b>	<b>L3</b>	873
<b>COM/4</b>	78	<b>13</b>	390	<b>22</b>	<b>L4</b>	1,135
<b>5</b>	111	<b>14</b>	432	<b>23</b>	<b>L5</b>	1,396
<b>6</b>	145	<b>15</b>	473	<b>24</b>		
<b>7</b>	179	<b>16</b>	517	<b>25</b>		
<b>8</b>	212	<b>17</b>	559	<b>26</b>		
<b>9</b>	246	<b>18</b>	601	<b>27</b>		

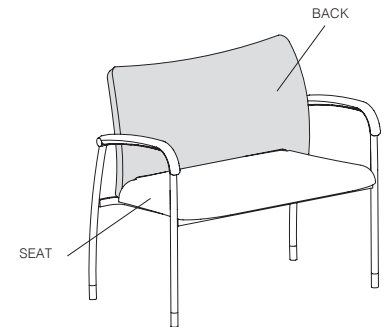

TO ORDER PLEASE SPECIFY THE FOLLOWING:

<input type="text"/>	<input type="text"/>	<input type="text"/>	<input type="text"/>	<input type="text"/>	<input type="text"/>	<input type="text"/>	<input type="text"/>
<b>MODEL NUMBER</b>	<b>FRAME</b>	<b>FINISH</b>	<b>GANGING</b>	<b>FLAMMABILITY RATING</b>	<b>GORE BARRIER</b>	<b>SEAT UPHOLSTERY</b>	<b>BACK UPHOLSTERY</b>
	P71 Black PR6 Silver	Cherry finishes on Maple Walnut finishes on Maple Maple finishes on Maple Oak finishes on Maple Please refer to the Multi® product page on www.gunlocke.com for standard finish options.	Ganging device on leg available. Please specify by adding suffix to model number. G Ganging device +\$34 GN No Ganging	U CTB117	GBN No Gore	Select upholstery for the seat. Please refer to list of available upholstery and leather selections on www.gunlocke.com	Select upholstery for the back. Please refer to list of available upholstery and leather selections on www.gunlocke.com

Example

GK9961W.P71.215.GN.U.GBN.DOL728.SPNN04

GK9961W	P71	215	GN	U	GBN	DOL728	SPNN04
MODEL NUMBER	FRAME	FINISH	GANGING	FLAMMABILITY RATING	GORE BARRIER	SEAT UPHOLSTERY	BACK UPHOLSTERY

# TIA™ BARSTOOL

Bar Height | Single Upholstery

Seating  
02/24

model number	fabric grades							dimensions	W	D	H	
<b>GMHB17-011</b> Bar height, single upholstery	<b>1</b>	1,760	<b>10</b>	1,996	<b>19</b>	2,304	<b>L1</b>	2,014	Overall	19"	21 1/2"	40 5/8"
	<b>2</b>	1,782	<b>11</b>	2,026	<b>20</b>	2,340	<b>L2</b>	2,233	Seat	18 1/2"	16 3/4"	30 1/2"
	<b>3</b>	1,804	<b>12</b>	2,054	<b>21</b>	2,376	<b>L3</b>	2,500	<b>Upholstery Requirements: GMHB17-011</b>			
	<b>COM/4</b>	1,825	<b>13</b>	2,090	<b>22</b>	2,412	<b>L4</b>	2,720	Fabric yards	1.1		
	<b>5</b>	1,854	<b>14</b>	2,126	<b>23</b>	2,483	<b>L5</b>	2,941	Leather feet²	18.7		
	<b>6</b>	1,882	<b>15</b>	2,162	<b>24</b>	2,555			Shipping weight	31 lbs.		
	<b>7</b>	1,912	<b>16</b>	2,196	<b>25</b>	2,627			Cube	13.6		
	<b>8</b>	1,940	<b>17</b>	2,232	<b>26</b>	2,698			<b>Note:</b> Footrest for bar height Tia™ is 12 1/8" high off the floor.			
	<b>9</b>	1,969	<b>18</b>	2,268	<b>27</b>	2,769						



## TO ORDER PLEASE SPECIFY THE FOLLOWING:

<input type="text"/>	<input type="text"/>	<input type="text"/>	<input type="text"/>	<input type="text"/>
<b>MODEL NUMBER</b>	<b>FOOTREST COLOR</b>	<b>FINISH</b>	<b>FLAMMABILITY RATING</b>	<b>UPHOLSTERY</b>

Polished Stainless **PS +\$57**  
 Brushed Stainless **BS +\$57**  
 Black Powder Coat **BK**  
 White Powder Coat **WH**

These seating models are available in the following hardwoods:  
 Maple **NE**  
 Ash **QA**  
 Please refer to the Tia product page on [www.gunlocke.com](http://www.gunlocke.com) for standard finish options.

**U CTB117**

Please refer to list of available upholstery and leather selections on [www.gunlocke.com](http://www.gunlocke.com)

**Cherry finishes on Maple or Ash**  
**Walnut finishes on Maple or Ash**  
**Maple finishes on Maple or Ash**  
**Oak finishes on Maple or Ash**  
*Natural Cherry 222, Clear Maple 800, Clear Oak 300 and Fawn Cypress 108 not available on Ash.*  
*Light Rift Oak 301 not available on Maple.*

## Example

<b>GMHB17-011.PS.QA629.U.DOL728</b>				
GMHB17-011	PS	QA629	U	DOL728
<b>MODEL NUMBER</b>	<b>FOOTREST COLOR</b>	<b>FINISH</b>	<b>FLAMMABILITY</b>	<b>UPHOLSTERY</b>

model number	fabric grades								dimensions	W	D	H
<b>GMHB17-041</b> Counter height, single upholstery	<b>1</b>	1,760	<b>10</b>	1,996	<b>19</b>	2,304	<b>L1</b>	2,014	Overall	19"	21 1/2"	36 3/8"
	<b>2</b>	1,782	<b>11</b>	2,026	<b>20</b>	2,340	<b>L2</b>	2,233	Seat	18 1/2"	16 3/4"	26 1/4"
	<b>3</b>	1,804	<b>12</b>	2,054	<b>21</b>	2,376	<b>L3</b>	2,500	<b>Upholstery Requirements: GMHB17-041</b>			
	<b>COM/4</b>	1,825	<b>13</b>	2,090	<b>22</b>	2,412	<b>L4</b>	2,720	Fabric yards	1.1		
	<b>5</b>	1,854	<b>14</b>	2,126	<b>23</b>	2,483	<b>L5</b>	2,941	Leather feet <sup>2</sup>	18.7		
	<b>6</b>	1,882	<b>15</b>	2,162	<b>24</b>	2,555			Shipping weight	30 lbs.		
	<b>7</b>	1,912	<b>16</b>	2,196	<b>25</b>	2,627			Cube	12.3		
	<b>8</b>	1,940	<b>17</b>	2,232	<b>26</b>	2,698			<b>Note:</b> Footrest for counter height Tia™ is 7 7/8" high off the floor.			
	<b>9</b>	1,969	<b>18</b>	2,268	<b>27</b>	2,769						



TO ORDER PLEASE SPECIFY THE FOLLOWING:

<input type="text"/>	<input type="text"/>	<input type="text"/>	<input type="text"/>	<input type="text"/>
<b>MODEL NUMBER</b>	<b>FOOTREST COLOR</b>	<b>FINISH</b>	<b>FLAMMABILITY RATING</b>	<b>UPHOLSTERY</b>

- Polished Stainless **PS +\$57**
- Brushed Stainless **BS +\$57**
- Black Powder Coat **BK**
- White Powder Coat **WH**

These seating models are available in the following hardwoods:  
 Maple **NE**  
 Ash **QA**  
 Please refer to the Tia product page on [www.gunlocke.com](http://www.gunlocke.com) for standard finish options.

**U CTB117**

Please refer to list of available upholstery and leather selections on [www.gunlocke.com](http://www.gunlocke.com)

**Cherry finishes on Maple or Ash**  
**Walnut finishes on Maple or Ash**  
**Maple finishes on Maple or Ash**  
**Oak finishes on Maple or Ash**  
*Natural Cherry 222, Clear Maple 800, Clear Oak 300 and Fawn Cypress 108 not available on Ash.*  
*Light Rift Oak 301 not available on Maple.*

Example

<b>GMHB17-041.PS.QA629.U.DOL728</b>				
GMHB17-041	PS	QA629	U	DOL728
<b>MODEL NUMBER</b>	<b>FOOTREST COLOR</b>	<b>FINISH</b>	<b>FLAMMABILITY</b>	<b>UPHOLSTERY</b>

# TRILLIA™ BARSTOOL

Upholstered Seat

Seating  
02/24

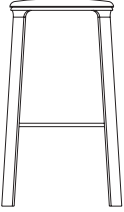
model number	fabric grades							dimensions	W	D	H	
<b>GMQA16-011</b> Bar height, upholstered seat pad 	<b>1</b>	2,055	<b>10</b>	2,185	<b>19</b>	2,352	<b>L1</b>	2,195	Overall	17 5/8"	17 5/8"	30 H"
	<b>2</b>	2,067	<b>11</b>	2,201	<b>20</b>	2,372	<b>L2</b>	2,314	Seat	17 5/8"	17 5/8"	
	<b>3</b>	2,079	<b>12</b>	2,215	<b>21</b>	2,391	<b>L3</b>	2,459	<b>Upholstery Requirements: GMQA16-011</b>			
	<b>COM/4</b>	2,091	<b>13</b>	2,236	<b>22</b>	2,411	<b>L4</b>	2,579	Fabric yards	Seat pad	0.6	
	<b>5</b>	2,107	<b>14</b>	2,254	<b>23</b>	2,450	<b>L5</b>	2,699	Leather feet <sup>2</sup>	Seat pad	10.2	
	<b>6</b>	2,122	<b>15</b>	2,275	<b>24</b>	2,489			Shipping weight	15 lbs.		
	<b>7</b>	2,138	<b>16</b>	2,294	<b>25</b>	2,527			Cube	8.3		
	<b>8</b>	2,153	<b>17</b>	2,313	<b>26</b>	2,566			<b>Note:</b> Footrest for Bar Height Trillia™ is 12" high off the floor.			
	<b>9</b>	2,170	<b>18</b>	2,334	<b>27</b>	2,607						

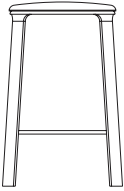
<b>GMQA16-041</b> Counter height, upholstered seat pad 	<b>1</b>	2,055	<b>10</b>	2,185	<b>19</b>	2,352	<b>L1</b>	2,195	Overall	17 1/8"	17 1/8"	26 H"
	<b>2</b>	2,067	<b>11</b>	2,201	<b>20</b>	2,372	<b>L2</b>	2,314	Seat	17 1/8"	17 1/8"	
	<b>3</b>	2,079	<b>12</b>	2,215	<b>21</b>	2,391	<b>L3</b>	2,459	<b>Upholstery Requirements: GMQA16-041</b>			
	<b>COM/4</b>	2,091	<b>13</b>	2,236	<b>22</b>	2,411	<b>L4</b>	2,579	Fabric yards	Seat pad	0.6	
	<b>5</b>	2,107	<b>14</b>	2,254	<b>23</b>	2,450	<b>L5</b>	2,699	Leather feet <sup>2</sup>	Seat pad	10.2	
	<b>6</b>	2,122	<b>15</b>	2,275	<b>24</b>	2,489			Shipping weight	14 lbs.		
	<b>7</b>	2,138	<b>16</b>	2,294	<b>25</b>	2,527			Cube	7.2		
	<b>8</b>	2,153	<b>17</b>	2,313	<b>26</b>	2,566			<b>Note:</b> Footrest for Counter Height Trillia™ is 7 3/4" high off the floor.			
	<b>9</b>	2,170	<b>18</b>	2,334	<b>27</b>	2,607						

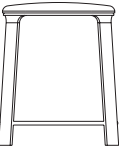
<b>GMQA16-071</b> Standard height, upholstered seat pad 	<b>1</b>	1,787	<b>10</b>	1,917	<b>19</b>	2,084	<b>L1</b>	1,927	Overall	16 1/4"	16 1/4"	19 3/8"
	<b>2</b>	1,799	<b>11</b>	1,933	<b>20</b>	2,104	<b>L2</b>	2,046	Seat	16 1/4"	16 1/4"	
	<b>3</b>	1,811	<b>12</b>	1,947	<b>21</b>	2,123	<b>L3</b>	2,191	<b>Upholstery Requirements: GMQA16-071</b>			
	<b>COM/4</b>	1,823	<b>13</b>	1,968	<b>22</b>	2,143	<b>L4</b>	2,311	Fabric yards	Seat pad	0.6	
	<b>5</b>	1,839	<b>14</b>	1,986	<b>23</b>	2,182	<b>L5</b>	2,431	Leather feet <sup>2</sup>	Seat pad	10.2	
	<b>6</b>	1,854	<b>15</b>	2,007	<b>24</b>	2,221			Shipping weight	14 lbs.		
	<b>7</b>	1,870	<b>16</b>	2,026	<b>25</b>	2,259			Cube	4.8		
	<b>8</b>	1,885	<b>17</b>	2,045	<b>26</b>	2,298			<b>Note:</b> Footrest for Standard Height Trillia™ is 2 1/2" high off the floor.			
	<b>9</b>	1,902	<b>18</b>	2,066	<b>27</b>	2,339						

<b>TO ORDER PLEASE SPECIFY THE FOLLOWING:</b>												
<input type="text"/>	<input type="text"/>	<input type="text"/>	<input type="text"/>	<input type="text"/>								
<b>MODEL NUMBER</b>	<b>SPECIES &amp; FINISH</b>	<b>STITCH DETAIL</b>	<b>FLAMMABILITY RATING</b>	<b>UPHOLSTERY</b>								
These seating models are available in the following hardwoods: Ash <b>QA</b> Please refer to the Trillia product page on <a href="http://www.gunlocke.com">www.gunlocke.com</a> for standard finish options. <b>Cherry finishes on Ash</b> <b>Walnut finishes on Ash</b> <b>Oak finishes on Ash</b> <i>Natural Cherry 222, Ebony Maple 555, Clear Oak 300 and Fawn Cypress 108 not available on Ash.</i>		Not Required <b>NR</b> Stitch Detail <b>SD +\$91</b>	<b>U</b> CTB117	Please refer to list of available upholstery and leather selections on <a href="http://www.gunlocke.com">www.gunlocke.com</a>								

## Example

<b>GMQA16-011.QA601.SD.U.DOL728</b>				
GMQA16-011	QA601	SD	U	DOL728
<b>MODEL NUMBER</b>	<b>FINISH</b>	<b>STITCH DETAIL</b>	<b>FLAMMABILITY</b>	<b>UPHOLSTERY</b>

model number	list	dimensions	W	D	H
--------------	------	------------	---	---	---

**GMQA16-021**  
Bar height,  
wood seat

1,944

Overall	17 5/8"	17 5/8"	29 5/8"
Seat	17 5/8"	17 5/8"	
Shipping weight			13 lbs.
Cube			8.1

**Note:** Footrest for Bar Height Trillia™ is 12" high off the floor.

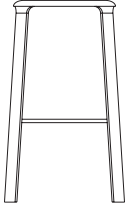

**GMQA16-051**  
Counter height,  
wood seat

1,944

Overall	17 1/8"	17 1/8"	25 3/8"
Seat	17 1/8"	17 1/8"	
Shipping weight			12 lbs.
Cube			7.0

**Note:** Footrest for Counter Height Trillia™ is 7 3/4" high off the floor.

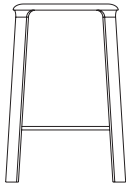

**GMQA16-081**  
Standard height,  
wood seat

1,676

Overall	16 1/4"	16 1/4"	18 H"
Seat	16 1/4"	16 1/4"	
Shipping weight			12 lbs.
Cube			4.6

**Note:** Footrest for Standard Height Trillia™ is 2 1/2" high off the floor.

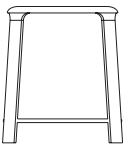

**TO ORDER PLEASE SPECIFY THE FOLLOWING:**

--	--

**MODEL NUMBER**      **SPECIES & FINISH**

These seating models are available in the following hardwoods:

Ash **QA**

Please refer to the Trillia product page on [www.gunlocke.com](http://www.gunlocke.com) for standard finish options.

**Cherry finishes on Ash**

**Walnut finishes on Ash**

**Oak finishes on Ash**

*Natural Cherry 222, Ebony Maple 555, Clear Oak 300 and Fawn Cypress 108 not available on Ash.*

**Example**

**GMQA16-021.QA601**

GMQA16-021

QA601

**MODEL NUMBER**

**FINISH**



Swivel Seating . . . . . 63-79  
Swivel Seating Product Specifications . . . . . 64-67  
Avoca™ . . . . . 68-69  
Genesee . . . . . 70-72  
Geneva . . . . . 73-74  
Olla Executive . . . . . 75-78  
Washington Series . . . . . 79

# SWIVEL SEATING

## Product Specifications

Seating  
02/24

### AVOCA™

---

**Seat:** High resilient foam overmolded onto rigid urethane pan, wrapped in 1/2" foam with additional 1/2" high resiliency foam topper.

**Back:** High resilient foam overmolded onto rigid urethane pan, wrapped in 1/4" foam with additional 1/2" high resiliency foam topper

**Arm:**

**Full Urethane:** Self-skinning urethane foam over steel structure.

**Full Polished:** Polished cast aluminum.

**Polished with Urethane Insert:** Polished cast aluminum with self-skinning urethane foam pad.

**Control:** Swivel-tilt with lockout. Or, premium Synchro-tilt with lockout, tilt tension, pneumatic height adjustment, and 3" range of seat depth adjustment.

**Base:** Black nylon plastic or die-cast polished aluminum 5 star.

**Caster:** Soft or Hard. Premium casters with chrome finish are optional.

**Upholstery:** French-stitch around edges, channel stitching optional.

**BIFMA Rating:**

ANSI/BIFMA X5.1 2017  
(300lb Weight Rating)

### GENESEE

---

**Seat:** High resiliency foam overmolded onto rigid urethane bucket, wrapped in 1/2" foam with additional 1/2" high resiliency foam topper.

**Back:** High resiliency foam overmolded onto rigid urethane bucket, wrapped in 1/2" foam.

**Arm:**

**Polished aluminum:** Polished cast aluminum.

**Upholstered:** Polished cast aluminum with routed upholstery groove, covered in J" high density foam, upholstery wrapped with welt cord to cover staples.

**Control:** Black mid-tilt control, tension adjustment, tilt lockout.

**Base:** Five-star, die-cast polished aluminum.

**Casters:** Soft or hard. Premium casters with chrome finish optional.

**Upholstery:** Top-stitch around edges of bucket.

**BIFMA Rating:**

ANSI/BIFMA X5.1 2017  
(300lb Weight Rating)

### GENEVA

---

**Frame:** Curved plywood

Seat and Back: Dacron over dual density cut foam.

**Arm:**

**Full Urethane:** Self-skinning urethane foam over steel structure

**Polished with Urethane Insert:** Polished cast aluminum with self-skinning urethane foam pad.

**Control:** Black mid-tilt control, tension adjustment, tilt lockout.

**Base:** Black nylon plastic or die-cast polished aluminum star.

**Casters:** Soft or hard.

**BIFMA Rating:**

ANSI/BIFMA X5.1 2017  
(300lb Weight Rating)



### OLLA SWIVEL

---

**Seat and Back:** Furniture-grade curved plywood covered with high-resiliency molded foam.

**Seat and Back Wood Decor:** Maple or Cherry Veneer over molded formed plywood (GK2804/GK2806).

**Metal J-Bar Cover:** Black, silver or polished aluminum.

**Arm:**

**Adjustable Arm:** Arm height range 4", Forward/Back 2", Width Adjustment 1". Arms available in black only.

**Upholstered Arm:** Cut foam over furniture-grade plywood.

**Urethane Arm:** Textured urethane.

**Control:** Synchronized tilt mechanism control, 5-position lock out, tension control and pneumatic height adjustment. The synchronized tilt ratio is 2.3 to 1 degree.

**Seat Depth Adjustment:** 2" range with 6 evenly spaced lockable positions.

**Tilt Lock:** 5 incremental positions. Back tilt travel 21 degrees rearward to a fully reclined position.

**Base:** 5-star base, die-cast aluminum. Available in black, silver and polished aluminum.

**Casters:** Soft or hard.

**Upholstery:** The back and seat upholstery is French-stitched.

**BIFMA Rating:**

ANSI/BIFMA X5.1 2017 w/ additional requirements (300lb Weight Rating, Adjustable Arms test to 275lbs)

### WASHINGTON

---

**Frame:** Hardwood joined by Double dowels, corner blocked.

**Seat:** Spring seat platform with foam and cotton filling. Upholstered. Cushion material is fabricated foam and dacron filled. Welted.

**Back:** Foam, cotton, and dacron filled over spring foundation. Upholstered. Welted.

**Arms:** Upholstered over dacron and foam.

**Swivel base:** Five leg, with brass capped detail. Manual lift.

**Casters:** 2" Bronze Ball.

**BIFMA Rating:**

ANSI/BIFMA X5.1 2015 w/ additional requirements (400lb Weight Rating)

# SWIVEL SEATING

## Product Specifications

### SWIVEL ERGONOMICS

#### Dual Point Synchro Tilt

In Synchronous tilt, the backrest and seat pan of a chair reclines at a different ratio (usually 2:1) as you lean back. For every 10 degrees of recline in the backrest for example, the seat pan only tilts back 5 degrees

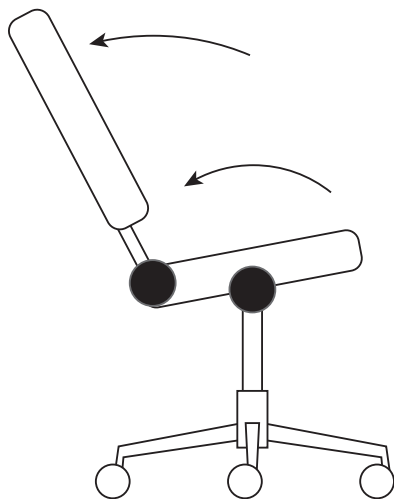

#### Single Point Mid Tilt

Mid tilt employs a basic tilt mechanism that's located in the center or back of the seat to tilt the seat pan and backrest in tandem. The angle of the front of the seat increases at the same rate as the backrest.

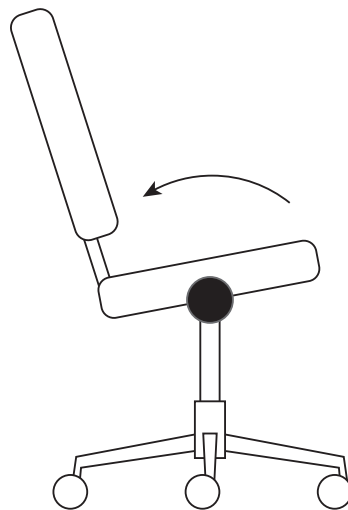

#### Single Point Knee Tilt

With a Knee tilt, the pivoting point is located near the very front of the seat, resulting in a wide angle tilt that still keeps the front of the seat relatively level. Knee tilt combines some qualities of synchro and mid tilting. With the pivoting point near the front of the seat, your feet remain on the ground even with a larger recline in the seat pan and backrest.

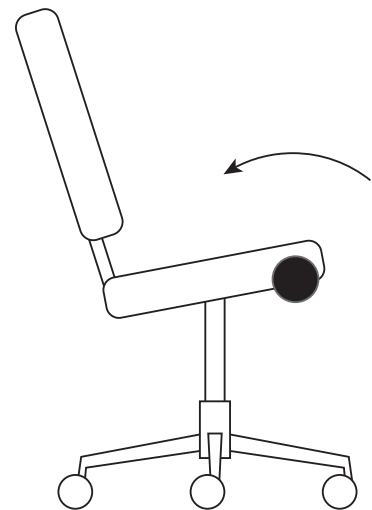

### CONTROL HOW TO'S

#### Mid-Tilt and Knee Tilt Mechanism

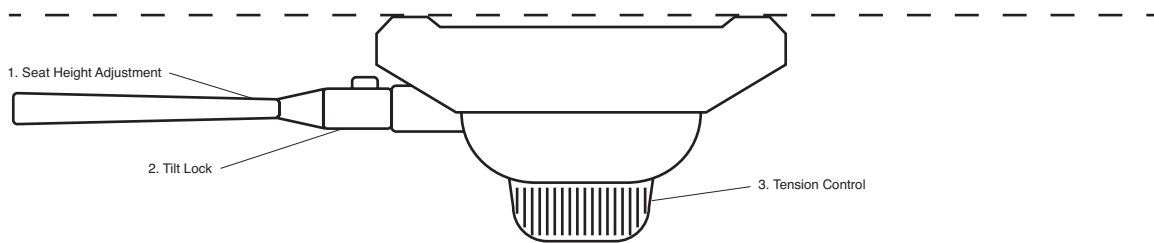

#### 1. SEAT HEIGHT ADJUSTMENT

Slightly lift body weight off seat and pull up on paddle to increase or decrease height. Release lever to lock into desired height.

#### 2. TILT LOCK

Push handle in towards center of control. This will lock the position of the tilt. Pull handle out to allow for free tilting.

#### 3. TENSION CONTROL

Decrease tension by rotating the knob left. Increase tension by rotating the knob right.

**Synchro-Tilt Mechanism**

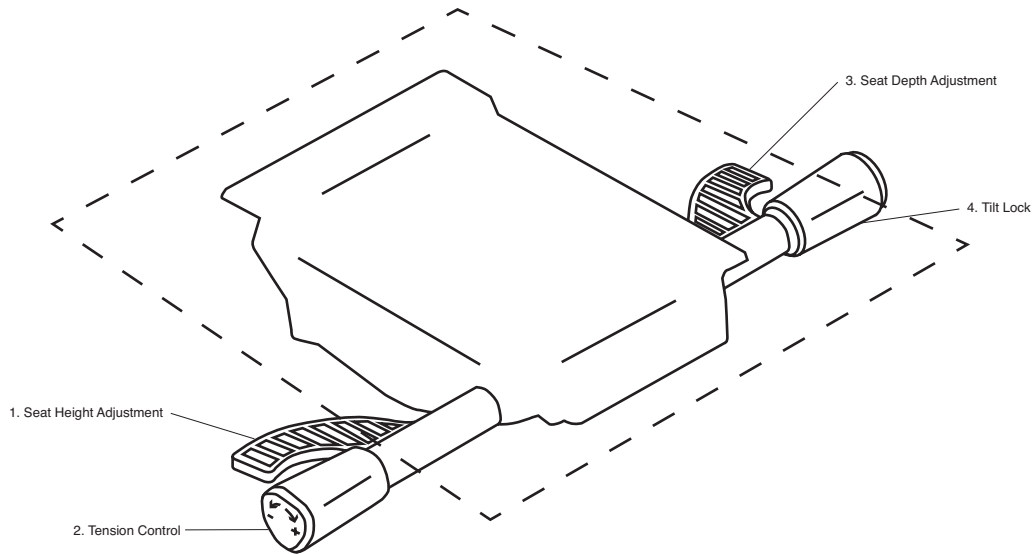

**1. SEAT HEIGHT ADJUSTMENT**

Slightly lift body weight off seat and pull up on paddle to increase height, or remain seated and pull up on paddle to decrease height. Release paddle to lock into desired height.

**2. TENSION CONTROL**

Extend Tension Control knob out to adjust. Increase tension by rotating the knob forward. Decrease tension by rotating the knob rearward. Push tension control knob in to original position when finished adjusting tension.

**3. SEAT DEPTH ADJUSTMENT**

Pull up on lever while seated and slide forward or rearward to desired depth. Release paddle handle to engage.

**4. TILT LOCK**

Lean back fully back in chair, then rotate handle forward to engage lockout. Rotate handle forward, then lean back into the chair to release the tilt lock feature.

**Manual Mechanism**

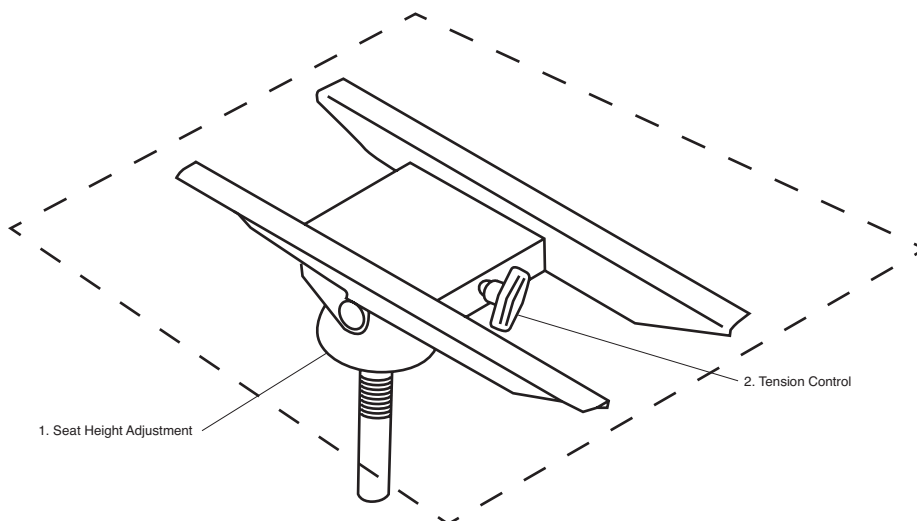

**1. SEAT HEIGHT ADJUSTMENT**

Slightly lift body weight off seat and rotate bell. Rotating to the right will lower the seat. Rotating to the left will raise seat.

**2. TENSION CONTROL**

Increase tension by rotating the knob to the right. Decrease tension by rotating the knob left.

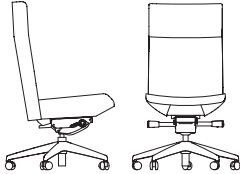
model number	fabric grades						dimensions	W	D	H			
<b>GSHA15-011</b> High back, armless  	<b>1</b>	2,123	<b>10</b>	2,531	<b>19</b>	3,063	<b>L1</b>	2,559	Overall	26 11/16"	25 3/4"	40 11/16"	
	<b>2</b>	2,161	<b>11</b>	2,581	<b>20</b>	3,125	<b>L2</b>	2,941	Seat	19-20"	19"	16 1/2 - 20 1/2"	
	<b>3</b>	2,198	<b>12</b>	2,630	<b>21</b>	3,186	<b>L3</b>	3,400	<b>Upholstery Requirements: GSHA15-011</b>				
	<b>COM/4</b>	2,235	<b>13</b>	2,692	<b>22</b>	3,248	<b>L4</b>	3,781	Fabric yards	1.9			
	<b>5</b>	2,284	<b>14</b>	2,754	<b>23</b>	3,371	<b>L5</b>	4,163	Leather feet <sup>2</sup>	32.3			
	<b>6</b>	2,334	<b>15</b>	2,816	<b>24</b>	3,494			Shipping weight	52 lbs.			
	<b>7</b>	2,383	<b>16</b>	2,877	<b>25</b>	3,618			Cube	21.6			
	<b>8</b>	2,432	<b>17</b>	2,939	<b>26</b>	3,742							
	<b>9</b>	2,482	<b>18</b>	3,001	<b>27</b>	3,865							

<b>GSHA15-021</b> Mid back, armless  	<b>1</b>	1,957	<b>10</b>	2,302	<b>19</b>	2,749	<b>L1</b>	2,325	Overall	26 11/16"	25 3/4"	35 11/16"	
	<b>2</b>	1,989	<b>11</b>	2,343	<b>20</b>	2,800	<b>L2</b>	2,647	Seat	19-20"	19"	16 1/2 - 20 1/2"	
	<b>3</b>	2,021	<b>12</b>	2,385	<b>21</b>	2,853	<b>L3</b>	3,033	<b>Upholstery Requirements: GSHA15-021</b>				
	<b>COM/4</b>	2,051	<b>13</b>	2,436	<b>22</b>	2,904	<b>L4</b>	3,353	Fabric yards	1.6			
	<b>5</b>	2,092	<b>14</b>	2,488	<b>23</b>	3,009	<b>L5</b>	3,675	Leather feet <sup>2</sup>	27.2			
	<b>6</b>	2,135	<b>15</b>	2,540	<b>24</b>	3,112			Shipping weight	51 lbs.			
	<b>7</b>	2,177	<b>16</b>	2,592	<b>25</b>	3,216			Cube	19.1			
	<b>8</b>	2,218	<b>17</b>	2,643	<b>26</b>	3,320							
	<b>9</b>	2,260	<b>18</b>	2,697	<b>27</b>	3,424							

Horizontal Channel Stitch Example:



High Back version shown; Mid Back version has channel stitching down entire back.

TO ORDER PLEASE SPECIFY THE FOLLOWING:

MODEL NUMBER	BASE	CASTER	CONTROL	STITCH DETAIL	FLAMMABILITY RATING	UPHOLSTERY
	These seating models are available with the following base option. <b>BBL</b> Black base <b>BAL</b> Polished Aluminum <b>+\$113</b>	<b>CH2</b> Hard <b>CS2</b> Soft <b>+\$62</b> <b>CHC2</b> Chrome, hard <b>+\$96</b>	<b>P</b> Swivel tilt <b>SKP</b> Synchro-Tilt, seat slider, pneumatic lift with lockout <b>+\$142</b>	<b>NR</b> Not required <b>SD</b> Horizontal Channel Stitch Detail <b>\$142</b> <b>NOTE:</b> Avoca High Back comes standard with a single horizontal French stitch across the back when the Stitch Not Required ( <b>NR</b> ) option is chosen.	<b>U</b> CTB117	Please refer to list of available upholstery and leather selections on <a href="http://www.gunlocke.com">www.gunlocke.com</a>

Example

GSHA15-011.BBL.CH2.P.NR.U.DOL728

GSHA15-011	BBL	CH2	P	NR	U	DOL728
MODEL NUMBER	BASE	CASTER	CONTROL	STITCH DETAIL	FLAMMABILITY	UPHOLSTERY

model number	fabric grades								dimensions	W	D	H
<b>GSHA15-031</b> High back with arms  	<b>1</b>	2,215	<b>10</b>	2,623	<b>19</b>	3,155	<b>L1</b>	2,651	Overall	26 11/16"	25 3/4"	40 11/16"
	<b>2</b>	2,253	<b>11</b>	2,673	<b>20</b>	3,217	<b>L2</b>	3,033	Seat	19-20"	19"	16 1/2" - 20 1/2"
	<b>3</b>	2,290	<b>12</b>	2,722	<b>21</b>	3,278	<b>L3</b>	3,492	Arm			24 7/8" - 28 7/8"
	<b>COM/4</b>	2,327	<b>13</b>	2,784	<b>22</b>	3,340	<b>L4</b>	3,873	Between arms	19 3/4"		
	<b>5</b>	2,376	<b>14</b>	2,846	<b>23</b>	3,463	<b>L5</b>	4,255	<b>Upholstery Requirements: GSHA15-031</b>			
	<b>6</b>	2,426	<b>15</b>	2,908	<b>24</b>	3,586			Fabric yards		1.9	
	<b>7</b>	2,475	<b>16</b>	2,969	<b>25</b>	3,710			Leather feet²		32.3	
	<b>8</b>	2,524	<b>17</b>	3,031	<b>26</b>	3,834			Shipping weight		56 lbs.	
	<b>9</b>	2,574	<b>18</b>	3,093	<b>27</b>	3,957			Cube		21.6	

<b>GSHA15-041</b> Mid back with arms  	<b>1</b>	2,046	<b>10</b>	2,391	<b>19</b>	2,838	<b>L1</b>	2,414	Overall	26 11/16"	25 3/4"	35 11/16"
	<b>2</b>	2,078	<b>11</b>	2,432	<b>20</b>	2,889	<b>L2</b>	2,736	Seat	19-20"	19"	16 1/2" - 20 1/2"
	<b>3</b>	2,110	<b>12</b>	2,474	<b>21</b>	2,942	<b>L3</b>	3,122	Arm			24 7/8" - 28 7/8"
	<b>COM/4</b>	2,140	<b>13</b>	2,525	<b>22</b>	2,993	<b>L4</b>	3,442	Between arms	19 3/4"		
	<b>5</b>	2,181	<b>14</b>	2,577	<b>23</b>	3,098	<b>L5</b>	3,764	<b>Upholstery Requirements: GSHA15-041</b>			
	<b>6</b>	2,224	<b>15</b>	2,629	<b>24</b>	3,201			Fabric yards		1.6	
	<b>7</b>	2,266	<b>16</b>	2,681	<b>25</b>	3,305			Leather feet²		27.2	
	<b>8</b>	2,307	<b>17</b>	2,732	<b>26</b>	3,409			Shipping weight		55 lbs.	
	<b>9</b>	2,349	<b>18</b>	2,786	<b>27</b>	3,513			Cube		19.	

Horizontal Channel Stitch Example:



High Back version shown; Mid Back version has channel stitching down entire back.

TO ORDER PLEASE SPECIFY THE FOLLOWING:

MODEL NUMBER	ARM	BASE	CASTER	CONTROL	STITCH DETAIL	FLAMMABILITY RATING	UPHOLSTERY
	<p>These seating models are available with the following arm options.</p> <p><b>ABL</b> Black Urethane Arm <b>APA</b> Full Polished Aluminum <b>+\$169</b> <b>API</b> Polished Aluminum with Urethane Arm Cap <b>+\$169</b></p>	<p>These seating models are available with the following base option.</p> <p><b>BBL</b> Black base <b>BAL</b> Polished Aluminum <b>+\$113</b></p>	<p><b>CH2</b> Hard <b>CS2</b> Soft <b>+\$62</b> <b>CHC2</b> Chrome, hard <b>+\$96</b></p>	<p><b>P</b> Swivel tilt <b>SKP</b> Synchro-Tilt, seat slider, pneumatic lift with lockout <b>+\$142</b></p>	<p><b>NR</b> Not required <b>SD</b> Horizontal Channel Stitch Detail <b>\$142</b> <b>NOTE:</b> Avoca High Back comes standard with a single horizontal French stitch across the back when the Stitch Not Required (<b>NR</b>) option is chosen.</p>	<p><b>U</b> CTB117</p>	<p><b>Please refer to list of available upholstery and leather selections on <a href="http://www.gunlocke.com">www.gunlocke.com</a></b></p>

Example

GSHA15-031.ABL.BBL.CH2.P.NR.U.DOL728

MODEL NUMBER	ARM	BASE	CASTER	CONTROL	STITCH DETAIL	FLAMMABILITY	UPHOLSTERY
GSHA15-031	ABL	BBL	CH2	P	NR	U	DOL728

# GENESEE

Armless

Seating  
02/24

model number	fabric grades								dimensions	W	D	H
<b>GSRA16-011</b> Swivel, High Back Armless	<b>1</b>	2,704	<b>10</b>	3,156	<b>19</b>	3,743	<b>L1</b>	3,187	Overall	25 3/4"	28"	38 1/8" - 41 5/8"
	<b>2</b>	2,746	<b>11</b>	3,210	<b>20</b>	3,811	<b>L2</b>	3,609	Seat	21"	19 1/4"	17" - 20 1/2"
	<b>3</b>	2,787	<b>12</b>	3,264	<b>21</b>	3,880	<b>L3</b>	4,116	<b>Upholstery Requirements: GSRA16-011</b>			
	<b>COM/4</b>	2,827	<b>13</b>	3,333	<b>22</b>	3,947	<b>L4</b>	4,536	Fabric yards	1.6		
	<b>5</b>	2,883	<b>14</b>	3,401	<b>23</b>	4,084	<b>L5</b>	4,958	Leather feet <sup>2</sup>	27.2		
	<b>6</b>	2,937	<b>15</b>	3,470	<b>24</b>	4,221			Shipping weight	44 lbs.		
	<b>7</b>	2,991	<b>16</b>	3,538	<b>25</b>	4,357			Cube	21.2		
	<b>8</b>	3,046	<b>17</b>	3,606	<b>26</b>	4,494						
	<b>9</b>	3,101	<b>18</b>	3,674	<b>27</b>	4,630						

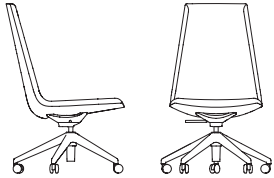

<b>GSRA16-021</b> Swivel, Mid Back Armless	<b>1</b>	2,543	<b>10</b>	2,909	<b>19</b>	3,384	<b>L1</b>	2,934	Overall	25 3/4"	26 1/2"	31 3/8" - 34 7/8"
	<b>2</b>	2,577	<b>11</b>	2,952	<b>20</b>	3,439	<b>L2</b>	3,275	Seat	21"	19 1/4"	17" - 20 1/2"
	<b>3</b>	2,610	<b>12</b>	2,998	<b>21</b>	3,494	<b>L3</b>	3,685	<b>Upholstery Requirements: GSRA16-021</b>			
	<b>COM/4</b>	2,644	<b>13</b>	3,052	<b>22</b>	3,550	<b>L4</b>	4,027	Fabric yards	1.5		
	<b>5</b>	2,688	<b>14</b>	3,108	<b>23</b>	3,660	<b>L5</b>	4,369	Leather feet <sup>2</sup>	25.5		
	<b>6</b>	2,732	<b>15</b>	3,163	<b>24</b>	3,770			Shipping weight	42 lbs.		
	<b>7</b>	2,776	<b>16</b>	3,217	<b>25</b>	3,881			Cube	16.9		
	<b>8</b>	2,821	<b>17</b>	3,274	<b>26</b>	3,992						
	<b>9</b>	2,864	<b>18</b>	3,328	<b>27</b>	4,102						

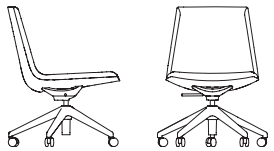



TO ORDER PLEASE SPECIFY THE FOLLOWING:

<b>MODEL NUMBER</b>	<b>CASTER</b>	<b>CONTROL</b>	<b>FLAMMABILITY RATING</b>	<b>UPHOLSTERY</b>
	<b>CH2</b> Hard <b>CS2</b> Soft +\$62 <b>CHC2</b> Chrome, hard +\$96	<b>P</b> Low-profile, polished swivel-tilt, pneumatic lift. <b>MP</b> Black, mid tilt, pneumatic lift with lockout.	<b>U</b> CTB117	Please refer to list of available upholstery and leather selections on <a href="http://www.gunlocke.com">www.gunlocke.com</a>

Example

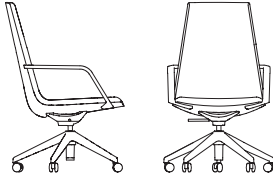
GSRA16-011.CH2.P.U.DOL728  
 GSRA16-011 CH2 P U DOL728  
 MODEL NUMBER CASTER CONTROL FLAMMABILITY UPHOLSTERY

model number	fabric grades								dimensions	W	D	H
<b>GSRA16-031</b> Swivel, High Back Polished Arms  	<b>1</b>	2,799	<b>10</b>	3,251	<b>19</b>	3,838	<b>L1</b>	3,282	Overall	27 1/2"	28"	38 1/8" - 41 5/8"
	<b>2</b>	2,841	<b>11</b>	3,305	<b>20</b>	3,906	<b>L2</b>	3,704	Seat	21"	19 1/4"	17" - 20 1/2"
	<b>3</b>	2,882	<b>12</b>	3,359	<b>21</b>	3,975	<b>L3</b>	4,211	Arm			23 1/2" - 27"
	<b>COM/4</b>	2,922	<b>13</b>	3,428	<b>22</b>	4,042	<b>L4</b>	4,631	Between arms	21"		
	<b>5</b>	2,978	<b>14</b>	3,496	<b>23</b>	4,179	<b>L5</b>	5,053	<b>Upholstery Requirements: GSRA16-031</b>			
	<b>6</b>	3,032	<b>15</b>	3,565	<b>24</b>	4,316			Fabric yards		1.6	
	<b>7</b>	3,086	<b>16</b>	3,633	<b>25</b>	4,452			Leather feet <sup>2</sup>		27.2	
	<b>8</b>	3,141	<b>17</b>	3,701	<b>26</b>	4,589			Shipping weight		49 lbs.	
	<b>9</b>	3,196	<b>18</b>	3,769	<b>27</b>	4,725			Cube		22.5	

<b>GSRA16-041</b> Swivel, Mid Back Polished Arms  	<b>1</b>	2,636	<b>10</b>	3,002	<b>19</b>	3,477	<b>L1</b>	3,027	Overall	27 1/2"	26 1/2"	31 3/8" - 34 7/8"
	<b>2</b>	2,670	<b>11</b>	3,045	<b>20</b>	3,532	<b>L2</b>	3,368	Seat	21"	19 1/4"	17" - 20 1/2"
	<b>3</b>	2,703	<b>12</b>	3,091	<b>21</b>	3,587	<b>L3</b>	3,778	Arm			23 1/2" - 27"
	<b>COM/4</b>	2,737	<b>13</b>	3,145	<b>22</b>	3,643	<b>L4</b>	4,120	Between arms	21"		
	<b>5</b>	2,781	<b>14</b>	3,201	<b>23</b>	3,753	<b>L5</b>	4,462	<b>Upholstery Requirements: GSRA16-041</b>			
	<b>6</b>	2,825	<b>15</b>	3,256	<b>24</b>	3,863			Fabric yards		1.5	
	<b>7</b>	2,869	<b>16</b>	3,310	<b>25</b>	3,974			Leather feet <sup>2</sup>		25.5	
	<b>8</b>	2,914	<b>17</b>	3,367	<b>26</b>	4,085			Shipping weight		47 lbs.	
	<b>9</b>	2,957	<b>18</b>	3,421	<b>27</b>	4,195			Cube		17.9	

TO ORDER PLEASE SPECIFY THE FOLLOWING:

<input type="text"/>	<input type="text"/>	<input type="text"/>	<input type="text"/>	<input type="text"/>
<b>MODEL NUMBER</b>	<b>CASTER</b>	<b>CONTROL</b>	<b>FLAMMABILITY RATING</b>	<b>UPHOLSTERY</b>
	<b>CH2</b> Hard <b>CS2</b> Soft +\$62 <b>CHC2</b> Chrome, hard +\$96	<b>P</b> Low-profile, polished swivel-tilt, pneumatic lift. <b>MP</b> Black, mid tilt, pneumatic lift with lockout.	<b>U</b> CTB117	Please refer to list of available upholstery and leather selections on <a href="http://www.gunlocke.com">www.gunlocke.com</a>

Example

GSRA16-031.CH2.P.U.DOL728  
 GSRA16-031 CH2 P U DOL728  
 MODEL NUMBER CASTER CONTROL FLAMMABILITY UPHOLSTERY

# GENESEE

## Upholstered Arms

Seating  
02/24

model number	fabric grades							dimensions	W	D	H	
<b>GSRA16-051</b> Swivel, High Back Upholstered Arms	<b>1</b>	2,936	<b>10</b>	3,408	<b>19</b>	4,024	<b>L1</b>	3,441	Overall	27 3/4"	28"	38 1/8" - 41 5/8"
	<b>2</b>	2,980	<b>11</b>	3,466	<b>20</b>	4,095	<b>L2</b>	3,883	Seat	21"	19 1/4"	17" - 20 1/2"
	<b>3</b>	3,022	<b>12</b>	3,523	<b>21</b>	4,166	<b>L3</b>	4,414	Arm			23 5/8" - 27 1/8"
	<b>COM/4</b>	3,066	<b>13</b>	3,595	<b>22</b>	4,238	<b>L4</b>	4,855	Between arms	20 3/4"		
	<b>5</b>	3,123	<b>14</b>	3,667	<b>23</b>	4,381	<b>L5</b>	5,298				
	<b>6</b>	3,181	<b>15</b>	3,738	<b>24</b>	4,525						
	<b>7</b>	3,237	<b>16</b>	3,809	<b>25</b>	4,667						
	<b>8</b>	3,294	<b>17</b>	3,881	<b>26</b>	4,811						
	<b>9</b>	3,352	<b>18</b>	3,952	<b>27</b>	4,953						

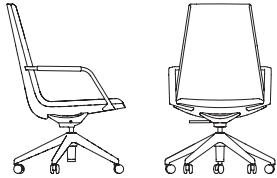

### Upholstery Requirements: GSRA16-051

Fabric yards	1.9
Leather feet <sup>2</sup>	32.3
Shipping weight	49 lbs.
Cube	22.7

<b>GSRA16-061</b> Swivel, Mid Back Upholstered Arms	<b>1</b>	2,772	<b>10</b>	3,180	<b>19</b>	3,712	<b>L1</b>	3,208
	<b>2</b>	2,810	<b>11</b>	3,230	<b>20</b>	3,774	<b>L2</b>	3,590
	<b>3</b>	2,847	<b>12</b>	3,279	<b>21</b>	3,835	<b>L3</b>	4,049
	<b>COM/4</b>	2,884	<b>13</b>	3,341	<b>22</b>	3,897	<b>L4</b>	4,430
	<b>5</b>	2,933	<b>14</b>	3,403	<b>23</b>	4,020	<b>L5</b>	4,812
	<b>6</b>	2,983	<b>15</b>	3,465	<b>24</b>	4,143		
	<b>7</b>	3,032	<b>16</b>	3,526	<b>25</b>	4,267		
	<b>8</b>	3,081	<b>17</b>	3,588	<b>26</b>	4,391		
	<b>9</b>	3,131	<b>18</b>	3,650	<b>27</b>	4,514		

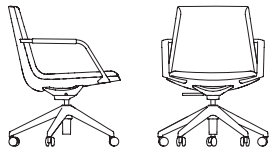

Overall	27 3/4"	26 1/2"	31 3/8" - 34 7/8"
Seat	21"	19 1/4"	17" - 20 1/2"
Arm			23 5/8" - 27 1/8"
Between arms	20 3/4"		

### Upholstery Requirements: GSRA16-061

Fabric yards	1.6
Leather feet <sup>2</sup>	27.2
Shipping weight	47 lbs.
Cube	18

TO ORDER PLEASE SPECIFY THE FOLLOWING:

<input type="text"/>	<input type="text"/>	<input type="text"/>	<input type="text"/>	<input type="text"/>
<b>MODEL NUMBER</b>	<b>CASTER</b>	<b>CONTROL</b>	<b>FLAMMABILITY RATING</b>	<b>UPHOLSTERY</b>
	<b>CH2</b> Hard <b>CS2</b> Soft +\$62 <b>CHC2</b> Chrome, hard +\$96	<b>P</b> Low-profile, polished swivel-tilt, pneumatic lift. <b>MP</b> Black, mid tilt, pneumatic lift with lockout.	<b>U</b> <b>CTB117</b>	Please refer to list of available upholstery and leather selections on <a href="http://www.gunlocke.com">www.gunlocke.com</a>

Example

GSRA16-051.CH2.P.215.U.DOL728  
 GSRA16-051 CH2 P U DOL728  
 MODEL NUMBER CASTER CONTROL FLAMMABILITY UPHOLSTERY



model number	fabric grades								dimensions	W	D	H
<b>GSGNV17-011</b> High Back, Pillow Single Uph	<b>1</b>	2,230	<b>10</b>	2,747	<b>19</b>	3,417	<b>L1</b>	2,782	Overall	27 1/4"	27"	42-46"
	<b>2</b>	2,278	<b>11</b>	2,808	<b>20</b>	3,494	<b>L2</b>	3,264	Seat	20"	18"	16 1/2" - 20 1/2"
	<b>3</b>	2,324	<b>12</b>	2,871	<b>21</b>	3,573	<b>L3</b>	3,842	Arm			23" - 27"
	<b>COM/4</b>	2,372	<b>13</b>	2,948	<b>22</b>	3,650	<b>L4</b>	4,323	Between arms	21"		
	<b>5</b>	2,434	<b>14</b>	3,027	<b>23</b>	3,806	<b>L5</b>	4,807	<b>Upholstery Requirements: GSGNV17-011</b>			
	<b>6</b>	2,496	<b>15</b>	3,105	<b>24</b>	3,962			Fabric yards			2.4
	<b>7</b>	2,559	<b>16</b>	3,183	<b>25</b>	4,118			Leather feet <sup>2</sup>			40.8
	<b>8</b>	2,621	<b>17</b>	3,260	<b>26</b>	4,274			Shipping weight			45 lbs.
	<b>9</b>	2,684	<b>18</b>	3,339	<b>27</b>	4,431			Cube			24.6

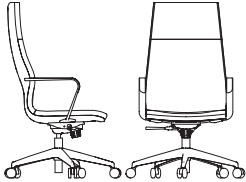

<b>GSGNV17-051</b> Mid Back, Pillow Single Uph	<b>1</b>	2,046	<b>10</b>	2,476	<b>19</b>	3,035	<b>L1</b>	2,505
	<b>2</b>	2,087	<b>11</b>	2,528	<b>20</b>	3,100	<b>L2</b>	2,907
	<b>3</b>	2,125	<b>12</b>	2,580	<b>21</b>	3,165	<b>L3</b>	3,390
	<b>COM/4</b>	2,164	<b>13</b>	2,645	<b>22</b>	3,230	<b>L4</b>	3,791
	<b>5</b>	2,216	<b>14</b>	2,711	<b>23</b>	3,360	<b>L5</b>	4,194
	<b>6</b>	2,268	<b>15</b>	2,775	<b>24</b>	3,490		
	<b>7</b>	2,319	<b>16</b>	2,840	<b>25</b>	3,620		
	<b>8</b>	2,372	<b>17</b>	2,904	<b>26</b>	3,750		
	<b>9</b>	2,425	<b>18</b>	2,969	<b>27</b>	3,880		



Overall	27 1/4"	26 1/2"	33" - 37"
Seat	20"	18"	16 1/2" - 20 1/2"
Arm		23" - 27"	
Between arms	21"		
<b>Upholstery Requirements: GSGNV17-051</b>			
Fabric yards			2
Leather feet <sup>2</sup>			34
Shipping weight			40 lbs.
Cube			19.5

TO ORDER PLEASE SPECIFY THE FOLLOWING:

<input type="text"/>	<input type="text"/>	<input type="text"/>	<input type="text"/>	<input type="text"/>	<input type="text"/>	<input type="text"/>
<b>MODEL NUMBER</b>	<b>ARM</b>	<b>BASE</b>	<b>CONTROL</b>	<b>CASTER</b>	<b>FLAMMABILITY RATING</b>	<b>UPHOLSTERY</b>

- |   |  |   |  |                |   |
|---|--|---|--|----------------|---|
| <b>ABL</b> Full Urethane Arms                   | These seating models are available with the following base option.<br><b>BBL</b> Black base<br><b>BAL</b> Polished Aluminum +\$113 | <b>MP</b> Black, mid tilt, pneumatic lift with lockout. | <b>CH2</b> Hard<br><b>CS2</b> Soft +\$62 | <b>U</b> CTB17 | Please refer to list of available upholstery and leather selections on <a href="http://www.gunlocke.com">www.gunlocke.com</a> |
| <b>API</b> Polished with urethane insert +\$169 |  |   |  |                |   |

Example

GSGNV17-011.ABL.BBL.MP.CH2.U.DOL728  
 GSGNV17-011    ABL    BBL    MP    CH2    U    DOL728  
 MODEL NUMBER    ARM    BASE    CONTROL    CASTER    FLAMMABILITY    UPHOLSTERY

model number	fabric grades						dimensions	W	D	H
<b>GSGNV17-031</b> High Back, Tight Single Uph	<b>1</b>	2,262	<b>10</b>	2,692	<b>19</b>	3,251	<b>L1</b>	2,721	Overall	27 1/4" 27" 42" -46"
	<b>2</b>	2,303	<b>11</b>	2,744	<b>20</b>	3,316	<b>L2</b>	3,123	Seat	20" 18" 16 1/2" - 20 1/2"
	<b>3</b>	2,341	<b>12</b>	2,796	<b>21</b>	3,381	<b>L3</b>	3,606	Arm	23" - 27"
	<b>COM/4</b>	2,380	<b>13</b>	2,861	<b>22</b>	3,446	<b>L4</b>	4,007	Between arms	21"
	<b>5</b>	2,432	<b>14</b>	2,927	<b>23</b>	3,576	<b>L5</b>	4,410	<b>Upholstery Requirements: GSGNV17-031</b>	
	<b>6</b>	2,484	<b>15</b>	2,991	<b>24</b>	3,706			Fabric yards	2
	<b>7</b>	2,535	<b>16</b>	3,056	<b>25</b>	3,836			Leather feet <sup>2</sup>	34
	<b>8</b>	2,588	<b>17</b>	3,120	<b>26</b>	3,966			Shipping weight	45 lbs.
	<b>9</b>	2,641	<b>18</b>	3,185	<b>27</b>	4,096			Cube	24.6

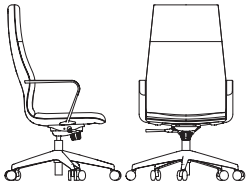

<b>GSGNV17-071</b> Mid Back, Tight Single Uph	<b>1</b>	2,075	<b>10</b>	2,483	<b>19</b>	3,015	<b>L1</b>	2,511	Overall	27 1/4" 26 1/2" 33" - 37"
	<b>2</b>	2,113	<b>11</b>	2,533	<b>20</b>	3,077	<b>L2</b>	2,893	Seat	20" 18" 16 1/2" - 20 1/2"
	<b>3</b>	2,150	<b>12</b>	2,582	<b>21</b>	3,138	<b>L3</b>	3,352	Arm	23" - 27"
	<b>COM/4</b>	2,187	<b>13</b>	2,644	<b>22</b>	3,200	<b>L4</b>	3,733	Between arms	21"
	<b>5</b>	2,236	<b>14</b>	2,706	<b>23</b>	3,323	<b>L5</b>	4,115	<b>Upholstery Requirements: GSGNV17-071</b>	
	<b>6</b>	2,286	<b>15</b>	2,768	<b>24</b>	3,446			Fabric yards	1.9
	<b>7</b>	2,335	<b>16</b>	2,829	<b>25</b>	3,570			Leather feet <sup>2</sup>	32.3
	<b>8</b>	2,384	<b>17</b>	2,891	<b>26</b>	3,694			Shipping weight	40 lbs.
	<b>9</b>	2,434	<b>18</b>	2,953	<b>27</b>	3,817			Cube	19.5



TO ORDER PLEASE SPECIFY THE FOLLOWING:

<input type="text"/>	<input type="text"/>	<input type="text"/>	<input type="text"/>	<input type="text"/>	<input type="text"/>	<input type="text"/>
<b>MODEL NUMBER</b>	<b>ARM</b>	<b>BASE</b>	<b>CONTROL</b>	<b>CASTER</b>	<b>FLAMMABILITY RATING</b>	<b>FABRIC</b>
	<b>ABL</b> Full Urethane Arms <b>API</b> Polished with urethane insert +\$169	These seating models are available with the following base option. <b>BBL</b> Black base <b>BAL</b> Polished Aluminum +\$113	<b>MP</b> Black, mid tilt, pneumatic lift with lockout.	<b>CH2</b> Hard <b>CS2</b> Soft +\$62	<b>U</b> CTB117	Please refer to list of available upholstery and leather selections on <a href="http://www.gunlocke.com">www.gunlocke.com</a>

Example

GSGNV17-031.ABL.BBL.MP.CH2.U.DOL728  
 GSGNV17-031 ABL BBL MP CH2 U DOL728  
 MODEL NUMBER ARM BASE CONTROL CASTER FLAMMABILITY UPHOLSTERY

model number	fabric grades						dimensions	W	D	H		
<b>GK2800</b> High back, fully upholstered, fixed arms	<b>1</b>	3,567	<b>10</b>	4,019	<b>19</b>	4,606	<b>L1</b>	4,050	Overall	26 1/2"	23 1/2"	43 1/2" - 47 1/2"
	<b>2</b>	3,609	<b>11</b>	4,073	<b>20</b>	4,674	<b>L2</b>	4,472	Seat		18 1/2"	17 3/4" - 21 1/2"
	<b>3</b>	3,650	<b>12</b>	4,127	<b>21</b>	4,743	<b>L3</b>	4,979	Arm			27 15/16"
	<b>COM/4</b>	3,690	<b>13</b>	4,196	<b>22</b>	4,810	<b>L4</b>	5,399	Between arms	19 1/2"		
	<b>5</b>	3,746	<b>14</b>	4,264	<b>23</b>	4,947	<b>L5</b>	5,821				
	<b>6</b>	3,800	<b>15</b>	4,333	<b>24</b>	5,084						
	<b>7</b>	3,854	<b>16</b>	4,401	<b>25</b>	5,220						
	<b>8</b>	3,909	<b>17</b>	4,469	<b>26</b>	5,357						
	<b>9</b>	3,964	<b>18</b>	4,537	<b>27</b>	5,493						

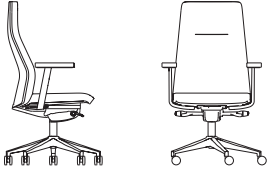

**Upholstery Requirements: GK2800**

Fabric yards	2.1
Leather feet <sup>2</sup>	35.7
Shipping weight	58 lb.
Cube	24

model number	fabric grades						dimensions	W	D	H		
<b>GK2804</b> High back, with Wood Décor, fixed arms	<b>1</b>	4,500	<b>10</b>	4,952	<b>19</b>	5,539	<b>L1</b>	4,983	Overall	26 1/2"	23 1/2"	43 1/2" - 47 1/2"
	<b>2</b>	4,542	<b>11</b>	5,006	<b>20</b>	5,607	<b>L2</b>	5,405	Seat		18"	17 3/4" - 21 3/4"
	<b>3</b>	4,583	<b>12</b>	5,060	<b>21</b>	5,676	<b>L3</b>	5,912	Arm			27 15/16"
	<b>COM/4</b>	4,623	<b>13</b>	5,129	<b>22</b>	5,743	<b>L4</b>	6,332	Between arms	19 1/2"		
	<b>5</b>	4,679	<b>14</b>	5,197	<b>23</b>	5,880	<b>L5</b>	6,754				
	<b>6</b>	4,733	<b>15</b>	5,266	<b>24</b>	6,017						
	<b>7</b>	4,787	<b>16</b>	5,334	<b>25</b>	6,153						
	<b>8</b>	4,842	<b>17</b>	5,402	<b>26</b>	6,290						
	<b>9</b>	4,897	<b>18</b>	5,470	<b>27</b>	6,426						



**Upholstery Requirements: GK2804**

Fabric yards	2.1
Leather feet <sup>2</sup>	35.7
Shipping weight	61 lb.
Cube	24

TO ORDER PLEASE SPECIFY THE FOLLOWING:

MODEL NUMBER	METAL FINISH	CASTER	SEAT DEPTH ADJUSTMENT	ARM CAP	WOOD DECOR FINISH	FLAMMABILITY RATING	UPHOLSTERY
	Specified finish applies to Base, and Metal J-bar cover. Metal J-Bar cover located on back of wood décor (models GK2812 and GK2814). Adjustable Arm is available in Black only. <b>BBL</b> Black <b>BSL</b> Silver <b>BAL</b> Polished Aluminum <b>+\$394</b>	<b>CH2</b> Hard <b>CS2</b> Soft <b>+\$62</b>	These seating models are available with the following seat depth adjustment option. Please specify by adding suffix to model number. <b>NSDA</b> No Seat Depth-Adjustment <b>SDA</b> Seat Depth Adjustment <b>+\$74</b>	Please specify by adding suffix to model number. <b>ARMUPH</b> Upholstered Arm <b>+\$197</b> <b>ARMU</b> Urethane Arm	<b>Note:</b> Required for GK2804 only <b>Cherry finishes on Maple</b> <b>Walnut finishes on Maple</b> <b>Maple finishes on Maple</b> <b>Oak finishes on Maple</b> Please refer to the Olla product page on <a href="http://www.gunlocke.com">www.gunlocke.com</a> for standard finish options. <i>Natural Cherry 222 not available on Cherry.</i>	<b>U</b> <b>CTB117</b>	Please refer to list of available upholstery and leather selections on <a href="http://www.gunlocke.com">www.gunlocke.com</a>

Example

GK2804.BAL.CH2.SDA.ARMUPH.NC701.U.DOL728

GK2804	BAL	CH2	SDA	ARMUPH	NC701	U	DOL728
MODEL NUMBER	METAL FINISH	CASTER	SEAT DEPTH ADJUSTMENT	ARM CAP	WOOD DECOR FINISH	FLAMMABILITY	UPHOLSTERY

# OLLA EXECUTIVE

Conference | Fixed Arm | Mid Back

Seating  
02/24

model number	fabric grades						dimensions	W	D	H		
<b>GK2802</b> Mid-back, fully upholstered, fixed arms	<b>1</b>	3,309	<b>10</b>	3,696	<b>19</b>	4,199	<b>L1</b>	3,724	Overall	26 1/2"	23 1/2"	39"- 43"
	<b>2</b>	3,345	<b>11</b>	3,743	<b>20</b>	4,257	<b>L2</b>	4,085	Seat		18"	17 3/4"- 21 3/4"
	<b>3</b>	3,381	<b>12</b>	3,789	<b>21</b>	4,316	<b>L3</b>	4,518	Arm			27 15/16"
	<b>COM/4</b>	3,416	<b>13</b>	3,848	<b>22</b>	4,375	<b>L4</b>	4,879	Between arms	19 1/2"		
	<b>5</b>	3,462	<b>14</b>	3,906	<b>23</b>	4,492	<b>L5</b>	5,241				
	<b>6</b>	3,508	<b>15</b>	3,966	<b>24</b>	4,609						
	<b>7</b>	3,556	<b>16</b>	4,024	<b>25</b>	4,726						
	<b>8</b>	3,603	<b>17</b>	4,082	<b>26</b>	4,842						
	<b>9</b>	3,649	<b>18</b>	4,141	<b>27</b>	4,960						



**Upholstery Requirements: GK2802**

Fabric yards	1.8
Leather feet <sup>2</sup>	30.6
Shipping weight	57 lb.
Cube	24

<b>GK2806</b> Mid-back, with Wood Décor, fixed arms	<b>1</b>	4,171	<b>10</b>	4,558	<b>19</b>	5,061	<b>L1</b>	4,586
	<b>2</b>	4,207	<b>11</b>	4,605	<b>20</b>	5,119	<b>L2</b>	4,947
	<b>3</b>	4,243	<b>12</b>	4,651	<b>21</b>	5,178	<b>L3</b>	5,380
	<b>COM/4</b>	4,278	<b>13</b>	4,710	<b>22</b>	5,237	<b>L4</b>	5,741
	<b>5</b>	4,324	<b>14</b>	4,768	<b>23</b>	5,354	<b>L5</b>	6,103
	<b>6</b>	4,370	<b>15</b>	4,828	<b>24</b>	5,471		
	<b>7</b>	4,418	<b>16</b>	4,886	<b>25</b>	5,588		
	<b>8</b>	4,465	<b>17</b>	4,944	<b>26</b>	5,704		
	<b>9</b>	4,511	<b>18</b>	5,003	<b>27</b>	5,822		



Overall	26 1/2"	23 1/2"	39"- 43"
Seat		18"	17 3/4"- 21 3/4"
Arm			27 15/16"
Between arms	19 1/2"		

**Upholstery Requirements: GK2806**

Fabric yards	1.8
Leather feet <sup>2</sup>	30.6
Shipping weight	60 lb.
Cube	24

## TO ORDER PLEASE SPECIFY THE FOLLOWING:

MODEL NUMBER	METAL FINISH	CASTER	SEAT DEPTH ADJUSTMENT	ARM CAP	WOOD DECOR FINISH	FLAMMABILITY RATING	UPHOLSTERY
	Specified finish applies to Base, and Metal J-bar cover. Metal J-Bar cover located on back of wood décor (models GK2812 and GK2814). Adjustable Arm is available in Black only. <b>BBL</b> Black <b>BSL</b> Silver <b>BAL</b> Polished Aluminum <b>+\$394</b>	<b>CH2</b> Hard <b>CS2</b> Soft <b>+\$62</b>	These seating models are available with the following seat depth adjustment option. Please specify by adding suffix to model number. <b>NSDA</b> No Seat Depth Adjustment <b>SDA</b> Seat Depth Adjustment <b>+\$74</b>	Please specify by adding suffix to model number. <b>ARMUPH</b> Upholstered Arm <b>+\$197</b> <b>ARMU</b> Urethane Arm	<b>Note:</b> Required for GK2806 only <b>Cherry finishes on Maple</b> <b>Walnut finishes on Maple</b> <b>Maple finishes on Maple</b> <b>Oak finishes on Maple</b> Please refer to the Olla product page on <a href="http://www.gunlocke.com">www.gunlocke.com</a> for standard finish options. <i>Natural Cherry 222 not available on Cherry.</i>	<b>U</b> <b>CTB117</b>	Please refer to list of available upholstery and leather selections on <a href="http://www.gunlocke.com">www.gunlocke.com</a>

## Example

GK2806.BAL.CH2.SDA.ARMUPH.NC701.U.DOL728

MODEL NUMBER	METAL FINISH	CASTER	SEAT DEPTH ADJUSTMENT	ARM CAP	WOOD DECOR FINISH	FLAMMABILITY	UPHOLSTERY
GK2806	BAL	CH2	SDA	ARMUPH	NC701	U	DOL728

model number	fabric grades						dimensions	W	D	H		
<b>GK2808</b> High back, fully upholstered, adjustable arms	<b>1</b>	3,567	<b>10</b>	4,019	<b>19</b>	4,606	<b>L1</b>	4,050	Overall	26 1/2"	23 1/2"	43 1/2" - 47 1/2"
	<b>2</b>	3,609	<b>11</b>	4,073	<b>20</b>	4,674	<b>L2</b>	4,472	Seat		18 1/2"	17 3/4" - 21 3/4"
	<b>3</b>	3,650	<b>12</b>	4,127	<b>21</b>	4,743	<b>L3</b>	4,979	Arm			25 1/2" - 29 1/2"
	<b>COM/4</b>	3,690	<b>13</b>	4,196	<b>22</b>	4,810	<b>L4</b>	5,399	Between arms	19 1/2"		
	<b>5</b>	3,746	<b>14</b>	4,264	<b>23</b>	4,947	<b>L5</b>	5,821	<b>Upholstery Requirements: GK2808</b>			
	<b>6</b>	3,800	<b>15</b>	4,333	<b>24</b>	5,084			Fabric yards		2.1	
	<b>7</b>	3,854	<b>16</b>	4,401	<b>25</b>	5,220			Leather feet <sup>2</sup>		35.7	
	<b>8</b>	3,909	<b>17</b>	4,469	<b>26</b>	5,357			Shipping weight		57 lb.	
	<b>9</b>	3,964	<b>18</b>	4,537	<b>27</b>	5,493			Cube		24	



<b>GK2812</b> High back, with Wood Décor, adjustable arms	<b>1</b>	4,500	<b>10</b>	4,952	<b>19</b>	5,539	<b>L1</b>	4,983	Overall	26 1/2"	23 1/2"	43 1/2" - 47 1/2"
	<b>2</b>	4,542	<b>11</b>	5,006	<b>20</b>	5,607	<b>L2</b>	5,405	Seat		18"	17 3/4" - 21 3/4"
	<b>3</b>	4,583	<b>12</b>	5,060	<b>21</b>	5,676	<b>L3</b>	5,912	Arm			25 1/2" - 29 1/2"
	<b>COM/4</b>	4,623	<b>13</b>	5,129	<b>22</b>	5,743	<b>L4</b>	6,332	Between arms	19 1/2"		
	<b>5</b>	4,679	<b>14</b>	5,197	<b>23</b>	5,880	<b>L5</b>	6,754	<b>Upholstery Requirements: GK2812</b>			
	<b>6</b>	4,733	<b>15</b>	5,266	<b>24</b>	6,017			Fabric yards		2.1	
	<b>7</b>	4,787	<b>16</b>	5,334	<b>25</b>	6,153			Leather feet <sup>2</sup>		35.7	
	<b>8</b>	4,842	<b>17</b>	5,402	<b>26</b>	6,290			Shipping weight		60 lb.	
	<b>9</b>	4,897	<b>18</b>	5,470	<b>27</b>	6,426			Cube		24	

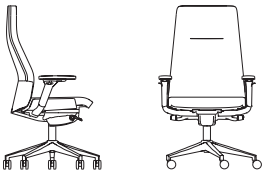

TO ORDER PLEASE SPECIFY THE FOLLOWING:

MODEL NUMBER	METAL FINISH	CASTER	SEAT DEPTH ADJUSTMENT	ARM CAP	WOOD DECOR FINISH	FLAMMABILITY RATING	UPHOLSTERY
<input type="text"/>	<input type="text"/>	<input type="text"/>	<input type="text"/>	<input type="text"/>	<input type="text"/>	<input type="text"/>	<input type="text"/>
Specified finish applies to Base, and Metal J-bar cover. Metal J-Bar cover located on back of wood décor (models GK2812 and GK2814). Adjustable Arm is available in Black only.	<b>CH2</b> Hard <b>CS2</b> Soft <b>+\$62</b>	These seating models are available with the following seat depth adjustment option. Please specify by adding suffix to model number. <b>NSDA</b> No Seat Depth-Adjustment <b>SDA</b> Seat Depth Adjustment <b>+\$74</b>	Please specify by adding suffix to model number. <b>ARMUPH</b> Upholstered Arm <b>+\$197</b> <b>ARMU</b> Urethane Arm	<b>Note:</b> Required for GK2812 only <b>Cherry finishes on Maple</b> <b>Walnut finishes on Maple</b> <b>Maple finishes on Maple</b> <b>Oak finishes on Maple</b> Please refer to the Olla product page on <a href="http://www.gunlocke.com">www.gunlocke.com</a> for standard finish options. <i>Natural Cherry 222 not available on Cherry.</i>	<b>U</b> <b>CTB117</b>	Please refer to list of available upholstery and leather selections on <a href="http://www.gunlocke.com">www.gunlocke.com</a>	

Example

GK2812.BAL.CH2.SDA.ARMUPH.NC701.U.DOL728

MODEL NUMBER	METAL FINISH	CASTER	SEAT DEPTH ADJUSTMENT	ARM CAP	WOOD DECOR FINISH	FLAMMABILITY	UPHOLSTERY
GK2812	BAL	CH2	SDA	ARMUPH	NC701	U	DOL728

# OLLA EXECUTIVE

Manager | Adjustable Arm | Mid Back

Seating  
02/24

model number	fabric grades							dimensions	W	D	H	
<b>GK2810</b> Mid-back, fully upholstered, adjustable arms	<b>1</b>	3,309	<b>10</b>	3,696	<b>19</b>	4,199	<b>L1</b>	3,724	Overall	26 1/2"	23 1/2"	39"- 43"
	<b>2</b>	3,345	<b>11</b>	3,743	<b>20</b>	4,257	<b>L2</b>	4,085	Seat		18"	17 3/4"- 21 3/4"
	<b>3</b>	3,381	<b>12</b>	3,789	<b>21</b>	4,316	<b>L3</b>	4,518	Arm			25 1/2"- 29 1/2"
	<b>COM/4</b>	3,416	<b>13</b>	3,848	<b>22</b>	4,375	<b>L4</b>	4,879	Between arms	19 1/2"		
	<b>5</b>	3,462	<b>14</b>	3,906	<b>23</b>	4,492	<b>L5</b>	5,241	<b>Upholstery Requirements: GK2810</b>			
	<b>6</b>	3,508	<b>15</b>	3,966	<b>24</b>	4,609			Fabric yards		1.8	
	<b>7</b>	3,556	<b>16</b>	4,024	<b>25</b>	4,726			Leather feet <sup>2</sup>		30.6	
	<b>8</b>	3,603	<b>17</b>	4,082	<b>26</b>	4,842			Shipping weight		56 lb.	
	<b>9</b>	3,649	<b>18</b>	4,141	<b>27</b>	4,960			Cube		24	



<b>GK2814</b> with Wood Décor, adjustable arms	<b>1</b>	4,171	<b>10</b>	4,558	<b>19</b>	5,061	<b>L1</b>	4,586	Overall	26 1/2"	23 1/2"	39"- 43"
	<b>2</b>	4,207	<b>11</b>	4,605	<b>20</b>	5,119	<b>L2</b>	4,947	Seat		18"	17 3/4"- 21 3/4"
	<b>3</b>	4,243	<b>12</b>	4,651	<b>21</b>	5,178	<b>L3</b>	5,380	Arm			25 1/2"- 29 1/2"
	<b>COM/4</b>	4,278	<b>13</b>	4,710	<b>22</b>	5,237	<b>L4</b>	5,741	Between arms	19 1/2"		
	<b>5</b>	4,324	<b>14</b>	4,768	<b>23</b>	5,354	<b>L5</b>	6,103	<b>Upholstery Requirements: GK2814</b>			
	<b>6</b>	4,370	<b>15</b>	4,828	<b>24</b>	5,471			Fabric yards		1.8	
	<b>7</b>	4,418	<b>16</b>	4,886	<b>25</b>	5,588			Leather feet <sup>2</sup>		30.6	
	<b>8</b>	4,465	<b>17</b>	4,944	<b>26</b>	5,704			Shipping weight		59 lb.	
	<b>9</b>	4,511	<b>18</b>	5,003	<b>27</b>	5,822			Cube		24	



## TO ORDER PLEASE SPECIFY THE FOLLOWING:

MODEL NUMBER	METAL FINISH	CASTER	SEAT DEPTH ADJUSTMENT	ARM CAP	WOOD DECOR FINISH	FLAMMABILITY RATING	UPHOLSTERY
	Specified finish applies to Base, and Metal J-bar cover. Metal J-Bar cover located on back of wood décor (models GK2812 and GK2814). Adjustable Arm is available in Black only. <b>BBL</b> Black <b>BSL</b> Silver <b>BAL</b> Polished Aluminum <b>+\$394</b>	<b>CH2</b> Hard <b>CS2</b> Soft <b>+\$62</b>	These seating models are available with the following seat depth adjustment option. Please specify by adding suffix to model number. <b>NSDA</b> No Seat Depth-Adjustment <b>SDA</b> Seat Depth Adjustment <b>+\$74</b>	Please specify by adding suffix to model number. <b>ARMUPH</b> Upholstered Arm <b>+\$197</b> <b>ARMU</b> Urethane Arm	<b>Note:</b> Required for GK2814 only <b>Cherry finishes on Maple</b> <b>Walnut finishes on Maple</b> <b>Maple finishes on Maple</b> <b>Oak finishes on Maple</b> Please refer to the Olla product page on <a href="http://www.gunlocke.com">www.gunlocke.com</a> for standard finish options. <i>Natural Cherry 222 not available on Cherry.</i>	<b>U</b> <b>CTB117</b>	Please refer to list of available upholstery and leather selections on <a href="http://www.gunlocke.com">www.gunlocke.com</a>

### Example

GK2814.BAL.CH2.SDA.ARMUPH.NC701.U.DOL728

MODEL NUMBER	METAL FINISH	CASTER	SEAT DEPTH ADJUSTMENT	ARM CAP	WOOD DECOR FINISH	FLAMMABILITY	UPHOLSTERY
GK2814	BAL	CH2	SDA	ARMUPH	NC701	U	DOL728

model number	fabric grades								dimensions	W	D	H
<b>GK3006N</b> Swivel	<b>1</b>	9,560	<b>10</b>	10,505	<b>19</b>	11,735	<b>L1</b>	10,570	Overall	28"	35"	45" - 47 1/2"
	<b>2</b>	9,646	<b>11</b>	10,619	<b>20</b>	11,877	<b>L2</b>	11,454	Seat		18 1/2"	19 1/2" - 22"
	<b>3</b>	9,733	<b>12</b>	10,733	<b>21</b>	12,021	<b>L3</b>	12,515	Arm			29 1/2" - 32"
	<b>COM/4</b>	9,818	<b>13</b>	10,877	<b>22</b>	12,163	<b>L4</b>	13,398	Between arms	20"		
	<b>5</b>	9,932	<b>14</b>	11,019	<b>23</b>	12,450	<b>L5</b>	14,282				
	<b>6</b>	10,047	<b>15</b>	11,163	<b>24</b>	12,736						
	<b>7</b>	10,162	<b>16</b>	11,305	<b>25</b>	13,021						
	<b>8</b>	10,276	<b>17</b>	11,448	<b>26</b>	13,308						
	<b>9</b>	10,391	<b>18</b>	11,592	<b>27</b>	13,594						

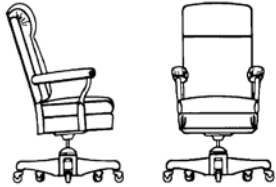

**Upholstery Requirements: GK3006N**

Fabric yards	4.4
Leather feet <sup>2</sup>	74.8
Shipping weight	95 lbs.
Cube	38.6

TO ORDER PLEASE SPECIFY THE FOLLOWING:

<input type="text"/>	<input type="text"/>	<input type="text"/>	<input type="text"/>	<input type="text"/>
<b>MODEL NUMBER</b>	<b>NAIL TRIM</b>	<b>FINISH</b>	<b>FLAMMABILITY RATING</b>	<b>UPHOLSTERY</b>

Standard nail trim is available in two varieties. Please specify by adding suffix to model number.  
**NABR**  
Antique brass

**Cherry finishes on Maple**  
**Walnut finishes on Maple**  
**Oak finishes on Maple**  
**Maple finishes on Maple**  
Please refer to the Washington Series product page on [www.gunlocke.com](http://www.gunlocke.com) for standard finish options.

**U** CTB117

Please refer to list of available upholstery and leather selections on [www.gunlocke.com](http://www.gunlocke.com)

Example

**GK3006N.NABR.215.U.DOL728**

GK3006N	NABR	215	U	DOL728
<b>MODEL NUMBER</b>	<b>NAIL TRIM</b>	<b>FINISH</b>	<b>FLAMMABILITY</b>	<b>UPHOLSTERY</b>





Lounge Seating . . . . .	81-171
Product Specifications. . . . .	82
Calm Lounge Ordering Option Codes. . . . .	84-85
Calm . . . . .	86-104
Ciji . . . . .	105-165
Iris . . . . .	166-171

# LOUNGE SEATING

## Product Specifications

### CALM

**Frame:** 3/4" x 3/4" steel legs with 3/4" x 2" cross rails, provides consistent 3/4" reveal on all sides.

**Deck Frame:** Constructed of 3/4" upholstery-grade plywood, assembled with box joint joinery using corner blocks, glue and fasteners.

**Seat:** Plywood seat frame foundation with stretched sheetwebbing suspension, covered with a 1" crown patch, and dual-layer 4 1/4" foam and dacron.

**Back:** 2"D top surface tapers to 6 1/2"D lumbar thickness for back support structure.

**Back Pillows:** 5" thick molded foam pillows, with tapered edges, wrapped in dacron. Has black velour panel on lower section of back surface, with HBF Heart-felt back panel used for attachment.

**Note:** Corner units must be used for modular turns when back support is needed – features two 5" pillows.

**Arms:** 2"W top surface tapers to 3 1/2"W at bottom of arm.

**Arm Pillows:** 3" thick molded foam pillows with tapered edges, wrapped in dacron. Has black velour panel at lower section of back surface, with HBF Heart-felt back panel used for attachment.

**Ganging Bracket:** Black powder coated steel bracket, with slots to mount into 4 t-nuts (order bracket separately).

**Glides:** 1/2" adjustable, threaded steel and nylon leveling glides.

#### BIFMA Rating:

ANSI/BIFMA X5.4 2020  
(275lb Weight Rating)

### CIJI

**Frame:** Upholstery-grade plywood built, box joint construction (using corner blocks, glue and fasteners).

**Seat & Back Cushions:** Dacron and dual-layer foam over plywood base with flexible foundation, upholstered.

**Wood Legs:** Tapered, three-sided solid maple. Nickel-plated steel glide 5/8" diameter.

**Metal Legs:** Anodized extruded aluminum. Nickel-plated steel glide 3/4" diameter.

**Stitch Detail Option:** Quilted, single stitch. Available on plain fabrics only.

**Ganging Bracket:** Plastic male-female alligator clip, 2 pair per unit. (Order separately).

**Note:** Specify configuration of seating of seating as if you were seated.

Replacement arm can be installed left or right. The replacement seat is for single seat.

Order multiple units for two and three seat lounges and benches.

#### BIFMA Rating:

ANSI/BIFMA X5.4 2020  
(275lb Weight Rating)

### IRIS

**Lounge Bucket:** Fiberglass-reinforced rigid urethane, with overmolded foam and 1/2" foam topper, wrapped in dacron. Outside edges wrapped in high-resiliency foam.

**Headrest:** Fiberglass-reinforced rigid urethane, with overmolded foam, wrapped in dacron. Contains two pocketed steel rods to secure headrest to lounge bucket. Outside edge wrapped in high-resiliency foam.

**Wood Legs:** Four turned maple or ash hardwood legs, secured into steel assembly with mortise-and-tenon leg attachment. Legs mechanically fastened into steel assembly, inset into rigid urethane bucket. Wood legs taper narrower from top to bottom.

**Glides:** Nickel-plated steel.

**Metal Lounge Base:** Four-star metal base, standard with return-to-center cylinder, at a fixed seat height. Comes with low-profile swivel tilt control, with tilt lockout.

**Metal Ottoman Base:** Four-star metal base, standard with fixed post, at a fixed seat height.

#### BIFMA Rating:

ANSI/BIFMA X5.4 2020  
(275lb Weight Rating)

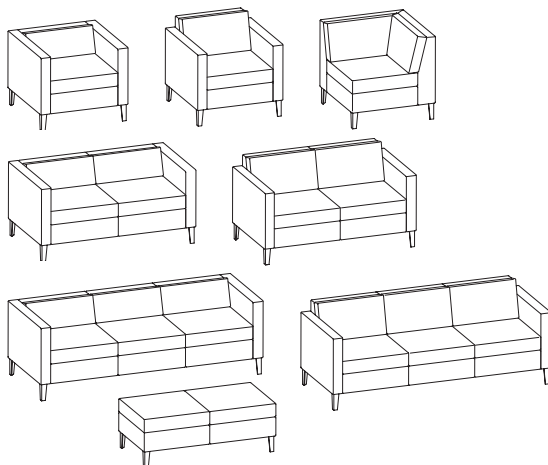



**WOOD FINISH**

**SELECT VENEERS**

**NATURAL CHERRY**

Cinnamon Cherry	<b>NC260</b>
Lowell Ash	<b>NC394</b>
Medium Red Cherry	<b>NC512</b>
Light Cherry	<b>NC701</b>
Shaker Cherry	<b>NC774</b>
Burnished Cherry	<b>NC777</b>

**NATURAL PLAIN SLICED MAPLE**

Natural Maple	<b>NE800</b>
Harvest Maple	<b>NE856</b>

**NATURAL WALNUT**

Light Walnut	<b>NT601</b>
Skyline Walnut	<b>NT625</b>
Nutmeg Walnut	<b>NT629</b>
Pinnacle Walnut	<b>NT679</b>
Sumatra Walnut	<b>NT693</b>
Ebony Walnut	<b>NT555</b>
Florence Walnut	<b>NT579</b>

**VENEER 1 (SELECT)**

**STRATAWOOD CHERRY**

Cinnamon/Biltmore	<b>SC260</b>
Lowell Ash	<b>SC394</b>
Clear	<b>SC700</b>
Light	<b>SC701</b>
Shaker	<b>SC774</b>
Burnished	<b>SC777</b>

**STRATAWOOD MAPLE**

Clear Maple	<b>SE800</b>
Harvest	<b>SE856</b>
Phantom Ecrú	<b>SE912</b>
(Use OP TopFin Only)	
Beigewood	<b>SE878</b>
Field Elm	<b>SE599</b>
Belair	<b>SE934</b>

**STRATAWOOD WALNUT**

Light	<b>ST601</b>
Skyline	<b>ST625</b>
Pinnacle	<b>ST679</b>
Sumatra	<b>ST693</b>
Florence Walnut	<b>ST579</b>

**STRATAWOOD OAK**

Clear	<b>SF300</b>
Dark	<b>SF331</b>

**STRATAWOOD SILVER OAK**

Clear	<b>SB100</b>
Portico Teak	<b>SB150</b>

**STRATAWOOD WASHED WALNUT**

Clear	<b>SW600</b>
Smoked Onyx	<b>SW697</b>
Smoked Grey	<b>SW612</b>

**PREMIER VENEERS**

**NATURAL QUARTER CUT WALNUT**

Light Walnut	<b>QT601</b>
Skyline Walnut	<b>QT625</b>
Nutmeg Walnut	<b>QT629</b>
Pinnacle Walnut	<b>QT679</b>
Sumatra Walnut	<b>QT693</b>
Ebony Walnut	<b>QT555</b>
Florence Walnut	<b>QT579</b>

**NATURAL RIFT CUT OAK**

Light Rift Cut Oak	<b>RF301</b>
Dark Rift Cut Oak	<b>RF331</b>
Phantom Ecrú	<b>RF912</b>
Fawn Cypress	<b>RF108</b>

**UV TOP FINISH**

Worksurfaces feature two low emitting UV finish options that enhance the beauty of natural wood and ensures the depth, clarity, color consistency and durability throughout the life of the product

Full-Fill Cleartech (upcharge)	<b>FF</b>
Open Pore Low Sheen	<b>OP</b>

Finish options are subject to change. For new finish information, visit us online [www.gunlocke.com/finishsystem](http://www.gunlocke.com/finishsystem)

**LAMINATE**

---

**SELECT LAMINATES**

**SOLID – Grade 1**

Designer White 15051	<b>LDW1</b>
Loft – Grey Cloud	<b>LM11</b>
Charcoal/Flint	<b>LM16</b>

**WOODGRAIN – Grade 1**

Natural Maple	<b>LWD</b>
Harvest Maple	<b>C</b>
Shaker Cherry	<b>LW7C</b>
Biltmore Cherry	<b>COGN</b>
Pinnacle Walnut	<b>PINC</b>
Florence Walnut	<b>LFW1</b>
Kingswood Walnut	<b>LKI1</b>
Neo Walnut	<b>LNV1</b>

**WOODGRAIN – GRADE 2**

Fawn Cypress	<b>LFC1</b>
Lowell Ash	<b>LLA1</b>
Natural Recon	<b>LNR1</b>
Phantom Ecu	<b>LPE1</b>
Portico Teak	<b>LPT1</b>
Skyline Walnut	<b>LSW1</b>
Veranda Teak	<b>LVT1</b>

**GLASS (12mm soft etched)**

---

Ice White -Designer White	<b>GWH</b>
Black	<b>GBK</b>
Muslin	<b>GML</b>

**SOLID SURFACE (12mm solid)**

---

Designer White	<b>SDW4</b>
Frosty White	<b>SFW3</b>
Night Stars	<b>SNS5</b>
Masoned Concrete	<b>SMC2</b>
Monte Amiata	<b>SMA1</b>

Finish options are subject to change. For new finish information, visit us online [www.gunlocke.com/finishsystem](http://www.gunlocke.com/finishsystem)

# CALM

## One Seat Lounge with Arms

Seating  
02/24

model number                      fabric grades                      dimensions      W      D      H

### GLGB17-011

One seat, with arms

1 4,342

Overall	32"	32"	30"
Seat	18"	21"	17"
Arm			30"
Between arms	18" - 21"		

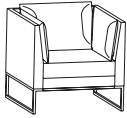

### Upholstery Requirements: GLGB17-011

	Dual Upholstery	
Fabric yds	Cushion 4	Frame 5
Leather ft <sup>2</sup>	Cushion 100	Frame 125
Shipping weight	95 lbs.	
Cube	23.4	

### Cushion

1	10	833	19	1,919	L1	1,404	
2	76	11	935	20	2,045	L2	2,552
3	152	12	1,035	21	2,172	L3	3,929
COM/4	227	13	1,161	22	2,297	L4	5,077
5	329	14	1,288	23	2,550	L5	6,223
6	430	15	1,414	24	2,803		
7	530	16	1,541	25	3,055		
8	632	17	1,666	26	3,308		
9	733	18	1,792	27	3,559		

To calculate price of lounge with different fabric for cushion and frame; start with Grade 1 price, add appropriate grade price located in second row for cushion, and last add appropriate grade price located in third row for frame to the sum of the Grade 1 and cushion price.

**Example: Grade 1 \$4,342 + grade 4 fabric cushion \$227 + grade 2 fabric frame \$95 = \$4,664**

### Frame

1	10	1,041	19	2,398	L1	1,756	
2	95	11	1,168	20	2,557	L2	3,190
3	190	12	1,294	21	2,714	L3	4,911
COM/4	285	13	1,452	22	2,872	L4	6,345
5	410	14	1,609	23	3,188	L5	7,780
6	537	15	1,767	24	3,503		
7	663	16	1,925	25	3,819		
8	790	17	2,083	26	4,134		
9	915	18	2,240	27	4,450		

Select upholstery for everything else other than the seat and back cushions (the outside back, arms, sides, seat frame). You can specify the same fabric as the cushions or select other fabric.

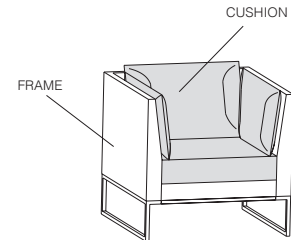

### TO ORDER PLEASE SPECIFY THE FOLLOWING:

<input type="text"/>	<input type="text"/>	<input type="text"/>	<input type="text"/>	<input type="text"/>
<b>MODEL NUMBER</b>	<b>FRAME COLOR</b>	<b>FLAMMABILITY RATING</b>	<b>CUSHION UPHOLSTERY</b>	<b>FRAME UPHOLSTERY</b>
	Polished Chrome Brushed Chrome Steel Black Designer White Matte Gold Silver Solar Black Titanium Bullseye Regatta	PC +\$137 BS +\$137 P71 PJW P8G PR6 P8X P8T PJF P8M	U CTB117	Please refer to list of available upholstery and leather selections on <a href="http://www.gunlocke.com">www.gunlocke.com</a>

### Example

GLGB17-011.PC.U.DOL728.SPNN04				
GLGB17-011	PC	U	DOL728	SPNN04
MODEL NUMBER	FRAME COLOR	FLAMMABILITY	CUSHION UPHOLSTERY	FRAME UPHOLSTERY

model number	fabric grades	dimensions	W	D	H
<b>GLGB17-021</b>	<b>1</b> 3,692	Overall	25"	32"	30"
One seat, armless		Seat	25"	21"	17"



**Upholstery Requirements: GLGB17-021**

Dual Upholstery	
Fabric yds	Cushion 2.2 Frame 2.8
Leather ft <sup>2</sup>	Cushion 55 Frame 70
Shipping weight	130 lbs.
Cube	18.7

Cushion

<b>1</b>	<b>10</b>	458	<b>19</b>	1,056	<b>L1</b>	773	
<b>2</b>	42	<b>11</b>	514	<b>20</b>	1,125	<b>L2</b>	1,404
<b>3</b>	83	<b>12</b>	569	<b>21</b>	1,194	<b>L3</b>	2,161
<b>COM/4</b>	126	<b>13</b>	639	<b>22</b>	1,264	<b>L4</b>	2,792
<b>5</b>	181	<b>14</b>	709	<b>23</b>	1,402	<b>L5</b>	3,423
<b>6</b>	237	<b>15</b>	778	<b>24</b>	1,542		
<b>7</b>	292	<b>16</b>	847	<b>25</b>	1,680		
<b>8</b>	347	<b>17</b>	917	<b>26</b>	1,820		
<b>9</b>	403	<b>18</b>	986	<b>27</b>	1,958		

To calculate price of lounge with different fabric for cushion and frame; start with Grade 1 price, add appropriate grade price located in second row for cushion, and last add appropriate grade price located in third row for frame to the sum of the Grade 1 and cushion price.

**Example: Grade 1 \$3,692 + grade 4 fabric cushion \$126 + grade 2 fabric frame \$54 = \$3,872**

Frame

<b>1</b>	<b>10</b>	584	<b>19</b>	1,343	<b>L1</b>	984	
<b>2</b>	54	<b>11</b>	654	<b>20</b>	1,432	<b>L2</b>	1,787
<b>3</b>	106	<b>12</b>	725	<b>21</b>	1,520	<b>L3</b>	2,751
<b>COM/4</b>	160	<b>13</b>	814	<b>22</b>	1,608	<b>L4</b>	3,554
<b>5</b>	230	<b>14</b>	902	<b>23</b>	1,785	<b>L5</b>	4,357
<b>6</b>	301	<b>15</b>	990	<b>24</b>	1,961		
<b>7</b>	371	<b>16</b>	1,079	<b>25</b>	2,138		
<b>8</b>	442	<b>17</b>	1,167	<b>26</b>	2,316		
<b>9</b>	513	<b>18</b>	1,255	<b>27</b>	2,492		

Select upholstery for everything else other than the seat and back cushions (the outside back, arms, sides, seat frame). You can specify the same fabric as the cushions or select other fabric.

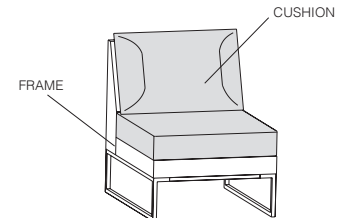

TO ORDER PLEASE SPECIFY THE FOLLOWING:

<input type="text"/>	<input type="text"/>	<input type="text"/>	<input type="text"/>	<input type="text"/>
<b>MODEL NUMBER</b>	<b>FRAME COLOR</b>	<b>FLAMMABILITY RATING</b>	<b>CUSHION UPHOLSTERY</b>	<b>FRAME UPHOLSTERY</b>
	Polished Chrome Brushed Chrome Steel Black Designer White Matte Gold Silver Solar Black Titanium Bullseye Regatta	<b>PC +\$137</b> <b>BS +\$137</b> <b>P71</b> <b>PJW</b> <b>P8G</b> <b>PR6</b> <b>P8X</b> <b>P8T</b> <b>PJF</b> <b>P8M</b>	<b>U CTB117</b>	Please refer to list of available upholstery and leather selections on <a href="http://www.gunlocke.com">www.gunlocke.com</a>

Example

<b>GLGB17-021.PC.U.DOL728.SPNN04</b>				
GLGB17-021	PC	U	DOL728	SPNN04
<b>MODEL NUMBER</b>	<b>FRAME COLOR</b>	<b>FLAMMABILITY</b>	<b>CUSHION UPHOLSTERY</b>	<b>FRAME UPHOLSTERY</b>

# CALM

One Seat Lounge, Arm Left

Seating  
02/24

model number	fabric grades	dimensions	W	D	H
<b>GLGB17-031</b>	<b>1</b> 4,016	Overall	28 1/2"	32"	30"
One seat, arm left		Seat	21 1/2"	21"	17"
		Arm			30"



### Upholstery Requirements: GLGB17-031

Dual Upholstery	
Fabric yds	Cushion 3 Frame 3.5
Leather ft <sup>2</sup>	Cushion 75 Frame 87.5
Shipping weight	140 lbs.
Cube	21.1

Cushion

<b>1</b>	<b>10</b>	625	<b>19</b>	1,439	<b>L1</b>	1,053
<b>2</b>	57	<b>11</b>	701	<b>20</b>	L2	1,915
<b>3</b>	114	<b>12</b>	777	<b>21</b>	L3	2,947
<b>COM/4</b>	171	<b>13</b>	871	<b>22</b>	L4	3,808
<b>5</b>	247	<b>14</b>	966	<b>23</b>	L5	4,668
<b>6</b>	322	<b>15</b>	1,061	<b>24</b>		
<b>7</b>	398	<b>16</b>	1,155	<b>25</b>		
<b>8</b>	474	<b>17</b>	1,250	<b>26</b>		
<b>9</b>	550	<b>18</b>	1,344	<b>27</b>		

To calculate price of lounge with different fabric for cushion and frame; start with Grade 1 price, add appropriate grade price located in second row for cushion, and last add appropriate grade price located in third row for frame to the sum of the Grade 1 and cushion price.

**Example: Grade 1 \$4,016 + grade 4 fabric cushion \$171 + grade 2 fabric frame \$67 = \$4,254**

Select upholstery for everything else other than the seat and back cushions (the outside back, arms, sides, seat frame). You can specify the same fabric as the cushions or select other fabric.

Frame

<b>1</b>	<b>10</b>	730	<b>19</b>	1,679	<b>L1</b>	1,229
<b>2</b>	67	<b>11</b>	818	<b>20</b>	L2	2,233
<b>3</b>	133	<b>12</b>	906	<b>21</b>	L3	3,438
<b>COM/4</b>	199	<b>13</b>	1,016	<b>22</b>	L4	4,442
<b>5</b>	287	<b>14</b>	1,126	<b>23</b>	L5	5,446
<b>6</b>	375	<b>15</b>	1,238	<b>24</b>		
<b>7</b>	465	<b>16</b>	1,348	<b>25</b>		
<b>8</b>	553	<b>17</b>	1,458	<b>26</b>		
<b>9</b>	641	<b>18</b>	1,569	<b>27</b>		

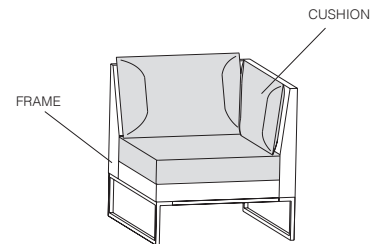

TO ORDER PLEASE SPECIFY THE FOLLOWING:

<input type="text"/>	<input type="text"/>	<input type="text"/>	<input type="text"/>	<input type="text"/>
<b>MODEL NUMBER</b>	<b>FRAME COLOR</b>	<b>FLAMMABILITY RATING</b>	<b>CUSHION UPHOLSTERY</b>	<b>FRAME UPHOLSTERY</b>

Polished Chrome **PC +\$137**  
 Brushed Chrome Steel **BS +\$137**  
 Black **P71**  
 Designer White **PJW**  
 Matte Gold **P8G**  
 Silver **PR6**  
 Solar Black **P8X**  
 Titanium **P8T**  
 Bullseye **PJF**  
 Regatta **P8M**

**U** CTB117

Please refer to list of available upholstery and leather selections on [www.gunlocke.com](http://www.gunlocke.com)

Please refer to list of available upholstery and leather selections on [www.gunlocke.com](http://www.gunlocke.com)

Example

GLGB17-031.PC.U.DOL728.SPNN04				
GLGB17-031	PC	U	DOL728	SPNN04
<b>MODEL NUMBER</b>	<b>FRAME COLOR</b>	<b>FLAMMABILITY</b>	<b>CUSHION UPHOLSTERY</b>	<b>FRAME UPHOLSTERY</b>



model number	fabric grades	dimensions	W	D	H
<b>GLGB17-041</b>	<b>1</b> 4,016	Overall	28 1/2"	32"	30"
One seat, arm right		Seat	21 1/2"	21"	17"
		Arm			30"



**Upholstery Requirements: GLGB17-041**

	Dual Upholstery	
Fabric yds	Cushion 3	Frame 3.5
Leather ft <sup>2</sup>	Cushion 75	Frame 87.5
Shipping weight	140 lbs.	
Cube	21.1	

Cushion

<b>1</b>	<b>10</b>	625	<b>19</b>	1,439	<b>L1</b>	1,053
<b>2</b>	57	<b>11</b>	701	<b>20</b>	L2	1,915
<b>3</b>	114	<b>12</b>	777	<b>21</b>	L3	2,947
<b>COM/4</b>	171	<b>13</b>	871	<b>22</b>	L4	3,808
<b>5</b>	247	<b>14</b>	966	<b>23</b>	L5	4,668
<b>6</b>	322	<b>15</b>	1,061	<b>24</b>		
<b>7</b>	398	<b>16</b>	1,155	<b>25</b>		
<b>8</b>	474	<b>17</b>	1,250	<b>26</b>		
<b>9</b>	550	<b>18</b>	1,344	<b>27</b>		

To calculate price of lounge with different fabric for cushion and frame; start with Grade 1 price, add appropriate grade price located in second row for cushion, and last add appropriate grade price located in third row for frame to the sum of the Grade 1 and cushion price.

**Example: Grade 1 \$4,016 + grade 4 fabric cushion \$171 + grade 2 fabric frame \$67 = \$4,254**

Frame

<b>1</b>	<b>10</b>	730	<b>19</b>	1,679	<b>L1</b>	1,229
<b>2</b>	67	<b>11</b>	818	<b>20</b>	L2	2,233
<b>3</b>	133	<b>12</b>	906	<b>21</b>	L3	3,438
<b>COM/4</b>	199	<b>13</b>	1,016	<b>22</b>	L4	4,442
<b>5</b>	287	<b>14</b>	1,126	<b>23</b>	L5	5,446
<b>6</b>	375	<b>15</b>	1,238	<b>24</b>		
<b>7</b>	465	<b>16</b>	1,348	<b>25</b>		
<b>8</b>	553	<b>17</b>	1,458	<b>26</b>		
<b>9</b>	641	<b>18</b>	1,569	<b>27</b>		

Select upholstery for everything else other than the seat and back cushions (the outside back, arms, sides, seat frame). You can specify the same fabric as the cushions or select other fabric.

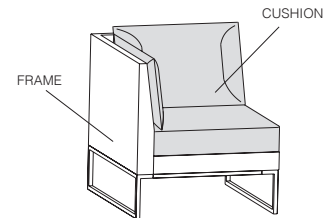

TO ORDER PLEASE SPECIFY THE FOLLOWING:

<input type="text"/>	<input type="text"/>	<input type="text"/>	<input type="text"/>	<input type="text"/>
<b>MODEL NUMBER</b>	<b>FRAME COLOR</b>	<b>FLAMMABILITY RATING</b>	<b>CUSHION UPHOLSTERY</b>	<b>FRAME UPHOLSTERY</b>
	Polished Chrome Brushed Chrome Steel Black Designer White Matte Gold Silver Solar Black Titanium Bullseye Regatta	<b>PC +\$137</b> <b>BS +\$137</b> <b>P71</b> <b>PJW</b> <b>P8G</b> <b>PR6</b> <b>P8X</b> <b>P8T</b> <b>PJF</b> <b>P8M</b>	<b>U CTB117</b>	Please refer to list of available upholstery and leather selections on <a href="http://www.gunlocke.com">www.gunlocke.com</a>
				Please refer to list of available upholstery and leather selections on <a href="http://www.gunlocke.com">www.gunlocke.com</a>

Example

<b>GLGB17-041.PC.U.DOL728.SPNN04</b>				
GLGB17-041	PC	U	DOL728	SPNN04
<b>MODEL NUMBER</b>	<b>FRAME COLOR</b>	<b>FLAMMABILITY</b>	<b>CUSHION UPHOLSTERY</b>	<b>FRAME UPHOLSTERY</b>

# CALM

## Two Seat Lounge with Arms

Seating  
02/24

model number	fabric grades	dimensions	W	D	H
<b>GLGB17-052</b>	<b>1</b> 5,950	Overall	57"	32"	30"
Two seat, with arms		Seat	43"	21"	17"
		Arm			30"
		Between arms	43" - 46"		

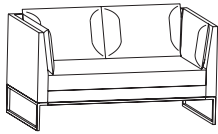

### Upholstery Requirements: GLGB17-052

	Dual Upholstery	
Fabric yds	Cushion 6	Frame 6.5
Leather ft <sup>2</sup>	Cushion 150	Frame 162.5
Shipping weight	190 lbs.	
Cube	40.1	

Cushion	1	10	1,250	19	2,878	L1	2,107
	2	114	11	1,401	20	3,068	L2 3,829
	3	227	12	1,553	21	3,256	L3 5,893
	COM/4	342	13	1,742	22	3,446	L4 7,614
	5	493	14	1,932	23	3,824	L5 9,335
	6	645	15	2,121	24	4,204	
	7	795	16	2,310	25	4,582	
	8	947	17	2,500	26	4,961	
	9	1,098	18	2,688	27	5,339	

To calculate price of lounge with different fabric for cushion and frame; start with Grade 1 price, add appropriate grade price located in second row for cushion, and last add appropriate grade price located in third row for frame to the sum of the Grade 1 and cushion price.

**Example: Grade 1 \$5,950 + grade 4 fabric cushion \$342 + grade 2 fabric frame \$124 = \$6,416**

Select upholstery for everything else other than the seat and back cushions (the outside back, arms, sides, seat frame). You can specify the same fabric as the cushions or select other fabric.

Frame	1	10	1,354	19	3,118	L1	2,283
	2	124	11	1,518	20	3,323	L2 4,147
	3	247	12	1,682	21	3,528	L3 6,385
	COM/4	370	13	1,887	22	3,733	L4 8,249
	5	534	14	2,092	23	4,144	L5 10,114
	6	698	15	2,297	24	4,553	
	7	862	16	2,503	25	4,963	
	8	1,026	17	2,708	26	5,374	
	9	1,190	18	2,913	27	5,784	

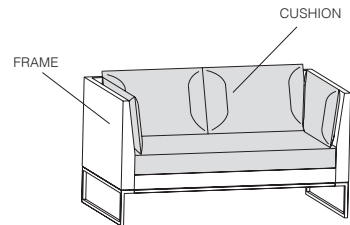

### TO ORDER PLEASE SPECIFY THE FOLLOWING:

<input type="text"/>	<input type="text"/>	<input type="text"/>	<input type="text"/>	<input type="text"/>
<b>MODEL NUMBER</b>	<b>FRAME COLOR</b>	<b>FLAMMABILITY RATING</b>	<b>CUSHION UPHOLSTERY</b>	<b>FRAME UPHOLSTERY</b>
	Polished Chrome Brushed Chrome Steel Black Designer White Matte Gold Silver Solar Black Titanium Bullseye Regatta	<b>PC +\$164</b> <b>BS +\$164</b> <b>P71</b> <b>PJW</b> <b>P8G</b> <b>PR6</b> <b>P8X</b> <b>P8T</b> <b>PJF</b> <b>P8M</b>	<b>U CTB117</b>  <b>Please refer to list of available upholstery and leather selections on <a href="http://www.gunlocke.com">www.gunlocke.com</a></b>	<b>Please refer to list of available upholstery and leather selections on <a href="http://www.gunlocke.com">www.gunlocke.com</a></b>

### Example

<b>GLGB17-052.PC.U.DOL728.SPNN04</b>				
GLGB17-052	PC	U	DOL728	SPNN04
<b>MODEL NUMBER</b>	<b>FRAME COLOR</b>	<b>FLAMMABILITY</b>	<b>CUSHION UPHOLSTERY</b>	<b>FRAME UPHOLSTERY</b>

model number	fabric grades	dimensions	W	D	H
<b>GLGB17-062</b>	<b>1</b> 5,057	Overall	50"	32"	30"
Two seat, armless		Seat	50"	21"	17"

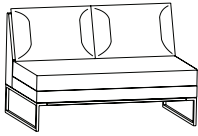

**Upholstery Requirements: GLGB17-062**

Dual Upholstery	
Fabric yds	Cushion 4.2 Frame 3.8
Leather ft <sup>2</sup>	Cushion 105 Frame 95
Shipping weight	170 lbs.
Cube	35.4

Cushion

<b>1</b>	<b>10</b>	875	<b>19</b>	2,015	<b>L1</b>	1,475
<b>2</b>	80	<b>11</b>	981	<b>20</b>	<b>L2</b>	2,680
<b>3</b>	160	<b>12</b>	1,087	<b>21</b>	<b>L3</b>	4,125
<b>COM/4</b>	239	<b>13</b>	1,220	<b>22</b>	<b>L4</b>	5,331
<b>5</b>	345	<b>14</b>	1,352	<b>23</b>	<b>L5</b>	6,535
<b>6</b>	451	<b>15</b>	1,485	<b>24</b>		
<b>7</b>	557	<b>16</b>	1,617	<b>25</b>		
<b>8</b>	663	<b>17</b>	1,750	<b>26</b>		
<b>9</b>	769	<b>18</b>	1,882	<b>27</b>		

To calculate price of lounge with different fabric for cushion and frame; start with Grade 1 price, add appropriate grade price located in second row for cushion, and last add appropriate grade price located in third row for frame to the sum of the Grade 1 and cushion price.

**Example: Grade 1 \$5,057 + grade 4 fabric cushion \$239 + grade 2 fabric frame \$72 = \$5,368**

Select upholstery for everything else other than the seat and back cushions (the outside back, arms, sides, seat frame). You can specify the same fabric as the cushions or select other fabric.

Frame

<b>1</b>	<b>10</b>	792	<b>19</b>	1,823	<b>L1</b>	1,335
<b>2</b>	72	<b>11</b>	888	<b>20</b>	<b>L2</b>	2,425
<b>3</b>	144	<b>12</b>	984	<b>21</b>	<b>L3</b>	3,733
<b>COM/4</b>	216	<b>13</b>	1,104	<b>22</b>	<b>L4</b>	4,823
<b>5</b>	312	<b>14</b>	1,223	<b>23</b>	<b>L5</b>	5,913
<b>6</b>	408	<b>15</b>	1,343	<b>24</b>		
<b>7</b>	504	<b>16</b>	1,463	<b>25</b>		
<b>8</b>	600	<b>17</b>	1,583	<b>26</b>		
<b>9</b>	696	<b>18</b>	1,703	<b>27</b>		

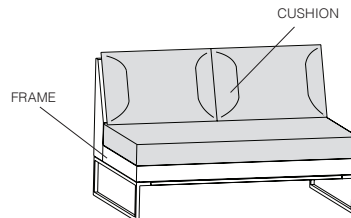

TO ORDER PLEASE SPECIFY THE FOLLOWING:

<input type="text"/>	<input type="text"/>	<input type="text"/>	<input type="text"/>	<input type="text"/>
<b>MODEL NUMBER</b>	<b>FRAME COLOR</b>	<b>FLAMMABILITY RATING</b>	<b>CUSHION UPHOLSTERY</b>	<b>FRAME UPHOLSTERY</b>
	Polished Chrome Brushed Chrome Steel Black Designer White Matte Gold Silver Solar Black Titanium Bullseye Regatta	<b>PC +\$164</b> <b>BS +\$164</b> <b>P71</b> <b>PJW</b> <b>P8G</b> <b>PR6</b> <b>P8X</b> <b>P8T</b> <b>PJF</b> <b>P8M</b>	<b>U</b> CTB117  <b>Please refer to list of available upholstery and leather selections on <a href="http://www.gunlocke.com">www.gunlocke.com</a></b>	<b>Please refer to list of available upholstery and leather selections on <a href="http://www.gunlocke.com">www.gunlocke.com</a></b>

Example

GLGB17-062.PC.U.DOL728.SPNN04

GLGB17-062	PC	U	DOL728	SPNN04
<b>MODEL NUMBER</b>	<b>FRAME COLOR</b>	<b>FLAMMABILITY</b>	<b>CUSHION UPHOLSTERY</b>	<b>FRAME UPHOLSTERY</b>

# CALM

Two Seat Lounge, Arm Left

Seating  
02/24

model number                      fabric grades                      dimensions                      W                      D                      H

**GLGB17-072**                      **1** 5,504  
Two seat, arm left

Overall	53 1/2"	32"	30"
Seat	46 1/2"	19 1/4"	17 "
Arm			30"

**Upholstery Requirements: GLGB17-072**

	Dual Upholstery	
Fabric yds	Cushion 5	Frame 4.75
Leather ft <sup>2</sup>	Cushion 125	Frame 118.8
Shipping weight	180 lbs.	
Cube	37.8	

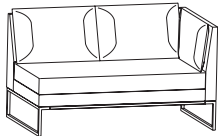

Cushion

<b>1</b>	<b>10</b>	1,041	<b>19</b>	2,398	<b>L1</b>	1,756	
<b>2</b>	95	<b>11</b>	1,168	<b>20</b>	2,557	<b>L2</b>	3,190
<b>3</b>	190	<b>12</b>	1,294	<b>21</b>	2,714	<b>L3</b>	4,911
<b>COM/4</b>	285	<b>13</b>	1,452	<b>22</b>	2,872	<b>L4</b>	6,345
<b>5</b>	410	<b>14</b>	1,609	<b>23</b>	3,188	<b>L5</b>	7,780
<b>6</b>	537	<b>15</b>	1,767	<b>24</b>	3,503		
<b>7</b>	663	<b>16</b>	1,925	<b>25</b>	3,819		
<b>8</b>	790	<b>17</b>	2,083	<b>26</b>	4,134		
<b>9</b>	915	<b>18</b>	2,240	<b>27</b>	4,450		

To calculate price of lounge with different fabric for cushion and frame; start with Grade 1 price, add appropriate grade price located in second row for cushion, and last add appropriate grade price located in third row for frame to the sum of the Grade 1 and cushion price.

**Example: Grade 1 \$5,504 + grade 4 fabric cushion \$285 + grade 2 fabric frame \$91 = \$5,880**

Select upholstery for everything else other than the seat and back cushions (the outside back, arms, sides, seat frame). You can specify the same fabric as the cushions or select other fabric.

Frame

<b>1</b>	<b>10</b>	1,000	<b>19</b>	2,303	<b>L1</b>	1,686	
<b>2</b>	91	<b>11</b>	1,121	<b>20</b>	2,454	<b>L2</b>	3,062
<b>3</b>	183	<b>12</b>	1,242	<b>21</b>	2,606	<b>L3</b>	4,715
<b>COM/4</b>	273	<b>13</b>	1,394	<b>22</b>	2,757	<b>L4</b>	6,091
<b>5</b>	394	<b>14</b>	1,545	<b>23</b>	3,060	<b>L5</b>	7,468
<b>6</b>	515	<b>15</b>	1,697	<b>24</b>	3,363		
<b>7</b>	637	<b>16</b>	1,848	<b>25</b>	3,666		
<b>8</b>	758	<b>17</b>	2,000	<b>26</b>	3,968		
<b>9</b>	879	<b>18</b>	2,151	<b>27</b>	4,271		

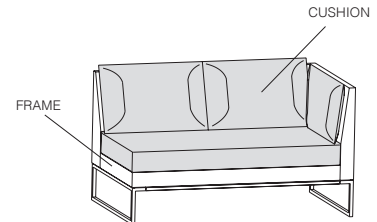

TO ORDER PLEASE SPECIFY THE FOLLOWING:

<input type="text"/>	<input type="text"/>	<input type="text"/>	<input type="text"/>	<input type="text"/>
<b>MODEL NUMBER</b>	<b>FRAME COLOR</b>	<b>FLAMMABILITY RATING</b>	<b>CUSHION UPHOLSTERY</b>	<b>FRAME UPHOLSTERY</b>
	Polished Chrome Brushed Chrome Steel Black Designer White Matte Gold Silver Solar Black Titanium Bullseye Regatta	<b>PC +\$164</b> <b>BS +\$164</b> <b>P71</b> <b>PJW</b> <b>P8G</b> <b>PR6</b> <b>P8X</b> <b>P8T</b> <b>PJF</b> <b>P8M</b>	<b>U</b> CTB117  Please refer to list of available upholstery and leather selections on <a href="http://www.gunlocke.com">www.gunlocke.com</a>	Please refer to list of available upholstery and leather selections on <a href="http://www.gunlocke.com">www.gunlocke.com</a>

Example

GLGB17-072.PC.U.DOL728.SPNN04  
 GLGB17-072    PC    U    DOL728    SPNN04  
 MODEL NUMBER    FRAME COLOR    FLAMMABILITY    CUSHION UPHOLSTERY    FRAME UPHOLSTERY

model number	fabric grades	dimensions	W	D	H
<b>GLGB17-082</b>	<b>1</b> 5,504	Overall	53 1/2"	32"	30"
Two seat, arm right		Seat	46 1/2"	21"	17"
		Arm			30"

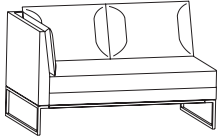

**Upholstery Requirements: GLGB17-082**

	Dual Upholstery	
Fabric yds	Cushion 5	Frame 4.75
Leather ft <sup>2</sup>	Cushion 125	Frame 118.75
Shipping weight	180 lbs.	
Cube	37.8	

Cushion	1	10	1,041	19	2,398	L1	1,756	
	2	95	11	1,168	20	2,557	L2	3,190
	3	190	12	1,294	21	2,714	L3	4,911
	COM/4	285	13	1,452	22	2,872	L4	6,345
	5	410	14	1,609	23	3,188	L5	7,780
	6	537	15	1,767	24	3,503		
	7	663	16	1,925	25	3,819		
	8	790	17	2,083	26	4,134		
	9	915	18	2,240	27	4,450		

To calculate price of lounge with different fabric for cushion and frame; start with Grade 1 price, add appropriate grade price located in second row for cushion, and last add appropriate grade price located in third row for frame to the sum of the Grade 1 and cushion price.

**Example: Grade 1 \$5,504 + grade 4 fabric cushion \$285 + grade 2 fabric frame \$91 = \$5,880**

Frame	1	10	1,000	19	2,303	L1	1,686	
	2	91	11	1,121	20	2,454	L2	3,062
	3	183	12	1,242	21	2,606	L3	4,715
	COM/4	273	13	1,394	22	2,757	L4	6,091
	5	394	14	1,545	23	3,060	L5	7,468
	6	515	15	1,697	24	3,363		
	7	637	16	1,848	25	3,666		
	8	758	17	2,000	26	3,968		
	9	879	18	2,151	27	4,271		

Select upholstery for everything else other than the seat and back cushions (the outside back, arms, sides, seat frame). You can specify the same fabric as the cushions or select other fabric.

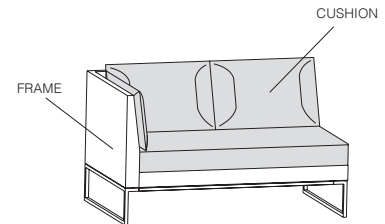

TO ORDER PLEASE SPECIFY THE FOLLOWING:

<input type="text"/>	<input type="text"/>	<input type="text"/>	<input type="text"/>	<input type="text"/>
<b>MODEL NUMBER</b>	<b>FRAME COLOR</b>	<b>FLAMMABILITY RATING</b>	<b>CUSHION UPHOLSTERY</b>	<b>FRAME UPHOLSTERY</b>
	Polished Chrome Brushed Chrome Steel Black Designer White Matte Gold Silver Solar Black Titanium Bullseye Regatta	PC +\$164 BS +\$164 P71 PJW P8G PR6 P8X P8T PJF P8M	U CTB117  Please refer to list of available upholstery and leather selections on <a href="http://www.gunlocke.com">www.gunlocke.com</a>	Please refer to list of available upholstery and leather selections on <a href="http://www.gunlocke.com">www.gunlocke.com</a>

Example

<b>GLGB17-082.PC.U.DOL728.SPNN04</b>				
GLGB17-082	PC	U	DOL728	SPNN04
<b>MODEL NUMBER</b>	<b>FRAME COLOR</b>	<b>FLAMMABILITY</b>	<b>CUSHION UPHOLSTERY</b>	<b>FRAME UPHOLSTERY</b>

# CALM

Three Seat Lounge, with Arms

Seating  
02/24

model number	fabric grades	dimensions	W	D	H
<b>GLGB17-093</b>	<b>1</b> 7,470	Overall	82"	32"	30"
Three seat, with arms		Seat	68"	21"	17"
		Arm			30"
		Between arms	68" - 71"		

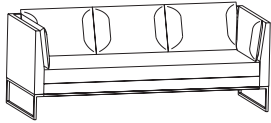

### Upholstery Requirements: GLGB17-093

	Dual Upholstery	
Fabric yds	Cushion 8.3	Frame 8.3
Leather ft <sup>2</sup>	Cushion 207.5	Frame 207.5
Shipping weight	300 lbs.	
Cube	56.8	

Cushion	1	10	1,729	19	3,981	L1	2,914	
	2	157	11	1,939	20	4,243	L2	5,296
	3	314	12	2,148	21	4,505	L3	8,153
	<b>COM/4</b>	471	<b>13</b>	2,409	<b>22</b>	4,767	<b>L4</b>	10,533
	5	682	14	2,672	23	5,290	L5	12,914
	6	891	15	2,934	24	5,815		
	7	1,100	16	3,195	25	6,338		
	8	1,310	17	3,457	26	6,862		
	9	1,520	18	3,720	27	7,385		

To calculate price of lounge with different fabric for cushion and frame; start with Grade 1 price, add appropriate grade price located in second row for cushion, and last add appropriate grade price located in third row for frame to the sum of the Grade 1 and cushion price.

**Example: Grade 1 \$7,470 + grade 4 fabric cushion \$471 + grade 2 fabric frame \$157 = \$8,098**

Select upholstery for everything else other than the seat and back cushions (the outside back, arms, sides, seat frame). You can specify the same fabric as the cushions or select other fabric.

Frame	1	10	1,729	19	3,981	L1	2,914	
	2	157	11	1,939	20	4,243	L2	5,296
	3	314	12	2,148	21	4,505	L3	8,153
	<b>COM/4</b>	471	<b>13</b>	2,409	<b>22</b>	4,767	<b>L4</b>	10,533
	5	682	14	2,672	23	5,290	L5	12,914
	6	891	15	2,934	24	5,815		
	7	1,100	16	3,195	25	6,338		
	8	1,310	17	3,457	26	6,862		
	9	1,520	18	3,720	27	7,385		

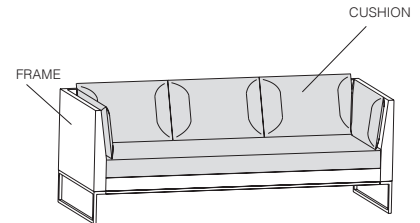

### TO ORDER PLEASE SPECIFY THE FOLLOWING:

<input type="text"/>	<input type="text"/>	<input type="text"/>	<input type="text"/>	<input type="text"/>
<b>MODEL NUMBER</b>	<b>FRAME COLOR</b>	<b>FLAMMABILITY RATING</b>	<b>CUSHION UPHOLSTERY</b>	<b>FRAME UPHOLSTERY</b>
	Polished Chrome Brushed Chrome Steel Black Designer White Matte Gold Silver Solar Black Titanium Bullseye Regatta	<b>PC +\$218</b> <b>BS +\$218</b> <b>P71</b> <b>PJW</b> <b>P8G</b> <b>PR6</b> <b>P8X</b> <b>P8T</b> <b>PJF</b> <b>P8M</b>	<b>U CTB117</b>  Please refer to list of available upholstery and leather selections on <a href="http://www.gunlocke.com">www.gunlocke.com</a>	Please refer to list of available upholstery and leather selections on <a href="http://www.gunlocke.com">www.gunlocke.com</a>

### Example

<b>GLGB17-093.PC.U.DOL728.SPNN04</b>				
GLGB17-093	PC	U	DOL728	SPNN04
<b>MODEL NUMBER</b>	<b>FRAME COLOR</b>	<b>FLAMMABILITY</b>	<b>CUSHION UPHOLSTERY</b>	<b>FRAME UPHOLSTERY</b>

model number	fabric grades	dimensions	W	D	H
<b>GLGB17-103</b>	<b>1</b> 6,350	Overall	75"	32"	30"
Three seat, armless		Seat	75"	21"	17"

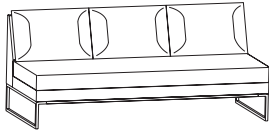

**Upholstery Requirements: GLGB17-103**

	Dual Upholstery	
Fabric yds	Cushion 6.3	Frame 5.3
Leather ft <sup>2</sup>	Cushion 156.3	Frame 131.5
Shipping weight	280 lbs.	
Cube	52.1	

Cushion

<b>1</b>	<b>10</b>	1,313	<b>19</b>	3,022	<b>L1</b>	2,212
<b>2</b>	<b>11</b>	1,472	<b>20</b>	3,220	<b>L2</b>	4,019
<b>3</b>	<b>12</b>	1,630	<b>21</b>	3,420	<b>L3</b>	6,188
<b>COM/4</b>	<b>13</b>	1,830	<b>22</b>	3,618	<b>L4</b>	7,996
<b>5</b>	<b>14</b>	2,028	<b>23</b>	4,016	<b>L5</b>	9,802
<b>6</b>	<b>15</b>	2,227	<b>24</b>	4,414		
<b>7</b>	<b>16</b>	2,426	<b>25</b>	4,811		
<b>8</b>	<b>17</b>	2,624	<b>26</b>	5,209		
<b>9</b>	<b>18</b>	2,824	<b>27</b>	5,606		

To calculate price of lounge with different fabric for cushion and frame; start with Grade 1 price, add appropriate grade price located in second row for cushion, and last add appropriate grade price located in third row for frame to the sum of the Grade 1 and cushion price.

**Example: Grade 1 \$6,350 + grade 4 fabric cushion \$358 + grade 2 fabric frame \$101 = \$6,809**

Select upholstery for everything else other than the seat and back cushions (the outside back, arms, sides, seat frame). You can specify the same fabric as the cushions or select other fabric.

Frame

<b>1</b>	<b>10</b>	1,105	<b>19</b>	2,542	<b>L1</b>	1,861
<b>2</b>	<b>11</b>	1,238	<b>20</b>	2,709	<b>L2</b>	3,382
<b>3</b>	<b>12</b>	1,372	<b>21</b>	2,877	<b>L3</b>	5,206
<b>COM/4</b>	<b>13</b>	1,538	<b>22</b>	3,044	<b>L4</b>	6,726
<b>5</b>	<b>14</b>	1,706	<b>23</b>	3,378	<b>L5</b>	8,246
<b>6</b>	<b>15</b>	1,873	<b>24</b>	3,713		
<b>7</b>	<b>16</b>	2,041	<b>25</b>	4,048		
<b>8</b>	<b>17</b>	2,208	<b>26</b>	4,382		
<b>9</b>	<b>18</b>	2,376	<b>27</b>	4,716		

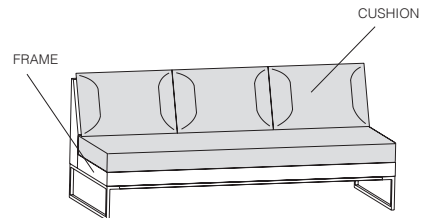

TO ORDER PLEASE SPECIFY THE FOLLOWING:

<input type="text"/>	<input type="text"/>	<input type="text"/>	<input type="text"/>	<input type="text"/>
<b>MODEL NUMBER</b>	<b>FRAME COLOR</b>	<b>FLAMMABILITY RATING</b>	<b>CUSHION UPHOLSTERY</b>	<b>FRAME UPHOLSTERY</b>
	Polished Chrome Brushed Chrome Steel Black Designer White Matte Gold Silver Solar Black Titanium Bullseye Regatta	<b>PC +\$218</b> <b>BS +\$218</b> <b>P71</b> <b>PJW</b> <b>P8G</b> <b>PR6</b> <b>P8X</b> <b>P8T</b> <b>PJF</b> <b>P8M</b>	<b>U</b> CTB117	Please refer to list of available upholstery and leather selections on <a href="http://www.gunlocke.com">www.gunlocke.com</a>
				Please refer to list of available upholstery and leather selections on <a href="http://www.gunlocke.com">www.gunlocke.com</a>

Example

<b>GLGB17-103.PC.U.DOL728.SPNN04</b>				
GLGB17-103	PC	U	DOL728	SPNN04
<b>MODEL NUMBER</b>	<b>FRAME COLOR</b>	<b>FLAMMABILITY</b>	<b>CUSHION UPHOLSTERY</b>	<b>FRAME UPHOLSTERY</b>

# CALM

## Three Seat Lounge, Arm Left

Seating  
02/24

model number	fabric grades	dimensions	W	D	H
<b>GLGB17-113</b>	<b>1</b> 6,908	Overall	78 1/2"	32"	30"
Three seat, arm left		Seat	71 1/2"	21"	17"
		Arm			30"



### Upholstery Requirements: GLGB17-113

	Dual Upholstery	
Fabric yds	Cushion 7	Frame 6.75
Leather ft <sup>2</sup>	Cushion 75	Frame 168.8
Shipping weight	290 lbs.	
Cube	54.5	

Cushion	1	10	1,458	19	3,358	L1	2,458	
	2	133	11	1,634	20	3,579	L2	4,466
	3	265	12	1,812	21	3,799	L3	6,875
	COM/4	398	13	2,032	22	4,020	L4	8,883
	5	575	14	2,254	23	4,462	L5	10,892
	6	752	15	2,474	24	4,903		
	7	928	16	2,695	25	5,346		
	8	1,105	17	2,916	26	5,787		
	9	1,281	18	3,136	27	6,229		

To calculate price of lounge with different fabric for cushion and frame; start with Grade 1 price, add appropriate grade price located in second row for cushion, and last add appropriate grade price located in third row for frame to the sum of the Grade 1 and cushion price.

**Example: Grade 1 \$6,908 + grade 4 fabric cushion \$398 + grade 2 fabric frame \$129 = \$7,435**

Select upholstery for everything else other than the seat and back cushions (the outside back, arms, sides, seat frame). You can specify the same fabric as the cushions or select other fabric.

Frame	1	10	1,416	19	3,262	L1	2,388	
	2	129	11	1,589	20	3,477	L2	4,339
	3	258	12	1,760	21	3,691	L3	6,679
	COM/4	386	13	1,974	22	3,906	L4	8,630
	5	559	14	2,189	23	4,334	L5	10,580
	6	730	15	2,404	24	4,764		
	7	902	16	2,618	25	5,193		
	8	1,073	17	2,832	26	5,622		
	9	1,245	18	3,047	27	6,051		

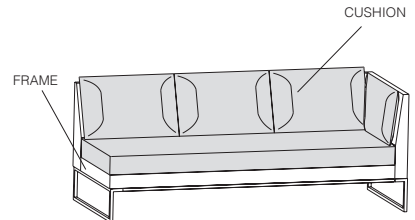

### TO ORDER PLEASE SPECIFY THE FOLLOWING:

<input type="text"/>	<input type="text"/>	<input type="text"/>	<input type="text"/>	<input type="text"/>
<b>MODEL NUMBER</b>	<b>FRAME COLOR</b>	<b>FLAMMABILITY RATING</b>	<b>CUSHION UPHOLSTERY</b>	<b>FRAME UPHOLSTERY</b>
	Polished Chrome Brushed Chrome Steel Black Designer White Matte Gold Silver Solar Black Titanium Bullseye Regatta	PC +\$218 BS +\$218 P71 PJW P8G PR6 P8X P8T PJF P8M	U CTB117	Please refer to list of available upholstery and leather selections on <a href="http://www.gunlocke.com">www.gunlocke.com</a>

### Example

GLGB17-113.PC.U.DOL728.SPNN04				
GLGB17-113	PC	U	DOL728	SPNN04
MODEL NUMBER	FRAME COLOR	FLAMMABILITY	CUSHION UPHOLSTERY	FRAME UPHOLSTERY



model number	fabric grades	dimensions	W	D	H
<b>GLGB17-123</b>	<b>1</b> 6,908	Overall	78 1/2"	32"	30"
Three seat, arm right		Seat	71 1/2"	21"	17"
		Arm			30"

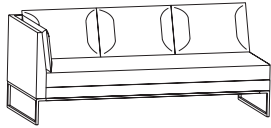

**Upholstery Requirements: GLGB17-123**

	Dual Upholstery	
Fabric yds	Cushion 7	Frame 6.75
Leather ft <sup>2</sup>	Cushion 75	Frame 168.8
Shipping weight	290 lbs.	
Cube	54.5	

Cushion	1	10	1,458	19	3,358	L1	2,458	
	2	133	11	1,634	20	3,579	L2	4,466
	3	265	12	1,812	21	3,799	L3	6,875
	COM/4	398	13	2,032	22	4,020	L4	8,883
	5	575	14	2,254	23	4,462	L5	10,892
	6	752	15	2,474	24	4,903		
	7	928	16	2,695	25	5,346		
	8	1,105	17	2,916	26	5,787		
	9	1,281	18	3,136	27	6,229		

To calculate price of lounge with different fabric for cushion and frame; start with Grade 1 price, add appropriate grade price located in second row for cushion, and last add appropriate grade price located in third row for frame to the sum of the Grade 1 and cushion price.

**Example: Grade 1 \$6,908 + grade 4 fabric cushion \$398 + grade 2 fabric frame \$129 = \$7,435**

Select upholstery for everything else other than the seat and back cushions (the outside back, arms, sides, seat frame). You can specify the same fabric as the cushions or select other fabric.

Frame	1	10	1,416	19	3,262	L1	2,388	
	2	129	11	1,589	20	3,477	L2	4,339
	3	258	12	1,760	21	3,691	L3	6,679
	COM/4	386	13	1,974	22	3,906	L4	8,630
	5	559	14	2,189	23	4,334	L5	10,580
	6	730	15	2,404	24	4,764		
	7	902	16	2,618	25	5,193		
	8	1,073	17	2,832	26	5,622		
	9	1,245	18	3,047	27	6,051		

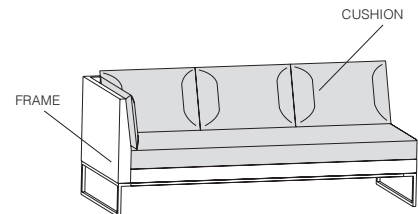

TO ORDER PLEASE SPECIFY THE FOLLOWING:

.  .  .  .

MODEL NUMBER	FRAME COLOR	FLAMMABILITY RATING	CUSHION UPHOLSTERY	FRAME UPHOLSTERY
	Polished Chrome	PC +\$218	U	CTB117
	Brushed Chrome Steel	BS +\$218		
	Black	P71		
	Designer White	PJW		
	Matte Gold	P8G		
	Silver	PR6		
	Solar Black	P8X		
	Titanium	P8T		
	Bullseye	PJF		
	Regatta	P8M		
			Please refer to list of available upholstery and leather selections on <a href="http://www.gunlocke.com">www.gunlocke.com</a>	Please refer to list of available upholstery and leather selections on <a href="http://www.gunlocke.com">www.gunlocke.com</a>

Example

<b>GLGB17-123.PC.U.DOL728.SPNN04</b>				
GLGB17-123	PC	U	DOL728	SPNN04
MODEL NUMBER	FRAME COLOR	FLAMMABILITY	CUSHION UPHOLSTERY	FRAME UPHOLSTERY

# CALM

Left Corner

model number	fabric grades	dimensions	W	D	H
<b>GLGB17-161</b> Left corner	<b>1</b> 4,560	Overall	32"	32"	30"
		Seat	21"	21"	17"

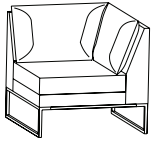

### Upholstery Requirements: GLGB17-161

	Dual Upholstery	
Fabric yds	Cushion 3	Frame 3.5
Leather ft2	Cushion 75	Frame 87.5
Shipping weight	145 lbs.	
Cube	23.4	

#### Cushion

<b>1</b>	<b>10</b>	625	<b>19</b>	1,439	<b>L1</b>	1,053	
<b>2</b>	57	<b>11</b>	701	<b>20</b>	1,534	<b>L2</b>	1,915
<b>3</b>	114	<b>12</b>	777	<b>21</b>	1,629	<b>L3</b>	2,947
<b>COM/4</b>	171	<b>13</b>	871	<b>22</b>	1,724	<b>L4</b>	3,808
<b>5</b>	247	<b>14</b>	966	<b>23</b>	1,912	<b>L5</b>	4,668
<b>6</b>	322	<b>15</b>	1,061	<b>24</b>	2,102		
<b>7</b>	398	<b>16</b>	1,155	<b>25</b>	2,292		
<b>8</b>	474	<b>17</b>	1,250	<b>26</b>	2,480		
<b>9</b>	550	<b>18</b>	1,344	<b>27</b>	2,670		

To calculate price of lounge with different fabric for cushion and frame; start with Grade 1 price, add appropriate grade price located in second row for cushion, and last add appropriate grade price located in third row for frame to the sum of the Grade 1 and cushion price.

**Example: Grade 1 \$4,560 + grade 4 fabric cushion \$171 + grade 2 fabric frame \$67 = \$4,798**

Select upholstery for everything else other than the seat and back cushions (the outside back, arms, sides, seat frame). You can specify the same fabric as the cushions or select other fabric.

#### Frame

<b>1</b>	<b>10</b>	730	<b>19</b>	1,679	<b>L1</b>	1,229	
<b>2</b>	67	<b>11</b>	818	<b>20</b>	1,789	<b>L2</b>	2,233
<b>3</b>	133	<b>12</b>	906	<b>21</b>	1,900	<b>L3</b>	3,438
<b>COM/4</b>	199	<b>13</b>	1,016	<b>22</b>	2,010	<b>L4</b>	4,442
<b>5</b>	287	<b>14</b>	1,126	<b>23</b>	2,232	<b>L5</b>	5,446
<b>6</b>	375	<b>15</b>	1,238	<b>24</b>	2,452		
<b>7</b>	465	<b>16</b>	1,348	<b>25</b>	2,673		
<b>8</b>	553	<b>17</b>	1,458	<b>26</b>	2,893		
<b>9</b>	641	<b>18</b>	1,569	<b>27</b>	3,115		

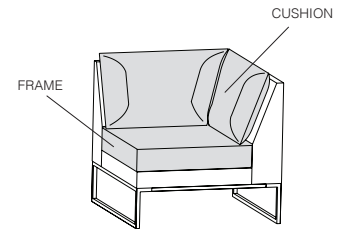

### TO ORDER PLEASE SPECIFY THE FOLLOWING:

<input type="text"/>	<input type="text"/>	<input type="text"/>	<input type="text"/>	<input type="text"/>
<b>MODEL NUMBER</b>	<b>FRAME COLOR</b>	<b>FLAMMABILITY RATING</b>	<b>CUSHION UPHOLSTERY</b>	<b>FRAME UPHOLSTERY</b>

- |                      |                  |                 |
|----------------------|------------------|-----------------|
| Polished Chrome      | <b>PC +\$137</b> | <b>U</b> CTB117 |
| Brushed Chrome Steel | <b>BS +\$137</b> |                 |
| Black                | <b>P71</b>       |                 |
| Designer White       | <b>PJW</b>       |                 |
| Matte Gold           | <b>P8G</b>       |                 |
| Silver               | <b>PR6</b>       |                 |
| Solar Black          | <b>P8X</b>       |                 |
| Titanium             | <b>P8T</b>       |                 |
| Bullseye             | <b>PJF</b>       |                 |
| Regatta              | <b>P8M</b>       |                 |

Please refer to list of available upholstery and leather selections on [www.gunlocke.com](http://www.gunlocke.com)

Please refer to list of available upholstery and leather selections on [www.gunlocke.com](http://www.gunlocke.com)

**NOTE:** Corner units MUST be used when creating a modular turn where backrests are needed. This aligns the depths between the two "backed" units, and keeps the consistent 5" pillow thickness for the modular turn.

#### Example

GLGB17-161.PC.U.DOL728.SPNN04				
GLGB17-161	PC	U	DOL728	SPNN04
<b>MODEL NUMBER</b>	<b>FRAME COLOR</b>	<b>FLAMMABILITY</b>	<b>CUSHION UPHOLSTERY</b>	<b>FRAME UPHOLSTERY</b>

model number	fabric grades	dimensions	W	D	H
<b>GLGB17-171</b> Right corner	<b>1</b> 4,560	Overall	32"	32"	30"
		Seat	21"	21"	17"

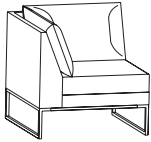

**Upholstery Requirements: GLGB17-171**

	Dual Upholstery	
Fabric yds	Cushion 3	Frame 3.5
Leather ft <sup>2</sup>	Cushion 75	Frame 87.5
Shipping weight	145 lbs.	
Cube	23.4	

Cushion

<b>1</b>	<b>10</b>	625	<b>19</b>	1,439	<b>L1</b>	1,053	
<b>2</b>	57	<b>11</b>	701	<b>20</b>	1,534	<b>L2</b>	1,915
<b>3</b>	114	<b>12</b>	777	<b>21</b>	1,629	<b>L3</b>	2,947
<b>COM/4</b>	171	<b>13</b>	871	<b>22</b>	1,724	<b>L4</b>	3,808
<b>5</b>	247	<b>14</b>	966	<b>23</b>	1,912	<b>L5</b>	4,668
<b>6</b>	322	<b>15</b>	1,061	<b>24</b>	2,102		
<b>7</b>	398	<b>16</b>	1,155	<b>25</b>	2,292		
<b>8</b>	474	<b>17</b>	1,250	<b>26</b>	2,480		
<b>9</b>	550	<b>18</b>	1,344	<b>27</b>	2,670		

To calculate price of lounge with different fabric for cushion and frame; start with Grade 1 price, add appropriate grade price located in second row for cushion, and last add appropriate grade price located in third row for frame to the sum of the Grade 1 and cushion price.

**Example: Grade 1 \$4,560 + grade 4 fabric cushion \$171 + grade 2 fabric frame \$67 = \$4,798**

Frame

<b>1</b>	<b>10</b>	730	<b>19</b>	1,679	<b>L1</b>	1,229	
<b>2</b>	67	<b>11</b>	818	<b>20</b>	1,789	<b>L2</b>	2,233
<b>3</b>	133	<b>12</b>	906	<b>21</b>	1,900	<b>L3</b>	3,438
<b>COM/4</b>	199	<b>13</b>	1,016	<b>22</b>	2,010	<b>L4</b>	4,442
<b>5</b>	287	<b>14</b>	1,126	<b>23</b>	2,232	<b>L5</b>	5,446
<b>6</b>	375	<b>15</b>	1,238	<b>24</b>	2,452		
<b>7</b>	465	<b>16</b>	1,348	<b>25</b>	2,673		
<b>8</b>	553	<b>17</b>	1,458	<b>26</b>	2,893		
<b>9</b>	641	<b>18</b>	1,569	<b>27</b>	3,115		

Select upholstery for everything else other than the seat and back cushions (the outside back, arms, sides, seat frame). You can specify the same fabric as the cushions or select other fabric.

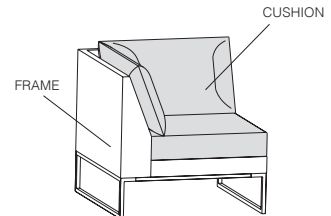

TO ORDER PLEASE SPECIFY THE FOLLOWING:

<input type="text"/>	<input type="text"/>	<input type="text"/>	<input type="text"/>	<input type="text"/>
<b>MODEL NUMBER</b>	<b>FRAME COLOR</b>	<b>FLAMMABILITY RATING</b>	<b>CUSHION UPHOLSTERY</b>	<b>FRAME UPHOLSTERY</b>
	Polished Chrome Brushed Chrome Steel Black Designer White Matte Gold Silver Solar Black Titanium Bullseye Regatta	<b>PC +\$137</b> <b>BS +\$137</b> <b>P71</b> <b>PJW</b> <b>P8G</b> <b>PR6</b> <b>P8X</b> <b>P8T</b> <b>PJF</b> <b>P8M</b>	<b>U</b> CTB117	Please refer to list of available upholstery and leather selections on <a href="http://www.gunlocke.com">www.gunlocke.com</a>
				Please refer to list of available upholstery and leather selections on <a href="http://www.gunlocke.com">www.gunlocke.com</a>

**NOTE:** Corner units MUST be used when creating a modular turn where backrests are needed. This aligns the depths between the two "backed" units, and keeps the consistent 5" pillow thickness for the modular turn.

Example

GLGB17-171.PC.U.DOL728.SPNN04				
GLGB17-171	PC	U	DOL728	SPNN04
<b>MODEL NUMBER</b>	<b>FRAME COLOR</b>	<b>FLAMMABILITY</b>	<b>CUSHION UPHOLSTERY</b>	<b>FRAME UPHOLSTERY</b>

# CALM

## One Seat Bench

Seating  
02/24

model number	fabric grades	dimensions	W	D	H
--------------	---------------	------------	---	---	---

**GBGB17-131**  
One seat bench

**1** 2,824

Overall 25" 32" 17"

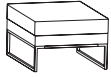

### Upholstery Requirements: GLGB17-131

	Dual Upholstery	
Fabric yds	Cushion 1	Frame 1.3
Leather ft <sup>2</sup>	Cushion 25	Frame 32.5
Shipping weight	90 lbs.	
Cube	11.3	

### Cushion

<b>1</b>	<b>10</b>	209	<b>19</b>	480	<b>L1</b>	351
<b>2</b>	19	<b>11</b>	234	<b>20</b>	512	<b>L2</b> 638
<b>3</b>	39	<b>12</b>	259	<b>21</b>	543	<b>L3</b> 983
<b>COM/4</b>	57	<b>13</b>	290	<b>22</b>	575	<b>L4</b> 1,269
<b>5</b>	82	<b>14</b>	322	<b>23</b>	638	<b>L5</b> 1,556
<b>6</b>	107	<b>15</b>	354	<b>24</b>	701	
<b>7</b>	133	<b>16</b>	385	<b>25</b>	765	
<b>8</b>	159	<b>17</b>	417	<b>26</b>	827	
<b>9</b>	184	<b>18</b>	448	<b>27</b>	890	

To calculate price of lounge with different fabric for cushion and frame; start with Grade 1 price, add appropriate grade price located in second row for cushion, and last add appropriate grade price located in third row for frame to the sum of the Grade 1 and cushion price.

**Example: Grade 1 \$2,824 + grade 4 fabric cushion \$57 + grade 2 fabric frame \$26 = \$2,907**

Select upholstery for everything else other than the seat and back cushions (the outside back, arms, sides, seat frame). You can specify the same fabric as the cushions or select other fabric.

### Frame

<b>1</b>	<b>10</b>	271	<b>19</b>	624	<b>L1</b>	457
<b>2</b>	26	<b>11</b>	304	<b>20</b>	665	<b>L2</b> 830
<b>3</b>	50	<b>12</b>	337	<b>21</b>	706	<b>L3</b> 1,277
<b>COM/4</b>	75	<b>13</b>	378	<b>22</b>	747	<b>L4</b> 1,650
<b>5</b>	107	<b>14</b>	419	<b>23</b>	829	<b>L5</b> 2,024
<b>6</b>	140	<b>15</b>	459	<b>24</b>	911	
<b>7</b>	173	<b>16</b>	501	<b>25</b>	993	
<b>8</b>	205	<b>17</b>	542	<b>26</b>	1,075	
<b>9</b>	238	<b>18</b>	583	<b>27</b>	1,157	

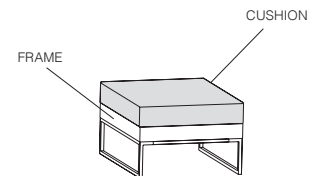

### TO ORDER PLEASE SPECIFY THE FOLLOWING:

<input type="text"/>	<input type="text"/>	<input type="text"/>	<input type="text"/>	<input type="text"/>
<b>MODEL NUMBER</b>	<b>FRAME COLOR</b>	<b>FLAMMABILITY RATING</b>	<b>CUSHION UPHOLSTERY</b>	<b>FRAME UPHOLSTERY</b>
	Polished Chrome Brushed Chrome Steel Black Designer White Matte Gold Silver Solar Black Titanium Bullseye Regatta	<b>PC +\$137</b> <b>BS +\$137</b> <b>P71</b> <b>PJW</b> <b>P8G</b> <b>PR6</b> <b>P8X</b> <b>P8T</b> <b>PJF</b> <b>P8M</b>	<b>U</b> CTB117  Please refer to list of available upholstery and leather selections on <a href="http://www.gunlocke.com">www.gunlocke.com</a>	Please refer to list of available upholstery and leather selections on <a href="http://www.gunlocke.com">www.gunlocke.com</a>

### Example

GBGB17-131.PC.U.DOL728.SPNN04				
GBGB17-131	PC	U	DOL728	SPNN04
MODEL NUMBER	FRAME COLOR	FLAMMABILITY	CUSHION UPHOLSTERY	FRAME UPHOLSTERY

model number                      fabric grades                      dimensions                      W                      D                      H

**GBGB17-142**                      **1** 3,866  
Two seat bench

Overall                      50"                      32"                      17"



**Upholstery Requirements: GLGB17-142**

	Dual Upholstery	
Fabric yds	Cushion 2.5	Frame 1.2
Leather ft <sup>2</sup>	Cushion 62.5	Frame 30
Shipping weight	135 lbs.	
Cube	21.5	

Cushion

<b>1</b>	<b>10</b>	522	<b>19</b>	1,199	<b>L1</b>	878	
<b>2</b>	47	<b>11</b>	585	<b>20</b>	1,278	<b>L2</b>	1,595
<b>3</b>	95	<b>12</b>	647	<b>21</b>	1,358	<b>L3</b>	2,456
<b>COM/4</b>	142	<b>13</b>	726	<b>22</b>	1,436	<b>L4</b>	3,173
<b>5</b>	205	<b>14</b>	805	<b>23</b>	1,594	<b>L5</b>	3,890
<b>6</b>	269	<b>15</b>	884	<b>24</b>	1,752		
<b>7</b>	332	<b>16</b>	963	<b>25</b>	1,909		
<b>8</b>	395	<b>17</b>	1,041	<b>26</b>	2,067		
<b>9</b>	458	<b>18</b>	1,121	<b>27</b>	2,225		

To calculate price of lounge with different fabric for cushion and frame; start with Grade 1 price, add appropriate grade price located in second row for cushion, and last add appropriate grade price located in third row for frame to the sum of the Grade 1 and cushion price.

**Example: Grade 1 \$3,866 + grade 4 fabric cushion \$142 + grade 2 fabric frame \$23 = \$4,031**

Select upholstery for everything else other than the seat and back cushions (the outside back, arms, sides, seat frame). You can specify the same fabric as the cushions or select other fabric.

Frame

<b>1</b>	<b>10</b>	250	<b>19</b>	576	<b>L1</b>	422	
<b>2</b>	23	<b>11</b>	281	<b>20</b>	614	<b>L2</b>	766
<b>3</b>	46	<b>12</b>	311	<b>21</b>	651	<b>L3</b>	1,179
<b>COM/4</b>	69	<b>13</b>	349	<b>22</b>	689	<b>L4</b>	1,523
<b>5</b>	99	<b>14</b>	386	<b>23</b>	766	<b>L5</b>	1,868
<b>6</b>	129	<b>15</b>	425	<b>24</b>	841		
<b>7</b>	160	<b>16</b>	463	<b>25</b>	917		
<b>8</b>	190	<b>17</b>	501	<b>26</b>	992		
<b>9</b>	220	<b>18</b>	538	<b>27</b>	1,069		

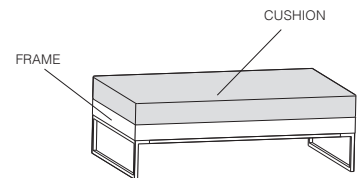

TO ORDER PLEASE SPECIFY THE FOLLOWING:

<input type="text"/>	<input type="text"/>	<input type="text"/>	<input type="text"/>	<input type="text"/>
<b>MODEL NUMBER</b>	<b>FRAME COLOR</b>	<b>FLAMMABILITY RATING</b>	<b>CUSHION UPHOLSTERY</b>	<b>FRAME UPHOLSTERY</b>
	Polished Chrome Brushed Chrome Steel Black Designer White Matte Gold Silver Solar Black Titanium Bullseye Regatta	<b>PC +\$164</b> <b>BS +\$164</b> <b>P71</b> <b>PJW</b> <b>P8G</b> <b>PR6</b> <b>P8X</b> <b>P8T</b> <b>PJF</b> <b>P8M</b>	<b>U</b> CTB117  <b>Please refer to list of available upholstery and leather selections on <a href="http://www.gunlocke.com">www.gunlocke.com</a></b>	<b>Please refer to list of available upholstery and leather selections on <a href="http://www.gunlocke.com">www.gunlocke.com</a></b>

Example

GLGB17-142.PC.U.DOL728.SPNN04  
 GLGB17-142    PC    U    DOL728    SPNN04  
 MODEL NUMBER    FRAME COLOR    FLAMMABILITY    CUSHION UPHOLSTERY    FRAME UPHOLSTERY

# CALM

## Three Seat Bench

Seating  
02/24

model number                      fabric grades                      dimensions                      W                      D                      H

**GBGB17-153**  
Three seat bench

**1** 4,855

Overall                      75"                      32"                      17"



### Upholstery Requirements: GLGB17-153

	Dual Upholstery	
Fabric yds	Cushion 4	Frame 1.5
Leather ft <sup>2</sup>	Cushion 100	Frame 37.5
Shipping weight	180 lbs.	
Cube	31.6	

### Cushion

<b>1</b>	<b>10</b>	833	<b>19</b>	1,919	<b>L1</b>	1,404	
<b>2</b>	76	<b>11</b>	935	<b>20</b>	2,045	<b>L2</b>	2,552
<b>3</b>	152	<b>12</b>	1,035	<b>21</b>	2,172	<b>L3</b>	3,929
<b>COM/4</b>	227	<b>13</b>	1,161	<b>22</b>	2,297	<b>L4</b>	5,077
<b>5</b>	329	<b>14</b>	1,288	<b>23</b>	2,550	<b>L5</b>	6,223
<b>6</b>	430	<b>15</b>	1,414	<b>24</b>	2,803		
<b>7</b>	530	<b>16</b>	1,541	<b>25</b>	3,055		
<b>8</b>	632	<b>17</b>	1,666	<b>26</b>	3,308		
<b>9</b>	733	<b>18</b>	1,792	<b>27</b>	3,559		

To calculate price of lounge with different fabric for cushion and frame; start with Grade 1 price, add appropriate grade price located in second row for cushion, and last add appropriate grade price located in third row for frame to the sum of the Grade 1 and cushion price.

**Example: Grade 1 \$4,855 + grade 4 fabric cushion \$227 + grade 2 fabric frame \$29 = \$5,111**

Select upholstery for everything else other than the seat and back cushions (the outside back, arms, sides, seat frame). You can specify the same fabric as the cushions or select other fabric.

### Frame

<b>1</b>	<b>10</b>	313	<b>19</b>	720	<b>L1</b>	527	
<b>2</b>	29	<b>11</b>	350	<b>20</b>	767	<b>L2</b>	958
<b>3</b>	57	<b>12</b>	389	<b>21</b>	815	<b>L3</b>	1,474
<b>COM/4</b>	86	<b>13</b>	435	<b>22</b>	862	<b>L4</b>	1,904
<b>5</b>	124	<b>14</b>	483	<b>23</b>	956	<b>L5</b>	2,334
<b>6</b>	162	<b>15</b>	530	<b>24</b>	1,051		
<b>7</b>	199	<b>16</b>	578	<b>25</b>	1,146		
<b>8</b>	237	<b>17</b>	625	<b>26</b>	1,241		
<b>9</b>	275	<b>18</b>	673	<b>27</b>	1,335		

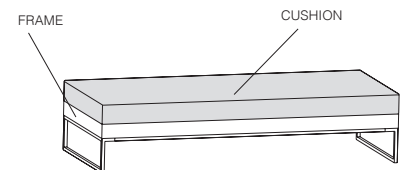

### TO ORDER PLEASE SPECIFY THE FOLLOWING:

<input type="text"/>	<input type="text"/>	<input type="text"/>	<input type="text"/>	<input type="text"/>
<b>MODEL NUMBER</b>	<b>FRAME COLOR</b>	<b>FLAMMABILITY RATING</b>	<b>CUSHION UPHOLSTERY</b>	<b>FRAME UPHOLSTERY</b>
	Polished Chrome Brushed Chrome Steel Black Designer White Matte Gold Silver Solar Black Titanium Bullseye Regatta	<b>PC +\$218</b> <b>BS +\$218</b> <b>P71</b> <b>PJW</b> <b>P8G</b> <b>PR6</b> <b>P8X</b> <b>P8T</b> <b>PJF</b> <b>P8M</b>	<b>U CTB117</b>	<b>Please refer to list of available upholstery and leather selections on <a href="http://www.gunlocke.com">www.gunlocke.com</a></b>

### Example

**GBGB17-153.PC.U.DOL728.SPNN04**  
 GBGB17-153    PC    U    DOL728    SPNN04  
 MODEL NUMBER    FRAME COLOR    FLAMMABILITY    CUSHION UPHOLSTERY    FRAME UPHOLSTERY

model number                      fabric grades                      dimensions      W      D      H

**GLGB17-181**  
Ottoman                      **1** 2,961

Overall                      32"                      32"                      17"

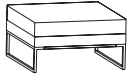

**Upholstery Requirements: GLGB17-181**

	Dual Upholstery	
Fabric yds	Cushion 1	Frame 1.25
Leather ft <sup>2</sup>	Cushion 25	Frame 31.25
Shipping weight	100 lbs.	
Cube	14.2	

Cushion

<b>1</b>	<b>10</b>	209	<b>19</b>	480	<b>L1</b>	351
<b>2</b>	19	<b>11</b>	234	<b>20</b>	512	<b>L2</b> 638
<b>3</b>	39	<b>12</b>	259	<b>21</b>	543	<b>L3</b> 983
<b>COM/4</b>	57	<b>13</b>	290	<b>22</b>	575	<b>L4</b> 1,269
<b>5</b>	82	<b>14</b>	322	<b>23</b>	638	<b>L5</b> 1,556
<b>6</b>	107	<b>15</b>	354	<b>24</b>	701	
<b>7</b>	133	<b>16</b>	385	<b>25</b>	765	
<b>8</b>	159	<b>17</b>	417	<b>26</b>	827	
<b>9</b>	184	<b>18</b>	448	<b>27</b>	890	

To calculate price of lounge with different fabric for cushion and frame; start with Grade 1 price, add appropriate grade price located in second row for cushion, and last add appropriate grade price located in third row for frame to the sum of the Grade 1 and cushion price.

**Example: Grade 1 \$2,961 + grade 4 fabric cushion \$57 + grade 2 fabric frame \$24 = \$3,042**

Frame

<b>1</b>	<b>10</b>	261	<b>19</b>	600	<b>L1</b>	440
<b>2</b>	24	<b>11</b>	293	<b>20</b>	639	<b>L2</b> 798
<b>3</b>	47	<b>12</b>	324	<b>21</b>	678	<b>L3</b> 1,228
<b>COM/4</b>	71	<b>13</b>	363	<b>22</b>	719	<b>L4</b> 1,586
<b>5</b>	103	<b>14</b>	403	<b>23</b>	797	<b>L5</b> 1,945
<b>6</b>	135	<b>15</b>	442	<b>24</b>	876	
<b>7</b>	166	<b>16</b>	481	<b>25</b>	955	
<b>8</b>	198	<b>17</b>	522	<b>26</b>	1,034	
<b>9</b>	229	<b>18</b>	561	<b>27</b>	1,112	

Select upholstery for everything else other than the seat and back cushions (the outside back, arms, sides, seat frame). You can specify the same fabric as the cushions or select other fabric.

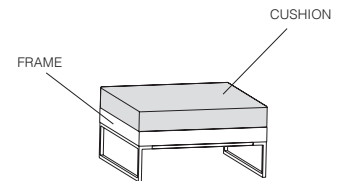

TO ORDER PLEASE SPECIFY THE FOLLOWING:

.  .  .  .

**MODEL NUMBER**      **FRAME COLOR**      **FLAMMABILITY RATING**      **CUSHION UPHOLSTERY**      **FRAME UPHOLSTERY**

- Polished Chrome      **PC +\$137**
- Brushed Chrome Steel      **BS +\$137**
- Black      **P71**
- Designer White      **PJW**
- Matte Gold      **P8G**
- Silver      **PR6**
- Solar Black      **P8X**
- Titanium      **P8T**
- Bullseye      **PJF**
- Regatta      **P8M**

**U** CTB117

Please refer to list of available upholstery and leather selections on [www.gunlocke.com](http://www.gunlocke.com)

Please refer to list of available upholstery and leather selections on [www.gunlocke.com](http://www.gunlocke.com)

**NOTE:** Ottoman to be used in line with lounge units, to create a 32"D x 32"W seating surface..

Example

GLGB17-181.PC.U.DOL728.DOL728

GLGB17-181      PC      U      DOL728      SPNN04  
 MODEL NUMBER      FRAME COLOR      FLAMMABILITY      CUSHION UPHOLSTERY      FRAME UPHOLSTERY

model number	list	dimensions	W	D	H
--------------	------	------------	---	---	---

**GAGB17-198**  
Ganging bracket

161

14.5" 4" 1.5"



- **Note:** No options are selected for ganging bracket model (GAGB17-198).
- One ganging bracket shipped per GAGB17-198 model ordered.
- Lounge units gang together with one ganging bracket per ganged position.

**ACPUNDER-EU**  
Standard Plug

426

5.5" 3" 2"



- **Note:** Power unit mounts at left or right hand side of lounge units only. Positions are predetermined at mounting points into lounge frame (see example below).

**ACPUNDER-EU-HW**  
Hardwired

426

5.5" 3" 2"



- **Note:** Power unit mounts at left or right hand side of lounge units only. Positions are predetermined at mounting points into lounge frame (see example below).

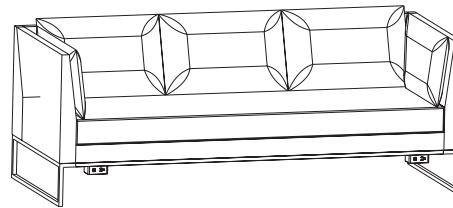
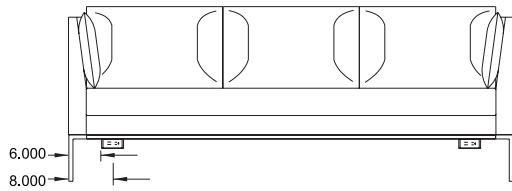

- **Note:** Power unit can be mounted directly into lounge unit frames. Edge of power unit is 6" from outside of lounge, or 8" to center of power unit from outside of lounge. Includes wire clips to attach plug cord to underside of lounge.

TO ORDER PLEASE SPECIFY THE FOLLOWING:

.

MODEL NUMBER . POWER COLOR

Option available for  
ACPUNDER-EU and  
ACPUNDER-EU-HW models only.

White **WH**  
Black **BK**  
Silver **SV**

Example

ACPUNDER-EU.WH  
ACPUNDER-EU WH  
MODEL NUMBER POWER COLOR



**Seating**  
02/24

**CIJI SINGLE SEAT**

Low Back, with Arms, Wood Legs

model number	fabric grades
<b>GK1101-1W</b>	<b>1</b> 3,779

Low back, with arms,  
Wood legs

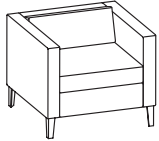

dimensions	W	D	H
Overall	31 3/4"	31 1/2"	27 7/8"
Seat	24"	21"	17 1/4"
Arm			26 7/8"
Between arms	24"		

**Upholstery Requirements: GK1101-1W**

	Dual Upholstery	
Fabric yds	Cushions 1.5	Frame 3.8
Leather ft <sup>2</sup>	Cushions 34.5	Frame 87.4
Shipping weight		97 lbs.
Cube		28.0

Cushion

<b>1</b>	<b>10</b>	323	<b>19</b>	742	<b>L1</b>	494
<b>2</b>	30	<b>11</b>	361	<b>20</b>	<b>L2</b>	902
<b>3</b>	59	<b>12</b>	401	<b>21</b>	<b>L3</b>	1,391
<b>COM/4</b>	89	<b>13</b>	449	<b>22</b>	<b>L4</b>	1,799
<b>5</b>	128	<b>14</b>	498	<b>23</b>	<b>L5</b>	2,206
<b>6</b>	167	<b>15</b>	546	<b>24</b>		1,083
<b>7</b>	205	<b>16</b>	596	<b>25</b>		1,181
<b>8</b>	245	<b>17</b>	644	<b>26</b>		1,279
<b>9</b>	284	<b>18</b>	694	<b>27</b>		1,376

To calculate price of lounge with different fabric for cushion and frame; start with Grade 1 price, add appropriate grade price located in second row for cushion, and last add appropriate grade price located in third row for frame to the sum of the Grade 1 and cushion price.

**Example: Grade 1 \$3,779 + grade 4 fabric cushion \$89 + grade 2 fabric frame \$75 = \$3,943**

Select upholstery for everything else other than the seat and back cushions (the outside back, arms, sides, seat frame). You can specify the same fabric as the cushions or select other fabric.

Frame

<b>1</b>	<b>10</b>	816	<b>19</b>	1,878	<b>L1</b>	1,250
<b>2</b>	75	<b>11</b>	915	<b>20</b>	<b>L2</b>	2,282
<b>3</b>	149	<b>12</b>	1,014	<b>21</b>	<b>L3</b>	3,522
<b>COM/4</b>	223	<b>13</b>	1,138	<b>22</b>	<b>L4</b>	4,555
<b>5</b>	322	<b>14</b>	1,260	<b>23</b>	<b>L5</b>	5,587
<b>6</b>	421	<b>15</b>	1,384	<b>24</b>		2,742
<b>7</b>	520	<b>16</b>	1,507	<b>25</b>		2,990
<b>8</b>	618	<b>17</b>	1,631	<b>26</b>		3,237
<b>9</b>	717	<b>18</b>	1,755	<b>27</b>		3,484

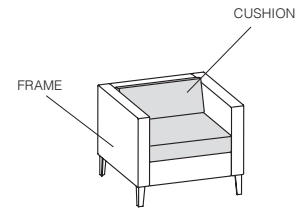

TO ORDER PLEASE SPECIFY THE FOLLOWING:

<input type="text"/>	<input type="text"/>	<input type="text"/>	<input type="text"/>	<input type="text"/>	<input type="text"/>
<b>MODEL NUMBER</b>	<b>WOOD FINISH</b>	<b>STITCH DETAIL</b>	<b>FLAMMABILITY RATING</b>	<b>CUSHION UPHOLSTERY</b>	<b>FRAME UPHOLSTERY</b>
	Cherry finishes on Maple Walnut finishes on Maple Maple finishes on Maple Oak finishes on Maple <i>Light Rift Oak 301 not available on Maple.</i>	None NR Stitch detail SD +\$197	U CTB117	Please refer to list of available upholstery and leather selections on www.gunlocke.com	Please refer to list of available upholstery and leather selections on www.gunlocke.com

Example

GK1101-1W.777.NR.U.DOL728.SPNN04					
GK1101-1W	777	NR	U	DOL728	SPNN04
MODEL NUMBER	WOOD FINISH	STITCH DETAIL	FLAMMABILITY	CUSHION UPHOLSTERY	FRAME UPHOLSTERY

Please refer to the Ciji product page on www.gunlocke.com for standard finish options.

# CIJI SINGLE SEAT

Low Back, with Arms, Aluminum Legs

Seating  
02/24

model number	fabric grades	dimensions	W	D	H
--------------	---------------	------------	---	---	---

**GK1101-1A**  
Low back, with arms,  
Aluminum legs

**1** 4,063

Overall	31 3/4"	31 1/2"	27 7/8"
Seat	24"	21"	17 1/4"
Arm			26 7/8"
Between arms	24"		

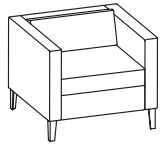

### Upholstery Requirements: GK1101-1A

	Dual Upholstery	
Fabric yds	Cushions 1.5	Frame 3.8
Leather ft <sup>2</sup>	Cushions 34.5	Frame 87.4
Shipping weight	97 lbs.	
Cube	28.0	

Cushion

<b>1</b>	<b>10</b>	323	<b>19</b>	742	<b>L1</b>	494
<b>2</b>	30	<b>11</b>	361	<b>20</b>	<b>L2</b>	902
<b>3</b>	59	<b>12</b>	401	<b>21</b>	<b>L3</b>	1,391
<b>COM/4</b>	89	<b>13</b>	449	<b>22</b>	<b>L4</b>	1,799
<b>5</b>	128	<b>14</b>	498	<b>23</b>	<b>L5</b>	2,206
<b>6</b>	167	<b>15</b>	546	<b>24</b>		1,083
<b>7</b>	205	<b>16</b>	596	<b>25</b>		1,181
<b>8</b>	245	<b>17</b>	644	<b>26</b>		1,279
<b>9</b>	284	<b>18</b>	694	<b>27</b>		1,376

To calculate price of lounge with different fabric for cushion and frame; start with Grade 1 price, add appropriate grade price located in second row for cushion, and last add appropriate grade price located in third row for frame to the sum of the Grade 1 and cushion price.

**Example: Grade 1 \$4,063 + grade 4 fabric cushion \$89 + grade 2 fabric frame \$75 = \$4,227**

Select upholstery for everything else other than the seat and back cushions (the outside back, arms, sides, seat frame). You can specify the same fabric as the cushions or select other fabric.

Frame

<b>1</b>	<b>10</b>	816	<b>19</b>	1,878	<b>L1</b>	1,250
<b>2</b>	75	<b>11</b>	915	2,002	<b>L2</b>	2,282
<b>3</b>	149	<b>12</b>	1,014	2,125	<b>L3</b>	3,522
<b>COM/4</b>	223	<b>13</b>	1,138	2,249	<b>L4</b>	4,555
<b>5</b>	322	<b>14</b>	1,260	2,495	<b>L5</b>	5,587
<b>6</b>	421	<b>15</b>	1,384	2,742		
<b>7</b>	520	<b>16</b>	1,507	2,990		
<b>8</b>	618	<b>17</b>	1,631	3,237		
<b>9</b>	717	<b>18</b>	1,755	3,484		

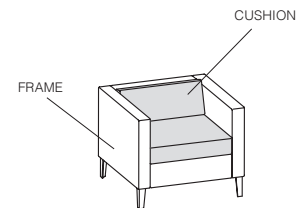

TO ORDER PLEASE SPECIFY THE FOLLOWING:

<input type="text"/>	<input type="text"/>	<input type="text"/>	<input type="text"/>	<input type="text"/>
<b>MODEL NUMBER</b>	<b>STITCH DETAIL</b>	<b>FLAMMABILITY RATING</b>	<b>CUSHION UPHOLSTERY</b>	<b>FRAME UPHOLSTERY</b>
	None <b>NR</b> Stitch detail SD +\$197	<b>U</b> CTB117	Please refer to list of available upholstery and leather selections on <a href="http://www.gunlocke.com">www.gunlocke.com</a>	Please refer to list of available upholstery and leather selections on <a href="http://www.gunlocke.com">www.gunlocke.com</a>

Example

GK1101-1A.NR.U.DOL728.SPNN04

GK1101-1A	NR	U	DOL728	SPNN04
MODEL NUMBER	STITCH	FLAMMABILITY DETAIL	CUSHION UPHOLSTERY	FRAME UPHOLSTERY

Please refer to the Ciji product page on [www.gunlocke.com](http://www.gunlocke.com) for standard finish options.

**Seating**  
02/24

**CIJI SINGLE SEAT**

Low Back, Armless, Wood Legs

model number

fabric grades

dimensions

W

D

H

**GK1103-1W**

Low back, armless  
Wood legs

**1** 2,897

Overall	24 5/8"	31 1/2"	27 7/8"
Seat	24"	21"	17 1/4"

**Upholstery Requirements: GK1103-1W**

	Dual Upholstery	
Fabric yds	Cushions 1.5	Frame 1.5
Leather ft <sup>2</sup>	Cushions 34.5	Frame 34.5
Shipping weight	77 lbs.	
Cube	28.0	



Cushion

<b>1</b>	<b>10</b>	323	<b>19</b>	742	<b>L1</b>	494
<b>2</b>	30	<b>11</b>	361	<b>20</b>	<b>L2</b>	902
<b>3</b>	59	<b>12</b>	401	<b>21</b>	<b>L3</b>	1,391
<b>COM/4</b>	89	<b>13</b>	449	<b>22</b>	<b>L4</b>	1,799
<b>5</b>	128	<b>14</b>	498	<b>23</b>	<b>L5</b>	2,206
<b>6</b>	167	<b>15</b>	546	<b>24</b>		1,083
<b>7</b>	205	<b>16</b>	596	<b>25</b>		1,181
<b>8</b>	245	<b>17</b>	644	<b>26</b>		1,279
<b>9</b>	284	<b>18</b>	694	<b>27</b>		1,376

To calculate price of lounge with different fabric for cushion and frame; start with Grade 1 price, add appropriate grade price located in second row for cushion, and last add appropriate grade price located in third row for frame to the sum of the Grade 1 and cushion price.

**Example: Grade 1 \$2,897 + grade 4 fabric cushion \$89 + grade 2 fabric frame \$30 = \$3,016**

Select upholstery for everything else other than the seat and back cushions (the outside back, arms, sides, seat frame). You can specify the same fabric as the cushions or select other fabric.

Frame

<b>1</b>	<b>10</b>	323	<b>19</b>	742	<b>L1</b>	494
<b>2</b>	30	<b>11</b>	361	<b>20</b>	<b>L2</b>	902
<b>3</b>	59	<b>12</b>	401	<b>21</b>	<b>L3</b>	1,391
<b>COM/4</b>	89	<b>13</b>	449	<b>22</b>	<b>L4</b>	1,799
<b>5</b>	128	<b>14</b>	498	<b>23</b>	<b>L5</b>	2,206
<b>6</b>	167	<b>15</b>	546	<b>24</b>		1,083
<b>7</b>	205	<b>16</b>	596	<b>25</b>		1,181
<b>8</b>	245	<b>17</b>	644	<b>26</b>		1,279
<b>9</b>	284	<b>18</b>	694	<b>27</b>		1,376

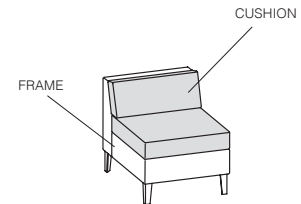

**TO ORDER PLEASE SPECIFY THE FOLLOWING:**

.  .  .  .  .

**MODEL NUMBER**

**WOOD FINISH**

Cherry finishes on Maple  
Walnut finishes on Maple  
Maple finishes on Maple  
Oak finishes on Maple  
*Light Rift Oak 301 not available on Maple.*

**STITCH DETAIL**

None NR  
Stitch detail  
SD +\$197

**FLAMMABILITY RATING**

U CTB117

**CUSHION UPHOLSTERY**

Please refer to list of available upholstery and leather selections on [www.gunlocke.com](http://www.gunlocke.com)

**FRAME UPHOLSTERY**

Please refer to list of available upholstery and leather selections on [www.gunlocke.com](http://www.gunlocke.com)

**Example**

GK1103-1W.777.NR.U.DOL728.SPNN04

GK1103-1W	777	NR	U	DOL728	SPNN04
MODEL NUMBER	WOOD FINISH	STITCH DETAIL	FLAMMABILITY	CUSHION UPHOLSTERY	FRAME UPHOLSTERY

Please refer to the Ciji product page on [www.gunlocke.com](http://www.gunlocke.com) for standard finish options.

# CIJI SINGLE SEAT

Seating  
02/24

Low Back, Armless, Aluminum Legs

model number                      fabric grades                      dimensions                      W                      D                      H

**GK1103-1A**  
Low back, armless  
Aluminum legs

**1** 3,179

Overall	24 5/8"	31 1/2"	27 7/8"
Seat	24"	21"	17 1/4"



**Upholstery Requirements: GK1103-1A**

	Dual Upholstery		
Fabric yds	Cushions 1.5	Frame 1.5	
Leather ft <sup>2</sup>	Cushions 34.5	Frame 34.5	
Shipping weight	77 lbs.		
Cube	28.0		

GK1103-1A

<b>1</b>	<b>10</b>	323	<b>19</b>	742	<b>L1</b>	494
<b>2</b>	30	<b>11</b>	361	<b>20</b>	<b>L2</b>	902
<b>3</b>	59	<b>12</b>	401	<b>21</b>	<b>L3</b>	1,391
<b>COM/4</b>	89	<b>13</b>	449	<b>22</b>	<b>L4</b>	1,799
<b>5</b>	128	<b>14</b>	498	<b>23</b>	<b>L5</b>	2,206
<b>6</b>	167	<b>15</b>	546	<b>24</b>		1,083
<b>7</b>	205	<b>16</b>	596	<b>25</b>		1,181
<b>8</b>	245	<b>17</b>	644	<b>26</b>		1,279
<b>9</b>	284	<b>18</b>	694	<b>27</b>		1,376

To calculate price of lounge with different fabric for cushion and frame; start with Grade 1 price, add appropriate grade price located in second row for cushion, and last add appropriate grade price located in third row for frame to the sum of the Grade 1 and cushion price.

**Example: Grade 1 \$3,179 + grade 4 fabric cushion \$89 + grade 2 fabric frame \$30 = \$3,298**

Select upholstery for everything else other than the seat and back cushions (the outside back, arms, sides, seat frame). You can specify the same fabric as the cushions or select other fabric.

Frame

<b>1</b>	<b>10</b>	323	<b>19</b>	742	<b>L1</b>	494
<b>2</b>	30	<b>11</b>	361	<b>20</b>	<b>L2</b>	902
<b>3</b>	59	<b>12</b>	401	<b>21</b>	<b>L3</b>	1,391
<b>COM/4</b>	89	<b>13</b>	449	<b>22</b>	<b>L4</b>	1,799
<b>5</b>	128	<b>14</b>	498	<b>23</b>	<b>L5</b>	2,206
<b>6</b>	167	<b>15</b>	546	<b>24</b>		1,083
<b>7</b>	205	<b>16</b>	596	<b>25</b>		1,181
<b>8</b>	245	<b>17</b>	644	<b>26</b>		1,279
<b>9</b>	284	<b>18</b>	694	<b>27</b>		1,376

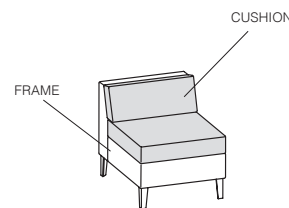

TO ORDER PLEASE SPECIFY THE FOLLOWING:

<input type="text"/>	<input type="text"/>	<input type="text"/>	<input type="text"/>	<input type="text"/>
<b>MODEL NUMBER</b>	<b>STITCH DETAIL</b>	<b>FLAMMABILITY RATING</b>	<b>CUSHION UPHOLSTERY</b>	<b>FRAME UPHOLSTERY</b>
	None <b>NR</b> Stitch detail <b>SD +\$197</b>	<b>U</b> CTB117	Please refer to list of available upholstery and leather selections on <a href="http://www.gunlocke.com">www.gunlocke.com</a>	Please refer to list of available upholstery and leather selections on <a href="http://www.gunlocke.com">www.gunlocke.com</a>

Example

GK1103-1A.NR.U.DOL728.SPNN04				
GK1103-1A	NR	U	DOL728	SPNN04
<b>MODEL NUMBER</b>	<b>STITCH</b>	<b>FLAMMABILITY DETAIL</b>	<b>CUSHION UPHOLSTERY</b>	<b>FRAME UPHOLSTERY</b>

Please refer to the Ciji product page on [www.gunlocke.com](http://www.gunlocke.com) for standard finish options.

model number                      fabric grades                      dimensions                      W                      D                      H

**GK1105-1W**

Low back, arm left.  
Wood legs

**1** 3,561

Overall	28 1/8"	31 1/2"	27 1/8"
Seat	24"	21"	17 1/4"
Arm			26 1/8"
Between arms			



**Upholstery Requirements: GK1105-1W**

	Dual Upholstery	
Fabric yds	Cushions 1.5	Frame 2.8
Leather ft <sup>2</sup>	Cushions 34.5	Frame 64.4
Shipping weight		87 lbs.
Cube		28.0

Cushion

<b>1</b>	<b>10</b>	323	<b>19</b>	742	<b>L1</b>	494
<b>2</b>	30	<b>11</b>	361	<b>20</b>	<b>L2</b>	902
<b>3</b>	59	<b>12</b>	401	<b>21</b>	<b>L3</b>	1,391
<b>COM/4</b>	89	<b>13</b>	449	<b>22</b>	<b>L4</b>	1,799
<b>5</b>	128	<b>14</b>	498	<b>23</b>	<b>L5</b>	2,206
<b>6</b>	167	<b>15</b>	546	<b>24</b>		1,083
<b>7</b>	205	<b>16</b>	596	<b>25</b>		1,181
<b>8</b>	245	<b>17</b>	644	<b>26</b>		1,279
<b>9</b>	284	<b>18</b>	694	<b>27</b>		1,376

To calculate price of lounge with different fabric for cushion and frame; start with Grade 1 price, add appropriate grade price located in second row for cushion, and last add appropriate grade price located in third row for frame to the sum of the Grade 1 and cushion price.

**Example: Grade 1 \$3,561 + grade 4 fabric cushion \$89 + grade 2 fabric frame \$56 = \$3,706**

Select upholstery for everything else other than the seat and back cushions (the outside back, arms, sides, seat frame). You can specify the same fabric as the cushions or select other fabric.

Frame

<b>1</b>	<b>10</b>	602	<b>19</b>	1,384	<b>L1</b>	920
<b>2</b>	56	<b>11</b>	674	<b>20</b>	<b>L2</b>	1,681
<b>3</b>	110	<b>12</b>	747	<b>21</b>	<b>L3</b>	2,595
<b>COM/4</b>	165	<b>13</b>	839	<b>22</b>	<b>L4</b>	3,357
<b>5</b>	237	<b>14</b>	930	<b>23</b>	<b>L5</b>	4,118
<b>6</b>	311	<b>15</b>	1,020	<b>24</b>		2,020
<b>7</b>	383	<b>16</b>	1,112	<b>25</b>		2,203
<b>8</b>	456	<b>17</b>	1,203	<b>26</b>		2,386
<b>9</b>	529	<b>18</b>	1,293	<b>27</b>		2,567

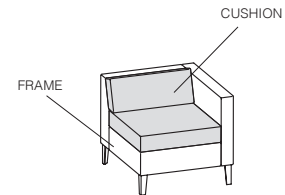

TO ORDER PLEASE SPECIFY THE FOLLOWING:

.  .  .  .  .

<b>MODEL NUMBER</b>	<b>WOOD FINISH</b>	<b>STITCH DETAIL</b>	<b>FLAMMABILITY RATING</b>	<b>CUSHION UPHOLSTERY</b>	<b>FRAME UPHOLSTERY</b>
	Cherry finishes on Maple Walnut finishes on Maple Maple finishes on Maple Oak finishes on Maple <i>Light Rift Oak 301 not available on Maple.</i>	None NR Stitch detail SD +\$197	U CTB117	Please refer to list of available upholstery and leather selections on www.gunlocke.com	Please refer to list of available upholstery and leather selections on www.gunlocke.com

Example

GK1105-1W.777.NR.U.DOL728.SPNN04

GK1105-1W	777	NR	U	DOL728	SPNN04
MODEL NUMBER	WOOD FINISH	STITCH DETAIL	FLAMMABILITY	CUSHION UPHOLSTERY	FRAME UPHOLSTERY

Please refer to the Ciji product page on www.gunlocke.com for standard finish options.

# CIJI SINGLE SEAT

Low Back, Arm Left, Aluminum Legs

Seating  
02/24

model number                      fabric grades                      dimensions                      W                      D                      H

**GK1105-1A**

Low back, arm left.  
Aluminum legs

1 3,844

Overall	28 1/8"	31 1/2"	27 1/8"
Seat	24"	21"	17 1/4"
Arm			26 1/8"
Between arms			



**Upholstery Requirements: GK1105-1A**

	Dual Upholstery		
Fabric yds	Cushions 1.5	Frame 2.8	
Leather ft <sup>2</sup>	Cushions 34.5	Frame 64.4	
Shipping weight			87 lbs.
Cube			28.0

Cushion

<b>1</b>	<b>10</b>	323	<b>19</b>	742	<b>L1</b>	494
<b>2</b>	30	<b>11</b>	361	<b>20</b>	<b>L2</b>	902
<b>3</b>	59	<b>12</b>	401	<b>21</b>	<b>L3</b>	1,391
<b>COM/4</b>	89	<b>13</b>	449	<b>22</b>	<b>L4</b>	1,799
<b>5</b>	128	<b>14</b>	498	<b>23</b>	<b>L5</b>	2,206
<b>6</b>	167	<b>15</b>	546	<b>24</b>		
<b>7</b>	205	<b>16</b>	596	<b>25</b>		
<b>8</b>	245	<b>17</b>	644	<b>26</b>		
<b>9</b>	284	<b>18</b>	694	<b>27</b>		

To calculate price of lounge with different fabric for cushion and frame; start with Grade 1 price, add appropriate grade price located in second row for cushion, and last add appropriate grade price located in third row for frame to the sum of the Grade 1 and cushion price.

**Example: Grade 1 \$3,844 + grade 4 fabric cushion \$89 + grade 2 fabric frame \$56 = \$3,989**

Frame

<b>1</b>	<b>10</b>	602	<b>19</b>	1,384	<b>L1</b>	920
<b>2</b>	56	<b>11</b>	674	<b>20</b>	<b>L2</b>	1,681
<b>3</b>	110	<b>12</b>	747	<b>21</b>	<b>L3</b>	2,595
<b>COM/4</b>	165	<b>13</b>	839	<b>22</b>	<b>L4</b>	3,357
<b>5</b>	237	<b>14</b>	930	<b>23</b>	<b>L5</b>	4,118
<b>6</b>	311	<b>15</b>	1,020	<b>24</b>		
<b>7</b>	383	<b>16</b>	1,112	<b>25</b>		
<b>8</b>	456	<b>17</b>	1,203	<b>26</b>		
<b>9</b>	529	<b>18</b>	1,293	<b>27</b>		

Select upholstery for everything else other than the seat and back cushions (the outside back, arms, sides, seat frame). You can specify the same fabric as the cushions or select other fabric.

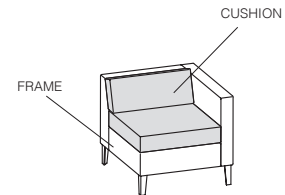

**TO ORDER PLEASE SPECIFY THE FOLLOWING:**

<input type="text"/>	<input type="text"/>	<input type="text"/>	<input type="text"/>	<input type="text"/>
<b>MODEL NUMBER</b>	<b>STITCH DETAIL</b>	<b>FLAMMABILITY RATING</b>	<b>CUSHION UPHOLSTERY</b>	<b>FRAME UPHOLSTERY</b>
	None <b>NR</b> Stitch detail <b>SD +\$197</b>	<b>U</b> <b>CTB117</b>	Please refer to list of available upholstery and leather selections on <a href="http://www.gunlocke.com">www.gunlocke.com</a>	Please refer to list of available upholstery and leather selections on <a href="http://www.gunlocke.com">www.gunlocke.com</a>

Example

GK1105-1A.NR.U.DOL728.SPNN04

GK1105-1A	NR	U	DOL728	SPNN04
MODEL NUMBER	STITCH	FLAMMABILITY DETAIL	CUSHION UPHOLSTERY	FRAME UPHOLSTERY

Please refer to the Ciji product page on [www.gunlocke.com](http://www.gunlocke.com) for standard finish options.

model number                      fabric grades                      dimensions                      W                      D                      H

**GK1107-1W**

Low back, arm right  
Wood legs

**1** 3,561

Overall	28 1/8"	31 1/2"	27 7/8"
Seat	24"	21"	17 1/4"
Arm			26 7/8"
Between arms			



**Upholstery Requirements: GK1107-1W**

	Dual Upholstery	
Fabric yds	Cushions 1.5	Frame 2.8
Leather ft <sup>2</sup>	Cushions 34.5	Frame 64.4
Shipping weight		87 lbs.
Cube		28.0

Cushion

<b>1</b>	<b>10</b>	323	<b>19</b>	742	<b>L1</b>	494
<b>2</b>	30	<b>11</b>	361	<b>20</b>	<b>L2</b>	902
<b>3</b>	59	<b>12</b>	401	<b>21</b>	<b>L3</b>	1,391
<b>COM/4</b>	89	<b>13</b>	449	<b>22</b>	<b>L4</b>	1,799
<b>5</b>	128	<b>14</b>	498	<b>23</b>	<b>L5</b>	2,206
<b>6</b>	167	<b>15</b>	546	<b>24</b>		1,083
<b>7</b>	205	<b>16</b>	596	<b>25</b>		1,181
<b>8</b>	245	<b>17</b>	644	<b>26</b>		1,279
<b>9</b>	284	<b>18</b>	694	<b>27</b>		1,376

To calculate price of lounge with different fabric for cushion and frame; start with Grade 1 price, add appropriate grade price located in second row for cushion, and last add appropriate grade price located in third row for frame to the sum of the Grade 1 and cushion price.

**Example: Grade 1 \$3,561 + grade 4 fabric cushion \$89 + grade 2 fabric frame \$56 = \$3,706**

Select upholstery for everything else other than the seat and back cushions (the outside back, arms, sides, seat frame). You can specify the same fabric as the cushions or select other fabric.

Frame

<b>1</b>	<b>10</b>	602	<b>19</b>	1,384	<b>L1</b>	920
<b>2</b>	56	<b>11</b>	674	<b>20</b>	<b>L2</b>	1,681
<b>3</b>	110	<b>12</b>	747	<b>21</b>	<b>L3</b>	2,595
<b>COM/4</b>	165	<b>13</b>	839	<b>22</b>	<b>L4</b>	3,357
<b>5</b>	237	<b>14</b>	930	<b>23</b>	<b>L5</b>	4,118
<b>6</b>	311	<b>15</b>	1,020	<b>24</b>		2,020
<b>7</b>	383	<b>16</b>	1,112	<b>25</b>		2,203
<b>8</b>	456	<b>17</b>	1,203	<b>26</b>		2,386
<b>9</b>	529	<b>18</b>	1,293	<b>27</b>		2,567

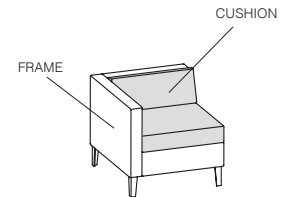

**TO ORDER PLEASE SPECIFY THE FOLLOWING:**

.  .  .  .  .

<b>MODEL NUMBER</b>	<b>WOOD FINISH</b>	<b>STITCH DETAIL</b>	<b>FLAMMABILITY RATING</b>	<b>CUSHION UPHOLSTERY</b>	<b>FRAME UPHOLSTERY</b>
	Cherry finishes on Maple Walnut finishes on Maple Maple finishes on Maple Oak finishes on Maple <i>Light Rift Oak 301 not available on Maple.</i>	None <b>NR</b> Stitch detail <b>SD +\$197</b>	<b>U</b> CTB117	Please refer to list of available upholstery and leather selections on <a href="http://www.gunlocke.com">www.gunlocke.com</a>	Please refer to list of available upholstery and leather selections on <a href="http://www.gunlocke.com">www.gunlocke.com</a>

Example

GK1107-1W.777.NR.U.DOL728.SPNN04

GK1107-1W	777	NR	U	DOL728	SPNN04
MODEL NUMBER	WOOD FINISH	STITCH DETAIL	FLAMMABILITY	CUSHION UPHOLSTERY	FRAME UPHOLSTERY

Please refer to the Ciji product page on [www.gunlocke.com](http://www.gunlocke.com) for standard finish options.

# CIJI SINGLE SEAT

Low Back, Arm Right, Aluminum Legs

Seating  
02/24

model number	fabric grades	dimensions	W	D	H
--------------	---------------	------------	---	---	---

**GK1107-1A**  
Low back, arm right  
Aluminum legs

1 3,844

Overall	28 1/8"	31 1/2"	27 7/8"
Seat	24"	21"	17 1/4"
Arm			26 7/8"
Between arms			



### Upholstery Requirements: GK1107-1A

	Dual Upholstery	
Fabric yds	Cushions 1.5	Frame 2.8
Leather ft <sup>2</sup>	Cushions 34.5	Frame 64.4
Shipping weight	87 lbs.	
Cube	28.0	

Cushion

<b>1</b>	<b>10</b>	323	<b>19</b>	742	<b>L1</b>	494
<b>2</b>	30	<b>11</b>	361	<b>20</b>	<b>L2</b>	902
<b>3</b>	59	<b>12</b>	401	<b>21</b>	<b>L3</b>	1,391
<b>COM/4</b>	89	<b>13</b>	449	<b>22</b>	<b>L4</b>	1,799
<b>5</b>	128	<b>14</b>	498	<b>23</b>	<b>L5</b>	2,206
<b>6</b>	167	<b>15</b>	546	<b>24</b>		
<b>7</b>	205	<b>16</b>	596	<b>25</b>		
<b>8</b>	245	<b>17</b>	644	<b>26</b>		
<b>9</b>	284	<b>18</b>	694	<b>27</b>		

To calculate price of lounge with different fabric for cushion and frame; start with Grade 1 price, add appropriate grade price located in second row for cushion, and last add appropriate grade price located in third row for frame to the sum of the Grade 1 and cushion price.

**Example: Grade 1 \$3,844 + grade 4 fabric cushion \$89 + grade 2 fabric frame \$56 = \$3,989**

Select upholstery for everything else other than the seat and back cushions (the outside back, arms, sides, seat frame). You can specify the same fabric as the cushions or select other fabric.

Frame

<b>1</b>	<b>10</b>	602	<b>19</b>	1,384	<b>L1</b>	920
<b>2</b>	56	<b>11</b>	674	<b>20</b>	<b>L2</b>	1,681
<b>3</b>	110	<b>12</b>	747	<b>21</b>	<b>L3</b>	2,595
<b>COM/4</b>	165	<b>13</b>	839	<b>22</b>	<b>L4</b>	3,357
<b>5</b>	237	<b>14</b>	930	<b>23</b>	<b>L5</b>	4,118
<b>6</b>	311	<b>15</b>	1,020	<b>24</b>		
<b>7</b>	383	<b>16</b>	1,112	<b>25</b>		
<b>8</b>	456	<b>17</b>	1,203	<b>26</b>		
<b>9</b>	529	<b>18</b>	1,293	<b>27</b>		

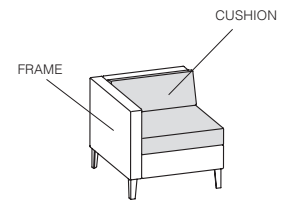

TO ORDER PLEASE SPECIFY THE FOLLOWING:

<input type="text"/>	<input type="text"/>	<input type="text"/>	<input type="text"/>	<input type="text"/>
<b>MODEL NUMBER</b>	<b>STITCH DETAIL</b>	<b>FLAMMABILITY RATING</b>	<b>CUSHION UPHOLSTERY</b>	<b>FRAME UPHOLSTERY</b>
	None <b>NR</b> Stitch detail <b>SD +\$197</b>	<b>U</b> CTB117	Please refer to list of available upholstery and leather selections on <a href="http://www.gunlocke.com">www.gunlocke.com</a>	Please refer to list of available upholstery and leather selections on <a href="http://www.gunlocke.com">www.gunlocke.com</a>

Example

GK1107-1A.NR.U.DOL728.SPNN04

GK1107-1A	NR	U	DOL728	SPNN04
MODEL NUMBER	STITCH	FLAMMABILITY DETAIL	CUSHION UPHOLSTERY	FRAME UPHOLSTERY

Please refer to the Ciji product page on [www.gunlocke.com](http://www.gunlocke.com) for standard finish options.



model number	fabric grades
<b>GK1101-2W</b>	<b>1</b> 5,294

Low back, with arms  
Wood legs

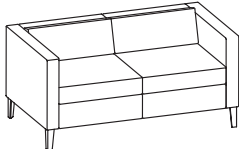

dimensions	W	D	H
Overall	56 1/4"	31 1/2"	27 1/8"
Seat	48 1/2"	21"	17 1/4"
Arm			26 1/8"
Between arms	48 1/2"		

**Upholstery Requirements: GK1101-2W**

	Dual Upholstery
Fabric yds	Cushions 2.9 Frame 5.2
Leather ft <sup>2</sup>	Cushions 66.7 Frame 119.6
Shipping weight	119 lbs.
Cube	35

Cushion

<b>1</b>	<b>10</b>	623	<b>19</b>	1,433	<b>L1</b>	954	
<b>2</b>	57	<b>11</b>	698	<b>20</b>	1,528	<b>L2</b>	1,742
<b>3</b>	115	<b>12</b>	773	<b>21</b>	1,622	<b>L3</b>	2,688
<b>COM/4</b>	170	<b>13</b>	868	<b>22</b>	1,716	<b>L4</b>	3,476
<b>5</b>	246	<b>14</b>	963	<b>23</b>	1,905	<b>L5</b>	4,264
<b>6</b>	321	<b>15</b>	1,056	<b>24</b>	2,093		
<b>7</b>	397	<b>16</b>	1,151	<b>25</b>	2,282		
<b>8</b>	472	<b>17</b>	1,245	<b>26</b>	2,469		
<b>9</b>	547	<b>18</b>	1,339	<b>27</b>	2,659		

To calculate price of lounge with different fabric for cushion and frame; start with Grade 1 price, add appropriate grade price located in second row for cushion, and last add appropriate grade price located in third row for frame to the sum of the Grade 1 and cushion price.

**Example: Grade 1 \$5,294 + grade 4 fabric cushion \$170 + grade 2 fabric frame \$102 = \$5,566**

Frame

<b>1</b>	<b>10</b>	1,116	<b>19</b>	2,569	<b>L1</b>	1,709	
<b>2</b>	102	<b>11</b>	1,252	<b>20</b>	2,739	<b>L2</b>	3,123
<b>3</b>	204	<b>12</b>	1,387	<b>21</b>	2,908	<b>L3</b>	4,819
<b>COM/4</b>	305	<b>13</b>	1,556	<b>22</b>	3,077	<b>L4</b>	6,232
<b>5</b>	440	<b>14</b>	1,725	<b>23</b>	3,415	<b>L5</b>	7,645
<b>6</b>	576	<b>15</b>	1,894	<b>24</b>	3,753		
<b>7</b>	710	<b>16</b>	2,063	<b>25</b>	4,091		
<b>8</b>	846	<b>17</b>	2,231	<b>26</b>	4,428		
<b>9</b>	981	<b>18</b>	2,400	<b>27</b>	4,767		

Select upholstery for everything else other than the seat and back cushions (the outside back, arms, sides, seat frame). You can specify the same fabric as the cushions or select other fabric.

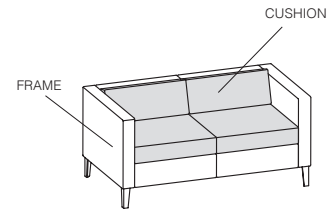

TO ORDER PLEASE SPECIFY THE FOLLOWING:

.  .  .  .  .

<b>MODEL NUMBER</b>	<b>WOOD FINISH</b>	<b>STITCH DETAIL</b>	<b>FLAMMABILITY RATING</b>	<b>CUSHION UPHOLSTERY</b>	<b>FRAME UPHOLSTERY</b>
	Cherry finishes on Maple Walnut finishes on Maple Maple finishes on Maple Oak finishes on Maple <i>Light Rift Oak 301 not available on Maple.</i>	None NR Stitch detail SD +\$197	U CTB117	Please refer to list of available upholstery and leather selections on <a href="http://www.gunlocke.com">www.gunlocke.com</a>	Please refer to list of available upholstery and leather selections on <a href="http://www.gunlocke.com">www.gunlocke.com</a>

Example

GK1101-2W.777.NR.U.DOL728.SPNN04					
GK1101-2W	777	NR	U	DOL728	SPNN04
MODEL NUMBER	WOOD FINISH	STITCH DETAIL	FLAMMABILITY	CUSHION UPHOLSTERY	FRAME UPHOLSTERY

Please refer to the Ciji product page on [www.gunlocke.com](http://www.gunlocke.com) for standard finish options.

# CIJI TWO SEAT

Low Back, with Arms, Aluminum Legs

**Seating**  
02/24

model number	fabric grades	dimensions	W	D	H
--------------	---------------	------------	---	---	---

**GK1101-2A**  
Low back, with arms,  
Aluminum Legs

**1** 5,577

Overall	56 1/4"	31 1/2"	27 1/8"
Seat	48 1/2"	21"	17 1/4"
Arm			26 1/8"
Between arms	48 1/2"		

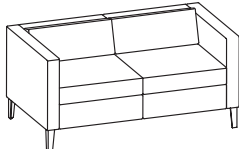

### Upholstery Requirements: GK1101-2A

	Dual Upholstery
Fabric yds	Cushions 2.9 Frame 5.2
Leather ft <sup>2</sup>	Cushions 66.7 Frame 119.6
Shipping weight	119 lbs.
Cube	35

Cushion

<b>1</b>	<b>10</b>	623	<b>19</b>	1,433	<b>L1</b>	954	
<b>2</b>	57	<b>11</b>	698	<b>20</b>	1,528	<b>L2</b>	1,742
<b>3</b>	115	<b>12</b>	773	<b>21</b>	1,622	<b>L3</b>	2,688
<b>COM/4</b>	170	<b>13</b>	868	<b>22</b>	1,716	<b>L4</b>	3,476
<b>5</b>	246	<b>14</b>	963	<b>23</b>	1,905	<b>L5</b>	4,264
<b>6</b>	321	<b>15</b>	1,056	<b>24</b>	2,093		
<b>7</b>	397	<b>16</b>	1,151	<b>25</b>	2,282		
<b>8</b>	472	<b>17</b>	1,245	<b>26</b>	2,469		
<b>9</b>	547	<b>18</b>	1,339	<b>27</b>	2,659		

To calculate price of lounge with different fabric for cushion and frame; start with Grade 1 price, add appropriate grade price located in second row for cushion, and last add appropriate grade price located in third row for frame to the sum of the Grade 1 and cushion price.

**Example: Grade 1 \$5,577 + grade 4 fabric cushion \$170 + grade 2 fabric frame \$102 = \$5,849**

Frame

<b>1</b>	<b>10</b>	1,116	<b>19</b>	2,569	<b>L1</b>	1,709	
<b>2</b>	102	<b>11</b>	1,252	<b>20</b>	2,739	<b>L2</b>	3,123
<b>3</b>	204	<b>12</b>	1,387	<b>21</b>	2,908	<b>L3</b>	4,819
<b>COM/4</b>	305	<b>13</b>	1,556	<b>22</b>	3,077	<b>L4</b>	6,232
<b>5</b>	440	<b>14</b>	1,725	<b>23</b>	3,415	<b>L5</b>	7,645
<b>6</b>	576	<b>15</b>	1,894	<b>24</b>	3,753		
<b>7</b>	710	<b>16</b>	2,063	<b>25</b>	4,091		
<b>8</b>	846	<b>17</b>	2,231	<b>26</b>	4,428		
<b>9</b>	981	<b>18</b>	2,400	<b>27</b>	4,767		

Select upholstery for everything else other than the seat and back cushions (the outside back, arms, sides, seat frame). You can specify the same fabric as the cushions or select other fabric.

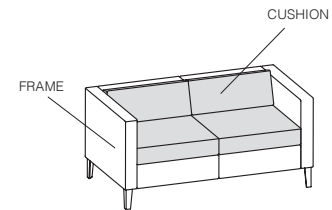

TO ORDER PLEASE SPECIFY THE FOLLOWING:

<input type="text"/>	<input type="text"/>	<input type="text"/>	<input type="text"/>	<input type="text"/>
<b>MODEL NUMBER</b>	<b>STITCH DETAIL</b>	<b>FLAMMABILITY RATING</b>	<b>CUSHION UPHOLSTERY</b>	<b>FRAME UPHOLSTERY</b>
	None <b>NR</b> Stitch detail <b>SD +\$197</b>	<b>U</b> CTB117	Please refer to list of available upholstery and leather selections on <a href="http://www.gunlocke.com">www.gunlocke.com</a>	Please refer to list of available upholstery and leather selections on <a href="http://www.gunlocke.com">www.gunlocke.com</a>

Example

GK1101-2A.NR.U.DOL728.SPNN04

GK1101-2A	NR	U	DOL728	SPNN04
MODEL NUMBER	STITCH	FLAMMABILITY DETAIL	CUSHION UPHOLSTERY	FRAME UPHOLSTERY

Please refer to the Ciji product page on [www.gunlocke.com](http://www.gunlocke.com) for standard finish options.

model number	fabric grades
<b>GK1103-2W</b>	<b>1</b> 4,370

Low back, armless,  
Wood legs

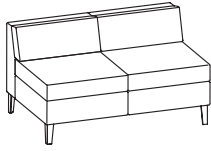

dimensions	W	D	H
Overall	49 1/8"	31 1/2"	27 7/8"
Seat	48 1/2"	21"	17 1/4"

**Upholstery Requirements: GK1103-2W**

	Dual Upholstery	
Fabric yds	Cushions 2.9	Frame 2.3
Leather ft <sup>2</sup>	Cushions 66.7	Frame 52.9
Shipping weight	99 lbs.	
Cube	35	

Cushion

<b>1</b>	<b>10</b>	623	<b>19</b>	1,433	<b>L1</b>	954
<b>2</b>	57	<b>11</b>	698	<b>20</b>	1,528	<b>L2</b> 1,742
<b>3</b>	115	<b>12</b>	773	<b>21</b>	1,622	<b>L3</b> 2,688
<b>COM/4</b>	170	<b>13</b>	868	<b>22</b>	1,716	<b>L4</b> 3,476
<b>5</b>	246	<b>14</b>	963	<b>23</b>	1,905	<b>L5</b> 4,264
<b>6</b>	321	<b>15</b>	1,056	<b>24</b>	2,093	
<b>7</b>	397	<b>16</b>	1,151	<b>25</b>	2,282	
<b>8</b>	472	<b>17</b>	1,245	<b>26</b>	2,469	
<b>9</b>	547	<b>18</b>	1,339	<b>27</b>	2,659	

To calculate price of lounge with different fabric for cushion and frame; start with Grade 1 price, add appropriate grade price located in second row for cushion, and last add appropriate grade price located in third row for frame to the sum of the Grade 1 and cushion price.

**Example: Grade 1 \$4,370 + grade 4 fabric cushion \$170 + grade 2 fabric frame \$46 = \$4,586**

Select upholstery for everything else other than the seat and back cushions (the outside back, arms, sides, seat frame). You can specify the same fabric as the cushions or select other fabric.

Frame

<b>1</b>	<b>10</b>	494	<b>19</b>	1,138	<b>L1</b>	757
<b>2</b>	46	<b>11</b>	555	<b>20</b>	1,213	<b>L2</b> 1,382
<b>3</b>	91	<b>12</b>	614	<b>21</b>	1,287	<b>L3</b> 2,132
<b>COM/4</b>	135	<b>13</b>	690	<b>22</b>	1,362	<b>L4</b> 2,757
<b>5</b>	195	<b>14</b>	764	<b>23</b>	1,512	<b>L5</b> 3,383
<b>6</b>	255	<b>15</b>	839	<b>24</b>	1,661	
<b>7</b>	316	<b>16</b>	913	<b>25</b>	1,809	
<b>8</b>	374	<b>17</b>	988	<b>26</b>	1,959	
<b>9</b>	434	<b>18</b>	1,062	<b>27</b>	2,110	

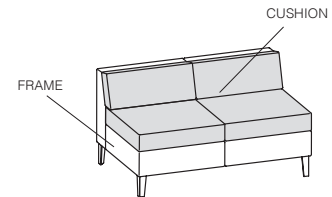

TO ORDER PLEASE SPECIFY THE FOLLOWING:

.  .  .  .  .

<b>MODEL NUMBER</b>	<b>WOOD FINISH</b>	<b>STITCH DETAIL</b>	<b>FLAMMABILITY RATING</b>	<b>CUSHION UPHOLSTERY</b>	<b>FRAME UPHOLSTERY</b>
	Cherry finishes on Maple Walnut finishes on Maple Maple finishes on Maple Oak finishes on Maple <i>Light Rift Oak 301 not available on Maple.</i>	None NR Stitch detail SD +\$197	U CTB117	Please refer to list of available upholstery and leather selections on www.gunlocke.com	Please refer to list of available upholstery and leather selections on www.gunlocke.com

Example

GK1103-2W.777.NR.U.DOL728.SPNO4					
GK1103-2W	777	NR	U	DOL728	SPNO4
MODEL NUMBER	WOOD FINISH	STITCH DETAIL	FLAMMABILITY	CUSHION UPHOLSTERY	FRAME UPHOLSTERY

Please refer to the Ciji product page on www.gunlocke.com for standard finish options.

# CIJI TWO SEAT

Low Back, Armless, Aluminum Legs

Seating  
02/24

model number

fabric grades

dimensions

W

D

H

## GK1103-2A

Low back, armless,  
Aluminum legs

**1** 4,655

Overall	49 1/8"	31 1/2"	27 7/8"
Seat	48 1/2"	21"	17 1/4"

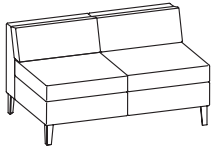

### Upholstery Requirements: GK1103-2A

	Dual Upholstery
Fabric yds	Cushions 2.9 Frame 2.3
Leather ft <sup>2</sup>	Cushions 66.7 Frame 52.9
Shipping weight	99 lbs.
Cube	35

Cushion

<b>1</b>	<b>10</b>	623	<b>19</b>	1,433	<b>L1</b>	954	
<b>2</b>	57	<b>11</b>	698	<b>20</b>	1,528	<b>L2</b>	1,742
<b>3</b>	115	<b>12</b>	773	<b>21</b>	1,622	<b>L3</b>	2,688
<b>COM/4</b>	170	<b>13</b>	868	<b>22</b>	1,716	<b>L4</b>	3,476
<b>5</b>	246	<b>14</b>	963	<b>23</b>	1,905	<b>L5</b>	4,264
<b>6</b>	321	<b>15</b>	1,056	<b>24</b>	2,093		
<b>7</b>	397	<b>16</b>	1,151	<b>25</b>	2,282		
<b>8</b>	472	<b>17</b>	1,245	<b>26</b>	2,469		
<b>9</b>	547	<b>18</b>	1,339	<b>27</b>	2,659		

To calculate price of lounge with different fabric for cushion and frame; start with Grade 1 price, add appropriate grade price located in second row for cushion, and last add appropriate grade price located in third row for frame to the sum of the Grade 1 and cushion price.

**Example: Grade 1 \$4,655 + grade 4 fabric cushion \$170 + grade 2 fabric frame \$46 = \$4,871**

Frame

<b>1</b>	<b>10</b>	494	<b>19</b>	1,138	<b>L1</b>	757	
<b>2</b>	46	<b>11</b>	555	<b>20</b>	1,213	<b>L2</b>	1,382
<b>3</b>	91	<b>12</b>	614	<b>21</b>	1,287	<b>L3</b>	2,132
<b>COM/4</b>	135	<b>13</b>	690	<b>22</b>	1,362	<b>L4</b>	2,757
<b>5</b>	195	<b>14</b>	764	<b>23</b>	1,512	<b>L5</b>	3,383
<b>6</b>	255	<b>15</b>	839	<b>24</b>	1,661		
<b>7</b>	316	<b>16</b>	913	<b>25</b>	1,809		
<b>8</b>	374	<b>17</b>	988	<b>26</b>	1,959		
<b>9</b>	434	<b>18</b>	1,062	<b>27</b>	2,110		

Select upholstery for everything else other than the seat and back cushions (the outside back, arms, sides, seat frame). You can specify the same fabric as the cushions or select other fabric.

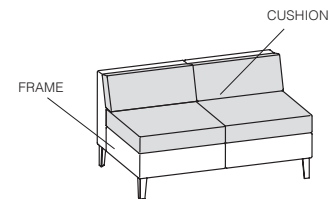

TO ORDER PLEASE SPECIFY THE FOLLOWING:

<input type="text"/>	<input type="text"/>	<input type="text"/>	<input type="text"/>	<input type="text"/>
<b>MODEL NUMBER</b>	<b>STITCH DETAIL</b>	<b>FLAMMABILITY RATING</b>	<b>CUSHION UPHOLSTERY</b>	<b>FRAME UPHOLSTERY</b>
	None <b>NR</b> Stitch detail <b>SD +\$197</b>	<b>U</b> CTB117	Please refer to list of available upholstery and leather selections on www. gunlocke.com	Please refer to list of available upholstery and leather selections on www. gunlocke.com

Example

GK1103-2A.NR.U.DOL728.SPNN04

GK1103-2A	NR	U	DOL728	SPNN04
MODEL NUMBER	STITCH	FLAMMABILITY DETAIL	CUSHION UPHOLSTERY	FRAME UPHOLSTERY

Please refer to the Ciji product page  
on www.gunlocke.com  
for standard finish options.

model number	fabric grades	dimensions	W	D	H
--------------	---------------	------------	---	---	---

**GK1105-2W**

Low back, arm left,  
Wood legs

**1** 5,076

Overall	52 5/8"	31 1/2"	27 7/8"
Seat	48 1/2"	21"	17 1/4"
Arm			26 7/8"
Between arms			

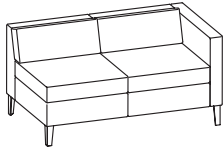

**Upholstery Requirements: GK1105-2W**

	Dual Upholstery	
Fabric yds	Cushions 2.9	Frame 3.8
Leather ft <sup>2</sup>	Cushions 66.7	Frame 87.4
Shipping weight		109 lbs.
Cube		35

Cushion

<b>1</b>	<b>10</b>	623	<b>19</b>	1,433	<b>L1</b>	954	
<b>2</b>	57	<b>11</b>	698	<b>20</b>	1,528	<b>L2</b>	1,742
<b>3</b>	115	<b>12</b>	773	<b>21</b>	1,622	<b>L3</b>	2,688
<b>COM/4</b>	170	<b>13</b>	868	<b>22</b>	1,716	<b>L4</b>	3,476
<b>5</b>	246	<b>14</b>	963	<b>23</b>	1,905	<b>L5</b>	4,264
<b>6</b>	321	<b>15</b>	1,056	<b>24</b>	2,093		
<b>7</b>	397	<b>16</b>	1,151	<b>25</b>	2,282		
<b>8</b>	472	<b>17</b>	1,245	<b>26</b>	2,469		
<b>9</b>	547	<b>18</b>	1,339	<b>27</b>	2,659		

To calculate price of lounge with different fabric for cushion and frame; start with Grade 1 price, add appropriate grade price located in second row for cushion, and last add appropriate grade price located in third row for frame to the sum of the Grade 1 and cushion price.

**Example: Grade 1 \$5,076 + grade 4 fabric cushion \$170 + grade 2 fabric frame \$75 = \$5,321**

Frame

<b>1</b>	<b>10</b>	816	<b>19</b>	1,878	<b>L1</b>	1,250	
<b>2</b>	75	<b>11</b>	915	<b>20</b>	2,002	<b>L2</b>	2,282
<b>3</b>	149	<b>12</b>	1,014	<b>21</b>	2,125	<b>L3</b>	3,522
<b>COM/4</b>	223	<b>13</b>	1,138	<b>22</b>	2,249	<b>L4</b>	4,555
<b>5</b>	322	<b>14</b>	1,260	<b>23</b>	2,495	<b>L5</b>	5,587
<b>6</b>	421	<b>15</b>	1,384	<b>24</b>	2,742		
<b>7</b>	520	<b>16</b>	1,507	<b>25</b>	2,990		
<b>8</b>	618	<b>17</b>	1,631	<b>26</b>	3,237		
<b>9</b>	717	<b>18</b>	1,755	<b>27</b>	3,484		

Select upholstery for everything else other than the seat and back cushions (the outside back, arms, sides, seat frame). You can specify the same fabric as the cushions or select other fabric.

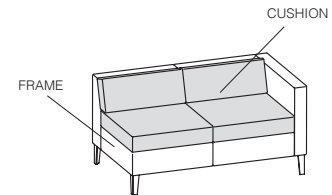

TO ORDER PLEASE SPECIFY THE FOLLOWING:

.  .  .  .  .

MODEL NUMBER	WOOD FINISH	STITCH DETAIL	FLAMMABILITY RATING	CUSHION UPHOLSTERY	FRAME UPHOLSTERY
	Cherry finishes on Maple Walnut finishes on Maple Maple finishes on Maple Oak finishes on Maple <i>Light Rift Oak 301 not available on Maple.</i>	None NR Stitch detail SD +\$197	U CTB117	Please refer to list of available upholstery and leather selections on www.gunlocke.com	Please refer to list of available upholstery and leather selections on www.gunlocke.com

Example

GK1105-2W.777.NR.U.DOL728.SPNN04

GK1105-2W	777	NR	U	DOL728	SPNN04
MODEL NUMBER	WOOD FINISH	STITCH DETAIL	FLAMMABILITY	CUSHION UPHOLSTERY	FRAME UPHOLSTERY

Please refer to the Ciji product page on www.gunlocke.com for standard finish options.

# CIJI TWO SEAT

Low Back, Arm Left, Aluminum Legs

**Seating**  
02/24

model number                      fabric grades                      dimensions                      W                      D                      H

**GK1105-2A**                      1 5,362  
Low back, arm left,  
Aluminum legs

Overall	52 5/8"	31 1/2"	27 7/8"
Seat	48 1/2"	21"	17 1/4"
Arm			26 7/8"
Between arms			

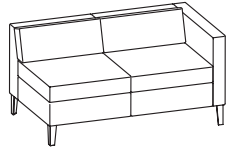

**Upholstery Requirements: GK1105-2A**

	Dual Upholstery	
Fabric yds	Cushions 2.9	Frame 3.8
Leather ft <sup>2</sup>	Cushions 66.7	Frame 87.4
Shipping weight	109 lbs.	
Cube	35	

Cushion

<b>1</b>	<b>10</b>	623	<b>19</b>	1,433	<b>L1</b>	954	
<b>2</b>	57	<b>11</b>	698	<b>20</b>	1,528	<b>L2</b>	1,742
<b>3</b>	115	<b>12</b>	773	<b>21</b>	1,622	<b>L3</b>	2,688
<b>COM/4</b>	170	<b>13</b>	868	<b>22</b>	1,716	<b>L4</b>	3,476
<b>5</b>	246	<b>14</b>	963	<b>23</b>	1,905	<b>L5</b>	4,264
<b>6</b>	321	<b>15</b>	1,056	<b>24</b>	2,093		
<b>7</b>	397	<b>16</b>	1,151	<b>25</b>	2,282		
<b>8</b>	472	<b>17</b>	1,245	<b>26</b>	2,469		
<b>9</b>	547	<b>18</b>	1,339	<b>27</b>	2,659		

To calculate price of lounge with different fabric for cushion and frame; start with Grade 1 price, add appropriate grade price located in second row for cushion, and last add appropriate grade price located in third row for frame to the sum of the Grade 1 and cushion price.

**Example: Grade 1 \$5,362 + grade 4 fabric cushion \$170 + grade 2 fabric frame \$75 = \$5,607**

Frame

<b>1</b>	<b>10</b>	816	<b>19</b>	1,878	<b>L1</b>	1,250	
<b>2</b>	75	<b>11</b>	915	<b>20</b>	2,002	<b>L2</b>	2,282
<b>3</b>	149	<b>12</b>	1,014	<b>21</b>	2,125	<b>L3</b>	3,522
<b>COM/4</b>	223	<b>13</b>	1,138	<b>22</b>	2,249	<b>L4</b>	4,555
<b>5</b>	322	<b>14</b>	1,260	<b>23</b>	2,495	<b>L5</b>	5,587
<b>6</b>	421	<b>15</b>	1,384	<b>24</b>	2,742		
<b>7</b>	520	<b>16</b>	1,507	<b>25</b>	2,990		
<b>8</b>	618	<b>17</b>	1,631	<b>26</b>	3,237		
<b>9</b>	717	<b>18</b>	1,755	<b>27</b>	3,484		

Select upholstery for everything else other than the seat and back cushions (the outside back, arms, sides, seat frame). You can specify the same fabric as the cushions or select other fabric.

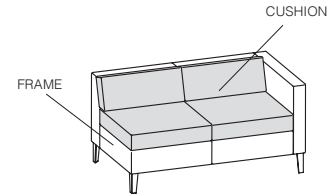

**TO ORDER PLEASE SPECIFY THE FOLLOWING:**

<input type="text"/>	<input type="text"/>	<input type="text"/>	<input type="text"/>	<input type="text"/>
<b>MODEL NUMBER</b>	<b>STITCH DETAIL</b>	<b>FLAMMABILITY RATING</b>	<b>CUSHION UPHOLSTERY</b>	<b>FRAME UPHOLSTERY</b>
	None <b>NR</b> Stitch detail <b>SD +\$197</b>	<b>U</b> CTB117	Please refer to list of available upholstery and leather selections on <a href="http://www.gunlocke.com">www.gunlocke.com</a>	Please refer to list of available upholstery and leather selections on <a href="http://www.gunlocke.com">www.gunlocke.com</a>

**Example**

GK1105-2A.NR.U.DOL728.SPNN04  
GK1105-2A    NR    U    DOL728    SPNN04  
MODEL NUMBER    STITCH    FLAMMABILITY    CUSHION    FRAME  
DETAIL    RATING    UPHOLSTERY    UPHOLSTERY

Please refer to the Ciji product page on [www.gunlocke.com](http://www.gunlocke.com) for standard finish options.

**Seating**  
02/24

**CIJI TWO SEAT**

Low Back, Arm Right, Wood Legs

model number                      fabric grades  
**GK1107-2W**                      **1** 5,076

Low back, arm right,  
Wood legs

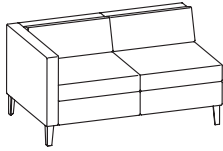

dimensions	W	D	H
Overall	52 5/8"	31 1/2"	27 7/8"
Seat	48 1/2"	21"	17 1/4"
Arm			26 7/8"
Between arms			

**Upholstery Requirements: GK1107-2W**

	Dual Upholstery	
Fabric yds	Cushions 2.9	Frame 3.8
Leather ft <sup>2</sup>	Cushions 66.7	Frame 87.4
Shipping weight	109 lbs.	
Cube	35	

Cushion

<b>1</b>	<b>10</b>	623	<b>19</b>	1,433	<b>L1</b>	954	
<b>2</b>	57	<b>11</b>	698	<b>20</b>	1,528	<b>L2</b>	1,742
<b>3</b>	115	<b>12</b>	773	<b>21</b>	1,622	<b>L3</b>	2,688
<b>COM/4</b>	170	<b>13</b>	868	<b>22</b>	1,716	<b>L4</b>	3,476
<b>5</b>	246	<b>14</b>	963	<b>23</b>	1,905	<b>L5</b>	4,264
<b>6</b>	321	<b>15</b>	1,056	<b>24</b>	2,093		
<b>7</b>	397	<b>16</b>	1,151	<b>25</b>	2,282		
<b>8</b>	472	<b>17</b>	1,245	<b>26</b>	2,469		
<b>9</b>	547	<b>18</b>	1,339	<b>27</b>	2,659		

To calculate price of lounge with different fabric for cushion and frame; start with Grade 1 price, add appropriate grade price located in second row for cushion, and last add appropriate grade price located in third row for frame to the sum of the Grade 1 and cushion price.

**Example: Grade 1 \$5,076 + grade 4 fabric cushion \$170 + grade 2 fabric frame \$75 = \$5,321**

Select upholstery for everything else other than the seat and back cushions (the outside back, arms, sides, seat frame). You can specify the same fabric as the cushions or select other fabric.

Frame

<b>1</b>	<b>10</b>	816	<b>19</b>	1,878	<b>L1</b>	1,250	
<b>2</b>	75	<b>11</b>	915	<b>20</b>	2,002	<b>L2</b>	2,282
<b>3</b>	149	<b>12</b>	1,014	<b>21</b>	2,125	<b>L3</b>	3,522
<b>COM/4</b>	223	<b>13</b>	1,138	<b>22</b>	2,249	<b>L4</b>	4,555
<b>5</b>	322	<b>14</b>	1,260	<b>23</b>	2,495	<b>L5</b>	5,587
<b>6</b>	421	<b>15</b>	1,384	<b>24</b>	2,742		
<b>7</b>	520	<b>16</b>	1,507	<b>25</b>	2,990		
<b>8</b>	618	<b>17</b>	1,631	<b>26</b>	3,237		
<b>9</b>	717	<b>18</b>	1,755	<b>27</b>	3,484		

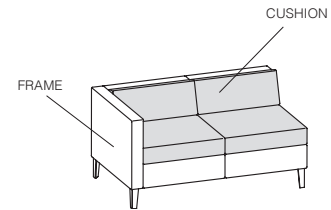

TO ORDER PLEASE SPECIFY THE FOLLOWING:

<input type="text"/>	<input type="text"/>	<input type="text"/>	<input type="text"/>	<input type="text"/>	<input type="text"/>
<b>MODEL NUMBER</b>	<b>WOOD FINISH</b>	<b>STITCH DETAIL</b>	<b>FLAMMABILITY RATING</b>	<b>CUSHION UPHOLSTERY</b>	<b>FRAME UPHOLSTERY</b>
	Cherry finishes on Maple Walnut finishes on Maple Maple finishes on Maple Oak finishes on Maple <i>Light Rift Oak 301 not available on Maple.</i>	None NR Stitch detail SD +\$197	U CTB117	Please refer to list of available upholstery and leather selections on www.gunlocke.com	Please refer to list of available upholstery and leather selections on www.gunlocke.com

Example

GK1107-2W.777.NR.U.DOL728.SPNN04  
 GK1107-2W    777    NR    U    DOL728    SPNN04  
 MODEL NUMBER    WOOD FINISH    STITCH DETAIL    FLAMMABILITY    CUSHION UPHOLSTERY    FRAME UPHOLSTERY

Please refer to the Ciji product page on www.gunlocke.com for standard finish options.

# CIJI TWO SEAT

Low Back, Arm Right, Aluminum Legs

Seating  
02/24

model number	fabric grades	dimensions	W	D	H
--------------	---------------	------------	---	---	---

**GK1107-2A**  
Low back, arm right  
Aluminum legs

**1** 5,362

Overall	52 5/8"	31 1/2"	27 7/8"
Seat	48 1/2"	21"	17 1/4"
Arm			26 7/8"
Between arms			

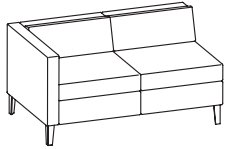

### Upholstery Requirements: GK1107-2A

	Dual Upholstery	
Fabric yds	Cushions 2.9	Frame 3.8
Leather ft <sup>2</sup>	Cushions 66.7	Frame 87.4
Shipping weight	109 lbs.	
Cube	35	

Cushion

<b>1</b>	<b>10</b>	623	<b>19</b>	1,433	<b>L1</b>	954	
<b>2</b>	57	<b>11</b>	698	<b>20</b>	1,528	<b>L2</b>	1,742
<b>3</b>	115	<b>12</b>	773	<b>21</b>	1,622	<b>L3</b>	2,688
<b>COM/4</b>	170	<b>13</b>	868	<b>22</b>	1,716	<b>L4</b>	3,476
<b>5</b>	246	<b>14</b>	963	<b>23</b>	1,905	<b>L5</b>	4,264
<b>6</b>	321	<b>15</b>	1,056	<b>24</b>	2,093		
<b>7</b>	397	<b>16</b>	1,151	<b>25</b>	2,282		
<b>8</b>	472	<b>17</b>	1,245	<b>26</b>	2,469		
<b>9</b>	547	<b>18</b>	1,339	<b>27</b>	2,659		

To calculate price of lounge with different fabric for cushion and frame; start with Grade 1 price, add appropriate grade price located in second row for cushion, and last add appropriate grade price located in third row for frame to the sum of the Grade 1 and cushion price.

**Example: Grade 1 \$5,362 + grade 4 fabric cushion \$170 + grade 2 fabric frame \$75 = \$5,607**

Frame

<b>1</b>	<b>10</b>	816	<b>19</b>	1,878	<b>L1</b>	1,250	
<b>2</b>	75	<b>11</b>	915	<b>20</b>	2,002	<b>L2</b>	2,282
<b>3</b>	149	<b>12</b>	1,014	<b>21</b>	2,125	<b>L3</b>	3,522
<b>COM/4</b>	223	<b>13</b>	1,138	<b>22</b>	2,249	<b>L4</b>	4,555
<b>5</b>	322	<b>14</b>	1,260	<b>23</b>	2,495	<b>L5</b>	5,587
<b>6</b>	421	<b>15</b>	1,384	<b>24</b>	2,742		
<b>7</b>	520	<b>16</b>	1,507	<b>25</b>	2,990		
<b>8</b>	618	<b>17</b>	1,631	<b>26</b>	3,237		
<b>9</b>	717	<b>18</b>	1,755	<b>27</b>	3,484		

Select upholstery for everything else other than the seat and back cushions (the outside back, arms, sides, seat frame). You can specify the same fabric as the cushions or select other fabric.

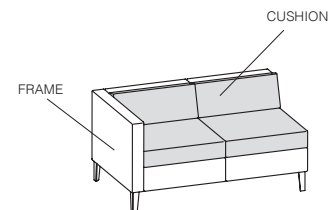

TO ORDER PLEASE SPECIFY THE FOLLOWING:

<input type="text"/>	<input type="text"/>	<input type="text"/>	<input type="text"/>	<input type="text"/>
<b>MODEL NUMBER</b>	<b>STITCH DETAIL</b>	<b>FLAMMABILITY RATING</b>	<b>CUSHION UPHOLSTERY</b>	<b>FRAME UPHOLSTERY</b>
	None <b>NR</b> Stitch detail <b>SD +\$197</b>	<b>U</b> CTB117	Please refer to list of available upholstery and leather selections on <a href="http://www.gunlocke.com">www.gunlocke.com</a>	Please refer to list of available upholstery and leather selections on <a href="http://www.gunlocke.com">www.gunlocke.com</a>

Example

GK1107-2A.NR.U.DOL728.SPNN04

GK1107-2A	NR	U	DOL728	SPNN04
<b>MODEL NUMBER</b>	<b>STITCH</b>	<b>FLAMMABILITY DETAIL</b>	<b>CUSHION UPHOLSTERY</b>	<b>FRAME UPHOLSTERY</b>

Please refer to the Ciji product page on [www.gunlocke.com](http://www.gunlocke.com) for standard finish options.



**Seating**  
02/24

**CIJI THREE SEAT**

Low Back, with Arms, Wood Legs

model number                      fabric grades  
**GK1101-3W**                      **1** 6,745

Low back, with arms,  
Wood legs

dimensions	W	D	H
Overall	80 3/4"	31 1/2"	27 7/8"
Seat	73"	21"	17 1/4"
Arm			26 7/8"
Between arms	73"		

**Upholstery Requirements: GK1101-3W**

	Dual Upholstery	
Fabric yds	Cushions 4.4	Frame 5.9
Leather ft <sup>2</sup>	Cushions 101.2	Frame 135.7
Shipping weight	181 lbs.	
Cube	78.5	

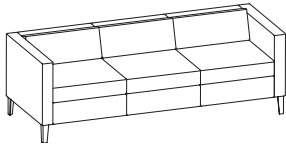

Cushion

<b>1</b>	<b>10</b>	945	<b>19</b>	2,175	<b>L1</b>	1,447	
<b>2</b>	86	<b>11</b>	1,059	<b>20</b>	2,317	<b>L2</b>	2,642
<b>3</b>	173	<b>12</b>	1,173	<b>21</b>	2,461	<b>L3</b>	4,077
<b>COM/4</b>	258	<b>13</b>	1,317	<b>22</b>	2,603	<b>L4</b>	5,273
<b>5</b>	372	<b>14</b>	1,459	<b>23</b>	2,890	<b>L5</b>	6,470
<b>6</b>	487	<b>15</b>	1,603	<b>24</b>	3,176		
<b>7</b>	602	<b>16</b>	1,745	<b>25</b>	3,461		
<b>8</b>	716	<b>17</b>	1,888	<b>26</b>	3,748		
<b>9</b>	831	<b>18</b>	2,032	<b>27</b>	4,034		

To calculate price of lounge with different fabric for cushion and frame; start with Grade 1 price, add appropriate grade price located in second row for cushion, and last add appropriate grade price located in third row for frame to the sum of the Grade 1 and cushion price.

**Example: Grade 1 \$6,745 + grade 4 fabric cushion \$258 + grade 2 fabric frame \$116 = \$7,119**

Select upholstery for everything else other than the seat and back cushions (the outside back, arms, sides, seat frame). You can specify the same fabric as the cushions or select other fabric.

Frame

<b>1</b>	<b>10</b>	1,266	<b>19</b>	2,915	<b>L1</b>	1,940	
<b>2</b>	116	<b>11</b>	1,420	<b>20</b>	3,108	<b>L2</b>	3,543
<b>3</b>	231	<b>12</b>	1,572	<b>21</b>	3,300	<b>L3</b>	5,468
<b>COM/4</b>	346	<b>13</b>	1,765	<b>22</b>	3,490	<b>L4</b>	7,070
<b>5</b>	499	<b>14</b>	1,956	<b>23</b>	3,874	<b>L5</b>	8,675
<b>6</b>	654	<b>15</b>	2,149	<b>24</b>	4,259		
<b>7</b>	806	<b>16</b>	2,341	<b>25</b>	4,641		
<b>8</b>	959	<b>17</b>	2,531	<b>26</b>	5,025		
<b>9</b>	1,114	<b>18</b>	2,724	<b>27</b>	5,408		

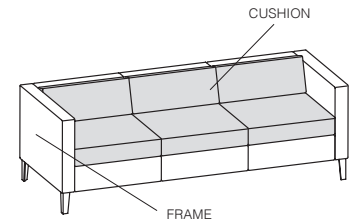

TO ORDER PLEASE SPECIFY THE FOLLOWING:

.  .  .  .  .

**MODEL NUMBER**

**WOOD FINISH**

Cherry finishes on Maple  
Walnut finishes on Maple  
Maple finishes on Maple  
Oak finishes on Maple  
*Light Rift Oak 301 not available on Maple.*

**STITCH DETAIL**

None **NR**  
Stitch detail  
**SD +\$197**

**FLAMMABILITY RATING**

**U** CTB117

**CUSHION UPHOLSTERY**

Please refer to list of available upholstery and leather selections on [www.gunlocke.com](http://www.gunlocke.com)

**FRAME UPHOLSTERY**

Please refer to list of available upholstery and leather selections on [www.gunlocke.com](http://www.gunlocke.com)

Example

GK1101-3W.777.NR.U.DOL728.SPNN04

GK1101-3W    777    NR    U    DOL728    SPNN04  
MODEL NUMBER    WOOD FINISH    STITCH DETAIL    FLAMMABILITY    CUSHION UPHOLSTERY    FRAME UPHOLSTERY

Please refer to the Ciji product page on [www.gunlocke.com](http://www.gunlocke.com) for standard finish options.

# CIJI THREE SEAT

Low Back, with Arms, Aluminum Legs

Seating  
02/24

model number	fabric grades	dimensions	W	D	H
<b>GK1101-3A</b>	<b>1</b> 7,027	Overall	80 3/4"	31 1/2"	27 7/8"
Low back, with arms, Aluminum legs		Seat	73"	21"	17 1/4"
		Arm		26 7/8"	
		Between arms	73"		

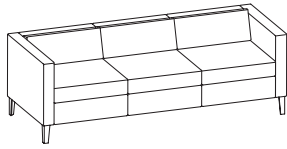

### Upholstery Requirements: GK1101-3A

	Dual Upholstery
Fabric yds	Cushions 4.4 Frame 5.9
Leather ft <sup>2</sup>	Cushions 101.2 Frame 135.7
Shipping weight	181 lbs.
Cube	78.5

Cushion	1	10	945	19	2,175	L1	1,447
	2	86	11	1,059	20	2,317	L2 2,642
	3	173	12	1,173	21	2,461	L3 4,077
	COM/4	258	13	1,317	22	2,603	L4 5,273
	5	372	14	1,459	23	2,890	L5 6,470
	6	487	15	1,603	24	3,176	
	7	602	16	1,745	25	3,461	
	8	716	17	1,888	26	3,748	
	9	831	18	2,032	27	4,034	

To calculate price of lounge with different fabric for cushion and frame; start with Grade 1 price, add appropriate grade price located in second row for cushion, and last add appropriate grade price located in third row for frame to the sum of the Grade 1 and cushion price.

**Example: Grade 1 \$7,027 + grade 4 fabric cushion \$258 + grade 2 fabric frame \$116 = \$7,401**

Select upholstery for everything else other than the seat and back cushions (the outside back, arms, sides, seat frame). You can specify the same fabric as the cushions or select other fabric.

Frame	1	10	1,266	19	2,915	L1	1,940
	2	116	11	1,420	20	3,108	L2 3,543
	3	231	12	1,572	21	3,300	L3 5,468
	COM/4	346	13	1,765	22	3,490	L4 7,070
	5	499	14	1,956	23	3,874	L5 8,675
	6	654	15	2,149	24	4,259	
	7	806	16	2,341	25	4,641	
	8	959	17	2,531	26	5,025	
	9	1,114	18	2,724	27	5,408	

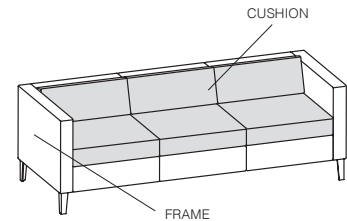

### TO ORDER PLEASE SPECIFY THE FOLLOWING:

<input type="text"/>	<input type="text"/>	<input type="text"/>	<input type="text"/>	<input type="text"/>
<b>MODEL NUMBER</b>	<b>STITCH DETAIL</b>	<b>FLAMMABILITY RATING</b>	<b>CUSHION UPHOLSTERY</b>	<b>FRAME UPHOLSTERY</b>
	None <b>NR</b> Stitch detail <b>SD +\$197</b>	<b>U</b> CTB117	Please refer to list of available upholstery and leather selections on <a href="http://www.gunlocke.com">www.gunlocke.com</a>	Please refer to list of available upholstery and leather selections on <a href="http://www.gunlocke.com">www.gunlocke.com</a>

### Example

GK1101-3A.NR.U.DOL728.SPNN04				
GK1101-3A	NR	U	DOL728	SPNN04
MODEL NUMBER	STITCH	FLAMMABILITY DETAIL	CUSHION UPHOLSTERY	FRAME UPHOLSTERY

Please refer to the Ciji product page on [www.gunlocke.com](http://www.gunlocke.com) for standard finish options.

model number                      fabric grades                      dimensions                      W                      D                      H

**GK1103-3W**                      **1** 5,619  
Low back, armless,  
Wood legs

Overall	73 5/8"	31 1/2"	27 7/8"
Seat	73"	21"	17 1/4"

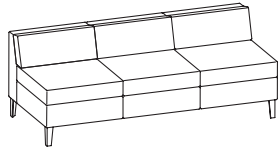

**Upholstery Requirements: GK1103-3W**

	Dual Upholstery	
Fabric yds	Cushions 4.4	Frame 3.2
Leather ft <sup>2</sup>	Cushions 101.2	Frame 73.6
Shipping weight	161 lbs.	
Cube	78.5	

Cushion	<b>1</b>	<b>10</b>	945	<b>19</b>	2,175	<b>L1</b>	1,447	
	<b>2</b>	86	<b>11</b>	1,059	<b>20</b>	2,317	<b>L2</b>	2,642
	<b>3</b>	173	<b>12</b>	1,173	<b>21</b>	2,461	<b>L3</b>	4,077
	<b>COM/4</b>	258	<b>13</b>	1,317	<b>22</b>	2,603	<b>L4</b>	5,273
	<b>5</b>	372	<b>14</b>	1,459	<b>23</b>	2,890	<b>L5</b>	6,470
	<b>6</b>	487	<b>15</b>	1,603	<b>24</b>	3,176		
	<b>7</b>	602	<b>16</b>	1,745	<b>25</b>	3,461		
	<b>8</b>	716	<b>17</b>	1,888	<b>26</b>	3,748		
	<b>9</b>	831	<b>18</b>	2,032	<b>27</b>	4,034		

To calculate price of lounge with different fabric for cushion and frame; start with Grade 1 price, add appropriate grade price located in second row for cushion, and last add appropriate grade price located in third row for frame to the sum of the Grade 1 and cushion price.

**Example: Grade 1 \$5,619 + grade 4 fabric cushion \$258 + grade 2 fabric frame \$64 = \$5,941**

Select upholstery for everything else other than the seat and back cushions (the outside back, arms, sides, seat frame). You can specify the same fabric as the cushions or select other fabric.

Frame	<b>1</b>	<b>10</b>	686	<b>19</b>	1,582	<b>L1</b>	1,052	
	<b>2</b>	64	<b>11</b>	770	<b>20</b>	1,687	<b>L2</b>	1,921
	<b>3</b>	125	<b>12</b>	854	<b>21</b>	1,790	<b>L3</b>	2,966
	<b>COM/4</b>	189	<b>13</b>	957	<b>22</b>	1,894	<b>L4</b>	3,836
	<b>5</b>	271	<b>14</b>	1,062	<b>23</b>	2,102	<b>L5</b>	4,706
	<b>6</b>	355	<b>15</b>	1,165	<b>24</b>	2,310		
	<b>7</b>	438	<b>16</b>	1,269	<b>25</b>	2,518		
	<b>8</b>	521	<b>17</b>	1,375	<b>26</b>	2,726		
	<b>9</b>	604	<b>18</b>	1,478	<b>27</b>	2,934		

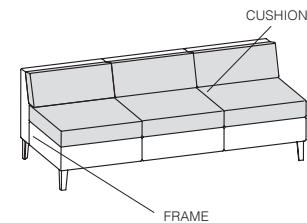

**TO ORDER PLEASE SPECIFY THE FOLLOWING:**

.  .  .  .  .

<b>MODEL NUMBER</b>	<b>WOOD FINISH</b>	<b>STITCH DETAIL</b>	<b>FLAMMABILITY RATING</b>	<b>CUSHION UPHOLSTERY</b>	<b>FRAME UPHOLSTERY</b>
	Cherry finishes on Maple Walnut finishes on Maple Maple finishes on Maple Oak finishes on Maple <i>Light Rift Oak 301 not available on Maple.</i>	None NR Stitch detail SD +\$197	U CTB117	Please refer to list of available upholstery and leather selections on www.gunlocke.com	Please refer to list of available upholstery and leather selections on www.gunlocke.com

**Example**

<b>GK1103-3W.777.NR.U.DOL728.SPNO4</b>					
GK1103-3W	777	NR	U	DOL728	SPNO4
MODEL NUMBER	WOOD FINISH	STITCH DETAIL	FLAMMABILITY	CUSHION UPHOLSTERY	FRAME UPHOLSTERY

Please refer to the Ciji product page on www.gunlocke.com for standard finish options.

# CIJI THREE SEAT

Low Back, Armless, Aluminum Legs

Seating  
02/24

model number	fabric grades	dimensions	W	D	H
--------------	---------------	------------	---	---	---

### GK1103-3A

Low back, armless,  
Aluminum legs

1 5,905

Overall	73 5/8"	31 1/2"	27 7/8"
Seat	73"	21"	17 1/4"

### Upholstery Requirements: GK1103-3A

	Dual Upholstery	
Fabric yds	Cushions 4.4	Frame 3.2
Leather ft <sup>2</sup>	Cushions 101.2	Frame 73.6
Shipping weight	161 lbs.	
Cube	78.5	

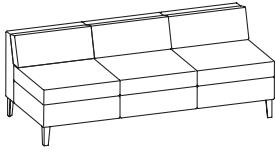

### Cushion

1	10	945	19	2,175	L1	1,447
2	86	11	1,059	20	L2	2,642
3	173	12	1,173	21	L3	4,077
COM/4	258	13	1,317	22	L4	5,273
5	372	14	1,459	23	L5	6,470
6	487	15	1,603	24		
7	602	16	1,745	25		
8	716	17	1,888	26		
9	831	18	2,032	27		

To calculate price of lounge with different fabric for cushion and frame; start with Grade 1 price, add appropriate grade price located in second row for cushion, and last add appropriate grade price located in third row for frame to the sum of the Grade 1 and cushion price.

**Example: Grade 1 \$5,905 + grade 4 fabric cushion \$258 + grade 2 fabric frame \$64 = \$6,227**

### Frame

1	10	686	19	1,582	L1	1,052
2	64	11	770	20	L2	1,921
3	125	12	854	21	L3	2,966
COM/4	189	13	957	22	L4	3,836
5	271	14	1,062	23	L5	4,706
6	355	15	1,165	24		
7	438	16	1,269	25		
8	521	17	1,375	26		
9	604	18	1,478	27		

Select upholstery for everything else other than the seat and back cushions (the outside back, arms, sides, seat frame). You can specify the same fabric as the cushions or select other fabric.

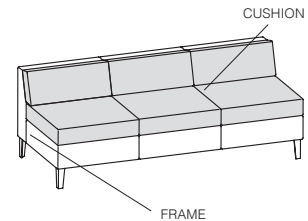

## TO ORDER PLEASE SPECIFY THE FOLLOWING:

<input type="text"/>	<input type="text"/>	<input type="text"/>	<input type="text"/>	<input type="text"/>
<b>MODEL NUMBER</b>	<b>STITCH DETAIL</b>	<b>FLAMMABILITY RATING</b>	<b>CUSHION UPHOLSTERY</b>	<b>FRAME UPHOLSTERY</b>
	None NR Stitch detail SD +\$197	U CTB117	Please refer to list of available upholstery and leather selections on <a href="http://www.gunlocke.com">www.gunlocke.com</a>	Please refer to list of available upholstery and leather selections on <a href="http://www.gunlocke.com">www.gunlocke.com</a>

### Example

GK1103-3A.NR.U.DOL728.SPNN04

GK1103-3A	NR	U	DOL728	SPNN04
MODEL NUMBER	STITCH	FLAMMABILITY DETAIL	CUSHION UPHOLSTERY	FRAME UPHOLSTERY

Please refer to the Ciji product page on [www.gunlocke.com](http://www.gunlocke.com) for standard finish options.

**Seating**  
02/24

**CIJI THREE SEAT**  
Low Back, Arm Left, Wood Legs

model number                      fabric grades                      dimensions                      W                      D                      H

**GK1105-3W**                      1 6,501  
Low back, arm left,  
Wood legs

Overall	77 1/8"	31 1/2"	27 7/8"
Seat	73"	21"	17 1/4"
Arm			26 7/8"
Between arms			

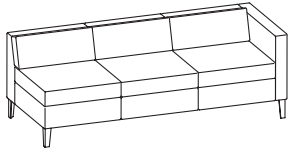

**Upholstery Requirements: GK1105-3W**

	Dual Upholstery	
Fabric yds	Cushions 4.4	Frame 5.2
Leather ft <sup>2</sup>	Cushions 101.2	Frame 119.6
Shipping weight		171 lbs.
Cube		78.5

Cushion	<b>1</b>	<b>10</b>	945	<b>19</b>	2,175	<b>L1</b>	1,447	
	<b>2</b>	86	<b>11</b>	1,059	<b>20</b>	2,317	<b>L2</b>	2,642
	<b>3</b>	173	<b>12</b>	1,173	<b>21</b>	2,461	<b>L3</b>	4,077
	<b>COM/4</b>	258	<b>13</b>	1,317	<b>22</b>	2,603	<b>L4</b>	5,273
	<b>5</b>	372	<b>14</b>	1,459	<b>23</b>	2,890	<b>L5</b>	6,470
	<b>6</b>	487	<b>15</b>	1,603	<b>24</b>	3,176		
	<b>7</b>	602	<b>16</b>	1,745	<b>25</b>	3,461		
	<b>8</b>	716	<b>17</b>	1,888	<b>26</b>	3,748		
	<b>9</b>	831	<b>18</b>	2,032	<b>27</b>	4,034		

To calculate price of lounge with different fabric for cushion and frame; start with Grade 1 price, add appropriate grade price located in second row for cushion, and last add appropriate grade price located in third row for frame to the sum of the Grade 1 and cushion price.

**Example: Grade 1 \$6,501 + grade 4 fabric cushion \$258 + grade 2 fabric frame \$102 = \$6,861**

Select upholstery for everything else other than the seat and back cushions (the outside back, arms, sides, seat frame). You can specify the same fabric as the cushions or select other fabric.

Frame	<b>1</b>	<b>10</b>	1,116	<b>19</b>	2,569	<b>L1</b>	1,709	
	<b>2</b>	102	<b>11</b>	1,252	<b>20</b>	2,739	<b>L2</b>	3,123
	<b>3</b>	204	<b>12</b>	1,387	<b>21</b>	2,908	<b>L3</b>	4,819
	<b>COM/4</b>	305	<b>13</b>	1,556	<b>22</b>	3,077	<b>L4</b>	6,232
	<b>5</b>	440	<b>14</b>	1,725	<b>23</b>	3,415	<b>L5</b>	7,645
	<b>6</b>	576	<b>15</b>	1,894	<b>24</b>	3,753		
	<b>7</b>	710	<b>16</b>	2,063	<b>25</b>	4,091		
	<b>8</b>	846	<b>17</b>	2,231	<b>26</b>	4,428		
	<b>9</b>	981	<b>18</b>	2,400	<b>27</b>	4,767		

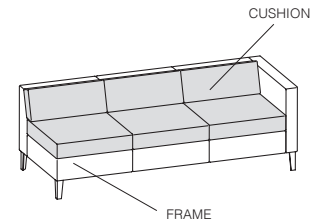

**TO ORDER PLEASE SPECIFY THE FOLLOWING:**

.  .  .  .  .

<b>MODEL NUMBER</b>	<b>WOOD FINISH</b>	<b>STITCH DETAIL</b>	<b>FLAMMABILITY RATING</b>	<b>CUSHION UPHOLSTERY</b>	<b>FRAME UPHOLSTERY</b>
	Cherry finishes on Maple Walnut finishes on Maple Maple finishes on Maple Oak finishes on Maple <i>Light Rift Oak 301 not available on Maple.</i>	None NR Stitch detail SD +\$197	U CTB117	Please refer to list of available upholstery and leather selections on www.gunlocke.com	Please refer to list of available upholstery and leather selections on www.gunlocke.com

**Example**

GK1105-3W.777.NR.U.DOL728.SPNN04  
 GK1105-3W    777    NR    U    DOL728    SPNN04  
 MODEL NUMBER    WOOD FINISH    STITCH DETAIL    FLAMMABILITY    CUSHION UPHOLSTERY    FRAME UPHOLSTERY

Please refer to the Ciji product page on www.gunlocke.com for standard finish options.

# CIJI THREE SEAT

Low Back, Arm Left, Aluminum Legs

**Seating**  
02/24

model number	fabric grades	dimensions	W	D	H
--------------	---------------	------------	---	---	---

**GK1105-3A**  
Low back, arm left,  
Aluminum legs

**1** 6,786

Overall	77 1/8"	31 1/2"	27 7/8"
Seat	73"	21"	17 1/4"
Arm			26 7/8"
Between arms			

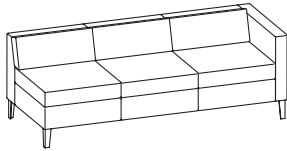

### Upholstery Requirements: GK1105-3A

	Dual Upholstery	
Fabric yds	Cushions 4.4	Frame 5.2
Leather ft <sup>2</sup>	Cushions 101.2	Frame 119.6
Shipping weight		171 lbs.
Cube		78.5

Cushion

<b>1</b>	<b>10</b>	945	<b>19</b>	2,175	<b>L1</b>	1,447
<b>2</b>	86	<b>11</b>	1,059	<b>20</b>	<b>L2</b>	2,642
<b>3</b>	173	<b>12</b>	1,173	<b>21</b>	<b>L3</b>	4,077
<b>COM/4</b>	258	<b>13</b>	1,317	<b>22</b>	<b>L4</b>	5,273
<b>5</b>	372	<b>14</b>	1,459	<b>23</b>	<b>L5</b>	6,470
<b>6</b>	487	<b>15</b>	1,603	<b>24</b>		
<b>7</b>	602	<b>16</b>	1,745	<b>25</b>		
<b>8</b>	716	<b>17</b>	1,888	<b>26</b>		
<b>9</b>	831	<b>18</b>	2,032	<b>27</b>		

To calculate price of lounge with different fabric for cushion and frame; start with Grade 1 price, add appropriate grade price located in second row for cushion, and last add appropriate grade price located in third row for frame to the sum of the Grade 1 and cushion price.

**Example: Grade 1 \$6,786 + grade 4 fabric cushion \$258 + grade 2 fabric frame \$102 = \$7,146**

Frame

<b>1</b>	<b>10</b>	1,116	<b>19</b>	2,569	<b>L1</b>	1,709
<b>2</b>	102	<b>11</b>	1,252	<b>20</b>	<b>L2</b>	3,123
<b>3</b>	204	<b>12</b>	1,387	<b>21</b>	<b>L3</b>	4,819
<b>COM/4</b>	305	<b>13</b>	1,556	<b>22</b>	<b>L4</b>	6,232
<b>5</b>	440	<b>14</b>	1,725	<b>23</b>	<b>L5</b>	7,645
<b>6</b>	576	<b>15</b>	1,894	<b>24</b>		
<b>7</b>	710	<b>16</b>	2,063	<b>25</b>		
<b>8</b>	846	<b>17</b>	2,231	<b>26</b>		
<b>9</b>	981	<b>18</b>	2,400	<b>27</b>		

Select upholstery for everything else other than the seat and back cushions (the outside back, arms, sides, seat frame). You can specify the same fabric as the cushions or select other fabric.

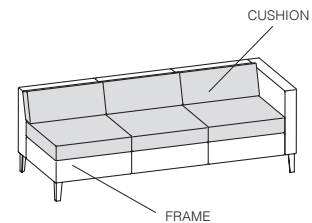

TO ORDER PLEASE SPECIFY THE FOLLOWING:

<input type="text"/>	<input type="text"/>	<input type="text"/>	<input type="text"/>	<input type="text"/>
<b>MODEL NUMBER</b>	<b>STITCH DETAIL</b>	<b>FLAMMABILITY RATING</b>	<b>CUSHION UPHOLSTERY</b>	<b>FRAME UPHOLSTERY</b>
	None <b>NR</b> Stitch detail <b>SD +\$197</b>	<b>U</b> CTB117	Please refer to list of available upholstery and leather selections on <a href="http://www.gunlocke.com">www.gunlocke.com</a>	Please refer to list of available upholstery and leather selections on <a href="http://www.gunlocke.com">www.gunlocke.com</a>

Example

GK1105-3A.NR.U.DOL728.SPNN04

GK1105-3A	NR	U	DOL728	SPNN04
<b>MODEL NUMBER</b>	<b>STITCH</b>	<b>FLAMMABILITY DETAIL</b>	<b>CUSHION UPHOLSTERY</b>	<b>FRAME UPHOLSTERY</b>

Please refer to the Ciji product page on [www.gunlocke.com](http://www.gunlocke.com) for standard finish options.

**Seating**  
02/24

**CIJI THREE SEAT**

Low Back, Arm Right, Wood Legs

model number                      fabric grades  
**GK1107-3W**                      **1** 6,501

Low back, arm right,  
Wood legs

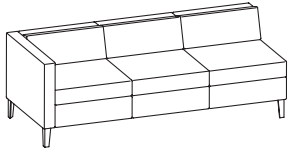

dimensions	W	D	H
Overall	77 1/8"	31 1/2"	27 7/8"
Seat	73"	21"	17 1/4"
Arm			26 7/8"
Between arms			

**Upholstery Requirements: GK1107-3W**

	Dual Upholstery	
Fabric yds	Cushions 4.4	Frame 5.2
Leather ft <sup>2</sup>	Cushions 101.2	Frame 119.6
Shipping weight		171 lbs.
Cube		78.5

Cushion

<b>1</b>	<b>10</b>	945	<b>19</b>	2,175	<b>L1</b>	1,447
<b>2</b>	86	<b>11</b>	1,059	<b>20</b>	<b>L2</b>	2,642
<b>3</b>	173	<b>12</b>	1,173	<b>21</b>	<b>L3</b>	4,077
<b>COM/4</b>	258	<b>13</b>	1,317	<b>22</b>	<b>L4</b>	5,273
<b>5</b>	372	<b>14</b>	1,459	<b>23</b>	<b>L5</b>	6,470
<b>6</b>	487	<b>15</b>	1,603	<b>24</b>		
<b>7</b>	602	<b>16</b>	1,745	<b>25</b>		
<b>8</b>	716	<b>17</b>	1,888	<b>26</b>		
<b>9</b>	831	<b>18</b>	2,032	<b>27</b>		

To calculate price of lounge with different fabric for cushion and frame; start with Grade 1 price, add appropriate grade price located in second row for cushion, and last add appropriate grade price located in third row for frame to the sum of the Grade 1 and cushion price.

**Example: Grade 1 \$6,501 + grade 4 fabric cushion \$258 + grade 2 fabric frame \$102 = \$6,861**

Frame

<b>1</b>	<b>10</b>	1,116	<b>19</b>	2,569	<b>L1</b>	1,709
<b>2</b>	102	<b>11</b>	1,252	<b>20</b>	<b>L2</b>	3,123
<b>3</b>	204	<b>12</b>	1,387	<b>21</b>	<b>L3</b>	4,819
<b>COM/4</b>	305	<b>13</b>	1,556	<b>22</b>	<b>L4</b>	6,232
<b>5</b>	440	<b>14</b>	1,725	<b>23</b>	<b>L5</b>	7,645
<b>6</b>	576	<b>15</b>	1,894	<b>24</b>		
<b>7</b>	710	<b>16</b>	2,063	<b>25</b>		
<b>8</b>	846	<b>17</b>	2,231	<b>26</b>		
<b>9</b>	981	<b>18</b>	2,400	<b>27</b>		

Select upholstery for everything else other than the seat and back cushions (the outside back, arms, sides, seat frame). You can specify the same fabric as the cushions or select other fabric.

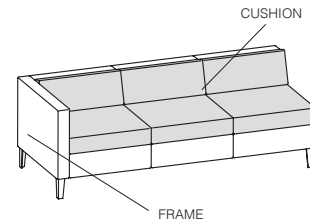

TO ORDER PLEASE SPECIFY THE FOLLOWING:

.  .  .  .  .

**MODEL NUMBER**

**WOOD FINISH**

Cherry finishes on Maple  
Walnut finishes on Maple  
Maple finishes on Maple  
Oak finishes on Maple  
*Light Rift Oak 301 not available on Maple.*

**STITCH DETAIL**

None **NR**  
Stitch detail  
**SD +\$197**

**FLAMMABILITY RATING**

**U** CTB117

**CUSHION UPHOLSTERY**

Please refer to list of available upholstery and leather selections on [www.gunlocke.com](http://www.gunlocke.com)

**FRAME UPHOLSTERY**

Please refer to list of available upholstery and leather selections on [www.gunlocke.com](http://www.gunlocke.com)

Example

GK1107-3W.777.NR.U.DOL728.SPNN04

GK1107-3W	777	NR	U	DOL728	SPNN04
MODEL NUMBER	WOOD FINISH	STITCH DETAIL	FLAMMABILITY	CUSHION UPHOLSTERY	FRAME UPHOLSTERY

Please refer to the Ciji product page on [www.gunlocke.com](http://www.gunlocke.com) for standard finish options.

# CIJI THREE SEAT

Low Back, Arm Right, Aluminum Legs

**Seating**  
02/24

model number fabric grades dimensions W D H

## GK1107-3A

Low back, arm right,  
Aluminum legs

**1** 6,786

Overall	77 1/8"	31 1/2"	27 7/8"
Seat	73"	21"	17 1/4"
Arm			26 7/8"
Between arms			

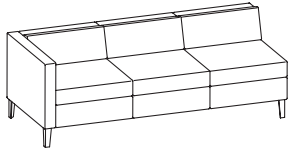

### Upholstery Requirements: GK1107-3A

	Dual Upholstery	
Fabric yds	Cushions 4.4	Frame 5.2
Leather ft <sup>2</sup>	Cushions 101.2	Frame 119.6
Shipping weight		171 lbs.
Cube		78.5

Cushion

<b>1</b>	<b>10</b>	945	<b>19</b>	2,175	<b>L1</b>	1,447	
<b>2</b>	86	<b>11</b>	1,059	<b>20</b>	2,317	<b>L2</b>	2,642
<b>3</b>	173	<b>12</b>	1,173	<b>21</b>	2,461	<b>L3</b>	4,077
<b>COM/4</b>	258	<b>13</b>	1,317	<b>22</b>	2,603	<b>L4</b>	5,273
<b>5</b>	372	<b>14</b>	1,459	<b>23</b>	2,890	<b>L5</b>	6,470
<b>6</b>	487	<b>15</b>	1,603	<b>24</b>	3,176		
<b>7</b>	602	<b>16</b>	1,745	<b>25</b>	3,461		
<b>8</b>	716	<b>17</b>	1,888	<b>26</b>	3,748		
<b>9</b>	831	<b>18</b>	2,032	<b>27</b>	4,034		

To calculate price of lounge with different fabric for cushion and frame; start with Grade 1 price, add appropriate grade price located in second row for cushion, and last add appropriate grade price located in third row for frame to the sum of the Grade 1 and cushion price.

**Example: Grade 1 \$6,786 + grade 4 fabric cushion \$258 + grade 2 fabric frame \$102 = \$7,146**

Frame

<b>1</b>	<b>10</b>	1,116	<b>19</b>	2,569	<b>L1</b>	1,709	
<b>2</b>	102	<b>11</b>	1,252	<b>20</b>	2,739	<b>L2</b>	3,123
<b>3</b>	204	<b>12</b>	1,387	<b>21</b>	2,908	<b>L3</b>	4,819
<b>COM/4</b>	305	<b>13</b>	1,556	<b>22</b>	3,077	<b>L4</b>	6,232
<b>5</b>	440	<b>14</b>	1,725	<b>23</b>	3,415	<b>L5</b>	7,645
<b>6</b>	576	<b>15</b>	1,894	<b>24</b>	3,753		
<b>7</b>	710	<b>16</b>	2,063	<b>25</b>	4,091		
<b>8</b>	846	<b>17</b>	2,231	<b>26</b>	4,428		
<b>9</b>	981	<b>18</b>	2,400	<b>27</b>	4,767		

Select upholstery for everything else other than the seat and back cushions (the outside back, arms, sides, seat frame). You can specify the same fabric as the cushions or select other fabric.

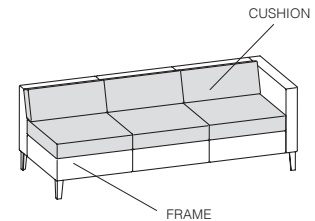

TO ORDER PLEASE SPECIFY THE FOLLOWING:

<input type="text"/>	<input type="text"/>	<input type="text"/>	<input type="text"/>	<input type="text"/>
<b>MODEL NUMBER</b>	<b>STITCH DETAIL</b>	<b>FLAMMABILITY RATING</b>	<b>CUSHION UPHOLSTERY</b>	<b>FRAME UPHOLSTERY</b>
	None <b>NR</b> Stitch detail <b>SD +\$197</b>	<b>U CTB117</b>	Please refer to list of available upholstery and leather selections on <a href="http://www.gunlocke.com">www.gunlocke.com</a>	Please refer to list of available upholstery and leather selections on <a href="http://www.gunlocke.com">www.gunlocke.com</a>

Example

GK1107-3A.NR.U.DOL728.SPNN04

GK1107-3A	NR	U	DOL728	SPNN04
MODEL NUMBER	STITCH	FLAMMABILITY DETAIL	CUSHION UPHOLSTERY	FRAME UPHOLSTERY

Please refer to the Ciji product page on [www.gunlocke.com](http://www.gunlocke.com) for standard finish options.



**Seating**  
02/24

**CIJI SINGLE SEAT**

Mid Back, with Arms, Wood Legs

model number	fabric grades
<b>GK1111-1W</b>	<b>1</b> 3,843

Mid back, with arms,  
Wood legs

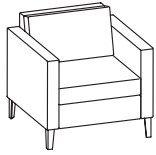

dimensions	W	D	H
Overall	31 3/4"	31 1/2"	32 1/8"
Seat	24"	21"	17 1/4"
Arm			26 7/8"
Between arms	24"		

**Upholstery Requirements: GK1111-1W**

	Dual Upholstery	
Fabric yds	Cushions 1.5	Frame 3.8
Leather ft <sup>2</sup>	Cushions 34.5	Frame 87.4
Shipping weight		102 lbs.
Cube		28.0

Cushion

<b>1</b>	<b>10</b>	323	<b>19</b>	742	<b>L1</b>	494
<b>2</b>	30	<b>11</b>	361	<b>20</b>	<b>L2</b>	902
<b>3</b>	59	<b>12</b>	401	<b>21</b>	<b>L3</b>	1,391
<b>COM/4</b>	89	<b>13</b>	449	<b>22</b>	<b>L4</b>	1,799
<b>5</b>	128	<b>14</b>	498	<b>23</b>	<b>L5</b>	2,206
<b>6</b>	167	<b>15</b>	546	<b>24</b>		1,083
<b>7</b>	205	<b>16</b>	596	<b>25</b>		1,181
<b>8</b>	245	<b>17</b>	644	<b>26</b>		1,279
<b>9</b>	284	<b>18</b>	694	<b>27</b>		1,376

To calculate price of lounge with different fabric for cushion and frame; start with Grade 1 price, add appropriate grade price located in second row for cushion, and last add appropriate grade price located in third row for frame to the sum of the Grade 1 and cushion price.

**Example: Grade 1 \$3,843 + grade 4 fabric cushion \$89 + grade 2 fabric frame \$75 = \$4,007**

Select upholstery for everything else other than the seat and back cushions (the outside back, arms, sides, seat frame). You can specify the same fabric as the cushions or select other fabric.

Frame

<b>1</b>	<b>10</b>	816	<b>19</b>	1,878	<b>L1</b>	1,250
<b>2</b>	75	<b>11</b>	915	<b>20</b>	<b>L2</b>	2,282
<b>3</b>	149	<b>12</b>	1,014	<b>21</b>	<b>L3</b>	3,522
<b>COM/4</b>	223	<b>13</b>	1,138	<b>22</b>	<b>L4</b>	4,555
<b>5</b>	322	<b>14</b>	1,260	<b>23</b>	<b>L5</b>	5,587
<b>6</b>	421	<b>15</b>	1,384	<b>24</b>		2,742
<b>7</b>	520	<b>16</b>	1,507	<b>25</b>		2,990
<b>8</b>	618	<b>17</b>	1,631	<b>26</b>		3,237
<b>9</b>	717	<b>18</b>	1,755	<b>27</b>		3,484

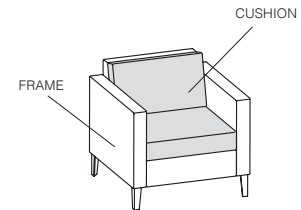

TO ORDER PLEASE SPECIFY THE FOLLOWING:

.  .  .  .  .

<b>MODEL NUMBER</b>	<b>WOOD FINISH</b>	<b>STITCH DETAIL</b>	<b>FLAMMABILITY RATING</b>	<b>CUSHION UPHOLSTERY</b>	<b>FRAME UPHOLSTERY</b>
	Cherry finishes on Maple Walnut finishes on Maple Maple finishes on Maple Oak finishes on Maple <i>Light Rift Oak 301 not available on Maple.</i>	None NR Stitch detail SD +\$197	U CTB117	Please refer to list of available upholstery and leather selections on www.gunlocke.com	Please refer to list of available upholstery and leather selections on www.gunlocke.com

Example

GK1111-1W.777.NR.U.DOL728.SPNO4					
GK1111-1W	777	NR	U	DOL728	SPNO4
MODEL NUMBER	WOOD FINISH	STITCH DETAIL	FLAMMABILITY	CUSHION UPHOLSTERY	FRAME UPHOLSTERY

Please refer to the Ciji product page on www.gunlocke.com for standard finish options.

# CIJI SINGLE SEAT

Mid Back, with Arms, Aluminum Legs

Seating  
02/24

model number	fabric grades	dimensions	W	D	H
<b>GK1111-1A</b> Mid back, with arms, Aluminum legs	<b>1</b> 4,125	Overall	31 3/4"	31 1/2"	32 1/8"
		Seat	24"	21"	17 1/4"
		Arm			26 7/8"
		Between arms	24"		

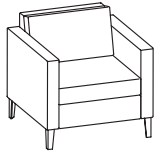

### Upholstery Requirements: GK1111-1A

	Dual Upholstery	
Fabric yds	Cushions 1.5	Frame 3.8
Leather ft²	Cushions 34.5	Frame 87.4
Shipping weight	102 lbs.	
Cube	28.0	

#### Cushion

<b>1</b>	<b>10</b>	323	<b>19</b>	742	<b>L1</b>	494
<b>2</b>	30	<b>11</b>	361	<b>20</b>	<b>L2</b>	902
<b>3</b>	59	<b>12</b>	401	<b>21</b>	<b>L3</b>	1,391
<b>COM/4</b>	89	<b>13</b>	449	<b>22</b>	<b>L4</b>	1,799
<b>5</b>	128	<b>14</b>	498	<b>23</b>	<b>L5</b>	2,206
<b>6</b>	167	<b>15</b>	546	<b>24</b>		
<b>7</b>	205	<b>16</b>	596	<b>25</b>		
<b>8</b>	245	<b>17</b>	644	<b>26</b>		
<b>9</b>	284	<b>18</b>	694	<b>27</b>		

To calculate price of lounge with different fabric for cushion and frame; start with Grade 1 price, add appropriate grade price located in second row for cushion, and last add appropriate grade price located in third row for frame to the sum of the Grade 1 and cushion price.

**Example: Grade 1 \$4,125 + grade 4 fabric cushion \$89 + grade 2 fabric frame \$75 = \$4,289**

Select upholstery for everything else other than the seat and back cushions (the outside back, arms, sides, seat frame). You can specify the same fabric as the cushions or select other fabric.

#### Frame

<b>1</b>	<b>10</b>	816	<b>19</b>	1,878	<b>L1</b>	1,250
<b>2</b>	75	<b>11</b>	915	<b>20</b>	<b>L2</b>	2,282
<b>3</b>	149	<b>12</b>	1,014	<b>21</b>	<b>L3</b>	3,522
<b>COM/4</b>	223	<b>13</b>	1,138	<b>22</b>	<b>L4</b>	4,555
<b>5</b>	322	<b>14</b>	1,260	<b>23</b>	<b>L5</b>	5,587
<b>6</b>	421	<b>15</b>	1,384	<b>24</b>		
<b>7</b>	520	<b>16</b>	1,507	<b>25</b>		
<b>8</b>	618	<b>17</b>	1,631	<b>26</b>		
<b>9</b>	717	<b>18</b>	1,755	<b>27</b>		

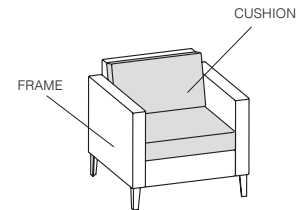

### TO ORDER PLEASE SPECIFY THE FOLLOWING:

<input type="text"/>	<input type="text"/>	<input type="text"/>	<input type="text"/>	<input type="text"/>
<b>MODEL NUMBER</b>	<b>STITCH DETAIL</b>	<b>FLAMMABILITY RATING</b>	<b>CUSHION UPHOLSTERY</b>	<b>FRAME UPHOLSTERY</b>
	None <b>NR</b> Stitch detail <b>SD +\$197</b>	<b>U</b> CTB117	Please refer to list of available upholstery and leather selections on <a href="http://www.gunlocke.com">www.gunlocke.com</a>	Please refer to list of available upholstery and leather selections on <a href="http://www.gunlocke.com">www.gunlocke.com</a>

#### Example

GK1111-1A.NR.U.DOL728.SPNN04

GK1111-1A	NR	U	DOL728	SPNN04
MODEL NUMBER	STITCH	FLAMMABILITY DETAIL	CUSHION UPHOLSTERY	FRAME UPHOLSTERY

Please refer to the Ciji product page on [www.gunlocke.com](http://www.gunlocke.com) for standard finish options.

model number	fabric grades	dimensions	W	D	H
<b>GK1113-1W</b> Mid back, armless, Wood Legs	<b>1</b> 2,943	Overall	24 5/8"	31 1/2"	32 1/8"
		Seat	24"	21"	17 1/4"



**Upholstery Requirements: GK1113-1W**

	Dual Upholstery	
Fabric yds	Cushions 1.5	Frame 1.5
Leather ft <sup>2</sup>	Cushions 34.5	Frame 34.5
Shipping weight	82 lbs.	
Cube	28.0	

Cushion

<b>1</b>	<b>10</b>	323	<b>19</b>	742	<b>L1</b>	494
<b>2</b>	30	<b>11</b>	361	<b>20</b>	<b>L2</b>	902
<b>3</b>	59	<b>12</b>	401	<b>21</b>	<b>L3</b>	1,391
<b>COM/4</b>	89	<b>13</b>	449	<b>22</b>	<b>L4</b>	1,799
<b>5</b>	128	<b>14</b>	498	<b>23</b>	<b>L5</b>	2,206
<b>6</b>	167	<b>15</b>	546	<b>24</b>		1,083
<b>7</b>	205	<b>16</b>	596	<b>25</b>		1,181
<b>8</b>	245	<b>17</b>	644	<b>26</b>		1,279
<b>9</b>	284	<b>18</b>	694	<b>27</b>		1,376

To calculate price of lounge with different fabric for cushion and frame; start with Grade 1 price, add appropriate grade price located in second row for cushion, and last add appropriate grade price located in third row for frame to the sum of the Grade 1 and cushion price.

**Example: Grade 1 \$2,943 + grade 4 fabric cushion \$89 + grade 2 fabric frame \$30 = \$3,062**

Select upholstery for everything else other than the seat and back cushions (the outside back, arms, sides, seat frame). You can specify the same fabric as the cushions or select other fabric.

Frame

<b>1</b>	<b>10</b>	323	<b>19</b>	742	<b>L1</b>	494
<b>2</b>	30	<b>11</b>	361	<b>20</b>	<b>L2</b>	902
<b>3</b>	59	<b>12</b>	401	<b>21</b>	<b>L3</b>	1,391
<b>COM/4</b>	89	<b>13</b>	449	<b>22</b>	<b>L4</b>	1,799
<b>5</b>	128	<b>14</b>	498	<b>23</b>	<b>L5</b>	2,206
<b>6</b>	167	<b>15</b>	546	<b>24</b>		1,083
<b>7</b>	205	<b>16</b>	596	<b>25</b>		1,181
<b>8</b>	245	<b>17</b>	644	<b>26</b>		1,279
<b>9</b>	284	<b>18</b>	694	<b>27</b>		1,376

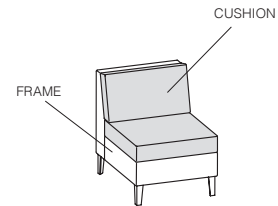

TO ORDER PLEASE SPECIFY THE FOLLOWING:

.  .  .  .  .

MODEL NUMBER	WOOD FINISH	STITCH DETAIL	FLAMMABILITY RATING	CUSHION UPHOLSTERY	FRAME UPHOLSTERY
	Cherry finishes on Maple Walnut finishes on Maple Maple finishes on Maple Oak finishes on Maple <i>Light Rift Oak 301 not available on Maple.</i>	None NR Stitch detail SD +\$197	U CTB117	Please refer to list of available upholstery and leather selections on www.gunlocke.com	Please refer to list of available upholstery and leather selections on www.gunlocke.com

Example

GK1113-1W.777.NR.U.DOL728.SPNN04					
GK1113-1W	777	NR	U	DOL728	SPNN04
MODEL NUMBER	WOOD FINISH	STITCH DETAIL	FLAMMABILITY	CUSHION UPHOLSTERY	FRAME UPHOLSTERY

Please refer to the Ciji product page on www.gunlocke.com for standard finish options.

# CIJI SINGLE SEAT

Mid Back, Armless, Aluminum Legs

Seating  
02/24

model number                      fabric grades                      dimensions                      W                      D                      H

**GK1113-1A**  
Mid back, armless,  
Aluminum Legs

1 3,229

Overall	24 5/8"	31 1/2"	32 1/8"
Seat	24"	21"	17 1/4"

### Upholstery Requirements: GK1113-1A

	Dual Upholstery	
Fabric yds	Cushions 1.5	Frame 1.5
Leather ft <sup>2</sup>	Cushions 34.5	Frame 34.5
Shipping weight	82 lbs.	
Cube	28.0	



Cushion

<b>1</b>	<b>10</b>	323	<b>19</b>	742	<b>L1</b>	494
<b>2</b>	30	<b>11</b>	361	<b>20</b>	<b>L2</b>	902
<b>3</b>	59	<b>12</b>	401	<b>21</b>	<b>L3</b>	1,391
<b>COM/4</b>	89	<b>13</b>	449	<b>22</b>	<b>L4</b>	1,799
<b>5</b>	128	<b>14</b>	498	<b>23</b>	<b>L5</b>	2,206
<b>6</b>	167	<b>15</b>	546	<b>24</b>		1,083
<b>7</b>	205	<b>16</b>	596	<b>25</b>		1,181
<b>8</b>	245	<b>17</b>	644	<b>26</b>		1,279
<b>9</b>	284	<b>18</b>	694	<b>27</b>		1,376

To calculate price of lounge with different fabric for cushion and frame; start with Grade 1 price, add appropriate grade price located in second row for cushion, and last add appropriate grade price located in third row for frame to the sum of the Grade 1 and cushion price.

**Example: Grade 1 \$3,229 + grade 4 fabric cushion \$89 + grade 2 fabric frame \$30 = \$3,348**

Select upholstery for everything else other than the seat and back cushions (the outside back, arms, sides, seat frame). You can specify the same fabric as the cushions or select other fabric.

Frame

<b>1</b>	<b>10</b>	323	<b>19</b>	742	<b>L1</b>	494
<b>2</b>	30	<b>11</b>	361	<b>20</b>	<b>L2</b>	902
<b>3</b>	59	<b>12</b>	401	<b>21</b>	<b>L3</b>	1,391
<b>COM/4</b>	89	<b>13</b>	449	<b>22</b>	<b>L4</b>	1,799
<b>5</b>	128	<b>14</b>	498	<b>23</b>	<b>L5</b>	2,206
<b>6</b>	167	<b>15</b>	546	<b>24</b>		1,083
<b>7</b>	205	<b>16</b>	596	<b>25</b>		1,181
<b>8</b>	245	<b>17</b>	644	<b>26</b>		1,279
<b>9</b>	284	<b>18</b>	694	<b>27</b>		1,376

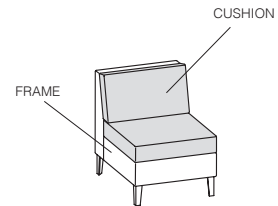

TO ORDER PLEASE SPECIFY THE FOLLOWING:

<input type="text"/>	<input type="text"/>	<input type="text"/>	<input type="text"/>	<input type="text"/>
<b>MODEL NUMBER</b>	<b>STITCH DETAIL</b>	<b>FLAMMABILITY RATING</b>	<b>CUSHION UPHOLSTERY</b>	<b>FRAME UPHOLSTERY</b>
	None <b>NR</b> Stitch detail <b>SD +\$197</b>	<b>U</b> CTB117	Please refer to list of available upholstery and leather selections on <a href="http://www.gunlocke.com">www.gunlocke.com</a>	Please refer to list of available upholstery and leather selections on <a href="http://www.gunlocke.com">www.gunlocke.com</a>

Example

GK1113-1A.NR.U.DOL728.SPNN04  
GK1113-1A    NR    U    DOL728    SPNN04  
MODEL NUMBER    STITCH    FLAMMABILITY    CUSHION    FRAME  
DETAIL    RATING    UPHOLSTERY    UPHOLSTERY

Please refer to the Ciji product page on [www.gunlocke.com](http://www.gunlocke.com) for standard finish options.

**Seating**  
02/24

**CIJI SINGLE SEAT**

Mid Back, Arm Left, Wood Legs

model number                      fabric grades                      dimensions                      W                      D                      H

**GK1115-1W**

Mid back, arm left,  
Wood legs

**1** 3,619

Overall	28 1/8"	31 1/2"	32 1/8"
Seat	24"	21"	17 1/4"
Arm			26 7/8"
Between arms			



**Upholstery Requirements: GK1115-1W**

	Dual Upholstery	
Fabric yds	Cushions 1.5	Frame 3
Leather ft <sup>2</sup>	Cushions 34.5	Frame 57.5
Shipping weight		92 lbs.
Cube		28.0

Cushion

<b>1</b>	<b>10</b>	323	<b>19</b>	742	<b>L1</b>	494
<b>2</b>	30	<b>11</b>	361	<b>20</b>	<b>L2</b>	902
<b>3</b>	59	<b>12</b>	401	<b>21</b>	<b>L3</b>	1,391
<b>COM/4</b>	89	<b>13</b>	449	<b>22</b>	<b>L4</b>	1,799
<b>5</b>	128	<b>14</b>	498	<b>23</b>	<b>L5</b>	2,206
<b>6</b>	167	<b>15</b>	546	<b>24</b>		1,083
<b>7</b>	205	<b>16</b>	596	<b>25</b>		1,181
<b>8</b>	245	<b>17</b>	644	<b>26</b>		1,279
<b>9</b>	284	<b>18</b>	694	<b>27</b>		1,376

To calculate price of lounge with different fabric for cushion and frame; start with Grade 1 price, add appropriate grade price located in second row for cushion, and last add appropriate grade price located in third row for frame to the sum of the Grade 1 and cushion price.

**Example: Grade 1 \$3,619 + grade 4 fabric cushion \$89 + grade 2 fabric frame \$59 = \$3,767**

Select upholstery for everything else other than the seat and back cushions (the outside back, arms, sides, seat frame). You can specify the same fabric as the cushions or select other fabric.

Frame

<b>1</b>	<b>10</b>	644	<b>19</b>	1,483	<b>L1</b>	987
<b>2</b>	59	<b>11</b>	723	<b>20</b>	<b>L2</b>	1,802
<b>3</b>	118	<b>12</b>	801	<b>21</b>	<b>L3</b>	2,780
<b>COM/4</b>	177	<b>13</b>	898	<b>22</b>	<b>L4</b>	3,596
<b>5</b>	255	<b>14</b>	995	<b>23</b>	<b>L5</b>	4,411
<b>6</b>	332	<b>15</b>	1,093	<b>24</b>		2,166
<b>7</b>	410	<b>16</b>	1,190	<b>25</b>		2,361
<b>8</b>	489	<b>17</b>	1,288	<b>26</b>		2,555
<b>9</b>	567	<b>18</b>	1,385	<b>27</b>		2,751

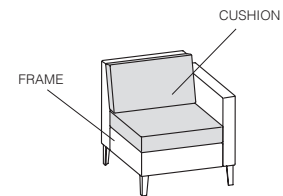

TO ORDER PLEASE SPECIFY THE FOLLOWING:

<input type="text"/>	<input type="text"/>	<input type="text"/>	<input type="text"/>	<input type="text"/>	<input type="text"/>
<b>MODEL NUMBER</b>	<b>WOOD FINISH</b>	<b>STITCH DETAIL</b>	<b>FLAMMABILITY RATING</b>	<b>CUSHION UPHOLSTERY</b>	<b>FRAME UPHOLSTERY</b>
	Cherry finishes on Maple Walnut finishes on Maple Maple finishes on Maple Oak finishes on Maple <i>Light Rift Oak 301 not available on Maple.</i>	None NR Stitch detail SD +\$197	U CTB117	Please refer to list of available upholstery and leather selections on www.gunlocke.com	Please refer to list of available upholstery and leather selections on www.gunlocke.com

Example

GK1115-1W.777.NR.U.DOL728.SPNO4					
GK1115-1W	777	NR	U	DOL728	SPNO4
MODEL NUMBER	WOOD FINISH	STITCH DETAIL	FLAMMABILITY	CUSHION UPHOLSTERY	FRAME UPHOLSTERY

Please refer to the Ciji product page on www.gunlocke.com for standard finish options.

# CIJI SINGLE SEAT

Seating  
02/24

Mid Back, Arm Left, Aluminum Legs

model number	fabric grades	dimensions	W	D	H
<b>GK1115-1A</b> Mid back, arm left, Aluminum legs	<b>1</b> 3,903	Overall	28 1/8"	31 1/2"	32 1/8"
		Seat	24"	21"	17 1/4"
		Arm			26 7/8"
		Between arms			



### Upholstery Requirements: GK1115-1A

	Dual Upholstery	
Fabric yds	Cushions 1.5	Frame 3
Leather ft²	Cushions 34.5	Frame 57.5
Shipping weight	92 lbs.	
Cube	28.0	

Cushion	1	10	323	19	742	L1	494	
	2	30	11	361	20	791	L2	902
	3	59	12	401	21	840	L3	1,391
	COM/4	89	13	449	22	888	L4	1,799
	5	128	14	498	23	985	L5	2,206
	6	167	15	546	24	1,083		
	7	205	16	596	25	1,181		
	8	245	17	644	26	1,279		
	9	284	18	694	27	1,376		

To calculate price of lounge with different fabric for cushion and frame; start with Grade 1 price, add appropriate grade price located in second row for cushion, and last add appropriate grade price located in third row for frame to the sum of the Grade 1 and cushion price.

**Example: Grade 1 \$3,903 + grade 4 fabric cushion \$89 + grade 2 fabric frame \$59 = \$4,051**

Select upholstery for everything else other than the seat and back cushions (the outside back, arms, sides, seat frame). You can specify the same fabric as the cushions or select other fabric.

Frame	1	10	644	19	1,483	L1	987	
	2	59	11	723	20	1,581	L2	1,802
	3	118	12	801	21	1,678	L3	2,780
	COM/4	177	13	898	22	1,776	L4	3,596
	5	255	14	995	23	1,970	L5	4,411
	6	332	15	1,093	24	2,166		
	7	410	16	1,190	25	2,361		
	8	489	17	1,288	26	2,555		
	9	567	18	1,385	27	2,751		

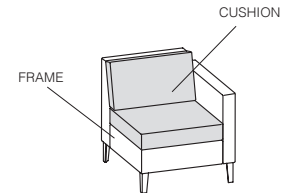

### TO ORDER PLEASE SPECIFY THE FOLLOWING:

<input type="text"/>	<input type="text"/>	<input type="text"/>	<input type="text"/>	<input type="text"/>
<b>MODEL NUMBER</b>	<b>STITCH DETAIL</b>	<b>FLAMMABILITY RATING</b>	<b>CUSHION UPHOLSTERY</b>	<b>FRAME UPHOLSTERY</b>
	None <b>NR</b> Stitch detail <b>SD +\$197</b>	<b>U</b> CTB117	Please refer to list of available upholstery and leather selections on <a href="http://www.gunlocke.com">www.gunlocke.com</a>	Please refer to list of available upholstery and leather selections on <a href="http://www.gunlocke.com">www.gunlocke.com</a>

### Example

GK1115-1A.NR.U.DOL728.SPNN04

GK1115-1A	NR	U	DOL728	SPNN04
MODEL NUMBER	STITCH	FLAMMABILITY DETAIL	CUSHION UPHOLSTERY	FRAME UPHOLSTERY

Please refer to the Ciji product page on [www.gunlocke.com](http://www.gunlocke.com) for standard finish options.

**Seating**  
02/24

**CIJI SINGLE SEAT**

Mid Back, Arm Right, Wood Legs

model number	fabric grades
<b>GK1117-1W</b>	<b>1</b> 3,619

Mid back, arm right,  
Wood legs



dimensions	W	D	H
Overall	28 1/8"	31 1/2"	32 1/8"
Seat	24"	21"	17 1/4"
Arm			26 7/8"
Between arms			

**Upholstery Requirements: GK1117-1W**

	Dual Upholstery	
Fabric yds	Cushions 1.5	Frame 3
Leather ft <sup>2</sup>	Cushions 34.5	Frame 69
Shipping weight		92 lbs.
Cube		28.0

Cushion

<b>1</b>	<b>10</b>	323	<b>19</b>	742	<b>L1</b>	494
<b>2</b>	30	<b>11</b>	361	<b>20</b>	<b>L2</b>	902
<b>3</b>	59	<b>12</b>	401	<b>21</b>	<b>L3</b>	1,391
<b>COM/4</b>	89	<b>13</b>	449	<b>22</b>	<b>L4</b>	1,799
<b>5</b>	128	<b>14</b>	498	<b>23</b>	<b>L5</b>	2,206
<b>6</b>	167	<b>15</b>	546	<b>24</b>		1,083
<b>7</b>	205	<b>16</b>	596	<b>25</b>		1,181
<b>8</b>	245	<b>17</b>	644	<b>26</b>		1,279
<b>9</b>	284	<b>18</b>	694	<b>27</b>		1,376

To calculate price of lounge with different fabric for cushion and frame; start with Grade 1 price, add appropriate grade price located in second row for cushion, and last add appropriate grade price located in third row for frame to the sum of the Grade 1 and cushion price.

**Example: Grade 1 \$3,619 + grade 4 fabric cushion \$89 + grade 2 fabric frame \$59 = \$3,767**

Select upholstery for everything else other than the seat and back cushions (the outside back, arms, sides, seat frame). You can specify the same fabric as the cushions or select other fabric.

Frame

<b>1</b>	<b>10</b>	644	<b>19</b>	1,483	<b>L1</b>	987
<b>2</b>	59	<b>11</b>	723	<b>20</b>	<b>L2</b>	1,802
<b>3</b>	118	<b>12</b>	801	<b>21</b>	<b>L3</b>	2,780
<b>COM/4</b>	177	<b>13</b>	898	<b>22</b>	<b>L4</b>	3,596
<b>5</b>	255	<b>14</b>	995	<b>23</b>	<b>L5</b>	4,411
<b>6</b>	332	<b>15</b>	1,093	<b>24</b>		2,166
<b>7</b>	410	<b>16</b>	1,190	<b>25</b>		2,361
<b>8</b>	489	<b>17</b>	1,288	<b>26</b>		2,555
<b>9</b>	567	<b>18</b>	1,385	<b>27</b>		2,751

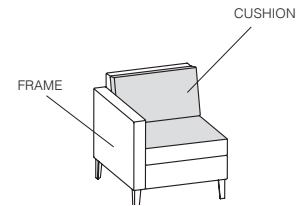

TO ORDER PLEASE SPECIFY THE FOLLOWING:

<input type="text"/>	<input type="text"/>	<input type="text"/>	<input type="text"/>	<input type="text"/>	<input type="text"/>
<b>MODEL NUMBER</b>	<b>WOOD FINISH</b>	<b>STITCH DETAIL</b>	<b>FLAMMABILITY RATING</b>	<b>CUSHION UPHOLSTERY</b>	<b>FRAME UPHOLSTERY</b>
	Cherry finishes on Maple Walnut finishes on Maple Maple finishes on Maple Oak finishes on Maple <i>Light Rift Oak 301 not available on Maple.</i>	None NR Stitch detail SD +\$197	U CTB117	Please refer to list of available upholstery and leather selections on www.gunlocke.com	Please refer to list of available upholstery and leather selections on www.gunlocke.com

Example

GK1117-1W.777.NR.U.DOL728.SPNO4					
GK1117-1W	777	NR	U	DOL728	SPNO4
MODEL NUMBER	WOOD FINISH	STITCH DETAIL	FLAMMABILITY	CUSHION UPHOLSTERY	FRAME UPHOLSTERY

Please refer to the Ciji product page on www.gunlocke.com for standard finish options.

# CIIJ SINGLE SEAT

Mid Back, Arm Left, Aluminum Legs

**Seating**  
02/24

model number fabric grades dimensions W D H

**GK1117-1A**  
1 3,903  
Mid back, arm left,  
Aluminum legs

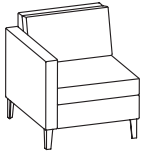

Overall	28 1/8"	31 1/2"	32 1/8"
Seat	24"	21"	17 1/4"
Arm			26 7/8"
Between arms			

### Upholstery Requirements: GK1117-1A

	Dual Upholstery	
Fabric yds	Cushions 1.5	Frame 3
Leather ft²	Cushions 34.5	Frame 57.5
Shipping weight		92 lbs.
Cube		28.0

Cushion

<b>1</b>	<b>10</b>	323	<b>19</b>	742	<b>L1</b>	494
<b>2</b>	30	<b>11</b>	361	<b>20</b>	<b>L2</b>	902
<b>3</b>	59	<b>12</b>	401	<b>21</b>	<b>L3</b>	1,391
<b>COM/4</b>	89	<b>13</b>	449	<b>22</b>	<b>L4</b>	1,799
<b>5</b>	128	<b>14</b>	498	<b>23</b>	<b>L5</b>	2,206
<b>6</b>	167	<b>15</b>	546	<b>24</b>		
<b>7</b>	205	<b>16</b>	596	<b>25</b>		
<b>8</b>	245	<b>17</b>	644	<b>26</b>		
<b>9</b>	284	<b>18</b>	694	<b>27</b>		

To calculate price of lounge with different fabric for cushion and frame; start with Grade 1 price, add appropriate grade price located in second row for cushion, and last add appropriate grade price located in third row for frame to the sum of the Grade 1 and cushion price.

**Example: Grade 1 \$3,903 + grade 4 fabric cushion \$89 + grade 2 fabric frame \$59 = \$4,051**

Select upholstery for everything else other than the seat and back cushions (the outside back, arms, sides, seat frame). You can specify the same fabric as the cushions or select other fabric.

Frame

<b>1</b>	<b>10</b>	644	<b>19</b>	1,483	<b>L1</b>	987
<b>2</b>	59	<b>11</b>	723	<b>20</b>	<b>L2</b>	1,802
<b>3</b>	118	<b>12</b>	801	<b>21</b>	<b>L3</b>	2,780
<b>COM/4</b>	177	<b>13</b>	898	<b>22</b>	<b>L4</b>	3,596
<b>5</b>	255	<b>14</b>	995	<b>23</b>	<b>L5</b>	4,411
<b>6</b>	332	<b>15</b>	1,093	<b>24</b>		
<b>7</b>	410	<b>16</b>	1,190	<b>25</b>		
<b>8</b>	489	<b>17</b>	1,288	<b>26</b>		
<b>9</b>	567	<b>18</b>	1,385	<b>27</b>		

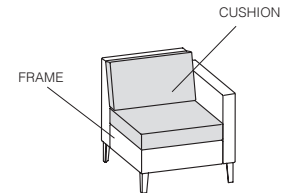

### TO ORDER PLEASE SPECIFY THE FOLLOWING:

<input type="text"/>	<input type="text"/>	<input type="text"/>	<input type="text"/>	<input type="text"/>
<b>MODEL NUMBER</b>	<b>STITCH DETAIL</b>	<b>FLAMMABILITY RATING</b>	<b>CUSHION UPHOLSTERY</b>	<b>FRAME UPHOLSTERY</b>
	None <b>NR</b> Stitch detail <b>SD +\$197</b>	<b>U</b> CTB117	Please refer to list of available upholstery and leather selections on <a href="http://www.gunlocke.com">www.gunlocke.com</a>	Please refer to list of available upholstery and leather selections on <a href="http://www.gunlocke.com">www.gunlocke.com</a>

### Example

GK1117-1A.NR.U.DOL728.SPNN04  
 GK1117-1A NR U DOL728 SPNN04  
 MODEL NUMBER STITCH FLAMMABILITY RATING CUSHION UPHOLSTERY FRAME UPHOLSTERY

Please refer to the Ciji product page on [www.gunlocke.com](http://www.gunlocke.com) for standard finish options.



model number	fabric grades
<b>GK1111-2W</b>	<b>1</b> 5,384

Mid back, with arms,  
Wood legs

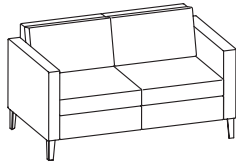

dimensions	W	D	H
Overall	56 1/4"	31 1/2"	32 1/8"
Seat	48 1/2"	21"	17 1/4"
Arm			26 7/8"
Between arms	48 1/2"		

**Upholstery Requirements: GK1111-2W**

	Dual Upholstery	
Fabric yds	Cushions 2.9	Frame 5.3
Leather ft <sup>2</sup>	Cushions 66.7	Frame 121.9
Shipping weight		127 lbs.
Cube		35

Cushion	<b>1</b>	<b>10</b>	623	<b>19</b>	1,433	<b>L1</b>	954	
	<b>2</b>	57	<b>11</b>	698	<b>20</b>	1,528	<b>L2</b>	1,742
	<b>3</b>	115	<b>12</b>	773	<b>21</b>	1,622	<b>L3</b>	2,688
	<b>COM/4</b>	170	<b>13</b>	868	<b>22</b>	1,716	<b>L4</b>	3,476
	<b>5</b>	246	<b>14</b>	963	<b>23</b>	1,905	<b>L5</b>	4,264
	<b>6</b>	321	<b>15</b>	1,056	<b>24</b>	2,093		
	<b>7</b>	397	<b>16</b>	1,151	<b>25</b>	2,282		
	<b>8</b>	472	<b>17</b>	1,245	<b>26</b>	2,469		
	<b>9</b>	547	<b>18</b>	1,339	<b>27</b>	2,659		

To calculate price of lounge with different fabric for cushion and frame; start with Grade 1 price, add appropriate grade price located in second row for cushion, and last add appropriate grade price located in third row for frame to the sum of the Grade 1 and cushion price.

**Example: Grade 1 \$5,384 + grade 4 fabric cushion \$170 + grade 2 fabric frame \$105 = \$5,659**

Select upholstery for everything else other than the seat and back cushions (the outside back, arms, sides, seat frame). You can specify the same fabric as the cushions or select other fabric.

Frame	<b>1</b>	<b>10</b>	1,139	<b>19</b>	2,619	<b>L1</b>	1,742	
	<b>2</b>	105	<b>11</b>	1,276	<b>20</b>	2,791	<b>L2</b>	3,183
	<b>3</b>	208	<b>12</b>	1,414	<b>21</b>	2,964	<b>L3</b>	4,912
	<b>COM/4</b>	311	<b>13</b>	1,585	<b>22</b>	3,136	<b>L4</b>	6,353
	<b>5</b>	449	<b>14</b>	1,758	<b>23</b>	3,480	<b>L5</b>	7,792
	<b>6</b>	587	<b>15</b>	1,930	<b>24</b>	3,825		
	<b>7</b>	724	<b>16</b>	2,103	<b>25</b>	4,170		
	<b>8</b>	863	<b>17</b>	2,275	<b>26</b>	4,514		
	<b>9</b>	1,001	<b>18</b>	2,448	<b>27</b>	4,858		

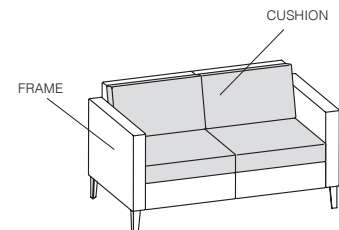

TO ORDER PLEASE SPECIFY THE FOLLOWING:

<input type="text"/>	<input type="text"/>	<input type="text"/>	<input type="text"/>	<input type="text"/>	<input type="text"/>
<b>MODEL NUMBER</b>	<b>WOOD FINISH</b>	<b>STITCH DETAIL</b>	<b>FLAMMABILITY RATING</b>	<b>CUSHION UPHOLSTERY</b>	<b>FRAME UPHOLSTERY</b>
	Cherry finishes on Maple Walnut finishes on Maple Maple finishes on Maple Oak finishes on Maple <i>Light Rift Oak 301 not available on Maple.</i>	None NR Stitch detail SD +\$197	U CTB117	Please refer to list of available upholstery and leather selections on www.gunlocke.com	Please refer to list of available upholstery and leather selections on www.gunlocke.com

Example

GK1111-2W.777.NR.U.DOL728.SPNO4					
GK1111-2W	777	NR	U	DOL728	SPNO4
MODEL NUMBER	WOOD FINISH	STITCH DETAIL	FLAMMABILITY UPHOLSTERY	CUSHION UPHOLSTERY	FRAME REQUEST

Please refer to the Ciji product page on www.gunlocke.com for standard finish options.

# CIJI TWO SEAT

Mid Back, with Arms, Aluminum Legs

**Seating**  
02/24

model number	fabric grades	dimensions	W	D	H
--------------	---------------	------------	---	---	---

**GK1111-2A**  
Mid back, with arms,  
Aluminum legs

**1** 5,668

Overall	56 1/4"	31 1/2"	32 1/8"
Seat	48 1/2"	21"	17 1/4"
Arm			26 7/8"
Between arms	48 1/2"		

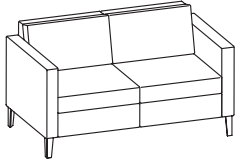

### Upholstery Requirements: GK1111-2A

	Dual Upholstery
Fabric yds	Cushions 2.9 Frame 5.3
Leather ft <sup>2</sup>	Cushions 66.7 Frame 121.9
Shipping weight	127 lbs.
Cube	35

Cushion

<b>1</b>	<b>10</b>	623	<b>19</b>	1,433	<b>L1</b>	954	
<b>2</b>	57	<b>11</b>	698	<b>20</b>	1,528	<b>L2</b>	1,742
<b>3</b>	115	<b>12</b>	773	<b>21</b>	1,622	<b>L3</b>	2,688
<b>COM/4</b>	170	<b>13</b>	868	<b>22</b>	1,716	<b>L4</b>	3,476
<b>5</b>	246	<b>14</b>	963	<b>23</b>	1,905	<b>L5</b>	4,264
<b>6</b>	321	<b>15</b>	1,056	<b>24</b>	2,093		
<b>7</b>	397	<b>16</b>	1,151	<b>25</b>	2,282		
<b>8</b>	472	<b>17</b>	1,245	<b>26</b>	2,469		
<b>9</b>	547	<b>18</b>	1,339	<b>27</b>	2,659		

To calculate price of lounge with different fabric for cushion and frame; start with Grade 1 price, add appropriate grade price located in second row for cushion, and last add appropriate grade price located in third row for frame to the sum of the Grade 1 and cushion price.

**Example: Grade 1 \$5,668 + grade 4 fabric cushion \$170 + grade 2 fabric frame \$105 = \$5,943**

Frame

<b>1</b>	<b>10</b>	1,139	<b>19</b>	2,619	<b>L1</b>	1,742	
<b>2</b>	105	<b>11</b>	1,276	<b>20</b>	2,791	<b>L2</b>	3,183
<b>3</b>	208	<b>12</b>	1,414	<b>21</b>	2,964	<b>L3</b>	4,912
<b>COM/4</b>	311	<b>13</b>	1,585	<b>22</b>	3,136	<b>L4</b>	6,353
<b>5</b>	449	<b>14</b>	1,758	<b>23</b>	3,480	<b>L5</b>	7,792
<b>6</b>	587	<b>15</b>	1,930	<b>24</b>	3,825		
<b>7</b>	724	<b>16</b>	2,103	<b>25</b>	4,170		
<b>8</b>	863	<b>17</b>	2,275	<b>26</b>	4,514		
<b>9</b>	1,001	<b>18</b>	2,448	<b>27</b>	4,858		

Select upholstery for everything else other than the seat and back cushions (the outside back, arms, sides, seat frame). You can specify the same fabric as the cushions or select other fabric.

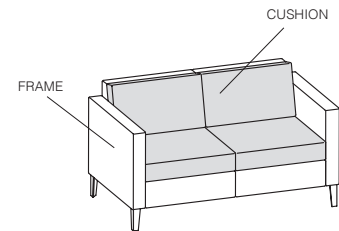

TO ORDER PLEASE SPECIFY THE FOLLOWING:

<input type="text"/>	<input type="text"/>	<input type="text"/>	<input type="text"/>	<input type="text"/>
<b>MODEL NUMBER</b>	<b>STITCH DETAIL</b>	<b>FLAMMABILITY RATING</b>	<b>CUSHION UPHOLSTERY</b>	<b>FRAME UPHOLSTERY</b>
	None <b>NR</b> Stitch detail <b>SD +\$197</b>	<b>U</b> CTB117	Please refer to list of available upholstery and leather selections on <a href="http://www.gunlocke.com">www.gunlocke.com</a>	Please refer to list of available upholstery and leather selections on <a href="http://www.gunlocke.com">www.gunlocke.com</a>

Example

GK1111-2A.NR.U.DOL728.SPNN04

GK1111-2A	NR	U	DOL728	SPNN04
MODEL NUMBER	STITCH	FLAMMABILITY DETAIL	CUSHION UPHOLSTERY	FRAME UPHOLSTERY

Please refer to the Ciji product page on [www.gunlocke.com](http://www.gunlocke.com) for standard finish options.

model number                      fabric grades                      dimensions                      W                      D                      H

**GK1113-2W**

Mid back, armless,  
Wood Legs

**1** 4,444

Overall	49 1/8"	31 1/2"	32 1/8"
Seat	48 1/2"	21"	17 1/4"

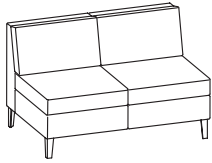

**Upholstery Requirements: GK1113-2W**

Dual Upholstery	
Fabric yds	Cushions 2.9    Frame 2.5
Leather ft <sup>2</sup>	Cushions 66.7    Frame 57.5
Shipping weight	107 lbs.
Cube	35

Cushion

<b>1</b>	<b>10</b>	623	<b>19</b>	1,433	<b>L1</b>	954
<b>2</b>	57	<b>11</b>	698	<b>20</b>	1,528	<b>L2</b> 1,742
<b>3</b>	115	<b>12</b>	773	<b>21</b>	1,622	<b>L3</b> 2,688
<b>COM/4</b>	170	<b>13</b>	868	<b>22</b>	1,716	<b>L4</b> 3,476
<b>5</b>	246	<b>14</b>	963	<b>23</b>	1,905	<b>L5</b> 4,264
<b>6</b>	321	<b>15</b>	1,056	<b>24</b>	2,093	
<b>7</b>	397	<b>16</b>	1,151	<b>25</b>	2,282	
<b>8</b>	472	<b>17</b>	1,245	<b>26</b>	2,469	
<b>9</b>	547	<b>18</b>	1,339	<b>27</b>	2,659	

To calculate price of lounge with different fabric for cushion and frame; start with Grade 1 price, add appropriate grade price located in second row for cushion, and last add appropriate grade price located in third row for frame to the sum of the Grade 1 and cushion price.

**Example: Grade 1 \$4,444 + grade 4 fabric cushion \$170 + grade 2 fabric frame \$49 = \$4,663**

Frame

<b>1</b>	<b>10</b>	538	<b>19</b>	1,235	<b>L1</b>	822
<b>2</b>	49	<b>11</b>	603	<b>20</b>	1,317	<b>L2</b> 1,502
<b>3</b>	98	<b>12</b>	667	<b>21</b>	1,399	<b>L3</b> 2,317
<b>COM/4</b>	147	<b>13</b>	748	<b>22</b>	1,480	<b>L4</b> 2,997
<b>5</b>	212	<b>14</b>	830	<b>23</b>	1,642	<b>L5</b> 3,677
<b>6</b>	278	<b>15</b>	911	<b>24</b>	1,805	
<b>7</b>	342	<b>16</b>	992	<b>25</b>	1,967	
<b>8</b>	407	<b>17</b>	1,073	<b>26</b>	2,130	
<b>9</b>	472	<b>18</b>	1,155	<b>27</b>	2,292	

Select upholstery for everything else other than the seat and back cushions (the outside back, arms, sides, seat frame). You can specify the same fabric as the cushions or select other fabric.

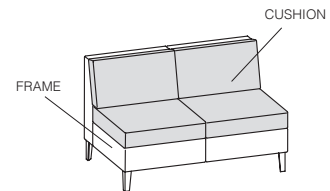

**TO ORDER PLEASE SPECIFY THE FOLLOWING:**

.  .  .  .  .

**MODEL NUMBER**

**WOOD FINISH**

Cherry finishes on Maple  
Walnut finishes on Maple  
Maple finishes on Maple  
Oak finishes on Maple  
*Light Rift Oak 301 not available on Maple.*

**STITCH DETAIL**

None **NR**  
Stitch detail **SD +\$197**

**FLAMMABILITY RATING**

**U** **CTB117**

**CUSHION UPHOLSTERY**

Please refer to list of available upholstery and leather selections on [www.gunlocke.com](http://www.gunlocke.com)

**FRAME UPHOLSTERY**

Please refer to list of available upholstery and leather selections on [www.gunlocke.com](http://www.gunlocke.com)

Example

GK1113-2W.777.NR.U.DOL728.SPNO4

GK1113-2W	777	NR	U	DOL728	SPNO4
MODEL NUMBER	WOOD FINISH	STITCH DETAIL	FLAMMABILITY UPHOLSTERY	CUSHION UPHOLSTERY	FRAME REQUEST

Please refer to the Ciji product page on [www.gunlocke.com](http://www.gunlocke.com) for standard finish options.

# CIJI TWO SEAT

Mid Back, Armless, Aluminum Legs

Seating  
02/24

model number	fabric grades	dimensions	W	D	H
<b>GK1113-2A</b>	<b>1</b> 4,727	Overall	49 1/8"	31 1/2"	32 1/8"
Mid back, armless, Aluminum Legs		Seat	48 1/2"	21"	17 1/4"

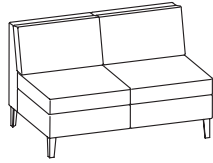

### Upholstery Requirements: GK1113-2A

Dual Upholstery	
Fabric yds	Cushions 2.9 Frame 2.5
Leather ft <sup>2</sup>	Cushions 66.7 Frame 57.5
Shipping weight	107 lbs.
Cube	35

Cushion

<b>1</b>	<b>10</b>	623	<b>19</b>	1,433	<b>L1</b>	954	
<b>2</b>	57	<b>11</b>	698	<b>20</b>	1,528	<b>L2</b>	1,742
<b>3</b>	115	<b>12</b>	773	<b>21</b>	1,622	<b>L3</b>	2,688
<b>COM/4</b>	170	<b>13</b>	868	<b>22</b>	1,716	<b>L4</b>	3,476
<b>5</b>	246	<b>14</b>	963	<b>23</b>	1,905	<b>L5</b>	4,264
<b>6</b>	321	<b>15</b>	1,056	<b>24</b>	2,093		
<b>7</b>	397	<b>16</b>	1,151	<b>25</b>	2,282		
<b>8</b>	472	<b>17</b>	1,245	<b>26</b>	2,469		
<b>9</b>	547	<b>18</b>	1,339	<b>27</b>	2,659		

To calculate price of lounge with different fabric for cushion and frame; start with Grade 1 price, add appropriate grade price located in second row for cushion, and last add appropriate grade price located in third row for frame to the sum of the Grade 1 and cushion price.

**Example: Grade 1 \$4,727 + grade 4 fabric cushion \$170 + grade 2 fabric frame \$49 = \$4,946**

Frame

<b>1</b>	<b>10</b>	538	<b>19</b>	1,235	<b>L1</b>	822	
<b>2</b>	49	<b>11</b>	603	<b>20</b>	1,317	<b>L2</b>	1,502
<b>3</b>	98	<b>12</b>	667	<b>21</b>	1,399	<b>L3</b>	2,317
<b>COM/4</b>	147	<b>13</b>	748	<b>22</b>	1,480	<b>L4</b>	2,997
<b>5</b>	212	<b>14</b>	830	<b>23</b>	1,642	<b>L5</b>	3,677
<b>6</b>	278	<b>15</b>	911	<b>24</b>	1,805		
<b>7</b>	342	<b>16</b>	992	<b>25</b>	1,967		
<b>8</b>	407	<b>17</b>	1,073	<b>26</b>	2,130		
<b>9</b>	472	<b>18</b>	1,155	<b>27</b>	2,292		

Select upholstery for everything else other than the seat and back cushions (the outside back, arms, sides, seat frame). You can specify the same fabric as the cushions or select other fabric.

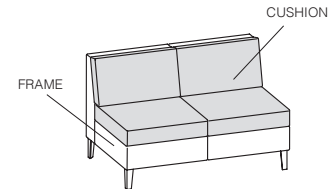

TO ORDER PLEASE SPECIFY THE FOLLOWING:

<input type="text"/>	<input type="text"/>	<input type="text"/>	<input type="text"/>	<input type="text"/>
<b>MODEL NUMBER</b>	<b>STITCH DETAIL</b>	<b>FLAMMABILITY RATING</b>	<b>CUSHION UPHOLSTERY</b>	<b>FRAME UPHOLSTERY</b>
	None <b>NR</b> Stitch detail <b>SD +\$197</b>	<b>U</b> CTB117	Please refer to list of available upholstery and leather selections on <a href="http://www.gunlocke.com">www.gunlocke.com</a>	Please refer to list of available upholstery and leather selections on <a href="http://www.gunlocke.com">www.gunlocke.com</a>

Example

GK1113-2A.NR.U.DOL728.SPNN04				
GK1113-2A	NR	U	DOL728	SPNN04
<b>MODEL NUMBER</b>	<b>STITCH</b>	<b>FLAMMABILITY DETAIL</b>	<b>CUSHION UPHOLSTERY</b>	<b>FRAME UPHOLSTERY</b>

Please refer to the Ciji product page on [www.gunlocke.com](http://www.gunlocke.com) for standard finish options.

model number fabric grades

**GK1115-2W**

Mid back, arm left,  
Wood Legs

**1** 5,162

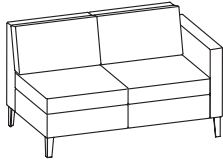

dimensions W D H

Overall 52 5/8" 31 1/2" 32 1/8"

Seat 48 1/2" 21" 17 1/4"

Arm 26 7/8"

Between arms

**Upholstery Requirements: GK1115-2W**

	Dual Upholstery	
Fabric yds	Cushions 2.9	Frame 3.8
Leather ft <sup>2</sup>	Cushions 66.7	Frame 87.4
Shipping weight	117 lbs.	
Cube	35	

Cushion

<b>1</b>	<b>10</b>	623	<b>19</b>	1,433	<b>L1</b>	954	
<b>2</b>	57	<b>11</b>	698	<b>20</b>	1,528	<b>L2</b>	1,742
<b>3</b>	115	<b>12</b>	773	<b>21</b>	1,622	<b>L3</b>	2,688
<b>COM/4</b>	170	<b>13</b>	868	<b>22</b>	1,716	<b>L4</b>	3,476
<b>5</b>	246	<b>14</b>	963	<b>23</b>	1,905	<b>L5</b>	4,264
<b>6</b>	321	<b>15</b>	1,056	<b>24</b>	2,093		
<b>7</b>	397	<b>16</b>	1,151	<b>25</b>	2,282		
<b>8</b>	472	<b>17</b>	1,245	<b>26</b>	2,469		
<b>9</b>	547	<b>18</b>	1,339	<b>27</b>	2,659		

To calculate price of lounge with different fabric for cushion and frame; start with Grade 1 price, add appropriate grade price located in second row for cushion, and last add appropriate grade price located in third row for frame to the sum of the Grade 1 and cushion price.

**Example: Grade 1 \$5,162 + grade 4 fabric cushion \$170 + grade 2 fabric frame \$75 = \$5,407**

Select upholstery for everything else other than the seat and back cushions (the outside back, arms, sides, seat frame). You can specify the same fabric as the cushions or select other fabric.

Frame

<b>1</b>	<b>10</b>	816	<b>19</b>	1,878	<b>L1</b>	1,250	
<b>2</b>	75	<b>11</b>	915	<b>20</b>	2,002	<b>L2</b>	2,282
<b>3</b>	149	<b>12</b>	1,014	<b>21</b>	2,125	<b>L3</b>	3,522
<b>COM/4</b>	223	<b>13</b>	1,138	<b>22</b>	2,249	<b>L4</b>	4,555
<b>5</b>	322	<b>14</b>	1,260	<b>23</b>	2,495	<b>L5</b>	5,587
<b>6</b>	421	<b>15</b>	1,384	<b>24</b>	2,742		
<b>7</b>	520	<b>16</b>	1,507	<b>25</b>	2,990		
<b>8</b>	618	<b>17</b>	1,631	<b>26</b>	3,237		
<b>9</b>	717	<b>18</b>	1,755	<b>27</b>	3,484		

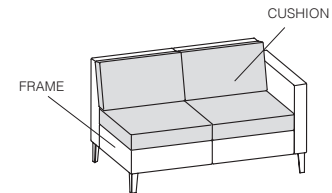

**TO ORDER PLEASE SPECIFY THE FOLLOWING:**

.  .  .  .  .

**MODEL NUMBER**

**WOOD FINISH**

Cherry finishes on Maple  
Walnut finishes on Maple  
Maple finishes on Maple  
Oak finishes on Maple  
*Light Rift Oak 301 not available on Maple.*

**STITCH DETAIL**

None **NR**  
Stitch detail **SD +\$197**

**FLAMMABILITY RATING**

**U** **CTB117**

**CUSHION UPHOLSTERY**

Please refer to list of available upholstery and leather selections on [www.gunlocke.com](http://www.gunlocke.com)

**FRAME UPHOLSTERY**

Please refer to list of available upholstery and leather selections on [www.gunlocke.com](http://www.gunlocke.com)

**Example**

GK1115-2W.777.NR.U.DOL728.SPNN04

GK1115-2W	777	NR	U	DOL728	SPNN04
MODEL NUMBER	WOOD FINISH	STITCH DETAIL	FLAMMABILITY UPHOLSTERY	CUSHION UPHOLSTERY	FRAME REQUEST

Please refer to the Ciji product page on [www.gunlocke.com](http://www.gunlocke.com) for standard finish options.

# CIJI TWO SEAT

Mid Back, Arm Left, Aluminum Legs

**Seating**  
02/24

model number	fabric grades	dimensions	W	D	H
--------------	---------------	------------	---	---	---

**GK1115-2A**  
Mid back, arm left,  
Aluminum Legs

**1** 5,447

Overall	52 5/8"	31 1/2"	32 1/8"
Seat	48 1/2"	21"	17 1/4"
Arm			26 7/8"
Between arms			

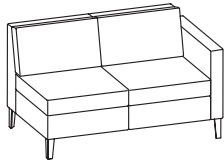

### Upholstery Requirements: GK1115-2A

	Dual Upholstery	
Fabric yds	Cushions 2.9	Frame 3.8
Leather ft <sup>2</sup>	Cushions 66.7	Frame 87.4
Shipping weight		117 lbs.
Cube		35

Cushion

<b>1</b>	<b>10</b>	623	<b>19</b>	1,433	<b>L1</b>	954	
<b>2</b>	57	<b>11</b>	698	<b>20</b>	1,528	<b>L2</b>	1,742
<b>3</b>	115	<b>12</b>	773	<b>21</b>	1,622	<b>L3</b>	2,688
<b>COM/4</b>	170	<b>13</b>	868	<b>22</b>	1,716	<b>L4</b>	3,476
<b>5</b>	246	<b>14</b>	963	<b>23</b>	1,905	<b>L5</b>	4,264
<b>6</b>	321	<b>15</b>	1,056	<b>24</b>	2,093		
<b>7</b>	397	<b>16</b>	1,151	<b>25</b>	2,282		
<b>8</b>	472	<b>17</b>	1,245	<b>26</b>	2,469		
<b>9</b>	547	<b>18</b>	1,339	<b>27</b>	2,659		

To calculate price of lounge with different fabric for cushion and frame; start with Grade 1 price, add appropriate grade price located in second row for cushion, and last add appropriate grade price located in third row for frame to the sum of the Grade 1 and cushion price.

**Example: Grade 1 \$5,447 + grade 4 fabric cushion \$170 + grade 2 fabric frame \$75 = \$5,692**

Select upholstery for everything else other than the seat and back cushions (the outside back, arms, sides, seat frame). You can specify the same fabric as the cushions or select other fabric.

Frame

<b>1</b>	<b>10</b>	816	<b>19</b>	1,878	<b>L1</b>	1,250	
<b>2</b>	75	<b>11</b>	915	<b>20</b>	2,002	<b>L2</b>	2,282
<b>3</b>	149	<b>12</b>	1,014	<b>21</b>	2,125	<b>L3</b>	3,522
<b>COM/4</b>	223	<b>13</b>	1,138	<b>22</b>	2,249	<b>L4</b>	4,555
<b>5</b>	322	<b>14</b>	1,260	<b>23</b>	2,495	<b>L5</b>	5,587
<b>6</b>	421	<b>15</b>	1,384	<b>24</b>	2,742		
<b>7</b>	520	<b>16</b>	1,507	<b>25</b>	2,990		
<b>8</b>	618	<b>17</b>	1,631	<b>26</b>	3,237		
<b>9</b>	717	<b>18</b>	1,755	<b>27</b>	3,484		

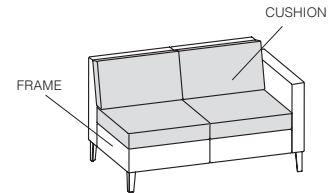

TO ORDER PLEASE SPECIFY THE FOLLOWING:

<input type="text"/>	<input type="text"/>	<input type="text"/>	<input type="text"/>	<input type="text"/>
<b>MODEL NUMBER</b>	<b>STITCH DETAIL</b>	<b>FLAMMABILITY RATING</b>	<b>CUSHION UPHOLSTERY</b>	<b>FRAME UPHOLSTERY</b>
	None <b>NR</b> Stitch detail <b>SD +\$197</b>	<b>U</b> CTB117	Please refer to list of available upholstery and leather selections on <a href="http://www.gunlocke.com">www.gunlocke.com</a>	Please refer to list of available upholstery and leather selections on <a href="http://www.gunlocke.com">www.gunlocke.com</a>

Example

GK1115-2A.NR.U.DOL728.SPNN04				
GK1115-2A	NR	U	DOL728	SPNN04
MODEL NUMBER	STITCH	FLAMMABILITY DETAIL	CUSHION UPHOLSTERY	FRAME UPHOLSTERY

Please refer to the Ciji product page on [www.gunlocke.com](http://www.gunlocke.com) for standard finish options.

model number	fabric grades
<b>GK1117-2W</b>	<b>1</b> 5,162

Mid back, arm right,  
Wood Legs

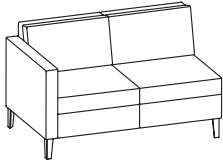

dimensions	W	D	H
Overall	52 5/8"	31 1/2"	32 1/8"
Seat	48 1/2"	21"	17 1/4"
Arm			26 7/8"
Between arms			

**Upholstery Requirements: GK1117-2W**

	Dual Upholstery	
Fabric yds	Cushions 2.9	Frame 3.8
Leather ft <sup>2</sup>	Cushions 66.7	Frame 87.4
Shipping weight		117 lbs.
Cube		35

Cushion

<b>1</b>	<b>10</b>	623	<b>19</b>	1,433	<b>L1</b>	954	
<b>2</b>	57	<b>11</b>	698	<b>20</b>	1,528	<b>L2</b>	1,742
<b>3</b>	115	<b>12</b>	773	<b>21</b>	1,622	<b>L3</b>	2,688
<b>COM/4</b>	170	<b>13</b>	868	<b>22</b>	1,716	<b>L4</b>	3,476
<b>5</b>	246	<b>14</b>	963	<b>23</b>	1,905	<b>L5</b>	4,264
<b>6</b>	321	<b>15</b>	1,056	<b>24</b>	2,093		
<b>7</b>	397	<b>16</b>	1,151	<b>25</b>	2,282		
<b>8</b>	472	<b>17</b>	1,245	<b>26</b>	2,469		
<b>9</b>	547	<b>18</b>	1,339	<b>27</b>	2,659		

To calculate price of lounge with different fabric for cushion and frame; start with Grade 1 price, add appropriate grade price located in second row for cushion, and last add appropriate grade price located in third row for frame to the sum of the Grade 1 and cushion price.

**Example: Grade 1 \$5,162 + grade 4 fabric cushion \$170 + grade 2 fabric frame \$75 = \$5,407**

Select upholstery for everything else other than the seat and back cushions (the outside back, arms, sides, seat frame). You can specify the same fabric as the cushions or select other fabric.

Frame

<b>1</b>	<b>10</b>	816	<b>19</b>	1,878	<b>L1</b>	1,250	
<b>2</b>	75	<b>11</b>	915	<b>20</b>	2,002	<b>L2</b>	2,282
<b>3</b>	149	<b>12</b>	1,014	<b>21</b>	2,125	<b>L3</b>	3,522
<b>COM/4</b>	223	<b>13</b>	1,138	<b>22</b>	2,249	<b>L4</b>	4,555
<b>5</b>	322	<b>14</b>	1,260	<b>23</b>	2,495	<b>L5</b>	5,587
<b>6</b>	421	<b>15</b>	1,384	<b>24</b>	2,742		
<b>7</b>	520	<b>16</b>	1,507	<b>25</b>	2,990		
<b>8</b>	618	<b>17</b>	1,631	<b>26</b>	3,237		
<b>9</b>	717	<b>18</b>	1,755	<b>27</b>	3,484		

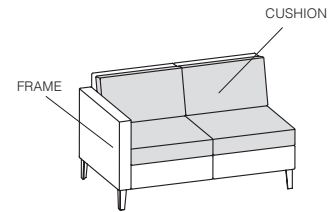

TO ORDER PLEASE SPECIFY THE FOLLOWING:

.  .  .  .  .

<b>MODEL NUMBER</b>	<b>WOOD FINISH</b>	<b>STITCH DETAIL</b>	<b>FLAMMABILITY RATING</b>	<b>CUSHION UPHOLSTERY</b>	<b>FRAME UPHOLSTERY</b>
	Cherry finishes on Maple Walnut finishes on Maple Maple finishes on Maple Oak finishes on Maple <i>Light Rift Oak 301 not available on Maple.</i>	None NR Stitch detail SD +\$197	U CTB117	Please refer to list of available upholstery and leather selections on <a href="http://www.gunlocke.com">www.gunlocke.com</a>	Please refer to list of available upholstery and leather selections on <a href="http://www.gunlocke.com">www.gunlocke.com</a>

Example

GK1117-2W.777.NR.U.DOL728.SPNN04

GK1117-2W	777	NR	U	DOL728	SPNN04
MODEL NUMBER	WOOD FINISH	STITCH DETAIL	FLAMMABILITY UPHOLSTERY	CUSHION UPHOLSTERY	FRAME REQUEST

Please refer to the Ciji product page on [www.gunlocke.com](http://www.gunlocke.com) for standard finish options.

# CIJI TWO SEAT

Mid Back, Arm Right, Aluminum Legs

**Seating**  
02/24

model number	fabric grades	dimensions	W	D	H
--------------	---------------	------------	---	---	---

**GK1117-2A**  
Mid back, arm right,  
Aluminum Legs

**1** 5,447

Overall	52 5/8"	31 1/2"	32 1/8"
Seat	48 1/2"	21"	17 1/4"
Arm			26 7/8"
Between arms			

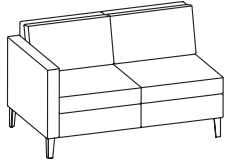

### Upholstery Requirements: GK1117-2A

	Dual Upholstery	
Fabric yds	Cushions 2.9	Frame 3.8
Leather ft <sup>2</sup>	Cushions 66.7	Frame 87.4
Shipping weight		117 lbs.
Cube		35

Cushion

<b>1</b>	<b>10</b>	623	<b>19</b>	1,433	<b>L1</b>	954	
<b>2</b>	57	<b>11</b>	698	<b>20</b>	1,528	<b>L2</b>	1,742
<b>3</b>	115	<b>12</b>	773	<b>21</b>	1,622	<b>L3</b>	2,688
<b>COM/4</b>	170	<b>13</b>	868	<b>22</b>	1,716	<b>L4</b>	3,476
<b>5</b>	246	<b>14</b>	963	<b>23</b>	1,905	<b>L5</b>	4,264
<b>6</b>	321	<b>15</b>	1,056	<b>24</b>	2,093		
<b>7</b>	397	<b>16</b>	1,151	<b>25</b>	2,282		
<b>8</b>	472	<b>17</b>	1,245	<b>26</b>	2,469		
<b>9</b>	547	<b>18</b>	1,339	<b>27</b>	2,659		

To calculate price of lounge with different fabric for cushion and frame; start with Grade 1 price, add appropriate grade price located in second row for cushion, and last add appropriate grade price located in third row for frame to the sum of the Grade 1 and cushion price.

**Example: Grade 1 \$5,447 + grade 4 fabric cushion \$170 + grade 2 fabric frame \$75 = \$5,692**

Select upholstery for everything else other than the seat and back cushions (the outside back, arms, sides, seat frame). You can specify the same fabric as the cushions or select other fabric.

Frame

<b>1</b>	<b>10</b>	816	<b>19</b>	1,878	<b>L1</b>	1,250	
<b>2</b>	75	<b>11</b>	915	<b>20</b>	2,002	<b>L2</b>	2,282
<b>3</b>	149	<b>12</b>	1,014	<b>21</b>	2,125	<b>L3</b>	3,522
<b>COM/4</b>	223	<b>13</b>	1,138	<b>22</b>	2,249	<b>L4</b>	4,555
<b>5</b>	322	<b>14</b>	1,260	<b>23</b>	2,495	<b>L5</b>	5,587
<b>6</b>	421	<b>15</b>	1,384	<b>24</b>	2,742		
<b>7</b>	520	<b>16</b>	1,507	<b>25</b>	2,990		
<b>8</b>	618	<b>17</b>	1,631	<b>26</b>	3,237		
<b>9</b>	717	<b>18</b>	1,755	<b>27</b>	3,484		

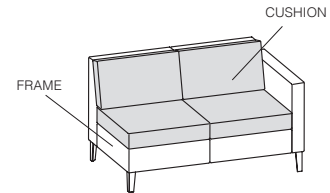

TO ORDER PLEASE SPECIFY THE FOLLOWING:

<input type="text"/>	<input type="text"/>	<input type="text"/>	<input type="text"/>	<input type="text"/>
<b>MODEL NUMBER</b>	<b>STITCH DETAIL</b>	<b>FLAMMABILITY RATING</b>	<b>CUSHION UPHOLSTERY</b>	<b>FRAME UPHOLSTERY</b>
	None <b>NR</b> Stitch detail <b>SD +\$197</b>	<b>U</b> CTB117	Please refer to list of available upholstery and leather selections on <a href="http://www.gunlocke.com">www.gunlocke.com</a>	Please refer to list of available upholstery and leather selections on <a href="http://www.gunlocke.com">www.gunlocke.com</a>

Example

GK1117-2A.NR.U.DOL728.SPNN04

GK1117-2A	NR	U	DOL728	SPNN04
MODEL NUMBER	STITCH	FLAMMABILITY DETAIL	CUSHION UPHOLSTERY	FRAME UPHOLSTERY

Please refer to the Ciji product page on [www.gunlocke.com](http://www.gunlocke.com) for standard finish options.



**Seating**  
02/24

**CIJI THREE SEAT**

Mid Back, with Arms, Wood Legs

model number fabric grades

**GK1111-3W** 1 6,855  
Mid back, with arms.  
Wood legs

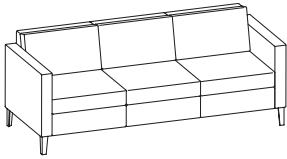

dimensions	W	D	H
Overall	80 3/4"	31 1/2"	32 1/8"
Seat	73"	21"	17 1/4"
Arm			26 7/8"
Between arms	73"		

**Upholstery Requirements: GK1111-3W**

	Dual Upholstery	
Fabric yds	Cushions 4.4	Frame 5.9
Leather ft <sup>2</sup>	Cushions 101.2	Frame 135.7
Shipping weight		188 lbs.
Cube		78.5

Cushion

<b>1</b>	<b>10</b>	945	<b>19</b>	2,175	<b>L1</b>	1,447
<b>2</b>	86	<b>11</b>	1,059	<b>20</b>	<b>L2</b>	2,642
<b>3</b>	173	<b>12</b>	1,173	<b>21</b>	<b>L3</b>	4,077
<b>COM/4</b>	258	<b>13</b>	1,317	<b>22</b>	<b>L4</b>	5,273
<b>5</b>	372	<b>14</b>	1,459	<b>23</b>	<b>L5</b>	6,470
<b>6</b>	487	<b>15</b>	1,603	<b>24</b>		
<b>7</b>	602	<b>16</b>	1,745	<b>25</b>		
<b>8</b>	716	<b>17</b>	1,888	<b>26</b>		
<b>9</b>	831	<b>18</b>	2,032	<b>27</b>		

To calculate price of lounge with different fabric for cushion and frame; start with Grade 1 price, add appropriate grade price located in second row for cushion, and last add appropriate grade price located in third row for frame to the sum of the Grade 1 and cushion price.

**Example: Grade 1 \$6,855 + grade 4 fabric cushion \$258 + grade 2 fabric frame \$116 = \$7,229**

Select upholstery for everything else other than the seat and back cushions (the outside back, arms, sides, seat frame). You can specify the same fabric as the cushions or select other fabric.

Frame

<b>1</b>	<b>10</b>	1,266	<b>19</b>	2,915	<b>L1</b>	1,940
<b>2</b>	116	<b>11</b>	1,420	<b>20</b>	<b>L2</b>	3,543
<b>3</b>	231	<b>12</b>	1,572	<b>21</b>	<b>L3</b>	5,468
<b>COM/4</b>	346	<b>13</b>	1,765	<b>22</b>	<b>L4</b>	7,070
<b>5</b>	499	<b>14</b>	1,956	<b>23</b>	<b>L5</b>	8,675
<b>6</b>	654	<b>15</b>	2,149	<b>24</b>		
<b>7</b>	806	<b>16</b>	2,341	<b>25</b>		
<b>8</b>	959	<b>17</b>	2,531	<b>26</b>		
<b>9</b>	1,114	<b>18</b>	2,724	<b>27</b>		

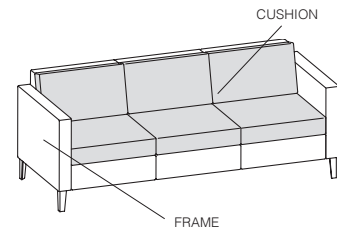

TO ORDER PLEASE SPECIFY THE FOLLOWING:

<input type="text"/>	<input type="text"/>	<input type="text"/>	<input type="text"/>	<input type="text"/>	<input type="text"/>
<b>MODEL NUMBER</b>	<b>WOOD FINISH</b>	<b>STITCH DETAIL</b>	<b>FLAMMABILITY RATING</b>	<b>CUSHION UPHOLSTERY</b>	<b>FRAME UPHOLSTERY</b>
	Cherry finishes on Maple Walnut finishes on Maple Maple finishes on Maple Oak finishes on Maple <i>Light Rift Oak 301 not available on Maple.</i>	None NR Stitch detail SD +\$197	U CTB117	Please refer to list of available upholstery and leather selections on <a href="http://www.gunlocke.com">www.gunlocke.com</a>	Please refer to list of available upholstery and leather selections on <a href="http://www.gunlocke.com">www.gunlocke.com</a>

Example

GK1111-3W.777.NR.U.DOL728.SPNN04  
GK1111-3W 777 NR U DOL728 SPNN04  
MODEL NUMBER WOOD FINISH STITCH DETAIL FLAMMABILITY UPHOLSTERY CUSHION UPHOLSTERY FRAME REQUEST

Please refer to the Ciji product page on [www.gunlocke.com](http://www.gunlocke.com) for standard finish options.

# CIJI THREE SEAT

**Seating**

02/24

Mid Back, with Arms, Aluminum Legs

model number                      fabric grades                      dimensions      W                      D                      H

## GK1111-3A

1 7,141

Mid back, with arms,  
Aluminum legs

Overall	80 3/4"	31 1/2"	32 1/8"
Seat	73"	21"	17 1/4"
Arm			26 7/8"
Between arms	73"		

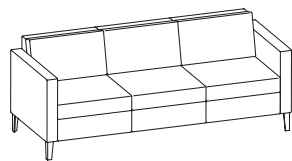

### **Upholstery Requirements: GK1111-3A**

	Dual Upholstery	
Fabric yds	Cushions 4.4	Frame 5.9
Leather ft <sup>2</sup>	Cushions 101.2	Frame 135.7
Shipping weight	188 lbs.	
Cube	78.5	

### Cushion

<b>1</b>	<b>10</b>	945	<b>19</b>	2,175	<b>L1</b>	1,447	
<b>2</b>	86	<b>11</b>	1,059	<b>20</b>	2,317	<b>L2</b>	2,642
<b>3</b>	173	<b>12</b>	1,173	<b>21</b>	2,461	<b>L3</b>	4,077
<b>COM/4</b>	258	<b>13</b>	1,317	<b>22</b>	2,603	<b>L4</b>	5,273
<b>5</b>	372	<b>14</b>	1,459	<b>23</b>	2,890	<b>L5</b>	6,470
<b>6</b>	487	<b>15</b>	1,603	<b>24</b>	3,176		
<b>7</b>	602	<b>16</b>	1,745	<b>25</b>	3,461		
<b>8</b>	716	<b>17</b>	1,888	<b>26</b>	3,748		
<b>9</b>	831	<b>18</b>	2,032	<b>27</b>	4,034		

To calculate price of lounge with different fabric for cushion and frame; start with Grade 1 price, add appropriate grade price located in second row for cushion, and last add appropriate grade price located in third row for frame to the sum of the Grade 1 and cushion price.

**Example: Grade 1 \$7,141 + grade 4 fabric cushion \$258 + grade 2 fabric frame \$116 = \$7,515**

Select upholstery for everything else other than the seat and back cushions (the outside back, arms, sides, seat frame). You can specify the same fabric as the cushions or select other fabric.

### Frame

<b>1</b>	<b>10</b>	1,266	<b>19</b>	2,915	<b>L1</b>	1,940	
<b>2</b>	116	<b>11</b>	1,420	<b>20</b>	3,108	<b>L2</b>	3,543
<b>3</b>	231	<b>12</b>	1,572	<b>21</b>	3,300	<b>L3</b>	5,468
<b>COM/4</b>	346	<b>13</b>	1,765	<b>22</b>	3,490	<b>L4</b>	7,070
<b>5</b>	499	<b>14</b>	1,956	<b>23</b>	3,874	<b>L5</b>	8,675
<b>6</b>	654	<b>15</b>	2,149	<b>24</b>	4,259		
<b>7</b>	806	<b>16</b>	2,341	<b>25</b>	4,641		
<b>8</b>	959	<b>17</b>	2,531	<b>26</b>	5,025		
<b>9</b>	1,114	<b>18</b>	2,724	<b>27</b>	5,408		

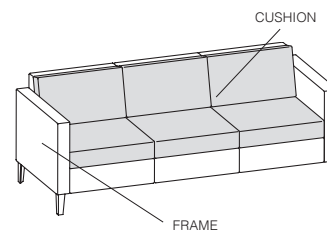

## TO ORDER PLEASE SPECIFY THE FOLLOWING:

<input type="text"/>	<input type="text"/>	<input type="text"/>	<input type="text"/>	<input type="text"/>
<b>MODEL NUMBER</b>	<b>STITCH DETAIL</b>	<b>FLAMMABILITY RATING</b>	<b>CUSHION UPHOLSTERY</b>	<b>FRAME UPHOLSTERY</b>
	None <b>NR</b> Stitch detail <b>SD +\$197</b>	<b>U</b> CTB117	Please refer to list of available upholstery and leather selections on www. gunlocke.com	Please refer to list of available upholstery and leather selections on www. gunlocke.com

### Example

Please refer to the Ciji product page on [www.gunlocke.com](http://www.gunlocke.com) for standard finish options.

**GK1111-3A.NR.U.DOL728.SPNN04**

GK1111-3A	NR	U	DOL728	SPNN04
<b>MODEL NUMBER</b>	<b>STITCH</b>	<b>FLAMMABILITY DETAIL</b>	<b>CUSHION UPHOLSTERY</b>	<b>FRAME UPHOLSTERY</b>

model number                      fabric grades                      dimensions                      W                      D                      H

**GK1113-3W**                      1 5,717  
Mid back, armless,  
Wood Legs

Overall	73 5/8"	31 1/2"	32 1/8"
Seat	73"	21"	17 1/4"

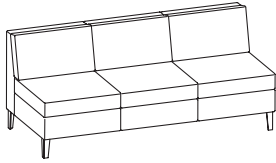

**Upholstery Requirements: GK1113-3W**

	Dual Upholstery	
Fabric yds	Cushions 4.4	Frame 3.3
Leather ft <sup>2</sup>	Cushions 101.2	Frame 75.9
Shipping weight	168 lbs.	
Cube	78.5	

Cushion

<b>1</b>	<b>10</b>	945	<b>19</b>	2,175	<b>L1</b>	1,447
<b>2</b>	86	<b>11</b>	1,059	<b>20</b>	<b>L2</b>	2,642
<b>3</b>	173	<b>12</b>	1,173	<b>21</b>	<b>L3</b>	4,077
<b>COM/4</b>	258	<b>13</b>	1,317	<b>22</b>	<b>L4</b>	5,273
<b>5</b>	372	<b>14</b>	1,459	<b>23</b>	<b>L5</b>	6,470
<b>6</b>	487	<b>15</b>	1,603	<b>24</b>		
<b>7</b>	602	<b>16</b>	1,745	<b>25</b>		
<b>8</b>	716	<b>17</b>	1,888	<b>26</b>		
<b>9</b>	831	<b>18</b>	2,032	<b>27</b>		

To calculate price of lounge with different fabric for cushion and frame; start with Grade 1 price, add appropriate grade price located in second row for cushion, and last add appropriate grade price located in third row for frame to the sum of the Grade 1 and cushion price.

**Example: Grade 1 \$5,717 + grade 4 fabric cushion \$258 + grade 2 fabric frame \$65 = \$6,040**

Select upholstery for everything else other than the seat and back cushions (the outside back, arms, sides, seat frame). You can specify the same fabric as the cushions or select other fabric.

Frame

<b>1</b>	<b>10</b>	708	<b>19</b>	1,631	<b>L1</b>	1,085
<b>2</b>	65	<b>11</b>	795	<b>20</b>	<b>L2</b>	1,982
<b>3</b>	130	<b>12</b>	880	<b>21</b>	<b>L3</b>	3,059
<b>COM/4</b>	194	<b>13</b>	988	<b>22</b>	<b>L4</b>	3,955
<b>5</b>	280	<b>14</b>	1,094	<b>23</b>	<b>L5</b>	4,852
<b>6</b>	366	<b>15</b>	1,203	<b>24</b>		
<b>7</b>	452	<b>16</b>	1,309	<b>25</b>		
<b>8</b>	538	<b>17</b>	1,417	<b>26</b>		
<b>9</b>	623	<b>18</b>	1,524	<b>27</b>		

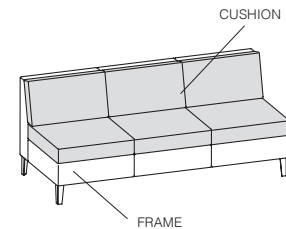

**TO ORDER PLEASE SPECIFY THE FOLLOWING:**

.  .  .  .  .

<b>MODEL NUMBER</b>	<b>WOOD FINISH</b>	<b>STITCH DETAIL</b>	<b>FLAMMABILITY RATING</b>	<b>CUSHION UPHOLSTERY</b>	<b>FRAME UPHOLSTERY</b>
	Cherry finishes on Maple Walnut finishes on Maple Maple finishes on Maple Oak finishes on Maple <i>Light Rift Oak 301 not available on Maple.</i>	None NR Stitch detail SD +\$197	U CTB117	Please refer to list of available upholstery and leather selections on <a href="http://www.gunlocke.com">www.gunlocke.com</a>	Please refer to list of available upholstery and leather selections on <a href="http://www.gunlocke.com">www.gunlocke.com</a>

Example

GK1113-3W.777.NR.U.DOL728.SPNO4

GK1113-3W	777	NR	U	DOL728	SPNO4
MODEL NUMBER	WOOD FINISH	STITCH DETAIL	FLAMMABILITY UPHOLSTERY	CUSHION UPHOLSTERY	FRAME REQUEST

Please refer to the Ciji product page on [www.gunlocke.com](http://www.gunlocke.com) for standard finish options.

# CIJI THREE SEAT

Mid Back, Armless, Aluminum Legs

model number	fabric grades	dimensions	W	D	H
--------------	---------------	------------	---	---	---

## GK1113-3A

Mid back, armless,  
Aluminum Legs

**1** 6,001

Overall	73 5/8"	31 1/2"	32 1/8"
Seat	73"	21"	17 1/4"

### Upholstery Requirements: GK1113-3A

	Dual Upholstery	
Fabric yds	Cushions 4.4	Frame 3.3
Leather ft <sup>2</sup>	Cushions 101.2	Frame 75.9
Shipping weight	168 lbs.	
Cube	78.5	

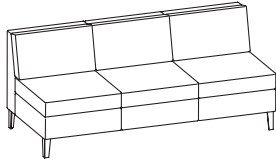

### Cushion

<b>1</b>	<b>10</b>	945	<b>19</b>	2,175	<b>L1</b>	1,447
<b>2</b>	86	<b>11</b>	1,059	<b>20</b>	<b>L2</b>	2,642
<b>3</b>	173	<b>12</b>	1,173	<b>21</b>	<b>L3</b>	4,077
<b>COM/4</b>	258	<b>13</b>	1,317	<b>22</b>	<b>L4</b>	5,273
<b>5</b>	372	<b>14</b>	1,459	<b>23</b>	<b>L5</b>	6,470
<b>6</b>	487	<b>15</b>	1,603	<b>24</b>		
<b>7</b>	602	<b>16</b>	1,745	<b>25</b>		
<b>8</b>	716	<b>17</b>	1,888	<b>26</b>		
<b>9</b>	831	<b>18</b>	2,032	<b>27</b>		

To calculate price of lounge with different fabric for cushion and frame; start with Grade 1 price, add appropriate grade price located in second row for cushion, and last add appropriate grade price located in third row for frame to the sum of the Grade 1 and cushion price.

**Example: Grade 1 \$6,001 + grade 4 fabric cushion \$258 + grade 2 fabric frame \$65 = \$6,324**

Select upholstery for everything else other than the seat and back cushions (the outside back, arms, sides, seat frame). You can specify the same fabric as the cushions or select other fabric.

### Frame

<b>1</b>	<b>10</b>	708	<b>19</b>	1,631	<b>L1</b>	1,085
<b>2</b>	65	<b>11</b>	795	<b>20</b>	<b>L2</b>	1,982
<b>3</b>	130	<b>12</b>	880	<b>21</b>	<b>L3</b>	3,059
<b>COM/4</b>	194	<b>13</b>	988	<b>22</b>	<b>L4</b>	3,955
<b>5</b>	280	<b>14</b>	1,094	<b>23</b>	<b>L5</b>	4,852
<b>6</b>	366	<b>15</b>	1,203	<b>24</b>		
<b>7</b>	452	<b>16</b>	1,309	<b>25</b>		
<b>8</b>	538	<b>17</b>	1,417	<b>26</b>		
<b>9</b>	623	<b>18</b>	1,524	<b>27</b>		

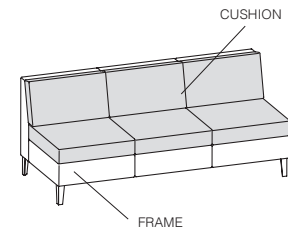

## TO ORDER PLEASE SPECIFY THE FOLLOWING:

<input type="text"/>	<input type="text"/>	<input type="text"/>	<input type="text"/>	<input type="text"/>
<b>MODEL NUMBER</b>	<b>STITCH DETAIL</b>	<b>FLAMMABILITY RATING</b>	<b>CUSHION UPHOLSTERY</b>	<b>FRAME UPHOLSTERY</b>
	None <b>NR</b> Stitch detail <b>SD +\$197</b>	<b>U</b> CTB117	Please refer to list of available upholstery and leather selections on <a href="http://www.gunlocke.com">www.gunlocke.com</a>	Please refer to list of available upholstery and leather selections on <a href="http://www.gunlocke.com">www.gunlocke.com</a>

### Example

GK1113-3A.NR.U.DOL728.SPNN04				
GK1111-3A	NR	U	DOL728	SPNN04
<b>MODEL NUMBER</b>	<b>STITCH</b>	<b>FLAMMABILITY DETAIL</b>	<b>CUSHION UPHOLSTERY</b>	<b>FRAME UPHOLSTERY</b>

Please refer to the Ciji product page on [www.gunlocke.com](http://www.gunlocke.com) for standard finish options.

**Seating**  
02/24

**CIJI THREE SEAT**  
Mid Back, Arm Left, Wood Legs

model number                      fabric grades                      dimensions                      W                      D                      H

**GK1115-3W**                      **1** 6,614  
Mid back, arm left,  
Wood legs

Overall	77 1/8"	31 1/2"	32 1/8"
Seat	73"	21"	17 1/4"
Arm			26 7/8"
Between arms			

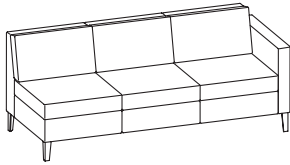

**Upholstery Requirements: GK1115-3W**

	Dual Upholstery	
Fabric yds	Cushions 4.4	Frame 5.3
Leather ft <sup>2</sup>	Cushions 101.2	Frame 121.9
Shipping weight		178 lbs.
Cube		78.5

Cushion

<b>1</b>	<b>10</b>	945	<b>19</b>	2,175	<b>L1</b>	1,447
<b>2</b>	86	<b>11</b>	1,059	<b>20</b>	<b>L2</b>	2,642
<b>3</b>	173	<b>12</b>	1,173	<b>21</b>	<b>L3</b>	4,077
<b>COM/4</b>	258	<b>13</b>	1,317	<b>22</b>	<b>L4</b>	5,273
<b>5</b>	372	<b>14</b>	1,459	<b>23</b>	<b>L5</b>	6,470
<b>6</b>	487	<b>15</b>	1,603	<b>24</b>		
<b>7</b>	602	<b>16</b>	1,745	<b>25</b>		
<b>8</b>	716	<b>17</b>	1,888	<b>26</b>		
<b>9</b>	831	<b>18</b>	2,032	<b>27</b>		

To calculate price of lounge with different fabric for cushion and frame; start with Grade 1 price, add appropriate grade price located in second row for cushion, and last add appropriate grade price located in third row for frame to the sum of the Grade 1 and cushion price.

**Example: Grade 1 \$6,614 + grade 4 fabric cushion \$258 + grade 2 fabric frame \$105 = \$6,977**

Select upholstery for everything else other than the seat and back cushions (the outside back, arms, sides, seat frame). You can specify the same fabric as the cushions or select other fabric.

Frame

<b>1</b>	<b>10</b>	1,139	<b>19</b>	2,619	<b>L1</b>	1,742
<b>2</b>	105	<b>11</b>	1,276	<b>20</b>	<b>L2</b>	3,183
<b>3</b>	208	<b>12</b>	1,414	<b>21</b>	<b>L3</b>	4,912
<b>COM/4</b>	311	<b>13</b>	1,585	<b>22</b>	<b>L4</b>	6,353
<b>5</b>	449	<b>14</b>	1,758	<b>23</b>	<b>L5</b>	7,792
<b>6</b>	587	<b>15</b>	1,930	<b>24</b>		
<b>7</b>	724	<b>16</b>	2,103	<b>25</b>		
<b>8</b>	863	<b>17</b>	2,275	<b>26</b>		
<b>9</b>	1,001	<b>18</b>	2,448	<b>27</b>		

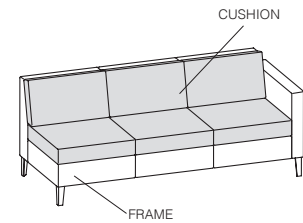

TO ORDER PLEASE SPECIFY THE FOLLOWING:

.  .  .  .  .

<b>MODEL NUMBER</b>	<b>WOOD FINISH</b>	<b>STITCH DETAIL</b>	<b>FLAMMABILITY RATING</b>	<b>CUSHION UPHOLSTERY</b>	<b>FRAME UPHOLSTERY</b>
	Cherry finishes on Maple Walnut finishes on Maple Maple finishes on Maple Oak finishes on Maple <i>Light Rift Oak 301 not available on Maple.</i>	None NR Stitch detail SD +\$197	U CTB117	Please refer to list of available upholstery and leather selections on <a href="http://www.gunlocke.com">www.gunlocke.com</a>	Please refer to list of available upholstery and leather selections on <a href="http://www.gunlocke.com">www.gunlocke.com</a>

Example

GK1115-3W.777.NR.U.DOL728.SPNO4					
GK1115-3W	777	NR	U	DOL728	SPNO4
MODEL NUMBER	WOOD FINISH	STITCH DETAIL	FLAMMABILITY UPHOLSTERY	CUSHION UPHOLSTERY	FRAME REQUEST

Please refer to the Ciji product page on [www.gunlocke.com](http://www.gunlocke.com) for standard finish options.

# CIJI THREE SEAT

Mid Back, Arm Left, Aluminum Legs

**Seating**  
02/24

model number	fabric grades	dimensions	W	D	H
--------------	---------------	------------	---	---	---

**GK1115-3A**  
Mid back, arm left,  
Aluminum legs

**1** 6,899

Overall	77 1/8"	31 1/2"	32 1/8"
Seat	73"	21"	17 1/4"
Arm			26 7/8"
Between arms			

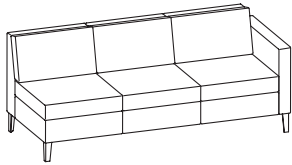

### Upholstery Requirements: GK1115-3A

	Dual Upholstery
Fabric yds	Cushions 4.4 Frame 5.3
Leather ft <sup>2</sup>	Cushions 101.2 Frame 121.9
Shipping weight	178 lbs.
Cube	78.5

Cushion	1	10	945	19	2,175	L1	1,447
	2	86	11	1,059	20	2,317	L2 2,642
	3	173	12	1,173	21	2,461	L3 4,077
	COM/4	258	13	1,317	22	2,603	L4 5,273
	5	372	14	1,459	23	2,890	L5 6,470
	6	487	15	1,603	24	3,176	
	7	602	16	1,745	25	3,461	
	8	716	17	1,888	26	3,748	
	9	831	18	2,032	27	4,034	

To calculate price of lounge with different fabric for cushion and frame; start with Grade 1 price, add appropriate grade price located in second row for cushion, and last add appropriate grade price located in third row for frame to the sum of the Grade 1 and cushion price.

**Example: Grade 1 \$6,899 + grade 4 fabric cushion \$258 + grade 2 fabric frame \$105 = \$7,262**

Frame	1	10	1,139	19	2,619	L1	1,742
	2	105	11	1,276	20	2,791	L2 3,183
	3	208	12	1,414	21	2,964	L3 4,912
	COM/4	311	13	1,585	22	3,136	L4 6,353
	5	449	14	1,758	23	3,480	L5 7,792
	6	587	15	1,930	24	3,825	
	7	724	16	2,103	25	4,170	
	8	863	17	2,275	26	4,514	
	9	1,001	18	2,448	27	4,858	

Select upholstery for everything else other than the seat and back cushions (the outside back, arms, sides, seat frame). You can specify the same fabric as the cushions or select other fabric.

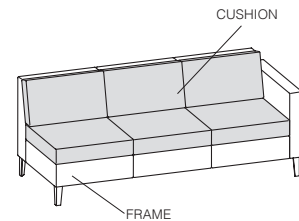

### TO ORDER PLEASE SPECIFY THE FOLLOWING:

<input type="text"/>	<input type="text"/>	<input type="text"/>	<input type="text"/>	<input type="text"/>
<b>MODEL NUMBER</b>	<b>STITCH DETAIL</b>	<b>FLAMMABILITY RATING</b>	<b>CUSHION UPHOLSTERY</b>	<b>FRAME UPHOLSTERY</b>
	None <b>NR</b> Stitch detail <b>SD +\$197</b>	<b>U</b> CTB117	Please refer to list of available upholstery and leather selections on <a href="http://www.gunlocke.com">www.gunlocke.com</a>	Please refer to list of available upholstery and leather selections on <a href="http://www.gunlocke.com">www.gunlocke.com</a>

### Example

GK1115-3A.NR.U.DOL728.SPNN04

GK1115-3A	NR	U	DOL728	SPNN04
MODEL NUMBER	STITCH	FLAMMABILITY DETAIL	CUSHION UPHOLSTERY	FRAME UPHOLSTERY

Please refer to the Ciji product page on [www.gunlocke.com](http://www.gunlocke.com) for standard finish options.

**Seating**  
02/24

**CIJI THREE SEAT**

Mid Back, Arm Right, Wood Legs

model number	fabric grades
<b>GK1117-3W</b>	<b>1</b> 6,614

Mid back, arm right,  
Wood legs

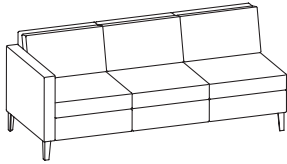

dimensions	W	D	H
Overall	77 1/8"	31 1/2"	32 1/8"
Seat	73"	21"	17 1/4"
Arm			26 7/8"
Between arms			

**Upholstery Requirements: GK1117-3W**

	Dual Upholstery	
Fabric yds	Cushions 4.4	Frame 5.3
Leather ft <sup>2</sup>	Cushions 101.2	Frame 121.9
Shipping weight		178 lbs.
Cube		78.5

Cushion	<b>1</b>	<b>10</b>	945	<b>19</b>	2,175	<b>L1</b>	1,447	
	<b>2</b>	86	<b>11</b>	1,059	<b>20</b>	2,317	<b>L2</b>	2,642
	<b>3</b>	173	<b>12</b>	1,173	<b>21</b>	2,461	<b>L3</b>	4,077
	<b>COM/4</b>	258	<b>13</b>	1,317	<b>22</b>	2,603	<b>L4</b>	5,273
	<b>5</b>	372	<b>14</b>	1,459	<b>23</b>	2,890	<b>L5</b>	6,470
	<b>6</b>	487	<b>15</b>	1,603	<b>24</b>	3,176		
	<b>7</b>	602	<b>16</b>	1,745	<b>25</b>	3,461		
	<b>8</b>	716	<b>17</b>	1,888	<b>26</b>	3,748		
	<b>9</b>	831	<b>18</b>	2,032	<b>27</b>	4,034		

To calculate price of lounge with different fabric for cushion and frame; start with Grade 1 price, add appropriate grade price located in second row for cushion, and last add appropriate grade price located in third row for frame to the sum of the Grade 1 and cushion price.

**Example: Grade 1 \$6,614 + grade 4 fabric cushion \$258 + grade 2 fabric frame \$105 = \$6,977**

Select upholstery for everything else other than the seat and back cushions (the outside back, arms, sides, seat frame). You can specify the same fabric as the cushions or select other fabric.

Frame	<b>1</b>	<b>10</b>	1,139	<b>19</b>	2,619	<b>L1</b>	1,742	
	<b>2</b>	105	<b>11</b>	1,276	<b>20</b>	2,791	<b>L2</b>	3,183
	<b>3</b>	208	<b>12</b>	1,414	<b>21</b>	2,964	<b>L3</b>	4,912
	<b>COM/4</b>	311	<b>13</b>	1,585	<b>22</b>	3,136	<b>L4</b>	6,353
	<b>5</b>	449	<b>14</b>	1,758	<b>23</b>	3,480	<b>L5</b>	7,792
	<b>6</b>	587	<b>15</b>	1,930	<b>24</b>	3,825		
	<b>7</b>	724	<b>16</b>	2,103	<b>25</b>	4,170		
	<b>8</b>	863	<b>17</b>	2,275	<b>26</b>	4,514		
	<b>9</b>	1,001	<b>18</b>	2,448	<b>27</b>	4,858		

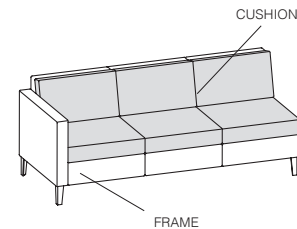

**TO ORDER PLEASE SPECIFY THE FOLLOWING:**

.  .  .  .  .

<b>MODEL NUMBER</b>	<b>WOOD FINISH</b>	<b>STITCH DETAIL</b>	<b>FLAMMABILITY RATING</b>	<b>CUSHION UPHOLSTERY</b>	<b>FRAME UPHOLSTERY</b>
	Cherry finishes on Maple Walnut finishes on Maple Maple finishes on Maple Oak finishes on Maple <i>Light Rift Oak 301 not available on Maple.</i>	None NR Stitch detail SD +\$197	U CTB117	Please refer to list of available upholstery and leather selections on <a href="http://www.gunlocke.com">www.gunlocke.com</a>	Please refer to list of available upholstery and leather selections on <a href="http://www.gunlocke.com">www.gunlocke.com</a>

**Example**

GK1117-3W.777.NR.U.DOL728.SPNNO4					
GK1117-3W	777	NR	U	DOL728	SPNNO4
MODEL NUMBER	WOOD FINISH	STITCH DETAIL	FLAMMABILITY UPHOLSTERY	CUSHION UPHOLSTERY	FRAME REQUEST

Please refer to the Ciji product page on [www.gunlocke.com](http://www.gunlocke.com) for standard finish options.

# CIJI THREE SEAT

Mid Back, Arm Right, Aluminum Legs

Seating  
02/24

model number	fabric grades	dimensions	W	D	H
--------------	---------------	------------	---	---	---

## GK1117-3A

Mid back, arm right,  
Aluminum legs

1 6,899

Overall	77 1/8"	31 1/2"	32 1/8"
Seat	73"	21"	17 1/4"
Arm			26 7/8"
Between arms			

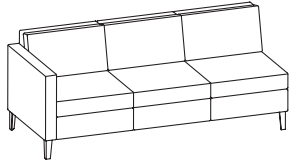

### Upholstery Requirements: GK1117-3A

	Dual Upholstery		
Fabric yds	Cushions 4.4	Frame 5.3	
Leather ft <sup>2</sup>	Cushions 101.2	Frame 121.9	
Shipping weight			178 lbs.
Cube			78.5

### Cushion

1	10	945	19	2,175	L1	1,447
2	86	11	1,059	20	L2	2,642
3	173	12	1,173	21	L3	4,077
COM/4	258	13	1,317	22	L4	5,273
5	372	14	1,459	23	L5	6,470
6	487	15	1,603	24		
7	602	16	1,745	25		
8	716	17	1,888	26		
9	831	18	2,032	27		

To calculate price of lounge with different fabric for cushion and frame; start with Grade 1 price, add appropriate grade price located in second row for cushion, and last add appropriate grade price located in third row for frame to the sum of the Grade 1 and cushion price.

**Example: Grade 1 \$6,899 + grade 4 fabric cushion \$258 + grade 2 fabric frame \$105 = \$7,262**

### Frame

1	10	1,139	19	2,619	L1	1,742
2	105	11	1,276	20	L2	3,183
3	208	12	1,414	21	L3	4,912
COM/4	311	13	1,585	22	L4	6,353
5	449	14	1,758	23	L5	7,792
6	587	15	1,930	24		
7	724	16	2,103	25		
8	863	17	2,275	26		
9	1,001	18	2,448	27		

Select upholstery for everything else other than the seat and back cushions (the outside back, arms, sides, seat frame). You can specify the same fabric as the cushions or select other fabric.

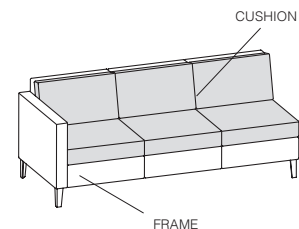

## TO ORDER PLEASE SPECIFY THE FOLLOWING:

<input type="text"/>	<input type="text"/>	<input type="text"/>	<input type="text"/>	<input type="text"/>
<b>MODEL NUMBER</b>	<b>STITCH DETAIL</b>	<b>FLAMMABILITY RATING</b>	<b>CUSHION UPHOLSTERY</b>	<b>FRAME UPHOLSTERY</b>
	None NR Stitch detail SD +\$197	U CTB117	Please refer to list of available upholstery and leather selections on <a href="http://www.gunlocke.com">www.gunlocke.com</a>	Please refer to list of available upholstery and leather selections on <a href="http://www.gunlocke.com">www.gunlocke.com</a>

### Example

GK1117-3A.NR.U.DOL728.SPNN04

GK1117-3A	NR	U	DOL728	SPNN04
MODEL NUMBER	STITCH	FLAMMABILITY DETAIL	CUSHION UPHOLSTERY	FRAME UPHOLSTERY

Please refer to the Ciji product page on [www.gunlocke.com](http://www.gunlocke.com) for standard finish options.



model number                      fabric grades                      dimensions                      W                      D                      H

**GK1109W**  
Low back,  
Wood Legs

**1** 3,974

Overall                      31 3/4"                      31 1/4"                      27 7/8"  
Seat                      20 3/4"                      20 3/4"                      17 1/4"

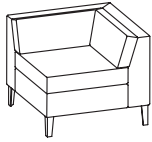

**Upholstery Requirements: GK1109W**

	Dual Upholstery	
Fabric yds	Cushions 2.7	Frame 2.4
Leather ft <sup>2</sup>	Cushions 62.1	Frame 55.2
Shipping weight	93 lbs.	
Cube	28	

Cushion

<b>1</b>	<b>10</b>	580	<b>19</b>	1,334	<b>L1</b>	888
<b>2</b>	54	<b>11</b>	650	<b>20</b>	1,422	<b>L2</b> 1,622
<b>3</b>	107	<b>12</b>	720	<b>21</b>	1,509	<b>L3</b> 2,502
<b>COM/4</b>	159	<b>13</b>	808	<b>22</b>	1,597	<b>L4</b> 3,237
<b>5</b>	229	<b>14</b>	896	<b>23</b>	1,774	<b>L5</b> 3,971
<b>6</b>	299	<b>15</b>	983	<b>24</b>	1,949	
<b>7</b>	369	<b>16</b>	1,072	<b>25</b>	2,124	
<b>8</b>	440	<b>17</b>	1,159	<b>26</b>	2,300	
<b>9</b>	509	<b>18</b>	1,247	<b>27</b>	2,476	

To calculate price of lounge with different fabric for cushion and frame; start with Grade 1 price, add appropriate grade price located in second row for cushion, and last add appropriate grade price located in third row for frame to the sum of the Grade 1 and cushion price.

**Example: Grade 1 \$3,974 + grade 4 fabric cushion \$159 + grade 2 fabric frame \$48 = \$4,181**

Select upholstery for everything else other than the seat and back cushions (the outside back, arms, sides, seat frame). You can specify the same fabric as the cushions or select other fabric.

Frame

<b>1</b>	<b>10</b>	517	<b>19</b>	1,187	<b>L1</b>	789
<b>2</b>	48	<b>11</b>	578	<b>20</b>	1,264	<b>L2</b> 1,441
<b>3</b>	94	<b>12</b>	641	<b>21</b>	1,343	<b>L3</b> 2,225
<b>COM/4</b>	142	<b>13</b>	718	<b>22</b>	1,420	<b>L4</b> 2,877
<b>5</b>	204	<b>14</b>	797	<b>23</b>	1,576	<b>L5</b> 3,529
<b>6</b>	266	<b>15</b>	875	<b>24</b>	1,732	
<b>7</b>	329	<b>16</b>	953	<b>25</b>	1,888	
<b>8</b>	391	<b>17</b>	1,030	<b>26</b>	2,044	
<b>9</b>	454	<b>18</b>	1,109	<b>27</b>	2,201	

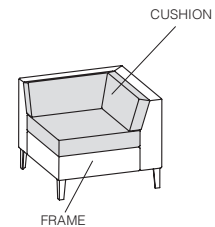

**TO ORDER PLEASE SPECIFY THE FOLLOWING:**

.  .  .  .  .

<b>MODEL NUMBER</b>	<b>WOOD FINISH</b>	<b>STITCH DETAIL</b>	<b>FLAMMABILITY RATING</b>	<b>CUSHION UPHOLSTERY</b>	<b>FRAME UPHOLSTERY</b>
	Cherry finishes on Maple Walnut finishes on Maple Maple finishes on Maple Oak finishes on Maple <i>Light Rift Oak 301 not available on Maple.</i>	None NR Stitch detail SD +\$197	U CTB117	Please refer to list of available upholstery and leather selections on <a href="http://www.gunlocke.com">www.gunlocke.com</a>	Please refer to list of available upholstery and leather selections on <a href="http://www.gunlocke.com">www.gunlocke.com</a>

Example

GK1109W.777.NR.U.DOL728.SPNN04  
 GK1109W      777      NR      U      DOL728      SPNN04  
 MODEL NUMBER      WOOD FINISH      STITCH DETAIL      FLAMMABILITY UPHOLSTERY      CUSHION UPHOLSTERY      FRAME REQUEST

Please refer to the Ciji product page on [www.gunlocke.com](http://www.gunlocke.com) for standard finish options.

# CIJI CORNER UNIT

Low Back, Aluminum Legs

Seating  
02/24

model number                      fabric grades                      dimensions      W      D      H

**GK1109A**  
Low back,  
Aluminum Legs

**1** 4,257

Overall	31 3/4"	31 1/4"	27 7/8"
Seat	20 3/4"	20 3/4"	17 1/4"

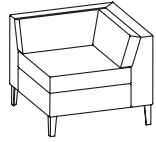

**Upholstery Requirements: GK1109A**

	Dual Upholstery	
Fabric yds	Cushions 2.7	Frame 2.4
Leather ft <sup>2</sup>	Cushions 62.1	Frame 55.2
Shipping weight	93 lbs.	
Cube	28	

Cushion

<b>1</b>	<b>10</b>	580	<b>19</b>	1,334	<b>L1</b>	888
<b>2</b>	54	<b>11</b>	650	<b>20</b>	1,422	<b>L2</b> 1,622
<b>3</b>	107	<b>12</b>	720	<b>21</b>	1,509	<b>L3</b> 2,502
<b>COM/4</b>	159	<b>13</b>	808	<b>22</b>	1,597	<b>L4</b> 3,237
<b>5</b>	229	<b>14</b>	896	<b>23</b>	1,774	<b>L5</b> 3,971
<b>6</b>	299	<b>15</b>	983	<b>24</b>	1,949	
<b>7</b>	369	<b>16</b>	1,072	<b>25</b>	2,124	
<b>8</b>	440	<b>17</b>	1,159	<b>26</b>	2,300	
<b>9</b>	509	<b>18</b>	1,247	<b>27</b>	2,476	

To calculate price of lounge with different fabric for cushion and frame; start with Grade 1 price, add appropriate grade price located in second row for cushion, and last add appropriate grade price located in third row for frame to the sum of the Grade 1 and cushion price.

**Example: Grade 1 \$4,257 + grade 4 fabric cushion \$159 + grade 2 fabric frame \$48 = \$4,464**

Frame

<b>1</b>	<b>10</b>	517	<b>19</b>	1,187	<b>L1</b>	789
<b>2</b>	48	<b>11</b>	578	<b>20</b>	1,264	<b>L2</b> 1,441
<b>3</b>	94	<b>12</b>	641	<b>21</b>	1,343	<b>L3</b> 2,225
<b>COM/4</b>	142	<b>13</b>	718	<b>22</b>	1,420	<b>L4</b> 2,877
<b>5</b>	204	<b>14</b>	797	<b>23</b>	1,576	<b>L5</b> 3,529
<b>6</b>	266	<b>15</b>	875	<b>24</b>	1,732	
<b>7</b>	329	<b>16</b>	953	<b>25</b>	1,888	
<b>8</b>	391	<b>17</b>	1,030	<b>26</b>	2,044	
<b>9</b>	454	<b>18</b>	1,109	<b>27</b>	2,201	

Select upholstery for everything else other than the seat and back cushions (the outside back, arms, sides, seat frame). You can specify the same fabric as the cushions or select other fabric.

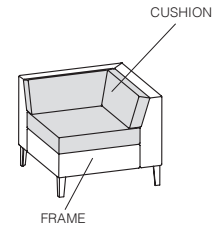

**TO ORDER PLEASE SPECIFY THE FOLLOWING:**

<input type="text"/>	<input type="text"/>	<input type="text"/>	<input type="text"/>	<input type="text"/>
<b>MODEL NUMBER</b>	<b>STITCH DETAIL</b>	<b>FLAMMABILITY RATING</b>	<b>CUSHION UPHOLSTERY</b>	<b>FRAME UPHOLSTERY</b>
	None <b>NR</b> Stitch detail <b>SD +\$197</b>	<b>U</b> CTB117	Please refer to list of available upholstery and leather selections on <a href="http://www.gunlocke.com">www.gunlocke.com</a>	Please refer to list of available upholstery and leather selections on <a href="http://www.gunlocke.com">www.gunlocke.com</a>

Example

<b>GK1109A.NR.U.DOL728.SPNN04</b>				
GK1109A	NR	U	DOL728	SPNN04
<b>MODEL NUMBER</b>	<b>STITCH</b>	<b>FLAMMABILITY DETAIL</b>	<b>CUSHION UPHOLSTERY</b>	<b>FRAME UPHOLSTERY</b>

Please refer to the Ciji product page on [www.gunlocke.com](http://www.gunlocke.com) for standard finish options.

model number                      fabric grades                      dimensions                      W                      D                      H

**GK1119W**  
Mid back,  
Wood legs

**1** 4,042

Overall	31 3/4"	31 1/2"	32 1/8"
Seat	20 3/4"	20 3/4"	17 1/4"

**Upholstery Requirements: GK1119W**

	Dual Upholstery	
Fabric yds	Cushions 2.7	Frame 2.5
Leather ft <sup>2</sup>	Cushions 62.1	Frame 57.5
Shipping weight	97 lbs.	
Cube	28	



Cushion

<b>1</b>	<b>10</b>	580	<b>19</b>	1,334	<b>L1</b>	888
<b>2</b>	54	<b>11</b>	650	<b>20</b>	1,422	<b>L2</b> 1,622
<b>3</b>	107	<b>12</b>	720	<b>21</b>	1,509	<b>L3</b> 2,502
<b>COM/4</b>	159	<b>13</b>	808	<b>22</b>	1,597	<b>L4</b> 3,237
<b>5</b>	229	<b>14</b>	896	<b>23</b>	1,774	<b>L5</b> 3,971
<b>6</b>	299	<b>15</b>	983	<b>24</b>	1,949	
<b>7</b>	369	<b>16</b>	1,072	<b>25</b>	2,124	
<b>8</b>	440	<b>17</b>	1,159	<b>26</b>	2,300	
<b>9</b>	509	<b>18</b>	1,247	<b>27</b>	2,476	

To calculate price of lounge with different fabric for cushion and frame; start with Grade 1 price, add appropriate grade price located in second row for cushion, and last add appropriate grade price located in third row for frame to the sum of the Grade 1 and cushion price.

**Example: Grade 1 \$4,042 + grade 4 fabric cushion \$159 + grade 2 fabric frame \$49 = \$4,250**

Select upholstery for everything else other than the seat and back cushions (the outside back, arms, sides, seat frame). You can specify the same fabric as the cushions or select other fabric.

Frame

<b>1</b>	<b>10</b>	538	<b>19</b>	1,235	<b>L1</b>	822
<b>2</b>	49	<b>11</b>	603	<b>20</b>	1,317	<b>L2</b> 1,502
<b>3</b>	98	<b>12</b>	667	<b>21</b>	1,399	<b>L3</b> 2,317
<b>COM/4</b>	147	<b>13</b>	748	<b>22</b>	1,480	<b>L4</b> 2,997
<b>5</b>	212	<b>14</b>	830	<b>23</b>	1,642	<b>L5</b> 3,677
<b>6</b>	278	<b>15</b>	911	<b>24</b>	1,805	
<b>7</b>	342	<b>16</b>	992	<b>25</b>	1,967	
<b>8</b>	407	<b>17</b>	1,073	<b>26</b>	2,130	
<b>9</b>	472	<b>18</b>	1,155	<b>27</b>	2,292	

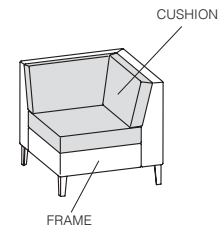

TO ORDER PLEASE SPECIFY THE FOLLOWING:

.  .  .  .  .

<b>MODEL NUMBER</b>	<b>WOOD FINISH</b>	<b>STITCH DETAIL</b>	<b>FLAMMABILITY RATING</b>	<b>CUSHION UPHOLSTERY</b>	<b>FRAME UPHOLSTERY</b>
	Cherry finishes on Maple Walnut finishes on Maple Maple finishes on Maple Oak finishes on Maple <i>Light Rift Oak 301 not available on Maple.</i>	None NR Stitch detail SD +\$197	U CTB117	Please refer to list of available upholstery and leather selections on <a href="http://www.gunlocke.com">www.gunlocke.com</a>	Please refer to list of available upholstery and leather selections on <a href="http://www.gunlocke.com">www.gunlocke.com</a>

Example

GK1119W.777.NR.U.DOL728.SPNN04  
 GK1119W    777    NR    U    DOL728    SPNN04  
 MODEL NUMBER    WOOD FINISH    STITCH DETAIL    FLAMMABILITY UPHOLSTERY    CUSHION UPHOLSTERY    FRAME REQUEST

Please refer to the Ciji product page on [www.gunlocke.com](http://www.gunlocke.com) for standard finish options.

# CIJI CORNER UNIT

Mid Back, Aluminum Legs

Seating  
02/24

model number	fabric grades	dimensions	W	D	H
--------------	---------------	------------	---	---	---

**GK1119A**  
Mid back,  
Aluminum legs

Overall	31 3/4"	31 1/2"	32 1/8"
Seat	20 3/4"	20 3/4"	17 1/4"



### Upholstery Requirements: GK1119A

Dual Upholstery	
Fabric yds	Cushions 2.7 Frame 2.5
Leather ft <sup>2</sup>	Cushions 62.1 Frame 57.5
Shipping weight	97 lbs.
Cube	28

Cushion	1	10	580	19	1,334	L1	888
	2	54	11	650	20	L2	1,622
	3	107	12	720	21	L3	2,502
	COM/4	159	13	808	22	L4	3,237
	5	229	14	896	23	L5	3,971
	6	299	15	983	24		
	7	369	16	1,072	25		
	8	440	17	1,159	26		
	9	509	18	1,247	27		

To calculate price of lounge with different fabric for cushion and frame; start with Grade 1 price, add appropriate grade price located in second row for cushion, and last add appropriate grade price located in third row for frame to the sum of the Grade 1 and cushion price.

**Example: Grade 1 \$4,326 + grade 4 fabric cushion \$159 + grade 2 fabric frame \$49 = \$4,534**

Select upholstery for everything else other than the seat and back cushions (the outside back, arms, sides, seat frame). You can specify the same fabric as the cushions or select other fabric.

Frame	1	10	538	19	1,235	L1	822
	2	49	11	603	20	L2	1,502
	3	98	12	667	21	L3	2,317
	COM/4	147	13	748	22	L4	2,997
	5	212	14	830	23	L5	3,677
	6	278	15	911	24		
	7	342	16	992	25		
	8	407	17	1,073	26		
	9	472	18	1,155	27		

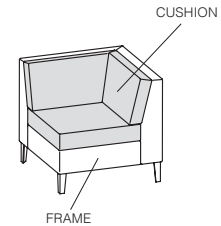

### TO ORDER PLEASE SPECIFY THE FOLLOWING:

<input type="text"/>	<input type="text"/>	<input type="text"/>	<input type="text"/>	<input type="text"/>
<b>MODEL NUMBER</b>	<b>STITCH DETAIL</b>	<b>FLAMMABILITY RATING</b>	<b>CUSHION UPHOLSTERY</b>	<b>FRAME UPHOLSTERY</b>
	None <b>NR</b> Stitch detail <b>SD +\$197</b>	<b>U</b> CTB117	Please refer to list of available upholstery and leather selections on <a href="http://www.gunlocke.com">www.gunlocke.com</a>	Please refer to list of available upholstery and leather selections on <a href="http://www.gunlocke.com">www.gunlocke.com</a>

### Example

GK1119A.NR.U.DOL728.SPNN04				
GK1119A	NR	U	DOL728	SPNN04
MODEL NUMBER	STITCH	FLAMMABILITY DETAIL	CUSHION UPHOLSTERY	FRAME UPHOLSTERY

Please refer to the Ciji product page on [www.gunlocke.com](http://www.gunlocke.com) for standard finish options.

model number	fabric grades
<b>GK1121-1W</b>	<b>1</b> 2,169

Single seat,  
Wood legs

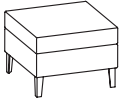

dimensions	W	D	H
Overall	24 5/8"	24 3/4"	17 1/4"
Seat	24 5/8"	24 3/4"	17 1/4"

**Upholstery Requirements: GK1121-1W**

	Dual Upholstery	
Fabric yds	Cushions 1.2	Frame 1.3
Leather ft <sup>2</sup>	Cushions 27.6	Frame 29.9
Shipping weight	64 lbs.	
Cube	28	

Cushion

<b>1</b>	<b>10</b>	258	<b>19</b>	594	<b>L1</b>	395
<b>2</b>	24	<b>11</b>	290	<b>20</b>	<b>L2</b>	721
<b>3</b>	48	<b>12</b>	321	<b>21</b>	<b>L3</b>	1,113
<b>COM/4</b>	72	<b>13</b>	360	<b>22</b>	<b>L4</b>	1,439
<b>5</b>	102	<b>14</b>	398	<b>23</b>	<b>L5</b>	1,765
<b>6</b>	133	<b>15</b>	438	<b>24</b>		
<b>7</b>	165	<b>16</b>	477	<b>25</b>		
<b>8</b>	196	<b>17</b>	517	<b>26</b>		1,022
<b>9</b>	227	<b>18</b>	555	<b>27</b>		1,102

To calculate price of lounge with different fabric for cushion and frame; start with Grade 1 price, add appropriate grade price located in second row for cushion, and last add appropriate grade price located in third row for frame to the sum of the Grade 1 and cushion price.

**Example: Grade 1 \$2,169 + grade 4 fabric cushion \$72 + grade 2 fabric frame \$27 = \$2,268**

Frame

<b>1</b>	<b>10</b>	280	<b>19</b>	643	<b>L1</b>	428
<b>2</b>	27	<b>11</b>	314	<b>20</b>	<b>L2</b>	781
<b>3</b>	52	<b>12</b>	348	<b>21</b>	<b>L3</b>	1,206
<b>COM/4</b>	78	<b>13</b>	390	<b>22</b>	<b>L4</b>	1,559
<b>5</b>	111	<b>14</b>	432	<b>23</b>	<b>L5</b>	1,912
<b>6</b>	145	<b>15</b>	473	<b>24</b>		
<b>7</b>	179	<b>16</b>	517	<b>25</b>		1,023
<b>8</b>	212	<b>17</b>	559	<b>26</b>		1,108
<b>9</b>	246	<b>18</b>	601	<b>27</b>		1,192

Select upholstery for everything else other than the seat and back cushions (the outside back, arms, sides, seat frame). You can specify the same fabric as the cushions or select other fabric.

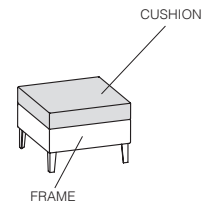

TO ORDER PLEASE SPECIFY THE FOLLOWING:

<input type="text"/>	<input type="text"/>	<input type="text"/>	<input type="text"/>	<input type="text"/>	<input type="text"/>
<b>MODEL NUMBER</b>	<b>WOOD FINISH</b>	<b>STITCH DETAIL</b>	<b>FLAMMABILITY RATING</b>	<b>CUSHION UPHOLSTERY</b>	<b>FRAME UPHOLSTERY</b>
	Cherry finishes on Maple Walnut finishes on Maple Maple finishes on Maple Oak finishes on Maple <i>Light Rift Oak 301 not available on Maple.</i>	None NR Stitch detail SD +\$197	U CTB117	Please refer to list of available upholstery and leather selections on <a href="http://www.gunlocke.com">www.gunlocke.com</a>	Please refer to list of available upholstery and leather selections on <a href="http://www.gunlocke.com">www.gunlocke.com</a>

Example

GK1121-1W.777.NR.U.DOL728.SPNN04					
GK1121-1W	777	NR	U	DOL728	SPNN04
MODEL NUMBER	WOOD FINISH	STITCH DETAIL	FLAMMABILITY UPHOLSTERY	CUSHION UPHOLSTERY	FRAME REQUEST

Please refer to the Ciji product page on [www.gunlocke.com](http://www.gunlocke.com) for standard finish options.

# CIJI BENCH

Single Seat, Aluminum Legs

Seating  
02/24

model number	fabric grades	dimensions	W	D	H
<b>GK1121-1A</b> Single seat, Aluminum legs	<b>1</b> 2,451	Overall	24 5/8"	24 3/4"	17 1/4"
		Seat	24 5/8"	24 3/4"	17 1/4"

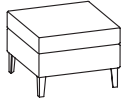

### Upholstery Requirements: GK1121-1A

Dual Upholstery	
Fabric yds	Cushions 1.2 Frame 1.3
Leather ft <sup>2</sup>	Cushions 27.6 Frame 29.9
Shipping weight	64 lbs.
Cube	28

Cushion

<b>1</b>	<b>10</b>	258	<b>19</b>	594	<b>L1</b>	395	
<b>2</b>	24	<b>11</b>	290	<b>20</b>	633	<b>L2</b>	721
<b>3</b>	48	<b>12</b>	321	<b>21</b>	671	<b>L3</b>	1,113
<b>COM/4</b>	72	<b>13</b>	360	<b>22</b>	710	<b>L4</b>	1,439
<b>5</b>	102	<b>14</b>	398	<b>23</b>	789	<b>L5</b>	1,765
<b>6</b>	133	<b>15</b>	438	<b>24</b>	867		
<b>7</b>	165	<b>16</b>	477	<b>25</b>	945		
<b>8</b>	196	<b>17</b>	517	<b>26</b>	1,022		
<b>9</b>	227	<b>18</b>	555	<b>27</b>	1,102		

To calculate price of lounge with different fabric for cushion and frame; start with Grade 1 price, add appropriate grade price located in second row for cushion, and last add appropriate grade price located in third row for frame to the sum of the Grade 1 and cushion price.

**Example: Grade 1 \$2,451 + grade 4 fabric cushion \$72 + grade 2 fabric frame \$27 = \$2,550**

Frame

<b>1</b>	<b>10</b>	280	<b>19</b>	643	<b>L1</b>	428	
<b>2</b>	27	<b>11</b>	314	<b>20</b>	685	<b>L2</b>	781
<b>3</b>	52	<b>12</b>	348	<b>21</b>	728	<b>L3</b>	1,206
<b>COM/4</b>	78	<b>13</b>	390	<b>22</b>	770	<b>L4</b>	1,559
<b>5</b>	111	<b>14</b>	432	<b>23</b>	854	<b>L5</b>	1,912
<b>6</b>	145	<b>15</b>	473	<b>24</b>	939		
<b>7</b>	179	<b>16</b>	517	<b>25</b>	1,023		
<b>8</b>	212	<b>17</b>	559	<b>26</b>	1,108		
<b>9</b>	246	<b>18</b>	601	<b>27</b>	1,192		

Select upholstery for everything else other than the seat and back cushions (the outside back, arms, sides, seat frame). You can specify the same fabric as the cushions or select other fabric.

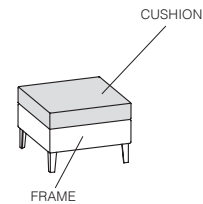

TO ORDER PLEASE SPECIFY THE FOLLOWING:

<input type="text"/>	<input type="text"/>	<input type="text"/>	<input type="text"/>	<input type="text"/>
<b>MODEL NUMBER</b>	<b>STITCH DETAIL</b>	<b>FLAMMABILITY RATING</b>	<b>CUSHION UPHOLSTERY</b>	<b>FRAME UPHOLSTERY</b>
	None <b>NR</b> Stitch detail <b>SD +\$197</b>	<b>U</b> CTB117	Please refer to list of available upholstery and leather selections on <a href="http://www.gunlocke.com">www.gunlocke.com</a>	Please refer to list of available upholstery and leather selections on <a href="http://www.gunlocke.com">www.gunlocke.com</a>

Example

GK1121-1A.NR.U.DOL728.SPNN04				
GK1121-1A	NR	U	DOL728	SPNN04
<b>MODEL NUMBER</b>	<b>STITCH</b>	<b>FLAMMABILITY DETAIL</b>	<b>CUSHION UPHOLSTERY</b>	<b>FRAME UPHOLSTERY</b>

Please refer to the Ciji product page on [www.gunlocke.com](http://www.gunlocke.com) for standard finish options.

model number	fabric grades
<b>GK1121-2W</b>	<b>1</b> 3,014

Two seat,  
Wood legs

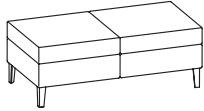

dimensions	W	D	H
Overall	49 1/8"	24 3/4"	17 1/4"
Seat	49 1/8"	24 3/4"	17 1/4"

**Upholstery Requirements: GK1121-2W**

	Dual Upholstery	
Fabric yds	Cushions 1.5	Frame 1.9
Leather ft <sup>2</sup>	Cushions 34.5	Frame 43.7
Shipping weight	74 lbs.	
Cube	35	

Cushion

<b>1</b>	<b>10</b>	323	<b>19</b>	742	<b>L1</b>	494
<b>2</b>	30	<b>11</b>	361	<b>20</b>	<b>L2</b>	902
<b>3</b>	59	<b>12</b>	401	<b>21</b>	<b>L3</b>	1,391
<b>COM/4</b>	89	<b>13</b>	449	<b>22</b>	<b>L4</b>	1,799
<b>5</b>	128	<b>14</b>	498	<b>23</b>	<b>L5</b>	2,206
<b>6</b>	167	<b>15</b>	546	<b>24</b>		1,083
<b>7</b>	205	<b>16</b>	596	<b>25</b>		1,181
<b>8</b>	245	<b>17</b>	644	<b>26</b>		1,279
<b>9</b>	284	<b>18</b>	694	<b>27</b>		1,376

To calculate price of lounge with different fabric for cushion and frame; start with Grade 1 price, add appropriate grade price located in second row for cushion, and last add appropriate grade price located in third row for frame to the sum of the Grade 1 and cushion price.

**Example: Grade 1 \$3,014 + grade 4 fabric cushion \$89 + grade 2 fabric frame \$38 = \$3,141**

Select upholstery for everything else other than the seat and back cushions (the outside back, arms, sides, seat frame). You can specify the same fabric as the cushions or select other fabric.

Frame

<b>1</b>	<b>10</b>	408	<b>19</b>	940	<b>L1</b>	626
<b>2</b>	38	<b>11</b>	458	<b>20</b>	<b>L2</b>	1,142
<b>3</b>	75	<b>12</b>	507	<b>21</b>	<b>L3</b>	1,762
<b>COM/4</b>	112	<b>13</b>	569	<b>22</b>	<b>L4</b>	2,278
<b>5</b>	161	<b>14</b>	631	<b>23</b>	<b>L5</b>	2,794
<b>6</b>	211	<b>15</b>	693	<b>24</b>		1,371
<b>7</b>	260	<b>16</b>	754	<b>25</b>		1,495
<b>8</b>	309	<b>17</b>	816	<b>26</b>		1,619
<b>9</b>	359	<b>18</b>	878	<b>27</b>		1,742

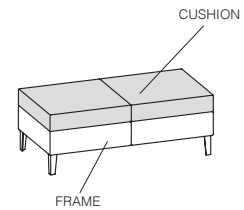

TO ORDER PLEASE SPECIFY THE FOLLOWING:

--	--	--	--	--	--

<b>MODEL NUMBER</b>	<b>WOOD FINISH</b>	<b>STITCH DETAIL</b>	<b>FLAMMABILITY RATING</b>	<b>CUSHION UPHOLSTERY</b>	<b>FRAME UPHOLSTERY</b>
	Cherry finishes on Maple Walnut finishes on Maple Maple finishes on Maple Oak finishes on Maple <i>Light Rift Oak 301 not available on Maple.</i>	None NR Stitch detail SD +\$197	U CTB117	Please refer to list of available upholstery and leather selections on <a href="http://www.gunlocke.com">www.gunlocke.com</a>	Please refer to list of available upholstery and leather selections on <a href="http://www.gunlocke.com">www.gunlocke.com</a>

Example

GK1121-2W.777.NR.U.DOL728.SPNN04					
GK1121-2W	777	NR	U	DOL728	SPNN04
MODEL NUMBER	WOOD FINISH	STITCH DETAIL	FLAMMABILITY UPHOLSTERY	CUSHION UPHOLSTERY	FRAME REQUEST

Please refer to the Ciji product page on [www.gunlocke.com](http://www.gunlocke.com) for standard finish options.

# CIJI BENCH

Two Seat, Aluminum Legs

Seating  
02/24

model number	fabric grades
<b>GK1121-2A</b>	<b>1</b> 3,297

Two seat,  
Aluminum legs

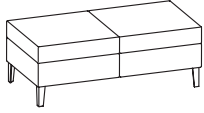

dimensions	W	D	H
Overall	49 1/8"	24 3/4"	17 1/4"
Seat	49 1/8"	24 3/4"	17 1/4"

### Upholstery Requirements: GK1121-2A

	Dual Upholstery	
Fabric yds	Cushions 1.5	Frame 1.9
Leather ft <sup>2</sup>	Cushions 34.5	Frame 43.7
Shipping weight	74 lbs.	
Cube	35	

Cushion	1	10	323	19	742	L1	494	
	2	30	11	361	20	791	L2	902
	3	59	12	401	21	840	L3	1,391
	COM/4	89	13	449	22	888	L4	1,799
	5	128	14	498	23	985	L5	2,206
	6	167	15	546	24	1,083		
	7	205	16	596	25	1,181		
	8	245	17	644	26	1,279		
	9	284	18	694	27	1,376		

To calculate price of lounge with different fabric for cushion and frame; start with Grade 1 price, add appropriate grade price located in second row for cushion, and last add appropriate grade price located in third row for frame to the sum of the Grade 1 and cushion price.

**Example: Grade 1 \$3,297 + grade 4 fabric cushion \$89 + grade 2 fabric frame \$38 = \$3,424**

Select upholstery for everything else other than the seat and back cushions (the outside back, arms, sides, seat frame). You can specify the same fabric as the cushions or select other fabric.

Frame	1	10	408	19	940	L1	626	
	2	38	11	458	20	1,002	L2	1,142
	3	75	12	507	21	1,063	L3	1,762
	COM/4	112	13	569	22	1,125	L4	2,278
	5	161	14	631	23	1,248	L5	2,794
	6	211	15	693	24	1,371		
	7	260	16	754	25	1,495		
	8	309	17	816	26	1,619		
	9	359	18	878	27	1,742		

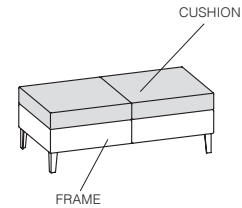

### TO ORDER PLEASE SPECIFY THE FOLLOWING:

<input type="text"/>	<input type="text"/>	<input type="text"/>	<input type="text"/>	<input type="text"/>
<b>MODEL NUMBER</b>	<b>STITCH DETAIL</b>	<b>FLAMMABILITY RATING</b>	<b>CUSHION UPHOLSTERY</b>	<b>FRAME UPHOLSTERY</b>
	None <b>NR</b> Stitch detail <b>SD +\$197</b>	<b>U</b> CTB117	Please refer to list of available upholstery and leather selections on <a href="http://www.gunlocke.com">www.gunlocke.com</a>	Please refer to list of available upholstery and leather selections on <a href="http://www.gunlocke.com">www.gunlocke.com</a>

### Example

GK1121-2A.NR.U.DOL728.SPNN04				
GK1121-2A	NR	U	DOL728	SPNN04
MODEL NUMBER	STITCH	FLAMMABILITY DETAIL	CUSHION UPHOLSTERY	FRAME UPHOLSTERY

Please refer to the Ciji product page on [www.gunlocke.com](http://www.gunlocke.com) for standard finish options.



model number	fabric grades	dimensions	W	D	H
<b>GK1121-3W</b> Three seat, Wood legs	<b>1</b> 3,876	Overall	73 5/8"	24 3/4"	17 1/4"
		Seat	73 5/8"	24 3/4"	17 1/4"

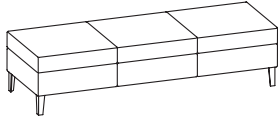

**Upholstery Requirements: GK1121-3W**

	Dual Upholstery	
Fabric yds	Cushions 2.8	Frame 1.9
Leather ft <sup>2</sup>	Cushions 64.4	Frame 43.7
Shipping weight	125 lbs.	
Cube	78.5	

Cushion

<b>1</b>	<b>10</b>	602	<b>19</b>	1,384	<b>L1</b>	920	
<b>2</b>	56	<b>11</b>	674	<b>20</b>	1,475	<b>L2</b>	1,681
<b>3</b>	110	<b>12</b>	747	<b>21</b>	1,566	<b>L3</b>	2,595
<b>COM/4</b>	165	<b>13</b>	839	<b>22</b>	1,657	<b>L4</b>	3,357
<b>5</b>	237	<b>14</b>	930	<b>23</b>	1,839	<b>L5</b>	4,118
<b>6</b>	311	<b>15</b>	1,020	<b>24</b>	2,020		
<b>7</b>	383	<b>16</b>	1,112	<b>25</b>	2,203		
<b>8</b>	456	<b>17</b>	1,203	<b>26</b>	2,386		
<b>9</b>	529	<b>18</b>	1,293	<b>27</b>	2,567		

To calculate price of lounge with different fabric for cushion and frame; start with Grade 1 price, add appropriate grade price located in second row for cushion, and last add appropriate grade price located in third row for frame to the sum of the Grade 1 and cushion price.

**Example: Grade 1 \$3,876 + grade 4 fabric cushion \$165 + grade 2 fabric frame \$38 = \$4,079**

Select upholstery for everything else other than the seat and back cushions (the outside back, arms, sides, seat frame). You can specify the same fabric as the cushions or select other fabric.

Frame

<b>1</b>	<b>10</b>	408	<b>19</b>	940	<b>L1</b>	626	
<b>2</b>	38	<b>11</b>	458	<b>20</b>	1,002	<b>L2</b>	1,142
<b>3</b>	75	<b>12</b>	507	<b>21</b>	1,063	<b>L3</b>	1,762
<b>COM/4</b>	112	<b>13</b>	569	<b>22</b>	1,125	<b>L4</b>	2,278
<b>5</b>	161	<b>14</b>	631	<b>23</b>	1,248	<b>L5</b>	2,794
<b>6</b>	211	<b>15</b>	693	<b>24</b>	1,371		
<b>7</b>	260	<b>16</b>	754	<b>25</b>	1,495		
<b>8</b>	309	<b>17</b>	816	<b>26</b>	1,619		
<b>9</b>	359	<b>18</b>	878	<b>27</b>	1,742		

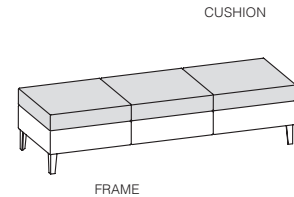

TO ORDER PLEASE SPECIFY THE FOLLOWING:

.  .  .  .  .

MODEL NUMBER	WOOD FINISH	STITCH DETAIL	FLAMMABILITY RATING	CUSHION UPHOLSTERY	FRAME UPHOLSTERY
	Cherry finishes on Maple Walnut finishes on Maple Maple finishes on Maple Oak finishes on Maple <i>Light Rift Oak 301 not available on Maple.</i>	None NR Stitch detail SD +\$197	U CTB117	Please refer to list of available upholstery and leather selections on <a href="http://www.gunlocke.com">www.gunlocke.com</a>	Please refer to list of available upholstery and leather selections on <a href="http://www.gunlocke.com">www.gunlocke.com</a>

Example

GK1121-3W.777.NR.U.DOL728.SPNO4					
GK1121-3W	777	NR	U	DOL728	SPNO4
MODEL NUMBER	WOOD FINISH	STITCH DETAIL	FLAMMABILITY UPHOLSTERY	CUSHION UPHOLSTERY	FRAME REQUEST

Please refer to the Ciji product page on [www.gunlocke.com](http://www.gunlocke.com) for standard finish options.

# CIJI BENCH

Three Seat, Aluminum Legs

Seating  
02/24

model number	fabric grades	dimensions	W	D	H
<b>GK1121-3A</b>	<b>1</b> 4,160	Overall	73 5/8"	24 3/4"	17 1/4"
Three seat, Aluminum legs		Seat	73 5/8"	24 3/4"	17 1/4"

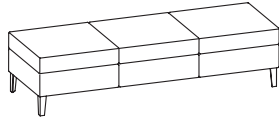

### Upholstery Requirements: GK1121-3A

	Dual Upholstery	
Fabric yds	Cushions 2.8	Frame 1.9
Leather ft <sup>2</sup>	Cushions 64.4	Frame 43.7
Shipping weight	125 lbs.	
Cube	78.5	

Cushion	1	10	602	19	1,384	L1	920
	2	56	11	674	20	L2	1,681
	3	110	12	747	21	L3	2,595
	COM/4	165	13	839	22	L4	3,357
	5	237	14	930	23	L5	4,118
	6	311	15	1,020	24		
	7	383	16	1,112	25		
	8	456	17	1,203	26		
	9	529	18	1,293	27		

To calculate price of lounge with different fabric for cushion and frame; start with Grade 1 price, add appropriate grade price located in second row for cushion, and last add appropriate grade price located in third row for frame to the sum of the Grade 1 and cushion price.

**Example: Grade 1 \$4,160 + grade 4 fabric cushion \$165 + grade 2 fabric frame \$38 = \$4,363**

Select upholstery for everything else other than the seat and back cushions (the outside back, arms, sides, seat frame). You can specify the same fabric as the cushions or select other fabric.

Frame	1	10	408	19	940	L1	626
	2	38	11	458	20	L2	1,142
	3	75	12	507	21	L3	1,762
	COM/4	112	13	569	22	L4	2,278
	5	161	14	631	23	L5	2,794
	6	211	15	693	24		
	7	260	16	754	25		
	8	309	17	816	26		
	9	359	18	878	27		

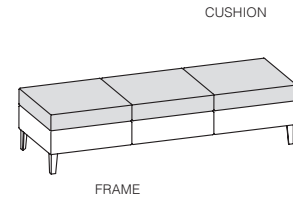

### TO ORDER PLEASE SPECIFY THE FOLLOWING:

<input type="text"/>	<input type="text"/>	<input type="text"/>	<input type="text"/>	<input type="text"/>
<b>MODEL NUMBER</b>	<b>STITCH DETAIL</b>	<b>FLAMMABILITY RATING</b>	<b>CUSHION UPHOLSTERY</b>	<b>FRAME UPHOLSTERY</b>
	None <b>NR</b> Stitch detail SD +\$197	<b>U</b> CTB117	Please refer to list of available upholstery and leather selections on <a href="http://www.gunlocke.com">www.gunlocke.com</a>	Please refer to list of available upholstery and leather selections on <a href="http://www.gunlocke.com">www.gunlocke.com</a>

### Example

GK1121-3A.NR.U.DOL728.SPNN04				
GK1121-3A	NR	U	DOL728	SPNN04
MODEL NUMBER	STITCH	FLAMMABILITY DETAIL	CUSHION UPHOLSTERY	FRAME UPHOLSTERY

Please refer to the Ciji product page on [www.gunlocke.com](http://www.gunlocke.com) for standard finish options.

**Seating**  
02/24

**CIJI REPLACEMENT PARTS**

Back Cushions

model number	fabric grades								dimensions	W	D	H
<b>GK1131</b> Replacement back cushion for low back lounge	<b>1</b>	583	<b>10</b>	906	<b>19</b>	1,325	<b>L1</b>	1,077	Overall	24 5/8"	4"	11"
	<b>2</b>	613	<b>11</b>	944	<b>20</b>	1,374	<b>L2</b>	1,485	Upholstery Fabric yds	1.5		
	<b>3</b>	642	<b>12</b>	984	<b>21</b>	1,423	<b>L3</b>	1,974	Leather ft <sup>2</sup>	34.5		
	<b>COM/4</b>	672	<b>13</b>	1,032	<b>22</b>	1,471	<b>L4</b>	2,382				
	<b>5</b>	711	<b>14</b>	1,081	<b>23</b>	1,568	<b>L5</b>	2,789				
	<b>6</b>	750	<b>15</b>	1,129	<b>24</b>	1,666						
	<b>7</b>	788	<b>16</b>	1,179	<b>25</b>	1,764						
	<b>8</b>	828	<b>17</b>	1,227	<b>26</b>	1,862						
	<b>9</b>	867	<b>18</b>	1,277	<b>27</b>	1,959						

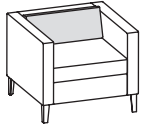

<b>GK1133</b> Replacement back cushion for low back corner unit	<b>1</b>	1,092	<b>10</b>	1,415	<b>19</b>	1,834	<b>L1</b>	1,586	Overall	27 1/4"	4"	11"
	<b>2</b>	1,122	<b>11</b>	1,453	<b>20</b>	1,883	<b>L2</b>	1,994	Upholstery Fabric yds	1.5		
	<b>3</b>	1,151	<b>12</b>	1,493	<b>21</b>	1,932	<b>L3</b>	2,483	Leather ft <sup>2</sup>	34.5		
	<b>COM/4</b>	1,181	<b>13</b>	1,541	<b>22</b>	1,980	<b>L4</b>	2,891				
	<b>5</b>	1,220	<b>14</b>	1,590	<b>23</b>	2,077	<b>L5</b>	3,298				
	<b>6</b>	1,259	<b>15</b>	1,638	<b>24</b>	2,175						
	<b>7</b>	1,297	<b>16</b>	1,688	<b>25</b>	2,273						
	<b>8</b>	1,337	<b>17</b>	1,736	<b>26</b>	2,371						
	<b>9</b>	1,376	<b>18</b>	1,786	<b>27</b>	2,468						

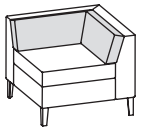

<b>GK1137</b> Replacement back cushion for mid back lounge	<b>1</b>	583	<b>10</b>	906	<b>19</b>	1,325	<b>L1</b>	1,077	Overall	24 5/8"	4"	15"
	<b>2</b>	613	<b>11</b>	944	<b>20</b>	1,374	<b>L2</b>	1,485	Upholstery Fabric yds	1.5		
	<b>3</b>	642	<b>12</b>	984	<b>21</b>	1,423	<b>L3</b>	1,974	Leather ft <sup>2</sup>	34.5		
	<b>COM/4</b>	672	<b>13</b>	1,032	<b>22</b>	1,471	<b>L4</b>	2,382				
	<b>5</b>	711	<b>14</b>	1,081	<b>23</b>	1,568	<b>L5</b>	2,789				
	<b>6</b>	750	<b>15</b>	1,129	<b>24</b>	1,666						
	<b>7</b>	788	<b>16</b>	1,179	<b>25</b>	1,764						
	<b>8</b>	828	<b>17</b>	1,227	<b>26</b>	1,862						
	<b>9</b>	867	<b>18</b>	1,277	<b>27</b>	1,959						

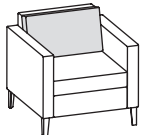

TO ORDER PLEASE SPECIFY THE FOLLOWING:

.  .  .

**MODEL NUMBER**

**STITCH DETAIL**

**FLAMMABILITY RATING**

**CUSHIONS UPHOLSTERY**

None **NR**  
Stitch detail **SD +\$197**

**U** CTB117

Please refer to list of available upholstery and leather selections on [www.gunlocke.com](http://www.gunlocke.com)

Example

GK1131.NR.U.DOL728

GK1131      NR      U      DOL728  
MODEL NUMBER      STITCH DETAIL      FLAMMABILITY      CUSHION UPHOLSTERY

# CIJI REPLACEMENT PARTS

Seating  
02/24

## Cushions and Arms

model number	fabric grades								dimensions	W	D	H
<b>GK1139</b> Replacement back cushions for mid back corner unit	<b>1</b>	1,092	<b>10</b>	1,415	<b>19</b>	1,834	<b>L1</b>	1,586	Overall	24 5/8"	4"	15"
	<b>2</b>	1,122	<b>11</b>	1,453	<b>20</b>	1,883	<b>L2</b>	1,994	Upholstery Fabric yds	1.5		
	<b>3</b>	1,151	<b>12</b>	1,493	<b>21</b>	1,932	<b>L3</b>	2,483	Leather ft <sup>2</sup>	34.5		
	<b>COM/4</b>	1,181	<b>13</b>	1,541	<b>22</b>	1,980	<b>L4</b>	2,891				
	<b>5</b>	1,220	<b>14</b>	1,590	<b>23</b>	2,077	<b>L5</b>	3,298				
	<b>6</b>	1,259	<b>15</b>	1,638	<b>24</b>	2,175						
	<b>7</b>	1,297	<b>16</b>	1,688	<b>25</b>	2,273						
	<b>8</b>	1,337	<b>17</b>	1,736	<b>26</b>	2,371						
	<b>9</b>	1,376	<b>18</b>	1,786	<b>27</b>	2,468						



<b>GK1143</b> Replacement seat cushion	<b>1</b>	801	<b>10</b>	1,124	<b>19</b>	1,543	<b>L1</b>	1,295	Overall	24 5/8"	24 5/8"	5"
	<b>2</b>	831	<b>11</b>	1,162	<b>20</b>	1,592	<b>L2</b>	1,703	Upholstery Fabric yds	1.5		
	<b>3</b>	860	<b>12</b>	1,202	<b>21</b>	1,641	<b>L3</b>	2,192	Leather ft <sup>2</sup>	34.5		
	<b>COM/4</b>	890	<b>13</b>	1,250	<b>22</b>	1,689	<b>L4</b>	2,600				
	<b>5</b>	929	<b>14</b>	1,299	<b>23</b>	1,786	<b>L5</b>	3,007				
	<b>6</b>	968	<b>15</b>	1,347	<b>24</b>	1,884						
	<b>7</b>	1,006	<b>16</b>	1,397	<b>25</b>	1,982						
	<b>8</b>	1,046	<b>17</b>	1,445	<b>26</b>	2,080						
	<b>9</b>	1,085	<b>18</b>	1,495	<b>27</b>	2,177						

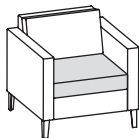

<b>GK1145R</b> Replacement arm right or left	<b>1</b>	872	<b>10</b>	1,366	<b>19</b>	2,010	<b>L1</b>	1,629	Overall	31"	3 1/2"	20 7/8"
	<b>2</b>	918	<b>11</b>	1,427	<b>20</b>	2,085	<b>L2</b>	2,254	Upholstery Fabric yds	2.3		
	<b>3</b>	963	<b>12</b>	1,486	<b>21</b>	2,159	<b>L3</b>	3,004	Leather ft <sup>2</sup>	52.9		
	<b>COM/4</b>	1,007	<b>13</b>	1,562	<b>22</b>	2,234	<b>L4</b>	3,629				
	<b>5</b>	1,067	<b>14</b>	1,636	<b>23</b>	2,384	<b>L5</b>	4,255				
	<b>6</b>	1,127	<b>15</b>	1,711	<b>24</b>	2,533						
	<b>7</b>	1,188	<b>16</b>	1,785	<b>25</b>	2,681						
	<b>8</b>	1,246	<b>17</b>	1,860	<b>26</b>	2,831						
	<b>9</b>	1,306	<b>18</b>	1,934	<b>27</b>	2,982						

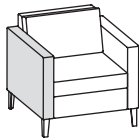

TO ORDER PLEASE SPECIFY THE FOLLOWING:

.  .  .

MODEL NUMBER

STITCH DETAIL

FLAMMABILITY RATING

CUSHIONS UPHOLSTERY

None **NR**  
Stitch detail **SD +\$197**

**U** CTB117

Please refer to list of available upholstery and leather selections on [www.gunlocke.com](http://www.gunlocke.com)

Option not available for GK1145R or GK1145L

### Example

GK1139.NR.U.DOL728

GK1139      NR      U      DOL728  
MODEL NUMBER      STITCH DETAIL      FLAMMABILITY      CUSHION UPHOLSTERY

model number	list	dimensions	W	D	H
<b>GK1155</b> Replacement wood leg	367		3 1/2	3 1/2	6
					
<b>GK1157</b> Replacement aluminum leg	239		3 1/2	3 1/2	6
					
<b>GK1159</b> Plate for joining 3 lounge units	149		6 3/4"	2 5/8"	2 3/4"
	<ul style="list-style-type: none"> <li>• Used to span the corner formed by the intersection of two armless lounges with a corner unit when assembled in L-shape. This bracket replaces three leg units with one in permanent L-setups</li> </ul>				
<b>GK1161</b> Power module	588		1 7/8"	5"	5/8"
	<ul style="list-style-type: none"> <li>• 15 amp, 72" cord</li> </ul>				
<b>GK1163</b> Ganging bracket, set of two	178				
					

TO ORDER PLEASE SPECIFY THE FOLLOWING:

.

MODEL NUMBER    WOOD FINISH

Option available for GK1155 only.  
**Cherry finishes on Maple**  
**Walnut finishes on Maple**  
**Maple finishes on Maple**  
**Oak finishes on Maple**  
*Light Rift Oak 301 not available on Maple.*  
 Please refer to the Ciji product page on [www.gunlocke.com](http://www.gunlocke.com) for standard finish options.

Example

GK1155.215  
 GK1155                      215  
 MODEL NUMBER        WOOD FINISH

# IRIS

## Single Upholstery, Metal Base

model number	fabric grades							dimensions	W	D	H	
<b>GLIRS17-011</b> Single upholstery lounge, return-to-center metal base	<b>1</b>	4,482	<b>10</b>	5,084	<b>19</b>	5,866	<b>L1</b>	5,125	Overall	29 5/8"	27 1/2"	34 3/4"
	<b>2</b>	4,538	<b>11</b>	5,156	<b>20</b>	5,957	<b>L2</b>	5,688	Seat	22"	19 3/4"	17 5/8"
	<b>3</b>	4,592	<b>12</b>	5,229	<b>21</b>	6,048	<b>L3</b>	6,362	<b>Upholstery Requirements: GLIRS17-011</b>			
	<b>COM/4</b>	4,647	<b>13</b>	5,321	<b>22</b>	6,139	<b>L4</b>	6,925	Fabric yards	2.8		
	<b>5</b>	4,719	<b>14</b>	5,412	<b>23</b>	6,321	<b>L5</b>	7,487	Leather feet <sup>2</sup>	47.6		
	<b>6</b>	4,793	<b>15</b>	5,502	<b>24</b>	6,502			Shipping weight	45 lbs.		
	<b>7</b>	4,865	<b>16</b>	5,594	<b>25</b>	6,685			Cube	21.7		
	<b>8</b>	4,938	<b>17</b>	5,685	<b>26</b>	6,868			<b>Note:</b> Lounge 4-star metal base comes standard at a fixed height with return-to-center base.			
	<b>9</b>	5,011	<b>18</b>	5,775	<b>27</b>	7,049						



<b>GLIRS17-031</b> Single upholstery ottoman, fixed metal base	<b>1</b>	1,811	<b>10</b>	2,091	<b>19</b>	2,454	<b>L1</b>	2,109	Overall	21 3/4"	17 3/4"	15 1/4"
	<b>2</b>	1,838	<b>11</b>	2,125	<b>20</b>	2,496	<b>L2</b>	2,371	<b>Upholstery Requirements: GLIRS17-031</b>			
	<b>3</b>	1,863	<b>12</b>	2,159	<b>21</b>	2,539	<b>L3</b>	2,684	Fabric yards	1.3		
	<b>COM/4</b>	1,889	<b>13</b>	2,201	<b>22</b>	2,581	<b>L4</b>	2,946	Leather feet <sup>2</sup>	22.1		
	<b>5</b>	1,922	<b>14</b>	2,243	<b>23</b>	2,665	<b>L5</b>	3,207	Shipping weight	20 lbs.		
	<b>6</b>	1,956	<b>15</b>	2,284	<b>24</b>	2,750			Cube	5.4		
	<b>7</b>	1,990	<b>16</b>	2,328	<b>25</b>	2,834			<b>Note:</b> Ottoman metal base comes standard at a fixed height with fixed base.			
	<b>8</b>	2,023	<b>17</b>	2,370	<b>26</b>	2,919						
	<b>9</b>	2,057	<b>18</b>	2,412	<b>27</b>	3,003						



### TO ORDER PLEASE SPECIFY THE FOLLOWING:

--	--	--	--

<b>MODEL NUMBER</b>	<b>BASE COLOR</b>	<b>FLAMMABILITY RATING</b>	<b>UPHOLSTERY</b>
	Polished Aluminum <b>BAL</b>	<b>U CTB117</b>	Please refer to list of available upholstery and leather selections on <a href="http://www.gunlocke.com">www.gunlocke.com</a>

### Example

**GLIRS17-011.BAL.U.DOL728**

GLIRS17-011	BAL	U	DOL728
MODEL NUMBER	BASE COLOR	FLAMMABILITY	UPHOLSTERY

Dual Upholstery Lounge, Metal Base

model number	fabric grades
<b>GLIRS17-021</b>	<b>1</b> 4,570

Dual upholstery lounge,  
return-to-center metal base



dimensions	W	D	H
Overall	29 5/8"	27 1/2"	34 1"
Seat	22"	19 3/4"	17 5/8"

**Upholstery Requirements: GLIRS17-021**

	Dual Upholstery	
Fabric yds	Inside 1.8	Outside 1.2
Leather ft <sup>2</sup>	Inside 30.6	Outside 20.4
Shipping weight	45 lbs.	
Cube	21.7	

**Note:** Lounge 4-star metal base comes standard at a fixed height with return-to-center base.

Inside	1	10	387	19	890	L1	415	
	2	36	11	434	20	948	L2	776
	3	72	12	480	21	1,007	L3	1,209
	<b>COM/4</b>	107	<b>13</b>	539	<b>22</b>	1,066	<b>L4</b>	1,570
	5	153	14	597	23	1,183	L5	1,932
	6	199	15	657	24	1,300		
	7	247	16	715	25	1,417		
	8	294	17	773	26	1,533		
	9	340	18	832	27	1,651		

To calculate price of lounge with different fabric for Inside and Outside, start with Grade 1 price, add appropriate grade price located in second row for Inside, and last add appropriate grade price located in third row for arms to the sum of the Grade 1 and Inside/Outside price.

**Example: Grade 1 \$4,570 + grade 4 fabric Inside \$107 + grade 2 fabric Outside \$24 = \$4,701**

Outside	1	10	258	19	594	L1	277	
	2	24	11	290	20	633	L2	518
	3	48	12	321	21	671	L3	806
	<b>COM/4</b>	72	<b>13</b>	360	<b>22</b>	710	<b>L4</b>	1,047
	5	102	14	398	23	789	L5	1,289
	6	133	15	438	24	867		
	7	165	16	477	25	945		
	8	196	17	517	26	1,022		
	9	227	18	555	27	1,102		

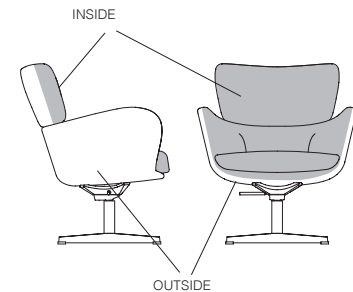

**TO ORDER PLEASE SPECIFY THE FOLLOWING:**

<input type="text"/>	<input type="text"/>	<input type="text"/>	<input type="text"/>	<input type="text"/>
<b>MODEL NUMBER</b>	<b>BASE COLOR</b>	<b>FLAMMABILITY RATING</b>	<b>INSIDE UPHOLSTERY</b>	<b>OUTSIDE UPHOLSTERY</b>
	Polished Aluminum <b>BAL</b>	U <b>CTB117</b>	Please refer to list of available upholstery and leather selections on <a href="http://www.gunlocke.com">www.gunlocke.com</a>	Please refer to list of available upholstery and leather selections on <a href="http://www.gunlocke.com">www.gunlocke.com</a>

**Example**

**GLIRS17-021.BAL.U.DOL728.SPNN04**

GLIRS17-021	BAL	U	DOL728	SPNN04
<b>MODEL NUMBER</b>	<b>BASE COLOR</b>	<b>FLAMMABILITY</b>	<b>INSIDE UPHOLSTERY</b>	<b>OUTSIDE UPHOLSTERY</b>

# IRIS

## Dual Upholstery Ottoman, Metal Base

Seating  
02/24

model number	fabric grades	dimensions	W	D	H
<b>GLIRS17-041</b>	<b>1</b> 1,843	Overall	21 3/4"	17 3/4"	15 1/4"

**GLIRS17-041**  
Dual upholstery ottoman,  
fixed metal base



### Upholstery Requirements: GLIRS17-041

Dual Upholstery	
Fabric yds	Top 0.6 Bottom 1
Leather ft <sup>2</sup>	Top 10.2 Bottom 17
Shipping weight	20 lbs.
Cube	5.4

**Note:** Ottoman metal base comes standard at a fixed height with return-to-center base.

Top

<b>1</b>	<b>10</b>	130	<b>19</b>	297	<b>L1</b>	140	
<b>2</b>	12	<b>11</b>	146	<b>20</b>	317	<b>L2</b>	259
<b>3</b>	24	<b>12</b>	160	<b>21</b>	336	<b>L3</b>	404
<b>COM/4</b>	36	<b>13</b>	181	<b>22</b>	356	<b>L4</b>	524
<b>5</b>	52	<b>14</b>	199	<b>23</b>	395	<b>L5</b>	644
<b>6</b>	67	<b>15</b>	220	<b>24</b>	434		
<b>7</b>	83	<b>16</b>	239	<b>25</b>	472		
<b>8</b>	98	<b>17</b>	258	<b>26</b>	511		
<b>9</b>	115	<b>18</b>	279	<b>27</b>	552		

To calculate price of lounge with different fabric for Inside and Outside, start with Grade 1 price, add appropriate grade price located in second row for Top, and last add appropriate grade price located in third row for Bottom to the sum of the Grade 1, Top/Bottom price.

**Example: Grade 1 \$1,843 + grade 4 fabric Top \$36 + grade 2 fabric Bottom \$20 = \$1,899**

Bottom

<b>1</b>	<b>10</b>	216	<b>19</b>	495	<b>L1</b>	230	
<b>2</b>	20	<b>11</b>	242	<b>20</b>	528	<b>L2</b>	431
<b>3</b>	41	<b>12</b>	267	<b>21</b>	560	<b>L3</b>	672
<b>COM/4</b>	59	<b>13</b>	299	<b>22</b>	593	<b>L4</b>	873
<b>5</b>	85	<b>14</b>	332	<b>23</b>	658	<b>L5</b>	1,075
<b>6</b>	111	<b>15</b>	365	<b>24</b>	723		
<b>7</b>	137	<b>16</b>	397	<b>25</b>	788		
<b>8</b>	164	<b>17</b>	430	<b>26</b>	852		
<b>9</b>	190	<b>18</b>	462	<b>27</b>	917		

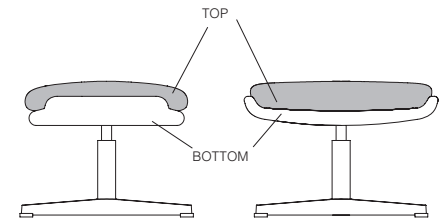

TO ORDER PLEASE SPECIFY THE FOLLOWING:

<input type="text"/>	<input type="text"/>	<input type="text"/>	<input type="text"/>	<input type="text"/>
<b>MODEL NUMBER</b>	<b>BASE COLOR</b>	<b>FLAMMABILITY RATING</b>	<b>TOP UPHOLSTERY</b>	<b>BOTTOM UPHOLSTERY</b>
	Polished Aluminum <b>BAL</b>	<b>U</b> CTB117	Please refer to list of available upholstery and leather selections on <a href="http://www.gunlocke.com">www.gunlocke.com</a>	Please refer to list of available upholstery and leather selections on <a href="http://www.gunlocke.com">www.gunlocke.com</a>

Example

GLIRS17-041.BAL.U.DOL728.SPNN04				
GLIRS17-041	BAL	U	DOL728	SPNN04
<b>MODEL NUMBER</b>	<b>BASE COLOR</b>	<b>FLAMMABILITY</b>	<b>TOP UPHOLSTERY</b>	<b>BOTTOM UPHOLSTERY</b>



model number	fabric grades								dimensions	W	D	H
<b>GLIRS17-051</b> Single upholstery lounge, wood legs 	<b>1</b>	4,570	<b>10</b>	5,172	<b>19</b>	5,954	<b>L1</b>	5,213	Overall	29 5/8"	27 1/2"	34 3/4"
	<b>2</b>	4,626	<b>11</b>	5,244	<b>20</b>	6,045	<b>L2</b>	5,776	Seat	22"	19 3/4"	18 3/4"
	<b>3</b>	4,680	<b>12</b>	5,317	<b>21</b>	6,136	<b>L3</b>	6,450	<b>Upholstery Requirements: GLIRS17-051</b>			
	<b>COM/4</b>	4,735	<b>13</b>	5,409	<b>22</b>	6,227	<b>L4</b>	7,013	Fabric yards	2.8		
	<b>5</b>	4,807	<b>14</b>	5,500	<b>23</b>	6,409	<b>L5</b>	7,575	Leather feet <sup>2</sup>	47.6		
	<b>6</b>	4,881	<b>15</b>	5,590	<b>24</b>	6,590			Shipping weight	45 lbs.		
	<b>7</b>	4,953	<b>16</b>	5,682	<b>25</b>	6,773			Cube	21.7		
	<b>8</b>	5,026	<b>17</b>	5,773	<b>26</b>	6,956						
	<b>9</b>	5,099	<b>18</b>	5,863	<b>27</b>	7,137						

<b>GLIRS17-071</b> Single upholstery ottoman, wood legs 	<b>1</b>	1,843	<b>10</b>	2,123	<b>19</b>	2,486	<b>L1</b>	2,141	Overall	21 3/4"	17 3/4"	15 1/4"
	<b>2</b>	1,870	<b>11</b>	2,157	<b>20</b>	2,528	<b>L2</b>	2,403	<b>Upholstery Requirements: GLIRS17-071</b>			
	<b>3</b>	1,895	<b>12</b>	2,191	<b>21</b>	2,571	<b>L3</b>	2,716	Fabric yards	1.3		
	<b>COM/4</b>	1,921	<b>13</b>	2,233	<b>22</b>	2,613	<b>L4</b>	2,978	Leather feet <sup>2</sup>	22.1		
	<b>5</b>	1,954	<b>14</b>	2,275	<b>23</b>	2,697	<b>L5</b>	3,239	Shipping weight	20 lbs.		
	<b>6</b>	1,988	<b>15</b>	2,316	<b>24</b>	2,782			Cube	5.4		
	<b>7</b>	2,022	<b>16</b>	2,360	<b>25</b>	2,866						
	<b>8</b>	2,055	<b>17</b>	2,402	<b>26</b>	2,951						
	<b>9</b>	2,089	<b>18</b>	2,444	<b>27</b>	3,035						

TO ORDER PLEASE SPECIFY THE FOLLOWING:

<input type="text"/>	<input type="text"/>	<input type="text"/>	<input type="text"/>
<b>MODEL NUMBER</b>	<b>FINISH</b>	<b>FLAMMABILITY RATING</b>	<b>UPHOLSTERY</b>

These seating models are available in the following hardwoods:

Maple **NE**  
Ash **QA**

Please refer to the Tia product page on [www.gunlocke.com](http://www.gunlocke.com) for standard finish options.

**Cherry finishes on Maple or Ash**  
**Walnut finishes on Maple or Ash**  
**Maple finishes on Maple or Ash**  
**Oak finishes on Maple or Ash**

*Natural Cherry 222, Clear Maple 800, Clear Oak 300 and Fawn Cypress 108 not available on Ash.*

*Light Rift Oak 301 not available on Maple.*

**U CTB117**

**Please refer to list of available upholstery and leather selections on [www.gunlocke.com](http://www.gunlocke.com)**

Example

GLIRS17-051.QA629.U.DOL728

GLIRS17-051	QA629	U	DOL728
<b>MODEL NUMBER</b>	<b>FINISH</b>	<b>FLAMMABILITY</b>	<b>UPHOLSTERY</b>

# IRIS

## Dual Upholstery Lounge, Wood Legs

Seating  
02/24

model number	fabric grades
<b>GLIRS17-061</b>	<b>1</b> 4,657

Dual upholstery lounge,  
wood legs



dimensions	W	D	H
Overall	32"	32"	30"
Seat	22"	19 3/4"	18 3/4"

### Upholstery Requirements: GLIRS17-061

	Dual Upholstery	
Fabric yds	Inside 1.8	Outside 1.2
Leather ft <sup>2</sup>	Inside 30.6	Outside 20.4
Shipping weight	45 lbs.	
Cube	21.7	

Inside

<b>1</b>	<b>10</b>	387	<b>19</b>	890	<b>L1</b>	415	
<b>2</b>	36	<b>11</b>	434	<b>20</b>	948	<b>L2</b>	776
<b>3</b>	72	<b>12</b>	480	<b>21</b>	1,007	<b>L3</b>	1,209
<b>COM/4</b>	107	<b>13</b>	539	<b>22</b>	1,066	<b>L4</b>	1,570
<b>5</b>	153	<b>14</b>	597	<b>23</b>	1,183	<b>L5</b>	1,932
<b>6</b>	199	<b>15</b>	657	<b>24</b>	1,300		
<b>7</b>	247	<b>16</b>	715	<b>25</b>	1,417		
<b>8</b>	294	<b>17</b>	773	<b>26</b>	1,533		
<b>9</b>	340	<b>18</b>	832	<b>27</b>	1,651		

To calculate price of lounge with different fabric for Inside and Outside, start with Grade 1 price, add appropriate grade price located in second row for Inside, and last add appropriate grade price located in third row for arms to the sum of the Grade 1 and Inside/Outside price.

**Example: Grade 1 \$4,657 + grade 4 fabric Inside \$107 + grade 2 fabric Outside \$24 = \$4,788**

Outside

<b>1</b>	<b>10</b>	258	<b>19</b>	594	<b>L1</b>	277	
<b>2</b>	24	<b>11</b>	290	<b>20</b>	633	<b>L2</b>	518
<b>3</b>	48	<b>12</b>	321	<b>21</b>	671	<b>L3</b>	806
<b>COM/4</b>	72	<b>13</b>	360	<b>22</b>	710	<b>L4</b>	1,047
<b>5</b>	102	<b>14</b>	398	<b>23</b>	789	<b>L5</b>	1,289
<b>6</b>	133	<b>15</b>	438	<b>24</b>	867		
<b>7</b>	165	<b>16</b>	477	<b>25</b>	945		
<b>8</b>	196	<b>17</b>	517	<b>26</b>	1,022		
<b>9</b>	227	<b>18</b>	555	<b>27</b>	1,102		

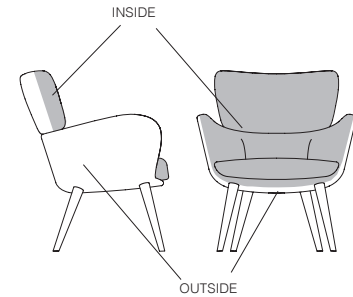

### TO ORDER PLEASE SPECIFY THE FOLLOWING:

<input type="text"/>	<input type="text"/>	<input type="text"/>	<input type="text"/>	<input type="text"/>
<b>MODEL NUMBER</b>	<b>FINISH</b>	<b>FLAMMABILITY RATING</b>	<b>INSIDE UPHOLSTERY</b>	<b>OUTSIDE UPHOLSTERY</b>

These seating models are available in the following hardwoods:

Maple **NE**  
Ash **QA**

Please refer to the Tia product page on [www.gunlocke.com](http://www.gunlocke.com) for standard finish options.

**Cherry finishes on Maple or Ash**  
**Walnut finishes on Maple or Ash**  
**Maple finishes on Maple or Ash**  
**Oak finishes on Maple or Ash**

*Natural Cherry 222, Clear Maple 800, Clear Oak 300 and Fawn Cypress 108 not available on Ash.*

*Light Rift Oak 301 not available on Maple.*

**U** CTB117

Please refer to list of available upholstery and leather selections on [www.gunlocke.com](http://www.gunlocke.com)

Please refer to list of available upholstery and leather selections on [www.gunlocke.com](http://www.gunlocke.com)

### Example

GLIRS17-061.QA629.U.DOL728.SPNN04

GLIRS17-061	QA629	U	DOL728	SPNN04
<b>MODEL NUMBER</b>	<b>FINISH</b>	<b>FLAMMABILITY</b>	<b>INSIDE UPHOLSTERY</b>	<b>OUTSIDE UPHOLSTERY</b>

model number	fabric grades	dimensions	W	D	H
--------------	---------------	------------	---	---	---

**GLIRS17-081**  
Dual upholstery ottoman,  
wood legs

**1** 1,879

Overall 21 3/4" 17 3/4" 15 1/4"

**Upholstery Requirements: GLIRS17-081**

	Dual Upholstery	
Fabric yds	Top 0.6	Bottom 1
Leather ft <sup>2</sup>	Top 10.2	Bottom 17
Shipping weight	20 lbs.	
Cube	5.4	



Top

<b>1</b>	<b>10</b>	130	<b>19</b>	297	<b>L1</b>	140	
<b>2</b>	12	<b>11</b>	146	<b>20</b>	317	<b>L2</b>	259
<b>3</b>	24	<b>12</b>	160	<b>21</b>	336	<b>L3</b>	404
<b>COM/4</b>	36	<b>13</b>	181	<b>22</b>	356	<b>L4</b>	524
<b>5</b>	52	<b>14</b>	199	<b>23</b>	395	<b>L5</b>	644
<b>6</b>	67	<b>15</b>	220	<b>24</b>	434		
<b>7</b>	83	<b>16</b>	239	<b>25</b>	472		
<b>8</b>	98	<b>17</b>	258	<b>26</b>	511		
<b>9</b>	115	<b>18</b>	279	<b>27</b>	552		

To calculate price of lounge with different fabric for Inside and Outside, start with Grade 1 price, add appropriate grade price located in second row for Top, and last add appropriate grade price located in third row for Bottom to the sum of the Grade 1, Top/Bottom price.

**Example: Grade 1 \$1,879 + grade 4 fabric Top \$36 + grade 2 fabric Bottom \$20 = \$1,935**

Bottom

<b>1</b>	<b>10</b>	216	<b>19</b>	495	<b>L1</b>	230	
<b>2</b>	20	<b>11</b>	242	<b>20</b>	528	<b>L2</b>	431
<b>3</b>	41	<b>12</b>	267	<b>21</b>	560	<b>L3</b>	672
<b>COM/4</b>	59	<b>13</b>	299	<b>22</b>	593	<b>L4</b>	873
<b>5</b>	85	<b>14</b>	332	<b>23</b>	658	<b>L5</b>	1,075
<b>6</b>	111	<b>15</b>	365	<b>24</b>	723		
<b>7</b>	137	<b>16</b>	397	<b>25</b>	788		
<b>8</b>	164	<b>17</b>	430	<b>26</b>	852		
<b>9</b>	190	<b>18</b>	462	<b>27</b>	917		

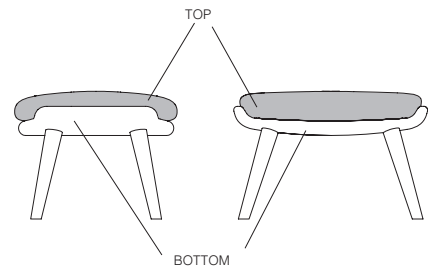

**TO ORDER PLEASE SPECIFY THE FOLLOWING:**

.  .  .  .

**MODEL NUMBER**    **FINISH**    **FLAMMABILITY RATING**    **TOP UPHOLSTERY**    **BOTTOM UPHOLSTERY**

These seating models are available in the following hardwoods:  
Maple **NE**  
Ash **QA**  
Please refer to the Tia product page on [www.gunlocke.com](http://www.gunlocke.com) for standard finish options.  
**Cherry finishes on Maple or Ash**  
**Walnut finishes on Maple or Ash**  
**Maple finishes on Maple or Ash**  
**Oak finishes on Maple or Ash**  
*Natural Cherry 222, Clear Maple 800, Clear Oak 300 and Fawn Cypress 108 not available on Ash.*  
*Light Rift Oak 301 not available on Maple.*

**U** CTB117

Please refer to list of available upholstery and leather selections on [www.gunlocke.com](http://www.gunlocke.com)

Please refer to list of available upholstery and leather selections on [www.gunlocke.com](http://www.gunlocke.com)

**Example**

**GLIRS17-081.QA629.U.DOL728.SPNN04**





GLIRS17-081	QA629	U	DOL728	SPNN04
<b>MODEL NUMBER</b>	<b>FINISH</b>	<b>FLAMMABILITY</b>	<b>TOP UPHOLSTERY</b>	<b>BOTTOM UPHOLSTERY</b>

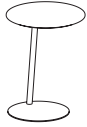

Occasional Tables.....	173-180
Briefing .....	174
Calm .....	175-177
Cylinder.....	178
Cube .....	179
Letchworth .....	180

# BRIEFING OCCASIONAL TABLES

Seating  
02/24

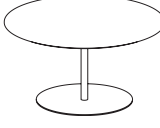
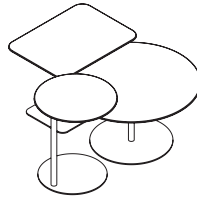
	D	W	H	model number + type	veneer 1	veneer 2	veneer 3	laminated	solid surface
<b>LAPTOP TABLE</b> 24H 	18	18	24 1/2	<b>GM2LTRD18H24-</b> [ ]	2,086	2,295	2,504	2,052	2,556
				<ul style="list-style-type: none"> <li>• Top size 18" Dia.</li> <li>• Disc size 14" Dia.</li> </ul>					
<b>END TABLE</b> 24H 	18	18	24 1/2	<b>GM2ETRD18H24-</b> [ ]	2,086	2,295	2,504	2,053	2,558
				<ul style="list-style-type: none"> <li>• Top size 18" Dia.</li> <li>• Disc size 14" Dia.</li> </ul>					
<b>NESTING TABLE</b> 19H 	18	18	19 1/2	<b>GM2NTRD18H19-</b> [ ]	2,086	2,295	2,504	2,052	2,556
				<ul style="list-style-type: none"> <li>• Top size 18" Dia.</li> <li>• Disc size 14" Dia.</li> </ul>					
<b>NESTING TABLE</b> 17H 	18	24	17 1/2	<b>GM2NTRS1824H17-</b> [ ]	2,574	2,832	3,089	2,575	3,104
				<ul style="list-style-type: none"> <li>• Top size 18" x 24"</li> <li>• Disc size 12" x 18"</li> </ul>					
<b>NESTING TABLE</b> 15H 	30	30	15 1/2	<b>GM2NTRD30H15-</b> [ ]	2,901	3,192	3,482	2,858	3,471
				<ul style="list-style-type: none"> <li>• Top size 30" Dia.</li> <li>• Disc size 18" Dia.</li> </ul>					
				Nested tables can be grouped together to create a collection with varying heights. 					

## PRODUCT INFO

Top thickness:

Wood 3/4"

Laminate 3/4"

Glass 1/2"

Solid Surface 1/2"

Top includes inserts for connection to base.

Tops include a knife edge standard.

 Units shipped as separate packages and require field assembly.

## TO ORDER PLEASE SPECIFY THE FOLLOWING:

### WOOD

1. MODEL NUMBER + W

2. FSC

3. FINISH

4. TOP FINISH

5. HARDWARE OPTION

- P71** Black
- PR6** Silver
- P8G** Matte Gold
- PJE** Pyrite
- PJW** Designer White
- P8X** Solar Black
- P8T** Titanium
- PJF** Bullseye
- P8M** Regatta
- PC** Polished Chrome (add \$225)

### LAMINATE

1. MODEL NUMBER + L

2. FSC

3. FINISH

4. HARDWARE OPTION

- P71** Black
- PR6** Silver
- P8G** Matte Gold
- PJE** Pyrite
- PJW** Designer White
- P8X** Solar Black
- P8T** Titanium
- PJF** Bullseye
- P8M** Regatta
- PC** Polished Chrome (add \$225)

### SOLID SURFACE

1. MODEL NUMBER + S

2. FINISH

3. HARDWARE OPTION

- P71** Black
- PR6** Silver
- P8G** Matte Gold
- PJE** Pyrite
- PJW** Designer White
- P8X** Solar Black
- P8T** Titanium
- PJF** Bullseye
- P8M** Regatta
- PC** Polished Chrome (add \$225)

### Example

GM2LTRD18H24-W.X.NC260.OP.P71

GM2LTRD18H24-W	X	NC260	OP	P71
MODEL NUMBER + TYPE	FSC	FINISH	TOP FINISH	HARDWARE OPTION

32" Depth Occasional Tables

	D	W	H	model number + type	veneer 2	veneer 3	laminat	solid surface	glass	field-installed top
<b>32"D x 25"W</b> Occasional table	32	25	17	<b>GTGB17-3225H17-</b> <input type="checkbox"/>	3,107	3,413	2,641	4,738	4,037	2,952
				Shipping wgt	45 lb	45 lb	45 lb	55 lb	55 lb	35 lb
				Cubes	11.3	11.3	11.3	11.3	11.3	11.1

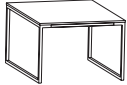

<b>32"D x 32"W</b> Occasional table	32	32	17	<b>GTGB17-3232H17-</b> <input type="checkbox"/>	3,373	3,704	2,865	5,144	4,384	3,204
				Shipping wgt	50 lb	50 lb	50 lb	60 lb	60 lb	40 lb
				Cubes	14.2	14.2	14.2	14.2	14.2	13.8

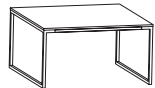

<b>32"D x 50"W</b> Occasional table	32	50	17	<b>GTGB17-3250H17-</b> <input type="checkbox"/>	3,904	4,287	3,317	5,952	5,076	3,709
				Shipping wgt	55 lb	55 lb	55 lb	65 lb	65 lb	45 lb
				Cubes	21.5	21.5	21.5	21.5	21.5	20.9



**Note:** 32"D occasional tables can be used in-line with lounge units, but are freestanding and do not gang.

TO ORDER PLEASE SPECIFY THE FOLLOWING:

.  .  .

MODEL NUMBER + TYPE	FRAME COLOR	TOP MATERIAL	TOP FINISH (WOOD TOPS ONLY)
<b>Note:</b> Type must be specified as part of model number. Wood Veneer <b>W</b> Laminate <b>L</b> Solid Surface <b>S</b> Glass <b>G</b> Field-Installed Top <b>F</b>	Polished Chrome <b>\$113</b> - 32x25 <b>\$142</b> - 32x32 <b>\$169</b> - 32x50 Brushed Chrome Steel <b>\$113</b> - 32x25 <b>\$142</b> - 32x32 <b>\$169</b> - 32x50 Black Designer White Matte Gold Silver Solar Black Titanium Bullseye Regatta	<b>PC</b>  <b>BS</b>   <b>P71</b> <b>PJW</b> <b>P8G</b> <b>PR6</b> <b>P8X</b> <b>P8T</b> <b>PJF</b> <b>P8M</b>	<b>Note:</b> Wood and laminate tops are 1 1/8" thick, rabbeted and inset to leave 1/2" thick edge detail. solid surface and glass tops are 12mm thick, with an inset 3/4" MDF subtop. Field-installed tops receive an inset 3/4" MDF subtop. Wood, laminate, solid surfaces and glass tops all have 1/16" overhang per side.  <b>See page 84-85 for required option codes.</b>

Example



GTGB17-3225H17-W.PC.NC215.OP



GTGB17-3225H17-W	PC	NC215	OP
MODEL NUMBER	FRAME COLOR	TOP MATERIAL	TOP FINISH

# CALM

## 16" Depth Occasional Tables





Seating  
02/24

	D	W	H	model number + type	veneer 2	veneer 3	laminata	solid surface	glass	field-installed top
<b>16"D x 32"W</b> Occasional table	16	32	17	<b>GTGB17-1632H17-</b> 	2,841	3,120	2,414	4,331	3,690	2,698
				Shipping wgt	35 lb	35 lb	35 lb	45 lb	45 lb	25 lb
				Cubes	7.7	7.7	7.7	7.7	7.7	7.5

<b>16"D x 50"W</b> Occasional table	16	50	17	<b>GTGB17-1650H17-</b> 	3,107	3,413	2,641	4,738	4,037	2,952
				Shipping wgt	40 lb	40 lb	40 lb	50 lb	50 lb	30 lb
				Cubes	11.7	11.7	11.7	11.7	11.7	11.4

**Note:** 16"D x 32"W occasional table can be used in-line with lounge units, but are freestanding and do not gang.

### TO ORDER PLEASE SPECIFY THE FOLLOWING:

MODEL NUMBER + TYPE	FRAME COLOR	TOP MATERIAL	TOP FINISH (WOOD TOPS ONLY)
			
<b>Note:</b> Type must be specified as part of model number. Wood Veneer <b>W</b> Laminate <b>L</b> Solid Surface <b>S</b> Glass <b>G</b> Field-Installed Top <b>F</b>	Polished Chrome <b>PC</b> \$113 - 16x32 \$142 - 16x50 Brushed Chrome Steel <b>BS</b> \$113 - 16x32 \$142 - 16x50 Black <b>P71</b> Designer White <b>PJW</b> Matte Gold <b>P8G</b> Silver <b>PR6</b> Solar Black <b>P8X</b> Titanium <b>P8T</b> Bullseye <b>PJF</b> Regatta <b>P8M</b>	See page 84-85 for required option codes.	

**Note:** Wood and laminate tops are 1 1/8" thick, rabbeted and inset to leave 1/2" thick edge detail. solid surface and glass tops are 12mm thick, with an inset 3/4" MDF subtop. Field-installed tops receive an inset 3/4" MDF subtop. Wood, laminate, solid surfaces and glass tops all have 1/16" overhang per side.

### Example

GTGB17-1632H17-W.PC.NC215.OP			
GTGB17-1632H17-W	PC	NC215	OP
MODEL NUMBER	FRAME COLOR	TOP MATERIAL	TOP FINISH

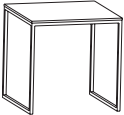

	D	W	H	model number + type	veneer 2	veneer 3	laminate	solid surface	glass	field-installed top
<b>12"D x 18"W</b> Laptop table	12	18	26	<b>GTGB17-1218H26-</b> <input type="checkbox"/>	1,951	2,143	1,659	2,975	2,538	1,853
				Shipping wgt	15 lb	15 lb	15 lb	20 lb	20 lb	10 lb
				Cubes	5.3	5.3	5.3	5.3	5.3	5.2
<b>24"D x 24"W</b> Side table	24	24	24	<b>GTGB17-2424H24-</b> <input type="checkbox"/>	3,283	3,606	2,791	5,007	4,268	3,120
				Shipping wgt	25 lb	25 lb	25 lb	30 lb	30 lb	20 lb
				Cubes	11.4	11.4	11.4	11.4	11.4	11.2

TO ORDER PLEASE SPECIFY THE FOLLOWING:

.  .  .

**MODEL NUMBER + TYPE**

**FRAME COLOR**

**TOP MATERIAL**

**TOP FINISH (WOOD TOPS ONLY)**

**Note:**

Type must be specified as part of model number.  
Wood Veneer **W**  
Laminate **L**  
Solid Surface **S**  
Glass **G**  
Field-Installed Top **F**

Polished Chrome **PC +\$85**  
Brushed Chrome Steel **BS +\$85**  
Black **P71**  
Designer White **PJW**  
Matte Gold **P8G**  
Silver **PR6**  
Solar Black **P8X**  
Titanium **P8T**  
Bullseye **PJF**  
Regatta **P8M**

See page 84-85 for required option codes.

**Note:** Wood and laminate tops are 1 1/8" thick, rabbeted and inset to leave 1/2" thick edge detail. solid surface and glass tops are 12mm thick, with an inset 3/4" MDF subtop. Field-installed tops receive an inset 3/4" MDF subtop. Wood, laminate, solid surfaces and glass tops all have 1/16" overhang per side.

Example

GTGB17-1218H26-W.PC.NC215.OP

GTGB17-1218H26-W PC NC215 OP  
MODEL NUMBER FRAME COLOR TOP MATERIAL TOP FINISH

# CYLINDER OCCASIONAL TABLES

Seating  
02/24

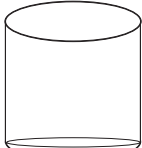
	diameter	H	model number	veneer 2
<b>CYLINDER TABLES</b> 	18	20	<b>GNTOCY1820</b>	2,309
	18	24	<b>GNTOCY1824</b>	2,390
	24	20	<b>GNTOCY2420</b>	2,980
	24	24	<b>GNTOCY2424</b>	3,111
	36	16	<b>GNTOCY3616</b>	3,852

## SUNBURST PATTERN OPTION

TOP VIEW

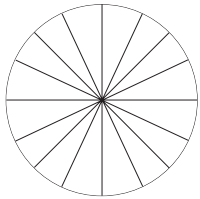

### PRODUCT INFO

TO ORDER PLEASE SPECIFY THE FOLLOWING:

<input type="text"/>	<input type="text"/>	<input type="text"/>
<b>MODEL NUMBER</b>	<b>SPECIES &amp; FINISH</b>	<b>VENEER PATTERN</b>

Select veneers:  
**Cherry**  
**Maple**

Standard veneer pattern **NP**  
Sunburst pattern **SV (+\$347)**

Please refer to [Gunlocke.com](http://Gunlocke.com)  
for standard finish options.

Example

**GNTOCY1820.NC260.NP**

GNTOCY1820	NC260	NP
<b>MODEL NUMBER</b>	<b>FINISH</b>	<b>VENEER PATTERN</b>

	D	W	H	model number	veneer 2
<b>CUBE TABLES</b>	18	18	24	<b>GNTOCB1824</b>	2,861
	24	24	20	<b>GNTOCB2420</b>	3,005
	24	24	24	<b>GNTOCB2424</b>	3,074
	36	36	16	<b>GNTOCB3616</b>	3,852

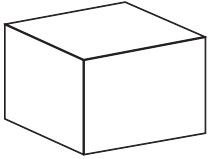

TOP VIEW

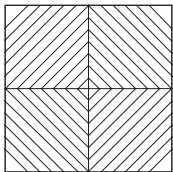

DIAMOND  
VENEER OPTION

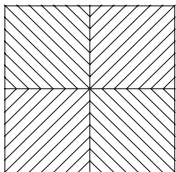

REVERSE  
DIAMOND  
VENEER OPTION

PRODUCT INFO

TO ORDER PLEASE SPECIFY THE FOLLOWING:

.  .

**MODEL NUMBER**      **SPECIES & FINISH**      **VENEER PATTERN**

Select veneers:

**Cherry**  
**Maple**

Standard veneer pattern  
Diamond pattern  
Reverse diamond

**NP**  
**DV (+\$347)**  
**RD (+\$357)**

Please refer to [Gunlocke.com](http://Gunlocke.com)  
for standard finish options.

Example

**GNTOCB1824.NC260.NP**

GNTOCB1824	NC260	NP
<b>MODEL NUMBER</b>	<b>FINISH</b>	<b>VENEER PATTERN</b>

# LETCHWORTH OCCASIONAL TABLES

**Seating**  
02/24

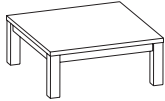
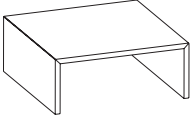
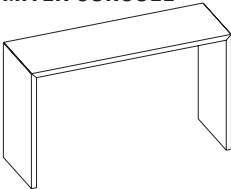
	D	W	H	model number	veneer 2	veneer 3	veneer 4
<b>PARSONS OCCASIONAL</b> 	24	24	21	<b>GABTRT21H2424-WW</b>	2,394	2,636	2,754
	36	36	17	<b>GABTRT17H3636-WW</b>	2,704	2,975	3,111
	42	42	17	<b>GABTRT17H4242-WW</b>	3,014	3,317	3,468
	24	54	17	<b>GABTRT17H2454-WW</b>	2,928	3,222	3,369
<b>MITER OCCASIONAL</b> 	24	24	21	<b>GMBTRT21H2424-WW</b>	6,806	7,488	7,828
	36	36	17	<b>GMBTRT17H3636-WW</b>	2,704	2,975	3,111
	42	42	17	<b>GMBTRT17H4242-WW</b>	3,014	3,317	3,468
	24	54	17	<b>GMBTRT17H2454-WW</b>	2,928	3,222	3,369
<b>MITER CONSOLE</b> 	20	60	36	<b>GMBTRT36H2060-WW</b>	3,372	3,688	3,849

## PRODUCT INFO

Tables are shipped in one complete piece and cannot be disassembled. Confirm elevator/doors/hallways for clearance.

## TO ORDER PLEASE SPECIFY THE FOLLOWING:

1.  MODEL NUMBER
2.  FINISH
3.  TOP FINISH

See inside front cover for required option codes

### Example

GABTRT21H2424-WW.NT629.OP  
 GABTRT21H2424-WW    NT629    OP  
 MODEL NUMBER        FINISH        TOP FINISH

THIS PAGE INTENTIONALLY LEFT BLANK

---

---

# Gunlocke®

One Gunlocke Drive  
Wayland, NY 14572  
800 828 6300

[GUNLOCKE.COM](http://GUNLOCKE.COM)

FORM #G1064.A3 (6/24)