

CONCINNITY™



Concinnity™ Executive Workstation shown with Ignition® and Grove® Seating and Flock® Tables.

CONCINNITY™

Clean styling. Rich woodgrains. Mixed materials. A coordinated suite of components. With Concinnity, you can create an upscale look for all types of office spaces — from open to collaborative to private. Choose from a variety of desk configurations and an extensive selection of storage options to create the ideal solution to fit your footprint and your needs.



FEATURES

- Cohesive visual signature highlighted by clean lines, vertical grain, and components that fit together like custom cabinetry.
- Modular design delivers an unbeatable combination of versatility, style, and personalization to any workspace.
- Wide array of aesthetic options, including edge profiles, handles, mixed materials, and laminate finish combinations.
- Extensive assortment of storage solutions allow users to increase functionality, maximize space and keep everything conveniently within reach.
- Products to create flat, continuous horizontal planes or multi-level, overlapping, layered surfaces.
- Standing-height workstations to support today's healthy work styles; available with adjustable or fixed height bases.

CONCINNITY™ ORDERING INFORMATION

WORKSURFACES

L1 LAMINATES CODES

Woodgrain

◆ Bourbon Cherry	H
◆ Cognac	COGN
◆ Florence Walnut	LFW1
◆ Harvest	C
◆ Kingswood Walnut	LK11
◆ Mahogany	N
◆ Mocha	MOCH
◆ Natural Maple	D
◆ Pinnacle	PINC
◆ Shaker Cherry	F
◆ Sterling Ash	LSA1

Solid

◆ Black	P
◆ Charcoal	S
◆ Designer White	LDW1
◆ Loft	LOFT

Patterned

◆ Sheer Mesh	A5
◆ Silver Mesh	B9

L2 LAMINATES CODES

Woodgrain

◆ Lowell Ash	LLA1
◆ Natural Recon	LNRI
◆ Phantom Ecru	LPE1
◆ Portico Teak	LPT1
◆ Skyline Walnut	LSW1

DRAWER AND DOOR FRONTS

L1 LAMINATES CODES

Woodgrain

◆ Bourbon Cherry	H
◆ Cognac	COGN
◆ Florence Walnut	LFW1
◆ Harvest	C
◆ Kingswood Walnut	LK11
◆ Mahogany	N
◆ Mocha	MOCH
◆ Natural Maple	D
◆ Pinnacle	PINC
◆ Shaker Cherry	F
◆ Sterling Ash	LSA1

Solid

◆ Black	P
◆ Charcoal	S
◆ Designer White	LDW1
◆ Loft	LOFT

Patterned

◆ Sheer Mesh	A5
◆ Silver Mesh	B9

L2 LAMINATES CODES

Woodgrain

◆ Lowell Ash	LLA1
◆ Natural Recon	LNRI
◆ Phantom Ecru	LPE1
◆ Portico Teak	LPT1
◆ Skyline Walnut	LSW1

HANDLE/LOCK

FINISHES CODES

P1

◆ Black	P
◆ Satin	SA

CHASSIS, END, MODESTY, AND BACK PANELS

L1 LAMINATES CODES

Woodgrain

◆ Bourbon Cherry	H
◆ Cognac	COGN
◆ Florence Walnut	LFW1
◆ Harvest	C
◆ Kingswood Walnut	LK11
◆ Mahogany	N
◆ Mocha	MOCH
◆ Natural Maple	D
◆ Pinnacle	PINC
◆ Shaker Cherry	F
◆ Sterling Ash	LSA1

Solid

◆ Black	P
◆ Charcoal	S
◆ Designer White	LDW1
◆ Loft	LOFT

L2 LAMINATES CODES

Woodgrain

◆ Lowell Ash	LLA1
◆ Natural Recon	LNRI
◆ Phantom Ecru	LPE1
◆ Portico Teak	LPT1
◆ Skyline Walnut	LSW1

HMBPOST AND HMBTLEG24

PAINTS CODES

P1

◆ Black	P
---------------	---

P2

◆ Platinum Metallic	T1
---------------------------	----

SILVER COLORWAY: The following finish options are coordinating silver colorways — Satin, Satin Nickel, Matte Chrome, Platinum, and Platinum Metallic.

EDGE PROFILES “B” AND “V”

EDGEBAND COLORS CODES

Woodgrain

◆ Bourbon Cherry	H
◆ Cognac	COGN
◆ Florence Walnut	FW
◆ Harvest	C
◆ Kingswood Walnut	KI
◆ Mahogany	N
◆ Mocha	MOCH
◆ Natural Maple	D
◆ Pinnacle	PINC
◆ Shaker Cherry	F
◆ Sterling Ash	SA

EDGE PROFILE “G”

EDGEBAND COLORS CODES

Woodgrain

◆ Bourbon Cherry	H
◆ Cognac	COGN
◆ Florence Walnut	FW
◆ Harvest	C
◆ Kingswood Walnut	KI
◆ Lowell Ash	DL
◆ Mahogany	N
◆ Mocha	MOCH
◆ Natural Maple	D
◆ Natural Recon	NR
◆ Phantom Ecru	PE
◆ Pinnacle	PINC
◆ Portico Teak	DP
◆ Shaker Cherry	F
◆ Skyline Walnut	SW
◆ Sterling Ash	SA

Solid

◆ Black	P
◆ Charcoal	S
◆ Designer White	DW
◆ Loft	LOFT

Pattern laminates do not have a matching edgeband color; they are available with a woodgrain or solid color edge.

◆◆◆ For lead time information see page 19.

CONCINNITY™ ORDERING SPECIFICATION/MODEL LOGIC

DESKS	
Double Pedestal Desk	Model Edge Profile + Edge Color Handle Worksurface Grommet Finish Worksurface Color Chassis Color Drawer Front Color
Single Pedestal Desk (Left & Right)	Model Edge Profile + Edge Color Handle Worksurface Grommet Finish Worksurface Color Chassis Color Drawer Front Color
CREDENZAS	
Credenza w/ Storage	Model Edge Profile + Edge Color Handle Worksurface Grommet Finish Worksurface Color Chassis Color Drawer/Door Front Color
Credenza w/ Kneespace	Model Edge Profile + Edge Color Handle Worksurface Grommet Finish Worksurface Color Chassis Color Drawer Front Color
Credenza w/ Lateral File (Left & Right)	Model Edge Profile + Edge Color Handle Worksurface Grommet Finish Worksurface Color Chassis Color Drawer Front Color
Single Pedestal Credenza (Left & Right)	Model Edge Profile + Edge Color Handle Worksurface Grommet Finish Worksurface Color Chassis Color Drawer Front Color
Credenzas - Low/Bench-Height	Model Edge Profile + Edge Color Handle Top Color Chassis Color Drawer Front Color
RETURNS	
Return (Left & Right)	Model Edge Profile + Edge Color Handle Worksurface Grommet Finish Worksurface Color Chassis Color Drawer Front Color
BULLET PENINSULA	
Bullet Peninsula	Model Edge Profile + Edge Color Worksurface Color Chassis Color
BRIDGES	
Bridge	Model Edge Profile + Edge Color Worksurface Grommet Finish Worksurface Color Chassis Color
CORNER UNITS	
Corner Unit	Model Edge Profile + Edge Color Worksurface Grommet Finish Worksurface Color Chassis Color
JETTY PENINSULAS	
Jetty Peninsula	Model Edge Profile + Edge Color Worksurface Grommet Finish Worksurface Color Chassis Color
STACK-ON STORAGE	
Stack-On Storage w/ Laminate Doors	Model Chassis Color Door Front Color
Stack-On Storage w/ Laminate Locking Doors	Model Lock Finish Chassis Color Door Front Color
Stack-On Storage w/ Frosted Doors	Model Chassis Color
Stack-On Storage w/ Sliding Door	Model Chassis Color Door Front Color
Stack-On Space Saver End Panels	Model Laminate Color
WALL MOUNTED STORAGE	
Wall Mounted Storage w/ Laminate Doors	Model Chassis Color Door Front Color
Wall Mounted Storage w/ Laminate Locking Doors	Model Lock Finish Chassis Color Door Front Color
Wall Mounted Storage w/ Frosted Doors	Model Chassis Color
Wall Mounted Storage w/ Sliding Door	Model Chassis Color Door Front Color
BOOKCASE HUTCHES	
Bookcase Hutch - No Doors/Open	Model Laminate Color
Bookcase Hutch w/ Laminate Doors	Model Handle Chassis Color Door Front Color
Bookcase Hutch w/ Frosted Doors	Model Laminate Color
RECEPTION STATIONS	
Reception Station	Model Edge Profile Edge Color Counter Color Chassis Color
Reception Station Counter	Model Edge Profile + Edge Color Counter Color Chassis Color
L-Reception Station Counter	Model Edge Profile + Edge Color Counter Color Chassis Color
Reception Desk with Transaction Counter	Model Edge Profile + Edge Color Worksurface Grommet Color Worksurface Color Chassis Color Accent Color
Reception Return with Transaction Counter	Model Edge Profile + Edge Color Worksurface Color Chassis Color
L-Reception Station with Transaction Counter	Model Edge Profile + Edge Color Counter Color Chassis Color
Transaction Counter Organizer	Model Edge Profile + Edge Color Counter Color Chassis Color
LATERAL FILES & STORAGE CABINETS	
Lateral File	Model Edge Profile + Edge Color Handle Top Color Chassis Color Drawer Front Color
Storage Cabinet - 78 $\frac{1}{8}$ " and 64 $\frac{3}{4}$ "H	Model Handle Chassis Color Door Front Color
Storage Cabinet - 29 $\frac{1}{2}$ "H	Model Edge Profile + Edge Color Handle Top Color Chassis Color Door Front Color
Storage/File Cabinet - No Doors/Open	Model Handle Chassis Color Drawer Front Color
Storage/File Cabinet w/ Laminate Door	Model Handle Chassis Color Door & Drawer Front Color
Storage Cabinet/Lateral File	Model Handle Chassis Color Door & Drawer Front Color

CONCINNITY™ ORDERING SPECIFICATION/MODEL LOGIC

WARDROBES	
Wardrobe/Storage Cabinet	Model Handle Chassis Color Door Front Color
Wardrobe/Bookcase	Model Handle Chassis Color Door Front Color
STORAGE TOWERS	
24"W Storage Tower	Model Handle Chassis Color Door & Drawer Front Color
18"W Storage Tower	Model Handle Chassis Color Door Front Color
BOOKCASES	
Bookcase	Model Edge Profile and Edge Color Top Color Chassis Color
Bookcase w/ Coat Hooks	Model Laminate Color
WORKSURFACES	
Rectangle Worksurface	Model Edge Profile + Edge Color Grommet Worksurface Color
Bow Worksurface	Model Edge Profile + Edge Color Grommet Worksurface Color
Bullet Worksurface	Model Edge Profile + Edge Color Grommet Worksurface Color
Extended Corner Worksurface	Model Edge Profile + Edge Color Worksurface Grommet Worksurface Color End Panel Color
PANELS & LEGS	
27 ¹ / ₈ "H Modesty/Back Panel	Model Grommet Laminate Color
10"H Modesty/Back Panel	Model Laminate Color
10"H Modesty Panel for Desks with O-Legs	Model Laminate Color
14"H Floating Modesty Panel	Model Laminate Color or Mixed Material
Half-Height Modesty Panel	Model Laminate Color
Full-Height Modesty Panel	Model Laminate Color
Full Back Panel for Pedestals - 30" & 36"W x 27 ¹ / ₈ "H	Model Grommet Laminate Color
Full Back Panel for Pedestals - 9 ¹ / ₂ ", 15 ³ / ₄ ", & 18"W	Model Laminate Color
Full Back Panel for Pedestals - 9 ¹ / ₂ " & 15 ³ / ₄ "W x 40 ³ / ₈ "H	Model Laminate Color
Low Back Panel for Pedestal	Model Laminate Color
Laminate End Panel - 1 ¹ / ₈ "W x 28 ¹ / ₂ " or 41"H	Model Grommet Laminate Color
Laminate End Panel - 1 ¹ / ₈ "W x 7"H	Model Laminate Color
Laminate End Panel - L-Shape	Model Grommet Laminate Color
Laminate End Panel - T-Shape	Model Laminate Color
Laminate End Panel - Kneespace Clearance	Model Laminate Color
Laminate End Panel - Support Brace	Model Laminate Color
Metal O-Leg	Model Paint Color
PEDESTALS	
Pedestal - Narrow Box/Box/File	Model Handle Grommet Chassis Color Drawer Front Color
Pedestal - Narrow File/File	Model Handle Grommet Chassis Color Drawer Front Color
Pedestal - Box/Box/File	Model Handle Grommet Chassis Color Drawer Front Color
Pedestal - File/File	Model Handle Grommet Chassis Color Drawer Front Color
Pedestal - Lateral File	Model Handle Grommet Chassis Color Drawer Front Color
Pedestal - Shelf/Box/Box/Lateral File	Model Handle Grommet Chassis Color Drawer Front Color
Pedestal - Storage Cabinet	Model Handle Grommet Chassis Color Door Front Color
Pedestal - Bookcase	Model Grommet Chassis Color
Pedestal - Bookcase End Support	Model Chassis Color
Mobile Pedestal - Box/Box/File, File/File, Box/File	Model Handle Chassis Color Drawer Front Color
Mobile Pedestal - 30"W Shelf/File/Cabinet	Model Edge Profile + Edge Color Handle Top Color Chassis Color Drawer/Door Front Color
Pedestal Tops	Model Edge Profile + Edge Color Top Color
Pedestal - Box/Box/File/File	Model Handle Grommet Chassis Color Drawer Front Color
Pedestal - Shelf/Box/Box/File	Model Handle Grommet Chassis Color Drawer Front Color
Pedestal - Narrow Box/Box/File/File	Model Handle Grommet Chassis Color Drawer Front Color
ACCESSORIES	
Laminate Center Drawer	Model Laminate Color
Collaborative Desk Shelf	Model Laminate Color
Wall Mount Markerboard	Model
Wall Mount Tackboard	Model Fabric
Field Installable Grommet	Model
Lock Core Kit	Model

CONCINNITY™ LAMINATE DESIGN/MATERIALS INFORMATION

STYLING AND CONSTRUCTION

- Conventional desking or light scale components.
- Clean, uninterrupted lines and precise fits; no gaps.
- All end, modesty, and back panels, as well as drawer and door fronts, that are specified in a woodgrain color, feature vertical grain; drawer fronts are vertically-aligned, continuous grain and are matched sets.
- All desk, credenza, and return models feature full-to-the-floor pedestals to maximize storage space.
- Factory-configured (i.e., built-up; assembled) 72"W desks can be specified with breakfront or recessed modesty panels.
- Formal, full height modesty panels on factory-configured (i.e., built-up; assembled) desks, credenzas, and returns; modular components available with full or 10" modesty panels.
- Drawer and door fronts over end panels.
- Back panel-over-end panel on desks, credenzas, returns, mobile pedestals, 29½"H lateral files and storage cabinets, and full-length modesty panels for modular pedestals.
- Top-between-end panels on stack-on and wall mount storage, 66⅝"H & 79½"H storage and combination storage cabinets, wardrobes and towers.
- Option choices include:
 - Edge profile and edge color
 - Handle design
 - Handle/worksurface grommet/lock face finish
 - Worksurface color
 - Chassis color
 - Drawer front/door color
- **IMPORTANT NOTE:** Designed and sized to coordinate with 65"H Accelerate® Panels.
 - Desks, credenzas, returns, 2-drawer lateral files, and 29½"H storage cabinets, plus 35¼"H stack-on storage or bookcase hutch, are 64¾"H.
 - Additional solutions ≤65"H include the following: storage cabinet, storage/file cabinet, storage cabinet/lateral file, 18" and 36"W wardrobe/storage cabinets, wardrobe/bookcase, storage tower, and 5-shelf bookcase.

MATERIALS

- Easy-care, scratch-, spill- and stain-resistant thermal-fused laminate (TFL) over solid core, high performance particleboard;
 - Component model thickness: 1⅛" worksurfaces and end panels; ¾" modesty panel and drawer/door fronts.
- Durable, impact-resistant banding protects edges.

- Bottom of end panels on base units and stack-ons feature edgebanding for added strength and to seal out moisture.
- HPL worksurfaces are available via special request.

DRAWER SPECIFICATIONS

- Operate on steel ball-bearing slides to ensure smooth, quiet, long-lasting operation.
- Full extension drawers allow complete access to contents.
- Drawers feature 5-sided construction for added strength and easy alignment or replacement of drawer fronts.
- File drawers include integrated hangrails for side-to-side letter or legal filing; and front-to-back for letter filing.
- One molded black pencil tray is included in each box/box/file pedestal.
- Drawer fronts are edgebanded on all four sides.

CORE REMOVABLE LOCKS

- All drawers/doors lock on the following products:
 - All desk, credenza, and return pedestals (NOTE: The lock is on the face of the pedestal)
 - Stack-on and wall mount storage with laminate locking doors ("LL" models)
 - Wall mount storage with sliding door
 - Mobile pedestals
 - Lateral files
 - Storage cabinets
 - Storage/file cabinet
 - Storage cabinet/lateral file
 - Wardrobe/storage cabinets
 - Storage towers
 - Modular pedestals
- On products that are equipped with two locks, the locks are keyed alike:
 - Double pedestal desks
 - Credenza with storage
 - Credenzas with kneespace
 - Low credenzas with four drawers
 - Storage and combination storage/file cabinets
 - Storage towers
 - Stack-on and wall mount storage 60" - 78"W
- Lock faces are available in black or satin.

CONCINNITY™

LAMINATE DESIGN/MATERIALS INFORMATION

- Locks feature a removable cylinder (core) that can be interchanged as needed; allows all furniture pieces within an individual workstation to be accessed with one key for convenience, and allows locks to be differentiated between workstations and offices for security. Makes re-keying quick and easy.
 - Keyed alike cores must be ordered separately by specification of the key number. For all products, except stack-on and wall mounted storage, the removable lock core kits are HF23B for Black and HF23S for Satin (Silver).
 - EXCEPTION - IMPORTANT - NOTE: The removable lock core kit for stack-on and wall mounted storage is model HF27B (Black) or HF27S (Satin).

CORD MANAGEMENT

- Cord management grommets and pass-through cutouts, for routing and hiding wires and cables, are standard in a pre-determined location on a number of factory-configured (i.e., built-up; assembled) products:
 - Two grommets are located in the tops of desks and credenzas; one grommet is located in the top of returns, bridges, jetty peninsulas, and corner units.
 - All desk, credenza, and return pedestals are designed with two cord pass-through grommets, one per side; end panels of single pedestal desks and single pedestal credenzas feature one cord pass-through grommet.
 - Pass-through in the sides of pedestals and end panels enable the routing of cords below the worksurface and connections between workstations.
 - A pass-through grommet, to facilitate reaching wall electrical outlets, is located in the back panels of credenza with storage, credenza with kneespace, single pedestal credenzas, credenzas with 36" lateral file, returns and bridges.
- See chart on page 36 for cord management options. Worksurfaces/tops, end and modesty panels, and pedestals can be specified with or without grommets.
- Grommets on worksurfaces are sized to accept optional grommet mount power hub (HGRMTAC) and USB (HGRMTUSB2) models.

- Grommet color/shape/size:
 - Worksurfaces, Black or Platinum, Round, 3" diameter hole with a 3½" plastic cap.
 - Back/modesty panels, Black, Round, 2½" diameter hole with a 3" plastic cap.
 - End panels and pedestal sides, Black, Half-round, 1¾" diameter hole with a 2" x 2½" plastic cap.

LEVELING GLIDES

- Adjustable hex glides to compensate for uneven floors; allow furniture to be easily leveled without lifting the unit.
 - Glides have a 1¼" adjustable range.
 - The hex adjustment is on the foot of the glide for all products except for the 9½", 15¾", and 18"W modular pedestals, in which case it is on the top of the glide stem.

IMPORTANT — OTHER







- Products ship fully assembled, unless otherwise noted (NOTE:  — easy-to-assemble — items are designated in the "DESCRIPTIONS").
- All models must meet or exceed ANSI/BIFMA & ISTA performance standards.
- Products covered by HON Limited Lifetime Warranty.
- Indoor Advantage™ Gold. Indoor Air Quality Certified to SCS-EC10.3-2014 v3.0.
- BIFMA level® 2 certified. Conforms to ANSI/BIFMA e32014e Furniture Sustainability Standard.

CONCINNITY™

LAMINATE ORDERING/SPECIFICATION INFORMATION

WORKSURFACE/TOP EDGE DETAILS

- Three options; two contoured profiles and one smooth, flat edge.
- For beaded (B) and tri-oval (V) edge shapes, tops are profiled on the user and approach sides, and flat on the ends; the flat edges allow side-by-side placement of worksurfaces without gaps. The only exceptions are return, bridge, corner unit, extended corner worksurface, and rectangle worksurface with vertical grain models, tops on these items are profiled on the user's side and flat banded on the approach side and ends.
 - Bookcases have profiled edge on the front, user side only.
 - The reception station transaction counter and the L-reception station with transaction counter (for the desk) models, have profiled edgeband on the approach and user sides.
 - The L-reception station with the transaction counter models, on which the counter runs around the entire perimeter of the L-configuration, have a profiled edge on the front of the transaction counter on the desk approach side only.

Edge Options:	Profiles	Designator
Beaded		 B
Smooth, Flat		 G
Tri-Oval		 V

WORKSURFACE EDGE COLORS

- Woodgrain and solid color laminates can be specified with a matching, complementary, or contrasting edgeband color; options include:
 - Matching the worksurface edge to a common worksurface, chassis, and drawer front color.
 - Matching the worksurface edge to the worksurface laminate and selecting a different laminate color for the chassis.
 - Matching the worksurface edge to the chassis laminate and selecting a different laminate color for the worksurface.

- Beaded (B) and tri-oval (V) edges are available in L1 woodgrain colors only.
- The smooth, flat (G) edge is available in woodgrain and solid colors.
- Pattern laminates do not have a matching edgeband color; the patterns are available with a woodgrain or solid color edge.

DRAWER/DOOR DECORATIVE HANDLES

- Three handle style options, each available in Satin or Black finish.
- Distinct, easy to grasp designs.
- Handles are metal.
- The hole spacing is 128mm.
- The handle style/finish has to be specified on drawer fronts (desk/credenza/return, mobile and modular pedestals), lateral file drawer fronts, the doors of the storage cabinet, storage/file cabinet, storage cabinet/lateral file, wardrobe/storage cabinet, wardrobe/bookcase, and storage tower.
 - NOTE: Decorative handles are not used on the doors of stack-on storage units or wall mounted storage cabinets.
 - Bookcase hatches with frosted doors are equipped with a push latch release.

Handle Options	Finish	Designator
Cylinder	Satin	A
Cylinder	Black	B
Canopy	Satin	C
Canopy	Black	D
Loop	Satin	E
Loop	Black	F

- NOTE: The Linear and Arch field installable drawer/door handle kit models can be attached using 128mm hole spacing.

LAMINATE ORDERING/SPECIFICATION INFORMATION

CORD MANAGEMENT GROMMETS

- Grommets are standard on desk, credenza, return, bridge, jetty peninsula, and corner unit models. Specification logic includes the grommet finish for tops; choose from Black (P) or Platinum (T1). Grommets in modesty and end panels are Black only.
- Grommets are optional on modular component worksurfaces, full-length (27⁷/₈"H) modesty panels, end panels (1¹/₈", L-shaped) and the sides of support storage pedestals. On worksurfaces, choose from Black (P), Platinum (T1), or no grommet(s) (X). On modesty, end, and side panels the options are grommet Black (P) or no grommet (X).
- See cord management chart on page 36 for details.

LOCK FINISH

- Finish is determined by, and automatically aligned with, the handle finish specified. If there is no decorative handle on the product, such as on locking stack-on or wall mount storage models, the lock finish is specified separately in the option string.
 - When specification is required, the lock finish options are Black (P) or Satin (SA).
- Removable, interchangeable lock core kits must be ordered separately:
 - For all models, except stack-on and wall mount storage, specify model HF23B (Black) or HF23S (Satin), and the specific key number required.
 - For stack-on and wall mount storage, specify model HF27B (Black) or HF27S (Satin), and the specific key number required.

SILVER COLORWAY

- The following finish options are coordinating Silver colorways: Satin, Satin Nickel, Matte Chrome, Platinum, and Platinum Metallic.

LAMINATE COLORS

- Palette choices include eight (15) woodgrain, four (4) solid, and two (2) pattern colors.

Woodgrain		Solid Color		Pattern	
Bourbon Cherry	H	Black	P	Sheer Mesh	A5
Cognac	COGN	Charcoal	S	Silver Mesh	B9
Florence Walnut	LFW1	Designer White	LDW1		
Harvest	C	Loft	LOFT		
Kingswood Walnut	LK11				
Lowell Ash	LLA1				
Mahogany	N				
Mocha	MOCH				
Natural Maple	D				
Natural Recon	LNR1				
Phantom Ecru	LPE1				
Pinnacle	PINC				
Portico Teak	LPT1				
Shaker Cherry	F				
Skyline Walnut	LSW1				
Sterling Ash	LSA1				

- Worksurface, chassis and drawer/door fronts are specified separately to enable a single, color-matched visual, or a complementary or contrasting, multi-tone aesthetic.
- Worksurfaces/tops are available in woodgrain, solid, or pattern laminate colors.
- Chassis and drawer fronts are available in woodgrain or solid laminate colors.
- Pattern colors are available on worksurface tops only.

Worksurface		Chassis		Drawer/Door	
Bourbon Cherry	H	Bourbon Cherry	H	Bourbon Cherry	H
Cognac	COGN	Cognac	COGN	Cognac	COGN
Florence Walnut	LFW1	Florence Walnut	LFW1	Florence Walnut	LFW1
Harvest	C	Harvest	C	Harvest	C
Kingswood Walnut	LK11	Kingswood Walnut	LK11	Kingswood Walnut	LK11
Lowell Ash	LLA1	Lowell Ash	LLA1	Lowell Ash	LLA1
Mahogany	N	Mahogany	N	Mahogany	N
Mocha	MOCH	Mocha	MOCH	Mocha	MOCH
Natural Maple	D	Natural Maple	D	Natural Maple	D
Natural Recon	LNR1	Natural Recon	LNR1	Natural Recon	LNR1
Phantom Ecru	LPE1	Phantom Ecru	LPE1	Phantom Ecru	LPE1
Pinnacle	PINC	Pinnacle	PINC	Pinnacle	PINC
Portico Teak	LPT1	Portico Teak	LPT1	Portico Teak	LPT1
Shaker Cherry	F	Shaker Cherry	F	Shaker Cherry	F
Skyline Walnut	LSW1	Skyline Walnut	LSW1	Skyline Walnut	LSW1
Sterling Ash	LSA1	Sterling Ash	LSA1	Sterling Ash	LSA1
Black	P	Black	P	Black	P
Charcoal	S	Charcoal	S	Charcoal	S
Designer White	LDW1	Designer White	LDW1	Designer White	LDW1
Loft	LOFT	Loft	LOFT	Loft	LOFT
Sheer Mesh	A5				
Silver Mesh	B9				

- Two-tone color options allow specification of different, complementary laminate combinations:

Color #1	Color #2
Top	Chassis and Drawer Fronts
Top and Drawer Fronts	Chassis
Top and Chassis	Drawer Fronts

- Modesty panels and the backs of storage chassis that are specified in L2 laminates and wider than 60"W will ship as horizontal grain.

CONCINNITY™ CORD MANAGEMENT

	GROMMET	# OF GROMMETS	LOCATION	CUTOUT SHAPE	MATERIAL	COLOR/FINISH
BUILT-UP/FACTORY-CONFIGURED						
DESK						
Top	Standard/Fixed Location	2	Back Left & Right	3" Round	Plastic	Black or Platinum
End Panel	Standard/Fixed Location	2 (1 per EP)	Top Back Corner	1¼" Round	Plastic	Black
Modesty/Back	Not Available	0	N/A	N/A	N/A	N/A
CREDENZA						
Top	Standard/Fixed Location	2	Back Left & Right	3" Round	Plastic	Black or Platinum
End Panel	Standard/Fixed Location	2 (1 per EP)	Top Back Corner	1¼" Round	Plastic	Black
Modesty/Back	Standard/Fixed Location	1	Top Center	2½" Round	Plastic	Black
RETURN						
Top	Standard/Fixed Location	1	Top Center	3" Round	Plastic	Black or Platinum
End Panel	Standard/Fixed Location	1	Top Back Corner	1¼" Round	Plastic	Black
Modesty/Back	Standard/Fixed Location	1	Top Center	2½" Round	Plastic	Black
BRIDGE						
Top	Standard/Fixed Location	1	Back Center	3" Round	Plastic	Black or Platinum
Modesty/Back	Standard/Fixed Location	1	Top Center	2½" Round	Plastic	Black
BULLET PENINSULA						
Top	Not Available	0				
End Panel	Not Available; Pass-Thru in Brace Panel	0				
JETTY PENINSULA						
Top	Standard/Fixed Location	1	Back, Approach-Side Corner	3" Round	Plastic	Black or Platinum
End Panel	Not Available; Pass-Thru Standard in Brace Panel	0				
CORNER UNIT						
Top	Standard/Fixed Location	1	Back Corner	3" Round	Plastic	Black or Platinum
Modesty/Back	Not Available; Pass-Thru Standard in Brace Panels	0				
Stack-on	Standard/Fixed Location	1	1¼" Side-to-Side Gap at Top or Bottom of Back Panel, Below Cabinet			
MODULAR COMPONENTS – WORKSURFACES						
Rectangle – 60" to 96"W	Optional – Specify: Black (P) or Platinum (T1) or None (X)	2	Back Left & Right	3" Round	Plastic	Black or Platinum
Rectangle – 30" to 54"W	Optional – Specify: Black (P) or Platinum (T1) or None (X)	1	Back Center	3" Round	Plastic	Black or Platinum
Bullet Shape	Optional – Specify: Black (P) or Platinum (T1) or None (X)	1	Centered Along EP; Over Brace Leg Cutout	3" Round	Plastic	Black or Platinum
Ext. Corner	Optional – Specify: Black (P) or Platinum (T1) or None (X)	1	Back Corner of Top and Long End Panel	3" Round	Plastic	Black or Platinum
MODULAR COMPONENTS – MODESTY PANELS						
Full-Length – ≥30"W	Optional – Specify: Black (P) or None (X)	1	Top Center	2½" Round	Plastic	Black
10"	No	0				
MODULAR COMPONENTS – END PANELS						
1½" Thick	Optional – Specify: Black (P) or None (X)	1	Top Back Corner	1¼" Round	Plastic	Black
T-Shaped	No	0				
L-Shaped	Optional – Specify: Black (P) or None (X)	1	Top or Bottom Centered	1¼" Round	Plastic	Black
MODULAR COMPONENTS – STORAGE PEDESTALS						
Pedestal	Optional – Specify: Black (P) or None (X)	2 (1 per EP)	Top Back Corner	1¼" Round	Plastic	Black

NOTE: If customer wants a desk, credenza, return, or bridge without grommets, they can specify modular components.

Grommet Locations in Tops

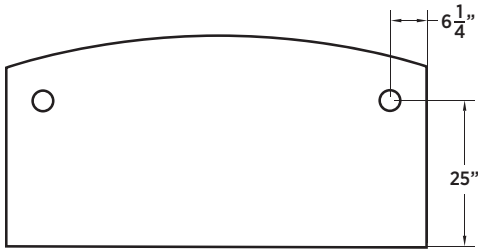

Bow Top Desks and Worksurfaces

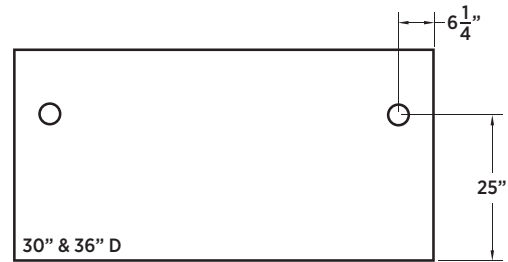

Desks and Rectangle Worksurfaces

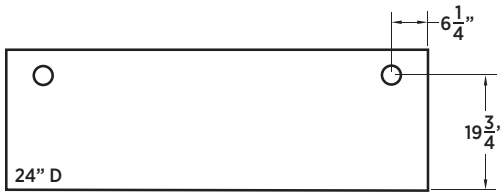

Credenzas and Rectangle Worksurfaces

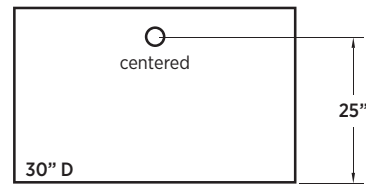

Rectangle Worksurfaces

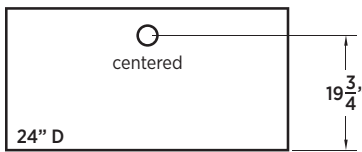

Returns, Bridges, and Rectangle Worksurfaces

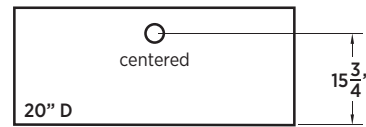

Rectangle Worksurfaces



Bullet Worksurfaces

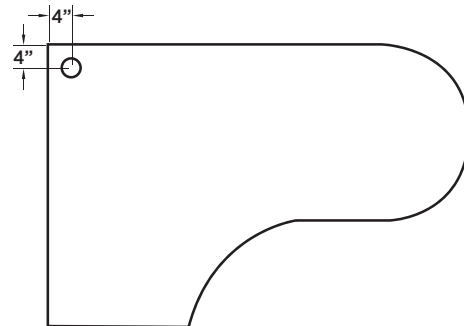

Jetty Peninsula

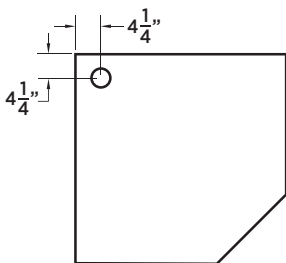

Corner Unit

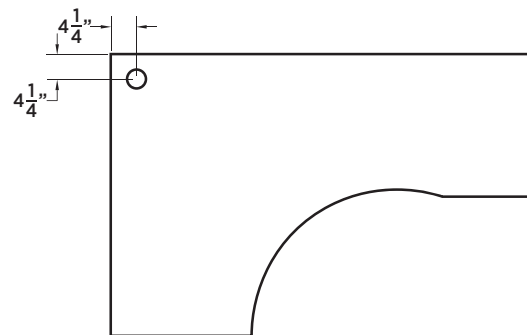

Extended Corner Worksurfaces

CONCINNITY™

Typicals



Icon Legend on page 19

QTY	DESCRIPTION	MODEL	LIST PRICE	PRICE EXTENSION
1	Double Pedestal Desk, Bow Top, Breakfront Frosted Modesty Panel 72"W x 36"D x 29½"H	HNL3672DPBBF	\$2,883	\$2,883
1	Credenza with Kneespace 72"W x 24"D x 29½"H	HNL2472DPK	\$1,818	\$1,818
1	Wall Mount Storage, Frosted Doors with Silver Frame 72"W x 15"D x 28½"H	HNL2972FD	\$2,361	\$2,361
1	Storage/File Cabinet, Hinged Right 18"W x 24"D x 64¾"H	HNL241865SFLR	\$1,740	\$1,740
1	Storage/File Cabinet, Hinged Left 18"W x 24"D x 64¾"H	HNL241865SFL	\$1,740	\$1,740
TOTAL:			\$10,542	

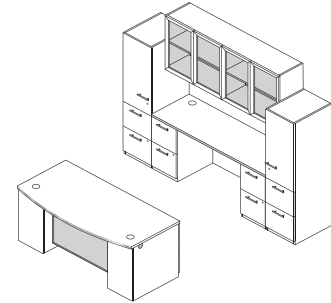
**DESK — CREDENZA — STORAGE**

QTY	DESCRIPTION	MODEL	LIST PRICE	PRICE EXTENSION
1	Left Pedestal Desk, Rectangle Top, Breakfront Modesty Panel 72"W x 36"D x 29½"H	HNL3672LPRB	\$1,911	\$1,911
1	Rectangle Worksurface with Vertical Grain 42"W x 24"D	HNLRC2442V	\$256	\$256
1	Narrow File/File Pedestal 9½"W x 23⅞"D x 28½"H	HNL231028PFF	\$690	\$690
1	Modesty/Back Panel — Full-Length 42"W x 27⅞"H	HNLMP4228	\$204	\$204
1	Stack-on Storage, Sliding Door 78"W x 15"D x 35¼"H	HNL3678SD	\$1,267	\$1,267
1	Storage/File Cabinet, Open Shelves 18"W x 24"D x 64¾"H	HNL241865SFX	\$1,651	\$1,651
TOTAL:			\$5,979	

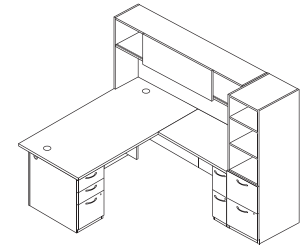
**L-WORKSTATION**

QTY	DESCRIPTION	MODEL	LIST PRICE	PRICE EXTENSION
1	Rectangle Worksurface 72"W x 30"D	HNLRC3072	\$429	\$429
1	Narrow Box/Box/File Pedestal 9½"W x 29⅞"D x 28½"H	HNL291028PBBF	\$772	\$772
1	Full Back Panel — For 9½"W Pedestal 9½"W x 27⅞"H	HNLPB1028	\$125	\$125
1	Laminate Floating Modesty Panel 36"W x 14"H	HLSL3614L	\$179	\$179
1	Bookcase End Support 12"W x 30"D x 28½"H	HNL123028BKE	\$507	\$507
1	Rectangle Worksurface 72"W x 24"D	HNLRC2472	\$366	\$366
1	Shelf/Box/Box/Lateral File Pedestal 36"W x 23⅞"D x 28½"H	HNL233628PSL	\$1,245	\$1,245
1	Storage Cabinet Pedestal 36"W x 23⅞"D x 28½"H	HNL233628PSC	\$810	\$810
1	Modesty/Back Panel — Full-Length 72"W x 27⅞"H	HNLMP7228	\$285	\$285
1	Stack-on Storage, Sliding Door 72"W x 15"D x 35¼"H	HNL3672SD	\$1,229	\$1,229
1	Bookcase with Coat Hooks, 5-Shelf, Left 24"W x 24"D x 64¾"H	HNL2424BK5CL	\$958	\$958
TOTAL:			\$6,905	

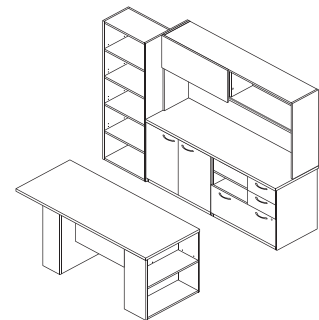
**DESK — CREDENZA — STORAGE**



Icon Legend on page 19

CONCINNITY™ Typicals

QTY	DESCRIPTION	MODEL	LIST PRICE	PRICE EXTENSION
1	Rectangle Worksurface 60"W x 24"D	HNLRC2460	\$325	\$325
1	Height Adjustable Base	HHAB3S2L	\$1,120	\$1,120
1	Rectangle Worksurface 84"W x 24"D	HNLRC2484	\$493	\$493
1	End Panel, Left 1½"W x 23⅞"D x 28½"H	HNL2428L	\$204	\$204
1	Shelf/Box/Box/Lateral File Pedestal 36"W x 23⅞"D x 28½"H	HNL233628PSL	\$1,245	\$1,245
1	Modesty/Back Panel — Short 84"W x 10"H	HNLMP8410	\$347	\$347
1	Low Back Panel — For 28½"H Pedestal 36"W x 18"H	HNLB3618	\$149	\$149
2	Stack-on Storage, Frosted Doors with Silver Frame 42"W x 15"D x 35¼"H	HNL3642FD	\$1,313	\$2,626
1	Space Saver End Panels for Stack-on Storage ¾"W x 14¼"D x 35¼"H	HNL3605SSEP	\$379	\$379
1	Wardrobe/Storage Cabinet, Hinged Right 18"W x 24"D x 64¾"H	HNL241865WLR	\$1,590	\$1,590

TOTAL: \$8,478

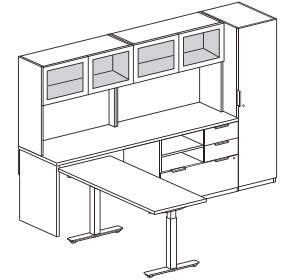

L-WORKSTATION WITH HEIGHT-ADJUSTABLE DESK — OPEN PLAN

QTY	DESCRIPTION	MODEL	LIST PRICE	PRICE EXTENSION
1	Bullet Worksurface 84"W x 30"D	HNLBU3084	\$602	\$602
1	T-Shaped End Panel — For Bullet Worksurface 11⅝"W x 29⅞"D x 28½"H	HNLTEP3028	\$353	\$353
1	Support Column — For Bullet Worksurface 4½" Diameter	HPC190X	\$161	\$161
1	Bridge 48"W x 24"D x 29½"H	HNL2448BF	\$448	\$448
1	Rectangle Worksurface 84"W x 24"D	HNLRC2484	\$493	\$493
1	End Panel, Left 1½"W x 23⅞"D x 28½"H	HNL2428L	\$204	\$204
1	Shelf/Box/Box/Lateral File Pedestal 36"W x 23⅞"D x 28½"H	HNL233628PSL	\$1,245	\$1,245
1	Modesty/Back Panel — Full-Length 84"W x 27⅞"H	HNLMP8428	\$347	\$347
2	Stack-on Storage, Laminate Doors 42"W x 15"D x 48⅝"H	HNL4942LD	\$1,206	\$2,412
1	Space Saver End Panels for Stack-on Storage ¾"W x 14¼"D x 48⅝"H	HNL4905SSEP	\$513	\$513

TOTAL: \$6,778

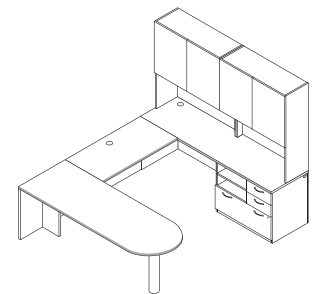

U-WORKSTATION WITH 84" W WORKSURFACE

QTY	DESCRIPTION	MODEL	LIST PRICE	PRICE EXTENSION
1	Left Pedestal Desk, Rectangle Top, Breakfront Frosted Modesty Panel 72"W x 36"D x 29½"H	HNL3672LPRBF	\$2,385	\$2,385
1	Rectangle Worksurface with Vertical Grain 48"W x 24"D	HNLRC2448V	\$274	\$274
1	Modesty/Back Panel — Short 48"W x 10"H	HNLMP4810	\$221	\$221
1	Right Credenza with Lateral File 72"W x 24"D x 29½"H	HNL2472RLC	\$1,584	\$1,584
1	Stack-on Storage, Frosted Doors with Silver Frame 72"W x 15"D x 48⅝"H	HNL4972FD	\$2,571	\$2,571
1	Vertical Paper Manager	HLVPM1	\$327	\$327
1	Wardrobe Left, Bookcase Right 36"W x 24"D x 78⅞"H	HNL243679WLBR	\$2,533	\$2,533

TOTAL: \$9,895

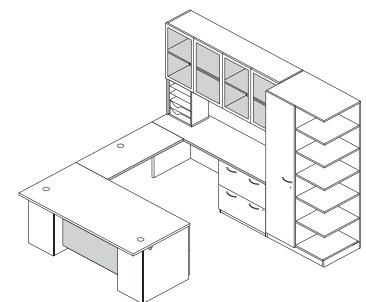

U-WORKSTATION

CONCINNITY™

Typicals



Icon Legend on page 19

QTY	DESCRIPTION	MODEL	LIST PRICE	PRICE EXTENSION
1	Rectangle Worksurface 72"W x 30"D	HNLRC3072	\$429	\$429
1	Rectangle Worksurface with Vertical Grain 42"W x 24"D	HNLRC2442V	\$256	\$256
1	Height Adjustable Base, 3-Leg	HHAB3S3L	\$1,896	\$1,896
1	Mixed Material Floating Modesty Panel 60"W x 14"H	HLSL6014MM	\$1,113	\$1,113
1	Rectangle Worksurface 72"W x 24"D	HNLRC2472	\$366	\$366
1	End Panel, Right 1½"W x 23½"D x 28½"H	HNLEP2428R	\$204	\$204
1	Box/Box/File Pedestal 15¾"W x 23½"D x 28½"H	HNL231628PBBF	\$714	\$714
1	Low Back Panel — For 15¾"W Pedestal 15¾"W x 18"H	HNLLB1618	\$127	\$127
1	Modesty/Back Panel — Short 72"W x 10"H	HNLMP7210	\$285	\$285
1	Wall Mount Storage, Frosted Doors with Silver Frame 72"W x 15"D x 15"H	HNL1572FD	\$1,775	\$1,775
1	Storage/File Cabinet, Hinged Left 18"W x 24"D x 64¾"H	HNL241865SFL	\$1,740	\$1,740
TOTAL:			\$8,905	

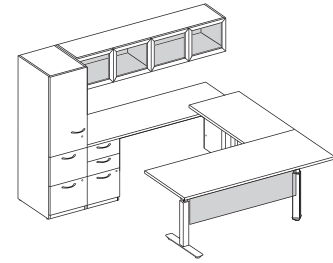

U-WORKSTATION WITH HEIGHT-ADJUSTABLE L-WORKSURFACE

QTY	DESCRIPTION	MODEL	LIST PRICE	PRICE EXTENSION
1	Rectangle Worksurface 72"W x 24"D	HNLRC2472	\$366	\$366
2	O-Leg Support for 24"D Worksurface 24"D x 28½"H	HLSL2428O	\$316	\$632
1	External Support Channel for 72"W Worksurface	HLSLZ5SC78	\$110	\$110
1	Low Credenza, Drawers Left, Bookcase Right 60"W x 20"D x 21½"H	HNL206021LD2	\$1,264	\$1,264
1	Rectangle Worksurface 54"W x 24"D	HNLRC2454	\$299	\$299
1	Standing-Height O-Leg Support for 24"D Worksurface 24"D x 41"H	HLSL2441O	\$424	\$424
1	Narrow Box/Box/File/File Pedestal 9½"W x 23½"D x 41"H	HNL231041PBBFF	\$1,322	\$1,322
1	Full Back Panel — For 41"H Pedestal 9½"W x 40¾"H	HNLBP1041	\$139	\$139
1	Storage Tower, Hinged Left 18"W x 24"D x 50"H	HNL241850TLL	\$1,245	\$1,245
TOTAL:			\$5,801	

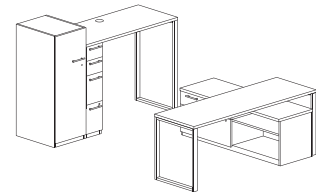

U-WORKSTATION WITH SITTING AND STANDING-HEIGHT WORKSURFACES — OPEN PLAN



Icon Legend on page 19

CONCINNITY™ Typicals

QTY	DESCRIPTION	MODEL	LIST PRICE	PRICE EXTENSION
1	Rectangle Worksurface 72"W x 30"D	HNLRC3072	\$429	\$429
1	O-Leg Support for 30"D Worksurface 30"D x 28½"H	HLSL30280	\$352	\$352
1	O-Leg Support over Low Credenza 30"D x 7"H	HLSL3070	\$271	\$271
1	External Support Channel for 72"W Worksurface	HLSLZ5SC78	\$110	\$110
1	Low Credenza, Drawers Right, Bookcase Left 60"W x 20"D x 21½"H	HNL206021RD2	\$1,264	\$1,264
1	Low Credenza, Drawers Left, Bookcase Right 60"W x 20"D x 21½"H	HNL206021LD2	\$1,264	\$1,264
2	Wall Mount Storage, Laminate Doors 30"W x 15"D x 28½"H	HNL2930LD	\$819	\$1,638
1	Wall Mount Storage, Frosted Doors with Silver Frame 30"W x 15"D x 28½"H	HNL2930FD	\$1,284	\$1,284
1	Wall Mount Markerboard 30"W x 48½"H	HNL4930WB	\$231	\$231
TOTAL:			\$6,843	

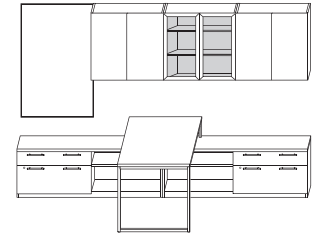

**WORKSTATION WITH
WORKWALL – OPEN PLAN**

QTY	DESCRIPTION	MODEL	LIST PRICE	PRICE EXTENSION
3	Rectangle Worksurface with Vertical Grain 48"W x 24"D	HNLRC2448V	\$274	\$822
3	O-Leg Support for 48"W x 24"D Worksurface 24"D x 28½"H	HLSL24280	\$316	\$948
3	Mixed Material Floating Modesty Panel 42"W x 14"H	HLSL4214MM	\$811	\$2,433
3	Rectangle Worksurface 72"W x 24"D	HNLRC2472	\$366	\$1,098
3	L-Shaped End Panel, Left 15¾"W x 24"D x 28½"H	HNLLEP2428L	\$332	\$996
3	Shelf/Box/Box/Lateral File Pedestal 30"W x 23⅞"D x 28½"H	HNL233028PSL	\$1,221	\$3,663
3	Modesty/Pedestal Back Panel 30"W x 27⅞"H	HNLMP3028	\$175	\$525
3	Wall Mount Storage, Frosted Doors with Silver Frame 72"W x 15"D x 15"H	HNL1572FD	\$1,775	\$5,325
TOTAL:			\$15,810	

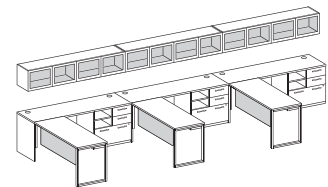

L-WORKSTATIONS – OPEN PLAN

CONCINNITY™

Typicals



Icon Legend on page 19

QTY	DESCRIPTION	MODEL	LIST PRICE	PRICE EXTENSION
1	Rectangle Worksurface with Vertical Grain 48"W x 24"D	HNLRC2448V	\$274	\$274
1	O-Leg Support for 48"W x 24"D Worksurface 24"D x 28½"H	HLSL2428O	\$316	\$316
1	Rectangle Worksurface 96"W x 24"D	HNLRC2496	\$532	\$532
1	Storage Cabinet Pedestal 36"W x 23⅞"D x 28½"H	HNL233628PSC	\$810	\$810
1	End Panel, Left 1⅞"W x 23⅞"D x 28½"H	HNLEP2428L	\$204	\$204
1	Modesty/Back Panel — Full-Length 96"W x 27⅞"H	HNLMP9628	\$430	\$430
1	Bookcase Hutch, Frosted Doors with Silver Frame 36"W x 15"D x 48⅝"H	HNL4936BHFD	\$1,678	\$1,678
1	Wall Mount Storage, Frosted Doors with Silver Frame 60"W x 15"D x 28½"H	HNL2960FD	\$2,217	\$2,217
1	Vertical Paper Manager	HLVPM1	\$327	\$327
1	Storage Tower, Wardrobe Right, Cabinet Left 24"W x 24"D x 78⅞"H	HNL242465TLR	\$2,235	\$2,235
TOTAL:			\$9,023	

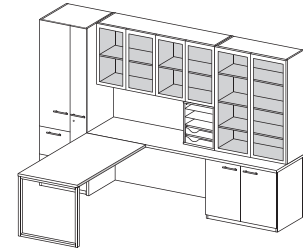

WORKSTATION WITH WORKWALL — OPEN PLAN

QTY	DESCRIPTION	MODEL	LIST PRICE	PRICE EXTENSION
4	Rectangle Worksurface 60"W x 24"D	HNLRC2460	\$325	\$1,300
4	Shelf/Box/Box/File Pedestal 15¾"W x 23⅞"D x 41"H	HNL231641PSBBF	\$1,503	\$6,012
4	Full Back Panel — For 15¾"W Pedestal 15¾"W x 40⅝"H	HNLPB1641	\$153	\$612
4	Narrow Box/Box/File/File Pedestal 9½"W x 23⅞"D x 41"H	HNL231041PBFBF	\$1,322	\$5,288
4	Full Back Panel — For 9½"W Pedestal 9½"W x 40⅝"H	HNLPB1041	\$139	\$556
2	Above/Below Privacy Screen, Frosted 30"W x 28"H	HLSL2830	\$800	\$1,600
2	5-Shelf Bookcase with Coat Hooks, Right 24"W x 24"D x 64¾"H	HNL2424BK5CR	\$958	\$1,916
2	5-Shelf Bookcase with Coat Hooks, Left 24"W x 24"D x 64¾"H	HNL2424BK5CL	\$958	\$1,916
TOTAL:			\$19,200	

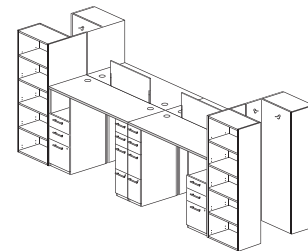

STANDING-HEIGHT — TEAMING WORKSTATION — OPEN PLAN



Icon Legend on page 19

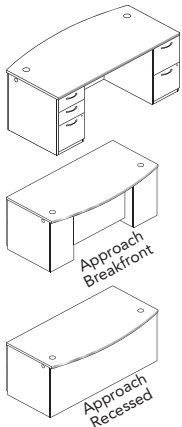

DESCRIPTION	APPROACH SIDE OVERHANG	MODEL	SHIP WEIGHT	CUBE	L1 LIST	L2 UPCHARGES		
						WORKSURFACES	CHASSIS	FRONTS
Double Pedestal Desk — Bow Top								
72"W x 36"D x 29½"H, Recessed Modesty Panel	6"	HNL3672DPBR	298	51.8	\$2309	\$25	\$40	\$10
72"W x 36"D x 29½"H, Breakfront Modesty Panel	6-12"	HNL3672DPBB	282	51.8	\$2400	\$25	\$40	\$10
72"W x 36"D x 29½"H, Breakfront Frosted Modesty Panel	6-12"	HNL3672DPBBF	266	51.8	\$2883	\$25	\$40	\$10

NOTES: For laminate center drawer, see page 106. For pull-out collaborative shelf, for desks with breakfront modesty panel, see page 106.

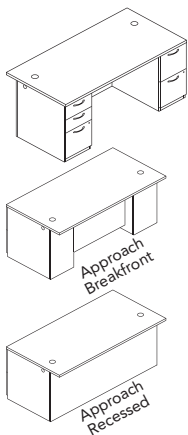

Double Pedestal Desk — Rectangle Top								
72"W x 36"D x 29½"H, Rectangle Top, Recessed Modesty Panel	6"	HNL3672DPRR	292	51.8	\$1955	\$25	\$40	\$10
66"W x 30"D x 29½"H, Rectangle Top, Flush Modesty Panel		HNL3066DPRF	267	40.2	\$1838	\$20	\$35	\$10
60"W x 30"D x 29½"H, Rectangle Top, Flush Modesty Panel		HNL3060DPRF	257	40.2	\$1718	\$20	\$45	\$20
72"W x 36"D x 29½"H, Rectangle Top, Breakfront Modesty Panel	6-12"	HNL3672DPRB	287	51.8	\$2175	\$25	\$40	\$10
72"W x 36"D x 29½"H, Rectangle Top, Breakfront Frosted Modesty Panel	6-12"	HNL3672DPRBF	270	51.8	\$2658	\$25	\$40	\$10

NOTES: For laminate center drawer, see page 106. For pull-out collaborative shelf, for desks with breakfront modesty panel, see page 106.

NOTES:

- Feature full-to-the-floor pedestals to maximize storage space.
- Double pedestal desks have 3/2 drawer configuration (box/box/file on left pedestal, file/file on right pedestal).
- Single pedestal desks have a box/box/file pedestal.
- One molded black pencil tray is included in each box/box/file pedestal.
- 72"W models are available with Rectangle- or bow-shaped tops.
- Bow top desk models measure 36"D at the crest and 30"D along the end panels.
- Formal breakfront or recessed modesty panel.
- Breakfront desk features a floating modesty panel which can be specified in laminate or frosted material. Floating design provides space for optional pull-out collaborative shelf for visitors. See page 106.
- Recessed modesty panel design has a full-width conference overhang, providing worksurface and kneespace for guests.
- 66"W and 60"W desks have a flush modesty panel (i.e., no conference overhang).
- Two cord management grommets, for routing and hiding wires and cables, are located in desktops.
- Grommets can be replaced with optional Power (model HGRMTAC) or USB Hub (HGRMTUSB2).
- Pedestal sides and end panels are standard with pass-through grommets to enable the routing of cords below the worksurface, and connections between workstations.
- Specification logic includes the grommet finish for tops; choose from Black (P) or Platinum (T1). Side grommets on pedestal are black only.
- See "Modular Components" for cord management options. Worksurfaces/tops, end and modesty panels, and pedestals can be specified with or without grommets.
- Finish of pedestal lock(s) is determined by, and aligned with, the handle finish specified.
- Adjustable hex leveling glides.
- Ship fully assembled.

HOW TO SPECIFY

<p>Select Model Number</p> <p>See page 29</p> <p>H N L 3 6 7 2 D P B R</p>	<p>Select Edge Profile and Edge Color</p> <p>See page 29</p> <p>B H</p>	<p>Select Handle</p> <p>A Cylinder – Satin B Cylinder – Black C Canopy – Satin D Canopy – Black E Loop – Satin F Loop – Black</p> <p>E</p>	<p>Select Worksurface Grommet Finish</p> <p>P Black T1 Platinum</p> <p>T 1</p>	<p>Select Worksurface Color</p> <p>See page 29</p> <p>H</p>	<p>Select Chassis Color</p> <p>See page 29</p> <p>H</p>	<p>Select Drawer Front Color</p> <p>See page 29</p> <p>H</p>
--	---	---	---	---	---	--

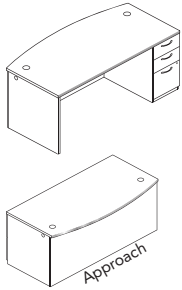

DESCRIPTION	APPROACH SIDE OVERHANG	MODEL	SHIP WEIGHT	CUBE	L1 LIST	L2 UPCHARGES		
						WORKSURFACES	CHASSIS	FRONTS
Single Pedestal Desk — Bow Top 72"W x 36"D x 29½"H, Right, Recessed Modesty Panel (shown)	6"	HNL3672RPBR	238	51.8	\$1856	\$25	\$40	\$10
72"W x 36"D x 29½"H, Left, Recessed Modesty Panel	6"	HNL3672LPBR	238	51.8	\$1856	\$25	\$40	\$10
72"W x 36"D x 29½"H, Right, Breakfront Modesty Panel	6-12"	HNL3672RPBB	237	51.8	\$2091	\$25	\$40	\$10
72"W x 36"D x 29½"H, Left, Breakfront Modesty Panel	6-12"	HNL3672LPBB	237	51.8	\$2091	\$25	\$40	\$10
72"W x 36"D x 29½"H, Right, Breakfront Frosted Modesty Panel	6-12"	HNL3672RPBBF	221	51.8	\$2565	\$25	\$40	\$10
72"W x 36"D x 29½"H, Left, Breakfront Frosted Modesty Panel	6-12"	HNL3672LPBBF	221	51.8	\$2565	\$25	\$40	\$10

NOTES: For laminate center drawer, see page 106. For pull-out collaborative shelf, for desks with breakfront modesty panel, see page 106.

NOTES:

- Feature full-to-the-floor pedestals to maximize storage space.
- Double pedestal desks have 3/2 drawer configuration (box/box/file on left pedestal, file/file on right pedestal).
- Single pedestal desks have a box/box/file pedestal.
- One molded black pencil tray is included in each box/box/file pedestal.
- 72"W models are available with Rectangle- or bow-shaped tops.
- Bow top desk models measure 36"D at the crest and 30"D along the end panels.
- Formal breakfront or recessed modesty panel.
- Breakfront desk features a floating modesty panel which can be specified in laminate or frosted material. Floating design provides space for optional pull-out collaborative shelf for visitors. See page 106.
- Recessed modesty panel design has a full-width conference overhang, providing workspace and kneespace for guests.
- 66"W and 60"W desks have a flush modesty panel (i.e., no conference overhang).
- Two cord management grommets, for routing and hiding wires and cables, are located in desktops.
- Grommets can be replaced with optional Power (model HGRMTAC) or USB Hub (HGRMTUSB2).
- Pedestal sides and end panels are standard with pass-through grommets to enable the routing of cords below the workspace, and connections between workstations.
- Specification logic includes the grommet finish for tops; choose from Black (P) or Platinum (TI). Side grommets on pedestal are black only.
- See "Modular Components" for cord management options. Worksurfaces/tops, end and modesty panels, and pedestals can be specified with or without grommets.
- Finish of pedestal lock(s) is determined by, and aligned with, the handle finish specified.
- Adjustable hex leveling glides.
- Ship fully assembled.

HOW TO SPECIFY

Select Model Number	Select Edge Profile and Edge Color	Select Handle	Select Worksurface Grommet Finish	Select Worksurface Color	Select Chassis Color	Select Drawer Front Color
See page 29	See page 29	See page 29	See page 29	See page 29	See page 29	See page 29
H N L 3 6 7 2 R P B R	B H	E	T 1	H	H	H

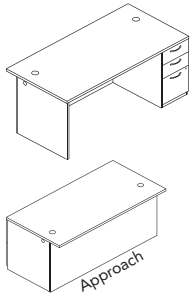

DESCRIPTION	APPROACH SIDE OVERHANG	MODEL	SHIP WEIGHT	CUBE	L1 LIST	L2 UPCHARGES		
						WORKSURFACES	CHASSIS	FRONTS
Single Pedestal Desk — Rectangle Top 72"W x 36"D x 29½"H, Right, Recessed Modesty Panel (shown)	6"	HNL3672RPRR	242	51.8	\$1602	\$25	\$40	\$10
72"W x 36"D x 29½"H, Left, Recessed Modesty Panel	6"	HNL3672LPRR	242	51.8	\$1602	\$25	\$40	\$10
66"W x 30"D x 29½"H, Right, Flush Modesty Panel		HNL3066RPRF	217	40.2	\$1564	\$20	\$35	\$10
66"W x 30"D x 29½"H, Left, Flush Modesty Panel		HNL3066LPRF	217	40.2	\$1564	\$20	\$35	\$10
72"W x 36"D x 29½"H, Right, Breakfront Modesty Panel	6-12"	HNL3672RPRB	242	51.8	\$1911	\$25	\$40	\$10
72"W x 36"D x 29½"H, Left, Breakfront Modesty Panel	6-12"	HNL3672LPRB	242	51.8	\$1911	\$25	\$40	\$10
72"W x 36"D x 29½"H, Right, Breakfront Frosted Modesty Panel	6-12"	HNL3672RPRBF	225	51.8	\$2385	\$25	\$40	\$10
72"W x 36"D x 29½"H, Left, Breakfront Frosted Modesty Panel	6-12"	HNL3672LPRBF	225	51.8	\$2385	\$25	\$40	\$10

NOTES: For laminate center drawer, see page 106. For pull-out collaborative shelf, for desks with breakfront modesty panel, see page 106.

NOTES:

- Feature full-to-the-floor pedestals to maximize storage space.
- Double pedestal desks have 3/2 drawer configuration (box/box/file on left pedestal, file/file on right pedestal).
- Single pedestal desks have a box/box/file pedestal.
- One molded black pencil tray is included in each box/box/file pedestal.
- 72"W models are available with Rectangle- or bow-shaped tops.
- Bow top desk models measure 36"D at the crest and 30"D along the end panels.
- Formal breakfront or recessed modesty panel.
- Breakfront desk features a floating modesty panel which can be specified in laminate or frosted material. Floating design provides space for optional pull-out collaborative shelf for visitors. See page 106.
- Recessed modesty panel design has a full-width conference overhang, providing workspace and kneespace for guests.
- 66"W and 60"W desks have a flush modesty panel (i.e., no conference overhang).
- Two cord management grommets, for routing and hiding wires and cables, are located in desktops.
- Grommets can be replaced with optional Power (model HGRMTAC) or USB Hub (HGRMTUSB2).
- Pedestal sides and end panels are standard with pass-through grommets to enable the routing of cords below the worksurface, and connections between workstations.
- Specification logic includes the grommet finish for tops; choose from Black (P) or Platinum (T1). Side grommets on pedestal are black only.
- See "Modular Components" for cord management options. Worksurfaces/tops, end and modesty panels, and pedestals can be specified with or without grommets.
- Finish of pedestal lock(s) is determined by, and aligned with, the handle finish specified.
- Adjustable hex leveling glides.
- Ship fully assembled.

HOW TO SPECIFY

Select Model Number	Select Edge Profile and Edge Color	Select Handle	Select Worksurface Grommet Finish	Select Worksurface Color	Select Chassis Color	Select Drawer Front Color
	See page 29	A Cylinder – Satin B Cylinder – Black C Canopy – Satin D Canopy – Black E Loop – Satin F Loop – Black	P Black T1 Platinum	See page 29	See page 29	See page 29
H N L 3 6 7 2 R P R R .	B H .	E .	T 1 .	H .	H .	H .

CONCINNITY™

Peninsulas

GSA SIN 33721



Icon Legend on page 19

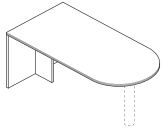

Support column sold separately



DESCRIPTION	MODEL	SHIP WEIGHT	CUBE	L1 LIST	L2 UPCHARGES	
					WORKSURFACE	CHASSIS
Bullet Peninsula with End Panel						
72"W x 36"D x 29½"H	HNL3672BUEP	131	6.6	\$898	\$25	\$40
72"W x 30"D x 29½"H	HNL3072BUEP	112	5.6	\$782	\$20	\$25
66"W x 30"D x 29½"H	HNL3066BUEP	105	5.1	\$702	\$20	\$35

NOTES: For use in "U" or "L" shaped furniture layouts; not to be used freestanding. Comprised of top and end/brace panels (Note: Must specify support column; sold separately). Cord routing notch in the brace panel. Adjustable hex leveling glides. For cord grommet options, see "Modular Components". Options include center drawers and modesty panels. Modesty panel is available in laminate or frosted material. Ships

Not designed to be used freestanding.

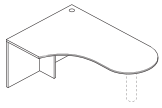
Right-hand model
HNL4872JREP shown

Support column sold separately



DESCRIPTION	MODEL	SHIP WEIGHT	CUBE	L1 LIST	L2 UPCHARGES	
					WORKSURFACE	CHASSIS
Jetty Peninsula with End Panel						
72"W x 30/48"D x 29½"H, Right	HNL4872JREP	147	8.9	\$1079	\$30	\$25
72"W x 30/48"D x 29½"H, Left	HNL4872JLEP	147	8.9	\$1079	\$30	\$25
72"W x 30/42"D x 29½"H, Right	HNL4272JREP	134	17.0	\$1003	\$30	\$25
72"W x 30/42"D x 29½"H, Left	HNL4272JLEP	134	17.0	\$1003	\$30	\$25

NOTES: Worksurface designed and sized to efficiently serve as both a computing and conferencing space. Two sizes, 42"D and 48"D. The 48"D unit is specifically intended to be used with the 48"D extended corner modular top/back components to form a two-piece U-shaped workstation with a 42" cockpit area. For use in "U" or "L" shaped furniture layouts; not to be used freestanding. Comprised of top and end/brace panels (Note: Must specify support column; sold separately). One cord management grommet in the top; cord routing notch in the brace panel. Adjustable hex leveling glides. Field installable modesty panel is optional. Ships

Not designed to be used freestanding.

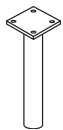

DESCRIPTION	MODEL	SHIP WEIGHT	CUBE	LIST PRICE
Support Column for Bullet and Jetty Peninsulas 4½" Diameter. Specify: HPC190X.P. Black only.	HPC190X	12	1.0	\$161
Support Column for Bullet and Jetty Peninsulas 4½" Diameter. Specify: HPC191X.X. Available in Silver only.	HPC191X	12	1.0	\$161

Support Column must be specified/ordered with Bullet and Jetty peninsulas.

NOTES:



- See pages 92-96 for shared components.

HOW TO SPECIFY

Select Model Number H N L 3 6 7 2 B U E P	Select Edge Profile and Edge Color See page 29 B H	Select Worksurface Color See page 29 H	Select Chassis Color See page 29 H	
Select Model Number H N L 4 8 7 2 J R E P	Select Edge Profile and Edge Color See page 29 B H	Select Worksurface Grommet Finish P Black T1 Platinum	Select Worksurface Color See page 29 H	Select Chassis Color See page 29 H

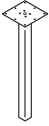

Icon Legend on page 19

	DESCRIPTION	MODEL	SHIP WEIGHT	CUBE	LIST PRICE BY PAINT GRADE		
					P1	P2	P3
	Post Leg Base 28½" H x 2" square NOTES: Can only be used as the outbound support in a peninsula or island extension worksurface application. Glides have 2" of adjustability. Ship 1/pack. SPECIFYING EXAMPLE: HLSL28P.T1	HLSL28P	15	1.0	\$292	\$296	\$312
	Field Installable Modesty Panel for Bullet and Jetty Peninsulas, Laminate (Vertical Grain) 50¼"W x ¾" Thick x 18"H NOTES: Center drawer model H1522 can be used in conjunction with laminate modesty panel model HPC180W. Cord pass-through notch in top corner. SPECIFYING EXAMPLE: HPC180W.H	HPC180W	28	3.6	\$215		
	Field Installable Modesty Panel for Bullet and Jetty Peninsulas, Frosted with Silver Frame 50¼"W x ¾" Thick x 18"H ⓘ Cord pass-through notch is not available on the Frosted/Silver model HPC180G. Notch is on laminate model HPC180W only. ⓘ Center drawers not designed to be used with the frosted/silver modesty panel model HPC180G.	HPC180G	33	1.5	\$694		

NOTES:

- See pages 92-96 for shared components.

HOW TO SPECIFY

Select Model Number

H	L	S	L	2	8	P
---	---	---	---	---	---	---

CONCINNITY™

Corner Unit

GSA SIN 33721



Icon Legend on page 19

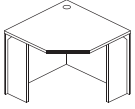

DESCRIPTION	MODEL	SHIP WEIGHT	CUBE	L1 LIST	L2 UPCHARGES	
					WORKSURFACE	CHASSIS
Corner Unit 24"W x 36"D x 24" x 29½"H	HNL3636CU	109	26.4	\$944	\$15	\$20
NOTES: Designed for use with 24"D returns or bridges. Can be used freestanding. Can be used with two 36"W modular returns to achieve an efficient 6' x 6' layout. One cord management grommet in the top; cord routing notches in the leg panels. The worksurface grommet can be replaced with optional power (model HGRMTAC) or USB (model HGRMTUSB2) hub. Adjustable hex leveling glides. When connected to a 42"W return or modular return, the 78"W stack-on storage unit spans the total depth dimension (78"D). When connected to a 36"W modular return, the 72"W stack-on storage unit spans the total depth dimension (72"D). Edgebanding on the corner unit is profiled on the user's side and flat on the back (approach side) and ends. Ships fully assembled.						

NOTES:

- For Extended Corner Worksurface sizes, see "Modular Components" on page 78.

HOW TO SPECIFY

Select
Model Number

H N L 3 6 3 6 C U .

Select
Edge Profile and Edge
Color

See page 29

B H .

Select
Worksurface Grommet
Finish

P Black
T1 Platinum

P .

Select
Worksurface Color

See page 29

H .

Select
Chassis Color

See page 29

H

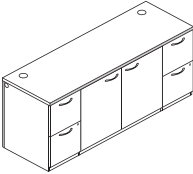
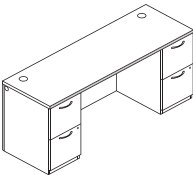
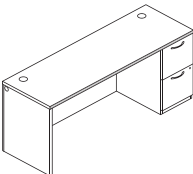
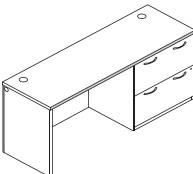

DESCRIPTION	MODEL	SHIP WEIGHT	CUBE	L1 LIST	L2 UPCHARGES		
					WORKSURFACES	CHASSIS	FRONTS
 <p>Credenza with Storage 72"W x 24"D x 29½"H</p> <p>NOTES: For use behind a desk or as a stand-alone storage piece. Four file drawers, 2-left, 2-right and one storage cabinet with hinged doors. One adjustable shelf, which adjusts in 2½" increments, behind doors. Drawers lock. Finish of locks is determined by, and aligned with, the handle finish specified. Storage cabinet doors are non-locking.</p>	HNL2472DPS	323	35.6	\$2403	\$20	\$45	\$40
 <p>Credenza with Kneespace 72"W x 24"D x 29½"H 66"W x 24"D x 29½"H 60"W x 24"D x 29½"H</p> <p>NOTES: For use behind a desk or as a stand-alone storage piece. Four locking file drawers, 2-left, 2-right. Finish of locks determined by, and aligned with, the handle finish specified.</p>	HNL2472DPK	247	35.6	\$1818	\$20	\$40	\$20
	HNL2466DPK	239	32.7	\$1735	\$20	\$40	\$20
	HNL2460DPK	230	29.9	\$1706	\$20	\$35	\$20
 <p>Credenza, Single Pedestal 72"W x 24"D x 29½"H, Right 72"W x 24"D x 29½"H, Left</p> <p>NOTES: Primary use is as part of a connected U-shaped workstation with a bridge and single pedestal desk. Two locking file drawers. Finish of lock determined by, and aligned with, the handle finish specified. Can be used with modular or mobile pedestals.</p>	HNL2472RP	199	35.6	\$1449	\$20	\$35	\$10
	HNL2472LP	199	35.6	\$1449	\$20	\$35	\$10
 <p>Credenza with Lateral File 72"W x 24"D x 29½"H, Right 72"W x 24"D x 29½"H, Left</p> <p>NOTES: Storage file measures 30"W (36"W can be specified using modular components). Mechanical interlock inhibits the extension of more than one drawer at a time. Finish of lock is determined by, and aligned with, the handle finish specified. Can be used with modular or mobile pedestals.</p>	HNL2472RLC	245	35.6	\$1584	\$20	\$35	\$20
	HNL2472LLC	245	35.6	\$1584	\$20	\$35	\$20

NOTES:

- Optional 72"W, 66"W and 60"W stack-on sizes maximize storage space.
- Two cord management grommets, for routing and hiding wires and cables, are located in top.
- Modesty panel and pedestal grommets are black only.
- A cord pass-through grommet is located in the sides of the pedestal and top center of the back (modesty panel) to facilitate reaching wall electrical outlets.
- Specification logic includes the grommet finish for tops; choose from Black (P) or Platinum (T1).
- Worksurfaces/tops, end and modesty panels, and pedestals can be specified with or without grommets. See "Modular Components" on page 36 for cord management options.
- For paper organizers, see page 110.

HOW TO SPECIFY

<p>Select Model Number</p> <p>H N L 2 4 7 2 D P S .</p>	<p>Select Edge Profile and Edge Color</p> <p>See page 29</p> <p>B H .</p>	<p>Select Handle</p> <p>A Cylinder – Satin B Cylinder – Black C Canopy – Satin D Canopy – Black E Loop – Satin F Loop – Black</p> <p>E .</p>	<p>Select Worksurface Grommet Finish</p> <p>P Black T1 Platinum</p> <p>T 1 .</p>	<p>Select Worksurface Color</p> <p>See page 29</p> <p>H .</p>	<p>Select Chassis Color</p> <p>See page 29</p> <p>H .</p>	<p>Select Drawer Front Color</p> <p>See page 29</p> <p>H .</p>
--	--	---	---	--	--	---

CONCINNITY™

Low Credenzas

GSA SIN 33721



Icon Legend on page 19

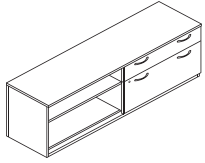

DESCRIPTION	MODEL	SHIP WEIGHT	CUBE	L1 LIST	L2 UPCHARGES		
					WORKSURFACES	CHASSIS	FRONTS
Low Credenza (Bench-Height) 72"W x 20"D x 21½"H, Drawers Right, Bookcase Left (shown)	HNL207221RD2	219	21.6	\$1408	\$15	\$25	\$20
72"W x 20"D x 21½"H, Drawers Left, Bookcase Right	HNL207221LD2	219	21.6	\$1408	\$15	\$25	\$20
60"W x 20"D x 21½"H, Drawers Right, Bookcase Left	HNL206021RD2	187	18.1	\$1264	\$20	\$15	\$20
60"W x 20"D x 21½"H, Drawers Left, Bookcase Right	HNL206021LD2	187	18.1	\$1264	\$20	\$15	\$20

NOTES: Combination storage design comprised of two locking drawers (1-box/supply and 1-file) plus a bookcase. File drawers include integrated hangrails for letter- or legal-sized folders. Bookcase has one adjustable shelf; adjusts in 2½" increments.

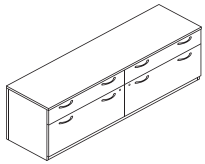

Low Credenza, 2 Box/2 File 72"W x 20"D x 21½"H	HNL207221D4	308	21.6	\$1712	\$15	\$25	\$40
60"W x 20"D x 21½"H	HNL206021D4	260	18.1	\$1517	\$15	\$20	\$40

NOTES: Four locking drawers (2-box/supply and 2-file). File drawers include integrated hangrails for letter- or legal-sized folders.

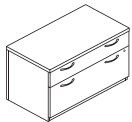

Low Credenza, Box/File 36"W x 20"D x 21½"H	HNL203621D2	143	11.8	\$992	\$10	\$15	\$20
30"W x 20"D x 21½"H	HNL203021D2	121	10.0	\$932	\$10	\$15	\$20

NOTES: Unit contains two drawers, one box and one lateral file.

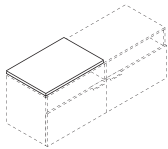

DESCRIPTION	MODEL	SHIP WEIGHT	CUBE	LIST PRICE BY FABRIC GRADE					
				1	2	3	4	5	6
Credenza Cushion 36"W x 20"D x 1"H for 72" and 36"W Low Credenzas	HLSL2036CH2	11	2.2	\$402	\$440	\$478	\$517	\$566	\$616
30"W x 20"D x 1"H for 60" and 30"W Low Credenzas	HLSL2030CH2	9	1.9	\$372	\$408	\$444	\$480	\$526	\$573

NOTES: See pages 22-24 for available fabrics.

Seat cushions are optional; HLSL2036CH2 for 72" and 36"W, HLSL2030CH2 for 60" and 30"W.

! For model HLSL2030CH2 must order two cushions to cover entire 60" Credenza surface.

SPECIFYING EXAMPLE: HLSL2036CH2.APN23

NOTES:

- Versatile, space-saving solutions double as a compact storage unit and convenient bench seat.
- When combined with 29½"H worksurfaces, the 21½"H credenzas can be positioned to create multi-level, overlapping surfaces that optimize floor space, organization and display needs.
- The distinct, clean horizontal planes provide a light scale, layered look.
- Low-heights help facilitate team collaboration.
- Finish of lock(s) is determined by, and aligned with, the handle finish specified.
- Overlapping surfaces can be supported by a 28½"H or 7"H O-leg or 7"H laminate end panel.

HOW TO SPECIFY

Select Model Number H N L 2 0 7 2 2 1 R D 2 .	Select Edge Profile and Edge Color See page 29 B H .	Select Handle A Cylinder - Satin B Cylinder - Black C Canopy - Satin D Canopy - Black E Loop - Satin F Loop - Black E .	Select Top Color See page 29 H .	Select Chassis Color See page 29 H .	Select Drawer Front Color See page 29 H .
---	---	---	---	---	--

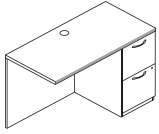

DESCRIPTION	MODEL	SHIP		L1 LIST	L2 UPCHARGES		
		WEIGHT	CUBE		WORKSURFACES	CHASSIS	FRONTS
Return							
48"W x 24"D x 29½"H, Right (shown)	HNL2448RP	141	24.8	\$1039	\$15	\$15	\$10
48"W x 24"D x 29½"H, Left	HNL2448LP	141	24.8	\$1039	\$15	\$15	\$10
42"W x 24"D x 29½"H, Right	HNL2442RP	132	22.0	\$996	\$15	\$15	\$10
42"W x 24"D x 29½"H, Left	HNL2442LP	132	22.0	\$996	\$15	\$15	\$10

NOTES: For L-shaped workstations. Connects to single pedestal desk, peninsula (bullet or jetty), or component worksurface with end panel. Drawers lock. Finish of lock is determined by, and aligned with, the handle finish specified. Formal, full-height modesty panel. One cord grommet in top for routing and hiding wires and cables. One cord pass-through grommet is located in the sides of the pedestal and top center of the back (modesty panel) to facilitate reaching wall electrical outlets. Specification logic includes the grommet finish for tops; choose from Black (P) or Platinum (TI). Modesty panel and pedestal grommets are black only. Edgebanding on 42"W and 48"W returns is profiled on the user's side and flat on the back (approach side) and ends. Woodgrain direction on worksurface runs vertical (i.e., front-to-back). Smaller and larger return sizes can be specified using modular worksurface and modesty panel components. Optional stack-on solutions maximize storage space. Ship fully assembled.

See chart on page 36 for cord management options. Worksurfaces/tops, end and modesty panels, and pedestals can be specified with or without grommets. For easy access to wall electrical outlets, options include a short (10") modesty panel or no back panel.

For paper organizers, see page 110.

HOW TO SPECIFY

<p>Select Model Number</p>	<p>Select Edge Profile and Edge Color</p> <p>See page 29</p>	<p>Select Handle</p> <p>A Cylinder – Satin B Cylinder – Black C Canopy – Satin D Canopy – Black E Loop – Satin F Loop – Black</p>	<p>Select Worksurface Grommet Finish</p> <p>P Black TI Platinum</p>	<p>Select Worksurface Color</p> <p>See page 29</p>	<p>Select Chassis Color</p> <p>See page 29</p>	<p>Select Drawer Front Color</p> <p>See page 29</p>
<p>H N L 2 4 4 8 R P .</p>	<p>B H .</p>	<p>E .</p>	<p>T I .</p>	<p>H .</p>	<p>H .</p>	<p>H .</p>

CONCINNITY™ Bridges

GSA SIN 33721



Icon Legend on page 19

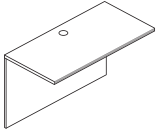

DESCRIPTION	MODEL	SHIP WEIGHT	CUBE	L1 LIST	L2 UPCHARGES		
					WORKSURFACES	CHASSIS	FRONTS
Bridge 48"W x 24"D x 29½"H	HNL2448BF	71	3.0	\$448	\$15	\$15	N/A
42"W x 24"D x 29½"H	HNL2442BF	62	2.5	\$428	\$15	\$15	N/A

NOTES: For U-shaped workstation layouts. Connects single pedestal desk, peninsula (bullet or jetty), or component worksurface to corner unit or to single pedestal credenza, credenza with lateral file, or rectangle worksurface. Formal, full-height modesty panel. One cord grommet in top for routing and hiding wires and cables. One cord pass-through grommet in top center of back (modesty panel). Specification logic includes the grommet finish for tops; choose from Black (P) or Platinum (T1). Clear inside depth 22⁷/₈"D. Edgebanding on 42"W and 48"W bridges is profiled on the user's side and flat on the back (approach side) and ends. Woodgrain direction on worksurface runs vertical (i.e., front-to-back). Additional sizes, including 30"W and 36"W for use with corner or extended corner units, as well as jetty peninsulas, can be specified using modular worksurface and modesty panel components. Ship — quick, simple assembly. See chart on page 36 for cord management options. Worksurfaces/tops and modesty panels can be specified with or without grommets. For easy access to wall electrical outlets, options include a short (10") modesty panel or no back panel.

HOW TO SPECIFY

Select
Model Number

H N L 2 4 4 8 B F .

Select
Edge Profile and Edge
Color

See page 29

B H .

Select
Worksurface Grommet
Finish

P Black
T1 Platinum

P .

Select
Worksurface Color

See page 29

H .

Select
Chassis Color

See page 29

H

CONCINNITY™ STACK-ON STORAGE APPLICATIONS

STACK-ON STORAGE APPLICATIONS

78"W

- Spans full-width of 78"W modular credenza or return.
- Spans total depth dimension of "L" workstation configurations comprised of:
 - 48"W return or modular return attached to a 36"D single pedestal desk with a bow front (78"D).
 - NOTE: The 36"D single pedestal desk with bow front is 30"D along end panel.
 - 48"W return or modular return attached to a 30"D single pedestal desk, modular desk, or bullet peninsula (78"D).
 - 42"W return or modular return attached to a 36"D single pedestal desk with rectangle top, modular desk, or bullet peninsula (78"D).
 - 42"W return or modular return attached to a 36" corner unit or 36"D extended corner unit (78"D).
 - 36"W modular return attached to a 42"D jetty peninsula (78"D).
 - 30"W modular return attached to a 48"D jetty peninsula (78"D).
 - 30"W modular return attached to a 48"D extended corner unit (78"D).

72"W

- Spans full-width of 72"W desks with rectangle top, credenzas, extended corner units, or modular desk, credenza, or return.
- Spans total depth dimension of "L" workstation configurations comprised of:
 - 48"W return or modular return attached to a 24"D single pedestal credenza or modular credenza (72"D).
 - 42"W return or modular return attached to a 36"D single pedestal desk with a bow front (72"D).
 - NOTE: The 36"D single pedestal desk with bow front is 30"D along end panel.
 - 42"W return or modular return attached to a 30"D single pedestal desk, modular desk, or bullet peninsula (72"D).
 - 36"W modular return attached to a 36"D single pedestal desk with rectangle top, modular desk, or bullet peninsula (72"D).
 - 36"W modular return attached to a 36" corner unit or 36"D extended corner unit (72"D).
 - 30"W modular return attached to a 42"D jetty peninsula (72"D).

66"W

- Spans full-width of 66"W desk, credenza, or modular desk, credenza, or return.
- Spans total depth dimension of "L" workstation configurations comprised of:
 - 42"W return or modular return attached to a 24"D single pedestal credenza or modular credenza (66"D).

- 36"W modular return attached to a 30"D single pedestal desk, bullet peninsula, or modular desk (66"D).
- 36"W modular return attached to a 36"D single pedestal desk with a bow front (66"D).
 - NOTE: The 36"D single pedestal desk with bow front is 30"D along end panel.
- 30"W modular return attached to a 36"D single pedestal desk with rectangle top or modular desk (66"D).
- 30"W modular return attached to a 36" corner unit (66"D).

60"W

- Spans full-width of 60"W desk, credenza, or modular desk, credenza, or return.
- Spans total depth dimension of "L" workstation configurations comprised of:
 - 36"W modular return attached to a 24"D single pedestal credenza or modular credenza (60"D).
 - 30"W modular return attached to a 30"D single pedestal desk or modular desk (60"D).

48"W

- Spans full-width of 48"W return, modular return, or modular desk or credenza.
- Spans full-depth of the 48"D jetty peninsula or extended corner unit.

42"W

- Spans full-width of 42"W return, modular return, or modular desk or credenza.
- Spans full-depth of 42"D jetty peninsula.

36"W

- Spans full-width of 36"W modular return, modular desk or credenza, two drawer lateral file, or 29½"H storage cabinet with doors.
- Spans full-depth of 36"D desks with rectangle top, bullet peninsula, extended corner unit, or 36" corner unit.

OPTIONS INCLUDE:

- Door/Storage Options:

Door(s)	Standard-Height	Executive-Height
Laminate	•	•
Laminate Locking	•	•
Frosted/Silver	•	•
Sliding	•	•

- Available in 35¼" or 78⅛"H; when positioned on 29½"H base unit, heights respectively align with 64¾" and 78⅛"H storage- and wardrobe-type cabinets.
- Paper organizers for stack-on and wall mounted storage cabinets (see application and compatibility information on page 111).

CONCINNITY™ STACK-ON STORAGE APPLICATIONS

- Fabric-Covered Tackboards:
 - Sized $\frac{3}{4}$ " narrower than the stack-on storage back enclosure, allowing $\frac{3}{8}$ " on each side to route task light cords.
 - Includes adhesive latch & hook tape for attachment to stack-on storage back panel and fasteners for wall mount applications.
 - For a list of standard fabrics, see pages 25-26. For a complete list of fabrics, please go to hon.com/fabricsandfinishes.
- Markerboards:
 - HLSL1530SOMB: 29½"W x 12½"H panel attaches to 60" and 66"W stack-on and wall mounted storage with sliding door models with double-sided tape.
 - HLSL1536SOMB: 35½"W x 12½"H panel attaches to 72" and 78"W stack-on and wall mounted storage with sliding door models with double-sided tape.
- Markerboards will not fit on stack-on storage laminate or laminate locking door models.
- Task Lights:
 - Attach to underside of stack-on and wall mount storage cabinets.
 - Fluorescent or LED options.
 - Tackboard and fluorescent and LED task light solutions, by model, for each stack-on storage size:

Stack-on Storage	Tackboard	Fluorescent Task Light	LED Task Light
78"W	H90057	HH870960, HH870960CH	HLED31A, HLED31AUO
72"W	H90056	HH870960, HH870960CH	HLED31A, HLED31AUO
66"W	H90055	HH870960, HH870960CH	HLED31A, HLED17AUO
60"W	H90054	HH870960, HH870960CH	HLED31A, HLED17AUO
48"W	H90053	HH870942, HH870942CH	HLED31AS
42"W	H90052	HH870942, HH870942CH	HLED31AS
36"W	H90051	HH870930, HH870930CH	HLED17AS



CONCINNITY™ Stack-on Storage

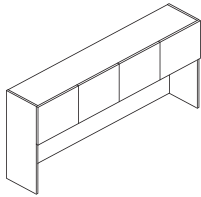

DESCRIPTION

Stack-on Storage, Laminate Doors
 78"W x 15"D x 35¼"H — 4 doors, 2 compartments
 72"W x 15"D x 35¼"H — 4 doors, 2 compartments
 66"W x 15"D x 35¼"H — 4 doors, 2 compartments
 60"W x 15"D x 35¼"H — 4 doors, 2 compartments
 48"W x 15"D x 35¼"H — 3 doors, 2 compartments
 42"W x 15"D x 35¼"H — 2 doors, 1 compartment
 36"W x 15"D x 35¼"H — 2 doors, 1 compartment

MODEL	SHIP WEIGHT	CUBE	L1 LIST	L2 UPCHARGES	
				CHASSIS	FRONTS
HNL3678LD	173	31.8	\$1322	\$45	\$20
HNL3672LD	162	29.0	\$1267	\$35	\$20
HNL3666LD	151	26.7	\$1250	\$35	\$20
HNL3660LD	139	24.3	\$1140	\$35	\$20
HNL3648LD	117	19.6	\$1029	\$30	\$20
HNL3642LD	100	18.1	\$1003	\$30	\$10
HNL3636LD	88	15.3	\$848	\$30	\$10

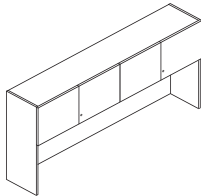

Stack-on Storage, Laminate Locking Doors

78"W x 15"D x 35¼"H — 4 doors, 2 compartments
 72"W x 15"D x 35¼"H — 4 doors, 2 compartments
 66"W x 15"D x 35¼"H — 4 doors, 2 compartments
 60"W x 15"D x 35¼"H — 4 doors, 2 compartments
 48"W x 15"D x 35¼"H — 3 doors, 2 compartments
 42"W x 15"D x 35¼"H — 2 doors, 1 compartment
 36"W x 15"D x 35¼"H — 2 doors, 1 compartment

HNL3678LL	173	31.8	\$1405	\$45	\$20
HNL3672LL	162	29.0	\$1350	\$35	\$20
HNL3666LL	151	26.7	\$1332	\$35	\$20
HNL3660LL	139	24.3	\$1223	\$35	\$20
HNL3648LL	117	19.6	\$1070	\$30	\$20
HNL3642LL	100	18.1	\$1044	\$30	\$10
HNL3636LL	88	15.3	\$889	\$30	\$10

ⓘ Lock available in Black (P) or Satin (SA) finish. Lock is core removable. Keyed alike cores must be ordered separately. For stack-on and wall mount storage with locking hinged doors, specify model HF27B (Black) or HF27S (Satin) and the key number, see page 112. Model HNL3648LL has one lock, which secures two of the three doors.

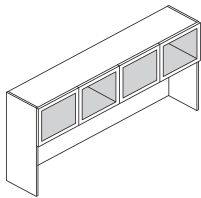

Stack-on Storage, Frosted Doors with Silver Frame

78"W x 15"D x 35¼"H — 4 doors, 2 compartments
 72"W x 15"D x 35¼"H — 4 doors, 2 compartments
 66"W x 15"D x 35¼"H — 4 doors, 2 compartments
 60"W x 15"D x 35¼"H — 4 doors, 2 compartments
 48"W x 15"D x 35¼"H — 3 doors, 2 compartments
 42"W x 15"D x 35¼"H — 2 doors, 1 compartment
 36"W x 15"D x 35¼"H — 2 doors, 1 compartment

HNL3678FD	153	31.8	\$1942	\$45	N/A
HNL3672FD	143	29.0	\$1887	\$35	N/A
HNL3666FD	134	26.7	\$1869	\$35	N/A
HNL3660FD	124	24.3	\$1760	\$35	N/A
HNL3648FD	104	19.6	\$1493	\$30	N/A
HNL3642FD	89	18.1	\$1313	\$30	N/A
HNL3636FD	79	15.3	\$1158	\$30	N/A

ⓘ Frosted/silver door units do not have a lock option.

NOTES:

- Convenient off-the-worksurface storage requires no additional floor space.
- 35¼"H stack-on storage models ship fully assembled.
- Fully enclosed back provides privacy; includes a 1¼", full-width pass-through for 3-prong electrical plugs; facilitates routing cords and reaching wall electrical outlets.
- Lower back panel can be attached with cord pass-through at bottom next to the worksurface or at top for close proximity to task light cord.
- Lower back panel can be removed to facilitate collaboration in teaming configurations.
- Valance hides task light.
- Vertical clearance for computer monitor is 20".
- Laminate vertical paper organizer (HLVPMI) sized to fit below storage compartments.
- Can be specified in seven widths (36", 42", 48", 60", 66", 72", and 78"W) and two heights, standard (35¼"H) or executive (48⅝"H).
- Available with laminate doors, frosted/silver doors, or sliding door.
- Doors are sized to overlap the top, end panels and light valance, to provide a clean design.
- Laminate and frosted/silver door units are equipped with self-closing, adjustable hinges.
- Laminate hinged door units are available with or without a lock.
- For tackboards, see page 59.
- For task lights, see page 113.
- For paper organizers, see page 110.

HOW TO SPECIFY

<p>Select Model Number</p> <p>H N L 3 6 7 2 L D</p>	<p>Select Chassis Color</p> <p>See page 29</p> <p>H</p>	<p>Select Door Front Color</p> <p>See page 29</p> <p>H</p>	
<p>Select Model Number</p> <p>H N L 3 6 7 2 L L</p>	<p>Select Lock Finish</p> <p>See page 29</p> <p>P</p>	<p>Select Chassis Color</p> <p>See page 29</p> <p>H</p>	<p>Select Door Front Color</p> <p>See page 29</p> <p>H</p>
<p>Select Model Number</p> <p>H N L 3 6 7 2 F D</p>	<p>Select Chassis Color</p> <p>See page 29</p> <p>H</p>		

CONCINNITY™

Stack-on Storage

GSA SIN 33721

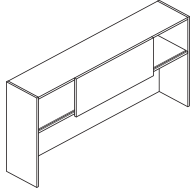

Icon Legend on page 19

**DESCRIPTION****Stack-on Storage, Sliding Door**

78"W x 15"D x 35¼"H
 72"W x 15"D x 35¼"H
 66"W x 15"D x 35¼"H
 60"W x 15"D x 35¼"H
 48"W x 15"D x 35¼"H

MODEL

HNL3678SD
HNL3672SD
HNL3666SD
HNL3660SD
HNL3648SD

SHIP WEIGHT

161
 151
 141
 131
 110

CUBE

31.8
 29.0
 26.7
 24.3
 19.6

L1 LIST

\$1267
\$1229
\$1133
\$1101
\$1041

L2 UPCHARGES

CHASSIS	FRONTS
\$45	\$20
\$35	\$20
\$35	\$20
\$35	\$20
\$30	\$20

NOTES: Sliding door units have one door per cabinet; standard with black lock, which is located on inside vertical support panel. Lock is core removable. Keyed alike cores must be ordered separately. For stack-on and wall mount storage with sliding door, specify model HF27B (Black) and the key number, see page 112. Sliding door availability limited to select sizes.

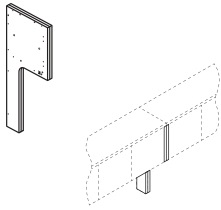
**Stack-on Space Saver End Panels**

¾"W x 14¼"D x 35¼"H

HNL3605SSEP

14

1.7

\$379**\$15****N/A**

NOTES: Two field installable end panels (1-right; 1-left) for use in ganging two stack-on storage units. Combining stack-on allows users to span longer worksurfaces, including 84" (2 - 42"W), 96" (2 - 48"W), 120" (2 - 60"W), and 144" (2 - 72"W). Narrow, space-saving panel size replaces the full 15"D end panels to expand worksurface space. The 4¼" right end panel is to replace the standard 15"D right end panel on one stack-on storage unit, the 4¼" left end panel is to replace the standard 15"D left end panel on a separate, adjacent stack-on storage unit that is in linear alignment with the first unit. Kit includes: (2) narrow end panel supports; European-style fasteners; dowels; joint connector bolts with sleeve nuts (for ganging stack-on storage units). Can be used to connect up to two stack-on storage units in a line (requires 1 kit). Can be specified in a woodgrain or solid laminate color only.

SPECIFYING EXAMPLE: HNL3605SSEP.H

NOTES:

- Convenient off-the-worksurface storage requires no additional floor space.
- 35¼"H stack-on storage models ship fully assembled.
- Fully enclosed back provides privacy; includes a 1¼", full-width pass-through for 3-prong electrical plugs; facilitates routing cords and reaching wall electrical outlets.
- Lower back panel can be attached with cord pass-through at bottom next to the worksurface or at top for close proximity to task light cord.
- Lower back panel can be removed to facilitate collaboration in teaming configurations.
- Valance hides task light.
- Vertical clearance for computer monitor is 20".
- Laminate vertical paper organizer (HLVPM1) sized to fit below storage compartments.
- Can be specified in seven widths (36", 42", 48", 60", 66", 72", and 78"W) and two heights, standard (35¼"H) or executive (48⅝"H).
- Available with laminate doors, frosted/silver doors, or sliding door.
- Doors are sized to overlap the top, end panels and light valance, to provide a clean design.
- Laminate and frosted/silver door units are equipped with self-closing, adjustable hinges.
- Laminate hinged door units are available with or without a lock.
- For tackboards, see page 59.
- For task lights, see page 113.
- For paper organizers, see page 110.

HOW TO SPECIFY**Select Model Number**

H N L 3 6 7 2 S D

Select Chassis Color

See page 29

H

Select Door Front Color

See page 29

H



CONCINNITY™ Stack-on Storage

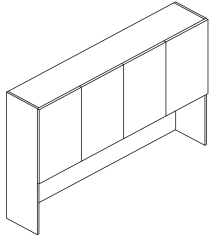

DESCRIPTION

Stack-on Storage, Laminate Doors
 78"W x 15"D x 48⁵/₈"H — 4 doors, 2 compartments
 72"W x 15"D x 48⁵/₈"H — 4 doors, 2 compartments
 66"W x 15"D x 48⁵/₈"H — 4 doors, 2 compartments
 60"W x 15"D x 48⁵/₈"H — 4 doors, 2 compartments
 48"W x 15"D x 48⁵/₈"H — 3 doors, 2 compartments
 42"W x 15"D x 48⁵/₈"H — 2 doors, 1 compartment
 36"W x 15"D x 48⁵/₈"H — 2 doors, 1 compartment

MODEL	SHIP WEIGHT	CUBE	L1 LIST	L2 UPCHARGES	
				CHASSIS	FRONTS
HNL4978LD	264	31.3	\$1784	\$60	\$20
HNL4972LD	243	29.1	\$1642	\$50	\$20
HNL4966LD	229	26.8	\$1551	\$50	\$20
HNL4960LD	212	24.5	\$1443	\$50	\$20
HNL4948LD	175	26.4	\$1376	\$45	\$20
HNL4942LD	149	23.2	\$1206	\$45	\$20
HNL4936LD	145	20.3	\$1167	\$45	\$20

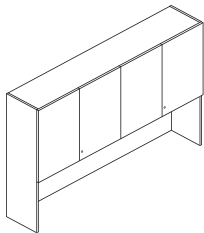

Stack-on Storage, Laminate Locking Doors
 78"W x 15"D x 48⁵/₈"H — 4 doors, 2 compartments
 72"W x 15"D x 48⁵/₈"H — 4 doors, 2 compartments
 66"W x 15"D x 48⁵/₈"H — 4 doors, 2 compartments
 60"W x 15"D x 48⁵/₈"H — 4 doors, 2 compartments
 48"W x 15"D x 48⁵/₈"H — 3 doors, 2 compartments
 42"W x 15"D x 48⁵/₈"H — 2 doors, 1 compartment
 36"W x 15"D x 48⁵/₈"H — 2 doors, 1 compartment

HNL4978LL	264	31.3	\$1866	\$60	\$20
HNL4972LL	243	29.1	\$1725	\$50	\$20
HNL4966LL	229	26.8	\$1634	\$50	\$20
HNL4960LL	212	24.5	\$1526	\$50	\$20
HNL4948LL	175	26.4	\$1417	\$45	\$20
HNL4942LL	149	23.2	\$1248	\$45	\$20
HNL4936LL	145	20.3	\$1209	\$45	\$20

Lock available in Black (P) or Satin (SA) finish. Lock is core removable. Keyed alike cores must be ordered separately. For stack-on and wall mount storage with locking hinged doors, specify model HF27B (Black) or HF27S (Satin) and the key number, see page 112. Model HNL4948LL has one lock, which secures two of the three doors.

NOTES:

- Convenient off-the-worksurface storage requires no additional floor space.
- 48⁵/₈"H units have a fixed, intermittent shelf; storage space above and below the shelf is 12⁵/₈".
- Product applications are detailed on pages 53-54.
- Fully enclosed back provides privacy; includes a 1¹/₄", full-width pass-through for 3-prong electrical plugs; facilitates routing cords and reaching wall electrical outlets.
- Lower back panel can be attached with cord pass-through at bottom next to the worksurface or at top for close proximity to task light cord.
- Lower back panel can be removed to facilitate collaboration in teaming configurations.
- Valance hides task light.
- Vertical clearance for computer monitor is 20".
- Laminate vertical paper organizer (HLVPMI) sized to fit below storage compartments.
- Can be specified in seven widths (36", 42", 48", 60", 66", 72", and 78"W) and two heights, standard (35¹/₄"H) or executive (48⁵/₈"H).
- Available with laminate doors, frosted/silver doors, or sliding door.
- Doors are sized to overlap the top, end panels and light valance, to provide a clean design.
- Laminate and frosted/silver door units are equipped with self-closing, adjustable hinges.
- Laminate hinged door units are available with or without a lock.
- For tackboards, see page 59.
- For task lights, see page 113.
- For paper organizers, see page 110.

HOW TO SPECIFY

<p>Select Model Number</p> <p>H N L 4 9 7 8 L D</p>	<p>Select Chassis Color</p> <p>See page 29</p> <p>H</p>	<p>Select Door Front Color</p> <p>See page 29</p> <p>H</p>	
<p>Select Model Number</p> <p>H N L 4 9 7 8 L L</p>	<p>Select Lock Finish</p> <p>See page 29</p> <p>P</p>	<p>Select Chassis Color</p> <p>See page 29</p> <p>H</p>	<p>Select Door Front Color</p> <p>See page 29</p> <p>H</p>

CONCINNITY™

Stack-on Storage

GSA SIN 33721

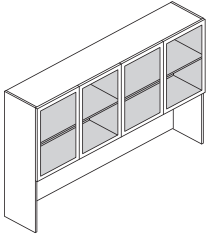

Icon Legend on page 19

**DESCRIPTION****Stack-on Storage, Frosted Doors with Silver Frame**

78"W x 15"D x 48⁵/₈"H — 4 doors, 2 compartments
 72"W x 15"D x 48⁵/₈"H — 4 doors, 2 compartments
 66"W x 15"D x 48⁵/₈"H — 4 doors, 2 compartments
 60"W x 15"D x 48⁵/₈"H — 4 doors, 2 compartments
 48"W x 15"D x 48⁵/₈"H — 3 doors, 2 compartments
 42"W x 15"D x 48⁵/₈"H — 2 doors, 1 compartment
 36"W x 15"D x 48⁵/₈"H — 2 doors, 1 compartment

! Frosted/silver door units do not have a lock option.

MODEL**SHIP WEIGHT****CUBE****L1 LIST****L2 UPCHARGES**
CHASSIS FRONTS

HNL4978FD	225	31.3	\$2713	\$60	N/A
HNL4972FD	207	29.1	\$2571	\$50	N/A
HNL4966FD	196	26.8	\$2481	\$50	N/A
HNL4960FD	182	24.5	\$2372	\$50	N/A
HNL4948FD	152	26.4	\$2073	\$45	N/A
HNL4942FD	128	23.2	\$1671	\$45	N/A
HNL4936FD	114	20.3	\$1632	\$45	N/A

NOTES:

- Convenient off-the-worksurface storage requires no additional floor space.
- 48⁵/₈"H units have a fixed, intermittent shelf; storage space above and below the shelf is 12⁵/₈".
- Product applications are detailed on pages 53-54.
- Fully enclosed back provides privacy; includes a 1/4", full-width pass-through for 3-prong electrical plugs; facilitates routing cords and reaching wall electrical outlets.
- Lower back panel can be attached with cord pass-through at bottom next to the worksurface or at top for close proximity to task light cord.
- Lower back panel can be removed to facilitate collaboration in teaming configurations.
- Valance hides task light.
- Vertical clearance for computer monitor is 20".
- Laminate vertical paper organizer (HLVPM1) sized to fit below storage compartments.
- Can be specified in seven widths (36", 42", 48", 60", 66", 72", and 78"W) and two heights, standard (35¹/₄"H) or executive (48⁵/₈"H).
- Available with laminate doors, frosted/silver doors, or sliding door.
- Doors are sized to overlap the top, end panels and light valance, to provide a clean design.
- Laminate and frosted/silver door units are equipped with self-closing, adjustable hinges.
- Laminate hinged door units are available with or without a lock.
- For tackboards, see page 59.
- For task lights, see page 113.
- For paper organizers, see page 110.

HOW TO SPECIFY

Select
Model Number

H N L 4 9 7 8 F D

Select
Chassis Color

See page 29

H

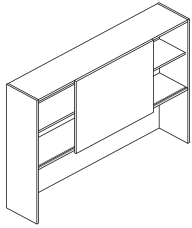

DESCRIPTION	MODEL	COM	SHIP WEIGHT	CUBE	L1 LIST	L2 UPCHARGES	
						CHASSIS	FRONTS
Stack-on Storage, Sliding Door							
78"W x 15"D x 48 ⁵ / ₈ "H	HNL4978SD		236	31.3	\$1809	\$60	\$20
72"W x 15"D x 48 ⁵ / ₈ "H	HNL4972SD		221	29.1	\$1712	\$50	\$20
66"W x 15"D x 48 ⁵ / ₈ "H	HNL4966SD		207	26.8	\$1674	\$50	\$20
60"W x 15"D x 48 ⁵ / ₈ "H	HNL4960SD		192	24.5	\$1475	\$50	\$20
48"W x 15"D x 48 ⁵ / ₈ "H	HNL4948SD		162	26.4	\$1405	\$45	\$20

NOTES: Sliding door units have one door per cabinet; standard with black lock, which is located on inside vertical support panel. Lock is core removable. Keyed alike cores must be ordered separately. For stack-on and wall mount storage with sliding door, specify model HF27B (Black) and the key number, see page 112. Sliding door availability limited to select sizes.

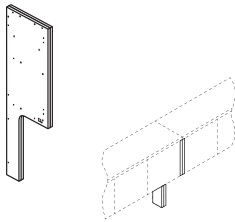

DESCRIPTION	MODEL	COM	SHIP WEIGHT	CUBE	L1 LIST	L2 UPCHARGES
Stack-on Space Saver End Panels 3/4"W x 14 1/4"D x 48 5/8"H	HNL4905SEP		23	2.2	\$513	\$15 N/A

NOTES: Two field installable end panels (1-right; 1-left) for use in ganging two stack-on storage units. Combining stack-on allows users to span longer worksurfaces, including 84" (2 - 42"W), 96" (2 - 48"W), 120" (2 - 60"W), and 144" (2 - 72"W). Narrow, space-saving panel size replaces the full 15"D end panels to expand worksurface space. The 4 1/4" right end panel is to replace the standard 15"D right end panel on one stack-on storage unit, the 4 1/4" left end panel is to replace the standard 15"D left end panel on a separate, adjacent stack-on storage unit that is in linear alignment with the first unit. Kit includes: (2) narrow end panel supports; European-style fasteners; dowels; joint connector bolts with sleeve nuts (for ganging stack-on storage units). Can be used to connect up to two stack-on storage units in a line (requires 1 kit). Can be specified in a woodgrain or solid laminate color only.

SPECIFYING EXAMPLE: HNL4905SEP.H

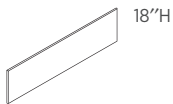

DESCRIPTION	MODEL	COM	SHIP WEIGHT	CUBE	L1 LIST	L2 UPCHARGES
Tackboards for use with Stack-on Storage						
75"W - for 78"W	H90057	3.0	13	3.2	\$317	N/A N/A
68 3/4"W - for 72"W	H90056	2.0	12	2.7	\$301	N/A N/A
62 3/4"W - for 66"W	H90055	2.0	11	2.5	\$286	N/A N/A
56 3/4"W - for 60"W	H90054	2.0	10	2.2	\$252	N/A N/A
44 3/4"W - for 48"W	H90053	2.0	8	1.8	\$242	N/A N/A
39"W - for 42"W	H90052	2.0	7	1.6	\$223	N/A N/A
33"W - for 36"W	H90051	1.0	6	1.4	\$196	N/A N/A
26 3/4"W	H90050	1.0	5	1.2	\$196	N/A N/A

NOTES: Specify fabric, see pages 25-26. Upcharges may apply to premium fabric grades.

Disperse (DISP) fabric not available on sizes wider than 60". Analog (ANLG) and Exchange (EXG) not available on sizes wider than 72".

SPECIFYING EXAMPLE: H90057.APN15

NOTES:

- Convenient off-the-worksurface storage requires no additional floor space.
- 48⁵/₈"H units have a fixed, intermittent shelf; storage space above and below the shelf is 12⁵/₈".
- Fully enclosed back provides privacy; includes a 1/4", full-width pass-through for 3-prong electrical plugs; facilitates routing cords and reaching wall electrical outlets.
- Lower back panel can be attached with cord pass-through at bottom next to the worksurface or at top for close proximity to task light cord.
- Lower back panel can be removed to facilitate collaboration in teaming configurations.
- Valance hides task light.
- Vertical clearance for computer monitor is 20".
- Laminate vertical paper organizer (HLVPM1) sized to fit below storage compartments.
- Can be specified in seven widths (36", 42", 48", 60", 66", 72", and 78"W) and two heights, standard (35 1/4"H) or executive (48 5/8"H).
- Available with laminate doors, frosted/silver doors, or sliding door.
- Doors are sized to overlap the top, end panels and light valance, to provide a clean design.
- Laminate and frosted/silver door units are equipped with self-closing, adjustable hinges.
- Laminate hinged door units are available with or without a lock.
- For tackboards, see above.
- For task lights, see page 113.
- For paper organizers, see page 110.

HOW TO SPECIFY

Select Model Number H N L 4 9 7 8 S D	Select Chassis Color See page 29 H	Select Door Front Color See page 29 H
---	---	--

CONCINNITY™ WALL MOUNT STORAGE APPLICATIONS

- Installation (review carefully):
 - **Attachment requires individual cabinets be secured by a minimum of two (2) wall mounting locations/studs.**
 - **Designed for interior and perimeter walls that are constructed with wood or metal studs.**
 - **Attaches to wall with horizontally mounted, interlocking brackets.**
 - **The HON Company is not responsible for any liabilities resulting from wall mounted storage cabinets that are not properly installed.**
- Laminate, laminate locking, and frosted/silver door units can be specified in eight widths (30", 36", 42", 48", 60", 66", 72", and 78"W) and two heights, standard (15"H) or executive (29½"H).
- Sliding door units can be specified in five widths (48", 60", 66", 72", and 78"W) and two heights, standard (15"H) or executive (29½"H).
- Product placement can be aligned to match the height of 64¾"H or 78⅛"H storage- and wardrobe-type cabinets.
- Available with laminate doors, frosted/silver doors, or sliding door.
 - Door design overlaps end panels so that when multiple units are placed side-by-side they appear as one continuous unit.
 - Laminate and frosted/silver door units are equipped with self-closing, adjustable hinges.
 - Laminate hinged door units are available with or without a lock.
 - Lock available in Black (P) or Satin (SA).
 - Lock is core removable; keyed alike cores must be ordered separately — for overhead storage with hinged doors specify model HF27B or HF27S and the key number.
 - Frosted/silver hinged door units do not have a lock option.
 - Sliding door units have one door per cabinet; standard with black lock, which is located on inside vertical support panel. Lock is core removable; keyed alike cores must be ordered separately — for overhead storage with a sliding door specify model HF23B (Black) and the key number.
 - Laminate and frosted/silver door cabinets in 30", 36", and 42"W have two doors; 48"W has three doors; 60", 66", 72", and 78"W have four doors.
- Inside storage dimensions of 15"H cabinets:
 - 30"W = one compartment, sized 28⅜"W x 13⅜"D x 12¾"H
 - 36"W = one compartment, sized 34⅜"W x 13⅜"D x 12¾"H
 - 42"W = one compartment, sized 40⅜"W x 13⅜"D x 12¾"H
 - 48"W = two compartments, one sized 30⅝"W x 13⅜"D x 12¾"H; one sized 14⅝"W x 13⅜"D x 12¾"H
 - 60"W = two compartments, each 28⅝"W x 13⅜"D x 12¾"H
 - 66"W = two compartments, each 31⅝"W x 13⅜"D x 12¾"H
 - 72"W = two compartments, each 34⅝"W x 13⅜"D x 12¾"H
 - 78"W = two compartments, each 37⅝"W x 13⅜"D x 12¾"H
- 28½"H units have a fixed, intermittent shelf; storage space above and below the shelf is 12⅝".
- Wall mounted storage cabinets are not designed for attachment to O-leg models HLSL65OS or HLSL50OS.
- Horizontal interlocking rails are included; due to varying types of walls, installers are responsible for selecting and supplying the appropriate fasteners.
- Ship fully assembled.

CONCINNITY™ WALL MOUNT STORAGE APPLICATIONS

OPTIONS INCLUDE:

- Door/Storage Options:

Door(s)	Standard-Height	Executive-Height
Laminate	•	•
Laminate Locking	•	•
Frosted/Silver	•	•
Sliding	48"-78"W only	48"-78"W only

- Paper organizers for stack-on and wall mounted storage cabinets (see compatibility information on page 111).
- Fabric-Covered Tackboards:
 - Tackboards mount directly to wall using the fasteners or hook-and-loop tape provided.
 - For a list of standard fabrics, see pages 25-26. For a complete list of fabrics, please go to hon.com/fabricsandfinishes.
 - See compatibility cross reference below.
 - NOTE: Tackboard widths differ slightly from the wall mounted storage cabinet widths. For applications where multiple wall mounted storage units are placed side-by-side, the preferred tackboard solution may be to utilize a larger tackboard size.
For example, H90057 = 75"W; H90056 = 68³/₄"W; H90055 = 62³/₄"W; H90054 = 56³/₄"W.
- Markerboards:
 - HL1530SOMB: 29¹/₂"W x 12¹/₂"H panel attaches to 60" and 66"W stack-on and wall mounted storage with sliding door models with double-sided tape.
 - HL1536SOMB: 35¹/₂"W x 12¹/₂"H panel attaches to 72" and 78"W stack-on and wall mounted storage with sliding door models with double-sided tape.
- Task Lights:
 - Attach to underside of stack-on and wall mount storage cabinets.
 - Fluorescent or LED options.
 - Compatibility: Tackboard and task light solutions, by model, for each wall mounted storage cabinet size:

Wall Mounted Storage	Tackboard	Fluorescent Task Light	LED Task Light
78"W	H90057 (75"W) or qty 2 of H90052 (39"W ea.)	HH870960, HH870960CH	HLED31A, HLED31AUO
72"W	H90056 (71 ¹ / ₂ "W)	HH870960, HH870960CH	HLED31A, HLED31AUO
66"W	H90055 (65 ¹⁵ / ₁₆ "W)	HH870960, HH870960CH	HLED31A, HLED17AUO
60"W	H90054 (59 ¹⁵ / ₁₆ "W)	HH870960, HH870960CH	HLED31A, HLED17AUO
48"W	H90053 (44 ³ / ₄ "W)	HH870942, HH870942CH	HLED31AS
42"W	H90052 (39"W)	HH870942, HH870942CH	HLED31AS
36"W	H90051 (33"W)	HH870930, HH870930CH	HLED17AS
30"W	H90050 (26 ³ / ₄ "W)	HH870930, HH870930CH	HLED17AS

CONCINNITY™

Wall Mount Storage

GSA SIN 33721

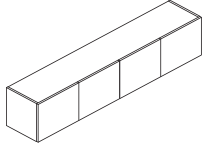

Icon Legend on page 19

**DESCRIPTION****Wall Mount Storage, Laminate Doors**

78"W x 15"D x 15"H — 4 doors, 2 compartments
 72"W x 15"D x 15"H — 4 doors, 2 compartments
 66"W x 15"D x 15"H — 4 doors, 2 compartments
 60"W x 15"D x 15"H — 4 doors, 2 compartments
 48"W x 15"D x 15"H — 3 doors, 2 compartments
 42"W x 15"D x 15"H — 2 doors, 1 compartment
 36"W x 15"D x 15"H — 2 doors, 1 compartment
 30"W x 15"D x 15"H — 2 doors, 1 compartment

MODEL**SHIP WEIGHT****CUBE****L1 LIST****L2 UPCHARGES**
CHASSIS FRONTS

HNL1578LD	126	17.1	\$1245	\$35	\$20
HNL1572LD	118	15.9	\$1156	\$25	\$20
HNL1566LD	109	14.6	\$1101	\$25	\$20
HNL1560LD	100	13.3	\$989	\$25	\$20
HNL1548LD	83	10.9	\$892	\$20	\$20
HNL1542LD	68	9.7	\$842	\$20	\$10
HNL1536LD	60	8.4	\$770	\$20	\$10
HNL1530LD	51	7.2	\$711	\$20	\$10

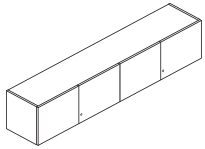
**Wall Mount Storage, Laminate Locking Doors**

78"W x 15"D x 15"H — 4 doors, 2 compartments
 72"W x 15"D x 15"H — 4 doors, 2 compartments
 66"W x 15"D x 15"H — 4 doors, 2 compartments
 60"W x 15"D x 15"H — 4 doors, 2 compartments
 48"W x 15"D x 15"H — 3 doors, 2 compartments
 42"W x 15"D x 15"H — 2 doors, 1 compartment
 36"W x 15"D x 15"H — 2 doors, 1 compartment
 30"W x 15"D x 15"H — 2 doors, 1 compartment

HNL1578LL	126	17.1	\$1327	\$35	\$20
HNL1572LL	118	15.9	\$1238	\$25	\$20
HNL1566LL	109	14.6	\$1184	\$25	\$20
HNL1560LL	100	13.3	\$1071	\$25	\$20
HNL1548LL	83	10.9	\$933	\$20	\$20
HNL1542LL	68	9.7	\$883	\$20	\$10
HNL1536LL	60	8.4	\$811	\$20	\$10
HNL1530LL	51	7.2	\$752	\$20	\$10

! Lock available in Black (P) or Satin (SA) finish. Lock is core removable. Keyed alike cores must be ordered separately. For stack-on and wall mount storage with locking hinged doors, specify model HF27B (Black) or HF27S (Satin) and the key number, see page 112. Model HNL1548LL has one lock, which secures two of the three doors.

NOTES:

- Convenient off-the-worksurface storage requires no additional floor space.
- Available with laminate doors, frosted/silver doors, or sliding door.
- Doors are sized to overlap the top, end panels and light valance, to provide a clean design.
- Laminate and frosted/silver door units are equipped with self-closing, adjustable hinges.
- Laminate hinged door units are available with or without a lock.
- For tackboards, see page 65.
- For task lights, see page 113.
- For paper organizers, see page 110.
- **IMPORTANT: See installation guidelines at top of page 60.**

HOW TO SPECIFY**Select Model Number**

H N L 1 5 7 8 L D

Select Chassis Color

See page 29

H

Select Door Front Color

See page 29

H

Select Model Number

H N L 1 5 7 8 L L

Select Lock Finish

See page 29

P

Select Chassis Color

See page 29

H

Select Door Front Color

See page 29

H



CONCINNITY™ Wall Mount Storage

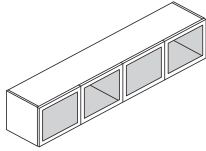

DESCRIPTION

Wall Mount Storage, Frosted Doors with Silver Frame

- 78"W x 15"D x 15"H — 4 doors, 2 compartments
- 72"W x 15"D x 15"H — 4 doors, 2 compartments
- 66"W x 15"D x 15"H — 4 doors, 2 compartments
- 60"W x 15"D x 15"H — 4 doors, 2 compartments
- 48"W x 15"D x 15"H — 3 doors, 2 compartments
- 42"W x 15"D x 15"H — 2 doors, 1 compartment
- 36"W x 15"D x 15"H — 2 doors, 1 compartment
- 30"W x 15"D x 15"H — 2 doors, 1 compartment

MODEL

SHIP WEIGHT

CUBE

L1 LIST

**L2 UPCHARGES
CHASSIS FRONTS**

HNL1578FD	106	17.1	\$1864	\$35	N/A
HNL1572FD	99	15.9	\$1775	\$25	N/A
HNL1566FD	92	14.6	\$1721	\$25	N/A
HNL1560FD	85	13.3	\$1608	\$25	N/A
HNL1548FD	71	10.9	\$1356	\$20	N/A
HNL1542FD	57	9.7	\$1152	\$20	N/A
HNL1536FD	50	8.4	\$1079	\$20	N/A
HNL1530FD	43	7.2	\$1021	\$20	N/A

❗ Frosted door models do not have a lock option.

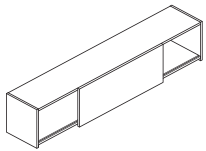

Wall Mount Storage, Sliding Door

- 78"W x 15"D x 15"H
- 72"W x 15"D x 15"H
- 66"W x 15"D x 15"H
- 60"W x 15"D x 15"H
- 48"W x 15"D x 15"H

HNL1578SD	114	17.1	\$1212	\$35	\$20
HNL1572SD	107	15.9	\$1113	\$25	\$20
HNL1566SD	99	14.6	\$1036	\$25	\$20
HNL1560SD	91	13.3	\$941	\$25	\$20
HNL1548SD	76	10.9	\$881	\$20	\$20

NOTES: One door per unit. Standard with black lock, which is located on the inside vertical support panel. Lock is core removable. Keyed alike cores must be ordered separately. For stack-on and wall mount storage with sliding door, specify model HF23B (Black) and the key number, see page 112.

NOTES:

- Convenient off-the-worksurface storage requires no additional floor space.
- Available with laminate doors, frosted/silver doors, or sliding door.
- Doors are sized to overlap the top, end panels and light valance, to provide a clean design.
- Laminate and frosted/silver door units are equipped with self-closing, adjustable hinges.
- Laminate hinged door units are available with or without a lock.
- For tackboards, see page 65.
- For task lights, see page 113.
- For paper organizers, see page 110.
- **IMPORTANT: See installation guidelines at top of page 60.**

HOW TO SPECIFY

<p>Select Model Number</p> <div style="border: 1px solid black; display: flex; justify-content: space-between; align-items: center; padding: 2px;"> HNL1578FD </div>	<p>Select Chassis Color</p> <p>See page 29</p> <div style="border: 1px solid black; display: flex; justify-content: space-between; align-items: center; padding: 2px;"> H </div>	
<p>Select Model Number</p> <div style="border: 1px solid black; display: flex; justify-content: space-between; align-items: center; padding: 2px;"> HNL1578SD </div>	<p>Select Chassis Color</p> <p>See page 29</p> <div style="border: 1px solid black; display: flex; justify-content: space-between; align-items: center; padding: 2px;"> H </div>	<p>Select Door Front Color</p> <p>See page 29</p> <div style="border: 1px solid black; display: flex; justify-content: space-between; align-items: center; padding: 2px;"> H </div>

CONCINNITY™

Wall Mount Storage

GSA SIN 33721

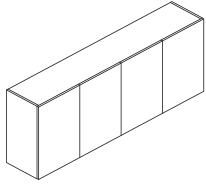

Icon Legend on page 19

**DESCRIPTION****Wall Mount Storage, Laminate Doors**

78"W x 15"D x 28½"H — 4 doors, 2 compartments
 72"W x 15"D x 28½"H — 4 doors, 2 compartments
 66"W x 15"D x 28½"H — 4 doors, 2 compartments
 60"W x 15"D x 28½"H — 4 doors, 2 compartments
 48"W x 15"D x 28½"H — 3 doors, 2 compartments
 42"W x 15"D x 28½"H — 2 doors, 1 compartment
 36"W x 15"D x 28½"H — 2 doors, 1 compartment
 30"W x 15"D x 28½"H — 2 doors, 1 compartment

MODEL**SHIP WEIGHT****CUBE****L1 LIST****L2 UPCHARGES**
CHASSIS FRONTS

HNL2978LD	213	30.8	\$1509	\$50	\$40
HNL2972LD	199	28.6	\$1432	\$40	\$40
HNL2966LD	185	26.4	\$1387	\$40	\$40
HNL2960LD	170	24.1	\$1288	\$40	\$40
HNL2948LD	142	19.7	\$1173	\$35	\$30
HNL2942LD	116	17.4	\$964	\$35	\$20
HNL2936LD	101	15.2	\$918	\$35	\$20
HNL2930LD	87	12.9	\$819	\$35	\$20

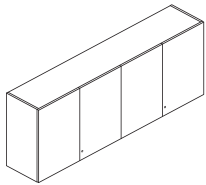
**Wall Mount Storage, Laminate Locking Doors**

78"W x 15"D x 28½"H — 4 doors, 2 compartments
 72"W x 15"D x 28½"H — 4 doors, 2 compartments
 66"W x 15"D x 28½"H — 4 doors, 2 compartments
 60"W x 15"D x 28½"H — 4 doors, 2 compartments
 48"W x 15"D x 28½"H — 3 doors, 2 compartments
 42"W x 15"D x 28½"H — 2 doors, 1 compartment
 36"W x 15"D x 28½"H — 2 doors, 1 compartment
 30"W x 15"D x 28½"H — 2 doors, 1 compartment

HNL2978LL	213	30.8	\$1592	\$50	\$40
HNL2972LL	199	28.6	\$1514	\$40	\$40
HNL2966LL	185	26.4	\$1470	\$40	\$40
HNL2960LL	170	24.1	\$1371	\$40	\$40
HNL2948LL	142	19.7	\$1215	\$35	\$30
HNL2942LL	116	17.4	\$1005	\$35	\$20
HNL2936LL	101	15.2	\$960	\$35	\$20
HNL2930LL	87	12.9	\$861	\$35	\$20

! Lock available in Black (P) or Satin (SA) finish. Lock is core removable. Keyed alike cores must be ordered separately. For stack-on and wall mount storage with locking hinged doors, specify model HF27B (Black) or HF27S (Satin) and the key number, see page 112. Model HNL2948LL has one lock, which secures two of the three doors.

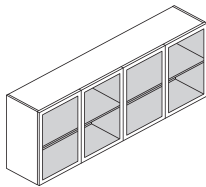
**Wall Mount Storage, Frosted Doors with Silver Frame**

78"W x 15"D x 28½"H — 4 doors, 2 compartments
 72"W x 15"D x 28½"H — 4 doors, 2 compartments
 66"W x 15"D x 28½"H — 4 doors, 2 compartments
 60"W x 15"D x 28½"H — 4 doors, 2 compartments
 48"W x 15"D x 28½"H — 3 doors, 2 compartments
 42"W x 15"D x 28½"H — 2 doors, 1 compartment
 36"W x 15"D x 28½"H — 2 doors, 1 compartment
 30"W x 15"D x 28½"H — 2 doors, 1 compartment

HNL2978FD	174	30.8	\$2438	\$50	N/A
HNL2972FD	163	28.6	\$2361	\$40	N/A
HNL2966FD	152	26.4	\$2316	\$40	N/A
HNL2960FD	140	24.1	\$2217	\$40	N/A
HNL2948FD	118	19.7	\$1870	\$35	N/A
HNL2942FD	94	17.4	\$1428	\$35	N/A
HNL2936FD	83	15.2	\$1383	\$35	N/A
HNL2930FD	72	12.9	\$1284	\$35	N/A

! Frosted door models do not have a lock option.

NOTES:

- Convenient off-the-worksurface storage requires no additional floor space.
- Available with laminate doors, frosted/silver doors, or sliding door.
- Doors are sized to overlap the top, end panels and light valance, to provide a clean design.
- Laminate and frosted/silver door units are equipped with self-closing, adjustable hinges.
- Laminate hinged door units are available with or without a lock.

- 28½"H units have a fixed, intermittent shelf; storage space above and below the shelf is 12½".
- For tackboards, see page 65.
- For task lights, see page 113.
- For paper organizers, see page 110.
- **IMPORTANT: See installation guidelines at top of page 60.**

HOW TO SPECIFY**Select Model Number**

H N L 2 9 7 8 L D

Select Chassis Color

See page 29

H

Select Door Front Color

See page 29

H

Select Model Number

H N L 2 9 7 8 L L

Select Lock Finish

See page 29

P

Select Chassis Color

See page 29

H

Select Door Front Color

See page 29

H

Select Model Number

H N L 2 9 7 8 F D

Select Chassis Color

See page 29

H



Icon Legend on page 19

CONCINNITY™ Wall Mount Storage

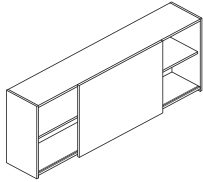

DESCRIPTION	MODEL	COM	SHIP WEIGHT	CUBE	L1 LIST	L2 UPCHARGES	
						CHASSIS	FRONTS
Wall Mount Storage, Sliding Door							
78"W x 15"D x 28½"H	HNL2978SD		189	30.8	\$1569	\$50	\$40
72"W x 15"D x 28½"H	HNL2972SD		177	28.6	\$1498	\$40	\$40
66"W x 15"D x 28½"H	HNL2966SD		165	26.4	\$1463	\$40	\$40
60"W x 15"D x 28½"H	HNL2960SD		153	24.1	\$1369	\$40	\$40
48"W x 15"D x 28½"H	HNL2948SD		129	19.7	\$1200	\$35	\$30

NOTES: One door per unit. Standard with black lock, which is located on the inside vertical support panel. Lock is core removable. Keyed alike cores must be ordered separately. For stack-on and wall mount storage with sliding door, specify model HF23B (Black) and the key number, see page 112.

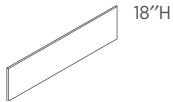

Tackboards for use with Wall Mount Storage

75"W - for 78"W	H90057	3.0	13	3.2	\$317	N/A	N/A
68¾"W - for 72"W	H90056	2.0	12	2.7	\$301	N/A	N/A
62¾"W - for 66"W	H90055	2.0	11	2.5	\$286	N/A	N/A
56¾"W - for 60"W	H90054	2.0	10	2.2	\$252	N/A	N/A
44¾"W - for 48"W	H90053	2.0	8	1.8	\$242	N/A	N/A
39"W - for 42"W	H90052	2.0	7	1.6	\$223	N/A	N/A
33"W - for 36"W	H90051	1.0	6	1.4	\$196	N/A	N/A
26¾"W	H90050	1.0	5	1.2	\$196	N/A	N/A

NOTES: Specify fabric, see pages 25-26. Upcharges may apply to premium fabric grades.

Tackboard widths differ slightly from the wall mounted storage cabinet widths. For applications where multiple wall mounted storage units are placed side-by-side, the preferred tackboard solution may be to utilize a larger tackboard size. For example, H90057 = 75"W; H90056 = 68¾"W; H90055 = 62¾"W; H90054 = 56¾"W.

! Disperse (DISP) fabric not available on sizes wider than 60". Analog (ANLG) and Exchange (EXG) not available on sizes wider than 72".

SPECIFYING EXAMPLE: H90057.APN15

NOTES:

- Convenient off-the-worksurface storage requires no additional floor space.
- Valance hides task light.
- Available with laminate doors, frosted/silver doors, or sliding door.
- Doors are sized to overlap the top, end panels and light valance, to provide a clean design.
- Laminate and frosted/silver door units are equipped with self-closing, adjustable hinges.
- Laminate hinged door units are available with or without a lock.
- 28½"H units have a fixed, intermittent shelf; storage space above and below the shelf is 12⅝".
- For tackboards, see above.
- For task lights, see page 113.
- For paper organizers, see page 110.
- **IMPORTANT: See installation guidelines at top of page 60.**

HOW TO SPECIFY

<p>Select Model Number</p> <p>H N L 2 9 7 8 S D</p>	<p>Select Chassis Color</p> <p>See page 29</p> <p>H</p>	<p>Select Door Front Color</p> <p>See page 29</p> <p>H</p>
--	--	---

CONCINNITY™

Bookcase Hutches

GSA SIN 33721

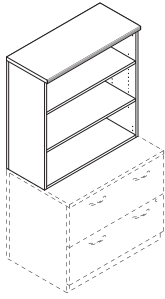

Icon Legend on page 19

**DESCRIPTION****Bookcase Hutch, No Doors/Open**

36"W x 14¼"D x 35¼"H (shown)
30"W x 14¼"D x 35¼"H

36"W x 14¼"D x 48⅝"H
30"W x 14¼"D x 48⅝"H

MODEL**SHIP WEIGHT****CUBE****L1 LIST****L2 UPCHARGES**
CHASSIS FRONTS

HNL3636BHxD
HNL3630BHxD

213
199

15.3
12.5

\$584
\$570

\$15
\$15

N/A
N/A

HNL4936BHxD
HNL4930BHxD

213
199

125.0
109.0

\$738
\$689

\$25
\$25

N/A
N/A

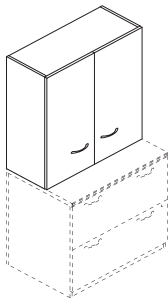
**Bookcase Hutch, Laminate Doors**

36"W x 15"D x 35¼"H (shown)
30"W x 15"D x 35¼"H

36"W x 15"D x 48⅝"H
30"W x 15"D x 48⅝"H

HNL3636BHLD
HNL3630BHLD

213
199

15.3
12.5

\$755
\$709

\$15
\$15

\$20
\$20

HNL4936BHLD
HNL4930BHLD

213
199

165.0
142.0

\$904
\$848

\$25
\$25

\$30
\$30

NOTES:

- Designed for use on worksurfaces, or on 30" or 36" W x 29½" H lateral file or storage cabinet with doors.
- Two widths, 30" and 36"; two heights, 35¼" and 48⅝".
- The 35¼" H unit has three shelves, two are adjustable in ¼" increments with a total range of 17½"; bottom shelf is fixed.
- The 48⅝" H unit has four shelves, three are adjustable in ¼" increments with a total range of 25"; bottom shelf is fixed.
- Available with laminate doors or frosted/silver doors or no doors (open).
- Door units equipped with self-closing, adjustable hinges.
- Laminate doors have decorative handles.
- Frosted door units have push/touch latch release.
- Doors are non-locking.
- To align with the top of the 35¼" H bookcase hutch, use 64¾" H floor-standing storage models; to align with the top of the 48⅝" H bookcase hutch, use 78⅝" H models.
- Ship fully assembled.

HOW TO SPECIFY**Select Model Number**

H N L 3 6 3 6 B H X D .

Select Laminate Color

See page 29

H

Select Model Number

H N L 3 6 3 6 B H L D .

Select Handle

- A Cylinder - Satin
- B Cylinder - Black
- C Canopy - Satin
- D Canopy - Black
- E Loop - Satin
- F Loop - Black

E .

Select Chassis Color

See page 29

H .

Select Door Front Color

See page 29

H



CONCINNITY™ Bookcase Hutches

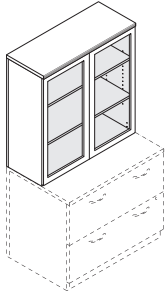

DESCRIPTION	MODEL	SHIP WEIGHT	CUBE	L1 LIST	L2 UPCHARGES	
					CHASSIS	FRONTS
Bookcase Hutch, Frosted Doors with Silver Frame 36"W x 15"D x 35¼"H (shown)	HNL3636BHFD	199	15.3	\$1375	\$15	N/A
36"W x 15"D x 48⅝"H	HNL4936BHFD	213	134.0	\$1678	\$25	N/A

NOTES:

- Designed for use on worksurfaces, or on 30" or 36"W x 29½"H lateral file or storage cabinet with doors.
- Two widths, 30" and 36"; two heights, 35¼" and 48⅝".
- The 35¼"H unit has three shelves, two are adjustable in 1¼" increments with a total range of 17½"; bottom shelf is fixed.
- The 48⅝"H unit has four shelves, three are adjustable in 1¼" increments with a total range of 25"; bottom shelf is fixed.
- Available with laminate doors or frosted/silver doors or no doors (open).
- Door units equipped with self-closing, adjustable hinges.
- Laminate doors have decorative handles.
- Frosted door units have push/touch latch release.
- Doors are non-locking.
- To align with the top of the 35¼"H bookcase hutch, use 64¾"H floor-standing storage models; to align with the top of the 48⅝"H bookcase hutch, use 78⅞"H models.
- Ship fully assembled.

HOW TO SPECIFY

<p>Select Model Number</p> <p>H N L 3 6 3 6 B H F D .</p>	<p>Select Chassis Color</p> <p>See page 29</p> <p>H</p>
--	--

CONCINNITY™

Reception Stations

GSA SIN 33721



Icon Legend on page 19

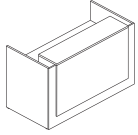

DESCRIPTION	MODEL	SHIP WEIGHT	CUBE	L1 LIST	L2 UPCHARGES		ACCENT PANEL
					WORKSURFACE	CHASSIS	

Reception Desk with Transaction Counter72"W x 36³/₄"D x 44"H**HLAM3772RD**

324

13.5

\$1474**\$35****\$70****\$25**

NOTES: Non-handed. Counter measures 60"W x 15¹/₄"D. Flat edge (G) matches 10500 Series™. For beaded (B) and tri-oval (V) edge shapes, the transaction counter is profiled on the approach and user sides, and the desk worksurface is profiled on the user's side. Beaded (B) and tri-oval (V) edges are available in L1 woodgrains colors only. Smooth and flat (G) edge available in all woodgrains and solid colors. Vertical grain on approach side and front accent panel for L1 laminates except Kingswood Walnut and Florence Walnut. Horizontal grain on L2 laminates and Kingswood and Florence Walnut. Vertical grain on end panels and horizontal grain on worksurface and transaction counter. Two worksurface cord management grommets for routing and hiding wires and cables; can be specified in Black (P) or Platinum (TI) finish.

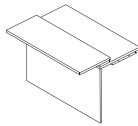
**Reception Return with 32'H Transaction Counter**48¹/₄"W x 32⁷/₈"D x 32"H**HLAM3348RR**

145

3.7

\$829**\$35****\$35****N/A**

NOTES: Non-handed. For use with HLAM3772RD and Reception Desk Shell (H105724). Counter facilitates accessibility; measures 48"W x 12"D x 32"H. Flat edge (G) matches 10500 Series™. For beaded (B) and tri-oval (V) edge shapes, the transaction counter is profiled on the approach side, and the return worksurface is profiled on the user's side. All other edges are flat banded. Beaded (B) and tri-oval (V) available in L1 woodgrain colors only. Flat edge (G) available in all woodgrains and solid colors. Pattern laminates do not have matching edge color; patterns can be specified with woodgrain or solid edge. Vertical grain on approach side, end panel, worksurface, and transaction counter. Assembly required.

Specify: Model.Edge Profile & EdgeColor.Worksurface & Counter Color.Chassis Color

SPECIFYING EXAMPLE: HLAM3348RR.GN.N.N**HOW TO SPECIFY**

Select Model Number

Select Edge Profile and Edge Color

See page 29

Select Grommet Color

P Black
TI Platinum
 Not specified for model HLAM3348RR

Select Worksurface Laminate

See page 29

Select Chassis Laminate

See page 29

Select Accent Panel Laminate

See page 29
 Not specified for model HLAM3348RR

H L A M 3 7 7 2 R D .

G N .

P .

N .

N .

L D W 1



Icon Legend on page 19

CONCINNITY™ Reception Stations

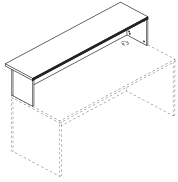

DESCRIPTION

Reception Station Counter for Desk
72"W x 17"D x 14 5/8"H

MODEL	SHIP WEIGHT	CUBE	L1 LIST	L2 UPCHARGES	
				COUNTER	CHASSIS
HNL1772RT	74	4.3	\$552	\$10	\$15

Compatible for use on 72"W x 30" or 36"D desktops and worksurfaces. For cleanest approach-side aesthetic, use on desk built with modular components; desk comprised of either 72"W x 30"D rectangle worksurface and 72"W x 27 7/8"H modesty/back panel, supported by 29 1/8"D pedestal(s) and/or end panel(s), or 72"W x 36"D worksurface and 72"W x 27 7/8"H modesty/back panel, supported by 35"D left and right end panels. The counter is 17"D with a 4" approach-side overhang; end panels are 12 3/8"D. Ships with Transaction counter organizer (model HTCOL52) is available as an option; fits under transaction counter; organizer is available in black only.

SPECIFYING EXAMPLE: HNL1772RT.BH.H.H

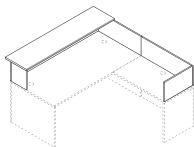

For Station with Right Return

L-Reception Station with Transaction Counter for Desk

72"W x 88"D x 14 5/8"H
72"W x 82"D x 14 5/8"H

HNL8472RT	103	4.5	\$881	\$10	\$25
HNL7872RT	101	4.5	\$860	\$10	\$25

NOTES: Intended for use on desk built with modular components, for clean approach-side aesthetic, connected to a return or modular return. Layout for 78" and 84"D footprints:

- 72"W x 78"D:
 - Desk = 72"W x 30"D worksurface, 72"W x 27 7/8"H modesty/back panel, supported by 29 1/8"D pedestal(s) and/or end panel(s).
 - Return = 48"W x 24"D return; or 48"W x 24"D worksurface with vertical grain, 48"W x 27 7/8"H modesty/back panel, supported by a 23 1/8"D pedestal and/or end panel.
- 72"W x 84"D:
 - Desk = 72"W x 36"D worksurface, 72"W x 27 7/8"H modesty/back panel, supported by 1-left and 1-right 35"D panel.
 - Return = 42"W x 24"D return; or 42"W x 24"D worksurface with vertical grain, 42"W x 27 7/8"H modesty/back panel, supported by a 23 1/8"D pedestal and/or end panel.
- 72"W x 84"D:
 - Desk = 72"W x 36"D worksurface, 72"W x 27 7/8"H modesty/back panel, supported by 1-left and 1-right 35"D end panel.
 - Return = 48"W x 24"D return; or 48"W x 24"D worksurface with vertical grain, 48"W x 27 7/8"H modesty/back panel, supported by a 23 1/8"D pedestal and/or end panel.

Comprised of 17"D transaction counter, with 4" approach-side overhang, for the desk and a vertical privacy panel extending the depth of the desk and width of the return. Ships with Transaction counter organizer (model HTCOL52) is available as an option; fits under transaction counter; organizer is available in black only.

SPECIFYING EXAMPLE: HNL8472RT.BH.H.H

NOTES:

- Reception Station Counter for Desk, and L-Reception Station with Transaction Counter for Desk, have profiled edgeband on the approach and user sides.
- L-Reception Station with Transaction Counter for Desk and Return has profiled edgeband on front side of transaction counter on desk approach-side only.
- For L-reception station layouts where the return is not against a wall, specify return using modular components, as the modesty/back panel can be specified without a grommet. Assembled returns come standard with cord grommet in modesty/back panel.

HOW TO SPECIFY

<p>Select Model Number</p> <p>H N L 1 7 7 2 R T</p>	<p>Select Edge Profile and Edge Color</p> <p>See page 29</p> <p>B H</p>	<p>Select Counter Color</p> <p>See page 29</p> <p>H</p>	<p>Select Chassis Color</p> <p>See page 29</p> <p>H</p>
--	--	--	--

CONCINNITY™

Reception Stations

GSA SIN 33721



Icon Legend on page 19

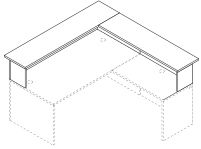

For Station with Right Return

DESCRIPTION	MODEL	SHIP WEIGHT	CUBE	L1 LIST	L2 UPCHARGES	
					COUNTER	CHASSIS
L-Reception Station with Transaction Counter for Desk and Return						
76"W x 88"D x 14 $\frac{5}{8}$ "H	HNL8472RLT	145	5.6	\$1056	\$10	\$25
76"W x 82"D x 14 $\frac{5}{8}$ "H	HNL7872RLT	139	5.6	\$1019	\$10	\$25
NOTES: Intended for use on desk built with modular components, for clean approach-side aesthetic, connected to a return or modular return. Layout for 78" and 84"D footprints:						
• 72"W x 78"D:						
- Desk = 72"W x 30"D worksurface, 72"W x 27 $\frac{7}{8}$ "H modesty/back panel, supported by 29 $\frac{1}{8}$ "D pedestal(s) and/or end panel(s).						
- Return = 48"W x 24"D worksurface with vertical grain, 48"W x 27 $\frac{7}{8}$ "H modesty/back panel, supported by a 23 $\frac{1}{8}$ "D pedestal and/or end panel.						
• 72"W x 78"D:						
- Desk = 72"W x 36"D worksurface, 72"W x 27 $\frac{7}{8}$ "H modesty/back panel, supported by 1-left and 1-right 35"D panel.						
- Return = 42"W x 24"D worksurface with vertical grain, 42"W x 27 $\frac{7}{8}$ "H modesty/back panel, supported by a 23 $\frac{1}{8}$ "D pedestal and/or end panel.						
• 72"W x 84"D:						
- Desk = 72"W x 36"D worksurface, 72"W x 27 $\frac{7}{8}$ "H modesty/back panel, supported by 1-left and 1-right 35"D end panel.						
- Return = 48"W x 24"D worksurface with vertical grain, 48"W x 27 $\frac{7}{8}$ "H modesty/back panel, supported by a 23 $\frac{1}{8}$ "D pedestal and/or end panel.						
! The 17"D transaction counter, with 4" overhang, extends around the perimeter of the station, across the width of the desk, as well as along the depth of the desk and width of the return. Ships with Transaction counter organizer (model HTCOL52) is available as an option; fits under transaction counter; organizer is available in black only.						
SPECIFYING EXAMPLE: HNL8472RLT.BH.H.H						

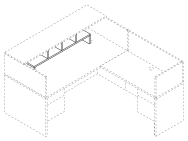

Transaction Counter Organizer						
48 $\frac{3}{4}$ "W x 11 $\frac{1}{8}$ "D x 13"H	HTCOL52	24	1.1	\$283	N/A	N/A
NOTES: Fits under reception station counters.						
! Black only.						
SPECIFYING EXAMPLE: HTCOL52.P						

NOTES:

- Reception Station Counter for Desk, and L-Reception Station with Transaction Counter for Desk, have profiled edgeband on the approach and user sides.
- ! L-Reception Station with Transaction Counter for Desk and Return has profiled edgeband on front side of transaction counter on desk approach-side only.
- ! For L-reception station layouts where the return is not against a wall, specify return using modular components, as the modesty/back panel can be specified without a grommet. Assembled returns come standard with cord grommet in modesty/back panel.

HOW TO SPECIFY

Select Model Number H N L 8 4 7 2 R L T .	Select Edge Profile and Edge Color See page 29 B H .	Select Counter Color See page 29 H .	Select Chassis Color See page 29 H
---	---	---	---



CONCINNITY™ Mobile Pedestals



DESCRIPTION	MODEL	SHIP WEIGHT	CUBE	L1 LIST	L2 UPCHARGES			
					TOP	CHASSIS	FRONTS	
Mobile Pedestal — 15¾" W								
15¾"W x 20⅞"D x 28⅜"H, Box/Box/File	HNL2116MBBF	69	7.4	\$898	N/A	\$20	\$10	
15¾"W x 20⅞"D x 28⅜"H, File/File	HNL2116MFF	70	7.4	\$898	N/A	\$20	\$10	
15¾"W x 20⅞"D x 21½"H, Box/File	HNL2116MBF	55	5.8	\$760	N/A	\$20	\$10	

NOTES: Well suited to a variety of office layouts, including private, open floor plan, and cubicle workspaces. Design positions the center of gravity towards the back of the cabinet to inhibit tipping. All drawers lock; interchangeable core removable lock makes re-keying quick and easy. Finish of lock is determined by, and aligned with, the handle finish specified. Keyed alike cores must be ordered separately; specify model HF23B (Black) or HF23S (Satin) and specific key number required. Pedestals, excluding cushion option, are sized to be positioned under 29½"H worksurfaces. Seat cushion model HLSL2016PH2 is optional. Cushion adds 1" to the height of the pedestal. Box/File unit with cushion will fit below 29½"H worksurface. ¾" thick top with flat edgeband; back inside end panel construction. Ships fully assembled.

SPECIFYING EXAMPLE: HNL2116MBBF.E.H.H

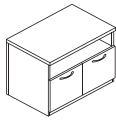

Mobile Pedestal — 30" W								
30"W x 20"D x 21½"H, Shelf/File/Cabinet	HNL2030MSFC	105	10.7	\$1129	\$10	\$25	\$15	

NOTES: Sized to align with 20"D x 20⅞"H low credenzas. Open shelf over file drawer left and cabinet with door right. Design positions the center of gravity towards the back of the cabinet to inhibit tipping. Seat cushion model HNL2030CH2 is optional. Cushion adds 1" to the height of the pedestal. 1⅞" thick top matches low credenza design. Ships fully assembled.

SPECIFYING EXAMPLE: HNL2030MSFC.BH.E.H.H.H

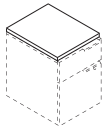

DESCRIPTION	MODEL	SHIP WEIGHT	CUBE	LIST PRICE BY FABRIC GRADE						
				1	2	3	4	5	6	
Mobile Pedestal Cushion										
30"W x 20"D x 1"H	HLSL2030CH2	9	1.9	\$372	\$408	\$444	\$480	\$526	\$573	
15¾"W x 20"D x 1"H	HLSL2016PH2	6	1.1	\$309	\$333	\$357	\$381	\$412	\$443	

NOTES: See pages 22-24 for available fabrics.

SPECIFYING EXAMPLE: HLSL2016PH2.APN23

NOTES:

- Mobile pedestals roll easily on four casters to provide convenient, flexible placement of personal storage needs.
- Drawers operate on steel ball-bearing suspension with full extension.
- File drawers include hangrails for side-to-side letter and legal filing; and front-to-back for letter filing.
- ! 28⅜"H mobile pedestals are not designed for use with the 28½"H metal O-leg due to interference caused by (1) the O-leg worksurface attachment bracket, and (2) the external support channel on the underside of a 72", 66", and 60"W rectangle worksurface supported by O-leg(s).

HOW TO SPECIFY

<p>Select Model Number</p>	<p>Select Handle</p> <p>A Cylinder – Satin B Cylinder – Black C Canopy – Satin D Canopy – Black E Loop – Satin F Loop – Black</p>	<p>Select Chassis Color</p> <p>See page 29</p>	<p>Select Drawer Front Color</p> <p>See page 29</p>
<p>H N L 2 1 1 6 M B B F .</p>	<p>E .</p>	<p>H .</p>	<p>H</p>

<p>Select Model Number</p>	<p>Select Edge Profile and Edge Color</p> <p>See page 29</p>	<p>Select Handle</p> <p>A Cylinder – Satin B Cylinder – Black C Canopy – Satin D Canopy – Black E Loop – Satin F Loop – Black</p>	<p>Select Top Color</p> <p>See page 29</p>	<p>Select Chassis Color</p> <p>See page 29</p>	<p>Select Drawer/Door Front Color</p> <p>See page 29</p>
<p>H N L 2 0 3 0 M S F C .</p>	<p>B H .</p>	<p>E .</p>	<p>H .</p>	<p>H .</p>	<p>H</p>

CONCINNITY™

Lateral Files

GSA SIN 33721



Icon Legend on page 19



DESCRIPTION	MODEL	SHIP WEIGHT	CUBE	L1 LIST	L2 UPCHARGES		
					TOP	CHASSIS	FRONTS
Lateral File 36"W x 24"D x 59½"H, 4-Drawer	HNL2436LD4	276	34.3	\$2125	\$15	\$30	\$30
36"W x 24"D x 45½"H, 3-Drawer	HNL2436LD3	222	26.0	\$1762	\$15	\$25	\$25
36"W x 24"D x 29½"H, 2-Drawer	HNL2436LD2	178	18.4	\$1167	\$15	\$20	\$20

NOTES: Equipped with safety restraints; mechanical interlock inhibits the extension of more than one drawer at a time; counterweight positions the center of gravity towards the back of the cabinet to inhibit tipping. 24" depth aligns evenly with credenzas, returns, storage cabinet, storage/file cabinet, storage cabinet/lateral file, wardrobe/storage cabinet, wardrobe/bookcase, storage towers, and 24"D modular components. 29½"H unit is sized to accommodate 36"W stack-on storage or bookcase hutch options. Drawers lock; interchangeable core removable lock makes re-keying quick and easy. Finish of lock is determined by, and aligned with, the handle finish specified. Keyed alike cores must be ordered separately; specify model HF23B (Black) or HF23S (Satin) and specific key number required. Ship fully assembled. 30"W two-drawer size can be specified and assembled using modular components. Drawers include hangrails to accept folders in letter or legal size.

SPECIFYING EXAMPLE: HNL2436LD2.BH.E.H.H.H

HOW TO SPECIFY

Select Model Number	Select Edge Profile and Edge Color	Select Handle	Select Top Color	Select Chassis Color	Select Drawer Front Color
	See page 29	A Cylinder – Satin B Cylinder – Black C Canopy – Satin D Canopy – Black E Loop – Satin F Loop – Black	See page 29	See page 29	See page 29
H N L 2 4 3 6 L D 4 .	B H .	E .	H .	H .	H .



CONCINNITY™ Storage Cabinets

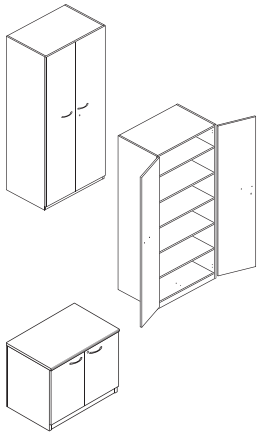

DESCRIPTION

Storage Cabinet with Laminate Doors

36"W x 24"D x 78 1/8"H (shown)
36"W x 24"D x 64 3/4"H
36"W x 24"D x 29 1/2"H

MODEL

HNL243679SC
HNL243665SC
HNL243629SC

SHIP WEIGHT

CUBE

L1 LIST

L2 UPCHARGES
TOP CHASSIS FRONTS

317	47.4	\$2301	N/A	\$60	\$25
252	40.8	\$2165	N/A	\$55	\$20
158	18.4	\$1039	\$15	\$20	\$20

NOTES: 29 1/2"H size has one adjustable interior shelf. Shelf adjusts in 2 1/2" increments over a total range of 10"H, 64 3/4"H and 78 1/8" have five shelves (four adjustable) and six shelves (five adjustable), respectively; shelves adjust in 2 1/2" increments. Locking doors. 24" depth aligns evenly with credenzas, returns, lateral files, storage/file cabinet, storage cabinet/lateral file, wardrobe/storage cabinet, wardrobe/bookcase, storage tower, bookcase with coat hook, and 24"D modular components. 29 1/2"H unit is sized to accommodate 36"W stack-on storage or bookcase hutch options. Ships fully assembled. 30"W x 24"D x 29 1/2"H freestanding unit can be built using modular components.

SPECIFYING EXAMPLE (29 1/2"H): HNL243629SC.BH.E.H.H.H
SPECIFYING EXAMPLE (64 3/4-78 1/8"H): HNL243665SC.E.H.H

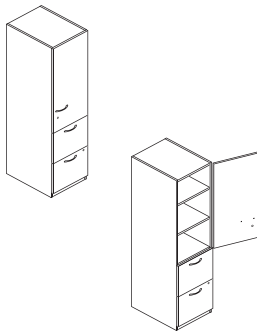

Storage/File Cabinet

18"W x 24"D x 64 3/4"H, File/File, Laminate
Door Hinged Right (shown)
18"W x 24"D x 64 3/4"H, File/File, Laminate
Door Hinged Left
18"W x 24"D x 64 3/4"H, File/File, Open
Shelves

HNL241865SFLR
HNL241865SFLL
HNL241865SFX

184
184
169

21.6
21.6
21.6

\$1740
\$1740
\$1651

N/A
N/A
N/A

\$25
\$25
\$25

\$15
\$15
\$15

NOTES: Versatile unit features a storage cabinet plus two file drawers. Storage cabinet includes three shelves, two are adjustable; shelves adjust in 2 1/2" increments. Can be specified with door hinged left, door hinged right, or no door/open shelves. File drawers operate on steel ball-bearing suspensions with full extension. File drawers include hangrails to accept folders in letter or legal size. Storage cabinet door and file drawers lock separately; the two locks are keyed alike. Unit height is designed to match desk, credenza, or return plus 35 1/4"H stack-on storage (= 64 3/4"). Ships fully assembled.

SPECIFYING EXAMPLE (WITH DOOR): HNL241865SFLR.E.H.H
SPECIFYING EXAMPLE (WITHOUT DOOR): HNL241865SFX.E.H.H

NOTES:

- Interchangeable core removable lock makes re-keying quick and easy.
- Finish of lock is determined by, and aligned with, the handle finish specified.
- Keyed alike cores must be ordered separately; specify model HF23B (Black) or HF23S (Satin) and specific key number required.

HOW TO SPECIFY

<p>Select Model Number</p> <p>H N L 2 4 3 6 2 9 S C .</p>	<p>Select Edge Profile and Edge Color</p> <p>See page 29</p> <p>B H .</p>	<p>Select Handle</p> <p>A Cylinder - Satin B Cylinder - Black C Canopy - Satin D Canopy - Black E Loop - Satin F Loop - Black</p> <p>E .</p>	<p>Select Top Color</p> <p>See page 29</p> <p>H .</p>	<p>Select Chassis Color</p> <p>See page 29</p> <p>H .</p>	<p>Select Drawer Front Color</p> <p>See page 29</p> <p>H .</p>
--	--	---	--	--	---

<p>Select Model Number</p> <p>H N L 2 4 3 6 6 5 S C .</p> <p>H N L 2 4 1 8 6 5 S F X .</p>	<p>Select Handle</p> <p>A Cylinder - Satin B Cylinder - Black C Canopy - Satin D Canopy - Black E Loop - Satin F Loop - Black</p> <p>E .</p> <p>E .</p>	<p>Select Chassis Color</p> <p>See page 29</p> <p>H .</p> <p>H .</p>	<p>Select Drawer Front Color</p> <p>See page 29</p> <p>H .</p> <p>H .</p>
---	--	---	--

CONCINNITY™ Storage Cabinets

GSA SIN 33721



Icon Legend on page 19

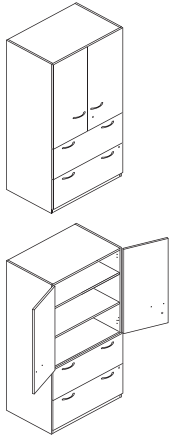

DESCRIPTION	MODEL	SHIP WEIGHT	CUBE	L1 LIST	L2 UPCHARGES		
					TOP	CHASSIS	FRONTS
Storage Cabinet/Lateral File, Laminate Doors 36"W x 24"D x 64¾"H	HNL243665SLL	328	40.8	\$2334	N/A	\$55	\$20

NOTES: Cabinet includes one fixed and two full-width adjustable shelves; adjustable shelves can be removed. Overall storage compartment measures 34"W x 22"D x 34½"H and will accommodate supplies, books and binders. Lateral file equipped with mechanical interlock to inhibit the extension of more than one drawer at a time. Lateral file drawers include handrails to accept folders in letter or legal size. Storage cabinet and lateral file lock independently; upper lock secures cabinet; lower locks secure file drawers. Locks are keyed alike. Door hinges rotate to 94 degrees. Unit height is designed to match desk, credenza, or return plus 35¼"H stack-on storage (= 64¾"). Ships fully assembled.

SPECIFYING EXAMPLE: HNL243665SLL.E.H.H

NOTES:

- Interchangeable core removable lock makes re-keying quick and easy.
- Finish of lock is determined by, and aligned with, the handle finish specified.
- Keyed alike cores must be ordered separately; specify model HF23B (Black) or HF23S (Satin) and specific key number required.

HOW TO SPECIFY

<p>Select Model Number</p> <p>H N L 2 4 3 6 6 5 S L L .</p>	<p>Select Handle</p> <p>A Cylinder - Satin B Cylinder - Black C Canopy - Satin D Canopy - Black E Loop - Satin F Loop - Black</p> <p>E .</p>	<p>Select Chassis Color</p> <p>See page 29</p> <p>H .</p>	<p>Select Door/Drawer Front Color</p> <p>See page 29</p> <p>H</p>
--	--	--	--



DESCRIPTION	MODEL	SHIP WEIGHT	CUBE	L1 LIST	L2 UPCHARGES	
					CHASSIS	FRONTS
Wardrobe/Storage Cabinet, Laminate Doors — 36"W 36"W x 24"D x 78 ¹ / ₈ "H 36"W x 24"D x 64 ³ / ₄ "H	HNL243679WL	303	40.8	\$2643	\$60	\$25
	HNL243665WL	284	40.8	\$2533	\$55	\$20

NOTES: Spacious design combines a cabinet with adjustable shelves and a generous personal wardrobe compartment with a coat rod and upper shelf. 64³/₄"H and 78¹/₈"H have five shelves (four adjustable) and six shelves (five adjustable), respectively; shelves adjust in 2¹/₂" increments. One lock secures both doors. Ships fully assembled.

SPECIFYING EXAMPLE: HNL243665WL.E.H.H

Wardrobe/Storage Cabinet, Laminate Door — 18"W 18"W x 24"D x 78 ¹ / ₈ "H, Hinged Right (shown) 18"W x 24"D x 78 ¹ / ₈ "H, Hinged Left 18"W x 24"D x 64 ³ / ₄ "H, Hinged Right 18"W x 24"D x 64 ³ / ₄ "H, Hinged Left	HNL241879WLR	205	24.8	\$1734	\$30	\$20
	HNL241879WLL	205	24.8	\$1734	\$30	\$20
	HNL241865WLR	157	21.6	\$1590	\$25	\$15
	HNL241865WLL	157	21.6	\$1590	\$25	\$15

NOTES: Design includes coat rod and shelves. 64³/₄"H and 78¹/₈"H have five shelves (four adjustable) and six shelves (five adjustable), respectively; shelves adjust in 2¹/₂" increments. Middle shelves can be removed to provide space for garments; coat rod can be removed for storage only applications. Lock to secure contents. Ships fully assembled.

SPECIFYING EXAMPLE: HNL241865WLR.E.H.H

Wardrobe/Bookcase, Laminate Door 36"W x 24"D x 78 ¹ / ₈ "H, Wardrobe Left, Bookcase Right 36"W x 24"D x 78 ¹ / ₈ "H, Wardrobe Right, Bookcase Left 36"W x 24"D x 64 ³ / ₄ "H, Wardrobe Left, Bookcase Right 36"W x 24"D x 64 ³ / ₄ "H, Wardrobe Right, Bookcase Left (shown)	HNL243679WLBR	302	47.4	\$2533	\$60	\$25
	HNL243679WRBL	302	47.4	\$2533	\$60	\$25
	HNL243665WLBR	230	40.8	\$2395	\$55	\$20
	HNL243665WRBL	230	40.8	\$2395	\$55	\$20

NOTES: Combination closed-door wardrobe closet and open shelf bookcase. 64³/₄"H and 78¹/₈"H bookcases have five and six fixed shelves, respectively. Locking wardrobe compartment includes a coat rod and one shelf; shelf is positioned above the coat rod. Bookcase can be accessed from front or side. Left (L) model is wardrobe on left, bookcase on right; Right (R) model is wardrobe on right, bookcase on left. Ships fully assembled.

SPECIFYING EXAMPLE: HNL243665WRBL.E.H.H

NOTES:

- Heights designed to match desk, credenza, or return plus 35¹/₄"H stack-on storage (= 64³/₄"H) or 48⁵/₈"H stack-on storage (= 78¹/₈"H).
- Finish of locks is determined by, and aligned with, the handle finish specified.
- Keyed alike cores must be ordered separately; specify model HF23B (Black) or HF23S (Satin) and specific key number required.

HOW TO SPECIFY

<p>Select Model Number</p> <p>H N L 2 4 3 6 5 W L .</p>	<p>Select Handle</p> <p>A Cylinder – Satin B Cylinder – Black C Canopy – Satin D Canopy – Black E Loop – Satin F Loop – Black</p> <p>E .</p>	<p>Select Chassis Color</p> <p>See page 29</p> <p>H .</p>	<p>Select Door Front Color</p> <p>See page 29</p> <p>H</p>
--	--	--	---

CONCINNITY™

Storage Towers

GSA SIN 33721

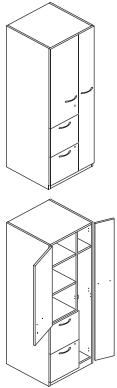

Icon Legend on page 19

**DESCRIPTION****Storage Towers, Laminate Doors — 24" W**24" W x 24" D x 78¹/₈" H, Wardrobe Hinged Left, Cabinet Hinged Right**MODEL****SHIP WEIGHT****CUBE****L1 LIST****L2 UPCHARGES**
CHASSIS **FRONTS**24" W x 24" D x 78¹/₈" H, Wardrobe Hinged Right, Cabinet Hinged Left**HNL242479TLL**

284

32.4

\$2455**\$70****\$45**24" W x 24" D x 64³/₄" H, Wardrobe Hinged Left, Cabinet Hinged Right**HNL242479TLR**

284

32.4

\$2455**\$70****\$45**24" W x 24" D x 64³/₄" H, Wardrobe Hinged Right, Cabinet Hinged Left (shown)**HNL242465TLL**

241

27.6

\$2235**\$60****\$35****HNL242465TLR**

241

27.6

\$2235**\$60****\$35**

NOTES: Versatile design includes a wardrobe closet, storage cabinet, and two file drawers, in one compact unit. Wardrobe contains a coat rod and upper shelf. 64³/₄" H and 78¹/₈" H cabinets have three shelves (two adjustable) and four shelves (three adjustable), respectively; shelves adjust in 2¹/₂" increments. File drawers operate on ball-bearing suspensions with full extension. File drawer design includes integrated hangrails for side-to-side letter or legal filing; and front-to-back for letter filing. Upper lock secures wardrobe closet and storage cabinet; lower lock secures file drawers; the two locks are keyed alike. Left (L) model is wardrobe hinged left, cabinet hinged right; Right (R) model is wardrobe hinged right, cabinet hinged left. Ships fully assembled.

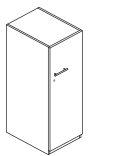
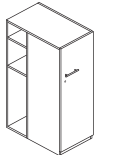
SPECIFYING EXAMPLE: HNL242465TLR.E.H.HHinged Right
HNL241850TLR shownHinged Right
HNL301850TLR shown**Storage Towers, Laminate Door — 50" H**

18" W x 30" D x 50" H, Hinged Right

HNL301850TLR

135

19.8

\$1385**\$50****\$35**

18" W x 30" D x 50" H, Hinged Left

HNL301850TLL

135

19.8

\$1385**\$50****\$35**

18" W x 24" D x 50" H, Hinged Right

HNL241850TLR

121

15.9

\$1245**\$50****\$35**

18" W x 24" D x 50" H, Hinged Left

HNL241850TLL

121

15.9

\$1245**\$50****\$35**

NOTES: Low profile design is well-suited for open plan layouts. Can be used next to 29¹/₂" H to standing, 42" H worksurfaces. Cabinet includes coat hook on back of door, perfect for jackets, sweaters, and purses. Two adjustable interior shelves, plus bottom of unit; shelves adjust in 2¹/₂" increments. 30" D size has a slim side access storage space at rear of unit with two fixed interior shelves; the lower shelf is positioned to align with a 29¹/₂" H worksurface, the upper shelf with a 42" H worksurface. Hardware bag includes an extra coat hook which can be positioned on the side of the unit, below the worksurface; ideal for back packs. Left (L) model is door hinged left; Right (R) model is door hinged right. Worksurface tower bracket kit (model HSTB2W1) can be used to attach a worksurface directly to the tower. Bracket (1) eliminates the need for one end panel or O-leg support; (2) is not designed to be used as a support when a stack-on storage unit is placed over bracket. Ships fully assembled.

SPECIFYING EXAMPLE: HNL182450TLR.E.H.H**NOTES:**

- Equipped with interchangeable core removable locks.
- Finish of locks is determined by, and aligned with, the handle finish specified.
- Keyed alike cores must be ordered separately; specify model HF23B (Black) or HF23S (Satin) and specific key number required.

CABINET/WARDROBE/TOWER SOLUTIONS BY SIZE

	Low/50" H	Standard/64 ³ / ₄ " H	Executive/78 ¹ / ₈ " H
Storage Cabinet with Doors		•	•
Storage/File Cabinet		•	
Storage Cabinet/Lateral File		•	
Wardrobe/Storage Cabinet		•	•
Wardrobe/Bookcase		•	•
Storage Tower		•	•
Storage Tower with Side Access on 30" D	•		
Bookcase with Coat Hook		•	

HOW TO SPECIFY

Select Model Number H N L 2 4 2 4 6 5 T L R .	Select Handle A Cylinder – Satin B Cylinder – Black C Canopy – Satin D Canopy – Black E Loop – Satin F Loop – Black E .	Select Chassis Color See page 29 H .	Select Door Front Color See page 29 E
---	---	---	--

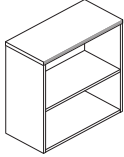

DESCRIPTION

Bookcase with Adjustable Shelves

- 30"W x 14 1/4"D x 78 1/8"H, 6-Shelf
- 30"W x 14 1/4"D x 65"H, 5-Shelf
- 30"W x 14 1/4"D x 52 3/4"H, 4-Shelf
- 30"W x 14 1/4"D x 42"H, 3-Shelf
- 30"W x 14 1/4"D x 29 1/2"H, 2-Shelf

MODEL	SHIP WEIGHT	CUBE	L1 LIST	L2 UPCHARGES	
				TOP	CHASSIS
HNL1530BK6	170	25.7	\$947	\$30	\$35
HNL1530BK5	143	21.1	\$840	\$25	\$30
HNL1530BK4	118	17.4	\$727	\$20	\$25
HNL1530BK3	95	14.1	\$640	\$15	\$20
HNL1530BK2	69	10.2	\$562	\$15	\$15

NOTES: Profiled top edge; choose from edge detail options. Number of total and adjustable shelves:

Height	Shelves	Adjustable Shelves
29 1/2"	2	1
42"	3	2
52 3/4"	4	3
65"	5	4
78 1/8"	6	5

3/4" thick shelves adjust in 1/4" increments. Inside shelf dimensions on all units are 28 1/2"W x 13 1/4"D. Ships fully assembled.

SPECIFYING EXAMPLE: HNL1530BK2.BH.H.H

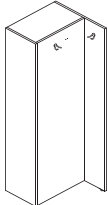
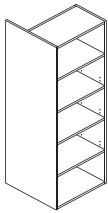

Back View

DESCRIPTION

Bookcase with Coat Hooks

- 24"W x 24"D x 64 3/4"H, 5-Shelf, with Coat Hooks, Right (shown)
- 24"W x 24"D x 64 3/4"H, 5-Shelf, with Coat Hooks, Left

MODEL	SHIP WEIGHT	CUBE	L1 LIST PRICE	L2
				UPCHARGE
HNL2424BK5CR	133	27.6	\$958	\$30
HNL2424BK5CL	133	27.6	\$958	\$30

NOTES: Inside shelf dimensions are 28 1/2"W x 13 1/4"D. Two out of sight coat hooks for garments are secluded behind bookcase. One end panel measures 14 1/4"D, the other 24"D. "R" indicates coat hook access is on the right and the full 24"D end panel on the left; for use next to credenza or return with pedestal on right. "L" indicates coat hook access is on the left and the full 24"D end panel is on the right; for use next to credenza or return with pedestal on left. Unit height is designed to match desk, credenza, or return plus 35 1/4"H stack-on storage (= 64 3/4"). 3/4" thick, non-profiled top edge. Not available in two-tone laminate color combinations. Ships fully assembled.

SPECIFYING EXAMPLE: HNL2424BK5CR.H

HOW TO SPECIFY

<p>Select Model Number</p> <p>H N L 1 5 3 0 B K 2 .</p>	<p>Select Edge Profile and Edge Color</p> <p>See page 29</p> <p>B H .</p>	<p>Select Top Color</p> <p>See page 29</p> <p>H .</p>	<p>Select Chassis Color</p> <p>See page 29</p> <p>H</p>
<p>Select Model Number</p> <p>H N L 2 4 2 4 B K 5 C R .</p>	<p>Select Laminate</p> <p>See page 29</p> <p>H</p>		

CONCINNITY™ COMPONENTS

MODULAR COMPONENTS

- Smart, adaptable, reconfigurable assortment to maximize office layout flexibility and optimize floor space.
- Components for all popular office layouts.
- Selection allows user to choose their own workstation shape, size, and storage.
- Sizes for large and small spaces:
 - 36"D x 72"W or 84"W
 - 30"D — six sizes up to 84"W
 - 24"D — in 6" increments, from 30"W to 96"W
- Worksurfaces supported by post legs with casters provide added layout flexibility.
- Mobile desks quickly convert an office into a small conference space; desks roll easily and can be repositioned in seconds.
- Grommet options provide cord management from the top, side, and back in appropriate models.
- Broad menu of under-surface storage to enable user to specify the solution that best meets their individual needs.
 - Non-handed units can be configured to meet individual tastes and reconfigured when preferences or floor space requirements change.
 - Applications include:
 - The ability to “build” contiguous customized/personalized storage behind the desk that looks like custom architectural millwork, but at a fraction of the price. Allows for multiple storage pedestals to be configured under a single top with clean lines and no gaps.
 - Choosing the storage solution to go under desks, credenzas, and returns.

WORKSURFACES

- Available in a variety of shapes and sizes.
- Scratch-, stain-, and spill-resistant laminate over durable 1 $\frac{1}{8}$ " solid core high performance particleboard; resists warping.
- An external support channel, for attachment under worksurfaces, is required for all unsupported spans — a distance in which there is not a vertical support (point of contact) between the underside of the worksurface and the floor — greater than 54"W.
- For tri-oval and beaded edge options on tops with horizontal grain, there is a shaped profile on the user and approach sides, and a flat edge on the ends.
- For tri-oval and beaded edge options on tops with vertical grain, there is a shaped profile on the user side and a flat edge on the approach side and the ends.
- Grommets are an option and require specification. If grommets are selected, grommets come in a pre-determined location.

- Must be specified with support components; for pedestal, end panel, column, and leg options, see “Components — Supports” listings.

SUPPORTS

- For use with rectangle, bow, bullet, and extended corner worksurfaces.
- Available in 28 $\frac{1}{2}$ " and 41"H.
- Adjustable hex glides allow floor-standing units to be easily leveled, without lifting, to compensate for uneven floors; glides have 1 $\frac{1}{4}$ " adjustable range on most components; 2" on O-legs.
- Bottom of laminate end panels are edgebanded for added strength and to seal out moisture.

FOR 29 $\frac{1}{2}$ "H WORKSURFACES

- Specify from a broad assortment of solutions, including —
 - Modular Pedestals
 - Laminate end panels (must be used in conjunction with a laminate modesty panel)
 - Laminate L-shaped end panels
 - Laminate T-shaped end panels
 - Metal O-legs — for use with worksurfaces up to 78"W (when using an 84" or wider worksurface, cannot use two O-legs; must use at least one 1 $\frac{3}{4}$ " or wider pedestal for the other support).
 - 4 $\frac{1}{2}$ " diameter metal column
 - 2" square metal post leg

FOR 42"H WORKSURFACES

- 42", fixed standing-height workstations give users the option of changing postures from sitting to standing throughout the day to help achieve their wellness goals.
- Specify supports from —
 - Modular Pedestals
 - Laminate end panels (must be used in conjunction with a laminate modesty panel)
 - Laminate L-shaped end panels
 - Metal O-legs
- When combined with a stool-height task chair, provides users the benefit of alternating their work between a seated or standing position.
- An external support channel, for attachment under worksurfaces, is required for all unsupported spans greater than 54"W.

- Worksurface End Support (panel, leg, column, base, pedestal) requirements by product type are as follows —
 - Desk, peninsula, or credenza — qty. 2
 - Return — qty. 1
 - Island extension — qty. 1

COORDINATE™ HEIGHT ADJUSTABLE BASE

- Height adjustable bases deliver a healthier style of working by allowing a seamless transition between sitting and standing throughout the day. For open, private, or training spaces.
- Frame rises from 21⁵/₈" to 47³/₄".
- Telescoping base design.
- Accommodates rectangle worksurface sizes 24" to 30"D and 48" to 72"W.
- Standard-height adjustable control included with base. Memory control allows preset worksurface heights for consistency.
- Shipped complete with a pre-assembled electric motor.

CONCINNITY™

Components — Worksurfaces

GSA SIN 33721



Icon Legend on page 19

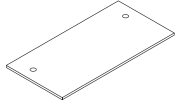

DESCRIPTION	MODEL	SHIP WEIGHT	CUBE	L1 LIST PRICE	L2 UPCHARGE
Rectangle Worksurface with Horizontal Grain					
84"W x 36"D	HNLRC3684	105	7.7	\$640	\$30
72"W x 36"D (shown)	HNLRC3672	90	6.7	\$534	\$30
84"W x 30"D	HNLRC3084	88	6.5	\$518	\$25
78"W x 30"D	HNLRC3078	81	6.1	\$468	\$25
72"W x 30"D	HNLRC3072	75	5.6	\$429	\$20
66"W x 30"D	HNLRC3066	69	5.2	\$395	\$20
60"W x 30"D	HNLRC3060	62	4.7	\$369	\$20
48"W x 30"D	HNLRC3048	50	3.9	\$301	\$15
96"W x 24"D	HNLRC2496	80	5.8	\$532	\$30
90"W x 24"D	HNLRC2490	75	5.5	\$522	\$30
84"W x 24"D	HNLRC2484	70	5.3	\$493	\$25
78"W x 24"D	HNLRC2478	65	4.9	\$440	\$20
72"W x 24"D	HNLRC2472	60	4.6	\$366	\$20
66"W x 24"D	HNLRC2466	55	4.2	\$353	\$20
60"W x 24"D	HNLRC2460	50	3.9	\$325	\$20
54"W x 24"D	HNLRC2454	45	3.5	\$299	\$20
48"W x 24"D	HNLRC2448	40	3.1	\$274	\$15
42"W x 24"D	HNLRC2442	35	2.8	\$256	\$15
36"W x 24"D Rectangle Worksurface/Pedestal Top	HNLRC2436	30	2.4	\$230	\$15
30"W x 24"D Rectangle Worksurface/Pedestal Top	HNLRC2430	25	2.1	\$230	\$15

NOTES: See chart on page 36 for cord management options.

- When grommets are specified for 30"D and 36"D rectangle worksurfaces, pre-drilled holes will not be included for a 4½" diameter support column.

NOTES:

- Grain direction on all rectangle worksurfaces runs horizontal (side-to-side) except as follows: 30"W - 36"W - 42"W - 48"W - 54"W - 60"W x 24"D tops can be specified with horizontal (side-to-side) or vertical (front-to-back) grain.
- 42"W and 48"W x 20"D tops are available with vertical (front-to-back) grain only.
- 48" - 72"W x 24" - 30"D worksurfaces are compatible for use with height adjustable electric base model HHAB3S2L.
- For standing-height requirements, use worksurface with 41"H O-leg, end panel, L-shaped end panel, or pedestal supports.
- For mobile desks and tables, use post leg with casters.
- For paper organizers, see page 110.
- Attachment of above privacy screen models requires a minimum 1" clear space/overhang on the underside of worksurface.
- Worksurfaces used with Coordinate™ Height Adjustable Bases should have 1" perimeter gap on each side to provide clearance between other furniture. Failure to do so risks injury or product damage (not covered by warranty).
- When using end panels or O-legs with 84", 90", or 96"W worksurfaces, interior weight-bearing support components are required to minimize worksurface deflection.
- Attachment of above/below privacy screen models requires a minimum 2" clear space/overhang on the underside of the worksurface.
- Steel external support channel can be attached to the underside of worksurfaces that are subjected to heavier loads. Channel is recommended to provide extra support on unsupported spans of 54"W or greater or per user preference. Ordered separately from worksurface.
- If using a 54"W or 60"W floating modesty panel, it is not necessary to specify an external support channel.
- When using an external support channel under the worksurface, the depth clearance for center drawers and keyboard platforms decreases by 8".
- See "External Channel (Recommended Use)" chart on page 85.

HOW TO SPECIFY

Select Model Number See page 29 H N L R C 3 6 8 4	Select Edge Profile and Edge Color See page 29 B H	Select Worksurface Grommet Finish P Black T1 Platinum X No Grommet P	Select Worksurface Color See page 29 H
---	--	--	--



CONCINNITY™

Components — Worksurfaces

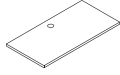

DESCRIPTION	MODEL	SHIP WEIGHT	CUBE	L1 LIST PRICE	L2 UPCHARGE
Rectangle Worksurface with Vertical Grain					
60"W x 24"D	HNLRC2460V	50	3.9	\$325	\$20
54"W x 24"D	HNLRC2454V	45	3.5	\$299	\$20
48"W x 24"D (shown)	HNLRC2448V	40	3.1	\$274	\$15
42"W x 24"D	HNLRC2442V	35	2.8	\$256	\$15
36"W x 24"D Rectangle Worksurface/Pedestal Top	HNLRC2436V	30	2.4	\$230	\$15
30"W x 24"D Rectangle Worksurface/Pedestal Top	HNLRC2430V	25	2.1	\$230	\$15
48"W x 20"D	HNLRC2048V	33	2.7	\$257	\$10
42"W x 20"D	HNLRC2042V	29	2.3	\$237	\$10

NOTES: Can be used in a host of applications, including as a desk, credenza, return, bridge, stationary or mobile table surface, in U- or L-shaped configurations, as part of a work wall layout with an island extension, or with the height adjustable electric base. The conference overhang dimension on the approach side of worksurfaces varies depending on the supports and modesty panels specified. Top can be positioned with a cantilevered conference overhang on one end when used with select worksurface supports, including an O-leg or 9½"W modular pedestal. For return applications in which there is an unsupported span wider than 54", such as a 72"W x 24"D worksurface supported by a 15¾"W modular pedestal (= 56¼") or a 60"W x 24"D worksurface supported by a 1½" thick end panel (= 58¾"), use internal support panel model HNL11SUPP. For bridges wider than 54", use internal support panel HNL11SUPP. When using a 30"W, 36"W, 42"W, or 48"W rectangle worksurface as a bridge, no support legs are needed. When specifying a 84"W, 90"W, or 96"W worksurface, cannot use two O-legs for the supports. In these applications, the maximum number of supports that can be an O-leg is one; must choose from a 15¾" or wider modular pedestal for use as the additional support component. For applications requiring connection to an adjoining worksurface, two flat brackets are included with 24"D and 20"D worksurfaces that are ≤48"W; one flat bracket is included with 24"D worksurfaces that are ≥54"W. Underside of worksurface includes pilot mounting holes for O-leg, 1½" thick laminate end panel, pedestals, and flat brackets. See chart on page 36 for cord management options.

ⓘ When grommets are specified for 30"D and 36"D rectangle worksurfaces, pre-drilled holes will not be included for attachment of a 4½" diameter support column.

NOTES:

- Grain direction on all rectangle worksurfaces runs horizontal (side-to-side) except as follows: 30"W - 36"W - 42"W - 48"W - 54"W - 60"W x 24"D tops can be specified with horizontal (side-to-side) or vertical (front-to-back) grain.
- 42"W and 48"W x 20"D tops are available with vertical (front-to-back) grain only.
- 48" - 72"W x 24" - 30"D worksurfaces are compatible for use with height adjustable electric base model HHAB3S2L.
- For standing-height requirements, use worksurface with 41"H O-leg, end panel, L-shaped end panel, or pedestal supports.
- For mobile desks and tables, use post leg with casters.
- For paper organizers, see page 110.
- ⓘ Attachment of above privacy screen models requires a minimum 1" clear space/overhang on the underside of worksurface.
- ⓘ Worksurfaces used with Coordinate™ Height Adjustable Bases should have 1" perimeter gap on each side to provide clearance between other furniture. Failure to do so risks injury or product damage (not covered by warranty).
- ⓘ Attachment of above/below privacy screen models requires a minimum 2" clear space/overhang on the underside of the worksurface.
- ⓘ Steel external support channel can be attached to the underside of worksurfaces that are subjected to heavier loads. Channel is recommended to provide extra support on unsupported spans of 54"W or greater or per user preference. Ordered separately from worksurface.
- ⓘ If using a 54"W or 60"W floating modesty panel, it is not necessary to specify an external support channel.
- ⓘ When using an external support channel under the worksurface, the depth clearance for center drawers and keyboard platforms decreases by 8".
- ⓘ See "External Channel (Recommended Use)" chart on page 85.

HOW TO SPECIFY

Select Model Number See page 29 H N L R C 2 4 6 0 V	Select Edge Profile and Edge Color See page 29 B H	Select Worksurface Grommet Finish P Black T1 Platinum X No Grommet P	Select Worksurface Color See page 29 H
---	--	---	--

CONCINNITY™

Components — Worksurfaces

GSA SIN 33721

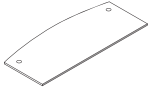
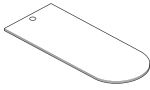

Icon Legend on page 19

	DESCRIPTION	MODEL	SHIP WEIGHT	CUBE	L1 LIST PRICE	L2 UPCHARGE
	Bow Worksurface					
	84"W x 36"D	HNLBW3684	94	7.7	\$683	\$30
	72"W x 36"D	HNLBW3672	80	6.7	\$617	\$30
	NOTES: 84"W size is ideal for executive layouts or for user's who require additional worksurface space. 72"W top can be combined with different pedestal support options to allow users to personalize their storage needs. Underside of worksurface includes pilot mounting holes for 1½" and L-shaped laminate end panels, and 29½"D pedestals. Grain direction runs horizontal (side-to-side). See chart on page 36 for cord management options.					
	Bullet Worksurface					
	84"W x 30"D	HNLBU3084	84	6.3	\$602	\$25
	78"W x 30"D	HNLBU3078	78	6.3	\$573	\$20
	72"W x 30"D	HNLBU3072	72	5.5	\$498	\$20
	66"W x 30"D	HNLBU3066	66	5.5	\$474	\$20
	60"W x 30"D	HNLBU3060	60	4.7	\$441	\$20
	48"W x 30"D	HNLBU3048	54	3.7	\$387	\$15
	NOTES: Applications include U- or L-shaped peninsula configurations and island extensions. Underside of worksurface includes pilot mounting holes for O-leg, T-shaped end panel, 29½"D pedestals, 4½" diameter support column, and 2" square post leg. One flat bracket is packaged with each worksurface for applications requiring connection to an adjoining worksurface. Grain direction runs horizontal (side-to-side). Can be used in combination with a 15¾"W or 9½"W x 29½"D x 28¼"H modular pedestal to create a freestanding desk. See chart on page 36 for cord management options.					

NOTES:

- ❗ When specifying an 84"W size, cannot use two O-legs; must use another type of support component such as a pedestal.
- ❗ Steel external support channel can be attached to the underside of worksurfaces that are subjected to heavier loads. Channel is recommended to provide extra support on unsupported spans of 54"W or greater or per user preference. Ordered separately from worksurface.
- ❗ If using a 54"W or 60"W floating modesty panel, it is not necessary to specify an external support channel.
- ❗ When using an external support channel under the worksurface, the depth clearance for center drawers and keyboard platforms decreases by 8".
- ❗ See "External Channel (Recommended Use)" chart on page 85.

HOW TO SPECIFY

Select Model Number <div style="border: 1px solid #ccc; padding: 2px; display: flex; gap: 5px;"> HNLBW3684 </div>	Select Edge Profile and Edge Color See page 29 <div style="border: 1px solid #ccc; padding: 2px; display: flex; gap: 5px;"> BH </div>	Select Worksurface Grommet Finish P Black T1 Platinum X No Grommet <div style="border: 1px solid #ccc; padding: 2px; display: flex; gap: 5px;"> P </div>	Select Worksurface Color See page 29 <div style="border: 1px solid #ccc; padding: 2px; display: flex; gap: 5px;"> H </div>
--	--	--	--



CONCINNITY™ Components — Worksurfaces

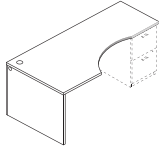

Right-hand model
HNLEC367224R shown

DESCRIPTION	MODEL	SHIP WEIGHT	CUBE	L1 LIST	L2 UPCHARGES	
					WORKSURFACE	END PANEL
Extended Corner Worksurface						
72"W x 48"D, Right	HNLEC487224R	130	8.9	\$1039	\$50	\$50
72"W x 48"D, Left	HNLEC487224L	130	8.9	\$1039	\$50	\$50
72"W x 36"D, Right	HNLEC367224R	106	6.6	\$860	\$45	\$45
72"W x 36"D, Left	HNLEC367224L	106	6.6	\$860	\$45	\$45

NOTES: For use in U- or L-shaped layouts. Includes top and long (47"D or 35"D) end panel components. Installation also requires modesty panel and either a 1½" thick end panel or 15¾" x 23⅜"D pedestal support for opposite end; both ordered separately. 72"W x 24/48"D or 48/24"D top is intended for use with 30/48"D or 48/30"D jetty peninsula to create a 2-piece "U" station with a curved cockpit on user's side. 72"W x 24/36"D or 36/24"D size is intended for use with 24"D returns or bridges. Underside of worksurface has pilot mounting holes for 1½" thick end panel and 15¾" x 23⅜"D modular pedestal. Edgebanding on the extended corner worksurface is profiled on the user's side and flat on the back (approach side) and ends. Grain direction runs horizontal (side-to-side).

ⓘ One flat bracket is packaged with each 48"D worksurface for applications requiring connection to a 48"D jetty peninsula. For 36"D extended corner worksurface, the flat bracket is shipped with the adjoining return or bridge. See chart on page 36 for cord management options. If grommet option is chosen, the worksurface component will match the color specified; the long end panel grommet color will be black.

NOTES:

- ⓘ When specifying an 84"W size, cannot use two O-legs; must use another type of support component such as a pedestal.
- ⓘ Steel external support channel can be attached to the underside of worksurfaces that are subjected to heavier loads. Channel is recommended to provide extra support on unsupported spans of 54"W or greater or per user preference. Ordered separately from worksurface.
- ⓘ If using a 54"W or 60"W floating modesty panel, it is not necessary to specify an external support channel.
- ⓘ When using an external support channel under the worksurface, the depth clearance for center drawers and keyboard platforms decreases by 8".
- ⓘ See "External Channel (Recommended Use)" chart on page 85.

HOW TO SPECIFY

<p>Select Model Number</p>	<p>Select Edge Profile and Edge Color</p> <p>See page 29</p>	<p>Select Worksurface Grommet Finish</p> <p>P Black T1 Platinum X No Grommet</p>	<p>Select Worksurface Color</p> <p>See page 29</p>	<p>Select End Panel Color</p> <p>See page 29</p>
<p>H N L E C 4 8 7 2 2 4 R .</p>	<p>B H .</p>	<p>X .</p>	<p>H .</p>	<p>H</p>

CONCINNITY™

Components — Supports

GSA SIN 33721 EXCEPT AS NOTED

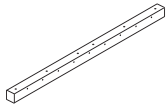

Icon Legend on page 19

**DESCRIPTION****External Support Channel**

72"W for a 78" Worksurface
 66"W for a 72" Worksurface
 60"W for a 66" Worksurface
 54"W for a 60" Worksurface
 48"W for a 54" Worksurface

MODEL**SHIP WEIGHT****CUBE****LIST PRICE**

HLSLZ5SC84	12	0.7	\$110
HLSLZ5SC78	7	0.5	\$110
HLSLZ5SC72	7	0.5	\$110
HLSLZ5SC66	7	0.5	\$101
HLSLZ5SC60	6	0.5	\$98

! Available in Graphite paint only.

! Attaches to underside of worksurface; required for unsupported spans greater than 54"W.

! When specifying a 54"W or 60"W Floating Modesty Panel, it is not necessary to specify an external channel.

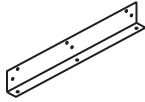

HVPWLBK24 shown

OPEN MARKET

Worksurface Wall Mount Bracket

For 30"
 For 24"

HVPWLBK30

2

0.3

\$83**HVPWLBK24**

2

0.3

\$76

NOTES: Can be used in place of an end panel to support a worksurface. Cannot be used as a support when placing a stack-on storage unit on worksurface over bracket; must have two full-sized floor supports when using stack-on storage. Finish option not required.

SPECIFYING EXAMPLE: HVPWLBK30**DESCRIPTION****Worksurface to Tower Bracket Kit**

18½" long bracket for attaching 24"D worksurface directly to storage tower, wardrobe/bookcase, wardrobe/storage cabinet, storage cabinet/lateral file, storage cabinet, or lateral file.

MODEL**SHIP WEIGHT****CUBE****LIST PRICE BY PAINT GRADE****P1****P2****P3****HSTB2W1**

4

0.6

\$76**\$89****\$100**

NOTES: Can be used in place of end panel or O-leg to support worksurfaces.

! Bracket not designed for use as a support if placing Stack-on Storage on worksurface over/above bracket. Two full-sized supports required when using Stack-on Storage.

NOTES:

• Use the worksurface to tower bracket kit to attach worksurfaces to Storage Tower models.

! Depending on your support combination, an external channel may be required for extra support on unsupported spans greater than 54"W.

HOW TO SPECIFY

Select
 Model Number

H L S L Z 5 S C 8 4

HNL Support Options — External Channel (model HLSLZ5SCxx) - Recommended Use

	Support Combination		Worksurface Width											
	Support 1	Support 2	30"	36"	42"	48"	54"	60"	66"	72"	78"	84"	90"	96"
O-LEG ON ONE END	O-Leg	O-Leg	NR	NR	NR	NR	60	66	72	78	84	NA	NA	NA
	O-Leg	9½"W Ped	NR	NR	NR	NR	NR	60	66	72	78	84	NA	NA
	O-Leg	End Bookcase	NA	NR	NR	NR	NR	NR	60	66	72	78	84	NA
	O-Leg	L End Panel	NR	NR	NR	NR	NR	60	66	72	78	84	NA	NA
	O-Leg	15¾"W Ped	NA	NR	NR	NR	NR	NR	NR	60	66	72	78	NA
	O-Leg	18"W Ped	NA	NA	NR	NR	NR	NR	NR	60	66	72	78	84
	O-Leg	30"W Ped	NA	NA	NA	NA	NR	NR	NR	NR	NR	60	66	72
	O-Leg	36"W Ped	NA	NA	NA	NA	NA	NR	NR	NR	NR	NR	60	66
	NARROW PED	9½"W Ped	9½"W Ped	NA	NA	NR	NR	NR	NR	NR	60	66	72	78
9½"W Ped		End Bookcase	NA	NA	NR	NR	NR	NR	NR	60	66	72	78	84
9½"W Ped		L End Panel	NA	NR	NR	NR	NR	NR	60	66	72	78	84	NA
9½"W Ped		15¾"W Ped	NA	NA	NA	NR	NR	NR	NR	NR	60	66	72	78
9½"W Ped		18"W Ped	NA	NA	NA	NR	NR	NR	NR	NR	60	66	72	78
9½"W Ped		30"W Ped	NA	NA	NA	NA	NA	NR	NR	NR	NR	NR	60	66
9½"W Ped		36"W Ped	NA	NA	NA	NA	NA	NA	NR	NR	NR	NR	NR	60
END BOOKCASE PED		End Bookcase	End Bookcase	NA	NA	NR	NR	NR	NR	NR	NR	60	66	72
	End Bookcase	L End Panel	NA	NA	NR	NR	NR	NR	NR	60	66	72	78	84
	End Bookcase	15¾"W Ped	NA	NA	NA	NR	NR	NR	NR	NR	60	66	72	78
	End Bookcase	18"W Ped	NA	NA	NA	NR	NR	NR	NR	NR	NR	60	66	72
	End Bookcase	30"W Ped	NA	NA	NA	NA	NA	NR	NR	NR	NR	NR	60	
	End Bookcase	36"W Ped	NA	NA	NA	NA	NA	NA	NR	NR	NR	NR	NR	
	L END PANEL	L End Panel	L End Panel	NA	NR	NR	NR	NR	NR	60	66	72	78	84
L End Panel		15¾"W Ped	NA	NA	NR	NR	NR	NR	NR	NR	60	66	72	78
L End Panel		18"W Ped	NA	NA	NA	NR	NR	NR	NR	NR	60	66	72	78
L End Panel		30"W Ped	NA	NA	NA	NA	NA	NR	NR	NR	NR	NR	60	66
L End Panel		36"W Ped	NA	NA	NA	NA	NA	NA	NR	NR	NR	NR	NR	60
TWO PEDS		15¾"W Ped	15¾"W Ped	NA	NA	NA	NA	NR	NR	NR	NR	NR	60	66
	15¾"W Ped	18"W Ped	NA	NA	NA	NA	NR	NR	NR	NR	NR	60	66	72
	15¾"W Ped	30"W Ped	NA	NA	NA	NA	NA	NA	NR	NR	NR	NR	NR	60
	15¾"W Ped	36"W Ped	NA	NA	NA	NA	NA	NA	NA	NR	NR	NR	NR	NR
	18"W Ped	18"W Ped	NA	NR	NA	NA	NR	NR	NR	NR	NR	NR	60	66
	18"W Ped	30"W Ped	NA	NA	NA	NR	NA	NA	NR	NR	NR	NR	NR	NR
	18"W Ped	36"W Ped	NA	NA	NA	NA	NA	NA	NA	NR	NR	NR	NR	NR
	30"W Ped	30"W Ped	NA	NA	NA	NA	NA	NR	NA	NA	NR	NR	NR	NR
	30"W Ped	36"W Ped	NA	NA	NA	NA	NA	NA	NR	NA	NA	NR	NR	NR
	36"W Ped	36"W Ped	NA	NA	NA	NA	NA	NA	NA	NR	NA	NA	NR	NR
	RETURN CONFIGURATION	None	O-Leg	NR	NR	NR	NR	60	66	72	78	84	NA	NA
None		9½"W Ped	NR	NR	NR	NR	NR	60	66	72	78	84	NA	NA
None		End Bookcase	NA	NR	NR	NR	NR	NR	60	66	72	78	84	NA
None		L End Panel	NR	NR	NR	NR	NR	60	66	72	78	84	NA	NA
None		15¾"W Ped	NA	NR	NR	NR	NR	NR	NR	60	66	72	78	NA
None		18"W Ped	NA	NA	NR	NR	NR	NR	NR	60	66	72	78	84
None		30"W Ped	NA	NA	NA	NA	NR	NR	NR	NR	NR	60	66	72
None		36"W Ped	NA	NA	NA	NA	NA	NR	NR	NR	NR	NR	60	66

NA = Stiffener not applicable due to invalid worksurface width and support combination

NR = Applicable worksurface width and support combination, but stiffener not required

! The chart reference is to be used to complete the model number. It is not the actual length dimension of the external support channel.

CONCINNITY™

Components — Modesty/Back Panels

GSA SIN 33721

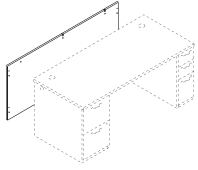

Icon Legend on page 19

**DESCRIPTION****Modesty/Back Panels — Full-Length**

96"W x 27¹/₈"H
 90"W x 27¹/₈"H
 84"W x 27¹/₈"H
 78"W x 27¹/₈"H
 72"W x 27¹/₈"H
 66"W x 27¹/₈"H
 60"W x 27¹/₈"H
 54"W x 27¹/₈"H
 48"W x 27¹/₈"H
 42"W x 27¹/₈"H

MODEL

HNLMP9628
HNLMP9028
HNLMP8428
HNLMP7828
HNLMP7228
HNLMP6628
HNLMP6028
HNLMP5428
HNLMP4828
HNLMP4228

SHIP WEIGHT

62
58
54
50
46
42
38
34
30
26

CUBE

7.2
6.7
6.1
5.5
5.3
4.8
4.4
4.0
3.6
3.2

L1 LIST PRICE

\$430
\$419
\$347
\$308
\$285
\$268
\$243
\$235
\$221
\$204

L2 UPCHARGE

\$25
\$25
\$25
\$20
\$20
\$20
\$20
\$20
\$15
\$15

36"W x 27¹/₈"H Modesty/Pedestal Back Panel
 30"W x 27¹/₈"H Modesty/Pedestal Back Panel

HNLMP3628
HNLMP3028

22
18

2.8
2.4

\$188
\$175

\$12
\$12

Modesty/Back Panels — Short

96"W x 10"H
 90"W x 10"H
 84"W x 10"H
 78"W x 10"H
 72"W x 10"H
 66"W x 10"H
 60"W x 10"H
 54"W x 10"H
 48"W x 10"H
 42"W x 10"H
 36"W x 10"H
 30"W x 10"H

HNLMP9610
HNLMP9010
HNLMP8410
HNLMP7810
HNLMP7210
HNLMP6610
HNLMP6010
HNLMP5410
HNLMP4810
HNLMP4210
HNLMP3610
HNLMP3010

22
21
20
19
18
17
16
15
14
13
12
11

3.0
2.8
2.8
2.3
2.1
1.9
1.8
1.6
1.4
1.3
1.1
0.9

\$430
\$419
\$347
\$308
\$285
\$268
\$243
\$235
\$221
\$204
\$188
\$175

\$15
\$15
\$15
\$12
\$12
\$12
\$12
\$12
\$10
\$10
\$10
\$10

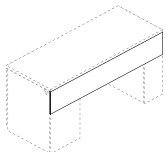

Back View

NOTES: For use with modular worksurface and support components. Component is 3/4" thick. Full-to-floor sizes can be specified with or without grommet; see chart on page 36 for cord management options. For standing-height applications, a worksurface supported by 1 1/8" thick x 41"H laminate end panel(s) and/or 41"H support pedestal(s), the recommended modesty panel length extends 27 1/8" below the underside of the top, leaving 13" of wall access; 9 1/2" and 15 3/4" W x 13"H backs are available to enclose the balance of the pedestal back. Worksurfaces supported by a 1 1/8" thick x 41"H laminate end panel and 41"H support pedestal, or by two 41"H support pedestals, can be used with a 10" modesty panel to increase the amount of wall access, however in this application the pedestal(s) should be positioned against a wall, as there is not a 30 7/8"H panel to cover the back of the pedestal that is exposed below the modesty panel. The 10"H modesty panel is not recommended for use in a standing-height shell, where both supports are 41"H laminate end panels; for this solution use the 27 1/8"H modesty panel. For standing-height applications with the worksurface supported by 41"H O-legs or L-shaped end panels, use the appropriate floating modesty panel size.

NOTES:

- Provide approach-side kneespace privacy for user seated at desks, credenzas, returns, and bridges.
- Full-width laminate panel can be specified in 6" increments from 30"-96"W, and in full-length (27 1/8"H) or short (10"H).
- Formal, full-length, 27 1/8"H models extend from the underside of the worksurface to the floor.
- 10"H sizes allow quick and easy access to wall power outlets.
- 30"W and 36"W x 27 1/8"H are sized to serve as a modesty panel, or pedestal back for respective 30"W and 36"W support storage pedestal models.

! The full-width panel designs are specifically for use when the worksurface supports are two 1 1/8" thick end panels, two support storage pedestals, or one 1 1/8" thick end panel and one support storage pedestal; not for use with O-legs or L-shaped end panels.

HOW TO SPECIFY

Select Model Number H N L M P 7 2 2 8	Select Grommet P Black X No Grommet X	Select Laminate Color See page 29 H
---	---	--

Select Model Number H N L M P 7 2 1 0	Select Laminate Color See page 29 H
---	--



CONCINNITY™

Components — Modesty/Back Panels

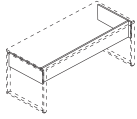

Not available in two-tone laminate

DESCRIPTION	MODEL	SHIP WEIGHT	CUBE	L1 LIST PRICE	L2 UPCHARGE
Modesty Panels for Desks with O-Legs					
68 ³ / ₈ "W x 3/4"D x 10"H — For 72" x 30" Desks	HLAMMP7230	26	2.1	\$289	\$15
56 ³ / ₈ "W x 3/4"D x 10"H — For 60" x 30" Desks	HLAMMP6030	23	1.8	\$264	\$15

NOTES: For use with 60"W or 72"W worksurfaces supported by O-legs. Comprised of three panels: one approach side and one for each end. Length below bottom of worksurface is 10". Steel external support channel (ordered separately) is recommended for unsupported spans greater than 54"W (i.e.: a distance in which there is not a vertical support between the underside of the worksurface and floor). Grain direction is vertical on approach and side panels for 56³/₈"W (all laminate colors) and 68³/₈"W (L1 laminate except Florence Walnut and Kingswood Walnut). Vertical on 27⁵/₈" end panels (all laminate colors). Horizontal on all panels for L2 laminates as well as Florence Walnut and Kingswood Walnut.

Specify: Model.Laminate

SPECIFYING EXAMPLE: HLAMMP7230.N

! \$15 upcharge for L2 laminates. See pages 236-237 for laminate options.

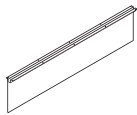

Laminate Floating Modesty Panel	MODEL	SHIP WEIGHT	CUBE	L1 LIST PRICE	L2 UPCHARGE
60"W x 14"H	HLSL6014L	20	1.1	\$250	\$12
54"W x 14"H	HLSL5414L	18	1.1	\$232	\$12
48"W x 14"H	HLSL4814L	16	1.1	\$212	\$12
42"W x 14"H	HLSL4214L	14	0.8	\$193	\$10
36"W x 14"H	HLSL3614L	12	0.8	\$179	\$10
30"W x 14"H	HLSL3014L	10	0.8	\$169	\$10

NOTES: The attachment bracket and modesty panel are packaged separately.

Specify: Model.Laminate.Paint

SPECIFYING EXAMPLE: HLSL3014L.N.P (Black is the only paint option for this model)

! When specifying the 54"W or 60"W Laminate Floating Modesty Panel, it is not necessary to specify an external support channel.

! 30"W and 36"W screens attach with L-brackets, not the external channel.

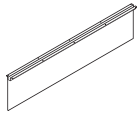

Mixed Material Floating Modesty Panel	MODEL	SHIP WEIGHT	CUBE	L1 LIST PRICE	L2 UPCHARGE
60"W x 14"H	HLSL6014MM	13	3.3	\$1113	N/A
54"W x 14"H	HLSL5414MM	13	3.3	\$974	N/A
48"W x 14"H	HLSL4814MM	11	2.6	\$898	N/A
42"W x 14"H	HLSL4214MM	9	2.3	\$811	N/A
36"W x 14"H	HLSL3614MM	8	2.0	\$726	N/A
30"W x 14"H	HLSL3014MM	8	2.0	\$676	N/A

NOTES: The attachment bracket and modesty panel are packaged separately.

Specify: Model.Mixed Material.Paint

SPECIFYING EXAMPLE: HLSL3014MM.FT01.P (Frosted Translucent mixed material and Black paint are the only options for this model)

! When specifying the 54"W or 60"W Mixed Material Floating Modesty Panel, it is not necessary to specify an external support channel.

NOTES:

- Floating panel options attach under worksurfaces and are available in laminate or mixed (frosted translucent) material. The modesty panel and attachment bracket are packaged separately.
- If using a 54"W or 60"W floating modesty panel, it is not necessary to specify an external support channel.
- When using a floating modesty panel under the worksurface, the depth clearance for center drawers and keyboard platforms decreases by 8".
- The full width/half-height and full-to-floor/full-height panels are filler options designed only for use on 60", 66", and 72"W x 29¹/₂"H, double, 15³/₄"W, pedestal desks and credenzas that are specified/built with modular components.

HOW TO SPECIFY

Select Model Number

HLSL3014MM.

Select Mixed Material

FT01 Frosted Translucent

FT01

CONCINNITY™

Components — Modesty/Back Panels

GSA SIN 33721

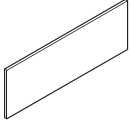
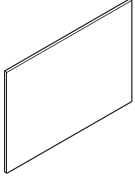

Icon Legend on page 19

	DESCRIPTION	MODEL	SHIP WEIGHT	CUBE	L1 LIST PRICE	L2 UPCHARGE
	Full Width/Half-Height Laminate Modesty Panel					
	40"W x 14"H, for use with 72" desks	HLSL4014LM	29	2.4	\$199	\$10
	34"W x 14"H, for use with 66" desks	HLSL3414LM	23	1.9	\$190	\$10
	28"W x 14"H, for use with 60" desks	HLSL2814LM	19	1.6	\$185	\$10
	NOTES: Filler piece that can only be used between the following supports: two 15¾"W modular pedestals, two 15¾"W L-shaped end panels, or one 15¾"W modular pedestal and one 15¾"W L-shaped end panel. Attachment brackets included.					
	Full-to-Floor/Full-Length Laminate Modesty Panel					
	40"W x 28½"H, for use with 72" desks	HLSL4028LM	44	3.6	\$306	\$12
	34"W x 28½"H, for use with 66" desks	HLSL3428LM	38	3.2	\$290	\$12
	28"W x 28½"H, for use with 60" desks	HLSL2828LM	33	2.7	\$247	\$12
	NOTES: Filler piece that can only be used between the following supports: two 15¾"W modular pedestals, two 15¾"W L-shaped end panels, or one 15¾"W modular pedestal and one 15¾"W L-shaped end panel. Attachment brackets included.					

NOTES:

- Floating panel options attach under worksurfaces and are available in laminate or mixed (frosted translucent) material. The modesty panel and attachment bracket are packaged separately.
- If using a 54"W or 60"W floating modesty panel, it is not necessary to specify an external support channel.
- When using a floating modesty panel under the worksurface, the depth clearance for center drawers and keyboard platforms decreases by 8".
- The full width/half-height and full-to-floor/full-height panels are filler options designed only for use on 60", 66", and 72"W x 29½"H, double, 15¾"W, pedestal desks and credenzas that are specified/built with modular components.

HOW TO SPECIFY

Select Model Number <input type="text" value="HLSL2814LM."/>	Select Laminate Color <input type="text" value="N"/>
See page 29	

CONCINNITY™ MODESTY/BACK PANELS

HNL Floating Modesty Panel — HSLxx14L/MM — Selection Guide														
	Support Combination		Worksurface Width											
	Support 1	Support 2	30"	36"	42"	48"	54"	60"	66"	72"	78"	84"	90"	96"
O-LEG ON ONE END	O-Leg	O-Leg	NA	NA	36	42	48	54	60	60	60	NA	NA	NA
	O-Leg	9½"W Ped	NA	NA	NA	30	36	42	48	54	60	60	NA	NA
	O-Leg	End Bookcase	NA	NA	NA	30	36	42	48	54	60	60	60	NA
	O-Leg	L End Panel	NA	NA	NA	36	42	48	54	60	60	60	NA	NA
	O-Leg	15¾"W Ped	NA	NA	NA	NA	30	36	42	48	54	60	60	NA
	O-Leg	18"W Ped	NA	NA	NA	NA	30	36	42	48	54	60	60	60
	O-Leg	30"W Ped	NA	NA	NA	NA	NA	NA	30	36	42	48	54	60
	O-Leg	36"W Ped	NA	NA	NA	NA	NA	NA	NA	30	36	42	48	54
NARROW PED	9½"W Ped	9½"W Ped	NA	NA	NA	NA	30	36	42	48	54	60	60	60
	9½"W Ped	End Bookcase	NA	NA	NA	NA	30	36	42	48	54	60	60	60
	9½"W Ped	L End Panel	NA	NA	NA	NA	30	36	42	48	54	60	60	NA
	9½"W Ped	15¾"W Ped	NA	NA	NA	NA	NA	30	36	42	48	54	60	60
	9½"W Ped	18"W Ped	NA	NA	NA	NA	NA	30	36	42	48	54	60	60
	9½"W Ped	30"W Ped	NA	NA	NA	NA	NA	NA	NA	NA	30	36	48	48
	9½"W Ped	36"W Ped	NA	NA	NA	NA	NA	NA	NA	NA	30	36	42	48
END BOOKCASE PED	End Bookcase	End Bookcase	NA	NA	NA	NA	NA	30	36	42	48	54	60	60
	End Bookcase	L End Panel	NA	NA	NA	NA	30	36	36	48	54	60	60	60
	End Bookcase	15¾"W Ped	NA	NA	NA	NA	NA	30	36	42	48	54	60	60
	End Bookcase	18"W Ped	NA	NA	NA	NA	NA	NA	30	36	42	48	54	60
	End Bookcase	30"W Ped	NA	NA	NA	NA	NA	NA	NA	NA	30	36	42	48
	End Bookcase	36"W Ped	NA	NA	NA	NA	NA	NA	NA	NA	NA	30	36	42
L END PANEL	L End Panel	L End Panel	NA	NA	NA	NA	36	36	48	54	60	60	60	NA
	L End Panel	15¾"W Ped	NA	NA	NA	NA	NA	30	36	42	48	54	60	60
	L End Panel	18"W Ped	NA	NA	NA	NA	NA	30	36	42	48	54	60	60
	L End Panel	30"W Ped	NA	NA	NA	NA	NA	NA	NA	30	36	42	48	54
	L End Panel	36"W Ped	NA	NA	NA	NA	NA	NA	NA	NA	30	36	42	48
TWO PEDS	15¾"W Ped	15¾"W Ped	NA	NA	NA	NA	NA	NA	30	36	42	48	54	60
	15¾"W Ped	18"W Ped	NA	NA	NA	NA	NA	NA	30	36	36	48	54	60
	15¾"W Ped	30"W Ped	NA	NA	NA	NA	NA	NA	NA	NA	30	36	42	48
	15¾"W Ped	36"W Ped	NA	NA	NA	NA	NA	NA	NA	NA	NA	30	36	42
	18"W Ped	18"W Ped	NA	NA	NA	NA	NA	NA	NA	30	36	42	48	54
	18"W Ped	30"W Ped	NA	NA	NA	NA	NA	NA	NA	NA	NA	30	36	42
	18"W Ped	36"W Ped	NA	NA	NA	NA	NA	NA	NA	NA	NA	NA	30	36
	30"W Ped	30"W Ped	NA	NA	NA	NA	NA	NA	NA	NA	NA	NA	NA	30
	30"W Ped	36"W Ped	NA	NA	NA	NA	NA	NA	NA	NA	NA	NA	NA	NA
	36"W Ped	36"W Ped	NA	NA	NA	NA	NA	NA	NA	NA	NA	NA	NA	NA
HT ADJ BASE	Height Adjustable Electric Base (model HHAB3S2L)		NA	NA	NA	42	48	54	60	60	NA	NA	NA	NA
PENINSULA	Support Column	T End Panel	NA	NA	NA	30	30	36	42	48	54	60	60	60
	Support Column	9½"W Ped	NA	NA	NA	NA	NA	30	36	42	48	54	60	60
	Support Column	15¾"W Ped	NA	NA	NA	NA	NA	NA	30	36	42	48	54	60
	Support Column	18"W Ped	NA	NA	NA	NA	NA	NA	30	36	42	48	54	60
	Support Column	30"W Ped	NA	NA	NA	NA	NA	NA	NA	NA	30	36	42	48
	Support Column	36"W Ped	NA	NA	NA	NA	NA	NA	NA	NA	NA	30	36	42
RETURN CONFIGURATION	None	O-Leg	NA	NA	36	42	48	54	60	60	60	NA	NA	NA
	None	9½"W Ped	NA	NA	NA	30	36	42	48	54	60	60	NA	NA
	None	End Bookcase	NA	NA	NA	30	36	42	48	54	60	60	60	NA
	None	L End Panel	NA	NA	36	36	42	48	54	60	60	60	NA	NA
	None	15¾"W Ped	NA	NA	NA	NA	30	36	42	48	54	60	60	NA
	None	18"W Ped	NA	NA	NA	NA	30	36	42	48	54	60	60	60
	None	30"W Ped	NA	NA	NA	NA	NA	NA	30	36	42	48	54	60
	None	36"W Ped	NA	NA	NA	NA	NA	NA	NA	30	36	42	48	60

NA = Floating Modesty Panel not applicable for use with worksurface width and support combination

CONCINNITY™

Components — Supports

GSA SIN 33721

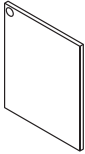
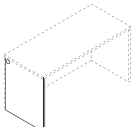
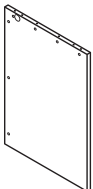

Icon Legend on page 19

	DESCRIPTION	MODEL	SHIP WEIGHT	CUBE	L1 LIST PRICE	L2 UPCHARGE
 HNLEP2428R shown	1 1/8" Laminate End Panels — For 29 1/2"H 1 1/8"W x 35"D x 28 1/2"H for 36"D, Right 1 1/8"W x 35"D x 28 1/2"H for 36"D, Left	HNLEP3628R HNLEP3628L	39 39	2.8 2.8	\$260 \$260	\$20 \$20
	1 1/8"W x 29 1/8"D x 28 1/2"H for 30"D, Right 1 1/8"W x 29 1/8"D x 28 1/2"H for 30"D, Left	HNLEP3028R HNLEP3028L	32 32	2.3 2.3	\$229 \$229	\$15 \$15
 HNLEP2428L shown	1 1/8"W x 23 1/8"D x 28 1/2"H for 24"D, Right 1 1/8"W x 23 1/8"D x 28 1/2"H for 24"D, Left	HNLEP2428R HNLEP2428L	22 22	1.9 1.9	\$204 \$204	\$10 \$10
	1 1/8" Laminate End Panels — For 42"H 1 1/8"W x 29 1/8"D x 41"H for 30"D, Right 1 1/8"W x 29 1/8"D x 41"H for 30"D, Left	HNLEP3041R HNLEP3041L	47 47	3.2 3.2	\$259 \$259	\$20 \$20
 HNLEP2441R shown	1 1/8"W x 23 1/8"D x 41"H for 24"D, Right 1 1/8"W x 23 1/8"D x 41"H for 24"D, Left	HNLEP2441R HNLEP2441L	37 37	2.6 2.6	\$243 \$243	\$15 \$15

NOTES: Supports the end of a component worksurface where there is no modular pedestal. 1 1/8" Laminate End Panels must be used with a full-length (27 7/8"H) or short (10"H) modesty/back panel; ordered separately, see page 86. The depth of an end panel is 3/4" less than the depth of the worksurface, to accommodate the modesty/back panel. Handed design (left and right models). Bottom of end panel is edgebanded for added strength and to seal out moisture. Applications include — For the non-pedestal end of single pedestal desks or credenzas utilizing modular storage components. For returns that do not have a modular storage pedestal to support the worksurface. For extended corner units that do not utilize a 15 3/4"W x 23 1/8"D modular storage pedestal to support the 24"D worksurface dimension. For building desk or credenza shells comprised of a worksurface top and modesty/back panel components, and left and right end panel. Available in a woodgrain or solid laminate color only. Can be specified with or without grommet; see chart on page 36 for cord management options. If grommet option is chosen, the color is black only.

NOTES:

❗ 1 1/8" Laminate End Panels must be used with a full-length (27 7/8"H) or short (10"H) modesty/back panel; ordered separately, see page 86.

HOW TO SPECIFY**Select Model Number**

Select Grommet

P Black
 X No Grommet

Select Laminate Color

See page 29

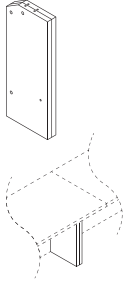

DESCRIPTION	MODEL	SHIP WEIGHT	CUBE	L1	L2
				LIST PRICE	UPCHARGE
Kneespace Clearance End Panels 1 1/8"W x 11 1/4"D x 41"H for 24"D, 2 pk	HNLEP1141	25	2.8	\$285	\$10
1 1/8"W x 11 1/4"D x 28 1/2"H for 24"D, 2 pk	HNLEP1128	25	2.0	\$233	\$10

NOTES: Creates additional kneespace for the user. Two 1 1/8"W x 11 1/4"D laminate end panels, one left, one right; sized to support two adjoining, contiguous 24"D worksurfaces. Can be specified with worksurfaces at time of installation or ordered as replacement for two side-by-side 1 1/8"W x 23"D end panels. Available in 28 1/2" and 41"H. Can be used to connect up to three credenzas in line (2 kits). Not designed for use with returns. Allows conversion of units currently in the field; European fasteners make installation quick and easy. Cord routing notch in top back of each panel. Includes two 1 1/8" thick panels; European fastening hardware; flat connector bracket; self-tapping wood screws for ganging credenza to adjacent worksurface; and adjustable leveling glides. Can be specified in a woodgrain or solid laminate color only; not in a two-tone combination.

SPECIFYING EXAMPLE: HNLEP1128.H

HOW TO SPECIFY

<p>Select Model Number</p> <p>HNLEP1128</p>	<p>Select Grommet</p> <p>P Black X No Grommet</p> <p>X</p>
--	---

CONCINNITY™

Components — Supports

GSA SIN 33721



Icon Legend on page 19

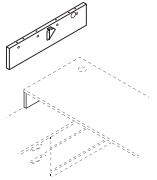

HNLEP307L shown

DESCRIPTION	MODEL	SHIP WEIGHT	CUBE	L1 LIST PRICE	L2 UPCHARGE
Laminate End Panel — 7" H Support for Worksurfaces					
1 $\frac{1}{8}$ " W x 30" D x 7" H, Right	HNLEP307R	7	0.7	\$133	\$10
1 $\frac{1}{8}$ " W x 30" D x 7" H, Left	HNLEP307L	7	0.7	\$133	\$10
1 $\frac{1}{8}$ " W x 24" D x 7" H, Right	HNLEP247R	6	0.7	\$133	\$10
1 $\frac{1}{8}$ " W x 24" D x 7" H, Left	HNLEP247L	6	0.7	\$133	\$10

NOTES: Specifically for layered surface applications; used to support a 29 $\frac{1}{2}$ " H component work surface over a 21 $\frac{1}{2}$ " H low credenza unit. 1 $\frac{1}{8}$ " thick. Handed design (left and right models). Includes cord routing notch. Bottom of end panel is edgebanded for added strength and to seal out moisture. Attaches to underside of work surface via cam fasteners and L-bracket; attaches to top of low credenza with double-sided tape. Can be specified in a woodgrain or solid laminate color only. For 7" H metal O-leg support see page 94.

SPECIFYING EXAMPLE: HNLEP307R.H

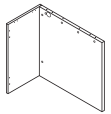

HNLLEP3028R shown

DESCRIPTION	MODEL	SHIP WEIGHT	CUBE	L1 LIST PRICE	L2 UPCHARGE
Laminate L-Shaped End Panels — For 29$\frac{1}{2}$" H					
15 $\frac{3}{4}$ " W x 30" D x 28 $\frac{1}{2}$ " H, Right	HNLLEP3028R	38	4.3	\$368	\$15
15 $\frac{3}{4}$ " W x 30" D x 28 $\frac{1}{2}$ " H, Left	HNLLEP3028L	38	4.3	\$368	\$15
15 $\frac{3}{4}$ " W x 24" D x 28 $\frac{1}{2}$ " H, Right	HNLLEP2428R	32	2.8	\$332	\$15
15 $\frac{3}{4}$ " W x 24" D x 28 $\frac{1}{2}$ " H, Left	HNLLEP2428L	32	2.8	\$332	\$15

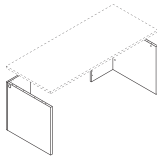

HNLLEP3028R and HNLLEP3028L shown

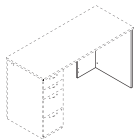
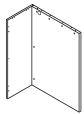

HNLLEP3041R shown



DESCRIPTION	MODEL	SHIP WEIGHT	CUBE	L1 LIST PRICE	L2 UPCHARGE
Laminate L-Shaped End Panels — For 42" H					
15 $\frac{3}{4}$ " W x 30" D x 41" H, Right	HNLLEP3041R	55	4.3	\$407	\$20
15 $\frac{3}{4}$ " W x 30" D x 41" H, Left	HNLLEP3041L	55	4.3	\$407	\$20
15 $\frac{3}{4}$ " W x 24" D x 41" H, Right	HNLLEP2441R	47	2.8	\$364	\$20
15 $\frac{3}{4}$ " W x 24" D x 41" H, Left	HNLLEP2441L	47	2.8	\$364	\$20

NOTES: Supports the end of a component work surface where there is no modular pedestal. Provides easy, open access to wall electrical outlets. For configurations requiring a modesty panel, options include a laminate floating modesty panel or a mixed material floating modesty panel — see page 87. Tops and bottoms of panels are edgebanded. Two pieces; 1 $\frac{1}{8}$ " end panel and $\frac{3}{4}$ " back panel. Ships simple assembly. Can be specified in a woodgrain or solid laminate color only; not available in a two-tone combination. See chart on page 36 for cord management options. If grommet option is chosen for the end panel, the color is black only.

SPECIFYING EXAMPLE: HNLLEP2428R.X.H

HOW TO SPECIFY

Select Model Number

H N L E P 3 0 7 R .

Select Laminate Color

See page 29

H

Select Model Number

H N L L E P 3 0 2 8 R .

Select Grommet

P Black
X No Grommet

X

Select Laminate Color

See page 29

H



CONCINNITY™ Components — Supports

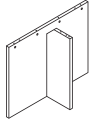

DESCRIPTION

MODEL

SHIP WEIGHT

CUBE

**L1
LIST PRICE**

**L2
UPCHARGE**

Laminate T-Shaped End Panels — For 29½”H

11⅝”W x 35⅞”D x 28½”H

HNLTEP3628

45

3.7

\$375

\$20

11⅝”W x 29⅞”D x 28½”H

HNLTEP3028

39

3.3

\$353

\$20

11⅝”W x 23⅞”D x 28½”H

HNLTEP2428

33

2.9

\$332

\$20

NOTES: Supports the end of a component worksurface where there is no modular pedestal. Available in 24”, 30”, and 36”D x 28½”H. Two 1⅝” thick pieces; one end and one brace panel. Cord routing notch in brace panel. Non-handed. Ships ; simple assembly. Can be specified in a woodgrain or solid laminate color only; not available in a two-tone combination.

SPECIFYING EXAMPLE: HNLTEP3628.H

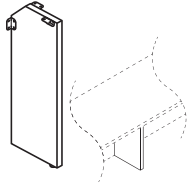

Support Brace — For 29½”H

1⅝”W x 10½”D x 28½”H

HNL11SUPP

11

0.9

\$149

\$10

NOTES: Minimizes worksurface deflection by providing added internal support under 24”D tops with an unsupported span of 54” or wider (distance for which there is no panel, leg, or pedestal support component). Not for use as an end panel. 11”D size provides kneespace clearance. Attaches with brackets to both the underside of the worksurface top and either a conventional full-length or 10” laminate modesty panel; not for use with O-leg or L-shaped end panel supports. 1⅝” thick. Cord routing notch in brace panel. Can be specified in a woodgrain or solid laminate color only.

SPECIFYING EXAMPLE: HNL11SUPP.H

HOW TO SPECIFY

Select Model Number

H N L 1 1 S U P P . H

Select Laminate Color

See page 29

H

CONCINNITY™

Components — Supports

GSA SIN 33721

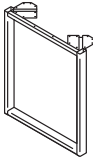
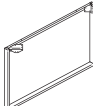
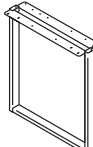
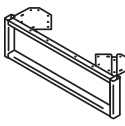
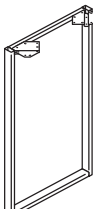
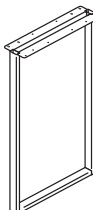

Icon Legend on page 19

	DESCRIPTION	MODEL	SHIP WEIGHT	CUBE	LIST PRICE BY PAINT GRADE		
					P1	P2	P3
	O-Leg 30"D x 28½"H 24"D x 28½"H	HLSL3028O HLSL2428O	19 17	5.4 3.7	\$352 \$316	\$356 \$320	\$372 \$336
	NOTES: Ship fully assembled, 1/pack. Non-handed. IMPORTANT: The O-leg attachment bracket interferes with placement of 28¾"H mobile pedestals, preventing them from being positioned directly next to (flush with) the O-leg. Box/file mobile pedestal (model HNL2116MBF) can be positioned along side the O-leg. SPECIFYING EXAMPLE: HLSL2428O.T1						
	Double-Depth O-Leg Support for Worksurfaces 60"D x 28½"H 48"D x 28½"H	HLSL6028O HLSL4828O	19 18	8.7 7.0	\$665 \$597	\$673 \$605	\$685 \$617
	NOTES: Ship fully assembled, 1/pack. Non-handed. 48"D and 60"D sizes span back-to-back 24"D and 30"D worksurfaces, respectively.						
	O-Leg Shared Support for Worksurfaces 30"D x 28½"H 24"D x 28½"H	HLSL3028SL HLSL2428SL	19 17	5.4 3.7	\$438 \$394	\$442 \$398	\$458 \$414
	NOTES: Ship fully assembled, 1/pack. Non-handed. ! Specify paint only. SPECIFYING EXAMPLE: HLSL2028SL.T1						
	O-Leg Support for Low Credenzas 30"D x 7"H 24"D x 7"H	HLSL307O HLSL247O	7 6	1.0 1.0	\$271 \$213	\$275 \$217	\$291 \$233
	NOTES: Ship fully assembled, 1/pack. Non-handed. For 7"H laminate support see page 92. ! Specify paint only. SPECIFYING EXAMPLE: HLSL207O.T1						
	Standing-Height O-Leg Support for Worksurfaces 30"D x 41"H 24"D x 41"H	HLSL3041O HLSL2441O	17 16	6.5 5.3	\$474 \$424	\$480 \$430	\$494 \$444
	NOTES: Ship fully assembled, 1/pack. Non-handed.						
	Standing-Height O-Leg Shared Support for Worksurfaces 30"D x 41"H 24"D x 41"H	HLSL3041SL HLSL2441SL	17 16	6.5 5.3	\$529 \$478	\$535 \$484	\$549 \$498
	NOTES: Ship fully assembled, 1/pack. Non-handed. For use with two 24"D or 30"D worksurfaces positioned side-by-side along the depth dimension.						

NOTES:

- Open frame, metal design.
- O-leg ships fully assembled with mounting hardware.
- O-leg glides have 2" adjustability.
- Will have 6" overhang when using 30"D O-legs with a 36"D worksurface.
- Shared O-legs create a cleaner aesthetic in all applications where two legs are used side-by-side.

! O-legs may only be attached to worksurfaces, not storage units.

! O-leg installation requires 6" of clearance from the worksurface end.

! For use with worksurfaces up to 78"W. When using an 84"W or wider worksurface, cannot use two O-legs; must use one 15¼" or wider pedestal for the other support.

HOW TO SPECIFY

Select Model Number	Select Paint Color
HLSL3028O	See page 171
T1	

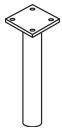

	DESCRIPTION	MODEL	SHIP WEIGHT	CUBE	LIST PRICE
	Support Column 4½" Diameter. Specify: HPC190X.P. Black only.	HPC190X	12 ☹	1.0	\$161
	Support Column 4½" Diameter. Specify: HPC191X.X. Available in Silver only.	HPC191X	12 ☹	1.0	\$161
NOTES: For peninsula or island extension worksurface application.					

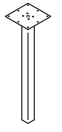
	DESCRIPTION	MODEL	SHIP WEIGHT	CUBE	LIST PRICE BY PAINT GRADE	
					P1	P2
	Post Leg Base 28½"H x 2" square	HLSL28P	15	1.0	\$292	\$296
	NOTES: Can only be used as the outbound support in a peninsula or island extension worksurface application. Glides have 2" of adjustability. Ship 1/pack. SPECIFYING EXAMPLE: HLSL28P.T1					

NOTES:

- All bases allow tops to sit at 29½" from the floor with glides half-way seated.
 - Height Adjustable Base**
 - 3-Stage column design.
 - Frame rises from 23¾" to 49¼" for a sit-to-stand desk option.
 - Ships complete with a pre-assembled motor.
 - Base telescopes to accommodate any worksurface between 48"W and 72"W.
 - Accommodates rectangular worksurfaces between 24"D x 48"W and 30"D x 72"W.
 - Standard height adjustable control ships with base.
 - Dynamic load capacity when worksurface is moving is 300 lbs.
 - Optional Memory Control allows preset worksurface heights for consistency. Ships separately.
 - Silver finish matches any neutral HON paint or finish color.
 - Tops and bases are ordered and sold separately.
 - Post and T-Leg Bases**
 - Both glides and casters attach to the foot easily without tools for assembly.
 - Bases specified with casters include two locking and two non-locking casters.
 - Bases specified with glides have four adjustable glides, which adjust 1".
 - When post legs are used with 18"W tops, post leg to be specified with glides only.
- ! Support column must be specified for worksurfaces used as peninsulas or as an island extension.
- ! Post leg can only be used to support peninsula, not as primary supports for a top.

HOW TO SPECIFY

<p>Select Model Number</p> <p>H P C 1 9 0 X .</p>	<p>Select Paint Color</p> <p>See page 171</p> <p>T 1</p>
--	---

CONCINNITY™

Components — Supports

GSA SIN 33721

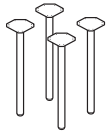

Icon Legend on page 19

**DESCRIPTION****Post Leg Base (Includes 4 Post Legs)**

24"D and 30"D Worksurfaces up to 72"W

MODEL**HMBPOST****SHIP WEIGHT**

18

CUBE

2.3

LIST PRICE**\$352**

NOTES: For 54" and 60" worksurfaces, use one external channel, centered between user and approach sides. For 66" and 72"W worksurfaces, use two external channels; if no grommets, locate the channels 3" from user and approach sides; if grommets are in the worksurface, locate channels 3" from user and 6" from approach sides.

1¾" diameter Post Leg Base with glide (HMBPOST.G); qty. 4; for 30" to 72"W x 24"D and 48" to 72"W x 30"D tops

1¾" diameter Post Leg Base with casters (HMBPOST.C); qty. 4; for 30" to 72"W x 24"D and 48" to 72"W x 30"D tops

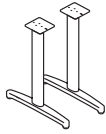
**Fixed Height T-Leg Base (Includes 2 T-legs)**

For 24"D and 30"D Worksurfaces up to 72"W

HMBTLEG24

14

3.6

\$418

NOTES: Use external channel when space between the two legs is 54"W or greater. Center the channel between approach and user sides. See model listing on page 84.

Fixed Height T-Leg Base with glide (HMBTLEG24.G); qty. 2; for 24" and 30"D tops up to 72"W; adjustable glides have 1" range

Fixed Height T-Leg Base with casters (HMBTLEG24.C); qty. 2; for 24" and 30"D tops up to 72"W; two locking and two non-locking casters

NOTES:

- All bases allow tops to sit at 29½" from the floor with glides half-way seated.

Post and T-Leg Bases

- Both glides and casters attach to the foot easily without tools for assembly.
- Bases specified with glides have four adjustable glides, which adjust 1".
- When post legs are used with 18"W tops, post leg to be specified with glides only.

ⓘ Support column must be specified for worksurfaces used as peninsulas or as an island extension.

ⓘ Post leg can only be used to support peninsula, not as primary supports for a top.

HOW TO SPECIFY**Select Model Number**

HMBTLEG24

Select Glide/Caster Option**G** Glide**C** Caster

18"D tops are not available in Concinnity™

G

Select Paint Color

See page 29

\$20 upcharge per model, for Metallic paint

T1



Icon Legend on page 19

CONCINNITY™ Height Adjustable Bases

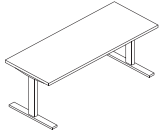

Base shown with worksurface attached.

DESCRIPTION

Coordinate™ Height Adjustable Base – 3 Stage
24”D Feet and Worksurface Brackets

MODEL

HHAB3S2L

SHIP WEIGHT

67

CUBE

2.4

LIST PRICE

\$1120

NOTES: Support option for 24” and 30” rectangle worksurfaces. Worksurfaces are ordered separately, see model listing on pages 80-81.

⚠ Telescoping horizontal frame will extend just over 2” from underside of the worksurface.

⚠ Coordinate™ Height Adjustable Bases not compatible with 36”D rectangular worksurfaces.

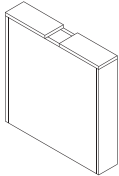

Not available in two-tone laminate.

SIN 33721

Shroud for Height Adjustable Base

5 1/8”W x 26”D x 26 1/4”H for Base with 30”D Top

HLAMSHB30

39

3.7

\$848

NOTES: Decorative laminate enclosure covers the Coordinate™ metal leg and foot. Lowest base adjustment position when the shroud is installed is 29 1/2”H; memory controller must be set at that height to avoid interference. For use with standard 10500 Series™, Concinnity™, and Voi® rectangle worksurfaces, 48-72”W x 30”D, supported by Height Adjustable Base models HHAB3S2L or HHAB2S2L. For height adjustable desks requiring a modesty panel, options include: 14”H laminate (HLSLXX14L) or mixed material (HLSLXX14MM) floating modesty panels, laminate full length (HNLMPXX28) or short (HNLMPXX10) modesty/back panel plus external support channel (HLSLZ5SCXX). External support channel attachment screws and modesty/back panel cover caps are included in the shroud hardware pack. External support channel size recommendation, specific to worksurface attached to Height Adjustable Base with optional laminate full-length or short modesty back/panel (HNLMPXX28/10) see below. Ships one per carton. To conceal both metal legs on the Height Adjustable Base order two.

Specify: Model.Laminate; see pages 236-237.

SPECIFYING EXAMPLE: HLAMSHB30.N

⚠ The Height Adjustable Base must be reset at the time of installation, after every loss of power, if the unit is not functioning properly, or if the legs are uneven. To reset the base requires removing the laminate shroud(s), as well as the full-length modesty panel if one is being used, then adjusting the base to its lowest position. Disassembly of the shroud is quick and easy.

⚠ \$25 upcharge for L2 laminates.

Worksurface Width	Modesty/Back Panel Width	External Support Channel
72”W	72”W	HLSLZ5SC78
66”W	66”W	HLSLZ5SC72
60”W	60”W	HLSLZ5SC66
54”W	54”W	HLSLZ5SC60
48”W	48”W	HLSLZ5SC54

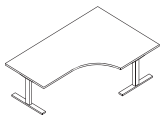

Base shown with worksurface attached.

Coordinate™ 3-Leg Height Adjustable Base – 3 Stage

24”D Feet and Worksurface Brackets

HHAB3S3L

91

3.6

\$1896

NOTES: Supports two rectangular worksurfaces to create a height adjustable L-shaped configuration. The 3-leg base supports corner coves or two-piece worksurfaces 41”-72”W x 35”-72”L x 23 1/4”-30”D. 48”W 120 degree corner worksurfaces are also supported. When using two worksurfaces, the connection between the two must be over the telescoping frame. Supports weight capacity of 375 lbs. (excluding worksurface weight).

⚠ Telescoping horizontal frame will extend just over 2” from underside of the worksurface.

NOTES:

Height Adjustable Base

- 3-Stage column design.
- Frame rises from 21 1/8” to 47 3/4” for a sit-to-stand desk option.
- Ships complete with a pre-assembled motor.
- Comes standard with one-touch, four memory controller with digital display; no specification needed, available in black finish only.
- Base telescopes to accommodate any worksurface between 48”W and 72”W.
- Accommodates rectangular worksurfaces between 24”D x 48”W and 30”D x 72”W.
- Standard height adjustable control ships with base.
- Dynamic load capacity when worksurface is moving is 250 lbs.
- Tops and bases are ordered and sold separately.
- For additional information see page 581.
- **HON 5-Year Limited Warranty.**

⚠ Worksurfaces used with Coordinate™ Height Adjustable Bases should have 1” perimeter gap on each side to provide clearance between other furniture. Failure to do so risks injury or product damage (not covered by warranty).

HOW TO SPECIFY

Select Model Number

HHAB3S2L.

Select Finish

P71 Black
P8L Nickel
PDB White

P8L

CONCINNITY™

Components — Privacy Screens

GSA SIN 33721

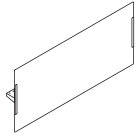

Icon Legend on page 19

**DESCRIPTION****Above/Below Privacy Screen**

60"W x 28"H
54"W x 28"H
48"W x 28"H
42"W x 28"H
36"W x 28"H
30"W x 28"H

MODEL

HLSL2860
HLSL2854
HLSL2848
HLSL2842
HLSL2836
HLSL2830

SHIP WEIGHT

9
9
8
6
6
6

CUBE

8.6
8.6
8.2
6.3
6.4
6.4

LIST PRICE

\$1397
\$1389
\$1192
\$1120
\$1106
\$800

NOTES: Attachment bracket extends 2" into top and underside of worksurface. Screen is frosted translucent acrylic. All brackets are platinum (no need to specify). Extends 13" above and 13" below worksurface.

❗ See page 99 for the "Above-Below Privacy Screen — HLSL28xx — Selection Guide".

❗ Available in Frosted Translucent Acrylic ONLY HLSL2830.FT01.

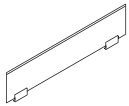
**Above Privacy Screen**

60"W x 13"H
54"W x 13"H
48"W x 13"H
42"W x 13"H
36"W x 13"H
30"W x 13"H

HLSL1260
HLSL1254
HLSL1248
HLSL1242
HLSL1236
HLSL1230

24
22
20
18
15
13

2.9
2.9
2.3
2.3
1.8
1.5

\$453
\$421
\$394
\$344
\$308
\$279

NOTES: Attachment requires 1" clear space/overhang on the underside of the worksurface. Screen is frosted glass. All brackets are platinum (no need to specify).

❗ Available in Frosted Glass ONLY HLSL1230.G.

❗ Above only privacy screen clamps onto worksurface and cannot be installed where support storage will be attached.

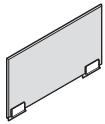
**Above Frosted Polymer (Side) Privacy Screen**

36"W x 13"H
30"W x 13"H
24"W x 13"H

HLSL1236FS
HLSL1230FS
HLSL1224FS

19 Ⓢ
16 Ⓢ
14 Ⓢ

1.9
1.6
1.4

\$398
\$356
\$329

NOTES: Attach to top and side of worksurface with adhesive banding. Platinum color brackets are intended to be attached between users sitting side-by-side. Brackets create a 1/8" separation between adjacent worksurfaces.

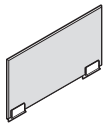
**Above Frosted Glass (Side) Privacy Screen**

36"W x 13"H
30"W x 13"H
24"W x 13"H

HLSL1236GS
HLSL1230GS
HLSL1224GS

20 Ⓢ
18 Ⓢ
16 Ⓢ

1.9
1.6
1.4

\$331
\$297
\$274

NOTES: Attach to top and side of worksurface with adhesive banding. Platinum color brackets are intended to be attached between users sitting side-by-side. Brackets create a 1/8" separation between adjacent worksurfaces.

NOTES:

- Ships complete with attachment brackets.
- All brackets are Platinum.
- Above Privacy Screen attaches to top of worksurface.
- Above and below privacy screen extends 13" above and 13" below the worksurface.
- ❗ Above screens must attach to edgeband and top of surface.
- ❗ Screens cannot be used with T-mold on series such as tables. Screens can only attach to edgeband. Surfaces must be cleaned prior to adhering the screen and must be left to cure for 24 hours without touching for best adhesion.

HOW TO SPECIFY**Select Model Number**

HLSL2830 .

HLSL1230 .

Select Mixed Material

FT01 Frosted Translucent Acrylic
Specified for Above/Below Privacy Screens only
G Frosted Glass
Specified for Above Privacy Screens only

FT01

G

Select Model Number

HLSL1224FS .

HLSL1224GS .

Select Mixed Material

FT01 Frosted Translucent Acrylic
Specified for Above Screen models HLSL1224FS-HLSL1236FS only
G Frosted Glass
Specified for Above Screen models HLSL1224GS-HLSL1236GS only

FT01

G

CONCINNITY™ PRIVACY SCREENS

HNL Above-Below Privacy Screen — HLSL28xx — Selection Guide

	Support Combination		Worksurface Width											
	Support 1	Support 2	30"	36"	42"	48"	54"	60"	66"	72"	78"	84"	90"	96"
O-LEG ON ONE END	O-Leg	O-Leg	NA	30	36	42	48	54	60	60	60	NA	NA	NA
	O-Leg	9½"W Ped	NA	NA	30	36	42	48	54	60	60	60	NA	NA
	O-Leg	End Bookcase	NA	NA	NA	30	36	42	48	54	60	60	60	NA
	O-Leg	L End Panel	NA	NA	NA	36	42	48	54	60	60	60	NA	NA
	O-Leg	15¾"W Ped	NA	NA	NA	30	36	42	48	54	60	60	60	NA
	O-Leg	18"W Ped	NA	NA	NA	NA	30	36	42	48	54	60	60	60
	O-Leg	30"W Ped	NA	NA	NA	NA	NA	NA	30	36	42	48	54	60
	O-Leg	36"W Ped	NA	NA	NA	NA	NA	NA	NA	30	36	42	48	54
NARROW PED	9½"W Ped	9½"W Ped	NA	NA	NA	NA	30	36	42	48	54	60	60	60
	9½"W Ped	End Bookcase	NA	NA	NA	NA	30	36	42	48	54	60	60	60
	9½"W Ped	L End Panel	NA	NA	NA	30	36	42	48	48	60	60	60	NA
	9½"W Ped	15¾"W Ped	NA	NA	NA	NA	NA	30	36	42	48	54	60	60
	9½"W Ped	18"W Ped	NA	NA	NA	NA	NA	30	36	42	48	54	60	60
	9½"W Ped	30"W Ped	NA	NA	NA	NA	NA	NA	NA	30	36	42	48	54
	9½"W Ped	36"W Ped	NA	NA	NA	NA	NA	NA	NA	NA	30	36	42	48
END BOOKCASE PED	End Bookcase	End Bookcase	NA	NA	NA	NA	30	36	42	48	54	60	60	60
	End Bookcase	L End Panel	NA	NA	NA	NA	30	36	42	48	54	60	60	60
	End Bookcase	15¾"W Ped	NA	NA	NA	NA	NA	30	36	42	48	54	60	60
	End Bookcase	18"W Ped	NA	NA	NA	NA	NA	30	36	42	48	54	60	60
	End Bookcase	30"W Ped	NA	NA	NA	NA	NA	NA	NA	30	36	42	48	54
	End Bookcase	36"W Ped	NA	NA	NA	NA	NA	NA	NA	NA	30	36	42	48
L END PANEL	L End Panel	L End Panel	NA	NA	NA	30	36	42	48	54	60	60	60	NA
	L End Panel	15¾"W Ped	NA	NA	NA	NA	30	36	42	48	54	60	60	60
	L End Panel	18"W Ped	NA	NA	NA	NA	NA	30	36	42	48	54	60	60
	L End Panel	30"W Ped	NA	NA	NA	NA	NA	NA	NA	30	36	42	48	54
	L End Panel	36"W Ped	NA	NA	NA	NA	NA	NA	NA	NA	30	36	42	48
TWO PEDS	15¾"W Ped	15¾"W Ped	NA	NA	NA	NA	NA	NA	30	36	42	48	54	60
	15¾"W Ped	18"W Ped	NA	NA	NA	NA	NA	NA	30	36	42	48	54	60
	15¾"W Ped	30"W Ped	NA	NA	NA	NA	NA	NA	NA	NA	30	36	42	48
	15¾"W Ped	36"W Ped	NA	NA	NA	NA	NA	NA	NA	NA	NA	30	36	42
	18"W Ped	18"W Ped	NA	NA	NA	NA	NA	NA	30	36	42	48	48	60
	18"W Ped	30"W Ped	NA	NA	NA	NA	NA	NA	NA	NA	30	36	42	48
	18"W Ped	36"W Ped	NA	NA	NA	NA	NA	NA	NA	NA	NA	30	36	42
	30"W Ped	30"W Ped	NA	NA	NA	NA	NA	NA	NA	NA	NA	NA	30	36
	30"W Ped	36"W Ped	NA	NA	NA	NA	NA	NA	NA	NA	NA	NA	NA	30
	36"W Ped	36"W Ped	NA	NA	NA	NA	NA	NA	NA	NA	NA	NA	NA	NA
HT ADJ BASE	Height Adjustable Base (model HHAB3S2L)		NA	NA	NA	42	48	54	60	60	NA	NA	NA	NA
RETURN CONFIGURATION	None	O-Leg	NA	30	36	42	48	54	60	60	60	NA	NA	NA
	None	9½"W Ped	NA	NA	30	36	42	48	54	60	60	60	NA	NA
	None	End Bookcase	NA	NA	NA	30	36	42	48	54	60	60	60	NA
	None	L End Panel	NA	NA	30	36	42	48	54	60	60	60	NA	NA
	None	15¾"W Ped	NA	NA	NA	30	36	36	48	54	60	60	60	NA
	None	18"W Ped	NA	NA	NA	NA	30	36	42	48	54	60	60	60
	None	30"W Ped	NA	NA	NA	NA	NA	NA	30	36	42	48	54	60
	None	36"W Ped	NA	NA	NA	NA	NA	NA	NA	30	36	42	48	54

NA = Above-Below Screen not applicable for use with worksurface width and support combination

CONCINNITY™ COMPONENTS — SUPPORTS

SUPPORT STORAGE PEDESTALS — 28½”H

- Non-handed, interchangeable design reconfigures easily.
- For use with component top and modesty/back panels or pedestal top and back panels.
 - Pedestals are not fully enclosed and require a component top/worksurface and modesty/back panel or a pedestal back, both of which must be ordered separately.
 - Pedestal’s front and side panels are finished.
- The pedestal depth dimension is less than the like-size depth of the component top, to accommodate addition of a modesty/back panel.
 - 29½”D pedestals can be used under 30” or 36”D worksurfaces; 23½”D pedestals can be used under 24” or 30”D worksurfaces.
 - When specifying a 29½”D pedestal with ¾” modesty panel under a 36”D worksurface, or a 23½”D pedestal with a ¾” modesty panel under a 30”D worksurface, there will be a 6” approach side overhang.
- Bottom of side panels are edgebanded for added strength and to seal out moisture.
- Drawers:
 - Operate on steel ball-bearing suspensions to ensure smooth, quiet, long-lasting operation; full extension allows easy access to contents.
 - Fronts are edgebanded on all four sides.
 - Feature 5-sided construction for added strength and easy alignment or replacement of drawer fronts.

- Interchangeable core removable locks are located on front of all modular storage products, except the storage cabinet.
- Finish of lock is determined by, and aligned with, the handle finish specified.
- Locks feature a removable cylinder that can be interchanged as needed; allows users to access all furniture pieces in an office with a single key for convenience and security. Makes re-keying quick and easy. Keyed alike cores must be ordered separately by specification of the key number (removable lock core kit models available in Black [model HF23B] or Satin [model HF23S]).
- Ship fully assembled.
- Chassis and drawer front colors are specified separately; can be selected with common woodgrain or solid laminate color, or with different, complementary chassis and drawer/door colors.
- See chart on page 36 for cord management options. If the pedestal grommet option is chosen, two cutouts, one per end/side panel, each with a black plastic cap, are included.



SUPPORT STORAGE PEDESTALS — 41”H STANDING-HEIGHT

- Same as above except — not to be used freestanding; top and back are not enclosed.
 - Rear of pedestal can be enclosed with a full, 40¾”H back panel or with a 27⅞”H modesty panel combined with a lower, 13”H pedestal back component. Pedestal back and modesty panel must be ordered separately.

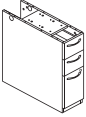
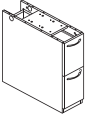

Icon Legend on page 19

CONCINNITY™ Components — Supports

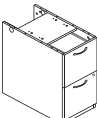
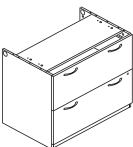
	DESCRIPTION	MODEL	SHIP WEIGHT	CUBE	L1 LIST	L2 UPCHARGES	
						CHASSIS	FRONTS
	Narrow Box/Box/File Pedestal 9½"W x 29⅞"D x 28½"H	HNL291028PBBF	64	10.6	\$772	\$25	\$10
	9½"W x 23⅞"D x 28½"H	HNL231028PBBF	53	8.6	\$690	\$20	\$10
NOTES: Efficient, space saving design for smaller footprints. Three locking drawers; two box (supply) drawers, one for files. File drawer has high sides to accept hanging folders; hangrails are included for side-to-side letter or legal filing. Pedestal's top and back are open and require top and back panel components — ordered separately. See chart on page 36 for cord management options. Ships fully assembled. SPECIFYING EXAMPLE: HNL291028PBBF.E.X.H.H							
	Narrow File/File Pedestal 9½"W x 29⅞"D x 28½"H	HNL291028PFF	69	10.6	\$772	\$25	\$10
	9½"W x 23⅞"D x 28½"H	HNL231028PFF	54	10.6	\$690	\$20	\$10
NOTES: Efficient, space saving design for smaller footprints. Two locking file drawers. Drawers have high sides to accept hanging folders; hangrails are included for side-to-side letter or legal filing. Pedestal's top and back are open and require top and back panel components — ordered separately. See chart on page 36 for cord management options. Ships fully assembled. SPECIFYING EXAMPLE: HNL291028PFF.E.X.H.H							
	Box/Box/File Pedestal 15¾"W x 29⅞"D x 28½"H	HNL291628PBBF	76	10.6	\$782	\$25	\$10
	18"W x 23⅞"D x 28½"H	HNL231828PBBF	72	9.8	\$785	\$20	\$10
	15¾"W x 23⅞"D x 28½"H	HNL231628PBBF	69	8.6	\$714	\$20	\$10
NOTES: Three locking drawers; two box (supply) drawers, one for files. File drawer has high sides to accept hanging folders; hangrails are included for side-to-side letter or legal filing; and front-to-back for letter filing. Pedestal's top and back are open and require top and back panel components — ordered separately. See chart on page 36 for cord management options. Ships fully assembled. SPECIFYING EXAMPLE: HNL291628PBBF.E.X.H.H							
	File/File Pedestal 15¾"W x 29⅞"D x 28½"H	HNL291628PFF	78	10.6	\$782	\$25	\$10
	18"W x 23⅞"D x 28½"H	HNL231828PFF	72	9.8	\$785	\$20	\$10
	15¾"W x 23⅞"D x 28½"H	HNL231628PFF	70	8.6	\$714	\$20	\$10
NOTES: Two locking file drawers. Drawers have high sides to accept hanging folders; hangrails are included for side-to-side letter or legal filing; and front-to-back for letter filing. Pedestal's top and back are open and require top and back panel components — ordered separately. See chart on page 36 for cord management options. Ships fully assembled. SPECIFYING EXAMPLE: HNL291628PFF.E.X.H.H							
	Lateral File Pedestal 36"W x 23⅞"D x 28½"H	HNL233628PLF	134	18.4	\$1056	\$40	\$20
	30"W x 23⅞"D x 28½"H	HNL233028PLF	115	15.0	\$964	\$35	\$20
NOTES: Two locking file drawers; drawers include hangrails to accept folders in letter or legal size. For use under 24"D rectangle worksurface. Widths can also span depth dimension of respective 30" or 36"D rectangle worksurface. Anti-tip design includes mechanical interlock to inhibit the extension of more than one drawer at a time. Pedestal's top and back are open and require top and back panel components — ordered separately. See chart on page 36 for cord management options. Ships fully assembled. SPECIFYING EXAMPLE: HNL233628PLF.E.X.H.H							

NOTES:

- 29⅞"D pedestals can be used under 30" or 36"D worksurfaces; 23⅞"D pedestals can be used under 24" or 30"D worksurfaces.
- Drawers operate on steel ball-bearing suspensions to ensure smooth, quiet, long-lasting operation; full extension allows easy access to contents.
- Interchangeable core removable locks allow users to access all furniture pieces in an office with a single key for convenience and security. Makes re-keying quick and easy.
- See chart on page 36 for cord management options. If the pedestal grommet option is chosen, two cutouts, one per end/side panel, each with a black plastic cap, are included.

ⓘ Pedestal tops and backs are open and require top and back panel components — ordered separately.

ⓘ 9½"W pedestals are not designed to be used independently in a stand-alone application.

HOW TO SPECIFY

<p>Select Model Number</p> <p>H N L 2 9 1 0 2 8 P B B F .</p>	<p>Select Handle</p> <p>A Cylinder – Satin B Cylinder – Black C Canopy – Satin D Canopy – Black E Loop – Satin F Loop – Black</p> <p>E .</p>	<p>Select Grommet</p> <p>P Black X No Grommet</p> <p>X .</p>	<p>Select Chassis Color</p> <p>See page 29</p> <p>H .</p>	<p>Select Drawer Front Color</p> <p>See page 29</p> <p>H</p>
--	---	---	--	---

CONCINNITY™

Components — Supports

GSA SIN 33721

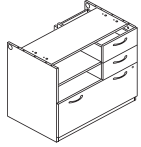

Icon Legend on page 19

**DESCRIPTION****Shelf/Box/Box/Lateral File Pedestal**

36"W x 23 1/8"D x 28 1/2"H

30"W x 23 1/8"D x 28 1/2"H

MODEL**HNL233628PSL****HNL233028PSL****SHIP WEIGHT**

145

126

CUBE

18.4

15.0

L1 LIST**\$1245****\$1221****L2 UPCHARGES****CHASSIS****\$40****\$35****FRONTS****\$20****\$20**

NOTES: Versatile unit features an open shelf and three drawers; two for supplies and one for files. For use under 24"D rectangle worksurface. Widths can also span depth dimension of respective 30" or 36"D rectangle worksurface. Box (supply) drawers are located on the right and open shelves on the left. All drawers lock. Pedestal's top and back are open and require top and back panel components — ordered separately. See chart on page 36 for cord management options. Ships fully assembled.

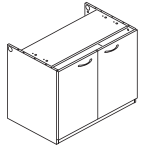
SPECIFYING EXAMPLE: HNL233628PSL.E.X.H.H**Storage Cabinet Pedestal**

36"W x 23 1/8"D x 28 1/2"H

30"W x 23 1/8"D x 28 1/2"H

HNL233628PSC**HNL233028PSC**

104

91

18.4

15.0

\$810**\$782****\$40****\$35****\$20****\$20**

NOTES: One adjustable shelf, which adjusts in 2 1/2" increments. For use under 24"D rectangle worksurface. Widths can also span depth dimension of respective 30" or 36"D rectangle worksurface. Doors are non-locking. Pedestal's top and back are open and require top and back panel components — ordered separately. See chart on page 36 for cord management options. Ships fully assembled.

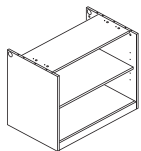
SPECIFYING EXAMPLE: HNL233628PSC.E.X.H.H**Bookcase Pedestal**

36"W x 23 1/8"D x 28 1/2"H

30"W x 23 1/8"D x 28 1/2"H

HNL233628PBK**HNL233028PBK**

82

73

18.4

15.0

\$712**\$695****\$40****\$35****N/A****N/A**

NOTES: Two shelves; bottom of unit plus one adjustable shelf, which adjusts in 2 1/2" increments. For use under 24"D rectangle worksurface. Widths can also span depth dimension of respective 30" or 36"D rectangle worksurface. Pedestal's top and back are open and require top and back panel components — ordered separately. See chart on page 36 for cord management options. Ships fully assembled.

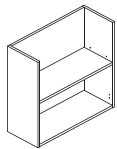
SPECIFYING EXAMPLE: HNL233628PBK.X.H**Bookcase End Support**

12"W x 36"D x 28 1/2"H

12"W x 30"D x 28 1/2"H

12"W x 24"D x 28 1/2"H

HNL123628BKE**HNL123028BKE****HNL122428BKE**

48

48

41

11.0

10.2

7.4

\$534**\$507****\$481****\$25****\$20****\$20****N/A****N/A****N/A**

NOTES: Two shelves; bottom of unit plus one adjustable shelf, which adjusts in 1 1/4" increments. Designed to span the depth dimension of 24", 30", or 36"D rectangle worksurface; shelves can be oriented facing outwards, or inwards towards the user's kneespace. Includes fully finished back. Ships with two (2) extra L-brackets for applications requiring attachment of a laminate modesty panel; the panel brackets to the back of the bookcase end support. Modesty panel specified should be 12" less than the worksurface width. Open top; for use under worksurface only — ordered separately. Ships fully assembled.

SPECIFYING EXAMPLE: HNL123628BKE.H**NOTES:**

- 23 1/8"D pedestals can be used under 24" or 30"D worksurfaces.
- Drawers operate on steel ball-bearing suspensions to ensure smooth, quiet, long-lasting operation; full extension allows easy access to contents.
- Interchangeable core removable locks allow users to access all furniture pieces in an office with a single key for convenience and security. Makes re-keying quick and easy.
- See chart on page 36 for cord management options. If the pedestal grommet option is chosen, two cutouts, one per end/side panel, each with a black plastic cap, are included.

! Pedestal tops and backs are open and require top and back panel components — ordered separately.

HOW TO SPECIFY

Select Model Number H N L 2 3 3 6 2 8 P S L .	Select Handle A Cylinder – Satin B Cylinder – Black C Canopy – Satin D Canopy – Black E Loop – Satin F Loop – Black E .	Select Grommet P Black X No Grommet X .	Select Chassis Color See page 29 H .	Select Drawer Front Color See page 29 H
---	---	---	---	--



Icon Legend on page 19

CONCINNITY™ Components — Supports

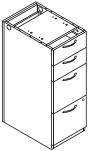
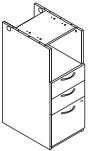
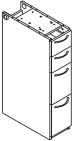
	DESCRIPTION	MODEL	SHIP WEIGHT	CUBE	L1 LIST	L2 UPCHARGES	
						CHASSIS	FRONTS
	Box/Box/File/File Pedestal 15¾"W x 29⅞"D x 41"H	HNL291641PBBFF	114	14.7	\$1602	\$45	\$10
	15¾"W x 23⅞"D x 41"H	HNL231641PBBFF	102	11.9	\$1503	\$40	\$10
<p>NOTES: Four drawers: two box (supply) and two file. File drawer has high sides to accept hanging folders; hangrails are included for side-to-side letter or legal filing; and front-to-back for letter filing. The two box drawers do not lock. Pedestal's top and back are open and require top and back panel components — ordered separately. See chart on page 36 for cord management options. Ships fully assembled. SPECIFYING EXAMPLE: HNL291641PBBFF.E.X.H.H</p>							
	Shelf/Box/Box/File Pedestal 15¾"W x 29⅞"D x 41"H	HNL291641PSBBF	99	14.7	\$1602	\$45	\$10
	15¾"W x 23⅞"D x 41"H	HNL231641PSBBF	89	11.9	\$1503	\$40	\$10
<p>NOTES: Open shelf over three drawers: two box (supply) and one file. Interior dimensions of the open storage area are: 14⅞"W x 28¼"D x 12¼"H for the 29⅞"D pedestal. 14⅞"W x 22¼"D x 12¼"H for the 23⅞"D pedestal. File drawer has high sides to accept hanging folders; hangrails are included for side-to-side letter or legal filing; and front-to-back for letter filing. All drawers lock. Pedestal's top and back are open and require top and back panel components — ordered separately. See chart on page 36 for cord management options. Ships fully assembled. SPECIFYING EXAMPLE: HNL291641PSBBF.E.X.H.H</p>							
	Narrow Box/Box/File/File Pedestal 9½"W x 29⅞"D x 41"H	HNL291041PBBFF	88	14.7	\$1410	\$45	\$20
	9½"W x 23⅞"D x 41"H	HNL231041PBBFF	79	11.9	\$1322	\$40	\$20
<p>NOTES: Efficient, space saving design for smaller footprints. Four drawers: two box (supply) and two file. File drawers have high sides to accept hanging folders; hangrails are included for side-to-side letter or legal filing. When used in a double pedestal configuration under a 60" and 48"W worksurface, provides 41" and 29" of kneespace width, respectively. The two box drawers do not lock. Pedestal's top and back are open and require top and back panel components — ordered separately. See chart on page 36 for cord management options. Ships fully assembled. SPECIFYING EXAMPLE: HNL291041PBBFF.E.X.H.H</p>							

NOTES:

- Pedestals for standing-height workstations.
 - 29⅞"D pedestals can be used under 30" or 36"D worksurfaces; 23⅞"D pedestals can be used under 24" or 30"D worksurfaces.
 - Drawers operate on steel ball-bearing suspensions to ensure smooth, quiet, long-lasting operation; full extension allows easy access to contents.
 - See chart on page 36 for cord management options. If the pedestal grommet option is chosen, two cutouts, one per end/side panel, each with a black plastic cap, are included.
- ! Pedestal tops and backs are open and require top and back panel components — ordered separately.
- ! 9½"W pedestals are not designed to be used independently in a stand-alone application.

HOW TO SPECIFY

<p>Select Model Number</p>	<p>Select Handle</p> <p>A Cylinder – Satin B Cylinder – Black C Canopy – Satin D Canopy – Black E Loop – Satin F Loop – Black</p>	<p>Select Grommet</p> <p>P Black X No Grommet</p>	<p>Select Chassis Color</p> <p>See page 29</p>	<p>Select Drawer Front Color</p> <p>See page 29</p>
<p>H N L 2 9 1 6 4 1 P B B F F .</p>	<p>E .</p>	<p>X .</p>	<p>H .</p>	<p>H .</p>

CONCINNITY™

Components — Pedestal Tops

GSA SIN 33721



Icon Legend on page 19

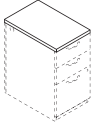

DESCRIPTION	MODEL	SHIP WEIGHT	CUBE	L1	L2
				LIST PRICE	UPCHARGE
Pedestal Tops					
15¾"W x 30"D	HNLPT3016	16	1.4	\$231	\$10
18"W x 24"D	HNLPT2418	15	1.3	\$216	\$10
15¾"W x 24"D	HNLPT2416	13	1.2	\$216	\$10

NOTES: Component is 1½" thick. Underside of top includes pilot mounting holes for pedestals. Grain direction on 15¾" and 18"W pedestal tops runs horizontal (side-to-side). Component tops for 30" and 36"W pedestals are listed with rectangle worksurface sizes. Grain direction on 30" and 36"W pedestal tops can be specified horizontal (side-to-side) or vertical (front-to-back). For tri-oval and beaded edge options, there is a shaped profile on the user and approach sides, and a flat edge on the ends.

- ⓘ For modular pedestals used in freestanding applications; not compatible when pedestal is positioned under a worksurface.
- ⓘ 9½"W pedestals are not designed to be used independently in a freestanding application, so 9½"W tops are not available to order.

HOW TO SPECIFY

Select
Model Number

H N L P T 3 0 1 6 .

Select
Edge Profile and Edge Color

See page 29

B H .

Select
Top Color

See page 29

H



CONCINNITY™

Components — Pedestal Back Panels

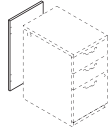
**DESCRIPTION****MODEL****SHIP WEIGHT****CUBE****L1 LIST PRICE****L2 UPCHARGE****Full Back Panels — For 28½”H Pedestals**

18”W x 27⅞”H

HNLBP1828

11

1.5

\$149**\$10**

15¾”W x 27⅞”H

HNLBP1628

10

1.3

\$133**\$10**

9½”W x 27⅞”H

HNLBP1028

6

0.9

\$125**\$10**

NOTES: Encloses the rear of 28½”H modular support pedestals, which come standard with an open, unfinished back. For use when a support storage pedestal is positioned under a 29½”H worksurface and a conventional worksurface width x 27⅞”H modesty/back panel is not specified to cover the back of the pedestal. Examples of when to use a 27⅞” pedestal back include: A worksurface supported by an O-leg on one end and support pedestal on the other, with open wall access; or a worksurface with an O-leg and pedestal support flanking a floating modesty panel. Can be specified in a woodgrain or solid laminate color only. For 30” and 36”W pedestals, use the respective modesty/pedestal back panel size, see page 86.

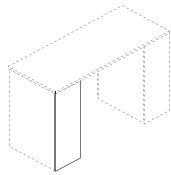
SPECIFYING EXAMPLE (9½”, 15¾”, 18”W): HNLBP1028.H

Back View

Full Back Panels — For 41”H Pedestals

15¾”W x 40⅜”H

HNLBP1641

15

1.8

\$153**\$15**

9½”W x 40⅜”H

HNLBP1041

9

1.2

\$139**\$15**

NOTES: Encloses the rear of 41”H modular support pedestals, which come standard with an open, unfinished back. For use when a support storage pedestal is positioned under a 42”H worksurface and no full-width, 27⅞”H laminate modesty and low, 13”H pedestal back panel are specified. Examples of when to use a 40⅜” pedestal back include: A worksurface supported by an O-leg on one end and support pedestal on the other, with open wall access; or a worksurface with an O-leg and pedestal support flanking a floating modesty panel. Can be specified in a woodgrain or solid laminate color only.

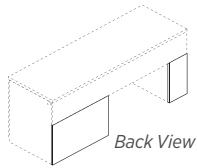
SPECIFYING EXAMPLE: HNLBP1641.H

Back View

Shown with HNLB3018 and HNLB1018

Low Back Panels — For 28½”H Pedestals

36”W x 18”H

HNLB3618

15

1.9

\$149**\$15**

30”W x 18”H

HNLB3018

12

1.6

\$149**\$15**

18”W x 18”H

HNLB1818

7

1.0

\$133**\$15**

15¾”W x 18”H

HNLB1618

6

0.9

\$127**\$10**

9½”W x 18”H

HNLB1018

4

0.6

\$119**\$10**

NOTES: Encloses the rear of 28½”H modular support pedestals when positioned under a 29½”H worksurface with a full-width, 10” laminate modesty panel. The modesty panel extends down from the underside of the worksurface to cover the upper back portion of the pedestal, the lower panel component encloses the remainder of the pedestal back. When used in combination, the 10” modesty and pedestal low back panels fully conceal the rear of the pedestal. The pedestal low back panel is only for use when a modular pedestal is used in conjunction with a worksurface with a 10” laminate modesty panel and the customer wants/needs to fully enclose the back section of the pedestal. Can be specified in a woodgrain or solid laminate color only.

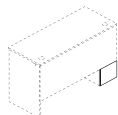

Back View

Low Back Panels — For 41”H Pedestals

15¾”W x 13”H

HNLB1613

4

0.7

\$127**\$10**

9½”W x 13”H

HNLB1013

3

0.5

\$119**\$10**

NOTES: Encloses the rear of 41”H modular support pedestals when positioned under a 42”H worksurface with a full-width, 27⅞” laminate modesty panel. The modesty panel extends down from the underside of the worksurface to cover the upper back portion of the pedestal, the lower panel component encloses the remainder of the pedestal back. When used in combination, the 27⅞” modesty and pedestal low back panels fully conceal the rear of the pedestal. The pedestal low back panel is only for use when a modular pedestal is used in conjunction with a worksurface with a 27⅞” laminate modesty panel and the customer wants/needs to fully enclose the back section of the pedestal. Can be specified in a woodgrain or solid laminate color only.

HOW TO SPECIFY**Select Model Number**

H N L P B 1 8 2 8

Select Laminate Color

See page 29

H

Select Model Number

H N L L B 3 6 1 8

Select Laminate Color

See page 29

H



Refer to page 106 for Center Drawer compatibility information

DESCRIPTION	MODEL	SHIP WEIGHT	CUBE	L1 LIST PRICE	L2 UPCHARGE
Laminate Center Drawer 26" x 15 ³ / ₈ "	H1526	12 Ⓔ	1.2	\$198	\$15
22" x 15 ³ / ₈ " • 12" drawer extension (3/4). • Inside drawer dimension for H1526: 22 ⁷ / ₈ "W x 15 ¹ / ₂ "D x 1 ¹ / ₂ "H. • Inside drawer dimension for H1522: 18 ⁷ / ₈ "W x 15 ¹ / ₂ "D x 1 ¹ / ₂ "H. • Minimum clearance for mounting H1526: 27 ¹ / ₄ "W x 18 ¹ / ₂ "D compatible with 72"W x 36"D, 66"W x 30"D, 60"W x 30"D Double Pedestal Desks, 72"W x 24"D, 66"W x 24"D, 60"W x 24"D Credenza w/Kneespace, 48"W x 24"D Return • Minimum clearance for mounting H1522: 22 ³ / ₄ "W x 18 ¹ / ₂ "D compatible with 72"W x 36"D, 66"W x 30"D, 60"W x 30"D Double Pedestal Desks, 72"W x 36"D, 66"W x 30"D Single Pedestal Desks, Bullet and P-shaped Peninsulas, 72"W x 24"D, 66"W x 24"D, 60"W x 24"D Credenza w/Kneespace, 72"W x 24"D, 66"W x 24"D Single Pedestal Credenzas, 48"W x 24"D, 42"W x 24"D Returns	H1522	11 Ⓔ	1.1	\$184	\$15

NOTES: Specify laminate for drawer. Model H1522 or H1022 can be used on peninsulas with modesty panel, model HPC180W. Laminate center drawers include pencil tray. For center drawer laminate colors, see page 29.

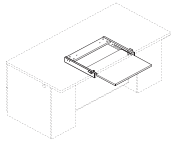

DESCRIPTION	MODEL	SHIP WEIGHT	CUBE	L1 LIST PRICE	L2 UPCHARGE
Collaborative Desk Shelf 25"W x 23"D x 2 ¹ / ₂ "H	HNLCDSEHF	18	1.5	\$345	\$20

NOTES: Convenient slide-out shelf on approach-side of desk provides workspace for guests. For use with 72"W x 36"D breakfront desk designs — see listings on page 43 — or with 60" or wider worksurface, supported by pedestals, and no modesty panel. Minimum clearance for mounting: 28"W x 19³/₄"D. Fully extended shelf dimensions: 24"W x 19"D. Shelf extends 12³/₈". ³/₄" thick. Not compatible on desks with under surface center drawer or keyboard platform attached. Can be specified in a woodgrain or solid laminate color only.

! Collaborative desk shelf for use with 72"W x 36"D breakfront, floating modesty panel desk designs or with 60" or wider worksurface, supported by pedestals, and no modesty panel.

SPECIFYING EXAMPLE: HNLCDSEHF.H

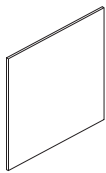

DESCRIPTION	MODEL	SHIP WEIGHT	CUBE	LIST PRICE
Wall Mount Tackboard 36"W x 35 ¹ / ₄ "H	HNL3636TB	20	2.9	\$300
30"W x 35 ¹ / ₄ "H	HNL3630TB	16	2.9	\$256
36"W x 48 ⁵ / ₈ "H	HNL4936TB	27	5.5	\$334
30"W x 48 ⁵ / ₈ "H	HNL4930TB	22	3.7	\$290

NOTES: For a list of standard fabrics, see pages 25-26. For a complete list of fabrics, please go to hon.com/fabricsandfinishes. When positioned above 29¹/₂"H floor-standing storage, the sizes align with overhead storage height options. Can be positioned side-by-side with corresponding wall mount markerboard sizes. Easy to install; includes mounting hardware. Attaches to wall with horizontally mounted, interlocking Z-clip brackets. For the space directly below stack-on and wall mount storage cabinets, use the 18"H tackboard models listed on Pricer pages 59 and 65.

SPECIFYING EXAMPLE: HNL3636TB.APN15

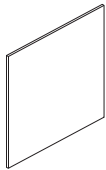

Wall Mount Markerboard 36"W x 35 ¹ / ₄ "H	HNL3636WB	16	2.9	\$204
30"W x 35 ¹ / ₄ "H	HNL3630WB	14	2.9	\$191
36"W x 48 ⁵ / ₈ "H	HNL4936WB	22	5.5	\$251
30"W x 48 ⁵ / ₈ "H	HNL4930WB	20	3.7	\$231

NOTES: Smooth, white, magnetic surface. Metal material produces clear graphics and cleans easily. Compatible for use with dry- or wet-erase markers. When positioned above 29¹/₂"H floor-standing storage, the sizes align with overhead storage height options. Can be positioned side-by-side with corresponding wall mount tackboard sizes. Easy to install; includes mounting hardware. Attaches to wall with horizontally mounted, interlocking Z-clip brackets.

SPECIFYING EXAMPLE: HNL3636WB

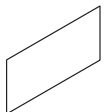

Markerboard 36"W x 15"D	HLSL1536SOMB	8	1.0	\$179
30"W x 15"D	HLSL1530SOMB	6	1.0	\$132

NOTES: Markerboard laminate material with black edges, no frame. Adheres to laminate doors. Includes double-sided tape. No specification necessary.

HOW TO SPECIFY

Select Model Number

Select Laminate Color

See page 29

H N L C D S H E L F . H

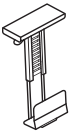
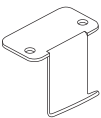

Icon Legend on page 19

	DESCRIPTION	MODEL	SHIP WEIGHT	CUBE	LIST PRICE
	<p>CPU Holder</p> <ul style="list-style-type: none"> Vertically mounts to underside of worksurface. 360° swivel. Supports up to 55 lbs. Height adjustable from 16" to 22" below worksurface. Width adjustable to accept units from 3¼" to 6". <p>NOTES: Arms fold back to post to allow more desktop room. Arms feature double extension, allowing 20"+ of back and forth movement. Cable management on both pole and arm assemblies. Counterbalance adjustment provides stability for monitors up to 17.6 lbs per arm. Made of high quality aluminum alloy material.</p> <p>! Silver finish only, no specification needed.</p>	HCPU *	16 Ⓢ	0.5	\$259
	<p>Back Pack Hook (10 per carton)</p> <p>12"W x 14½"D x 1½"H</p> <p>NOTES: Assembly: attaches to bottom of desk with (2) screws, included.</p> <p>! Available in Platinum Metallic finish only, no specification needed.</p>	HCLA65	10 Ⓢ	0.1	\$94

NOTES:

* De-emphasized.

HOW TO SPECIFY

Select Model Number

H
C
P
U



Black only

SIN 33721

DESCRIPTION**Field Installable Grommet — For 2½" Diameter Hole**

- Intended for use in tops and end panels to route/hide cords and in modesty panels to facilitate reaching wall electrical outlets.
- Grommet is field installable.
- Requires a 2½" diameter hole saw and drill for installation (not included).
- Grommet shape is round.
- Includes grommet cap and sleeve.
- Grommet cap measures 3" diameter and includes a ¾" diameter cord access hole.
- Grommet sleeve measures 2½" O.D. x ¾" thick.
- Includes instructions to locate grommet position for desks, credenzas, returns, and bridges.

! Black Finish

SPECIFYING EXAMPLE: HFLDGRMT**MODEL****HFLDGRMT****SHIP WEIGHT**

0.1 Ⓢ

CUBE

0.01

LIST PRICE**\$32**

SIN 33721

Field Installable Grommet — For 3" Diameter Hole

- Intended for use in tops and end panels to route/hide cords and in modesty panels to facilitate reaching wall electrical outlets.
- Grommet is field installable.
- Requires a 3" diameter hole saw and drill for installation (not included).
- Grommet shape is round.
- Includes grommet cap and sleeve.
- Grommet outside dimensions measures 3½" diameter and includes two cord access holes.
- Grommet sleeve measures 3" O.D. x 1" thick.
- Includes instructions to locate grommet position for desks, credenzas, returns, and bridges.

! Black Finish

SPECIFYING EXAMPLE: HFLDGRMT3**HFLDGRMT3**

0.1 Ⓢ

0.3

\$32

OPEN MARKET

Field Installable Grommet — For 3" Diameter Hole

- Intended for use in tops to route/hide cords.
- Requires a 3" diameter hole saw and drill for installation (not included).
- Includes grommet cap, with two access holes, and sleeve components.
- Outside dimension measures 3½" diameter.
- Sleeve hole in worksurface measures 3" O.D. x 1" thick.
- Includes instructions to locate grommet position for desks, credenzas, returns, and bridges.

! Platinum Finish

SPECIFYING EXAMPLE: HFLDGRMT4**HFLDGRMT4**

0.1

0.01

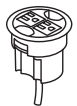
\$32

SIN 33721T

Power Hub, 3" Grommet Mount, 6' Cord

- Fits in 3" round grommet holes on the following product lines: 10500, 10700, Concinnity, Coordinate, and Voi desks; Abound Worksurfaces; Huddle and Motivate tables and SmartLink.
- Two grounded AC power outlets.
- Two cord pass-through holes in cap.
- Includes 6' cord with three-prong plug.
- Field installed; easy plug-and-play.
- UL Listed.

! Available in black only (no color designation so use .X - Specify: HGRMTAC.X).

HGRMTAC

1.3

0.2

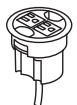
\$111

SIN 33721T

3" Round Power Grommet – 2 Outlets, 10' Cord

- Includes 10' cord with three-prong plug.
- Fits in 3" round grommet holes on the following product lines: Coordinate, Huddle, Motivate, all laminate and veneer casegoods series, and Systems Worksurfaces.
- Two grounded AC power outlets.
- Field installed with Plug-and-play ease.

NOTES: Power Modules will also work with standing-height applications for 10500 Series™ and Voi® desks. Optional Memory Control allows preset worksurface heights for consistency. Ships separately. Dynamic load capacity when worksurface is moving is 300 lbs.

! Available in black finish only, no specification needed.

HGRMTAC2

1.5

0.2

\$148

SIN 33721T

Power/USB Hub, 3" Grommet Mount

- One grounded AC power outlet with 2 USB ports.
- Two cord pass-through holes in cap.
- Includes 6' cord with three-prong plug.
- Field installed; easy plug-and-play.
- UL Listed.

! Available in black only (no color designation so use .X - Specify: HGRMTUSB2.X).

HGRMTUSB2

1.3 Ⓢ





0.2

\$224**HOW TO SPECIFY**Select
Model Number

HGRMTAC

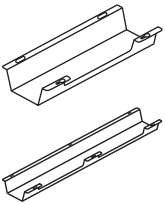

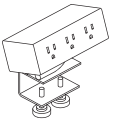
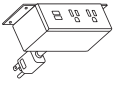
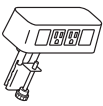
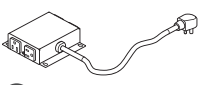
Icon Legend on page 19

	DESCRIPTION	MODEL	SHIP WEIGHT	CUBE	LIST PRICE
	Cable Management Troughs				
	17"W — Single	HCTROUGH17	2.7 Ⓢ	0.5	\$67
	17"W — 10-Pack	HCTROUGH1710	14.0 Ⓢ	0.5	\$620
	36"W — Single	HCTROUGH36	4.9 Ⓢ	0.9	\$113
	36"W — 10-Pack	HCTROUGH3610	30.0 Ⓢ	0.9	\$1045
	<ul style="list-style-type: none"> • Cable management troughs ship flat packed. • The troughs attach to underneath the worksurface with screws. • The 17"W has one wire access cut out on the user side. The 36" has two wire access cut outs. These cut outs give users access to inside the trough without having to detach it from the worksurface. • Color: Graphite. • Material: Metal. • TAA Compliant. 				
 <p>OPEN MARKET</p>	O-Leg Cord Clips				
	Clips for 28½" Worksurface O-Legs — 8-Pack	HWMCLIPLG	0.8 Ⓢ	0.1	\$99
	Clips for Layering O-Legs — 4-Pack	HWMCLIPSM	0.5 Ⓢ	0.1	\$65
	<p>NOTES: Wire clips work with 7" Low Credenza O-leg and 29"H Support O-leg.</p> <p>ⓘ Available in frosted plastic material only.</p>				
 <p>Model HPWRMOD3WC shown</p>  <p>Model HPWRMOD2UWM shown</p>	Power Modules				
	3 Receptacles with Worksurface Clamp	HPWRMOD3WC	2.3 Ⓢ	0.2	\$307
	3 Receptacles with Under-Worksurface Mounting Bracket	HPWRMOD3UWM	2.3 Ⓢ	0.2	\$307
	2 Receptacles 2 USB with Worksurface Clamp	HPWRMOD2WC	2.3 Ⓢ	0.2	\$491
	2 Receptacles 2 USB with Under-Worksurface Mounting Bracket	HPWRMOD2UWM	2.3 Ⓢ	0.2	\$491
	<ul style="list-style-type: none"> • 6' power cord with standard three-prong plug. • Under-worksurface mounting bracket models work with any top that has a 5" x 5" square clearance. • Worksurface clamp models work on any top with a 4" overhang. • UL Listed. <p>ⓘ Color finish coordinates with HON's Charcoal or White. Specify <i>STRM</i> for Storm or <i>SNW</i> for Snow when ordering. Example: <i>HPWRMOD3WC.STRM</i>.</p>				
	Power & Data Center				
	2 Receptacles 2 Data Accessory	HCOMDOME2	2.5 Ⓢ	0.2	\$293
	<ul style="list-style-type: none"> • Standard with two receptacles and openings for two data ports. • 6' power cord with standard three-prong plug. • Fits on any worksurface with a 4" overhang. • UL Listed. <p>ⓘ Color finish coordinates with HON's Loft. Specify <i>LOFT</i> when ordering. Example: <i>HCOMDOME2.LOFT</i>.</p>				
 <p>EZ</p>	Under Worksurface Power Module — 4 Outlets, 10' Cord				
		HPWRMOD2	1.5	0.2	\$401
	<ul style="list-style-type: none"> • Includes 10' cord with three-prong plug. • Fits in cable management troughs. • 4 outlets on side create easy access. <p>NOTES: Power Modules will also work with standing-height applications for 10500 Series™ and Voi® desks.</p> <p>ⓘ Available in black finish only, no specification needed.</p>				
	Vertebrae				
		HMPVWM28	3.0	0.3	\$221
	<p>NOTES: 30"H x 3¼"W x 1½"D. Ships unassembled.</p> <p>ⓘ Clear finish. Specify "X" for finish option.</p> <p>SPECIFYING EXAMPLE: HMPVWM28.X</p>				

HOW TO SPECIFY

Select Model Number

H P W R M O D 3 W C

CONCINNITY™

Accessories — Paper Organizers

GSA SIN 33721



Icon Legend on page 19

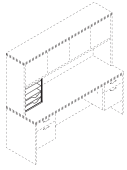

Not available in two-tone laminates

DESCRIPTION

Vertical Paper Manager
14⁷/₈"W x 10⁷/₈"D x 19¹/₈"H

MODEL**HLVPM1****SHIP WEIGHT**

27.0

CUBE

2.8

L1 LIST PRICE**\$327****L2 UPCHARGE****\$10**

NOTES: Keeps papers, files, and books neatly organized and within easy reach from a seated position. Designed for desk, credenza, and return tops. Fits under stack-on storage models. Two pullout drawers and three fixed shelves. Not available in pattern laminate colors. Ships fully assembled.

ⓘ When used in conjunction with wall mounted storage cabinets, allow 19³/₄" minimum clearance above the worksurface.

SPECIFYING EXAMPLE: HLVPM1.N

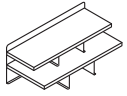

Not available in two-tone laminate

DESCRIPTION

Desktop Storage Terrace
26¹/₂"W x 12¹/₂"D x 10¹/₂"H

MODEL**HLDSTI**

24.0

1.1

\$306**\$10**

NOTES: Keeps work-in-process, priority files, loose pages, and mail neatly organized and in view. Mixed material design comprised of sturdy laminate shelves with metal back and support panels. Not available in two-tone laminate combination or pattern laminate colors. Choose from Platinum Metallic (TI), Black (P), and Charcoal (S) for the metal components. Designed to be used on worksurfaces. Also sized to fit in stack-on and wall mounted storage cabinets, see compatibility chart on page 111.

Specify: Model.Laminate.Paint

SPECIFYING EXAMPLE: HLDSTI.N.TI

DESCRIPTION

Stacked Paper Management
32¹/₂"W x 12⁵/₈"D x 4¹/₄"H

MODEL**HLVPM2**

22.0

1.25

\$163

NOTES: Segments and organizes stack-on and wall mount storage compartments (see compatibility chart on page 111), as well as bookcase shelves. In some cases, installation may require removing the stack-on or wall mount storage doors.

ⓘ Black only.

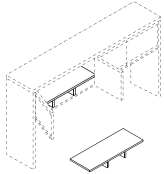
**DESCRIPTION**

Hanging Paper Shelf
28¹/₈"W x 11¹/₈"D x 4⁵/₈"H

MODEL**HHPS1**

7.0

2.9

\$198

NOTES: Attaches quickly and easily (screws included). Maximizes worksurface space; de-clutters desktop while placing priority communications and active project folders within easy reach. Angled design allows contents to be distinguished at a glance. Mixed material styling features strong painted metal frame with a frosted shelf.

Attaches quickly and easily to laminate stack-on and wall mount storage models (except the 36"W Voi® overhead hutch with O-legs or panel mount brackets). Not for use with 38000 Series™ and Systems.

Specify: Model.Paint

SPECIFYING EXAMPLE: HHPS1.TI

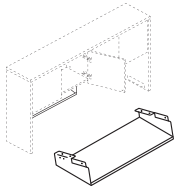
**DESCRIPTION**

Desktop Paper Shelf
28¹/₈"W x 11⁵/₈"D x 5"H

MODEL**HDPS1**

7.0

2.9

\$198

NOTES: Desktop Paper Shelf and Storage Terrace include protective, non-slip pads on the base. Paper Shelf can stack two-high. Organizer shelf provides a place and space for work-in-process and piling to keep worksurfaces neat and tidy. Convenient, scalable design with interlocking side supports allow two units to be stacked and integrated. Durable painted metal frame with a frosted shelf; mixed material styling matches hanging paper shelf.

Can also be used inside select overhead storage, including the following stack-on with clearance and hinged door models: 10500 and Valido 36", 42", 66", 72", 78"W and 10700 68⁵/₈"W.

Specify: Model.Paint

SPECIFYING EXAMPLE: HDPS1.TI

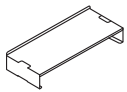
**DESCRIPTION**

Storage Cube
12"W x 12"D

MODEL**HLSL1212**

1.0

0.3

\$294

SPECIFYING EXAMPLE: HLSL1212.P8S

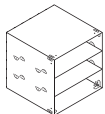
**HOW TO SPECIFY**

Select
Model Number

H L V P M 1 .

Select
Laminate Color

See page 29

N

CONCINNITY™ PAPER ORGANIZER COMPATIBILITY

PAPER ORGANIZERS FOR STACK-ON AND WALL MOUNTED STORAGE CABINETS

- Laminate vertical paper manager (HLVPM1) is designed for desk, credenza, and return tops; fits under stack-on and wall mount storage units.
- Laminate desktop storage terrace (HLDST1) for use on worksurfaces, or inside overhead storage compartments >26½"W.
- Metal desktop paper shelf (HDPS1) for use on worksurfaces, can be stacked two high, or inside overhead storage compartments >28¾"W.
- Stacked paper management (HLVPM2) can be positioned inside overhead storage cabinets >32½"W.
- Metal hanging paper shelf (HHPS1) attaches quickly and easily to the underside of stack-on and wall mounted storage models.
- For applications using the organizers inside stack-on and wall mounted storage compartments, the fit compatibility is as follows:

OUTSIDE WIDTH	INSIDE WIDTH	Stacked Paper Mgt. — 32½"W HLVPM2	Desktop Paper Shelf — 28¾"W HDPS1	Desktop Storage Terrace — 26½"W HLDST1	Hanging Paper Shelf — 28¾"W HHPS1
		Yes or No	Yes or No	Yes or No	*Qty — see NOTE
STACK-ON STORAGE W/ LAM DOORS, LAM LOCKING DOORS, FROSTED DOORS					
36"W	34.34	Y	Y	Y	1
42"W	40.34	Y	Y	Y	1
48"W (large compartment)	30.60	N	Y	Y	1
60"W	28.60	N	N	Y	2
66"W	31.60	N	Y	Y	2
72"W	34.60	Y	Y	Y	2
78"W	37.60	Y	Y	Y	2
STACK-ON STORAGE W/ SLIDING DOOR					
48"W	22.60	N	N	N	1
60"W	28.60	N	N	Y	2
66"W	31.60	N	Y	Y	2
72"W	34.60	Y	Y	Y	2
78"W	37.60	Y	Y	Y	2
WALL MOUNT STORAGE W/ LAM DOORS, LAM LOCKING DOORS, FROSTED DOORS					
30"W	28.35	N	N	Y	N
36"W	33.67	Y	Y	Y	1
42"W	39.67	Y	Y	Y	1
48"W (large compartment)	30.22	N	Y	Y	1
60"W	28.22	N	N	Y	2
66"W	31.22	N	Y	Y	2
72"W	34.22	Y	Y	Y	2
78"W	37.22	Y	Y	Y	2
WALL MOUNT STORAGE W/ SLIDING DOOR					
48"W	22.46	N	N	N	1
60"W	28.46	N	N	Y	2
66"W	31.46	N	Y	Y	2
72"W	34.46	Y	Y	Y	2
78"W	37.46	Y	Y	Y	2

*NOTE: For model HHPS1, quantity represents the number that can be mounted side-by-side under the cabinet.





CONCINNITY™

Accessories — Lock Kits

GSA SIN 33721 EXCEPT AS NOTED

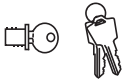

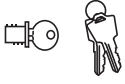
Icon Legend on page 19

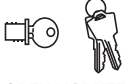
	DESCRIPTION	MODEL	SHIP WEIGHT	CUBE	LIST PRICE
	Black Removable Lock Core Kit <ul style="list-style-type: none"> Specify quantity of each key number from 101E-225E. Includes: 1-core, 2-keys, 1-core removal tool, and instructions. NOTES: If key number isn't specified, number will be at random.	HF23B	0.1 	0.1	\$32
	Satin Removable Lock Core Kit <ul style="list-style-type: none"> Specify quantity of each key number from 101E-225E. Includes: 1-core, 2-keys, 1-core removal tool, and instructions. NOTES: If key number isn't specified, number will be at random.	HF23S	0.1 	0.1	\$40
	Removable Lock Core Kit Black Satin	HF27B HF27S	0.2 0.2	0.02 0.02	\$32 \$32
OPEN MARKET	<ul style="list-style-type: none"> For stack-on and wall mounted storage laminate models (with locks) in 10500, 10700, Valido, Voi, Concinnity, and 94000 Series. Specify quantity of each key number from 101E to 225E. Includes: 1-core, 2-keys, 1-core removal tool, and instructions. NOTES: If key number isn't specified, number will be at random.				

NOTES:

- Interchangeable core removable locks are standard on most HON products.
- Removable lock core kits with specific key number must be ordered to facilitate keying alike in the field.
- For keyed alike locks:
 - Order standard product which will be shipped with factory installed locks and random numbered cores.
 - Order the appropriate quantity of like numbered cores required for each workstation or keyed area.
 - Simply replace the factory installed cores with the replacement cores after product has been installed.
- To install new core:
 - Lock must be in the unlocked position.
 - Insert core removal key and pull core straight out.
 - Insert new core with core removable key, hold core into lock and withdraw core removal key.
 - Retain original core for future use.
- For master key, see model HF22 on page 853.
- To provide normal lead times, key numbers cannot be specified on HON products at time of order. This also eliminates need for tagging and tracking each product's lock number during installation.

HOW TO ORDER CORE REMOVABLE LOCK KITS:

Specify: Model Number.X
Key Number

Examples: HF23S.X121E
HF23S.X (Key number not specified)

NOTES: Key orders without numbers specified will be keyed at random.
Numbers 101E-225E are available.

SAMPLE ORDER:

Quantity	Model	Key Code
4	HF23B.	X121E

HOW TO SPECIFY

Select
Model Number

H F 2 3 B



CONCINNITY™ Accessories — Task Lights

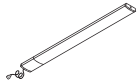

OPEN MARKET

DESCRIPTION

LED Task Lights — For Stack-on and Wall Mounted Storage Cabinets

MODEL	SHIP WEIGHT	CUBE	LIST PRICE	
17" LED Light with Power Supply (Single)	HLED17AS	1.2 Ⓢ	0.05	\$420
31" LED Light with Power Supply (Single)	HLED31AS	1.5 Ⓢ	0.09	\$565
17" LED Light with Power Supply for Daisy-chain (Starter)	HLED17A	1.0 Ⓢ	0.05	\$462
31" LED Light with Power Supply for Daisy-chain (Starter)	HLED31A	1.4 Ⓢ	0.09	\$620
17" LED Light with 8" Jumper Cord for Daisy-chain (Follower)	HLED17AUO	1.0 Ⓢ	0.03	\$377
31" LED Light with 8" Jumper Cord for Daisy-chain (Follower)	HLED31AUO	1.0 Ⓢ	0.05	\$502
Undercabinet Occupancy Sensor with 1" End to End Connector	HLEDOSA	0.2 Ⓢ	0.01	\$89

NOTES: To use the daisy chain application, must start with model HLED17A or HLED31A. No finish specification required. Attaches magnetically to underside of overhead storage, or attaches with provided screws or double-sided tape. Occupancy sensor attaches to a single or starter LED light and will automatically turn the light off after no motion is detected for 30 minutes. Just like all the LED light models, the occupancy sensor features a soft-touch on/off switch. LED task lights have a lifetime of 50,000 hours and have a dimmer feature that allows the user to adjust the amount of light output.

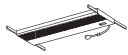

OPEN MARKET

Recessed Task Lights — For Stack-on and Wall Mounted Storage Cabinets

- Color: Black.
- Slim profile design.
- Mount to stack-on storage and wall mounted storage cabinets (see pages 55-59 and 62-65).
- Electronic ballast for increased energy efficiency.
- T5 bulb, included, which contains less mercury.
- 9-foot black cord and switch off right rear corner.

22 ⁷ / ₈ "W x 3 ¹ / ₁₆ "D x 1 ¹ / ₈ "H	HH870930	7.0 Ⓢ	0.60	\$231
Chicago code version (with fused plug)	HH870930CH	7.0 Ⓢ	0.60	\$301
34 ⁵ / ₈ "W x 3 ¹ / ₁₆ "D x 1 ¹ / ₈ "H	HH870942	10.0 Ⓢ	0.90	\$250
Chicago code version (with fused plug)	HH870942CH	10.0 Ⓢ	0.90	\$317
46 ¹ / ₂ "W x 3 ¹ / ₁₆ "D x 1 ¹ / ₈ "H	HH870960	12.0 Ⓢ	1.10	\$270
Chicago code version (with fused plug)	HH870960CH	12.0 Ⓢ	1.10	\$337



SIN 33721

Articulating Desk Lamp	HLED1	1.2 Ⓢ	6.5	\$402
Articulating Desk Lamp w/ Occupancy Sensor	HLED10C	1.2 Ⓢ	6.5	\$490



SIN 33721

Task Desk Lamp	HLED2	0.7 Ⓢ	3.0	\$348
-----------------------	--------------	-------	-----	--------------

HOW TO SPECIFY

Select Model Number

HH870930



Refer to pages 829-830 for additional product information

SIN 33721



DESCRIPTION	MODEL	SHIP WEIGHT	CUBE	LIST PRICE BY PAINT GRADE	
				P1	P2
Sit to Stand Arm with Convertible Keyboard Platform	H2516 OPEN MARKET *	17 ₤	1.6	\$618	
Articulating Arm with Convertible Keyboard Platform	H2107 OPEN MARKET *	16 ₤	1.3	\$529	
Articulating Arm with Keyboard Platform	H1706 OPEN MARKET *	16 ₤	1.4	\$493	
Slide-Away Keyboard Platform (Specify: Laminate)	H4022	10 ₤	0.6	\$213	
Extended Tray Slide-Away Keyboard Platform (Specify: Laminate)	HE4022	12 ₤	0.7	\$302	
Metal Keyboard and Mouse Tray (Specify paint)	H4028 OPEN MARKET	11 ₤	1.5	\$153	\$163
Metal Keyboard Tray (Specify paint)	H4029 OPEN MARKET	11 ₤	1.5	\$138	\$148

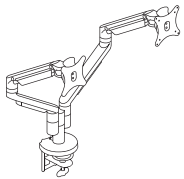

DESCRIPTION	MODEL	SHIP WEIGHT	CUBE	LIST PRICE
Dual Dynamic Monitor Arm <ul style="list-style-type: none"> • 150° of rotation at base with optional 360° rotation. • Arms extend 22" and retract up to 3". • Monitor mount rotates 180° and tilts +/-30°. • Monitor can be rotated from landscape to portrait position. <p>! Arms hold monitors from 6.2-18 lbs. Optional counterweight HPACW available to support monitors as low as 5 lbs. (see page 827).</p>	HMASD	17.0 ₤	1.1	\$750

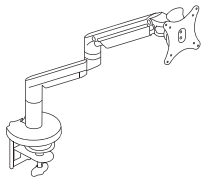

Single Dynamic Monitor Arm <ul style="list-style-type: none"> • 180° of rotation at base with optional 360° rotation. • Arms extend 22" and retract up to 3". • Monitor mount rotates 180° and tilts +/-30°. • Monitor can be rotated from landscape to portrait position. <p>! Arms hold monitors from 6.2-18 lbs. Optional counterweight HPACW available to support monitors as low as 5 lbs. (see page 827).</p>	HMASTS	11.5 ₤	0.8	\$390
--	--------	--------	-----	-------

NOTES:

Monitor Arms Only

- Arms fold back to post to allow more desktop room.
- Arms feature double extension, allowing 20"+ of back and forth movement.
- Cable management on both pole and arm assemblies.
- Counterbalance adjustment provides stability for monitors up to 17 lbs per arm.
- Made of high quality aluminum alloy material.
- See pages 825-826 for additional monitor arm models.

* De-emphasized.

HOW TO SPECIFY

Select Model Number

H M A S D

Select Finish

Specify for models HMASD and HMASTS only

SVR Silver
BLK Black

S V R

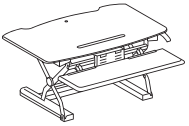
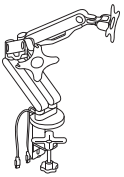
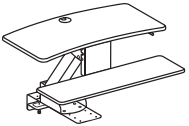
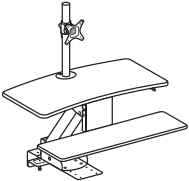
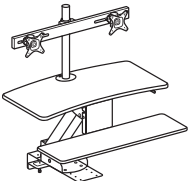

	DESCRIPTION	MODEL	SHIP WEIGHT	CUBE	LIST PRICE
	Coordinate™ Portable Desktop Riser 31"D x 5"-16½"H x 35"W NOTES: Available in Black (BLK) or White (WHT) finish. Desktop riser dimensions (without keyboard tray): 22"D x 5"-16½"H x 35"W. Keyboard tray dimensions: 9"D x 30"W. Max loading capacity is 33 lbs for the desktop riser surface and 4 lbs for the keyboard tray. Easily transition from seated to standing positions throughout the workday. Sits atop an existing desk to create sit-to-stand functionality by raising the computer. Includes keyboard tray and surface for computer monitors. HON 5-Year Limited Warranty. ⓘ Not intended for use on mobile workstations.	HBXRISER	54.0	4.1	\$619
	Dual Monitor Arm with 2 USB Ports NOTES: Easy adjustment. Height adjusts to 17" tall. Monitor tilt and swivel capability. Enclosed cable management. Grommet or desktop mounting. Clean appearance. In some applications the Monitor Arms may extend 12 or more inches into the worksurface. HON 5-Year Limited Warranty. ⓘ No specification needed.	HBDMAUSB	41.9	2.6	\$441
	Coordinate™ Mounted Desktop Riser NOTES: Does not include a monitor arm and is suitable for laptops and/or monitors on their original stands. ⓘ No specification needed.	HS1100	60.0 ⓘ	3.2	\$664
	Coordinate™ Mounted Desktop Riser with Single Monitor Arm NOTES: Includes a monitor arm for a single monitor. ⓘ No specification needed.	HS1101	62.0 ⓘ	3.2	\$777
	Coordinate™ Mounted Desktop Riser with Dual Monitor Arm NOTES: Includes a monitor arm for dual monitors. ⓘ No specification needed.	HS1102	63.0 ⓘ	3.2	\$883

NOTES FOR HS1100, HS1101, HS1102:

- These products are designed to allow the user to transition from seating position to standing position throughout the workday.
- Gas-assist lever-operated mechanism with positive stop.
- Clamp mount compatible with worksurfaces depths of 20"-30". 20" is for systems only.
- Clamp requires 3.5" of clearance along back edge of worksurface.
- Black seamless worksurfaces.
- Silver powder coated metal components.
- Lowers below worksurface level on 24" and 30"D worksurfaces.
- All models contain a large primary worksurface and a smaller keyboard / mouse surface.
- Beveled edges for sleek appearance and comfort while typing.
- Monitor arms include height, width, and swivel adjustment.

- Not for use under overhead storage, with flush mounted modesty panels, or worksurfaces thinner than 1".

ⓘ Not recommended for use on mobile (castered) worksurfaces.

MOUNTING AND COMPATIBILITY FOR HS1100, HS1101, HS1102:

- This product is intended to be installed on commercial-grade worksurfaces in good condition.
- Compatible with freestanding worksurfaces 24"-30"D or panel-supported worksurfaces 24"-30"D.
- Not for use on mobile worksurfaces.

Clamp Mount

Use when 3.5" minimum overhang is available

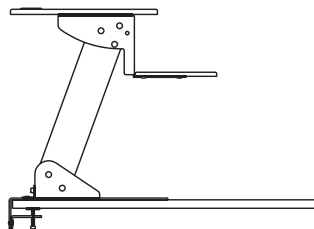

Screw Mount

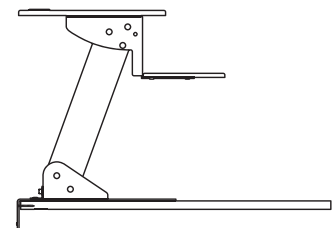

Use when no overhang is available. Worksurface must be minimum 1" thick.



HOW TO SPECIFY

<p>Select Model Number</p> <p>HBXRISER.</p>	<p>Select Finish</p> <p>BLK Black WHT White</p> <p>BLK</p>
--	---

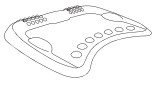
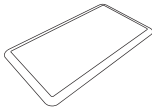
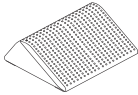

	DESCRIPTION	MODEL	SHIP WEIGHT	CUBE	LIST PRICE
	Rectangle Wobble Board — Anti-Fatigue Mat 18"D x 3"H x 22½"W ⓘ Available in Black (T) finish ONLY. Recommended weight capacity not to exceed 250 pounds. HON 5-Year Limited Warranty. SPECIFYING EXAMPLE: HVL981.T	HVL981	10.0 ⓘ	0.9	\$120
	Round Wobble Board — Anti-Fatigue Mat 18½"D x 2½"H x 18½"W ⓘ Available in Black (T) finish ONLY. Recommended weight capacity not to exceed 250 pounds. HON 5-Year Limited Warranty. SPECIFYING EXAMPLE: HVL982.T	HVL982	5.8 ⓘ	0.6	\$102
	Ergonomic Anti-Fatigue Mat 25"D x 2¾"H x 29⅞"W ⓘ Available in Black ONLY. No specification needed. SPECIFYING EXAMPLE: HBEAFM1	HBEAFM1	7.0	1.4	\$219
	Rectangle Anti-Fatigue Mat 20"D x ¾"H x 36"W ⓘ Available in Black ONLY. No specification needed. SPECIFYING EXAMPLE: HBAFM2036	HBAFM2036	5.4	0.4	\$100
	Footrest — Anti-Slip Cover 13¾"D x 5½"H x 16"W ⓘ Available in Black (T) finish ONLY. Recommended weight capacity not to exceed 250 pounds. HON 5-Year Limited Warranty. SPECIFYING EXAMPLE: HVL991.T	HVL991	7.0 ⓘ	0.9	\$82

HOW TO SPECIFY

Select
Model Number

H V L 9 8 1 .

Select
Finish

T Black

T