

# EMPOWER®



Empower 2- and 4-Pack Benching Systems with Ignition® Seating, Voi® and Contain® Storage and Arrange® Tables.

## EMPOWER®

Need a simple way to get up and running fast? No problem. Looking to expand and customize workstations for a growing business? Empower does that, too. With Empower benching, you've got the power to do more. Offer more personal space. Enjoy more adaptability. Route power more efficiently. It's simple to order, easy to install and quick to reconfigure. When you Empower your people, you keep pace with the changing demands of today's workplace.



## FEATURES

- With numerous laminate selections to choose from, it's easy to get the exact look you want.
- Integrated height adjustability supports the work style of any user.
- Frosted glass. Colorful fabrics. Magnetic metal. Empower screens add style, privacy and functionality.
- Choose from multiple paint finishes to blend in or stand out.
- As the main electrical artery, power and data cables are laid into the trough.
- Plug power modules into the duplex in the trough and attach them to the worksurface for easy access to electrical and USB ports.
- Power entry can be accommodated through the ceiling, floor, or wall.
- Keep cords collected and controlled from floor to wire trough with vertebra.
- Support any work style by adding HON pedestals, credenzas and storage towers to Empower benching.

# EMPOWER<sup>®</sup> FABRIC SCREENS — ALL PANEL MODELS

## PRICE CODE AA

FACTOR	FACT
◆ Bark	FACT20
◆ Barley	FACT15
◆ Cascade	FACT25
◆ Feather	FACT30

## PRICE CODE A

APPOINT	APN
◆ Artichoke	APN11
◆ Blackberry	APN32
◆ Bronze	APN22
◆ Carbon	APN28
◆ Chai	APN12
◆ Cherry	APN30
◆ Dark Pewter	APN17
◆ Dune	APN15
◆ Espresso	APN23
◆ Framboise	APN31
◆ Frost	APN34
◆ Jet	APN27
◆ Lawn	APN25
◆ Mandarin	APN29
◆ Morel	APN09
◆ Nimbus	APN16
◆ Platinum	APN24
◆ Turquoise	APN26

## CENTURION CU

◆ Apricot	CU47
◆ Bark	CU25
◆ Black	CU10
◆ Espresso	CU49
◆ Fog	CU03
◆ Frost	CU22
◆ Goldenrod	CU27
◆ Indigo	CU06
◆ Iris	CU50
◆ Iron Ore	CU19
◆ Jade	CU83
◆ Marsala	CU63
◆ Morel	CU24
◆ Navy	CU98
◆ Peacock	CU97
◆ Pear	CU84
◆ Ruby	CU67
◆ Sapphire	CU09

## PRICE CODE A *continued*

ETCH*	ECH
◆ Axis	ECH13
◆ Blend	ECH14
◆ Cast	ECH12
◆ Highlight	ECH10
◆ Midtone	ECH11
◆ Outline	ECH08
◆ Shade	ECH09
◆ Tonal	ECH16
◆ Vanish	ECH15

## EXCHANGE\* EXG

◆ Iron	EXG916
◆ Nickel	EXG914
◆ Pistachio	EXG910
◆ Root	EXG913
◆ Rupee	EXG903
◆ Shadow	EXG911
◆ Silver	EXG915
◆ Sisal	EXG917
◆ Stone	EXG912

## LANDSCAPE\* LN

◆ Azure	LN55
◆ Cornsilk	LN15
◆ Drift	LN05
◆ Khaki	LN20
◆ Sheen	LN10
◆ Slate	LN35
◆ Umber	LN25
◆ Urban	LN30

## LUCY\* LC

◆ Aspen	LC32
◆ Cornsilk	LC30
◆ Dusk	LC22
◆ Fawn	LC33
◆ Graphite	LC34
◆ Mist	LC20
◆ Neutra	LC24
◆ Pewter	LC35
◆ Snowdrop	LC28

## PRICE CODE A *continued*

REFLECTIONS*	REF
◆ Galvanized	REF29
◆ Ice	REF20
◆ Loggia	REF21
◆ Mistral	REF28
◆ Moonstone	REF23
◆ Pewter	REF22
◆ Stainless	REF24
◆ Vanilla	REF25
◆ Winter	REF27

## REFUGE\* RFG

◆ Artesian	RFG96
◆ Dune	RFG92
◆ Eclipse	RFG90
◆ Frost	RFG93
◆ Glacier	RFG91
◆ Mineral	RFG98
◆ Tidal	RFG94

## SARTO\* SRT

◆ Ash	SRT88
◆ Fog	SRT14
◆ Lemongrass	SRT49
◆ Mist	SRT45
◆ Mushroom	SRT76
◆ Oyster	SRT18
◆ Reef	SRT64
◆ Sesame	SRT93
◆ Shale	SRT52

## TEMPEST\* TP

◆ Dragonfly	TP30
◆ Frost	TP15
◆ Full Stream	TP80
◆ Gold Rush	TP10
◆ Slate	TP45
◆ Tumbleweed	TP70
◆ Wind Chill	TP40
◆ Zebra	TP35

NOTES: Analog, Disperse, and Exchange panel fabrics will be applied pattern cut. Disperse will not be available on 72"W panels.

◆◆◆ For lead time information see page 19.

\* Directional fabrics

# EMPOWER® FABRIC SCREENS — ALL PANEL MODELS

**PRICE CODE B**

ANALOG*	ANLG
◆ Album	ANLG06
◆ Cartridge	ANLG04
◆ Cassette	ANLG09
◆ Dial	ANLG02
◆ Media	ANLG08
◆ Reel	ANLG07
◆ Signal	ANLG03
◆ Stereo	ANLG01
◆ Track	ANLG05

**COAST\***

COAST*	COA
◆ Channel	COA14
◆ Dune	COA03
◆ Headlands	COA10
◆ Marsh	COA02
◆ Pebble	COA12
◆ Pier	COA13
◆ Shoal	COA01
◆ Silt	COA06
◆ Tide	COA08

**DISPERSE\***

DISPERSE*	DISP
◆ Autumn	DISP03
◆ Branch	DISP10
◆ Coffee Bean	DISP13
◆ Dusk	DISP09
◆ Emerald City	DISP08
◆ Gold Rush	DISP02
◆ Igloo	DISP11
◆ Ink	DISP06
◆ Mist	DISP12
◆ Oatmeal	DISP15
◆ Prince	DISP07
◆ Reservoir	DISP01
◆ Rose	DISP04
◆ Spring	DISP05
◆ Steel	DISP16
◆ Taupe	DISP14

**PRICE CODE B** *continued*

MICA*	MCA
◆ Anthracite	MCA11
◆ Breeze	MCA18
◆ Bronze	MCA13
◆ Buff	MCA14
◆ Cremini	MCA17
◆ Crystal	MCAWIT
◆ Dew	MCA20
◆ Dove	MCA12
◆ Fresh	MCA16
◆ Mineral	MCA15
◆ Nectar	MCA19
◆ Shale	MCA10

**PRICE CODE B** *continued*

SPIN*	SPIN
◆ Alabaster	SPIN02
◆ Cavern	SPIN03
◆ Cobblestone	SPIN04
◆ Ember	SPIN06
◆ Flame	SPIN07
◆ Heron	SPIN13
◆ Oat	SPIN01
◆ Ocean	SPIN12
◆ Plum	SPIN15
◆ Pool	SPIN11
◆ Raven	SPIN10
◆ Rhubarb	SPIN14
◆ Tropic	SPIN08
◆ Willow	SPIN05

**PRICE CODE B** *continued*

TERRAIN*	TRRN
◆ Bay	TRRN05
◆ Bayou	TRRN35
◆ Canyon	TRRN30
◆ Cliff	TRRN45
◆ Crest	TRRN25
◆ Delta	TRRN10
◆ Plateau	TRRN15
◆ Ridge	TRRN20
◆ Valley	TRRN40

NOTES: Analog, Disperse, and Exchange panel fabrics will be applied pattern cut. Disperse will not be available on 72"W panels.

◆◆◆ For lead time information see page 19.

\* Directional fabrics

# EMPOWER® FINISH OPTIONS

## WORKSURFACES

### L1 LAMINATES CODES

- Woodgrain**
- ◆ Bourbon Cherry ..... H
  - ◆ Cognac ..... COGN
  - ◆ Florence Walnut ..... LFW1
  - ◆ Harvest ..... C
  - ◆ Kingswood Walnut ..... LK11
  - ◆ Mahogany ..... N
  - ◆ Mocha ..... MOCH
  - ◆ Natural Maple ..... D
  - ◆ Pinnacle ..... PINC
  - ◆ Shaker Cherry ..... F
  - ◆ Sterling Ash ..... LSA1

- Solid**
- ◆ Black ..... P
  - ◆ Charcoal ..... S
  - ◆ Designer White ..... LDW1
  - ◆ Loft ..... LOFT

- Patterned**
- ◆ Canyon Zephyr ..... K9
  - ◆ Desert Zephyr ..... K8
  - ◆ Gray ..... G2
  - ◆ Grey Tigris ..... L6
  - ◆ Shadow Zephyr ..... K1
  - ◆ Sheer Mesh ..... A5
  - ◆ Silver Mesh ..... B9
  - ◆ Steel Mesh ..... A9
  - ◆ White ..... G1
  - ◆ Whitestone ..... K4

### L2 LAMINATES CODES

- Woodgrain**
- ◆ Lowell Ash ..... LLA1
  - ◆ Natural Recon ..... LNRI
  - ◆ Phantom Ecru ..... LPE1
  - ◆ Portico Teak ..... LPT1
  - ◆ Skyline Walnut ..... LSW1

## WORKSURFACE EDGE BAND

- Woodgrain**
- ◆ Bourbon Cherry ..... H
  - ◆ Cognac ..... COGN
  - ◆ Florence Walnut ..... FW
  - ◆ Harvest ..... C
  - ◆ Kingswood Walnut ..... KI
  - ◆ Lowell Ash ..... LLA1
  - ◆ Mahogany ..... N
  - ◆ Mocha ..... MOCH
  - ◆ Natural Maple ..... D
  - ◆ Natural Recon ..... LNRI
  - ◆ Phantom Ecru ..... LPE1
  - ◆ Pinnacle ..... PINC
  - ◆ Portico Teak ..... LPT1
  - ◆ Shaker Cherry ..... F
  - ◆ Skyline Walnut ..... LSW1
  - ◆ Sterling Ash ..... SA

- Solid**
- ◆ Black ..... P
  - ◆ Charcoal ..... S
  - ◆ Designer White ..... LDW1
  - ◆ Greige ..... R
  - ◆ Loft ..... LOFT
  - ◆ Muslin ..... T
  - ◆ Platinum ..... K
  - ◆ Shadow \* ..... SHDW

## END OF RUN SCREENS

### L1 LAMINATES CODES

- Woodgrain**
- ◆ Bourbon Cherry ..... H
  - ◆ Cognac ..... COGN
  - ◆ Florence Walnut ..... LFW1
  - ◆ Harvest ..... C
  - ◆ Kingswood Walnut ..... LK11
  - ◆ Mahogany ..... N
  - ◆ Mocha ..... MOCH
  - ◆ Natural Maple ..... D
  - ◆ Pinnacle ..... PINC
  - ◆ Shaker Cherry ..... F
  - ◆ Sterling Ash ..... LSA1

- Solid**
- ◆ Black ..... P
  - ◆ Charcoal ..... S
  - ◆ Designer White ..... LDW1
  - ◆ Loft ..... LOFT

- Patterned**
- ◆ Sheer Mesh ..... A5
  - ◆ Silver Mesh ..... B9

### L2 LAMINATES CODES

- Woodgrain**
- ◆ Lowell Ash ..... LLA1
  - ◆ Natural Recon ..... LNRI
  - ◆ Phantom Ecru ..... LPE1
  - ◆ Portico Teak ..... LPT1
  - ◆ Skyline Walnut ..... LSW1

## STATIC LEGS AND TROUGHS

### PAINTS CODES

- P1**
- ◆ Black ..... P
  - ◆ Brownstone ..... P7D
  - ◆ Charcoal ..... S
  - ◆ Designer White ..... PJW
  - ◆ Fossil ..... P28
  - ◆ Greige ..... T5
  - ◆ Light Gray ..... Q
  - ◆ Loft ..... LOFT
  - ◆ Muslin ..... T3
  - ◆ Putty ..... L
  - ◆ Shadow \* ..... SHDW
  - ◆ Titanium ..... P8T

- P2**
- ◆ Champagne Metallic ..... T4
  - ◆ Platinum Metallic ..... T1
  - ◆ Silver ..... PR6
  - ◆ Solar Black ..... P8X

- P3**
- ◆ Atom ..... P8S
  - ◆ Bullseye ..... PJF
  - ◆ Ember ..... P8P
  - ◆ Ion ..... P8N
  - ◆ Iris ..... P8J
  - ◆ Krypton ..... P8F
  - ◆ Regatta ..... P8M

## POWER POLE

### PAINTS CODES

- P1**
- ◆ Black ..... P
  - ◆ Charcoal ..... S
  - ◆ Designer White ..... PJW
  - ◆ Greige ..... T5
  - ◆ Light Gray ..... Q
  - ◆ Loft ..... LOFT
  - ◆ Muslin ..... T3
  - ◆ Shadow \* ..... SHDW

## PAINTED METAL SCREENS AND SCREEN BRACKETS

### PAINTS CODES

- P1**
- ◆ Black ..... P
  - ◆ Brownstone ..... P7D
  - ◆ Charcoal ..... S
  - ◆ Designer White ..... PJW
  - ◆ Fossil ..... P28
  - ◆ Greige ..... T5
  - ◆ Light Gray ..... Q
  - ◆ Loft ..... LOFT
  - ◆ Muslin ..... T3
  - ◆ Putty ..... L
  - ◆ Shadow \* ..... SHDW
  - ◆ Titanium ..... P8T

- P2**
- ◆ Champagne Metallic ..... T4
  - ◆ Platinum Metallic ..... T1
  - ◆ Silver ..... PR6
  - ◆ Solar Black ..... P8X
  - ◆ White Markerboard ..... MKB

- P3**
- ◆ Atom ..... P8S
  - ◆ Bullseye ..... PJF
  - ◆ Ember ..... P8P
  - ◆ Ion ..... P8N
  - ◆ Iris ..... P8J
  - ◆ Krypton ..... P8F
  - ◆ Regatta ..... P8M

**Recommended Color to use with Duplex and Data Electric Kits**

Paint	Duplex-Data Code
Black P	Black P
Brownstone P7D	Brownstone EY
Charcoal S	Charcoal S
Designer White PJW	Designer White DW
Fossil P28	Charcoal S
Greige T5	Muslin T3
Light Gray Q	Loft LOFT
Loft LOFT	Loft LOFT
Muslin T3	Muslin T3
Putty L	Black P
Shadow SHDW	Muslin T3
Silver PR6	Titanium T1
Titanium P8T	Titanium T1
Champagne Metallic T4	Muslin T3
Platinum Metallic T1	Titanium T1

WORKSURFACE LAMINATES	CODES	EDGE BAND OPTIONS						
		Matching Edge	Designer White (DW)	Loft (LOFT)	Muslin (T)	Shadow (SHDW)	Black (P)	Charcoal (S)
Black	P						•	
Bourbon Cherry	H	•	•		•			
Charcoal	S							•
Cognac	COGN	•	•		•			
Designer White	LDW1		•					
Harvest	C	•	•		•			
Loft	LOFT			•				
Lowell Ash	LLA1	•	•	•	•			
Mahogany	N	•		•		•		
Mocha	MOCH	•	•		•			
Natural Maple	D	•	•	•	•			
Natural Recon	LNRI	•	•	•	•			
Phantom Ecru	LPE1	•	•	•	•			
Pinnacle	PINC	•	•		•			
Portico Teak	LPT1	•	•	•	•			
Shaker Cherry	F	•	•	•	•	•		
Sheer Mesh	A5				•			
Silver Mesh	B9			•				
Skyline Walnut	LSW1	•	•	•	•			
Sterling Ash	LSA1	•	•	•			•	

◆◆◆ For lead time information see page 19.  
\* De-emphasized

# EMPOWER<sup>®</sup> Step-by-Step Guide

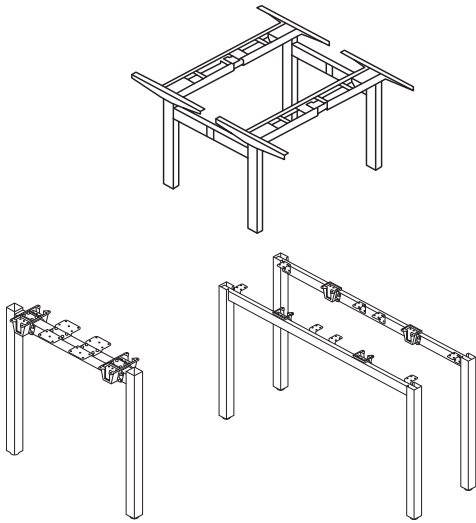

## STEP 1: LEGS

All necessary brackets ship attached to the legs.

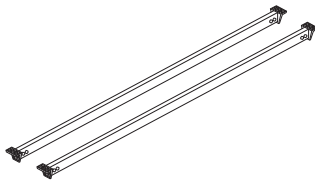

## STEP 2: SUPPORT BEAMS (STATIC ONLY)

All necessary brackets ship attached to the beam. Simply fasten to the legs with the provided screws.

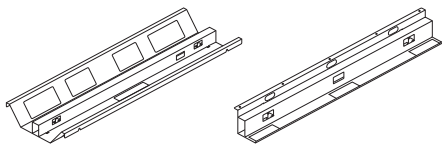

## STEP 3: TROUGHS

Slide the trough over the support beams for double-sided. Screw the trough into the surface for single-sided.

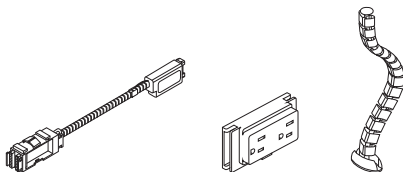

## STEP 4: ELECTRICAL

Slide 8-wire harnesses/duplexes into pre-installed clips on the trough. Lay in data if necessary and cover.

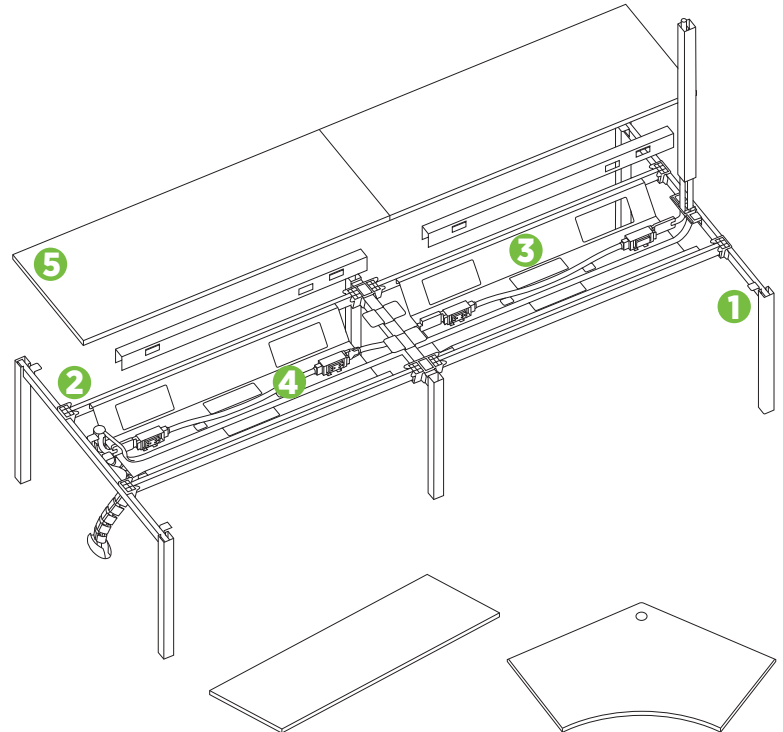

## STEP 5: WORKSURFACES

All necessary brackets ship attached to the beam. Simply fasten to the legs with the provided screws.

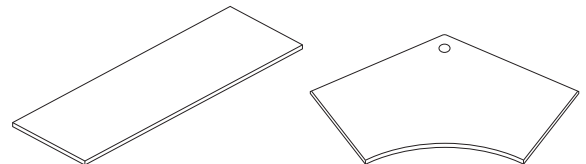

## STEP 6: SCREENS

Drop shared screens into installed brackets, slide side screens into place or attach end of run screens at end of worksurfaces.

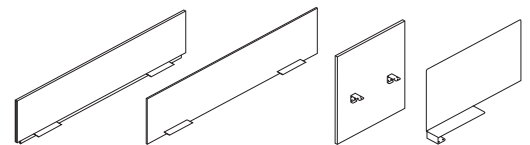

## STEP 7: STORAGE

Choose your storage, from pedestals, to credenzas to towers — whatever suits your needs.

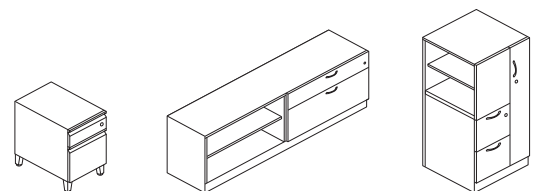

# EMPOWER® 72"W Typical with 24"D Worksurfaces



Icon Legend on page 19

WORKSTATIONS

QTY	DESCRIPTION	MODEL	LIST PRICE	PRICE EXTENSION
2	Worksurface, Edgeband, No Grommets 24" x 72"	HWR2472PN	\$529	\$1,058
1	Double Depth U-Leg (Box of 2)	HMPEL4828	\$1,136	\$1,136
1	Support Beams (Box of 2) 72"W	HMPUB272	\$704	\$704
1	Shared Trough 72"W	HMPROUGH72	\$479	\$479
1	End of Run Electrical Kit 72"W	HMPEEK72	\$214	\$214
1	Duplex 1	HH871501	\$43	\$43
1	Duplex 2	HH871502	\$43	\$43
1	Duplex 3	HH871503	\$43	\$43
1	Duplex 4	HH871504	\$43	\$43
<b>TOTAL:</b>			<b>\$3,763</b>	

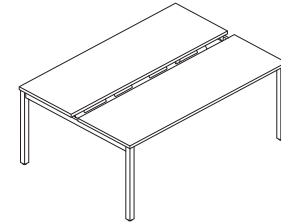

**2-PACK — 72"  
72"W x 51"D**

QTY	DESCRIPTION	BUNDLE SKU	LIST PRICE
1	<b>2-PACK BUNDLE</b> Includes all Components Listed Above	HMP2472PK2	<b>\$3,763</b>

**SPECIFYING EXAMPLE: Model.Laminate.Edgeband.Paint2.DuplexColor**

NOTES: Typical DO NOT include power in-feeds, screens, storage, or seating.

**ADD 1 FABRIC SCREEN: \$727— SEE PAGE 495**

**ADD 2 MOBILE PEDESTALS: \$1,138— SEE PAGE 530**

**SEE PAGE 498 FOR BUNDLE SKU INFORMATION**

QTY	DESCRIPTION	MODEL	LIST PRICE	PRICE EXTENSION
4	Worksurface, Edgeband, No Grommets 24" x 72"	HWR2472PN	\$529	\$2,116
1	Double Depth U-Leg (Box of 2)	HMPEL4828	\$1,136	\$1,136
1	Double Depth Shared U-Leg (Singles)	HMPSL4828	\$468	\$468
2	Support Beams (Box of 2) 72"W	HMPUB272	\$704	\$1,408
2	Shared Trough 72"W	HMPROUGH72	\$479	\$958
1	Power Harness 72"W	HH871272	\$214	\$214
1	End of Run Electrical Kit 72"W	HMPEEK72	\$214	\$214
2	Duplex 1	HH871501	\$43	\$86
2	Duplex 2	HH871502	\$43	\$86
2	Duplex 3	HH871503	\$43	\$86
2	Duplex 4	HH871504	\$43	\$86
<b>TOTAL:</b>			<b>\$6,858</b>	

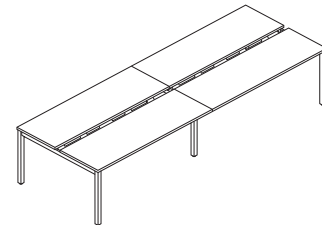

**4-PACK — 72"  
144"W x 51"D**

QTY	DESCRIPTION	BUNDLE SKU	LIST PRICE
1	<b>4-PACK BUNDLE</b> Includes all Components Listed Above	HMP2472PK4	<b>\$6,858</b>

**SPECIFYING EXAMPLE: Model.Laminate.Edgeband.Paint2.DuplexColor**

NOTES: Typical DO NOT include power in-feeds, screens, storage, or seating.

**ADD 2 FABRIC SCREENS: \$1,454— SEE PAGE 495**

**ADD 4 MOBILE PEDESTALS: \$2,276— SEE PAGE 530**

**SEE PAGE 498 FOR BUNDLE SKU INFORMATION**



Icon Legend on page 19

# EMPOWER<sup>®</sup>

## 72"W Typicals with 24"D Worksurfaces

WORKSTATIONS

QTY	DESCRIPTION	MODEL	LIST PRICE	PRICE EXTENSION
6	Worksurface, Edgeband, No Grommets 24" x 72"	HWR2472PN	\$529	\$3,174
1	Double Depth U-Leg (Box of 2)	HMPEL4828	\$1,136	\$1,136
2	Double Depth Shared U-Leg (Singles)	HMPSL4828	\$468	\$936
3	Support Beams (Box of 2) 72"W	HMPUB272	\$704	\$2,112
3	Shared Trough 72"W	HMPROUGH72	\$479	\$1,437
2	Power Harness 72"W	HH871272	\$214	\$428
1	End of Run Electrical Kit 72"W	HMPEEK72	\$214	\$214
3	Duplex 1	HH871501	\$43	\$129
3	Duplex 2	HH871502	\$43	\$129
3	Duplex 3	HH871503	\$43	\$129
3	Duplex 4	HH871504	\$43	\$129
<b>TOTAL:</b>				<b>\$9,953</b>

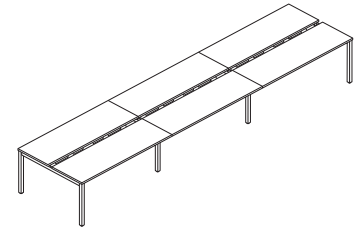

**6-PACK — 72"**  
**216"W x 51"D**

QTY	DESCRIPTION	BUNDLE SKU	LIST PRICE
1	<b>6-PACK BUNDLE</b> Includes all Components Listed Above	HMP2472PK6	<b>\$9,953</b>

SPECIFYING EXAMPLE: Model.Laminate.Edgeband.Paint2.DuplexColor

NOTES: Typicals DO NOT include power in-feeds, screens, storage, or seating.

ADD 3 FABRIC SCREENS: \$2,181 — SEE PAGE 495

ADD 6 MOBILE PEDESTALS: \$3,414 — SEE PAGE 530

SEE PAGE 498 FOR BUNDLE SKU INFORMATION

QTY	DESCRIPTION	MODEL	LIST PRICE	PRICE EXTENSION
8	Worksurface, Edgeband, No Grommets 24" x 72"	HWR2472PN	\$529	\$4,232
1	Double Depth U-Leg (Box of 2)	HMPEL4828	\$1,136	\$1,136
3	Double Depth Shared U-Leg (Singles)	HMPSL4828	\$468	\$1,404
4	Support Beams (Box of 2) 72"W	HMPUB272	\$704	\$2,816
4	Shared Trough 72"W	HMPROUGH72	\$479	\$1,916
3	Power Harness 72"W	HH871272	\$214	\$642
1	End of Run Electrical Kit 72"W	HMPEEK72	\$214	\$214
4	Duplex 1	HH871501	\$43	\$172
4	Duplex 2	HH871502	\$43	\$172
4	Duplex 3	HH871503	\$43	\$172
4	Duplex 4	HH871504	\$43	\$172
<b>TOTAL:</b>				<b>\$13,048</b>

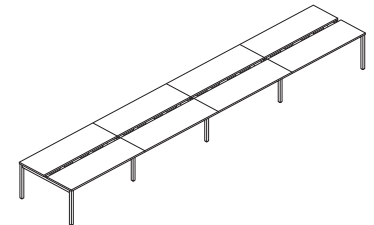

**8-PACK — 72"**  
**288"W x 51"D**

QTY	DESCRIPTION	BUNDLE SKU	LIST PRICE
1	<b>8-PACK BUNDLE</b> Includes all Components Listed Above	HMP2472PK8	<b>\$13,048</b>

SPECIFYING EXAMPLE: Model.Laminate.Edgeband.Paint2.DuplexColor

NOTES: Typicals DO NOT include power in-feeds, screens, storage, or seating.

ADD 4 FABRIC SCREENS: \$2,908 — SEE PAGE 495

ADD 8 MOBILE PEDESTALS: \$4,552 — SEE PAGE 530

SEE PAGE 498 FOR BUNDLE SKU INFORMATION



# EMPOWER<sup>®</sup> 72"W Typical with 24"D Worksurfaces



Icon Legend on page 19

WORKSTATIONS

QTY	DESCRIPTION	MODEL	LIST PRICE	PRICE EXTENSION
2	Electrical Power Harness Panels w/Duplex Capacity	HH871272	\$214	\$428
1	End of Run Electrical Kit 72"W	HMPPEEK72	\$214	\$214
1	Duplex Receptacle Circuit 1 3-1 & 2-2 Systems	HH871501	\$43	\$43
1	Duplex Receptacle Circuit 2 3-1 & 2-2 Systems	HH871502	\$43	\$43
1	Duplex Receptacle Circuit 3 3-1 System Only	HH871503	\$43	\$43
3	Duplex Receptacle Circuit 4 3-1 & 2-2 Systems	HH871504	\$43	\$129
1	Single Depth U-Leg (Box of 2)	HMPPEL2428	\$568	\$568
1	Single Depth Return Leg — Left	HMPRREL2428	\$345	\$345
2	Single Depth Return Leg — Right	HMPRREL2428	\$345	\$690
2	Single Depth Shared U-Leg (Singles)	HMPSL2428	\$345	\$690
3	Single-Side Trough 72"W	HMPSTROUGH72	\$508	\$1,524
2	Support Beams (Box of 1) 48"W	HMPUB148	\$286	\$572
1	Support Beams (Box of 1) 60"W	HMPUB160	\$319	\$319
3	Support Beams (Box of 1) 72"W	HMPUB172	\$353	\$1,059
2	Systems Rectangular Worksurface, Edgeband, No Grommets 24"D x 36"W	HWR2436PN	\$346	\$692
1	Systems Rectangular Worksurface, Edgeband, No Grommets 24"D x 48"W	HWR2448PN	\$404	\$404
3	Systems Rectangular Worksurface, Edgeband, No Grommets 24"D x 72"W	HWR2472PN	\$529	\$1,587
<b>TOTAL:</b>			<b>\$9,350</b>	

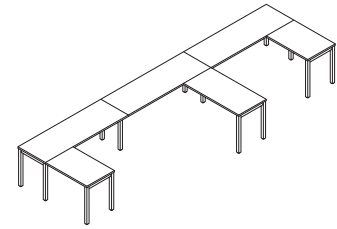

**6-PACK W/RETURNS — 72"  
216"W x 72"D**

NOTES: Typical DO NOT include power in-feeds, screens, storage, or seating.

ADD 3 FABRIC SCREENS: \$1,974 — SEE PAGE 495

ADD 3 MOBILE PEDESTALS: \$1,707 — SEE PAGE 530

SEE PAGE 498 FOR BUNDLE SKU INFORMATION

QTY	DESCRIPTION	MODEL	LIST PRICE	PRICE EXTENSION
2	Electrical Power Harness Panels w/Duplex Capacity	HH871272	\$214	\$428
1	End of Run Electrical Kit 72"W	HMPPEEK72	\$214	\$214
3	Duplex Receptacle Circuit 1 3-1 & 2-2 Systems	HH871501	\$43	\$129
3	Duplex Receptacle Circuit 2 3-1 & 2-2 Systems	HH871502	\$43	\$129
3	Duplex Receptacle Circuit 3 3-1 System Only	HH871503	\$43	\$129
3	Duplex Receptacle Circuit 4 3-1 & 2-2 Systems	HH871504	\$43	\$129
1	Double Depth U-Leg (Box of 2)	HMPPEL4828	\$1,136	\$1,136
2	Single Depth Return Leg — Left	HMPRREL2428	\$345	\$690
2	Single Depth Return Leg — Right	HMPRREL2428	\$345	\$690
2	Double Depth Shared U-Leg (Singles)	HMPSL4828	\$468	\$936
3	Shared Trough 72"W	HMPSTROUGH72	\$479	\$1,437
3	Support Beams (Box of 1) 48"W	HMPUB148	\$286	\$858
1	Support Beams (Box of 1) 60"W	HMPUB160	\$319	\$319
3	Support Beams (Box of 2) 72"W	HMPUB272	\$704	\$2,112
3	Systems Rectangular Worksurface, Edgeband, No Grommets 24"D x 36"W	HWR2436PN	\$346	\$1,038
1	Systems Rectangular Worksurface, Edgeband, No Grommets 24"D x 48"W	HWR2448PN	\$404	\$404
6	Systems Rectangular Worksurface, Edgeband, No Grommets 24"D x 72"W	HWR2472PN	\$529	\$3,174
<b>TOTAL:</b>			<b>\$13,952</b>	

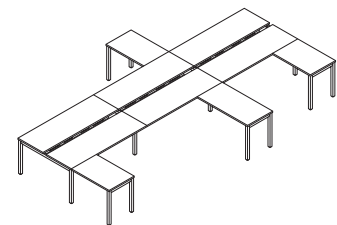

**3-PACK W/RETURNS — 72"  
216"W x 132"D**

NOTES: Typical DO NOT include power in-feeds, screens, storage, or seating.

ADD 3 FABRIC SCREENS: \$2,181 — SEE PAGE 495

ADD 6 MOBILE PEDESTALS: \$3,414 — SEE PAGE 530

SEE PAGE 498 FOR BUNDLE SKU INFORMATION





Icon Legend on page 19

# EMPOWER<sup>®</sup>

## 60"W Typicals with 24"D Worksurfaces

WORKSTATIONS

QTY	DESCRIPTION	MODEL	LIST PRICE	PRICE EXTENSION
2	Worksurface, Edgeband, No Grommets 24" x 60"	HWR2460PN	\$477	\$954
1	Double Depth U-Leg (Box of 2)	HMPEL4828	\$1,136	\$1,136
1	Support Beams (Box of 2) 60"W	HMPUB260	\$635	\$635
1	Shared Trough 60"W	HMPROUGH60	\$436	\$436
1	End of Run Electrical Kit 60"W	HMPEEK60	\$214	\$214
1	Duplex 1	HH871501	\$43	\$43
1	Duplex 2	HH871502	\$43	\$43
1	Duplex 3	HH871503	\$43	\$43
1	Duplex 4	HH871504	\$43	\$43
<b>TOTAL:</b>			<b>\$3,547</b>	

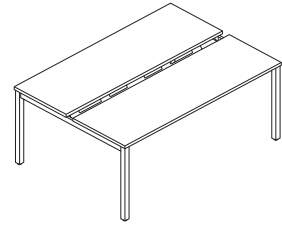

**2-PACK — 60"**  
**60"W x 51"D**

QTY	DESCRIPTION	BUNDLE SKU	LIST PRICE
1	2-PACK BUNDLE Includes all Components Listed Above	HMP2460PK2	\$3,547

SPECIFYING EXAMPLE: Model.Laminate.Edgeband.Paint2.DuplexColor

NOTES: Typicals DO NOT include power in-feeds, screens, storage, or seating.

ADD 1 FABRIC SCREEN: \$656 — SEE PAGE 495

ADD 2 MOBILE PEDESTALS: \$1,138 — SEE PAGE 530

SEE PAGE 498 FOR BUNDLE SKU INFORMATION

QTY	DESCRIPTION	MODEL	LIST PRICE	PRICE EXTENSION
4	Worksurface, Edgeband, No Grommets 24" x 60"	HWR2460PN	\$477	\$1,908
1	Double Depth U-Leg (Box of 2)	HMPEL4828	\$1,136	\$1,136
1	Double Depth Shared U-Leg (Singles)	HMPSL4828	\$468	\$468
2	Support Beams (Box of 2) 60"W	HMPUB260	\$635	\$1,270
2	Shared Trough 60"W	HMPROUGH60	\$436	\$872
1	Power Harness 60"W	HH871260	\$214	\$214
1	End of Run Electrical Kit 60"W	HMPEEK60	\$214	\$214
2	Duplex 1	HH871501	\$43	\$86
2	Duplex 2	HH871502	\$43	\$86
2	Duplex 3	HH871503	\$43	\$86
2	Duplex 4	HH871504	\$43	\$86
<b>TOTAL:</b>			<b>\$6,426</b>	

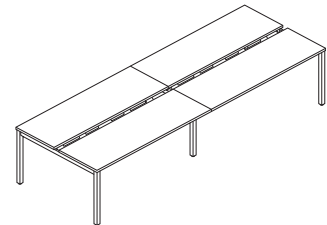

**4-PACK — 60"**  
**144"W x 51"D**

QTY	DESCRIPTION	BUNDLE SKU	LIST PRICE
1	4-PACK BUNDLE Includes all Components Listed Above	HMP2460PK4	\$6,426

SPECIFYING EXAMPLE: Model.Laminate.Edgeband.Paint2.DuplexColor

NOTES: Typicals DO NOT include power in-feeds, screens, storage, or seating.

ADD 2 FABRIC SCREENS: \$1,312 — SEE PAGE 495

ADD 4 MOBILE PEDESTALS: \$2,276 — SEE PAGE 530

SEE PAGE 498 FOR BUNDLE SKU INFORMATION

# EMPOWER®

## 60"W Typicals with 24"D Worksurfaces



Icon Legend on page 19

WORKSTATIONS

QTY	DESCRIPTION	MODEL	LIST PRICE	PRICE EXTENSION
6	Worksurface, Edgeband, No Grommets 24" x 60"	HWR2460PN	\$477	\$2,862
1	Double Depth U-Leg (Box of 2)	HMPEL4828	\$1,136	\$1,136
2	Double Depth Shared U-Leg (Singles)	HMPSL4828	\$468	\$936
3	Support Beams (Box of 2) 60"W	HMPUB260	\$635	\$1,905
3	Shared Trough 60"W	HMPTROUGH60	\$436	\$1,308
2	Power Harness 60"W	HH871260	\$214	\$428
1	End of Run Electrical Kit 60"W	HMPEEK60	\$214	\$214
3	Duplex 1	HH871501	\$43	\$129
3	Duplex 2	HH871502	\$43	\$129
3	Duplex 3	HH871503	\$43	\$129
3	Duplex 4	HH871504	\$43	\$129
<b>TOTAL:</b>				<b>\$9,305</b>

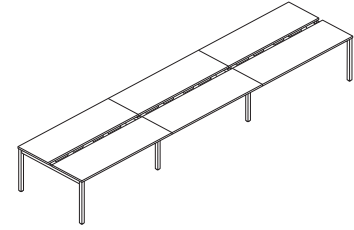

**6-PACK — 60"  
180"W x 51"D**

QTY	DESCRIPTION	BUNDLE SKU	LIST PRICE
1	<b>6-PACK BUNDLE</b> Includes all Components Listed Above	HMP2460PK6	<b>\$9,305</b>

**SPECIFYING EXAMPLE: Model.Laminate.Edgeband.Paint2.DuplexColor**

NOTES: Typicals DO NOT include power in-feeds, screens, storage, or seating.

**ADD 3 FABRIC SCREENS: \$1,968 — SEE PAGE 495**

**ADD 6 MOBILE PEDESTALS: \$3,414 — SEE PAGE 530**

**SEE PAGE 498 FOR BUNDLE SKU INFORMATION**

QTY	DESCRIPTION	MODEL	LIST PRICE	PRICE EXTENSION
8	Worksurface, Edgeband, No Grommets 24" x 60"	HWR2460PN	\$477	\$3,816
1	Double Depth U-Leg (Box of 2)	HMPEL4828	\$1,136	\$1,136
3	Double Depth Shared U-Leg (Singles)	HMPSL4828	\$468	\$1,404
4	Support Beams (Box of 2) 60"W	HMPUB260	\$635	\$2,540
4	Shared Trough 60"W	HMPTROUGH60	\$436	\$1,744
3	Power Harness 60"W	HH871260	\$214	\$642
1	End of Run Electrical Kit 60"W	HMPEEK60	\$214	\$214
4	Duplex 1	HH871501	\$43	\$172
4	Duplex 2	HH871502	\$43	\$172
4	Duplex 3	HH871503	\$43	\$172
4	Duplex 4	HH871504	\$43	\$172
<b>TOTAL:</b>				<b>\$12,184</b>

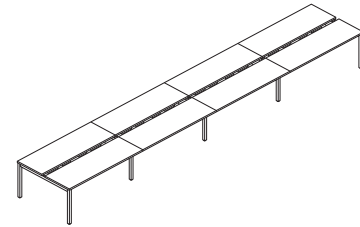

**8-PACK — 60"  
240"W x 51"D**

QTY	DESCRIPTION	BUNDLE SKU	LIST PRICE
1	<b>8-PACK BUNDLE</b> Includes all Components Listed Above	HMP2460PK8	<b>\$12,184</b>

**SPECIFYING EXAMPLE: Model.Laminate.Edgeband.Paint2.DuplexColor**

NOTES: Typicals DO NOT include power in-feeds, screens, storage, or seating.

**ADD 4 FABRIC SCREENS: \$2,624 — SEE PAGE 495**

**ADD 8 MOBILE PEDESTALS: \$4,552 — SEE PAGE 530**

**SEE PAGE 498 FOR BUNDLE SKU INFORMATION**



Icon Legend on page 19

# EMPOWER<sup>®</sup>

## 72"W Typical with 30"D Worksurfaces

WORKSTATIONS

QTY	DESCRIPTION	MODEL	LIST PRICE	PRICE EXTENSION
2	Worksurface, Edgeband, No Grommets 30" x 72"	HWR3072PN	\$593	\$1,186
1	Double Depth U-Leg (Box of 2)	HMPEL6028	\$1,249	\$1,249
1	Support Beams (Box of 2) 72"W	HMPUB272	\$704	\$704
1	Shared Trough 72"W	HMPROUGH72	\$479	\$479
1	End of Run Electrical Kit 72"W	HMPEEK72	\$214	\$214
1	Duplex 1	HH871501	\$43	\$43
1	Duplex 2	HH871502	\$43	\$43
1	Duplex 3	HH871503	\$43	\$43
1	Duplex 4	HH871504	\$43	\$43
<b>TOTAL:</b>				<b>\$4,004</b>

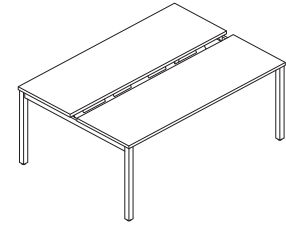

**2-PACK — 72"**  
**72"W x 63"D**

QTY	DESCRIPTION	BUNDLE SKU	LIST PRICE
1	<b>2-PACK BUNDLE</b> Includes all Components Listed Above	HMP3072PK2	<b>\$4,004</b>

SPECIFYING EXAMPLE: Model.Laminate.Edgeband.Paint2.DuplexColor

NOTES: Typicals DO NOT include power in-feeds, screens, storage, or seating.

ADD 1 FABRIC SCREEN: \$727 — SEE PAGE 495

ADD 2 MOBILE PEDESTALS: \$1,138 — SEE PAGE 530

SEE PAGE 498 FOR BUNDLE SKU INFORMATION

QTY	DESCRIPTION	MODEL	LIST PRICE	PRICE EXTENSION
4	Worksurface, Edgeband, No Grommets 30" x 72"	HWR3072PN	\$593	\$2,372
1	Double Depth U-Leg (Box of 2)	HMPEL6028	\$1,249	\$1,249
1	Double Depth Shared U-Leg (Singles)	HMPSL6028	\$514	\$514
2	Support Beams (Box of 2) 72"W	HMPUB272	\$704	\$1,408
2	Shared Trough 72"W	HMPROUGH72	\$479	\$958
1	Power Harness 72"W	HH871272	\$214	\$214
1	End of Run Electrical Kit 72"W	HMPEEK72	\$214	\$214
2	Duplex 1	HH871501	\$43	\$86
2	Duplex 2	HH871502	\$43	\$86
2	Duplex 3	HH871503	\$43	\$86
2	Duplex 4	HH871504	\$43	\$86
<b>TOTAL:</b>				<b>\$7,273</b>

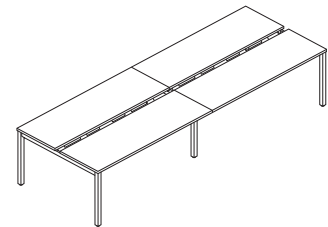

**4-PACK — 72"**  
**144"W x 63"D**

QTY	DESCRIPTION	BUNDLE SKU	LIST PRICE
1	<b>4-PACK BUNDLE</b> Includes all Components Listed Above	HMP3072PK4	<b>\$7,273</b>

SPECIFYING EXAMPLE: Model.Laminate.Edgeband.Paint2.DuplexColor

NOTES: Typicals DO NOT include power in-feeds, screens, storage, or seating.

ADD 2 FABRIC SCREENS: \$1,454 — SEE PAGE 495

ADD 4 MOBILE PEDESTALS: \$2,276 — SEE PAGE 530

SEE PAGE 498 FOR BUNDLE SKU INFORMATION

# EMPOWER® 72"W Typicals with 30"D Worksurfaces



Icon Legend on page 19

WORKSTATIONS

QTY	DESCRIPTION	MODEL	LIST PRICE	PRICE EXTENSION
6	Worksurface, Edgeband, No Grommets 30" x 72"	HWR3072PN	\$593	\$3,558
1	Double Depth U-Leg (Box of 2)	HMPEL6028	\$1,249	\$1,249
2	Double Depth Shared U-Leg (Singles)	HMPSL6028	\$514	\$1,028
3	Support Beams (Box of 2) 72"W	HMPUB272	\$704	\$2,112
3	Shared Trough 72"W	HMPTROUGH72	\$479	\$1,437
2	Power Harness 72"W	HH871272	\$214	\$428
1	End of Run Electrical Kit 72"W	HMPEEK72	\$214	\$214
3	Duplex 1	HH871501	\$43	\$129
3	Duplex 2	HH871502	\$43	\$129
3	Duplex 3	HH871503	\$43	\$129
3	Duplex 4	HH871504	\$43	\$129
<b>TOTAL:</b>				<b>\$10,542</b>

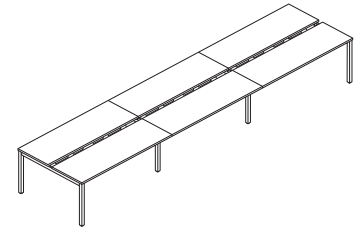

**6-PACK — 72"  
216"W x 63"D**

QTY	DESCRIPTION	BUNDLE SKU	LIST PRICE
1	<b>6-PACK BUNDLE</b> Includes all Components Listed Above	HMP3072PK6	<b>\$10,542</b>

**SPECIFYING EXAMPLE:** Model.Laminate.Edgeband.Paint2.DuplexColor

NOTES: Typicals DO NOT include power in-feeds, screens, storage, or seating.

**ADD 3 FABRIC SCREENS: \$2,181 — SEE PAGE 495**

**ADD 6 MOBILE PEDESTALS: \$3,414 — SEE PAGE 530**

**SEE PAGE 498 FOR BUNDLE SKU INFORMATION**

QTY	DESCRIPTION	MODEL	LIST PRICE	PRICE EXTENSION
8	Worksurface, Edgeband, No Grommets 30" x 72"	HWR3072PN	\$593	\$4,744
1	Double Depth U-Leg (Box of 2)	HMPEL6028	\$1,249	\$1,249
3	Double Depth Shared U-Leg (Singles)	HMPSL6028	\$514	\$1,542
4	Support Beams (Box of 2) 72"W	HMPUB272	\$704	\$2,816
4	Shared Trough 72"W	HMPTROUGH72	\$479	\$1,916
3	Power Harness 72"W	HH871272	\$214	\$642
1	End of Run Electrical Kit 72"W	HMPEEK72	\$214	\$214
4	Duplex 1	HH871501	\$43	\$172
4	Duplex 2	HH871502	\$43	\$172
4	Duplex 3	HH871503	\$43	\$172
4	Duplex 4	HH871504	\$43	\$172
<b>TOTAL:</b>				<b>\$13,811</b>

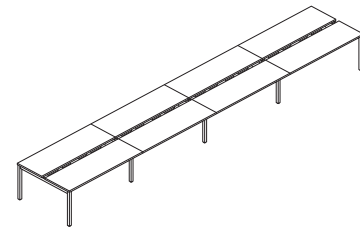

**8-PACK — 72"  
288"W x 63"D**

QTY	DESCRIPTION	BUNDLE SKU	LIST PRICE
1	<b>8-PACK BUNDLE</b> Includes all Components Listed Above	HMP3072PK8	<b>\$13,811</b>

**SPECIFYING EXAMPLE:** Model.Laminate.Edgeband.Paint2.DuplexColor

NOTES: Typicals DO NOT include power in-feeds, screens, storage, or seating.

**ADD 4 FABRIC SCREENS: \$2,908 — SEE PAGE 495**

**ADD 8 MOBILE PEDESTALS: \$4,552 — SEE PAGE 530**

**SEE PAGE 498 FOR BUNDLE SKU INFORMATION**



Icon Legend on page 19

# EMPOWER<sup>®</sup>

## 60"W Typicals with 30"D Worksurfaces

WORKSTATIONS

QTY	DESCRIPTION	MODEL	LIST PRICE	PRICE EXTENSION
2	Worksurface, Edgeband, No Grommets 30" x 60"	HWR3060PN	\$520	\$1,040
1	Double Depth U-Leg (Box of 2)	HMPEL6028	\$1,249	\$1,249
1	Support Beams (Box of 2) 60"W	HMPUB260	\$635	\$635
1	Shared Trough 60"W	HMPTROUGH60	\$436	\$436
1	End of Run Electrical Kit 60"W	HMPEEK60	\$214	\$214
1	Duplex 1	HH871501	\$43	\$43
1	Duplex 2	HH871502	\$43	\$43
1	Duplex 3	HH871503	\$43	\$43
1	Duplex 4	HH871504	\$43	\$43
<b>TOTAL:</b>			<b>\$3,746</b>	

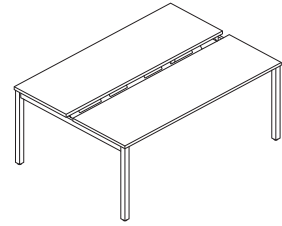

**2-PACK — 60"**  
**60"W x 63"D**

QTY	DESCRIPTION	BUNDLE SKU	LIST PRICE
1	<b>2-PACK BUNDLE</b> Includes all Components Listed Above	HMP3060PK2	<b>\$3,746</b>

SPECIFYING EXAMPLE: Model.Laminate.Edgeband.Paint2.DuplexColor

NOTES: Typicals DO NOT include power in-feeds, screens, storage, or seating.

ADD 1 FABRIC SCREEN: \$656 — SEE PAGE 495

ADD 2 MOBILE PEDESTALS: \$1,138 — SEE PAGE 530

SEE PAGE 498 FOR BUNDLE SKU INFORMATION

QTY	DESCRIPTION	MODEL	LIST PRICE	PRICE EXTENSION
4	Worksurface, Edgeband, No Grommets 30" x 60"	HWR3060PN	\$520	\$2,080
1	Double Depth U-Leg (Box of 2)	HMPEL6028	\$1,249	\$1,249
1	Double Depth Shared U-Leg (Singles)	HMPSL6028	\$514	\$514
2	Support Beams (Box of 2) 60"W	HMPUB260	\$635	\$1,270
2	Shared Trough 60"W	HMPTROUGH60	\$436	\$872
1	Power Harness 60"W	HH871260	\$214	\$214
1	End of Run Electrical Kit 60"W	HMPEEK60	\$214	\$214
2	Duplex 1	HH871501	\$43	\$86
2	Duplex 2	HH871502	\$43	\$86
2	Duplex 3	HH871503	\$43	\$86
2	Duplex 4	HH871504	\$43	\$86
<b>TOTAL:</b>			<b>\$6,757</b>	

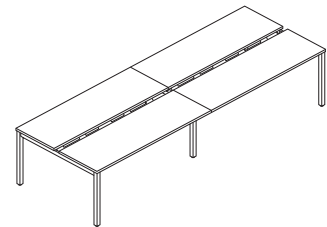

**4-PACK — 60"**  
**144"W x 63"D**

QTY	DESCRIPTION	BUNDLE SKU	LIST PRICE
1	<b>4-PACK BUNDLE</b> Includes all Components Listed Above	HMP3060PK4	<b>\$6,757</b>

SPECIFYING EXAMPLE: Model.Laminate.Edgeband.Paint2.DuplexColor

NOTES: Typicals DO NOT include power in-feeds, screens, storage, or seating.

ADD 2 FABRIC SCREENS: \$1,312 — SEE PAGE 495

ADD 4 MOBILE PEDESTALS: \$2,276 — SEE PAGE 530

SEE PAGE 498 FOR BUNDLE SKU INFORMATION

# EMPOWER®

## 60"W Typicals with 30"D Worksurfaces



Icon Legend on page 19

QTY	DESCRIPTION	MODEL	LIST PRICE	PRICE EXTENSION
6	Worksurface, Edgeband, No Grommets 30" x 60"	HWR3060PN	\$520	\$3,120
1	Double Depth U-Leg (Box of 2)	HMPEL6028	\$1,249	\$1,249
2	Double Depth Shared U-Leg (Singles)	HMPSL6028	\$514	\$1,028
3	Support Beams (Box of 2) 60"W	HMPUB260	\$635	\$1,905
3	Shared Trough 60"W	HMPTROUGH60	\$436	\$1,308
2	Power Harness 60"W	HH871260	\$214	\$428
1	End of Run Electrical Kit 60"W	HMPEEK60	\$214	\$214
3	Duplex 1	HH871501	\$43	\$129
3	Duplex 2	HH871502	\$43	\$129
3	Duplex 3	HH871503	\$43	\$129
3	Duplex 4	HH871504	\$43	\$129
<b>TOTAL:</b>				<b>\$9,768</b>

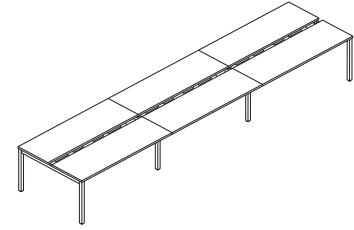

**6-PACK — 60"  
180"W x 63"D**

QTY	DESCRIPTION	BUNDLE SKU	LIST PRICE
1	<b>6-PACK BUNDLE</b> Includes all Components Listed Above	HMP3060PK6	<b>\$9,768</b>

**SPECIFYING EXAMPLE: Model.Laminate.Edgeband.Paint2.DuplexColor**

NOTES: Typicals DO NOT include power in-feeds, screens, storage, or seating.

**ADD 3 FABRIC SCREENS: \$1,968 — SEE PAGE 495**

**ADD 6 MOBILE PEDESTALS: \$3,414 — SEE PAGE 530**

**SEE PAGE 498 FOR BUNDLE SKU INFORMATION**

QTY	DESCRIPTION	MODEL	LIST PRICE	PRICE EXTENSION
8	Worksurface, Edgeband, No Grommets 30" x 60"	HWR3060PN	\$520	\$4,160
1	Double Depth U-Leg (Box of 2)	HMPEL6028	\$1,249	\$1,249
3	Double Depth Shared U-Leg (Singles)	HMPSL6028	\$514	\$1,542
4	Support Beams (Box of 2) 60"W	HMPUB260	\$635	\$2,540
4	Shared Trough 60"W	HMPTROUGH60	\$436	\$1,744
3	Power Harness 60"W	HH871260	\$214	\$642
1	End of Run Electrical Kit 60"W	HMPEEK60	\$214	\$214
4	Duplex 1	HH871501	\$43	\$172
4	Duplex 2	HH871502	\$43	\$172
4	Duplex 3	HH871503	\$43	\$172
4	Duplex 4	HH871504	\$43	\$172
<b>TOTAL:</b>				<b>\$12,779</b>

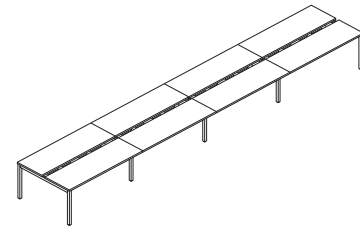

**8-PACK — 60"  
240"W x 63"D**

QTY	DESCRIPTION	BUNDLE SKU	LIST PRICE
1	<b>8-PACK BUNDLE</b> Includes all Components Listed Above	HMP3060PK8	<b>\$12,779</b>

**SPECIFYING EXAMPLE: Model.Laminate.Edgeband.Paint2.DuplexColor**

NOTES: Typicals DO NOT include power in-feeds, screens, storage, or seating.

**ADD 4 FABRIC SCREENS: \$2,624 — SEE PAGE 495**

**ADD 8 MOBILE PEDESTALS: \$4,552 — SEE PAGE 530**

**SEE PAGE 498 FOR BUNDLE SKU INFORMATION**



Icon Legend on page 19

# EMPOWER<sup>®</sup> 120° Workstation Typicals

QTY	DESCRIPTION	MODEL	LIST PRICE	PRICE EXTENSION
3	<b>120 Degree Corner Worksurfaces with Curved User Edge, No Grommets</b> 48"W x 30"D	HBWCT4830PN	\$1,164	\$3,492
3	<b>Double Depth U-Leg (Single Leg)</b>	HMP120EL4828	\$569	\$1,707
3	<b>Single Post Leg</b> 28½"H	HMP120POST	\$297	\$891
3	<b>Support Beams (Box of 2)</b> 48"W	HMP120UB248	\$571	\$1,713
3	<b>Double-Sided Trough</b> 48"W	HMP120TROUGH48	\$396	\$1,188
<b>TOTAL:</b>				<b>\$8,991</b>

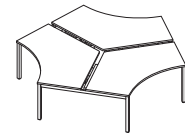

**3-PACK – 120°**

NOTES: Typicals DO NOT include power in-feeds, screens, storage, or seating.

**ADD 3 FABRIC SCREENS: \$1,662 — SEE PAGE 495**

**ADD 3 MOBILE PEDESTALS: \$1,707 — SEE PAGE 530**

QTY	DESCRIPTION	MODEL	LIST PRICE	PRICE EXTENSION
6	<b>120 Degree Corner Worksurfaces with Curved User Edge, No Grommets</b> 48"W x 30"D	HBWCT4830PN	\$1,164	\$6,984
4	<b>Double Depth U-Leg (Single Leg)</b>	HMP120EL4828	\$569	\$2,276
6	<b>Single Post Leg</b> 28½"H	HMP120POST	\$297	\$1,782
6	<b>Support Beams (Box of 2)</b> 48"W	HMP120UB248	\$571	\$3,426
6	<b>Double-Sided Trough</b> 48"W	HMP120TROUGH48	\$396	\$2,376
2	<b>Double Depth Shared U-Leg (Singles)</b>	HMP120SL4828	\$468	\$936
2	<b>Worksurface with Edgeband</b> 48"W x 30"D	HWR3048PN	\$436	\$872
1	<b>Support Beams (Box of 2)</b> 48"W	HMPUB248	\$571	\$571
1	<b>Double-Sided Trough</b> 48"W	HMP120TROUGH48	\$396	\$396
<b>TOTAL:</b>				<b>\$19,619</b>

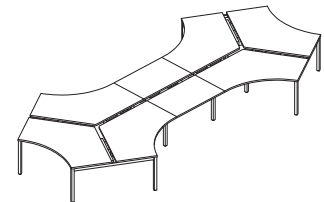

**DOG BONE – 120°**

NOTES: Typicals DO NOT include power in-feeds, screens, storage, or seating.

**ADD 7 FABRIC SCREENS: \$3,878 — SEE PAGE 495**

**ADD 6 MOBILE PEDESTALS: \$3,414 — SEE PAGE 530**



# EMPOWER® 120° Workstation Typical



Icon Legend on page 19

WORKSTATIONS

QTY	DESCRIPTION	MODEL	LIST PRICE	PRICE EXTENSION
9	<b>120 Degree Corner Worksurfaces with Curved User Edge, No Grommets</b> 48"W x 30"D	HBWCT4830PN	\$1,164	\$10,476
5	<b>Double Depth U-Leg (Single Leg)</b>	HMP120EL4828	\$569	\$2,845
9	<b>Single Post Leg</b> 28½"H	HMP120POST	\$297	\$2,673
9	<b>Support Beams (Box of 2)</b> 48"W	HMP120UB248	\$571	\$5,139
9	<b>Double-Sided Trough</b> 48"W	HMP120TROUGH48	\$396	\$3,564
2	<b>Double Depth Shared U-Leg (Singles)</b>	HMPSL4828	\$468	\$936
<b>TOTAL:</b>				<b>\$25,633</b>

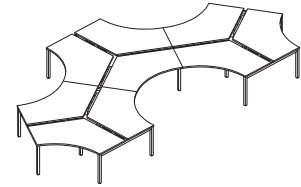

**MULTIPLE PODS — 120°**

NOTES: Typical DO NOT include power in-feeds, screens, storage, or seating.

**ADD 9 FABRIC SCREENS: \$4,986 — SEE PAGE 495**

**ADD 9 MOBILE PEDESTALS: \$5,121 — SEE PAGE 530**



Icon Legend on page 19

QTY	DESCRIPTION	MODEL	LIST PRICE	PRICE EXTENSION
2	Worksurface, Edgeband, No Grommets 24" x 72"	HHAW2472PN	\$552	\$1,104
1	Height Adjustable Base	HMPHA2S4C	\$2,286	\$2,286
1	Height Adjustable Shared Trough 72"W	HMPHATROUGH72	\$479	\$479
2	Single-Sided Trough Lid	HMPHASLID72	\$138	\$276
1	End of Run Electrical Kit 72"W	HMPEEK72	\$214	\$214
1	Duplex 1	HH871501	\$43	\$43
1	Duplex 2	HH871502	\$43	\$43
1	Duplex 3	HH871503	\$43	\$43
1	Duplex 4	HH871504	\$43	\$43
<b>TOTAL:</b>				<b>\$4,531</b>

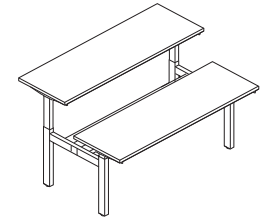
**2-PACK — 72"  
72"W x 51"D**

QTY	DESCRIPTION	BUNDLE SKU	LIST PRICE
1	<b>2-PACK BUNDLE</b> Includes all Components Listed Above	HMPHA2472PK2	<b>\$4,531</b>

**SPECIFYING EXAMPLE:** Model.Laminate.Edgeband.BasePaint.TroughPaint.DuplexColor

NOTES: Typicals DO NOT include power in-feeds, screens, storage, or seating.

**ADD 2 FABRIC SCREENS: \$1,454— SEE PAGE 495****ADD 2 MOBILE PEDESTALS: \$1,138— SEE PAGE 530****SEE PAGE 499 FOR BUNDLE SKU INFORMATION**

QTY	DESCRIPTION	MODEL	LIST PRICE	PRICE EXTENSION
4	Worksurface, Edgeband, No Grommets 24" x 72"	HHAW2472PN	\$552	\$2,208
2	Height Adjustable Base	HMPHA2S4C	\$2,286	\$4,572
2	Height Adjustable Shared Trough 72"W	HMPHATROUGH72	\$479	\$958
4	Single-Sided Trough Lid	HMPHASLID72	\$138	\$552
1	Power Harness 72"W	HH871272	\$214	<del>\$214</del>
1	End of Run Electrical Kit 72"W	HMPEEK72	<del>\$214</del>	<del>\$214</del>
2	Duplex 1	HH871501	\$43	\$86
2	Duplex 2	HH871502	\$43	\$86
2	Duplex 3	HH871503	\$43	\$86
2	Duplex 4	HH871504	\$43	\$86
<b>TOTAL:</b>				<b>\$9,062</b>

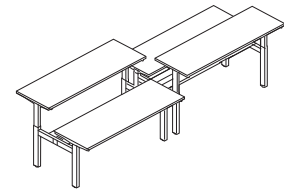
**4-PACK — 72"  
144"W x 51"D**

QTY	DESCRIPTION	BUNDLE SKU	LIST PRICE
1	<b>4-PACK BUNDLE</b> Includes all Components Listed Above	HMPHA2472PK4	<b>\$9,062</b>

**SPECIFYING EXAMPLE:** Model.Laminate.Edgeband.BasePaint.TroughPaint.DuplexColor

NOTES: Typicals DO NOT include power in-feeds, screens, storage, or seating.

**ADD 4 FABRIC SCREENS: \$2,908— SEE PAGE 495****ADD 4 MOBILE PEDESTALS: \$2,276— SEE PAGE 530****SEE PAGE 499 FOR BUNDLE SKU INFORMATION**



QTY	DESCRIPTION	MODEL	LIST PRICE	PRICE EXTENSION
6	Worksurface, Edgeband, No Grommets 24" x 72"	HHAW2472PN	\$552	\$3,312
3	Height Adjustable Base	HMPHA2S4C	\$2,286	\$6,858
3	Height Adjustable Shared Trough 72"W	HMPHATROUGH72	\$479	\$1,437
6	Single-Sided Trough Lid	HMPHASLID72	\$138	\$828
2	Power Harness 72"W	HH871272	\$214	\$428
1	End of Run Electrical Kit 72"W	HMPEEK72	\$214	\$214
3	Duplex 1	HH871501	\$43	\$129
3	Duplex 2	HH871502	\$43	\$129
3	Duplex 3	HH871503	\$43	\$129
3	Duplex 4	HH871504	\$43	\$129
<b>TOTAL:</b>				<b>\$13,593</b>

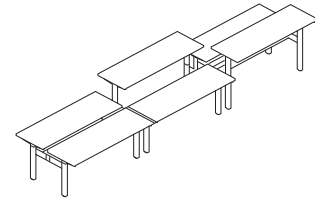

**6-PACK — 72"**  
**216"W x 51"D**

QTY	DESCRIPTION	BUNDLE SKU	LIST PRICE
1	<b>6-PACK BUNDLE</b> Includes all Components Listed Above	HMPHA2472PK6	<b>\$13,593</b>

**SPECIFYING EXAMPLE:** Model.Laminate.Edgeband.BasePaint.TroughPaint.DuplexColor

NOTES: Typicals DO NOT include power in-feeds, screens, storage, or seating.

**ADD 6 FABRIC SCREENS: \$4,362 — SEE PAGE 495**

**ADD 6 MOBILE PEDESTALS: \$3,414 — SEE PAGE 530**

**SEE PAGE 499 FOR BUNDLE SKU INFORMATION**

QTY	DESCRIPTION	MODEL	LIST PRICE	PRICE EXTENSION
8	Worksurface, Edgeband, No Grommets 24" x 72"	HHAW2472PN	\$552	\$4,416
4	Height Adjustable Base	HMPHA2S4C	\$2,286	\$9,144
4	Height Adjustable Shared Trough 72"W	HMPHATROUGH72	\$479	\$1,916
8	Single-Sided Trough Lid	HMPHASLID72	\$138	\$1,104
3	Power Harness 72"W	HH871272	\$214	\$642
1	End of Run Electrical Kit 72"W	HMPEEK72	\$214	\$214
4	Duplex 1	HH871501	\$43	\$172
4	Duplex 2	HH871502	\$43	\$172
4	Duplex 3	HH871503	\$43	\$172
4	Duplex 4	HH871504	\$43	\$172
<b>TOTAL:</b>				<b>\$18,124</b>

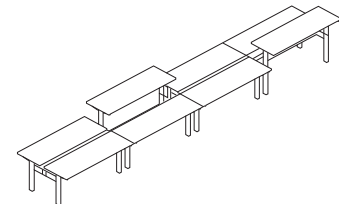

**8-PACK — 72"**  
**288"W x 51"D**

QTY	DESCRIPTION	BUNDLE SKU	LIST PRICE
1	<b>8-PACK BUNDLE</b> Includes all Components Listed Above	HMPHA2472PK8	<b>\$18,124</b>

**SPECIFYING EXAMPLE:** Model.Laminate.Edgeband.BasePaint.TroughPaint.DuplexColor

NOTES: Typicals DO NOT include power in-feeds, screens, storage, or seating.

**ADD 8 FABRIC SCREENS: \$5,816 — SEE PAGE 495**

**ADD 8 MOBILE PEDESTALS: \$4,552 — SEE PAGE 530**

**SEE PAGE 499 FOR BUNDLE SKU INFORMATION**



Icon Legend on page 19

QTY	DESCRIPTION	MODEL	LIST PRICE	PRICE EXTENSION
2	Worksurface, Edgeband, No Grommets 24" x 60"	HHAW2460PN	\$499	\$998
1	Height Adjustable Base	HMPHA2S4C	\$2,286	\$2,286
1	Height Adjustable Shared Trough 60"W	HMPHATROUGH60	\$436	\$436
2	Single-Sided Trough Lid	HMPHASLID60	\$126	\$252
1	End of Run Electrical Kit 60"W	HMPEEK60	\$214	\$214
1	Duplex 1	HH871501	\$43	\$43
1	Duplex 2	HH871502	\$43	\$43
1	Duplex 3	HH871503	\$43	\$43
1	Duplex 4	HH871504	\$43	\$43
<b>TOTAL:</b>				<b>\$4,358</b>

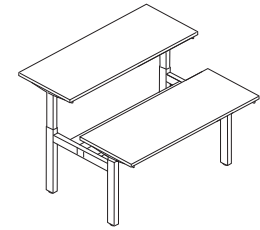
**2-PACK — 60"  
60"W x 51"D**

QTY	DESCRIPTION	BUNDLE SKU	LIST PRICE
1	<b>2-PACK BUNDLE</b> Includes all Components Listed Above	HMPHA2460PK2	<b>\$4,358</b>

SPECIFYING EXAMPLE: Model.Laminate.Edgeband.BasePaint.TroughPaint.DuplexColor

NOTES: Typicals DO NOT include power in-feeds, screens, storage, or seating.

ADD 2 FABRIC SCREENS: \$1,312 — SEE PAGE 495

ADD 2 MOBILE PEDESTALS: \$1,138 — SEE PAGE 530

SEE PAGE 499 FOR BUNDLE SKU INFORMATION

QTY	DESCRIPTION	MODEL	LIST PRICE	PRICE EXTENSION
4	Worksurface, Edgeband, No Grommets 24" x 60"	HHAW2460PN	\$499	\$1,996
2	Height Adjustable Base	HMPHA2S4C	\$2,286	\$4,572
2	Height Adjustable Shared Trough 60"W	HMPHATROUGH60	\$436	\$872
4	Single-Sided Trough Lid	HMPHASLID60	\$126	\$504
1	Power Harness 60"W	HH871260	\$214	\$214
1	End of Run Electrical Kit 60"W	HMPEEK60	\$214	\$214
2	Duplex 1	HH871501	\$43	\$86
2	Duplex 2	HH871502	\$43	\$86
2	Duplex 3	HH871503	\$43	\$86
2	Duplex 4	HH871504	\$43	\$86
<b>TOTAL:</b>				<b>\$8,716</b>

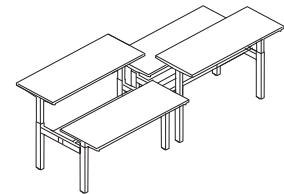
**4-PACK — 60"  
120"W x 51"D**

QTY	DESCRIPTION	BUNDLE SKU	LIST PRICE
1	<b>4-PACK BUNDLE</b> Includes all Components Listed Above	HMPHA2460PK4	<b>\$8,716</b>

SPECIFYING EXAMPLE: Model.Laminate.Edgeband.BasePaint.TroughPaint.DuplexColor

NOTES: Typicals DO NOT include power in-feeds, screens, storage, or seating.

ADD 4 FABRIC SCREENS: \$2,624 — SEE PAGE 495

ADD 4 MOBILE PEDESTALS: \$2,276 — SEE PAGE 530

SEE PAGE 499 FOR BUNDLE SKU INFORMATION



QTY	DESCRIPTION	MODEL	LIST PRICE	PRICE EXTENSION
6	Worksurface, Edgeband, No Grommets 24" x 60"	HHAW2460PN	\$499	\$2,994
3	Height Adjustable Base	HMPHA2S4C	\$2,286	\$6,858
3	Height Adjustable Shared Trough 60"W	HMPHATROUGH60	\$436	\$1,308
6	Single-Sided Trough Lid	HMPHASLID60	\$126	\$756
2	Power Harness 60"W	HH871260	\$214	\$428
1	End of Run Electrical Kit 60"W	HMPEEK60	\$214	\$214
3	Duplex 1	HH871501	\$43	\$129
3	Duplex 2	HH871502	\$43	\$129
3	Duplex 3	HH871503	\$43	\$129
3	Duplex 4	HH871504	\$43	\$129
<b>TOTAL:</b>				<b>\$13,074</b>

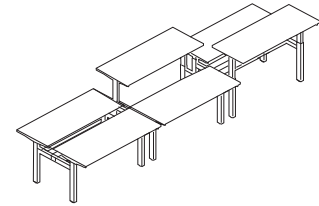

**6-PACK — 60"**  
**180"W x 51"D**

QTY	DESCRIPTION	BUNDLE SKU	LIST PRICE
1	<b>6-PACK BUNDLE</b> Includes all Components Listed Above	HMPHA2460PK6	<b>\$13,074</b>

**SPECIFYING EXAMPLE:** Model.Laminate.Edgeband.BasePaint.TroughPaint.DuplexColor

NOTES: Typicals DO NOT include power in-feeds, screens, storage, or seating.

**ADD 6 FABRIC SCREENS: \$3,936 — SEE PAGE 495**

**ADD 6 MOBILE PEDESTALS: \$3,414 — SEE PAGE 530**

**SEE PAGE 499 FOR BUNDLE SKU INFORMATION**

QTY	DESCRIPTION	MODEL	LIST PRICE	PRICE EXTENSION
8	Worksurface, Edgeband, No Grommets 24" x 60"	HHAW2460PN	\$499	\$3,992
4	Height Adjustable Base	HMPHA2S4C	\$2,286	\$9,144
4	Height Adjustable Shared Trough 60"W	HMPHATROUGH60	\$436	\$1,744
8	Single-Sided Trough Lid	HMPHASLID60	\$126	\$1,008
3	Power Harness 60"W	HH871260	\$214	\$642
1	End of Run Electrical Kit 60"W	HMPEEK60	\$214	\$214
4	Duplex 1	HH871501	\$43	\$172
4	Duplex 2	HH871502	\$43	\$172
4	Duplex 3	HH871503	\$43	\$172
4	Duplex 4	HH871504	\$43	\$172
<b>TOTAL:</b>				<b>\$17,432</b>

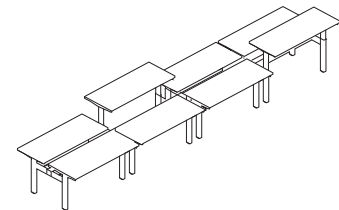

**8-PACK — 60"**  
**240"W x 51"D**

QTY	DESCRIPTION	BUNDLE SKU	LIST PRICE
1	<b>8-PACK BUNDLE</b> Includes all Components Listed Above	HMPHA2460PK8	<b>\$17,432</b>

**SPECIFYING EXAMPLE:** Model.Laminate.Edgeband.BasePaint.TroughPaint.DuplexColor

NOTES: Typicals DO NOT include power in-feeds, screens, storage, or seating.

**ADD 8 FABRIC SCREENS: \$5,248 — SEE PAGE 495**

**ADD 8 MOBILE PEDESTALS: \$4,552 — SEE PAGE 530**

**SEE PAGE 499 FOR BUNDLE SKU INFORMATION**



Icon Legend on page 19

QTY	DESCRIPTION	MODEL	LIST PRICE	PRICE EXTENSION
2	Worksurface, Edgeband, No Grommets 30" x 72"	HHAW3072PN	\$616	\$1,232
1	Height Adjustable Base	HMPHA2S4C	\$2,286	\$2,286
1	Height Adjustable Shared Trough 72"W	HMPHATROUGH72	\$479	\$479
2	Single-Sided Trough Lid	HMPHASLID72	\$138	\$276
1	End of Run Electrical Kit 72"W	HMPEEK72	\$214	\$214
1	Duplex 1	HH871501	\$43	\$43
1	Duplex 2	HH871502	\$43	\$43
1	Duplex 3	HH871503	\$43	\$43
1	Duplex 4	HH871504	\$43	\$43
<b>TOTAL:</b>				<b>\$4,659</b>

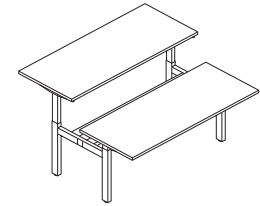
**2-PACK — 72"  
72"W x 63"D**

QTY	DESCRIPTION	BUNDLE SKU	LIST PRICE
1	<b>2-PACK BUNDLE</b> Includes all Components Listed Above	HMPHA3072PK2	<b>\$4,659</b>

SPECIFYING EXAMPLE: Model.Laminate.Edgeband.BasePaint.TroughPaint.DuplexColor

NOTES: Typicals DO NOT include power in-feeds, screens, storage, or seating.

ADD 2 FABRIC SCREENS: \$1,454 — SEE PAGE 495

ADD 2 MOBILE PEDESTALS: \$1,138 — SEE PAGE 530

SEE PAGE 499 FOR BUNDLE SKU INFORMATION

QTY	DESCRIPTION	MODEL	LIST PRICE	PRICE EXTENSION
4	Worksurface, Edgeband, No Grommets 30" x 72"	HHAW3072PN	\$616	\$2,464
2	Height Adjustable Base	HMPHA2S4C	\$2,286	\$4,572
2	Height Adjustable Shared Trough 72"W	HMPHATROUGH72	\$479	\$958
4	Single-Sided Trough Lid	HMPHASLID72	\$138	\$552
1	Power Harness 72"W	HH871272	\$214	\$214
1	End of Run Electrical Kit 72"W	HMPEEK72	\$214	\$214
2	Duplex 1	HH871501	\$43	\$86
2	Duplex 2	HH871502	\$43	\$86
2	Duplex 3	HH871503	\$43	\$86
2	Duplex 4	HH871504	\$43	\$86
<b>TOTAL:</b>				<b>\$9,318</b>

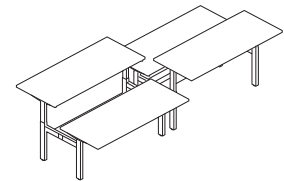
**4-PACK — 72"  
144"W x 63"D**

QTY	DESCRIPTION	BUNDLE SKU	LIST PRICE
1	<b>4-PACK BUNDLE</b> Includes all Components Listed Above	HMPHA3072PK4	<b>\$9,318</b>

SPECIFYING EXAMPLE: Model.Laminate.Edgeband.BasePaint.TroughPaint.DuplexColor

NOTES: Typicals DO NOT include power in-feeds, screens, storage, or seating.

ADD 4 FABRIC SCREENS: \$2,908 — SEE PAGE 495

ADD 4 MOBILE PEDESTALS: \$2,276 — SEE PAGE 530

SEE PAGE 499 FOR BUNDLE SKU INFORMATION



QTY	DESCRIPTION	MODEL	LIST PRICE	PRICE EXTENSION
6	Worksurface, Edgeband, No Grommets 30" x 72"	HHAW3072PN	\$616	\$3,696
3	Height Adjustable Base	HMPHA2S4C	\$2,286	\$6,858
3	Height Adjustable Shared Trough 72"W	HMPHATROUGH72	\$479	\$1,437
6	Single-Sided Trough Lid	HMPHASLID72	\$138	\$828
2	Power Harness 72"W	HH871272	\$214	\$428
1	End of Run Electrical Kit 72"W	HMPEEK72	\$214	\$214
3	Duplex 1	HH871501	\$43	\$129
3	Duplex 2	HH871502	\$43	\$129
3	Duplex 3	HH871503	\$43	\$129
3	Duplex 4	HH871504	\$43	\$129
<b>TOTAL:</b>				<b>\$13,977</b>

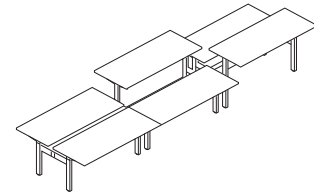

**6-PACK — 72"  
216"W x 63"D**

QTY	DESCRIPTION	BUNDLE SKU	LIST PRICE
1	<b>6-PACK BUNDLE</b> Includes all Components Listed Above	HMPHA3072PK6	<b>\$13,977</b>

**SPECIFYING EXAMPLE:** Model.Laminate.Edgeband.BasePaint.TroughPaint.DuplexColor

NOTES: Typicals DO NOT include power in-feeds, screens, storage, or seating.

**ADD 6 FABRIC SCREENS: \$4,362 — SEE PAGE 495**

**ADD 6 MOBILE PEDESTALS: \$3,414 — SEE PAGE 530**

**SEE PAGE 499 FOR BUNDLE SKU INFORMATION**

QTY	DESCRIPTION	MODEL	LIST PRICE	PRICE EXTENSION
8	Worksurface, Edgeband, No Grommets 30" x 72"	HHAW3072PN	\$616	\$4,928
4	Height Adjustable Base	HMPHA2S4C	\$2,286	\$9,144
4	Height Adjustable Shared Trough 72"W	HMPHATROUGH72	\$479	\$1,916
8	Single-Sided Trough Lid	HMPHASLID72	\$138	\$1,104
3	Power Harness 72"W	HH871272	\$214	\$642
1	End of Run Electrical Kit 72"W	HMPEEK72	\$214	\$214
4	Duplex 1	HH871501	\$43	\$172
4	Duplex 2	HH871502	\$43	\$172
4	Duplex 3	HH871503	\$43	\$172
4	Duplex 4	HH871504	\$43	\$172
<b>TOTAL:</b>				<b>\$18,636</b>

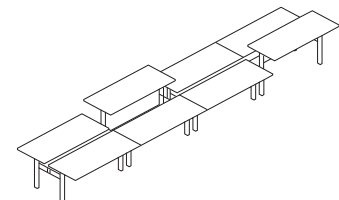

**8-PACK — 72"  
288"W x 63"D**

QTY	DESCRIPTION	BUNDLE SKU	LIST PRICE
1	<b>8-PACK BUNDLE</b> Includes all Components Listed Above	HMPHA3072PK8	<b>\$18,636</b>

**SPECIFYING EXAMPLE:** Model.Laminate.Edgeband.BasePaint.TroughPaint.DuplexColor

NOTES: Typicals DO NOT include power in-feeds, screens, storage, or seating.

**ADD 8 FABRIC SCREENS: \$5,816 — SEE PAGE 495**

**ADD 8 MOBILE PEDESTALS: \$4,552 — SEE PAGE 530**

**SEE PAGE 499 FOR BUNDLE SKU INFORMATION**





Icon Legend on page 19

QTY	DESCRIPTION	MODEL	LIST PRICE	PRICE EXTENSION
2	Worksurface, Edgeband, No Grommets 30" x 60"	HHAW3060PN	\$544	\$1,088
1	Height Adjustable Base	HMPHA2S4C	\$2,286	\$2,286
1	Height Adjustable Shared Trough 60"W	HMPHATROUGH60	\$436	\$436
2	Single-Sided Trough Lid	HMPHASLID60	\$126	\$252
1	End of Run Electrical Kit 60"W	HMPEEK60	\$214	\$214
1	Duplex 1	HH871501	\$43	\$43
1	Duplex 2	HH871502	\$43	\$43
1	Duplex 3	HH871503	\$43	\$43
1	Duplex 4	HH871504	\$43	\$43
<b>TOTAL:</b>				<b>\$4,448</b>

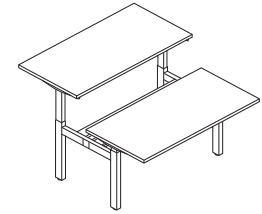
**2-PACK — 60"  
60"W x 63"D**

QTY	DESCRIPTION	BUNDLE SKU	LIST PRICE
1	<b>2-PACK BUNDLE</b> Includes all Components Listed Above	HMPHA3060PK2	<b>\$4,448</b>

SPECIFYING EXAMPLE: Model.Laminate.Edgeband.BasePaint.TroughPaint.DuplexColor

NOTES: Typicals DO NOT include power in-feeds, screens, storage, or seating.

ADD 2 FABRIC SCREENS: \$1,312 — SEE PAGE 495

ADD 2 MOBILE PEDESTALS: \$1,138 — SEE PAGE 530

SEE PAGE 499 FOR BUNDLE SKU INFORMATION

QTY	DESCRIPTION	MODEL	LIST PRICE	PRICE EXTENSION
4	Worksurface, Edgeband, No Grommets 30" x 60"	HHAW3060PN	\$544	\$2,176
2	Height Adjustable Base	HMPHA2S4C	\$2,286	\$4,572
2	Height Adjustable Shared Trough 60"W	HMPHATROUGH60	\$436	\$872
4	Single-Sided Trough Lid	HMPHASLID60	\$126	\$504
1	Power Harness 60"W	HH871260	\$214	\$214
1	End of Run Electrical Kit 60"W	HMPEEK60	\$214	\$214
2	Duplex 1	HH871501	\$43	\$86
2	Duplex 2	HH871502	\$43	\$86
2	Duplex 3	HH871503	\$43	\$86
2	Duplex 4	HH871504	\$43	\$86
<b>TOTAL:</b>				<b>\$8,896</b>

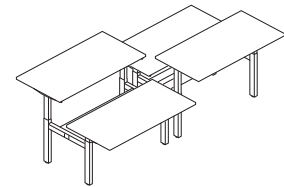
**4-PACK — 60"  
120"W x 63"D**

QTY	DESCRIPTION	BUNDLE SKU	LIST PRICE
1	<b>4-PACK BUNDLE</b> Includes all Components Listed Above	HMPHA3060PK4	<b>\$8,896</b>

SPECIFYING EXAMPLE: Model.Laminate.Edgeband.BasePaint.TroughPaint.DuplexColor

NOTES: Typicals DO NOT include power in-feeds, screens, storage, or seating.

ADD 4 FABRIC SCREENS: \$2,624 — SEE PAGE 495

ADD 4 MOBILE PEDESTALS: \$2,276 — SEE PAGE 530

SEE PAGE 499 FOR BUNDLE SKU INFORMATION



QTY	DESCRIPTION	MODEL	LIST PRICE	PRICE EXTENSION
6	Worksurface, Edgeband, No Grommets 30" x 60"	HHAW3060PN	\$544	\$3,264
3	Height Adjustable Base	HMPHA2S4C	\$2,286	\$6,858
3	Height Adjustable Shared Trough 60"W	HMPHATROUGH60	\$436	\$1,308
6	Single-Sided Trough Lid	HMPHASLID60	\$126	\$756
2	Power Harness 60"W	HH871260	\$214	\$428
1	End of Run Electrical Kit 60"W	HMPEEK60	\$214	\$214
3	Duplex 1	HH871501	\$43	\$129
3	Duplex 2	HH871502	\$43	\$129
3	Duplex 3	HH871503	\$43	\$129
3	Duplex 4	HH871504	\$43	\$129
<b>TOTAL:</b>				<b>\$13,344</b>

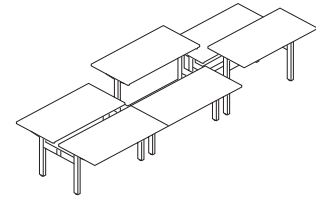

**6-PACK — 60"  
180"W x 63"D**

QTY	DESCRIPTION	BUNDLE SKU	LIST PRICE
1	<b>6-PACK BUNDLE</b> Includes all Components Listed Above	HMPHA3060PK6	<b>\$13,344</b>

**SPECIFYING EXAMPLE:** Model.Laminate.Edgeband.BasePaint.TroughPaint.DuplexColor

NOTES: Typicals DO NOT include power in-feeds, screens, storage, or seating.

**ADD 6 FABRIC SCREENS: \$3,936 — SEE PAGE 495**

**ADD 6 MOBILE PEDESTALS: \$3,414 — SEE PAGE 530**

**SEE PAGE 499 FOR BUNDLE SKU INFORMATION**

QTY	DESCRIPTION	MODEL	LIST PRICE	PRICE EXTENSION
8	Worksurface, Edgeband, No Grommets 30" x 60"	HHAW3060PN	\$544	\$4,352
4	Height Adjustable Base	HMPHA2S4C	\$2,286	\$9,144
4	Height Adjustable Shared Trough 60"W	HMPHATROUGH60	\$436	\$1,744
8	Single-Sided Trough Lid	HMPHASLID60	\$126	\$1,008
3	Power Harness 60"W	HH871260	\$214	\$642
1	End of Run Electrical Kit 60"W	HMPEEK60	\$214	\$214
4	Duplex 1	HH871501	\$43	\$172
4	Duplex 2	HH871502	\$43	\$172
4	Duplex 3	HH871503	\$43	\$172
4	Duplex 4	HH871504	\$43	\$172
<b>TOTAL:</b>				<b>\$17,792</b>

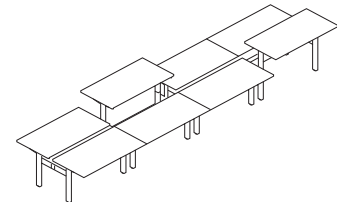

**8-PACK — 60"  
240"W x 63"D**

QTY	DESCRIPTION	BUNDLE SKU	LIST PRICE
1	<b>8-PACK BUNDLE</b> Includes all Components Listed Above	HMPHA3060PK8	<b>\$17,792</b>

**SPECIFYING EXAMPLE:** Model.Laminate.Edgeband.BasePaint.TroughPaint.DuplexColor

NOTES: Typicals DO NOT include power in-feeds, screens, storage, or seating.

**ADD 8 FABRIC SCREENS: \$5,248 — SEE PAGE 495**

**ADD 8 MOBILE PEDESTALS: \$4,552 — SEE PAGE 530**

**SEE PAGE 499 FOR BUNDLE SKU INFORMATION**

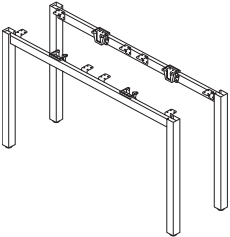
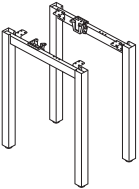
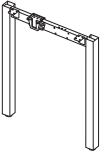

# EMPOWER® Legs for Linear Applications

	DESCRIPTION	MODEL	SHIP WEIGHT	CUBE	LIST PRICE BY PAINT GRADE		
					P1	P2	P3
	<b>Double Depth U-Leg (Box of 2)</b> 50½"D for use with 24"D Worksurfaces 62½"D for use with 30"D Worksurfaces NOTES: Ships as a box of 2 legs.	<b>HMPPEL4828</b> <b>HMPPEL6028</b>	32.4 34.8	14.9 18.5	<b>\$1136</b> <b>\$1249</b>	<b>\$1140</b> <b>\$1253</b>	<b>\$1170</b> <b>\$1286</b>
	<b>Double Depth Shared U-Leg (Singles)</b> 30"D for use with 24"D Worksurfaces 42"D for use with 30"D Worksurfaces	<b>HMPPSL4828</b> <b>HMPPSL6028</b>	21.1 22.5	4.9 6.4	<b>\$468</b> <b>\$514</b>	<b>\$472</b> <b>\$518</b>	<b>\$482</b> <b>\$529</b>
	<b>Single Depth U-Leg (Box of 2)</b> 24"D for use with 24"D Worksurfaces 30"D for use with 30"D Worksurfaces	<b>HMPPEL2428</b> <b>HMPPEL3028</b>	23.7 24.9	7.6 9.4	<b>\$568</b> <b>\$626</b>	<b>\$572</b> <b>\$630</b>	<b>\$596</b> <b>\$657</b>
	<b>Single Depth Shared U-Leg (Singles)</b> 18"D for use with 24"D Worksurfaces 24"D for use with 30"D Worksurfaces	<b>HMPPSL2428</b> <b>HMPPSL3028</b>	14.8 15.6	3.2 4.0	<b>\$345</b> <b>\$380</b>	<b>\$349</b> <b>\$384</b>	<b>\$362</b> <b>\$399</b>
	<b>Single Depth Return U-Leg (Singles)</b> Left Right NOTES: Return U-Legs ship with two flat brackets.	<b>HMPPREL2428</b> <b>HMPPREL2428</b>	23.7 23.7	4.0 4.0	<b>\$345</b> <b>\$345</b>	<b>\$349</b> <b>\$349</b>	<b>\$362</b> <b>\$362</b>

## HOW TO SPECIFY

<b>Select Model Number</b> H M P E L 4 8 2 8	<b>Select Paint Color</b> See page 464 T 1
---	--

# EMPOWER<sup>®</sup>

## Legs for 120° Applications

GSA SIN 33721



Icon Legend on page 19

WORKSTATIONS

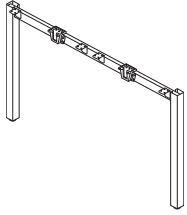

DESCRIPTION	MODEL	SHIP WEIGHT	CUBE	LIST PRICE BY PAINT GRADE		
				P1	P2	P3
<b>Double Depth U-Leg (Single Leg for 120° Applications)</b> 50½"D for use with 24"D Worksurfaces	<b>HMP120EL4828</b>	19	7.9	\$569	\$573	\$597
60½"D for use with 30"D Worksurfaces	<b>HMP120EL6028</b>	20	9.6	\$626	\$630	\$657

NOTES: Ships as single leg for 120 degree applications.

! 120 degree surfaces must be used in back-to-back applications — cannot be used freestanding.



DESCRIPTION	MODEL	SHIP WEIGHT	CUBE	P1	P2	P3
<b>Post Leg for 120° Applications (Singles)</b> 28½"H	<b>HMP120POST</b>	10	1.4	\$297	\$301	\$312

NOTES: One post leg needed per 120 degree worksurface. Post leg ships with attachment brackets needed to connect support beams and worksurfaces.

! 120 degree surfaces must be used in back-to-back applications — cannot be used freestanding.

Worksurface Width	Electrical Model	Quantity
36"	HH871124	1
36"	HH871148	2
42"	HH871124	1
42"	HH871160	2
48"	HH871124	1
48"	HH871172	2

### HOW TO SPECIFY

Select Model Number

HMP120EL4828

Select Paint Color

See page 464

T1

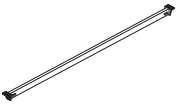
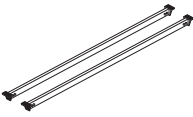
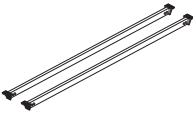

# EMPOWER<sup>®</sup> Support Beams

	DESCRIPTION	MODEL	SHIP WEIGHT	CUBE	LIST PRICE
	<b>Support Beams (Box of 1)</b>				
	48"W	<b>HMPUB148</b>	7.0	0.5	<b>\$286</b>
	60"W	<b>HMPUB160</b>	8.3	0.7	<b>\$319</b>
	72"W	<b>HMPUB172</b>	9.6	0.9	<b>\$353</b>
	NOTES: One support beam per worksurface is needed. ⓘ Available in graphite finish only. No specification needed.				
	<b>Support Beams (Box of 2)</b>				
	48"W	<b>HMPUB248</b>	13.3	0.5	<b>\$571</b>
	60"W	<b>HMPUB260</b>	15.8	0.7	<b>\$635</b>
	72"W	<b>HMPUB272</b>	18.2	0.9	<b>\$704</b>
	NOTES: For use with double-sided stations. One support beam per worksurface is needed. ⓘ Available in graphite finish only. No specification needed.				
	<b>Support Beams for 120° Applications (Box of 2)</b>				
	36"W	<b>HMP120UB236</b>	7.8	0.9	<b>\$452</b>
	42"W	<b>HMP120UB242</b>	9.5	0.9	<b>\$508</b>
	48"W	<b>HMP120UB248</b>	11.0	0.9	<b>\$571</b>
	NOTES: Two support beams per 120 degree worksurface are needed. ⓘ Available in graphite finish only. No specification needed.				

**NOTES:**

- For use with stationary, single-sided stations. 36"W returns will use the 48"W Support Beam and 48"W returns will use the 60"W Support Beam.

## HOW TO SPECIFY

Select Model Number

H M P 1 2 0 U B 2 3 6

# EMPOWER® Wire Troughs

GSA SIN 33721



Icon Legend on page 19

WORKSTATIONS

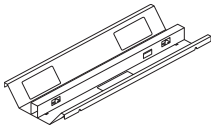
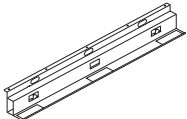
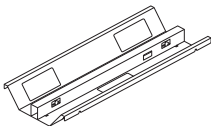
	DESCRIPTION	MODEL	SHIP WEIGHT	CUBE	LIST PRICE
	<b>Trough — Double-Sided</b>				
	48"W	<b>HMPTROUGH48</b>	3.3	5.3	<b>\$396</b>
	60"W	<b>HMPTROUGH60</b>	4.3	6.8	<b>\$436</b>
	72"W	<b>HMPTROUGH72</b>	5.3	8.3	<b>\$479</b>
	Available in graphite finish only. No specification needed.				
	<b>Trough — Single-Sided</b>				
	48"W	<b>HMPSTROUGH48</b>	3.0	5.3	<b>\$296</b>
	60"W	<b>HMPSTROUGH60</b>	4.0	6.8	<b>\$402</b>
	72"W	<b>HMPSTROUGH72</b>	5.0	8.3	<b>\$508</b>
	Available in graphite finish only. No specification needed.				
	<b>Trough — Double-Sided for 120° Applications</b>				
	36"W	<b>HMP120TROUGH36</b>	6.9	3.8	<b>\$322</b>
	42"W	<b>HMP120TROUGH42</b>	8.4	3.8	<b>\$357</b>
	48"W	<b>HMP120TROUGH48</b>	9.9	5.3	<b>\$396</b>
	Available in graphite finish only. No specification needed.				

**NOTES:**

- Slots available in trough to zip tie data cables to the trough.
- Double-sided wire trough rests on top of support bars. No fasteners needed.
- Single-sided trough is used for single-sided applications only. Screws into bottom side of worksurface for attachment.

For use with stationary Empower® only.

**HOW TO SPECIFY**

Select Model Number

H M P T R O U G H 4 8



# EMPOWER® Return Components

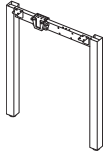

**DESCRIPTION**

**Single Depth Return Leg (Singles)**

Left  
Right

NOTES: Return legs ship with two flat brackets.

MODEL	SHIP WEIGHT	CUBE	LIST PRICE BY PAINT GRADE		
			P1	P2	P3
HMPRELEL2428	23.7	4.0	\$345	\$349	\$362
HMPRRELEL2428	23.7	4.0	\$345	\$349	\$362

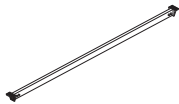

**DESCRIPTION**

**Support Beams (Box of 1)**

48"W  
60"W

NOTES: For use with single-sided stations. 36"W returns will use the 48"W Support Beam and 48"W returns will use the 60"W Support Beam.

ⓘ Available in graphite finish only. No specification needed.

MODEL	SHIP WEIGHT	CUBE	LIST PRICE
HMPUB148	7.0	0.5	\$286
HMPUB160	8.3	0.7	\$319

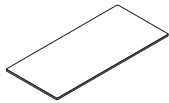

**DESCRIPTION**

**24"D Worksurface with Edgeband**

36"W x 24"D

NOTES: For use as a return surface only.

48"W x 24"D

NOTES: Can be used as a primary surface or a return surface.

MODEL	SHIP WEIGHT	CUBE	LIST PRICE BY LAMINATE GRADE	
			L1	L2
HWR2436PN	46 ⓘ	2.5	\$346	\$361
HWR2448PN	58 ⓘ	3.3	\$404	\$419

**NOTES:**

- Worksurfaces are constructed of laminate on 1/8" solid core high-performance particleboard.
- Return legs ship with two flat brackets. 36"W returns will use the 48"W Support Beam and 48"W returns will use the 60"W Support Beam.
- ⓘ All worksurfaces load tested to BIFMA standards.
- ⓘ Stack-on storage cannot be used on Empower® benching.
- ⓘ For use with static linear applications only.

## HOW TO SPECIFY

<p>Select Model Number</p> <p>H M P R L E L 2 4 2 8 .</p>	<p>Select Paint Color</p> <p>See page 464</p> <p>T 1</p>	
<p>Select Model Number</p> <p>H W R 2 4 3 6 P N .</p>	<p>Select Laminate Color</p> <p>See page 464</p> <p>L D W 1 .</p>	<p>Select Edgeband Color</p> <p>See page 464</p> <p>L D W 1</p>



# EMPOWER<sup>®</sup> Systems Worksurfaces

GSA SIN 33721



Icon Legend on page 19

WORKSTATIONS

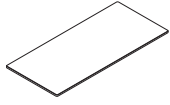

### DESCRIPTION

#### 24"D Worksurface with Edgeband

36"W x 24"D

NOTES: For use as a return surface only.

48"W x 24"D

NOTES: Can be used as a primary surface or a return surface.

60"W x 24"D

72"W x 24"D

NOTES: For use as a primary surface.

### MODEL

HWR2436PN

HWR2448PN

HWR2460PN

HWR2472PN

### SHIP WEIGHT

46 Ⓢ

58 Ⓢ

70

89

### CUBE

2.5

3.3

4.0

4.8

### LIST PRICE BY LAMINATE GRADE

#### L1

\$346

\$404

\$477

\$529

#### L2

\$361

\$419

\$497

\$549

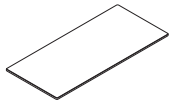

#### 30"D Worksurface with Edgeband

48"W x 30"D

60"W x 30"D

72"W x 30"D

HWR3048PN

HWR3060PN

HWR3072PN

58 Ⓢ

70

89

3.3

4.0

4.8

\$436

\$520

\$593

\$451

\$540

\$613

### NOTES:

- Worksurfaces are constructed of laminate on 1 1/8" solid core high-performance particleboard.

- ⓘ All worksurfaces load tested to BIFMA standards.
- ⓘ Stack-on storage cannot be used on Empower<sup>®</sup> benching.
- ⓘ Height adjustable worksurfaces are reduced 2" in width and 0.75" in depth to prevent pinch points.

## HOW TO SPECIFY

Select Model Number

HWR2448PN

Select Laminate Color

See page 464

LDW1

Select Edgeband Color

See page 464

LDW1



# SYSTEMS WORKSURFACES

## 120 Degree Corner

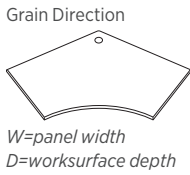

**DESCRIPTION**

**Abound® and Accelerate® 120 Degree Corner Worksurfaces with Curved User Edge**

36"W x 24"D  
42"W x 24"D  
48"W x 24"D

**MODEL**

**HBWCT3624P**  
**HBWCT4224P**  
**HBWCT4824P**

**SHIP WEIGHT**

75  
96  
107

**CUBE**

7.7  
9.2  
9.2

**L1 LIST PRICE**

**\$777**  
**\$833**  
**\$965**

**L2 LIST PRICE**

**\$792**  
**\$848**  
**\$980**

42"W x 30"D  
48"W x 30"D

**HBWCT4230P**  
**HBWCT4830P**

102  
112

11.4  
11.4

**\$1094**  
**\$1164**

**\$1109**  
**\$1179**

- HBWCT3624P will not accept the H4022, HE4022, H4028, or H4029 keyboard platforms.
- One small worksurface bracket standard with each worksurface.

❗ Corner worksurfaces must match exactly the panel behind them, i.e.: a 36" panel must be used on the back two sides of model HBWCT3624P.

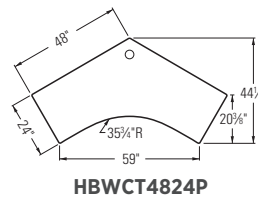
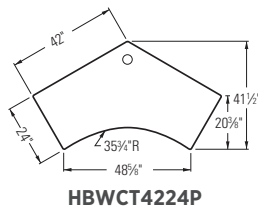
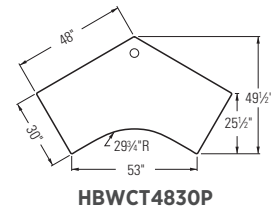
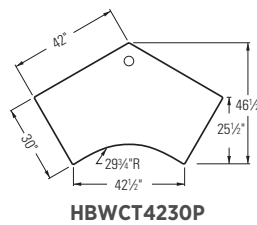
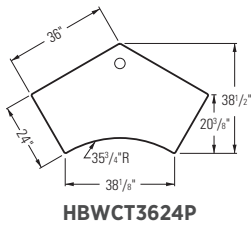

**NOTES:**

- Worksurfaces are constructed of laminate on 1/8" solid core high-performance particleboard.
- Add suffix "N" to Model Number for worksurfaces with no grommets. No upcharge.
- Refer to Worksurface Supports, pages 587-591.
- If used at an end of run, full end panel needs to be ordered — see page 587.

- ❗ Cannot use keyboard tray or full height pedestal under 120 degree corner worksurface.
- ❗ For use with linear applications only.

**HOW TO SPECIFY**

<p><b>Select Model Number</b></p> <p>No Grommet option: Add "N" suffix (no upcharge)</p> <p>HBWCT3624P .</p> <p>HBWCT3624PN .</p>	<p><b>Select Laminate</b></p> <p>See page 441</p> <p>AS .</p> <p>AS .</p>	<p><b>Select Edge Color</b></p> <p>See page 441</p> <p>K .</p> <p>K .</p>	<p><b>Select Grommet Color</b></p> <p>See page 441</p> <p>T1</p>
---	---	---	--

# EMPOWER® Height Adjustable Bases

OPEN MARKET

Icon Legend on page 19

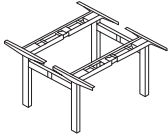

**DESCRIPTION**

**Height Adjustable Base**  
Back-to-Back Workstation

**MODEL**

**HMPHA2S4C**

**SHIP WEIGHT**

130

**CUBE**

5.3

**LIST PRICE**

**\$2286**



**End of Run Kit**

! End of Run Kit needs to be attached to one side of HMPHA2S4C. End of Run Kit cannot stand on its own.

**HMPHABEORKIT**

15

3.1

**\$176**

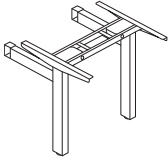

**NOTES:**

- Bases are steel construction with telescoping horizontal frame that adjusts from 41"-71"W to accommodate 42"-72"W worksurfaces. Memory controller features four memory presets, programmable upper and lower limit, and keypad lock to prevent unintentional movement. Dour motor with 250 lbs. load capacity per surface. Travel range of 19 5/8" adjustment from 25 5/8" to 45 1/4" (excluding worksurface dimension).
- ! Height adjustable benching cannot be single-sided; must always be used in back to back layouts.
- ! HBSMAUSB and HBDMAUSB cannot be used in Empower® height adjustable applications.

**DESCRIPTION**

**Trough for Height Adjustable Base — Double-Sided**  
48"W  
60"W  
72"W

**MODEL**

**HMPHATROUGH48**  
**HMPHATROUGH60**  
**HMPHATROUGH72**

**SHIP WEIGHT**

5.0  
6.5  
7.0

**CUBE**

1.7  
2.2  
2.7

**LIST PRICE**

**\$396**  
**\$436**  
**\$479**

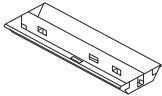

**Trough for Height Adjustable End of Run**  
20"W

**HMPHATROUGH20**

3.0

0.4

**\$320**

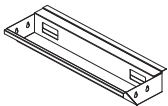

**Single-Sided Trough Lid — Single Pack**

For 48"W Trough  
For 60"W Trough  
For 72"W Trough  
For Height Adjustable Base 20"W End of Run Trough

**HMPHASLID48**  
**HMPHASLID60**  
**HMPHASLID72**  
**HMPHASLID20**

3.0  
4.0  
5.0  
2.0

0.4  
0.5  
0.6  
0.4

**\$115**  
**\$126**  
**\$138**  
**\$92**

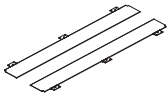

**NOTES:**

- Slots available in trough to zip tie data cables to the trough.
- Trough attaches to crossbeam connected to the height adjustable columns.
- 2 trough lids needed per double-sided trough.
- 1 trough lid needed for end of run trough.
- \$4 upcharge for P2 Paints.
- \$10 upcharge for P3 Paints on Trough Covers and End of Run Trough.
- \$20 upcharge for P3 Paints on Troughs.

**HOW TO SPECIFY**

<p>Select Model Number</p> <p>H M P H A 2 S 4 C .</p>	<p>Select Paint Color</p> <p>P71 Black P8L Nickel PD8 White</p> <p>P 8 L</p>
---	--

<p>Select Model Number</p> <p>H M P H A T R O U G H 4 8 .</p>	<p>Select Paint Color</p> <p>See page 464</p> <p>P 8 S</p>
---	--



Icon Legend on page 19

# EMPOWER® Systems Worksurfaces

	DESCRIPTION	MODEL	SHIP WEIGHT	CUBE	LIST PRICE BY LAMINATE GRADE	
					L1	L2
	<b>24"D Height Adjustable Worksurfaces</b>					
	48"W x 24"D	HHAW2448PN	58	3.1	\$429	\$444
	60"W x 24"D	HHAW2460PN	70	3.9	\$499	\$519
	72"W x 24"D	HHAW2472PN	89	4.6	\$552	\$572
	<b>30"D Height Adjustable Worksurfaces</b>					
	48"W x 30"D	HHAW3048PN	68	3.9	\$458	\$473
	60"W x 30"D	HHAW3060PN	101	4.8	\$544	\$564
	72"W x 30"D	HHAW3072PN	105	5.7	\$616	\$636
	<b>Half-Round Worksurfaces for End of Run</b>					
	50"W x 30"D	HHAWD2450PN	54	4.8	\$618	\$633
	62"W x 30"D	HHAWD3062PN	77	5.9	\$720	\$740

**OPEN MARKET**

**NOTES:**

- Worksurfaces are constructed of laminate on 1/8" solid core high-performance particleboard.
- ! All worksurfaces load tested to BIFMA standards.
- ! Stack-on storage cannot be used on Empower® benching.
- ! Height adjustable worksurfaces are reduced 2" in width and 0.75" in depth to prevent pinch points.

## HOW TO SPECIFY

<p><b>Select Model Number</b></p> <p>HHAW2448PN.</p>	<p><b>Select Laminate Color</b></p> <p>See page 464</p> <p>WHIT.</p>	<p><b>Select Edgeband Color</b></p> <p>See page 464</p> <p>WHIT</p>
--	--	---

# EMPOWER<sup>®</sup> Side Screens

GSA SIN 33721



Icon Legend on page 19

WORKSTATIONS

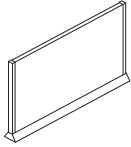

## DESCRIPTION

### Fabric Side Screen

24"D x 13"H  
24"D x 20"H

30"D x 13"H  
30"D x 20"H

## MODEL

## SHIP WEIGHT CUBE

## LIST PRICE BY FABRIC GRADE

### AA A B

<b>HMPDFS2413</b>	4.5	2.1	<b>\$399</b>	<b>\$419</b>	<b>\$439</b>
<b>HMPDFS2420</b>	4.5	1.6	<b>\$440</b>	<b>\$460</b>	<b>\$480</b>
<b>HMPDFS3013</b>	5.0	1.9	<b>\$439</b>	<b>\$459</b>	<b>\$479</b>
<b>HMPDFS3020</b>	5.0	2.2	<b>\$484</b>	<b>\$504</b>	<b>\$524</b>

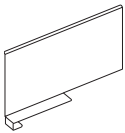

## DESCRIPTION

### Painted Metal Side Screen

24"D x 13"H  
30"D x 13"H

## MODEL

## SHIP WEIGHT CUBE

## LIST PRICE BY PAINT GRADE

### P1 P2 P3

<b>HMPDMS2413</b>	6.3	2.0	<b>\$280</b>	<b>\$284</b>	<b>\$300</b>
<b>HMPDMS3013</b>	7.7	2.8	<b>\$321</b>	<b>\$325</b>	<b>\$341</b>

## NOTES:

- Fabric screen adheres to the top of the worksurface with heavy-duty double stick tape.
- Metal screen slides over the edge of the worksurface and screws in under the worksurface.
- Metal screen is available in markerboard paint.
- For use on stationary and height adjustable setups.

## HOW TO SPECIFY

### Select Model Number

H M P D F S 2 4 1 3 .

### Select Paint Color

See page 464

T 1 .

### Select Fabric

See pages 462-463

A P N 1 1

### Select Model Number

H M P D M S 2 4 1 3 .

### Select Paint Color

See page 464

P 8 S



Icon Legend on page 19

# EMPOWER<sup>®</sup> Center Screens Fabric

WORKSTATIONS

	DESCRIPTION	MODEL	SHIP WEIGHT	CUBE	LIST PRICE BY FABRIC GRADE			
					AA	A	B	
	<b>Fabric Screens (Shared) — 13”H</b>							
	24”W	HMPCFS2413	6.3	0.9	\$299	\$319	\$339	
	30”W	HMPCFS3013	7.3	1.1	\$372	\$392	\$412	
	36”W	HMPCFS3613	8.3	1.4	\$453	\$473	\$493	
	42”W	HMPCFS4213	9.3	1.6	\$466	\$486	\$506	
	48”W	HMPCFS4813	10.3	1.8	\$577	\$597	\$617	
	60”W	HMPCFS6013	12.3	2.3	\$663	\$683	\$703	
	❗ For use on stationary stations only.							
		<b>Fabric Screens (Shared) — 20”H</b>						
		24”W	HMPCFS2420	7.3	1.6	\$381	\$401	\$421
30”W		HMPCFS3020	8.5	1.6	\$475	\$495	\$515	
36”W		HMPCFS3620	9.8	2.1	\$578	\$598	\$618	
42”W		HMPCFS4220	11.0	2.4	\$554	\$574	\$594	
48”W		HMPCFS4820	12.3	2.8	\$656	\$676	\$696	
60”W		HMPCFS6020	14.8	3.5	\$727	\$747	\$767	
❗ For use on stationary stations only.								
		<b>Fabric Screens (Single) — 13”H</b>						
		36”W	HMPFSS3613	9.7	2.4	\$448	\$468	\$488
	42”W	HMPFSS4213	11.0	1.7	\$461	\$481	\$501	
	48”W	HMPFSS4813	12.3	2.9	\$572	\$592	\$612	
	54”W	HMPFSS5413	13.6	2.4	\$600	\$620	\$640	
	60”W	HMPFSS6013	14.8	3.6	\$658	\$678	\$698	
OPEN MARKET	NOTES: For use on single-sided stationary stations or height adjustable stations (one per worksurface).							
	<b>Fabric Screens (Single) — 20”H</b>							
	36”W	HMPFSS3620	11.2	3.2	\$573	\$593	\$613	
	42”W	HMPFSS4220	12.8	2.7	\$549	\$569	\$589	
	48”W	HMPFSS4820	14.3	4.0	\$651	\$671	\$691	
	54”W	HMPFSS5420	15.9	3.6	\$682	\$702	\$722	
	60”W	HMPFSS6020	17.3	4.9	\$722	\$742	\$762	
OPEN MARKET	NOTES: For use on single-sided stationary stations or height adjustable stations (one per worksurface).							

**NOTES:**

- ❗ Only single-sided screens can be specified with height adjustable workstations.
- ❗ When using a power pole, the screen on the station with the pole must be 6” shorter to allow space for the pole to be mounted.

**Fabric Screen Specifying Guide**

Static Rectangle Worksurface Width	Inset 6” on Each Side	Full Length
48”	36”	48”
60”	48”	60”
72”	60”	N/A

120 Side Width	Inset 6” on Each Side	Full Length
36”	24”	36”
42”	30”	42”
48”	36”	48”

Height Adjustable Rectangle Worksurface Width	Inset 5” on Each Side	Inset 2” on Each Side
48” (undersized)	36”	42”
60” (undersized)	48”	54”
72” (undersized)	60”	N/A

**HOW TO SPECIFY**

<p><b>Select Model Number</b></p> <p>H M P C F S 3 6 2 0 .</p>	<p><b>Select Paint Color</b></p> <p>See page 464 \$4 upcharge for P2 Paints \$20 upcharge for P3 Paints</p> <p>T 1 .</p>	<p><b>Select Fabric</b></p> <p>See pages 462-463</p> <p>A P N 1 1</p>
--	--	---

# EMPOWER® Center Screens Frosted Glass

GSA SIN 33721



Icon Legend on page 19

WORKSTATIONS

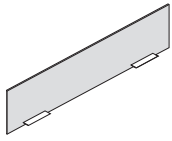

DESCRIPTION	MODEL	SHIP WEIGHT	CUBE	LIST PRICE BY PAINT GRADE	
				P1	P2
<b>Frosted Glass Screens (Shared) — 13”H</b>					
24”W	HMPFG2413	18.2	1.4	\$329	\$333
30”W	HMPFG3013	21.0	1.6	\$408	\$412
36”W	HMPFG3613	23.8	1.9	\$497	\$501
42”W	HMPFG4213	26.5	2.2	\$514	\$518
48”W	HMPFG4813	29.3	2.4	\$608	\$612
60”W	HMPFG6013	35.3	3.0	\$728	\$732
72”W	HMPFG7213	43.3	3.5	\$800	\$804

! For use on stationary stations only.

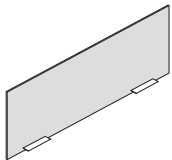

<b>Frosted Glass Screens (Shared) — 20”H</b>					
24”W	HMPFG2420	24.8	2.0	\$417	\$421
30”W	HMPFG3020	28.8	2.4	\$520	\$524
36”W	HMPFG3620	32.8	2.8	\$608	\$612
42”W	HMPFG4220	37.3	3.1	\$609	\$613
48”W	HMPFG4820	41.3	3.5	\$719	\$723
60”W	HMPFG6020	49.3	4.3	\$799	\$803
72”W	HMPFG7220	60.3	5.1	\$878	\$882

! For use on stationary stations only.

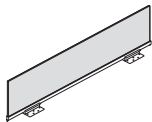

<b>Frosted Glass Screens (Single) — 13”H</b>					
36”W	HMPFGS3613	25.2	1.9	\$492	\$496
42”W	HMPFGS4213	28.3	2.2	\$509	\$513
48”W	HMPFGS4813	31.3	2.4	\$603	\$607
54”W	HMPFGS5413	34.4	2.8	\$660	\$664
60”W	HMPFGS6013	37.8	3.0	\$723	\$727
72”W	HMPFGS7213	46.3	3.5	\$795	\$799

NOTES: For use on single-sided stationary stations or height adjustable stations (one per worksurface).

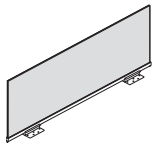

<b>Frosted Glass Screens (Single) — 20”H</b>					
36”W	HMPFGS3620	34.2	2.8	\$603	\$607
42”W	HMPFGS4220	38.8	3.1	\$604	\$608
48”W	HMPFGS4820	43.3	3.5	\$714	\$718
54”W	HMPFGS5420	47.9	3.8	\$751	\$755
60”W	HMPFGS6020	51.8	4.3	\$794	\$798
72”W	HMPFGS7220	63.3	5.1	\$873	\$877

NOTES: For use on single-sided stationary stations or height adjustable stations (one per worksurface).

! 20”H glass cannot be used on 24”D single-sided stations.

**NOTES:**

- ! Only single-sided screens can be specified with height adjustable workstations.
- ! When using a power pole, the screen on the station with the pole must be 6” shorter to allow space for the pole to be mounted.

**Glass Screen Specifying Guide**

Rectangle Worksurface Width	Inset 6” on Each Side	Full Length
48”	36”	48”
60”	48”	60”
72”	60”	72”

120 Side Width	Inset 6” on Each Side	Full Length
36”	24”	36”
42”	30”	42”
48”	36”	48”

Height Adjustable Rectangle Worksurface Width	Inset 5” on Each Side	Inset 2” on Each Side
48” (undersized)	36”	42”
60” (undersized)	48”	54”
72” (undersized)	60”	N/A

**HOW TO SPECIFY**

<p>Select Model Number</p> <p>H M P F G 3 6 1 3 .</p>	<p>Select Paint Color</p> <p>See page 464</p> <p>T 1 .</p>	<p>Select Frosted Glass</p> <p>R Frosted Glass</p> <p>R</p>
---	--	---





Icon Legend on page 19

# Modesty Panels/End of Run Screens

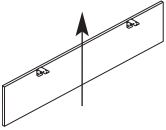
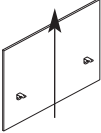
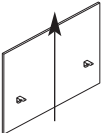
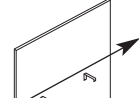
DESCRIPTION	MODEL	SHIP WEIGHT	CUBE	LIST PRICE BY LAMINATE GRADE	
				L1	L2
 <p><b>Laminate Modesty Panels — 13”H</b>                      36”W for use with 48”W Worksurfaces                      48”W for use with 60”W Worksurfaces                      60”W for use with 72”W Worksurfaces</p> <p>NOTES: Vertical grain.                      ⓘ For use on single-sided stationary Empower® only.</p>	<b>HMPLM3613</b>	12.9	1.9	<b>\$181</b>	<b>\$191</b>
	<b>HMPLM4813</b>	16.9	2.4	<b>\$272</b>	<b>\$282</b>
	<b>HMPLM6013</b>	19.9	2.9	<b>\$311</b>	<b>\$321</b>
 <p><b>Single-Side Laminate End of Run Screens</b>                      Single — 24”W x 26”H                      Single — 24”W x 34”H                      Single — 30”W x 26”H                      Single — 30”W x 34”H</p> <p>NOTES: 24”W and 48”W models used on 24”D Worksurfaces and 30”W and 60”W models are used on 30”D Worksurfaces. Vertical grain.</p>	<b>HMPLM2426</b>	16.9	2.2	<b>\$184</b>	<b>\$194</b>
	<b>HMPLM2434</b>	20.9	2.8	<b>\$201</b>	<b>\$211</b>
	<b>HMPLM3026</b>	20.5	2.7	<b>\$209</b>	<b>\$219</b>
	<b>HMPLM3034</b>	25.5	3.4	<b>\$231</b>	<b>\$241</b>
 <p><b>Double-Side Laminate End of Run Screens</b>                      Double — 48”W x 26”H                      Double — 48”W x 34”H                      Double — 60”W x 26”H                      Double — 60”W x 34”H</p> <p>NOTES: 24”W and 48”W models used on 24”D Worksurfaces and 30”W and 60”W models are used on 30”D Worksurfaces. Vertical grain.</p>	<b>HMPLM4826</b>	30.9	4.1	<b>\$269</b>	<b>\$279</b>
	<b>HMPLM4834</b>	38.9	5.2	<b>\$295</b>	<b>\$305</b>
	<b>HMPLM6026</b>	38.1	5.1	<b>\$363</b>	<b>\$373</b>
	<b>HMPLM6034</b>	48.3	6.4	<b>\$394</b>	<b>\$404</b>
 <p><b>Double-Side Laminate Gallery Panel for Height Adjustable</b>                      48”W x 50”H                      60”W x 50”H</p> <p>NOTES: Horizontal grain.</p>	<b>HMPLGP4850</b>	82.0	6.6	<b>\$614</b>	<b>\$624</b>
	<b>HMPLGP6050</b>	100.0	9.2	<b>\$682</b>	<b>\$692</b>

**OPEN MARKET**

**NOTES:**

- End of run screens sit -1” inset on each side of the depth of the run.
- Static end of run screens are 13” below the surface and either 13”H or 20”H above the surface.
- Height adjustable end of run screens extend to the floor and are 50”H.

## HOW TO SPECIFY

<p><b>Select Model Number</b></p> <p>HMPLM3613</p>	<p><b>Select Laminate Color</b></p> <p>See page 464</p> <p>PINCPINC</p>	<p><b>Select Paint Color</b></p> <p>Bracket paint must be specified</p> <p>T1</p>
--	---	---

# EMPOWER<sup>®</sup> Typicals

GSA SIN 33721



Icon Legend on page 19

WORKSTATIONS

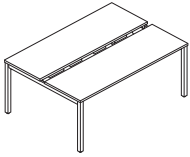
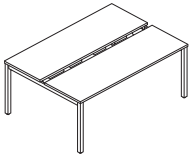
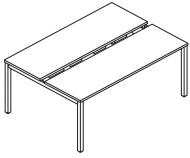
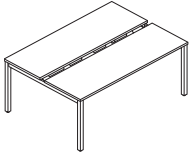
	DESCRIPTION	MODEL	SHIP WEIGHT	CUBE	LIST PRICE BY LAMINATE GRADE	
					L1	L2
	<b>Bundles — 72" W with 24" D Worksurfaces</b>					
	2-Pack	<b>HMP2472PK2</b>	238.9	35.3	<b>\$3763</b>	<b>\$3803</b>
	4-Pack	<b>HMP2472PK4</b>	465.8	59.4	<b>\$6858</b>	<b>\$6938</b>
	6-Pack	<b>HMP2472PK6</b>	692.7	83.9	<b>\$9953</b>	<b>\$10073</b>
	8-Pack	<b>HMP2472PK8</b>	919.6	108.5	<b>\$13048</b>	<b>\$13208</b>
	<b>Bundles — 60" W with 24" D Worksurfaces</b>					
	2-Pack	<b>HMP2460PK2</b>	198.9	35.3	<b>\$3547</b>	<b>\$3587</b>
	4-Pack	<b>HMP2460PK4</b>	385.8	59.4	<b>\$6426</b>	<b>\$6506</b>
	6-Pack	<b>HMP2460PK6</b>	572.7	83.9	<b>\$9305</b>	<b>\$9425</b>
	8-Pack	<b>HMP2460PK8</b>	759.6	108.5	<b>\$12184</b>	<b>\$12344</b>
	<b>Bundles — 72" W with 30" D Worksurfaces</b>					
	2-Pack	<b>HMP3072PK2</b>	238.9	35.3	<b>\$4004</b>	<b>\$4044</b>
	4-Pack	<b>HMP3072PK4</b>	465.8	59.4	<b>\$7273</b>	<b>\$7353</b>
	6-Pack	<b>HMP3072PK6</b>	692.7	83.9	<b>\$10542</b>	<b>\$10662</b>
	8-Pack	<b>HMP3072PK8</b>	919.6	108.5	<b>\$13811</b>	<b>\$13971</b>
	<b>Bundles — 60" W with 30" D Worksurfaces</b>					
	2-Pack	<b>HMP3060PK2</b>	198.9	35.3	<b>\$3746</b>	<b>\$3786</b>
	4-Pack	<b>HMP3060PK4</b>	385.8	59.4	<b>\$6757</b>	<b>\$6837</b>
	6-Pack	<b>HMP3060PK6</b>	572.7	83.9	<b>\$9768</b>	<b>\$9888</b>
	8-Pack	<b>HMP3060PK8</b>	759.6	108.5	<b>\$12779</b>	<b>\$12939</b>
<b>SPECIFYING EXAMPLE: Model.Laminate.Edgeband.Paint2.DuplexColor (S only)</b>						

**NOTES:**

- Bundles include worksurfaces, support legs, support bars, wire management troughs, harnesses, and duplexes.
- Please specify in-feed, screens, storage, and seating separately.

ⓘ Stack-on storage cannot be used on Empower benching.

## HOW TO SPECIFY

<p>Select Model Number</p> <p>HMP2472PK2</p>	<p>Select Laminate Color</p> <p>See page 464</p> <p>LDW1</p>	<p>Select Edgeband Color</p> <p>See page 464</p> <p>LDW1</p>	<p>Select Paint Color</p> <p>See page 464</p> <p>\$4 upcharge for P2 Paints</p> <p>T1</p>	<p>Select Duplex Color</p> <p>See page 464</p> <p>S</p>
--	--	--	---	---



# EMPOWER® Height Adjustable Typicals

	DESCRIPTION	MODEL	SHIP WEIGHT	CUBE	LIST PRICE BY LAMINATE GRADE	
					L1	L2
	<b>Bundles — 72" W with 24" D Worksurfaces</b>					
	2-Pack	HMPHA2472PK2	331	19.1	\$4531	\$4571
	4-Pack	HMPHA2472PK4	662	37.6	\$9062	\$9142
	6-Pack	HMPHA2472PK6	993	56.2	\$13593	\$13713
	8-Pack	HMPHA2472PK8	1324	74.7	\$18124	\$18284
	<b>Bundles — 60" W with 24" D Worksurfaces</b>					
	2-Pack	HMPHA2460PK2	291	16.9	\$4358	\$4398
	4-Pack	HMPHA2460PK4	581	33.1	\$8716	\$8796
	6-Pack	HMPHA2460PK6	872	49.4	\$13074	\$13194
	8-Pack	HMPHA2460PK8	1162	65.7	\$17432	\$17592
	<b>Bundles — 72" W with 30" D Worksurfaces</b>					
	2-Pack	HMPHA3072PK2	363	21.3	\$4659	\$4699
	4-Pack	HMPHA3072PK4	726	41.9	\$9318	\$9398
	6-Pack	HMPHA3072PK6	1089	62.6	\$13977	\$14097
	8-Pack	HMPHA3072PK8	1452	83.3	\$18636	\$18796
	<b>Bundles — 60" W with 30" D Worksurfaces</b>					
	2-Pack	HMPHA3060PK2	353	18.7	\$4448	\$4488
	4-Pack	HMPHA3060PK4	705	36.7	\$8896	\$8976
	6-Pack	HMPHA3060PK6	1058	54.8	\$13344	\$13464
	8-Pack	HMPHA3060PK8	1410	72.9	\$17792	\$17952

**SPECIFYING EXAMPLE: Model.Laminate.Edgeband.BasePaint.TroughPaint.DuplexColor**

**NOTES:**

- Bundles include worksurfaces, wire management troughs, trough covers, harnesses, duplexes, and bases.
- Please specify in-feed, screens, storage, and seating separately.

- ! Stack-on storage cannot be used on Empower benching.
- ! HBSMAUSB and HBDMAUSB cannot be used in Empower® height adjustable applications.

**HOW TO SPECIFY**

<p>Select Model Number</p> <p>H M P H A 2 4 7 2 P K 2</p>	<p>Select Laminate Color</p> <p>See page 464</p> <p>L D W 1</p>	<p>Select Edgeband Color</p> <p>See page 464</p> <p>L D W 1</p>	<p>Select Base Paint Color</p> <p>See page 464</p> <p>Upcharge for P2 and P3 Paints</p> <p>T 1</p>	<p>Select Trough Paint Color</p> <p>See page 464</p> <p>S</p>	<p>Select Duplex Color</p> <p>See page 464</p> <p>S</p>
---	---	---	--	---	---

# EMPOWER<sup>®</sup> ELECTRICAL SPECIFYING INFORMATION

**To Order:**

1. Determine which electrical system you will use after consulting your electrician and computer support personnel:

- **The Four-circuit system (4-Hot/2-Neutral/2-Ground)**
  - 3 + 1 option
  - 2 + 2 option
- **The Three-circuit system (3-Hot/3-Neutral/2-Ground)**

2. Determine location, quantity and circuit of duplexes.
3. Determine the appropriate choice and use of Isolated, Isolated/Dedicated and Separate Neutral circuits.
4. Specify appropriate Power Harnesses\* and Pass-Thru Cables.\*
5. Determine the location, quantity and type of Power In-feed needed.

\* Select Power Harness models (HH8712XX) and Pass-Thru Cables (HH8711XX) with the last two digits being the same as the associated worksurface width.

## Electrical System Options

The four-circuit, eight-wire electrical system is widely specified and trusted by hundreds of thousands of end-users. This proven system delivers four circuits for every power in-feed in either a 3 + 1 or 2 + 2 configuration. The isolated/dedicated circuits are ideal for sensitive computing equipment, while the common circuits are suitable for faxes, copiers, task lights and other peripherals.

Both the 3 + 1 and 2 + 2 systems use the same pre-wired components, making it easy to adjust as electrical needs change.

You can also choose a three-circuit, eight-wire system that has a dedicated neutral for every hot circuit. The three-circuit components have model numbers with an "A" suffix and appear in a gray box in this pricer.

### Four-circuit, 3 + 1 Receptacle Option

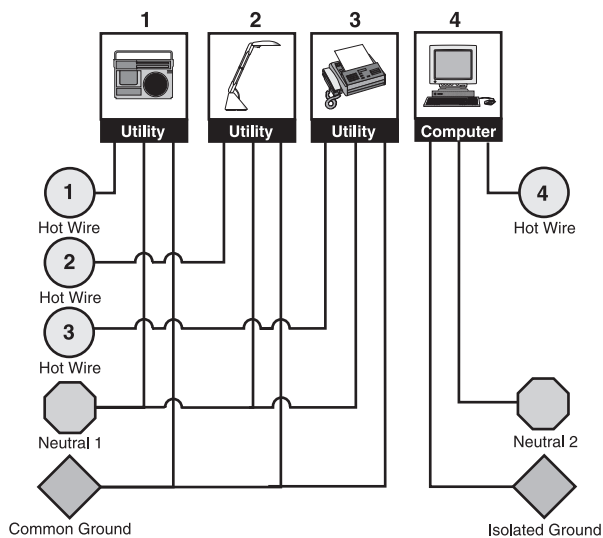

The 3 + 1 option is the electrical standard used by The HON Company for many years in most of their systems products. This wiring option provides three utility circuits plus an isolated/dedicated circuit for more sensitive equipment.

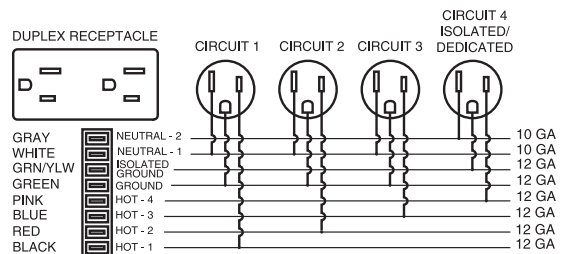

### Four-circuit, 2 + 2 Receptacle Option

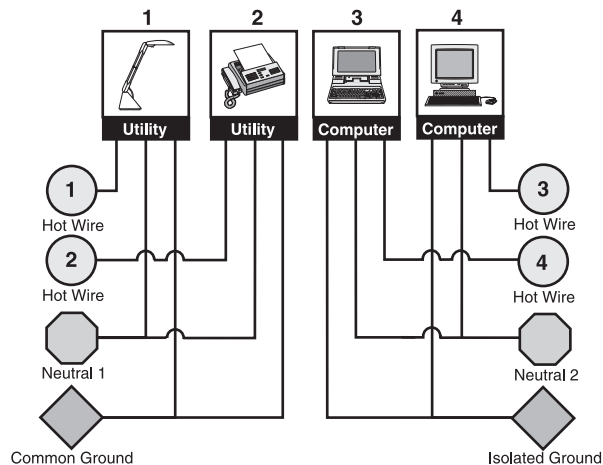

The 2 + 2 option is a wiring option that provides two utility circuits and two isolated circuits for more extensive computer usage applications.

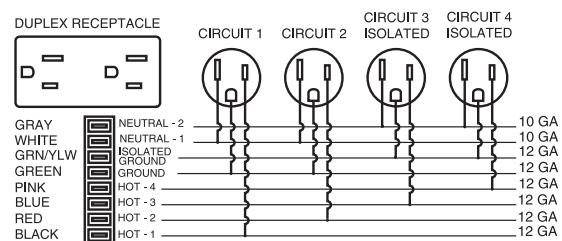

# EMPOWER<sup>®</sup> ELECTRICAL SPECIFYING INFORMATION

## Three-circuit, separate neutrals

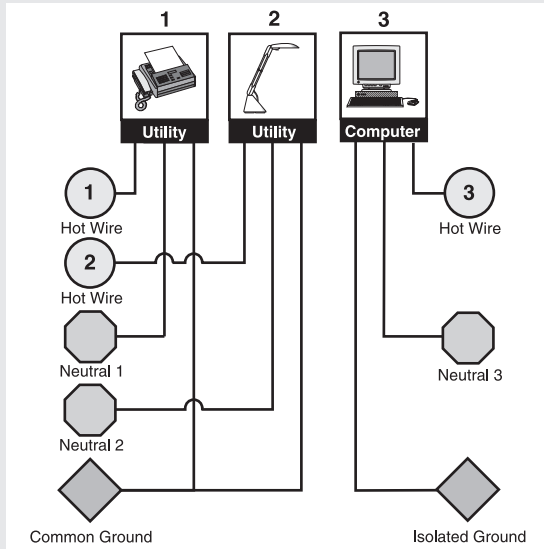

The Three-circuit, separate neutrals configuration is a wiring option that provides separate neutrals for each of the three circuits. Two circuits share a common ground, and one circuit is isolated/dedicated. The three-circuit components have model numbers with an "A" suffix and appear in a gray box in this price.

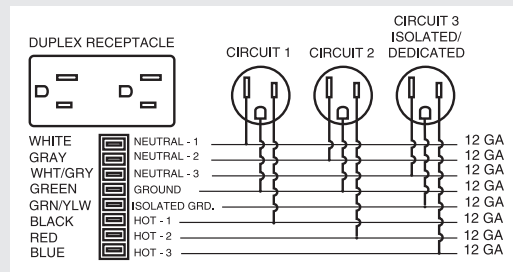

Two 8-wire, 20 AMP (15 AMP Canadian) electrical systems are offered					
Electrical System	Circuitry	Receptacle Capacity			
<b>Four-circuit 4-Hot/2-Neutral/2-Ground</b>  (10 gauge neutral wires)	3 + 1	Common Circuit-1 <b>HH873501</b>	Common Circuit-2 (1) <b>HH873502</b>	Common Circuit-3 <b>HH873503</b>	Iso/Dedicated Circuit-4 <b>HH873504</b>
	2 + 2	Common Circuit-1 <b>HH873501</b>	Common Circuit-2 <b>HH873502</b>	Isolated Circuit-3 <b>HH873506</b>	Isolated Circuit-4 <b>HH873504</b>
<b>Three-circuit 3-Hot/3-Neutral/2-Ground</b> (12 gauge neutral wires)	w/separate neutrals	Common Circuit-1 <b>HH873501A</b>	Common Circuit-2 <b>HH873502A</b>	Iso/Dedicated Circuit-3 <b>HH873503A</b>	N/A

(1) Circuit-2 (one of the 3 common circuits sharing a neutral wire) cannot be used with a single-phase building electrical supply.

### Notes:

- Four-circuit components and three-circuit components (with suffix "A") cannot be used together.
- Components of the two systems are keyed differently to prevent components of one system from being connected to components of another system.
- HON Cat. Nos. are printed on the UL labels, and components are color-coded to provide visual identification of the different components.
- Four-circuit components have black plastic parts.
- Three-circuit components have rust-colored terminal ends and receptacle backs are rust colored.

## Typical power usage by the most commonly specified office equipment.

Source: Industry Analysis, Inc., Rochester, NY

EQUIPMENT	AMPS	EQUIPMENT	AMPS	EQUIPMENT	AMPS
<b>Computers</b>		<b>Copiers</b>		<b>FAX Machines</b>	
Personal Computer	3	Desktop Copier	15	InkJet FAX	less than 1
Notebook Computer	3	Console Copier	20	Thermal FAX	less than 1
		Copier/Duplicator	30	Plain paper FAX	8
<b>Monitors</b>		<b>Printers</b>		<b>Task Lights</b>	
13" Color Monitor	2	Dot Matrix	less than 1	36" T8 Fluorescent	0.2/bulb
17" Color Monitor	3	InkJet	less than 1	48" T8 Fluorescent	0.3/bulb
21" Color Monitor	4	Personal Laser or LED	8		
		Workgroup Laser or LED	15		

## Duplex Receptacles



15 AMP Receptacle

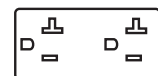

20 AMP Receptacle  
(Required by some large copiers.)

# EMPOWER<sup>®</sup> ELECTRICAL SPECIFYING INFORMATION

- Electrical components are UL Listed and CSA Certified.
- It is the customer's responsibility to ensure that use of the pre-wired electrical system, the number of receptacles used on a given circuit, and connection to a building power source, be in compliance with all local and national electrical codes.
- Contact Customer Service for additional information.
- Four-circuit components and Three-circuit components (with suffix "A") cannot be used together. See pages 500-501.
- ! A licensed electrician must make connections to a building electrical supply.

**Definition of components:**

**Electrical Power Harness**



- Used to distribute power in workstations.
- Power distribution in either direction.
- Specify Power Harness to match workstation width.
- Double-sided: receptacles can be inserted into both sides of Power Blocks.

**Electrical Pass-Thru Cables**

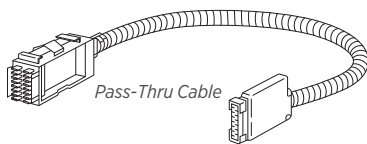

**Pass-Thru Cable With Duplex Capacity:**

- Use in workstations where multiple receptacles are not required.
- Added feature: has capacity for one receptacle on each side of a workstation. Feature offers future expansion and is an alternative to Power Harnesses.

**Duplex Receptacles**

- 15 amp outlet configuration.
- Models HH871601 and HH871601A have a 20 amp outlet configuration.
- Fit back-to-back into the Power Block(s) of Power and Pass-Thru Harnesses.
- Labeled with the provided circuit. Circuits connected to the Isolated Ground are identified with an orange triangle; circuits that do not share a neutral or ground have an orange circuit number.

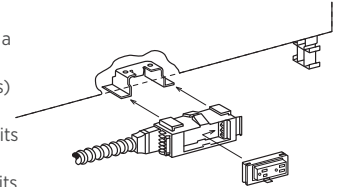

**Power In-Feed Model (Floor or Ceiling) HMP144**

- Used to connect the workstation electrical system to the building electrical supply.
- ! A licensed electrician must make connections to a building electrical supply.
- ! Conduit is UL listed Black Liquid-tight conduit (outside diameter is 7/8").



Note: In-feed cables listed above may be field-cut to desired length.

**3-Pack 120 Degree Electric Specification Guide**

	A	B
36" 120 surface	HH871124	HH871148
42" 120 surface	HH871124	HH871160
48" 120 surface	HH871124	HH871172

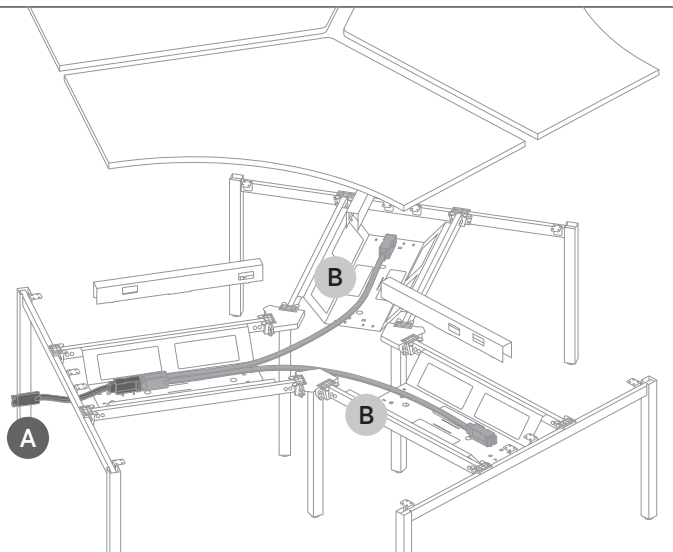

# EMPOWER<sup>®</sup> ELECTRICAL SPECIFYING INFORMATION

- Electrical components are UL Listed and CSA Certified.
- It is the customer's responsibility to ensure that use of the pre-wired electrical system, the number of receptacles used on a given circuit, and connection to a building power source, be in compliance with all local and national electrical codes.
- ! A licensed electrician must make connections to a building electrical supply.

**Vertebrae:**  
**17 Cables, 0.250 Diameter (CAT-6)**

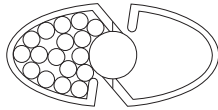

**Single-Depth Cable Trough Cover Capacity:**  
**13 Cables, 0.250 Diameter (CAT-6)**

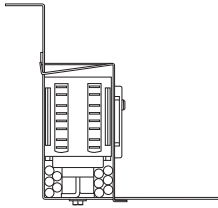

**Double-Depth Cable Trough Cover Capacity:**  
**14 Cables, 0.250 Diameter (CAT-6)**

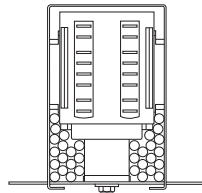

**Data Cable Packing in Power Pole:**  
**33 Cables, 0.250 Diameter (CAT-6)**

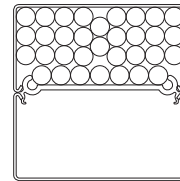

**Data Cable Packing in Wire Trough Cover:**  
**14 Cables, 0.250 Diameter (CAT-6)**

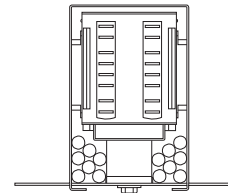

# EMPOWER<sup>®</sup> Electrical and Data

GSA SIN 33721 EXCEPT AS NOTED



Icon Legend on page 19

WORKSTATIONS

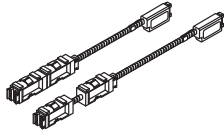
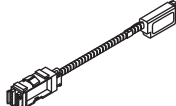
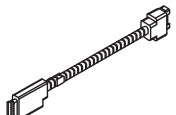
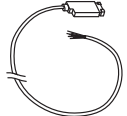
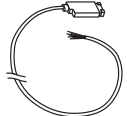
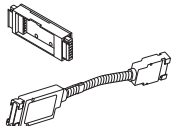
	DESCRIPTION	MAX. RECEPT. CAP. PER PANEL SIDE	MODEL		SHIP WEIGHT	CUBE	LIST PRICE
			FOUR-CIRCUIT 3 + 1 2 + 2	THREE-CIRCUIT, SEPARATE NEUTRALS			
	<b>Electrical Power Harnesses, Frames — w/duplex capacity</b>						
	For 48"W	2	HH871248	HH871248A	3.0 Ⓢ	0.5	\$214
	For 60"W	2	HH871260	HH871260A	3.0 Ⓢ	0.5	\$214
	For 72"W	2	HH871272	HH871272A	5.0 Ⓢ	0.5	\$214
	<b>Electrical Pass-Thru Cables, Frames — w/duplex capacity</b>						
	For 48"W	1	HH871148	HH871148A	2.5 Ⓢ	0.5	\$134
	For 60"W	1	HH871160	HH871160A	3.0 Ⓢ	0.5	\$134
	For 72"W	1	HH871172	HH871172A	5.0 Ⓢ	0.5	\$134
	<b>Electrical Pass-Thru Harness without Power Block</b>						
	For 24"W Frames	0	HH871024	HH871024A	2.0 Ⓢ	0.5	\$118
	For 48"W Frames	0	HH871048	HH871048A	3.0 Ⓢ	0.5	\$123
	For 60"W Frames	0	HH871060	HH871060A	3.0 Ⓢ	0.5	\$123
	For 72"W Frame Runs	0	HH871072		4.0 Ⓢ	0.5	\$170
<p>! 24" Pass-Thru Harness without Power Block is only used when specifying Power In-Feed with Sealtight as a floor in-feed. Harness is not needed for the standard in-feed.</p>							
	<b>Power In-Feed — Sealtight</b>						
	144" long conduit, Sealtight Cable — 7/8" diameter		HMP144		7.0	1.2	\$331
<p>NOTES: For use as ceiling, floor and wall in-feed. If three-circuit, separate neutral in-feed is required, please contact Tailored Solutions.</p>							
	<b>Metal Flexible Conduit</b>						
	144" long conduit, Flex Cable — 7/8" dia.		HH871912		4.0 Ⓢ	0.5	\$235
<p>NOTES: Metal Flexible Conduit. Best option for use with power pole due to bend radius flexibility.</p>							
	<b>Power Jumper</b>						
	For End of Run		HMPJUMP		2.0	0.3	\$168
<p>OPEN MARKET</p>							



## HOW TO SPECIFY

Select  
Model Number

HH871248



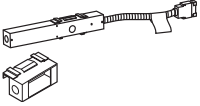

DESCRIPTION	MODEL		SHIP WEIGHT	CUBE	LIST PRICE
	FOUR-CIRCUIT 3 + 1 2 + 2	THREE-CIRCUIT, SEPARATE NEUTRALS			
 <b>Hardwire Applications</b> Hardwire Power In-feed ⚠ Customer to furnish all cabling and wiring from power entry to power source (approved for use by city of New York).	<b>HH871400</b>	<b>HH871400A</b>	4.0 Ⓢ	0.3	<b>\$222</b>
Hardwire Junction Box (6-pack) ⚠ Hardwire Junction Boxes cannot be installed back-to-back in panel applications.	<b>HH871500</b>		4.5 Ⓢ	0.1	<b>\$472</b>
 Each marked with Circuit Number	<b>Duplex Receptacles</b>				
Circuit 1	<b>HH871501</b>	<b>HH871501A</b>	1.0 Ⓢ	0.5	<b>\$43</b>
Circuit 2	<b>HH871502</b>	<b>HH871502A</b>	1.0 Ⓢ	0.5	<b>\$43</b>
Circuit 3 (except 2 + 2 — see below)	<b>HH871503</b>	<b>HH871503A</b>	1.0 Ⓢ	0.5	<b>\$43</b>
Circuit 4 — isolated, dedicated circuit	<b>HH871504</b>		1.0 Ⓢ	0.5	<b>\$43</b>
Circuit 1 (20 amp outlet configuration)	<b>HH871601</b>		1.0 Ⓢ	0.5	<b>\$43</b>
Circuit 3 (2 + 2)	<b>HH871506</b>		1.0 Ⓢ	0.5	<b>\$43</b>
Specify Paint. Charcoal (S) matches Empower trough.					

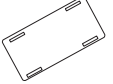
DESCRIPTION	MODEL	SHIP WEIGHT	CUBE	LIST PRICE
 <b>Receptacle Cover Replacements</b> Quantity 25 ⚠ Specify Color—Available in Black (P), Muslin (T3) and Shadow (SHDW) only.	<b>HEREPCVR</b>	1.0 Ⓢ	0.1	<b>\$72</b>

**NOTES:**

- ⚠ Customer must furnish conduit, wiring and designer type receptacles. (Approved for use by city of Chicago.)
- ⚠ Junction boxes cannot be used back-to-back.

Duplex Color Recommended to Coordinate with Paint Color			
Paint Color	Paint Code	Duplex Color	Duplex Code
Black	P	Black	P
Brownstone	P7D	Brownstone	EY
Charcoal	S	Charcoal	S
Designer White	PJW	Designer White	DW
Fossil	P28	Charcoal	S
Greige	T5	Muslin	T3
Light Gray	Q	Loft	LOFT
Loft	LOFT	Loft	LOFT
Muslin	T3	Muslin	T3
Putty	L	Black	P
Shadow	SHDW	Muslin	T3
Silver	PR6	Titanium	TI
Titanium	P8T	Titanium	TI
Champagne Metallic	T4	Muslin	T3
Platinum Metallic	T1	Titanium	Ti

**HOW TO SPECIFY**

<p>Select Model Number</p> <p>HH871400 .</p>	<p>Select Paint Color</p> <p>See page 464</p> <p>P</p>
--	--

# EMPOWER® Electrical Accessories

GSA SIN 33721 EXCEPT AS NOTED

ABI

Icon Legend on page 19

WORKSTATIONS

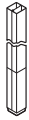

## DESCRIPTION

**Power Pole**  
10'5"

## MODEL

**HMPPP125**

## SHIP WEIGHT

14

## CUBE

0.7

## LIST PRICE

### P1

**\$460**

NOTES: Power Pole ships with bracket to attach under stationary Empower® worksurfaces and feed directly into the Wire Management Trough. Power Pole will run to the floor on height adjustable Empower®.



## DESCRIPTION

**Vertebrae**

## MODEL

**HMPVWM28**

## SHIP WEIGHT

3.0

## CUBE

0.3

## LIST PRICE

**\$221**

NOTES: 30"H x 3 1/4"W x 1 1/2"D. Ships unassembled. For additional information see page 852. For use with stationary Empower®.

❗ Clear finish. Specify "X" for finish option.

**SPECIFYING EXAMPLE: HMPVWM28.X**

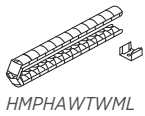

HMPHAWTWM



HMPHATFWML

## Wire Managers for Height Adjustable

Workstation to Trough  
Trough to Floor

## MODEL

**HMPHAWTWM**

3.0

0.1

**\$264**

❗ Wire Manager Workstation to Trough only available in black.

## MODEL

**HMPHATFWML**

2.0

0.3

**\$249**

## OPEN MARKET

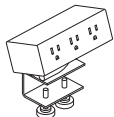

Model HPWRMOD3WC shown

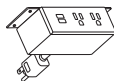

Model HPWRMOD2UWM shown

## Power Modules

- 3 Receptacles with Worksurface Clamp
- 3 Receptacles with Under-Worksurface Mounting Bracket
- 2 Receptacles 2 USB with Worksurface Clamp
- 2 Receptacles 2 USB with Under-Worksurface Mounting Bracket
- 6' power cord with standard three-prong plug.
- Under-worksurface mounting bracket models work with any top that has a 5" x 5" square clearance.
- Worksurface clamp models work on any top with a 4" overhang.
- UL Listed.

## MODEL

**HPWRMOD3WC**

2.3 Ⓢ

0.2

**\$307**

## MODEL

**HPWRMOD3UWM**

2.3

0.2

**\$307**

## MODEL

**HPWRMOD2WC**

2.3

0.2

**\$491**

## MODEL

**HPWRMOD2UWM**

2.3

0.2

**\$491**

NOTES: For additional information see page 849.

❗ Color finish coordinates with HON's Charcoal or White. Specify STRM for Storm or SNW for Snow when ordering. Example: HPWRMOD3WC.STRM.

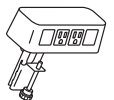

## Power & Data Center

- 2 Receptacles 2 Data Accessory
- Standard with two receptacles and openings for two data ports.
- 6' power cord with standard three-prong plug.
- Fits on any worksurface with a 4" overhang.
- UL Listed.

## MODEL

**HCOMDOME2**

2.5 Ⓢ

0.2

**\$293**

NOTES: For additional information see page 849.

❗ Color finish coordinates with HON's Loft. Specify LOFT when ordering. Example: HCOMDOME2.LOFT



## Under Worksurface Power Module — 4 Outlets, 10' Cord

- Includes 10' cord with three-prong plug.
- Fits in cable management troughs. See page 564.
- 4 outlets on side create easy access.

## MODEL

**HPWRMOD2**

1.5 Ⓢ

0.2

**\$401**

NOTES: Power Modules will also work with standing-height applications for 10500 Series™ and Voi® desks. Mounting Clearance: 5.025" x 4.875" x 1.375". For additional information see page 849.

❗ Black finish only, no specification needed.

## HOW TO SPECIFY

Select Model Number

Select Finish Color

**STRM** Storm  
**SNW** Snow  
**LOFT** Loft

Specify Loft finish for HCOMDOME2 only

H M P P P 1 2 5 .

S T R M



# EMPOWER<sup>®</sup> Voi<sup>®</sup> Laminate Low Credenzas

GSA SIN 33721



Icon Legend on page 19

WORKSTATIONS

	DESCRIPTION	MODEL	SHIP WEIGHT	CUBE	L1 LIST	L2 UPCHARGES				
						CHASSIS	FRONTS			
	<b>Low Credenza, 2 File/2 Box</b> 72"W x 20"D x 21½"H 60"W x 20"D x 21½"H NOTES: Unit is locking.	<b>HLSL2072LD4</b>	230	21.9	<b>\$1605</b>	<b>\$40</b>	<b>\$40</b>			
		<b>HLSL2060LD4</b>	190	18.9	<b>\$1462</b>	<b>\$35</b>	<b>\$40</b>			
	<b>Low Credenza, 2 File Drawers, Open Top</b> 72"W x 20"D x 21½"H 60"W x 20"D x 21½"H NOTES: Unit is non-locking.	<b>HLSL2072LD2</b>	200	21.9	<b>\$1501</b>	<b>\$40</b>	<b>\$30</b>			
		<b>HLSL2060LD2</b>	160	18.9	<b>\$1370</b>	<b>\$35</b>	<b>\$30</b>			
	<b>Low Credenza, Left Hand Drawers</b> 72"W x 20"D x 21½"H 60"W x 20"D x 21½"H NOTES: Unit is locking.	<b>HLSL2072LL2</b>	200	21.9	<b>\$1486</b>	<b>\$40</b>	<b>\$20</b>			
		<b>HLSL2060LL2</b>	160	18.9	<b>\$1254</b>	<b>\$35</b>	<b>\$20</b>			
	<b>Low Credenza, Right Hand Drawers</b> 72"W x 20"D x 21½"H 60"W x 20"D x 21½"H NOTES: Unit is locking.	<b>HLSL2072LR2</b>	200	21.9	<b>\$1486</b>	<b>\$40</b>	<b>\$20</b>			
		<b>HLSL2060LR2</b>	160	18.9	<b>\$1254</b>	<b>\$35</b>	<b>\$20</b>			
	<b>Low Credenza, Open</b> 72"W x 20"D x 21½"H 60"W x 20"D x 21½"H <b>SPECIFYING EXAMPLE: HLSL2072LDO.Z (model.chassis only)</b>	<b>HLSL2072LDO</b>	170	21.9	<b>\$1262</b>	<b>\$40</b>	N/A			
		<b>HLSL2060LDO</b>	130	18.9	<b>\$1048</b>	<b>\$35</b>	N/A			
	<b>Low Credenza, 4 Storage Doors</b> 72"W x 20"D x 21½"H 60"W x 20"D x 21½"H NOTES: Unit is locking.	<b>HLSL2072S4</b>	190	21.9	<b>\$1593</b>	<b>\$40</b>	<b>\$40</b>			
		<b>HLSL2060S4</b>	160	18.9	<b>\$1367</b>	<b>\$35</b>	<b>\$40</b>			
	<b>Credenza Cushion</b> 20"W x 36"D x 1"H for 72" Credenzas 20"W x 30"D x 1"H for 60" Credenzas NOTES: See pages 462-463 for available fabrics. <b>SPECIFYING EXAMPLE: HLSL2036CH2.APN23</b>	<b>HLSL2036CH2</b>	11	2.2	<b>\$402</b>	<b>\$440</b>	<b>\$478</b>	<b>\$517</b>	<b>\$566</b>	<b>\$616</b>
		<b>HLSL2030CH2</b>	9	1.9	<b>\$372</b>	<b>\$408</b>	<b>\$444</b>	<b>\$480</b>	<b>\$526</b>	<b>\$573</b>

**NOTES:**

- Chassis and drawer fronts woodgrains and solid laminates are specified separately (see SIF options below).
- File drawers accept hanging folders in letter size.
- Multiple handle locations possible per customer preference.
- Seat cushions are available for low credenzas and mobile pedestals (specify separately).

- Storage accessory model HLSLDRWORG works with box doors.
- Adjustable hex leveling glides allow floor-standing furniture to be easily leveled without lifting the unit; glides have 1¼" adjustable range.
- Ships with one handle per drawer on all units.

⚠ Locking units equipped with HON "One Key" interchangeable core removable locks. Keyed alike core must be ordered separately.

## HOW TO SPECIFY

<p><b>Select Model Number</b></p> <p>HLSL2072LD4</p>	<p><b>Select Chassis Laminate</b></p> <p>See page 171</p> <p>N</p>	<p><b>Select Drawer Front Laminate</b></p> <p>See page 171</p> <p>N</p>	<p><b>Select Pull Color</b></p> <p>See page 171</p> <p>Not specified for Open Credenza models HLSL2072LDO, HLSL2060LDO</p> <p>T4</p>
--	--	---	--



Icon Legend on page 19

# EMPOWER<sup>®</sup> Voi<sup>®</sup> Laminate Low Credenzas

WORKSTATIONS

	DESCRIPTION	MODEL	SHIP WEIGHT	CUBE	L1 LIST	L2 UPCHARGES				
						CHASSIS	FRONTS			
	<b>Low Credenza — Open</b> 30"W x 20"D x 21½"H 36"W x 20"D x 21½"H	<b>HLSL2030LDO</b> <b>HLSL2036LDO</b>	65 85	9.8 12.0	<b>\$868</b> <b>\$894</b>	<b>\$25</b> <b>\$30</b>	<b>N/A</b> <b>N/A</b>			
	<b>Low Credenza — Open Top, File Drawer</b> 30"W x 20"D x 21½"H 36"W x 20"D x 21½"H	<b>HLSL2030LD1</b> <b>HLSL2036LD1</b>	75 95	9.8 12.0	<b>\$964</b> <b>\$992</b>	<b>\$25</b> <b>\$30</b>	<b>\$15</b> <b>\$15</b>			
	<b>Low Credenza — 1 File Drawer, 1 Box Drawer</b> 30"W x 20"D x 21½"H 36"W x 20"D x 21½"H	<b>HLSL2030LD2</b> <b>HLSL2036LD2</b>	80 100	9.8 12.0	<b>\$1071</b> <b>\$1103</b>	<b>\$25</b> <b>\$30</b>	<b>\$20</b> <b>\$20</b>			
	<b>Credenza Cushion</b> 20"W x 36"D x 1"H for 72" Credenzas 20"W x 30"D x 1"H for 60" Credenzas	<b>HLSL2036CH2</b> <b>HLSL2030CH2</b>	11 9	2.2 1.9	<b>\$402</b> <b>\$372</b>	<b>\$440</b> <b>\$408</b>	<b>\$478</b> <b>\$444</b>	<b>\$517</b> <b>\$480</b>	<b>\$566</b> <b>\$526</b>	<b>\$616</b> <b>\$573</b>
	NOTES: See pages 462-463 for available fabrics. <b>!</b> For model HLSL2030CH2 must order two cushions to cover entire 60" Credenza surface. <b>SPECIFYING EXAMPLE: HLSL2036CH2.APN23</b>									

**NOTES:**

- File drawers accept hanging folders in letter size.
  - Multiple handle locations possible per customer preference.
  - Seat cushions are available for low credenzas and mobile pedestals (specify separately).
  - Storage accessory model HLSLDRWORG works with box doors.
  - Utilize in small footprint applications.
  - Adjustable hex leveling glides allow floor-standing furniture to be easily leveled without lifting the unit; glides have 1/4" adjustable range.
  - Ships with one handle per drawer on all units.
- !** Locking units equipped with HON "One Key" interchangeable core removable locks. Keyed alike core must be ordered separately.

**HOW TO SPECIFY**

<p><b>Select Model Number</b></p> <p>See page 171</p> <p>H L S L 2 0 3 0 L D O .</p>	<p><b>Select Chassis Laminate</b></p> <p>See page 171</p> <p>N .</p>	<p><b>Select Drawer Front Laminate</b></p> <p>See page 171</p> <p>Not specified for Open Credenza models HLSL2030LDO, HLSL2036LDO</p> <p>N .</p>	<p><b>Select Pull Color</b></p> <p>See page 171</p> <p>Not specified for Open Credenza models HLSL2030LDO, HLSL2036LDO</p> <p>T 4</p>
--	--	--	---

# EMPOWER® Voi® Laminate Mobile Storage

GSA SIN 33721



Icon Legend on page 19

WORKSTATIONS

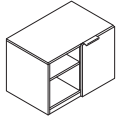

**DESCRIPTION**

**Mobile Credenza**  
30"W x 20"D x 21½"H  
NOTES: Unit is non-locking.

MODEL	SHIP WEIGHT	CUBE	L1 LIST	L2 UPCHARGES	
				CHASSIS	FRONTS
HLSL2030MCO	80	9.8	\$1399	\$25	\$10

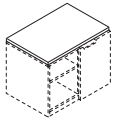

**DESCRIPTION**

**Credenza Cushion**  
20"W x 30"D x 1"H for 60" Credenzas  
NOTES: See pages 462-463 for available fabrics.  
SPECIFYING EXAMPLE: HLSL2030CH2.APN23

MODEL	SHIP WEIGHT	CUBE	1	2	3	4	5	6
HLSL2030CH2	9	1.9	\$372	\$408	\$444	\$480	\$526	\$573

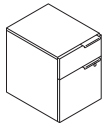

**DESCRIPTION**

**Mobile Pedestal**  
15¾"W x 20⅞"D x 21⅞"H  
NOTES: Unit is locking.

MODEL	SHIP WEIGHT	CUBE	L1 LIST	L2 UPCHARGES	
				CHASSIS	FRONTS
HLSL2016MP2	65	5.7	\$794	\$20	\$10

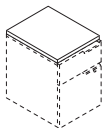

**DESCRIPTION**

**Mobile Pedestal Cushion**  
15⅞"W x 20"D x 1"H for Pedestals  
NOTES: See pages 462-463 for available fabrics.  
SPECIFYING EXAMPLE: HLSL2016PH2.APN23

MODEL	SHIP WEIGHT	CUBE	1	2	3	4	5	6
HLSL2016PH2	6	1.1	\$309	\$333	\$357	\$381	\$412	\$443

**NOTES:**

- Chassis and drawer fronts woodgrains and solid laminates are specified separately (see SIF options below).
- File drawers accept hanging folders in letter or legal size.
- Multiple handle locations possible per customer preference.
- Seat cushions are available for low credenzas, floor credenzas, and mobile pedestals (specify separately). See pages 508-510 for Pedestal and Credenza cushion models.
- Storage accessory model HSLDRWORG works with box doors.
- Standard box drawers operate on ball-bearing suspension with 70% extension. File drawers operate on ball-bearing suspension with 70% extension.
- Ships with one handle per drawer on all units.

! Locking units equipped with HON "One Key" interchangeable core removable locks. Keyed alike core must be ordered separately.

**HOW TO SPECIFY**

<p><b>Select Model Number</b></p> <p>HLSL2030MCO</p>	<p><b>Select Chassis Laminate</b></p> <p>See page 464</p> <p>N</p>	<p><b>Select Drawer Front Laminate</b></p> <p>See page 464</p> <p>N</p>	<p><b>Select Pull Color</b></p> <p>P Black T4 Champagne T1 Platinum PJW Designer White PR6 Silver PBX Solar Black</p> <p>T4</p>
--	--	---	---

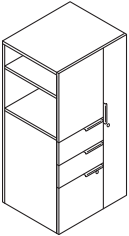
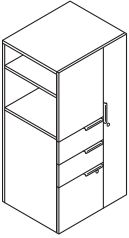
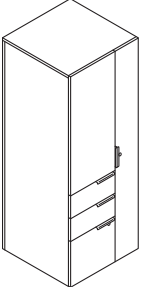
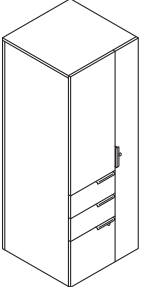

# EMPOWER<sup>®</sup> Voi<sup>®</sup> Laminate Storage Towers

	DESCRIPTION	MODEL	SHIP WEIGHT	CUBE	L1 LIST	L2 UPCHARGES	
						CHASSIS	FRONTS
	<b>24"W x 20"D Storage Tower — Right Hand Drawers, Left Hand Door</b>						
	24"W x 20"D x 50"H, Left	<b>HLSLW045L</b>	167	17.4	<b>\$1919</b>	<b>\$50</b>	<b>\$35</b>
	24"W x 20"D x 65"H, Left	<b>HLSLW046L</b>	200	22.5	<b>\$2188</b>	<b>\$55</b>	<b>\$35</b>
	<b>24"W x 20"D Storage Tower — Left Hand Drawers, Right Hand Door</b>						
	24"W x 20"D x 50"H, Right	<b>HLSLW045R</b>	167	17.4	<b>\$1919</b>	<b>\$50</b>	<b>\$35</b>
	24"W x 20"D x 65"H, Right	<b>HLSLW046R</b>	200	22.5	<b>\$2188</b>	<b>\$55</b>	<b>\$35</b>
	<b>24"W x 24"D Storage Tower — Right Hand Drawers, Left Hand Door</b>						
	24"W x 24"D x 50"H, Left	<b>HLSLW445L</b>	200	20.7	<b>\$2078</b>	<b>\$55</b>	<b>\$35</b>
	24"W x 24"D x 65"H, Left	<b>HLSLW446L</b>	240	27.8	<b>\$2304</b>	<b>\$60</b>	<b>\$35</b>
	<b>24"W x 24"D Storage Tower — Left Hand Drawers, Right Hand Door</b>						
	24"W x 24"D x 50"H, Right	<b>HLSLW445R</b>	200	20.7	<b>\$2078</b>	<b>\$55</b>	<b>\$35</b>
	24"W x 24"D x 65"H, Right	<b>HLSLW446R</b>	240	27.8	<b>\$2304</b>	<b>\$60</b>	<b>\$35</b>
	<b>24"W x 24"D Personal Storage Tower</b>						
	24"W x 24"D x 65"H, Left	<b>HLSLW446LP</b>	250	27.8	<b>\$2609</b>	<b>\$60</b>	<b>\$35</b>
	24"W x 24"D x 65"H, Right	<b>HLSLW446RP</b>	250	27.8	<b>\$2609</b>	<b>\$60</b>	<b>\$35</b>

**NOTES:**

- Chassis and drawer fronts woodgrains and solid laminates are specified separately (see SIF options below).
  - File drawers accept hanging folders in letter or legal size.
  - Wardrobe, middle box drawer and file drawer are locking.
  - Standard box drawers operate on ball-bearing suspension with full extension. File, lateral, and wide box drawers operate on ball-bearing suspension with full extension.
  - Ships with one handle per drawer on all units.
  - Adjustable hex leveling glides allow floor-standing furniture to be easily leveled without lifting the unit; glides have 1/4" adjustable range.
  - Wardrobe/storage cabinet includes coat rod.
  - Wardrobes contain easy access side storage shelves.
- ⓘ Locking units equipped with HON "One Key" interchangeable core removable locks. Keyed alike core must be ordered separately.

**HOW TO SPECIFY**

<p><b>Select Model Number</b></p> <p>HL SLW045L</p>	<p><b>Select Chassis Laminate</b></p> <p>See page 171</p> <p>N</p>	<p><b>Select Drawer Front Laminate</b></p> <p>See page 171</p> <p>N</p>	<p><b>Select Pull Color</b></p> <p>See page 171</p> <p>T4</p>
---	--	---	---

# EMPOWER® Voi® Laminate Storage Towers

GSA SIN 33721



Icon Legend on page 19

WORKSTATIONS



DESCRIPTION	MODEL	SHIP WEIGHT	CUBE	L1 LIST	L2 UPCHARGES	
					CHASSIS	FRONTS
<b>18''W x 20''D Storage Towers — Right Hand Drawers, Left Hand Door</b>						
18''W x 20''D x 50''H, Left	<b>HLSLW085L</b>	139	13.4	<b>\$1728</b>	<b>\$45</b>	<b>\$35</b>
18''W x 20''D x 65''H, Left	<b>HLSLW086L</b>	167	17.3	<b>\$1973</b>	<b>\$50</b>	<b>\$35</b>
<b>18''W x 20''D Storage Towers — Left Hand Drawers, Right Hand Door</b>						
18''W x 20''D x 50''H, Right	<b>HLSLW085R</b>	139	13.4	<b>\$1728</b>	<b>\$45</b>	<b>\$35</b>
18''W x 20''D x 65''H, Right	<b>HLSLW086R</b>	167	17.3	<b>\$1973</b>	<b>\$50</b>	<b>\$35</b>

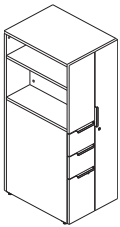

<b>18''W x 24''D Storage Towers — Right Hand Drawers, Left Hand Door</b>						
18''W x 24''D x 50''H, Left	<b>HLSLW485L</b>	167	15.8	<b>\$1966</b>	<b>\$50</b>	<b>\$35</b>
18''W x 24''D x 65''H, Left	<b>HLSLW486L</b>	200	21.5	<b>\$2191</b>	<b>\$55</b>	<b>\$35</b>
<b>18''W x 24''D Storage Towers — Left Hand Drawers, Right Hand Door</b>						
18''W x 24''D x 50''H, Right	<b>HLSLW485R</b>	167	15.8	<b>\$1966</b>	<b>\$50</b>	<b>\$35</b>
18''W x 24''D x 65''H, Right	<b>HLSLW486R</b>	200	21.5	<b>\$2191</b>	<b>\$55</b>	<b>\$35</b>

**NOTES:**

- Ships with one handle per drawer on all units.
- Chassis and drawer fronts woodgrains and solid laminates are specified separately (see SIF options below).
- File drawers accept hanging folders in letter or legal size.
- Standard box drawers operate on ball-bearing suspension with full extension. File and box drawers operate on ball-bearing suspension with full extension.
- Adjustable hex leveling glides allow floor-standing furniture to be easily leveled without lifting the unit; glides have 1/4" adjustable range.
- Wardrobe/storage cabinet includes coat rod.
- Wardrobes contain easy access side storage shelves.
- Wardrobe, middle box drawer and file drawer are locking.

! Locking units equipped with HON "One Key" interchangeable core removable locks. Keyed alike core must be ordered separately.

**HOW TO SPECIFY**

<p><b>Select Model Number</b></p> <p>HL S L W 0 8 5 L</p>	<p><b>Select Chassis Laminate</b></p> <p>See page 171</p> <p>N</p>	<p><b>Select Door/Drawer Front Laminate</b></p> <p>See page 171</p> <p>N</p>	<p><b>Select Pull Color</b></p> <p>See page 171</p> <p>T 4</p>
---	--	--	--





Icon Legend on page 19

# EMPOWER<sup>®</sup> Contain<sup>®</sup> Metal Credenzas

	DESCRIPTION	MODEL	SHIP WEIGHT	CUBE	LIST PRICE BY PAINT GRADE		
					P1	P2	P3
	<b>Low Credenza, Box/Lateral Left, Open Shelf Right</b>						
	72"W x 18"D x 22"H	<b>HSCBX227218RBFOM(?)</b> ⓧ	150	20.7	<b>\$1921</b>	<b>\$1988</b>	<b>\$2056</b>
	60"W x 18"D x 22"H	<b>HSCBX226018RBFOM(?)</b> ⓧ	130	17.3	<b>\$1733</b>	<b>\$1800</b>	<b>\$1868</b>
	48"W x 18"D x 22"H	<b>HSCBX224818RBFOM(?)</b> ⓧ	111	14.0	<b>\$1598</b>	<b>\$1665</b>	<b>\$1733</b>
	<b>Low Credenza, Box/Lateral Right, Open Shelf Left</b>						
	72"W x 18"D x 22"H	<b>HSCBX227218LBFOM(?)</b> ⓧ	150	20.7	<b>\$1921</b>	<b>\$1988</b>	<b>\$2056</b>
	60"W x 18"D x 22"H	<b>HSCBX226018LBFOM(?)</b> ⓧ	130	17.3	<b>\$1733</b>	<b>\$1800</b>	<b>\$1868</b>
	48"W x 18"D x 22"H	<b>HSCBX224818LBFOM(?)</b> ⓧ	111	14.0	<b>\$1598</b>	<b>\$1665</b>	<b>\$1733</b>
	<b>Low Credenza, Box/Lateral</b>						
	36"W x 18"D x 22"H	<b>HSCBX223618BFM(?)</b> ⓧ	87	10.6	<b>\$1175</b>	<b>\$1208</b>	<b>\$1243</b>
	30"W x 18"D x 22"H	<b>HSCBX223018BFM(?)</b> ⓧ	76	9.0	<b>\$1125</b>	<b>\$1158</b>	<b>\$1193</b>
	<b>Open Shelf</b>						
	36"W x 18"D x 22"H	<b>HSCBX2236180</b> ⓧ	66	10.6	<b>\$836</b>	<b>\$869</b>	<b>\$904</b>
	30"W x 18"D x 22"H	<b>HSCBX2230180</b> ⓧ	60	9.0	<b>\$771</b>	<b>\$804</b>	<b>\$839</b>

**NOTES:**

- Metal chassis and drawer fronts.
  - Lateral and wide box drawers operate on ball-bearing suspension with full extension.
  - Steel ball-bearing drawer suspensions.
  - Ships complete with standard kickplate.
  - Field installable counterweight sold separately.
  - File drawers accept hanging folders in letter or legal size.
  - Steel frame provides durability.
  - Use with laminate tops and credenza seat cushions. Order separately — see pages 634 and 517.
- ⓘ Locking units equipped with HON "One Key" interchangeable core removable locks. Keyed alike core model HF23S, in Satin, must be ordered separately. See page 634.
- ⓧ Discontinued 4/6/20.

**HOW TO SPECIFY**

<p><b>Select Model Number</b></p> <p>Replace (?) with handle choice</p> <p><b>A</b> Satin Chrome Arch <b>N</b> Full Face Integral <b>R</b> Full Radius Pull</p> <p>Pull not specified for Open Shelf models</p>	<p><b>Select Paint Color</b></p> <p>See page 464 Contain<sup>®</sup> Storage finish options</p>	<p><b>Select Lock Option</b></p> <p><b>L</b> Standard Lock <b>X</b> Omit Lock (deduct \$20)</p> <p>Not specified for models HSCBX2236180 and HSCBX2230180</p>
<p>H S C B X 2 2 7 2 1 8 R B F O M A .</p>	<p>P .</p>	<p>L</p>

# EMPOWER® Contain® Footed Metal Credenzas

GSA SIN 33721



Icon Legend on page 19

WORKSTATIONS

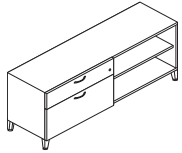

**DESCRIPTION**

**Footed Low Credenza, Box/Lateral Left, Open Shelf Right**  
 72"W x 18"D x 22"H  
 60"W x 18"D x 22"H  
 48"W x 18"D x 22"H

**MODEL**

**HSCSF227218RBFOM(?)** Ⓢ  
**HSCSF226018RBFOM(?)** Ⓢ  
**HSCSF224818RBFOM(?)** Ⓢ

**SHIP WEIGHT**

**CUBE**

150  
130  
111

17.7  
14.9  
12.0

**LIST PRICE BY PAINT GRADE**

**P1 P2 P3**

**\$2076 \$2143 \$2211**  
**\$1889 \$1956 \$2024**  
**\$1723 \$1790 \$1858**

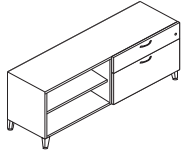

**Footed Low Credenza, Box/Lateral Right, Open Shelf Left**  
 72"W x 18"D x 22"H  
 60"W x 18"D x 22"H  
 48"W x 18"D x 22"H

**HSCSF227218LBFOM(?)** Ⓢ  
**HSCSF226018LBFOM(?)** Ⓢ  
**HSCSF224818LBFOM(?)** Ⓢ

150  
130  
111

17.7  
14.9  
12.0

**\$2076 \$2143 \$2211**  
**\$1889 \$1956 \$2024**  
**\$1723 \$1790 \$1858**



**Footed Low Credenza, Box/Lateral**  
 36"W x 18"D x 22"H  
 30"W x 18"D x 22"H

**HSCSF223618BFM(?)** Ⓢ  
**HSCSF223018BFM(?)** Ⓢ

87  
76

9.1  
7.7

**\$1299 \$1332 \$1367**  
**\$1249 \$1282 \$1317**



**Footed Open Shelf**  
 36"W x 18"D x 22"H  
 30"W x 18"D x 22"H

**HSCSF223618O** Ⓢ  
**HSCSF223018O** Ⓢ

66  
60

9.1  
7.7

**\$961 \$994 \$1029**  
**\$895 \$928 \$963**

**NOTES:**

- Lateral and wide box drawers operate on ball-bearing suspension with full extension.
- Steel ball-bearing drawer suspensions.
- Ships complete with standard footed base.
- Field installable counterweight sold separately.
- File drawers accept hanging folders in letter or legal size.
- Steel frame provides durability.
- Feet are shipped with the credenza unit and are easily assembled.
- Use with laminate tops and credenza seat cushions. Order separately — see pages 634 and 517.

⚠ Locking units equipped with HON "One Key" interchangeable core removable locks. Keyed alike core model HF23S, in Satin, must be ordered separately. See page 634.

Ⓢ Discontinued 4/6/20.

**HOW TO SPECIFY**

**Select Model Number**

Replace (?) with handle choice

- A** Satin Chrome Arch
- N** Full Face Integral
- R** Full Radius Pull

Pull not specified for Open Shelf models

H S C S F 2 2 7 2 1 8 R B F O M A .

**Select Paint Color**

See page 464 Contain® Storage finish options

P .

**Select Lock Option**

- L** Standard Lock
- X** Omit Lock (deduct \$20)

Not specified for models HSCSF223618O and HSCSF223018O

L .

**Select Foot Color**

- T1** Platinum Metallic
- PR6** Silver

T 1



Icon Legend on page 19

## Contain® Metal Credenzas with Laminate Fronts

	DESCRIPTION	MODEL	SHIP WEIGHT	CUBE	LIST PRICE BY PAINT GRADE		
					P1	P2	P3
	<b>Metal Low Credenza, Laminated Front, Box/Lateral Left, Open Shelf Right</b>						
	72"W x 18"D x 22"H	<b>HSCBX227218RBFOL(?)</b> Ⓢ	152	20.7	\$2131	\$2198	\$2266
	60"W x 18"D x 22"H	<b>HSCBX226018RBFOL(?)</b> Ⓢ	132	17.3	\$1943	\$2010	\$2078
	48"W x 18"D x 22"H	<b>HSCBX224818RBFOL(?)</b> Ⓢ	113	14.0	\$1808	\$1875	\$1943
	! Replace (?) with handle choice. Available in Satin Chrome Arch only.						
	<b>Metal Low Credenza, Laminated Front, Box/Lateral Right, Open Shelf Left</b>						
	72"W x 18"D x 22"H	<b>HSCBX227218LBFOL(?)</b> Ⓢ	152	20.7	\$2131	\$2198	\$2266
	60"W x 18"D x 22"H	<b>HSCBX226018LBFOL(?)</b> Ⓢ	132	17.3	\$1943	\$2010	\$2078
	48"W x 18"D x 22"H	<b>HSCBX224818LBFOL(?)</b> Ⓢ	113	14.0	\$1808	\$1875	\$1943
	! Replace (?) with handle choice. Available in Satin Chrome Arch only.						
	<b>Metal Low Credenza, Laminated Front Box/Lateral</b>						
	36"W x 18"D x 22"H	<b>HSCBX223618BFL(?)</b> Ⓢ	89	10.6	\$1385	\$1418	\$1453
	30"W x 18"D x 22"H	<b>HSCBX223018BFL(?)</b> Ⓢ	76	9.0	\$1335	\$1368	\$1403
	! Replace (?) with handle choice. Available in Satin Chrome Arch only.						

**NOTES:**

- Lateral and wide box drawers operate on ball-bearing suspension with full extension.
- Steel ball-bearing drawer suspensions.
- Ships complete with standard kickplate.
- Field installable counterweight sold separately.
- File drawers accept hanging folders in letter or legal size.
- Steel frame provides durability.
- Use with laminate tops and credenza seat cushions. Order separately — see pages 634 and 517.

! Available in Satin Chrome Arch only.

! Locking units equipped with HON "One Key" interchangeable core removable locks. Keyed alike core model HF23S, in Satin, must be ordered separately. See page 634.

Ⓢ Discontinued 4/6/20.

### HOW TO SPECIFY

<p><b>Select Model Number</b></p> <p>Replace (?) with handle choice</p> <p><b>A</b> Satin Chrome Arch</p>	<p><b>Select Paint Color</b></p> <p>See page 464 Contain® Storage finish options</p>	<p><b>Select Lock Option</b></p> <p><b>L</b> Standard Lock <b>X</b> Omit Lock (deduct \$20)</p>	<p><b>Select Laminate Option</b></p> <p>L1 (no upcharge)</p> <p><b>COGN</b> Cognac <b>C</b> Harvest <b>N</b> Mahogany <b>MOCH</b> Mocha <b>D</b> Natural Maple <b>PINC</b> Pinnacle <b>F</b> Shaker Cherry</p> <p>L2 (\$35 upcharge)</p> <p><b>LLA1</b> Lowell Ash <b>LNRI</b> Natural Recon <b>LPE1</b> Phantom Ecru <b>LPT1</b> Portico Teak <b>LSW1</b> Skyline Walnut</p>
<p>H S C B X 2 2 7 2 1 8 R B F O L A .</p>	<p>P .</p>	<p>L .</p>	<p>C</p>



Icon Legend on page 19

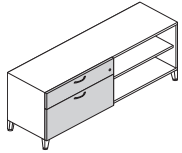

DESCRIPTION	MODEL	SHIP WEIGHT	CUBE	LIST PRICE BY PAINT GRADE		
				P1	P2	P3
<b>Footed Low Credenza, Laminate Front, Box/Lateral Left, Open Shelf Right</b>						
72"W x 18"D x 22"H	<b>HSCSF227218RBFOL(?)</b> ⓧ	152	17.7	<b>\$2287</b>	<b>\$2354</b>	<b>\$2422</b>
60"W x 18"D x 22"H	<b>HSCSF226018RBFOL(?)</b> ⓧ	132	14.9	<b>\$2097</b>	<b>\$2164</b>	<b>\$2232</b>
48"W x 18"D x 22"H	<b>HSCSF224818RBFOL(?)</b> ⓧ	113	12.0	<b>\$1932</b>	<b>\$1999</b>	<b>\$2067</b>

⚠ Replace (?) with handle choice. Available in Satin Chrome Arch only.

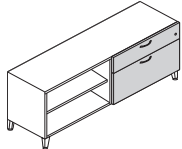

<b>Footed Low Credenza, Laminate Front, Box/Lateral Right, Open Shelf Left</b>						
72"W x 18"D x 22"H	<b>HSCSF227218LBFOL(?)</b> ⓧ	152	17.7	<b>\$2287</b>	<b>\$2354</b>	<b>\$2422</b>
60"W x 18"D x 22"H	<b>HSCSF226018LBFOL(?)</b> ⓧ	132	14.9	<b>\$2097</b>	<b>\$2164</b>	<b>\$2232</b>
48"W x 18"D x 22"H	<b>HSCSF224818LBFOL(?)</b> ⓧ	113	12.0	<b>\$1932</b>	<b>\$1999</b>	<b>\$2067</b>

⚠ Replace (?) with handle choice. Available in Satin Chrome Arch only.

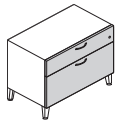

<b>Footed Low Credenza, Laminate Front Box/Lateral</b>						
36"W x 18"D x 22"H	<b>HSCSF223618BFL(?)</b> ⓧ	89	9.1	<b>\$1509</b>	<b>\$1542</b>	<b>\$1577</b>
30"W x 18"D x 22"H	<b>HSCSF223018BFL(?)</b> ⓧ	78	7.7	<b>\$1460</b>	<b>\$1493</b>	<b>\$1528</b>

⚠ Replace (?) with handle choice. Available in Satin Chrome Arch only.

**NOTES:**

- Lateral and wide box drawers operate on ball-bearing suspension with full extension.
- Steel ball-bearing drawer suspensions.
- Ships complete with standard footed base.
- Field installable counterweight sold separately.
- File drawers accept hanging folders in letter or legal size.
- Steel frame provides durability.
- Feet are shipped with the credenza unit and are easily assembled.
- Use with laminate tops and credenza seat cushions. Order separately — see pages 634 and 517.

⚠ Available in Satin Chrome Arch only.

⚠ Locking units equipped with HON "One Key" interchangeable core removable locks. Keyed alike core model HF23S, in Satin, must be ordered separately. See page 634.

ⓧ Discontinued 4/6/20.

### HOW TO SPECIFY

Select Model Number	Select Paint Color	Select Lock Option	Select Laminate Option	Select Foot Color
Replace (?) with handle choice A Satin Chrome Arch	See page 464 Contain® Storage finish options	L Standard Lock X Omit Lock (deduct \$20)	L1 (no upcharge) <b>COGN</b> Cognac <b>C</b> Harvest <b>N</b> Mahogany <b>MOCH</b> Mocha <b>D</b> Natural Maple <b>PINC</b> Pinnacle <b>F</b> Shaker Cherry L2 (\$35 upcharge) <b>LLA1</b> Lowell Ash <b>LNRI</b> Natural Recon <b>LPE1</b> Phantom Ecru <b>LPT1</b> Portico Teak <b>LSW1</b> Skyline Walnut	T1 Platinum Metallic PR6 Silver
H S C S F 2 2 7 2 1 8 R B F O L A .	P .	L .	C .	T 1



Icon Legend on page 19

# Contain® Metal Credenzas Accessories

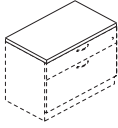

DESCRIPTION	MODEL	SHIP WEIGHT	CUBE												
				1	2	3	4	5	6	7	8	9	10	11	12
<b>Credenza Cushion</b> 36"W x 18"D for 60" and 72" Credenzas	<b>HSCAUC1836</b> Ⓢ	16.3	1.6	\$278	\$316	\$354	\$393	\$442	\$492	\$542	\$591	\$641	\$690	\$740	\$790
30"W x 18"D for 48" and 60" Credenzas	<b>HSCAUC1830</b> Ⓢ	16.3	1.6	\$259	\$297	\$335	\$374	\$423	\$473	\$523	\$572	\$622	\$671	\$721	\$771
24"W x 18"D for 48" Credenzas	<b>HSCAUC1824</b> Ⓢ	16.3	1.9	\$242	\$280	\$318	\$357	\$406	\$456	\$506	\$555	\$605	\$654	\$704	\$754

NOTES: For matching Pedestal Seats, see page 530. Credenza Cushions are available in 24", 30" and 36" size options. Choose from multiple upholstery options, see pages 462-463. See pages 22-24 for available fabrics.

**SPECIFYING EXAMPLE: HSCAUC1836.APN23**

**NOTES:**

Ⓢ Discontinued 4/6/20.

## HOW TO SPECIFY

<p><b>Select Model Number</b></p> <p>H S C A U C 1 8 3 6 .</p>	<p><b>Select Fabric</b></p> <p>See pages 462-463</p> <p>A B 1 0</p>
--	---

# EMPOWER® Contain® Metal Personal Towers

GSA SIN 33721



Icon Legend on page 19

WORKSTATIONS

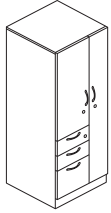

DESCRIPTION	MODEL	SHIP WEIGHT	CUBE	LIST PRICE BY PAINT GRADE		
				P1	P2	P3
<b>Personal Tower with Metal Fronts, Door/Box/Box/File</b>						
65"H x 24"W x 24"D, Wardrobe Left	<b>HSTBX652424LBBFM(?)</b> Ⓢ	255	25.6	<b>\$2617</b>	<b>\$2694</b>	<b>\$2762</b>
65"H x 24"W x 24"D, Wardrobe Right	<b>HSTBX652424RBBFM(?)</b> Ⓢ	255	25.6	<b>\$2617</b>	<b>\$2694</b>	<b>\$2762</b>

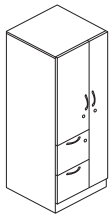

<b>Personal Tower with Metal Fronts, Door/File/File</b>						
65"H x 24"W x 24"D, Wardrobe Left	<b>HSTBX652424LFFM(?)</b> Ⓢ	255	25.6	<b>\$2617</b>	<b>\$2694</b>	<b>\$2762</b>
65"H x 24"W x 24"D, Wardrobe Right	<b>HSTBX652424RFFM(?)</b> Ⓢ	255	25.6	<b>\$2617</b>	<b>\$2694</b>	<b>\$2762</b>

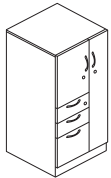

<b>Personal Tower with Metal Fronts, Door/Box/Box/File</b>						
50"H x 24"W x 24"D, Wardrobe Left	<b>HSTBX502424LBBFM(?)</b> Ⓢ	215	19.8	<b>\$2146</b>	<b>\$2223</b>	<b>\$2281</b>
50"H x 24"W x 24"D, Wardrobe Right	<b>HSTBX502424RBBFM(?)</b> Ⓢ	215	19.8	<b>\$2146</b>	<b>\$2223</b>	<b>\$2281</b>

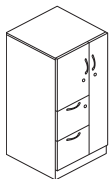

<b>Personal Tower with Metal Fronts, Door/File/File</b>						
50"H x 24"W x 24"D, Wardrobe Left	<b>HSTBX502424LFFM(?)</b> Ⓢ	215	19.8	<b>\$2146</b>	<b>\$2223</b>	<b>\$2281</b>
50"H x 24"W x 24"D, Wardrobe Right	<b>HSTBX502424RFFM(?)</b> Ⓢ	215	19.8	<b>\$2146</b>	<b>\$2223</b>	<b>\$2281</b>

**NOTES:**

- Metal chassis and drawer fronts.
- Steel frame provides durability.
- Leveling glides can be adjusted from outside or inside the case.
- Heavy-duty, telescoping ball-bearing slides.
- Durable baked enamel finish is applied over rust-inhibiting phosphate pre-treatment.
- Three locks secure doors and drawers.
- Pencil tray standard in top box drawer.

- One box divider standard in each box drawer.
- One crossrail standard in each file drawer.

ⓘ Locking units equipped with HON "One Key" interchangeable core removable locks. Keyed alike core model HF23S, in Satin, must be ordered separately. See page 634.

Ⓢ Discontinued 4/6/20.

**HOW TO SPECIFY**

<p><b>Select Model Number</b></p> <p>Replace (?) with handle choice</p> <p><b>A</b> Satin Chrome Arch <b>N</b> Full Face Integral <b>R</b> Full Radius</p>	<p><b>Select Paint Color</b></p> <p>See page 464 Contain® Storage finish options</p>	<p><b>Select Lock Option</b></p> <p><b>L</b> Standard Lock <b>X</b> Omit Lock (deduct \$60)</p>
<p>H S T B X 6 5 2 4 2 4 L B B F M A .</p>	<p>P .</p>	<p>L</p>



Icon Legend on page 19

Contain® Metal Side Access Towers

	DESCRIPTION	MODEL	SHIP WEIGHT	CUBE	LIST PRICE BY PAINT GRADE		
					P1	P2	P3
	<b>Side Access Tower with Metal Fronts, Shelves/Box/Box/File</b>						
	65”H x 24”W x 24”D, Wardrobe Left	<b>HSTSBX652424LBBFM(?)</b> Ⓣ	255	25.6	\$2454	\$2531	\$2599
	65”H x 24”W x 24”D, Wardrobe Right	<b>HSTSBX652424RBBFM(?)</b> Ⓣ	255	25.6	\$2454	\$2531	\$2599
	<b>Side Access Tower with Metal Fronts, Shelves/File/File</b>						
	65”H x 24”W x 24”D, Wardrobe Left	<b>HSTSBX652424LFFM(?)</b> Ⓣ	255	25.6	\$2454	\$2531	\$2599
	65”H x 24”W x 24”D, Wardrobe Right	<b>HSTSBX652424RFFM(?)</b> Ⓣ	255	25.6	\$2454	\$2531	\$2599
	<b>Side Access Tower with Metal Fronts, Shelves/Box/Box/File</b>						
	50”H x 24”W x 24”D, Wardrobe Left	<b>HSTSBX502424LBBFM(?)</b> Ⓣ	215	19.8	\$2082	\$2159	\$2217
	50”H x 24”W x 24”D, Wardrobe Right	<b>HSTSBX502424RBBFM(?)</b> Ⓣ	215	19.8	\$2082	\$2159	\$2217
	<b>Side Access Tower with Metal Fronts, Shelves/File/File</b>						
	50”H x 24”W x 24”D, Wardrobe Left	<b>HSTSBX502424LFFM(?)</b> Ⓣ	215	19.8	\$2082	\$2159	\$2217
	50”H x 24”W x 24”D, Wardrobe Right	<b>HSTSBX502424RFFM(?)</b> Ⓣ	215	19.8	\$2082	\$2159	\$2217

**NOTES:**

- A Worksurface to Tower Bracket Kit ships standard with each model.
- Metal chassis and drawer fronts.
- Steel frame provides durability.
- Leveling glides can be adjusted from outside or inside the case.
- Heavy-duty, telescoping ball-bearing slides.
- Durable baked enamel finish is applied over rust-inhibiting phosphate pre-treatment.
- Two locks secure doors and drawers.
- Pencil tray standard in top box drawer.
- One box divider standard in each box drawer.
- One crossrail standard in each file drawer.

ⓘ Locking units equipped with HON “One Key” interchangeable core removable locks. Keyed alike core model HF23S, in Satin, must be ordered separately. See page 634.

Ⓣ Discontinued 4/6/20.

**HOW TO SPECIFY**

<p><b>Select Model Number</b></p> <p>Replace (?) with handle choice</p> <p><b>A</b> Satin Chrome Arch  <b>N</b> Full Face Integral  <b>R</b> Full Radius</p>	<p><b>Select Paint Color</b></p> <p>See page 464 Contain® Storage finish options</p>	<p><b>Select Lock Option</b></p> <p><b>L</b> Standard Lock  <b>X</b> Omit Lock (deduct \$60)</p>
<p>H S T S B X 6 5 2 4 2 4 L B B F M A .</p>	<p>P .</p>	<p>L</p>



Icon Legend on page 19

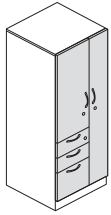

DESCRIPTION	MODEL	SHIP WEIGHT	CUBE	LIST PRICE BY PAINT GRADE		
				P1	P2	P3
<b>Personal Tower with Laminate Fronts, Door/Box/Box/File</b>						
65"H x 24"W x 24"D, Wardrobe Left	<b>HSTBX652424LBBFL(?)</b> Ⓢ	255	25.6	<b>\$2987</b>	<b>\$3064</b>	<b>\$3132</b>
65"H x 24"W x 24"D, Wardrobe Right	<b>HSTBX652424RBBFL(?)</b> Ⓢ	255	25.6	<b>\$2987</b>	<b>\$3064</b>	<b>\$3132</b>

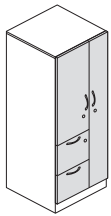

<b>Personal Tower with Laminate Fronts, Door/File/File</b>						
65"H x 24"W x 24"D, Wardrobe Left	<b>HSTBX652424LFFL(?)</b> Ⓢ	255	25.6	<b>\$2987</b>	<b>\$3064</b>	<b>\$3132</b>
65"H x 24"W x 24"D, Wardrobe Right	<b>HSTBX652424RFFL(?)</b> Ⓢ	255	25.6	<b>\$2987</b>	<b>\$3064</b>	<b>\$3132</b>

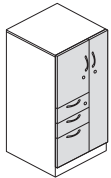

<b>Personal Tower with Laminate Fronts, Door/Box/Box/File</b>						
50"H x 24"W x 24"D, Wardrobe Left	<b>HSTBX502424LBBFL(?)</b> Ⓢ	215	19.8	<b>\$2468</b>	<b>\$2545</b>	<b>\$2603</b>
50"H x 24"W x 24"D, Wardrobe Right	<b>HSTBX502424RBBFL(?)</b> Ⓢ	215	19.8	<b>\$2468</b>	<b>\$2545</b>	<b>\$2603</b>

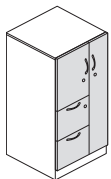

<b>Personal Tower with Laminate Fronts, Door/File/File</b>						
50"H x 24"W x 24"D, Wardrobe Left	<b>HSTBX502424LFFL(?)</b> Ⓢ	215	19.8	<b>\$2468</b>	<b>\$2545</b>	<b>\$2603</b>
50"H x 24"W x 24"D, Wardrobe Right	<b>HSTBX502424RFFL(?)</b> Ⓢ	215	19.8	<b>\$2468</b>	<b>\$2545</b>	<b>\$2603</b>

**NOTES:**

- Metal chassis with laminate drawer/door fronts.
- Steel frame provides durability.
- Leveling glides can be adjusted from outside or inside the case.
- Heavy-duty, telescoping ball-bearing slides.
- Durable baked enamel finish is applied over rust-inhibiting phosphate pre-treatment.
- Three locks secure doors and drawers.
- Pencil tray standard in top box drawer.
- One box divider standard in each box drawer.
- One crossrail standard in each file drawer.
- ⓘ Available in Satin Chrome Arch only.
- ⓘ Locking units equipped with HON "One Key" interchangeable core removable locks. Keyed alike core model HF23S, in Satin, must be ordered separately. See page 634.
- Ⓢ Discontinued 4/6/20.

**HOW TO SPECIFY**

<p><b>Select Model Number</b></p> <p>Replace (?) with handle choice</p> <p><b>A</b> Satin Chrome Arch</p>	<p><b>Select Paint Color</b></p> <p>See page 464 Contain® Storage finish options</p>	<p><b>Select Lock Option</b></p> <p><b>L</b> Standard Lock <b>X</b> Omit Lock (deduct \$60)</p>	<p><b>Select Laminate Option</b></p> <p>L1 (no upcharge)</p> <p><b>COGN</b> Cognac <b>C</b> Harvest <b>N</b> Mahogany <b>MOCH</b> Mocha <b>D</b> Natural Maple <b>PINC</b> Pinnacle <b>F</b> Shaker Cherry</p> <p>L2 (\$35 upcharge)</p> <p><b>LLA1</b> Lowell Ash <b>LNRI</b> Natural Recon <b>LPE1</b> Phantom Ecru <b>LPT1</b> Portico Teak <b>LSW1</b> Skyline Walnut</p>
<p>H S T B X 6 5 2 4 2 4 L B B F L A .</p>	<p>P .</p>	<p>L .</p>	<p>C</p>





Icon Legend on page 19

## Contain® Metal Side Access Towers with Laminate Fronts

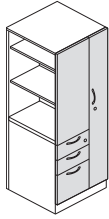

DESCRIPTION	MODEL	SHIP WEIGHT	CUBE	LIST PRICE BY PAINT GRADE		
				P1	P2	P3
<b>Side Access Tower with Laminate Fronts, Shelves/Box/Box/File</b>						
65”H x 24”W x 24”D, Wardrobe Left	<b>HSTSBX652424LBBFL(?)</b> Ⓢ	255	25.6	<b>\$2824</b>	<b>\$2901</b>	<b>\$2969</b>
65”H x 24”W x 24”D, Wardrobe Right	<b>HSTSBX652424RBBFL(?)</b> Ⓢ	255	25.6	<b>\$2824</b>	<b>\$2901</b>	<b>\$2969</b>

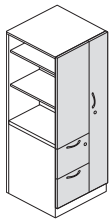

<b>Side Access Tower with Laminate Fronts, Shelves/File/File</b>						
65”H x 24”W x 24”D, Wardrobe Left	<b>HSTSBX652424LFFL(?)</b> Ⓢ	255	25.6	<b>\$2824</b>	<b>\$2901</b>	<b>\$2969</b>
65”H x 24”W x 24”D, Wardrobe Right	<b>HSTSBX652424RFFL(?)</b> Ⓢ	255	25.6	<b>\$2824</b>	<b>\$2901</b>	<b>\$2969</b>

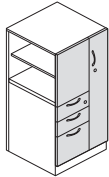

<b>Side Access Tower with Laminate Fronts, Shelves/Box/Box/File</b>						
50”H x 24”W x 24”D, Wardrobe Left	<b>HSTSBX502424LBBFL(?)</b> Ⓢ	215	19.8	<b>\$2404</b>	<b>\$2481</b>	<b>\$2539</b>
50”H x 24”W x 24”D, Wardrobe Right	<b>HSTSBX502424RBBFL(?)</b> Ⓢ	215	19.8	<b>\$2404</b>	<b>\$2481</b>	<b>\$2539</b>

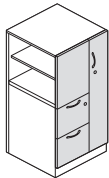

<b>Side Access Tower with Laminate Fronts, Shelves/File/File</b>						
50”H x 24”W x 24”D, Wardrobe Left	<b>HSTSBX502424LFFL(?)</b> Ⓢ	215	19.8	<b>\$2404</b>	<b>\$2481</b>	<b>\$2539</b>
50”H x 24”W x 24”D, Wardrobe Right	<b>HSTSBX502424RFFL(?)</b> Ⓢ	215	19.8	<b>\$2404</b>	<b>\$2481</b>	<b>\$2539</b>

**NOTES:**

- A Worksurface to Tower Bracket Kit ships standard with each model.
- Metal chassis with laminate drawer/door fronts.
- Steel frame provides durability.
- Leveling glides can be adjusted from outside or inside the case.
- Heavy-duty, telescoping ball-bearing slides.
- Durable baked enamel finish is applied over rust-inhibiting phospho pre-treatment.
- Two locks secure doors and drawers.
- Pencil tray standard in top box drawer.

- One box divider standard in each box drawer.
- One crossrail standard in each file drawer.
- ⓘ Available in Satin Chrome Arch only.
- ⓘ Locking units equipped with HON “One Key” interchangeable core removable locks. Keyed alike core model HF23S, in Satin, must be ordered separately. See page 634.
- Ⓢ Discontinued 4/6/20.

**HOW TO SPECIFY**

<p><b>Select Model Number</b></p> <p>Replace (?) with handle choice</p> <p><b>A</b> Satin Chrome Arch</p>	<p><b>Select Paint Color</b></p> <p>See page 464 Contain® Storage finish options</p>	<p><b>Select Lock Option</b></p> <p><b>L</b> Standard Lock <b>X</b> Omit Lock (deduct \$60)</p>	<p><b>Select Laminate Option</b></p> <p>L1 (no upcharge)</p> <p><b>COGN</b> Cognac <b>C</b> Harvest <b>N</b> Mahogany <b>MOCH</b> Mocha <b>D</b> Natural Maple <b>PINC</b> Pinnacle <b>F</b> Shaker Cherry</p> <p>L2 (\$35 upcharge)</p> <p><b>LLA1</b> Lowell Ash <b>LNRI</b> Natural Recon <b>LPE1</b> Phantom Ecru <b>LPT1</b> Portico Teak <b>LSW1</b> Skyline Walnut</p>
<p>H S T S B X 6 5 2 4 2 4 L B B F L A .</p>	<p>P .</p>	<p>L .</p>	<p>C</p>

# EMPOWER®

## Contain® Footed Metal Personal Towers

GSA SIN 33721



WORKSTATIONS

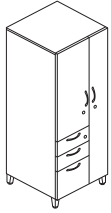

DESCRIPTION	MODEL	SHIP WEIGHT	CUBE	LIST PRICE BY PAINT GRADE		
				P1	P2	P3
<b>Footed Personal Tower with Metal Fronts, Door/Box/Box/File</b>						
65"H x 24"W x 24"D, Wardrobe Left	<b>HSTSF652424LBBFM(?)</b> Ⓢ	255	24.3	<b>\$2736</b>	<b>\$2813</b>	<b>\$2881</b>
65"H x 24"W x 24"D, Wardrobe Right	<b>HSTSF652424RBBFM(?)</b> Ⓢ	255	24.3	<b>\$2736</b>	<b>\$2813</b>	<b>\$2881</b>

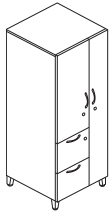

<b>Footed Personal Tower with Metal Fronts, Door/File/File</b>						
65"H x 24"W x 24"D, Wardrobe Left	<b>HSTSF652424LFFM(?)</b> Ⓢ	255	24.3	<b>\$2736</b>	<b>\$2813</b>	<b>\$2881</b>
65"H x 24"W x 24"D, Wardrobe Right	<b>HSTSF652424RFFM(?)</b> Ⓢ	255	24.3	<b>\$2736</b>	<b>\$2813</b>	<b>\$2881</b>



<b>Footed Personal Tower with Metal Fronts, Door/Box/Box/File</b>						
50"H x 24"W x 24"D, Wardrobe Left	<b>HSTSF502424LBBFM(?)</b> Ⓢ	215	18.6	<b>\$2267</b>	<b>\$2344</b>	<b>\$2402</b>
50"H x 24"W x 24"D, Wardrobe Right	<b>HSTSF502424RBBFM(?)</b> Ⓢ	215	18.6	<b>\$2267</b>	<b>\$2344</b>	<b>\$2402</b>

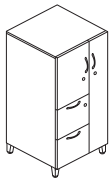

<b>Footed Personal Tower with Metal Fronts, Door/File/File</b>						
50"H x 24"W x 24"D, Wardrobe Left	<b>HSTSF502424LFFM(?)</b> Ⓢ	215	18.6	<b>\$2267</b>	<b>\$2344</b>	<b>\$2402</b>
50"H x 24"W x 24"D, Wardrobe Right	<b>HSTSF502424RFFM(?)</b> Ⓢ	215	18.6	<b>\$2267</b>	<b>\$2344</b>	<b>\$2402</b>

### NOTES:

- Metal chassis and drawer fronts.
- Steel frame provides durability.
- Leveling glides can be adjusted from outside or inside the case.
- Heavy-duty, telescoping ball-bearing slides.
- Durable baked enamel finish is applied over rust-inhibiting phosphate pre-treatment.
- Three locks secure doors and drawers.
- Pencil tray standard in top box drawer.
- One box divider standard in each box drawer.
- One crossrail standard in each file drawer.

⚠ Locking units equipped with HON "One Key" interchangeable core removable locks. Keyed alike core model HF23S, in Satin, must be ordered separately. See page 634.

Ⓢ Discontinued 4/6/20.

## HOW TO SPECIFY

### Select Model Number

Replace (?) with handle choice

- A** Satin Chrome Arch
- N** Full Face Integral
- R** Full Radius

H S T S F 6 5 2 4 2 4 L B B F M A .

### Select Paint Color

See page 464 Contain® Storage finish options

P .

### Select Lock Option

- L** Standard Lock
- X** Omit Lock (deduct \$60)

L .

### Select Foot Color

- T1** Platinum Metallic
- PR6** Silver

T 1



Icon Legend on page 19

## Contain® Footed Metal Side Access Towers

	DESCRIPTION	MODEL	SHIP WEIGHT	CUBE	LIST PRICE BY PAINT GRADE		
					P1	P2	P3
	<b>Footed Side Access Tower with Metal Fronts, Shelves/Box/Box/File</b>						
	65"H x 24"W x 24"D, Wardrobe Left	<b>HSTSSF652424LBBFM(?)</b> ⓧ	255	24.3	<b>\$2573</b>	<b>\$2650</b>	<b>\$2718</b>
	65"H x 24"W x 24"D, Wardrobe Right	<b>HSTSSF652424RBBFM(?)</b> ⓧ	255	24.3	<b>\$2573</b>	<b>\$2650</b>	<b>\$2718</b>
	<b>Footed Side Access Tower with Metal Fronts, Shelves/File/File</b>						
	65"H x 24"W x 24"D, Wardrobe Left	<b>HSTSSF652424LFFM(?)</b> ⓧ	255	24.3	<b>\$2573</b>	<b>\$2650</b>	<b>\$2718</b>
	65"H x 24"W x 24"D, Wardrobe Right	<b>HSTSSF652424RFFM(?)</b> ⓧ	255	24.3	<b>\$2573</b>	<b>\$2650</b>	<b>\$2718</b>
	<b>Footed Side Access Tower with Metal Fronts, Shelves/Box/Box/File</b>						
	50"H x 24"W x 24"D, Wardrobe Left	<b>HSTSSF502424LBBFM(?)</b> ⓧ	215	18.6	<b>\$2202</b>	<b>\$2279</b>	<b>\$2337</b>
	50"H x 24"W x 24"D, Wardrobe Right	<b>HSTSSF502424RBBFM(?)</b> ⓧ	215	18.6	<b>\$2202</b>	<b>\$2279</b>	<b>\$2337</b>
	<b>Footed Side Access Tower with Metal Fronts, Shelves/File/File</b>						
	50"H x 24"W x 24"D, Wardrobe Left	<b>HSTSSF502424LFFM(?)</b> ⓧ	215	18.6	<b>\$2202</b>	<b>\$2279</b>	<b>\$2337</b>
	50"H x 24"W x 24"D, Wardrobe Right	<b>HSTSSF502424RFFM(?)</b> ⓧ	215	18.6	<b>\$2202</b>	<b>\$2279</b>	<b>\$2337</b>

**NOTES:**

- A Worksurface to Tower Bracket Kit ships standard with each model.
- Metal chassis and drawer fronts.
- Steel frame provides durability.
- Leveling glides can be adjusted from outside or inside the case.
- Heavy-duty, telescoping ball-bearing slides.
- Durable baked enamel finish is applied over rust-inhibiting phosphate pre-treatment.
- Two locks secure doors and drawers.
- Pencil tray standard in top box drawer.
- One box divider standard in each box drawer.
- One crossrail standard in each file drawer.
- ⓘ Locking units equipped with HON "One Key" interchangeable core removable locks. Keyed alike core model HF23S, in Satin, must be ordered separately. See page 634.
- ⓧ Discontinued 4/6/20.

### HOW TO SPECIFY

<p><b>Select Model Number</b></p> <p>Replace (?) with handle choice</p> <p><b>A</b> Satin Chrome Arch <b>N</b> Full Face Integral <b>R</b> Full Radius</p>	<p><b>Select Paint Color</b></p> <p>See page 464 Contain® Storage finish options</p>	<p><b>Select Lock Option</b></p> <p><b>L</b> Standard Lock <b>X</b> Omit Lock (deduct \$60)</p>	<p><b>Select Foot Color</b></p> <p><b>T1</b> Platinum Metallic <b>PR6</b> Silver</p>
HSTSSF652424LBBFMA	P	L	T1



Icon Legend on page 19

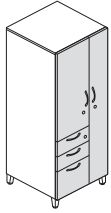

DESCRIPTION	MODEL	SHIP WEIGHT	CUBE	LIST PRICE BY PAINT GRADE		
				P1	P2	P3
<b>Footed Personal Tower with Laminate Fronts, Door/Box/Box/File</b>						
65"H x 24"W x 24"D, Wardrobe Left	<b>HSTSF652424LBBFL(?)</b> Ⓢ	255	24.3	<b>\$3107</b>	<b>\$3184</b>	<b>\$3252</b>
65"H x 24"W x 24"D, Wardrobe Right	<b>HSTSF652424RBBFL(?)</b> Ⓢ	255	24.3	<b>\$3107</b>	<b>\$3184</b>	<b>\$3252</b>

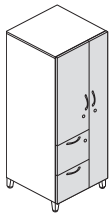

<b>Footed Personal Tower with Laminate Fronts, Door/File/File</b>						
65"H x 24"W x 24"D, Wardrobe Left	<b>HSTSF652424LFFL(?)</b> Ⓢ	255	24.3	<b>\$3107</b>	<b>\$3184</b>	<b>\$3252</b>
65"H x 24"W x 24"D, Wardrobe Right	<b>HSTSF652424RFFL(?)</b> Ⓢ	255	24.3	<b>\$3107</b>	<b>\$3184</b>	<b>\$3252</b>

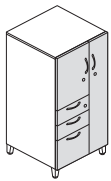

<b>Footed Personal Tower with Laminate Fronts, Door/Box/Box/File</b>						
50"H x 24"W x 24"D, Wardrobe Left	<b>HSTSF502424LBBFL(?)</b> Ⓢ	215	18.6	<b>\$2589</b>	<b>\$2666</b>	<b>\$2724</b>
50"H x 24"W x 24"D, Wardrobe Right	<b>HSTSF502424RBBFL(?)</b> Ⓢ	215	18.6	<b>\$2589</b>	<b>\$2666</b>	<b>\$2724</b>

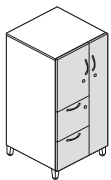

<b>Footed Personal Tower with Laminate Fronts, Door/File/File</b>						
50"H x 24"W x 24"D, Wardrobe Left	<b>HSTSF502424LFFL(?)</b> Ⓢ	215	18.6	<b>\$2589</b>	<b>\$2666</b>	<b>\$2724</b>
50"H x 24"W x 24"D, Wardrobe Right	<b>HSTSF502424RFFL(?)</b> Ⓢ	215	18.6	<b>\$2589</b>	<b>\$2666</b>	<b>\$2724</b>

**NOTES:**

- Metal chassis with laminate drawer/door fronts.
- Steel frame provides durability.
- Leveling glides can be adjusted from outside or inside the case.
- Heavy-duty, telescoping ball-bearing slides.
- Durable baked enamel finish is applied over rust-inhibiting phosphate pre-treatment.
- Three locks secure doors and drawers.
- Pencil tray standard in top box drawer.
- One box divider standard in each box drawer.
- One crossrail standard in each file drawer.
- ⓘ Available in Satin Chrome Arch only.
- ⓘ Locking units equipped with HON "One Key" interchangeable core removable locks. Keyed alike core model HF23S, in Satin, must be ordered separately. See page 634.

Ⓢ Discontinued 4/6/20.

**HOW TO SPECIFY**

<p><b>Select Model Number</b></p> <p>Replace (?) with handle choice</p> <p><b>A</b> Satin Chrome Arch</p>	<p><b>Select Paint Color</b></p> <p>See page 464 Contain® Storage finish options</p>	<p><b>Select Lock Option</b></p> <p><b>L</b> Standard Lock <b>X</b> Omit Lock (deduct \$60)</p>	<p><b>Select Laminate Option</b></p> <p>L1 (no upcharge) <b>COGN</b> Cognac <b>C</b> Harvest <b>N</b> Mahogany <b>MOCH</b> Mocha <b>D</b> Natural Maple <b>PINC</b> Pinnacle <b>F</b> Shaker Cherry L2 (\$35 upcharge) <b>LLA1</b> Lowell Ash <b>LNRI</b> Natural Recon <b>LPE1</b> Phantom Ecru <b>LPT1</b> Portico Teak <b>LSW1</b> Skyline Walnut</p>	<p><b>Select Foot Color</b></p> <p><b>T1</b> Platinum Metallic <b>PR6</b> Silver</p>
H S T S F 6 5 2 4 2 4 L B B F L A .	P .	L .	C .	T 1



Icon Legend on page 19

## Contain® Footed Metal Side Access Towers with Laminate Fronts

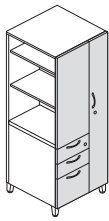

DESCRIPTION	MODEL	SHIP WEIGHT	CUBE	LIST PRICE BY PAINT GRADE		
				P1	P2	P3
<b>Footed Side Access Tower with Laminate Fronts, Shelves/Box/Box/File</b>						
65"H x 24"W x 24"D, Wardrobe Left	<b>HSTSSF652424LBBFL(?)</b> Ⓢ	255	24.3	<b>\$2944</b>	<b>\$3021</b>	<b>\$3089</b>
65"H x 24"W x 24"D, Wardrobe Right	<b>HSTSSF652424RBBFL(?)</b> Ⓢ	255	24.3	<b>\$2944</b>	<b>\$3021</b>	<b>\$3089</b>

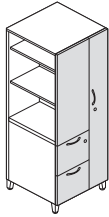

<b>Footed Side Access Tower with Laminate Fronts, Shelves/File/File</b>						
65"H x 24"W x 24"D, Wardrobe Left	<b>HSTSSF652424LFFL(?)</b> Ⓢ	255	24.3	<b>\$2944</b>	<b>\$3021</b>	<b>\$3089</b>
65"H x 24"W x 24"D, Wardrobe Right	<b>HSTSSF652424RFFL(?)</b> Ⓢ	255	24.3	<b>\$2944</b>	<b>\$3021</b>	<b>\$3089</b>

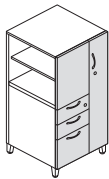

<b>Footed Side Access Tower with Laminate Fronts, Shelves/Box/Box/File</b>						
50"H x 24"W x 24"D, Wardrobe Left	<b>HSTSSF502424LBBFL(?)</b> Ⓢ	215	18.6	<b>\$2524</b>	<b>\$2601</b>	<b>\$2659</b>
50"H x 24"W x 24"D, Wardrobe Right	<b>HSTSSF502424RBBFL(?)</b> Ⓢ	215	18.6	<b>\$2524</b>	<b>\$2601</b>	<b>\$2659</b>

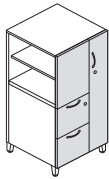

<b>Footed Side Access Tower with Laminate Fronts, Shelves/File/File</b>						
50"H x 24"W x 24"D, Wardrobe Left	<b>HSTSSF502424LFFL(?)</b> Ⓢ	215	18.6	<b>\$2524</b>	<b>\$2601</b>	<b>\$2659</b>
50"H x 24"W x 24"D, Wardrobe Right	<b>HSTSSF502424RFFL(?)</b> Ⓢ	215	18.6	<b>\$2524</b>	<b>\$2601</b>	<b>\$2659</b>

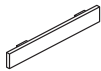

<b>Tower Kickplates (Field Installable)</b>						
For 24" Tower, Left	<b>HSTAKL</b> Ⓢ	2	0.3	<b>\$158</b>	<b>\$166</b>	<b>\$171</b>
For 24" Tower, Right	<b>HSTAKR</b> Ⓢ	2	0.3	<b>\$158</b>	<b>\$166</b>	<b>\$171</b>
Specify: Model.Paint						
<b>SPECIFYING EXAMPLE: HSATKL.P</b>						

**NOTES:**

- A Worksurface to Tower Bracket Kit ships standard with each model.
- Metal chassis with laminate drawer/door fronts.
- Steel frame provides durability.
- Leveling glides can be adjusted from outside or inside the case.
- Heavy-duty, telescoping ball-bearing slides.
- Durable baked enamel finish is applied over rust-inhibiting phospho pre-treatment.
- Two locks secure doors and drawers.
- Pencil tray standard in top box drawer.

- One box divider standard in each box drawer.
- One crossrail standard in each file drawer.

ⓘ Available in Satin Chrome Arch only.

ⓘ Locking units equipped with HON "One Key" interchangeable core removable locks. Keyed alike core model HF23S, in Satin, must be ordered separately. See page 634.

Ⓢ Discontinued 4/6/20.

### HOW TO SPECIFY

<p><b>Select Model Number</b></p> <p>Replace (?) with handle choice</p> <p><b>A</b> Satin Chrome Arch</p>	<p><b>Select Paint Color</b></p> <p>See page 464 Contain® Storage finish options</p>	<p><b>Select Lock Option</b></p> <p><b>L</b> Standard Lock <b>X</b> Omit Lock (deduct \$60)</p>	<p><b>Select Laminate Option</b></p> <p>L1 (no upcharge) <b>COGN</b> Cognac <b>C</b> Harvest <b>N</b> Mahogany <b>MOCH</b> Mocha <b>D</b> Natural Maple <b>PINC</b> Pinnacle <b>F</b> Shaker Cherry L2 (\$35 upcharge) <b>LLA1</b> Lowell Ash <b>LNR1</b> Natural Recon <b>LPE1</b> Phantom Ecru <b>LPT1</b> Portico Teak <b>LSW1</b> Skyline Walnut</p>	<p><b>Select Foot Color</b></p> <p><b>T1</b> Platinum Metallic <b>PR6</b> Silver</p>
HSTSSF652424LBBFLA .	P .	L .	C .	T1

# EMPOWER<sup>®</sup> Contain<sup>®</sup> Metal Pedestals

GSA SIN 33721



Icon Legend on page 19

WORKSTATIONS

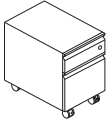

DESCRIPTION	MODEL	SHIP WEIGHT	CUBE	LIST PRICE BY PAINT GRADE		
				P1	P2	P3
<b>Mobile Pedestal with Metal Fronts, Box/File</b>						
21"H x 15"W x 18"D	<b>HSPM211518BFM(?)</b>	63.5	4.4	<b>\$559</b>	<b>\$587</b>	<b>\$615</b>
21"H x 15"W x 24"D	<b>HSPM211524BFM(?)</b>	61.9	5.7	<b>\$599</b>	<b>\$627</b>	<b>\$655</b>

NOTES: Ball-bearing suspension on box and file drawer. (100%) Drawers color to be interior gray steel. See page 529 for Pedestal Seat. File drawer has high sides and back for filing front to back and side to side. Counterweight standard on all mobile peds. Optional steel tops and pedestal seat cushions available. See pages 527 and 530. Pencil tray standard in top box drawer. One box divider standard in each box drawer. One crossrail standard in each file drawer.

- ! Available drawer fronts; R-Pull, A-Pull and N-Pull. A-Pull available in Satin Chrome only.
- ! Peds come with a plinth base, footed base or mobile base.

## HOW TO SPECIFY

### Select Model Number

Replace (?) with handle choice

- A** Satin Chrome Arch
- N** Full Face Integral
- R** Full Radius

H S P M 2 1 1 5 1 8 B F M A .

### Select Paint Color

See page 464 Contain<sup>®</sup> Storage finish options

P .

### Select Lock Option

- L** Standard Lock
- X** Omit Lock (deduct \$20)

L



Icon Legend on page 19

# EMPOWER® Contain® Footed Metal Pedestals

WORKSTATIONS

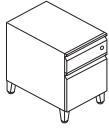

**DESCRIPTION**

**Footed Freestanding Pedestal with Metal Fronts, Box/File**

22"H x 15"W x 18"D  
22"H x 15"W x 24"D

**MODEL**

**HSPFSF221518BFM(?)**  
**HSPFSF221524BFM(?)**

**SHIP WEIGHT**   **CUBE**

66.8   4.4  
73.1   5.7

**LIST PRICE BY PAINT GRADE**

**P1   P2   P3**

**\$656   \$684   \$712**  
**\$694   \$722   \$750**

NOTES: Ball-bearing suspension on box and file drawer. (100%) Drawers color to be interior gray steel. File drawer has high sides and back for filing front to back and side to side. Counterweight standard on all mobile peds. Optional steel tops and pedestal seat cushions available. See pages 527 and 530. Pencil tray standard in top box drawer. One box divider standard in each box drawer. One crossrail standard in each file drawer.

- ❗ Available drawer fronts; R-Pull, A-Pull and N-Pull. A-Pull available in Satin Chrome only.
- ❗ Peds come with a plinth base, footed base or mobile base.

**DESCRIPTION**

**Counterweight — Freestanding Support Pedestals or Systems Support and Mobile Pedestals**

**MODEL   SHIP WEIGHT   CUBE   LIST PRICE**

**HPCW1   18   0.1   \$195**

**DESCRIPTION**

**Pedestal Seat**  
15"W x 22 7/8"D x 2"H

**MODEL**

**HPSEAT24ND**

**SHIP WEIGHT   CUBE   FABRIC PRICE CODES**

10 Ⓞ   1.2

1	\$194	8	\$390
2	\$218	9	\$421
3	\$242	10	\$452
4	\$266	11	\$483
5	\$297	12	\$514
6	\$328	L	—
7	\$359		

NOTES: For seating fabrics, see pages 22-24.  
**SPECIFYING EXAMPLE: HPSEAT24ND.APN23**

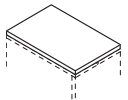

OPEN MARKET

**DESCRIPTION**

**Optional Pencil Tray**

NOTES: For additional information see page 846.

**MODEL   SHIP WEIGHT   CUBE   LIST PRICE**

**HV-UT1   0.5   0.1   \$66**

- ❗ For use with mobile and freestanding pedestal models.
- ❗ No specification required.

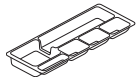

## HOW TO SPECIFY

<p><b>Select Model Number</b></p> <p>Replace (?) with handle choice</p> <p><b>A</b> Satin Chrome Arch <b>N</b> Full Face Integral <b>R</b> Full Radius</p> <p><b>H S P F S F 2 2 1 5 1 8 B F M A</b> .</p>	<p><b>Select Paint Color</b></p> <p>See page 464 Contain® Storage finish options</p> <p><b>P</b> .</p>	<p><b>Select Lock Option</b></p> <p><b>L</b> Standard Lock <b>X</b> Omit Lock (deduct \$20)</p> <p><b>L</b> .</p>	<p><b>Select Foot Color</b></p> <p><b>T1</b> Platinum Metallic <b>PR6</b> Silver</p> <p><b>T 1</b></p>
--	--	---	--



Icon Legend on page 19

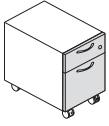

DESCRIPTION	MODEL	SHIP WEIGHT	CUBE	LIST PRICE BY PAINT GRADE		
				P1	P2	P3
<b>Mobile Pedestal with Laminate Fronts, Box/File</b>						
21"H x 15"W x 18"D, Arch Pull	<b>HSPM211518BFL(?)</b>	65.3	4.4	<b>\$715</b>	<b>\$743</b>	<b>\$771</b>
21"H x 15"W x 24"D, Arch Pull	<b>HSPM211524BFL(?)</b>	63.7	5.7	<b>\$755</b>	<b>\$783</b>	<b>\$811</b>

NOTES: Ball-bearing suspension on box and file drawer. (100%) Drawers color to be interior gray steel. File drawer has high sides and back for filing front to back and side to side. Counterweight standard on all mobile peds. See page 529 for Pedestal Seat. Optional pedestal seat cushions available. See page 530. Pencil tray standard in top box drawer. One box divider standard in each box drawer. One crossrail standard in each file drawer.

- ! Drawer Fronts available with Satin Chrome Arch only.
- ! Peds come with a plinth base, footed base or mobile base.

### HOW TO SPECIFY

<p><b>Select Model Number</b></p> <p>Replace (?) with handle choice</p> <p><b>A</b> Satin Chrome Arch</p>	<p><b>Select Paint Color</b></p> <p>See page 464 Contain® Storage finish options</p>	<p><b>Select Lock Option</b></p> <p><b>L</b> Standard Lock <b>X</b> Omit Lock (deduct \$20)</p>	<p><b>Select Laminate Option</b></p> <p>L1 (no upcharge)</p> <p><b>COGN</b> Cognac <b>C</b> Harvest <b>N</b> Mahogany <b>MOCH</b> Mocha <b>D</b> Natural Maple <b>PINC</b> Pinnacle <b>F</b> Shaker Cherry</p> <p>L2 (\$10 upcharge)</p> <p><b>LLA1</b> Lowell Ash <b>LNRI</b> Natural Recon <b>LPE1</b> Phantom Ecru <b>LPT1</b> Portico Teak <b>LSW1</b> Skyline Walnut</p>
<p>H S P M 2 1 1 5 1 8 B F L A .</p>	<p>P .</p>	<p>L .</p>	<p>C</p>





Icon Legend on page 19

## Contain® Footed Metal Pedestals with Laminate Fronts

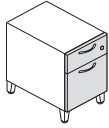

SIN 33721

DESCRIPTION	MODEL	SHIP WEIGHT	CUBE	LIST PRICE BY PAINT GRADE		
				P1	P2	P3
<b>Footed Freestanding Pedestal with Laminate Fronts, Box/File</b> 22"H x 15"W x 18"D, Arch Pull	<b>HSPFSF221518BFL(?)</b>	69.0	4.4	<b>\$812</b>	<b>\$840</b>	<b>\$868</b>
22"H x 15"W x 24"D, Arch Pull	<b>HSPFSF221524BFL(?)</b>	75.3	5.7	<b>\$850</b>	<b>\$878</b>	<b>\$906</b>

NOTES: Ball-bearing suspension on box and file drawer. (100%) Drawers color to be interior gray steel. File drawer has high sides and back for filing front to back and side to side. Counterweight standard on all mobile peds. See below for pedestal seat. Optional pedestal seat cushions available. See page 530. Pencil tray standard in top box drawer. One box divider standard in each box drawer. One crossrail standard in each file drawer. See Brigade® pedestals on page 615 for additional pedestal options. See pages 679-680 for Pedestal Accessories.

- ⓘ Drawer Fronts available with Satin Chrome Arch only.
- ⓘ Peds come with a plinth base, footed base or mobile base.

### HOW TO SPECIFY

<p><b>Select Model Number</b></p> <p>Replace (?) with handle choice</p> <p><b>A</b> Satin Chrome Arch</p>	<p><b>Select Paint Color</b></p> <p>See page 464 Contain® Storage finish options</p>	<p><b>Select Lock Option</b></p> <p><b>L</b> Standard Lock <b>X</b> Omit Lock (deduct \$20)</p>	<p><b>Select Laminate Option</b></p> <p>L1 (no upcharge)</p> <p><b>COGN</b> Cognac <b>C</b> Harvest <b>N</b> Mahogany <b>MOCH</b> Mocha <b>D</b> Natural Maple <b>PINC</b> Pinnacle <b>F</b> Shaker Cherry</p> <p>L2 (\$10 upcharge)</p> <p><b>LLA1</b> Lowell Ash <b>LNRI</b> Natural Recon <b>LPE1</b> Phantom Ecrú <b>LPT1</b> Portico Teak <b>LSW1</b> Skyline Walnut</p>	<p><b>Select Foot Color</b></p> <p><b>T1</b> Platinum Metallic <b>PR6</b> Silver</p>
<p>H S P F S F 2 2 1 5 1 8 B F L A .</p>	<p>P .</p>	<p>L .</p>	<p>C .</p>	<p>T 1</p>

DESCRIPTION	MODEL	SHIP WEIGHT	CUBE	FABRIC PRICE CODES		
<b>Pedestal Seat</b> 15"W x 22 <sup>7</sup> / <sub>8</sub> "D x 2"H	<b>HPSEAT24ND</b>	10 ⓘ	1.2	<b>1</b> \$194	<b>8</b> \$390	
NOTES: For seating fabrics, see pages 22-24.				<b>2</b> \$218	<b>9</b> \$421	
				<b>3</b> \$242	<b>10</b> \$452	
				<b>4</b> \$266	<b>11</b> \$483	
				<b>5</b> \$297	<b>12</b> \$514	
				<b>6</b> \$328	<b>L</b> —	
				<b>7</b> \$359		

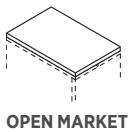

OPEN MARKET

### HOW TO SPECIFY

<p><b>Select Model Number</b></p>	<p><b>Select Fabric</b></p> <p>See pages 462-463 for seating fabric options</p>
<p>H P S E A T 2 4 .</p>	<p>A P N 2 3</p>

# EMPOWER® Flagship® Mobile Pedestals

GSA SIN AS NOTED



Icon Legend on page 19

WORKSTATIONS

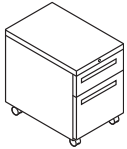

H15923N

SIN 33721

DESCRIPTION	MODEL	SHIP WEIGHT	CUBE	LIST PRICE BY PAINT GRADE		
				P1	P2	P3
<b>Mobile Pedestals — Box/File</b> 15"W x 22 <sup>7</sup> / <sub>8</sub> "D x 22"H  NOTES: Pencil tray standard in top box drawer. One box divider standard in each box drawer. One crossrail standard in each file drawer. File drawers have high sides for filing front-to-back. Steel ball-bearing suspension on file and box drawers. See pages 679-680 for accessories and pedestal utilization information. Arch pull available in Satin Chrome only. Choose from any of three pull options with no upcharge. Available in Arch (A), Full Face Integral (N) and Full Radius (R) Drawer Pulls. See page 612 for pull options. Equipped with HON "One Key" interchangeable core removable locks. Counterweight standard. Omit lock-option available. See page 853 for ordering instructions. See Brigade® pedestals on page 615 for additional pedestal options. See pages 679-680 for Pedestal Accessories.	H15923(?)	92	6.0	\$569	\$597	\$625

## HOW TO SPECIFY

<b>Select Model Number</b> A Satin Chrome Arch N Full Face Integral R Full Radius  H 1 5 9 2 3 A .	<b>Select Lock Option</b> L Lock (no upcharge) X Omit Lock (deduct \$20)  X .	<b>Select Paint Color</b> See page 464  T 1
---	---	--

DESCRIPTION	MODEL	SHIP WEIGHT	CUBE	FABRIC PRICE CODES		
<b>Pedestal Seat</b> 15"W x 22 <sup>7</sup> / <sub>8</sub> "D x 2"H  NOTES: For seating fabrics, see pages 22-24.	HPSEAT24ND	10	1.2	1 \$194	8 \$390	
				2 \$218	9 \$421	
				3 \$242	10 \$452	
				4 \$266	11 \$483	
				5 \$297	12 \$514	
				6 \$328	L —	
				7 \$359		

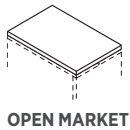

## HOW TO SPECIFY

<b>Select Model Number</b>  H P S E A T 2 4 .	<b>Select Fabric</b> See pages 462-463 for seating fabric options  A P N 2 3
---	---

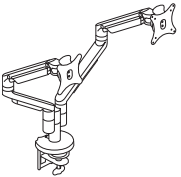
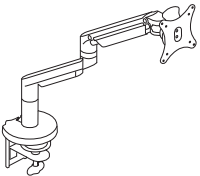
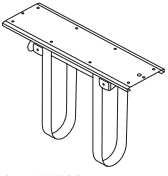

Icon Legend on page 19

	DESCRIPTION	MODEL	SHIP WEIGHT	CUBE	LIST PRICE
	<p><b>Dual Dynamic Monitor Arm</b></p> <ul style="list-style-type: none"> <li>• 150° of rotation at base with optional 360° rotation.</li> <li>• Arms extend 22" and retract up to 3".</li> <li>• Monitor mount rotates 180° and tilts +/-30°.</li> <li>• Monitor can be rotated from landscape to portrait position.</li> </ul> <p>! Arms hold monitors from 6.2-18 lbs. Optional counterweight HPACW available to support monitors as low as 5 lbs. (see page 827).</p>	<b>HMASD</b>	17.0	1.1	<b>\$750</b>
	<p><b>Single Dynamic Monitor Arm</b></p> <ul style="list-style-type: none"> <li>• 180° of rotation at base with optional 360° rotation.</li> <li>• Arms extend 22" and retract up to 3".</li> <li>• Monitor mount rotates 180° and tilts +/-30°.</li> <li>• Monitor can be rotated from landscape to portrait position.</li> </ul> <p>! Arms hold monitors from 6.2-18 lbs. Optional counterweight HPACW available to support monitors as low as 5 lbs. (see page 827).</p>	<b>HMASTS</b>	11.5	0.8	<b>\$390</b>
	<p><b>360° Swivel CPU Holder with Adjustable Straps</b></p> <ul style="list-style-type: none"> <li>• Supports CPUs 3¾" wide up to 64" perimeter and holds up to 75 lbs.</li> <li>• 360° rotation.</li> <li>• Ships complete and includes necessary mounting hardware and instruction sheet.</li> </ul> <p>! Available in Black only, no specification needed.</p>	<b>HCPU1</b>	7.0	0.2	<b>\$243</b>

SIN 33721

**NOTES:**

- For additional information see pages 825-827.



**Monitor Arms**

- Arms fold back to post to allow more desktop room.
- Arms feature double extension, allowing 20"+ of back and forth movement.
- Cable management on both pole and arm assemblies.
- Counterbalance adjustment provides stability for monitors up to 17.6 lbs per arm.
- Made of high quality aluminum alloy material.
- See pages 825-826 for additional monitor arm models.

## HOW TO SPECIFY

<p><b>Select Model Number</b></p>	<p><b>Select Finish</b></p> <p><i>Specify for models HMASD and HMASTS only</i></p> <p><b>SVR</b> Silver <b>BLK</b> Black</p>
<p><b>HMASD</b></p>	<p><b>SVR</b></p>

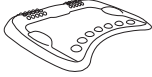
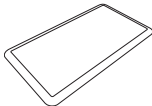
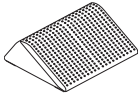

	DESCRIPTION	MODEL	SHIP WEIGHT	CUBE	LIST PRICE
	<b>Rectangle Wobble Board — Anti-Fatigue Mat</b> 18"D x 3"H x 22½"W ⓘ Available in Black (T) finish ONLY. Recommended weight capacity not to exceed 250 pounds. <b>HON 5-Year Limited Warranty.</b> <b>SPECIFYING EXAMPLE: HVL981.T</b>	<b>HVL981</b>	10.0 ⓘ	0.9	<b>\$120</b>
	<b>Round Wobble Board — Anti-Fatigue Mat</b> 18½"D x 2½"H x 18½"W ⓘ Available in Black (T) finish ONLY. Recommended weight capacity not to exceed 250 pounds. <b>HON 5-Year Limited Warranty.</b> <b>SPECIFYING EXAMPLE: HVL982.T</b>	<b>HVL982</b>	5.8 ⓘ	0.6	<b>\$102</b>
	<b>Ergonomic Anti-Fatigue Mat</b> 25"D x 2¾"H x 29⅞"W ⓘ Available in Black ONLY. No specification needed. <b>SPECIFYING EXAMPLE: HBEAFM1</b>	<b>HBEAFM1</b>	7.0	1.4	<b>\$219</b>
	<b>Rectangle Anti-Fatigue Mat</b> 20"D x ¾"H x 36"W ⓘ Available in Black ONLY. No specification needed. <b>SPECIFYING EXAMPLE: HBAFM2036</b>	<b>HBAFM2036</b>	5.4	0.4	<b>\$100</b>
	<b>Footrest — Anti-Slip Cover</b> 13¾"D x 5½"H x 16"W ⓘ Available in Black (T) finish ONLY. Recommended weight capacity not to exceed 250 pounds. <b>HON 5-Year Limited Warranty.</b> <b>SPECIFYING EXAMPLE: HVL991.T</b>	<b>HVL991</b>	7.0 ⓘ	0.9	<b>\$82</b>

## HOW TO SPECIFY

<b>Select Model Number</b> H V L 9 8 1 .	<b>Select Finish</b> T Black
---	---------------------------------