

# 10700 SERIES™



10700 Series™ Teaming Workstations shown with Ignition® and Flock® Seating.

## 10700 SERIES™

Talk about a high achiever! The versatile 10700 Series offers a wide selection of layout configurations — making it easy to get the clean, cohesive look your office needs. Designed to withstand frequent moving and reconfiguration, the 10700 Series boasts contract grade high-pressure laminate and a durable inner-frame construction. Whatever the look you go for, this all-around performer is a smart choice.



## FEATURES

- Contoured, solid wood accents and waterfall-shaped edges combine form and function for lasting comfort.
- Make the most of both large and small spaces with flexible storage options that work well together.
- With a variety of mixed materials to choose from, you can customize your look to perfectly match your aesthetic.
- Available in eight woodgrain patterns, our laminate desks are the definition of scratch-, spill- and stain-resistant durability.

# 10700 SERIES™ ORDERING INFORMATION

## LAMINATE FINISHES AVAILABILITY

### L1 LAMINATES ..... CODES

#### Woodgrain

- ◆ Bourbon Cherry ..... **HH**
- ◆ Cognac ..... **COGNCOGN**
- ◆ Harvest ..... **CC**
- ◆ Mahogany ..... **NN**
- ◆ Mocha ..... **MOCHMOCH**
- ◆ Natural Maple ..... **DD**
- ◆ Pinnacle ..... **PINCPINC**
- ◆ Shaker Cherry ..... **FF**

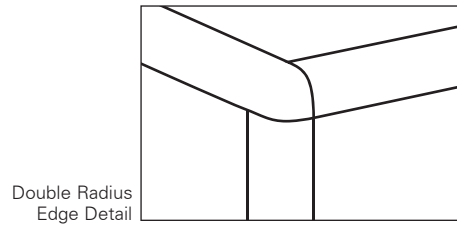

Double Radius  
Edge Detail

◆◆◆ For lead time information see page 19.

# 10700 SERIES™

## Typicals



Icon Legend on page 19

Components used are listed on pages 300-321. Order components individually. Other configurations are possible, including various sizes of some components.

QTY	DESCRIPTION	MODEL	LIST PRICE	PRICE EXTENSION
1	<b>Double Pedestal Desk – 2/2</b> 60"W x 30"D x 29½"H	H10771	\$1,367	\$1,367
1	<b>Credenza with Kneespace – 2/0/2</b> 60"W x 24"D x 29½"H	H10765	\$1,304	\$1,304
<b>TOTAL:</b>			<b>\$2,671</b>	

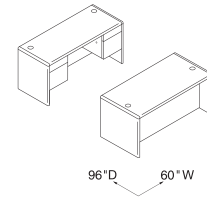

**DESK WORKSTATION**  
**60"W x 96"D**

QTY	DESCRIPTION	MODEL	LIST PRICE	PRICE EXTENSION
1	<b>Corner Unit</b> 24" x 36" x 36" x 24" x 29½"H	H107811	\$1,196	\$1,196
1	<b>Return, Right – B/F</b> 48"W x 24"D x 29½"H	H10715R	\$905	\$905
1	<b>Return, Left – B/F</b> 48"W x 24"D x 29½"H	H10716L	\$905	\$905
1	<b>Stack-on Storage</b> 44⅝"W x 14⅝"D x 37⅞"H	H107313	\$1,067	\$1,067
<b>TOTAL:</b>			<b>\$4,073</b>	

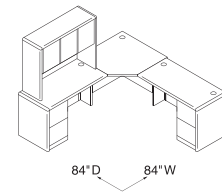

**CORNER "L" WORKSTATION**  
**84"W x 84"D**

QTY	DESCRIPTION	MODEL	LIST PRICE	PRICE EXTENSION
1	<b>Single Pedestal Desk, Left – B/F</b> 72"W x 36"D x 29½"H	H10786L	\$1,346	\$1,346
1	<b>Bridge</b> 47"W x 24"D x 29½"H	H10770	\$409	\$409
1	<b>Credenza with Lateral, Right</b> 72"W x 24"D x 29½"H	H10747R	\$1,626	\$1,626
1	<b>Stack-on Storage</b> 68⅝"W x 14⅝"D x 37⅞"H	H10734	\$1,211	\$1,211
<b>TOTAL:</b>			<b>\$4,592</b>	

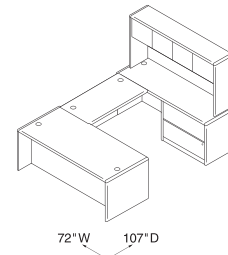

**DESK "U" WORKSTATION – RIGHT**  
**72"W x 107"D**

QTY	DESCRIPTION	MODEL	LIST PRICE	PRICE EXTENSION
1	<b>Double Pedestal Desk – 3/2</b> 72"W x 36"D x 29½"H	H10799	\$2,081	\$2,081
1	<b>Credenza with Storage</b> 72"W x 24"D x 29½"H	H10742	\$2,081	\$2,081
<b>TOTAL:</b>			<b>\$4,162</b>	

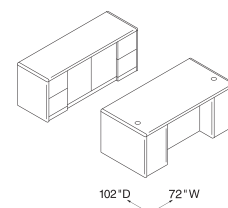

**DESK WORKSTATION WITH  
STORAGE CRENZA**  
**72"W x 102"D**



Icon Legend on page 19

# 10700 SERIES™ Typicals

Components used are listed on pages 300-321. Order components individually. Other configurations are possible, including various sizes of some components.

QTY	DESCRIPTION	MODEL	LIST PRICE	PRICE EXTENSION
1	<b>Double Pedestal Desk – 3/2</b> 72"W x 36"D x 29½"H	H10799	\$2,081	\$2,081
1	<b>Credenza with Kneespace – 2/0/2</b> 72"W x 24"D x 29½"H	H10741	\$1,796	\$1,796
1	<b>Stack-on Storage</b> 68⅝"W x 14⅝"D x 37⅞"H	H10734	\$1,211	\$1,211
1	<b>Wardrobe/Storage Cabinet, Right</b> 18"W x 24"D x 66⅝"H	H107295R	\$1,839	\$1,839
<b>TOTAL:</b>			<b>\$6,927</b>	

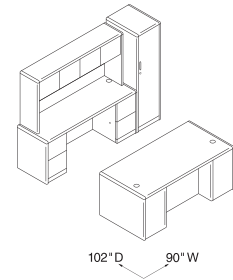

**DESK WORKSTATION**  
**90"W x 102"D**

QTY	DESCRIPTION	MODEL	LIST PRICE	PRICE EXTENSION
1	<b>Peninsula</b> 72"W x 36"D x 29½"H	H10721	\$1,329	\$1,329
1	<b>Return, Left – F/F</b> 42"W x 24"D x 29½"H	H107192L	\$1,092	\$1,092
1	<b>Stack-on Storage</b> 74⅝"W x 14⅝"D x 37⅞"H	H107318	\$1,329	\$1,329
<b>TOTAL:</b>			<b>\$3,750</b>	

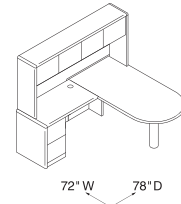

**PENINSULA "L" WORKSTATION – LEFT**  
**72"W x 78"D**

QTY	DESCRIPTION	MODEL	LIST PRICE	PRICE EXTENSION
1	<b>Single Pedestal Desk, Right – B/B/F</b> 66"W x 30"D x 29½"H	H10701R	\$1,651	\$1,651
1	<b>Return, Left – F/F</b> 48"W x 24"D x 29½"H	H10712L	\$1,105	\$1,105
1	<b>Stack-on Storage</b> 74⅝"W x 14⅝"D x 37⅞"H	H107318	\$1,329	\$1,329
1	<b>2-Drawer Lateral File</b> 36"W x 24"D x 29½"H	H107690	\$1,206	\$1,206
<b>TOTAL:</b>			<b>\$5,291</b>	

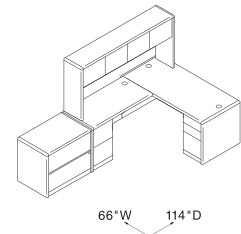

**DESK "L" WORKSTATION – LEFT**  
**66"W x 114"D**

QTY	DESCRIPTION	MODEL	LIST PRICE	PRICE EXTENSION
1	<b>Peninsula</b> 72"W x 36"D x 29½"H	H10721	\$1,329	\$1,329
1	<b>Bridge</b> 47"W x 24"D x 29½"H	H10770	\$409	\$409
1	<b>Credenza Shell with Full Modesty Panel</b> 72"W x 24"D x 29½"H	H107817	\$904	\$904
1	<b>Multi File Pedestal</b> 36"W x 20"D x 28"H	H10505	\$1,249	\$1,249
1	<b>Stack-on Storage</b> 68⅝"W x 14⅝"D x 37⅞"H	H10734	\$1,211	\$1,211
<b>TOTAL:</b>			<b>\$5,102</b>	

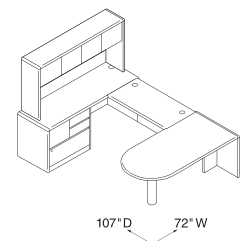

**PENINSULA "U" WORKSTATION – LEFT**  
**72"W x 107"D**

# 10700 SERIES™

## Typicals



Icon Legend on page 19

Components used are listed on pages 300-321. Order components individually. Other configurations are possible, including various sizes of some components.

QTY	DESCRIPTION	MODEL	LIST PRICE	PRICE EXTENSION
1	<b>Single Pedestal Desk, Left - B/B/F</b> 72"W x 36"D x 29½"H	H10788L	\$1,796	\$1,796
1	<b>Bridge</b> 47"W x 24"D x 29½"H	H10770	\$409	\$409
1	<b>Single Pedestal Credenza, Right - F/F</b> 72"W x 24"D x 29½"H	H10707R	\$1,469	\$1,469
1	<b>Stack-on Storage</b> 68⅝"W x 14⅝"D x 37⅞"H	H10734	\$1,211	\$1,211
1	<b>Wardrobe/Storage Cabinet, Right</b> 18"W x 24"D x 66⅝"H	H107295R	\$1,839	\$1,839
<b>TOTAL:</b>			<b>\$6,724</b>	

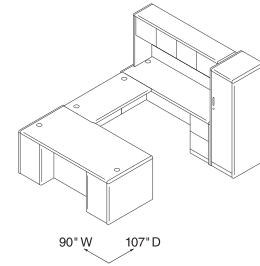

**DESK "U" WORKSTATION - RIGHT**

**90"W x 107"D**

QTY	DESCRIPTION	MODEL	LIST PRICE	PRICE EXTENSION
1	<b>Return Shell, Left</b> 36"W x 24"D x 29½"H	H107802L	\$608	\$608
1	<b>Corner Unit</b> 24" x 36" x 36" x 24" x 29½"H	H107811	\$1,196	\$1,196
1	<b>Return Shell, Right</b> 36"W x 24"D x 29½"H	H107801R	\$608	\$608
1	<b>Stack-on Storage</b> 68⅝"W x 14⅝"D x 37⅞"H	H10734	\$1,211	\$1,211
1	<b>Mobile Pedestal - B/B/F</b> 15¾"W x 22¾"D x 28"H	H105102	\$854	\$854
1	<b>Mobile Pedestal - F/F</b> 15¾"W x 22¾"D x 28"H	H105104	\$854	\$854
<b>TOTAL:</b>			<b>\$5,331</b>	

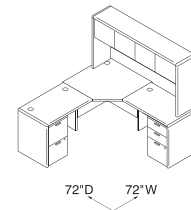

**CORNER 6' X 6' WORKSTATION**

**72"W x 72"D**

QTY	DESCRIPTION	MODEL	LIST PRICE	PRICE EXTENSION
1	<b>Desk Shell</b> 66"W x 30"D x 29½"H	H107826	\$968	\$968
1	<b>Credenza Shell</b> 66"W x 24"D x 29½"H	H107816	\$843	\$843
2	<b>Mobile Pedestal - B/B/F</b> 15¾"W x 22¾"D x 28"H	H105102	\$854	\$1,708
2	<b>Mobile Pedestal - F/F</b> 15¾"W x 22¾"D x 28"H	H105104	\$854	\$1,708
<b>TOTAL:</b>			<b>\$5,227</b>	

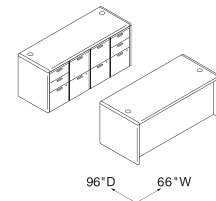

**MODULAR DESK AND CREDEZA**

**66"W x 96"D**

QTY	DESCRIPTION	MODEL	LIST PRICE	PRICE EXTENSION
1	<b>Peninsula</b> 66"W x 30"D x 29½"H	H10722	\$1,161	\$1,161
1	<b>Bridge</b> 42"W x 24"D x 29½"H	H10760	\$394	\$394
1	<b>Corner Unit</b> 24" x 36" x 36" x 24" x 29½"H	H107811	\$1,196	\$1,196
1	<b>Return Shell, Right</b> 42"W x 24"D x 29½"H	H107803R	\$608	\$608
1	<b>Mobile Pedestal - B/B/F</b> 15¾"W x 22¾"D x 28"H	H105102	\$854	\$854
1	<b>Mobile Pedestal - F/F</b> 15¾"W x 22¾"D x 28"H	H105104	\$854	\$854
1	<b>Stack-on Storage</b> 74⅝"W x 14⅝"D x 37⅞"H	H107318	\$1,329	\$1,329
<b>TOTAL:</b>			<b>\$6,396</b>	

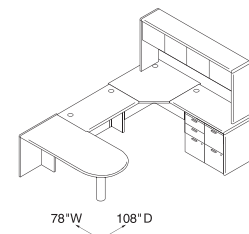

**PENINSULA "U" WITH  
MODULAR COMPONENTS**

**78"W x 108"D**



Icon Legend on page 19

# 10700 SERIES™ Bundles Typicals

## Mahogany H107LL7284N

QTY	DESCRIPTION	MODEL	LIST PRICE	PRICE EXTENSION
1	Left Pedestal Desk	H10786L	\$1,346	\$1,346
1	Right Return	H10715R	\$905	\$905
<b>TOTAL:</b>			<b>\$2,251</b>	

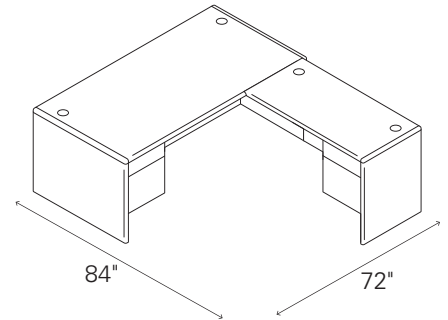

**L-STATION (LEFT DESK, RIGHT RETURN)**

## Mahogany H107LR7284N

QTY	DESCRIPTION	MODEL	LIST PRICE	PRICE EXTENSION
1	Right Pedestal Desk	H10785R	\$1,346	\$1,346
1	Left Return	H10716L	\$905	\$905
<b>TOTAL:</b>			<b>\$2,251</b>	

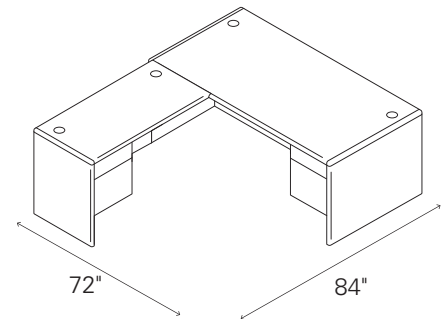

**L-STATION (RIGHT DESK, LEFT RETURN)**

## Mahogany H107UL72108N

QTY	DESCRIPTION	MODEL	LIST PRICE	PRICE EXTENSION
1	Left Pedestal Desk	H10786L	\$1,346	\$1,346
1	Right Pedestal Credenza	H10745R	\$1,181	\$1,181
1	Bridge	H10770	\$409	\$409
<b>TOTAL:</b>			<b>\$2,936</b>	

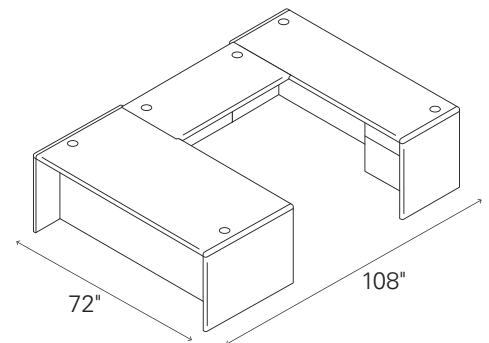

**U-STATION (LEFT DESK, RIGHT CREDENZA)**

# 10700 SERIES™

## Bundles Typicals



Icon Legend on page 19

Mahogany  
H107UR72108N

QTY	DESCRIPTION	MODEL	LIST PRICE	PRICE EXTENSION
1	Right Pedestal Desk	H10785R	\$1,346	\$1,346
1	Left Pedestal Credenza	H10746L	\$1,181	\$1,181
1	Bridge	H10770	\$409	\$409
<b>TOTAL:</b>			<b>\$2,936</b>	

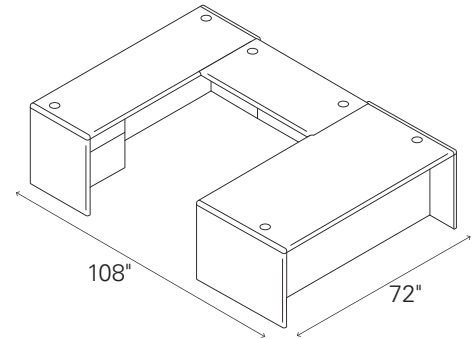

**U-STATION (RIGHT DESK, LEFT CREDENZA)**

Mahogany  
H107LLH7284N

QTY	DESCRIPTION	MODEL	LIST PRICE	PRICE EXTENSION
1	Left Pedestal Desk	H10786L	\$1,346	\$1,346
1	Right Return	H10715R	\$905	\$905
1	Stack-on Storage	H107313	\$1,067	\$1,067
<b>TOTAL:</b>			<b>\$3,318</b>	

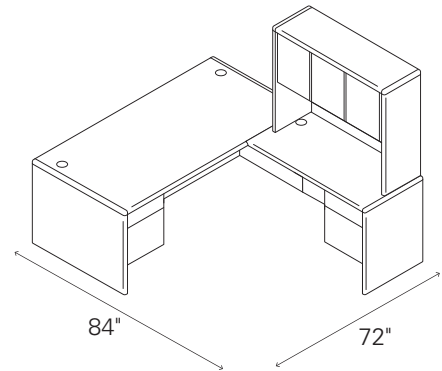

**L-STATION WITH STACK-ON STORAGE  
(LEFT DESK, RIGHT RETURN)**

Mahogany  
H107LRH7284N

QTY	DESCRIPTION	MODEL	LIST PRICE	PRICE EXTENSION
1	Right Pedestal Desk	H10785R	\$1,346	\$1,346
1	Left Return	H10716L	\$905	\$905
1	Stack-on Storage	H107313	\$1,067	\$1,067
<b>TOTAL:</b>			<b>\$3,318</b>	

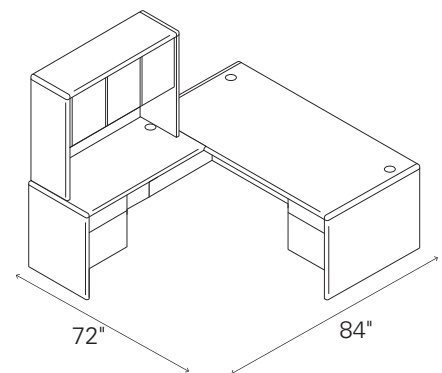

**L-STATION WITH STACK-ON STORAGE  
(RIGHT DESK, LEFT RETURN)**



Icon Legend on page 19

# 10700 SERIES™ Bundles Typicals

DESKS

Mahogany  
H107ULH72108N

QTY	DESCRIPTION	MODEL	LIST PRICE	PRICE EXTENSION
1	Left Pedestal Desk	H10786L	\$1,346	\$1,346
1	Right Pedestal Credenza	H10745R	\$1,181	\$1,181
1	Bridge	H10770	\$409	\$409
1	Stack-on Storage	H10734	\$1,211	\$1,211
<b>TOTAL:</b>			<b>\$4,147</b>	<b>\$4,147</b>

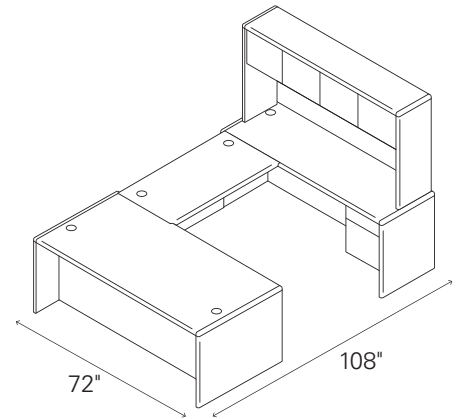

**U-STATION WITH STACK-ON STORAGE  
(LEFT DESK, RIGHT CREDENZA)**

Mahogany  
H107URH72108N

QTY	DESCRIPTION	MODEL	LIST PRICE	PRICE EXTENSION
1	Right Pedestal Desk	H10785R	\$1,346	\$1,346
1	Left Pedestal Credenza	H10746L	\$1,181	\$1,181
1	Bridge	H10770	\$409	\$409
1	Stack-on Storage	H10734	\$1,211	\$1,211
<b>TOTAL:</b>			<b>\$4,147</b>	<b>\$4,147</b>

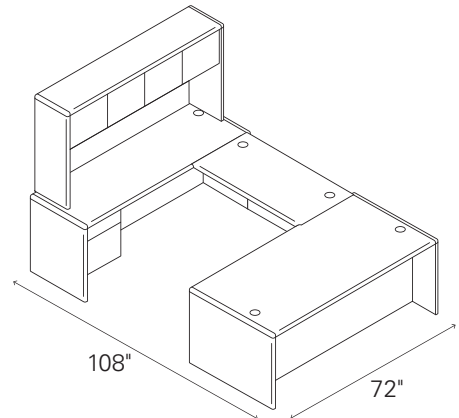

**U-STATION WITH STACK-ON STORAGE  
(RIGHT DESK, LEFT CREDENZA)**



# 10700 SERIES™

## Laminate Modular Components

GSA SIN 33721



Icon Legend on page 19

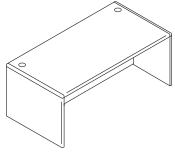

DESCRIPTION	INSIDE DIMENSIONS	FULL WIDTH OVERHANG	MODEL	SHIP WEIGHT	CUBE	LIST PRICE
<b>Desk Shell w/Full Modesty Panel</b>						
72"W x 36"D x 29½"H	69½"W x 24⅝"D	10½"	<b>H107827</b>	213	7.0	<b>\$1094</b>
72"W x 30"D x 29½"H	69½"W x 24⅝"D	4½"	<b>H107829</b>	167	4.7	<b>\$972</b>
66"W x 30"D x 29½"H	63½"W x 24⅝"D	4½"	<b>H107826</b>	175	5.5	<b>\$968</b>
60"W x 30"D x 29½"H	57½"W x 24⅝"D	4½"	<b>H107825</b>	164	5.0	<b>\$838</b>
48"W x 30"D x 29½"H	45½"W x 24⅝"D	4½"	<b>H107824</b>	143	5.0	<b>\$814</b>

NOTES: Can be used freestanding or connected to a 42"W return shell to achieve a space efficient 6' x 6' L-shaped workstation layout. Accepts stack-on storage models H10734, H10734K or H10734G. See page 320 for optional center drawers.

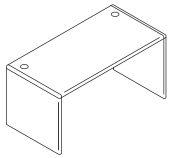

<b>Desk Shell w/10" Modesty Panel</b>						
60"W x 30"D x 29½"H	57½"W x 24⅝"D	4½"	<b>H107825X</b>	161	4.0	<b>\$838</b>

NOTES: Makes reaching wall electrical outlets quick and easy. Provides more than 18" of clearance. Can be used freestanding or connected to a 30"W return shell to achieve a compact 5' x 5' L-shaped workstation layout. Accepts stack-on storage models H10732, H10732K. See page 320 for optional center drawers.

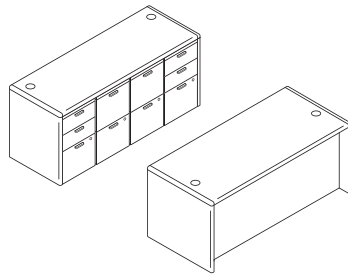

96"D 66"W

1 – H107826  
1 – H107816  
2 – H105102  
2 – H105104

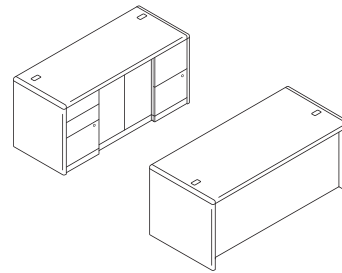

96"D 60"W

1 – H107825  
1 – H107815  
1 – H10508  
1 – H10504  
1 – H10502

! All 10700 Series™ grommets on desk, credenza, credenza shell, return, return shell, bridge and corner unit worksurfaces changed from rectangle-shaped to round, effective November, 2011.

### NOTES:

- Desk, credenza, and return shells, combined with a variety of under-the-worksurface storage solutions, maximize office layout flexibility. Products can be reconfigured quickly and easily when user preferences or space needs change.
- Worksurfaces and end panels feature contract-grade scratch, stain and spill resistant laminate over durable 1⅛" solid core high-performance particleboard; resists warping.
- Contoured hardwood trim; stained to match laminate.
- User friendly waterfall-shaped edges and round corners.
- 3" round cord management grommets, for routing and hiding wires and cables, are located in the tops of desk, credenza, and return shells. Grommets also serve as anchor points for stack-on storage and organizers.
- Grommet can be replaced with optional Power Hub or Power/USB Hub for easy plug-and-play. See page 322.
- Shells utilize 10500 Series™ mobile pedestals or modular pedestals. See pages 258-260.
- See pages 304-305 for modular storage components.

### HOW TO SPECIFY

Select Model Number

H 1 0 7 8 2 7 .



Select Laminate

See page 293

N N

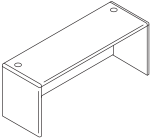
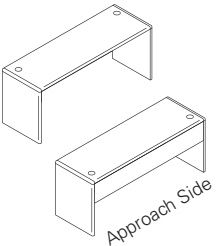

# 10700 SERIES™ Laminate Modular Components

	DESCRIPTION	INSIDE DIMENSIONS	MODEL	SHIP WEIGHT	CUBE	LIST PRICE
	<b>Credenza Shell w/Full Modesty Panel</b>					
	72"W x 24"D x 29½"H	69½"W x 22¾"D	<b>H107817</b>	156	6.0	<b>\$904</b>
	66"W x 24"D x 29½"H	63½"W x 22¾"D	<b>H107816</b>	145	5.5	<b>\$843</b>
	60"W x 24"D x 29½"H	57½"W x 22¾"D	<b>H107815</b>	133	5.0	<b>\$796</b>
	72"W x 20"D x 29½"H	69½"W x 18¾"D	<b>H107837</b>	140	5.3	<b>\$883</b>
	66"W x 20"D x 29½"H	63½"W x 18¾"D	<b>H107836</b>	132	4.8	<b>\$823</b>
	60"W x 20"D x 29½"H	57½"W x 18¾"D	<b>H107835</b>	127	3.8	<b>\$782</b>
	NOTES: One cord pass-through grommet in top center of modesty panel to reach wall electrical outlets. See pages 312-313 for optional stack-on storage.					
	<b>Credenza Shell w/10"H Modesty Panel</b>					
	72"W x 24"D x 29½"H	69½"W x 22¾"D	<b>H107817X</b>	127	6.0	<b>\$904</b>
	66"W x 24"D x 29½"H	63½"W x 22¾"D	<b>H107816X</b>	121	5.5	<b>\$843</b>
	60"W x 24"D x 29½"H	57½"W x 22¾"D	<b>H107815X</b>	115	5.0	<b>\$796</b>
	NOTES: Makes reaching wall electrical outlets quick and easy. Provides more than 18" of clearance. See pages 312-313 for optional stack-on storage.					
	<b>Kneespace Clearance End Panel Kits (field installable)</b>					
	1½"W x 11¼"D x 28⅞"H		<b>H105098</b>	13	0.9	<b>\$210</b>
	For use at either end of 10700, 10500 or Valido Series® 24"D Credenza Shells (with full or 10" modesty panel) or non-pedestal end of single pedestal credenzas or credenzas with lateral files.					
	1⅞"W x 17¼"D x 28⅞"H		<b>H105099</b>	11	0.8	<b>\$220</b>
	For use at either end of 10700, 10500 or Valido Series® 30"D Desk Shells or non-pedestal end of 30"D single pedestal desks.					
	Kits include: (1) support panel; European fastening hardware; flat connector bracket; joint connector bolts with sleeve nuts (for ganging credenza to adjacent worksurface); and adjustable leveling glides. Allows conversion of units currently in the field.					
	NOTES: Can be used to connect up to three 24"D credenzas or 30"D desks in line (requires 4 kits).					
	⚠ Not designed to be used freestanding. Not designed to be used with returns, 36"D desks or desk shells.					
	<b>SPECIFYING EXAMPLE: H105098.N</b>					

**NOTES:**

- Desk, credenza, and return shells, combined with a variety of under-the-worksurface storage solutions, maximize office layout flexibility. Products can be reconfigured quickly and easily when user preferences or space needs change.
- Worksurfaces and end panels feature contract-grade scratch, stain and spill resistant laminate over durable 1/8" solid core high-performance particleboard; resists warping.
- Contoured hardwood trim; stained to match laminate.
- User friendly waterfall-shaped edges and rounded corners.
- Formal, full height or 10" modesty panels.
- Cord management grommets, for routing and hiding wires and cables, are located in the tops of desk, credenza, and return shells. Grommets also serve as anchor points for stack-on storage and organizers.
- Shells utilize 10500 Series™ mobile pedestals or modular pedestals. See pages 258-260.
- See pages 304-305 for modular storage components.

**HOW TO SPECIFY**

<b>Select Model Number</b>	<b>Select Laminate</b>
	See page 293
H 1 0 7 8 1 7 .	N N

# 10700 SERIES™

## Laminate Modular Components

GSA SIN 33721



Icon Legend on page 19

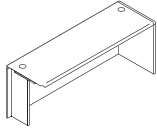

Model H10772R shown

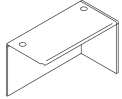

Model H107805R shown

DESCRIPTION	INSIDE DIMENSIONS	MODEL	SHIP WEIGHT	CUBE	LIST PRICE
<b>Right Return Shell w/Full Modesty Panel</b>					
72"W x 24"D x 29½"H, Right (w/support; 2 grommets)	67"W x 22¾"D	<b>H10772R</b>	145	5.6	<b>\$904</b>
60"W x 24"D x 29½"H, Right (w/support; 2 grommets)	55"W x 22¾"D	<b>H107807R</b>	129	4.7	<b>\$796</b>
48"W x 24"D x 29½"H, Right (2 grommets)	47"W x 22¾"D	<b>H107805R</b>	100	4.0	<b>\$637</b>
42"W x 24"D x 29½"H, Right (2 grommets)	41"W x 22¾"D	<b>H107803R</b>	95	3.5	<b>\$608</b>
36"W x 24"D x 29½"H, Right (2 grommets)	34¾"W x 22⅝"D	<b>H107801R</b>	83	3.4	<b>\$608</b>
30"W x 24"D x 29½"H (1 grommet)	28¾"W x 22¾"D	<b>H107725R</b>	69	2.4	<b>\$591</b>
<b>Left Return Shell w/Full Modesty Panel</b>					
72"W x 24"D x 29½"H, Left (w/support; 2 grommets)	67"W x 22¾"D	<b>H107728L</b>	145	5.6	<b>\$904</b>
60"W x 24"D x 29½"H, Left (w/support; 2 grommets)	55"W x 22¾"D	<b>H107808L</b>	129	4.7	<b>\$796</b>
48"W x 24"D x 29½"H, Left (2 grommets)	47"W x 22¾"D	<b>H107806L</b>	100	4.0	<b>\$637</b>
42"W x 24"D x 29½"H, Left (2 grommets)	41"W x 22¾"D	<b>H107804L</b>	95	3.5	<b>\$608</b>
36"W x 24"D x 29½"H, Left (2 grommets)	34¾"W x 22⅝"D	<b>H107802L</b>	83	3.4	<b>\$608</b>
30"W x 24"D x 29½"H (1 grommet)	28¾"W x 22¾"D	<b>H107726L</b>	69	2.4	<b>\$591</b>

NOTES: One cord pass-through grommet in top center of modesty panel to reach wall electrical outlets. Woodgrain direction on modesty/back panel runs vertical on 30"W-60"W sizes and horizontal on 72"W unit. Stack-on model H10734 is sized to be used on the 72"W return shell. Stack-on model H10732 will work on the 60"W return shell. Stack-on storage model H107313 fits on the 48"W return shell. Stack-on storage model H10734 will work on a 36"W return shell attached to the 36" corner unit; attaches to the return shell through the grommet hole and to the corner unit via double-sided tape. 36"W return shell can be used to achieve a 6' x 6' footprint when connected to either a 72"W x 36"D single pedestal desk, desk shell or peninsula, or when two are connected to a 36" corner unit model H107811.

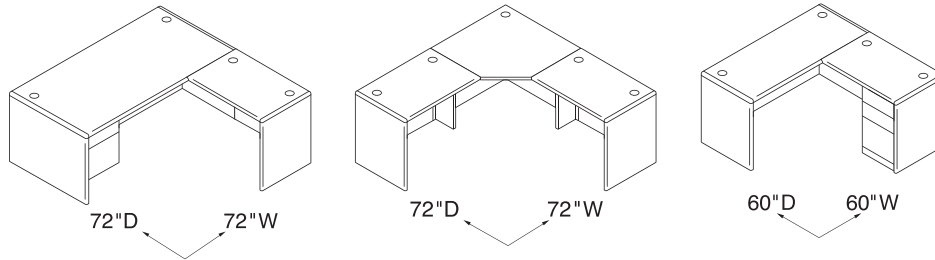

! All 10700 Series™ grommets on desk, credenza, credenza shell, return, return shell, bridge and corner unit worksurfaces changed from rectangle-shaped to round, effective November, 2011.

### NOTES:

- Worksurfaces and end panels feature contract-grade scratch, stain and spill resistant laminate over durable 1½" solid core high-performance particleboard; resists warping.
- Contoured hardwood trim; stained to match laminate.
- User friendly waterfall-shaped edges and rounded corners.
- Formal, full height or 10" modesty panels.
- Cord management grommets, for routing and hiding wires and cables, are located in the tops of desk, credenza, and return shells. Grommets also serve as anchor points for stack-on storage and organizers.
- For work-in-process paper management tools, see page 319.
- For conference table options, see the Preside® table tops and bases on pages 774-779.
- Shells utilize 10500 Series™ mobile pedestals or modular pedestals. See pages 258-260.
- See pages 304-305 for modular storage components.

### HOW TO SPECIFY

Select  
Model Number

H 1 0 7 7 2 7 R .

Select  
Laminate

See page 293

N N

	DESCRIPTION	INSIDE DIMENSIONS	MODEL	SHIP WEIGHT	CUBE	LIST PRICE
	<b>Right Return Shell w/10" H Modesty Panel</b>					
	72"W x 24"D x 29½"H, Right (w/support; 2 grommets)	67"W x 22¾"D	<b>H107727RX</b>	113	5.6	<b>\$904</b>
	60"W x 24"D x 29½"H, Right (w/support; 2 grommets)	55"W x 22¾"D	<b>H107807RX</b>	105	4.7	<b>\$796</b>
	48"W x 24"D x 29½"H, Right (2 grommets)	47"W x 22¾"D	<b>H107805RX</b>	81	4.0	<b>\$637</b>
	42"W x 24"D x 29½"H, Right (2 grommets)	41"W x 22¾"D	<b>H107803RX</b>	78	3.5	<b>\$608</b>
	36"W x 24"D x 29½"H, Right (2 grommets)	34¾"W x 22⅞"D	<b>H107801RX</b>	69	3.4	<b>\$608</b>
	<b>Left Return Shell w/10" H Modesty Panel</b>					
	72"W x 24"D x 29½"H, Left (w/support; 2 grommets)	67"W x 22¾"D	<b>H107728LX</b>	113	5.6	<b>\$904</b>
	60"W x 24"D x 29½"H, Left (w/support; 2 grommets)	55"W x 22¾"D	<b>H107808LX</b>	105	4.7	<b>\$796</b>
	48"W x 24"D x 29½"H, Left (2 grommets)	47"W x 22¾"D	<b>H107806LX</b>	81	4.0	<b>\$637</b>
	42"W x 24"D x 29½"H, Left (2 grommets)	41"W x 22¾"D	<b>H107804LX</b>	78	3.5	<b>\$608</b>
	36"W x 24"D x 29½"H, Left (2 grommets)	34¾"W x 22⅞"D	<b>H107802LX</b>	69	3.4	<b>\$608</b>

NOTES: Makes reaching wall electrical outlets quick and easy. Provides more than 18" of clearance.

	<b>Non-Handed Return Shell w/10" H Modesty Panel</b>					
	30"W x 20"D x 29½"H	28¾"W x 18¾"D	<b>H107270X</b>	47	2.4	<b>\$564</b>

NOTES: Makes reaching wall electrical outlets quick and easy; provides more than 18" of clearance. Ideal for smaller spaces. Connects to single pedestal desks and credenzas, peninsulas, or desk or credenza shells. Designed to fit over 10500 Series™ mobile pedestal models H105106 (box/file) or H105109 (shelf/box/file) and modular pedestal models H105012 (box/box/file) or H105014 (file/file).

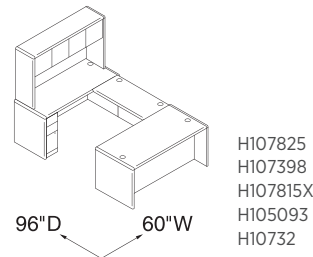
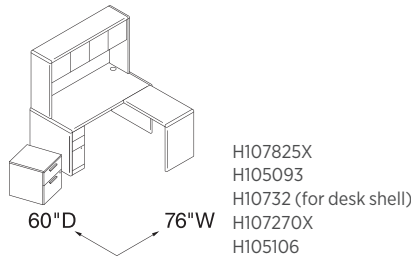

! All 10700 Series™ grommets on desk, credenza, credenza shell, return, return shell, bridge and corner unit worksurfaces changed from rectangle-shaped to round, effective November, 2011.

**NOTES:**

- Worksurfaces and end panels feature contract-grade scratch, stain and spill resistant laminate over durable 1½" solid core high-performance particleboard; resists warping.
- Contoured hardwood trim; stained to match laminate.
- User friendly waterfall-shaped edges and rounded corners.
- Formal, full height or 10" modesty panels.
- 3" round cord management grommets, for routing and hiding wires and cables, are located in the tops of desk, credenza, and return shells. Grommets also serve as anchor points for stack-on storage and organizers.
- Grommet can be replaced with optional Power Hub or Power/USB Hub for easy plug-and-play. See page 322.
- For conference table options, see the Preside® table tops and bases on pages 774-779.
- Shells utilize 10500 Series™ mobile pedestals or modular pedestals. See pages 258-260.
- See pages 304-305 for modular storage components.

! Disperse fabrics not available on 72"W panels.

**HOW TO SPECIFY**

<p>Select Model Number</p> <p>H 1 0 7 7 2 7 R X</p>	<p>Select Laminate</p> <p>See page 293</p> <p>N N</p>
---	---

# 10700 SERIES™

## Laminate Modular Components

GSA SIN 33721

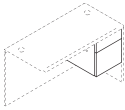
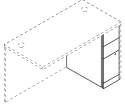
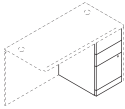
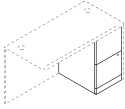
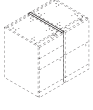

Icon Legend on page 19

	DESCRIPTION	MODEL	SHIP WEIGHT	CUBE	LIST PRICE
	<p><b>Box/File Pedestal (with core removable lock)</b> 15<math>\frac{3}{8}</math>"W x 22<math>\frac{3}{4}</math>"D x 17<math>\frac{3}{4}</math>"H — for use under 24"D, 30"D and 36"D desk, credenza and return shells</p> <p>NOTES: Hangrails included. Lock can be positioned on either the right or left side. Attaches to underside of worksurface top. Not for use under 20"D shells.</p> <p>⚠ Not designed to be used freestanding. Unfinished top and back.</p>	<b>H10501</b>	57	5.5	<b>\$523</b>
	<p><b>Narrow Box/Box/File Pedestal (with core removable lock) — floor-standing</b> 9<math>\frac{1}{2}</math>"W x 22<math>\frac{3}{4}</math>"D x 28"H — for use under 24"D, 30"D and 36"D desk, credenza and return shells</p> <p>NOTES: Compact design is ideal for use in U- and L-shaped layouts for smaller spaces such as 5' x 8' U-workstation or a 5' x 5' L-workstation. Middle box drawer and file drawer lock; top box drawer does not lock. File drawer includes integrated hangrails for side-to-side letter or legal filing. Field installable handle choices for this model are the Sweep, Crescent, and Arch only. Not for use with 20"D shells.</p> <p>⚠ Not designed to be used freestanding; unfinished top and back.</p>	<b>H105093</b>	61	5.6	<b>\$676</b>
	<p><b>Box/Box/File Pedestal (with core removable lock) — floor-standing</b> 15<math>\frac{3}{8}</math>"W x 22<math>\frac{3}{4}</math>"D x 28"H — for use under 24"D, 30"D and 36"D desk, credenza and return shells</p> <p>NOTES: Top box drawer does not lock. Hangrails included. Not for use under 20"D shells.</p> <p>⚠ Not designed to be used freestanding. Unfinished top and back.</p>	<b>H10502</b>	90	8.4	<b>\$686</b>
	<p><b>File/File Pedestal (with core removable lock) — floor-standing</b> 15<math>\frac{3}{8}</math>"W x 22<math>\frac{3}{4}</math>"D x 28"H — for use under 24"D, 30"D and 36"D desk, credenza and return shells</p> <p>NOTES: Hangrails included. Not for use under 20"D shells.</p> <p>⚠ Not designed to be used freestanding. Unfinished top and back.</p>	<b>H10504</b>	85	8.2	<b>\$686</b>
	<p><b>Access Strip (Filler)</b> 1<math>\frac{1}{8}</math>"W x 20<math>\frac{1}{2}</math>"D x 28"H</p> <p>NOTES: For use with B/B/F, F/F, and or P/M/F pedestals are configured side-by-side. Not required when pedestals are used in conjunction with lateral file pedestal, multi file pedestal or cabinet pedestal. Not for use under 20"D shells.</p> <p>⚠ All 10700 Series™ grommets on desk, credenza, credenza shell, return, return shell, bridge and corner unit worksurfaces changed from rectangle-shaped to round, effective November, 2011.</p>	<b>H10524</b>	21	0.9	<b>\$176</b>

**NOTES:**



- Pedestals can be reconfigured quickly and easily when user preferences or space needs change.
- Pedestal models ship assembled unless designated ⚠.
- Locking units equipped with interchangeable core removable locks.
- See pages 300-303 for modular desk, credenza and return shells.
- ⚠ Keyed alike cores must be ordered separately — see page 853.
- ⚠ Pedestals are not designed to be used freestanding. Unfinished top and back.
- ⚠ Access strip (filler) required when full height pedestals are configured side-by-side to allow access for opening the drawers.

**HOW TO SPECIFY**

<b>Select Model Number</b> <input type="text" value="H10501"/>	<b>Select Laminate</b> <input type="text" value="N"/>
See page 293	

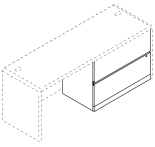
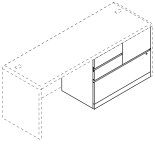
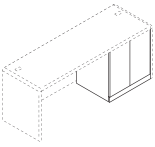

# 10700 SERIES™ Laminate Modular Components

	DESCRIPTION	MODEL	SHIP WEIGHT	CUBE	LIST PRICE
	<p><b>Lateral File Pedestal (with core removable lock) – floor-standing</b> 36"W x 20"D x 28"H — for use under 24"D, 30"D and 36"D desk, credenza and return shells</p> <p>NOTES: Designed for use with credenza or return shells. Hangrails included. Mechanical interlock inhibits extension of more than one drawer at a time. Not for use under 20"D shells.</p> <p>! Not designed to be used freestanding. Unfinished top and back.</p>	<b>H10503</b>	127	15.6	<b>\$1042</b>
	<p><b>Multi File Pedestal (with core removable lock) – floor-standing</b> 36"W x 20"D x 28"H — for use under 24"D, 30"D and 36"D desk, credenza and return shells</p> <p>NOTES: Designed for use with credenza or return shells. Versatile four drawer unit features one lateral file drawer, one vertical file drawer, and two box drawers. Box drawers do not lock. Hangrails included. Mechanical interlock in lateral drawer inhibits extension of more than one drawer at a time. Not for use under 20"D shells.</p> <p>! Not designed to be used freestanding. Unfinished top and back.</p>	<b>H10505</b>	155	15.6	<b>\$1249</b>
	<p><b>Cabinet Pedestal – floor-standing</b> 26"W x 21¼"D x 28"H — for use under 24"D, 30"D and 36"D desk, credenza and return shells</p> <p>NOTES: One adjustable shelf at 2½" increments. For use with credenza or return shells. Doors are non-locking. Not for use under 20"D shells.</p> <p>! Not designed to be used freestanding. Unfinished top and back.</p>	<b>H10508</b>	78	12.2	<b>\$777</b>
	<p><b>Mobile Printer/Fax Cart</b> 20"W x 19⅞"D x 14⅞"H</p> <p>NOTES: Holds laser printers, inkjet printers or fax machines. Ideal for limited space. Low profile cart stores conveniently and easily under desks and workstations. Interior compartment shelving is Black. Four casters. Not for use under 20"D shells. <b>Flat edge profile on top.</b></p> <p><b>SPECIFYING EXAMPLE: H105679.NN</b></p> <p>! All 10700 Series™ grommets on desk, credenza, credenza shell, return, return shell, bridge and corner unit worksurfaces changed from rectangle-shaped to round, effective November, 2011.</p>	<b>H105679</b>	52	2.9	<b>\$420</b>

**NOTES:**

- Pedestals can be reconfigured quickly and easily when user preferences or space needs change.
- Locking units equipped with interchangeable core removable locks.
- See pages 300-303 for modular desk, credenza and return shells.
- ! Keyed alike cores must be ordered separately — see HF23B on page 853.
- ! Pedestals are not designed to be used freestanding. Unfinished top and back.
- ! Access strip (filler) required when full height pedestals are configured side-by-side to allow access for opening the drawers.

**HOW TO SPECIFY**

<b>Select Model Number</b> H 1 0 5 0 3 . N	<b>Select Laminate</b> See page 293
---	--

# 10700 SERIES™

## Laminate Wood Desks — Full Pedestals

GSA SIN 33721



Icon Legend on page 19

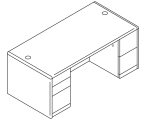

DESCRIPTION	RECESSED MODESTY PANEL	MODEL	SHIP WEIGHT	CUBE	LIST PRICE
<b>Double Pedestal Desk w/Woodgrain Breakfront Modesty Panel — 3/2</b>					
72"W x 36"D x 29½"H	10½"	<b>H10799</b>	371	52.9	<b>\$2081</b>
66"W x 30"D x 29½"H	4½"	<b>H10774</b>	313	40.9	<b>\$2007</b>
60"W x 30"D x 29½"H	4½"	<b>H10773</b>	305	37.3	<b>\$1910</b>
NOTES: All drawers lock. Two worksurface grommets to route/hide cords. See page 320 for optional center drawers.					

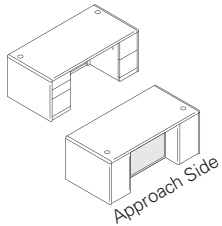

<b>Double Pedestal Desk w/Frosted Breakfront Modesty Panel — 3/2</b>					
72"W x 36"D x 29½"H	10½"	<b>H10799G</b>	366	51.8	<b>\$2550</b>
NOTES: All drawers lock. Two worksurface grommets to route/hide cords. See page 320 for optional center drawers.					

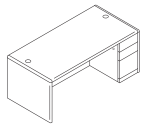

<b>Single Pedestal Desk w/Woodgrain Breakfront Modesty Panel — Box/box/file</b>					
72"W x 36"D x 29½"H, Right	10½"	<b>H10787R</b>	317	52.9	<b>\$1796</b>
66"W x 30"D x 29½"H, Right	4½"	<b>H10701R</b>	270	40.9	<b>\$1651</b>
72"W x 36"D x 29½"H, Left	10½"	<b>H10788L</b>	317	52.9	<b>\$1796</b>
66"W x 30"D x 29½"H, Left	4½"	<b>H10702L</b>	270	40.9	<b>\$1651</b>
NOTES: Drawers lock. Two worksurface grommets to route/hide cords. See page 320 for optional center drawers.					

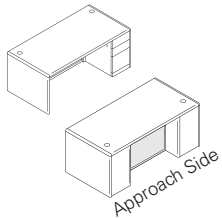

<b>Single Pedestal Desk w/Frosted Breakfront Modesty Panel — Box/box/file</b>					
72"W x 36"D x 29½"H, Right	10½"	<b>H10787RG</b>	313	51.8	<b>\$2265</b>
72"W x 36"D x 29½"H, Left	10½"	<b>H10788LG</b>	313	51.8	<b>\$2265</b>
NOTES: Drawers lock. Two worksurface grommets to route/hide cords. See page 320 for optional center drawers.					

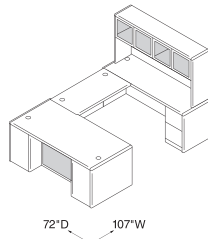

H10788L  
H10770  
H10707R  
H10734G

! All 10700 Series™ grommets on desk, credenza, credenza shell, return, return shell, bridge and corner unit worksurfaces changed from rectangle-shaped to round, effective November, 2011.

### NOTES:

- Worksurfaces and end panels feature contract-grade scratch, stain and spill resistant high-pressure laminate over durable 1/8" solid core high-performance particleboard.
- Contoured hardwood trim; stained to match laminate.
- User friendly waterfall-shaped edges.
- Full-to-floor pedestals maximize storage space.
- Breakfront modesty panel design on full height pedestal desks. See approach side illustration above.
- Grommet can be replaced with optional Power Hub or Power/USB Hub for easy plug-and-play. See page 322.
- All drawers are 5-sided construction, which allows easy drawer alignment or replacement of drawer fronts.
- File drawer design includes integrated handrails for side-to-side letter or legal filing; and front-to-back for letter filing.
- Adjustable hex leveling glides allow floor-standing furniture to be easily leveled without lifting the unit; glides have 3/4" adjustable range.
- Desk, credenza, and return models ship assembled; ready to set in place.
- See pages 310-322 for shared components.

### HOW TO SPECIFY

<b>Select Model Number</b> H 1 0 7 9 9 .	<b>Select Laminate</b> See page 293 N N
---	---



# 10700 SERIES™

## Laminate Wood Desks — Full Pedestals

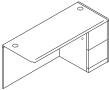
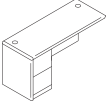
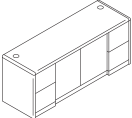
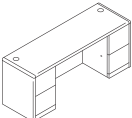
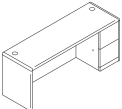
	DESCRIPTION	RECESSED MODESTY PANEL	MODEL	SHIP WEIGHT	CUBE	LIST PRICE
	<b>Return — Right file/file (2 grommets)</b>					
	60"W x 24"D x 29½"H		<b>H10709R</b>	176	29.7	<b>\$1275</b>
	48"W x 24"D x 29½"H		<b>H10711R</b>	158	24.9	<b>\$1105</b>
	42"W x 24"D x 29½"H		<b>H107191R</b>	150	22.1	<b>\$1092</b>
	NOTES: Drawers lock. Two worksurface grommets to route/hide cords and one cord pass-through grommet in top center of modesty panel. See pages 312-313 for optional stack-on storage.					
	⚠ Not designed to be used freestanding.					
	<b>Return — Left file/file (2 grommets)</b>					
	60"W x 24"D x 29½"H		<b>H10710L</b>	176	29.7	<b>\$1275</b>
	48"W x 24"D x 29½"H		<b>H10712L</b>	158	24.9	<b>\$1105</b>
	42"W x 24"D x 29½"H		<b>H107192L</b>	150	22.1	<b>\$1092</b>
	NOTES: Drawers lock. Two worksurface grommets to route/hide cords and one cord pass-through grommet in top center of modesty panel. See pages 312-313 for optional stack-on storage.					
	⚠ Not designed to be used freestanding.					
	<b>Credenza with Doors</b>					
	72"W x 24"D x 29½"H	3½"	<b>H10742</b>	314	36.0	<b>\$2081</b>
	NOTES: All drawers lock. Doors are non-locking. Two worksurface grommets to route/hide cords and one pass-through grommet in top center of modesty panel. Includes a fixed shelf located at the bottom of the center storage area. No intermittent shelf. See pages 312-313 for optional stack-on storage.					
	<b>Credenza with Kneespace — 2/0/2</b>					
	72"W x 24"D x 29½"H	3½"	<b>H10741</b>	280	36.0	<b>\$1796</b>
	66"W x 24"D x 29½"H	3½"	<b>H10768</b>	270	33.4	<b>\$1689</b>
	60"W x 24"D x 29½"H	3½"	<b>H10767</b>	241	28.8	<b>\$1641</b>
	NOTES: All drawers lock. Two worksurface grommets to route/hide cords and one pass-through grommet in top center of modesty panel. See pages 312-313 for optional stack-on storage.					
	⚠ Not designed to be used with 22¾"D modular or mobile pedestals. Modesty/back panel is inset 3½".					
	<b>Single Pedestal Credenza, File/File</b>					
	72"W x 24"D x 29½"H, Right	3½"	<b>H10707R</b>	235	36.3	<b>\$1469</b>
	66"W x 24"D x 29½"H, Right	3½"	<b>H10705R</b>	225	33.4	<b>\$1444</b>
	72"W x 24"D x 29½"H, Left	3½"	<b>H10708L</b>	235	36.3	<b>\$1469</b>
	66"W x 24"D x 29½"H, Left	3½"	<b>H10706L</b>	225	33.4	<b>\$1444</b>
	NOTES: Drawers lock. Two worksurface grommets to route/hide cords and one cord pass-through grommet in top center of modesty panel. See pages 312-313 for optional stack-on storage.					
	⚠ Not designed to be used with 22¾"D modular or mobile pedestals. Modesty/back panel is inset 3½".					
	⚠ All 10700 Series™ grommets on desk, credenza, credenza shell, return, return shell, bridge and corner unit worksurfaces changed from rectangle-shaped to round, effective November, 2011.					

**NOTES:**

- Worksurfaces and end panels feature contract-grade scratch, stain and spill resistant high-pressure laminate over durable 1/8" solid core high-performance particleboard.
- Contoured hardwood trim; stained to match laminate.
- User friendly waterfall-shaped edges.
- Full-to-floor pedestals maximize storage space.
- Breakfront modesty panel design on full height pedestal desks. See approach side illustration on page 306.
- Cord management grommets serve as anchor points for stack-on storage and organizers.
- All drawers are 5-sided construction, which allows easy drawer alignment or replacement of drawer fronts.
- File drawer design includes integrated hangrails for side-to-side letter or legal filing; and front-to-back for letter filing.
- Adjustable hex leveling glides allow floor-standing furniture to be easily leveled without lifting the unit; glides have 3/4" adjustable range.
- Desk, credenza, and return models ship assembled; ready to set in place.
- For work-in-process paper management tools, see page 319.
- See pages 310-322 for shared components.

**HOW TO SPECIFY**

<b>Select Model Number</b>	<b>Select Laminate</b>
H 1 0 7 0 9 R .	See page 293
	N N



# 10700 SERIES™

## Laminate Wood Desks — 3/4 Pedestals

GSA SIN 33721

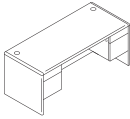
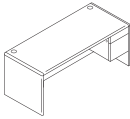
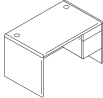
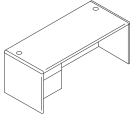
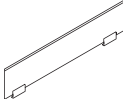

Icon Legend on page 19

	DESCRIPTION	FULL WIDTH OVERHANG	MODEL	SHIP WEIGHT	CUBE	LIST PRICE
	<b>Double Pedestal Desk, 2-2</b>					
	72"W x 36"D x 29½"H	10½"	<b>H10791</b>	340	52.9	<b>\$1625</b>
	66"W x 30"D x 29½"H	4½"	<b>H10775</b>	290	40.9	<b>\$1552</b>
	60"W x 30"D x 29½"H	4½"	<b>H10771</b>	266	37.4	<b>\$1367</b>
	NOTES: All drawers lock. Two worksurface grommets to route/hide cords. See page 320 for optional center drawers.					
	<b>Single Pedestal Desk, Right box/file</b>					
	72"W x 36"D x 29½"H	10½"	<b>H10785R</b>	279	52.9	<b>\$1346</b>
	66"W x 30"D x 29½"H	4½"	<b>H10783R</b>	239	41.0	<b>\$1228</b>
	NOTES: Drawers lock. Two worksurface grommets to route/hide cords. See page 320 for optional center drawers.					
	<b>Small Office Desk, 3/4 Pedestal, Right box/file</b>					
	48"W x 30"D x 29½"H		<b>H107885R</b>	191	30.2	<b>\$1126</b>
	NOTES: Footprint is ideal for limited space. Drawers lock. Two cord management grommets in the top. 3/4 height modesty panel facilitates reaching wall electrical outlets. Optional stack-on storage model H107313 maximizes storage space. See page 320 for optional center drawers.					
	<b>Single Pedestal Desk, Left box/file</b>					
	72"W x 36"D x 29½"H	10½"	<b>H10786L</b>	279	52.9	<b>\$1346</b>
	66"W x 30"D x 29½"H	4½"	<b>H10784L</b>	239	41.0	<b>\$1228</b>
	NOTES: Drawers lock. Two worksurface grommets to route/hide cords. See page 320 for optional center drawers.					
<p>! All 10700 Series™ grommets on desk, credenza, credenza shell, return, return shell, bridge and corner unit worksurfaces changed from rectangle-shaped to round, effective November, 2011.</p>						
	<b>Above Privacy Screen</b>					
	60"W x 13"H		<b>HLSL1260</b>	24	2.9	<b>\$453</b>
	54"W x 13"H		<b>HLSL1254</b>	22	2.9	<b>\$421</b>
	48"W x 13"H		<b>HLSL1248</b>	20	2.3	<b>\$394</b>
	42"W x 13"H		<b>HLSL1242</b>	18	2.3	<b>\$344</b>
	36"W x 13"H		<b>HLSL1236</b>	15	1.8	<b>\$308</b>
	30"W x 13"H		<b>HLSL1230</b>	13	1.5	<b>\$279</b>
	NOTES: Ships complete with attachment bracket. Bracket is Platinum only, no need to specify. Attaches to top of rectangle worksurfaces; requires a minimum overhang of 1½".					
	! Available in Frosted Glass ONLY HLSL1230.G.					
	! Above only Privacy Screen clamps onto worksurface and cannot be installed where support storage will be attached.					

**NOTES:**

- Worksurfaces and end panels feature contract-grade scratch, stain and spill resistant high-pressure laminate over durable 1½" solid core high-performance particleboard.
- Contoured hardwood trim; stained to match laminate.
- User friendly waterfall-shaped edges and rounded corners.
- 3/4 pedestal design increases budget flexibility.
- Formal, full height modesty panels.
- Drawers operate on full extension, ball-bearing suspensions to ensure smooth, quiet, long-lasting operation.
- All drawers are 5-sided construction, which allows easy drawer alignment or replacement of drawer fronts.
- File drawer design includes integrated hangrails for side-to-side letter or legal filing; and front-to-back for letter filing.
- Grommet can be replaced with optional Power Hub or Power/USB Hub for easy plug-and-play. See page 322.
- Adjustable hex leveling glides allow floor-standing furniture to be easily leveled without lifting the unit; glides have ¾" adjustable range.
- Desk, credenza, and return models ship assembled; ready to set in place.
- Center drawers conveniently store writing instruments, paper and other miscellaneous items. Includes pencil tray. See page 320.
- See pages 310-322 for shared components.

**HOW TO SPECIFY**

<b>Select Model Number</b>	<b>Select Laminate</b>
H 1 0 7 9 1 .	See page 293
	N N



# 10700 SERIES™

## Laminate Wood Desks — 3/4 Pedestals

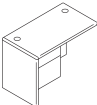
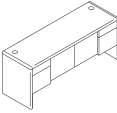
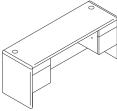
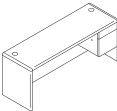
	DESCRIPTION	FULL WIDTH OVERHANG	MODEL	SHIP WEIGHT	CUBE	LIST PRICE
 <p>Model H10717R shown</p>	<b>Return — Right box/file (2 grommets)</b>					
	60"W x 24"D x 29½"H		<b>H10717R</b>	173	29.7	<b>\$1025</b>
	48"W x 24"D x 29½"H		<b>H10715R</b>	147	25.3	<b>\$905</b>
	42"W x 24"D x 29½"H		<b>H107193R</b>	136	22.1	<b>\$881</b>
	NOTES: Drawers lock. Two worksurface grommets and one cord pass-through grommet in top center of modesty panel. See pages 312-313 for optional stack-on storage.					
	⚠ Not designed to be used freestanding.					
 <p>Model H10716L shown</p>	<b>Return — Left box/file (2 grommets)</b>					
	60"W x 24"D x 29½"H		<b>H10718L</b>	173	29.7	<b>\$1025</b>
	48"W x 24"D x 29½"H		<b>H10716L</b>	147	25.3	<b>\$905</b>
	42"W x 24"D x 29½"H		<b>H107194L</b>	136	22.1	<b>\$881</b>
	NOTES: Drawers lock. Two worksurface grommets and one cord pass-through grommet in top center of modesty panel to reach wall electrical outlets. See pages 312-313 for optional stack-on storage.					
	⚠ Not designed to be used freestanding.					
	<b>Credenza with Doors</b>	3½"	<b>H10744</b>	278	36.0	<b>\$1638</b>
	72"W x 24"D x 29½"H					
	NOTES: All drawers lock. Hinged doors are non-locking. Two worksurface grommets and one cord pass-through grommet in top center of modesty panel to reach wall electrical outlets. Includes a fixed shelf located at the bottom of the center storage area. No intermittent shelf. See pages 312-313 for optional stack-on storage.					
	<b>Credenza with Kneespace</b>					
	72"W x 24"D x 29½"H	3½"	<b>H10743</b>	243	36.3	<b>\$1461</b>
	66"W x 24"D x 29½"H	3½"	<b>H10766</b>	234	33.4	<b>\$1365</b>
	60"W x 24"D x 29½"H	3½"	<b>H10765</b>	229	28.8	<b>\$1304</b>
	NOTES: Drawers lock. Two worksurface grommets and one cord pass-through grommet in top center of modesty panel to reach wall electrical outlets. See pages 312-313 for optional stack-on storage.					
	⚠ Not designed to be used with 22¾"D modular or mobile pedestals. Modesty/back panel is inset 3½".					
	<b>Single Pedestal Credenza, Box/File</b>					
	72"W x 24"D x 29½"H, Right	3½"	<b>H10745R</b>	212	36.0	<b>\$1181</b>
	66"W x 24"D x 29½"H, Right	3½"	<b>H10763R</b>	203	33.4	<b>\$1161</b>
	72"W x 24"D x 29½"H, Left	3½"	<b>H10746L</b>	212	36.0	<b>\$1181</b>
	66"W x 24"D x 29½"H, Left	3½"	<b>H10764L</b>	203	33.4	<b>\$1161</b>
	NOTES: Drawers lock. Two worksurface grommets and one cord pass-through grommet in top center of modesty panel to reach wall electrical outlets. See pages 312-313 for optional stack-on storage.					
	⚠ Not designed to be used with 22¾"D modular or mobile pedestals. Modesty/back panel is inset 3½".					
	⚠ All 10700 Series™ grommets on desk, credenza, credenza shell, return, return shell, bridge and corner unit worksurfaces changed from rectangle-shaped to round, effective November, 2011.					

**NOTES:**

- Worksurfaces and end panels feature contract-grade scratch, stain and spill resistant high-pressure laminate over durable 1½" solid core high-performance particleboard.
- Contoured hardwood trim; stained to match laminate.
- User friendly waterfall-shaped edges and rounded corners.
- 3/4 pedestal design increases budget flexibility.
- Formal, full height modesty panels.
- Cord management grommets also serve as anchor points for stack-on storage and organizers.
- All drawers are 5-sided construction, which allows easy drawer alignment or replacement of drawer fronts.
- File drawer design includes integrated hangrails for side-to-side letter or legal filing; and front-to-back for letter filing.
- Adjustable hex leveling glides allow floor-standing furniture to be easily leveled without lifting the unit; glides have ¾" adjustable range.
- Desk, credenza, and return models ship assembled; ready to set in place.
- For work-in-process paper management tools, see page 319.
- See pages 310-322 for shared components.

**HOW TO SPECIFY**

<b>Select Model Number</b>	<b>Select Laminate</b>
See page 293	See page 293
H 1 0 7 4 5 R .	N N



# 10700 SERIES™

## Shared Components and Accessories

GSA SIN 33721

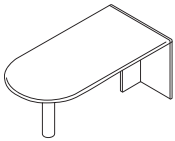

Icon Legend on page 19

	DESCRIPTION	MODEL	SHIP WEIGHT	CUBE	LIST PRICE
	<b>Peninsula w/End Panel and Steel Support Column</b> 72"W x 36"D x 29½"H 66"W x 30"D x 29½"H  NOTES: Use for "U" or "L" configuration. Cord routing notch in brace panel. Round support column is black. Peninsula models H10721 and H10722 ship complete with end panel and black 4½" diameter support column. For a silver support column option, please see model HPC191X on page 251 (ordered separately).	<b>H10721</b>	150	15.1	<b>\$1329</b>
		<b>H10722</b>	125	11.8	<b>\$1161</b>
	<b>Field Installable Laminate Modesty Panel</b> 50¼"W x ¾"Thick x 18"H  NOTES: Center drawer model H1522 can be used in conjunction with modesty panel. Cord pass-through notch in top corner of modesty panel. See page 320 for optional center drawers.  ! Not designed to attach to peninsulas manufactured prior to 12/1/2001. <b>SPECIFYING EXAMPLE: H10528.N</b>	<b>H10528</b>	25	1.3	<b>\$188</b>
	<b>Field Installable Modesty Panel, Frosted with Silver Frame</b> 50¼"W x ¾"Thick x 18"H — for use on 72"W peninsulas  ! Center drawers not designed to be used with the frosted/silver modesty panel.	<b>HPC180G</b>	33	1.5	<b>\$694</b>

**NOTES:**

- Shared components on this page can be used with modular, full pedestal, and ¾ pedestal models shown on pages 300-309.
  - Multi file is a versatile four drawer unit featuring two box drawers, one file drawer, and one lateral file drawer with mechanical interlock.
  - Cord management grommets, for routing and hiding wires and cables, are located in the tops of desks, credenzas, and returns. Grommets also serve as anchor points for stack-on storage and organizers.
  - Cord pass-through grommet located in the back/modesty panel of returns, bridges and credenzas, facilitates reaching wall electrical outlets.
  - All drawers are 5-sided construction, which allows easy drawer alignment or replacement of drawer fronts.
  - Locking units equipped with interchangeable core removable locks.
  - Stack-on storage attaches with two removable mounting brackets.
  - Adjustable hex leveling glides allow floor-standing furniture to be easily leveled without lifting the unit; glides have ¾" adjustable range.
  - See pages 310-322 for shared components.
- ! Keyed alike cores must be ordered separately — see page 853.

**HOW TO SPECIFY**

<b>Select Model Number</b> H 1 0 7 2 1 .	<b>Select Laminate</b> See page 293 N N
---	---



	DESCRIPTION	MODEL	SHIP WEIGHT	CUBE	LIST PRICE
	<p><b>Corner Unit</b> 24" x 36" x 36" x 24" x 29½"H - (1 grommet in top) Works with 24"D x 29½"H returns or bridges.</p> <p>NOTES: The corner unit has rounded, solid wood trim on the front and back. Return and bridge connections are inset inside the wood profiles, per the drawing shown. Support legs feature cutouts for routing cords. Can be used freestanding.</p>	<b>H107811</b>	136	4.2	<b>\$1196</b>

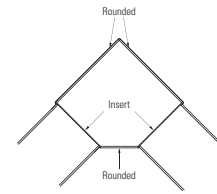
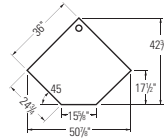

	DESCRIPTION	FULL WIDTH OVERHANG	MODEL	SHIP WEIGHT	CUBE	LIST PRICE
	<p><b>Bridge (Single Ped. Desk, Desk Shell or Peninsula to Corner Unit or Single Ped. Credenza or Credenza Shell)</b></p> <p>47"W x 24"D x 29½"H, (Clear inside depth = 22¾"D) 42"W x 24"D x 29½"H, (Clear inside depth = 22¾"D) 36"W x 24"D x 29½"H, (Clear inside depth = 22¾"D) (for use with Corner Units) 47"W x 20"D x 29½"H, (Clear inside depth = 18¾"D) 42"W x 20"D x 29½"H, (Clear inside depth = 18¾"D)</p> <p>NOTES: Two cord grommets in top; one cord pass-through grommet in top center of modesty panel. Grommets can be replaced with optional Power Hub or Power/USB Hub for easy plug-and-play (see page 322). Kneespace of desk limited to 24¾"W if bridge is used with 66"W single pedestal desk.</p>		<p><b>H10770</b> 81 2.5 <b>\$409</b>  <b>H10760</b> 69 2.6 <b>\$394</b>  <b>H10751</b> 64 2.5 <b>\$390</b>  <b>H107399</b> 68 2.8 <b>\$394</b>  <b>H107398</b> 56 2.6 <b>\$381</b></p>			

	<p><b>Credenza with 36" Lateral (with core removable lock) - 2 cord grommets in top</b></p> <p>72"W x 24"D x 29½"H, Right 3½" 72"W x 24"D x 29½"H, Left 3½"</p> <p>NOTES: One cord pass-through grommet in top center of modesty panel. Mechanical interlock inhibits the extension of more than one drawer at a time. Optional stack-on models H10734, H10734K, and H10734G maximize storage space.</p> <p>⚠ Not designed to be used with 22¾"D modular or mobile pedestals. Modesty/back panel is inset 3½".</p>	<p><b>H10747R</b> 247 36.0 <b>\$1626</b>  <b>H10748L</b> 247 36.0 <b>\$1626</b></p>
--	--	---

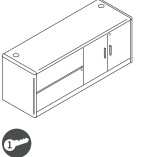
	<p><b>Credenza with Lateral File, Left and Storage Cabinet, Right</b></p> <p>72"W x 24"D x 29½"H 3½"</p> <p>NOTES: Lateral file is equipped with mechanical interlock to inhibit the extension of more than one drawer at a time. Storage cabinet has one adjustable interior shelf which adjusts in 1¼" increments over a range of 5". Drawers and doors lock separately; the two locks are keyed alike. Can be used with optional stack-on storage. See page 312 for Stack-on Storage models H10734/H10734K/H10734G.</p>	<p><b>H107492</b> 307 35.6 <b>\$2016</b></p>
---	--	--

**NOTES:**

- Cord management grommets, for routing and hiding wires and cables, are located in the tops of desks, credenzas, and returns. Grommets also serve as anchor points for stack-on storage and organizers.
- Cord pass-through grommet located in the back/modesty panel of returns, bridges and credenzas, facilitates reaching wall electrical outlets.
- All drawers are 5-sided construction, which allows easy drawer alignment or replacement of drawer fronts.
- Locking units equipped with interchangeable core removable locks.
- Stack-on storage attaches with two removable mounting brackets.
- Adjustable hex leveling glides allow floor-standing furniture to be easily leveled without lifting the unit; glides have ¾" adjustable range.
- See pages 310-322 for shared components.

**HOW TO SPECIFY**

<p>Select Model Number</p> <p>H 1 0 7 7 0 .</p>	<p>Select Laminate</p> <p>See page 293</p> <p>N N</p>
---	---

# 10700 SERIES™

## Shared Components and Accessories

GSA SIN 33721

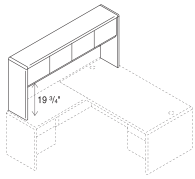

Icon Legend on page 19

**DESCRIPTION****Stack-on Storage for "L" Workstation**

74<sup>5</sup>/<sub>8</sub>"W x 14<sup>5</sup>/<sub>8</sub>"D x 37<sup>1</sup>/<sub>8</sub>"H  
(Use Task Light model HH870960, see page 321)

**Stack-on Storage for "L" Workstation, Locking**

74<sup>5</sup>/<sub>8</sub>"W x 14<sup>5</sup>/<sub>8</sub>"D x 37<sup>1</sup>/<sub>8</sub>"H  
(Use Task Light model HH870960, see page 321)

NOTES: Spans the total depth dimension of configurations comprised of: 48"W return or return shell attached to a 30"D single pedestal desk, desk shell or peninsula (78"D); 42"W return or return shell attached to a 36"D single pedestal desk, desk shell or peninsula (78"D) or 42"W return or return shell attached to a 36" corner unit (78"D). Attaches to desk, peninsula, or corner unit via double-sided tape, and to return through grommet hole. Inside storage consists of two compartments each 34<sup>3</sup>/<sub>4</sub>"W x 12<sup>1</sup>/<sub>8</sub>"D x 12"H. Use back enclosure model H107358 and tackboard model H90035. For vertical paper manager, see page 319.

**MODEL****SHIP WEIGHT****CUBE****LIST PRICE****H107318**

198

15.8

**\$1329****H107318K**

198

15.8

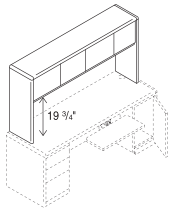
**\$1412****Stack-on Storage**

68<sup>5</sup>/<sub>8</sub>"W x 14<sup>5</sup>/<sub>8</sub>"D x 37<sup>1</sup>/<sub>8</sub>"H, 4 doors (For 72"W Credenza)

62<sup>5</sup>/<sub>8</sub>"W x 14<sup>5</sup>/<sub>8</sub>"D x 37<sup>1</sup>/<sub>8</sub>"H, 4 doors (For 66"W Credenza)

56<sup>5</sup>/<sub>8</sub>"W x 14<sup>5</sup>/<sub>8</sub>"D x 37<sup>1</sup>/<sub>8</sub>"H, 4 doors (For 60"W Credenza or Return)

44<sup>5</sup>/<sub>8</sub>"W x 14<sup>5</sup>/<sub>8</sub>"D x 37<sup>1</sup>/<sub>8</sub>"H, 3 doors (For 48"W Return or 48"W Small Office Desk)

**Stack-on Storage, Locking**

68<sup>5</sup>/<sub>8</sub>"W x 14<sup>5</sup>/<sub>8</sub>"D x 37<sup>1</sup>/<sub>8</sub>"H, 4 doors (For 72"W Credenza)

62<sup>5</sup>/<sub>8</sub>"W x 14<sup>5</sup>/<sub>8</sub>"D x 37<sup>1</sup>/<sub>8</sub>"H, 4 doors (For 66"W Credenza)

56<sup>5</sup>/<sub>8</sub>"W x 14<sup>5</sup>/<sub>8</sub>"D x 37<sup>1</sup>/<sub>8</sub>"H, 4 doors (For 60"W Credenza or Return)

44<sup>5</sup>/<sub>8</sub>"W x 14<sup>5</sup>/<sub>8</sub>"D x 37<sup>1</sup>/<sub>8</sub>"H, 3 doors (For 48"W Return or 48"W Small Office Desk)

NOTES: Inside storage for H10734, H10733 and H10732 contains two compartments each sized: 32<sup>1</sup>/<sub>2</sub>"W, 28<sup>3</sup>/<sub>4</sub>"W, 25<sup>3</sup>/<sub>4</sub>"W respectively x 12<sup>7</sup>/<sub>8</sub>"D x 12"H. H107313 has 3 doors. Inside storage for H107313 contains two compartments: right side 12<sup>7</sup>/<sub>8</sub>"W, left side 26<sup>3</sup>/<sub>4</sub>"W respectively x 12<sup>7</sup>/<sub>8</sub>"D x 12"H. Stack-ons attach through grommet holes on the worksurfaces of desks, credenzas and returns. Model 10734 can be used for "L" configuration comprised of 30"D desk, desk shell or peninsula and 42"W return or return shell; or a 36"D desk, desk shell, peninsula or corner unit and 36"W return shell. Model H107313K has one lock which secures two of the three doors. For task light and vertical paper manager, see pages 319 and 321.

**H10734**

175

16.0

**\$1211****H10733**

168

14.4

**\$1195****H10732**

161

13.0

**\$1161****H107313**

147

10.3

**\$1067****H10734K**

175

16.0

**\$1294****H10733K**

168

14.4

**\$1279****H10732K**

161

13.0

**\$1244****H107313K**

147

10.3

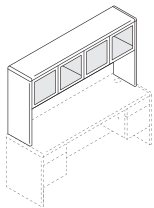
**\$1109****Stack-on Storage w/Frosted Doors w/Silver Frame**

68<sup>5</sup>/<sub>8</sub>"W x 14<sup>5</sup>/<sub>8</sub>"D x 37<sup>1</sup>/<sub>8</sub>"H

**H10734G**

185

16.2

**\$1836**

NOTES: Rich woodgrain laminate and contemporary frosted doors with silver frames add a sleek mixed materials option to 10700 Series™. Accepts back enclosure model H10738, tackboard for use with back enclosure model H90034, task light HH870960 and vertical paper manager HVLPM1. Frosted door models are non-locking.

**NOTES:**

- Shared components on this page can be used with modular, full pedestal, and 3/4 pedestal models shown on pages 300-309.
- Stack-on storage models are equipped with self closing, adjustable hinged doors, and valance to hide task light.
- When spanning the total depth of an L-workstation, stack-on storage attaches to the desk, peninsula or corner unit via double-sided tape, and to the return through the grommet hole.
- Stack-on storage end panels are
- Stack-on storage and organizers attach with two removable mounting brackets, except for "L" workstation unit.
- Stacked paper management segments and organizes stack-on storage compartments and bookcase shelves. Unit can be used in stack-on storage models H107318 and H10734. See HLVPM2 on page 319.
- Vertical paper manager keeps papers, files, and books neatly organized and within easy reach from a seated position. Fits under stack-on storage models. See page 319.
- See pages 310-322 for shared components.

Upcharges may apply to premium tackboard fabric grades.

Removable lock core kit for locking stack-on storage is model HF27B. See page 853.

**HOW TO SPECIFY**

Select Model Number

H 1 0 7 3 4 .

Select Laminate

See page 293

N N



# 10700 SERIES™

## Shared Components and Accessories

	DESCRIPTION	MODEL	COM	SHIP WEIGHT	CUBE	LIST PRICE
 18 5/8" H	<b>Back Enclosure for Stack-on Storage</b>					
	72 1/4" W - for 74 5/8" W model #H107318/H107318K	<b>H107358</b>		34	1.3	<b>\$273</b>
	66 1/4" W - for 68 5/8" W model #H10734/H10734K	<b>H10738</b>		31	1.3	<b>\$251</b>
	60 1/4" W - for 62 5/8" W model #H10733/H10733K	<b>H10737</b>		29	1.3	<b>\$233</b>
	54 1/4" W - for 56 5/8" W model #H10732/H10732K	<b>H10736</b>		27	1.3	<b>\$223</b>
	42 1/4" W - for 44 5/8" W model #H107313/H107313K	<b>H107353</b>		22	0.9	<b>\$223</b>
	NOTES: Non-tackable. Specify laminate. Features full width 1 1/8" slot at bottom to facilitate routing cords and reaching wall electrical outlets. H10738 can also be used with H10634 and H94234 stack-ons.					
 18" H	<b>Tackboards for use with Stack-on Back Enclosures (Back Enclosures must be ordered separately.)</b>					
	71 1/2" W - for 74 5/8" W model #H107318/H107318K Hutch with #H107358 Enclosure	<b>H90035</b>	2.0	13	2.8	<b>\$326</b>
	65 1/4" W - for 68 5/8" W model #H10734/H10734K Hutch with #H10738 Enclosure	<b>H90034</b>	2.0	11	2.0	<b>\$310</b>
	59 1/4" W - for 62 5/8" W model #H10733/H10733K Hutch with #H10737 Enclosure	<b>H90033</b>	2.0	10	1.8	<b>\$295</b>
	53 1/4" W - for 56 5/8" W model #H10732/H10732K Hutch with #H10736 Enclosure	<b>H90032</b>	2.0	9	1.8	<b>\$259</b>
	41 1/2" W - for 44 5/8" W model #H107313/H107313K Hutch with #H107353 Enclosure	<b>H90031</b>	2.0	7	1.7	<b>\$248</b>
	NOTES: Tackboards are sized 3/4" narrower than respective stack-on storage back enclosure, allowing 3/8" each side to route task light cords. Specify fabric selection from pages 25-26. Board is attached using latch & hook tape provided. H90034 can also be used with H10738 on H10634 and H94234 stack-ons.					
<p>ⓘ Disperse (DISP) fabric not available on sizes wider than 60".</p> <p><b>SPECIFYING EXAMPLE: H90035.APN15</b></p>						

**NOTES:**

- Shared components on this page can be used with modular, full pedestal, and 3/4 pedestal models shown on pages 300-309.
- Stacked paper management segments and organizes stack-on storage compartments and bookcase shelves. Unit can be used in stack-on storage models H107318 and H10734. See HLVPM2 on page 319.
- Vertical paper manager keeps papers, files, and books neatly organized and within easy reach from a seated position. Fits under stack-on storage models. See page 319.
- See pages 310-322 for shared components.

ⓘ Upcharges may apply to premium tackboard fabric grades.

**HOW TO SPECIFY**

<b>Select Model Number</b> H 1 0 7 3 5 8 .	<b>Select Laminate</b> See page 293 N
---	---





# 10700 SERIES™

## Shared Components and Accessories

GSA SIN 33721

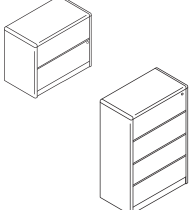
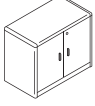
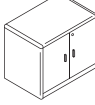
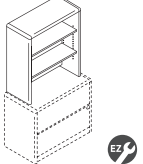

Icon Legend on page 19

	DESCRIPTION	MODEL	SHIP WEIGHT	CUBE	LIST PRICE
	<b>Box/Box/File Mobile Pedestal (with core removable lock)</b> 15 $\frac{3}{4}$ "W x 22 $\frac{3}{4}$ "D x 28 $\frac{5}{8}$ "H — use freestanding or under 24"D, 30"D and 36"D modular shells NOTES: Top box drawer does not lock. File drawer includes hangrails.	<b>H105102</b>	121	8.5	<b>\$854</b>
	<b>File/File Mobile Pedestal (with core removable lock)</b> 15 $\frac{3}{4}$ "W x 22 $\frac{3}{4}$ "D x 28 $\frac{5}{8}$ "H — use freestanding or under 24"D, 30"D and 36"D modular shells NOTES: File drawers include hangrails.	<b>H105104</b>	121	8.4	<b>\$854</b>
	<b>Box/File Mobile Pedestal (with core removable lock)</b> 15 $\frac{3}{4}$ "W x 18 $\frac{1}{8}$ "D x 21 $\frac{1}{8}$ "H — use freestanding or under 20"D, 24"D, 30"D and 36"D modular shells	<b>H105106</b>	65	5.8	<b>\$714</b>
 <i>Mobile pedestals have smooth, flat edges.</i>	<b>Shelf/Box/File Mobile Pedestal (with core removable lock)</b> 15 $\frac{3}{4}$ "W x 18 $\frac{1}{8}$ "D x 28 $\frac{5}{8}$ "H — use freestanding or under 20"D, 24"D, 30"D and 36"D modular shells NOTES: Interior dimensions of the open storage area of the Shelf/Box/File model are 14 $\frac{1}{8}$ "W x 16 $\frac{3}{4}$ "D x 6 $\frac{5}{8}$ "H.	<b>H105109</b>	73	7.3	<b>\$786</b>
	<b>Lateral File (with core removable lock)</b> 36"W x 24"D x 29 $\frac{1}{2}$ "H — two drawer — matches depth of credenzas and returns 36"W x 20"D x 29 $\frac{1}{2}$ "H — two drawer 36"W x 20"D x 45 $\frac{1}{2}$ "H — three drawer 36"W x 20"D x 59 $\frac{1}{8}$ "H — four drawer NOTES: Includes hangrails, mechanical interlock and, in H10762 and H107690, a counterweight. Interlock inhibits the extension of more than one drawer from opening at a time. 24"D size aligns evenly with 24"D credenzas, credenza shells, returns, return shells, and wardrobe/storage cabinets to provide linear layout continuity.	<b>H107690</b> <b>H10762</b> <b>H107698</b> <b>H107699</b>	191 168 240 296	18.6 15.6 23.2 31.0	<b>\$1206</b> <b>\$1161</b> <b>\$1787</b> <b>\$2466</b>
	<b>Storage Cabinet with Doors (with core removable lock)</b> 36"W x 20"D x 29 $\frac{1}{2}$ "H NOTES: One adjustable interior shelf.	<b>H107291</b>	144	15.0	<b>\$940</b>
	<b>Storage Cabinet with Doors (with core removable lock)</b> 36"W x 24"D x 29 $\frac{1}{2}$ "H — matches depth of credenzas and returns NOTES: One adjustable interior shelf. 24"D size aligns evenly with 24"D credenzas, credenza shells, returns, return shells, and wardrobe/storage cabinets to provide linear layout continuity.	<b>H107290</b>	162	18.6	<b>\$1034</b>
	<b>Bookcase Hutch</b> 32 $\frac{5}{8}$ "W x 14 $\frac{5}{8}$ "D x 37 $\frac{1}{8}$ "H NOTES: For use with Lateral Files (H10762, H107690) and Storage Cabinets (H107291, H107290). Cord pass-through gap behind shelves and a 1 $\frac{1}{8}$ " full-width cord management slot at the bottom of the back panel to facilitate routing cords and reaching wall electrical outlets. When placed on a 29 $\frac{1}{2}$ "H base unit, the total 66 $\frac{5}{8}$ "H matches the height of credenzas with stack-on storage and the height of the wardrobe/storage cabinet. Two shelves are adjustable in 1 $\frac{1}{4}$ " increments.	<b>H107292</b>	93	5.1	<b>\$697</b>

**NOTES:**

- Shared components on this page can be used with modular, full pedestal, and 3/4 pedestal models shown on pages 300-309.
- Broad family of storage components takes organization way beyond the confines of a desk drawer.
- Mobile pedestal tops have smooth, flat edges. Units are standard with counterweight and four 2" diameter, non-locking casters.
- Locking units equipped with interchangeable core removable locks.
- Mobile pedestals, lateral files, storage cabinets, and bookcases ship assembled.
- See pages 310-322 for shared components.

🔑 Keyed alike cores must be ordered separately — see model HF23B on page 853 — makes re-keying quick and easy.

**HOW TO SPECIFY**

<b>Select Model Number</b>	<b>Select Laminate</b>
See page 293	See page 293
H 1 0 5 1 0 2 .	N N



# 10700 SERIES™

## Shared Components and Accessories

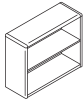

**DESCRIPTION**

**Bookcase w/Fixed Shelves**

- 36"W x 13 1/8"D x 71"H, 5-Shelf
- 36"W x 13 1/8"D x 57 1/8"H, 4-Shelf
- 36"W x 13 1/8"D x 43 3/8"H, 3-Shelf
- 36"W x 13 1/8"D x 29 5/8"H, 2-Shelf

MODEL	SHIP WEIGHT	CUBE	LIST PRICE
<b>H10755</b>	187	25.3	<b>\$1035</b>
<b>H10754</b>	156	20.3	<b>\$875</b>
<b>H10753</b>	122	15.6	<b>\$777</b>
<b>H10752</b>	90	10.9	<b>\$644</b>

NOTES: 36"W models with finished back. No assembly required. Ready to set in place.

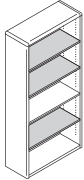

**Bookcase w/Adjustable Shelves**

- 32 3/8"W x 13 1/8"D x 71"H, 5-Shelf

<b>H107569</b>	170	25.1	<b>\$1022</b>
----------------	-----	------	---------------

NOTES: 32 3/8"W design with five shelves; two fixed, three adjustable. Shelves adjust in 2 1/2" increments. Finished back.

*Shaded shelves are adjustable.*

**NOTES:**

- Shared components on this page can be used with modular, full pedestal, and 3/4 pedestal models shown on pages 300-309.
- Broad family of storage components takes organization way beyond the confines of a desk drawer.
- Conventional bookcase designs ship fully assembled to ease and speed installation.
- See pages 310-322 for shared components.

**HOW TO SPECIFY**

Select Model Number

H 1 0 7 5 2 .

Select Laminate

See page 293

N N



# 10700 SERIES™

## Shared Components and Accessories

GSA SIN 33721



Icon Legend on page 19



Doors open 110 degrees from closed position.

**DESCRIPTION****Storage Cabinet (with core removable lock)**36"W x 24"D x 66 $\frac{5}{8}$ "H**MODEL****H107299****SHIP WEIGHT**

341

**CUBE**

41.0

**LIST PRICE****\$2275**

NOTES: Large storage area includes five, full-width (side-to-side) shelves; three are adjustable in 2 $\frac{1}{2}$ " increments. Unit height is designed to match credenza or return plus stack-on height (66 $\frac{5}{8}$ ").



Doors open 110 degrees from closed position.

**Storage Cabinet/Lateral File (with core removable lock)**36"W x 24"D x 66 $\frac{5}{8}$ "H**H107293**

365

41.0

**\$2501**

NOTES: Storage cabinet is standard with one fixed and two full-width adjustable shelves in top compartment; adjustable shelves can be removed. Overall storage compartment measures 31 $\frac{1}{4}$ "W x 22"D x 36 $\frac{1}{8}$ "H and will accommodate supplies, books and binders, as well as business machines and electronic equipment. Cord pass-through gap behind shelves and grommet in back of the cabinet to facilitate routing cords and reaching wall electrical outlets. Two drawer lateral file on bottom. Cabinet and lateral file lock independently.

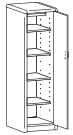

Right-hand model H107295R shown.

**Wardrobe/Storage Cabinet (with core removable lock)**18"W x 24"D x 66 $\frac{5}{8}$ "H, with coat rod and 4 adjustable shelves, Hinged Right**H107295R**

225

22.9

**\$1839**18"W x 24"D x 66 $\frac{5}{8}$ "H, with coat rod and 4 adjustable shelves, Hinged Left**H107296L**

225

22.9

**\$1839**

NOTES: Unit is standard with four adjustable shelves, coat rod, and core removable lock. Shelves adjust in 2 $\frac{1}{2}$ " increments. Unit height is designed to match credenza or return plus stack-on storage height. Cabinet can be used as a wardrobe by removing four adjustable shelves. Coat rod can be removed from cabinet for storage only applications.

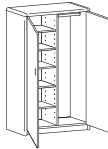

Doors open 110 degrees from closed position.

**Personal Wardrobe/Storage Cabinet (with core removable lock)**36"W x 24"D x 66 $\frac{5}{8}$ "H**H10730**

335

40.6

**\$2485**

NOTES: Spacious design is standard with four adjustable shelves (one shelf is fixed), coat rod and core removable lock which locks both doors. Shelves adjust in 2 $\frac{1}{2}$ " increments. Unit height is designed to match credenza or return plus stack-on storage height.



Right-hand model H107301R shown.

**Personal Storage Towers**24"W x 24"D x 66 $\frac{5}{8}$ "H, Wardrobe Hinged Right, Storage Cabinet Hinged Left**H107301R**

299

27.8

**\$2360**24"W x 24"D x 66 $\frac{5}{8}$ "H, Wardrobe Hinged Left, Storage Cabinet Hinged Right**H107302L**

299

27.8

**\$2360**

NOTES: Spacious design includes a wardrobe closet, storage cabinet, and two file drawers in one compact unit. Wardrobe closet contains a coat rod. Storage cabinet includes three shelves, two are adjustable in 2 $\frac{1}{2}$ " increments. Door hinged left or right models available. File drawers operate on ball-bearing suspensions with full extension. File drawers have high sides to accept hanging folders in letter or legal size. Drawers standard with hangrails. Equipped with interchangeable core removable locks. Upper lock secures storage cabinet and wardrobe closet doors; lower lock secures file drawers. Unit height is designed to match credenza or return plus stack-on storage height.

**NOTES:**

- Broad family of storage components takes storage way beyond the confines of a desk drawer.
- The 18"W wardrobe/storage cabinet can be used as wardrobe by removing some or all of the adjustable shelves, coat rod can be removed for storage only.
- Locking units equipped with interchangeable core removable locks.
- See pages 310-322 for shared components.

! Keyed alike cores must be ordered separately — see model HF23B on page 853 — makes re-keying quick and easy.

**HOW TO SPECIFY**

Select  
Model Number

H 1 0 7 2 9 3 .

Select  
Laminate







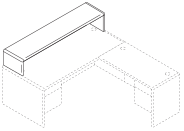

See page 293

N N

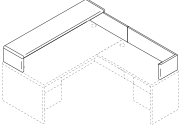

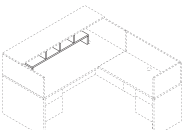
# 10700 SERIES™

## Shared Components and Accessories

	DESCRIPTION	MODEL	SHIP WEIGHT	CUBE	LIST PRICE
 	<b>Reception Station/Transaction Counter</b> 68 $\frac{5}{8}$ "W x 14 $\frac{5}{8}$ "D x 14 $\frac{1}{4}$ "H Intended for use with H10700 72"W double and single pedestal desk models and 72"W desk shells. NOTES: Cord management grommets on desktops serve as anchor points. Transaction counter organizer (HTCOL52) fits under/inside of transaction counter.	<b>H107720</b>	76	3.2	<b>\$677</b>
 	<b>Reception Station for an "L" Workstation</b> 68 $\frac{5}{8}$ "W x 75 $\frac{1}{2}$ "D x 14 $\frac{1}{4}$ "H Intended for use with a 72"W x 36"D left single pedestal desk or modular desk shell with a 42"W x 24"D right pedestal return or modular right return shell. Intended for use with a 72"W x 36"D right single pedestal desk or modular desk shell with a 42"W x 24"D left pedestal return or modular left return shell. NOTES: Cord management grommets on desktop and return serves as the anchor points for the reception station for return.	<b>H107721R</b>	108	4.3	<b>\$974</b>
 	<b>Transaction Counter Organizer</b> 48 $\frac{3}{4}$ "W x 11 $\frac{1}{8}$ "D x 13"H Fits under Transaction Counter Models H107720, H107721R and H107722L. ⚠ Black only. <b>SPECIFYING EXAMPLE: HTCOL52.P</b>	<b>HTCOL52</b>	24	1.1	<b>\$283</b>
 <p>Base sold separately.</p> 	<b>42" Diameter Table Top</b> NOTES: Underside of top features a factory-installed template. The template, which is trilingual, facilitates assembly of the base to the top by designating the specific attachment location for multiple base designs. Bases attach to the top with self drilling screws, no drilling is required. All top + base models are 29 $\frac{1}{2}$ "H. For Base Options see Preside® Table Base pages 776-779. ⚠ Requires specification of a support base model shown on pages 776-779. <b>SPECIFYING EXAMPLE: H107242.N</b>	<b>H107242</b>	58	4.1	<b>\$651</b>

**NOTES:**

- "L" Reception station includes components for both the reception/transaction counter for desk and the reception station for return.
- Round table design is well suited to a variety of applications, including use in private or open plan offices.
- See pages 310-322 for shared components.

**HOW TO SPECIFY**

<b>Select Model Number</b> H 1 0 7 7 2 0	<b>Select Laminate</b> See page 293 N N
---	---

# 10700 SERIES™

## Shared Components and Accessories

GSA SIN 33721

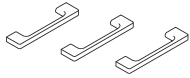
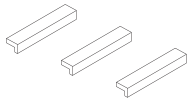

Icon Legend on page 19

**DESCRIPTION****Field Installable Drawer/Door Handle Kits**

Linear, Black, 2-pack

Linear, Matte Chrome, 2-pack

Linear, Black, 3-pack

Linear, Matte Chrome, 3-pack

Specify Linear handles in black to coordinate with 10700 or 10500 Series™ models that ship standard with a decorative handle, such as mobile pedestals, storage cabinets and wardrobes.

Arch, Black, 2-pack

Arch, Matte Chrome, 2-pack

Arch, Black, 3-pack

Arch, Matte Chrome, 3-pack

NOTES: Handles are for purchase and field installation on 10700 or 10500 Series™ desks, credenzas, returns, lateral files and modular pedestals. Instructions include mounting hardware and paper template for drilling holes.

Applications include:

- box/file and file/file pedestals = one 2-pack per pedestal
- box/box/file and pencil/media/file pedestals = one 3-pack per pedestal
- two drawer lateral file = two 2-packs per unit
- four drawer lateral file = four 2-packs per unit

The Linear and Arch handles can be attached using 96mm (approx. 3¾") or 128mm (approx. 5") hole spacing. Important note: effective January 1, 2007, the holes used for the black drawer/door handle that comes standard on several HON 10700 or 10500 Series™ products, including mobile pedestals, storage cabinet with doors, storage/file cabinet, storage cabinet/lateral file, personal wardrobe/storage cabinets, and personal storage towers, will accept the Linear and Arch handles. Units manufactured prior to January 1, 2007, have 64mm (approx. 2½") hole spacing and will not accept the Linear and Arch handles.

! **Must be ordered with a configurable end product. If ordered separately, not on GSA contract.**

**MODEL****SHIP WEIGHT****CUBE****LIST PRICE****HLINEARA2**0.4 **Ⓢ**

0.3

**\$56****HLINEARC2**0.4 **Ⓢ**

0.3

**\$56****HLINEARA3**0.5 **Ⓢ**

0.3

**\$64****HLINEARC3**0.5 **Ⓢ**

0.3

**\$64****HARCHA2**0.4 **Ⓢ**

0.3

**\$56****HARCHC2**0.4 **Ⓢ**

0.3

**\$56****HARCHA3**0.5 **Ⓢ**

0.3

**\$64****HARCHC3**0.5 **Ⓢ**

0.3

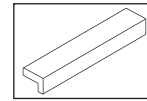
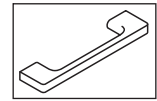
**\$64****Linear Handle****Arch Handle****Field Installable Drawer/Door Handle Kits**

Sweep Black, 2-pack

Sweep Satin Nickel, 2-pack

Sweep Black, 3-pack

Sweep Satin Nickel, 3-pack

Crescent Black, 2-pack

Crescent Satin Nickel, 2-pack

Crescent Black, 3-pack

Crescent Satin Nickel, 3-pack

NOTES: Handles are for purchase and field installation on 10700 or 10500 Series™ desks, credenzas, returns, and lateral files, as well as for the modular pedestals used with 10700 and 10500.

Applications include:

- box/file and file/file pedestals = one 2-pack per pedestal
- box/box/file and pencil/media/file pedestals = one 3-pack per pedestal
- two drawer lateral file = two 2-packs per unit
- four drawer lateral file = four 2-packs per unit

The hole spacing for the Sweep and Crescent handles is 96mm (approx. 3¾"). Important note: effective January 1, 2007, the holes used for the black drawer/door handle that comes standard on several HON 10700 or 10500 Series™ products, including mobile pedestals, storage cabinet with doors, storage/file cabinet, storage cabinet/lateral file, personal wardrobe/storage cabinets, and personal storage towers, will accept the Sweep and Crescent handles. Units manufactured prior to January 1, 2007, have 64mm (approx. 2½") hole spacing and will not accept the Sweep and Crescent handles. Instructions include mounting hardware and paper template.

! **Must be ordered with a configurable end product. If ordered separately, not on GSA contract.**

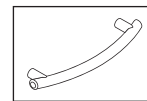
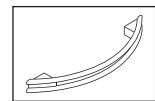
**Sweep Handle****Crescent Handle****NOTES:**

- Field Installable Drawer/Door Handle Kits for use on 10700 Series™ desks, credenzas, returns, lateral files and storage cabinets.
- A metal template is available to facilitate field installation of the Linear, Arch, Sweep and Crescent decorative handles on 10500 and 10700 Series™ drawer fronts; order model SPLH-SYST-DRKNB.M263164.
- See pages 310-322 for shared components.

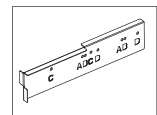
**Metal Template****HOW TO SPECIFY**

Select  
Model Number

H L I N E A R A 2



# 10700 SERIES™

## Shared Components and Accessories

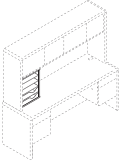
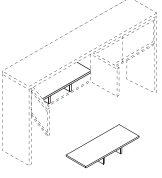
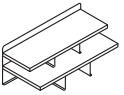
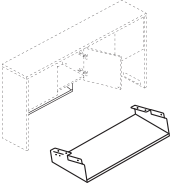
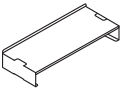
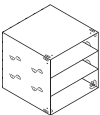
	DESCRIPTION	MODEL	SHIP WEIGHT	CUBE	LIST PRICE
	<b>Vertical Paper Manager</b> 14 <sup>7</sup> / <sub>8</sub> "W x 10 <sup>7</sup> / <sub>8</sub> "D x 19 <sup>1</sup> / <sub>16</sub> "H NOTES: Keeps papers, files, and books neatly organized and within easy reach from a seated position. Designed for desk, credenza, and return tops. Fits under stack-on storage models. Two pullout drawers and three fixed shelves. Vertical paper manager designed for desk, credenza, and return tops. Fits under stack-on storage. For additional information see page 844.	HLVPM1	27	2.8	\$327
	<b>Stacked Paper Management</b> 32 <sup>1</sup> / <sub>2</sub> "W x 12 <sup>5</sup> / <sub>8</sub> "D x 4 <sup>1</sup> / <sub>4</sub> "H NOTES: Segments and organizes stack-on and wall mount storage compartments, as well as bookcase shelves. In some cases, installation may require removing the stack-on or wall mount storage doors. For additional information see page 845. <b>!</b> Black only.	HLVPM2	22	1.25	\$163
 <i>Not available in two-tone laminate</i>	<b>Desktop Storage Terrace</b> 26 <sup>1</sup> / <sub>2</sub> "W x 12 <sup>1</sup> / <sub>2</sub> "D x 10 <sup>1</sup> / <sub>2</sub> "H NOTES: Keeps work-in-process, priority files, loose pages, and mail neatly organized and in view. Mixed material design comprised of sturdy laminate shelves with metal back and support panels. Not available in two-tone laminate combination or pattern laminate colors. Choose from Platinum Metallic (TI), Black (P), and Charcoal (S) for the metal components. Sized to fit in stack-on and wall mounted storage cabinets in 10500, 10700, Valido, 94000, and 38000 Series. Fits in Voi stack-on and overhead cabinets except for 48"W or smaller sliding door models. For additional information see page 844. Specify: Model.Laminate.Paint <b>SPECIFYING EXAMPLE: HLDST1.N.TI</b>	HLDST1	24	1.1	\$306
	<b>Hanging Paper Shelf</b> 28 <sup>1</sup> / <sub>16</sub> "W x 11 <sup>7</sup> / <sub>16</sub> "D x 4 <sup>5</sup> / <sub>16</sub> "H NOTES: Maximizes worksurface space; de-clutters desktop while placing priority communications and active project folders within easy reach. Angled design allows contents to be distinguished at a glance. Mixed material styling features strong painted metal frame with a frosted shelf. Attaches quickly and easily to stack-on and wall mount storage models in the following series: 10500, 10700, Valido, 94000, and Voi (except the 36"W overhead hutch with O-legs or panel mount brackets). Not for use with 38000 Series. For additional information see page 824. Specify: Model.Paint <b>SPECIFYING EXAMPLE: HHPS1.TI</b>	HHPS1	7	2.9	\$198
	<b>Desktop Paper Shelf</b> 28 <sup>1</sup> / <sub>16</sub> "W x 11 <sup>5</sup> / <sub>16</sub> "D x 5"H NOTES: Organizer shelf provides a place and space for work-in-process and piling to keep worksurfaces neat and tidy. Convenient, scalable design with interlocking side supports allow two units to be stacked and integrated. Durable painted metal frame with a frosted shelf; mixed material styling matches hanging paper shelf. Can also be used inside select overhead storage, including the following stack-on with hinged door models: 10500 and Valido 36", 42", 66", 72", 78"W and 10700 68 <sup>5</sup> / <sub>16</sub> "W. For additional information see page 824. Specify: Model.Paint <b>SPECIFYING EXAMPLE: HDPS1.TI</b>	HDPS1	7	2.9	\$198
	<b>Storage Cube</b> 12"W x 12"D NOTES: For additional information see page 846. <b>SPECIFYING EXAMPLE: HLST1212.P8S</b>	HLST1212	1	0.3	\$294

**NOTES:**

- See pages 310-322 for shared components.

**HOW TO SPECIFY**

<b>Select Model Number</b> H L V P M 1 . N	<b>Select Laminate</b> See page 293
---	--









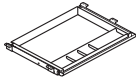

# 10700 SERIES™

## Shared Components and Accessories

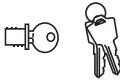
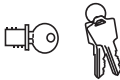
OPEN MARKET EXCEPT AS NOTED

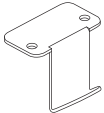

Icon Legend on page 19

	DESCRIPTION	MODEL	SHIP WEIGHT	CUBE	LIST PRICE
 Refer to page 106 for Center Drawer compatibility information <b>SIN 33721</b>	<b>Angled Wood Center Drawer</b> 26" x 15 <sup>3</sup> / <sub>8</sub> " 22" x 15 <sup>3</sup> / <sub>8</sub> "	<b>H1526</b> <b>H1522</b>	12.0  11.0 	1.2 1.1	<b>\$198</b> <b>\$184</b>
	NOTES: Center drawers ideal for pens, pencils and other miscellaneous storage. Feature ball-bearing slide suspension. Compatibility (where to use) information is detailed on page 106. Specify laminate for drawer. Model H1522 or H1022 can be used on peninsulas with modesty panel, model H10528. For additional information see page 832.				
	<b>Polymer Center Drawer</b> <ul style="list-style-type: none"> <li>Color: Black.</li> <li>Material: ABS.</li> <li>Opening Requirements: 23"W x 16<sup>1</sup>/<sub>4</sub>"D x 2"H.</li> <li>Retracts on 16" ball-bearing slides.</li> <li>Can be used on worksurfaces with Coordinate™ Height Adjustable Bases as long as it is attached with spacer model HKBS.</li> <li>Can store up to 25 lbs.</li> </ul> NOTES: For additional information see page 833.  Black finish only, no specification needed.	<b>HCD1</b>	7.0	0.5	<b>\$108</b>
 <b>SIN 33721</b>	<b>Black Removable Lock Core Kit</b> — see page 853. NOTES: Lock with a removable cylinder that can be interchanged as needed; allows users to access all furniture pieces in an office with a single key for convenience and security. Makes re-keying quick and easy.	<b>HF23B</b>	0.1	0.1	<b>\$32</b>
 	<b>Removable Lock Core Kit</b> Black <ul style="list-style-type: none"> <li>For stack-on and wall mounted storage laminate models (with locks) in 10500, 10700, Valido, Voi, Concinity, and 94000 Series.</li> <li>Specify quantity of each key number from 101E to 225E.</li> <li>Includes: 1-core, 2-keys, 1-core removal tool, and instructions.</li> </ul> NOTES: If key number isn't specified, number will be at random.	<b>HF27B</b>	0.2	0.02	<b>\$32</b>
 	<b>Back Pack Hook (10 per carton)</b> 12"W x 14 <sup>1</sup> / <sub>2</sub> "D x 1 <sup>1</sup> / <sub>2</sub> "H NOTES: Assembly: attaches to bottom of desk with (2) screws, included. For additional information see page 846.  Available in Platinum Metallic finish only, no specification needed.	<b>HCLA65</b>	10.0 	0.1	<b>\$94</b>

**NOTES:**

- For master key, see model HF22 on page 853.
- See pages 310-322 for shared components.

**HOW TO SPECIFY**

<b>Select Model Number</b> H 1 5 2 6 .	<b>Select Laminate</b> See page 293 N N
---	---

# 10700 SERIES™

## Shared Components and Accessories



Refer to pages 829-831 for additional product information

**SIN 33721**



DESCRIPTION	MODEL	SHIP WEIGHT	CUBE	LIST PRICE BY PAINT GRADE	
				P1	P2
<b>Sit to Stand Arm with Convertible Keyboard Platform</b>	<b>H2516 OPEN MARKET *</b>	17 <b>Ⓔ</b>	1.6	<b>\$618</b>	
<b>Articulating Arm with Convertible Keyboard Platform</b>	<b>H2107 OPEN MARKET *</b>	16 <b>Ⓔ</b>	1.3	<b>\$529</b>	
<b>Articulating Arm with Keyboard Platform</b>	<b>H1706 OPEN MARKET *</b>	16 <b>Ⓔ</b>	1.4	<b>\$493</b>	
<b>Slide-Away Keyboard Platform</b> (Specify: Laminate)	<b>H4022</b>	10 <b>Ⓔ</b>	0.6	<b>\$213</b>	
<b>Extended Tray Slide-Away Keyboard Platform</b> (Specify: Laminate)	<b>HE4022</b>	12 <b>Ⓔ</b>	0.7	<b>\$302</b>	
<b>Metal Keyboard and Mouse Tray</b> (Specify paint)	<b>H4028 OPEN MARKET</b>	11 <b>Ⓔ</b>	1.5	<b>\$153</b>	<b>\$163</b>
<b>Metal Keyboard Tray</b> (Specify paint)	<b>H4029 OPEN MARKET</b>	11 <b>Ⓔ</b>	1.5	<b>\$138</b>	<b>\$148</b>
<b>Corner Sleeve</b> — Square Edge (22½" leading edge x 18"D) Specify paint color.	<b>H51206</b>	10 <b>Ⓔ</b>	1.5	<b>\$155</b>	<b>\$165</b>

NOTES: For additional information see pages 829-831.



**SIN 33721**



**SIN 33721**

DESCRIPTION	MODEL	SHIP WEIGHT	CUBE	LIST PRICE
<b>LED Task Lights</b>				
<b>Articulating Desk Lamp</b>	<b>HLED1</b>	1.2 <b>Ⓔ</b>	6.5	<b>\$402</b>
<b>Articulating Desk Lamp w/ Occupancy Sensor</b>	<b>HLED10C</b>	1.2 <b>Ⓔ</b>	6.5	<b>\$490</b>
NOTES: For additional information see page 841.				
<b>Task Desk Lamp</b>	<b>HLED2</b>	0.7 <b>Ⓔ</b>	3.0	<b>\$348</b>
NOTES: For additional information see page 841.				

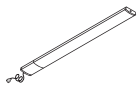

**OPEN MARKET**

<b>LED Task Lights — for Stack-on Storage Models</b>				
17" LED Light with Power Supply (Single)	<b>HLED17AS</b>	1.2 <b>Ⓔ</b>	0.05	<b>\$420</b>
31" LED Light with Power Supply (Single)	<b>HLED31AS</b>	1.5 <b>Ⓔ</b>	0.09	<b>\$565</b>
17" LED Light with Power Supply for Daisy-chain (Starter)	<b>HLED17A</b>	1.0 <b>Ⓔ</b>	0.05	<b>\$462</b>
31" LED Light with Power Supply for Daisy-chain (Starter)	<b>HLED31A</b>	1.4 <b>Ⓔ</b>	0.09	<b>\$620</b>
17" LED Light with 8" and 30" Jumper Cord for Daisy-chain (Follower)	<b>HLED17AUO</b>	1.0 <b>Ⓔ</b>	0.03	<b>\$377</b>
31" LED Light with 8" and 30" Jumper Cord for Daisy-chain (Follower)	<b>HLED31AUO</b>	1.0 <b>Ⓔ</b>	0.05	<b>\$502</b>
<b>Undercabinet Occupancy Sensor with 1" End to End Connector</b>	<b>HLEDOSA</b>	0.2 <b>Ⓔ</b>	0.01	<b>\$89</b>
NOTES: To use the daisy chain application, must start with model HLED17A or HLED31A. No finish specification required. Attaches magnetically to underside of overhead storage, or attaches with provided screws or double-sided tape. Occupancy sensor attaches to a single or starter LED light and will automatically turn the light off after no motion is detected for 30 minutes. Just like all the LED light models, the occupancy sensor features a soft-touch on/off switch. LED task lights have a lifetime of 30,000 hours and have a dimmer feature that allows the user to adjust the amount of light output. For additional information see page 842.				

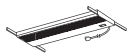

Refer to page 842

**OPEN MARKET**

<b>Task Light — for Stack-on Storage Models</b>				
46½"W x 3½"D x 1½"H, for models H107318, H10734, H10733 or H10732	<b>HH870960</b>	12.0 <b>Ⓔ</b>	1.1	<b>\$270</b>
34½"W x 3½"D x 1½"H, for model H107313	<b>HH870942</b>	10.0 <b>Ⓔ</b>	0.9	<b>\$250</b>
NOTES: Task light and Chicago Code models see page 545. For additional information see page 842.				

### NOTES:

- Task lights are designed for use with stack-on storage and wall mounted storage cabinets.
- Task lights feature a new slim profile and electronic ballast for increased energy efficiency.
- Task lights include a T5 bulb which contains less mercury.

\* De-emphasized.

# 10700 SERIES™

## Shared Components and Accessories

GSA SIN 33721T EXCEPT AS NOTED

ABI

Icon Legend on page 19



SIN 33721

**DESCRIPTION****MODEL****SHIP WEIGHT****CUBE****LIST PRICE****Field Installable Grommet****HFLDGRMT**

0.1 Ⓢ

0.01

**\$32**

- Intended for use in tops and end panels to route/hide cords and in modesty panels to facilitate reaching wall electrical outlets.
- Grommet is field installable.
- Grommet shape is round.
- Includes grommet cap and sleeve.
- Grommet cap measures 3" diameter and includes a 3/4" diameter cord access hole.
- Grommet sleeve measures 2 1/2" O.D. x 3/4" thick.
- Includes instructions to locate grommet position for desks, credenzas, returns and bridges.

! Black Finish

! Requires a 2 1/2" diameter hole saw and drill for installation (not included).



SIN 33721

**Field Installable Grommet****HFLDGRMT3**

0.1 Ⓢ

0.3

**\$32**

- Intended for use in tops and end panels to route/hide cords and in modesty panels to facilitate reaching wall electrical outlets.
- Grommet is field installable.
- Grommet shape is round.
- Includes grommet cap and sleeve.
- Grommet outside dimensions measure 3 1/2" diameter and includes two cord access holes.
- Grommet sleeve measures 3" O.D. x 1" thick.
- Includes instructions to locate grommet position for desks, credenzas, returns and bridges.

! Black Finish

! Requires a 3" diameter hole saw and drill for installation (not included).

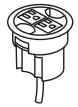
**Power Hub, 3" Grommet Mount, 6' Cord****HGRMTAC**

1.3

0.2

**\$111**

- Two grounded AC power outlets.
- Two cord pass-through holes in cap.
- Includes 6' cord with three-prong plug.

! Available in Black only (no color designation - Specify: HGRMTAC.X).

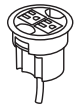
**3" Round Power Grommet - 2 Outlets, 10' Cord****HGRMTAC2**

1.5

0.2

**\$148**

- Includes 10' cord with three-prong plug.
- Fits in 3" round grommet holes on the following product lines: Coordinate, Huddle, Motivate, all laminate and veneer casegoods series, and Systems Worksurfaces.
- Two grounded AC power outlets.
- Field installed with Plug-and-play ease.

NOTES: Power Modules will also work with standing-height applications for 10500 Series™ and Voi® desks. Optional Memory Control allows preset worksurface heights for consistency. Ships separately. Dynamic load capacity when worksurface is moving is 300 lbs.

! Available in black finish only, no specification needed.

**Power/USB Hub, 3" Grommet Mount****HGRMTUSB2**

1.3 Ⓢ

0.02

**\$224**

- One grounded AC power outlet with 2 USB ports.
- Two cord pass-through holes in cap.
- Includes 6' cord with three-prong plug.

! Available in black only (no color designation so use .X - Specify: HGRMTUSB2.X).

**NOTES:**

- The power and power/USB hub models bring the ease of plug-and-play to the desktop.
- Models HFLDGRMT3, HGRMTAC, and HGRMTUSB2 fit in 3" round grommet holes in 10700 Series™ desks, credenzas, and returns; not compatible with 10700 products with rectangle-shaped grommets.
- For additional information see page 848.

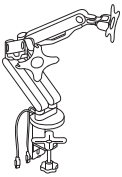
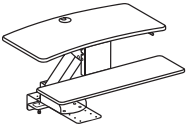
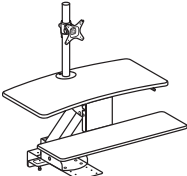
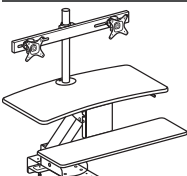
	DESCRIPTION	MODEL	SHIP WEIGHT	CUBE	LIST PRICE
	<p><b>Coordinate™ Portable Desktop Riser</b> 31"D x 5'-16½"H x 35"W</p> <p>NOTES: Available in Black (BLK) or White (WHT) finish. Desktop riser dimensions (without keyboard tray): 22"D x 5'-16½"H x 35"W. Keyboard tray dimensions: 9"D x 30"W. Max loading capacity is 33 lbs for the desktop riser surface and 4 lbs for the keyboard tray. Easily transition from seated to standing positions throughout the workday. Sits atop an existing desk to create sit-to-stand functionality by raising the computer. Includes keyboard tray and surface for computer monitors. <b>HON 5-Year Limited Warranty.</b></p> <p>ⓘ Not intended for use on mobile workstations.</p>	<b>HBXRISER</b>	54.0	4.1	<b>\$619</b>
	<p><b>Dual Monitor Arm with 2 USB Ports</b></p> <p>NOTES: Easy adjustment. Height adjusts to 17" tall. Monitor tilt and swivel capability. Enclosed cable management. Grommet or desktop mounting. Clean appearance. In some applications the Monitor Arms may extend 12 or more inches into the worksurface. For additional information see page 825. <b>HON 5-Year Limited Warranty.</b></p> <p>ⓘ No specification needed.</p>	<b>HBDMAUSB</b>	41.9	2.6	<b>\$441</b>
	<p><b>Coordinate™ Mounted Desktop Riser</b></p> <p>NOTES: Does not include a monitor arm and is suitable for laptops and/or monitors on their original stands.</p> <p>ⓘ No specification needed.</p>	<b>HS1100</b>	60.0 ⓘ	3.2	<b>\$664</b>
	<p><b>Coordinate™ Mounted Desktop Riser with Single Monitor Arm</b></p> <p>NOTES: Includes a monitor arm for a single monitor.</p> <p>ⓘ No specification needed.</p>	<b>HS1101</b>	62.0 ⓘ	3.2	<b>\$777</b>
	<p><b>Coordinate™ Mounted Desktop Riser with Dual Monitor Arm</b></p> <p>NOTES: Includes a monitor arm for dual monitors.</p> <p>ⓘ No specification needed.</p>	<b>HS1102</b>	63.0 ⓘ	3.2	<b>\$883</b>

**NOTES FOR HS1100, HS1101, HS1102:**

- These products are designed to allow the user to transition from seating position to standing position throughout the workday.
- Gas-assist lever-operated mechanism with positive stop.
- Clamp mount compatible with worksurfaces depths of 20"-30". 20" is for systems only.
- Clamp requires 3.5" of clearance along back edge of worksurface.
- Black seamless worksurfaces.
- Silver powder coated metal components.
- Lowers below worksurface level on 24" and 30"D worksurfaces.
- All models contain a large primary worksurface and a smaller keyboard / mouse surface.
- Beveled edges for sleek appearance and comfort while typing.
- Monitor arms include height, width, and swivel adjustment.
- For additional information see page 838.

- Not for use under overhead storage, with flush mounted modesty panels, or worksurfaces thinner than 1".

ⓘ Not recommended for use on mobile (castered) worksurfaces.

**MOUNTING AND COMPATIBILITY FOR HS1100, HS1101, HS1102:**

- This product is intended to be installed on commercial-grade worksurfaces in good condition.
- Compatible with freestanding worksurfaces 24"-30"D or panel-supported worksurfaces 24"-30"D.
- Not for use on mobile worksurfaces.

**Clamp Mount**

Use when 3.5" minimum overhang is available

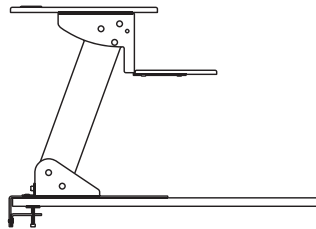

**Screw Mount**

Use when no overhang is available. Worksurface must be minimum 1" thick.

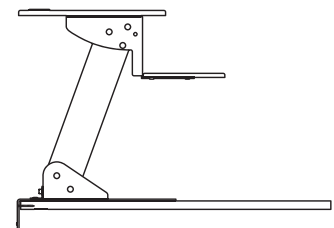

**HOW TO SPECIFY**

<p><b>Select Model Number</b></p> <p>HBXRISER.</p>	<p><b>Select Finish</b></p> <p>BLK Black WHT White</p> <p>BLK</p>
--	---





# 10700 SERIES™

## Accessories

OPEN MARKET

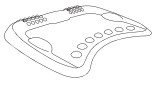
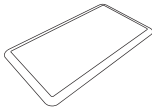
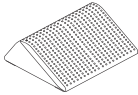

Icon Legend on page 19

	DESCRIPTION	MODEL	SHIP WEIGHT	CUBE	LIST PRICE
	<b>Rectangle Wobble Board — Anti-Fatigue Mat</b> 18"D x 3"H x 22½"W ⓘ Available in Black (T) finish ONLY. Recommended weight capacity not to exceed 250 pounds. <b>HON 5-Year Limited Warranty.</b> <b>SPECIFYING EXAMPLE: HVL981.T</b>	<b>HVL981</b>	10.0 Ⓢ	0.9	<b>\$120</b>
	<b>Round Wobble Board — Anti-Fatigue Mat</b> 18½"D x 2½"H x 18½"W ⓘ Available in Black (T) finish ONLY. Recommended weight capacity not to exceed 250 pounds. <b>HON 5-Year Limited Warranty.</b> <b>SPECIFYING EXAMPLE: HVL982.T</b>	<b>HVL982</b>	5.8 Ⓢ	0.6	<b>\$102</b>
	<b>Ergonomic Anti-Fatigue Mat</b> 25"D x 2¾"H x 29⅞"W ⓘ Available in Black ONLY. No specification needed. <b>SPECIFYING EXAMPLE: HBEAFM1</b>	<b>HBEAFM1</b>	7.0	1.4	<b>\$219</b>
	<b>Rectangle Anti-Fatigue Mat</b> 20"D x ¾"H x 36"W ⓘ Available in Black ONLY. No specification needed. <b>SPECIFYING EXAMPLE: HBAFM2036</b>	<b>HBAFM2036</b>	5.4	0.4	<b>\$100</b>
	<b>Footrest — Anti-Slip Cover</b> 13¾"D x 5½"H x 16"W ⓘ Available in Black (T) finish ONLY. Recommended weight capacity not to exceed 250 pounds. <b>HON 5-Year Limited Warranty.</b> <b>SPECIFYING EXAMPLE: HVL991.T</b>	<b>HVL991</b>	7.0 Ⓢ	0.9	<b>\$82</b>

### HOW TO SPECIFY

Select  
Model Number

H V L 9 8 1 .

Select  
Finish

T Black

T