

Approach Table Desk

Installation Instructions

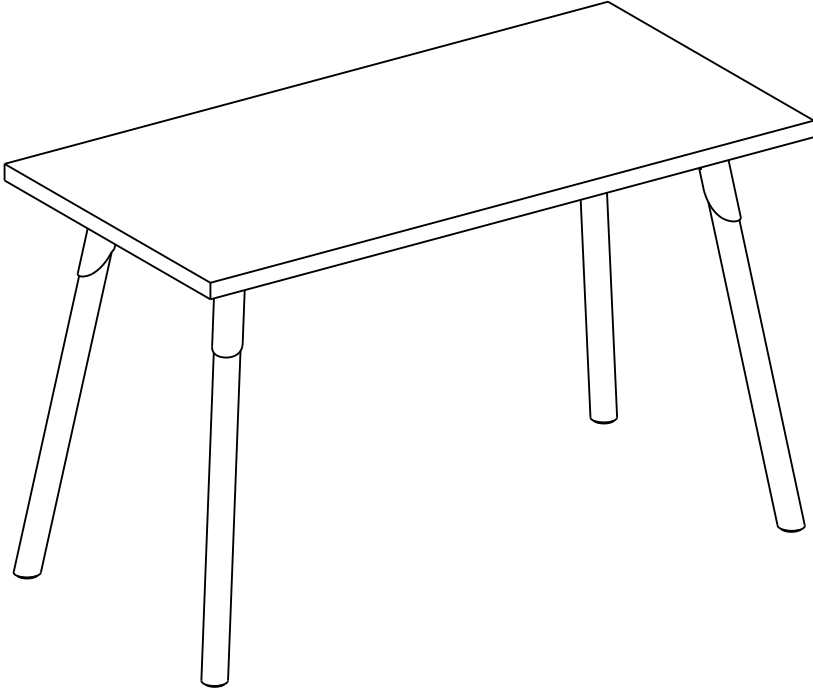

Allsteel®

Allsteel Inc.
Muscatine, Iowa 52761-0071
www.allsteeloffice.com

Pour des instructions en francias, appelar le 800-822-7653
Para instrucciones en espanol, llame al 800-822-7653

⚠ WARNING

Failure to install product as instructed, use of hardware other than that which is provided, or failure to comply with instructions can result in product failure, personal injury, or property damage.

Hardware - Total Quantities Shown:

1/4-20 x 3/4" Truss Head Screw

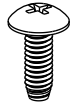

X 16

Phillips Screwdriver

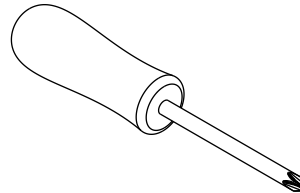

X 1

Build staging – Step 1

1. Protect worksurface by clearing the build area of any debris that can cause damage.
2. Place worksurface upside down (as shown) on carpet, cardboard or equivalent to protect upward facing show surface during the installation process.
3. Open hardware pack and lay out the contents.

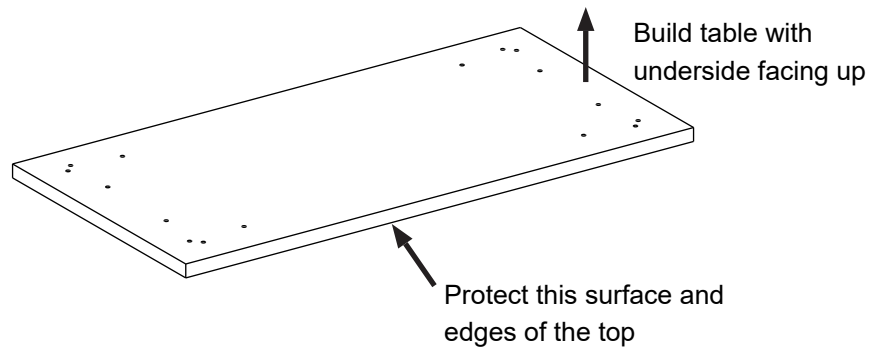

- Step 2**
1. Align leg with pre-drilled holes.
 2. Use Truss head screws provided in hardware pack to assemble legs to worksurface.
- *Only 4 of 8 holes will be used per leg

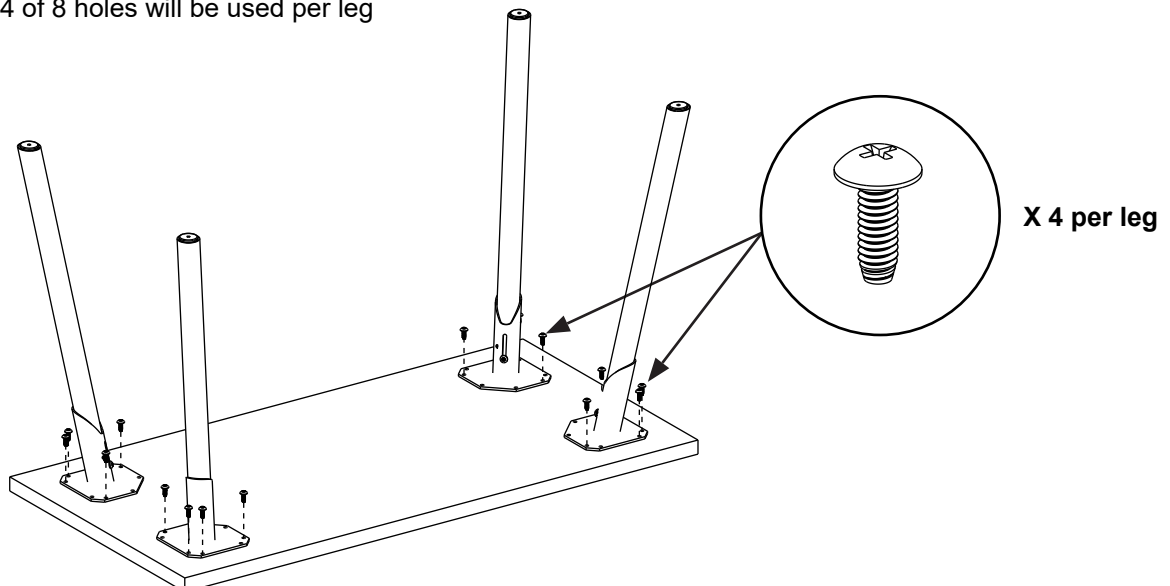

Step 3 - Flip table

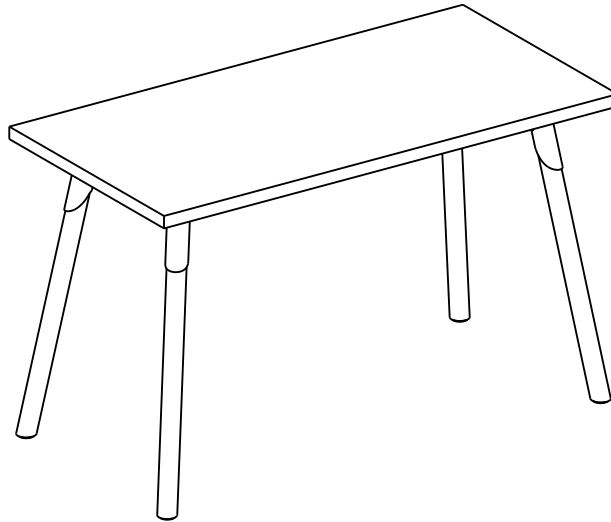

Leg Adjustment:

1/8" ALLEN KEY (used for minor adjustment – not provided)

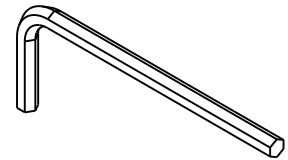

Note: Use the pre-installed leveler for micro-adjustments only. The leveler is not intended to be used as main method of levelling.

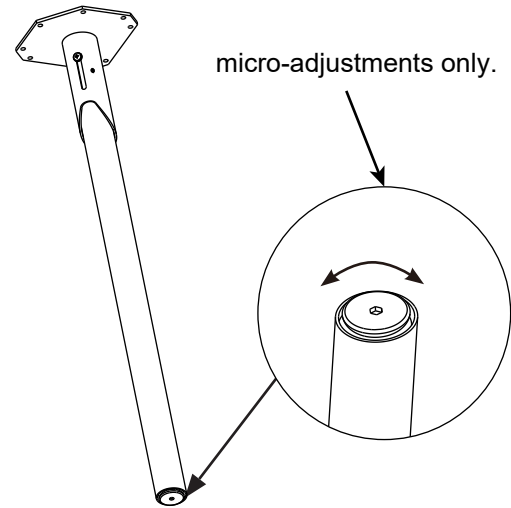

Leg Adjustment w/ Allen Key

1. Loosen bolt (screwdriver) and set screw (1/8" Allen key) to allow for leveling.
2. While lifting slightly on the worksurface, slide the leg up or down to level as needed.
3. Tighten both the bolt and the set screw. Ensure the set screw is tightened until flush with the outer surface of the shroud.

