

Digital Lock User Guide

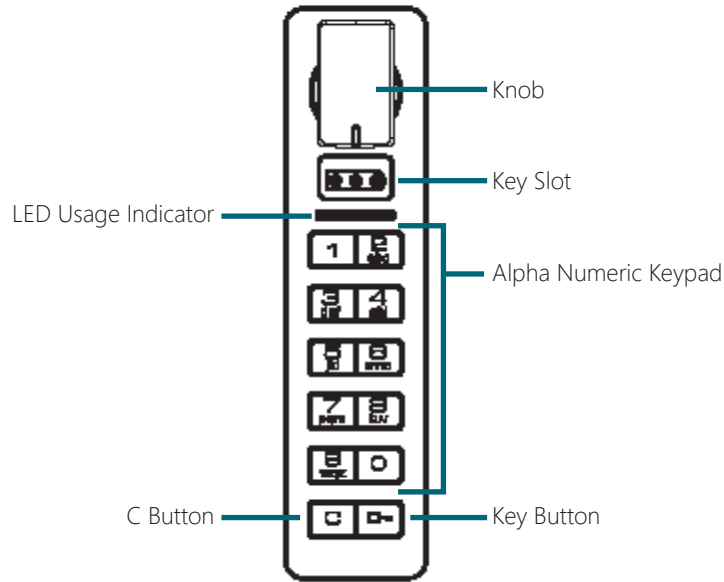



Keypad

Keypad digital locks are operated by a 4-7 digit User Code. Manager Keys provide management access and external power. Programming is accomplished via a Programming Key unique to the lock system.



KEYS

	 Manager Key	 Programming Key ²
Operates the lock	●	●
Overrides user access	●	●
Allows management inspection	●	●
Provides external power	●	●
Programs Manager Keys to the lock	●	●
Assigns user credentials ³ (in assigned use functionality)	●	●
Sets lock functionality	●	●

¹Up to 6 Manager Keys may be programmed to each lock.

²1 Programming Key allowed per lock system.

³Up to 20 user credentials may be assigned to each lock.

KEY INSERTION

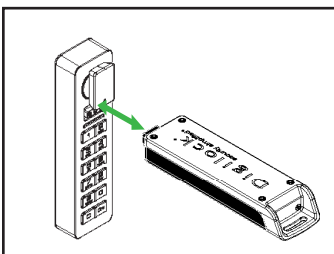

Digilock logo must face up.

SETUP

Locks are shipped with factory default settings (only operates by pressing **[C]** **[0m]**). Each lock must be set up to operate with a Programming Key and Manager Keys.

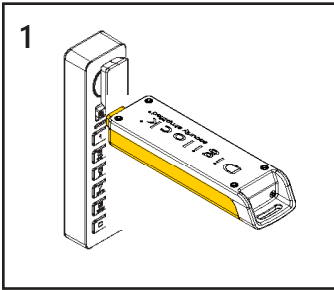

1
Insert the Programming Key.
A two-tone beep will be heard and the LED will flash.

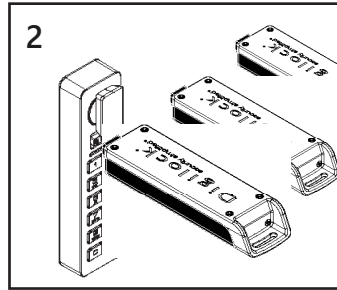

2
While the LED is flashing, insert one Manager Key at a time.
A beep will be heard for each Manager Key programmed.

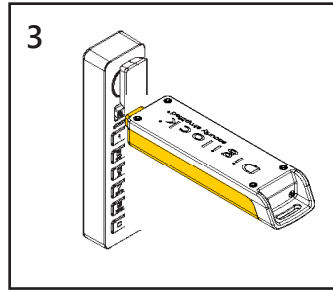

3
Insert the Programming Key.
A two-tone beep will be heard and the LED will turn off.

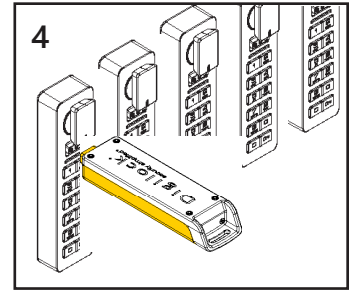

4
Repeat above steps for each lock or follow instructions to Express Register Manager Keys to setup all locks.

PROGRAMMING INSTRUCTIONS

Express Register Manager Credentials

Express Register Manager Keys The Programming Key can quickly program multiple locks to operate with the same Manager Keys.

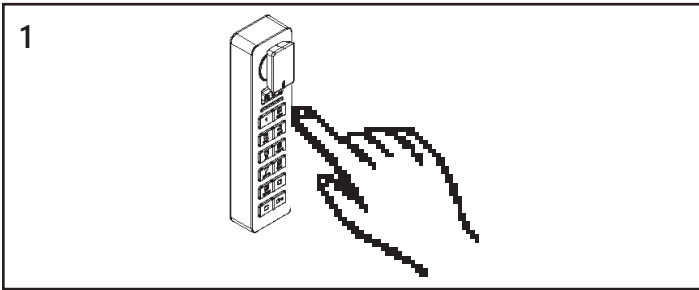

1
Go to a lock already programmed to operate with the Manager Keys.
Press: **[C]** **[0m]** **[6]** **[1]** **[0m]**. The LED will flash.

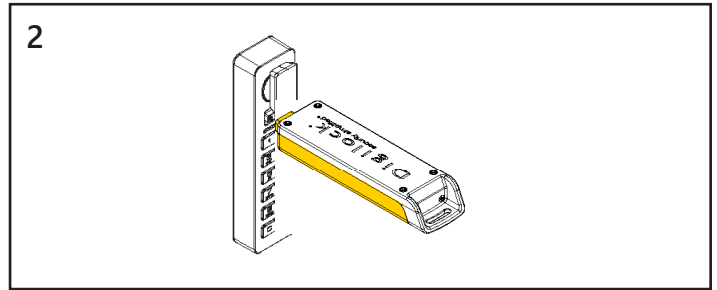

2
While the LED is flashing, insert the Programming Key.
A two-tone beep will be heard and the LED will turn off.

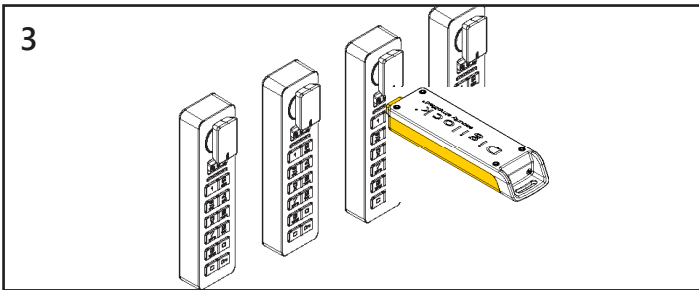

3
Insert the Programming Key to program each lock to operate with the same Manager Keys.
Two sets of two-tone beeps will be heard and the LED will flash twice to indicate successful programming.

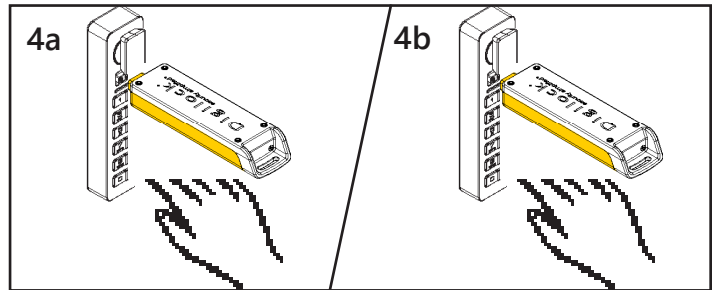

4a
End Express Registration mode.*
Go to any programmed lock.
Press: **[C]** **[0m]** then insert the Programming Key.

*The Programming Key will continue to function in Express Registration mode until it is used to operate a lock.

PROGRAMMING INSTRUCTIONS

Add Manager Keys

Manager Keys can be programmed to the locks at any time.

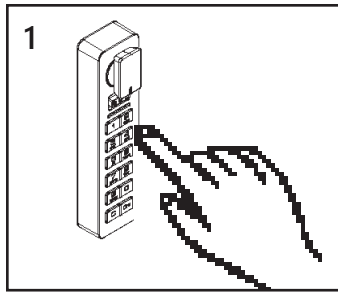

Go to a lock requiring additional Manager Keys.

Press: **C** **0** **5** **5** **0**

The LED will flash.

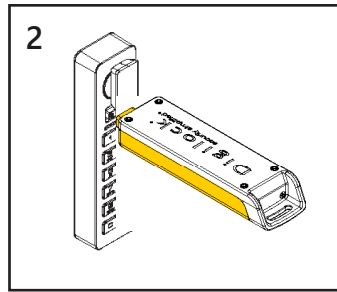

While the LED is flashing, insert the Programming Key.

A two-tone beep will be heard.

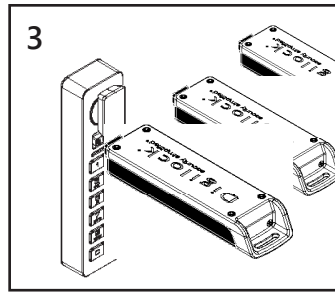

While the LED is flashing, insert each additional Manager Key one at a time.

A beep will be heard for each Manager Key programmed.

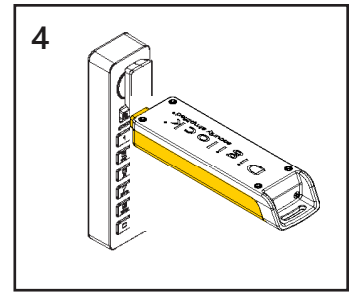

Insert the Programming Key.

A two-tone beep will be heard and the LED will turn off.

Repeat above steps for each lock or follow instructions to Express Register Manager Keys to quickly program multiple locks to operate with the same Manager Keys.

PROGRAMMING INSTRUCTIONS

Set Lock Functionality

Each lock can be set for either shared or assigned use functionality. By default, your lock is in shared use. Press **C** to check functionality. If in shared use, LED is red. If in assigned use, LED is green.

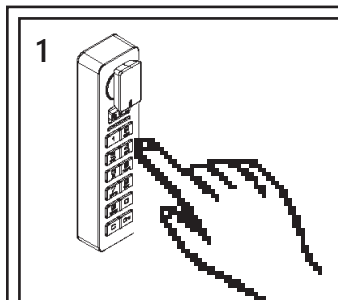

To set for assigned use:

Press: **C** **0** **6** **5** **0**

The red LED will turn on.

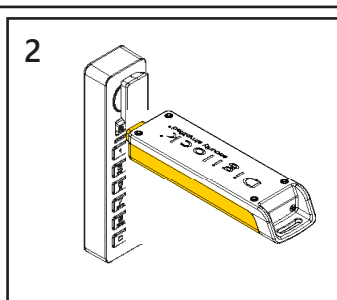

Insert the Programming Key.

A two-tone beep will be heard and the green LED will flash once.

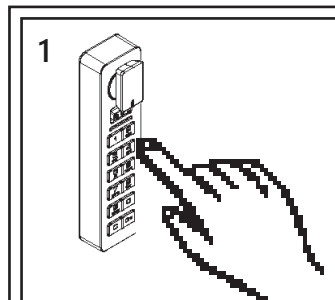

To set for shared use:

Press: **C** **0** **5** **5** **0**

The green LED will turn on.

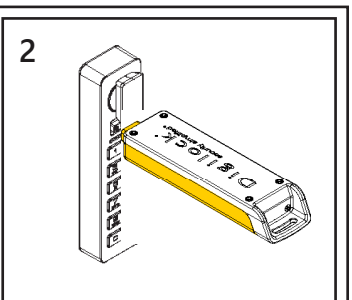

Insert the Programming Key.

A two-tone beep will be heard and the red LED will flash once.

PROGRAMMING INSTRUCTIONS - IN ASSIGNED USE FUNCTIONALITY

Assign User Credentials (for assigned use functionality only)

Make sure that the lock is set for assigned use functionality (a green LED will flash when is pressed). Up to 20 user credentials (User Codes and/or User Keys) may be assigned to each lock.

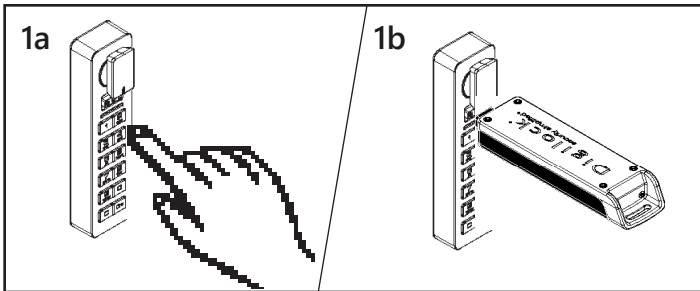

Assign User Codes:

Press: **[C] [0] [5] [5] [0]**. The LED will flash.

While the LED is flashing, insert a valid Manager Key. A two-tone beep will be heard and the LED will turn on.

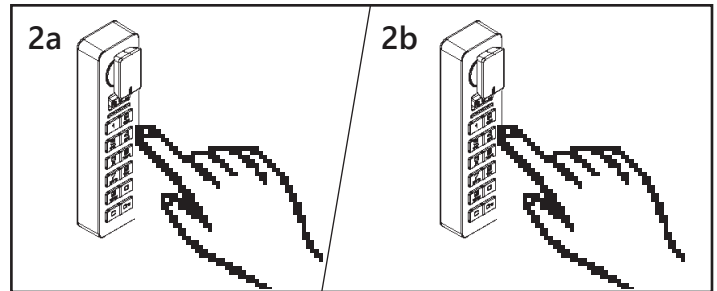

While the LED is on,

Press: **[C] [new 4-7 digit code] [0]**. A two-tone beep will be heard.

Press: **[C] [the same 4-7 digit code] [0]**

Two sets of two-tone beeps will be heard and the LED will turn off.

Remove User Credentials (for assigned use functionality only)

Make sure the lock is in assigned use functionality (a green LED will flash when is pressed). The locks must be reprogrammed to remove user credentials from operating a lock.

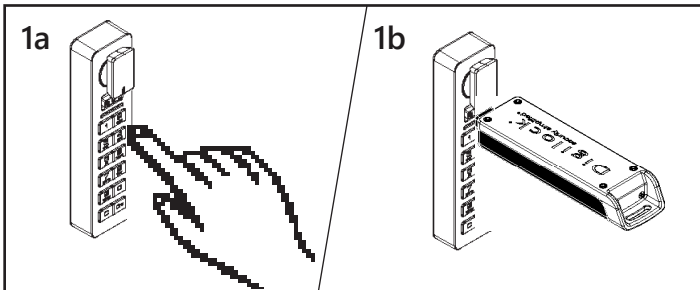

Press: **[C] [0] [5] [5] [0]**. The LED will flash.

While the LED is flashing, insert a valid Manager Key. A two-tone beep will be heard.

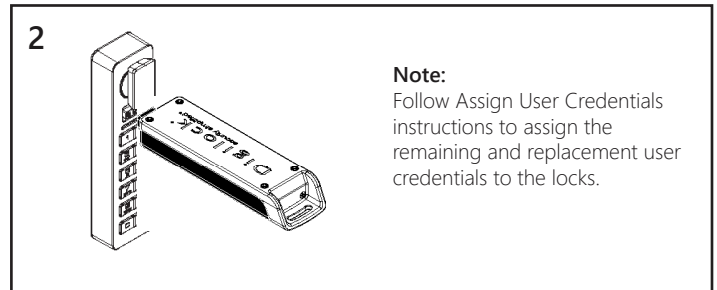

Insert the Manager Key again.

Three sets of two-tone beeps will be heard and the LED will turn off. All previously assigned user credentials will be removed.

Note:

Follow Assign User Credentials instructions to assign the remaining and replacement user credentials to the locks.

Replace an Assigned User Code with a New User Code

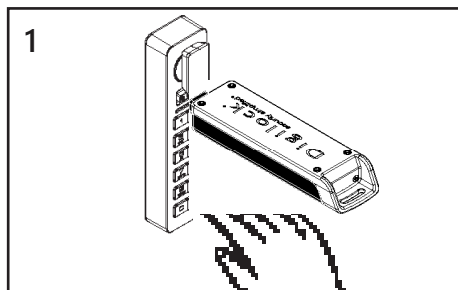

Press: **[C] [0]** then insert a valid Manager Key.

A two-tone beep will be heard and the LED will turn on.

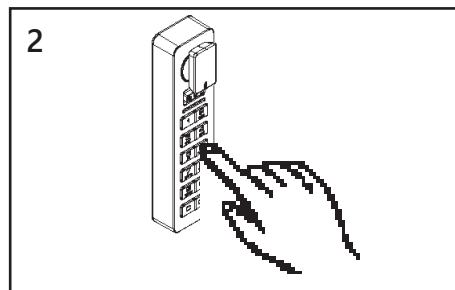

While the LED is on,

Press: **[C] [assigned user code] [0]**

A two-tone beep will be heard.

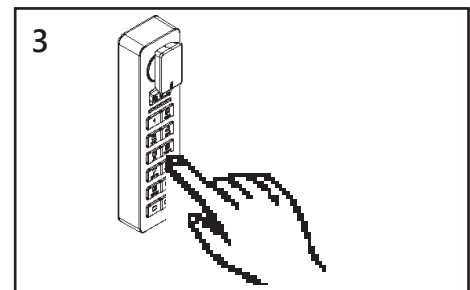

While the LED is on,

Press **[C] [new 4-7 digit user code] [0]**

[C] [the same 4-7 digit user code] [0]

Two sets of two-tone beeps will be heard and the LED will turn off.

OPERATING INSTRUCTIONS - IN SHARED USE FUNCTIONALITY

In shared use functionality, the user enters any 4-7 digit User Code to lock and the same User Code to unlock. Once unlocked, the lock is available for a different user.

Operate with a User Code

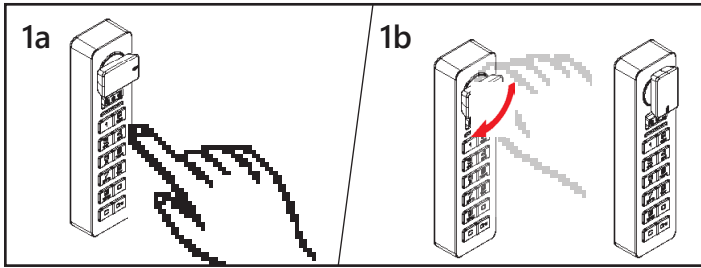

To lock: Close the door. Press [C] [any 4-7 digit user code] [OK] then turn the knob to the locked position.

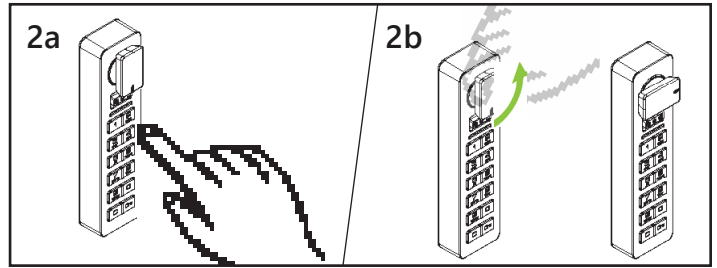

To unlock: Press [C] [the same 4-7 digit user code] [OK] then turn the knob to the unlocked position. Open the door.

Operate with a Manager Key

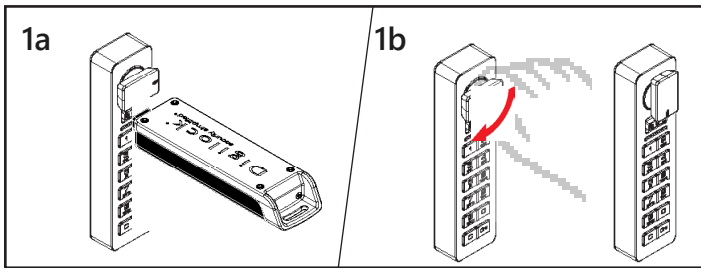

To lock: Close the door. Insert a valid Manager Key then turn the knob to the locked position.

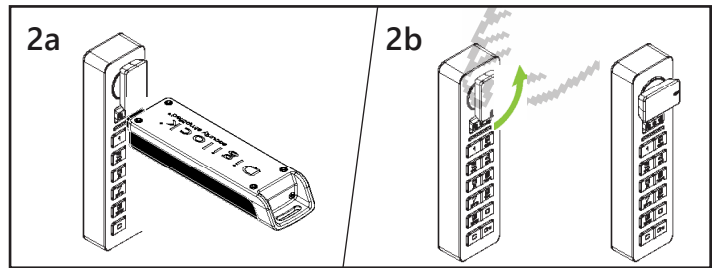

To unlock: Insert a valid Manager Key then turn the knob to the unlocked position. Open the door.

OPERATING INSTRUCTIONS - IN ASSIGNED USE FUNCTIONALITY

In assigned use functionality, users operate the lock with their assigned user credential.

Operate with a User Code

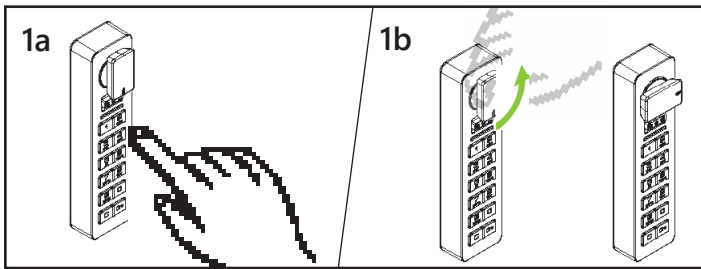

To unlock: Press [C] [any assigned 4-7 digit user code] [OK] then turn the knob to the unlocked position. Open the door.

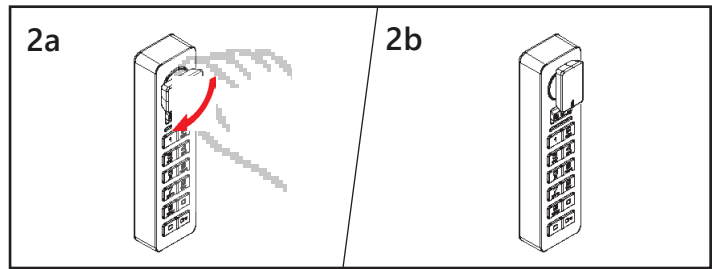

To lock: Close the door then turn the knob to the locked position.

Operate with a Manager Key

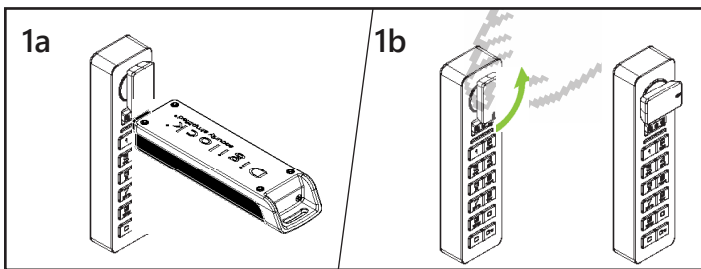

To unlock: Insert a valid Manager Key then turn the knob to the unlocked position. Open the door.

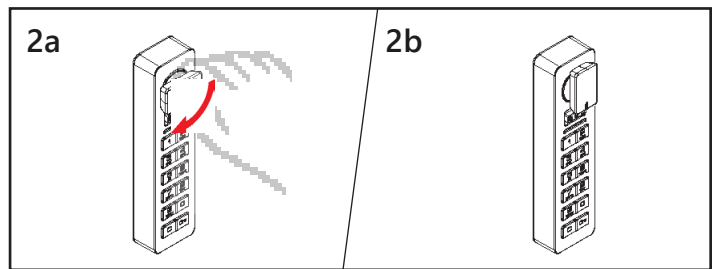

To lock: Close the door then turn the knob to the locked position.

SUPPORT

Sleep Mode

After three consecutive incorrect User Code entries to unlock, the lock will enter Sleep Mode for one minute. For each subsequent incorrect entry, the lock will remain in Sleep Mode for an additional minute. The keypad is disabled while in Sleep Mode. A valid Manager Key may be used to unlock while lock is in Sleep Mode.

Low Battery Indicator

After locking or unlocking, the lock emits two sets of three beeps indicating that the batteries are low. Replace the batteries.

Does not unlock with the User Code or User Key

The lock does not recognize the User Code or User Key. For immediate access, operate with a valid Manager Key. If in assigned use functionality, follow instructions to Assign User Credentials to assign a new User Code or User Key to the lock.

Does not Operate with a Manager Key

The lock does not recognize the Manager Key. Follow instructions to Add Manager Keys to program the Manager Key to the lock. For immediate access, operate with another valid Manager Key.

No Audible Feedback when is Pressed

The lock may be in Sleep Mode or the batteries may need to be replaced. For immediate access, operate with a valid Manager Key. If the error condition persists, replace the batteries.

* After 3 consecutive incorrect User Code entries, the keypad will be disabled for 1 minute (Sleep Mode).

† The lock will remain in the locked position if the knob is not turned within approximately 6 seconds.

BATTERY REPLACEMENT*

It is not necessary to uninstall the lock from the door.

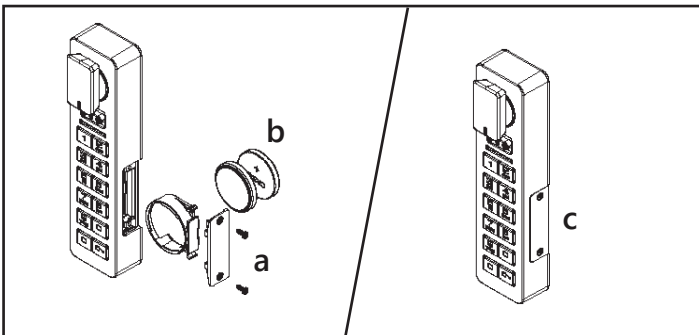

- a Remove the screws and the battery pack.
- b Replace the two premium lithium CR2032 batteries.
- c Re-Insert battery pack and screws.

Note: Never re-insert the battery pack empty as the tray cannot be removed from the lock housing without batteries.