

HUDDLE



Huddle tables shown with Motivate seating.

HUDDLE

These sturdy, versatile tables link and unlink to quickly transform a space. Temporary workstation? Done. Impromptu conference table? Easy! Training session? No problem. Huddle helps you maximize time and square footage — not costs. And for today's businesses, that's a nice change of pace.



FEATURES

- 1 1/8" Heavy-grade, warp-resistant particleboard tops and bases withstand heavy activity.
- Mobile nesting base option lets tables fold up and roll away until you need them.
- Choose wiring and power options so Huddle tables are ready to work when you are.
- Modesty panels offer the added level of privacy your employees want.
- Two edge profiles in over 20 colors and patterns to accommodate differing tastes.
- Height adjustable laptop table offers a mobile, personal table for working anywhere.

HUDDLE ORDERING INFORMATION

LAMINATE

TOPS/L1 LAMINATES CODES

Woodgrain

- ◆ Bourbon Cherry **H**
- ◆ Cognac **COGN**
- ◆ Florence Walnut **LFW1**
- ◆ Harvest **C**
- ◆ Kingswood Walnut **LK11**
- ◆ Mahogany **N**
- ◆ Mocha **MOCH**
- ◆ Natural Maple **D**
- ◆ Pinnacle **PINC**
- ◆ Shaker Cherry **F**
- ◆ Sterling Ash **LSA1**

Solid

- ◆ Black **P**
- ◆ Charcoal **S**
- ◆ Designer White **LDW1**
- ◆ Loft **LOFT**

Patterned

- ◆ Sheer Mesh **A5**
- ◆ Silver Mesh **B9**
- ◆ Steel Mesh **A9**
- ◆ Canyon Zephyr **K9**
- ◆ Desert Zephyr **K8**
- ◆ Shadow Zephyr **K1**
- ◆ Battleship **LBT1***
- ◆ Gray **G2**
- ◆ Grey Tigris **L6**
- ◆ Moroccan **LMN1***
- ◆ Mushroom **LMH1***
- ◆ Neon Carrot **LNC1***
- ◆ Tennis Ball **LTB1***
- ◆ White **G1**
- ◆ Whitestone **K4**

TOPS/L2 LAMINATES CODES

Woodgrain

- ◆ Lowell Ash **LLA1**
- ◆ Natural Recon **LNR1**
- ◆ Phantom Ecru **LPE1**
- ◆ Portico Teak **LPT1**
- ◆ Skyline Walnut **LSW1**

L5 LAMINATES CODES

- ◆ White Markerboard **FMQ1***

EDGE BAND

EDGES/ EDGE BAND (2MM) CODES

- ◆ Black **P**
- ◆ Bourbon Cherry **H**
- ◆ Charcoal **S**
- ◆ Cognac **COGN**
- ◆ Designer White **DW**
- ◆ Florence Walnut **FW**
- ◆ Greige **R**
- ◆ Harvest **C**
- ◆ Kingswood Walnut **KI**
- ◆ Loft **LOFT**
- ◆ Lowell Ash **DL**
- ◆ Mahogany **N**
- ◆ Mocha **MOCH**
- ◆ Muslin **T**
- ◆ Natural Maple **D**
- ◆ Natural Recon **NR**
- ◆ Phantom Ecru **PE**
- ◆ Pinnacle **PINC**
- ◆ Platinum **K**
- ◆ Portico Teak **DP**
- ◆ Shadow * **SHDW**
- ◆ Shaker Cherry **F**
- ◆ Skyline Walnut **SW**
- ◆ Sterling Ash **SA**

T-MOLD

T-MOLD CODES

- ◆ Black **P**
- ◆ Charcoal **S**
- ◆ Designer White **DW**
- ◆ Greige **R**
- ◆ Loft **LOFT**
- ◆ Lowell Ash **DL**
- ◆ Muslin **T**
- ◆ Natural Recon **NR**
- ◆ Phantom Ecru **PE**
- ◆ Platinum **K**
- ◆ Portico Teak **DP**
- ◆ Shadow * **SHDW**
- ◆ Skyline Walnut **SW**
- ◆ Atom **AT***
- ◆ Bullseye **BY***
- ◆ Charcoal **S***
- ◆ Ember **MR***
- ◆ Ion **IO***
- ◆ Iris **IR***
- ◆ Krypton **KT***
- ◆ Regatta **RE***

PAINT

BASE PAINT CODES

P1

- ◆ Black **P**
- ◆ Brownstone **P7D**
- ◆ Charcoal **S**
- ◆ Designer White **PJW**
- ◆ Fossil **P28**
- ◆ Greige **T5**
- ◆ Light Gray **Q**
- ◆ Loft **LOFT**
- ◆ Muslin **T3**
- ◆ Putty **L**
- ◆ Shadow * **SHDW**
- ◆ Titanium **P8T**

P2

- ◆ Champagne Metallic **T4**
- ◆ Platinum Metallic **T1**
- ◆ Silver **PR6**

P3

- ◆ Atom **P8S**
- ◆ Bullseye **PJF**
- ◆ Ember **P8P**
- ◆ Ion **P8N**
- ◆ Iris **P8J**
- ◆ Krypton **P8F**
- ◆ Regatta **P8M**

Recommended Edgeband Color Selection:

Laminate		Edge	
Bourbon Cherry	H	Bourbon Cherry	H
Cognac	COGN	Cognac	COGN
Florence Walnut	LFW1	Florence Walnut	FW
Harvest	C	Harvest	C
Kingswood Walnut	LK11	Kingswood Walnut	KI
Mahogany	N	Mahogany	N
Mocha	MOCH	Mocha	MOCH
Natural Maple	D	Natural Maple	D
Pinnacle	PINC	Pinnacle	PINC
Shaker Cherry	F	Shaker Cherry	F
Sterling Ash	LSA1	Sterling Ash	SA
Black	P	Black	P
Charcoal	S	Charcoal	S
Designer White	LDW1	Designer White	DW
Loft	LOFT	Loft	LOFT
Whitestone	K4	Muslin	T
Sheer Mesh	A5	Muslin	T
Silver Mesh	B9	Loft	LOFT
Steel Mesh	A9	Charcoal	S
Canyon Zephyr	K9	Greige	R
Desert Zephyr	K8	Greige	R
Shadow Zephyr	K1	Loft	LOFT
Gray	G2	Charcoal	S
Grey Tigris	L6	Greige	R
White	G1	Charcoal	S
Lowell Ash	LLA1	Lowell Ash	DL
Natural Recon	LNR1	Natural Recon	NR
Phantom Ecru	LPE1	Phantom Ecru	PE
Portico Teak	LPT1	Portico Teak	DP
Skyline Walnut	LSW1	Skyline Walnut	SW

◆◆◆ For lead time information see page 19.

* De-emphasized

* Available on laptop table only.

HUDDLE

Multi-Purpose Tables

Huddle Multi-Purpose Tables are ready to jump into action for training, meetings, collaboration and more. Thoughtful design, flexibility and plenty of base, edge and finish options, make Huddle tables capable of meeting the needs of smart, agile businesses.

Tops - Rectangle

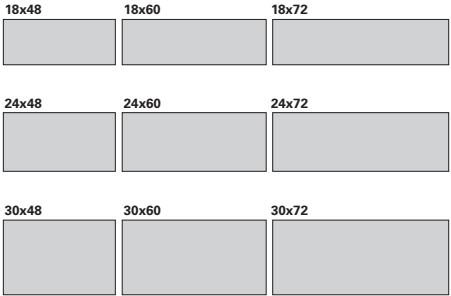

Edge Options

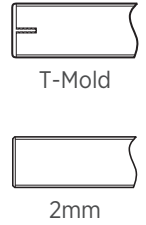

Tops - Half-Round and Extended Half-Round

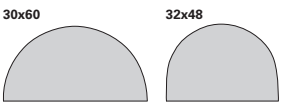

Bases

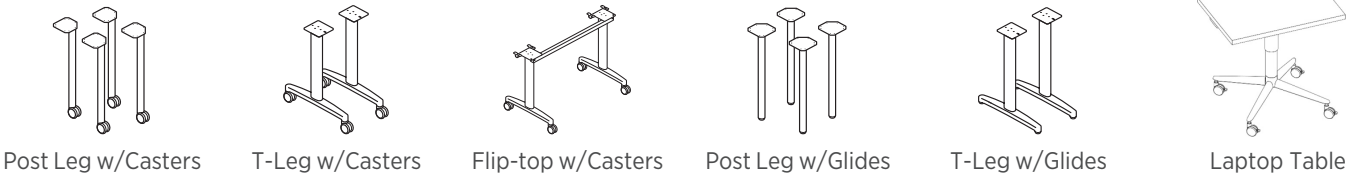

Accessories

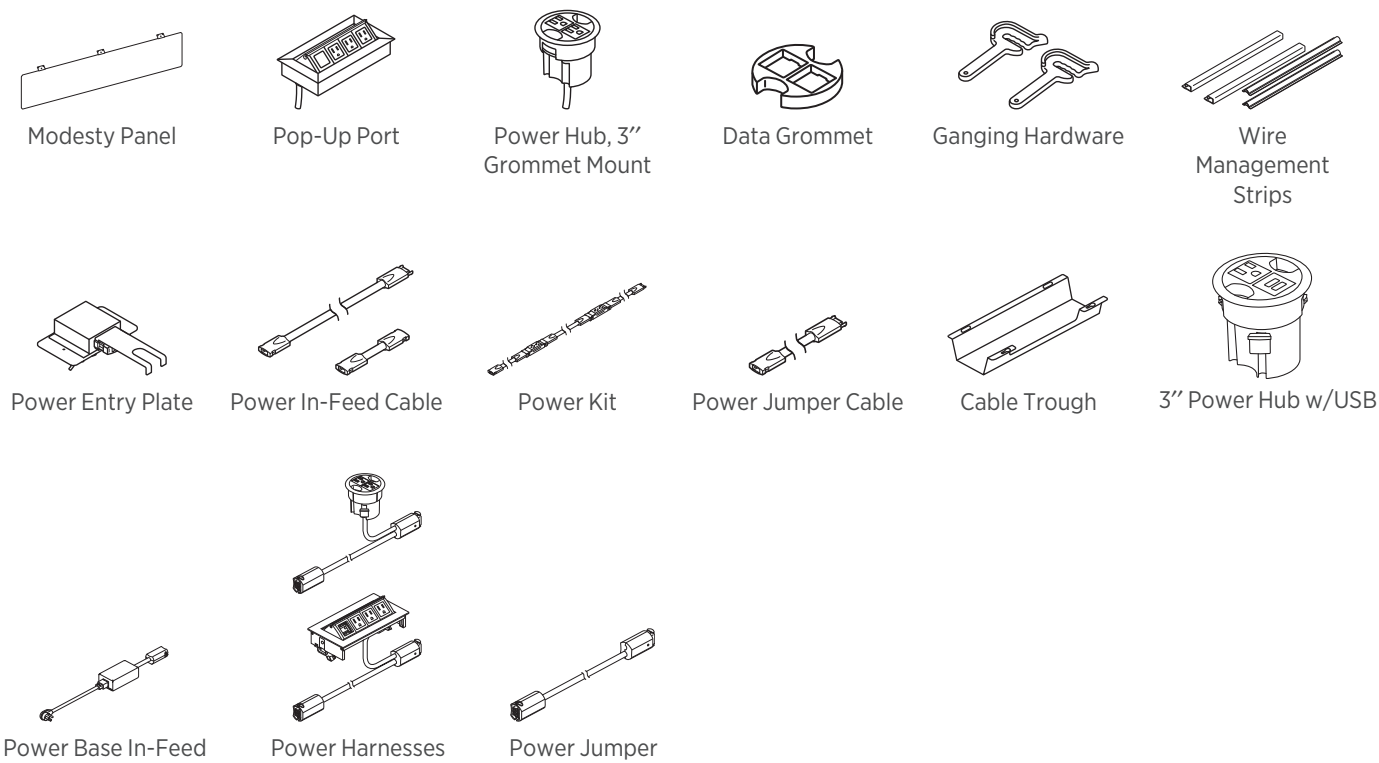

HUDDLE Typicals



Icon Legend on page 19

QTY	DESCRIPTION	MODEL	LIST PRICE	PRICE EXTENSION
12	Rectangular Table Top 60"W x 24"D	HMT2460G	\$389	\$4,668
12	Flip-top Base	HMBFLIP24L.C	\$626	\$7,512
21	Perpetual® Nesting Chair	HPN1	\$694	\$14,574
TOTAL:				\$26,754

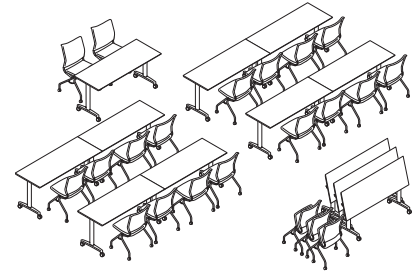

TRAINING

QTY	DESCRIPTION	MODEL	LIST PRICE	PRICE EXTENSION
4	Rectangular Table Top 72"W x 30"D	HMT3072G	\$458	\$1,832
4	Post Leg Base	HMBPOST	\$359	\$1,436
8	Perpetual® Nesting Chair	HPN1	\$694	\$5,552
TOTAL:				\$8,820

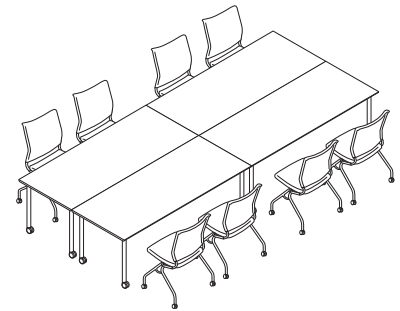

MEETING/CONFERENCE

QTY	DESCRIPTION	MODEL	LIST PRICE	PRICE EXTENSION
2	Rectangular Table Top 72"W x 30"D	HMT3072G	\$458	\$916
2	Half-round Table Top	HMTHR3060G	\$441	\$882
2	Flip-top Base	HMBFLIP30L	\$626	\$1,252
2	Flip-top Base	HMBFLIP24S	\$626	\$1,252
4	Perpetual® Nesting Chair	HPN1	\$694	\$2,776
TOTAL:				\$7,078

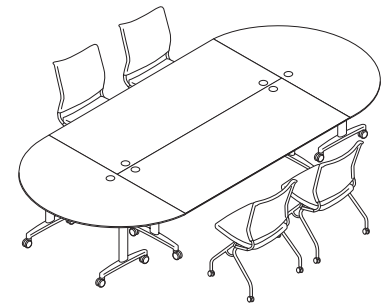

MEETING



Icon Legend on page 19

HUDDLE Typicals

QTY	DESCRIPTION	MODEL	LIST PRICE	PRICE EXTENSION
8	Rectangular Table Top 60"W x 30"D	HMT3060G	\$401	\$3,208
8	Fixed Height T-Leg Base with Casters	HMBTLEG24.C	\$426	\$3,408
8	Perpetual® Nesting Chair	HPN1	\$694	\$5,552
TOTAL:				\$12,168

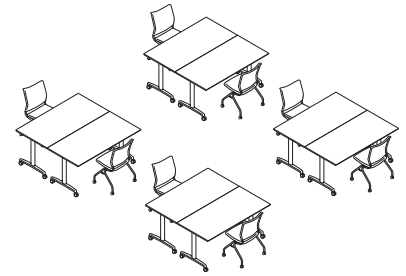

GROUP BREAKOUT

QTY	DESCRIPTION	MODEL	LIST PRICE	PRICE EXTENSION
6	Rectangular Table Top 72"W x 24"D	HMT2472G	\$430	\$2,580
6	Fixed Height T-Leg Base with Casters	HMBTLEG24.C	\$426	\$2,556
12	Perpetual® Nesting Chair	HPN1	\$694	\$8,328
TOTAL:				\$13,464

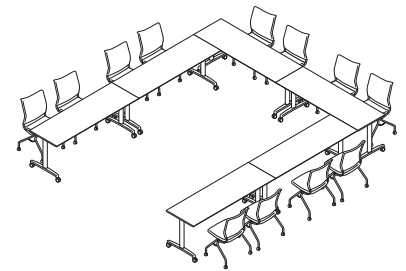

PRESENTATION

HUDDLE

Multi-Purpose Table Tops

GSA SIN 33721



Icon Legend on page 19

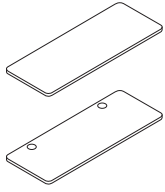

HMT1848E

DESCRIPTION

Rectangular T-Mold Table Tops

48"W x 18"D
60"W x 18"D
72"W x 18"D

48"W x 24"D
60"W x 24"D
72"W x 24"D

48"W x 30"D
60"W x 30"D
72"W x 30"D

MODEL

HMT1848E
HMT1860E
HMT1872E

HMT2448E
HMT2460E
HMT2472E

HMT3048E
HMT3060E
HMT3072E

SHIP WEIGHT CUBE

34 2.9
42 3.5
51 3.9

45 3.7
57 4.5
68 5.0

57 4.4
71 5.4
85 6.0

LIST PRICE BY LAMINATE GRADE

L1 L2

\$312 \$322
\$332 \$347
\$408 \$423

\$351 \$366
\$389 \$409
\$430 \$450

\$366 \$381
\$401 \$421
\$458 \$478

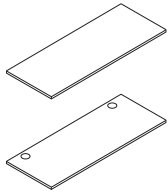

HMT1848G

Rectangular Edgeband Table Tops

48"W x 18"D
60"W x 18"D
72"W x 18"D

48"W x 24"D
60"W x 24"D
72"W x 24"D

48"W x 30"D
60"W x 30"D
72"W x 30"D

HMT1848G
HMT1860G
HMT1872G

HMT2448G
HMT2460G ⓘ
HMT2472G

HMT3048G
HMT3060G
HMT3072G

34 2.9
42 3.5
51 3.9

45 3.7
57 4.5
68 5.0

57 4.4
71 5.4
85 6.0

\$312 \$322
\$332 \$347
\$408 \$423

\$351 \$366
\$389 \$409
\$430 \$450

\$366 \$381
\$401 \$421
\$458 \$478

NOTES:



- Table tops are 1/8" thick.
- When post legs are used with 18"D tops, post leg to be specified with glides only.
- ⓘ Round grommets available in Black only.
- ⓘ Pop-up Port option (G1) is unfinished. Insert accessory must be ordered separately.

HOW TO SPECIFY

<p>Select Model Number</p> <p>HMT1848G</p>	<p>Select Grommet Option</p> <p>N No Grommet G 2 Grommets (Black only) (\$30 upcharge) G1 Cutout for Pop-up Port (\$40 upcharge). Order port separately.</p> <p>N</p>	<p>Select Laminate</p> <p>See page 80</p> <p>D</p>	<p>Select Edge Color</p> <p>See page 80</p> <p>D</p>
---	---	---	---

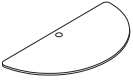

HUDDLE Multi-Purpose Table Tops

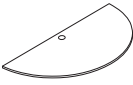
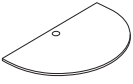
	DESCRIPTION	MODEL	SHIP WEIGHT	CUBE	LIST PRICE BY LAMINATE GRADE	
					L1	L2
 HMTHR3060E	Half-Round and Extended Half-Round T-Mold Table Tops 60"W x 30"D, Half-Round Table Tops (use bases: HMBFLIP24S or HMBTLEG24 or HMBPOST)	HMTHR3060E	69	6.1	\$441	\$461
	48"W x 32"D, Extended Half-Round Table Tops (use bases: HMBFLIP24S or HMBTLEG24)	HMTHR3248E	57	6.1	\$430	\$450
 HMTHR3248E	Half-Round and Extended Half-Round Edgeband Table Tops 60"W x 30"D, Half-Round Table Tops (use bases: HMBFLIP24S or HMBTLEG24 or HMBPOST)	HMTHR3060G	69	6.1	\$441	\$461
	48"W x 32"D, Extended Half-Round Table Tops (use bases: HMBFLIP24S or HMBTLEG24)	HMTHR3248G	57	6.1	\$430	\$450
 HMTHR3060G						
 HMTHR3248G						

NOTES:

- Table tops are 1½" thick.
- ⓘ Round grommets available in Black only.
- ⓘ Pop-up Port option (G1) is unfinished. Insert accessory must be ordered separately.

HOW TO SPECIFY

<p>Select Model Number</p> <p>H M T H R 3 2 4 8 G .</p>	<p>Select Grommet Option</p> <p>N No Grommet G 1 Grommet (Black only) (\$15 upcharge) G1 Cutout for Pop-up Port (\$40 upcharge). Order port separately.</p> <p>N .</p>	<p>Select Laminate</p> <p>See page 80</p> <p>D .</p>	<p>Select Edge Color</p> <p>See page 80</p> <p>D .</p>
--	--	---	---

HUDDLE

Multi-Purpose Table Bases

GSA SIN 33721



Icon Legend on page 19

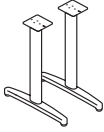

DESCRIPTION

Fixed Height T-Leg Base (Includes 2 T-legs)
 For 18"D Table Tops
 For 24"D and 30"D Table Tops

MODEL

HMBTLEG18
HMBTLEG24

SHIP WEIGHT

12
 14

CUBE

3.6
 3.6

LIST PRICE BY PAINT GRADE

P1	P2	P3
\$426	\$446	\$456
\$426	\$446	\$456



Flip-top Base (Includes 1 Complete Base)

For 18"D x 48"W Rectangular Table Tops
 For 18"D x 60"W, 72"W Rectangular Table Tops
 For 24"D x 48"W and 32"D x 48"W Rectangular
 Tops and 30"D x 60"W Half-Round Table Tops
 For 24"D x 60"W, 72"W Rectangular Table Tops
 For 30"D x 48"W Rectangular Table Tops
 For 30"D x 60"W, 72"W Rectangular Table Tops

HMBFLIP18S
HMBFLIP18L
HMBFLIP24S

HMBFLIP24L
HMBFLIP30S
HMBFLIP30L

23
 26
 24

 27
 24
 27

4.1
 4.1
 4.1

 4.1
 4.1
 4.1

P1	P2	P3
\$626	\$646	\$656
\$626	\$646	\$656
\$626	\$646	\$656
\$626	\$646	\$656
\$626	\$646	\$656
\$626	\$646	\$656

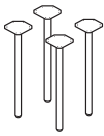

Post Leg Base (Includes 4 Post Legs)
 For all Tops

HMBPOST

18
 2.3

P1	P2	P3
\$359	\$379	\$389

Table Top to Base Compatibility Chart:

	Flip-Top	T-Leg	Post Leg
18"D x 48"W	HMBFLIP18S	HMBTLEG18	HMBPOST*
18"D x 60"W	HMBFLIP18L	HMBTLEG18	HMBPOST*
18"D x 72"W	HMBFLIP18L	HMBTLEG18	HMBPOST*
24"D x 48"W	HMBFLIP24S	HMBTLEG24	HMBPOST
32"D x 48"W HR	HMBFLIP24S	HMBTLEG24	N/A
30"D x 60"W HR	HMBFLIP24S	HMBTLEG24	HMBPOST
24"D x 60"W	HMBFLIP24L	HMBTLEG24	HMBPOST
24"D x 72"W	HMBFLIP24L	HMBTLEG24	HMBPOST
30"D x 48"W	HMBFLIP30S	HMBTLEG24	HMBPOST
30"D x 60"W	HMBFLIP30L	HMBTLEG24	HMBPOST
30"D x 72"W	HMBFLIP30L	HMBTLEG24	HMBPOST

*Post legs should be specified with glides for use on 18"D worksurfaces.
 NOTE: Glides/casters are NOT interchangeable on Post Leg and T-base.

NOTES:



- When glides are specified, adjustable range is 1".
- Flip-top base is standard with casters.
- When post legs are used with 18"D tops, post leg to be specified with glides only.

HOW TO SPECIFY

<p>Select Model Number</p> <p>H M B T L E G 1 8</p>	<p>Select Glide/Caster Option</p> <p>G Glide C Caster</p> <p>Flip-top base is available with casters only When post legs are used with 18"D tops, specify with glides only</p> <p>G</p>	<p>Select Paint Color</p> <p>See page 80 \$20 upcharge per model, for P2 paint \$30 upcharge per model, for P3 paint</p> <p>T 1</p>
--	--	--



HUDDLE Mobile Laptop Table

	DESCRIPTION	MODEL	SHIP WEIGHT	CUBE	LIST PRICE	UPCHARGE BY LAMINATE/PAINT GRADE			
						L2	L5	P2	P3
	T-Mold 28"W x 20"D	HPHAP2028E	59	8.7	\$809	\$20	\$80	\$20	\$30
	Edgeband 28"W x 20"D	HPHAP2028G	59	8.7	\$809	\$20	\$80	\$20	\$30

NOTES:

- Tables adjust from 26"-33"H.
- Pneumatic height adjustment so no electricity is required to adjust height of table.

HOW TO SPECIFY

<p>Select Model Number</p> <p>HPHAT2028E</p>	<p>Select Laminate</p> <p>See page 80</p> <p>LFW1</p>	<p>Select Edge Color</p> <p>See page 80</p> <p>FW</p>	<p>Select Paint Color</p> <p>See page 80</p> <p>P8T</p>
---	--	--	--



HUDDLE

Table Accessories

GSA SIN 33721

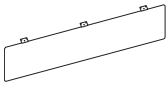

Icon Legend on page 19

	DESCRIPTION	MODEL	SHIP WEIGHT	CUBE	LIST PRICE BY PAINT GRADE		
					P1	P2	P3
	Universal Modesty Panel						
	For 48"W Huddle Tables	HMTUMOD32	9	1.9	\$214	\$234	\$244
	For 60"W & 72"W Huddle Tables	HMTUMOD44	12	2.5	\$234	\$254	\$264
	NOTES: Universal Modesty Panels nest between the table legs.						
	Ganging Hardware	HMAGANG	1 ☉	0.1	\$94		
	<ul style="list-style-type: none"> Includes two ganging links and two screws No color designator when specifying. <i>Example: HMAGANG.</i> 						

NOTES:

- Ganging Hardware must be ordered and installed on tables when using 4-trac electrical systems.
- Ganging hardware attaches to underside of table in pre-drilled pilot holes.
- Vertical Wire Management Strips must be trimmed when applied to legs of T-Leg and Flip-Top Bases with casters.

HOW TO SPECIFY

Select Model Number	Select Paint Color
H M T U M O D 3 2 .	See page 98
	S

GSA SIN AS NOTED

CABLE MANAGEMENT

Icon Legend on page 19

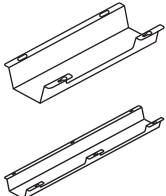
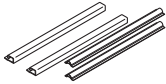
	DESCRIPTION	MODEL	SHIP WEIGHT	CUBE	LIST PRICE
	Cable Management Troughs				
	17"W — Single	HCTROUGH17	3 ☉	0.5	\$67
	17"W — 10-Pack	HCTROUGH1710	14 ☉	0.5	\$620
	36"W — Single	HCTROUGH36	5 ☉	0.9	\$113
	36"W — 10-Pack	HCTROUGH3610	30 ☉	0.9	\$1045
	<ul style="list-style-type: none"> Metal Cable Management Troughs ship flat Troughs attach to underside of worksurface with screws Cutouts in trough allow access to power without the need to detach from surface. 17"W = 1 cutout; 36"W = 2 cutouts. Graphite only, no need to specify Slim profile design 				
	NOTES: For additional information see page 240.				
	Wire Management Strips	HBTMS	3 ☉	0.2	\$119
	Includes: 2 - 24" vertical strips 2 - 24" horizontal strips <ul style="list-style-type: none"> Available in Black only. <i>Specify P when ordering. Example: HBTMS.P.</i> HON 5-Year Limited Warranty. 				
OPEN MARKET					

HOW TO SPECIFY

Select Model Number
H C T R O U G H 1 7

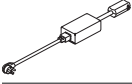
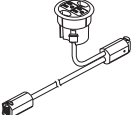
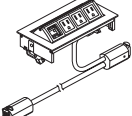
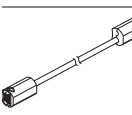
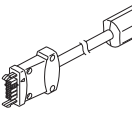
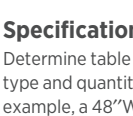

INTERLINK IQ ELECTRICAL

	DESCRIPTION	MODEL	SHIP WEIGHT	CUBE	LIST PRICE
	Power Base In-Feed • 12 amp circuit breaker is built in to the Power Base In-Feed. • Available in Black finish, no specification needed.	HQB	2	0.2	\$525
	Power Harness – 1’ Power Hub, 3” Round Grommet Mount • Available in Black finish, no specification needed.	HQH1-3	2	0.2	\$172
	Power Harness – 5’ Power Hub, 3” Round Grommet Mount • Available in Black finish, no specification needed.	HQH5-3	2	0.2	\$193
	Power Harness – 5’ with 4” x 8” Pop-Up Port (3 Power, 1 Blank) • For use with tables G1 grommet. Specify paint.	HQH5-P-3P1B	3	0.3	\$378
	Power Jumper – 3’ • Available in Black finish, no specification needed.	HQJ3	2	0.2	\$107
	IQ 1.0 Backward Compatible Jumper 36” • Available in Black finish, no specification needed. • Use when connecting Interlink IQ 1.0 power harness (rectangle end) to Interlink IQ 2.0 (oval end) power harness. ! If using Interlink IQ 2.0 in-feed with Interlink IQ 1.0 power harness please contact Customer Support.	HQBCJ36	2	0.2	\$82

Specification guide for IQ Electrical on Huddle tables

Determine table width, the type of power access being used (3” grommet or 4x8 pop-up) and the desired number per table (Columns 1, 2 or 3). The table will then identify the type and quantity of components needed per table along with the maximum table run. Note that this is in addition to the Power base in-feed which is needed for each run. For example, a 48”W table with two 3” power grommets per table will require (1) HQH5-3 harness and (1) HQH1-3 harness per table with a maximum run of four tables.

Top Width	POWER ONE (1) PER TABLE 3” ROUND POWER GROMMET		POWER TWO (2) PER TABLE 3” ROUND POWER GROMMETS		POWER ONE (1) PER TABLE 4x8 POP-UP PORT	
	Quantity	Table Run Maximum	Quantity	Table Run Maximum	Quantity	Table Run Maximum
36”	(1) HQH5-3	8	N/A	N/A	(1) HQH5-P	8
42”	(1) HQH5-3	8	N/A	N/A	(1) HQH5-P	8
48”	(1) HQH5-3	8	(1) HQH5-3 (1) HQH1-3	4 Max Table Run	(1) HQH5-P	8 Max Table Run
54”	(1) HQH5-3	8	(1) HQH5-3 (1) HQH1-3	4 Max Table Run	(1) HQH5-P	8 Max Table Run
60”	(1) HQH5-3	8	(1) HQH5-3 (1) HQH1-3	4 Max Table Run	(1) HQH5-P	8 Max Table Run
66”	(1) HQH5-3 (1) HQJ3	4 Table Run Maximum	(1) HQH5-3 (1) HQH1-3	4 Max Table Run	(1) HQH5-P (1) HQJ3	4 Max Table Run
72”	(1) HQH5-3 (1) HQJ3	4 Table Run Maximum	(1) HQH5-3 (1) HQH1-3	4 Max Table Run	(1) HQH5-P (1) HQJ3	4 Max Table Run
84”	(1) HQH5-3 (1) HQJ3	4 Table Run Maximum	(2) HQH5-3	4 Max Table Run	(1) HQH5-P (1) HQJ3	4 Max Table Run
96”	(1) HQH5-3 (1) HQJ3	4 Table Run Maximum	(2) HQH5-3	4 Max Table Run	(1) HQH5-P (1) HQJ3	4 Max Table Run
Half-Round (all sizes)	(1) HQH1-3	2 Tables Maximum	N/A	N/A	(1) HQH5-P	2 Max Table Run
Trapezoid (all sizes)	(1) HQH5-3	8 Table Run Maximum	N/A	N/A	(1) HQH5-P	8 Max Table Run

NOTES:

- Interlink IQ Electrical is a pluggable, single circuit electrical system.
- All electrical models include wire management clips and hardware.
- Interlink IQ Electrical is non-sequential/non-directional. It can be installed in any direction.
- Interlink IQ Electrical is UL Recognized as a Powered Table System and meets the requirements of UL 962.

! 40’ maximum run, or no more than 8 units, whichever comes first. Interlink IQ system will automatically shut off if maximum requirements are exceeded. Maximum run is based upon electrical harness width, not table width.

HOW TO SPECIFY

Select Model Number HQH5 - P - 3 P1 B .	Select Paint Color FOG Fog SVR Silver BLK Black SVR
---	--

4-TRAC HARDWIRE ELECTRICAL SYSTEM

4-Trac Electrical System

The 4-Trac Electrical System is a UL-recognized Manufactured Wiring System that seamlessly passes power from one worksurface to another. This low-profile non-sequential electrical system allows tables to be “daisy-chained” together in any desired order and allows users to reconfigure quickly due to simple connectable/disconnectable links.

- Meets requirements of UL 183 and National Electric Code Article 604
- 4-Wires, 2-circuits, 20 Amps each (Circuit 1 and Circuit 2 only)
- 13 Duplex Receptacles per circuit, 26, 15 Amp Duplex receptacle per power in-feed
- Electrical system attaches directly to underside of worksurface with included brackets
- Up to twelve tables can be linked together

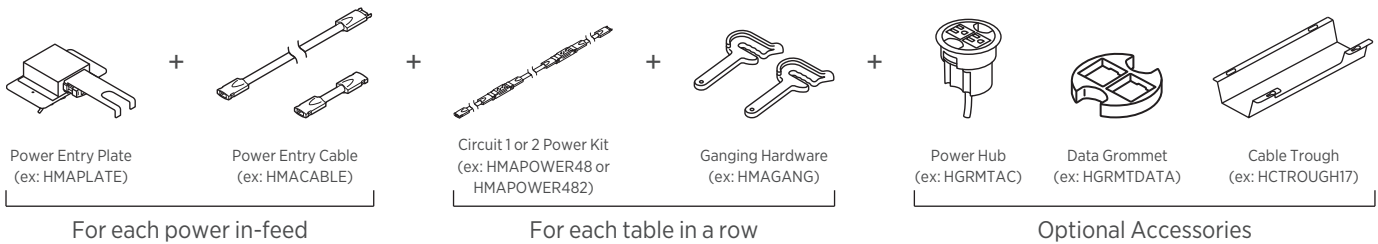

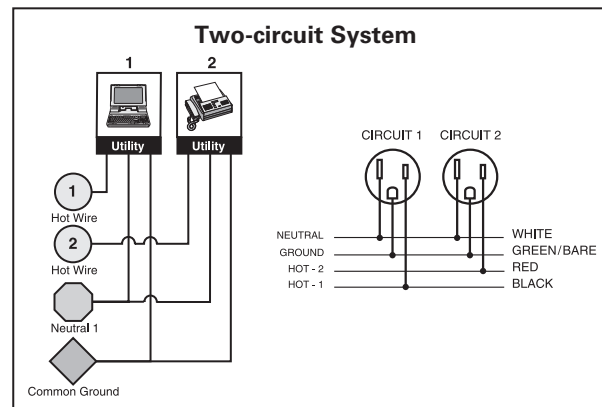
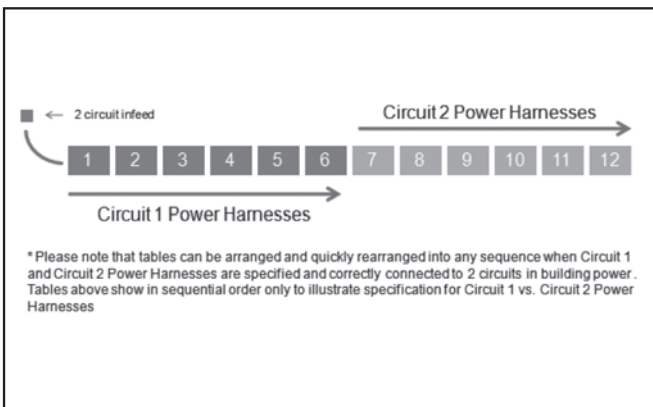

Steps for Electrical Specifications:

- Determine how many rows of tables are needed and order the following:
 - One HMAPLATE per row (or power in-feed)
 - One HMACABLE per row (or power in-feed)
- Order one power harness per table in each row
 - For 1-6 tables in a row (see illustration 1)
 - Order Circuit 1 Power Harnesses (ex. If powering six 24x60 tables order six sets of HMAPOWER60)
 - For 7-12 tables in a row (see illustration 1)
 - Order Circuit 1 Power Harness for first six tables and Circuit 2 Power Harness for remaining tables (ex. If powering eight 24x60 tables, order six sets of HMAPOWER60 and two sets of HMAPOWER602)
- Order one set of ganging hardware per table (ex. HMAGANG)
- Determine which accessories are needed:
 - Power Hub model HGRMTAC — to access power at worksurface.
 - Data Grommet model HGRMTDATA — to access data at worksurface.
 - Wire Management strips model HBTMS — for vertical and horizontal wire management.

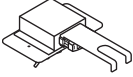
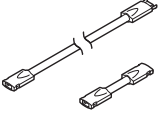

4-TRAC HARDWIRE ELECTRICAL SYSTEM

	DESCRIPTION	MODEL	SHIP WEIGHT	CUBE	LIST PRICE
	Power Entry Plate	HMAPLATE	1.0	0.2	\$94
	Power Entry Cable • 6' power entry cable with male/female adapter. • Connects table to power entry plate.	HMACABLE	1.8	0.2	\$147
	Power Jumper Cable To connect tables front to front	HMAJUMP	0.5	0.3	\$50
	Circuit 1 Power Kit for 48" W Table	HMAPOWER48	1.8	0.3	\$272
	Circuit 1 Power Kit for 60" W Table	HMAPOWER60	2.0	0.3	\$280
	Circuit 1 Power Kit for 72" W Table	HMAPOWER72	2.2	0.3	\$286
	Circuit 1 Power Kit for 84" W Table	HMAPOWER84	2.4	0.3	\$297
	Circuit 1 Power Kit for 96" W Table	HMAPOWER96	2.6	0.3	\$306
	Circuit 2 Power Kit for 48" W Table	HMAPOWER482	1.8	0.3	\$272
	Circuit 2 Power Kit for 60" W Table	HMAPOWER602	2.0	0.3	\$280
	Circuit 2 Power Kit for 72" W Table	HMAPOWER722	2.2	0.3	\$286
	Circuit 2 Power Kit for 84" W Table	HMAPOWER842	2.4	0.3	\$297
	Circuit 2 Power Kit for 96" W Table	HMAPOWER962	2.6	0.3	\$306

NOTES:

- Ganging Hardware must be ordered and installed on tables when using 4-trac electrical systems. See page 88 for Ganging Hardware.
- Each power kit includes two duplex receptacles and attaches to the underside of the worksurface with included brackets.

HOW TO SPECIFY

Select
Model Number

H M A P L A T E

HUDDLE

Power and Cable Management

GSA SIN AS NOTED

ABI

Icon Legend on page 19

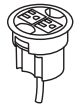

SIN 33721T

DESCRIPTION**Power Hub, 3" Grommet Mount, 6' Cord**

- Fits in 3" round grommet holes.
- Field installed with Plug-and-play ease.
- Two grounded AC power outlets.
- Includes 6' cord with three-prong plug.
- Available in Black only. *Specify X when ordering. Example: HGRMTAC.X.*

NOTES: For additional information see page 236.

MODEL**HGRMTAC****SHIP WEIGHT**

1.3

CUBE

0.2

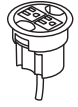
LIST PRICE**\$116**

SIN 33721T

3" Round Power Grommet – 2 Outlets, 10' Cord

- Includes 10' cord with three-prong plug.
- Fits in 3" round grommet holes.
- Two grounded AC power outlets.
- Field installed with Plug-and-play ease.

NOTES: Power Modules will also work with standing-height applications for 10500 Series™ and Voi® desks.

- ! Available in black finish only, no specification needed.

HGRMTAC2

1.5

0.2

\$148

SIN 33721T

Power/USB Hub, 3" Grommet Mount

- One grounded AC power outlet with 2 USB ports.
- UL Listed.

NOTES: For additional information see page 236.

- ! Available in black only (no color designation so use .X – Specify: HGRMTUSB2.X).

HGRMTUSB2

1.3

0.2

\$226

SIN 33721

Data Grommet

Blank grommet kit that includes adapters for a variety of manufacturers jacks and couplers.

- Fits in existing 3" round grommet housing.
- Available in Black only. *Specify P when ordering. Example: HGRMTDATA.P.*

NOTES: For additional information see page 236.

HGRMTDATA

0.2

0.2

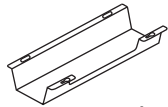
\$20

SIN 33721

Cable Management Troughs

17"W – Single

17"W – 10-Pack

36"W – Single

36"W – 10-Pack

- Cable management troughs ship flat packed.
- The troughs attach to underneath the worksurface with screws.
- Cutouts in trough allow access to power without the need to detach from surface. 17"W = 1 cutout; 36"W = 2 cutouts.
- Color: Graphite.

NOTES: For additional information see page 240.

HCTROUGH17

2.7

0.5

\$67**HCTROUGH1710**

14.0

0.5

\$620**HCTROUGH36**

4.9

0.9

\$113**HCTROUGH3610**

30.0

0.9

\$1045**HOW TO SPECIFY**Select
Model Number

H G R M T A C