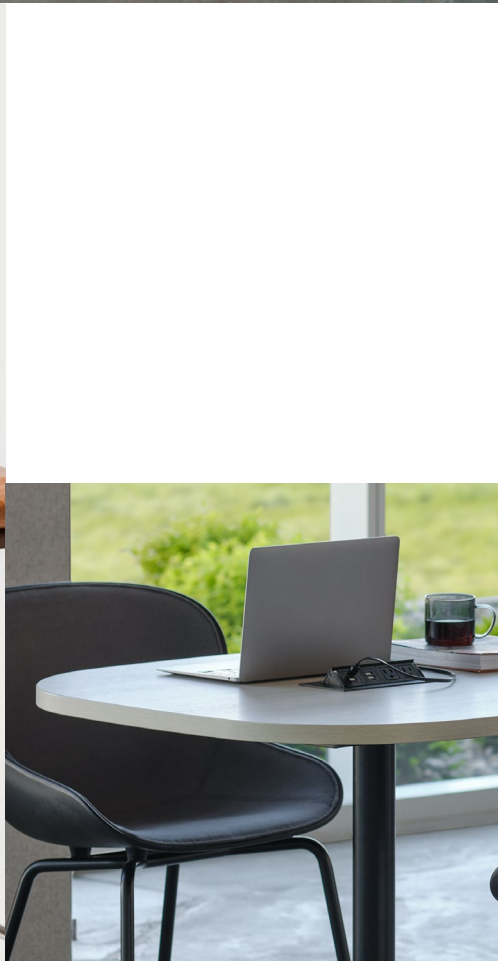


Allsteel



Work Geometry

# Table & Chair Pairing Guide





Work Geometry is  
Allsteel's human-centric  
consideration of posture,  
fit, and tools to create  
comfortable furniture for  
how people actually work.

Allsteel believes that one common thread informs our product design philosophy; furniture needs to solve a work problem while supporting a wide range of different activities.

Whether you are designing for an individual focus area, small informal collaboration space, or large conference room, this tool will help guide you to some suggested pairings of tables and seating. Choose your table height to browse options and featured pairings to accommodate a variety of postures and settings.





Continental Tables	4
Standard Tables	9
Counter Tables	22

Bar Tables	28
Product Index	40
Table Pairing Reference Guide	44

Although task and conference seating can be paired with many of these scenarios, this document is highlighting non-adjustable options.





Continental height tables are lower than standard height, meaning they are great for discussions that are more informal with relaxed postures. For more casual or intimate conversations with people in positions of trust, consider smaller table sizes.

**Table Height** 26"  
**Seating Clearance** 8.5" - 10"



# Continental Tables



# Structure Continental Table

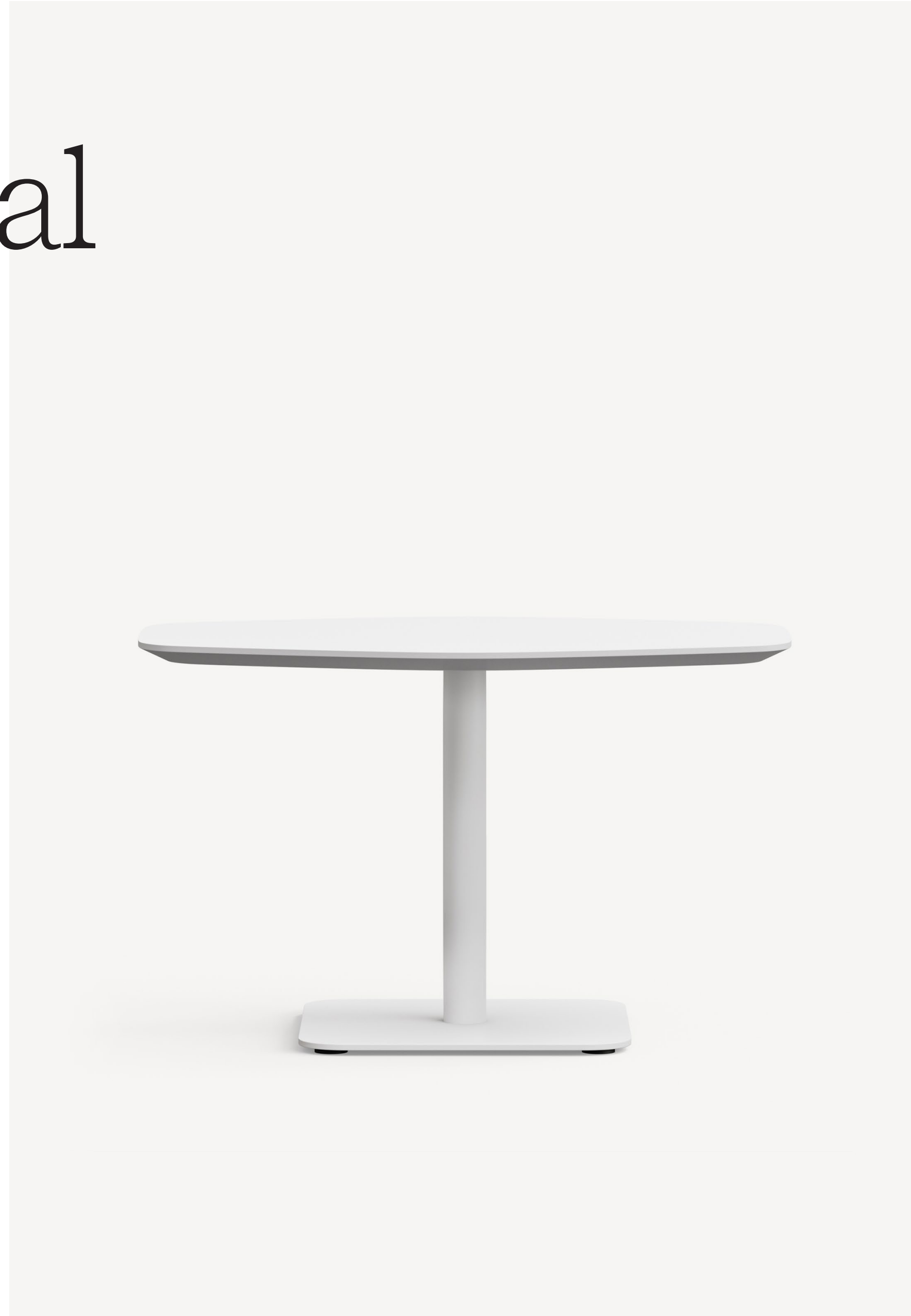
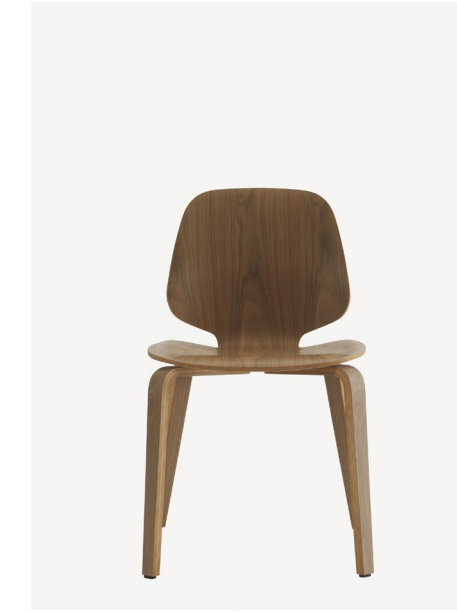


Table Height 26"

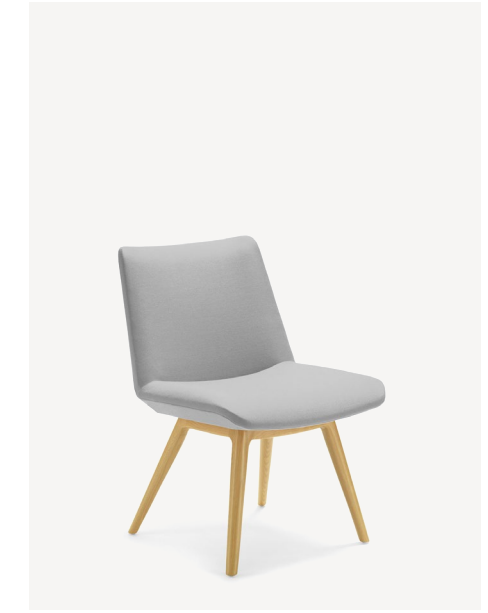
Structure supports collaborative interaction, whether it's to gather for impromptu team brainstorming sessions, relax and unwind during a break, or come together for an all-hands-on-deck conference. Structure is seamless in use with add-on amenities to make the office work for you.



My Chair  
by Normann Copenhagen



Form Chair  
by Normann Copenhagen



November Side  
by HBF



November Lounge  
by HBF



Vicinity Lounge



# Admix Table

Table Height 26"

Designed for collaboration, Admix tables seamlessly adapt to evolving workplace needs. They offer an array of designs and configuration options to accommodate a variety of workspaces. Admix affords designers the capability to define angles conducive to their spatial layouts, harmonizing with their technological requirements to create tailored office environments.



My Chair  
by Normann Copenhagen



Form Chair  
by Normann Copenhagen



November Side  
by HBF



# Meki 26" Table

by HBF



**Table Height** 26"

The Meki Table Collection of tops and bases by Todd Bracher is designed to allow clients to mix and match finish materials, sizes and shapes, making each table uniquely its own. Whether in a café, conference or evolving environment, its design creates an optical illusion - the top appears to float. The simplistic use of materials also make this table timeless.



My Chair  
by Normann Copenhagen



Form Chair  
by Normann Copenhagen



November Side  
by HBF



November Lounge  
by HBF

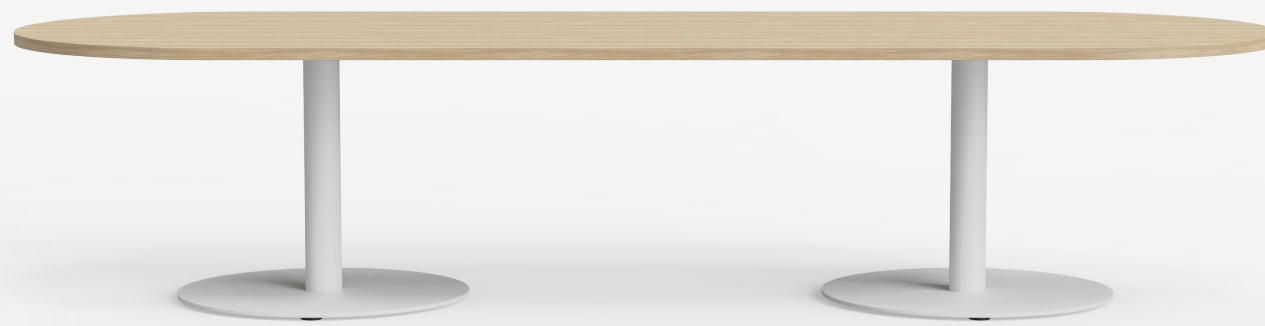


Vicinity Lounge





Structure Continental Table



Admix Table



Meki 26" Table

Table Height 26"  
 Seating Clearance 8.5" - 10"

# Continental Tables



For longer meetings where technology and power access is important, a standard work height is ideal. It can accommodate various group sizes participating in casual meetings or formal conferences, or be a place to relax and unwind during a break. Power access allows teams to be productive during longer working sessions.

**Table Height** 28" - 29.75"  
**Seating Clearance** 10" - 11"



# Standard Tables



# Briefing Conference Table

Table Height 27.75"

The Briefing collection is an amazing array of adaptable products that includes conference, training, occasional, café, and media tables. This complete offering addresses wide-ranging workplace applications, while enabling an attractive and intelligent integration of styles, materials, and shapes. Briefing delivers.



Clarity Task



Form Chair  
by Normann Copenhagen



Hyg Side  
by Normann Copenhagen



Form Swivel Chair  
by Normann Copenhagen



# Recharge Work Table

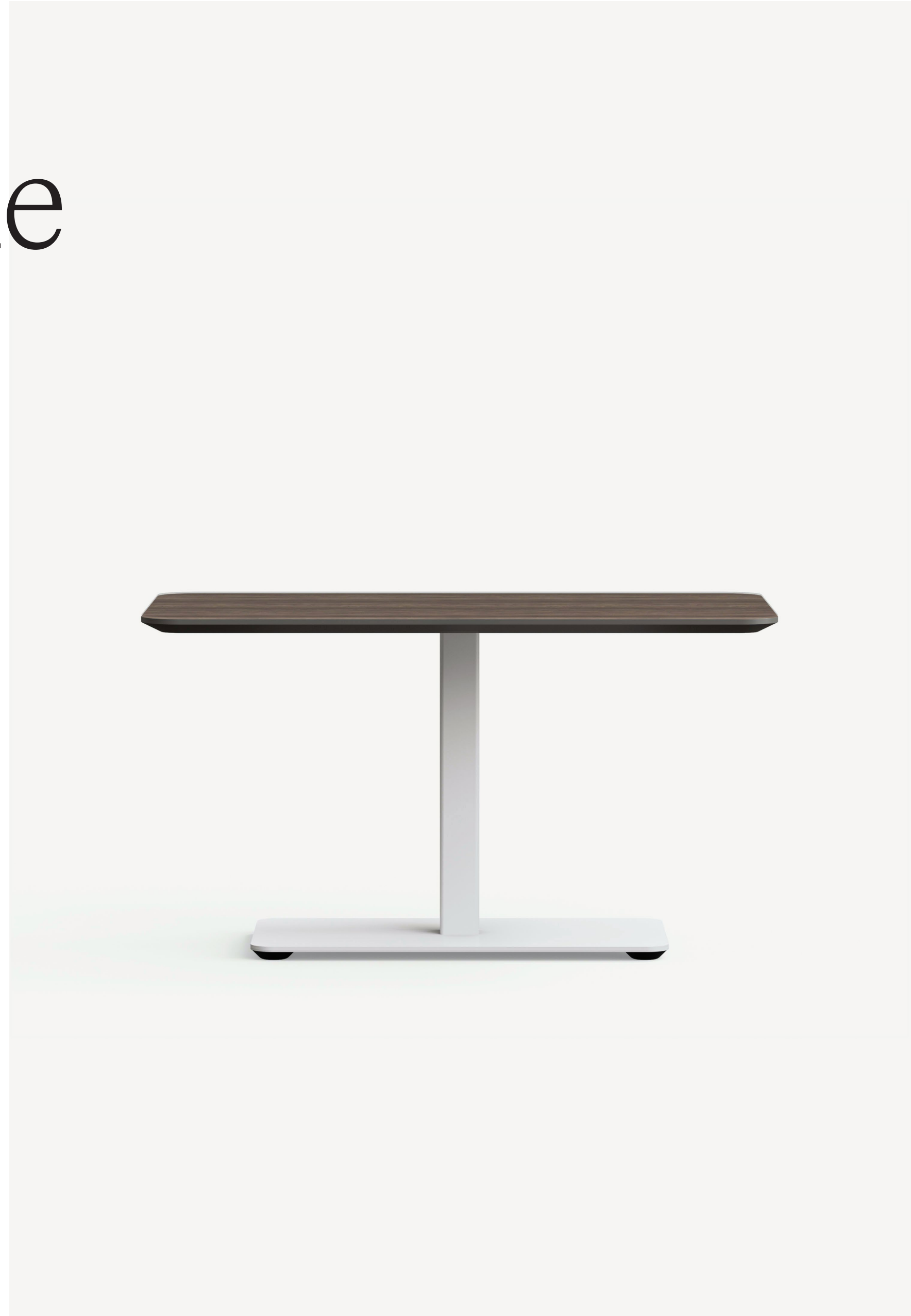


Table Height 28"

Comfortable, soft seating forms the core of the Recharge collection to create supportive, alternative workspaces. Conceived as a set of uniquely adaptable components, Recharge can be easily arranged into a diverse array of solo, team, and common applications, complemented by thoughtfully designed details to promote worker choice, autonomy, and collaboration.



Recharge Bench with Bolster



Recharge Bench with Bolster and Screen



Herit  
by Normann Copenhagen



Vicinity Side



My Chair  
by Normann Copenhagen



# Admix Conference Table

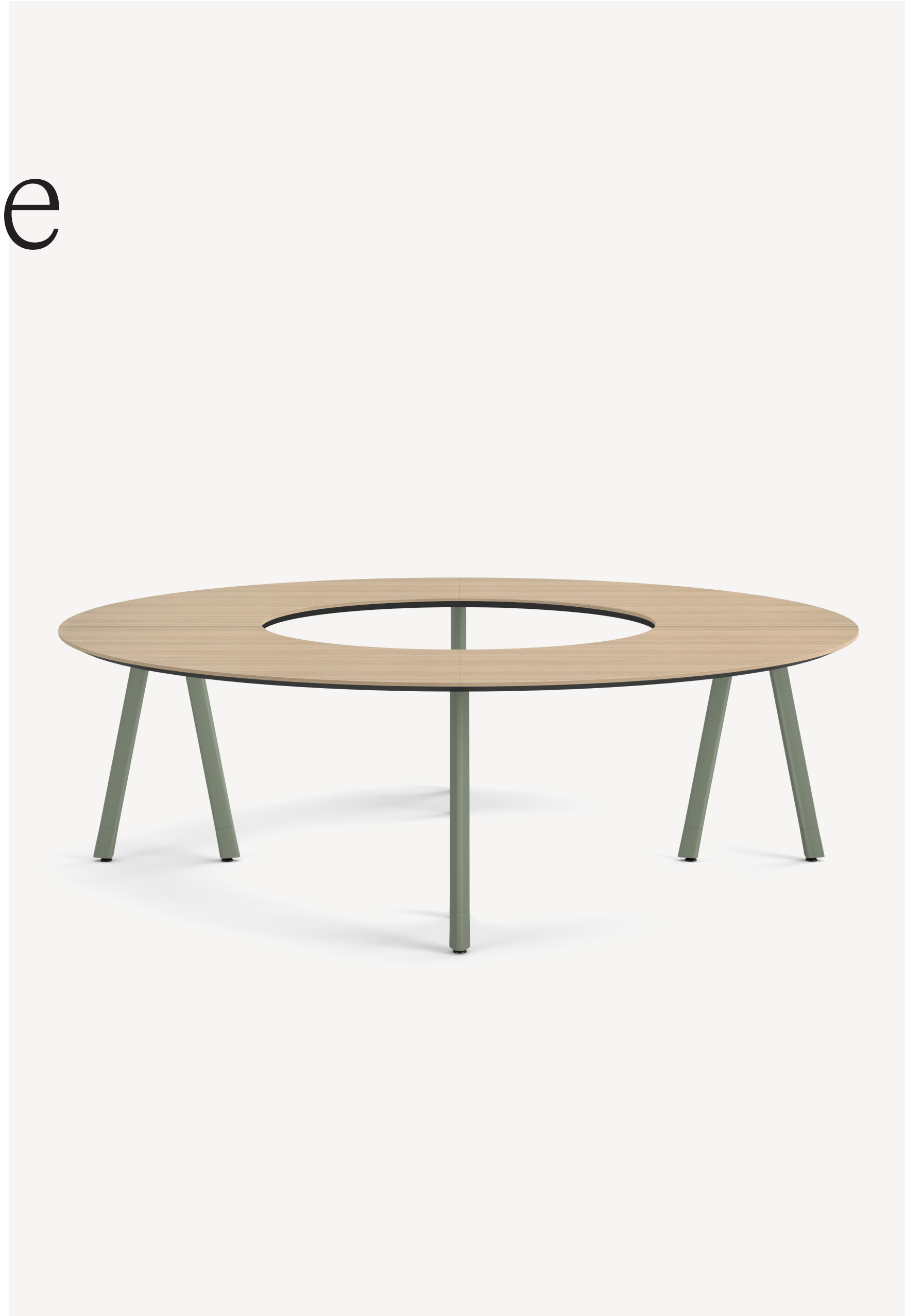


Table Height 28"

Designed for collaboration, Admix tables seamlessly adapt to evolving workplace needs. They offer an array of designs and configuration options to accommodate a variety of workspaces. Admix affords designers the capability to define angles conducive to their spatial layouts, harmonizing with their technological requirements to create tailored office environments.



Clarity Task



LIV Side  
by Gunlocke



Vicinity Side



Evo Side



# Ami Round Low Conference, Dining Table

by HBF

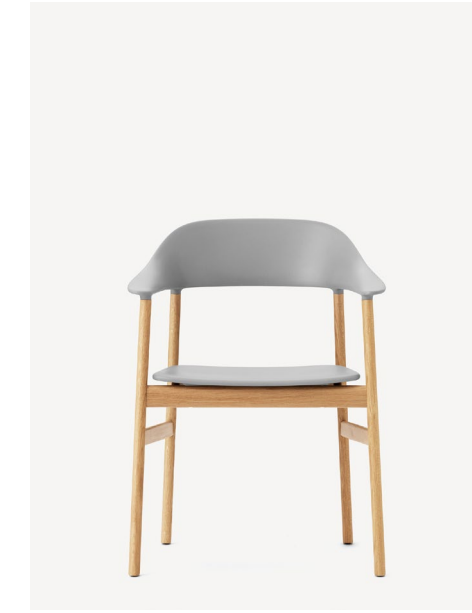


**Table Height** 28"

Named after the Latin word, Ami, Todd Bracher intended this table to have friendly interactions with every chair and environment. It's simple and pure form is adaptable and meant to disappear and never play the hero of the space. Easy to live with, Ami can be used as dining or conference and is compatible with all seating.



LIV Side  
by Gunlocke



Herit  
by Normann Copenhagen



# Park Work Pill Table



Table Height 28.625"

A collaboration between Allsteel and Norm Architects, Park is a collection of soft seating, tables, and accessories that blends high-quality American steel production with the meticulous beauty of Danish craft. Park is a perfectly balanced, contemporary workplace solution that preserves the usability of shared, open spaces.



Park Lo Settee



Park Hi Settee



Evo Side



My Chair  
by Normann Copenhagen



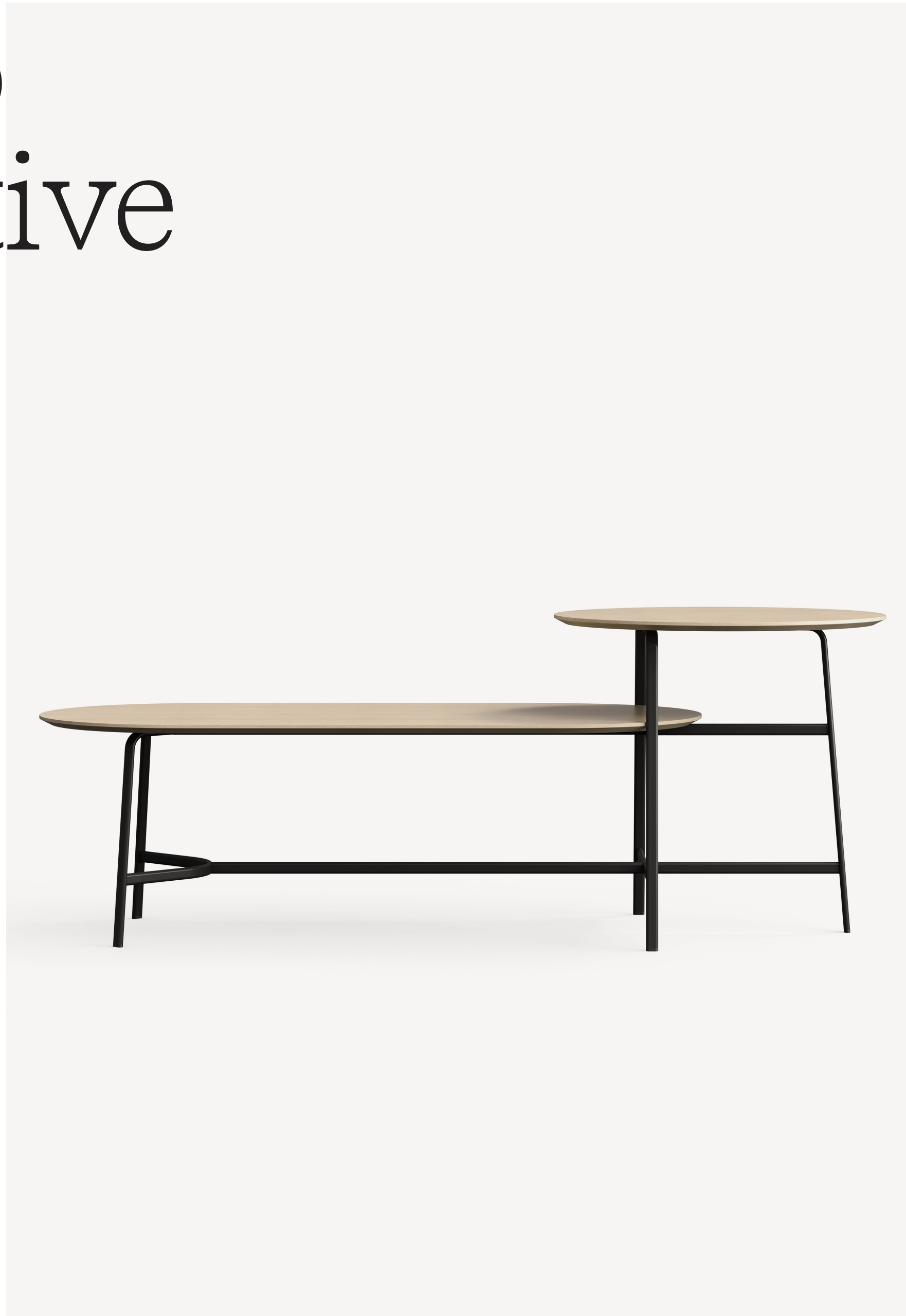
Hyg Side  
by Normann Copenhagen



Clarity Task



# Park Hi|Lo Collaborative Table



**Table Height** 28.875"  
**Bar Counter Height** 41"

A collaboration between Allsteel and Norm Architects, Park is a collection of soft seating, tables, and accessories that blends high-quality American steel production with the meticulous beauty of Danish craft. Park is a perfectly balanced, contemporary workplace solution that preserves the usability of shared, open spaces.



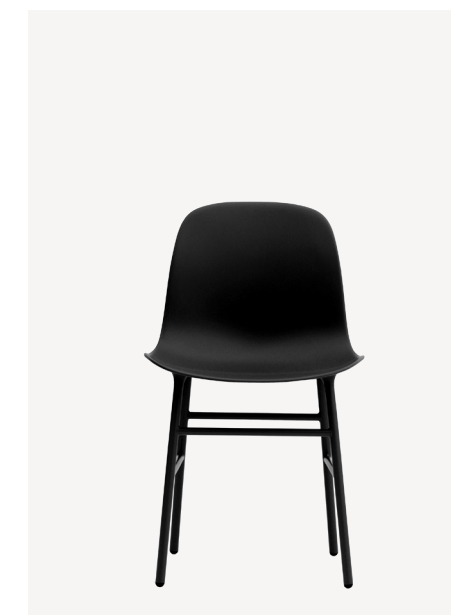
Form Swivel Chair  
by Normann Copenhagen



Vicinity Side



Essens Guest  
by HBF



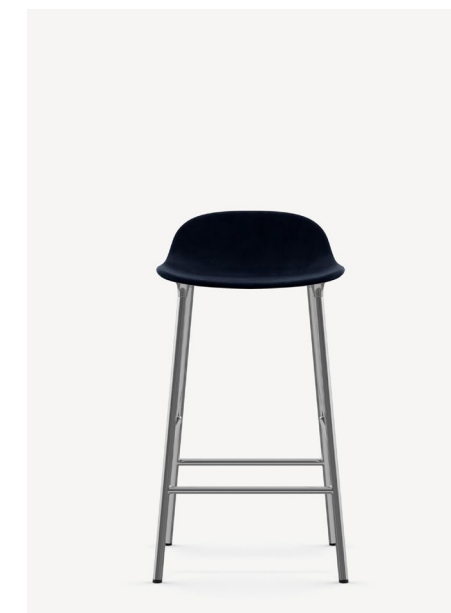
Form Chair  
by Normann Copenhagen



Vicinity Stool



Essens Bar Stool  
by HBF



Form Bar Stool  
by Normann Copenhagen



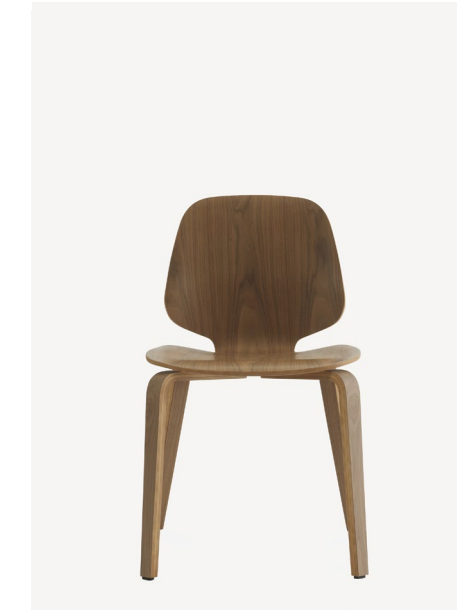
# Harvest Rustic Table



Table Height 29"

Inspired by gathering spaces where people like to talk and share, like the dining room table or coffee area in the workplace, Harvest is a table offered in seated and standing heights, and a variety of sizes. Harvest invites conversation and interaction wherever people gather.

Storage cubby below worksurface reduces clearance which may impact posture changes such as crossing your legs. Clearance from floor to underside of cubby is 25.125"



My Chair  
by Normann Copenhagen



Form Chair  
by Normann Copenhagen



LIV Side  
by Gunlocke



Evo Side



# Harvest Metal Table



Table Height 29.5"

Inspired by gathering spaces where people like to talk and share, like the dining room table or coffee area in the workplace, Harvest is a table offered in seated and standing heights, and a variety of sizes. Harvest invites conversation and interaction wherever people gather.

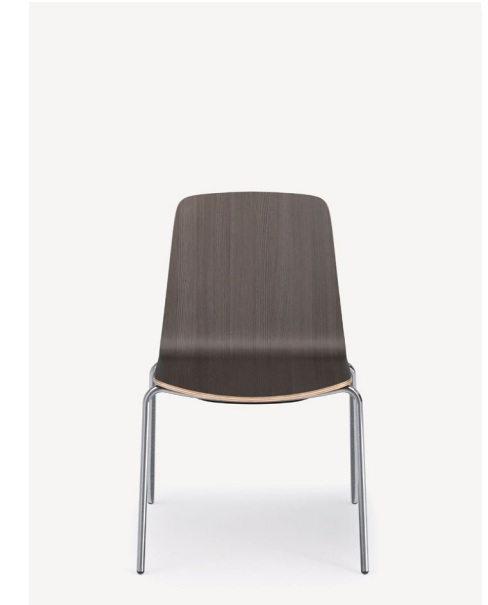
Storage cubby below worksurface reduces clearance which may impact posture changes such as crossing your legs. Clearance from floor to underside of cubby is 25.125"



My Chair  
by Normann Copenhagen



Form Chair  
by Normann Copenhagen



LIV Side  
by Gunlocke



Evo Side

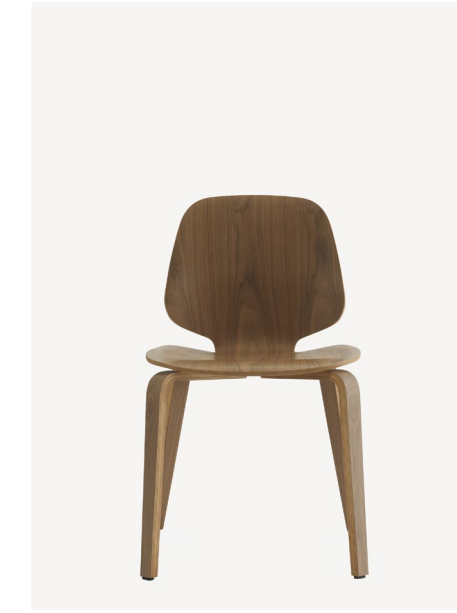


# Harvest Classic Table



**Table Height** 29.6"

Inspired by gathering spaces where people like to talk and share, like the dining room table or coffee area in the workplace, Harvest is a table offered in seated and standing heights, and a variety of sizes. Harvest invites conversation and interaction wherever people gather.



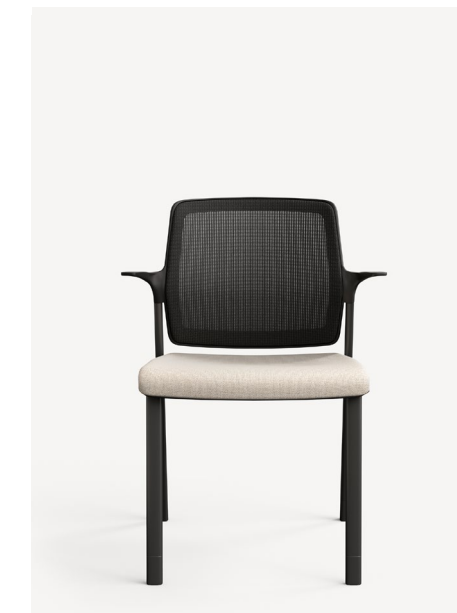
My Chair  
by Normann Copenhagen



Form Chair  
by Normann Copenhagen



LIV Side  
by Gunlocke



Evo Side

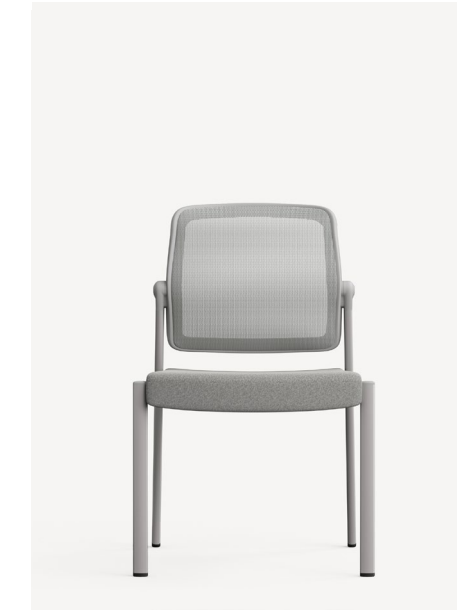


# Structure Table

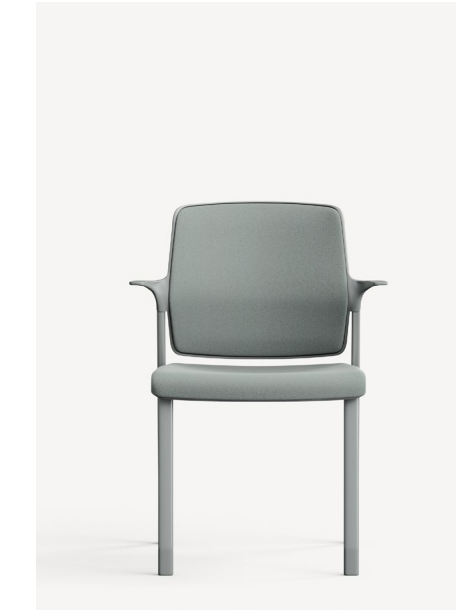


Table Height 29"

Structure supports collaborative interaction, whether it's to gather for impromptu team brainstorming sessions, relax and unwind during a break, or come together for an all-hands-on-deck conference. Structure is seamless in use with add-on amenities to make the office work for you.



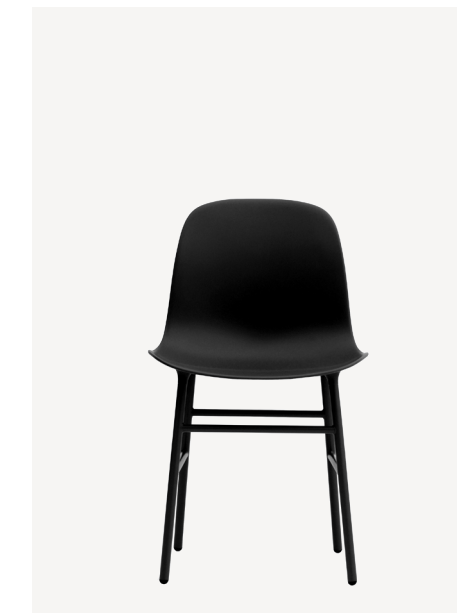
Acuity Side



Lyric Side



Vicinity Side



Form Chair  
by Normann Copenhagen



Herit  
by Normann Copenhagen

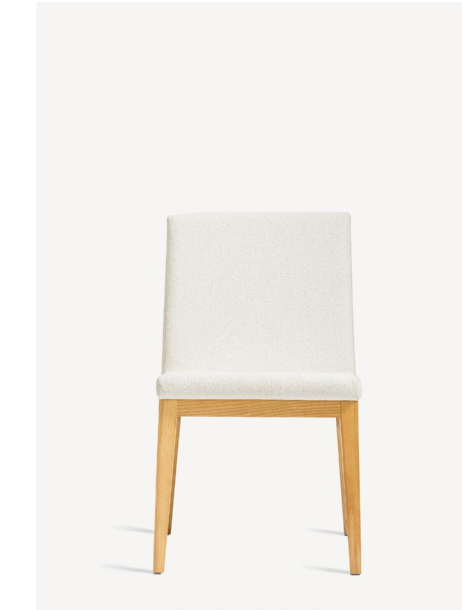
# Letchworth Table

by Gunlocke



**Table Height** 29"

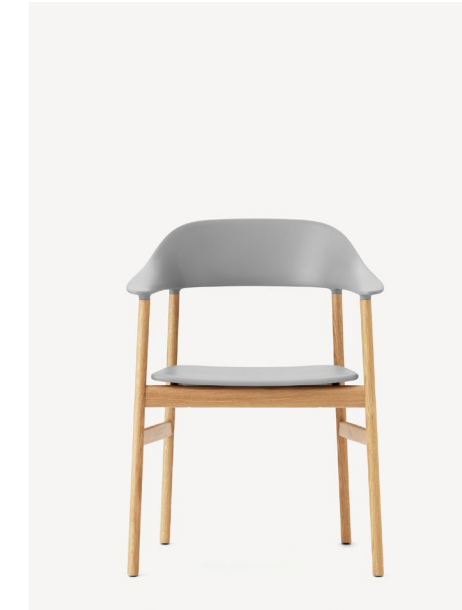
Less suit-and-tie. More laid back. Letchworth brings rustic design and residential influence to informal meeting spaces. Choose standard, counter or bar height. Parsons, workbench, picnic or miter style. Letchworth inspires collaboration and innovation.



**Tia Guest**  
by Gunlocke



**LIV Side**  
by Gunlocke



**Herit**  
by Normann Copenhagen



**Metta Chair**  
by Gunlocke



**Hyg Side**  
by Normann Copenhagen





Recharge Work Table



Briefing Table



Ami Round Low Conference, Dining Table



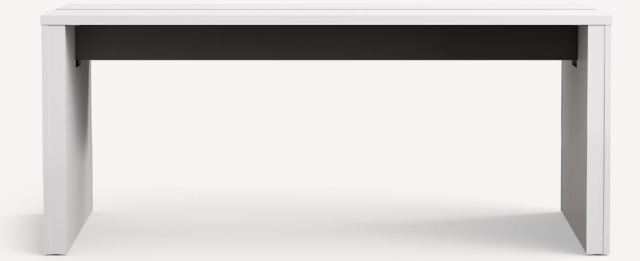
Park Work Pill Table



Park HiLo Collaborative Table



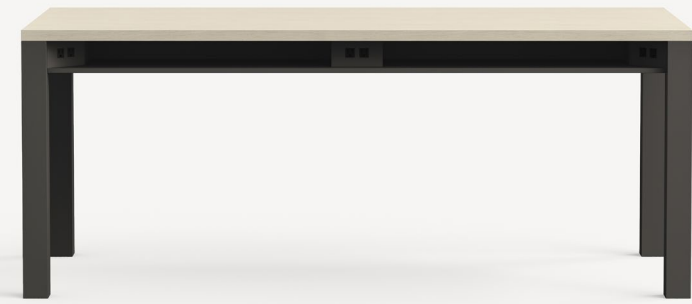
Structure Table



Harvest Classic Table



Harvest Rustic Table



Harvest Metal Table



Admix Table



Letchworth Table



Briefing Conference Table

Table Height 28" - 29.75"

Seating Clearance 10" - 11"

# Standard Tables



Counter height tables are comfortable for both standing and sitting with a proper stool. These heights offer a great option to introduce posture variety into meetings. Gatherings of various sizes can be casual or formal, and power access is important for tech. A footrest on the table or stool encourages perching, leaning, or fidgeting movement for comfort. Consider a higher stool back for support during longer conversations or meals.

**Table Height**      36" - 37.6"  
**Seating Clearance**    10" - 12"



# Counter Tables



# Structure Counter-Height Table

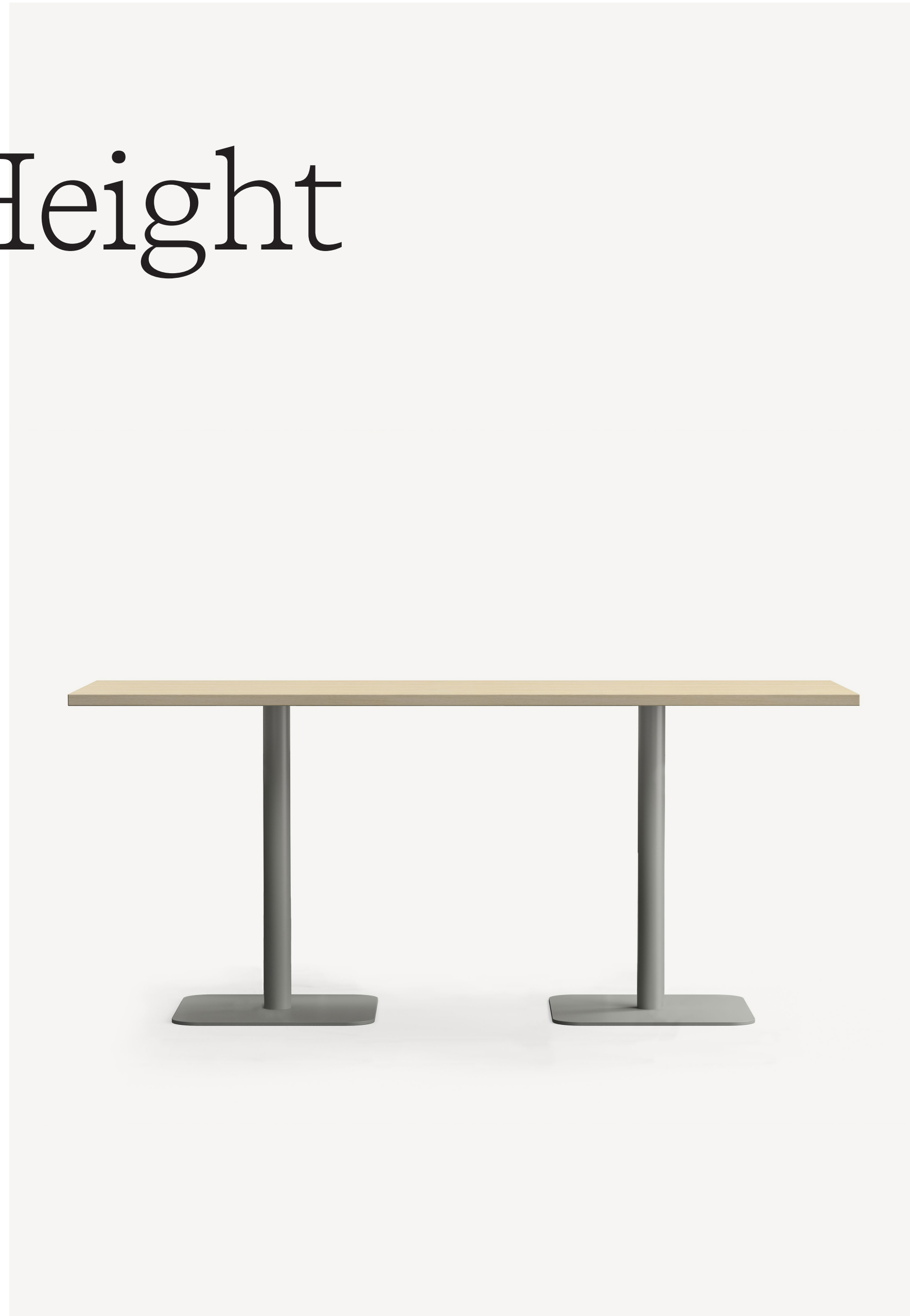
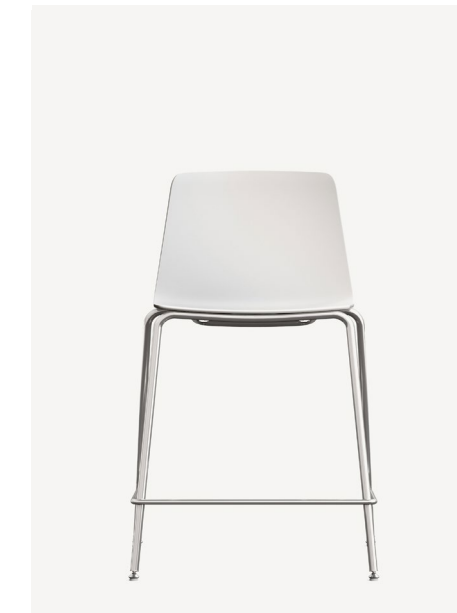
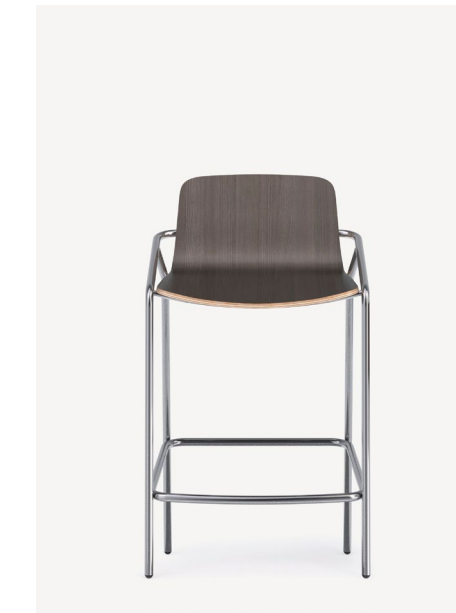


Table Height 36"

Structure supports collaborative interaction, whether it's to gather for impromptu team brainstorming sessions, relax and unwind during a break, or come together for an all-hands-on-deck conference. Structure is seamless in use with add-on amenities to make the office work for you.



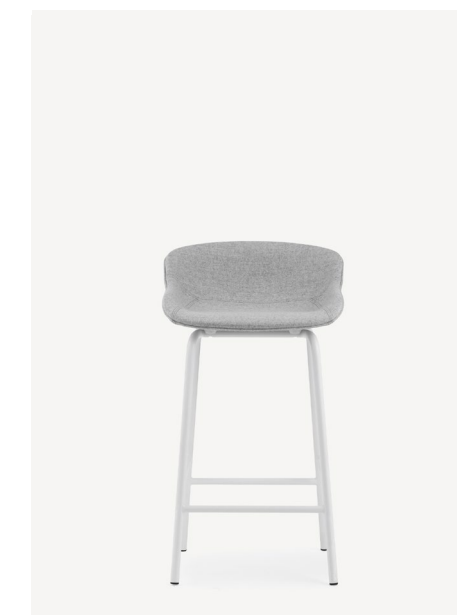
Vicinity Counter Stool



LIV Counter Stool  
by Gunlocke



Tia Counter Stool  
by Gunlocke



Hyg Counter Stool  
by Normann Copenhagen



My Chair Counter Stool  
by Normann Copenhagen



Form Counter Stool  
by Normann Copenhagen

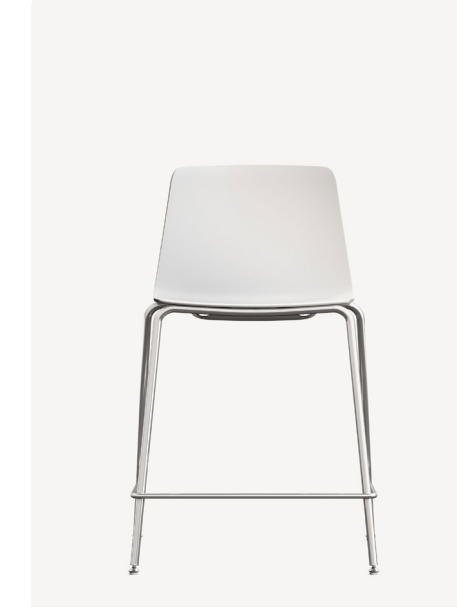
# Letchworth Counter-Height Table

by Gunlocke

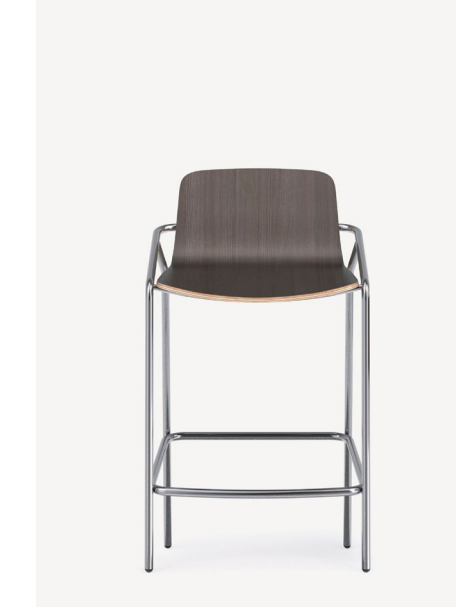


**Table Height** 36"

Less suit-and-tie. More laid back. Letchworth brings rustic design and residential influence to informal meeting spaces. Choose standard, counter or bar height. Letchworth inspires collaboration and innovation.



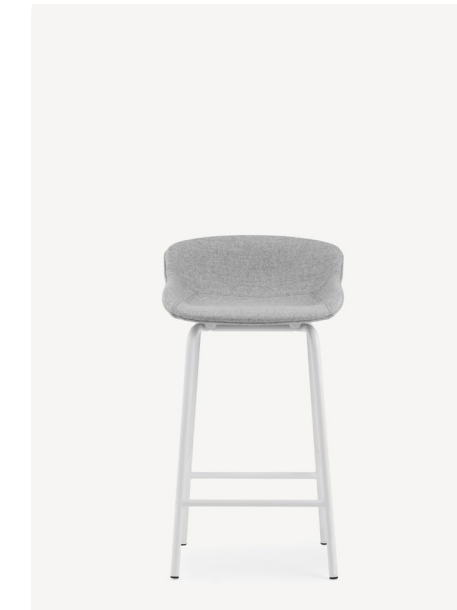
Vicinity Counter Stool



LIV Counter Stool  
by Gunlocke



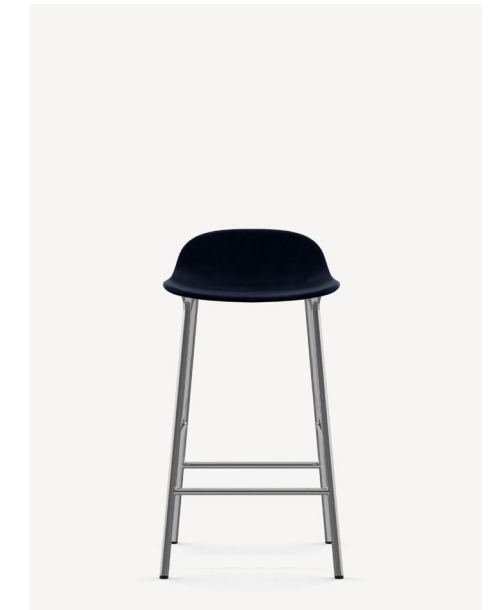
Tia Counter Stool  
by Gunlocke



Hyg Counter Stool  
by Normann Copenhagen



My Chair Counter Stool  
by Normann Copenhagen



Form Counter Stool  
by Normann Copenhagen



# Admix Counter-Height Table

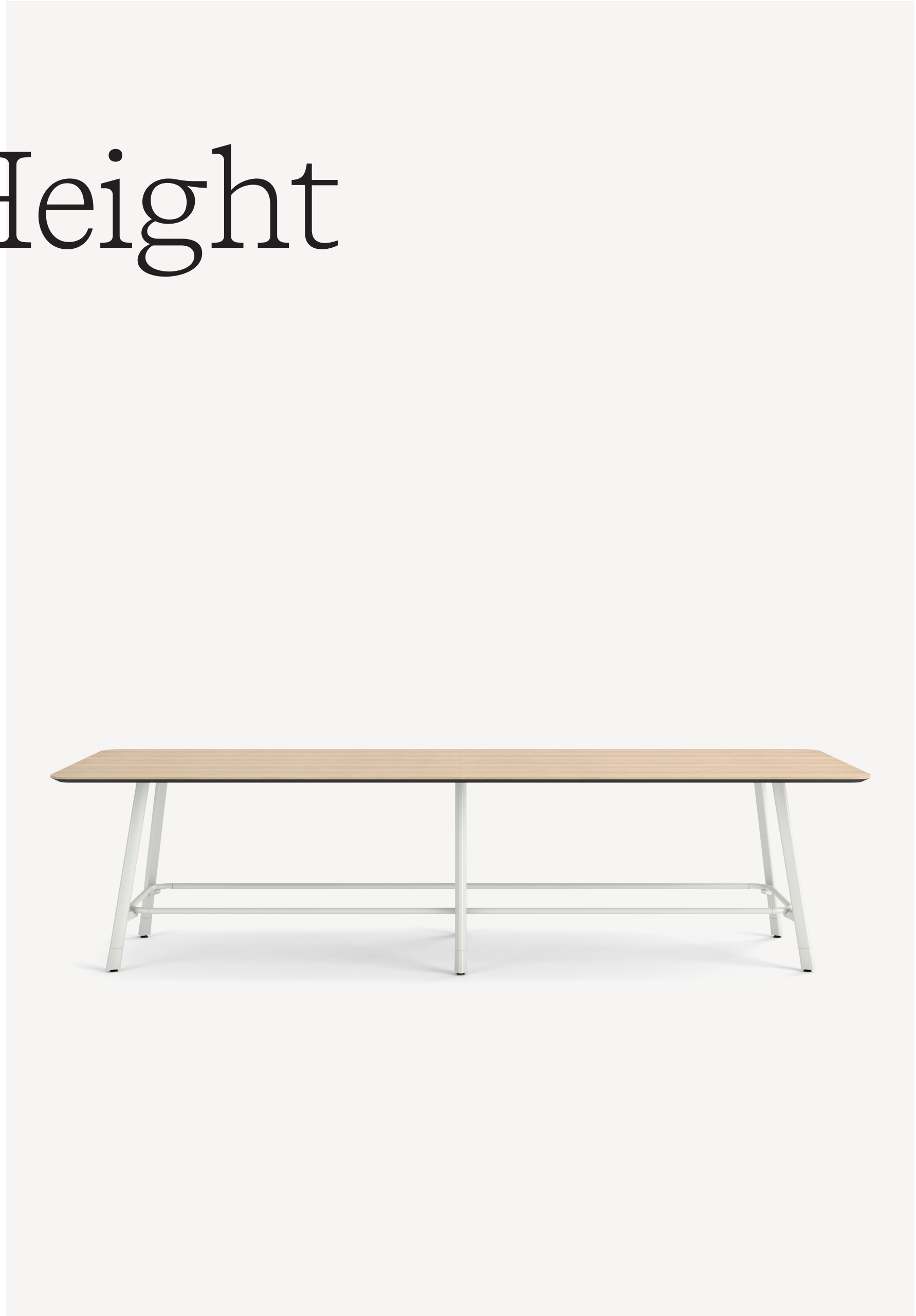


Table Height 37"

Designed for collaboration, Admix tables seamlessly adapt to evolving workplace needs. They offer an array of designs and configuration options to accommodate a variety of workspaces. Admix affords designers the capability to define angles conducive to their spatial layouts, harmonizing with their technological requirements to create tailored office environments.



Vicinity Counter Stool



LIV Counter Stool  
by Gunlocke



Form Counter Stool  
by Normann Copenhagen



My Chair Counter Stool  
by Normann Copenhagen



Barn Stool  
by Corral

# Union Counter-Height Table

by Normann Copenhagen



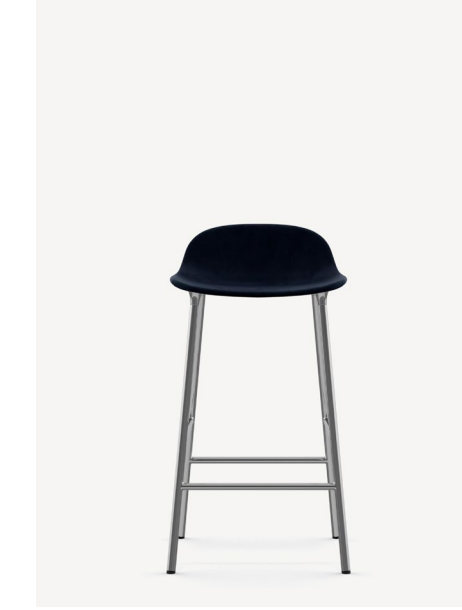
Table Height

37.6"

A place for meals, work, studying, conversations and relaxation; a table is a base and gathering place for all sorts of activity, and the Union collection accommodates them all. An all-round collection of tables in a minimalist design, which gets an elegant lift from shiny brass feet.



Tia Counter Stool  
by Gunlocke



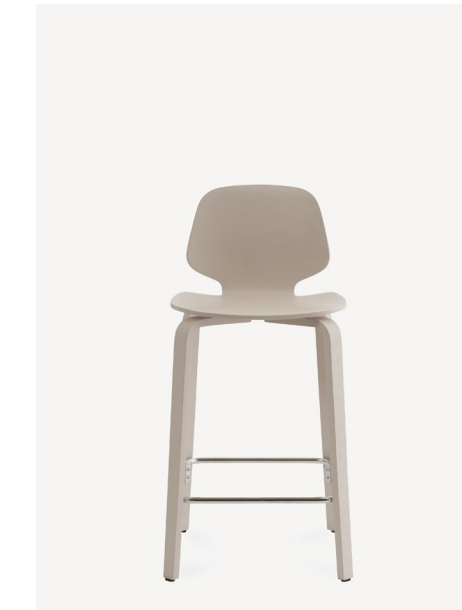
Form Counter Stool  
by Normann Copenhagen



Ace Counter Stool  
by Normann Copenhagen



Hyg Counter Stool  
by Normann Copenhagen



My Chair Counter Stool  
by Normann Copenhagen



Barn Stool  
by Corral





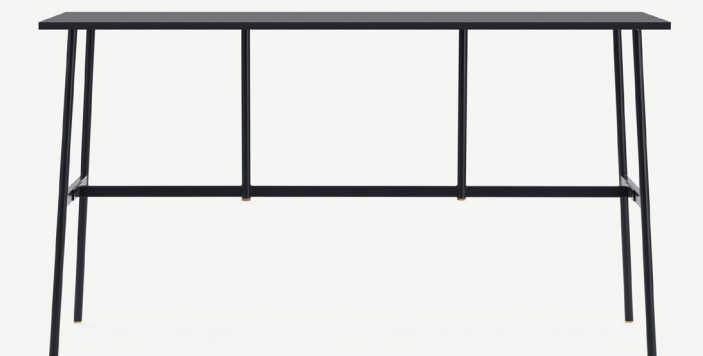
Structure Counter-Height Table



Letchworth Counter-Height Table



Admix Counter-Height Table



Union Counter-Height Table

Table Height 36" - 37.6"

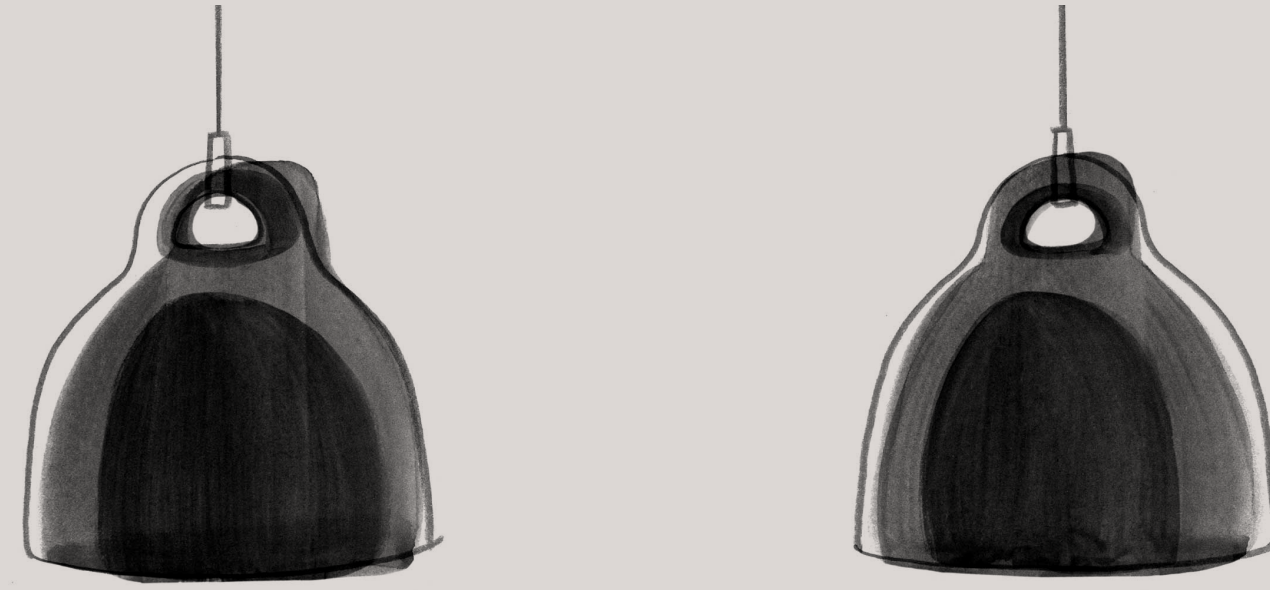
Seating Clearance 10" - 12"

# Counter Tables



For quick, casual conversations, a bar height table provides a place to pause, lean, and chat. It can be the perfect place for impromptu brainstorming or brief, productive standing meetings. Consider a lower stool back that can be tucked under the table and declutter the visual landscape. A footrest on the table or stool provides comfort and makes it easy to adjust postures.

**Table Height** 41" - 42"  
**Seating Clearance** 10" - 12"



# Bar Tables

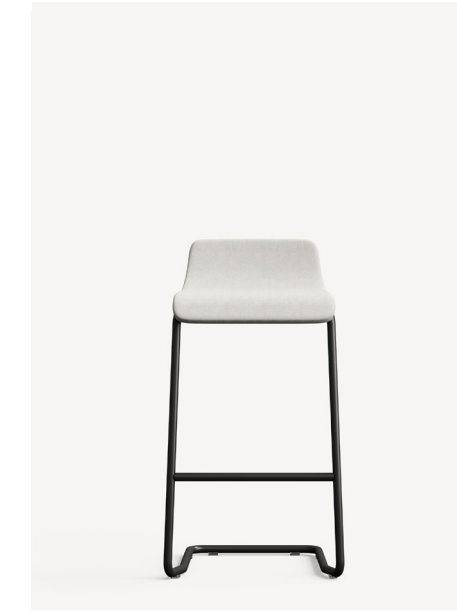
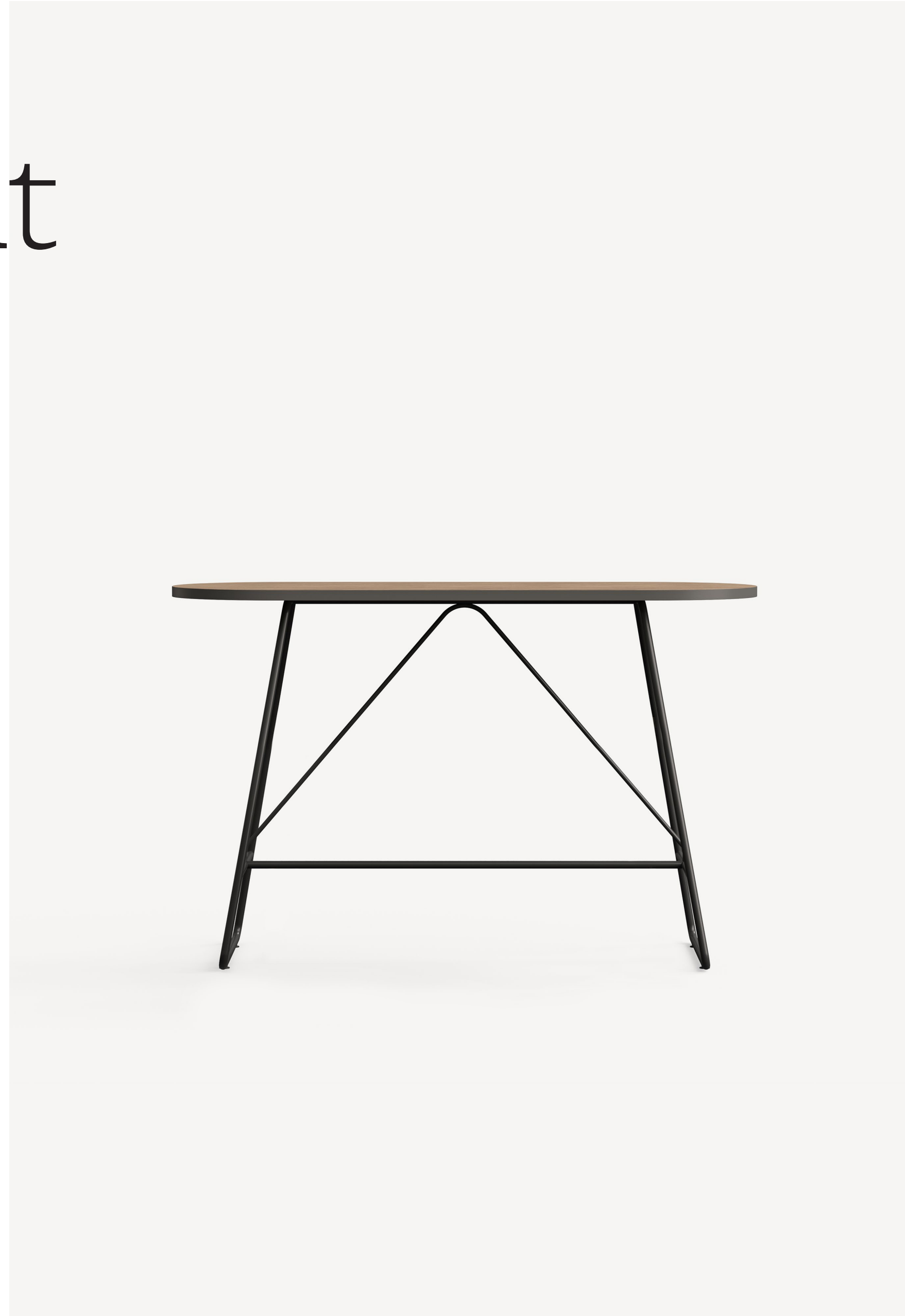


# Picnic Bar-Height Table

Table Height

41.125"

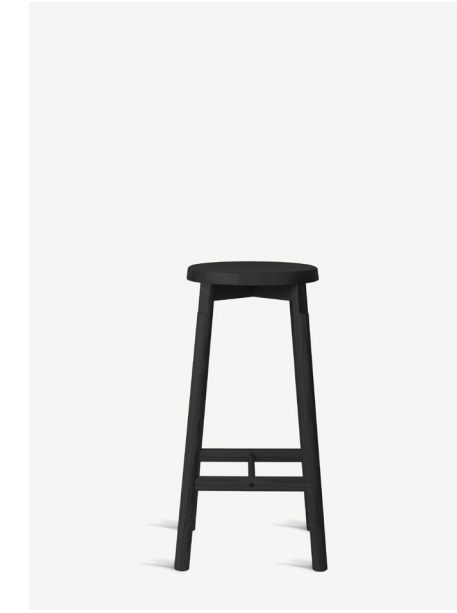
Increased individual and group activities carried out in modern, shared spaces require a certain degree of flexibility, privacy, and functionality. The Townhall™ Collection, with products like Picnic, create sought-after, active enclaves that support multiple work modes and the changing postures necessary for individual or team work. Picnic is a collection of seated-height and standing-height tables, benches, and stool that turns underutilized, out-of-the-way spaces into agile touchdown areas for personal or team work.



Summit Bar Stool

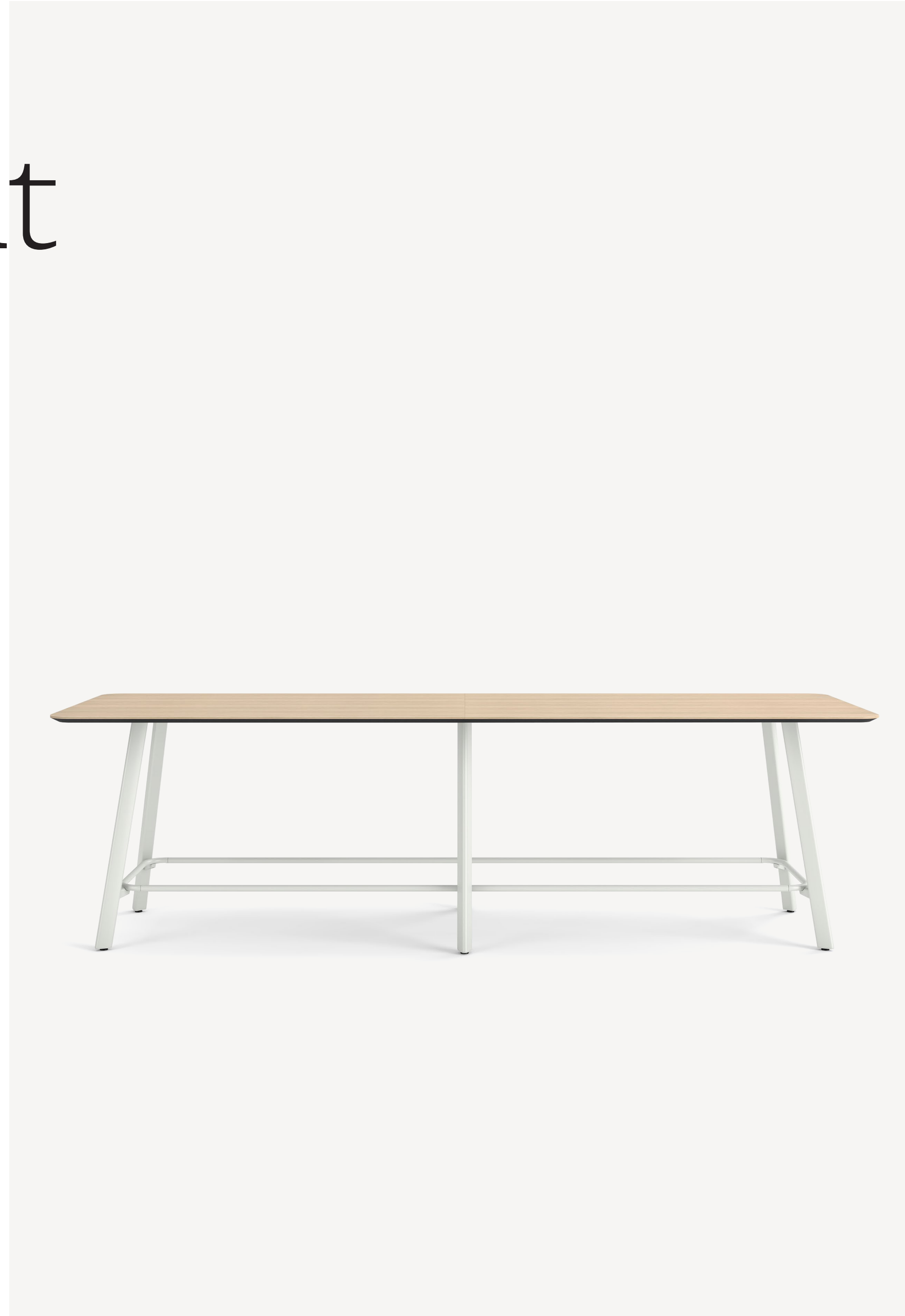


Form Bar Stool  
by Normann Copenhagen



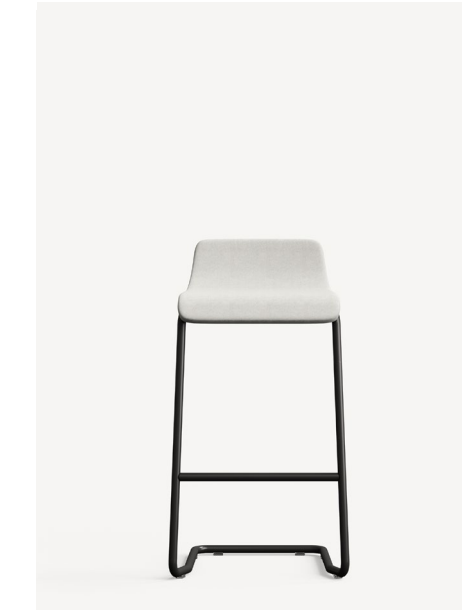
Barn Stool  
by Corral

# Admix Bar-Height Table



**Table Height** 41.125"

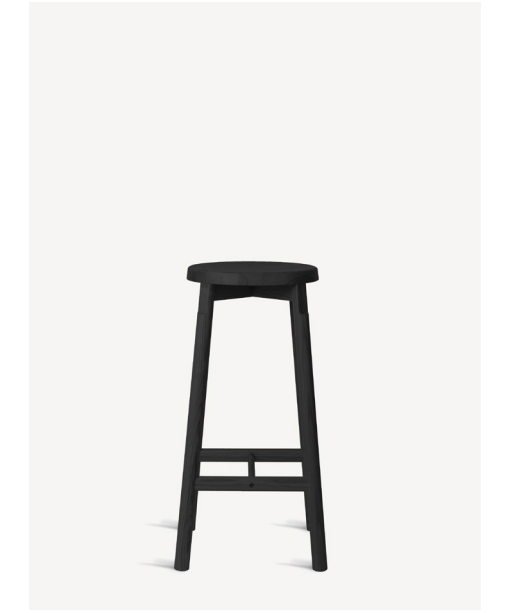
Designed for collaboration, Admix tables seamlessly adapt to evolving workplace needs. They offer an array of designs and configuration options to accommodate a variety of workspaces. Admix affords designers the capability to define angles conducive to their spatial layouts, harmonizing with their technological requirements to create tailored office environments.



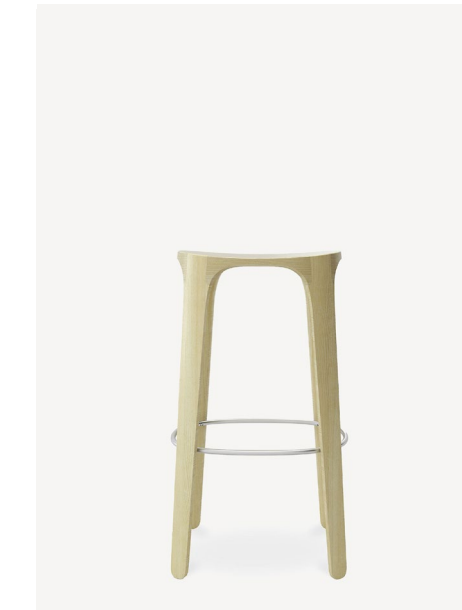
Summit Bar Stool



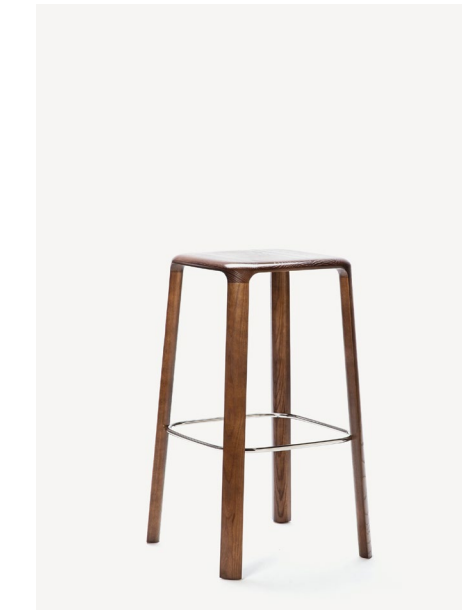
Form Bar Stool  
by Normann Copenhagen



Barn Stool  
by Corral



Jueki Bar Stool  
by HBF



Trillia Bar Stool  
by Gunlocke



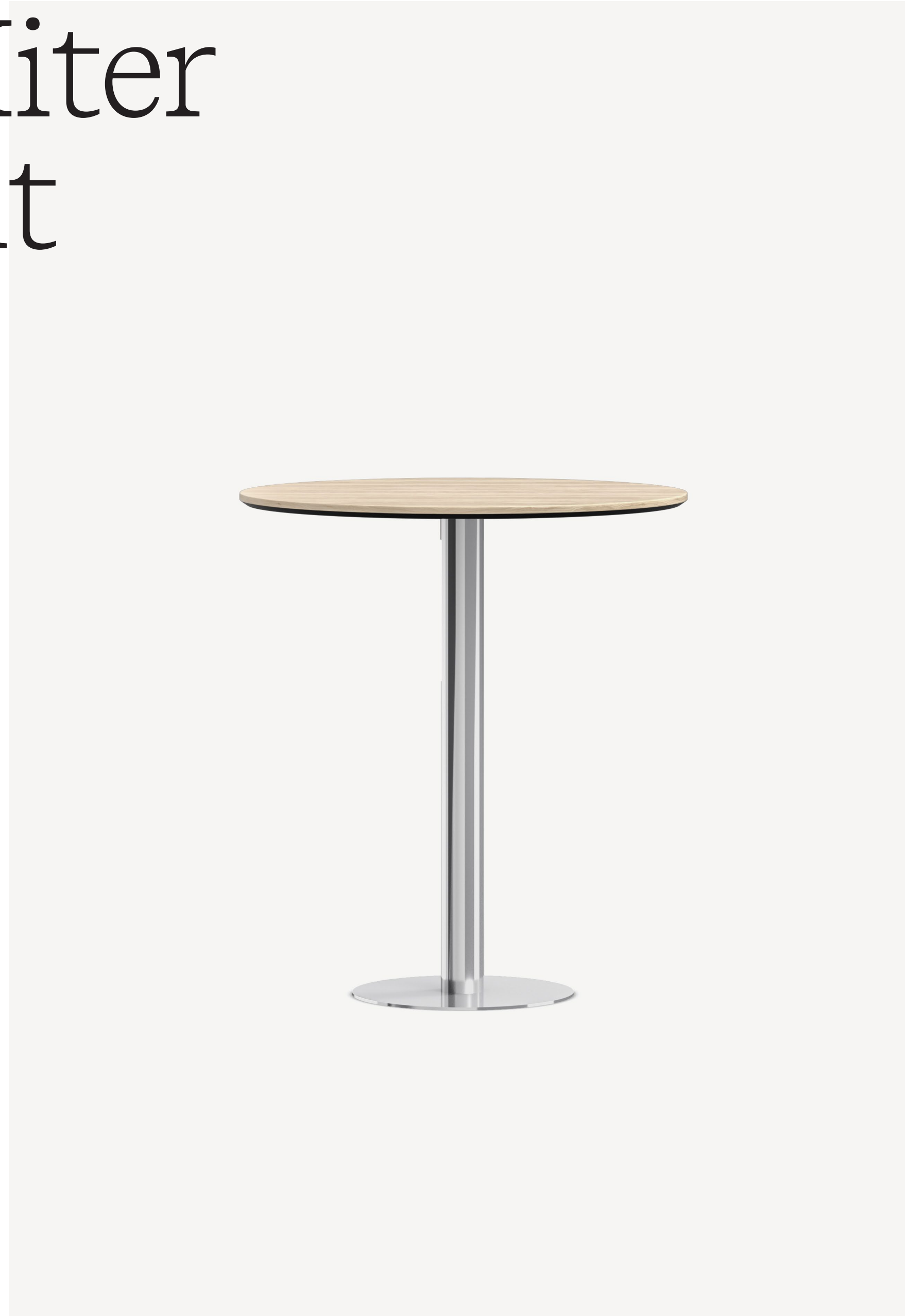
# Briefing Miter Bar-Height Table

by Gunlocke

**Table Height**

41.125"

The Briefing collection is an amazing array of adaptable products that includes conference, training, occasional, café, and media tables. This complete offering addresses wide-ranging workplace applications, while enabling an attractive and intelligent integration of styles, materials, and shapes. Briefing delivers.



Andaz Laminate Bar Stool  
by HBF



Andaz Upholstered Bar Stool  
by HBF



Essens Bar Stool  
by HBF

# Union Bar-Height Table

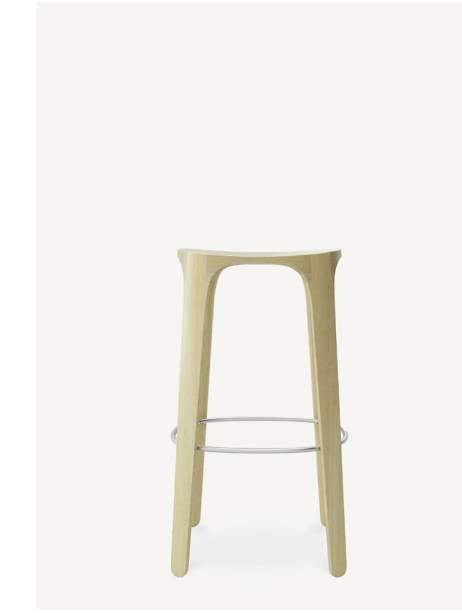
by Normann Copenhagen



Table Height

41.53"

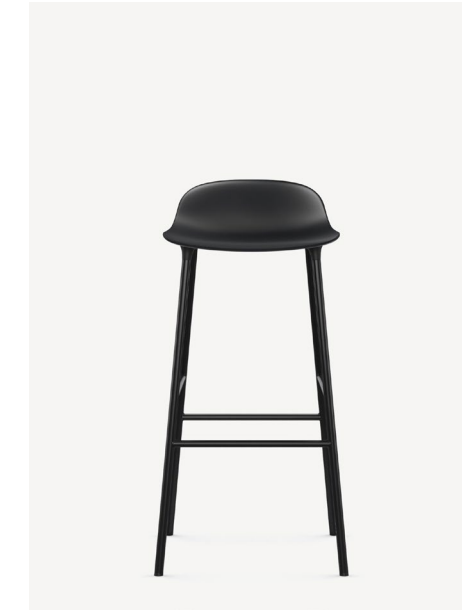
A place for meals, work, studying, conversations and relaxation; a table is a base and gathering place for all sorts of activity, and the Union collection accommodates them all. An all-round collection of tables in a minimalist design, which gets an elegant lift from shiny brass feet.



Jueki Bar Stool  
by HBF



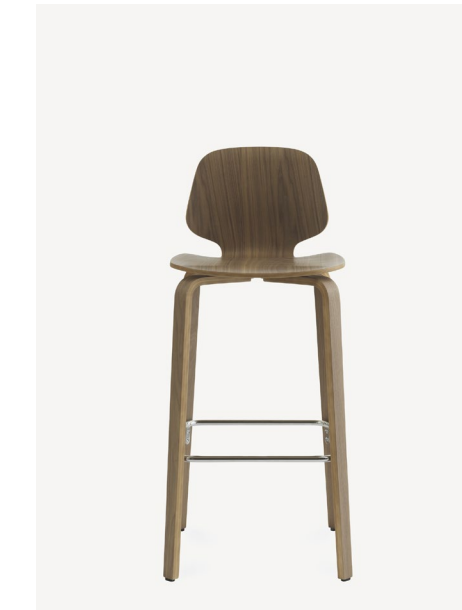
Vicinity Bar Stool



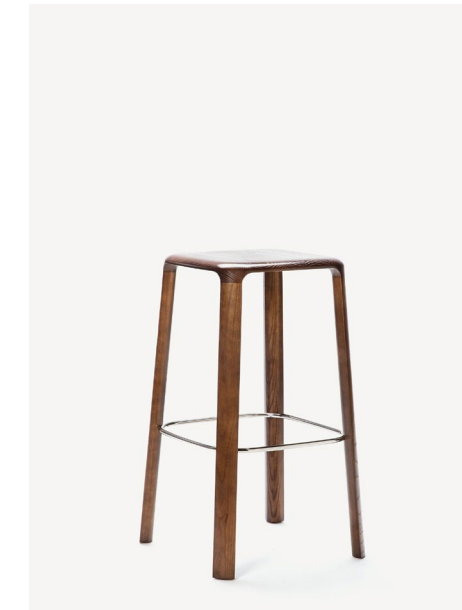
Form Bar Stool  
by Normann Copenhagen



Hyg Bar Stool  
by Normann Copenhagen



My Chair Bar Stool  
by Normann Copenhagen



Trillia Bar Stool  
by Gunlocke

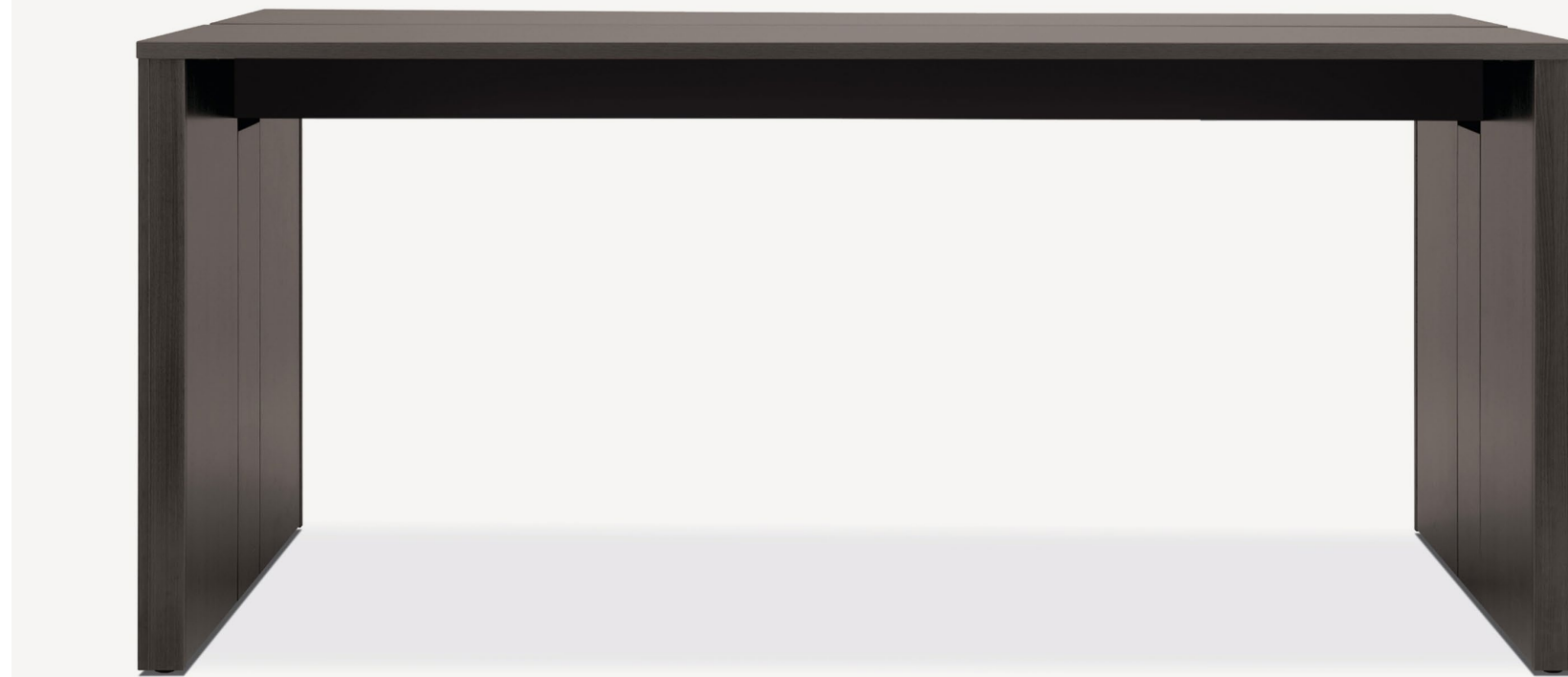


# Harvest Classic Standing Table

Table Height

42"

Inspired by gathering spaces where people like to talk and share, like the dining room table or coffee area in the workplace, Harvest is a table offered in seated and standing heights, and a variety of sizes. Harvest invites conversation and interaction wherever people gather.



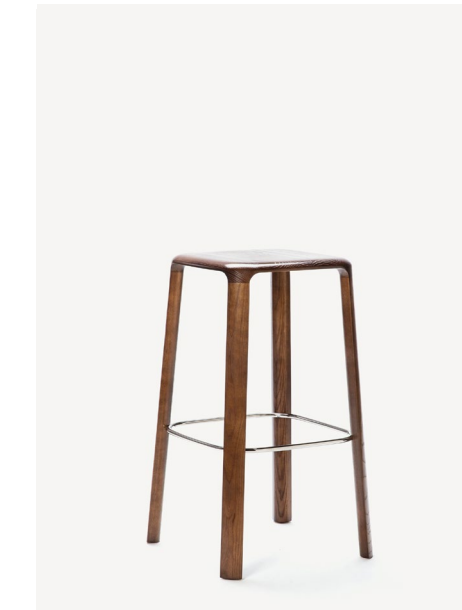
Convo Bar Stool  
by Gunlocke



LIV Bar Stool  
by Gunlocke



Vicinity Bar Stool



Trillia Bar Stool  
by Gunlocke

# Harvest Rustic Standing Table



Table Height 42"

Inspired by gathering spaces where people like to talk and share, like the dining room table or coffee area in the workplace, Harvest is a table offered in seated and standing heights, and a variety of sizes. Harvest invites conversation and interaction wherever people gather.



Convo Bar Stool  
by Gunlocke



LIV Bar Stool  
by Gunlocke



Vicinity Bar Stool



Trillia Bar Stool  
by Gunlocke



# Harvest Metal Standing Table



Table Height 42"

Inspired by gathering spaces where people like to talk and share, like the dining room table or coffee area in the workplace, Harvest is a table offered in seated and standing heights, and a variety of sizes. Harvest invites conversation and interaction wherever people gather.



Convo Bar Stool  
by Gunlocke



LIV Bar Stool  
by Gunlocke



Vicinity Bar Stool



Trillia Bar Stool  
by Gunlocke

# Structure Bar-Height Table

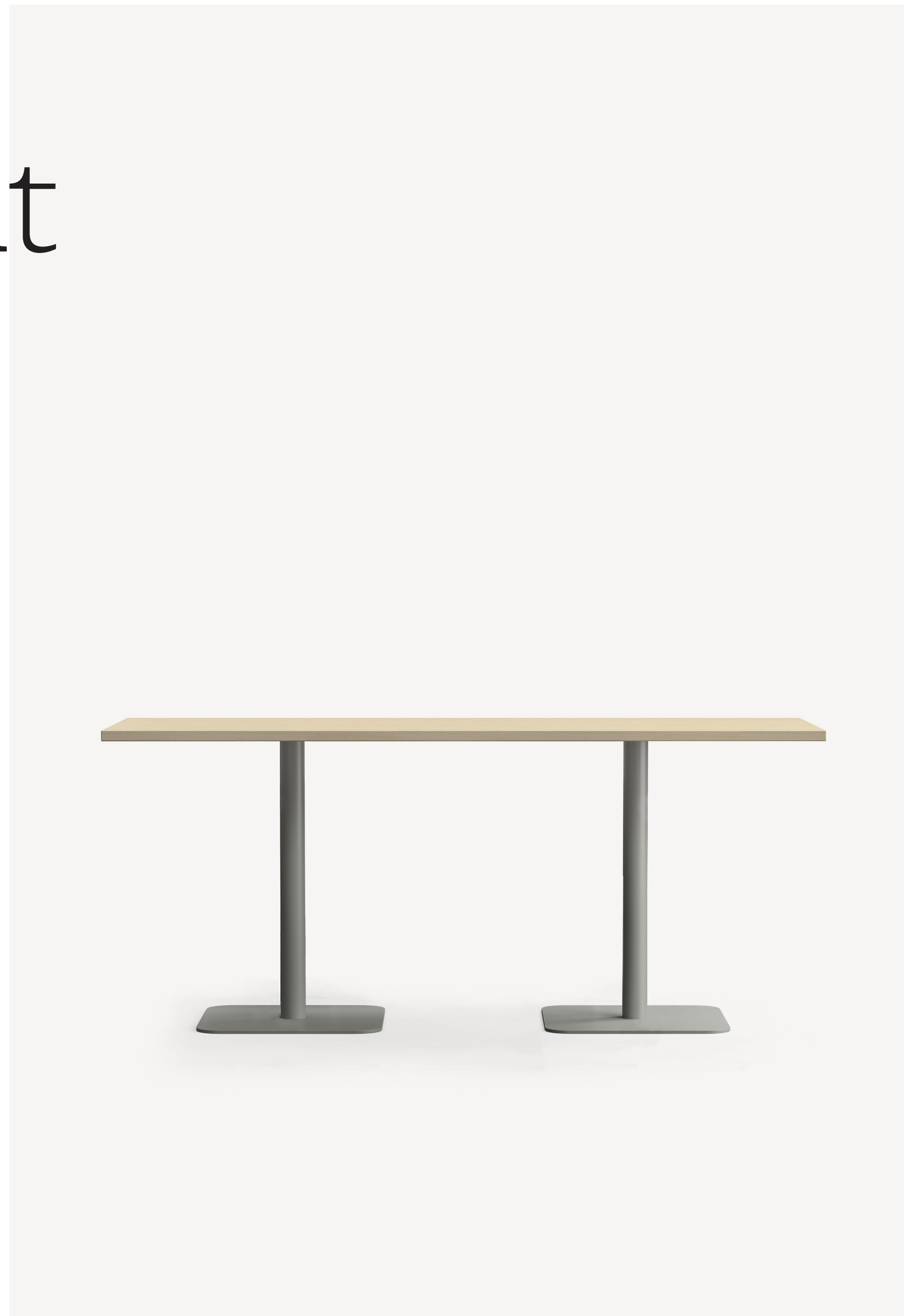


Table Height 42"

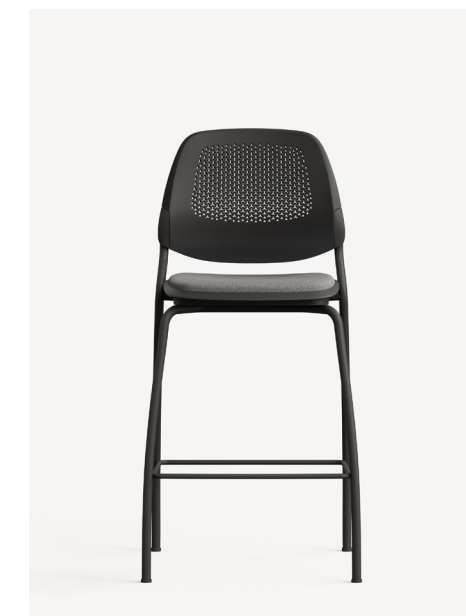
Structure supports collaborative interaction, whether it's to gather for impromptu team brainstorming sessions, relax and unwind during a break, or come together for an all-hands-on-deck conference. Structure is seamless in use with add-on amenities to make the office work for you.



Vicinity Bar Stool



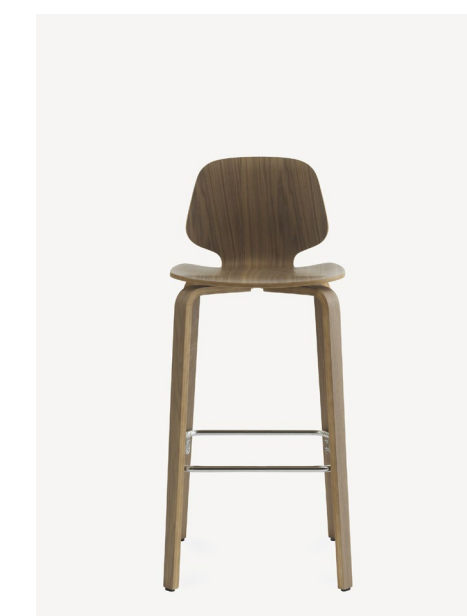
Lyric Bar Stool



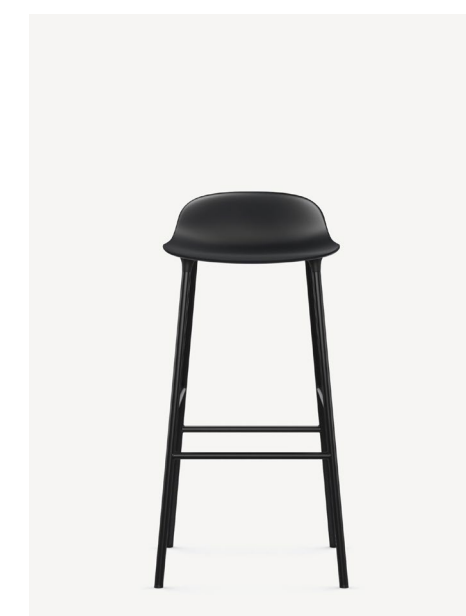
Inspire Bar Stool



Hyg Bar Stool  
by Normann Copenhagen



My Chair Bar Stool  
by Normann Copenhagen

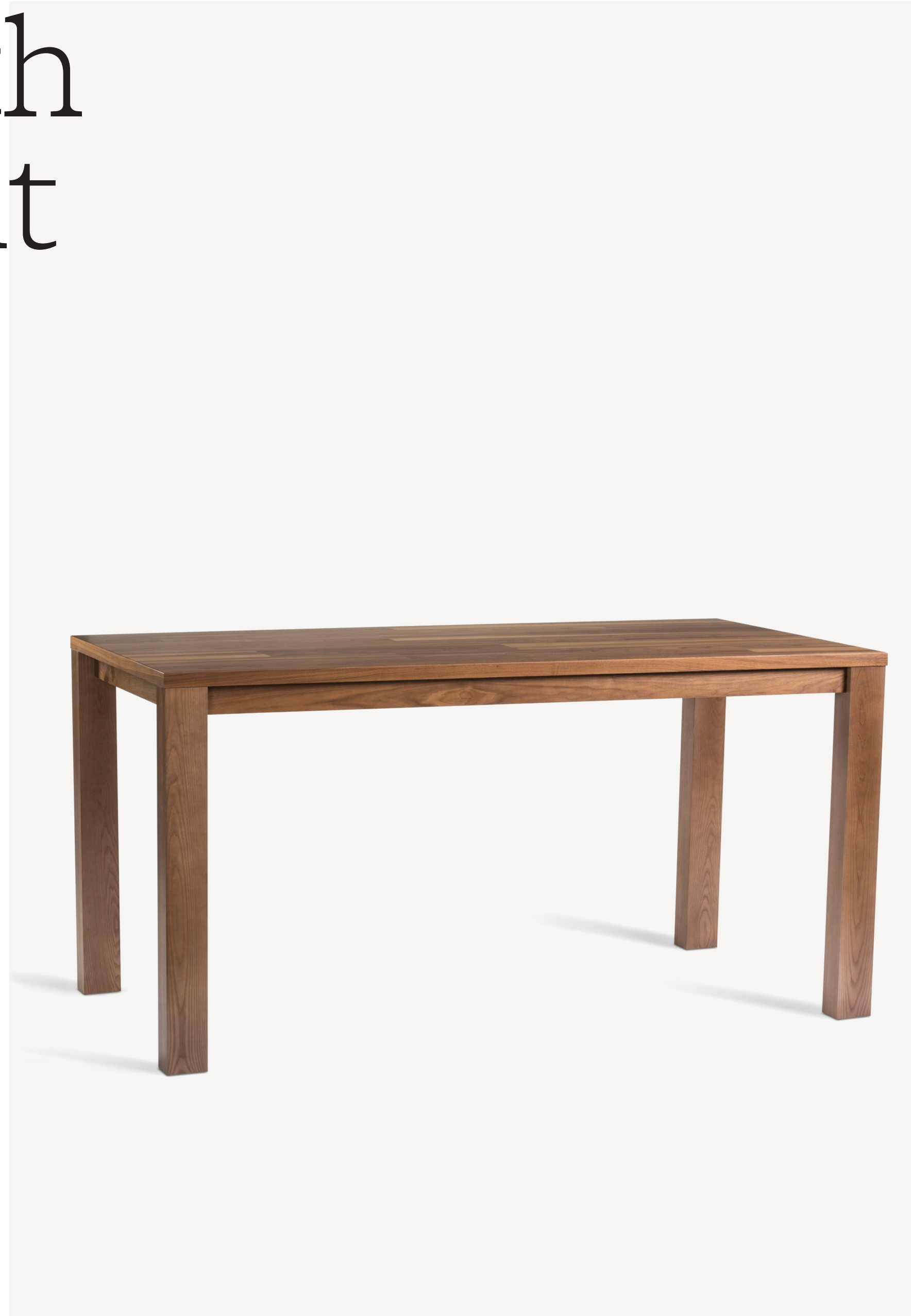


Form Bar Stool  
by Normann Copenhagen



# Letchworth Bar-Height Table

by Gunlocke



**Table Height** 42"

Less suit-and-tie. More laid back. Letchworth brings rustic design and residential influence to informal meeting spaces. Choose standard, counter or bar height. Parsons, workbench, picnic or miter style. Letchworth inspires collaboration and innovation.



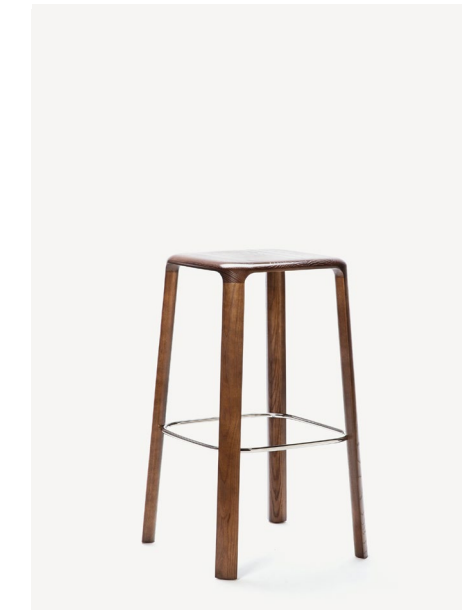
Tia Bar Stool  
by Gunlocke



Hyg Bar Stool  
by Normann Copenhagen



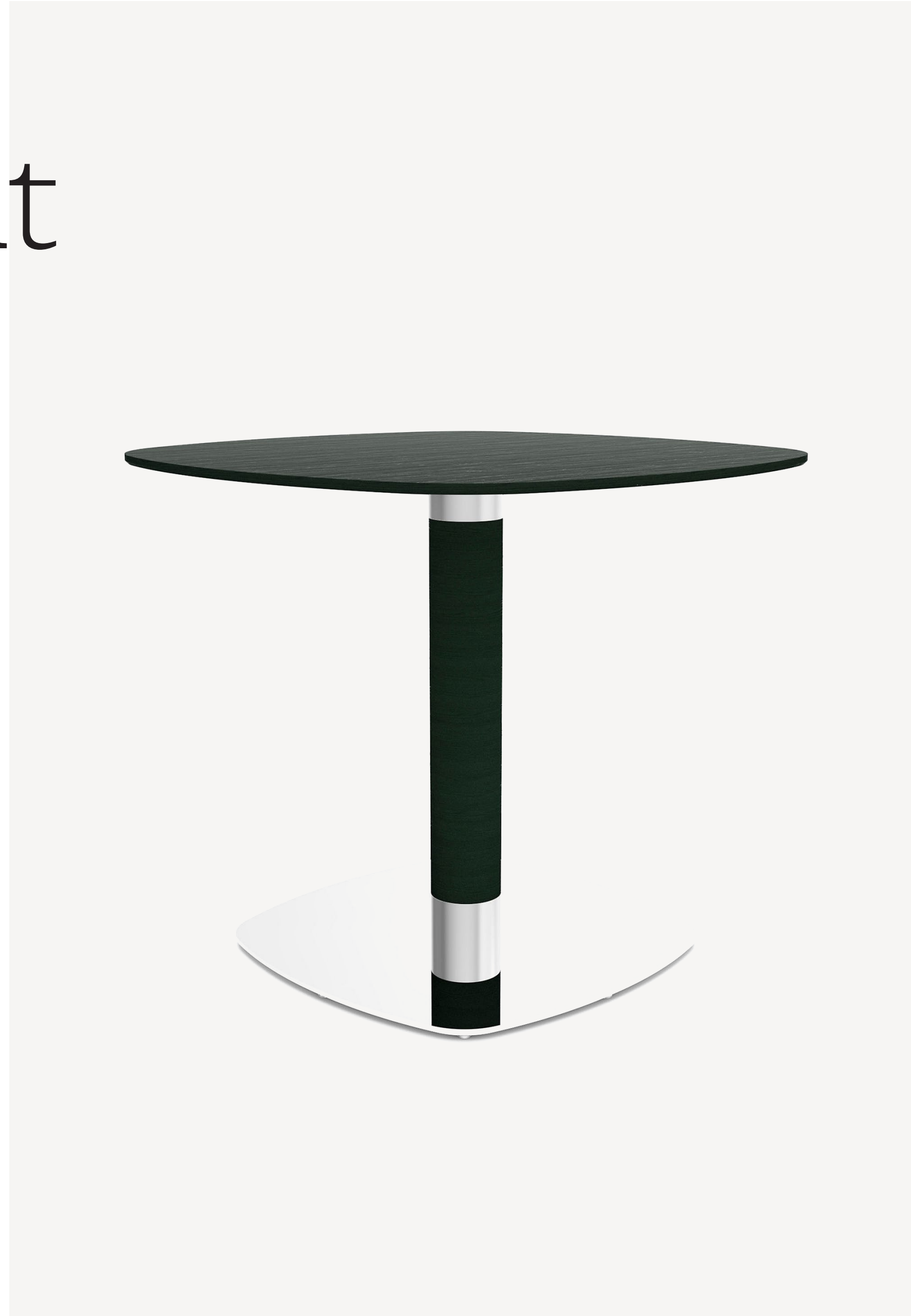
LIV Bar Stool  
by Gunlocke



Trillia Bar Stool  
by Gunlocke

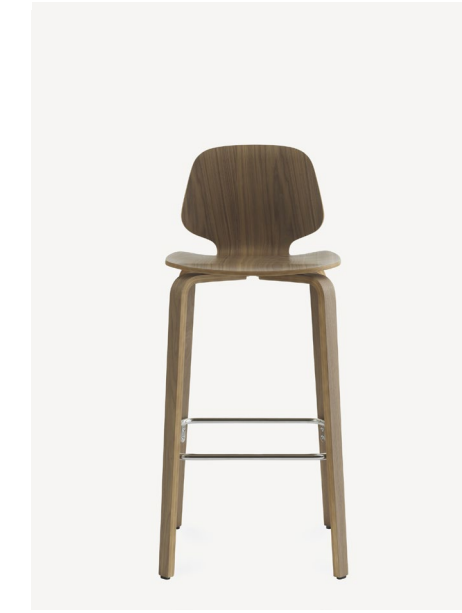
# Meki Bar-Height Table

by HBF



**Table Height** 42"

The Meki Table Collection of tops and bases by Todd Bracher is designed to allow clients to mix and match finish materials, sizes and shapes, making each table uniquely its own. Whether in a café, conference or evolving environment, its design creates an optical illusion – the top appears to float. The simplistic use of materials also make this table timeless.



My Chair Bar Stool  
by Normann Copenhagen



Essens Bar Stool  
by HBF



Andaz Upholstered Bar Stool  
by HBF



Convo Bar Stool  
by Gunlocke





Picnic Bar-Height Table



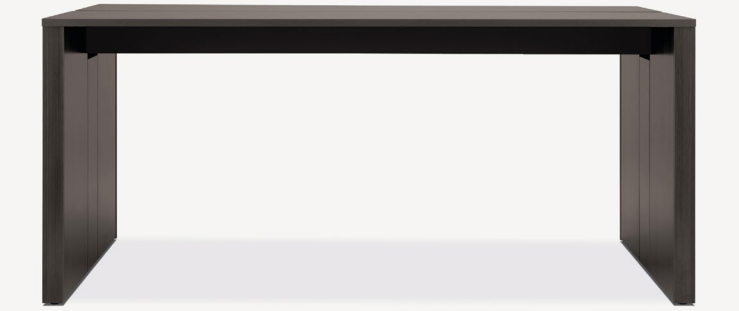
Briefing Miter Bar-Height Table



Admix Bar-Height Table



Union Bar-Height Table



Harvest Classic Standing Table



Harvest Rustic Standing Table



Harvest Metal Standing Table



Structure Bar-Height Table



Letchworth Bar-Height Table



Meki Bar-Height Table

Table Height 41" - 42"

Seating Clearance 10" - 12"

# Bar Tables

# Product Index



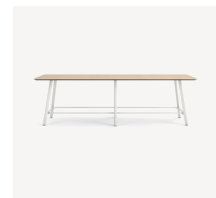
# A



Ace Counter Stool  
by Normann  
Copenhagen  
Page 26



Acuity Side  
Page 19



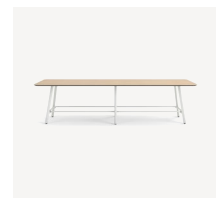
Admix Bar  
Height Table  
Page 30, 39



Admix  
Conference  
Table  
Page 12, 21



Admix  
Continental  
Table  
Page 6, 8



Admix Counter  
Height Table  
Page 25, 27



Ami Round Low  
Conference,  
Dining Table  
by HBF  
Page 13, 21



Andaz Laminate  
Bar Stool  
by HBF  
Page 31



Andaz  
Upholstered  
Bar Stool  
by HBF  
Page 31, 38

# B



Barn Stool  
by Corral  
Page 25, 26, 29,  
30



Briefing Miter  
Bar-Height Table  
by Gunlocke  
Page 31, 39

# C



Clarity Task  
Page 10, 12, 14



Convo Bar Stool  
by Gunlocke  
Page 33, 34, 35,  
38

# E



Essens Guest  
by HBF  
Page 15



Essens Stool  
by HBF  
Page 15, 31, 38



Evo Side  
Page 12, 14, 16,  
17, 18

# F



Form Bar Stool  
by Normann  
Copenhagen  
Page 15, 29, 30,  
32, 36



Form Chair  
by Normann  
Copenhagen  
Page 10, 15, 16,  
17, 18, 19



Form  
Counter Stool  
by Normann  
Copenhagen  
Page 23, 24, 25,  
26



Form Swivel  
Chair  
by Normann  
Copenhagen  
Page 5, 6, 7, 10,  
15

# H



Harvest  
Classic  
Standing Table  
Page 33, 39



Harvest  
Classic Table  
Page 18, 21



Harvest  
Metal Table  
Page 17, 21



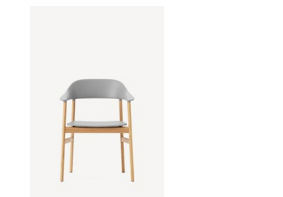
Harvest Metal  
Standing Table  
Page 35, 39



Harvest Rustic  
Table  
Page 16, 21



Harvest Rustic  
Standing Table  
Page 34, 39



Herit Chair  
by Normann  
Copenhagen  
Page 11, 13, 19,  
20



Hyg Bar Stool  
by Normann  
Copenhagen  
Page 32, 36, 37



Hyg Counter  
Stool  
by Normann  
Copenhagen  
Page 23, 24, 26



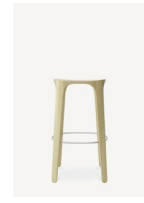
Hyg Side  
by Normann  
Copenhagen  
Page 10, 14, 20

# I



Inspire Bar Stool  
Page 36

# J



Jueki Bar Stool  
by HBF  
Page 30, 32

# L



Letchworth Table  
by Gunlocke  
Page 20, 21



Letchworth Counter-Height Table  
by Gunlocke  
Page 24, 27



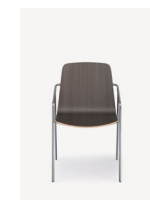
Letchworth Bar-Height Table  
by Gunlocke  
Page 37, 39



LIV Bar Stool  
by Gunlocke  
Page 33, 34, 35, 37



LIV Counter Stool  
by Gunlocke  
Page 23, 24, 25



LIV Side  
by Gunlocke  
Page 12, 13, 16, 17, 18, 20



Lyric Bar Stool  
Page 36



Lyric Side  
Page 19

# M



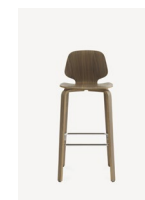
Meki 26"  
by HBF  
Page 7, 8



Meki Bar-Height Table  
by HBF  
Page 38, 39



My Chair  
by Normann  
Copenhagen  
Page 5, 6, 7, 11, 14, 16, 17, 18



My Chair Bar Stool  
by Normann  
Copenhagen  
Page 32, 36, 38



My Chair Counter Stool  
by Normann  
Copenhagen  
Page 23, 24, 25, 26

# N



November Lounge  
by HBF  
Page 5, 7

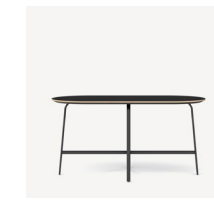


November Side  
by HBF  
Page 5, 6, 7

# P



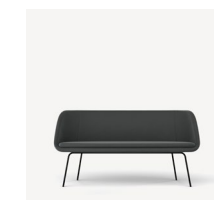
Park HiLo Meeting Table  
Page 15, 21



Park Work Pill Table  
Page 14, 21



Park Hi Settee  
Page 14

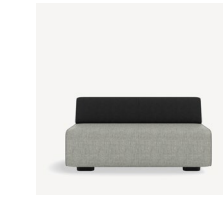


Park Lo Settee  
Page 14

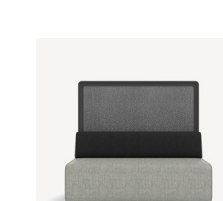


Picnic Bar-Height Table  
Page 29, 39

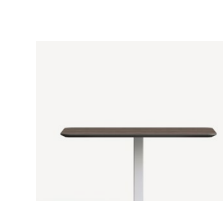
# R



Recharge Bench with Bolster  
Page 11



Recharge Bench with Bolster and Screen  
Page 11



Recharge Work Table  
Page 11, 21

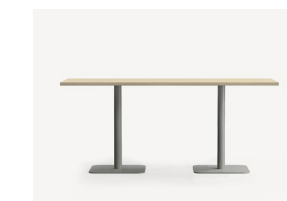
# S



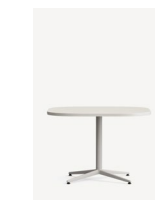
Structure Bar-Height Table  
Page 36, 39



Structure Continental Table  
Page 5, 8



Structure Counter-Height Table  
Page 23, 27



Structure Table  
Page 19, 21



Summit Bar Stool  
Page 29, 30

# T



Tia Bar Stool  
by Gunlocke  
Page 37



Tia Counter Stool  
by Gunlocke  
Page 23, 24, 26



Tia Guest  
by Gunlocke  
Page 20



Trillia Bar Stool  
by Gunlocke  
Page 30, 32, 33, 34, 35, 37



# U



Union Bar-Height Table  
by Normann  
Copenhagen  
Page 32, 39



Union Counter-Height Table  
by Normann  
Copenhagen  
Page 26, 27

# V



Vicinity Bar Stool  
Page 32, 33, 34,  
35, 36



Vicinity  
Counter Stool  
Page 15, 21, 22



Vicinity Lounge  
Page 5, 7



Vicinity Side  
Page 11, 12, 16

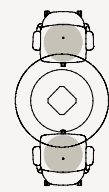




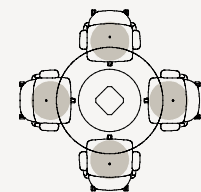
# Table Pairing Reference Guide



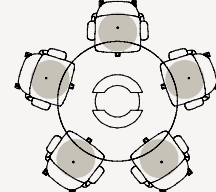
Round



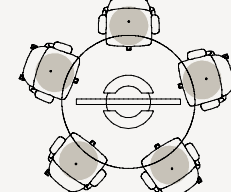
42" DIA.



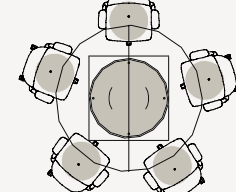
48" DIA.



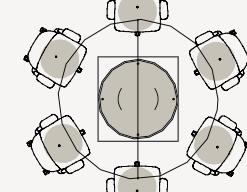
54" DIA.



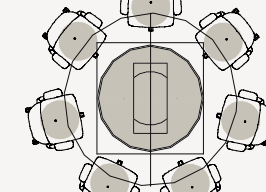
60" DIA.



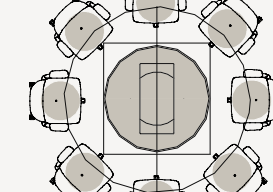
66" DIA.



72" DIA.

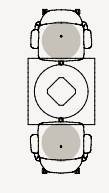


78" DIA.

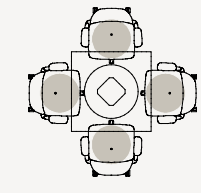


84" DIA.

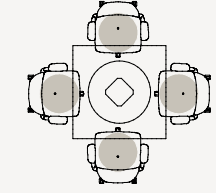
Square



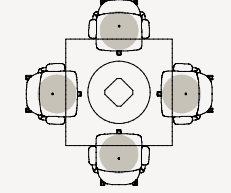
30" SQ.



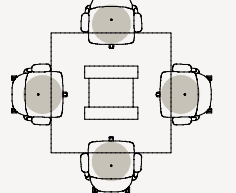
36" SQ.



42" SQ.

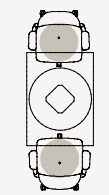


48" SQ.

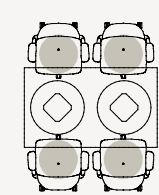


54" SQ.

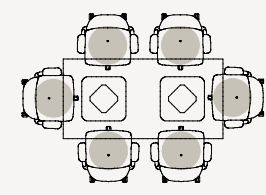
Rectangular



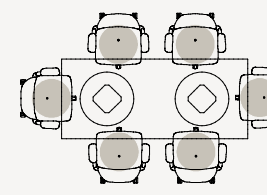
30" X 42"



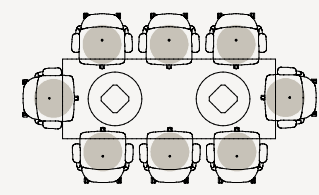
36" X 60"



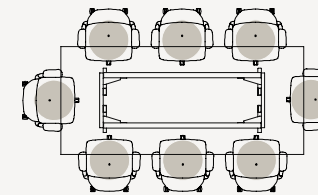
36" X 72"



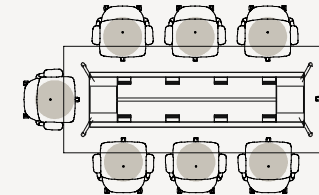
36" X 84"



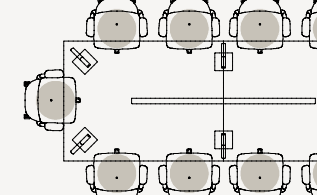
36" X 96"



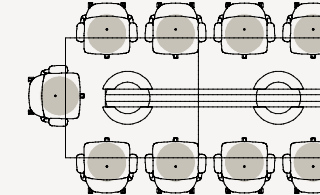
48" X 108"



48" X 120"

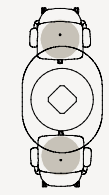


54" X 144"

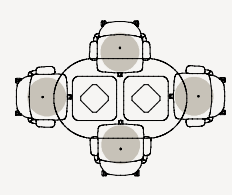


54"x192"

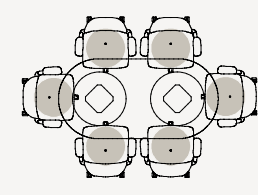
Racetrack & Ellipse



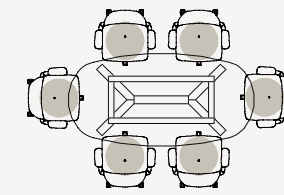
36" x 48"



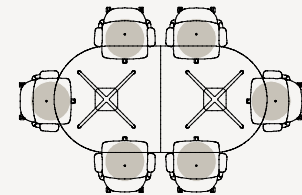
36" x 60"



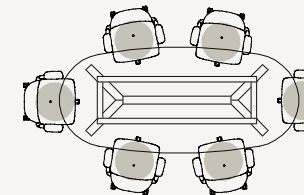
36" x 72"



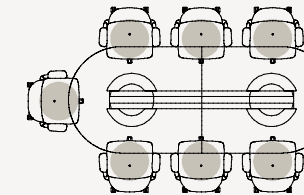
48" x 84"



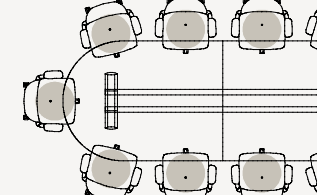
54" x 96"



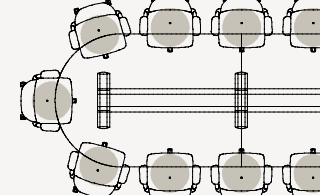
48" x 108"



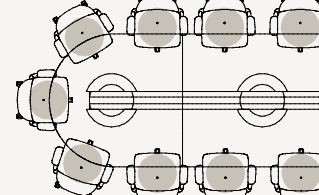
48" x 120"



54" x 144"



60" x 168"

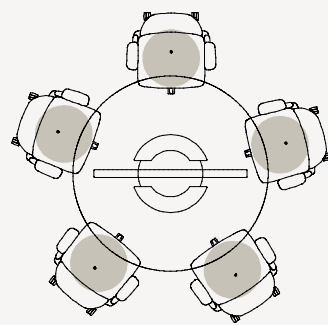


60" x 192"

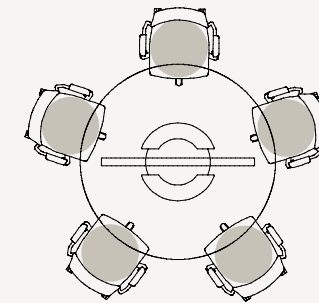
# Table Dimension & Estimated Seat Counts

# Seating Style & Spacing/Count Impacts

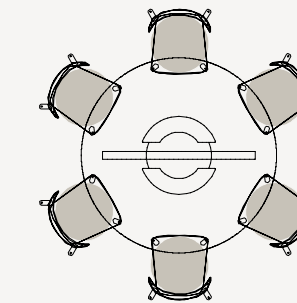
Round  
Allsteel Structure  
60" Diam.



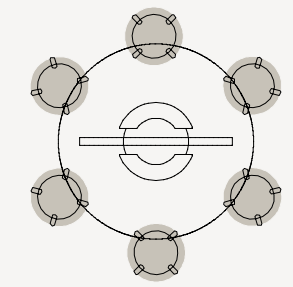
MP Task Chair



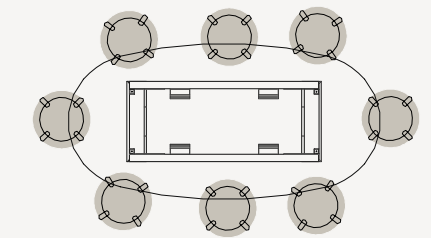
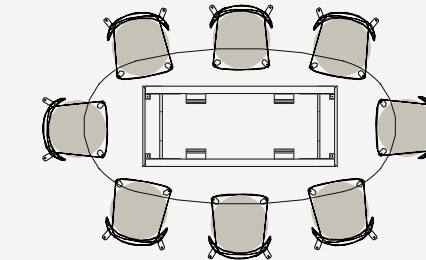
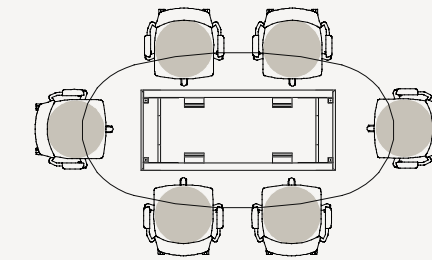
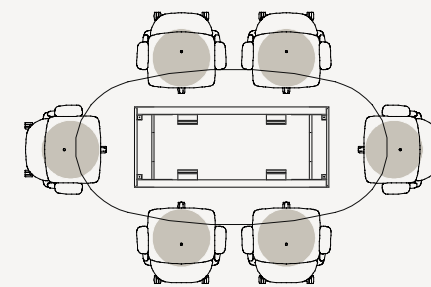
Side Chair



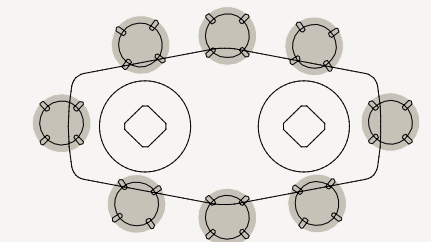
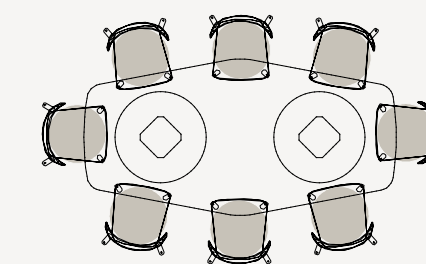
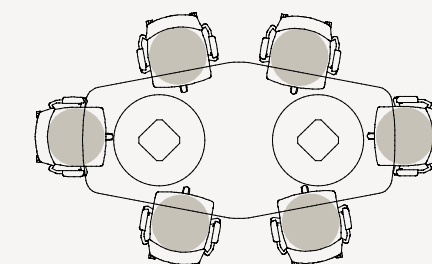
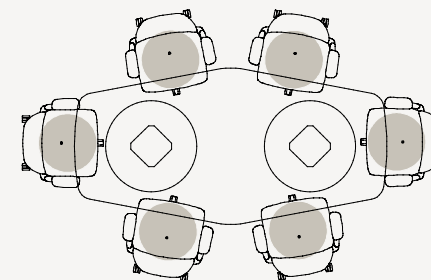
Light Scale Stool



Ellipse  
Gunlocke Briefing  
48" x 96"



Diamond  
Allsteel Structure  
48" x 96"



Seating style selections can support a range of user activities, depending on desired posture/ergonomics, intended duration of sit, or aesthetic look-and-feel. It is important to consider the scale and positioning of seating options to allow for easy user access and provide comfortable side-to-side clearance – avoid overcrowding or seating that feels too sparse.



# Base Considerations

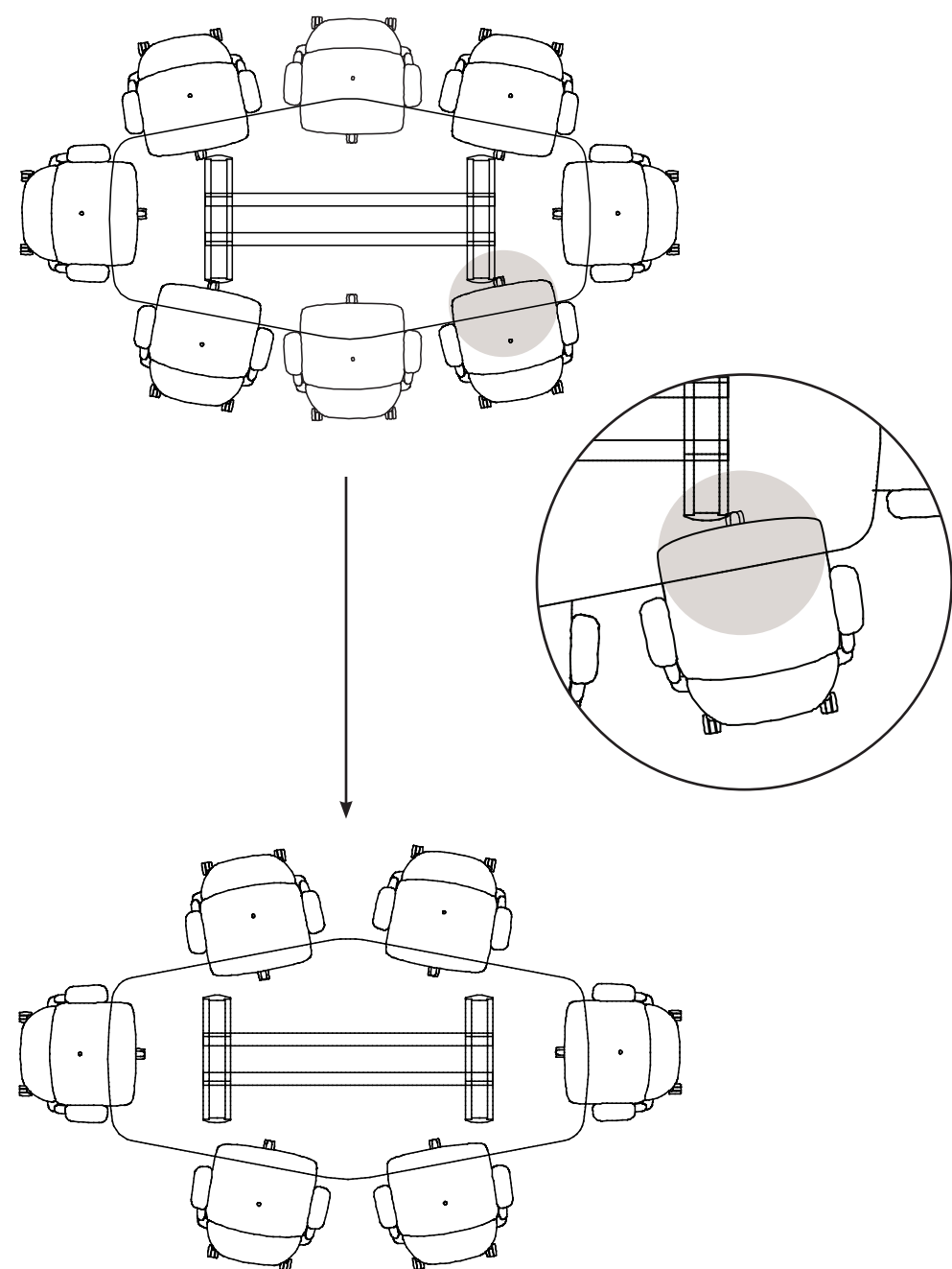
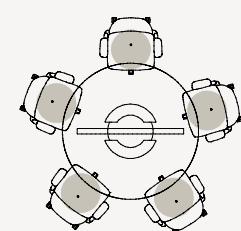
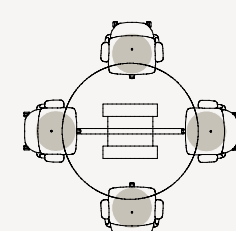


Table base pairings can help create a dynamic visual aesthetic, but it is important to be mindful of how base position and size can impact ideal seating positioning and quantities. Be mindful to avoid chair/base conflicts and that there is ample knee clearance to create an equitable experience for all users.

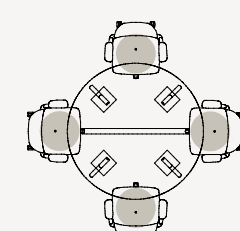
Round  
60" Diam.



60" ROUND  
CYLINDER

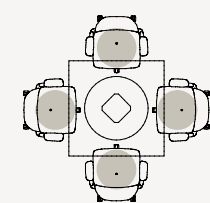


60" ROUND  
CUBE

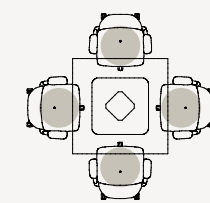


60" ROUND  
COMMUNITY LEGS

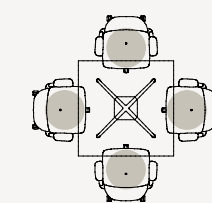
Square  
42" x 42"



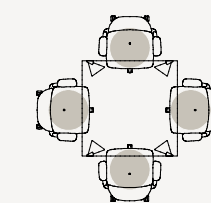
42" SQ.  
ROUND DISC



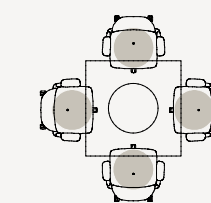
42" SQ.  
SQUARE DISC



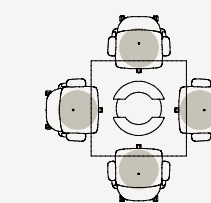
42" SQ.  
X-BASE



42" SQ.  
POST LEGS

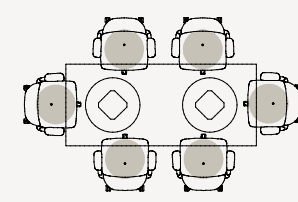


42" SQ.  
SMALL CYLINDER

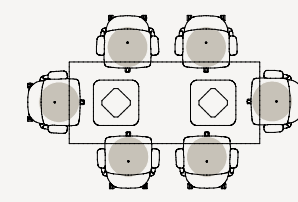


42" SQ.  
CYLINDER

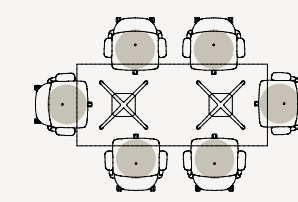
Rectangular  
36" x 84"



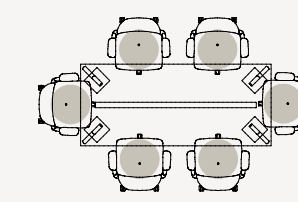
36"x84"  
ROUND DISC



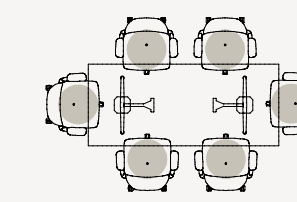
36"x84"  
SQUARE DISC



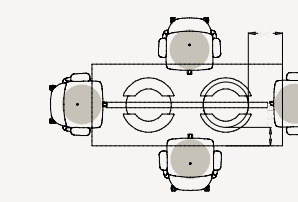
36"x84"  
X-BASE



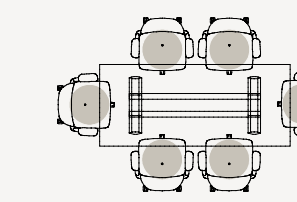
36"x84"  
COMMUNITY LEGS



36"x84"  
T-LEGS

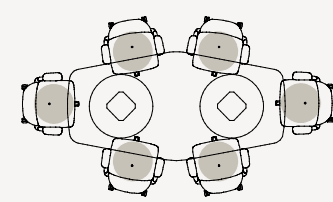


36"x84"  
CYLINDER

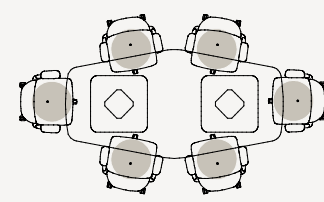


36"x84"  
PANEL

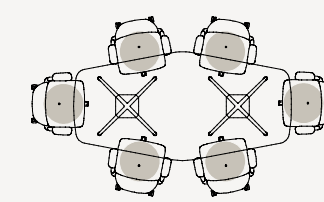
Diamond  
48" x 96"



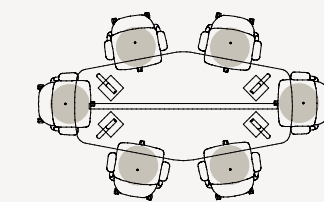
48"x96" DIAMOND  
ROUND DISC



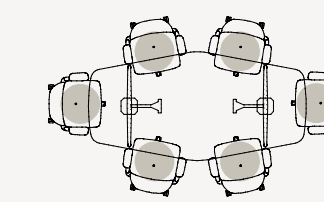
48"x96" DIAMOND  
SQUARE DISC



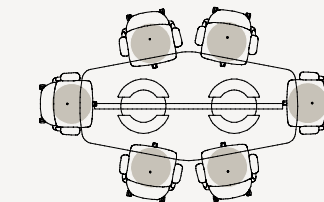
48"x96" DIAMOND  
X-BASE



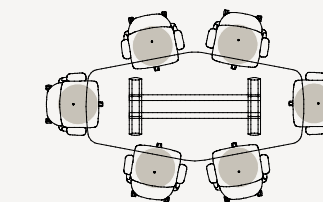
48"x96" DIAMOND  
COMMUNITY LEGS



48"x96" DIAMOND  
T-LEGS

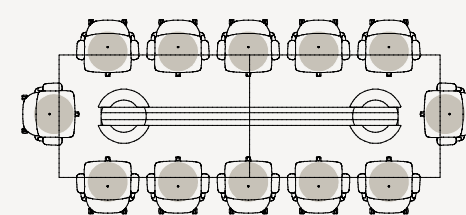


48"x96" DIAMOND  
CYLINDER

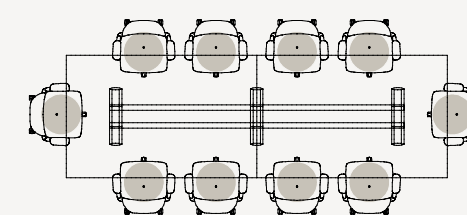


48"x96" DIAMOND  
PANEL

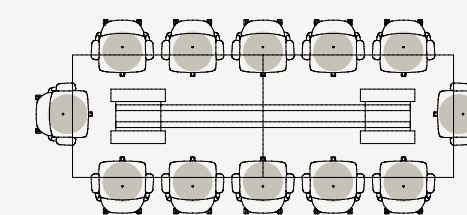
Rectangular  
(Large Conf.)  
54" x 168"



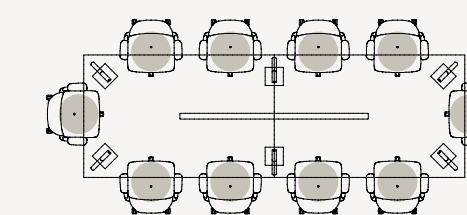
54"x168"  
CYLINDER



54"x168"  
PANEL



54"x168"  
CUBE



54"x168"  
COMMUNITY LEGS

[Learn More About Work Geometry →](#)

Pairings were based on ergonomic principle and anthropometric measurements. User experience may vary based on individual preferences, environmental situations, and materiality.