

Make your space work.

HON®



2021 List Pricer

SHARED SPACES

Tables | Education | Seating | Workplace Tools

Effective Date
October 2021

LIST PRICER

Effective Date: October 2021

- All illustrations and specifications in this publication are based on the latest product information available at the time of print. For the most recent version, please go to www.hon.com.
- Software support packages furnished to the customer, either by The HON Company or by another source, which support the sale of HON products are superseded by printed price lists.
- All dimensions shown in this publication are nominal.
- Pricing is subject to change without notice.
- All orders are subject to prices in effect at the time of order.
- Ordering information appears at the beginning of a section complete with examples on how to specify. These specifying information pages are referenced at the bottom center of product pages.
- HON Full Lifetime Warranty applies unless otherwise noted.
- HON nationwide customer service:
Phone: (800) 833-3964

HON LIST PRICER

Table of Contents

INTRODUCTION

Table of Contents.....	1-3
Additions.....	4
Discontinuations.....	5
HON Full Lifetime Warranty Information.....	6
HON Limited 5-Year Warranty Information.....	7
Ordering Information.....	8
Integrated Design Solutions.....	9
Tailored Solutions Ordering Information.....	10
Customer's Own Material Ordering Information.....	11-12
Partnership Textile Information.....	13
Paint Program.....	14
Environmental Statement.....	15
Important Information.....	16
Legend.....	17
Fabric Patterns & Codes.....	18
Lead Times.....	19
Fabric Patterns & Codes.....	20-22
Panel Fabric Patterns & Codes.....	23-24

TABLES

Arrange®	26
Arrange® Café Tables Ordering Information	27
Arrange® Café Table Tops.....	28
Arrange® Café Table Bases.....	29
Arrange® Café Accessories.....	30
Between™ Tables	31
Between™ Ordering Information	32
Between™ Table Tops.....	33
Between™ Table Bases.....	34
Between™ Rectangular Table Tops.....	35
Between™ Table Bases for Rectangular Tops.....	35
Between™ Nesting Tables.....	36
Between™ Shared Components.....	36
Between™ Accessories.....	37
Birk™ Tables	38
Birk™ Ordering Information	39
Birk™ Table Tops.....	40
Birk™ Bases.....	41
Birk™ Personal Table.....	42
Cantilever Table	43
Flock®	44
Flock® Collaborative Tables Ordering Information	45
Flock® Collaborative Solutions Table Specifying Information	46
Flock® Collaborative Laminate Table Tops.....	47
Flock® Collaborative Table Bases.....	48
Flock® Collaborative Tables.....	49-50
Flock® Collaborative Accessories.....	51
Huddle	52
Huddle Ordering Information	53
Huddle Multi-Purpose Tables	54
Huddle Typical.....	55-56
Huddle Multi-Purpose Table Tops.....	57-58
Huddle Multi-Purpose Table Bases.....	59
Huddle Mobile Laptop Table.....	60
Huddle Table Accessories.....	61
Cable Management.....	61
Interlink IQ Electrical.....	62

4-Trac Hardwire Electrical System.....	63-64
Huddle Power and Cable Management.....	65
Occasional Tables	66
Laminate Occasional Tables Options	67
Laminate Occasional Tables.....	68
Laminate Contemporary Occasional Tables.....	69
Motivate®	70
Motivate® Tables Specifying Information	71
Motivate® Fixed Height Tables.....	72
Motivate® Nesting Tables.....	73
Motivate® Adjustable Height Tables.....	74
Motivate® Shared Components.....	75-76
Interlink IQ Electrical.....	77
4-Trac Hardwire Electrical System.....	78-79
Optional Electrical Accessories.....	80
Preside®	81
Preside® Ordering Information	82
Preside® Specifying Information	83-92
Preside® Grommet Cutout Placement.....	93
Preside® Laminate Table Tops.....	94-95
Preside® Laminate Bases.....	96-97
Preside® Metal Bases.....	98-100
Preside® Laminate Bases.....	101
Preside® Metal Bases.....	102
Preside® Collaborative Tables.....	103
Preside® Ganging Tables.....	104
Preside® Collaborative Tables.....	105
Preside® Ganging Tables.....	106
Preside® Mobile Collaborative Tables.....	107
Preside® Team Touchdown Tables.....	108
Preside® Ancillary.....	109
Preside® Laminar Storage.....	110-111
Modular Components.....	112
Modular Components Back Panels.....	112
Wall Mount Storage.....	113-114
Preside® Laminate Shared Components.....	115
Cable Management.....	116
Preside® Table Power Accessories.....	117-118
Preside® Laminate Tables.....	119
Preside® Laminate Tables — Pre-defined Typical.....	120
Scramble™ Occasional Tables	121
Scramble™ Options	122
Scramble™ Coffee Tables.....	123
Scramble™ End Tables.....	124
Utility Tables	125
Utility Tables Ordering Information	126
Utility Tables.....	127
EDUCATION	
Cross Reference by Application	128-129
Build™	130
Build™ Ordering Information	131
Build™ Shape Matrix.....	132
Build™ Table Configurations.....	133-135
Build™ Table Tops.....	136-138
Build™ Tables.....	139
Build™ Nesting Tables.....	140
Build™ Accessories.....	141
Build™ Student Desk Surface Dimensions.....	142

Build™ Student Desk Configurations.....	143-144
Build™ Student Desks.....	145-146
Build™ Student Desk Accessories.....	147
Build™ Makerspace Table.....	148-150
Build™ Makerspace Table Accessories.....	151
Build™ Makerspace Stools.....	152
Revel™	153
Revel™ Stool.....	154
SmartLink®	155
SmartLink® Ordering Information	156
SmartLink® Specifying Information	157-162
SmartLink® Student Desks.....	163
SmartLink® Value Series Student Desks.....	164
SmartLink® Student Desk Accessories.....	165
SmartLink® Chairs.....	166-169
SmartLink® Teacher Stations.....	170
SmartLink® Value Teacher Stations.....	171
SmartLink® Teacher Station Accessories.....	172
SmartLink® Modular Storage.....	173-174
SmartLink® Modular Storage and Accessories.....	175
SmartLink® Wall Rail System.....	176
SmartLink® Wall Rail System Accessories.....	177
SmartLink® Value Mobile Storage.....	178-180

WORKPLACE TOOLS

Workplace Tools	181
Workplace Tools Ordering Information	182
Monitor Arms.....	183-184
CPU Holders.....	185
Keyboard Trays.....	186-187
Corner Sleeves.....	188
Center Drawers.....	189-190
Coordinate™ Desktop Riser.....	191
Ergonomic Solutions.....	192
Chair Mats.....	193
Task Lights.....	194-195
Paper Management & Organizational Tools.....	196-199
Interlink IQ Electrical.....	200-201
4-Trac Hardwire Electrical System.....	202-203
Power & Cable Management.....	204
Power.....	205-207
Power & Cable Management.....	208
Healthy Workplace Tools.....	209-210

SEATING

Seating Functions	212-213
Ordering Information	214-215
Fire Code/Compliant Seating	216
Accommodate®	217
Accommodate® Options	218
Accommodate® Fabric Options	219
Accommodate®.....	220-223
Adjustable Task/Lab Stools	224
Assemble™ Nesting/Stacking Chairs	225
Astir™ Collaborative Work Seating	226
Astir™ Options	227
Astir™ Finish Options	228
Astir™ Collaborative Work Seating.....	229-240
Astir™ Power.....	241

For information regarding HON registered and unregistered trademarks, please go to hon.com/protected-marks. Haworth®, Herman Miller®, Knoll®, and Steelcase® are registered trademarks of their respective owners and use of the marks do not imply affiliation or endorsement of The HON Company or its products.

LIST PRICER

Effective Date: October 2021

- All illustrations and specifications in this publication are based on the latest product information available at the time of print. For the most recent version, please go to www.hon.com.
- Software support packages furnished to the customer, either by The HON Company or by another source, which support the sale of HON products are superseded by printed price lists.
- All dimensions shown in this publication are nominal.
- Pricing is subject to change without notice.

- All orders are subject to prices in effect at the time of order.
- Ordering information appears at the beginning of a section complete with examples on how to specify. These specifying information pages are referenced at the bottom center of product pages.
- HON Full Lifetime Warranty applies unless otherwise noted.
- HON nationwide customer service:
Phone: (800) 833-3964

HON LIST PRICER

Table of Contents

Cambia™ 2160 Series	242	Ignition®	327	Neutralize™	401
Cambia™ 2160 Series Options	243	Ignition® Options	328-329	Neutralize™ Mesh Chair.....	402
Cambia™ 2160 Series.....	244	Ignition® 2.0 Options	330-331	Nucleus®	403
Ceres®	245	Ignition® 2.0 Dimensions	332-333	Nucleus® Task Chair Options	404
Ceres® Task Chair Options	246	Ignition® 2.0.....	334-338	Nucleus® Multi-Purpose and Café Chair Options	405
Ceres® Multi-Purpose Chair Options	247	Ignition® 2.0 ReActiv®.....	339-340	Nucleus® Fabric Options	406
Ceres® Fabric Options	248	Ignition® 2.0 Upholstered.....	341-342	Nucleus®.....	407-408
Ceres®.....	249-250	Ignition® 2.0 Accessories.....	343-344	High-Density Olson Stacker® 4040 Series	409
Charge™	251	Ignition® Multi-Purpose Chair Options	345	High-Density Olson Stacker® 4040 Series.....	410
Circulate™ Club/Lounge	252	Ignition® Multi-Purpose.....	346	Pagoda®	411
Client™	253	Ignition® Multi-Fabric Multi-Purpose.....	347	Pagoda® Options	412-413
Cliq™	254	Ignition® Multi-Fabric Stools.....	348	Pagoda® 4070 Series.....	414-415
Cliq™ Fabric Options	255	Ignition® Guest.....	349	Pagoda® 4090 Series.....	416-417
Cliq™.....	256-257	Ignition® Task Chair Options	350	Pagoda® 4070/4090 Series.....	418
Comfortask® 5900 Series	258	Ignition® Fabric Options	351	Park Avenue Collection® 5000 Series	419
Comfortask® 5900 Series Options	259	Ignition®.....	352-355	Park Avenue Collection® 5000 Series Options	420
Comfortask® 5900 Series Fabric Options	260	Ignition® Accessories.....	356	Park Avenue Collection® 5000 Series.....	421
Comfortask® 5900 Series.....	261-262	Instigate™ Mesh Guest Chairs	357	Perch™ Active Seating	422
Convergence®	263	Invitation® 2110 Series	358	Perpetual® Nesting Chairs	423
Convergence® Options	264	Invitation® 2110 Series Options	359	Perpetual® Nesting Chairs Options	424
Convergence® Fabric Options	265	Invitation® 2110 Series.....	360	Perpetual® Nesting Chairs.....	425
Convergence® Standard Task Chairs.....	266	Invitation® 2110 Series Connectors.....	361	Pillow-Soft® 2090 Series	426
Convergence® Value Task Chairs.....	267	Invitation® Lounge	362	Pillow-Soft® 2090 Series Options	427
Corral™ Contemporary Lounge	268	Invitation® Lounge Options	363	Pillow-Soft® 2090 Series.....	428
Contemporary Occasional Tables	269	Invitation® Lounge.....	364	Pillow-Soft® 2190 Series	429
Crio™ Mesh Chairs	270	Lota®	365	Pillow-Soft® 2190 Series Options	430
Define™ Executive Chairs	271	Lota® Options	366	Pillow-Soft® 2190 Series.....	431
Endorse® Collection	272	Lota® Fabric Options	367	Prominent™ Mesh Chairs	432-433
Endorse® Options	273	Lota®.....	368	Ruck™	434
Endorse® Dimensions	274	Matter™	369	Ruck™ Options	435
Endorse® Fabric Options	275	Matter™ Multi-Purpose Chairs.....	370	Ruck™ Laminate Seating.....	436
Endorse®.....	276-280	Mav™	371	Ruck™ Wood Seating.....	437
Endorse® Accessories.....	281	Mav™ Finish Options	372	Ryder™	438
Entire™ Mesh Chairs	282	Mav™.....	373-377	Ryder™ Sport Executive Chairs.....	439
Exposure™ Mesh Chairs	283	Merit™	378	Scatter™ Guest Chairs	440
Flock®	284	Merit™ Executive Conference Chair.....	379	Skip	441
Flock® Options	285-286	Motivate® Chairs	380	Skip Collaborative Chair.....	442
Flock® Fabric Options	287	Motivate® Task Chair Options	381	Solutions Seating® 4000 Series	443
Flock® Collaborative.....	288-292	Motivate® Task Chair Fabric Options	382	Solutions Seating® 4000 Series Options	444
Flock® Multi-Fabric Collaborative.....	293-297	Motivate® Task Chairs.....	383	Solutions Seating® 4000 Series.....	445
Flock® Base Frames and Legs.....	298	Motivate® High-Density Sled Base Chair Options	384	Solve®	446
Flock® Options	299	Motivate® High-Density Sled Base Chairs.....	385-386	Solve® Options	447-449
Flock® Fabric Options	300	Motivate® 4-Leg Chair Options	387	Solve®.....	450-456
Flock® Collaborative.....	301-303	Motivate® 4-Leg Chair Fabric Options	388	Solve® Accessories.....	457
Flock® Multi-Fabric Collaborative.....	304	Motivate® 4-Leg Chairs.....	389-390	Soothe®	458
Flock® Options	305	Motivate® Nesting/Stacking Flex-Back Chair Options	391	Soothe® Options	459-460
Flock® Mini Cube and Cylinders.....	306	Motivate® Nesting/Stacking Flex-Back Chair Fabric Options	392	Soothe®.....	461
Flock® Multi-Fabric Mini Cube and Cylinder.....	307	Motivate® Nesting/Stacking Flex-Back Chairs.....	393	Soothe® Multi-Fabric.....	463-464
Gateway™	308	Motivate® Chair with Tablet Arm Options	394	Soothe® Benches.....	465
Gateway™ Fabric Options	309	Motivate® Chair with Tablet Arm Fabric Options	395	Soothe® Tables.....	466
Gateway™ Standard Task Chair.....	310	Motivate® Chair with Tablet Arm.....	396	Soothe® Brackets.....	467
Gateway™ Value Task Chair.....	311	Motivate® Flex-Back Chair with Tablet Arm Options	397	TopFlight™ Wood Seating	468
Grove®	312	Motivate® Flex-Back Chair with Tablet Arm Fabric Options	398	Torch™ Mesh Chairs	469
Grove® Options	313-314	Motivate® Flex-Back Chair with Tablet Arm.....	399	Traction™ Executive Chairs	470
Grove® Fabric Options	315	Network™	400	Validate™	471
Grove®.....	316-318			ValuTask®	472
Grove® Multi-Fabric.....	319-322			Versant® Tandem	473
Grove® Accessories.....	323			Versant® Tandem Options	474
GuestStacker® 4030 Series	324				
GuestStacker® 4030 Series.....	325				

For information regarding HON registered and unregistered trademarks, please go to hon.com/protected-marks. Haworth®, Herman Miller®, Knoll®, and Steelcase® are registered trademarks of their respective owners and use of the marks do not imply affiliation or endorsement of The HON Company or its products.

LIST PRICER

Effective Date: October 2021

- All illustrations and specifications in this publication are based on the latest product information available at the time of print. For the most recent version, please go to www.hon.com.
- Software support packages furnished to the customer, either by The HON Company or by another source, which support the sale of HON products are superseded by printed price lists.
- All dimensions shown in this publication are nominal.
- Pricing is subject to change without notice.
- All orders are subject to prices in effect at the time of order.
- Ordering information appears at the beginning of a section complete with examples on how to specify. These specifying information pages are referenced at the bottom center of product pages.
- HON Full Lifetime Warranty applies unless otherwise noted.
- HON nationwide customer service:
Phone: (800) 833-3964

HON LIST PRICER

Table of Contents

Versant® Tandem.....	475	Wave™ Mesh Chairs	486	Mesh Chairs	504
Versant® Tandem Laminate Occasional Tables.....	476	West Hill™ Casual Lounge Seating	487	Nesting Chairs	505
Versant® Tandem.....	477	West Hill™ Options	488	Task Chairs	506
Volt®	478	West Hill™ Finish Options	489	Workplace Tools Ergonomic Solutions	507
Volt® 5700/5710 Series Options	479	West Hill™ Casual Lounge Seating.....	490-495	Workplace Tools Chair Mats	508
Volt® 5700 Series.....	480	West Hill™ Ottomans.....	496		
Volt® 5710 Series.....	481	West Hill™ Casual Lounge Seating	497-498	INDEX	
Volt® 5720/5730 Series Options	482	Throw Pillows.....	499	Cross Reference Index.....	509-514
Volt® 5720/5730 Series Fabric Options	483	West Hill™ Accessories.....	500	Information on Ordering Parts.....	528
Volt® 5720 Series.....	484	Executive Chairs	501-502		
Volt® 5730 Series.....	485	Guest Chairs	503		

ADDITIONS

NEW ADDITIONS: PRODUCTS

Tables	Effective Date
Scramble™ Models: HSCCSR2448LMK, HSCCSR2448BPG, HSCCSS36LMK, HSCCSS48LMK, HSCCSS36BPG, HSCCSS48BPG, HSCCR36LMK, HSCCR48LMK, HSCCR36BPG, HSCCR48BPG, HSCCESS24LMK, HSCCESS24BPG, HSCER24LMK, HSCER24BPG	January 1, 2021
Seating	Effective Date
Cliq™ Model: HCLQS	July 1, 2021
Ignition® Models: HIWMMHR, HIWMBT, HIWMMS, HIWMMSKD, HI2HR, HI2BTHR	July 1, 2021
Fabrics and Finishes	Effective Date
Laminates Handspun Chestnut (LAHC), Handspun Dove (LAHD), Handspun Pearl (LAHP), Handspun Slate (LAHS)	July 1, 2021

DISCONTINUATIONS

Tables	Effective Date	Workplace Tools	Effective Date
66000 Series Models: H66591, H66581, H66571, H66551, H66531, H66541, H66597, H66582, H66577, H66557, H66537, H66547, H66280, H66282	December 31, 2021	Coordinate™ Models: HS1100, HS1101 Model: HS1102	December 31, 2021 June 30, 2021
Preside® Model: H94011	December 31, 2021	Ergonomic Solutions Model: HBEAFM1	December 31, 2021
Seating	Effective Date	Fabrics and Finishes	Effective Date
Accommodate® Fire Code Models: HSCS1FC, HSCS1DFFC, HSGSXFC, HSGSXDFFC, HSGS6FC, HSGS6DFFC, HSB50FC, HSB50DFFC, HSCS2FC, HSCS2DFFC	December 31, 2021	4-Way Stretch Mesh Chai (IH), Navy (IY)	July 1, 2021
Boda™ Fire Code Models: HMH01, HMH02	December 31, 2021	Fabrics Clyde Weathered (CLYD09)	December 31, 2020
Cambia™ Fire Code Models: H2165FC, H2164FC	December 31, 2021	Laminates Sheer Mesh (A5) Canyon Zephyr (K9) Desert Zephyr (K8) Shadow Zephyr (K1) Grey Tigris (L6) Whitestone (K4)	June 30, 2022 June 30, 2022 June 30, 2022 June 30, 2022 June 30, 2022 June 30, 2022
Ceres® Model: HCW1.PB	December 31, 2021		
Ceres® Fire Code Models: HCW1FC, HCG6FC, HCG6DFFC	December 31, 2021		
ComforTask® Fire Code Models: H5905FC, H5903FC, H5902FC, H5901FC	December 31, 2021		
Endorse® Fire Code Models: HLWUFC, HLWUBTFC, HLWMFC, HLWMBTFC, HLTUFC, HLTSUFC, HLTSPFC, HLTMFC, HLTDFC, HLTDFC, HLEUFC, HLEUBTFC	December 31, 2021		
Flock® Fire Code Models: HFL450FC, HFLCC1DFFC, HFLCC1FC, HFLMC1DFFC, HFLMC1FC, HFLMC1SDFFC, HFLMC1SFC, HFLML1DFFC, HFLML1FC, HFLMR1DFFC, HFLMR1FC, HFLSC1DFFC, HFLSC1FC, HFLSC1SDFFC, HFLSC1SFC, HFLS01FC, HFLWI45DFFC, HFLWI45FC, HFLWO45DFFC, HFLWO45FC	December 31, 2021		
Grove® Fire Code Models: HML1SDFFC, HML1SFC, HML2SDFFC, HML2SFC, HML2SDFFC, HML2STFC, HML3SDFFC, HML3SFC	December 31, 2021		
Ignition® Fire Code Model: HIGB1	December 31, 2021		
Invitation® Fire Code Models: HFAA01FC, HFALO2FC, HFAS03FC	December 31, 2021		
Lota® Model: H2282	December 31, 2021		
Network™ Fire Code Models: HVL281, HVL289	December 31, 2021		
Nucleus® Fire Code Models: HN7FC, HN6FC, HNIUFC, HNIFC	December 31, 2021		
Pagoda® Fire Code Models: H4099FC, H4097FC, H4095FC, H4093FC, H4091FC, H4079FC, H4077FC, H4075FC, H4073FC, H4071FC	December 31, 2021		
Park Avenue Seating® Fire Code Models: H5001FC, H5002FC	December 31, 2021		
Perpetual® Fire Code Models: HPN2FC, HPN1FC	December 31, 2021		
Pillow-Soft® 2090 Series Fire Code Models: H2093FC, H2092FC, H2091FC	December 31, 2021		
Pillow-Soft® 2190 Series Fire Code Models: H2194FC, H2192FC, H2191FC	December 31, 2021		
Solutions Seating® Fire Code Models: H4008FC, H4003FC, H4002FC, H4001FC	December 31, 2021		
Solve® Fire Code Models: HSLVSMMSFC, HSLVTMMSFC, HSLVTMMFC, HSLVSMFC	December 31, 2021		
Soothe® Fire Code Models: HHCPIFC, HHCP1DFFC, HHCGB31FC, HHCGB21FC, HHCGB50FC, HHCGB50DFFC, HHCGB21FC, HHCGB21DFFC, HHCGB11FC, HHCGB11DFFC	December 31, 2021		
Tilt™ Model: HVL951	December 31, 2021		
Traction™ Models: HVL103.SB06, HVL103.SB42	December 31, 2021		
Versant® Fire Code Models: HHB02FC, HHB03FC, HHCBS0FC, HHCT01FC, HHCT02FC, HHCT12FC	December 31, 2021		

HON FULL LIFETIME WARRANTY INFORMATION



FULL LIFETIME WARRANTY

YOUR HON FULL LIFETIME WARRANTY

Every time you purchase a HON product, you're making an investment in your future. We're proud to play a part in that future, and you can trust us to do our best for as long as you need us.

The HON Full Lifetime Warranty is our assurance to you that the HON desks, workstations, seating, tables, or storage you purchase will be free from defective material or workmanship for the life of the product.

In the unlikely event that any HON product or component covered by the HON Full Lifetime Warranty should fail under normal workplace use as a result of defective material or workmanship, HON shall repair or replace with comparable product (at HON's discretion), free of charge.

WHAT'S COVERED BY THE HON FULL LIFETIME WARRANTY?

Your HON Full Lifetime Warranty applies to product manufactured after January 1, 2011. All HON product lines, materials, and components are covered by the HON Full Lifetime Warranty except for the items described below.

The specific product lines, materials, and components listed below are covered under HON's Full 12-Year, Full 10-Year, and Full 5-Year Warranties (from date of purchase).

HON'S FULL 12-YEAR WARRANTY

- Electrical components (lamps and ballasts are not covered)
- 4-Way Stretch Mesh
- Seating controls
- Pneumatic Cylinders
- Wood Seating
- Accessories
- Laminate Surfaces

HON'S FULL 10-YEAR WARRANTY

- Coordinate™ Height Adjustable Bases (HHATB)

HON'S FULL 7-YEAR WARRANTY

- Coordinate™ Legacy Bases (HHAB and HREC)
- Workwall Markerboard Glass Tiles

HON'S FULL 5-YEAR WARRANTY

- All LED task lights
- Panel and seating textiles
- Coordinate™ ETA Height Adjustable Base (HHABETA2S2L)
- Coze™
- Between™ Multi-Purpose Table
- Acoustic Solutions by Unika Vaev
- Mod

HON'S FULL 1-YEAR WARRANTY

- Healthy Workplace Tools & Acrylic Screens

These warranties apply to HON products sold within the United States of America, U.S. Territories, and Canada, as well as U.S. Military and Federal Agency purchases (regardless of location).

IS ANYTHING NOT COVERED?

There are a few exclusions to the HON Full Lifetime Warranty and to the 12-, 10-, and 5-year warranties. These exclusions are:

- All HON products that are covered under a separate 5-year warranty.
- Color-fastness or matching of colors, woodgrains, or textures occurring in wood, leather, or other materials that naturally exhibit inherent color variations.
- Customer's own materials (COM) selected by and used at the request of the user.
- Modifications or attachments to the product that are not approved by The HON Company and product failures resulting from such modifications or attachments.
- Product normal wear and tear, which are to be expected over the course of ownership.
- Products that were not installed, used, or maintained in accordance with product instructions and warnings.
- Products used for rental purposes.
- Damage caused by cleaning chemicals.
- Dye transfer caused by external contaminants (including clothing and accessory dyes such as those used on denim jeans) may migrate to lighter colors. This phenomenon is increased by humidity and temperature and is irreversible.
- Fabric pattern match seat to back or chair to chair. If pattern match is needed, please submit a Tailored Solutions request or contact HON Customer Support/Tailored Solutions with questions.

WARRANTY REQUESTS OR QUESTIONS?

Your HON Dealer is our mutual partner in supporting your warranty requests. To obtain service under this warranty, please contact your HON dealer. If you are not sure who your dealer is, please call HON Customer Support at 800.833.3964.

THAT'S YOUR HON FULL LIFETIME WARRANTY AS AN OWNER OF HON PRODUCT, THE WARRANTY EXPLAINED HERE IS YOUR SOLE AND EXCLUSIVE REMEDY. THERE ARE SOME EXCEPTIONS IF YOU PURCHASED THE PRODUCT FOR HOME OR PERSONAL USE WHICH ARE EXPLAINED BELOW. TO THE EXTENT ALLOWED BY LAW, THE HON COMPANY MAKES NO OTHER WARRANTY, EITHER EXPRESS OR IMPLIED, INCLUDING ANY WARRANTY OF MERCHANTABILITY OR FITNESS FOR A PARTICULAR PURPOSE. THE HON COMPANY WILL NOT BE LIABLE FOR ANY CONSEQUENTIAL OR INCIDENTAL DAMAGES.

A WORD ABOUT PURCHASES FOR HOME OR PERSONAL USE

Please note, this section only applies if you purchased your HON product for your home or for your own personal or family use. HON's warranties give you specific legal rights and you may have other rights, which vary from state to state. As a consumer purchaser, the complete exclusion of implied warranties noted in the above paragraph does not apply to you, however, to the extent allowed by applicable state law, the implied warranties are limited to the applicable term of the warranty. Some states do not allow the exclusion or limitation of incidental or consequential damages, so the above exclusion or limitation may not apply to you.

HON LIMITED 5-YEAR WARRANTY INFORMATION



LIMITED 5-YEAR WARRANTY

The HON Company promises to repair or replace HON products or components covered under this warranty that are found to be defective in material or workmanship within five (5) years from the date of original purchase so long as you, the original purchaser, still owns it. This is your sole and exclusive remedy. This warranty is subject to the provisions below. It applies to the products listed here manufactured after January 1, 2018.

LIMITATIONS:

- Upholstery on chairs is warranted for two years from date of purchase.
- Damage caused by the carrier in-transit is handled under separate terms.

EXCLUSIONS:

This warranty does not apply and no other warranty applies to:

- Normal wear and tear, which are to be expected over the course of ownership.
- Modifications or attachments to the product that are not approved by The HON Company.
- Products that were not installed, used or maintained in accordance with product instructions and warnings.
- Products used for rental purposes.

SEATING USAGE

Normal commercial use for seating is identified as the equivalent of a single shift, forty-(40) hour workweek. To the extent that a seating product is used in a manner exceeding this, the applicable warranty period will be reduced in a pro-rata manner.

A WORD ABOUT COLOR VARIATIONS, FABRICS AND FINISHES:

The HON Company does not warrant the color-fastness or matching of colors, grains or textures of covering materials.

CUSTOMER'S OWN MATERIAL (COM)

Not available on HON products covered under the HON 5-year warranty.

TO THE EXTENT ALLOWED BY LAW, THE HON COMPANY MAKES NO OTHER WARRANTY, EITHER EXPRESS OR IMPLIED, INCLUDING ANY WARRANTY OF MERCHANTABILITY OR FITNESS FOR A PARTICULAR PURPOSE. THE HON COMPANY WILL NOT BE LIABLE FOR ANY CONSEQUENTIAL OR INCIDENTAL DAMAGES.

NOTICE TO PURCHASERS FOR HOME OR PERSONAL USE:

Federal law does not permit the exclusion of certain implied warranties for consumer products. Therefore, if you are purchasing this product for home or personal use, the exclusion of implied warranties noted in the above paragraph does not apply to you. Some states do not allow the exclusion or limitation of incidental or consequential damages, so the above limitation or exclusion may not apply to you. This warranty gives you specific legal rights, and you may also have other rights which vary from state to state.

This warranty applies only to products sold within the United States of America and the Commonwealth of Canada.

TO OBTAIN SERVICE UNDER THIS WARRANTY:

Your HON® Dealer is our mutual partner in supporting your warranty requests. By following the procedures outlined below, you can be assured of the best level of service. Please note: Consent of The HON Company must be obtained before any warranty work is performed. To obtain consent, please take the following steps:

1. Contact the Dealer from whom the product was purchased within 30 days of discovery of the defect. Be prepared to affirm that you are the original purchaser of the product and to provide the serial number(s) from the product in question.
2. Your Dealer will gather all pertinent information regarding the claim, inspect the product and contact a HON Company customer service representative. (Please allow a reasonable amount of time for inspection and review.)
3. If The HON Company affirms that the product in question is eligible under the conditions of the warranty as stated above, the customer service representative or another representative of the Company will determine whether to provide replacement parts, authorize repairs or replace the product.

ORDERING INFORMATION

ORDERING

Electronic ordering is the standard order process for HON. HON supports the following primary methods for the electronic transmission of orders and order related documents:

Electronic Ordering

Available in the HONReady portal at honready.hon.com. There are multiple options available for processing orders electronically.

Integration with the standard Office Furniture business systems or other pre-approved proprietary software packages.

SIF file upload using fully optioned SIF files into the electronic ordering applications.

Manual entry of line items into the electronic ordering application.

EDI-System to System Integration

With standard Office Product systems or other pre-approved proprietary software systems.

Training, technical set-up and support is available through our Dealer Operations Team at honready@honcompany.com.

ORDER REQUIREMENTS

- Customer must provide complete and correct information, including complete model number, finishes, colors, options, and quantity.
- If a bid quotation or other special pricing applies, such information must be clearly stated on the order with applicable bid number or contract number.
- Order Management contact name and phone number.
- Delivery Appointment contact name and phone number at the dealership or installation company. HON does not accept orders with end user appointment contacts.
- Dealer Sales Representative, primary or multiple DSRs.
- “Best Date Available” for the entire order is standard service for HON. If eligible, other Date Requests may be requested and must be submitted with the order. Other Date Requests are subject to review by HON prior to acceptance:
 - “Ship After” requests are eligible on all order sizes
 - “Deliver On” requests are eligible for full truckload orders
- Additional services outside of HON’s standard services may be available through HON’s ‘Enhanced Services’ for a corresponding fee. Requested services from ‘Enhanced Services’ must be provided at time of order placement.
- The Company reserves the right to require electronic orders or charge \$50 fee per Purchase Order (PO) for manual order processing.
- Failure to provide complete and accurate information results in delayed order entry and acknowledgment. Incomplete orders will not be produced and will be returned to Dealer for correction.

ACKNOWLEDGMENT SERVICE

- E-mailed acknowledgments are available by customer request.
- An acknowledgment will be emailed the morning of the next business day, unless order is placed on credit or other order hold.
- The order will not receive an acknowledged shipment date until all order holds are released.

ORDER CHANGES OR CANCELLATIONS

For Order Changes or Cancellations, please contact Customer Support at 800-833-3964.

TERMS AND CONDITIONS

See **HON NOW** on honready.hon.com for more information about HON NOW delivery, services and ordering information.

INTEGRATED DESIGN SOLUTIONS

HON INTEGRATED DESIGN SOLUTIONS

Need design assistance? We can help! Our expert design staff will create a professional design package that is sure to put you one step ahead of the competition. And the best part is – it's free!

AUDIT

We will check your drawing and parts list for accuracy. We verify quantity, specification accuracy, product compatibility and structural support.

PLAN & SPECIFY

We will provide a professional design package including a CAD furniture plan, 3-D line drawing and complete parts list based on the rough sketch and work order forms you supply.

VALUE ENGINEERING

We will optimize workstation layouts and propose potential cost saving measures to help your customer save money and make you more competitive and profitable.

RENDERING

We will create a photo realistic rendering of your furniture plan to help your customer visualize what their desired office space will look like.

*SPACE PLANNING (BILLABLE SERVICE)

Let our team do the creative work for you. Our low rates and expert staff will create a furniture layout and design that best suits your customer.

PLANNING TYPICALS

Quick planning ideas to share with your clients. Various settings showcasing desks, tables and workstations available in multiple formats. View them today under Design Resources on the HON Ready Portal.

CONTACT INTEGRATED DESIGN SOLUTIONS

Questions? Please reach out to your region's dedicated designer. Not sure how to reach your designer? Send us a note at the email below.

E-Mail: integrateddesign@honcompany.com



Solve® Chair shown with Coordinate™ Height Adjustable Table.

Project Space

A place for all HON Project Services

Project Space provides one platform to access the full portfolio of HON services including:

- Plan & Specify
- Audit
- Product Modification
- Special Laminates
- Value Engineering
- Rendering
- Customer's Own Material
- Dual Fabric Applications
- Space Planning
- Special Paints
- Project Bid Pricing

Submit your request on the Community powered by HNI, Projects.

Project Space Lead Time: 1-3 business days depending on complexity and size of your project.

TAILORED SOLUTIONS ORDERING INFORMATION

PRODUCT MODIFICATIONS

Modifications include structural and dimensional modifications to existing product and Dual Fabric Applications, when standard model is not available.

The HON Company, at its own discretion, may modify standard products to meet specific needs. Product specials can be requested on HON brand product only.

List prices contained in published list pricers are for standard catalog items only. Changes or alterations to catalog items other than those listed as catalog options are subject to additional charges. Pricing will only be furnished upon approval of the special request.

Requests to have the product produced in more than one fabric (e.g., fabric on the seat is different than the fabric on the back), are considered a Dual Fabric Applications request and follow the Product Modification request process within MyProjects.

SPECIAL LAMINATES

Special laminates include requests for laminates not available as part of The HON Company's standard offering. Requests for special laminates are subject to manufacturing approval and minimum order quantities. The HON Company approved special laminates will be subject to a designated upcharge per unit.

Requests for special laminates should be submitted through the MyProjects Application on the HON Ready portal. Pricing will only be furnished upon approval of the special request.

SPECIAL PAINTS

- The HON Company's paint matching equipment can match almost any color, excluding some metallic and whites.
- Special paint requests must be submitted on the HON Ready Portal MyProjects application.
- In order to request a paint sample, the customer must have a minimum order of 10 like product units. Any requests with less than that amount will not be processed.
 - For each new paint request, there will be a \$500 net charge. A sample of the exact color desired is required for matching and approval. The HON Company will match the color and provide a production sample for the customer to review and approve.

- Once the signed paint sample is received at The HON Company, the request will be approved.
- Each unique color or finish combination incurs a designated upcharge per color per order (all standard discounts/competitive project pricing applies).

Special note: Some special colors could fall outside of this program due to production costs or not meeting The HON Company's quality standards. The HON Company may apply additional charges to some colors which are costly to apply, and refuse some orders on colors that cannot meet The HON Company's high-quality standards. The HON Company will notify the customer upon completion of The HON Company's evaluation if a change in price is required or rejection of the order.

DISCONTINUED PRODUCT

Requests for discontinued product require engineering evaluation, safety review, and testing to current standards prior to approval. Many discontinued products are not available for order. Requests for discontinued products should be submitted through the MyProjects Application on the HON Ready portal.

LEAD TIMES FOR SPECIALS PRODUCT

Lead times on orders containing specials are subject to production capacity and material availability. When possible, the customer should order special products separately to avoid extended lead times for standard products. Extended lead times will be noted on the specials request.

CHANGES TO SPECIALS PRODUCT

A special model will be provided for each approved special item to process orders. Once an order is placed, no changes or cancellations can be made to the order without approval from Tailored Solutions.

CONTACT TAILORED SOLUTIONS

Phone: 800.833.3964 and listen for Tailored Solutions offering on the menu.

Email: HONSpecials@honcompany.com

CUSTOMER'S OWN MATERIAL ORDERING INFORMATION

CUSTOMER'S OWN MATERIAL (COM) PROGRAM

Customer's Own Material (COM) is a request to use fabrics not available as part of HON's standard fabric offering. Manufacture to Supply (MTS) and Dealer to Supply (DTS) are the two ordering methods. The HON Company has partnered with fabric manufacturers to provide competitive pricing and selection through the MTS program. MTS will be the standard offering unless The HON Company is unable to procure the fabric. If there is a DTS request submitted, The HON Company will advise at the time of the request if DTS is available.

CUSTOMER WARRANTY EXCLUSION

The HON Company shall have no responsibility for the condition, quality, value, performance, physical properties, or any other aspects of the COM.

The HON Company shall have no liability for any damages, injuries, or losses to the customer or to any third party that shall be caused by any COM or product modification, and the customer shall hold The HON Company harmless for all liability.

The HON Company assumes no responsibility for the overall appearance, flammability, normal durability, colorfastness, or any other quality of the COM or product modification after its application on a HON product beyond normal quality standards. The HON Company reserves the right to reject a COM fabric if the quality of the COM is not satisfactory for the product. Should this occur, the customer will be notified with an explanation of the issue.

The HON Company is not responsible for fabric that has become obsolete at the COM supplier, that is of poor quality, or that is delivered late to The HON Company from the COM supplier. The HON Company is not responsible for excess yardage created by DTS orders and reserves the right to dispose of the excess fabric.

As a standard HON does not pattern match any standard, partnership or COM fabric, therefore pattern match is not applicable under warranty. If pattern match is needed please submit a Tailored Solutions request or contact HON Customer Support/Tailored Solutions once your COM has been approved.

COM TESTING

As a result of recent legal requirements, The HON Company will need to obtain specific information from the fabric supplier about treatments and chemicals used in the fabric. To the extent the supplier is unwilling or unable to provide the necessary information, which could extend the testing lead time of the request.

To check if a COM has been tested previously, utilize the COM Search Tool on the HON Ready Portal > Design Resources > Textiles & Finishes section using the following information:

- COM Supplier's Name
- Fabric Pattern Name
- Color Name
- If the COM fabric has been tested and previously approved, the COM will not need to be re-tested unless testing standards have changed, fabric is to be used on a different series, or direction of the fabric has changed from what was previously approved. Please note that Panel product must be approved for each model and color.
- If the pattern has previously been tested and approved, but not in the specific requested color, the customer will need to request an order code for that color only. No further testing will be necessary since the pattern has already been approved.

If the fabric has not previously been tested, the customer must enter the COM request on the HON Ready Portal > Textiles & Finishes > COM Search Tool.

Complete the Supplier Name, Pattern, and Color drop-down fields. For quicker results in these fields, type the first letter of the (supplier, pattern, color) name and, when done, click Add and then Submit. (Multiple series can be added to the same request if they are the same supplier, pattern, and color.)

An email will be sent to the requestor stating the COM Request was successfully submitted. Up to four emails could be received: submitted, in testing, testing materials requested, and final approval/denial with price grade and fabric code. The testing process takes approximately 48 hours.

COM yardage in the pricer is shown as pattern cut only.

COM TESTING — FLAMMABILITY TESTING INFORMATION

The customer is responsible for ensuring that the COM fabric is certified to meet all flame-retardant requirements. All COM seating fabric must, at minimum, meet CAL 117 requirements. If the customer requires the chair be tested to meet the fire safety standards of CAL 133, additional testing and information is required.

MTS COM

As previously mentioned, MTS is the primary COM method.

If the COM fabric has not been tested, a COM request must be submitted on the HON Ready Portal.

For MTS orders, The HON Company will procure fabric needed for production. Should The HON Company not be able to obtain fabric yardage, the customer will be contacted.

CUSTOMER'S OWN MATERIAL ORDERING INFORMATION

When testing has been completed, the customer will be notified by the COM team of the test results. If the COM is approved, The HON Company will provide a COM tracking order code for MTS. That tracking code is required on the order in place of the standard fabric code.

If approved, MTS product will be assigned an appropriate fabric grade for pricing. The pricing can be found on the HON Ready Portal > Design Resources > Textiles & Finishes. (All standard discounts/competitive project pricing applies).

Written COM price quotes are valid for 90 days after the issue date.

DTS COM

DTS COM is only available if the COM fabric cannot be procured by The HON Company. If the fabric can be procured by The HON Company, the customer will be contacted to switch to MTS or cancel the request.

If your fabric is not listed as approved, and it is not a Partnership fabric you may request a "Dealer to Supply" code. Select the "Request COM Test" link on the COM Search website. Complete the Supplier Name, Pattern, and Color drop-down fields. For quicker results in these fields, type the first letter of the (supplier, pattern, color) name and, when done, click Add and then Submit. (Multiple series can be added to the same request if they are the same supplier, pattern, and color.)

An email will be sent to the requestor stating the COM Request was successfully submitted. Up to four emails could be received: submitted, in testing, testing materials requested, and final approval/denial with price grade and fabric code. It's rare actual test yardage is required. Testing is mainly done by reviewing the attributes of the fabric. The testing process takes approximately 48 hours.

If the COM has not been tested, a COM request must be submitted on the HON Ready Portal > Design Resources > Textiles & Finishes.

When testing has been completed, the customer will be notified by the COM team of the test results. If the COM is approved, The HON Company will provide a COM tracking order code. That tracking code is required on the order in the place of the standard fabric code.

DTS product is priced at the following grades (all standard discounts/competitive project pricing applies):

- Chairs are a Grade 4
- Panel product is a Grade D

Written COM price quotes are valid for 90 days after the issue date.

COM LEAD TIME

Ship dates will be based on fabric receipt and The HON Company's standard lead time. All fabric must be properly tagged and shipped to the appropriate producing location (provided in the approval email).

- Specific to DTS orders, COM orders will not receive a ship (acknowledged) date until The HON Company has the fabric in its possession for production.
- Specific to DTS orders, the customer may send the required yardage for the order to the address listed on the approval email to arrive no sooner than 4 weeks in advance of the acknowledgment date.

HON will make every effort to locate mis-directed COM shipments on behalf of the customer. However, The HON Company will not be responsible for any COM received without a tracking number or incorrectly shipped by the fabric vendor to an incorrect producing facility.

COM ORDERING INFORMATION

The following information must appear on or accompany the product purchase order:

- Approval tracking number and the customer's purchase order number
- COM supplier, pattern, and color name/number

The packing list for the COM must include the following information when The HON Company receives the shipment for production:

- Dealer or Wholesaler Name
- Purchase order number submitted to The HON Company
- Fabric name
- Yardage shipped
- Approval ordering code

If The HON Company receives fabric with incorrect labeling that cannot be linked to an order, The HON Company will hold the fabric for up to 7 days while the COM team attempts to identify the order. After 7 days, The HON Company will return the fabric to the sender.

Specific to DTS orders; the customer should send only the amount needed for the order. Excess yardage will be disposed of at The HON Company's discretion.

CHANGES TO COM PRODUCT

Once a COM product is ordered, no changes or cancellations can be made to the COM product without approval from the HON COM team.

CONTACT COM TEAM

Phone: 800.833.3964 and listen for COM TEAM offering on the menu.

COM Email: HONCOMTeam@honcompany.com

PARTNERSHIP TEXTILE INFORMATION

Partnership Textiles is the result of The HON Company's partnership with textile industry leaders Camira, HBF Textiles, Maharam, Stinson, and Ultrafabrics, LLC. The extensive collection of design-driven textiles create a superior offering at a great value. Partnership Textiles significantly updates HON's offering, expanding it with fresh and exciting options.

- **Fabric Warranty:** Partnership Textiles are covered by HON's Full Lifetime Warranty.
- **Lead Times:** Orders specified with Partnership Textiles will be acknowledged based on the supplier's availability and delivery schedule.
- **Availability:** The HON Company will regularly introduce new Partnership Textiles and reserves the right to change the offering at any time.
- **Fabric Cards:** A curated set of Partnership Textiles are carded jointly by HON and the supplier.

Camira

- Blazer

HBF Textiles*

- Everyday Textures

*HBF Textiles patterns are graded in to HON's offering.

Maharam

- Apt
- Bluff
- Collection 1
- Lariat
- Meld
- 6M

Stinson

- Edge
- Elevate
- Flow II
- Reliance IV

Ultrafabrics, LLC

- Brisa
- Ultraleather Pro

Fabric Memo Samples: Please contact the supplier directly:

Camira: memos@camirafabrics.com

HBF Textiles: Phone: +1 (877) 494-5727, orders@hbftextiles.com

Maharam: (800) 645-3943

Stinson: (800) 841-6279

Ultrafabrics: (877) 309-6648

HON BRANDED, PARTNERSHIP AND COM PATTERN MATCH

- Pattern matching provides alignment of patterns or stripes across individual chair surfaces. Additional yardage may be required depending on pattern repeat. If Pattern Match is needed, please contact HON Customer Support/Tailored Solutions.
- Chair to Chair Pattern Match provides identical pattern alignment from unit to unit and is available with an upcharge. Chair to Chair Pattern Match is reviewed on a case by case basis as several factors are reviewed to determine additional yardage required, including repeat and pattern direction. If Chair to Chair Pattern Match is needed, please contact HON Customer Support/Tailored Solutions.



PAINT PROGRAM

The HON Company has established paint grades to allow customers flexibility and ease in doing business with HON. HON has three paint grades P1, P2, and P3.

P1 PAINT COLORS

HON has established P1 paints which are available on a majority of core products.

P2 PAINT COLORS

Please see individual pricer pages for eligible series and upcharges for P2 paints. P2 paints are listed in the pricer pages under the column P2. Upcharges vary by product (all standard discounts/competitive project pricing applies). No minimum quantity required.

P3 PAINT COLORS

Please see individual pricer pages for eligible series and upcharges for P3 paints. P3 paints are listed in the pricer pages under the column P3. Upcharges vary by product (all standard discounts/competitive project pricing applies). No minimum quantity required.

SPECIAL PAINT COLORS (P4-P6)

With The HON Company's state of the art color matching equipment just about any color can be matched, excluding some metallic and whites. A sample of the exact color desired is required for matching and approval.

- For each newly requested paint, a net fee of \$500 will be charged to cover costs associated with the matching process.
- For existing, previously matched paints, there is no matching fee, however there is a \$100 net fee for sample panels required for the approval process. Refer to MyProjects on the HON Portal for a list of approved special paints.

For all special paint requests, HON will send a production sample for the customer to review and approve. Once the signed paint sample is received at HON the order can be entered. Upcharges vary by product (all standard discounts/competitive project pricing applies). A quantity of 10 like-model minimum order is required for special paints. For complete program details, access Tailored Solutions on the HON Ready Portal at honready.hon.com.

Some special colors could fall outside of this program due to production costs or not meeting HON quality standards. The HON Company may apply additional charges to some colors which are costly to apply, and deny some orders on colors that cannot meet our high-quality standards. We will notify the customer upon completion of our evaluation if a change in price is required or if the request is denied.

ENVIRONMENTAL STATEMENT

We continually reevaluate our purpose and processes, from fostering transparency and circularity in our supply chain to empowering our members to do and be better. We do it so the environments you create will be safer, more socially responsible, and more sustainable.

We've pursued product certifications to help communicate our commitment to developing sustainable products.

Clearing the air.

In 2006, The HON Company became one of the first office furniture manufacturer to have products certified under the Indoor Advantage™ program. Virtually all manufactured products emit chemical compounds into the air. Indoor Advantage™ certification helps assure customers that certified products will help improve the air quality within their offices and workspaces.

Developed by SCS Global Services, Indoor Advantage™ evaluates products against indoor air quality standards, like ANSI/BIFMA Furniture Emissions Standard, X7.1 and CDPH. The ANSI/BIFMA X7.1 standard allows manufacturers to test individual components, as well as complete products for emissions from volatile organic compounds (VOCs). This allows us to identify problematic materials and phase them out of our products.

Indoor Advantage™ certified products meet the LEED and WELL criteria for low-emitting materials.

Indoor Advantage™ offers two levels of certification, including Indoor Advantage™ and Indoor Advantage™ Gold.



On the LEVEL®.

LEVEL®, the certification program for the BIFMA e3 Sustainability Standard, was developed in response to increasing demand for proof that manufacturers were living up to their environmental claims. LEVEL® is a multi-attribute sustainability certification label for products that have met criteria in four categories of impact: Materials, Energy and Atmosphere, Human and Ecosystem Health, and Social Responsibility.

HON's products are certified to LEVEL 2 and LEVEL 3, the highest achievement.



Evaluating Our Impacts.

HON has begun studying the impacts our products have on the environment through lifecycle assessments and creating Environmental Product Declarations (EPDs). EPDs provide an understandable report of how a product impacts natural resources, the environment, and the atmosphere throughout its lifecycle.

Products that meet these specifications are identified throughout this publication with the following icons:

Certified SCS Indoor Advantage™

LEVEL® certified to the BIFMA e3 Sustainability Standard

Environmental Product Declarations

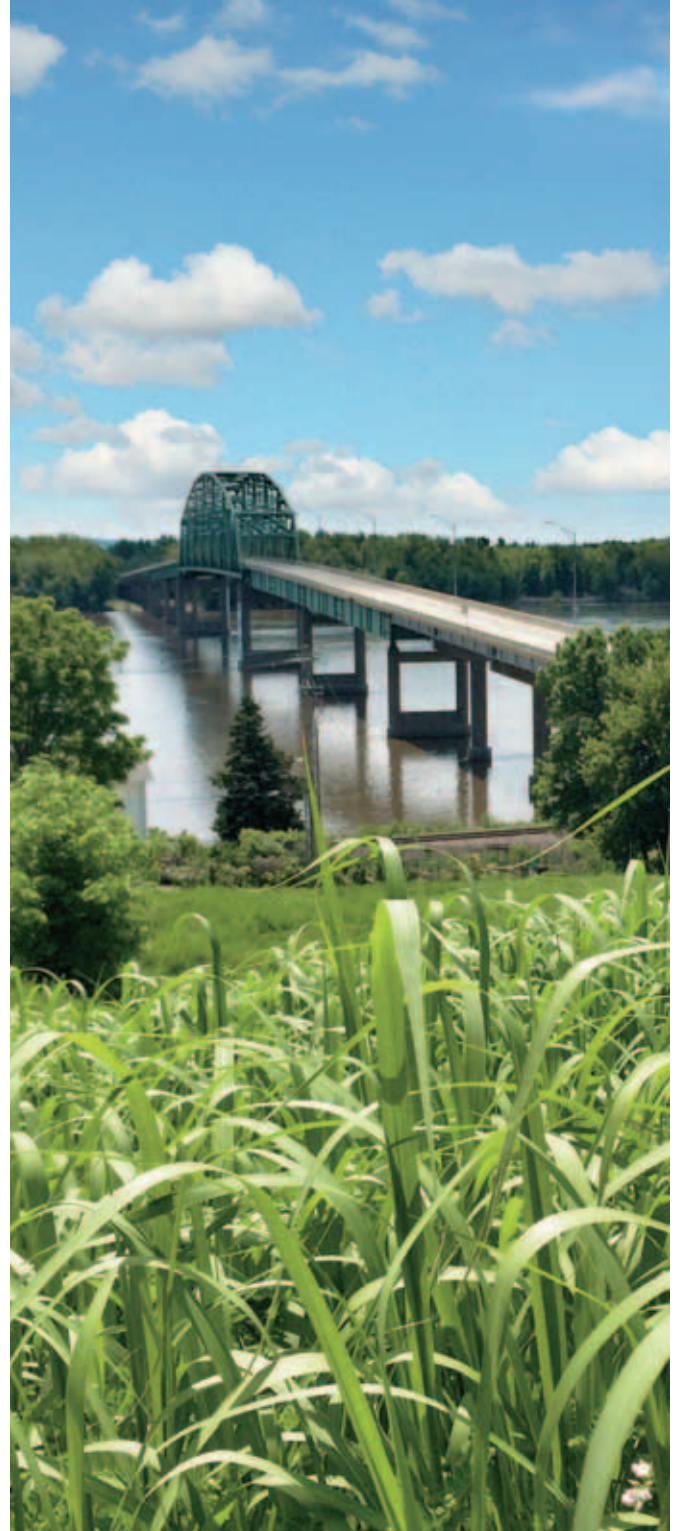

IMPORTANT INFORMATION

HON NOW™

SUPERIOR OFFICE SOLUTIONS AT THE SPEED YOU NEED

To keep your business at peak productivity, waiting is not always an option. The HON NOW™ Quickship program was designed for movers and shakers like you who want exceptional quality, durability, and versatility without compromising valuable time. Whether you're outfitting a brand new workspace or simply expanding the one you already have, we've got a variety of dependable and supportive office furniture solutions designed to fit your needs and your schedule — in a hurry, without the hassle.

To learn more, visit hon.to/now.

GSA CONTRACT INFORMATION

Model numbers identified with the verbiage “**Open Market**” are not offered on HON's GSA contract GS-27F-0015S. Model numbers identified with the following verbiage “Must be purchased with a configurable end product. If ordered separately, not on GSA contract” is to mean that these configurable components or options:

- Have no functionality or capability without being integrated into an end product, and
- Are not separately orderable; an eligible Schedule ordering activity may only purchase them with a configured system that is on contract.

HON CUSTOMER SUPPORT CONTACT INFORMATION

Nationwide CS Phone – (800) 833-3964

Nationwide CS Email – HONTeamBox@honcompany.com

Nationwide Order Entry – email: HONOE@honcompany.com

Government CS Phone – (800) 466-8694

GSA Team: HONGSATEAM@honcompany.com

GSA Order Entry: HONGSAOE@honcompany.com

Integrated Design Solutions – integrateddesign@honcompany.com

Online Order and Tool Support – HONReady@honcompany.com

DASH (transportation and delivery assistance) – (800) 334-8057

HON Literature Fulfillment Phone – (800) 466-4808



Nationwide CS Phone

800-833-3964

THE FOLLOWING ICONS MAY BE USED THROUGHOUT THIS PUBLICATION

	Meets or exceeds ANSI/BIFMA and ISTA performance standards		Readily Available. For additional lead time information see page 19.
	Certified SCS Indoor Advantage™ See page 15 for more details.		Available within a “standard” or “extended” lead time. For additional lead time information see page 19.
	Complies to the BIFMA e3 Sustainability Standard. See page 15 for more details.		May have extended lead times. For additional lead time information see page 19.
	Caution		Product shipped two to a carton
	Easy to assemble		Product shipped four to a carton
	Shippable by small-package carrier		Fire Code
	Wheel-chair compatible		Core Product Line
	Soft-tread caster option available		ColorCorrect® Eligible Product
	HON “One Key” Interchangeable core removable locks (see the Accessories section in the 2021 Workspaces Pricer).		Product scheduled for discontinuation
	Omit core removable lock option available. Allows keyed alike workstations (see the Accessories section in the 2021 Workspaces Pricer).		DE-EMPHASIZED: Product or fabric/surface material is de-emphasized, effective date as noted. Not carded. View online at honready.hon.com
	Base models available on the HON NOW Quickship Program with select options and finishes. View the entire NOW collection at honready.hon.com .		Warranted for multiple shift use, 24 hours a day 7 days a week

FABRIC PATTERNS & CODES



FABRIC PATTERNS & CODES

- For additional HON to Supply COM fabric grade pricing, go to honready.hon.com and search on the HON to Supply COM link.
- All specifications in this publication are based on the latest product information available at the time of print.
- Certain dyes (including clothing and accessory dyes such as those used on denim jeans) may migrate to lighter colors. This phenomenon is increased by humidity and temperature and is irreversible. The HON Company LLC does not assume responsibility for dye transfer caused by external contaminants.
- COM Ordering Information and pricing on page 12.
- See page 13 for Partnership Textile program information.
- All standard fabrics are carded. Cards are available through HON Literature Fulfillment.
- Fabrics and foam meet requirements for CAL-TB 117-2013.
- ! Different fabrics and finishes have different recommended cleaning and maintenance methods. For the correct product care for all finishes view the HON Product Care guide at hon.com/customer-support/product-care.

LEAD TIMES

THE FOLLOWING ICONS ARE USED TO DENOTE FABRIC OPTION LEAD TIMES

FABRIC/FINISH LEAD TIME INDICATOR



Fabric is readily available. Products using these fabrics will receive the best available product lead time and are a good option for standards programs as they will be in the HON portfolio for several years. Go to honready.hon.com and use **Compass** for product lead times by series.



Fabric is available within standard lead times. Products using these fabrics will receive a “standard” or “extended” lead time. The lead time will be determined by the combination of product and fabric. Go to honready.hon.com and use **Compass** for product lead times by series.



Fabric may have extended lead times. Products using these fabrics will typically have a 4+ week lead time. Go to honready.hon.com and use the **Compass** tool for product lead times by series.

HON EXPRESS QUICK SHIP PROGRAM

For the full list of products delivered in 5 business days or less, visit honready.hon.com.

PRODUCT LEAD TIMES

Standard lead times for products are between 2-4 weeks. For current exceptions to our standard lead time, go to honready.hon.com and use the **Compass** tool.

In order to establish accurate expectations for your project, please review this listing prior to submitting your purchase order.

Lead time calculation begins when order is free from any holds (i.e., bad lines, material, credit, etc.).

Please note, these production lead time estimates do NOT include delivery time. All published lead times are estimates, not guarantees of delivery.

For further information concerning lead times, please contact HON Customer Support via email HONTeamBox@honcompany or by phone at **800-833-3964**.

FABRIC PATTERNS & CODES

GRADE 1

APEX	APX
◆ Basalt	APX25
◆ Beet	APX12
◆ Blackberry	APX20
◆ Chive	APX05
◆ Iris	APX03
◆ Kiwi	APX06
◆ Lemonade	APX08
◆ Navy	APX13
◆ Papaya	APX09
◆ Pumice	APX23
◆ Rain	APX19
◆ Resort	APX15
◆ Royal	APX14
◆ Tiki	APX29
◆ Tomato	APX11

ATTIRE AI

◆ Blaze *	AI42
◆ Blue Lagoon *	AI90
◆ Crimson *	AI62
◆ Fatigue *	AI76
◆ Ivy *	AI82
◆ Lithium *	AI19
◆ Onyx *	AI10
◆ Sable *	AI49
◆ Taupe *	AI26
◆ Turquoise *	AI96

BLACK FABRIC ACCF

◆ Black	ACCF10
---------	--------

BLACK MESH ACCM

◆ Black	ACCM10
---------	--------

CENTURION CU

◆ Apricot	CU47
◆ Bark	CU25
◆ Black	CU10
◆ Espresso	CU49
◆ Fog	CU03
◆ Frost	CU22
◆ Goldenrod	CU27
◆ Indigo	CU06
◆ Iris	CU50
◆ Iron Ore	CU19
◆ Jade	CU83
◆ Marsala	CU63
◆ Morel	CU24
◆ Navy	CU98
◆ Peacock	CU97
◆ Pear	CU84
◆ Ruby	CU67
◆ Sapphire	CU09

GRADE 1 *continued*

COMPASS	COMP
◆ Beach	COMP16
◆ Bittersweet	COMP46
◆ Chocolate	COMP49
◆ Ink	COMP10
◆ Meadow	COMP82
◆ Midnight	COMP90
◆ Putty	COMP22
◆ Ruby	COMP62
◆ Sterling	COMP19
◆ Taupe	COMP26
◆ Tide	COMP96

COMPASS FOAM* COMF

◆ Bittersweet	COMF46
◆ Ink	COMF10
◆ Meadow	COMF82
◆ Midnight	COMF90
◆ Putty	COMF22
◆ Sterling	COMF19

**This fabric available for Solve* Upholstered Back models only.*

CONTOURETT UR

◆ Baltic	UR94
◆ Beach	UR23
◆ Black	UR10
◆ Bordeaux	UR63
◆ Buff	UR22
◆ Cloud	UR18
◆ Coffee Bean	UR49
◆ Crater	UR51
◆ Flame	UR62
◆ Graphite	UR19
◆ Iron	UR20
◆ Luggage	UR26
◆ Marine	UR92
◆ Navy	UR95
◆ Nimbus	UR93
◆ Ocean	UR96
◆ Pumpkin	UR42
◆ Quarry	UR24
◆ Red	UR64
◆ Safari	UR27
◆ Sage	UR82
◆ Steel	UR21
◆ Storm	UR17
◆ Taupe	UR28
◆ Trunk	UR50

GRADE 1 *continued*

DAPPER	DAPR
◆ Ash	DAPR20
◆ Azalea *	DAPR95
◆ Breeze	DAPR06
◆ Canvas	DAPR25
◆ Charcoal	DAPR01
◆ Clover	DAPR22
◆ Currant	DAPR00
◆ Emerald *	DAPR75
◆ Fawn	DAPR35
◆ Fern	DAPR85
◆ Gerbera	DAPR16
◆ Grape	DAPR33
◆ Jewel	DAPR08
◆ Marigold	DAPR65
◆ Onyx	DAPR10
◆ Orchid	DAPR90
◆ Parrot	DAPR59
◆ Peony *	DAPR50
◆ Pool *	DAPR05
◆ Poppy	DAPR19
◆ Rose *	DAPR40
◆ Sapphire	DAPR07
◆ Scarlet	DAPR45
◆ Sepia	DAPR30
◆ Sky	DAPR44
◆ Slate	DAPR15
◆ Sorbet	DAPR55
◆ Spice *	DAPR60
◆ Spring	DAPR80
◆ Terracotta	DAPR13
◆ Titanium	DAPR17
◆ Varsity	DAPR09
◆ Zest	DAPR70

ENSEMBLE ENSB

◆ Aquamarine	ENSB30
◆ Ash	ENSB39
◆ Greige	ENSB36
◆ Harbor	ENSB34
◆ Navy	ENSB35
◆ Oat	ENSB37
◆ Pear	ENSB33
◆ Sand	ENSB38
◆ Scarlet	ENSB32
◆ Slate	ENSB31
◆ Stone	ENSB40

GRADE 1 *continued*

HAMILTON	HAML
◆ Azure	HAML10
◆ Biscotti	HAML11
◆ Cabernet	HAML08
◆ Carolina	HAML21
◆ Charcoal	HAML17
◆ Chocolate	HAML13
◆ Cloud	HAML18
◆ Dane	HAML16
◆ Dusty Rose	HAML07
◆ Esmeralda	HAML06
◆ Fern	HAML04
◆ Fresh	HAML03
◆ Granola	HAML19
◆ Lilac	HAML14
◆ Lime	HAML05
◆ Lipstick	HAML09
◆ Oxford	HAML20
◆ Passion Fruit	HAML02
◆ Pepper	HAML15
◆ Powder	HAML12
◆ Sunrise	HAML01

INERTIA NR

◆ Amethyst	NR61
◆ Calypso	NR98
◆ Cherry	NR66
◆ Cobalt	NR91
◆ Coffee	NR49
◆ Fog	NR19
◆ Fuchsia	NR63
◆ Gecko	NR76
◆ Glow	NR27
◆ Leaf	NR75
◆ Lime	NR82
◆ Loft	NR22
◆ Mandarin	NR47
◆ Meteor	NR30
◆ Mustard	NR26
◆ Nickel	NR23
◆ Onyx	NR10
◆ Regatta	NR90
◆ Shadow	NR20
◆ Surf	NR96
◆ Tangelo	NR46

OPTIC OP

◆ Aurora	OP72
◆ Bark	OP24
◆ Canopy	OP84
◆ Char	OP49
◆ Ruby	OP42
◆ Sand	OP17
◆ Sky	OP83
◆ Slate	OP19
◆ Sprout	OP74
◆ Starry Night	OP11
◆ Storm	OP56
◆ Wildfire	OP66

* Fabric is de-emphasized.

FABRIC PATTERNS & CODES

GRADE 1 *continued*

PEBBLE	PBLE
◆ Amber	PBLE01
◆ Chalk	PBLE02
◆ Coal	PBLE03
◆ Gravel	PBLE04
◆ Magma	PBLE06
◆ Moss	PBLE05
◆ Sandstone	PBLE07
◆ Talc	PBLE08
◆ Topaz	PBLE09
◆ Zircon	PBLE10

GRADE 2

APPOINT SEATING	PNS
◆ Artichoke	PNS014
◆ Blackberry	PNS012
◆ Bronze	PNS002
◆ Carbon	PNS008
◆ Chai	PNS013
◆ Cherry	PNS010
◆ Dark Pewter	PNS017
◆ Dune	PNS015
◆ Espresso	PNS003
◆ Framboise	PNS011
◆ Frost	PNS034
◆ Jet	PNS007
◆ Lawn	PNS005
◆ Mandarin	PNS009
◆ Morel	PNS001
◆ Nimbus	PNS016
◆ Platinum	PNS004
◆ Turquoise	PNS006

BLUME	BLME
◆ Chalk	BLME03
◆ Char	BLME00
◆ Coin	BLME02
◆ Driftwood	BLME05
◆ Emerald City	BLME07
◆ Fir	BLME09
◆ Harvest	BLME04
◆ Haze	BLME08
◆ Hyacinth	BLME14
◆ Jasper	BLME13
◆ Merlot	BLME10
◆ Moonstone	BLME01
◆ Opal	BLME06
◆ Scarlet	BLME11
◆ Slate	BLME12

CLYDE	CLYD
◆ Antique	CLYD04
◆ Artifact	CLYD01
◆ Blacksmith	CLYD10
◆ Claret	CLYD13
◆ Craftsman	CLYD08
◆ Crate	CLYD12
◆ Fossil	CLYD02
◆ Heirloom	CLYD05
◆ Iron	CLYD11
◆ Keepsake	CLYD15
◆ Linen	CLYD14
◆ Relic	CLYD06
◆ Seasoned	CLYD03
◆ Trestle	CLYD07

GRADE 2 *continued*

DOTTY	DOT
◆ Candy	DOT63
◆ Gelato	DOT34
◆ Indigo	DOT31
◆ Onyx	DOT35
◆ Park	DOT83
◆ Peat	DOT24
◆ Peony	DOT32
◆ Suit	DOT20
◆ Sunflower	DOT33
◆ Tailor	DOT21
◆ Tide	DOT90
◆ Velum	DOT29
◆ Violet	DOT30

RUSH	RUSH
◆ Anchor	RUSH07
◆ Basil	RUSH16
◆ Blueberry	RUSH10
◆ Flamingo	RUSH21
◆ Greenery	RUSH15
◆ Greyhound	RUSH06
◆ Marina	RUSH13
◆ Merlot	RUSH19
◆ Midnight	RUSH11
◆ Mint	RUSH09
◆ Mulberry	RUSH18
◆ Pumice	RUSH01
◆ Punch	RUSH20
◆ Sage	RUSH14
◆ Salsa	RUSH24
◆ Sand	RUSH05
◆ Seal	RUSH08
◆ Soot	RUSH02
◆ Stout	RUSH03
◆ Sunshine	RUSH23
◆ Tapestry	RUSH04
◆ Tiger	RUSH22
◆ Vintage	RUSH17
◆ Wave	RUSH12

SEED	SED
◆ Apple	SED11
◆ Ash	SED15
◆ Cardinal	SED09
◆ Cinder	SED17
◆ Cream	SED12
◆ Driftwood	SED13
◆ Harbor	SED10
◆ Onyx	SED18
◆ Smoke	SED16
◆ Truffle	SED14

GRADE 2 *continued*

SPIN SEATING	SPNN
◆ Alabaster	SPNN02
◆ Cavern	SPNN03
◆ Cobblestone	SPNN04
◆ Ember	SPNN06
◆ Flame	SPNN07
◆ Heron	SPNN13
◆ Oat	SPNN01
◆ Ocean	SPNN12
◆ Plum	SPNN15
◆ Pool	SPNN11
◆ Raven	SPNN10
◆ Rhubarb	SPNN14
◆ Tropic	SPNN08
◆ Willow	SPNN05

WHISPER VINYL	WP
◆ Antelope	WP20
◆ Black	WP40
◆ Bone	WP17
◆ Bordeaux	WP26
◆ Brick Red	WP99
◆ Camel	WP18
◆ Cappuccino	WP21
◆ Carotene	WP97
◆ Cashew	WP29
◆ Cerulean	WP36
◆ Charcoal	WP39
◆ Cinnamon	WP25
◆ Cognac	WP62
◆ Cucumber	WP88
◆ Elephant	WP38
◆ Espresso	WP49
◆ Fawn	WP91
◆ Fog	WP100
◆ Forest	WP82
◆ Gravel	WP19
◆ Indigo	WP86
◆ Luggage	WP23
◆ Mahogany	WP93
◆ Mallard	WP90
◆ Merlot	WP27
◆ Molten	WP98
◆ Navy	WP37
◆ Ochre	WP96
◆ Paradise	WP85
◆ Patina	WP34
◆ Pewter	WP83
◆ Putty	WP84
◆ Salsa	WP42
◆ Sangre	WP28
◆ Sassafras	WP89
◆ Storm	WP92
◆ Truffle	WP95
◆ Zest	WP87

FABRIC PATTERNS & CODES

GRADE 3

IN SEASON	ISN
◇ Black	ISN001
◇ Blue Jay	ISN007
◇ Fire	ISN004
◇ Jungle	ISN008
◇ Lake	ISN006
◇ Lead	ISN002
◇ Limestone	ISN041
◇ Ocean	ISN005
◇ Silver	ISN003
◇ Smoke	ISN020
◇ Tundra	ISN011

MOXIE

SX

◆ Barnwood	SX09
◆ Basalt	SX23
◆ Bayou	SX02
◆ Biscotti	SX08
◆ Blackberry	SX48
◆ Blarney	SX49
◆ Blueberry	SX05
◆ Bonsai	SX20
◆ Carob	SX24
◆ Chalk	SX50
◆ Chartreuse	SX34
◆ Cherry	SX38
◆ Cinnamon	SX13
◆ Cobalt	SX01
◆ Coconut	SX06
◆ Concrete	SX43
◆ Cumin	SX32
◆ Dragonfly	SX44
◆ Earl Grey	SX40
◆ Elysian	SX04
◆ Evergreen	SX21
◆ Fatigue	SX18
◆ Fawn	SX30
◆ Flint	SX39
◆ Hazel	SX31
◆ Hemp	SX45
◆ Hickory	SX25
◆ Holly	SX51
◆ Jam	SX16
◆ Kelly	SX33
◆ Lemongrass	SX19
◆ Lime	SX41
◆ Macintosh	SX12
◆ Mulberry	SX15
◆ Parchment	SX07
◆ Peacock	SX03
◆ Pineapple	SX42
◆ Plum	SX17
◆ Punch	SX46
◆ Riverstone	SX47
◆ Russet	SX14
◆ Smokestack	SX22
◆ Tangerine	SX37
◆ Terracotta	SX11
◆ Thicket	SX35
◆ Walnut	SX10

GRADE 3

continued

PARKER	PRKR
◇ Aloe	PRKR01
◆ Cumulus	PRKR05
◆ Cyan	PRKR06
◆ Domino	PRKR07
◆ Fossil	PRKR10
◆ Graphite	PRKR11
◇ Grass	PRKR12
◆ Grenadine	PRKR13
◆ Griffin	PRKR14
◆ Kiln	PRKR16
◆ Magnesium	PRKR18
◆ Magnet	PRKR19
◆ Mica	PRKR20
◆ Mink	PRKR21
◆ Nightfall	PRKR22
◆ Paprika	PRKR24
◆ Pine	PRKR25
◆ Rapids	PRKR28
◆ Rioja	PRKR30

PURL

PURL

◇ Alpaca	PURL08
◇ Braid	PURL10
◇ Deep	PURL12
◆ Graze	PURL05
◆ Loom	PURL06
◆ Needle	PURL07
◆ Pasture	PURL02
◆ Ranch	PURL04
◆ Shuttle	PURL09
◆ Skein	PURL01
◆ Thistle	PURL11
◆ Yearling	PURL03

QUILL

QUL

◇ Aviary	QUL03
◇ Feather	QUL02
◇ Fountain	QUL06
◇ Ink	QUL05
◆ Metal	QUL04
◆ Reed	QUL08
◆ Scroll	QUL01
◆ Well	QUL07

GRADE L1

DENVER LEATHER	SS
◆ Black	SS11

For a complete list of fabrics, including partnership fabrics, go to hon.com/fabricsandfinishes.

PANEL FABRIC PATTERNS & CODES

PRICE CODE AA		PRICE CODE A		PRICE CODE A <i>continued</i>		PRICE CODE A <i>continued</i>	
FACTOR	FACT	APPOINT	APN	ETCH*	ECH	REFLECTIONS*	REF
◇ Bark	FACT20	◇ Artichoke	APN11	◇ Axis	ECH13	◇ Galvanized	REF29
◇ Barley	FACT15	◇ Blackberry	APN32	◇ Blend	ECH14	◇ Ice	REF20
◇ Cascade	FACT25	◇ Bronze	APN22	◇ Cast	ECH12	◇ Loggia	REF21
◇ Feather	FACT30	◇ Carbon	APN28	◇ Highlight	ECH10	◇ Mistral	REF28
		◇ Chai	APN12	◇ Midtone	ECH11	◇ Moonstone	REF23
		◇ Cherry	APN30	◇ Outline	ECH08	◇ Pewter	REF22
		◇ Dark Pewter	APN17	◇ Shade	ECH09	◇ Stainless	REF24
		◇ Dune	APN15	◇ Tonal	ECH16	◇ Vanilla	REF25
		◇ Espresso	APN23	◇ Vanish	ECH15	◇ Winter	REF27
		◇ Framboise	APN31				
		◇ Frost	APN34	EXCHANGE*		REFUGE*	
		◇ Jet	APN27	IRON	EXG	ARTESIAN	RFG
		◇ Lawn	APN25	◇ Iron	EXG916	◇ Artesian	RFG96
		◇ Mandarin	APN29	◇ Nickel	EXG914	◇ Dune	RFG92
		◇ Morel	APN09	◇ Pistachio	EXG910	◇ Eclipse	RFG90
		◇ Nimbus	APN16	◇ Root	EXG913	◇ Frost	RFG93
		◇ Platinum	APN24	◇ Rupee	EXG903	◇ Glacier	RFG91
		◇ Turquoise	APN26	◇ Shadow	EXG911	◇ Mineral	RFG98
				◇ Silver	EXG915	◇ Tidal	RFG94
				◇ Sisal	EXG917		
				◇ Stone	EXG912		
CENTURION		CU		LANDSCAPE*		SARTO*	
		◇ Apricot	CU47	AZURE	LN	ASH	SRT
		◇ Bark	CU25	◇ Azure	LN55	◇ Ash	SRT88
		◇ Black	CU10	◇ Cornsilk	LN15	◇ Fog	SRT14
		◇ Espresso	CU49	◇ Drift	LN05	◇ Lemongrass	SRT49
		◇ Fog	CU03	◇ Khaki	LN20	◇ Mist	SRT45
		◇ Frost	CU22	◇ Sheen	LN10	◇ Mushroom	SRT76
		◇ Goldenrod	CU27	◇ Slate	LN35	◇ Oyster	SRT18
		◇ Indigo	CU06	◇ Umber	LN25	◇ Reef	SRT64
		◇ Iris	CU50	◇ Urban	LN30	◇ Sesame	SRT93
		◇ Iron Ore	CU19			◇ Shale	SRT52
		◇ Jade	CU83	LUCY*		TEMPEST*	
		◇ Marsala	CU63	ASPEN	LC	DRAGONFLY	TP
		◇ Morel	CU24	◇ Aspen	LC32	◇ Dragonfly	TP30
		◇ Navy	CU98	◇ Cornsilk	LC30	◇ Frost	TP15
		◇ Peacock	CU97	◇ Dusk	LC22	◇ Full Stream	TP80
		◇ Pear	CU84	◇ Fawn	LC33	◇ Gold Rush	TP10
		◇ Ruby	CU67	◇ Graphite	LC34	◇ Slate	TP45
		◇ Sapphire	CU09	◇ Mist	LC20	◇ Tumbleweed	TP70
				◇ Neutra	LC24	◇ Wind Chill	TP40
				◇ Pewter	LC35	◇ Zebra	TP35
				◇ Snowdrop	LC28		

NOTES: Centurion fabrics not available on panels that exceed a width and height of 54"H.

Exchange is applied pattern cut and is not available on 78"W tackboards, Voi® screens, and Empower®.

Disperse is applied pattern cut and is not available on 72"W Accelerate® panels and not available on 66"W tackboards, Voi® screens, and Empower®.

◇◇◇ For lead time information see page 17.

* Directional fabrics

PANEL FABRIC PATTERNS & CODES

PRICE CODE B

ANALOG	ANLG
<i>Not available on Accelerate®</i>	
◆ Album	ANLG06
◆ Cartridge	ANLG04
◆ Cassette	ANLG09
◆ Dial	ANLG02
◆ Media	ANLG08
◆ Reel	ANLG07
◆ Signal	ANLG03
◆ Stereo	ANLG01
◆ Track	ANLG05

COAST*

COAST*	COA
<i>Not available on Accelerate®</i>	
◆ Channel	COA14
◆ Dune	COA03
◆ Headlands	COA10
◆ Marsh	COA02
◆ Pebble	COA12
◆ Pier	COA13
◆ Shoal	COA01
◆ Silt	COA06
◆ Tide	COA08

PRICE CODE B *continued*

DISPERSE*	DISP
◆ Autumn	DISP03
◆ Branch	DISP10
◆ Coffee Bean	DISP13
◆ Dusk	DISP09
◆ Emerald City	DISP08
◆ Gold Rush	DISP02
◆ Igloo	DISP11
◆ Ink	DISP06
◆ Mist	DISP12
◆ Oatmeal	DISP15
◆ Prince	DISP07
◆ Reservoir	DISP01
◆ Rose	DISP04
◆ Spring	DISP05
◆ Steel	DISP16
◆ Taupe	DISP14

MICA*

MICA*	MCA
◆ Anthracite	MCA11
◆ Breeze	MCA18
◆ Bronze	MCA13
◆ Buff	MCA14
◆ Cremini	MCA17
◆ Crystal	MCAWIT
◆ Dew	MCA20
◆ Dove	MCA12
◆ Fresh	MCA16
◆ Mineral	MCA15
◆ Nectar	MCA19
◆ Shale	MCA10

PRICE CODE B *continued*

SPIN*	SPIN
◆ Alabaster	SPIN02
◆ Cavern	SPIN03
◆ Cobblestone	SPIN04
◆ Ember	SPIN06
◆ Flame	SPIN07
◆ Heron	SPIN13
◆ Oat	SPIN01
◆ Ocean	SPIN12
◆ Plum	SPIN15
◆ Pool	SPIN11
◆ Raven	SPIN10
◆ Rhubarb	SPIN14
◆ Tropic	SPIN08
◆ Willow	SPIN05

TERRAIN*

TERRAIN*	TRRN
◆ Bay	TRRN05
◆ Bayou	TRRN35
◆ Canyon	TRRN30
◆ Cliff	TRRN45
◆ Crest	TRRN25
◆ Delta	TRRN10
◆ Plateau	TRRN15
◆ Ridge	TRRN20
◆ Valley	TRRN40

NOTES: Exchange is applied pattern cut and is not available on 78"W tackboards, Voi® screens, and Empower®.

Disperse is applied pattern cut and is not available on 72"W Accelerate® panels and not available on 66"W tackboards, Voi® screens, and Empower®.

◆◆◆ For lead time information see page 17.

* Directional fabrics

ARRANGE®

Want to see more? Scan here
to check out hon.com.



Arrange® Tables shown with Accommodate® Seating.

ARRANGE®

Non-traditional workspace? Transform it with Arrange tables. Ideal for cafés and other collaborative spaces, Arrange tables are available in seated, counter and standing-heights, and can accommodate anywhere from two to eight people. With four tabletop shapes and more than 40 different finish options, you can create a unique and usable space that brings people together.



FEATURES

- Simple, clean design coordinates nicely with other HON furniture.
- The traditional x-base can be updated with a disc shroud.
- Tables come with optional cord grommets and outlets to accommodate a wide range of technical needs — or none at all.
- Aluminum bases are durable, long-lasting and lightweight, making it easy to move and rearrange floor plans.
- Laminate surfaces are durable and resist scratches, spills and stains.

ARRANGE® CAFÉ TABLES ORDERING INFORMATION

LAMINATE

TOPS/L1 LAMINATES CODES

Woodgrain

- ◆ Bourbon Cherry **H**
- ◆ Cognac **COGN**
- ◆ Florence Walnut **LFW1**
- ◆ Harvest **C**
- ◆ Kingswood Walnut **LK11**
- ◆ Mahogany **N**
- ◆ Mocha **MOCH**
- ◆ Natural Maple **D**
- ◆ Pinnacle **PINC**
- ◆ Shaker Cherry **F**
- ◆ Sterling Ash **LSA1**

Solid

- ◆ Black **P**
- ◆ Charcoal **S**
- ◆ Designer White **LDW1**
- ◆ Loft **LOFT**

Patterned

- ◆ Handspun Chestnut **LAHC**
- ◆ Handspun Dove **LAHD**
- ◆ Handspun Pearl **LAHP**
- ◆ Handspun Slate **LAHS**
- ◆ Sheer Mesh * **A5**
- ◆ Silver Mesh **B9**
- ◆ Steel Mesh * **A9**
- ◆ Canyon Zephyr * **K9**
- ◆ Desert Zephyr * **K8**
- ◆ Shadow Zephyr * **K1**
- ◆ Gray **G2**
- ◆ Grey Tigris * **L6**
- ◆ White **G1**
- ◆ Whitestone * **K4**

TOPS/L2 LAMINATES CODES

Woodgrain

- ◆ Lowell Ash **LLA1**
- ◆ Natural Recon **LNR1**
- ◆ Phantom Ecru **LPE1**
- ◆ Portico Teak **LPT1**
- ◆ Skyline Walnut **LSW1**

PAINT

PAINT CODES

P1

- ◆ Textured Black **BLCK**
- ◆ Textured Brownstone **P7J**
- ◆ Textured Charcoal **P7A**
- ◆ Textured Designer White ... **PK7**
- ◆ Textured Loft **P7L**
- ◆ Textured Muslin **P7M**
- ◆ Textured Platinum
Metallic **PLAT**
- ◆ Textured Titanium **P8V**

P2

- ◆ Solar Black **P8X**
- ◆ Textured Silver **PR8**

EDGE BAND

EDGE BAND CODES

- ◆ Black **P**
- ◆ Bourbon Cherry **H**
- ◆ Brownstone **EY**
- ◆ Charcoal **S**
- ◆ Cognac **COGN**
- ◆ Designer White **DW**
- ◆ Florence Walnut **FW**
- ◆ Fossil **EH**
- ◆ Greige **R**
- ◆ Harvest **C**
- ◆ Kingswood Walnut **KI**
- ◆ Loft **LOFT**
- ◆ Lowell Ash **DL**
- ◆ Mahogany **N**
- ◆ Mocha **MOCH**
- ◆ Muslin **T**
- ◆ Natural Maple **D**
- ◆ Natural Recon **NR**
- ◆ Phantom Ecru **PE**
- ◆ Pinnacle **PINC**
- ◆ Platinum **K**
- ◆ Portico Teak **DP**
- ◆ Shadow * **SHDW**
- ◆ Shaker Cherry **F**
- ◆ Skyline Walnut **SW**
- ◆ Sterling Ash **SA**

Recommended Edgeband Color Selection:

Laminate		Edgeband	
Bourbon Cherry	H	Bourbon Cherry	H
Cognac	COGN	Cognac	COGN
Florence Walnut	LFW1	Florence Walnut	FW
Grey Tigris	L6	Greige	R
Harvest	C	Harvest	C
Kingswood Walnut	LK11	Kingswood Walnut	KI
Mahogany	N	Mahogany	N
Mocha	MOCH	Mocha	MOCH
Natural Maple	D	Natural Maple	D
Pinnacle	PINC	Pinnacle	PINC
Shaker Cherry	F	Shaker Cherry	F
Sterling Ash	LSA1	Sterling Ash	SA
Black	P	Black	P
Charcoal	S	Charcoal	S
Designer White	LDW1	Designer White	DW
Whitestone	K4	Muslin	T
Sheer Mesh	A5	Muslin	T
Silver Mesh	B9	Loft	LOFT
Steel Mesh	A9	Charcoal	S
Canyon Zephyr	K9	Greige	R
Desert Zephyr	K8	Greige	R
Shadow Zephyr	K1	Loft	LOFT
Lowell Ash	LLA1	Lowell Ash	DL
Natural Recon	LNR1	Natural Recon	NR
Phantom Ecru	LPE1	Phantom Ecru	PE
Portico Teak	LPT1	Portico Teak	DP
Skyline Walnut	LSW1	Skyline Walnut	SW
Loft	LOFT	Loft	LOFT

◆◆◆ For lead time information see page 17.

* De-emphasized

ARRANGE[®] Café Table Tops

GSA SIN 33721



Icon Legend on page 17

	DESCRIPTION	MODEL	SHIP WEIGHT	CUBE	LIST PRICE BY LAMINATE GRADE	
					L1	L2
	Café Round Table Tops					
	24"W Round Top	HCTRND24	19	1.9	\$336	\$351
	30"W Round Top	HCTRND30	31	2.9	\$362	\$377
	36"W Round Top	HCTRND36	44	4.0	\$394	\$409
	42"W Round Top	HCTRND42	57	5.4	\$467	\$487
	Square Table Tops					
	24"W Square Top	HCTSQR24	19	2.2	\$319	\$334
	30"W Square Top	HCTSQR30	31	2.9	\$344	\$359
	36"W Square Top	HCTSQR36	44	4.1	\$375	\$390
	42"W Square Top	HCTSQR42	57	5.6	\$447	\$467
	Soft Square Table Tops					
	24"W Soft Square Top	HCTSFT24	19	1.9	\$336	\$351
	30"W Soft Square Top	HCTSFT30	31	2.9	\$362	\$377
	36"W Soft Square Top	HCTSFT36	44	4.0	\$394	\$409
	42"W Soft Square Top	HCTSFT42	57	5.4	\$467	\$487
	Rectangle Table Tops					
	48"W x 24"D Rectangle Top	HCTRECT2448	36	3.6	\$380	\$395
	60"W x 24"D Rectangle Top	HCTRECT2460	44	4.4	\$416	\$431
	72"W x 24"D Rectangle Top	HCTRECT2472	56	4.9	\$441	\$461
	48"W x 30"D Rectangle Top	HCTRECT3048	51	4.4	\$394	\$409
	60"W x 30"D Rectangle Top	HCTRECT3060	63	5.4	\$441	\$456
	72"W x 30"D Rectangle Top	HCTRECT3072	75	6.0	\$489	\$509

NOTES:

- 2 grommet cutouts on Rectangles which will be positioned over the installed bases.

HOW TO SPECIFY

<p>Select Model Number</p>	<p>Select Grommet Option</p> <p>G Round Grommet (\$15 upcharge) N No Grommet</p> <p>Upcharge doubles for HCTRECT models</p>	<p>Select Laminate</p> <p>See page 27</p>	<p>Select Edge Color</p> <p>See page 27</p>
<div style="border: 1px solid black; padding: 2px; display: inline-block;">H C T R N D 2 4 .</div>	<div style="border: 1px solid black; padding: 2px; display: inline-block;">G .</div>	<div style="border: 1px solid black; padding: 2px; display: inline-block;">C .</div>	<div style="border: 1px solid black; padding: 2px; display: inline-block;">C</div>



Icon Legend on page 17

ARRANGE® Café Table Bases

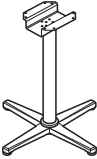
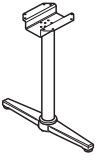
	DESCRIPTION	MODEL	SHIP WEIGHT	CUBE	LIST PRICE	P2 UPCHARGE
	Café Table Bases — X-Base					
	Seated-Height X-base for 24"-30"D Surfaces	HCT29SX	22	3.3	\$509	\$20
	Seated-Height X-base for 36"D Surfaces	HCT29MX	23	3.3	\$566	\$20
	Seated-Height X-base for 42"D Surfaces	HCT29LX	25	3.3	\$621	\$20
	Counter-Height X-base for 24"-30"D Surfaces	HCT36SX	24	4.6	\$566	\$20
	Counter-Height X-base for 36"D Surfaces	HCT36MX	25	4.6	\$621	\$20
	Counter-Height X-base for 42"D Surfaces	HCT36LX	27	4.6	\$678	\$20
	Bar-Height X-base for 24"-30"D Surfaces	HCT42SX	25	4.6	\$621	\$20
	Bar-Height X-base for 36"D Surfaces	HCT42MX	26	4.6	\$678	\$20
Bar-Height X-base for 42"D Surfaces	HCT42LX	27	4.6	\$734	\$20	
	Café Table Bases — T-Leg Base					
	Seated-Height T-legs for 24"D Surfaces (2 bases incl.)	HCT29ST	33	3.3	\$689	\$20
	Seated-Height T-legs for 30"D Surfaces (2 bases incl.)	HCT29MT	34	3.3	\$767	\$20
	Counter-Height T-legs for 24"D Surfaces (2 bases incl.)	HCT36ST	36	4.6	\$741	\$20
	Counter-Height T-legs for 30"D Surfaces (2 bases incl.)	HCT36MT	37	4.6	\$799	\$20
	Bar-Height T-legs for 24"D Surfaces (2 bases incl.)	HCT42ST	37	4.6	\$794	\$20
Bar-Height T-legs for 30"D Surfaces (2 bases incl.)	HCT42MT	38	4.6	\$852	\$20	

NOTES:

- Wire management is standard through table column.
- Adjustable glides available on all feet.

HOW TO SPECIFY

Select Model Number	Select Paint Color
	See page 27
HCT29SX	BLCK

ARRANGE® Café Accessories

GSA SIN 3372IT EXCEPT AS NOTED



Icon Legend on page 17



SIN 33721



DESCRIPTION

Café Table Bases — Disc Shroud

Small Disc Shroud for bases that support 24"-30" Surfaces
 Medium Disc Shroud for bases that support 36" Surfaces
 Large Disc Shroud for bases that support 42" Surfaces

MODEL

SHIP WEIGHT

CUBE

LIST PRICE

HCTS DS	9.0	2.0	\$102
HCTM DS	12.0	2.4	\$118
HCTL DS	17.0	3.4	\$136

NOTES: Shroud is used as an optional accessory to provide the aesthetic of a disc base. Shroud can be added to existing X-base configurations to provide a new and updated aesthetic. Shroud is made of 18 gauge steel.

- ! Shroud to be used in conjunction with X-bases only and cannot be used with a T-leg configuration.
- ! Shroud cannot be used as a support piece by itself.

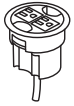

Power Hub, 3" Grommet Mount, 6' Cord

HGRMTAC

1.3

0.2

\$126

- Fits in 3" round grommet cutouts.
- Two grounded AC power outlets.
- Includes 6' cord with three-prong plug.
- Field installed with Plug-and-play ease.

NOTES: For additional information see page 204.

- ! Available in black only (no color designation so use .X - Specify: HGRMTAC.X).

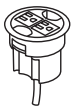

Power Hub, 3" Grommet Mount, 10' Cord

HGRMTAC2

1.5

0.2

\$159

- Includes 10' cord with three-prong plug.
- Fits in 3" round grommet holes.
- Two grounded AC power outlets.
- Field installed with Plug-and-play ease.

- ! Available in black finish only, no specification needed.

NOTES:

- ! HGRMTUSB2 is not compatible with Arrange® bases.

HOW TO SPECIFY

<p>Select Model Number</p> <p>H C T S D S .</p>	<p>Select Paint Color</p> <p><i>For HCTS DS, HCTM DS and HCTL DS models only</i></p> <p>See page 27</p> <p>B L C K</p>
--	---

BETWEEN™ TABLES

Want to see more? Scan here
to check out hon.com.



Between™ Tables shown with
Motivate® and Ignition® Seating.

BETWEEN™ TABLES

That moment when everything you want meets everything you need. Choose Between table options that offer up a variety of sizes and top shapes, seated or café heights, training tables with fixed or nesting bases, and a wide range of laminates to fit in with any environment. With so many different uses, it will be easy to pick Between. Whether you're working here, there, or anywhere Between, this table collection's got you covered.



FEATURES

- Allows you to get the most out of every inch of space by creating hubs for people to engage, socialize, and be productive.
- This versatile, lightweight table line is simple to specify and easy to reconfigure, all at a competitive price point.
- Round, square, soft square, or rectangle tops and fixed, nesting, disc, or X-bases, allow versatility in design and function.
- With both standing- and seated-height options, Between tables can be used in multiple areas throughout your office, such as breakrooms, cafés, or breakaway spaces that support today's agile workforce.
- Choose from multiple, durable, high-quality laminate, edge, and finish options.

BETWEEN™ ORDERING INFORMATION

LAMINATE

TOPS/L1 LAMINATES CODES

Woodgrain

- ◆ Bourbon Cherry H
- ◆ Cognac COGN
- ◆ Florence Walnut LFW1
- ◆ Harvest C
- ◆ Kingswood Walnut LK11
- ◆ Mahogany N
- ◆ Mocha MOCH
- ◆ Natural Maple D
- ◆ Pinnacle PINC
- ◆ Shaker Cherry F
- ◆ Sterling Ash LSA1

Solid

- ◆ Black P
- ◆ Charcoal S
- ◆ Designer White LDW1
- ◆ Loft LOFT

Patterned

- ◆ Handspun Chestnut LAHC
- ◆ Handspun Dove LAHD
- ◆ Handspun Pearl LAHP
- ◆ Handspun Slate LAHS
- ◆ Sheer Mesh * A5
- ◆ Silver Mesh B9
- ◆ Steel Mesh * A9
- ◆ Canyon Zephyr * K9
- ◆ Desert Zephyr * K8
- ◆ Shadow Zephyr * K1
- ◆ Whitestone * K4

TOPS/L2 LAMINATES CODES

Woodgrain

- ◆ Lowell Ash LLA1
- ◆ Natural Recon LNR1
- ◆ Phantom Ecru LPE1
- ◆ Portico Teak LPT1
- ◆ Skyline Walnut LSW1

SEATED-, STANDING-, AND X-BASES

PAINT CODES

- P1**
- ◆ Black Mica Texture P6P
 - ◆ Textured Brownstone P7J
 - ◆ Textured Charcoal P7A
 - ◆ Textured Designer White ... PK7
 - ◆ Textured Loft P7L
 - ◆ Textured Muslin P7M
 - ◆ Textured Titanium P8V
- P2**
- ◆ Textured Silver PR8

FIXED AND NESTING BASES

PAINT CODES

- P1**
- ◆ Black P71
 - ◆ Brownstone P7D
 - ◆ Charcoal P02
 - ◆ Designer White PJW
 - ◆ Fossil P28
 - ◆ Greige T5
 - ◆ Loft LOFT
 - ◆ Muslin T3
 - ◆ Titanium P8T
- P2**
- ◆ Silver PR6

EDGE BAND

EDGE BAND CODES

- ◆ Black P
- ◆ Bourbon Cherry H
- ◆ Brownstone EY
- ◆ Charcoal S
- ◆ Cognac COGN
- ◆ Designer White DW
- ◆ Florence Walnut FW
- ◆ Fossil EH
- ◆ Greige R
- ◆ Harvest C
- ◆ Kingswood Walnut KI
- ◆ Loft LOFT
- ◆ Lowell Ash DL
- ◆ Mahogany N
- ◆ Mocha MOCH
- ◆ Muslin T
- ◆ Natural Maple D
- ◆ Natural Recon NR
- ◆ Phantom Ecru PE
- ◆ Pinnacle PINC
- ◆ Platinum K
- ◆ Portico Teak DP
- ◆ Shadow * SHDW
- ◆ Shaker Cherry F
- ◆ Skyline Walnut SW
- ◆ Sterling Ash SA

Recommended Edgeband Color Selection:

Laminate		Edgeband	
Bourbon Cherry	H	Bourbon Cherry	H
Cognac	COGN	Cognac	COGN
Florence Walnut	LFW1	Florence Walnut	FW
Harvest	C	Harvest	C
Kingswood Walnut	LK11	Kingswood Walnut	KI
Mahogany	N	Mahogany	N
Mocha	MOCH	Mocha	MOCH
Natural Maple	D	Natural Maple	D
Pinnacle	PINC	Pinnacle	PINC
Shaker Cherry	F	Shaker Cherry	F
Sterling Ash	LSA1	Sterling Ash	SA
Black	P	Black	P
Charcoal	S	Charcoal	S
Designer White	LDW1	Designer White	DW
Whitestone	K4	Muslin	T
Sheer Mesh	A5	Muslin	T
Silver Mesh	B9	Loft	LOFT
Steel Mesh	A9	Charcoal	S
Canyon Zephyr	K9	Greige	R
Desert Zephyr	K8	Greige	R
Shadow Zephyr	K1	Loft	LOFT
Lowell Ash	LLA1	Lowell Ash	DL
Natural Recon	LNR1	Natural Recon	NR
Phantom Ecru	LPE1	Phantom Ecru	PE
Portico Teak	LPT1	Portico Teak	DP
Skyline Walnut	LSW1	Skyline Walnut	SW
Loft	LOFT	Loft	LOFT



◆◆◆ For lead time information see page 17.

* De-emphasized

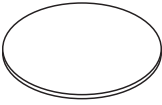

Icon Legend on page 17

BETWEEN™ Table Tops

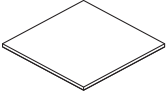
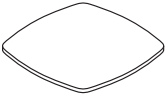
	DESCRIPTION	MODEL	SHIP WEIGHT	CUBE	LIST PRICE BY LAMINATE GRADE	
					L1	L2
	Round Table Tops					
	30"W Round Top	HBTRND30	31	2.9	\$338	\$353
	36"W Round Top	HBTRND36 	44	4.0	\$370	\$386
	42"W Round Top	HBTRND42	57	5.4	\$437	\$457
	Square Table Tops					
	30"W Square Top	HBTSQR30	31	2.9	\$322	\$336
	36"W Square Top	HBTSQR36	44	4.1	\$352	\$368
	42"W Square Top	HBTSQR42	57	5.6	\$418	\$437
	Soft Square Table Tops					
	30"W Soft Square Top	HBTSFT30	31	2.9	\$338	\$353
	36"W Soft Square Top	HBTSFT36	44	4.0	\$370	\$386
	42"W Soft Square Top	HBTSFT42	57	5.4	\$437	\$457

HOW TO SPECIFY

<p>Select Model Number</p> <p>H B T T R N D 3 0</p>	<p>Select Grommet Option</p> <p>N No Grommet</p> <p>N</p>	<p>Select Laminate</p> <p>See page 32</p> <p>C</p>	<p>Select Edge Color</p> <p>See page 32</p> <p>C</p>
--	--	---	---

BETWEEN™ Table Bases

OPEN MARKET EXCEPT AS NOTED



Icon Legend on page 17

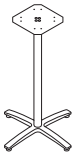

SIN 33721

DESCRIPTION	MODEL	SHIP WEIGHT	CUBE	LIST PRICE
X-Base				
Seated-Height X-base for Support of 30", 36" Tops	HBTTX30S	27	5.2	\$325
Seated-Height X-base for Support of 42" Tops	HBTTX30L	29	5.2	\$476
Bar-Height X-base for Support of 30", 36" Tops	HBTTX42S ⓘ	30	5.2	\$391
Bar-Height X-base for 42" Tops	HBTTX42L ⓘ	34	5.2	\$546

NOTES:

- Seated-Height (30¾" to top of surface).
- Bar-Height (42¼" to top of surface).
- Adjustable glides with ¾" adjustment available on all feet.



Seated-Height Disc Base	HBTTD30	24	3.3	\$392
ⓘ Disc Base not for use with 42" square top.				

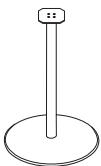

Standing-Height Disc Base	HBTTD42	27	3.3	\$463
ⓘ Disc Base not for use with 42" square top.				



Counterweight Kit for Disc Base	HBTTCW	16	0.2	\$156
ⓘ Required when using disc base with 42" round and soft square tops. Optional for smaller top sizes.				

NOTES:

- Seated-Height (29" to top of surface).
- Bar-Height (42" to top of surface).
- Counterweight Kit required when using disc base with 42" round or soft square tops. Kit can be used for added stability on 30" or 36" round, square, and soft square tops if desired.

HOW TO SPECIFY

<p>Select Model Number</p> <p>HBTTX30S .</p>	<p>Select Paint Color</p> <p>See page 32</p> <p>PR8</p>
---	--

OPEN MARKET



Icon Legend on page 17

BETWEEN™ Rectangular Table Tops

TABLES

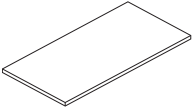
	DESCRIPTION	MODEL	SHIP WEIGHT	CUBE	LIST PRICE BY LAMINATE GRADE	
					L1	L2
	Rectangular Table Tops					
	48"W x 24"D	HMPTT2448	45	3.7	\$378	\$395
	60"W x 24"D	HMPTT2460	57	4.5	\$418	\$437
	72"W x 24"D	HMPTT2472	68	5.0	\$463	\$484
	48"W x 30"D	HMPTT3048	57	4.4	\$394	\$412
	60"W x 30"D	HMPTT3060	71	5.4	\$431	\$451
	72"W x 30"D	HMPTT3072	85	6.0	\$492	\$514

NOTES:

- HON 5-Year Limited Warranty.

HOW TO SPECIFY

<p>Select Model Number</p> <p>HMPTT2448</p>	<p>Select Grommet Option</p> <p>N No Grommet</p> <p>N</p>	<p>Select Laminate</p> <p>See page 32</p> <p>C</p>	<p>Select Edge Color</p> <p>See page 32</p> <p>C</p>
--	--	---	---

OPEN MARKET



Icon Legend on page 17

BETWEEN™ Table Bases for Rectangular Tops

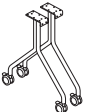
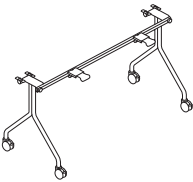
	DESCRIPTION	MODEL	SHIP WEIGHT	CUBE	LIST PRICE
	Fixed Leg	HMPTBFX	27	6.3	\$287
	Nesting Base				
	For use with 48"W Rectangular Tops	HMPTBNSS	18	6.3	\$331
	For use with 60"W and 72"W Rectangular Tops	HMPTBNSL	19	6.3	\$353

NOTES:

- Tops and bases ship in separate cartons.
- Recommend ordering HMAGANG when intending to gang multiple tables together. See page 61.
- HON 5-Year Limited Warranty.

HOW TO SPECIFY

<p>Select Model Number</p> <p>HMPTBFX</p>	<p>Select Paint Color</p> <p>See page 32</p> <p>P71</p>
--	--

BETWEEN™ Nesting Tables

OPEN MARKET



Icon Legend on page 17

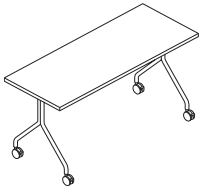

DESCRIPTION

Nesting Table
 48"W x 24"D
 60"W x 24"D
 72"W x 24"D

 48"W x 30"D
 60"W x 30"D
 72"W x 30"D

MODEL

SHIP WEIGHT

CUBE

LIST PRICE

HMPT2448NS	69	8.9	\$638
HMPT2460NS Ⓢ	81	10.7	\$693
HMPT2472NS Ⓢ	92	12.4	\$733
HMPT3048NS	81	10.9	\$651
HMPT3060NS	95	13.1	\$705
HMPT3072NS	109	15.0	\$759

NOTES:

- Top and base ship in one carton.
- Limited finishes available on single-carton tables.
- Recommend ordering HMAGANG when intending to gang multiple tables together. See page 61.
- **HON 5-Year Limited Warranty.**

HOW TO SPECIFY

<p>Select Model Number</p> <p>HMPT2448NS</p>	<p>Select Grommet Option</p> <p>N No Grommet</p> <p>N</p>	<p>Select Laminate/Edge</p> <p>B9LOFT Silver Mesh/Loft Edge FF Shaker Cherry/Shaker Cherry Edge PINCPINC Pinnacle/Pinnacle Edge</p> <p>B9LOFT</p>	<p>Select Base Paint</p> <p>P71 Black</p> <p>P71</p>
---	--	---	--

BETWEEN™ Shared Components

GSA SIN 33721



Icon Legend on page 17

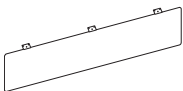

DESCRIPTION

Universal Modesty Panel
 For 48"W Between™ Tables
 For 60"/72"W Between™ Tables

MODEL

SHIP WEIGHT

CUBE

LIST PRICE BY PAINT GRADE

P1

P2

HMTUMOD38	11	2.2	\$241	\$261
HMTUMOD50	14	3.1	\$263	\$283

NOTES:

- Table Modesty Panels are hinged for use with Nesting Table models.

HOW TO SPECIFY

<p>Select Model Number</p> <p>HMTUMOD38</p>	<p>Select Paint Color</p> <p>See page 32</p> <p>T1</p>
--	---



Icon Legend on page 17

BETWEEN™ Accessories

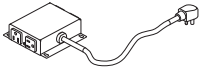

DESCRIPTION

Under Worksurface Power Module

NOTES: For additional information see page 205.

MODEL

HPWRMOD2

SHIP WEIGHT

1.5

CUBE

0.2

LIST PRICE

\$441

HOW TO SPECIFY

Select
Model Number

H P W R M O D 2

BIRK™ TABLES

Want to see more? Scan here
to check out [hon.com](https://www.hon.com).



Birk™ Tables

BIRK™ TABLES

Why complicate matters when you can keep it simple? Offering a modern, minimalist design, Birk tables have a look that's as streamlined as its specification process. Whether you're looking for something well-rounded or think it's hip to be square, Birk is there for you with a variety of top shapes, sizes, and table heights. It's the support system you need to help people come together, collaborate, and socialize — anywhere.



FEATURES

- Ideal for informal meeting spaces and hospitality areas.
- Modern, minimalist design makes it easy to match a variety of styles.
- Designed for use with HON chairs, stools, and soft seating.
- Five different base heights outfit a variety of spaces.
- Five unique top shapes and sizes coordinate seamlessly with any surrounding aesthetic.
- The personal table is light in scale and gives people the ability to take notes and work in a lounge setting.

BIRK™ ORDERING INFORMATION

LAMINATE

L1 LAMINATES CODES

Woodgrain

- ◆ Bourbon Cherry **H**
- ◆ Cognac **COGN**
- ◆ Florence Walnut **LFW1**
- ◆ Harvest **C**
- ◆ Kingswood Walnut **LK11**
- ◆ Mahogany **N**
- ◆ Mocha **MOCH**
- ◆ Natural Maple **D**
- ◆ Pinnacle **PINC**
- ◆ Shaker Cherry **F**
- ◆ Sterling Ash **LSA1**

Solid

- ◆ Black **P**
- ◆ Charcoal **S**
- ◆ Designer White **LDW1**
- ◆ Loft **LOFT**

Patterned

- ◆ Handspun Chestnut **LAHC**
- ◆ Handspun Dove **LAHD**
- ◆ Handspun Pearl **LAHP**
- ◆ Handspun Slate **LAHS**
- ◆ Sheer Mesh * **A5**
- ◆ Silver Mesh **B9**
- ◆ Steel Mesh * **A9**

L2 LAMINATES CODES

Woodgrain

- ◆ Lowell Ash **LLA1**
- ◆ Natural Recon **LNRI**
- ◆ Phantom Ecu **LPE1**
- ◆ Portico Teak **LPT1**
- ◆ Skyline Walnut **LSW1**

EDGE BAND

EDGE BAND CODES

- ◆ Black **P**
- ◆ Bourbon Cherry **H**
- ◆ Brownstone **EY**
- ◆ Charcoal **S**
- ◆ Cognac **COGN**
- ◆ Designer White **DW**
- ◆ Florence Walnut **FW**
- ◆ Fossil **EH**
- ◆ Greige **R**
- ◆ Harvest **C**
- ◆ Kingswood Walnut **KI**
- ◆ Loft **LOFT**
- ◆ Lowell Ash **DL**
- ◆ Mahogany **N**
- ◆ Mocha **MOCH**
- ◆ Muslin **T**
- ◆ Natural Maple **D**
- ◆ Natural Recon **NR**
- ◆ Phantom Ecu **PE**
- ◆ Pinnacle **PINC**
- ◆ Platinum **K**
- ◆ Portico Teak **DP**
- ◆ Shaker Cherry **F**
- ◆ Skyline Walnut **SW**
- ◆ Sterling Ash **SA**

PAINT

PAINT CODES

P1

- ◆ Black Mica Texture **P6P**
- ◆ Textured Brownstone **P7J**
- ◆ Textured Charcoal **P7A**
- ◆ Textured Designer White ... **PK7**
- ◆ Textured Loft **P7L**
- ◆ Textured Muslin **P7M**
- ◆ Textured Titanium **P8V**

P2

- ◆ Solar Black **P8X**
- ◆ Textured Silver **PR8**

Recommended Edgeband Color Selection:

Laminate		Edgeband	
Bourbon Cherry	H	Bourbon Cherry	H
Cognac	COGN	Cognac	COGN
Florence Walnut	LFW1	Florence Walnut	FW
Harvest	C	Harvest	C
Kingswood Walnut	LK11	Kingswood Walnut	KI
Mahogany	N	Mahogany	N
Mocha	MOCH	Mocha	MOCH
Natural Maple	D	Natural Maple	D
Pinnacle	PINC	Pinnacle	PINC
Shaker Cherry	F	Shaker Cherry	F
Sterling Ash	LSA1	Sterling Ash	SA
Black	P	Black	P
Charcoal	S	Charcoal	S
Designer White	LDW1	Designer White	DW
Sheer Mesh	A5	Muslin	T
Silver Mesh	B9	Loft	LOFT
Steel Mesh	A9	Charcoal	S
Lowell Ash	LLA1	Lowell Ash	DL
Natural Recon	LNRI	Natural Recon	NR
Phantom Ecu	LPE1	Phantom Ecu	PE
Portico Teak	LPT1	Portico Teak	DP
Skyline Walnut	LSW1	Skyline Walnut	SW
Loft	LOFT	Loft	LOFT

* De-emphasized

BIRK™ Table Tops

OPEN MARKET



Icon Legend on page 17

	DESCRIPTION	MODEL	SHIP WEIGHT	CUBE	LIST PRICE BY LAMINATE GRADE	
					L1	L2
	Round Tops with Knife Edge					
	30"W Round Top	HCWTRND30J	28	2.8	\$477	\$500
	36"W Round Top	HCWTRND36J	38	3.8	\$520	\$545
	42"W Round Top	HCWTRND42J	50	5.1	\$613	\$642
	Round Tops with Flat Edge					
	30"W Round Top	HCWTRND30G	28	2.8	\$368	\$385
	36"W Round Top	HCWTRND36G	38	3.8	\$400	\$419
	42"W Round Top	HCWTRND42G	50	5.1	\$473	\$495
	Square Tops with Knife Edge					
	30"W Square Top	HCWTSQR30J	34	2.6	\$422	\$442
	36"W Square Top	HCWTSQR36J	47	3.8	\$495	\$518
	42"W Square Top	HCWTSQR42J	62	5.0	\$586	\$614
	Square Tops with Flat Edge					
	30"W Square Top	HCWTSQR30G	34	2.6	\$326	\$342
	36"W Square Top	HCWTSQR36G	47	3.8	\$381	\$399
	42"W Square Top	HCWTSQR42G	62	5.0	\$452	\$473
	Soft Square Tops with Knife Edge					
	30"W Soft Square Top	HCWTSFTS30J	34	2.6	\$477	\$500
	36"W Soft Square Top	HCWTSFTS36J	47	3.8	\$520	\$545
	42"W Soft Square Top	HCWTSFTS42J	62	5.0	\$613	\$642
	Soft Square Tops with Flat Edge					
	30"W Soft Square Top	HCWTSFTS30G	34	2.6	\$368	\$385
	36"W Soft Square Top	HCWTSFTS36G	47	3.8	\$400	\$419
	42"W Soft Square Top	HCWTSFTS42G	62	5.0	\$473	\$495
	Booth Tops with Knife Edge					
	56"W x 36"D Booth Top	HCWTB3656J	90	5.6	\$661	\$692
	84"W x 36"D Booth Top	HCWTB3684J	150	8.2	\$997	\$1044
	Booth Tops with Flat Edge					
	56"W x 36"D Booth Top	HCWTB3656G	90	5.6	\$508	\$532
	84"W x 36"D Booth Top	HCWTB3684G	150	8.2	\$767	\$803
	Soft Rectangle Tops with Knife Edge					
	56"W x 36"D Soft Rectangle Top	HCWTSR3656J	90	5.6	\$688	\$720
	84"W x 36"D Soft Rectangle Top	HCWTSR3684J	150	8.2	\$1025	\$1073
	Soft Rectangle Tops with Flat Edge					
	56"W x 36"D Soft Rectangle Top	HCWTSR3656G	90	5.6	\$529	\$554
	84"W x 36"D Soft Rectangle Top	HCWTSR3684G	150	8.2	\$789	\$826

NOTES:

- Tops configured with pilot holes for easy installation of base.

HOW TO SPECIFY

<p>Select Model Number</p> <p>HCWTSQR36J</p>	<p>Select Grommet Option</p> <p>N No Grommet</p> <p>N</p>	<p>Select Laminate</p> <p>See page 39</p> <p>LSA1</p>	<p>Select Edge Color</p> <p>See page 39</p> <p>SA</p>
--	---	---	---

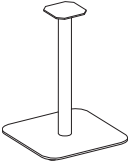
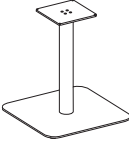
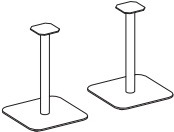

Icon Legend on page 17

	DESCRIPTION	MODEL	SHIP WEIGHT	CUBE	LIST PRICE BY PAINT GRADE	
					P1	P2
	Single Pedestal, Medium					
	Occasional-Height Single Pedestal Base	HCWTSBM18	60	3.3	\$592	\$647
	Working Lounge-Height Single Pedestal Base	HCWTSBM27	60	3.3	\$596	\$652
	Seated-Height Single Pedestal Base	HCWTSBM29	60	3.3	\$601	\$657
	Counter-Height Single Pedestal Base	HCWTSBM36	62	3.3	\$607	\$664
	Bar-Height Single Pedestal Base	HCWTSBM42	66	3.6	\$615	\$673
	Single Pedestal, Large					
	Occasional-Height Single Pedestal Base	HCWTSBL18	95	3.8	\$775	\$847
	Working Lounge-Height Single Pedestal Base	HCWTSBL27	95	3.8	\$802	\$877
	Seated-Height Single Pedestal Base	HCWTSBL29	95	3.8	\$838	\$916
	Counter-Height Single Pedestal Base	HCWTSBL36	98	3.8	\$850	\$929
	Bar-Height Single Pedestal Base	HCWTSBL42	101	4.2	\$867	\$948
	Double Pedestal, Medium					
	Working Lounge-Height Double Pedestal Base	HCWTDSBM27	120	6.5	\$1192	\$1304
	Seated-Height Double Pedestal Base	HCWTDSBM29	120	6.5	\$1202	\$1314
	Counter-Height Double Pedestal Base	HCWTDSBM36	124	6.5	\$1214	\$1328
	Bar-Height Double Pedestal Base	HCWTDSBM42	132	7.2	\$1230	\$1346

NOTES:

- See application matrix for top and base compatibility.
- Bases feature 1/4" H non-leveling slide glides.
- Some assembly required.

Top & Base Compatibility Matrix		Top				
		Round, Square, Soft Square			Booth, Soft Rectangle	
		30"W	36"W	42"W	56"W	84"W
Base	Single Pedestal, Medium	•	•			
	Single Pedestal, Large			•		
	Double Pedestal, Medium				•	•

HOW TO SPECIFY

<p>Select Model Number</p> <p>HCWTSBL36</p>	<p>Select Paint Color</p> <p>See page 39</p> <p>PR8</p>
--	--

BIRK™ Personal Table

OPEN MARKET



Icon Legend on page 17

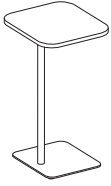

DESCRIPTION

Personal Table
17"W x 15"D x 28"H

MODEL	SHIP WEIGHT	CUBE	LIST PRICE BY LAMINATE GRADE	
			L1	L2
HCWPT	18	2.7	\$341	\$351

NOTES:

- Top features flat edge on all sides.
- Top configured with pilot holes for easy installation of base.
- Some assembly required.

HOW TO SPECIFY

<p>Select Model Number</p> <p>See page 39</p> <p>HCWPT</p>	<p>Select Laminate</p> <p>See page 39</p> <p>LSA1</p>	<p>Select Edge Color</p> <p>See page 39</p> <p>SA</p>	<p>Select Paint Color</p> <p>See page 39</p> <p>P2 upcharge + \$12</p> <p>PR8</p>
---	--	--	--

OPEN MARKET



Icon Legend on page 17

CANTILEVER TABLE

TABLES

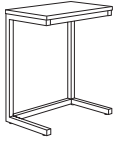

DESCRIPTION

Cantilever Table
17½"W x 9¾"D x 20¾"H

MODEL	SHIP WEIGHT	CUBE	LIST PRICE
HML8858	12.8	1.1	\$203

NOTES:

- HON 5-Year Limited Warranty.

HOW TO SPECIFY

Select Model Number

H M L 8 8 5 8 .

Select Finish

P Black

P

FLOCK®

Want to see more? Scan here
to check out hon.com.



Flock® Tables and Seating.

FLOCK®

Great things happen when people come together, and Flock Collaborative Tables create the places that help make that possible. Quiet corners. Vibrant communal areas. Beautiful, comfortable spaces where clean lines and distinctive geometric design improve productivity and inspire big ideas. Choose from a variety of mix-and-match shapes and sizes to design spaces where your Flock will flourish.



FEATURES

- Flock Tables coordinate seamlessly with Flock Seating to support collaborative areas in any workplace.
- Choose from Square, Round, Rectangle or Racetrack shaped table tops.
- Table bases available in multiple heights and styles.
- Add convenient options like integrated power, cord grommets and tablet pedestals, and Flock is ready to work.
- Configurable and scalable, Flock Tables offer smaller footprints to better fit compact spaces.

COLLABORATIVE TABLES ORDERING INFORMATION

LAMINATE

TOPS/L1 LAMINATES CODES

Woodgrain

- ◆ Bourbon Cherry **H**
- ◆ Cognac **COGN**
- ◆ Florence Walnut **LFW1**
- ◆ Harvest **C**
- ◆ Kingswood Walnut **LK11**
- ◆ Mahogany **N**
- ◆ Mocha **MOCH**
- ◆ Natural Maple **D**
- ◆ Pinnacle **PINC**
- ◆ Shaker Cherry **F**
- ◆ Sterling Ash **LSA1**

Solid

- ◆ Black **P**
- ◆ Charcoal **S**
- ◆ Designer White **LDW1**
- ◆ Loft **LOFT**

Patterned

- ◆ Handspun Chestnut **LAHC**
- ◆ Handspun Dove **LAHD**
- ◆ Handspun Pearl **LAHP**
- ◆ Handspun Slate **LAHS**
- ◆ Sheer Mesh * **A5**
- ◆ Silver Mesh **B9**
- ◆ Steel Mesh * **A9**
- ◆ Canyon Zephyr * **K9**
- ◆ Desert Zephyr * **K8**
- ◆ Shadow Zephyr * **K1**
- ◆ Whitestone * **K4**

TOPS/L2 LAMINATES CODES

Woodgrain

- ◆ Lowell Ash **LLA1**
- ◆ Natural Recon **LNR1**
- ◆ Phantom Ecu **LPE1**
- ◆ Portico Teak **LPT1**
- ◆ Skyline Walnut **LSW1**

PAINT

PAINT CODES

- P1**
- ◆ Textured Charcoal **P7A**
- P2**
- ◆ Textured Silver **PR8**

EDGE BAND

EDGE BAND CODES

- ◆ Black **P**
- ◆ Bourbon Cherry **H**
- ◆ Brownstone **EY**
- ◆ Charcoal **S**
- ◆ Cognac **COGN**
- ◆ Designer White **DW**
- ◆ Florence Walnut **FW**
- ◆ Fossil **EH**
- ◆ Greige **R**
- ◆ Harvest **C**
- ◆ Kingswood Walnut **KI**
- ◆ Loft **LOFT**
- ◆ Lowell Ash **DL**
- ◆ Mahogany **N**
- ◆ Mocha **MOCH**
- ◆ Muslin **T**
- ◆ Natural Maple **D**
- ◆ Natural Recon **NR**
- ◆ Phantom Ecu **PE**
- ◆ Pinnacle **PINC**
- ◆ Platinum **K**
- ◆ Portico Teak **DP**
- ◆ Shadow * **SHDW**
- ◆ Shaker Cherry **F**
- ◆ Skyline Walnut **SW**
- ◆ Sterling Ash **SA**

Recommended Edgeband Color Selection:

Laminate		Edgeband	
Bourbon Cherry	H	Bourbon Cherry	H
Cognac	COGN	Cognac	COGN
Florence Walnut	LFW1	Florence Walnut	FW
Harvest	C	Harvest	C
Kingswood Walnut	LK11	Kingswood Walnut	KI
Mahogany	N	Mahogany	N
Mocha	MOCH	Mocha	MOCH
Natural Maple	D	Natural Maple	D
Pinnacle	PINC	Pinnacle	PINC
Shaker Cherry	F	Shaker Cherry	F
Sterling Ash	LSA1	Sterling Ash	SA
Black	P	Black	P
Charcoal	S	Charcoal	S
Designer White	LDW1	Designer White	DW
Whitestone	K4	Muslin	T
Sheer Mesh	A5	Muslin	T
Silver Mesh	B9	Loft	LOFT
Steel Mesh	A9	Charcoal	S
Canyon Zephyr	K9	Greige	R
Desert Zephyr	K8	Greige	R
Shadow Zephyr	K1	Loft	LOFT
Lowell Ash	LLA1	Lowell Ash	DL
Natural Recon	LNR1	Natural Recon	NR
Phantom Ecu	LPE1	Phantom Ecu	PE
Portico Teak	LPT1	Portico Teak	DP
Skyline Walnut	LSW1	Skyline Walnut	SW
Loft	LOFT	Loft	LOFT

◆◆◆ For lead time information see page 17.

* De-emphasized

FLOCK®

COLLABORATIVE SOLUTIONS TABLE SPECIFYING INFORMATION

TOP SHAPES

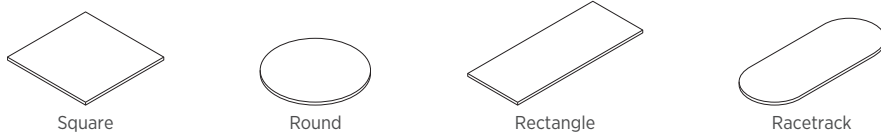
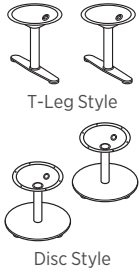
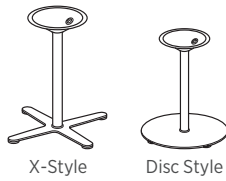

TABLE BASES

For Occasional-Height Tables



For Seated-Height Tables



For 41" H Bar-Height Tables

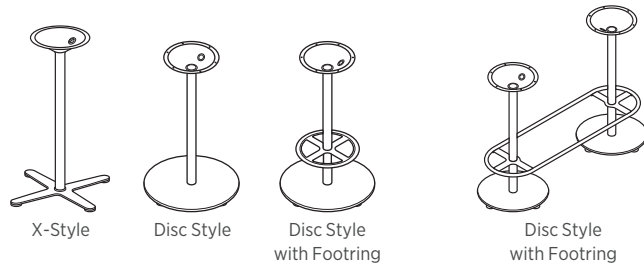

OCCASIONAL TABLES

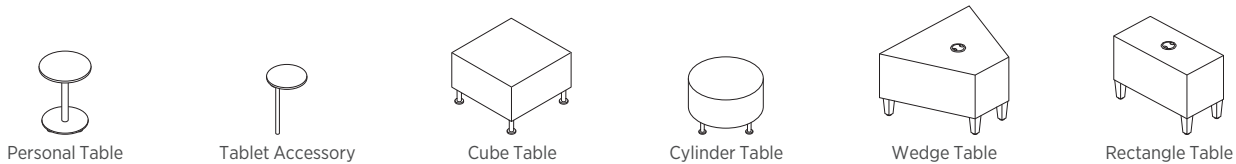

GROMMET MATRIX — ALL TABLES/TOPS

TOP WIDTH	NO GROMMET	1-3" ROUND GROMMET CENTERED	2-3" ROUND GROMMET LEFT & RIGHT
SIF OPTION CODE	N	G	G
24" Cube	YES	YES	N/A
26" Cylinder	YES	YES	N/A
18" Personal	N/A	N/A	N/A
30" Square/Round	YES	YES	N/A
36" Square/Round	YES	YES	N/A
60" Rectangle/Racetrack	YES	N/A	YES
72" Rectangle/Racetrack	YES	N/A	YES
84" Rectangle/Racetrack	YES	N/A	YES
96" Rectangle/Racetrack	YES	N/A	YES

NOTES: 3" round grommet color will need to be specified for tops. Grommet will coordinate with paint color specified for cube/cylinder tables. Charcoal grommets will be used with Textured Charcoal paint and Platinum Metallic grommets will be used with Textured Silver paint.

Grommet options can be used in conjunction with accessory ports on cube/cylinder tables. Grommet models HGRMTAC and HGRMTDATA on page 51 can also be used with Flock® tables.

3" ROUND GROMMET LOCATIONS

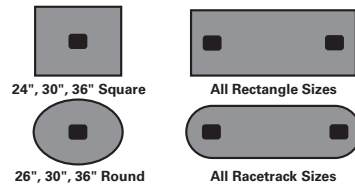

ACCESSORY PORT LOCATIONS

Only applies to models HFTLS24 and HFTLD26.

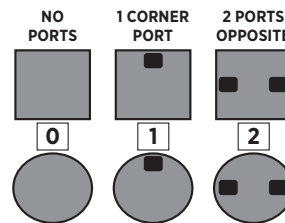

NOTES:

Port location 1 allows for one tablet accessory — see model on pages 49-50.

Port location 2 allows for two tablet accessories — see model on pages 49-50.



FLOCK® Collaborative Laminate Table Tops

	DESCRIPTION	MODEL	SHIP WEIGHT	CUBE	LIST PRICE BY LAMINATE GRADE	
					L1	L2
	Laminate Table Tops					
	36" Square Top	HFTLS36	45	1.2	\$468	\$488
	30" Square Top	HFTLS30	32	1.0	\$415	\$435
	36" Round Top	HFTLD36	35	1.2	\$468	\$488
	30" Round Top	HFTLD30	25	1.0	\$415	\$435
	96"W x 33"D Rectangle Top	HFTLC3396	105	2.9	\$826	\$861
	84"W x 33"D Rectangle Top	HFTLC3384	90	2.5	\$706	\$736
	72"W x 33"D Rectangle Top	HFTLC3372	78	2.2	\$591	\$616
	60"W x 24"D Rectangle Top	HFTLC2460	47	1.3	\$432	\$447
	96"W x 33"D Racetrack Top	HFTLA3396	101	2.9	\$826	\$861
84"W x 33"D Racetrack Top	HFTLA3384	83	2.5	\$706	\$736	
72"W x 33"D Racetrack Top	HFTLA3372	70	2.2	\$591	\$616	
60"W x 24"D Racetrack Top	HFTLA2460	43	1.3	\$432	\$447	

NOTES:

- Grommet models HGRMTAC and HGRMTDATA on page 51 can also be used with Flock® tables.
- Rectangle and Racetrack tops come with 2 grommet cutouts if specified with Round grommet.
- For a complete line of compatible Flock® collaborative seating solutions, please see pages 284-307.

HOW TO SPECIFY





<p>Select Model Number</p> <p>HFTLS36</p>	<p>Select Edge Detail</p> <p>G 2mm Edge</p> <p>Select Edge Color</p> <p>See page 45</p> <p>GK</p>	<p>Select Grommet Option</p> <p>N No Grommet G Round Grommet (\$15 upcharge per grommet cutout)</p> <p>See page 46 for Grommet placement</p> <p>Select Grommet Color</p> <p>S Charcoal T1 Platinum Metallic</p> <p>GT1</p>	<p>Select Laminate Color</p> <p>See page 45</p> <p>K7</p>
--	---	--	--

FLOCK® Collaborative Table Bases

GSA SIN 33721

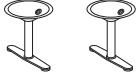
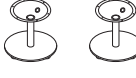

Icon Legend on page 17

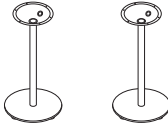
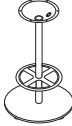
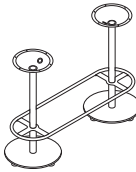
	DESCRIPTION	MODEL	SHIP WEIGHT	CUBE	LIST PRICE BY PAINT GRADE	
					P1	P2
	Base T-Leg Style — For 18”H Tables For 60”W x 24”D Rectangle or Racetrack Table Tops • Two bases shipped in separate cartons.	HFTB17N	40	6.0	\$1042	\$1062
	Base Disc Style — For 18”H Tables • Use with 60”W x 24”D Racetrack or Rectangle table tops only. • Two bases shipped in separate cartons.	HFDB17N	74	6.0	\$1142	\$1162
	Base Disc Style — For 18”H Tables For 30” and 36” Round or Square Table Tops	HFDB17B	37	3.0	\$560	\$580
	Base X-Style — For 29½”H Tables For 30” Round or Square Table Tops For 36” Round or Square Table Tops Use with 33”D x 72”W x 84”W and 96”W Rectangle or Racetrack Table Tops • Two bases shipped in separate cartons	HFXB29A HFXB29B HFXB29AN	40 53 80	16.1 16.1 32.2	\$650 \$687 \$1300	\$670 \$707 \$1340
	Base X-Style — For 18”H Tables For 30” and 36” Round or Square Table Tops	HFXB17B	37	3.0	\$560	\$580
	Base Disc Style — For 29½”H Tables For 30” Round or Square Table Tops For 36” Round or Square Table Tops Use with 33”D x 72”W x 84”W and 96”W Rectangle or Racetrack Table Tops • Two bases shipped in separate cartons	HFDB29A HFDB29B HFDB29AN	40 56 80	16.1 16.1 32.2	\$650 \$687 \$1300	\$660 \$707 \$1320
	Base X-Style — For 41”H Standing-Height Tables • Use with 33”D x 72”W, 84”W and 96”W Rectangle or Racetrack Table Tops • Two bases shipped in separate cartons	HFXB42AN	84	36.4	\$1364	\$1404
	Base X-Style — For 41”H Standing-Height Tables For 30” Round or Square Table Tops For 36” Round or Square Table Tops	HFXB42A HFXB42B	42 55	18.2 16.1	\$682 \$720	\$702 \$740
	Base Disc Style — For 41”H Standing-Height Tables • Use with 33”D x 72”W, 84”W and 96”W Rectangle or Racetrack table tops, when a Footring is not desired • Two bases shipped in separate cartons	HFDB42AN	92	19.0	\$1322	\$1362
	Base Disc Style — For 41”H Standing-Height Tables For 30” Round or Square Table Tops For 36” Round or Square Table Tops	HFDB42A HFDB42B	46 62	9.5 13.5	\$661 \$702	\$681 \$722
	Base Disc Style with Footring — For 41”H Standing-Height Tables For 30” Round or Square Table Tops For 36” Round or Square Table Tops Use with 33”D x 72”W x 84”W and 96”W Rectangle or Racetrack Table Tops • Two bases shipped in separate cartons	HFDB42AF HFDB42BF HFDB42AFN	56 68 112	9.5 13.5 32.2	\$857 \$898 \$1714	\$877 \$918 \$1754
	Base Disc Style with Footring — For 41”H Standing-Height Tables For 33”D x 96”W Rectangle or Racetrack Table Tops For 33”D x 84”W Rectangle or Racetrack Table Tops For 33”D x 72”W Rectangle or Racetrack Table Tops NOTES: Includes two bases and a single oval footring that spans both tables. Two bases and footring shipped in three separate cartons.	HFDB42AF96 HFDB42AF84 HFDB42AF72	121 123 125	19.7 19.8 19.9	\$1980 \$1916 \$1882	\$2020 \$1956 \$1922

NOTES:
 • Each base includes adjustable leveling glides.

HOW TO SPECIFY

Select Model Number HFTB17N	Select Paint Color PR8 Textured Silver P7A Textured Charcoal
---------------------------------------	---



FLOCK® Collaborative Tables

	DESCRIPTION	MODEL	SHIP WEIGHT	CUBE	L1 LIST PRICE	L2 UPCHARGE
	Laminated Personal Table 18" Dia. x 25"H	HFTPTL18	36	4.5	\$675	\$12

HOW TO SPECIFY

Select Model Number HFTPTL18	Select Edge Detail G 2mm Edge Select Edge Color See page 45 GK	Select Laminate Top Color See page 45 H	Select Base Paint Color PR8 Textured Silver P7A Textured Charcoal PR8
--	--	--	---

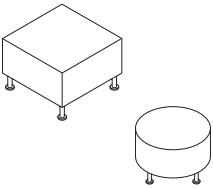
	DESCRIPTION	MODEL	SHIP WEIGHT	CUBE	L1 LIST PRICE	L2 UPCHARGE
	Laminated Collaborative Cube and Cylinder Tables 24" Laminated Cube Table — 24"W x 24"D x 17 1/8"H 26" Laminated Cylinder Table — 26" Dia. x 17 1/8"H	HFTLS24 HFTLD26	44 39	5.0 5.0	\$811 \$744	\$30 \$30
	NOTES: Accessory port quantity and configuration on tables should correspond to the accessories planned for the table. For grommet and port information, see page 46.					

NOTES:

- Accessory port options on the collaborative cube and cylinder tables allow for tablet accessory to be added.
- For grommet and port information, see page 46.
- HGRMTAC and HGRMTDATA on page 51 can also be used with Flock® tables.
- Standard Leg (L) can be adjusted for leveling.
- For a complete line of compatible Flock® collaborative seating solutions, please see pages 284-307.

HOW TO SPECIFY

Select Model Number HFTLS24	Select Grommet Option See page 46 for Grommet placement N No Grommet G Round Grommet — centered (\$15 upcharge)	Select Accessory Port Option See page 46 for Port placement 0 No Port 1 One Corner Port 2 Two Ports — Opposite (\$10 upcharge per port)	Select Laminate See page 45 H	Select Leg Option L Standard Leg Leg Options TR Tapered Round Leg TS Tapered Square Leg	Select Paint Color PR8 Textured Silver P7A Textured Charcoal PR8
---	---	--	--	---	--

FLOCK® Collaborative Tables

GSA SIN AS NOTED



Icon Legend on page 17

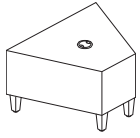

Shown with Round Grommet

OPEN MARKET

DESCRIPTION

Laminate Wedge Table
22.17"W x 29.43"D x 17"H

MODEL

HFTLW45

SHIP WEIGHT

34

CUBE

7.7

L1 LIST PRICE

\$774

L2 UPCHARGE

\$30

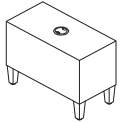

Shown with Round Grommet

OPEN MARKET

Laminate Rectangle Table
24"W x 12"D x 17"H

HFTLR12

29

3.9

\$540

\$20



SIN 33721

Laminate Tablet Accessory
14" Dia. x 10"H from table top

HFTTAL14

6

2.5

\$402

\$15

NOTES: Use with Collaborative Cube and Cylinder tables for additional workspace. Attaches to tables through ports. Multiple port location options are available. Tablet pivots/swivels toward the user.

NOTES:

- Accessory Port options on the Collaborative Cube and Cylinder Tables allow for Tablet Accessory to be added.
- For grommet and port information, see page 46.
- HGRMTAC and HGRMTDATA on page 51 can also be used with Flock® tables.
- Standard Leg (L) can be adjusted for leveling.
- For a complete line of compatible Flock® collaborative seating solutions, please see pages 284-307.

HOW TO SPECIFY



<p>Select Model Number</p> <p>HFTLW45</p>	<p>Select Grommet Option</p> <p>See page 46 for Grommet placement</p> <p>N No Grommet G Round Grommet — centered (\$15 upcharge)</p> <p>N</p>	<p>Select Accessory Port Option</p> <p>See page 46 for Port placement</p> <p>O No Port</p> <p>O</p>	<p>Select Laminate Top Color</p> <p>See page 45</p> <p>N</p>	<p>Select Leg Option</p> <p>L Standard Leg TR Tapered Round Leg TS Tapered Square Leg</p> <p>TS</p>	<p>Select Paint Color</p> <p>PR8 Textured Silver P7A Textured Charcoal</p> <p>P7A</p>
--	--	---	---	---	--

<p>Select Model Number</p> <p>HFTTAL14</p>	<p>Select Edge Detail</p> <p>G 2mm Edge</p> <p>Select Edge Color</p> <p>See page 45</p> <p>GK</p>	<p>Select Laminate Top Color</p> <p>See page 45</p> <p>H</p>	<p>Select Paint Color</p> <p>PR8 Textured Silver P7A Textured Charcoal</p> <p>PR8</p>
---	--	---	--

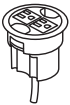
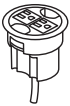

Icon Legend on page 17

Collaborative Accessories

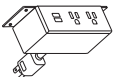
	DESCRIPTION	MODEL	SHIP WEIGHT	CUBE	LIST PRICE
	<p>Power Hub, 3" Grommet Mount, 6' Cord</p> <ul style="list-style-type: none"> Fits in 3" round grommet holes Field installed with Plug-and-play ease Two grounded AC power outlets Includes 6' cord with three-prong plug Available in Black only. <i>Specify X when ordering. Example: HGRMTAC.X.</i> <p>NOTES: For additional information see page 204.</p>	HGRMTAC	1.3	0.2	\$126
	<p>3" Round Power Grommet - 2 Outlets, 10' Cord</p> <ul style="list-style-type: none"> Includes 10' cord with three-prong plug. Fits in 3" round grommet holes. Two grounded AC power outlets. Field installed with Plug-and-play ease. <p>NOTES: For additional information see page 204.</p> <p>⚠ Available in black finish only, no specification needed.</p>	HGRMTAC2	1.5	0.2	\$159
	<p>Power/USB Hub, 3" Grommet Mount</p> <ul style="list-style-type: none"> One grounded AC power outlet with 2 USB ports UL Listed <p>NOTES: For additional information see page 204.</p> <p>⚠ Available in black only (no color designation so use .X - Specify: HGRMTUSB2.X).</p>	HGRMTUSB2	1.3 Ⓢ	0.2	\$250
	<p>Data Grommet</p> <p>Blank grommet kit that includes adapters for a variety of manufacturers jacks and couplers.</p> <ul style="list-style-type: none"> Fits in existing 3" round grommet housing Available in Black only. <i>Specify P when ordering. Example: HGRMTDATA.P.</i> <p>NOTES: For additional information see page 204.</p>	HGRMTDATA	0.2	0.2	\$23
	<p>Power Modules</p> <p>3 Receptacles with Under-Worksurface Mounting Bracket</p> <p>2 Receptacles 2 USB with Under-Worksurface Mounting Bracket</p> <ul style="list-style-type: none"> 6' power cord with standard three-prong plug. Under-worksurface mounting bracket models work with any top that has a 5" x 5" square clearance. Worksurface clamp models work on any top with a 4" overhang. UL Listed. <p>NOTES: For additional information see page 205.</p> <p>⚠ Finish choices coordinate with HON's Charcoal or Designer White. <i>Specify STRM for Storm or SNW for Snow. Example: HPWRMOD3UWM.SNW.</i></p>	<p>HPWRMOD3UWM</p> <p>HPWRMOD2UWM</p>	<p>2.3 Ⓢ</p> <p>2.3 Ⓢ</p>	<p>0.2</p> <p>0.2</p>	<p>\$342</p> <p>\$546</p>

SIN 33721

Model HPWRMOD2UWM shown

SIN 33721

HUDDLE

Want to see more? Scan here
to check out hon.com.



Huddle Tables shown with Motivate® Seating.

HUDDLE

These sturdy, versatile tables link and unlink to quickly transform a space. Temporary workstation? Done. Impromptu conference table? Easy! Training session? No problem. Huddle helps you maximize time and square footage — not costs. And for today's businesses, that's a nice change of pace.



FEATURES

- 1½" thick solid core top is made from durable high-performance particleboard.
- Heavy-grade, warp-resistant particleboard tops and bases withstand heavy activity.
- Mobile nesting base option lets tables fold up and roll away until you need them.
- Choose wiring and power options so Huddle tables are ready to work when you are.
- Modesty panels offer the added level of privacy your employees want.
- Two edge profiles in over 20 colors and patterns to accommodate differing tastes.
- Height adjustable laptop table offers a mobile, personal table for working anywhere.

HUDDLE ORDERING INFORMATION

LAMINATE

TOPS/L1 LAMINATES CODES

- Woodgrain**
- ◆ Bourbon Cherry H
 - ◆ Cognac COGN
 - ◆ Florence Walnut LFW1
 - ◆ Harvest C
 - ◆ Kingswood Walnut LK11
 - ◆ Mahogany N
 - ◆ Mocha MOCH
 - ◆ Natural Maple D
 - ◆ Pinnacle PINC
 - ◆ Shaker Cherry F
 - ◆ Sterling Ash LSA1
- Solid**
- ◆ Black P
 - ◆ Charcoal S
 - ◆ Designer White LDW1
 - ◆ Loft LOFT
- Patterned**
- ◆ Handspun Chestnut LAHC
 - ◆ Handspun Dove LAHD
 - ◆ Handspun Pearl LAHP
 - ◆ Handspun Slate LAHS
 - ◆ Sheer Mesh * A5
 - ◆ Silver Mesh B9
 - ◆ Steel Mesh * A9
 - ◆ Canyon Zephyr * K9
 - ◆ Desert Zephyr * K8
 - ◆ Shadow Zephyr * K1
 - ◆ Battleship LBTT*
 - ◆ Gray G2
 - ◆ Grey Tigris * L6
 - ◆ Moroccan LMN1*
 - ◆ Mushroom LMH1*
 - ◆ Neon Carrot LNC1*
 - ◆ Tennis Ball LTB1*
 - ◆ White G1
 - ◆ Whitestone * K4

TOPS/L2 LAMINATES CODES

- Woodgrain**
- ◆ Lowell Ash LLA1
 - ◆ Natural Recon LNR1
 - ◆ Phantom Ecru LPE1
 - ◆ Portico Teak LPT1
 - ◆ Skyline Walnut LSW1

EDGE BAND

EDGES/ EDGE BAND (2MM) CODES

- ◆ Black P
- ◆ Bourbon Cherry H
- ◆ Brownstone EY
- ◆ Charcoal S
- ◆ Cognac COGN
- ◆ Designer White DW
- ◆ Florence Walnut FW
- ◆ Fossil EH
- ◆ Greige R
- ◆ Harvest C
- ◆ Kingswood Walnut KI
- ◆ Loft LOFT
- ◆ Lowell Ash DL
- ◆ Mahogany N
- ◆ Mocha MOCH
- ◆ Muslin T
- ◆ Natural Maple D
- ◆ Natural Recon NR
- ◆ Phantom Ecru PE
- ◆ Pinnacle PINC
- ◆ Platinum K
- ◆ Portico Teak DP
- ◆ Shadow * SHDW
- ◆ Shaker Cherry F
- ◆ Skyline Walnut SW
- ◆ Sterling Ash SA

T-MOLD

T-MOLD CODES

- ◆ Atom AT*
- ◆ Black P
- ◆ Brownstone EY
- ◆ Bullseye BY*
- ◆ Charcoal S*
- ◆ Designer White DW
- ◆ Ember MR*
- ◆ Fossil EH
- ◆ Greige R
- ◆ Ion IO*
- ◆ Iris IR*
- ◆ Krypton KT*
- ◆ Loft LOFT
- ◆ Lowell Ash DL
- ◆ Muslin T
- ◆ Natural Recon NR
- ◆ Phantom Ecru PE
- ◆ Platinum K
- ◆ Portico Teak DP
- ◆ Regatta RE*
- ◆ Shadow * SHDW
- ◆ Skyline Walnut SW

PAINT

BASE PAINT CODES

- P1**
- ◆ Black P
 - ◆ Brownstone P7D
 - ◆ Charcoal S
 - ◆ Designer White PJW
 - ◆ Fossil P28
 - ◆ Greige T5
 - ◆ Light Gray Q
 - ◆ Loft LOFT
 - ◆ Muslin T3
 - ◆ Putty L
 - ◆ Shadow * SHDW
 - ◆ Titanium P8T
- P2**
- ◆ Champagne Metallic T4
 - ◆ Platinum Metallic T1
 - ◆ Silver PR6
- P3**
- ◆ Atom P8S
 - ◆ Bullseye PJF
 - ◆ Ember P8P
 - ◆ Ion P8N
 - ◆ Iris P8J
 - ◆ Krypton P8F
 - ◆ Regatta P8M

Recommended Edgeband Color Selection:

Laminate		Edge	
Bourbon Cherry	H	Bourbon Cherry	H
Cognac	COGN	Cognac	COGN
Florence Walnut	LFW1	Florence Walnut	FW
Harvest	C	Harvest	C
Kingswood Walnut	LK11	Kingswood Walnut	KI
Mahogany	N	Mahogany	N
Mocha	MOCH	Mocha	MOCH
Natural Maple	D	Natural Maple	D
Pinnacle	PINC	Pinnacle	PINC
Shaker Cherry	F	Shaker Cherry	F
Sterling Ash	LSA1	Sterling Ash	SA
Black	P	Black	P
Charcoal	S	Charcoal	S
Designer White	LDW1	Designer White	DW
Loft	LOFT	Loft	LOFT
Whitestone	K4	Muslin	T
Sheer Mesh	A5	Muslin	T
Silver Mesh	B9	Loft	LOFT
Steel Mesh	A9	Charcoal	S
Canyon Zephyr	K9	Greige	R
Desert Zephyr	K8	Greige	R
Shadow Zephyr	K1	Loft	LOFT
Gray	G2	Charcoal	S
Grey Tigris	L6	Greige	R
White	G1	Charcoal	S
Lowell Ash	LLA1	Lowell Ash	DL
Natural Recon	LNR1	Natural Recon	NR
Phantom Ecru	LPE1	Phantom Ecru	PE
Portico Teak	LPT1	Portico Teak	DP
Skyline Walnut	LSW1	Skyline Walnut	SW

* Available on Laptop Table only.

◆◆◆ For lead time information see page 17.

* De-emphasized

HUDDLE

Multi-Purpose Tables

Huddle Multi-Purpose Tables are ready to jump into action for training, meetings, collaboration and more. Thoughtful design, flexibility and plenty of base, edge and finish options, make Huddle tables capable of meeting the needs of smart, agile businesses.

Tops - Rectangle

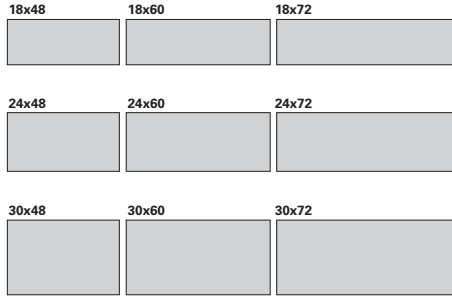

Edge Options

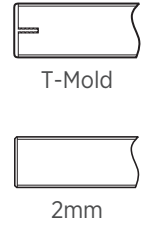

Tops - Half-Round and Extended Half-Round

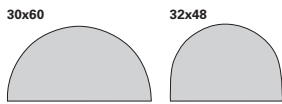

Bases

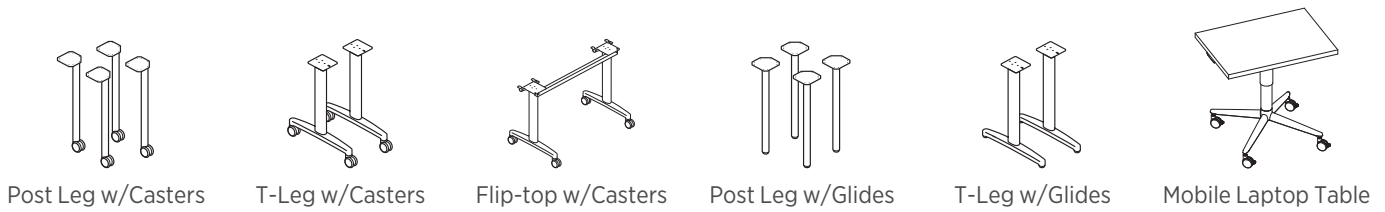

Accessories

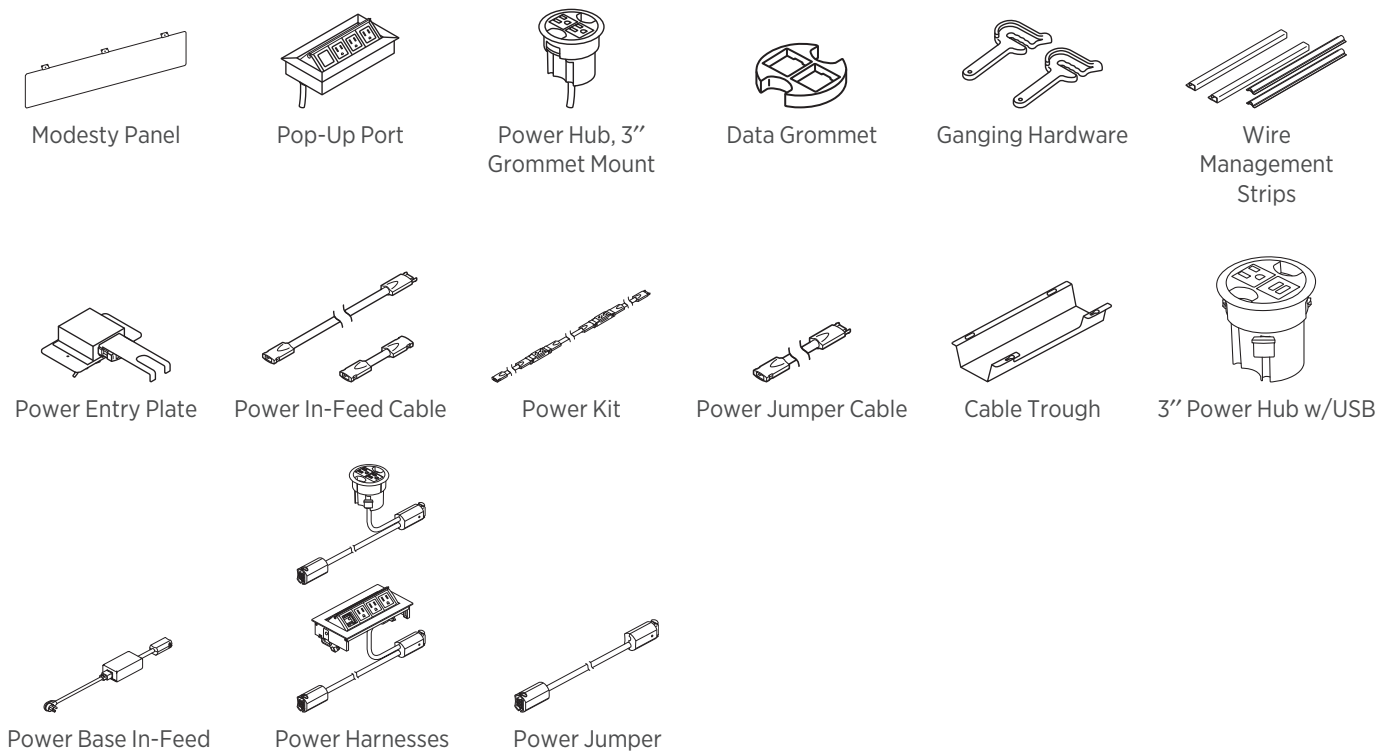



Icon Legend on page 17

HUDDLE Typicals

QTY	DESCRIPTION	MODEL	LIST PRICE	PRICE EXTENSION
12	Rectangular Table Top 60"W x 24"D	HMT2460G	\$419	\$5,028
12	Flip-top Base	HMBFLIP24L.C	\$675	\$8,100
21	Perpetual® Nesting Chair	HPN1	\$774	\$16,254
TOTAL:				\$29,382

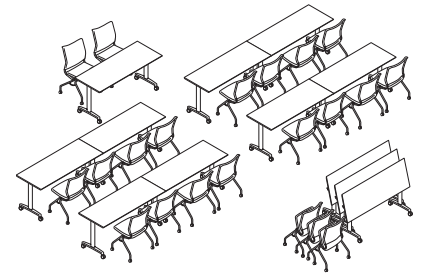

TRAINING

QTY	DESCRIPTION	MODEL	LIST PRICE	PRICE EXTENSION
4	Rectangular Table Top 72"W x 30"D	HMT3072G	\$494	\$1,976
4	Post Leg Base	HMBPOST	\$388	\$1,552
8	Perpetual® Nesting Chair	HPN1	\$774	\$6,192
TOTAL:				\$9,720

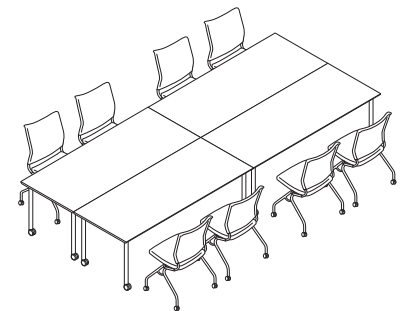

MEETING/CONFERENCE

QTY	DESCRIPTION	MODEL	LIST PRICE	PRICE EXTENSION
2	Rectangular Table Top 72"W x 30"D	HMT3072G	\$494	\$988
2	Half-round Table Top	HMTHR3060G	\$475	\$950
2	Flip-top Base	HMBFLIP30L	\$675	\$1,350
2	Flip-top Base	HMBFLIP24S	\$675	\$1,350
4	Perpetual® Nesting Chair	HPN1	\$774	\$3,096
TOTAL:				\$7,734

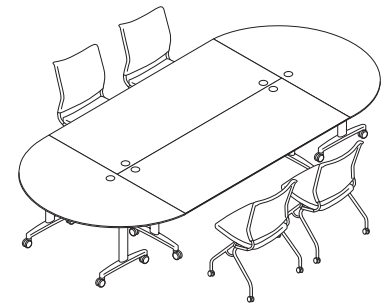

MEETING

HUDDLE Typicals



Icon Legend on page 17

QTY	DESCRIPTION	MODEL	LIST PRICE	PRICE EXTENSION
8	Rectangular Table Top 60"W x 30"D	HMT3060G	\$433	\$3,464
8	Fixed Height T-Leg Base with Casters	HMBTLEG24.C	\$459	\$3,672
8	Perpetual® Nesting Chair	HPN1	\$774	\$6,192
TOTAL:				\$13,328

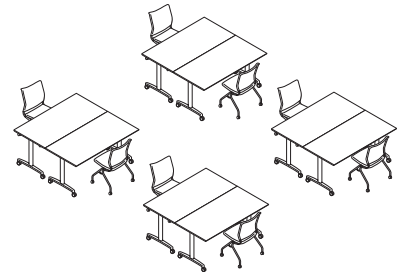

GROUP BREAKOUT

QTY	DESCRIPTION	MODEL	LIST PRICE	PRICE EXTENSION
6	Rectangular Table Top 72"W x 24"D	HMT2472G	\$464	\$2,784
6	Fixed Height T-Leg Base with Casters	HMBTLEG24.C	\$459	\$2,754
12	Perpetual® Nesting Chair	HPN1	\$774	\$9,288
TOTAL:				\$14,826

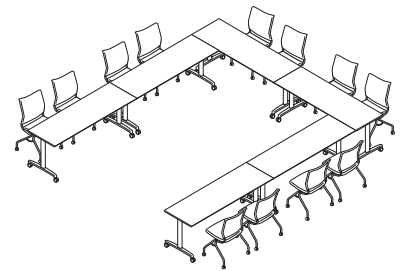

PRESENTATION

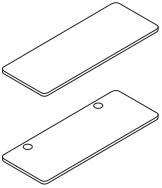
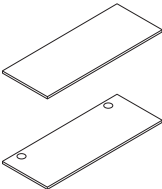

HUDDLE Multi-Purpose Table Tops

	DESCRIPTION	MODEL	SHIP WEIGHT	CUBE	LIST PRICE BY LAMINATE GRADE		
					L1	L2	
 <p>HMT1848E</p>	Rectangular T-Mold Table Tops						
	48"W x 18"D	HMT1848E	34	2.9	\$337	\$347	
	60"W x 18"D	HMT1860E	42	3.5	\$358	\$373	
	72"W x 18"D	HMT1872E	51	3.9	\$440	\$455	
	48"W x 24"D	HMT2448E	45	3.7	\$379	\$394	
	60"W x 24"D	HMT2460E	57	4.5	\$419	\$439	
	72"W x 24"D	HMT2472E	68	5.0	\$464	\$484	
	48"W x 30"D	HMT3048E	57	4.4	\$395	\$410	
	60"W x 30"D	HMT3060E	71	5.4	\$433	\$453	
	72"W x 30"D	HMT3072E	85	6.0	\$494	\$514	
	 <p>HMT1848G</p>	Rectangular Edgeband Table Tops					
		48"W x 18"D	HMT1848G	34	2.9	\$337	\$347
60"W x 18"D		HMT1860G	42	3.5	\$358	\$373	
72"W x 18"D		HMT1872G	51	3.9	\$440	\$455	
48"W x 24"D		HMT2448G	45	3.7	\$379	\$394	
60"W x 24"D		HMT2460G ⓘ	57	4.5	\$419	\$439	
72"W x 24"D		HMT2472G	68	5.0	\$464	\$484	
48"W x 30"D		HMT3048G	57	4.4	\$395	\$410	
60"W x 30"D		HMT3060G	71	5.4	\$433	\$453	
72"W x 30"D		HMT3072G	85	6.0	\$494	\$514	

NOTES:

- Table tops are 1/8" thick.
- When post legs are used with 18"D tops, post leg to be specified with glides only.
- ⓘ Round grommets available in Black only.
- ⓘ Pop-up Port option (G1) is unfinished. Insert accessory must be ordered separately.

HOW TO SPECIFY

<p>Select Model Number</p> <p>HMT1848G</p>	<p>Select Grommet Option</p> <p>N No Grommet G 2 Grommets (Black only) (\$30 upcharge) G1 Cutout for Pop-up Port (\$40 upcharge). Order port separately.</p> <p>N</p>	<p>Select Laminate</p> <p>See page 53</p> <p>D</p>	<p>Select Edge Color</p> <p>See page 53</p> <p>D</p>
---	--	---	---



HUDDLE

Multi-Purpose Table Tops

GSA SIN 33721

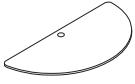

Icon Legend on page 17

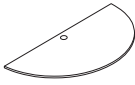
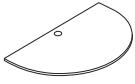
	DESCRIPTION	MODEL	SHIP WEIGHT	CUBE	LIST PRICE BY LAMINATE GRADE	
					L1	L2
 HMTHR3060E	Half-Round and Extended Half-Round T-Mold Table Tops 60"W x 30"D, Half-Round Table Tops (use bases: HMBFLIP24S or HMBTLEG24 or HMBPOST)	HMTHR3060E	69	6.1	\$475	\$495
	48"W x 32"D, Extended Half-Round Table Tops (use bases: HMBFLIP24S or HMBTLEG24)	HMTHR3248E	57	6.1	\$464	\$484
 HMTHR3248E						
 HMTHR3060G	Half-Round and Extended Half-Round Edgeband Table Tops 60"W x 30"D, Half-Round Table Tops (use bases: HMBFLIP24S or HMBTLEG24 or HMBPOST)	HMTHR3060G	69	6.1	\$475	\$495
	48"W x 32"D, Extended Half-Round Table Tops (use bases: HMBFLIP24S or HMBTLEG24)	HMTHR3248G	57	6.1	\$464	\$484
 HMTHR3248G						

NOTES:

- Table tops are 1½" thick.
- ❗ Round grommets available in Black only.
- ❗ Pop-up Port option (G1) is unfinished. Insert accessory must be ordered separately.

HOW TO SPECIFY

<p>Select Model Number</p> <p>H M T H R 3 2 4 8 G .</p>	<p>Select Grommet Option</p> <p>N No Grommet G 1 Grommet (Black only) (\$15 upcharge) G1 Cutout for Pop-up Port (\$40 upcharge). Order port separately.</p> <p>N .</p>	<p>Select Laminate</p> <p>See page 53</p> <p>D .</p>	<p>Select Edge Color</p> <p>See page 53</p> <p>D</p>
--	--	---	---



HUDDLE

Multi-Purpose Table Bases





	DESCRIPTION	MODEL	SHIP WEIGHT	CUBE	LIST PRICE BY PAINT GRADE		
					P1	P2	P3
	Fixed Height T-Leg Base (Includes 2 T-legs)						
	For 18"D Table Tops For 24"D and 30"D Table Tops	HMBTLEG18 HMBTLEG24 	12 14	3.6 3.6	\$459 \$459	\$479 \$479	\$489 \$489
	Flip-top Base (Includes 1 Complete Base)						
	For 18"D x 48"W Rectangular Table Tops	HMBFLIP18S	23	4.1	\$675	\$695	\$705
	For 18"D x 60"W, 72"W Rectangular Table Tops	HMBFLIP18L	26	4.1	\$675	\$695	\$705
	For 24"D x 48"W and 32"D x 48"W Rectangular Table Tops and 30"D x 60"W Half-Round Table Tops	HMBFLIP24S	24	4.1	\$675	\$695	\$705
	For 24"D x 60"W, 72"W Rectangular Table Tops	HMBFLIP24L 	27	4.1	\$675	\$695	\$705
	For 30"D x 48"W Rectangular Table Tops For 30"D x 60"W, 72"W Rectangular Table Tops	HMBFLIP30S HMBFLIP30L	24 27	4.1 4.1	\$675 \$675	\$695 \$695	\$705 \$705
	Post Leg Base (Includes 4 Post Legs)						
For all Tops	HMBPOST	18	2.3	\$388	\$408	\$418	

Table Top to Base Compatibility Chart:

	Flip-Top	T-Leg	Post Leg
18"D x 48"W	HMBFLIP18S	HMBTLEG18	HMBPOST*
18"D x 60"W	HMBFLIP18L	HMBTLEG18	HMBPOST*
18"D x 72"W	HMBFLIP18L	HMBTLEG18	HMBPOST*
24"D x 48"W	HMBFLIP24S	HMBTLEG24	HMBPOST
32"D x 48"W HR	HMBFLIP24S	HMBTLEG24	N/A
30"D x 60"W HR	HMBFLIP24S	HMBTLEG24	HMBPOST
24"D x 60"W	HMBFLIP24L	HMBTLEG24	HMBPOST
24"D x 72"W	HMBFLIP24L	HMBTLEG24	HMBPOST
30"D x 48"W	HMBFLIP30S	HMBTLEG24	HMBPOST
30"D x 60"W	HMBFLIP30L	HMBTLEG24	HMBPOST
30"D x 72"W	HMBFLIP30L	HMBTLEG24	HMBPOST

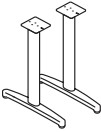
*Post legs should be specified with glides for use on 18"D worksurfaces.

NOTE: Glides/casters are NOT interchangeable on Post Leg and T-base.

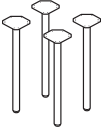
NOTES:

- When glides are specified, adjustable range is 1".
- Flip-top base is standard with casters.
- When post legs are used with 18"D tops, post leg to be specified with glides only.

HOW TO SPECIFY

Select Model Number <div style="border: 1px solid black; padding: 2px; display: flex; gap: 5px;"> HMBTLEG18 </div>	Select Glide/Caster Option G Glide C Caster Flip-top base is available with casters only When post legs are used with 18"D tops, specify with glides only <div style="border: 1px solid black; padding: 2px; display: flex; gap: 5px;"> G </div>	Select Paint Color See page 53 \$20 upcharge per model, for P2 paint \$30 upcharge per model, for P3 paint <div style="border: 1px solid black; padding: 2px; display: flex; gap: 5px;"> T1 </div>
---	---	---

HUDDLE

Mobile Laptop Table

GSA SIN 33721



Icon Legend on page 17



DESCRIPTION	MODEL	SHIP WEIGHT	CUBE	LIST PRICE	UPCHARGE BY LAMINATE/PAINT GRADE			
					L2	L5	P2	P3
T-Mold 28"W x 20"D	HPHAP2028E	59	8.7	\$873	\$20	\$80	\$20	\$30



Edgeband 28"W x 20"D	HPHAP2028G	59	8.7	\$873	\$20	\$80	\$20	\$30
--------------------------------	-------------------	----	-----	--------------	-------------	-------------	-------------	-------------

NOTES:



- Tables adjust from 26"-33"H.
- Pneumatic height adjustment so no electricity is required to adjust height of table.

HOW TO SPECIFY

<p>Select Model Number</p> <p>HPHAP2028E</p>	<p>Select Laminate</p> <p>See page 53</p> <p>LFW1</p>	<p>Select Edge Color</p> <p>See page 53</p> <p>FW</p>	<p>Select Paint Color</p> <p>See page 53</p> <p>P8T</p>
---	--	--	--

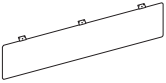

HUDDLE Table Accessories

	DESCRIPTION	MODEL	SHIP WEIGHT	CUBE	LIST PRICE BY PAINT GRADE		
					P1	P2	P3
	Universal Modesty Panel For 48"W Huddle Tables	HMTUMOD32	9	1.9	\$232	\$252	\$262
	For 60"W & 72"W Huddle Tables	HMTUMOD44	12	2.5	\$253	\$273	\$283
NOTES: Universal Modesty Panels nest between the table legs.							
	Ganging Hardware • Includes two ganging links and two screws • No color designator when specifying. <i>Example: HMAGANG.</i>	HMAGANG	1 ☉	0.1	\$102		

NOTES:

- Ganging Hardware must be ordered and installed on tables when using 4-trac electrical systems.
- Ganging hardware attaches to underside of table in pre-drilled pilot holes.
- Vertical Wire Management Strips must be trimmed when applied to legs of T-Leg and Flip-Top Bases with casters.

HOW TO SPECIFY

Select Model Number <input type="text" value="HMTUMOD32"/>	Select Paint Color <input type="text" value="S"/>
--	---

CABLE MANAGEMENT

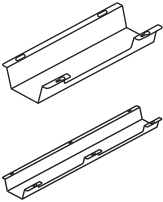
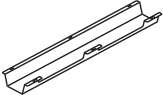
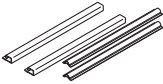
	DESCRIPTION	MODEL	SHIP WEIGHT	CUBE	LIST PRICE
	Cable Management Troughs 17"W — Single	HCTROUGH17	3 ☉	0.5	\$73
	17"W — 10-Pack	HCTROUGH1710	14 ☉	0.5	\$665
	36"W — Single	HCTROUGH36	5 ☉	0.9	\$122
	36"W — 10-Pack	HCTROUGH3610	30 ☉	0.9	\$1121
• Metal Cable Management Troughs ship flat • Troughs attach to underside of worksurface with screws • Cutouts in trough allow access to power without the need to detach from surface. 17"W = 1 cutout; 36"W = 2 cutouts. • Graphite only, no need to specify • Slim profile design NOTES: For additional information see page 208.					
	Wire Management Strips Includes: 2 - 24" vertical strips 2 - 24" horizontal strips • Available in Black only. <i>Specify P when ordering. Example: HBTMS.P.</i> • HON 5-Year Limited Warranty.	HBTMS	3 ☉	0.2	\$126
OPEN MARKET					



HOW TO SPECIFY

Select Model Number <input type="text" value="HCTROUGH17"/>

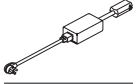

Icon Legend on page 17

INTERLINK IQ ELECTRICAL

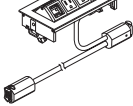
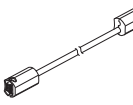
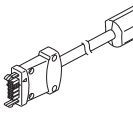
	DESCRIPTION	MODEL	SHIP WEIGHT	CUBE	LIST PRICE
	Power Base In-Feed • 12 amp circuit breaker is built in to the Power Base In-Feed. • Available in Black finish, no specification needed.	HQB	2	0.2	\$566
	Power Harness – 1' Power Hub, 3'' Round Grommet Mount • Available in Black finish, no specification needed.	HQH1-3	2	0.2	\$186
	Power Harness – 5' Power Hub, 3'' Round Grommet Mount • Available in Black finish, no specification needed.	HQH5-3	2	0.2	\$208
	Power Harness – 5' with 4'' x 8'' Pop-Up Port (3 Power, 1 Blank) • For use with tables G1 grommet. Specify paint.	HQH5-P-3P1B	3	0.3	\$408
	Power Jumper – 3' • Available in Black finish, no specification needed.	HQJ3	2	0.2	\$117
	IQ 1.0 Backward Compatible Jumper 36" • Available in Black finish, no specification needed. • Use when connecting Interlink IQ 1.0 power harness (rectangle end) to Interlink IQ 2.0 (oval end) power harness. ! If using Interlink IQ 2.0 in-feed with Interlink IQ 1.0 power harness please contact Customer Support.	HQBCJ36	2	0.2	\$89

Specification guide for IQ Electrical on Huddle tables

Determine table width, the type of power access being used (3" grommet or 4x8 pop-up) and the desired number per table (Columns 1, 2 or 3). The table will then identify the type and quantity of components needed per table along with the maximum table run. Note that this is in addition to the Power base in-feed which is needed for each run. For example, a 48"W table with two 3" power grommets per table will require (1) HQH5-3 harness and (1) HQH1-3 harness per table with a maximum run of four tables.

Top Width	POWER ONE (1) PER TABLE 3" ROUND POWER GROMMET		POWER TWO (2) PER TABLE 3" ROUND POWER GROMMETS		POWER ONE (1) PER TABLE 4x8 POP-UP PORT	
	Quantity	Table Run Maximum	Quantity	Table Run Maximum	Quantity	Table Run Maximum
36"	(1) HQH5-3	8	N/A	N/A	(1) HQH5-P	8
42"	(1) HQH5-3	8	N/A	N/A	(1) HQH5-P	8
48"	(1) HQH5-3	8	(1) HQH5-3 (1) HQH1-3	4 Max Table Run	(1) HQH5-P	8 Max Table Run
54"	(1) HQH5-3	8	(1) HQH5-3 (1) HQH1-3	4 Max Table Run	(1) HQH5-P	8 Max Table Run
60"	(1) HQH5-3	8	(1) HQH5-3 (1) HQH1-3	4 Max Table Run	(1) HQH5-P	8 Max Table Run
66"	(1) HQH5-3 (1) HQJ3	4 Table Run Maximum	(1) HQH5-3 (1) HQH1-3	4 Max Table Run	(1) HQH5-P (1) HQJ3	4 Max Table Run
72"	(1) HQH5-3 (1) HQJ3	4 Table Run Maximum	(1) HQH5-3 (1) HQH1-3	4 Max Table Run	(1) HQH5-P (1) HQJ3	4 Max Table Run
84"	(1) HQH5-3 (1) HQJ3	4 Table Run Maximum	(2) HQH5-3	4 Max Table Run	(1) HQH5-P (1) HQJ3	4 Max Table Run
96"	(1) HQH5-3 (1) HQJ3	4 Table Run Maximum	(2) HQH5-3	4 Max Table Run	(1) HQH5-P (1) HQJ3	4 Max Table Run
Half-Round (all sizes)	(1) HQH1-3	2 Tables Maximum	N/A	N/A	(1) HQH5-P	2 Max Table Run
Trapezoid (all sizes)	(1) HQH5-3	8 Table Run Maximum	N/A	N/A	(1) HQH5-P	8 Max Table Run

NOTES:

- Interlink IQ Electrical is a pluggable, single circuit electrical system.
- All electrical models include wire management clips and hardware.
- Interlink IQ Electrical is non-sequential/non-directional. It can be installed in any direction.
- Interlink IQ Electrical is UL Recognized as a Powered Table System and meets the requirements of UL 962.

! 40' maximum run, or no more than 8 units, whichever comes first. Interlink IQ system will automatically shut off if maximum requirements are exceeded. Maximum run is based upon electrical harness width, not table width.

HOW TO SPECIFY

Select Model Number

H Q H 5 - P - 3 P 1 B .

Select Paint Color

FOG Fog
SVR Silver
BLK Black

S V R

4-TRAC HARDWIRE ELECTRICAL SYSTEM

4-Trac Electrical System

The 4-Trac Electrical System is a UL-recognized Manufactured Wiring System that seamlessly passes power from one worksurface to another. This low-profile non-sequential electrical system allows tables to be “daisy-chained” together in any desired order and allows users to reconfigure quickly due to simple connectable/disconnectable links.

- Meets requirements of UL 183 and National Electric Code Article 604
- 4-Wires, 2-circuits, 20 Amps each (Circuit 1 and Circuit 2 only)
- 13 Duplex Receptacles per circuit, 26, 15 Amp Duplex receptacle per power in-feed
- Electrical system attaches directly to underside of worksurface with included brackets
- Up to twelve tables can be linked together

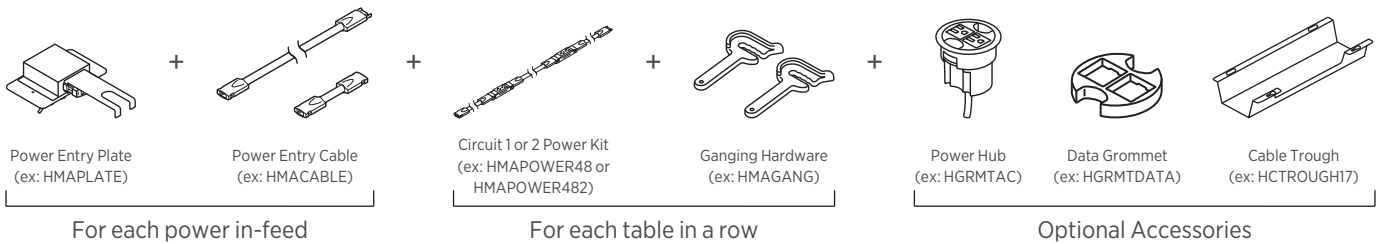

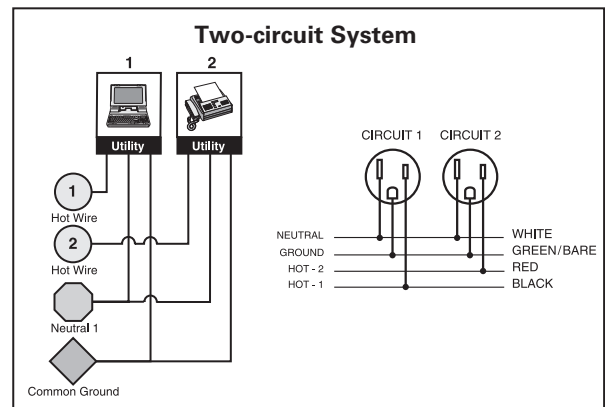
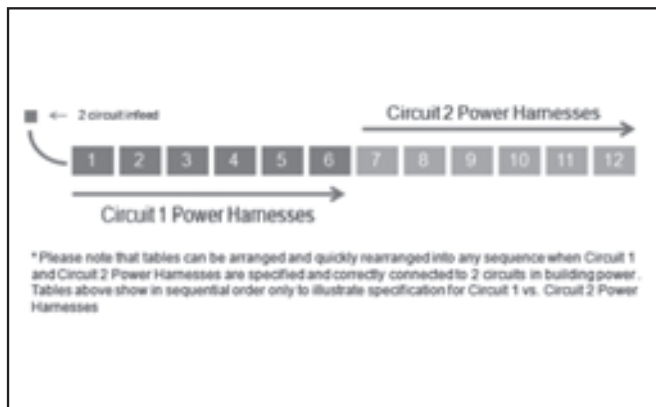

Steps for Electrical Specifications:

- Determine how many rows of tables are needed and order the following:
 - One HMAPLATE per row (or power in-feed)
 - One HMAPOWER48 per row (or power in-feed)
- Order one power harness per table in each row
 - For 1-6 tables in a row (see illustration 1)
 - Order Circuit 1 Power Harnesses (ex. If powering six 24x60 tables order six sets of HMAPOWER60)
 - For 7-12 tables in a row (see illustration 1)
 - Order Circuit 1 Power Harness for first six tables and Circuit 2 Power Harness for remaining tables (ex. If powering eight 24x60 tables, order six sets of HMAPOWER60 and two sets of HMAPOWER602)
- Order one set of ganging hardware per table (ex. HMAGANG)
- Determine which accessories are needed:
 - Power Hub model HGRMTAC — to access power at worksurface.
 - Data Grommet model HGRMTDATA — to access data at worksurface.
 - Wire Management strips model HBTMS — for vertical and horizontal wire management.

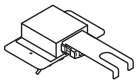
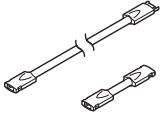
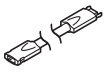
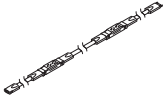

4-TRAC HARDWIRE ELECTRICAL SYSTEM

Icon Legend on page 17

	DESCRIPTION	MODEL	SHIP WEIGHT	CUBE	LIST PRICE
	Power Entry Plate	HMAPLATE	1.0	0.2	\$102
	Power Entry Cable • 6' power entry cable with male/female adapter. • Connects table to power entry plate.	HMACABLE	1.8	0.2	\$159
	Power Jumper Cable To connect tables front to front	HMAJUMP	0.5	0.3	\$54
	Circuit 1 Power Kit for 48" W Table	HMAPOWER48	1.8	0.3	\$294
	Circuit 1 Power Kit for 60" W Table	HMAPOWER60	2.0	0.3	\$302
	Circuit 1 Power Kit for 72" W Table	HMAPOWER72	2.2	0.3	\$309
	Circuit 1 Power Kit for 84" W Table	HMAPOWER84	2.4	0.3	\$320
	Circuit 1 Power Kit for 96" W Table	HMAPOWER96	2.6	0.3	\$331
	Circuit 2 Power Kit for 48" W Table	HMAPOWER482	1.8	0.3	\$294
	Circuit 2 Power Kit for 60" W Table	HMAPOWER602	2.0	0.3	\$302
	Circuit 2 Power Kit for 72" W Table	HMAPOWER722	2.2	0.3	\$309
	Circuit 2 Power Kit for 84" W Table	HMAPOWER842	2.4	0.3	\$320
	Circuit 2 Power Kit for 96" W Table	HMAPOWER962	2.6	0.3	\$331
	Electrical Connectors 4-Way Splitter ! Available in Black (P) only. SPECIFYING EXAMPLE: HMASPLIT.P	HMASPLIT	0.9	0.1	\$55

NOTES:

- Ganging Hardware must be ordered and installed on tables when using 4-trac electrical systems. See page 61 for Ganging Hardware.
- Each power kit includes two duplex receptacles and attaches to the underside of the worksurface with included brackets.

HOW TO SPECIFY



Select
Model Number

H M A P L A T E

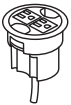
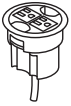

Icon Legend on page 17

HUDDLE Power and Cable Management

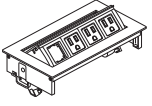
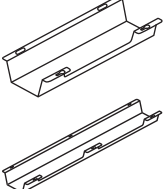
	DESCRIPTION	MODEL	SHIP WEIGHT	CUBE	LIST PRICE
 SIN 33721T	Power Hub, 3" Grommet Mount, 6' Cord <ul style="list-style-type: none"> Fits in 3" round grommet holes. Field installed with Plug-and-play ease. Two grounded AC power outlets. Includes 6' cord with three-prong plug. Available in Black only. <i>Specify X when ordering. Example: HGRMTAC.X.</i> NOTES: For additional information see page 204.	HGRMTAC	1.3	0.2	\$126
 SIN 33721T	3" Round Power Grommet - 2 Outlets, 10' Cord <ul style="list-style-type: none"> Includes 10' cord with three-prong plug. Fits in 3" round grommet holes. Two grounded AC power outlets. Field installed with Plug-and-play ease. NOTES: Power Modules will also work with standing-height applications for 10500 Series™ and Voi® desks. ! Available in black finish only, no specification needed.	HGRMTAC2	1.5	0.2	\$159
 SIN 33721T	Power/USB Hub, 3" Grommet Mount <ul style="list-style-type: none"> One grounded AC power outlet with 2 USB ports. UL Listed. NOTES: For additional information see page 204. ! Available in black only (no color designation so use .X - Specify: HGRMTUSB2.X).	HGRMTUSB2	1.3 [Ⓞ]	0.2	\$250
 SIN 33721	Data Grommet Blank grommet kit that includes adapters for a variety of manufacturers jacks and couplers. <ul style="list-style-type: none"> Fits in existing 3" round grommet housing. Available in Black only. <i>Specify P when ordering. Example: HGRMTDATA.P.</i> NOTES: For additional information see page 204.	HGRMTDATA	0.2	0.2	\$23
 SIN 33721	MhoB 4" x 8" Pop-up Port <ul style="list-style-type: none"> Specify G1 cutout in table top. Pop-up Port provides three power ports and one blank data receptacle. Sits flush with worksurface when closed. Includes 6' cord with three-prong plug. 	HTG1PWR-3P-1B	5.0	0.3	\$424
 SIN 33721	Cable Management Troughs 17"W - Single 17"W - 10-Pack 36"W - Single 36"W - 10-Pack <ul style="list-style-type: none"> Cable management troughs ship flat packed. The troughs attach to underneath the worksurface with screws. Cutouts in trough allow access to power without the need to detach from surface. 17"W = 1 cutout; 36"W = 2 cutouts. Color: Graphite. NOTES: For additional information see page 208.	HCTROUGH17 HCTROUGH1710 HCTROUGH36 HCTROUGH3610	2.7 [Ⓞ] 14.0 [Ⓞ] 4.9 [Ⓞ] 30.0 [Ⓞ]	0.5 0.5 0.9 0.9	\$73 \$665 \$122 \$1121

HOW TO SPECIFY

Select Model Number

H G R M T A C

Select Model Number

H T G 1 P W R - 3 P - 1 B .

Select Paint Color

FOG Fog
SVR Silver
BLK Black

S V R

OCCASIONAL TABLES

Want to see more? Scan here
to check out hon.com.



Occasional Tables shown with Ceres® Seating.

OCCASIONAL TABLES

Durable materials and construction make HON Occasional Tables ideal for high-traffic areas such as lobbies, reception areas and lounges. The versatile design also dresses up any corner of the executive office where casual, but important, conversations are held. Use them to hold lamps, magazines and more. They're available in 14 woodgrain, patterned or solid color laminates to coordinate with any decor.



FEATURES

- A high-quality solution for any organization wanting to make a great impression on clients and visitors.
- Scratch-, spill- and stain-resistant laminate stands up to heavy use.
- Heavy-grade, warp-resistant particleboard features high recycled content.
- Complement many interiors and furniture designs.
- Brings people together comfortably in reception areas, lounges and offices.

LAMINATE OCCASIONAL TABLES OPTIONS

H80191, H80192, H80193

L1 LAMINATES CODES

Woodgrain

- ◆ Bourbon Cherry H
- ◆ Cognac COGN
- ◆ Florence Walnut LFW1
- ◆ Harvest C
- ◆ Kingswood Walnut LK11
- ◆ Mahogany N
- ◆ Mocha MOCH
- ◆ Natural Maple D
- ◆ Pinnacle PINC
- ◆ Shaker Cherry F
- ◆ Sterling Ash LSA1

Solid

- ◆ Black P
- ◆ Charcoal S
- ◆ Designer White LDW1
- ◆ Loft LOFT

Patterned Top*

- ◆ Grey Tigris * L6
- ◆ Handspun Chestnut LAHC
- ◆ Handspun Dove LAHD
- ◆ Handspun Pearl LAHP
- ◆ Handspun Slate LAHS
- ◆ Sheer Mesh * A5
- ◆ Silver Mesh A9
- ◆ Canyon Zephyr * K9
- ◆ Desert Zephyr * K8

H80170, H80180

L1 LAMINATES CODES

Woodgrain

- ◆ Bourbon Cherry H
- ◆ Cognac COGN
- ◆ Florence Walnut LFW1
- ◆ Harvest C
- ◆ Kingswood Walnut LK11
- ◆ Mahogany N
- ◆ Mocha MOCH
- ◆ Natural Maple D
- ◆ Pinnacle PINC
- ◆ Shaker Cherry F
- ◆ Sterling Ash LSA1

Solid

- ◆ Black P
- ◆ Charcoal S
- ◆ Designer White LDW1
- ◆ Loft LOFT

Two-Tone Options for Laminate Occasional Tables (H80191, H80192 and H80193)

Black/Charcoal (PS)	Handspun Pearl/Fossil (LAHP/EH)
Black/Designer White (PLDW1)	Handspun Slate/Charcoal (LAHS/S)
Bourbon Cherry/Black (HP)	Harvest/Black (CP)
Bourbon Cherry/Charcoal (HS)	Harvest/Charcoal (CS)
Bourbon Cherry/Designer White (HLDW1)	Harvest/Designer White (CLDW1)
Charcoal/Black (SP)	Kingswood Walnut/Black (LK11P)
Charcoal/Designer White (SLDW1)	Kingswood Walnut/Charcoal (LK11S)
Cognac/Black (COGNP)	Kingswood Walnut/Designer White (LK11LDW1)
Cognac/Charcoal (COGNS)	Kingswood Walnut/Loft (LK11LOFT)
Cognac/Designer White (COGNLDW1)	Mahogany/Black (NP)
Designer White/Black (LDW1P)	Mahogany/Charcoal (NS)
Designer White/Bourbon Cherry (LDW1H)	Mahogany/Designer White (NLDW1)
Designer White/Charcoal (LDW1S)	Mocha/Black (MOCHP)
Designer White/Cognac (LDW1COGN)	Mocha/Charcoal (MOCHS)
Designer White/Harvest (LDW1C)	Mocha/Designer White (MOCHLDW1)
Designer White/Mahogany (LDW1N)	Natural Maple/Black (DP)
Designer White/Mocha (LDW1MOCH)	Natural Maple/Charcoal (DS)
Designer White/Natural Maple (LDW1D)	Natural Maple/Designer White (DLDW1)
Designer White/Pinnacle (LDW1PINC)	Pinnacle/Black (PINCP)
Designer White/Shaker Cherry (LDW1F)	Pinnacle/Charcoal (PINCS)
Florence Walnut/Black (LFW1P)	Pinnacle/Designer White (PINCLDW1)
Florence Walnut/Charcoal (LFW1S)	Shaker Cherry/Black (FP)
Florence Walnut/Designer White (LFW1LDW1)	Shaker Cherry/Charcoal (FS)
Florence Walnut/Loft (LFW1LOFT)	Shaker Cherry/Designer White (FLDW1)
Handspun Chestnut/Loft (LAHC/LOFT)	Sterling Ash/Black (LSA1P)
Handspun Dove/Fossil (LAHD/EH)	Sterling Ash/Charcoal (LSA1S)
	Sterling Ash/Designer White (LSA1LDW1)

* NOTE: For patterned top laminates, select one of the following for the edgeband around the top, apron, and legs — Black (P), Bourbon Cherry (H), Charcoal (S), Cognac (COGN), Designer White (LDW1), Florence Walnut (LFW1), Harvest (C), Kingswood Walnut (LK11), Mahogany (N), Mocha (MOCH), Natural Maple (D), Pinnacle (PINC), Shaker Cherry (F), Sterling Ash (LSA1).

◆◆◆ For lead time information see page 17.







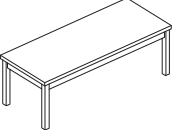

* De-emphasized

LAMINATE Occasional Tables

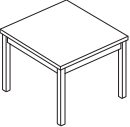
GSA SIN 33721

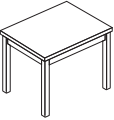

Icon Legend on page 17

	DESCRIPTION	MODEL	SHIP WEIGHT	CUBE	LIST PRICE
	Coffee Table 48"W x 20"D x 16"H	H80191	48 	3.4	\$541
	Corner Table 24"W x 24"D x 20"H	H80192	35 	2.1	\$466
	End Table 24"W x 20"D x 20"H	H80193	29 	1.8	\$445
	Cylinder Table 20" Diameter x 20"H	H80170	40	6.2	\$728
	Cube Table 24"W x 24"D x 20"H	H80180	55	8.6	\$788

NOTES:

- Durable material and construction make laminate occasional tables ideal for high traffic areas such as lobbies, reception rooms and lounges. Versatile design is also well suited to private offices.
- Coffee, Corner and End Tables feature top-over-apron styling with square corner detail, which complements many interiors and furniture designs, including the 10500 Series.
- Tables accommodate lamps, magazines, plants, laptops and more.
- Tops are abrasion- and stain-resistant laminate over 1/8" thick solid core high-performance particleboard.
- Cylinder and cube tables have recessed black plinth base with tack glides. Tops and sides are covered with high-pressure laminate.



H80191, H80192, H80193
Edge Detail

HOW TO SPECIFY

<p>Select Model Number</p> <p>H 8 0 1 9 1 .</p>	<p>Select Laminate</p> <p>See page 67 for Select Laminate noted with each model</p> <p>N N</p>
--	---

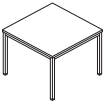

LAMINATE Contemporary Occasional Tables

	DESCRIPTION	MODEL	SHIP WEIGHT	CUBE	LIST PRICE
	Laminated Corner Table 24"W x 24"D x 17½"H	HML8851	24	1.7	\$216

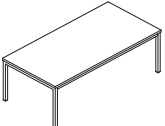
	Laminated Coffee Table 48"W x 24"D x 15½"H	HML8852	38	3.1	\$270
---	--	----------------	----	-----	--------------

NOTES:

- Silver frame.
- **HON 5-Year Limited Warranty.**
- ! Metal leg occasional tables available in Black laminate ONLY.

HOW TO SPECIFY

<p>Select Model Number</p> <p>H M L 8 8 5 1 .</p>	<p>Select Laminate</p> <p>P Black</p> <p>P</p>
--	---

	DESCRIPTION	MODEL	SHIP WEIGHT	CUBE	LIST PRICE
	Coffee Table 42"W x 20"D x 16"H	HBLH3160	24	3.0	\$321

	Corner Table 24"W x 24"D x 20"H	HBLH3170	9	1.7	\$250
---	---	-----------------	---	-----	--------------

NOTES:

Square Edge Detail (Laminate)



- **HON 5-Year Limited Warranty.**
- Ideal for reception areas, lounges and offices.
- Laminate tops have a hollow core honeycomb substructure, making them extremely lightweight.
- 2" thick top.
- Sleek contemporary design.
- Models HBLH3160 and HBLH3170 available in Black finish only.

HOW TO SPECIFY

<p>Select Model Number</p> <p>H B L H 3 1 6 0 .</p>	<p>Select Laminate</p> <p>P Black</p> <p>P</p>
--	---

MOTIVATE®

Want to see more? Scan here
to check out hon.com.



Motivate® Tables, Chairs, and Presentation Tools.

MOTIVATE®

Motivate tables were designed with flexible spaces in mind. Work patterns can change throughout the day. Task areas become collaborative areas. Learning areas become conference areas. Created for HON by designer Wolfgang Deisig, Motivate tables are mobile, lightweight and ready to support the many ways you work — adapting and reacting to your needs with ease. Because flexible spaces make for dynamic workplaces.



FEATURES

- 1½" thick solid core top is made from durable high-performance particleboard.
- Motivate Tables are available in three base options — fixed, nesting and height adjustable.
- Optional modular power can be ganged together without any tools.
- Motivate Tables coordinate perfectly with Motivate chairs — an ideal fit for flexible spaces.
- Add a mobile presentation cart or markerboard for increased function and productivity in your workspace.
- Available in multiple top shapes, edge types, and bases with a variety of laminate and paint finish options.

MOTIVATE® TABLES SPECIFYING INFORMATION

LAMINATE

L1 LAMINATES CODES

- Woodgrain**
- ◆ Bourbon Cherry H
 - ◆ Cognac COGN
 - ◆ Florence Walnut LFW1
 - ◆ Harvest C
 - ◆ Kingswood Walnut LK11
 - ◆ Mahogany N
 - ◆ Mocha MOCH
 - ◆ Natural Maple D
 - ◆ Pinnacle PINC
 - ◆ Shaker Cherry F
 - ◆ Sterling Ash LSA1
- Solid**
- ◆ Black P
 - ◆ Charcoal S
 - ◆ Designer White LDW1
 - ◆ Loft LOFT
- Patterned**
- ◆ Handspun Chestnut LAHC
 - ◆ Handspun Dove LAHD
 - ◆ Handspun Pearl LAHP
 - ◆ Handspun Slate LAHS
 - ◆ Sheer Mesh * A5
 - ◆ Silver Mesh B9
 - ◆ Steel Mesh * A9
 - ◆ Canyon Zephyr * K9
 - ◆ Desert Zephyr * K8
 - ◆ Shadow Zephyr * K1
 - ◆ Gray G2
 - ◆ White G1
 - ◆ Whitestone * K4

L2 LAMINATES CODES

- Woodgrain**
- ◆ Lowell Ash LLA1
 - ◆ Natural Recon LNR1
 - ◆ Phantom Ecu LPE1
 - ◆ Portico Teak LPT1
 - ◆ Skyline Walnut LSW1

EDGE BAND

EDGE BAND 2mm CODES

- ◆ Black P
- ◆ Bourbon Cherry H
- ◆ Brownstone EY
- ◆ Charcoal S
- ◆ Cognac COGN
- ◆ Designer White DW
- ◆ Florence Walnut FW
- ◆ Fossil EH
- ◆ Greige R
- ◆ Harvest C
- ◆ Kingswood Walnut KI
- ◆ Loft LOFT
- ◆ Lowell Ash DL
- ◆ Mahogany N
- ◆ Mocha MOCH
- ◆ Muslin T
- ◆ Natural Maple D
- ◆ Natural Recon NR
- ◆ Phantom Ecu PE
- ◆ Pinnacle PINC
- ◆ Platinum K
- ◆ Portico Teak DP
- ◆ Shadow * SHDW
- ◆ Shaker Cherry F
- ◆ Skyline Walnut SW
- ◆ Sterling Ash SA

ERGO

ERGO-EDGE CODES

- ◆ Black P
- ◆ Platinum K

PAINT

PAINT CODES

- P1**
- ◆ Black P
 - ◆ Brownstone P7D
 - ◆ Charcoal S
 - ◆ Designer White PJW
 - ◆ Fossil P28
 - ◆ Greige T5
 - ◆ Loft LOFT
 - ◆ Muslin T3
 - ◆ Putty L
 - ◆ Textured Black BLCK
 - ◆ Textured Platinum Metallic PLAT
 - ◆ Titanium P8T
- P2**
- ◆ Champagne Metallic T4
 - ◆ Platinum Metallic T1
 - ◆ Silver PR6
 - ◆ Solar Black P8X
 - ◆ Textured Silver P8B
- P3**
- ◆ Atom P8S
 - ◆ Bullseye PJF
 - ◆ Ember P8P
 - ◆ Ion P8N
 - ◆ Iris P8J
 - ◆ Krypton P8F
 - ◆ Regatta P8M

Recommended Edgeband Color Selection:

Laminate		Edgeband	
Bourbon Cherry	H	Bourbon Cherry	H
Cognac	COGN	Cognac	COGN
Florence Walnut	LFW1	Florence Walnut	FW
Harvest	C	Harvest	C
Kingswood Walnut	LK11	Kingswood Walnut	KI
Mahogany	N	Mahogany	N
Mocha	MOCH	Mocha	MOCH
Natural Maple	D	Natural Maple	D
Pinnacle	PINC	Pinnacle	PINC
Shaker Cherry	F	Shaker Cherry	F
Sterling Ash	LSA1	Sterling Ash	SA
Black	P	Black	P
Charcoal	S	Charcoal	S
Designer White	LDW1	Designer White	DW
Whitestone	K4	Muslin	T
Sheer Mesh	A5	Muslin	T
Silver Mesh	B9	Loft	LOFT
Steel Mesh	A9	Charcoal	S
Canyon Zephyr	K9	Greige	R
Desert Zephyr	K8	Greige	R
Shadow Zephyr	K1	Loft	LOFT
Gray	G2	Charcoal	S
White	G1	Charcoal	S
Lowell Ash	LLA1	Lowell Ash	DL
Natural Recon	LNR1	Natural Recon	NR
Phantom Ecu	LPE1	Phantom Ecu	PE
Portico Teak	LPT1	Portico Teak	DP
Skyline Walnut	LSW1	Skyline Walnut	SW
Loft	LOFT	Loft	LOFT

◆◆◆ For lead time information see page 17.

* De-emphasized

MOTIVATE® Fixed Height Tables

GSA SIN 33721



Icon Legend on page 17



DESCRIPTION	MODEL	SHIP WEIGHT	CUBE	LIST PRICE BY LAMINATE GRADE			
				"G" 2MM EDGE		"R" ERGO EDGE	
				L1	L2	L1	L2
Rectangular Tables, Fixed Base							
72"W x 18"D	HMVR-1872(?) -FX	80	6.6	\$1031	\$1046	\$1365	\$1380
60"W x 18"D	HMVR-1860(?) -FX	70	6.0	\$949	\$964	\$1238	\$1253
48"W x 18"D	HMVR-1848(?) -FX	54	5.3	\$940	\$950	\$1200	\$1210
96"W x 24"D	HMVR-2496(?) -FX	118	8.8	\$1320	\$1345	N/A	N/A
84"W x 24"D	HMVR-2484(?) -FX	109	8.1	\$1266	\$1291	N/A	N/A
72"W x 24"D	HMVR-2472(?) -FX	96	7.3	\$1053	\$1073	\$1403	\$1423
66"W x 24"D	HMVR-2466(?) -FX	90	7.3	\$1032	\$1052	N/A	N/A
60"W x 24"D	HMVR-2460(?) -FX	83	6.6	\$1009	\$1029	\$1326	\$1346
54"W x 24"D	HMVR-2454(?) -FX	71	6.6	\$990	\$1010	N/A	N/A
48"W x 24"D	HMVR-2448(?) -FX	65	5.8	\$968	\$983	\$1253	\$1268
42"W x 24"D	HMVR-2442(?) -FX	60	5.4	\$947	\$962	N/A	N/A
36"W x 24"D	HMVR-2436(?) -FX	54	5.1	\$931	\$946	N/A	N/A
96"W x 30"D	HMVR-3096(?) -FX	145	10.7	\$1428	\$1453	N/A	N/A
84"W x 30"D	HMVR-3084(?) -FX	131	10.7	\$1415	\$1440	N/A	N/A
72"W x 30"D	HMVR-3072(?) -FX	115	9.8	\$1146	\$1166	\$1519	\$1539
66"W x 30"D	HMVR-3066(?) -FX	108	9.8	\$1115	\$1135	N/A	N/A
60"W x 30"D	HMVR-3060(?) -FX	100	8.9	\$1087	\$1107	\$1429	\$1449
54"W x 30"D	HMVR-3054(?) -FX	87	8.9	\$1066	\$1086	N/A	N/A
48"W x 30"D	HMVR-3048(?) -FX	80	7.9	\$1052	\$1067	\$1351	\$1366
42"W x 30"D	HMVR-3042(?) -FX	73	7.4	\$1026	\$1041	N/A	N/A
36"W x 30"D	HMVR-3036(?) -FX	65	6.9	\$1005	\$1020	N/A	N/A
72"W x 36"D	HMVR-3672(?) -FX	131	10.8	\$1312	\$1337	N/A	N/A
60"W x 36"D	HMVR-3660(?) -FX	114	9.7	\$1217	\$1242	N/A	N/A
48"W x 36"D	HMVR-3648(?) -FX	91	9.7	\$1137	\$1157	N/A	N/A
Half-Round Tables, Fixed Base							
72"W x 36"D	HMVH-3672(?) -FX	103	10.8	\$1367	\$1392	N/A	N/A
60"W x 30"D	HMVH-3060(?) -FX	75	7.6	\$1066	\$1091	\$1430	\$1455
48"W x 24"D	HMVH-2448(?) -FX	56	5.8	\$996	\$1016	\$1303	\$1323
Trapezoid Tables, Fixed Base							
72"W x 36"D	HMVT-3672(?) -FX	91	10.8	\$1389	\$1414	N/A	N/A
60"W x 30"D	HMVT-3060(?) -FX	66	7.6	\$1075	\$1100	\$1446	\$1471
48"W x 24"D	HMVT-2448(?) -FX	56	5.8	\$1015	\$1035	\$1325	\$1345

NOTES:

- Specification includes top and base, however, top and base are boxed separately.
- Ergo edge is a bullnose on user side and 3mm on all other sides.
- Tops are 1 1/8" thick.
- Fixed Height base is standard 29 1/2" seated-height.
- See grommet matrix on page 77 for grommet location/placement.
- 36"-42" tops and all half-round and trapezoid tops standard with one 3" round grommet, 48"-96" tops standard with two 3" round grommets. When G1 grommet is selected, all tops standard with one cutout.

Edge Treatments

- HOW TO ORDER
 - 1) Select desired model numbers.
 - 2) Select desired top edge treatment.
 - 3) Replace the (?) after each model number with the suffix representing the chosen top edge treatment.



"G" 2mm Edge







"R" Ergo Edge

HOW TO SPECIFY

Select Model Number	Select Grommet Option	Select Laminate	Select Edge Color	Select Caster/Glide Option	Select Base Paint Color
N	N No Grommet G Grommet (\$15 upcharge PER grommet) G1 Electrical Port (\$40 upcharge)	See page 71	See page 71	C Multi-Surface Caster G Glide	See page 71 \$20 upcharge per model, for P2 paint
HMVR-1872G-FX	N	C	C	T	C



MOTIVATE® Nesting Tables

DESCRIPTION	MODEL	SHIP WEIGHT	CUBE	LIST PRICE BY LAMINATE GRADE			
				"G" 2MM EDGE		"R" ERGO EDGE	
				L1	L2	L1	L2
Rectangular Nesting Tables							
 72"W x 18"D	HMVR-1872(?) -NS	90	8.5	\$1356	\$1371	\$1690	\$1705
60"W x 18"D	HMVR-1860(?) -NS	79	7.6	\$1269	\$1284	\$1542	\$1557
48"W x 18"D	HMVR-1848(?) -NS	60	6.5	\$1264	\$1274	\$1518	\$1528
 96"W x 24"D	HMVR-2496(?) -NS	134	11.4	\$1623	\$1648	N/A	N/A
84"W x 24"D	HMVR-2484(?) -NS	122	10.4	\$1591	\$1616	N/A	N/A
72"W x 24"D	HMVR-2472(?) -NS	106	9.2	\$1378	\$1398	\$1728	\$1748
66"W x 24"D	HMVR-2466(?) -NS	100	9.1	\$1352	\$1372	N/A	N/A
60"W x 24"D	HMVR-2460(?) -NS	92	8.2	\$1329	\$1349	\$1646	\$1666
54"W x 24"D	HMVR-2454(?) -NS	80	8.2	\$1315	\$1335	N/A	N/A
48"W x 24"D	HMVR-2448(?) -NS	73	7.2	\$1286	\$1301	\$1571	\$1586
42"W x 24"D	HMVR-2442(?) -NS	67	6.6	\$1267	\$1282	N/A	N/A
36"W x 24"D	HMVR-2436(?) -NS	60	6.3	\$1249	\$1264	N/A	N/A
96"W x 30"D	HMVR-3096(?) -NS	161	13.3	\$1776	\$1801	N/A	N/A
84"W x 30"D	HMVR-3084(?) -NS	144	13.0	\$1763	\$1788	N/A	N/A
72"W x 30"D	HMVR-3072(?) -NS	125	11.7	\$1494	\$1514	\$1867	\$1887
66"W x 30"D	HMVR-3066(?) -NS	118	11.6	\$1458	\$1478	N/A	N/A
60"W x 30"D	HMVR-3060(?) -NS	109	10.5	\$1430	\$1450	\$1757	\$1777
54"W x 30"D	HMVR-3054(?) -NS	96	10.5	\$1414	\$1434	N/A	N/A
48"W x 30"D	HMVR-3048(?) -NS	88	9.3	\$1393	\$1408	\$1692	\$1707
42"W x 30"D	HMVR-3042(?) -NS	80	8.1	\$1369	\$1384	N/A	N/A
36"W x 30"D	HMVR-3036(?) -NS	71	8.1	\$1346	\$1361	N/A	N/A
72"W x 36"D	HMVR-3672(?) -NS	141	12.7	\$1660	\$1685	N/A	N/A
60"W x 36"D	HMVR-3660(?) -NS	123	11.3	\$1560	\$1585	N/A	N/A
48"W x 36"D	HMVR-3648(?) -NS	99	11.1	\$1478	\$1498	N/A	N/A
Half-Round Nesting Tables							
 72"W x 36"D	HMVH-3672(?) -NS	111	12.2	\$1708	\$1733	N/A	N/A
60"W x 30"D	HMVH-3060(?) -NS	82	8.8	\$1473	\$1498	\$1837	\$1862
48"W x 24"D	HMVH-2448(?) -NS	62	7.0	\$1314	\$1334	\$1621	\$1641
Trapezoid Nesting Tables							
 72"W x 36"D	HMVT-3672(?) -NS	98	12.0	\$1732	\$1757	N/A	N/A
60"W x 30"D	HMVT-3060(?) -NS	72	8.8	\$1393	\$1418	\$1749	\$1774
48"W x 24"D	HMVT-2448(?) -NS	57	7.0	\$1342	\$1362	\$1643	\$1663

NOTES:

- Ergo edge is a bullnose on user side and 3mm on all other sides.
- Tops are 1 1/8" thick.
- Specification includes top and base, however, top and base are boxed separately.
- See grommet matrix on page 77 for grommet location/placement.
- 36"-42" tops and all half-round and trapezoid tops standard with one 3" round grommet, 48"-96" tops standard with two 3" round grommets. When G1 grommet is selected, all tops standard with one cutout.

Edge Treatments

HOW TO ORDER

- Select desired model numbers.
- Select desired top edge treatment.
- Replace the (?) after each model number with the suffix representing the chosen top edge treatment.



"G" 2mm Edge



"R" Ergo Edge

HOW TO SPECIFY

<p>Select Model Number</p> <p>HMVR-1872G-NS</p>	<p>Select Grommet Option</p> <p>N No Grommet G Grommet (\$15 upcharge PER grommet) G1 Electrical Port (\$40 upcharge)</p> <p>N</p>	<p>Select Laminate</p> <p>See page 71</p> <p>C</p>	<p>Select Edge Color</p> <p>See page 71</p> <p>C</p>	<p>Select Caster/Glide Option</p> <p>C Multi-Surface Caster G Glide</p> <p>C</p>	<p>Select Base Paint Color</p> <p>See page 71 \$20 upcharge per model, for P2 paint</p> <p>T1</p>
--	---	---	---	---	--

MOTIVATE® Adjustable Height Tables

GSA SIN 33721



Icon Legend on page 17

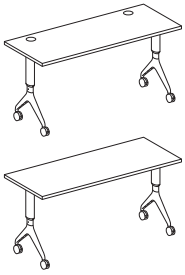

DESCRIPTION	MODEL	SHIP WEIGHT	CUBE	LIST PRICE BY LAMINATE GRADE			
				"G" 2MM EDGE		"R" ERGO EDGE	
				L1	L2	L1	L2
Rectangular Tables, Adjustable Height Base							
72"W x 18"D	HMVR-1872(?) -AH	83	6.6	\$1341	\$1356	\$1675	\$1690
60"W x 18"D	HMVR-1860(?) -AH	73	6.0	\$1259	\$1274	\$1548	\$1563
48"W x 18"D	HMVR-1848(?) -AH	57	5.3	\$1250	\$1260	\$1510	\$1520
72"W x 24"D	HMVR-2472(?) -AH	99	7.3	\$1363	\$1383	\$1713	\$1733
66"W x 24"D	HMVR-2466(?) -AH	93	7.3	\$1342	\$1362	N/A	N/A
60"W x 24"D	HMVR-2460(?) -AH	86	6.6	\$1319	\$1339	\$1636	\$1656
54"W x 24"D	HMVR-2454(?) -AH	74	6.6	\$1300	\$1320	N/A	N/A
48"W x 24"D	HMVR-2448(?) -AH	68	5.8	\$1278	\$1293	\$1563	\$1578
42"W x 24"D	HMVR-2442(?) -AH	63	5.4	\$1257	\$1272	N/A	N/A
36"W x 24"D	HMVR-2436(?) -AH	57	5.1	\$1241	\$1256	N/A	N/A
72"W x 30"D	HMVR-3072(?) -AH	118	9.8	\$1479	\$1499	\$1852	\$1872
66"W x 30"D	HMVR-3066(?) -AH	111	9.8	\$1448	\$1468	N/A	N/A
60"W x 30"D	HMVR-3060(?) -AH	103	8.9	\$1420	\$1440	\$1762	\$1782
54"W x 30"D	HMVR-3054(?) -AH	90	8.9	\$1399	\$1419	N/A	N/A
48"W x 30"D	HMVR-3048(?) -AH	83	7.9	\$1385	\$1400	\$1684	\$1699
42"W x 30"D	HMVR-3042(?) -AH	76	7.4	\$1359	\$1374	N/A	N/A
36"W x 30"D	HMVR-3036(?) -AH	68	6.9	\$1338	\$1353	N/A	N/A
72"W x 36"D	HMVR-3672(?) -AH	134	10.8	\$1645	\$1670	N/A	N/A
60"W x 36"D	HMVR-3660(?) -AH	117	9.7	\$1550	\$1575	N/A	N/A
48"W x 36"D	HMVR-3648(?) -AH	94	9.7	\$1470	\$1490	N/A	N/A

NOTES:

- Ergo edge is a bullnose on user side and 3mm on all other sides.
 - Tops are 1 1/8" thick.
 - Specification includes top and base, however, top and base are boxed separately.
 - Seated height adjustment from 27 1/2" - 32 1/2" in 1" increments.
 - See grommet matrix on page 77 for grommet location/placement.
 - 36"-42" tops and all half-round and trapezoid tops standard with one 3" round grommet, 48"-96" tops standard with two 3" round grommets. When G1 grommet is selected, all tops standard with one cutout.
- ! No tool required, adjustable bases have ratchet style adjustment mechanism.

Edge Treatments

HOW TO ORDER

- Select desired model numbers.
- Select desired top edge treatment.
- Replace the (?) after each model number with the suffix representing the chosen top edge treatment.



"G" 2mm Edge



"R" Ergo Edge

HOW TO SPECIFY

<p>Select Model Number</p> <p>HMVR-1872G-AH</p>	<p>Select Grommet Option</p> <p>N No Grommet G Grommet (\$15 upcharge PER grommet) G1 Electrical Port (\$40 upcharge)</p> <p>N</p>	<p>Select Laminate</p> <p>See page 71</p> <p>C</p>	<p>Select Edge Color</p> <p>See page 71</p> <p>C</p>	<p>Select Caster/Glide Option</p> <p>C Multi-Surface Caster G Glide</p> <p>C</p>	<p>Select Base Paint Color</p> <p>See page 71 \$20 upcharge per model, for P2 paint</p> <p>P</p>
--	---	---	---	---	---

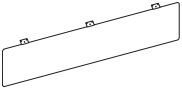

MOTIVATE® Shared Components

DESCRIPTION	MODEL	SHIP WEIGHT	CUBE	LIST PRICE BY PAINT GRADE	
				P1	P2
 <p>Universal Modesty Panel For 96"W Motivate® Tables For 84"W Motivate® Tables For 72"W Motivate® Tables For 66"W Motivate® Tables For 60"W Motivate® Tables For 54"W Motivate® Tables For 48"W Motivate® Tables For 42"W Motivate® Tables For 36"W Motivate® Tables</p>	HMTUMOD86	21	4.8	\$305	\$325
	HMTUMOD74	20	4.4	\$295	\$315
	HMTUMOD62	17	3.6	\$284	\$304
	HMTUMOD56	16	3.4	\$274	\$294
	HMTUMOD50	14	3.1	\$263	\$283
	HMTUMOD44	12	2.5	\$253	\$273
	HMTUMOD38	11	2.2	\$241	\$261
	HMTUMOD32	9	1.9	\$232	\$252
	HMTUMOD26	8	1.7	\$221	\$241

NOTES:

- Modesty Panels are hinged to nest along with Nesting Tables. Modesty Panels can be used with all base types.
- ! Use field installed Table Modesty Panels with all table widths 36"-96". Cannot be used with Half-Round or Trapezoid tables.

HOW TO SPECIFY

<p>Select Model Number</p> <p>HMTUMOD86</p>	<p>Select Paint Color</p> <p>See page 71 \$20 upcharge per model, for P2 paint</p> <p>T1</p>
--	--

MOTIVATE®

Shared Components

GSA SIN 33721 EXCEPT AS NOTED

ABI

Icon Legend on page 17

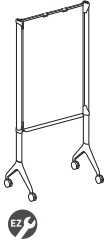
**DESCRIPTION****Mobile Markerboard**

36"W x 72"H
30"W x 72"H

Actual Markerboard size:
HMVMB-3672WW – 36¼"W x 42"H
HMVMB-3072WW – 30¼"W x 42"H

NOTES: 2-Sided Mobile Markerboard is porcelain over steel with four locking casters. Mobile Markerboard includes marker tray and flip-chart paper clips.

Porcelain Markerboard cleaning instructions: For everyday cleaning, use Clorox wipes. Use a citrus cleaner if a permanent marker is used by accident.

! A citrus cleaner is not recommended for everyday use as it leaves residue.

! \$20 list upcharge for P2 paint.

Specify Model.Base.Casters.Paint SPECIFYING EXAMPLE: HMVMB-3072WW.C.P

MODEL**SHIP WEIGHT****CUBE****LIST PRICE**

HMVMB-3672WW
HMVMB-3072WW

59
53

7.9
7.1

\$1599
\$1570

**Presentation Cart, Concave Front, Fixed Leg**

18"D x 30"W x 35"H, 2mm Edge
18"D x 30"W x 35"H, Ergo Edge

NOTES: Presentation Cart tops are 1⅝" thick with a concave user side. Choose from a 2mm or Ergo edge.

! \$10 list upcharge for L2 laminates.

Specify Model.Caster.TopLaminate.EdgeColor.Paint SPECIFYING EXAMPLE: HMVPCF-1830G.C.D.D.TI

HMVPCF-1830G
HMVPCF-1830R

38
38

3.9
3.9

\$981
\$1328

**Presentation Cart, Concave Front, Seated Height Adjustable-Leg**

18"D x 30"W x 27½"-34½"H, 2mm Edge
18"D x 30"W x 27½"-34½"H, Ergo Edge

NOTES: Presentation Cart tops are 1⅝" thick with a concave user side. Choose from a 2mm or Ergo edge.

! \$10 list upcharge for L2 laminates.

Specify Model.Caster.TopLaminate.EdgeColor.Paint SPECIFYING EXAMPLE: HMVPCA1-1830G.C.D.D.TI

HMVPCA1-1830G
HMVPCA1-1830R

40
40

3.9
3.9

\$1294
\$1656

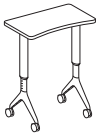
**Presentation Cart, Concave Front, Standing-Height Adjustable-Leg**

18"D x 30"W x 31½"-38½"H, 2mm Edge
18"D x 30"W x 31½"-38½"H, Ergo Edge

NOTES: Presentation Cart tops are 1⅝" thick with a concave user side. Choose from a 2mm or Ergo edge.

! \$10 list upcharge for L2 laminates.

Specify Model.Caster.TopLaminate.EdgeColor.Paint SPECIFYING EXAMPLE: HMVPCA1-1830G.C.D.D.TI

HMVPCA2-1830G
HMVPCA2-1830R

42
42

3.9
3.9

\$1294
\$1656

**Presentation Cart, Modesty Panel**

Specify Model.Paint SPECIFYING EXAMPLE: HMVPC-MP.P

HMVPC-MP

6

1.4

\$200

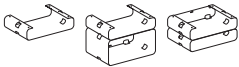
**Presentation Cart, Storage Shelves**

Single, 4" Open Back
Double, 4" Open Back / 4" Closed Back
Double, 4" Open Back / 9" Closed Back
Single, 4" Closed Back
Double, 4" Closed Back / 4" Closed Back
Double, 4" Closed Back / 9" Closed Back

NOTES: Storage Shelves for Presentation Carts are available in three preconfigured sizes and may be used on fixed or adjustable height models.

Specify Model.Paint SPECIFYING EXAMPLE: HMVPCSS-40.TI

HMVPCSS-40
HMVPCSS-404C
HMVPCSS-409C
HMVPCSS-4C
HMVPCSS-4C4C
HMVPCSS-4C9C

8
17
20
9
18
21

1.4
2.6
3.6
1.4
2.6
3.6

\$102
\$208
\$325
\$111
\$218
\$335

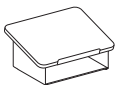
**Presentation Cart Desk Top Lectern, 2mm Edge**

NOTES: Desk Top Lectern may be used on the Presentation Cart or is removable for use on table tops.

! \$15 list upcharge for L2 laminates.

! Desktop Lectern only available with 2mm edge.

Specify Model.LaminateTop.EdgeColor.Paint SPECIFYING EXAMPLE: HMVPC-DTLG.D.D.TI

HMVPC-DTLG

16

2.4

\$374

OPEN MARKET





HOW TO SPECIFY

Select
Model Number

H M V M B - 3 6 7 2 W W

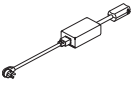

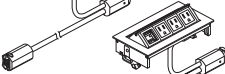
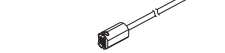
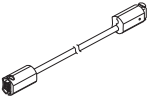
INTERLINK IQ ELECTRICAL

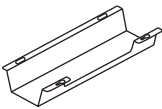
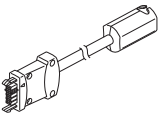
	DESCRIPTION	MODEL	SHIP WEIGHT	CUBE	LIST PRICE
	Power Base In-Feed • 12 amp circuit breaker is built in to the Power Base In-Feed. • Available in Black finish, no specification needed.	HQB	2.0	0.2	\$566
	Power Harness – 1' Power Hub, 3'' Round Grommet Mount • Available in Black finish, no specification needed.	HQH1-3	2.0	0.2	\$186
	Power Harness – 5' Power Hub, 3'' Round Grommet Mount • Available in Black finish, no specification needed.	HQH5-3	2.0	0.2	\$208
	Power Harness – 5' with 4'' x 8'' Pop-Up Port (3 Power, 1 Blank) • For use with tables G1 grommet. Specify paint.	HQH5-P-3P1B	3.0	0.3	\$408
	Power Jumper – 3' • Available in Black finish, no specification needed.	HQJ3	2.0	0.2	\$117
	Ganging Hardware • Includes two ganging links and two screws. • No color designator when specifying. <i>Example: HMAGANG.</i>	HMAGANG	1.0	0.1	\$102
	Cable Management Troughs 17''W – Single 17''W – 10-Pack • Available in Graphite finish, no specification needed. NOTES: For additional information see page 208.	HCTROUGH17 HCTROUGH1710	2.7 14.0	0.5 0.5	\$73 \$665
	IQ 1.0 Backward Compatible Jumper 36'' • Available in Black finish, no specification needed. • Use when connecting Interlink IQ 1.0 power harness (rectangle end) to Interlink IQ 2.0 (oval end) power harness. ! If using Interlink IQ 2.0 in-feed with Interlink IQ 1.0 power harness please contact Customer Support.	HQB CJ36	2.0	0.2	\$89

Specification guide for IQ Electrical on Motivate® tables

Determine table width, the type of power access being used (3'' grommet or 4x8 pop-up) and the desired number per table (Columns 1, 2 or 3). The table will then identify the type and quantity of components needed per table along with the maximum table run. Note that this is in addition to the Power base in-feed which is needed for each run. For example, a 48''W table with two 3'' power grommets per table will require (1) HQH5-3 harness and (1) HQH1-3 harness per table with a maximum run of four tables.

Top Width	POWER ONE (1) PER TABLE 3'' ROUND POWER GROMMET		POWER TWO (2) PER TABLE 3'' ROUND POWER GROMMETS		POWER ONE (1) PER TABLE 4x8 POP-UP PORT	
	Quantity	Table Run Maximum	Quantity	Table Run Maximum	Quantity	Table Run Maximum
36''	(1) HQH5-3	8	N/A	N/A	(1) HQH5-P	8
42''	(1) HQH5-3	8	N/A	N/A	(1) HQH5-P	8
48''	(1) HQH5-3	8	(1) HQH5-3 (1) HQH1-3	4 Max Table Run	(1) HQH5-P	8
54''	(1) HQH5-3	8	(1) HQH5-3 (1) HQH1-3	4 Max Table Run	(1) HQH5-P	8
60''	(1) HQH5-3	8	(1) HQH5-3 (1) HQH1-3	4 Max Table Run	(1) HQH5-P	8
66''	(1) HQH5-3 (1) HQJ3	4	(1) HQH5-3 (1) HQH1-3	4 Max Table Run	(1) HQH5-P (1) HQJ3	4
72''	(1) HQH5-3 (1) HQJ3	4	(1) HQH5-3 (1) HQH1-3	4 Max Table Run	(1) HQH5-P (1) HQJ3	4
84''	(1) HQH5-3 (1) HQJ3	4	(2) HQH5-3	4 Max Table Run	(1) HQH5-P (1) HQJ3	4
96''	(1) HQH5-3 (1) HQJ3	4	(2) HQH5-3	4 Max Table Run	(1) HQH5-P (1) HQJ3	4
Half-Round (all sizes)	(1) HQH1-3	2	N/A	N/A	(1) HQH5-P	2
Trapezoid (all sizes)	(1) HQH5-3	8	N/A	N/A	(1) HQH5-P	8

NOTES:

- Interlink IQ Electrical is a pluggable, single circuit electrical system.
- All electrical models include wire management clips and hardware.
- Interlink IQ Electrical is non-sequential/non-directional.

- Interlink IQ Electrical is UL Recognized as a Powered Table System and meets the requirements of UL 962 when paired with Motivate® or Huddle tables.

! 40' maximum run, or no more than 8 units, whichever comes first. Interlink IQ system will automatically shut off if maximum requirements are exceeded. Maximum run is based upon electrical harness width, not table width.

HOW TO SPECIFY

<p>Select Model Number</p> <p>H Q H 5 - P - 3 P 1 B .</p>	<p>Select Paint Color</p> <p>FOG Fog SVR Silver BLK Black</p> <p>S V R</p>
--	---

4-TRAC HARDWIRE ELECTRICAL SYSTEM

4-Trac Electrical System

The 4-Trac Electrical System is a UL-recognized Manufactured Wiring System that seamlessly passes power from one worksurface to another. This low-profile non-sequential electrical system allows tables to be “daisy-chained” together in any desired order and allows users to reconfigure quickly due to simple connectable/disconnectable links.

- Meets requirements of UL 183 and National Electric Code Article 604
- 4-Wires, 2-circuits, 20 Amps each (Circuit 1 and Circuit 2 only)
- 13 Duplex Receptacles per circuit, 26, 15 Amp Duplex receptacle per power in-feed
- Electrical system attaches directly to underside of worksurface with included brackets
- Up to twelve tables can be linked together

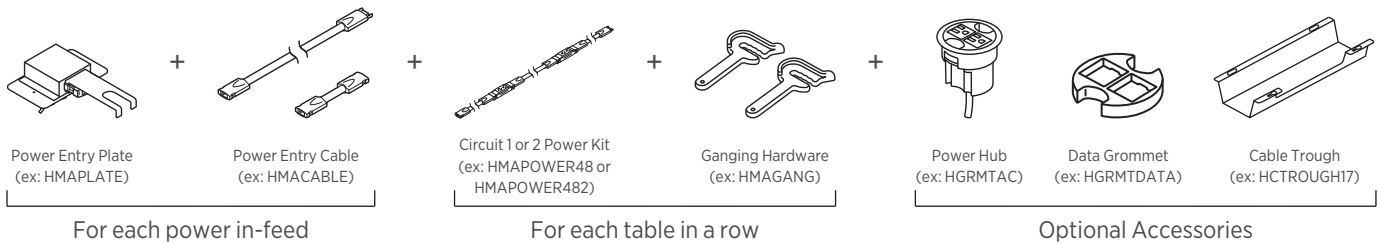



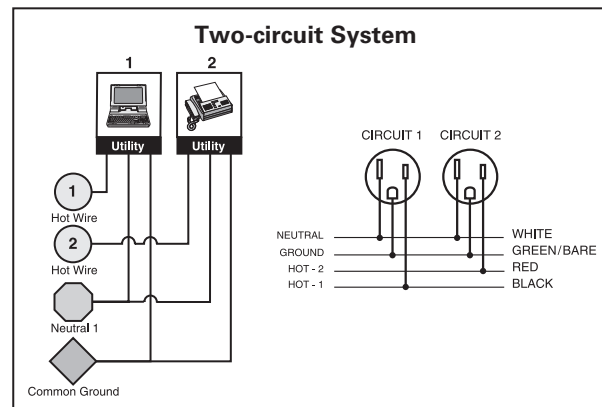
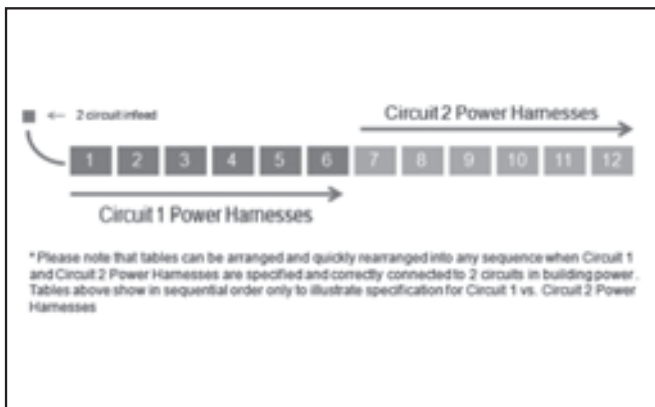

Steps for Electrical Specifications:

- Determine how many rows of tables are needed and order the following:
 - One HMAPLATE per row (or power in-feed)
 - One HMACABLE per row (or power in-feed)
- Order one power harness per table in each row
 - For 1-6 tables in a row (see illustration 1)
 - Order Circuit 1 Power Harnesses (ex. If powering six 24x60 tables order six sets of HMAPOWER60)
 - For 7-12 tables in a row (see illustration 1)
 - Order Circuit 1 Power Harness for first six tables and Circuit 2 Power Harness for remaining tables (ex. If powering eight 24x60 tables, order six sets of HMAPOWER60 and two sets of HMAPOWER602)
- Order one set of ganging hardware per table (ex. HMAGANG)
- Determine which accessories are needed:
 - Power Hub model HGRMTAC — to access power at worksurface.
 - Data Grommet model HGRMTDATA — to access data at worksurface.
 - Wire Management strips model HBTMS — for vertical and horizontal wire management.

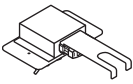
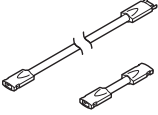

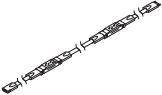
4-TRAC HARDWIRE ELECTRICAL SYSTEM

	DESCRIPTION	MODEL	SHIP WEIGHT	CUBE	LIST PRICE
	Power Entry Plate	HMAPLATE	1.0	0.2	\$102
	Power Entry Cable • 6' power entry cable with male/female adapter. • Connects table to power entry plate.	HMACABLE	1.8	0.2	\$159
	Power Jumper Cable To connect tables front to front	HMAJUMP	0.5	0.3	\$54
	Circuit 1 Power Kit for 36" W Table	HMAPOWER36	1.5	0.3	\$289
	Circuit 1 Power Kit for 42" W Table	HMAPOWER42	1.8	0.3	\$292
	Circuit 1 Power Kit for 48" W Table	HMAPOWER48	1.8	0.3	\$294
	Circuit 1 Power Kit for 54" W Table	HMAPOWER54	2.0	0.3	\$299
	Circuit 1 Power Kit for 60" W Table	HMAPOWER60	2.0	0.3	\$302
	Circuit 1 Power Kit for 66" W Table	HMAPOWER66	2.2	0.3	\$306
	Circuit 1 Power Kit for 72" W Table	HMAPOWER72	2.2	0.3	\$309
	Circuit 1 Power Kit for 84" W Table	HMAPOWER84	2.4	0.3	\$320
	Circuit 1 Power Kit for 96" W Table	HMAPOWER96	2.6	0.3	\$331
	Circuit 2 Power Kit for 36" W Table	HMAPOWER362	1.5	0.3	\$289
	Circuit 2 Power Kit for 42" W Table	HMAPOWER422	1.8	0.3	\$292
	Circuit 2 Power Kit for 48" W Table	HMAPOWER482	1.8	0.3	\$294
	Circuit 2 Power Kit for 54" W Table	HMAPOWER542	2.0	0.3	\$299
	Circuit 2 Power Kit for 60" W Table	HMAPOWER602	2.0	0.3	\$302
Circuit 2 Power Kit for 66" W Table	HMAPOWER662	2.2	0.3	\$306	
Circuit 2 Power Kit for 72" W Table	HMAPOWER722	2.2	0.3	\$309	
Circuit 2 Power Kit for 84" W Table	HMAPOWER842	2.4	0.3	\$320	
Circuit 2 Power Kit for 96" W Table	HMAPOWER962	2.6	0.3	\$331	
	Electrical Connectors 4-Way Splitter  Available in Black (P) only. SPECIFYING EXAMPLE: HMASPLIT.P	HMASPLIT	0.9	0.1	\$55

NOTES:

- Each power kit includes two duplex receptacles and attaches to the underside of the worksurface with included brackets.
- Power Kits are compatible with various base types including nesting bases.

HOW TO SPECIFY

Select
Model Number

H M A P L A T E

OPTIONAL ELECTRICAL ACCESSORIES

GSA SIN 33721 EXCEPT AS NOTED



Icon Legend on page 17

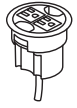

SIN 33721T

DESCRIPTION

Power Hub, 3" Grommet Mount, 6' Cord

- Fits in 3" round grommet holes.
- Field installed with Plug-and-play ease.
- Two grounded AC power outlets.
- Includes 6' cord with three-prong plug.
- Available in Black only. *Specify X when ordering. Example: HGRMTAC.X.*

NOTES: For additional information see page 204.

MODEL

HGRMTAC

SHIP WEIGHT

1.3

CUBE

0.2

LIST PRICE

\$126

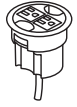

SIN 33721T

3" Round Power Grommet - 2 Outlets, 10' Cord

- Includes 10' cord with three-prong plug.
- Fits in 3" round grommet holes.
- Two grounded AC power outlets.
- Field installed with Plug-and-play ease.

NOTES: Power Modules will also work with standing-height applications for 10500 Series™ and Voi® desks.

- ! Available in black finish only, no specification needed.

HGRMTAC2

1.5

0.2

\$159



Data Grommet

Blank grommet kit that includes adapters for a variety of manufacturers jacks and couplers.

- Fits in existing 3" round grommet housing.
- Available in Black only. *Specify P when ordering. Example: HGRMTDATA.P.*

NOTES: For additional information see page 204.

HGRMTDATA

0.2

0.2

\$23

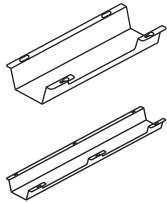

Cable Management Troughs

- 17"W - Single
- 17"W - 10-Pack
- 36"W - Single
- 36"W - 10-Pack

- Cable management troughs ship flat packed.
- The troughs attach to underneath the worksurface with screws.
- Cutouts in trough allow access to power without the need to detach from surface. 17"W = 1 cutout; 36"W = 2 cutouts.
- Color: Graphite.

NOTES: For additional information see page 208.

HCTROUGH17

2.7

0.5

\$73

HCTROUGH1710

14.0

0.5

\$665

HCTROUGH36

4.9

0.9

\$122

HCTROUGH3610

30.0

0.9

\$1121

HOW TO SPECIFY

Select Model Number

H T P W R G R O M 1



Preside® tables and bench shown
with Flock® guest seating.

PRESIDE®

Whether you're craving social interaction or breaking away for some "me time", Preside tables support the work activities you need to get it done. Versatile enough for touchdown spaces, meeting rooms, and even cafés, Preside offers everything from a contemporary light-scale vibe to a more classic aesthetic. Add in optional power for a dynamic table collection that lets you work your way.



FEATURES

- Preside offers a complete line of conference accessories, including presentation cabinets, hospitality and more.
- Optional flip-top and pop-up ports provide options today and for future data and power needs.
- Scratch-, spill- and stain-resistant laminate will look great for years to come.
- Add a splash of color to Preside using Colorwav™ paints to brighten any space.
- Enhanced aesthetics with power management options to keep the workspace tidy and looking its best.

PRESIDE® ORDERING INFORMATION

LAMINATE GROUP A

L1 LAMINATES CODES

- Woodgrain**
- ◆ Bourbon Cherry H
 - ◆ Cognac COGN
 - ◆ Florence Walnut LFW1
 - ◆ Harvest C
 - ◆ Kingswood Walnut LK11
 - ◆ Mahogany N
 - ◆ Mocha MOCH
 - ◆ Natural Maple D
 - ◆ Pinnacle PINC
 - ◆ Shaker Cherry F
 - ◆ Sterling Ash LSA1

- Solid**
- ◆ Black P
 - ◆ Charcoal S
 - ◆ Designer White LDW1
 - ◆ Loft LOFT

- Patterned**
- ◆ Handspun Chestnut LAHC
 - ◆ Handspun Dove LAHD
 - ◆ Handspun Pearl LAHP
 - ◆ Handspun Slate LAHS
 - ◆ Sheer Mesh * A5
 - ◆ Silver Mesh B9
 - ◆ Steel Mesh * A9
 - ◆ Canyon Zephyr * K9
 - ◆ Desert Zephyr * K8
 - ◆ Gray G2
 - ◆ Grey Tigris * L6
 - ◆ White G1
 - ◆ Whitestone * K4

L2 LAMINATES CODES

- Woodgrain**
- ◆ Lowell Ash LLA1
 - ◆ Natural Recon LNRI
 - ◆ Phantom Ecreu LPE1
 - ◆ Portico Teak LPT1
 - ◆ Skyline Walnut LSW1

LAMINATE GROUP B

L1 LAMINATES CODES

- Woodgrain**
- ◆ Bourbon Cherry H
 - ◆ Cognac COGN
 - ◆ Florence Walnut LFW1
 - ◆ Harvest C
 - ◆ Kingswood Walnut LK11
 - ◆ Mahogany N
 - ◆ Mocha MOCH
 - ◆ Natural Maple D
 - ◆ Pinnacle PINC
 - ◆ Shaker Cherry F
 - ◆ Sterling Ash LSA1

- Solid**
- ◆ Black P
 - ◆ Charcoal S
 - ◆ Designer White LDW1
 - ◆ Loft LOFT

L2 LAMINATES CODES

- Woodgrain**
- ◆ Lowell Ash LLA1
 - ◆ Natural Recon LNRI
 - ◆ Phantom Ecreu LPE1
 - ◆ Portico Teak LPT1
 - ◆ Skyline Walnut LSW1

LAMINATE GROUP C

L1 LAMINATES CODES

- Woodgrain**
- ◆ Bourbon Cherry H
 - ◆ Cognac COGN
 - ◆ Florence Walnut LFW1
 - ◆ Harvest C
 - ◆ Kingswood Walnut LK11
 - ◆ Mahogany N
 - ◆ Mocha MOCH
 - ◆ Natural Maple D
 - ◆ Pinnacle PINC
 - ◆ Shaker Cherry F
 - ◆ Sterling Ash LSA1

- Solid**
- ◆ Black P
 - ◆ Charcoal S
 - ◆ Designer White LDW1
 - ◆ Loft LOFT
 - ◆ Platinum LEPI

L2 LAMINATES CODES

- Woodgrain**
- ◆ Lowell Ash LLA1
 - ◆ Natural Recon LNRI
 - ◆ Phantom Ecreu LPE1
 - ◆ Portico Teak LPT1
 - ◆ Skyline Walnut LSW1

LAMINATE GROUP D

L1 LAMINATES CODES

- Woodgrain**
- ◆ Mahogany N

PAINT GROUP A

P1 CODES

- ◆ Black P
- ◆ Brownstone P7D
- ◆ Charcoal S
- ◆ Designer White PJW
- ◆ Fossil P28
- ◆ Greige T5
- ◆ Loft LOFT
- ◆ Muslin T3
- ◆ Titanium P8T

P2 CODES

- ◆ Champagne Metallic T4
- ◆ Platinum Metallic T1
- ◆ Silver PR6
- ◆ Solar Black P8X

P3 CODES

- ◆ Atom P8S
- ◆ Bullseye PJF
- ◆ Ember P8P
- ◆ Ion P8N
- ◆ Iris P8J
- ◆ Krypton P8F
- ◆ Regatta P8M

HON BRANDED FABRICS

GRADE 1

- Apex
- Attire
- Centurion
- Compass
- Contourett
- Dapper
- Ensemble
- Hamilton
- Inertia
- Optic
- Pebble

GRADE 2

- Appoint Seating
- Blume
- Clyde
- Dotty
- Rush
- Spin
- Whisper Vinyl

GRADE 3

- In Season
- Silvertex™ Vinyl

NOTES: Fabrics on Preside® bench cushion are upholstered in the railroad direction.

◆◆◆ For lead time information see page 17.

* De-emphasized

PRESIDE® SPECIFYING INFORMATION

EDGE BAND OPTIONS	CODES	2mm (G)	Knife (J)	T-Mold (E)	Traditional (T)
Bourbon Cherry	H	•	•		
Cognac	COGN	•	•	•	
Florence Walnut	FW	•	•	•	
Harvest	C	•	•		
Kingswood Walnut	KI	•	•	•	
Mahogany	N	•	•	•	•
Mocha	MOCH	•	•	•	
Natural Maple	D	•	•		
Shaker Cherry	F	•	•		
Sterling Ash	SA	•	•	•	
Black	P	•	•	•	
Brownstone	EY	•	•	•	
Charcoal	S	•	•	•	
Designer WHIT	DW	•	•	•	
Fossil	EH	•	•	•	
Greige	R	•	•	•	
Loft	LOFT	•	•	•	
Muslin	T	•	•	•	
Pinnacle	PINC	•	•	•	
Platinum	K	•	•		
Lowell Ash	DL	•	•		
Natural Recon	NR	•	•		
Phantom Ecu	PE	•	•		
Portico Teak	DP	•	•		
Skyline Walnut	SW	•	•		

Recommended Edgeband Color Selection:

Laminate	Edge
Bourbon Cherry H	Bourbon Cherry H
Cognac COGN	Cognac COGN
Florence Walnut LFW1	Florence Walnut FW
Harvest C	Harvest C
Kingswood Walnut LK11	Kingswood Walnut KI
Mahogany N	Mahogany N
Mocha MOCH	Mocha MOCH
Natural Maple D	Natural Maple D
Pinnacle PINC	Pinnacle PINC
Shaker Cherry F	Shaker Cherry F
Sterling Ash LSA1	Sterling Ash SA
Black P	Black P
Charcoal S	Charcoal S
Designer White LDW1	Designer White DW
Loft LOFT	Loft LOFT
Whitestone K4	Muslin T
Sheer Mesh A5	Muslin T
Silver Mesh B9	Loft LOFT
Steel Mesh A9	Charcoal S
Canyon Zephyr K9	Greige R
Desert Zephyr K8	Greige R
Shadow Zephyr K1	Loft LOFT
Gray G2	Charcoal S
Grey Tigris L6	Greige R
White G1	Charcoal S
Lowell Ash LLA1	Lowell Ash DL
Natural Recon LNR1	Natural Recon NR
Phantom Ecu LPE1	Phantom Ecu PE
Portico Teak LPT1	Portico Teak DP
Skyline Walnut LSW1	Skyline Walnut SW

PRESIDE® SPECIFYING INFORMATION

Statement of Line

TOP SHAPES



Square



Round



Soft Square



Rectangle

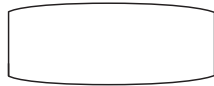

Boat



Racetrack



Arc End

TOP EDGE PROFILES

For Laminate Tops

Square/2mm Edgeband (1/8")



Knife Edge (1/8")



Traditional Edge (1/8")



T-Mold Edge (1/8")



BASES

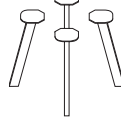
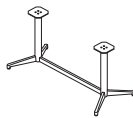
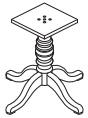
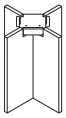
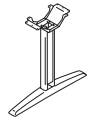
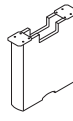
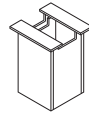
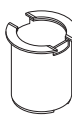
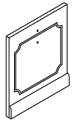
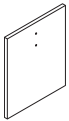

ANCILLARY COMPONENTS

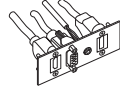
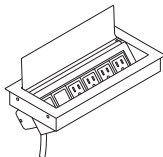
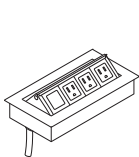
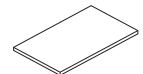
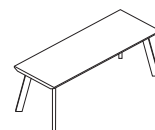
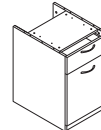
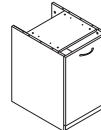
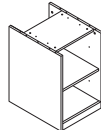
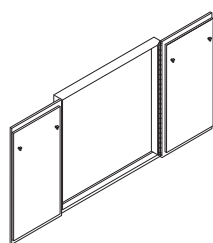
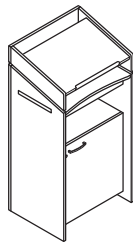
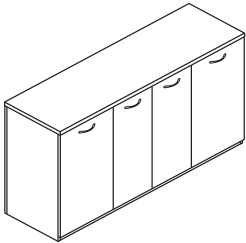







PRESIDE[®] SPECIFYING INFORMATION

Preside conference tops come in single piece or multi-piece sections depending on specified size. See below for top sizes, sections, and suggested seating capacity.





Product Reference: Sizes, Sections, Seating Capacity

Multi-piece tops: Rectangle, Racetrack, Boat, and Arc End Tops.



















Notes: Single- and two-piece tops ship in one carton, three-piece tops ship in two cartons.
Three-piece tops and larger will not contain grain match for all pieces.

	Feet	Inches	42"D	48"D	54"D	Suggested Capacity
	30	360"	6 6 6 6 6	6 6 6 6 6	6 6 6 6 6	28-30
	28	336"	5 6 6 6 5	5 6 6 6 5	5 6 6 6 5	26-28
	26	312"	7 6 6 7	7 6 6 7	7 6 6 7	24-26
	24	288"	6 6 6 6	6 6 6 6	6 6 6 6	22-24
	22	264"	5 6 6 5	5 6 6 5	5 6 6 5	20-22
	20	240"	7 6 7	7 6 7	7 6 7	18-20
	18	216"	6 6 6	6 6 6	6 6 6	16-18
	16	192"	5 6 5	5 6 5	5 6 5	14-16
	15	180"	4½ 6 4½	4½ 6 4½	4½ 6 4½	14-16
	14	168"	7 7	7 7	7 7	12-14
	12	144"	6 6	6 6	6 6	10-12
	10	120"	5 5	5 5	5 5	8-10
	9	108"	4½ 4½	4½ 4½	4½ 4½	8-10

Single-piece tops: Rectangle, Racetrack, Boat, and Arc End Tops

	Feet	Inches	30"D	36"D	42"D	48"D	Suggested Capacity
	8	96"			8	8	6-8
	7	84"			7		4-6
	6	72"		6			4-6
	5	60"	5				4-6

Single-piece tops: Round, Square, and Soft Square

		24"	30"	36"	42"	48"	60"*	Suggested Capacity
	Round							2-4 (*2-5)
	Square							2-4
	Soft Square							2-4

PRESIDE® SPECIFYING INFORMATION

Material	Type	Shape	Size					
			24"	30"	36"	42"	48"	60"
Laminate	Cylinder	Round	N/A	N/A	● ○ ○ ○ ○ ● ○ ○ ○ ○	○ ○ ○ ○ ○ ● ○ ○ ○ ○	○ ○ ○ ○ ○ ● ○ ○ ○ ○	N/A
		Square	N/A	N/A	○ ○ ○ ○ ○ ● ○ ○ ○ ○	○ ○ ○ ○ ○ ● ○ ○ ○ ○	○ ○ ○ ○ ○ ● ○ ○ ○ ○	
		Soft Square	N/A	N/A	○ ○ ○ ○ ○ ● ○ ○ ○ ○	○ ○ ○ ○ ○ ● ○ ○ ○ ○	○ ○ ○ ○ ○ ● ○ ○ ○ ○	
	Cube	Round	N/A	N/A	N/A	N/A	○ ○ ○ ○ ○ ● ○ ○ ○ ○	○ ○ ○ ○ ○ ● ○ ○ ○ ○
		Square	N/A	N/A	N/A	N/A	○ ○ ○ ○ ○ ● ○ ○ ○ ○	
		Soft Square	N/A	N/A	N/A	N/A	○ ○ ○ ○ ○ ● ○ ○ ○ ○	
	X-Base	Round	N/A	N/A	○ ○ ○ ○ ○ ● ○ ○ ○ ○	○ ○ ○ ○ ○ ● ○ ○ ○ ○	○ ○ ○ ○ ○ ● ○ ○ ○ ○	N/A
		Square	N/A	N/A	○ ○ ○ ○ ○ ● ○ ○ ○ ○	○ ○ ○ ○ ○ ● ○ ○ ○ ○	○ ○ ○ ○ ○ ● ○ ○ ○ ○	
		Soft Square	N/A	N/A	○ ○ ○ ○ ○ ● ○ ○ ○ ○	○ ○ ○ ○ ○ ● ○ ○ ○ ○	○ ○ ○ ○ ○ ● ○ ○ ○ ○	
	Traditional X-Base	Round	N/A	N/A	○ ○ ○ ○ ○ ● ○ ○ ○ ○	○ ○ ○ ○ ○ ● ○ ○ ○ ○	○ ○ ○ ○ ○ ● ○ ○ ○ ○	N/A
		Square	N/A	N/A	○ ○ ○ ○ ○ ● ○ ○ ○ ○	○ ○ ○ ○ ○ ● ○ ○ ○ ○	N/A	
		Soft Square	N/A	N/A	○ ○ ○ ○ ○ ● ○ ○ ○ ○	○ ○ ○ ○ ○ ● ○ ○ ○ ○	N/A	

●	●	●	●
○	○	○	○
Working Lounge	Seated	Counter	Standing
27H	29H	36H	42H
● Available			
○ Unavailable or Not Compatible			

PRESIDE® SPECIFYING INFORMATION

		Rectangle - Boat - Racetrack - Arc End													
Material	Type	Width	60"	72"	84"	96"	108"	120"	144"	168"	180"	192"	216"	240"	72" Adder
		Depth													
Painted	Footed Y-Base	30"	●●●●●												
		36"		●●●●●											
		42"			●●●●●	●●●●●	●●●●●	●●●●●	●●●●●	●●●●●	●●●●●	●●●●●	●●●●●	●●●●●	●●●●●
		48"				●●●●●	●●●●●	●●●●●	●●●●●	●●●●●	●●●●●	●●●●●	●●●●●	●●●●●	●●●●●
		54"					N/A	N/A	N/A	N/A	N/A	N/A	N/A	N/A	N/A
	Angled Leg	30"	○●●●●												
		36"		○●●●●											
		42"			○●●●●	○●●●●	○●●●●	○●●●●	○●●●●	○●●●●	○●●●●	○●●●●	○●●●●	○●●●●	○●●●●
		48"				○●●●●	○●●●●	○●●●●	○●●●●	○●●●●	○●●●●	○●●●●	○●●●●	○●●●●	○●●●●
		54"					○●●●●	○●●●●	○●●●●	○●●●●	○●●●●	○●●●●	○●●●●	○●●●●	○●●●●
	T-Leg	30"	○●●●●												
		36"		○●●●●											
		42"			○●●●●	○●●●●	○●●●●	○●●●●	○●●●●	○●●●●	○●●●●	○●●●●	○●●●●	○●●●●	○●●●●
		48"				○●●●●	○●●●●	○●●●●	○●●●●	○●●●●	○●●●●	○●●●●	○●●●●	○●●●●	○●●●●
		54"					○●●●●	○●●●●	○●●●●	○●●●●	○●●●●	○●●●●	○●●●●	○●●●●	○●●●●

	<ul style="list-style-type: none"> ● Available ○ Unavailable or Not Compatible
--	--

PRESIDE® SPECIFYING INFORMATION

		Rectangle - Boat - Racetrack - Arc End														
Material	Type	Width	60"	72"	84"	96"	108"	120"	144"	168"	180"	192"	216"	240"	72" Adder	
		Depth														
Laminate	Panel	30"														
		36"														
		42"														
		48"														
		54"														
	Traditional Panel	30"	N/A													
		36"														
		42"									N/A	N/A	N/A	N/A	N/A	
		48"									N/A	N/A	N/A	N/A	N/A	
		54"									N/A	N/A	N/A	N/A	N/A	
	Hollow Panel	30"	N/A													
		36"		N/A												
		42"			N/A	N/A	N/A	N/A	N/A	N/A	N/A	N/A	N/A	N/A	N/A	
		48"														
		54"														

				● Available ○ Unavailable or Not Compatible
27H	29H	36H	42H	
Working Lounge	Seated	Counter	Standing	

PRESIDE® SPECIFYING INFORMATION

Specify Preside tables with two steps—select a top and select a base.

1. Select desired top size, shape, and edge profile.

Multi-piece Tops:

Multi-piece tops are made of 108", 120", 144" and 168" two-piece "starter-sections" in rectangle, boat, arc end, or racetrack shapes in 42", 48", or 54" depths. For tables up to 20', models are preconfigured for you. If you need a table top longer than 20', add as many 72" adder sections as you need. The examples below illustrate preconfigured sizes as well as how starter section and adder section tops can be used to create tables in virtually any length. **Please note that 2-piece tops, in woodgrain colors, will not have exact grain alignment in the center where the two halves meet, a reasonable match can be expected. For tops utilizing an adder section, there will not be a grain match for those pieces.**

Preconfigured and Modular Size Examples

	Feet	Inches	Ex. Top Starter Section	Quantity	Adder Section	Quantity	Total Number of Top Sections
Preconfigured Sizes	9'	108"	HTLC48108	1	n/a	n/a	2
	10'	120"	HTLC48120	1	n/a	n/a	2
	12'	144"	HTLC48144	1	n/a	n/a	2
	14'	168"	HTLC48168	1	n/a	n/a	2
	15'	180"	HTLC48180	1	n/a	n/a	3
	16'	192"	HTLC48192	1	n/a	n/a	3
	18'	216"	HTLC48216	1	n/a	n/a	3
	20'	240"	HTLC48240	1	n/a	n/a	3
Modular Sizes	22'	264"	HTLC48120	1	HTLM4872	2	4
	24'	288"	HTLC48144	1	HTLM4872	2	4
	26'	312"	HTLC48168	1	HTLM4872	2	4
	28'	336"	HTLC48120	1	HTLM4872	3	5
	30'	360"	HTLC48144	1	HTLM4872	3	5

Note: Beyond 30', tables can be configured in 6' increments to any length.

Illustrations of Preconfigured Tops

48" x 108" Table Top (9')

54"	54"
-----	-----

Ex: HTLC48108

48" x 120" Table Top (10')

60"	60"
-----	-----

Ex: HTLC48120

48" x 144" Table Top (12')

72"	72"
-----	-----

Ex: HTLC48144

48" x 168" Table Top (14')

84"	84"
-----	-----

Ex: HTLC48168

48" x 180" Table Top (15')

54"	72"	54"
-----	-----	-----

Ex: HTLC48180

48" x 192" Table Top (16')

60"	72"	60"
-----	-----	-----

Ex: HTLC48192

48" x 216" Table Top (18')

72"	72"	72"
-----	-----	-----

Ex: HTLC48216

48" x 240" Table Top (20')

84"	72"	84"
-----	-----	-----

Ex: HTLC48240

Illustrations of User Configured Modular Tops

48" x 72" Adder Section

72"

Ex: HTLM4872

48"D x 360"W Table Top (30')

72"	72"	72"	72"	72"
-----	-----	-----	-----	-----

Ex: HTLC48144 + HTLM4872 + HTLM4872 + HTLM4872

PRESIDE® SPECIFYING INFORMATION

2. Select desired base style and identify model that coincides with top length.

Bases for Tops in Preconfigured Sizes

Bases include the appropriate number of supports for tables up to 20'. Simply identify the length of the table top in inches and specify the base with the same length in the model number. The example below illustrates how to select a base for a preconfigured size top.

Examples of Base for Preconfigured Top Size

Example top: HTLC48240 Top Description: 240" Rectangle Top
 Example base: HTLHP240 Base Description: Hollow Panel Base for 240" Top

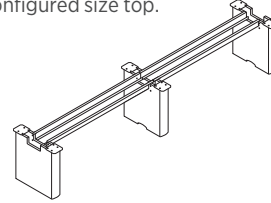

Example: HTLHP240

Bases for Tops in User Configured Modular Sizes

If you need a table top longer than 20', add as many 72" adder section bases as needed. The examples below illustrate preconfigured sizes as well as how starter section and adder section bases can be used to create tables in any desired length.

Examples of Tops and Bases for User Configured Modular Top

	Feet	Inches	Ex. Top Starter Section		Ex. Top Adder Section		Ex. Base Starter Section		Ex. Base Adder Section		Total # of Top Sections
			Quantity	Quantity	Quantity	Quantity	Quantity	Quantity			
Preconfigured Sizes	9'	108"	HTLC48108	1	n/a	n/a	HTLHP108	1	n/a	n/a	2
	10'	120"	HTLC48120	1	n/a	n/a	HTLHP120	1	n/a	n/a	2
	12'	144"	HTLC48144	1	n/a	n/a	HTLHP144	1	n/a	n/a	2
	14'	168"	HTLC48168	1	n/a	n/a	HTLHP168	1	n/a	n/a	2
	15'	180"	HTLC48180	1	n/a	n/a	HTLHP180	1	n/a	n/a	3
	16'	192"	HTLC48192	1	n/a	n/a	HTLHP192	1	n/a	n/a	3
	18'	216"	HTLC48216	1	n/a	n/a	HTLHP216	1	n/a	n/a	3
	20'	240"	HTLC48240	1	n/a	n/a	HTLHP240	1	n/a	n/a	3
Modular Sizes	22'	264"	HTLC48120	1	HTLM4872	2	HTLHP120	1	HTLHPM	2	4
	24'	288"	HTLC48144	1	HTLM4872	2	HTLHP144	1	HTLHPM	2	4
	26'	312"	HTLC48168	1	HTLM4872	2	HTLHP168	1	HTLHPM	2	4
	28'	336"	HTLC48120	1	HTLM4872	3	HTLHP120	1	HTLHPM	3	5
	30'	360"	HTLC48144	1	HTLM4872	3	HTLHP144	1	HTLHPM	3	5

Note: Tables can be configured to any desired length beyond 30' in 6' increments.

Note: Preconfigured bases include the appropriate number of supports for tables up to 20'. Depending on base type, number of required supports varies. For information regarding total number of supports please refer to chart below.

Feet	Inches	HTLP	HTLT	HTTLEG	HTLHP	HTLCUBE/S	HTLR/C	HTYLEG	HTALEG
9'	108"	2	2	2	2	2	2	3	6
10'	120"	2	2	2	2	2	2	3	6
12'	144"	2	2	2	2	2	2	3	6
14'	168"	3	3	3	3	2	2	3	6
15'	180"	3	n/a	3	3	3	3	4	8
16'	192"	3	n/a	3	3	3	3	4	8
18'	216"	3	n/a	3	3	3	3	4	8
20'	240"	4	n/a	4	3	3	3	4	8

Base Model Descriptions

- HTLP = Panel Base
- HTLT = Traditional Panel Base
- HTTLEG = Aluminum T-Leg
- HTLHP = Hollow Panel Base
- HTLCUBE = Cube Base
- HTLCUBES = Standing-Height Cube Base
- HTLR = Cylinder Base
- HTLRC = Wire Management Cylinder Base
- HTYLEG = Footed Y-Leg Base
- HTALEG = Angled Leg

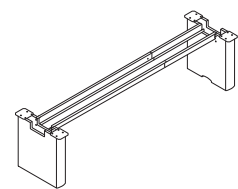

Example: HTHLP168

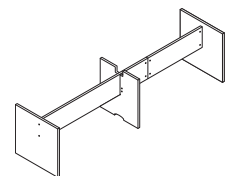

Example: HTLP168

PRESIDE® Grommet Cutout Placement

Tops specified with a grommet cutout get one cutout per section of top, centered in both directions. Cutouts do not include blank or powered inserts. Inserts must be specified separately.

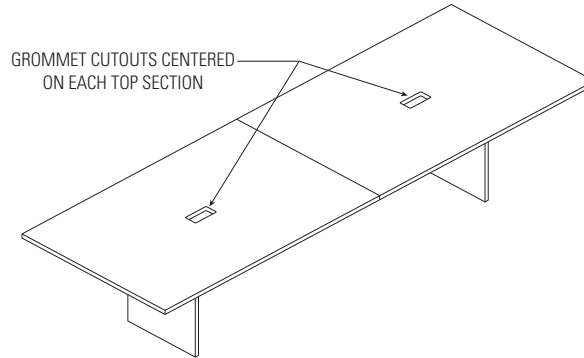

Upcharges for grommet cutouts (\$15 per G cutout, \$40 per G1 cutout, \$50 per G2 cutout)

Top Width	# Cutouts	G	G1	G2
24"	1	\$15	N/A	N/A
30"	1	\$15	N/A	N/A
36"	1	N/A	\$40	\$50
42"	1	N/A	\$40	\$50
48"	1	N/A	\$40	\$50
60"	1	N/A	\$40	\$50
72"	1	N/A	\$40	\$50
84"	1	N/A	\$40	\$50
96"	1	N/A	\$40	\$50
108"	2	N/A	\$80	\$100
120"	2	N/A	\$80	\$100
144"	2	N/A	\$80	\$100
168"	2	N/A	\$80	\$100
180"	3	N/A	\$120	\$150
192"	3	N/A	\$120	\$150
216"	3	N/A	\$120	\$150
240"	3	N/A	\$120	\$150

PRESIDE® Laminate Table Tops

GSA SIN 33721

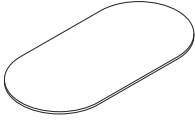
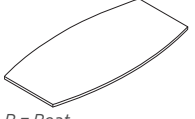
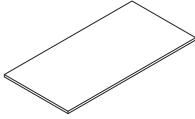
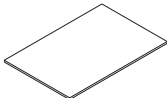

Icon Legend on page 17

DESCRIPTION	MODEL	SHIP WEIGHT	CUBE	LIST PRICE BY EDGE TREATMENT				L2 UPCHARGE	
				"E"	"G"	"J"	"T"		
Laminate Boat, Racetrack, Rectangle and Arc End Shaped Tops									
 A = Racetrack Not available in "T" edge option	240"W x 54"D	HTL(?)54240	425	25.1	N/A	\$2975	\$4780	N/A	\$125
	216"W x 54"D	HTL(?)54216	384	23.3	N/A	\$2600	\$4074	N/A	\$105
	192"W x 54"D	HTL(?)54192	345	21.4	N/A	\$2423	\$3864	N/A	\$100
	180"W x 54"D	HTL(?)54180	442	21.4	N/A	\$2423	\$3864	N/A	\$100
	168"W x 54"D	HTL(?)54168	300	13.5	\$1854	\$2002	\$3121	N/A	\$85
	144"W x 54"D	HTL(?)54144	259	11.6	\$1514	\$1627	\$2415	N/A	\$65
	120"W x 54"D	HTL(?)54120	220	9.8	\$1345	\$1450	\$2205	N/A	\$60
	108"W x 54"D	HTL(?)54108	324	9.8	\$1345	\$1450	\$2205	N/A	\$60
 B = Boat Not available in "T" edge option	240"W x 48"D	HTL(?)48240	392	21.9	N/A	\$2416	\$3882	N/A	\$105
	216"W x 48"D	HTL(?)48216	351	19.7	N/A	\$2116	\$3322	N/A	\$90
	192"W x 48"D	HTL(?)48192	312	18.1	N/A	\$1976	\$3153	N/A	\$85
	180"W x 48"D	HTL(?)48180	300	18.6	N/A	\$1976	\$3153	N/A	\$85
	168"W x 48"D	HTL(?)48168	281	12.1	\$1482	\$1602	\$2495	\$4121	\$70
	144"W x 48"D	HTL(?)48144	240	9.8	\$1212	\$1302	\$1935	\$3579	\$55
	120"W x 48"D	HTL(?)48120	201	8.2	\$1077	\$1162	\$1766	\$2898	\$50
	108"W x 48"D	HTL(?)48108	203	9.8	\$1077	\$1162	\$1766	N/A	\$50
	96"W x 48"D	HTL(?)4896	153	13.2	\$914	\$945	\$1414	\$2236	\$50
 C = Rectangle	240"W x 42"D	HTL(?)42240	382	27.1	\$2116	\$2221	\$3469	N/A	\$99
	216"W x 42"D	HTL(?)42216	350	25.8	\$1889	\$1977	\$3097	N/A	\$88
	192"W x 42"D	HTL(?)42192	317	22.2	\$1776	\$1856	\$2912	N/A	\$83
	180"W x 42"D	HTL(?)42180	302	22.2	\$1776	\$1856	\$2912	N/A	\$83
	168"W x 42"D	HTL(?)42168	255	18.7	\$1414	\$1519	\$2318	N/A	\$66
	144"W x 42"D	HTL(?)42144	223	17.4	\$1187	\$1275	\$1946	N/A	\$55
	120"W x 42"D	HTL(?)42120	190	13.8	\$1074	\$1154	\$1761	N/A	\$50
	108"W x 42"D	HTL(?)42108	175	13.8	\$1074	\$1154	\$1761	N/A	\$50
	96"W x 42"D	HTL(?)4296	159	22.8	N/A	\$954	\$1423	N/A	\$40
	84"W x 42"D	HTL(?)4284	157	12.1	\$914	\$945	\$1414	N/A	\$40
	72"W x 36"D	HTL(?)3672	90	7.9	\$609	\$663	\$1070	\$1167	\$30
	60"W x 30"D	HTL(?)3060	63	5.6	\$482	\$525	\$861	N/A	\$20
Laminate Adder Section for Boat, Racetrack, Rectangle and Arc Shaped Tops									
 M = Mid-section Adder	72"W x 54"D	HTLM5472	125	11.6	N/A	\$973	\$1659	N/A	\$40
	72"W x 48"D	HTLM4872	111	9.8	N/A	\$814	\$1387	N/A	\$35
	72"W x 42"D	HTLM4272	127	8.4	\$702	\$754	\$1151	N/A	\$33

ⓘ Adder section cannot be used as stand-alone table. Only long edges are finished.

NOTES:

- Tops with E, G, and T edge details feature durable laminate tops over solid core high-performance particleboard. Tops with J edge feature an MDF core.
- Laminate tops with Traditional (T) edge feature high gloss laminate and wood edge to coordinate with 94000 Series Desks.
- Tops with E edge detail have 3" radius corners. All other edge details have 90 degree corners.
- See page 93 for number of cutouts for each table top size.

ⓘ Tops with Traditional edge available in Mahogany only.

ⓘ See pages 85-90 for top and base compatibility.

HOW TO SPECIFY

<p>Select Model Number</p> <p>For laminate tops with Traditional (T) edge, place a "T" at the end of the base model.</p> <p>HTLC4296</p> <p>Traditional Edge</p> <p>HTLC4896T</p>	<p>Select Edge Detail and Edge Color</p> <p>See page 83</p> <p>For laminate tops with Traditional (T) edge, select edge color ONLY.</p> <p>JC</p> <p>N</p>	<p>Select Cutout Option</p> <p>N No Cutout</p> <p>G1 Cutout for Pop-up Port (\$40 upcharge per cutout)</p> <p>G2 Cutout for Flip-top Port (\$50 upcharge per cutout) Flip-top Port cannot be specified for Round or Square tops</p> <p>G2</p> <p>G2</p>	<p>Select Laminate</p> <p>See page 82, Laminate Group A</p> <p>D</p> <p>See page 82, Laminate Group D</p> <p>N</p>
---	---	--	---



PRESIDE® Laminate Table Tops

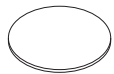

D = Round

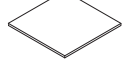

S = Square



SFT = Soft Square

DESCRIPTION	MODEL	SHIP WEIGHT			LIST PRICE BY EDGE TREATMENT					L2 UPCHARGE
		ROUND	SQUARE	SOFT SQUARE	CUBE	"E"	"G"	"J"	"T"	
Laminate Round, Square, and Soft Square Tops										
60" Round Top	HTLD60	95	N/A	N/A	10.1	\$655	\$704	\$1073	N/A	\$31
48" Top	HTL(?)48	66	76	80	6.3	\$523	\$563	\$908	\$1061	\$25
42" Top	HTL(?)42	51	61	61	4.9	\$466	\$509	\$845	\$928	\$20
36" Top	HTL(?)36	36	46	46	3.7	\$408	\$467	\$723	\$837	\$20
30" Top	HTL(?)30	28	33	33	3.0	\$369	\$397	\$604	N/A	\$17
24" Top	HTL(?)24	19	23	23	2.1	\$341	\$367	\$559	N/A	\$16

NOTES: Tops are available in three shapes: Round (D), Square (S), and Soft Square (SFT). Replace the (?) shown in each model with D, S, or SFT to specify shape.

❗ 60" top only available in Round (D) shape.

NOTES:

- Tops with E, G, and T edge details feature durable laminate tops over solid core high-performance particleboard. Tops with J edge feature an MDF core.
- Laminate tops with Traditional (T) edge feature high gloss laminate and wood edge to coordinate with 94000 Series Desks.
- Tops with E edge detail have 3" radius corners. All other edge details have 90 degree corners.
- See page 93 for number of cutouts for each table top size.

❗ Tops with Traditional edge available in Mahogany only.

❗ See pages 85-90 for top and base compatibility.

HOW TO SPECIFY

Select Model Number	Select Edge Detail and Edge Color	Select Cutout Option	Select Laminate
<p>See page 83</p> <p>HTLD48</p> <p>Traditional Edge</p> <p>HTLD48T</p>	<p>See page 83</p> <p>JC</p> <p>N</p>	<p>No Cutout</p> <p>G Cutout for 24" and 30" tops (+ \$15 upcharge)</p> <p>G1 Cutout for Pop-up Port (+ \$40 upcharge per cutout)</p> <p>G2 Cutout for Flip-top Port (+ \$50 upcharge per cutout)</p> <p>G1</p> <p>G1</p>	<p>See page 82, Laminate Group A</p> <p>D</p> <p>N</p>

PRESIDE® Laminate Bases

GSA SIN 33721



Icon Legend on page 17

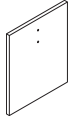

DESCRIPTION	PANELS INCLUDED PER KIT	MODEL	SHIP WEIGHT	CUBE	LIST PRICE BY LAMINATE GRADE	
					L1	L2
Laminate Seated-Height Panel Base for Tops 60" or Wider						
For 240"W Table Tops	4	HTLP240	197	16.4	\$1496	\$1576
For 216"W Table Tops	3	HTLP216	158	12.4	\$1145	\$1202
For 192"W Table Tops	3	HTLP192	147	11.6	\$1145	\$1202
For 180"W Table Tops	3	HTLP180	147	11.6	\$1145	\$1202
For 168"W Table Tops	3	HTLP168	136	10.6	\$998	\$1053
For 144"W Table Tops	2	HTLP144	97	6.6	\$647	\$679
For 120"W Table Tops	2	HTLP120	86	5.8	\$647	\$679
For 108"W Table Tops	2	HTLP108	86	5.8	\$647	\$679
For 96"W Table Tops	2	HTLP96	75	4.9	\$647	\$679
For 84"W Table Tops	2	HTLP84	75	5.0	\$647	\$679
For 72"W Table Tops	2	HTLP72	25	2.9	\$608	\$640
For 60"W Table Tops	2	HTLP60	25	2.9	\$608	\$640
For 72" Adder Section	1	HTLPM	61	5.8	\$498	\$523

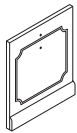

Laminate Seated-Height Traditional Panel Base for Tops 72" or Wider						
For 168"W Table Tops	3	HTLT168	145	12.1	\$1243	N/A
For 144"W Table Tops	2	HTLT144	106	8.2	\$892	N/A
For 120"W Table Tops	2	HTLT120	95	7.3	\$892	N/A
For 96"W Table Tops	2	HTLT96	62	4.6	\$892	N/A
For 72"W Table Tops	2	HTLT72	84	6.5	\$818	N/A

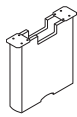

Laminate Seated-Height Hollow Panel Base for Tops 84" or Wider						
For 240"W Table Tops	3	HTLHP240	206	17.5	\$3258	\$3378
For 216"W Table Tops	3	HTLHP216	204	17.3	\$3173	\$3293
For 192"W Table Tops	3	HTLHP192	202	17.1	\$3101	\$3221
For 180"W Table Tops	3	HTLHP180	202	17.1	\$3101	\$3221
For 168"W Table Tops	3	HTLHP168	193	16.9	\$3000	\$3120
For 144"W Table Tops	2	HTLHP144	133	11.4	\$2059	\$2139
For 120"W Table Tops	2	HTLHP120	131	11.2	\$1987	\$2067
For 108"W Table Tops	2	HTLHP108	131	11.2	\$1987	\$2067
For 96"W Table Tops	2	HTLHP96	125	11.0	\$1915	\$1995
For 84"W Table Tops	2	HTLHP84	125	11.0	\$1915	\$1995
For 72" Adder Section	1	HTLHPM	71	5.9	\$1114	\$1154

NOTES:

- Tops and bases are sold and shipped separately.
- End caps for Hollow Panel bases can be matched to woodgrain finishes or specified in select solid colors.
- Bases ship with appropriate number of supports for table width. See page 92 for details.
- Laminate panel bases feature sturdy 1½" thick x 12"H particleboard support beam in matching finish.
- Traditional panel base for 168"W Top includes two traditional panels and one standard panel.

- ! Traditional style bases available in Mahogany (N) only.
- ! For Base and Top compatibility, see base information on pages 85-92.
- ! Laminate hollow panel bases feature dual aluminum support beams with integrated wire management.

HOW TO SPECIFY**Select
Model Number**

HTLHP240

**Select
Laminate**

See page 82, Laminate Group B

D

**Select
Endcap/Inlay Option**See page 82, Laminate Group C
(Specify for Hollow Panel Bases only)

LFW1



PRESIDE® Laminate Bases

DESCRIPTION	PANELS INCLUDED		SHIP WEIGHT	CUBE	LIST PRICE BY LAMINATE GRADE	
	PER KIT	MODEL			L1	L2
Laminate Seated-Height Cube Base for Tops 84" or Wider						
For 240"W Table Tops	3	HTLCUBE240	278	29.2	\$3900	\$4035
For 216"W Table Tops	3	HTLCUBE216	276	29.0	\$3815	\$3950
For 192"W Table Tops	3	HTLCUBE192	274	28.8	\$3743	\$3878
For 180"W Table Tops	3	HTLCUBE180	274	28.8	\$3743	\$3878
For 168"W Table Tops	2	HTLCUBE168	183	19.4	\$2572	\$2662
For 144"W Table Tops	2	HTLCUBE144	181	19.2	\$2487	\$2577
For 120"W Table Tops	2	HTLCUBE120	179	19.0	\$2415	\$2505
For 108"W Table Tops	2	HTLCUBE108	179	19.0	\$2415	\$2505
For 96"W Table Tops	2	HTLCUBE96	164	18.2	\$2140	\$2230
For 84"W Table Tops	2	HTLCUBE84	164	18.2	\$2140	\$2230
For 72" Adder Section	1	HTLCUBEM	95	9.8	\$1328	\$1373
Laminate Standing-Height Cube Base for Tops 48" or Wider						
For 240"W Table Tops	3	HTLCUBES240	302	45.7	\$4716	\$4881
For 216"W Table Tops	3	HTLCUBES216	300	45.5	\$4631	\$4796
For 192"W Table Tops	3	HTLCUBES192	298	45.3	\$4559	\$4724
For 180"W Table Tops	3	HTLCUBES180	298	45.3	\$4559	\$4724
For 168"W Table Tops	2	HTLCUBES168	199	30.4	\$3116	\$3226
For 144"W Table Tops	2	HTLCUBES144	197	30.2	\$3031	\$3141
For 120"W Table Tops	2	HTLCUBES120	195	30.0	\$2959	\$3069
For 108"W Table Tops	2	HTLCUBES108	195	30.0	\$2959	\$3069
For 96"W Table Tops	2	HTLCUBES96	180	29.2	\$2684	\$2794
For 72" Adder	1	HTLCUBESM	103	15.3	\$1600	\$1655
Laminate Seated-Height Cylinder Base for Tops 84" or Wider						
For 240"W Table Tops	3	HTLR240	191	51.9	\$3159	\$3264
For 216"W Table Tops	3	HTLR216	189	51.7	\$3074	\$3179
For 192"W Table Tops	3	HTLR192	187	51.5	\$3002	\$3107
For 180"W Table Tops	3	HTLR180	187	51.5	\$3002	\$3107
For 168"W Table Tops	2	HTLR168	125	34.5	\$2078	\$2148
For 144"W Table Tops	2	HTLR144	123	34.3	\$1993	\$2063
For 120"W Table Tops	2	HTLR120	121	34.1	\$1921	\$1991
For 108"W Table Tops	2	HTLR108	121	34.1	\$1921	\$1991
For 96"W Table Tops	2	HTLR96	106	33.3	\$1646	\$1716
For 84"W Table Tops	2	HTLR84	106	33.3	\$1646	\$1716
For 72" Adder Section	1	HTLRM	66	17.4	\$1081	\$1116
Laminate Seated-Height Cylinder Base with Wire Management for Tops 84" or Wider						
For 240"W Table Tops	3	HTLRC240	191	51.9	\$4107	\$4242
For 216"W Table Tops	3	HTLRC216	189	51.7	\$4022	\$4157
For 192"W Table Tops	3	HTLRC192	187	51.4	\$3950	\$4085
For 180"W Table Tops	3	HTLRC180	187	51.4	\$3950	\$4085
For 168"W Table Tops	2	HTLRC168	125	34.5	\$2710	\$2800
For 144"W Table Tops	2	HTLRC144	123	34.3	\$2625	\$2715
For 120"W Table Tops	2	HTLRC120	121	34.1	\$2553	\$2643
For 108"W Table Tops	2	HTLRC108	121	34.1	\$2553	\$2643
For 96"W Table Tops	2	HTLRC96	106	33.3	\$2278	\$2368
For 84"W Table Tops	2	HTLRC84	106	33.3	\$2278	\$2368
For 72" Adder	1	HTLRM	66	17.4	\$1397	\$1442

NOTES:

- Tops and bases are sold and shipped separately.
- Bases ship with appropriate number of supports for table width. See page 92 for details.
- Standing-Height Cube Bases are 39"H.
- Laminate cube and cylinder bases for tops 108"W and greater feature dual aluminum support beams with integrated wire management.
- Cube bases feature removable door to allow access to cables and enable wire routing.
- Standing-Height Bases feature a hinged door for easy access and for cable routing through the base.

① Seated Cube Base requires 150 lbs. of sand or other ballast in each base for stability (not supplied). Standing-Height Cube Base does not require additional ballast.

② For Base and Top compatibility, see base information on pages 85-92.

HOW TO SPECIFY

Select Model Number	Select Laminate	See page 82, Laminate Group B
HTLCUBE180	LFW1	

PRESIDE[®] Metal Bases

OPEN MARKET



Icon Legend on page 17

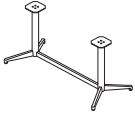

DESCRIPTION	MODEL	SHIP WEIGHT	CUBE	LIST PRICE BY PAINT GRADE		
				P1	P2	P3
Footed Y-Base for Tops 60" or Wider						
42½"H Standing Height Base for 42" and 48" x 240" Tops	HT42FB48240	88	10.8	\$2697	\$2947	\$3073
42½"H Standing Height Base for 42" and 48" x 216" Tops	HT42FB48216	85	10.4	\$2578	\$2818	\$2938
42½"H Standing Height Base for 42" and 48" x 192" Tops	HT42FB48192	82	10.1	\$2484	\$2715	\$2830
42½"H Standing Height Base for 42" and 48" x 180" Tops	HT42FB48180	82	10.1	\$2484	\$2715	\$2830
42½"H Standing Height Base for 42" and 48" x 168" Tops	HT42FB48168	67	9.3	\$1907	\$2084	\$2173
36½"H Counter Height Base for 42" and 48" x 240" Tops						
36½"H Counter Height Base for 42" and 48" x 216" Tops	HT36FB48240	86	10.8	\$2633	\$2879	\$3001
36½"H Counter Height Base for 42" and 48" x 192" Tops	HT36FB48192	80	10.1	\$2420	\$2647	\$2758
36½"H Counter Height Base for 42" and 48" x 180" Tops	HT36FB48180	80	10.1	\$2420	\$2647	\$2758
36½"H Counter Height Base for 42" and 48" x 168" Tops	HT36FB48168	65	9.3	\$1859	\$2033	\$2119
29½"H Seated Height Base for 42" and 48" x 240" Tops						
29½"H Seated Height Base for 42" and 48" x 216" Tops	HT29FB48216	81	10.4	\$2450	\$2678	\$2794
29½"H Seated Height Base for 42" and 48" x 192" Tops	HT29FB48192	78	10.1	\$2356	\$2575	\$2686
29½"H Seated Height Base for 42" and 48" x 180" Tops	HT29FB48180	78	10.1	\$2356	\$2575	\$2686
29½"H Seated Height Base for 42" and 48" x 168" Tops	HT29FB48168	63	9.3	\$1811	\$1979	\$2065
27¼"H Working Lounge Base for 42" and 48" x 240" Tops						
27¼"H Working Lounge Base for 42" and 48" x 216" Tops	HT27FB48216	79	10.4	\$2410	\$2634	\$2746
27¼"H Working Lounge Base for 42" and 48" x 192" Tops	HT27FB48192	76	10.1	\$2316	\$2531	\$2638
27¼"H Working Lounge Base for 42" and 48" x 180" Tops	HT27FB48180	76	10.1	\$2316	\$2531	\$2638
27¼"H Working Lounge Base for 42" and 48" x 168" Tops	HT27FB48168	61	9.3	\$1781	\$1946	\$2029

NOTES:

- Tops and bases are sold and shipped separately.
- Bases ship with appropriate number of supports for table width.
- ⚠ Footed base not to be used on 54"D conference tables.
- ⚠ See pages 85-90 for top and base compatibility.
- ⚠ Footed Y-base for tops 84"W or greater feature dual aluminum support beams with integrated wire management. Footed Y-base for 60"W and 72"W tops do not include aluminum beams.

HOW TO SPECIFY

<p>Select Model Number</p> <p>HT27FB48168</p>	<p>Select Paint Color</p> <p>See page 82, Paint Group A</p> <p>T1</p>
--	--



Icon Legend on page 17

PRESIDE® Metal Bases

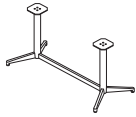

DESCRIPTION

MODEL

SHIP WEIGHT CUBE

LIST PRICE BY PAINT GRADE
P1 P2 P3

Footed Y-Base for Tops 60" or Wider

42½"H Standing Height Base for 42" and 48" x 144" Tops	HT42FB48144	64	8.9	\$1788	\$1955	\$2038
42½"H Standing Height Base for 42" and 48" x 120" Tops	HT42FB48120	61	8.7	\$1694	\$1852	\$1930
42½"H Standing Height Base for 42" and 48" x 108" Tops	HT42FB48108	61	8.7	\$1694	\$1852	\$1930
42½"H Standing Height Base for 42" and 48" x 96" Tops	HT42FB4896	37	4.9	\$1146	\$1252	\$1306
42½"H Standing Height Base for 42" x 84" Tops	HT42FB4284	36	4.8	\$1129	\$1234	\$1287
42½"H Standing Height Base for 36" x 72" Tops	HT42FB3672	27	4.2	\$1019	\$1105	\$1148
42½"H Standing Height Base for 30" x 60" Tops	HT42FB3060	25	4.2	\$893	\$976	\$1018

36½"H Counter Height Base for 42" and 48" x 144" Tops	HT36FB48144	62	8.9	\$1740	\$1904	\$1984
36½"H Counter Height Base for 42" and 48" x 120" Tops	HT36FB48120	59	8.7	\$1646	\$1801	\$1876
36½"H Counter Height Base for 42" and 48" x 108" Tops	HT36FB48108	59	8.7	\$1646	\$1801	\$1876
36½"H Counter Height Base for 42" and 48" x 96" Tops	HT36FB4896	36	4.9	\$1114	\$1218	\$1270
36½"H Counter Height Base for 42" x 84" Tops	HT36FB4284	35	4.8	\$1097	\$1200	\$1251
36½"H Counter Height Base for 36" x 72" Tops	HT36FB3672	26	4.2	\$987	\$1071	\$1112
36½"H Counter Height Base for 30" x 60" Tops	HT36FB3060	24	4.2	\$863	\$944	\$984

29½"H Seated Height Base for 42" and 48" x 144" Tops	HT29FB48144	60	8.9	\$1692	\$1850	\$1930
29½"H Seated Height Base for 42" and 48" x 120" Tops	HT29FB48120	57	8.7	\$1598	\$1747	\$1822
29½"H Seated Height Base for 42" and 48" x 108" Tops	HT29FB48108	57	8.7	\$1598	\$1747	\$1822
29½"H Seated Height Base for 42" and 48" x 96" Tops	HT29FB4896	35	4.9	\$1082	\$1182	\$1234
29½"H Seated Height Base for 42" x 84" Tops	HT29FB4284	34	4.8	\$1065	\$1164	\$1215
29½"H Seated Height Base for 36" x 72" Tops	HT29FB3672	25	4.2	\$955	\$1035	\$1076
29½"H Seated Height Base for 30" x 60" Tops	HT29FB3060	23	4.2	\$831	\$908	\$946

27¼"H Working Lounge Base for 42" and 48" x 144" Tops	HT27FB48144	58	8.9	\$1662	\$1817	\$1894
27¼"H Working Lounge Base for 42" and 48" x 120" Tops	HT27FB48120	55	8.7	\$1568	\$1714	\$1786
27¼"H Working Lounge Base for 42" and 48" x 108" Tops	HT27FB48108	55	8.7	\$1568	\$1714	\$1786
27¼"H Working Lounge Base for 42" and 48" x 96" Tops	HT27FB4896	34	4.9	\$1062	\$1160	\$1210
27¼"H Working Lounge Base for 42" x 84" Tops	HT27FB4284	33	4.8	\$1045	\$1142	\$1191
27¼"H Working Lounge Base for 36" x 72" Tops	HT27FB3672	24	4.2	\$935	\$1013	\$1052
27¼"H Working Lounge Base for 30" x 60" Tops	HT27FB3060	22	4.2	\$809	\$884	\$922

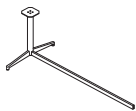

Footed Base Adder for 72"W or Wider Tops

42"H	HT42FBM	40	4.9	\$1820	\$1940	\$2000
36"H	HT36FBM	39	4.9	\$1772	\$1890	\$1948
29"H	HT29FBM	38	4.9	\$1724	\$1838	\$1896
27"H	HT27FBM	37	4.9	\$1694	\$1806	\$1862



Wire Manager

Manager for 42"H Footed Base — 1-Pack	HTFWMGR42	2	0.3	\$157	\$172	\$179
Manager for 36"H Footed Base — 1-Pack	HTFWMGR36	1	0.3	\$148	\$162	\$169
Manager for 29"H Footed Base — 1-Pack	HTFWMGR29	1	0.4	\$140	\$153	\$160
Manager for 27"H Footed Base — 1-Pack	HTFWMGR27	1	0.4	\$131	\$143	\$149

NOTES:

- Tops and bases are sold and shipped separately.
- Bases ship with appropriate number of supports for table width.
- To conceal any power cords from table top to floor, specify wire manager based on table height. Wire manager adheres to the vertical column of the base.
- ❗ Footed base not to be used on 54"D conference tables.
- ❗ See pages 85-90 for top and base compatibility.
- ❗ Footed Y-base for tops 84"W or greater feature dual aluminum support beams with integrated wire management. Footed Y-base for 60"W and 72"W tops do not include aluminum beams.

HOW TO SPECIFY

<p>Select Model Number</p> <p>HT29FB48144</p>	<p>Select Paint Color</p> <p>See page 82, Paint Group A</p> <p>T1</p>
--	--

PRESIDE® Metal Bases

GSA SIN 33721 EXCEPT AS NOTED



Icon Legend on page 17

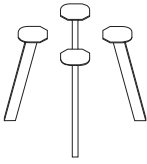

OPEN MARKET

DESCRIPTION	MODEL	SHIP		LIST PRICE BY PAINT GRADE		
		WEIGHT	CUBE	P1	P2	P3
Angled Leg						
42½" H Standing Height Base for Round, Square, and Soft Square Tops	HT42ALEG	32	2.6	\$1726	\$1886	\$1966
29½" H Seated Height Base for Round, Square, and Soft Square Tops	HT29ALEG	25	2.6	\$1404	\$1534	\$1600
42½" H Standing Height Base for 96" W Tops	HT42AL96	32	2.6	\$2589	\$2829	\$2949
42½" H Standing Height Base for 84" W Tops	HT42AL84	41	3.1	\$1929	\$2108	\$2198
42½" H Standing Height Base for 72" W Tops	HT42AL72	32	2.6	\$1726	\$1886	\$1966
42½" H Standing Height Base for 60" W Tops	HT42AL60	32	2.6	\$1726	\$1886	\$1966
29½" H Seated Height Base for 240" W Tops	HT29AL240	57	4.5	\$3498	\$3823	\$3987
29½" H Seated Height Base for 216" W Tops	HT29AL216	55	4.2	\$3413	\$3730	\$3890
29½" H Seated Height Base for 192" W Tops	HT29AL192	53	4.0	\$3341	\$3651	\$3808
29½" H Seated Height Base for 180" W Tops	HT29AL180	53	4.0	\$3341	\$3651	\$3808
29½" H Seated Height Base for 168" W Tops	HT29AL168	44	3.8	\$2538	\$2774	\$2893
29½" H Seated Height Base for 144" W Tops	HT29AL144	42	3.5	\$2453	\$2681	\$2796
29½" H Seated Height Base for 120" W Tops	HT29AL120	40	3.3	\$2381	\$2602	\$2714
29½" H Seated Height Base for 108" W Tops	HT29AL108	40	3.3	\$2381	\$2602	\$2714
29½" H Seated Height Base for 96" W Tops	HT29AL96	37	3.3	\$1609	\$1756	\$1831
29½" H Seated Height Base for 84" W Tops	HT29AL84	34	3.1	\$1607	\$1756	\$1832
29½" H Seated Height Base for 72" W Tops	HT29AL72	25	2.6	\$1404	\$1534	\$1600
29½" H Seated Height Base for 60" W Tops	HT29AL60	25	2.6	\$1404	\$1534	\$1600
29½" H Seated Height Base for 72" W Adder	HT29ALM	38	3.3	\$960	\$1049	\$1094

Wire Manager

Angled Leg Wire Manager for 42½" H Leg
 Angled Leg Wire Manager for 29½" H Leg

HTALWMGR42
 HTALWMGR29

3 4.0
 2 4.0

\$104 \$114 \$119
 \$82 \$90 \$94

OPEN MARKET

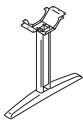

DESCRIPTION	LEGS INCLUDED PER KIT	MODEL	SHIP		LIST PRICE BY PAINT GRADE		
			WEIGHT	CUBE	P1	P2	P3
Aluminum T-Leg for Tops 60" or Wider							
For 240" W Table Tops	4	HTTLEG240	76	8.9	\$2042	\$2082	\$2102
For 216" W Table Tops	3	HTTLEG216	65	8.6	\$1632	\$1672	\$1692
For 192" W Table Tops	3	HTTLEG192	63	8.4	\$1560	\$1600	\$1620
For 180" W Table Tops	3	HTTLEG180	63	8.4	\$1560	\$1600	\$1620
For 168" W Table Tops	3	HTTLEG168	54	8.2	\$1459	\$1499	\$1519
For 144" W Table Tops	2	HTTLEG144	39	4.5	\$1023	\$1043	\$1053
For 120" W Table Tops	2	HTTLEG120	37	4.3	\$951	\$971	\$981
For 108" W Table Tops	2	HTTLEG108	37	4.2	\$951	\$971	\$981
For 96" W Table Tops	2	HTTLEG96	31	4.0	\$879	\$899	\$909
For 84" W Table Tops	2	HTTLEG84	31	4.0	\$879	\$899	\$909
For 72" W Table Tops	2	HTTLEG72	26	3.5	\$676	\$696	\$706
For 60" W Table Tops	2	HTTLEG60	22	3.5	\$676	\$696	\$706
For 72" Adder Section	1	HTTLEGM	26	4.2	\$609	N/A	N/A

NOTES:

- Tops and bases are sold and shipped separately.
- Bases ship with appropriate number of supports for table width.
- To conceal any power cords from table top to floor, specify wire manager based on table height. Angled leg wire manager is friction fit with magnets to hold in place.
- ❗ Aluminum T-legs for tops 84" and greater feature dual aluminum support beams with integrated wire management. Aluminum T-legs for 60" and 72" tops do not include aluminum beams.
- ❗ Footed base not to be used on 54"D conference tables.
- ❗ See pages 85-90 for top and base compatibility.

HOW TO SPECIFY

Select Model Number	Select Paint Color
HT42ALEG	See page 82, Paint Group A
PR6	



PRESIDE® Laminate Bases

	DESCRIPTION	BASES INCLUDED		SHIP WEIGHT	CUBE	LIST PRICE BY LAMINATE GRADE	
		PER KIT	MODEL			L1	L2
	Laminate Cube Base for Round, Square, and Soft Square Tops						
	For 60" Round and all 48" Tops, Seated-Height	1	HTLCUBE48	82	9.1	\$1070	\$1115
	For 60" Round and all 48" Tops, Standing-Height	1	HTLCUBES48	90	14.6	\$1342	\$1397
 Used with 36" and 42" table tops Used with 48" table tops	Laminate Cylinder Base for Round, Square, and Soft Square Tops						
	For 48" Tops	1	HTLR48	53	16.7	\$823	\$858
	For 42" Tops	1	HTLR42	42	11.6	\$743	\$778
	For 36" Tops	1	HTLR36	42	11.6	\$743	\$778
	For 48" Tops, with Wire Management	1	HTLRC48	53	16.7	\$1139	\$1184
	Laminate Panel X-Base	1	HTLXP48	54	5.2	\$478	\$498
		1	HTLXP42	54	5.2	\$478	\$498
		1	HTLXP36	47	4.7	\$445	\$465

NOTES: Can be used with 36", 42" and 48" Round and Soft Square Tops, and 36" and 42" Square Tops.

⚠ Not compatible with cutouts or power ports.

NOTES:

- Tops and bases are sold and shipped separately.
- Cube Base features removable door for wire management.
- ⚠ Cube Base requires 150 lbs. of sand or other ballast in each base for stability (not supplied).
- ⚠ See pages 85-90 for top and base compatibility.

HOW TO SPECIFY

<p>Select Model Number</p> <p>HTLCUBE48</p>	<p>Select Laminate</p> <p>See page 82, Laminate Group B</p> <p>D</p>
--	---

PRESIDE® Metal Bases

GSA SIN 33721 EXCEPT AS NOTED



Icon Legend on page 17



DESCRIPTION

Aluminum X-Leg Base for 36", 42", and 48" Round, Square, and Soft Square Tops

MODEL

HTXLEG

SHIP WEIGHT

16

CUBE

3.5

LIST PRICE

\$536

P2 LIST PRICE

\$556



Standing-Height Aluminum X-Leg Base for 36" and 42" Round, Square, and Soft Square Tops

HTXLEGSH

17

3.5

\$669

\$689



OPEN MARKET

DESCRIPTION

Footed Café X-Base

42½"H Standing Height X-Base for 48" Tops
 42½"H Standing Height X-Base for 36" and 42" Tops
 42½"H Standing Height X-Base for 30" Tops
 36½"H Counter Height X-Base for 48" Tops
 36½"H Counter Height X-Base for 36" and 42" Tops
 36½"H Counter Height X-Base for 30" Tops
 29½"H Seated Height X-Base for 48" and 60" Tops
 29½"H Seated Height X-Base for 36" and 42" Tops
 29½"H Seated Height X-Base for 30" Tops
 29½"H Seated Height X-Base for 24" Tops
 27¼"H Working Lounge X-Base for 48" and 60" Tops
 27¼"H Working Lounge X-Base for 36" and 42" Tops
 27¼"H Working Lounge X-Base for 30" Tops
 27¼"H Working Lounge X-Base for 24" Tops

MODEL

HTFXL42
 HTFXM42
 HTFXS42
 HTFXL36
 HTFXM36
 HTFXS36
 HTFXL29
 HTFXM29
 HTFXS29
 HTFXT29
 HTFXL27
 HTFXM27
 HTFXS27
 HTFXT27

SHIP WEIGHT

32
 31
 30
 31
 30
 29
 30
 29
 28
 27
 29
 28
 27
 26

CUBE

3.7
 3.7
 3.7
 3.7
 3.7
 3.7
 3.7
 3.7
 3.7
 3.7
 3.7
 3.7
 3.7
 3.7

LIST PRICE BY PAINT GRADE

P1	P2	P3
\$740	\$809	\$843
\$676	\$739	\$770
\$579	\$633	\$660
\$692	\$756	\$788
\$625	\$683	\$712
\$541	\$591	\$616
\$616	\$673	\$702
\$568	\$621	\$647
\$503	\$550	\$573
\$460	\$503	\$524
\$563	\$615	\$641
\$513	\$561	\$585
\$455	\$497	\$518
\$432	\$472	\$492

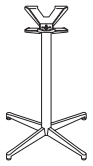

OPEN MARKET

Footed Café X-Base w/Power

42½"H Standing Height X-Base for 48" Tops
 42½"H Standing Height X-Base for 36" and 42" Tops
 42½"H Standing Height X-Base for 30" Tops
 36½"H Counter Height X-Base for 48" Tops
 36½"H Counter Height X-Base for 36" and 42" Tops
 36½"H Counter Height X-Base for 30" Tops
 29½"H Seated Height X-Base for 48" and 60" Tops
 29½"H Seated Height X-Base for 36" and 42" Tops
 29½"H Seated Height X-Base for 30" Tops
 29½"H Seated Height X-Base for 24" Tops
 27¼"H Working Lounge X-Base for 48" and 60" Tops
 27¼"H Working Lounge X-Base for 36" and 42" Tops
 27¼"H Working Lounge X-Base for 30" Tops
 27¼"H Working Lounge X-Base for 24" Tops

HTFXL42P
 HTFXM42P
 HTFXS42P
 HTFXL36P
 HTFXM36P
 HTFXS36P
 HTFXL29P
 HTFXM29P
 HTFXS29P
 HTFXT29P
 HTFXL27P
 HTFXM27P
 HTFXS27P
 HTFXT27P

32
 31
 30
 31
 31
 29
 30
 29
 28
 27
 29
 28
 27
 26

3.7
 3.7
 3.7
 3.7
 3.7
 3.7
 3.7
 3.7
 3.7
 3.7
 3.7
 3.7
 3.7
 3.7

P1	P2	P3
\$740	\$809	\$843
\$676	\$739	\$770
\$579	\$633	\$660
\$692	\$756	\$788
\$625	\$683	\$712
\$541	\$591	\$616
\$616	\$673	\$702
\$568	\$621	\$647
\$503	\$550	\$573
\$460	\$503	\$524
\$563	\$615	\$641
\$513	\$561	\$585
\$455	\$497	\$518
\$432	\$472	\$492



OPEN MARKET

Footed Café X-Base w/Casters

42½"H Standing Height X-Base for 48" Tops
 42½"H Standing Height X-Base for 36" and 42" Tops
 36½"H Counter Height X-Base for 48" Tops
 36½"H Counter Height X-Base for 36" and 42" Tops
 29½"H Seated Height X-Base for 48" Tops
 29½"H Seated Height X-Base for 36" and 42" Tops
 27¼"H Working Lounge X-Base for 48" Tops
 27¼"H Working Lounge X-Base for 36" and 42" Tops

HTFXL42C
 HTFXM42C
 HTFXL36C
 HTFXM36C
 HTFXL29C
 HTFXM29C
 HTFXL27C
 HTFXM27C

32
 31
 31
 30
 30
 29
 29
 28

3.7
 3.7
 3.7
 3.7
 3.7
 3.7
 3.7
 3.7

P1	P2	P3
\$767	\$838	\$874
\$702	\$767	\$800
\$719	\$786	\$819
\$652	\$713	\$743
\$643	\$703	\$733
\$594	\$649	\$677
\$589	\$644	\$671
\$541	\$591	\$616

NOTES:

- Tops and bases are sold and shipped separately.
- HTXLEG and HTXLEGSH allow wires to pass through the center of the leg.
- Grommet cutouts not compatible with Footed Café X-Base and Footed Café X-Base with Casters.
- ! Footed Café X-Base with Power allows wires to pass through the center of the leg except when using HTPWRGROM2.
- ! Cannot specify grommet cutouts in top when using footed X-base and footed X-base with casters. Utilize footed X-base with power for situations where power/grommet cutouts are needed.
- ! See pages 85-90 for top and base compatibility.

HOW TO SPECIFY

<p>Select Model Number</p> <p>HTFXL42</p>	<p>Select Paint Color</p> <p>See page 82, Paint Group A</p> <p>PJW</p>
---	--



Icon Legend on page 17

PRESIDE® Collaborative Tables

	DESCRIPTION	MODEL	SHIP WEIGHT	CUBE	LIST PRICE BY LAMINATE GRADE	
					L1	L2
	Seated-Height, Collaborative Table with Partial Modesty Panel					
	60"W x 42"D	HTLC4260LCTP	152	2.8	\$1246	\$1268
	72"W x 42"D	HTLC4272LCTP	167	14.5	\$1483	\$1513
	96"W x 42"D	HTLC4296LCTP	122	18.3	\$1827	\$1857
	Standing-Height, Collaborative Table with Partial Modesty Panel					
	60"W x 42"D	HTLC4260HCTP	187	3.7	\$1424	\$1446
	72"W x 42"D	HTLC4272HCTP	187	15.7	\$1661	\$1691
	96"W x 42"D	HTLC4296HCTP	242	19.4	\$2005	\$2035
	Seated-Height, Collaborative Table with Full Modesty Panel					
	60"W x 42"D	HTLC4260LCTFP	167	13.4	\$1246	\$1268
	72"W x 42"D	HTLC4272LCTFP	175	14.9	\$1483	\$1513
	96"W x 42"D	HTLC4296LCTFP	233	18.8	\$1827	\$1857
	Standing-Height, Collaborative Table with Full Modesty Panel					
	60"W x 42"D	HTLC4260HCTFP	202	17.0	\$1424	\$1446
	72"W x 42"D	HTLC4272HCTFP	211	17.9	\$1661	\$1691
	96"W x 42"D	HTLC4296HCTFP	275	22.4	\$2005	\$2035
	Seated-Height, Collaborative Table with Power Management, No Modesty Panel					
	60"W x 42"D	HTLC4260LCTHP	153	10.8	\$1546	\$1568
	72"W x 42"D	HTLC4272LCTHP	196	13.6	\$1781	\$1811
	96"W x 42"D	HTLC4296LCTHP	244	16.0	\$2124	\$2154
NOTES: Wire management available underneath top and through the base. Bases include a removable door to access cords at any time.						
	Standing-Height, Collaborative Table with Power Management, No Modesty Panel					
	60"W x 42"D	HTLC4260HCTHP	173	12.0	\$1898	\$1920
	72"W x 42"D	HTLC4272HCTHP	236	15.8	\$2133	\$2163
	96"W x 42"D	HTLC4296HCTHP	284	18.3	\$2476	\$2506
NOTES: Wire management available underneath top and through the base. Bases include a removable door to access cords at any time.						

NOTES:

- Tops feature 2mm flat edge.
- Partial modesty models will feature different modesty heights than units produced on or before March 16, 2020.
- ! Tables with partial and full modesty panels always feature cutout in modesty panel to accommodate grommet inserts in the top. However, top cutout is optional. Wire management is not included in legs.
- ! Collaborative Tables with power management will not have modesty panels.

HOW TO SPECIFY

<p>Select Model Number</p> <p>HTLC4272LCTP</p>	<p>Select Cutout Option</p> <p>N No Cutout G1 Cutout for Pop-up Port (\$40 upcharge) G2 Cutout for Flip-top Port (\$50 upcharge)</p> <p>N</p>	<p>Select Top Laminate Color</p> <p>See page 82, Laminate Group A</p> <p>H</p>	<p>Select Base Laminate Color</p> <p>See page 82, Laminate Group B</p> <p>H</p>	<p>Select Modesty Laminate Color</p> <p>See page 82, Laminate Group B</p> <p><i>Do not specify for Power Management models</i></p> <p>LDW1</p>	<p>Select 2mm Edge Color</p> <p>See page 83</p> <p>H</p>
---	---	---	--	---	---

PRESIDE® Ganging Tables

OPEN MARKET



Icon Legend on page 17

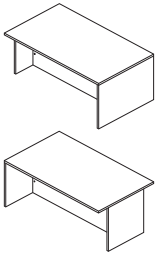
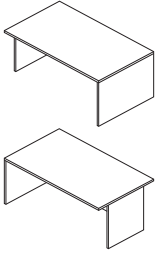

DESCRIPTION	MODEL	SHIP WEIGHT	CUBE	LIST PRICE BY LAMINATE GRADE	
				L1	L2
Seated-Height, Partial Modesty — Full Right Leg					
60"W x 42"D	HTLC4260LCTPR	165	13.8	\$1254	\$1276
72"W x 42"D	HTLC4272LCTPR	170	14.2	\$1491	\$1521
96"W x 42"D	HTLC4296LCTPR	223	38.9	\$1835	\$1878
Seated-Height, Partial Modesty — Full Left Leg					
60"W x 42"D	HTLC4260LCTPL	165	13.8	\$1254	\$1276
72"W x 42"D	HTLC4272LCTPL	170	14.2	\$1491	\$1521
96"W x 42"D	HTLC4296LCTPL	223	38.9	\$1835	\$1878
Standing-Height, Partial Modesty — Full Right Leg					
60"W x 42"D	HTLC4260HCTPR	207	16.2	\$1432	\$1454
72"W x 42"D	HTLC4272HCTPR	216	16.9	\$1669	\$1699
96"W x 42"D	HTLC4296HCTPR	274	41.6	\$2013	\$2056
Standing-Height, Partial Modesty — Full Left Leg					
60"W x 42"D	HTLC4260HCTPL	207	16.2	\$1432	\$1454
72"W x 42"D	HTLC4272HCTPL	216	16.9	\$1669	\$1699
96"W x 42"D	HTLC4296HCTPL	274	41.6	\$2013	\$2056
Seated-Height, Full Modesty — Full Right Leg					
60"W x 42"D	HTLC4260LCTFPR	180	14.2	\$1254	\$1276
72"W x 42"D	HTLC4272LCTFPR	188	14.2	\$1491	\$1521
96"W x 42"D	HTLC4296LCTFPR	247	39.3	\$1835	\$1878
Seated-Height, Full Modesty — Full Left Leg					
60"W x 42"D	HTLC4260LCTFPL	180	14.2	\$1254	\$1276
72"W x 42"D	HTLC4272LCTFPL	188	14.2	\$1491	\$1521
96"W x 42"D	HTLC4296LCTFPL	247	39.3	\$1835	\$1878
Standing-Height, Full Modesty — Full Right Leg					
60"W x 42"D	HTLC4260HCTFPR	223	18.0	\$1432	\$1454
72"W x 42"D	HTLC4272HCTFPR	234	18.9	\$1669	\$1699
96"W x 42"D	HTLC4296HCTFPR	299	44.7	\$2013	\$2056
Standing-Height, Full Modesty — Full Left Leg					
60"W x 42"D	HTLC4260HCTFPL	223	18.0	\$1432	\$1454
72"W x 42"D	HTLC4272HCTFPL	234	18.9	\$1669	\$1699
96"W x 42"D	HTLC4296HCTFPL	299	44.7	\$2013	\$2056

NOTES:

- Maximum of 2 ganging tables can be used together. However, different widths may be combined to optimize your space (i.e., 60"W left-hand and 96"W right-hand can be combined).
- Ganging tables ship with all required hardware and light gap filler strip for use between the two partial legs.
- Tops feature 2mm flat edge.

! Tables with partial and full modesty panels always feature cutout in modesty panel to accommodate grommet inserts in the top. However, top cutout is optional. Wire management is not included in legs.

HOW TO SPECIFY

<p>Select Model Number</p>	<p>Select Grommet Cutout</p> <p>N No Grommet G1 G1 Grommet (centered, + \$40 upcharge) G2 G2 Grommet (centered, + \$50 upcharge)</p>	<p>Select Top Laminate Color</p> <p>See page 82, Laminate Group A</p>	<p>Select Base Laminate Color</p> <p>See page 82, Laminate Group B</p>	<p>Select Modesty Laminate Color</p> <p>See page 82, Laminate Group B <i>Do not specify for Power Management models</i></p>	<p>Select 2mm Edge Color</p> <p>See page 83</p>
HTLC4260LCTPR	G1	LSA1	H	LSA1	H



PRESIDE® Collaborative Tables

	DESCRIPTION	MODEL	SHIP WEIGHT	CUBE	LIST PRICE BY LAMINATE GRADE	
					L1	L2
	Seated-Height, Collaborative Table with Partial Modesty Panel					
	60"W x 30"D	HTLC3060LCTP	136	11.1	\$1055	\$1074
	72"W x 30"D	HTLC3072LCTP	150	12.6	\$1274	\$1300
	96"W x 30"D	HTLC3096LCTP	184	15.7	\$1583	\$1620
	Standing-Height, Collaborative Table with Partial Modesty Panel					
	60"W x 30"D	HTLC3060HCTP	174	13.1	\$1207	\$1226
	72"W x 30"D	HTLC3072HCTP	192	14.8	\$1426	\$1452
	96"W x 30"D	HTLC3096HCTP	232	18.0	\$1735	\$1772
	Seated-Height, Collaborative Table with Full Modesty Panel					
	60"W x 30"D	HTLC3060LCTFP	151	11.5	\$1055	\$1074
	72"W x 30"D	HTLC3072LCTFP	168	13.1	\$1274	\$1300
	96"W x 30"D	HTLC3096LCTFP	208	16.1	\$1583	\$1620
	Standing-Height, Collaborative Table with Full Modesty Panel					
	60"W x 30"D	HTLC3060HCTFP	190	14.8	\$1207	\$1226
	72"W x 30"D	HTLC3072HCTFP	210	16.9	\$1426	\$1452
	96"W x 30"D	HTLC3096HCTFP	256	21.1	\$1735	\$1772
	Seated-Height, Collaborative Table with Power Management, No Modesty Panel					
	60"W x 30"D	HTLC3060LCTHP	133	8.3	\$1312	\$1331
	72"W x 30"D	HTLC3072LCTHP	135	9.1	\$1529	\$1555
	96"W x 30"D	HTLC3096LCTHP	164	11.3	\$1837	\$1874
NOTES: Wire management available underneath top and through the base. Bases include a removable door to access cords at any time.						
	Standing-Height, Collaborative Table with Power Management, No Modesty Panel					
	60"W x 30"D	HTLC3060HCTHP	156	9.8	\$1616	\$1653
	72"W x 30"D	HTLC3072HCTHP	158	10.5	\$1833	\$1859
	96"W x 30"D	HTLC3096HCTHP	187	12.8	\$2141	\$2178
NOTES: Wire management available underneath top and through the base. Bases include a removable door to access cords at any time.						

NOTES:

- Tops feature 2mm flat edge.
- ! Tables with partial and full modesty panels always feature cutout in modesty panel to accommodate grommet inserts in the top. However, top cutout is optional. Wire management is not included in legs.
- ! Collaborative Tables with power management will not have modesty panels.

HOW TO SPECIFY

<p>Select Model Number</p> <p>HTLC3060LCTP .</p>	<p>Select Cutout Option</p> <p>N No Cutout G1 Cutout for Pop-up Port (\$40 upcharge) G2 Cutout for Flip-top Port (\$50 upcharge)</p> <p>N .</p>	<p>Select Top Laminate Color</p> <p>See page 82, Laminate Group A</p> <p>H .</p>	<p>Select Base Laminate Color</p> <p>See page 82, Laminate Group B</p> <p>H .</p>	<p>Select Modesty Laminate Color</p> <p>See page 82, Laminate Group B</p> <p><i>Do not specify for Power Management models</i></p> <p>LDW1 .</p>	<p>Select 2mm Edge Color</p> <p>See page 83</p> <p>H</p>
---	---	---	--	---	---

PRESIDE® Ganging Tables

OPEN MARKET



Icon Legend on page 17

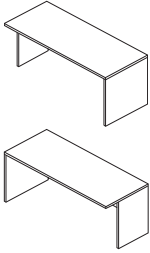

DESCRIPTION	MODEL	SHIP WEIGHT	CUBE	LIST PRICE BY LAMINATE GRADE	
				L1	L2
Seated-Height, Partial Modesty — Full Right Leg					
60"W x 30"D	HTLC3060LCTPR	128	11.1	\$1055	\$1074
72"W x 30"D	HTLC3072LCTPR	175	12.6	\$1274	\$1300
96"W x 30"D	HTLC3096LCTPR	286	15.7	\$1583	\$1620
Seated-Height, Partial Modesty — Full Left Leg					
60"W x 30"D	HTLC3060LCTPL	128	11.1	\$1055	\$1074
72"W x 30"D	HTLC3072LCTPL	175	12.6	\$1274	\$1300
96"W x 30"D	HTLC3096LCTPL	286	15.7	\$1583	\$1620
Standing-Height, Partial Modesty — Full Right Leg					
60"W x 30"D	HTLC3060HCTPR	163	13.1	\$1207	\$1226
72"W x 30"D	HTLC3072HCTPR	180	14.8	\$1426	\$1452
96"W x 30"D	HTLC3096HCTPR	220	18.0	\$1735	\$1772
Standing-Height, Partial Modesty — Full Left Leg					
60"W x 30"D	HTLC3060HCTPL	163	13.1	\$1207	\$1226
72"W x 30"D	HTLC3072HCTPL	180	14.8	\$1426	\$1452
96"W x 30"D	HTLC3096HCTPL	220	18.0	\$1735	\$1772

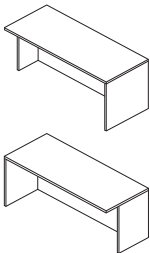

Seated-Height, Full Modesty — Full Right Leg					
60"W x 30"D	HTLC3060LCTFPR	143	11.5	\$1055	\$1074
72"W x 30"D	HTLC3072LCTFPR	160	13.1	\$1274	\$1300
96"W x 30"D	HTLC3096LCTFPR	200	16.1	\$1583	\$1620
Seated-Height, Full Modesty — Full Left Leg					
60"W x 30"D	HTLC3060LCTFPL	143	11.5	\$1055	\$1074
72"W x 30"D	HTLC3072LCTFPL	160	13.1	\$1274	\$1300
96"W x 30"D	HTLC3096LCTFPL	200	16.1	\$1583	\$1620
Standing-Height, Full Modesty — Full Right Leg					
60"W x 30"D	HTLC3060HCTFPR	178	14.8	\$1207	\$1226
72"W x 30"D	HTLC3072HCTFPR	199	16.9	\$1426	\$1452
96"W x 30"D	HTLC3096HCTFPR	245	21.1	\$1735	\$1772
Standing-Height, Full Modesty — Full Left Leg					
60"W x 30"D	HTLC3060HCTFPL	178	14.8	\$1207	\$1226
72"W x 30"D	HTLC3072HCTFPL	199	16.9	\$1426	\$1452
96"W x 30"D	HTLC3096HCTFPL	245	21.1	\$1735	\$1772

NOTES:

- Maximum of 2 ganging tables can be used together. However, different widths may be combined to optimize your space (i.e., 60"W left-hand and 96"W right-hand can be combined).
- Ganging tables ship with all required hardware and light gap filler strip for use between the two partial legs.
- Tops feature 2mm flat edge.
- ⚠ Tables with partial and full modesty panels always feature cutout in modesty panel to accommodate grommet inserts in the top. However, top cutout is optional. Wire management is not included in legs.
- ⚠ Collaborative Tables with power management will not have modesty panels.

HOW TO SPECIFY

<p>Select Model Number</p> <p>HTLC3060LCTPR</p>	<p>Select Grommet Cutout</p> <p>N No Grommet G1 G1 Grommet (centered, + \$40 upcharge) G2 G2 Grommet (centered, + \$50 upcharge)</p> <p>G1</p>	<p>Select Top Laminate Color</p> <p>See page 82, Laminate Group A</p> <p>LSA1</p>	<p>Select Base Laminate Color</p> <p>See page 82, Laminate Group B</p> <p>H</p>	<p>Select Modesty Laminate Color</p> <p>See page 82, Laminate Group B</p> <p>LSA1</p>	<p>Select 2mm Edge Color</p> <p>See page 83</p> <p>H</p>
--	---	--	--	--	---

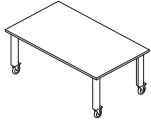

DESCRIPTION	MODEL	SHIP WEIGHT	CUBE	LIST PRICE BY LAMINATE GRADE	
				L1	L2
Mobile Collaborative Tables					
42" x 96" Seated	HTMC304296	205	16.5	\$2339	\$2382
42" x 72" Seated	HTMC304272	167	13.4	\$2050	\$2087
42" x 60" Seated	HTMC304260	147	12.1	\$1783	\$1811
Mobile Collaborative Tables with Butcher Block Top					
42" x 96" Standing	HTMC424296	219	17.8	\$2417	\$2460
42" x 72" Standing	HTMC424272	181	14.6	\$2128	\$2165
42" x 60" Standing	HTMC424260	161	13.3	\$1861	\$1889

DESCRIPTION	MODEL	SHIP WEIGHT	CUBE	BUTCHER BLOCK
42" x 96" Seated	HTMC304296BB	206	9.6	\$3507
42" x 72" Seated	HTMC304272BB	191	7.6	\$3006
42" x 60" Seated	HTMC304260BB	167	7.1	\$2637
42" x 96" Standing	HTMC424296BB	220	10.9	\$3585
42" x 72" Standing	HTMC424272BB	205	8.9	\$3084
42" x 60" Standing	HTMC424260BB	181	8.5	\$2715

NOTES:

- Mobile collaborative tables standard with 4 locking 5" casters.
- Laminate tops feature 2mm flat edge.
- Butcher block top is 1½" thick and features 1½" radius corners.
- Butcher block tops will naturally feature variation between tops due to the nature of the real wood finish. Constructed of natural Birch wood, no two tops are exactly alike. Top is coated in a clear polyurethane finish for maximum durability.

HOW TO SPECIFY

Select Model Number	Select Grommet Cutout N No Grommet	Select Top Laminate Color See page 82, Laminate Group A	Select Edge Color See page 83	Select Caster C With Caster	Select Paint Color See page 82
HTMC304296	N	LSA1	LSA1	C	T1

Select Model Number	Select Grommet Cutout N No Grommet	Select Wood LH903 Butcher Block	Select Caster C With Caster	Select Paint Color See page 82
HTMC304296BB	N	LH903	C	T1

PRESIDE® Team Touchdown Tables

OPEN MARKET



Icon Legend on page 17

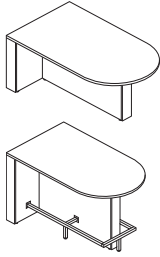

DESCRIPTION	MODEL	SHIP WEIGHT	CUBE	LIST PRICE BY LAMINATE GRADE	
				L1	L2
Team Touchdown Tables					
42" x 72" Seated Table	HTLMT4272L	202	12.5	\$1416	\$1451
42" x 60" Seated Table	HTLMT4260L	170	10.0	\$1168	\$1196
42" x 72" Standing Table	HTLMT4272H	246	14.2	\$1740	\$1775
42" x 60" Standing Table	HTLMT4260H	208	11.4	\$1442	\$1470
42" x 72" Standing Table w/ Footring	HTLMT4272HFR	272	24.5	\$2850	\$2885
42" x 60" Standing Table w/ Footring	HTLMT4260HFR	231	19.6	\$2371	\$2399
Back Panel for Seated Team Touchdown Table	HTLMTLBACK	23	3.2	\$321	\$336
Back Panel for Standing Team Touchdown Table	HTLMT HBACK	33	4.5	\$363	\$380

NOTES: Specify Laminate, see page 82, Laminate Group B.
SPECIFYING EXAMPLE: HTLMTLBACK.LSA1

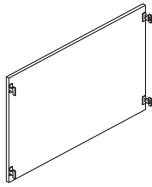

NOTES:

- Team Touchdown Tables feature open back standard. If closed back is desired, back panels must be specified separately.
- Back panel provides clearance for TV mount.
- Tops feature 2mm flat edge.

HOW TO SPECIFY

<p>Select Model Number</p> <p>HTLMT4272L</p>	<p>Select Grommet Cutout</p> <p>N No Grommet G1 G1 Grommet (centered, + \$40 upcharge) G2 G2 Grommet (centered, + \$50 upcharge)</p> <p>G1</p>	<p>Select Top Laminate Color</p> <p>See page 82, Laminate Group A</p> <p>LSA1</p>	<p>Select Edge Color</p> <p>See page 83</p> <p>LSA1</p>	<p>Select Chassis Laminate</p> <p>See page 82, Laminate Group B</p> <p>LSA1</p>	<p>Select Paint Color</p> <p><i>Footring only available on FR models in P6P only</i></p> <p>P6P</p>
---	--	--	--	--	--

DESCRIPTION	MODEL	SHIP WEIGHT	CUBE	LIST PRICE BY PAINT GRADE	
				P1	P2
TV Mount	HTLMTTV	4	1.0	\$324	\$354

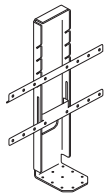

NOTES:

- TV mount is used to mount a television to the flat end of a Team Touchdown Table.
- Mounting hardware provided for television sizes 32" to 50" with VESA mounts of 100x100 to 200x200; for some televisions, additional hardware will be required (not provided).

HOW TO SPECIFY

<p>Select Model Number</p> <p>HTLMTTV</p>	<p>Select Paint Color</p> <p>P Black</p> <p>P</p>
--	---



DESCRIPTION	MODEL	SHIP WEIGHT	CUBE	LIST PRICE BY PAINT GRADE		L2 UPCHARGE
				P1	P2	
Benches						
18"D x 60"W	HTLBENCH60	23	2.3	\$1593	\$1693	\$24
18"D x 48"W	HTLBENCH48	21	1.8	\$1295	\$1375	\$20
18"D x 30"W	HTLBENCH30	18	1.8	\$945	\$1003	\$15

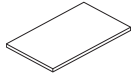

DESCRIPTION	MODEL	SHIP WEIGHT	CUBE	LIST PRICE BY FABRIC GRADE					
				1	2	3	4	5	6
Bench Cushion									
18"D x 60"W	HTLBENCHCUSH60	16	3.6	\$362	\$406	\$479	\$499	\$556	\$616
18"D x 48"W	HTLBENCHCUSH48	12	2.9	\$322	\$361	\$427	\$445	\$495	\$549
18"D x 30"W	HTLBENCHCUSH30	8	1.9	\$274	\$307	\$363	\$378	\$421	\$466

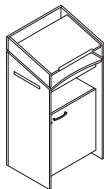

DESCRIPTION	MODEL	SHIP WEIGHT	CUBE	LIST PRICE BY LAMINATE GRADE	
				L1	L2
Laminate Lectern	HTLLECTA	132	15.6	\$1623	\$1688

- Overall cabinet dimensions 24"W x 18"D x 50"H.
- Adjustable top worksurface features 3 tilt positions.
- Top of lectern can be removed and used on table top.
- Laptop shelf slides left or right.
- Includes 2 locking and 2 non-locking casters.
- Includes adjustable shelf in storage compartment.
- Features scallops in rear of lectern to route and conceal cables and wires.
- Metal components standard in black finish.

NOTES:

- Bench features knife edge along two long sides of seat; depth edges of top features flat edge allowing benches to be placed side by side without gaps.
- Bench cushions attach to bench seat with hook and loop.
- Fabric for bench cushions is upholstered in the railroad direction.

HOW TO SPECIFY

<p>Select Model Number</p> <p>HTLBENCH48</p>	<p>Select Top Laminate Color</p> <p>See page 82, Laminate Group A</p> <p>LSA1</p>	<p>Select Edge Color</p> <p>See page 83</p> <p>SA</p>	<p>Select Paint Color</p> <p>See page 82, Paint Group A</p> <p>T1</p>
--	---	---	---

<p>Select Model Number</p> <p>HTLBENCHCUSH48</p>	<p>Select Fabric</p> <p>See page 82</p> <p>PBLE09</p>
--	---

<p>Select Model Number</p> <p>HTLLECTA</p>	<p>Select Laminate</p> <p>See page 82, Laminate Group B</p> <p>H</p>	<p>Select Pull</p> <p>J Loop Satin Nickel G Loop Black</p> <p>G</p>
--	--	---

PRESIDE® Laminate Storage

GSA SIN AS NOTED



Icon Legend on page 17

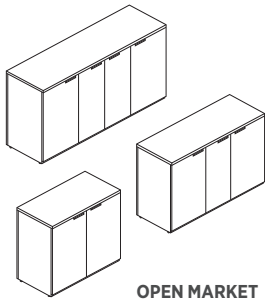

OPEN MARKET

DESCRIPTION

Hospitality Credenza
20\"/>

MODEL	SHIP WEIGHT	CUBE	LIST PRICE BY LAMINATE GRADE	
			L1	L2
HTLCRED72	301	40.0	\$3023	\$3073
HTLCRED57	250	31.8	\$2622	\$2662
HTLCRED42	200	23.7	\$2087	\$2184

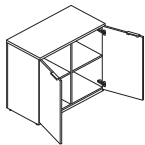

OPEN MARKET

Hospitality Credenza with Shelves

20\"/>

HTLCRED72S	311	41.5	\$3175	\$3225
HTLCRED57S	260	33.3	\$2774	\$2814
HTLCRED42S	210	25.2	\$2239	\$2336

NOTES: Hospitality credenzas with shelves ship with 2 shelves in separate cartons. Additional shelves can be ordered separately if desired.

HOW TO SPECIFY

Select Model Number	Select Top Laminate Color	Select 2mm Edge Color	Select Chassis Laminate	Select Pull	Select Back Cutout	Select Shelf Laminate
See page 82, Laminate Group A	See page 82, Laminate Group B	See page 83	See page 82, Laminate Group B	J Loop Satin Nickel G Loop Black 3 Rounded Square Matte Chrome 4 Rounded Square Black VP HLSL Voi® Pull Black VPJW HLSL Voi® Pull Designer White VT4 HLSL Voi® Pull Champagne Metallic VT1 HLSL Voi® Pull Platinum Metallic VPR6 HLSL Voi® Pull Silver VP8X HLSL Voi® Pull Solar Black	C Vent Cutout (+ \$50) N No Cutout	See page 82, Laminate Group B <i>Specify for shelf models only</i>
HTLCRED57S	LSA1	SA	LSA1	J	C	T1

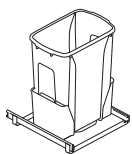

OPEN MARKET

DESCRIPTION

Trash Bin Slide
 • Holds a 35 quart bin.
 • Trash bin is included with model.
 • Can be used in outer compartments of credenza models above.

MODEL	SHIP WEIGHT	CUBE	L1 LIST PRICE	L2 UPCHARGE
HTBINSLIDE	15	3.5	\$226	N/A

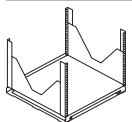

SIN 33721

Mounted AV Rack

• Can be used in outer compartments of credenza models above.

HTRACK	15	4.8	\$2049	N/A
---------------	----	-----	---------------	------------



SIN 33721

Laminate Credenza Shelf

• Shelf can be utilized in the outer compartments of the credenza.
 • 3 mounting locations within outer compartment on the credenza.
 • Mounting locations are 6\"/>

HTLSHELF	10	1.5	\$76	\$10
-----------------	----	-----	-------------	-------------

HOW TO SPECIFY

Select Model Number	Select Laminate
See page 82, Laminate Group B	
HTLSHELF	H



Icon Legend on page 17

PRESIDE® Laminate Storage

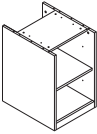
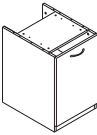
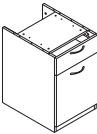
	DESCRIPTION	MODEL	SHIP WEIGHT	CUBE	LIST PRICE BY LAMINATE GRADE	
					L1	L2
 <i>Model HTLMC1828O shown</i>	Modular Pedestal, Bookshelf, No Door	HTLMC1828O	70	9.8	\$592	\$617
 <i>Model HTLMC1828L shown</i>	Modular Pedestal, Bookshelf, with Door (left)	HTLMC1828L	70	9.8	\$723	\$753
	Modular Pedestal, Bookshelf, with Door (right)	HTLMC1828R	70	9.8	\$723	\$753
 <i>Model HTLMC1828DR shown</i>	Modular Pedestal, Box Drawer, Cabinet Door (left)	HTLMC1828DL	70	9.8	\$769	\$799
	Modular Pedestal, Box Drawer, Cabinet Door (right)	HTLMC1828DR	70	9.8	\$769	\$799

NOTES:

- Use Concinnity™ laminate tops and backs with Preside® modular storage for a finished look. See page 112.

HOW TO SPECIFY

<p>Select Model Number</p> <p>HTLMC1828L</p>	<p>Select Pull Option</p> <p>J Loop Satin Handle G Loop Black 3 Rounded Square Matte Chrome 4 Rounded Square Black X No Pull (for model HTLMC1828O only)</p> <p>J</p>	<p>Select Laminate</p> <p>See page 82, Laminate Group B</p> <p>N</p>
---	--	---

MODULAR COMPONENTS

OPEN MARKET



Icon Legend on page 17

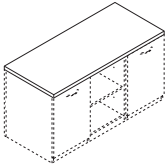

DESCRIPTION	MODEL	SHIP WEIGHT	CUBE	LIST PRICE BY LAMINATE GRADE	
				L1	L2
Concinnity™ Rectangle Worksurface with Horizontal Grain					
90"W x 24"D	HNLRC2490	75	5.5	\$572	\$602
72"W x 24"D	HNLRC2472	60	4.6	\$402	\$422
54"W x 24"D	HNLRC2454	45	3.5	\$328	\$348
36"W x 24"D Rectangle Worksurface/Pedestal Top	HNLRC2436	30	2.4	\$253	\$268

NOTES: Use Concinnity™ laminate tops and backs with Preside® modular storage for a finished look.

- ! Grain direction on all rectangle worksurfaces runs horizontal (side-to-side) except as follows: 30"W - 36"W - 42"W - 48"W - 54"W - 60"W x 24"D tops can be specified with horizontal (side-to-side) or vertical (front-to-back) grain.
- ! 42"W and 48"W x 20"D tops are available with vertical (front-to-back) grain only.

HOW TO SPECIFY

<p>Select Model Number</p> <p>H N L R C 2 4 9 0 .</p>	<p>Select Edge Profile and Edge Color</p> <p>See page 29 in the 2021 Workspaces Pricer</p> <p>B H .</p>	<p>Select Worksurface Grommet Finish</p> <p>P Black T1 Platinum X No Grommet</p> <p>P .</p>	<p>Select Worksurface Color</p> <p>See page 29 in the 2021 Workspaces Pricer</p> <p>H</p>
--	--	--	--

MODULAR COMPONENTS

Back Panels

OPEN MARKET



Icon Legend on page 17

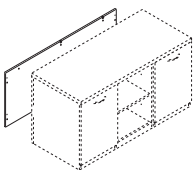

DESCRIPTION	MODEL	SHIP WEIGHT	CUBE	LIST PRICE BY LAMINATE GRADE	
				L1	L2
Concinnity™ Modesty/Back Panels — Full-Length					
90"W x 27 ⁷ / ₈ "H	HNLMP9028	58	6.7	\$459	\$484
72"W x 27 ⁷ / ₈ "H	HNLMP7228	46	5.3	\$314	\$334
54"W x 27 ⁷ / ₈ "H	HNLMP5428	34	4.0	\$258	\$278
36"W x 27 ⁷ / ₈ "H Modesty/Pedestal Back Panel	HNLMP3628	22	2.8	\$208	\$220

NOTES: Component is 3/4" thick. Provide approach-side kneespace privacy for user seated at desks, credenzas, returns, and bridges.

HOW TO SPECIFY

<p>Select Model Number</p> <p>H N L M P 7 2 2 8 .</p>	<p>Select Grommet</p> <p>P Black X No Grommet</p> <p>X .</p>	<p>Select Laminate Color</p> <p>See page 29 in the 2021 Workspaces Pricer</p> <p>H</p>
--	---	---



WALL MOUNT STORAGE

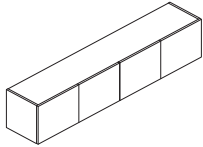

DESCRIPTION

Concinnity™ Wall Mount Storage, Laminate Doors

- 78"W x 15"D x 15"H — 4 doors, 2 compartments
- 72"W x 15"D x 15"H — 4 doors, 2 compartments
- 66"W x 15"D x 15"H — 4 doors, 2 compartments
- 60"W x 15"D x 15"H — 4 doors, 2 compartments
- 48"W x 15"D x 15"H — 3 doors, 2 compartments
- 42"W x 15"D x 15"H — 2 doors, 1 compartment
- 36"W x 15"D x 15"H — 2 doors, 1 compartment
- 30"W x 15"D x 15"H — 2 doors, 1 compartment

MODEL	SHIP WEIGHT	CUBE	L1 LIST	L2 UPCHARGES	
				CHASSIS	FRONTS
HNL1578LD	126	17.1	\$1362	\$35	\$20
HNL1572LD	118	15.9	\$1265	\$25	\$20
HNL1566LD	109	14.6	\$1206	\$25	\$20
HNL1560LD	100	13.3	\$1083	\$25	\$20
HNL1548LD	83	10.9	\$977	\$20	\$20
HNL1542LD	68	9.7	\$923	\$20	\$10
HNL1536LD	60	8.4	\$842	\$20	\$10
HNL1530LD	51	7.2	\$777	\$20	\$10

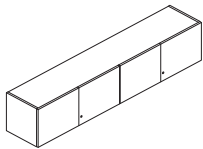

Concinnity™ Wall Mount Storage, Laminate Locking Doors

- 78"W x 15"D x 15"H — 4 doors, 2 compartments
- 72"W x 15"D x 15"H — 4 doors, 2 compartments
- 66"W x 15"D x 15"H — 4 doors, 2 compartments
- 60"W x 15"D x 15"H — 4 doors, 2 compartments
- 48"W x 15"D x 15"H — 3 doors, 2 compartments
- 42"W x 15"D x 15"H — 2 doors, 1 compartment
- 36"W x 15"D x 15"H — 2 doors, 1 compartment
- 30"W x 15"D x 15"H — 2 doors, 1 compartment

HNL1578LL	126	17.1	\$1451	\$35	\$20
HNL1572LL	118	15.9	\$1354	\$25	\$20
HNL1566LL	109	14.6	\$1295	\$25	\$20
HNL1560LL	100	13.3	\$1172	\$25	\$20
HNL1548LL	83	10.9	\$1044	\$20	\$20
HNL1542LL	68	9.7	\$967	\$20	\$10
HNL1536LL	60	8.4	\$887	\$20	\$10
HNL1530LL	51	7.2	\$822	\$20	\$10

! Lock available in Black (P) or Satin (SA) finish. Lock is core removable. Keyed alike cores must be ordered separately. For stack-on and wall mount storage with locking hinged doors, specify model HF27B (Black) or HF27S (Satin) and the key number, see the Desks section in the 2021 Workspaces Pricer. Model HNL1548LL has one lock, which secures two of the three doors.

NOTES:

- Preside® tables pair well with Concinnity™ Wall Mounted Storage to create a complete conference or collaborative layout.
- Convenient off-the-worksurface storage requires no additional floor space.
- Available with laminate doors, frosted/silver doors, or sliding door.
- Doors are sized to overlap the top, end panels and light valance, to provide a clean design.
- Laminate and frosted/silver door units are equipped with self-closing, adjustable hinges.
- Laminate hinged door units are available with or without a lock.
- For tackboards, see the Desks section in the 2021 Workspaces Pricer.
- For task lights, see the Desks section in the 2021 Workspaces Pricer.
- For paper organizers, see the Desks section in the 2021 Workspaces Pricer.
- **IMPORTANT: See installation guidelines in the Desks section in the 2021 Workspaces Pricer.**

HOW TO SPECIFY

<p>Select Model Number</p> <p>H N L 1 5 7 8 L D</p>	<p>Select Chassis Color</p> <p>See page 29 in the 2021 Workspaces Pricer</p> <p>H</p>	<p>Select Door Front Color</p> <p>See page 29 in the 2021 Workspaces Pricer</p> <p>H</p>	
<p>Select Model Number</p> <p>H N L 1 5 7 8 L L</p>	<p>Select Lock Finish</p> <p>See page 29 in the 2021 Workspaces Pricer</p> <p>P</p>	<p>Select Chassis Color</p> <p>See page 29 in the 2021 Workspaces Pricer</p> <p>H</p>	<p>Select Door Front Color</p> <p>See page 29 in the 2021 Workspaces Pricer</p> <p>H</p>

WALL MOUNT STORAGE

OPEN MARKET



Icon Legend on page 17

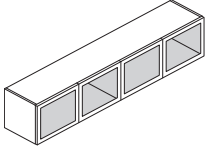

DESCRIPTION	MODEL	SHIP WEIGHT	CUBE	L1 LIST	L2 UPCHARGES	
					CHASSIS	FRONTS
Concinnity™ Wall Mount Storage, Frosted Doors with Silver Frame						
78"W x 15"D x 15"H — 4 doors, 2 compartments	HNL1578FD	106	17.1	\$2060	\$35	N/A
72"W x 15"D x 15"H — 4 doors, 2 compartments	HNL1572FD	99	15.9	\$1961	\$25	N/A
66"W x 15"D x 15"H — 4 doors, 2 compartments	HNL1566FD	92	14.6	\$1901	\$25	N/A
60"W x 15"D x 15"H — 4 doors, 2 compartments	HNL1560FD	85	13.3	\$1777	\$25	N/A
48"W x 15"D x 15"H — 3 doors, 2 compartments	HNL1548FD	71	10.9	\$1498	\$20	N/A
42"W x 15"D x 15"H — 2 doors, 1 compartment	HNL1542FD	57	9.7	\$1274	\$20	N/A
36"W x 15"D x 15"H — 2 doors, 1 compartment	HNL1536FD	50	8.4	\$1193	\$20	N/A
30"W x 15"D x 15"H — 2 doors, 1 compartment	HNL1530FD	43	7.2	\$1127	\$20	N/A

❗ Frosted door models do not have a lock option.

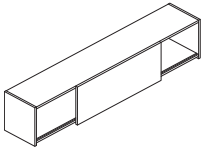

Concinnity™ Wall Mount Storage, Sliding Door						
78"W x 15"D x 15"H	HNL1578SD	114	17.1	\$1325	\$35	\$20
72"W x 15"D x 15"H	HNL1572SD	107	15.9	\$1217	\$25	\$20
66"W x 15"D x 15"H	HNL1566SD	99	14.6	\$1135	\$25	\$20
60"W x 15"D x 15"H	HNL1560SD	91	13.3	\$1031	\$25	\$20
48"W x 15"D x 15"H	HNL1548SD	76	10.9	\$965	\$20	\$20

NOTES: One door per unit. Standard with black lock, which is located on the inside vertical support panel.

NOTES:

- Preside® tables pair well with Concinnity™ Wall Mounted Storage to create a complete conference or collaborative layout.
- Convenient off-the-worksurface storage requires no additional floor space.
- Available with laminate doors, frosted/silver doors, or sliding door.
- Doors are sized to overlap the top, end panels and light valance, to provide a clean design.
- Laminate and frosted/silver door units are equipped with self-closing, adjustable hinges.
- Laminate hinged door units are available with or without a lock.
- For tackboards, see the Desks section in the 2021 Workspaces Pricer.
- For task lights, see the Desks section in the 2021 Workspaces Pricer.
- For paper organizers, see the Desks section in the 2021 Workspaces Pricer.
- **IMPORTANT: See installation guidelines in the Desks section in the 2021 Workspaces Pricer.**

HOW TO SPECIFY

<p>Select Model Number</p> <p>H N L 1 5 7 8 F D</p>	<p>Select Chassis Color</p> <p>See page 29 in the 2021 Workspaces Pricer</p> <p>H</p>	
<p>Select Model Number</p> <p>H N L 1 5 7 8 S D</p>	<p>Select Chassis Color</p> <p>See page 29 in the 2021 Workspaces Pricer</p> <p>H</p>	<p>Select Door Front Color</p> <p>See page 29 in the 2021 Workspaces Pricer</p> <p>H</p>



Icon Legend on page 17

PRESIDE® Laminate Shared Components

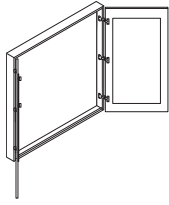

DESCRIPTION

Laminate Presentation Cabinet

- Overall cabinet dimensions 48⁷/₈"W x 5"D x 49¹/₂"H.
- Mounts to wall.
- Presentation cabinet features one magnetic white board, one tackboard and one paper pad.
- Self-adjusting hinges ensure doors are in alignment.

MODEL	SHIP WEIGHT	CUBE	LIST PRICE BY LAMINATE GRADE	
			L1	L2
HTLPRES	169	10.9	\$1777	\$1857

HOW TO SPECIFY

Select Model Number	Select Laminate
H T L P R E S .	See page 82, Laminate Group B
	D

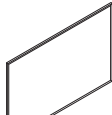
DESCRIPTION	MODEL	SHIP WEIGHT	CUBE	LIST PRICE
 <p>Markerboard</p> <ul style="list-style-type: none"> • Overall markerboard dimensions 48"W x 31"H. • Mounts on wall. Can be mounted horizontally or vertically. • Markerboard is magnetic. • No specification required. 	HLSL4831MB	44.0	3.4	\$713

OPEN MARKET

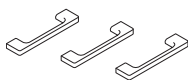
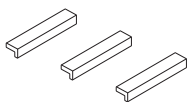

Field Installable Drawer/Door Handle Kits

Linear, Black, 1-pack	HLINEARA1	0.5	1.4	\$37
Linear, Matte Chrome, 1-pack	HLINEARC1	0.5	1.4	\$37
Linear, Black, 8-pack	HLINEARA8	0.5	1.4	\$197
Linear, Matte Chrome, 8-pack	HLINEARC8	0.5	1.4	\$197
Arch, Black, 1-pack	HARCHA1	0.5	1.4	\$37
Arch, Matte Chrome, 1-pack	HARCHC1	0.5	1.4	\$37
Arch, Black, 8-pack	HARCHA8	0.5	1.4	\$197
Arch, Matte Chrome, 8-pack	HARCHC8	0.5	1.4	\$197

HOW TO SPECIFY

Select Model Number	
H L I N E A R A 1	



Icon Legend on page 17

CABLE MANAGEMENT

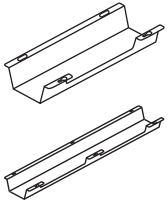
**DESCRIPTION****Cable Management Troughs**

17"W — Single

17"W — 10-Pack

36"W — Single

36"W — 10-Pack

- Cable management troughs ship flat packed.
- The troughs attach to underneath the worksurface with screws.
- Cutouts in trough allow access to power without the need to detach from surface. 17"W = 1 cutout; 36"W = 2 cutouts.
- Color: Graphite.
- Material: Metal.
- TAA Compliant.

MODEL**SHIP WEIGHT****CUBE****LIST PRICE****HCTROUGH17**

2.7

0.5

\$73**HCTROUGH1710**

14.0

0.5

\$665**HCTROUGH36**

4.9

0.9

\$122**HCTROUGH3610**

30.0

0.9

\$1121

HOW TO SPECIFY

Select
Model Number

HCTROUGH17



Icon Legend on page 17

PRESIDE® Table Power Accessories

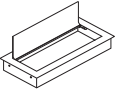
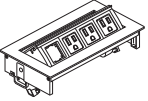
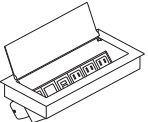
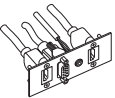
	DESCRIPTION	MODEL	SHIP WEIGHT	CUBE	LIST PRICE
	Blank G1 Cutout Insert Blank G2 Cutout Insert ! Grommets available in BLK, FOG, and SVR only.	HGROM1BLANK HGROM2BLANK	2 2	0.2 0.2	\$163 \$249
	MhoB 4" x 8" Pop-up Port • Specify G1 cutout in table top. • Pop-up Port provides three power ports and one blank data receptacle. • Sits flush with worksurface when closed. • Includes 6' cord with three-prong plug.	HTG1PWR-3P-1B	5	0.3	\$424
	ElloraB 5" x 11" Flip-top Port • Specify G2 cutout in table top. • Flip-top Port provides four power ports and two blank data receptacles. • Conceals wires and allows power cords to be plugged in while in use. • Includes 10' cord with three-prong circuit breaker plug. NOTES: Two circuit breaker plugs do not fit into one duplex.	HTG2PWR-4P-2B	5	0.3	\$626
	ElloraB 5" x 11" Flip-top Port • Specify G2 cutout in table top. • Flip-top Port provides one blank for Extron plate and three power ports. • Extron AAP plates can be integrated into grommet to support changing technology. • Conceals wires and allows power cords to be plugged in while in use. • Includes 10' cord with three-prong plug.	HTG2PWR-3P-1E	5	0.3	\$767
	ElloraB 5" x 11" Flip-top Port • Specify G2 cutout in table top. • Flip-top Port provides 3 Power, 1 USB, and 2 Blank Data Ports. • Conceals wires and allows power cords to be plugged in while in use. • Includes 10' cord with three-prong plug.	HTG2PWR-3P-2B-2U	5	0.3	\$909
	ElloraB 5" x 11" Flip-top Port • Specify G2 cutout in table top. • Flip-top Port provides 3 Power, 1 USB, and Qi wireless charging lid. • Conceals wires and allows power cords to be plugged in while in use. • Includes 10' cord with three-prong plug.	HTG2PWR-3P-1U-W	5	0.3	\$930
	Extron Plate (Double Space) — VGA, HDMI, HDMI, Audio NOTES: 1 Double Space plate can be used in a single HTG2PWR-3P-1E flip-top port. ! Extron plates can be retrofitted to be used on HTG2PWR-3P-1E.	HTPLATEVHAU	1	0.1	\$428

HOW TO SPECIFY

<p>Select Model Number</p> <p>HTG2PWR-4P-2B.</p>	<p>Select Paint Color</p> <p>FOG Fog SVR Silver BLK Black</p> <p>SVR</p>
---	--

PRESIDE® Table Power Accessories

GSA SIN 33721



Icon Legend on page 17

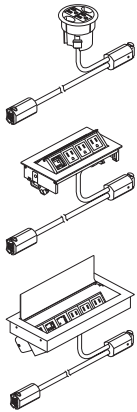

DESCRIPTION	MODEL	SHIP WEIGHT	CUBE	LIST PRICE
Interlink IQ Power Harness – 1’ Power Hub, 3” Round Grommet Mount • Available in Black finish, no specification needed.	HQH1-3	2.0	0.2	\$186
Interlink IQ Power Harness – 5’ Power Hub, 3” Round Grommet Mount • Available in Black finish, no specification needed.	HQH5-3	2.0	0.2	\$208
Interlink IQ Power Harness – 5’ with 4” x 8” Pop-Up Port (3 Power, 1 Blank) • For use with tables G1 grommet. Specify paint.	HQH5-P-3P1B	3.0	0.3	\$408
Interlink IQ Power Harness – 5’ with 5” x 11” Flip-Top Port (3 Power, 3 Blank) • For use with Preside® G2 grommet. Specify paint.	HQH5-E-3P3B	5.0	0.2	\$429
Interlink IQ Power Harness – 5’ with 5” x 11” Flip-Top Port (3 Power, 1 Extron Double Space) • For use with Preside® G2 grommet. Specify paint.	HQH5-E-3P1E	5.0	0.2	\$452
Interlink IQ Power Harness – 5’ with 5” x 11” Flip-Top Port (3 Power, 2 USB, 2 Blank) • For use with Preside® G2 grommet. Specify paint.	HQH5-E-3P1U2B	5.0	0.2	\$473

Hardwire Power System:

The hardwire power system is only needed if 6’ power cables from power ports are not long enough to reach an outlet, or if there is a need to route power below entire length of worksurface from one power in-feed. By specifying one power kit for each top section, there will be two duplex receptacles below each top section. For technical details regarding 2-circuit power system, see page 63.

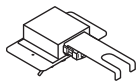

4-Trac Power Entry Plate • Connects to wall to route power to table.	HMAPLATE	1.0	0.2	\$102
--	----------	-----	-----	-------

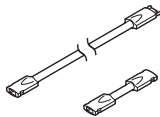

4-Trac Power Entry Cable • 6’ power entry cable with male/female adapter. • Connects table to power entry plate.	HMACABLE	1.8	0.2	\$159
---	----------	-----	-----	-------

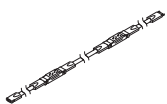

4-Trac Circuit 1 Power Kit for 60”W Top Section	HMAPOWER60	2.0	0.3	\$302
4-Trac Circuit 1 Power Kit for 72”W Top Section	HMAPOWER72	2.2	0.3	\$309
4-Trac Circuit 1 Power Kit for 84”W Top Section	HMAPOWER84	2.4	0.3	\$320
4-Trac Circuit 1 Power Kit for 96”W Top Section	HMAPOWER96	2.6	0.3	\$331

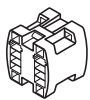

Electrical Connectors 4-Way Splitter ⚠ Available in Black (P) only. SPECIFYING EXAMPLE: HMASPLIT.P	HMASPLIT	0.9	0.1	\$55
---	----------	-----	-----	------

HOW TO SPECIFY

Select Model Number HQH5-E-3P3B	Select Paint Color FOG Fog SVR Silver BLK Black SVR
---	--

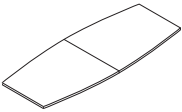
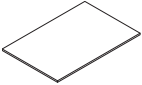
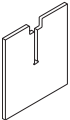

PRESIDE® Laminate Tables

	DESCRIPTION	MODEL	SHIP WEIGHT	CUBE	LIST PRICE
	Laminate Boat Shaped Table Tops with Stretcher				
	168"W x 48"D	HTLB16848P	319	11.9	\$1564
	144"W x 48"D	HTLB14448P	266	9.8	\$1242
	120"W x 48"D	HTLB12048P	217	8.2	\$1126
	Laminate Adder Section with Stretcher 72"W x 48"D	HTLM7248P	144	9.8	\$826
	Laminate Bases				
	Laminate Panel Bases, Double Pack	HTLPB	53	3.1	\$448
	Laminate Panel Bases, Single Pack	HTLPBS	28	3.1	\$271

	With Panel Base
HTLB12048P HTLB14448P	1 x HTLPB (Laminate Panel Base)
HTLB16848P	1 x HTLPB (Laminate Panel Base) 1 x HTLPBS (Laminate Panel Mid-Base)
HTLM7248P	1 x HTLPBS (Laminate Panel Mid-Base)

NOTES:

- Tops and Modesty Panels are 1/8" Melamine.
- 168"W Boat-Shaped Top needs 3 bases; 72"W Middle Adder needs 1 base. All other tops need 2 bases.
- 120", 144", and 168"W Tops ship in 2 pieces to facilitate handling and installation; these top sizes will not have an exact grain alignment where the two halves meet, a reasonable match can be expected.
- ! Tops with Stretcher and Adder Section with Stretcher available in Harvest (C) and Mahogany (N) finishes only.
- ! Tops available in Boat Shape with G edge (2mm self edge) only; Middle Adder is rectangular with G edge.
- ! Edge finish always matches top finish.

HOW TO SPECIFY

<p>Select Model Number</p> <p>H T L B 1 6 8 4 8 P .</p>	<p>Select Grommet Option</p> <p>N No grommet (only option)</p> <p>N .</p>	<p>Select Laminate</p> <p>C Harvest N Mahogany</p> <p>C</p>
--	--	--

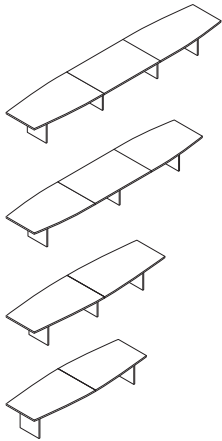

DESCRIPTION	MODEL	SHIP WEIGHT	CUBE	LIST PRICE
Boat Shape Laminate Tables with Panel Base				
240"W x 48"D	HTLB2048LP	572	31.0	\$3380
216"W x 48"D	HTLB1848LP	491	25.9	\$2787
192"W x 48"D	HTLB1648LP	442	24.3	\$2671
168"W x 48"D	HTLB1448LP	400	18.1	\$2283
144"W x 48"D	HTLB1248LP	319	12.9	\$1690
120"W x 48"D	HTLB1048LP	270	11.3	\$1574

NOTES: Order entire typical with one model number to get desired table size. Table top and bases are included.

NOTES:

- Tops and Modesty Panels are 1/8" Melamine.
- 168"W Boat-Shaped Top needs 3 bases; 72"W Middle Adder needs 1 base. All other tops need 2 bases.
- 120", 144", and 168"W Tops ship in 2 pieces to facilitate handling and installation; these top sizes will not have an exact grain alignment where the two halves meet, a reasonable match can be expected.
- ! Available in Harvest (C) and Mahogany (N) finishes only.
- ! Tops available in Boat Shape with G edge (2mm self edge) only; Middle Adder is rectangular with G edge.
- ! Edge finish always matches top finish.

HOW TO SPECIFY

<p>Select Model Number</p> <p>HTLB2048LP</p>	<p>Select Grommet Option</p> <p>N No grommet (only option)</p> <p>N</p>	<p>Select Laminate</p> <p>C Harvest N Mahogany</p> <p>C</p>	<p>Select Edge Color</p> <p>C Harvest N Mahogany</p> <p>C</p>
---	--	--	--

SCRAMBLE™ OCCASIONAL TABLES

Want to see more? Scan here
to check out hon.com.



Scramble™ Coffee Table shown with
West Hill™ Casual Lounge Seating.

SCRAMBLE™

For every tablet, coffee mug, or notepad there's a need for an occasional table. Don't scramble to find an open meeting room when you can move to where relaxed productivity happens whether it's a lounge, commons, or nook area. Designed to coordinate with any of HON's soft seating lines, Scramble occasional tables fit in any space you need to work comfortably.



FEATURES

- Select from Soft Rectangle, Soft Square, and Round top shapes.
- Multiple size ranges available from side to large coffee tables.
- Coordinate with any of HON's soft seating series to create a space that works.
- Angled hardwood legs with metal stretcher bars provide a mid-century feel.
- Assorted leg and stretcher bar finishes available to match any aesthetic.
- Match the style of any space, with laminate tops including both flat and knife edges, as well as premium back-painted glass tops.

SCRAMBLE™ Options

MODEL OPTIONS

HSCCSR2448LM
HSCCSR2448LMK
HSCCSR2448BPG



Coffee Table
Soft Rectangle

HSCCSS36LM, HSCCSS36LMK, HSCCSS36BPG
HSCCSS48LM, HSCCSS48LMK, HSCCSS48BPG



Coffee Table
Soft Square

HSCCR36LM, HSCCR36LMK, HSCCR36BPG
HSCCR48LM, HSCCSS48LMK, HSCCR48BPG



Coffee Table
Round

HSCSS24LM
HSCSS24LMK
HSCSS24BPG



End Table
Soft Square

HSCER24LM
HSCER24LMK
HSCER24BPG



End Table
Round

Available Laminates and Corresponding Edge:

Laminate		Edgeband	
Charcoal	S	Charcoal	S
Designer White	LDW1	Designer White	DW
Florence Walnut	LFW1	Florence Walnut	FW
Handspun Chestnut	LAHC	Loft	LOFT
Handspun Dove	LAHD	Fossil	EH
Handspun Pearl	LAHP	Fossil	EH
Handspun Slate	LAHS	Charcoal	S
Kingswood Walnut	LKI1	Kingswood Walnut	KI
Lowell Ash	LLA1	Lowell Ash	DL
Natural Maple	D	Natural Maple	D
Natural Recon	LNR1	Natural Recon	NR
Phantom Ecru	LPE1	Phantom Ecru	PE
Pinnacle	PINC	Pinnacle	PINC
Portico Teak	LPT1	Portico Teak	PT
Skyline Walnut	LSW1	Skyline Walnut	SW
Sterling Ash	LSA1	Sterling Ash	SA

EDGE & MATERIAL OPTIONS



Laminate
2mm Edge, 3/4" thick

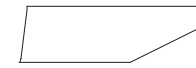

Laminate*
Knife Edge, 1 1/8" thick

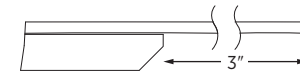

Back-Painted Glass*

- 1/4" thick glass, painted on the bottom surface with frosted/etched top and sides.
- 3/4" MDF sub-top inset 3" from all sides, for attachment to base.

*Coming Soon

WOOD LEG OPTIONS

CODE	DESCRIPTION	PRICE
LFW1	Florence Walnut	+\$0
LKI1	Kingswood Walnut	+\$0
LLA1	Lowell Ash	+\$0
D	Natural Maple	+\$0
LNR1	Natural Recon	+\$0
LPE1	Phantom Ecru	+\$0
PINC	Pinnacle	+\$0
LPT1	Portico Teak	+\$0
LSW1	Skyline Walnut	+\$0
LSA1	Sterling Ash	+\$0
LE404	Warm White	+\$0
LE405	Mist	+\$0
LE408	Peppercorn	+\$0

NOTES: Wood Legs are stained solid maple. Stain finishes will be tonal matches to the respective laminate finishes. Some natural woodgrain may show through the stain; therefore, stained wood legs may have slight variation in appearance.

STRETCHER BAR PAINT OPTIONS

CODE	DESCRIPTION	PRICE
Grade P1		
P7A	Textured Charcoal	+\$0
P8V	Textured Titanium	+\$0
Grade P2		
PR5	Champagne Metallic	+\$20
P8X	Solar Black	+\$20



BACK-PAINTED GLASS OPTION

CODE	DESCRIPTION	PRICE
GWH1	Ice White, Etched	+\$0

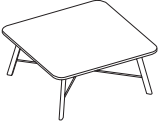

Icon Legend on page 17

SCRAMBLE™ Coffee Tables

	DESCRIPTION	MODEL	SHIP WEIGHT	CUBE	LIST PRICE BY LAMINATE GRADE		GLASS LIST PRICE
					L1	L2	
	Coffee Table, Soft Rectangle 24"D x 48"W x 16"H, Laminate Top, 2mm Edge	HSCCSR2448LM	46.5	9.7	\$1333	\$1353	
	24"D x 48"W x 16"H, Laminate Top, Knife Edge	HSCCSR2448LMK	94.0	6.4	\$1599	\$1619	
	24"D x 48"W x 16"H, Back-Painted Glass Top	HSCCSR2448BPG	61.5	5.9			\$3076
	Coffee Table, Soft Square 36"D x 36"W x 16"H, Laminate Top, 2mm Edge	HSCCSS36LM	48.5	9.0	\$1281	\$1301	
	48"D x 48"W x 16"H, Laminate Top, 2mm Edge	HSCCSS48LM	80.5	12.8	\$1387	\$1407	
	36"D x 36"W x 16"H, Laminate Top, Knife Edge	HSCCSS36LMK	63.0	6.7	\$1494	\$1514	
	48"D x 48"W x 16"H, Laminate Top, Knife Edge	HSCCSS48LMK	96.5	9.9	\$1706	\$1726	
	36"D x 36"W x 16"H, Back-Painted Glass Top	HSCCSS36BPG	66.0	6.2			\$3340
48"D x 48"W x 16"H, Back-Painted Glass Top	HSCCSS48BPG	110.5	9.1			\$3869	
	Coffee Table, Round 36"D x 16"H, Laminate Top, 2mm Edge	HSCCR36LM	41.0	8.8	\$1281	\$1301	
	48"D x 16"H, Laminate Top, 2mm Edge	HSCCR48LM	70.0	12.6	\$1387	\$1407	
	36"D x 16"H, Laminate Top, Knife Edge	HSCCR36LMK	49.0	6.7	\$1494	\$1514	
	48"D x 16"H, Laminate Top, Knife Edge	HSCCR48LMK	82.0	9.0	\$1706	\$1726	
	36"D x 16"H, Back-Painted Glass Top	HSCCR36BPG	49.0	6.2			\$3340
48"D x 16"H, Back-Painted Glass Top	HSCCR48BPG	90.0	8.2			\$3869	

HOW TO SPECIFY

<p>Select Model Number</p> <p>See page 122</p>	<p>Select Laminate and Edge or Glass</p> <p>See page 122</p>	<p>Select Leg Finish</p> <p>See page 122</p>	<p>Select Stretcher Bar Paint Color</p> <p>See page 122</p>
H S C C S R 2 4 4 8 L M .	L S A 1 S A .	L S A 1 .	P 8 V

SCRAMBLE™ End Tables

OPEN MARKET



Icon Legend on page 17



DESCRIPTION	MODEL	SHIP WEIGHT	CUBE	LIST PRICE BY LAMINATE GRADE		GLASS LIST PRICE
				L1	L2	
End Table, Soft Square 24"W x 24"D x 22"H, Laminate Top, 2mm Edge	HSCCESS24LM	34.5	19.0	\$1227	\$1247	
24"W x 24"D x 22"H, Laminate Top, Knife Edge	HSCCESS24LMK	42.0	3.9	\$1388	\$1408	
24"W x 24"D x 22"H, Back-Painted Glass Top	HSCCESS24BPG	38.0	3.7			\$2601



End Table, Round 24"D x 22"H, Laminate Top, 2mm Edge	HSCER24LM	32.0	19.0	\$1227	\$1247	
24"D x 22"H, Laminate Top, Knife Edge	HSCER24LMK	33.0	3.9	\$1388	\$1408	
24"D x 22"H, Back-Painted Glass Top	HSCER24BPG	33.0	3.7			\$2601

HOW TO SPECIFY

<p>Select Model Number</p> <p>See page 122</p> <p>H S C E S S 2 4 L M .</p>	<p>Select Laminate and Edge or Glass</p> <p>See page 122</p> <p>L S A 1 S A .</p>	<p>Select Leg Finish</p> <p>See page 122</p> <p>L S A 1 .</p>	<p>Select Stretcher Bar Paint Color</p> <p>See page 122</p> <p>P 8 V</p>
--	--	--	---

UTILITY TABLES

Want to see more? Scan here
to check out hon.com.



Utility Tables shown with Accommodate® Seating.

UTILITY TABLES

All-purpose Utility Tables from HON have a place in every work and educational setting. The Chrome steel legs and square edge detail complement HON 34000 Series desks. The top is scratch-, spill-, and stain-resistant laminate. Adjustable glides won't mar hard-surface floors.



FEATURES

- Scratch-, spill- and stain-resistant laminate stands up to heavy use and is specially treated to withstand boiling liquids.
- Heavy-grade, warp-resistant particleboard withstands high activity.
- Formed steel legs and perimeter frame are built to endure frequent moves and high activity.
- Leveling glides compensate for uneven floors.

UTILITY TABLES ORDERING INFORMATION

LAMINATE

- LAMINATES CODES**
- Woodgrain**
- ◆ Bourbon Cherry **H**
 - ◆ Cognac **COGN**
 - ◆ Florence Walnut **LFW1**
 - ◆ Harvest **C**
 - ◆ Kingswood Walnut **LKI1**
 - ◆ Mahogany **N**
 - ◆ Mocha **MOCH**
 - ◆ Natural Maple **D**
 - ◆ Pinnacle **PINC**
 - ◆ Shaker Cherry **F**
 - ◆ Sterling Ash **LSA1**
- Solid**
- ◆ Designer White **LDW1**
 - ◆ Loft **LOFT**
- Patterned**
- ◆ Gray **G2**

PAINT

- BASE PAINT CODES**
- P1**
- ◆ Black **P**
 - ◆ Brownstone **P7D**
 - ◆ Charcoal **S**
 - ◆ Designer White **PJW**
 - ◆ Fossil **P28**
 - ◆ Greige **T5**
 - ◆ Loft **LOFT**
 - ◆ Muslin **T3**
 - ◆ Putty **L**
 - ◆ Shadow* **SHDW**
 - ◆ Titanium **P8T**

LEG FINISH

- BASE PAINT CODES**
- ◆ Black **P**
 - ◆ Chrome **CHR**

Recommended Edgeband Color Selection:

Laminate		Edge	
Bourbon Cherry	H	Bourbon Cherry	H
Cognac	COGN	Cognac	COGN
Florence Walnut	LFW1	Florence Walnut	FW
Harvest	C	Harvest	C
Kingswood Walnut	LKI1	Kingswood Walnut	KI
Mahogany	N	Mahogany	N
Mocha	MOCH	Mocha	MOCH
Natural Maple	D	Natural Maple	D
Pinnacle	PINC	Pinnacle	PINC
Shaker Cherry	F	Shaker Cherry	F
Gray	G2	Charcoal	S

◆◆◆ For lead time information see page 17.
* De-emphasized



Icon Legend on page 17

UTILITY TABLES



DESCRIPTION

Rectangle Shaped Utility Table — Metal

72"W x 18"D x 29"H

40"W x 20"D x 29"H

60"W x 20"D x 29"H

60"W x 24"D x 29"H

60"W x 30"D x 29"H

72"W x 30"D x 29"H

72"W x 36"D x 29"H

MODEL	SHIP WEIGHT	CUBE	LIST PRICE
HUTM1872	73	4.8	\$631
HUTM2040	50	3.3	\$522
HUTM2060	68	4.9	\$583
HUTM2460	81	5.6	\$620
HUTM3060	88	6.5	\$637
HUTM3072	106	7.2	\$795
HUTM3672	116	10.4	\$843

NOTES:

- 1/8" thick top with self-edge.
- Adjustable non-marring leveling floor glides.
- 90-degree square corners.
- Legs secured to top with steel corner brace.
- ! 1/4" square Chrome or Black painted legs ONLY.

HOW TO SPECIFY

<p>Select Model Number</p> <p>HUTM1872</p>	<p>Select Laminate</p> <p>See page 126</p> <p>MOCH</p>	<p>Select Paint Color</p> <p>See page 126</p> <p>P</p>	<p>Select Leg Paint Color or Finish</p> <p>P Black CHR Chrome</p> <p>CHR</p>
---	---	---	---

CROSS REFERENCE BY APPLICATION

	Page
CLASSROOM	
Student Desks	
SmartLink® Student Desks	163-165
Teacher/Administration Desks	
SmartLink® Teacher Stations	170-172
Voi®	<i>See the Desks section in the 2021 Workspaces Pricer.</i>
10700 Series™	<i>See the Desks section in the 2021 Workspaces Pricer.</i>
10500 Series™	<i>See the Desks section in the 2021 Workspaces Pricer.</i>
Mentor® Series Desks	<i>See the Desks section in the 2021 Workspaces Pricer.</i>
38000 Series™ ...	<i>See the Desks section in the 2021 Workspaces Pricer.</i>
Seating	
SmartLink® Seating	166-169
Perpetual® Nesting	423-425
Olson Stacker® - 4040 Series	
High-Density	409-410
Motivate® Seating	380-399
Volt® - 5700/5710/5720/5730 Series	478-485
ComforTask® - 5900 Series	258-262
Ignition®/Ignition® 2.0	327-356
Solve®	446-457
Convergence®	263-267
Storage & Files	
SmartLink® Modular Storage	173-175
Brigade® 800 Series Lateral Files	<i>See the Storage section in the 2021 Workspaces Pricer.</i>
Brigade® 700 Series Lateral Files	<i>See the Storage section in the 2021 Workspaces Pricer.</i>
Brigade® 600 Series Lateral Files	<i>See the Storage section in the 2021 Workspaces Pricer.</i>
Lateral File Accessories	<i>See the Storage section in the 2021 Workspaces Pricer.</i>
310 Series Vertical Files - 26½"D	<i>See the Storage section in the 2021 Workspaces Pricer.</i>
510 Series Vertical Files - 25"D	<i>See the Storage section in the 2021 Workspaces Pricer.</i>
Flagship® Bookcases and Storage Cabinets	<i>See the Storage section in the 2021 Workspaces Pricer.</i>
Brigade® Storage Cabinets	<i>See the Storage section in the 2021 Workspaces Pricer.</i>
Brigade® Steel Bookcases	<i>See the Storage section in the 2021 Workspaces Pricer.</i>
10500 Series™ Bookcases	<i>See the Storage section in the 2021 Workspaces Pricer.</i>
1870 Series Bookcases	<i>See the Storage section in the 2021 Workspaces Pricer.</i>
Tables	
Huddle Multi-Purpose Tables	54-61
Motivate® Tables	72-76
Utility Tables	125-127
Learning Applications	
SmartLink® Wall Rail System	176-177
Motivate® Mobile Markerboards	76
COMPUTER LAB	
Tables	
Huddle Multi-Purpose Tables	54-61
Motivate® Tables	72-76
Between™ Tables	33-37
Seating	
Motivate® Seating	380-399
Perpetual® Nesting	423-425

	Page
CAFETERIA	
Seating	
SmartLink® Seating	166-169
Motivate® Seating	380-399
Olson Stacker® - 4040 Series	
High-Density	409-410
Tables	
Huddle Multi-Purpose Tables	54-61
Motivate® Tables	72-76
Between™ Tables	33-37
COMMON AREAS	
Reception Seating	
Flock® Lounge	284-307
Grove®	312-323
Accommodate®	217-223
Invitation® - 2110 Series	358-361
Cambia™ - 2160 Series	242-244
Pagoda® - 4070/4090 Series	411-418
Invitation® Lounge	362-364
Tables	
Huddle Multi-Purpose Tables	54-61
Motivate® Tables	72-76
Laminate Occasional Tables	68
Flock®	46-51
Between™ Tables	33-37
LIBRARY / MEDIA CENTER	
Storage	
Flagship® Bookcases	<i>See the Storage section in the 2021 Workspaces Pricer.</i>
Brigade® Steel Bookcases	<i>See the Storage section in the 2021 Workspaces Pricer.</i>
SmartLink® Modular Storage	173-175
Reception Seating	
Flock® Lounge	284-307
Grove®	312-323
Accommodate®	217-223
Invitation® - 2110 Series	358-361
Cambia™ - 2160 Series	242-244
Pagoda® - 4070/4090 Series	411-418
Invitation® Lounge	362-364
Student Seating	
SmartLink® Seating	166-169
Motivate® Seating	380-399
Accommodate®	217-223
Tables	
Huddle Multi-Purpose Tables	54-61
Motivate® Tables	72-76
Laminate Occasional Tables	68
Flock®	46-51
Between™ Tables	33-37

CROSS REFERENCE BY APPLICATION

	Page
ART ROOM	
Seating	
Motivate® Seating	380-399
Storage	
SmartLink® Modular Storage	173-175
Flagship® Storage Cabinets	<i>See the Storage section in the 2021 Workspaces Pricer.</i>
Brigade® Storage Cabinets	<i>See the Storage section in the 2021 Workspaces Pricer.</i>
Flagship® Bookcases	<i>See the Storage section in the 2021 Workspaces Pricer.</i>
Brigade® Steel Bookcases	<i>See the Storage section in the 2021 Workspaces Pricer.</i>
10500 Series™ Bookcases	<i>See the Storage section in the 2021 Workspaces Pricer.</i>
1870 Series Bookcases	<i>See the Storage section in the 2021 Workspaces Pricer.</i>
Tables	
Huddle Multi-Purpose Tables	54-61
Motivate® Tables	72-76

TEACHER PLANNING

Desks	
SmartLink® Teacher Stations	170-172
Voi®	<i>See the Desks section in the 2021 Workspaces Pricer.</i>
10700 Series™	<i>See the Desks section in the 2021 Workspaces Pricer.</i>
10500 Series™	<i>See the Desks section in the 2021 Workspaces Pricer.</i>
Mentor® Series Desks	<i>See the Desks section in the 2021 Workspaces Pricer.</i>
38000 Series™ ...	<i>See the Desks section in the 2021 Workspaces Pricer.</i>
Seating	
Volt® - 5700/5710/5720/5730 Series	478-485
ComforTask® - 5900 Series	258-262
Ignition®/Ignition® 2.0	327-356
Solve®	446-457
Convergence®	263-267
Storage	
SmartLink® Modular Storage	173-175
Brigade® 800 Series Lateral Files	<i>See the Storage section in the 2021 Workspaces Pricer.</i>
Brigade® 700 Series Lateral Files	<i>See the Storage section in the 2021 Workspaces Pricer.</i>
Brigade® 600 Series Lateral Files	<i>See the Storage section in the 2021 Workspaces Pricer.</i>
Flagship® Lateral Files	<i>See the Storage section in the 2021 Workspaces Pricer.</i>
400 Series Lateral Files	<i>See the Storage section in the 2021 Workspaces Pricer.</i>
Lateral File Accessories	<i>See the Storage section in the 2021 Workspaces Pricer.</i>
210 Series Vertical Files - 28½"D	<i>See the Storage section in the 2021 Workspaces Pricer.</i>
310 Series Vertical Files - 26½"D	<i>See the Storage section in the 2021 Workspaces Pricer.</i>
510 Series Vertical Files - 25"D	<i>See the Storage section in the 2021 Workspaces Pricer.</i>
Vertical File Accessories	<i>See the Storage section in the 2021 Workspaces Pricer.</i>
Flagship® Storage Cabinets	<i>See the Storage section in the 2021 Workspaces Pricer.</i>
Brigade® Storage Cabinets	<i>See the Storage section in the 2021 Workspaces Pricer.</i>
Flagship® Bookcases	<i>See the Storage section in the 2021 Workspaces Pricer.</i>
Brigade® Steel Bookcases	<i>See the Storage section in the 2021 Workspaces Pricer.</i>
10500 Series™ Bookcases	<i>See the Storage section in the 2021 Workspaces Pricer.</i>
1870 Series Bookcases	<i>See the Storage section in the 2021 Workspaces Pricer.</i>

	Page
TEACHER PLANNING (continued)	
Tables	
Huddle Multi-Purpose Tables	54-61
Motivate® Tables	72-76
Flock®	46-51
Between™ Tables	33-37

ADMINISTRATION

Desks	
10700 Series™	<i>See the Desks section in the 2021 Workspaces Pricer.</i>
10500 Series™	<i>See the Desks section in the 2021 Workspaces Pricer.</i>
Mentor® Series Desks	<i>See the Desks section in the 2021 Workspaces Pricer.</i>
38000 Series™ ...	<i>See the Desks section in the 2021 Workspaces Pricer.</i>
Reception Seating	
Invitation® - 2110 Series	358-361
Cambia™ - 2160 Series	242-244
Pagoda® - 4070/4090 Series	411-418
Task / Administrative Seating	
Ignition®/Ignition® 2.0	327-356
Motivate® Seating	380-399
Pillow-Soft® - 2190 Series	429-431
Volt® - 5700/5710/5720/5730 Series	478-485
ComforTask® - 5900 Series	258-262
Solve®	446-457
Convergence®	263-267
Storage & Files	
SmartLink® Modular Storage	173-175
Brigade® 800 Series Lateral Files	<i>See the Storage section in the 2021 Workspaces Pricer.</i>
Brigade® 700 Series Lateral Files	<i>See the Storage section in the 2021 Workspaces Pricer.</i>
Brigade® 600 Series Lateral Files	<i>See the Storage section in the 2021 Workspaces Pricer.</i>
Lateral File Accessories	<i>See the Storage section in the 2021 Workspaces Pricer.</i>
310 Series Vertical Files - 26½"D	<i>See the Storage section in the 2021 Workspaces Pricer.</i>
510 Series Vertical Files - 25"D	<i>See the Storage section in the 2021 Workspaces Pricer.</i>
Flagship® Bookcases and Storage Cabinets	<i>See the Storage section in the 2021 Workspaces Pricer.</i>
Brigade® Storage Cabinets	<i>See the Storage section in the 2021 Workspaces Pricer.</i>
Brigade® Steel Bookcases	<i>See the Storage section in the 2021 Workspaces Pricer.</i>
10500 Series™ Bookcases	<i>See the Storage section in the 2021 Workspaces Pricer.</i>
1870 Series Bookcases	<i>See the Storage section in the 2021 Workspaces Pricer.</i>
Tables	
Huddle Multi-Purpose Tables	54-61
Motivate® Tables	72-76
Flock®	46-51
Between™ Tables	33-37
Occasional Tables	
Laminate Occasional Tables	68
Flock®	46-51



Build™ Student Desks and Tables shown
with SmartLink® Seating and Storage.

BUILD™

Inspiring the next generation takes a higher degree of mobility and hands-on learning. The Build™ series, an educational product collection of tables, student desks, and seating, is lightweight, durable, reconfigurable, and customizable. Build encourages creativity and adaptability so students can support collaboration and social interaction or create personal space for focused study time. Build supports the movers and shakers, the hands-on doers, and the leaders who crave creativity. The future of education takes shape with Build.



FEATURES

- 15 table shapes and 6 student desk shapes make reconfiguration fun and easy.
- In addition to all standard HON laminates, Build tops are available in bright, bold laminates and a dry-erase markerboard finish to enhance any learning environment. Or try Butcher Block tops on Makerspace tables.
- Table legs are available in multiple height adjustable ranges and nesting bases to accommodate different user applications.
- Adjustable height student desk legs accommodate any students in K-12 grades and beyond.
- The durable Makerspace table features à la carte storage accessories and allows you to keep a creative space clean, organized, and customizable.

BUILD™ ORDERING INFORMATION

LAMINATE GROUP A (TOP LAMINATES)

L1 LAMINATES CODES

Woodgrain

- ◆ Bourbon Cherry H
- ◆ Cognac COGN
- ◆ Florence Walnut LFW1
- ◆ Harvest C
- ◆ Kingswood Walnut LK11
- ◆ Loft LOFT
- ◆ Mahogany N
- ◆ Mocha MOCH
- ◆ Natural Maple D
- ◆ Pinnacle PINC
- ◆ Shaker Cherry F
- ◆ Sterling Ash LSA1

Solid

- ◆ Black P
- ◆ Charcoal S
- ◆ Designer White LDW1
- ◆ Loft LOFT

Patterned

- ◆ Handspun Chestnut LAHC
- ◆ Handspun Dove LAHD
- ◆ Handspun Pearl LAHP
- ◆ Handspun Slate LAHS
- ◆ Sheer Mesh * A5
- ◆ Silver Mesh B9
- ◆ Steel Mesh * A9
- ◆ Canyon Zephyr * K9
- ◆ Desert Zephyr * K8
- ◆ Shadow Zephyr * K1
- ◆ Battleship LBT1
- ◆ Gray G2
- ◆ Grey Tigris * L6
- ◆ Moroccan LMN1
- ◆ Mushroom LMH1
- ◆ Neon Carrot LNC1
- ◆ Tennis Ball LTB1
- ◆ White G1
- ◆ Whitestone * K4

L2 LAMINATES CODES

Woodgrain

- ◆ Lowell Ash LLA1
- ◆ Natural Recon LNR1
- ◆ Phantom Ecru LPE1
- ◆ Portico Teak LPT1
- ◆ Skyline Walnut LSW1

L5 LAMINATES CODES

- ◆ White Markerboard FMQ1

LAMINATE GROUP B (SHELF LAMINATES)

L1 LAMINATES CODES

Woodgrain

- ◆ Bourbon Cherry H
- ◆ Cognac COGN
- ◆ Florence Walnut LFW1
- ◆ Harvest C
- ◆ Kingswood Walnut LK11
- ◆ Mahogany N
- ◆ Natural Maple D
- ◆ Pinnacle PINC
- ◆ Shaker Cherry F
- ◆ Sterling Ash LSA1

Solid

- ◆ Black P
- ◆ Charcoal S
- ◆ Designer White LDW1
- ◆ Loft LOFT

L2 LAMINATES CODES

Woodgrain

- ◆ Lowell Ash LLA1
- ◆ Natural Recon LNR1
- ◆ Phantom Ecru LPE1
- ◆ Portico Teak LPT1
- ◆ Skyline Walnut LSW1

PAINT GROUP A (TABLE AND STUDENT DESK LEG PAINT)

PAINT CODES

- P1**
- ◆ Black P
- P2**
- ◆ Platinum Metallic T1

PAINT GROUP B (MAKERSPACE TABLE BASE AND STOOL)

PAINT CODES

P1

- ◆ Black P
- ◆ Brownstone P7D
- ◆ Charcoal S
- ◆ Designer White PJW
- ◆ Fossil P28
- ◆ Greige T5
- ◆ Loft LOFT
- ◆ Muslin T3
- ◆ Titanium P8T

P2

- ◆ Champagne Metallic T4
- ◆ Platinum Metallic T1
- ◆ Silver PR6

P3

- ◆ Atom P8S
- ◆ Bullseye PJF
- ◆ Ember P8P
- ◆ Ion P8N
- ◆ Iris P8J
- ◆ Krypton P8F
- ◆ Regatta P8M

PAINT GROUP C (MAKERSPACE TABLE END PANEL)

PAINT CODES

P1

- ◆ Black P
- ◆ Brownstone P7D
- ◆ Charcoal S
- ◆ Designer White PJW
- ◆ Fossil P28
- ◆ Greige T5
- ◆ Loft LOFT
- ◆ Muslin T3
- ◆ Titanium P8T

P2

- ◆ Champagne Metallic T4
- ◆ Platinum Metallic T1
- ◆ Silver PR6

P3

- ◆ Atom P8S
- ◆ Bullseye PJF
- ◆ Ember P8P
- ◆ Ion P8N
- ◆ Iris P8J
- ◆ Krypton P8F
- ◆ Regatta P8M

P6

- ◆ Markerboard MKB

MAKERSPACE BUTCHER BLOCK

- ◆ Butcher Block LH903

EDGE

EDGE CODES

Woodgrain

- ◆ Cognac COGN
- ◆ Florence Walnut FW
- ◆ Kingswood Walnut KI
- ◆ Lowell Ash DL
- ◆ Mahogany N
- ◆ Mocha MOCH
- ◆ Natural Maple D
- ◆ Natural Recon NR
- ◆ Phantom Ecru PE
- ◆ Pinnacle PINC
- ◆ Portico Teak DP
- ◆ Shaker Cherry F
- ◆ Skyline Walnut SW
- ◆ Sterling Ash SA

Solid















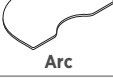

- ◆ Atom AT
- ◆ Black P
- ◆ Brownstone EY
- ◆ Bullseye BY
- ◆ Charcoal S
- ◆ Designer White DW
- ◆ Ember MR
- ◆ Fossil EH
- ◆ Greige R
- ◆ Ion IO
- ◆ Iris IR
- ◆ Krypton KT
- ◆ Loft LOFT
- ◆ Muslin T
- ◆ Platinum K
- ◆ Regatta RE

◆◆◆ For lead time information see page 17.

* De-emphasized

BUILD™ Shape Matrix

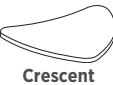
EDUCATION

Top Shape/Model	Tables				Student Desks
	Youth Height Leg Adjusts 13'-18"	Standard Height Leg Adjusts 22'-34"	Standing Height Leg Adjusts 30'-42"	Nesting Base	Seated Height Leg Adjusts 22'-34"
 Kite	X	X	X		
 Ribbon	X	X	X	X	X
 Wisp	X	X	X		
 Snap	X	X	X		
 Rectangle	X	X	X		X
 Half-Round	X	X	X		
 Arc	X	X	X		
 Round	X	X	X		
 Square	X	X	X		
 Trapezoid	X	X	X		X
 Horseshoe	X	X	X		
 Home Plate	X	X	X		
 Spooky	X	X	X	X	X
 Tide	X	X	X		
 Dart	X	X	X	X	
 Crescent					X
 Fin					X

Snap



3 PEOPLE/1 TABLE

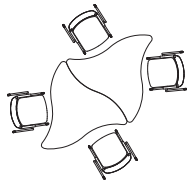

4 PEOPLE/2 TABLES

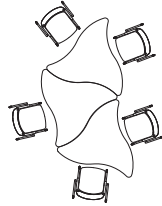

5 PEOPLE/3 TABLES

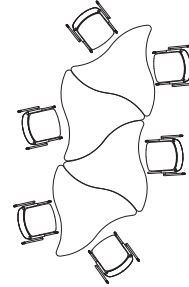

6 PEOPLE/4 TABLES

Tide

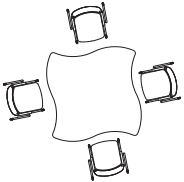

4 PEOPLE/1 TABLE

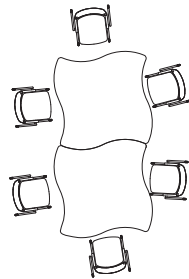

6 PEOPLE/2 TABLES

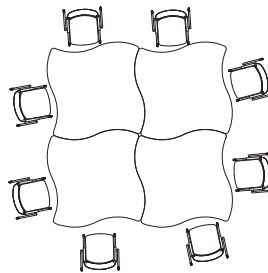

8 PEOPLE/4 TABLES

Kite



2 PEOPLE/1 TABLE

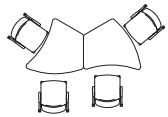

4 PEOPLE/2 TABLES

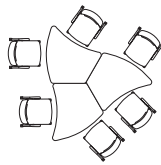

6 PEOPLE/3 TABLES

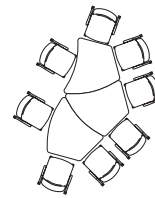

8 PEOPLE/3 TABLES

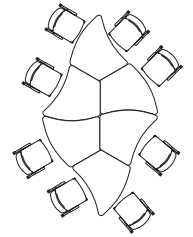

8 PEOPLE/6 TABLES

Dart

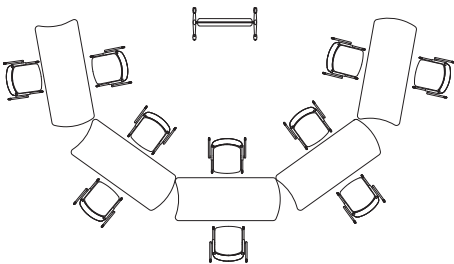

10 PEOPLE/5 TABLES

BUILD™ Table Configurations

EDUCATION

Wisp



4 PEOPLE/1 TABLE

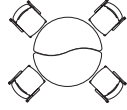

4 PEOPLE/2 TABLES



6 PEOPLE/3 TABLES

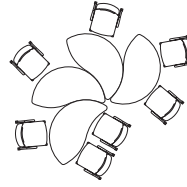

7 PEOPLE/4 TABLES

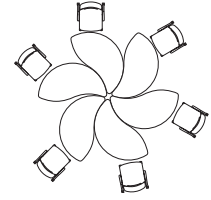

6 PEOPLE/6 TABLES

Ribbon

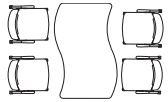

4 PEOPLE/1 TABLE

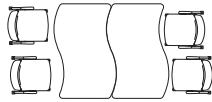

4 PEOPLE/2 TABLES

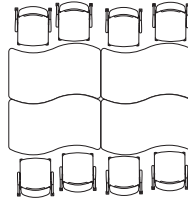

8 PEOPLE/4 TABLES

Home Plate

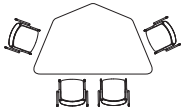

4 PEOPLE/1 TABLE

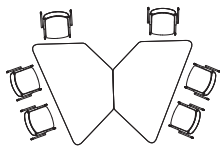

6 PEOPLE/2 TABLES

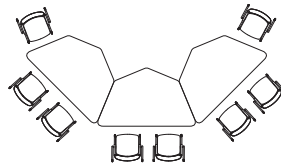

8 PEOPLE/3 TABLES

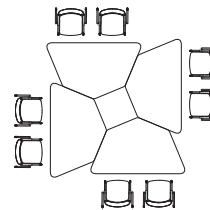

8 PEOPLE/4 TABLES

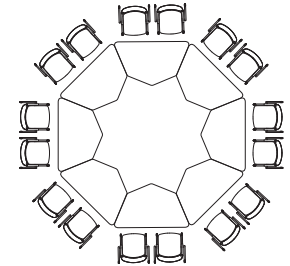

16 PEOPLE/8 TABLES

Horseshoe

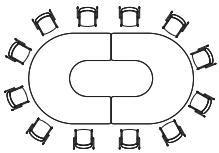

12 PEOPLE/2 TABLES

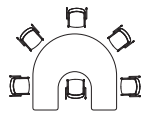

6 PEOPLE/1 TABLE

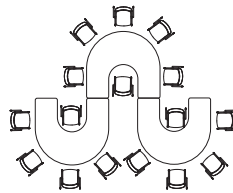

16 PEOPLE/3 TABLES

Spooky



2 PEOPLE/1 TABLE

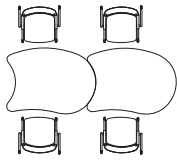

4 PEOPLE/2 TABLES

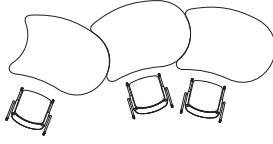

3 PEOPLE/3 TABLES

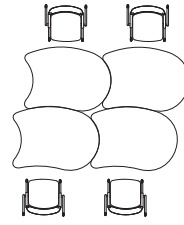

4 PEOPLE/4 TABLES

Combinations

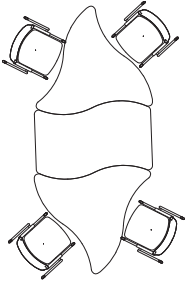

4 PEOPLE/3 TABLES
Ribbon and Snap

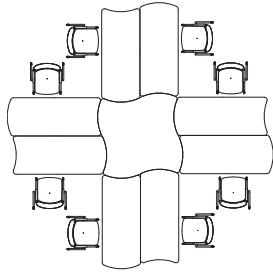

8 PEOPLE/9 TABLES
Tide and Dart

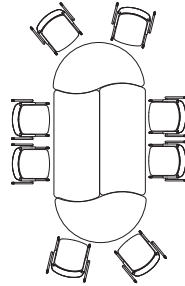

8 PEOPLE/4 TABLES
Dart and Wisp



BUILD™ Table Tops

GSA SIN 33721

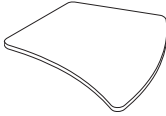
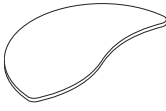
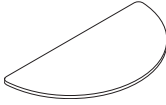
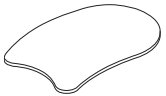

Icon Legend on page 17

EDUCATION

	DESCRIPTION	MODEL	LEGS REQUIRED	SHIP WEIGHT	CUBE	LIST PRICE BY LAMINATE GRADE		
						L1	L2	L5
	Snap Table Top 54"W x 34"D	HESNP54E	3	46	2.8	\$507	\$530	\$619
	Kite Table Top 40"W x 24"D 50"W x 30"D	HESA2440E	4	30	3.9	\$486	\$501	\$546
		HESA3050E	4	50	5.8	\$507	\$527	\$587
	Wisp Table Top 54"W x 30"D	HESN3054E	4	63	4.6	\$491	\$511	\$571
	Half-Round Table Top 60"W x 30"D	HESH3060E	4	69	6.0	\$468	\$488	\$548
	Spooky Table Top 36"W x 54"D	HESY3654E	4	61	14.4	\$440	\$460	\$538
	Ribbon Table Top 54"W x 30"D	HESW3054E	4	65	5.4	\$438	\$458	\$518

NOTES:

- Quick set bracket factory installed for easy leg location and installation.

! Top and legs specified separately. Table tops compatible only with leg models on page 139.

HOW TO SPECIFY

<p>Select Model Number</p> <p>HESH3060E</p>	<p>Select Grommet</p> <p>N No Grommet</p> <p>N</p>	<p>Select Top Laminate</p> <p>See page 131, Group A</p> <p>LDW1</p>	<p>Select Edge Color</p> <p>See page 131</p> <p>LDW1</p>
--	---	--	---



	DESCRIPTION	MODEL	LEGS REQUIRED	SHIP WEIGHT	CUBE	LIST PRICE BY LAMINATE GRADE		
						L1	L2	L5
	Rectangle Table Top							
	48"W x 24"D	HETR2448E	4	71.0	3.6	\$371	\$386	\$431
	60"W x 24"D	HETR2460E	4	57.0	4.4	\$412	\$432	\$492
	72"W x 24"D	HETR2472E	4	68.0	4.9	\$456	\$476	\$536
	48"W x 30"D	HETR3048E	4	62.0	4.4	\$388	\$403	\$448
	60"W x 30"D	HETR3060E	4	71.0	5.4	\$424	\$444	\$504
	72"W x 30"D	HETR3072E	4	85.0	4.9	\$485	\$505	\$565
	Round Table Top							
	42" Diameter	HERD42E	4	51.0	4.7	\$332	\$347	\$405
	48" Diameter	HERD48E	4	66.0	6.1	\$374	\$391	\$456
	Square Table Top							
	36"W x 36"D	HESQ36E	4	46.0	3.7	\$282	\$295	\$344
	42"W x 42"D	HESQ42E	4	61.0	4.9	\$362	\$378	\$442
	48"W x 48"D	HESQ48E	4	76.0	6.2	\$396	\$414	\$483
	Tide Table Top							
	54"W x 54"D	HETD54E	4	106.0	9.2	\$622	\$650	\$759
	Trapezoid Table Top							
		HETZ3060E	4	58.1	4.8	\$351	\$367	\$428
	Home Plate Table Top							
	36"W x 60"D	HEHP3660E	4	64.0	15.9	\$424	\$444	\$504

NOTES:

- Quick set bracket factory installed for easy leg location and installation.
- **Top and legs specified separately. Table tops compatible only with leg models on page 139.**

HOW TO SPECIFY

<p>Select Model Number</p> <p>H E T R 2 4 4 8 E .</p>	<p>Select Grommet</p> <p>N No Grommet</p> <p>N .</p>	<p>Select Top Laminate</p> <p>See page 131, Group A</p> <p>L D W 1 .</p>	<p>Select Edge Color</p> <p>See page 131</p> <p>L D W 1</p>
--	---	---	--



BUILD™ Table Tops

GSA SIN 33721

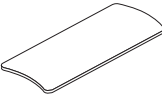

Icon Legend on page 17

EDUCATION

	DESCRIPTION	MODEL	LEGS REQUIRED	SHIP WEIGHT	CUBE	LIST PRICE BY LAMINATE GRADE		
						L1	L2	L5
	Dart Table Top 36"W x 60"D	HEDRT2766E	4	86	4.3	\$444	\$464	\$542
	Arc Table Top 72"W x 48"D	HESKD4872E	4	112	8.2	\$711	\$731	\$791
	Horseshoe Table Top 60"W x 66"D	HESH6066E	4	103	21.7	\$843	\$883	\$1002

NOTES:

- Quick set bracket factory installed for easy leg location and installation.
- ! Top and legs specified separately. Table tops compatible only with leg models on page 139.

HOW TO SPECIFY

<p>Select Model Number</p> <p>H E S H 6 0 6 6 E .</p>	<p>Select Grommet</p> <p>N No Grommet</p> <p>N .</p>	<p>Select Top Laminate</p> <p>See page 131, Group A</p> <p>L D W 1 .</p>	<p>Select Edge Color</p> <p>See page 131</p> <p>L D W 1</p>
--	---	---	--



	DESCRIPTION	MODEL	HEIGHT RANGE	SHIP WEIGHT	CUBE	LIST PRICE P1/P2
	Build™ Table Adjustable Height Leg Pack Youth Height Legs, Pack of 4	HEBY4LEG	13"-18"	19	0.9	\$159
	Build™ Table Adjustable Height Leg Pack Standard Table Height Legs, Pack of 4	HEB4LEG	22"-34"	19	1.2	\$210
	Build™ Table Adjustable Height Leg Pack Standing Height Legs, Pack of 4	HEBS4LEG	30"-42"	25	2.2	\$259

NOTES:

- Specify paint for upper portion of leg. Bottom is chrome.

! Compatible only with top models on pages 136-138.

	Yes	No
Standing		X
Youth	X	
Table	X	

! See pages 136-138 for number of legs required per top. Legs always ship 4 per carton. Use chart below for quantity of 4-leg packs required for shapes that utilize three legs.

DESKS	LEGS NEEDED	ADJUSTABLE POST LEGS 4-PACKS
1	3	1
2	6	2
3	9	3
4	12	3
5	15	4
6	18	5
7	21	6
8	24	6
9	27	7
10	30	8

HOW TO SPECIFY

Select Model Number	Select Paint Color
HEBS4LEG.	See page 131, Paint Group A
T1	

BUILD™ Nesting Tables

GSA SIN 33721



Icon Legend on page 17

EDUCATION



DESCRIPTION

Dart Table with Nesting Base
66"W x 27"D

MODEL

HEDRT-2766E-NS

SHIP WEIGHT

113

CUBE

8.7

LIST PRICE BY LAMINATE GRADE

L1

\$1119

L2

\$1139

L5

\$1217

NOTES: Ribbon, Wisp, Snap, Tide and Dart can all be used together.

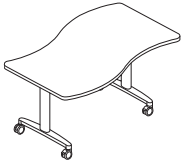

Ribbon Nesting Table
54"W x 30"D

HESW-3054E-NS

89

8.1

\$1109

\$1129

\$1189



Spooky Nesting Table
54"W x 36"D

HESY-3654E-NS

85

17.1

\$1115

\$1135

\$1213

DESCRIPTION

Nesting Spacer Kit

MODEL

HESPCR

SHIP WEIGHT

2 Ⓞ

CUBE

0.1

LIST PRICE

\$55

NOTES: Use with Build™ standard height post legs and nesting bases to create even table heights. Specify 1 kit per nesting table.

ⓘ Available in P Black only. Specify: HESPCR.P.

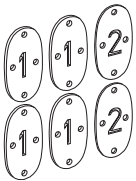

NOTES:

ⓘ Nesting bases are not intended to be used in combination with youth, standing, or desk post-legs.

ⓘ Nesting bases have a height difference of 1/2" when used with Build™ Standard Table Height Post Leg models. Use Nesting Spacer Kit HESPCR to create even table heights.

<p>Select Model Number</p> <p>HEDRT-2766E-NS</p>	<p>Select Grommet</p> <p>N No Grommet</p> <p>N</p>	<p>Select Laminate Color</p> <p>See page 131, Group A</p> <p>LBA1</p>	<p>Select Edge Color</p> <p>See page 131</p> <p>K</p>	<p>Select Caster</p> <p>C Caster ONLY</p> <p>C</p>	<p>Select Paint Color</p> <p>See page 131, Paint Group A</p> <p>T1</p>
---	---	--	--	---	---



	DESCRIPTION	MODEL	SHIP WEIGHT	CUBE	LIST PRICE
 OPEN MARKET	Book Box Bracket NOTES: Use with HFMBIN3 trays. Specify 1 bracket per tray. For full book box solution specify both HEBBXRL and HFMBIN3. ⓘ Available in P Black only. No specification needed. ⓘ Minimum mounting clearance required: 13½"W x 15"D.	HEBBXRL	2.1	0.6	\$44
 SIN 33721	Accessories — Tray Kit 3"H, 2 bins and 4 rails NOTES: For full book box solution specify both HEBBXRL and HFMBIN3. (1) HFMBIN3 needed for every (2) HEBBXRL as bins are ordered in a set of 2. ⓘ Semi-translucent white. No specification needed. ⓘ Bins ship with rails intended for use in storage. When bins are used with Book Box Bracket, rails will not be used.	HFMBIN3	7.0 ⓘ	4.0	\$59
 SIN 33721 	Locking Casters, 4-Pack <ul style="list-style-type: none"> • Black only • 4 casters per pack • Caster pack adds 1⅞" to the overall height. • All casters lockable • Threaded attachment bolts • Can retrofit on Build™ units with glides. ⓘ For use on youth and standard table post legs only. * On 4-leg Build™ tables, can utilize 2 casters and 2 glides for easy repositioning of tables.	HHABCASTER*	1.0	0.1	\$80
 SIN 33721	Ganging Hardware <ul style="list-style-type: none"> • Includes two ganging links and two screws • No color designator when specifying. <i>Example: HMAGANG.</i> 	HMAGANG	1.0 ⓘ	0.1	\$102
 OPEN MARKET    	Back Pack Hook (10 per carton) 12"W x 14½"D x 1½"H NOTES: Attaches to bottom of surface with 2 screws, included. ⓘ Available in Platinum Metallic finish only, no specification needed.	HCLA65	10.0 ⓘ	0.1	\$101

NOTES:
 ⓘ See Workplace Tools Pricer for compatible electrical components.

HOW TO SPECIFY

Select Model Number

H	H	A	B	C	A	S	T	E	R
---	---	---	---	---	---	---	---	---	---

BUILD™ Student Desk Surface Dimensions

EDUCATION

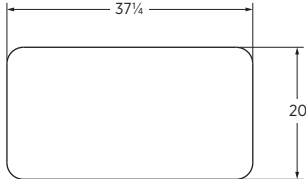
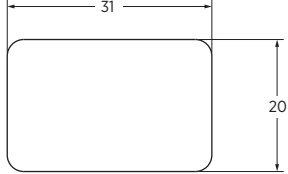
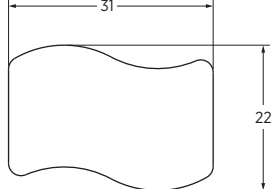
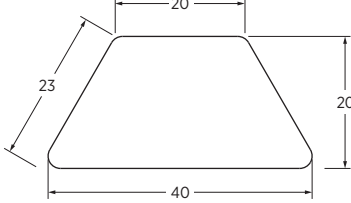
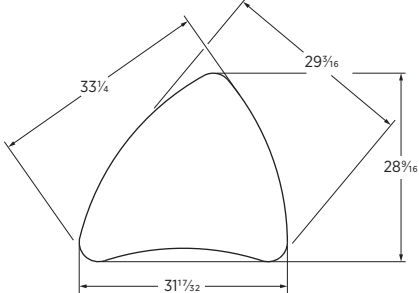
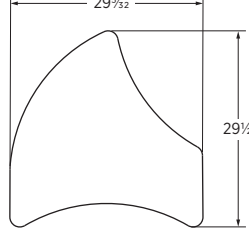
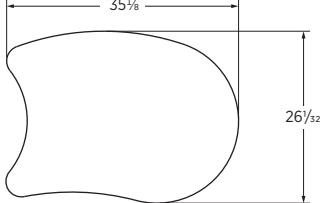
Name	Model	Dimensions
Rectangle	HBSDRECT2038	
Rectangle	HBSDRECT2031	
Ribbon	HBSDRBN2231	
Trapezoid	HBSDTRP2040	
Crescent	HBSDCSNT2832	
Fin	HBSDFN3030	
Spooky	HBSDSPY2636	

Fin

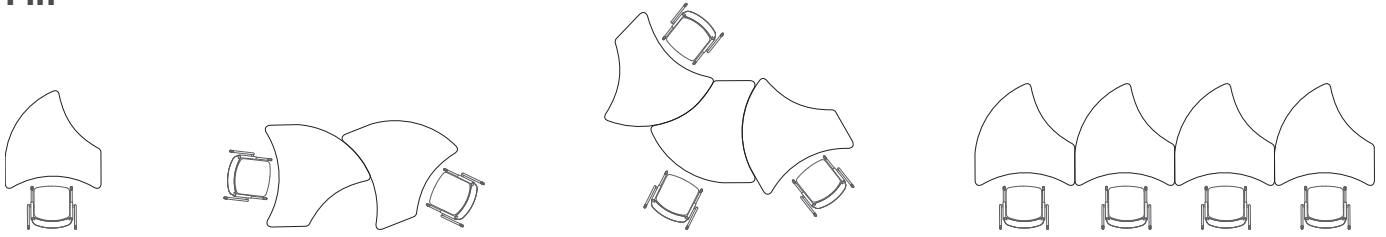

Crescent

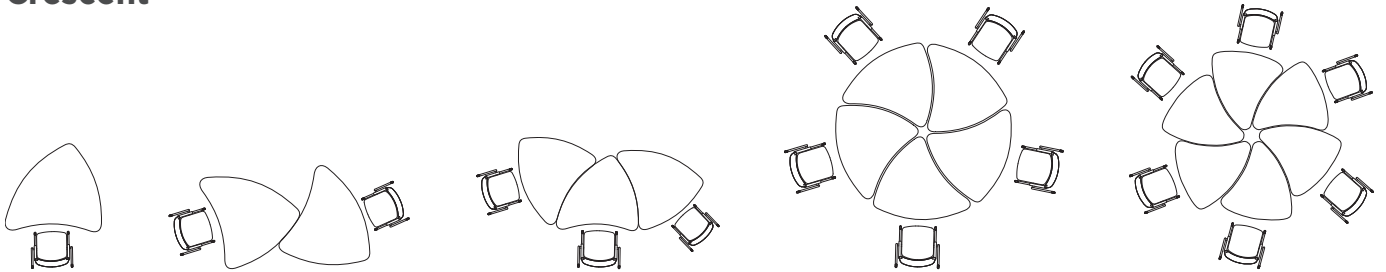

Trapezoid

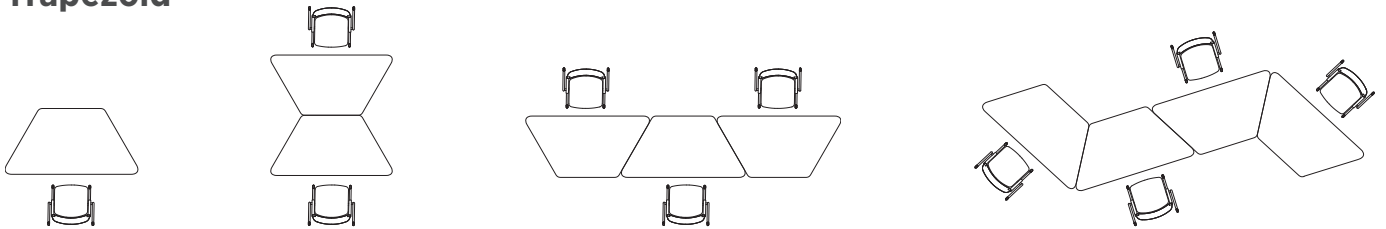

Spooky

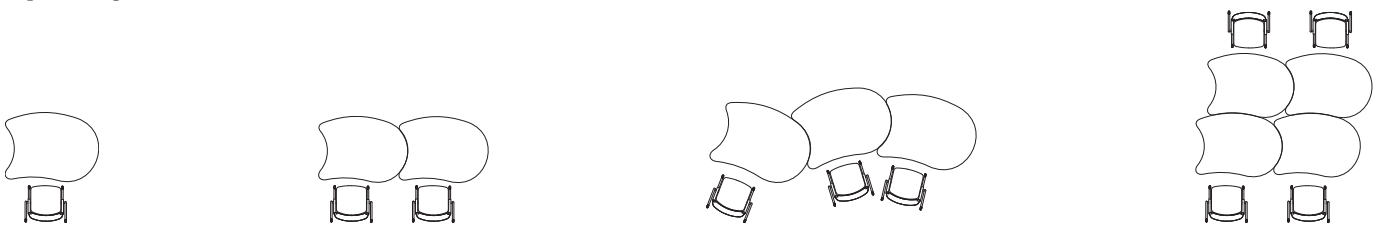

BUILD™ Student Desk Configurations

Rectangle

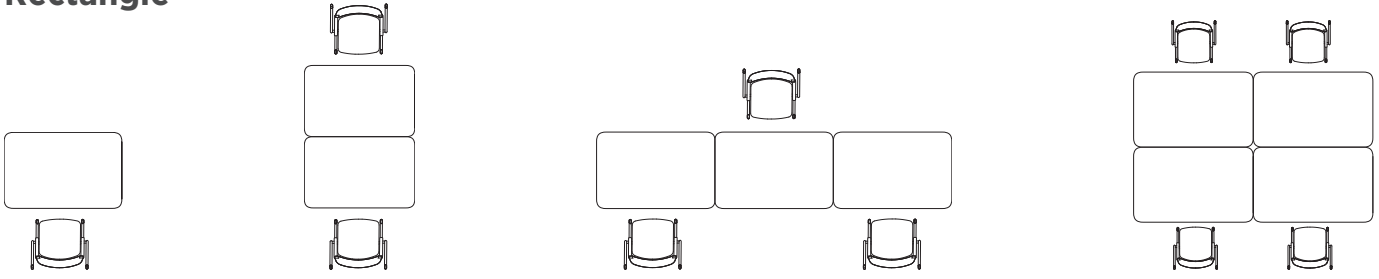

Ribbon

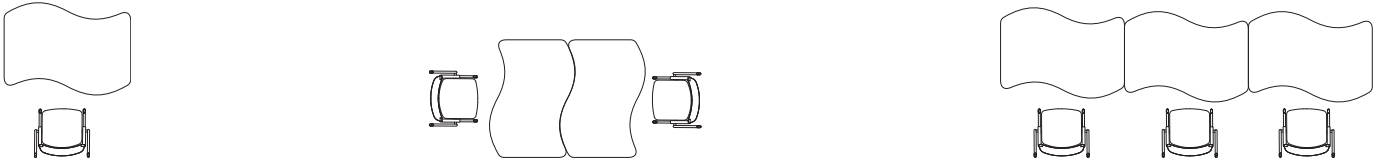



BUILD™ Student Desks

	DESCRIPTION	MODEL	LEGS REQUIRED	SHIP WEIGHT	CUBE	LIST PRICE BY LAMINATE GRADE		
						L1	L2	L5
	Rectangle Student Desk Top 31"W x 20"D	HBSDRECT2031	4	29	2.4	\$183	\$192	\$218
	38"W x 20"D	HBSDRECT2038*	4	33	2.0	\$187	\$196	\$222
* HBSDRECT2038 desk is wheelchair friendly.								
	Trapezoid Student Desk Top 40"W x 20"D	HBSDTRP2040	4	29	5.8	\$211	\$221	\$251
	Ribbon Student Desk Top 31"W x 22"D	HBSDRBN2231	4	27	2.2	\$187	\$196	\$222
	Spooky Student Desk Top 36"W x 26"D	HBSDSPY2636	4	32	6.5	\$211	\$221	\$251
	Fin Student Desk Top 30"W x 30"D	HBSDFN3030	3	26	5.7	\$208	\$218	\$247
	Crescent Student Desk Top 32"W x 28"D	HBSDCNT2832	3	28	5.7	\$208	\$218	\$247

NOTES:

- Top and legs specified separately.

HOW TO SPECIFY

Select Model Number H B S D R B N 2 2 3 1 .	Select Grommet N No Grommet	Select Top Laminate See page 131, Group A L D W 1 .	Select Edge Color See page 131 D W
---	---------------------------------------	--	---

BUILD™ Student Desks

OPEN MARKET



Icon Legend on page 17

DESCRIPTION

Student Desk Leg, 4-Pack

MODEL

HEBSD4LEG

HEIGHT RANGE

22"-34"

SHIP WEIGHT

15

CUBE

1.1

LIST PRICE P1/P2

\$187



NOTES:

- Specify paint for upper portion of leg. Bottom is chrome.

ⓘ Student desk legs not compatible with casters.

ⓘ See page 145 for number of legs required per top. Legs always ship 4 per carton. Use chart below for quantity of 4-leg packs required for shapes that utilize three legs.

DESKS	LEGS NEEDED	ADJUSTABLE POST LEGS 4-PACKS
1	3	1
2	6	2
3	9	3
4	12	3
5	15	4
6	18	5
7	21	6
8	24	6
9	27	7
10	30	8

HOW TO SPECIFY



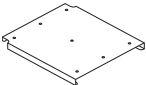

<p>Select Model Number</p> <p>HEBSD4LEG</p>	<p>Select Paint Color</p> <p>See page 131, Paint Group A</p> <p>T1</p>
---	--

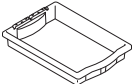

	DESCRIPTION	MODEL	SHIP WEIGHT	CUBE	LIST PRICE
 OPEN MARKET	Book Box Bracket NOTES: Use with HFMBIN3 trays. Specify 1 bracket per tray. For full book box solution specify both HEBBXRL and HFMBIN3. ⓘ Available in P Black paint only. ⓘ Minimum mounting clearance required: 13½"W x 15"D.	HEBBXRL	2.1	0.6	\$44

 SIN 33721	Accessories – Tray Kit 3"H, 2 bins and 4 rails NOTES: For full book box solution specify both HEBBXRL and HFMBIN3. (1) HFMBIN3 needed for every (2) HEBBXRL as bins are ordered in a set of 2. ⓘ Semi-translucent white. No specification needed. ⓘ Bins ship with rails intended for use in storage. When bins are used with Book Box Bracket, rails will not be used.	HFMBIN3	7.0 ⓘ	4.0	\$59
---	--	----------------	-------	-----	-------------

- NOTES:**
- Front and rear handles are integrated for easy handling/transport.
 - Translucent material provides visibility to contents.

	DESCRIPTION	MODEL	SHIP WEIGHT	CUBE	LIST PRICE
 OPEN MARKET    	Back Pack Hook (10 per carton) 12"W x 14½"D x 1½"H NOTES: Attaches to bottom of surface with 2 screws, included. ⓘ Available in Platinum Metallic finish only, no specification needed.	HCLA65	10 ⓘ	0.1	\$101

HOW TO SPECIFY

Select Model Number H E B B X R L .	Select Paint Color P
--	-------------------------

BUILD™ Makerspace Table

GSA SIN 33721



Icon Legend on page 17

EDUCATION



DESCRIPTION	MODEL	SHIP WEIGHT	CUBE	LIST PRICE	UPCHARGE BY LAMINATE/PAINT GRADE				
					L2	L5	P2	P3	
Seated-Height Table with Laminate Top									
60"W x 42"D x 29"H	HEMKR426029L	153	9.4	\$1801	\$34	\$133	\$32	\$52	
72"W x 42"D x 29"H	HEMKR427229L	169	9.7	\$1963	\$41	\$163	\$32	\$52	



Seated-Height Table with Butcher Block Top									
60"W x 42"D x 29"H	HEMKR426029BB	179	9.9	\$2552	N/A	N/A	\$32	\$52	
72"W x 42"D x 29"H	HEMKR427229BB	201	10.4	\$2840	N/A	N/A	\$32	\$52	



Counter-Height Table with Laminate Top									
60"W x 42"D x 36"H	HEMKR426036L	158	10.4	\$1831	\$34	\$133	\$32	\$53	
72"W x 42"D x 36"H	HEMKR427236L	174	10.8	\$1993	\$41	\$163	\$32	\$53	



Counter-Height Table with Butcher Block Top									
60"W x 42"D x 36"H	HEMKR426036BB	184	11.0	\$2582	N/A	N/A	\$32	\$53	
72"W x 42"D x 36"H	HEMKR427236BB	213	12.9	\$2870	N/A	N/A	\$32	\$53	



Standing-Height Table with Laminate Top									
60"W x 42"D x 42"H	HEMKR426042L	173	11.4	\$1862	\$34	\$133	\$33	\$55	
72"W x 42"D x 42"H	HEMKR427242L	189	11.7	\$2024	\$41	\$163	\$33	\$55	



Standing-Height Table with Butcher Block Top									
60"W x 42"D x 42"H	HEMKR426042BB	199	11.9	\$2613	N/A	N/A	\$33	\$55	
72"W x 42"D x 42"H	HEMKR427242BB	221	12.4	\$2901	N/A	N/A	\$33	\$55	

NOTES:

- Laminate top is 1/8" thick and features 3" radius corners.
- Butcher Block top is 1 1/2" thick and features 1/2" radius corners with 1/8" radius around entire perimeter of top.
- Butcher Block tops will naturally feature variation between tops due to the nature of the real wood finish. Constructed of natural Birch wood, no two tops are exactly alike. Top is coated in a clear polyurethane finish for maximum durability.
- Both laminate and Butcher Block tops include threaded metal inserts for easy base connection. This also allows for easy base removal and reconnection if table needs to be moved through standard doorways.
- Up to 4 SmartLink® bins will fit between lower foot rails on standing-height table if desired. Compatible with all 3 heights.

HOW TO SPECIFY

Select Model Number H E M K R 4 2 7 2 2 9 L	Select Grommet N No Grommet	Select Laminate Color See page 131, Group A L S A 1	Select Edge Color See page 131 S A	Select Caster C Casters	Select Paint Color See page 131, Paint Group B P
---	---------------------------------------	--	---	-----------------------------------	---

Select Model Number H E M K R 4 2 7 2 2 9 B B	Select Grommet N No Grommet	Select Wood LH903 Butcher Block L H 9 0 3	Select Caster C Casters	Select Paint Color See page 131, Paint Group B P
---	---------------------------------------	--	-----------------------------------	---

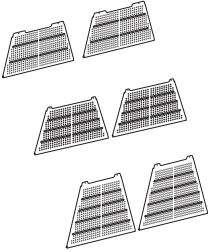
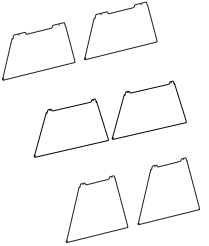

BUILD™ Makerspace Table

	DESCRIPTION	MODEL	SHIP WEIGHT	CUBE	LIST PRICE BY PAINT GRADE			
					P1	P2	P3	P6
	Slotted/Pegboard End Panels For Seated-Height (2/pack)	HEMKREND29-SP	29	2.6	\$464	\$478	\$486	\$552
	For Counter-Height (2/pack)	HEMKREND36-SP	29	2.7	\$520	\$535	\$545	\$618
	For Standing-Height (2/pack)	HEMKREND42-SP	33	3.3	\$579	\$596	\$607	\$688
	Solid Full End Panels For Seated-Height (2/pack)	HEMKREND29-F	29	2.6	\$464	\$478	\$486	\$552
	For Counter-Height (2/pack)	HEMKREND36-F	29	2.7	\$520	\$535	\$545	\$618
	For Standing-Height (2/pack)	HEMKREND42-F	33	3.3	\$579	\$596	\$607	\$688

NOTES:

- Panels ship 2 per carton.
- Slotted/pegboard end panels accept Fuse™ hanging accessories or any standard ¼" pegboard accessory.
- End panels are magnetic.
- End panels feature welded vertical stiffener on inside of panel for maximum rigidity.
- End panels are installed after table is fully built allowing you to add on to table base at a later date if desired.
- End panels are non-handed.

STANDING-HEIGHT TABLES

Top Slot	8¾"W
2nd Slot	10¼"W
3rd Slot	11¾"W
4th Slot	13¼"W

SEATED HEIGHT TABLES

Top Slot	12¼"W
Bottom Slot	13¾"W

HOW TO SPECIFY

Select Model Number	Select Paint Color See page 131, Paint Group C
H E M K R E N D 2 9 - S P .	P

BUILD™ Makerspace Table

GSA SIN 33721



Icon Legend on page 17

EDUCATION

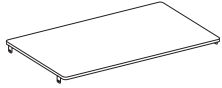

DESCRIPTION	MODEL	SHIP WEIGHT	CUBE	LIST PRICE	UPCHARGE BY LAMINATE/PAINT GRADE		
					L2	P2	P3
Makerspace Table Shelf 50½"W x 31"D ⓘ For use with standing-height tables only.	HEMKRSHELF	39	1.1	\$671	\$21	\$7	\$11

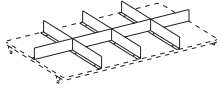

DESCRIPTION	MODEL	SHIP WEIGHT	CUBE	LIST PRICE BY PAINT GRADE		
				P1	P2	P3
Shelf Divider	HEMKRDIVIDER	10	0.6	\$168	\$173	\$176

NOTES:

- Shelves are ¾" thick thermal-fused laminate with 1mm edgeband. Edge color is predetermined by and matches laminate selection.
- Shelf can be used with or without divider (specified separately).
- Shelf always contains small pilot through-holes for shelf divider installation.

HOW TO SPECIFY

Select Model Number HEMKRSHELF	Select Laminate Color See page 131, Laminate Group B LDW1	Select Paint Color See page 131, Paint Group B P
--	--	---

Select Model Number HEMKRDIVIDER	Select Paint Color See page 131, Paint Group B P
--	---





Icon Legend on page 17

Makerspace Table Accessories

	DESCRIPTION	MODEL	SHIP WEIGHT	CUBE	LIST PRICE
	Side Saddle 12¼"W x 2½"D x 4"H	HAESS	0.6	0.1	\$42
	Hook 1⅝"W x 2¼"D x 3¼"H	HAECBH	0.1	0.1	\$28
	Hot File 12¼"W x 3⅞"D x 9½"H	HAEHF	0.7	1.5	\$62

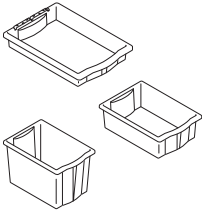

NOTES:

- Hook weight limit 20 lbs.

	DESCRIPTION	MODEL	SHIP WEIGHT	CUBE	LIST PRICE
	Accessories — Tray Kit				
	3"H, 2 bins and 4 rails	HFMBIN3	7 	4.0	\$59
	6"H, 2 bins and 4 rails	HFMBIN6	10 	4.5	\$72
	12"H, 2 bins and 4 rails	HFMBIN12	12 	5.0	\$84

SIN 33721

NOTES:

-  Semi-translucent white. No specification needed.
-  Bins ship with metal rails intended for use in SmartLink® Value Mobile Storage. When bins are used with shelf or foot rails on Makerspace table, rails will not be used.

HOW TO SPECIFY

Select Model Number	Select Color
HAESS	DW Designer White
HAESS	DW

BUILD™ Makerspace Stools

OPEN MARKET



Icon Legend on page 17

EDUCATION



MODEL/DESCRIPTION	DEPTH	WIDTH	HEIGHT	SHIP		LIST PRICE BY PAINT GRADE		
				WEIGHT	CUBE	P1	P2	P3
HE4LSTL18 Seated-Height Stool				12	3.3	\$154	\$159	\$162
Maximum:	15½	15½	18					
Seat:	12	12	18					
Seat to Floor:			18					
Usable Seat Depth:	12							



HE4LSTL30 Café-Height Stool				17	7.6	\$208	\$214	\$218
Maximum:	16⅞	16⅞	30					
Seat:	12	12	30					
Seat to Floor:			30					
Usable Seat Depth:	12							

NOTES:

- Weight Rating: 300 lbs.
- Features non-leveling nylon glides.
- Stackable up to 4-high.

HOW TO SPECIFY

Select Model Number	Select Paint Color
	See page 131, Paint Group B
HE4LSTL18	T1



Revel™ Fidget Stools shown with Build™ Student Desks and SmartLink® Seating.

REVEL™

Revel in the movement and give classroom fidgeting a new meaning. Move side to side, back and forth, or spin in a full circle. Revel brings movement and mobility to active learners.



FEATURES

- Seat available in 3 colors, base available in 1.
- Adjust stool height with the push of a button. Stool ranges in height from 13¾”H-18½”H.
- With a slip resistant base and plastic body, you can feel comfortable using the stool in your most creative space with easy cleanup afterwards.
- Tested to hold up to 250 lbs.
- Backed by the HON Full Lifetime Warranty.

REVEL™ Stool

OPEN MARKET



Icon Legend on page 17

HEFS01

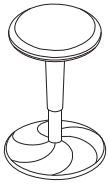

ADJUSTABLE HEIGHT FIDGET STOOL

DIMENSIONS

Depth:	15 ³ / ₈	Seat Height:	13 ³ / ₄ -18 ¹ / ₂
Width:	15 ³ / ₈	Ship Weight:	20.1
Height:	13 ³ / ₄ -18 ¹ / ₂	Cube:	1.4
Seat Depth:	15 ³ / ₈	Weight Rating:	250 lbs.
Seat Width:	15 ³ / ₈		

LIST PRICE

\$265

NOTES: Two buttons integrated in underside of seat for height adjustment control while maintaining a clean aesthetic. Stool seat and base are all plastic for easy cleanability. Anti-slip rubber attached to underside of base allows for comfortable movement of user while maintaining contact with floor. Base color is similar to HON Loft.

EDUCATION

HOW TO SPECIFY

<p>Select Model Number</p> <p>HEFS01</p>	<p>Select Seat Color</p> <p>BZ Breeze S Charcoal BL Black</p> <p>BL</p>
---	--



SmartLink® Student Desks, Seating, Storage, and Teacher Desk.

SMARTLINK®

Show of hands — who loves long lectures? Today's classroom is more hands-on and collaborative, involving group interactions that better stimulate learning. That's why we've done our homework in the design of SmartLink. This collection of lightweight and mobile desks, chairs, storage, and presentation tools earns high marks by being easy to arrange and rearrange, keeping active minds and bodies fully engaged.



FEATURES

- Put teachers in control of their storage, technology and environment.
- Worksurface shape supports creative configurations.
- Designed to the unique ways students sit and move throughout the day.
- Organize lesson plans and make the most of unused wall space.
- Move educational tools wherever the activities demand.
- SmartLink chairs warranted for users up to 300 lbs.

SMARTLINK® ORDERING INFORMATION

TEACHER DESK & MODULAR STORAGE

LAMINATES CODES

- L1
- ◆ Harvest CC
- ◆ Natural Maple DD
- ◆ Sheer Mesh A5
- ◆ Silver Mesh B9

PAINTS CODES

- P1
- ◆ Charcoal S
- P2
- ◆ Platinum Metallic T1

EDGE CODES

- ◆ Charcoal S
- ◆ Platinum K

STUDENT DESK

PLASTIC CODES

- ◆ Breeze G9
- ◆ Harvest CC
- ◆ Natural Maple DD
- ◆ Sand G8
- ◆ White G1

PAINTS CODES

- P1
- ◆ Charcoal S
- P2
- ◆ Platinum Metallic T1

VALUE MOBILE STORAGE

PAINTS CODES

- P1
- ◆ Black P
- ◆ Brownstone P7D
- ◆ Charcoal S
- ◆ Designer White PJW
- ◆ Fossil P28
- ◆ Greige T5
- ◆ Loft LOFT
- ◆ Muslin T3
- ◆ Shadow * SHDW
- ◆ Titanium P8T

P2

- ◆ Champagne Metallic T4
- ◆ Platinum Metallic T1
- ◆ Silver PR6

P3

- ◆ Atom P8S
- ◆ Bullseye PJF
- ◆ Ember P8P
- ◆ Ion P8N
- ◆ Iris P8J
- ◆ Krypton P8F
- ◆ Regatta P8M

VALUE TEACHER DESK

LAMINATES CODES

- L1
- ◆ Black P
- ◆ Bourbon Cherry H
- ◆ Charcoal S
- ◆ Cognac COGN
- ◆ Designer White LDW1
- ◆ Florence Walnut LFW1
- ◆ Handspun Chestnut LAHC
- ◆ Handspun Dove LAHD
- ◆ Handspun Pearl LAHP
- ◆ Handspun Slate LAHS
- ◆ Harvest C
- ◆ Kingswood Walnut LK11
- ◆ Loft LOFT
- ◆ Mahogany N
- ◆ Mocha MOCH
- ◆ Natural Maple D
- ◆ Pinnacle PINC
- ◆ Shaker Cherry F
- ◆ Sheer Mesh * A5
- ◆ Silver Mesh B9
- ◆ Steel Mesh * A9
- ◆ Sterling Ash LSA1

L2

- ◆ Lowell Ash LLA1
- ◆ Natural Recon LNR1
- ◆ Phantom Ecru LPE1
- ◆ Portico Teak LPT1
- ◆ Skyline Walnut LSW1

PAINTS CODES

- P1
- ◆ Charcoal S
- ◆ Designer White PJW

P2

- ◆ Platinum Metallic T1
- ◆ Silver PR6

P3

- ◆ Atom P8S
- ◆ Bullseye PJF
- ◆ Ember P8P
- ◆ Ion P8N
- ◆ Iris P8J
- ◆ Krypton P8F
- ◆ Regatta P8M

EDGE CODES

- ◆ Atom AT
- ◆ Bullseye BY
- ◆ Charcoal S
- ◆ Ember MR
- ◆ Ion IO
- ◆ Iris IR
- ◆ Krypton KT
- ◆ Platinum K
- ◆ Regatta RE

VALUE STUDENT DESK

PLASTIC CODES

- ◆ Breeze G9
- ◆ Harvest CC
- ◆ Natural Maple DD
- ◆ Sand G8
- ◆ White G1

PAINTS CODES

- P1
- ◆ Charcoal S
- P2
- ◆ Platinum Metallic T1

P3

- ◆ Atom P8S
- ◆ Bullseye PJF
- ◆ Ember P8P
- ◆ Ion P8N
- ◆ Iris P8J
- ◆ Krypton P8F
- ◆ Regatta P8M

UNIVERSAL MODESTY PANEL

PAINTS CODES

- P1
- ◆ Black P
- ◆ Brownstone P7D
- ◆ Charcoal S
- ◆ Designer White PJW
- ◆ Fossil P28
- ◆ Greige T5
- ◆ Light Gray Q
- ◆ Loft LOFT
- ◆ Muslin T3
- ◆ Putty L
- ◆ Shadow * SHDW
- ◆ Textured Black Mica BLCK
- ◆ Textured Platinum Metallic PLAT
- ◆ Titanium P8T

P2

- ◆ Champagne Metallic T4
- ◆ Platinum Metallic T1
- ◆ Silver PR6
- ◆ Solar Black P8X
- ◆ Textured Silver PR8

P3

- ◆ Atom P8S
- ◆ Bullseye PJF
- ◆ Ember P8P
- ◆ Ion P8N
- ◆ Iris P8J
- ◆ Krypton P8F
- ◆ Regatta P8M

4-LEG, CANTILEVER CHAIR, TASK CHAIR, STOOL SHELLS

SHELL CODES

- ◆ Calypso CP
- ◆ Cherry CR
- ◆ Lava LA
- ◆ Lime LM
- ◆ Mulberry MB
- ◆ Onyx ON
- ◆ Platinum PT
- ◆ Regatta RE
- ◆ Shadow SD
- ◆ Surf BU
- ◆ Tangelo RG

4-LEG AND CANTILEVER CHAIR AND STOOL FRAME

PAINTS CODES

- P1
- ◆ Designer White Texture PK7
- ◆ Textured Charcoal P7A
- ◆ Textured Platinum Metallic PLAT

P2

- ◆ Silver Texture PR8

P3

- ◆ Atom P8S
- ◆ Bullseye PJF
- ◆ Ember P8P
- ◆ Ion P8N
- ◆ Iris P8J
- ◆ Krypton P8F
- ◆ Regatta P8M

P4

- ◆ Polished Chrome* Y

*\$52 upcharge. Polished Chrome not available on models HSS4L-06A, HSS4L-24B, and HSS4L-30B.

◆◆◆ For lead time information see page 17.

* De-emphasized





SMARTLINK® SPECIFYING INFORMATION

FINDING THE RIGHT FIT FOR YOUR STUDENT DESK & CHAIR

With the SmartLink® student desk's innovative shape, you can create dynamic learning environments and every space can be tailored to fit the lesson plan whether the need is for individual, student/group collaboration or teacher centered layouts. In addition to the desk's innovative top shape you can also select from three leg configurations to meet your specific needs for classroom or collaborative spaces.



STEP 1

Choose a grade range to find the recommended SmartLink® desk height.

 <p>K-2nd Seated 22"-27" Standing 24"-30"</p>	 <p>3rd-5th Seated 23"-29" Standing 29"-35"</p>	 <p>6th-8th Seated 25"-30" Standing 32"-40"</p>	 <p>9th & Up Seated 29"-30" Standing 38"-43"</p>
---	---	--	--

STEP 2

Pick the SmartLink® model that meets the student height needs.

 <p>Model: HLD-M3A Adjustable Height 23"-33" Height Range</p>	<p>Use the color-coated circles in the chart on the right to find a compatible chair.</p>
 <p>Model: HLD-M3F Fixed Height 30" Fixed Height</p>	
 <p>Model: HLD-M3T Sit-to-Stand 30"-43" Height Range</p>	

STEP 3

Determine the suggested chair height within your desk size range.

Desk Height	Chair Seat Height	Type of Chair
22" ●	12"	4-Leg, Cantilever or Task
23-24" ●		
25-27" ●	14"	
28-29" ●	16-18"	
30" ●○●	18"	Stool
31-33" ●○	22-24"	
34-41" ○	24-31"	
42-43" ○	30-32"	

SMARTLINK® SPECIFYING INFORMATION

Individual Layouts

- The non-handed top allows the desk to be positioned to better support right-handed or left-handed individuals or be used in a forward position.



LH Position



Forward Position



RH Position

Group/Collaborative Layouts

Below are examples of how the student desks can be configured to support multiple students or group activities.

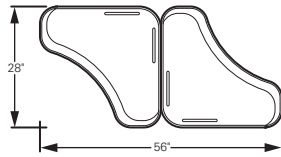

Student Desk
2-Desk Configuration

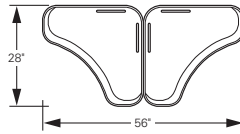

Opposing Student Desk
2-Desk Configuration

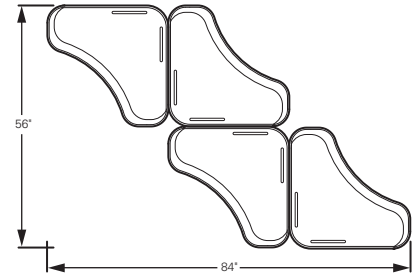

Student Desk
4-Desk Configuration

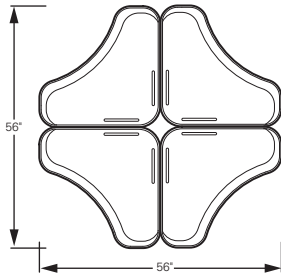

Student Desk
4-Desk Cluster Configuration

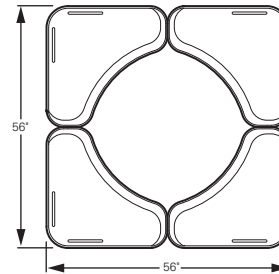

Student Desk
4-Desk Work Group Configuration
Can accommodate up to 8 students

Teacher Centered Layouts

- Reverse the layout and use the student desks to create layouts for teacher centers that can accommodate up to 6 students.
- 23 $\frac{5}{8}$ " distance between legs when used from either side.

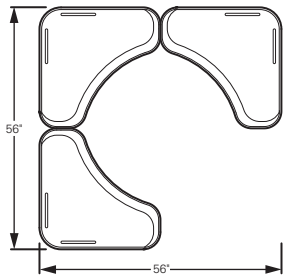

Teacher Centered Layout

Standard Row Layout

While a variety of classroom configurations are possible, a standard row layout shown below with 25 student desks utilizes a footprint of 199" deep by 284" wide. A 30 student desk row layout (5 rows deep by 6 rows wide) will require a footprint of 199" deep by 348" wide.

These dimensions are based upon 36"W aisles. Actual dimensions should be based upon local building codes.

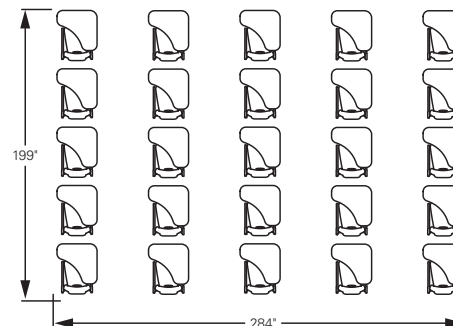

SMARTLINK® SPECIFYING INFORMATION

TEACHER STATION

SmartLink®

The following planning and specifying information is intended to help you imagine and create stimulating SmartLink classrooms that can integrate technology while helping rooms stay adaptable, organized and attractive. SmartLink offers you everything you need to create flexible, clutter-free learning environments for students of all ages.

Teacher Station – Standard Double Pedestal

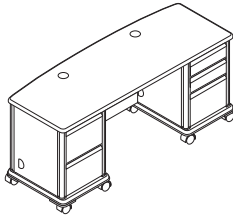

HLT2672-23.C

Storage

- Box/box/file pedestal is always standard on the right-hand side. Pedestal is locking.
- Available kneespace is 33 $\frac{1}{4}$ "W x 20"D for all models.
- Non-locking Center Drawer (HD8X) may be field installed in the kneespace. Tops are pre-drilled to accept the drawer.
- Center drawers and CPU holders cannot be installed together.

Cable Management

- Both the left-hand and right-hand end panels may be removed to provide access to power and cable management within the side power cabinet.
- Grommets are standard in each removable end panel allow a power cord to exit and be plugged into a floor or wall outlet.
- Two "Smart Grommets" with a wireway cover are standard on each station's top surface.

Teacher Station – Standard Single Pedestal

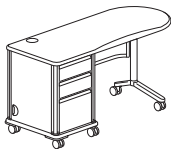

HLT2460-L3.C

Storage

- Single pedestal desk available in Left-hand or Right-hand pedestal/storage configurations.
- Pedestal options include Box/Box/File locking.

Cable Management

- The pedestals end panel may be removed to provide access to power and cable management within the side power cabinet.
- A grommet is standard in the removable end panel to allow a power cord to exit and be plugged into a floor or wall outlet.
- A single "Smart Grommet" with a wireway cover is standard on each station's top surface.

Teacher Station – Value Double Pedestal

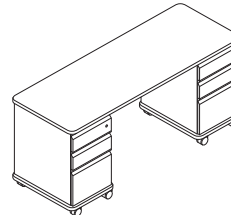

HLTV2466T-33

- Larger top size provides ample work/conference area or space for equipment.
- Standard with Heavy-duty 3", 360-degree swivel casters, 4-locking, 4-non-locking.
- Storage options include: Locking box/box/file.
- Kneewell space accommodates optional (specified separately) and field installed non-locking center drawer and CPU holders (see page 172).
- Modesty specified separately.
- Power modules can be ordered separately and mounted to the desk. See Power & Cable Management page 204.

Teacher Station – Value Single Pedestal

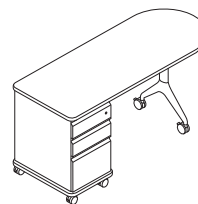

HLTV2460T-3

- Standard with Heavy-duty 3", 360-degree swivel casters, 4-locking, 4-non-locking.
- Storage options include: Locking box/box/file.
- Kneewell space accommodates optional (specified separately) and field installed non-locking center drawer and CPU holders (see page 172).
- Right or left assembled in the field.
- D-shape top encourages conferencing and provides ample work and conference area.
- Modesty specified separately.
- Power modules can be ordered separately and mounted to the desk. See Power & Cable Management page 204.

SMARTLINK® SPECIFYING INFORMATION

MODULAR STORAGE

SmartLink® Modular Storage is comprised of cases, accessories and support rails. However, only the cases and accessories need to be specified. The following guidelines should help you plan and specify SmartLink Storage.

Planning Notes

Cases

- A laminate top with a soft feel vinyl edge provides a classic look with exceptional durability.
- **Storage cases do NOT include accessories. Accessories are specified and sold separately.**
- Case configurations are based off of 12"W or 30"W columns.
- Internal case configurations cannot be changed (i.e., cannot change an HLSF52-3 to a HLSF52-21).
- Cases are designed to allow the users to create a variety of accessory configurations using different tray heights and shelves.
- Cases can be specified with or without locking doors.
- Door models may be converted to non-door models in the field.

Accessories

- Accessories include trays in 3", 6" and 12" heights, shelves in 12" and 30" widths and a 12"W coat rod.
- **All accessories are sold and specified separately as kits and include 1 pair of storage rails per tray or shelf.**
- The support rails simple "no tool" attachment method allows users to easily install and change rail (tray or shelf) positions as needed.
- Kits include:

Accessory	Quantity Per Kit	Where Used
3"H trays	7 trays / 14 support rails	12"W columns only
6"H trays	4 trays / 8 support rails	12"W columns only
12"H trays	2 trays / 4 support rails	12"W columns only
12"W shelf	2 shelves / 4 support rails	12"W columns only
30"W shelf	2 shelves / 4 support rails	30"W columns only
Coat Rod	1 coat rod	12"W columns — Full Height case only

- Cabinet Whiteboard Bracket kit is available which allows whiteboards to be mounted to the back of the full height cabinets. Kit includes upper and lower rails with integrated marker tray and attachment hardware. Use wall rail sliding whiteboards. Rails will accept one (1) 48" x 48" board or two (2) 24" x 48" boards.

Specification Notes

- Number of accessory openings
SmartLink storage cases are available in six (6) standard case types that feature combinations of 12" or 30" internal column widths. The following illustration shows the number of openings by column width for each case configuration.

Full Height Storage (61¾"H)

30"	12"	12"	12"	12"
1	1	1	1	1
2	2	2	2	2
3	3	3	3	3
4	4	4	4	4
5	5	5	5	5
6	6	6	6	6
7	7	7	7	7
8	8	8	8	8
9	9	9	9	9
10	10	10	10	10
11	11	11	11	11
12	12	12	12	12
13	13	13	13	13
14	14	14	14	14
15	15	15	15	15
16	16	16	16	16

16-30"W Openings
16-12"W Openings

HLSF52-21

Credenza Height Storage (30"H)

30"
1
2
3
4
5
6
7

7-30"W Openings

HLSC36-1

12"	12"
1	1
2	2
3	3
4	4
5	5
6	6
7	7

14-12"W Openings

HLSC36-2

30"	12"
1	1
2	2
3	3
4	4
5	5
6	6
7	7

7-30"W Openings
7-12"W Openings

HLSC52-21

12"	12"	12"
1	1	1
2	2	2
3	3	3
4	4	4
5	5	5
6	6	6
7	7	7

21-12"W Openings

HLSC52-3

SMARTLINK® SPECIFYING INFORMATION

- Openings used by Accessory type:

Accessory	Openings used per Accessory
3”H tray	1
6”H tray	2
12”H tray	4
12”W shelf	1
30”W shelf	1

- Any combination of trays or shelves (of common width) can be used as long as the openings used equal the total number of openings available per column. The following illustrations show a variety of tray configuration options. Numbers shown in the opening refers to the tray size.

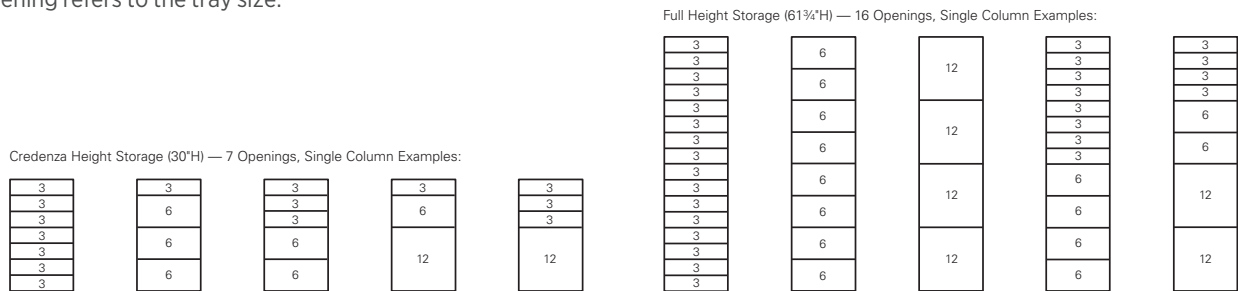

Using the information above, follow these guidelines to help determine accessory quantities.

1. Determine the total number of available “openings” by width (12”, 30”) for each case type.
Example: HLSF52T-3F has 3 columns of 16 openings, total 48 openings
2. On a PER COLUMN basis, determine the desired tray/shelf configurations total number of openings used so they equal the total openings available per column. Total accessory quantities per case then multiply by the total number of like cases.
Example: If each column will have 2-12” trays, 2-6” trays and 4-3” trays. The number of openings used for this column combination is 16. Assuming all three columns are the same total tray quantities for this case will be 12-3”, 6-6” and 6-12”.
3. Once total tray and shelf quantities are determined, simply divide by the kit quantity to determine the number of kits required.
Example: 3” trays = $12 \div 7 = 2$ kits, 6” trays = $6 \div 4 = 2$ kits, 12” trays = $6 \div 2 = 3$ kits

• Shelf Spacing

The clearance between shelves is approximately 3³/₈” for every support rail that is not used between shelves. The following illustration shows the clearance between shelves when 0-4 support rail positions are not utilized.

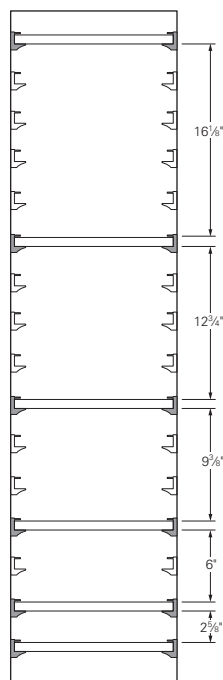

SMARTLINK® SPECIFYING INFORMATION

WALL RAIL SYSTEM

The SmartLink® wall rail is a multi-layered, multi-functional system that can accommodate a variety of presentation boards and accessories. The multiple tracks allow boards to be easily positioned and changed to support today's interactive learning environments.

Planning Notes

- Installation of the wall rail system over existing white or chalkboards is not recommended.
- The rail and wall bracket provide three separate tracks for the Learning boards. The REAR or wall/bracket track is occupied by the fixed wall board. The MIDDLE and FRONT tracks are for sliding boards.
- To allow for greater utilization of the rear fixed board a maximum width of 96" of sliding boards on the middle or front track is recommended.

The illustration below shows the overall wall space requirements for the rail system and recommended mounting height for use in K-12 classroom applications.

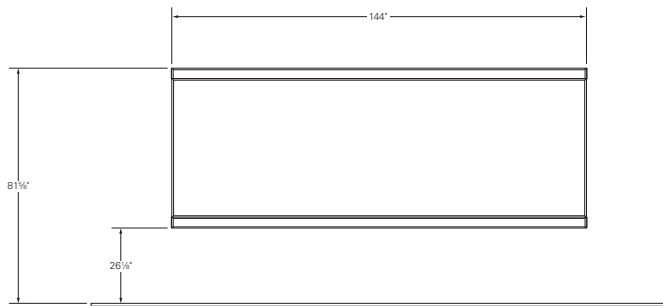

Sliding boards are removable and reversible so a wide variety of layouts are possible. The following illustrations highlight a couple of the more common applications. Layouts 2A and 2B provide the greatest amount of board space and overall flexibility. When used with rail mounted worksurfaces, use 24"W boards on the front rail as shown in 2C in front of each worksurface to provide information specific to that work area. Boards could then be added to the middle rail for information/work to be shared between the stations.

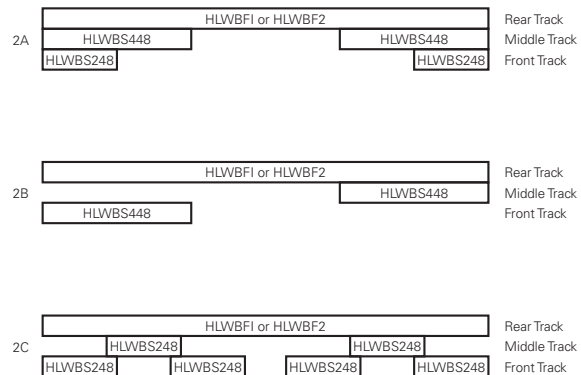







Specification Notes

- Boards are specified individually.
- Hardware to mount to the wall brackets is not provided by HON and **MUST BE SOURCED LOCALLY**.
- Learning board only applications require two (2) HLWR-12 rails to be specified.
- REFER TO PRODUCT INSTALLATION INSTRUCTIONS FOR DETAILED INSTALLATION INFORMATION.

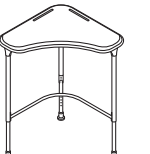

SMARTLINK® Student Desks



	DESCRIPTION	MODEL	SHIP WEIGHT	CUBE	LIST PRICE
	Student Desk, Fixed Height 28"W x 28"W, User side 36¼"W 30" Fixed Height Hard Plastic Top Ships  Ships Assembled Ships Assembled with HLDA-15 Book Box attached	HLD-M3F	63	5.5	\$787
		HLD-M3FA	58	17.9	\$830
		HLD-M3FB	65	17.9	\$958
	Student Desk, Adjustable Height 28"W x 28"W, User side 36¼"W Adjustable: 23"-33" height adjustment range. Legs ship pre-set for 30" overall desk height when factory installed. Hard Plastic Top Ships  Ships Assembled Ships Assembled with HLDA-15 Book Box attached	HLD-M3A	63 	5.5	\$787
		HLD-M3AA	58	17.9	\$830
		HLD-M3AB	65	17.9	\$958
 	Student Desk, Sit-to-Stand 28"W x 28"W, User side 36¼"W Adjustable: 30"-43" height adjustment range. Leg height is set during field installation. Hard Plastic Top	HLD-M3T	65	5.5	\$1119

NOTES:

- Non-handed desk top constructed of ¾" hard plastic, includes dual pencil grooves.
- Hard plastic top features comfort edge on user side and soft radius with rounded corners on all sides.
- May also be specified to ship fully assembled, with or without HLDA-15 Book Box.
- Upper leg is painted, lower leg standard chrome finish on Adjustable and Sit-to-Stand models.
- Nylon swivel glides are standard on adjustable and fixed leg models.
- 29.60" distance between legs on user side. Outside distance between legs is 23⅜".
- Sit-to-Stand model features bell glides.
- Sit-to-Stand is height adjustable from 30"-43"H and includes a footrest.
- Accepts optional book box (HLDA-15) and backpack hooks (HCLA65).

SPECIFICATION TIP: Consider available kneespace when specifying under desk storage Wire Book Box. Available kneespace will vary significantly given set desk height. Use the following example to calculate the available and usable kneespace.

EXAMPLE: HLDV-M3A Student Desk, HLDA-15 Wire Book Box
 (user set desk height – top thickness – seat height = available kneespace)
 (29"H – 1" thickness – 18" seat height = 10" available kneespace)
 (available kneespace – book basket/box height = usable kneespace)
 (10" available kneespace – 5" basket height = 5" usable kneespace)

-  Field installed felt glide caps (HGDK3-F) are recommended for use on VCT flooring.
-  All Student Desks are ordered and shipped two (2) desks per carton. Legs and cross-brace ship unattached on  models. Pricing shown is per carton. Ordering two of model HLD-M3A or HLD-M3T will result in 2 cartons being shipped, giving you 4 desks.

HOW TO SPECIFY

<p>Select Model Number</p> <p>H L D - M 3 A .</p>	<p>Select Glide Option</p> <p>E Hard-Surface (no upcharge) (Fixed or Adjustable models only) G Bell Glide (Sit-to-stand model only)</p> <p>E .</p>	<p>Select Top Color</p> <p>See page 156</p> <p>G 9 .</p>	<p>Select Upper Leg Color</p> <p>See page 156</p> <p>S</p>
--	--	---	---

SMARTLINK® Value Series Student Desks

GSA SIN 33721T



Icon Legend on page 17

EDUCATION



DESCRIPTION

Student Desk, Fixed Height

28"W x 28"W, User side 36¼"W
30" Fixed Height

Hard Plastic Top

MODEL

HLDV-M3F

SHIP WEIGHT

63

CUBE

18.0

LIST PRICE BY PAINT GRADE

P1

\$643

P2

\$643

P3

\$673

NOTES: The cross-brace is installed to maximize kneespace but will not allow for book basket (HLDA-15) installation. The cross-brace orientation can be switched in the field to allow for book basket install.

Student Desks are ordered and shipped two (2) desks per carton. Legs and cross-brace ship attached. The cross-brace is installed to maximize kneespace but will not allow for book basket (HLDA-15) installation. Pricing shown is per carton. Ordering two of model HLDV-M3F will result in 2 cartons being shipped, giving you 4 desks.



Student Desk, Adjustable Height

28"W x 28"W, User side 36¼"W
Adjustable: 23"-33" height adjustment range.

Hard Plastic Top

HLDV-M3A

59

12.5

\$643

\$643

\$673

NOTES: Accepts book basket (HLDA-15) installation without repositioning crossbar.

Student Desks are ordered and shipped two (2) desks per carton. Upper leg and cross-brace ship attached. Lower adjustable legs ship unattached for field installation. Pricing shown is per carton. Ordering two of model HLDV-M3A will result in 2 cartons being shipped, giving you 4 desks.

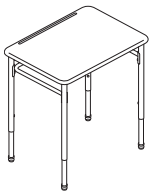

Rectangle Student Desk, Adjustable Height

20"W x 26"D
Adjustable: 23"-33" height adjustment range.

HLDV-MRECT2026A

57

9.19

\$643

\$643

\$673

NOTES: Accepts book basket (HLDA-15) installation without repositioning crossbar.

Student Desks are ordered and shipped two (2) desks per carton. Legs and cross-brace ship attached. Pricing shown is per carton. Ordering two of model HLDV-MRECT2026A will result in 2 cartons being shipped, giving you 4 desks.

NOTES:

- Upper leg is painted, lower leg standard chrome finish on Adjustable Height models.
- Non-handed desk top constructed of ¾" hard plastic.
- Hard plastic tops include pencil grooves.
- Nylon swivel glides are standard on adjustable and fixed leg models.
- Fixed Height models ship fully assembled. Adjustable models have the upper leg and cross-brace installed. The lower leg ships unattached for field installation.
- 29.60" distance between legs on user side. Outside distance between legs is 23¾".
- Accepts optional backpack hooks (HCLA65).
- Book boxes are only available as an accessory for field installation on Value Series desks.

SPECIFICATION TIP: Consider available kneespace when specifying under desk storage Wire Book Box. Available kneespace will vary significantly given set desk height. Use the following example to calculate the available and usable kneespace.

EXAMPLE: HLDV-M3A Student Desk, HLDA-15 Wire Book Box

(user set desk height – top thickness – seat height = available kneespace)

(29"H – 1" thickness – 18" seat height = 10" available kneespace)

(available kneespace – book basket/box height = usable kneespace)

(10" available kneespace – 5" basket height = 5" usable kneespace)

Field installed felt glide caps (HGDK3-F) are recommended for use on VCT flooring.







All Student Desks are ordered and shipped two (2) desks per carton. Ordering two of any model will result in 2 cartons being shipped, giving you 4 desks.

HOW TO SPECIFY

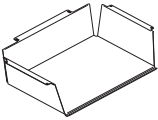
Select Model Number H L D V - M 3 F .	Select Glide Option E Hard-Surface (no upcharge)	Select Top Color See page 156 G 9 .	Select Upper Leg Color See page 156 S
---	--	--	--

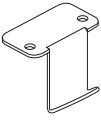





SMARTLINK® Student Accessories

	DESCRIPTION	MODEL	SHIP WEIGHT	CUBE	LIST PRICE
 SIN 33721T  	Metal Book Box (4 per Carton) 19½"W x 13"D x 5"H NOTES: Attaches to bottom of desk with 6 screws, included. Field installed. For use on model HLD-M3A, HLD-M3F, HLDV-MRECT2026A or HLD-M3T. Features integrated, full-width pencil holder. ⓘ Platinum finish only.	HLD A-15	15	2.0	\$277
 OPEN MARKET  	Back Pack Hook (10 per carton) NOTES: Assembly: attaches to bottom of desk with (2) screws, included. ⓘ Available in Platinum Metallic finish only, no specification needed.	HCLA65	10	0.1	\$101
 OPEN MARKET	Glide Kit — Felt Glide Caps <ul style="list-style-type: none"> • Recommended for use on VCT flooring. • Caps easily and securely snap over existing nylon swivel glide. • Kit includes 100 caps. • Field installed. ⓘ Not designed to be used with Sit-to-Stand Bell Glides (model HLD-M3T). Must be ordered with a configurable end product. If ordered separately, not on GSA Contract.	HGDK3-F	2	0.2	\$133

HOW TO SPECIFY

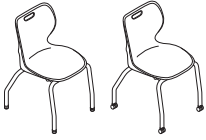
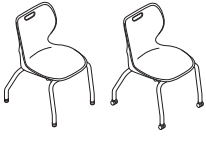
Select Model Number

H L D A - 1 5

	MODEL/DESCRIPTION	DEPTH	WIDTH	HEIGHT	SHIP WEIGHT	CUBE	PER CARTON LIST
	HSS4L-18B 18"H 4-Leg Chair, Armless	Maximum: 19 ⁵ / ₈ Seat: 16 ¹ / ₄ Back: 15 ³ / ₈ Seat to Floor: 18 Usable Seat Depth: 16 ¹ / ₈	19 ¹ / ₂	31	58	15.6	P1 \$618 (reference single unit @ \$154.50) P2 \$618 (reference single unit @ \$154.50) P3 \$647 (reference single unit @ \$161.75)
	HSS4L-16B 16"H 4-Leg Chair, Armless	Maximum: 19 ⁵ / ₈ Seat: 16 ¹ / ₄ Back: 15 ³ / ₈ Seat to Floor: 16 Usable Seat Depth: 16 ¹ / ₈	19 ¹ / ₄	29	54	15.6	P1 \$618 (reference single unit @ \$154.50) P2 \$618 (reference single unit @ \$154.50) P3 \$647 (reference single unit @ \$161.75)
	HSS4L-14A 14"H 4-Leg Chair, Armless	Maximum: 17 Seat: 14 ³ / ₄ Back: 13 ³ / ₈ Seat to Floor: 14 Usable Seat Depth: 14	17	25 ¹ / ₂	49	11.9	P1 \$589 (reference single unit @ \$147.25) P2 \$589 (reference single unit @ \$147.25) P3 \$617 (reference single unit @ \$154.25)
	HSS4L-12A 12"H 4-Leg Chair, Armless	Maximum: 17 Seat: 14 ³ / ₄ Back: 13 ³ / ₈ Seat to Floor: 14 Usable Seat Depth: 14	17	23 ¹ / ₂	45	11.9	P1 \$589 (reference single unit @ \$147.25) P2 \$589 (reference single unit @ \$147.25) P3 \$617 (reference single unit @ \$154.25)
	HSS4L-06A 6"H 4-Leg Chair, Armless	Maximum: 17 Seat: 14 ³ / ₄ Back: 13 ³ / ₈ Seat to Floor: 14 Usable Seat Depth: 14	17	17 ¹ / ₂	37	8.6	P1 \$574 (reference single unit @ \$143.50) P2 \$574 (reference single unit @ \$143.50) P3 \$601 (reference single unit @ \$150.25)

NOTES:





- High strength tubular steel frame.
- Seat Shell is one-piece injection molded.
- 16"H and 18"H models accept Wire Storage Basket model HSSA-WB1618.
- Casters are available on 16"H and 18"H chairs only.
- 4-Leg models stack 5-high on floor.
- Nylon or steel glides accept felt glide caps (HGDK3-F) which are recommended for use on VCT flooring.
- Durable textured powder coated paint finish or chrome option finish.

⊕ SmartLink® 4-Leg Chairs are ordered and shipped four (4) chairs per carton. Pricing shown is per carton. Each set of four chairs (one carton) must have the same shell/frame color combination. Ordering 2 of Model HSS4L-06A, HSS4L-12A, HSS4L-14A, HSS4L-16B or HSS4L-18B will result in 2 cartons being shipped, giving you 8 chairs.

HOW TO SPECIFY

<p>Select Model Number</p> <p>H S S 4 L - 1 2 A .</p>	<p>Select Glide Option</p> <p>E Nylon Glide N Nickel Steel Glide C Caster (\$196 upcharge)</p> <p>Caster option not available for models HSS4L-06A, HSS4L-12A or HSS4L-14A</p> <p>E .</p>	<p>Select Shell Color</p> <p>See page 156</p> <p>R G .</p>	<p>Select Frame Color</p> <p>See page 156</p> <p>P4 option Polished Chrome (Y) \$52 upcharge</p> <p>P L A T</p>
--	--	---	--

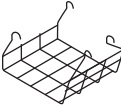



	MODEL/DESCRIPTION	DEPTH	WIDTH	HEIGHT	SHIP WEIGHT	CUBE	LIST PRICE BY PAINT GRADE		
							P1	P2	P3
	HSS4L-24B 24"H 4-Leg Stool, Armless Maximum: Seat: Back: Seat to Floor: Usable Seat Depth:	21½	22	38¼	30	16.8	\$300	\$300	\$315
	HSS4L-30B 30"H 4-Leg Stool, Armless Maximum: Seat: Back: Seat to Floor: Usable Seat Depth:	23½	22½	43¾	31	19.1	\$316	\$316	\$331
	Wire Storage Basket (4 per carton) 15¾"W x 12¼"D x 9¾"H For 16" and 18" 4-Leg Chairs only. Chrome finish only, no specification needed. Chairs cannot be stacked when utilizing Wire Storage Basket. Not compatible with 4-Leg Stools or Cantilever Chairs.					14		1.6	\$149
	Felt Cap Glide Kit for 4-Leg SmartLink® Recommended for use on VCT flooring. Caps easily and securely snap over the existing nylon swivel glide. Kit includes 100 caps for 25 chairs or desks. Field installed. Must be ordered with a configurable end product. If ordered separately, not on GSA Contract.					2		0.2	\$133

NOTES:

- 4-Leg Stools may stack up to 5-high on floor.
- Lead times may vary by shell color.

HOW TO SPECIFY

<p>Select Model Number</p> <p>H S S 4 L - 2 4 B</p>	<p>Select Glide Option</p> <p>E Nylon Glide N Nickel Steel Glide</p> <p>E</p>	<p>Select Shell Color</p> <p>See page 156</p> <p>R G</p>	<p>Select Frame Color</p> <p>See page 156 P4 option Chrome (Y) \$52 upcharge</p> <p>P L A T</p>
--	--	---	--

	MODEL/DESCRIPTION	DEPTH	WIDTH	HEIGHT	SHIP		PER CARTON LIST
					WEIGHT	CUBE	
	HSSCL-18B 18"H Cantilever Base Chair, Armless	Maximum: Seat: Back: Seat to Floor: Usable Seat Depth:	21¾ 16⅞ 16½ 15⅜ 16⅞	22¾ 16½ 15⅜	31¼ 18 13⅜ 18¼	80 23.7	P1 \$897 (reference single unit @ \$224.25) P2 \$897 (reference single unit @ \$224.25) P3 \$939 (reference single unit @ \$234.75)
	HSSCL-16B 16"H Cantilever Base Chair, Armless	Maximum: Seat: Back: Seat to Floor: Usable Seat Depth:	21¾ 16⅞ 16½ 15⅜ 16⅞	22¾ 16½ 15⅜	29¼ 16 13⅜ 16¼	55 16.8	P1 \$853 (reference single unit @ \$213.25) P2 \$853 (reference single unit @ \$213.25) P3 \$893 (reference single unit @ \$223.25)
	HSSCL-14A 14"H Cantilever Base Chair, Armless	Maximum: Seat: Back: Seat to Floor: Usable Seat Depth:	21¾ 16⅞ 16½ 15⅜ 16⅞	22¾ 16½ 15⅜	27¼ 14 13⅜ 14¼	52 16.8	P1 \$837 (reference single unit @ \$209.25) P2 \$837 (reference single unit @ \$209.25) P3 \$876 (reference single unit @ \$219.00)

NOTES:



- High strength tubular steel frame.
- Glides available with nylon or felt inserts. See ordering information below.
- Seat shell is one-piece injection molded.
- Cantilever models stack 5-high on floor.
- Durable textured powder coated paint or chrome option finish.

SmartLink® Cantilever Chairs are ordered and shipped four (4) chairs per carton. Pricing shown is per carton. Each set of four chairs (one carton) must have the same shell/frame color combination. Ordering 2 of Model HSSCL-18B will result in 2 cartons being shipped, giving you 8 chairs.

HOW TO SPECIFY

<p>Select Model Number</p> <p>H S S C L - 1 8 B .</p>	<p>Select Glide Option</p> <p>E All-purpose Glide Insert (no upcharge) F Felt Glide Insert (\$36 list upcharge; \$9 per single unit see page 165)</p> <p>E .</p>	<p>Select Shell Color</p> <p>See page 156</p> <p>R G .</p>	<p>Select Frame Color</p> <p>See page 156 P4 option Polished Chrome (Y) \$52 upcharge</p> <p>P L A T</p>
--	---	---	---



	MODEL/DESCRIPTION	DEPTH	WIDTH	HEIGHT	SHIP WEIGHT	CUBE	PER CARTON LIST
	HSSTK-18B 18"H Task Swivel Chair, Pneumatic Seat Height Adjustment				23	5.2	\$337
	Maximum:	22 ⁵ / ₈	22 ¹ / ₂	34 ³ / ₄			
	Seat:	16 ¹ / ₄	16 ¹ / ₂	18			
	Back:		15 ³ / ₈	13 ³ / ₈			
	Seat to Floor:			16-21			
	HSSST-18B 18"H Task Swivel Stool, Pneumatic Seat Height Adjustment, Footring Adjustment				28	12.8	\$414
Maximum:	24 ¹ / ₄	25 ³ / ₄	45 ¹ / ₂				
Seat:	16 ¹ / ₄	16 ¹ / ₂	18				
Back:		15 ³ / ₈	13 ³ / ₈				
Seat to Floor:			22-32				
Usable Seat Depth:	16 ³ / ₈						

NOTES:

- Seat Shell is one-piece injection molded.
 - Task Swivel Chair has a pneumatic seat height adjustment.
 - Choose between hard and soft casters (no upcharge) or bell glide (\$25 upcharge) options.
 - Stool has an adjustable footring.
 - Swivel Task Chair and Stool ship one per carton.
- !** Swivel Task Chair and Stool are available with a black frame only.

HOW TO SPECIFY

<p>Select Model Number</p> <p>H S S T K - 1 8 B</p>	<p>Select Glide Option</p> <p>S Soft Caster (no upcharge) H Hard Caster (no upcharge) G Bell Glide (\$25 upcharge)</p> <p>S</p>	<p>Select Shell Color</p> <p>See page 156</p> <p>R G</p>
---	--	--

SMARTLINK® Teacher Stations

GSA SIN 33721T



Icon Legend on page 17

EDUCATION

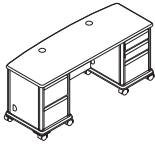

DESCRIPTION

Teacher Station
72"W x 26"D x 30"H
File/File Pedestal, Left
Box/Box/File Pedestal, Right

MODEL

HLT2672T-23

SHIP WEIGHT

254

CUBE

37.2

LIST PRICE

\$2342



Teacher Station
60"W x 24"D x 30"H
Box/Box/File Storage, Single Pedestal, Right

HLT2460T-R3

136

29.3

\$2109

Teacher Station
60"W x 24"D x 30"H
Box/Box/File Storage, Single Pedestal, Left

HLT2460T-L3

136

29.3

\$2109

NOTES:

- Tops/Bases are Laminate with T-mold edge.
- Larger top size provides ample work/conference area or space for equipment.
- Standard with Heavy-duty 3", 360-degree swivel casters, 4-locking, 4-non-locking.
- Storage options include: Locking box/box/file and locking file/file.
- Kneewell space accommodates separately specified and field installed non-locking center drawer and CPU holders (see page 172).
- End panels are removable to access standard power management cabinets on both ends of the station for safe and secure storage of plug-strips, power cords and cables.
- Removable end panels have one outside cord management grommet.
- Full width cable management system provides easy access to and from each side cabinet.
- Standard with two Smart Grommets with wireway covers.
- Smart Grommets accept optional power inserts (see page 172).
- Single pedestal available in right and left handed configurations.
- D-shape top encourages conferencing and provides ample work and conference area.
- Standard with modesty panel.
- Modesty and column leg will match the specified metal surface color.

HOW TO SPECIFY

Select Model Number HLT2672T-23	Select Casters C Hard-Surface (no upcharge)	Select Top and Base Color Laminate See page 156 B9	Select T-Mold and Paint Color See page 156 T1
---	---	--	--

DESCRIPTION

Accessory Rail (Side Mount)
21"W x 1/2"D x 1/2"H

MODEL

HLTA-TR24

SHIP WEIGHT

3 Ⓞ

CUBE

0.3

LIST PRICE

\$172

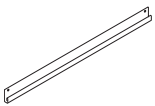

NOTES:

- Field installed.
- 21" Usable width.
- Specify paint.
- Mounts to either side of the Teacher Station or Storage Cases.
- Accepts file folder, Pencil holder, or other accessories (see page 177).

HOW TO SPECIFY

Select Model Number HLTA-TR24	Select Frame Color S Charcoal T1 Platinum (\$12 upcharge) S
---	---



Icon Legend on page 17

SMARTLINK® Value Teacher Stations

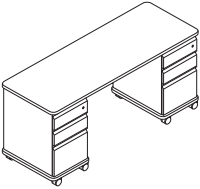
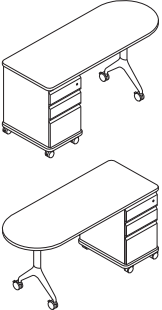
	DESCRIPTION	MODEL	SHIP WEIGHT	CUBE	LIST PRICE BY PAINT GRADE		
					P1	P2	P3
	Value Teacher Station 66"W x 24"D x 30"H Box/Box/File Pedestal, Left Box/Box/File Pedestal, Right	HLTV2466T-33	240	21.1	\$1926	\$1958	\$1980
	Value Teacher Station 60"W x 24"D x 30"H Box/Box/File Storage	HLTV2460T-3	158	14.18	\$1465	\$1491	\$1508

NOTES:

- Tops/Bases are Laminate with T-mold edge.
- Standard with Heavy-duty 3", 360-degree swivel casters, 4-locking, 4-non-locking.
- Storage options include: Locking box/box/file.
- Kneewell space accommodates separately specified and field installed non-locking center drawer and CPU holders (see page 172).
- D-shape top encourages conferencing and provides ample work and conference area.
- Right or left assembled in the field.
- Modesty specified separately.
- Power modules can be ordered separately and mounted to the desk.

HOW TO SPECIFY

Select Model Number	Select Top and Base Color Laminate See page 156	Select T-Mold Color See page 156	Select Paint Color See page 156
H L T V 2 4 6 6 T - 3 3 .	B 9 .	K .	T 1

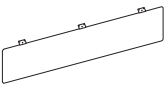
	DESCRIPTION	MODEL	SHIP WEIGHT	CUBE	LIST PRICE BY PAINT GRADE		
					P1	P2	P3
	Universal Modesty Panel	HMTUMOD32	9	1.9	\$232	\$252	\$262

SIN 33721

HOW TO SPECIFY

Select Model Number	Select Paint Color See page 156
H M T U M O D 3 2 .	S

SMARTLINK® Teacher Station Accessories

GSA SIN 33721T EXCEPT AS NOTED



Icon Legend on page 17

EDUCATION

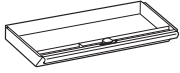

(Angled front)

DESCRIPTION

Metal Center Drawer, Non-Locking
24¾"W x 14¾"D x 3"H

MODEL	SHIP WEIGHT	CUBE	LIST PRICE BY PAINT GRADE	
			P1	P2
HD8X	12 Ⓞ	1.2	\$265	\$275

NOTES: Not for use on 24" x 60" Teacher's Stations. Field installed. Non-locking. Minimum clearance for mounting: 27¾"W x 19¼"D. Specify paint. Available in Charcoal (S) or Platinum (T1) \$10 upcharge.

SPECIFYING EXAMPLE: HD8X.S

DESCRIPTION

360° Swivel CPU Holder with Adjustable Straps

- Supports CPUs 3¾" wide up to 64" perimeter and holds up to 75 lbs.
- 360° rotation.
- Ships complete and includes necessary mounting hardware and instruction sheet.

ⓘ Available in Black only, no specification needed.

MODEL	SHIP WEIGHT	CUBE	LIST PRICE
HCPU1	7.0 Ⓞ	0.2	\$260

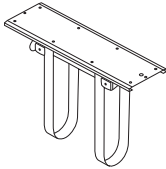

SIN 33721

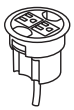

Power Hub, 3" Grommet Mount, 6' Cord

- Fits in 3" round grommet holes.
- Two grounded AC power outlets.
- Includes 6' cord with three-prong plug.
- Field installed with Plug-and-play ease.

NOTES: For additional information see page 204.

ⓘ Available in black only (no color designation so use .X - Specify: HGRMTAC.X).

MODEL	SHIP WEIGHT	CUBE	LIST PRICE
HGRMTAC	1.3	0.2	\$126

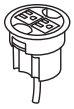

3" Round Power Grommet - 2 Outlets, 10' Cord

- Includes 10' cord with three-prong plug.
- Fits in 3" round grommet holes.
- Two grounded AC power outlets.
- Field installed with Plug-and-play ease.

ⓘ Available in black finish only, no specification needed.

MODEL	SHIP WEIGHT	CUBE	LIST PRICE
HGRMTAC2	1.5	0.2	\$159



Power/USB Hub, 3" Grommet Mount

- One grounded AC power outlet with 2 USB ports.
- Two cord pass-through holes in cap.
- Includes 6' cord with three-prong plug.
- Field installed; easy plug-and-play.
- UL Listed.

NOTES: For additional information see page 204.

ⓘ Available in black only (no color designation so use .X - Specify: HGRMTUSB2.X).

MODEL	SHIP WEIGHT	CUBE	LIST PRICE
HGRMTUSB2	1.3 Ⓞ	0.2	\$250

HOW TO SPECIFY

Select Model Number	Select Paint
P Black	LOFT Loft
P7D Brownstone	T3 Muslin
PJW Designer White	L Putty
S Charcoal	SHDW Shadow ⓘ
P28 Fossil	P8T Titanium
T5 Greige	T4 Champagne Metallic (\$10 upcharge)
Q Light Grey	T1 Platinum Metallic (\$10 upcharge)

HD8X.S

ⓘ De-emphasized

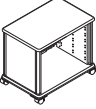
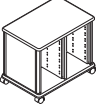
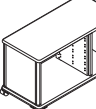
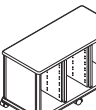
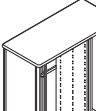
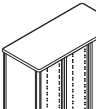

	DESCRIPTION	MODEL	SHIP WEIGHT	CUBE	LIST PRICE
	Modular Storage Cabinet, Credenza Height 1 – 30"W Column 36 ³ / ₄ "W x 24 ¹ / ₄ "D x 30"H	HLSC36T-1N	98	17.7	\$1335
	Modular Storage Cabinet, Credenza Height 2 – 12"W Columns 36 ³ / ₄ "W x 24 ¹ / ₄ "D x 30"H	HLSC36T-2N	103	17.7	\$1460
	Modular Storage Cabinet, Credenza Height 1 – 30"W Left-hand Column 1 – 12"W Right-hand Column 52 ³ / ₄ "W x 24 ¹ / ₄ "D x 30"H	HLSC52T-21N	154	25.3	\$1716
	Modular Storage Cabinet, Credenza Height 3 – 12"W Columns 52 ³ / ₄ "W x 24 ¹ / ₄ "D x 30"H	HLSC52T-3N	159	25.3	\$1843
	Modular Storage Cabinet, Full Height 1 – 30"W Left-hand Column 1 – 12"W Right-hand Column 52 ³ / ₄ "W x 24 ¹ / ₄ "D x 61 ³ / ₄ "H	HLSF52T-21N	254	51.4	\$2326
	Modular Storage Cabinet, Full Height 3 – 12"W Columns 52 ³ / ₄ "W x 24 ¹ / ₄ "D x 61 ³ / ₄ "H	HLSF52T-3N	164	51.4	\$2576

NOTES:

- Cases will accept a variety of storage accessories including trays, shelves, and coat rods. Refer to pages 160-161 for capacity specification/planning guidelines by cabinet size.
- Specify trays, shelves, or coat rod accessories separately, see page 175.
- Standard with Heavy-duty 3", 360-degree swivel casters, 36" with case includes four casters (2-locking, 2-non-locking), 52"W cases include six casters (3-locking, 3-non-locking).

HOW TO SPECIFY

Select Model Number HLSC36T-1N	Select Casters C Hard-Surface (no upcharge)	Select Top and Base Color Laminate See page 156	Select T-Mold and Paint Color See page 156
HLSC36T-1N	C	DD	T1

SMARTLINK® Modular Storage

GSA SIN 33721T



Icon Legend on page 17

EDUCATION

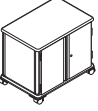
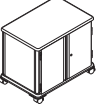
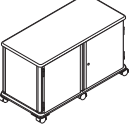
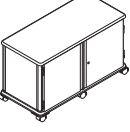
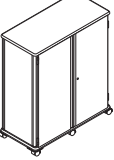
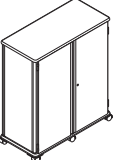
	DESCRIPTION	MODEL	SHIP WEIGHT	CUBE	LIST PRICE
	Modular Storage Cabinet, Credenza Height 1 – 30”W Column 36¾”W x 24¼”D x 30”H	HLSC36T-1D	114	17.7	\$1510
	Modular Storage Cabinet, Credenza Height 2 – 12”W Columns 36¾”W x 24¼”D x 30”H	HLSC36T-2D	119	17.7	\$1630
	Modular Storage Cabinet, Credenza Height 1 – 30”W Left-hand Column 1 – 12”W Right-hand Column 52¾”W x 24¼”D x 30”H	HLSC52T-21D	174	25.3	\$1845
	Modular Storage Cabinet, Credenza Height 3 – 12”W Columns 52¾”W x 24¼”D x 30”H	HLSC52T-3D	179	25.3	\$1964
	Modular Storage Cabinet, Full Height 1 – 30”W Left-hand Column 1 – 12”W Right-hand Column 52¾”W x 24¼”D x 61¾”H	HLSF52T-21D	286	51.4	\$2489
	Modular Storage Cabinet, Full Height 3 – 12”W Columns 52¾”W x 24¼”D x 61¾”H	HLSF52T-3D	296	51.4	\$2719

NOTES:

- Cases will accept a variety of storage accessories including trays, shelves, and coat rods. Refer to pages 160-161 for capacity specification/planning guidelines by cabinet size.
- Specify trays, shelves, or coat rod accessories separately, see page 175.
- Standard with Heavy-duty 3”, 360-degree swivel casters, 36” with case includes four casters (2-locking, 2-non-locking), 52”W cases include six casters (3-locking, 3-non-locking).

HOW TO SPECIFY

<p>Select Model Number</p> <p>HLSC36T-1D</p>	<p>Select Casters</p> <p>C Hard-Surface (no upcharge)</p> <p>C</p>	<p>Select Top and Base Color</p> <p>Laminate</p> <p>See page 156</p> <p>DD</p>	<p>Select T-Mold and Paint Color</p> <p>See page 156</p> <p>T1</p>
---	---	---	---



SMARTLINK® Modular Storage and Accessories

	DESCRIPTION	MODEL	SHIP WEIGHT	CUBE	LIST PRICE
	Tray Kits				
	3"H x 12"W, 7 trays and 14 rails per kit	HLSA-TK3	12.0	2.7	\$209
	6"H x 12"W, 4 trays and 8 rails per kit	HLSA-TK6	10.0	2.7	\$145
	12"H x 12"W, 2 trays and 4 rails per kit	HLSA-TK12	7.0	2.7	\$109
	NOTES: Field installed. See pages 160-161 for specifying guidelines. Semi-translucent white SPECIFYING EXAMPLE: HLSA-TK3.X				
	Shelf Kits, 2 shelves and 4 rails per kit				
	12"W x 24"D 30"W x 24"D	HLSA-SK1220T HLSA-SK3020T	14.0 28.0	0.6 1.2	\$312 \$453
	NOTES: Field installed. See pages 160-161 for specifying guidelines. Specify color.				
	Coat Rod, Single Unit 12"W x 1" diameter	HLSA-CR12	0.5	0.1	\$109
	NOTES: Use with Full-height cases, 12" columns only. Field installed. Anodized finish only.				
	Hanging Folder Rail Kit 12"W Rails 4 rails per kit, each tray uses 2 rails	HLSA-HRK	0.5	0.2	\$44
	NOTES: Use with 12" trays only. Field installed. Anodized finish only.				
	Cabinet Whiteboard Mounting Bracket 52"W Includes 1 pair (upper and lower) of rails and mounting hardware.	HLSA-WBK52	5.0	0.3	\$192
	<ul style="list-style-type: none"> Accommodates: 1 – 48" x 48" Sliding Board or 2 – 24" x 48" Sliding Boards Compatible Sliding Boards (see page 176) HLWBS-448WW HLWBS-248WW HLWBS-448WT HLWBS-248WT Requires field installation. NOTES: For use on full-height cabinets only. Rails feature an integrated marker tray. Specify Charcoal (S) or Platinum (T1) color. SPECIFYING EXAMPLE: HLSA-WBK52.S				

NOTES:

- Mounting bracket model HLSA-WBK52 mounts whiteboard to back of full-height Modular Storage unit.
- For use in Modular Storage cases.
- Trays for use in 12" width columns only. Shelves are available for use in 12" and 30" width columns.
- Trays and shelves hang off a pair of accessory rails.
- Trays and shelves are sold in "kit quantities" and include necessary accessory rails for installation.
- 12" trays accept rails to accommodate hanging file folders (side-to-side).
- All accessories are field installed.
- Trays feature front and rear handles for easy handling and are semi-translucent white for visibility to contents.
- All shelves feature an integrated finger pull and safety mechanism to prevent accidental removal.
- See pages 160-161 for specifying details.

HOW TO SPECIFY

Select Model Number <div style="border: 1px solid black; padding: 2px; display: flex; gap: 5px;"> HLSA-SK1220T </div>	Select Shelf Color C Harvest D Natural Maple LDW1 Designer White LOFT Loft <div style="border: 1px solid black; padding: 2px; display: inline-block; width: 20px; height: 20px; text-align: center; line-height: 20px;">C</div>
---	---

SMARTLINK® Wall Rail System

GSA SIN 33721T



Icon Legend on page 17

EDUCATION

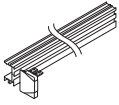

DESCRIPTION	MODEL	SHIP WEIGHT	CUBE	LIST PRICE
Wall Rail 144"	HLWR-12	22	1.4	\$827

NOTES: Rail model includes: 1 – 144" rail, 9 – wall mounting brackets and 2 – rail end caps.

- ❗ Must be mounted in accordance with published installation instructions. Wall mounting hardware NOT INCLUDED. Must be sourced locally.
- ❗ Must order Quantity 2 rails when using with Whiteboards and Whiteboards/Tackboards.
- ❗ Platinum finish only.

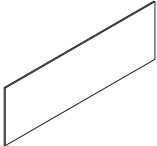

Learning Board, Fixed Whiteboard, 1-sided 144"W x 48"H, Quantity 1	HLWBF1-1248W	124	13.0	\$1978
--	---------------------	-----	------	---------------

SPECIFYING EXAMPLE: HLWBF-1248W.X

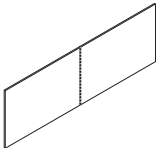

Learning Board, Fixed Whiteboards, 1-sided 72"W x 48"H, Quantity 2 with spacer (included)	HLWBF2-1248W	125	6.7	\$1978
---	---------------------	-----	-----	---------------

NOTES: Includes center cover/spacer.
SPECIFYING EXAMPLE: HLWBF2-1248W.X

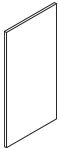

Learning Board, Sliding Whiteboard/Whiteboard 48"W x 48"H	HLWBS-448WW	47	4.6	\$954
24"W x 48"H	HLWBS-248WW	26	2.5	\$610

NOTES: May be used with HLSA-WBK52 to mount to the back of full-height Mobile Cabinets. (See page 175.)

SPECIFYING EXAMPLE: HLWBS-448WW.X

Model HLWBS-248WW shown

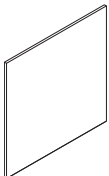

Learning Board, Sliding Whiteboard/Tackboard 48"W x 48"H	HLWBS-448WT	64	4.6	\$993
24"W x 48"H	HLWBS-248WT	34	2.5	\$636

NOTES: May be used with HLSA-WBK52 to mount to the back of full-height Mobile Cabinets. (See page 175.)
Tackboard Side available in the following fabric: Lucy Neutra (LC24).

SPECIFYING EXAMPLE: HLWBS-448WT.X.LC24

Model HLWBS-448WT shown

NOTES:

- Multi-functional wall rails can accommodate whiteboards and organizational accessories. See above and page 177.
- Sliding learning boards may be attached to the back of Mobile, full-height cabinets with bracket kit HLSA-WBK52 (see page 175).
- Multi-track rail allows for up to three layers of whiteboards. Rear track supports a fixed board, middle and front tracks support sliding boards. Outer rail channel is for attachment of organizational accessories.
- Sliding learning boards are removable and reversible.
- All fixed and sliding boards:
 - Require two (upper and lower) rails for installation.
 - Feature a full aluminum frame.
 - Are high-quality porcelain over steel and non-shadowing.
 - Are low gloss for projection use and allows for use of magnets.

HOW TO SPECIFY





Select Model Number HLWBS - 448WT .	Select Side A Color X Whiteboard	Select Tackboard Fabric LC24 Lucy Neutra Specify for models HLWBS-448WT and HLWBS-248WT only
---	--	---



Icon Legend on page 17

SMARTLINK® Wall Rail System Accessories

EDUCATION

	DESCRIPTION	MODEL	SHIP WEIGHT	CUBE	LIST PRICE BY PAINT GRADE		
					P1	P2	P3
	Marker Tray (Single Pack) 7"W x 3½"D x 2"H NOTES: Holds dry-erase markers, push pins and other small objects.	HPPMMT	1	0.2	\$95	\$107	\$118
	Paper Clip (2 per carton) 5"W x 2"H NOTES: Use individually for artwork or smaller items. Use in pairs for larger notepad size pieces of paper.	HPPMPC	1	0.2	\$103	\$115	\$126
	All-Purpose Hook (10 per carton) NOTES: Use for hanging back-packs, coats and other items. Hooks slide horizontally and cannot be removed without first removing the rail end cap. ! Specify paint — Platinum Metallic only.	HPPMHK	1	0.2	N/A	\$231	N/A
 SIN 33721	CD/Pencil Holder 5¼"W x 1½"D x 5"H NOTES: Installs on the Wall Rail or Accessory Rail (HLTA-TR24) for use on the Teacher's Desk or Storage Cases. May also be mounted on Folder Bins.	HPPMPB	1	0.2	\$114	\$126	\$137
 SIN 33721	Folder Bin 12¼"W x 1¼"D x 9"H NOTES: Installs on the Wall Rail or Accessory Rail (HLTA-TR24) for use on the Teacher's Desk or Storage Cases. Folder Bin may be mounted (stacked) to each other.	HPPMFB	2	0.3	\$114	\$126	\$137

NOTES:

- Accessories above to be used on the Wall Rail System — see page 176.
- All accessories mount on the rail's outer channel and may be used with sliding boards.
- All accessories may be mounted and moved to any position along the width of the rail.
- All accessories may be easily removed from the rail with the exception of the All-Purpose Hook. All-Purpose Hook can slide horizontally along the rail but cannot be removed without removing a rail end cap.

HOW TO SPECIFY

<p>Select Model Number</p> <p>H P P M M T . T 1</p>	<p>Select Paint Color</p> <p>See page 156 Model HPPMHK available in Platinum Metallic only</p>
--	---

SMARTLINK® Value Mobile Storage

GSA SIN 33721 EXCEPT AS NOTED



Icon Legend on page 17

EDUCATION

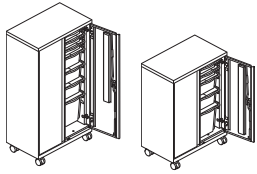

HLVMSC5630R HLVMSC4330R

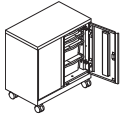

HLVMSC3330R

DESCRIPTION

Mobile Storage Cabinet with Bins

18"D x 30"W x 32¼"H
18"D x 30"W x 42¼"H
18"D x 30"W x 56"H

MODEL

HLVMSC3330R
HLVMSC4330R Ⓢ
HLVMSC5630R

SHIP WEIGHT

152.6
171.6
209.6

CUBE

13.4
18.0
23.5

LIST PRICE BY PAINT GRADE

P1 P2 P3

\$1540 \$1584 \$1613
\$1693 \$1741 \$1773
\$1948 \$2003 \$2040

OPEN MARKET

NOTES:

- Full radius "R" handle on doors.
- Units include 2 locking and 2 non-locking casters.
- Equipped with HON "One Key" interchangeable core removable locks.

ⓘ Pre-configured trays and rails included in mobile storage cabinets with bins. See chart below for configurations and capacity. Additional bin and rail kits may be purchased separately.

DESCRIPTION

Accessories — Tray Kit

3"H, 2 bins and 4 rails
6"H, 2 bins and 4 rails
12"H, 2 bins and 4 rails

MODEL

HFMBIN3
HFMBIN6
HFMBIN12

SHIP WEIGHT

7 Ⓢ
10 Ⓢ
12 Ⓢ

CUBE

4.0
4.5
5.0

LIST PRICE

\$59
\$72
\$84

NOTES: Value mobile storage cabinets ship with pre-determined rails and bins. Additional bins and rails may be ordered in sets of two utilizing the models shown. Availability and usage are outlined below.

ⓘ Semi-translucent white.

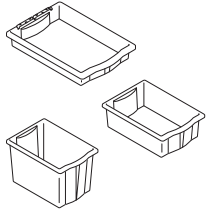

Pre-Configured Cabinets/Tray Kits

56"H Cabinet

1	2
3	4
5	6
1	2
3	4
5	6
1	2

42¼"H Cabinet

1	2
3	4
1	2
3	4
1	2

32¼"H Cabinet

1	2
3	4
1	2
3	4

56"H Cabinet

1	14
2	15
3	16
4	17
5	18
6	19
7	20
8	21
9	22
10	23
11	24
12	25
13	26

42¼"H Cabinet

1	11
2	12
3	13
4	14
5	15
6	16
7	17
8	18
9	19
10	20

32¼"H Cabinet

1	7
2	8
3	9
4	10
5	11
6	12

Hanging Slots 12"H Bin 6"H Bin 3"H Bin

1			
2			
3			
4			

26 - 12"W Openings

20 - 12"W Openings

12 - 12"W Openings

HOW TO SPECIFY

Select Model Number

HLVMSC3330R

Select Lock Option

- L Lock (no upcharge)
- X Omit Lock (deduct \$20)

L

Select Paint Color

See page 156

PJW



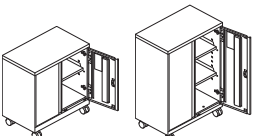
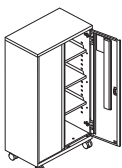

Icon Legend on page 17

SMARTLINK® Value Mobile Storage

	DESCRIPTION	MODEL	SHIP WEIGHT	CUBE	LIST PRICE BY PAINT GRADE		
					P1	P2	P3
 HLVSC3330R HLVSC4330R	Mobile Storage Cabinet without Bins 18"D x 30"W x 32¼"H 18"D x 30"W x 42¼"H 18"D x 30"W x 56"H	HLVSC3330R HLVSC4330R HLVSC5630R	152.6 171.6 209.6	13.4 18.0 23.5	\$1401 \$1540 \$1847	\$1441 \$1584 \$1899	\$1467 \$1613 \$1934
	 HLVSC5630R						

NOTES:

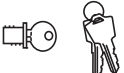
- Full radius "R" handle on doors.
- Units include 2 locking and 2 non-locking casters.
- Includes shelves which are adjustable in 2" increments.
- Equipped with HON "One Key" interchangeable core removable locks.
- Wire management grommet in back of unit.

	DESCRIPTION	MODEL	SHIP WEIGHT	CUBE	LIST PRICE
 SIN 33721	Chrome Removable Lock Core Kit (for metal casegoods) • Use when specifying omit lock application. • Specify quantity of each key number from 101E-225E. • Includes: 1-core, 2-keys, 1-core removal tool and instructions. • Removable lock core kits with specific key number must be ordered to facilitate keying alike in the field. • For specific models, look for the Omit Lock Core icon throughout this publication.	HF23C	0.1 	0.1	\$49
	NOTES: If key number isn't specified, number will be at random. Core matches manufactured lock on metal casegoods product but can be used with Contain® and laminate product.				

HOW TO SPECIFY

Select Model Number H L V S C 3 3 3 0 R .	Select Lock Option L Lock (no upcharge) X Omit Lock (deduct \$20) L .	Select Paint Color See page 156 P J W
---	---	--

EDUCATION

SMARTLINK® Value Mobile Storage

OPEN MARKET



Icon Legend on page 17

EDUCATION

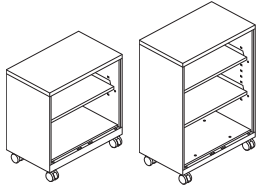

HLVBC3330

HLVBC4330

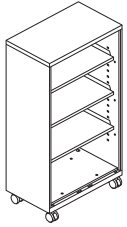

HLVBC5630

DESCRIPTION

Mobile Bookcases

18"D x 30"W x 31¼"H

18"D x 30"W x 42¼"H

18"D x 30"W x 56"H

MODEL	SHIP WEIGHT	CUBE	LIST PRICE BY PAINT GRADE		
			P1	P2	P3
HLVBC3330	118.6	13.4	\$1272	\$1308	\$1332
HLVBC4330	134.6	18.0	\$1401	\$1441	\$1467
HLVBC5630	157.6	23.5	\$1680	\$1728	\$1759

NOTES:

- Units include 2 locking and 2 non-locking casters.
- Shelves adjust in 2" increments.
- Wire management grommet in back of unit.

HOW TO SPECIFY

Select Model Number

HLVBC3330

Select Paint Color

See page 156

PJW

WORKPLACE TOOLS



Flock® Modular Seating with Dean Power Module Under-Surface Mount.

WORKPLACE TOOLS

Workplace tools provide the finishing touch on any high-performance workspace. From storage options to technological tools and lighting solutions, HON's Workplace Tools deliver organization and efficiency to the office. Workplace Tools put everything you need to be productive within arm's reach, provide easy access to the connectivity you need to be successful and help you keep your workspace neat.



PRODUCT CATEGORIES

- Monitor Arms
- Keyboard Trays and Center Drawers
- Paper Management and Organizational Tools
- Task Lights
- Electrical and Power Management Accessories
- Ergonomic and Healthy Workplace Solutions

WORKPLACE TOOLS ORDERING INFORMATION

LAMINATE CENTER DRAWERS, LAMINATE PAPER MANAGEMENT MODELS HLVP1/HLDST1/ HLSL1472LS/HLSL1460LS

L1 LAMINATES CODES

Woodgrain

- ◆ Bourbon Cherry H
- ◆ Cognac COGN
- ◆ Florence Walnut LFW1
- ◆ Harvest C
- ◆ Kingswood Walnut LK11
- ◆ Mahogany N
- ◆ Mocha MOCH
- ◆ Natural Maple D
- ◆ Pinnacle PINC
- ◆ Shaker Cherry F
- ◆ Sterling Ash LSA1

Solid

- ◆ Black P
- ◆ Charcoal S
- ◆ Designer White LDW1
- ◆ Loft LOFT

L2 LAMINATES CODES

Woodgrain

- ◆ Lowell Ash LLA1
- ◆ Natural Recon LNR1
- ◆ Phantom Ecru LPE1
- ◆ Portico Teak LPT1
- ◆ Skyline Walnut LSW1

LAMINATE KEYBOARD PLATFORM MODELS H4022/HE4022

L1 LAMINATES CODES

Woodgrain

- ◆ Bourbon Cherry H
- ◆ Cognac COGN
- ◆ Florence Walnut LFW1
- ◆ Harvest C
- ◆ Kingswood Walnut LK11
- ◆ Mahogany N
- ◆ Mocha MOCH
- ◆ Natural Maple D
- ◆ Pinnacle PINC
- ◆ Shaker Cherry F
- ◆ Sterling Ash LSA1

Solid

- ◆ Black P
- ◆ Charcoal S
- ◆ Designer White LDW1
- ◆ Whitestone K4

Patterned

- ◆ Handspun Chestnut LAHC
- ◆ Handspun Dove LAHD
- ◆ Handspun Pearl LAHP
- ◆ Handspun Slate LAHS
- ◆ Sheer Mesh * A5
- ◆ Silver Mesh B9
- ◆ Steel Mesh * A9
- ◆ Canyon Zephyr * K9
- ◆ Desert Zephyr * K8
- ◆ Shadow Zephyr * K1
- ◆ Gray G2
- ◆ Grey Tigris * L6
- ◆ White G1

L2 LAMINATES CODES

Woodgrain

- ◆ Lowell Ash LLA1
- ◆ Natural Recon LNR1
- ◆ Phantom Ecru LPE1
- ◆ Portico Teak LPT1
- ◆ Skyline Walnut LSW1

METAL PAPER MANAGEMENT MODELS HHPS1 AND HDPS1

PAINT CODES

P1

- ◆ Black P
- ◆ Brownstone P7D
- ◆ Charcoal S
- ◆ Designer White PJW
- ◆ Fossil P28
- ◆ Greige T5
- ◆ Light Gray Q
- ◆ Loft LOFT
- ◆ Muslin T3
- ◆ Putty L
- ◆ Shadow * SHDW
- ◆ Titanium P8T

P2

- ◆ Champagne Metallic T4
- ◆ Platinum Metallic T1
- ◆ Silver PR6

P3

- ◆ Amethyst P091
- ◆ Atom P8S
- ◆ Blossom P8K
- ◆ Bullseye PJF
- ◆ Cabernet * P7T
- ◆ Cobalt Mica P090
- ◆ Conifer * P8H
- ◆ Ember P8P
- ◆ Ion P8N
- ◆ Iris P8J
- ◆ Krypton P8F
- ◆ Ochre P093
- ◆ Regatta P8M
- ◆ Sienna P092
- ◆ Succulent P8A

METAL CENTER DRAWERS*, CORNER SLEEVES, METAL KEYBOARD PLATFORM, STORAGE CUBES, DRAWER ORGANIZER, HAND SANITIZER STATION

PAINT CODES

P1

- ◆ Black P
- ◆ Brownstone P7D
- ◆ Charcoal S
- ◆ Designer White PJW
- ◆ Fossil P28
- ◆ Greige T5
- ◆ Light Gray Q
- ◆ Loft LOFT
- ◆ Muslin T3
- ◆ Putty L
- ◆ Shadow * SHDW
- ◆ Titanium P8T

P2

- ◆ Champagne Metallic T4
- ◆ Platinum Metallic T1
- ◆ Silver PR6
- ◆ Solar Black P8X

P3

- ◆ Amethyst P091
- ◆ Atom P8S
- ◆ Blossom P8K
- ◆ Bullseye PJF
- ◆ Cabernet * P7T
- ◆ Cobalt Mica P090
- ◆ Conifer * P8H
- ◆ Ember P8P
- ◆ Ion P8N
- ◆ Iris P8J
- ◆ Krypton P8F
- ◆ Ochre P093
- ◆ Regatta P8M
- ◆ Sienna P092
- ◆ Succulent P8A

* Metal center drawer models HD2 and HD8 limited to P1 Paints, Champagne Metallic, and Platinum Metallic.

◆◆◆ For lead time information see page 17.

* De-emphasized

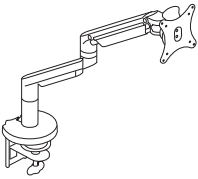
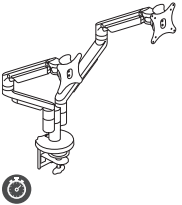
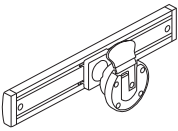
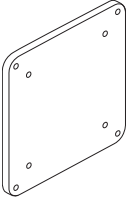

MONITOR ARMS

	DESCRIPTION	MODEL	SHIP WEIGHT	CUBE	LIST PRICE
	<p>Single Dynamic Monitor Arm</p> <ul style="list-style-type: none"> • 180° of rotation at base with optional 360° rotation. • Arms extend 22" and retract up to 3". • Monitor mount rotates 180° and tilts +/-30°. • Monitor can be rotated from landscape to portrait position. <p>⚠ Arms hold monitors from 6.2-18 lbs. Optional counterweight HPACW available to support monitors as low as 5 lbs.</p> <p>⚠ Back side of monitor arm base features opening for wire management through grommet when utilizing clamp mount.</p>	HMASTS	11.5	0.8	\$501
	<p>Dual Dynamic Monitor Arm</p> <ul style="list-style-type: none"> • Arms have 65° rotation at base with optional 130° and 360° rotations. • Arms extend 22" and retract up to 3". • Monitor mount rotates 180° and tilts +/-30°. • Monitor can be rotated from landscape to portrait position. <p>⚠ Arms hold monitors from 6.2-18 lbs. Optional counterweight HPACW available to support monitors as low as 5 lbs.</p> <p>⚠ Back side of monitor arm base features opening for wire management through grommet when utilizing clamp mount.</p>	HMASD	17.0	1.1	\$962
	<p>Sliding Mount for Monitor Arm</p> <ul style="list-style-type: none"> • Supports monitors up to 18 lbs. • Compatible with VESA 75mm and 100mm mounts. • Compatible with models HMASTS, HMASD, HPASD, HPADD, and HPATF. • Available in two paint finishes, Silver (SVR) and Black (BLK). Plastic components ship in like color with specified paint finish. 	HPACSM	3.0	0.3	\$206
	<p>Monitor Arm Counterweight</p> <ul style="list-style-type: none"> • Optional counterweight for monitors as low as 5 lbs. • Minimum weight for monitors without counterweight is 6.2 lbs. <p>⚠ Available in Black only, no specification needed.</p> <p>⚠ Compatible with models HMASTS, HPASD, HMASD, HPADD, and HPATF.</p>	HPACW	3.0	0.1	\$30

SIN 33721

WORKPLACE TOOLS

HOW TO SPECIFY

Select Model Number	Select Finish
	SVR Silver BLK Black
HMASTS.	SVR

MONITOR ARMS

DESCRIPTION

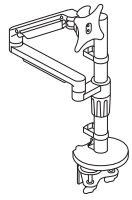

Post Mount with Single Dynamic Arm

- Arm has 360° rotation at base.
- Monitor mount rotates 180° and tilts +/-30°.
- Monitor can be rotated from landscape to portrait position.
- Arm extends up to 20".
- Arm has 17¾" of vertical adjustment.

ⓘ Available in Silver (SVR) finish only.

ⓘ Arms hold monitors from 6.2-18 lbs. Optional counterweight HPACW available to support monitors as low as 5 lbs. (see page 183).

MODEL

HPASD

SHIP WEIGHT

15.5 Ⓢ

CUBE

1.3

LIST PRICE

\$732

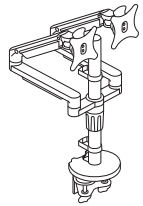

Post Mount with Dual Dynamic Arms

- Arms have 360° rotation at base.
- Monitor mount rotates 180° and tilts +/-30°.
- Monitor can be rotated from landscape to portrait position.
- Arms extend up to 20".
- Arms have 17¾" of vertical adjustment.

ⓘ Available in Silver (SVR) finish only.

ⓘ Arms hold monitors from 6.2-18 lbs. Optional counterweight HPACW available to support monitors as low as 5 lbs. (see page 183).

HPADD

19.5 Ⓢ

1.3

\$1064

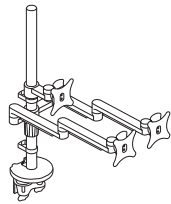

Post Mount with Triple Fixed Arms

- Features two fixed extended arms and one fixed center mount.
- Arms have 360° rotation at base.
- Monitor mount rotates 180° and tilts +/-30°.
- Monitor can be rotated from landscape to portrait position.
- Arms extend up to 20".
- Arms have 27½" of vertical adjustment.

ⓘ Available in Silver (SVR) finish only.

ⓘ Arms hold monitors from 6.2-18 lbs. Optional counterweight HPACW available to support monitors as low as 5 lbs. (see page 183).

HPATF

22.0 Ⓢ

1.9

\$1218

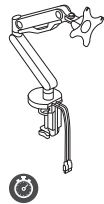

Single Monitor Arm with 2 USB Ports

NOTES: Easy adjustment. Height adjusts to 17" tall. Monitor tilt and swivel capability. Enclosed cable management. Grommet or desktop mounting. Clean appearance. **HON 5-Year Limited Warranty.**

ⓘ No specification needed.

ⓘ Cannot be used in Empower® height adjustable applications.

HBSMAUSB

38.6

2.4

\$274

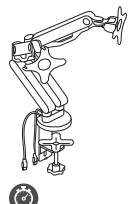

Dual Monitor Arm with 2 USB Ports

NOTES: Easy adjustment. Height adjusts to 17" tall. Monitor tilt and swivel capability. Enclosed cable management. Grommet or desktop mounting. Clean appearance. In some applications the Monitor Arms may extend 12 or more inches into the worksurface. **HON 5-Year Limited Warranty.**

ⓘ No specification needed.

ⓘ Cannot be used in Empower® height adjustable applications.

HBDMAUSB

41.9

2.6

\$410

HOW TO SPECIFY

Select Model Number HPASD	Select Finish SVR Silver
-------------------------------------	------------------------------------



CPU HOLDERS

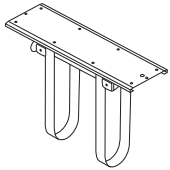

DESCRIPTION

360° Swivel CPU Holder with Adjustable Straps

- Supports CPUs 3¾" wide up to 64" perimeter and holds up to 75 lbs.
- 360° rotation.
- Ships complete and includes necessary mounting hardware and instruction sheet.

ⓘ Available in Black only, no specification needed.

MODEL	SHIP WEIGHT	CUBE	LIST PRICE
HCPU1	7	0.2	\$260



HOW TO SPECIFY

Select Model Number

H C P U 1

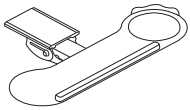

KEYBOARD TRAYS

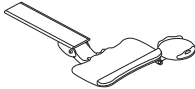
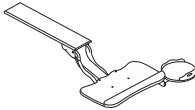
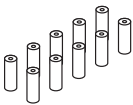
	DESCRIPTION	MODEL	SHIP WEIGHT	CUBE	LIST PRICE
	Short Track and Keyboard Platform <ul style="list-style-type: none"> Height adjustable total of 5$\frac{3}{4}$" (1$\frac{3}{4}$" above and 4" below). +10°, -20° of tilt adjustment. 360° rotation. 	HKTSHORT	10 	0.8	\$602
	Mid Track with Keyboard and Mouse Platform <ul style="list-style-type: none"> Height adjustable total of 8" (3" above and 5" below). +10°, -20° of tilt adjustment. 360° rotation. 	HKT MID	17	1.2	\$554
	Sit to Stand Long Track with Keyboard and Mouse <ul style="list-style-type: none"> Height adjustable total of 12$\frac{1}{2}$" (7$\frac{1}{2}$" above and 5" below). +10°, -20° of tilt adjustment. 360° rotation. 	HKT LONG	17	0.8	\$647
	Keyboard Spacer <ul style="list-style-type: none"> Used when attaching HKT MID or HKT LONG to Coordinate™ and Voi® or Systems Worksurface with an external channel. The kit includes ten cylinder spacers and ten screws. Spacers are $\frac{3}{4}$"W x 2$\frac{1}{8}$"H. Specify one kit per keyboard tray. 	HKBS	1	0.8	\$100

NOTES:

-  Black finish only, no specification needed.

HOW TO SPECIFY

Select
Model Number

H K T M I D

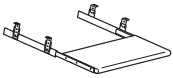
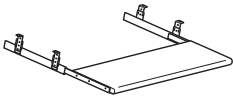

KEYBOARD TRAYS

	DESCRIPTION	MODEL	SHIP WEIGHT	CUBE	LIST PRICE BY LAMINATE GRADE	
					L1	L2
	Laminate Keyboard Platform <ul style="list-style-type: none"> Laminate Tray dimensions: 21½"W x 10"D x 1⅛" Thick. Minimum clearance for mounting: 22⅞"W x 17"D. Surface can be positioned 2", 2½", 3" or 3½" below bottom of worksurface. Will not fit on a 37" x 24" Corner worksurface. Specify laminate. 	H4022	10	0.6	\$228	\$243
	Laminate Keyboard Platform with Extended Tray <ul style="list-style-type: none"> Laminate Tray dimensions: 30"W x 10"D x 1⅛" Thick. Minimum clearance for mounting: 32½"W x 17"D. Surface can be positioned 2", 2½", 3" or 3½" below bottom of worksurface. Will not fit on a 37" x 24" Corner worksurface. Ball-bearing slide; slide and brackets are Black. 	HE4022	12	0.7	\$323	\$338

HOW TO SPECIFY

Select Model Number <input type="text" value="H4022"/>	Select Laminate See page 182 <input type="text" value="H"/>
--	--

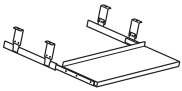
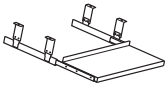
	DESCRIPTION	MODEL	SHIP WEIGHT	CUBE	LIST PRICE BY PAINT GRADE		
					P1	P2	P3
	Metal Keyboard Platforms 30"W Metal Keyboard and Mouse Tray <ul style="list-style-type: none"> Designed to hold keyboards and allow room for mouse pads. Tray dimensions: 30"W x 10"D. Minimum clearance for mounting: 32½"W x 15"D. Surface is positioned 3" below bottom of worksurface. Non-articulating, only movement is front-to-back. Does not tilt or swivel. Specify paint color. 	H4028	11	1.5	\$164	\$174	\$182
	24"W Metal Keyboard Tray <ul style="list-style-type: none"> Designed to hold ONLY keyboards. Tray dimensions: 24"W x 10"D. Minimum clearance for mounting: 26½"W x 15"D. Surface is positioned 3" below bottom of worksurface. Non-articulating, only movement is front-to-back. Does not tilt or swivel. Specify paint color. 	H4029	11	1.5	\$148	\$158	\$166

HOW TO SPECIFY

Select Model Number <input type="text" value="H4028"/>	Select Paint Color See page 182 <input type="text" value="P"/>
--	---



Icon Legend on page 17

CORNER SLEEVES

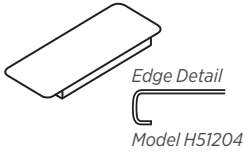
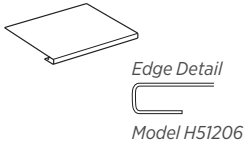
	DESCRIPTION	MODEL	SHIP WEIGHT	CUBE	LIST PRICE BY PAINT GRADE		
					P1	P2	P3
 <p>Edge Detail Model H51204</p>	<p>Metal Corner Sleeves</p> <p>22½"W Leading Edge x 9"D</p> <ul style="list-style-type: none"> Fits 1⅝" thick square edge detail. Smaller design is more aesthetically pleasing. 	H51204	10	1.5	\$171	\$178	\$185
 <p>Edge Detail Model H51206</p>	<p>22½"W Leading Edge x 18"D</p> <ul style="list-style-type: none"> Fits 1⅝" thick square edge detail. 	H51206	10	1.5	\$171	\$181	\$188

NOTES:

- Corner sleeve connects intersecting worksurfaces to create "corner desk" work areas.
- Specify paint color.

HOW TO SPECIFY

<p>Select Model Number</p> <p>H 5 1 2 0 4 .</p>	<p>Select Paint Color</p> <p>See page 182</p> <p>P</p>
--	---



CENTER DRAWERS

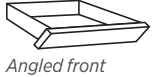

DESCRIPTION

Laminate Center Drawer

22"W x 15³/₈"D x 2¹/₂"H

Specify laminate.

26"W x 15³/₈"D x 2¹/₂"H

Specify laminate.

- Ball-bearing slide suspension.
- 12" drawer extension (3/4).
- Inside drawer dimension for H1522: 18⁷/₈"W x 15¹/₂"D x 1¹/₂"H.
- Inside drawer dimension for H1526: 22³/₄"W x 15¹/₂"D x 1¹/₂"H.
- Minimum clearance for mounting H1522: 22³/₄"W x 18¹/₂"D compatible with 72"W x 36"D, 66"W x 30"D, 60"W x 30"D Double Pedestal Desks, 72"W x 36"D, 66"W x 30"D Single Pedestal Desks, Bullet and P-Shaped Peninsulas, 72"W x 24"D, 66"W x 24"D, 60"W x 24"D Credenza w/Kneespace, 72"W x 24"D, 66"W x 24"D Single Pedestal Credenzas, 48"W x 24"D, 42"W x 24"D Returns
- Minimum clearance for mounting H1526: 27¹/₄"W x 18¹/₂"D compatible with 72"W x 36"D, 66"W x 30"D, 60"W x 30"D Double Pedestal Desks, 72"W x 24"D, 66"W x 24"D, 60"W x 24"D Credenza w/Kneespace, 48"W x 24"D Return
- Designed for use with Concinnity™, Voi®, Valido®/11500, 10700 and 10500 Series™.
- Includes pencil tray.

NOTES: For 60"W x 30"D Modular Desk Shells with two 15⁵/₈"W Storage Pedestals or 60"W x 24"D Modular Credenza Shells with two 15⁵/₈"W Storage Pedestals, use center drawer H1522.

MODEL	SHIP WEIGHT	CUBE	L1 LIST PRICE	L2 LIST PRICE
H1522	11	1.1	\$199	\$214
H1526	12	1.2	\$214	\$229

HOW TO SPECIFY

<p>Select Model Number</p> <p>H 1 5 2 2 .</p>	<p>Select Laminate</p> <p>See page 182</p> <p>H</p>
--	--



Icon Legend on page 17

CENTER DRAWERS

DESCRIPTION

MODEL	SHIP WEIGHT	CUBE	LIST PRICE BY PAINT GRADE	
			P1	P2

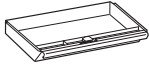

Angled front



Metal Center Drawer w/Lock
 19"W x 14³/₄"D x 3"H
 Specify paint color.

- Ball-bearing slide suspension.
- 12" drawer extension (3/4).
- Inside drawer dimension: 19"W x 13"D x 2³/₈"H.
- Minimum clearance for mounting: 21³/₄"W x 19¹/₄"D.
- Core removable lock.

HD2	9	1.0	\$297	\$307
------------	---	-----	--------------	--------------



Angled front



Metal Center Drawer w/Lock
 24³/₄"W x 14³/₄"D x 3"H
 Specify paint color.

- Ball-bearing slide suspension.
- 12" drawer extension (3/4).
- Inside drawer dimension: 24¹/₂"W x 13"D x 2³/₈"H.
- Minimum clearance for mounting: 27³/₈"W x 19¹/₄"D.
- Core removable lock.

HD8	12	1.2	\$297	\$307
------------	----	-----	--------------	--------------

DESCRIPTION

MODEL	SHIP WEIGHT	CUBE	LIST PRICE
-------	-------------	------	------------

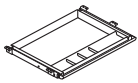

OPEN MARKET

Polymer Center Drawer

- Color: Black.
- Material: ABS.
- Minimum clearance for mounting: 23"W x 16¹/₄"D x 2"H.
- Retracts on 16" ball-bearing slides.
- Can be used on worksurfaces with Coordinate™ Height Adjustable Bases as long as it is attached with spacer model HKBS.
- Can store up to 25 lbs.

Black finish only, no specification needed.

HCD1	7	0.5	\$126
-------------	---	-----	--------------

NOTES:

- All metal center drawers feature pencil trays with three compartments for storage.
- All metal center drawers feature core removable locks for greater personal and departmental security.

HOW TO SPECIFY

<p>Select Model Number</p> <p>HD2 .</p>	<p>Select Paint Color</p> <p>See page 182</p> <p>P</p>
---	--



Icon Legend on page 17

COORDINATE™ Desktop Riser

DESCRIPTION

Portable Desktop Riser
31"D x 5"-16½"H x 35"W

NOTES: Available in Black (BLK) or White (WHT) finish. Desktop riser dimensions (without keyboard tray): 22"D x 5"-16½"H x 35"W. Keyboard tray dimensions: 9"D x 30"W. Max loading capacity is 33 lbs for the desktop riser surface and 4 lbs for the keyboard tray. Easily transition from seated to standing positions throughout the workday. Sits atop an existing desk to create sit-to-stand functionality by raising the computer. Includes keyboard tray and surface for computer monitors. **HON 5-Year Limited Warranty.**

! Not intended for use on mobile workstations.

MODEL SHIP WEIGHT CUBE LIST PRICE

HBXRISER 54 4.1 \$657



HOW TO SPECIFY

Select Model Number

HBXRISER.

Select Finish

BLK Black
WHT White

BLK

ERGONOMIC SOLUTIONS



Icon Legend on page 17

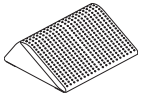

DESCRIPTION

Footrest — Anti-Slip Cover
13 3/4" D x 5 1/2" H x 16" W

ⓘ Available in Black (T) finish ONLY. Recommended weight capacity not to exceed 250 pounds. **HON 5-Year Limited Warranty.**
SPECIFYING EXAMPLE: HVL991.T

MODEL

SHIP WEIGHT

CUBE

LIST PRICE

HVL991

7 Ⓞ

0.9

\$89

WORKPLACE TOOLS

HOW TO SPECIFY

Select Model Number

Select Finish

T Black

H V L 9 9 1 .

T

CHAIR MATS

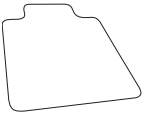
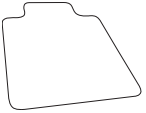
	DESCRIPTION	MODEL	SHIP WEIGHT	CUBE	LIST PRICE
	Lipped Chair Mat with Studs 60"W x 46"D 48"W x 36"D	HCM4660LS	13.9	1.0	\$158
		HCM3648LS	8.8	0.6	\$95
	Lipped Chair Mat without Studs 60"W x 46"D 48"W x 36"D	HCM4660LN	13.2	0.5	\$158
		HCM3648LN	8.3	0.3	\$95

NOTES:

- Available with studs for carpet and without studs for hard-surface floors.
 - Ships rolled.
 - **HON 5-Year Limited Warranty.**
- ⓘ Clear finish only. No specification needed.

HOW TO SPECIFY

Select Model Number

H C M 4 6 6 0 L S



TASK LIGHTS



DESCRIPTION

Articulating Desk Lamp

Articulating Desk Lamp w/ Occupancy Sensor

- Full-range dimming from 10% to 100%.
- Designed for 50,000 hours of life.
- Occupancy sensor is built into the head of the lamp and will automatically shut the lamp off after 6 minutes of undetected movement.
- Base swivel is 180 degrees.
- Uses only 5 watts of energy.
- Light comes with a silver 9' 4" power cord.
- Base diameter is 7.5".
- 3500K Color Temperature.
- 80 Color Rendering Index.
- TAA Compliant.

! Available in Matte Silver finish only, no specification needed.

MODEL

SHIP WEIGHT

CUBE

LIST PRICE

HLED1

1.2

6.5

\$430

HLED1OC

1.2

6.5

\$524



Task Desk Lamp

- Full-range dimming from 10% to 100%.
- Designed for 50,000 hours of life.
- Lamp is 15.83" tall.
- Desk lamp does not articulate at base. The pivoting head provides custom positioning, as it can be twisted 360 degrees.
- Uses only 5 watts of energy.
- Light comes with a silver 9' 4" power cord.
- Base diameter is 6.7".
- 3500K Color Temperature.
- 80 Color Rendering Index.
- TAA Compliant.

! Available in Brushed Nickel finish only, no specification needed.

HLED2

0.7

3.0

\$373

HOW TO SPECIFY

Select
Model Number

HLED1



TASK LIGHTS

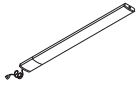

DESCRIPTION

LED Task Lights

17" LED Light with Power Supply (Single)
31" LED Light with Power Supply (Single)

17" LED Light with Power Supply for Daisy-chain (Starter)
31" LED Light with Power Supply for Daisy-chain (Starter)

17" LED Light with 8" Jumper Cord for Daisy-chain (Follower)
31" LED Light with 8" Jumper Cord for Daisy-chain (Follower)

Undercabinet Occupancy Sensor with 1" End to End Connector

NOTES: To use the daisy chain application, must start with model HLED17A or HLED31A. No finish specification required. Attaches magnetically to underside of overhead storage, or attaches with provided screws or double-sided tape. Occupancy sensor attaches to a single or starter LED light and will automatically turn the light off after no motion is detected for 30 minutes. Just like all the LED light models, the occupancy sensor features a soft-touch on/off switch. LED task lights have a lifetime of 50,000 hours and have a dimmer feature that allows the user to adjust the amount of light output.

MODEL SHIP WEIGHT CUBE LIST PRICE

HLED17AS ☉	1.2	0.05	\$450
HLED31AS ☉	1.5	0.09	\$603
HLED17A	1.0	0.05	\$493
HLED31A	1.4	0.09	\$662
HLED17AUO ☉	1.0	0.03	\$404
HLED31AUO ☉	1.0	0.05	\$539
HLEDOSA ☉	0.2	0.01	\$97

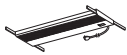

Recessed Task Lights

- Color: Black.
- Slim profile design.
- Mount to stack-on storage and wall mounted storage cabinets.
- Electronic ballast for increased energy efficiency.
- T5 fluorescent bulb included, which contains less mercury.
- 9-foot black cord and switch off right rear corner.

18 ³ / ₈ "W x 3 ¹ / ₁₆ "D x 1 ¹ / ₈ "H Chicago code version (with fused plug)	HH870924	5.0	0.40	\$243
	HH870924CH	5.0	0.40	\$308
22 ⁷ / ₈ "W x 3 ¹ / ₁₆ "D x 1 ¹ / ₈ "H Chicago code version (with fused plug)	HH870930	7.0	0.60	\$247
	HH870930CH	7.0	0.60	\$322
34 ⁵ / ₈ "W x 3 ¹ / ₁₆ "D x 1 ¹ / ₈ "H Chicago code version (with fused plug)	HH870942	10.0	0.90	\$267
	HH870942CH	10.0	0.90	\$339
46 ¹ / ₂ "W x 3 ¹ / ₁₆ "D x 1 ¹ / ₈ "H Chicago code version (with fused plug)	HH870960	12.0	1.10	\$290
	HH870960CH	12.0	1.10	\$361

HOW TO SPECIFY

Select Model Number

HH870924

PAPER MANAGEMENT & ORGANIZATIONAL TOOLS

GSA SIN 33721



Icon Legend on page 17

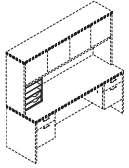

Not available in two-tone laminate

DESCRIPTION	MODEL	SHIP WEIGHT	CUBE	LIST PRICE BY LAMINATE GRADE	
				L1	L2
Vertical Paper Manager 14 $\frac{7}{8}$ "W x 10 $\frac{7}{8}$ "D x 19 $\frac{3}{8}$ "H NOTES: Keeps papers, files, and books neatly organized and within easy reach from a seated position. Designed for desk, credenza, and return tops. Fits under stack-on storage models. Two pullout drawers and three fixed shelves. Not available in pattern laminate colors. Ships fully assembled. ⚠ Requires 19 $\frac{3}{4}$ "H minimum of clear space between underside of overhead storage unit and worksurface. SPECIFYING EXAMPLE: HLVPM1.N	HLVPM1	27	2.8	\$351	\$361

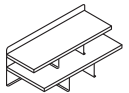

Not available in two-tone laminate



Desktop Storage Terrace 26 $\frac{1}{2}$ "W x 12 $\frac{1}{2}$ "D x 10 $\frac{1}{2}$ "H NOTES: For use on the tops of 29 $\frac{1}{2}$ "H desks, credenzas, and returns. Features six storage sections plus top display shelf. Keeps work-in-process, priority files, loose pages, and mail neatly organized and in view. Mixed material design comprised of sturdy laminate shelves with metal back and support panels. Not available in two-tone laminate combination or pattern laminate colors. Choose from Platinum Metallic (T1), Black (P), and Charcoal (S) for the metal components. Sized to fit in stack-on and wall mount storage cabinets in 10500, 10700, Valido, Concinnity, 94000, and 38000 Series. Fits in Concinnity and Voi sliding door models, except for 48"W or smaller models. Specify: Model.Laminate.Paint SPECIFYING EXAMPLE: HLDST1.N.T1	HLDST1	24	1.1	\$329	\$339
--	---------------	----	-----	--------------	--------------

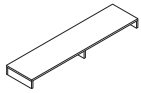

Layering Shelf 72"W x 14 $\frac{1}{2}$ "D x 5 $\frac{1}{2}$ "H 60"W x 14 $\frac{1}{2}$ "D x 5 $\frac{1}{2}$ "H NOTES: Layering shelf works with lower credenzas to provide additional storage areas. ⚠ Layering Shelves cannot be stacked. ⚠ Cannot add a hutch on top of a layering shelf.	HLSL1472LS HLSL1460LS	50 39	4.6 1.3	\$488 \$410	\$498 \$420
---	--	----------	------------	------------------------------	------------------------------

WORKPLACE TOOLS

HOW TO SPECIFY

Select Model Number HLVPMT1	Select Laminate See page 182 N
---------------------------------------	---



PAPER MANAGEMENT & ORGANIZATIONAL TOOLS

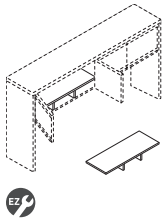

DESCRIPTION

Stacked Paper Management
32½"W x 12½"D x 4¼"H

MODEL SHIP WEIGHT CUBE LIST PRICE

HLVPM2 22 1.25 \$175

NOTES: Segments and organizes stack-on and wall mount storage compartments, as well as bookcase shelves. Unit can be used in Models H105327, H10534, H105322, H105321, H105382 and H105381.

- ! Available in Black finish only, no specification needed.
- ! In some cases, installation of Stacked Paper Management may require removing the stack-on or wall mount storage doors.

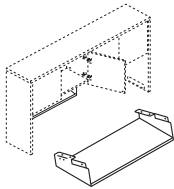

DESCRIPTION

Hanging Paper Shelf
28½"W x 11½"D x 4¾"H

MODEL SHIP WEIGHT CUBE LIST PRICE BY PAINT GRADE
P1 P2 P3

HHPS1 7 2.9 \$214 \$222 \$234

NOTES: Attaches quickly and easily (screws included). Maximizes worksurface space; de-clutters desktop while placing priority communications and active project folders within easy reach. Angled design allows contents to be distinguished at a glance. Mixed material styling features strong painted metal frame with a frosted shelf.

Attaches quickly and easily to laminate stack-on and wall mount storage models (except the 36"W Voi® overhead hutch with O-legs or panel mount brackets). Not for use with 38000 Series™ and Systems.

Specify: Model.Paint

SPECIFYING EXAMPLE: HHPS1.T1

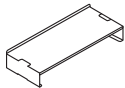

Desktop Paper Shelf

28½"W x 11½"D x 5"H

HDPS1 7 2.9 \$214 \$222 \$234

NOTES: Desktop Paper Shelf and Storage Terrace include protective, non-slip pads on the base. Paper Shelf can stack two-high. Organizer shelf provides a place and space for work-in-process and piling to keep worksurfaces neat and tidy. Convenient, scalable design with interlocking side supports allow two units to be stacked and integrated. Durable painted metal frame with a frosted shelf; mixed material styling matches hanging paper shelf.

Can also be used inside select overhead storage, including the following stack-on with clearance and hinged door models: 10500 and Valido 36", 42", 66", 72", 78"W and 10700 68½"W.

Specify: Model.Paint

SPECIFYING EXAMPLE: HDPS1.T1

WORKPLACE TOOLS

HOW TO SPECIFY

Select Model Number	Select Paint Color						
	See page 182						
<table border="1" style="display: inline-table;"> <tr> <td>H</td> <td>H</td> <td>P</td> <td>S</td> <td>1</td> </tr> </table>	H	H	P	S	1	<table border="1" style="display: inline-table;"> <tr> <td>P</td> </tr> </table>	P
H	H	P	S	1			
P							

PAPER MANAGEMENT & ORGANIZATIONAL TOOLS

GSA SIN 33721 EXCEPT AS NOTED



Icon Legend on page 17



DESCRIPTION

Storage Cube
12"W x 12"D
SPECIFYING EXAMPLE: HLSL1212.P8S

MODEL

HLSL1212

SHIP WEIGHT

1

CUBE

0.3

LIST PRICE BY PAINT GRADE

P1

\$316

P2

\$316

P3

\$316

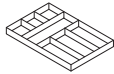

Drawer Organizer
12"W x 14½"D x 1½"H

SPECIFYING EXAMPLE: HSLDRWORG.P8F

HSLDRWORG

1

0.5

\$172

\$172

\$172

DESCRIPTION

Optional Pencil Tray

❗ For use with mobile and freestanding pedestal models.

❗ No specification required.

MODEL

HV-UT1

SHIP WEIGHT

0.5

CUBE

0.1

LIST PRICE

\$77

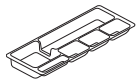

Back Pack Hook (10 per carton)

12"W x 14½"D x 1½"H

NOTES: Assembly: attaches to bottom of desk with (2) screws, included.

❗ Available in Platinum Metallic finish only, no specification needed.

HCLA65

10.0 Ⓞ

0.1

\$101

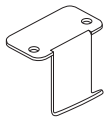

OPEN MARKET



WORKPLACE TOOLS

HOW TO SPECIFY

Select Model Number

Select Paint Color

See page 182

Only specify for models HLSL1212 and HSLDRWORG





H L S L 1 2 1 2 .

P 8 S

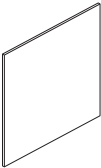
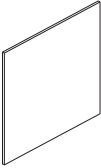
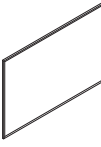

Icon Legend on page 17

PAPER MANAGEMENT & ORGANIZATIONAL TOOLS

	DESCRIPTION	MODEL	SHIP WEIGHT	CUBE	LIST PRICE
	Wall Mount Tackboard				
	36"W x 35¼"H	HNL3636TB	20	2.9	\$323
	30"W x 35¼"H	HNL3630TB	16	2.9	\$275
	36"W x 48⅝"H	HNL4936TB	27	5.5	\$359
	30"W x 48⅝"H	HNL4930TB	22	3.7	\$312
	NOTES: When positioned above 29½"H floor-standing storage, the sizes align with overhead storage height options. Can be positioned side-by-side with corresponding wall mount markerboard sizes. Easy to install; includes mounting hardware. Attaches to wall with horizontally mounted, interlocking Z-clip brackets. For the space directly below stack-on and wall mount storage cabinets, use the 18"H tackboard models listed in the Desks section in the 2021 Workspaces Pricer. SPECIFYING EXAMPLE: HNL3636TB.APN15				
	Wall Mount Markerboard				
	36"W x 35¼"H	HNL3636WB	16	2.9	\$221
	30"W x 35¼"H	HNL3630WB	14	2.9	\$206
	36"W x 48⅝"H	HNL4936WB	22	5.5	\$270
	30"W x 48⅝"H	HNL4930WB	20	3.7	\$249
	NOTES: Smooth, white, magnetic surface. Metal material produces clear graphics and cleans easily. Compatible for use with dry- or wet-erase markers. When positioned above 29½"H floor-standing storage, the sizes align with overhead storage height options. Can be positioned side-by-side with corresponding wall mount tackboard sizes. Easy to install; includes mounting hardware. Attaches to wall with horizontally mounted, interlocking Z-clip brackets. SPECIFYING EXAMPLE: HNL3636WB				
	Markerboard				
48"W x 31"H	HLSL4831MB	44	3.4	\$713	
	NOTES: Wall mounted.  No specification required.				
OPEN MARKET  					

WORKPLACE TOOLS

HOW TO SPECIFY

<p>Select Model Number</p> <p>H N L 3 6 3 6 T B</p>	<p>Select Fabric Color</p> <p>See pages 23-24</p> <p>A P N 1 1</p>
---	--

INTERLINK IQ ELECTRICAL

Specification guide for IQ Electrical on Training tables

Determine table width, the type of power access being used (3" grommet or 4x8 pop-up) and the desired number per table (Columns 1, 2 or 3). The table will then identify the type and quantity of components needed per table along with the maximum table run. Note that this is in addition to the Power base in-feed which is needed for each run. For example, a 48"W table with two 3" power grommets per table will require (1) HQH5-3 harness and (1) HQH1-3 harness per table with a maximum run of four tables.

Top Width	POWER ONE (1) PER TABLE 3" ROUND POWER GROMMET		POWER TWO (2) PER TABLE 3" ROUND POWER GROMMETS		POWER ONE (1) PER TABLE 4x8 POP-UP PORT	
36"	(1) HQH5-3	8 Table Run Maximum	N/A	N/A	(1) HQH5-P	8 Max Table Run
42"	(1) HQH5-3	8 Table Run Maximum	N/A	N/A	(1) HQH5-P	8 Max Table Run
48"	(1) HQH5-3	8 Table Run Maximum	(1) HQH5-3 (1) HQH1-3	4 Max Table Run	(1) HQH5-P	8 Max Table Run
54"	(1) HQH5-3	8 Table Run Maximum	(1) HQH5-3 (1) HQH1-3	4 Max Table Run	(1) HQH5-P	8 Max Table Run
60"	(1) HQH5-3	8 Table Run Maximum	(1) HQH5-3 (1) HQH1-3	4 Max Table Run	(1) HQH5-P	8 Max Table Run
66"	(1) HQH5-3 (1) HJQ3	4 Table Run Maximum	(1) HQH5-3 (1) HQH1-3	4 Max Table Run	(1) HQH5-P (1) HJQ3	4 Max Table Run
72"	(1) HQH5-3 (1) HJQ3	4 Table Run Maximum	(1) HQH5-3 (1) HQH1-3	4 Max Table Run	(1) HQH5-P (1) HJQ3	4 Max Table Run
84"	(1) HQH5-3 (1) HJQ3	4 Table Run Maximum	(2) HQH5-3	4 Max Table Run	(1) HQH5-P (1) HJQ3	4 Max Table Run
96"	(1) HQH5-3 (1) HJQ3	4 Table Run Maximum	(2) HQH5-3	4 Max Table Run	(1) HQH5-P (1) HJQ3	4 Max Table Run
Half-Round (all sizes)	(1) HQH1-3	2 Tables Maximum	N/A	N/A	(1) HQH5-P	2 Max Table Run
Trapezoid (all sizes)	(1) HQH5-3	8 Table Run Maximum	N/A	N/A	(1) HQH5-P	8 Max Table Run

NOTES:

- Interlink IQ Electrical is a pluggable, single circuit electrical system.
 - All electrical models include wire management clips and hardware.
 - Interlink IQ Electrical is non-sequential/non-directional.
 - Interlink IQ Electrical is UL Recognized as a Powered Table System and meets the requirements of UL 962 when paired with Motivate® or Huddle tables.
- ⓘ 40' maximum run, or no more than 8 units, whichever comes first. Interlink IQ system will automatically shut off if maximum requirements are exceeded. Maximum run is based upon electrical harness width, not table width.

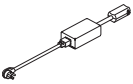
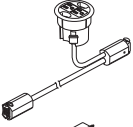
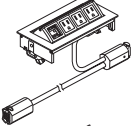
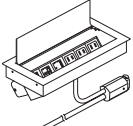
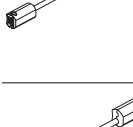
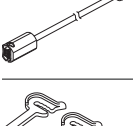
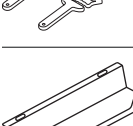
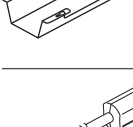
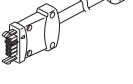
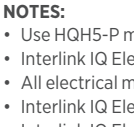
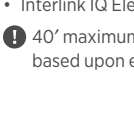

INTERLINK IQ ELECTRICAL

	DESCRIPTION	MODEL	SHIP WEIGHT	CUBE	LIST PRICE
	Power Base In-Feed <ul style="list-style-type: none"> 12 amp circuit breaker is built in to the Power Base In-Feed. Available in Black finish, no specification needed. 	HQB	2.0	0.2	\$566
	Power Harness – 1' Power Hub, 3" Round Grommet Mount <ul style="list-style-type: none"> Available in Black finish, no specification needed. 	HQH1-3	2.0	0.2	\$186
	Power Harness – 5' Power Hub, 3" Round Grommet Mount <ul style="list-style-type: none"> Available in Black finish, no specification needed. 	HQH5-3	2.0	0.2	\$208
	Power Harness – 5' with 4" x 8" Pop-Up Port (3 Power, 1 Blank) <ul style="list-style-type: none"> For use with tables G1 grommet. Specify paint. 	HQH5-P-3P1B	3.0	0.3	\$408
	Power Harness – 5' with 5" x 11" Flip-Top Port (3 Power, 3 Blank) <ul style="list-style-type: none"> For use with Preside® G2 grommet. Specify paint. 	HQH5-E-3P3B	5.0	0.2	\$429
	Power Harness – 5' with 5" x 11" Flip-Top Port (3 Power, 1 Extron Double Space) <ul style="list-style-type: none"> For use with Preside® G2 grommet. Specify paint. 	HQH5-E-3P1E	5.0	0.2	\$452
	Power Harness – 5' with 5" x 11" Flip-Top Port (3 Power, 2 USB, 2 Blank) <ul style="list-style-type: none"> For use with Preside® G2 grommet. Specify paint. 	HQH5-E-3P1U2B	5.0	0.2	\$473
	Power Jumper – 3' <ul style="list-style-type: none"> Available in Black finish, no specification needed. 	HQJ3	2.0	0.2	\$117
	Ganging Hardware <ul style="list-style-type: none"> Includes two ganging links and two screws. No color designator when specifying. <i>Example: HMAGANG.</i> 	HMAGANG	1.0	0.1	\$102
	Cable Management Troughs 17"W – Single 17"W – 10-Pack <ul style="list-style-type: none"> Available in Graphite finish, no specification needed. NOTES: For additional information see page 208.	HCTROUGH17 HCTROUGH1710	2.7 14.0	0.5 0.5	\$73 \$665
	IQ 1.0 Backward Compatible Jumper 36" <ul style="list-style-type: none"> Available in Black finish, no specification needed. Use when connecting Interlink IQ 1.0 power harness (rectangle end) to Interlink IQ 2.0 (oval end) power harness. ! If using Interlink IQ 2.0 in-feed with Interlink IQ 1.0 power harness please contact Customer Support.	HQBCJ36	2.0	0.2	\$89

NOTES:

- Use HQH5-P models with G1 table top cutouts and HQH5-E models with G2 table top cutouts.
- Interlink IQ Electrical is a pluggable, single circuit electrical system.
- All electrical models include wire management clips and hardware.
- Interlink IQ Electrical is non-sequential/non-directional.
- Interlink IQ Electrical is UL Recognized as a Powered Table System and meets the requirements of UL 962 when paired with Motivate® or Huddle tables.
- !** 40' maximum run, or no more than 8 units, whichever comes first. Interlink IQ system will automatically shut off if maximum requirements are exceeded. Maximum run is based upon electrical harness width, not table width.

HOW TO SPECIFY

Select Model Number HQH5-E-3P3B	Select Paint Color FOG Fog SVR Silver BLK Black SVR
---	--

4-TRAC HARDWIRE ELECTRICAL SYSTEM

4-Trac Electrical System

The 4-Trac Electrical System is a UL-recognized Manufactured Wiring System that seamlessly passes power from one worksurface to another. This low-profile non-sequential electrical system allows tables to be “daisy-chained” together in any desired order and allows users to reconfigure quickly due to simple connectable/disconnectable links.

- Meets requirements of UL 183 and National Electric Code Article 604
- 4-Wires, 2-circuits, 20 Amps each (Circuit 1 and Circuit 2 only)
- 13 Duplex Receptacles per circuit, 26, 15 Amp Duplex receptacle per power in-feed
- Electrical system attaches directly to underside of worksurface with included brackets
- Up to twelve tables can be linked together

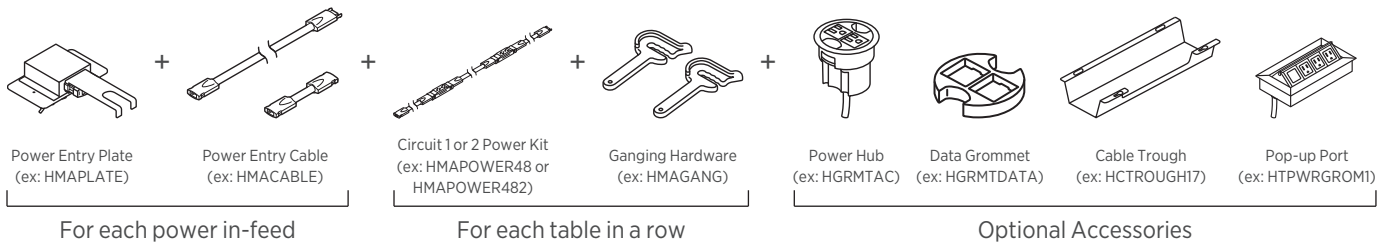



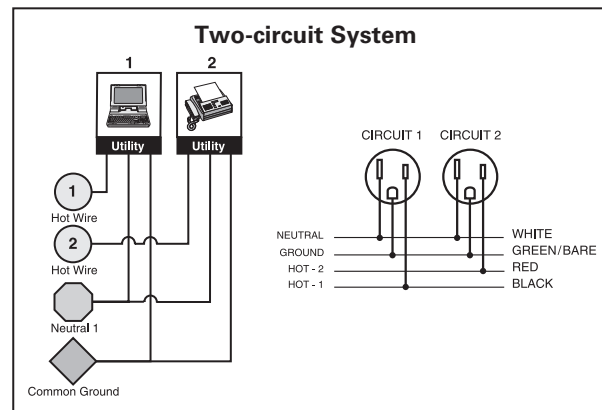
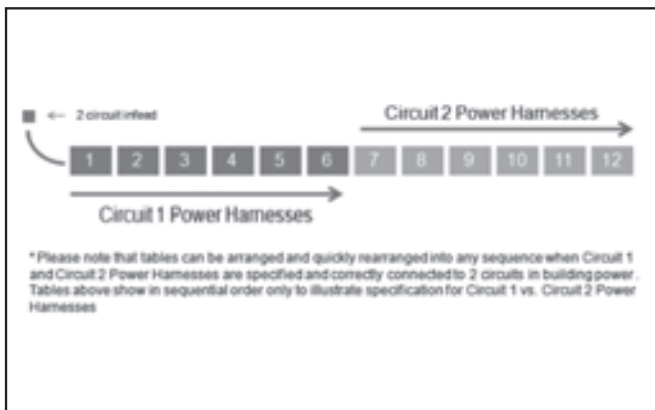

Steps for Electrical Specifications:

- Determine how many rows of tables are needed and order the following:
 - One HMAPLATE per row (or power in-feed)
 - One HMAPOWER48 per row (or power in-feed)
- Order one power harness per table in each row
 - For 1-6 tables in a row (see illustration 1)
 - Order Circuit 1 Power Harnesses (ex. If powering six 24x60 tables order six sets of HMAPOWER60)
 - For 7-12 tables in a row (see illustration 1)
 - Order Circuit 1 Power Harness for first six tables and Circuit 2 Power Harness for remaining tables (ex. If powering eight 24x60 tables, order six sets of HMAPOWER60 and two sets of HMAPOWER602)
- Order one set of ganging hardware per table (ex. HMAGANG)
- Determine which accessories are needed:
 - Power Hub model HGRMTAC — to access power at worksurface.
 - Data Grommet model HGRMTDATA — to access data at worksurface.
 - Wire Management strips model HBTMS — for vertical and horizontal wire management.

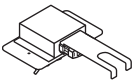
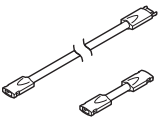

4-TRAC HARDWIRE ELECTRICAL SYSTEM

	DESCRIPTION	MODEL	SHIP WEIGHT	CUBE	LIST PRICE
	Power Entry Plate	HMAPLATE	1.0	0.2	\$102
	Power Entry Cable • 6' power entry cable with male/female adapter. • Connects table to power entry plate.	HMACABLE	1.8	0.2	\$159
	Power Jumper Cable To connect tables front to front	HMAJUMP	0.5	0.3	\$54
	Circuit 1 Power Kit for 36" W Table	HMAPOWER36	1.5	0.3	\$289
	Circuit 1 Power Kit for 42" W Table	HMAPOWER42	1.8	0.3	\$292
	Circuit 1 Power Kit for 48" W Table	HMAPOWER48	1.8	0.3	\$294
	Circuit 1 Power Kit for 54" W Table	HMAPOWER54	2.0	0.3	\$299
	Circuit 1 Power Kit for 60" W Table	HMAPOWER60	2.0	0.3	\$302
	Circuit 1 Power Kit for 66" W Table	HMAPOWER66	2.2	0.3	\$306
	Circuit 1 Power Kit for 72" W Table	HMAPOWER72	2.2	0.3	\$309
	Circuit 1 Power Kit for 84" W Table	HMAPOWER84	2.4	0.3	\$320
	Circuit 1 Power Kit for 96" W Table	HMAPOWER96	2.6	0.3	\$331
	Circuit 2 Power Kit for 36" W Table	HMAPOWER362	1.5	0.3	\$289
	Circuit 2 Power Kit for 42" W Table	HMAPOWER422	1.8	0.3	\$292
	Circuit 2 Power Kit for 48" W Table	HMAPOWER482	1.8	0.3	\$294
	Circuit 2 Power Kit for 54" W Table	HMAPOWER542	2.0	0.3	\$299
	Circuit 2 Power Kit for 60" W Table	HMAPOWER602	2.0	0.3	\$302
Circuit 2 Power Kit for 66" W Table	HMAPOWER662	2.2	0.3	\$306	
Circuit 2 Power Kit for 72" W Table	HMAPOWER722	2.2	0.3	\$309	
Circuit 2 Power Kit for 84" W Table	HMAPOWER842	2.4	0.3	\$320	
Circuit 2 Power Kit for 96" W Table	HMAPOWER962	2.6	0.3	\$331	
	Electrical Connectors 4-Way Splitter  Available in Black (P) only. SPECIFYING EXAMPLE: HMASPLIT.P	HMASPLIT	0.9	0.1	\$55

NOTES:





- Each power kit includes two duplex receptacles and attaches to the underside of the worksurface with included brackets.
- Power Kits are compatible with various base types including nesting bases.
- Available in Black finish, no specification needed.

HOW TO SPECIFY

Select
Model Number

H M A P L A T E

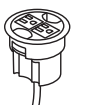
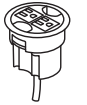
POWER & CABLE MANAGEMENT

	DESCRIPTION	MODEL	SHIP WEIGHT	CUBE	LIST PRICE
 Black only SIN 33721	Black Field Installable Grommet with One Access Hole <ul style="list-style-type: none"> Intended for use in tops and end panels to route/hide cords and facilitate reaching wall electrical outlets. Requires a 2½" diameter hole saw and drill for installation (not included). Grommet cap measures 3" diameter and includes a ¾" diameter cord access hole. Grommet sleeve measures 2½" O.D. x ¾" thick. Includes instructions to locate grommet position for desks, credenzas, returns and bridges. <p>⚠ The grommet is not designed to be used with the following HON Series: 94000, 38000, Mentor®, Metro Classic or 34000.</p>	HFLDGRMT	0.1 Ⓢ	0.01	\$35
 SIN 33721	Black Field Installable Grommet with Two Access Holes <ul style="list-style-type: none"> Requires a 3" diameter hole saw and drill for installation (not included). Grommet outside dimensions measures 3½" diameter. Grommet sleeve measures 3" O.D. x 1" thick. Includes instructions to locate grommet position for desks, credenzas, returns and bridges. 	HFLDGRMT3	0.1 Ⓢ	0.3	\$35
 OPEN MARKET	Platinum Field Installable Grommet with Two Access Holes <ul style="list-style-type: none"> Requires a 3" diameter hole saw and drill for installation (not included). Outside dimension measures 3½" diameter. Sleeve hole in worksurface measures 3" O.D. x 1" thick. Includes instructions to locate grommet position for desks, credenzas, returns, and bridges. 	HFLDGRMT4	0.1	0.01	\$35
 SIN 33721T	Power Hub, 3" Grommet Mount, 6' Cord <ul style="list-style-type: none"> Fits in 3" round grommet holes. Two grounded AC power outlets. Includes 6' cord with three-prong plug. Field installed with Plug-and-play ease. <p>⚠ Available in black only (no color designation so use .X - Specify: HGRMTAC.X).</p>	HGRMTAC	1.3	0.2	\$126
 SIN 33721T	3" Round Power Grommet - 2 Outlets, 10' Cord <ul style="list-style-type: none"> Includes 10' cord with three-prong plug. Fits in 3" round grommet holes. Two grounded AC power outlets. Field installed with Plug-and-play ease. <p>NOTES: Power Modules will also work with standing-height applications for 10500 Series™ and Voi® desks. Optional Memory Control allows preset worksurface heights for consistency. Ships separately. Dynamic load capacity when worksurface is moving is 300 lbs.</p> <p>⚠ Available in black finish only, no specification needed.</p>	HGRMTAC2	1.5	0.2	\$159
 SIN 33721T	Power/USB Hub, 3" Grommet Mount <ul style="list-style-type: none"> One grounded AC power outlet with 2 USB ports. UL Listed. <p>⚠ Available in black only (no color designation so use .X - Specify: HGRMTUSB2.X).</p> <p>⚠ Not compatible with Arrange® tables.</p>	HGRMTUSB2	1.3 Ⓢ	0.2	\$250
 SIN 33721	Data Grommet Blank grommet kit that includes adapters for a variety of manufacturers jacks and couplers. <ul style="list-style-type: none"> Fits in existing 3" round grommet housing. <p>⚠ Available in black only. Specify P when ordering. Example: HGRMTDATA.P.</p>	HGRMTDATA	0.2	0.2	\$23

HOW TO SPECIFY

Select
Model Number

H F L D G R M T



Icon Legend on page 17

POWER



Model HPWRMOD3WC shown

DESCRIPTION

Dean Power Modules with Worksurface Clamp
 3 Receptacles
 2 Receptacles, 2 USB
 2 Receptacles, 2 USB with Qi Wireless Charging Top
 • 6' power cord with standard three-prong plug.
 • Worksurface clamp models work on any top with a 4" overhang.
 • UL Listed.

MODEL

HPWRMOD3WC
HPWRMOD2WC
HPWRMOD4WC

SHIP WEIGHT

2.3
 2.3
 2.3

CUBE

0.2
 0.2
 0.2

LIST PRICE

\$342
\$546
\$738

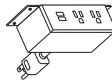

Model HPWRMOD2UWM shown

Dean Power Modules with Under-Worksurface Mounting Bracket
 3 Receptacles
 2 Receptacles, 2 USB
 • 6' power cord with standard three-prong plug.
 • Under-worksurface mounting bracket models work with any top that has a 5" x 5" square clearance.
 • UL Listed.

HPWRMOD3UWM
HPWRMOD2UWM

2.3
 2.3

0.2
 0.2

\$342
\$546

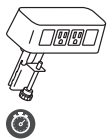

Power & Data Center
 2 Receptacles 2 Data Accessory
 • Standard with two receptacles and openings for two data ports.
 • 6' power cord with standard three-prong plug.
 • Fits on any worksurface with a 4" overhang.
 • UL Listed.

HCOMDOME2

2.5

0.2

\$327

Color finish coordinates with HON's Loft. Specify LOFT when ordering. Example: HCOMDOME2.LOFT.

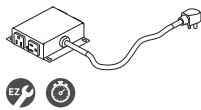

Under Worksurface Power Module — 4 Outlets, 10' Cord
 • Includes 10' cord with three-prong plug.
 • Fits in cable management troughs. See page 208.
 • 4 outlets on side create easy access.

HPWRMOD2

1.5

0.2

\$441

NOTES: Power Modules will also work with standing-height applications for 10500 Series™ and Voi® desks.

Available in black finish only, no specification needed.

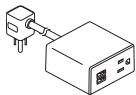

OPEN MARKET

Miki Surface Sit Power Module
 • Includes 6' cord with three-prong plug.
 • 1 Receptacle, 2 USB
 • Unit features non-slip grip on underside.

HSMPOWER-1P-2U

2.0

0.6

\$166

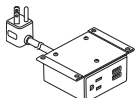

OPEN MARKET

Miki Under-Worksurface Power Module
 • Includes 6' cord with three-prong plug.
 • 1 Receptacle, 2 USB

HUMPWR-1P-2U

2.0

0.6

\$191

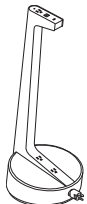

OPEN MARKET

Vesta Mobile Power Station
 • Includes 10' retractable cord with three-prong plug.
 • 3 AC, 1 Dual USB-A, 1 USB-C at top
 • 2 AC at base
 • Specify Paint and Plastic.

HPWRMOB1

14.0

3.3

\$1100

SPECIFYING EXAMPLE: HPWRMOB1.BLK.STRM

HOW TO SPECIFY

Select Model Number

H S M P W R - 1 P - 2 U .

Select Plastic

Specify for Dean and Miki models

STRM Storm
 SNW Snow

S N W

Select Model Number

H P W R M O B 1 .

Select Exterior Paint Color

Specify for model HPWRMOB1 only

FOG Fog
 STRM Storm
 BLK Black
 SNW Snow

B L K .

Select Paint Color

Specify for model HPWRMOB1 only

FOG Fog
 STRM Storm
 BLK Black
 SNW Snow

S T R M

WORKPLACE TOOLS



POWER

DESCRIPTION **MODEL** **SHIP WEIGHT** **CUBE** **LIST PRICE**



MhoB 4" x 8" Pop-up Port **HTG1PWR-3P-1B** 5 0.3 **\$424**

- Specify G1 cutout in table top.
- Pop-up Port provides three power ports and one blank data receptacle.
- Sits flush with worksurface when closed.
- Includes 6' cord with three-prong plug.

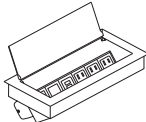

ElloraB 5" x 11" Flip-top Port **HTG2PWR-4P-2B** 5 0.3 **\$626**

- Specify G2 cutout in table top.
- Flip-top Port provides four power ports and two blank data receptacles.
- Conceals wires and allows power cords to be plugged in while in use.
- Includes 10' cord with three-prong circuit breaker plug.

NOTES: Two circuit breaker plugs do not fit into one duplex.

ElloraB 5" x 11" Flip-top Port **HTG2PWR-3P-1E** 5 0.3 **\$767**

- Specify G2 cutout in table top.
- Flip-top Port provides one blank for Extron plate and three power ports.
- Extron AAP plates can be integrated into grommet to support changing technology.
- Conceals wires and allows power cords to be plugged in while in use.
- Includes 10' cord with three-prong plug.

ElloraB 5" x 11" Flip-top Port **HTG2PWR-3P-2B-2U** 5 0.3 **\$909**

- Specify G2 cutout in table top.
- Flip-top Port provides 3 Power, 1 USB, and 2 Blank Data Ports.
- Conceals wires and allows power cords to be plugged in while in use.
- Includes 10' cord with three-prong plug.

ElloraB 5" x 11" Flip-top Port **HTG2PWR-3P-1U-W** 5 0.3 **\$930**

- Specify G2 cutout in table top.
- Flip-top Port provides 3 Power, 1 USB, and Qi wireless charging lid.
- Conceals wires and allows power cords to be plugged in while in use.
- Includes 10' cord with three-prong plug.

WORKPLACE TOOLS

HOW TO SPECIFY

<p>Select Model Number</p> <p>HTG2PWR-4P-2B.</p>	<p>Select Paint Color</p> <p>SVR Silver BLK Black FOG Fog</p> <p>BLK</p>
---	--

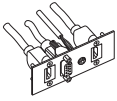

DESCRIPTION

Extron Plate (Double Space) — VGA, HDMI, HDMI, Audio

MODEL

HTPLATEVHAU

SHIP WEIGHT

1

CUBE

0.1

LIST PRICE

\$428

NOTES:

- 1 Double Space Plate can be used with HTG2PWR-3P-1E or HTPWRGROM4 Flip-top Port.
- ! Available in Black finish only, no specification needed.

HOW TO SPECIFY

Select Model Number

H T P L A T E V H A U

POWER & CABLE MANAGEMENT

Icon Legend on page 17

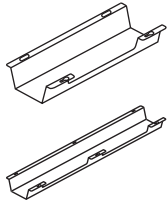

DESCRIPTION

Cable Management Troughs

17"W — Single
17"W — 10-Pack
36"W — Single
36"W — 10-Pack

- Cable management troughs ship flat packed.
- The troughs attach to underneath the worksurface with screws.
- Cutouts in trough allow access to power without the need to detach from surface. 17"W = 1 cutout; 36"W = 2 cutouts.
- Color: Graphite.
- Material: Metal.
- TAA Compliant.

MODEL

SHIP WEIGHT

CUBE

LIST PRICE

HCTROUGH17	2.7 Ⓢ	0.5	\$73
HCTROUGH1710	14.0 Ⓢ	0.5	\$665
HCTROUGH36	4.9 Ⓢ	0.9	\$122
HCTROUGH3610	30.0 Ⓢ	0.9	\$1121



OPEN MARKET

O-Leg Cord Clips

Clips for 28½" Worksurface O-Legs — 8-Pack
Clips for Stack-on Storage, Hutch and Layering O-Legs — 4-Pack

HWMCLIPLG

0.8 **Ⓢ**

0.1

\$110

HWMCLIPSM

0.5 **Ⓢ**

0.1

\$73

NOTES: Wire clips work with 7" Low Credenza O-leg and 29"H Support O-leg. Wire clips also work with the 50" and 65" Overhead O-leg supports.

- ! Available in frosted plastic material only.

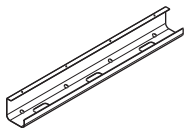

Black only

Cable Management Tray

24"
36"

- ! Available in Black only.

HHCMT24

2.0 **Ⓢ**

0.3

\$82

HHCMT36

3.0 **Ⓢ**

0.4

\$101



Vertical Wire Management Vertebrae

NOTES: 30"H x 3⅞"W x 1½"D. Ships unassembled.

- ! Clear finish. Specify "X" for finish option.

SPECIFYING EXAMPLE: HMPVWM28.X

HMPVWM28

3.0

0.3

\$246

HOW TO SPECIFY

Select
Model Number

Select
Paint Color

P Black

H H C M T 2 4 .

P

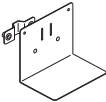
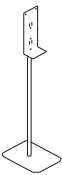
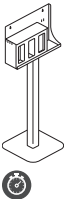
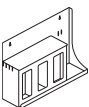

HEALTHY WORKPLACE TOOLS

	DESCRIPTION	MODEL	SHIP WEIGHT	CUBE	LIST PRICE BY PAINT GRADE		
					P1	P2	P3
	<p>Hand Sanitizer Station Mounting Area: 6"W x 12"H Base: 12"W x 16"H</p> <p>NOTES: Freestanding. Stand is compatible with most manufacturers' automatic hand sanitizer dispensers, sold separately. No assembly required. Metal base for added stability.</p>	HHC-SANSTND	15	6.1	\$278	\$304	\$316
	<p>Retrofit Tray Kit for Sanitizer Station</p> <p>NOTES: Allows for easy conversion of HHC-SANSTND to HHC-SANSTND2. Adjustable strap allows for usage with most hand sanitizer bottles with pump or wipe containers.</p>	HHC-SANSTND-TRAY	8	0.2	\$82	\$95	\$101
	<p>Hand Sanitizer Station with Tray</p> <p>NOTES: Freestanding. Stand is compatible with most manufacturers' automatic hand sanitizer dispensers, sold separately. Adjustable strap allows for usage with most hand sanitizer bottles with pump or wipe containers. No assembly required. Metal base for added stability.</p>	HHC-SANSTND2	15	6.1	\$319	\$345	\$357
	<p>Freestanding PPE Stand</p> <p>NOTES: Freestanding. 3 closed compartments fit most manufacturers' boxed PPE, including gloves, masks, wipes, and tissues. Closed compartments have adjustable back to best fit. Each closed compartment measures 5"W x 5¼"D x 10"H. Open space can accommodate most manufacturers' automatic hand sanitizer dispensers, hand sanitizer bottles, or wipe containers, sold separately.</p>	HHC-PPESTND	39	7.7	\$600	\$652	\$676
	<p>Wall Mounted PPE Stand</p> <p>NOTES: Wall mounted. 3 closed compartments fit most manufacturers' boxed PPE, including gloves, masks, wipes, and tissues. Closed compartments have adjustable back to best fit. Each closed compartment measures 5"W x 5¼"D x 10"H. Open space can accommodate most manufacturers' automatic hand sanitizer dispensers, hand sanitizer bottles, or wipe containers, sold separately.</p> <p>ⓘ Model does not come equipped with wall mounted hardware.</p>	HHC-PPEWALL	14	2.2	\$336	\$375	\$393

WORKPLACE TOOLS

HOW TO SPECIFY

<p>Select Model Number</p> <p>H H C - S A N S T N D .</p>	<p>Select Finish</p> <p>P 8 T</p>
---	-----------------------------------

HEALTHY WORKPLACE TOOLS

OPEN MARKET



Icon Legend on page 17

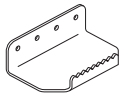

DESCRIPTION

Metal Foot Pull

5"W x 3¼"D x 1½"HK

Pack of 5

Pack of 15

MODEL

HHC-FOOTPULL5

HHC-FOOTPULL15

SHIP WEIGHT

8

23

CUBE

0.7

0.7

LIST PRICE

\$358

\$1001

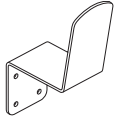

Metal Arm Pull

2½"W x 4½"D x 7½"H

Pack of 5

Pack of 15

HHC-ARMPULL5

HHC-ARMPULL15

8

23

0.7

0.7

\$358

\$1001

NOTES:

- Pulls are made from 10-gauge steel.
- Mounting hardware included for attaching to steel and wood doors.
- Available in Textured Black and Textured Titanium.
- Available in 5-packs and 15-packs.

WORKPLACE TOOLS

HOW TO SPECIFY

Select Model Number

Select Finish

- P6P** Textured Black
- P8V** Textured Titanium

H H C - F O O T P U L L 5 . P 6 P

SEATING FUNCTIONS

Work/task chairs need to be adjusted to deliver optimum support. Cross-reference the letter key below to identify the chairs in this section that best meet your needs.

PROPORTIONAL ADJUSTMENTS

These controls adapt the dimensions of the chair to fit the user.



A. Pneumatic seat height adjustment — Regulates height of chair relative to floor.

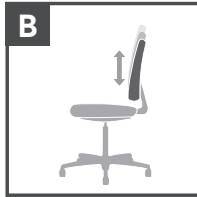

B. Back height adjustment — Positions lumbar support within a fixed range.

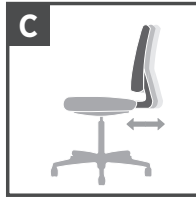

C. Seat depth adjustment — Positions chair back relative to seat.

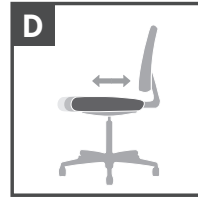

D. Seat slide mechanism — Seat cushion travels forward and back, then locks into position.

ARM OPTIONS

These adjustments accommodate different sized users and support keyboarding.



Q. Adjustable height arms — Provide improved upper-torso support. Can be adjusted periodically to relieve strain and provide variety.

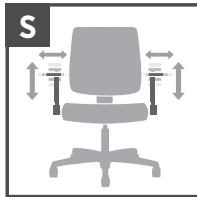

S. Height and width adjustable arms — Controls both height and width of arms for optimum comfort.



T. Loop arms — Largely specified for aesthetics. Frequently used in management settings.

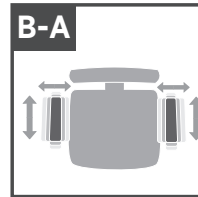

B-A. All-adjustable arms — Arms adjust in height, width, and depth.

POSTURE CONTROLS

The controls modify the position and angle of the seat and back to respond to changing tasks.



E. 360° Swivel

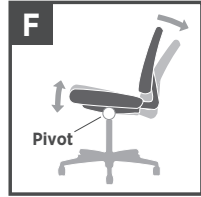

F. Tilt — Pivot point located directly above center of chair base.

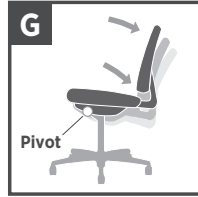

G. Mid-range knee tilt — Pivot point located slightly ahead of center of chair base. Allows user to recline at a slightly more relaxed angle than conventional tilt.

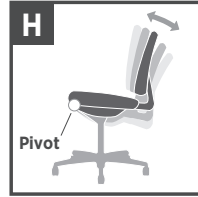

H. Knee tilt — Pivot point located near front edge of chair. Allows user to keep feet flat on floor while chair reclines.

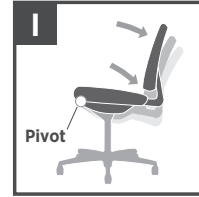

I. Synchronized knee tilt — Back reclines at a 2-to-1 ratio to seat angle. Pivot point located near front edge of chair.

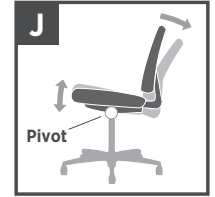

J. Synchro-tilt — Back reclines at a 2-to-1 ratio to seat angle. Allows user to recline while keeping seat cushion relatively level to floor.



K. Tilt tension — Controls rate and ease of recline.



L. Tilt lock — Locks out tilt function.



M. Posture mechanism/lock — Back angle adjusts independently of seat, and can be locked in an infinite number of positions within a fixed range.



N. Multi-task control — Adjusts seat and back angles independently with a single lever (infinite locking within a fixed range).



O. Asynchronous control — High performance system with three levers to modify: angle of back relative to seat, tilt (free float or infinite locking) and forward tilt.

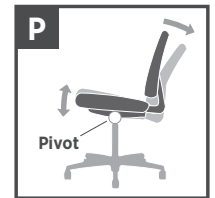

P. Weight-activated synchro-tilt — Back reclines at a 2 to 1 ratio to seat angle. Tilt tension automatically adjusts to user's body weight as user reclines.



W. Integral lumbar support — Easily adjusts to enhance comfort.



X. Dual-clutch posture control — Adjusts seat and back angles independently with two levers (infinite locking within a fixed range).

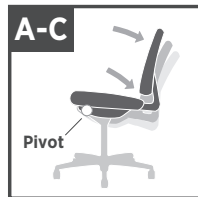

A-C. Synchronized tilt — Back reclines at a 2.5 to 1 ratio to seat angle. Variable lock.

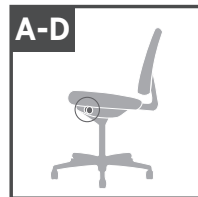

A-D. Side tilt tension — Controls rate and ease of recline. Conveniently located on the right side.



A-E. Back reclines at a 2 to 1 ratio to seat angle. Back angle adjusts independently of seat and can be locked in infinite number of positions within a fixed range.

ORDERING INFORMATION

Seating	Standard Fabric Selections by Series with Price Code and Fabric Material																														
	1	1	1	1	1	1	1	1	1	1	1	1	1	1	1	1	1	2	2	2	2	2	2	2	2	2	3	3	3	3	3
Model/Series	APX	AI	EB	VA	GA	MM	EA	CU	COMP	COMF	UR	DAPR	ENSB	HAML	NR	OP	PBLE	PNS	BLME	CLYD	DOT	RUSH	SED	SPNN	WP	ISN	SX	PRKR	PURL	QULL	SS
Accommodate®	•	•						•	•		•	•	•	•	•	•	•	•	•	•	•	•	•	•	•	•	•	•	•	•	•
Adjustable Task/Lab Stool							•																								
Astir™	•	•						•	•		•	•	•	•	•	•	•	•	•	•	•	•	•	•	•	•	•	•	•	•	•
Boda™						•																									
Ceres® Series	•	•						•	•		•	•	•	•	•	•	•	•	•	•	•	•	•	•	•	•	•	•	•	•	•
Clig™	•	•						•	•		•	•	•	•	•	•	•	•	•	•	•	•	•	•	•	•	•	•	•	•	•
ComforTask® 5900 Series	•	•						•	•		•	•	•	•	•	•	•	•	•	•	•	•	•	•	•	•	•	•	•	•	•
Convergence®	•	•						•	•		•	•	•	•	•	•	•	•	•	•	•	•	•	•	•	•	•	•	•	•	•
Endorse® Task****	•	•						•	•		•	•	•	•	•	•	•	•	•	•	•	•	•	•	•	•	•	•	•	•	•
Flock**	•	•						•	•		•	•	•	•	•	•	•	•	•	•	•	•	•	•	•	•	•	•	•	•	•
Flock® Round Lounge HFLRCI/DF and Stool HFSS7	•							•	•		•	•	•	•	•	•	•	•	•	•	•	•	•	•	•	•	•	•	•	•	•
Grove®	•	•						•	•		•	•	•	•	•	•	•	•	•	•	•	•	•	•	•	•	•	•	•	•	•
Ignition® Series	•	•						•	•		•	•	•	•	•	•	•	•	•	•	•	•	•	•	•	•	•	•	•	•	•
Invitation® Lounge Series	•	•						•	•		•	•	•	•	•	•	•	•	•	•	•	•	•	•	•	•	•	•	•	•	•
Lota® H2281 / H2285				•																											
Lota® H2282	•	•						•	•		•	•	•	•	•	•	•	•	•	•	•	•	•	•	•	•	•	•	•	•	•
Mav™	•	•						•	•		•	•	•	•	•	•	•	•	•	•	•	•	•	•	•	•	•	•	•	•	•
Motivate®	•	•						•	•		•	•	•	•	•	•	•	•	•	•	•	•	•	•	•	•	•	•	•	•	•
Nucleus® Series	•	•						•	•		•	•	•	•	•	•	•	•	•	•	•	•	•	•	•	•	•	•	•	•	•
Pagoda® 4070/4090 Series**	•	•						•	•		•	•	•	•	•	•	•	•	•	•	•	•	•	•	•	•	•	•	•	•	•
Perpetual® Nesting	•	•						•	•		•	•	•	•	•	•	•	•	•	•	•	•	•	•	•	•	•	•	•	•	•
Pillow-Soft® 2090 Series	•	•	•					•	•		•	•	•	•	•	•	•	•	•	•	•	•	•	•	•	•	•	•	•	•	•
Solutions Seating® 4000 Series	•	•						•	•		•	•	•	•	•	•	•	•	•	•	•	•	•	•	•	•	•	•	•	•	•
Solve®	•	•						•	•	•	•	•	•	•	•	•	•	•	•	•	•	•	•	•	•	•	•	•	•	•	•
Soothe®	•	•						•	•		•	•	•	•	•	•	•	•	•	•	•	•	•	•	•	•	•	•	•	•	•
Soothe® High-Back																															
Volt® 5700/5710 Series					•																										
Volt® 5720/5730 Series	•	•						•	•		•	•	•	•	•	•	•	•	•	•	•	•	•	•	•	•	•	•	•	•	•
West Hill™	•	•						•	•		•	•	•	•	•	•	•	•	•	•	•	•	•	•	•	•	•	•	•	•	•
Credenza/Pedestal Cushions	•	•						•	•		•	•	•	•	•	•	•	•	•	•	•	•	•	•	•	•	•	•	•	•	•

*Flock® chair model HFLRCI has fabric limitations, please see the Flock® seating pages 288-297 for details.

**Pagoda® wood back models available in Harvest (C), Natural Maple (D), Shaker Cherry (F), Bourbon Cherry (H) and Mahogany (N) only.

***Denver Leather (SS) may not be available on every model within a specific series, please refer to the model's page for details.

****Attire and Pebble available on Endorse® Task as seat option only.

ORDERING INFORMATION

- Seating pages are now arranged in alpha, then numeric, order.
- **All specifications in this publication are based on the latest product information available at the time of print.**
- COM Ordering Information and pricing on page 12.
- Remember to add an FC to the base model number when fire code fabric is selected. See page 216 for available models/fabrics.
- Wood components are well-seasoned select hardwoods, chosen for their strength, their ability to machine well and their superior uniformity of stain and finish.
- Chairs with leather feature matching vinyl backs and vinyl seat bottom when applicable (Non-contact areas are vinyl).

Wood Seating	Finish Codes							Standard Fabric Selections by Series with Price Code and Fabric Material																			
								1	1	1	1	1	1	1	1	1	2	2	2	2	2	2	2	2	3	3	L
Model/Series	Bourbon Cherry	Cognac	Harvest	Mahogany	Mocha	Natural Maple	Pinnacle	Shaker Cherry	AI	EB	CU	COMP	DAPR	HAML	NR	OP	PNS	CLYD	DOT	RUSH	SED	SPNN	WP	ISN	PURL	SS	
Cambia™ 2160 Series	H	COGN	C	N	MOCH	D	PINC	F	•		•	•	•	•	•	•	•	•	•	•	•	•	•	•	•	•	•
Invitation® 2110 Series	H	COGN	C	N	MOCH	D	PINC	F	•		•	•	•	•	•	•	•	•	•	•	•	•	•	•	•	•	•
Park Avenue Collection® 5000 Series	H	COGN	C	N	MOCH	D	PINC	F			•	•	•	•	•	•	•	•	•	•	•	•	•		•	•	•
Pillow-Soft® 2190 Series	H	COGN	C	N	MOCH	D	PINC	F		•	•	•	•	•	•	•	•	•	•	•	•	•	•	•		•	•
Versant® Tandem Wood	H	COGN	C	N	MOCH	D	PINC	F	•		•	•	•	•	•	•	•	•	•	•	•	•	•	•	•	•	•

Note: Gathers and creases may be more visible with AI and OP fabrics due to the inherent design and construction of these fabrics.

FIRE CODE/COMPLIANT SEATING

FIRE SAFETY

Definitive Protection — CAL TB 117-2013

- TB 117-2013 — The State of California, Department of Consumer Affairs, Bureau of Electronic and Home Appliance Repair, Home Furnishings and Thermal Insulation (BEARHFTI) Technical Bulletin (TB) 117-2013 is the industry flammability standard for upholstered furniture, and provides methods for smolder resistance of cover fabrics, barrier materials, resilient filling materials, and decking materials for use in upholstered furniture.
- The fabrics and resilient filling materials used in upholstered seating manufactured by The HON Company meet or exceed the flame retardant requirements of State of California TB 117-2013. The label attached to the seat bottom indicates compliance with these requirements.

Elevate Fire Safety to a Higher Standard — CAL TB 133

- The State of California announced in January 2019 that Technical Bulletin (TB) 113, The Flammability Test Procedure for Seating Furniture for Use in Public Occupancies has been repealed effective January 22, 2019.
- While the CAL 133 standard has been repealed, a select subset of The HON Company's most popular chair models are still available in an array of fabrics that include an advanced barrier of fire protection to help comply with CAL 133 requirements.
- To ensure that the chairs you order comply with CAL 133, specify one of the fabrics listed below. Then simply add "FC" to the model number when ordering one of the select available models. A standard upcharge of \$90 will be applied per seat model for all single seat chairs.
- **SPECIFYING EXAMPLE: HIWMMFC.Y2.A.H.IM.CU10.NL.SB.T**

MOISTURE BARRIER

- This extra layer of protection prevents moisture from penetrating the foam to improve cleanability and extend product longevity. Moisture barrier is available as an option for the seat only. The recliner gets moisture barrier on seat and footrest.
- **Moisture barrier is not available for the fire code models.**

How to Order

- When specifying Moisture Barrier simply add "MB" to the model number when ordering.

SPECIFYING EXAMPLE: HHCG11MB.S.AI90.P6N.PR8.

Upcharges for Moisture Barrier on Soothe® models

Model	Moisture Barrier
HHCG11	\$80
HHCG50	\$120
HHCG21	\$160
HHCGB21	\$160
HHCGB31	\$240
HHCP1	\$80

CAL 133 COMPLIANT MODELS

IGNITION® SEATING

HIEH1FC, HIEH2FC, HIEH3FC, HIWM1FC, HIWM2FC, HIWM3FC, HIWM8FC, HITL1FC, HITL2FC, HITL3FC, HITS5FC, HIGCLFC, HIGS6FC, HISB6FC, HICS7FC, HIB50FC, HITLMFC, HIWMMFC, HITSMFC

MOTIVATE® SEATING

HMN2FC — Available in ONYX (ON) shell only.

NOTES:

- Creases and gathers may be visible with CAL 133 Fire Code seating due to the construction of the fire barrier material used.
- Please refer to each model's page for specific fabric availability.
- Contact HON Tailored Solutions Team for all other requests.

CAL 133 COMPLIANT FABRIC

GRADE 1

AI	Attire
APX	Apex
COMP	Compass
CU	Centurion
DAPR	Dapper
ENSB	Ensemble
HAML	Hamilton
NR	Inertia
OP	Optic

GRADE 2

BLME	Blume
CLYD	Clyde
DOT	Dotty
PNS	Appoint Seating
RUSH	Rush
SED	Seed
SPNN	Spin
WP	Whisper Vinyl

GRADE 3

ISN	In Season
PURL	Purl
QUL	Quill

GRADE L

SS	Leather
-----------	---------

ACCOMMODATE®

Want to see more? Scan here
to check out hon.com.



Accommodate® Café-Height Stools shown in Centurion Black.

ACCOMMODATE®

The key to designing a collaborative environment is to support productivity throughout the space. From waiting areas and cafés to meeting spaces and offices, Accommodate creates opportunities for people to get work done in a comfortable, casual setting. Cluster together. Form neat rows. Stack four high. With guest and bariatric chairs, as well as café and counter-height stools, Accommodate brings greater comfort, versatility and continuity throughout your space with a seating collection that adapts to your environment, people and budget.



FEATURES

- Thin profile seat cushion conforms to your body.
- Contoured back ergonomically supports the spine.
- Chairs can stack up to four high.
- Chairs can gang together to form neat rows.
- Waterfall seat edge enhances leg circulation.
- Lightweight frame is easy to move.
- Nylon glides slide effortlessly on hard surfaces.
- Tube rolled steel frame adds durability.
- Wall-saver design protects walls and cabinets.
- Warranted for users up to 300 lbs. (Models HSB50 and HSB50DF are warranted for users up to 500 lbs.)
- Available in Seated-, Counter-, and Café-heights.

SEATING

ACCOMMODATE® Options

MODEL OPTIONS

HSGS6
HSGS6DF - Multi-Fabric



Guest Chair

HSCS1
HSCS1DF - Multi-Fabric



Counter-Height Stool

HSCS2
HSCS2DF - Multi-Fabric



Café-Height Stool

HSB50
HSB50DF - Multi-Fabric

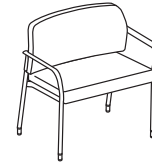

Bariatric Chair





ARM STYLE

	CODE	DESCRIPTION	PRICE
	N	Armless	+\$0
	F	Fixed Arms	+\$30

FRAME

	CODE	DESCRIPTION	PRICE
	BLCK	Textured Black Mica	+\$0
	PK7	Textured Designer White	+\$0
	P7J	Textured Brownstone	+\$0
	P7A	Textured Charcoal	+\$0
	P7L	Textured Loft	+\$0
	P7M	Textured Muslin	+\$0
	PR8	Textured Silver	+\$0
	P8V	Textured Titanium	+\$0

CASTERS/ GLIDES

	CODE	DESCRIPTION	PRICE
	E	Standard Nylon Glide	+\$0
	H	Black Hard Caster	+\$0
	S	Black All-Surface Caster	+\$20
	B	Both Hard Casters and Standard Nylon Glides	+\$20

*Options H, S & B available for HSGS6 and HSGS6DF models only

HON BRANDED FABRICS

GRADE 1	GRADE 2	GRADE 3
Apex	Appoint Seating	In Season
Attire	Blume	Moxie
Centurion	Clyde	Parker
Compass	Dotty	Purl
Contourett	Rush	Quill
Dapper	Seed	
Ensemble	Spin	
Hamilton	Whisper Vinyl	
Inertia		
Optic		
Pebble		

For a complete list of fabrics, including partnership fabrics, go to hon.com/fabricsandfinishes.
Reference Fabric Color Combinations on pages 18-22 for color codes and legend on page 19 for lead times.

ACCOMMODATE®

GSA SIN 33721



Icon Legend on page 17

HSGS6

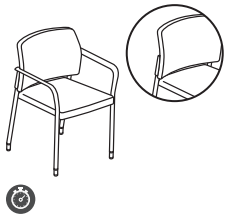

GUEST CHAIR

Set of Two Guest Chairs

DIMENSIONS

Depth:	22¼	Seat to Floor Height:	18¼
Height:	31½	Usable Seat Depth:	17
Seat Depth:	20¾	Ship Weight (with arms):	50
Seat Width:	17½	Ship Weight (armless):	48
Back Width:	19¾	Cube (with arms):	15.8
Back Height:	16¼	Cube (armless):	15.8
Width (with arms):	23½	COM (per 2 pack):	3.0
Width (armless):	19¾	Weight Rating:	300 lbs.
Arm Width:	20¼		

FABRIC PRICE CODES

1	\$835	8	\$1249
2	\$907	9	\$1303
3	\$979	10	\$1357
4	\$1033	11	\$1411
5	\$1087	12	\$1465
6	\$1141	L	—
7	\$1195		

NOTES: For Ganging Brackets see page 223. Accommodate® Guest Chairs stack 4-high.

HSCS1

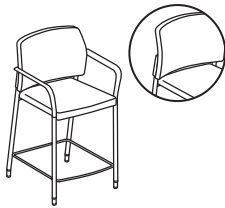

COUNTER-HEIGHT STOOL

DIMENSIONS

Depth:	23½	Seat to Floor Height:	25½
Height:	38¾	Usable Seat Depth:	17
Seat Depth:	20¾	Ship Weight (with arms):	36
Seat Width:	17½	Ship Weight (armless):	35
Back Width:	19¾	Cube (with arms):	15.8
Back Height:	16¼	Cube (armless):	15.8
Width (with arms):	23½	COM:	2.0
Width (armless):	19¾	Weight Rating:	300 lbs.
Arm Width:	20¼		

FABRIC PRICE CODES

1	\$506	8	\$713
2	\$542	9	\$740
3	\$578	10	\$767
4	\$605	11	\$794
5	\$632	12	\$821
6	\$659	L	—
7	\$686		

HSGANG

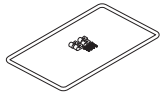

GANGING BRACKET

(hardware included)

DIMENSIONS

Ship Weight: **5** Ⓢ

LIST PRICE

\$37

NOTES: For use on models HSGS6 and HSGS6DF.

! No specification required for bracket. The ganging bracket is only available in black. The ganging bracket does not work on the bariatric unit.

HON Recommendation: HSGS6.N.E.CU__PR8 - List Price \$835

HOW TO SPECIFY

Select Model Number H S G S 6 .	Select Arm Type N Armless F Fixed Arms (+ \$30 per chair)	Select Caster/Glide E Standard Nylon Glide H Hard Caster S Soft Caster (+ \$20 per chair) B Both Hard Casters and Standard Nylon Glides (+ \$20 per chair) <i>Options H, S & B available for HSGS6 model only</i>	Select Fabric See page 219 C U 1 0 .	Select Frame See page 218 P R 8
---	--	---	---	--



ACCOMMODATE®

HSCS2

CAFÉ-HEIGHT STOOL



DIMENSIONS

Depth:	24½	Seat to Floor Height:	31½
Height:	44¾	Usable Seat Depth:	17
Seat Depth:	20¾	Ship Weight (with arms):	38
Seat Width:	17½	Ship Weight (armless):	37
Back Width:	19¾	Cube (with arms):	19.1
Back Height:	16¼	Cube (armless):	19.1
Width (with arms):	23½	COM:	2.0
Width (armless):	19¾	Weight Rating:	300 lbs.
Arm Width:	20¼		

FABRIC PRICE CODES

1	\$555	8	\$762
2	\$591	9	\$789
3	\$627	10	\$816
4	\$654	11	\$843
5	\$681	12	\$870
6	\$708	L	—
7	\$735		

HSB50

BARIATRIC CHAIR

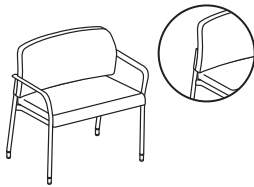

DIMENSIONS

Depth:	21½	Seat to Floor Height:	19
Height:	32½	Usable Seat Depth:	16¾
Seat Depth:	20¼	Ship Weight (with arms):	50
Seat Width:	28	Ship Weight (armless):	49
Back Width:	29	Cube (with arms):	27.2
Back Height:	16½	Cube (armless):	27.2
Width (with arms):	33½	COM:	2.0
Width (armless):	30	Weight Rating:	500 lbs.
Arm Width:	30		

FABRIC PRICE CODES

1	\$895	8	\$1171
2	\$943	9	\$1207
3	\$991	10	\$1243
4	\$1027	11	\$1279
5	\$1063	12	\$1315
6	\$1099	L	—
7	\$1135		

HON Recommendation: HSCS2.N.E.CU__PR8 - List Price \$555

HOW TO SPECIFY

<p>Select Model Number</p> <p>H S C S 2 .</p>	<p>Select Arm Type</p> <p>N Armless F Fixed Arms (+ \$30 per chair)</p> <p>N .</p>	<p>Select Caster/Glide</p> <p>E Standard Nylon Glide</p> <p>E .</p>	<p>Select Fabric</p> <p>See page 219</p> <p>C U 1 0 .</p>	<p>Select Frame</p> <p>See page 218</p> <p>P R 8</p>
--	---	--	--	---

ACCOMMODATE®



Icon Legend on page 17

HSGS6DF

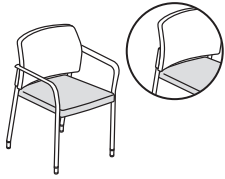

GUEST CHAIR

Multi-Fabric
Set of Two Guest Chairs

DIMENSIONS

Depth:	22 ¹ / ₄	Seat to Floor Height:	18 ¹ / ₄
Height:	31 ¹ / ₂	Usable Seat Depth:	17
Seat Depth:	20 ³ / ₄	Ship Weight (with arms):	50
Seat Width:	17 ¹ / ₂	Ship Weight (armless):	48
Back Width:	19 ³ / ₄	Cube (with arms):	15.8
Back Height:	16 ¹ / ₄	Cube (armless):	15.8
Width (with arms):	23 ¹ / ₂	COM (Seat, per 2 pack):	1.5
Width (armless):	19 ³ / ₄	COM (Back, per 2 pack):	1.5
Arm Width:	20 ¹ / ₄	Weight Rating:	300 lbs.

FABRIC PRICE CODES

1 \$1004

Add to Base Price Above

	Back	Seat
2	\$36	\$36
3	\$72	\$72
4	\$99	\$99
5	\$126	\$126
6	\$153	\$153
7	\$180	\$180
8	\$207	\$207
9	\$234	\$234
10	\$261	\$261
11	\$288	\$288
12	\$315	\$315

NOTES: For Ganging Brackets see page 223. Accommodate® Guest Chairs stack 4-high.

HSCS1DF

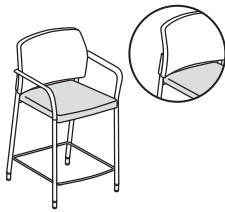

COUNTER-HEIGHT STOOL

Multi-Fabric

DIMENSIONS

Depth:	23 ¹ / ₂	Seat to Floor Height:	25 ¹ / ₂
Height:	38 ³ / ₄	Usable Seat Depth:	17
Seat Depth:	20 ³ / ₄	Ship Weight (with arms):	36
Seat Width:	17 ¹ / ₂	Ship Weight (armless):	35
Back Width:	19 ³ / ₄	Cube (with arms):	15.8
Back Height:	16 ¹ / ₄	Cube (armless):	15.8
Width (with arms):	23 ¹ / ₂	COM (Seat):	1.0
Width (armless):	19 ³ / ₄	COM (Back):	1.0
Arm Width:	20 ¹ / ₄	Weight Rating:	300 lbs.

FABRIC PRICE CODES

1 \$594

Add to Base Price Above

	Back	Seat
2	\$18	\$18
3	\$36	\$36
4	\$50	\$50
5	\$63	\$63
6	\$77	\$77
7	\$90	\$90
8	\$104	\$104
9	\$117	\$117
10	\$131	\$131
11	\$144	\$144
12	\$158	\$158

HON Recommendation: HSGS6DF.N.E.CU__CU__PR8 - List Price \$1004

HOW TO SPECIFY

Select Model Number	Select Arm Type	Select Caster/Glide	Select Back Fabric	Select Seat Fabric	Select Frame
HSGS6DF	<p>N Armless</p> <p>F Fixed Arms (+ \$30 per chair)</p>	<p>E Standard Nylon Glide</p> <p>H Hard Caster</p> <p>S Soft Caster (+ \$20 per chair)</p> <p>B Both Hard Casters and Standard Nylon Glides (+ \$20 per chair)</p> <p><i>Options H, S & B available for HSGS6DF model only</i></p>	See page 219	See page 219	See page 218
	N	E	CU22	CU10	PR8



ACCOMMODATE®

HSCS2DF



CAFÉ-HEIGHT STOOL

Multi-Fabric

DIMENSIONS

Depth:	24½	Seat to Floor Height:	31½
Height:	44¾	Usable Seat Depth:	17
Seat Depth:	20¾	Ship Weight (with arms):	38
Seat Width:	17½	Ship Weight (armless):	37
Back Width:	19¾	Cube (with arms):	19.1
Back Height:	16¼	Cube (armless):	19.1
Width (with arms):	23½	COM (Seat):	1.0
Width (armless):	19¾	COM (Back):	1.0
Arm Width:	20¼	Weight Rating:	300 lbs.

FABRIC PRICE CODES

1	\$644	
<i>Add to Base Price Above</i>		
	Back	Seat
2	\$18	\$18
3	\$36	\$36
4	\$50	\$50
5	\$63	\$63
6	\$77	\$77
7	\$90	\$90
8	\$104	\$104
9	\$117	\$117
10	\$131	\$131
11	\$144	\$144
12	\$158	\$158

HSB50DF

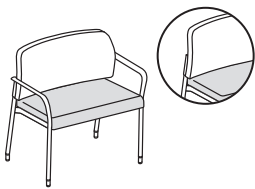

BARIATRIC CHAIR

Multi-Fabric

DIMENSIONS

Depth:	21½	Seat to Floor Height:	19
Height:	32½	Usable Seat Depth:	16¾
Seat Depth:	20¼	Ship Weight (with arms):	50
Seat Width:	28	Ship Weight (armless):	49
Back Width:	29	Cube (with arms):	27.2
Back Height:	16½	Cube (armless):	27.2
Width (with arms):	33½	COM (Seat):	1.0
Width (armless):	30	COM (Back):	1.0
Arm Width:	30	Weight Rating:	500 lbs.

FABRIC PRICE CODES

1	\$982	
<i>Add to Base Price Above</i>		
	Back	Seat
2	\$24	\$24
3	\$48	\$48
4	\$66	\$66
5	\$84	\$84
6	\$102	\$102
7	\$120	\$120
8	\$138	\$138
9	\$156	\$156
10	\$174	\$174
11	\$192	\$192
12	\$210	\$210

HSGANG

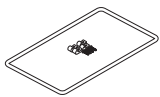

GANGING BRACKET

(hardware included)

DIMENSIONS

Ship Weight: 5 Ⓞ

LIST PRICE

\$37

NOTES: For use on models HSGS6 and HSGS6DF.

ⓘ No specification required for bracket. The ganging bracket is only available in black. The ganging bracket does not work on the bariatric unit.

HON Recommendation: HSCS2DF.N.E.CU__CU__PR8 - List Price \$644

SEATING

HOW TO SPECIFY

<p>Select Model Number</p> <p>H S C S 2 D F .</p>	<p>Select Arm Type</p> <p>N Armless F Fixed Arms (+ \$30)</p> <p>N .</p>	<p>Select Caster/Glide</p> <p>E Standard Nylon Glide</p> <p>E .</p>	<p>Select Back Fabric</p> <p>See page 219</p> <p>C U 2 2 .</p>	<p>Select Seat Fabric</p> <p>See page 219</p> <p>C U 1 0 .</p>	<p>Select Frame</p> <p>See page 218</p> <p>P R 8</p>
--	---	--	---	---	---

ADJUSTABLE TASK/LAB Stools

OPEN MARKET



Icon Legend on page 17

HMTS01

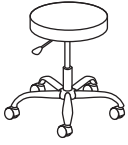

TASK/LAB STOOL

without Back
Pneumatic
Swivel
Functions: **A, E**
(Function Key on pages 212-213)

DIMENSIONS

Depth:	27¼	Seat to Floor Height:	17¾-22
Width:	24⅞	Usable Seat Depth:	16
Height:	17¾-22	Ship Weight:	22
Seat:	16" Dia.	Cube:	2.5
		Weight Rating:	250 lbs.

FABRIC PRICE CODE

1 \$397

NOTES: EA vinyl is a healthcare covering that meets AATCC Test Method 147-2004.
ⓘ Available in polished base ONLY. Available in Grade 1, Black, EA11 fabric ONLY.

HMTS11

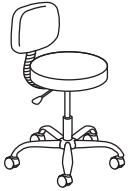

TASK/LAB STOOL

with Back
Pneumatic
Back Height
Seat Depth
Swivel
Functions: **A, B, C, E**
(Function Key on pages 212-213)

DIMENSIONS

Depth:	27¼	Seat to Floor Height:	17¾-22
Width:	24⅞	Usable Seat Depth:	14¾-16
Height:	31½-38	Ship Weight:	29
Seat:	16" Dia.	Cube:	2.7
Back Width:	15½	Weight Rating:	250 lbs.
Back Height:	8¾-16		

FABRIC PRICE CODE

1 \$532

NOTES: EA vinyl is a healthcare covering that meets AATCC Test Method 147-2004.
ⓘ Available in polished base ONLY. Available in Grade 1, Black, EA11 fabric ONLY.

HOW TO SPECIFY

Select
Model Number

H M T S 0 1 .

Select
Fabric

EA11 Black, Grade 1 (only)

E A 1 1



ASSEMBLE™ Nesting/Stacking Chairs

HVL304



NESTING/STACKING

Upholstered Seat and Mesh Back
Casters
Armless
Ships 2 per Carton

DIMENSIONS

Depth:	24	Seat to Floor Height:	17
Width:	24	Usable Seat Depth:	17
Height:	34¾	Ship Weight:	57
Seat Depth:	17	Cube:	9.0
Seat Width:	18	Weight Rating:	250 lbs.
Back Width:	16¾		

LIST PRICE PER CARTON

\$622
(reference single unit @
\$311.00

NOTES: Stacks 4-high. Comfortable and breathable mesh back. Armless. Black fabric seat. Specify Black (T) or Silver (X) frame. Ships two per carton. **HON 5-Year Limited Warranty.**

fb Mesh Nesting Chairs are ordered and shipped two (2) chairs per carton. Pricing shown is per carton. Each set of two chairs (one carton) must have the same fabric/frame color. Ordering 2 of any model will result in 2 cartons being shipped, giving you 4 chairs.

HON Recommendation: HVL304.VA10.T - List Price \$622

HVL314



NESTING/STACKING

Upholstered Seat and Mesh Back
Casters
Arms
Ships 2 per Carton

DIMENSIONS

Depth:	24	Arm Width:	18
Width:	24	Seat to Floor Height:	17
Height:	34¾	Usable Seat Depth:	17
Seat Depth:	17	Ship Weight:	57
Seat Width:	18	Cube:	9.2
Back Width:	16¾	Weight Rating:	250 lbs.

LIST PRICE PER CARTON

\$649
(reference single unit @
\$324.50

NOTES: Stacks 4-high. Comfortable and breathable mesh back. With arms. Black fabric seat. Specify Black (T) or Silver (X) frame. Ships two per carton. **HON 5-Year Limited Warranty.**

fb Mesh Nesting Chairs are ordered and shipped two (2) chairs per carton. Pricing shown is per carton. Each set of two chairs (one carton) must have the same fabric/frame color. Ordering 2 of any model will result in 2 cartons being shipped, giving you 4 chairs.

HON Recommendation: HVL314.VA10.T - List Price \$649

HOW TO SPECIFY

Select Model Number

HVL304

Select Fabric

VA10 Black

VA10

Select Frame

T Black
X Silver

T

ASTIR™ COLLABORATIVE WORK SEATING

Want to see more?
Scan here to check
out hon.com.



Astir™ Collaborative Work Seating shown with Birk™ Tables and Acoustic Solutions by Unika Vaev.

ASTIR™

Astir™ Collaborative Work answers the call for soft seating solutions while providing separate work spaces and sturdy posture support for those looking to step away from their desks. The line provides a soft yet upright sit to keep employees engaged and working comfortably at a table setting. High back and side options help keep private conversations private — so teams don't have to be confined in close quarters, such as a conference room. And a unique, single-seat style with high screens on three sides creates a quiet, secure and comfortable space for individual focus.



FEATURES

- Seat height and back angle are scaled for more of an upright working posture.
- Choose from One+, Two- or Three-Seat Lounges in low- or high-back options.
- High-back screens available in knit mesh or fabric options and provide visual privacy on back and sides.
- Fabric high-back screen option available in cleanable fabrics (see HON's cleaning guide for instructions).
- Choose from three different leg styles to customize your look.
- Two- or Three-Seat Benches add extra seating for commons or reception areas.
- Pouf model functions as both impromptu seating and a place to kick up your feet.
- Replaceable seat cushion enhances comfort and cleanability, and allows for easy changing.
- With the multi-fabric options, seat cushion and frame can be specified in different fabrics for a modern aesthetic.
- Add an optional power module to route power directly underneath the seat.

MODEL OPTIONS

**HASLB1, HASLB1MF -
Multi-Fabric**



Lounge
One+ Seat, Low-Back

**HASLB2, HASLB2MF -
Multi-Fabric**

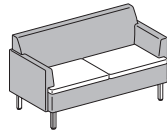

Lounge
Two-Seat, Low-Back

**HASLB3, HASLB3MF -
Multi-Fabric**

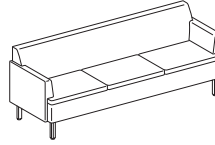

Lounge
Three-Seat, Low-Back

**HASLBTC, HASLBTCMF -
Multi-Fabric**

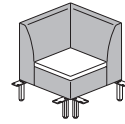

Lounge
True Corner, Low-Back

**HASHB1, HASHB1MF -
Multi-Fabric**

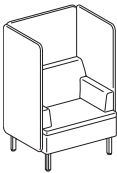

Lounge
One+ Seat, High-Back Screen

**HASHB2, HASHB2MF -
Multi-Fabric**

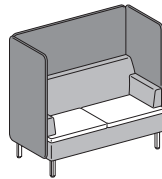

Lounge
Two-Seat, High-Back Screen

**HASHB3, HASHB3MF -
Multi-Fabric**

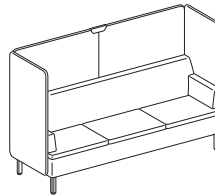

Lounge
Three-Seat, High-Back Screen

**HASHBTC, HASHBTCMF -
Multi-Fabric**

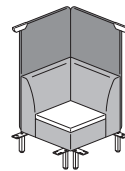

Lounge
True Corner, High-Back Screen

**HASB2, HASB2MF -
Multi-Fabric**

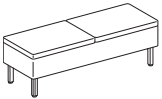

Bench
Two-Seat Bench

**HASB3, HASB3MF -
Multi-Fabric**

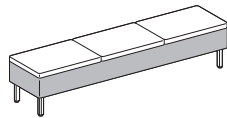

Bench
Three-Seat Bench

**HASPSS, HASPSSMF -
Multi-Fabric**



Pouf

Low-Back, Multi-Fabric



High-Back, Multi-Fabric



ASTIR™ Finish Options

HON BRANDED FABRICS

GRADE 1	GRADE 2	GRADE 3	KNIT
Apex	Appoint Seating	Moxie	Light
Centurion	Blume	Purl	Medium
Contourett	Clyde	Quill	Dark
Dapper	Rush		
Ensemble	Seed		
Hamilton	Whisper Vinyl		
Inertia			
Pebble			

SCREEN FABRIC OPTIONS

FABRICS
Apex
Blume
Contourett
Moxie
Pebble
Whisper Vinyl

LEG STYLE

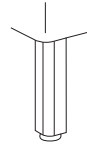

CODE	DESCRIPTION	PRICE
PM	Post Metal	+\$50
<i>Available in the following finishes:</i>		
P8V	Textured Titanium	
P7A	Textured Charcoal	
P8X	Solar Black	+\$20
PR5	Champagne Metallic	+\$20

For a complete list of fabrics, including partnership fabrics, go to hon.com/fabricsandfinishes.

Reference Fabric Color Combinations on pages 18-22 for color codes and legend on page 19 for lead times.

LEG STYLE

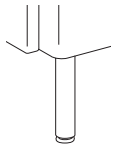

CODE	DESCRIPTION	PRICE
DW	Dowel Wood	+\$0
<i>Available in the following finishes:</i>		
LFW1	Florence Walnut	
LK11	Kingswood Walnut	
LLA1	Lowell Ash	
D	Natural Maple	
LNRI	Natural Recon	
LPE1	Phantom Ecru	
PINC	Pinnacle	
LPT1	Portico Teak	
LSW1	Skyline Walnut	
LSA1	Sterling Ash	

LEG STYLE

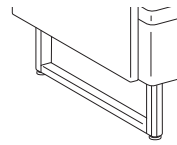

CODE	DESCRIPTION	PRICE
SW	Sled Wood	+\$100
<i>Available in the following finishes:</i>		
LFW1	Florence Walnut	
LK11	Kingswood Walnut	
LLA1	Lowell Ash	
D	Natural Maple	
LNRI	Natural Recon	
LPE1	Phantom Ecru	
PINC	Pinnacle	
LPT1	Portico Teak	
LSW1	Skyline Walnut	
LSA1	Sterling Ash	

MULTI-FABRIC COM YARDAGE

Due to fabric pattern nesting and potential reduction of fabric yield, some multi-fabric models may require more total yardage than standard models.

MODEL	COM (ARMLESS)			COM (ONE ARM/SIDE)			COM (BOTH ARMS/SIDES)		
	Seat	Back/Frame	Screen	Seat	Back/Frame	Screen	Seat	Back/Frame	Screen
HASLB1	—	—	—	—	—	—	6.5	—	—
HASLB1MF	—	—	—	—	—	—	1.5	5.0	—
HASLBTC	—	5.0	—	—	—	—	—	—	—
HASLBTCMF	1.5	4.0	—	—	—	—	—	—	—
HASLB2	—	7.0	—	—	8.0	—	—	9.0	—
HASLB2MF	3.0	4.5	—	3.0	5.5	—	3.0	6.5	—
HASLB3	—	10.0	—	—	11.0	—	—	12.0	—
HASLB3MF	4.0	6.0	—	4.0	7.5	—	4.0	8.5	—
HASHB1	—	—	—	—	—	—	—	4.5	8.0
HASHB1MF	—	—	—	—	—	—	1.5	3.5	8.0
HASHBTC	—	5.0	5.5	—	—	—	—	—	—
HASHBTCMF	1.5	4.0	5.5	—	—	—	—	—	—
HASHB2	—	7.0	5.5	—	7.0	8.0	—	7.0	11.0
HASHB2MF	3.0	4.5	5.5	3.0	4.5	8.0	3.0	4.5	11.0
HASHB3	—	10.5	5.5	—	10.5	8.0	—	10.5	11.0
HASHB3MF	4.0	7.0	5.5	4.0	7.0	8.0	4.0	7.0	11.0
HAS PSS	—	2.0	—	—	—	—	—	—	—
HAS PSSMF	1.0	1.5	—	—	—	—	—	—	—
HASB2	—	4.5	—	—	—	—	—	—	—
HASB2MF	3.0	2.0	—	—	—	—	—	—	—
HASB3	—	6.5	—	—	—	—	—	—	—
HASB3MF	4.0	2.5	—	—	—	—	—	—	—



HASLB1

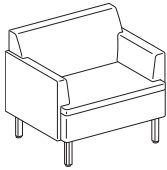

ONE+ SEAT — LOW-BACK

DIMENSIONS

Depth:	29	Back Height:	16
Height:	32	Back Width:	33½
Width:	36½	Arm Height:	7½
Usable Seat Depth:	19¾	Ship Weight:	95
Seat to Floor Height:	18¾	Cube:	21.2
Seat Width:	27	COM:	See page 228
		Weight Rating:	300 lbs.

FABRIC PRICE CODES

1	\$2099	8	\$3277
2	\$2255	9	\$3306
3	\$2414	10	\$3465
4	\$2546	11	\$3624
5	\$2723	12	\$3784
6	\$2903	L	—
7	\$3088		

HASLB1MF

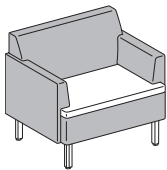

ONE+ SEAT — LOW-BACK, MULTI-FABRIC

DIMENSIONS

Depth:	29	Back Height:	16
Height:	32	Back Width:	33½
Width:	36½	Arm Height:	7½
Usable Seat Depth:	19¾	Ship Weight:	95
Seat to Floor Height:	18¾	Cube:	21.2
Seat Width:	27	COM:	See page 228
		Weight Rating:	300 lbs.

FABRIC PRICE CODES

1	\$2258		
<i>Add to Base Price Above</i>			
	Seat	Frame/Back	
2	\$36	\$120	
3	\$73	\$242	
4	\$103	\$344	
5	\$144	\$480	
6	\$186	\$619	
7	\$228	\$761	
8	\$272	\$906	
9	\$279	\$929	
10	\$315	\$1051	
11	\$352	\$1173	
12	\$389	\$1296	

HON Recommendation: HASLB1.B.PURL__DW__ - List Price \$2414

HOW TO SPECIFY

<p>Select Model Number</p> <p>HASLB1MF .</p>	<p>Select Arm Type</p> <p>B Both Arms</p> <p>B .</p>	<p>Select Fabric</p> <p>See page 228 <i>Specify for Single Fabric model only</i></p> <p>PBLE07 .</p>	<p>Select Seat Cushion Fabric</p> <p>See page 228 <i>Specify for MF model only</i></p> <p>PBLE09 .</p>	<p>Select Back and Frame Fabric</p> <p>See page 228 <i>Specify for MF model only</i></p> <p>PBLE06 .</p>	<p>Select Leg and Color</p> <p>DW Dowel Wood PM Post Metal (+ \$50) SW Sled Wood (+ \$100) See page 228 for colors</p> <p>PMP8V</p>
---	---	---	---	---	--

ASTIR™ Collaborative Work Seating

OPEN MARKET



Icon Legend on page 17

HASHB1

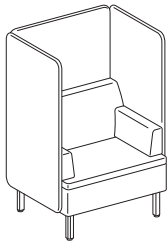

ONE+ SEAT — HIGH-BACK SCREEN

DIMENSIONS

Depth:	29¾	Back Height:	16
Height:	54	Back Width:	33½
Width:	35	Arm Height:	7½
Usable Seat Depth:	19¾	Ship Weight*:	124
Seat to Floor Height:	18¾	Cube:	24.1
Seat Width:	25½	COM:	See page 228
		Weight Rating:	300 lbs.

FABRIC PRICE CODES

1 \$2890

Add to Base Price Above

	Unit	Knit	Screen
1	—	1	\$150
2	\$120	2	\$342
3	\$242	3	\$538
4	\$344	4	\$700
5	\$480	5	\$918
6	\$619	6	\$1140
7	\$761	7	\$1367
8	\$906	8	\$1600
9	\$929	9	\$1636
10	\$1051	10	\$1832
11	\$1173	11	\$2028
12	\$1296	12	\$2223

*Ships in two cartons.

HASHB1MF

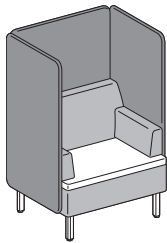

ONE+ SEAT — HIGH-BACK SCREEN, MULTI-FABRIC

DIMENSIONS

Depth:	29¾	Back Height:	16
Height:	54	Back Width:	33½
Width:	35	Arm Height:	7½
Usable Seat Depth:	19¾	Ship Weight*:	124
Seat to Floor Height:	18¾	Cube:	24.1
Seat Width:	25½	COM:	See page 228
		Weight Rating:	300 lbs.

FABRIC PRICE CODES

1 \$3050

Add to Base Price Above

	Seat	Back/ Frame	Knit	Screen
1	—	—	1	\$150
2	\$36	\$96	2	\$342
3	\$73	\$194	3	\$538
4	\$103	\$275	4	\$700
5	\$144	\$384	5	\$918
6	\$186	\$495	6	\$1140
7	\$228	\$609	7	\$1367
8	\$272	\$725	8	\$1600
9	\$279	\$743	9	\$1636
10	\$315	\$841	10	\$1832
11	\$352	\$939	11	\$2028
12	\$389	\$1037	12	\$2223

*Ships in two cartons.

HON Recommendation: HASHB1.B.PURL__KMD.DW__ - List Price \$3132

SEATING

HOW TO SPECIFY

Select Model Number	Select Arm Type	Select Fabric	Select Seat Cushion Fabric	Select Back and Frame Fabric	Select Screen Knit or Fabric	Select Leg and Color
	B Both Side Screens	See page 228 Specify for Single Fabric model only	See page 228 Specify for MF model only	See page 228 Specify for MF model only	Knit Options: KLT Light KMD Medium KDK Dark See page 228 for all options	DW Dowel Wood PM Post Metal (+ \$50) SW Sled Wood (+ \$100) See page 228 for colors
H A S H B 1 M F .	B .	P B L E 0 7 .	P B L E 0 9 .	P B L E 0 6 .	K M D .	P M P 8 V



ASTIR™ Collaborative Work Seating

HASLB2

TWO-SEAT LOUNGE — LOW-BACK



Armless

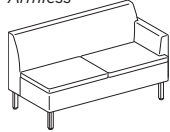

Left

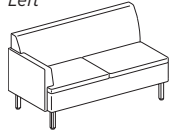

Right

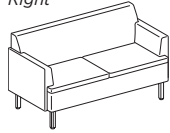

Both Arms

DIMENSIONS

Depth:	29	Back Height:	16
Height:	32	Back Width:	56½
Width (armless):	56½	Arm Height:	7½
Width (one arm):	58	Ship Weight (armless):	113
Width (both arms):	59½	Ship Weight (one arm):	122
Usable Seat Depth:	19¾	Ship Weight (both arms):	131
Seat to Floor Height:	18¾	Cube:	35.1
Seat Width (armless):	56½	COM:	See page 228
Seat Width (one arm):	53¼		228
Seat Width (both arms):	50	Weight Rating:	300 lbs. (per seat)

FABRIC PRICE CODES

1	\$2343	8	\$3974
2	\$2558	9	\$4014
3	\$2779	10	\$4235
4	\$2962	11	\$4455
5	\$3207	12	\$4676
6	\$3457	L	—
7	\$3713		

HASLB2MF

TWO-SEAT LOUNGE — LOW-BACK, MULTI-FABRIC

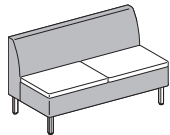

Armless

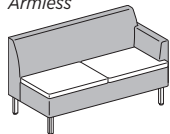

Left

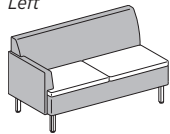

Right

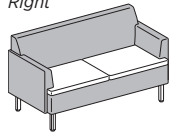

Both Arms

DIMENSIONS

Depth:	29	Back Height:	16
Height:	32	Back Width:	56½
Width (armless):	56½	Arm Height:	7½
Width (one arm):	58	Ship Weight (armless):	113
Width (both arms):	59½	Ship Weight (one arm):	122
Usable Seat Depth:	19¾	Ship Weight (both arms):	131
Seat to Floor Height:	18¾	Cube:	35.1
Seat Width (armless):	56½	COM:	See page 228
Seat Width (one arm):	53¼		228
Seat Width (both arms):	50	Weight Rating:	300 lbs. (per seat)

FABRIC PRICE CODES

1	\$2502		
<i>Add to Base Price Above</i>			
		Seat	Frame/Back
2	\$72	\$156	\$156
3	\$145	\$315	\$315
4	\$206	\$447	\$447
5	\$288	\$624	\$624
6	\$371	\$804	\$804
7	\$457	\$989	\$989
8	\$544	\$1178	\$1178
9	\$557	\$1207	\$1207
10	\$631	\$1366	\$1366
11	\$704	\$1525	\$1525
12	\$778	\$1685	\$1685

HON Recommendation: HASLB2.B.PURL__DW__ - List Price \$3229

HOW TO SPECIFY

Select Model Number HASLB2MF	Select Arm Type N Armless L Left Side (+ \$225) R Right Side (+ \$225) B Both Arms (+ \$450)	Select Fabric See page 228 Specify for Single Fabric model only	Select Seat Cushion Fabric See page 228 Specify for MF model only	Select Back and Frame Fabric See page 228 Specify for MF model only	Select Leg and Color DW Dowel Wood PM Post Metal (+ \$50) SW Sled Wood (+ \$100) See page 228 for colors
	B	PBLE07	PBLE09	PBLE06	PMP8V

ASTIR™ Collaborative Work Seating

OPEN MARKET



Icon Legend on page 17

HASHB2

TWO-SEAT LOUNGE — HIGH-BACK SCREEN

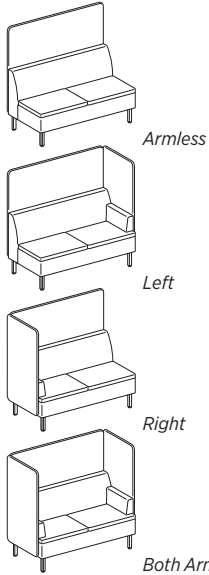

DIMENSIONS

Depth:	29¾	Back Height:	16
Height:	54	Back Width:	56½
Width (armless):	56½	Arm Height:	7½
Width (one arm):	57¼	Ship Weight* (armless):	136
Width (both arms):	58	Ship Weight* (one arm):	156
Usable Seat Depth:	19¾	Ship Weight* (both arms):	176
Seat to Floor Height:	18¾	Cube:	29.4
Seat Width (armless):	56½	COM:	See page 228
Seat Width (one arm):	52¼	Weight Rating:	300 lbs. (per seat)
Seat Width (both arms):	48¼		

FABRIC PRICE CODES

1 \$3329
Add to Base Price Above

	Unit	Knit	Screen
	1	1	\$150
	2	2	\$413
	3	3	\$683
	4	4	\$906
	5	5	\$1206
	6	6	\$1511
	7	7	\$1824
	8	8	\$2143
	9	9	\$2193
	10	10	\$2462
	11	11	\$2732
	12	12	\$3001

*Ships in two cartons.

HASHB2MF

TWO-SEAT LOUNGE — HIGH-BACK SCREEN, MULTI-FABRIC

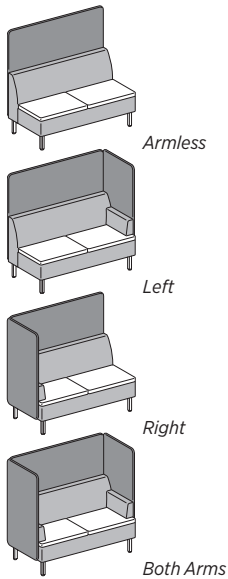

DIMENSIONS

Depth:	29¾	Back Height:	16
Height:	54	Back Width:	56½
Width (armless):	56½	Arm Height:	7½
Width (one arm):	57¼	Ship Weight* (armless):	136
Width (both arms):	58	Ship Weight* (one arm):	156
Usable Seat Depth:	19¾	Ship Weight* (both arms):	176
Seat to Floor Height:	18¾	Cube:	29.4
Seat Width (armless):	56½	COM:	See page 228
Seat Width (one arm):	52¼	Weight Rating:	300 lbs. (per seat)
Seat Width (both arms):	48¼		

FABRIC PRICE CODES

1 \$3489
Add to Base Price Above

	Seat	Back/Frame	Knit	Screen	
	1	—	1	\$150	
	2	\$72	\$120	2	\$413
	3	\$145	\$242	3	\$683
	4	\$206	\$344	4	\$906
	5	\$288	\$480	5	\$1206
	6	\$371	\$619	6	\$1511
	7	\$457	\$761	7	\$1824
	8	\$544	\$906	8	\$2143
	9	\$557	\$929	9	\$2193
	10	\$631	\$1051	10	\$2462
	11	\$704	\$1173	11	\$2732
	12	\$778	\$1296	12	\$3001

*Ships in two cartons.

HON Recommendation: [HASHB2.B.PURL__KMD.DW__](#) - List Price \$4617

HOW TO SPECIFY

Select Model Number	Select Arm Type	Select Fabric	Select Seat Cushion Fabric	Select Back and Frame Fabric	Select Screen Knit or Fabric	Select Leg and Color
	N Armless L Left Side (+ \$450) R Right Side (+ \$450) B Both Side Screens (+ \$900)	See page 228 Specify for Single Fabric model only	See page 228 Specify for MF model only	See page 228 Specify for MF model only	Knit Options: KLT Light KMD Medium KDK Dark See page 228 for all options	DW Dowel Wood PM Post Metal (+ \$50) SW Sled Wood (+ \$100) See page 228 for colors
H A S H B 2 M F .	B .	P B L E 0 7 .	P B L E 0 9 .	P B L E 0 6 .	K M D .	P M P 8 V



ASTIR™ Collaborative Work Seating

HASLB3

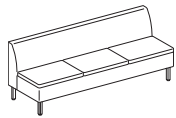

Armless

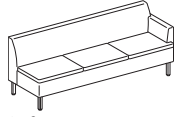

Left

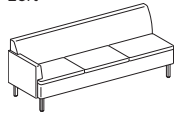

Right

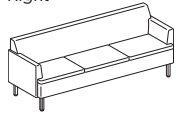

Both Arms

THREE-SEAT LOUNGE — LOW-BACK

DIMENSIONS

Depth:	29	Back Height:	16
Height:	32	Back Width:	84½
Width (armless):	84½	Arm Height:	7½
Width (one arm):	86	Ship Weight (armless):	152
Width (both arms):	87½	Ship Weight (one arm):	161
Usable Seat Depth:	19¾	Ship Weight (both arms):	170
Seat to Floor Height:	18¾	Cube:	47.9
Seat Width (armless):	84½	COM:	See page 228
Seat Width (one arm):	81¼	Weight Rating:	300 lbs. (per seat)
Seat Width (both arms):	78		

FABRIC PRICE CODES

1	\$3096	8	\$5270
2	\$3383	9	\$5325
3	\$3678	10	\$5618
4	\$3921	11	\$5912
5	\$4248	12	\$6206
6	\$4581	L	—
7	\$4922		

HASLB3MF

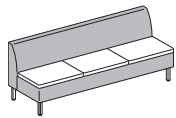

Armless

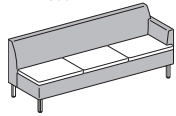

Left

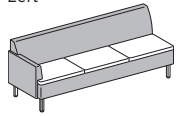

Right

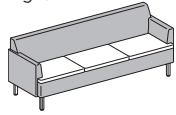

Both Arms

THREE-SEAT LOUNGE — LOW-BACK, MULTI-FABRIC

DIMENSIONS

Depth:	29	Back Height:	16
Height:	32	Back Width:	84½
Width (armless):	84½	Arm Height:	7½
Width (one arm):	86	Ship Weight (armless):	152
Width (both arms):	87½	Ship Weight (one arm):	161
Usable Seat Depth:	19¾	Ship Weight (both arms):	170
Seat to Floor Height:	18¾	Cube:	47.9
Seat Width (armless):	84½	COM:	See page 228
Seat Width (one arm):	81¼	Weight Rating:	300 lbs. (per seat)
Seat Width (both arms):	78		

FABRIC PRICE CODES

1	\$3255		
<i>Add to Base Price Above</i>			
	Seat	Frame/Back	
2	\$96	\$203	
3	\$194	\$412	
4	\$275	\$584	
5	\$384	\$816	
6	\$495	\$1052	
7	\$609	\$1293	
8	\$725	\$1540	
9	\$743	\$1579	
10	\$841	\$1787	
11	\$939	\$1995	
12	\$1037	\$2203	

HON Recommendation: HASLB3.B.PURL__DW__ - List Price \$4128

HOW TO SPECIFY

<p>Select Model Number</p> <p>HASLB3MF</p>	<p>Select Arm Type</p> <p>N Armless L Left Side (+ \$225) R Right Side (+ \$225) B Both Arms (+ \$450)</p> <p>B</p>	<p>Select Fabric</p> <p>See page 228 Specify for Single Fabric model only</p> <p>PBLE07</p>	<p>Select Seat Cushion Fabric</p> <p>See page 228 Specify for MF model only</p> <p>PBLE09</p>	<p>Select Back and Frame Fabric</p> <p>See page 228 Specify for MF model only</p> <p>PBLE06</p>	<p>Select Leg and Color</p> <p>DW Dowel Wood PM Post Metal (+ \$50) SW Sled Wood (+ \$100) See page 228 for colors</p> <p>PMP8V</p>
---	--	--	--	--	--

ASTIR™ Collaborative Work Seating

OPEN MARKET



Icon Legend on page 17

HASHB3

THREE-SEAT LOUNGE — HIGH-BACK SCREEN

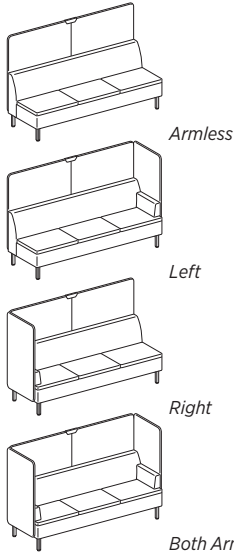

DIMENSIONS

Depth:	29¾	Back Height:	16
Height:	54	Back Width:	84½
Width (armless):	84½	Arm Height:	7½
Width (one arm):	85¼	Ship Weight* (armless):	185
Width (both arms):	86	Ship Weight* (one arm):	205
Usable Seat Depth:	19¾	Ship Weight* (both arms):	225
Seat to Floor Height:	18¾	Cube:	39
Seat Width (armless):	84½	COM:	See page 228
Seat Width (one arm):	80½	Weight Rating:	300 lbs. (per seat)
Seat Width (both arms):	76½		

FABRIC PRICE CODES

1 \$4548

Add to Base Price Above

	Unit	Knit	Screen
	1	1	\$150
	2	2	\$413
	3	3	\$683
	4	4	\$906
	5	5	\$1206
	6	6	\$1511
	7	7	\$1824
	8	8	\$2143
	9	9	\$2193
	10	10	\$2462
	11	11	\$2732
	12	12	\$3001

*Ships in two cartons.

HASHB3MF

THREE-SEAT LOUNGE — HIGH-BACK SCREEN, MULTI-FABRIC

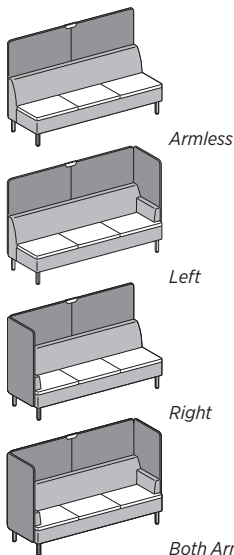

DIMENSIONS

Depth:	29¾	Back Height:	16
Height:	54	Back Width:	84½
Width (armless):	84½	Arm Height:	7½
Width (one arm):	85¼	Ship Weight* (armless):	185
Width (both arms):	86	Ship Weight* (one arm):	205
Usable Seat Depth:	19¾	Ship Weight* (both arms):	225
Seat to Floor Height:	18¾	Cube:	39
Seat Width (armless):	84½	COM:	See page 228
Seat Width (one arm):	80½	Weight Rating:	300 lbs. (per seat)
Seat Width (both arms):	76½		

FABRIC PRICE CODES

1 \$4708

Add to Base Price Above

	Seat	Back/Frame	Knit	Screen	
	1	—	1	\$150	
	2	\$96	\$168	2	\$413
	3	\$194	\$339	3	\$683
	4	\$275	\$481	4	\$906
	5	\$384	\$672	5	\$1206
	6	\$495	\$866	6	\$1511
	7	\$609	\$1065	7	\$1824
	8	\$725	\$1268	8	\$2143
	9	\$743	\$1300	9	\$2193
	10	\$841	\$1471	10	\$2462
	11	\$939	\$1643	11	\$2732
	12	\$1037	\$1814	12	\$3001

*Ships in two cartons.

HON Recommendation: HASHB3.B.PURL__KMD.DW__ - List Price \$5957

HOW TO SPECIFY

Select Model Number	Select Arm Type	Select Fabric	Select Seat Cushion Fabric	Select Back and Frame Fabric	Select Screen Knit or Fabric	Select Leg and Color
H A S H B 3 M F .	N Armless L Left Side (+ \$450) R Right Side (+ \$450) B Both Side Screens (+ \$900)	See page 228 Specify for Single Fabric model only	See page 228 Specify for MF model only	See page 228 Specify for MF model only	Knit Options: KLT Light KMD Medium KDK Dark See page 228 for all options	DW Dowel Wood PM Post Metal (+ \$50) SW Sled Wood (+ \$100) See page 228 for colors
	B .	P B L E 0 7 .	P B L E 0 9 .	P B L E 0 6 .	K M D .	P M P 8 V



HASLBTC

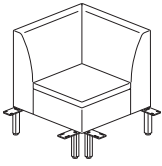

TRUE CORNER LOUNGE — LOW-BACK

DIMENSIONS

Depth:	29	Back Height:	16
Height:	32	Back Width:	29
Width:	29	Ship Weight:	90
Usable Seat Depth:	19¾	Cube:	21.2
Seat to Floor Height:	18¾	COM:	See page 228
Seat Width:	20¼	Weight Rating:	300 lbs.

FABRIC PRICE CODES

1	\$2195	8	\$3101
2	\$2315	9	\$3124
3	\$2437	10	\$3246
4	\$2539	11	\$3368
5	\$2675	12	\$3491
6	\$2814	L	—
7	\$2956		

NOTES: True Corner uses legs from adjacent units, and can work with all leg styles. For adjacent units with sled legs, pick a single leg option for the True Corner rear leg.

- ! True Corner designed to act as a corner between two adjacent units, not as a stand-alone unit.
- ! True Corner leg selection refers to back corner leg only, and ships with only that leg.

HASLBTCMF

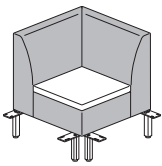

TRUE CORNER LOUNGE — LOW-BACK, MULTI-FABRIC

DIMENSIONS

Depth:	29	Back Height:	16
Height:	32	Back Width:	29
Width:	29	Ship Weight:	90
Usable Seat Depth:	19¾	Cube:	21.2
Seat to Floor Height:	18¾	COM:	See page 228
Seat Width:	20¼	Weight Rating:	300 lbs.

FABRIC PRICE CODES

1	\$2354	
<i>Add to Base Price Above</i>		
	Seat	Frame/Back
2	\$36	\$96
3	\$73	\$194
4	\$103	\$275
5	\$144	\$384
6	\$186	\$495
7	\$228	\$609
8	\$272	\$725
9	\$279	\$743
10	\$315	\$841
11	\$352	\$939
12	\$389	\$1037

NOTES: True Corner uses legs from adjacent units, and can work with all leg styles. For adjacent units with sled legs, pick a single leg option for the True Corner rear leg.

- ! True Corner designed to act as a corner between two adjacent units, not as a stand-alone unit.
- ! True Corner leg selection refers to back corner leg only, and ships with only that leg.

HON Recommendation: HASLBTC.PURL__DW__ - List Price \$2437

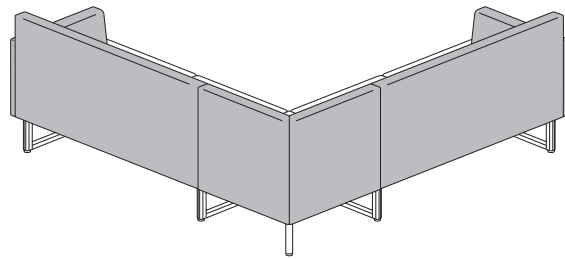
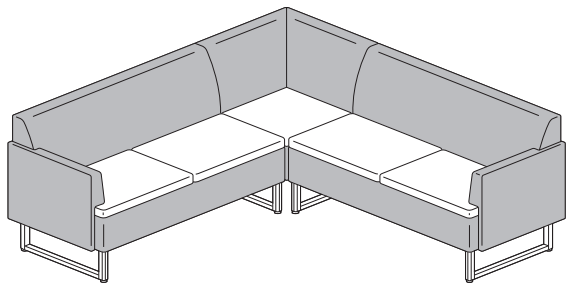

HOW TO SPECIFY

<p>Select Model Number</p> <p>See page 228</p> <p><i>Specify for Single Fabric model only</i></p>	<p>Select Fabric</p> <p>See page 228</p> <p><i>Specify for Single Fabric model only</i></p>	<p>Select Seat Cushion Fabric</p> <p>See page 228</p> <p><i>Specify for MF model only</i></p>	<p>Select Back and Frame Fabric</p> <p>See page 228</p> <p><i>Specify for MF model only</i></p>	<p>Select Leg and Color</p> <p>DW Dowel Wood PM Post Metal (+ \$50)</p> <p>See page 228 for colors</p>
<p>HASLBTCMF</p>	<p>PBLE07</p>	<p>PBLE09</p>	<p>PBLE06</p>	<p>PMP8V</p>

ASTIR™ Collaborative Work Seating

OPEN MARKET



Icon Legend on page 17

HASHBTC

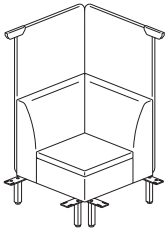

TRUE CORNER LOUNGE — HIGH-BACK SCREEN

DIMENSIONS

Depth:	29¾	Back Height:	16
Height:	54	Back Width:	29
Width:	29¾	Ship Weight:	119
Usable Seat Depth:	19¾	Cube:	28.1
Seat to Floor Height:	18¾	COM:	See page 228
Seat Width:	20¼	Weight Rating:	300 lbs.

FABRIC PRICE CODES

1 \$3021

Add to Base Price Above

	Unit	Knit	Screen
1	—	1	\$150
2	\$120	2	\$282
3	\$242	3	\$417
4	\$344	4	\$528
5	\$480	5	\$678
6	\$619	6	\$831
7	\$761	7	\$987
8	\$906	8	\$1147
9	\$929	9	\$1171
10	\$1051	10	\$1306
11	\$1173	11	\$1441
12	\$1296	12	\$1575

NOTES: True Corner uses legs from adjacent units, and can work with all leg styles. For adjacent units with sled legs, pick a single leg option for the True Corner rear leg.

- ❗ True Corner designed to act as a corner between two adjacent units, not as a stand-alone unit.
- ❗ True Corner leg selection refers to back corner leg only, and ships with only that leg.

HASHBTCMF

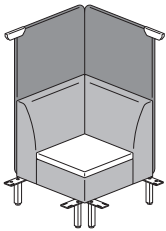

TRUE CORNER LOUNGE — HIGH-BACK SCREEN, MULTI-FABRIC

DIMENSIONS

Depth:	29¾	Back Height:	16
Height:	54	Back Width:	29
Width:	29¾	Ship Weight:	119
Usable Seat Depth:	19¾	Cube:	28.1
Seat to Floor Height:	18¾	COM:	See page 228
Seat Width:	20¼	Weight Rating:	300 lbs.

FABRIC PRICE CODES

1 \$3180

Add to Base Price Above

	Seat	Back/Frame	Knit	Screen
1	—	—	1	\$150
2	\$36	\$96	2	\$282
3	\$73	\$194	3	\$417
4	\$103	\$275	4	\$528
5	\$144	\$384	5	\$678
6	\$186	\$495	6	\$831
7	\$228	\$609	7	\$987
8	\$272	\$725	8	\$1147
9	\$279	\$743	9	\$1171
10	\$315	\$841	10	\$1306
11	\$352	\$939	11	\$1441
12	\$389	\$1037	12	\$1575

NOTES: True Corner uses legs from adjacent units, and can work with all leg styles. For adjacent units with sled legs, pick a single leg option for the True Corner rear leg.

- ❗ True Corner designed to act as a corner between two adjacent units, not as a stand-alone unit.
- ❗ True Corner leg selection refers to back corner leg only, and ships with only that leg.

HON Recommendation: HASHBTC.PURL__KMD.DW__ - List Price \$3263

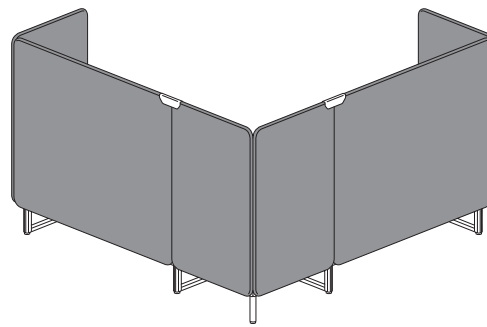
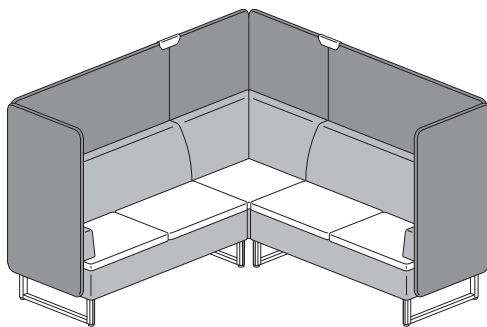

SEATING

HOW TO SPECIFY

<p>Select Model Number</p> <p>H A S H B T C M F .</p>	<p>Select Fabric</p> <p>See page 228 Specify for Single Fabric model only</p> <p>P B L E 0 7 .</p>	<p>Select Seat Cushion Fabric</p> <p>See page 228 Specify for MF model only</p> <p>P B L E 0 9 .</p>	<p>Select Back and Frame Fabric</p> <p>See page 228 Specify for MF model only</p> <p>P B L E 0 6 .</p>	<p>Select Screen Knit or Fabric</p> <p>Knit Options: KLT Light KMD Medium KDK Dark See page 228 for all options</p> <p>K M D .</p>	<p>Select Leg and Color</p> <p>DW Dowel Wood PM Post Metal (+ \$50) See page 228 for colors</p> <p>P M P 8 V</p>
--	---	---	---	---	---



HASB2

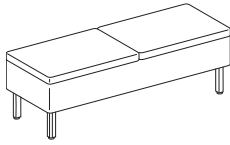

TWO-SEAT BENCH

DIMENSIONS

Depth:	20¼	Seat Width:	56¼
Height:	19	Ship Weight:	46
Width:	56½	Cube:	8.7
Usable Seat Depth:	20¼	COM:	See page 228
Seat to Floor Height:	18¾	Weight Rating:	300 lbs. (per seat)

FABRIC PRICE CODES

1	\$2120	8	\$2935
2	\$2228	9	\$2956
3	\$2338	10	\$3066
4	\$2429	11	\$3176
5	\$2552	12	\$3286
6	\$2677	L	—
7	\$2805		

HASB2MF

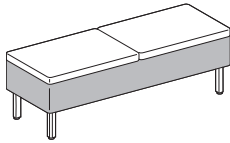

TWO-SEAT BENCH, MULTI-FABRIC

DIMENSIONS

Depth:	20¼	Seat Width:	56¼
Height:	19	Ship Weight:	46
Width:	56½	Cube:	8.7
Usable Seat Depth:	20¼	COM:	See page 228
Seat to Floor Height:	18¾	Weight Rating:	300 lbs. (per seat)

FABRIC PRICE CODES

1	\$2279		
<i>Add to Base Price Above</i>			
	Seat	Frame	
2	\$72	\$48	
3	\$145	\$97	
4	\$206	\$137	
5	\$288	\$192	
6	\$371	\$248	
7	\$457	\$304	
8	\$544	\$362	
9	\$557	\$371	
10	\$631	\$420	
11	\$704	\$469	
12	\$778	\$518	

HON Recommendation: HASB2.PURL___.DW__ - List Price \$2338

HOW TO SPECIFY

<p>Select Model Number</p> <p>HASB2MF</p>	<p>Select Fabric</p> <p>See page 228 <i>Specify for Single Fabric model only</i></p> <p>PBLE07</p>	<p>Select Seat Cushion Fabric</p> <p>See page 228 <i>Specify for MF model only</i></p> <p>PBLE09</p>	<p>Select Frame Fabric</p> <p>See page 228 <i>Specify for MF model only</i></p> <p>PBLE06</p>	<p>Select Leg and Color</p> <p>DW Dowel Wood PM Post Metal (+ \$50) SW Sled Wood (+ \$100) See page 228 for colors</p> <p>PMP8V</p>
--	---	---	--	--

ASTIR™ Collaborative Work Seating

OPEN MARKET



Icon Legend on page 17

HASB3

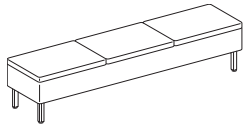

THREE-SEAT BENCH

DIMENSIONS

Depth:	20¼	Seat Width:	84½
Height:	19	Ship Weight:	61
Width:	84½	Cube:	12.2
Usable Seat Depth:	20¼	COM:	See page 228
Seat to Floor Height:	18¾	Weight Rating:	300 lbs. (per seat)

FABRIC PRICE CODES

1	\$2650	8	\$3828
2	\$2806	9	\$3857
3	\$2965	10	\$4016
4	\$3097	11	\$4175
5	\$3274	12	\$4335
6	\$3454	L	—
7	\$3639		

HASB3MF

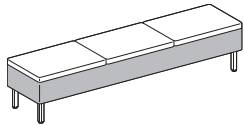

THREE-SEAT BENCH, MULTI-FABRIC

DIMENSIONS

Depth:	20¼	Seat Width:	84½
Height:	19	Ship Weight:	61
Width:	84½	Cube:	12.2
Usable Seat Depth:	20¼	COM:	See page 228
Seat to Floor Height:	18¾	Weight Rating:	300 lbs. (per seat)

FABRIC PRICE CODES

1	\$2809		
<i>Add to Base Price Above</i>			
	Seat	Frame	
2	\$96	\$60	
3	\$194	\$121	
4	\$275	\$172	
5	\$384	\$240	
6	\$495	\$309	
7	\$609	\$380	
8	\$725	\$453	
9	\$743	\$464	
10	\$841	\$525	
11	\$939	\$587	
12	\$1037	\$648	

HON Recommendation: HASB3.PURL__DW__ - List Price \$2965

SEATING

HOW TO SPECIFY

<p>Select Model Number</p> <p>HASB3MF .</p>	<p>Select Fabric</p> <p>See page 228 <i>Specify for Single Fabric model only</i></p> <p>PBLE07 .</p>	<p>Select Seat Cushion Fabric</p> <p>See page 228 <i>Specify for MF model only</i></p> <p>PBLE09 .</p>	<p>Select Frame Fabric</p> <p>See page 228 <i>Specify for MF model only</i></p> <p>PBLE06 .</p>	<p>Select Leg and Color</p> <p>DW Dowel Wood PM Post Metal (+ \$50) SW Sled Wood (+ \$100) See page 228 for colors</p> <p>PMP8V</p>
--	---	---	--	---



ASTIR™ Collaborative Work Seating

HASPSS

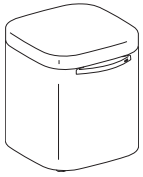

POUF

DIMENSIONS

Depth:	17¼	Seat Width:	16½
Height:	18¾	Ship Weight:	25
Width:	16½	Cube:	3.5
Usable Seat Depth:	16½	COM:	See page 228
Seat to Floor Height:	17½	Weight Rating:	300 lbs. (per seat)

FABRIC PRICE CODES

1	\$631	8	\$993
2	\$679	9	\$1002
3	\$728	10	\$1051
4	\$768	11	\$1100
5	\$823	12	\$1149
6	\$879	L	—
7	\$935		

HASPSSMF

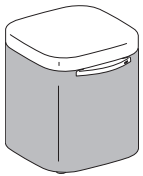

POUF, MULTI-FABRIC

DIMENSIONS

Depth:	17¼	Seat Width:	16½
Height:	18¾	Ship Weight:	25
Width:	16½	Cube:	3.5
Usable Seat Depth:	16½	COM:	See page 228
Seat to Floor Height:	17½	Weight Rating:	300 lbs. (per seat)

FABRIC PRICE CODES

1	\$790	
<i>Add to Base Price Above</i>		
	Seat	Frame
2	\$24	\$36
3	\$48	\$73
4	\$69	\$103
5	\$96	\$144
6	\$124	\$186
7	\$152	\$228
8	\$181	\$272
9	\$186	\$279
10	\$210	\$315
11	\$235	\$352
12	\$259	\$389

HON Recommendation: HASPSS.PURL__H.BL - List Price \$728

HOW TO SPECIFY

<p>Select Model Number</p> <p>See page 228</p> <p>H A S P S S .</p>	<p>Select Fabric</p> <p>See page 228</p> <p>P B L E 0 7 .</p>	<p>Select Leg and Color</p> <p>HG Hidden Glide H Caster</p> <p>H G .</p>	<p>Select Handle Color</p> <p>BL Black Handle</p> <p>B L</p>
---	---	--	--

HOW TO SPECIFY

<p>Select Model Number</p> <p>See page 228</p> <p>H A S P S S M F .</p>	<p>Select Seat Cushion Fabric</p> <p>See page 228</p> <p>P B L E 0 7 .</p>	<p>Select Frame Fabric</p> <p>See page 228</p> <p>P B L E 0 6 .</p>	<p>Select Leg and Color</p> <p>HG Hidden Glide H Caster</p> <p>H G .</p>	<p>Select Handle Color</p> <p>BL Black Handle</p> <p>B L</p>
---	--	---	--	--

SEATING

ASTIR™ Collaborative Work Seating

OPEN MARKET



Icon Legend on page 17

HASSP

HIGH-BACK SCREEN — SIDE PRIVACY

DIMENSIONS

Ship Weight: 3.2
Cube: 3.2
COM: 3.0

LIST PRICE

Knit \$1590

1	\$1640	7	\$2097
2	\$1712	8	\$2184
3	\$1785	9	\$2197
4	\$1846	10	\$2271
5	\$1928	11	\$2344
6	\$2011	12	\$2418

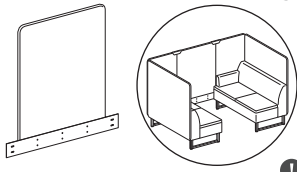

ⓘ Requires High-Back Screen units with arms on each unit.

HASGBSL

SHARED LEG GANGING BRACKET

DIMENSIONS

Ship Weight: 4
Cube: 0.1

LIST PRICE

\$212

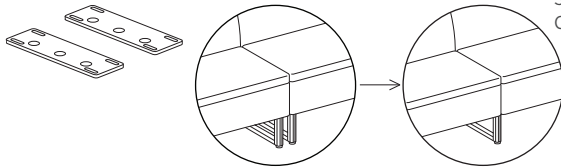

NOTES: Uses existing legs on units being ganged. No specification needed.
SPECIFYING EXAMPLE: HASGBSL

HASSGC

SCREEN GANGING CLIP

DIMENSIONS

Ship Weight: 1
Cube: 0.1

LIST PRICE

\$106

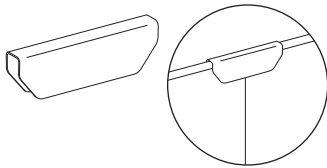

ⓘ Required when ganging multiple high-back units together.
ⓘ Already included on individual units where applicable.

HOW TO SPECIFY

Select Model Number

Select Screen Knit or Fabric

Knit Options:
KLT Light
KMD Medium
KDK Dark
See page 228 for all options

HASSP.

KMD

HOW TO SPECIFY

Select Model Number



Select Paint Color

P7A Textured Charcoal

HASSGC.

P7A

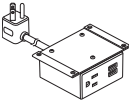

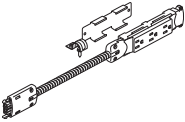
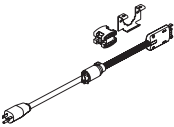
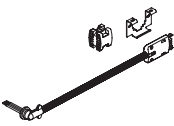
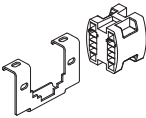
	DESCRIPTION	MODEL	SHIP WEIGHT	CUBE	LIST PRICE
	<p>Miki Under-Mount Power Module</p> <ul style="list-style-type: none"> Includes 6' cord with three-prong plug. 1 Receptacle, 2 USB Available in STRM Storm and SNW Snow. <p>SPECIFYING EXAMPLE: HUMPWR-1P-2U.STRM</p>	HUMPWR-1P-2U	2	0.6	\$191
	<p>Vesta Mobile Power Station</p> <ul style="list-style-type: none"> Includes 10' retractable cord with three-prong plug. 3 AC, 1 Dual USB-A, 1 USB-C at top Specify Paint and Plastic. <p>SPECIFYING EXAMPLE: HPWRMOB1.BLK.STRM</p>	HPWRMOB1	14	3.3	\$1100
	<p>Triplex Electrical Harness</p> <p>48"W, Circuit 1 60"W, Circuit 1 72"W, Circuit 1</p> <p>48"W, Circuit 2 60"W, Circuit 2 72"W, Circuit 2</p>	<p>HTPKIT48 HTPKIT60 HTPKIT72</p> <p>HTPKIT482 HTPKIT602 HTPKIT722</p>	5 5 5 5 5 5	0.3 0.3 0.3 0.3 0.3 0.3	\$215 \$220 \$225 \$215 \$220 \$225
	<p>Triplex Corded In-Feed</p> <p>48"W Corded In-feed 72"W Corded In-feed</p> <p>NOTES: Corded in-feed ships with (1) 4-way splitter, (1) 4-way splitter mounting bracket, (1) conduit clip, and (1) in-feed. Utilizes standard 3-prong plug for easy setup and installation. Use with circuit 1 harnesses only. Corded in-feed not UL listed.</p>	<p>HTPCIF48 HTPCIF72</p>	5 5	0.3 0.3	\$279 \$295
	<p>Triplex Hardwire In-Feed</p> <p>48"W Hardwire In-feed</p> <p>NOTES: Hardwire in-feed ships with (1) 4-way splitter, (1) 4-way splitter mounting bracket, (1) conduit clip, and (1) in-feed. Hardwire in-feed must be installed by a licensed electrician.</p>	HTPHWIF72	5	0.3	\$241
	<p>Triplex 4-Way Splitter</p> <p>4-Way Splitter</p> <p>NOTES: 4-way splitter utilized in instances where one power harness feeds into 2-3 power harnesses.</p>	HTPSPLIT	5	0.3	\$73

NOTES:

- Triplex is a 4-trac system with 3 connected simplexes per harness.
- Choose either a corded or hardwire in-feed.
- UL listed as a manufactured wiring system (UL 183) when hardwire in-feed is used.
- cUL Certified for Canada with hardwire in-feed.
- Hardwire in-feed complies with municipal standards such as in New York, Los Angeles, and San Francisco. However, it is customer's responsibility to verify local code compliance.
- Plug in any standard 2- or 3-prong plug accessory to triplex simplexes to get power to where you need it most.

HOW TO SPECIFY

<p>Select Model Number</p> <p>HPWRMOB1</p>	<p>Select Exterior Paint Color</p> <p><i>Specify for model HPWRMOB1 only</i></p> <p>FOG Fog STRM Storm BLK Black SNW Snow</p> <p>BLK</p>	<p>Select Paint Color</p> <p><i>Specify for model HPWRMOB1 only</i></p> <p>FOG Fog STRM Storm BLK Black SNW Snow</p> <p>STRM</p>
---	---	---

CAMBIA™ 2160 SERIES

Want to see more? Scan here
to check out [hon.com](https://www.hon.com).



Cambia Upholstered Back Guest
Chairs shown with Preside® table.

CAMBIA™ 2160 SERIES

Cambia's comfort and style is a warm invitation for any guest or coworker. With two back variations and arm options, this is a guest chair collection designed to adapt. Each back option offers a choice of a wood slat design or upholstered panel to suit any space or personal taste. Choose from eight rich hardwood finishes and hundreds of quality HON fabrics to express your style and reflect your brand.



FEATURES

- Wood slat back panel complements a variety of surroundings.
- Upholstered seat and back features cushioning for additional comfort and support.
- Personalize your space with a choice of back styles.
- Fixed arms provide support and take pressure off the upper body and shoulders.
- Solid hardwood in one of eight attractive finishes.
- Available in hundreds of quality HON fabrics.
- Warranted for users up to 250 lbs.

CAMBIA™

2160 Series Options

MODEL OPTIONS

H2164



Guest Chair

Upholstered Back, Leg Base,
Arch Arms

H2165



Guest Chair

Wood Slat Back, Leg Base,
Arch Arms

AVAILABLE FINISHES

Cambia™ 2160 Series Seating is available in 8 wood finishes.

WOOD FINISHES

Bourbon Cherry (H)

Cognac (COGN)

Harvest (C)

Mahogany (N)

Mocha (MOCH)

Natural Maple (D)

Pinnacle (PINC)

Shaker Cherry (F)

HON BRANDED FABRICS

GRADE 1

Apex
Attire
Centurion
Compass
Contourett
Dapper
Ensemble
Hamilton
Inertia
Optic
Pebble

GRADE 2

Appoint Seating
Blume
Clyde
Dotty
Rush
Seed
Spin
Whisper Vinyl

GRADE 3

In Season
Moxie
Parker
Purl
Quill

GRADE L

Denver Leather

For a complete list of fabrics, including partnership fabrics, go to hon.com/fabricsandfinishes.

Reference Fabric Color Combinations on pages 18-22 for color codes and legend on page 19 for lead times. For additional HON to Supply COM fabric grade pricing, go to honready.hon.com and click on the HON to Supply COM link.

CAMBIA™ 2160 Series

GSA SIN 33721



Icon Legend on page 17

H2164



GUEST CHAIR

Upholstered Back
Leg Base
Arch Arms

DIMENSIONS

Depth:	24¼	Arm Width:	19
Width:	21¾	Seat to Floor Height:	19
Height:	31¾	Usable Seat Depth:	21
Seat Depth:	21	Ship Weight:	30
Seat Width:	21¾	Cube:	22.6
Back Width:	21¾	COM:	1.5
Back Height:	13¾	Weight Rating:	250 lbs.

FABRIC PRICE CODES

1	\$788	8	\$1133
2	\$848	9	\$1178
3	\$908	10	\$1223
4	\$953	11	\$1268
5	\$998	12	\$1313
6	\$1043	L	\$1288
7	\$1088		

H2165



GUEST CHAIR

Wood Slat Back
Leg Base
Arch Arms

DIMENSIONS

Depth:	24¼	Arm Width:	19
Width:	21¾	Seat to Floor Height:	19
Height:	31¾	Usable Seat Depth:	21
Seat Depth:	21	Ship Weight:	30
Seat Width:	21¾	Cube:	22.6
Back Width:	21¾	COM:	1.3
Back Height:	13¾	Weight Rating:	250 lbs.

FABRIC PRICE CODES

1	\$830	8	\$1037
2	\$866	9	\$1064
3	\$902	10	\$1091
4	\$929	11	\$1118
5	\$956	12	\$1145
6	\$983	L	\$1130
7	\$1010		

HON Recommendation: H2164.MOCH.CU__ - List Price \$788

HOW TO SPECIFY

Select
Model Number

H 2 1 6 4 .

Select
Finish

See page 243

M O C H .

Select
Fabric

See page 243

C U 1 0 .

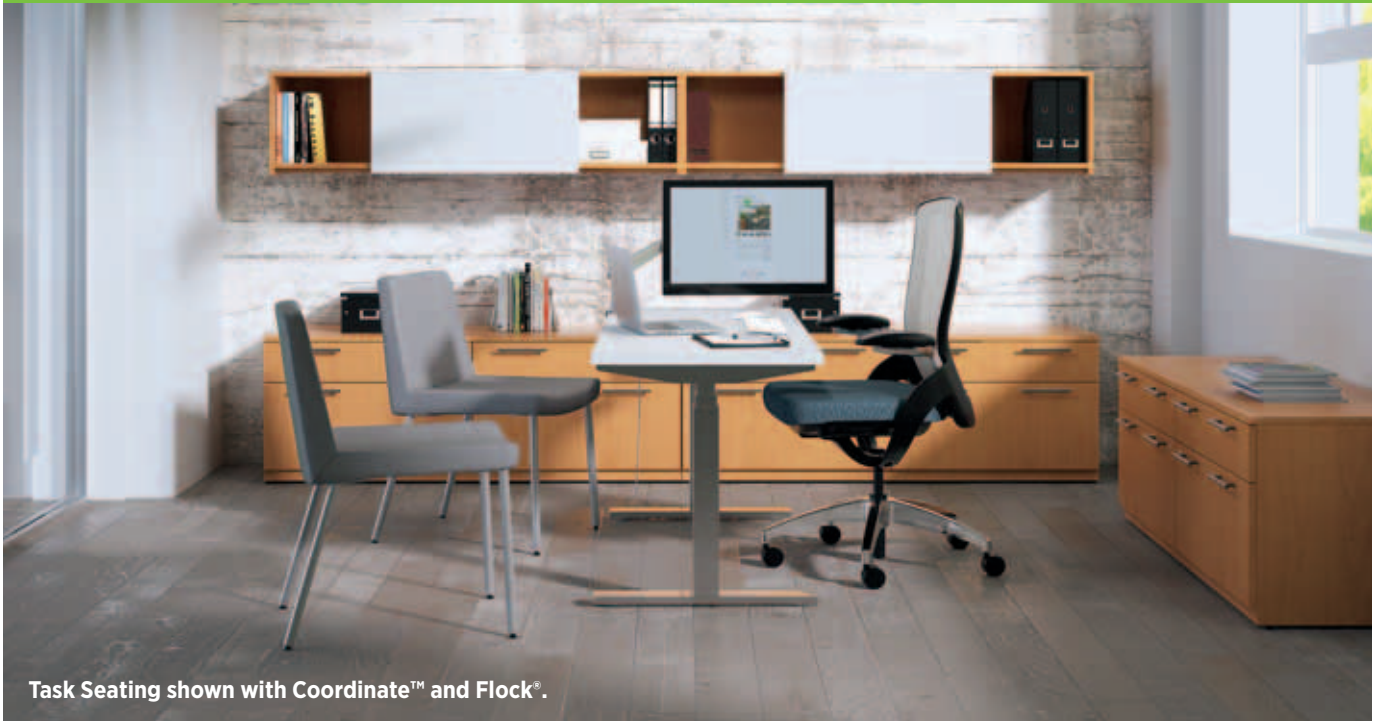

Task Seating shown with Coordinate™ and Flock®.

CERES®

Seating is personal. At the same time, it's also universal. Ceres is designed to bridge that gap by creating a holistic seating family that allows everyone to stay in control of their own comfort. As the result of exhaustive ergonomic research, the stunning Ceres collection of task and guest chairs feature total support for anyone and any space. The comfort contours cradle you throughout the workday, while projecting the right personality for your brand.



GUEST/MULTI-PURPOSE FEATURES

- 4-Way Stretch mesh back is available in seven colors.
- Model HCG6 is a four-leg multi-purpose chair with a pivoting back for added comfort.
- Model HCG6 stacks up to four high on the floor.
- Guest chairs are available with or without arms.
- Available in a multi-fabric option.
- Warranted for users up to 300 lbs.

TASK CHAIR FEATURES

- Height- and width-adjustable arms provide a custom fit.
- Seat depth adjustment adapts to users of various heights.
- One-touch seat height adjustment easily moves the seat up and down.
- Tilt tension controls the rate and ease of recline.
- Tilt lock allows the user to lock the back in multiple recline positions.
- Warranted for users up to 300 lbs.

CERES® Task Chair Options

MODEL OPTION



HCW1 *





Task Chair

Pneumatic, Swivel, Synchro-tilt,
Seat Glide Tilt Tension, Height,
Width and Depth Adjustable Arms

ARM STYLE	CODE	DESCRIPTION	PRICE
	ABLCK	Textured Black	+\$0
	APLAT	Textured Platinum Metallic	+\$0
	APA	Polished Aluminum	+\$75

CASTERS	CODE	DESCRIPTION	PRICE
	H	Black Hard Caster	+\$0
	S	Black All-Surface Caster	+\$40

BACK STYLE	CODE	DESCRIPTION	PRICE
	<i>4-Way Stretch options:</i>		
	IM	Black	+\$0
	IB	Breeze	+\$0
	IK	Brownstone	+\$0
	IC	Charcoal	+\$0
	IF	Fog	+\$0
	IR	Regatta	+\$0
	IT	Titanium	+\$0

BASE	CODE	DESCRIPTION	PRICE
	SB	Standard Base	+\$0
	PA	Polished Aluminum	+\$110

FRAME	CODE	DESCRIPTION	PRICE
	T	Black	+\$0

* De-emphasized

CERES® Multi-Purpose Chair Options

MODEL OPTION

HCG6



Multi-Purpose

Four-leg stacking frame
with pivoting back

HCG6DF - Multi-Fabric



Multi-Purpose

Four-leg stacking frame
with pivoting back

ARM STYLE



CODE	DESCRIPTION	PRICE
N	Armless	+\$0



F	Fixed Arms	+\$55
----------	------------	--------------

CASTERS/ GLIDE



CODE	DESCRIPTION	PRICE
H	Black Hard Caster	+\$0



S	Black All-Surface Caster	+\$30
----------	--------------------------	--------------



E	Glide	+\$0
----------	-------	-------------

BACK STYLE



CODE	DESCRIPTION	PRICE
PB	Upholstered in-back	+\$0



4-Way Stretch options:

IM	Black	+\$0
IB	Breeze	+\$0
IK	Brownstone	+\$0
IC	Charcoal	+\$0
IF	Fog	+\$0
IR	Regatta	+\$0
IT	Titanium	+\$0

FRAME

CODE	DESCRIPTION	PRICE
BLCK	Textured Black Mica	+\$0
PLAT	Textured Platinum Metallic	+\$0

CERES[®] Fabric Options

HON BRANDED FABRICS

GRADE 1	GRADE 2	GRADE 3	GRADE L
Apex	Appoint Seating	In Season	Denver Leather*
Attire	Blume	Moxie	
Centurion	Clyde	Parker	
Compass	Dotty	Purl	
Contourett	Rush	Quill	
Dapper	Seed		
Ensemble	Spin		
Hamilton	Whisper Vinyl		
Inertia			
Optic			
Pebble			

For a complete list of fabrics, including partnership fabrics, go to hon.com/fabricsandfinishes.

Reference Fabric Color Combinations on pages 18-22 for color codes and legend on page 19 for lead times. For additional HON to Supply COM fabric grade pricing, go to honready.hon.com and click on the HON to Supply COM link.

*Denver Leather (SS) may not be available on every model within a specific series, please refer to the model's page for details.



HCW1



TASK CHAIR

Pneumatic
Swivel
Synchro-tilt
Seat Glide Tilt Tension
Height, Width and Depth
Adjustable Arms
Functions:
A, D, E, A-C, A-D, B-A
(Function Key on pages 212-213)

DIMENSIONS

Depth: 27¾
Width: 27½
Height: 43⅞
Seat Depth: 19
Seat Width: 20
Back Width: 16½
Back Height: 22½
Arm Width: 17½-21
Seat to Floor Height: 17-21½
Usable Seat Depth: 17-19½
Ship Weight (upholstered back): 39
Ship Weight (mesh back): 39
Cube (upholstered back): 11.3
Cube (mesh back): 11.3
COM (upholstered back): 1.0
COM (mesh back): 1.0
Weight Rating: 300 lbs.

FABRIC PRICE CODES

1	\$1542	8	\$1680
2	\$1566	9	\$1698
3	\$1590	10	\$1716
4	\$1608	11	\$1734
5	\$1626	12	\$1752
6	\$1644	L	\$1742
7	\$1662		

HON Recommendation: HCW1.ABLCK.H.IM.CU__SB.T - List Price \$1542

* De-emphasized

HOW TO SPECIFY

Select Model Number	Select Arm Option	Select Caster/Glide	Select Back Option	Select Fabric	Select Base	Select Frame
Adjustable Arms Finishes ABLCK Textured Black APLAT Textured Platinum Metallic APA Polished Aluminum (+ \$75)	H Black Hard Caster S Black All-Surface Caster (+ \$40)	PB Upholstered in-back Mesh Back Options IM Black IB Breeze IK Brownstone IC Charcoal IF Fog IR Regatta IT Titanium	See page 248	SB Standard Base PA Polished Aluminum (+ \$110)	T Black	
HCW1	ABLCK	H	IM	CU10	SB	T

HCG6

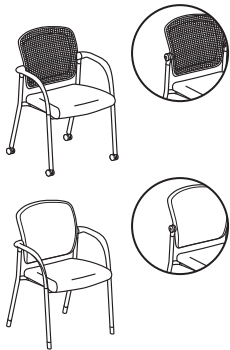

MULTI-PURPOSE

Four-leg stacking frame with pivoting back

DIMENSIONS

Depth:	25	Seat to Floor Height:	18¾
Width:	24½	Usable Seat Depth:	17¼
Height:	35	Ship Weight (upholstered back):	22
Seat Depth:	19½	Ship Weight (mesh back):	22
Seat Width:	20	Cube (upholstered back):	15.2
Back Width:	17½	Cube (mesh back):	15.2
Back Height:	17	COM (upholstered back):	1.0
Arm Width:	20¼	COM (mesh back):	1.0
		Weight Rating:	300 lbs.

FABRIC PRICE CODES

1	\$605	8	\$743
2	\$629	9	\$761
3	\$653	10	\$779
4	\$671	11	\$797
5	\$689	12	\$815
6	\$707	L	\$805
7	\$725		

NOTES: Multi-purpose model HCG6, with or without arms, stacks up to 4-high.

HON Recommendation: HCG6.F.H.IM.CU__BLCK - List Price \$660

HOW TO SPECIFY

Select Model Number HCG6	Select Arm Option F Fixed Arms (+ \$55) N Armless	Select Caster/Glide E Glide H Black Hard Caster S Black All-Surface Caster (+ \$30)	Select Back Option PB Upholstered in-back Mesh Back Options IM Black IB Breeze IK Brownstone IC Charcoal IF Fog IR Regatta IT Titanium	Select Fabric See page 248	Select Frame BLCK Textured Black Mica PLAT Textured Platinum Metallic
--	--	---	--	--------------------------------------	--

HCG6DF

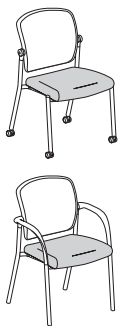

MULTI-PURPOSE

Multi-Fabric
Four-leg stacking frame with pivoting back

DIMENSIONS

Depth:	25	Arm Width:	20¼
Width:	24½	Seat to Floor Height:	18¾
Height:	35	Usable Seat Depth:	17¼
Seat Depth:	19½	Ship Weight (upholstered back):	22
Seat Width:	20	Cube (upholstered back):	15.2
Back Width:	17½	COM (back):	0.8
Back Height:	17	COM (seat):	1.0
		Weight Rating:	300 lbs.

FABRIC PRICE CODES

1	\$680		
		<i>Add to Base Price Above</i>	
		Back	Seat
2	\$18	\$24	
3	\$36	\$48	
4	\$50	\$66	
5	\$63	\$84	
6	\$77	\$102	
7	\$90	\$120	
8	\$104	\$138	
9	\$117	\$156	
10	\$131	\$174	
11	\$144	\$192	
12	\$158	\$210	
L	\$150	\$200	

NOTES: Multi-purpose model HCG6DF, with or without arms, stacks up to 4-high.

HON Recommendation: HCG6DF.F.H.PB.CU__CU__BLCK - List Price \$777

HOW TO SPECIFY

Select Model Number HCG6DF	Select Arm Option F Fixed Arms (+ \$55) N Armless	Select Caster/Glide E Glide H Black Hard Caster S Black All-Surface Caster (+ \$30)	Select Back Option PB Upholstered in-back	Select Back Fabric See page 248	Select Seat Fabric See page 248	Select Frame BLCK Textured Black Mica PLAT Textured Platinum Metallic
--	--	---	---	---	---	--



HVL643



GUEST CHAIR

4-Leg Base
Padded Arms

DIMENSIONS

Depth:	28½	Arm Width:	18½
Width:	24½	Seat to Floor Height:	19½
Height:	34½	Usable Seat Depth:	19½
Seat Depth:	19½	Ship Weight:	36
Seat Width:	19	Cube:	4.5
Back Width:	21¼	Weight Rating:	250 lbs.
Back Height:	18		

PRICE CODE

Leather **\$400**

NOTES: Black Bonded Leather with pleated stitching detail. Black frame. **HON 5-Year Limited Warranty.**

HON Recommendation: HVL643.SB11 - List Price \$400

HOW TO SPECIFY

Select Model Number	Select Fabric
	SB11 Black Bonded Leather
H V L 6 4 3 .	S B 1 1



HVL871

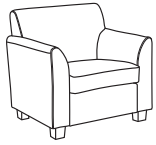

CLUB CHAIR

DIMENSIONS

Depth:	28¾	Arm Width:	21½
Width:	33	Seat to Floor Height:	18½
Height:	32	Usable Seat Depth:	21
Seat Depth:	21	Ship Weight:	51
Seat Width:	21½	Cube:	20.7
Back Width:	30	Weight Rating:	250 lbs.
Back Height:	18½		

PRICE CODE

Leather **\$1413**

NOTES: Legs available in Black. Legs ship unattached. Available in SB11 Black Bonded Leather only. **HON 5-Year Limited Warranty.**

HON Recommendation: HVL871.SB11 - List Price \$1413

HVL872

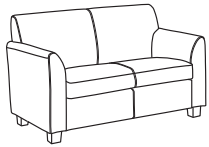

LOVE SEAT

DIMENSIONS

Depth:	28¾	Arm Width:	42
Width:	53½	Seat to Floor Height:	18½
Height:	32	Usable Seat Depth:	21
Seat Depth:	21	Ship Weight:	76
Seat Width:	42	Cube:	33.1
Back Width:	50	Weight Rating:	250 lbs.
Back Height:	18½		

PRICE CODE

Leather **\$1792**

NOTES: Legs available in Black. Legs ship unattached. Available in SB11 Black Bonded Leather only. **HON 5-Year Limited Warranty.**

HON Recommendation: HVL872.SB11 - List Price \$1792

HVL873

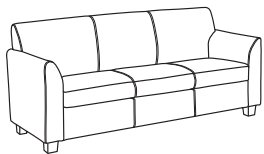

SOFA

DIMENSIONS

Depth:	28¾	Arm Width:	61½
Width:	73	Seat to Floor Height:	18½
Height:	32	Usable Seat Depth:	21
Seat Depth:	21	Ship Weight:	122
Seat Width:	61½	Cube:	45.0
Back Width:	70	Weight Rating:	250 lbs.
Back Height:	18½		

PRICE CODE

Leather **\$2239**

NOTES: Legs available in Black. Legs ship unattached. Available in SB11 Black Bonded Leather only. **HON 5-Year Limited Warranty.**

HON Recommendation: HVL873.SB11 - List Price \$2239

HOW TO SPECIFY

Select Model Number H V L 8 7 1 .	Select Fabric SB11 Black Bonded Leather S B 1 1
---	--



HVL691



HIGH-BACK

Pneumatic
Swivel
Tilt
Tilt Tension
Tilt Lock
Fixed Padded Arms

Functions: **A, E, F, K, L**
(Function Key on pages 212-213)

DIMENSIONS

Depth:	28¾	Arm Width:	21
Width:	27	Seat to Floor Height:	18¾-21¾
Height:	47¼	Usable Seat Depth:	17¾
Seat Depth:	20¼	Ship Weight:	50
Seat Width:	21½	Cube:	7.2
Back Width:	21½	Weight Rating:	250 lbs.
Back Height:	27		

PRICE CODE

Leather \$644

NOTES: Black Bonded Leather. Sturdy textured black frame. Fixed padded loop arms. Built-in lumbar support. Use with coordinating Guest Chair model HVL693 shown below. **HON 5-Year Limited Warranty.**

HON Recommendation: HVL691.SB11 - List Price \$644

HVL693



GUEST CHAIR

Sled Base
Padded Arms

DIMENSIONS

Depth:	26	Arm Width:	18½
Width:	24¾	Seat to Floor Height:	18¼
Height:	33½	Usable Seat Depth:	18¼
Seat Depth:	18¼	Ship Weight:	38
Seat Width:	20¾	Cube:	5.2
Back Width:	21	Weight Rating:	250 lbs.
Back Height:	16¼		

PRICE CODE

Leather \$417

NOTES: Black Bonded Leather with tailored stitching detail. Sturdy textured black frame. Built-in lumbar support. Use with coordinating Executive Chair model HVL691 shown above. **HON 5-Year Limited Warranty.**

HON Recommendation: HVL693.SB11 - List Price \$417

HOW TO SPECIFY

Select Model Number	Select Fabric
	SB11 Black Bonded Leather
H V L 6 9 1 .	S B 1 1



Cliq™ Seating shown with
Preside® Table and Credenza.

CLIQ™

Some of the best work results from a collaborative effort. That's why Cliq brings people together. Designed with a weight-activated control that responds to your body and its movements, Cliq just gets you — providing instant comfort without a lot of adjustments. It's light-scaled for a modern look that's also easy to maneuver around wherever the group discussion takes you. Available as a task chair or stool, Cliq features a wide selection of fabric choices and frame and mesh colors. Intuitive, stylish, and supportive — it just clicks with any collaborative environment.



FEATURES

- Intuitive functionality and design provides comfort and support without the need for multiple adjustments.
- Weight-activated control automatically adjusts to you as you sit.
- Thin profile offers a modern aesthetic, while a wide range of fabric choices ensures the perfect look within any space.
- 4-Way Stretch Mesh flexes in every direction to dynamically move with you — available in 7 colors.
- Choose between fixed arms or armless to get exactly the look you want.
- Task Chairs are available with a conference cylinder or task cylinder so you can choose the chair that best fits your space.
- Task Stools feature an adjustable footring for additional lower body support.
- One-touch seat height adjustment easily moves the seat up and down.
- Choose from 3 frame options: Black, Titanium, and Designer White.

HON BRANDED FABRICS

GRADE 1

Apex
Attire
Centurion
Compass
Contourett
Dapper
Ensemble
Hamilton
Inertia
Optic
Pebble

GRADE 2

Appoint Seating
Blume
Clyde
Dotty
Rush
Seed
Spin Seating
Whisper Vinyl

GRADE 3

In Season
Moxie
Parker
Purl
Quill

For a complete list of fabrics, including partnership fabrics, go to hon.com/fabricsandfinishes.

Reference Fabric Color Combinations on pages 18-22 for color codes and legend on page 19 for lead times.



HCLQT



LIGHT TASK CHAIR

Mesh Back
 Pneumatic
 Swivel
 Weight-activated
 Synchro-tilt
 Tilt Lock
 Functions: **A, E, J, L, P**
 (Function Key on pages 212-213)

DIMENSIONS

Depth:	27	Seat to Floor Height	
Width:	27	(Task Cylinder):	17-22
Height:	41	Seat to Floor Height	
Seat Depth:	17	(Conference Cylinder):	15 ⁵ / ₈ -19 ³ / ₈
Seat Width:	19 ¹ / ₄	Usable Seat Depth:	17
Back Width:	19 ¹ / ₄	Ship Weight:	45
Back Height:	21	Cube:	10.7
		COM:	1.0
		Weight Rating:	300 lbs.

FABRIC PRICE CODES

1	\$628	8	\$766
2	\$652	9	\$784
3	\$676	10	\$802
4	\$694	11	\$820
5	\$712	12	\$838
6	\$730	L	—
7	\$748		

NOTES: When selecting the Conference Cylinder, the maximum arm height from floor is 28¹/₂".

HON Recommendation: HCLQT.W0.TC2.F.S.IT.CU__NL.SB.TI - List Price \$693

HOW TO SPECIFY

Select Model Number	Select Control Type	Select Cylinder	Select Arm Type	Select Caster	Select Back Option	Select Fabric	Select Lumbar	Select Base	Select Frame
W0 Weight-Activated	TC2 Task Cylinder CC1 Conference Cylinder	N Armless F Fixed (+\$30)	S Black All-Surface Caster	IM Black IB Breeze IK Brownstone IC Charcoal IF Fog IR Regatta IT Titanium	See page 255	NL No Lumbar	SB Standard Base PA Polished Aluminum (+\$110)	T Black TI Titanium (+\$35) DW Designer White (+\$35)	
HCLQT	W0	TC2	F	S	IT	CU19	NL	SB	TI



Icon Legend on page 17

HCLQS*



TASK STOOL

Mesh Back

- Pneumatic
- Swivel
- Weight-activated
- Synchro-tilt
- Tilt Lock

Functions: **A, E, J, L, P**
 (Function Key on pages 212-213)

DIMENSIONS

Depth:	28¾	Seat to Floor Height:	23-33
Width:	28¾	Usable Seat Depth:	17
Height:	52	Ship Weight:	50
Seat Depth:	17	Cube:	10.7
Seat Width:	19¼	Weight Rating:	300 lbs.
Back Width:	19¼		
Back Height:	21		

FABRIC PRICE CODES

1	\$697	8	\$835
2	\$721	9	\$853
3	\$745	10	\$871
4	\$763	11	\$889
5	\$781	12	\$907
6	\$799	L	—
7	\$817		

HON Recommendation: HCLQS.W0.SC2.F.S.IT.CU__NL.SB.TI - List Price \$782

*Coming Soon

HOW TO SPECIFY

Select Model Number	Select Control Type	Select Cylinder	Select Arm Type	Select Caster	Select Back Option	Select Fabric	Select Lumbar	Select Base	Select Frame
W0 Weight-Activated	SC2 Stool Cylinder	N Armless F Fixed (+\$30)	S Black All-Surface Caster	IM Black IB Breeze IK Brownstone IC Charcoal IF Fog IR Regatta IT Titanium	See page 255	NL No Lumbar	SB Standard Base PA Polished Aluminum (+\$110)	T Black TI Titanium (+\$55) DW Designer White (+\$55)	
HCLQS	W0	SC2	F	S	IT	CU19	NL	SB	TI

COMFORTASK® 5900 SERIES

Want to see more? Scan here
to check out hon.com.



ComforTask Chair shown
with Metro Classic desks.

COMFORTASK® 5900 SERIES

What's in a name? If it's ComforTask, it's the support you need to get the job done. ComforTask seating is a proven office performer, with cushioning in all the right places, a waterfall seat edge and the customizable comfort that allows everyone to create a personal fit. Advanced controls such as back height and seat depth adjustments take the personalization to an even higher level, earning fans throughout the office.



FEATURES

- Back height adjustment moves the back up or down to provide a custom fit.
- Seat depth adjustment on model H5901 adapts to users of various heights.
- Contoured seat and back provide targeted support.
- Waterfall seat edge encourages leg circulation.
- One-touch seat height adjustment easily moves the seat up and down.
- 360-degree swivel provides freedom of movement in any direction.
- Molded polymer outer back for added durability.
- Available in hundreds of quality HON fabrics.
- Warranted for users up to 300 lbs.

COMFORTASK® 5900 Series Options

MODEL OPTIONS

H5901



Task Chair

Pneumatic, Back Height, Seat Depth, Swivel

H5902



Task Chair

Pneumatic, Back Height, Swivel, Tilt, Tilt Tension, Tilt Lock

H5903



Task Chair

Pneumatic, Back Height, Swivel, Multi-task

H5905



Task Stool

Pneumatic, Back Height, Swivel, Adjustable Height Footring

CASTERS/ GLIDE



CODE	DESCRIPTION	PRICE
H	Black Hard Caster	+\$0



S	Black All-Surface Caster	+\$40
----------	--------------------------	--------------



G	Bell Glide	+\$25
----------	------------	--------------

*G only available on model H5905

FRAME

CODE	DESCRIPTION	PRICE
T	Black	+\$0

COMFORTASK®

5900 Series Fabric Options

HON BRANDED FABRICS

GRADE 1

Apex
Attire
Centurion
Compass
Contourett
Dapper
Ensemble
Hamilton
Inertia
Optic
Pebble

GRADE 2

Appoint Seating
Blume
Clyde
Dotty
Rush
Seed
Spin
Whisper Vinyl

GRADE 3

In Season
Moxie
Parker
Purl
Quill

For a complete list of fabrics, including partnership fabrics, go to hon.com/fabricsandfinishes.

Reference Fabric Color Combinations on pages 18-22 for color codes and legend on page 19 for lead times. COM yardage shown is for Pattern Cut only. Contact Customer Service for Railroaded yardage requirements. For additional HON to Supply COM fabric grade pricing, go to honready.hon.com and click on the HON to Supply COM link.



Icon Legend on page 17

COMFORTASK® 5900 Series

H5901



TASK

Pneumatic
Back Height
Seat Depth
Swivel
Functions: **A, B, C, E**
(Function Key on pages 212-213)

NOTES: Seat depth adjustment.

DIMENSIONS

Depth: 28¾
Width: 23
Height: 38¼
Seat Depth: 18
Seat Width: 20
Back Width: 16¼
Back Height: 17¾
Seat to Floor Height: 14⅞-19¾
Usable Seat Depth: 16⅝-18⅞
Ship Weight: 30
Cube: 7.8
COM: 1.0
Weight Rating: 300 lbs.

FABRIC PRICE CODES

1	\$322	8	\$460
2	\$346	9	\$478
3	\$370	10	\$496
4	\$388	11	\$514
5	\$406	12	\$532
6	\$424	L	—
7	\$442		

H5902



TASK

Pneumatic
Back Height
Swivel
Tilt
Tilt Tension
Tilt Lock
Functions: **A, B, E, F, K, L**
(Function Key on pages 212-213)

DIMENSIONS

Depth: 27¾
Width: 23
Height: 39¾
Seat Depth: 18
Seat Width: 20
Back Width: 16¼
Back Height: 21
Seat to Floor Height: 17-22
Usable Seat Depth: 16¾
Ship Weight: 30
Cube: 7.8
COM: 1.0
Weight Rating: 300 lbs.

FABRIC PRICE CODES

1	\$344	8	\$482
2	\$368	9	\$500
3	\$392	10	\$518
4	\$410	11	\$536
5	\$428	12	\$554
6	\$446	L	—
7	\$464		

H5903



TASK

Pneumatic
Back Height
Swivel
Multi-task
Functions: **A, B, E, N**
(Function Key on pages 212-213)

DIMENSIONS

Depth: 34¼
Width: 24
Height: 40½
Seat Depth: 18
Seat Width: 20
Back Width: 16¼
Back Height: 20¼
Seat to Floor Height: 16¼-20⅞
Usable Seat Depth: 13¾-17
Ship Weight: 32
Cube: 7.8
COM: 1.0
Weight Rating: 300 lbs.

FABRIC PRICE CODES

1	\$486	8	\$624
2	\$510	9	\$642
3	\$534	10	\$660
4	\$552	11	\$678
5	\$570	12	\$696
6	\$588	L	—
7	\$606		

HON Recommendation: H5901.H.CU__T with optional H5995 - List Price \$450

HOW TO SPECIFY

<p>Select Model Number</p> <p>H 5 9 0 1 .</p>	<p>Select Caster/Glide</p> <p>H Black Hard Caster S Black All-Surface Caster (+ \$40)</p> <p>H .</p>	<p>Select Fabric</p> <p>See page 260</p> <p>C U 1 0 .</p>	<p>Select Frame</p> <p>T Black</p> <p>T</p>
--	---	--	--

COMFORTASK® 5900 Series

GSA SIN 33721



Icon Legend on page 17

H5905



TASK STOOL

Pneumatic
Back Height
Swivel
Adjustable Height Footring
Functions: **A, B, E**
(Function Key on pages 212-213)

DIMENSIONS

Depth:	30	Seat to Floor Height:	21¾-31⅞
Width:	26¾	Footring Width:	20
Height:	49¾	Footring Height:	12-14½
Seat Depth:	18	Usable Seat Depth:	17
Seat Width:	20	Ship Weight:	34
Back Width:	16¼	Cube:	10.4
Back Height:	17¾	COM:	1.0
		Weight Rating:	300 lbs.

FABRIC PRICE CODES

1	\$469	8	\$607
2	\$493	9	\$625
3	\$517	10	\$643
4	\$535	11	\$661
5	\$553	12	\$679
6	\$571	L	—
7	\$589		

NOTES: Available with optional Bell Glides.

H5991



T-ARMS

Fixed Position

DIMENSIONS

Arm Width:	18¾
Height from Seat:	8½
Ship Weight:	6
Cube:	1.0

LIST PRICE

\$88

H5995



ADJUSTABLE HEIGHT ARMS

Functions: **Q**
(Function Key on pages 212-213)

DIMENSIONS

Arm Width:	18¾
Height from Seat:	6½-8¾
Ship Weight:	8
Cube:	0.6

LIST PRICE

\$128

HOW TO SPECIFY

<p>Select Model Number</p> <p>H 5 9 0 5 .</p>	<p>Select Caster/Glide</p> <p>H Black Hard Caster S Black All-Surface Caster (+ \$40)</p> <p>G Bell Glide (+ \$25) <i>Specify for model H5905 only</i></p> <p>H .</p>	<p>Select Fabric</p> <p>See page 260</p> <p>C U 1 0 .</p>	<p>Select Frame</p> <p>T Black</p> <p>T</p>
--	---	--	---

CONVERGENCE®

Want to see more? Scan here
to check out hon.com.



Convergence® Task Chairs shown with
Empower® Height-Adjustable Workstations.

CONVERGENCE®

What happens when support and affordability come together? Convergence. This is the task chair that is as attainable as is it comfortable with customizable features. Lumbar support that adds a little extra lower back comfort. Thick seat cushions to take the stress off the lower body throughout the day. Arm choices that let you decide how much upper body support you want. A breathable mesh back that flexes and responds to your movements. Convergence puts all the features you're looking for into one low-priced task chair.



FEATURES

- Choice of swivel tilt or synchro-tilt control with seat slide.
- Black mesh back is breathable for all-day comfort and support.
- Comfort options include adjustable lumbar support, adjustable arms, seat glide and synchro-tilt.
- Three arm options.
- Two control options.
- Integrated handle on the back makes it easy to move and reposition the chair.
- Hard casters move effortlessly on any surface.
- Black frame sits atop a durable five-star base.
- Warranted for users up to 275 lbs.
- 3" thick seat cushion.

SEATING

CONVERGENCE®

Options



BACK OPTIONS

HCT1MM

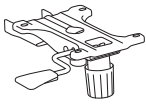

Mid-back

Mesh Task Chair
with Adjustable
Lumbar Support

MECHANISM	CODE	FUNCTIONS	PRICE
	Z1	Swivel-Tilt Control A, E, F, K, L, W	+\$0
	Y1	Limited Synchro-Tilt A, D, E, J, K, L, W	+\$35

(See pages 212-213 for Seating Functions.)

ARM STYLE	CODE	DESCRIPTION	PRICE
	N	Armless	+\$0
	H	Height-Adjustable Arms	+\$55
	A	Height and Width Adjustable Arms	+\$85

CASTERS	CODE	DESCRIPTION	PRICE
	H	Black Hard Caster	+\$0

BACK STYLE	CODE	DESCRIPTION	PRICE
	M	Mesh	+\$0

BASE	CODE	DESCRIPTION	PRICE
	SB	Standard Base	+\$0

LUMBAR	CODE	DESCRIPTION	PRICE
	AL	Adjustable Lumbar	+\$0

FRAME	CODE	DESCRIPTION	PRICE
	T	Black	+\$0

HON BRANDED FABRICS

GRADE 1

Apex
Attire
Centurion
Compass
Contourett
Dapper
Ensemble
Hamilton
Inertia
Optic
Pebble

GRADE 2

Appoint Seating
Blume
Clyde
Dotty
Rush
Seed
Spin
Whisper Vinyl

GRADE 3

In Season
Moxie
Parker
Purl
Quill

For a complete list of fabrics, including partnership fabrics, go to hon.com/fabricsandfinishes.

Reference Fabric Color Combinations on pages 18-22 for color codes and legend on page 19 for lead times. For additional HON to Supply COM fabric grade pricing, go to honready.hon.com and click on the HON to Supply COM link.

CONVERGENCE® Standard Task Chairs

OPEN MARKET



Icon Legend on page 17

HCT1MM



MID-BACK TASK

Mesh Back
Pneumatic
Swivel
Tilt Tension
Tilt Lock
Adjustable Lumbar Support
Functions: **A, E, K, L, W**
(Function Key on pages 212-213)

DIMENSIONS

Depth: 27½
Width: 27¾
Height: 42
Seat Depth: 19
Seat Width: 20
Back Width: 18
Back Height: 22
Adjustable Arms Width: 20
Seat to Floor Height: 15¾-20
Usable Seat Depth: 17-19
Ship Weight: 44
Cube: 5.8
COM: 1.0
Weight Rating: 275 lbs.

FABRIC PRICE CODES

1	\$364	7	\$424
2	\$376	8	\$433
3	\$388	9	\$442
4	\$397	10	\$451
5	\$406	11	\$460
6	\$415	12	\$469

NOTES: Arm width adjustment range is 3" (from 17"-20"). Lumbar adjustment is 3". Seat depth range is only for Y1 control. Seat depth on Z1 control is 19".

HSCASTER

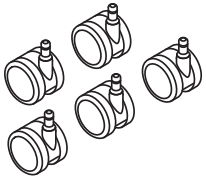

SET OF 5 ALL-SURFACE CASTERS

DIMENSIONS

Size: 60mm
Ship Weight: 2
Cube: 0.1

LIST PRICE

\$59

! Available in Black finish only, no specification needed.

HON Recommendation: HCT1MM.Y1.A.H.M.CU10.AL.SB.T - List Price \$484

SEATING

HOW TO SPECIFY

Select Model Number	Select Control Type	Select Arm Type	Select Caster	Select Back Type	Select Upholstery	Select Lumbar	Select Base	Select Frame
Z1 Swivel-Tilt Control Y1 Simple Synchro-Tilt w/ Seat Slide Control (+ \$35)	N Armless H Height-Adjustable Arms (+ \$55) A Height & Width Adjustable Arms (+ \$85)	H Black Hard Casters	M Mesh	See page 265	AL Adjustable Lumbar	SB Standard Base	T Black	
HCT1MM	Y1	A	H	M	CU10	AL	SB	T



CONVERGENCE® Value Task Chairs

HCAT1MM



MID-BACK TASK VALUE MODEL

Mesh Back

- Pneumatic
- Swivel
- Tilt Tension
- Tilt Lock
- Adjustable Lumbar Support

Functions: **A, E, K, L, W**
(Function Key on pages 212-213)

NOTES: Lumbar adjustment is 3". Seat depth range is only for Y1 control. Seat depth on Z1 control is 19".

DIMENSIONS

Depth:	27½	Adjustable Arms Width:	17-20
Width:	27¾	Seat to Floor Height:	15¾-20
Height:	42	Usable Seat Depth:	17-19
Seat Depth:	19	Ship Weight:	44
Seat Width:	20	Cube:	5.8
Back Width:	18	Weight Rating:	275 lbs.
Back Height:	22		

LIST PRICE

\$420

HSCASTER

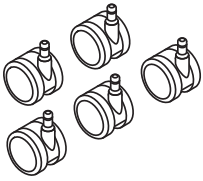

SET OF 5 ALL-SURFACE CASTERS

DIMENSIONS

Size:	60mm
Ship Weight:	2
Cube:	0.1

LIST PRICE

\$59

ⓘ Available in Black finish only, no specification needed.

HON Recommendation: HCAT1MM.Z1.A.H.M.ACCF10.AL.SB.T - List Price \$420

HOW TO SPECIFY

Select Model Number	Select Control Type	Select Arm Type	Select Caster	Select Back Type	Select Upholstery	Select Lumbar	Select Base	Select Frame
Z1 Swivel-Tilt Control Y1 Simple Synchro-Tilt w/ Seat Slide Control (+ \$35)	A Height & Width Adjustable Arms	H Black Hard Casters	M Mesh	ACCF10 Black	AL Adjustable Lumbar	SB Standard Base	T Black	
HCAT1MM	Y1	A	H	M	ACCF10	AL	SB	T

CORRAL™ Contemporary Lounge

OPEN MARKET



Icon Legend on page 17

HVL887



CLUB CHAIR

DIMENSIONS

Depth:	28	Arm Width:	22¼
Width:	31½	Seat to Floor Height:	17⅞
Height:	30½	Usable Seat Depth:	19¾
Seat Depth:	19¾	Ship Weight:	51 Ⓢ
Seat Width:	22¼	Cube:	8.9
Back Width:	22¼	Weight Rating:	250 lbs.
Back Height:	17½		

PRICE CODE

Leather **\$1079**

NOTES: Legs available in Platinum. Legs and back ship unattached. Pair with contemporary occasional tables on page 269. **HON 5-Year Limited Warranty.**

ⓘ Available in SB11 Black Bonded Leather only.

HON Recommendation: HVL887.SB11 - List Price \$1079

HVL888

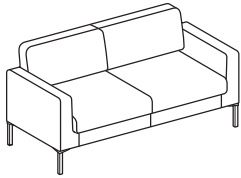

SOFA

DIMENSIONS

Depth:	28	Arm Width:	55
Width:	67	Seat to Floor Height:	17⅞
Height:	30½	Usable Seat Depth:	19¾
Seat Depth:	19¾	Ship Weight:	78
Seat Width:	55	Cube:	18.3
Back Width:	55	Weight Rating:	250 lbs.
Back Height:	17½		

PRICE CODE

Leather **\$1384**

NOTES: Legs available in Platinum. Legs and back ship unattached. Pair with contemporary occasional tables on page 269. **HON 5-Year Limited Warranty.**

ⓘ Available in SB11 Black Bonded Leather only.

HON Recommendation: HVL888.SB11 - List Price \$1384

SEATING

HOW TO SPECIFY

Select
Model Number

Select
Fabric

SB11 Black Bonded Leather

H V L 8 8 7 .

S B 1 1



CONTEMPORARY OCCASIONAL TABLES

HML8851

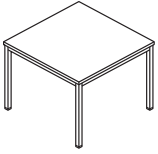

LAMINATE CORNER TABLE DIMENSIONS

Depth:	24	Ship Weight:	24
Width:	24	Cube:	1.7

LIST PRICE

\$216

NOTES: Metal leg occasional tables available in Black laminate. Choose from Corner or Coffee Table options. **HON 5-Year Limited Warranty.**

HON Recommendation: HML8851.P - List Price \$216

HML8852

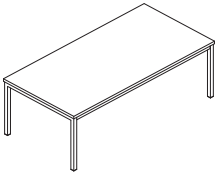

LAMINATE COFFEE TABLE DIMENSIONS

Depth:	24	Ship Weight:	38
Width:	48	Cube:	3.1

LIST PRICE

\$270

NOTES: Metal leg occasional tables available in Black laminate. Choose from Corner or Coffee Table options. **HON 5-Year Limited Warranty.**

HON Recommendation: HML8852.P - List Price \$270

HOW TO SPECIFY

<p>Select Model Number</p>	<p>Select Laminate</p> <p>P Black</p>
<p>H M L 8 8 5 1 .</p>	<p>P</p>

CRIO™ Mesh Chairs

OPEN MARKET



Icon Legend on page 17

HVL581



HIGH-BACK

Pneumatic
Swivel
Tilt
Tilt Tension
Tilt Lock
Height and Width Adjustable
Arms
Adjustable Lumbar

Functions: **A, E, F, K, L, S, W**
(Function Key on pages 212-213)

NOTES: Comfortable and breathable mesh back. Black fabric or Black Bonded Leather. Black frame. Height and width adjustable arms. Adjustable lumbar. **HON 5-Year Limited Warranty.**

HON Recommendation: HVL581.ES10.T - List Price \$409

DIMENSIONS

Depth:	25½	Arm Width:	19⅞
Width:	28¾	Seat to Floor Height:	16½-20¼
Height:	42⅞	Usable Seat Depth:	17¼
Seat Depth:	17¼	Ship Weight:	39.8
Seat Width:	20¼	Cube:	4.8
Back Width:	18½	Weight Rating:	250 lbs.

PRICE CODE

Fabric	\$409
Leather	\$434

HVL582



HIGH-BACK

Pneumatic
Swivel
Tilt
Tilt Tension
Tilt Lock
Asynchronous Control
Seat Glide Mechanism
Adjustable Lumbar
Height and Width Adjustable
Arms

Functions: **A, E, F, L, O, S, W**
(Function Key on pages 212-213)

NOTES: Comfortable and breathable mesh back. Black fabric or Black Bonded Leather. Black frame. Height and width adjustable arms. Seat glide mechanism. Asynchronous control with independent seat and back angle adjustment. Adjustable lumbar. **HON 5-Year Limited Warranty.**

HON Recommendation: HVL582.ES10.T - List Price \$504

DIMENSIONS

Depth:	27½	Arm Width:	19⅞
Width:	28¾	Seat to Floor Height:	20½-22⅞
Height:	43¾	Usable Seat Depth:	17¼
Seat Depth:	17¼	Ship Weight:	50.4
Seat Width:	19⅞	Cube:	6.8
Back Width:	18½	Weight Rating:	250 lbs.

PRICE CODE

Fabric	\$504
Leather	\$529

HVL585



EXECUTIVE BIG AND TALL

Pneumatic
Swivel
Tilt
Tilt Tension
Tilt Lock
Height and Width Adjustable
Arms
Adjustable Lumbar

Functions: **A, E, F, K, L, S, W**
(Function Key on pages 212-213)

NOTES: Large scale model HVL585 will support 450 lbs with normal use. Black fabric. Black frame. Height and width adjustable arms. Adjustable lumbar. **HON 5-Year Limited Warranty.**

ⓘ Available in Black fabric only.

HON Recommendation: HVL585.ES10.T - List Price \$709

DIMENSIONS

Depth:	29⅞	Arm Width:	20½
Width:	28¾	Seat to Floor Height:	17⅞-21¾
Height:	45⅞	Usable Seat Depth:	19⅞
Seat Depth:	19⅞	Ship Weight:	55.4
Seat Width:	22	Cube:	7.2
Back Width:	20⅞	Weight Rating:	450 lbs.

PRICE CODE

Fabric	\$709
---------------	--------------

SEATING

HOW TO SPECIFY

Select
Model Number

H V L 5 8 1 .

Select
Fabric

ES10 Black
SB11 Black Bonded Leather
Available on HVL581 and HVL582 only

E S 1 0 .

Select
Frame

T Black

T



DEFINE™ Executive Chairs

HVL108



HIGH-BACK

Pneumatic
Swivel
Synchro-tilt
Height-adjustable Arms
Functions: **A, E, J, K, Q**
(Function Key on pages 212-213)

DIMENSIONS

Depth:	29¾	Arm Width:	19½
Width:	29¾	Seat to Floor Height:	17⅞-21⅜
Height:	46⅞	Usable Seat Depth:	17½
Seat Depth:	17½	Ship Weight:	47.3
Seat Width:	21	Cube:	7.2
Back Width:	20	Weight Rating:	250 lbs.
Back Height:	26½		

PRICE CODE

Leather \$657

NOTES: Available in Black Bonded Leather. Polished base. Polished arm accents. Height-adjustable arms. **HON 5-Year Limited Warranty.**

HON Recommendation: HVL108.SB11 - List Price \$657

SEATING

HOW TO SPECIFY

Select Model Number	Select Fabric
	SB11 Black Bonded Leather
H V L 1 0 8 .	S B 1 1

ENDORSE® COLLECTION

Want to see more? Scan here
to check out hon.com.



Endorse® Mid-Back Task Chair
shown with Preside® Conference Table.

ENDORSE® COLLECTION

You need inviting, comfy seats up front, and task chairs that support productivity in workstations. Achieve harmony throughout your space with a multi-functional collection of Endorse task seating. Endorse supports the diversity of applications throughout your workplace with sophisticated design. Varied options. Diverse materials. Simply pick the model that suits your space and people. Add the options that fit your needs. Then get ready to Endorse a higher level of productivity.

SEATING



TASK CHAIR FEATURES

- Available in high-, mid- and low-back options.
- Available in three different back materials — upholstered, mesh and plastic outer back.
- Comfort options include adjustable lumbar support, adjustable arms, seat glide, multi-position tilt and synchro-tilt.
- Optional seat slide adjustment adapts to users of various heights.
- Control options include limited synchro-tilt, advanced synchro-tilt, advanced synchro-tilt with independent back angle and weight-activated control.
- Arm options include fixed, armless, height- and width-adjustable and all-adjustable.
- Caster options include hard, All-Surface and roll control.
- Available in hundreds of quality HON fabrics.
- Warranted for users up to 300 lbs.
(450 lbs. for Big and Tall chairs)

BACK OPTIONS

HLEU
HLEUBT - Big & Tall



High-back

Upholstered with Adjustable Lumbar Support

HLWU
HLWUBT - Big & Tall



Mid-back

Upholstered with Adjustable Lumbar Support

HLWM
HLWMBT - Big & Tall

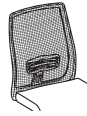

Mid-back

Mesh with Adjustable Lumbar Support

HLTU
HLTSU - Stool



Low-back

Upholstered with Adjustable Lumbar Support

HLTM
HLTSM - Stool



Low-back

Mesh with Adjustable Lumbar Support

HLTP
HLTSP - Stool



Low-back

Upholstered with Plastic Outer Back and Adjustable Lumbar Support

MESH BACK COLOR CODES (no upcharge): Black - **IM** Breeze - **IB** Brownstone - **IK** Charcoal - **IC** Fog - **IF** Regatta - **IR** Titanium - **IT**

MECHANISM

MECHANISM	CODE	FUNCTIONS	PRICE
	S0	Limited Recline Synchro-Tilt A, E, J, K, L	+\$0
	S1	Limited Recline Synchro-Tilt w/ Seat Slider (available on Stools only) A, D, E, J, K, L	+\$20
	Y2	Advanced Synchro-Tilt A, D, E, J, L, W, A-D	+\$65
	Y3	Advanced Synchro-Tilt with Independent Back Angle A, D, E, J, L, W, A-E	+\$105
	Y4	Synchro-Tilt A, D, E, J, L, W, A-D (Big and Tall models only)	+\$0
	W5	Weight-Activated A, D, E, L, W, A-D	+\$150

(See pages 212-213 for Seating Functions.)

BASE

BASE	CODE	DESCRIPTION	PRICE
	SB	Standard Base	+\$0
	PA	Polished Aluminum	+\$110

ARM STYLE





































ARM STYLE	CODE	DESCRIPTION	PRICE
	N	Armless	+\$0
	F	Fixed - Black	+\$65
	A	Height and Width Adjustable Arms	+\$85
	V	All-Adjustable Arms - includes pivot	+\$130
	P	Fixed - Polished Alum.	+\$175

CASTERS

CASTERS	CODE	DESCRIPTION	PRICE
	A	Black All-Surface Caster (High-back and Big and Tall models only)	+\$0
	H	Black Hard Caster	+\$0
	S	Black All-Surface Caster	+\$40
	R	Black Roll Control Caster	+\$50

ENDORSE® Dimensions

TASK DIMENSIONS

MODEL		HLEU	HLWU	HLWM	HLTU	HLTM	HLTP
Overall Width Armless		28½	28½	28½	28½	28½	28½
Overall Width with Arms	A/V	28½	28½	28½	28½	28½	28½
	F/P	28½	28½	28½	28½	28½	28½
Overall Depth		28½	28½	28½	28½	28½	28½
Overall Height	S0	49	45½	45½	42	42	42
	Y2	49¾	46¼	46¼	42¾	42¾	42¾
	Y3	49½	46	46	42½	42½	42½
	W5	49	48¾	48¾	43	43	43
Seat Width		20	20	20	19	19	19
Seat Depth		18½	18½	18½	18¾	18¾	18¾
Usable Seat Depth	S0	17¾	17¾	17¾	17⅝	17⅝	17⅝
	Y2	15½-18	15½-18	15½-18	15½-18	15½-18	15½-18
	Y3	15¼-18¼	15¼-18¼	15¼-18¼	15¼-18¼	15¼-18¼	15¼-18¼
	W5	15½-17¾	15½-17¾	15½-17¾	15½-17¾	15½-17¾	15½-17¾
Seat Height (mechanism)	S0	17-21½	17-21½	17-21½	17-21½	17-21½	17-21½
	Y2	17¾-22¼	17¾-22¼	17¾-22¼	17¾-22¼	17¾-22¼	17¾-22¼
	Y3	17½-22	17½-22	17½-22	17½-22	17½-22	17½-22
	W5	17¼-21¾	17¼-21¾	17¼-21¾	17¼-21¾	17¼-21¾	17¼-21¾
Back Width		21⅝	21¼	19¼	19¾	18	19¾
Back Height		29¾	25	25	22¾	21¼	22¾
Ship Weight Armless	S0	52	43	40	49	41	50
	Y2	57 	48 	45 	54 	46 	56 
	Y3	60 	52 	48 	58 	50 	59 
	W5	56 	47 	44 	54 	45 	55 
Weight with Arms	S0	60	51	48	57	49	58
	Y2	65 	56 	53 	62 	54 	64 
	Y3	68 	60 	56 	66 	58 	67 
	W5	64 	55 	52 	62 	53 	63 
Between Arms	A/V	17½-20	17½-20	17½-20	16¾-19¼	16¾-19¼	16¾-19¼
	F/P	20½	20½	20½	20½	20½	20½
COM		2.0	2.0	1.0	2.0	1.0	2.0
Weight Capacity		300 lbs	300 lbs	300 lbs	300 lbs	300 lbs	300 lbs

BIG & TALL & STOOL DIMENSIONS

MODEL		HLEUBT	HLWUBT	HLWMBT	HLTSU	HLTSM	HLTSP
Overall Width Armless		28½	28½	28½	28½	28½	28½
Overall Width with Arms	A/V	28½	28½	28½	28½	28½	28½
	F/P	28½	28½	28½	28½	28½	28½
Overall Depth		28½	28½	28½	28½	28½	28½
Overall Height	S0/S1	-	-	-	53	53	53
	Y4	49	49	49	-	-	-
Seat Width		23	23	23	19	19	19
Seat Depth	S0/S1	-	-	-	18¾	18¾	18¾
	Y4	20¼	20¼	20¼	-	-	-
Usable Seat Depth	S0	-	-	-	17⅝	17⅝	17⅝
	S1	-	-	-	15¼-18¼	15¼-18¼	15¼-18¼
	Y4	17¾-19¼	17¾-19¼	17¼-18¾	-	-	-
Seat Height (mechanism)	S0/S1	-	-	-	22¾-32¾	22¾-32¾	22¾-32¾
	Y4	17½-22	17½-22	17½-22	-	-	-
Back Width		23¼	23½	22½	19¾	19¾	19¾
Back Height		28¼	25	25¾	22¾	22¾	22¾
Ship Weight Armless	S0	-	-	-	50	42	51
	S1	-	-	-	52	44	53
	Y4	57	57	57	-	-	-
Weight with Arms	S0	-	-	-	58	50	59
	S1	-	-	-	60	52	61
	Y4	65	65	65	-	-	-
Between Arms	A/V	20½-23	20½-23	20½-23	16¾-19¼	16¾-19¼	16¾-19¼
	F/P	23½	23½	23½	20½	20½	20½
COM		2.0	2.0	1.5	2.0	2.0	2.0
Weight Capacity		450 lbs	450 lbs	450 lbs	300 lbs	300 lbs	300 lbs

HON BRANDED FABRICS *(For Seating)*

GRADE 1

Apex
Attire
Centurion
Compass
Contourett
Dapper
Ensemble
Hamilton
Inertia
Optic
Pebble

GRADE 2

Appoint Seating
Blume
Clyde
Dotty
Rush
Seed
Spin Seating
Whisper Vinyl

GRADE 3

In Season
Moxie
Parker
Purl
Quill

For a complete list of fabrics, including partnership fabrics, go to hon.com/fabricsandfinishes.

Reference Fabric Color Combinations on pages 18-22 for color codes and legend on page 19 for lead times. For additional HON to Supply COM fabric grade pricing, go to honready.hon.com and click on the HON to Supply COM link.



HLEU

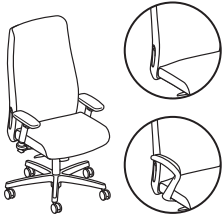

EXECUTIVE HIGH-BACK

Upholstered Back

- Pneumatic
- Swivel
- Synchro-tilt
- Tilt Tension
- Tilt Lock
- Integral Lumbar Support
- Optional Seat Glide

Functions: **A, E, J, K, L, W**

(Function Key on pages 212-213)

! See page 274 for additional specifications and dimensions.

DIMENSIONS

Depth:	31½	Back Width:	21⅝
Width:	31½	Back Height:	29¾
Height:	47¾	Cube:	16.0
Seat Depth:	15¾	COM:	2.0
Seat Width:	19¾	Weight Rating:	300 lbs.

FABRIC PRICE CODES

1	\$860	8	\$1136
2	\$908	9	\$1172
3	\$956	10	\$1208
4	\$992	11	\$1244
5	\$1028	12	\$1280
6	\$1064	L	—
7	\$1100		

HON Recommendation: HLEU.Y2.A.A.CU__SB - List Price \$1010

HOW TO SPECIFY

Select Model Number	Select Control Type	Select Arm Type	Select Caster/Glide	Select Fabric	Select Base
<p>S0 Limited Recline Synchro-Tilt</p> <p>Y2 Advanced Synchro-Tilt (+ \$65)</p> <p>Y3 Synchro-Tilt with Independent Back Angle (+ \$105)</p> <p>W5 Weight-Activated (+ \$150)</p>	<p>N Armless</p> <p>F Fixed Arms - Black (+ \$65)</p> <p>A Height and Width Adjustable Arms (+ \$85)</p> <p>V All-Adjustable Arms (includes pivot) (+ \$130)</p> <p>P Fixed Arms - Polished (+ \$175)</p>	<p>A Black All-Surface Caster</p>	<p>See page 275</p>	<p>SB Standard Base</p> <p>PA Polished Aluminum (+ \$110)</p>	
HLEU	Y2	A	A	CU10	SB



Icon Legend on page 17

HLWU

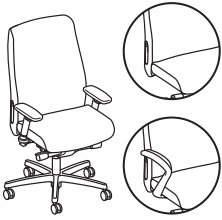

TASK MID-BACK

Upholstered Back

- Pneumatic
- Swivel
- Synchro-tilt
- Tilt Tension
- Tilt Lock
- Integral Lumbar Support
- Optional Seat Glide

Functions: **A, E, J, K, L, W**
(Function Key on pages 212-213)

! See page 274 for additional specifications and dimensions.

DIMENSIONS

Depth:	28½	Back Width:	21¼
Width:	28½	Back Height:	25
Height:	44½	Cube:	10.8
Seat Depth:	15¾	COM:	2.0
Seat Width:	19¾	Weight Rating:	300 lbs.

FABRIC PRICE CODES

1	\$827	8	\$1103
2	\$875	9	\$1139
3	\$923	10	\$1175
4	\$959	11	\$1211
5	\$995	12	\$1247
6	\$1031	L	—
7	\$1067		

HLWM



TASK MID-BACK

4-Way Stretch Back

- Pneumatic
- Swivel
- Synchro-tilt
- Tilt Tension
- Tilt Lock
- Integral Lumbar Support
- Optional Seat Glide

Functions: **A, E, J, K, L, W**
(Function Key on pages 212-213)

NOTES: For Mesh Back models, specify the 4-Way Stretch back option below. Headrest available on Mid-back 4-Way Stretch models only - Black only.

! See page 274 for additional specifications and dimensions.

DIMENSIONS

Depth:	28½	Back Width:	19
Width:	28½	Back Height:	25
Height:	44½	Cube:	10.8
Seat Depth:	15¾	COM:	1.0
Seat Width:	19¾	Weight Rating:	300 lbs.

FABRIC PRICE CODES

1	\$827	8	\$965
2	\$851	9	\$983
3	\$875	10	\$1001
4	\$893	11	\$1019
5	\$911	12	\$1037
6	\$929	L	—
7	\$947		

HON Recommendation: HLWM.Y2.A.H.IM.CU__SB.N - List Price \$977

HOW TO SPECIFY

Select Model Number	Select Control Type	Select Arm Type	Select Caster/Glide	Select Mesh Back	Select Fabric	Select Base	Select Headrest
S0 Limited Recline Y2 Synchro-Tilt Y3 Advanced Synchro-Tilt (+ \$65) Y3 Synchro-Tilt with Independent Back Angle (+ \$105) W5 Weight-Activated (+ \$150)	N Armless F Fixed Arms - Black (+ \$65) A Height and Width Adjustable Arms (+ \$85) V All-Adjustable Arms (includes pivot) (+ \$130) P Fixed Arms - Polished (+ \$175)	H Black Hard Caster S Black All-Surface Caster (+ \$40) R Black Roll Control Caster (+ \$50)	IM Black IB Breeze IK Brownstone IC Charcoal IF Fog IR Regatta IT Titanium <i>Specify the back for Mesh Back models only</i>	See page 275	SB Standard Base PA Polished Aluminum (+ \$110)	N No Headrest HR Headrest (+ \$80) <i>Black only. Specify for model HLWM only</i>	
HLWM	Y2	A	H	IM	CU10	SB	N

ENDORSE®



Icon Legend on page 17

HLTU

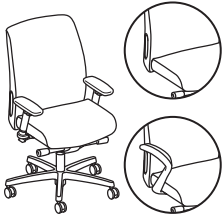

TASK LOW-BACK

Upholstered Back

- Pneumatic
- Swivel
- Synchro-tilt
- Tilt Tension
- Tilt Lock
- Integral Lumbar Support
- Optional Seat Glide

Functions: **A, E, J, K, L, W**
(Function Key on pages 212-213)

! Do not need to specify back option for Upholstered Back models. See page 274 for additional specifications and dimensions.

DIMENSIONS

Depth:	28½	Back Width:	19¾
Width:	28½	Back Height:	22¾
Height:	41¼	Cube:	10.8
Seat Depth:	15½	COM:	2.0
Seat Width:	18¾	Weight Rating:	300 lbs.

FABRIC PRICE CODES

1	\$769	8	\$1045
2	\$817	9	\$1081
3	\$865	10	\$1117
4	\$901	11	\$1153
5	\$937	12	\$1189
6	\$973	L	—
7	\$1009		

HLTM



TASK LOW-BACK

4-Way Stretch Back

- Pneumatic
- Swivel
- Synchro-tilt
- Tilt Tension
- Tilt Lock
- Integral Lumbar Support
- Optional Seat Glide

Functions: **A, E, J, K, L, W**
(Function Key on pages 212-213)

NOTES: For Mesh Back models, specify the 4-Way Stretch back option below.

! See page 274 for additional specifications and dimensions.

DIMENSIONS

Depth:	28½	Back Width:	17¾
Width:	28½	Back Height:	21¾
Height:	40¼	Cube:	10.8
Seat Depth:	15½	COM:	1.0
Seat Width:	18¾	Weight Rating:	300 lbs.

FABRIC PRICE CODES

1	\$769	8	\$907
2	\$793	9	\$925
3	\$817	10	\$943
4	\$835	11	\$961
5	\$853	12	\$979
6	\$871	L	—
7	\$889		

HLTP

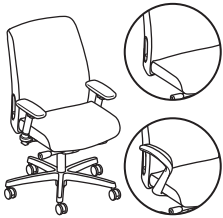

TASK LOW-BACK

Plastic Outer Back

- Pneumatic
- Swivel
- Synchro-tilt
- Tilt Tension
- Tilt Lock
- Integral Lumbar Support
- Optional Seat Glide

Functions: **A, E, J, K, L, W**
(Function Key on pages 212-213)

! Do not need to specify back option for Plastic Outer Back models. See page 274 for additional specifications and dimensions.

DIMENSIONS

Depth:	28½	Back Width:	19¾
Width:	28½	Back Height:	22¾
Height:	41¼	Cube:	10.8
Seat Depth:	15½	COM:	2.0
Seat Width:	18¾	Weight Rating:	300 lbs.

FABRIC PRICE CODES

1	\$833	8	\$1109
2	\$881	9	\$1145
3	\$929	10	\$1181
4	\$965	11	\$1217
5	\$1001	12	\$1253
6	\$1037	L	—
7	\$1073		

HON Recommendation: HLTM.Y2.A.H.IM.CU__SB - List Price \$919

SEATING

HOW TO SPECIFY

Select Model Number	Select Control Type	Select Arm Type	Select Caster/Glide	Select Mesh Back	Select Fabric	Select Base
<p>S0 Limited Recline Synchro-Tilt</p> <p>Y2 Advanced Synchro-Tilt (+ \$65)</p> <p>Y3 Synchro-Tilt with Independent Back Angle (+ \$105)</p> <p>W5 Weight-Activated (+ \$150)</p>	<p>N Armless</p> <p>F Fixed Arms - Black (+ \$65)</p> <p>A Height and Width Adjustable Arms (+ \$85)</p> <p>V All-Adjustable Arms (includes pivot) (+ \$130)</p> <p>P Fixed Arms - Polished (+ \$175)</p>	<p>H Black Hard Caster</p> <p>S Black All-Surface Caster (+ \$40)</p> <p>R Black Roll Control Caster (+ \$50)</p>	<p>4-Way Stretch options</p> <p>IM Black</p> <p>IB Breeze</p> <p>IK Brownstone</p> <p>IC Charcoal</p> <p>IF Fog</p> <p>IR Regatta</p> <p>IT Titanium</p> <p><i>Specify the back for Mesh Back models only</i></p>	See page 275	<p>SB Standard Base</p> <p>PA Polished Aluminum (+ \$110)</p>	
HLTM	Y2	A	H	IM	CU10	SB



HLWUBT

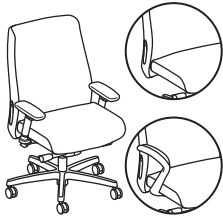

TASK MID-BACK

Big and Tall Upholstered Back

- Pneumatic
- Seat-glide
- Swivel
- Synchro-tilt
- Tilt Lock
- Side Tilt Tension
- Integral Lumbar Support

Functions: **A, D, E, A-D, J, L, W**
(Function Key on pages 212-213)

! Do not need to specify back option for Upholstered Back models.

DIMENSIONS

Depth:	31½	Adjustable Arms Width:	21½-23¾
Width:	31½	Fixed Arms Width:	24
Height:	44⅝	Seat to Floor Height:	18-22
Seat Depth:	21	Usable Seat Depth:	17¾-19¼
Seat Width:	23	Ship Weight:	65
Back Width:	23½	Cube:	15.3
Back Height:	25	COM:	2.0
		Weight Rating:	450 lbs.

FABRIC PRICE CODES

1	\$1374	8	\$1650
2	\$1422	9	\$1686
3	\$1470	10	\$1722
4	\$1506	11	\$1758
5	\$1542	12	\$1794
6	\$1578	L	—
7	\$1614		

HLWMBT

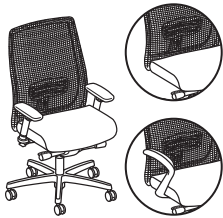

TASK MID-BACK

Big and Tall 4-Way Stretch Back

- Pneumatic
- Seat-glide
- Swivel
- Synchro-tilt
- Tilt Lock
- Side Tilt Tension
- Integral Lumbar Support

Functions: **A, D, E, A-D, J, L, W**
(Function Key on pages 212-213)

NOTES: For Mesh Back models, specify the 4-Way Stretch back option below. Headrest available on Mid-back 4-Way Stretch models only - Black only.

DIMENSIONS

Depth:	31½	Adjustable Arms Width:	21½-23¾
Width:	31½	Fixed Arms Width:	24
Height:	44⅝	Seat to Floor Height:	18-22
Seat Depth:	21	Usable Seat Depth:	17¼-18¾
Seat Width:	23	Ship Weight:	75
Back Width:	22½	Cube:	15.3
Back Height:	25¾	COM:	1.5
		Weight Rating:	450 lbs.

FABRIC PRICE CODES

1	\$1374	8	\$1581
2	\$1410	9	\$1608
3	\$1446	10	\$1635
4	\$1473	11	\$1662
5	\$1500	12	\$1689
6	\$1527	L	—
7	\$1554		

HLEUBT

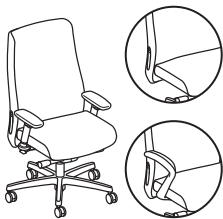

EXECUTIVE HIGH-BACK

Big and Tall Upholstered Back

- Pneumatic
- Seat-glide
- Swivel
- Synchro-tilt
- Tilt Lock
- Side Tilt Tension
- Integral Lumbar Support

Functions: **A, D, E, A-D, J, L, W**
(Function Key on pages 212-213)

! Executive High-back Big and Tall models are available with an upholstered back only.

DIMENSIONS

Depth:	31½	Adjustable Arms Width:	21½-23¾
Width:	31½	Fixed Arms Width:	24
Height:	46⅝	Seat to Floor Height:	18-22
Seat Depth:	21	Usable Seat Depth:	17¾-19¼
Seat Width:	23	Ship Weight:	74
Back Width:	23¼	Cube:	16.0
Back Height:	28¼	COM:	2.0
		Weight Rating:	450 lbs.

FABRIC PRICE CODES

1	\$1407	8	\$1683
2	\$1455	9	\$1719
3	\$1503	10	\$1755
4	\$1539	11	\$1791
5	\$1575	12	\$1827
6	\$1611	L	—
7	\$1647		

HON Recommendation: HLWMBT.Y4.A.A.IM.CU__SB.N - List Price \$1459

HOW TO SPECIFY

Select Model Number	Select Control Type	Select Arm Type	Select Caster/Glide	Select Mesh Back	Select Fabric	Select Base	Select Headrest
HLWMBT	Y4 <i>Y4 is the only control option for the Big and Tall models</i>	N Armless F Fixed Arms - Black (+ \$65) A Height and Width Adjustable Arms (+ \$85) V All-Adjustable Arms (includes pivot) (+ \$130) P Fixed Arms - Polished (+ \$175)	A Black All-Surface Caster	4-Way Stretch option <i>Black only</i> IM Black <i>Specify the back for Mesh Back models only</i>	See page 275	SB Standard Base	N No Headrest HR Headrest (+ \$80) <i>Black only. Specify for model HLWMBT only</i>
HLWMBT	Y4	A	A	IM	CU10	SB	N



HLTSU



STOOL

Upholstered Back

Pneumatic
Swivel
Synchro-tilt
Tilt Tension
Tilt Lock
Integral Lumbar Support

Functions: **A, E, J, K, L, W**
(Function Key on pages 212-213)

DIMENSIONS

Depth: 28½" Back Width: 19¾"
Width: 28½" Back Height: 22¾"
Height: 53½" Cube: 10.8
Seat Depth: 15½" COM: 2.0
Seat Width: 18¾" Weight Rating: 300 lbs.

FABRIC PRICE CODES

1	\$918	8	\$1194
2	\$966	9	\$1230
3	\$1014	10	\$1266
4	\$1050	11	\$1302
5	\$1086	12	\$1338
6	\$1122	L	—
7	\$1158		

Do not need to specify back option for Upholstered Back models. See page 274 for additional specifications and dimensions.

HLTSM



STOOL

4-Way Stretch Back

Pneumatic
Swivel
Synchro-tilt
Tilt Tension
Tilt Lock
Integral Lumbar Support

Functions: **A, E, J, K, L, W**
(Function Key on pages 212-213)

DIMENSIONS

Depth: 28½" Back Width: 17¾"
Width: 28½" Back Height: 21¾"
Height: 52½" Cube: 10.8
Seat Depth: 15½" COM: 1.0
Seat Width: 18¾" Weight Rating: 300 lbs.

FABRIC PRICE CODES

1	\$918	8	\$1056
2	\$942	9	\$1074
3	\$966	10	\$1092
4	\$984	11	\$1110
5	\$1002	12	\$1128
6	\$1020	L	—
7	\$1038		

NOTES: For Mesh Back models, specify the 4-Way Stretch back option below. See page 274 for additional specifications and dimensions.

HLTSP



STOOL

Plastic Outer Back

Pneumatic
Swivel
Synchro-tilt
Tilt Tension
Tilt Lock
Integral Lumbar Support

Functions: **A, E, J, K, L, W**
(Function Key on pages 212-213)

DIMENSIONS

Depth: 28½" Back Width: 19¾"
Width: 28½" Back Height: 22¾"
Height: 52½" Cube: 10.8
Seat Depth: 15½" COM: 2.0
Seat Width: 18¾" Weight Rating: 300 lbs.

FABRIC PRICE CODES

1	\$982	8	\$1258
2	\$1030	9	\$1294
3	\$1078	10	\$1330
4	\$1114	11	\$1366
5	\$1150	12	\$1402
6	\$1186	L	—
7	\$1222		

Do not need to specify back option for Outer Back models. See page 274 for additional specifications and dimensions.

HON Recommendation: HLTSM.S1.A.H.IM.CU__SB - List Price \$1023

HOW TO SPECIFY

Select Model Number	Select Control Type	Select Arm Type	Select Caster/Glide	Select Mesh Back	Select Fabric	Select Base
HLTSM	<p>S0 Limited Recline Synchro-Tilt</p> <p>S1 Limited Recline Synchro-Tilt w/ Seat Slider (+ \$20)</p>	<p>N Armless</p> <p>F Fixed Arms - Black (+ \$65)</p> <p>A Height and Width Adjustable Arms (+ \$85)</p> <p>V All-Adjustable Arms (includes pivot) (+ \$130)</p> <p>P Fixed Arms - Polished (+ \$175)</p>	<p>H Black Hard Caster</p> <p>S Black All-Surface Caster (+ \$40)</p> <p>R Black Roll Control Caster (+ \$50)</p>	<p>4-Way Stretch options</p> <p>IM Black</p> <p>IB Breeze</p> <p>IK Brownstone</p> <p>IC Charcoal</p> <p>IF Fog</p> <p>IR Regatta</p> <p>IT Titanium</p> <p><i>Specify the back for Mesh Back models only</i></p>	See page 275	<p>SB Standard Base</p> <p>PA Polished Aluminum (+ \$110)</p>
HLTSM	S1	A	H	IM	CU10	SB



Icon Legend on page 17

HL2DARM



ADJUSTABLE T-ARMS

Height and Width
Functions: **S**
(Function Key on pages 212-213)

DIMENSIONS

Adjustable Arms Width: 16¾-19¼
Height from Seat: 7¼-11
Ship Weight: 8
Cube: 1.0

LIST PRICE

\$138

ⓘ Available in Black only. No need to specify.

HL4DARM

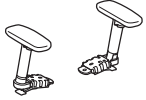

ALL-ADJUSTABLE ARMS

Height, Width, Depth and Pivot

DIMENSIONS

Adjustable Arms Width: 16¾-19¼
Height from Seat: 7¼-11
Ship Weight: 8
Cube: 1.0

LIST PRICE

\$185

ⓘ Available in Black only. No need to specify.

HI2FHA



FIXED HEIGHT ARMS

DIMENSIONS

Arm Width: 20
Height from Seat: 9½
Ship Weight: 7
Cube: 1.0

LIST PRICE

\$122

HIPAA

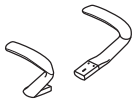

POLISHED ALUMINUM ARMS

Fixed Height

DIMENSIONS

Arm Width: 20
Height from Seat: 9½
Ship Weight: 10
Cube: 1.0

LIST PRICE

\$201

HLMSHHR



MESH HEADREST

DIMENSIONS

Mesh Width: 12
Mesh Height: 6
Ship Weight: 3
Cube: 1.0

QA DIMENSIONS

(Attachment Mechanism)

Width: 12
Depth: 6
Height: 12

LIST PRICE

\$153

ⓘ Available in Black Mesh (IM) only. For use with Mesh Mid-back models only.

HSCASTER

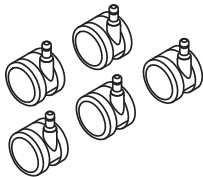

SET OF 5 ALL-SURFACE CASTERS

DIMENSIONS

Size: 60mm
Ship Weight: 2
Cube: 0.1

LIST PRICE

\$59

ⓘ Available in Black finish only, no specification needed.

OPEN MARKET

ENTIRE™ Mesh Chairs

OPEN MARKET



Icon Legend on page 17

HVL541



HIGH-BACK

Pneumatic
Swivel
Tilt
Tilt Tension
Tilt Lock
Adjustable Lumbar
Height-adjustable Arms

Functions: **A, E, F, K, L, Q, W**
(Function Key on pages 212-213)

DIMENSIONS

Depth:	28 ³ / ₈	Arm Width:	19 ³ / ₄
Width:	28 ³ / ₈	Seat to Floor Height:	17 ³ / ₄ -22 ¹ / ₂
Height:	43 ³ / ₈	Usable Seat Depth:	19 ¹ / ₄
Seat Depth:	19 ¹ / ₄	Ship Weight:	44
Seat Width:	19 ⁵ / ₈	Cube:	4.0
Back Width:	16 ³ / ₄	Weight Rating:	250 lbs.
Back Height:	22 ³ / ₄		

PRICE CODE

Fabric **\$467**

NOTES: Comfortable and breathable mesh back. Black fabric seat. Black frame. Height-adjustable arms. **HON 5-Year Limited Warranty.**

HON Recommendation: HVL541.LH10 - List Price \$467

SEATING

HOW TO SPECIFY

Select
Model Number

H V L 5 4 1 .

Select
Fabric

LH10 Black Fabric

L H 1 0



Icon Legend on page 17

EXPOSURE™ Mesh Chairs

HVL721



HIGH-BACK

Pneumatic
Swivel
Synchronized Tilt
Tilt Tension
Tilt Lock
Seat Glide Mechanism
Adjustable Lumbar
Height and Width Adjustable
Arms

Functions: **A, D, E, J, K, L, S, W**
(Function Key on pages 212-213)

DIMENSIONS

Depth:	26¾	Arm Width:	16½-18¾
Width:	26½	Seat to Floor Height:	18¼-22¾
Height:	42½	Usable Seat Depth:	17½-19½
Seat Depth:	17½-19½	Ship Weight:	40
Seat Width:	19½	Cube:	5.5
Back Width:	18½	Weight Rating:	250 lbs.
Back Height:	24¼		

PRICE CODE

Fabric **\$641**

NOTES: Available in Black fabric with Black accents. Comfortable and breathable mesh back. Adjustable seat glide mechanism. Height and width adjustable arms. Adjustable lumbar support. **HON 5-Year Limited Warranty.**

HON Recommendation: HVL721.LH10 - List Price \$641

HOW TO SPECIFY

Select Model Number	Select Fabric
	LH10 Black Fabric
H V L 7 2 1 .	L H 1 0



Flock® Seating and Tables.

FLOCK®

Break away. Come together. Wherever people migrate within a space, Flock is designed to support their needs. With a full collection of modular and comfortable seating elements and coordinating collaborative tables that work seamlessly together, you can make the most of every square inch of your space. Modular lounge chairs and ottomans stand alone or combine to create large arrangements. Multi-purpose stools and chairs add comfort to open spaces. Collaborative tables that bring the whole group together. Flock helps people interact with each other, challenge one another, and receive the support they need.

SEATING



CHAIR FEATURES

- Round and square lounge chairs are fully-upholstered.
- The contemporary aesthetic easily matches a variety of surroundings.
- Support everything from one-on-one conversations to large meetings.
- Choose from four leg options — standard, tapered round, tapered square, hard casters, or a 4-star base.
- Swivel, X-, or 4-star base options include return-to-center feature.
- Available in hundreds of quality HON fabrics.
- Warranted for users up to 300 lbs.

COLLABORATIVE TABLES

- Choose from round, square, rectangle or racetrack shaped table tops.
- Optional grommets neatly route cords.
- Bases available in disc, T-leg and X-leg styles.
- Choose bases with or without footings.

MODEL OPTIONS

HFLSC1
HFLSC1DF - Multi-Fabric

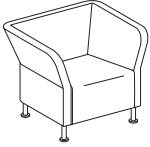

Lounge Chair
Square

HFLRC1
HFLRC1DF - Multi-Fabric

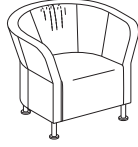

Lounge Chair
Round

HFLMC1
HFLMC1DF - Multi-Fabric

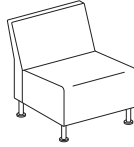

Modular Chair

HFLML1
HFLML1DF - Multi-Fabric

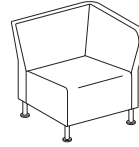

Modular
Left End

HFLMR1
HFLMR1DF - Multi-Fabric

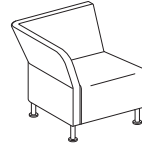

Modular
Right End

HFLCC1
HFLCC1DF - Multi-Fabric

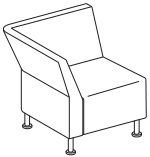

True Chair
Corner

HFLW145
HFLW145DF - Multi-Fabric

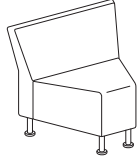

Wedge
Inside

HFLW045
HFLW045DF - Multi-Fabric



Wedge
Outside

HFL450

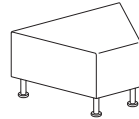

Wedge Ottoman

HFLSC1S
HFLSC1SDF - Multi-Fabric

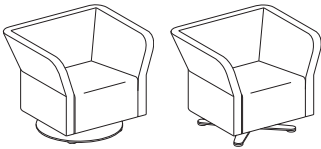

Square Lounge Chair
Swivel Base or X-Base

HFLRC1S
HFLRC1SDF - Multi-Fabric

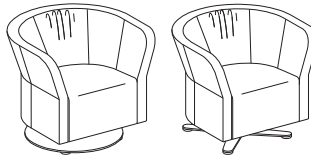

Round Lounge Chair
Swivel Base or X-Base

HFLMC1S
HFLMC1SDF - Multi-Fabric

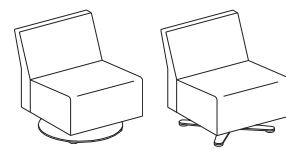

Modular Chair
Swivel Base or X-Base

LEG STYLE



CODE	DESCRIPTION	PRICE
L	Standard Leg	+\$0



TS	Tapered Square	+\$0
-----------	----------------	-------------



TR	Tapered Round	+\$0
-----------	---------------	-------------



H	Hard Casters	+\$0
----------	--------------	-------------

LEG COLOR

CODE	DESCRIPTION	PRICE
PR8	Textured Silver	+\$0
P7A	Textured Charcoal	+\$0

**Specify PR8 & P7A for Standard Legs and Tapered Round & Tapered Square Legs only*

T	Black Hard Caster	+\$0
----------	-------------------	-------------

**Specify for Hard Caster option only*

FLOCK® Options

MODEL OPTIONS

HFLB2

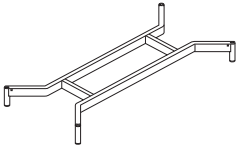

Two-Seat Base Frame

HFLB3

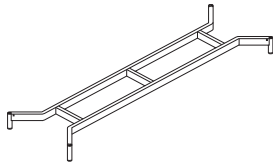

Three-Seat Base Frame

HTSSRD

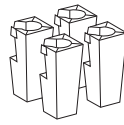

Tapered Square
Leg - Shroud Pack

COMPATIBLE MODELS

HFLMC1
HFLMC1DF - Multi-Fabric



Modular Chair

HFLML1
HFLML1DF - Multi-Fabric

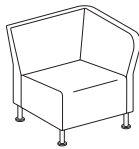

Modular
Left End

HFLMR1
HFLMR1DF - Multi-Fabric

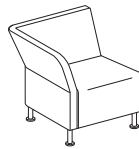

Modular
Right End

HFLCC1
HFLCC1DF - Multi-Fabric

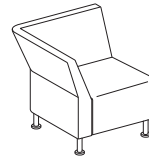

True Chair
Corner

HFLSO1

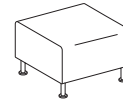

Square Ottoman

LEG STYLE



CODE	DESCRIPTION	PRICE
RS	Round Straight Leg	+\$0

Available in the following finishes:

PR8	Textured Silver
P7A	Textured Charcoal



TS	Tapered Square	+\$75
-----------	----------------	--------------

Available in the following finishes:

PR8	Textured Silver
P7A	Textured Charcoal

HON BRANDED FABRICS

GRADE 1	GRADE 2	GRADE 3	GRADE L
Apex	Appoint Seating	In Season	Denver Leather*
Attire	Blume	Moxie	
Centurion	Clyde	Parker	
Compass	Dotty	Purl	
Contourett	Rush	Quill	
Dapper	Seed		
Ensemble	Spin Seating		
Hamilton	Whisper Vinyl		
Inertia			
Optic			
Pebble			

For a complete list of fabrics, including partnership fabrics, go to hon.com/fabricsandfinishes.

Flock® chair model HFLRC1 has fabric limitations, please see the Flock® seating pages 288-297 for details.

Reference Fabric Color Combinations on pages 18-22 for color codes and legend on page 19 for lead times.

*Denver Leather (SS) may not be available on every model within a specific series, please refer to the model's page for details.

❗ Due to the inherent characteristics of upholstery materials, the seat of Flock® may become more relaxed to show wrinkles over time.

FLOCK® ROUND LOUNGE HFLRC1/DF HON BRANDED FABRICS

GRADE 1	GRADE 2	GRADE 3	GRADE L
Apex	Appoint Seating	In Season	Denver Leather**
Centurion	Blume	Moxie	
Compass	Clyde	Parker	
Contourett	Rush	Purl	
Dapper	Seed*	Quill	
Ensemble	Spin Seating*		
Hamilton	Whisper Vinyl		
Inertia			
Optic			
Pebble			

For a complete list of fabrics, including partnership fabrics, go to hon.com/fabricsandfinishes.

Reference Fabric Color Combinations on pages 18-22 for color codes and legend on page 19 for lead times.

*Available on seat only.

**Denver Leather (SS) may not be available on every model within a specific series, please refer to the model's page for details.

❗ Due to the inherent characteristics of upholstery materials, the seat of Flock® may become more relaxed to show wrinkles over time.



HFLSC1

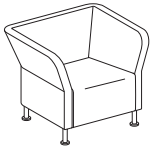

LOUNGE CHAIR

Square

DIMENSIONS

Depth:	28½	Arm Width:	27½
Width:	34¼	Seat to Floor Height:	17
Height:	28	Usable Seat Depth:	20½
Seat Depth:	20½	Ship Weight:	79
Seat Width:	21½	Cube:	21.9
Back Width:	21½	COM:	5.0
Back Height:	18½	Weight Rating:	300 lbs.

FABRIC PRICE CODES

1	\$1973	8	\$2594
2	\$2081	9	\$2675
3	\$2189	10	\$2756
4	\$2270	11	\$2837
5	\$2351	12	\$2918
6	\$2432	L	\$2873
7	\$2513		

! Leg options – Standard Leg (L), Tapered Square (TS) and Tapered Round (TR) are available in Textured Silver (PR8) and Textured Charcoal (P7A) only. Hard Casters (H) are available on Black (T) only.

HFLRC1

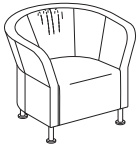

Due to the inherent design of the Round Lounge chair, material gathers will be present in the back.

LOUNGE CHAIR

Round

DIMENSIONS

Depth:	29	Arm Width:	27½
Width:	33½	Seat to Floor Height:	17
Height:	28	Usable Seat Depth:	20½
Seat Depth:	20½	Ship Weight:	57
Seat Width:	20½	Cube:	21.9
Back Width:	20½	Weight Rating:	300 lbs.
Back Height:	18½		

FABRIC PRICE CODES

1	\$2061	8	\$2613
2	\$2157	9	\$2685
3	\$2253	10	\$2757
4	\$2325	11	\$2829
5	\$2397	12	\$2901
6	\$2469	L	\$2861
7	\$2541		

! Round Lounge models HFLRC1 / HFLRC1DF are offered in select fabrics; for availability, please see the Fabric Matrix on page 287. Also approved in limited Partnership Fabrics. Leg options – Standard Leg (L), Tapered Square (TS) and Tapered Round (TR) are available in Textured Silver (PR8) and Textured Charcoal (P7A) only. Hard Casters (H) are available on Black (T) only.
! Customer's Own Material (COM) is not available on Flock® model HFLRC1.

HON Recommendation: HFLSC1.TS.PNS___.PR8 - List Price \$2081

HOW TO SPECIFY

<p>Select Model Number</p> <p>HFLSC1</p>	<p>Select Leg Option</p> <p>L Standard Leg TS Tapered Square TR Tapered Round H Hard Casters</p> <p>TS</p>	<p>Select Fabric</p> <p>See page 287</p> <p>PNS007</p>	<p>Select Leg Color</p> <p>PR8 Textured Silver P7A Textured Charcoal</p> <p><i>Specify for Standard, Tapered Round and Tapered Square legs only</i></p> <p>T Black Hard Caster <i>Specify for Hard Caster option only</i></p> <p>PR8</p>
---	---	---	---



HFLMC1

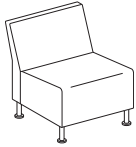

MODULAR CHAIR

DIMENSIONS

Depth:	28½	Seat to Floor Height:	17
Width:	25	Usable Seat Depth:	20½
Height:	28	Ship Weight:	54
Seat Depth:	20½	Cube:	21.9
Seat Width:	25	COM:	3.0
Back Width:	25	Weight Rating:	300 lbs.
Back Height:	18½		

FABRIC PRICE CODES

1	\$1446	8	\$1860
2	\$1518	9	\$1914
3	\$1590	10	\$1968
4	\$1644	11	\$2022
5	\$1698	12	\$2076
6	\$1752	L	\$2046
7	\$1806		

ⓘ Leg options – Standard Leg (L), Tapered Square (TS) and Tapered Round (TR) are available in Textured Silver (PR8) and Textured Charcoal (P7A) only. Hard Casters (H) are available on Black (T) only.

HFLML1

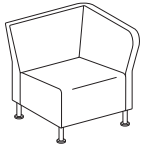

MODULAR

Left End

DIMENSIONS

Depth:	28½	Seat to Floor Height:	17
Width:	28½	Usable Seat Depth:	20½
Height:	28	Ship Weight:	72
Seat Depth:	20½	Cube:	21.9
Seat Width:	22¼	COM:	4.0
Back Width:	22¼	Weight Rating:	300 lbs.
Back Height:	18½		

FABRIC PRICE CODES

1	\$1706	8	\$2258
2	\$1802	9	\$2330
3	\$1898	10	\$2402
4	\$1970	11	\$2474
5	\$2042	12	\$2546
6	\$2114	L	\$2506
7	\$2186		

ⓘ Leg options – Standard Leg (L), Tapered Square (TS) and Tapered Round (TR) are available in Textured Silver (PR8) and Textured Charcoal (P7A) only. Hard Casters (H) are available on Black (T) only.

HFLMR1



MODULAR

Right End

DIMENSIONS

Depth:	28½	Seat to Floor Height:	17
Width:	28½	Usable Seat Depth:	20½
Height:	28	Ship Weight:	72
Seat Depth:	20½	Cube:	21.9
Seat Width:	22¼	COM:	4.0
Back Width:	22¼	Weight Rating:	300 lbs.
Back Height:	18½		

FABRIC PRICE CODES

1	\$1706	8	\$2258
2	\$1802	9	\$2330
3	\$1898	10	\$2402
4	\$1970	11	\$2474
5	\$2042	12	\$2546
6	\$2114	L	\$2506
7	\$2186		

ⓘ Leg options – Standard Leg (L), Tapered Square (TS) and Tapered Round (TR) are available in Textured Silver (PR8) and Textured Charcoal (P7A) only. Hard Casters (H) are available on Black (T) only.

HON Recommendation: HFLMC1.TS.PNS___.PR8 - List Price \$1518

HOW TO SPECIFY

<p>Select Model Number</p> <p>H F L M C 1 .</p>	<p>Select Leg Option</p> <p>L Standard Leg TS Tapered Square TR Tapered Round H Hard Casters</p> <p>T S .</p>	<p>Select Fabric</p> <p>See page 287</p> <p>P N S 0 0 7 .</p>	<p>Select Leg Color</p> <p>PR8 Textured Silver P7A Textured Charcoal</p> <p><i>Specify for Standard, Tapered Round and Tapered Square legs only</i></p> <p>T Black Hard Caster <i>Specify for Hard Caster option only</i></p> <p>P R 8</p>
--	---	--	---



HFLCC1

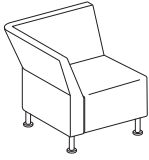

TRUE CORNER CHAIR

DIMENSIONS

Depth:	28½	Seat to Floor Height:	17
Width:	28½	Usable Seat Depth:	20½
Height:	28	Ship Weight:	60
Seat Depth:	20½	Cube:	21.9
Seat Width:	20½	COM:	4.0
Back Width:	22¼	Weight Rating:	300 lbs.
Back Height:	18½		

FABRIC PRICE CODES

1	\$1698	8	\$2482
2	\$1794	9	\$2606
3	\$1890	10	\$2730
4	\$1986	11	\$2854
5	\$2110	12	\$2978
6	\$2234	L	\$2498
7	\$2358		

! Leg options – Standard Leg (L), Tapered Square (TS) and Tapered Round (TR) are available in Textured Silver (PR8) and Textured Charcoal (P7A) only.

HFLWI45

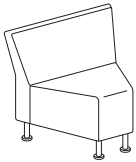

INSIDE WEDGE

DIMENSIONS

Depth:	26¼	Seat to Floor Height:	17
Width:	31½	Usable Seat Depth:	19
Height:	28	Ship Weight:	45
Seat Depth:	19½	Cube:	21.9
Seat Width:	25¾	COM:	3.0
Back Width:	31½	Weight Rating:	300 lbs.
Back Height:	18½		

FABRIC PRICE CODES

1	\$1696	8	\$2480
2	\$1792	9	\$2604
3	\$1888	10	\$2728
4	\$1984	11	\$2852
5	\$2108	12	\$2976
6	\$2232	L	\$2496
7	\$2356		

! Leg options – Standard Leg (L), Tapered Square (TS) and Tapered Round (TR) are available in Textured Silver (PR8) and Textured Charcoal (P7A) only.

HFLWO45

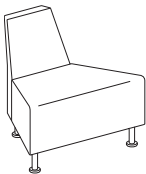

OUTSIDE WEDGE

DIMENSIONS

Depth:	26¼	Seat to Floor Height:	17
Width:	32	Usable Seat Depth:	19
Height:	28	Ship Weight:	35
Seat Depth:	19½	Cube:	21.9
Seat Width:	32	COM:	3.0
Back Width:	16¼	Weight Rating:	300 lbs.
Back Height:	18½		

FABRIC PRICE CODES

1	\$1696	8	\$2480
2	\$1792	9	\$2604
3	\$1888	10	\$2728
4	\$1984	11	\$2852
5	\$2108	12	\$2976
6	\$2232	L	\$2496
7	\$2356		

! Leg options – Standard Leg (L), Tapered Square (TS) and Tapered Round (TR) are available in Textured Silver (PR8) and Textured Charcoal (P7A) only.

HON Recommendation: HFLCC1.TS.PNS__PR8 - List Price \$1698

HOW TO SPECIFY

<p>Select Model Number</p> <p>HFLCC1</p>	<p>Select Leg Option</p> <p>L Standard Leg TS Tapered Square TR Tapered Round</p> <p>TS</p>	<p>Select Fabric</p> <p>See page 287</p> <p>PNS007</p>	<p>Select Leg Color</p> <p>PR8 Textured Silver P7A Textured Charcoal</p> <p><i>Specify for Standard, Tapered Round and Tapered Square legs only</i></p> <p>PR8</p>
---	--	---	---



HFL450

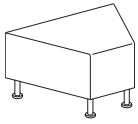

WEDGE OTTOMAN

DIMENSIONS

Depth:	23½	Usable Seat Depth:	23½
Width:	32	Ship Weight:	33
Height:	17	Cube:	12.6
Seat Depth:	23½	COM:	2.0
Seat Width:	32	Weight Rating:	300 lbs.
Seat to Floor Height:	17		

FABRIC PRICE CODES

1	\$833	8	\$1225
2	\$881	9	\$1287
3	\$929	10	\$1349
4	\$977	11	\$1411
5	\$1039	12	\$1473
6	\$1101	L	\$1233
7	\$1163		

ⓘ Leg options – Standard Leg (L), Tapered Square (TS) and Tapered Round (TR) are available in Textured Silver (PR8) and Textured Charcoal (P7A) only.

HFLS01

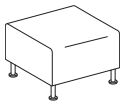

OTTOMAN

Square

DIMENSIONS

Depth:	25	Ship Weight:	30.0
Width:	25	Cube:	7.5
Height:	17	COM:	2.0
Seat Depth:	25	Weight Rating:	300 lbs.
Seat Width:	25		

FABRIC PRICE CODES

1	\$845	8	\$1121
2	\$893	9	\$1157
3	\$941	10	\$1193
4	\$977	11	\$1229
5	\$1013	12	\$1265
6	\$1049	L	\$1245
7	\$1085		

ⓘ Leg options – Standard Leg (L), Tapered Square (TS) and Tapered Round (TR) are available in Textured Silver (PR8) and Textured Charcoal (P7A) only. Hard Casters (H) are available on Black (T) only.

ⓘ While the top surface of the ottoman is flat, modular models (pages 289-290 and 294-296) have a slight angle to their seats. Therefore, there will not be alignment between these units when placed side-by-side.

HFLGANG



GANGING BRACKET

For Flock® Modular Seating Models

- Can be used for in-line ganging ONLY
- Use bracket set to connect two models. Do not connect more than four models.
- No specification required for bracket

DIMENSIONS

Ship Weight:	0.5
Cube:	0.1

LIST PRICE

\$37

HON Recommendation: HFLS01.TS.PNS__PR8 - List Price \$893

HOW TO SPECIFY

<p>Select Model Number</p> <p>H F L S 0 1 .</p>	<p>Select Leg Option</p> <p>L Standard Leg TS Tapered Square TR Tapered Round H Hard Casters</p> <p>T S .</p>	<p>Select Fabric</p> <p>See page 287</p> <p>P N S 0 0 7 .</p>	<p>Select Leg Color</p> <p>PR8 Textured Silver P7A Textured Charcoal</p> <p><i>Specify for Standard, Tapered Round and Tapered Square legs only</i></p> <p>T Black Hard Caster <i>Specify for Hard Caster option only</i></p> <p>P R 8</p>
--	---	--	---

HFLSC1S

SQUARE LOUNGE CHAIR W/ SWIVEL BASE

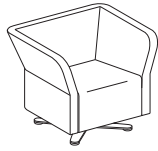

X-Base

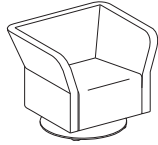

Disc Base

DIMENSIONS

Depth:	28 ⁹ / ₁₆	Arm Width:	27 ¹ / ₂
Width:	34 ⁵ / ₃₂	Seat to Floor Height:	17
Height:	28	Usable Seat Depth:	20 ¹ / ₂
Seat Depth:	20 ⁷ / ₃₂	Ship Weight (X-base):	116
Seat Width:	21 ¹ / ₂	Ship Weight (Round base):	148
Back Width:	21 ¹ / ₂	Cube:	21.9
Back Height:	18 ¹ / ₂	COM:	5.0
		Weight Rating:	300 lbs.

FABRIC PRICE CODES

1	\$2567	8	\$3188
2	\$2675	9	\$3269
3	\$2783	10	\$3350
4	\$2864	11	\$3431
5	\$2945	12	\$3512
6	\$3026	L	\$3467
7	\$3107		

HFLRC1S

ROUND LOUNGE CHAIR W/ SWIVEL BASE



X-Base

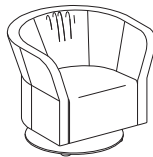

Disc Base

DIMENSIONS

Depth:	29 ¹ / ₁₆	Arm Width:	27 ¹ / ₂
Width:	33 ⁵ / ₃₂	Seat to Floor Height:	17
Height:	28	Usable Seat Depth:	20 ¹ / ₂
Seat Depth:	20 ¹ / ₂	Ship Weight (X-base):	94
Seat Width:	20 ¹ / ₂	Ship Weight (Round base):	126
Back Width:	20 ¹ / ₂	Cube:	21.9
Back Height:	18 ¹ / ₂	Weight Rating:	300 lbs.

FABRIC PRICE CODES

1	\$2662	8	\$3214
2	\$2758	9	\$3286
3	\$2854	10	\$3358
4	\$2926	11	\$3430
5	\$2998	12	\$3502
6	\$3070	L	\$3462
7	\$3142		

- ! Round Lounge model HFLRC1S is offered in select fabrics; for availability please see Fabric matrix on page 287. Also approved in limited Partnership Fabrics. Base options are available in Textured Silver (PR8) and Textured Charcoal (P7A) only.
- ! Customer's Own Material (COM) is not available on HFLRC1S.

HFLMC1S

MODULAR CHAIR W/ SWIVEL BASE



X-Base



Disc Base

DIMENSIONS

Depth:	28 ¹ / ₂	Seat to Floor Height:	17
Width:	25	Usable Seat Depth:	20 ¹ / ₂
Height:	28	Ship Weight (X-base):	91
Seat Depth:	20 ¹ / ₂	Ship Weight (Round base):	123
Seat Width:	25	Cube:	21.9
Back Width:	25	COM:	3.0
Back Height:	18 ¹ / ₂	Weight Rating:	300 lbs.

FABRIC PRICE CODES

1	\$1906	8	\$2320
2	\$1978	9	\$2374
3	\$2050	10	\$2428
4	\$2104	11	\$2482
5	\$2158	12	\$2536
6	\$2212	L	\$2506
7	\$2266		

HON Recommendation: HFLMC1S.X.PNS__PR8 - List Price \$1906

HOW TO SPECIFY

Select Model Number H F L M C 1 S .	Select Swivel Option X X Base D Disc Base X .	Select Fabric See page 287 P N S 0 0 7 .	Select Base Color PR8 Textured Silver P7A Textured Charcoal P R 8
---	---	---	---



HFLSC1DF

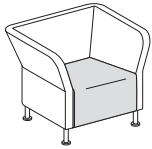

LOUNGE CHAIR

Multi-Fabric
Square

DIMENSIONS

Depth:	28½	Arm Width:	27½
Width:	34¼	Seat to Floor Height:	17
Height:	28	Usable Seat Depth:	20½
Seat Depth:	20½	Ship Weight:	48
Seat Width:	21½	Cube:	27.0
Back Width:	21½	COM:	See page 305
Back Height:	18½	Weight Rating:	300 lbs.

FABRIC PRICE CODES

1	\$2059	
<i>Add to Base Price Above</i>		
	Back	Seat
2	\$80	\$28
3	\$160	\$56
4	\$220	\$77
5	\$280	\$98
6	\$340	\$119
7	\$400	\$140
8	\$460	\$161
9	\$519	\$183
10	\$579	\$204
11	\$639	\$225
12	\$699	\$246
L	\$666	\$234

For multi-fabric models, start with the base price, then add the additional amount for the back and seat from the corresponding matrix to determine the final list price. Choose any combination of fabric grades for the back and seat.

Example: HFLSC1DF base price (\$2059) + Grade 2 back fabric (add \$80) + Grade 4 seat fabric (add \$77) = Total \$2216 List
 HFLSC1DF base price (\$2059) + Grade 5 back fabric (add \$280) + Grade 3 seat fabric (add \$56) = Total \$2395 List

HFLRC1DF

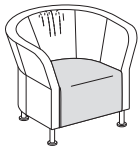

LOUNGE CHAIR

Multi-Fabric
Round

DIMENSIONS

Depth:	29	Arm Width:	27½
Width:	33½	Seat to Floor Height:	17
Height:	28	Usable Seat Depth:	20½
Seat Depth:	20½	Ship Weight:	39
Seat Width:	20½	Cube:	27.0
Back Width:	20½	Weight Rating:	300 lbs.
Back Height:	18½		

FABRIC PRICE CODES

1	\$2148	
<i>Add to Base Price Above</i>		
	Back	Seat
2	\$71	\$25
3	\$142	\$50
4	\$195	\$69
5	\$249	\$87
6	\$302	\$106
7	\$355	\$125
8	\$408	\$144
9	\$462	\$162
10	\$515	\$181
11	\$568	\$200
12	\$622	\$218
L	\$592	\$208

NOTES: Due to the inherent design of the Round Lounge chair, material gathers will be present in the back.
 ⓘ Round Lounge models HFLRC1 / HFLRC1DF are offered in select fabrics; for availability, please see the Fabric Matrix on page 287. Also approved in limited Partnership Fabrics.

For multi-fabric models, start with the base price, then add the additional amount for the back and seat from the corresponding matrix to determine the final list price. Choose any combination of fabric grades for the back and seat.

Example: HFLRC1DF base price (\$2148) + Grade 2 back fabric (add \$71) + Grade 4 seat fabric (add \$69) = Total \$2288 List
 HFLRC1DF base price (\$2148) + Grade 5 back fabric (add \$249) + Grade 3 seat fabric (add \$50) = Total \$2447 List

HON Recommendation: HFLSC1DF.TS.PNS__PNS__PR8 - List Price \$2167

HOW TO SPECIFY

<p>Select Model Number</p> <p>HFLSC1DF</p>	<p>Select Leg Option</p> <p>L Standard Leg TS Tapered Square TR Tapered Round H Hard Casters</p> <p>TS</p>	<p>Select Back Fabric</p> <p>See page 287</p> <p>PNS004</p>	<p>Select Seat Fabric</p> <p>See page 287</p> <p>PNS007</p>	<p>Select Leg Color</p> <p>PR8 Textured Silver P7A Textured Charcoal</p> <p><i>Specify for Standard, Tapered Round and Tapered Square legs only</i></p> <p>T Black Hard Caster <i>Specify for Hard Caster option only</i></p> <p>PR8</p>
---	--	--	--	---

FLOCK® Multi-Fabric Collaborative

GSA SIN 33721



Icon Legend on page 17

HFLMC1DF

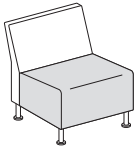

MODULAR CHAIR

Multi-Fabric

DIMENSIONS

Depth:	28½	Seat to Floor Height:	17
Width:	25	Usable Seat Depth:	20½
Height:	28	Ship Weight:	52
Seat Depth:	20½	Cube:	24.0
Seat Width:	25	COM:	See page 305
Back Width:	25	Weight Rating:	300 lbs.
Back Height:	18½		

FABRIC PRICE CODES

1	\$1533	
	<i>Add to Base Price Above</i>	
	Back	Seat
2	\$36	\$36
3	\$72	\$72
4	\$99	\$99
5	\$126	\$126
6	\$153	\$153
7	\$180	\$180
8	\$207	\$207
9	\$234	\$234
10	\$261	\$261
11	\$288	\$288
12	\$315	\$315
L	\$300	\$300

HFLML1DF

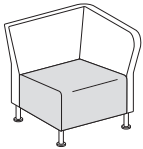

MODULAR LEFT END

Multi-Fabric

DIMENSIONS

Depth:	28½	Seat to Floor Height:	17
Width:	28½	Usable Seat Depth:	20½
Height:	28	Ship Weight:	72
Seat Depth:	20½	Cube:	24.0
Seat Width:	22¼	COM:	See page 305
Back Width:	22¼	Weight Rating:	300 lbs.
Back Height:	18½		

FABRIC PRICE CODES

1	\$1792	
	<i>Add to Base Price Above</i>	
	Back	Seat
2	\$71	\$25
3	\$142	\$50
4	\$195	\$69
5	\$249	\$87
6	\$302	\$106
7	\$355	\$125
8	\$408	\$144
9	\$462	\$162
10	\$515	\$181
11	\$568	\$200
12	\$622	\$218
L	\$592	\$208

HON Recommendation: HFLMC1DF.TS.PNS__PNS__PR8 - List Price \$1605

SEATING

HOW TO SPECIFY

<p>Select Model Number</p> <p>H F L M C 1 D F .</p>	<p>Select Leg Option</p> <p>L Standard Leg TS Tapered Square TR Tapered Round H Hard Casters</p> <p>T S .</p>	<p>Select Back Fabric</p> <p>See page 287</p> <p>P N S 0 0 4 .</p>	<p>Select Seat Fabric</p> <p>See page 287</p> <p>P N S 0 0 7 .</p>	<p>Select Leg Color</p> <p>PR8 Textured Silver P7A Textured Charcoal</p> <p><i>Specify for Standard, Tapered Round and Tapered Square legs only</i></p> <p>T Black Hard Caster</p> <p><i>Specify for Hard Caster option only</i></p> <p>P R 8</p>
--	--	---	---	--



FLOCK® Multi-Fabric Collaborative

HFLMR1DF

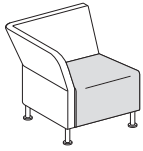

MODULAR RIGHT END

Multi-Fabric

DIMENSIONS

Depth:	28½	Seat to Floor Height:	17
Width:	28½	Usable Seat Depth:	20½
Height:	28	Ship Weight:	72.0
Seat Depth:	20½	Cube:	24.0
Seat Width:	22¼	COM:	See page 305
Back Width:	22¼	Weight Rating:	300 lbs.
Back Height:	18½		

FABRIC PRICE CODES

1	\$1792	
<i>Add to Base Price Above</i>		
	Back	Seat
2	\$71	\$25
3	\$142	\$50
4	\$195	\$69
5	\$249	\$87
6	\$302	\$106
7	\$355	\$125
8	\$408	\$144
9	\$462	\$162
10	\$515	\$181
11	\$568	\$200
12	\$622	\$218
L	\$592	\$208

HON Recommendation: HFLMR1DF.TS.PNS__PNS__.PR8 - List Price \$1888

HOW TO SPECIFY

<p>Select Model Number</p> <p>HFLMR1DF</p>	<p>Select Leg Option</p> <p>L Standard Leg TS Tapered Square TR Tapered Round H Hard Casters</p> <p>TS</p>	<p>Select Back Fabric</p> <p>See page 287</p> <p>PNS004</p>	<p>Select Seat Fabric</p> <p>See page 287</p> <p>PNS007</p>	<p>Select Leg Color</p> <p>PR8 Textured Silver P7A Textured Charcoal</p> <p><i>Specify for Standard, Tapered Round and Tapered Square legs only</i></p> <p>T Black Hard Caster</p> <p><i>Specify for Hard Caster option only</i></p> <p>PR8</p>
---	--	--	--	---

SEATING

FLOCK® Multi-Fabric Collaborative

GSA SIN 33721



Icon Legend on page 17

HFLCC1DF

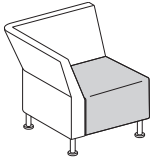

TRUE CORNER CHAIR

Multi-Fabric

DIMENSIONS

Depth:	28½	Seat to Floor Height:	17
Width:	28½	Usable Seat Depth:	21
Height:	28	Ship Weight:	60
Seat Depth:	20½	Cube:	21.9
Seat Width:	20½	COM:	See page 305
Back Width:	22¼	Weight Rating:	300 lbs.
Back Height:	18½		

FABRIC PRICE CODES

1	\$1783	
	<i>Add to Base Price Above</i>	
	Back	Seat
2	\$48	\$48
3	\$96	\$96
4	\$144	\$144
5	\$206	\$206
6	\$268	\$268
7	\$330	\$330
8	\$392	\$392
9	\$454	\$454
10	\$516	\$516
11	\$578	\$578
12	\$640	\$640
L	\$400	\$400

! Leg options – Standard Leg (L), Tapered Square (TS) and Tapered Round (TR) are available in Textured Silver (PR8) and Textured Charcoal (P7A) only. Hard Casters (H) are available on Black (T) only.

HFLWI45DF

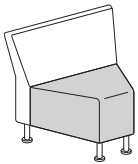

INSIDE WEDGE

Multi-Fabric

DIMENSIONS

Depth:	26¼	Seat to Floor Height:	17
Width:	31½	Usable Seat Depth:	19
Height:	28	Ship Weight:	45
Seat Depth:	19½	Cube:	21.9
Seat Width:	25¾	COM:	See page 305
Back Width:	31½	Weight Rating:	300 lbs.
Back Height:	18½		

FABRIC PRICE CODES

1	\$1783	
	<i>Add to Base Price Above</i>	
	Back	Seat
2	\$48	\$48
3	\$96	\$96
4	\$144	\$144
5	\$206	\$206
6	\$268	\$268
7	\$330	\$330
8	\$392	\$392
9	\$454	\$454
10	\$516	\$516
11	\$578	\$578
12	\$640	\$640
L	\$400	\$400

! Leg options – Standard Leg (L), Tapered Square (TS) and Tapered Round (TR) are available in Textured Silver (PR8) and Textured Charcoal (P7A) only. Hard Casters (H) are available on Black (T) only.

HFLWO45DF

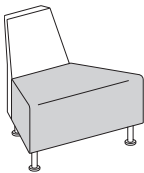

OUTSIDE WEDGE

Multi-Fabric

DIMENSIONS

Depth:	26½	Seat to Floor Height:	17
Width:	32	Usable Seat Depth:	19
Height:	28	Ship Weight:	35
Seat Depth:	19½	Cube:	21.9
Seat Width:	32	COM:	See page 305
Back Width:	16¼	Weight Rating:	300 lbs.
Back Height:	18½		

FABRIC PRICE CODES

1	\$1783	
	<i>Add to Base Price Above</i>	
	Back	Seat
2	\$48	\$48
3	\$96	\$96
4	\$144	\$144
5	\$206	\$206
6	\$268	\$268
7	\$330	\$330
8	\$392	\$392
9	\$454	\$454
10	\$516	\$516
11	\$578	\$578
12	\$640	\$640
L	\$400	\$400

! Leg options – Standard Leg (L), Tapered Square (TS) and Tapered Round (TR) are available in Textured Silver (PR8) and Textured Charcoal (P7A) only. Hard Casters (H) are available on Black (T) only.

HOW TO SPECIFY **HON Recommendation: HFLCC1DF.TS.PNS__PNS__PR8 - List Price \$1879**

Select Model Number HFLCC1DF	Select Leg Option L Standard Leg TS Tapered Square TR Tapered Round H Hard Casters	Select Back Fabric See page 287	Select Seat Fabric See page 287	Select Leg Color PR8 Textured Silver P7A Textured Charcoal <i>Specify for Standard, Tapered Round and Tapered Square legs only</i> T Black Hard Caster <i>Specify for Hard Caster option only</i>
HFLCC1DF	TS	PNS004	PNS007	PR8



HFLSC1SDF

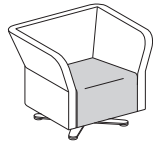

X-Base

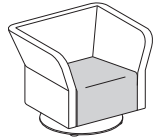

Disc Base

SQUARE LOUNGE CHAIR W/ SWIVEL BASE

Multi-Fabric

DIMENSIONS

Depth:	28 ⁹ / ₁₆	Arm Width:	27 ¹ / ₂
Width:	34 ³ / ₃₂	Seat to Floor Height:	17
Height:	28	Usable Seat Depth:	20 ¹ / ₂
Seat Depth:	20 ¹⁷ / ₃₂	Ship Weight (X-base):	116
Seat Width:	21 ¹ / ₂	Ship Weight (Round base):	148
Back Width:	21 ¹ / ₂	Cube:	21.9
Back Height:	18 ¹ / ₂	COM:	See page 305
		Weight Rating:	300 lbs.

FABRIC PRICE CODES

1	\$2660	
<i>Add to Base Price Above</i>		
	Back	Seat
2	\$80	\$28
3	\$160	\$56
4	\$220	\$77
5	\$280	\$98
6	\$340	\$119
7	\$400	\$140
8	\$460	\$161
9	\$519	\$183
10	\$579	\$204
11	\$639	\$225
12	\$699	\$246
L	\$666	\$234

HFLRC1SDF



X-Base

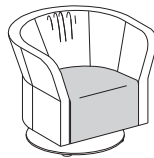

Disc Base

ROUND LOUNGE CHAIR W/ SWIVEL BASE

Multi-Fabric

DIMENSIONS

Depth:	29 ¹ / ₁₆	Arm Width:	27 ¹ / ₂
Width:	33 ³ / ₃₂	Seat to Floor Height:	17
Height:	28	Usable Seat Depth:	20 ¹ / ₂
Seat Depth:	20 ¹ / ₂	Ship Weight (X-base):	94
Seat Width:	20 ¹ / ₂	Ship Weight (Round base):	126
Back Width:	20 ¹ / ₂	Cube:	21.9
Back Height:	18 ¹ / ₂	Weight Rating:	300 lbs.

FABRIC PRICE CODES

1	\$2754	
<i>Add to Base Price Above</i>		
	Back	Seat
2	\$71	\$25
3	\$142	\$50
4	\$195	\$69
5	\$249	\$87
6	\$302	\$106
7	\$355	\$125
8	\$408	\$144
9	\$462	\$162
10	\$515	\$181
11	\$568	\$200
12	\$622	\$218
L	\$592	\$208

NOTES: Due to the inherent design of the Round Lounge chair, material gathers will be present in the back.

! Round Lounge model HFLRC1SDF is offered in select fabrics; for availability, please see the Fabric Matrix on page 287. Also approved in limited Partnership Fabrics.

For multi-fabric models, start with the base price, then add the additional amount for the back and seat from the corresponding matrix to determine the final list price. Choose any combination of fabric grades for the back and seat.

Example: HFLRC1SDF base price (\$2754) + Grade 2 back fabric (add \$71) + Grade 4 seat fabric (add \$69) = Total \$2894 List

HFLMC1SDF



X-Base

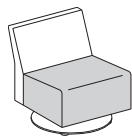

Disc Base

MODULAR CHAIR W/ SWIVEL BASE

Multi-Fabric

DIMENSIONS

Depth:	28 ¹ / ₂	Seat to Floor Height:	17
Width:	25	Usable Seat Depth:	20 ¹ / ₂
Height:	28 ¹ / ₂	Ship Weight (X-base):	91
Seat Depth:	20 ¹ / ₂	Ship Weight (Round base):	123
Seat Width:	25	Cube:	21.9
Back Width:	25	COM:	See page 305
Back Height:	18 ¹ / ₂	Weight Rating:	300 lbs.

FABRIC PRICE CODES

1	\$1995	
<i>Add to Base Price Above</i>		
	Back	Seat
2	\$36	\$36
3	\$72	\$72
4	\$99	\$99
5	\$126	\$126
6	\$153	\$153
7	\$180	\$180
8	\$207	\$207
9	\$234	\$234
10	\$261	\$261
11	\$288	\$288
12	\$315	\$315
L	\$300	\$300

HOW TO SPECIFY

HON Recommendation: HFLMC1SDF.X.PNS__PNS__PR8 - List Price \$2067

<p>Select Model Number</p> <p>H F L M C 1 S D F</p>	<p>Select Swivel Option</p> <p>X X Base D Disc Base</p> <p>X</p>	<p>Select Back Fabric</p> <p>See page 287</p> <p>P N S 0 0 4</p>	<p>Select Seat Fabric</p> <p>See page 287</p> <p>P N S 0 0 7</p>	<p>Select Base Color</p> <p>PR8 Textured Silver P7A Textured Charcoal</p> <p>PR8</p>
---	--	--	--	--

FLOCK® Base Frames and Legs

OPEN MARKET



Icon Legend on page 17

	DESCRIPTION	MODEL	SHIP WEIGHT	CUBE	LIST PRICE
	Two-Seat Base Frame	HFLB2	25	5.9	\$447
	Three-Seat Base Frame	HFLB3	33	7.8	\$558

HOW TO SPECIFY

<p>Select Model Number</p> <p>H F L B 2 .</p>	<p>Select Leg Option</p> <p>RS Round Straight Leg TS Tapered Square Leg (+ \$75)</p> <p>Select Leg Color</p> <p>PR8 Textured Silver P7A Textured Charcoal</p> <p>R S P R 8</p>
--	--

	DESCRIPTION	MODEL	SHIP WEIGHT	CUBE	LIST PRICE
	Tapered Square Leg — Shroud Pack	HTSSRD	2	1.0	\$85

HOW TO SPECIFY

<p>Select Model Number</p> <p>H T S S R D .</p>	<p>Select Leg Color</p> <p>PR8 Textured Silver P7A Textured Charcoal</p> <p>P R 8</p>
--	--

SEATING

MODEL OPTIONS

HFSS7



Stool

HFCG6
HFCG6DF - Multi-Fabric



Guest Chair
Casual

HFCL2
HFCL2DF - Multi-Fabric



Wide Lounge Chair
With 4-Star Return-to-Center

HFLSC2
HFLSC2DF - Multi-Fabric



Square Chair
With 4-Star Return-to-Center

HFSS74L
HFSS74LDF - Multi-Fabric



Stool
4-Leg

SHELL COLOR

CODE	DESCRIPTION	PRICE
LA	Lava	+\$0
ON	Onyx	+\$0
PT	Platinum	+\$0
SD	Shadow	+\$0

**Available for model HFSS7 only*

FRAME

CODE	DESCRIPTION	PRICE
4S	4-Star Return-to-Center*	+\$0
<i>*Available for models HFCL2 and HFLSC2 only</i>		
<i>Available in the following finishes:</i>		
PR8	Textured Silver	
P7A	Textured Charcoal	

FLOCK® Fabric Options

HON BRANDED FABRICS

GRADE 1	GRADE 2	GRADE 3	GRADE L
Apex	Appoint Seating	In Season	Denver Leather*
Attire	Blume	Moxie	
Centurion	Clyde	Parker	
Compass	Dotty	Purl	
Contourett	Rush	Quill	
Dapper	Seed		
Ensemble	Spin Seating		
Hamilton	Whisper Vinyl		
Inertia			
Optic			
Pebble			

For a complete list of fabrics, including partnership fabrics, go to hon.com/fabricsandfinishes.

Flock® chair models HFLRC1 and HFLRC1DF have fabric limitations, please see the Flock® seating pages 288-297 and 301 for details.

Reference Fabric Color Combinations on pages 18-22 for color codes and legend on page 19 for lead times.

*Denver Leather (SS) may not be available on every model within a specific series, please refer to the model's page for details.

FLOCK® SQUARE CHAIR HFLSC2/DF HON BRANDED FABRICS

GRADE 1	GRADE 2	GRADE 3	GRADE L
Apex	Appoint Seating	In Season	Denver Leather**
Centurion	Blume	Moxie	
Compass	Clyde	Parker	
Contourett	Rush	Purl	
Dapper	Seed*	Quill	
Ensemble	Spin Seating*		
Hamilton	Whisper Vinyl		
Inertia			
Optic*			
Pebble			

For a complete list of fabrics, including partnership fabrics, go to hon.com/fabricsandfinishes.

Flock® chair model HFLSC2/DF has fabric limitations, please see the Flock® seating pages 302-304 for details.

*Available on seat only.

**Denver Leather (SS) may not be available on every model within a specific series, please refer to the model's page for details.

Reference Fabric Color Combinations on pages 18-22 for color codes and legend on page 19 for lead times.



HFSS7

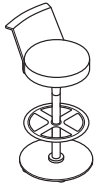

STOOL

DIMENSIONS

Depth:	18	Seat to Floor Height:	31
Width:	18	Usable Seat Depth:	15 ³ / ₄
Height:	39 ¹ / ₈	Ship Weight:	57
Seat Depth:	15 ³ / ₄	Cube:	11.0
Seat Width:	15 ³ / ₄	Weight Rating:	300 lbs.
Back Width:	15 ³ / ₄		
Back Height:	8		

FABRIC PRICE CODES

1	\$900	8	\$1107
2	\$936	9	\$1134
3	\$972	10	\$1161
4	\$999	11	\$1188
5	\$1026	12	\$1215
6	\$1053	L	—
7	\$1080		

! Customer's Own Material (COM) is not available on Flock® models HFLRC1 or HFSS7.

HON Recommendation: HFSS7.PT.PNS__PR8 - List Price \$936

HOW TO SPECIFY

Select Model Number HFSS7	Select Shell Color LA Lava ON Onyx PT Platinum SD Shadow PT	Select Fabric See page 300 PNS007	Select Frame PR8 Textured Silver P7A Textured Charcoal PR8
---	---	--	--

HFCG6



GUEST CHAIR

Casual

DIMENSIONS

Depth:	23 ⁵ / ₁₆	Seat to Floor Height:	18 ¹ / ₄
Width:	19	Usable Seat Depth:	16 ⁷ / ₈
Height:	32 ¹ / ₂	Ship Weight:	24
Seat Depth:	16 ⁷ / ₈	Cube:	10.4
Seat Width:	19	COM:	1.8
Back Width:	19	Weight Rating:	300 lbs.
Back Height:	14 ¹ / ₄		

FABRIC PRICE CODES

1	\$668	8	\$944
2	\$716	9	\$980
3	\$764	10	\$1016
4	\$800	11	\$1052
5	\$836	12	\$1088
6	\$872	L	\$1068
7	\$908		

HFSS74L



STOOL

4-Leg

DIMENSIONS

Depth:	21 ⁵ / ₈	Seat to Floor Height:	30
Width:	18	Usable Seat Depth:	15 ⁷ / ₈
Height:	40 ⁷ / ₈	Ship Weight:	35
Seat Depth:	15 ⁷ / ₈	Cube:	21.8
Seat Width:	18	COM:	1.9
Back Width:	18	Weight Rating:	300 lbs.
Back Height:	10 ⁷ / ₈		

FABRIC PRICE CODES

1	\$841	8	\$1117
2	\$889	9	\$1153
3	\$937	10	\$1189
4	\$973	11	\$1225
5	\$1009	12	\$1261
6	\$1045	L	\$1241
7	\$1081		

HON Recommendation: HFSS74L.PNS__PR8 - List Price \$889

HOW TO SPECIFY

Select Model Number HFSS74L	Select Fabric See page 300 PNS007	Select Frame PR8 Textured Silver PR8
---	--	---



HFCL2



WIDE LOUNGE CHAIR

with 4-Star Return-to-Center

DIMENSIONS

Depth:	27½	Seat to Floor Height:	17
Width:	26¾	Usable Seat Depth:	19
Height:	32¼	Ship Weight:	53
Seat Width:	26	Cube:	25.1
Back Width:	25½	COM:	2.5
Back Height:	19½	Weight Rating:	300 lbs.

FABRIC PRICE CODES

1	\$1138	8	\$1552
2	\$1210	9	\$1606
3	\$1282	10	\$1660
4	\$1336	11	\$1714
5	\$1390	12	\$1768
6	\$1444	L	\$1738
7	\$1498		

HFLSC2



SQUARE CHAIR

with 4-Star Return-to-Center

DIMENSIONS

Depth:	26½	Seat to Floor Height:	18
Width:	27½	Usable Seat Depth:	18¾
Height:	32¼	Ship Weight:	46
Seat Width:	17½	Cube:	25.1
Back Width:	16	COM:	See note
Back Height:	17¾	Weight Rating:	300 lbs.

FABRIC PRICE CODES

1	\$1640	8	\$2054
2	\$1712	9	\$2108
3	\$1784	10	\$2162
4	\$1838	11	\$2216
5	\$1892	12	\$2270
6	\$1946	L	\$2240
7	\$2000		

NOTES: Due to fabric limitations, COM is unavailable for back upholstery. See HFLSC2DF for COM available on the seat only.

HON Recommendation: HFLSC2.PNS__4SPR8 - List Price \$1640

HOW TO SPECIFY

Select Model Number

HFLSC2

Select Fabric

See page 300

PNS007

Select Base Option

4S 4-Star Return-to-Center

Select Base Color

PR8 Textured Silver
P7A Textured Charcoal

4SPR8



HFSG6DF



CASUAL GUEST CHAIR

Multi-Fabric

DIMENSIONS

Depth:	23 ⁵ / ₁₆	Seat to Floor Height:	18 ¹ / ₄
Width:	19	Usable Seat Depth:	16 ⁷ / ₈
Height:	32 ¹ / ₂	Ship Weight:	24
Seat Depth:	16 ⁷ / ₈	Cube:	10.4
Seat Width:	19	COM:	See page 305
Back Width:	19	Weight Rating:	300 lbs.
Back Height:	14 ¹ / ₄		

FABRIC PRICE CODES

1	\$757	
<i>Add to Base Price Above</i>		
	Back	Seat
2	\$24	\$24
3	\$48	\$48
4	\$66	\$66
5	\$84	\$84
6	\$102	\$102
7	\$120	\$120
8	\$138	\$138
9	\$156	\$156
10	\$174	\$174
11	\$192	\$192
12	\$210	\$210
L	\$200	\$200

HFSS74LDF



4-LEG STOOL

Multi-Fabric

DIMENSIONS

Depth:	21 ¹ / ₈	Seat to Floor Height:	30
Width:	18	Usable Seat Depth:	15 ⁷ / ₈
Height:	40 ⁷ / ₈	Ship Weight:	35
Seat Depth:	15 ⁷ / ₈	Cube:	21.8
Seat Width:	18	COM:	See page 305
Back Width:	18	Weight Rating:	300 lbs.
Back Height:	10 ⁷ / ₈		

FABRIC PRICE CODES

1	\$932	
<i>Add to Base Price Above</i>		
	Back	Seat
2	\$24	\$24
3	\$48	\$48
4	\$66	\$66
5	\$84	\$84
6	\$102	\$102
7	\$120	\$120
8	\$138	\$138
9	\$156	\$156
10	\$174	\$174
11	\$192	\$192
12	\$210	\$210
L	\$200	\$200

HON Recommendation: HFSS74LDF.PNS___.PNS___.PR8 - List Price \$980

HOW TO SPECIFY

<p>Select Model Number</p> <p>HFSS74LDF</p>	<p>Select Back Fabric</p> <p>See page 300</p> <p>PNS004</p>	<p>Select Seat Fabric</p> <p>See page 300</p> <p>PNS007</p>	<p>Select Frame</p> <p>PR8 Textured Silver (only)</p> <p>PR8</p>
--	--	--	---

FLOCK® Multi-Fabric Collaborative

OPEN MARKET



Icon Legend on page 17

HFCL2DF



WIDE LOUNGE CHAIR

with 4-Star Return-to-Center

DIMENSIONS

Depth:	27½	Seat to Floor Height:	17
Width:	26¾	Usable Seat Depth:	19
Height:	32¼	Ship Weight:	53
Seat Width:	26	Cube:	25.1
Back Width:	25½	COM:	See page 305
Back Height:	19½	Weight Rating:	300 lbs.

FABRIC PRICE CODES

1	\$1218	
<i>Add to Base Price Above</i>		
	Back	Seat
2	\$36	\$36
3	\$108	\$108
4	\$162	\$162
5	\$216	\$216
6	\$270	\$270
7	\$324	\$324
8	\$378	\$378
9	\$432	\$432
10	\$486	\$486
11	\$540	\$540
12	\$594	\$594
L	\$300	\$300

HFLSC2DF



SQUARE CHAIR

with 4-Star Return-to-Center

DIMENSIONS

Depth:	26½	Seat to Floor Height:	18
Width:	27½	Usable Seat Depth:	18¾
Height:	32¼	Ship Weight:	46
Seat Width:	17½	Cube:	25.1
Back Width:	16	COM:	See note
Back Height:	17¾	Weight Rating:	300 lbs.

FABRIC PRICE CODES

1	\$1723	
<i>Add to Base Price Above</i>		
	Back	Seat
2	\$48	\$24
3	\$120	\$96
4	\$174	\$150
5	\$228	\$204
6	\$282	\$258
7	\$336	\$312
8	\$390	\$366
9	\$444	\$420
10	\$498	\$474
11	\$552	\$528
12	\$606	\$582
L	\$400	\$200

NOTES: Due to fabric limitations, COM is unavailable for back upholstery. See HFLSC2DF for COM available on the seat only.

HON Recommendation: HFLSC2DF.PURL__PURL__.4SPR8 - List Price \$1939

SEATING

HOW TO SPECIFY

<p>Select Model Number</p> <p>H F L S C 2 D F .</p>	<p>Select Back Fabric</p> <p>See page 300</p> <p>P U R L 1 2 .</p>	<p>Select Seat Fabric</p> <p>See page 300</p> <p>P U R L 1 2 .</p>	<p>Select Base Option</p> <p>4S 4-Star Return-to-Center</p> <p>Select Base Color</p> <p>PR8 Textured Silver P7A Textured Charcoal</p> <p>4 S P R 8</p>
--	---	---	--

MODEL OPTIONS

HFLC01
HFLC01DF - Multi-Fabric

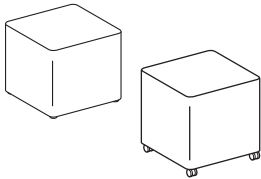

Mini Cube

HFLY01
HFLY01DF - Multi-Fabric

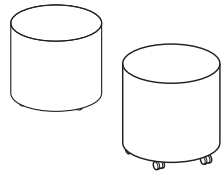

Mini Cylinder

CASTER/ GLIDES

CODE	DESCRIPTION	PRICE
A	Active Base*	+\$75
<i>*Available on models HFLY01 and HFLY01DF only</i>		
H	Hard Caster	+\$0
HG	Hidden Glide	+\$0
LPR8	Textured Silver Disc Glide	+\$45
LP7A	Textured Charcoal Disc Glide	+\$45

MULTI-FABRIC COM YARDAGE

Due to fabric pattern nesting and potential reduction of fabric yield, some multi-fabric models may require more total yardage than standard models.

MODEL	BACK COM	SEAT COM
HFLMC1DF	1.6	1.5
HFLML1DF	2.9	1.4
HFLMR1DF	2.9	1.4
HFCG6DF	1.8	1.9
HFSS74LDF	1.4	1.9
HFLWI45DF	2.3	1.4
HFLWO45DF	1.0	1.4
HFLCC1DF	2.3	1.4
HFLSC1SDF	3.6	1.4
HFLMC1SDF	1.6	1.5
HFCL2DF	N/A	2.0
HFLSC2DF	N/A	3.0
TOP	SIDE	
HFLC01DF	0.7	1.2
HFLY01DF	0.7	1.2

HON BRANDED FABRICS

GRADE 1	GRADE 2	GRADE 3	GRADE L
Apex	Appoint Seating	In Season	Denver Leather
Attire	Blume	Moxie	
Centurion	Clyde	Parker	
Compass	Dotty	Purl	
Contourett	Rush	Quill	
Dapper	Spin Seating		
Ensemble	Whisper Vinyl		
Hamilton			
Inertia			
Optic			
Pebble			

For a complete list of fabrics, including partnership fabrics, go to hon.com/fabricsandfinishes.

Reference Fabric Color Combinations on pages 18-22 for color codes and legend on page 19 for lead times.

FLOCK® Mini Cube and Cylinders

GSA SIN 33721



Icon Legend on page 17

HFLCO1

MINI CUBE

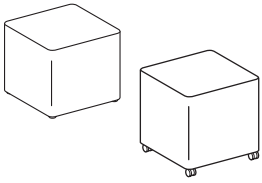

DIMENSIONS

Depth:	18½	Seat to Floor Height:	17
Width:	18½	Usable Seat Depth:	18½
Height:	17	Ship Weight:	15
Seat Depth:	18½	Cube:	5.0
Seat Width:	18½	COM:	2.0
		Weight Rating:	300 lbs.

FABRIC PRICE CODES

1	\$506	8	\$713
2	\$542	9	\$740
3	\$578	10	\$767
4	\$605	11	\$794
5	\$632	12	\$821
6	\$659	L	\$806
7	\$686		

HFLY01

MINI CYLINDER

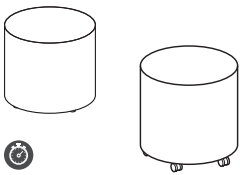

DIMENSIONS

Depth:	18½	Seat to Floor Height:	17
Width:	18½	Usable Seat Depth:	18½
Height:	17	Ship Weight:	13
Seat Depth:	18½	Cube:	5.0
Seat Width:	18½	COM:	2.0
		Weight Rating:	300 lbs.

FABRIC PRICE CODES

1	\$505	8	\$712
2	\$541	9	\$739
3	\$577	10	\$766
4	\$604	11	\$793
5	\$631	12	\$820
6	\$658	L	\$805
7	\$685		

HON Recommendation: HFLY01.LPR8.PNS__ - List Price \$586

SEATING

HOW TO SPECIFY

Select Model Number

HFLY01

Select Base

- A** Active Base* (+ \$75)
- *Available on model HFLY01 only*
- H** Caster
- HG** Hidden Glide
- LPR8** Textured Silver Disc Glide (+ \$45)
- LP7A** Textured Charcoal Disc Glide (+ \$45)

LPR8

Select Fabric

See page 305

PNS007

Multi-Fabric Mini Cube and Cylinder

HFLCO1DF

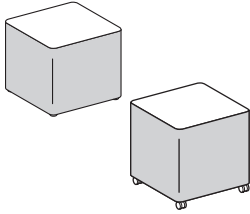

MINI CUBE

Multi-Fabric

DIMENSIONS

Depth:	18½	Seat to Floor Height:	17
Width:	18½	Usable Seat Depth:	18½
Height:	17	Ship Weight:	15
Seat Depth:	18½	Cube:	5.0
Seat Width:	18½	COM:	See page 305
		Weight Rating:	300 lbs.

FABRIC PRICE CODES

1	\$593	
<i>Add to Base Price Above</i>		
	Top	Sides
2	\$11	\$25
3	\$22	\$50
4	\$30	\$69
5	\$38	\$88
6	\$46	\$107
7	\$54	\$126
8	\$62	\$145
9	\$70	\$164
10	\$78	\$183
11	\$86	\$202
12	\$95	\$221
L	\$90	\$210

HFLY01DF

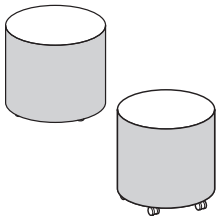

MINI CYLINDER

Multi-Fabric

DIMENSIONS

Depth:	18½	Seat to Floor Height:	17
Width:	18½	Usable Seat Depth:	18½
Height:	17	Ship Weight:	13
Seat Depth:	18½	Cube:	5.0
Seat Width:	18½	COM:	See page 305
		Weight Rating:	300 lbs.

FABRIC PRICE CODES

1	\$592	
<i>Add to Base Price Above</i>		
	Top	Sides
2	\$11	\$25
3	\$22	\$50
4	\$30	\$69
5	\$38	\$88
6	\$46	\$107
7	\$54	\$126
8	\$62	\$145
9	\$70	\$164
10	\$78	\$183
11	\$86	\$202
12	\$95	\$221
L	\$90	\$210

HON Recommendation: HFLCO1DF.HG.PNS___.PNS__ - List Price \$629

HOW TO SPECIFY

<p>Select Model Number</p> <p>H F L C O 1 D F .</p>	<p>Select Base</p> <p>A Active Base* (+ \$75) *Available on model HFLY01DF only</p> <p>H Caster HG Hidden Glide LPR8 Textured Silver Disc Glide (+ \$45) LP7A Textured Charcoal Disc Glide (+ \$45)</p> <p>H G .</p>	<p>Select Top Fabric</p> <p>See page 305</p> <p>P N S 0 0 7 .</p>	<p>Select Side Fabric</p> <p>See page 305</p> <p>P N S 0 0 4 .</p>
--	--	--	---

GATEWAY™

Want to see more? Scan here
to check out hon.com.



Gateway™ Chairs shown
with Huddle Tables.

GATEWAY™

So you need a new chair, but it has to look as cool as it is comfortable. We've got you covered. Gateway takes the complexity out of finding the perfect chair by focusing on exactly what you're looking for. Cool, breathable mesh. Personalized seat fabrics. Targeted back support. Just what you need. Nothing you don't. All at a price you'll have to look at twice to make sure it's not a typo.



FEATURES

- Seat has comfortable, waterfall edge.
- Mesh back material flexes for a relaxed fit.
- Adjustable lumbar.
- Adjustable tilt to recline based on body type.
- Three arm options.
- Carton is 2 cubic feet smaller than the industry average.

HON BRANDED FABRICS

GRADE 1

Centurion
Contourett

GRADE 2

Dotty

For a complete list of fabrics, including partnership fabrics, go to hon.com/fabricsandfinishes.

Reference Fabric Color Combinations on pages 18-22 for color codes and legend on page 19 for lead times.

GATEWAY™ Standard Task Chair

OPEN MARKET



Icon Legend on page 17

HGTMM

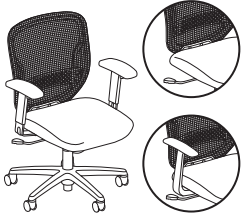

TASK CHAIR

- Mesh Back
- Pneumatic
- Swivel
- Tilt Tension
- Tilt Lock
- Adjustable Lumbar Support

Functions: **A, E, F, K, L, W**
(Function Key on pages 212-213)

NOTES: **HON 5-Year Limited Warranty.**

DIMENSIONS

Depth:	25¼	Seat to Floor Height:	17-22
Width:	27	Usable Seat Depth:	19
Height:	38	Ship Weight:	35
Seat Depth:	19	Cube:	3.4
Seat Width:	18½	Weight Rating:	250 lbs.
Back Width:	18		
Back Height:	18½		

FABRIC PRICE CODES

1	\$289
2	\$301

HOW TO SPECIFY

Select Model Number	Select Control Type	Select Arm Type	Select Caster	Select Back Type	Select Fabric	Select Lumbar	Select Base	Select Frame
	Z1 Swivel-Tilt Control	N Armless F Fixed Arms (+ \$35) H Height-Adjustable Arms (+ \$55)	H Black Hard Caster	M Mesh	See page 309	AL Adjustable Lumbar	SB Standard Base	T Black
HGTMM	Z1	H	H	M	CU10	AL	SB	T



GATEWAY™ Value Task Chair

HGV1MM



TASK CHAIR VALUE MODEL

Mesh Back

- Pneumatic
- Swivel
- Tilt Tension
- Tilt Lock
- Adjustable Lumbar Support

Functions: **A, E, F, K, L, W**
(Function Key on pages 212-213)

NOTES: **HON 5-Year Limited Warranty.**

DIMENSIONS

Depth:	25¼	Seat to Floor Height:	17-22
Width:	27	Usable Seat Depth:	19
Height:	38	Ship Weight:	35
Seat Depth:	19	Cube:	3.4
Seat Width:	18½	Weight Rating:	250 lbs.
Back Width:	18		
Back Height:	18½		

LIST PRICE

\$258

HOW TO SPECIFY

Select Model Number	Select Control Type	Select Arm Type	Select Caster	Select Back Type	Select Fabric	Select Lumbar	Select Base	Select Frame
Z1 Swivel-Tilt Control	N Armless F Fixed Arms (+ \$35) H Height-Adjustable Arms (+ \$55)	H Black Hard Caster	M Mesh	ACCF10 Black	AL Adjustable Lumbar	SB Standard Base	T Black	
HGV1MM	Z1	H	H	M	ACCF10	AL	SB	T



Grove® Lounge shown with Flock® Table.

GROVE®

Find a comfy place to put your feet up, huddle up and power up. Grove is the versatile lounge seating designed to help you greet, meet, focus, relax and accomplish more. This change-of-pace collection delivers the comfort people crave, while encouraging focus and interaction throughout the workplace. Grove's attractive design is rivaled only by its flexibility. Models include a single seat, two-seat, three-seat, and two-seat with table — all with three arm style options, as well as accessories that support connectivity and collaboration. Grove has the look you're going for, and the comfort and versatility people have been waiting for.



FEATURES

- Each model can be combined to create arrangements suitable for any space.
- Optional integrated worksurfaces create more personal space and provide a convenient worksurface.
- Design complements Flock ottomans and tables.
- Integrated power grommets keep laptops and phone powered up anywhere.
- The multi-fabric option coordinates two high-quality HON fabrics for a contemporary look.
- Choose from Single Seat, Two-Seat, Three-Seat Lounge, or Two-Seat with Table options.
- Choose from 3 arm options — Armless (N), Straight Arms (A), or Tapered Arm (B).
- Table available with two grommets and an accessory port option.
- Offers a table between the seats that provides separation and a usable worksurface.
- Warranted for users up to 300 lbs.

MODEL OPTIONS

HML1S
HML1SDF - Multi-Fabric

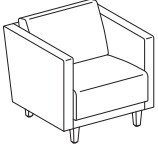

Lounge
Single Seat

HML2S
HML2SDF - Multi-Fabric

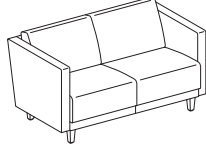

Lounge
Two-Seat

HML3S
HML3SDF - Multi-Fabric

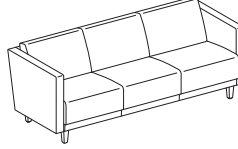

Lounge
Three-Seat

HML2ST
HML2STDF - Multi-Fabric

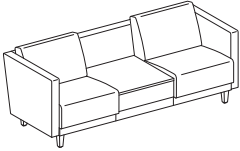

Lounge
Two-Seat with Table

GROVE® Options

ARM STYLE

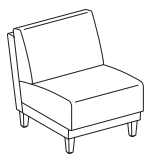

CODE	DESCRIPTION	PRICE
N	Armless	+\$0

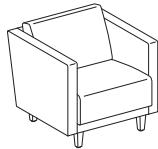

A	Straight Arms	+\$300
----------	---------------	---------------

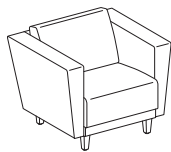

B	Tapered Arms	+\$350
----------	--------------	---------------

LEG STYLE



CODE	DESCRIPTION	PRICE
TS	Tapered Square	+\$0



TR	Tapered Round	+\$0
-----------	---------------	-------------

LEG COLOR

CODE	DESCRIPTION	PRICE
PR8	Textured Silver	+\$0
P7A	Textured Charcoal	+\$0
H	Bourbon Cherry	+\$100
F	Shaker Cherry	+\$100
N	Mahogany	+\$100
C	Harvest	+\$100
D	Natural Maple	+\$100
LK11	Kingswood Walnut	+\$100
LSA1	Sterling Ash	+\$100

CUT OUT

CODE	DESCRIPTION	PRICE
N	No Cutout	+\$0
G	Round Grommet Cutout	+\$30
G1	Pop-Up Port Cutout	+\$40

**Specify for models HML2ST and HML2STDF only*

ACCESSORY PORT LOCATION

CODE	DESCRIPTION	PRICE
0	No Port	+\$0
2	Two Tablet Ports Opposite	+\$20

**Specify for models HML2ST and HML2STDF only*

L1 LAMINATE COLOR CODE

Black	P
Bourbon Cherry	H
Designer White	LDW1
Charcoal	S
Cognac	COGN
Florence Walnut	LFW1
Harvest	C
Kingswood Walnut	LK11
Loft	LOFT
Mahogany	N
Mocha	MOCH
Natural Maple	D
Pinnacle	PINC
Shaker Cherry	F
Sterling Ash	LSA1

L2 LAMINATE COLOR CODE

Lowell Ash	LLA1
Natural Recon	LNR1
Phantom Ecrú	LPE1
Portico Teak	LPT1
Skyline Walnut	LSW1

**Specify for models HML2ST and HML2STDF only*

HON BRANDED FABRICS

GRADE 1	GRADE 2	GRADE 3	GRADE L
Apex	Appoint Seating	In Season	Denver Leather
Centurion	Blume	Moxie	
Compass	Clyde	Parker	
Contourett	Dotty	Purl	
Dapper	Rush	Quill	
Ensemble	Seed		
Hamilton	Spin Seating		
Inertia	Whisper Vinyl		
Optic			
Pebble			

For a complete list of fabrics, including partnership fabrics, go to hon.com/fabricsandfinishes.

Reference Fabric Color Combinations on pages 18-22 for color codes and legend on page 19 for lead times. For additional HON to Supply COM fabric grade pricing, go to honready.hon.com and click on the HON to Supply COM link.

i Due to the inherent characteristics of upholstery materials, the seat of Grove® may become more relaxed to show wrinkles over time.

MULTI-FABRIC COM YARDAGE

Due to fabric pattern nesting and potential reduction of fabric yield, some multi-fabric models may require more total yardage than standard models.

MODEL	COM (ARMLESS)		COM (w/ STRAIGHT ARMS)		COM (w/ TAPERED ARMS)	
	Back	Seat	Back	Seat	Back	Seat
HML1S	3		5		5	
HML1SDF	1.5	2	4	2	4	2
HML2S	5		7.5		7.5	
HML2SDF	2	3.5	4	3.5	4	3.5
HML2ST	6		8		8	
HML2STDF	3	3.5	5.5	3.5	5.5	3.5
HML3	7.5		9		9.5	
HML3DF	3	5	5.5	5	5.5	5

HML1S

LOUNGE

Single Seat

DIMENSIONS

Depth:	31½	Ship Weight (armless):	61
Height:	35	Ship Weight (with straight arms):	77
Seat Width:	23½	Ship Weight (with tapered arms):	85
Back Width:	23½	Cube (armless):	19.8
Back Height:	19	Cube (with straight arms):	19.8
Width (armless):	23½	Cube (with tapered arms):	19.8
Width (with straight arms):	29¾	COM:	See
Width (with tapered arms):	35		page 315
Arm Width:	23½	Weight Rating:	300 lbs.
Seat to Floor Height:	16		(per seat)
Usable Seat Depth:	18¾		

FABRIC PRICE CODES

1	\$1474	8	\$1888
2	\$1546	9	\$1942
3	\$1618	10	\$1996
4	\$1672	11	\$2050
5	\$1726	12	\$2104
6	\$1780	L	\$2074
7	\$1834		

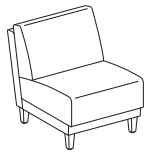

Armless

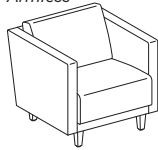

Straight Arms

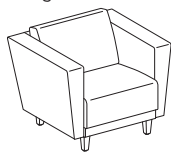

Tapered Arms

HML2S

LOUNGE

Two-Seat

DIMENSIONS

Depth:	31½	Ship Weight (armless):	100
Height:	35	Ship Weight (with straight arms):	116
Seat Width:	48	Ship Weight (with tapered arms):	124
Back Width:	48	Cube (armless):	35.6
Back Height:	19	Cube (with straight arms):	35.6
Width (armless):	48	Cube (with tapered arms):	35.6
Width (with straight arms):	54¼	COM:	See
Width (with tapered arms):	59½		page 315
Arm Width:	48	Weight Rating:	300 lbs.
Seat to Floor Height:	16		(per seat)
Usable Seat Depth:	18¾		

FABRIC PRICE CODES

1	\$2329	8	\$3019
2	\$2449	9	\$3109
3	\$2569	10	\$3199
4	\$2659	11	\$3289
5	\$2749	12	\$3379
6	\$2839	L	\$3329
7	\$2929		

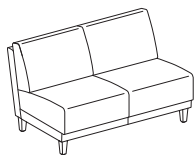

Armless

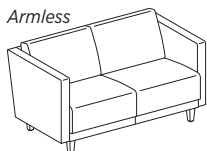

Straight Arms

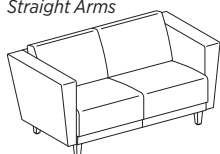

Tapered Arms

HON Recommendation: HML1S.A.PNS__TS.P7A - List Price \$1846

HOW TO SPECIFY

Select Model Number HML1S	Select Arm Type N Armless A Straight Arms (+ \$300) B Tapered Arms (+ \$350)	Select Fabric See page 315	Select Leg Type TS Tapered Square TR Tapered Round	Select Leg Color PR8 Textured Silver P7A Textured Charcoal H Bourbon Cherry (+ \$100) F Shaker Cherry (+ \$100) N Mahogany (+ \$100) C Harvest (+ \$100) D Natural Maple (+ \$100) LK11 Kingswood Walnut (+ \$100) LSA1 Sterling Ash (+ \$100)
HML1S	A	PNS007	TS	P7A

! Leg options - Tapered Square (TS) and Tapered Round (TR) are available in 2 poly and 13 woodgrain options.



HML3S

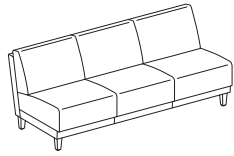

Armless

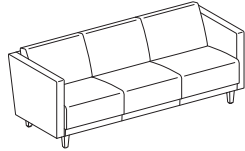

Straight Arms

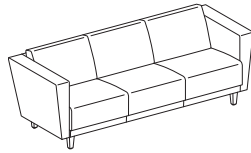

Tapered Arms

LOUNGE

Three-Seat

DIMENSIONS

Depth:	31½	Ship Weight (armless):	141
Height:	35	Ship Weight (with straight arms):	157
Seat Width:	71½	Ship Weight (with tapered arms):	165
Back Width:	71½	Cube (armless):	48.9
Back Height:	19	Cube (with straight arms):	48.9
Width (armless):	71½	Cube (with tapered arms):	48.9
Width (with straight arms):	77½	COM:	See
Width (with tapered arms):	82½		page 315
Arm Width:	71½	Weight Rating:	300 lbs.
Seat to Floor Height:	16		(per seat)
Usable Seat Depth:	18¾		

FABRIC PRICE CODES

1	\$3124	8	\$4159
2	\$3304	9	\$4294
3	\$3484	10	\$4429
4	\$3619	11	\$4564
5	\$3754	12	\$4699
6	\$3889	L	\$4624
7	\$4024		

HON Recommendation: HML3S.A.PNS__TS.P7A - List Price \$3604

HOW TO SPECIFY

<p>Select Model Number</p>	<p>Select Arm Type</p> <p>N Armless A Straight Arms (+ \$300) B Tapered Arms (+ \$350)</p>	<p>Select Fabric</p> <p>See page 315</p>	<p>Select Leg Type</p> <p>TS Tapered Square TR Tapered Round</p>	<p>Select Leg Color</p> <p>PR8 Textured Silver P7A Textured Charcoal H Bourbon Cherry (+ \$100) F Shaker Cherry (+ \$100) N Mahogany (+ \$100) C Harvest (+ \$100) D Natural Maple (+ \$100) LK11 Kingswood Walnut (+ \$100) LSA1 Sterling Ash (+ \$100)</p>
<p>H M L 3 S .</p>	<p>A .</p>	<p>P N S 0 0 7 .</p>	<p>T S .</p>	<p>P 7 A</p>

! Leg options - Tapered Square (TS) and Tapered Round (TR) are available in 2 poly and 13 woodgrain options.

HML2ST

LOUNGE

Two-Seat with Table

DIMENSIONS

Depth:	31½	Ship Weight (armless):	146
Height:	35	Ship Weight (with straight arms):	162
Seat Width:	71½	Ship Weight (with tapered arms):	170
Back Width:	71½	Cube (armless):	48.9
Back Height:	19	Cube (with straight arms):	48.9
Width (armless):	71½	Cube (with tapered arms):	48.9
Width (with straight arms):	77½	COM:	See
Width (with tapered arms):	82½	Weight Rating:	page 315
Arm Width:	71½		300 lbs.
Seat to Floor Height:	16		(per seat)
Usable Seat Depth:	18¾		

FABRIC PRICE CODES

1	\$3366	8	\$4194
2	\$3510	9	\$4302
3	\$3654	10	\$4410
4	\$3762	11	\$4518
5	\$3870	12	\$4626
6	\$3978	L	\$4566
7	\$4086		

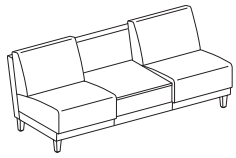

Armless

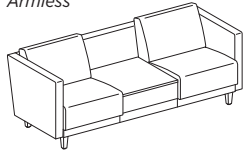

Straight Arms

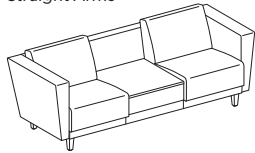

Tapered Arms

NOTES: Offers a table between the seats that provides separation and a usable worksurface. Table available with two grommet and an accessory port option.

HON Recommendation: HML2ST.A.PNS__TS.P7A.N.G1.0 - List Price \$3850

HOW TO SPECIFY

Select Model Number	Select Arm Type	Select Fabric	Select Leg Type	Select Leg Color	Select Laminate	Select Cut Out	Accessory Port Location
HML2ST	<ul style="list-style-type: none"> N Armless A Straight Arms (+ \$300) B Tapered Arms (+ \$350) 	See page 315	<ul style="list-style-type: none"> TS Tapered Square TR Tapered Round 	<ul style="list-style-type: none"> PR8 Textured Silver P7A Textured Charcoal H Bourbon Cherry (+ \$100) F Shaker Cherry (+ \$100) N Mahogany (+ \$100) C Harvest (+ \$100) D Natural Maple (+ \$100) LK11 Kingswood Walnut (+ \$100) LSA1 Sterling Ash (+ \$100) 	See Chart on page 314 L2 (+ \$125)	<ul style="list-style-type: none"> N No Cutout G Round Grommet Cutout (+ \$30) G1 Pop-Up Port Cutout (+ \$40) 	<ul style="list-style-type: none"> 0 No Port 2 Two Tablet Ports Opposite (+ \$20)
HML2ST	A	PNS007	TS	P7A	N	G1	0

! Leg options - Tapered Square (TS) and Tapered Round (TR) are available in 2 poly and 8 woodgrain options.



HML1SDF

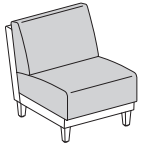

Armless

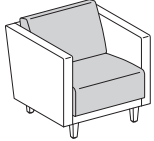

Straight Arms

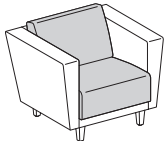

Tapered Arms

SINGLE SEAT LOUNGE

Multi-Fabric

DIMENSIONS

Depth:	31½	Ship Weight (armless):	61
Height:	35	Ship Weight (with straight arms):	77
Seat Width:	23½	Ship Weight (with tapered arms):	85
Back Width:	23½	Cube (armless):	19.8
Back Height:	19	Cube (with straight arms):	19.8
Width (armless):	23½	Cube (with tapered arms):	19.8
Width (with straight arms):	29¾	COM:	See
Width (with tapered arms):	35		page 315
Arm Width:	23½	Weight Rating:	300 lbs.
Seat to Floor Height:	16		(per seat)
Usable Seat Depth:	18¾		

FABRIC PRICE CODES

1	\$1567		
<i>Add to Base Price Above</i>			
	Frame/Arms	Back/Seat Cushions	
2	\$36	\$48	
3	\$72	\$96	
4	\$99	\$132	
5	\$126	\$168	
6	\$153	\$204	
7	\$180	\$240	
8	\$207	\$276	
9	\$234	\$312	
10	\$261	\$348	
11	\$288	\$384	
12	\$315	\$420	
L	\$300	\$400	

For multi-fabric models, start with the base price, then add the additional amount for the back and seat from the corresponding matrix to determine the final list price. Choose any combination of fabric grades for the back and seat.

Example: HML1SDF base price (\$1567) + Grade 2 frame/arms fabric (add \$36) + Grade 4 back/seat fabric (add \$132) = Total \$1735 List
 HML1SDF base price (\$1567) + Grade 5 frame/arms fabric (add \$126) + Grade 3 back/seat fabric (add \$96) = Total \$1789 List

HON Recommendation: HML1SDF.A.PNS___.PNS___.TS.P7A - List Price \$1951

HOW TO SPECIFY

Select Model Number	Select Arm Type	Select Frame/Arms Fabric	Select Back/Seat Cushions Fabric	Select Leg Type	Select Leg Color
HML1SDF	N Armless A Straight Arms (+ \$300) B Tapered Arms (+ \$350)	See page 315	See page 315	TS Tapered Square TR Tapered Round	PR8 Textured Silver P7A Textured Charcoal H Bourbon Cherry (+ \$100) F Shaker Cherry (+ \$100) N Mahogany (+ \$100) C Harvest (+ \$100) D Natural Maple (+ \$100) LK11 Kingswood Walnut (+ \$100) LSA1 Sterling Ash (+ \$100)
HML1SDF	A	PNS004	PNS007	TS	P7A

! Leg options - Tapered Square (TS) and Tapered Round (TR) are available in 2 poly and 8 woodgrain options.



HML2SDF

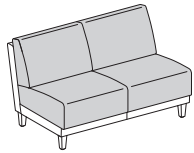

Armless

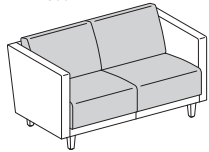

Straight Arms

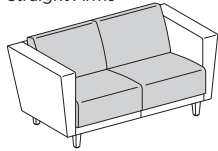

Tapered Arms

TWO-SEAT LOUNGE

Multi-Fabric

DIMENSIONS

Depth:	31½	Ship Weight (armless):	100
Height:	35	Ship Weight (with straight arms):	116
Seat Width:	48	Ship Weight (with tapered arms):	124
Back Width:	48	Cube (armless):	35.6
Back Height:	19	Cube (with straight arms):	35.6
Width (armless):	48	Cube (with tapered arms):	35.6
Width (with straight arms):	54¼	COM:	See
Width (with tapered arms):	59½	Weight Rating:	page 315 300 lbs. (per seat)
Arm Width:	48		
Seat to Floor Height:	16		
Usable Seat Depth:	18¾		

FABRIC PRICE CODES

1 \$2340

Add to Base Price Above

	Frame/ Arms	Back/Seat Cushions
2	\$60	\$84
3	\$120	\$168
4	\$165	\$231
5	\$210	\$294
6	\$255	\$357
7	\$300	\$420
8	\$345	\$483
9	\$390	\$546
10	\$435	\$609
11	\$480	\$672
12	\$525	\$735
L	\$500	\$700

For multi-fabric models, start with the base price, then add the additional amount for the back and seat from the corresponding matrix to determine the final list price. Choose any combination of fabric grades for the back and seat.

Example: HML2SDF base price (\$2340) + Grade 2 frame/arms fabric (add \$60) + Grade 4 back/seat fabric (add \$231) = Total \$2631 List
 HML2SDF base price (\$2340) + Grade 5 frame/arms fabric (add \$210) + Grade 3 back/seat fabric (add \$168) = Total \$2718 List

HON Recommendation: HML2SDF.A.PNS__PNS__TS.P7A - List Price \$2784

HOW TO SPECIFY

Select Model Number	Select Arm Type	Select Frame/Arms Fabric	Select Back/Seat Cushions Fabric	Select Leg Type	Select Leg Color
HML2SDF	N Armless A Straight Arms (+ \$300) B Tapered Arms (+ \$350)	See page 315	See page 315	TS Tapered Square TR Tapered Round	PR8 Textured Silver P7A Textured Charcoal H Bourbon Cherry (+ \$100) F Shaker Cherry (+ \$100) N Mahogany (+ \$100) C Harvest (+ \$100) D Natural Maple (+ \$100) LK11 Kingswood Walnut (+ \$100) LSA1 Sterling Ash (+ \$100)
HML2SDF	A	PNS004	PNS007	TS	P7A

! Leg options - Tapered Square (TS) and Tapered Round (TR) are available in 2 poly and 8 woodgrain options.



HML3SDF

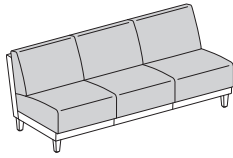

Armless

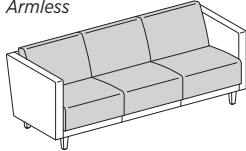

Straight Arms

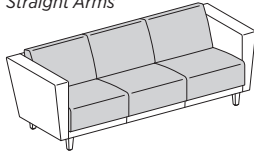

Tapered Arms

THREE-SEAT LOUNGE

Multi-Fabric

DIMENSIONS

Depth:	31½	Ship Weight (armless):	141
Height:	35	Ship Weight (with straight arms):	157
Seat Width:	71½	Ship Weight (with tapered arms):	165
Back Width:	71½	Cube (armless):	48.9
Back Height:	19	Cube (with straight arms):	48.9
Width (armless):	71½	Cube (with tapered arms):	48.9
Width (with straight arms):	77½	COM:	See
Width (with tapered arms):	82½		page 315
Arm Width:	71½	Weight Rating:	300 lbs.
Seat to Floor Height:	16		(per seat)
Usable Seat Depth:	18¾		

FABRIC PRICE CODES

1	\$3221		
<i>Add to Base Price Above</i>			
		Frame/ Arms	Back/Seat Cushions
2	\$72		\$132
3	\$144		\$264
4	\$198		\$363
5	\$252		\$462
6	\$306		\$561
7	\$360		\$660
8	\$414		\$759
9	\$468		\$858
10	\$522		\$957
11	\$576		\$1056
12	\$630		\$1155
L	\$600		\$1100

For multi-fabric models, start with the base price, then add the additional amount for the back and seat from the corresponding matrix to determine the final list price. Choose any combination of fabric grades for the back and seat.

Example: HML3SDF base price (\$3221) + Grade 2 frame/arms fabric (add \$72) + Grade 4 back/seat fabric (add \$363) = Total \$3656 List
 HML3SDF base price (\$3221) + Grade 5 frame/arms fabric (add \$252) + Grade 3 back/seat fabric (add \$264) = Total \$3737 List

HON Recommendation: HML3SDF.A.PNS___.PNS___.TS.P7A - List Price \$3725

HOW TO SPECIFY

Select Model Number	Select Arm Type	Select Frame/Arms Fabric	Select Back/Seat Cushions Fabric	Select Leg Type	Select Leg Color
HML3SDF	N Armless A Straight Arms (+ \$300) B Tapered Arms (+ \$350)	See page 315	See page 315	TS Tapered Square TR Tapered Round	PR8 Textured Silver P7A Textured Charcoal H Bourbon Cherry (+ \$100) F Shaker Cherry (+ \$100) N Mahogany (+ \$100) C Harvest (+ \$100) D Natural Maple (+ \$100) LK11 Kingswood Walnut (+ \$100) LSA1 Sterling Ash (+ \$100)
HML3SDF	A	PNS004	PNS007	TS	P7A

! Leg options - Tapered Square (TS) and Tapered Round (TR) are available in 2 poly and 8 woodgrain options.

HML2STDF

TWO-SEAT WITH TABLE

Multi-Fabric

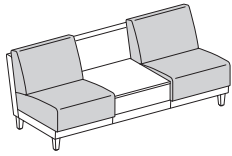

Armless

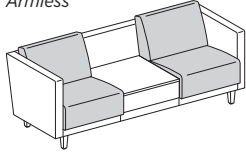

Straight Arms

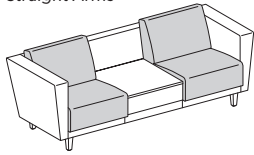

Tapered Arms

DIMENSIONS

Depth:	31½	Ship Weight (armless):	146
Height:	35	Ship Weight (with straight arms):	162
Seat Width:	71½	Ship Weight (with tapered arms):	170
Back Width:	71½	Cube (armless):	48.9
Back Height:	19	Cube (with straight arms):	48.9
Width (armless):	71½	Cube (with tapered arms):	48.9
Width (with straight arms):	77½	COM:	See page 315
Width (with tapered arms):	82½	Weight Rating:	300 lbs. (per seat)
Arm Width:	71½		
Seat to Floor Height:	16		
Usable Seat Depth:	18¾		

FABRIC PRICE CODES

1	\$3461		
<i>Add to Base Price Above</i>			
	Frame/Arms	Back/Seat Cushions	
2	\$72	\$84	
3	\$144	\$168	
4	\$198	\$231	
5	\$252	\$294	
6	\$306	\$357	
7	\$360	\$420	
8	\$414	\$483	
9	\$468	\$546	
10	\$522	\$609	
11	\$576	\$672	
12	\$630	\$735	
L	\$600	\$700	

NOTES: Offers a table between the seats that provides separation and a usable worksurface. Table available with two grommet and an accessory port option.

HON Recommendation: HML2STDF.A.PNS__PNS__TS.P7A.N.G1.0 - List Price \$3957

HOW TO SPECIFY

Select Model Number	Select Arm Type	Select Frame/Arms Fabric	Select Back/Seat Cushions Fabric	Select Leg Type	Select Leg Color	Select Laminate	Select Cut Out	Accessory Port Location
	N Armless A Straight Arms (+ \$300) B Tapered Arms (+ \$350)	See page 315	See page 315	TS Tapered Square TR Tapered Round	PR8 Textured Silver P7A Textured Charcoal H Bourbon Cherry (+ \$100) F Shaker Cherry (+ \$100) N Mahogany (+ \$100) C Harvest (+ \$100) D Natural Maple (+ \$100) LK11 Kingswood Walnut (+ \$100) LSA1 Sterling Ash (+ \$100)	<i>See Chart on page 314</i> L2 (+ \$125)	N No Cutout G Round Grommet Cutout (+ \$30) G1 Pop-Up Port Cutout (+ \$40)	0 No Port 2 Two Tablet Ports Opposite (+ \$20)
HML2STDF	A	PNS004	PNS007	TS	P7A	N	G1	0

! Leg options - Tapered Square (TS) and Tapered Round (TR) are available in 2 poly and 8 woodgrain options.

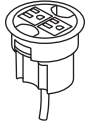
HGRMTAC

SIN 33721T

POWER HUB**3" Grommet Mount, 6' Cord****DIMENSIONS**Ship Weight: 1.3
Cube: 0.2**LIST PRICE****\$126**

NOTES: Fits in 3" round grommet holes. Field installed with Plug-and-play ease. Two grounded AC power outlets. Includes 6' cord with three-prong plug.

ⓘ Available in black only (no color designation so use .X)

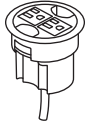
HGRMTAC2

SIN 33721T

3" ROUND POWER GROMMET**2 Outlets, 10' Cord****DIMENSIONS**Ship Weight: 1.5
Cube: 0.2**LIST PRICE****\$159**

NOTES: Power Modules will also work with standing-height applications for 10500 Series™ and Voi® desks. Optional Memory Control allows preset worksurface heights for consistency. Ships separately. Dynamic load capacity when worksurface is moving is 300 lbs. Includes 10' cord with three-prong plug. Fits in 3" round grommet holes on the following product lines: Coordinate™, Huddle, Motivate®, all laminate and veneer casegoods series, and Systems Worksurfaces. Two grounded AC power outlets. Field installed with Plug-and-play ease.

ⓘ Available in black finish only, no specification needed.

HGRMTUSB2

SIN 33721T

POWER/USB HUB**3" Grommet Mount****DIMENSIONS**Ship Weight: 1.3 ⓘ
Cube: 0.2**LIST PRICE****\$250**

NOTES: One grounded AC power outlet with 2 USB ports. UL Listed.

ⓘ Available in black only (no color designation so use .X)

HFTTAL14

SIN 33721

TABLET ACCESSORY**Laminate****DIMENSIONS**Diameter: 14 Ship Weight: 6.0
Height from Table Top: 10 Cube: 2.5**LIST PRICE****\$402**

NOTES: Use with Collaborative Cube and Cylinder tables for additional workspace. Attaches to tables through ports. Multiple port location options are available. Tablet pivots/swivels toward the user.

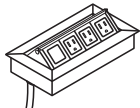
HTG1PWR-3P-1B

SIN 33721

POP-UP PORT**DIMENSIONS**Ship Weight: 5.0
Cube: 0.3**LIST PRICE****\$424**

NOTES: Fits into 4" x 8" cutout. Specify G1 cutout in table top. Pop-up Port provides three power ports and one blank data receptacle. Sits flush with worksurface when closed. Finish is anodized aluminum. Includes 6' cord with three-prong plug.

HON Recommendation: HTG1PWR-3P-1B - List Price \$424

HOW TO SPECIFY

Select
Model Number

H G R M T A C

GUESTSTACKER® 4030 Series

Want to see more? Scan here
to check out [hon.com](https://www.hon.com).



GuestStacker Stacking Chair shown in Regatta.

GUESTSTACKER® 4030 SERIES

Support your people with a comfortable chair whenever needed, then quickly clear the room. GuestStacker helps you make the most of valuable floor space by stacking six high on the floor or 28 high on a cart. Each set of four chairs provides ergonomic support to users with a contoured seat and back that are molded to fit the natural curves of your body. When you need to put guests at ease for any length of time, you need GuestStacker chairs.



FEATURES

- Ships four chairs per carton.
- Chairs stack six high on the floor.
- Copolymer resin seat and back shell.
- Integrated lumbar support delivers long-lasting comfort.
- Wall-saver design protects walls and cabinets.
- Tubular steel frame adds durability.
- Optional ganging glides create straight rows.
- Stacks up to 28 high on HON Model 4033 Cart.
- Ships fully assembled.
- Warranted for users up to 300 lbs.



GUESTSTACKER® 4030 Series

H4031



STACKING CHAIRS

Textured Copolymer Seat & Back
Painted Legs — Black (T) ONLY

DIMENSIONS

Depth:	21½	Seat to Floor Height:	17½
Width:	21	Usable Seat Depth:	17½
Height:	31	Ship Weight:	51
Seat Depth:	19	Cube:	12.9
Seat Width:	18	Weight Rating:	300 lbs.
Back Width:	20		
Back Height:	11		

LIST PRICE PER CARTON

\$712
(reference single unit @ \$178.00)

- ⊕ 4030 Series is ordered and shipped four (4) chairs per carton. Pricing shown is per carton. Each set of four (one carton), must have the same shell/frame color combination. Ordering 2 of Model H4031 will result in 2 cartons being shipped, giving you 8 chairs.
- ⚠ Shipped fully assembled — 4 chairs per carton. All GuestStacker® shell colors are CA Technical Bulletin 133 compliant (no upcharge).

H4033

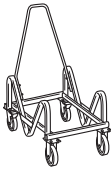

CART FOR STACKING CHAIRS

DIMENSIONS

Depth:	35½	Ship Weight:	40 Ⓢ
Width:	21¾	Cube:	8.9
Height:	37¾		

LIST PRICE

\$598

- NOTES: Holds 28 stack chairs (6'-8"), some assembly required. (Chairs stack 6 high without cart.)
⚠ Specify Black paint (T) ONLY.

H4039

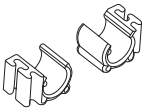

GANGING CHAIR GLIDES

DIMENSIONS

Box of 48	Ship Weight:	1 Ⓢ
	Cube:	0.04

LIST PRICE

\$120

HON Recommendation: H4031.LA.T - List Price \$712

HOW TO SPECIFY

<p>Select Model Number</p> <p>H 4 0 3 1 .</p>	<p>Select Shell Color</p> <p>LA Lava MB Mulberry ON Onyx RE Regatta</p> <p>L A .</p>	<p>Select Frame</p> <p>T Black</p> <p>T</p>
---	--	---

NOTES



Ignition® Seating.

IGNITION®

People come in all shapes and sizes, which is why Ignition does as well. From guest and lounge chairs to executive seating, Ignition allows you to mix and match adjustment features, back height, lumbar, and other options to fit your chair to your needs. It's the easy, affordable way to furnish an entire workplace in style and comfort. Ignition fits who you are, where you work and how you work.



FEATURES

IGNITION® 2.0

- Choice of upholstered, 4-Way Stretch mesh or ReActiv® back options.
- ReActiv® back features zonal comfort that delivers optimal support and flexibility.
- The unique hammock-like inner support allows the upholstered back version to feature a slim profile and provide built-in comfort.
- Optional adjustable lumbar allows users to tailor their support.
- 8 different adjustable lumbar colors available on 4-Way Stretch mesh and ReActiv® task chair models.
- Passive movement back adjusts with you.
- Multiple arm options to accommodate user requirements.
- Available in 7 colors of 4-Way Stretch mesh and 3 ReActiv® colors.
- Molded foam seat for better support and added comfort.
- Black, Titanium, and Designer White frame.
- Mesh seat option with waterfall seat available to reduce pressure points and provide breathability.
- Warranted for users up to 300 lbs., 450 lbs. for Big & Tall.











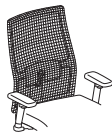

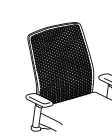
IGNITION®

- Ignition Series seating addresses the needs of the total office with Executive, Task, Stool, Guest and Lounge Seating Solutions.
- Three different back sizes, three different controls and multiple arm options to fit you and how you work.
- Back height adjustment moves the back up or down to fit various body sizes.
- Contoured back on multi-purpose seating offers greater comfort than typical stack chairs or stools.
- Warranted for users up to 300 lbs., 450 lbs. for Big & Tall.
- Multi-purpose chair stacks four high.

IGNITION® Options

MODEL OPTIONS

<p>HITLM</p>  <p>Task Low-Back 4-Way Stretch Mesh Back, Pneumatic, Swivel, Synchro-tilt, Tilt Tension, Tilt Lock, Optional Lumbar Support</p>	<p>HITSM</p>  <p>Task Low-Back Stool 4-Way Stretch Mesh Back, Pneumatic, Swivel, Synchro-tilt, Tilt Tension, Tilt Lock, Optional Lumbar Support</p>	<p>HITLRA</p>  <p>Task Low-Back ReActiv® ReActiv® Back, Pneumatic, Swivel, Synchro-tilt, Tilt Tension, Tilt Lock, Optional Lumbar Support</p>	<p>HITSRA</p>  <p>Task Low-Back Stool ReActiv® ReActiv® Back, Pneumatic, Swivel, Synchro-tilt, Tilt Tension, Tilt Lock, Optional Lumbar Support</p>
<p>HIWMM</p>  <p>Task Mid-Back 4-Way Stretch Mesh Back, Pneumatic, Swivel, Synchro-tilt, Tilt Tension, Tilt Lock, Optional Lumbar Support</p>	<p>HIWMMHR</p>  <p>Task Mid-Back w/Headrest 4-Way Stretch Mesh Back, Pneumatic, Swivel, Synchro-tilt, Tilt Tension, Tilt Lock, Optional Lumbar Support, Headrest</p>	<p>HIWMS</p>  <p>Task Mid-Back w/Mesh Seat 4-Way Stretch Mesh Back, Pneumatic, Swivel, Synchro-tilt, Tilt Tension, Tilt Lock, Optional Lumbar Support, Mesh Seat</p>	<p>HIWMBT</p>  <p>Task Mid-Back Big & Tall 4-Way Stretch Mesh Back, Pneumatic, Swivel, Synchro-tilt, Tilt Tension, Tilt Lock, Optional Lumbar Support</p>
<p>HIWMRA</p>  <p>Task Mid-Back ReActiv® ReActiv® Back, Pneumatic, Swivel, Synchro-tilt, Tilt Tension, Tilt Lock, Optional Lumbar Support</p>	<p>HIWMMU</p>  <p>Upholstered Mid-Back Upholstered Back, Pneumatic, Swivel, Synchro-tilt, Tilt Tension, Tilt Lock</p>	<p>HIWMMUL</p>  <p>Upholstered Mid-Back with Lumbar Support Upholstered Back, Pneumatic, Swivel, Synchro-tilt, Tilt Tension, Tilt Lock, Adjustable Lumbar</p>	

SEATING

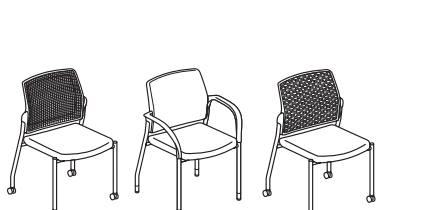
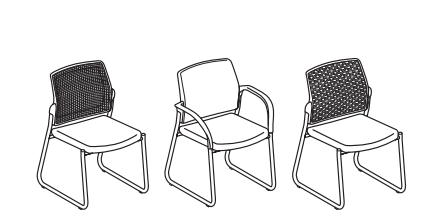
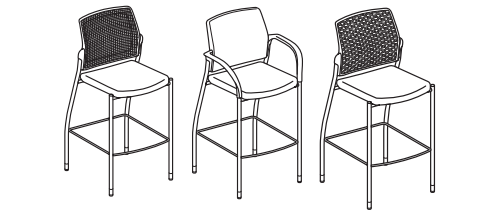
<p>HIGS6</p>  <p>Multi-Purpose Four Legs</p>	<p>HISB6</p>  <p>Multi-Purpose Sled Base</p>	<p>HICS7</p>  <p>Café-Height Stool Four Legs</p>
--	---	--

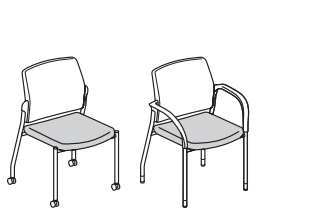
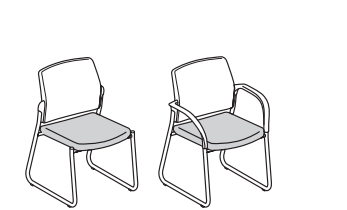
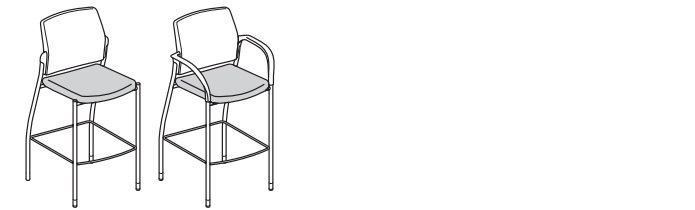
<p>HIGS6DF - Multi-Fabric</p>  <p>Multi-Purpose Four Legs</p>	<p>HISB6DF - Multi-Fabric</p>  <p>Multi-Purpose Sled Base</p>	<p>HICS7DF - Multi-Fabric</p>  <p>Café-Height Stool Four Legs</p>
---	--	---

MODEL OPTIONS

HIGCL



Guest Chair

Fixed Arms, Glides

HIB50

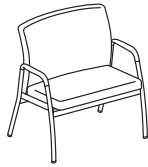

Bariatric Lounge

Fixed Arms, Glides

HITL1



Task Low-Back

Pneumatic, Back Height Adjustment, Swivel, Tilt, Tilt Tension, Tilt Lock

HITL2



Task Low-Back

Pneumatic, Back Height Adjustment, Synchro-tilt, Tilt Tension, Tilt Lock, Seat Glide

HITL3



Task Low-Back

Pneumatic, Back Height Adjustment, Synchro-tilt, Back Angle Adjustment, Tilt Tension, Tilt Lock, Seat Glide

HITS5



Task Stool

Pneumatic, Swivel Back Height Adjustment, Adjustable Footrest

HIWM1



Mid-Back

Pneumatic, Back Height Adjustment, Swivel, Tilt, Tilt Tension, Tilt Lock

HIWM2



Mid-Back

Pneumatic, Back Height Adjustment, Synchro-tilt, Tilt Tension, Tilt Lock, Seat Glide

HIWM3



Mid-Back

Pneumatic, Back Height Adjustment, Synchro-tilt, Back Angle Adjustment, Tilt Tension, Tilt Lock, Seat Glide

HIEH1



Executive High-Back

Pneumatic, Back Height Adjustment, Swivel, Tilt, Tilt Tension, Tilt Lock

HIEH2



Executive High-Back

Pneumatic, Back Height Adjustment, Synchro-tilt, Tilt Tension, Seat Glide

HIEH3



Executive High-Back

Pneumatic, Back Height Adjustment, Synchro-tilt, Back Angle Adjustment, Tilt Tension, Seat Glide

HIWM8













Task Mid-Back







Big and Tall, Pneumatic, Swivel-tilt, Tilt Tension

IGNITION® 2.0

Options

ARM STYLE	CODE	DESCRIPTION	PRICE
	N	Armless	+\$0
	F	Fixed Arms	+\$65
	A	Height and Width Adjustable Arms	+\$85
	V	All-Adjustable Arms (includes Pivot)	+\$130
	P	Fixed Polished Aluminum Arms	+\$175

CASTERS	CODE	DESCRIPTION	PRICE
	H	Black Hard Caster	+\$0
	S	Black All-Surface Caster	+\$40
	R	Black Roll Control Caster	+\$50
	TS	Titanium All-Surface Caster	+\$40
	A	Black All-Surface Caster (Big & Tall models only)	+\$0

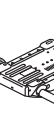
MECHANISM	CODE	DESCRIPTION	PRICE
	Y0	Synchro-Tilt A, E, J, K, L	+\$0
	Y1	Synchro-Tilt w/ Seat Slider A, D, E, J, K, L	+\$20
	Y2	Advanced Synchro-Tilt A, D, E, J, L, A-D	+\$65
	Y3	Synchro-Tilt with Independent Back Angle A, D, E, J, L, A-E	+\$105
	Y4	Synchro-Tilt (Big & Tall models only) A, D, E, J, L, A-D	+\$0
	S0	Limited Recline Synchro-Tilt A, E, J, K, L	+\$0
	S1	Limited Recline Synchro-Tilt w/ Seat Slider A, D, E, J, K, L	+\$20
		<i>*Only available on HITSM</i>	
	S2	Limited Recline Advanced Synchro-Tilt A, D, E, J, L, A-D	+\$65
		<i>*Only available on HIWMMS, HIWMMSKD</i>	

LUMBAR	CODE	DESCRIPTION	PRICE
	NL	No Lumbar	+\$0
	BL	Black Adjustable Lumbar	+\$30
	BY	Bullseye Adjustable Lumbar	+\$30
	DW	Designer White Adjustable Lumbar	+\$30
	MR	Ember Adjustable Lumbar	+\$30
	IR	Iris Adjustable Lumbar	+\$30
	KT	Krypton Adjustable Lumbar	+\$30
	RE	Regatta Adjustable Lumbar	+\$30
	TL	Titanium Adjustable Lumbar	+\$30
		<i>*Adjustable Lumbar not available on CAL 133 (FC) models</i>	

IGNITION® 2.0 Options

BASE



CODE	DESCRIPTION	PRICE
SB	Standard Base	+\$0

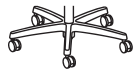

PA	Polished Aluminum	+\$110
-----------	-------------------	---------------

FRAME

CODE	DESCRIPTION	PRICE
T	Black Frame	+\$0
DWX	Designer White	+\$35
TI	Titanium Frame	+\$35

BACK STYLE

CODE	DESCRIPTION	PRICE
------	-------------	-------

4-Way Stretch mesh back options:

IM	Black	+\$0
IB	Breeze	+\$0
IK	Brownstone	+\$0
IC	Charcoal	+\$0
IF	Fog	+\$0
IR	Regatta	+\$0
IT	Titanium	+\$0

ReActiv® back options:

OS	Charcoal	+\$0
DWR	Designer White	+\$0
TI	Titanium	+\$0

IGNITION® 2.0

Dimensions

TASK DIMENSIONS

MODEL		HIWMM, HIWMRA, HIWMMU, & HIWMMUL	HIWMMHR	HIWMMS	HITLM & HITLRA	HITSM & HITSRA
Overall Width Armless		21	21	21	20	20
Overall Width with Arms	A	27	27	27	26	26
Overall Depth		24	24	24	22	22
Overall Height	S0/S1	-	-	-	-	52½
	Y0/Y1	43¾	54	43¾	40½	-
	S2	-	-	44½	-	-
	Y2	44½	55	-	41¼	-
	Y3	44½	55	-	41¼	-
	Y4	-	-	-	-	-
Seat Width		20	20	20	18½	18½
Seat Depth		18¾	18¾	18¾	17¾	17¾
Usable Seat Depth	S0	-	-	-	-	16¾
	S1	-	-	-	-	15½ - 16¾
	S2	-	-	16½ - 18¼	-	-
	Y0	17¾	17¾	17½	16¾	-
	Y1	17½ - 19½	17½ - 19½	16¾ - 18¼	15½ - 17½	-
	Y2	16¼ - 19¼	16¼ - 19¼	-	15¾ - 18½	-
	Y3	16½ - 19½	16½ - 19½	-	16¼ - 18¾	-
	Y4	-	-	-	-	-
Seat Height	S0/S1	-	-	-	-	22¾ - 31¾
	S2	-	-	17½ - 22¼	-	-
	Y0/Y1	16¾ - 21¼	16¾ - 21¼	16¾ - 21½	16¾ - 21¼	-
	Y2	17½ - 21½	17½ - 21½	-	17½ - 21½	-
	Y3	17½ - 21½	17½ - 21½	-	17¾ - 21¾	-
	Y4	-	-	-	-	-
Back Width		19	19	19	19	17½
Back Height		23	23	23	19	19
Ship Weight Armless	S0	-	-	-	-	44 Ⓢ
	S1	-	-	-	-	46 Ⓢ
	S2	-	-	42 Ⓢ	-	-
	Y0	38 Ⓢ	38 Ⓢ	38 Ⓢ	38 Ⓢ	-
	Y1	38 Ⓢ	38 Ⓢ	38 Ⓢ	38 Ⓢ	-
	Y2	42 Ⓢ	42 Ⓢ	-	42 Ⓢ	-
	Y3	46 Ⓢ	46 Ⓢ	-	45 Ⓢ	-
	Y4	-	-	-	-	-
Ship Weight with Arms	S0	-	-	-	-	51 Ⓢ
	S1	-	-	-	-	53 Ⓢ
	S2	-	-	49 Ⓢ	-	-
	Y0	45 Ⓢ	45 Ⓢ	45 Ⓢ	45 Ⓢ	-
	Y1	45 Ⓢ	45 Ⓢ	45 Ⓢ	45 Ⓢ	-
	Y2	49 Ⓢ	49 Ⓢ	-	49 Ⓢ	-
	Y3	53 Ⓢ	53 Ⓢ	-	52 Ⓢ	-
	Y4	-	-	-	-	-
Width Between Arms	F	20¼	20¼	20¾	19	19
	P	20¼	20¼	20¾	19	19
	A	18 - 20½	18 - 20½	17½ - 21	17 - 19½	17 - 19½
	V	12½ - 27½	12½ - 27½	12 - 27	11½ - 26½	11½ - 26½
Cube		10.8	10.8	10.8	10.8	10.8
Cube with Y3 Control		12	12	-	12	-
COM		1.0	1.0	-	1.0	1.0
Weight Capacity		300 lbs	300 lbs	300 lbs	300 lbs	300 lbs

IGNITION® 2.0

Dimensions

TASK DIMENSIONS

MODEL	HITLMKD & HITLRAKD	HIWMMKD, HIWMRAKD, HIWUMKD, & HIWMULKD	HIWMMSKD	HIWMBT
Overall Width Armless	20	21	21	30
Overall Width with Arms	A	26	27	30
Overall Depth	22	24	24	30
Overall Height	S0/S1	-	-	-
	Y0/Y1	40½	43¾	-
	S2	-	44½	-
	Y2	-	-	-
	Y3	-	-	-
	Y4	-	-	46 (+10½ for HR)
Seat Width	18½	20	20	23½
Seat Depth	17⅝	18⅝	18⅝	20¼
Usable Seat Depth	S0	-	-	-
	S1	-	-	-
	S2	-	16½ - 18¼	-
	Y0	16¾	17¾	-
	Y1	15½ - 17½	17½ - 19½	16¾ - 18¼
	Y2	-	-	-
	Y3	-	-	-
	Y4	-	-	17¾ - 19½
Seat Height	S0/S1	-	-	-
	S2	-	17½ - 22¼	-
	Y0/Y1	16¾ - 21¼	16⅝ - 21¼	16¾ - 21½
	Y2	-	-	-
	Y3	-	-	-
	Y4	-	-	17 - 21½
Back Width	17½	19	19	22¾
Back Height	19	23	23	24¾
Ship Weight Armless	S0	-	-	-
	S1	-	-	-
	S2	-	42 Ⓢ	-
	Y0	38 Ⓢ	38 Ⓢ	-
	Y1	38 Ⓢ	38 Ⓢ	-
	Y2	-	-	-
	Y3	-	-	-
	Y4	-	-	68
Ship Weight with Arms	S0	-	-	-
	S1	-	-	-
	S2	-	49 Ⓢ	-
	Y0	45 Ⓢ	45 Ⓢ	-
	Y1	45 Ⓢ	45 Ⓢ	-
	Y2	-	-	-
	Y3	-	-	-
	Y4	-	-	75
Width Between Arms	F	19	20¼	-
	P	19	20¼	-
	A	17 - 19½	18 - 20½	-
	V	11½ - 26½	12½ - 27½	14 - 29
Cube	5.6	6.3	10.8	15.3
Cube with Y3 Control	-	-	-	-
COM	-	-	-	1.5
Weight Capacity	300 lbs	300 lbs	300 lbs	450 lbs

IGNITION® 2.0



Icon Legend on page 17

HITLM

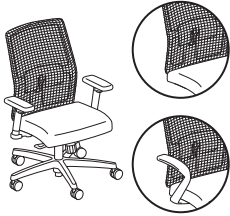

TASK LOW-BACK

- 4-Way Stretch Mesh Back**
- Pneumatic
- Swivel
- Synchro-tilt
- Tilt Tension
- Tilt Lock
- Optional Lumbar Support

DIMENSIONS

Depth:	22	Width (with arms):	26
Height:	40½	Width (armless):	20
Seat Depth:	16	Cube:	10.8
Seat Width:	18½	COM:	1.0
Back Width:	17½	Weight Rating:	300 lbs.
Back Height:	19		

FABRIC PRICE CODES

1	\$532	8	\$670
2	\$556	9	\$688
3	\$580	10	\$706
4	\$598	11	\$724
5	\$616	12	\$742
6	\$634	L	\$732
7	\$652		

! See page 332 for additional specifications and dimensions.

HIWMM

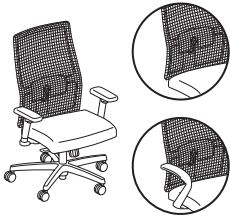

TASK MID-BACK

- 4-Way Stretch Mesh Back**
- Pneumatic
- Swivel
- Synchro-tilt
- Tilt Tension
- Tilt Lock
- Optional Lumbar Support

DIMENSIONS

Depth:	24	Width (with arms):	27
Height:	43¾	Width (armless):	21
Seat Depth:	17¾	Cube:	10.8
Seat Width:	20	COM:	1.0
Back Width:	19	Weight Rating:	300 lbs.
Back Height:	23		

FABRIC PRICE CODES

1	\$583	8	\$721
2	\$607	9	\$739
3	\$631	10	\$757
4	\$649	11	\$775
5	\$667	12	\$793
6	\$685	L	\$783
7	\$703		

! See page 332 for additional specifications and dimensions.

HITSM



TASK LOW-BACK STOOL

- 4-Way Stretch Mesh Back**
- Pneumatic
- Swivel
- Synchro-tilt
- Tilt Tension
- Tilt Lock
- Optional Lumbar Support

DIMENSIONS

Depth:	22	Width (with arms):	26
Height:	52½	Width (armless):	20
Seat Depth:	16	Cube:	10.8
Seat Width:	18½	COM:	1.0
Back Width:	17½	Weight Rating:	300 lbs.
Back Height:	19		

FABRIC PRICE CODES

1	\$637	8	\$775
2	\$661	9	\$793
3	\$685	10	\$811
4	\$703	11	\$829
5	\$721	12	\$847
6	\$739	L	\$837
7	\$757		

! See page 332 for additional specifications and dimensions.

! Not available in Polished Aluminum Base.

HON Recommendation: HIWMM.Y2.A.H.IM.CU__BL.SB.T - List Price \$763

HOW TO SPECIFY

Select Model Number	Select Control Type	Select Arm Type	Select Caster	Select Mesh	Select Fabric	Select Lumbar	Select Base	Select Frame
Y0 Synchro-Tilt	N Armless	H Black Hard Caster	IM Black	See page 351	NL No Lumbar	SB Standard Base	T Black	
Y1 Synchro-Tilt w/ Seat Slider (+ \$20)	A Height and Width Adjustable Arms (+ \$85)	S Black All-Surface Caster (+ \$40)	IB Breeze		BL Black Adjustable Lumbar (+ \$30)	PA Polished Aluminum (+ \$110)	DWX Designer White (+ \$35 for HITLM and HIWMM; + \$55 for HITSM)	
Y2 Advanced Synchro-Tilt (+ \$65)	V All-Adjustable Arms (includes pivot) (+ \$130)	TS Titanium All-Surface Caster (+ \$40)	IK Brownstone		BY Bullseye Adjustable Lumbar (+ \$30)		TI Titanium (+ \$35 for HITLM and HIWMM; + \$55 for HITSM)	
Y3 Synchro-Tilt with Independent Back Angle (+ \$105)	F Fixed Arms (+ \$65)	R Black Roll Control Caster (+ \$50)	IC Charcoal		DW Designer White Adjustable Lumbar (+ \$30)			
S0 Limited Recline Synchro-Tilt (for HITSM only)	P Fixed Arms - Polished (+ \$175)		IF Fog		MR Ember Adjustable Lumbar (+ \$30)			
S1 Limited Recline Synchro-Tilt w/ Seat Slider (+ \$20 for HITSM only)			IR Regatta		IR Iris Adjustable Lumbar (+ \$30)			
			IT Titanium		KT Krypton Adjustable Lumbar (+ \$30)			
					RE Regatta Adjustable Lumbar (+ \$30)			
					TL Titanium Adjustable Lumbar (+ \$30)			

HITLM . Y2 . A . H . IM . CU10 . BL . SB . T



Icon Legend on page 17

IGNITION® 2.0

HIWMMHR



TASK MID-BACK

4-Way Stretch Mesh Back w/ Headrest
 Pneumatic
 Swivel
 Synchro-tilt
 Tilt Tension
 Tilt Lock
 Optional Lumbar Support
 Headrest

DIMENSIONS

Depth:	24	Width (with arms):	27
Height:	54	Width (armless):	21
Seat Depth:	17¾	Cube:	10.8
Seat Width:	20	COM:	1.0
Back Width:	19	Weight Rating:	300 lbs.
Back Height:	23		

FABRIC PRICE CODES

1	\$583	8	\$721
2	\$607	9	\$739
3	\$631	10	\$757
4	\$649	11	\$775
5	\$667	12	\$793
6	\$685	L	\$783
7	\$703		

! See page 332 for additional specifications and dimensions.

HON Recommendation: HIWMMHR.Y2.A.TS.IF.CU__DW.SB.DWX.HR - List Price \$918

HOW TO SPECIFY

Select Model Number	Select Control Type	Select Arm Type	Select Caster	Select Mesh	Select Fabric	Select Lumbar	Select Base	Select Frame	Select Headrest
YO Synchro-Tilt w/ Seat Slider (+ \$20) Y1 Synchro-Tilt w/ Seat Slider (+ \$20) Y2 Advanced Synchro-Tilt (+ \$65) Y3 Synchro-Tilt with Independent Back Angle (+ \$105)	N Armless A Height and Width Adjustable Arms (+ \$85) V All-Adjustable Arms (includes pivot) (+ \$130) F Fixed Arms (+ \$65) P Fixed Arms - Polished (+ \$175)	H Black Hard Caster S Black All-Surface Caster (+ \$40) TS Titanium All-Surface Caster (+ \$40) R Black Roll Control Caster (+ \$50)	IM Black IB Breeze IK Brownstone IC Charcoal IF Fog IR Regatta IT Titanium	See page 351	NL No Lumbar BL Black Adjustable Lumbar (+ \$30) BY Bullseye Adjustable Lumbar (+ \$30) DW Designer White Adjustable Lumbar (+ \$30) MR Ember Adjustable Lumbar (+ \$30) IR Iris Adjustable Lumbar (+ \$30) KT Krypton Adjustable Lumbar (+ \$30) RE Regatta Adjustable Lumbar (+ \$30) TL Titanium Adjustable Lumbar (+ \$30)	SB Standard Base PA Polished Aluminum (+ \$110)	T Black DWX Designer White (+ \$35) TI Titanium (+ \$35)	HR Headrest (+ \$80) <i>Headrest color will match chair frame selection. Headrest mesh color will match mesh back color selection.</i>	
HIWMMHR	Y2	A	H	IM	CU10	BL	SB	T	HR

SEATING

IGNITION® 2.0



Icon Legend on page 17

HITLMKD



TASK LOW-BACK

4-Way Stretch Mesh Back
Pneumatic
Swivel
Synchro-tilt
Tilt Tension
Tilt Lock
Optional Lumbar Support

DIMENSIONS

Depth:	22	Back Height:	19
Height:	40½	Width (with arms):	26
Seat Depth:	16	Width (armless):	20
Seat Width:	18½	Cube:	5.6
Back Width:	17½	Weight Rating:	300 lbs.

FABRIC PRICE CODES

1	\$492
2	\$516
3	\$540

! See page 332 for additional specifications and dimensions.

HIWMMKD



TASK MID-BACK

4-Way Stretch Mesh Back
Pneumatic
Swivel
Synchro-tilt
Tilt Tension
Tilt Lock
Optional Lumbar Support

DIMENSIONS

Depth:	24	Back Height:	23
Height:	43¾	Width (with arms):	27
Seat Depth:	17¾	Width (armless):	21
Seat Width:	20	Cube:	6.3
Back Width:	19	Weight Rating:	300 lbs.

FABRIC PRICE CODES

1	\$543
2	\$567
3	\$591

! See page 332 for additional specifications and dimensions.

HON Recommendation: HIWMMKD.Y2.A.H.IM.CU__BL.SB.T - List Price \$723

HOW TO SPECIFY

Select Model Number	Select Control Type	Select Arm Type	Select Caster	Select Mesh	Select Fabric	Select Lumbar	Select Base	Select Frame
Y1 Synchro-Tilt w/ Seat Slider (+ \$20) Y2 Advanced Synchro-Tilt (+ \$65)	A Height and Width Adjustable Arms (+ \$85)	H Black Hard Caster	IM Black IF Fog IC Charcoal	See page 351	NL No Lumbar BL Black Adjustable Lumbar (+ \$30) BY Bullseye Adjustable Lumbar (+ \$30) DW Designer White Adjustable Lumbar (+ \$30) MR Ember Adjustable Lumbar (+ \$30) IR Iris Adjustable Lumbar (+ \$30) KT Krypton Adjustable Lumbar (+ \$30) RE Regatta Adjustable Lumbar (+ \$30) TL Titanium Adjustable Lumbar (+ \$30)	SB Standard Base	T Black DWX Designer White (+ \$35) TI Titanium (+ \$35)	
H I W M M K D .	Y 2 .	A .	H .	I M .	C U 1 0 .	B L .	S B .	T



Icon Legend on page 17

IGNITION® 2.0

HIWMBT



TASK MID-BACK

- 4-Way Stretch Mesh Back**
- Pneumatic
- Swivel
- Synchro-tilt
- Tilt Tension
- Tilt Lock
- Optional Lumbar Support

DIMENSIONS

Depth:	30	Width (with arms):	30
Height:	47	Width (armless):	30
Seat Depth:	20¼	Cube:	15.3
Seat Width:	23½	COM:	1.5
Back Width:	22¾	Weight Rating:	450 lbs.
Back Height:	24¾		

FABRIC PRICE CODES

1	\$982	8	\$1120
2	\$1006	9	\$1138
3	\$1030	10	\$1156
4	\$1048	11	\$1174
5	\$1066	12	\$1192
6	\$1084	L	\$1182
7	\$1102		

! See page 332 for additional specifications and dimensions.

HON Recommendation: HIWMBT.Y4.V.A.IC.CU__TL.SB.TI.N - List Price \$1177

HOW TO SPECIFY

Select Model Number	Select Control Type	Select Arm Type	Select Caster	Select Mesh	Select Fabric	Select Lumbar	Select Base	Select Frame	Select Headrest
	Y4 Synchro-Tilt	V All-Adjustable Arms (includes pivot) (+ \$130) N Armless	A All-Surface Caster	IM Black IF Fog IC Charcoal	See page 351	NL No Lumbar BL Black Adjustable Lumbar (+ \$30) BY Bullseye Adjustable Lumbar (+ \$30) DW Designer White Adjustable Lumbar (+ \$30) MR Ember Adjustable Lumbar (+ \$30) IR Iris Adjustable Lumbar (+ \$30) KT Krypton Adjustable Lumbar (+ \$30) RE Regatta Adjustable Lumbar (+ \$30) TL Titanium Adjustable Lumbar (+ \$30)	SB Standard Base	T Black DWX Designer White (+ \$35) TI Titanium (+ \$35)	N No Headrest HR Headrest (+ \$80) <i>Big & Tall headrest frame is black. Mesh color matches mesh back selection.</i>
HIWMBT	Y4	V	A	IM	CU10	BL	SB	T	HR

SEATING

IGNITION® 2.0

OPEN MARKET



Icon Legend on page 17

HIWMMS



TASK MID-BACK

4-Way Stretch Mesh Back and Seat
 Pneumatic
 Swivel
 Synchro-tilt
 Tilt Tension
 Tilt Lock
 Optional Lumbar Support
 Optional Headrest

DIMENSIONS

Depth: 24
 Height: 43¾
 Seat Depth: 17¾
 Seat Width: 20
 Back Width: 19
 Back Height: 23
 Width (with arms): 27
 Width (armless): 21
 Cube: 10.8
 Weight Rating: 300 lbs.

LIST PRICE

\$681

See page 332 for additional specifications and dimensions.

HIWMMSKD



TASK MID-BACK

4-Way Stretch Mesh Back and Seat
 Pneumatic
 Swivel
 Synchro-tilt
 Tilt Tension
 Tilt Lock
 Optional Lumbar Support
 Optional Headrest

DIMENSIONS

Depth: 24
 Height: 43¾
 Seat Depth: 17¾
 Seat Width: 20
 Back Width: 19
 Back Height: 23
 Width (with arms): 27
 Width (armless): 21
 Cube: 7.9
 Weight Rating: 300 lbs.

LIST PRICE

\$641

See page 332 for all other control specifications.

HON Recommendation: HIWMMS.W2.A.H.IM.IMS.BL.SB.T.N - List Price \$861

HOW TO SPECIFY

Select Model Number	Select Control Type	Select Arm Type	Select Caster	Select Back Mesh	Select Seat Mesh	Select Lumbar	Select Base	Select Frame	Select Headrest
Y0 Synchro-Tilt <i>Available on model HIWMMS only</i>	N Armless A Height and Width Adjustable Arms (+ \$85) F Fixed Arms (+ \$65) V All-Adjustable Arms (+ \$130) P Fixed Polished Arms (+ \$175) <i>F, V, and P available on model HIWMMS only</i>	H Black Hard Caster S Black All-Surface Caster (+ \$40) <i>Available on model HIWMMS only</i>	IM Black	IMS Black Mesh	NL No Lumbar BL Black Adjustable Lumbar (+ \$30) BY Bullseye Adjustable Lumbar (+ \$30) DW Designer White Adjustable Lumbar (+ \$30) MR Ember Adjustable Lumbar (+ \$30) IR Iris Adjustable Lumbar (+ \$30) KT Krypton Adjustable Lumbar (+ \$30) RE Regatta Adjustable Lumbar (+ \$30) TL Titanium Adjustable Lumbar (+ \$30)	SB Standard Base PA Polished Aluminum (+ \$110) <i>Available on model HIWMMS only</i>	T Black	N No Headrest HR Headrest (+ \$80) <i>Headrest frame color will match chair frame selection. Headrest mesh color will match mesh back selection.</i>	
Y1 Synchro-Tilt w/ Seat Slider (+ \$20)									
S2 Limited Recline Advanced Synchro-Tilt (+ \$65)									
H I W M M S	Y 1	A	H	I M	I M S	B L	S B	T	N

SEATING



Icon Legend on page 17

IGNITION® 2.0 ReActiv®

HITLRA

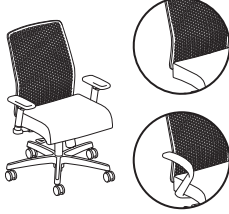

TASK LOW-BACK

- ReActiv® Back**
- Pneumatic
- Swivel
- Synchro-tilt
- Tilt Tension
- Tilt Lock
- Optional Lumbar Support

DIMENSIONS

Depth:	22	Width (with arms):	26
Height:	40½	Width (armless):	20
Seat Depth:	16	Cube:	10.8
Seat Width:	18½	COM:	1.0
Back Width:	17½	Weight Rating:	300 lbs.
Back Height:	19		

FABRIC PRICE CODES

1	\$567	8	\$705
2	\$591	9	\$723
3	\$615	10	\$741
4	\$633	11	\$759
5	\$651	12	\$777
6	\$669	L	\$767
7	\$687		

! See page 332 for all other control specifications.

HIWMRA

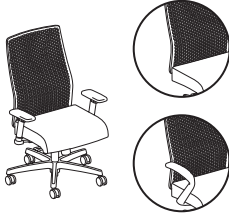

TASK MID-BACK

- ReActiv® Back**
- Pneumatic
- Swivel
- Synchro-tilt
- Tilt Tension
- Tilt Lock
- Optional Lumbar Support

DIMENSIONS

Depth:	24	Width (with arms):	27
Height:	43¾	Width (armless):	21
Seat Depth:	17¾	Cube:	10.8
Seat Width:	20	COM:	1.0
Back Width:	19	Weight Rating:	300 lbs.
Back Height:	23		

FABRIC PRICE CODES

1	\$618	8	\$756
2	\$642	9	\$774
3	\$666	10	\$792
4	\$684	11	\$810
5	\$702	12	\$828
6	\$720	L	\$818
7	\$738		

! See page 332 for all other control specifications.

HITSRA

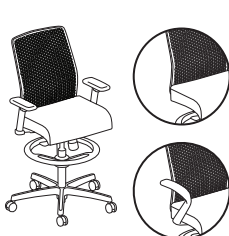

TASK LOW-BACK STOOL

- ReActiv® Back**
- Pneumatic
- Swivel
- Synchro-tilt
- Tilt Tension
- Tilt Lock
- Optional Lumbar Support

DIMENSIONS

Depth:	22	Width (with arms):	26
Height:	52½	Width (armless):	20
Seat Depth:	16	Cube:	10.8
Seat Width:	18½	COM:	1.0
Back Width:	17½	Weight Rating:	300 lbs.
Back Height:	19		

FABRIC PRICE CODES

1	\$672	8	\$810
2	\$696	9	\$828
3	\$720	10	\$846
4	\$738	11	\$864
5	\$756	12	\$882
6	\$774	L	\$872
7	\$792		

! See page 332 for all other control specifications.

! Not available in Polished Aluminum Base.

HON Recommendation: HIWMRA.Y2.A.H.___CU__BL.SB.T - List Price \$798

HOW TO SPECIFY

Select Model Number	Select Control Type	Select Arm Type	Select Caster	Select Back Color	Select Fabric	Select Lumbar	Select Base	Select Frame
Y0 Synchro-Tilt	N Armless	H Black Hard Caster	OS Charcoal ReActiv®	See page 351	NL No Lumbar	SB Standard Base	T Black	
Y1 Synchro-Tilt w/ Seat Slider (+ \$20)	A Height and Width Adjustable Arms (+ \$85)	S Black All-Surface Caster (+ \$40)	DWR Designer White ReActiv®		BL Black Adjustable Lumbar (+ \$30)	PA Polished Aluminum (+ \$110)	DWX Designer White (+ \$35 for HITLRA and HIWMRA; + \$55 for HITSRA)	
Y2 Advanced Synchro-Tilt (+ \$65)	V All-Adjustable Arms (includes pivot) (+ \$130)	TS Titanium All-Surface Caster (+ \$40)	TI Titanium ReActiv®		BY Bullseye Adjustable Lumbar (+ \$30)		TI Titanium (+ \$35 for HITLRA and HIWMRA; + \$55 for HITSRA)	
Y3 Synchro-Tilt with Independent Back Angle (+ \$105)	F Fixed Arms (+ \$65)	R Black Roll Control Caster (+ \$50)			DW Designer White Adjustable Lumbar (+ \$30)			
S0 Limited Synchro-Tilt (for HITSRA only)	P Fixed Arms - Polished (+ \$175)				MR Ember Adjustable Lumbar (+ \$30)			
S1 Limited Synchro-Tilt w/ Seat Slider (+ \$20 for HITSRA only)					IR Iris Adjustable Lumbar (+ \$30)			
<i>Specify S0 or S1 for HITSRA model ONLY</i>					KT Krypton Adjustable Lumbar (+ \$30)			
					RE Regatta Adjustable Lumbar (+ \$30)			
					TL Titanium Adjustable Lumbar (+ \$30)			

HITLRA - Y2 - A - H - OS - CU10 - BL - SB - T

IGNITION® 2.0 ReActiv®

OPEN MARKET



Icon Legend on page 17

HITLRAKD

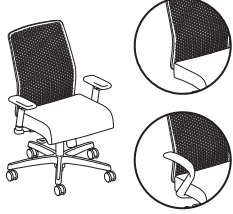

TASK LOW-BACK

ReActiv® Back
Pneumatic
Swivel
Synchro-tilt
Tilt Tension
Tilt Lock
Optional Lumbar Support

DIMENSIONS

Depth: 22
Height: 40½
Seat Depth: 16
Seat Width: 18½
Back Width: 17½
Back Height: 25½
Width (with arms): 26
Width (armless): 20
Cube: 5.6
Weight Rating: 300 lbs.

FABRIC PRICE CODES

1 \$527
2 \$551
3 \$575

! See page 332 for all other control specifications.

HIWMRAKD

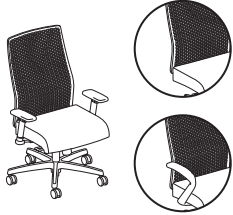

TASK MID-BACK

ReActiv® Back
Pneumatic
Swivel
Synchro-tilt
Tilt Tension
Tilt Lock
Optional Lumbar Support

DIMENSIONS

Depth: 24
Height: 43¾
Seat Depth: 17¾
Seat Width: 20
Back Width: 19
Back Height: 29
Width (with arms): 27
Width (armless): 21
Cube: 6.3
Weight Rating: 300 lbs.

FABRIC PRICE CODES

1 \$578
2 \$602
3 \$626

! See page 332 for all other control specifications.

HON Recommendation: HIWMRAKD.Y2.A.H.__CU__BL.SB.T - List Price \$758

HOW TO SPECIFY

Select Model Number	Select Control Type	Select Arm Type	Select Caster	Select Back Color	Select Fabric	Select Lumbar	Select Base	Select Frame
	Y1 Synchro-Tilt w/ Seat Slider (+ \$20) Y2 Advanced Synchro-Tilt (+ \$65)	N Armless A Height and Width Adjustable Arms (+ \$85)	H Black Hard Caster	OS Charcoal ReActiv® DWR Designer White ReActiv® TI Titanium ReActiv®	See page 351	NL No Lumbar BL Black Adjustable Lumbar (+ \$30) BY Bullseye Adjustable Lumbar (+ \$30) DW Designer White Adjustable Lumbar (+ \$30) MR Ember Adjustable Lumbar (+ \$30) IR Iris Adjustable Lumbar (+ \$30) KT Krypton Adjustable Lumbar (+ \$30) RE Regatta Adjustable Lumbar (+ \$30) TL Titanium Adjustable Lumbar (+ \$30)	SB Standard Base	T Black DWX Designer White (+ \$35) TI Titanium (+ \$35)
H I W M R A K D .	Y 2 .	A .	H .	O S .	C U 1 0 .	B L .	S B .	T



Icon Legend on page 17

IGNITION® 2.0 Upholstered

HIWMU



TASK MID-BACK

Upholstered Back

- Pneumatic
- Swivel
- Synchro-tilt
- Tilt Tension
- Tilt Lock

DIMENSIONS

Depth:	24	Width (with arms):	27
Height:	43¾	Width (armless):	21
Seat Depth:	17¾	Cube:	10.8
Seat Width:	20	COM:	3.0
Back Width:	19	Weight Rating:	300 lbs.
Back Height:	23		

FABRIC PRICE CODES

1	\$583	7	\$883
2	\$643	8	\$928
3	\$703	9	\$973
4	\$748	10	\$1018
5	\$793	11	\$1063
6	\$838	12	\$1108

! See page 332 for additional specifications and dimensions.

HIWMUL



TASK MID-BACK WITH ADJUSTABLE LUMBAR

Upholstered Back

- Pneumatic
- Swivel
- Synchro-tilt
- Tilt Tension
- Tilt Lock
- Adjustable Lumbar

DIMENSIONS

Depth:	24½	Width (with arms):	27
Height:	43¾	Width (armless):	21
Seat Depth:	17¾	Cube:	10.8
Seat Width:	20	COM:	3.0
Back Width:	19	Weight Rating:	300 lbs.
Back Height:	23		

FABRIC PRICE CODES

1	\$616	7	\$916
2	\$676	8	\$961
3	\$736	9	\$1006
4	\$781	10	\$1051
5	\$826	11	\$1096
6	\$871	12	\$1141

! See page 332 for additional specifications and dimensions.

HON Recommendation: HIWMU.Y2.A.H.CU__NL.SB.T - List Price \$733

HOW TO SPECIFY

Select Model Number	Select Control Type	Select Arm Type	Select Caster	Select Fabric	Select Lumbar	Select Base	Select Frame
Y0 Synchro-Tilt Y1 Synchro-Tilt w/ Seat Slider (+ \$20) Y2 Advanced Synchro-Tilt (+ \$65) Y3 Synchro-Tilt with Independent Back Angle (+ \$105)	N Armless A Height and Width Adjustable Arms (+ \$85) V All-Adjustable Arms (+ \$130) F Fixed Arms (+ \$65) P Fixed Arms - Polished (+ \$175)	H Black Hard Caster S Black All-Surface Caster (+ \$40) TS Titanium All-Surface Caster (+ \$40) R Black Roll Control Caster (+ \$50)	See page 351	NL No Lumbar <i>Specify for model HIWMU only</i> AL Adjustable Lumbar <i>Specify for model HIWMUL only</i>	SB Standard Base PA Polished Aluminum (+ \$110)	T Black DWX Designer White (+ \$35) TI Titanium (+ \$35)	
HIWMU	Y2	A	H	CU10	NL	SB	T

IGNITION® 2.0 Upholstered

GSA SIN 33721



Icon Legend on page 17

HIWMUKD



TASK MID-BACK

Upholstered Back
Pneumatic
Swivel
Synchro-tilt
Tilt Tension
Tilt Lock

DIMENSIONS

Depth:	24	Back Height:	23
Height:	43¾	Width (with arms):	27
Seat Depth:	17¾	Width (armless):	21
Seat Width:	20	Cube:	6.3
Back Width:	19	Weight Rating:	300 lbs.

FABRIC PRICE CODES

1	\$543
2	\$603
3	\$663

! See page 332 for additional specifications and dimensions.

HIWMULKD



TASK MID-BACK WITH ADJUSTABLE LUMBAR

Upholstered Back
Pneumatic
Swivel
Synchro-tilt
Tilt Tension
Tilt Lock
Adjustable Lumbar

DIMENSIONS

Depth:	24½	Back Height:	23
Height:	43¾	Width (with arms):	27
Seat Depth:	17¾	Width (armless):	21
Seat Width:	20	Cube:	6.3
Back Width:	19	Weight Rating:	300 lbs.

FABRIC PRICE CODES

1	\$576
2	\$636
3	\$696

! See page 332 for additional specifications and dimensions.

HON Recommendation: HIWMUKD.Y2.A.H.CU__NL.SB.T - List Price \$693

HOW TO SPECIFY

Select Model Number	Select Control Type	Select Arm Type	Select Caster	Select Fabric	Select Lumbar	Select Base	Select Frame
HIWMUKD	<p>Y1 Synchro-Tilt w/ Seat Slider (+ \$20)</p> <p>Y2 Advanced Synchro-Tilt (+ \$65)</p>	<p>N Armless</p> <p>A Height and Width Adjustable Arms (+ \$85)</p>	H Black Hard Caster	See page 351	<p>NL No Lumbar <i>Specify for model HIWMUKD only</i></p> <p>AL Adjustable Lumbar <i>Specify for model HIWMULKD only</i></p>	SB Standard Base	<p>T Black</p> <p>DWX Designer White (+ \$35)</p> <p>TI Titanium (+ \$35)</p>
HIWMUKD	Y2	A	H	CU10	NL	SB	T



Icon Legend on page 17

IGNITION® 2.0 Accessories

HI2ATA



ADJUSTABLE ARMS

Height and Width
Functions: **S**
(Function Key on pages 212-213)

DIMENSIONS

Adjustable Arms Width: 17-19½
Height from Seat: 8-11
Ship Weight: 8
Cube: 1.0

LIST PRICE

\$132

HI2AAA

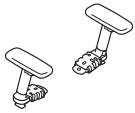

ALL-ADJUSTABLE ARMS

Height, Width, Depth and Pivot

DIMENSIONS

Adjustable Arms Width: 17-20
Height from Seat: 7-11
Ship Weight: 8
Cube: 1.0

LIST PRICE

\$178

HI2FHA



FIXED HEIGHT ARMS

DIMENSIONS

Arm Width: 20
Height from Seat: 9½
Ship Weight: 7
Cube: 1.0

LIST PRICE

\$122

HIPAA

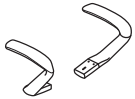

POLISHED ALUMINUM ARMS

Fixed Height

DIMENSIONS

Arm Width: 20
Height from Seat: 9½
Ship Weight: 10
Cube: 1.0

LIST PRICE

\$201

HILMBR



LUMBAR SUPPORT

DIMENSIONS

Ship Weight: 8
Cube: 1.0

LIST PRICE

\$35

HSCASTER

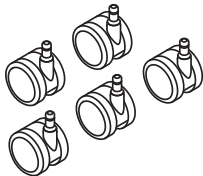

SET OF 5 ALL-SURFACE CASTERS

DIMENSIONS

Size: 60mm
Ship Weight: 2
Cube: 0.1

LIST PRICE

\$59

ⓘ Available in Black finish only, no specification needed.

OPEN MARKET

HOW TO SPECIFY

<p>Select Model Number</p> <p>HI2ATA.</p>	<p>Select Frame</p> <p>T Black DWX Designer White TI Titanium</p> <p><i>Not specified for model HIPAA</i></p> <p>T</p>
---	--

HOW TO SPECIFY

<p>Select Model Number</p> <p>HILMBR.</p>	<p>Select Lumbar Color</p> <p>BL Black MR Ember RE Regatta BY Bullseye IR Iris TL Titanium DW Designer White KT Krypton</p> <p>BL</p>
---	--

IGNITION® 2.0 Accessories

OPEN MARKET



Icon Legend on page 17

HI2HR

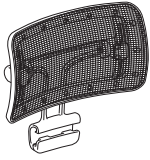

MESH HEADREST

DIMENSIONS

Mesh Width:	12
Mesh Height:	6
Ship Weight:	3
Cube:	1.0

LIST PRICE

\$145

NOTES: Headrest is compatible with Ignition® mid-back mesh back models HIWMM, HIWMMKD, HIWMMS, and HIWMMSKD purchased after July 2021.

HI2BTHR

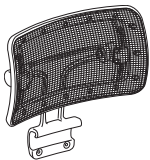

BIG & TALL MESH HEADREST

DIMENSIONS

Mesh Width:	12
Mesh Height:	6
Ship Weight:	3
Cube:	1.0

LIST PRICE

\$153

NOTES: Headrest is compatible with Ignition® mid-back mesh back Big & Tall model HIWMBT.

HOW TO SPECIFY

Select Model Number

Select Mesh

Select Frame

- IM Black
- IB Breeze
- IK Brownstone
- IC Charcoal
- IF Fog
- IR Regatta
- IT Titanium

- T Black
- DWX Designer White (+ \$35)
- TI Titanium (+ \$35)

HI2HR.

IM.

T

HOW TO SPECIFY

Select Model Number

Select Mesh

Select Frame

- IM Black
- IC Charcoal
- IF Fog

- T Black

HI2BTHR.

IM.

T

SEATING

IGNITION[®]

Multi-Purpose Chair Options

ARM STYLE	CODE	DESCRIPTION	PRICE
	N	Armless	+\$0
	F	Fixed Arms	+\$30



CASTERS/ GLIDE	CODE	DESCRIPTION	PRICE
	H	Black Hard Caster	+\$0
	S	Black All-Surface Caster	+\$30
	E	Glide	+\$0

Castors only available on HIGS6



MESH STYLE	CODE	DESCRIPTION	PRICE
	IM	Black	+\$0
	IB	Breeze	+\$0
	IK	Brownstone	+\$0
	IC	Charcoal	+\$0
	IF	Fog	+\$0
	IR	Regatta	+\$0
	IT	Titanium	+\$0
	U	Upholstered	+\$0

FRAME	CODE	DESCRIPTION	PRICE
	T	Black	+\$0
	BLCK	Textured Black Mica	+\$0
	PK7	Textured Designer White	+\$35
	PLAT	Textured Platinum Metallic	+\$0
	PR8T	Textured Silver	+\$35

By selecting PR8T, unit will be produced with titanium colored arm caps, back frame, & glides

By selecting PK7, unit will be produced with Designer White colored arm caps, back frame, & glides

By selecting PLAT, unit will be produced with black arm caps, black back frame, black glides, and platinum colored legs

Refer to Configurator on HON.com for visualization

IGNITION® Multi-Purpose

GSA SIN 33721



Icon Legend on page 17

HIGS6

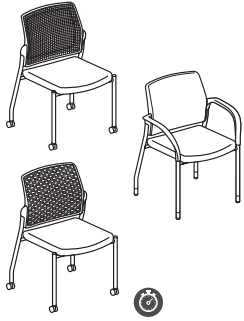

MULTI-PURPOSE

Four Legs

DIMENSIONS

Depth:	21 ³ / ₄	Seat to Floor Height:	18 ³ / ₈
Width:	25	Usable Seat Depth:	17 ³ / ₈
Height:	33 ¹ / ₂	Ship Weight:	28
Seat Depth:	17 ³ / ₈	Cube:	15.1
Seat Width:	18 ³ / ₄	COM (upholstered back):	1.5
Back Width:	18 ¹ / ₄	COM (mesh/ReActiv® back):	1.0
Back Height:	18 ¹ / ₈	Weight Rating:	300 lbs.
Arm Width:	21 ¹ / ₂		

FABRIC PRICE CODES

1	\$466	8	\$673
2	\$502	9	\$700
3	\$538	10	\$727
4	\$565	11	\$754
5	\$592	12	\$781
6	\$619	L	\$766
7	\$646		

NOTES: Stacks 4-high.

- ! Ganging brackets work with armless Guest/Multi-purpose models only.
- ! ReActiv® back option not available on FC models.

HISB6

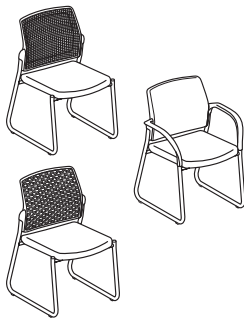

MULTI-PURPOSE

Sled Base

DIMENSIONS

Depth:	23 ³ / ₄	Seat to Floor Height:	18 ³ / ₈
Width:	25	Usable Seat Depth:	17 ³ / ₈
Height:	33 ¹ / ₂	Ship Weight:	30
Seat Depth:	17 ³ / ₈	Cube:	15.1
Seat Width:	18 ³ / ₄	COM (upholstered back):	1.5
Back Width:	18 ¹ / ₄	COM (mesh/ReActiv® back):	1.0
Back Height:	18 ¹ / ₈	Weight Rating:	300 lbs.
Arm Width:	21 ¹ / ₂		

FABRIC PRICE CODES

1	\$466	8	\$673
2	\$502	9	\$700
3	\$538	10	\$727
4	\$565	11	\$754
5	\$592	12	\$781
6	\$619	L	\$766
7	\$646		

- ! Ganging brackets work with armless Guest/Multi-purpose models only.
- ! ReActiv® back option not available on FC models.

HICS7



CAFÉ-HEIGHT STOOL

Four Legs

DIMENSIONS

Depth:	23	Seat to Floor Height:	31
Width:	25	Usable Seat Depth:	17 ³ / ₈
Height:	46 ¹ / ₂	Ship Weight:	37
Seat Depth:	17 ³ / ₈	Cube:	21.8
Seat Width:	18 ³ / ₄	COM (upholstered back):	1.5
Back Width:	18 ¹ / ₄	COM (mesh/ReActiv® back):	1.0
Back Height:	18 ¹ / ₈	Weight Rating:	300 lbs.
Arm Width:	21 ¹ / ₂		

FABRIC PRICE CODES

1	\$588	8	\$795
2	\$624	9	\$822
3	\$660	10	\$849
4	\$687	11	\$876
5	\$714	12	\$903
6	\$741	L	\$888
7	\$768		

- ! Ganging brackets work with armless Guest/Multi-purpose models only.
- ! ReActiv® back option not available on FC models.

HON Recommendation: HIGS6.F.H.IM.CU__T - List Price \$496

HOW TO SPECIFY

<p>Select Model Number</p> <p>F Fixed Arms (+ \$30) N Armless</p>	<p>Select Arm Type</p> <p>F Fixed Arms (+ \$30) N Armless</p>	<p>Select Glide</p> <p>E Glide H Black Hard Caster S Black All-Surface Caster (+ \$30) <i>Casters available on HIGS6 only</i></p>	<p>Select Back Type</p> <p>IM Black IB Breeze IK Brownstone IC Charcoal OS Charcoal ReActiv® (+ \$30) DWR Designer White ReActiv® (+ \$30) IF Fog IR Regatta IT Titanium TI Titanium ReActiv® (+ \$30) U Upholstered</p>	<p>Select Fabric</p> <p>See page 351</p>	<p>Select Frame</p> <p>T Black BLCK Textured Black Mica PK7 Textured Designer White (+ \$35) PLAT Textured Platinum Metallic PR8T Textured Silver (+ \$35)</p>
HIGS6	F	H	IM	CU10	T



Multi-Fabric Multi-Purpose

HIGS6DF

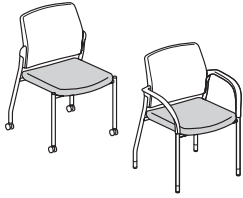

MULTI-PURPOSE

Multi-Fabric
Four Legs

DIMENSIONS

Depth:	21 ³ / ₄	Arm Width:	21 ¹ / ₂
Width:	25	Seat to Floor Height:	18 ³ / ₈
Height:	33 ¹ / ₂	Usable Seat Depth:	17 ³ / ₈
Seat Depth:	17 ³ / ₈	Ship Weight (upholstered back):	28
Seat Width:	18 ³ / ₄	Cube (upholstered back):	15.1
Back Width:	18 ¹ / ₄	COM (back):	0.75
Back Height:	18 ¹ / ₈	COM (seat):	0.75
		Weight Rating:	300 lbs.

FABRIC PRICE CODES

1	\$541	
<i>Add to Base Price Above</i>		
	Back	Seat
2	\$18	\$18
3	\$36	\$36
4	\$50	\$50
5	\$63	\$63
6	\$77	\$77
7	\$90	\$90
8	\$104	\$104
9	\$117	\$117
10	\$131	\$131
11	\$144	\$144
12	\$158	\$158
L	\$150	\$150

NOTES: Stacks 4-high.

! Ganging brackets work with armless Guest/Multi-purpose models only.

HISB6DF

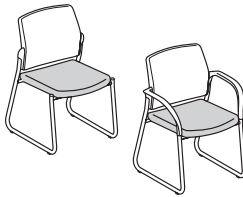

MULTI-PURPOSE

Multi-Fabric
Sled Base

DIMENSIONS

Depth:	23 ³ / ₄	Arm Width:	21 ¹ / ₂
Width:	25	Seat to Floor Height:	18 ³ / ₈
Height:	33 ¹ / ₂	Usable Seat Depth:	17 ³ / ₈
Seat Depth:	17 ³ / ₈	Ship Weight (upholstered back):	30
Seat Width:	18 ³ / ₄	Cube (upholstered back):	15.1
Back Width:	18 ¹ / ₄	COM (back):	0.75
Back Height:	18 ¹ / ₈	COM (seat):	0.75
		Weight Rating:	300 lbs.

FABRIC PRICE CODES

1	\$541	
<i>Add to Base Price Above</i>		
	Back	Seat
2	\$18	\$18
3	\$36	\$36
4	\$50	\$50
5	\$63	\$63
6	\$77	\$77
7	\$90	\$90
8	\$104	\$104
9	\$117	\$117
10	\$131	\$131
11	\$144	\$144
12	\$158	\$158
L	\$150	\$150

! Ganging brackets work with armless Guest/Multi-purpose models only.

HON Recommendation: HIGS6DF.F.H.U.CU__UR__.T - List Price \$571

HOW TO SPECIFY

Select Model Number	Select Arm Type	Select Glide	Select Back Type	Select Back Fabric	Select Seat Fabric	Select Frame
	F Fixed Arms (+ \$30) N Armless	E Glide H Black Hard Caster S Black All-Surface Caster (+ \$30) <i>Casters available on HIGS6DF only</i>	U Upholstered	See page 351	See page 351	T Black BLCK Textured Black Mica PK7 Textured Designer White (+ \$35) PLAT Textured Platinum Metallic PR8T Textured Silver (+ \$35)
HIGS6DF	F	H	U	CU10	UR10	T

IGNITION® Multi-Fabric Stools

GSA SIN 33721



Icon Legend on page 17

HICS7DF



CAFÉ-HEIGHT STOOL

Multi-Fabric
Four Legs

DIMENSIONS

Depth:	23	Arm Width:	21½
Width:	25	Seat to Floor Height:	31
Height:	46½	Usable Seat Depth:	17¾
Seat Depth:	17¾	Ship Weight (upholstered back):	37
Seat Width:	18¾	Cube (upholstered back):	21.8
Back Width:	18¼	COM (back):	0.75
Back Height:	18½	COM (seat):	0.75
		Weight Rating:	300 lbs.

FABRIC PRICE CODES

1 \$663

Add to Base Price Above

	Back	Seat
2	\$18	\$18
3	\$36	\$36
4	\$50	\$50
5	\$63	\$63
6	\$77	\$77
7	\$90	\$90
8	\$104	\$104
9	\$117	\$117
10	\$131	\$131
11	\$144	\$144
12	\$158	\$158
L	\$150	\$150

! Ganging brackets work with armless Guest/Multi-purpose models only.

HON Recommendation: HICS7DF.F.E.U.CU__UR__T - List Price \$693

HOW TO SPECIFY

Select Model Number	Select Arm Type	Select Glide	Select Back Type	Select Back Fabric	Select Seat Fabric	Select Frame
HICS7DF	F Fixed Arms (+ \$30) N Armless	E Glide	U Upholstered	See page 351	See page 351	T Black BLCK Textured Black Mica PK7 Textured Designer White (+ \$35) PLAT Textured Platinum Metallic PR8T Textured Silver (+ \$35)
	F	E	U	CU10	UR10	T



HIGCL



GUEST CHAIR

Fixed Arms
Glides

DIMENSIONS

Depth:	24	Arm Width:	19¼
Width:	23	Seat to Floor Height:	18½
Height:	35½	Usable Seat Depth:	16¾
Seat Depth:	18	Ship Weight:	42
Seat Width:	19½	Cube:	15.2
Back Width:	19½	COM:	2.0
Back Height:	20	Weight Rating:	300 lbs.

FABRIC PRICE CODES

1	\$498	8	\$774
2	\$546	9	\$810
3	\$594	10	\$846
4	\$630	11	\$882
5	\$666	12	\$918
6	\$702	L	\$798
7	\$738		

HON Recommendation: HIGCL.E.U.CU__T - List Price \$498

HOW TO SPECIFY

Select Model Number HIGCL	Select Glide E Glide E	Select Back Type U Upholstered U	Select Fabric See page 351 CU10	Select Frame T Black BLCK Textured Black Mica PLAT Textured Platinum Metallic T
---	-------------------------------------	---	--	--

HIB50

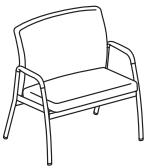

BARITRATIC LOUNGE

Fixed Arms
Glides

DIMENSIONS

Depth:	25½	Arm Width:	30
Width:	33¾	Seat to Floor Height:	20
Height:	35¾	Usable Seat Depth:	18¾
Seat Depth:	18¾	Ship Weight:	70
Seat Width:	29¾	Cube:	27.5
Back Width:	29	COM:	2.5
Back Height:	19¼	Weight Rating:	500 lbs.

FABRIC PRICE CODES

1	\$1448	8	\$1793
2	\$1508	9	\$1838
3	\$1568	10	\$1883
4	\$1613	11	\$1928
5	\$1658	12	\$1973
6	\$1703	L	—
7	\$1748		



HOW TO SPECIFY

Select Model Number HIB50	Select Arm Type F Fixed Arms F	Select Glide E Glide E	Select Back Type U Upholstered U	Select Fabric See page 351 CU10	Select Frame T Black BLCK Textured Black Mica PLAT Textured Platinum Metallic T
---	---	-------------------------------------	---	--	--

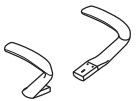

IGNITION® Task Chair Options

GSA SIN 33721

ARM STYLE	CODE	DESCRIPTION	PRICE
	N	Armless	+\$0
	F	Fixed Arms	+\$65
	A	Height and Width Adjustable Arms	+\$85
	V	All-Adjustable Arms (includes Pivot)	+\$130
	P	Fixed Polished Aluminum Arms	+\$175

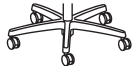
BACK STYLE	CODE	DESCRIPTION	PRICE
	U	Upholstered	+\$0
	M	Mesh	+\$0

BASE	CODE	DESCRIPTION	PRICE
	SB	Standard Base	+\$0
	PA	Polished Aluminum	+\$110

CASTERS	CODE	DESCRIPTION	PRICE
	A	Black All-Surface Caster <i>*Must specify for model HIWM8 only</i>	+\$0
	H	Black Hard Caster	+\$0
	S	Black All-Surface Caster	+\$30

SEATING

HON BRANDED FABRICS

GRADE 1	GRADE 2	GRADE 3	GRADE L
Apex	Appoint Seating	In Season	Denver Leather*
Attire	Blume	Moxie	
Centurion	Clyde	Parker	
Compass	Dotty	Purl	
Contourett	Rush	Quill	
Dapper	Seed**		
Ensemble	Spin Seating		
Hamilton	Whisper Vinyl		
Inertia			
Optic**			
Pebble			

For a complete list of fabrics, including partnership fabrics, go to hon.com/fabricsandfinishes.

Reference Fabric Color Combinations on pages 18-22 for color codes and legend on page 19 for lead times. For additional HON to Supply COM fabric grade pricing, go to honready.hon.com and click on the HON to Supply COM link.

*Denver Leather (SS) may not be available on every model within a specific series, please refer to the model's page for details.

**Not available as a back upholstery on Ignition[®] 2.0.

 For Fire Code model, availability, and ordering method, refer to page 216. Available on select models, contact HON Customer Support for availability.



HITL1



TASK LOW-BACK

Pneumatic
Back Height Adjustment
Swivel
Tilt
Tilt Tension
Tilt Lock
Functions: **A, B, E, J, K, L**
(Function Key on pages 212-213)

DIMENSIONS

Upholstered Back
Width: 17½
Upholstered Back
Height: 18¾-21¾
Mesh Back Width: 17½
Mesh Back Height: 20¾-23¼
Depth: 36
Width: 27½
Height: 41
Seat Depth: 17
Seat Width: 19

Adjustable Arms Width: 17-19½
Fixed Arms Width: 20
Seat to Floor Height: 17-21½
Usable Seat Depth: 15¾
Ship Weight (upholstered back): 50
Ship Weight (mesh back): 45
Cube (upholstered back): 10.8
Cube (mesh back): 10.8
COM (upholstered back): 2.0
COM (mesh back): 1.0
Weight Rating: 300 lbs.

FABRIC PRICE CODES

1	\$655	8	\$931
2	\$703	9	\$967
3	\$751	10	\$1003
4	\$787	11	\$1039
5	\$823	12	\$1075
6	\$859	L	—
7	\$895		

NOTES: See page 356 for arm packs.

HITL2



TASK LOW-BACK

Pneumatic
Back Height Adjustment
Synchro-tilt
Tilt Tension
Tilt Lock
Seat Glide
Functions:
A, B, D, E, J, A-D, L
(Function Key on pages 212-213)

DIMENSIONS

Upholstered Back
Width: 17½
Upholstered Back
Height: 19½-22½
Mesh Back Width: 17½
Mesh Back Height: 20¾-23¼
Depth: 38½
Width: 27½
Height: 43
Seat Depth: 16-18
Seat Width: 19

Adjustable Arms Width: 17-19½
Fixed Arms Width: 20
Seat to Floor Height: 17-21½
Usable Seat Depth: 15½-17½
Ship Weight (upholstered back): 54
Ship Weight (mesh back): 49
Cube (upholstered back): 10.8
Cube (mesh back): 10.8
COM (upholstered back): 2.0
COM (mesh back): 1.0
Weight Rating: 300 lbs.

FABRIC PRICE CODES

1	\$739	8	\$1015
2	\$787	9	\$1051
3	\$835	10	\$1087
4	\$871	11	\$1123
5	\$907	12	\$1159
6	\$943	L	—
7	\$979		

NOTES: See page 356 for arm packs.

HITL3



TASK LOW-BACK

Pneumatic
Back Height Adjustment
Synchro-tilt
Back Angle Adjustment
Tilt Tension
Tilt Lock
Seat Glide
Functions:
A, B, D, E, A-D, A-E, L
(Function Key on pages 212-213)

DIMENSIONS

Upholstered Back
Width: 17½
Upholstered Back
Height: 20¾-23¾
Mesh Back Width: 17½
Mesh Back Height: 20¾-23¼
Depth: 39
Width: 27
Height: 44
Seat Depth: 16-18
Seat Width: 19

Adjustable Arms Width: 17-19½
Fixed Arms Width: 20
Seat to Floor Height: 17-21½
Usable Seat Depth: 14½-16½
Ship Weight (upholstered back): 58
Ship Weight (mesh back): 53
Cube (upholstered back): 10.8
Cube (mesh back): 10.8
COM (upholstered back): 2.0
COM (mesh back): 1.0
Weight Rating: 300 lbs.

FABRIC PRICE CODES

1	\$788	8	\$1064
2	\$836	9	\$1100
3	\$884	10	\$1136
4	\$920	11	\$1172
5	\$956	12	\$1208
6	\$992	L	—
7	\$1028		

NOTES: See page 356 for arm packs.

HON Recommendation: HITL1.A.H.M.CU__T.SB - List Price \$740

HOW TO SPECIFY

Select Model Number	Select Arm Type	Select Caster/Glide	Select Back Type	Select Fabric	Select Frame	Select Base
N Armless F Fixed Arms - Black (+ \$65) A Height and Width Adjustable Arms (+ \$85) V All-Adjustable Arms (includes Pivot) (+ \$130) P Fixed Arms - Polished (+ \$175)	H Black Hard Caster S Black All-Surface Caster (+ \$40)	U Upholstered M Mesh	See page 351	T Black	SB Standard Base PA Polished Aluminum (+ \$110)	
HITL1	A	H	M	CU10	T	SB



HIWM1



MID-BACK

Pneumatic
Back Height Adjustment
Swivel
Tilt
Tilt Tension
Tilt Lock
Functions: **A, B, E, J, K, L**
(Function Key on pages 212-213)

DIMENSIONS

Upholstered Back Width: 18½
Upholstered Back Height: 21-24
Mesh Back Width: 19
Mesh Back Height: 21½-24
Depth: 35½
Width: 27
Height: 44
Seat Depth: 18
Seat Width: 20
Adjustable Arms Width: 18-20½
Fixed Arms Width: 20

Seat to Floor Height: 17-21½
Usable Seat Depth: 17½
Ship Weight (upholstered back): 54
Ship Weight (mesh back): 48
Cube (upholstered back): 10.8
Cube (mesh back): 10.8
COM (upholstered back): 2.0
COM (mesh back): 1.0
Weight Rating: 300 lbs.

FABRIC PRICE CODES

1	\$720	8	\$996
2	\$768	9	\$1032
3	\$816	10	\$1068
4	\$852	11	\$1104
5	\$888	12	\$1140
6	\$924	L	\$1020
7	\$960		

NOTES: See page 356 for arm packs.

HIWM2



MID-BACK

Pneumatic
Back Height Adjustment
Synchro-tilt
Tilt Tension
Tilt Lock
Seat Glide
Functions:
A, B, D, E, J, A-D, L
(Function Key on pages 212-213)

DIMENSIONS

Upholstered Back Width: 18½
Upholstered Back Height: 21-24
Mesh Back Width: 19
Mesh Back Height: 21½-24
Depth: 38
Width: 27
Height: 46½
Seat Depth: 17-19
Seat Width: 20
Adjustable Arms Width: 18-20½
Fixed Arms Width: 20

Seat to Floor Height: 17¼-21¾
Usable Seat Depth: 16¼-18¼
Ship Weight (upholstered back): 58
Ship Weight (mesh back): 52
Cube (upholstered back): 10.8
Cube (mesh back): 10.8
COM (upholstered back): 2.0
COM (mesh back): 1.0
Weight Rating: 300 lbs.

FABRIC PRICE CODES

1	\$797	8	\$1073
2	\$845	9	\$1109
3	\$893	10	\$1145
4	\$929	11	\$1181
5	\$965	12	\$1217
6	\$1001	L	\$1097
7	\$1037		

NOTES: See page 356 for arm packs.

HIWM3



MID-BACK

Pneumatic
Back Height Adjustment
Synchro-tilt
Back Angle Adjustment
Tilt Tension
Tilt Lock
Seat Glide
Functions:
A, B, D, E, A-D, A-E, L
(Function Key on pages 212-213)

DIMENSIONS

Upholstered Back Width: 18½
Upholstered Back Height: 21-24
Mesh Back Width: 19
Mesh Back Height: 21½-24
Depth: 39
Width: 27
Height: 44
Seat Depth: 17-19
Seat Width: 20
Adjustable Arms Width: 18-20½
Fixed Arms Width: 20

Seat to Floor Height: 17¼-21¾
Usable Seat Depth: 15¼-17¼
Ship Weight (upholstered back): 63
Ship Weight (mesh back): 58
Cube (upholstered back): 10.8
Cube (mesh back): 10.8
COM (upholstered back): 2.0
COM (mesh back): 1.0
Weight Rating: 300 lbs.

FABRIC PRICE CODES

1	\$850	8	\$1126
2	\$898	9	\$1162
3	\$946	10	\$1198
4	\$982	11	\$1234
5	\$1018	12	\$1270
6	\$1054	L	\$1150
7	\$1090		

NOTES: See page 356 for arm packs.

HON Recommendation: HIWM2.A.H.M.CU__T.SB - List Price \$882

HOW TO SPECIFY

Select Model Number	Select Arm Type	Select Caster/Glide	Select Back Type	Select Fabric	Select Frame	Select Base
N Armless F Fixed Arms - Black (+ \$65) A Height and Width Adjustable Arms (+ \$85) V All-Adjustable Arms (includes Pivot) (+ \$130) P Fixed Arms - Polished (+ \$175)	H Black Hard Caster S Black All-Surface Caster (+ \$40)	U Upholstered M Mesh	See page 351	T Black	SB Standard Base PA Polished Aluminum (+ \$110)	
HIWM1	A	H	M	CU10	T	SB

IGNITION®



Icon Legend on page 17

HIEH1



EXECUTIVE HIGH-BACK

Pneumatic
Back Height Adjustment
Swivel
Tilt
Tilt Tension
Tilt Lock
Functions: **A, B, E, F, K, L**
(Function Key on pages 212-213)

DIMENSIONS

Depth: 38½
Width: 27
Height: 47½
Seat Depth: 18
Seat Width: 20
Back Width: 20
Back Height: 24¾-27¾
Arm Width: 20
Seat to Floor Height: 16¾-21¼
Usable Seat Depth: 17⅞
Ship Weight: 56
Cube: 16.0
COM: 2.5
Weight Rating: 300 lbs.

FABRIC PRICE CODES

1	\$745	8	\$1021
2	\$793	9	\$1057
3	\$841	10	\$1093
4	\$877	11	\$1129
5	\$913	12	\$1165
6	\$949	L	\$1045
7	\$985		

NOTES: See page 356 for arm packs.

HIEH2



EXECUTIVE HIGH-BACK

Pneumatic
Back Height Adjustment
Synchro-tilt
Tilt Tension
Seat Glide
Functions: **A, B, D, E, J, A-D, L**
(Function Key on pages 212-213)

DIMENSIONS

Depth: 41
Width: 27
Height: 49
Seat Depth: 17-19
Seat Width: 20
Back Width: 19½
Back Height: 24¾-27¾
Arm Width: 20
Seat to Floor Height: 17-21½
Usable Seat Depth: 16½-18
Ship Weight: 61
Cube: 16.0
COM: 2.5
Weight Rating: 300 lbs.

FABRIC PRICE CODES

1	\$828	8	\$1104
2	\$876	9	\$1140
3	\$924	10	\$1176
4	\$960	11	\$1212
5	\$996	12	\$1248
6	\$1032	L	\$1128
7	\$1068		

NOTES: See page 356 for arm packs.

HIEH3



EXECUTIVE HIGH-BACK

Pneumatic
Back Height Adjustment
Synchro-tilt
Back Angle Adjustment
Tilt Tension
Seat Glide
Functions: **A, B, D, E, A-D, A-E, L**
(Function Key on pages 212-213)

DIMENSIONS

Depth: 45½
Width: 27
Height: 49
Seat Depth: 17-19
Seat Width: 20
Back Width: 19½
Back Height: 24¾-27¾
Arm Width: 20
Seat to Floor Height: 17-21½
Usable Seat Depth: 15¼-17¼
Ship Weight: 65
Cube: 16.0
COM: 2.5
Weight Rating: 300 lbs.

FABRIC PRICE CODES

1	\$877	8	\$1153
2	\$925	9	\$1189
3	\$973	10	\$1225
4	\$1009	11	\$1261
5	\$1045	12	\$1297
6	\$1081	L	\$1177
7	\$1117		

NOTES: See page 356 for arm packs.

HON Recommendation: HIEH1.F.H.U.CU__T.SB - List Price \$810

SEATING

HOW TO SPECIFY

Select Model Number H I E H 1	Select Arm Type N Armless F Fixed Arms - Black (+ \$65) A Height and Width Adjustable Arms (+ \$85) V All-Adjustable Arms (includes Pivot) (+ \$130) P Fixed Arms - Polished (+ \$175)	Select Caster/Glide H Black Hard Caster S Black All-Surface Caster (+ \$40)	Select Back Type U Upholstered	Select Fabric See page 351	Select Frame T Black	Select Base SB Standard Base PA Polished Aluminum (+ \$110)
---	--	--	--	--------------------------------------	--------------------------------	--



HITS5



TASK STOOL

Pneumatic
Swivel Back Height
Adjustment
Adjustable Footrest
Functions: **A, B, E**
(Function Key on pages
212-213)

DIMENSIONS

Upholstered Back Width:	17½	Adjustable Arms Width:	17-19½
Upholstered Back Height:	18¾-21¾	Fixed Arms Width:	20
Mesh Back Width:	17½	Seat to Floor Height:	23⅝-33⅝
Mesh Back Height:	20¾-23¾	Usable Seat Depth:	15¾
Depth:	27½	Ship Weight (upholstered back):	56 Ⓢ
Width:	27	Ship Weight (mesh back):	51 Ⓢ
Height:	44	Cube (upholstered back):	10.8
Seat Depth:	17	Cube (mesh back):	10.8
Seat Width:	19	COM (upholstered back):	2.0
		COM (mesh back):	1.0
		Weight Rating:	300 lbs.

FABRIC PRICE CODES

1	\$774	8	\$1050
2	\$822	9	\$1086
3	\$870	10	\$1122
4	\$906	11	\$1158
5	\$942	12	\$1194
6	\$978	L	—
7	\$1014		

NOTES: See page 356 for arm packs.

HIWM8



TASK MID-BACK

Big and Tall
Pneumatic
Swivel-tilt
Tilt Tension
Functions: **A, E, F, K, L**
(Function Key on pages
212-213)

DIMENSIONS

Depth:	28	Arm Width:	23-25½
Width:	32¼	Seat to Floor Height:	16⅝-20⅝
Height:	43⅝	Usable Seat Depth:	19½
Seat Depth:	19½	Ship Weight:	60
Seat Width:	23½	Cube:	16.0
Back Width:	23½	COM:	3.0
Back Height:	23	Weight Rating:	450 lbs.

FABRIC PRICE CODES

1	\$1424	8	\$1838
2	\$1496	9	\$1892
3	\$1568	10	\$1946
4	\$1622	11	\$2000
5	\$1676	12	\$2054
6	\$1730	L	—
7	\$1784		

NOTES: See page 356 for arm packs.

HON Recommendation: HITS5.A.H.M.CU__T.SB - List Price \$859

HOW TO SPECIFY

Select Model Number	Select Arm Type	Select Caster/Glide	Select Back Type	Select Fabric	Select Frame	Select Base
N Armless F Fixed Arms - Black (+ \$65) A Height and Width Adjustable Arms (+ \$85) V All-Adjustable Arms (includes Pivot) (+ \$130) P Fixed Arms - Polished (+ \$175)	H Black Hard Caster S Black All-Surface Caster (+ \$40) A Black All-Surface Caster (available on model HIWM8 only) <i>H and S caster options not available on model HIWM8</i>	U Upholstered M Mesh <i>Mesh back not available on HIWM8</i>	See page 351	T Black	SB Standard Base	

HITS5 . **A** . **H** . **M** . **CU10** . **T** . **SB**



Icon Legend on page 17

HI2ATA

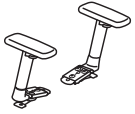

ADJUSTABLE ARMS

Height and Width
Functions: **S**
(Function Key on pages 212-213)

DIMENSIONS

Adjustable Arms Width: 17-19½
Height from Seat: 8-11
Ship Weight: 8
Cube: 1.0

LIST PRICE

\$132

HI2AAA

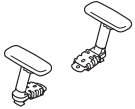

ALL-ADJUSTABLE ARMS

Height, Width, Depth and Pivot

DIMENSIONS

Adjustable Arms Width: 17-20
Height from Seat: 7-11
Ship Weight: 8
Cube: 1.0

LIST PRICE

\$178

HI2FHA



FIXED HEIGHT ARMS

DIMENSIONS

Arm Width: 20
Height from Seat: 9½
Ship Weight: 7
Cube: 1.0

LIST PRICE

\$122

HIPAA

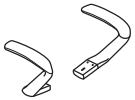

POLISHED ALUMINUM ARMS

Fixed Height

DIMENSIONS

Arm Width: 20
Height from Seat: 9½
Ship Weight: 10
Cube: 1.0

LIST PRICE

\$201

HSCASTER

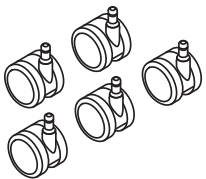

SET OF 5 ALL-SURFACE CASTERS

DIMENSIONS

Size: 60mm
Ship Weight: 2
Cube: 0.1

LIST PRICE

\$59

! Available in Black finish only, no specification needed.

OPEN MARKET

HOW TO SPECIFY

Select Model Number

Select Frame

Specify for models HI2ATA, HI2AAA, and HI2FHA

T Black
DWX Designer White
TI Titanium

HI2ATA.

T



INSTIGATE™ Mesh Guest Chairs

HVL508



GUEST CHAIR

Leg Base
Armless
Stacks up to Four High

DIMENSIONS

Depth:	22¼	Back Height:	19
Width:	24	Seat to Floor Height:	18¾
Height:	35¾	Usable Seat Depth:	17½
Seat Depth:	17½	Ship Weight:	18.8
Seat Width:	18½	Cube:	3.1
Back Width:	17½	Weight Rating:	250 lbs.

PRICE CODE

Fabric **\$247**

NOTES: Mesh back. Black fabric seat. Double cross bar frame increases strength and durability. Stackable up to 4-high. **HON 5-Year Limited Warranty.**

HON Recommendation: HVL508.ES10 - List Price \$247

HVL518



GUEST CHAIR

Leg Base
Arms
Stacks up to Four High

DIMENSIONS

Depth:	22¼	Arm Width:	20¼
Width:	24	Seat to Floor Height:	17¾
Height:	35¾	Usable Seat Depth:	17½
Seat Depth:	17½	Ship Weight:	22.2
Seat Width:	18½	Cube:	3.2
Back Width:	17½	Weight Rating:	250 lbs.
Back Height:	19		

PRICE CODE

Fabric **\$275**

NOTES: Mesh back. Fixed arms. Double cross bar frame increases strength and durability. Stackable up to 4-high. Black fabric seat. **HON 5-Year Limited Warranty.**

HON Recommendation: HVL518.ES10 - List Price \$275

HOW TO SPECIFY

Select Model Number	Select Fabric
	ES10 Black Fabric (only)
H V L 5 1 8 .	E S 1 0

INVITATION® 2110 SERIES

Want to see more? Scan here
to check out hon.com.



Invitation Guest Chairs
and Table Connectors.

INVITATION® 2110 SERIES

Invitation brings the comforts of home into the workplace. Enjoy the simple pleasure of welcoming guests in arm chairs with integrated tables. Invitation guest chairs coordinate with Invitation lounge seating to make any space more comfortable and cohesive. Arrange in rows, groups or any configuration to suit your space or needs. The practical design and long-lasting comfort adds up to a stylish Invitation.



FEATURES

- Contoured back rest on guest chairs delivers ergonomic comfort.
- Floating back design enables easy wipe-out cleaning.
- Guest chairs can be ganged together to create straight rows.
- Molded polymer seat shell increases comfort and durability.
- Solid hardwood in one of eight attractive finishes.
- Warranted for users up to 250 lbs.

INVITATION® 2110 Series Options

MODEL OPTIONS

H2111



Guest Chair

Leg Base, Arms

H2112

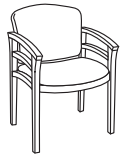

Guest Chair

Leg Base, Double
Rail Arms

HON BRANDED FABRICS

GRADE 1

Apex
Attire
Centurion
Compass
Contourett
Dapper
Ensemble
Hamilton
Inertia
Optic
Pebble

GRADE 2

Appoint Seating
Blume
Clyde
Dotty
Rush
Seed
Spin Seating
Whisper Vinyl

GRADE 3

In Season
Moxie
Parker
Purl
Quill

AVAILABLE FINISHES

Invitation® 2110 Series Seating is available in 8 wood finishes.

WOOD FINISHES

Bourbon Cherry (H)

Cognac (COGN)

Harvest (C)

Mahogany (N)

Mocha (MOCH)

Natural Maple (D)

Pinnacle (PINC)

Shaker Cherry (F)

For a complete list of fabrics, including partnership fabrics, go to hon.com/fabricsandfinishes.

Reference Fabric Color Combinations on pages 18-22 for color codes and legend on page 19 for lead times. COM yardage shown is for Pattern Cut only. Contact Customer Service for Railroaded yardage requirements. For additional HON to Supply COM fabric grade pricing, go to honready.hon.com and click on the HON to Supply COM link.

INVITATION® 2110 Series

GSA SIN 33721



Icon Legend on page 17

H2111



GUEST CHAIR

Leg Base
Arms

DIMENSIONS

Depth:	22	Arm Width:	18 ⁷ / ₈
Width:	23 ¹ / ₂	Seat to Floor Height:	18 ¹ / ₂
Height:	33 ³ / ₈	Usable Seat Depth:	17
Seat Depth:	17	Ship Weight:	24
Seat Width:	20	Cube:	15.0
Back Width:	21	COM:	1.5
Back Height:	16	Weight Rating:	250 lbs.

FABRIC PRICE CODES

1	\$1045	8	\$1252
2	\$1081	9	\$1279
3	\$1117	10	\$1306
4	\$1144	11	\$1333
5	\$1171	12	\$1360
6	\$1198	L	—
7	\$1225		

H2112



GUEST CHAIR

Leg Base
Double Rail Arms

DIMENSIONS

Depth:	22	Arm Width:	18 ⁷ / ₈
Width:	23 ¹ / ₂	Seat to Floor Height:	18 ¹ / ₂
Height:	33 ³ / ₈	Usable Seat Depth:	17
Seat Depth:	17	Ship Weight:	28
Seat Width:	20	Cube:	15.0
Back Width:	21	COM:	1.5
Back Height:	16	Weight Rating:	250 lbs.

FABRIC PRICE CODES

1	\$1148	8	\$1355
2	\$1184	9	\$1382
3	\$1220	10	\$1409
4	\$1247	11	\$1436
5	\$1274	12	\$1463
6	\$1301	L	—
7	\$1328		

HON Recommendation: H2111.MOCH.CU__ - List Price \$1045

HOW TO SPECIFY

Select
Model Number

H 2 1 1 1 .

Select
Finish

See page 359

M O C H .

Select
Fabric

See page 359

C U 1 0



INVITATION® 2110 Series Connectors

H2141



CONNECTORS

for Model H2111
One connector per two chairs

DIMENSIONS

Depth:	13 ⁵ / ₁₆	Ship Weight:	2.0
Width:	4 ⁷ / ₈	Cube:	0.3
Height:	1	Weight Rating:	300 lbs.

LIST PRICE

\$75

H2142

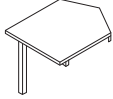

CORNER TABLE CONNECTOR

for Model H2111

DIMENSIONS

Depth:	28	Ship Weight:	25.5
Width:	28	Cube:	2.6
Height:	17 ¹ / ₄	Weight Rating:	300 lbs.

LIST PRICE

\$651



! Customer or dealer must attach leg to table.

H2143

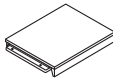

STRAIGHT TABLE CONNECTOR

for Model H2111

DIMENSIONS

Depth:	17 ¹ / ₈	Ship Weight:	16.5
Width:	21	Cube:	1.5
Height:	17 ¹ / ₄	Weight Rating:	300 lbs.

LIST PRICE

\$471

H2144



CONNECTORS

for Model H2112
One connector per two chairs

DIMENSIONS

Depth:	13 ⁵ / ₁₆	Ship Weight:	2.0
Width:	4 ⁷ / ₈	Cube:	0.3
Height:	1 ⁵ / ₁₆	Weight Rating:	300 lbs.

LIST PRICE

\$75

H2145

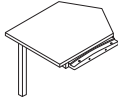

CORNER TABLE CONNECTOR

for Model H2112

DIMENSIONS

Depth:	28	Ship Weight:	25.5
Width:	28	Cube:	2.6
Height:	17 ¹ / ₄	Weight Rating:	300 lbs.

LIST PRICE

\$651



! Customer or dealer must attach leg to table.

H2146

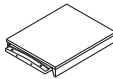

STRAIGHT TABLE CONNECTOR

for Model H2112

DIMENSIONS

Depth:	17 ¹ / ₈	Ship Weight:	16.5
Width:	21	Cube:	1.5
Height:	17 ¹ / ₄	Weight Rating:	300 lbs.

LIST PRICE

\$471

HOW TO SPECIFY

Select Model Number	Select Finish
	See page 359
H 2 1 4 1 .	H

INVITATION® LOUNGE

Want to see more? Scan here
to check out hon.com.



Invitation Lounge.

INVITATION® LOUNGE

Welcome your guests in professional style. Enjoy the simple pleasure of relaxing on a sofa with a laptop or welcoming guests in plush arm chairs. The Invitation lounge collection combines gracefully sloping arms, tapered wood legs and the deep-foam comfort of separate seat cushions.



FEATURES

- Transitional design blends contemporary lines and traditional details.
- Clean lines and refined scale easily adapt to any private office or lobby.
- Contemporary tapered legs are offered in Platinum metallic or Black finish.
- Impressive design and fine craftsmanship in an affordably priced lounge chair.
- Removable seat cushion is deeply padded for added comfort.
- Warranted for users up to 250 lbs.

INVITATION[®]

Lounge Options

MODEL OPTIONS

HFAA01



Arm Chair

HFALO2

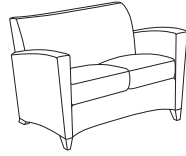

Love Seat

HFAS03

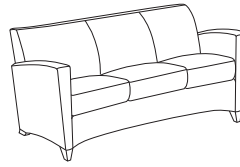

Sofa

LEG COLOR



CODE	DESCRIPTION	PRICE
T	Black	+\$0



T1	Platinum Metallic	+\$0
----	-------------------	-------------

CARTON

CODE	DESCRIPTION	PRICE
BC	Carton	+\$0

HON BRANDED FABRICS

GRADE 1

Apex
Attire
Centurion
Compass
Contourett
Dapper
Ensemble
Hamilton
Inertia
Optic
Pebble

GRADE 2

Appoint Seating
Blume
Clyde
Dotty
Rush
Seed
Spin Seating
Whisper Vinyl

GRADE 3

In Season
Moxie
Parker
Purl
Quill

GRADE L

Denver Leather

For a complete list of fabrics, including partnership fabrics, go to hon.com/fabricsandfinishes.

Reference Fabric Color Combinations on pages 18-22 for color codes and legend on page 19 for lead times. For additional HON to Supply COM fabric grade pricing, go to honready.hon.com and click on the HON to Supply COM link.

INVITATION® Lounge

GSA SIN 33721



Icon Legend on page 17

HFAA01

ARM CHAIR



DIMENSIONS

Depth:	31½	Arm Width:	20
Width:	30	Seat to Floor Height:	18
Height:	34	Usable Seat Depth:	20
Seat Depth:	20	Ship Weight:	73
Seat Width:	20	Cube:	27.0
Back Width:	20	COM:	5.0
Back Height:	16	Weight Rating:	250 lbs.

FABRIC PRICE CODES

1	\$2195	8	\$2885
2	\$2315	9	\$2975
3	\$2435	10	\$3065
4	\$2525	11	\$3155
5	\$2615	12	\$3245
6	\$2705	L	\$3195
7	\$2795		

HFAL02

LOVE SEAT

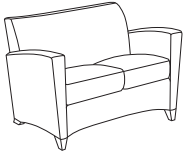

DIMENSIONS

Depth:	31¾	Arm Width:	40¼
Width:	50¼	Seat to Floor Height:	18
Height:	34¼	Usable Seat Depth:	20
Seat Depth:	20	Ship Weight:	112
Seat Width:	40¼	Cube:	55.7
Back Width:	40¼	COM:	6.5
Back Height:	16	Weight Rating:	250 lbs.

FABRIC PRICE CODES

1	\$3014	8	\$3911
2	\$3170	9	\$4028
3	\$3326	10	\$4145
4	\$3443	11	\$4262
5	\$3560	12	\$4379
6	\$3677	L	\$4314
7	\$3794		

HFAS03

SOFA

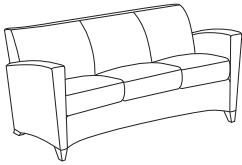

DIMENSIONS

Depth:	32	Arm Width:	60½
Width:	70½	Seat to Floor Height:	18
Height:	34½	Usable Seat Depth:	20
Seat Depth:	20	Ship Weight:	140
Seat Width:	60½	Cube:	72.0
Back Width:	60½	COM:	8.5
Back Height:	16	Weight Rating:	250 lbs.

FABRIC PRICE CODES

1	\$3835	8	\$5008
2	\$4039	9	\$5161
3	\$4243	10	\$5314
4	\$4396	11	\$5467
5	\$4549	12	\$5620
6	\$4702	L	\$5535
7	\$4855		

HON Recommendation: HFAA01.PNS__T.BC - List Price \$2315

SEATING

HOW TO SPECIFY

<p>Select Model Number</p> <p>HFAA01</p>	<p>Select Fabric</p> <p>See page 363</p> <p>PNS007</p>	<p>Select Leg Color</p> <p>T Black T1 Platinum Metallic</p> <p>T</p>	<p>Select Carton Option</p> <p>BC Carton</p> <p>BC</p>
--	--	--	--



Lota Mesh Back Work and Side Chair with Voi® desks.

LOTA®

If you're looking for all-day comfort without breaking the bank, look no further than Lota. This mesh back family of task and guest chairs offer advanced features for customizable comfort that make it an upscale choice at an affordable price. Lota's control mechanism uses your own weight to provide perfect balance while reclining, and the pivoting arms put upper body support right where it's needed. If you sit for hours on end, put yourself in more control over your comfort.



FEATURES

- Weight-activated control responds naturally to your body's movements without any adjustments.
- 3-way arms adjust to various heights, depths and pivot positions.
- Multi-purpose chairs feature black arms and base.
- One-touch seat height adjustment easily moves the seat up and down.
- Tilt lock allows the user to lock out the tilt function.
- 360-degree swivel provides freedom of movement in any direction.
- Model H2281 available in black, charcoal and navy fabrics.
- H2285 available in black fabric only.
- Multi-purpose chairs stack four high on the floor.
- Warranted for users up to 275 lbs.

LOTA[®] Options

MODEL OPTIONS

H2281 *



Mid-Back Work (Mesh Back)

Pneumatic, Tilt Lock, Weight-Activated Control, Height, Depth, Pivot Adjustable Arms, Black Arms and Base

H2285



Multi-Purpose (Mesh Back)

4-Leg Stacking Frame, Fixed Arms

FRAME

CODE	DESCRIPTION	PRICE
T	Black	+\$0

* De-emphasized

LOTA[®] MID-BACK WORK H2281

GRADE 1

Black Fabric
Charcoal Fabric
Navy Fabric

GRADE 2

GRADE 3

MULTI-PURPOSE H2285 HON BRANDED FABRICS

GRADE 1

Black Fabric

GRADE 2

GRADE 3

H2281*



MID-BACK WORK CHAIR

Mesh Back
 Pneumatic
 Tilt Lock
 Weight-activated Control
 Height, Depth, Pivot Adjustable
 Arms
 Black Arms and Base

DIMENSIONS

Depth:	27¾	Arm Width:	20⅞
Width:	26¾	Seat to Floor Height:	17⅞-21⅞
Height:	43½	Usable Seat Depth:	17¼
Seat Depth:	17¼	Ship Weight:	50
Seat Width:	19½	Cube:	6.5
Back Width:	17¾	Weight Rating:	250 lbs.
Back Height:	23½		

LIST PRICE

\$828

Functions: **A, E, F, L, Q**
 (Function Key on pages 212-213)

❗ Black Mesh back only.

HON Recommendation: H2281.VA10.T - List Price \$828

H2285



MULTI-PURPOSE CHAIR

Mesh Back
 4-Leg Stacking Frame
 Fixed Arms

DIMENSIONS

Depth:	24¾	Arm Width:	19⅞
Width:	23	Seat to Floor Height:	19⅞
Height:	34½	Usable Seat Depth:	17¾
Seat Depth:	17¾	Ship Weight:	20
Seat Width:	18⅞	Cube:	2.8
Back Width:	17⅞	Weight Rating:	250 lbs.
Back Height:	17¾		

LIST PRICE

\$417

NOTES: Casters and glides ship packaged together for customer's assembly choice. Stacks 4-high on floor.

❗ Available in VA10 Black fabric seat and Black frame only. Black Mesh back only.

* De-emphasized

HOW TO SPECIFY

Select Model Number

H 2 2 8 5 .

Select Fabric

VA10 Black Fabric
VA19 Charcoal Fabric
Specify for model H2281 only
VA90 Navy Fabric
Specify for model H2281 only

V A 1 0 .

Select Frame

T Black

T

MATTER™

Want to see more? Scan here
to check out hcn.com.



Matter™ Upholstered Chair with
5-Star Base with Preside® Table.

MATTER™

This modern take on the traditional task chair combines the comfort of a lounge chair and posture of a task chair. The swivel-tilt control allows you to find that reclining position that's just right for you, and the five-star base lets you move around effortlessly. This cool twist on the traditional guest chair puts the comfort of a lounge chair right on top of a traditional four-leg base.



FEATURES

- Brings a modern design aesthetic into any reception or guest area.
- Available in a 5-star base and 4-leg natural wood base. Hardwood legs in Harvest.
- Swivel-tilt mechanism offers a full range of reclining positions.
- Chrome base provides a contemporary accent.
- 360-degree swivel.
- Easily assembled in minutes.
- Backed by HON 5-year limited warranty.

MATTER™ Multi-Purpose Chairs

OPEN MARKET



Icon Legend on page 17

HVL232



GRAY UPHOLSTERED CHAIR

with 5-Star Base
Swivel
Tilt

DIMENSIONS

Depth:	24 ⁴ / ₅	Arm Width:	3
Width:	23	Seat to Floor Height:	19
Height:	34	Usable Seat Depth:	18
Seat Depth:	18 ³ / ₁₀	Ship Weight:	21
Seat Width:	16 ¹ / ₂	Cube:	5.6
Back Width:	23	Weight Rating:	250 lbs.
Back Height:	12 ² / ₅		

LIST PRICE

\$515

NOTES: HON 5-Year Limited Warranty.

HVL238



GRAY UPHOLSTERED CHAIR

Wood Leg Base
Harvest Wood Legs
4-Leg Wood Base

DIMENSIONS

Depth:	24 ⁴ / ₅	Arm Width:	3
Width:	23	Seat to Floor Height:	19
Height:	34	Usable Seat Depth:	18
Seat Depth:	18 ³ / ₁₀	Ship Weight:	21
Seat Width:	16 ¹ / ₂	Cube:	5.6
Back Width:	23	Weight Rating:	250 lbs.
Back Height:	12 ² / ₅		

LIST PRICE

\$475

NOTES: HON 5-Year Limited Warranty.

HOW TO SPECIFY

Select
Model Number

Select
Fabric

GRY01 Light Gray

H V L 2 3 8 .

G R Y 0 1



Mav™ Single Lounge shown with West Hill™ Seating and Scramble™ Coffee Table.

MAV™

With plenty of base, back, and seat options offset with mid-century flair and richly colored fabrics, the Mav Single Lounge Series is designed to function well in virtually any space. Whether it's configured for a multi-use zone, in a private office, or to stand alone as a statement piece, Mav is an ideal place for impromptu or collaborative gatherings, a quick break, or focused, heads-down work.



FEATURES

- Subtle seat and back contours and refined details create an inviting, contemporary aesthetic.
- Choose from a mid-back or high-back option.
- Contoured arms provide support and create a striking look.
- Armless models offer a range of seated postures.
- High-back models available with a 4-star metal base with return-to-center, 4-leg wood base, or 5-star base with swivel knee tilt.
- Mid-back models offered in 4-star metal base with return-to-center, 4-leg wood base, wire sled base, or 5-star base with swivel knee tilt.
- Multi-Fabric option — seat cushion and frame can be specified in different fabrics for a modern aesthetic.
- Ottoman lets you kick up your feet or use as impromptu seating.
- Seat cushion attaches with Velcro for easy cleaning or replacement.
- Available in a wide range of cleanable fabrics to achieve the perfect look (see HON's Cleaning Guide).
- Choose from 10 wood base or 4 metal base finish options.

MAV™ Finish Options

HON BRANDED FABRICS

GRADE 1	GRADE 2	GRADE 3
Apex	Appoint Seating	In Season
Attire*	Blume	Moxie
Centurion	Clyde	Parker
Compass	Dotty	Purl
Contourett**	Rush	Quill
Dapper	Seed*	
Ensemble	Spin Seating	
Hamilton	Whisper Vinyl**	
Inertia		
Optic*		
Pebble		

For a complete list of fabrics, including partnership fabrics, go to hon.com/fabricsandfinishes.

Reference Fabric Color Combinations on pages 18-22 for color codes and legend on page 19 for lead times.

*Not available on Single Fabric models or as multi-fabric frame option.

**Due to the inherent design of Mav™ high-back chairs, coated fabrics may show material gathers, particularly around the headrest.

LEG STYLE

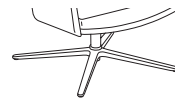

CODE	DESCRIPTION	PRICE
4S	4-Star Return-to-Center	+\$0
<i>Available in the following finishes:</i>		
P8V	Textured Titanium	
P7A	Textured Charcoal	
P8X	Solar Black	+\$20
Y	Polished	+\$50

LEG STYLE

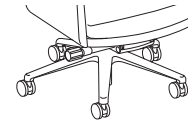

CODE	DESCRIPTION	PRICE
5S	5-Star w/Swivel Knee Tilt, Hard Caster	+\$25
5SS	5-Star w/Swivel Knee Tilt, All-Surface Caster	+\$55
<i>Available in the following finishes:</i>		
P8V	Textured Titanium	
P7A	Textured Charcoal	
P8X	Solar Black	+\$20
Y	Polished	+\$50

LEG STYLE

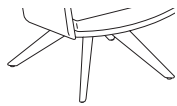

CODE	DESCRIPTION	PRICE
WD	Wood	+\$250
<i>Available in the following finishes:</i>		
LFW1	Florence Walnut	
LK11	Kingswood Walnut	
LLA1	Lowell Ash	
D	Natural Maple	
LN11	Natural Recon	
LPE1	Phantom Ecrú	
PINC	Pinnacle	
LPT1	Portico Teak	
LSW1	Skyline Walnut	
LSA1	Sterling Ash	

LEG STYLE

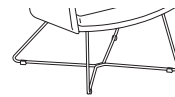

CODE	DESCRIPTION	PRICE
SD	Sled*	+\$0
<i>Available in the following finishes:</i>		
P8V	Textured Titanium	
P7A	Textured Charcoal	
P8X	Solar Black	+\$20
Y	Polished	+\$50

*Available on Mid-Back models only

SEATING

Low-Back, Multi-Fabric



High-Back, Multi-Fabric





HMAVMN



MID-BACK SINGLE LOUNGE, ARMLESS

DIMENSIONS

Depth (4-Star, 5-Star, & Wood):	28¾	Back Height:	18¾
Depth (Sled):	27½	Back Width:	20
Height (4-Star):	29½	Ship Weight:	45
Height (5-Star):	33½-37¼	Ship Weight (5-Star):	55
Height (Wood):	30	Cube:	20.1
Height (Sled):	30¾	COM:	3.5
Width:	24	Weight Rating:	300 lbs.
Usable Seat Depth:	19		
Seat to Floor Height:	17¾		
Seat to Floor Height (5-Star):	17¼-21		
Seat Width:	21		

FABRIC PRICE CODES

1	\$1458	8	\$2092
2	\$1542	9	\$2108
3	\$1628	10	\$2194
4	\$1699	11	\$2279
5	\$1794	12	\$2365
6	\$1891	L	\$2965
7	\$1991		

HMAVMNMF



MID-BACK SINGLE LOUNGE, ARMLESS, MULTI-FABRIC

DIMENSIONS

Depth (4-Star, 5-Star, & Wood):	28¾	Back Height:	18¾
Depth (Sled):	27½	Back Width:	20
Height (4-Star):	29½	Ship Weight:	45
Height (5-Star):	33½-37¼	Ship Weight (5-Star):	55
Height (Wood):	30	Cube:	20.1
Height (Sled):	30¾	COM (Seat Cushion):	1.5
Width:	24	COM (Back/Frame):	2.5
Usable Seat Depth:	19	Weight Rating:	300 lbs.
Seat to Floor Height:	17¾		
Seat to Floor Height (5-Star):	17¼-21		
Seat Width:	21		

FABRIC PRICE CODES

1	\$1617	
	<i>Add to Base Price Above</i>	
	Seat	Frame
2	\$24	\$60
3	\$48	\$121
4	\$69	\$172
5	\$96	\$240
6	\$124	\$309
7	\$152	\$380
8	\$181	\$453
9	\$186	\$464
10	\$210	\$525
11	\$235	\$587
12	\$259	\$648

HON Recommendation: HMAVMNMF.PURL__PURL__4S__ - List Price \$1786

HOW TO SPECIFY

<p>Select Model Number</p>	<p>Select Fabric</p> <p>See page 372 Specify for single fabric model only</p>	<p>Select Seat Fabric</p> <p>See page 372 Specify for multi-fabric model only</p>	<p>Select Frame Fabric</p> <p>See page 372 Specify for multi-fabric model only</p>	<p>Select Base and Base Color</p> <p>See page 372</p> <p>4S 4-Star Return-to-Center 5S 5-Star, Hard Caster (+ \$25) 5SS 5-Star, All-Surface Caster (+ \$55) WD Wood (+ \$250) SD Sled</p>
HMAVMNMF	PURL05	PURL05	PURL03	4SP7A



HMAVMA



MID-BACK SINGLE LOUNGE, ARMS

DIMENSIONS

Depth (4-Star, 5-Star, & Wood):	28¾	Back Height:	18¾
Depth (Sled):	27½	Back Width:	20
Height (4-Star):	29½	Arm Height:	8½
Height (5-Star):	33½-37¼	Ship Weight:	53
Height (Wood):	30	Ship Weight (5-Star):	63
Height (Sled):	30¾	Cube:	20.1
Width:	25	COM:	4.0
Usable Seat Depth:	19	Weight Rating:	300 lbs.
Seat to Floor Height:	17¾		
Seat to Floor Height (5-Star):	17¼-21		
Seat Width:	21		

FABRIC PRICE CODES

1	\$1829	8	\$2554
2	\$1925	9	\$2572
3	\$2023	10	\$2670
4	\$2104	11	\$2768
5	\$2213	12	\$2866
6	\$2324	L	\$3551
7	\$2438		

HMAVMAMF



MID-BACK SINGLE LOUNGE, ARMS, MULTI-FABRIC

DIMENSIONS

Depth (4-Star, 5-Star, & Wood):	28¾	Back Height:	18¾
Depth (Sled):	27½	Back Width:	20
Height (4-Star):	29½	Arm Height:	8½
Height (5-Star):	33½-37¼	Ship Weight:	53
Height (Wood):	30	Ship Weight (5-Star):	63
Height (Sled):	30¾	Cube:	20.1
Width:	25	COM (Seat Cushion):	1.5
Usable Seat Depth:	19	COM (Back/Frame):	4.0
Seat to Floor Height:	17¾	Weight Rating:	300 lbs.
Seat to Floor Height (5-Star):	17¼-21		
Seat Width:	21		

FABRIC PRICE CODES

1	\$1988		
		<i>Add to Base Price Above</i>	
		Seat	Back
2	\$24	\$24	\$72
3	\$48	\$48	\$145
4	\$69	\$69	\$206
5	\$96	\$96	\$288
6	\$124	\$124	\$371
7	\$152	\$152	\$457
8	\$181	\$181	\$544
9	\$186	\$186	\$557
10	\$210	\$210	\$631
11	\$235	\$235	\$704
12	\$259	\$259	\$778

HON Recommendation: HMAVMAMF.PURL__PURL__4S__ - List Price \$2181

HOW TO SPECIFY

<p>Select Model Number</p>	<p>Select Fabric</p> <p>See page 372</p> <p><i>Specify for single fabric model only</i></p>	<p>Select Seat Fabric</p> <p>See page 372</p> <p><i>Specify for multi-fabric model only</i></p>	<p>Select Frame Fabric</p> <p>See page 372</p> <p><i>Specify for multi-fabric model only</i></p>	<p>Select Base and Base Color</p> <p>See page 372</p> <p>4S 4-Star Return-to-Center</p> <p>5S 5-Star w/Swivel Knee Tilt, Hard Caster (+ \$25)</p> <p>5SS 5-Star w/Swivel Knee Tilt, All-Surface Caster (+ \$55)</p> <p>WD Wood (+ \$250)</p> <p>SD Sled</p>
HMAVMAMF	PURL05	PURL05	PURL03	4SP7A



HMAVHN



HIGH-BACK SINGLE LOUNGE, ARMLESS

DIMENSIONS

Depth:	30¼	Back Height:	32½
Height (4-Star):	43½	Back Width:	20
Height (5-Star):	47-50¾	Ship Weight:	50
Height (Wood):	44	Ship Weight (5-Star):	59
Width:	24	Cube:	29
Usable Seat Depth:	19	COM:	4.0
Seat to Floor Height:	17¾	Weight Rating:	300 lbs.
Seat to Floor Height (5-Star):	17¼-21		
Seat Width:	21		

FABRIC PRICE CODES

1	\$1643	8	\$2277
2	\$1727	9	\$2293
3	\$1813	10	\$2379
4	\$1884	11	\$2464
5	\$1979	12	\$2550
6	\$2076	L	\$3150
7	\$2176		

HMAVHNMF

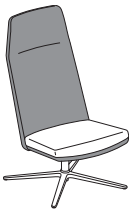

HIGH-BACK SINGLE LOUNGE, ARMLESS, MULTI-FABRIC

DIMENSIONS

Depth:	30¼	Back Height:	32½
Height (4-Star):	43½	Back Width:	20
Height (5-Star):	47-50¾	Ship Weight:	50
Height (Wood):	44	Ship Weight (5-Star):	59
Width:	24	Cube:	29
Usable Seat Depth:	19	COM (Seat Cushion):	1.5
Seat to Floor Height:	17¾	COM (Back/Frame):	3.5
Seat to Floor Height (5-Star):	17¼-21	Weight Rating:	300 lbs.
Seat Width:	21		

FABRIC PRICE CODES

1	\$1802		
		<i>Add to Base Price Above</i>	
		Seat	Frame
2	\$24	\$60	
3	\$48	\$121	
4	\$69	\$172	
5	\$96	\$240	
6	\$124	\$309	
7	\$152	\$380	
8	\$181	\$453	
9	\$186	\$464	
10	\$210	\$525	
11	\$235	\$587	
12	\$259	\$648	

HON Recommendation: HMAVHNMF.PURL__PURL__4S__ - List Price \$1971

HOW TO SPECIFY

<p>Select Model Number</p> <p>See page 372</p>	<p>Select Fabric</p> <p>See page 372</p> <p><i>Specify for single fabric model only</i></p>	<p>Select Seat Fabric</p> <p>See page 372</p> <p><i>Specify for multi-fabric model only</i></p>	<p>Select Frame Fabric</p> <p>See page 372</p> <p><i>Specify for multi-fabric model only</i></p>	<p>Select Base and Base Color</p> <p>See page 372</p> <p>4S 4-Star Return-to-Center 5S 5-Star w/Swivel Knee Tilt, Hard Caster (+ \$25) 5SS 5-Star w/Swivel Knee Tilt, All-Surface Caster (+ \$55) WD Wood (+ \$250)</p>
HMAVHNMF .	PURL05 .	PURL05 .	PURL03 .	4SP7A



HMAVHA



HIGH-BACK SINGLE LOUNGE, ARMS

DIMENSIONS

Depth:	30¼	Back Height:	32½
Height (4-Star):	43½	Back Width:	20
Height (5-Star):	47-50¾	Arm Height:	8½
Height (Wood):	44	Ship Weight:	59
Width:	25	Ship Weight (5-Star):	67
Usable Seat Depth:	19	Cube:	29
Seat to Floor Height:	17¾	COM:	5.0
Seat to Floor Height (5-Star):	17¼-21	Weight Rating:	300 lbs.
Seat Width:	21		

FABRIC PRICE CODES

1	\$2014	8	\$2739
2	\$2110	9	\$2757
3	\$2208	10	\$2855
4	\$2289	11	\$2953
5	\$2398	12	\$3051
6	\$2509	L	\$3736
7	\$2623		

HMAVHAMF



HIGH-BACK SINGLE LOUNGE, ARMS, MULTI-FABRIC

DIMENSIONS

Depth:	30¼	Back Height:	32½
Height (4-Star):	43½	Back Width:	20
Height (5-Star):	47-50¾	Arm Height:	8½
Height (Wood):	44	Ship Weight:	59
Width:	25	Ship Weight (5-Star):	67
Usable Seat Depth:	19	Cube:	29
Seat to Floor Height:	17¾	COM (Seat Cushion):	1.5
Seat to Floor Height (5-Star):	17¼-21	COM (Back/Frame):	4.0
Seat Width:	21	Weight Rating:	300 lbs.

FABRIC PRICE CODES

1	\$2173	
	<i>Add to Base Price Above</i>	
	Seat	Frame
2	\$24	\$72
3	\$48	\$145
4	\$69	\$206
5	\$96	\$288
6	\$124	\$371
7	\$152	\$457
8	\$181	\$544
9	\$186	\$557
10	\$210	\$631
11	\$235	\$704
12	\$259	\$778

HON Recommendation: HMAVHAMF.PURL__PURL__4S__ - List Price \$2366

HOW TO SPECIFY

<p>Select Model Number</p> <p>See page 372</p> <p><i>Specify for single fabric model only</i></p>	<p>Select Fabric</p> <p>See page 372</p> <p><i>Specify for single fabric model only</i></p>	<p>Select Seat Fabric</p> <p>See page 372</p> <p><i>Specify for multi-fabric model only</i></p>	<p>Select Frame Fabric</p> <p>See page 372</p> <p><i>Specify for multi-fabric model only</i></p>	<p>Select Base and Base Color</p> <p>See page 372</p> <p>4S 4-Star Return-to-Center 5S 5-Star w/Swivel Knee Tilt, Hard Caster (+ \$25) 5SS 5-Star w/Swivel Knee Tilt, All-Surface Caster (+ \$55) WD Wood (+ \$250)</p>
HMAVHAMF .	PURL05 .	PURL05 .	PURL03 .	4SP7A



HMAVO



SINGLE LOUNGE OTTOMAN

DIMENSIONS

Depth:	22	Ship Weight:	33
Height:	15	Cube:	9.5
Width:	24	COM:	3.5
Usable Seat Depth:	24	Weight Rating:	300 lbs.
Seat to Floor Height:	15		
Seat Width:	22		

FABRIC PRICE CODES

1	\$901	8	\$1626
2	\$997	9	\$1644
3	\$1095	10	\$1742
4	\$1176	11	\$1840
5	\$1285	12	\$1938
6	\$1396	L	\$2623
7	\$1510		

HMAVOMF

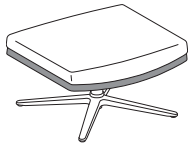

SINGLE LOUNGE OTTOMAN, MULTI-FABRIC

DIMENSIONS

Depth:	22	Ship Weight:	33
Height:	15	Cube:	9.5
Width:	24	COM (Seat Cushion):	1.5
Usable Seat Depth:	24	COM (Frame):	2.5
Seat to Floor Height:	15	Weight Rating:	300 lbs.
Seat Width:	22		

FABRIC PRICE CODES

1	\$981		
<i>Add to Base Price Above</i>			
	Seat	Frame	
2	\$24	\$72	
3	\$48	\$145	
4	\$69	\$206	
5	\$96	\$288	
6	\$124	\$371	
7	\$152	\$457	
8	\$181	\$544	
9	\$186	\$557	
10	\$210	\$631	
11	\$235	\$704	
12	\$259	\$778	

HON Recommendation: HMAVOMF.PURL___.PURL___.4S__ - List Price \$1174

HOW TO SPECIFY

<p>Select Model Number</p> <p>HMAVOMF</p>	<p>Select Fabric</p> <p>See page 372 Specify for single fabric model only</p> <p>PURL05</p>	<p>Select Seat Fabric</p> <p>See page 372 Specify for multi-fabric model only</p> <p>PURL05</p>	<p>Select Frame Fabric</p> <p>See page 372 Specify for multi-fabric model only</p> <p>PURL03</p>	<p>Select Base and Base Color</p> <p>See page 372 4S 4-Star</p> <p>4SP7A</p>
--	--	--	---	---



Merit™ Executive Conference
Chair with Voi® Desks.

MERIT™

Merit™ is the answer for anyone who wants the experience of sitting in a refined executive chair combined with the sleek look of a European conference chair. A channel stitched back and polished aluminum arm and base accents provide the initial attraction, but the supreme comfort of the weight-activated control makes them stay. This modern, streamlined look is complemented by a luxurious sitting experience.



FEATURES

- Weight-activated tilt-control mechanism provides natural, ergonomic reclining position.
- Leather wrapped back includes channel stitching for upscale look. Available in Black or Gray.
- Color-matched soft arm cap.
- Pneumatic seat height adjustment.
- Molded foam seat and back.
- Padded headrest.
- Weight rating of 275 lbs.



Executive Conference Chair

HME3



EXECUTIVE CONFERENCE CHAIR

Pneumatic
Swivel
Weight-activated Control
Tilt Lock
Fixed Arms

Functions: **A, E, F, L, T**
(Function Key on pages 212-213)

DIMENSIONS

Depth:	27¼	Arm Width:	20½
Width:	27¼	Seat to Floor Height:	18-21
Height:	49¾	Usable Seat Depth:	20
Seat Depth:	20	Ship Weight:	47.5
Seat Width:	20½	Cube:	14.3
Back Width:	19	Weight Rating:	275 lbs.
Back Height:	29¼		

LIST PRICE

Leather \$1159

NOTES: Black or Gray leather options. Detailed channel stitching on back. Polished arms and base. Fixed arms with color-matched soft arm cap.

HON Recommendation: HME3.W5.P.H.LR58.PA - List Price \$1159

HOW TO SPECIFY

<p>Select Model Number</p> <p>HME3</p>	<p>Select Control Type</p> <p>W5 Weight-Activated</p>	<p>Select Arm Type</p> <p>P Fixed Arms - Polished</p>	<p>Select Caster</p> <p>H Black Hard Caster</p>	<p>Select Fabric</p> <p>LR58 Black Leather LR29 Gray Leather</p>	<p>Select Base</p> <p>PA Polished Aluminum</p>
---	--	--	--	---	---

MOTIVATE® CHAIRS

Want to see more? Scan here
to check out hon.com.



Motivate® 4-Leg Stacking Chairs and Between™ Table.

MOTIVATE® CHAIRS

A presentation in the morning. A training session in the afternoon. Today's multi-purpose spaces are in constant flux, and need an adaptable seating solution that delivers instant comfort for all, while easily moving around to support various activities. Motivate task chairs, stacking/nesting chairs and guest chairs create a streamlined collection of seating that intuitively responds to your body's natural movements and curves. Whether sitting for five minutes or five hours, when you Motivate your team you put everyone at ease.



FEATURES

- Choose plastic, upholstered or 4-Way Stretch mesh back.
- Easily move chairs around the space for quick rearrangement.
- HMN1 nesting/stacking chairs stack four high on the floor.
- HMS1 sled base chairs stack 12 high on the floor or 40 high on a cart.
- HMS2 sled base chairs stack six high on the floor.
- Dynamic flex-zone motion in seat and back provides balance and lumbar support.
- Model HMT5 task stool features an adjustable footring.
- Plastic shell is available in 13 colors.
- Available in hundreds of quality HON fabrics.
- Warranted for users up to 300 lbs.

TASK CHAIR FEATURES

- One-touch seat height adjustment easily moves the seat up and down.
- 360-degree swivel provides freedom of movement in any direction.
- Warranted for users up to 300 lbs.

MOTIVATE® Task Chair Options

MODEL OPTIONS

HMT1



Flex-back

Upholstered Seat,
Pneumatic, Swivel

HMT5



Flex-back

Upholstered Seat,
Pneumatic, Swivel
Adjustable Footring

ARM STYLE

CODE	DESCRIPTION	PRICE
N	Armless	+\$0
A	Adjustable Arms	+\$70



CASTERS

CODE	DESCRIPTION	PRICE
H	Hard Caster	+\$0
S	All-Surface Caster	+\$40



BACK STYLE

CODE	DESCRIPTION	PRICE
------	-------------	-------

Plastic/Upholstered Options:



PS	Plastic Shell	+\$0
-----------	---------------	-------------



PB	Upholstered	+\$70
-----------	-------------	--------------

4-Way Stretch Options:



IM	Black	+\$80
IB	Breeze	+\$80
IK	Brownstone	+\$80
IC	Charcoal	+\$80
IF	Fog	+\$80
IR	Regatta	+\$80
IT	Titanium	+\$80

PLASTIC SHELL COLOR CODES (no upcharge):	Tangelo - RG	Cherry - CR	Lime - LM	Calypso - CP	Surf - BU
	Regatta - RE	Mulberry - MB	Loft - LO	Platinum - PT	Shadow - SD
	Lava - LA	Onyx - ON	White - WT		

BASE



CODE	DESCRIPTION	PRICE
SB	Standard Base	+\$0

FRAME COLOR

CODE	DESCRIPTION	PRICE
T	Black	+\$0

SEATING

MOTIVATE®

Task Chair Fabric Options

HON BRANDED FABRICS

GRADE 1	GRADE 2	GRADE 3	GRADE L
Apex	Appoint Seating	In Season	Denver Leather
Attire	Blume	Moxie	
Centurion	Clyde	Parker	
Compass	Dotty	Purl	
Contourett	Rush	Quill	
Dapper	Seed		
Ensemble	Spin Seating		
Hamilton	Whisper Vinyl		
Inertia			
Optic			
Pebble			

For a complete list of fabrics, including partnership fabrics, go to hon.com/fabricsandfinishes.

Reference Fabric Color Combinations on pages 18-22 for color codes and legend on page 19 for lead times.



Icon Legend on page 17

MOTIVATE® Task Chairs

HMT1

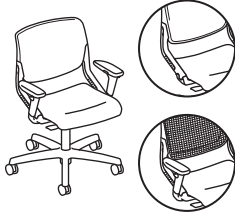

TASK CHAIR

Flex-back
Upholstered Seat
Pneumatic
Swivel

DIMENSIONS

Depth:	27½	Seat to Floor Height:	17-22½
Width:	27½	Usable Seat Depth:	18
Height:	37½	Ship Weight (upholstered back):	39
Seat Depth:	18	Ship Weight (plastic/mesh back):	38
Seat Width:	17½	Cube (upholstered back):	10.0
Back Width:	19½	Cube (plastic/mesh back):	10.0
Back Height:	17¾	COM (upholstered back):	1.5
Arm Width:	18½-20	COM (plastic/mesh back):	1.0
		Weight Rating:	300 lbs.

FABRIC PRICE CODES

1	\$493	8	\$700
2	\$529	9	\$727
3	\$565	10	\$754
4	\$592	11	\$781
5	\$619	12	\$808
6	\$646	L	—
7	\$673		

❗ When a Plastic Shell (PS) or Upholstered Back (PB) option is chosen, you must select a shell color. If the mesh back option is chosen, the shell color is not specified.

HMT5

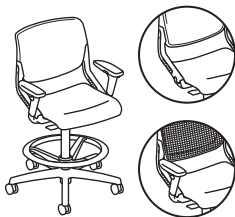

TASK STOOL

Flex-back
Upholstered Seat
Pneumatic
Swivel Adjustable Footring

DIMENSIONS

Depth:	28¼	Seat to Floor Height:	22½-32½
Width:	28¼	Usable Seat Depth:	18
Height:	50½	Ship Weight (upholstered back):	44
Seat Depth:	18	Ship Weight (plastic/mesh back):	43
Seat Width:	17½	Cube (upholstered back):	10.0
Back Width:	19½	Cube (plastic/mesh back):	10.0
Back Height:	17¾	COM (upholstered back):	1.5
Arm Width:	18½-20	COM (plastic/mesh back):	1.0
		Weight Rating:	300 lbs.

FABRIC PRICE CODES

1	\$560	8	\$767
2	\$596	9	\$794
3	\$632	10	\$821
4	\$659	11	\$848
5	\$686	12	\$875
6	\$713	L	—
7	\$740		

NOTES: Stool model has adjustable footring.

❗ When a Plastic Shell (PS) or Upholstered Back (PB) option is chosen, you must select a shell color. If the mesh back option is chosen, the shell color is not specified.

HON Recommendation: HMT1.A.H.IM.CU__SB.T - List Price \$643

HOW TO SPECIFY

Select Model Number	Select Arm Type	Select Caster	Select Back Type/Color	Select Fabric	Select Base	Select Frame
A Adjustable Arms (+ \$70) N Armless	H Hard Caster S All-Surface Caster (+ \$40)	PS Plastic Shell PB Upholstered (+ \$70) If PS or PB options are chosen, select shell color. Plastic Shell Colors RG Tangelo LO Loft CR Cherry PT Platinum LM Lime SD Shadow CP Calypso LA Lava BU Surf ON Onyx RE Regatta WT White MB Mulberry 4-Way Stretch options (+ \$80) IM Black IF Fog IB Breeze IR Regatta IK Brownstone IT Titanium IC Charcoal	See page 382	SB Standard Base	T Black	
HMT1	A	H	IM	CU10	SB	T
HMT1	A	H	PSLA	CU10	SB	T

SEATING

MOTIVATE® High-Density Sled Base Chair Options

MODEL OPTIONS

HMS1



High-Density Stacker

Sled Leg Base

HMS2



High-Density Stacker

Upholstered Seat, Sled Leg Base

ARM STYLE

CODE	DESCRIPTION	PRICE
F	Fixed Arms	+\$30
N	Armless	+\$0



FRAME

CODE	DESCRIPTION	PRICE
Y	Chrome	+\$0
P1 PAINT:		+\$0
BLCK	Textured Black Mica	
P7J	Textured Brownstone	
P7A	Textured Charcoal	
PK7	Textured Designer White	
P7L	Textured Loft	
P7M	Textured Muslin	
PLAT	Textured Platinum Metallic	
P8V	Textured Titanium	
P2 PAINT:		+\$0
PR8	Textured Silver	
P3 PAINT:		+\$30
P8S	Atom	
PJF	Bullseye	
P8P	Ember	
P8N	Ion	
P8J	Iris	
P8F	Krypton	
P8M	Regatta	

PLASTIC SHELL COLOR CODES (no upcharge):

Tangelo - RG	Cherry - CR	Lime - LM	Calypso - CP	Surf - BU
Regatta - RE	Mulberry - MB	Loft - LO	Platinum - PT	Shadow - SD
Lava - LA	Onyx - ON	White - WT		

HON BRANDED FABRICS

GRADE 1

Apex
Attire
Centurion
Compass
Contourett
Dapper
Ensemble
Hamilton
Inertia
Optic
Pebble

GRADE 2

Appoint Seating
Blume
Clyde
Dotty
Rush
Seed
Spin Seating
Whisper Vinyl

GRADE 3

In Season
Parker
Purl
Quill

For a complete list of fabrics, including partnership fabrics, go to hon.com/fabricsandfinishes.

Reference Fabric Color Combinations on pages 18-22 for color codes and legend on page 19 for lead times.



MOTIVATE® High-Density Sled Base Chairs

HMS1

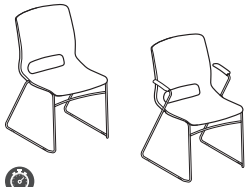

HIGH-DENSITY STACKER

Sled Leg Base

DIMENSIONS

Depth:	23	Arm Width:	18 ³ / ₈
Width:	21	Seat to Floor Height:	17 ³ / ₄
Height:	32 ¹ / ₄	Usable Seat Depth:	18 ³ / ₄
Seat Depth:	18 ³ / ₄	Ship Weight:	72
Seat Width:	17 ³ / ₄	Cube:	15.2
Back Width:	17 ¹ / ₄	Weight Rating:	300 lbs.
Back Height:	18		

LIST PRICE PER CARTON

\$941

(reference single unit @
\$235.25)

NOTES: HMS1 Sled Base chairs stack 12-high on the floor, or 40-high on the chair cart model HMSCART. Field installed glides snap-on using existing locations on the sled base frames.

- ❗ Ganging Chair Glides are designed for use on armless models of the Motivate® High-Density Sled Base Chairs only. Not for use on models specified with arms.
- 📦 Ships four (4) chairs per carton.

HMS2

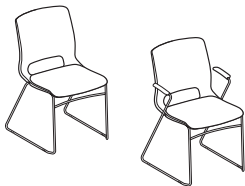

HIGH-DENSITY STACKER

Upholstered Seat
Sled Leg Base
Set of 4

DIMENSIONS

Depth:	23	Arm Width:	18 ³ / ₈
Width:	21	Seat to Floor Height:	18 ¹ / ₄
Height:	32 ¹ / ₄	Usable Seat Depth:	18 ³ / ₄
Seat Depth:	18 ³ / ₄	Ship Weight:	80
Seat Width:	17 ³ / ₄	Cube:	15.2
Back Width:	17 ¹ / ₄	COM (per 4 pack):	1.6
Back Height:	17 ¹ / ₂	Weight Rating:	300 lbs.

FABRIC PRICE CODES

1	\$1206	8	\$1344
2	\$1230	9	\$1362
3	\$1254	10	\$1380
4	\$1272	11	\$1398
5	\$1290	12	\$1416
6	\$1308	L	—
7	\$1326		

NOTES: HMS2 Sled Base chairs stack 6-high on the floor. Field installed glides snap-on using existing locations on the sled base frames.

- ❗ Ganging Chair Glides are designed for use on armless models of the Motivate® High-Density Sled Base Chairs only. Not for use on models specified with arms. Upholstered seat model HMS2 is not designed to be stacked on the HMSCART.
- 📦 Motivate® Sled Base Chairs are ordered and shipped four (4) chairs per carton. Pricing shown is per carton. Each set of four chairs (one carton), must have the same shell/frame color combination. Ordering 2 of Model HMS1, HMS2 will result in 2 cartons being shipped, giving you 8 chairs.

HMSCART

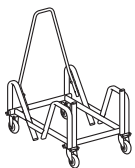

CART FOR HMS1 STACKING CHAIRS

DIMENSIONS

Depth:	34 ¹ / ₄	Ship Weight:	40
Width:	21 ³ / ₈	Cube:	7.8
Height:	36 ³ / ₈		

LIST PRICE

\$540

NOTES: Holds up to 40 Stacking Chairs.

HON Recommendation: HMS1.N.ON.Y - List Price \$887

HOW TO SPECIFY

<p>Select Model Number</p> <p>HMS1 .</p> <p>HMS2 .</p>	<p>Select Arm Type</p> <p>F Fixed Arms (+ \$30 per chair)</p> <p>N Armless</p> <p>N .</p> <p>N .</p>	<p>Select Shell Color</p> <p>RG Tangelo LO Loft</p> <p>CR Cherry PT Platinum</p> <p>LM Lime SD Shadow</p> <p>CP Calypso LA Lava</p> <p>BU Surf ON Onyx</p> <p>RE Regatta WT White</p> <p>MB Mulberry</p> <p>ON .</p> <p>ON .</p>	<p>Select Fabric</p> <p>See page 384</p> <p>Not specified for HMS1 models</p> <p>CU10 .</p>	<p>Select Frame</p> <p>See page 384</p> <p>BLCK</p> <p>BLCK</p>
---	---	---	--	--

SEATING

MOTIVATE® High-Density Sled Base Chairs

OPEN MARKET



Icon Legend on page 17

HMSGLD

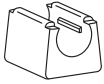

GLIDES FOR MOTIVATE® HIGH-DENSITY STACKER

- Kit includes 48 glides for 12 chairs
- Field installed
- Snap-on using existing locations on frames

DIMENSIONS

Ship Weight: 1
Cube: 0.2

LIST PRICE

\$72

HMSFLTGLD



FELT GLIDES FOR MOTIVATE® HIGH-DENSITY STACKER

- Kit includes 48 glides for 12 chairs
- Field installed
- Snap-on using existing locations on frames

DIMENSIONS

Ship Weight: 1
Cube: 0.2

LIST PRICE

\$183

HMSSTLGLD



STEEL GLIDES FOR MOTIVATE® HIGH-DENSITY STACKER

- Kit includes 48 glides for 12 chairs
- Field installed
- Snap-on using existing locations on frames

DIMENSIONS

Ship Weight: 1
Cube: 0.2

LIST PRICE

\$183

HMSGANG

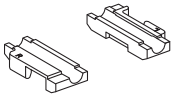

GANGING CONNECTORS FOR MOTIVATE® HIGH- DENSITY STACKER

- 48 ganging connectors
- Requires 4 connectors per ganging connection
- For use on HMS1.N and HMS2.N only (armless models)
- Field installed
- Snap-on using existing locations on frames

DIMENSIONS

Ship Weight: 1
Cube: 0.2

LIST PRICE

\$133

Floor Covering	TYPE OF GLIDE		
	Polycarbonate/Nylon	Felt	Steel
Carpet	Best	Not Recommended	Good
Polished concrete	Best	Good	Not Recommended
Hard wood	Not Recommended	Best	Not Recommended
Vinyl (includes LVT)	Best	Better	Good
VCT	Best	Good	Not Recommended
Tile (Porcelain/Ceramic)	Best	Good	Not Recommended

HOW TO SPECIFY

Select
Model Number

H M S G L D

MOTIVATE® 4-Leg Chair Options

MODEL OPTIONS

HMG1



Stack Chair

Four Legs, Set of 2

HMG2



Stack Chair

Four Legs, Upholstered Seat, Set of 2

HMG3

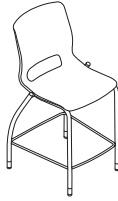

Counter-Height Stool

Four Legs

HMG4



Counter-Height Stool

Four Legs, Upholstered Seat

HMG5



Café-Height Stool

Four Legs

HMG7



Café-Height Stool

Four Legs, Upholstered Seat

ARM STYLE



CODE	DESCRIPTION	PRICE
F	Fixed Arms	+\$30



N	Armless	+\$0
----------	---------	-------------

CASTERS/ GLIDES



CODE	DESCRIPTION	PRICE
H	Hard Caster	+\$0



S	All-Surface Caster	+\$30
----------	--------------------	--------------

**Casters only available on HMG1 and HMG2*



E	Standard Nylon Glide	+\$0
----------	----------------------	-------------

F	Felt Glide	+\$30
----------	------------	--------------

R	Rubber Glide	+\$30
----------	--------------	--------------

T	Steel Glide	+\$30
----------	-------------	--------------

FRAME

CODE	DESCRIPTION	PRICE
P1 PAINT:		+\$0
BLCK	Textured Black Mica	
P7J	Textured Brownstone	
P7A	Textured Charcoal	
PK7	Textured Designer White	
P7L	Textured Loft	
P7M	Textured Muslin	
PLAT	Textured Platinum Metallic	
P8V	Textured Titanium	
P2 PAINT:		+\$0
PR8	Textured Silver	
P3 PAINT:		+\$30
P8S	Atom	
PJF	Bullseye	
P8P	Ember	
P8N	Ion	
P8J	Iris	
P8F	Krypton	
P8M	Regatta	

PLASTIC SHELL COLOR CODES (no upcharge):				
Tangelo - RG	Cherry - CR	Lime - LM	Calypso - CP	Surf - BU
Regatta - RE	Mulberry - MB	Loft - LO	Platinum - PT	Shadow - SD
Lava - LA	Onyx - ON	White - WT		

SEATING

MOTIVATE®

4-Leg Chair Fabric Options

HON BRANDED FABRICS

GRADE 1

Apex
Attire
Centurion
Compass
Contourett
Dapper
Ensemble
Hamilton
Inertia
Optic
Pebble

GRADE 2

Appoint Seating
Blume
Clyde
Dotty
Rush
Seed
Spin Seating
Whisper Vinyl

GRADE 3

In Season
Moxie
Parker
Purl
Quill

For a complete list of fabrics, including partnership fabrics, go to hon.com/fabricsandfinishes.

Reference Fabric Color Combinations on pages 18-22 for color codes and legend on page 19 for lead times.



MOTIVATE® 4-Leg Chairs

HMG1

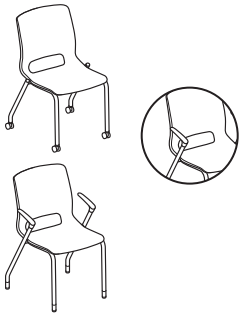

STACK CHAIR

Four Legs
Set of 2

DIMENSIONS

Depth:	23	Arm Width:	18
Width:	21	Seat to Floor Height:	17¾
Height:	32¼	Usable Seat Depth:	18¼
Seat Depth:	18¼	Ship Weight:	38
Seat Width:	17¾	Cube:	13.0
Back Width:	17¼	Weight Rating:	300 lbs.
Back Height:	18		

LIST PRICE PER CARTON

\$612
(reference single unit @ \$306.00)

NOTES: 4-Leg chairs stack 6-high on the floor.

Ships two (2) chairs per carton.

HMG2

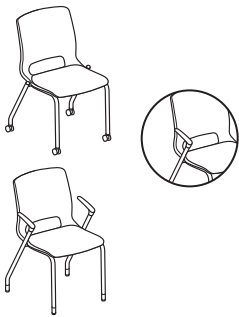

STACK CHAIR

Four Legs
Upholstered Seat
Set of 2

DIMENSIONS

Depth:	23	Arm Width:	18
Width:	21	Seat to Floor Height:	18¼
Height:	32¼	Usable Seat Depth:	18¼
Seat Depth:	18¼	Ship Weight:	44
Seat Width:	17¾	Cube:	13.0
Back Width:	17¼	COM (per 2 pack):	1.0
Back Height:	17½	Weight Rating:	300 lbs.

FABRIC PRICE CODES

1	\$753	8	\$891
2	\$777	9	\$909
3	\$801	10	\$927
4	\$819	11	\$945
5	\$837	12	\$963
6	\$855	L	—
7	\$873		

NOTES: 4-Leg chairs stack 6-high on the floor.

Motivate® 4-leg Chairs are ordered and shipped two (2) chairs per carton. Pricing shown is per carton. Each set of two chairs (one carton), must have the same shell/frame color combination. Ordering 2 of Model HMG1, HMG2 will result in 2 cartons being shipped, giving you 4 chairs. 4-Leg chairs stack 6-high on the floor.

HON Recommendation: HMG1.N.H.ON.PLAT - List Price \$612

HOW TO SPECIFY

Select Model Number	Select Arm Type	Select Caster/Glide	Select Shell Color	Select Fabric	Select Frame
F Fixed Arms (+ \$30 per chair) N Armless	H Hard Caster S All-Surface Caster (+ \$30 per chair) <i>Casters only available on HMG1 and HMG2</i> E Standard Nylon Glide F Felt Glide (+ \$30 per chair) R Rubber Glide (+ \$30 per chair) T Steel Glide (+ \$30 per chair)	RG Tangelo CR Cherry LM Lime CP Calypso BU Surf RE Regatta MB Mulberry	LO Loft PT Platinum SD Shadow LA Lava ON Onyx WT White	See page 388 <i>Not specified for models HMG1 and HMG5</i>	See page 387
HMG1	N	H	ON		PLAT
HMG2	N	H	ON	CU10	PLAT

SEATING

MOTIVATE® 4-Leg Chairs

GSA SIN 33721



Icon Legend on page 17

HMG3

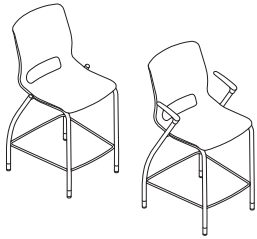

COUNTER-HEIGHT STOOL

Four Legs

DIMENSIONS

Depth:	23	Arm Width:	18
Width:	21	Seat to Floor Height:	24½
Height:	40½	Usable Seat Depth:	18½
Seat Depth:	18½	Ship Weight:	26
Seat Width:	17¾	Cube:	13.8
Back Width:	17¼	Weight Rating:	300 lbs.
Back Height:	18		

LIST PRICE

\$430

HMG4



COUNTER-HEIGHT STOOL

Four Legs
Upholstered Seat

DIMENSIONS

Depth:	23	Arm Width:	18
Width:	21	Seat to Floor Height:	25
Height:	40½	Usable Seat Depth:	18¼
Seat Depth:	18½	Ship Weight:	26
Seat Width:	17¾	Cube:	13.8
Back Width:	17¼	COM:	1.0
Back Height:	17½	Weight Rating:	300 lbs.

FABRIC PRICE CODES

1	\$509	8	\$647
2	\$533	9	\$665
3	\$557	10	\$683
4	\$575	11	\$701
5	\$593	12	\$719
6	\$611	L	—
7	\$629		

HMG5

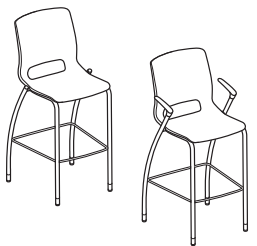

CAFÉ-HEIGHT STOOL

Four Legs

DIMENSIONS

Depth:	23	Arm Width:	18
Width:	21	Seat to Floor Height:	30
Height:	44½	Usable Seat Depth:	18½
Seat Depth:	18½	Ship Weight:	30
Seat Width:	17¾	Cube:	19.3
Back Width:	17¼	Weight Rating:	300 lbs.
Back Height:	18		

LIST PRICE

\$451

HMG7

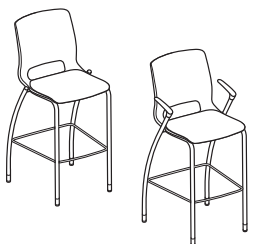

CAFÉ-HEIGHT STOOL

Four Legs
Upholstered Seat

DIMENSIONS

Depth:	23	Arm Width:	18
Width:	21	Seat to Floor Height:	30½
Height:	44½	Usable Seat Depth:	18¼
Seat Depth:	18½	Ship Weight:	34
Seat Width:	17¾	Cube:	19.3
Back Width:	17¼	COM:	1.0
Back Height:	17½	Weight Rating:	300 lbs.

FABRIC PRICE CODES

1	\$535	8	\$673
2	\$559	9	\$691
3	\$583	10	\$709
4	\$601	11	\$727
5	\$619	12	\$745
6	\$637	L	—
7	\$655		

HON Recommendation: HMG5.N.E.ON.PLAT - List Price \$451

HOW TO SPECIFY

Select Model Number	Select Arm Type	Select Glide	Select Shell Color	Select Fabric	Select Frame
HMG5	F Fixed Arms (+ \$30 per chair) N Armless	E Standard Nylon Glide F Felt Glide (+ \$30 per chair) R Rubber Glide (+ \$30 per chair) T Steel Glide (+ \$30 per chair)	RG Tangelo CR Cherry LM Lime CP Calypso BU Surf RE Regatta MB Mulberry	LO Loft PT Platinum SD Shadow LA Lava ON Onyx WT White	See page 388 <i>Not specified for models HMG1 and HMG5</i>
HMG7	N	E	ON	CU10	PLAT

SEATING

MOTIVATE® Nesting/Stacking Flex-Back Chair Options

MODEL OPTIONS

HMN1



Flex-back

Nesting/Stacking,
Four Legs

HMN2



Flex-back

Nesting/Stacking, Four
Legs, Upholstered Seat

ARM STYLE

CODE	DESCRIPTION	PRICE
F	Fixed Arms	+\$50
N	Armless	+\$0



CASTERS/ GLIDE



CODE	DESCRIPTION	PRICE
H	Hard Caster	+\$0
S	All-Surface Caster	+\$30
E	Standard Nylon Glide	+\$0

BACK STYLE

CODE	DESCRIPTION	PRICE
<i>Plastic/Upholstered Options:</i>		
PS	Plastic Shell	+\$0
PB	Upholstered	+\$70
<i>*PB only available on HMN2</i>		
<i>4-Way Stretch Options:</i>		
IM	Black	+\$80
IF	Fog	+\$80
IC	Charcoal	+\$80



FRAME

CODE	DESCRIPTION	PRICE
P1 PAINT:		+\$0
BLCK	Textured Black Mica	
P7J	Textured Brownstone	
P7A	Textured Charcoal	
PK7	Textured Designer White	
P7L	Textured Loft	
P7M	Textured Muslin	
PLAT	Textured Platinum Metallic	
P8V	Textured Titanium	
P2 PAINT:		+\$0
PR8	Textured Silver	
P3 PAINT:		+\$30
P8S	Atom	
PJF	Bullseye	
P8P	Ember	
P8N	Ion	
P8J	Iris	
P8F	Krypton	
P8M	Regatta	

SEATING

PLASTIC SHELL COLOR CODES (no upcharge):					
Tangelo - RG	Cherry - CR	Lime - LM	Calypso - CP	Surf - BU	
Regatta - RE	Mulberry - MB	Loft - LO	Platinum - PT	Shadow - SD	
Lava - LA	Onyx - ON	White - WT			

MOTIVATE®

Nesting/Stacking Flex-Back Chair Fabric Options

HON BRANDED FABRICS

GRADE 1

Apex
Attire
Centurion
Compass
Contourett
Dapper
Ensemble
Hamilton
Inertia
Optic
Pebble

GRADE 2

Appoint Seating
Blume
Clyde
Dotty
Rush
Seed
Spin Seating
Whisper Vinyl

GRADE 3

In Season
Moxie
Parker
Purl
Quill

For a complete list of fabrics, including partnership fabrics, go to hon.com/fabricsandfinishes.

Reference Fabric Color Combinations on pages 18-22 for color codes and legend on page 19 for lead times.

 For Fire Code model, availability, and ordering method, refer to page 216. Available on select models, contact HON Customer Support for availability.

MOTIVATE® Nesting/Stacking Flex-Back Chairs

HMN1

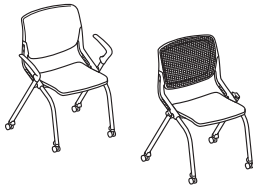

CHAIR

Flex-back
Nesting/Stacking
Four Legs

DIMENSIONS

Depth:	23 ³ / ₈	Arm Width:	24
Width:	26 ³ / ₄	Seat to Floor Height:	18 ¹ / ₄
Height:	34	Usable Seat Depth:	16 ³ / ₄
Seat Depth:	16 ³ / ₄	Ship Weight:	27
Seat Width:	17	Cube:	15.1
Back Width:	19 ¹ / ₂	Weight Rating:	300 lbs.
Back Height:	19		

LIST PRICE

\$512

NOTES: Stack 4-high on floor.

! When selecting the mesh back option, seat shell will be in the specified shell color chosen but the frame around the mesh will always be black.

HMN2



CHAIR

Flex-back
Nesting/Stacking
Four Legs
Upholstered Seat

DIMENSIONS

Depth:	23 ³ / ₈	Seat to Floor Height:	19 ¹ / ₄
Width:	26 ³ / ₄	Usable Seat Depth:	17
Height:	34	Ship Weight (upholstered back):	29
Seat Depth:	17	Ship Weight (plastic/mesh back):	28
Seat Width:	17 ³ / ₈	Cube (upholstered back):	15.1
Back Width:	19 ¹ / ₂	Cube (plastic/mesh back):	15.1
Back Height:	18 ³ / ₈	COM (upholstered back):	1.0
Arm Width:	24	COM (plastic/mesh back):	1.0
		Weight Rating:	300 lbs.

FABRIC PRICE CODES

1	\$583	8	\$721
2	\$607	9	\$739
3	\$631	10	\$757
4	\$649	11	\$775
5	\$667	12	\$793
6	\$685	L	—
7	\$703		

NOTES: Stack 4-high on floor.

! When selecting the mesh back option, seat shell will be in the specified shell color chosen but the frame around the mesh will always be black.

HON Recommendation: HMN1.N.H.IM.ON.CU__PLAT - List Price \$592

HOW TO SPECIFY

Select Model Number	Select Arm Type	Select Caster/Glide	Select Back Type	Select Shell Color	Select Fabric	Select Frame
HMN1	F Fixed Arms (+ \$50) N Armless	E Standard Nylon Glide H Hard Caster S All-Surface Caster (+ \$30)	PS Plastic Shell PB Upholstered (+ \$70) <i>PB option available on HMN2 only</i> 4-Way Stretch options (+ \$80) IM Black IF Fog IC Charcoal	RG Tangelo CR Cherry LM Lime CP Calypso BU Surf RE Regatta MB Mulberry LO Loft PT Platinum SD Shadow LA Lava ON Onyx WT White	See page 392 <i>Specify for model HMN2 only</i>	See page 391
HMN2	N	H	IM	ON		PLAT
	N	H	PB	ON	CU10	PLAT

SEATING

MOTIVATE®

Chair with Tablet Arm Options

MODEL OPTIONS

HMG1



with Tablet Arm

Four Legs

HMG2



with Tablet Arm

Four Legs, Upholstered Seat

CASTERS/ GLIDES



CODE	DESCRIPTION	PRICE
H	Hard Caster	+\$0



S	All-Surface Caster	+\$30
----------	--------------------	--------------



E	Standard Nylon Glide	+\$0
F	Felt Glide	+\$30
R	Rubber Glide	+\$30
T	Steel Glide	+\$30

TABLET SIDE



CODE	DESCRIPTION	PRICE
RT	Right Side	+\$0
LT	Left Side	+\$0



TABLET COLOR

CODE	DESCRIPTION	PRICE
T	Black	+\$0
D	Natural Maple	+\$0

FRAME

CODE	DESCRIPTION	PRICE
P1 PAINT:		+\$0
BLCK	Textured Black Mica	
P7J	Textured Brownstone	
P7A	Textured Charcoal	
PK7	Textured Designer White	
P7L	Textured Loft	
P7M	Textured Muslin	
PLAT	Textured Platinum Metallic	
P8V	Textured Titanium	
P2 PAINT:		+\$0
PR8	Textured Silver	
P3 PAINT:		+\$30
P8S	Atom	
PJF	Bullseye	
P8P	Ember	
P8N	Ion	
P8J	Iris	
P8F	Krypton	
P8M	Regatta	

PLASTIC SHELL COLOR CODES (no upcharge):

Tangelo - **RG**
Regatta - **RE**
Lava - **LA**

Cherry - **CR**
Mulberry - **MB**
Onyx - **ON**

Lime - **LM**
Loft - **LO**
White - **WT**

Calypso - **CP**
Platinum - **PT**

Surf - **BU**
Shadow - **SD**

MOTIVATE[®]

Chair with Tablet Arm Fabric Options

HON BRANDED FABRICS

GRADE 1

Apex
Attire
Centurion
Compass
Contourett
Dapper
Ensemble
Hamilton
Inertia
Optic
Pebble

GRADE 2

Appoint Seating
Blume
Clyde
Dotty
Rush
Seed
Spin Seating
Whisper Vinyl

GRADE 3

In Season
Moxie
Parker
Purl
Quill

For a complete list of fabrics, including partnership fabrics, go to hon.com/fabricsandfinishes.

Reference Fabric Color Combinations on pages 18-22 for color codes and legend on page 19 for lead times.

MOTIVATE® Chair with Tablet Arm

GSA SIN 33721



Icon Legend on page 17

HMGT1

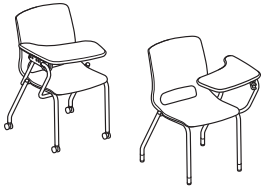

CHAIR

with Tablet Arm
Four Legs

DIMENSIONS

Depth:	30	Back Width:	17¼
Width:	21	Back Height:	18
Height:	32¼	Seat to Floor Height:	17¾
Seat Depth:	18¼	Tablet Height from Floor:	28¾
Seat Width:	17¾	Ship Weight:	41
		Cube:	18.4
		Weight Rating:	300 lbs.

LIST PRICE PER CARTON

\$587

NOTES: Tablet can be specified on right or left side.

HMGT2

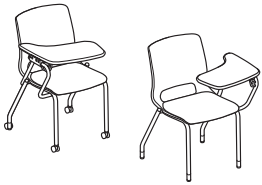

CHAIR

with Tablet Arm
Four Legs
Upholstered Seat

DIMENSIONS

Depth:	30	Back Width:	17¼
Width:	21	Back Height:	17½
Height:	32¼	Seat to Floor Height:	18¼
Seat Depth:	18¼	Tablet Height from Floor:	28¾
Seat Width:	17¾	Ship Weight:	43
		Cube:	18.4
		Weight Rating:	300 lbs.

FABRIC PRICE CODES

1	\$668	8	\$806
2	\$692	9	\$824
3	\$716	10	\$842
4	\$734	11	\$860
5	\$752	12	\$878
6	\$770	L	—
7	\$788		

NOTES: Tablet can be specified on right or left side.

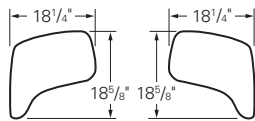

HON Recommendation: HMGT1.E.ON.RT.D.PLAT - List Price \$587

HOW TO SPECIFY

Select Model Number	Select Caster/Glide	Select Shell Color	Select Fabric	Select Tablet Side	Select Tablet Color	Select Frame
H S E F R T	H Hard Caster S All-Surface Caster (+ \$30 per chair) E Standard Nylon Glide F Felt Glide (+ \$30 per chair) R Rubber Glide (+ \$30 per chair) T Steel Glide (+ \$30 per chair)	RG Tangelo CR Cherry LM Lime CP Calypso BU Surf RE Regatta MB Mulberry LO Loft PT Platinum SD Shadow LA Lava ON Onyx WT White	See page 395 <i>Not specified for HMGT1 models</i>	RT Right Side LT Left Side	T Black D Natural Maple	See page 394
HMGT1	E	ON		RT	D	PLAT
HMGT2	E	ON	CU10	RT	D	PLAT

MOTIVATE® Flex-Back Chair with Tablet Arm Options

MODEL OPTIONS

HMNT1



Flex-back with Tablet Arm

HMNT2



Flex-back with Tablet Arm
Upholstered Seat

CASTERS/ GLIDE



CODE	DESCRIPTION	PRICE
H	Hard Caster	+\$0



S	All-Surface Caster	+\$30
----------	--------------------	--------------



E	Standard Nylon Glide	+\$0
----------	----------------------	-------------

BACK STYLE

CODE	DESCRIPTION	PRICE
------	-------------	-------

Plastic/Upholstered Options:



PS	Plastic Shell	+\$0
-----------	---------------	-------------



PB	Upholstered	+\$70
-----------	-------------	--------------

4-Way Stretch Options:



IM	Black	+\$80
IF	Fog	+\$80
IC	Charcoal	+\$80

TABLET SIDE



CODE	DESCRIPTION	PRICE
RT	Right Side	+\$0
LT	Left Side	+\$0



TABLET COLOR

CODE	DESCRIPTION	PRICE
T	Black	+\$0
D	Natural Maple	+\$0

FRAME

CODE	DESCRIPTION	PRICE
P1 PAINT:		+\$0
BLCK	Textured Black Mica	
P7J	Textured Brownstone	
P7A	Textured Charcoal	
PK7	Textured Designer White	
P7L	Textured Loft	
P7M	Textured Muslin	
PLAT	Textured Platinum Metallic	
P8V	Textured Titanium	
P2 PAINT:		+\$0
PR8	Textured Silver	
P3 PAINT:		+\$30
P8S	Atom	
PJF	Bullseye	
P8P	Ember	
P8N	Ion	
P8J	Iris	
P8F	Krypton	
P8M	Regatta	

PLASTIC SHELL COLOR CODES (no upcharge):		Tangelo - RG	Cherry - CR	Lime - LM	Calypso - CP	Surf - BU
		Regatta - RE	Mulberry - MB	Loft - LO	Platinum - PT	Shadow - SD
		Lava - LA	Onyx - ON	White - WT		

SEATING

MOTIVATE[®]

Flex-Back Chair with Tablet Arm Fabric Options

HON BRANDED FABRICS

GRADE 1

Apex
Attire
Centurion
Compass
Contourett
Dapper
Ensemble
Hamilton
Inertia
Optic
Pebble

GRADE 2

Appoint Seating
Blume
Clyde
Dotty
Rush
Seed
Spin Seating
Whisper Vinyl

GRADE 3

In Season
Moxie
Parker
Purl
Quill

For a complete list of fabrics, including partnership fabrics, go to hon.com/fabricsandfinishes.

Reference Fabric Color Combinations on pages 18-22 for color codes and legend on page 19 for lead times.



MOTIVATE® Flex-Back Chair with Tablet Arm

HMNT1

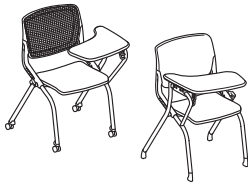

CHAIR

Flex-back with Tablet Arm

DIMENSIONS

Depth:	30 ³ / ₈	Seat to Floor Height:	18 ¹ / ₄
Width:	23 ¹ / ₂	Tablet Height from Floor:	29 ¹ / ₂
Height:	34	Ship Weight:	41
Seat Depth:	17 ¹ / ₄	Cube:	18.4
Seat Width:	17	Weight Rating:	300 lbs.
Back Width:	19 ¹ / ₂		
Back Height:	19		

LIST PRICE

\$804

NOTES: Tablet can be specified on right or left side.

❗ Model HMNT1 is not available with an upholstered back.

❗ When selecting the mesh back option, seat shell will be in the specified shell color chosen but the frame around the mesh will always be black.

HMNT2

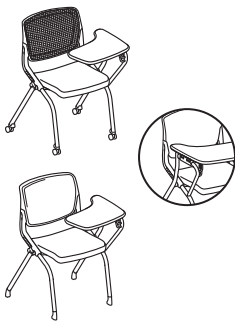

CHAIR

Flex-back with Tablet Arm
Upholstered Seat

DIMENSIONS

Depth:	30 ³ / ₈	Seat to Floor Height:	19 ¹ / ₄
Width:	23 ¹ / ₂	Tablet Height from Floor:	29 ¹ / ₂
Height:	34	Ship Weight:	42
Seat Depth:	17 ⁵ / ₈	Cube:	18.4
Seat Width:	17 ⁵ / ₈	Weight Rating:	300 lbs.
Back Width:	19 ¹ / ₂		
Back Height:	18 ⁵ / ₈		

FABRIC PRICE CODES

1	\$886	8	\$1024
2	\$910	9	\$1042
3	\$934	10	\$1060
4	\$952	11	\$1078
5	\$970	12	\$1096
6	\$988	L	—
7	\$1006		

NOTES: Tablet can be specified on right or left side.

❗ When selecting the mesh back option, seat shell will be in the specified shell color chosen but the frame around the mesh will always be black.

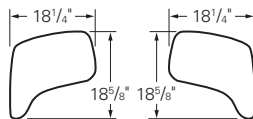

HON Recommendation: HMNT1.E.IM.ON.RT.D.PLAT - List Price \$884

HOW TO SPECIFY

Select Model Number	Select Caster/Glide	Select Back Type	Select Shell Color	Select Fabric	Select Tablet Side	Select Tablet Color	Select Frame
E Standard Nylon Guide H Hard Caster S All-Surface Caster (+ \$30)	PS Plastic Shell PB Upholstered (+ \$70) <i>PB option not available on HMNT1</i> 4-Way Stretch options (+ \$80) IM Black IF Fog IC Charcoal	RG Tangelo CR Cherry LM Lime CP Calypso BU Surf RE Regatta MB Mulberry LO Loft PT Platinum SD Shadow LA Lava ON Onyx WT White	See page 398 <i>Specify for model HMNT2 only</i>	RT Right Side LT Left Side	T Black D Natural Maple	See page 397	
HMNT1	E	IM	ON		RT	D	PLAT
HMNT2	E	PB	ON	CU10	RT	D	PLAT



HVL282



MID-BACK TASK CHAIR

Upholstered
Swivel-tilt
Height and Width Adjustable
Arms
Height-adjustable Back
Functions: **A, B, E, F, K, L, S**
(Function Key on pages 212-213)

DIMENSIONS

Depth: 25¼ Arm Width: 18½
Width: 26½ Seat to Floor Height: 18¾-22¾
Height: 43¾ Ship Weight: 47.0
Seat Depth: 16¾ Cube: 6.0
Seat Width: 19⅞ Weight Rating: 250 lbs.
Back Width: 19⅞
Back Height: 20½

LIST PRICE

Swivel-tilt **\$449**
Asynchronous **\$504**

NOTES: **HON 5-Year Limited Warranty.**

HON Recommendation: HVL282.Z1.VA10.T - List Price \$449

HVL283



HIGH-BACK TASK CHAIR

Upholstered
Asynchronous with Seat Slide
Height and Width Adjustable
Arms
Functions: **A, D, E, O, S**
(Function Key on pages 212-213)

DIMENSIONS

Depth: 25¼ Arm Width: 17¾
Width: 26½ Seat to Floor Height: 18¾-22¾
Height: 47¼ Ship Weight: 53.3
Seat Depth: 17⅞ Cube: 6.9
Seat Width: 19⅞ Weight Rating: 250 lbs.
Back Width: 20⅞
Back Height: 23¾

LIST PRICE

\$625

NOTES: **HON 5-Year Limited Warranty.**

HON Recommendation: HVL283.A2.VA10.T - List Price \$625

HOW TO SPECIFY

Select Model Number	Select Control	Select Fabric	Select Frame
HVL282	Z1 Swivel Tilt <i>Available on HVL282 only</i> A2 Asynchronous with Seat Slide <i>Available on HVL282 and HVL283 only</i>	VA10 Black Fabric	T Black

NEUTRALIZE™

Want to see more? Scan here
to check out hon.com.



Neutralize™ Mesh Task Chair with
Empower® Desks and Fuse™ Storage.

NEUTRALIZE™

Don't adjust your sitting preferences to fit your chair, make it fit your needs. Neutralize™ adjusts practically everywhere to perfectly fit your body and your work style. The breathable mesh back is made up of three articulating sections to fit anyone, including an adjustable headrest. The synchro-tilt control and fully adjustable arms support your body in any posture or position.



FEATURES

- Contemporary segmented mesh back enhancing support and increasing airflow.
- Height, width, depth, and pivot arms provide support right where you want it.
- Adjustable headrest delivers executive-level comfort.
- Mesh seat and seat slide conform to your body to reduce pressure points.
- HON 5-Year Limited Warranty.

NEUTRALIZE™ Mesh Chair

OPEN MARKET



Icon Legend on page 17

HVL791



MESH TASK CHAIR

Pneumatic
Swivel
Synchronized Tilt
Tilt Tension
Tilt Lock
Seat Glide Mechanism
Adjustable Headrest
All-Adjustable Arms

Functions: **A, D, E, J, K, L, B-A**
(Function Key on pages 212-213)

DIMENSIONS

Depth:	28¼	Arm Width:	20½
Width:	26¾	Seat to Floor Height:	18-21
Height:	52¼	Usable Seat Depth:	20
Seat Depth:	17¼-19¼	Ship Weight:	47.5
Seat Width:	19½	Cube:	7.8
Back Width:	20¼	Weight Rating:	250 lbs.
Back Height:	32		

LIST PRICE

\$906

NOTES: Comfortable and breathable mesh seat and back. Black frame with subtle chrome accents. Adjustable seat glide mechanism. Height, width, depth and pivot adjustable arms. Adjustable headrest. **HON 5-Year Limited Warranty.**

HON Recommendation: HVL791.BM.SB - List Price \$906

SEATING

HOW TO SPECIFY

Select
Model Number

H V L 7 9 1 .

Select
Fabric

BM Black Mesh

B M .

Select
Base

SB Standard Base

S B



Nucleus Work Chairs shown
with Preside® Conference Table.

NUCLEUS®

Enjoy seating that delivers comfort from the inside out. Nucleus task and guest chairs adapt to everyone's unique body types to create a custom fit and targeted support. The back flexes with the spine. The seat cradles you like a hammock. The sophisticated aesthetic makes a stylish statement. Nucleus is the powerhouse seating family that brings cool and comfortable together.



GUEST CHAIR FEATURES

- Stacking chairs stack up to four high on the floor.
- HN6 guest chair available with glides, hard or all-surface casters.
- Available in hundreds of quality HON fabrics.
- Warranted for users up to 300 lbs.

TASK CHAIR FEATURES

- Advanced suspension material in the seat combines with molded foam to create unparalleled support.
- Choose between the 4-Way Stretch mesh back or an upholstered suspension back.
- 4-Way Stretch mesh back is available in seven colors.
- Choose between armless, fixed arms or height- and width-adjustable arms.
- Responsive synchro-tilt control provides a smooth, natural recline.
- Available in Black or Polished Aluminum base.
- Tilt tension controls the rate and ease of recline.
- Tilt lock allows the user to lock the back in multiple recline positions.
- Available in hundreds of quality HON fabrics.
- Warranted for users up to 300 lbs.

NUCLEUS[®] Task Chair Options

MODEL OPTIONS

HN1



Task Chair (4-Way Stretch Back)

Pneumatic, Swivel, Seat Glide, Synchro-tilt, Tilt Tension, Tilt Lock, Armless

HN1U *



Task Chair (Upholstered Back)

Pneumatic, Swivel, Seat Glide, Synchro-tilt, Tilt Tension, Tilt Lock, Armless

ARM STYLE

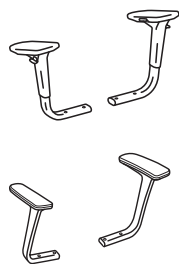

CODE	DESCRIPTION	PRICE
N	Armless	+\$0
A	Height and Width Adjustable Arms	+\$85
P	Fixed Arms - Polished	+\$175

BASE

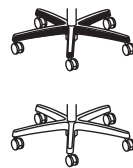

CODE	DESCRIPTION	PRICE
SB	Standard Base	+\$0
PA	Polished Aluminum	+\$110

FRAME

CODE	DESCRIPTION	PRICE
T	Black	+\$0

CASTERS



CODE	DESCRIPTION	PRICE
H	Black Hard Caster	+\$0
S	Black All-Surface Caster	+\$40

BACK STYLE

CODE	DESCRIPTION	PRICE
<i>4-Way Stretch mesh back options:</i>		
IM	Black	+\$0
IB	Breeze	+\$0
IK	Brownstone	+\$0
IC	Charcoal	+\$0
IF	Fog	+\$0
IR	Regatta	+\$0
IT	Titanium	+\$0

* De-emphasized

NUCLEUS® Multi-Purpose and Café Chair Options

MODEL OPTIONS

HN6



**Multi-Purpose Stack Chair
(4-Way Stretch Back)**

Four Legs

HN7*

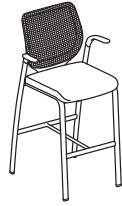

Café-Height Stool (4-Way Stretch Back)

Four Legs

ARM STYLE

CODE	DESCRIPTION	PRICE
N	Armless	+\$0
F	Fixed Arms	+\$30



CASTERS/ GLIDE

CODE	DESCRIPTION	PRICE
H	Black Hard Caster <i>*Not available on HN7</i>	+\$0
S	Black All-Surface Caster <i>*Not available on HN7</i>	+\$20
E	Glide	+\$0



BACK STYLE

CODE	DESCRIPTION	PRICE
<i>4-Way Stretch mesh back options:</i>		
IM	Black	+\$0
IB	Breeze	+\$0
IK	Brownstone	+\$0
IC	Charcoal	+\$0
IF	Fog	+\$0
IR	Regatta	+\$0
IT	Titanium	+\$0

FRAME

CODE	DESCRIPTION	PRICE
T	Black	+\$0
T1	Platinum Metallic	+\$0

* De-emphasized

NUCLEUS[®]

Fabric Options

HON BRANDED FABRICS

GRADE 1

Apex
Attire
Centurion
Compass
Contourett
Dapper
Ensemble
Hamilton
Inertia
Optic
Pebble

GRADE 2

Appoint Seating
Blume
Clyde
Dotty
Rush
Seed
Spin Seating
Whisper Vinyl

GRADE 3

In Season
Moxie
Parker
Purl
Quill

For a complete list of fabrics, including partnership fabrics, go to hon.com/fabricsandfinishes.

Reference Fabric Color Combinations on pages 18-22 for color codes and legend on page 19 for lead times. For additional HON to Supply COM fabric grade pricing, go to honready.hon.com and click on the HON to Supply COM link.



Icon Legend on page 17

HN1



TASK CHAIR

4-Way Stretch Back

- Pneumatic
- Swivel
- Seat Glide
- Synchro-tilt
- Tilt Tension
- Tilt Lock
- Armless

Functions:

A, D, E, A-C, A-D, J, L

(Function Key on pages 212-213)

DIMENSIONS

Depth:	25¾	Arm Width:	17-20
Width:	28¾	Seat to Floor Height:	17-22
Height:	45¼	Usable Seat Depth:	16½-19½
Seat Depth:	20	Ship Weight:	52
Seat Width:	20	Cube:	11.3
Back Width:	19¼	COM:	1.0
Back Height:	25¼	Weight Rating:	300 lbs.

FABRIC PRICE CODES

1	\$932	8	\$1070
2	\$956	9	\$1088
3	\$980	10	\$1106
4	\$998	11	\$1124
5	\$1016	12	\$1142
6	\$1034	L	—
7	\$1052		

HON Recommendation: HN1.A.H.IM.CU__SB.T - List Price \$1017

HOW TO SPECIFY

Select Model Number	Select Arm Type	Select Caster/Glide	Select Back Type	Select Fabric	Select Base	Select Frame
	N Armless A Height and Width Adjustable Arms (+ \$85) P Fixed Arms - Polished (+ \$175)	H Black Hard Caster S Black All-Surface Caster (+ \$40)	4-Way Stretch options IM Black IB Breeze IK Brownstone IC Charcoal IF Fog IR Regatta IT Titanium	See page 406	SB Standard Base PA Polished Aluminum (+ \$110)	See page 404 T Black
HN1	A	H	IM	CU10	SB	T

HN1U*



TASK CHAIR

Upholstered Back

- Pneumatic
- Swivel
- Seat Glide
- Synchro-tilt
- Tilt Tension
- Tilt Lock
- Armless

Functions:

A, D, E, A-C, A-D, J, L

(Function Key on pages 212-213)

DIMENSIONS

Depth:	26	Arm Width:	19⅞
Width:	28¾	Seat to Floor Height:	17-22
Height:	44¼	Usable Seat Depth:	16-19
Seat Depth:	20	Ship Weight:	49
Seat Width:	20	Cube:	12.6
Back Width:	18¼	COM:	2.0
Back Height:	25½	Weight Rating:	300 lbs.

FABRIC PRICE CODES

1	\$932	8	\$1208
2	\$980	9	\$1244
3	\$1028	10	\$1280
4	\$1064	11	\$1316
5	\$1100	12	\$1352
6	\$1136	L	—
7	\$1172		

HON Recommendation: HN1U.A.H.CU__SB.T - List Price \$1017

* De-emphasized

HOW TO SPECIFY

Select Model Number	Select Arm Type	Select Caster/Glide	Select Fabric	Select Base	Select Frame
	N Armless A Height and Width Adjustable Arms (+ \$85) P Fixed Arms - Polished (+ \$175)	H Black Hard Caster S Black All-Surface Caster (+ \$40)	See page 406	SB Standard Base PA Polished Aluminum (+ \$110)	See page 404 T Black
HN1U	A	H	CU10	SB	T

NUCLEUS®



Icon Legend on page 17

HN6

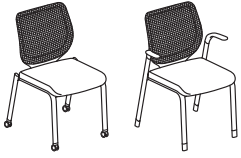

MULTI-PURPOSE STACK CHAIR

4-Way Stretch Back
Four Legs

DIMENSIONS

Depth:	26¼	Arm Width:	21½
Width:	27	Seat to Floor Height:	18½
Height:	37½	Usable Seat Depth:	18½
Seat Depth:	19	Ship Weight:	31
Seat Width:	19	Cube:	15.2
Back Width:	18	COM:	1.0
Back Height:	18½	Weight Rating:	300 lbs.

FABRIC PRICE CODES

1	\$571	8	\$709
2	\$595	9	\$727
3	\$619	10	\$745
4	\$637	11	\$763
5	\$655	12	\$781
6	\$673	L	—
7	\$691		

HN7 *

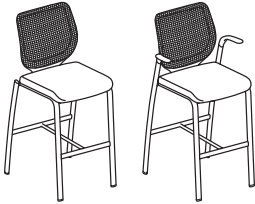

CAFÉ-HEIGHT STOOL

4-Way Stretch Back
Four Legs

DIMENSIONS

Depth:	24½	Arm Width:	21½
Width:	25	Seat to Floor Height:	30
Height:	46½	Usable Seat Depth:	18½
Seat Depth:	19	Ship Weight:	40
Seat Width:	19	Cube:	21.4
Back Width:	18	COM:	1.0
Back Height:	18½	Weight Rating:	300 lbs.

FABRIC PRICE CODES

1	\$622	8	\$760
2	\$646	9	\$778
3	\$670	10	\$796
4	\$688	11	\$814
5	\$706	12	\$832
6	\$724	L	—
7	\$742		

HON Recommendation: HN6.F.H.IM.CU__T - List Price \$601

* De-emphasized

HOW TO SPECIFY

Select Model Number	Select Arm Type	Select Caster/Glide	Select Back Type	Select Fabric	Select Frame
	F Fixed Arms (+ \$30) N Armless	E Glide H Black Hard Caster S Black All-Surface Caster (+ \$30) <i>Casters available on HN6 only</i>	4-Way Stretch options IM Black IB Breeze IK Brownstone IC Charcoal IF Fog IR Regatta IT Titanium	See page 406	T Black T1 Platinum Metallic
HN6	F	H	IM	CU10	T

HNATA *



ADJUSTABLE ARM PACK

Height and Width
Functions: **S**
(Function Key on pages 212-213)

DIMENSIONS

Arm Width:	17-20
Height from Seat:	6⅞-10⅞
Ship Weight:	7.5 S
Cube:	1.0

LIST PRICE

\$133

HNFPA *



POLISHED ALUMINUM ARM PACK

Fixed Height

DIMENSIONS

Arm Width:	19⅞
Height from Seat:	7¼
Ship Weight:	7.5 S
Cube:	1.0

LIST PRICE

\$208

OPEN MARKET

* De-emphasized

HOW TO SPECIFY

Select Model Number
HNATA

HIGH-DENSITY OLSON STACKER® 4040 SERIES

Want to see more?
Scan here to check
out hon.com.



Olson Stacker.

HIGH-DENSITY OLSON STACKER® 4040 SERIES

Adaptable spaces such as multi-purpose and training areas demand a chair equally flexible. Olson stacking chairs fit that bill with a lightweight frame that is easy to move throughout a space. Chairs stack up to 12 high on the floor or up to 40 high on their specially designed cart to maximize floor space when not in use. A convenient cutout in the back makes it easy to pick up and move, while the molded seat shells deliver surprising comfort. Olson stacking chairs ship in sets of four to accommodate large groups. With Olson, the benefits really stack up.



FEATURES

- Chairs ship four per carton.
- Contoured seat and back shell provide targeted support.
- Integrated lumbar support delivers long-lasting comfort.
- Integrated handle makes chair easy to carry.
- Optional ganging brackets connect chairs to form neat rows.
- Stacks up to 12 high on floor.
- Stacks up to 40 high on cart.
- Shell colors are CA Technical Bulletin 133 compliant.
- Warranted for users up to 300 lbs.

HIGH-DENSITY OLSON STACKER® 4040 Series

GSA SIN 33721



Icon Legend on page 17

H4041



POLYMER SEAT AND BACK DIMENSIONS

7/16" Steel Rod Frame
Chrome Legs

Depth:	21 ⁵ / ₈	Seat to Floor Height:	17 ³ / ₄
Width:	19 ¹ / ₈	Usable Seat Depth:	17
Height:	30 ⁵ / ₈	Ship Weight:	57
Seat Depth:	18 ¹ / ₄	Cube:	10.6
Seat Width:	17 ³ / ₄	Weight Rating:	300 lbs.
Back Width:	17 ¹ / ₂		
Back Height:	16 ¹ / ₄		

LIST PRICE PER CARTON

\$770
(reference single unit @
\$192.50)

⊕ 4040 Series is ordered and shipped four (4) chairs per carton. Pricing shown is per carton. Each set of four (one carton), must have the same shell color. Ordering 2 of Model H4041 will result in 2 cartons being shipped, giving you 8 chairs.

⚠ Shipped fully assembled — 4 chairs per carton. All High-Density Olson Stacker® shell colors are CA Technical Bulletin 133 compliant (no upcharge).

H4043

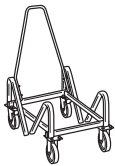

CART FOR STACKING CHAIRS

DIMENSIONS

Depth:	35 ¹ / ₂	Ship Weight:	34
Width:	21 ³ / ₈	Cube:	7.8
Height:	37		

LIST PRICE

\$537

NOTES: Holds 40 stack chairs (6'-8"), some assembly required. (Chairs stack 12 high without cart.)

⚠ Specify Black paint (T) ONLY.

H4048

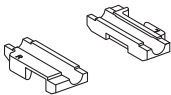

GANGING CHAIR GLIDES

Box of 48
For use on models H4041, HG51
and HG52

DIMENSIONS

Ship Weight:	1
Cube:	0.04

LIST PRICE

\$137

H4049

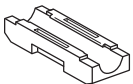

NON-GANGING CHAIR GLIDES

Box of 48
For use on models H4041,
HFLEX01, HG51 and HG52

DIMENSIONS

Ship Weight:	1
Cube:	0.04

LIST PRICE

\$109

HOW TO SPECIFY

<p>Select Model Number</p> <p>H 4 0 4 1 .</p>	<p>Select Shell Color</p> <table border="0"> <tr> <td>RG Tangelo</td> <td>LO Loft</td> </tr> <tr> <td>CR Cherry</td> <td>PT Platinum</td> </tr> <tr> <td>LM Lime</td> <td>SD Shadow</td> </tr> <tr> <td>CP Calypso</td> <td>LA Lava</td> </tr> <tr> <td>BU Surf</td> <td>ON Onyx</td> </tr> <tr> <td>RE Regatta</td> <td>WT White</td> </tr> <tr> <td>MB Mulberry</td> <td></td> </tr> </table> <p>ON .</p>	RG Tangelo	LO Loft	CR Cherry	PT Platinum	LM Lime	SD Shadow	CP Calypso	LA Lava	BU Surf	ON Onyx	RE Regatta	WT White	MB Mulberry		<p>Select Frame</p> <p>Y Chrome</p> <p>Y</p>
RG Tangelo	LO Loft															
CR Cherry	PT Platinum															
LM Lime	SD Shadow															
CP Calypso	LA Lava															
BU Surf	ON Onyx															
RE Regatta	WT White															
MB Mulberry																



Pagoda® Guest Chairs with
Preside® Tables Café Stools.

PAGODA®

Roll out the welcome mat with Pagoda guest chairs. Reception areas. Private offices. Anywhere in between. Pagoda is a coordinated, versatile collection of stacking chairs and stools that easily match any environment and offer comfort for any type of activity. Standard-height chairs stack up to five high to clear valuable floor space whenever needed. Counter-height stools are great for cafés or common areas. Wherever comfort and style are equally important, Pagoda will create the look and feel you need.



FEATURES

- Guest chairs stack up to five high on the floor.
- Fully-upholstered outer back.
- Molded seat underpan protects seat fabric and creates a finished appearance when stacked.
- Optional fixed arms are gently sloped for maximum comfort.
- Tube rolled steel frame adds durability.
- Create a contemporary mixed material aesthetic.
- Optional wood veneer back is available in five attractive finishes.
- Available in hundreds of quality HON fabrics.
- Warranted for users up to 250 lbs.

PAGODA[®]

Options

MODEL OPTIONS

H4071



Stacking Arm Guest Chairs
Set of Two

H4073



Stacking Armless Guest Chairs
Set of Two

H4075

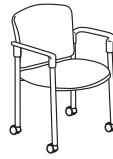

Stacking Arm Guest Chairs
Set of Two

H4077



Mobile Stacking Armless Guest Chairs
Set of Two

H4091



Stacking Arm Guest Chairs (Wood Back)
Set of Two

H4093



Stacking Armless Guest Chairs (Wood Back)
Set of Two

H4095



Stacking Arm Guest Chairs (Wood Back)
Set of Two

H4097



Mobile Stacking Armless Guest Chairs (Wood Back)
Set of Two

H4099

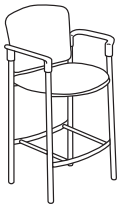

Café-Height Stool (Wood Back)
Footrest, Arms

H4079



Café-Height Stool (Upholstered Back)
Footrest, Arms

CASTERS				FINISH			
	CODE	DESCRIPTION	PRICE		CODE	DESCRIPTION	PRICE
	H	Hard Caster	+\$0		C	Harvest	+\$0
	S	Soft Caster	+\$20		D	Natural Maple	+\$0
					F	Shaker Cherry	+\$0
					H	Bourbon Cherry	+\$0
					N	Mahogany	+\$0

**Specify for models H4075 and H4077 only*

**Specify for models H4091, H4093, H4095, H4097 and H4099 only*

FRAME			
	CODE	DESCRIPTION	PRICE
	T	Black	+\$0
	T1	Platinum Metallic	+\$0

HON BRANDED FABRICS

GRADE 1

Apex
Attire
Centurion
Compass
Contourett
Dapper
Ensemble
Hamilton
Inertia
Optic
Pebble

GRADE 2

Appoint Seating
Blume
Clyde
Dotty
Rush
Seed
Spin Seating
Whisper Vinyl

GRADE 3

In Season
Moxie
Parker
Purl
Quill

For a complete list of fabrics, including partnership fabrics, go to hon.com/fabricsandfinishes.

**Pagoda® wood back models available in Harvest (C), Natural Maple (D), Shaker Cherry (F), Bourbon Cherry (H) and Mahogany (N) only.

Reference Fabric Color Combinations on pages 18-22 for color codes and legend on page 19 for lead times. For additional HON to Supply COM fabric grade pricing, go to honready.hon.com and click on the HON to Supply COM link.

PAGODA® 4070 Series

GSA SIN 33721



Icon Legend on page 17

H4071



STACKING ARM GUEST CHAIRS

Set of Two

DIMENSIONS

Depth:	22½	Arm Width:	23¾
Width:	27¼	Seat to Floor Height:	18
Height:	33	Usable Seat Depth:	16¾
Seat Depth:	19¾	Ship Weight:	56
Seat Width:	20¼	Cube:	19.6
Back Width:	21¼	COM (per 2 pack):	2.5
Back Height:	16¼	Weight Rating:	250 lbs.

FABRIC PRICE CODES

	Per Carton List Price	Single Unit List Price
1	\$1135	\$567.50
2	\$1183	\$591.50
3	\$1231	\$615.50
4	\$1267	\$633.50
5	\$1303	\$651.50
6	\$1339	\$669.50
7	\$1375	\$687.50
8	\$1411	\$705.50
9	\$1447	\$723.50
10	\$1483	\$741.50
11	\$1519	\$759.50
12	\$1555	\$777.50
L	—	—

NOTES: Use Model H4069 Ganging Connectors on page 418. Ships two to a container. See shipping notes on page 415.

H4073



STACKING ARMLESS GUEST CHAIRS

Set of Two

DIMENSIONS

Depth:	22½	Seat to Floor Height:	18
Width:	21¼	Usable Seat Depth:	16¾
Height:	33	Ship Weight:	52
Seat Depth:	19¾	Cube:	18.9
Seat Width:	20¼	COM (per 2 pack):	2.5
Back Width:	21¼	Weight Rating:	250 lbs.
Back Height:	16¼		

FABRIC PRICE CODES

	Per Carton List Price	Single Unit List Price
1	\$1059	\$529.50
2	\$1107	\$553.50
3	\$1155	\$577.50
4	\$1191	\$595.50
5	\$1227	\$613.50
6	\$1263	\$631.50
7	\$1299	\$649.50
8	\$1335	\$667.50
9	\$1371	\$685.50
10	\$1407	\$703.50
11	\$1443	\$721.50
12	\$1479	\$739.50
L	—	—

NOTES: Use Model H4069 Ganging Connectors on page 418. Ships two to a container. See shipping notes on page 415.

HOW TO SPECIFY

Select
Model Number

H 4 0 7 1 .

Select
Fabric

See page 413

C U 1 0 .

Select
Frame

T Black
T1 Platinum Metallic

T



PAGODA® 4070 Series

H4075



STACKING ARM GUEST CHAIRS

Set of Two

DIMENSIONS

Depth:	22½	Arm Width:	23¾
Width:	27¼	Seat to Floor Height:	18
Height:	33	Usable Seat Depth:	16¾
Seat Depth:	19¾	Ship Weight:	56
Seat Width:	20¼	Cube:	19.6
Back Width:	21¼	COM (per 2 pack):	2.5
Back Height:	16¼	Weight Rating:	250 lbs.

FABRIC PRICE CODES

	Per Carton List Price	Single Unit List Price
1	\$1271	\$635.50
2	\$1319	\$659.50
3	\$1367	\$683.50
4	\$1403	\$701.50
5	\$1439	\$719.50
6	\$1475	\$737.50
7	\$1511	\$755.50
8	\$1547	\$773.50
9	\$1583	\$791.50
10	\$1619	\$809.50
11	\$1655	\$827.50
12	\$1691	\$845.50
L	—	—

H4077



MOBILE STACKING ARMLESS GUEST CHAIRS

Set of Two

DIMENSIONS

Depth:	22½	Seat to Floor Height:	18
Width:	21¼	Usable Seat Depth:	16¾
Height:	33	Ship Weight:	56
Seat Depth:	19¾	Cube:	19.5
Seat Width:	20¼	COM (per 2 pack):	2.5
Back Width:	21¼	Weight Rating:	250 lbs.
Back Height:	16¼		

FABRIC PRICE CODES

	Per Carton List Price	Single Unit List Price
1	\$1196	\$598.00
2	\$1244	\$622.00
3	\$1292	\$646.00
4	\$1328	\$664.00
5	\$1364	\$682.00
6	\$1400	\$700.00
7	\$1436	\$718.00
8	\$1472	\$736.00
9	\$1508	\$754.00
10	\$1544	\$772.00
11	\$1580	\$790.00
12	\$1616	\$808.00
L	—	—

ⓘ 4070 Series is ordered and shipped two (2) chairs per carton. Pricing shown is per carton. Each set of two (one carton), must have the same fabric/frame color. (COM yardage shown is for two chairs.) Ordering 2 of any model will result in 2 cartons being shipped, giving you 4 chairs.

HOW TO SPECIFY

<p>Select Model Number</p> <p>H 4 0 7 5 .</p>	<p>Select Caster</p> <p>H Hard Caster S Soft Caster (+ \$20) <i>Specify for models H4075 and H4077 only</i></p> <p>H .</p>	<p>Select Fabric</p> <p>See page 413</p> <p>C U 1 0 .</p>	<p>Select Frame</p> <p>T Black TI Platinum Metallic</p> <p>T</p>
--	---	--	---

PAGODA® 4090 Series

GSA SIN 33721



Icon Legend on page 17

H4091



STACKING ARM GUEST CHAIRS

Wood Back
Set of Two

DIMENSIONS

Depth:	22½	Arm Width:	23¾
Width:	27¼	Seat to Floor Height:	18
Height:	32½	Usable Seat Depth:	16¾
Seat Depth:	19¾	Ship Weight:	51
Seat Width:	20¼	Cube:	19.6
Back Width:	21¼	COM (per 2 pack):	1.0
Back Height:	16¼	Weight Rating:	250 lbs.

FABRIC PRICE CODES

	Per Carton List Price	Single Unit List Price
1	\$1318	\$659.00
2	\$1342	\$671.00
3	\$1366	\$683.00
4	\$1384	\$692.00
5	\$1402	\$701.00
6	\$1420	\$710.00
7	\$1438	\$719.00
8	\$1456	\$728.00
9	\$1474	\$737.00
10	\$1492	\$746.00
11	\$1510	\$755.00
12	\$1528	\$764.00
L	—	—

NOTES: Use Model H4069 Ganging Connectors on page 418.

! Ships two per carton. See note on page 417 for ordering.

H4093



STACKING ARMLESS GUEST CHAIRS

Wood Back
Set of Two

DIMENSIONS

Depth:	22½	Seat to Floor Height:	18
Width:	21¼	Usable Seat Depth:	16¾
Height:	32½	Ship Weight:	49
Seat Depth:	19¾	Cube:	18.9
Seat Width:	20¼	COM (per 2 pack):	1.0
Back Width:	20½	Weight Rating:	250 lbs.
Back Height:	16¼		

FABRIC PRICE CODES

	Per Carton List Price	Single Unit List Price
1	\$1242	\$621.00
2	\$1266	\$633.00
3	\$1290	\$645.00
4	\$1308	\$654.00
5	\$1326	\$663.00
6	\$1344	\$672.00
7	\$1362	\$681.00
8	\$1380	\$690.00
9	\$1398	\$699.00
10	\$1416	\$708.00
11	\$1434	\$717.00
12	\$1452	\$726.00
L	—	—

NOTES: Use Model H4069 Ganging Connectors on page 418.

! Ships two per carton. See note on page 417 for ordering.

! Pagoda® wood back models available in Harvest (C), Natural Maple (D), Shaker Cherry (F), Bourbon Cherry (H) and Mahogany (N) only.

HOW TO SPECIFY

Select Model Number H 4 0 9 1 .	Select Finish Color See page 413 H .	Select Fabric See page 413 C U 1 0 .	Select Frame T Black TI Platinum Metallic T
---	---	---	---



PAGODA® 4090 Series

H4095



STACKING ARM GUEST CHAIRS

Wood Back
Set of Two

DIMENSIONS

Depth:	22½	Arm Width:	23¾
Width:	27¼	Seat to Floor Height:	18
Height:	32½	Usable Seat Depth:	16¾
Seat Depth:	19¾	Ship Weight:	53
Seat Width:	20¼	Cube:	19.6
Back Width:	20½	COM (per 2 pack):	1.0
Back Height:	16¼	Weight Rating:	250 lbs.

FABRIC PRICE CODES

	Per Carton List Price	Single Unit List Price
1	\$1458	\$729.00
2	\$1482	\$741.00
3	\$1506	\$753.00
4	\$1524	\$762.00
5	\$1542	\$771.00
6	\$1560	\$780.00
7	\$1578	\$789.00
8	\$1596	\$798.00
9	\$1614	\$807.00
10	\$1632	\$816.00
11	\$1650	\$825.00
12	\$1668	\$834.00
L	—	—

! Ships two per carton. See note below for ordering.

H4097



MOBILE STACKING ARMLESS GUEST CHAIRS

Wood Back
Set of Two

DIMENSIONS

Depth:	22½	Seat to Floor Height:	18
Width:	21¼	Usable Seat Depth:	16¾
Height:	32½	Ship Weight:	51
Seat Depth:	19¾	Cube:	19.6
Seat Width:	20¼	COM (per 2 pack):	1.0
Back Width:	20½	Weight Rating:	250 lbs.
Back Height:	16¼		

FABRIC PRICE CODES

	Per Carton List Price	Single Unit List Price
1	\$1383	\$691.50
2	\$1407	\$703.50
3	\$1431	\$715.50
4	\$1449	\$724.50
5	\$1467	\$733.50
6	\$1485	\$742.50
7	\$1503	\$751.50
8	\$1521	\$760.50
9	\$1539	\$769.50
10	\$1557	\$778.50
11	\$1575	\$787.50
12	\$1593	\$796.50
L	—	—

! Ships two per carton. See note below for ordering.

- 2 4090 Series is ordered and shipped two (2) chairs per carton. Pricing shown is per carton. Each set of two (one carton), must have the same fabric/frame color. (COM yardage shown is for two chairs.) Ordering 2 of any model will result in 2 cartons being shipped, giving you 4 chairs.
- ! Pagoda® wood back models available in Harvest (C), Natural Maple (D), Shaker Cherry (F), Bourbon Cherry (H) and Mahogany (N) only.

HOW TO SPECIFY

<p>Select Model Number</p> <p>H 4 0 9 5 .</p>	<p>Select Finish Color</p> <p>See page 413</p> <p>H .</p>	<p>Select Fabric</p> <p>See page 413</p> <p>C U 1 0 .</p>	<p>Select Frame</p> <p>T Black TI Platinum Metallic</p> <p>T</p>
--	--	--	---

PAGODA® 4070/4090 Series

GSA SIN 33721



Icon Legend on page 17

H4099

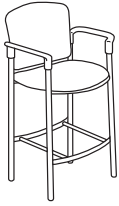

CAFÉ-HEIGHT STOOL

Wood Back
Footrest
Arms

DIMENSIONS

Depth:	22½	Arm Width:	23¾
Width:	27¼	Seat to Floor Height:	29⅝
Height:	44⅝	Usable Seat Depth:	16¾
Seat Depth:	19¾	Ship Weight:	34
Seat Width:	20¼	Cube:	19.3
Back Width:	20½	COM:	1.0
Back Height:	16¼	Weight Rating:	250 lbs.

FABRIC PRICE CODES

Single Unit List Price

1	\$851.00
2	\$875.00
3	\$899.00
4	\$917.00
5	\$935.00
6	\$953.00
7	\$971.00
8	\$989.00
9	\$1007.00
10	\$1025.00
11	\$1043.00
12	\$1061.00
L	—

NOTES: Model H4099 is ordered and shipped one (1) per carton.

H4079



CAFÉ-HEIGHT STOOL

Upholstered Back
Footrest
Arms

DIMENSIONS

Depth:	22½	Arm Width:	23¾
Width:	27¼	Seat to Floor Height:	29⅝
Height:	44⅝	Usable Seat Depth:	16¾
Seat Depth:	19¾	Ship Weight:	39
Seat Width:	20¼	Cube:	19.3
Back Width:	21¼	COM:	1.0
Back Height:	16¼	Weight Rating:	250 lbs.

FABRIC PRICE CODES

Single Unit List Price

1	\$741.00
2	\$789.00
3	\$837.00
4	\$873.00
5	\$909.00
6	\$945.00
7	\$981.00
8	\$1017.00
9	\$1053.00
10	\$1089.00
11	\$1125.00
12	\$1161.00
L	—

NOTES: Upholstered back. Model H4079 is ordered and shipped one (1) per carton.

H4069

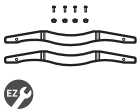

GANGING CONNECTORS

(hardware included)

DIMENSIONS

Ship Weight:	2 Ⓢ
Cube:	0.05

LIST PRICE

\$69.00

NOTES: Specify Chairs frame color: Black (T)

! For use on models H4071, H4073, H4091 and H4093.

HOW TO SPECIFY

<p>Select Model Number</p> <p>See page 413</p> <p><i>Specify for model H4099 only</i></p> <p>H 4 0 7 9 .</p> <p>H 4 0 9 9 .</p>	<p>Select Finish Color</p> <p>See page 413</p> <p><i>Specify for model H4099 only</i></p> <p>H .</p>	<p>Select Fabric</p> <p>See page 413</p> <p>C U 1 0 .</p> <p>C U 1 0 .</p>	<p>Select Frame</p> <p>T Black T1 Platinum Metallic</p> <p>T</p> <p>T</p>
--	---	---	--

PARK AVENUE COLLECTION® 5000 SERIES

Want to see more? Scan here
to check out hon.com.



Park Avenue Executive High-Back Chair
shown with 94000 Series™ Desk and Credenza.

PARK AVENUE COLLECTION® 5000 SERIES

Park Avenue seating is your address for elegance. Task chairs feature inlaid wood accents, as well as an elegant tuxedo back design that creates a sophisticated look.



TASK CHAIR FEATURES

- Mid-range knee-tilt mechanism allows for a natural, comfortable recline.
- Pneumatic seat height adjustment moves the seat up and down to adapt to various body heights.
- Tilt tension controls the rate and ease of recline.
- Tilt lock allows the user to lock out the tilt function.
- Arms feature a urethane top pad.
- Base features a steel substrate with hardwood base caps.
- Warranted for users up to 275 lbs.

SEATING

PARK AVENUE COLLECTION®

5000 Series Options

MODEL OPTIONS

H5001



Executive High-Back

Pneumatic, Swivel, Mid-range Knee Tilt, Tilt Tension, Tilt Lock, Open Loop Arms

H5002



Managerial Mid-Back

Pneumatic, Swivel, Mid-range Knee Tilt, Tilt Tension, Tilt Lock, Open Loop Arms

AVAILABLE FINISHES

Park Avenue Collection® 5000 Series Seating is available in 8 wood finishes.

WOOD FINISHES

Bourbon Cherry (H)

Cognac (COGN)

Harvest (C)

Mahogany (N)

Mocha (MOCH)

Natural Maple (D)

Pinnacle (PINC)

Shaker Cherry (F)

HON BRANDED FABRICS

GRADE 1

Apex
Centurion
Compass
Contourett
Dapper
Ensemble
Hamilton
Inertia
Optic
Pebble

GRADE 2

Appoint Seating
Clyde
Dotty
Rush
Seed
Spin Seating
Whisper Vinyl

GRADE 3

Moxie
Parker
Purl

GRADE L

Denver Leather

For a complete list of fabrics, including partnership fabrics, go to hon.com/fabricsandfinishes.

Reference Fabric Color Combinations on pages 18-22 for color codes and legend on page 19 for lead times. For additional HON to Supply COM fabric grade pricing, go to honready.hon.com and click on the HON to Supply COM link.



PARK AVENUE COLLECTION®

5000 Series

H5001



EXECUTIVE HIGH-BACK

- Pneumatic
- Swivel
- Mid-range Knee Tilt
- Tilt Tension
- Tilt Lock
- Open Loop Arms

Functions: **A, E, G, K, L**
 (Function Key on pages 212-213)

DIMENSIONS

Depth:	29	Arm Width:	20
Width:	26	Seat to Floor Height:	17¾-22½
Height:	44½	Usable Seat Depth:	17⅝
Seat Depth:	19½	Ship Weight:	61
Seat Width:	20	Cube:	23.7
Back Width:	20	COM:	3.0
Back Height:	26¼	Weight Rating:	250 lbs.

FABRIC PRICE CODES

1	\$1185	8	\$1599
2	\$1257	9	\$1653
3	\$1329	10	\$1707
4	\$1383	11	\$1761
5	\$1437	12	\$1815
6	\$1491	L	\$1785
7	\$1545		

NOTES: Arms are selected hardwood with urethane top pads.

H5002



MANAGERIAL MID-BACK

- Pneumatic
- Swivel
- Mid-range Knee Tilt
- Tilt Tension
- Tilt Lock
- Open Loop Arms

Functions: **A, E, G, K, L**
 (Function Key on pages 212-213)

DIMENSIONS

Depth:	29	Arm Width:	20
Width:	26	Seat to Floor Height:	17¾-22½
Height:	39½	Usable Seat Depth:	17⅝
Seat Depth:	19½	Ship Weight:	57
Seat Width:	20	Cube:	18.5
Back Width:	20	COM:	2.5
Back Height:	19¼	Weight Rating:	250 lbs.

FABRIC PRICE CODES

1	\$1155	8	\$1500
2	\$1215	9	\$1545
3	\$1275	10	\$1590
4	\$1320	11	\$1635
5	\$1365	12	\$1680
6	\$1410	L	\$1655
7	\$1455		

NOTES: Arms are selected hardwood with urethane top pads.

HON Recommendation: H5001.MOCH.CU__ - List Price \$1185

HOW TO SPECIFY

<p>Select Model Number</p> <div style="border: 1px solid black; display: flex; justify-content: space-between; align-items: center; padding: 5px;"> H5001 </div>	<p>Select Finish</p> <p>See page 420</p> <div style="border: 1px solid black; display: flex; justify-content: space-between; align-items: center; padding: 5px;"> MOCH </div>	<p>Select Fabric</p> <p>See page 420</p> <div style="border: 1px solid black; display: flex; justify-content: space-between; align-items: center; padding: 5px;"> CU10 </div>
--	--	--

PERCH™ Active Seating

OPEN MARKET



Icon Legend on page 17

HVLPERCH*

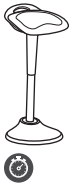

PERCH STOOL

Pneumatic
Swivel
Pivot Base

DIMENSIONS

Depth:	16½	Seat to Floor Height:	23¾-35
Width:	15¾	Usable Seat Depth:	14½
Seat Depth:	14½	Ship Weight:	22 Ⓢ
Seat Width:	14½	Cube:	3.13
		Weight Rating:	250 lbs.

PRICE CODE

Fabric **\$581**

NOTES: Fabric seat in Black and Charcoal. Built-in handle. Active pivot base. Silver frame. **HON 5-Year Limited Warranty.**

HON Recommendation: HVLPERCH.ASF10.X - List Price \$581

HVL991

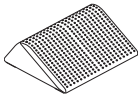

FOOTREST

Anti-Slip Cover

DIMENSIONS

Depth:	13¾	Ship Weight:	7 Ⓢ
Width:	16	Cube:	0.9
Height:	5½	Weight Rating:	250 lbs.

LIST PRICE

\$89

! Available in Black (T) finish ONLY. **HON 5-Year Limited Warranty.**

SPECIFYING EXAMPLE: HVL991.T

SEATING

* De-emphasized

HOW TO SPECIFY

<p>Select Model Number</p> <p>H V L P E R C H .</p>	<p>Select Fabric</p> <p>ASF10 Black Fabric ASF19 Charcoal Fabric</p> <p>A S F 1 0 .</p>	<p>Select Frame</p> <p>X Silver</p> <p>X</p>
--	--	---

PERPETUAL[®] NESTING CHAIRS

Want to see more? Scan here
to check out hon.com.



Perpetual Nesting Chairs and Huddle[®] Tables.

PERPETUAL[®] NESTING CHAIRS

Provide full-time comfort to even part-time workers with the Perpetual line of multi-purpose seating. The flip-up seat design maximizes space by allowing Perpetual to be easily nested. The passive back design moves with the user to deliver added comfort for all day meetings. Save space without sacrificing comfort with Perpetual.



FEATURES

- Flip-up seat allows chairs to nest and save floor space.
- Backrest reclines for added comfort.
- Tube rolled steel frame adds durability.
- Underside of seat is fully-upholstered for a clean appearance when nested.
- All-surface casters roll effortlessly and silently.
- Available in hundreds of quality HON fabrics.
- Warranted for users up to 300 lbs.

PERPETUAL[®] Nesting Chairs Options

MODEL OPTIONS

HPN1



Nesting Chair (Flex-back)

Armless, Four Legs

HPN2



Nesting Chair (Flex-back)

Fixed Arms, Four Legs

CASTER/ GLIDE



CODE	DESCRIPTION	PRICE
A	All-Surface	+\$0
G	Bell Glide	+\$25

FRAME

CODE	DESCRIPTION	PRICE
T	Black	+\$0
T1	Platinum Metallic	+\$0

BACK STYLE



CODE	DESCRIPTION	PRICE
UU	Upholstered Back	+\$0

HON BRANDED FABRICS

GRADE 1

Apex
Attire
Centurion
Compass
Contourett
Dapper
Ensemble
Hamilton
Inertia
Optic
Pebble

GRADE 2

Appoint Seating
Blume
Clyde
Dotty
Rush
Seed
Spin Seating
Whisper Vinyl

GRADE 3

Moxie
Parker
Purl
Quill

For a complete list of fabrics, including partnership fabrics, go to hon.com/fabricsandfinishes.

Reference Fabric Color Combinations on pages 18-22 for color codes and legend on page 19 for lead times. For additional HON to Supply COM fabric grade pricing, go to honready.hon.com and click on the HON to Supply COM link.



PERPETUAL[®] Nesting Chairs

HPN1



Model HPN1AUU shown

NESTING CHAIR

Flex-back
Armless
Four Legs

DIMENSIONS

Depth:	26	Seat to Floor Height:	19 $\frac{1}{8}$
Width:	26	Usable Seat Depth:	16 $\frac{1}{2}$
Height:	36	Ship Weight:	38
Seat Depth:	17 $\frac{3}{4}$	Cube:	15.2
Seat Width:	17	COM:	1.5
Back Width:	17 $\frac{1}{2}$	Weight Rating:	300 lbs.
Back Height:	15 $\frac{3}{4}$		

FABRIC PRICE CODES

1	\$774	8	\$981
2	\$810	9	\$1008
3	\$846	10	\$1035
4	\$873	11	\$1062
5	\$900	12	\$1089
6	\$927	L	—
7	\$954		

HPN2



Model HPN2AUU shown

NESTING CHAIR

Flex-back
Fixed Arms
Four Legs

DIMENSIONS

Depth:	26	Arm Width:	20 $\frac{3}{4}$
Width:	26	Seat to Floor Height:	19 $\frac{1}{8}$
Height:	36	Usable Seat Depth:	16 $\frac{1}{2}$
Seat Depth:	17 $\frac{3}{4}$	Ship Weight:	41
Seat Width:	17	Cube:	15.2
Back Width:	17 $\frac{1}{2}$	COM:	1.5
Back Height:	15 $\frac{3}{4}$	Weight Rating:	300 lbs.

FABRIC PRICE CODES

1	\$856	8	\$1063
2	\$892	9	\$1090
3	\$928	10	\$1117
4	\$955	11	\$1144
5	\$982	12	\$1171
6	\$1009	L	—
7	\$1036		

HOW TO SPECIFY

<p>Select Model Number</p> <p>HPN1</p>	<p>Select Caster/Glide</p> <p>A All-Surface G Glide (+ \$25)</p> <p>A</p>	<p>Select Back Type</p> <p>UU Upholstered Back</p> <p>UU</p>	<p>Select Fabric</p> <p>Note: For models with upholstered back, seat and back are always matching fabric See page 424</p> <p>CU10</p>	<p>Select Frame</p> <p>T Black T1 Platinum Metallic</p> <p>T</p>
---	--	---	--	---

PILLOW-SOFT® 2090 SERIES

Want to see more? Scan here
to check out hon.com.



Pillow-Soft High-Back Executive and Sled Base Guest Chairs shown with 10700 Series™ desks.

PILLOW-SOFT® 2090 SERIES

Pillow-Soft chairs combine comfort, style and selection to deliver the ultimate seating experience. Each executive chair in the collection combines thick memory foam cushioning with built-in lumbar support to reduce fatigue and increase comfort. Besides the full body support, it adds an authoritative presence to the office. The plush tufted leather or fabric will add a touch of sophistication to your office.



FEATURES

- Responsive memory foam eliminates pressure points and provides lasting comfort.
- Loop arms relieve stress on the shoulder and neck.
- Fully-upholstered outer back.
- Memory foam seat cushion reduces pressure points and responds to contours of the body for lasting comfort.
- Task chairs come standard with pneumatic seat height adjustment, tilt, tilt tension and tilt lock.
- Dual-wheel casters roll effortlessly and silently.
- Warranted for users up to 300 lbs.
- H2095 model warranted for users up to 275 lbs.

PILLOW-SOFT® 2090 Series Options

MODEL OPTIONS

H2091



Executive High-Back

Pneumatic, Swivel, Tilt, Tilt Tension, Tilt Lock, Arms

H2095



Executive High-Back

Pneumatic, Swivel, Tilt, Tilt Tension, Tilt Lock, Arms

H2092



Managerial Mid-Back

Pneumatic, Swivel, Tilt, Tilt Tension, Tilt Lock, Arms

H2093



Guest Chair

Sled Base, Arms

CASTERS



CODE	DESCRIPTION	PRICE
H	Black Hard Caster	+\$0



S	Black All-Surface Caster	+\$40
----------	--------------------------	--------------

HON BRANDED FABRICS

GRADE 1

Apex
Black Vinyl
Burgundy Vinyl
Centurion
Compass
Contourett
Dapper
Ensemble
Hamilton
Inertia
Optic
Pebble

GRADE 2

Appoint Seating
Blume
Clyde
Dotty
Rush
Seed
Spin Seating
Whisper Vinyl

GRADE 3

Moxie
Parker
Purl
Quill

For a complete list of fabrics, including partnership fabrics, go to hon.com/fabricsandfinishes.

Reference Fabric Color Combinations on pages 18-22 for color codes and legend on page 19 for lead times. For additional HON to Supply COM fabric grade pricing, go to honready.hon.com and click on the HON to Supply COM link.

PILLOW-SOFT® 2090 Series

GSA SIN 33721 EXCEPT AS NOTED



Icon Legend on page 17

H2091



EXECUTIVE HIGH-BACK

Pneumatic
Swivel
Tilt
Tilt Tension
Tilt Lock
Arms
Functions: **A, E, F, K, L**
(Function Key on pages 212-213)

DIMENSIONS

Depth: 29¾
Width: 26¼
Height: 46½
Seat Depth: 21
Seat Width: 22
Back Width: 22
Back Height: 25
Arm Width: 20¼
Seat to Floor Height: 16¾-21¼
Usable Seat Depth: 18½
Ship Weight: 57
Cube: 16.0
COM: 3.0
Weight Rating: 300 lbs.

FABRIC PRICE CODES

1	\$718	8	\$1132
2	\$790	9	\$1186
3	\$862	10	\$1240
4	\$916	11	\$1294
5	\$970	12	\$1348
6	\$1024	L	\$868
7	\$1078		

NOTES: When selecting leather, the 2090 Series uses SR Leather only. All models are also available in Grade 1 EB vinyl (which matches SR Leather).

H2095



OPEN MARKET

EXECUTIVE HIGH-BACK

Pneumatic
Swivel
Tilt
Tilt Tension
Tilt Lock
Padded Loop Arms
Functions: **A, E, F, K, L**
(Function Key on pages 212-213)

DIMENSIONS

Depth: 29½
Width: 26¾
Height: 47½
Seat Depth: 17½
Seat Width: 21
Back Width: 21
Back Height: 29½
Arm Width: 21
Seat to Floor Height: 16-21
Usable Seat Depth: 17½
Ship Weight: 57
Cube: 7.1
COM: N/A
Weight Rating: 275 lbs.

FABRIC PRICE CODES

Fabric
PWST10 \$568 (Black)
Black Bonded Leather
PWST11 \$588 (Black)

NOTES: When selecting upholstery, the H2095 is only available in PWST10 (Black fabric) and PWST11 (Black Bonded Leather).

H2092



MANAGERIAL MID-BACK

Pneumatic
Swivel
Tilt
Tilt Tension
Tilt Lock
Arms
Functions: **A, E, F, K, L**
(Function Key on pages 212-213)

DIMENSIONS

Depth: 28¾
Width: 26¼
Height: 41¾
Seat Depth: 21
Seat Width: 22
Back Width: 22
Back Height: 19¾
Arm Width: 20¼
Seat to Floor Height: 16¾-21¼
Usable Seat Depth: 18½
Ship Weight: 54
Cube: 16.0
COM: 3.0
Weight Rating: 300 lbs.

FABRIC PRICE CODES

1	\$686	8	\$1100
2	\$758	9	\$1154
3	\$830	10	\$1208
4	\$884	11	\$1262
5	\$938	12	\$1316
6	\$992	L	\$836
7	\$1046		

NOTES: When selecting leather, the 2090 Series uses SR Leather only. All models are also available in Grade 1 EB vinyl (which matches SR Leather).

H2093



GUEST CHAIR

Sled Base
Arms

DIMENSIONS

Depth: 27¾
Width: 23¼
Height: 36
Seat Depth: 21½
Seat Width: 20¾
Back Width: 21½
Back Height: 19¼
Arm Width: 19¾
Seat to Floor Height: 19½
Usable Seat Depth: 19
Ship Weight: 38
Cube: 16.1
COM: 2.5
Weight Rating: 300 lbs.

FABRIC PRICE CODES

1	\$548	8	\$893
2	\$608	9	\$938
3	\$668	10	\$983
4	\$713	11	\$1028
5	\$758	12	\$1073
6	\$803	L	\$698
7	\$848		

NOTES: When selecting leather, the 2090 Series uses SR Leather only. All models are also available in Grade 1 EB vinyl (which matches SR Leather).

HOW TO SPECIFY

HON Recommendation: H2091.H.SR11.T - List Price \$868

<p>Select Model Number</p> <p>H 2 0 9 1 .</p>	<p>Select Caster</p> <p>H Black Hard Caster S Black All-Surface Caster (+ \$40) <i>Does not apply to models H2093 or H2095</i></p> <p>H .</p>	<p>Select Fabric</p> <p>See page 427 <i>H2095 only available in 2 fabric options. See above for pricing and selection.</i></p> <p>S R 1 1 .</p>	<p>Select Frame</p> <p>T Black</p> <p>T</p>
--	--	--	--

PILLOW-SOFT® 2190 SERIES

Want to see more? Scan here
to check out hon.com.



Pillow-Soft Executive High-Back and Guest Chairs shown with Park Avenue Collection® Laminate desks.

PILLOW-SOFT® 2190 SERIES

Pillow-Soft chairs combine comfort, style and selection to deliver the ultimate seating experience. Each executive chair in the collection combines thick memory foam cushioning with built-in lumbar support to reduce fatigue and increase comfort. Besides the full body support, it adds an authoritative presence to the office. The plush tufted leather or fabric and optional hardwood accents will add a touch of sophistication to your office.



FEATURES

- Responsive memory foam eliminates pressure points and provides lasting comfort.
- Loop arms relieve stress on the shoulder and neck.
- Fully-upholstered outer back.
- Base features a steel substrate with hardwood base caps.
- Memory foam seat cushion reduces pressure points and responds to contours of the body for lasting comfort.
- Dual-wheel casters roll effortlessly and silently.
- Solid hardwood in one of eight attractive finishes.
- Warranted for users up to 275 lbs.

PILLOW-SOFT® 2190 Series Options

MODEL OPTIONS

H2191



Executive High-Back

Pneumatic, Swivel, Tilt, Tilt Tension, Tilt Lock, Open Padded Loop Arms

H2192



Managerial Mid-Back

Pneumatic, Swivel, Tilt, Tilt Tension, Tilt Lock, Open Padded Loop Arms

H2194



Guest Chair

4-Leg Base, Open Loop Arms

AVAILABLE FINISHES

Pillow-Soft® 2190 Series Seating is available in 8 wood finishes.

WOOD FINISHES

Bourbon Cherry (H)

Cognac (COGN)

Harvest (C)

Mahogany (N)

Mocha (MOCH)

Natural Maple (D)

Pinnacle (PINC)

Shaker Cherry (F)

HON BRANDED FABRICS

GRADE 1

Apex
Black Vinyl
Burgundy Vinyl
Centurion
Compass
Contourett
Dapper
Ensemble
Hamilton
Inertia
Optic
Pebble

GRADE 2

Appoint Seating
Blume
Clyde
Dotty
Rush
Seed
Spin Seating
Whisper Vinyl

GRADE 3

Moxie
Parker
Purl
Quill

For a complete list of fabrics, including partnership fabrics, go to hon.com/fabricsandfinishes.

Reference Fabric Color Combinations on pages 18-22 for color codes and legend on page 19 for lead times. For additional HON to Supply COM fabric grade pricing, go to honready.hon.com and click on the HON to Supply COM link.



PILLOW-SOFT® 2190 Series

H2191



EXECUTIVE HIGH-BACK

Pneumatic
Swivel
Tilt
Tilt Tension
Tilt Lock
Open Padded Loop Arms
Functions: **A, E, F, K, L**
(Function Key on pages 212-213)

DIMENSIONS

Depth: 29¾
Width: 26¼
Height: 46½
Seat Depth: 21
Seat Width: 22
Back Width: 22
Back Height: 25
Arm Width: 22¼
Seat to Floor Height: 16¾-21¼
Usable Seat Depth: 18½
Ship Weight: 60
Cube: 16.0
COM: 3.0
Weight Rating: 250 lbs.

FABRIC PRICE CODES

1	\$1126	8	\$1540
2	\$1198	9	\$1594
3	\$1270	10	\$1648
4	\$1324	11	\$1702
5	\$1378	12	\$1756
6	\$1432	L	\$1276
7	\$1486		

NOTES: Arms are laminated hardwood with urethane top pads. Also available in Grade 1 vinyl EB11 and EB69. (EB matching vinyl used with SR Leather).

H2192



MANAGERIAL MID-BACK

Pneumatic
Swivel
Tilt
Tilt Tension
Tilt Lock
Open Padded Loop Arms
Functions: **A, E, F, K, L**
(Function Key on pages 212-213)

DIMENSIONS

Depth: 28¾
Width: 26¼
Height: 41¾
Seat Depth: 21
Seat Width: 22
Back Width: 22
Back Height: 19⅝
Arm Width: 22¼
Seat to Floor Height: 16¾-21¼
Usable Seat Depth: 18½
Ship Weight: 57
Cube: 16.0
COM: 2.5
Weight Rating: 250 lbs.

FABRIC PRICE CODES

1	\$1095	8	\$1440
2	\$1155	9	\$1485
3	\$1215	10	\$1530
4	\$1260	11	\$1575
5	\$1305	12	\$1620
6	\$1350	L	\$1245
7	\$1395		

NOTES: Arms are laminated hardwood with urethane top pads. Also available in Grade 1 vinyl EB11 and EB69. (EB matching vinyl used with SR Leather).

H2194



GUEST CHAIR

4-Leg Base
Open Loop Arms

DIMENSIONS

Depth: 27½
Width: 23¼
Height: 35½
Seat Depth: 21½
Seat Width: 20¾
Back Width: 21½
Back Height: 19¼
Arm Width: 19¾
Seat to Floor Height: 19½
Usable Seat Depth: 19
Ship Weight: 49
Cube: 17.3
COM: 2.5
Weight Rating: 250 lbs.

FABRIC PRICE CODES

1	\$891	8	\$1236
2	\$951	9	\$1281
3	\$1011	10	\$1326
4	\$1056	11	\$1371
5	\$1101	12	\$1416
6	\$1146	L	\$1041
7	\$1191		

NOTES: Guest Chairs available in 4-Leg Base. Also available in Grade 1 vinyl EB11 and EB69. (EB matching vinyl used with SR Leather).

HON Recommendation: H2191.MOCH.CU__ - List Price \$1126

HOW TO SPECIFY

<p>Select Model Number</p> <p>H 2 1 9 1</p>	<p>Select Finish</p> <p>See page 430</p> <p>M O C H</p>	<p>Select Fabric</p> <p>See page 430</p> <p>C U 1 0</p>
--	--	--

PROMINENT™ Mesh Chairs

OPEN MARKET



Icon Legend on page 17

HVL531



HIGH-BACK

Pneumatic
Swivel
Tilt
Tilt Tension
Tilt Lock
Height-adjustable Arms

Functions: **A, E, F, K, L, Q**
(Function Key on pages 212-213)

DIMENSIONS

Depth:	27	Arm Width:	20¼
Width:	27	Seat to Floor Height:	18-22
Height:	42½	Usable Seat Depth:	18
Seat Depth:	18	Ship Weight:	36
Seat Width:	21½	Cube:	5.1
Back Width:	18¾	Weight Rating:	250 lbs.
Back Height:	23		

PRICE CODE

Sandwich Mesh	\$451
Leather	\$476

NOTES: Comfortable and breathable mesh back. Black Sandwich Mesh or Black Bonded Leather seat. Black frame. Height-adjustable arms.

HON 5-Year Limited Warranty.

HON Recommendation: HVL531.MM10 - List Price \$451

HVL532



HIGH-BACK

Mesh Back
Pneumatic
Swivel
Asynchronous Control
Tilt
Tilt Tension
Tilt Lock
Seat Glide Mechanism
Back Height Adjustment
Height and Width Adjustable Arms

Functions: **A, B, D, E, F, L, O, S**
(Function Key on pages 212-213)

DIMENSIONS

Depth:	26	Back Height:	23¼-24½
Width:	30¾	Arm Width:	18-22½
Height:	44½	Seat to Floor Height:	17-20½
Seat Depth:	17⅞-20⅞	Ship Weight:	50
Seat Width:	20½	Cube:	6.5
Back Width:	19⅞	Weight Rating:	250 lbs.

PRICE CODE

Sandwich Mesh	\$536
Leather	\$561

NOTES: Comfortable and breathable mesh back. Black Sandwich Mesh or Black Bonded Leather seat. Black frame. Height and width adjustable arms. Seat glide mechanism. Asynchronous control with independent seat and back angle adjustment. **HON 5-Year Limited Warranty.**

HON Recommendation: HVL532.MM10 - List Price \$536

HOW TO SPECIFY

Select
Model Number

Select
Fabric

MM10 Black Sandwich Mesh Fabric
SB11 Black Bonded Leather

H V L 5 3 1 .

M M 1 0



PROMINENT™ Mesh Chairs

HVL534



HIGH-BACK

Pneumatic
Swivel
Tilt
Tilt Tension
Tilt Lock
Height-adjustable Arms

Functions: **A, E, F, K, L, Q**
(Function Key on pages 212-213)

DIMENSIONS

Depth:	27	Arm Width:	19 ⁵ / ₈
Width:	27	Seat to Floor Height:	17 ¹ / ₈ -20 ³ / ₄
Height:	41 ¹ / ₈	Usable Seat Depth:	19 ¹ / ₈
Seat Depth:	19 ¹ / ₈	Ship Weight:	40.6 Ⓢ
Seat Width:	20 ¹ / ₈	Cube:	5.7
Back Width:	19 ¹ / ₈	Weight Rating:	250 lbs.
Back Height:	22 ³ / ₈		

PRICE CODE

Mesh \$553

NOTES: Prominent™ HVL534. Comfortable and breathable mesh back. Black Mesh seat. Height-adjustable arms. **HON 5-Year Limited Warranty.**

HON Recommendation: HVL534.MST3 - List Price \$553

HVL539



TASK STOOL

Mesh Back
Pneumatic
Swivel
Height and Width Adjustable
Arms
Adjustable Footring

Functions: **A, E, S**
(Function Key on pages 212-213)

DIMENSIONS

Depth:	27 ⁹ / ₁₆	Arm Width:	18 ¹ / ₈
Width:	28 ¹⁷ / ₃₂	Seat to Floor Height:	21 ⁹ / ₃₂ -28 ⁵ / ₃₂
Height:	50	Usable Seat Depth:	17 ¹ / ₈
Seat Depth:	17 ¹ / ₈	Ship Weight:	44.0 Ⓢ
Seat Width:	20 ¹⁵ / ₃₂	Cube:	5.7
Back Width:	17 ¹ / ₈	Weight Rating:	250 lbs.
Back Height:	22 ²⁷ / ₃₂		

PRICE CODE

Sandwich Mesh \$493

NOTES: Prominent™ HVL539. Black upholstered seat. Height and width adjustable arms. **HON 5-Year Limited Warranty.**

HON Recommendation: HVL539.MM10 - List Price \$493

HOW TO SPECIFY

Select
Model Number

H V L 5 3 4 .

Select
Fabric

MM10 Black Sandwich Mesh Fabric
Specify for model HVL539 only
MST3 Black Mesh
Specify for model HVL534 only

M S T 3



Ruck™ Seating shown with West Hill™ Casual Lounge, Scramble™ Occasional Tables, and Unika Vaev Screens.

RUCK™

Easy on the eyes and even easier to move and stack, Ruck™ seating brings effortless style to working alone or together.

Available in a variety of finishes in both seated and stool heights, Ruck clicks with its surroundings — whether that's in a collaborative area, café setting, or as a side chair in a private office. Crafted with gentle, molded contours, Ruck makes being on the edge of your seat a more comfortable place to be.



FEATURES

- Available in both a seated and stool-height option.
- Lightweight frame can be easily moved to rearrange seating configurations.
- Waterfall seat edge promotes better leg circulation.
- Glides move effortlessly on hard surfaces.
- Both the chair and stool stack six high on the floor to maximize space.
- Single piece shell can be quickly wiped down for easy maintenance.
- Choose from 6 laminate and 4 veneer shell colors.
- Legs are available in a variety of finish options to match or complement other HON product lines.
- Backed by HON's industry-leading Lifetime Warranty.

MODEL OPTIONS

HRUCK1L



Chair

Laminate Shell

HRUCK5L



Stool

Laminate Shell

HRUCK1W



Chair

Wood Shell

HRUCK5W



Stool

Wood Shell

AVAILABLE FINISHES

Ruck Seating is available in 6 laminate finishes and 4 wood finishes.

LAMINATE FINISHES

Charcoal (S)

Designer White (LDW1)

Florence Walnut (LFW1)

Kingswood Walnut (LK11)

Natural Maple (D)

Pinnacle (PINC)

WOOD FINISHES

Black Wash (QA997)

Natural (QA447)

Pinnacle Walnut (QA679)

White Wash (QA921)

FRAME

CODE	DESCRIPTION	PRICE
P6P	Textured Black Mica	+\$0
P7J	Textured Brownstone	+\$0
P7A	Textured Charcoal	+\$0
PK7	Textured Designer White	+\$0
P7L	Textured Loft	+\$0
P7M	Textured Muslin	+\$0
P8V	Textured Titanium	+\$0

RUCK™ Laminate Seating

OPEN MARKET



Icon Legend on page 17

HRUCK1L



CHAIR, LAMINATE SHELL

DIMENSIONS

Depth:	22 ⁵ / ₈	Seat to Floor Height:	17 ³ / ₄
Width:	21 ⁵ / ₈	Usable Seat Depth:	18 ¹ / ₄
Height:	32 ⁵ / ₁₆	Ship Weight:	24
Seat Depth:	18 ¹ / ₄	Cube:	15.8
Seat Width:	17 ¹ / ₂	Weight Rating:	300 lbs.
Back Width:	17		
Back Height:	15 ⁵ / ₈		

LIST PRICE

\$530

HRUCK5L



STOOL, LAMINATE SHELL

DIMENSIONS

Depth:	22 ⁵ / ₈	Seat to Floor Height:	30
Width:	21 ⁵ / ₈	Usable Seat Depth:	18 ¹ / ₄
Height:	44 ¹ / ₂	Ship Weight:	32
Seat Depth:	18 ¹ / ₄	Cube:	22.2
Seat Width:	17 ¹ / ₂	Weight Rating:	300 lbs.
Back Width:	17		
Back Height:	15 ⁵ / ₈		

LIST PRICE

\$636

HON Recommendation: HRUCK1L.PINC.P8V - List Price \$530

SEATING

HOW TO SPECIFY

Select
Model Number

HRUCK1L .

Select
Laminate

See page 435

PINC .

Select
Frame

See page 435

P8V



Icon Legend on page 17

HRUCK1W



CHAIR, WOOD SHELL

DIMENSIONS

Depth:	22 ⁵ / ₈	Seat to Floor Height:	17 ³ / ₄
Width:	21 ⁵ / ₈	Usable Seat Depth:	18 ¹ / ₄
Height:	32 ⁵ / ₁₆	Ship Weight:	24
Seat Depth:	18 ¹ / ₄	Cube:	15.8
Seat Width:	17 ¹ / ₂	Weight Rating:	300 lbs.
Back Width:	17		
Back Height:	15 ⁵ / ₈		

LIST PRICE

\$557

HRUCK5W



STOOL, WOOD SHELL

DIMENSIONS

Depth:	22 ⁵ / ₈	Seat to Floor Height:	30
Width:	21 ⁵ / ₈	Usable Seat Depth:	18 ¹ / ₄
Height:	44 ¹ / ₂	Ship Weight:	32
Seat Depth:	18 ¹ / ₄	Cube:	22.2
Seat Width:	17 ¹ / ₂	Weight Rating:	300 lbs.
Back Width:	17		
Back Height:	15 ⁵ / ₈		

LIST PRICE

\$663

HON Recommendation: HRUCK1W.QA997.P8V - List Price \$557

HOW TO SPECIFY

<p>Select Model Number</p> <p>HRUCK1W</p>	<p>Select Finish</p> <p>See page 435</p> <p>QA997</p>	<p>Select Frame</p> <p>See page 435</p> <p>P8V</p>
--	--	---



Ryder™ Sport Executive Chair with
Voi® Desks and Fuse™ Storage.

RYDER™

Take your comfort to the extreme, and elevate the entire office with this high energy chair. The Ryder™ executive chair is the sporty answer to your grandfather's office seating. The unexpected curves and unconventional styling create uncommon comfort. Black Bonded Leather paired with carbon fiber pattern creates a sleek look for any modern office.



FEATURES

- Synchro-tilt mechanism offers full range of reclining positions.
- Height-adjustable arms put the support right where you want it.
- Unique multi-panel upholstery.
- Backed by the HON 5-Year Limited Warranty.



HVL149



SPORT EXECUTIVE CHAIR

DIMENSIONS

LIST PRICE

Pneumatic	Depth: 29	Arm Width: 21	\$581
Swivel	Width: 27¾	Seat to Floor Height: 18-22	
Synchronized Tilt	Height: 52¼	Usable Seat Depth: 19½	
Tilt Tension	Seat Depth: 19½	Ship Weight: 53	
Tilt Lock	Seat Width: 23	Cube: 8.5	
Height-adjustable Arms	Back Width: 22	Weight Rating: 250 lbs.	
Functions: A, E, J, K, L, Q	Back Height: 32		
(Function Key on pages 212-213)			

NOTES: Black Bonded Leather with tailored stitching and mock carbon fiber detail. Black frame. Height-adjustable arms. Integrated headrest support. **HON 5-Year Limited Warranty.**

HON Recommendation: HVL149.SB11 - List Price \$581

SEATING

HOW TO SPECIFY

Select Model Number	Select Fabric
	SB11 Black Bonded Leather
H V L 1 4 9 .	S B 1 1

SCATTER™ Guest Chairs

OPEN MARKET



Icon Legend on page 17

HVL606



GUEST CHAIR

Leg Base
Armless
Stacks up to Four High

DIMENSIONS

Depth:	21	Seat to Floor Height:	19
Width:	21¼	Usable Seat Depth:	17½
Height:	32¾	Ship Weight:	16
Seat Depth:	17½	Cube:	2.1
Seat Width:	19	Weight Rating:	250 lbs.
Back Width:	18½		
Back Height:	16		

PRICE CODE

Fabric	\$171
Leather	\$201

NOTES: Fabric or Black Bonded Leather. Stackable up to four high. Round tube construction. Frame available in Black. Casters and glides ship packaged together for customer's assembly choice. **HON 5-Year Limited Warranty.**

HON Recommendation: HVL606.VA10 - List Price \$171

HVL616



GUEST CHAIR

Leg Base
Arms
Stacks up to Four High

DIMENSIONS

Depth:	21	Arm Width:	20⅞
Width:	23¾	Seat to Floor Height:	19
Height:	32¾	Usable Seat Depth:	17½
Seat Depth:	17½	Ship Weight:	18
Seat Width:	19	Cube:	2.1
Back Width:	18½	Weight Rating:	250 lbs.
Back Height:	16		

PRICE CODE

Fabric	\$192
Leather	\$222

NOTES: Fabric or Black Bonded Leather. Stackable up to four high. Round tube construction. Frame available in Black. Casters and glides ship packaged together for customer's assembly choice. **HON 5-Year Limited Warranty.**

HON Recommendation: HVL616.VA10 - List Price \$192

SEATING

HOW TO SPECIFY

Select
Model Number

Select
Fabric

- SB11** Black Bonded Leather
- VA10** Black Fabric
- VA19** Charcoal Fabric
- VA90** Navy Fabric

H V L 6 0 6 .

V A 1 0

SKIP

Want to see more? Scan here
to check out [hon.com](https://www.hon.com).



Skip shown with Flock® Cylinder Table.

SKIP

It's hard to get creative when you're feeling all buttoned up. That's why workplaces are adding less formal, more dynamic spaces to foster more creativity and connection between workers. Designed to put the fun back in functional, Skip seating offers an engaging, active sit that lets you rock a meeting — literally. When it comes to casual and collaborative seating that's as lively as it is practical, this chair doesn't Skip a beat.



FEATURES

- Built-in handle makes it easy to move around.
- Textured finish is durable, easy to clean, UV resistant, and suitable for outdoor sitting.
- Optional cushion stays in place but is not permanently affixed.
- Cushion fabric is easy to wipe clean.

SKIP Collaborative Chair

OPEN MARKET



Icon Legend on page 17

HQQ1



COLLABORATIVE CHAIR

DIMENSIONS

Depth:	35½	Seat to Floor Height:	17
Width:	28	Usable Seat Depth:	17
Height:	31	Ship Weight:	35
Seat Depth:	18	Cube:	20.0
Seat Width:	28	Weight Rating:	275 lbs.
Back Width:	28		
Back Height:	21		

LIST PRICE

\$876

NOTES: HON 5-Year Limited Warranty.

HQQ1CUSH



CUSHION

DIMENSIONS

Depth:	17½	Ship Weight:	5 Ⓞ
Width:	25¾	Cube:	2.0
Height:	1½		

LIST PRICE

\$169

NOTES: HON 5-Year Limited Warranty.

SEATING

HOW TO SPECIFY

Select Model Number

HQQ1

HOW TO SPECIFY

Select Model Number

HQQ1CUSH.

Select Fabric

SLT Slate
NVY Navy

SLT

SOLUTIONS SEATING® 4000 SERIES

Want to see more? Scan here
to check out hon.com.



Solutions Managerial Mid-Back Chair shown with
34000 Series Desk and Brigade® 700 Series Lateral Files.

SOLUTIONS SEATING® 4000 SERIES

Looking for the perfect answer for your task and guest chair needs? HON has four Solutions for everything from workstations to open areas. The Solutions series includes a high-back and mid-back task chair, as well as matching four-leg and sled base guest chairs. The floating backrest provides ergonomic support for your spine. The tilt mechanism delivers a natural recline. Solutions are the chairs that really live up to their name.



GUEST CHAIR FEATURES

- Guest chairs feature molded polymer outer back shell for added durability.
- Back cushion enhances lumbar support and minimizes fatigue.
- Available in hundreds of quality HON fabrics.
- Warranted for users up to 300 lbs.

TASK CHAIR FEATURES

- One-touch seat height adjustment easily moves the seat up and down.
- Tilt tension controls the rate and ease of recline.
- Tilt lock allows the user to lock out the tilt function.
- 360-degree swivel provides freedom of movement in any direction.
- Model H4001 has a fully-upholstered outer back.
- Model H4002 has a molded polymer outer back shell.
- Back cushion enhances lumbar support and minimizes fatigue.
- Dual-wheeled casters roll effortlessly and quietly.
- Available in hundreds of quality HON fabrics.
- Warranted for users up to 300 lbs.

SOLUTIONS SEATING®

4000 Series Options

MODEL OPTIONS

H4001



Executive High-Back

Pneumatic, Swivel, Tilt, Tilt Tension, Tilt Lock, Loop Arms

H4002



Managerial Mid-Back

Pneumatic, Swivel, Tilt, Tilt Tension, Tilt Lock, Loop Arms

H4003



Guest Chair

Leg Base, Arms

H4008



Guest Chair

Sled Base, Arms

CASTERS



CODE	DESCRIPTION	PRICE
H	Black Hard Caster	+\$0



S	Black All-Surface Caster	+\$40
---	--------------------------	--------------

*Specify for models H4001 and H4002 only

FRAME

CODE	DESCRIPTION	PRICE
T	Black	+\$0

HON BRANDED FABRICS

GRADE 1

Apex
Attire
Centurion
Compass
Contourett
Dapper
Ensemble
Hamilton
Inertia
Optic
Pebble

GRADE 2

Appoint Seating
Blume
Clyde
Dotty
Rush
Seed
Spin Seating
Whisper Vinyl

GRADE 3

In Season
Moxie
Parker
Purl
Quill

For a complete list of fabrics, including partnership fabrics, go to hon.com/fabricsandfinishes.

Reference Fabric Color Combinations on pages 18-22 for color codes and legend on page 19 for lead times. COM yardage shown is for Pattern Cut only. Contact Customer Service for Railroaded yardage requirements. For additional HON to Supply COM fabric grade pricing, go to honready.hon.com and click on the HON to Supply COM link.



SOLUTIONS SEATING®

4000 Series

H4001



EXECUTIVE HIGH-BACK

- Pneumatic
- Swivel
- Tilt
- Tilt Tension
- Tilt Lock
- Loop Arms

Functions: **A, E, F, K, L**
 (Function Key on pages 212-213)

DIMENSIONS

Depth:	27	Arm Width:	20¼
Width:	26	Seat to Floor Height:	16¾-21¾
Height:	39½	Usable Seat Depth:	17¾
Seat Depth:	18	Ship Weight:	45
Seat Width:	20	Cube:	10.3
Back Width:	20½	COM:	1.5
Back Height:	20¾	Weight Rating:	250 lbs.

FABRIC PRICE CODES

1	\$540	8	\$747
2	\$576	9	\$774
3	\$612	10	\$801
4	\$639	11	\$828
5	\$666	12	\$855
6	\$693	L	—
7	\$720		

H4002

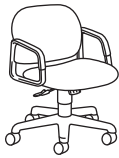

MANAGERIAL MID-BACK

- Pneumatic
- Swivel
- Tilt
- Tilt Tension
- Tilt Lock
- Loop Arms

Functions: **A, E, F, K, L**
 (Function Key on pages 212-213)

DIMENSIONS

Depth:	26¼	Arm Width:	18¾
Width:	26	Seat to Floor Height:	16¾-21¾
Height:	35½	Usable Seat Depth:	17¾
Seat Depth:	18	Ship Weight:	38
Seat Width:	20	Cube:	8.6
Back Width:	21	COM:	1.0
Back Height:	15	Weight Rating:	250 lbs.

FABRIC PRICE CODES

1	\$481	8	\$619
2	\$505	9	\$637
3	\$529	10	\$655
4	\$547	11	\$673
5	\$565	12	\$691
6	\$583	L	—
7	\$601		

H4003



GUEST CHAIR

- Leg Base
- Arms

DIMENSIONS

Depth:	24½	Arm Width:	18¾
Width:	23½	Seat to Floor Height:	19¼
Height:	32	Usable Seat Depth:	18¼
Seat Depth:	18	Ship Weight:	29
Seat Width:	20	Cube:	12.6
Back Width:	21	COM:	1.0
Back Height:	15	Weight Rating:	250 lbs.

FABRIC PRICE CODES

1	\$364	8	\$502
2	\$388	9	\$520
3	\$412	10	\$538
4	\$430	11	\$556
5	\$448	12	\$574
6	\$466	L	—
7	\$484		

H4008



GUEST CHAIR

- Sled Base
- Arms

DIMENSIONS

Depth:	25½	Arm Width:	19
Width:	23½	Seat to Floor Height:	19¼
Height:	32½	Usable Seat Depth:	18¼
Seat Depth:	18	Ship Weight:	33
Seat Width:	20	Cube:	12.6
Back Width:	21	COM:	1.0
Back Height:	15	Weight Rating:	250 lbs.

FABRIC PRICE CODES

1	\$407	8	\$545
2	\$431	9	\$563
3	\$455	10	\$581
4	\$473	11	\$599
5	\$491	12	\$617
6	\$509	L	—
7	\$527		

HON Recommendation: H4001.H.CU__T - List Price \$540
H4008.CU__T - List Price \$407

HOW TO SPECIFY

<p>Select Model Number</p> <p>H 4 0 0 8 .</p>	<p>Select Caster</p> <p>H Black Hard Caster S Black All-Surface Caster (+ \$40) Specify for models H4001 and H4002 only</p> <p>H .</p>	<p>Select Fabric</p> <p>See page 444</p> <p>C U 1 0 .</p>	<p>Select Frame</p> <p>T Black</p> <p>T</p>
--	---	--	--

SEATING



Solve Task Chairs and Stools.

SOLVE®

If you want to make a powerful statement, simply have a seat. With three back materials and an optional adjustable lumbar support, Solve answers the need for a higher level of personalization. Solve task chairs feature a geometric ReActiv® back to create a contemporary look, while the 4-Way Stretch mesh back offers a softer, more relaxed feel. The synchronized seat and back move in harmony with the user to provide continuous comfort that can be customized. Helping anyone achieve optimal balance, proper alignment and lumbar support, Solve is an ideal solution for everywhere and everybody.

SEATING



FEATURES

- Synchronized seat and back create continuous comfort.
- Waterfall seat edge encourages leg circulation.
- Optional seat depth adjustment adapts to users of various heights.
- ReActiv® back design moves with your body to provide continuous support and airflow for lasting comfort.
- Available with three control types — synchro-tilt, synchro-tilt with seat slider and advanced synchro-tilt.
- Choose from four different arm options — armless, fixed, height- and width-adjustable or all-adjustable arms.
- Optional lumbar support delivers long-lasting comfort.
- Available with bell glides, hard casters or all-surface casters.
- Upholstered ReActiv® back offers all the benefits of the ReActiv® back with a fabric cover for additional comfort.
- Back upholstery available in one of six attractive fabrics.
- Choose from 3 frame options: Black, Titanium and White.
- Available in seven mesh back and seven lumbar colors and thousands of fabrics.
- Warranted for users up to 300 lbs.

MODEL OPTIONS

HSLVTMM



Mid-Back Task (4-Way Stretch Back)

Pneumatic, Swivel, Synchro-tilt, Tilt Tension, Tilt Lock

HSLVSMM



Stool (4-Way Stretch Back)

Pneumatic, Swivel, Synchro-tilt, Tilt Tension, Tilt Lock

HSLVTMMS



Mid-Back Task (4-Way Stretch Back) with Designer White frame

Pneumatic, Swivel, Synchro-tilt, Tilt Tension, Tilt Lock

HSLVSMMS



Stool (4-Way Stretch Back) with Designer White frame

Pneumatic, Swivel, Synchro-tilt, Tilt Tension, Tilt Lock

HSLVTMR



Mid-Back Task (ReActiv® Back)

Pneumatic, Swivel, Synchro-tilt, Tilt Tension, Tilt Lock

HSLVSMR



Stool (ReActiv® Back)

Pneumatic, Swivel, Synchro-tilt, Tilt Tension, Tilt Lock

HSLVTMRS



Mid-Back Task (ReActiv® Back) with Designer White frame

Pneumatic, Swivel, Synchro-tilt, Tilt Tension, Tilt Lock

HSLVSMRS



Stool (ReActiv® Back) with Designer White frame

Pneumatic, Swivel, Synchro-tilt, Tilt Tension, Tilt Lock

HSLVTMU



Mid-Back Task (Upholstered Back)

Pneumatic, Swivel, Synchro-tilt, Tilt Tension, Tilt Lock

HSLVSMU

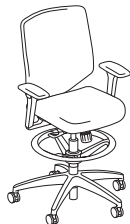

Stool (Upholstered Back)

Pneumatic, Swivel, Synchro-tilt, Tilt Tension, Tilt Lock

HSLVTMUS



Mid-Back Task (Upholstered Back) with Designer White frame

Pneumatic, Swivel, Synchro-tilt, Tilt Tension, Tilt Lock

HSLVSMUS





Stool (Upholstered Back) with Designer White frame



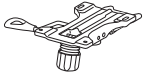
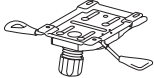
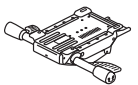

Pneumatic, Swivel, Synchro-tilt, Tilt Tension, Tilt Lock



SOLVE® Options

MECHANISM	CODE	DESCRIPTION	PRICE
	Y0	Synchro-Tilt A, E, J, K, L	+\$0
	Y1	Synchro-Tilt w/Seat Slider A, D, E, J, K, L	+\$20
	Y2	Advanced Synchro-Tilt A, D, E, J, L, A-D	+\$65

**Y2 control not available on stool models*

ARM STYLE	CODE	DESCRIPTION	PRICE
	N	Armless	+\$0
	F	Fixed Arms	+\$65
		<i>*Not available on Designer White models</i>	
	A	Height and Width Adjustable Arms	+\$85
	V	All-Adjustable Arms (includes Pivot)	+\$130
		<i>*Not available on Designer White models</i>	
	ADW	Height and Width Adjustable Arms	+\$85

CASTERS/ GLIDE	CODE	DESCRIPTION	PRICE
	H	Black Hard Caster	+\$0
	S	Black All-Surface Caster	+\$40
	R	Roll Control Caster	+\$50
	G	Bell Glide	+\$25

BACK STYLE	CODE	DESCRIPTION	PRICE
		<i>4-Way Stretch mesh back options:</i>	
	IM	Black	+\$0
	IB	Breeze	+\$0
	IK	Brownstone	+\$0
	IC	Charcoal	+\$0
	IF	Fog	+\$0
	IR	Regatta	+\$0
	IT	Titanium	+\$0
		<i>ReActiv® back options:</i>	
	OS	Charcoal	+\$0
	DW	Designer White	+\$0
	TI	Titanium	+\$0
		<i>Fabric options:</i>	
	COMF46	Bittersweet	+\$0
	COMF10	Ink	+\$0
	COMF82	Meadow	+\$0
	COMF90	Midnight	+\$0
	COMF22	Putty	+\$0
	COMF19	Sterling	+\$0

LUMBAR	CODE	DESCRIPTION	PRICE
	NL	No Lumbar	+\$0
	BL	Black Adjustable Lumbar	+\$30
	BY	Bullseye Adjustable Lumbar	+\$30
	DW	Designer White Adjustable Lumbar	+\$30
	KT	Krypton Adjustable Lumbar	+\$30
	MR	Ember Adjustable Lumbar	+\$30
	RE	Regatta Adjustable Lumbar	+\$30
	TL	Titanium Adjustable Lumbar	+\$30

BASE	CODE	DESCRIPTION	PRICE
	SB	Standard Base	+\$0

FRAME	CODE	DESCRIPTION	PRICE
	T	Black	+\$0
	TI	Titanium	+\$35
	DW	Designer White	+\$35

HON BRANDED FABRICS

GRADE 1	GRADE 2	GRADE 3	GRADE L
Apex	Appoint Seating	In Season	Denver Leather (Seat Only)
Attire	Blume	Moxie	
Centurion	Clyde	Parker	
Compass	Dotty	Purl	
Compass Foam	Rush	Quill	
Contourett	Seed		
Dapper	Spin Seating		
Ensemble	Whisper Vinyl		
Hamilton			
Inertia			
Optic			
Pebble			

For a complete list of fabrics, including partnership fabrics, go to hon.com/fabricsandfinishes.

Reference Fabric Color Combinations on pages 18-22 for color codes and legend on page 19 for lead times.

DIMENSIONS

NOTE: When selecting the .TI Titanium or .DW Designer White frame option, the chair's back frame, arms, and base will match. 4-Way Stretch, ReActiv®, and/or lumbar color must be selected separately.

MODEL		HSLVTMM /HSLVTMMS	HSLVSMM /HSLVSMS	HSLVTMR /HSLVTMRS	HSLVSMR /HSLVSMRS	HSLVTMU /HSLVTMUS	HSLVSMU /HSLVSMUS
Overall Width Armless		29½"	29½"	29½"	29½"	29½"	29½"
Overall Width with Arms	(A)	29½"	29½"	29½"	29½"	29½"	29½"
Overall Depth		29½"	29½"	29½"	29½"	29½"	29½"
Overall Height – Max	(Y0/Y1)	41¾"	52¾"	41¾"	52¾"	41¾"	52¾"
	(Y2)	42½"	—	42½"	—	42½"	—
Seat Width		19"	19"	19"	19"	19"	19"
Seat Depth (Cushion)		19¼"	19¼"	19¼"	19¼"	19¼"	19¼"
Usable Seat Depth	(Y0)	17⅝"	17⅝"	17⅝"	17⅝"	17⅝"	17⅝"
	(Y1)	16¼"-18½"	16¼"-18½"	16¼"-18½"	16¼"-18½"	16¼"-18½"	16¼"-18½"
	(Y2)	16¼"-19¼"	—	16¼"-19¼"	—	16¼"-19¼"	—
Seat Height	(Y0/Y1)	16¾"-21¾"	22¾"-32¾"	16¾"-21¾"	22¾"-32¾"	16¾"-21¾"	22¾"-32¾"
	(Y2)	17½"-22½"	—	17½"-22½"	—	17½"-22½"	—
Back Width		18¼"	18¼"	18¼"	18¼"	18¼"	18¼"
Back Height		21½"	21½"	21½"	21½"	21½"	21½"
Ship Weight Armless	(Y0)	40 Ⓢ	45 Ⓢ	41 Ⓢ	46 Ⓢ	41 Ⓢ	46 Ⓢ
	(Y1)	42 Ⓢ	47 Ⓢ	43 Ⓢ	48 Ⓢ	43 Ⓢ	48 Ⓢ
	(Y2)	45 Ⓢ	—	46 Ⓢ	—	46 Ⓢ	—
Ship Weight with Arms	(Y0)	44 Ⓢ	49 Ⓢ	45 Ⓢ	50 Ⓢ	45 Ⓢ	50 Ⓢ
	(Y1)	46 Ⓢ	51 Ⓢ	47 Ⓢ	52 Ⓢ	47 Ⓢ	52 Ⓢ
	(Y2)	49 Ⓢ	—	50 Ⓢ	—	50 Ⓢ	—
Width Between Arms		17½"-20"	17½"-20"	17½"-20"	17½"-20"	17½"-20"	17½"-20"
COM		1.0	1.0	1.0	1.0	1.0	1.0
Weight Capacity		300 lbs	300 lbs	300 lbs	300 lbs	300 lbs	300 lbs



HSLVTMM

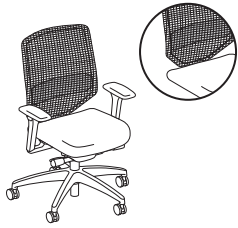

MID-BACK TASK

4-Way Stretch Back
Pneumatic
Swivel
Synchro-tilt
Tilt Tension
Tilt Lock

DIMENSIONS

Seat Depth: 19¼ Arm Width: 17½-20
Seat Width: 19 Cube: 10.8
Back Width: 18¼ Weight Rating: 300 lbs.
Back Height: 21½

FABRIC PRICE CODES

1	\$504	8	\$573
2	\$516	9	\$582
3	\$528	10	\$591
4	\$537	11	\$600
5	\$546	12	\$609
6	\$555	L	\$604
7	\$564		

NOTES: Please reference pages 448-449 for additional specifications and mechanism information.

HSLVTMMS

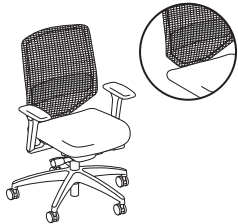

MID-BACK TASK IN DESIGNER WHITE

4-Way Stretch Back
Pneumatic
Swivel
Synchro-tilt
Tilt Tension
Tilt Lock

DIMENSIONS

Seat Depth: 19¼ Arm Width: 17½-20
Seat Width: 19 Cube: 10.8
Back Width: 18¼ Weight Rating: 300 lbs.
Back Height: 21½

FABRIC PRICE CODES

1	\$504	8	\$573
2	\$516	9	\$582
3	\$528	10	\$591
4	\$537	11	\$600
5	\$546	12	\$609
6	\$555	L	\$604
7	\$564		

OPEN MARKET

NOTES: Please reference pages 448-449 for additional specifications and mechanism information.

HON Recommendation: HSLVTMM.Y1.A.S.IM.CU__BL.SB.T - List Price \$679

HOW TO SPECIFY

Select Model Number	Select Control Type	Select Arm Type	Select Caster/Glide	Select Mesh Back	Select Fabric	Select Lumbar	Select Base	Select Frame
Y0 Synchro-Tilt Y1 Synchro-Tilt w/ Seat Slider (+ \$20) Y2 Advanced Synchro-Tilt (+ \$65)	N Armless F Fixed Arms (+ \$65) A Height and Width Adjustable Arms (+ \$85) V All-Adjustable Arms (includes pivot) (+ \$130)	H Black Hard Caster S Black All-Surface Caster (+ \$40) G Bell Glide (+ \$25) R Black Roll Control Caster (+ \$50)	IM Black IB Breeze IK Brownstone IC Charcoal IF Fog IR Regatta IT Titanium	4-Way Stretch options	See page 449	NL No Lumbar BL Black Adjustable Lumbar (+ \$30) BY Bullseye Adjustable Lumbar (+ \$30) DW Designer White Adjustable Lumbar (+ \$30) KT Krypton Adjustable Lumbar (+ \$30) MR Ember Adjustable Lumbar (+ \$30) RE Regatta Adjustable Lumbar (+ \$30) TL Titanium Adjustable Lumbar (+ \$30)	SB Standard Base	HSLVTMM Options T Black TI Titanium (+ \$35) HSLVTMMS Options DW Designer White (+ \$35) <i>Available for model HSLVTMMS only</i>
H S L V T M M	Y 1	A	S	I M	C U 1 0	B L	S B	T

SEATING



Icon Legend on page 17

HSLVSMM



STOOL

- 4-Way Stretch Back**
- Pneumatic
- Swivel
- Synchro-tilt
- Tilt Tension
- Tilt Lock

DIMENSIONS

Seat Depth:	19¼	Arm Width:	17½-20
Seat Width:	19	Cube:	10.8
Back Width:	18¼	Weight Rating:	300 lbs.
Back Height:	21½		

FABRIC PRICE CODES

1	\$564	8	\$633
2	\$576	9	\$642
3	\$588	10	\$651
4	\$597	11	\$660
5	\$606	12	\$669
6	\$615	L	\$664
7	\$624		

NOTES: Please reference pages 448-449 for additional specifications and mechanism information.

HSLVSMMS



STOOL IN DESIGNER WHITE

- 4-Way Stretch Back**
- Pneumatic
- Swivel
- Synchro-tilt
- Tilt Tension
- Tilt Lock

DIMENSIONS

Seat Depth:	19¼	Arm Width:	17½-20
Seat Width:	19	Cube:	10.8
Back Width:	18¼	Weight Rating:	300 lbs.
Back Height:	21½		

FABRIC PRICE CODES

1	\$564	8	\$633
2	\$576	9	\$642
3	\$588	10	\$651
4	\$597	11	\$660
5	\$606	12	\$669
6	\$615	L	\$664
7	\$624		

OPEN MARKET

NOTES: Please reference pages 448-449 for additional specifications and mechanism information.

HON Recommendation: HSLVSMM.Y1.A.S.IM.CU__BL.SB.T - List Price \$739

HOW TO SPECIFY

Select Model Number	Select Control Type	Select Arm Type	Select Caster/Glide	Select Mesh Back	Select Fabric	Select Lumbar	Select Base	Select Frame
YO Synchro-Tilt Y1 Synchro-Tilt w/ Seat Slider (+ \$20)	HSLVSMM Options N Armless F Fixed Arms (+ \$65) A Height and Width Adjustable Arms (+ \$85) V All-Adjustable Arms (includes pivot) (+ \$130) HSLVSMMS Options ADW Height and Width Adjustable Arms (+ \$85) Available for model HSLVSMMS only	H Black Hard Caster S Black All-Surface Caster (+ \$40) G Bell Glide (+ \$25) R Black Roll Control Caster (+ \$50)	4-Way Stretch options IM Black IB Breeze IK Brownstone IC Charcoal IF Fog IR Regatta IT Titanium	See page 449	NL No Lumbar BL Black Adjustable Lumbar (+ \$30) BY Bullseye Adjustable Lumbar (+ \$30) DW Designer White Adjustable Lumbar (+ \$30) KT Krypton Adjustable Lumbar (+ \$30) MR Ember Adjustable Lumbar (+ \$30) RE Regatta Adjustable Lumbar (+ \$30) TL Titanium Adjustable Lumbar (+ \$30)	SB Standard Base	T Black TI Titanium (+ \$35 for HSLVSMM; + \$55 for HSLVSMMS) DWX Designer White (+ \$55; available on HSLVSMMS only)	
H S L V S M M	Y 1	A	S	I M	C U I O	B L	S B	T

SEATING



HSLVTMR



MID-BACK TASK

ReActiv® Back
Pneumatic
Swivel
Synchro-tilt
Tilt Tension
Tilt Lock

DIMENSIONS

Seat Depth: 19¼ Arm Width: 17½-20
Seat Width: 19 Cube: 10.8
Back Width: 18¼ Weight Rating: 300 lbs.
Back Height: 21½

FABRIC PRICE CODES

1	\$539	8	\$608
2	\$551	9	\$617
3	\$563	10	\$626
4	\$572	11	\$635
5	\$581	12	\$644
6	\$590	L	\$639
7	\$599		

NOTES: Please reference pages 448-449 for additional specifications and mechanism information.

HSLVTMRS

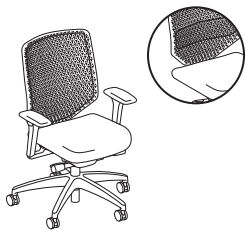

MID-BACK TASK IN DESIGNER WHITE

ReActiv® Back
Pneumatic
Swivel
Synchro-tilt
Tilt Tension
Tilt Lock

DIMENSIONS

Seat Depth: 19¼ Arm Width: 17½-20
Seat Width: 19 Cube: 10.8
Back Width: 18¼ Weight Rating: 300 lbs.
Back Height: 21½

FABRIC PRICE CODES

1	\$539	8	\$608
2	\$551	9	\$617
3	\$563	10	\$626
4	\$572	11	\$635
5	\$581	12	\$644
6	\$590	L	\$639
7	\$599		

OPEN MARKET

NOTES: Please reference pages 448-449 for additional specifications and mechanism information.

HON Recommendation: HSLVTMR.Y1.A.H.OS.CU__NL.SB.T - List Price \$644

HOW TO SPECIFY

Select Model Number	Select Control Type	Select Arm Type	Select Caster/Glide	Select Back Color	Select Fabric	Select Lumbar	Select Base	Select Frame
HSLVTMR	Y0 Synchro-Tilt Y1 Synchro-Tilt w/ Seat Slider (+ \$20) Y2 Advanced Synchro-Tilt (+ \$65)	HSLVTMR Options N Armless F Fixed Arms (+ \$65) A Height and Width Adjustable Arms (+ \$85) V All-Adjustable Arms (includes pivot) (+ \$130) HSLVTMRS Options ADW Height and Width Adjustable Arms (+ \$85) <i>Available for model HSLVTMRS only</i>	H Black Hard Caster S Black All-Surface Caster (+ \$40) G Bell Glide (+ \$25) R Black Roll Control Caster (+ \$50)	OS Charcoal TI Titanium DW Designer White	See page 449	NL No Lumbar BL Black Adjustable Lumbar (+ \$30) BY Bullseye Adjustable Lumbar (+ \$30) DW Designer White Adjustable Lumbar (+ \$30) KT Krypton Adjustable Lumbar (+ \$30) MR Ember Adjustable Lumbar (+ \$30) RE Regatta Adjustable Lumbar (+ \$30) TL Titanium Adjustable Lumbar (+ \$30)	SB Standard Base	HSLVTMR Options T Black TI Titanium (+ \$35) HSLVTMRS Options DW Designer White (+ \$35) <i>Available for model HSLVTMRS only</i>
H S L V T M R .	Y 1 .	A .	H .	O S .	C U 1 0 .	N L .	S B .	T



Icon Legend on page 17

HSLVSMR



STOOL

ReActiv[®] Back
Pneumatic
Swivel
Synchro-tilt
Tilt Tension
Tilt Lock

DIMENSIONS

Seat Depth: 19¼ Arm Width: 17½-20
Seat Width: 19 Cube: 10.8
Back Width: 18¼ Weight Rating: 300 lbs.
Back Height: 21½

FABRIC PRICE CODES

1	\$599	8	\$668
2	\$611	9	\$677
3	\$623	10	\$686
4	\$632	11	\$695
5	\$641	12	\$704
6	\$650	L	\$699
7	\$659		

NOTES: Please reference pages 448-449 for additional specifications and mechanism information.

HSLVSMRS



STOOL IN DESIGNER WHITE

ReActiv[®] Back
Pneumatic
Swivel
Synchro-tilt
Tilt Tension
Tilt Lock

DIMENSIONS

Seat Depth: 19¼ Arm Width: 17½-20
Seat Width: 19 Cube: 10.8
Back Width: 18¼ Weight Rating: 300 lbs.
Back Height: 21½

FABRIC PRICE CODES

1	\$599	8	\$668
2	\$611	9	\$677
3	\$623	10	\$686
4	\$632	11	\$695
5	\$641	12	\$704
6	\$650	L	\$699
7	\$659		

NOTES: Please reference pages 448-449 for additional specifications and mechanism information.

OPEN MARKET

HON Recommendation: HSLVSMR.Y1.A.H.OS.CU__NL.SB.T - List Price \$704

HOW TO SPECIFY

Select Model Number	Select Control Type	Select Arm Type	Select Caster/Glide	Select Back Color	Select Fabric	Select Lumbar	Select Base	Select Frame
Y1	Synchro-Tilt w/ Seat Slider (+ \$20)	HSLVSMR Options N Armless F Fixed Arms (+ \$65) A Height and Width Adjustable Arms (+ \$85) V All-Adjustable Arms (includes pivot) (+ \$130) HSLVSMRS Options ADW Height and Width Adjustable Arms (+ \$85) <i>Available for model HSLVSMRS only</i>	H Black Hard Caster S Black All-Surface Caster (+ \$40) G Bell Glide (+ \$25) R Black Roll Control Caster (+ \$50)	OS Charcoal TI Titanium DW Designer White	See page 449	NL No Lumbar BL Black Adjustable Lumbar (+ \$30) BY Bullseye Adjustable Lumbar (+ \$30) DW Designer White Adjustable Lumbar (+ \$30) KT Krypton Adjustable Lumbar (+ \$30) MR Ember Adjustable Lumbar (+ \$30) RE Regatta Adjustable Lumbar (+ \$30) TL Titanium Adjustable Lumbar (+ \$30)	SB Standard Base	T Black TI Titanium (+ \$35 for HSLVSMR; + \$55 for HSLVSMRS) DWX Designer White (+ \$55; available on HSLVSMRS only)
H S L V S M R	Y 1	A	H	O S	C U 1 0	N L	S B	T

SEATING



HSLVTMU

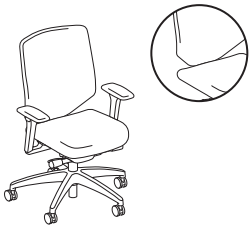

MID-BACK TASK

Upholstered Back
Pneumatic
Swivel
Synchro-tilt
Tilt Tension
Tilt Lock

DIMENSIONS

Seat Depth: 19¼ Arm Width: 17½-20
Seat Width: 19 Cube: 10.8
Back Width: 18¼ Weight Rating: 300 lbs.
Back Height: 21½

FABRIC PRICE CODES

1	\$554	8	\$623
2	\$566	9	\$632
3	\$578	10	\$641
4	\$587	11	\$650
5	\$596	12	\$659
6	\$605	L	\$654
7	\$614		

NOTES: Please reference pages 448-449 for additional specifications and mechanism information.

HSLVTMUS

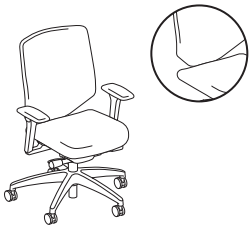

MID-BACK TASK IN DESIGNER WHITE

Upholstered Back
Pneumatic
Swivel
Synchro-tilt
Tilt Tension
Tilt Lock

DIMENSIONS

Seat Depth: 19¼ Arm Width: 17½-20
Seat Width: 19 Cube: 10.8
Back Width: 18¼ Weight Rating: 300 lbs.
Back Height: 21½

FABRIC PRICE CODES

1	\$554	8	\$623
2	\$566	9	\$632
3	\$578	10	\$641
4	\$587	11	\$650
5	\$596	12	\$659
6	\$605	L	\$654
7	\$614		

OPEN MARKET

NOTES: Please reference pages 448-449 for additional specifications and mechanism information.

HON Recommendation: HSLVTMU.Y1.A.H.OS.COMF10.COMP10.NL.SB.T - List Price \$659

HOW TO SPECIFY

Select Model Number	Select Control Type	Select Arm Type	Select Caster/Glide	Select Back Color	Select Back Fabric	Select Seat Fabric	Select Lumbar	Select Base	Select Frame
	Y0 Synchro-Tilt Y1 Synchro-Tilt w/ Seat Slider (+ \$20) Y2 Advanced Synchro-Tilt (+ \$65)	HSLVTMU Options N Armless F Fixed Arms (+ \$65) A Height and Width Adjustable Arms (+ \$85) V All-Adjustable Arms (includes pivot) (+ \$130)	H Black Hard Caster S Black All-Surface Caster (+ \$40) G Bell Glide (+ \$25) R Black Roll Control Caster (+ \$50)	OS Charcoal TI Titanium DW Designer White	COMF46 Bittersweet COMF10 Ink COMF82 Meadow COMF90 Midnight COMF22 Putty COMF19 Sterling	See page 449	NL No Lumbar BL Black Adjustable Lumbar (+ \$30) BY Bullseye Adjustable Lumbar (+ \$30) DW Designer White Adjustable Lumbar (+ \$30) KT Krypton Adjustable Lumbar (+ \$30) MR Ember Adjustable Lumbar (+ \$30) RE Regatta Adjustable Lumbar (+ \$30) TL Titanium Adjustable Lumbar (+ \$30)	SB Standard Base	HSLVTMU Options T Black TI Titanium (+ \$35) HSLVTMUS Options DW Designer White (+ \$35) Available for model HSLVTMUS only
HSLVTMU	Y1	A	H	OS	COMF10	COMP10	NL	SB	T

SEATING



Icon Legend on page 17

HSLVSMU

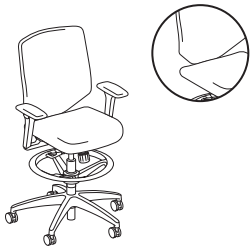

STOOL

Upholstered Back
 Pneumatic
 Swivel
 Synchro-tilt
 Tilt Tension
 Tilt Lock

DIMENSIONS

Seat Depth: 19¼ Arm Width: 17½-20
 Seat Width: 19 Cube: 10.8
 Back Width: 18¼ Weight Rating: 300 lbs.
 Back Height: 21½

FABRIC PRICE CODES

1	\$615	8	\$684
2	\$627	9	\$693
3	\$639	10	\$702
4	\$648	11	\$711
5	\$657	12	\$720
6	\$666	L	\$715
7	\$675		

NOTES: Please reference pages 448-449 for additional specifications and mechanism information.

HSLVSMUS



STOOL IN DESIGNER WHITE

Upholstered Back
 Pneumatic
 Swivel
 Synchro-tilt
 Tilt Tension
 Tilt Lock

DIMENSIONS

Seat Depth: 19¼ Arm Width: 17½-20
 Seat Width: 19 Cube: 10.8
 Back Width: 18¼ Weight Rating: 300 lbs.
 Back Height: 21½

FABRIC PRICE CODES

1	\$615	8	\$684
2	\$627	9	\$693
3	\$639	10	\$702
4	\$648	11	\$711
5	\$657	12	\$720
6	\$666	L	\$715
7	\$675		

OPEN MARKET

NOTES: Please reference pages 448-449 for additional specifications and mechanism information.

HON Recommendation: HSLVSMU.Y1.A.H.OS.COMF10.COMP10.NL.SB.T - List Price \$720

HOW TO SPECIFY

Select Model Number	Select Control Type	Select Arm Type	Select Caster/Glide	Select Back Color	Select Back Fabric	Select Seat Fabric	Select Lumbar	Select Base	Select Frame
Y0 Synchro-Tilt Y1 Synchro-Tilt w/ Seat Slider (+\$20)	HSLVSMU Options N Armless F Fixed Arms (+\$65) A Height and Width Adjustable Arms (+\$85) V All-Adjustable Arms (includes pivot) (+\$130) HSLVSMUS Options ADW Height and Width Adjustable Arms (+\$85) Available for model HSLVSMUS only	H Black OS Charcoal TI Titanium DW Designer White S Black All-Surface Caster (+\$40) G Bell Glide (+\$25) R Black Roll Control Caster (+\$50)	COMF46 Bittersweet COMF10 Ink COMF82 Meadow COMF90 Midnight COMF22 Putty COMF19 Sterling	See page 449	NL No Lumbar BL Black Adjustable Lumbar (+\$30) BY Bullseye Adjustable Lumbar (+\$30) DW Designer White Adjustable Lumbar (+\$30) KT Krypton Adjustable Lumbar (+\$30) MR Ember Adjustable Lumbar (+\$30) RE Regatta Adjustable Lumbar (+\$30) TL Titanium Adjustable Lumbar (+\$30)	SB Standard Base	T Black TI Titanium (+\$35 for HSLVSMU; +\$55 for HSLVSMUS) DWX Designer White (+\$55; available on HSLVSMUS only)		
HSLVSMU	Y1	A	H	OS	COMF10	COMP10	NL	SB	T

SEATING

HSLVTMMKD

MID-BACK TASK

DIMENSIONS

FABRIC PRICE CODES

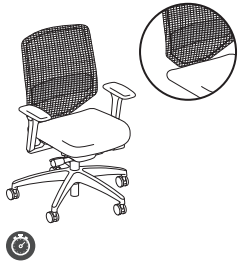

4-Way Stretch Back
Pneumatic
Swivel
Synchro-tilt
Tilt Tension
Tilt Lock

Seat Depth: 19¼ Arm Width: 17½-20
Seat Width: 19 Cube: 5.6
Back Width: 18¼ Weight Rating: 300 lbs.
Back Height: 21½

1 \$464
2 \$476
3 \$488

NOTES: Please reference pages 448-449 for additional specifications and mechanism information.

HSLVTMRKD

MID-BACK TASK

DIMENSIONS

FABRIC PRICE CODES

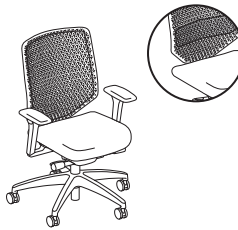

ReActiv® Back
Pneumatic
Swivel
Synchro-tilt
Tilt Tension
Tilt Lock

Seat Depth: 19¼ Arm Width: 17½-20
Seat Width: 19 Cube: 5.6
Back Width: 18¼ Weight Rating: 300 lbs.
Back Height: 21½

1 \$472
2 \$484
3 \$496

NOTES: Please reference pages 448-449 for additional specifications and mechanism information.

HSLVTMUKD

MID-BACK TASK

DIMENSIONS

FABRIC PRICE CODES

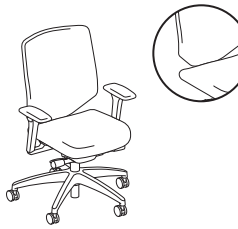

Upholstered Back
Pneumatic
Swivel
Synchro-tilt
Tilt Tension
Tilt Lock

Seat Depth: 19¼ Arm Width: 17½-20
Seat Width: 19 Cube: 5.6
Back Width: 18¼ Weight Rating: 300 lbs.
Back Height: 21½

1 \$514
2 \$526
3 \$538

NOTES: Please reference pages 448-449 for additional specifications and mechanism information.

HON Recommendation: HSLVTMMKD.Y1.A.H.IM.CU__BL.SB.T - List Price \$599

HOW TO SPECIFY

Select Model Number	Select Control Type	Select Arm Type	Select Caster	Select Mesh Back	Select Back Color	Select Back Fabric	Select Seat Fabric	Select Lumbar	Select Base	Select Frame
	Y1 Synchro-Tilt w/ Seat Slider (+ \$20)	A Height and Width Adjustable Arms (+ \$85)	H Black Hard Caster	4-Way Stretch options IM Black <i>Specify for model HSLVTMMKD only</i>	OS Charcoal TI Titanium <i>Specify for models HSLVTMRKD and HSLVTMUKD only</i>	COMF46 Bittersweet COMF10 Ink COMF82 Meadow COMF90 Midnight COMF22 Putty COMF19 Sterling <i>Specify for model HSLVTMUKD only</i>	See page 449	NL No Lumbar BL Black Adjustable Lumbar (+ \$30)	SB Standard Base	T Black
HSLVTMMKD	Y1	A	H	IM			CU10	BL	SB	T
HSLVTMRKD	Y1	A	H		OS		CU10	BL	SB	T
HSLVTMUKD	Y1	A	H		OS	COMF46	CU10	BL	SB	T



HSLVLMBR

LUMBAR PACK

DIMENSIONS

LIST PRICE

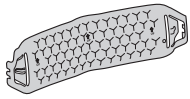

Ship Weight: 1
Cube: 0.2

\$36

HOW TO SPECIFY

Select Model Number

Select Color

- BY** Bullseye Adjustable Lumbar
- DW** Designer White Adjustable Lumbar
- KT** Krypton Adjustable Lumbar
- MR** Ember Adjustable Lumbar
- RE** Regatta Adjustable Lumbar
- T** Black
- TI** Titanium

H S L V L M B R .

T

HSLVFAP

FIXED ARM PACK

DIMENSIONS

LIST PRICE



Ship Weight: 6
Cube: 1.0

\$120

HSLV2DAP

ADJUSTABLE ARM PACK

DIMENSIONS

LIST PRICE



Height and Width

Adjustable Arms Width: 17½-20
Height from Seat: 7¼-11¼
Ship Weight: 6
Cube: 1.0

\$130

HSLV4DAP

ALL-ADJUSTABLE ARM PACK

DIMENSIONS

LIST PRICE



Including Pivot

Ship Weight: 6
Cube: 1.0

\$176

HSCASTER

SET OF 5 ALL-SURFACE CASTERS

DIMENSIONS

LIST PRICE

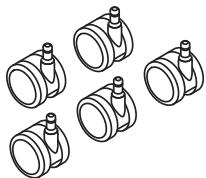

Size: 60mm
Ship Weight: 2
Cube: 0.1

\$59

ⓘ Available in Black finish only, no specification needed.

HOW TO SPECIFY

Select Model Number

Select Color

- T** Black
- TI** Titanium
- DW** Designer White (available on HSLV2DAP only)

H S L V 2 D A P .

T



Soothe Guest
Chairs and Tables.

SOOTHE®

Soothe offers the comfort and versatility to support a variety of healthcare and waiting environments. This family of patient and guest seats are constructed from durable materials and thoughtfully designed to be easily cleaned. The entire collection maximizes comfort along the patient's journey to recovery, enhances functionality for the caregiver, and creates the versatility required to deliver a higher level of care. Soothe simply helps create happier patients and better caregivers.



FEATURES

- Select Charcoal Urethane or solid hardwood arms in one of eight finishes.
- Wipeout space at the back of the seat allows for easy maintenance.
- Model HHCP1 has a responsive design back that moves with the patient for added comfort.
- Bench seating is available in two-seat or three-seat options.
- Choose Textured Charcoal or Textured Satin Chrome frame.
- Multi-fabric option offers endless color combinations.
- Chairs can be ganged together to create straight rows.
- Warranted for users up to 350 lbs. (Model HHCG50 bariatric chair warranted for 750 lbs.)

MODEL OPTIONS

HHCG11
HHCG11DF - Multi-Fabric



Guest Chair

HHCG21
HHCG21DF - Multi-Fabric

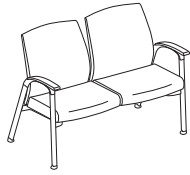

Two-Seat Chair

HHCG50
HHCG50DF - Multi-Fabric

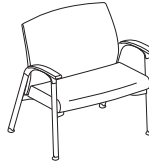

Bariatric Chair

HHCP1
HHCP1DF - Multi-Fabric



High-Back Patient Chair

HHCGB21

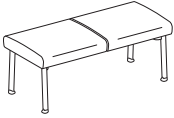

Two-Seat Bench

HHCGB31

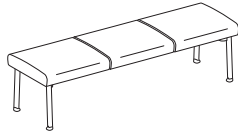

Three-Seat Bench

SOOTHE[®] Options

ARM CAP FINISH

CODE	DESCRIPTION	PRICE
S	Charcoal Urethane	+\$0
H	Bourbon Cherry	+\$100
F	Shaker Cherry	+\$100
C	Harvest	+\$100
D	Natural Maple	+\$100
N	Mahogany	+\$100
MOCH	Mocha	+\$100
COGN	Cognac	+\$100
PINC	Pinnacle	+\$100
LKI1	Kingswood Walnut	+\$100
LFW1	Florence Walnut	+\$100
LSA1	Sterling Ash	+\$100

FRAME

CODE	DESCRIPTION	PRICE
GRADE P1		
P6P	Textured Black Mica	+\$0
PK7	Textured Designer White	+\$0
P7A	Textured Charcoal	+\$0
P7J	Textured Brownstone	+\$0
P7L	Textured Loft	+\$0
P7M	Textured Muslin	+\$0
P8V	Textured Titanium	+\$0
GRADE P2		
PR8	Textured Silver	+\$0

HON BRANDED FABRICS

GRADE 1

Apex
Attire
Centurion
Compass
Contourett
Dapper
Ensemble
Hamilton
Inertia
Optic
Pebble

GRADE 2

Appoint Seating
Blume
Clyde
Dotty
Rush
Seed
Spin Seating
Whisper Vinyl

GRADE 3

In Season
Moxie
Parker
Purl
Quill

For a complete list of fabrics, including partnership fabrics, go to hon.com/fabricsandfinishes.

Reference Fabric Color Combinations on pages 18-22 for color codes and legend on page 19 for lead times. For Fire Code and Moisture Barrier model availability and ordering method, refer to pages 216. For additional HON to Supply COM fabric grade pricing, go to honready.hon.com and click on the HON to Supply COM link.

MULTI-FABRIC COM YARDAGE

Due to fabric pattern nesting and potential reduction of fabric yield, some multi-fabric models may require more total yardage than standard models.

	SEAT	BACK
HHCG11DF	1.4 yd	1.5 yd
HHCG21DF	1.7 yd	2.3 yd
HHCG50DF	1.4 yd	2.3 yd
HHCP1DF	1.4 yd	1.9 yd

SOOTHE[®]

Table Finish Options

AVAILABLE FINISHES

Soothe[®] Tables are available in 14 laminate colors. Each laminate has a specific selection of edges available.

LAMINATE TOP COLORS	EDGE BAND COLORS
Designer White (LDW1)	Designer White (DW)
Charcoal (S)	Charcoal (S)
Silver Mesh (B9)	Loft (LOFT)
Bourbon Cherry (H)	Bourbon Cherry (H), Muslin (T), White (DW)
Mahogany (N)	Mahogany (N), Loft (LOFT)
Natural Maple (D)	Natural Maple (D), Muslin (T), White (DW), Loft (LOFT)
Shaker Cherry (F)	Shaker Cherry (F), Muslin (T), White (DW), Loft (LOFT)
Harvest (C)	Harvest (C), Muslin (T), White (DW), Loft (LOFT)
Cognac (COGN)	Cognac (COGN), Muslin (T), White (DW)
Mocha (MOCH)	Mocha (MOCH), Muslin (T), White (DW), Loft (LOFT)
Pinnacle (PINC)	Pinnacle (PINC), Muslin (T), White (DW), Loft (LOFT)
Florence Walnut (LFW1)	Florence Walnut (FW)
Kingswood Walnut (LK11)	Kingswood Walnut (KI)
Sterling Ash (LSA1)	Sterling Ash (SA)



HHCG11

GUEST CHAIR



DIMENSIONS

Depth:	27	Arm Width:	20½
Width:	25½	Seat to Floor Height:	18⅝
Height:	35	Usable Seat Depth:	18
Seat Depth:	18	Ship Weight:	55
Seat Width:	21½	Cube:	14.9
Back Width:	21	COM:	2.0
Back Height:	20½	Weight Rating:	350 lbs.

FABRIC PRICE CODES

1	\$1139	8	\$1415
2	\$1139	9	\$1451
3	\$1235	10	\$1487
4	\$1271	11	\$1523
5	\$1307	12	\$1559
6	\$1343	L	—
7	\$1379		

HHCG21

TWO-SEAT CHAIR

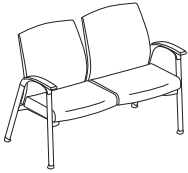

Outside Arms

DIMENSIONS

Depth:	27	Arm Width:	42¾
Width:	48	Seat to Floor Height:	18⅝
Height:	35	Usable Seat Depth:	18
Each Seat Depth:	18	Ship Weight:	109
Each Seat Width:	21½	Cube:	33.8
Each Back Width:	21	COM:	3.4
Each Back Height:	20¼	Weight Rating:	350 lbs.

FABRIC PRICE CODES

1	\$1882	8	\$2365
2	\$1966	9	\$2428
3	\$2050	10	\$2491
4	\$2113	11	\$2554
5	\$2176	12	\$2617
6	\$2239	L	—
7	\$2302		

HHCG50

BARIATRIC CHAIR



DIMENSIONS

Depth:	26	Arm Width:	29½
Width:	34½	Seat to Floor Height:	18⅝
Height:	35	Usable Seat Depth:	18
Seat Depth:	18	Ship Weight:	80
Seat Width:	30½	Cube:	25.1
Back Width:	30	COM:	3.0
Back Height:	20½	Weight Rating:	750 lbs.

FABRIC PRICE CODES

1	\$1429	8	\$1912
2	\$1513	9	\$1975
3	\$1597	10	\$2038
4	\$1660	11	\$2101
5	\$1723	12	\$2164
6	\$1786	L	—
7	\$1849		

! HHCG50 is a Single Seat Bariatric chair warranted to 750 lbs.

HHCP1

HIGH-BACK PATIENT CHAIR

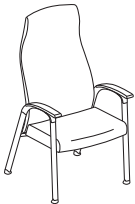

DIMENSIONS

Depth:	27	Arm Width:	20½
Width:	25½	Seat to Floor Height:	18⅝
Height:	46½	Usable Seat Depth:	18
Seat Depth:	18	Ship Weight:	61
Seat Width:	21½	Cube:	19.1
Back Width:	21	COM:	2.4
Back Height:	32	Weight Rating:	350 lbs.

FABRIC PRICE CODES

1	\$1269	8	\$1752
2	\$1353	9	\$1815
3	\$1437	10	\$1878
4	\$1500	11	\$1941
5	\$1563	12	\$2004
6	\$1626	L	—
7	\$1689		

! Only available in Moxie and In Season under HON's Standard Fabric. Healthcare Grade Partnership Fabrics are available. For a complete list, please visit the Fabrics and Finishes page at HON.com.

OPEN MARKET

HOW TO SPECIFY

Select Model Number HHCG11	Select Arm Cap Finish S Charcoal Urethane H Bourbon Cherry (+ \$100) F Shaker Cherry (+ \$100) C Harvest (+ \$100) D Natural Maple (+ \$100) N Mahogany (+ \$100) MOCH Mocha (+ \$100) COGN Cognac (+ \$100) PINC Pinnacle (+ \$100) LK11 Kingswood Walnut (+ \$100) LFW1 Florence Walnut (+ \$100) LSA1 Sterling Ash (+ \$100)	Select Fabric See page 460 A190	Select Frame See page 460 PR8
--	--	--	--



SOOTHE® Multi-Fabric

HHCG11DF



GUEST CHAIR

Multi-Fabric

DIMENSIONS

Depth:	27	Arm Width:	20½
Width:	25½	Seat to Floor Height:	18⅞
Height:	35	Usable Seat Depth:	18
Seat Depth:	18	Ship Weight:	55
Seat Width:	21½	Cube:	14.9
Back Width:	21	COM:	See page 460
Back Height:	20½	Weight Rating:	350 lbs.

FABRIC PRICE CODES

1	\$1228	
<i>Add to Base Price Above</i>		
	Back	Seat
2	\$24	\$24
3	\$48	\$48
4	\$66	\$66
5	\$84	\$84
6	\$102	\$102
7	\$120	\$120
8	\$138	\$138
9	\$156	\$156
10	\$174	\$174
11	\$192	\$192
12	\$210	\$210

NOTES: For multi-fabric models, start with the base price, then add the additional amount for the back and seat from the corresponding matrix to determine final price. Choose any combination of fabric grades for back and seat. See examples below:
HHCG11DF base price (\$1228) + Grade 2 back fabric (add \$24) + Grade 4 seat fabric (add \$66) = Total \$1318 List

HHCG21DF

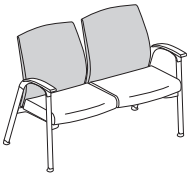

TWO-SEAT CHAIR

Multi-Fabric
Outside Arms

DIMENSIONS

Depth:	27	Arm Width:	42¾
Width:	48	Seat to Floor Height:	18⅞
Height:	35	Usable Seat Depth:	18
Each Seat Depth:	18	Ship Weight:	109
Each Seat Width:	21½	Cube:	33.8
Each Back Width:	21	COM:	See page 460
Each Back Height:	20¼	Weight Rating:	350 lbs.

FABRIC PRICE CODES

1	\$1971	
<i>Add to Base Price Above</i>		
	Back	Seat
2	\$48	\$36
3	\$96	\$72
4	\$132	\$99
5	\$168	\$126
6	\$203	\$154
7	\$239	\$181
8	\$275	\$208
9	\$311	\$235
10	\$347	\$262
11	\$383	\$289
12	\$419	\$316

NOTES: For multi-fabric models, start with the base price, then add the additional amount for the back and seat from the corresponding matrix to determine final price. Choose any combination of fabric grades for back and seat. See examples below:
HHCG21DF base price (\$1971) + Grade 2 back fabric (add \$48) + Grade 4 seat fabric (add \$99) = Total \$2118 List

HOW TO SPECIFY

Select Model Number H H C G 1 1 D F	Select Arm Cap Finish S Charcoal Urethane H Bourbon Cherry (+ \$100) F Shaker Cherry (+ \$100) C Harvest (+ \$100) D Natural Maple (+ \$100) N Mahogany (+ \$100) MOCH Mocha (+ \$100) COGN Cognac (+ \$100) PINC Pinnacle (+ \$100) LK11 Kingswood Walnut (+ \$100) LFW1 Florence Walnut (+ \$100) LSA1 Sterling Ash (+ \$100)	Select Back Fabric See page 460 A I 9 0	Select Seat Fabric See page 460 R S 1 4	Select Frame See page 460 P R 8
---	--	--	--	--

SEATING

SOOTHE[®] Multi-Fabric

GSA SIN AS NOTED



Icon Legend on page 17

HHCG50DF

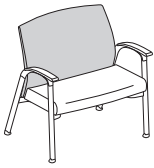

SIN 33721

BARIATRIC CHAIR

Multi-Fabric

DIMENSIONS

Depth:	26	Arm Width:	29½
Width:	34½	Seat to Floor Height:	18⅝
Height:	35	Usable Seat Depth:	18
Seat Depth:	18	Ship Weight:	80
Seat Width:	30½	Cube:	25.1
Back Width:	30	COM:	See page 460
Back Height:	20½	Weight Rating:	750 lbs.

FABRIC PRICE CODES

1	\$1518	
<i>Add to Base Price Above</i>		
	Back	Seat
2	\$48	\$36
3	\$96	\$72
4	\$132	\$99
5	\$168	\$126
6	\$203	\$154
7	\$239	\$181
8	\$275	\$208
9	\$311	\$235
10	\$347	\$262
11	\$383	\$289
12	\$419	\$316

NOTES: For multi-fabric models, start with the base price, then add the additional amount for the back and seat from the corresponding matrix to determine final price. Choose any combination of fabric grades for back and seat. See examples below:

HHCG50DF base price (\$1518) + Grade 2 back fabric (add \$48) + Grade 4 seat fabric (add \$99) = Total \$1665 List

❗ HHCG50DF is a Single Seat Bariatric chair warranted to 750 lbs.

HHCP1DF

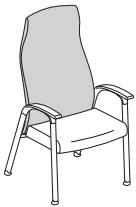

OPEN MARKET

HIGH-BACK PATIENT CHAIR

Multi-Fabric

DIMENSIONS

Depth:	27	Arm Width:	20½
Width:	25½	Seat to Floor Height:	18⅝
Height:	46½	Usable Seat Depth:	18
Seat Depth:	18	Ship Weight:	61
Seat Width:	21½	Cube:	19.1
Back Width:	21	COM:	See page 460
Back Height:	32	Weight Rating:	350 lbs.

FABRIC PRICE CODES

1	\$1357	
<i>Add to Base Price Above</i>		
	Back	Seat
2	\$60	\$24
3	\$119	\$49
4	\$164	\$67
5	\$209	\$85
6	\$253	\$104
7	\$298	\$122
8	\$343	\$140
9	\$388	\$158
10	\$432	\$177
11	\$477	\$195
12	\$522	\$213

NOTES: For multi-fabric models, start with the base price, then add the additional amount for the back and seat from the corresponding matrix to determine final price. Choose any combination of fabric grades for back and seat. See examples below:

HHCP1DF base price (\$1357) + Grade 2 back fabric (add \$60) + Grade 4 seat fabric (add \$67) = Total \$1484 List

❗ Only available in Moxie and In Season under HON's Standard Fabric. Healthcare Grade Partnership Fabrics are available. For a complete list, please visit the Fabrics and Finishes page at HON.com.

SEATING

HOW TO SPECIFY

Select Model Number	Select Arm Cap Finish	Select Back Fabric	Select Seat Fabric	Select Frame
	S Charcoal Urethane H Bourbon Cherry (+ \$100) F Shaker Cherry (+ \$100) C Harvest (+ \$100) D Natural Maple (+ \$100) N Mahogany (+ \$100) MOCH Mocha (+ \$100) COGN Cognac (+ \$100) PINC Pinnacle (+ \$100) LKI1 Kingswood Walnut (+ \$100) LFW1 Florence Walnut (+ \$100) LSA1 Sterling Ash (+ \$100)	See page 460	See page 460	See page 460
HHCG50DF	S	A190	RS14	PR8



HHCGB21

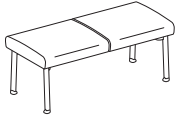

TWO-SEAT BENCH

DIMENSIONS

Depth:	20½	Seat to Floor Height:	17¾
Width:	44	Usable Seat Depth:	17¼
Height:	18¾	Ship Weight:	55
Seat Width:	22	Cube:	18.4
		COM:	1.9
		Weight Rating:	350 lbs.

FABRIC PRICE CODES

1	\$1365	8	\$1572
2	\$1401	9	\$1599
3	\$1437	10	\$1626
4	\$1464	11	\$1653
5	\$1491	12	\$1680
6	\$1518	L	—
7	\$1545		

ⓘ Benches cannot be ganged.

HHCGB31

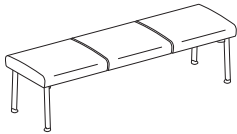

THREE-SEAT BENCH

DIMENSIONS

Depth:	20½	Seat to Floor Height:	17¾
Width:	66	Usable Seat Depth:	17¼
Height:	18¾	Ship Weight:	69
Seat Width:	22	Cube:	25.7
		COM:	2.6
		Weight Rating:	350 lbs.

FABRIC PRICE CODES

1	\$1756	8	\$1963
2	\$1792	9	\$1990
3	\$1828	10	\$2017
4	\$1855	11	\$2044
5	\$1882	12	\$2071
6	\$1909	L	—
7	\$1936		

ⓘ Benches cannot be ganged.

HOW TO SPECIFY

Select Model Number

HHCGB21

Select Fabric

See page 460

RS14

Select Frame

See page 460

PR8

HHCTS



IN-LINE TABLE TOP

DIMENSIONS

Depth:	22	Ship Weight:	8
Width:	16	Cube:	1.7
Height:	1½		

LIST PRICE

\$385

NOTES: Can be ganged between two chairs or freestanding.

HHCTC



90-DEGREE RADIUS CORNER TABLE TOP

DIMENSIONS

Depth:	29	Ship Weight:	15
Width:	29	Cube:	2.4
Height:	1½		

LIST PRICE

\$483

! Freestanding only.

HHCTRT



RECTANGLE TABLE TOP

DIMENSIONS

Depth:	22	Ship Weight:	20
Width:	40	Cube:	2.7
Height:	1½		

LIST PRICE

\$642

! Freestanding only.

HHCTL4

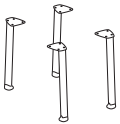

TABLE LEGS

Set of 4

DIMENSIONS

Ship Weight:	8
Cube:	0.4

LIST PRICE

\$260

NOTES: Can be attached to any of the table tops above to create a freestanding table.

HOW TO SPECIFY

<p>Select Model Number</p>	<p>Select Laminate and Edge</p> <p>See page 461</p>											
<table border="1" style="border-collapse: collapse;"> <tr> <td style="padding: 2px 5px;">H</td> <td style="padding: 2px 5px;">H</td> <td style="padding: 2px 5px;">C</td> <td style="padding: 2px 5px;">T</td> <td style="padding: 2px 5px;">S</td> <td style="padding: 2px 5px;">.</td> </tr> </table>	H	H	C	T	S	.	<table border="1" style="border-collapse: collapse;"> <tr> <td style="padding: 2px 5px;">D</td> <td style="padding: 2px 5px;">W</td> <td style="padding: 2px 5px;">H</td> <td style="padding: 2px 5px;">I</td> <td style="padding: 2px 5px;">T</td> </tr> </table>	D	W	H	I	T
H	H	C	T	S	.							
D	W	H	I	T								

HOW TO SPECIFY

<p>Select Model Number</p>	<p>Select Frame Color</p> <p>See page 460</p>										
<table border="1" style="border-collapse: collapse;"> <tr> <td style="padding: 2px 5px;">H</td> <td style="padding: 2px 5px;">H</td> <td style="padding: 2px 5px;">C</td> <td style="padding: 2px 5px;">T</td> <td style="padding: 2px 5px;">L</td> <td style="padding: 2px 5px;">4</td> <td style="padding: 2px 5px;">.</td> </tr> </table>	H	H	C	T	L	4	.	<table border="1" style="border-collapse: collapse;"> <tr> <td style="padding: 2px 5px;">P</td> <td style="padding: 2px 5px;">R</td> <td style="padding: 2px 5px;">8</td> </tr> </table>	P	R	8
H	H	C	T	L	4	.					
P	R	8									



HHCGBRCH

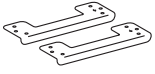

GANGING BRACKET

DIMENSIONS

Ship Weight: 2
Cube: 0.2

LIST PRICE

\$87

NOTES: For chair to chair connection. Does not connect a bench to other type of seating. Ganging brackets can be used with the seating models on pages 462-464. Bench models do not gang. Brackets are Charcoal only.

HHCGBR

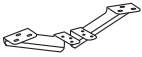

GANGING BRACKET

DIMENSIONS

Ship Weight: 5
Cube: 0.2

LIST PRICE

\$129

NOTES: For chair to table connection. Ganging brackets can be used with the seating models on pages 462-464. Bench models do not gang. Brackets are Charcoal only.

HOW TO SPECIFY

Select
Model Number

HHCGBRCH

TOPFLIGHT™ Wood Seating

OPEN MARKET



Icon Legend on page 17

HVL844



HIGH-BACK

Pneumatic
Swivel
Tilt
Tilt Tension
Tilt Lock
Fixed Padded Wood Arms and Base

Functions: **A, E, F, K, L**
(Function Key on pages 212-213)

DIMENSIONS

Depth:	30	Arm Width:	20¼
Width:	28	Seat to Floor Height:	17 ³ / ₁₆ -21 ¹ / ₁₆
Height:	47 ⁵ / ₁₆	Usable Seat Depth:	17½
Seat Depth:	18½	Ship Weight:	58
Seat Width:	20½	Cube:	6.4
Back Width:	20½	Weight Rating:	250 lbs.
Back Height:	27½		

PRICE CODE

Leather **\$762**

NOTES: Wood accents available in Mahogany. High-back design. Black Bonded Leather. Tailored padded back design provides strong lumbar support. Fixed padded loop arms. Use with coordinated Guest Chair models HVL852 and HVL853 shown below. **HON 5-Year Limited Warranty.**

HON Recommendation: HVL844.N.SB11 - List Price \$762

HVL852



GUEST CHAIR

Leg Base
Arms
Upholstered Back
Wood Frame

DIMENSIONS

Depth:	22	Arm Width:	20
Width:	22½	Seat to Floor Height:	18½
Height:	31	Usable Seat Depth:	17
Seat Depth:	17	Ship Weight:	26
Seat Width:	20	Cube:	3.4
Back Width:	20	Weight Rating:	250 lbs.
Back Height:	13		

PRICE CODE

Leather **\$481**

NOTES: Wood frames available in Mahogany. Black Bonded Leather inset in back and on seat. Easier assembly – seat now attached to frame. **HON 5-Year Limited Warranty.**

HON Recommendation: HVL852.N.SB11 - List Price \$481

HVL853

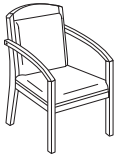

GUEST CHAIR

Leg Base
Arms
Upholstered Back
Wood Frame

DIMENSIONS

Depth:	23¾	Arm Width:	20¼
Width:	23¾	Seat to Floor Height:	19½
Height:	36¾	Usable Seat Depth:	18¼
Seat Depth:	18¼	Ship Weight:	35
Seat Width:	22	Cube:	6.9
Back Width:	18½	Weight Rating:	250 lbs.
Back Height:	15¼		

PRICE CODE

Leather **\$582**

NOTES: Wood frames available in Mahogany. Black Bonded Leather on fully-upholstered back panel and on seat. High-back design. **HON 5-Year Limited Warranty.**

HON Recommendation: HVL853.N.SB11 - List Price \$582

SEATING

HOW TO SPECIFY

Select
Model Number

H V L 8 4 4 .

Select
Wood Finish

N Mahogany

N .

Select
Fabric

SB11 Black Bonded Leather

S B 1 1



TORCH™ Mesh Chairs

HVL511



MID-BACK

Pneumatic
Swivel
Tilt
Tilt Tension
Tilt Lock
Fixed Arms

Functions: **A, E, F, K, L**
(Function Key on pages 212-213)

DIMENSIONS

Depth:	26	Arm Width:	18¾
Width:	26	Seat to Floor Height:	16⅝-20⅝
Height:	40½	Usable Seat Depth:	18¾
Seat Depth:	18¼	Ship Weight:	30
Seat Width:	19½	Cube:	3.8
Back Width:	17¾	Weight Rating:	250 lbs.
Back Height:	21¾		

PRICE CODE

Fabric **\$318**

NOTES: Mid-back Mesh chair. Comfortable and breathable mesh back. Black fabric seat. Black frame. Fixed arms. **HON 5-Year Limited Warranty.**

HON Recommendation: HVL511.LH10 - List Price \$318

HVL515



TASK STOOL

Pneumatic
Swivel
Fixed Arms

Functions: **A, E**
(Function Key on pages 212-213)

DIMENSIONS

Depth:	26	Arm Width:	18¾
Width:	26	Seat to Floor Height:	23⅝-33
Height:	52	Usable Seat Depth:	18¾
Seat Depth:	18¼	Ship Weight:	38
Seat Width:	19½	Cube:	4.6
Back Width:	17¾	Weight Rating:	250 lbs.
Back Height:	21¾		

PRICE CODE

Fabric **\$445**

NOTES: Comfortable and breathable mesh back. Black fabric seat. Fixed arms. **HON 5-Year Limited Warranty.**

HON Recommendation: HVL515.LH10 - List Price \$445

HOW TO SPECIFY

Select Model Number	Select Fabric
	LH10 Black Fabric
H V L 5 1 1 .	L H 1 0

TRACTION™ Executive Chairs

OPEN MARKET



Icon Legend on page 17

HVL103



HIGH-BACK

Pneumatic
Swivel
Tilt
Tilt Tension
Tilt Lock
Fixed Padded Arms

Functions: **A, E, F, K, L**
(Function Key on pages 212-213)

DIMENSIONS

Depth:	28 ³ / ₄	Arm Width:	18 ⁷ / ₈
Width:	26 ³ / ₄	Seat to Floor Height:	17 ¹ / ₄ -21
Height:	42 ¹ / ₂	Usable Seat Depth:	18 ¹ / ₄
Seat Depth:	18 ¹ / ₄	Ship Weight:	36.0
Seat Width:	19 ¹ / ₂	Cube:	4.1
Back Width:	19 ¹ / ₂	Weight Rating:	250 lbs.
Back Height:	24 ⁷ / ₈		

PRICE CODE

Leather **\$512**

NOTES: Black Bonded Leather. Polished base. Fixed, padded arms. **HON 5-Year Limited Warranty.**

HON Recommendation: HVL103.SB11 - List Price \$512

HVL102



HIGH-BACK MODERN GUEST CHAIR

Padded Arms
Cantilever Base

DIMENSIONS

Depth:	27 ¹ / ₆₄	Arm Width:	18 ⁴⁵ / ₆₄
Width:	20 ⁵ / ₆₄	Seat to Floor Height:	18 ²⁹ / ₃₂
Height:	39 ³ / ₈	Usable Seat Depth:	18 ⁷ / ₆₄
Seat Depth:	18 ⁷ / ₆₄	Ship Weight:	36.8
Seat Width:	19 ¹ / ₁₆	Cube:	4.4
Back Width:	18 ²⁹ / ₃₂	Weight Rating:	250 lbs.
Back Height:	24 ³⁹ / ₆₄		

PRICE CODE

Leather **\$370**

NOTES: Black Bonded Leather. Polished, cantilever base. Polished, padded arms. **HON 5-Year Limited Warranty.**

HON Recommendation: HVL102.SB11 - List Price \$370

SEATING

HOW TO SPECIFY

Select
Model Number

H V L 1 0 3 .

Select
Fabric

SB11 Black Bonded Leather
Specify for models HVL102 and HVL103 only

S B 1 1



HVL604



HIGH-BACK

Pneumatic
Swivel
Tilt
Tilt Tension
Tilt Lock
Fixed Arms

Functions: **A, E, F, K, L, T**
(Function Key on pages 212-213)

DIMENSIONS

Depth:	26½	Arm Width:	20½
Width:	25	Seat to Floor Height:	16¼-20¾
Height:	46½	Usable Seat Depth:	18¾
Seat Depth:	18¾	Ship Weight:	40
Seat Width:	19¾	Cube:	4.1
Back Width:	20	Weight Rating:	250 lbs.
Back Height:	26½		

PRICE CODE

Leather \$314

NOTES: Available in Black Bonded Leather SB11. High-back Executive Chair. Black frame. Fixed, tapered loop arms. Coordinating guest chair HVL605. **HON 5-Year Limited Warranty.**

HON Recommendation: HVL604.SB11 - List Price \$314

HVL605



GUEST CHAIR

Leg Base
Arms
Stacks up to Four High

DIMENSIONS

Depth:	24	Arm Width:	19½
Width:	23½	Seat to Floor Height:	18½
Height:	34½	Usable Seat Depth:	17½
Seat Depth:	17½	Ship Weight:	22.2
Seat Width:	18½	Cube:	3.0
Back Width:	18½	Weight Rating:	250 lbs.
Back Height:	17¾		

PRICE CODE

Leather \$302

NOTES: Validate™ HVL605 Guest Chair. Waterfall seat edge. Wall-saver design. Fixed arms. Stackable up to 4-high. Contemporary rectilinear steel frame in Matte Black. Use with coordinating Executive Chair model HVL604. **HON 5-Year Limited Warranty.**

HON Recommendation: HVL605.SB11 - List Price \$302

HVL685



HIGH-BACK

Pneumatic
Swivel
Tilt Tension
Tilt Lock
Fixed Padded Arms

Functions: **A, E, K, L**
(Function Key on pages 212-213)

DIMENSIONS

Depth:	32	Back Height:	28½
Width:	27½	Seat to Floor Height:	18¾-21¾
Height:	45	Usable Seat Depth:	20
Seat Depth:	20	Ship Weight:	67
Seat Width:	22¼	Cube:	9.5
Back Width:	21	Weight Rating:	450 lbs.

PRICE CODE

Leather \$1014

NOTES: Large scale model HVL685 will support up to 450 lbs with normal use. Available in Black Bonded Leather SB11. **HON 5-Year Limited Warranty.**

HON Recommendation: HVL685.SB11 - List Price \$1014

HOW TO SPECIFY

Select Model Number	Select Fabric
	SB11 Black Bonded Leather
H V L 6 0 4 .	S B 1 1



VALUTASK®

HVL205



LOW-BACK

Pneumatic
Swivel
Tilt
Tilt Tension
Tilt Lock

DIMENSIONS

Depth:	23	Back Height:	18
Width:	23	Seat to Floor Height:	15¼-19¼
Height:	39½	Usable Seat Depth:	18
Seat Depth:	18	Ship Weight:	29
Seat Width:	19	Cube:	3.2
Back Width:	18	Weight Rating:	250 lbs.

PRICE CODE

Mesh **\$286**

NOTES: Comfortable and breathable mesh back. Black Sandwich Mesh seat. Black frame. **HON 5-Year Limited Warranty.**

HON Recommendation: HVL205.MM10.T - List Price \$286

HVL210



TASK LOW-BACK

Pneumatic
Swivel
Tilt
Tilt Tension
Tilt Lock

Functions: **A, E, F, K, L**
(Function Key on pages 212-213)

DIMENSIONS

Depth:	33½	Back Height:	20¼
Width:	24½	Seat to Floor Height:	17-20½
Height:	38¼	Usable Seat Depth:	17¾
Seat Depth:	17¾	Ship Weight:	31
Seat Width:	19¾	Cube:	3.6
Back Width:	19¾	Weight Rating:	250 lbs.

PRICE CODE

Sandwich Mesh **\$261**

NOTES: Black Sandwich Mesh. Sturdy textured black frame. HVL995 optional arm pack available. **HON 5-Year Limited Warranty.**

HON Recommendation: HVL210.MM10 - List Price \$261

HVL215

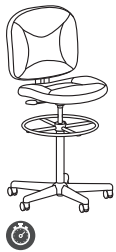

TASK STOOL

Pneumatic
Swivel
Functions: **A, E**
(Function Key on pages 212-213)

DIMENSIONS

Depth:	33½	Back Height:	19
Width:	24½	Seat to Floor Height:	24½-33½
Height:	51⅞	Usable Seat Depth:	17¾
Seat Depth:	17¾	Ship Weight:	37
Seat Width:	19¾	Cube:	5.7
Back Width:	19¾	Weight Rating:	250 lbs.

PRICE CODE

Sandwich Mesh **\$363**

NOTES: Black Sandwich Mesh. Sturdy textured black frame. HVL995 optional arm pack available. **HON 5-Year Limited Warranty.**

HON Recommendation: HVL215.MM10 - List Price \$363

HVL995

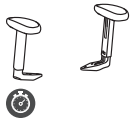

HEIGHT-ADJUSTABLE ARMS

Functions: **Q**
(Function Key on pages 212-213)

DIMENSIONS

Adjustable Arms Width:	18¾
Height from Seat:	8-11
Ship Weight:	7
Cube:	0.6

LIST PRICE

\$108

NOTES: Arm color is black. Height-adjustable. Compatible with HVL205, HVL210, and HVL215. **HON 5-Year Limited Warranty.**

HON Recommendation: HVL995 - List Price \$108

HOW TO SPECIFY

Select Model Number H V L 2 0 5	Select Fabric MM10 Black Sandwich Mesh Fabric M M 1 0	Select Frame T Black Specify frame color for model HVL205 only T
---	--	--

VERSANT® TANDEM

Want to see more? Scan here
to check out hon.com.



Versant® Tandem Seating and Laminate Occasional Tables.

VERSANT® TANDEM

Everyone deserves a break from time to time, and a comfy seat in which to enjoy one. Bring stylish support to your welcome areas, public spaces and breakrooms with Versant. With a combination of tandem seats and bariatric chairs, it's ideal for both healthcare environments and offices. Arched arms support the upper body and padded seats put people at ease for longer periods of time. Versant brings versatility to every corner of your space.



FEATURES

- Stylish arched arm offers greater upper body support.
- Seats are removable for easy cleaning and replacement.
- Contrasting covers are available as special order (please contact customer service).
- Solid hardwood in one of eight attractive finishes.
- Available in hundreds of quality HON fabrics.
- Warranted for users up to 350 lbs. (Model HHCB50 is warranted for users up to 500 lbs.)

VERSANT® Tandem Options

MODEL OPTIONS

HHB02



Two-Seat Bench

HHB03

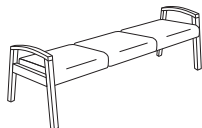

Three-Seat Bench

HHCT01



Single Seat

Leg Base, Arms

HHCT02

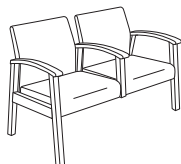

Two-Seat

Leg Base, Center Arm, Arms

HHCT12

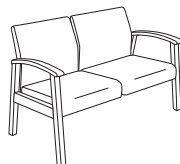

Two-Seat

Leg Base, Arms

HHCB50

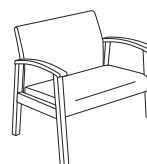

Bariatric Chair

Leg Base, Arms

AVAILABLE FINISHES

Versant® Tandem Seating is available in 8 wood finishes.

WOOD FINISHES

Bourbon Cherry (H)
Cognac (COGN)
Harvest (C)
Mahogany (N)
Mocha (MOCH)
Natural Maple (D)
Pinnacle (PINC)
Shaker Cherry (F)

AVAILABLE LAMINATES

Versant® Tandem Laminate Occasional Tables are available in 8 laminates.

LAMINATES

Bourbon Cherry (H)
Cognac (COGN)
Harvest (C)
Mahogany (N)
Mocha (MOCH)
Natural Maple (D)
Pinnacle (PINC)
Shaker Cherry (F)

HON BRANDED FABRICS

GRADE 1

Apex
Attire
Centurion
Contourett
Dapper
Ensemble
Hamilton
Inertia
Optic
Pebble

GRADE 2

Appoint Seating
Blume
Clyde
Dotty
Rush
Seed
Spin Seating
Whisper Vinyl

GRADE 3

In Season
Moxie
Parker
Purl
Quill

For a complete list of fabrics, including partnership fabrics, go to hon.com/fabricsandfinishes.

Reference Fabric Color Combinations on pages 18-22 for color codes and legend on page 19 for lead times. Contrasting covers on seat and back are available as special order. Please contact Customer Service. For additional HON to Supply COM fabric grade pricing, go to honready.hon.com and click on the HON to Supply COM link.



VERSANT® TANDEM

HHB02



TWO-SEAT BENCH

DIMENSIONS

Depth:	20 ³ / ₈	Seat to Floor Height:	19 ¹ / ₂
Width:	45 ¹ / ₂	Usable Seat Depth:	19 ³ / ₄
Height:	23	Ship Weight:	62
Each Seat Depth:	20 ³ / ₈	Cube:	16.2
Each Seat Width:	21 ¹ / ₂	COM:	2.0
Arm Width:	42 ¹ / ₂	Weight Rating:	350 lbs. (per seat)

FABRIC PRICE CODES

1	\$1845	8	\$2121
2	\$1893	9	\$2157
3	\$1941	10	\$2193
4	\$1977	11	\$2229
5	\$2013	12	\$2265
6	\$2049	L	\$2245
7	\$2085		

HHB03

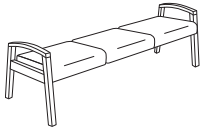

THREE-SEAT BENCH

DIMENSIONS

Depth:	20 ³ / ₈	Seat to Floor Height:	19 ¹ / ₂
Width:	66 ¹ / ₂	Usable Seat Depth:	19 ³ / ₄
Height:	23	Ship Weight:	80
Each Seat Depth:	20 ³ / ₈	Cube:	24.5
Each Seat Width:	21 ¹ / ₂	COM:	2.5
Arm Width:	63 ¹ / ₂	Weight Rating:	350 lbs. (per seat)

FABRIC PRICE CODES

1	\$2371	8	\$2716
2	\$2431	9	\$2761
3	\$2491	10	\$2806
4	\$2536	11	\$2851
5	\$2581	12	\$2896
6	\$2626	L	\$2871
7	\$2671		

HON Recommendation: HHB02.MOCH.SX__ - List Price \$1941

HOW TO SPECIFY

<p>Select Model Number</p> <p>HHB02</p>	<p>Select Finish</p> <p>See page 474</p> <p>MOCH</p>	<p>Select Seat Fabric</p> <p>See page 474</p> <p>SX05</p>
--	---	--

VERSANT® TANDEM

Laminate Occasional Tables

OPEN MARKET



Icon Legend on page 17

HHCT048

COFFEE TABLE

DIMENSIONS

Length: 48 Ship Weight: 44
 Width: 20 Cube: 3.0
 Height: 17

LIST PRICE

\$744

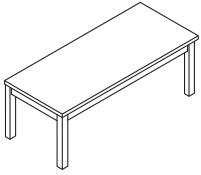

HHCT024

CORNER TABLE

DIMENSIONS

Length: 24 Ship Weight: 20
 Width: 24 Cube: 1.4
 Height: 17

LIST PRICE

\$623

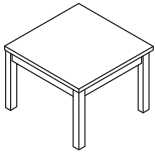

HHCT020

END TABLE

DIMENSIONS

Length: 24 Ship Weight: 22
 Width: 20 Cube: 1.4
 Height: 17

LIST PRICE

\$585

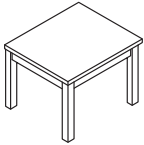

HON Recommendation: HHCT024.MOCH - List Price \$623

SEATING

HOW TO SPECIFY

Select Model Number

Select Laminate

See page 474

HHCT048

MOCH



Icon Legend on page 17

VERSANT® TANDEM

HHCT01



SINGLE SEAT

Leg Base
Arms

DIMENSIONS

Depth:	27	Arm Width:	20½
Width:	25	Seat to Floor Height:	18
Height:	34	Usable Seat Depth:	19¼
Seat Depth:	20¼	Ship Weight:	57
Seat Width:	21	Cube:	20.1
Back Width:	21	COM:	2.0
Back Height:	17	Weight Rating:	350 lbs.

FABRIC PRICE CODES

1	\$1407	8	\$1683
2	\$1455	9	\$1719
3	\$1503	10	\$1755
4	\$1539	11	\$1791
5	\$1575	12	\$1827
6	\$1611	L	\$1807
7	\$1647		

HHCT02

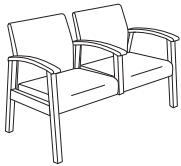

TWO-SEAT

Leg Base
Center Arm
Arms

DIMENSIONS

Depth:	27	Seat to Floor Height:	18
Width:	47½	Usable Seat Depth:	19¼
Height:	34	Ship Weight:	87
Each Seat Depth:	20¼	Cube:	33.7
Each Seat Width:	21	COM:	3.5
Each Back Width:	21	Weight Rating:	350 lbs.
Each Back Height:	17		(per seat)

FABRIC PRICE CODES

1	\$2455	8	\$2938
2	\$2539	9	\$3001
3	\$2623	10	\$3064
4	\$2686	11	\$3127
5	\$2749	12	\$3190
6	\$2812	L	\$3155
7	\$2875		

HHCT12

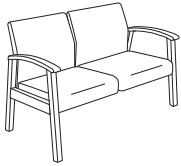

TWO-SEAT

Leg Base
Arms

DIMENSIONS

Depth:	27	Arm Width:	41½
Width:	46	Seat to Floor Height:	18
Height:	34	Usable Seat Depth:	19¼
Each Seat Depth:	20¼	Ship Weight:	87
Each Seat Width:	21	Cube:	33.0
Each Back Width:	21	COM:	3.5
Each Back Height:	17	Weight Rating:	350 lbs.
			(per seat)

FABRIC PRICE CODES

1	\$2349	8	\$2832
2	\$2433	9	\$2895
3	\$2517	10	\$2958
4	\$2580	11	\$3021
5	\$2643	12	\$3084
6	\$2706	L	\$3049
7	\$2769		

HHCB50

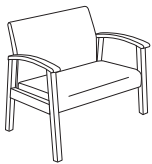

BARIATRIC SINGLE SEAT

Leg Base
Arms

DIMENSIONS

Depth:	27	Arm Width:	29
Width:	33½	Seat to Floor Height:	18
Height:	34	Usable Seat Depth:	19¼
Each Seat Depth:	20¼	Ship Weight:	80
Each Seat Width:	30	Cube:	29.0
Each Back Width:	30	COM:	3.0
Each Back Height:	17	Weight Rating:	500 lbs.

FABRIC PRICE CODES

1	\$2105	8	\$2519
2	\$2177	9	\$2573
3	\$2249	10	\$2627
4	\$2303	11	\$2681
5	\$2357	12	\$2735
6	\$2411	L	\$2705
7	\$2465		

HON Recommendation: HHCT01.MOCH.SX__ - List Price \$1503

HOW TO SPECIFY

<p>Select Model Number</p> <p>HHCT01</p>	<p>Select Finish</p> <p>MOCH</p> <p>See page 474</p>	<p>Select Seat Fabric</p> <p>SX05</p> <p>See page 474</p>
---	---	--



Volt® Task Chairs and Stools
shown with Voi® Desks.

VOLT®

Customizable comfort, distinctive styling and an affordable price point make Volt the family of task seating that supports your body and your budget. The stylish V-shaped back design can be specified in fabric, leather or breathable mesh, giving you more control over your look and feel. The personalized controls and generously proportioned seat and back deliver greater comfort, and are designed support to a wider variety of users. Volt delivers the look you desire, the comfort you demand, and the quality you expect. That's the power of practicality.



FEATURES

- Optional synchro-tilt control provides a smooth, natural recline.
- Optional height-adjustable arms provide a custom fit.
- Optional mesh back offers breathable support.
- Task stools feature an adjustable footring for additional lower body support.
- One-touch seat height adjustment easily moves the seat up and down.
- Tilt tension controls the rate and ease of recline.
- Tilt lock allows the user to lock out the tilt function.
- 360-degree swivel provides freedom of movement in any direction.
- Select models available in hundreds of quality HON fabrics.
- Warranted for users up to 275 lbs.

VOLT® 5700/5710 Series Options

MODEL OPTIONS

H5701



Task Chair

Pneumatic, Swivel, Tilt, Tilt Tension, Tilt Lock

H5703



Task Chair

Pneumatic, Swivel, Synchro-tilt, Tilt Tension, Tilt Lock

H5705



Task Stool

Pneumatic, Swivel, Adjustable Footring

H5711



Task Chair (Mesh Back)

Pneumatic, Swivel, Tilt, Tilt Tension, Tilt Lock

H5713



Task Chair (Mesh Back)

Pneumatic, Swivel, Synchro-tilt, Tilt Tension, Tilt Lock

H5715



Task Stool (Mesh Back)

Pneumatic, Swivel, Adjustable Footring

HON BRANDED FABRICS

GRADE 1

Black Fabric
Navy Fabric

GRADE 2

GRADE 3

For a complete list of fabrics, including partnership fabrics, go to hon.com/fabricsandfinishes.

Navy only available on select models.

Reference Fabric Color Combinations on pages 18-22 for color codes and legend on page 19 for lead times.

VOLT® 5700 Series

OPEN MARKET



Icon Legend on page 17

H5701



TASK CHAIR

Pneumatic
Swivel
Tilt
Tilt Tension
Tilt Lock
Functions: **A, E, F, K, L**
(Function Key on pages 212-213)

DIMENSIONS

Depth: 25³/₄
Width: 26
Height: 40
Seat Depth: 18³/₄
Seat Width: 18¹/₂
Back Width: 17¹/₄
Back Height: 18³/₄
Seat to Floor Height: 18-22¹/₄
Usable Seat Depth: 18³/₄
Ship Weight: 29
Cube: 5.1
Weight Rating: 275 lbs.

FABRIC PRICE CODES

1 \$312 L \$342

H5703



TASK CHAIR

Pneumatic
Swivel
Synchro-tilt
Tilt Tension
Tilt Lock
Functions: **A, E, J, K, L**
(Function Key on pages 212-213)

DIMENSIONS

Depth: 25³/₄
Width: 26
Height: 40
Seat Depth: 18³/₄
Seat Width: 18¹/₂
Back Width: 17¹/₄
Back Height: 18³/₄
Seat to Floor Height: 18-22¹/₄
Usable Seat Depth: 18³/₄
Ship Weight: 29
Cube: 5.1
Weight Rating: 275 lbs.

FABRIC PRICE CODES

1 \$362 L \$392

H5705



TASK STOOL

Pneumatic
Swivel
Adjustable Footring
Functions: **A, E**
(Function Key on pages 212-213)

DIMENSIONS

Depth: 29¹/₂
Width: 27
Height: 49⁷/₈
Seat Depth: 20
Seat Width: 19
Back Width: 16¹/₂
Back Height: 20
Seat to Floor Height: 22⁷/₈-32³/₈
Usable Seat Depth: 18
Ship Weight: 36
Cube: 6.0
Weight Rating: 275 lbs.

FABRIC PRICE CODES

1 \$511 L \$541

H5795

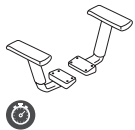

HEIGHT-ADJUSTABLE ARMS

Non-upholstered
Functions: **Q**
(Function Key on pages 212-213)

DIMENSIONS

Adjustable Arms Width: 17³/₈
Height from Seat: 7⁵/₈-10⁵/₈
Ship Weight: 5
Cube: 0.6

LIST PRICE

\$98

HON Recommendation: H5703.GA10.T with H5795 Arm Pack - List Price \$460

HOW TO SPECIFY

<p>Select Model Number</p> <p>H 5 7 0 3 .</p>	<p>Select Fabric</p> <p>SB11 Black Bonded Leather GA10 Black GA90 Navy (only available on H5701)</p> <p>G A 1 0 .</p>	<p>Select Frame</p> <p>T Black</p> <p>T</p>
---	---	---



VOLT® 5710 Series

H5711



TASK CHAIR

Mesh Back
Pneumatic
Swivel
Tilt
Tilt Tension
Tilt Lock
Functions: **A, E, F, K, L**
(Function Key on pages 212-213)

DIMENSIONS

Depth: 25³/₄ Seat to Floor Height: 18³/₄-22³/₈
Width: 26 Usable Seat Depth: 18
Height: 38³/₄ Ship Weight: 29
Seat Depth: 18³/₄ Cube: 5.1
Seat Width: 19¹/₄ Weight Rating: 275 lbs.
Back Width: 18
Back Height: 18³/₄

FABRIC PRICE CODES

1 \$431 L \$461

H5713



TASK CHAIR

Mesh Back
Pneumatic
Swivel
Synchro-tilt
Tilt Tension
Tilt Lock
Functions: **A, E, J, K, L**
(Function Key on pages 212-213)

DIMENSIONS

Depth: 25³/₄ Seat to Floor Height: 17³/₈-21¹/₈
Width: 26 Usable Seat Depth: 17⁷/₈
Height: 38¹/₂ Ship Weight: 32
Seat Depth: 18³/₄ Cube: 5.1
Seat Width: 19¹/₄ Weight Rating: 275 lbs.
Back Width: 18
Back Height: 18³/₄

FABRIC PRICE CODES

1 \$485 L \$515

H5715



TASK STOOL

Mesh Back
Pneumatic
Swivel
Adjustable Footring
Functions: **A, E**
(Function Key on pages 212-213)

DIMENSIONS

Depth: 28 Seat to Floor Height: 22⁷/₈-32³/₈
Width: 26 Usable Seat Depth: 18
Height: 49⁷/₈ Ship Weight: 36
Seat Depth: 20 Cube: 6.0
Seat Width: 19 Weight Rating: 275 lbs.
Back Width: 18
Back Height: 18¹/₂

FABRIC PRICE CODES

1 \$637 L \$667

H5795

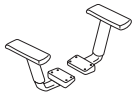

HEIGHT-ADJUSTABLE ARMS

Non-upholstered
Functions: **Q**
(Function Key on pages 212-213)

DIMENSIONS

Adjustable Arms Width: 17³/₈
Height from Seat: 7³/₈-10⁵/₈
Ship Weight: 5
Cube: 0.6

LIST PRICE

\$98

HON Recommendation: H5713.GA10.T with H5795 Arm Pack - List Price \$583

HOW TO SPECIFY

<p>Select Model Number</p> <p>H 5 7 1 3</p>	<p>Select Fabric</p> <p>SB11 Black Leather GA10 Black</p> <p>G A 1 0</p>	<p>Select Frame</p> <p>T Black</p> <p>T</p>
--	---	---

VOLT® 5720/5730 Series Options

MODEL OPTIONS

H5721



Task Chair

Pneumatic, Swivel, Tilt, Tilt Tension, Tilt Lock

H5723



Task Chair

Pneumatic, Swivel, Synchro-tilt, Tilt Tension, Tilt Lock

H5725



Task Stool

Pneumatic, Swivel, Adjustable Footring

H5731



Task Chair (Mesh Back)

Pneumatic, Swivel, Tilt, Tilt Tension, Tilt Lock

H5733



Task Chair (Mesh Back)

Pneumatic, Swivel, Synchro-tilt, Tilt Tension, Tilt Lock

H5735



Task Stool (Mesh Back)

Pneumatic, Swivel, Adjustable Footring

CASTERS



CODE	DESCRIPTION	PRICE
H	Black Hard Caster	+\$0



S	Black All-Surface Caster	+\$30
----------	--------------------------	--------------

FRAME

CODE	DESCRIPTION	PRICE
T	Black	+\$0

5720/5730 Series Fabric Options

HON BRANDED FABRICS

GRADE 1

Apex
Attire
Centurion
Compass
Contourett
Dapper
Ensemble
Hamilton
Inertia
Optic
Pebble

GRADE 2

Appoint Seating
Blume
Clyde
Dotty
Rush
Seed
Spin Seating
Whisper Vinyl

GRADE 3

In Season
Moxie
Parker
Purl
Quill

For a complete list of fabrics, including partnership fabrics, go to hon.com/fabricsandfinishes.

Reference Fabric Color Combinations on pages 18-22 for color codes and legend on page 19 for lead times. For additional HON to Supply COM fabric grade pricing, go to honready.hon.com and click on the HON to Supply COM link.

VOLT® 5720 Series

GSA SIN 33721 EXCEPT AS NOTED



Icon Legend on page 17

H5721



TASK CHAIR

Pneumatic
Swivel
Tilt
Tilt Tension
Tilt Lock

Functions: **A, E, F, K, L**
(Function Key on pages 212-213)

DIMENSIONS

Depth:	25 ³ / ₄	Seat to Floor Height:	17 ¹ / ₄ -22 ¹ / ₄
Width:	25 ³ / ₄	Usable Seat Depth:	18 ³ / ₄
Height:	40	Ship Weight:	36
Seat Depth:	18 ³ / ₄	Cube:	5.1
Seat Width:	18 ¹ / ₂	COM:	1.5
Back Width:	17 ¹ / ₄	Weight Rating:	275 lbs.
Back Height:	18 ³ / ₄		

FABRIC PRICE CODES

1	\$410	8	\$548
2	\$434	9	\$566
3	\$458	10	\$584
4	\$476	11	\$602
5	\$494	12	\$620
6	\$512	L	—
7	\$530		

H5723



TASK CHAIR

Pneumatic
Swivel
Synchro-tilt
Tilt Tension
Tilt Lock

Functions: **A, E, J, K, L**
(Function Key on pages 212-213)

DIMENSIONS

Depth:	25 ³ / ₄	Seat to Floor Height:	17 ¹ / ₄ -22 ¹ / ₄
Width:	25 ³ / ₄	Usable Seat Depth:	18 ³ / ₄
Height:	40	Ship Weight:	38
Seat Depth:	18 ³ / ₄	Cube:	5.1
Seat Width:	18 ¹ / ₂	COM:	1.5
Back Width:	17 ¹ / ₄	Weight Rating:	275 lbs.
Back Height:	18 ³ / ₄		

FABRIC PRICE CODES

1	\$456	8	\$594
2	\$480	9	\$612
3	\$504	10	\$630
4	\$522	11	\$648
5	\$540	12	\$666
6	\$558	L	—
7	\$576		

H5725

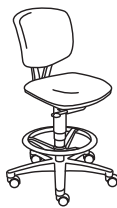

TASK STOOL

Pneumatic
Swivel
Adjustable Footring

Functions: **A, E**
(Function Key on pages 212-213)

DIMENSIONS

Depth:	29 ¹ / ₂	Seat to Floor Height:	22 ⁷ / ₈ -32 ³ / ₈
Width:	27	Usable Seat Depth:	18 ³ / ₄
Height:	49 ⁷ / ₈	Ship Weight:	39
Seat Depth:	20	Cube:	6.0
Seat Width:	19	COM:	1.5
Back Width:	17 ¹ / ₄	Weight Rating:	275 lbs.
Back Height:	18 ³ / ₄		

FABRIC PRICE CODES

1	\$594	8	\$732
2	\$618	9	\$750
3	\$642	10	\$768
4	\$660	11	\$786
5	\$678	12	\$804
6	\$696	L	—
7	\$714		

H5795

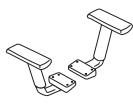

OPEN MARKET

HEIGHT-ADJUSTABLE ARMS

Non-upholstered

Functions: **Q**
(Function Key on pages 212-213)

DIMENSIONS

Adjustable Arms Width:	17 ³ / ₈
Height from Seat:	7 ⁷ / ₈ -10 ⁵ / ₈
Ship Weight:	5
Cube:	0.6

LIST PRICE

\$98

HSCASTER

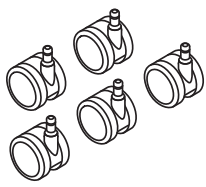

OPEN MARKET

SET OF 5 ALL-SURFACE CASTERS

DIMENSIONS

Size:	60mm
Ship Weight:	2
Cube:	0.1

LIST PRICE

\$59

! Available in Black finish only, no specification needed.

HON Recommendation: H5723.H.CU__T with H5795 Arm Pack - List Price \$554

HOW TO SPECIFY

Select Model Number H 5 7 2 3 .	Select Caster H Black Hard Caster S Black All-Surface Caster (+ \$40)	Select Fabric See page 483 CU 1 0 .	Select Frame T Black T
---	--	--	-------------------------------------



H5731



TASK CHAIR

Mesh Back
Pneumatic
Swivel
Tilt
Tilt Tension
Tilt Lock
Functions: **A, E, F, K, L**
(Function Key on pages 212-213)

DIMENSIONS

Depth: 25³/₄ Seat to Floor Height: 18³/₄-22³/₈
Width: 26 Usable Seat Depth: 18
Height: 38³/₄ Ship Weight: 29
Seat Depth: 18³/₄ Cube: 5.1
Seat Width: 19¹/₄ COM: 1.5
Back Width: 18 Weight Rating: 275 lbs.
Back Height: 18³/₄

FABRIC PRICE CODES

1	\$532	8	\$601
2	\$544	9	\$610
3	\$556	10	\$619
4	\$565	11	\$628
5	\$574	12	\$637
6	\$583	L	—
7	\$592		

H5733



TASK CHAIR

Mesh Back
Pneumatic
Swivel
Synchro-tilt
Tilt Tension
Tilt Lock
Functions: **A, E, J, K, L**
(Function Key on pages 212-213)

DIMENSIONS

Depth: 25³/₄ Seat to Floor Height: 17³/₈-21¹/₈
Width: 26 Usable Seat Depth: 17⁷/₈
Height: 38¹/₂ Ship Weight: 32
Seat Depth: 18³/₄ Cube: 5.1
Seat Width: 19¹/₄ COM: 1.5
Back Width: 18 Weight Rating: 275 lbs.
Back Height: 18³/₄

FABRIC PRICE CODES

1	\$582	8	\$651
2	\$594	9	\$660
3	\$606	10	\$669
4	\$615	11	\$678
5	\$624	12	\$687
6	\$633	L	—
7	\$642		

H5735



TASK STOOL

Mesh Back
Pneumatic
Swivel
Adjustable Footring
Functions: **A, E**
(Function Key on pages 212-213)

DIMENSIONS

Depth: 28 Seat to Floor Height: 22⁷/₈-32³/₈
Width: 26 Usable Seat Depth: 18
Height: 49⁷/₈ Ship Weight: 36
Seat Depth: 20 Cube: 6.0
Seat Width: 19 COM: 1.5
Back Width: 18 Weight Rating: 275 lbs.
Back Height: 18¹/₂

FABRIC PRICE CODES

1	\$723	8	\$792
2	\$735	9	\$801
3	\$747	10	\$810
4	\$756	11	\$819
5	\$765	12	\$828
6	\$774	L	—
7	\$783		

H5795

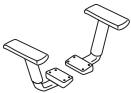

HEIGHT-ADJUSTABLE ARMS

Non-upholstered
Functions: **Q**
(Function Key on pages 212-213)

DIMENSIONS

Adjustable Arms Width: 17³/₈
Height from Seat: 7³/₈-10³/₈
Ship Weight: 5
Cube: 0.6

LIST PRICE

\$98

HSCASTER

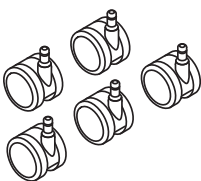

SET OF 5 ALL-SURFACE CASTERS

i Available in Black finish only, no specification needed.

DIMENSIONS

Size: 60mm
Ship Weight: 2
Cube: 0.1

LIST PRICE

\$59

HON Recommendation: H5733.H.CU__T with H5795 Arm Pack - List Price \$680

HOW TO SPECIFY

Select Model Number H 5 7 3 3	Select Caster H Black Hard Caster S Black All-Surface Caster (+ \$40) H	Select Fabric See page 483 CU10	Select Frame T Black T
---	---	--	---

WAVE™ Mesh Chairs

GSA SIN AS NOTED



Icon Legend on page 17

HVL701



SIN 33721

HIGH-BACK

Pneumatic
Swivel
Knee Tilt
Tilt Tension
Infinite Tilt Lock
Adjustable Lumbar
Height-adjustable Arms

Functions: **A, E, H, K, L, Q, W**
(Function Key on pages 212-213)

DIMENSIONS

Depth:	28	Arm Width:	19½
Width:	27½	Seat to Floor Height:	18½-21¼
Height:	44⅝	Usable Seat Depth:	19¼
Seat Depth:	20¾	Ship Weight:	53
Seat Width:	22	Cube:	5.8
Back Width:	23	Weight Rating:	250 lbs.
Back Height:	23¾		

PRICE CODE

Leather **\$756**

NOTES: Comfortable and breathable mesh back. Sturdy textured black frame. HVL701 has a Black leather upholstered seat with side mesh panels. Adjustable lumbar support. **HON 5-Year Limited Warranty.**

HON Recommendation: HVL701.SB11 - List Price \$756

HVL702



OPEN MARKET

HIGH-BACK

Pneumatic
Swivel
Synchro-tilt
Tilt Tension
Tilt Lock
Height-adjustable Arms

Functions: **A, E, J, K, L, Q**
(Function Key on pages 212-213)

DIMENSIONS

Depth:	26½	Arm Width:	19½
Width:	26½	Seat to Floor Height:	18½-23½
Height:	40½	Usable Seat Depth:	19¾
Seat Depth:	19¾	Ship Weight:	40
Seat Width:	21	Cube:	5.0
Back Width:	19½	Weight Rating:	250 lbs.
Back Height:	24		

PRICE CODE

Sandwich Mesh **\$613**

NOTES: Black Sandwich Mesh seat and mesh back. **HON 5-Year Limited Warranty.**

HON Recommendation: HVL702.MM10 - List Price \$613

HVL705



OPEN MARKET

EXECUTIVE BIG AND TALL

Pneumatic
Knee Tilt
Tilt Tension
Tilt Lock
Height and Width Adjustable Arms
Integrated Lumbar Support

Functions: **A, E, H, K, L, S**
(Function Key on pages 212-213)

DIMENSIONS

Depth:	25⅝	Back Height:	28
Width:	30¼	Seat to Floor Height:	18¾-23¾
Height:	43⅝	Usable Seat Depth:	18¾
Seat Depth:	18¾	Ship Weight:	59
Seat Width:	21⅝	Cube:	6.1
Back Width:	22¾	Weight Rating:	450 lbs.

PRICE CODE

Mesh **\$901**

NOTES: Large scale model HVL705 will support up to 450 lbs with normal use. Available in Black Mesh fabric VM10. **HON 5-Year Limited Warranty.**

HON Recommendation: HVL705.VM10 - List Price \$901

HVL712



SIN 33721

MID-BACK

Pneumatic
Swivel
Synchro-tilt
Tilt Tension
Tilt Lock
Height-adjustable Arms

Functions: **A, E, J, K, L, Q**
(Function Key on pages 212-213)

DIMENSIONS

Depth:	28½	Arm Width:	18⅝
Width:	29½	Seat to Floor Height:	18-22¼
Height:	41¾	Usable Seat Depth:	18
Seat Depth:	18½	Ship Weight:	39
Seat Width:	19¾	Cube:	5.4
Back Width:	20½	Weight Rating:	250 lbs.
Back Height:	20¾		

PRICE CODE

Sandwich Mesh **\$517**

NOTES: Black Sandwich Mesh seat and mesh back. **HON 5-Year Limited Warranty.**

HON Recommendation: HVL712.MM10 - List Price \$517

HOW TO SPECIFY

Select
Model Number

Select
Fabric

- SB11** Black Bonded Leather
Specify for model HVL701 only
- MM10** Black Sandwich Mesh Fabric
Specify for models HVL702 and HVL712 only
- VM10** Black Mesh Fabric
Specify for model HVL705 only

HVL701.

SB11

WEST HILL™ CASUAL LOUNGE SEATING

Want to see more? Scan here
to check out hon.com.



West Hill™ Casual Lounge Seating
shown with Scramble™ Coffee Table.

WEST HILL™

Whether you're a thought leader, innovator, or highly-motivated team player, West Hill casual lounge creates an inviting space that inspires relaxed productivity, sustains concentration, and sparks creativity.

With solid construction, a multitude of back cushion styling, and seating options from a single seat to three or more, and choices in leg styles, fabrics, and configurations, West Hill makes it easier to make your space exceptional.



FEATURES

- Contoured seat cushion design brings living room comfort to the work space.
- Choose between a Square Back or sink into a comfy Pillow Back cushion.
- Semi-attached back and seat cushions make replacement easy.
- Square, welted back cushion creates a modern look while providing casual comfort.
- The multi-fabric option allows you to specify up to three fabrics on one model.
- Select one of two square metal leg options or hardwood cone feet in one of 10 finishes.
- Order an optional Throw Pillow to add a little extra comfort or a splash of color.
- Cushion packs available in both Standard and Pillow Back, apply to both side and back applications.
- Each seat is warranted for users up to 300 pounds.
- Pair with Scramble™ Occasional Tables to complete the modern aesthetic.

SEATING

WEST HILL™ Options

MODEL OPTIONS

HWH1SS, HWH1SP
HWH1SSCF, HWH1SPCF -
Multi-Fabric



Lounge
Single Seat

HWH2SS, HWH2SP
HWH2SSCF, HWH2SPCF -
Multi-Fabric

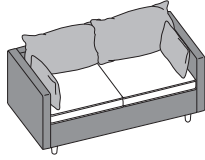

Lounge
Two-Seat

HWH3SS, HWH3SP
HWH3SSCF, HWH3SPCF -
Multi-Fabric

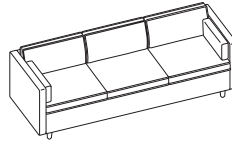

Lounge
Three-Seat

HWHITCS, HWHITCP
HWHITCSCF, HWHITPCF -
Multi-Fabric

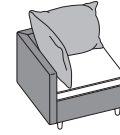

Lounge
True Corner

HWH1C
HWH1CCF - Multi-Fabric



Ottoman

HWHACPS, HWHACPP

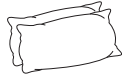

Arm Cushion Pack

HWHBCPS, HWHBCPP

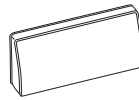

Back Cushion Pack

HWHLP, HWHSP18



**Lumbar and 18" Square
Throw Pillow**

Pillow Back Option, Multi-Fabric



Standard Back Option, Multi-Fabric

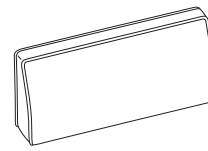
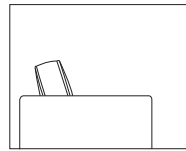
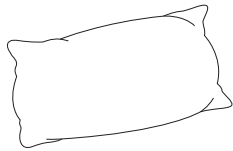
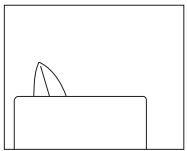

Choose from standard Single Fabric or Multi-Fabric options.
Specify up to three fabrics with the Multi-Fabric option.

HON BRANDED FABRICS

GRADE 1	GRADE 2	GRADE 3
Apex	Appoint Seating	In Season
Centurion	Blume	Moxie
Contourett	Clyde	Parker
Dapper	Dotty	Purl
Ensemble	Rush	Quill
Hamilton	Seed*	
Inertia*	Spin Seating	
Pebble	Whisper Vinyl*	

For a complete list of fabrics, including partnership fabrics, go to hon.com/fabricsandfinishes.

Reference Fabric Color Combinations on pages 18-22 for color codes and legend on page 19 for lead times.

*Because of the differing upholstery process for the standard back and pillow back options, these fabrics are not available as an option for the pillow back. Contact your HON representative for questions.

❗ Due to the inherent characteristics of upholstery materials and the casual nature of West Hill™, fabric may relax to show wrinkles over time especially on the pillow back options.

LEG STYLE	CODE	DESCRIPTION	PRICE	LEG STYLE	CODE	DESCRIPTION	PRICE
	CW	Cone Wood	+\$0		SM	Square Metal	+\$50
		<i>Available in the following finishes:</i>				<i>Available in the following finishes:</i>	
	LFW1	Florence Walnut			P7A	Textured Charcoal	
	LK11	Kingswood Walnut			P8V	Textured Titanium	
	LLA1	Lowell Ash					
	D	Natural Maple					
	LN1	Natural Recon					
	LPE1	Phantom Ecru					
	PINC	Pinnacle					
	LPT1	Portico Teak					
	LSW1	Skyline Walnut					
	LSA1	Sterling Ash					

MULTI-FABRIC COM YARDAGE

Due to fabric pattern nesting and potential reduction of fabric yield, some multi-fabric models may require more total yardage than standard models.

MODEL	COM (ARMLESS)			COM (ONE ARM)			COM (BOTH ARMS)		
	Seat	Frame	Back	Seat	Frame	Back	Seat	Frame	Back
HWH1SS		—			—			7.0	
HWH1SSCF	—	—	—	—	—	—	1.5	5.0	2.5
HWH1SP		—			—			7.0	
HWH1SPCF	—	—	—	—	—	—	1.5	5.0	1.5
HWH2SS		8.5			9.5			10.5	
HWH2SSCF	3.0	4.0	2.5	3.0	5.0	3.0	3.0	6.0	3.0
HWH2SP		8.5			9.5			11.0	
HWH2SPCF	3.0	4.0	2.0	3.0	5.0	2.5	3.0	6.0	3.0
HWH3SS		12.0			13.0			14.0	
HWH3SSCF	4.0	5.5	3.0	4.0	6.5	3.5	4.0	7.5	3.5
HWH3SP		12.5			13.5			14.5	
HWH3SPCF	4.0	5.5	3.0	4.0	6.5	3.5	4.0	7.5	4.0
HWH1C		3.0			—			—	
HWH1CCF	1.5	2.0	—	—	—	—	—	—	—
HWH1TCS		6.0			—			—	
HWH1TCSCF	1.5	3.5	2.5	—	—	—	—	—	—
HWH1TCP		7.0			—			—	
HWH1TCPF	1.5	3.5	2.0	—	—	—	—	—	—

WEST HILL™ Casual Lounge Seating

OPEN MARKET



Icon Legend on page 17

HWH1SS

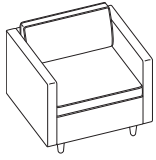

SINGLE SEAT LOUNGE — STANDARD CUSHION

DIMENSIONS

Depth:	30½	Back Height:	12
Height:	29¾	Back Width:	26¾
Width:	33¾	Arm Height:	8
Usable Seat Depth:	19	Ship Weight:	81
Seat to Floor Height:	17¾	Cube:	18.4
Seat Width:	26¾	COM:	See page 489
		Weight Rating:	300 lbs.

FABRIC PRICE CODES

1	\$2291	8	\$3559
2	\$2459	9	\$3591
3	\$2630	10	\$3762
4	\$2772	11	\$3934
5	\$2963	12	\$4105
6	\$3157	L	—
7	\$3356		

HWH1SP



SINGLE SEAT LOUNGE — PILLOW CUSHION

DIMENSIONS

Depth:	30½	Back Height:	13¾
Height:	31½	Back Width:	26¾
Width:	33¾	Arm Height:	8
Usable Seat Depth:	16½	Ship Weight:	81
Seat to Floor Height:	17¾	Cube:	18.4
Seat Width:	26¾	COM:	See page 489
		Weight Rating:	300 lbs.

FABRIC PRICE CODES

1	\$2291	8	\$3559
2	\$2459	9	\$3591
3	\$2630	10	\$3762
4	\$2772	11	\$3934
5	\$2963	12	\$4105
6	\$3157	L	—
7	\$3356		

HON Recommendation: HWH1SP.B.PURL__CW__ - List Price \$2630

SEATING

HOW TO SPECIFY

Select
Model Number

HWH1SP

Select
Arm Type

B Both Arms

B

Select
Fabric

See page 489

PBLE03

Select
Foot and Foot Color

SM Square Metal (+ \$50)

CW Cone Wood

See page 489 for colors

SMP8V



WEST HILL™ Casual Lounge Seating

HWH1SSCF

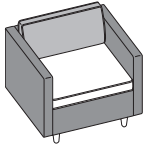

**SINGLE SEAT LOUNGE —
STANDARD CUSHION,
MULTI-FABRIC**

DIMENSIONS

Depth:	30½	Back Height:	12
Height:	29¾	Back Width:	26¾
Width:	33¾	Arm Height:	8
Usable Seat Depth:	19	Ship Weight:	81
Seat to Floor Height:	17¾	Cube:	18.4
Seat Width:	26¾	COM:	See page 489
		Weight Rating:	300 lbs.

FABRIC PRICE CODES

1 \$2467

Add to Base Price Above

	Seat	Frame	Back
2	\$36	\$120	\$36
3	\$73	\$242	\$73
4	\$103	\$344	\$103
5	\$144	\$480	\$144
6	\$186	\$619	\$186
7	\$228	\$761	\$228
8	\$272	\$906	\$272
9	\$279	\$929	\$279
10	\$315	\$1051	\$315
11	\$352	\$1173	\$352
12	\$389	\$1296	\$389

HWH1SPCF

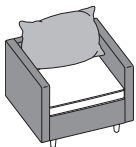

**SINGLE SEAT LOUNGE —
PILLOW CUSHION,
MULTI-FABRIC**

DIMENSIONS

Depth:	30½	Back Height:	13¾
Height:	31½	Back Width:	26¾
Width:	33¾	Arm Height:	8
Usable Seat Depth:	16½	Ship Weight:	81
Seat to Floor Height:	17¾	Cube:	18.4
Seat Width:	26¾	COM:	See page 489
		Weight Rating:	300 lbs.

FABRIC PRICE CODES

1 \$2467

Add to Base Price Above

	Seat	Frame	Back
2	\$36	\$120	\$36
3	\$73	\$242	\$73
4	\$103	\$344	\$103
5	\$144	\$480	\$144
6	\$186	\$619	\$186
7	\$228	\$761	\$228
8	\$272	\$906	\$272
9	\$279	\$929	\$279
10	\$315	\$1051	\$315
11	\$352	\$1173	\$352
12	\$389	\$1296	\$389

HON Recommendation: HWH1SPCF.B.PURL__PURL__PURL__CW__ - List Price \$2855

HOW TO SPECIFY

<p>Select Model Number</p> <p>HWH1SPCF .</p>	<p>Select Arm Type</p> <p>B Both Arms</p> <p>B .</p>	<p>Select Seat Fabric</p> <p>See page 489</p> <p>PBLE07 .</p>	<p>Select Frame Fabric</p> <p>See page 489</p> <p>PBLE03 .</p>	<p>Select Back Fabric</p> <p>See page 489</p> <p>PBLE01 .</p>	<p>Select Foot and Foot Color</p> <p>SM Square Metal (+ \$50) CW Cone Wood See page 489 for colors</p> <p>SMP8V</p>
---	---	--	---	--	--

WEST HILL™ Casual Lounge Seating

OPEN MARKET



Icon Legend on page 17

HWH2SS

TWO SEAT LOUNGE — STANDARD CUSHION

DIMENSIONS

FABRIC PRICE CODES



Armless

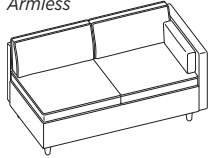

Left

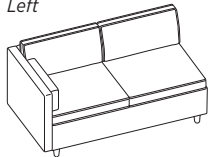

Right

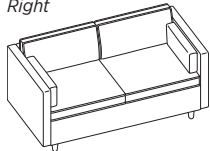

Both Arms

Depth:	30½	Back Height:	12
Height:	29¾	Back Width:	53¾
Width (armless):	53¾	Arm Height:	8
Width (one arm):	57	Ship Weight (armless):	107
Width (both arms):	60¼	Ship Weight (one arm):	121
Usable Seat Depth:	19	Ship Weight (both arms):	135
Seat to Floor Height:	17¾	Cube:	34.0
Seat Width (armless):	53¾	COM:	See page 489
Seat Width (one arm):	49½	Weight Rating:	300 lbs. (per seat)
Seat Width (both arms):	45¼		

1	\$3114	8	\$5017
2	\$3365	9	\$5064
3	\$3623	10	\$5321
4	\$3836	11	\$5578
5	\$4122	12	\$5835
6	\$4414	L	—
7	\$4712		

NOTES: Includes semi-attached arm cushions as shown.

HWH2SP

TWO SEAT LOUNGE — PILLOW CUSHION

DIMENSIONS

FABRIC PRICE CODES



Armless



Left

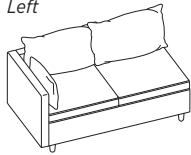

Right

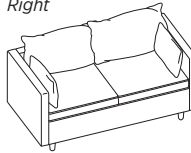

Both Arms

Depth:	30½	Back Height:	13¾
Height:	29¾	Back Width:	53¾
Width (armless):	53¾	Arm Height:	8
Width (one arm):	57	Ship Weight (armless):	107
Width (both arms):	60¼	Ship Weight (one arm):	121
Usable Seat Depth:	16½	Ship Weight (both arms):	135
Seat to Floor Height:	17¾	Cube:	34.0
Seat Width (armless):	53¾	COM:	See page 489
Seat Width (one arm):	48½	Weight Rating:	300 lbs. (per seat)
Seat Width (both arms):	43¼		

1	\$3114	8	\$5107
2	\$3377	9	\$5157
3	\$3647	10	\$5426
4	\$3870	11	\$5696
5	\$4170	12	\$5965
6	\$4475	L	—
7	\$4788		

NOTES: Includes semi-attached arm cushions as shown.

HON Recommendation: HWH2SP.B.PURL__CW__ - List Price \$3997

HOW TO SPECIFY

<p>Select Model Number</p> <p>HWH2SP</p>	<p>Select Arm Type</p> <p>N No Arms L Left Arm Only (+ \$175) R Right Arm Only (+ \$175) B Both Arms (+ \$350)</p> <p>B</p>	<p>Select Fabric</p> <p>See page 489</p> <p>PBLE03</p>	<p>Select Foot and Foot Color</p> <p>SM Square Metal (+ \$50) CW Cone Wood See page 489 for colors</p> <p>SMP8V</p>
---	--	---	--



WEST HILL™ Casual Lounge Seating

HWH2SSCF

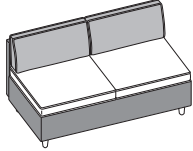

Armless

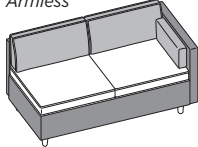

Left

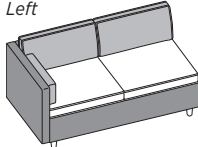

Right

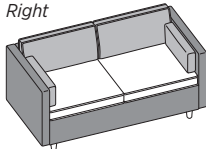

Both Arms

TWO SEAT LOUNGE — STANDARD CUSHION, MULTI-FABRIC

DIMENSIONS

Depth:	30½	Back Height:	12
Height:	29¾	Back Width:	53¾
Width (armless):	53¾	Arm Height:	8
Width (one arm):	57	Ship Weight (armless):	107
Width (both arms):	60¼	Ship Weight (one arm):	121
Usable Seat Depth:	19	Ship Weight (both arms):	135
Seat to Floor Height:	17¾	Cube:	34.0
Seat Width (armless):	53¾	COM:	See page 489
Seat Width (one arm):	49½	Weight Rating:	300 lbs. (per seat)
Seat Width (both arms):	45¼		

FABRIC PRICE CODES

1	\$3290		
<i>Add to Base Price Above</i>			
	Seat	Frame	Back
2	\$72	\$144	\$72
3	\$145	\$291	\$145
4	\$206	\$412	\$206
5	\$288	\$576	\$288
6	\$371	\$743	\$371
7	\$457	\$913	\$457
8	\$544	\$1087	\$544
9	\$557	\$1114	\$557
10	\$631	\$1261	\$631
11	\$704	\$1408	\$704
12	\$778	\$1555	\$778

NOTES: Includes semi-attached arm cushions as shown.

HWH2SPCF

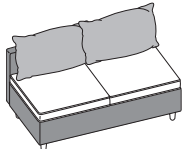

Armless

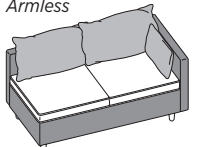

Left

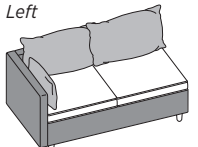

Right

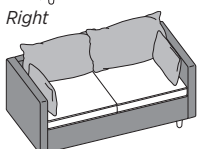

Both Arms

TWO SEAT LOUNGE — PILLOW CUSHION, MULTI-FABRIC

DIMENSIONS

Depth:	30½	Back Height:	13¾
Height:	29¾	Back Width:	53¾
Width (armless):	53¾	Arm Height:	8
Width (one arm):	57	Ship Weight (armless):	107
Width (both arms):	60¼	Ship Weight (one arm):	121
Usable Seat Depth:	16½	Ship Weight (both arms):	135
Seat to Floor Height:	17¾	Cube:	34.0
Seat Width (armless):	53¾	COM:	See page 489
Seat Width (one arm):	48½	Weight Rating:	300 lbs. (per seat)
Seat Width (both arms):	43¼		

FABRIC PRICE CODES

1	\$3290		
<i>Add to Base Price Above</i>			
	Seat	Frame	Back
2	\$72	\$144	\$72
3	\$145	\$291	\$145
4	\$206	\$412	\$206
5	\$288	\$576	\$288
6	\$371	\$743	\$371
7	\$457	\$913	\$457
8	\$544	\$1087	\$544
9	\$557	\$1114	\$557
10	\$631	\$1261	\$631
11	\$704	\$1408	\$704
12	\$778	\$1555	\$778

NOTES: Includes semi-attached arm cushions as shown.

HON Recommendation: HWH2SPCF.B.PURL__PURL__PURL__CW__ - List Price \$4221

HOW TO SPECIFY

Select Model Number HWH2SPCF	Select Arm Type N No Arms L Left Arm Only (+ \$175) R Right Arm Only (+ \$175) B Both Arms (+ \$350)	Select Seat Fabric See page 489	Select Frame Fabric See page 489	Select Back Fabric See page 489	Select Foot and Foot Color SM Square Metal (+ \$50) CW Cone Wood See page 489 for colors
HWH2SPCF	B	PBLE07	PBLE03	PBLE01	SMP8V

SEATING

WEST HILL™ Casual Lounge Seating

OPEN MARKET



Icon Legend on page 17

HWH3SS

THREE SEAT LOUNGE — STANDARD CUSHION

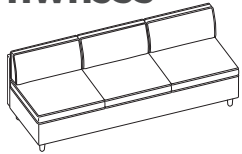

Armless

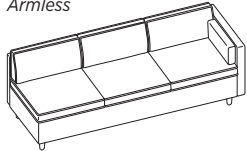

Left

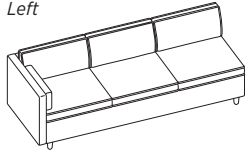

Right

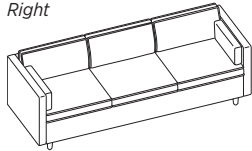

Both Arms

DIMENSIONS

Depth:	30½	Back Height:	12
Height:	29¾	Back Width:	80¾
Width (armless):	80¾	Arm Height:	8
Width (one arm):	84	Ship Weight (armless):	146
Width (both arms):	87¼	Ship Weight (one arm):	160
Usable Seat Depth:	19	Ship Weight (both arms):	174
Seat to Floor Height:	17¾	Cube:	46.5
Seat Width (armless):	80¾	COM:	See page 489
Seat Width (one arm):	76½	Weight Rating:	300 lbs. (per seat)
Seat Width (both arms):	72¼		

FABRIC PRICE CODES

1	\$4230	8	\$6767
2	\$4565	9	\$6830
3	\$4909	10	\$7173
4	\$5192	11	\$7516
5	\$5573	12	\$7858
6	\$5963	L	—
7	\$6360		

NOTES: Includes semi-attached arm cushions as shown.

HWH3SP

THREE SEAT LOUNGE — PILLOW CUSHION

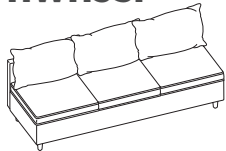

Armless

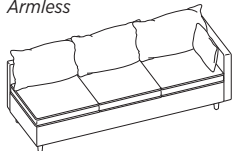

Left

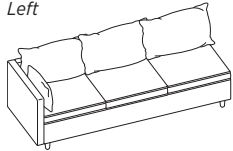

Right

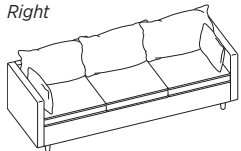

Both Arms

DIMENSIONS

Depth:	30½	Back Height:	13¾
Height:	31½	Back Width:	80¾
Width (armless):	80¾	Arm Height:	8
Width (one arm):	84	Ship Weight (armless):	146
Width (both arms):	87¼	Ship Weight (one arm):	160
Usable Seat Depth:	16½	Ship Weight (both arms):	174
Seat to Floor Height:	17¾	Cube:	46.5
Seat Width (armless):	80¾	COM:	See page 489
Seat Width (one arm):	75½	Weight Rating:	300 lbs. (per seat)
Seat Width (both arms):	70¼		

FABRIC PRICE CODES

1	\$4230	8	\$6857
2	\$4577	9	\$6923
3	\$4933	10	\$7278
4	\$5227	11	\$7633
5	\$5621	12	\$7988
6	\$6025	L	—
7	\$6436		

NOTES: Includes semi-attached arm cushions as shown.

HON Recommendation: HWH3SP.B.PURL__CW__ - List Price \$5283

HOW TO SPECIFY

<p>Select Model Number</p> <p>HWH3SP</p>	<p>Select Arm Type</p> <p>N No Arms L Left Arm Only (+ \$175) R Right Arm Only (+ \$175) B Both Arms (+ \$350)</p> <p>B</p>	<p>Select Fabric</p> <p>See page 489</p> <p>PBLE03</p>	<p>Select Foot and Foot Color</p> <p>SM Square Metal (+ \$50) CW Cone Wood</p> <p>See page 489 for colors</p> <p>SMP8V</p>
---	--	---	---



WEST HILL™ Casual Lounge Seating

HWH3SSCF

THREE SEAT LOUNGE — STANDARD CUSHION, MULTI-FABRIC

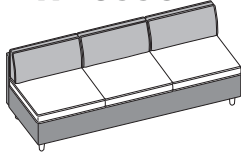

Armless

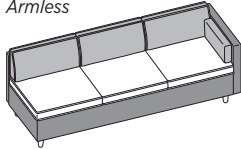

Left

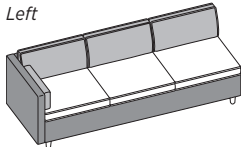

Right

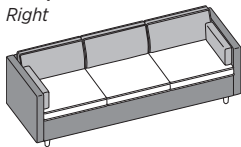

Both Arms

DIMENSIONS

Depth:	30½	Back Height:	12
Height:	29¾	Back Width:	80¾
Width (armless):	80¾	Arm Height:	8
Width (one arm):	84	Ship Weight (armless):	146
Width (both arms):	87¼	Ship Weight (one arm):	160
Usable Seat Depth:	19	Ship Weight (both arms):	174
Seat to Floor Height:	17¾	Cube:	46.5
Seat Width (armless):	80¾	COM:	See page 489
Seat Width (one arm):	76½	Weight Rating:	300 lbs. (per seat)
Seat Width (both arms):	72¼		

FABRIC PRICE CODES

1	\$4406		
<i>Add to Base Price Above</i>			
	Seat	Frame	Back
2	\$96	\$180	\$84
3	\$194	\$364	\$170
4	\$275	\$516	\$241
5	\$384	\$720	\$336
6	\$495	\$928	\$433
7	\$609	\$1141	\$533
8	\$725	\$1359	\$634
9	\$743	\$1393	\$650
10	\$841	\$1576	\$736
11	\$939	\$1760	\$821
12	\$1037	\$1944	\$907

NOTES: Includes semi-attached arm cushions as shown.

HWH3SPCF

THREE SEAT LOUNGE — PILLOW CUSHION, MULTI-FABRIC

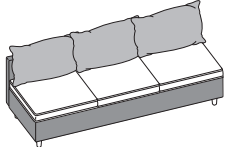

Armless

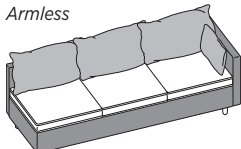

Left

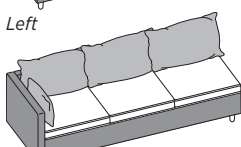

Right

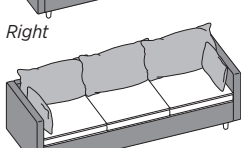

Both Arms

DIMENSIONS

Depth:	30½	Back Height:	13¾
Height:	31½	Back Width:	80¾
Width (armless):	80¾	Arm Height:	8
Width (one arm):	84	Ship Weight (armless):	146
Width (both arms):	87¼	Ship Weight (one arm):	160
Usable Seat Depth:	16½	Ship Weight (both arms):	174
Seat to Floor Height:	17¾	Cube:	46.5
Seat Width (armless):	80¾	COM:	See page 489
Seat Width (one arm):	75½	Weight Rating:	300 lbs. (per seat)
Seat Width (both arms):	70¼		

FABRIC PRICE CODES

1	\$4406		
<i>Add to Base Price Above</i>			
	Seat	Frame	Back
2	\$96	\$180	\$96
3	\$194	\$364	\$194
4	\$275	\$516	\$275
5	\$384	\$720	\$384
6	\$495	\$928	\$495
7	\$609	\$1141	\$609
8	\$725	\$1359	\$725
9	\$743	\$1393	\$743
10	\$841	\$1576	\$841
11	\$939	\$1760	\$939
12	\$1037	\$1944	\$1037

NOTES: Includes semi-attached arm cushions as shown.

HON Recommendation: HWH3SPCF.B.PURL__PURL__PURL__CW__ - List Price \$5508

HOW TO SPECIFY

<p>Select Model Number</p> <p>HWH3SPCF</p>	<p>Select Arm Type</p> <p>N No Arms L Left Arm Only (+ \$175) R Right Arm Only (+ \$175) B Both Arms (+ \$350)</p> <p>B</p>	<p>Select Seat Fabric</p> <p>See page 489</p> <p>PBLE07</p>	<p>Select Frame Fabric</p> <p>See page 489</p> <p>PBLE03</p>	<p>Select Back Fabric</p> <p>See page 489</p> <p>PBLE01</p>	<p>Select Foot and Foot Color</p> <p>SM Square Metal (+ \$50) CW Cone Wood See page 489 for colors</p> <p>SMP8V</p>
---	--	--	---	--	--

SEATING

WEST HILL™ Ottomans

OPEN MARKET



Icon Legend on page 17

HWH1C

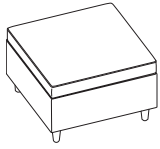

OTTOMAN

DIMENSIONS

Depth:	27¼	Ship Weight:	47
Height:	17¾	Cube:	18.4
Width:	27¼	COM:	See page 489
Usable Seat Depth:	27¼	Weight Rating:	300 lbs.
Seat to Floor Height:	17¾		
Seat Width:	27¼		

FABRIC PRICE CODES

1	\$1352	8	\$1896
2	\$1424	9	\$1909
3	\$1497	10	\$1983
4	\$1558	11	\$2056
5	\$1640	12	\$2130
6	\$1723	L	—
7	\$1809		

HWH1CCF

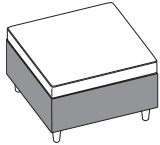

OTTOMAN, MULTI-FABRIC

DIMENSIONS

Depth:	27¼	Ship Weight:	47
Height:	17¾	Cube:	18.4
Width:	27¼	COM:	See page 489
Usable Seat Depth:	27¼	Weight Rating:	300 lbs.
Seat to Floor Height:	17¾		
Seat Width:	27¼		

FABRIC PRICE CODES

1	\$1528	
<i>Add to Base Price Above</i>		
	Seat	Frame
2	\$36	\$36
3	\$73	\$73
4	\$103	\$103
5	\$144	\$144
6	\$186	\$186
7	\$228	\$228
8	\$272	\$272
9	\$279	\$279
10	\$315	\$315
11	\$352	\$352
12	\$389	\$389

HON Recommendation: HWH1C.PURL___.CW__ - List Price \$1497

SEATING

HOW TO SPECIFY

Select
Model Number

HWH1CCF .

Select
Fabric

See page 489

PBLE03 .

Select
Seat Fabric

*Specify for model HWH1CCF
only*

PBLE03 .

Select
Frame Fabric

*Specify for model HWH1CCF
only*

PBLE07 .

Select
Foot and Foot Color

SM Square Metal (+ \$50)
CW Cone Wood
See page 489 for colors

SMP8V



WEST HILL™ Casual Lounge Seating

HWH1TCS

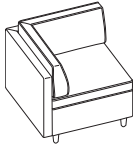

TRUE CORNER — STANDARD CUSHION

DIMENSIONS

Depth:	30½	Ship Weight:	73
Height:	29¾	Cube:	18.4
Width:	30½	COM:	See page 489
Usable Seat Depth:	19	Weight Rating:	300 lbs.
Seat to Floor Height:	17¾		
Back Height:	12		

FABRIC PRICE CODES

1	\$2291	8	\$3378
2	\$2435	9	\$3405
3	\$2582	10	\$3552
4	\$2703	11	\$3699
5	\$2867	12	\$3846
6	\$3034	L	—
7	\$3204		

HWH1TCP

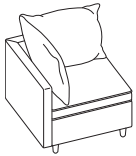

TRUE CORNER — PILLOW CUSHION

DIMENSIONS

Depth:	30½	Ship Weight:	73
Height:	31½	Cube:	18.4
Width:	30½	COM:	See page 489
Usable Seat Depth:	16½	Weight Rating:	300 lbs.
Seat to Floor Height:	17¾		
Back Height:	13¾		

FABRIC PRICE CODES

1	\$2291	8	\$3559
2	\$2459	9	\$3591
3	\$2630	10	\$3762
4	\$2772	11	\$3934
5	\$2963	12	\$4105
6	\$3157	L	—
7	\$3356		

HON Recommendation: HWH1TCP.PURL__CW__ - List Price \$2582

HOW TO SPECIFY

<p>Select Model Number</p> <p>HWH1TCP</p>	<p>Select Fabric</p> <p>See page 489</p> <p>PBLE03</p>	<p>Select Foot and Foot Color</p> <p>SM Square Metal (+ \$50) CW Cone Wood</p> <p>See page 489 for colors</p> <p>SMP8V</p>
--	---	---

WEST HILL™ Casual Lounge Seating

OPEN MARKET



Icon Legend on page 17

HWH1TCSCF

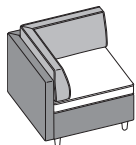

**TRUE CORNER —
STANDARD CUSHION,
MULTI-FABRIC**

DIMENSIONS

Depth:	30½	Ship Weight:	73
Height:	29¾	Cube:	18.4
Width:	30½	COM:	See page 489
Usable Seat Depth:	19	Weight Rating:	300 lbs.
Seat to Floor Height:	17¾		
Back Height:	12		

FABRIC PRICE CODES

1 \$2467

Add to Base Price Above

	Seat	Frame	Back
2	\$36	\$84	\$60
3	\$73	\$170	\$121
4	\$103	\$241	\$172
5	\$144	\$336	\$240
6	\$186	\$433	\$309
7	\$228	\$533	\$380
8	\$272	\$634	\$453
9	\$279	\$650	\$464
10	\$315	\$736	\$525
11	\$352	\$821	\$587
12	\$389	\$907	\$648

HWH1TCPF



**TRUE CORNER —
PILLOW CUSHION,
MULTI-FABRIC**

DIMENSIONS

Depth:	30½	Ship Weight:	73
Height:	31½	Cube:	18.4
Width:	30½	COM:	See page 489
Usable Seat Depth:	16½	Weight Rating:	300 lbs.
Seat to Floor Height:	17¾		
Back Height:	13¾		

FABRIC PRICE CODES

1 \$2467

Add to Base Price Above

	Seat	Frame	Back
2	\$36	\$84	\$48
3	\$73	\$170	\$97
4	\$103	\$241	\$137
5	\$144	\$336	\$192
6	\$186	\$433	\$248
7	\$228	\$533	\$304
8	\$272	\$634	\$362
9	\$279	\$650	\$371
10	\$315	\$736	\$420
11	\$352	\$821	\$469
12	\$389	\$907	\$518

HON Recommendation: HWH1TCPF.PURL__PURL__PURL__CW__ - List Price \$2807

HOW TO SPECIFY

<p>Select Model Number</p> <p>HWH1TCPCF</p>	<p>Select Seat Fabric</p> <p>See page 489</p> <p>PBLE07</p>	<p>Select Frame Fabric</p> <p>See page 489</p> <p>PBLE03</p>	<p>Select Back Fabric</p> <p>See page 489</p> <p>PBLE01</p>	<p>Select Foot and Foot Color</p> <p>SM Square Metal (+ \$50) CW Cone Wood</p> <p>See page 489 for colors</p> <p>SMP8V</p>
---	---	--	---	--



THROW PILLOWS

HWHLP



LUMBAR THROW PILLOW

DIMENSIONS

Height:	10
Width:	18
COM:	1.0
Ship Weight:	2.5
Cube:	2.3

FABRIC PRICE CODES

1	\$159	8	\$340
2	\$183	9	\$345
3	\$207	10	\$369
4	\$228	11	\$394
5	\$255	12	\$418
6	\$283	L	—
7	\$311		

HWHSP18



18" SQUARE THROW PILLOW

DIMENSIONS

Height:	18
Width:	18
COM:	1.0
Ship Weight:	3.0
Cube:	2.3

FABRIC PRICE CODES

1	\$196	8	\$377
2	\$220	9	\$382
3	\$244	10	\$406
4	\$265	11	\$431
5	\$292	12	\$455
6	\$320	L	—
7	\$348		

HOW TO SPECIFY

<p>Select Model Number</p> <p>HWHSP18</p>	<p>Select Fabric</p> <p>See page 489</p> <p>PBLE03</p>
---	--



HWHACPS

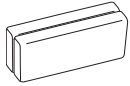

ARM CUSHION PACK — STANDARD

DIMENSIONS

COM: 1.0
Ship Weight: 4.1
Cube: 3.9

FABRIC PRICE CODES

1	\$236	8	\$417
2	\$260	9	\$422
3	\$284	10	\$446
4	\$305	11	\$471
5	\$332	12	\$495
6	\$360	L	—
7	\$388		

NOTES: Includes both L and R Arm Cushions.

ⓘ Cushion arm cushions can be replaced or switched out with these cushion packs.

HWHACPP



ARM CUSHION PACK — PILLOW

DIMENSIONS

COM: 1.0
Ship Weight: 5.7
Cube: 3.9

FABRIC PRICE CODES

1	\$236	8	\$417
2	\$260	9	\$422
3	\$284	10	\$446
4	\$305	11	\$471
5	\$332	12	\$495
6	\$360	L	—
7	\$388		

NOTES: Includes both L and R Arm Cushions.

ⓘ Cushion arm cushions can be replaced or switched out with these cushion packs.

HWHBCPS

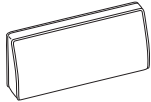

BACK CUSHION PACK — STANDARD

DIMENSIONS

COM: 2.5
Ship Weight: 8.1
Cube: 3.9

FABRIC PRICE CODES

1	\$236	8	\$689
2	\$296	9	\$700
3	\$357	10	\$761
4	\$408	11	\$823
5	\$476	12	\$884
6	\$545	L	—
7	\$616		

NOTES: Includes a single Standard Back Cushion.

ⓘ Cushion backs can be replaced or switched out with these cushion packs.

HWHBCPP

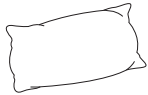

BACK CUSHION PACK — PILLOW

DIMENSIONS

COM: 1.5
Ship Weight: 8.1
Cube: 3.9

FABRIC PRICE CODES

1	\$236	8	\$508
2	\$272	9	\$515
3	\$309	10	\$551
4	\$339	11	\$588
5	\$380	12	\$625
6	\$422	L	—
7	\$464		

NOTES: Includes a single Pillow Back Cushion.

ⓘ Cushion backs can be replaced or switched out with these cushion packs.

HWHGB

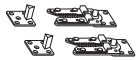

GANGING BRACKET

DIMENSIONS

Ship Weight: 1.0
Cube: 0.1

LIST PRICE

\$60

SPECIFYING EXAMPLE: HWHGB

HOW TO SPECIFY

Select Model Number	Select Fabric
	See page 489
H W H B C P P .	P B L E 0 3



EXECUTIVE CHAIRS

HVL105



HIGH-BACK

Pneumatic
Swivel
Tilt
Tilt Tension
Tilt Lock
Fixed Padded Arms

Functions: **A, E, F, K, L**
(Function Key on pages 212-213)

DIMENSIONS

Depth:	27½	Arm Width:	19
Width:	25	Seat to Floor Height:	17½-20¼
Height:	45¾	Usable Seat Depth:	20¼
Seat Depth:	20¼	Ship Weight:	46.0
Seat Width:	19½	Cube:	6.6
Back Width:	20½	Weight Rating:	250 lbs.
Back Height:	28¾		

PRICE CODE

Leather **\$594**

NOTES: Black Bonded Leather. Polished base. Fixed, padded arms. **HON 5-Year Limited Warranty.**

HON Recommendation: HVL105.SB11 - List Price \$594

HVL131



HIGH-BACK

Pneumatic
Swivel
Tilt
Tilt Tension
Tilt Lock
Fixed Padded Loop Arms

Functions: **A, E, F, K, L, T**
(Function Key on pages 212-213)

DIMENSIONS

Depth:	40	Arm Width:	20½
Width:	28½	Seat to Floor Height:	18½-22
Height:	45½	Usable Seat Depth:	18¼
Seat Depth:	18¼	Ship Weight:	42
Seat Width:	20¾	Cube:	6.3
Back Width:	20¾	Weight Rating:	250 lbs.
Back Height:	26⅞		

PRICE CODE

Vinyl **\$500**

NOTES: Black vinyl with contrasting top stitch. Black frame. Padded loop arms. **HON 5-Year Limited Warranty.**

HON Recommendation: HVL131.EN11 - List Price \$500

HVL151



HIGH-BACK

Pneumatic
Swivel
Tilt
Tilt Tension
Tilt Lock
Fixed Padded Loop Arms

Functions: **A, E, F, K, L, T**
(Function Key on pages 212-213)

DIMENSIONS

Depth:	37½	Arm Width:	20½
Width:	27	Seat to Floor Height:	17¾-21½
Height:	45½	Usable Seat Depth:	18⅝
Seat Depth:	18⅝	Ship Weight:	38
Seat Width:	20½	Cube:	5.1
Back Width:	20½	Weight Rating:	250 lbs.
Back Height:	27¼		

PRICE CODE

Leather **\$431**

NOTES: Black Bonded Leather. Black frame. Padded loop arms. **HON 5-Year Limited Warranty.**

HON Recommendation: HVL151.SB11 - List Price \$431

HOW TO SPECIFY

Select
Model Number

Select
Fabric

SB11 Black Bonded Leather
Specify for models HVL105 and HVL151 only
EN11 Black Vinyl
Specify for model HVL131 only

H V L 1 0 5 .

S B 1 1



Icon Legend on page 17

EXECUTIVE CHAIRS

HVL161



HIGH-BACK

Pneumatic
Swivel
Tilt
Tilt Tension
Tilt Lock
Fixed Padded Loop Arms

Functions: **A, E, F, K, L, T**
(Function Key on pages 212-213)

DIMENSIONS

Depth:	39¼	Arm Width:	19
Width:	25½	Seat to Floor Height:	18¾-22½
Height:	45	Usable Seat Depth:	18¾
Seat Depth:	18¾	Ship Weight:	35
Seat Width:	19	Cube:	4.8
Back Width:	19	Weight Rating:	250 lbs.
Back Height:	26¾		

PRICE CODE

Leather \$405

NOTES: Black Bonded Leather. Black frame. Padded loop arms. **HON 5-Year Limited Warranty.**

HON Recommendation: HVL161.SB11 - List Price \$405

HVL171



MID-BACK

Pneumatic
Swivel
Tilt
Tilt Tension
Tilt Lock
Fixed Loop Arms

Functions: **A, E, F, K, L, T**
(Function Key on pages 212-213)

DIMENSIONS

Depth:	34½	Arm Width:	19¾
Width:	25¾	Seat to Floor Height:	16¾-20½
Height:	38¾	Usable Seat Depth:	17¾
Seat Depth:	17¾	Ship Weight:	26
Seat Width:	19¾	Cube:	3.9
Back Width:	18¾	Weight Rating:	250 lbs.
Back Height:	21¾		

PRICE CODE

Leather \$330

NOTES: Black Bonded Leather. Black frame. Loop arms. **HON 5-Year Limited Warranty.**

HON Recommendation: HVL171.SB11 - List Price \$330

HVL402



HIGH-BACK

Pneumatic
Swivel
Tilt
Tilt Tension
Tilt Lock
Fixed Padded Loop Arms

Functions: **A, E, F, K, L, T**
(Function Key on pages 212-213)

DIMENSIONS

Depth:	28	Arm Width:	19½
Width:	26	Seat to Floor Height:	16½-20½
Height:	45½	Usable Seat Depth:	17½
Seat Depth:	17½	Ship Weight:	44
Seat Width:	19½	Cube:	6.1
Back Width:	19	Weight Rating:	250 lbs.
Back Height:	24½		

PRICE CODE

Vinyl \$479

NOTES: Available in Black and Brown vinyl with contrasting top stitch. EN11 features silver frame. EN45 features black frame. Padded loop arms. **HON 5-Year Limited Warranty.**

HON Recommendation: HVL402.EN11 - List Price \$479

HVL601



HIGH-BACK

Pneumatic
Swivel
Tilt
Tilt Tension
Tilt Lock
Loop Arms

Functions: **A, E, F, K, L, T**
(Function Key on pages 212-213)

DIMENSIONS

Depth:	27	Arm Width:	20½
Width:	26½	Seat to Floor Height:	16¾-20½
Height:	44	Usable Seat Depth:	17
Seat Depth:	17	Ship Weight:	38
Seat Width:	20½	Cube:	4.1
Back Width:	20½	Weight Rating:	250 lbs.
Back Height:	26½		

PRICE CODE

Fabric \$317
Leather \$347

NOTES: Tailored stitching detail in Black Bonded Leather or Black fabric. Fixed loop arms. Black frame. **HON 5-Year Limited Warranty.**

HON Recommendation: HVL601.SB11 - List Price \$347

HOW TO SPECIFY

Select Model Number	Select Fabric
	SB11 Black Bonded Leather <i>Specify for models HVL161, HVL171, and HVL601 only</i>
	EN11 Black Vinyl <i>Specify for model HVL402 only</i>
	EN45 Brown Vinyl <i>Specify for model HVL402 only</i>
	VA10 Black Fabric <i>Specify for model HVL601 only</i>

HVL161

SB11



GUEST CHAIRS

HVL653



GUEST CHAIR

Sled Base
Padded Arms

DIMENSIONS

Depth:	23	Arm Width:	17 ³ / ₄
Width:	22 ¹ / ₄	Seat to Floor Height:	17 ⁵ / ₈
Height:	32	Usable Seat Depth:	16 ³ / ₄
Seat Depth:	17	Ship Weight:	28
Seat Width:	20 ¹ / ₄	Cube:	3.1
Back Width:	18 ¹ / ₂	Weight Rating:	250 lbs.
Back Height:	12		

PRICE CODE

Leather **\$279**

NOTES: Black Bonded Leather with tailored stitching detail. Frame features steel tubular construction. Black frame.

HON Recommendation: HVL653.SB11 - List Price \$279

SEATING

HOW TO SPECIFY

Select Model Number	Select Fabric
	SB11 Black Bonded Leather
H V L 6 5 3 .	S B 1 1



Icon Legend on page 17

MESH CHAIRS

HVL521



MID-BACK

Pneumatic
Swivel
Tilt
Tilt Tension
Tilt Lock
Arms
Functions: **A, E, F, K, L**
(Function Key on pages 212-213)

DIMENSIONS

Depth:	35¼	Arm Width:	18½
Width:	26¼	Seat to Floor Height:	17½-22
Height:	41	Usable Seat Depth:	17¾
Seat Depth:	17¾	Ship Weight:	30
Seat Width:	19½	Cube:	4.1
Back Width:	18¾	Weight Rating:	250 lbs.
Back Height:	21½		

PRICE CODE

Fabric \$375

NOTES: Comfortable and breathable mesh back. Black fabric seat. Sturdy textured black frame. Fixed-height arms. **HON 5-Year Limited Warranty.**

HON Recommendation: HVL521.VA10 - List Price \$375

HVL525



HIGH-BACK

Pneumatic
Swivel
Tilt
Tilt Tension
Tilt Lock
Fixed Loop Arms
Functions: **A, E, F, K, L, T**
(Function Key on pages 212-213)

DIMENSIONS

Depth:	26	Arm Width:	20⅞
Width:	26	Seat to Floor Height:	16¾-21¼
Height:	42¾	Usable Seat Depth:	19
Seat Depth:	19	Ship Weight:	33
Seat Width:	19¾	Cube:	3.8
Back Width:	19¾	Weight Rating:	250 lbs.
Back Height:	23		

PRICE CODE

Fabric \$382

NOTES: Comfortable and breathable mesh back. Black upholstered seat. Fixed, loop arms. **HON 5-Year Limited Warranty.**

HON Recommendation: HVL525.ES10 - List Price \$382

SEATING

HOW TO SPECIFY

Select Model Number

Select Fabric

- VA10** Black Fabric
Specify for model HVL521 only
- ES10** Black Fabric
Specify for model HVL525 only

HVL521

VA10



NESTING CHAIRS

HVL303



SANDWICH MESH BACK AND SEAT

Upholstered Seat and Back
Casters
Arms

DIMENSIONS

Depth:	23 ³ / ₄	Back Height:	16
Width:	23 ³ / ₄	Seat to Floor Height:	19 ¹ / ₄
Height:	33 ¹ / ₂	Usable Seat Depth:	18 ¹ / ₂
Seat Depth:	18 ¹ / ₂	Ship Weight:	27
Seat Width:	19 ¹ / ₂	Cube:	2.1
Back Width:	19 ¹ / ₂	Weight Rating:	250 lbs.

LIST PRICE

\$341

NOTES: Seat and back upholstered in comfortable and breathable Black Sandwich Mesh. Specify Black (T) or Silver (X) frame. Ships one per carton. **HON 5-Year Limited Warranty.**

HON Recommendation: HVL303.MM10.T - List Price \$341

HOW TO SPECIFY

<p>Select Model Number</p> <p>H V L 3 0 3 .</p>	<p>Select Fabric</p> <p>MM10 Black Sandwich Mesh Fabric (only)</p> <p>M M 1 0 .</p>	<p>Select Frame</p> <p>T Black X Silver</p> <p>T</p>
--	--	---

TASK CHAIRS

OPEN MARKET



Icon Legend on page 17

HVL220

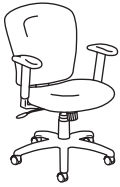

TASK MID-BACK

Pneumatic
Swivel
Tilt
Tilt Tension
Tilt Lock
Height-adjustable Arms

Functions: **A, E, F, K, L, Q**
(Function Key on pages 212-213)

DIMENSIONS

Depth:	34½	Arm Width:	17¾
Width:	26¾	Seat to Floor Height:	17½-21¼
Height:	41	Usable Seat Depth:	16¾
Seat Depth:	16¾	Ship Weight:	35
Seat Width:	20	Cube:	3.7
Back Width:	20¼	Weight Rating:	250 lbs.
Back Height:	22½		

PRICE CODE

Fabric **\$405**

NOTES: Black fabric. Sturdy textured black frame. Height-adjustable arms. **HON 5-Year Limited Warranty.**

HON Recommendation: HVL220.VA10 - List Price \$405

SEATING

HOW TO SPECIFY

Select
Model Number

H V L 2 2 0 .

Select
Fabric

VA10 Black Fabric

V A 1 0



WORKPLACE TOOLS

Ergonomic Solutions

HVL991

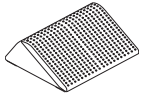

FOOTREST

Anti-Slip Cover

DIMENSIONS

Depth:	13¾	Ship Weight:	7 Ⓢ
Width:	16	Cube:	0.9
Height:	5½	Weight Rating:	250 lbs.

LIST PRICE

\$89

NOTES: **HON 5-Year Limited Warranty.**

! Available in Black (T) finish ONLY.

SPECIFYING EXAMPLE: HVL991.T

HSCASTER

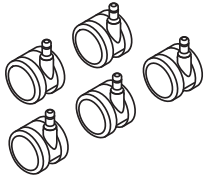

SET OF 5 SOFT CASTERS

DIMENSIONS

Size:	60mm
Ship Weight:	2 Ⓢ
Cube:	0.1

LIST PRICE

\$59

! Available in Black finish only, no specification needed.

HOW TO SPECIFY

Select Model Number	Select Finish
H V L 9 9 1 .	T Black

WORKPLACE TOOLS

Chair Mats

OPEN MARKET



Icon Legend on page 17

	DESCRIPTION	MODEL	SHIP WEIGHT	CUBE	LIST PRICE
	Lipped Chair Mat with Studs 60"W x 46"D 48"W x 36"D	HCM4660LS	13.9	1.0	\$158
		HCM3648LS	8.8	0.6	\$95
	Lipped Chair Mat without Studs 60"W x 46"D 48"W x 36"D	HCM4660LN	13.2	0.5	\$158
		HCM3648LN	8.3	0.3	\$95

NOTES:

- Available with studs for carpet and without studs for hard-surface floors.
- Ships rolled.
- **HON 5-Year Limited Warranty.**
- ! Clear finish only. No specification needed.

SEATING

HOW TO SPECIFY

Select Model Number

H C M 4 6 6 0 L S

CROSS REFERENCE INDEX

MODEL	PAGE	MODEL	PAGE	MODEL	PAGE	MODEL	PAGE
H1522	189	H5901	261	HBTTST42	33	HCTSQR36	28
H1526	189	H5902	261	HBTTSTQR30	33	HCTSQR42	28
H2091	428	H5903	261	HBTTSTQR36	33	HCWI	249
H2092	428	H5905	262	HBTTSTQR42	33	HCWPT	42
H2093	428	H5991	262	HBTTX30L	34	HCWTB3656G	40
H2095	428	H5995	262	HBTTX30S	34	HCWTB3656J	40
H2111	360	H80170	68	HBTTX42L	34	HCWTB3684G	40
H2112	360	H80180	68	HBTTX42S	34	HCWTB3684J	40
H2141	361	H80191	68	HBXRISER	191	HCWTDSBM27	41
H2142	361	H80192	68	HCATIMM	267	HCWTDSBM29	41
H2143	361	H80193	68	HCD1	190	HCWTDSBM36	41
H2144	361	HAECBH	151	HCG6	250	HCWTDSBM42	41
H2145	361	HAEHF	151	HCG6DF	250	HCWTRND30G	40
H2146	361	HAESS	151	HCLA65	141, 147, 165, 198	HCWTRND30J	40
H2164	244	HARCHA1	115	HCLQS	257	HCWTRND36G	40
H2165	244	HARCHA8	115	HCLQT	256	HCWTRND36J	40
H2191	431	HARCHC1	115	HCM3648LN	193, 508	HCWTRND42G	40
H2192	431	HARCHC8	115	HCM3648LS	193, 508	HCWTRND42J	40
H2194	431	HASB2	237	HCM4660LN	193, 508	HCWTSBL18	41
H2281	368	HASB2MF	237	HCM4660LS	193, 508	HCWTSBL27	41
H2285	368	HASB3	238	HCOMDOME2	205	HCWTSBL29	41
H4001	445	HASB3MF	238	HCPU1	172, 185	HCWTSBL36	41
H4002	445	HASGBSL	240	HCTIMM	266	HCWTSBL42	41
H4003	445	HASHB1	230	HCT29LX	29	HCWTSBM18	41
H4008	445	HASHB1MF	230	HCT29MT	29	HCWTSBM27	41
H4022	187	HASHB2	232	HCT29MX	29	HCWTSBM29	41
H4028	187	HASHB2MF	232	HCT29ST	29	HCWTSBM36	41
H4029	187	HASHB3	234	HCT29SX	29	HCWTSBM42	41
H4031	325	HASHB3MF	234	HCT36LX	29	HCWTSF30G	40
H4033	325	HASHBTC	236	HCT36MT	29	HCWTSF30J	40
H4039	325	HASHBTCMF	236	HCT36MX	29	HCWTSF36G	40
H4041	410	HASLB1	229	HCT36ST	29	HCWTSF36J	40
H4043	410	HASLB1MF	229	HCT36SX	29	HCWTSF36J	40
H4048	410	HASLB2	231	HCT42LX	29	HCWTSF36J	40
H4049	410	HASLB2MF	231	HCT42MT	29	HCWTSQR30G	40
H4069	418	HASLB3	233	HCT42MX	29	HCWTSQR30J	40
H4071	414	HASLB3MF	233	HCT42ST	29	HCWTSQR36G	40
H4073	414	HASLBTC	235	HCT42SX	29	HCWTSQR36J	40
H4075	415	HASLBTCMF	235	HCTLDS	30	HCWTSQR42G	40
H4077	415	HASPS	239	HCTMDS	30	HCWTSQR42J	40
H4079	418	HASPSMF	239	HCTRECT2448	28	HCWTSR3656G	40
H4091	416	HASSGC	240	HCTRECT2460	28	HCWTSR3656J	40
H4093	416	HASSP	240	HCTRECT2472	28	HCWTSR3684G	40
H4095	417	HBDMAUSB	184	HCTRECT3048	28	HCWTSR3684J	40
H4097	417	HBLH3160	69	HCTRECT3060	28	HD2	190
H4099	418	HBLH3170	69	HCTRECT3072	28	HD8	190
H5001	421	HBSDCSNT2832	145	HCTRND24	28	HD8X	172
H5002	421	HBSDFN3030	145	HCTRND30	28	HDPS1	197
H51204	188	HBSDRBN2231	145	HCTRND36	28	HE4022	187
H51206	188	HBSDRECT2031	145	HCTRND42	28	HE4LSTL18	152
H5701	480	HBSDRECT2038	145	HCTROUGH17	61, 65, 77, 80, 116, 201, 208	HE4LSTL30	152
H5703	480	HBSDSPY2636	145	HCTROUGH1710	61, 65, 77, 80, 116, 201, 208	HEB4LEG	139
H5705	480	HBSDTRP2040	145			HEBBXRL	141, 147
H5711	481	HBSMAUSB	184			HEBS4LEG	139
H5713	481	HBTMS	61	HCTROUGH36	61, 65, 80, 116, 208	HEBS4LEG	146
H5715	481	HBTTWCW	34	HCTROUGH3610	61, 65, 80, 116, 208	HEBY4LEG	139
H5721	484	HBTTD30	34	HCTS	30	HEDRT-2766E-NS	140
H5723	484	HBTTD42	34	HCTSFT24	28	HEDRT2766E	138
H5725	484	HBTTTRND30	33	HCTSFT30	28	HEFS01	154
H5731	485	HBTTTRND36	33	HCTSFT36	28	HEHP3660E	137
H5733	485	HBTTTRND42	33	HCTSFT42	28	HEMKR426029BB	148
H5735	485	HBTTSTFT30	33	HCTSQR24	28	HEMKR426029L	148
H5795	480, 481, 484, 485	HBTTSTFT36	33	HCTSQR30	28	HEMKR426036BB	148

CROSS REFERENCE INDEX

MODEL	PAGE	MODEL	PAGE	MODEL	PAGE	MODEL	PAGE
HEMKR426036L	148	HFDB42BF	48	HFxB29A	48	HI2ATA	343, 356
HEMKR426042BB	148	HFL45O	291	HFxB29AN	48	HI2BTHR	344
HEMKR426042L	148	HFLB2	298	HFxB29B	48	HI2FHA	281, 343, 356
HEMKR427229BB	148	HFLB3	298	HFxB42A	48	HI2HR	344
HEMKR427229L	148	HFLCC1	290	HFxB42AN	48	HIB50	349
HEMKR427236BB	148	HFLCCIDF	296	HFxB42B	48	HICS7	346
HEMKR427236L	148	HFLCO1	306	HGDK3-F	165, 167	HIGS7DF	348
HEMKR427242BB	148	HFLCOIDF	307	HGRMTAC 30, 51, 65, 80, 172, 204, 323		HIEH1	354
HEMKR427242L	148	HFLDGRMT	204	HGRMTAC2 30, 51, 65, 80, 172, 204, 323		HIEH2	354
HEMKRDIVIDER	150	HFLDGRMT3	204	HGRMTDATA 51, 65, 80, 204		HIEH3	354
HEMKREND29-F	149	HFLDGRMT4	204	HGRMTUSB2 51, 65, 172, 204, 323		HIGCL	349
HEMKREND29-SP	149	HFLGANG	291	HGROM1BLANK	117	HIGS6	346
HEMKREND36-F	149	HFLMC1	289	HGROM2BLANK	117	HIGS6DF	347
HEMKREND36-SP	149	HFLMCIDF	294	HGTMM	310	HILMBR	343
HEMKREND42-F	149	HFLMCIS	292	HGVIMM	311	HIPAA	281, 343, 356
HEMKREND42-SP	149	HFLMCISDF	297	HH870924	195	HISB6	346
HEMKRSHELF	150	HFLML1	289	HH870924CH	195	HISB6DF	347
HERD42E	137	HFLMLIDF	294	HH870930	195	HITL1	352
HERD48E	137	HFLMR1	289	HH870930CH	195	HITL2	352
HESA2440E	136	HFLMRIDF	295	HH870942	195	HITL3	352
HESA3050E	136	HFLRC1	288	HH870942CH	195	HITLM	334
HESH3060E	136	HFLRCIDF	293	HH870960	195	HITLMKD	336
HESH6066E	138	HFLRCIS	292	HH870960CH	195	HITLRA	339
HESKD4872E	138	HFLRCISDF	297	HHABCASTER	141	HITLRAKD	340
HESN3054E	136	HFLSC1	288	HHB02	475	HITS5	355
HESNP54E	136	HFLSCIDF	293	HHB03	475	HITSM	334
HESPCR	140	HFLSCIS	292	HHC-ARMPULL15	210	HITSRA	339
HESQ36E	137	HFLSCISDF	297	HHC-ARMPULL5	210	HIWM1	353
HESQ42E	137	HFLSC2	302	HHC-FOOTPULL15	210	HIWM2	353
HESQ48E	137	HFLSC2DF	304	HHC-FOOTPULL5	210	HIWM3	353
HESW-3054E-NS	140	HFLSO1	291	HHC-PPESTND	209	HIWM8	355
HESW3054E	136	HFLWI45	290	HHC-PPEWALL	209	HIWMBT	337
HESY-3654E-NS	140	HFLWI45DF	296	HHC-SANSTND-TRAY	209	HIWMM	334
HESY3654E	136	HFLWO45	290	HHC-SANSTND	209	HIWMMHR	335
HETD54E	137	HFLWO45DF	296	HHC-SANSTND2	209	HIWMMKD	336
HETR2448E	137	HFLYO1	306	HHCB50	477	HIWMMMS	338
HETR2460E	137	HFLYO1DF	307	HHCG11	462	HIWMMMSKD	338
HETR2472E	137	HFMBIN12	151, 178	HHCG11DF	463	HIWMRA	339
HETR3048E	137	HFMBIN3	141, 147, 151, 178	HHCG21	462	HIWMRAKD	340
HETR3060E	137	HFMBIN6	151, 178	HHCG21DF	463	HIWMU	341
HETR3072E	137	HFSS7	301	HHCG50	462	HIWMUKD	342
HETZ3060E	137	HFSS74L	301	HHCG50DF	464	HIWMUL	341
HF23C	179	HFSS74LDF	303	HHCGB21	465	HIWMULKD	342
HFAA01	364	HFTB17N	48	HHCGB31	465	HKBS	186
HFALO2	364	HFTLA2460	47	HHCGBR	467	HKTLONG	186
HFA503	364	HFTLA3372	47	HHCGBRCH	467	HKTMD	186
HFCG6	301	HFTLA3384	47	HHCMT24	208	HKTSHORT	186
HFCG6DF	303	HFTLA3396	47	HHCMT36	208	HL2DARM	281
HFCL2	302	HFTLC2460	47	HHCP1	462	HL4DARM	281
HFCL2DF	304	HFTLC3372	47	HHCPIDF	464	HLD-M3A	163
HFDB17B	48	HFTLC3384	47	HHCT01	477	HLD-M3AA	163
HFDB17N	48	HFTLC3396	47	HHCT02	477	HLD-M3AB	163
HFDB29A	48	HFTLD26	49	HHCT020	476	HLD-M3F	163
HFDB29AN	48	HFTLD30	47	HHCT024	476	HLD-M3FA	163
HFDB29B	48	HFTLD36	47	HHCT048	476	HLD-M3FB	163
HFDB42A	48	HFTLR12	50	HHCT12	477	HLD-M3T	163
HFDB42AF	48	HFTLS24	49	HHCTC	466	HLDA-15	165
HFDB42AF72	48	HFTLS30	47	HHCTL4	466	HLDST1	196
HFDB42AF84	48	HFTLS36	47	HHCTRT	466	HLDV-M3A	164
HFDB42AF96	48	HFTLW45	50	HHCTS	466	HLDV-M3F	164
HFDB42AFN	48	HFTPTL18	49	HHPS1	197	HLDV-MRECT2026A	164
HFDB42AN	48	HFTTAL14	50, 323	HI2AAA	343, 356	HLED1	194
HFDB42B	48	HFxB17B	48			HLED17A	195

CROSS REFERENCE INDEX

MODEL	PAGE	MODEL	PAGE	MODEL	PAGE	MODEL	PAGE
HLED17AS	195	HLWBF1-1248W	176	HMG2	396	HMTS01	224
HLED17AUO	195	HLWBF2-1248W	176	HML1S	316	HMTS11	224
HLED1IOC	194	HLWBS-248WT	176	HML1SDF	319	HMTUMOD26	75
HLED2	194	HLWBS-248WW	176	HML2S	316	HMTUMOD32	61, 75, 171
HLED31A	195	HLWBS-448WT	176	HML2SDF	320	HMTUMOD38	36, 75
HLED31AS	195	HLWBS-448WW	176	HML2ST	318	HMTUMOD44	61, 75
HLED31AUO	195	HLWM	277	HML2STDF	322	HMTUMOD50	36, 75
HLEDOSA	195	HLWMBT	279	HML3S	317	HMTUMOD56	75
HLEU	276	HLWR-12	176	HML3SDF	321	HMTUMOD62	75
HLEUBT	279	HLWU	277	HML8851	69, 269	HMTUMOD74	75
HLINEARA1	115	HLWUBT	279	HML8852	69, 269	HMTUMOD86	75
HLINEARA8	115	HMACABLE	64, 79, 118, 203	HML8858	43	HMVH-2448(?)-FX	72
HLINEARCI	115	HMAGANG	61, 77, 141, 201	HMNI	393	HMVH-2448(?)-NS	73
HLINEARC8	115	HMAJUMP	64, 79, 203	HMN2	393	HMVH-3060(?)-FX	72
HLMSHHR	281	HMAPLATE	64, 79, 118, 203	HMNT1	399	HMVH-3060(?)-NS	73
HLSA-CR12	175	HMAPOWER36	79, 203	HMNT2	399	HMVH-3672(?)-FX	72
HLSA-HRK	175	HMAPOWER362	79, 203	HMPT2448NS	36	HMVH-3672(?)-NS	73
HLSA-SK1220T	175	HMAPOWER42	79, 203	HMPT2460NS	36	HMVMB-3072WW	76
HLSA-SK3020T	175	HMAPOWER422	79, 203	HMPT2472NS	36	HMVMB-3672WW	76
HLSA-TK12	175	HMAPOWER48	64, 79, 203	HMPT3048NS	36	HMVPC-DTLG	76
HLSA-TK3	175	HMAPOWER482	64, 79, 203	HMPT3060NS	36	HMVPC-MP	76
HLSA-TK6	175	HMAPOWER54	79, 203	HMPT3072NS	36	HMVPCA1-1830G	76
HLSA-WBK52	175	HMAPOWER542	79, 203	HMPTBFX	35	HMVPCA1-1830R	76
HLSC36T-1D	174	HMAPOWER60	64, 79, 118, 203	HMPTBNSL	35	HMVPCA2-1830G	76
HLSC36T-1N	173	HMAPOWER602	64, 79, 203	HMPTBNSS	35	HMVPCA2-1830R	76
HLSC36T-2D	174	HMAPOWER66	79, 203	HMPPT2448	35	HMVPCF-1830G	76
HLSC36T-2N	173	HMAPOWER662	79, 203	HMPPT2460	35	HMVPCF-1830R	76
HLSC52T-21D	174	HMAPOWER72	64, 79, 118, 203	HMPPT2472	35	HMVPCSS-4C	76
HLSC52T-21N	173	HMAPOWER722	64, 79, 203	HMPPT3048	35	HMVPCSS-4C4C	76
HLSC52T-3D	174	HMAPOWER84	64, 79, 118, 203	HMPPT3060	35	HMVPCSS-4C9C	76
HLSC52T-3N	173	HMAPOWER842	64, 79, 203	HMPPT3072	35	HMVPCSS-4O	76
HLSF52T-21D	174	HMAPOWER96	64, 79, 118, 203	HMPVWM28	208	HMVPCSS-4O4C	76
HLSF52T-21N	173	HMAPOWER962	64, 79, 203	HMS1	385	HMVPCSS-4O9C	76
HLSF52T-3D	174	HMASD	183	HMS2	385	HMVR-1848(?)-AH	74
HLSF52T-3N	173	HMASPLIT	64, 79, 118, 203	HMSCART	385	HMVR-1848(?)-FX	72
HLSL1212	198	HMASTS	183	HMSFLTGLD	386	HMVR-1848(?)-NS	73
HLSL1460LS	196	HMAVHA	376	HMSGANG	386	HMVR-1860(?)-AH	74
HLSL1472LS	196	HMAVHAMF	376	HMSGLD	386	HMVR-1860(?)-FX	72
HLSL4831MB	115, 199	HMAVHN	375	HMSSTLGLD	386	HMVR-1860(?)-NS	73
HLSLDRWORG	198	HMAVHNMF	375	HMT1	383	HMVR-1872(?)-AH	74
HLT2460T-L3	170	HMAVMA	374	HMT1848E	57	HMVR-1872(?)-FX	72
HLT2460T-R3	170	HMAVMAMF	374	HMT1848G	57	HMVR-1872(?)-NS	73
HLT2672T-23	170	HMAVMN	373	HMT1860E	57	HMVR-2436(?)-AH	74
HLTA-TR24	170	HMAVMNMF	373	HMT1860G	57	HMVR-2436(?)-FX	72
HLTM	278	HMAVO	377	HMT1872E	57	HMVR-2436(?)-NS	73
HLTP	278	HMAVOMF	377	HMT1872G	57	HMVR-2442(?)-AH	74
HLTSM	280	HMBFLIP18L	59	HMT2448E	57	HMVR-2442(?)-FX	72
HLTSP	280	HMBFLIP18S	59	HMT2448G	57	HMVR-2442(?)-NS	73
HLTSU	280	HMBFLIP24L	59	HMT2460E	57	HMVR-2448(?)-AH	74
HLTU	278	HMBFLIP24S	59	HMT2460G	57	HMVR-2448(?)-FX	72
HLTV2460T-3	171	HMBFLIP30L	59	HMT2472E	57	HMVR-2448(?)-NS	73
HLTV2466T-33	171	HMBFLIP30S	59	HMT2472G	57	HMVR-2454(?)-AH	74
HLVBC3330	180	HMBPOST	59	HMT3048E	57	HMVR-2454(?)-FX	72
HLVBC4330	180	HMBTLEG18	59	HMT3048G	57	HMVR-2454(?)-NS	73
HLVBC5630	180	HMBTLEG24	59	HMT3060E	57	HMVR-2460(?)-AH	74
HLVMSC3330R	178	HME3	379	HMT3060G	57	HMVR-2460(?)-FX	72
HLVMSC4330R	178	HMG1	389	HMT3072E	57	HMVR-2460(?)-NS	73
HLVMSC5630R	178	HMG2	389	HMT3072G	57	HMVR-2466(?)-AH	74
HLVPM1	196	HMG3	390	HMT5	383	HMVR-2466(?)-FX	72
HLVPM2	197	HMG4	390	HMTHR3060E	58	HMVR-2466(?)-NS	73
HLVSC3330R	179	HMG5	390	HMTHR3060G	58	HMVR-2472(?)-AH	74
HLVSC4330R	179	HMG7	390	HMTHR3248E	58	HMVR-2472(?)-FX	72
HLVSC5630R	179	HMG1	396	HMTHR3248G	58	HMVR-2472(?)-NS	73

CROSS REFERENCE INDEX

MODEL	PAGE	MODEL	PAGE	MODEL	PAGE	MODEL	PAGE
HMVR-2484(?)-FX	72	HNL1560FD	114	HQQICUSH	442	HSS4L-30B	167
HMVR-2484(?)-NS	73	HNL1560LD	113	HRUCKIL	436	HSSA-WB1618	167
HMVR-2496(?)-FX	72	HNL1560LL	113	HRUCK1W	437	HSSCL-14A	168
HMVR-2496(?)-NS	73	HNL1560SD	114	HRUCK5L	436	HSSCL-16B	168
HMVR-3036(?)-AH	74	HNL1566FD	114	HRUCK5W	437	HSSCL-18B	168
HMVR-3036(?)-FX	72	HNL1566LD	113	HSB50	221	HSSST-18B	169
HMVR-3036(?)-NS	73	HNL1566LL	113	HSB50DF	223	HSSTK-18B	169
HMVR-3042(?)-AH	74	HNL1566SD	114	HSCASTER	266, 267, 281, 343, 356, 457, 484, 485, 507	HT27FB3060	99
HMVR-3042(?)-FX	72	HNL1572FD	114			HT27FB3672	99
HMVR-3042(?)-NS	73	HNL1572LD	113	HSCCR36BPG	123	HT27FB4284	99
HMVR-3048(?)-AH	74	HNL1572LL	113	HSCCR36LM	123	HT27FB48108	99
HMVR-3048(?)-FX	72	HNL1572SD	114	HSCCR36LMK	123	HT27FB48120	99
HMVR-3048(?)-NS	73	HNL1578FD	114	HSCCR48BPG	123	HT27FB48144	99
HMVR-3054(?)-AH	74	HNL1578LD	113	HSCCR48LM	123	HT27FB48168	98
HMVR-3054(?)-FX	72	HNL1578LL	113	HSCCR48LMK	123	HT27FB48180	98
HMVR-3054(?)-NS	73	HNL1578SD	114	HSCCSR2448BPG	123	HT27FB48192	98
HMVR-3060(?)-AH	74	HNL3630TB	199	HSCCSR2448LM	123	HT27FB48216	98
HMVR-3060(?)-FX	72	HNL3630WB	199	HSCCSR2448LMK	123	HT27FB48240	98
HMVR-3060(?)-NS	73	HNL3636TB	199	HSCCSS36BPG	123	HT27FB4896	99
HMVR-3066(?)-AH	74	HNL3636WB	199	HSCCSS36LM	123	HT27FBM	99
HMVR-3066(?)-FX	72	HNL4930TB	199	HSCCSS36LMK	123	HT29AL108	100
HMVR-3066(?)-NS	73	HNL4930WB	199	HSCCSS48BPG	123	HT29AL120	100
HMVR-3072(?)-AH	74	HNL4936TB	199	HSCCSS48LM	123	HT29AL144	100
HMVR-3072(?)-FX	72	HNL4936WB	199	HSCCSS48LMK	123	HT29AL168	100
HMVR-3072(?)-NS	73	HNLMP3628	112	HSCER24BPG	124	HT29AL180	100
HMVR-3084(?)-FX	72	HNLMP5428	112	HSCER24LM	124	HT29AL192	100
HMVR-3084(?)-NS	73	HNLMP7228	112	HSCER24LMK	124	HT29AL216	100
HMVR-3096(?)-FX	72	HNLMP9028	112	HSCCESS24BPG	124	HT29AL240	100
HMVR-3096(?)-NS	73	HNLRC2436	112	HSCCESS24LM	124	HT29AL60	100
HMVR-3648(?)-AH	74	HNLRC2454	112	HSCCESS24LMK	124	HT29AL72	100
HMVR-3648(?)-FX	72	HNLRC2472	112	HSCSI	220	HT29AL84	100
HMVR-3648(?)-NS	73	HNLRC2490	112	HSCS1DF	222	HT29AL96	100
HMVR-3660(?)-AH	74	HPACSM	183	HSCS2	221	HT29ALEG	100
HMVR-3660(?)-FX	72	HPACW	183	HSCS2DF	223	HT29ALM	100
HMVR-3660(?)-NS	73	HPADD	184	HSGANG	220, 223	HT29FB3060	99
HMVR-3672(?)-AH	74	HPASD	184	HSGS6	220	HT29FB3672	99
HMVR-3672(?)-FX	72	HPATF	184	HSGS6DF	222	HT29FB4284	99
HMVR-3672(?)-NS	73	HPHAP2028E	60	HSLV2DAP	457	HT29FB48108	99
HMVT-2448(?)-FX	72	HPHAP2028G	60	HSLV4DAP	457	HT29FB48120	99
HMVT-2448(?)-NS	73	HPN1	425	HSLVFAP	457	HT29FB48144	99
HMVT-3060(?)-FX	72	HPN2	425	HSLVLMBR	457	HT29FB48168	98
HMVT-3060(?)-NS	73	HPPMFB	177	HSLVSM	451	HT29FB48180	98
HMVT-3672(?)-FX	72	HPPMHK	177	HSLVSMMS	451	HT29FB48192	98
HMVT-3672(?)-NS	73	HPPMMT	177	HSLVSMR	453	HT29FB48216	98
HNI	407	HPPMPB	177	HSLVSMRS	453	HT29FB48240	98
HNIU	407	HPPMPC	177	HSLVSMU	455	HT29FB4896	99
HN6	408	HPWRMOB1	205, 241	HSLVSMUS	455	HT29FBM	99
HN7	408	HPWRMOD2	37, 205	HSLVTMM	450	HT36FB3060	99
HNATA	408	HPWRMOD2UWM	51, 205	HSLVTMMKD	456	HT36FB3672	99
HNFA	408	HPWRMOD2WC	205	HSLVTMMS	450	HT36FB4284	99
HNL1530FD	114	HPWRMOD3UWM	51, 205	HSLVTMR	452	HT36FB48108	99
HNL1530LD	113	HPWRMOD3WC	205	HSLVTMRKD	456	HT36FB48120	99
HNL1530LL	113	HPWRMOD4WC	205	HSLVTMRS	452	HT36FB48144	99
HNL1536FD	114	HQB	62, 77, 201	HSLVTMU	454	HT36FB48168	98
HNL1536LD	113	HQBCJ36	62, 77, 201	HSLVTMUKD	456	HT36FB48180	98
HNL1536LL	113	HQHI-3	62, 77, 118, 201	HSLVTMUS	454	HT36FB48192	98
HNL1542FD	114	HQH5-3	62, 77, 118, 201	HSMPWR-1P-2U	205	HT36FB48216	98
HNL1542LD	113	HQH5-E-3PIE	118, 201	HSS4L-06A	166	HT36FB48240	98
HNL1542LL	113	HQH5-E-3PIU2B	118, 201	HSS4L-12A	166	HT36FB4896	99
HNL1548FD	114	HQH5-E-3P3B	118, 201	HSS4L-14A	166	HT36FBM	99
HNL1548LD	113	HQH5-P-3P1B	62, 77, 118, 201	HSS4L-16B	166	HT42AL60	100
HNL1548LL	113	HQJ3	62, 77, 201	HSS4L-18B	166	HT42AL72	100
HNL1548SD	114	HQQ1	442	HSS4L-24B	167	HT42AL84	100

CROSS REFERENCE INDEX

MODEL	PAGE	MODEL	PAGE	MODEL	PAGE	MODEL	PAGE
HT42AL96	100	HTL(?)24	95	HTLC3072HCTFP	105	HTLC4296LCTFP	103
HT42ALEG	100	HTL(?)30	95	HTLC3072HCTFPL	106	HTLC4296LCTFPL	104
HT42FB3060	99	HTL(?)3060	94	HTLC3072HCTFPR	106	HTLC4296LCTFPR	104
HT42FB3672	99	HTL(?)36	95	HTLC3072HCTHP	105	HTLC4296LCTHP	103
HT42FB4284	99	HTL(?)3672	94	HTLC3072HCTP	105	HTLC4296LCTP	103
HT42FB48108	99	HTL(?)42	95	HTLC3072HCTPL	106	HTLC4296LCTPL	104
HT42FB48120	99	HTL(?)42108	94	HTLC3072HCTPR	106	HTLC4296LCTPR	104
HT42FB48144	99	HTL(?)42120	94	HTLC3072LCTFP	105	HTLCRED42	110
HT42FB48168	98	HTL(?)42144	94	HTLC3072LCTFPL	106	HTLCRED42S	110
HT42FB48180	98	HTL(?)42168	94	HTLC3072LCTFPR	106	HTLCRED57	110
HT42FB48192	98	HTL(?)42180	94	HTLC3072LCTHP	105	HTLCRED57S	110
HT42FB48216	98	HTL(?)42192	94	HTLC3072LCTP	105	HTLCRED72	110
HT42FB48240	98	HTL(?)42216	94	HTLC3072LCTPL	106	HTLCRED72S	110
HT42FB4896	99	HTL(?)42240	94	HTLC3072LCTPR	106	HTLCUBE108	97
HT42FBM	99	HTL(?)4284	94	HTLC3096HCTFP	105	HTLCUBE120	97
HTALWMGR29	100	HTL(?)4296	94	HTLC3096HCTFPL	106	HTLCUBE144	97
HTALWMGR42	100	HTL(?)48	95	HTLC3096HCTFPR	106	HTLCUBE168	97
HTBINSLIDE	110	HTL(?)48108	94	HTLC3096HCTHP	105	HTLCUBE180	97
HTFWMGR27	99	HTL(?)48120	94	HTLC3096HCTP	105	HTLCUBE192	97
HTFWMGR29	99	HTL(?)48144	94	HTLC3096HCTPL	106	HTLCUBE216	97
HTFWMGR36	99	HTL(?)48168	94	HTLC3096HCTPR	106	HTLCUBE240	97
HTFWMGR42	99	HTL(?)48180	94	HTLC3096LCTFP	105	HTLCUBE48	101
HTFXL27	102	HTL(?)48192	94	HTLC3096LCTFPL	106	HTLCUBE84	97
HTFXL27C	102	HTL(?)48216	94	HTLC3096LCTFPR	106	HTLCUBE96	97
HTFXL27P	102	HTL(?)48240	94	HTLC3096LCTHP	105	HTLCUBEM	97
HTFXL29	102	HTL(?)4896	94	HTLC3096LCTP	105	HTLCUBES108	97
HTFXL29C	102	HTL(?)54108	94	HTLC3096LCTPL	106	HTLCUBES120	97
HTFXL29P	102	HTL(?)54120	94	HTLC3096LCTPR	106	HTLCUBES144	97
HTFXL36	102	HTL(?)54144	94	HTLC4260HCTFP	103	HTLCUBES168	97
HTFXL36C	102	HTL(?)54168	94	HTLC4260HCTFPL	104	HTLCUBES180	97
HTFXL36P	102	HTL(?)54180	94	HTLC4260HCTFPR	104	HTLCUBES192	97
HTFXL42	102	HTL(?)54192	94	HTLC4260HCTHP	103	HTLCUBES216	97
HTFXL42C	102	HTL(?)54216	94	HTLC4260HCTP	103	HTLCUBES240	97
HTFXL42P	102	HTL(?)54240	94	HTLC4260HCTPL	104	HTLCUBES48	101
HTFXM27	102	HTLB1048LP	120	HTLC4260HCTPR	104	HTLCUBES96	97
HTFXM27C	102	HTLB12048P	119	HTLC4260LCTFP	103	HTLCUBESM	97
HTFXM27P	102	HTLB1248LP	120	HTLC4260LCTFPL	104	HTLD60	95
HTFXM29	102	HTLB14448P	119	HTLC4260LCTFPR	104	HTLHP108	96
HTFXM29C	102	HTLB1448LP	120	HTLC4260LCTHP	103	HTLHP120	96
HTFXM29P	102	HTLB1648LP	120	HTLC4260LCTP	103	HTLHP144	96
HTFXM36	102	HTLB16848P	119	HTLC4260LCTPL	104	HTLHP168	96
HTFXM36C	102	HTLB1848LP	120	HTLC4260LCTPR	104	HTLHP180	96
HTFXM36P	102	HTLB2048LP	120	HTLC4272HCTFP	103	HTLHP192	96
HTFXM42	102	HTLBENCH30	109	HTLC4272HCTFPL	104	HTLHP216	96
HTFXM42C	102	HTLBENCH48	109	HTLC4272HCTFPR	104	HTLHP240	96
HTFXM42P	102	HTLBENCH60	109	HTLC4272HCTHP	103	HTLHP84	96
HTFXS27	102	HTLBENCHCUSH30	109	HTLC4272HCTP	103	HTLHP96	96
HTFXS27P	102	HTLBENCHCUSH48	109	HTLC4272HCTPL	104	HTLHPM	96
HTFXS29	102	HTLBENCHCUSH60	109	HTLC4272HCTPR	104	HTLLECTA	109
HTFXS29P	102	HTLC3060HCTFP	105	HTLC4272LCTFP	103	HTLM4272	94
HTFXS36	102	HTLC3060HCTFPL	106	HTLC4272LCTFPL	104	HTLM4872	94
HTFXS36P	102	HTLC3060HCTFPR	106	HTLC4272LCTFPR	104	HTLM5472	94
HTFXS42	102	HTLC3060HCTHP	105	HTLC4272LCTHP	103	HTLM7248P	119
HTFXS42P	102	HTLC3060HCTP	105	HTLC4272LCTP	103	HTLMC1828DL	111
HTFXT27	102	HTLC3060HCTPL	106	HTLC4272LCTPL	104	HTLMC1828DR	111
HTFXT27P	102	HTLC3060HCTPR	106	HTLC4272LCTPR	104	HTLMC1828L	111
HTFXT29	102	HTLC3060LCTFP	105	HTLC4296HCTFP	103	HTLMC1828O	111
HTFXT29P	102	HTLC3060LCTFPL	106	HTLC4296HCTFPL	104	HTLMC1828R	111
HTG1PWR-3P-1B	65, 117, 206, 323	HTLC3060LCTFPR	106	HTLC4296HCTFPR	104	HTLMT4260H	108
HTG2PWR-3P-1E	117, 206	HTLC3060LCTHP	105	HTLC4296HCTHP	103	HTLMT4260HFR	108
HTG2PWR-3P-1U-W	117, 206	HTLC3060LCTP	105	HTLC4296HCTP	103	HTLMT4260L	108
HTG2PWR-3P-2B-2U	117, 206	HTLC3060LCTPL	106	HTLC4296HCTPL	104	HTLMT4272H	108
HTG2PWR-4P-2B	117, 206	HTLC3060LCTPR	106	HTLC4296HCTPR	104	HTLMT4272HFR	108

CROSS REFERENCE INDEX

MODEL	PAGE	MODEL	PAGE	MODEL	PAGE	MODEL	PAGE
HTLMT4272L	108	HTLT168	96	HUTM2040	127	HVL653	503
HTLMTHBACK	108	HTLT72	96	HUTM2060	127	HVL685	471
HTLMTLBACK	108	HTLT96	96	HUTM2460	127	HVL691	253
HTLMTTV	108	HTLXP36	101	HUTM3060	127	HVL693	253
HTLP108	96	HTLXP42	101	HUTM3072	127	HVL701	486
HTLP120	96	HTLXP48	101	HUTM3672	127	HVL702	486
HTLP144	96	HTMC304260	107	HV-UT1	198	HVL705	486
HTLP168	96	HTMC304260BB	107	HVL102	470	HVL712	486
HTLP180	96	HTMC304272	107	HVL103	470	HVL721	283
HTLP192	96	HTMC304272BB	107	HVL105	501	HVL791	402
HTLP216	96	HTMC304296	107	HVL108	271	HVL844	468
HTLP240	96	HTMC304296BB	107	HVL131	501	HVL852	468
HTLP60	96	HTMC424260	107	HVL149	439	HVL853	468
HTLP72	96	HTMC424260BB	107	HVL151	501	HVL871	252
HTLP84	96	HTMC424272	107	HVL161	502	HVL872	252
HTLP96	96	HTMC424272BB	107	HVL171	502	HVL873	252
HTLPB	119	HTMC424296	107	HVL205	472	HVL887	268
HTLPBS	119	HTMC424296BB	107	HVL210	472	HVL888	268
HTLPM	96	HTPCIF48	241	HVL215	472	HVL991	192, 422, 507
HTLPRES	115	HTPCIF72	241	HVL220	506	HVL995	472
HTLR108	97	HTPHWIF72	241	HVL232	370	HVLPERCH	422
HTLR120	97	HTPKIT48	241	HVL238	370	HWHIC	496
HTLR144	97	HTPKIT482	241	HVL282	400	HWHICCF	496
HTLR168	97	HTPKIT60	241	HVL283	400	HWHISP	490
HTLR180	97	HTPKIT602	241	HVL303	505	HWHISPCF	491
HTLR192	97	HTPKIT72	241	HVL304	225	HWHISS	490
HTLR216	97	HTPKIT722	241	HVL314	225	HWHISSCF	491
HTLR240	97	HTPLATEVHAU	117, 207	HVL402	502	HWHITCP	497
HTLR36	101	HTPSPLIT	241	HVL508	357	HWHITCPCF	498
HTLR42	101	HTRACK	110	HVL511	469	HWHITCS	497
HTLR48	101	HTSSRD	298	HVL515	469	HWHITCSCF	498
HTLR84	97	HTTLEG108	100	HVL518	357	HWH2SP	492
HTLR96	97	HTTLEG120	100	HVL521	504	HWH2SPCF	493
HTLRC108	97	HTTLEG144	100	HVL525	504	HWH2SS	492
HTLRC120	97	HTTLEG168	100	HVL531	432	HWH2SSCF	493
HTLRC144	97	HTTLEG180	100	HVL532	432	HWH3SP	494
HTLRC168	97	HTTLEG192	100	HVL534	433	HWH3SPCF	495
HTLRC180	97	HTTLEG216	100	HVL539	433	HWH3SS	494
HTLRC192	97	HTTLEG240	100	HVL541	282	HWH3SSCF	495
HTLRC216	97	HTTLEG60	100	HVL581	270	HWHACPP	500
HTLRC240	97	HTTLEG72	100	HVL582	270	HWHACPS	500
HTLRC48	101	HTTLEG84	100	HVL585	270	HWHBCPP	500
HTLRC84	97	HTTLEG96	100	HVL601	502	HWHBCPS	500
HTLRC96	97	HTTLEGM	100	HVL604	471	HWHGB	500
HTLRCM	97	HTXLEG	102	HVL605	471	HWHLP	499
HTLRM	97	HTXLEGSH	102	HVL606	440	HWHSP18	499
HTLSHELF	110	HUMPWR-IP-2U	205, 241	HVL616	440	HWMCLPLG	208
HTLT120	96	HUTM1872	127	HVL643	251	HWMCLPSM	208
HTLT144	96						

NOTES

NOTES

NOTES

NOTES

NOTES

NOTES

INFORMATION ON ORDERING PARTS

When parts are needed to repair HON products, the following guidelines should be followed to expedite the process.

1. Warranty orders are submitted on HON Ready via the Quick Claim tool. To purchase repair parts, please visit HONAccessories.com which can be found on HON.com.
2. There are no discounts applied to parts. Pricing quoted is the net value. Parts pricing is subject to change without notice.
3. For a part not covered by warranty applicable shipping charges will apply.
4. All keys are \$6.00 each plus a shipping and handling fee of \$3.00 per shipping location.
5. Parts may be paid for with an approved credit card. Approved Cards: MasterCard, VISA and American Express.
6. Payment terms for invoiced parts are Net 30 days.
7. Due to short leadtimes on parts, no changes will be accepted after the order has been placed.
8. When placing a **warranty** parts order:

If the product is under warranty, the product serial number must be provided. Most finished goods products have a serial number placed on them at the factory. The label containing the serial number is located:

Vertical Files — right side of the uppermost drawer

Lateral Files — left side of the uppermost drawer or shelf

Desk Towers — outside of top drawer

Desks, Credenzas, & Returns — on the outside, kneespace side of the top drawer. Fully extend the drawer to find it.

Desks, Credenzas, Corner Units, Bridges, Peninsulas & Returns without drawers — underside of top

Tables and Stands — underside of the top

Table Trucks — underside of side rail

Cabinets & Bookcases — left inner side of the case

Modular Component Top and Backs — underside of top

Modular End Panels — top inside surface

Reception Stations — top inside surface of back panel

Organizers — top inside surface of left end panel near back panel

Vertical Paper Manager — back panel inside surface near top

Pedestals — bottom drawer right side exterior

Seating — underside of the seat

Panels — underside of the top cap

Hutches, Storage Units, Overhead Storage — underside of the shelf

Hanging Bookshelves — underside of shelf

NOTE: Removal of the serial number tag from the product voids the warranty.

An important note regarding Product Serial Numbers:

HON desks, tables, chairs, files and systems components are tagged with a serial number. This number helps us identify *when and where your product was made*, and to identify and correct the root causes for the problem. NEITHER THE DEALER NOR THE CONSUMER SHOULD REMOVE THIS TAG UNDER ANY CIRCUMSTANCES. To do so immediately voids your Warranty coverage for that particular item *and prevents us from further identifying it*. Instead, please transcribe the number and call your Dealer.