



Request for Contract Update

Pursuant to the terms of contract number R191802 for Allsteel Inc. Contractor must notify and receive approval from Region 4 ESC when there is an update in the contract. No request will be officially approved without the prior authorization of Region 4 ESC. Region 4 ESC reserves the right to accept or reject any request.

Allsteel Inc. (Contractor) hereby provides notice of the following update on this date 8/24/2021.

Instructions: Contractor must check all that may apply and shall provide supporting documentation. Requests received without supporting documentation will be returned. This form is not intended for use if there is a material change in operations, such as assignment, bankruptcy, change of ownership, merger, etc. Material changes must be submitted on a "Notice of Material Change to Vendor Contract" form.

Authorized Distributors/Dealers
___ Addition
___ Deletion
___ Supporting Documentation

Price Update
___ Supporting Documentation

Products/Services
X New Addition
___ Update Only
X Supporting Documentation

Discontinued Products/Services
___ Supporting Documentation

States/Territories
___ Supporting Documentation

Other _____
___ Supporting Documentation

Notes: Contractor may include other notes regarding the contract update here: (attach another page if necessary). Allsteel Inc. is requesting to add new products to Contract R191804 effective immediately upon approval.

Submitted By: Cindy Hermann

Approved by Email: Date 9/7/2021 | 1:29 PM CDT

Title: Public Sector Contract Analyst

Denied by Email: Date _____

Email Address: allsteelgovcontracts@allsteeloffice.com

Region 4 ESC: DocuSigned by:
Robert Engelmann
0B1D33BB0130490...



August 24, 2021

ATTN: Robert Zingelmann
Chief Financial Officer
Region 4 – Education Service Center
7145 West Tidwell Road
Houston, TX 77092

RE: Allsteel Inc. request for price adjustment for Region 4 Furniture, Installation and Related Services
Contract R191802

Dear Mr. Zingelmann:

Allsteel Inc. would like to add the following new products to our current Contract R191802 effective immediately upon approval:

- Universal Screens – falls under the Systems product category already awarded on contract

The pricer pages are included with the attached Request for Contract Update along with an updated Discount Matrix.

If you have any questions, please do not hesitate to contact me at 563-316-9655 or email at allsteelgovcontracts@allsteeloffice.com.

Sincerely,

A handwritten signature in cursive script that reads "Cindy Hermann".

Cindy Hermann
Public Sector Contract Analyst

Enclosure

Screens

Further™ Adaptive — Metal Screens

GSA Reference Page

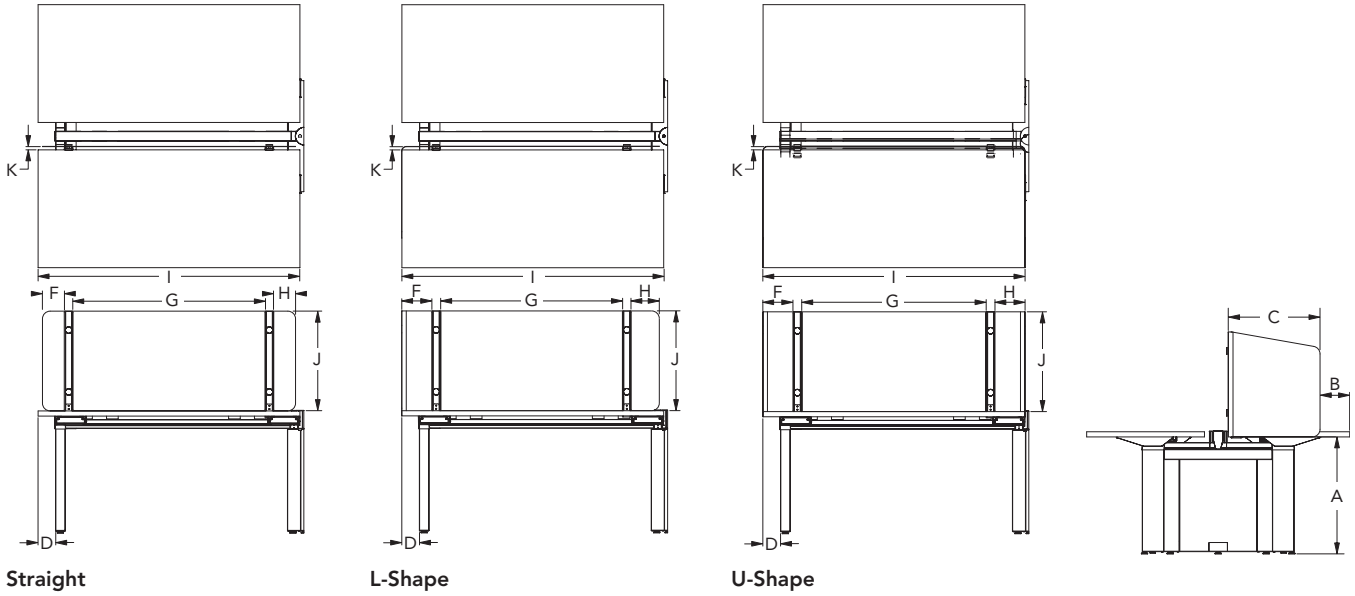

Size Reference Matrix

Models	A	B	C1	C2	D	E	F	G1	G2	H	I	J1	J2	K
	Under Desk Height	Wing to Front	Wing Width STD	Wing Width EXT	Left Leg to Edge	Right Leg to Edge	Left Side Panel to Support	Distance Between Supports	Distance Between Center/Right Support	Right Side Panel to Support	Overall Width	Desktop to Base of Panel	Desktop to Top of Panel	Cable Drop Space
AFAMS2048LH	26.8	6.8	21.1	24.3	4.1	-	6.9	29.7	-	6.4	48.1	-	22.9	0.7
AFAMS2054LH	26.8	6.8	21.1	24.3	4.1	-	6.9	35.7	-	6.4	54.1	-	22.9	0.7
AFAMS2060LH	26.8	6.8	21.1	24.3	4.1	-	6.9	41.7	-	6.4	60.1	-	22.9	0.7
AFAMS2066LH	26.8	6.8	21.1	24.3	4.1	-	6.9	22.8	22.8	6.4	66.1	-	22.9	0.7
AFAMS2072LH	26.8	6.8	21.1	24.3	4.1	-	6.9	25.8	25.8	6.4	72.1	-	22.9	0.7
AFAMS2048RH	26.8	6.8	21.1	24.3	4.0	-	6.4	29.7	-	6.9	48.1	-	22.9	0.7
AFAMS2054RH	26.8	6.8	21.1	24.3	4.0	-	6.4	35.7	-	6.9	54.1	-	22.9	0.7
AFAMS2060RH	26.8	6.8	21.1	24.3	4.0	-	6.4	41.7	-	6.9	60.1	-	22.9	0.7
AFAMS2066RH	26.8	6.8	21.1	24.3	4.0	-	6.4	22.8	22.8	6.9	66.1	-	22.9	0.7
AFAMS2072RH	26.8	6.8	21.1	24.3	4.0	-	6.4	25.8	25.8	6.9	72.1	-	22.9	0.7
AFAMS2048US	26.8	6.8	21.1	24.3	4.1	-	6.9	30.3	-	6.9	48.1	-	22.9	0.7
AFAMS2054US	26.8	6.8	21.1	24.3	4.1	-	6.9	36.3	-	6.9	54.1	-	22.9	0.7
AFAMS2060US	26.8	6.8	21.1	24.3	4.1	-	6.9	42.3	-	6.9	60.1	-	22.9	0.7
AFAMS2066US	26.8	6.8	21.1	24.3	4.1	-	6.9	23.1	23.1	6.9	66.1	-	22.9	0.7
AFAMS2072US	26.8	6.8	21.1	24.3	4.1	-	6.9	26.1	26.1	6.9	72.1	-	22.9	0.7
AFAMS2048SS	26.8	-	-	-	4.0	-	5.0	32.0	-	5.0	48.0	-	22.9	0.7
AFAMS2054SS	26.8	-	-	-	4.0	-	5.0	38.0	-	5.0	54.0	-	22.9	0.7
AFAMS2060SS	26.8	-	-	-	4.0	-	5.0	44.0	-	5.0	60.0	-	22.9	0.7
AFAMS2066SS	26.8	-	-	-	4.0	-	5.0	24.0	24.0	5.0	66.0	-	22.9	0.7
AFAMS2072SS	26.8	-	-C1	-	4.0	-	5.0	27.0	27.0	5.0	72.0	-	22.9	0.7

FURTHER

Further Adaptive — Metal Screens (page 78.3)

- Powder coated magnetic metal privacy screen.
- Metal surfaces can be easily disinfected with cleaners. See cleaning guide for more details at AllsteelOffice.com.
- Available in all standard paint colors.
- Provides ½" gap along the back for accessory mount and cord drop.
- Available in 48"W, 54"W, 60"W, 66"W and 72"W.
- 66"W and 72"W screens include 3rd center bracket.
- Available in Straight, L- and U-shape configurations. Above the desk only.
- L- and U-Shape screens are compatible with shrouded Further Adaptive Desk legs.
- Optional tackable accessories specified separately.
- 66"W tackable accessory comes as a set of (2) 24"W.
- 72"W tackable accessory comes as a set of (2) 20"W.
- Available in standard and extended wings.
- Wings mount flush to the edge of the surface with a VHB tape (included in hardware).
- 20"W tackable accessory must only be applied to both standard and extended wings without accessory slots.
- Wings are available with accessory slots that accept Raddii Hot File, Side Saddle and Coat hook.
- Top slot can accept one Raddii accessory.
- Bottom slot can accept a Coat hook and one other accessory.
- Accessories can hang on either side of the wing.
- TIP: If the Hot File is used in the top slot, it will block access for accessories in the bottom slot.
- Do not hang more than 5lbs of weight on wings.
- Screens are compatible with Raddii undermount storage.
- Not compatible with standard 120-worksurfaces. Contact Allsteel TPG for custom sizes.

Size Reference Matrix

Tackboards	Wing	48"W	54"W	60"W	66"W	72"W
Actual Dimensions	20"W	30"W	36"W	42"W	20"W	24"W
Set of Tackboards	1	1	1	1	2	2

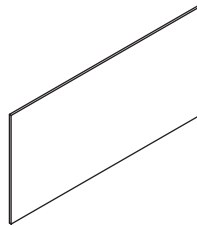
**Accessories — Tackboard** (page 78.3)

- Tackable accessories come with metal frame available in standard paint colors and fabric options.
- Attach to the screen using a dual lock tape (included in hardware).

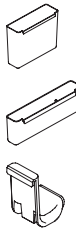
**Accessories — Raddii** (page 78.3)

- Wings are available with accessory slots that accept Raddii Hot File, Side Saddle and Coat hook.
- Top slot can accept one Raddii accessory.
- Bottom slot can accept a Coat hook and one other accessory.
- Accessories can hang on either side of the wing.
- TIP: If the Hot File is used in the top slot, it will block access for accessories in the bottom slot.

Accessories — Further Worksurface Rail Mount (page 135)



- Accessory rail must be field cut to fit between the screen brackets.
- The following accessories are not compatible with screens: U9WTC and U9TM.

Screens

Further™ Adaptive — Metal Screens / Tackboard Accessories

For specification information see pages 78.1-78.2.

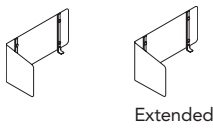
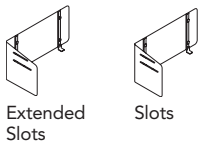
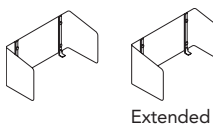
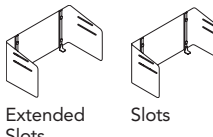
GSA SIN Pending

		Description	Model	P1 Paint List Price	P2 Paint Upcharge	P3 Paint Upcharge
		22\"H Metal L-Screen				
		48\"W	AFAMS2048LH (shown)	\$ 646	\$ 675	\$ 704
		54\"W	AFAMS2054LH	\$ 703	\$ 734	\$ 766
		60\"W	AFAMS2060LH	\$ 787	\$ 822	\$ 857
		66\"W	AFAMS2066LH	\$ 860	\$ 898	\$ 937
		72\"W	AFAMS2072LH	\$ 900	\$ 940	\$ 980
		22\"H Metal U-Screen				
		48\"W	AFAMS2048RH	\$ 646	\$ 675	\$ 704
		54\"W	AFAMS2054RH	\$ 703	\$ 734	\$ 766
		60\"W	AFAMS2060RH	\$ 787	\$ 822	\$ 857
		66\"W	AFAMS2066RH	\$ 860	\$ 898	\$ 937
		72\"W	AFAMS2072RH	\$ 900	\$ 940	\$ 980
		22\"H Metal U-Screen				
		48\"W	AFAMS2048US (shown)	\$ 843	\$ 881	\$ 918
		54\"W	AFAMS2054US	\$ 888	\$ 928	\$ 967
		60\"W	AFAMS2060US	\$ 928	\$ 969	\$ 1011
		66\"W	AFAMS2066US	\$ 1018	\$ 1063	\$ 1109
		72\"W	AFAMS2072US	\$ 1068	\$ 1116	\$ 1163
		22\"H Metal Straight Screen				
		48\"W	AFAMS2048SS (shown)	\$ 551	\$ 576	\$ 600
		54\"W	AFAMS2054SS	\$ 579	\$ 605	\$ 631
		60\"W	AFAMS2060SS	\$ 618	\$ 646	\$ 673
		66\"W	AFAMS2066SS	\$ 703	\$ 734	\$ 766
		72\"W	AFAMS2072SS	\$ 759	\$ 793	\$ 827
		15\"H Tackboard Accessories				
		20\"W	AAS1520 <input type="checkbox"/>	\$ 239	\$ 250	\$ 260
		48\"W	AAS1548 <input type="checkbox"/> (shown)	\$ 284	\$ 297	\$ 309
		54\"W	AAS1554 <input type="checkbox"/>	\$ 315	\$ 329	\$ 343
		60\"W	AAS1560 <input type="checkbox"/>	\$ 328	\$ 343	\$ 357
		66\"W	AAS1566 <input type="checkbox"/>	\$ 479	\$ 500	\$ 522
		72\"W	AAS1572 <input type="checkbox"/>	\$ 524	\$ 547	\$ 571

FURTHER

<p>How to specify — Select the Model Number from above.</p>	<p>1st Option: Wing Type :</p> <p>STD Standard EXT Extended</p>	<p>2nd Option: Accessories Slots:</p> <p>X No Accessory Cut Out SLT Accessory Cut Out</p>	<p>3rd Option: Paint Option:</p> <p><input type="radio"/> P1 <input type="radio"/> P2 <input type="radio"/> P3 See page 18 for finishes.</p>	<p>4th Option: Paint Option:</p> <p>NA Screen</p>	<p>5th Option: Accessories Color (if applicable):</p> <p>DW Designer White E9 Flint</p>
	<p>_____ . _____ . _____ . P ____ . NA . _____</p>				

Examples: AAS1548.PR6.APN911 AFAMS2048LH.STD.SLT.PR6.NA

Shippable by small-package carrier.

Screens

Further™ Adaptive — Tackboard Accessories

For specification information see pages 78.1-78.2.

GSA SIN Pending

Work Tools



Description	Model	List Price
Hot File (Designer White Only) 9½"H x 12¼"W x 3¾"D	AEHF	\$ 50
Side Saddle (Designer White Only) 4"H x 12¼"W x 2½"D	AESS	\$ 41
Bag or Coat Hook (Designer White Only) 3¼"H x 1⅝"W x 2¼"D	AECH	\$ 31

FURTHER

<p>How to specify — Select the Model Number from above.</p> <p>_____ .</p>	<p><i>1st Option:</i> Paint Option (if applicable):</p> <p>P1 P2 P3 See page 18 for finishes.</p> <p>P _____ .</p>	<p><i>2nd Option:</i> Fabric Option (if applicable):</p> <p>See page 10 for fabric options.</p> <p>_____ .</p>	<p><i>3rd Option:</i> Accessories Color (if applicable):</p> <p>DW Designer White E9 Flint</p> <p>_____</p>
---------------------------------------------------------------------------------------	-----------------------------------------------------------------------------------------------------------------------------------------------------	-------------------------------------------------------------------------------------------------------------------------------	----------------------------------------------------------------------------------------------------------------------------------------------

Examples: AEHF.PJW

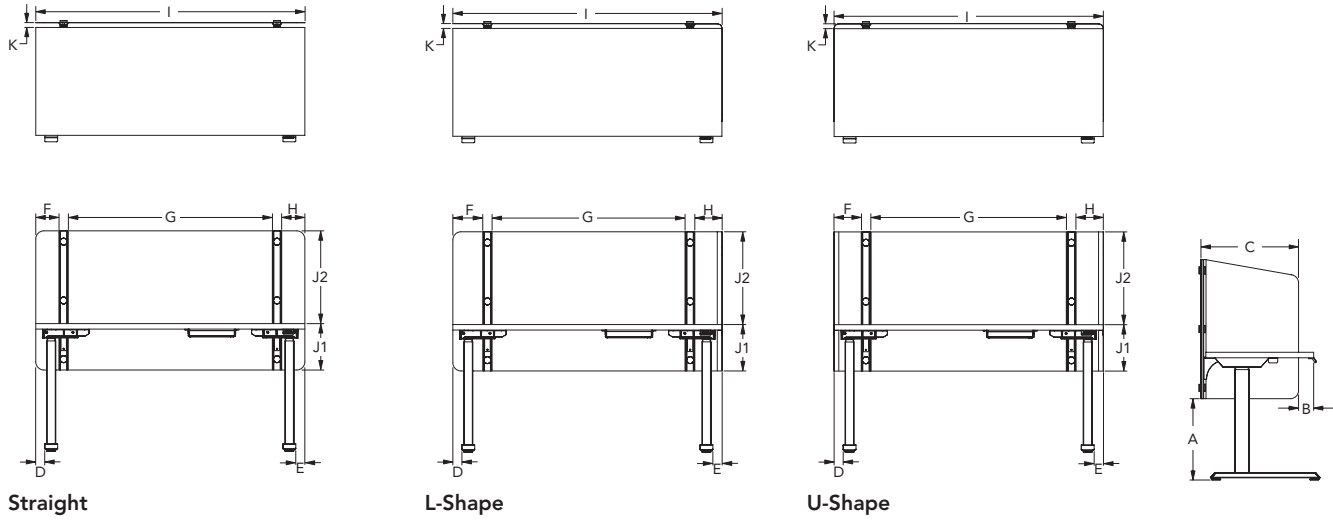

ALTITUDE

Size Reference Matrix

Models	A	B	C1	C2	D	E	F	G1	G2	H	I	J1	J2	K
	Under Desk Height	Wing to Front	Wing Width STD	Wing Width EXT	Left Leg to Edge	Right Leg to Edge	Left Side Panel to Support	Distance Between Supports	Distance Between Center/Right Support	Right Side Panel to Support	Overall Width	Desktop To Base of Panel	Desktop to Top of Panel	Cable Drop Space
AMS2048LH	24.7	3.3	21.1	24.3	2.0	2.0	5.9	29.7	-	6.4	46.1	2.9	20.0	1.0
AMS2054LH	24.7	3.3	21.1	24.3	2.0	2.0	5.9	35.7	-	6.4	52.1	2.9	20.0	1.0
AMS2060LH	24.7	3.3	21.1	24.3	2.0	2.0	5.9	41.7	-	6.4	58.1	2.9	20.0	1.0
AMS2066LH	24.7	3.3	21.1	24.3	2.0	2.0	5.9	22.8	22.8	6.4	64.1	2.9	20.0	1.0
AMS2072LH	24.7	3.3	21.1	24.3	2.0	2.0	5.9	25.8	25.8	6.4	70.1	2.9	20.0	1.0
AMS2048RH	24.7	3.3	21.1	24.3	2.0	2.0	6.4	29.7	-	5.9	46.1	2.9	20.0	1.0
AMS2054RH	24.7	3.3	21.1	24.3	2.0	2.0	6.4	35.7	-	5.9	52.1	2.9	20.0	1.0
AMS2060RH	24.7	3.3	21.1	24.3	2.0	2.0	6.4	41.7	-	5.9	58.1	2.9	20.0	1.0
AMS2066RH	24.7	3.3	21.1	24.3	2.0	2.0	6.4	22.8	22.8	5.9	64.1	2.9	20.0	1.0
AMS2072RH	24.7	3.3	21.1	24.3	2.0	2.0	6.4	25.8	25.8	5.9	70.1	2.9	20.0	1.0
AMS3248LH	17.5	3.3	21.1	24.3	2.0	2.0	5.9	29.7	-	6.4	46.1	10.0	20.0	1.0
AMS3254LH	17.5	3.3	21.1	24.3	2.0	2.0	5.9	35.7	-	6.4	52.1	10.0	20.0	1.0
AMS3260LH	17.5	3.3	21.1	24.3	2.0	2.0	5.9	41.7	-	6.4	58.1	10.0	20.0	1.0
AMS3266LH	17.5	3.3	21.1	24.3	2.0	2.0	5.9	22.8	22.8	6.4	64.1	10.0	20.0	1.0
AMS3272LH	17.5	3.3	21.1	24.3	2.0	2.0	5.9	25.8	25.8	6.4	70.1	10.0	20.0	1.0
AMS3248RH	17.5	3.3	21.1	24.3	2.0	2.0	6.4	29.7	-	5.9	46.1	10.0	20.0	1.0
AMS3254RH	17.5	3.3	21.1	24.3	2.0	2.0	6.4	35.7	-	5.9	52.1	10.0	20.0	1.0
AMS3260RH	17.5	3.3	21.1	24.3	2.0	2.0	6.4	41.7	-	5.9	58.1	10.0	20.0	1.0
AMS3266RH	17.5	3.3	21.1	24.3	2.0	2.0	6.4	22.8	22.8	5.9	64.1	10.0	20.0	1.0
AMS3272RH	17.5	3.3	21.1	24.3	2.0	2.0	6.4	25.8	25.8	5.9	70.1	10.0	20.0	1.0
AMS2048US	24.7	3.3	21.1	24.3	2.0	2.0	5.9	30.3	-	5.9	46.1	2.9	20.0	1.0
AMS2054US	24.7	3.3	21.1	24.3	2.0	2.0	5.9	36.3	-	5.9	52.1	2.9	20.0	1.0
AMS2060US	24.7	3.3	21.1	24.3	2.0	2.0	5.9	42.3	-	5.9	58.1	2.9	20.0	1.0
AMS2066US	24.7	3.3	21.1	24.3	2.0	2.0	5.9	23.1	23.1	5.9	64.1	2.9	20.0	1.0
AMS2072US	24.7	3.3	21.1	24.3	2.0	2.0	5.9	26.1	26.1	5.9	70.1	2.9	20.0	1.0
AMS3248US	17.5	3.3	21.1	24.3	2.0	2.0	5.9	30.3	-	5.9	46.1	10.0	20.0	1.0
AMS3254US	17.5	3.3	21.1	24.3	2.0	2.0	5.9	36.3	-	5.9	52.1	10.0	20.0	1.0
AMS3260US	17.5	3.3	21.1	24.3	2.0	2.0	5.9	42.3	-	5.9	58.1	10.0	20.0	1.0
AMS3266US	17.5	3.3	21.1	24.3	2.0	2.0	5.9	23.1	23.1	5.9	64.1	10.0	20.0	1.0
AMS3272US	17.5	3.3	21.1	24.3	2.0	2.0	5.9	26.1	26.1	5.9	70.1	10.0	20.0	1.0
AMS2048SS	24.7	-	-	-	2.0	2.0	5.0	32.0	-	5.0	46.0	2.9	20.0	1.0
AMS2054SS	24.7	-	-	-	2.0	2.0	5.0	38.0	-	5.0	52.0	2.9	20.0	1.0
AMS2060SS	24.7	-	-	-	2.0	2.0	5.0	44.0	-	5.0	58.0	2.9	20.0	1.0
AMS2066SS	24.7	-	-	-	2.0	2.0	5.0	24.0	24.0	5.0	64.0	2.9	20.0	1.0
AMS2072SS	24.7	-	-	-	2.0	2.0	5.0	27.0	27.0	5.0	70.0	2.9	20.0	1.0
AMS3248SS	17.5	-	-	-	2.0	2.0	5.0	32.0	-	5.0	46.0	10.0	20.0	1.0
AMS3254SS	17.5	-	-	-	2.0	2.0	5.0	38.0	-	5.0	52.0	10.0	20.0	1.0
AMS3260SS	17.5	-	-	-	2.0	2.0	5.0	44.0	-	5.0	58.0	10.0	20.0	1.0
AMS3266SS	17.5	-	-	-	2.0	2.0	5.0	24.0	24.0	5.0	64.0	10.0	20.0	1.0
AMS3272SS	17.5	-	-	-	2.0	2.0	5.0	27.0	27.0	5.0	70.0	10.0	20.0	1.0

Altitude — Metal Screens (page 301.1)

- Powder coated magnetic metal privacy screen.
- Metal surfaces can be easily disinfected with cleaners. See cleaning guide for more details at AllsteelOffice.com.
- Available in all standard paint colors.
- Provides 1" gap along the back for accessory mount and cord drop.
- Available in 48"W, 54"W, 60"W, 66"W and 72"W.
- 66"W and 72"W screens include 3rd center bracket.
- Available in Straight, L- and U-shape configurations. Above and Above/Below desk applications.
- L- and U-Shape screens are not compatible with shrouded Height Adjustable Table legs.
- Optional tackable accessories specified separately.
- 66"W tackable accessory comes as a set of (2) 24"W.
- 72"W tackable accessory comes as a set of (2) 20"W.
- Available in standard and extended wings.
- Wings mount flush to the edge of the surface with an L-Bracket.
- 20"W tackable accessory must only be applied to both standard and extended wings without accessory slots.
- Wings are available with accessory slots that accept Radii Hot File, Side Saddle and Coat hook.
- Top slot can accept one Radii accessory.
- Bottom slot can accept a Coat hook and one other accessory.
- Accessories can hang on either side of the wing.
- TIP: If the Hot File is used in the top slot, it will block access for accessories in the bottom slot.
- Do not hang more than 5lbs of weight on wings.
- Screens are compatible with Radii undermount storage.
- Not compatible with standard 120-worksurfaces. Contact Allsteel TPG for custom sizes.

Size Reference Matrix

Tackboards	Wing	48"W	54"W	60"W	66"W	72"W
Actual Dimensions	20"W	30"W	36"W	42"W	20"W	24"W
Set of Tackboards	1	1	1	1	2	2

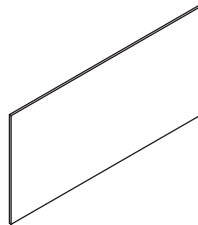
**Accessories — Tackboard** (page 301.2)

- Tackable accessories come with metal frame available in standard paint colors and fabric options.
- Attach to the screen using a dual lock tape (included in hardware).

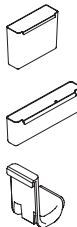
**Accessories — Radii** (page 301.2)

- Wings are available with accessory slots that accept Radii Hot File, Side Saddle and Coat hook.
- Top slot can accept one Radii accessory.
- Bottom slot can accept a Coat hook and one other accessory.
- Accessories can hang on either side of the wing.
- TIP: If the Hot File is used in the top slot, it will block access for accessories in the bottom slot.

Accessories — Further Worksurface Rail Mount (page 135)

- Accessory rail must be field cut to fit between the screen brackets.
- The following accessories are not compatible with screens: U9WTC and U9TM.

For specification information see pages 282.1-282.2.

GSA SIN Pending

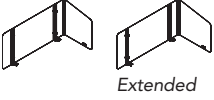
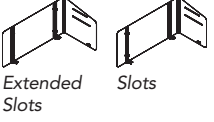
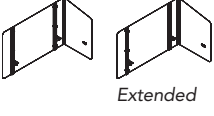
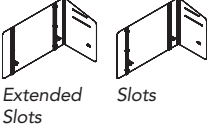
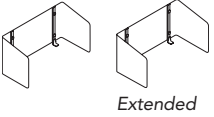
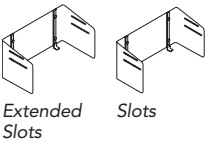
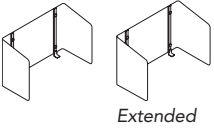
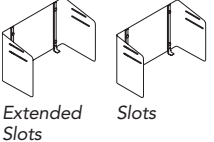
		Description	Model	P1 Paint List Price	P2 Paint Upcharge	P3 Paint Upcharge
		20"H Metal L-Screen				
	Extended	48"W	AMS2048LH	\$ 646	\$ 675	\$ 704
	Slots	54"W	AMS2054LH	\$ 703	\$ 734	\$ 766
		60"W	AMS2060LH	\$ 787	\$ 822	\$ 857
		66"W	AMS2066LH	\$ 860	\$ 898	\$ 937
		72"W	AMS2072LH	\$ 900	\$ 940	\$ 980
		20"H Metal L-Screen				
	Extended Slots	48"W	AMS2048RH (shown)	\$ 646	\$ 675	\$ 704
	Slots	54"W	AMS2054RH	\$ 703	\$ 734	\$ 766
		60"W	AMS2060RH	\$ 787	\$ 822	\$ 857
		66"W	AMS2066RH	\$ 860	\$ 898	\$ 937
		72"W	AMS2072RH	\$ 900	\$ 940	\$ 980
		30"H Metal L-Screen				
	Extended	48"W	AMS3248LH	\$ 838	\$ 875	\$ 913
		54"W	AMS3254LH	\$ 888	\$ 928	\$ 967
		60"W	AMS3260LH	\$ 928	\$ 969	\$ 1011
		66"W	AMS3266LH	\$ 1018	\$ 1063	\$ 1109
		72"W	AMS3272LH	\$ 1057	\$ 1104	\$ 1151
		30"H Metal L-Screen				
	Extended Slots	48"W	AMS3248RH (shown)	\$ 838	\$ 875	\$ 913
	Slots	54"W	AMS3254RH	\$ 888	\$ 928	\$ 967
		60"W	AMS3260RH	\$ 928	\$ 969	\$ 1011
		66"W	AMS3266RH	\$ 1018	\$ 1063	\$ 1109
		72"W	AMS3272RH	\$ 1057	\$ 1104	\$ 1151
		20"H Metal U-Screen				
	Extended	48"W	AMS2048US (shown)	\$ 843	\$ 881	\$ 918
		54"W	AMS2054US	\$ 888	\$ 928	\$ 967
		60"W	AMS2060US	\$ 928	\$ 969	\$ 1011
		66"W	AMS2066US	\$ 1018	\$ 1063	\$ 1109
		72"W	AMS2072US	\$ 1068	\$ 1116	\$ 1163
		20"H Metal U-Screen				
	Extended Slots	48"W	AMS2048US (shown)	\$ 843	\$ 881	\$ 918
	Slots	54"W	AMS2054US	\$ 888	\$ 928	\$ 967
		60"W	AMS2060US	\$ 928	\$ 969	\$ 1011
		66"W	AMS2066US	\$ 1018	\$ 1063	\$ 1109
		72"W	AMS2072US	\$ 1068	\$ 1116	\$ 1163
		30"H Metal U-Screen				
	Extended	48"W	AMS3248US (shown)	\$ 1012	\$ 1057	\$ 1102
		54"W	AMS3254US	\$ 1066	\$ 1113	\$ 1161
		60"W	AMS3260US	\$ 1113	\$ 1163	\$ 1212
		66"W	AMS3266US	\$ 1221	\$ 1275	\$ 1330
		72"W	AMS3272US	\$ 1282	\$ 1339	\$ 1396
		30"H Metal U-Screen				
	Extended Slots	48"W	AMS3248US (shown)	\$ 1012	\$ 1057	\$ 1102
	Slots	54"W	AMS3254US	\$ 1066	\$ 1113	\$ 1161
		60"W	AMS3260US	\$ 1113	\$ 1163	\$ 1212
		66"W	AMS3266US	\$ 1221	\$ 1275	\$ 1330
		72"W	AMS3272US	\$ 1282	\$ 1339	\$ 1396

How to specify — Select the Model Number from above.	1st Option: Wing Type : STD Standard EXT Extended	2nd Option: Accessories Slots: X No Accessory Cut Out SLT Accessory Cut Out	3rd Option: Paint Option: P1 P2 P3 See page 270 for finishes.	4th Option: Paint Option: NA Screen
	P

Examples: AMS2048LH.STD.SLT.PR6.NA AMS2048SS.PR6.NA

[5] Shippable by small-package carrier.



For specification information see pages [282.1-282.2](#).

GSA SIN Pending

Description	Model	P1 Paint List Price	P2 Paint Upcharge	P3 Paint Upcharge
20"H Metal Rectangular Screen				
48"W	AMS2048SS (shown)	\$ 551	\$ 576	\$ 600
54"W	AMS2054SS	\$ 579	\$ 605	\$ 631
60"W	AMS2060SS	\$ 618	\$ 646	\$ 673
66"W	AMS2066SS	\$ 703	\$ 734	\$ 766
72"W	AMS2072SS	\$ 759	\$ 793	\$ 827
30"H Metal Rectangular Screen				
48"W	AMS3248SS (shown)	\$ 675	\$ 705	\$ 735
54"W	AMS3254SS	\$ 703	\$ 734	\$ 766
60"W	AMS3260SS	\$ 748	\$ 781	\$ 815
66"W	AMS3266SS	\$ 843	\$ 881	\$ 918
72"W	AMS3272SS	\$ 888	\$ 928	\$ 967
15"H Tackboard Accessories				
20"W	AAS1520 <input type="checkbox"/>	\$ 239	\$ 250	\$ 260
48"W	AAS1548 <input type="checkbox"/> (shown)	\$ 284	\$ 297	\$ 309
54"W	AAS1554 <input type="checkbox"/>	\$ 315	\$ 329	\$ 343
60"W	AAS1560 <input type="checkbox"/>	\$ 328	\$ 343	\$ 357
66"W	AAS1566 <input type="checkbox"/>	\$ 479	\$ 500	\$ 522
72"W	AAS1572 <input type="checkbox"/>	\$ 524	\$ 547	\$ 571

<p>How to specify — Select the Model Number from above.</p>	<p>1st Option: Wing Type : STD Standard EXT Extended</p>	<p>2nd Option: Accessories Slots: X No Accessory Cut Out SLT Accessory Cut Out</p>	<p>3rd Option: Paint Option: P1 P2 P3 See page 18 for finishes.</p>	<p>4th Option: Paint Option: NA Screen</p>	<p>5th Option: Accessories Color (if applicable): DW Designer White E9 Flint</p>
	<p>_____ . _____ . _____ . P _____ . NA _____ . _____</p>				

Examples: AAS1548.PR6.APN911 AFAMS2048LH.STD.SLT.PR6.NA
AFAMS2048SS.PR6.NA

Work Tools	Description	Model	List Price
	Hot File (Designer White Only) 9½"H x 12¼"W x 3¾"D	AEHF	\$ 50
	Side Saddle (Designer White Only) 4"H x 12¼"W x 2½"D	AESS	\$ 41
	Bag or Coat Hook (Designer White Only) 3¼"H x 1½"W x 2¼"D	AECH	\$ 31

<p>How to specify — Select the Model Number from above.</p>	<p>1st Option: Paint Option (if applicable): P1 P2 P3 See page 270 for finishes.</p>	<p>2nd Option: Fabric Option (if applicable): See page 10 for fabric options.</p>	<p>3rd Option: Paint Option: NA Screen</p>	<p>4th Option: Accessories Color (if applicable): DW Designer White E9 Flint</p>
	<p>P _____ . _____ . _____ . NA _____ . _____</p>			

Example: AEHF.PJW

Shippable by small-package carrier.

OMNIA Partners Region 4 Education Service Center Discount Matrix
Allsteel Inc. Contract #R191802-Furniture, Installation and Related Services

Allsteel Price List: May 2021

Gunlocke Price List: May 2021

HBF Price List: April 2021

Products	List per Order	Discount From List
Stride Systems, Terrace, Concensys, Optimize, Further, Involve Casegoods, Approach, Stride Desking, Stride Benching, Pedestals, Overheads, Worksurfaces, Electrical & Accessories, Altitude Tables, Gallery Panels, Metal & Acrylic Table Screens, Universal Panel Stacker, Universal Screens	\$1 - \$100,000	69.5%
	\$100,001 - \$400,000	71.0%
	\$400,001 & Above	Negotiable
Lateral Files, Vertical Files, Storage (Towers, Bookcases, & Cabinets), Align Laterals, Align Storage, Align Credenzas, Stride Storage, Involve Storage, Raddi Storage	\$1 - \$100,000	64.0%
	\$100,001 - \$400,000	65.0%
	\$400,001 & Above	Negotiable
Trooper, Tolleson, and Nimble Seating	\$1 - \$100,000	64.0%
	\$100,001 - \$400,000	64.0%
	\$400,001 & Above	Negotiable
#19, Relate, Scout, Seek, Inspire, and Access Seating	\$1 - \$100,000	61.0%
	\$100,001 - \$400,000	61.0%
	\$400,001 & Above	Negotiable
Acuity, Mimeo, Lyric, Quip, Evo, and Svelte Seating	\$1 - \$100,000	58.0%
	\$100,001 - \$400,000	58.0%
	\$400,001 & Above	Negotiable
Merge, Aware, and Structure Tables	\$1 - \$100,000	64.0%
	\$100,001 - \$400,000	64.0%
	\$400,001 & Above	Negotiable
Wood Casegoods (Align Wood), Stride Painted Wood Casegoods Veneer	\$1 - \$100,000	60.0%
	\$100,001 - \$400,000	60.0%
	\$400,001 & Above	Negotiable
Social Collaborative Seating/Tables/Conferencing, Clarity, Co Ho, Parallel, Park, Recharge, Retreat, Townhall Collection (Rock, Wedge, Peak, Summit, Picnic, Cloud), Two-Thirds, and New Product Offering	\$1 - \$100,000	51.0%
	\$100,001 - \$400,000	54.0%
	\$400,001 & Above	Negotiable
Accessories (Wand & Link Lights, Ergonomic tools), Hands-Free Pulls, Hand Sanitizer Solutions, Acrylic Freestanding Screens	\$1 - \$100,000	55.0%
	\$100,001 - \$400,000	57.0%
	\$400,001 & Above	Negotiable
Gunlocke (All Product)	\$1 - \$250,000	55.6%
	\$250,001 & Above	Negotiable
HBF (All Product)	\$1 - \$100,000	49.0%
	\$100,001 - \$400,000	52.0%
	\$400,001 & Above	Negotiable
Aspect Architectural Products*	\$1 - \$250,000	62.3%
	\$250,001 & Above	Negotiable
Beyond Architectural Products*	\$1 - \$200,000	58.8%
	\$200,001 & Above	Negotiable
*Authorized Walls dealers only. Please contact beyondservices@allsteeloffice.com for additional information. See below for approved Walls Services		

Approved Furniture Services:

Service Type	Quote Type	Rate
Dock Delivery	NA	No charge
Inside Delivery	Hourly	Minimum of \$175. Hourly rates range from \$75 - \$90 with a NTE of \$90 per hour.
Install	Hourly	Minimum of \$175. Hourly rates range from \$90 - \$125 with a NTE of \$125 per hour.
Reconfiguration	Hourly	Minimum of \$125 per hour with a NTE maximum charge of \$150 per hour.
Design	Hourly	Minimum of \$75 per hour with a NTE maximum charge of \$90 per hour.
Project Management	Hourly	Minimum of \$75 per hour with a NTE maximum charge of \$90 per hour.
Storage		Prices range from \$2.50 per sq. ft. per month to \$5.00 per sq. ft. per month, NTE \$5.00 per sq. ft. per month.
Modular Walls		Prices range from \$110 per lineal foot to \$130 per lineal foot, not to exceed \$130 per lineal foot.
Applied Ergonomic Support		Prices range from \$200 per hour to \$500 per hour, not to exceed \$500 per hour.

Approved Walls Services:

Service Type	Quote Type	Rate
Install	Negotiated	NTE \$130/lineal foot
Design	Negotiated	NTE \$90/hr
Project Management	Negotiated	NTE \$90/hr
Reconfiguration	Negotiated	NTE \$150/hr

- Due to the extremely custom nature of demountable walls, list prices are part of the CET Designer software.
- Installation costs noted are for normal work hours, non-union wages. Union, prevailing wage, overtime, weekend work, and metropolitan area labor will be negotiated on a case-by-case basis.
- Prices for Allsteel Architectural Walls Product do not include applicable sales taxes or freight. These charges will be listed as separate line items on the quote, purchase order, and invoice, unless otherwise agreed to in writing, and each charge is contingent upon final destination of product. All applicable taxes and freight charges will be added to Allsteel's invoice, and customer agrees to pay the same.