

2025 List Pricer

Shared Spaces

Tables | Education | Seating



Make your space work®

Effective Date | May 2025

LIST PRICER

Effective Date: February 2025

- All illustrations and specifications in this publication are based on the latest product information available at the time of print. For the most recent version, please go to www.hon.com.
- Software support packages furnished to the customer, either by The HON Company or by another source, which support the sale of HON products are superseded by printed price lists.
- All dimensions shown in this publication are nominal.
- Pricing is subject to change without notice.
- All orders are subject to prices in effect at the time of order.
- Ordering information appears at the beginning of a section complete with examples on how to specify. These specifying information pages are referenced at the bottom center of product pages.
- HON Full Lifetime Warranty applies unless otherwise noted.
- HON nationwide customer service:
Phone: (800) 833-3964

HON LIST PRICER

Table of Contents

INTRODUCTION			
Table of Contents.....	1-3		
Additions.....	4		
Discontinuations.....	5		
HON Full Lifetime Warranty Information.....	7		
HON Limited 5-Year Warranty Information.....	8		
Ordering Information.....	9		
HON Design Services.....	10		
Tailored Solutions Ordering Information.....	11		
Customer's Own Material Ordering Information.....	12-13		
Partnership Textile Information.....	14		
Paint Program.....	15		
HON Open Line Laminate Program.....	16		
Environmental Statement.....	17		
Important Information.....	18		
Legend.....	19		
Fabric Patterns & Codes.....	20		
Lead Times.....	21		
Seating Fabric Patterns & Codes.....	22-25		
Panel Fabric Patterns & Codes.....	26-27		
TABLES			
Arrange®	28		
Arrange® Café Tables Ordering Information	29		
Arrange® Café Table Tops.....	30		
Arrange® Café Table Bases.....	31		
Arrange® Café Accessories.....	32		
Between™ Tables	33		
Between™ Ordering Information	34		
Between™ Table Tops.....	35		
Between™ Table Bases.....	36		
Between™ Rectangular Table Tops.....	37		
Between™ Table Bases for Rectangular Tops.....	37		
Between™ Nesting Tables.....	38		
Between™ Shared Components.....	38		
Birk™ Tables	39		
Birk™ Ordering Information	40		
Birk™ Table Tops.....	41		
Birk™ Bases.....	42		
Birk™ Personal Table.....	43		
Flock®	44		
Flock® Collaborative Tables Ordering Information	45		
Flock® Collaborative Solutions Table Specifying Information	46		
Flock® Collaborative Laminate Table Tops.....	47		
Flock® Collaborative Table Bases.....	48		
Flock® Collaborative Tables.....	49-50		
Huddle	51		
Huddle Ordering Information	52		
Huddle Multi-Purpose Tables	53		
Interlink IQ Electrical.....	54		
4-Trac Hardwire Electrical System.....	55		
Huddle Typical.....	56-57		
Huddle Multi-Purpose Table Tops.....	58		
Huddle Multi-Purpose Table Bases.....	59		
Huddle Mobile Laptop Table.....	60		
Huddle Table Accessories.....	61		
Occasional Tables	62		
Laminate Occasional Tables Options	63		
Laminate Occasional Tables.....	64		
Motivate®	65		
Motivate® Tables Specifying Information	66		
4-Trac Hardwire Electrical System.....	67		
Motivate® Fixed Height Tables.....	68		
Motivate® Nesting Tables.....	69		
Motivate® Adjustable Height Tables.....	70		
Motivate® Shared Components.....	71-72		
Preside®	73		
Preside® Ordering Information	74		
Preside® Specifying Information	75-84		
Preside® Grommet Cutout Placement.....	85		
Preside® Laminate Table Tops.....	86-88		
Preside® Laminate Bases.....	89-90		
Preside® Metal Bases.....	91-93		
Preside® Laminate Bases.....	94		
Preside® Metal Bases.....	95		
Preside® Collaborative Tables.....	96		
Preside® Ganging Tables.....	97		
Preside® Collaborative Tables.....	98		
Preside® Ganging Tables.....	99		
Preside® Mobile Collaborative Tables.....	100		
Preside® Team Touchdown Tables.....	101		
Preside® Ancillary.....	102		
Preside® Laminate Storage.....	103-104		
Modular Components.....	105		
Modular Components Back Panels.....	105		
Wall Mount Storage.....	106-107		
Preside® Laminate Shared Components.....	108		
Preside® Laminate Tables.....	109		
Preside® Laminate Tables — Pre-defined Typical.....	110		
Scramble™ Occasional Tables	111		
Scramble™ Options	112		
Scramble™ Coffee Tables.....	113		
Scramble™ End Tables.....	114		
Sculpt™	115		
Sculpt™ Ordering Information	116		
Sculpt™ Statement of Line	117		
Sculpt™ Laminate Top Tables.....	118-119		
Sculpt™ Wood Top Tables.....	120-121		
Sculpt™ Tray Top Tables.....	122-123		
Sculpt™ Personal & Console Tables.....	124		
Sculpt™ Planters.....	125		
Sculpt™ Accessories.....	126		
EDUCATION			
Cross Reference by Application	128-129		
Build™	130		
Build™ Ordering Information	131		
Build™ Shape Matrix.....	132		
Build™ Table Configurations.....	133-135		
Build™ Table Tops.....	136-138		
Build™ Tables.....	139		
Build™ Nesting Tables.....	140		
Build™ Accessories.....	141		
Build™ Student Desk Surface Dimensions.....	142		
Build™ Student Desk Configurations.....	143-144		
Build™ Student Desks.....	145-146		
Build™ Student Desk Accessories.....	147		
Build™ Makerspace Table.....	148-150		
Build™ Makerspace Table Accessories.....	151		
Build™ Makerspace Stools.....	152		
Class-ifi™	153		
Class-ifi™ Ordering Information	154		
Class-ifi™ Statement of Line	155-156		
Class-ifi™ Specifying Information	157-158		
Class-ifi™ Lockers.....	159		
Class-ifi™ Cubbies.....	160		
Class-ifi™ Combos.....	161		
Class-ifi™ Bookcases.....	162		
Class-ifi™ Tote Storage.....	163		
Class-ifi™ Command Station.....	164		
Class-ifi™ Accessories.....	165		
Confetti™	166		
Confetti™ Ordering Information	167		
Confetti™ Statement of Line	168		
Confetti™ Floor Seating.....	169		
Confetti™ Accessories.....	170		
Revel™	171		
Revel™ Stool.....	172		
Roll Call™	173		
Roll Call™ Ordering Information	174		
Roll Call™.....	175		
SmartLink®	176		
SmartLink® Ordering Information	177		
SmartLink® Specifying Information	178-181		
SmartLink® Series Student Desks.....	182		
SmartLink® Student Accessories.....	183		
SmartLink® Chairs.....	184-187		
SmartLink® Teacher Stations.....	188-189		
SmartLink® Wall Rail System.....	190		
SmartLink® Wall Rail System Accessories.....	191		
SmartLink® Mobile Storage.....	192-194		
Storyline™	195		
Storyline™ Ordering Information	196		
Storyline™ Specifying Information	197-199		
Storyline™ Linear Bookcases.....	200		
Storyline™ Curved Bookcases.....	201		
Storyline™ Bistro Tables.....	202		
Storyline™ Accessories.....	203		
Tangram™	204		
Tangram™ Ordering Information	205-206		
Tangram™ Statement of Line	207-208		
Tangram™ Typical.....	209-210		
Tangram™ Story Steps.....	211		
Tangram™ Multi-Fabric Story Steps.....	212		
Tangram™ In-Line Tables.....	213		
Tangram™ Modular Seating.....	214		
Tangram™ Modular Seating — Multi-Fabric.....	215-216		
Tangram™ Modular Seating.....	217		
Tangram™ Modular Seating — Multi-Fabric.....	218-219		
Tangram™ Modular Seating — Bistro-Back.....	220		
Tangram™ Modular Seating — Bistro-Back, Multi-Fabric.....	221-222		

For information regarding HON registered and unregistered trademarks, please go to hon.com/protected-marks. Haworth®, Herman Miller®, Knoll®, and Steelcase® are registered trademarks of their respective owners and use of the marks do not imply affiliation or endorsement of The HON Company or its products.

LIST PRICER

Effective Date: February 2025

- All illustrations and specifications in this publication are based on the latest product information available at the time of print. For the most recent version, please go to www.hon.com.
- Software support packages furnished to the customer, either by The HON Company or by another source, which support the sale of HON products are superseded by printed price lists.
- All dimensions shown in this publication are nominal.
- Pricing is subject to change without notice.

- All orders are subject to prices in effect at the time of order.
- Ordering information appears at the beginning of a section complete with examples on how to specify. These specifying information pages are referenced at the bottom center of product pages.
- HON Full Lifetime Warranty applies unless otherwise noted.
- HON nationwide customer service:
Phone: (800) 833-3964

HON LIST PRICER

Table of Contents

Tangram™ Ottomans	223-224	Confer™ Finish Options	317	Motivate® Chairs	420
Tangram™ Poufs	225	Confer™	318-321	Motivate® Task Chair Options	421
Tangram™ Accessories	226	Convergence®	322	Motivate® Task Chair Fabric Options	422
WORKPLACE TOOLS		Convergence® Options	323	Motivate® Task Chairs	423
Workplace Tools	227	Convergence® Fabric Options	324	Motivate® High-Density Sled Base Chair Options	424
Workplace Tools Ordering Information	228	Convergence® Standard Task Chairs.....	325	Motivate® High-Density Sled Base Chairs	425-426
Monitor Arms	229-230	Convergence® Value Task Chairs	326	Motivate® 4-Leg Chair Options	427
CPU Holders	231	Crio™ Mesh Chairs	327	Motivate® 4-Leg Chairs.....	428-429
Keyboard Trays	232-233	Define™ Executive Chairs	328	Motivate® Nesting/Stacking Flex-Back Chair Options	430
Corner Sleeves	234	Endorse® Collection	329	Motivate® Nesting/Stacking Flex-Back Chairs	431
Center Drawers	235-236	Endorse® Options	330	Motivate® Chair with Tablet Arm Options	432
Chair Mats	237	Endorse® Dimensions	331	Motivate® Chair with Tablet Arm	433
Task Lights.....	238-239	Endorse® Fabric Options	332	Motivate® Flex-Back Chair with Tablet Arm Options	434
Paper Management & Organizational Tools	240-243	Endorse®	333-336	Motivate® Flex-Back Chair with Tablet Arm	435
Interlink IQ Electrical	244-245	Endorse® Accessories	337	Nucleus®	437
4-Trac Hardwire Electrical System	246-247	Flexion™	338	Nucleus® Task Chair Options	438-439
Power & Cable Management	248	Flexion™ Options	339-340	Nucleus® Guest and Multi-Purpose Options	440
Power	249-252	Flexion™	341	Nucleus® Fabric Options	441
Power & Cable Management	253-255	Flock®	342	Nucleus® Dimensions	442-443
		Flock® Options	343-344	Nucleus®	444-447
		Flock® Fabric Options	345	High-Density Olson Stacker® 4040 Series	448
		Flock® Collaborative	346-349	High-Density Olson Stacker® 4040 Series	449
		Flock® Multi-Fabric Collaborative	350-353	Parkwyn™	450
		Flock® Base Frames and Legs	354	Parkwyn™ Options	451
		Flock® Options	355	Parkwyn™ Club/Lounge	452
		Flock® Collaborative.....	356-360	Perpetual® Nesting Chairs	453
		Flock® Multi-Fabric Collaborative	361	Perpetual® Nesting Chairs Options	454
		Flock® Options	362	Perpetual® Nesting Chairs	455
		Flock® Mini Cube and Cylinders	363	Pillow-Soft® 2090 Series	456
		Flock® Multi-Fabric Mini Cube and Cylinder	364	Pillow-Soft® 2090 Series Options	457
		Grove®	365	Pillow-Soft® 2090 Series	458
		Grove® Options	366-367	Prominent™ Mesh Chairs	459
		Grove® Fabric Options	368	Ruck™	460
		Grove®	369-371	Ruck™ Options	461
		Grove® Multi-Fabric	372-375	Ruck™ Laminate Seating	462
		Grove® Accessories	376	Ruck™ Wood Seating	463
		Ignition™	377	Scatter™ Guest Chairs	464
		Ignition™ Options	378-379	Skip	465
		Ignition™ 2.0 Options	380-381	Skip Collaborative Chair	466
		Ignition™ 2.0 Dimensions	382-383	SoCo™	467
		Ignition® 2.0	384-388	SoCo™ Statement of Line	468
		Ignition® 2.0 ReActiv®	389-390	SoCo™ Fabric Options	469
		Ignition® 2.0 Upholstered	391-392	SoCo™ Typicals	470
		Ignition® 2.0 Accessories	393-394	SoCo™	471-475
		Ignition® Multi-Purpose Chair Options	395	SoCo™ Power.....	476
		Ignition® Multi-Purpose.....	396	Solve®	477
		Ignition® Multi-Fabric Multi-Purpose	397	Solve® Options	478-480
		Ignition® Multi-Fabric Stools.....	398	Solve®	481-485
		Ignition® Guest	399	Solve® Accessories.....	486
		Ignition® Task Chair Options	400	Soothe®	487
		Ignition® Fabric Options	401	Soothe® Options	488-489
		Ignition®	402-405	Soothe®	490
		Ignition® Accessories	406	Soothe® Multi-Fabric.....	491-492
		Lota®	407	Soothe® Bracket.....	492
		Lota® Options	408	Soothe® Benches	493
		Lota®	409	Torch™ Mesh Chairs	494
		Matter™	410	Versant®	495
		Matter™ Multi-Purpose Chairs	411	Versant® Options	496
		Mav™	412	Versant®	497-498
		Mav™ Finish Options	413-414		
		Mav™	415-419		

For information regarding HON registered and unregistered trademarks, please go to hon.com/protected-marks. Haworth®, Herman Miller®, Knoll®, and Steelcase® are registered trademarks of their respective owners and use of the marks do not imply affiliation or endorsement of The HON Company or its products.

LIST PRICER

Effective Date: February 2025

- All illustrations and specifications in this publication are based on the latest product information available at the time of print. For the most recent version, please go to www.hon.com.
- Software support packages furnished to the customer, either by The HON Company or by another source, which support the sale of HON products are superseded by printed price lists.
- All dimensions shown in this publication are nominal.
- Pricing is subject to change without notice.
- All orders are subject to prices in effect at the time of order.
- Ordering information appears at the beginning of a section complete with examples on how to specify. These specifying information pages are referenced at the bottom center of product pages.
- HON Full Lifetime Warranty applies unless otherwise noted.
- HON nationwide customer service:
Phone: (800) 833-3964

HON LIST PRICER

Table of Contents

Volt*	499	Wave™ Mesh Chairs.....	507	Executive Chairs	523-524
Volt* 5700/5710 Series Options	500	West Hill™ Casual Lounge Seating	508	Workplace Tools Ergonomic Solutions.....	525
Volt* 5700 Series.....	501	West Hill™ Options	509	Workplace Tools Chair Mats.....	526
Volt* 5710 Series.....	502	West Hill™ Finish Options	510-511		
Volt* 5720/5730 Series Options	503	West Hill™ Casual Lounge Seating.....	512-517	INDEX	
Volt* 5720/5730 Series Fabric Options	504	West Hill™ Ottomans.....	518	Cross Reference Index.....	527-532
Volt* 5720 Series.....	505	West Hill™ Casual Lounge Seating.....	519-520	Information on Ordering Parts.....	544
Volt* 5730 Series.....	506	Throw Pillows.....	521		
		West Hill™ Accessories.....	522		

For information regarding HON registered and unregistered trademarks, please go to hon.com/protected-marks. Haworth®, Herman Miller®, Knoll®, and Steelcase® are registered trademarks of their respective owners and use of the marks do not imply affiliation or endorsement of The HON Company or its products.

ADDITIONS

NEW ADDITIONS: PRODUCTS

Tables	Effective Date
Preside® Equitable Meeting Worksurfaces Models: HTLCVN3060, HTLCVN3072, HTLCVN3660, HTLCVN3672, HTLTPR4896, HTLTPR60120, HTLBMR60144, HTLBMR60168, HTLMED4860	October 1, 2024

Workplace Tools	Effective Date
Accessories Models: HJTRGH24, HJTRGH36	January 5, 2024

Seating	Effective Date
Altern™ Models: HPTCC1-TIUM, HPTCC1-TIUU, HPTCC2-TIUM, HPTCC2-TIUU, HPTCC2-T3UM, HPTCC2-T3UU	October 1, 2024
Confer™ Models: HWCUSUBA, HWCUSWBA, HWCUSPBA, HWCUSUBN, HWCUSWBN, HWCUSPBN, HWCUSUBAMF, HWCUSPBAMF, HWCUSUBNMF, HWCUSPBNMF	October 1, 2024

Fabrics and Finishes	Effective Date
Fabrics	
Emphasis	July 1, 2024
Denim (EMP14)	
Evergreen (EMP09)	
Fog (EMP04)	
Garnet (EMP07)	
Gemstone (EMP15)	
Graphite (EMP02)	
Greenery (EMP10)	
Marsh (EMP11)	
Navy (EMP13)	
Obsidian (EMP01)	
Parchment (EMP16)	
Persimmon (EMP08)	
River (EMP12)	
Suit (EMP03)	
Tweed (EMP05)	
Twine (EMP06)	
Haute	July 1, 2024
Caviar (HAU01)	
Char (HAU04)	
Foggy (HAU06)	
Kelp (HAU08)	
Night Light (HAU07)	
Sanderling (HAU05)	
Toadstool (HAU02)	
Weathered (HAU03)	
Laminate	
Magnolia (LMG1)	July 1, 2024

DISCONTINUATIONS

Seating	Effective Date	Fabrics and Finishes	Effective Date
Convergence® Model: HCATIMM	June 30, 2024	Fabrics	
Gateway™ Model: HGVIMM, HGTMM	June 30, 2024	Blume	December 31, 2025
Performance Seating Models: HVL653, HVL685	June 30, 2024	Chalk (BLME03), Char (BLME00), Coin (BLME02), Driftwood (BLME05), Emerald City (BLME07), Fir (BLME09), Harvest (BLME04), Haze (BLME08), Hyacinth (BLME14), Jasper (BLME13), Merlot (BLME10), Moonstone (BLME01), Opal (BLME06), Scarlet (BLME11), Slate (BLME12)	
Sadie™ Models: HVST315, HVST911, HVST121	June 30, 2024	Compass Foam	June 2024
Sadie™ Models: HVST331, HVST101, HVST102	While Supplies Last	Bittersweet (COMF46), Ink (COMF10), Meadow (COMF82), Midnight (COMF90), Putty (COMF22), Sterling (COMF19)	
Solve® Models: HSLVTMU, HSLVSMU, HSLVTMUS, HSLVSMUS	June 30, 2024	Clyde	December 31, 2024
		Antique (CLYD04), Claret (CLYD13), Seasoned (CLYD03)	
		Denver Leather	December 31, 2025
		Black (SS11)	
		Dotty	December 31, 2024
		Candy (DOT63), Gelato (DOT34), Indigo (DOT31), Onyx (DOT35), Park (DOT83), Peat (DOT24), Peony (DOT32), Suit (DOT20), Sunflower (DOT33), Tailor (DOT21), Tide (DOT90), Velum (DOT29), Violet (DOT30)	
		Bark (FACT20), Barley (FACT15), Cascade (FACT25), Feather (FACT30)	
		Hamilton	December 31, 2024
		Agave (HAML28), Azure (HAML10), Biscotti (HAML11), Cabernet (HAML08), Caribbean (HAML29), Carolina (HAML21), Charcoal (HAML17), Chocolate (HAML13), Cloud (HAML18), Dane (HAML16), Deep (HAML27), Dove Grey (HAML33), Dusty Rose (HAML07), Esmeralda (HAML06), Fern (HAML04), Fresh (HAML03)	
		Inertia	December 31, 2024
		Amethyst (NR61), Calypso (NR98), Cherry (NR66), Cobalt (NR91), Coffee (NR49), Fog (NR19), Fuchsia (NR63), Gecko (NR76), Glow (NR27), Leaf (NR75), Lime (NR82), Loft (NR22), Mandarin (NR47), Meteor (NR30), Mustard (NR26), Nickel (NR23), Onyx (NR10), Regatta (NR90), Shadow (NR20), Surf (NR96), Tangelo (NR46)	
		Mica (Panel)	December 31, 2024
		Anthracite (MCA11), Breeze (MCA18), Bronze (MCA13), Buff (MCA14), Cremini (MCA17), Crystal (MCAWIT), Dew (MCA20), Dove (MCA12), Fresh (MCA16), Mineral (MCA15), Nectar (MCA19), Shale (MCA10)	
		Optic	June 30, 2024
		Aurora (OP72), Bark (OP24), Canopy (OP84), Char (OP49), Ruby (OP42), Sand (OP17), Sky (OP83), Slate (OP19), Sprout (OP74), Starry Night (OP11), Storm (OP56), Wildfire (OP66)	
		Paint	December 31, 2024
		Greige (T5)	
Workplace Tools	Effective Date		
Cable Management Models: HCTROUGH17, HCTROUGH1710, HCTROUGH36, HCTROUGH3610, HWMCLIPLG, HWMCLIPSM	June 30, 2024		
Power Models: HPWRMOD3WC, HPWRMOD2WC, HPWRMOD4WC, HPWRMOD3UWM, HPWRMOD2WM, HCOMDOME2, HPWRMOD2, HSMPWR-1P-2U, HUMPWR-1P-2U	June 30, 2024		
Desktop Riser Model: HBXRISER	June 30, 2024		
Tables	Effective Date		
Between™ Model: HMPTBFX	December 31, 2024		

NOTES

HON FULL LIFETIME WARRANTY INFORMATION



FULL LIFETIME WARRANTY

YOUR HON FULL LIFETIME WARRANTY

Every time you purchase a HON product, you're making an investment in your future. We're proud to play a part in that future, and you can trust us to do our best for as long as you need us.

The HON Full Lifetime Warranty is our assurance to you that the HON desks, workstations, seating, tables, or storage you purchase will be free from defective material or workmanship for the life of the product.

In the unlikely event that any HON product or component covered by the HON Full Lifetime Warranty should fail under normal workplace use as a result of defective material or workmanship, HON shall repair or replace with comparable product (at HON's discretion), free of charge.

WHAT'S COVERED BY THE HON FULL LIFETIME WARRANTY?

Your HON Full Lifetime Warranty applies to product manufactured after January 1, 2011. All HON product lines, materials, and components are covered by the HON Full Lifetime Warranty except for the items described below.

The specific product lines, materials, and components listed below are covered under HON's Full 12-Year, Full 10-Year, and Full 5-Year Warranties (from date of purchase).

HON'S FULL 12-YEAR WARRANTY

- Electrical components (lamps and ballasts are not covered)
- 4-Way Stretch Mesh
- Seating controls
- Pneumatic Cylinders
- Wood Seating
- Accessories
- Laminate Surfaces

HON'S FULL 10-YEAR WARRANTY

- Coordinate™ Height Adjustable Bases (HHATB)
- Spectrum Mesh

HON'S FULL 7-YEAR WARRANTY

- Coordinate™ Legacy Bases (HHAB and HREC)
- Workwall Markerboard Glass Tiles

HON'S FULL 5-YEAR WARRANTY

- All LED task lights
- Panel and seating textiles
- Mesh not branded/ marketed as '4-Way Stretch Mesh' or 'Spectrum Mesh'
- Coze™
- Between™ Multi-Purpose Table
- Acoustic Solutions by Unika Vaev
- Mod

HON'S FULL 1-YEAR WARRANTY

- Acrylic Screens

These warranties apply to HON products sold within the United States of America, U.S. Territories, and Canada, as well as U.S. Military and Federal Agency purchases (regardless of location).

IS ANYTHING NOT COVERED?

There are a few exclusions to the HON Full Lifetime Warranty and to the 12-, 10-, and 5-year warranties. These exclusions are:

- All HON products that are covered under a separate 5-year warranty.
- Color-fastness or matching of colors, woodgrains, or textures occurring in wood, leather, or other materials that naturally exhibit inherent color variations.
- Customer's own materials (COM) selected by and used at the request of the user.
- Modifications or attachments to the product that are not approved by The HON Company and product failures resulting from such modifications or attachments.
- Product normal wear and tear, which are to be expected over the course of ownership.
- Products that were not installed, used, or maintained in accordance with product instructions and warnings.
- Products used for rental purposes.
- Damage caused by cleaning chemicals.
- Dye transfer caused by external contaminants (including clothing and accessory dyes such as those used on denim jeans) may migrate to lighter colors. This phenomenon is increased by humidity and temperature and is irreversible.
- Fabric pattern match seat to back or chair to chair. If pattern match is needed, please submit a Tailored Solutions request or contact HON Customer Support/Tailored Solutions with questions.
- Storage Digilocks come with a 2-year warranty.

WARRANTY REQUESTS OR QUESTIONS?

Your HON Dealer is our mutual partner in supporting your warranty requests. To obtain service under this warranty, please contact your HON dealer. If you are not sure who your dealer is, please call HON Customer Support at 800.833.3964.

THAT'S YOUR HON FULL LIFETIME WARRANTY AS AN OWNER OF HON PRODUCT, THE WARRANTY EXPLAINED HERE IS YOUR SOLE AND EXCLUSIVE REMEDY. THERE ARE SOME EXCEPTIONS IF YOU PURCHASED THE PRODUCT FOR HOME OR PERSONAL USE WHICH ARE EXPLAINED BELOW. TO THE EXTENT ALLOWED BY LAW, THE HON COMPANY MAKES NO OTHER WARRANTY, EITHER EXPRESS OR IMPLIED, INCLUDING ANY WARRANTY OF MERCHANTABILITY OR FITNESS FOR A PARTICULAR PURPOSE. THE HON COMPANY WILL NOT BE LIABLE FOR ANY CONSEQUENTIAL OR INCIDENTAL DAMAGES.

A WORD ABOUT PURCHASES FOR HOME OR PERSONAL USE

Please note, this section only applies if you purchased your HON product for your home or for your own personal or family use. HON's warranties give you specific legal rights and you may have other rights, which vary from state to state. As a consumer purchaser, the complete exclusion of implied warranties noted in the above paragraph does not apply to you, however, to the extent allowed by applicable state law, the implied warranties are limited to the applicable term of the warranty. Some states do not allow the exclusion or limitation of incidental or consequential damages, so the above exclusion or limitation may not apply to you.

HON LIMITED 5-YEAR WARRANTY INFORMATION



LIMITED 5-YEAR WARRANTY

The HON Company promises to repair or replace HON products or components covered under this warranty that are found to be defective in material or workmanship within five (5) years from the date of original purchase so long as you, the original purchaser, still owns it. This is your sole and exclusive remedy. This warranty is subject to the provisions below. It applies to the products listed here manufactured after January 1, 2018.

LIMITATIONS:

- Upholstery on chairs is warranted for two years from date of purchase.
- Damage caused by the carrier in-transit is handled under separate terms.

EXCLUSIONS:

This warranty does not apply and no other warranty applies to:

- Normal wear and tear, which are to be expected over the course of ownership.
- Modifications or attachments to the product that are not approved by The HON Company.
- Products that were not installed, used or maintained in accordance with product instructions and warnings.
- Products used for rental purposes.

SEATING USAGE

Normal commercial use for seating is identified as the equivalent of a single shift, forty-(40) hour workweek. To the extent that a seating product is used in a manner exceeding this, the applicable warranty period will be reduced in a pro-rata manner.

A WORD ABOUT COLOR VARIATIONS, FABRICS AND FINISHES:

The HON Company does not warrant the color-fastness or matching of colors, grains or textures of covering materials.

CUSTOMER'S OWN MATERIAL (COM)

Not available on HON products covered under the HON 5-year warranty.

TO THE EXTENT ALLOWED BY LAW, THE HON COMPANY MAKES NO OTHER WARRANTY, EITHER EXPRESS OR IMPLIED, INCLUDING ANY WARRANTY OF MERCHANTABILITY OR FITNESS FOR A PARTICULAR PURPOSE. THE HON COMPANY WILL NOT BE LIABLE FOR ANY CONSEQUENTIAL OR INCIDENTAL DAMAGES.

NOTICE TO PURCHASERS FOR HOME OR PERSONAL USE:

Federal law does not permit the exclusion of certain implied warranties for consumer products. Therefore, if you are purchasing this product for home or personal use, the exclusion of implied warranties noted in the above paragraph does not apply to you. Some states do not allow the exclusion or limitation of incidental or consequential damages, so the above limitation or exclusion may not apply to you. This warranty gives you specific legal rights, and you may also have other rights which vary from state to state.

This warranty applies only to products sold within the United States of America and the Commonwealth of Canada.

TO OBTAIN SERVICE UNDER THIS WARRANTY:

Your HON® Dealer is our mutual partner in supporting your warranty requests. By following the procedures outlined below, you can be assured of the best level of service. Please note: Consent of The HON Company must be obtained before any warranty work is performed. To obtain consent, please take the following steps:

1. Contact the Dealer from whom the product was purchased within 30 days of discovery of the defect. Be prepared to affirm that you are the original purchaser of the product and to provide the serial number(s) from the product in question.
2. Your Dealer will gather all pertinent information regarding the claim, inspect the product and contact a HON Company customer service representative. (Please allow a reasonable amount of time for inspection and review.)
3. If The HON Company affirms that the product in question is eligible under the conditions of the warranty as stated above, the customer service representative or another representative of the Company will determine whether to provide replacement parts, authorize repairs or replace the product.

ORDERING

Electronic ordering is the standard order process for HON. HON supports the following primary methods for the electronic transmission of orders and order related documents:

Electronic Ordering

Available in the HONReady portal at hon.com. There are multiple options available for processing orders electronically.

Integration with the standard Office Furniture business systems or other pre-approved proprietary software packages.

SIF file upload using fully optioned SIF files into the electronic ordering applications.

Manual entry of line items into the electronic ordering application.

EDI-System to System Integration

With standard Office Product systems or other pre-approved proprietary software systems.

Training, technical set-up and support is available through our Dealer Operations Team at HONDigitalSupport@honcompany.com.

ORDER REQUIREMENTS

- Customer must provide complete and correct information, including complete model number, finishes, colors, options, and quantity.
- If a bid quotation or other special pricing applies, such information must be clearly stated on the order with applicable bid number or contract number.
- Order Management contact name and phone number.
- Delivery Appointment contact name and phone number at the dealership or installation company. HON does not accept orders with end user appointment contacts.
- Dealer Sales Representative, primary or multiple DSRs.
- “Best Date Available” for the entire order is standard service for HON. If eligible, other Date Requests may be requested and must be submitted with the order. Other Date Requests are subject to review by HON prior to acceptance:
 - “Ship After” requests are eligible on all order sizes
 - “Deliver On” requests are eligible for full truckload orders
- Additional services outside of HON’s standard services may be available through HON’s ‘Enhanced Services’ for a corresponding fee. Requested services from ‘Enhanced Services’ must be provided at time of order placement.
- Failure to provide complete and accurate information results in delayed order entry and acknowledgment. Incomplete orders will not be produced and will be returned to Dealer for correction.

ACKNOWLEDGMENT SERVICE

- E-mailed acknowledgments are available by customer request.
- An acknowledgment will be emailed the morning of the next business day, unless order is placed on credit or other order hold.
- The order will not receive an acknowledged shipment date until all order holds are released.

ORDER CHANGES OR CANCELLATIONS

For Order Changes or Cancellations, please contact Customer Support at 800-833-3964.

TERMS AND CONDITIONS

See **HON NOW** on hon.com for more information about HON NOW delivery, services and ordering information.

HON DESIGN SERVICES

HON DESIGN STUDIO

Need design assistance? We can help! Our expert design staff will create a professional design package that is sure to put you one step ahead of the competition. And the best part is – it's free!

AUDIT

We will check your drawing and parts list for accuracy. We verify quantity, specification accuracy, product compatibility and structural support.

DESIGN

We will provide a professional design package including a 2D furniture plan, renderings, and complete parts list based on the rough sketch and project information you supply.

CONSULTATION

A 1:1 meeting will be scheduled where we will provide guidance on product positioning, answer specification questions, and recommend value engineering opportunities.

CONTACT HON DESIGN SERVICES

Questions? Please reach out to your region's dedicated designer. Not sure how to reach your designer? Send us a note at the email below.

E-Mail: integrateddesign@honcompany.com



Solve® Chair shown with Coordinate™ Height Adjustable Table.

Project Space

A place for all HON Project Services

Project Space provides one platform to access the full portfolio of HON services including:

- Design
- Audit
- Product Modification
- Special Laminates
- Consultation
- Customer's Own Material
- Dual Fabric Applications
- Special Paints
- Project Bid Pricing

Submit your request on the Community powered by HNI, Projects.

Project lead time expectation is 3-5 business days, depending on scope of work.

TAILORED SOLUTIONS ORDERING INFORMATION

PRODUCT MODIFICATIONS

Modifications include structural and dimensional modifications to existing product and Dual Fabric Applications, when standard model is not available.

The HON Company, at its own discretion, may modify standard products to meet specific needs. Product specials can be requested on HON brand product only.

List prices contained in published list pricers are for standard catalog items only. Changes or alterations to catalog items other than those listed as catalog options are subject to additional charges. Pricing will only be furnished upon approval of the special request.

Requests to have the product produced in more than one fabric (e.g., fabric on the seat is different than the fabric on the back), are considered a Dual Fabric Applications request and follow the Product Modification request process within the Community.

SPECIAL LAMINATES

Special laminates include requests for laminates not available as part of The HON Company's standard offering. Requests for special laminates are subject to manufacturing approval and minimum order quantities. The HON Company approved special laminates will be subject to a designated upcharge per unit.

Requests for special laminates should be submitted through the Community. Pricing will only be furnished upon approval of the special request.

SPECIAL PAINTS

- The HON Company's paint matching equipment can match almost any color, excluding some metallic and whites.
- Special paint requests must be submitted on the Community.
- In order to request a paint sample, the customer must have a minimum order of 10 like product units. Any requests with less than that amount will not be processed.
 - For each new paint request, there will be a \$250 net charge. A sample of the exact color desired is required for matching and approval. The HON Company will match the color and provide a production sample for the customer to review and approve.

- Once written approval is received by The HON Company, the request will be approved.
- Each unique color or finish combination incurs a designated upcharge per color per order (all standard discounts/competitive project pricing applies).

Special note: Some special colors could fall outside of this program due to production costs or not meeting The HON Company's quality standards. The HON Company may apply additional charges to some colors which are costly to apply, and refuse some orders on colors that cannot meet The HON Company's high-quality standards. The HON Company will notify the customer upon completion of The HON Company's evaluation if a change in price is required or rejection of the order.

DISCONTINUED PRODUCT

Requests for discontinued product require engineering evaluation, safety review, and testing to current standards prior to approval. Many discontinued products are not available for order. Requests for discontinued products should be submitted through the Community.

LEAD TIMES FOR SPECIALS PRODUCT

Lead times on orders containing specials are subject to production capacity and material availability. When possible, the customer should order special products separately to avoid extended lead times for standard products. Extended lead times will be noted on Compass.

CHANGES TO SPECIALS PRODUCT

A special model will be provided for each approved special item to process orders. Once an order is placed, no changes or cancellations can be made to the order without approval from Tailored Solutions.

CONTACT TAILORED SOLUTIONS

Phone: 800.833.3964 and listen for Tailored Solutions offering on the menu.

Email: HONSpecials@honcompany.com

CUSTOMER'S OWN MATERIAL ORDERING INFORMATION

CUSTOMER'S OWN MATERIAL (COM) PROGRAM

Customer's Own Material (COM) is a request to use fabrics not available as part of HON's standard fabric offering. Manufacture to Supply (MTS) and Dealer to Supply (DTS) are the two ordering methods. The HON Company has partnered with fabric manufacturers to provide competitive pricing and selection through the MTS program. MTS will be the standard offering unless The HON Company is unable to procure the fabric. If there is a DTS request submitted, The HON Company will advise at the time of the request if DTS is available.

CUSTOMER WARRANTY EXCLUSION

The HON Company shall have no responsibility for the condition, quality, value, performance, physical properties, or any other aspects of the COM.

The HON Company shall have no liability for any damages, injuries, or losses to the customer or to any third party that shall be caused by any COM or product modification, and the customer shall hold The HON Company harmless for all liability.

The HON Company assumes no responsibility for the overall appearance, flammability, normal durability, colorfastness, or any other quality of the COM or product modification after its application on a HON product beyond normal quality standards. The HON Company reserves the right to reject a COM fabric if the quality of the COM is not satisfactory for the product. Should this occur, the customer will be notified with an explanation of the issue.

The HON Company is not responsible for fabric that has become obsolete at the COM supplier, that is of poor quality, or that is delivered late to The HON Company from the COM supplier. The HON Company is not responsible for excess yardage created by DTS orders or yardage not attached to an order and reserves the right to dispose of the excess fabric.

As a standard HON does not pattern match any standard, partnership or COM fabric, therefore pattern match is not applicable under warranty. If pattern match is needed please submit a Tailored Solutions request or contact HON Customer Support/Tailored Solutions once your COM has been approved.

COM TESTING

As a result of recent legal requirements, The HON Company will need to obtain specific information from the fabric supplier about treatments and chemicals used in the fabric. To the extent the supplier is unwilling or unable to provide the necessary information, which could extend the testing lead time of the request.

To check if a COM has been tested previously, utilize the COM Search Tool on the Website > Design Resources > Textiles & Finishes section using the following information:

- COM Supplier's Name
- Fabric Pattern Name
- Color Name
- If the COM fabric has been tested and previously approved, the COM will not need to be re-tested unless testing standards have changed, fabric is to be used on a different series, or direction of the fabric has changed from what was previously approved. Please note that Panel product must be approved for each model and color.
- If the pattern has previously been tested and approved, but not in the specific requested color, the customer will need to request an order code for that color only. No further testing will be necessary since the pattern has already been approved.

If the fabric has not previously been tested, the customer must enter the COM request on the Website > Textiles & Finishes > COM Search Tool.

Complete the Supplier Name, Pattern, and Color drop-down fields. For quicker results in these fields, type the first letter of the (supplier, pattern, color) name and, when done, click Add and then Submit. (Multiple series can be added to the same request if they are the same supplier, pattern, and color.)

An email will be sent to the requestor stating the COM Request was successfully submitted. Up to four emails could be received: submitted, in testing, testing materials requested, and final approval/denial with price grade and fabric code. The testing process takes approximately 48 hours.

COM yardage in the pricer is shown as pattern cut only.

COM TESTING — FLAMMABILITY TESTING INFORMATION

The customer is responsible for ensuring that the COM fabric is certified to meet all flame-retardant requirements. All COM seating fabric must, at minimum, meet CAL 117 requirements. If the customer requires the chair be tested to meet the fire safety standards of CAL 133, additional testing and information is required.

MTS COM

As previously mentioned, MTS is the primary COM method.

If the COM fabric has not been tested, a COM request must be submitted on the Website.

For MTS orders, The HON Company will procure fabric needed for production. Should The HON Company not be able to obtain fabric yardage, the customer will be contacted.

CUSTOMER'S OWN MATERIAL ORDERING INFORMATION

When testing has been completed, the customer will be notified by the COM team of the test results. If the COM is approved, The HON Company will provide a COM tracking order code for MTS. That tracking code is required on the order in place of the standard fabric code.

If approved, MTS product will be assigned an appropriate fabric grade for pricing. The pricing can be found on the Website > Design Resources > Textiles & Finishes. (All standard discounts/competitive project pricing applies).

Written COM price quotes are valid for 90 days after the issue date.

DTS COM

DTS COM is only available if the COM fabric cannot be procured by The HON Company. If the fabric can be procured by The HON Company, the customer will be contacted to switch to MTS or cancel the request.

If your fabric is not listed as approved, and it is not a Partnership fabric you may request a "Dealer to Supply" code. Select the "Request COM Test" link on the COM Search website. Complete the Supplier Name, Pattern, and Color drop-down fields. For quicker results in these fields, type the first letter of the (supplier, pattern, color) name and, when done, click Add and then Submit. (Multiple series can be added to the same request if they are the same supplier, pattern, and color.)

An email will be sent to the requestor stating the COM Request was successfully submitted. Up to four emails could be received: submitted, in testing, testing materials requested, and final approval/denial with price grade and fabric code. It's rare actual test yardage is required. Testing is mainly done by reviewing the attributes of the fabric. The testing process takes approximately 48 hours.

If the COM has not been tested, a COM request must be submitted on the Website > Design Resources > Textiles & Finishes.

When testing has been completed, the customer will be notified by the COM team of the test results. If the COM is approved, The HON Company will provide a COM tracking order code. That tracking code is required on the order in the place of the standard fabric code.

DTS product is priced at the following grades (all standard discounts/competitive project pricing applies):

- Chairs are a Grade 4
- Panel product is a Grade D

Written COM price quotes are valid for 90 days after the issue date.

COM LEAD TIME

Ship dates will be based on fabric receipt and The HON Company's standard lead time. All fabric must be properly tagged and shipped to the appropriate producing location (provided in the approval email).

- Specific to DTS orders, COM orders will not receive a ship (acknowledged) date until The HON Company has the fabric in its possession for production.
- Specific to DTS orders, the customer may send the required yardage for the order to the address listed on the approval email to arrive no sooner than 4 weeks in advance of the acknowledgment date.

HON will make every effort to locate mis-directed COM shipments on behalf of the customer. However, The HON Company will not be responsible for any COM received without a tracking number or incorrectly shipped by the fabric vendor to an incorrect producing facility.

COM ORDERING INFORMATION

The following information must appear on or accompany the product purchase order:

- Approval tracking number and the customer's purchase order number
- COM supplier, pattern, and color name/number

The packing list for the COM must include the following information when The HON Company receives the shipment for production:

- Dealer or Wholesaler Name
- Purchase order number submitted to The HON Company
- Fabric name
- Yardage shipped
- Approval ordering code

Specific to DTS orders; the customer should send only the amount needed for the order. Excess yardage or yardage not tied to an order will be disposed of at The HON Company.

CHANGES TO COM PRODUCT

Once a COM product is ordered, no changes or cancellations can be made to the COM product without approval from the HON COM team.

CONTACT COM TEAM

Phone: 800.833.3964 and listen for COM TEAM offering on the menu.

COM Email: HONCOMTeam@honcompany.com

PARTNERSHIP TEXTILE INFORMATION

Partnership Textiles is the result of The HON Company's partnership with textile industry leaders Camira, HBF Textiles, Maharam, Momentum, Stinson, and Ultrafabrics, LLC. The extensive collection of design-driven textiles create a superior offering at a great value. Partnership Textiles significantly updates HON's offering, expanding it with fresh and exciting options.

- Fabric Warranty: Partnership Textiles are covered by HON's Full Lifetime Warranty.
- Lead Times: Orders specified with Partnership Textiles will be acknowledged based on the supplier's availability and delivery schedule.
- Availability: The HON Company will regularly introduce new Partnership Textiles and reserves the right to change the offering at any time.
- Fabric Cards: A curated set of Partnership Textiles are carded jointly by HON and the supplier.

Camira

- Blazer

HBF Textiles*

- Cloverleaf
- Denim Wash
- Everyday Textiles II
- Everyday Textures

*HBF Textiles patterns are graded in to HON's offering.

Maharam

- Apt
- Bluff
- Collection 1
- Lariat
- Meld
- 6M

Mayer

- On Point
- Traverse

Momentum

- Chroma
- Jumpstart
- Nexus
- Smart Fusion

Stinson

- Elevate II

Ultrafabrics, LLC

- Brisa

Fabric Memo Samples: Please contact the supplier directly:

Camira: memos@camirafabrics.com

HBF Textiles: Phone: +1 (877) 494-5727, orders@hbftextiles.com

Maharam: (800) 645-3943

Mayer Fabrics: mayerfabrics.com (800) 428-4415

Momentum: customerservice@momtex.com (800) 366-6839

Stinson: (800) 841-6279

Ultrafabrics: (877) 309-6648

HON BRANDED, PARTNERSHIP AND COM PATTERN MATCH

- Pattern matching provides alignment of patterns or stripes across individual chair surfaces. Additional yardage may be required depending on pattern repeat. If Pattern Match is needed, please contact HON Customer Support/Tailored Solutions.
- Chair to Chair Pattern Match provides identical pattern alignment from unit to unit and is available with an upcharge. Chair to Chair Pattern Match is reviewed on a case by case basis as several factors are reviewed to determine additional yardage required, including repeat and pattern direction. If Chair to Chair Pattern Match is needed, please contact HON Customer Support/Tailored Solutions.



The HON Company has established paint grades to allow customers flexibility and ease in doing business with HON. HON has three paint grades P1, P2, and P3.

P1 PAINT COLORS

HON has established P1 paints which are available on a majority of core products.

P2 PAINT COLORS

Please see individual pricer pages for eligible series and upcharges for P2 paints. P2 paints are listed in the pricer pages under the column P2. Upcharges vary by product (all standard discounts/competitive project pricing applies). No minimum quantity required.

P3 PAINT COLORS

Please see individual pricer pages for eligible series and upcharges for P3 paints. P3 paints are listed in the pricer pages under the column P3. Upcharges vary by product (all standard discounts/competitive project pricing applies). No minimum quantity required.

SPECIAL PAINT COLORS (P4-P6)

With The HON Company's state of the art color matching equipment just about any color can be matched, excluding some metallic and whites. A sample of the exact color desired is required for matching and approval.

- For each newly requested paint, a net fee of \$250 will be charged to cover costs associated with the matching process.
- For existing, previously matched paints, there is no matching fee, however there is a \$100 net fee for sample panels required for the approval process. Refer to MyProjects on the HON Portal for a list of approved special paints.

For all special paint requests, HON will send a production sample for the customer to review and approve. Once the signed paint sample is received at HON the order can be entered. Upcharges vary by product (all standard discounts/competitive project pricing applies). A quantity of 10 like-model minimum order is required for special paints. For complete program details, access Tailored Solutions on the Website at hon.com.

Some special colors could fall outside of this program due to production costs or not meeting HON quality standards. The HON Company may apply additional charges to some colors which are costly to apply, and deny some orders on colors that cannot meet our high-quality standards. We will notify the customer upon completion of our evaluation if a change in price is required or if the request is denied.

HON OPEN LINE LAMINATE PROGRAM

The Open Line Laminate (OLL) program makes it even easier for a customer to tailor their HON product for a custom look. Select HON furniture products accommodate hundreds of graded-in high-pressure laminates (HPL) from the leading laminate manufacturers' open lines.

Laminates that are currently available in the program can be viewed in specification tools.

Requests to add laminates to the standard specials program can be submitted through the CET Specials Integration tool as well as Community.

Matching edge options are not available offered for laminates in the OLL program. When selecting a laminate please select an edge option from the HON standard offering. If a matching edge is required a modification request can be submitted through the CET Specials Integration tool as well as Community.

The OLL program is available with the following HON products and series:

- Abound® Hard-Surface Tiles
- Birk™ Tables
- Build™ Tables
- Coordinate™ Worksurfaces
- Gallery Panels
- Huddle Tables
- Preside® Tops
- Sculpt™/Occasional Tables
- SmartLink® Value Teacher Desk
- Systems Worksurfaces
- Tangram™
- Universal Screens

Due to manufacturing techniques, materials, quality issues of varying laminates, and minimum order quantities, some product exclusions will apply and some requests may be declined.

Extended lead times may apply on orders containing special laminates.

Contact the Tailored Products Group for questions or additional information regarding pre-approved laminates and pricing.

HON

Phone: 888-255-7833, Option 4.5

Email: HONSpecials@honcompany.com

For edgeband recommendations from the HON standard offering, please email the HNI Workplace Colors, Materials, and Finishes team at honfinishes@honcompany.com.

For laminate samples, please contact the manufacturer directly:

Wilsonart

<https://www.wilsonart.com/>
1-800-433-3222

Formica

<https://www.formica.com/en-us/>
1-800-FORMICA (367-6422)

Nevamar and Pionite

<https://www.panolam.com>
877-726-6526

ENVIRONMENTAL STATEMENT

We continually reevaluate our purpose and processes, from fostering transparency and circularity in our supply chain to empowering our members to do and be better. We do it so the environments you create will be safer, more socially responsible, and more sustainable.

We've pursued product certifications to help communicate our commitment to developing sustainable products.

Clearing the air.

In 2006, The HON Company became one of the first office furniture manufacturer to have products certified under the Indoor Advantage™ program. Virtually all manufactured products emit chemical compounds into the air. Indoor Advantage™ certification helps assure customers that certified products will help improve the air quality within their offices and workspaces.

Developed by SCS Global Services, Indoor Advantage™ evaluates products against indoor air quality standards, like ANSI/BIFMA Furniture Emissions Standard, M7.1/X7.1 and CDPH Standard Method v1.1. The ANSI/BIFMA X7.1 standard allows manufacturers to test individual components, as well as complete products for emissions from volatile organic compounds (VOCs). This allows us to identify problematic materials and phase them out of our products.

Indoor Advantage™ certified products meet the LEED and WELL criteria for low-emitting materials.

Indoor Advantage™ offers two levels of certification, including Indoor Advantage™ and Indoor Advantage™ Gold.



On the LEVEL®.

LEVEL®, the certification program for the BIFMA e3 Sustainability Standard, was developed in response to increasing demand for proof that manufacturers were living up to their environmental claims. LEVEL® is a multi-attribute sustainability certification label for products that have met criteria in four categories of impact: Materials, Energy and Atmosphere, Human and Ecosystem Health, and Social Responsibility.

HON's products are certified to LEVEL 2 and LEVEL 3, the highest achievement. BIFMA LEVEL 2 and LEVEL 3 certified products can contribute to LEED and WELL projects.



Evaluating Our Impacts.

HON has begun studying the impacts our products have on the environment through lifecycle assessments and creating Environmental Product Declarations (EPDs). EPDs provide an understandable report of a product's environmental impact throughout its life cycle; including raw material extraction and processing, product assembly, distribution and use, and end-of-life.

Products that meet these specifications are identified throughout this publication with the following icons:

Certified SCS Indoor Advantage™

LEVEL® certified to the BIFMA e3 Sustainability Standard

Environmental Product Declarations

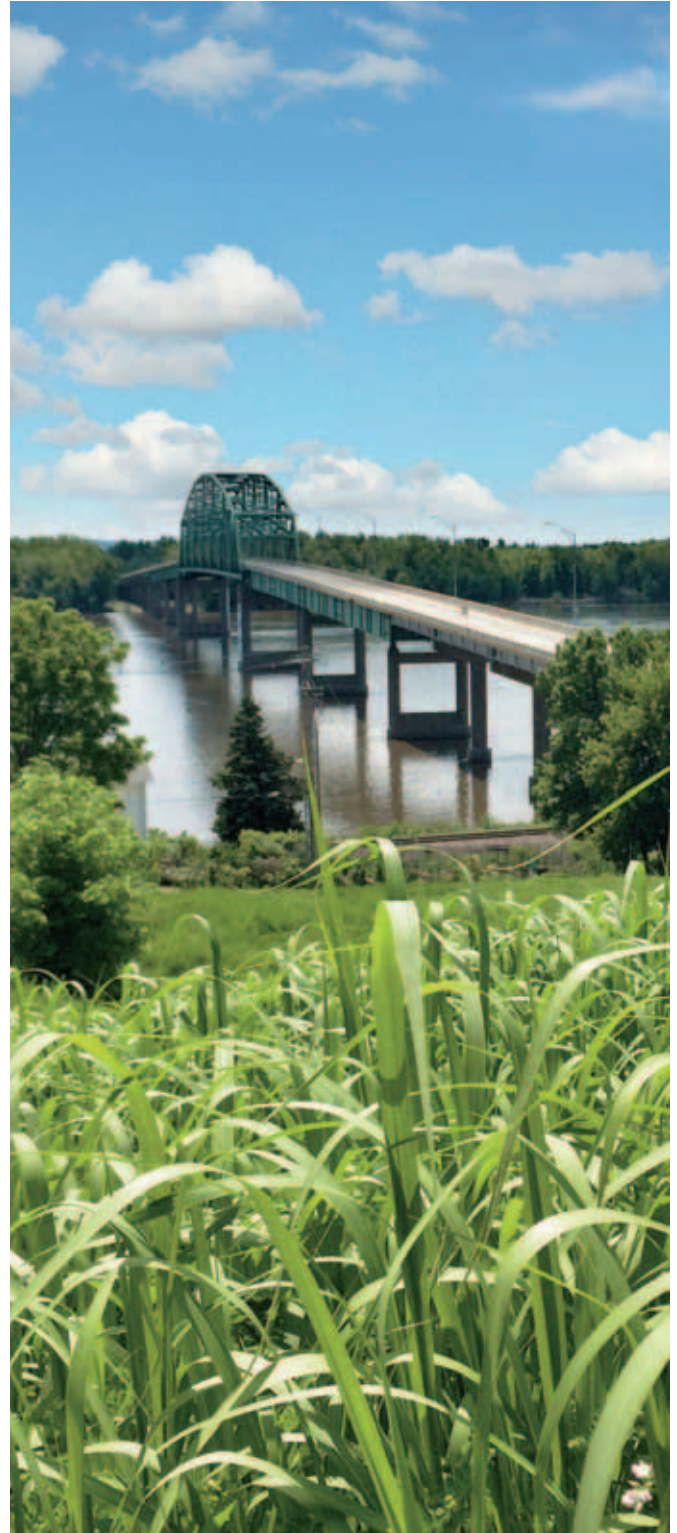

IMPORTANT INFORMATION

HON NOW™

A COMPLETE OFFICE SOLUTIONS AT THE SPEED YOU NEED

To keep your business at peak productivity, waiting is not always an option. The HON NOW™ Quickship program was designed for movers and shakers like you who want exceptional quality, durability, and versatility without compromising valuable time. Whether you're outfitting a brand new workspace or simply expanding the one you already have, we've got a variety of dependable and supportive office furniture solutions designed to fit your needs and your schedule — in a hurry, without the hassle.

To learn more, visit [hon.com/now](https://www.hon.com/now).

GSA/FEDERAL CONTRACT INFORMATION

Model numbers identified with the following verbiage "When purchased separately without a configurable TAA compliant end product, not on GSA contract" is to mean that these configurable parts or components:

- Have no functionality or capability without being integrated into an end product; and
- Are considered Open Market if purchased without a configurable TAA compliant end product.

ITEMS ON GSA CONTRACT

Please note, in order to verify if an item is on GSA Contract or is "Open Market," please use Compass quoting which is updated in real time with all GSA contract changes. If you need additional assistance, please contact your local sales representative. For more information visit: <https://www.hon.com/why-hon/csr>.

HON CUSTOMER SUPPORT CONTACT INFORMATION

Nationwide CS Phone – (800) 833-3964

Nationwide Order Entry – HONOE@honcompany.com

GSA Order Entry: HONGSAOE@honcompany.com

Integrated Design Solutions – integrateddesign@honcompany.com

Online Order and Tool Support – HONDigitalSupport@honcompany.com

DASH (transportation and delivery assistance) – (800) 334-8057

HON Literature Fulfillment Phone – (800) 466-4808

Government Support:

GovernmentSupport@hniworkplacefurnishings.com

Product, Parts, Non-Warranty Parts Orders:

ProductSupport@hniworkplacefurnishings.com

Quick Ship Orders: QuickShip@hniworkplacefurnishings.com

Order Status: OrderStatus@hniworkplacefurnishings.com

General Inquiries: GeneralSupport@hniworkplacefurnishings.com



Nationwide CS Phone
800-833-3964

THE FOLLOWING ICONS MAY BE USED THROUGHOUT THIS PUBLICATION

- 

Meets or exceeds ANSI/BIFMA and ISTA performance standards
- 

Certified SCS Indoor Advantage™ See page 17 for more details.
- 

Complies to the BIFMA e3 Sustainability Standard. See page 17 for more details.
- 

Caution
- 

Easy to assemble
- 

Shippable by small-package carrier
- 

Wheel-chair compatible
- 

Soft-tread caster option available
- 

HON “One Key” Interchangeable core removable locks (see the Accessories section in the 2025 Workspaces Pricer).
- 

Omit core removable lock option available. Allows keyed alike workstations (see the Accessories section in the 2025 Workspaces Pricer).
- 

Base models available on the HON NOW Quickship Program with select options and finishes. View the entire NOW collection at hon.com.
- 

Readily Available. For additional lead time information see page 21.
- 

Available within a “standard” or “extended” lead time. For additional lead time information see page 21.
- 

May have extended lead times. For additional lead time information see page 21.
- 

Product shipped two to a carton
- 

Product shipped four to a carton
- 

Fire Code
- 

Product scheduled for discontinuation. See page 5 for details.
- 

DE-EMPHASIZED: Product or fabric/surface material is de-emphasized. Not carded.
- 

Warranted for multiple shift use, 24 hours a day 7 days a week

FABRIC PATTERNS & CODES



FABRIC PATTERNS & CODES

- For additional HON to Supply COM fabric grade pricing, go to [hon.com](https://www.hon.com) and search on the HON to Supply COM link.
- All specifications in this publication are based on the latest product information available at the time of print.
- Certain dyes (including clothing and accessory dyes such as those used on denim jeans) may migrate to lighter colors. This phenomenon is increased by humidity and temperature and is irreversible. The HON Company LLC does not assume responsibility for dye transfer caused by external contaminants.
- COM Ordering Information and pricing on page 13.
- See page 14 for Partnership Textile program information.
- All standard fabrics are carded. Cards are available through HON Literature Fulfillment.
- Fabrics and foam meet requirements for CAL-TB 117-2013.
- ! Different fabrics and finishes have different recommended cleaning and maintenance methods. For the correct product care for all finishes view the HON Product Care guide at [hon.com/customer-support/product-care](https://www.hon.com/customer-support/product-care).

LEAD TIMES

THE FOLLOWING ICONS ARE USED TO DENOTE FABRIC OPTION LEAD TIMES

FABRIC/FINISH LEAD TIME INDICATOR



Fabric is readily available. Products using these fabrics will receive the best available product lead time and are a good option for standards programs as they will be in the HON portfolio for several years. Go to [hon.com](https://www.hon.com) and use **Compass** for product lead times by series.



Fabric is available within standard lead times. Products using these fabrics will receive a “standard” or “extended” lead time. The lead time will be determined by the combination of product and fabric. Go to [hon.com](https://www.hon.com) and use **Compass** for product lead times by series.



Fabric may have extended lead times. Products using these fabrics will typically have a 4+ week lead time. Go to [hon.com](https://www.hon.com) and use the **Compass** tool for product lead times by series.

HON EXPRESS QUICK SHIP PROGRAM

For the full list of products delivered in 5 business days or less, visit [hon.com](https://www.hon.com).

PRODUCT LEAD TIMES

Standard lead times for products are between 2-4 weeks. For current exceptions to our standard lead time, go to [hon.com](https://www.hon.com) and use the **Compass** tool.

In order to establish accurate expectations for your project, please review this listing prior to submitting your purchase order.

Lead time calculation begins when order is free from any holds (i.e., bad lines, material, credit, etc.).

Please note, these production lead time estimates do NOT include delivery time. All published lead times are estimates, not guarantees of delivery.

For further information concerning lead times, please contact HON Customer Support via email generalsupport@hniworkplacefurnishings.com or by phone at **800-833-3964**.

SEATING FABRIC PATTERNS & CODES

Scan here to check out our full Chair Fabrics solutions



GRADE 1

APEX	APX
◆ Basalt	APX25
◆ Beet	APX12
◆ Blackberry	APX20
◆ Chive	APX05
◆ Iris	APX03
◆ Kiwi	APX06
◆ Lemonade	APX08
◆ Navy	APX13
◆ Papaya	APX09
◆ Pumice	APX23
◆ Rain	APX19
◆ Resort	APX15
◆ Royal	APX14
◆ Tiki	APX29
◆ Tomato	APX11

BLACK FABRIC	ACCF
◆ Black	ACCF10

BLACK MESH	ACCM
◆ Black	ACCM10

CENTURION	CU
◆ Apricot	CU47
◆ Bark	CU25
◆ Black	CU10
◆ Espresso	CU49
◆ Fog	CU03
◆ Frost	CU22
◆ Goldenrod	CU27
◆ Indigo	CU06
◆ Iris	CU50
◆ Iron Ore	CU19
◆ Jade	CU83
◆ Marsala	CU63
◆ Morel	CU24
◆ Navy	CU98
◆ Peacock	CU97
◆ Pear	CU84
◆ Ruby	CU67
◆ Sapphire	CU09

COMPASS	COMP
◆ Beach	COMP16
◆ Bittersweet	COMP46
◆ Chocolate	COMP49
◆ Ink	COMP10
◆ Meadow	COMP82
◆ Midnight	COMP90
◆ Putty	COMP22
◆ Ruby	COMP62
◆ Sterling	COMP19
◆ Taupe	COMP26
◆ Tide	COMP96

GRADE 1 *continued*

CONTOURETT	UR
◆ Baltic	UR94
◆ Beach	UR23
◆ Black	UR10
◆ Bordeaux	UR63
◆ Buff	UR22
◆ Cloud	UR18
◆ Coffee Bean	UR49
◆ Crater	UR51
◆ Flame	UR62
◆ Graphite	UR19
◆ Iron	UR20
◆ Luggage	UR26
◆ Marine	UR92
◆ Navy	UR95
◆ Nimbus	UR93
◆ Ocean	UR96
◆ Pumpkin	UR42
◆ Quarry	UR24
◆ Red	UR64
◆ Safari	UR27
◆ Sage	UR82
◆ Steel	UR21
◆ Storm	UR17
◆ Taupe	UR28
◆ Trunk	UR50

DAPPER	DAPR
◆ Ash	DAPR20
◆ Breeze	DAPR06
◆ Canvas	DAPR25
◆ Charcoal	DAPR01
◆ Clover	DAPR22
◆ Currant	DAPR00
◆ Fawn	DAPR35
◆ Fern	DAPR85
◆ Gerbera	DAPR16
◆ Grape	DAPR33
◆ Jewel	DAPR08
◆ Marigold	DAPR65
◆ Onyx	DAPR10
◆ Orchid	DAPR90
◆ Parrot	DAPR59
◆ Poppy	DAPR19
◆ Sapphire	DAPR07
◆ Scarlet	DAPR45
◆ Sepia	DAPR30
◆ Sky	DAPR44
◆ Slate	DAPR15
◆ Sorbet	DAPR55
◆ Spring	DAPR80
◆ Terracotta	DAPR13
◆ Titanium	DAPR17
◆ Varsity	DAPR09
◆ Zest	DAPR70

GRADE 1 *continued*

EMPHASIS	EMP
◆ Denim	EMP14
◆ Evergreen	EMP09
◆ Fog	EMP04
◆ Garnet	EMP07
◆ Gemstone	EMP15
◆ Graphite	EMP02
◆ Greenery	EMP10
◆ Marsh	EMP11
◆ Navy	EMP13
◆ Obsidian	EMP01
◆ Parchment	EMP16
◆ Persimmon	EMP08
◆ River	EMP12
◆ Suit	EMP03
◆ Tweed	EMP05
◆ Twine	EMP06

ENSEMBLE	ENSB
◆ Aquamarine	ENSB30
◆ Ash	ENSB39
◆ Greige	ENSB36
◆ Harbor	ENSB34
◆ Navy	ENSB35
◆ Oat	ENSB37
◆ Pear	ENSB33
◆ Sand	ENSB38
◆ Scarlet	ENSB32
◆ Slate	ENSB31
◆ Stone	ENSB40

HAMILTON	HAML
◆ Agave	HAML28
◆ Azure	HAML10
◆ Cabernet	HAML08
◆ Caribbean	HAML29
◆ Carolina	HAML21
◆ Charcoal	HAML17
◆ Cloud	HAML18
◆ Dane	HAML16
◆ Deep	HAML27
◆ Dove Grey	HAML33
◆ Garnet	HAML22
◆ Granola	HAML19
◆ Hearth	HAML34
◆ Lilac	HAML14
◆ Mellow	HAML25
◆ Mossy Green	HAML26
◆ Oxford	HAML20
◆ Pepper	HAML15
◆ Royalty	HAML31
◆ Serene	HAML30
◆ Sunny Day	HAML24
◆ Terracotta	HAML23
◆ Winter Sky	HAML32

GRADE 1 *continued*

NOBLE SEATING	SNBLE
◆ Aegean	SNBLE18
◆ Amethyst	SNBLE19
◆ Aspen	SNBLE14
◆ Aster	SNBLE20
◆ Blossom	SNBLE21
◆ Bluebell	SNBLE22
◆ Bordeaux	SNBLE01
◆ Brick	SNBLE02
◆ Chambray	SNBLE10
◆ Chamomile	SNBLE23
◆ Clementine	SNBLE04
◆ Conifer	SNBLE24
◆ Cottage	SNBLE25
◆ Darkness	SNBLE26
◆ Dawn	SNBLE13
◆ Denim	SNBLE09
◆ Desert Sand	SNBLE27
◆ Dewfall	SNBLE28
◆ Dusted Sage	SNBLE29
◆ Flax	SNBLE30
◆ Grass	SNBLE07
◆ Gunmetal	SNBLE15
◆ Harmony	SNBLE31
◆ Harvest	SNBLE12
◆ Ice Caves	SNBLE32
◆ Icicle	SNBLE33
◆ Inky	SNBLE34
◆ Iris	SNBLE35
◆ Jade	SNBLE06
◆ Knight	SNBLE17
◆ Mesa	SNBLE03
◆ Monarch	SNBLE36
◆ Pacific	SNBLE08
◆ Pitch	SNBLE37
◆ Queen Bee	SNBLE38
◆ Rainforest	SNBLE05
◆ Regal	SNBLE11
◆ Sandcastle	SNBLE39
◆ Sedona	SNBLE40
◆ Stormy	SNBLE16
◆ Sunbeam	SNBLE41
◆ Voyager	SNBLE42
◆ Windy Day	SNBLE43

PEBBLE	PBLE
◆ Amber	PBLE01
◆ Chalk	PBLE02
◆ Coal	PBLE03
◆ Gravel	PBLE04
◆ Magma	PBLE06
◆ Moss	PBLE05
◆ Sandstone	PBLE07
◆ Talc	PBLE08
◆ Topaz	PBLE09
◆ Zircon	PBLE10



Scan here to check out
our full Chair Fabrics
solutions

SEATING FABRIC PATTERNS & CODES

GRADE 1 *continued*

VIBE	VIBE
◆ Bliss	VIBE03
◆ Calm	VIBE06
◆ Carefree	VIBE08
◆ Cheerful	VIBE17
◆ Compassion	VIBE01
◆ Connected	VIBE13
◆ Content	VIBE19
◆ Courage	VIBE12
◆ Dazed	VIBE21
◆ Delight	VIBE18
◆ Euphoria	VIBE15
◆ Gleeful	VIBE04
◆ Gloomy	VIBE22
◆ Hope	VIBE07
◆ Moody	VIBE05
◆ Nostalgia	VIBE09
◆ Perplexed	VIBE10
◆ Pride	VIBE02
◆ Relaxed	VIBE20
◆ Secure	VIBE16
◆ Serenity	VIBE11
◆ Trust	VIBE14

GRADE 2

APPOINT SEATING	PNS
◆ Artichoke	PNS014
◆ Blackberry	PNS012
◆ Bronze	PNS002
◆ Carbon	PNS008
◆ Chai	PNS013
◆ Cherry	PNS010
◆ Dark Pewter	PNS017
◆ Dune	PNS015
◆ Espresso	PNS003
◆ Framboise	PNS011
◆ Frost	PNS034
◆ Jet	PNS007
◆ Lawn	PNS005
◆ Mandarin	PNS009
◆ Morel	PNS001
◆ Nimbus	PNS016
◆ Platinum	PNS004
◆ Turquoise	PNS006

BLUME*	BLME
◆ Chalk	BLME03
◆ Char	BLME00
◆ Coin	BLME02
◆ Driftwood	BLME05
◆ Emerald City	BLME07
◆ Fir	BLME09
◆ Harvest	BLME04
◆ Haze	BLME08
◆ Hyacinth	BLME14
◆ Jasper	BLME13
◆ Merlot	BLME10
◆ Moonstone	BLME01

GRADE 2 *continued*

BLUME <i>continued</i>	BLME
◆ Opal	BLME06
◆ Scarlet	BLME11
◆ Slate	BLME12

CLYDE	CLYD
◆ Antique*	CLYD04
◆ Artifact	CLYD01
◆ Blacksmith	CLYD10
◆ Claret*	CLYD13
◆ Craftsman	CLYD08
◆ Crate	CLYD12
◆ Fossil	CLYD02
◆ Heirloom	CLYD05
◆ Iron	CLYD11
◆ Keepsake	CLYD15
◆ Linen	CLYD14
◆ Relic	CLYD06
◆ Seasoned*	CLYD03
◆ Trestle	CLYD07

HAUTE	HAU
◆ Caviar	HAU01
◆ Char	HAU04
◆ Foggy	HAU06
◆ Kelp	HAU0
◆ Night Light	HAU07
◆ Sanderling	HAU05
◆ Toadstool	HAU02
◆ Weathered	HAU03

KAI	KAI
◆ Algae	KAI07
◆ Barnacle	KAI19
◆ Clownfish	KAI04
◆ Coastal	KAI13
◆ Conch	KAI02
◆ Coral Reef	KAI16
◆ Crab	KAI01
◆ Ebb	KAI12
◆ Flow	KAI11
◆ Inlet	KAI03
◆ Jellyfish	KAI18
◆ Kelp	KAI08
◆ Orca	KAI26
◆ Otter	KAI22
◆ Puffer	KAI06
◆ Salty	KAI23
◆ Seahorse	KAI05
◆ Seashell	KAI20
◆ Seaweed	KAI09
◆ Shark	KAI24
◆ Shoreline	KAI21
◆ Stingray	KAI25
◆ Tide	KAI14
◆ Turtle	KAI10
◆ Urchin	KAI17
◆ Wave	KAI15

GRADE 2 *continued*

RUSH	RUSH
◆ Anchor	RUSH07
◆ Basil	RUSH16
◆ Blueberry	RUSH10
◆ Blue Sky	RUSH57
◆ Browned Butter	RUSH25
◆ Cherry Pie	RUSH40
◆ Cinnamon Sugar	RUSH35
◆ Dried Herb	RUSH62
◆ Flamingo	RUSH21
◆ Forest Green	RUSH67
◆ Greenery	RUSH15
◆ Greyhound	RUSH06
◆ Marina	RUSH13
◆ Merlot	RUSH19
◆ Midnight	RUSH11
◆ Mint	RUSH09
◆ Mulberry	RUSH18
◆ Obsidian	RUSH90
◆ Petals	RUSH77
◆ Pumice	RUSH01
◆ Punch	RUSH20
◆ Rain Drop	RUSH54
◆ Rush Smoke	RUSH84
◆ Sage	RUSH14
◆ Salsa	RUSH24
◆ Sand	RUSH05
◆ Seal	RUSH08
◆ Slate	RUSH89
◆ Soot	RUSH02
◆ Stout	RUSH03
◆ Sunshine	RUSH23
◆ Tapestry	RUSH04
◆ Tiger	RUSH22
◆ Vintage	RUSH17
◆ Wave	RUSH12

SPECTRUM MESH*	RM
◆ Beacon	RM27
◆ Blueberry	RM20
◆ Brick	RM16
◆ Bullseye	RM17
◆ Carbon	RM10
◆ Chalk	RM28
◆ Cobalt	RM14
◆ Espresso	RM15
◆ Gold Dust	RM31
◆ Kermit	RM23
◆ Key Lime	RM32
◆ Leaf	RM21
◆ Linen	RM30
◆ Loft	RM12
◆ Midnight	RM24
◆ Onyx	RM13
◆ Pear	RM29
◆ Quicksand	RM33
◆ Salamander	RM25
◆ Sky	RM19
◆ Steel	RM26
◆ Titanium	RM11

GRADE 2 *continued*

SPIN SEATING	SPNN
◆ Alabaster	SPNN02
◆ Cavern	SPNN03
◆ Cobblestone	SPNN04
◆ Ember	SPNN06
◆ Flame	SPNN07
◆ Heron	SPNN13
◆ Oat	SPNN01
◆ Ocean	SPNN12
◆ Plum	SPNN15
◆ Pool	SPNN11
◆ Raven	SPNN10
◆ Rhubarb	SPNN14
◆ Tropic	SPNN08
◆ Willow	SPNN05

WAVELENGTH	WVL
◆ Base	WVL21
◆ Crest	WVL14
◆ Cycle	WVL20
◆ Energy	WVL03
◆ Frequency	WVL04
◆ Infrared	WVL01
◆ Motion	WVL13
◆ Movement	WVL05
◆ Peak	WVL11
◆ Pressure	WVL06
◆ Shallow	WVL02
◆ Still	WVL07
◆ Surface	WVL18
◆ Surge	WVL10
◆ Swell	WVL08
◆ Tide	WVL16
◆ Transition	WVL15
◆ Trough	WVL19
◆ Tsunami	WVL09
◆ Ultraviolet	WVL12
◆ White Caps	WVL17

WHISPER VINYL	WP
◆ Antelope	WP20
◆ Auburn	WP02
◆ Black	WP40
◆ Bone	WP17
◆ Bordeaux	WP26
◆ Breeze	WP76
◆ Camel	WP18
◆ Cappuccino	WP21
◆ Cashew	WP29
◆ Cerulean	WP36
◆ Charcoal	WP39
◆ Cinnamon	WP25
◆ Coastal	WP81
◆ Cognac	WP62
◆ Elephant	WP38
◆ Emerald	WP80
◆ Espresso	WP49
◆ Farro	WP73
◆ Fawn	WP91
◆ Fog	WP100

* Fabric is de-emphasized.

*Only available on the seats of certain Ignition® 2.0 and all Nucleus® models.

SEATING FABRIC PATTERNS & CODES

Scan here to check out our full Chair Fabrics solutions



GRADE 2 *continued*

WHISPER VINYL <i>continued</i>	WP
◆ Fossil	WP01
◆ Herbal	WP79
◆ Indigo	WP86
◆ Islet	WP77
◆ Luggage	WP23
◆ Mahogany	WP93
◆ Mallard	WP90
◆ Molten	WP98
◆ Navy	WP37
◆ Paradise	WP85
◆ Patina	WP34
◆ Pavestone	WP74
◆ Pearl	WP71
◆ Pewter	WP83
◆ Powder	WP70
◆ Saddle	WP03
◆ Salsa	WP42
◆ Sand	WP72
◆ Sassafras	WP89
◆ Silver Leaf	WP78
◆ Slate	WP04
◆ Storm	WP92
◆ Terracotta	WP75
◆ Truffle	WP95
◆ Wolf Grey	WP55

GRADE 3

BRADBURY	BDY
◆ Acorn	BDY01
◆ Alabaster	BDY02
◆ Aspire	BDY03
◆ Blueberry	BDY04
◆ Carbon	BDY05
◆ Concord	BDY06
◆ Cozumel	BDY07
◆ Dolphin	BDY08
◆ Gala	BDY09
◆ Honey	BDY10
◆ Mushroom	BDY11
◆ Mystic	BDY12
◆ Oat	BDY13
◆ Rhino	BDY14
◆ Scallion	BDY15
◆ Sidewalk	BDY16
◆ Terrazzo	BDY17
◆ Vellum	BDY18
◆ Walnut	BDY19

COZY	COZY
◆ Blanket	COZY04
◆ Campfire	COZY17
◆ Cuddle	COZY03
◆ Home	COZY05
◆ Honey	COZY16
◆ Lush	COZY14
◆ Memory	COZY13
◆ Morning Air	COZY12
◆ Slippers	COZY02
◆ Snug	COZY06
◆ Socks	COZY01
◆ Solace	COZY10
◆ Sunshine	COZY15
◆ Tranquil	COZY09
◆ Twilight	COZY07
◆ Violet	COZY08
◆ Waterfall	COZY11

GETAWAY	GTWY
◆ Brig	GTWY15
◆ Canoe	GTWY03
◆ Catamaran	GTWY08
◆ Cruise Ship	GTWY10
◆ Cuddy	GTWY01
◆ Ferry	GTWY11
◆ Gondola	GTWY02
◆ Jet Ski	GTWY09
◆ Kayak	GTWY05
◆ Pontoon	GTWY13
◆ Runabout	GTWY14
◆ Sailboat	GTWY07
◆ Speedboat	GTWY12
◆ Wakeboard	GTWY06
◆ Yacht	GTWY04

GRADE 3 *continued*

MOXIE	SX
◆ Barnwood	SX09
◆ Basalt	SX23
◆ Bayou	SX02
◆ Bermuda	SX52
◆ Biscotti	SX08
◆ Blackberry	SX48
◆ Blarney	SX49
◆ Blueberry	SX05
◆ Bonsai	SX20
◆ Brigade	SX53
◆ Bitterscotch	SX54
◆ Carob	SX24
◆ Chalk	SX50
◆ Chartreuse	SX34
◆ Cherry	SX38
◆ Cinnamon	SX13
◆ Cobalt	SX01
◆ Coconut	SX06
◆ Concrete	SX43
◆ Cozumel	SX55
◆ Cumin	SX32
◆ Dover	SX56
◆ Dragonfly	SX44
◆ Earl Grey	SX40
◆ Elysian	SX04
◆ Evergreen	SX21
◆ Fatigue	SX18
◆ Fawn	SX30
◆ Flint	SX39
◆ Forsythia	SX57
◆ Grenache	SX58
◆ Hazel	SX31
◆ Hemp	SX45
◆ Hickory	SX25
◆ Holly	SX51
◆ Jam	SX16
◆ Kelly	SX33
◆ Lemongrass	SX19
◆ Lime	SX41
◆ Macintosh	SX12
◆ Midnight	SX59
◆ Mulberry	SX15
◆ Muslin	SX60
◆ Pacifica	SX61
◆ Parchment	SX07
◆ Peacock	SX03
◆ Phantom	SX62
◆ Pineapple	SX42
◆ Plum	SX17
◆ Punch	SX46
◆ Riverstone	SX47
◆ Russet	SX14
◆ Smokestack	SX22
◆ Tangerine	SX37
◆ Terracotta	SX11
◆ Thicket	SX35
◆ Walnut	SX10
◆ Whirlwind	SX63

GRADE 3 *continued*

NOTION	NTN
◆ Agave	NTN01
◆ Bark	NTN02
◆ Beeswax	NTN03
◆ Carbon	NTN04
◆ Cassis	NTN05
◆ Cement	NTN06
◆ Char	NTN07
◆ Chroma	NTN08
◆ Driftside	NTN09
◆ Drifter	NTN10
◆ Fog	NTN11
◆ Fountain	NTN12
◆ Fox	NTN13
◆ Grassland	NTN14
◆ Henna	NTN15
◆ Horizon	NTN16
◆ Ivy	NTN17
◆ Linen	NTN18
◆ Mykonos	NTN19
◆ Peat	NTN20
◆ Poppy	NTN21
◆ Rockfall	NTN22
◆ Sandwash	NTN23
◆ Stoneware	NTN24
◆ Sumac	NTN25
◆ Twilight	NTN26

PARKER	PRKR
◆ Aloe	PRKR01
◆ Cumulus	PRKR05
◆ Cyan	PRKR06
◆ Domino	PRKR07
◆ Fossil	PRKR10
◆ Graphite	PRKR11
◆ Grass	PRKR12
◆ Grenadine	PRKR13
◆ Griffin	PRKR14
◆ Kiln	PRKR16
◆ Magnesium	PRKR18
◆ Magnet	PRKR19
◆ Mica	PRKR20
◆ Mink	PRKR21
◆ Nightfall	PRKR22
◆ Paprika	PRKR24
◆ Pine	PRKR25
◆ Rapids	PRKR28
◆ Rioja	PRKR30



Scan here to check out our full Chair Fabrics solutions

SEATING FABRIC PATTERNS & CODES

GRADE 3 *continued*

PURL	PURL
◆ Alpaca	PURL08
◆ Braid	PURL10
◆ Deep	PURL12
◆ Graze	PURL05
◆ Loom	PURL06
◆ Needle	PURL07
◆ Pasture	PURL02
◆ Ranch	PURL04
◆ Shuttle	PURL09
◆ Skein	PURL01
◆ Thistle	PURL11
◆ Yearling	PURL03

QUILL	QUL
◆ Aviary	QUL03
◆ Feather	QUL02
◆ Fountain	QUL06
◆ Ink	QUL05
◆ Metal	QUL04
◆ Reed	QUL08
◆ Scroll	QUL01
◆ Well	QUL07

SAXONY	SXNY
◆ Arctic	SXNY14
◆ Azure	SXNY11
◆ Black	SXNY21
◆ Clover	SXNY06
◆ Cobalt	SXNY12
◆ Emerald	SXNY08
◆ Flare	SXNY02
◆ Fog	SXNY18
◆ Grass	SXNY05
◆ Iron	SXNY20
◆ Lagoon	SXNY07
◆ Lipstick	SXNY01
◆ Mandarin	SXNY03
◆ Navy	SXNY13
◆ Sand	SXNY16
◆ Sea	SXNY10
◆ Shell	SXNY15
◆ Sky	SXNY09
◆ Storm Cloud	SXNY19
◆ Taupe	SXNY17
◆ Zest	SXNY04

GRADE 4

CONSTANCE WITH SUPREEN™	CNST
◆ Airy	CNST01
◆ Aztec	CNST02
◆ Cassis	CNST03
◆ Copperplate	CNST04
◆ Cornerstone	CNST05
◆ Envy	CNST06
◆ Flagstone	CNST07
◆ Flax	CNST08
◆ Frost	CNST09
◆ Gateway	CNST10
◆ Grounds	CNST11
◆ Hayfield	CNST12
◆ Inkpad	CNST13
◆ Pewter	CNST14
◆ Pistachio	CNST15
◆ Pompeii	CNST16
◆ Poseidon	CNST17
◆ Reflection	CNST18
◆ Scuba	CNST19
◆ Stoic	CNST20
◆ Stonnington	CNST21
◆ Thunder	CNST22
◆ Waterfall	CNST23

LIVI WITH SUPREEN™	LIVI
◆ Asphalt	LIVI01
◆ Atlantis	LIVI02
◆ Bouquet	LIVI03
◆ Branch	LIVI04
◆ Coastal	LIVI05
◆ Cowboy	LIVI06
◆ Dawn	LIVI07
◆ Earth	LIVI09
◆ Evergreen	LIVI10
◆ Fennel	LIVI11
◆ Fog	LIVI12
◆ Honeycomb	LIVI13
◆ Jade	LIVI14
◆ Limestone	LIVI15
◆ Monochrome	LIVI16
◆ Night	LIVI17
◆ Overcast	LIVI18
◆ Pebble	LIVI19
◆ Pillow	LIVI08
◆ Plum	LIVI20
◆ Pumpkin	LIVI21
◆ Rhubarb	LIVI22
◆ Saxon	LIVI23
◆ Seaside	LIVI24
◆ Twine	LIVI25

GRADE 4 *continued*

LUCERNE WITH SUPREEN™	LUC
◆ Concord	LUC01
◆ Dutch Blue	LUC02
◆ Espresso	LUC03
◆ Globe	LUC04
◆ Golden	LUC05
◆ Hemp	LUC06
◆ Hibiscus	LUC07
◆ Oceanside	LUC08
◆ Pavement	LUC09
◆ Peacock	LUC10
◆ Pewter	LUC11
◆ Pine	LUC12
◆ Sand	LUC13
◆ Shale	LUC14
◆ Spring	LUC15
◆ Tailored	LUC16
◆ Terrain	LUC17

LUGANO WITH SUPREEN™	LUG
◆ Andromeda	LUG01
◆ Aquarelle	LUG02
◆ Bayou	LUG03
◆ Caviar	LUG04
◆ Cloud	LUG05
◆ Cobblestone	LUG06
◆ Dutch	LUG07
◆ Flirt	LUG08
◆ Florence	LUG09
◆ Frost	LUG10
◆ Ganache	LUG11
◆ Gravel	LUG12
◆ Juniper	LUG13
◆ Lapis	LUG14
◆ Moonstone	LUG15
◆ Mustard Seed	LUG16
◆ Sandstone	LUG17
◆ Sconce	LUG18
◆ Semolina	LUG19
◆ Spice Market	LUG20
◆ Sterling	LUG21

GRADE 4 *continued*

OXFORD WITH SUPREEN™	OXFD
◆ Armor	OXFD01
◆ Azurite	OXFD02
◆ Cadet	OXFD03
◆ Cider	OXFD04
◆ Clover	OXFD05
◆ Coal	OXFD16
◆ Coin	OXFD06
◆ Crema	OXFD07
◆ Currant	OXFD08
◆ Deluge	OXFD09
◆ Dewberry	OXFD10
◆ Falcon	OXFD11
◆ Gingerbread	OXFD12
◆ Laurel	OXFD13
◆ Odyssey	OXFD14
◆ Pavement	OXFD15
◆ Redvine	OXFD17
◆ Seadrift	OXFD18
◆ Shoji	OXFD19
◆ Tourmaline	OXFD20
◆ Vignette	OXFD21

GRADE L1

DAVENPORT LEATHER	DAV
◆ Atlantis	DAV02
◆ Austin	DAV21
◆ Bark	DAV18
◆ Bittersweet	DAV03
◆ Black	DAV01
◆ Brown	DAV14
◆ Camel	DAV13
◆ Cream	DAV11
◆ Dusk	DAV19
◆ Fog	DAV05
◆ Nutmeg	DAV20
◆ Olive	DAV09
◆ Porcellana	DAV12
◆ Red	DAV16
◆ Rosewood	DAV10
◆ Saddle	DAV07
◆ Smoke	DAV06
◆ Storm	DAV08
◆ Wet Sand	DAV15

DENVER LEATHER *	SS
◆ Black	SS11

* Fabric is de-emphasized.

For a complete list of fabrics, including partnership fabrics, go to hon.com/fabricsandfinishes.

PANEL FABRIC PATTERNS & CODES

Scan here to check out our full Panel Fabrics solutions



PRICE CODE A

APPOINT	APN
◆ Artichoke	APN11
◆ Blackberry	APN32
◆ Bronze	APN22
◆ Carbon	APN28
◆ Chai	APN12
◆ Cherry	APN30
◆ Dark Pewter	APN17
◆ Dune	APN15
◆ Espresso	APN23
◆ Framboise	APN31
◆ Frost	APN34
◆ Jet	APN27
◆ Lawn	APN25
◆ Mandarin	APN29
◆ Morel	APN09
◆ Nimbus	APN16
◆ Platinum	APN24
◆ Turquoise	APN26

CENTURION

CU	CU
◆ Apricot	CU47
◆ Bark	CU25
◆ Black	CU10
◆ Espresso	CU49
◆ Fog	CU03
◆ Frost	CU22
◆ Goldenrod	CU27
◆ Indigo	CU06
◆ Iris	CU50
◆ Iron Ore	CU19
◆ Jade	CU83
◆ Marsala	CU63
◆ Morel	CU24
◆ Navy	CU98
◆ Peacock	CU97
◆ Pear	CU84
◆ Ruby	CU67
◆ Sapphire	CU09

PRICE CODE A *continued*

ETCH*	ECH
◆ Axis	ECH13
◆ Blend	ECH14
◆ Cast	ECH12
◆ Highlight	ECH10
◆ Midtone	ECH11
◆ Outline	ECH08
◆ Shade	ECH09
◆ Tonal	ECH16
◆ Vanish	ECH15

LANDSCAPE*

LN	LN
◆ Azure	LN55
◆ Cornsilk	LN15
◆ Drift	LN05
◆ Khaki	LN20
◆ Sheen	LN10
◆ Slate	LN35
◆ Umber	LN25
◆ Urban	LN30

LUCY*

LC	LC
◆ Aspen	LC32
◆ Cornsilk	LC30
◆ Dusk	LC22
◆ Fawn	LC33
◆ Graphite	LC34
◆ Mist	LC20
◆ Neutra	LC24
◆ Pewter	LC35
◆ Snowdrop	LC28

PRICE CODE A *continued*

NOBLE	NBLE
◆ Aegean	NBLE18
◆ Amethyst	NBLE19
◆ Aspen	NBLE14
◆ Aster	NBLE20
◆ Blossom	NBLE21
◆ Bluebell	NBLE22
◆ Bordeaux	NBLE01
◆ Brick	NBLE02
◆ Chambray	NBLE10
◆ Chamomile	NBLE23
◆ Clementine	NBLE04
◆ Conifer	NBLE24
◆ Cottage	NBLE25
◆ Darkness	NBLE26
◆ Dawn	NBLE13
◆ Denim	NBLE09
◆ Desert Sand	NBLE27
◆ Dewfall	NBLE28
◆ Dusted Sage	NBLE29
◆ Flax	NBLE30
◆ Grass	NBLE07
◆ Gunmetal	NBLE15
◆ Harmony	NBLE31
◆ Harvest	NBLE12
◆ Ice Caves	NBLE32
◆ Icicle	NBLE33
◆ Inky	NBLE34
◆ Iris	NBLE35
◆ Jade	NBLE06
◆ Knight	NBLE17
◆ Mesa	NBLE03
◆ Monarch	NBLE36
◆ Pacific	NBLE08
◆ Pitch	NBLE37
◆ Queen Bee	NBLE38
◆ Rainforest	NBLE05
◆ Regal	NBLE11
◆ Sandcastle	NBLE39
◆ Sedona	NBLE40
◆ Stormy	NBLE16
◆ Sunbeam	NBLE41
◆ Voyager	NBLE42
◆ Windy Day	NBLE43

PRICE CODE A *continued*

REFLECTIONS*	REF
◆ Galvanized	REF29
◆ Ice	REF20
◆ Loggia	REF21
◆ Mistral	REF28
◆ Moonstone	REF23
◆ Pewter	REF22
◆ Stainless	REF24
◆ Vanilla	REF25
◆ Winter	REF27

REFUGE*

RFG	RFG
◆ Artesian	RFG96
◆ Dune	RFG92
◆ Eclipse	RFG90
◆ Frost	RFG93
◆ Glacier	RFG91
◆ Mineral	RFG98
◆ Tidal	RFG94

VAST

VST	VST
◆ Atmosphere	VST06
◆ Bay	VST04
◆ Beach	VST11
◆ Country Side	VST13
◆ Desert	VST12
◆ Garden	VST02
◆ Grasslands	VST03
◆ Highway	VST09
◆ Mountain Range	VST08
◆ Ocean	VST07
◆ Open Air	VST05
◆ Tundra	VST10
◆ Vineyard	VST01

NOTES: Centurion fabrics not available on panels that exceed a width and height of 54"H.

Disperse is applied pattern cut and is not available on 72"W Accelerate® panels and not available on 66"W tackboards, Voi® screens, and Empower®.

◆◆◆ For lead time information see page 21.

* Directional fabrics



Scan here to check out
our full Panel Fabrics
solutions

PANEL FABRIC PATTERNS & CODES

PRICE CODE B

COAST* COA

Not available on Accelerate®

◆ Channel	COA14
◆ Dune	COA03
◆ Headlands	COA10
◆ Marsh	COA02
◆ Pebble	COA12
◆ Pier	COA13
◆ Shoal	COA01
◆ Silt	COA06
◆ Tide	COA08

DISPERSE* DISP

◆ Autumn	DISP03
◆ Branch	DISP10
◆ Coffee Bean	DISP13
◆ Dusk	DISP09
◆ Emerald City	DISP08
◆ Gold Rush	DISP02
◆ Igloo	DISP11
◆ Ink	DISP06
◆ Mist	DISP12
◆ Oatmeal	DISP15
◆ Prince	DISP07
◆ Reservoir	DISP01
◆ Rose	DISP04
◆ Spring	DISP05
◆ Steel	DISP16
◆ Taupe	DISP14

PRICE CODE B *continued*

SPIN* SPIN

◆ Alabaster	SPIN02
◆ Cavern	SPIN03
◆ Cobblestone	SPIN04
◆ Ember	SPIN06
◆ Flame	SPIN07
◆ Heron	SPIN13
◆ Oat	SPIN01
◆ Ocean	SPIN12
◆ Plum	SPIN15
◆ Pool	SPIN11
◆ Raven	SPIN10
◆ Rhubarb	SPIN14
◆ Tropic	SPIN08
◆ Willow	SPIN05

TEMPEST* TP

◆ Dragonfly	TP30
◆ Frost	TP15
◆ Full Stream	TP80
◆ Gold Rush	TP10
◆ Slate	TP45
◆ Tumbleweed	TP70
◆ Wind Chill	TP40
◆ Zebra	TP35

TERRAIN* TRRN

◆ Bay	TRRN05
◆ Bayou	TRRN35
◆ Canyon	TRRN30
◆ Cliff	TRRN45
◆ Crest	TRRN25
◆ Delta	TRRN10
◆ Plateau	TRRN15
◆ Ridge	TRRN20
◆ Valley	TRRN40

NOTES: Disperse is applied pattern cut and is not available on 72"W Accelerate® panels and not available on 66"W tackboards, Voi® screens, and Empower®.

◆◆◆ For lead time information see page 21.

* Directional fabrics

ARRANGE®

Want to see more? Scan here
to check out hon.com.



Arrange® Tables shown with Ignition® Multi-Purpose Seating.

ARRANGE®

Non-traditional workspace? Transform it with Arrange tables. Ideal for cafés and other collaborative spaces, Arrange tables are available in seated, counter and standing-heights, and can accommodate anywhere from two to eight people. With four tabletop shapes and more than 40 different finish options, you can create a unique and usable space that brings people together.



FEATURES

- Simple, clean design coordinates nicely with other HON furniture.
- The traditional x-base can be updated with a disc shroud.
- Tables come with optional cord grommets and outlets to accommodate a wide range of technical needs — or none at all.
- Aluminum bases are durable, long-lasting and lightweight, making it easy to move and rearrange floor plans.
- Laminate surfaces are durable and resist scratches, spills and stains.

ARRANGE® CAFÉ TABLES ORDERING INFORMATION

LAMINATE

TOPS/L1 LAMINATES CODES

Woodgrain

- ◆ Bourbon Cherry **H**
- ◆ Cognac **COGN**
- ◆ Field Elm **LWFE**
- ◆ Florence Walnut **LFW1**
- ◆ Harvest **C**
- ◆ Kingswood Walnut **LK11**
- ◆ Mahogany **N**
- ◆ Mocha **MOCH**
- ◆ Natural Maple **D**
- ◆ Pinnacle **PINC**
- ◆ Shaker Cherry **F**
- ◆ Sterling Ash **LSA1**

Solid

- ◆ Black **P**
- ◆ Charcoal **S**
- ◆ Designer White **LDW1**
- ◆ Loft **LOFT**

Patterned

- ◆ Handspun Chestnut **LAHC**
- ◆ Handspun Dove **LAHD**
- ◆ Handspun Pearl **LAHP**
- ◆ Handspun Slate **LAHS**
- ◆ Silver Mesh **B9**
- ◆ Gray **G2**
- ◆ White **G1**

TOPS/L2 LAMINATES CODES

Woodgrain

- ◆ Beigewood **LWBE**
- ◆ Fawn Cypress **LFC1**
- ◆ Lowell Ash **LLA1**
- ◆ Natural Recon **LNRI**
- ◆ Phantom Ecrú **LPE1**
- ◆ Portico Teak **LPT1**
- ◆ Skyline Walnut **LSW1**

PAINT

PAINT CODES

P1

- ◆ Charblack **CBK**
- ◆ Textured Brownstone **P7J**
- ◆ Textured Charcoal **P7A**
- ◆ Textured Designer White ... **PK7**
- ◆ Textured Loft **P7L**
- ◆ Textured Muslin **P7M**
- ◆ Textured Platinum
Metallic **PLAT**
- ◆ Textured Titanium **P8V**

P2

- ◆ Solar Black **P8X**
- ◆ Textured Silver **PR8**

EDGE BAND

EDGE BAND CODES

- ◆ Beigewood **DE**
- ◆ Black **P**
- ◆ Bourbon Cherry **H**
- ◆ Brownstone **EY**
- ◆ Charcoal **S**
- ◆ Cognac **COGN**
- ◆ Designer White **DW**
- ◆ Fawn Cypress **FC**
- ◆ Field Elm **FE**
- ◆ Florence Walnut **FW**
- ◆ Fossil **EH**
- ◆ Greige **R**
- ◆ Harvest **C**
- ◆ Kingswood Walnut **KI**
- ◆ Loft **LOFT**
- ◆ Lowell Ash **DL**
- ◆ Mahogany **N**
- ◆ Mocha **MOCH**
- ◆ Muslin **T**
- ◆ Natural Maple **D**
- ◆ Natural Recon **NR**
- ◆ Phantom Ecrú **PE**
- ◆ Pinnacle **PINC**
- ◆ Platinum **K**
- ◆ Portico Teak **DP**
- ◆ Shaker Cherry **F**
- ◆ Skyline Walnut **SW**
- ◆ Sterling Ash **SA**

Recommended Edgeband Color Selection:

Laminate		Edgeband	
Bourbon Cherry	H	Bourbon Cherry	H
Cognac	COGN	Cognac	COGN
Florence Walnut	LFW1	Florence Walnut	FW
Harvest	C	Harvest	C
Kingswood Walnut	LK11	Kingswood Walnut	KI
Mahogany	N	Mahogany	N
Mocha	MOCH	Mocha	MOCH
Natural Maple	D	Natural Maple	D
Pinnacle	PINC	Pinnacle	PINC
Shaker Cherry	F	Shaker Cherry	F
Sterling Ash	LSA1	Sterling Ash	SA
Black	P	Black	P
Charcoal	S	Charcoal	S
Designer White	LDW1	Designer White	DW
Handspun Chestnut	LAHC	Brownstone	EY
Handspun Dove	LAHD	Fossil	EH
Handspun Pearl	LAHP	Fossil	EH
Handspun Slate	LAHS	Charcoal	S
Silver Mesh	B9	Loft	LOFT
Steel Mesh	A9	Charcoal	S
Lowell Ash	LLA1	Lowell Ash	DL
Natural Recon	LNRI	Natural Recon	NR
Phantom Ecrú	LPE1	Phantom Ecrú	PE
Portico Teak	LPT1	Portico Teak	DP
Skyline Walnut	LSW1	Skyline Walnut	SW
Loft	LOFT	Loft	LOFT

◆◆◆ For lead time information see page 21.

ARRANGE[®] Café Table Tops



	DESCRIPTION	MODEL	SHIP WEIGHT	CUBE	LIST PRICE BY LAMINATE GRADE	
					L1	L2
	Café Round Table Tops					
	24"W Round Top	HCTRND24	19	1.9	\$457	\$475
	30"W Round Top	HCTRND30	31	2.9	\$491	\$509
	36"W Round Top	HCTRND36	44	4.0	\$535	\$553
	42"W Round Top	HCTRND42	57	5.4	\$634	\$657
	Square Table Tops					
	24"W Square Top	HCTSQR24	19	2.2	\$434	\$452
	30"W Square Top	HCTSQR30	31	2.9	\$467	\$485
	36"W Square Top	HCTSQR36	44	4.1	\$510	\$528
	42"W Square Top	HCTSQR42	57	5.6	\$607	\$630
	Soft Square Table Tops					
	24"W Soft Square Top	HCTSFT24	19	1.9	\$457	\$475
	30"W Soft Square Top	HCTSFT30	31	2.9	\$491	\$509
	36"W Soft Square Top	HCTSFT36	44	4.0	\$535	\$553
	42"W Soft Square Top	HCTSFT42	57	5.4	\$634	\$657
	Rectangle Table Tops					
	48"W x 24"D Rectangle Top	HCTRECT2448	36	3.6	\$515	\$533
	60"W x 24"D Rectangle Top	HCTRECT2460	44	4.4	\$564	\$582
	72"W x 24"D Rectangle Top	HCTRECT2472	56	4.9	\$597	\$620
	48"W x 30"D Rectangle Top	HCTRECT3048	51	4.4	\$535	\$553
	60"W x 30"D Rectangle Top	HCTRECT3060	63	5.4	\$597	\$615
	72"W x 30"D Rectangle Top	HCTRECT3072	75	6.0	\$663	\$686

NOTES:

- 2 grommet cutouts on Rectangles which will be positioned over the installed bases.
- For compatible round grommet options, see page 248.
- ! HGRMTUSB2 is not compatible with Arrange[®] bases.

HOW TO SPECIFY

<p>Select Model Number</p> <p>H C T R N D 2 4 .</p>	<p>Select Grommet Option</p> <p>G Round Grommet (+ \$18) N No Grommet</p> <p>Upcharge doubles for HCTRECT models</p> <p>G .</p>	<p>Select Laminate</p> <p>See page 29</p> <p>C .</p>	<p>Select Edge Color</p> <p>See page 29</p> <p>C</p>
--	--	---	---

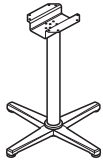

DESCRIPTION

MODEL SHIP WEIGHT CUBE LIST PRICE P2 UPCHARGE

Café Table Bases — X-Base

Seated-Height X-base for 24"-30"D Surfaces	HCT29SX	22	3.3	\$690	\$23
Seated-Height X-base for 36"D Surfaces	HCT29MX	23	3.3	\$767	\$23
Seated-Height X-base for 42"D Surfaces	HCT29LX	25	3.3	\$842	\$23
Counter-Height X-base for 24"-30"D Surfaces	HCT36SX	24	4.6	\$767	\$23
Counter-Height X-base for 36"D Surfaces	HCT36MX	25	4.6	\$842	\$23
Counter-Height X-base for 42"D Surfaces	HCT36LX	27	4.6	\$919	\$23
Bar-Height X-base for 24"-30"D Surfaces	HCT42SX	25	4.6	\$842	\$23
Bar-Height X-base for 36"D Surfaces	HCT42MX	26	4.6	\$919	\$23
Bar-Height X-base for 42"D Surfaces	HCT42LX	27	4.6	\$994	\$23

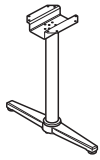

Café Table Bases — T-Leg Base

Seated-Height T-legs for 24"D Surfaces (2 bases incl.)	HCT29ST	33	3.3	\$933	\$23
Seated-Height T-legs for 30"D Surfaces (2 bases incl.)	HCT29MT	34	3.3	\$1038	\$23
Counter-Height T-legs for 24"D Surfaces (2 bases incl.)	HCT36ST	36	4.6	\$1004	\$23
Counter-Height T-legs for 30"D Surfaces (2 bases incl.)	HCT36MT	37	4.6	\$1082	\$23
Bar-Height T-legs for 24"D Surfaces (2 bases incl.)	HCT42ST	37	4.6	\$1077	\$23
Bar-Height T-legs for 30"D Surfaces (2 bases incl.)	HCT42MT	38	4.6	\$1155	\$23

NOTES:

- Wire management is standard through table column.
- Adjustable glides available on all feet.

HOW TO SPECIFY

Select Model Number	Select Paint Color
	See page 29
HCT29SX	BLCK

ARRANGE[®] Café Accessories



Icon Legend on page 19

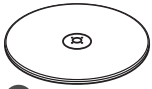

DESCRIPTION

MODEL

SHIP WEIGHT

CUBE

LIST PRICE

Café Table Bases — Disc Shroud

- Small Disc Shroud for bases that support 24"-30" Surfaces
- Medium Disc Shroud for bases that support 36" Surfaces
- Large Disc Shroud for bases that support 42" Surfaces

- HCTS DS**
- HCTM DS**
- HCTL DS**

- 9.0
- 12.0
- 17.0

- 2.0
- 2.4
- 3.4

- \$140**
- \$163**
- \$188**

NOTES: Shroud is used as an optional accessory to provide the aesthetic of a disc base. Shroud can be added to existing X-base configurations to provide a new and updated aesthetic. Shroud is made of 18 gauge steel.

- ! Shroud to be used in conjunction with X-bases only and cannot be used with a T-leg configuration.
- ! Shroud cannot be used as a support piece by itself.

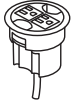

Power Hub, 3" Grommet Mount, 6' Cord

HGRMTAC

1.3

0.2

\$179

- Fits in 3" round grommet cutouts.
- Two grounded AC power outlets.
- Includes 6' cord with three-prong plug.
- Field installed with Plug-and-play ease.

NOTES: For additional information see page 248.

- ! Available in black only (no color designation so use .X - Specify: HGRMTAC.X).

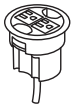

Power Hub, 3" Grommet Mount, 10' Cord

HGRMTAC2

1.5

0.2

\$211

- Includes 10' cord with three-prong plug.
- Fits in 3" round grommet holes.
- Two grounded AC power outlets.
- Field installed with Plug-and-play ease.

- ! Available in black finish only, no specification needed.

NOTES:

- ! HGRMTUSB2 is not compatible with Arrange[®] bases.

HOW TO SPECIFY

Select Model Number

Select Paint Color

For HCTS DS, HCTM DS and HCTL DS models only
See page 29

H C T S D S .

B L C K

BETWEEN™ TABLES

Want to see more? Scan here
to check out hon.com.



Between™ Tables shown
with Ruck™ Seating.

BETWEEN™ TABLES

That moment when everything you want meets everything you need. Choose Between table options that offer up a variety of sizes and top shapes, seated or café heights, training tables with fixed or nesting bases, and a wide range of laminates to fit in with any environment. With so many different uses, it will be easy to pick Between. Whether you're working here, there, or anywhere Between, this table collection's got you covered.



FEATURES

- Allows you to get the most out of every inch of space by creating hubs for people to engage, socialize, and be productive.
- This versatile, lightweight table line is simple to specify and easy to reconfigure, all at a competitive price point.
- Round, square, soft square, or rectangle tops and fixed, nesting, disc, or X-bases, allow versatility in design and function.
- With both standing- and seated-height options, Between tables can be used in multiple areas throughout your office, such as breakrooms, cafés, or breakaway spaces that support today's agile workforce.
- Choose from multiple, durable, high-quality laminate, edge, and finish options.

BETWEEN™ ORDERING INFORMATION

LAMINATE

TOPS/L1 LAMINATES CODES

Woodgrain

- ◆ Bourbon Cherry **H**
- ◆ Cognac **COGN**
- ◆ Field Elm **LWFE**
- ◆ Florence Walnut **LFW1**
- ◆ Harvest **C**
- ◆ Kingswood Walnut **LK11**
- ◆ Mahogany **N**
- ◆ Mocha **MOCH**
- ◆ Natural Maple **D**
- ◆ Pinnacle **PINC**
- ◆ Shaker Cherry **F**
- ◆ Sterling Ash **LSA1**

Solid

- ◆ Black **P**
- ◆ Charcoal **S**
- ◆ Designer White **LDW1**
- ◆ Loft **LOFT**

Patterned

- ◆ Handspun Chestnut **LAHC**
- ◆ Handspun Dove **LAHD**
- ◆ Handspun Pearl **LAHP**
- ◆ Handspun Slate **LAHS**
- ◆ Silver Mesh **B9**
- ◆ Steel Mesh **A9**

TOPS/L2 LAMINATES CODES

Woodgrain

- ◆ Beigewood **LWBE**
- ◆ Fawn Cypress **LFC1**
- ◆ Lowell Ash **LLA1**
- ◆ Natural Recon **LNRI**
- ◆ Phantom Ecru **LPE1**
- ◆ Portico Teak **LPT1**
- ◆ Skyline Walnut **LSW1**

SEATED-, STANDING-, AND X-BASES

PAINT CODES

- P1**
- ◆ Charblack **CBK**
 - ◆ Textured Brownstone **P7J**
 - ◆ Textured Charcoal **P7A**
 - ◆ Textured Designer White ... **PK7**
 - ◆ Textured Loft **P7L**
 - ◆ Textured Muslin **P7M**
 - ◆ Textured Titanium **P8V**
- P2**
- ◆ Textured Silver **PR8**

FIXED AND NESTING BASES

PAINT CODES

- P1**
- ◆ Black **P71**
 - ◆ Brownstone **P7D**
 - ◆ Charcoal **P02**
 - ◆ Designer White **PJW**
 - ◆ Fossil **P28**
 - ◆ Loft **LOFT**
 - ◆ Muslin **T3**
 - ◆ Titanium **P8T**
- P2**
- ◆ Silver **PR6**

EDGE BAND

EDGE BAND CODES

- ◆ Beigewood **DE**
- ◆ Black **P**
- ◆ Bourbon Cherry **H**
- ◆ Brownstone **EY**
- ◆ Charcoal **S**
- ◆ Cognac **COGN**
- ◆ Designer White **DW**
- ◆ Fawn Cypress **FC**
- ◆ Field Elm **FE**
- ◆ Florence Walnut **FW**
- ◆ Fossil **EH**
- ◆ Greige **R**
- ◆ Harvest **C**
- ◆ Kingswood Walnut **KI**
- ◆ Loft **LOFT**
- ◆ Lowell Ash **DL**
- ◆ Mahogany **N**
- ◆ Mocha **MOCH**
- ◆ Muslin **T**
- ◆ Natural Maple **D**
- ◆ Natural Recon **NR**
- ◆ Phantom Ecru **PE**
- ◆ Pinnacle **PINC**
- ◆ Platinum **K**
- ◆ Portico Teak **DP**
- ◆ Shaker Cherry **F**
- ◆ Skyline Walnut **SW**
- ◆ Sterling Ash **SA**

Recommended Edgeband Color Selection:

Laminate		Edgeband	
Bourbon Cherry	H	Bourbon Cherry	H
Cognac	COGN	Cognac	COGN
Florence Walnut	LFW1	Florence Walnut	FW
Harvest	C	Harvest	C
Kingswood Walnut	LK11	Kingswood Walnut	KI
Mahogany	N	Mahogany	N
Mocha	MOCH	Mocha	MOCH
Natural Maple	D	Natural Maple	D
Pinnacle	PINC	Pinnacle	PINC
Shaker Cherry	F	Shaker Cherry	F
Sterling Ash	LSA1	Sterling Ash	SA
Black	P	Black	P
Charcoal	S	Charcoal	S
Designer White	LDW1	Designer White	DW
Handspun Chestnut	LAHC	Brownstone	EY
Handspun Dove	LAHD	Fossil	EH
Handspun Pearl	LAHP	Fossil	EH
Handspun Slate	LAHS	Charcoal	S
Silver Mesh	B9	Loft	LOFT
Steel Mesh	A9	Charcoal	S
Lowell Ash	LLA1	Lowell Ash	DL
Natural Recon	LNRI	Natural Recon	NR
Phantom Ecru	LPE1	Phantom Ecru	PE
Portico Teak	LPT1	Portico Teak	DP
Skyline Walnut	LSW1	Skyline Walnut	SW
Loft	LOFT	Loft	LOFT

◆◆◆ For lead time information see page 21.

	DESCRIPTION	MODEL	SHIP WEIGHT	CUBE	LIST PRICE BY LAMINATE GRADE	
					L1	L2
	Round Table Tops					
	30"W Round Top	HBTRND30	31	2.9	\$428	\$446
	36"W Round Top	HBTRND36	44	4.0	\$468	\$487
	42"W Round Top	HBTRND42	57	5.4	\$552	\$575
	Square Table Tops					
	30"W Square Top	HBTSQR30	31	2.9	\$407	\$424
	36"W Square Top	HBTSQR36	44	4.1	\$444	\$463
	42"W Square Top	HBTSQR42	57	5.6	\$529	\$551
	Soft Square Table Tops					
	30"W Soft Square Top	HBTSFT30	31	2.9	\$428	\$446
	36"W Soft Square Top	HBTSFT36	44	4.0	\$468	\$487
	42"W Soft Square Top	HBTSFT42	57	5.4	\$552	\$575

HOW TO SPECIFY

Select Model Number HBTRND30	Select Grommet Option N No Grommet N	Select Laminate See page 34 C	Select Edge Color See page 34 C
--	---	--	--

BETWEEN™ Table Bases

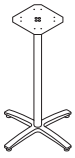

DESCRIPTION	MODEL	SHIP WEIGHT	CUBE	LIST PRICE
X-Base				
Seated-Height X-base for Support of 30", 36" Tops	HBTTX30S	27	5.2	\$411
Seated-Height X-base for Support of 42" Tops	HBTTX30L	29	5.2	\$600
Bar-Height X-base for Support of 30", 36" Tops	HBTTX42S	30	5.2	\$494
Bar-Height X-base for 42" Tops	HBTTX42L	34	5.2	\$690

NOTES:

- Seated-Height (30¾" to top of surface).
- Bar-Height (42¼" to top of surface).
- Adjustable glides with ¼" adjustment available on all feet.



Seated-Height Disc Base	HBTTD30	24	3.3	\$495
Disc Base not for use with 42" square top.				

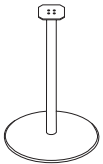

Standing-Height Disc Base	HBTTD42	27	3.3	\$586
Disc Base not for use with 42" square top.				



Counterweight Kit for Disc Base	HBTTCW	16	0.2	\$199
Required when using disc base with 42" round and soft square tops. Optional for smaller top sizes.				

NOTES:

- Seated-Height (29" to top of surface).
- Bar-Height (42" to top of surface).
- Counterweight Kit required when using disc base with 42" round or soft square tops. Kit can be used for added stability on 30" or 36" round, square, and soft square tops if desired.
- **HON Full Lifetime Warranty on Between™ Table Tops.**
- **HON 5-Year Limited Warranty on Between™ Table Bases.**

HOW TO SPECIFY

Select Model Number	Select Paint Color
See page 34	See page 34
H B T T X 3 0 S .	P R 8



Icon Legend on page 19

BETWEEN™ Rectangular Table Tops

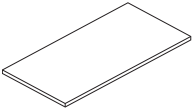
	DESCRIPTION	MODEL	SHIP WEIGHT	CUBE	LIST PRICE BY LAMINATE GRADE	
					L1	L2
	Rectangular Table Tops					
	48"W x 24"D	HMPTT2448	45	3.7	\$478	\$498
	60"W x 24"D	HMPTT2460	57	4.5	\$529	\$551
	72"W x 24"D	HMPTT2472	68	5.0	\$586	\$610
	48"W x 30"D	HMPTT3048	57	4.4	\$498	\$519
	60"W x 30"D	HMPTT3060	71	5.4	\$545	\$568
	72"W x 30"D	HMPTT3072	85	6.0	\$621	\$646

NOTES:

- HON 5-Year Limited Warranty.

HOW TO SPECIFY

Select Model Number <input type="text" value="HMPTT2448"/>	Select Grommet Option <input type="text" value="N"/>	Select Laminate <input type="text" value="C"/>	Select Edge Color <input type="text" value="C"/>
--	--	--	--



Icon Legend on page 19

BETWEEN™ Table Bases for Rectangular Tops

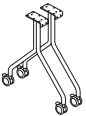
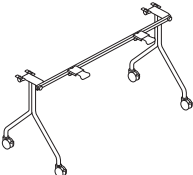
	DESCRIPTION	MODEL	SHIP WEIGHT	CUBE	LIST PRICE
	Fixed Leg	HMPTBFI	27	6.3	\$363
	Nesting Base				
	For use with 48"W Rectangular Tops	HMPTBNTS	18	6.3	\$418
	For use with 60"W and 72"W Rectangular Tops	HMPTBNTL	19	6.3	\$445

NOTES:

- Tops and bases ship in separate cartons.
- Recommend ordering HMAGANG when intending to gang multiple tables together. See page 61.
- HON 5-Year Limited Warranty.

HOW TO SPECIFY

Select Model Number <input type="text" value="HMPTBFX"/>	Select Paint Color <input type="text" value="P71"/>
--	---

BETWEEN™ Nesting Tables



Icon Legend on page 19

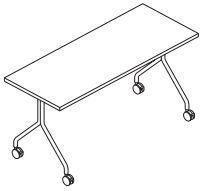

DESCRIPTION

Nesting Table
 48"W x 24"D
 60"W x 24"D
 72"W x 24"D

 48"W x 30"D
 60"W x 30"D
 72"W x 30"D

MODEL

SHIP WEIGHT

CUBE

LIST PRICE

HMPT2448NS	69	8.9	\$805
HMPT2460NS Ⓞ	81	10.7	\$875
HMPT2472NS Ⓞ	92	12.4	\$925
HMPT3048NS	81	10.9	\$822
HMPT3060NS	95	13.1	\$889
HMPT3072NS	109	15.0	\$957

NOTES:

- Top and base ship in one carton.
- Limited finishes available on single-carton tables.
- Recommend ordering HMAGANG when intending to gang multiple tables together. See page 61.
- **HON 5-Year Limited Warranty.**

HOW TO SPECIFY

<p>Select Model Number</p> <p>HMPT2448NS</p>	<p>Select Grommet Option</p> <p>N No Grommet</p> <p>N</p>	<p>Select Laminate/Edge</p> <p>B9LOFT Silver Mesh/Loft Edge FF Shaker Cherry/Shaker Cherry Edge PINCPINC Pinnacle/Pinnacle Edge</p> <p>B9LOFT</p>	<p>Select Base Paint</p> <p>P71 Black</p> <p>P71</p>
---	--	--	---

BETWEEN™ Shared Components



Icon Legend on page 19

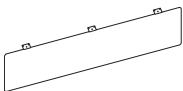

DESCRIPTION

Universal Modesty Panel
 For 48"W Between™ Tables
 For 60"/72"W Between™ Tables

MODEL

SHIP WEIGHT

CUBE

LIST PRICE BY PAINT GRADE

P1

P2

HMTUMOD38	11	2.2	\$291	\$314
HMTUMOD50 Ⓞ	14	3.1	\$318	\$341

NOTES:

- Table Modesty Panels are hinged for use with Nesting Table models.

HOW TO SPECIFY

<p>Select Model Number</p> <p>HMTUMOD38</p>	<p>Select Paint Color</p> <p>See page 34</p> <p>T1</p>
--	---

BIRK™ TABLES

Want to see more? Scan here
to check out hon.com.



Birk™ Tables shown with Flock® Seating.

BIRK™ TABLES

Why complicate matters when you can keep it simple? Offering a modern, minimalist design, Birk tables have a look that's as streamlined as its specification process. Whether you're looking for something well-rounded or think it's hip to be square, Birk is there for you with a variety of top shapes, sizes, and table heights. It's the support system you need to help people come together, collaborate, and socialize — anywhere.



FEATURES

- Ideal for informal meeting spaces and hospitality areas.
- Modern, minimalist design makes it easy to match a variety of styles.
- Designed for use with HON chairs, stools, and soft seating.
- Five different base heights outfit a variety of spaces.
- Five unique top shapes and sizes coordinate seamlessly with any surrounding aesthetic.
- The personal table is light in scale and gives people the ability to take notes and work in a lounge setting.

BIRK™ ORDERING INFORMATION

LAMINATE

L1 LAMINATES CODES

- Woodgrain**
- ◆ Bourbon Cherry **H**
 - ◆ Cognac **COGN**
 - ◆ Field Elm **LWFE**
 - ◆ Florence Walnut **LFW1**
 - ◆ Harvest **C**
 - ◆ Kingswood Walnut **LKI1**
 - ◆ Mahogany **N**
 - ◆ Mocha **MOCH**
 - ◆ Natural Maple **D**
 - ◆ Pinnacle **PINC**
 - ◆ Shaker Cherry **F**
 - ◆ Sterling Ash **LSA1**

- Solid**
- ◆ Black **P**
 - ◆ Charcoal **S**
 - ◆ Designer White **LDW1**
 - ◆ Loft **LOFT**

- Patterned**
- ◆ Handspun Chestnut **LAHC**
 - ◆ Handspun Dove **LAHD**
 - ◆ Handspun Pearl **LAHP**
 - ◆ Handspun Slate **LAHS**
 - ◆ Silver Mesh **B9**
 - ◆ Steel Mesh **A9**

L2 LAMINATES CODES

- Woodgrain**
- ◆ Beigewood **LWBE**
 - ◆ Fawn Cypress **LFC1**
 - ◆ Lowell Ash **LLA1**
 - ◆ Natural Recon **LNRI**
 - ◆ Phantom Ecru **LPE1**
 - ◆ Portico Teak **LPT1**
 - ◆ Skyline Walnut **LSW1**

EDGE BAND

EDGE BAND CODES

- ◆ Beigewood **DE**
- ◆ Black **P**
- ◆ Bourbon Cherry **H**
- ◆ Brownstone **EY**
- ◆ Charcoal **S**
- ◆ Cognac **COGN**
- ◆ Designer White **DW**
- ◆ Fawn Cypress **FC**
- ◆ Field Elm **FE**
- ◆ Florence Walnut **FW**
- ◆ Fossil **EH**
- ◆ Greige **R**
- ◆ Harvest **C**
- ◆ Kingswood Walnut **KI**
- ◆ Loft **LOFT**
- ◆ Lowell Ash **DL**
- ◆ Mahogany **N**
- ◆ Mocha **MOCH**
- ◆ Muslin **T**
- ◆ Natural Maple **D**
- ◆ Natural Recon **NR**
- ◆ Phantom Ecru **PE**
- ◆ Pinnacle **PINC**
- ◆ Platinum **K**
- ◆ Portico Teak **DP**
- ◆ Shaker Cherry **F**
- ◆ Skyline Walnut **SW**
- ◆ Sterling Ash **SA**

PAINT

PAINT CODES

- P1**
- ◆ Charblack **CBK**
 - ◆ Textured Brownstone **P7J**
 - ◆ Textured Charcoal **P7A**
 - ◆ Textured Designer White ... **PK7**
 - ◆ Textured Loft **P7L**
 - ◆ Textured Muslin **P7M**
 - ◆ Textured Titanium **P8V**
- P2**
- ◆ Solar Black **P8X**
 - ◆ Textured Silver **PR8**

Recommended Edgeband Color Selection:

Laminate		Edgeband	
Beigewood	LWBE	Beigewood	DE
Bourbon Cherry	H	Bourbon Cherry	H
Cognac	COGN	Cognac	COGN
Fawn Cypress	LFC1	Fawn Cypress	FC
Field Elm	LWFE	Field Elm	FE
Florence Walnut	LFW1	Florence Walnut	FW
Harvest	C	Harvest	C
Kingswood Walnut	LKI1	Kingswood Walnut	KI
Mahogany	N	Mahogany	N
Mocha	MOCH	Mocha	MOCH
Natural Maple	D	Natural Maple	D
Pinnacle	PINC	Pinnacle	PINC
Shaker Cherry	F	Shaker Cherry	F
Sterling Ash	LSA1	Sterling Ash	SA
Black	P	Black	P
Charcoal	S	Charcoal	S
Designer White	LDW1	Designer White	DW
Handspun Chestnut	LAHC	Brownstone	EY
Handspun Dove	LAHD	Fossil	EH
Handspun Pearl	LAHP	Fossil	EH
Handspun Slate	LAHS	Charcoal	S
Silver Mesh	B9	Loft	LOFT
Steel Mesh	A9	Charcoal	S
Lowell Ash	LLA1	Lowell Ash	DL
Natural Recon	LNRI	Natural Recon	NR
Phantom Ecru	LPE1	Phantom Ecru	PE
Portico Teak	LPT1	Portico Teak	DP
Skyline Walnut	LSW1	Skyline Walnut	SW
Loft	LOFT	Loft	LOFT

	DESCRIPTION	MODEL	SHIP WEIGHT	CUBE	LIST PRICE BY LAMINATE GRADE	
					L1	L2
	Round Tops with Knife Edge					
	30"W Round Top	HCWTRND30J	28	2.8	\$646	\$673
	36"W Round Top	HCWTRND36J	38	3.8	\$706	\$735
	42"W Round Top	HCWTRND42J	50	5.1	\$831	\$864
	Round Tops with Flat Edge					
	30"W Round Top	HCWTRND30G	28	2.8	\$502	\$522
	36"W Round Top	HCWTRND36G	38	3.8	\$542	\$564
	42"W Round Top	HCWTRND42G	50	5.1	\$641	\$666
	Square Tops with Knife Edge					
	30"W Square Top	HCWTSQR30J	34	2.6	\$571	\$594
	36"W Square Top	HCWTSQR36J	47	3.8	\$670	\$697
	42"W Square Top	HCWTSQR42J	62	5.0	\$794	\$826
	Square Tops with Flat Edge					
	30"W Square Top	HCWTSQR30G	34	2.6	\$442	\$461
	36"W Square Top	HCWTSQR36G	47	3.8	\$517	\$538
	42"W Square Top	HCWTSQR42G	62	5.0	\$614	\$638
	Soft Square Tops with Knife Edge					
	30"W Soft Square Top	HCWTSFTS30J	34	2.6	\$646	\$673
	36"W Soft Square Top	HCWTSFTS36J	47	3.8	\$706	\$735
	42"W Soft Square Top	HCWTSFTS42J	62	5.0	\$831	\$864
	Soft Square Tops with Flat Edge					
	30"W Soft Square Top	HCWTSFTS30G	34	2.6	\$502	\$522
	36"W Soft Square Top	HCWTSFTS36G	47	3.8	\$542	\$564
	42"W Soft Square Top	HCWTSFTS42G	62	5.0	\$641	\$666
	Booth Tops with Knife Edge					
	56"W x 36"D Booth Top	HCWTB3656J	90	5.6	\$896	\$932
	84"W x 36"D Booth Top	HCWTB3684J	150	8.2	\$1349	\$1403
	Booth Tops with Flat Edge					
	56"W x 36"D Booth Top	HCWTB3656G	90	5.6	\$689	\$717
	84"W x 36"D Booth Top	HCWTB3684G	150	8.2	\$1038	\$1080
	Soft Rectangle Tops with Knife Edge					
	56"W x 36"D Soft Rectangle Top	HCWTSR3656J	90	5.6	\$932	\$970
	84"W x 36"D Soft Rectangle Top	HCWTSR3684J	150	8.2	\$1387	\$1442
	Soft Rectangle Tops with Flat Edge					
	56"W x 36"D Soft Rectangle Top	HCWTSR3656G	90	5.6	\$717	\$746
	84"W x 36"D Soft Rectangle Top	HCWTSR3684G	150	8.2	\$1069	\$1112

NOTES:

- Tops configured with pilot holes for easy installation of base.

HOW TO SPECIFY

Select Model Number HCWTSQR36J	Select Grommet Option N No Grommet	Select Laminate See page 40 LSA1	Select Edge Color See page 40 SA
--	--	---	---

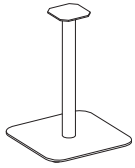
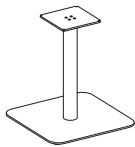
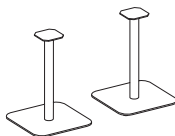
	DESCRIPTION	MODEL	SHIP WEIGHT	CUBE	LIST PRICE BY PAINT GRADE	
					P1	P2
	Single Pedestal, Medium					
	Occasional-Height Single Pedestal Base	HCWTSBM18	60	3.3	\$806	\$868
	Working Lounge-Height Single Pedestal Base	HCWTSBM27	60	3.3	\$810	\$873
	Seated-Height Single Pedestal Base	HCWTSBM29	60	3.3	\$817	\$880
	Counter-Height Single Pedestal Base	HCWTSBM36	62	3.3	\$826	\$890
	Bar-Height Single Pedestal Base	HCWTSBM42	66	3.6	\$836	\$901
	Single Pedestal, Large					
	Occasional-Height Single Pedestal Base	HCWTSBL18	95	3.8	\$1051	\$1133
	Working Lounge-Height Single Pedestal Base	HCWTSBL27	95	3.8	\$1089	\$1174
	Seated-Height Single Pedestal Base	HCWTSBL29	95	3.8	\$1138	\$1226
	Counter-Height Single Pedestal Base	HCWTSBL36	98	3.8	\$1153	\$1242
	Bar-Height Single Pedestal Base	HCWTSBL42	101	4.2	\$1175	\$1266
	Double Pedestal, Medium					
	Working Lounge-Height Double Pedestal Base	HCWTDSBM27	120	6.5	\$1620	\$1746
	Seated-Height Double Pedestal Base	HCWTDSBM29	120	6.5	\$1634	\$1760
	Counter-Height Double Pedestal Base	HCWTDSBM36	124	6.5	\$1652	\$1780
	Bar-Height Double Pedestal Base	HCWTDSBM42	132	7.2	\$1672	\$1802

- NOTES:**
- See application matrix for top and base compatibility.
 - Bases feature 1/4"H non-leveling slide glides.
 - Some assembly required.

Top & Base Compatibility Matrix						
		Top				
		Round, Square, Soft Square			Booth, Soft Rectangle	
		30"W	36"W	42"W	56"W	84"W
Base	Single Pedestal, Medium	•	•			
	Single Pedestal, Large			•		
	Double Pedestal, Medium				•	•

HOW TO SPECIFY

<p>Select Model Number</p> <p>HCWTSBL36</p>	<p>Select Paint Color</p> <p>See page 40</p> <p>PR8</p>
--	--



Icon Legend on page 19

BIRK™ Personal Table



DESCRIPTION

Personal Table
17"W x 15"D x 28"H

MODEL	SHIP WEIGHT	CUBE	LIST PRICE BY LAMINATE GRADE	
			L1	L2
HCWPT	18	2.7	\$466	\$479

NOTES:

- Top features flat edge on all sides.
- Top configured with pilot holes for easy installation of base.
- Some assembly required.

HOW TO SPECIFY

<p>Select Model Number</p> <p>HCWPT</p>	<p>Select Laminate</p> <p>See page 40</p> <p>LSA1</p>	<p>Select Edge Color</p> <p>See page 40</p> <p>SA</p>	<p>Select Paint Color</p> <p>See page 40</p> <p>P2 (+ \$15)</p> <p>PR8</p>
--	--	--	---

FLOCK®

Want to see more? Scan here
to check out [hon.com](https://www.hon.com).



Flock® Tables and Seating.

FLOCK®

Great things happen when people come together, and Flock Collaborative Tables create the places that help make that possible. Quiet corners. Vibrant communal areas. Beautiful, comfortable spaces where clean lines and distinctive geometric design improve productivity and inspire big ideas. Choose from a variety of mix-and-match shapes and sizes to design spaces where your Flock will flourish.



FEATURES

- Flock Tables coordinate seamlessly with Flock Seating to support collaborative areas in any workplace.
- Choose from Square, Round, Rectangle, or Racetrack shaped table tops.
- Table bases available in multiple heights and styles.
- Add convenient options like integrated power, cord grommets, and tablet pedestals, and Flock is ready to work.
- Configurable and scalable, Flock Tables offer smaller footprints to better fit compact spaces.

COLLABORATIVE TABLES ORDERING INFORMATION

LAMINATE

TOPS/L1 LAMINATES CODES

Woodgrain

- ◆ Bourbon Cherry **H**
- ◆ Cognac **COGN**
- ◆ Field Elm **LWFE**
- ◆ Florence Walnut **LFW1**
- ◆ Harvest **C**
- ◆ Kingswood Walnut **LKI1**
- ◆ Mahogany **N**
- ◆ Mocha **MOCH**
- ◆ Natural Maple **D**
- ◆ Pinnacle **PINC**
- ◆ Shaker Cherry **F**
- ◆ Sterling Ash **LSA1**

Solid

- ◆ Black **P**
- ◆ Charcoal **S**
- ◆ Designer White **LDW1**
- ◆ Loft **LOFT**

Patterned

- ◆ Handspun Chestnut **LAHC**
- ◆ Handspun Dove **LAHD**
- ◆ Handspun Pearl **LAHP**
- ◆ Handspun Slate **LAHS**
- ◆ Silver Mesh **B9**
- ◆ Steel Mesh **A9**

TOPS/L2 LAMINATES CODES

Woodgrain

- ◆ Beigewood **LWBE**
- ◆ Fawn Cypress **LFC1**
- ◆ Lowell Ash **LLA1**
- ◆ Natural Recon **LNRI**
- ◆ Phantom Ecru **LPE1**
- ◆ Portico Teak **LPT1**
- ◆ Skyline Walnut **LSW1**

PAINT

PAINT CODES

- P1**
- ◆ Textured Charcoal **P7A**
- P2**
- ◆ Textured Silver **PR8**

EDGE BAND

EDGE BAND CODES

- ◆ Beigewood **DE**
- ◆ Black **P**
- ◆ Bourbon Cherry **H**
- ◆ Brownstone **EY**
- ◆ Charcoal **S**
- ◆ Cognac **COGN**
- ◆ Designer White **DW**
- ◆ Fawn Cypress **FC**
- ◆ Field Elm **FE**
- ◆ Florence Walnut **FW**
- ◆ Fossil **EH**
- ◆ Greige **R**
- ◆ Harvest **C**
- ◆ Kingswood Walnut **KI**
- ◆ Loft **LOFT**
- ◆ Lowell Ash **DL**
- ◆ Mahogany **N**
- ◆ Mocha **MOCH**
- ◆ Muslin **T**
- ◆ Natural Maple **D**
- ◆ Natural Recon **NR**
- ◆ Phantom Ecru **PE**
- ◆ Pinnacle **PINC**
- ◆ Platinum **K**
- ◆ Portico Teak **DP**
- ◆ Shaker Cherry **F**
- ◆ Skyline Walnut **SW**
- ◆ Sterling Ash **SA**

Recommended Edgeband Color Selection:

Laminate		Edgeband	
Bourbon Cherry	H	Bourbon Cherry	H
Cognac	COGN	Cognac	COGN
Florence Walnut	LFW1	Florence Walnut	FW
Harvest	C	Harvest	C
Kingswood Walnut	LKI1	Kingswood Walnut	KI
Mahogany	N	Mahogany	N
Mocha	MOCH	Mocha	MOCH
Natural Maple	D	Natural Maple	D
Pinnacle	PINC	Pinnacle	PINC
Shaker Cherry	F	Shaker Cherry	F
Sterling Ash	LSA1	Sterling Ash	SA
Black	P	Black	P
Charcoal	S	Charcoal	S
Designer White	LDW1	Designer White	DW
Handspun Chestnut	LAHC	Brownstone	EY
Handspun Dove	LAHD	Fossil	EH
Handspun Pearl	LAHP	Fossil	EH
Handspun Slate	LAHS	Charcoal	S
Silver Mesh	B9	Loft	LOFT
Steel Mesh	A9	Charcoal	S
Lowell Ash	LLA1	Lowell Ash	DL
Natural Recon	LNRI	Natural Recon	NR
Phantom Ecru	LPE1	Phantom Ecru	PE
Portico Teak	LPT1	Portico Teak	DP
Skyline Walnut	LSW1	Skyline Walnut	SW
Loft	LOFT	Loft	LOFT

◆◆◆ For lead time information see page 21.

FLOCK®

COLLABORATIVE SOLUTIONS TABLE SPECIFYING INFORMATION

TOP SHAPES

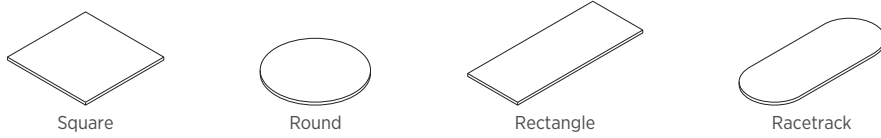
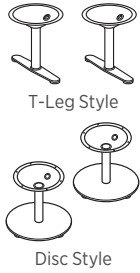
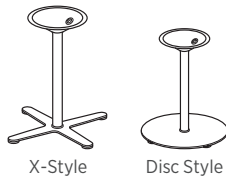

TABLE BASES

For Occasional-Height Tables



For Seated-Height Tables



For 41" H Bar-Height Tables

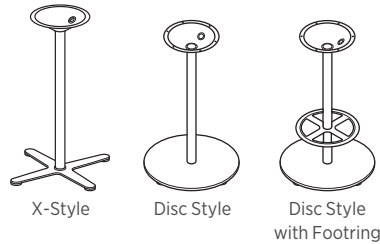

OCCASIONAL TABLES

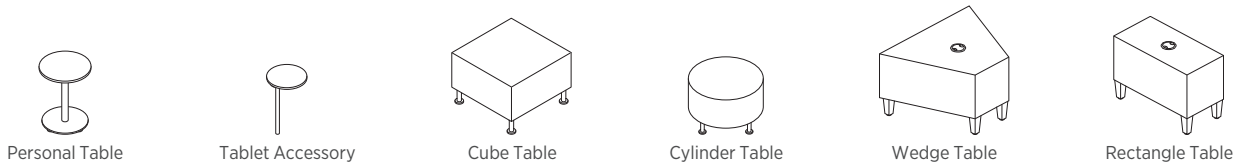

GROMMET MATRIX — ALL TABLES/TOPS

TOP WIDTH	NO GROMMET	1-3" ROUND GROMMET CENTERED	2-3" ROUND GROMMET LEFT & RIGHT
SIF OPTION CODE	N	G	G
24" Cube	YES	YES	N/A
26" Cylinder	YES	YES	N/A
18" Personal	N/A	N/A	N/A
30" Square/Round	YES	YES	N/A
36" Square/Round	YES	YES	N/A
60" Rectangle/Racetrack	YES	N/A	YES
72" Rectangle/Racetrack	YES	N/A	YES
84" Rectangle/Racetrack	YES	N/A	YES
96" Rectangle/Racetrack	YES	N/A	YES

NOTES: 3" round grommet color will need to be specified for tops. Grommet will coordinate with paint color specified for cube/cylinder tables. Charcoal grommets will be used with Textured Charcoal paint and Platinum Metallic grommets will be used with Textured Silver paint.

Grommet options can be used in conjunction with accessory ports on cube/cylinder tables. Grommet models HGRMTAC and HGRMTDATA on page 248 can also be used with Flock® tables.

3" ROUND GROMMET LOCATIONS

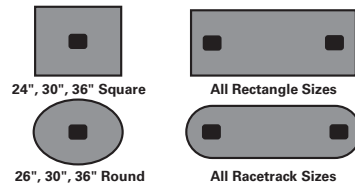

ACCESSORY PORT LOCATIONS

Only applies to models HFTLS24 and HFTLD26.

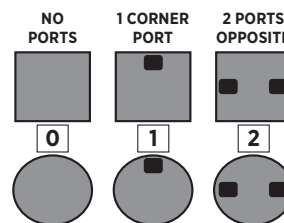

NOTES:

Port location 1 allows for one tablet accessory — see model on pages 49-50.

Port location 2 allows for two tablet accessories — see model on pages 49-50.



Icon Legend on page 19

FLOCK® Collaborative Laminate Table Tops

	DESCRIPTION	MODEL	SHIP WEIGHT	CUBE	LIST PRICE BY LAMINATE GRADE	
					L1	L2
	Laminate Table Tops					
	36" Square Top	HFTLS36	45	1.2	\$647	\$670
	30" Square Top	HFTLS30	32	1.0	\$575	\$598
	36" Round Top	HFTLD36	35	1.2	\$647	\$670
	30" Round Top	HFTLD30	25	1.0	\$575	\$598
	96"W x 33"D Rectangle Top	HFTLC3396	105	2.9	\$1139	\$1180
	84"W x 33"D Rectangle Top	HFTLC3384	90	2.5	\$975	\$1009
	72"W x 33"D Rectangle Top	HFTLC3372	78	2.2	\$816	\$845
	60"W x 24"D Rectangle Top	HFTLC2460	47	1.3	\$596	\$614
	96"W x 33"D Racetrack Top	HFTLA3396	101	2.9	\$1139	\$1180
	84"W x 33"D Racetrack Top	HFTLA3384	83	2.5	\$975	\$1009
	72"W x 33"D Racetrack Top	HFTLA3372	70	2.2	\$816	\$845
	60"W x 24"D Racetrack Top	HFTLA2460	43	1.3	\$596	\$614

NOTES:

- Grommet models HGRMTAC and HGRMTDATA on page 248 can also be used with Flock® tables.
- Rectangle and Racetrack tops come with 2 grommet cutouts if specified with Round grommet.
- For a complete line of compatible Flock® collaborative seating solutions, please see pages 342-364.
- For compatible round grommet options, see page 248.





HOW TO SPECIFY

<p>Select Model Number</p> <p>HFTLS36</p>	<p>Select Edge Detail</p> <p>G 2mm Edge</p> <p>Select Edge Color</p> <p>See page 45</p> <p>GK</p>	<p>Select Grommet Option</p> <p>N No Grommet G Round Grommet (+ \$18 per grommet cutout)</p> <p>See page 46 for Grommet placement</p> <p>Select Grommet Color</p> <p>S Charcoal T1 Platinum Metallic</p> <p>GT1</p>	<p>Select Laminate Color</p> <p>See page 45</p> <p>K7</p>
--	---	---	--

FLOCK® Collaborative Table Bases

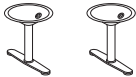
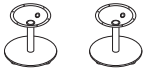

Icon Legend on page 19

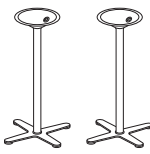
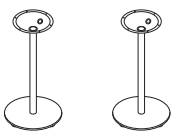
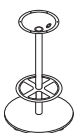
	DESCRIPTION	MODEL	SHIP WEIGHT	CUBE	LIST PRICE BY PAINT GRADE	
					P1	P2
	Base T-Leg Style — For 17”H Tables For 60”W x 24”D Rectangle or Racetrack Table Tops • Two bases shipped in separate cartons.	HFTB17N	40	6.0	\$1440	\$1463
	Base Disc Style — For 17”H Tables • Use with 60”W x 24”D Racetrack or Rectangle table tops only. • Two bases shipped in separate cartons.	HFDB17N	74	6.0	\$1578	\$1601
	Base Disc Style — For 17”H Tables For 30” and 36” Round or Square Table Tops	HFDB17B	37	3.0	\$774	\$797
	Base X-Style — For 29½”H Tables For 30” Round or Square Table Tops For 36” Round or Square Table Tops Use with 33”D x 72”W x 84”W and 96”W Rectangle or Racetrack Table Tops • Two bases shipped in separate cartons	HFXB29A HFXB29B HFXB29AN	40 53 80	16.1 16.1 32.2	\$898 \$948 \$1796	\$921 \$971 \$1842
	Base X-Style — For 18”H Tables For 30” and 36” Round or Square Table Tops	HFXB17B	37	3.0	\$774	\$797
	Base Disc Style — For 29½”H Tables For 30” Round or Square Table Tops For 36” Round or Square Table Tops Use with 33”D x 72”W x 84”W and 96”W Rectangle or Racetrack Table Tops • Two bases shipped in separate cartons	HFDB29A HFDB29B HFDB29AN	40 56 80	16.1 16.1 32.2	\$898 \$948 \$1796	\$911 \$971 \$1819
	Base X-Style — For 41”H Standing-Height Tables • Use with 33”D x 72”W, 84”W and 96”W Rectangle or Racetrack Table Tops • Two bases shipped in separate cartons	HFXB42AN	84	36.4	\$1884	\$1930
	Base X-Style — For 41”H Standing-Height Tables For 30” Round or Square Table Tops For 36” Round or Square Table Tops	HFXB42A HFXB42B	42 55	18.2 16.1	\$942 \$994	\$965 \$1017
	Base Disc Style — For 41”H Standing-Height Tables • Use with 33”D x 72”W, 84”W and 96”W Rectangle or Racetrack table tops, when a Footring is not desired • Two bases shipped in separate cartons	HFDB42AN	92	19.0	\$1826	\$1872
	Base Disc Style — For 41”H Standing-Height Tables For 30” Round or Square Table Tops For 36” Round or Square Table Tops	HFDB42A HFDB42B	46 62	9.5 13.5	\$913 \$970	\$936 \$993
	Base Disc Style with Footring — For 41”H Standing-Height Tables For 30” Round or Square Table Tops For 36” Round or Square Table Tops Use with 33”D x 72”W x 84”W and 96”W Rectangle or Racetrack Table Tops • Two bases shipped in separate cartons	HFDB42AF HFDB42BF HFDB42AFN	56 68 112	9.5 13.5 32.2	\$1183 \$1239 \$2366	\$1206 \$1262 \$2412

HOW TO SPECIFY

Select Model Number HFTB17N	Select Paint Color PR8 Textured Silver P7A Textured Charcoal
---------------------------------------	---



Icon Legend on page 19

FLOCK® Collaborative Tables



DESCRIPTION

Laminate Personal Table
18" Dia. x 25"H

MODEL

HFTPTL18

SHIP WEIGHT

36

CUBE

4.5

L1 LIST PRICE

\$933

L2 UPCHARGE

\$15

HOW TO SPECIFY

Select Model Number

H F T P T L 1 8 .

Select Edge Detail

G 2mm Edge

Select Edge Color

See page 45

G K .

Select Laminate Top Color

See page 45

H .

Select Base Paint Color

PR8 Textured Silver
P7A Textured Charcoal
(+ \$23 per model, for P2 paint)

P R 8

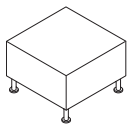

DESCRIPTION

Laminate Collaborative Cube and Cylinder Tables
24" Laminate Cube Table — 24"W x 24"D x 17½"H
26" Laminate Cylinder Table — 26" Dia. x 17½"H

MODEL

HFTLS24

HFTLD26

SHIP WEIGHT

44

39

CUBE

5.0

5.0

L1 LIST PRICE

\$1120

\$1027

L2 UPCHARGE

\$34

\$34

NOTES: Accessory port quantity and configuration on tables should correspond to the accessories planned for the table. For grommet and port information, see page 46.

NOTES:

- Accessory port options on the collaborative cube and cylinder tables allow for tablet accessory to be added.
- For grommet and port information, see page 46.
- HGRMTAC and HGRMTDATA on page 248 can also be used with Flock® tables.
- Standard Leg (L) can be adjusted for leveling.
- For a complete line of compatible Flock® collaborative seating solutions, please see pages 342-364.
- For compatible round grommet options, see page 248.

HOW TO SPECIFY

Select Model Number

H F T L S 2 4 .

Select Grommet Option

See page 46 for Grommet placement

N No Grommet
G Round Grommet — centered (+ \$18)

N .

Select Accessory Port Option

See page 46 for Port placement

0 No Port
1 One Corner Port
2 Two Ports — Opposite
((\$13 for one corner port, \$23 for two ports, \$34 for three ports)

2 D .

Select Laminate

See page 45

H .

Select Leg Option

L Standard Leg
Leg Options
TR Tapered Round Leg
TS Tapered Square Leg

T R .

Select Paint Color

PR8 Textured Silver
P7A Textured Charcoal
(+ \$0 per model, for P2 paint)

P R 8

FLOCK® Collaborative Tables



Icon Legend on page 19

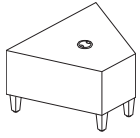

Shown with Round Grommet

DESCRIPTION

Laminate Wedge Table
22.17"W x 29.43"D x 17"H

MODEL

HFTLW45

SHIP WEIGHT

34

CUBE

7.7

L1 LIST PRICE

\$1068

L2 UPCHARGE

\$34

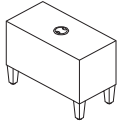

Shown with Round Grommet

Laminate Rectangle Table
24"W x 12"D x 17"H

HFTLR12

29

3.9

\$746

\$23



Laminate Tablet Accessory
14" Dia. x 10"H from table top

HFTAL14

6

2.5

\$556

\$18

NOTES: Use with Collaborative Cube and Cylinder tables for additional workspace. Attaches to tables through ports. Multiple port location options are available. Tablet pivots/swivels toward the user.

NOTES:

- Accessory Port options on the Collaborative Cube and Cylinder Tables allow for Tablet Accessory to be added.
- For grommet and port information, see page 46.
- HGRMTAC and HGRMTDATA on page 248 can also be used with Flock® tables.
- Standard Leg (L) can be adjusted for leveling.
- For a complete line of compatible Flock® collaborative seating solutions, please see pages 342-364.
- For compatible round grommet options, see page 248.

HOW TO SPECIFY

<p>Select Model Number</p> <p>HFTLW45</p>	<p>Select Grommet Option</p> <p>See page 46 for Grommet placement</p> <p>N No Grommet G Round Grommet — centered (+ \$18)</p> <p>N</p>	<p>Select Accessory Port Option</p> <p>See page 46 for Port placement</p> <p>O No Port</p> <p>O</p>	<p>Select Laminate Top Color</p> <p>See page 45</p> <p>N</p>	<p>Select Leg Option</p> <p>L Standard Leg Leg Options TR Tapered Round Leg TS Tapered Square Leg</p> <p>TS</p>	<p>Select Paint Color</p> <p>PR8 Textured Silver P7A Textured Charcoal (+ \$0 per model, for P2 paint)</p> <p>P7A</p>
--	---	---	---	--	--

<p>Select Model Number</p> <p>HFTTAL14</p>	<p>Select Edge Detail</p> <p>G 2mm Edge</p> <p>Select Edge Color</p> <p>See page 45</p> <p>GK</p>	<p>Select Laminate Top Color</p> <p>See page 45</p> <p>H</p>	<p>Select Paint Color</p> <p>PR8 Textured Silver P7A Textured Charcoal (+ \$13 per model, for P2 paint)</p> <p>PR8</p>
---	--	---	---

HUDDLE

Want to see more? Scan here
to check out hon.com.



Huddle Tables shown with Motivate® Seating.

HUDDLE

These sturdy, versatile tables link and unlink to quickly transform a space. Temporary workstation? Done. Impromptu conference table? Easy! Training session? No problem. Huddle helps you maximize time and square footage — not costs. And for today's businesses, that's a nice change of pace.



FEATURES

- 1½" thick solid core top is made from durable high-performance particleboard.
- Heavy-grade, warp-resistant particleboard tops and bases withstand heavy activity.
- Mobile nesting base option lets tables fold up and roll away until you need them.
- Choose wiring and power options so Huddle tables are ready to work when you are.
- Modesty panels offer the added level of privacy your employees want.
- Two edge profiles in over 20 colors and patterns to accommodate differing tastes.
- Height adjustable laptop table offers a mobile, personal table for working anywhere.

HUDDLE ORDERING INFORMATION

LAMINATE

- TOPS/L1 LAMINATES CODES**
- Woodgrain**
- ◆ Bourbon Cherry **H**
 - ◆ Cognac **COGN**
 - ◆ Field Elm **LWFE**
 - ◆ Florence Walnut **LFW1**
 - ◆ Harvest **C**
 - ◆ Kingswood Walnut **LKI1**
 - ◆ Mahogany **N**
 - ◆ Mocha **MOCH**
 - ◆ Natural Maple **D**
 - ◆ Pinnacle **PINC**
 - ◆ Shaker Cherry **F**
 - ◆ Sterling Ash **LSA1**
- Solid**
- ◆ Black **P**
 - ◆ Charcoal **S**
 - ◆ Designer White **LDW1**
 - ◆ Loft **LOFT**
- Patterned**
- ◆ Handspun Chestnut **LAHC**
 - ◆ Handspun Dove **LAHD**
 - ◆ Handspun Pearl **LAHP**
 - ◆ Handspun Slate **LAHS**
 - ◆ Silver Mesh **B9**
 - ◆ Steel Mesh **A9**
 - ◆ Battleship **LBT1***
 - ◆ Gray **G2**
 - ◆ Moroccan **LMN1***
 - ◆ Mushroom **LMH1***
 - ◆ Neon Carrot **LN1***
 - ◆ Tennis Ball **LTB1***
 - ◆ White **G1**

- TOPS/L2 LAMINATES CODES**
- Woodgrain**
- ◆ Beigewood **LWBE**
 - ◆ Fawn Cypress **LFC1**
 - ◆ Lowell Ash **LLA1**
 - ◆ Natural Recon **LN1***
 - ◆ Phantom Ecreu **LPE1**
 - ◆ Portico Teak **LPT1**
 - ◆ Skyline Walnut **LSW1**

EDGE BAND

- EDGES/ EDGE BAND (2MM) CODES**
- ◆ Beigewood **DE**
 - ◆ Black **P**
 - ◆ Bourbon Cherry **H**
 - ◆ Brownstone **EY**
 - ◆ Charcoal **S**
 - ◆ Cognac **COGN**
 - ◆ Designer White **DW**
 - ◆ Fawn Cypress **FC**
 - ◆ Field Elm **FE**
 - ◆ Florence Walnut **FW**
 - ◆ Fossil **EH**
 - ◆ Greige **R**
 - ◆ Harvest **C**
 - ◆ Kingswood Walnut **KI**
 - ◆ Loft **LOFT**
 - ◆ Lowell Ash **DL**
 - ◆ Mahogany **N**
 - ◆ Mocha **MOCH**
 - ◆ Muslin **T**
 - ◆ Natural Maple **D**
 - ◆ Natural Recon **NR**
 - ◆ Phantom Ecreu **PE**
 - ◆ Pinnacle **PINC**
 - ◆ Platinum **K**
 - ◆ Portico Teak **DP**
 - ◆ Shaker Cherry **F**
 - ◆ Skyline Walnut **SW**
 - ◆ Sterling Ash **SA**

T-MOLD

- T-MOLD CODES**
- ◆ Atom **AT***
 - ◆ Beigewood **DE**
 - ◆ Black **P**
 - ◆ Brownstone **EY**
 - ◆ Bullseye **BY***
 - ◆ Charcoal **S***
 - ◆ Designer White **DW**
 - ◆ Ember **MR***
 - ◆ Fawn Cypress **FC**
 - ◆ Field Elm **FE**
 - ◆ Fossil **EH**
 - ◆ Greige **R**
 - ◆ Ion **IO***
 - ◆ Iris **IR***
 - ◆ Krypton **KT***
 - ◆ Loft **LOFT**
 - ◆ Lowell Ash **DL**
 - ◆ Muslin **T**
 - ◆ Natural Recon **NR**
 - ◆ Phantom Ecreu **PE**
 - ◆ Platinum **K**
 - ◆ Portico Teak **DP**
 - ◆ Regatta **RE***
 - ◆ Skyline Walnut **SW**

PAINT

- BASE PAINT CODES**
- P1**
- ◆ Black **P**
 - ◆ Brownstone **P7D**
 - ◆ Charcoal **S**
 - ◆ Designer White **PJW**
 - ◆ Fossil **P28**
 - ◆ Light Gray **Q**
 - ◆ Loft **LOFT**
 - ◆ Muslin **T3**
 - ◆ Purity **L**
 - ◆ Titanium **P8T**
- P2**
- ◆ Champagne Metallic **T4**
 - ◆ Platinum Metallic **T1**
 - ◆ Silver **PR6**
- P3**
- ◆ Atom **P8S**
 - ◆ Bullseye **PJF**
 - ◆ Ember **P8P**
 - ◆ Ion **P8N**
 - ◆ Iris **P8J**
 - ◆ Krypton **P8F**
 - ◆ Regatta **P8M**

Recommended Edgeband Color Selection:

Laminate		Edge	
Bourbon Cherry	H	Bourbon Cherry	H
Cognac	COGN	Cognac	COGN
Florence Walnut	LFW1	Florence Walnut	FW
Harvest	C	Harvest	C
Kingswood Walnut	LKI1	Kingswood Walnut	KI
Mahogany	N	Mahogany	N
Mocha	MOCH	Mocha	MOCH
Natural Maple	D	Natural Maple	D
Pinnacle	PINC	Pinnacle	PINC
Shaker Cherry	F	Shaker Cherry	F
Sterling Ash	LSA1	Sterling Ash	SA
Black	P	Black	P
Charcoal	S	Charcoal	S
Designer White	LDW1	Designer White	DW
Handspun Chestnut	LAHC	Brownstone	EY
Handspun Dove	LAHD	Fossil	EH
Handspun Pearl	LAHP	Fossil	EH
Handspun Slate	LAHS	Charcoal	S
Loft	LOFT	Loft	LOFT
Silver Mesh	B9	Loft	LOFT
Steel Mesh	A9	Charcoal	S
Gray	G2	Charcoal	S
White	G1	Charcoal	S
Lowell Ash	LLA1	Lowell Ash	DL
Natural Recon	LN1*	Natural Recon	NR
Phantom Ecreu	LPE1	Phantom Ecreu	PE
Portico Teak	LPT1	Portico Teak	DP
Skyline Walnut	LSW1	Skyline Walnut	SW

* Available on Laptop Table only.

◆◆◆ For lead time information see page 21.

HUDDLE Multi-Purpose Tables

Huddle Multi-Purpose Tables are ready to jump into action for training, meetings, collaboration and more. Thoughtful design, flexibility and plenty of base, edge and finish options, make Huddle tables capable of meeting the needs of smart, agile businesses.

Tops - Rectangle

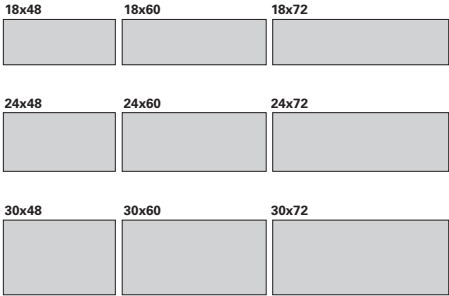

Edge Options

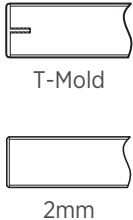

Bases

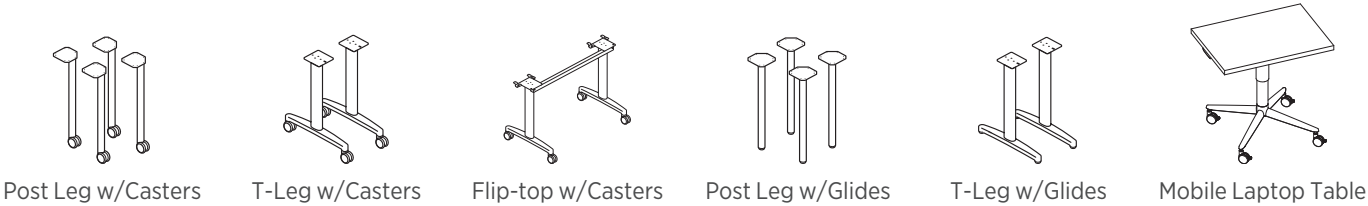

Accessories

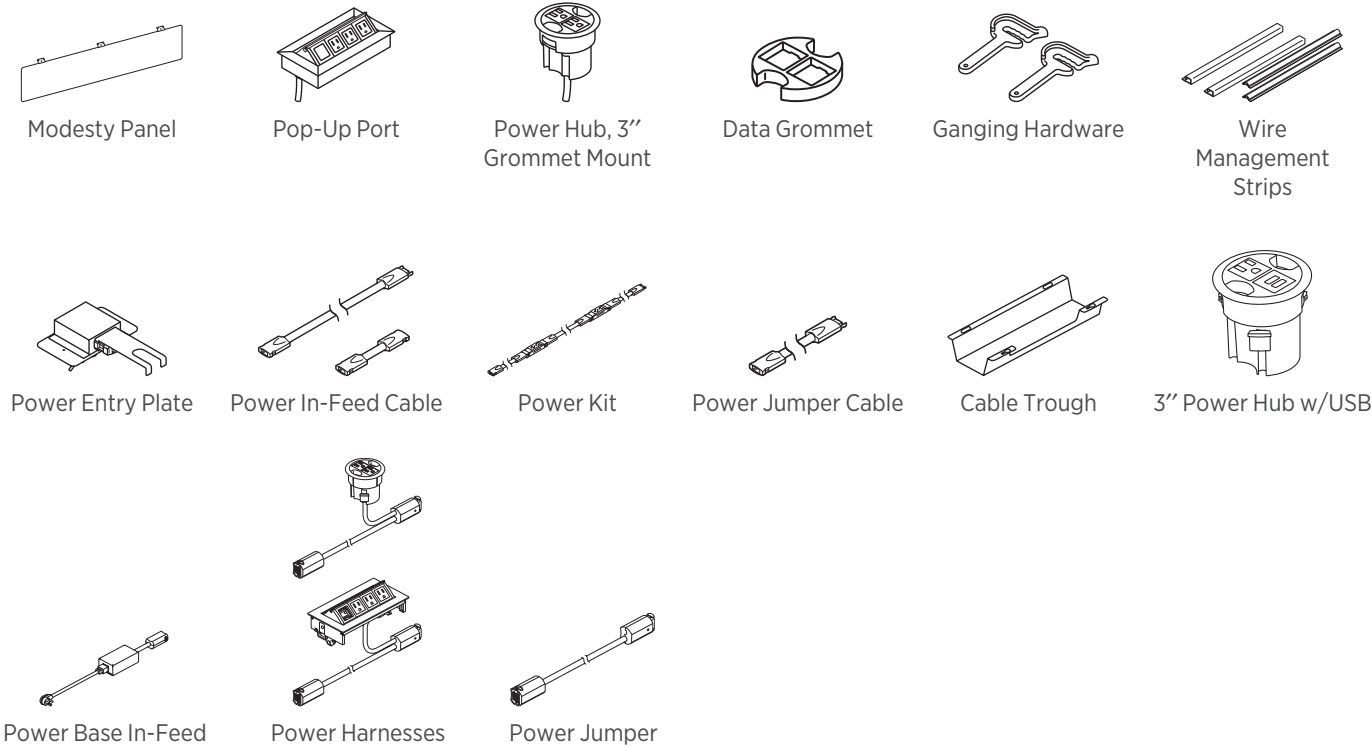

INTERLINK IQ ELECTRICAL

Specification guide for IQ Electrical on Huddle tables

Determine table width, the type of power access being used (3" grommet or 4x8 pop-up) and the desired number per table (Columns 1, 2 or 3). The table will then identify the type and quantity of components needed per table along with the maximum table run. Note that this is in addition to the Power base in-feed which is needed for each run. For example, a 48"W table with two 3" power grommets per table will require (1) HQH5-3 harness and (1) HQH1-3 harness per table with a maximum run of four tables.

Top Width	POWER ONE (1) PER TABLE 3" ROUND POWER GROMMET		POWER TWO (2) PER TABLE 3" ROUND POWER GROMMETS		POWER ONE (1) PER TABLE 4x8 POP-UP PORT	
	Component	Quantity	Component	Quantity	Component	Quantity
36"	(1) HQH5-3	8 Table Run Maximum	N/A	N/A	(1) HQH5-P	8 Max Table Run
42"	(1) HQH5-3	8 Table Run Maximum	N/A	N/A	(1) HQH5-P	8 Max Table Run
48"	(1) HQH5-3	8 Table Run Maximum	(1) HQH5-3 (1) HQH1-3	4 Max Table Run	(1) HQH5-P	8 Max Table Run
54"	(1) HQH5-3	8 Table Run Maximum	(1) HQH5-3 (1) HQH1-3	4 Max Table Run	(1) HQH5-P	8 Max Table Run
60"	(1) HQH5-3	8 Table Run Maximum	(1) HQH5-3 (1) HQH1-3	4 Max Table Run	(1) HQH5-P	8 Max Table Run
66"	(1) HQH5-3 (1) HQJ3	4 Table Run Maximum	(1) HQH5-3 (1) HQH1-3	4 Max Table Run	(1) HQH5-P (1) HQJ3	4 Max Table Run
72"	(1) HQH5-3 (1) HQJ3	4 Table Run Maximum	(1) HQH5-3 (1) HQH1-3	4 Max Table Run	(1) HQH5-P (1) HQJ3	4 Max Table Run
84"	(1) HQH5-3 (1) HQJ3	4 Table Run Maximum	(2) HQH5-3	4 Max Table Run	(1) HQH5-P (1) HQJ3	4 Max Table Run
96"	(1) HQH5-3 (1) HQJ3	4 Table Run Maximum	(2) HQH5-3	4 Max Table Run	(1) HQH5-P (1) HQJ3	4 Max Table Run
Half-Round (all sizes)	(1) HQH1-3	2 Tables Maximum	N/A	N/A	(1) HQH5-P	2 Max Table Run
Trapezoid (all sizes)	(1) HQH5-3	8 Table Run Maximum	N/A	N/A	(1) HQH5-P	8 Max Table Run

NOTES:

- Interlink IQ Electrical is a pluggable, single circuit electrical system.
- All electrical models include wire management clips and hardware.
- Interlink IQ Electrical is non-sequential/non-directional. It can be installed in any direction.
- Interlink IQ Electrical is UL Recognized as a Powered Table System and meets the requirements of UL 962.
- For compatible Interlink IQ Electrical solutions, see page 245.

⚠ 40' maximum run, or no more than 8 units, whichever comes first. Interlink IQ system will automatically shut off if maximum requirements are exceeded. Maximum run is based upon electrical harness width, not table width.

4-TRAC HARDWIRE ELECTRICAL SYSTEM

4-Trac Electrical System

The 4-Trac Electrical System is a UL-recognized Manufactured Wiring System that seamlessly passes power from one worksurface to another. This low-profile non-sequential electrical system allows tables to be “daisy-chained” together in any desired order and allows users to reconfigure quickly due to simple connectable/disconnectable links.

- Meets requirements of UL 183 and National Electric Code Article 604
- 4-Wires, 2-circuits, 20 Amps each (Circuit 1 and Circuit 2 only)
- 13 Duplex Receptacles per circuit, 26, 15 Amp Duplex receptacle per power in-feed
- Electrical system attaches directly to underside of worksurface with included brackets
- Up to twelve tables can be linked together
- For compatible 4-Trac Electrical solutions, see page 247.

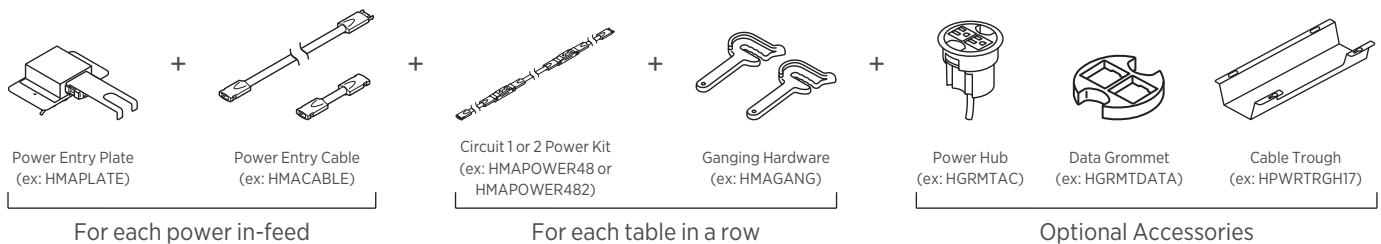

Steps for Electrical Specifications:

- Determine how many rows of tables are needed and order the following:
 - One HMAPLATE per row (or power in-feed)
 - One HMACABLE per row (or power in-feed)
- Order one power harness per table in each row
 - For 1-6 tables in a row (see illustration 1)
 - Order Circuit 1 Power Harnesses (ex. If powering six 24x60 tables order six sets of HMAPOWER60)
 - For 7-12 tables in a row (see illustration 1)
 - Order Circuit 1 Power Harness for first six tables and Circuit 2 Power Harness for remaining tables (ex. If powering eight 24x60 tables, order six sets of HMAPOWER60 and two sets of HMAPOWER602)
- Order one set of ganging hardware per table (ex. HMAGANG)
- Determine which accessories are needed:
 - Power Hub model HGRMTAC — to access power at worksurface.
 - Data Grommet model HGRMTDATA — to access data at worksurface.
 - Wire Management strips model HBTMS — for vertical and horizontal wire management.

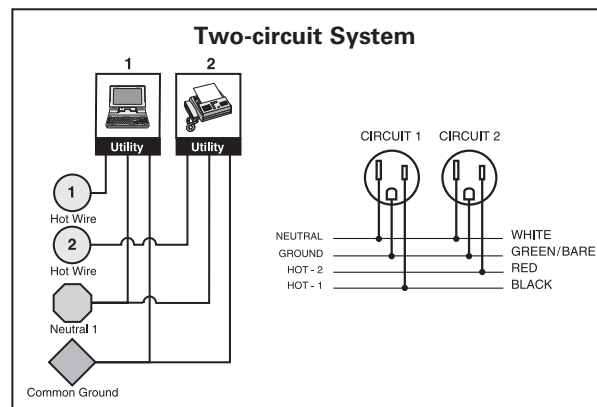
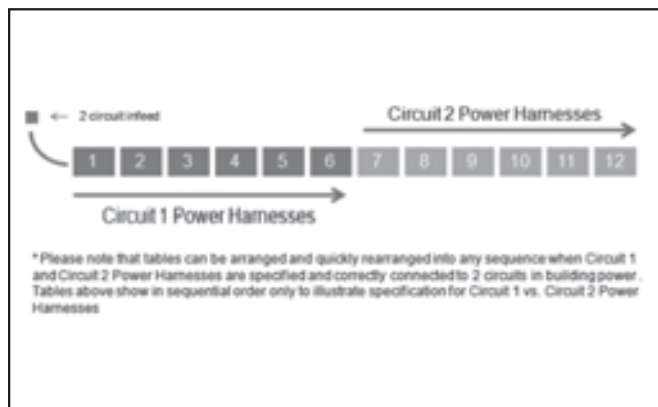

HUDDLE Typicals



Icon Legend on page 19

QTY	DESCRIPTION	MODEL	LIST PRICE	PRICE EXTENSION
12	Rectangular Table Top 60"W x 24"D	HMT2460G	\$583	\$6,996
12	Flip-top Base	HMBFLIP24L.C	\$938	\$11,256
21	Perpetual® Nesting Chair	HPN1	\$1,022	\$21,462
TOTAL:				\$39,714

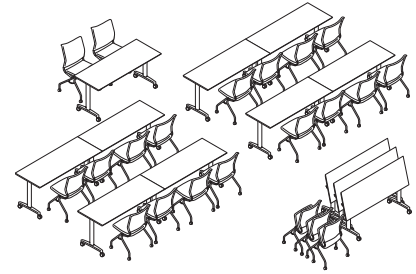

TRAINING

QTY	DESCRIPTION	MODEL	LIST PRICE	PRICE EXTENSION
4	Rectangular Table Top 72"W x 30"D	HMT3072G	\$688	\$2,752
4	Post Leg Base	HMBPOST	\$542	\$2,168
8	Perpetual® Nesting Chair	HPN1	\$1,022	\$8,176
TOTAL:				\$13,096

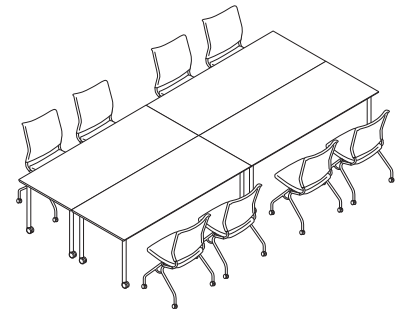

MEETING/CONFERENCE



Icon Legend on page 19

HUDDLE Typicals

QTY	DESCRIPTION	MODEL	LIST PRICE	PRICE EXTENSION
8	Rectangular Table Top 60"W x 30"D	HMT3060G	\$604	\$4,832
8	Fixed Height T-Leg Base with Casters	HMBTLEG24.C	\$640	\$5,120
8	Perpetual® Nesting Chair	HPN1	\$1,022	\$8,176
TOTAL:				\$18,128

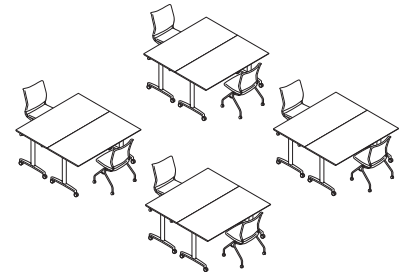

GROUP BREAKOUT

QTY	DESCRIPTION	MODEL	LIST PRICE	PRICE EXTENSION
6	Rectangular Table Top 72"W x 24"D	HMT2472G	\$646	\$3,876
6	Fixed Height T-Leg Base with Casters	HMBTLEG24.C	\$640	\$3,840
12	Perpetual® Nesting Chair	HPN1	\$1,022	\$12,264
TOTAL:				\$19,980

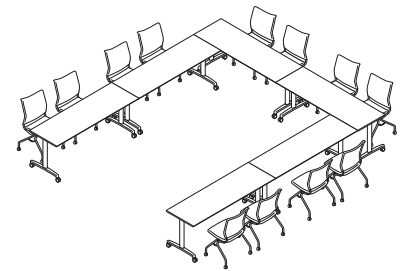

PRESENTATION

HUDDLE

Multi-Purpose Table Tops



Icon Legend on page 19

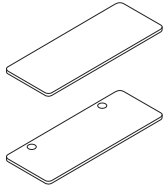

HMT1848E

DESCRIPTION

Rectangular T-Mold Table Tops

48"W x 18"D	HMT1848E	34	2.9	\$470	\$483
60"W x 18"D	HMT1860E	42	3.5	\$499	\$517
72"W x 18"D	HMT1872E	51	3.9	\$613	\$631
48"W x 24"D	HMT2448E	45	3.7	\$528	\$546
60"W x 24"D	HMT2460E	57	4.5	\$583	\$606
72"W x 24"D	HMT2472E	68	5.0	\$646	\$669
48"W x 30"D	HMT3048E	57	4.4	\$551	\$569
60"W x 30"D	HMT3060E	71	5.4	\$604	\$627
72"W x 30"D	HMT3072E	85	6.0	\$688	\$711

MODEL

SHIP WEIGHT

CUBE

LIST PRICE BY LAMINATE GRADE

L1

L2

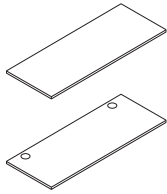

HMT1848G

Rectangular Edgeband Table Tops

48"W x 18"D	HMT1848G	34	2.9	\$470	\$483
60"W x 18"D	HMT1860G	42	3.5	\$499	\$517
72"W x 18"D	HMT1872G	51	3.9	\$613	\$631
48"W x 24"D	HMT2448G	45	3.7	\$528	\$546
60"W x 24"D	HMT2460G ⓘ	57	4.5	\$583	\$606
72"W x 24"D	HMT2472G	68	5.0	\$646	\$669
48"W x 30"D	HMT3048G	57	4.4	\$551	\$569
60"W x 30"D	HMT3060G	71	5.4	\$604	\$627
72"W x 30"D	HMT3072G	85	6.0	\$688	\$711

MODEL

SHIP WEIGHT

CUBE

L1

L2

NOTES:

- Table tops are 1½" thick.
- When post legs are used with 18"D tops, post leg to be specified with glides only.
- For compatible 4-Trac Electrical solutions, see page 247.
- For compatible Interlink IQ Electrical solutions, see page 245.
- 60"W and 72"W rectangular tops ship with external stiffener for stability.

- ⓘ Round grommets available in Black only.
- ⓘ Pop-up Port option (G1) is unfinished. Insert accessory must be ordered separately.

HOW TO SPECIFY

<p>Select Model Number</p> <p>HMT1848G</p>	<p>Select Grommet Option</p> <p>N No Grommet G 2 Grommets (Black only) (+ \$34) G1 Cutout for Pop-up Port (+ \$46). Order port separately.</p> <p>N</p>	<p>Select Laminate</p> <p>See page 52</p> <p>D</p>	<p>Select Edge Color</p> <p>See page 52</p> <p>D</p>
---	---	---	---



Icon Legend on page 19

HUDDLE Multi-Purpose Table Bases

	DESCRIPTION	MODEL	SHIP WEIGHT	CUBE	LIST PRICE BY PAINT GRADE		
					P1	P2	P3
	Fixed Height T-Leg Base (Includes 2 T-legs) For 18"D Table Tops For 24"D and 30"D Table Tops	HMBTLEG18 HMBTLEG24 ☉	12 14	3.6 3.6	\$640 \$640	\$663 \$663	\$674 \$674
	Flip-top Base (Includes 1 Complete Base) For 18"D x 48"W Rectangular Table Tops For 18"D x 60"W, 72"W Rectangular Table Tops For 24"D x 48"W and 32"D x 48"W Rectangular Table Tops and 30"D x 60"W Half-Round Table Tops For 24"D x 60"W, 72"W Rectangular Table Tops For 30"D x 48"W Rectangular Table Tops For 30"D x 60"W, 72"W Rectangular Table Tops	HMBFLIP18S HMBFLIP18L HMBFLIP24S HMBFLIP24L ☉ HMBFLIP30S HMBFLIP30L	23 26 24 27 24 27	4.1 4.1 4.1 4.1 4.1 4.1	\$938 \$938 \$938 \$938 \$938 \$938	\$961 \$961 \$961 \$961 \$961 \$961	\$972 \$972 \$972 \$972 \$972 \$972
	Post Leg Base (Includes 4 Post Legs) For all Tops	HMBPOST	18	2.3	\$542	\$565	\$576

Table Top to Base Compatibility Chart:

	Flip-Top	T-Leg	Post Leg
18"D x 48"W	HMBFLIP18S	HMBTLEG18	HMBPOST*
18"D x 60"W	HMBFLIP18L	HMBTLEG18	HMBPOST*
18"D x 72"W	HMBFLIP18L	HMBTLEG18	HMBPOST*
24"D x 48"W	HMBFLIP24S	HMBTLEG24	HMBPOST
32"D x 48"W HR	HMBFLIP24S	HMBTLEG24	N/A
30"D x 60"W HR	HMBFLIP24S	HMBTLEG24	HMBPOST
24"D x 60"W	HMBFLIP24L	HMBTLEG24	HMBPOST
24"D x 72"W	HMBFLIP24L	HMBTLEG24	HMBPOST
30"D x 48"W	HMBFLIP30S	HMBTLEG24	HMBPOST
30"D x 60"W	HMBFLIP30L	HMBTLEG24	HMBPOST
30"D x 72"W	HMBFLIP30L	HMBTLEG24	HMBPOST

*Post legs should be specified with glides for use on 18"D worksurfaces.
NOTE: Glides/casters are NOT interchangeable on Post Leg and T-base.

NOTES:

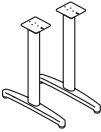
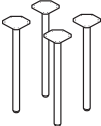
- When glides are specified, adjustable range is 1".
- Flip-top base is standard with casters.
- When post legs are used with 18"D tops, post leg to be specified with glides only.

HOW TO SPECIFY

Select Model Number <div style="border: 1px solid black; display: flex; justify-content: space-between; padding: 2px;"> HMBTLEG18 </div>	Select Glide/Caster Option G Glide C Caster Flip-top base is available with casters only When post legs are used with 18"D tops, specify with glides only <div style="border: 1px solid black; display: flex; justify-content: space-between; padding: 2px;"> G </div>	Select Paint Color See page 52 (+ \$23 per model, for P2 paint) (+ \$34 per model, for P3 paint) <div style="border: 1px solid black; display: flex; justify-content: space-between; padding: 2px;"> T1 </div>
---	---	---

HUDDLE Mobile Laptop Table



Icon Legend on page 19



DESCRIPTION	MODEL	SHIP WEIGHT	CUBE	LIST PRICE	UPCHARGE BY LAMINATE/PAINT GRADE			
					L2	L5	P2	P3
T-Mold 28"W x 20"D	HPHAP2028E	59	8.7	\$1217	\$23	\$90	\$23	\$34



Edgeband 28"W x 20"D	HPHAP2028G	59	8.7	\$1217	\$23	\$90	\$23	\$34
--------------------------------	-------------------	----	-----	--------	------	------	------	------

NOTES:

- Tables adjust from 26"-33"H.
- Pneumatic height adjustment so no electricity is required to adjust height of table.





HOW TO SPECIFY

<p>Select Model Number</p> <p>See page 52</p> <p>HPHAP2028E</p>	<p>Select Laminate</p> <p>See page 52</p> <p>LFW1</p>	<p>Select Edge Color</p> <p>See page 52</p> <p>FW</p>	<p>Select Paint Color</p> <p>See page 52</p> <p>P8T</p>
--	--	--	--

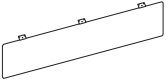

Icon Legend on page 19

HUDDLE Table Accessories

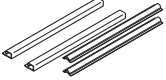
	DESCRIPTION	MODEL	SHIP WEIGHT	CUBE	LIST PRICE BY PAINT GRADE		
					P1	P2	P3
	Universal Modesty Panel						
	For 48"W Huddle Tables For 60"W & 72"W Huddle Tables	HMTUMOD32 HMTUMOD44	9 12	1.9 2.5	\$281 \$305	\$304 \$328	\$315 \$339
	NOTES: Universal Modesty Panels nest between the table legs.						
	Ganging Hardware	HMAGANG 	1 	0.1	\$145		
	<ul style="list-style-type: none"> Includes two ganging links and two screws No color designator when specifying. <i>Example: HMAGANG.</i> 						
	DESCRIPTION	MODEL	SHIP WEIGHT	CUBE	LIST PRICE		
	Wire Management Strips	HBTMS		3	0.25	\$170	
	NOTES: Only available in black.						

NOTES:

- Ganging Hardware must be ordered and installed on tables when using 4-trac electrical systems.
- Ganging hardware attaches to underside of table in pre-drilled pilot holes.
- Vertical Wire Management Strips must be trimmed when applied to legs of T-Leg and Flip-Top Bases with casters.

HOW TO SPECIFY

<p>Select Model Number</p> <p>H M T U M O D 3 2</p>	<p>Select Paint Color</p> <p>See page 52</p> <p>S</p>
--	--

OCCASIONAL TABLES

Want to see more? Scan here
to check out



Occasional Tables shown with Accommodate® Seating.

OCCASIONAL TABLES

Durable materials and construction make HON Occasional Tables ideal for high-traffic areas such as lobbies, reception areas and lounges. The versatile design also dresses up any corner of the executive office where casual, but important, conversations are held. Use them to hold lamps, magazines and more. They're available in 14 woodgrain, patterned or solid color laminates to coordinate with any decor.



FEATURES

- A high-quality solution for any organization wanting to make a great impression on clients and visitors.
- Scratch-, spill- and stain-resistant laminate stands up to heavy use.
- Heavy-grade, warp-resistant particleboard features high recycled content.
- Complement many interiors and furniture designs.
- Brings people together comfortably in reception areas, lounges and offices.

LAMINATE OCCASIONAL TABLES OPTIONS

H80191, H80192, H80193

L1 LAMINATES CODES

Woodgrain

- ◆ Bourbon Cherry H
- ◆ Cognac COGN
- ◆ Field Elm LWFE
- ◆ Florence Walnut LFW1
- ◆ Harvest C
- ◆ Kingswood Walnut LK11
- ◆ Mahogany N
- ◆ Mocha MOCH
- ◆ Natural Maple D
- ◆ Pinnacle PINC
- ◆ Shaker Cherry F
- ◆ Sterling Ash LSA1

Solid

- ◆ Black P
- ◆ Charcoal S
- ◆ Designer White LDW1
- ◆ Loft LOFT

Patterned Top*

- ◆ Handspun Chestnut LAHC
- ◆ Handspun Dove LAHD
- ◆ Handspun Pearl LAHP
- ◆ Handspun Slate LAHS
- ◆ Silver Mesh A9

H80170, H80180

L1 LAMINATES CODES

Woodgrain

- ◆ Bourbon Cherry H
- ◆ Cognac COGN
- ◆ Florence Walnut LFW1
- ◆ Harvest C
- ◆ Kingswood Walnut LK11
- ◆ Mahogany N
- ◆ Mocha MOCH
- ◆ Natural Maple D
- ◆ Pinnacle PINC
- ◆ Shaker Cherry F
- ◆ Sterling Ash LSA1

Solid

- ◆ Black P
- ◆ Charcoal S
- ◆ Designer White LDW1
- ◆ Loft LOFT

Two-Tone Recommended Options for Laminate Occasional Tables (H80191, H80192 and H80193)

Beigewood/Black (LWBEP)	Handspun Dove/Designer White (LAHDLDW1)
Beigewood/Charcoal (LWBES)	Handspun Pearl/Black (LAHPP)
Beigewood/Designer White (LWBELDW1)	Handspun Pearl/Charcoal (LAHPS)
Black/Charcoal (PS)	Handspun Pearl/Designer White (LAHPLDW1)
Black/Designer White (PLDW1)	Handspun Slate/Black (LAHSP)
Bourbon Cherry/Black (HP)	Handspun Slate/Charcoal (LAHSS)
Bourbon Cherry/Charcoal (HS)	Handspun Slate/Designer White (LAHSLDW1)
Bourbon Cherry/Designer White (HLDW1)	Harvest/Black (CP)
Charcoal/Black (SP)	Harvest/Charcoal (CS)
Charcoal/Designer White (SLDW1)	Harvest/Designer White (CLDW1)
Cognac/Black (COGNP)	Kingswood Walnut/Black (LK11P)
Cognac/Charcoal (COGNS)	Kingswood Walnut/Charcoal (LK11S)
Cognac/Designer White (COGNLDW1)	Kingswood Walnut/Designer White (LK11LDW1)
Designer White/Black (LDW1P)	Loft/Black (LOFTP)
Designer White/Bourbon Cherry (LDW1H)	Loft/Charcoal (LOFTS)
Designer White/Charcoal (LDW1S)	Loft/Designer White (LOFTLDW1)
Designer White/Cognac (LDW1COGN)	Mahogany/Black (NP)
Designer White/Harvest (LDW1C)	Mahogany/Charcoal (NS)
Designer White/Mahogany (LDW1N)	Mahogany/Designer White (NLDW1)
Designer White/Mocha (LDW1MOCH)	Mocha/Black (MOCHP)
Designer White/Natural Maple (LDW1D)	Mocha/Charcoal (MOCHS)
Designer White/Pinnacle (LDW1PINC)	Mocha/Designer White (MOCHLDW1)
Designer White/Shaker Cherry (LDW1F)	Natural Maple/Black (DP)
Fawn Cypress/Black (LFC1P)	Natural Maple/Charcoal (DS)
Fawn Cypress/Charcoal (LFC1S)	Natural Maple/Designer White (DLDW1)
Fawn Cypress/Designer White (LFC1LDW1)	Pinnacle/Black (PINCP)
Field Elm/Black (LWFEP)	Pinnacle/Charcoal (PINCS)
Field Elm/Charcoal (LWFES)	Pinnacle/Designer White (PINCLDW1)
Field Elm/Designer White (LWFELDW1)	Shaker Cherry/Black (FP)
Florence Walnut/Black (LFW1P)	Shaker Cherry/Charcoal (FS)
Florence Walnut/Charcoal (LFW1S)	Shaker Cherry/Designer White (FLDW1)
Florence Walnut/Designer White (LFW1LDW1)	Silver Mesh/Black (B9P)
Handspun Chestnut/Black (LAHCP)	Silver Mesh/Charcoal (B9S)
Handspun Chestnut/Charcoal (LAHCS)	Silver Mesh/Designer White (B9LDW1)
Handspun Chestnut/Designer White (LAHCLDW1)	Sterling Ash/Black (LSA1P)
Handspun Dove/Black (LAHDP)	Sterling Ash/Charcoal (LSA1S)
Handspun Dove/Charcoal (LAHDS)	Sterling Ash/Designer White (LSA1LDW1)











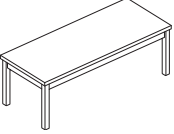

* NOTE: For patterned top laminates, select one of the following for the edgeband around the top, apron, and legs — Black (P), Bourbon Cherry (H), Charcoal (S), Cognac (COGN), Designer White (LDW1), Florence Walnut (LFW1), Harvest (C), Kingswood Walnut (LK11), Mahogany (N), Mocha (MOCH), Natural Maple (D), Pinnacle (PINC), Shaker Cherry (F), Sterling Ash (LSA1).

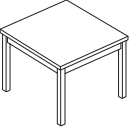
◆◆◆ For lead time information see page 21.

LAMINATE Occasional Tables

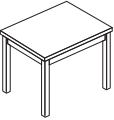

Icon Legend on page 19

	DESCRIPTION	MODEL	SHIP WEIGHT	CUBE	LIST PRICE
  	Coffee Table 48"W x 20"D x 16"H	H80191	48 	3.4	\$741
  	Corner Table 24"W x 24"D x 20"H	H80192	35 	2.1	\$639
 	End Table 24"W x 20"D x 20"H	H80193	29 	1.8	\$609
	Cylinder Table 20" Diameter x 20"H	H80170	40	6.2	\$995
	Cube Table 24"W x 24"D x 20"H	H80180	55	8.6	\$1077

NOTES:

- Durable material and construction make laminate occasional tables ideal for high traffic areas such as lobbies, reception rooms and lounges. Versatile design is also well suited to private offices.
- Coffee, Corner and End Tables feature top-over-apron styling with square corner detail, which complements many interiors and furniture designs, including the 10500 Series.
- Tables accommodate lamps, magazines, plants, laptops and more.
- Tops are abrasion- and stain-resistant laminate over 1/8" thick solid core high-performance particleboard.
- Cylinder and cube tables have recessed black plinth base with tack glides. Tops and sides are covered with high-pressure laminate.



H80191, H80192, H80193
Edge Detail

HOW TO SPECIFY

<p>Select Model Number</p> <p>H 8 0 1 9 1 .</p>	<p>Select Laminate</p> <p>See page 63 for Select Laminate noted with each model</p> <p>N N</p>
--	---

MOTIVATE®

Want to see more? Scan here
to check out hon.com.



Motivate® Tables, Chairs, and Markerboard.

MOTIVATE®

Motivate tables were designed with flexible spaces in mind. Work patterns can change throughout the day. Task areas become collaborative areas. Learning areas become conference areas. Created for HON by designer Wolfgang Deisig, Motivate tables are mobile, lightweight and ready to support the many ways you work — adapting and reacting to your needs with ease. Because flexible spaces make for dynamic workplaces.



FEATURES

- 1½” thick solid core top is made from durable high-performance particleboard.
- Motivate Tables are available in three base options — fixed, nesting and height adjustable.
- Optional modular power can be ganged together without any tools.
- Motivate Tables coordinate perfectly with Motivate chairs — an ideal fit for flexible spaces.
- Add a mobile presentation cart or markerboard for increased function and productivity in your workspace.
- Available in multiple top shapes, edge types, and bases with a variety of laminate and paint finish options.

MOTIVATE® TABLES SPECIFYING INFORMATION

LAMINATE

L1 LAMINATES CODES

- Woodgrain**
- ◆ Bourbon Cherry **H**
 - ◆ Cognac **COGN**
 - ◆ Field Elm **LWFE**
 - ◆ Florence Walnut **LFW1**
 - ◆ Harvest **C**
 - ◆ Kingswood Walnut **LKI1**
 - ◆ Mahogany **N**
 - ◆ Mocha **MOCH**
 - ◆ Natural Maple **D**
 - ◆ Pinnacle **PINC**
 - ◆ Shaker Cherry **F**
 - ◆ Sterling Ash **LSA1**

- Solid**
- ◆ Black **P**
 - ◆ Charcoal **S**
 - ◆ Designer White **LDW1**
 - ◆ Loft **LOFT**

- Patterned**
- ◆ Handspun Chestnut **LAHC**
 - ◆ Handspun Dove **LAHD**
 - ◆ Handspun Pearl **LAHP**
 - ◆ Handspun Slate **LAHS**
 - ◆ Silver Mesh **B9**
 - ◆ Steel Mesh **A9**
 - ◆ Gray **G2**
 - ◆ White **G1**

L2 LAMINATES CODES

- Woodgrain**
- ◆ Beigewood **LWBE**
 - ◆ Fawn Cypress **LFC1**
 - ◆ Lowell Ash **LLA1**
 - ◆ Natural Recon **LNRI**
 - ◆ Phantom Ecrú **LPE1**
 - ◆ Portico Teak **LPT1**
 - ◆ Skyline Walnut **LSW1**

EDGE BAND

EDGE BAND 2mm CODES

- ◆ Beigewood **DE**
- ◆ Black **P**
- ◆ Bourbon Cherry **H**
- ◆ Brownstone **EY**
- ◆ Charcoal **S**
- ◆ Cognac **COGN**
- ◆ Designer White **DW**
- ◆ Fawn Cypress **FC**
- ◆ Field Elm **FE**
- ◆ Florence Walnut **FW**
- ◆ Fossil **EH**
- ◆ Greige **R**
- ◆ Harvest **C**
- ◆ Kingswood Walnut **KI**
- ◆ Loft **LOFT**
- ◆ Lowell Ash **DL**
- ◆ Mahogany **N**
- ◆ Mocha **MOCH**
- ◆ Muslin **T**
- ◆ Natural Maple **D**
- ◆ Natural Recon **NR**
- ◆ Phantom Ecrú **PE**
- ◆ Pinnacle **PINC**
- ◆ Platinum **K**
- ◆ Portico Teak **DP**
- ◆ Shaker Cherry **F**
- ◆ Skyline Walnut **SW**
- ◆ Sterling Ash **SA**

ERGO

ERGO-EDGE CODES

- ◆ Black **P**
- ◆ Platinum **K**

PAINT

PAINT CODES

- P1**
- ◆ Black **P**
 - ◆ Brownstone **P7D**
 - ◆ Charcoal **S**
 - ◆ Charblack **CBK**
 - ◆ Designer White **PJW**
 - ◆ Fossil **P28**
 - ◆ Loft **LOFT**
 - ◆ Muslin **T3**
 - ◆ Putty **L**
 - ◆ Textured Platinum Metallic **PLAT**
 - ◆ Titanium **P8T**
- P2**
- ◆ Champagne Metallic **T4**
 - ◆ Platinum Metallic **T1**
 - ◆ Silver **PR6**
 - ◆ Solar Black **P8X**
 - ◆ Textured Silver **PR8**
- P3**
- ◆ Atom **P8S**
 - ◆ Bullseye **PJF**
 - ◆ Ember **P8P**
 - ◆ Ion **P8N**
 - ◆ Iris **P8J**
 - ◆ Krypton **P8F**
 - ◆ Regatta **P8M**

Recommended Edgeband Color Selection:

Laminate		Edgeband	
Bourbon Cherry	H	Bourbon Cherry	H
Cognac	COGN	Cognac	COGN
Florence Walnut	LFW1	Florence Walnut	FW
Harvest	C	Harvest	C
Kingswood Walnut	LKI1	Kingswood Walnut	KI
Mahogany	N	Mahogany	N
Mocha	MOCH	Mocha	MOCH
Natural Maple	D	Natural Maple	D
Pinnacle	PINC	Pinnacle	PINC
Shaker Cherry	F	Shaker Cherry	F
Sterling Ash	LSA1	Sterling Ash	SA
Black	P	Black	P
Charcoal	S	Charcoal	S
Designer White	LDW1	Designer White	DW
Handspun Chestnut	LAHC	Brownstone	EY
Handspun Dove	LAHD	Fossil	EH
Handspun Pearl	LAHP	Fossil	EH
Handspun Slate	LAHS	Charcoal	S
Silver Mesh	B9	Loft	LOFT
Steel Mesh	A9	Charcoal	S
Gray	G2	Charcoal	S
White	G1	Charcoal	S
Lowell Ash	LLA1	Lowell Ash	DL
Natural Recon	LNRI	Natural Recon	NR
Phantom Ecrú	LPE1	Phantom Ecrú	PE
Portico Teak	LPT1	Portico Teak	DP
Skyline Walnut	LSW1	Skyline Walnut	SW
Loft	LOFT	Loft	LOFT

- Edge Treatments** • HOW TO ORDER
- 1) Select desired model numbers.
 - 2) Select desired top edge treatment.
 - 3) Replace the (?) after each model number with the suffix representing the chosen top edge treatment.



"G" 2mm Edge



"R" Ergo Edge

◆◆◆ For lead time information see page 21.

4-TRAC HARDWIRE ELECTRICAL SYSTEM

4-Trac Electrical System

The 4-Trac Electrical System is a UL-recognized Manufactured Wiring System that seamlessly passes power from one worksurface to another. This low-profile non-sequential electrical system allows tables to be “daisy-chained” together in any desired order and allows users to reconfigure quickly due to simple connectable/disconnectable links.

- Meets requirements of UL 183 and National Electric Code Article 604
- 4-Wires, 2-circuits, 20 Amps each (Circuit 1 and Circuit 2 only)
- 13 Duplex Receptacles per circuit, 26, 15 Amp Duplex receptacle per power in-feed
- Electrical system attaches directly to underside of worksurface with included brackets
- Up to twelve tables can be linked together
- For compatible 4-Trac Electrical solutions, see page 247.

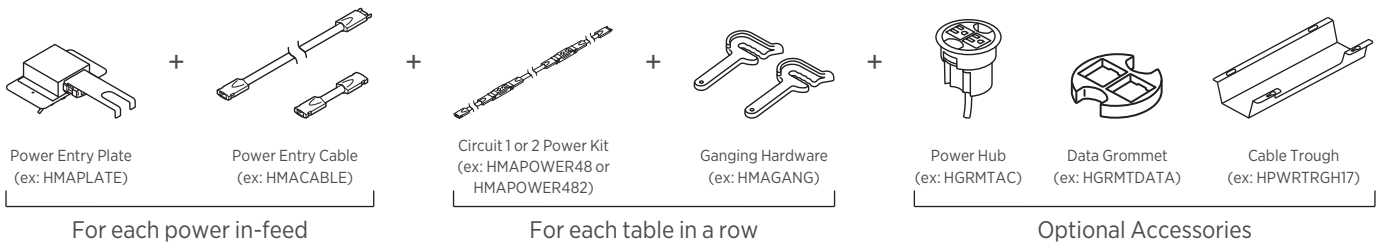

Steps for Electrical Specifications:

- Determine how many rows of tables are needed and order the following:
 - One HMAPLATE per row (or power in-feed)
 - One HMAPOWER482 per row (or power in-feed)
- Order one power harness per table in each row
 - For 1-6 tables in a row (see illustration 1)
 - Order Circuit 1 Power Harnesses (ex. If powering six 24x60 tables order six sets of HMAPOWER60)
 - For 7-12 tables in a row (see illustration 1)
 - Order Circuit 1 Power Harness for first six tables and Circuit 2 Power Harness for remaining tables (ex. If powering eight 24x60 tables, order six sets of HMAPOWER60 and two sets of HMAPOWER602)
- Order one set of ganging hardware per table (ex. HMAGANG)
- Determine which accessories are needed:
 - Power Hub model HGRMTAC — to access power at worksurface.
 - Data Grommet model HGRMTDATA — to access data at worksurface.
 - Wire Management strips model HBTMS — for vertical and horizontal wire management.

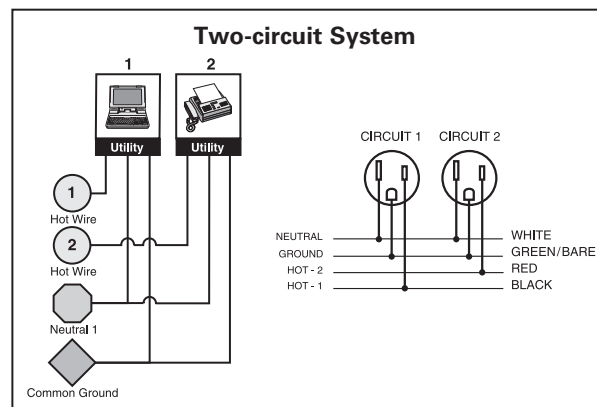
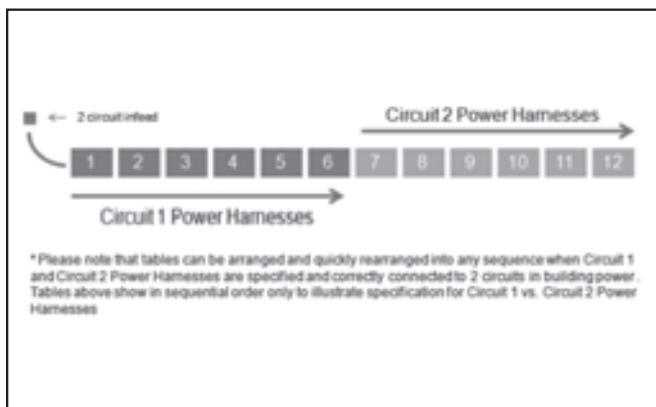

MOTIVATE® Fixed Height Tables





DESCRIPTION	MODEL	SHIP WEIGHT	CUBE	LIST PRICE BY LAMINATE GRADE					
				"G" 2MM EDGE		"R" ERGO EDGE			
				L1	L2	L1	L2		
Rectangular Tables, Fixed Base									
72"W x 18"D	HMVR-1872(?) -FX	80	6.6	\$1238	\$1256	\$1637	\$1655		
60"W x 18"D	HMVR-1860(?) -FX	70	6.0	\$1139	\$1157	\$1486	\$1504		
48"W x 18"D	HMVR-1848(?) -FX	54	5.3	\$1129	\$1142	\$1441	\$1454		
96"W x 24"D	HMVR-2496(?) -FX	118	8.8	\$1584	\$1613	N/A	N/A		
84"W x 24"D	HMVR-2484(?) -FX	109	8.1	\$1520	\$1549	N/A	N/A		
72"W x 24"D	HMVR-2472(?) -FX	96	7.3	\$1263	\$1286	\$1684	\$1707		
66"W x 24"D	HMVR-2466(?) -FX	90	7.3	\$1239	\$1262	N/A	N/A		
60"W x 24"D	HMVR-2460(?) -FX	83	6.6	\$1211	\$1234	\$1591	\$1614		
54"W x 24"D	HMVR-2454(?) -FX	71	6.6	\$1188	\$1211	N/A	N/A		
48"W x 24"D	HMVR-2448(?) -FX	65	5.8	\$1162	\$1180	\$1503	\$1521		
42"W x 24"D	HMVR-2442(?) -FX	60	5.4	\$1137	\$1155	N/A	N/A		
36"W x 24"D	HMVR-2436(?) -FX	54	5.1	\$1117	\$1135	N/A	N/A		
96"W x 30"D	HMVR-3096(?) -FX	145	10.7	\$1715	\$1744	N/A	N/A		
84"W x 30"D	HMVR-3084(?) -FX	131	10.7	\$1700	\$1729	N/A	N/A		
72"W x 30"D	HMVR-3072(?) -FX	115	9.8	\$1378	\$1401	\$1824	\$1847		
66"W x 30"D	HMVR-3066(?) -FX	108	9.8	\$1340	\$1363	N/A	N/A		
60"W x 30"D	HMVR-3060(?) -FX	100	8.9	\$1307	\$1330	\$1716	\$1739		
54"W x 30"D	HMVR-3054(?) -FX	87	8.9	\$1283	\$1306	N/A	N/A		
48"W x 30"D	HMVR-3048(?) -FX	80	7.9	\$1265	\$1283	\$1624	\$1642		
42"W x 30"D	HMVR-3042(?) -FX	73	7.4	\$1234	\$1252	N/A	N/A		
36"W x 30"D	HMVR-3036(?) -FX	65	6.9	\$1210	\$1228	N/A	N/A		
72"W x 36"D	HMVR-3672(?) -FX	131	10.8	\$1577	\$1606	N/A	N/A		
60"W x 36"D	HMVR-3660(?) -FX	114	9.7	\$1463	\$1492	N/A	N/A		
48"W x 36"D	HMVR-3648(?) -FX	91	9.7	\$1366	\$1389	N/A	N/A		
Half-Round Tables, Fixed Base									
72"W x 36"D	HMVH-3672(?) -FX	103	10.8	\$1642	\$1671	N/A	N/A		
60"W x 30"D	HMVH-3060(?) -FX	75	7.6	\$1280	\$1309	\$1716	\$1745		
48"W x 24"D	HMVH-2448(?) -FX	56	5.8	\$1195	\$1218	\$1563	\$1586		

NOTES:

- Specification includes top and base, however, top and base are boxed separately.
- Ergo edge is a bullnose on user side and 3mm on all other sides.
- Tops are 1 1/8" thick.
- Fixed Height base is standard 29 1/2" seated-height.
- See grommet matrix on page 244 for grommet location/placement.
- 36"-42" tops and all half-round and trapezoid tops standard with one 3" round grommet, 48"-96" tops standard with two 3" round grommets. When G1 grommet is selected, all tops standard with one cutout.
- For compatible 4-Trac Electrical solutions, see page 247.
- For compatible Interlink IQ Electrical solutions, see page 245.

HOW TO SPECIFY

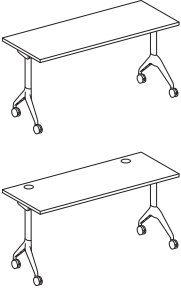
Select Model Number	Select Grommet Option	Select Laminate	Select Edge Color	Select Caster/Glide Option	Select Base Paint Color
<p>N No Grommet G Grommet (+ \$17 PER grommet) G1 Electrical Port (+ \$46)</p>	See page 66	See page 66	See page 66	<p>C Multi-Surface Caster G Glide</p>	See page 66 (+ \$23 per model, for P2 paint)
H M V R - 1 8 7 2 G - F X .	N .	C .	C .	T .	C .

	DESCRIPTION	MODEL	SHIP WEIGHT	CUBE	LIST PRICE BY LAMINATE GRADE				
					"G" 2MM EDGE		"R" ERGO EDGE		
					L1	L2	L1	L2	
	Rectangular Nesting Tables								
	72"W x 18"D	HMVR-1872(?) -NS	90	8.5	\$1630	\$1648	\$2029	\$2047	
	60"W x 18"D	HMVR-1860(?) -NS	79	7.6	\$1526	\$1544	\$1853	\$1871	
	48"W x 18"D	HMVR-1848(?) -NS	60	6.5	\$1520	\$1533	\$1825	\$1838	
	96"W x 24"D	HMVR-2496(?) -NS	134	11.4	\$1950	\$1979	N/A	N/A	
	84"W x 24"D	HMVR-2484(?) -NS	122	10.4	\$1912	\$1941	N/A	N/A	
	72"W x 24"D	HMVR-2472(?) -NS	106	9.2	\$1655	\$1678	\$2076	\$2099	
	66"W x 24"D	HMVR-2466(?) -NS	100	9.1	\$1626	\$1649	N/A	N/A	
	60"W x 24"D	HMVR-2460(?) -NS [Ⓞ]	92	8.2	\$1598	\$1621	\$1978	\$2001	
	54"W x 24"D	HMVR-2454(?) -NS	80	8.2	\$1580	\$1603	N/A	N/A	
	48"W x 24"D	HMVR-2448(?) -NS	73	7.2	\$1546	\$1564	\$1887	\$1905	
	42"W x 24"D	HMVR-2442(?) -NS	67	6.6	\$1524	\$1542	N/A	N/A	
	36"W x 24"D	HMVR-2436(?) -NS	60	6.3	\$1501	\$1519	N/A	N/A	
	96"W x 30"D	HMVR-3096(?) -NS	161	13.3	\$2132	\$2161	N/A	N/A	
	84"W x 30"D	HMVR-3084(?) -NS	144	13.0	\$2117	\$2146	N/A	N/A	
	72"W x 30"D	HMVR-3072(?) -NS	125	11.7	\$1795	\$1818	\$2241	\$2264	
	66"W x 30"D	HMVR-3066(?) -NS	118	11.6	\$1752	\$1775	N/A	N/A	
	60"W x 30"D	HMVR-3060(?) -NS	109	10.5	\$1719	\$1742	\$2111	\$2134	
54"W x 30"D	HMVR-3054(?) -NS	96	10.5	\$1700	\$1723	N/A	N/A		
48"W x 30"D	HMVR-3048(?) -NS	88	9.3	\$1674	\$1692	\$2033	\$2051		
42"W x 30"D	HMVR-3042(?) -NS	80	8.1	\$1646	\$1664	N/A	N/A		
36"W x 30"D	HMVR-3036(?) -NS	71	8.1	\$1619	\$1637	N/A	N/A		
72"W x 36"D	HMVR-3672(?) -NS	141	12.7	\$1994	\$2023	N/A	N/A		
60"W x 36"D	HMVR-3660(?) -NS	123	11.3	\$1875	\$1904	N/A	N/A		
48"W x 36"D	HMVR-3648(?) -NS	99	11.1	\$1775	\$1798	N/A	N/A		
	Half-Round Nesting Tables								
	72"W x 36"D	HMVH-3672(?) -NS	111	12.2	\$2051	\$2080	N/A	N/A	
	60"W x 30"D	HMVH-3060(?) -NS	82	8.8	\$1771	\$1800	\$2207	\$2236	
	48"W x 24"D	HMVH-2448(?) -NS	62	7.0	\$1579	\$1602	\$1947	\$1970	

NOTES:

- Ergo edge is a bullnose on user side and 3mm on all other sides.
- Tops are 1 1/8" thick.
- Specification includes top and base, however, top and base are boxed separately.
- See grommet matrix on page 244 for grommet location/placement.
- 36"-42" tops and all half-round and trapezoid tops standard with one 3" round grommet, 48"-96" tops standard with two 3" round grommets. When G1 grommet is selected, all tops standard with one cutout.
- For compatible 4-Trac Electrical solutions, see page 247.
- For compatible Interlink IQ Electrical solutions, see page 245.

HOW TO SPECIFY

Select Model Number	Select Grommet Option	Select Laminate	Select Edge Color	Select Caster/Glide Option	Select Base Paint Color
	N No Grommet G Grommet (+ \$17 PER grommet) G1 Electrical Port (+ \$46)	See page 66	See page 66	C Multi-Surface Caster G Glide	See page 66 (+ \$23 per model, for P2 paint)
H M V R - 1 8 7 2 G - N S .	N .	C .	C .	C .	T 1

MOTIVATE® Adjustable Height Tables

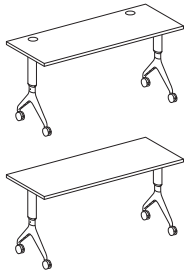

DESCRIPTION	MODEL	SHIP WEIGHT	CUBE	LIST PRICE BY LAMINATE GRADE			
				"G" 2MM EDGE		"R" ERGO EDGE	
				L1	L2	L1	L2
Rectangular Tables, Adjustable Height Base							
72"W x 18"D	HMVR-1872(?) -AH	83	6.6	\$1611	\$1629	\$2010	\$2028
60"W x 18"D	HMVR-1860(?) -AH	73	6.0	\$1512	\$1530	\$1859	\$1877
48"W x 18"D	HMVR-1848(?) -AH	57	5.3	\$1502	\$1515	\$1814	\$1827
72"W x 24"D	HMVR-2472(?) -AH	99	7.3	\$1636	\$1659	\$2057	\$2080
66"W x 24"D	HMVR-2466(?) -AH	93	7.3	\$1612	\$1635	N/A	N/A
60"W x 24"D	HMVR-2460(?) -AH	86	6.6	\$1584	\$1607	\$1964	\$1987
54"W x 24"D	HMVR-2454(?) -AH	74	6.6	\$1561	\$1584	N/A	N/A
48"W x 24"D	HMVR-2448(?) -AH	68	5.8	\$1535	\$1553	\$1876	\$1894
42"W x 24"D	HMVR-2442(?) -AH	63	5.4	\$1510	\$1528	N/A	N/A
36"W x 24"D	HMVR-2436(?) -AH	57	5.1	\$1490	\$1508	N/A	N/A
72"W x 30"D	HMVR-3072(?) -AH	118	9.8	\$1775	\$1798	\$2221	\$2244
66"W x 30"D	HMVR-3066(?) -AH	111	9.8	\$1737	\$1760	N/A	N/A
60"W x 30"D	HMVR-3060(?) -AH	103	8.9	\$1704	\$1727	\$2113	\$2136
54"W x 30"D	HMVR-3054(?) -AH	90	8.9	\$1680	\$1703	N/A	N/A
48"W x 30"D	HMVR-3048(?) -AH	83	7.9	\$1662	\$1680	\$2021	\$2039
42"W x 30"D	HMVR-3042(?) -AH	76	7.4	\$1631	\$1649	N/A	N/A
36"W x 30"D	HMVR-3036(?) -AH	68	6.9	\$1607	\$1625	N/A	N/A
72"W x 36"D	HMVR-3672(?) -AH	134	10.8	\$1974	\$2003	N/A	N/A
60"W x 36"D	HMVR-3660(?) -AH	117	9.7	\$1860	\$1889	N/A	N/A
48"W x 36"D	HMVR-3648(?) -AH	94	9.7	\$1763	\$1786	N/A	N/A

NOTES:

- Ergo edge is a bullnose on user side and 3mm on all other sides.
 - Tops are 1 1/8" thick.
 - Specification includes top and base, however, top and base are boxed separately.
 - Seated height adjustment from 27 1/2" - 32 1/2" in 1" increments.
 - See grommet matrix on page 244 for grommet location/placement.
 - 36"-42" tops and all half-round and trapezoid tops standard with one 3" round grommet, 48"-96" tops standard with two 3" round grommets. When G1 grommet is selected, all tops standard with one cutout.
 - For compatible 4-Trac Electrical solutions, see page 247.
 - For compatible Interlink IQ Electrical solutions, see page 245.
- ! No tool required, adjustable bases have ratchet style adjustment mechanism.



HOW TO SPECIFY

<p>Select Model Number</p> <p>HMVR-1872G-AH</p>	<p>Select Grommet Option</p> <p>N No Grommet G Grommet (+ \$17 PER grommet) G1 Electrical Port (+ \$46)</p> <p>N</p>	<p>Select Laminate</p> <p>See page 66</p> <p>C</p>	<p>Select Edge Color</p> <p>See page 66</p> <p>C</p>	<p>Select Caster/Glide Option</p> <p>C Multi-Surface Caster G Glide</p> <p>C</p>	<p>Select Base Paint Color</p> <p>See page 66 (+ \$23 per model, for P2 paint)</p> <p>P</p>
--	---	---	---	---	--

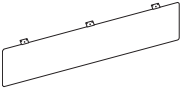

Icon Legend on page 19

MOTIVATE® Shared Components

DESCRIPTION	MODEL	SHIP WEIGHT	CUBE	LIST PRICE BY PAINT GRADE	
				P1	P2
 Universal Modesty Panel For 96"W Motivate® Tables For 84"W Motivate® Tables For 72"W Motivate® Tables For 66"W Motivate® Tables For 60"W Motivate® Tables For 54"W Motivate® Tables For 48"W Motivate® Tables For 42"W Motivate® Tables For 36"W Motivate® Tables	HMTUMOD86	21	4.8	\$367	\$390
	HMTUMOD74	20	4.4	\$356	\$379
	HMTUMOD62	17	3.6	\$342	\$365
	HMTUMOD56	16	3.4	\$330	\$353
	HMTUMOD50 	14	3.1	\$318	\$341
	HMTUMOD44	12	2.5	\$305	\$328
	HMTUMOD38	11	2.2	\$291	\$314
	HMTUMOD32	9	1.9	\$281	\$304
	HMTUMOD26	8	1.7	\$267	\$290

NOTES:

- Modesty Panels are hinged to nest along with Nesting Tables. Modesty Panels can be used with all base types.
- ! Use field installed Table Modesty Panels with all table widths 36"-96". Cannot be used with Half-Round or Trapezoid tables.

HOW TO SPECIFY

<p>Select Model Number</p> <p>HMTUMOD86</p>	<p>Select Paint Color</p> <p>See page 66 (+\$23 per model, for P2 paint)</p> <p>T1</p>
--	---

MOTIVATE® Shared Components



Icon Legend on page 19

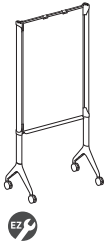

DESCRIPTION

Mobile Markerboard

36"W x 72"H
30"W x 72"H

Actual Markerboard size:
HMVMB-3672WW – 36¼"W x 42"H
HMVMB-3072WW – 30¼"W x 42"H

NOTES: 2-Sided Mobile Markerboard is porcelain over steel with four locking casters. Mobile Markerboard includes marker tray and flip-chart paper clips.

Porcelain Markerboard cleaning instructions: For everyday cleaning, use Clorox wipes. Use a citrus cleaner if a permanent marker is used by accident.

⚠ A citrus cleaner is not recommended for everyday use as it leaves residue.

⚠ (+ \$23, for P2 paint)

Specify Model.Base.Casters.Paint SPECIFYING EXAMPLE: HMVMB-3072WW.C.P

MODEL

SHIP WEIGHT

CUBE

LIST PRICE

HMVMB-3672WW	59	7.9	\$1920
HMVMB-3072WW	53	7.1	\$1884

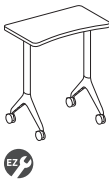

Presentation Cart, Concave Front, Fixed Leg

18"D x 30"W x 35"H, 2mm Edge
18"D x 30"W x 35"H, Ergo Edge

NOTES: Presentation Cart tops are 1⅝" thick with a concave user side. Choose from a 2mm or Ergo edge.

⚠ (+ \$13, for L2 laminates)

⚠ (+ \$23, for P2 paint)

Specify Model.Caster.TopLaminate.EdgeColor.Paint SPECIFYING EXAMPLE: HMVPCF-1830G.C.D.D.T1

HMVPCF-1830G	38	3.9	\$1178
HMVPCF-1830R	38	3.9	\$1593



Presentation Cart, Concave Front, Seated Height Adjustable-Leg

18"D x 30"W x 27½"-34½"H, 2mm Edge
18"D x 30"W x 27½"-34½"H, Ergo Edge

HMVPCA1-1830G Ⓢ	40	3.9	\$1553
HMVPCA1-1830R	40	3.9	\$1985

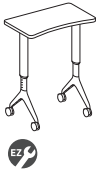

Presentation Cart, Concave Front, Standing-Height Adjustable-Leg

18"D x 30"W x 31½"-38½"H, 2mm Edge
18"D x 30"W x 31½"-38½"H, Ergo Edge

NOTES: Presentation Cart tops are 1⅝" thick with a concave user side. Choose from a 2mm or Ergo edge.

⚠ (+ \$13, for L2 laminates)

⚠ (+ \$23, for P2 paint)

Specify Model.Caster.TopLaminate.EdgeColor.Paint SPECIFYING EXAMPLE: HMVPCA1-1830G.C.D.D.T1

HMVPCA2-1830G	42	3.9	\$1553
HMVPCA2-1830R	42	3.9	\$1985



Presentation Cart, Modesty Panel

Specify Model.Paint SPECIFYING EXAMPLE: HMVPC-MP.P

HMVPC-MP	6	1.4	\$242
-----------------	---	-----	--------------



Presentation Cart, Storage Shelves

Single, 4" Open Back
Double, 4" Open Back / 4" Closed Back
Double, 4" Open Back / 9" Closed Back
Single, 4" Closed Back
Double, 4" Closed Back / 4" Closed Back
Double, 4" Closed Back / 9" Closed Back

HMVPCSS-40	8	1.4	\$124
HMVPCSS-404C	17	2.6	\$251
HMVPCSS-409C	20	3.6	\$392
HMVPCSS-4C	9	1.4	\$135
HMVPCSS-4C4C Ⓢ	18	2.6	\$263
HMVPCSS-4C9C	21	3.6	\$403

NOTES: Storage Shelves for Presentation Carts are available in three preconfigured sizes and may be used on fixed or adjustable height models.

Specify Model.Paint SPECIFYING EXAMPLE: HMVPCSS-40.T1



Presentation Cart Desk Top Lectern, 2mm Edge

NOTES: Desk Top Lectern may be used on the Presentation Cart or is removable for use on table tops.

⚠ (+ \$18, for L2 laminates)

⚠ Desktop Lectern only available with 2mm edge.

Specify Model.LaminateTop.EdgeColor.Paint SPECIFYING EXAMPLE: HMVPC-DTLG.D.D.T1

HMVPC-DTLG	16	2.4	\$450
-------------------	----	-----	--------------

HOW TO SPECIFY

Select Model Number

H M V M B - 3 6 7 2 W W



Preside® Tables shown with
Ruck™ and SoCo™ seating.

PRESIDE®

Whether you're craving social interaction or breaking away for some "me time", Preside tables support the work activities you need to get it done. Versatile enough for touchdown spaces, meeting rooms, and even cafés, Preside offers everything from a contemporary light-scale vibe to a more classic aesthetic. Add in optional power for a dynamic table collection that lets you work your way.



FEATURES

- Preside offers a complete line of conference accessories, including presentation cabinets, hospitality and more.
- Optional flip-top and pop-up ports provide options today and for future data and power needs.
- Scratch-, spill- and stain-resistant laminate will look great for years to come.
- Add a splash of color to Preside using Colorwav™ paints to brighten any space.
- Enhanced aesthetics with power management options to keep the workspace tidy and looking its best.
- Preside's clever equitable meeting worksurface shapes are designed to seamlessly accommodate both in-person and virtual meeting participants.

PRESIDE® ORDERING INFORMATION

LAMINATE GROUP A

L1 LAMINATES CODES

- Woodgrain**
- ◆ Bourbon Cherry H
 - ◆ Cognac COGN
 - ◆ Field Elm LWFE
 - ◆ Florence Walnut LFW1
 - ◆ Harvest C
 - ◆ Kingswood Walnut LK11
 - ◆ Mahogany N
 - ◆ Mocha MOCH
 - ◆ Natural Maple D
 - ◆ Pinnacle PINC
 - ◆ Shaker Cherry F
 - ◆ Sterling Ash LSA1

- Solid**
- ◆ Black P
 - ◆ Charcoal S
 - ◆ Designer White LDW1
 - ◆ Loft LOFT

- Patterned**
- ◆ Handspun Chestnut LAHC
 - ◆ Handspun Dove LAHD
 - ◆ Handspun Pearl LAHP
 - ◆ Handspun Slate LAHS
 - ◆ Silver Mesh B9
 - ◆ Steel Mesh A9
 - ◆ Gray G2
 - ◆ White G1

L2 LAMINATES CODES

- Woodgrain**
- ◆ Beigewood LWBE
 - ◆ Fawn Cypress LFC1
 - ◆ Lowell Ash LLA1
 - ◆ Natural Recon LNR1
 - ◆ Phantom Ecru LPE1
 - ◆ Portico Teak LPT1
 - ◆ Skyline Walnut LSW1

LAMINATE GROUP B

L1 LAMINATES CODES

- Woodgrain**
- ◆ Bourbon Cherry H
 - ◆ Cognac COGN
 - ◆ Field Elm LWFE
 - ◆ Florence Walnut LFW1
 - ◆ Harvest C
 - ◆ Kingswood Walnut LK11
 - ◆ Mahogany N
 - ◆ Mocha MOCH
 - ◆ Natural Maple D
 - ◆ Pinnacle PINC
 - ◆ Shaker Cherry F
 - ◆ Sterling Ash LSA1

- Solid**
- ◆ Black P
 - ◆ Charcoal S
 - ◆ Designer White LDW1
 - ◆ Loft LOFT

L2 LAMINATES CODES

- Woodgrain**
- ◆ Beigewood LWBE
 - ◆ Fawn Cypress LFC1
 - ◆ Lowell Ash LLA1
 - ◆ Natural Recon LNR1
 - ◆ Phantom Ecru LPE1
 - ◆ Portico Teak LPT1
 - ◆ Skyline Walnut LSW1

LAMINATE GROUP C

L1 LAMINATES CODES

- Woodgrain**
- ◆ Bourbon Cherry H
 - ◆ Cognac COGN
 - ◆ Field Elm LWFE
 - ◆ Florence Walnut LFW1
 - ◆ Harvest C
 - ◆ Kingswood Walnut LK11
 - ◆ Mahogany N
 - ◆ Mocha MOCH
 - ◆ Natural Maple D
 - ◆ Pinnacle PINC
 - ◆ Shaker Cherry F
 - ◆ Sterling Ash LSA1

- Solid**
- ◆ Black P
 - ◆ Charcoal S
 - ◆ Designer White LDW1
 - ◆ Loft LOFT

L2 LAMINATES CODES

- Woodgrain**
- ◆ Beigewood LWBE
 - ◆ Fawn Cypress LFC1
 - ◆ Lowell Ash LLA1
 - ◆ Natural Recon LNR1
 - ◆ Phantom Ecru LPE1
 - ◆ Portico Teak LPT1
 - ◆ Skyline Walnut LSW1

LAMINATE GROUP D

L1 LAMINATES CODES

- Woodgrain**
- ◆ Mahogany N

PAINT GROUP A

P1 CODES

- ◆ Black P
- ◆ Brownstone P7D
- ◆ Charcoal S
- ◆ Cove P096
- ◆ Designer White PJW
- ◆ Dune P094
- ◆ Fossil P28
- ◆ Harbor P097
- ◆ Loft LOFT
- ◆ Muslin T3
- ◆ Sage P095
- ◆ Salt P8C
- ◆ Titanium P8T

P2 CODES

- ◆ Champagne Metallic T4
- ◆ Gunmetal Metallic PR3
- ◆ Platinum Metallic T1
- ◆ Silver PR6
- ◆ Solar Black P8X

P3 CODES

- ◆ Atom P8S
- ◆ Bullseye PJF
- ◆ Ember P8P
- ◆ Ion P8N
- ◆ Iris P8J
- ◆ Krypton P8F
- ◆ Regatta P8M

HON BRANDED FABRICS

GRADE 1

- Apex
- Centurion
- Compass
- Contourett
- Dapper
- Emphasis
- Ensemble
- Hamilton
- Noble Seating
- Pebble
- Vibe

GRADE 2

- Appoint Seating
- Blume
- Clyde
- Haute
- Kai
- Rush
- Spin
- Wavelength
- Whisper Vinyl

GRADE 3

- Bradbury
- Cozy
- Getaway
- Moxie
- Notion
- Parker
- Saxony

GRADE 4

- Constance with Supreen™
- Livi with Supreen™
- Lucerne
- Lugano with Supreen™
- Oxford with Supreen™

NOTES: Fabrics on Preside® bench cushion are upholstered in the railroad direction.

◆◆◆ For lead time information see page 21.

PRESIDE® SPECIFYING INFORMATION

EDGE BAND OPTIONS	CODES	2mm (G)	Knife (J)	T-Mold (E)
Beigewood	DE	•	•	•
Bourbon Cherry	H	•	•	
Cognac	COGN	•	•	•
Fawn Cypress	FC	•	•	•
Field Elm	FE	•	•	•
Florence Walnut	FW	•	•	•
Harvest	C	•	•	
Kingswood Walnut	KI	•	•	•
Light Gray	Q	•	•	•
Mahogany	N	•	•	•
Mocha	MOCH	•	•	•
Natural Maple	D	•	•	
Shaker Cherry	F	•	•	
Sterling Ash	SA	•	•	•
Black	P	•	•	•
Brownstone	EY	•	•	•
Charcoal	S	•	•	•
Designer White	DW	•	•	•
Fossil	EH	•	•	•
Greige	R	•	•	•
Loft	LOFT	•	•	•
Muslin	T	•	•	•
Pinnacle	PINC	•	•	•
Platinum	K	•	•	•
Lowell Ash	DL	•	•	
Natural Recon	NR	•	•	
Phantom Ecu	PE	•	•	
Portico Teak	DP	•	•	•
Skyline Walnut	SW	•	•	•

Recommended Edgeband Color Selection:

Laminate		Edge	
Beigewood	LWBE	Beigewood	DE
Bourbon Cherry	H	Bourbon Cherry	H
Cognac	COGN	Cognac	COGN
Fawn Cypress	LFC1	Fawn Cypress	FC
Field Elm	LWFE	Field Elm	FE
Florence Walnut	LFW1	Florence Walnut	FW
Harvest	C	Harvest	C
Kingswood Walnut	LKI1	Kingswood Walnut	KI
Mahogany	N	Mahogany	N
Mocha	MOCH	Mocha	MOCH
Natural Maple	D	Natural Maple	D
Pinnacle	PINC	Pinnacle	PINC
Shaker Cherry	F	Shaker Cherry	F
Sterling Ash	LSA1	Sterling Ash	SA
Black	P	Black	P
Charcoal	S	Charcoal	S
Designer White	LDW1	Designer White	DW
Handspun Chestnut	LAHC	Brownstone	EY
Handspun Dove	LAHD	Fossil	EH
Handspun Pearl	LAHP	Fossil	EH
Handspun Slate	LAHS	Charcoal	S
Loft	LOFT	Loft	LOFT
Silver Mesh	B9	Loft	LOFT
Steel Mesh	A9	Charcoal	S
Gray	G2	Charcoal	S
White	G1	Charcoal	S
Lowell Ash	LLA1	Lowell Ash	DL
Natural Recon	LNRI	Natural Recon	NR
Phantom Ecu	LPE1	Phantom Ecu	PE
Portico Teak	LPT1	Portico Teak	DP
Skyline Walnut	LSW1	Skyline Walnut	SW

PRESIDE® SPECIFYING INFORMATION

Statement of Line

TOP SHAPES

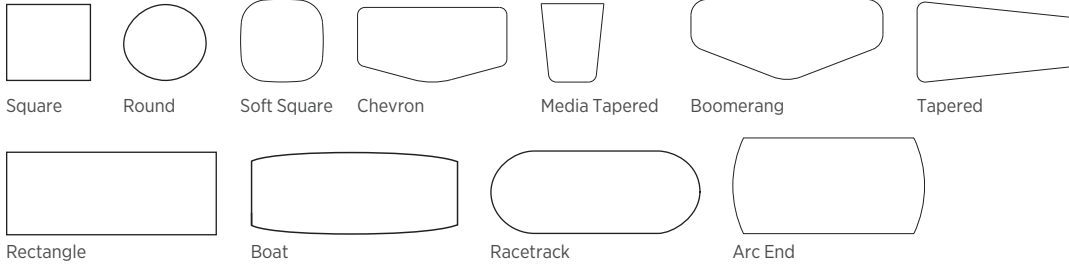

TOP EDGE PROFILES

For Laminate Tops

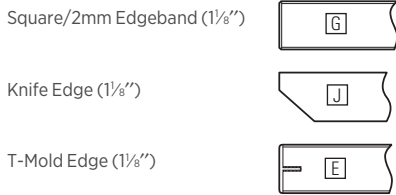

BASES

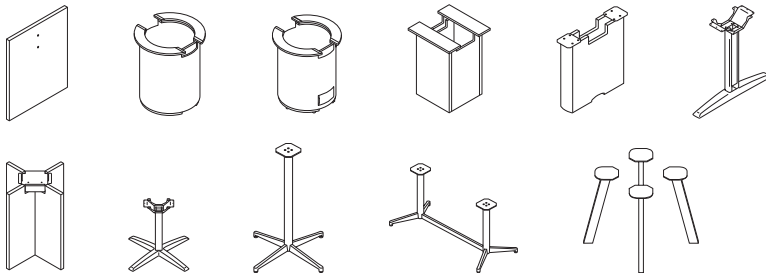

ANCILLARY COMPONENTS

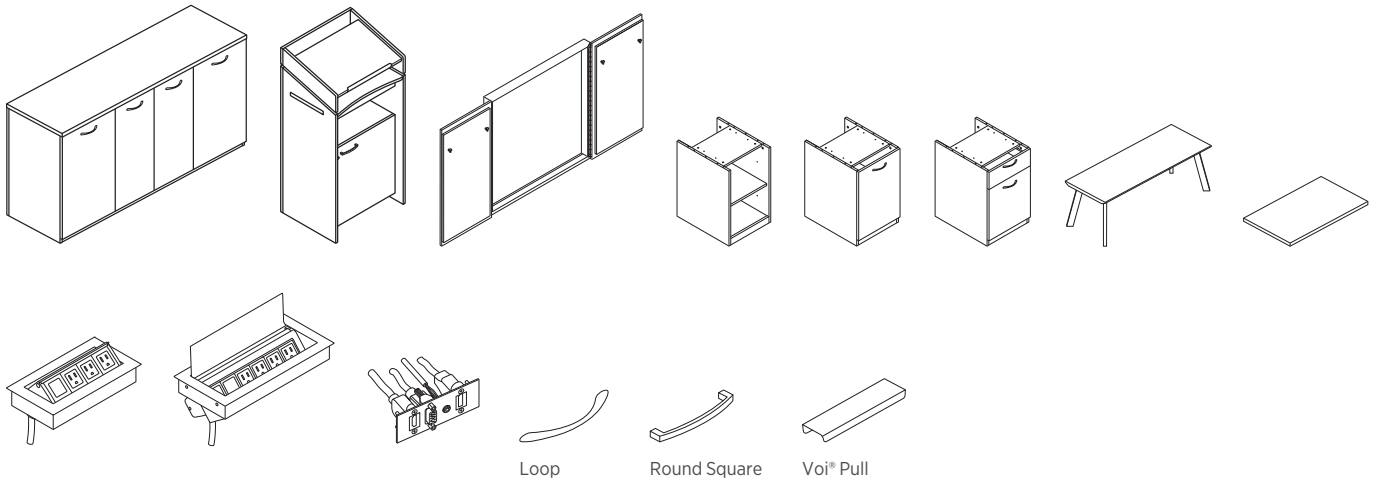





PRESIDE® SPECIFYING INFORMATION

Preside conference tops come in single piece or multi-piece sections depending on specified size. See below for top sizes, sections, and suggested seating capacity.





Product Reference: Sizes, Sections, Seating Capacity

Multi-piece tops: Rectangle, Racetrack, Boat, and Arc End Tops.



















Notes: Single- and two-piece tops ship in one carton, three-piece tops ship in two cartons.
Three-piece tops and larger will not contain grain match for all pieces.

	Feet	Inches	42"D	48"D	54"D	Suggested Capacity
	30	360"	6 6 6 6 6	6 6 6 6 6	6 6 6 6 6	28-30
	28	336"	5 6 6 6 5	5 6 6 6 5	5 6 6 6 5	26-28
	26	312"	7 6 6 7	7 6 6 7	7 6 6 7	24-26
	24	288"	6 6 6 6	6 6 6 6	6 6 6 6	22-24
	22	264"	5 6 6 5	5 6 6 5	5 6 6 5	20-22
	20	240"	7 6 7	7 6 7	7 6 7	18-20
	18	216"	6 6 6	6 6 6	6 6 6	16-18
	16	192"	5 6 5	5 6 5	5 6 5	14-16
	15	180"	4½ 6 4½	4½ 6 4½	4½ 6 4½	14-16
	14	168"	7 7	7 7	7 7	12-14
	12	144"	6 6	6 6	6 6	10-12
	10	120"	5 5	5 5	5 5	8-10
	9	108"	4½ 4½	4½ 4½	4½ 4½	8-10

Single-piece tops: Rectangle, Racetrack, Boat, and Arc End Tops

	Feet	Inches	30"D	36"D	42"D	48"D	Suggested Capacity
	8	96"			8	8	6-8
	7	84"			7		4-6
	6	72"		6			4-6
	5	60"	5				4-6

Single-piece tops: Round, Square, and Soft Square

		24"	30"	36"	42"	48"	60"*	Suggested Capacity
	Round							2-4 (*2-5)
	Square							2-4
	Soft Square							2-4

PRESIDE® SPECIFYING INFORMATION

Material	Type	Shape	Size						
			24"	30"	36"	42"	48"	60"	
Laminate	Cylinder	Round	N/A	N/A	<ul style="list-style-type: none"> ○ ○ ○ ○ ● ○ ○ ○ ○ ● ○ ○ ○ ○ 	<ul style="list-style-type: none"> ○ ○ ○ ○ ● ○ ○ ○ ○ ● ○ ○ ○ ○ 	<ul style="list-style-type: none"> ○ ○ ○ ○ ● ○ ○ ○ ○ ● ○ ○ ○ ○ 	N/A	
		Square	N/A	N/A	<ul style="list-style-type: none"> ○ ○ ○ ○ ● ○ ○ ○ ○ ● ○ ○ ○ ○ 	<ul style="list-style-type: none"> ○ ○ ○ ○ ● ○ ○ ○ ○ ● ○ ○ ○ ○ 	<ul style="list-style-type: none"> ○ ○ ○ ○ ● ○ ○ ○ ○ ● ○ ○ ○ ○ 		
		Soft Square	N/A	N/A	<ul style="list-style-type: none"> ○ ○ ○ ○ ● ○ ○ ○ ○ ● ○ ○ ○ ○ 	<ul style="list-style-type: none"> ○ ○ ○ ○ ● ○ ○ ○ ○ ● ○ ○ ○ ○ 	<ul style="list-style-type: none"> ○ ○ ○ ○ ● ○ ○ ○ ○ ● ○ ○ ○ ○ 		
	Cube	Round	N/A	N/A	N/A	N/A	<ul style="list-style-type: none"> ○ ○ ○ ○ ● ○ ○ ○ ○ ● ○ ○ ○ ○ 	<ul style="list-style-type: none"> ○ ○ ○ ○ ● ○ ○ ○ ○ ● ○ ○ ○ ○ 	<ul style="list-style-type: none"> ○ ○ ○ ○ ● ○ ○ ○ ○ ● ○ ○ ○ ○
		Square	N/A	N/A	N/A	N/A	<ul style="list-style-type: none"> ○ ○ ○ ○ ● ○ ○ ○ ○ ● ○ ○ ○ ○ 	<ul style="list-style-type: none"> ○ ○ ○ ○ ● ○ ○ ○ ○ ● ○ ○ ○ ○ 	
		Soft Square	N/A	N/A	N/A	N/A	<ul style="list-style-type: none"> ○ ○ ○ ○ ● ○ ○ ○ ○ ● ○ ○ ○ ○ 	<ul style="list-style-type: none"> ○ ○ ○ ○ ● ○ ○ ○ ○ ● ○ ○ ○ ○ 	
	X-Base	Round	N/A	N/A	<ul style="list-style-type: none"> ○ ○ ○ ○ ● ○ ○ ○ ○ ● ○ ○ ○ ○ 	<ul style="list-style-type: none"> ○ ○ ○ ○ ● ○ ○ ○ ○ ● ○ ○ ○ ○ 	<ul style="list-style-type: none"> ○ ○ ○ ○ ● ○ ○ ○ ○ ● ○ ○ ○ ○ 	N/A	
		Square	N/A	N/A	<ul style="list-style-type: none"> ○ ○ ○ ○ ● ○ ○ ○ ○ ● ○ ○ ○ ○ 	<ul style="list-style-type: none"> ○ ○ ○ ○ ● ○ ○ ○ ○ ● ○ ○ ○ ○ 	<ul style="list-style-type: none"> ○ ○ ○ ○ ● ○ ○ ○ ○ ● ○ ○ ○ ○ 		
		Soft Square	N/A	N/A	<ul style="list-style-type: none"> ○ ○ ○ ○ ● ○ ○ ○ ○ ● ○ ○ ○ ○ 	<ul style="list-style-type: none"> ○ ○ ○ ○ ● ○ ○ ○ ○ ● ○ ○ ○ ○ 	<ul style="list-style-type: none"> ○ ○ ○ ○ ● ○ ○ ○ ○ ● ○ ○ ○ ○ 		
	Traditional X-Base	Round	N/A	N/A	<ul style="list-style-type: none"> ○ ○ ○ ○ ● ○ ○ ○ ○ ● ○ ○ ○ ○ 	<ul style="list-style-type: none"> ○ ○ ○ ○ ● ○ ○ ○ ○ ● ○ ○ ○ ○ 	<ul style="list-style-type: none"> ○ ○ ○ ○ ● ○ ○ ○ ○ ● ○ ○ ○ ○ 	N/A	
		Square	N/A	N/A	<ul style="list-style-type: none"> ○ ○ ○ ○ ● ○ ○ ○ ○ ● ○ ○ ○ ○ 	<ul style="list-style-type: none"> ○ ○ ○ ○ ● ○ ○ ○ ○ ● ○ ○ ○ ○ 	<ul style="list-style-type: none"> ○ ○ ○ ○ ● ○ ○ ○ ○ ● ○ ○ ○ ○ 		
		Soft Square	N/A	N/A	<ul style="list-style-type: none"> ○ ○ ○ ○ ● ○ ○ ○ ○ ● ○ ○ ○ ○ 	<ul style="list-style-type: none"> ○ ○ ○ ○ ● ○ ○ ○ ○ ● ○ ○ ○ ○ 	<ul style="list-style-type: none"> ○ ○ ○ ○ ● ○ ○ ○ ○ ● ○ ○ ○ ○ 		

●	●	●	●
○	○	○	○
<ul style="list-style-type: none"> ● Available ○ Unavailable or Not Compatible ■ Top size does not exist 			

PRESIDE® SPECIFYING INFORMATION

		Rectangle - Boat - Racetrack - Arc End													
Material	Type	Width	60"	72"	84"	96"	108"	120"	144"	168"	180"	192"	216"	240"	72" Adder
		Depth	30"	36"	42"	48"	54"	30"	36"	42"	48"	54"	30"	36"	42"
Painted	Footed Y-Base	30"	●●●●●												
		36"		●●●●●											
		42"			●●●●●	●●●●●	●●●●●	●●●●●	●●●●●	●●●●●	●●●●●	●●●●●	●●●●●	●●●●●	●●●●●
		48"				●●●●●	●●●●●	●●●●●	●●●●●	●●●●●	●●●●●	●●●●●	●●●●●	●●●●●	●●●●●
		54"					N/A	N/A	N/A	N/A	N/A	N/A	N/A	N/A	N/A
	Angled Leg	30"	○●●●●												
		36"		○●●●●											
		42"			○●●●●	○●●●●	○●●●●	○●●●●	○●●●●	○●●●●	○●●●●	○●●●●	○●●●●	○●●●●	○●●●●
		48"				○●●●●	○●●●●	○●●●●	○●●●●	○●●●●	○●●●●	○●●●●	○●●●●	○●●●●	○●●●●
		54"					○●●●●	○●●●●	○●●●●	○●●●●	○●●●●	○●●●●	○●●●●	○●●●●	○●●●●
	T-Leg	30"	○●●●●												
		36"		○●●●●											
		42"			○●●●●	○●●●●	○●●●●	○●●●●	○●●●●	○●●●●	○●●●●	○●●●●	○●●●●	○●●●●	○●●●●
		48"				○●●●●	○●●●●	○●●●●	○●●●●	○●●●●	○●●●●	○●●●●	○●●●●	○●●●●	○●●●●
		54"					○●●●●	○●●●●	○●●●●	○●●●●	○●●●●	○●●●●	○●●●●	○●●●●	○●●●●

	<ul style="list-style-type: none"> ● Available ○ Unavailable or Not Compatible ■ Top size does not exist
--	---

PRESIDE® SPECIFYING INFORMATION

Material	Type	Rectangle - Boat - Racetrack - Arc End													
		Width Depth	60"	72"	84"	96"	108"	120"	144"	168"	180"	192"	216"	240"	72" Adder
Laminate	Panel	30"	● ○ ○ ○ ○ ○	■	■	■	■	■	■	■	■	■	■	■	■
		36"	■	○ ○ ○ ○ ○ ○	■	■	■	■	■	■	■	■	■	■	■
		42"	■	■	○ ○ ○ ○ ○ ○	○ ○ ○ ○ ○ ○	○ ○ ○ ○ ○ ○	○ ○ ○ ○ ○ ○	○ ○ ○ ○ ○ ○	○ ○ ○ ○ ○ ○	○ ○ ○ ○ ○ ○	○ ○ ○ ○ ○ ○	○ ○ ○ ○ ○ ○	○ ○ ○ ○ ○ ○	○ ○ ○ ○ ○ ○
		48"	■	■	○ ○ ○ ○ ○ ○	○ ○ ○ ○ ○ ○	○ ○ ○ ○ ○ ○	○ ○ ○ ○ ○ ○	○ ○ ○ ○ ○ ○	○ ○ ○ ○ ○ ○	○ ○ ○ ○ ○ ○	○ ○ ○ ○ ○ ○	○ ○ ○ ○ ○ ○	○ ○ ○ ○ ○ ○	○ ○ ○ ○ ○ ○
		54"	■	■	○ ○ ○ ○ ○ ○	○ ○ ○ ○ ○ ○	○ ○ ○ ○ ○ ○	○ ○ ○ ○ ○ ○	○ ○ ○ ○ ○ ○	○ ○ ○ ○ ○ ○	○ ○ ○ ○ ○ ○	○ ○ ○ ○ ○ ○	○ ○ ○ ○ ○ ○	○ ○ ○ ○ ○ ○	○ ○ ○ ○ ○ ○
	Hollow Panel	30"	N/A	■	■	■	■	■	■	■	■	■	■	■	■
		36"	■	N/A	■	■	■	■	■	■	■	■	■	■	■
		42"*	■	■	○ ○ ○ ○ ○ ○	○ ○ ○ ○ ○ ○	○ ○ ○ ○ ○ ○	○ ○ ○ ○ ○ ○	○ ○ ○ ○ ○ ○	○ ○ ○ ○ ○ ○	○ ○ ○ ○ ○ ○	○ ○ ○ ○ ○ ○	○ ○ ○ ○ ○ ○	○ ○ ○ ○ ○ ○	○ ○ ○ ○ ○ ○
		48"	■	■	○ ○ ○ ○ ○ ○	○ ○ ○ ○ ○ ○	○ ○ ○ ○ ○ ○	○ ○ ○ ○ ○ ○	○ ○ ○ ○ ○ ○	○ ○ ○ ○ ○ ○	○ ○ ○ ○ ○ ○	○ ○ ○ ○ ○ ○	○ ○ ○ ○ ○ ○	○ ○ ○ ○ ○ ○	○ ○ ○ ○ ○ ○
		54"	■	■	○ ○ ○ ○ ○ ○	○ ○ ○ ○ ○ ○	○ ○ ○ ○ ○ ○	○ ○ ○ ○ ○ ○	○ ○ ○ ○ ○ ○	○ ○ ○ ○ ○ ○	○ ○ ○ ○ ○ ○	○ ○ ○ ○ ○ ○	○ ○ ○ ○ ○ ○	○ ○ ○ ○ ○ ○	○ ○ ○ ○ ○ ○

***NOTE:** With 42" deep Hollow Base will result in decreased leg room at base location.

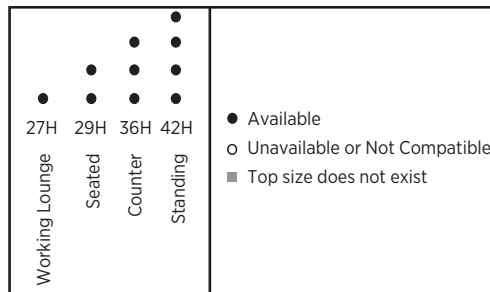

PRESIDE® SPECIFYING INFORMATION

Material	Type	Width Depth	Chevron Tops				Tapered Tops		Boomerang Tops		Media Tapered Tops	
			30" x 60"	30" x 72"	36" x 60"	36" x 72"	48" x 96"	60" x 120"	60" x 144"	60" x 168"	48" x 60"	
Laminate	Cylinder						○ ○ ● ● ○ ● ○ ○				○ ○ ○ ● ● ○ ● ○ ○ HTLR36 & HVPWL BK48	
	Cube						○ ● ● ○ ● ● ● ○ ● ● ●				● ○ ● ● ○ ● ● ● ○ ● ● ● HTLCUBE48 QR HTLCUBES48 paired with HVPWL BK48	
	Panel					○ ○ ● ○ ○ ● ○ ● ○ ● ○ ● ○	○ ○ ● ○ ○ ● ○ ●					
	Hollow Panel					○ ○ ● ○ ○ ● ○ ● ○ ● ○ ● ○					○ ○ ● ○ ○ ● ○ ● ○ ● ○ ● ○ HTLHPB & HVPWL BK48	
Painted	Footed Y			○ ○ ● ○ ○ ● ○ ●	○ ○ ● ○ ○ ● ○ ●	○ ○ ● ○ ○ ● ○ ●	○ ○ ● ○ ○ ● ○ ●					
	Angled Leg	○ ● ○ ● ○ ○ ● ○ ● ○	○ ● ○ ● ○ ○ ● ○ ● ○	○ ● ○ ● ○ ○ ● ○ ● ○	○ ● ○ ● ○ ○ ● ○ ● ○	○ ● ○ ● ○ ○ ● ○ ● ○	○ ● ○ ● ○ ○ ● ○ ● ○	○ ● ○ ● ○ ○ ● ○ ● ○	○ ● ○ ● ○ ○ ● ○ ● ○	○ ● ○ ● ○ ○ ● ○ ● ○	○ ● ○ ● ○ ○ ● ○ ● ○ HT29AL2PK QR HT42AL2PK paired with HVPWL BK48	
	T-Leg	○ ● ○ ● ○ ○ ● ○ ● ○	○ ● ○ ● ○ ○ ● ○ ● ○	○ ● ○ ● ○ ○ ● ○ ● ○	○ ● ○ ● ○ ○ ● ○ ● ○	○ ● ○ ● ○ ○ ● ○ ● ○	○ ● ○ ● ○ ○ ● ○ ● ○	○ ● ○ ● ○ ○ ● ○ ● ○				
	Footed Café X-Base										○ ● ○ ● ○ ○ ● ○ ● ○ HTFX()27/29/36/42 paired with HVPWL BK48	
	Aluminum X-Base										○ ● ○ ● ○ ○ ● ○ ● ○ HTXLEG OR HTXLEGSH paired with HVPWL BK48	

	<ul style="list-style-type: none"> ● Available ○ Unavailable or Not Compatible
--	--

PRESIDE® SPECIFYING INFORMATION

Specify Preside tables with two steps—select a top and select a base.

1. Select desired top size, shape, and edge profile.

Multi-piece Tops:

Multi-piece tops are made of 108", 120", 144" and 168" two-piece "starter-sections" in rectangle, boat, arc end, or racetrack shapes in 42", 48", or 54" depths. For tables up to 20', models are preconfigured for you. If you need a table top longer than 20', add as many 72" adder sections as you need. The examples below illustrate preconfigured sizes as well as how starter section and adder section tops can be used to create tables in virtually any length. **Please note that 2-piece tops, in woodgrain colors, will not have exact grain alignment in the center where the two halves meet, a reasonable match can be expected. For tops utilizing an adder section, there will not be a grain match for those pieces.**

Preconfigured and Modular Size Examples

	Feet	Inches	Ex. Top Starter Section	Quantity	Adder Section	Quantity	Total Number of Top Sections
Preconfigured Sizes	9'	108"	HTLC48108	1	n/a	n/a	2
	10'	120"	HTLC48120	1	n/a	n/a	2
	12'	144"	HTLC48144	1	n/a	n/a	2
	14'	168"	HTLC48168	1	n/a	n/a	2
	15'	180"	HTLC48180	1	n/a	n/a	3
	16'	192"	HTLC48192	1	n/a	n/a	3
	18'	216"	HTLC48216	1	n/a	n/a	3
	20'	240"	HTLC48240	1	n/a	n/a	3
Modular Sizes	22'	264"	HTLC48120	1	HTLM4872	2	4
	24'	288"	HTLC48144	1	HTLM4872	2	4
	26'	312"	HTLC48168	1	HTLM4872	2	4
	28'	336"	HTLC48120	1	HTLM4872	3	5
	30'	360"	HTLC48144	1	HTLM4872	3	5

Note: Beyond 30', tables can be configured in 6' increments to any length.

Illustrations of Preconfigured Tops

48" x 108" Table Top (9')

54"	54"
-----	-----

Ex: HTLC48108

48" x 120" Table Top (10')

60"	60"
-----	-----

Ex: HTLC48120

48" x 144" Table Top (12')

72"	72"
-----	-----

Ex: HTLC48144

48" x 168" Table Top (14')

84"	84"
-----	-----

Ex: HTLC48168

48" x 180" Table Top (15')

54"	72"	54"
-----	-----	-----

Ex: HTLC48180

48" x 192" Table Top (16')

60"	72"	60"
-----	-----	-----

Ex: HTLC48192

48" x 216" Table Top (18')

72"	72"	72"
-----	-----	-----

Ex: HTLC48216

48" x 240" Table Top (20')

84"	72"	84"
-----	-----	-----

Ex: HTLC48240

Illustrations of User Configured Modular Tops

48" x 72" Adder Section

72"

Ex: HTLM4872

48"D x 360"W Table Top (30')

72"	72"	72"	72"	72"
-----	-----	-----	-----	-----

Ex: HTLC48144 + HTLM4872 + HTLM4872 + HTLM4872

PRESIDE® SPECIFYING INFORMATION

2. Select desired base style and identify model that coincides with top length.

Bases for Tops in Preconfigured Sizes

Bases include the appropriate number of supports for tables up to 20'. Simply identify the length of the table top in inches and specify the base with the same length in the model number. The example below illustrates how to select a base for a preconfigured size top.

Examples of Base for Preconfigured Top Size

Example top: HTLC48240 Top Description: 240" Rectangle Top
 Example base: HTLHP240 Base Description: Hollow Panel Base for 240" Top

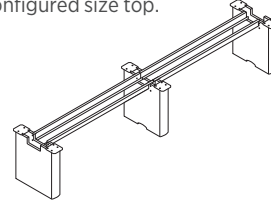

Example: HTLHP240

Bases for Tops in User Configured Modular Sizes

If you need a table top longer than 20', add as many 72" adder section bases as needed. The examples below illustrate preconfigured sizes as well as how starter section and adder section bases can be used to create tables in any desired length.

Examples of Tops and Bases for User Configured Modular Top

	Feet	Inches	Ex. Top Starter Section		Ex. Top Adder Section		Ex. Base Starter Section		Ex. Base Adder Section		Total # of Top Sections
			Quantity	Quantity	Quantity	Quantity	Quantity	Quantity			
Preconfigured Sizes	9'	108"	HTLC48108	1	n/a	n/a	HTLHP108	1	n/a	n/a	2
	10'	120"	HTLC48120	1	n/a	n/a	HTLHP120	1	n/a	n/a	2
	12'	144"	HTLC48144	1	n/a	n/a	HTLHP144	1	n/a	n/a	2
	14'	168"	HTLC48168	1	n/a	n/a	HTLHP168	1	n/a	n/a	2
	15'	180"	HTLC48180	1	n/a	n/a	HTLHP180	1	n/a	n/a	3
	16'	192"	HTLC48192	1	n/a	n/a	HTLHP192	1	n/a	n/a	3
	18'	216"	HTLC48216	1	n/a	n/a	HTLHP216	1	n/a	n/a	3
	20'	240"	HTLC48240	1	n/a	n/a	HTLHP240	1	n/a	n/a	3
Modular Sizes	22'	264"	HTLC48120	1	HTLM4872	2	HTLHP120	1	HTLHPM	2	4
	24'	288"	HTLC48144	1	HTLM4872	2	HTLHP144	1	HTLHPM	2	4
	26'	312"	HTLC48168	1	HTLM4872	2	HTLHP168	1	HTLHPM	2	4
	28'	336"	HTLC48120	1	HTLM4872	3	HTLHP120	1	HTLHPM	3	5
	30'	360"	HTLC48144	1	HTLM4872	3	HTLHP144	1	HTLHPM	3	5

Note: Tables can be configured to any desired length beyond 30' in 6' increments.

Note: Preconfigured bases include the appropriate number of supports for tables up to 20'. Depending on base type, number of required supports varies. For information regarding total number of supports please refer to chart below.

Feet	Inches	HTLP	HTTLEG	HTLHP	HTLCUBE/S	HTLR/C	HTYLEG	HTALEG
9'	108"	2	2	2	2	2	3	6
10'	120"	2	2	2	2	2	3	6
12'	144"	2	2	2	2	2	3	6
14'	168"	3	3	3	2	2	3	6
15'	180"	3	3	3	3	3	4	8
16'	192"	3	3	3	3	3	4	8
18'	216"	3	3	3	3	3	4	8
20'	240"	4	4	3	3	3	4	8

Base Model Descriptions

HTLP = Panel Base
 HTTLEG = Aluminum T-Leg
 HTLHP = Hollow Panel Base
 HTLCUBE = Cube Base
 HTLCUBES = Standing-Height Cube Base

HTLR = Cylinder Base
 HTLRC = Wire Management Cylinder Base
 HTYLEG = Footed Y-Leg Base
 HTALEG = Angled Leg

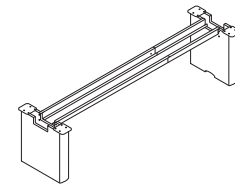

Example: HTHLP168

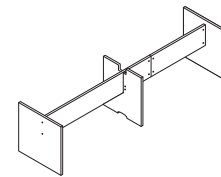

Example: HTLP168

PRESIDE® Grommet Cutout Placement

Tops specified with a grommet cutout get one cutout per section of top, centered in both directions. Cutouts do not include blank or powered inserts. Inserts must be specified separately.

- For compatible 4-Trac Electrical solutions, see page 247.
- For compatible grommet solutions, see page 251.

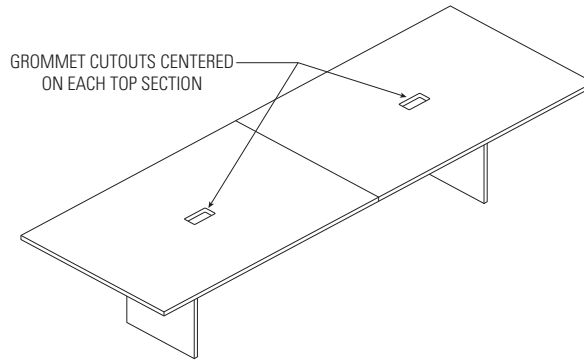

Upcharges for grommet cutouts (+ \$18 per G cutout, + \$46 per G1 cutout, + \$57 per G2 cutout)

Top Width	# Cutouts	G	G1	G2
24"	1	\$18	N/A	N/A
30"	1	\$18	N/A	N/A
36"	1	N/A	\$46	\$57
42"	1	N/A	\$46	\$57
48"	1	N/A	\$46	\$57
60"	1	N/A	\$46	\$57
72"	1	N/A	\$46	\$57
84"	1	N/A	\$46	\$57
96"	1	N/A	\$46	\$57
108"	2	N/A	\$90	\$113
120"	2	N/A	\$90	\$113
144"	2	N/A	\$90	\$113
168"	2	N/A	\$90	\$113
180"	3	N/A	\$134	\$167
192"	3	N/A	\$134	\$167
216"	3	N/A	\$134	\$167
240"	3	N/A	\$134	\$167

PRESIDE® Laminate Table Tops



	DESCRIPTION	MODEL	SHIP WEIGHT	CUBE	LIST PRICE BY EDGE TREATMENT			L2 UPCHARGE
					"E"	"G"	"J"	
Laminate Boat, Racetrack, Rectangle and Arc End Shaped Tops								
 A = Racetrack	240"W x 54"D	HTL(?)54240	425	25.1	N/A	\$3554	\$5556	\$140
	216"W x 54"D	HTL(?)54216	384	23.3	N/A	\$3109	\$4743	\$118
	192"W x 54"D	HTL(?)54192	345	21.4	N/A	\$2898	\$4495	\$113
	180"W x 54"D	HTL(?)54180	442	21.4	N/A	\$2898	\$4495	\$113
	168"W x 54"D	HTL(?)54168	300	13.5	\$2222	\$2387	\$3628	\$95
	144"W x 54"D	HTL(?)54144	259	11.6	\$1815	\$1942	\$2816	\$74
	120"W x 54"D	HTL(?)54120	220	9.8	\$1613	\$1731	\$2567	\$67
 B = Boat	108"W x 54"D	HTL(?)54108	324	9.8	\$1613	\$1731	\$2567	\$67
	240"W x 48"D	HTL(?)48240	392	21.9	N/A	\$2889	\$4515	\$118
	216"W x 48"D	HTL(?)48216	351	19.7	N/A	\$2532	\$3869	\$101
	192"W x 48"D	HTL(?)48192	312	18.1	N/A	\$2364	\$3669	\$95
	180"W x 48"D	HTL(?)48180	300	18.6	N/A	\$2364	\$3669	\$95
	168"W x 48"D	HTL(?)48168	281	12.1	\$1778	\$1912	\$2902	\$80
	144"W x 48"D	HTL(?)48144	240	9.8	\$1454	\$1555	\$2257	\$62
 C = Rectangle	120"W x 48"D	HTL(?)48120	201	8.2	\$1292	\$1387	\$2058	\$57
	108"W x 48"D	HTL(?)48108	203	9.8	\$1292	\$1387	\$2058	\$57
	96"W x 48"D	HTL(?)4896	153	13.2	\$1096	\$1132	\$1652	\$57
	240"W x 42"D	HTL(?)42240	382	27.1	\$2538	\$2656	\$4039	\$112
	216"W x 42"D	HTL(?)42216	350	25.8	\$2267	\$2365	\$3608	\$98
	192"W x 42"D	HTL(?)42192	317	22.2	\$2131	\$2221	\$3392	\$93
	180"W x 42"D	HTL(?)42180	302	22.2	\$2131	\$2221	\$3392	\$93
 E = Arc End	168"W x 42"D	HTL(?)42168	255	18.7	\$1695	\$1813	\$2699	\$75
	144"W x 42"D	HTL(?)42144	223	17.4	\$1424	\$1522	\$2267	\$62
	120"W x 42"D	HTL(?)42120	190	13.8	\$1288	\$1378	\$2051	\$57
	108"W x 42"D	HTL(?)42108	175	13.8	\$1288	\$1378	\$2051	\$57
	96"W x 42"D	HTL(?)4296	159	22.8	N/A	\$1144	\$1664	\$46
	84"W x 42"D	HTL(?)4284	157	12.1	\$1096	\$1132	\$1652	\$46
	72"W x 36"D	HTL(?)3672	90	7.9	\$732	\$793	\$1244	\$34
60"W x 30"D	HTL(?)3060	63	5.6	\$580	\$629	\$1002	\$23	
Laminate Adder Section for Boat, Racetrack, Rectangle and Arc Shaped Tops								
 M = Mid-section Adder	72"W x 54"D	HTLM5472	125	11.6	N/A	\$1167	\$1929	\$46
	72"W x 48"D	HTLM4872	111	9.8	N/A	\$977	\$1613	\$41
	72"W x 42"D	HTLM4272	127	8.4	N/A	\$902	\$1343	\$39

! Adder section cannot be used as stand-alone table. Only long edges are finished.

NOTES:

- Tops with E and G edge details feature durable laminate tops over solid core high-performance particleboard. Tops with J edge feature an MDF core.
- Tops with E edge detail have 3" radius corners. All other edge details have 90 degree corners.
- See page 85 for number of cutouts for each table top size.
- See page 247 for compatible 4-Trac Electrical solutions and 251 for compatible grommet solutions.

! See pages 77-82 for top and base compatibility.

HOW TO SPECIFY

<p>Select Model Number</p> <p>HTLC4296</p>	<p>Select Edge Detail and Edge Color</p> <p>See page 75</p> <p>JC</p>	<p>Select Cutout Option</p> <p>N No Cutout G1 Cutout for Pop-up Port (+ \$46 per cutout) G2 Cutout for Flip-top Port (+ \$57 per cutout) Flip-top Port cannot be specified for Round or Square tops</p> <p>G2</p>	<p>Select Laminate</p> <p>See page 74, Laminate Group A</p> <p>D</p>
---	--	---	---

	DESCRIPTION	MODEL	SHIP WEIGHT	CUBE	LIST PRICE BY EDGE TREATMENT			L2 UPCHARGE
					"E"	"G"	"J"	
	Chevron Tops							
	60"W x 30"D	HTLCVN3060	72	2.4	\$667	\$722	\$1141	\$34
	72"W x 30"D	HTLCVN3072	86	2.8	\$720	\$780	\$1232	\$38
	60"W x 36"D	HTLCVN3660	83	2.8	\$750	\$812	\$1284	\$40
	72"W x 36"D	HTLCVN3672	101	3.3	\$781	\$845	\$1337	\$41
	Tapered Tops							
	96"W x 48"D	HTLTPR4896	153	22.6	\$1250	\$1353	\$2139	\$65
	120"W x 60"D	HTLTPR60120	220	22.5	\$1690	\$1830	\$2891	\$87
	! 120"W x 60"D top is 2 piece top.							
	Boomerang Tops							
	144"W x 60"D	HTLBMR60144	318	27.1	\$1917	\$2075	\$3281	\$99
	168"W x 60"D	HTLBMR60168	366	35.5	\$2330	\$2522	\$3987	\$121
	! All Boomerang tops are 2 piece tops.							
	Media Tapered Tops							
	60"W x 48"D	HTLMED4860	115	16.4	\$1150	\$1245	\$1968	\$60
	<ul style="list-style-type: none"> If the Wall Mounting Bracket hits 2 wall studs and the bracket is more visible near the edge of the surface than is preferred, then making the bracket shorter would be acceptable. The Media Tapered Wall Mounting Bracket is intended to be cut in the field to size. 							
	! The Media Tapered Wall Mounting Bracket needs to hit a minimum of 2 wall studs to maintain stability.							
	DESCRIPTION	MODEL	SHIP WEIGHT	CUBE	LIST PRICE			
	Media Tapered Wall Mounting Bracket 48"W Worksurface Wall Mount Bracket	HVPWLBK48	4	0.4	\$152			
	<ul style="list-style-type: none"> For wall-mounted tops, not freestanding, a wall-mount bracket is used to fasten one end of the top to the wall (user to provide mounting hardware). The Media Tapered Wall Mounting Bracket is intended to be cut in the field to size. The Media Tapered Wall Mounting Bracket needs to hit a minimum of 2 wall studs to maintain stability. If the Wall Mounting Bracket hits 2 wall studs and the bracket is more visible near the edge of the surface than is preferred, then making the bracket shorter would be acceptable. 							
	! Wall mount bracket available in Black only.							

NOTES:

- Tops with E and G edge details feature durable laminate tops over solid core high-performance particleboard. Tops with J edge feature an MDF core.
- See page 85 for number of cutouts for each table top size.
- See page 247 for compatible 4-Trac Electrical solutions and 251 for compatible grommet solutions.
- ! Adder sections cannot be used with Chevron, Tapered, Boomerang, or Media Tapered Tops.
- ! See pages 77-82 for top and base compatibility.

HOW TO SPECIFY

<p>Select Model Number</p> <p>HTLCVN3060</p>	<p>Select Edge Detail and Edge Color</p> <p>See page 75</p> <p>J C</p>	<p>Select Cutout Option</p> <p>N No Cutout G1 Cutout for Pop-up Port (+ \$46 per cutout) G2 Cutout for Flip-top Port (+ \$57 per cutout) Flip-top Port cannot be specified for Round or Square tops</p> <p>G 2</p>	<p>Select Laminate</p> <p>See page 74, Laminate Group A</p> <p>D</p>
---	---	--	---

PRESIDE® Laminate Table Tops



Icon Legend on page 19



D = Round

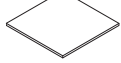

S = Square



SFT = Soft Square

DESCRIPTION	MODEL	SHIP WEIGHT			LIST PRICE BY EDGE TREATMENT				L2 UPCHARGE	
		ROUND	SQUARE	SOFT SQUARE	CUBE	"E"	"G"	"J"		
Laminate Round, Square, and Soft Square Tops										
60" Round Top	HTLD60	95	N/A	N/A	10.1	\$786	\$842	\$1251	\$36	
48" Top	HTL(?)48	66	76	80	6.3	\$629	\$675	\$1058	\$29	
42" Top	HTL(?)42	51	61	61	4.9	\$561	\$610	\$983	\$23	
36" Top	HTL(?)36	36	46	46	3.7	\$491	\$557	\$842	\$23	
30" Top	HTL(?)30	28	33	33	3.0	\$443	\$475	\$705	\$20	
24" Top	HTL(?)24	19	23	23	2.1	\$411	\$441	\$654	\$19	

NOTES: Tops are available in three shapes: Round (D), Square (S), and Soft Square (SFT). Replace the (?) shown in each model with D, S, or SFT to specify shape.

❗ 60" top only available in Round (D) shape.

NOTES:

- Tops with E and G edge details feature durable laminate tops over solid core high-performance particleboard. Tops with J edge feature an MDF core.
 - Tops with E edge detail have 3" radius corners. All other edge details have 90 degree corners.
 - See page 85 for number of cutouts for each table top size.
 - For compatible grommet solutions, see pages 248 and 251.
- ❗ See pages 77-82 for top and base compatibility.

HOW TO SPECIFY

<p>Select Model Number</p> <p>HTLD48</p>	<p>Select Edge Detail and Edge Color</p> <p>See page 75</p> <p>JC</p>	<p>Select Cutout Option</p> <p>N No Cutout G Cutout for 24" and 30" tops (+ \$18) G1 Cutout for Pop-up Port (+ \$46 per cutout) G2 Cutout for Flip-top Port (+ \$57 per cutout)</p> <p>G1</p>	<p>Select Laminate</p> <p>See page 74, Laminate Group A</p> <p>D</p>
--	---	--	--



Icon Legend on page 19

PRESIDE® Laminate Bases

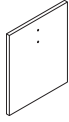

DESCRIPTION	PANELS INCLUDED PER KIT	MODEL	SHIP WEIGHT	CUBE	LIST PRICE BY LAMINATE GRADE	
					L1	L2
Laminate Seated-Height Panel Base for Tops 60" or Wider						
For 240"W Table Tops	4	HTLP240	197	16.4	\$1803	\$1893
For 216"W Table Tops	3	HTLP216	158	12.4	\$1378	\$1442
For 192"W Table Tops	3	HTLP192	147	11.6	\$1378	\$1442
For 180"W Table Tops	3	HTLP180	147	11.6	\$1378	\$1442
For 168"W Table Tops	3	HTLP168	136	10.6	\$1203	\$1265
For 144"W Table Tops	2	HTLP144	97	6.6	\$778	\$816
For 120"W Table Tops	2	HTLP120	86	5.8	\$778	\$816
For 108"W Table Tops	2	HTLP108	86	5.8	\$778	\$816
For 96"W Table Tops	2	HTLP96	75	4.9	\$778	\$816
For 84"W Table Tops	2	HTLP84	75	5.0	\$778	\$816
For 72"W Table Tops	2	HTLP72	25	2.9	\$731	\$769
For 60"W Table Tops	2	HTLP60	25	2.9	\$731	\$769
For 72" Adder Section	1	HTLPM	61	5.8	\$600	\$629

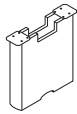

Laminate Seated-Height Hollow Panel Base for Tops 84" or Wider						
For 240"W Table Tops	3	HTLHP240	206	17.5	\$3912	\$4046
For 216"W Table Tops	3	HTLHP216	204	17.3	\$3810	\$3944
For 192"W Table Tops	3	HTLHP192	202	17.1	\$3723	\$3857
For 180"W Table Tops	3	HTLHP180	202	17.1	\$3723	\$3857
For 168"W Table Tops	3	HTLHP168	193	16.9	\$3601	\$3735
For 144"W Table Tops	2	HTLHP144	133	11.4	\$2472	\$2562
For 120"W Table Tops	2	HTLHP120	131	11.2	\$2385	\$2475
For 108"W Table Tops	2	HTLHP108	131	11.2	\$2385	\$2475
For 96"W Table Tops	2	HTLHP96	125	11.0	\$2300	\$2390
For 84"W Table Tops	2	HTLHP84	125	11.0	\$2300	\$2390
For 72" Adder Section	1	HTLHPM	71	5.9	\$1338	\$1384

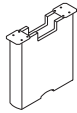

Stand Alone Hollow Panel	1	HTLHPB			\$1027	\$1073
Only to be used with Media Tapered Worksurface.						

NOTES:

- Tops and bases are sold and shipped separately.
- End caps for Hollow Panel bases can be matched to woodgrain finishes or specified in select solid colors.
- Bases ship with appropriate number of supports for table width. See page 84 for details.
- Laminate panel bases feature sturdy 1 1/8" thick x 12"H particleboard support beam in matching finish.
- For Base and Top compatibility, see base information on pages 77-84.
- Laminate hollow panel bases feature dual aluminum support beams with integrated wire management.

HOW TO SPECIFY

<p>Select Model Number</p> <p>HTLHP240</p>	<p>Select Laminate</p> <p>See page 74, Laminate Group B</p> <p>D</p>	<p>Select Endcap/Inlay Option</p> <p>See page 74, Laminate Group C (Specify for Hollow Panel Bases only)</p> <p>LFW1</p>
---	---	---

PRESIDE® Laminate Bases



Icon Legend on page 19

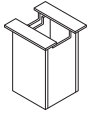

DESCRIPTION	PANELS INCLUDED PER KIT	MODEL	SHIP WEIGHT	CUBE	LIST PRICE BY LAMINATE GRADE	
					L1	L2
Laminate Seated-Height Cube Base for Tops 84" or Wider						
For 240"W Table Tops	3	HTLCUBE240	278	29.2	\$4683	\$4835
For 216"W Table Tops	3	HTLCUBE216	276	29.0	\$4581	\$4733
For 192"W Table Tops	3	HTLCUBE192	274	28.8	\$4494	\$4646
For 180"W Table Tops	3	HTLCUBE180	274	28.8	\$4494	\$4646
For 168"W Table Tops	2	HTLCUBE168	183	19.4	\$3088	\$3189
For 144"W Table Tops	2	HTLCUBE144	181	19.2	\$2986	\$3087
For 120"W Table Tops	2	HTLCUBE120	179	19.0	\$2899	\$3000
For 108"W Table Tops	2	HTLCUBE108	179	19.0	\$2899	\$3000
For 96"W Table Tops	2	HTLCUBE96	164	18.2	\$2568	\$2669
For 84"W Table Tops	2	HTLCUBE84	164	18.2	\$2568	\$2669
For 72" Adder Section	1	HTLCUBEM	95	9.8	\$1595	\$1647

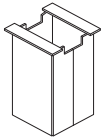

Laminate Standing-Height Cube Base for Tops 48" or Wider						
For 240"W Table Tops	3	HTLCUBES240	302	45.7	\$5661	\$5846
For 216"W Table Tops	3	HTLCUBES216	300	45.5	\$5559	\$5744
For 192"W Table Tops	3	HTLCUBES192	298	45.3	\$5472	\$5657
For 180"W Table Tops	3	HTLCUBES180	298	45.3	\$5472	\$5657
For 168"W Table Tops	2	HTLCUBES168	199	30.4	\$3740	\$3863
For 144"W Table Tops	2	HTLCUBES144	197	30.2	\$3638	\$3761
For 120"W Table Tops	2	HTLCUBES120	195	30.0	\$3551	\$3674
For 108"W Table Tops	2	HTLCUBES108	195	30.0	\$3551	\$3674
For 96"W Table Tops	2	HTLCUBES96	180	29.2	\$3220	\$3343
For 72" Adder	1	HTLCUBESM	103	15.3	\$1921	\$1983



Laminate Seated-Height Cylinder Base for Tops 84" or Wider						
For 240"W Table Tops	3	HTLR240	191	51.9	\$3795	\$3913
For 216"W Table Tops	3	HTLR216	189	51.7	\$3693	\$3811
For 192"W Table Tops	3	HTLR192	187	51.5	\$3606	\$3724
For 180"W Table Tops	3	HTLR180	187	51.5	\$3606	\$3724
For 168"W Table Tops	2	HTLR168	125	34.5	\$2496	\$2576
For 144"W Table Tops	2	HTLR144	123	34.3	\$2394	\$2474
For 120"W Table Tops	2	HTLR120	121	34.1	\$2307	\$2387
For 108"W Table Tops	2	HTLR108	121	34.1	\$2307	\$2387
For 96"W Table Tops	2	HTLR96	106	33.3	\$1976	\$2056
For 84"W Table Tops	2	HTLR84	106	33.3	\$1976	\$2056
For 72" Adder Section	1	HTLRM	66	17.4	\$1299	\$1340

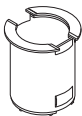

Laminate Seated-Height Cylinder Base with Wire Management for Tops 84" or Wider						
For 240"W Table Tops	3	HTLRC240	191	51.9	\$4932	\$5084
For 216"W Table Tops	3	HTLRC216	189	51.7	\$4830	\$4982
For 192"W Table Tops	3	HTLRC192	187	51.4	\$4743	\$4895
For 180"W Table Tops	3	HTLRC180	187	51.4	\$4743	\$4895
For 168"W Table Tops	2	HTLRC168	125	34.5	\$3254	\$3355
For 144"W Table Tops	2	HTLRC144	123	34.3	\$3152	\$3253
For 120"W Table Tops	2	HTLRC120	121	34.1	\$3065	\$3166
For 108"W Table Tops	2	HTLRC108	121	34.1	\$3065	\$3166
For 96"W Table Tops	2	HTLRC96	106	33.3	\$2734	\$2835
For 84"W Table Tops	2	HTLRC84	106	33.3	\$2734	\$2835
For 72" Adder	1	HTLRM	66	17.4	\$1678	\$1730

NOTES:

- Tops and bases are sold and shipped separately.
 - Bases ship with appropriate number of supports for table width. See page 84 for details.
 - Standing-Height Cube Bases are 39"H.
 - Laminate cube and cylinder bases for tops 108"W and greater feature dual aluminum support beams with integrated wire management.
 - Cube bases feature removable door to allow access to cables and enable wire routing.
 - Standing-Height Bases feature a hinged door for easy access and for cable routing through the base.
- ⚠ Seated Cube Base and Cylinder Base require 150 lbs. of sand or other ballast in each base for stability (not supplied). Standing-Height Cube Base does not require additional ballast.
- ⚠ For Base and Top compatibility, see base information on pages 77-84.

HOW TO SPECIFY

<p>Select Model Number</p> <p>HTLCUBE180</p>	<p>Select Laminate</p> <p>See page 74, Laminate Group B</p> <p>LFW1</p>
---	--



Icon Legend on page 19

PRESIDE[®] Metal Bases

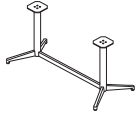

DESCRIPTION	MODEL	SHIP WEIGHT	CUBE	LIST PRICE BY PAINT GRADE		
				P1	P2	P3
Footed Y-Base for Tops 60" or Wider						
42½"H Standing Height Base for 42" and 48" x 240" Tops	HT42FB48240	88	10.8	\$3248	\$3527	\$3666
42½"H Standing Height Base for 42" and 48" x 216" Tops	HT42FB48216	85	10.4	\$3104	\$3371	\$3505
42½"H Standing Height Base for 42" and 48" x 192" Tops	HT42FB48192	82	10.1	\$2993	\$3251	\$3378
42½"H Standing Height Base for 42" and 48" x 180" Tops	HT42FB48180	82	10.1	\$2993	\$3251	\$3378
42½"H Standing Height Base for 42" and 48" x 168" Tops	HT42FB48168	67	9.3	\$2296	\$2493	\$2592
36½"H Counter Height Base for 42" and 48" x 240" Tops						
36½"H Counter Height Base for 42" and 48" x 216" Tops	HT36FB48240	86	10.8	\$3168	\$3442	\$3577
36½"H Counter Height Base for 42" and 48" x 216" Tops	HT36FB48216	83	10.4	\$3024	\$3287	\$3416
36½"H Counter Height Base for 42" and 48" x 192" Tops	HT36FB48192	80	10.1	\$2913	\$3167	\$3289
36½"H Counter Height Base for 42" and 48" x 180" Tops	HT36FB48180	80	10.1	\$2913	\$3167	\$3289
36½"H Counter Height Base for 42" and 48" x 168" Tops	HT36FB48168	65	9.3	\$2236	\$2430	\$2526
29½"H Seated Height Base for 42" and 48" x 240" Tops						
29½"H Seated Height Base for 42" and 48" x 240" Tops	HT29FB48240	84	10.8	\$3100	\$3365	\$3501
29½"H Seated Height Base for 42" and 48" x 216" Tops	HT29FB48216	81	10.4	\$2956	\$3211	\$3339
29½"H Seated Height Base for 42" and 48" x 192" Tops	HT29FB48192	78	10.1	\$2845	\$3089	\$3212
29½"H Seated Height Base for 42" and 48" x 180" Tops	HT29FB48180	78	10.1	\$2845	\$3089	\$3212
29½"H Seated Height Base for 42" and 48" x 168" Tops	HT29FB48168	63	9.3	\$2185	\$2373	\$2468
27¼"H Working Lounge Base for 42" and 48" x 240" Tops						
27¼"H Working Lounge Base for 42" and 48" x 240" Tops	HT27FB48240	82	10.8	\$3044	\$3305	\$3436
27¼"H Working Lounge Base for 42" and 48" x 216" Tops	HT27FB48216	79	10.4	\$2900	\$3151	\$3274
27¼"H Working Lounge Base for 42" and 48" x 192" Tops	HT27FB48192	76	10.1	\$2789	\$3028	\$3148
27¼"H Working Lounge Base for 42" and 48" x 180" Tops	HT27FB48180	76	10.1	\$2789	\$3028	\$3148
27¼"H Working Lounge Base for 42" and 48" x 168" Tops	HT27FB48168	61	9.3	\$2143	\$2328	\$2420

NOTES:

- Tops and bases are sold and shipped separately.
- Bases ship with appropriate number of supports for table width.
- ❗ Footed base not to be used on 54"D conference tables.
- ❗ See pages 77-82 for top and base compatibility.
- ❗ Footed Y-base for tops 84"W or greater feature dual aluminum support beams with integrated wire management. Footed Y-base for 60"W and 72"W tops do not include aluminum beams.

HOW TO SPECIFY

<p>Select Model Number</p> <p>HT27FB48168</p>	<p>Select Paint Color</p> <p>See page 74, Paint Group A</p> <p>T1</p>
---	---

PRESIDE® Metal Bases

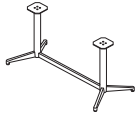

DESCRIPTION	MODEL	SHIP		LIST PRICE BY PAINT GRADE		
		WEIGHT	CUBE	P1	P2	P3
Footed Y-Base for Tops 60" or Wider						
42½"H Standing Height Base for 42" and 48" x 144" Tops	HT42FB48144	64	8.9	\$2152	\$2339	\$2431
42½"H Standing Height Base for 42" and 48" x 120" Tops	HT42FB48120	61	8.7	\$2041	\$2218	\$2304
42½"H Standing Height Base for 42" and 48" x 108" Tops	HT42FB48108	61	8.7	\$2041	\$2218	\$2304
42½"H Standing Height Base for 42" and 48" x 96" Tops	HT42FB4896	37	4.9	\$1381	\$1500	\$1561
42½"H Standing Height Base for 42" x 84" Tops	HT42FB4284	36	4.8	\$1360	\$1478	\$1537
42½"H Standing Height Base for 36" x 72" Tops	HT42FB3672	27	4.2	\$1228	\$1324	\$1373
42½"H Standing Height Base for 36" x 60" Tops	HT42FB3660	26	4.2	\$1102	\$1200	\$1246
42½"H Standing Height Base for 30" x 60" Tops	HT42FB3060	25	4.2	\$1078	\$1171	\$1218
Counter Height Base						
36½"H Counter Height Base for 42" and 48" x 144" Tops	HT36FB48144	62	8.9	\$2092	\$2276	\$2363
36½"H Counter Height Base for 42" and 48" x 120" Tops	HT36FB48120	59	8.7	\$1981	\$2154	\$2238
36½"H Counter Height Base for 42" and 48" x 108" Tops	HT36FB48108	59	8.7	\$1981	\$2154	\$2238
36½"H Counter Height Base for 42" and 48" x 96" Tops	HT36FB4896	36	4.9	\$1341	\$1458	\$1516
36½"H Counter Height Base for 42" x 84" Tops	HT36FB4284	35	4.8	\$1320	\$1436	\$1491
36½"H Counter Height Base for 36" x 72" Tops	HT36FB3672	26	4.2	\$1188	\$1282	\$1328
36½"H Counter Height Base for 36" x 60" Tops	HT36FB3660	25	4.2	\$1062	\$1158	\$1202
36½"H Counter Height Base for 30" x 60" Tops	HT36FB3060	24	4.2	\$1042	\$1133	\$1177
Seated Height Base						
29½"H Seated Height Base for 42" and 48" x 144" Tops	HT29FB48144	60	8.9	\$2041	\$2218	\$2306
29½"H Seated Height Base for 42" and 48" x 120" Tops	HT29FB48120	57	8.7	\$1930	\$2096	\$2181
29½"H Seated Height Base for 42" and 48" x 108" Tops	HT29FB48108	57	8.7	\$1930	\$2096	\$2181
29½"H Seated Height Base for 42" and 48" x 96" Tops	HT29FB4896	35	4.9	\$1307	\$1420	\$1476
29½"H Seated Height Base for 42" x 84" Tops	HT29FB4284	34	4.8	\$1286	\$1398	\$1453
29½"H Seated Height Base for 36" x 72" Tops	HT29FB3672	25	4.2	\$1154	\$1244	\$1289
29½"H Seated Height Base for 36" x 60" Tops	HT29FB3660	24	4.2	\$1028	\$1120	\$1163
29½"H Seated Height Base for 30" x 60" Tops	HT29FB3060	23	4.2	\$1000	\$1087	\$1129
Working Lounge Base						
27¼"H Working Lounge Base for 42" and 48" x 144" Tops	HT27FB48144	58	8.9	\$1999	\$2172	\$2258
27¼"H Working Lounge Base for 42" and 48" x 120" Tops	HT27FB48120	55	8.7	\$1888	\$2051	\$2131
27¼"H Working Lounge Base for 42" and 48" x 108" Tops	HT27FB48108	55	8.7	\$1888	\$2051	\$2131
27¼"H Working Lounge Base for 42" and 48" x 96" Tops	HT27FB4896	34	4.9	\$1279	\$1390	\$1444
27¼"H Working Lounge Base for 42" x 84" Tops	HT27FB4284	33	4.8	\$1258	\$1368	\$1421
27¼"H Working Lounge Base for 36" x 72" Tops	HT27FB3672	24	4.2	\$1126	\$1214	\$1257
27¼"H Working Lounge Base for 36" x 60" Tops	HT27FB3660	23	4.2	\$1000	\$1090	\$1131
27¼"H Working Lounge Base for 30" x 60" Tops	HT27FB3060	22	4.2	\$976	\$1061	\$1103
Footed Base Adder for 72"W or Wider Tops						
42"H	HT42FBM	40	4.9	\$2192	\$2326	\$2393
36"H	HT36FBM	39	4.9	\$2132	\$2264	\$2328
29"H	HT29FBM	38	4.9	\$2081	\$2209	\$2273
27"H	HT27FBM	37	4.9	\$2039	\$2165	\$2227
Wire Manager						
Manager for 42"H Footed Base — 1-Pack	HTFWMGR42	2	0.3	\$190	\$208	\$215
Manager for 36"H Footed Base — 1-Pack	HTFWMGR36	1	0.3	\$180	\$197	\$204
Manager for 29"H Footed Base — 1-Pack	HTFWMGR29	1	0.4	\$170	\$186	\$193
Manager for 27"H Footed Base — 1-Pack	HTFWMGR27	1	0.4	\$159	\$174	\$180

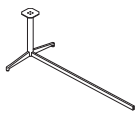

NOTES:

- Tops and bases are sold and shipped separately.
- Bases ship with appropriate number of supports for table width.
- To conceal any power cords from table top to floor, specify wire manager based on table height. Wire manager adheres to the vertical column of the base.
- ❶ Footed base not to be used on 54"D conference tables.
- ❶ See pages 77-82 for top and base compatibility.
- ❶ Footed Y-base for tops 84"W or greater feature dual aluminum support beams with integrated wire management. Footed Y-base for 60"W and 72"W tops do not include aluminum beams.

HOW TO SPECIFY

<p>Select Model Number</p> <p>HT29FB48144</p>	<p>Select Paint Color</p> <p>See page 74, Paint Group A</p> <p>T1</p>
---	---



Icon Legend on page 19

PRESIDE® Metal Bases

TABLES

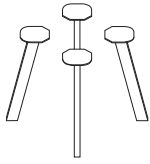

DESCRIPTION	MODEL	SHIP		LIST PRICE BY PAINT GRADE		
		WEIGHT	CUBE	P1	P2	P3
Angled Leg						
42½" H Standing Height Base for Round, Square, and Soft Square Tops	HT42ALEG	32	2.6	\$2074	\$2254	\$2341
29½" H Seated Height Base for Round, Square, and Soft Square Tops	HT29ALEG	25	2.6	\$1686	\$1832	\$1905
42½" H Standing Height Base for 96" W Tops	HT42AL96	32	2.6	\$3111	\$3378	\$3512
42½" H Standing Height Base for 84" W Tops	HT42AL84	41	3.1	\$2320	\$2520	\$2620
42½" H Standing Height Base for 72" W Tops	HT42AL72	32	2.6	\$2074	\$2254	\$2341
42½" H Standing Height Base for 60" W Tops	HT42AL60	32	2.6	\$2074	\$2254	\$2341
29½" H Seated Height Base for 240" W Tops	HT29AL240	57	4.5	\$4203	\$4565	\$4747
29½" H Seated Height Base for 216" W Tops	HT29AL216	55	4.2	\$4101	\$4454	\$4631
29½" H Seated Height Base for 192" W Tops	HT29AL192	53	4.0	\$4014	\$4359	\$4534
29½" H Seated Height Base for 180" W Tops	HT29AL180	53	4.0	\$4014	\$4359	\$4534
29½" H Seated Height Base for 168" W Tops	HT29AL168	44	3.8	\$3049	\$3312	\$3444
29½" H Seated Height Base for 144" W Tops	HT29AL144	42	3.5	\$2947	\$3202	\$3329
29½" H Seated Height Base for 120" W Tops	HT29AL120	40	3.3	\$2860	\$3106	\$3230
29½" H Seated Height Base for 108" W Tops	HT29AL108	40	3.3	\$2860	\$3106	\$3230
29½" H Seated Height Base for 96" W Tops	HT29AL96	37	3.3	\$1934	\$2098	\$2181
29½" H Seated Height Base for 84" W Tops	HT29AL84	34	3.1	\$1932	\$2098	\$2184
29½" H Seated Height Base for 72" W Tops	HT29AL72	25	2.6	\$1686	\$1832	\$1905
29½" H Seated Height Base for 60" W Tops	HT29AL60	25	2.6	\$1686	\$1832	\$1905
29½" H Seated Height Base for 72" W Adder	HT29ALM	38	3.3	\$1154	\$1254	\$1305
42½" H Seated Height 2-Pack	HT42AL2PK	32	2.6	\$1037	\$1127	\$1171
29½" H Seated Height 2-Pack	HT29AL2PK	25	2.6	\$843	\$917	\$954

! Only to be used with Media Tapered Worksurface.



DESCRIPTION	MODEL	SHIP WEIGHT	CUBE	P1	P2	P3
Wire Manager						
Angled Leg Wire Manager for 42½" H Leg	HTALWMGR42	3	4.0	\$126	\$139	\$144
Angled Leg Wire Manager for 29½" H Leg	HTALWMGR29	2	4.0	\$100	\$111	\$115

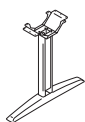

DESCRIPTION	LEGS INCLUDED PER KIT	MODEL	SHIP		LIST PRICE BY PAINT GRADE		
			WEIGHT	CUBE	P1	P2	P3
Aluminum T-Leg for Tops 60" or Wider							
For 240" W Table Tops	4	HTTLEG240	76	8.9	\$2453	\$2499	\$2520
For 216" W Table Tops	3	HTTLEG216	65	8.6	\$1962	\$2008	\$2029
For 192" W Table Tops	3	HTTLEG192	63	8.4	\$1875	\$1921	\$1942
For 180" W Table Tops	3	HTTLEG180	63	8.4	\$1875	\$1921	\$1942
For 168" W Table Tops	3	HTTLEG168	54	8.2	\$1753	\$1799	\$1820
For 144" W Table Tops	2	HTTLEG144	39	4.5	\$1229	\$1252	\$1263
For 120" W Table Tops	2	HTTLEG120	37	4.3	\$1142	\$1165	\$1176
For 108" W Table Tops	2	HTTLEG108	37	4.2	\$1142	\$1165	\$1176
For 96" W Table Tops	2	HTTLEG96	31	4.0	\$1057	\$1080	\$1091
For 84" W Table Tops	2	HTTLEG84	31	4.0	\$1057	\$1080	\$1091
For 72" W Table Tops	2	HTTLEG72	26	3.5	\$811	\$834	\$845
For 60" W Table Tops	2	HTTLEG60	22	3.5	\$811	\$834	\$845
For 72" Adder Section	1	HTTLEGM	26	4.2	\$733	N/A	N/A

NOTES:

- Tops and bases are sold and shipped separately.
- Bases ship with appropriate number of supports for table width.
- To conceal any power cords from table top to floor, specify wire manager based on table height. Angled leg wire manager is friction fit with magnets to hold in place.

! Aluminum T-legs for tops 84" and greater feature dual aluminum support beams with integrated wire management. Aluminum T-legs for 60" and 72" tops do not include aluminum beams.

! Footed base not to be used on 54"D conference tables.

! See pages 77-82 for top and base compatibility.



HOW TO SPECIFY

<p>Select Model Number</p> <p>HT42ALEG</p>	<p>Select Paint Color</p> <p>See page 74, Paint Group A</p> <p>PR6</p>
--	--

PRESIDE® Laminate Bases

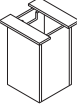
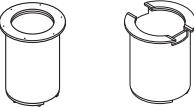
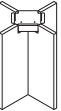

Icon Legend on page 19

	DESCRIPTION	BASES INCLUDED PER KIT	MODEL	SHIP WEIGHT	CUBE	LIST PRICE BY LAMINATE GRADE	
						L1	L2
	Laminate Cube Base for Round, Square, and Soft Square Tops						
	For 60" Round and all 48" Tops, Seated-Height	1	HTLCUBE48	82	9.1	\$1284	\$1336
	For 60" Round and all 48" Tops, Standing-Height	1	HTLCUBES48	90	14.6	\$1610	\$1672
	Laminate Cylinder Base for Round, Square, and Soft Square Tops						
	For 48" Tops	1	HTLR48	53	16.7	\$988	\$1029
	For 42" Tops	1	HTLR42	42	11.6	\$892	\$933
	For 36" Tops	1	HTLR36	42	11.6	\$892	\$933
<i>Used with 36" and 42" table tops</i>	For 48" Tops, with Wire Management	1	HTLRC48	53	16.7	\$1367	\$1419
	Laminate Panel X-Base	1	HTLXP48	54	5.2	\$574	\$597
		1	HTLXP42	54	5.2	\$574	\$597
		1	HTLXP36	47	4.7	\$535	\$558
	NOTES: Can be used with 36", 42" and 48" Round and Soft Square Tops, and 36" and 42" Square Tops.						
	! Not compatible with cutouts or power ports.						

NOTES:

- Tops and bases are sold and shipped separately.
- Cube Base features removable door for wire management.
- ! Cube and Cylinder Bases require 150 lbs. of sand or other ballast in each base for stability (not supplied).
- ! See pages 77-82 for top and base compatibility.

HOW TO SPECIFY

Select Model Number	Select Laminate
	See page 74, Laminate Group B
HTLCUBE48	D



Icon Legend on page 19

PRESIDE® Metal Bases

TABLES



DESCRIPTION

Aluminum X-Leg Base for 36", 42", and 48" Round, Square, and Soft Square Tops

MODEL
HTXLEG ©

SHIP WEIGHT
16

CUBE
3.5

LIST PRICE
\$643

P2 LIST PRICE
\$666

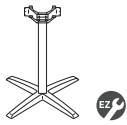

Standing-Height Aluminum X-Leg Base for 36" and 42" Round, Square, and Soft Square Tops

MODEL
HTXLEGSH

17

3.5

\$804

\$827



DESCRIPTION

Footed Café X-Base

42½"H Standing Height X-Base for 48" Tops
 42½"H Standing Height X-Base for 36" and 42" Tops
 42½"H Standing Height X-Base for 30" Tops
 36½"H Counter Height X-Base for 48" Tops
 36½"H Counter Height X-Base for 36" and 42" Tops
 36½"H Counter Height X-Base for 30" Tops
 29½"H Seated Height X-Base for 48" and 60" Tops
 29½"H Seated Height X-Base for 36" and 42" Tops
 29½"H Seated Height X-Base for 30" Tops
 29½"H Seated Height X-Base for 24" Tops
 27¼"H Working Lounge X-Base for 48" and 60" Tops
 27¼"H Working Lounge X-Base for 36" and 42" Tops
 27¼"H Working Lounge X-Base for 30" Tops
 27¼"H Working Lounge X-Base for 24" Tops

MODEL	SHIP WEIGHT	CUBE	LIST PRICE BY PAINT GRADE		
			P1	P2	P3
HTFXL42	32	3.7	\$889	\$968	\$1005
HTFXM42	31	3.7	\$811	\$882	\$917
HTFXS42	30	3.7	\$696	\$757	\$787
HTFXL36	31	3.7	\$831	\$904	\$940
HTFXM36	30	3.7	\$750	\$815	\$847
HTFXS36	29	3.7	\$650	\$707	\$735
HTFXL29	30	3.7	\$740	\$804	\$836
HTFXM29	29	3.7	\$682	\$742	\$771
HTFXS29	28	3.7	\$605	\$659	\$685
HTFXT29	27	3.7	\$554	\$603	\$627
HTFXL27	29	3.7	\$676	\$735	\$764
HTFXM27	28	3.7	\$616	\$671	\$698
HTFXS27	27	3.7	\$546	\$594	\$617
HTFXT27	26	3.7	\$520	\$566	\$587

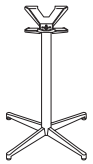

Footed Café X-Base w/Power

42½"H Standing Height X-Base for 48" Tops
 42½"H Standing Height X-Base for 36" and 42" Tops
 42½"H Standing Height X-Base for 30" Tops
 36½"H Counter Height X-Base for 48" Tops
 36½"H Counter Height X-Base for 36" and 42" Tops
 36½"H Counter Height X-Base for 30" Tops
 29½"H Seated Height X-Base for 48" and 60" Tops
 29½"H Seated Height X-Base for 36" and 42" Tops
 29½"H Seated Height X-Base for 30" Tops
 29½"H Seated Height X-Base for 24" Tops
 27¼"H Working Lounge X-Base for 48" and 60" Tops
 27¼"H Working Lounge X-Base for 36" and 42" Tops
 27¼"H Working Lounge X-Base for 30" Tops
 27¼"H Working Lounge X-Base for 24" Tops

HTFXL42P	32	3.7	\$889	\$968	\$1005
HTFXM42P	31	3.7	\$811	\$882	\$917
HTFXS42P	30	3.7	\$696	\$757	\$787
HTFXL36P	31	3.7	\$831	\$904	\$940
HTFXM36P	31	3.7	\$750	\$815	\$847
HTFXS36P	29	3.7	\$650	\$707	\$735
HTFXL29P	30	3.7	\$740	\$804	\$836
HTFXM29P	29	3.7	\$682	\$742	\$771
HTFXS29P	28	3.7	\$605	\$659	\$685
HTFXT29P	27	3.7	\$554	\$603	\$627
HTFXL27P	29	3.7	\$676	\$735	\$764
HTFXM27P	28	3.7	\$616	\$671	\$698
HTFXS27P	27	3.7	\$546	\$594	\$617
HTFXT27P	26	3.7	\$520	\$566	\$587



Footed Café X-Base w/Casters

42½"H Standing Height X-Base for 48" Tops
 42½"H Standing Height X-Base for 36" and 42" Tops
 36½"H Counter Height X-Base for 48" Tops
 36½"H Counter Height X-Base for 36" and 42" Tops
 29½"H Seated Height X-Base for 48" Tops
 29½"H Seated Height X-Base for 36" and 42" Tops
 27¼"H Working Lounge X-Base for 48" Tops
 27¼"H Working Lounge X-Base for 36" and 42" Tops

HTFXL42C	32	3.7	\$920	\$1001	\$1040
HTFXM42C	31	3.7	\$843	\$917	\$954
HTFXL36C	31	3.7	\$864	\$941	\$977
HTFXM36C	30	3.7	\$783	\$851	\$885
HTFXL29C	30	3.7	\$772	\$839	\$873
HTFXM29C	29	3.7	\$713	\$775	\$806
HTFXL27C	29	3.7	\$708	\$770	\$800
HTFXM27C	28	3.7	\$650	\$707	\$735

NOTES:

- Tops and bases are sold and shipped separately.
- HTXLEG and HTXLEGSH allow wires to pass through the center of the leg.
- Grommet cutouts not compatible with Footed Café X-Base and Footed Café X-Base with Casters.
- ! Footed Café X-Base with Power allows wires to pass through the center of the leg except when using power compatible with a G2 cutout.
- ! Cannot specify grommet cutouts in top when using footed X-base and footed X-base with casters. Utilize footed X-base with power for situations where power/grommet cutouts are needed.
- ! See pages 77-82 for top and base compatibility.

HOW TO SPECIFY

Select Model Number	Select Paint Color
	See page 74, Paint Group A
H T F X L 4 2 .	P J W

PRESIDE® Collaborative Tables



	DESCRIPTION	MODEL	SHIP WEIGHT	CUBE	LIST PRICE BY LAMINATE GRADE	
					L1	L2
	Seated-Height, Collaborative Table with Partial Modesty Panel					
	60"W x 42"D	HTLC4260LCTP	152	2.8	\$1498	\$1523
	72"W x 42"D	HTLC4272LCTP	167	14.5	\$1782	\$1816
	96"W x 42"D	HTLC4296LCTP	122	18.3	\$2195	\$2229
	Standing-Height, Collaborative Table with Partial Modesty Panel					
	60"W x 42"D	HTLC4260HCTP	187	3.7	\$1710	\$1735
	72"W x 42"D	HTLC4272HCTP	187	15.7	\$1994	\$2028
	96"W x 42"D	HTLC4296HCTP	242	19.4	\$2407	\$2441
	Seated-Height, Collaborative Table with Full Modesty Panel					
	60"W x 42"D	HTLC4260LCTFP	167	13.4	\$1498	\$1523
	72"W x 42"D	HTLC4272LCTFP	175	14.9	\$1782	\$1816
	96"W x 42"D	HTLC4296LCTFP	233	18.8	\$2195	\$2229
	Standing-Height, Collaborative Table with Full Modesty Panel					
	60"W x 42"D	HTLC4260HCTFP	202	17.0	\$1710	\$1735
	72"W x 42"D	HTLC4272HCTFP	211	17.9	\$1994	\$2028
	96"W x 42"D	HTLC4296HCTFP	275	22.4	\$2407	\$2441

NOTES:

- Tops feature 2mm flat edge.
- Partial modesty models will feature different modesty heights than units produced on or before March 16, 2020.

! Tables with partial and full modesty panels always feature cutout in modesty panel to accommodate grommet inserts in the top. However, top cutout is optional. Wire management is not included in legs.

HOW TO SPECIFY

<p>Select Model Number</p> <p>HTLC4272LCTP</p>	<p>Select Cutout Option</p> <p>N No Cutout G1 Cutout for Pop-up Port (+ \$46) G2 Cutout for Flip-top Port (= \$57)</p> <p>N</p>	<p>Select Top Laminate Color</p> <p>See page 74, Laminate Group A</p> <p>H</p>	<p>Select Base Laminate Color</p> <p>See page 74, Laminate Group B</p> <p>H</p>	<p>Select Modesty Laminate Color</p> <p>See page 74, Laminate Group B</p> <p><i>Do not specify for Power Management models</i></p> <p>LDW1</p>	<p>Select 2mm Edge Color</p> <p>See page 75</p> <p>H</p>
---	---	---	--	---	---

	DESCRIPTION	MODEL	SHIP WEIGHT	CUBE	LIST PRICE BY LAMINATE GRADE	
					L1	L2
	Seated-Height, Partial Modesty — Full Right Leg					
	60"W x 42"D	HTLC4260LCTPR	165	13.8	\$1506	\$1531
	72"W x 42"D	HTLC4272LCTPR	170	14.2	\$1790	\$1824
	96"W x 42"D	HTLC4296LCTPR	223	38.9	\$2203	\$2252
	Seated-Height, Partial Modesty — Full Left Leg					
	60"W x 42"D	HTLC4260LCTPL	165	13.8	\$1506	\$1531
	72"W x 42"D	HTLC4272LCTPL	170	14.2	\$1790	\$1824
	96"W x 42"D	HTLC4296LCTPL	223	38.9	\$2203	\$2252
	Standing-Height, Partial Modesty — Full Right Leg					
	60"W x 42"D	HTLC4260HCTPR	207	16.2	\$1721	\$1746
	72"W x 42"D	HTLC4272HCTPR	216	16.9	\$2005	\$2039
	96"W x 42"D	HTLC4296HCTPR	274	41.6	\$2418	\$2467
Standing-Height, Partial Modesty — Full Left Leg						
60"W x 42"D	HTLC4260HCTPL	207	16.2	\$1721	\$1746	
72"W x 42"D	HTLC4272HCTPL	216	16.9	\$2005	\$2039	
96"W x 42"D	HTLC4296HCTPL	274	41.6	\$2418	\$2467	
	Seated-Height, Full Modesty — Full Right Leg					
	60"W x 42"D	HTLC4260LCTFPR	180	14.2	\$1506	\$1531
	72"W x 42"D	HTLC4272LCTFPR	188	14.2	\$1790	\$1824
	96"W x 42"D	HTLC4296LCTFPR	247	39.3	\$2203	\$2252
	Seated-Height, Full Modesty — Full Left Leg					
	60"W x 42"D	HTLC4260LCTFPL	180	14.2	\$1506	\$1531
	72"W x 42"D	HTLC4272LCTFPL	188	14.2	\$1790	\$1824
	96"W x 42"D	HTLC4296LCTFPL	247	39.3	\$2203	\$2252
	Standing-Height, Full Modesty — Full Right Leg					
	60"W x 42"D	HTLC4260HCTFPR	223	18.0	\$1721	\$1746
	72"W x 42"D	HTLC4272HCTFPR	234	18.9	\$2005	\$2039
	96"W x 42"D	HTLC4296HCTFPR	299	44.7	\$2418	\$2467
Standing-Height, Full Modesty — Full Left Leg						
60"W x 42"D	HTLC4260HCTFPL	223	18.0	\$1721	\$1746	
72"W x 42"D	HTLC4272HCTFPL	234	18.9	\$2005	\$2039	
96"W x 42"D	HTLC4296HCTFPL	299	44.7	\$2418	\$2467	

NOTES:

- Maximum of 2 ganging tables can be used together. However, different widths may be combined to optimize your space (i.e., 60"W left-hand and 96"W right-hand can be combined).
- Ganging tables ship with all required hardware and light gap filler strip for use between the two partial legs.
- Tops feature 2mm flat edge.
- ! Tables with partial and full modesty panels always feature cutout in modesty panel to accommodate grommet inserts in the top. However, top cutout is optional. Wire management is not included in legs.

HOW TO SPECIFY

<p>Select Model Number</p> <p>HTLC4260LCTPR</p>	<p>Select Grommet Cutout</p> <p>N No Grommet G1 G1 Grommet (centered, + \$46) G2 G2 Grommet (centered, + \$57)</p> <p>G1</p>	<p>Select Top Laminate Color</p> <p>See page 74, Laminate Group A</p> <p>LSA1</p>	<p>Select Base Laminate Color</p> <p>See page 74, Laminate Group B</p> <p>H</p>	<p>Select Modesty Laminate Color</p> <p>See page 74, Laminate Group B</p> <p><i>Do not specify for Power Management models</i></p> <p>LSA1</p>	<p>Select 2mm Edge Color</p> <p>See page 75</p> <p>H</p>
--	---	--	--	---	---

PRESIDE® Collaborative Tables



	DESCRIPTION	MODEL	SHIP WEIGHT	CUBE	LIST PRICE BY LAMINATE GRADE	
					L1	L2
	Seated-Height, Collaborative Table with Partial Modesty Panel					
	60"W x 30"D	HTLC3060LCTP	136	11.1	\$1269	\$1291
	72"W x 30"D	HTLC3072LCTP	150	12.6	\$1531	\$1561
	96"W x 30"D	HTLC3096LCTP	184	15.7	\$1902	\$1945
	Standing-Height, Collaborative Table with Partial Modesty Panel					
	60"W x 30"D	HTLC3060HCTP	174	13.1	\$1451	\$1473
	72"W x 30"D	HTLC3072HCTP	192	14.8	\$1713	\$1743
	96"W x 30"D	HTLC3096HCTP	232	18.0	\$2084	\$2127
	Seated-Height, Collaborative Table with Full Modesty Panel					
	60"W x 30"D	HTLC3060LCTFP	151	11.5	\$1269	\$1291
	72"W x 30"D	HTLC3072LCTFP	168	13.1	\$1531	\$1561
	96"W x 30"D	HTLC3096LCTFP	208	16.1	\$1902	\$1945
	Standing-Height, Collaborative Table with Full Modesty Panel					
	60"W x 30"D	HTLC3060HCTFP	190	14.8	\$1451	\$1473
	72"W x 30"D	HTLC3072HCTFP	210	16.9	\$1713	\$1743
	96"W x 30"D	HTLC3096HCTFP	256	21.1	\$2084	\$2127

NOTES:

- Tops feature 2mm flat edge.

! Tables with partial and full modesty panels always feature cutout in modesty panel to accommodate grommet inserts in the top. However, top cutout is optional. Wire management is not included in legs.

! 30"D Preside Collaborative tables grommet is offset. Please see reference diagram below for exact location.

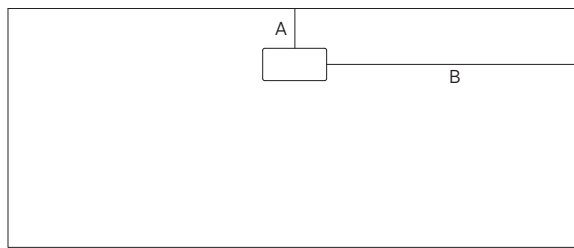

G1 CUTOUT		
WORKSURFACE WIDTH	"A" DIMENSION	"B" DIMENSION
60"	5.0"	25.96"
72"	5.0"	31.96"
96"	5.0"	43.96"

G2 CUTOUT		
WORKSURFACE WIDTH	"A" DIMENSION	"B" DIMENSION
60"	4.02"	24.45"
72"	4.02"	30.45"
96"	4.02"	42.45"

HOW TO SPECIFY

<p>Select Model Number</p> <p>HTLC3060LCTP</p>	<p>Select Cutout Option</p> <p>N No Cutout G1 Cutout for Pop-up Port (\$46) G2 Cutout for Flip-top Port (\$57)</p> <p>N</p>	<p>Select Top Laminate Color</p> <p>See page 74, Laminate Group A</p> <p>H</p>	<p>Select Base Laminate Color</p> <p>See page 74, Laminate Group B</p> <p>H</p>	<p>Select Modesty Laminate Color</p> <p>See page 74, Laminate Group B <i>Do not specify for Power Management models</i></p> <p>LDW1</p>	<p>Select 2mm Edge Color</p> <p>See page 75</p> <p>H</p>
---	---	---	--	---	---

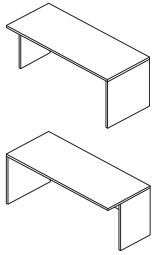

DESCRIPTION	MODEL	SHIP WEIGHT	CUBE	LIST PRICE BY LAMINATE GRADE	
				L1	L2
Seated-Height, Partial Modesty — Full Right Leg					
60"W x 30"D	HTLC3060LCTPR	128	11.1	\$1269	\$1291
72"W x 30"D	HTLC3072LCTPR	175	12.6	\$1531	\$1561
96"W x 30"D	HTLC3096LCTPR	286	15.7	\$1902	\$1945
Seated-Height, Partial Modesty — Full Left Leg					
60"W x 30"D	HTLC3060LCTPL	128	11.1	\$1269	\$1291
72"W x 30"D	HTLC3072LCTPL	175	12.6	\$1531	\$1561
96"W x 30"D	HTLC3096LCTPL	286	15.7	\$1902	\$1945
Standing-Height, Partial Modesty — Full Right Leg					
60"W x 30"D	HTLC3060HCTPR	163	13.1	\$1451	\$1473
72"W x 30"D	HTLC3072HCTPR	180	14.8	\$1713	\$1743
96"W x 30"D	HTLC3096HCTPR	220	18.0	\$2084	\$2127
Standing-Height, Partial Modesty — Full Left Leg					
60"W x 30"D	HTLC3060HCTPL	163	13.1	\$1451	\$1473
72"W x 30"D	HTLC3072HCTPL	180	14.8	\$1713	\$1743
96"W x 30"D	HTLC3096HCTPL	220	18.0	\$2084	\$2127

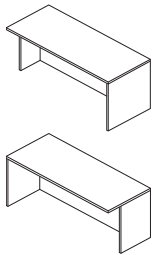

Seated-Height, Full Modesty — Full Right Leg					
60"W x 30"D	HTLC3060LCTFPR	143	11.5	\$1269	\$1291
72"W x 30"D	HTLC3072LCTFPR	160	13.1	\$1531	\$1561
96"W x 30"D	HTLC3096LCTFPR	200	16.1	\$1902	\$1945
Seated-Height, Full Modesty — Full Left Leg					
60"W x 30"D	HTLC3060LCTFPL	143	11.5	\$1269	\$1291
72"W x 30"D	HTLC3072LCTFPL	160	13.1	\$1531	\$1561
96"W x 30"D	HTLC3096LCTFPL	200	16.1	\$1902	\$1945
Standing-Height, Full Modesty — Full Right Leg					
60"W x 30"D	HTLC3060HCTFPR	178	14.8	\$1451	\$1473
72"W x 30"D	HTLC3072HCTFPR	199	16.9	\$1713	\$1743
96"W x 30"D	HTLC3096HCTFPR	245	21.1	\$2084	\$2127
Standing-Height, Full Modesty — Full Left Leg					
60"W x 30"D	HTLC3060HCTFPL	178	14.8	\$1451	\$1473
72"W x 30"D	HTLC3072HCTFPL	199	16.9	\$1713	\$1743
96"W x 30"D	HTLC3096HCTFPL	245	21.1	\$2084	\$2127

NOTES:

- Maximum of 2 ganging tables can be used together. However, different widths may be combined to optimize your space (i.e., 60"W left-hand and 96"W right-hand can be combined).
- Ganging tables ship with all required hardware and light gap filler strip for use between the two partial legs.
- Tops feature 2mm flat edge.
- ! Tables with partial and full modesty panels always feature cutout in modesty panel to accommodate grommet inserts in the top. However, top cutout is optional. Wire management is not included in legs.
- ! Collaborative Tables with power management will not have modesty panels.
- ! 30"D Collaborative Table Modesty Panel will be offset to allow more leg room on one side of the table.

HOW TO SPECIFY

Select Model Number	Select Grommet Cutout	Select Top Laminate Color	Select Base Laminate Color	Select Modesty Laminate Color	Select 2mm Edge Color
	N No Grommet G1 G1 Grommet (centered, + \$46) G2 G2 Grommet (centered, + \$57)	See page 74, Laminate Group A	See page 74, Laminate Group B	See page 74, Laminate Group B	See page 75
HTLC3060LCTPR	G1	LSA1	H	LSA1	H

PRESIDE® Mobile Collaborative Tables



Icon Legend on page 19

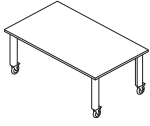

DESCRIPTION	MODEL	SHIP		LIST PRICE BY LAMINATE GRADE		UPCHARGE BY PAINT GRADE		
		WEIGHT	CUBE	L1	L2	P2	P3	
Mobile Collaborative Tables								
42" x 96" Seated	HTMC304296	205	16.5	\$2809	\$2858	\$147	\$220	
42" x 72" Seated	HTMC304272	167	13.4	\$2463	\$2506	\$131	\$196	
42" x 60" Seated	HTMC304260	147	12.1	\$2141	\$2173	\$123	\$185	
42" x 96" Standing	HTMC424296	219	17.8	\$2903	\$2952	\$156	\$232	
42" x 72" Standing	HTMC424272	181	14.6	\$2557	\$2600	\$140	\$209	
42" x 60" Standing	HTMC424260	161	13.3	\$2235	\$2267	\$132	\$196	

DESCRIPTION	MODEL	SHIP		BUTCHER BLOCK	UPCHARGE BY PAINT GRADE	
		WEIGHT	CUBE		P2	P3
Mobile Collaborative Tables with Butcher Block Top						
42" x 96" Seated	HTMC304296BB	206	9.6	\$4267	\$147	\$220
42" x 72" Seated	HTMC304272BB	191	7.6	\$3658	\$131	\$196
42" x 60" Seated	HTMC304260BB	167	7.1	\$3206	\$123	\$185
42" x 96" Standing	HTMC424296BB	220	10.9	\$4361	\$156	\$232
42" x 72" Standing	HTMC424272BB	205	8.9	\$3752	\$140	\$209
42" x 60" Standing	HTMC424260BB	181	8.5	\$3300	\$132	\$196

NOTES:

- Mobile collaborative tables standard with 4 locking 5" casters.
- Laminate tops feature 2mm flat edge.
- Butcher block top is 1½" thick and features 1½" radius corners.
- Butcher block tops will naturally feature variation between tops due to the nature of the real wood finish. Constructed of natural Birch wood, no two tops are exactly alike. Top is coated in a clear polyurethane finish for maximum durability.

HOW TO SPECIFY

Select Model Number HTMC304296	Select Grommet Cutout N No Grommet	Select Top Laminate Color See page 74, Laminate Group A LSA1	Select Edge Color See page 75 LSA1	Select Caster C With Caster	Select Paint Color See page 74 T1
--	--	---	---	---------------------------------------	--

Select Model Number HTMC304296BB	Select Grommet Cutout N No Grommet	Select Wood LH903 Butcher Block	Select Caster C With Caster	Select Paint Color See page 74 T1
--	--	---	---------------------------------------	--

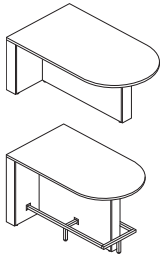

DESCRIPTION

Team Touchdown Tables

42" x 72" Seated Table
42" x 60" Seated Table

42" x 72" Standing Table
42" x 60" Standing Table

42" x 72" Standing Table w/ Footring
42" x 60" Standing Table w/ Footring

MODEL

HTLMT4272L
HTLMT4260L

HTLMT4272H
HTLMT4260H

HTLMT4272HFR
HTLMT4260HFR

SHIP WEIGHT

CUBE

LIST PRICE BY LAMINATE GRADE

L1

L2

\$1701 **\$1742**
\$1402 **\$1434**

\$2089 **\$2130**
\$1731 **\$1763**

\$3421 **\$3462**
\$2846 **\$2878**

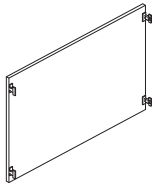

Back Panel for Seated Team Touchdown Table
Back Panel for Standing Team Touchdown Table

HTLMTLBACK
HTLMTLHBACK

23 3.2
33 4.5

\$387 **\$405**
\$437 **\$457**

NOTES: Specify Laminate, see page 74, Laminate Group B.

SPECIFYING EXAMPLE: HTLMTLBACK.LSA1

NOTES:

- Team Touchdown Tables feature open back standard. If closed back is desired, back panels must be specified separately.
- Back panel provides clearance for TV mount.
- Tops feature 2mm flat edge.

HOW TO SPECIFY

<p>Select Model Number</p> <p>HTLMT4272L</p>	<p>Select Grommet Cutout</p> <p>N No Grommet G1 G1 Grommet (centered, + \$46) G2 G2 Grommet (centered, + \$57)</p> <p>G1</p>	<p>Select Top Laminate Color</p> <p>See page 74, Laminate Group A</p> <p>LSA1</p>	<p>Select Edge Color</p> <p>See page 75</p> <p>LSA1</p>	<p>Select Chassis Laminate</p> <p>See page 74, Laminate Group B</p> <p>LSA1</p>	<p>Select Paint Color</p> <p><i>Footring only available on FR models in CBK only</i></p> <p>CBK</p>
---	--	--	--	--	--

DESCRIPTION	MODEL	SHIP WEIGHT	CUBE	LIST PRICE BY PAINT GRADE	
				P1	P2
 TV Mount	HTLMTTV	4	1.0	\$391	\$425

NOTES:

- TV mount is used to mount a television to the flat end of a Team Touchdown Table.
- Mounting hardware provided for television sizes 32" to 50" with VESA mounts of 100x100 to 200x200; for some televisions, additional hardware will be required (not provided).

HOW TO SPECIFY

<p>Select Model Number</p> <p>HTLMTTV</p>	<p>Select Paint Color</p> <p>P Black</p> <p>P</p>
--	---

PRESIDE® Ancillary



Icon Legend on page 19



DESCRIPTION	MODEL	SHIP WEIGHT	CUBE	LIST PRICE BY PAINT GRADE		L2 UPCHARGE
				P1	P2	
Benches						
18"D x 60"W	HTLBENCH60	23	2.3	\$1912	\$2025	\$28
18"D x 48"W	HTLBENCH48	21	1.8	\$1557	\$1647	\$23
18"D x 30"W	HTLBENCH30	18	1.8	\$1137	\$1202	\$18

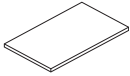

DESCRIPTION	MODEL	SHIP WEIGHT	CUBE	LIST PRICE BY FABRIC GRADE					
				1	2	3	4	5	6
Bench Cushion									
18"D x 60"W	HTLBENCHCUSH60	16	3.6	\$436	\$486	\$567	\$590	\$653	\$719
18"D x 48"W	HTLBENCHCUSH48	12	2.9	\$388	\$433	\$506	\$525	\$581	\$642
18"D x 30"W	HTLBENCHCUSH30	8	1.9	\$330	\$369	\$430	\$447	\$494	\$545

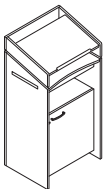

DESCRIPTION	MODEL	SHIP WEIGHT	CUBE	LIST PRICE BY LAMINATE GRADE	
				L1	L2
Laminate Lectern	HTLLECTA	132	15.6	\$1946	\$2020
<ul style="list-style-type: none"> • Overall cabinet dimensions 24"W x 18"D x 50"H. • Adjustable top worksurface features 3 tilt positions. • Top of lectern can be removed and used on table top. • Laptop shelf slides left or right. • Includes 2 locking and 2 non-locking casters. • Includes adjustable shelf in storage compartment. • Features scallops in rear of lectern to route and conceal cables and wires. • Metal components standard in black finish. 					

NOTES:

- Bench features knife edge along two long sides of seat; depth edges of top features flat edge allowing benches to be placed side by side without gaps.
- Bench cushions attach to bench seat with hook and loop.
- Fabric for bench cushions is upholstered in the railroad direction.

HOW TO SPECIFY

<p>Select Model Number</p> <p>HTLBENCH48</p>	<p>Select Top Laminate Color</p> <p>See page 74, Laminate Group A</p> <p>LSA1</p>	<p>Select Edge Color</p> <p>See page 75</p> <p>SA</p>	<p>Select Paint Color</p> <p>See page 74, Paint Group A</p> <p>T1</p>
<p>Select Model Number</p> <p>HTLBENCHCUSH48</p>	<p>Select Fabric</p> <p>See page 74</p> <p>PBLE09</p>		
<p>Select Model Number</p> <p>HTLLECTA</p>	<p>Select Laminate</p> <p>See page 74, Laminate Group B</p> <p>H</p>	<p>Select Pull</p> <p>J Loop Satin Nickel G Loop Black</p> <p>G</p>	



Icon Legend on page 19

PRESIDE® Laminate Storage

TABLES

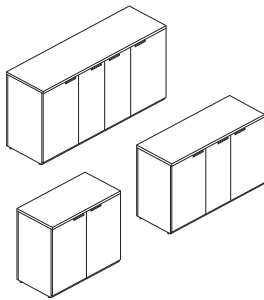

DESCRIPTION

Hospitality Credenza
 21¹/₁₆"D x 72"W x 36"H
 21¹/₁₆"D x 57"W x 36"H
 21¹/₁₆"D x 42"W x 36"H

MODEL	SHIP WEIGHT	CUBE	L1 LIST PRICE
HTLCRED72	301	40.0	\$3623
HTLCRED57	250	31.8	\$3143
HTLCRED42	200	23.7	\$2502

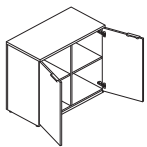

Hospitality Credenza with Shelves



21¹/₁₆"D x 72"W x 36"H
 21¹/₁₆"D x 57"W x 36"H
 21¹/₁₆"D x 42"W x 36"H

HTLCRED72S	311	41.5	\$3807
HTLCRED57S	260	33.3	\$3327
HTLCRED42S	210	25.2	\$2686

NOTES: Hospitality credenzas with shelves ship with 2 shelves in separate cartons. Additional shelves can be ordered separately if desired.

HOW TO SPECIFY

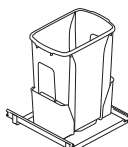
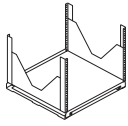
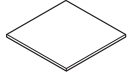
Select Model Number	Select Top Laminate Color	Select 2mm Edge Color	Select Chassis Laminate	Select Pull	Select Back Cutout	Select Shelf Laminate
See page 74, Laminate Group A	See page 74, Laminate Group B	See page 75	See page 74, Laminate Group B	See page 76 for line art visual	C Vent Cutout (+ \$57) N No Cutout	See page 74, Laminate Group B
L2 (+ \$57)	L2 (+ \$85)		L2 (+ \$85)	J Loop Satin Nickel G Loop Black 3 Rounded Square Matte Chrome 4 Rounded Square Black VP HLSL Voi® Pull Black VPJW HLSL Voi® Pull Designer White VT4 HLSL Voi® Pull Champagne Metallic VT1 HLSL Voi® Pull Platinum Metallic VPR6 HLSL Voi® Pull Silver VP8X HLSL Voi® Pull Solar Black		L2 (+ \$23) <i>Specify for shelf models only</i>
HTLCRED57S	LSA1	SA	LSA1	J	C	T1

DESCRIPTION	MODEL	SHIP WEIGHT	CUBE	L1 LIST PRICE	L2 UPCHARGE
 <p>Trash Bin Slide</p> <ul style="list-style-type: none"> • Holds a 35 quart bin. • Trash bin is included with model. • Can be used in outer compartments of credenza models above. 	HTBINSLIDE	15	3.5	\$272	N/A
 <p>Mounted AV Rack</p> <ul style="list-style-type: none"> • Can be used in outer compartments of credenza models above. 	HTRACK	15	4.8	\$2457	N/A
 <p>Laminate Credenza Shelf</p> <ul style="list-style-type: none"> • Shelf can be utilized in the outer compartments of the credenza. • 3 mounting locations within outer compartment on the credenza. • Mounting locations are 6" apart. 	HTLSHELF	10 	1.5	\$92	\$13

HOW TO SPECIFY

Select Model Number	Select Laminate
See page 74, Laminate Group B	
HTLSHELF	H

PRESIDE® Laminate Storage

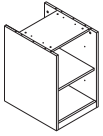
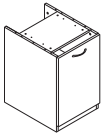
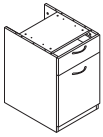

	DESCRIPTION	MODEL	SHIP WEIGHT	CUBE	LIST PRICE BY LAMINATE GRADE	
					L1	L2
 <i>Model HTLMC1828O shown</i>	Modular Pedestal, Bookshelf, No Door	HTLMC1828O	70	9.8	\$711	\$740
 <i>Model HTLMC1828L shown</i>	Modular Pedestal, Bookshelf, with Door (left)	HTLMC1828L	70	9.8	\$868	\$902
	Modular Pedestal, Bookshelf, with Door (right)	HTLMC1828R	70	9.8	\$868	\$902
 <i>Model HTLMC1828DR shown</i>	Modular Pedestal, Box Drawer, Cabinet Door (left)	HTLMC1828DL	70	9.8	\$922	\$956
	Modular Pedestal, Box Drawer, Cabinet Door (right)	HTLMC1828DR	70	9.8	\$922	\$956

NOTES:

- Use Concinnity™ laminate tops and backs with Preside® modular storage for a finished look. See page 105.

HOW TO SPECIFY

<p>Select Model Number</p> <p>HTLMC1828L</p>	<p>Select Pull Option</p> <p>J Loop Satin Handle G Loop Black 3 Rounded Square Matte Chrome 4 Rounded Square Black X No Pull (for model HTLMC1828O only)</p> <p>J</p>	<p>Select Laminate</p> <p>See page 74, Laminate Group B</p> <p>N</p>
---	--	---



Icon Legend on page 19

MODULAR COMPONENTS

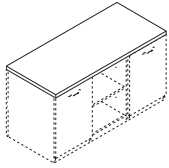

DESCRIPTION	MODEL	SHIP WEIGHT	CUBE	LIST PRICE BY LAMINATE GRADE	
				L1	L2
Concinnity™ Rectangle Worksurface with Horizontal Grain					
90"W x 24"D	HNLRC2490	75	5.5	\$736	\$770
72"W x 24"D	HNLRC2472	60	4.6	\$518	\$541
54"W x 24"D	HNLRC2454	45	3.5	\$423	\$446
36"W x 24"D Rectangle Worksurface/Pedestal Top	HNLRC2436	30	2.4	\$328	\$346

NOTES: Use Concinnity™ laminate tops and backs with Preside® modular storage for a finished look.

- ! Grain direction on all rectangle worksurfaces runs horizontal (side-to-side) except as follows: 30"W - 36"W - 42"W - 48"W - 54"W - 60"W x 24"D tops can be specified with horizontal (side-to-side) or vertical (front-to-back) grain.
- ! 42"W and 48"W x 20"D tops are available with vertical (front-to-back) grain only.

HOW TO SPECIFY

Select Model Number

H N L R C 2 4 9 0 .

Select Edge Profile and Edge Color

See page 31 in the 2025 Workspaces Pricer

B H .

Select Worksurface Grommet Finish

- P Black
- T1 Platinum
- X No Grommet

P .

Select Worksurface Color

See page 31 in the 2025 Workspaces Pricer

H



Icon Legend on page 19

MODULAR COMPONENTS

Back Panels

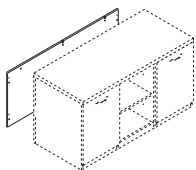

DESCRIPTION	MODEL	SHIP WEIGHT	CUBE	LIST PRICE BY LAMINATE GRADE	
				L1	L2
Concinnity™ Modesty/Back Panels — Full-Length					
90"W x 27 ⁷ / ₈ "H	HNLMP9028	58	6.7	\$590	\$619
72"W x 27 ⁷ / ₈ "H	HNLMP7228	46	5.3	\$405	\$428
54"W x 27 ⁷ / ₈ "H	HNLMP5428	34	4.0	\$333	\$356
36"W x 27 ⁷ / ₈ "H Modesty/Pedestal Back Panel	HNLMP3628	22	2.8	\$268	\$283

NOTES: Component is 3/4" thick. Provide approach-side kneespace privacy for user seated at desks, credenzas, returns, and bridges.

HOW TO SPECIFY

Select Model Number

H N L M P 7 2 2 8 .

Select Grommet

- P Black
- X No Grommet

X .

Select Laminate Color

See page 31 in the 2025 Workspaces Pricer

H

WALL MOUNT STORAGE



Icon Legend on page 19

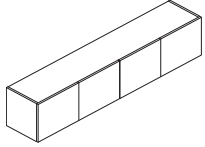

DESCRIPTION

Concinnity™ Wall Mount Storage, Laminate Doors

- 78"W x 15"D x 15"H — 4 doors, 2 compartments
- 72"W x 15"D x 15"H — 4 doors, 2 compartments
- 66"W x 15"D x 15"H — 4 doors, 2 compartments
- 60"W x 15"D x 15"H — 4 doors, 2 compartments
- 48"W x 15"D x 15"H — 3 doors, 2 compartments
- 42"W x 15"D x 15"H — 2 doors, 1 compartment
- 36"W x 15"D x 15"H — 2 doors, 1 compartment
- 30"W x 15"D x 15"H — 2 doors, 1 compartment

MODEL	SHIP WEIGHT	CUBE	L1 LIST	L2 UPCHARGES	
				CHASSIS	FRONTS
HNL1578LD	126	17.1	\$1748	\$41	\$23
HNL1572LD	118	15.9	\$1624	\$29	\$23
HNL1566LD	109	14.6	\$1548	\$29	\$23
HNL1560LD	100	13.3	\$1389	\$29	\$23
HNL1548LD	83	10.9	\$1254	\$23	\$23
HNL1542LD	68	9.7	\$1185	\$23	\$13
HNL1536LD	60	8.4	\$1081	\$23	\$13
HNL1530LD	51	7.2	\$999	\$23	\$13

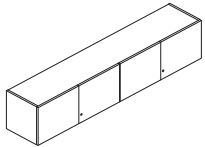

Concinnity™ Wall Mount Storage, Laminate Locking Doors

- 78"W x 15"D x 15"H — 4 doors, 2 compartments
- 72"W x 15"D x 15"H — 4 doors, 2 compartments
- 66"W x 15"D x 15"H — 4 doors, 2 compartments
- 60"W x 15"D x 15"H — 4 doors, 2 compartments
- 48"W x 15"D x 15"H — 3 doors, 2 compartments
- 42"W x 15"D x 15"H — 2 doors, 1 compartment
- 36"W x 15"D x 15"H — 2 doors, 1 compartment
- 30"W x 15"D x 15"H — 2 doors, 1 compartment

HNL1578LL	126	17.1	\$1861	\$41	\$23
HNL1572LL	118	15.9	\$1736	\$29	\$23
HNL1566LL	109	14.6	\$1661	\$29	\$23
HNL1560LL	100	13.3	\$1504	\$29	\$23
HNL1548LL	83	10.9	\$1339	\$23	\$23
HNL1542LL	68	9.7	\$1241	\$23	\$13
HNL1536LL	60	8.4	\$1139	\$23	\$13
HNL1530LL	51	7.2	\$1056	\$23	\$13

ⓘ Lock available in Black (P) or Satin (SA) finish. Lock is core removable. Keyed alike cores must be ordered separately. For stack-on and wall mount storage with locking hinged doors, specify model HF27B (Black) or HF27S (Satin) and the key number, see the Desks section in the 2025 Workspaces Pricer. Model HNL1548LL has one lock, which secures two of the three doors.

NOTES:

- Preside® tables pair well with Concinnity™ Wall Mounted Storage to create a complete conference or collaborative layout.
- Convenient off-the-worksurface storage requires no additional floor space.
- Available with laminate doors, frosted/silver doors, or sliding door.
- Doors are sized to overlap the top, end panels and light valance, to provide a clean design.
- Laminate and frosted/silver door units are equipped with self-closing, adjustable hinges.
- Laminate hinged door units are available with or without a lock.
- For tackboards, see the Desks section in the 2025 Workspaces Pricer.
- For task lights, see the Desks section in the 2025 Workspaces Pricer.
- For paper organizers, see the Desks section in the 2025 Workspaces Pricer.
- **IMPORTANT: See installation guidelines in the Desks section in the 2025 Workspaces Pricer.**

HOW TO SPECIFY

<p>Select Model Number</p> <p>H N L 1 5 7 8 L D .</p>	<p>Select Chassis Color</p> <p>See page 31 in the 2025 Workspaces Pricer</p> <p>H .</p>	<p>Select Door Front Color</p> <p>See page 31 in the 2025 Workspaces Pricer</p> <p>H</p>
--	--	---

<p>Select Model Number</p> <p>H N L 1 5 7 8 L L .</p>	<p>Select Lock Finish</p> <p>See page 31 in the 2025 Workspaces Pricer</p> <p>P .</p>	<p>Select Chassis Color</p> <p>See page 31 in the 2025 Workspaces Pricer</p> <p>H .</p>	<p>Select Door Front Color</p> <p>See page 31 in the 2025 Workspaces Pricer</p> <p>H</p>
--	--	--	---



Icon Legend on page 19

WALL MOUNT STORAGE

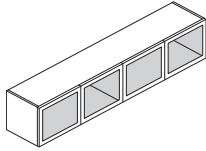

DESCRIPTION

Concinnity™ Wall Mount Storage, Frosted Doors with Silver Frame

- 78"W x 15"D x 15"H — 4 doors, 2 compartments
- 72"W x 15"D x 15"H — 4 doors, 2 compartments
- 66"W x 15"D x 15"H — 4 doors, 2 compartments
- 60"W x 15"D x 15"H — 4 doors, 2 compartments
- 48"W x 15"D x 15"H — 3 doors, 2 compartments
- 42"W x 15"D x 15"H — 2 doors, 1 compartment
- 36"W x 15"D x 15"H — 2 doors, 1 compartment
- 30"W x 15"D x 15"H — 2 doors, 1 compartment

MODEL	SHIP WEIGHT	CUBE	L1 LIST	L2 UPCHARGES	
				CHASSIS	FRONTS
HNL1578FD	106	17.1	\$2641	\$41	N/A
HNL1572FD	99	15.9	\$2515	\$29	N/A
HNL1566FD	92	14.6	\$2436	\$29	N/A
HNL1560FD	85	13.3	\$2279	\$29	N/A
HNL1548FD	71	10.9	\$1921	\$23	N/A
HNL1542FD	57	9.7	\$1634	\$23	N/A
HNL1536FD	50	8.4	\$1531	\$23	N/A
HNL1530FD	43	7.2	\$1447	\$23	N/A

❗ Frosted door models do not have a lock option.

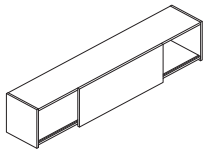

Concinnity™ Wall Mount Storage, Sliding Door

- 78"W x 15"D x 15"H
- 72"W x 15"D x 15"H
- 66"W x 15"D x 15"H
- 60"W x 15"D x 15"H
- 48"W x 15"D x 15"H

HNL1578SD	114	17.1	\$1700	\$41	\$23
HNL1572SD	107	15.9	\$1561	\$29	\$23
HNL1566SD	99	14.6	\$1456	\$29	\$23
HNL1560SD	91	13.3	\$1323	\$29	\$23
HNL1548SD	76	10.9	\$1239	\$23	\$23

NOTES: One door per unit. Standard with black lock, which is located on the inside vertical support panel.

NOTES:

- Preside® tables pair well with Concinnity™ Wall Mounted Storage to create a complete conference or collaborative layout.
- Convenient off-the-worksurface storage requires no additional floor space.
- Available with laminate doors, frosted/silver doors, or sliding door.
- Doors are sized to overlap the top, end panels and light valance, to provide a clean design.
- Laminate and frosted/silver door units are equipped with self-closing, adjustable hinges.
- Laminate hinged door units are available with or without a lock.
- For tackboards, see the Desks section in the 2025 Workspaces Pricer.
- For task lights, see the Desks section in the 2025 Workspaces Pricer.
- For paper organizers, see the Desks section in the 2025 Workspaces Pricer.
- **IMPORTANT: See installation guidelines in the Desks section in the 2025 Workspaces Pricer.**

HOW TO SPECIFY

<p>Select Model Number</p> <div style="border: 1px solid black; display: flex; justify-content: space-between; padding: 2px;"> HNL1578FD </div>	<p>Select Chassis Color</p> <p>See page 31 in the 2025 Workspaces Pricer</p> <div style="border: 1px solid black; display: flex; justify-content: space-between; padding: 2px;"> H </div>	
<p>Select Model Number</p> <div style="border: 1px solid black; display: flex; justify-content: space-between; padding: 2px;"> HNL1578SD </div>	<p>Select Chassis Color</p> <p>See page 31 in the 2025 Workspaces Pricer</p> <div style="border: 1px solid black; display: flex; justify-content: space-between; padding: 2px;"> H </div>	<p>Select Door Front Color</p> <p>See page 31 in the 2025 Workspaces Pricer</p> <div style="border: 1px solid black; display: flex; justify-content: space-between; padding: 2px;"> H </div>

PRESIDE® Laminate Shared Components

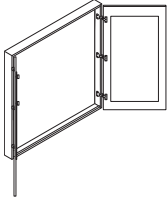

DESCRIPTION	MODEL	SHIP WEIGHT	CUBE	LIST PRICE BY LAMINATE GRADE	
				L1	L2
Laminate Presentation Cabinet <ul style="list-style-type: none"> Overall cabinet dimensions 48⁷/₈"W x 5"D x 49¹/₂"H. Mounts to wall. Presentation cabinet features one magnetic white board, one tackboard and one paper pad. Self-adjusting hinges ensure doors are in alignment. 	HTLPRES	169	10.9	\$2132	\$2222

HOW TO SPECIFY

Select Model Number HTLPRES.	Select Laminate See page 74, Laminate Group B
--	---

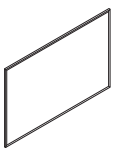

DESCRIPTION	MODEL	SHIP WEIGHT	CUBE	LIST PRICE
Markerboard <ul style="list-style-type: none"> Overall markerboard dimensions 48"W x 31"H. Mounts on wall. Can be mounted horizontally or vertically. Markerboard is magnetic. No specification required. 	HL4831MB	44.0	3.4	\$948

HOW TO SPECIFY

Select Model Number HL4831MB	
--	--



Icon Legend on page 19

PRESIDE[®] Laminate Tables

TABLES

	DESCRIPTION	MODEL	SHIP WEIGHT	CUBE	LIST PRICE
	Laminate Boat Shaped Table Tops with Stretcher				
	168"W x 48"D	HTLB16848P	319	11.9	\$1875
	144"W x 48"D	HTLB14448P	266	9.8	\$1490
	120"W x 48"D	HTLB12048P	217	8.2	\$1351
	Laminate Adder Section with Stretcher				
	72"W x 48"D	HTLM7248P	144	9.8	\$991
	Laminate Bases				
	Laminate Panel Bases, Double Pack	HTLPB	53	3.1	\$539
	Laminate Panel Bases, Single Pack	HTLPBS	28	3.1	\$327

	With Panel Base
HTLB12048P HTLB14448P	1 x HTLPB (Laminate Panel Base)
HTLB16848P	1 x HTLPB (Laminate Panel Base) 1 x HTLPBS (Laminate Panel Mid-Base)
HTLM7248P	1 x HTLPBS (Laminate Panel Mid-Base)

NOTES:

- Tops and Modesty Panels are 1/8" Melamine.
- 168"W Boat-Shaped Top needs 3 bases; 72"W Middle Adder needs 1 base. All other tops need 2 bases.
- 120", 144", and 168"W Tops ship in 2 pieces to facilitate handling and installation; these top sizes will not have an exact grain alignment where the two halves meet, a reasonable match can be expected.
- ! Tops with Stretcher and Adder Section with Stretcher available in Harvest (C) and Mahogany (N) finishes only.
- ! Tops available in Boat Shape with G edge (2mm self edge) only; Middle Adder is rectangular with G edge.
- ! Edge finish always matches top finish.

HOW TO SPECIFY

<p>Select Model Number</p> <p>HTLB16848P</p>	<p>Select Grommet Option</p> <p>N No grommet (only option)</p> <p>N</p>	<p>Select Laminate</p> <p>C Harvest N Mahogany</p> <p>C</p>
---	--	--

PRESIDE® Laminate Tables — Pre-defined Typicals



Icon Legend on page 19

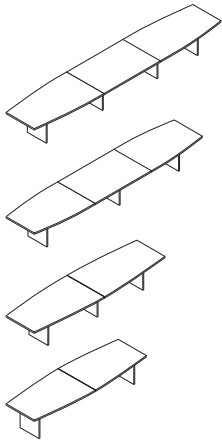

DESCRIPTION	MODEL	SHIP WEIGHT	CUBE	LIST PRICE
Boat Shape Laminate Tables with Panel Base				
240"W x 48"D	HTLB2048LP	572	31.0	\$4059
216"W x 48"D	HTLB1848LP	491	25.9	\$3347
192"W x 48"D	HTLB1648LP	442	24.3	\$3208
168"W x 48"D	HTLB1448LP	400	18.1	\$2741
144"W x 48"D	HTLB1248LP	319	12.9	\$2029
120"W x 48"D	HTLB1048LP	270	11.3	\$1890

NOTES: Order entire typical with one model number to get desired table size. Table top and bases are included.

NOTES:

- Tops and Modesty Panels are 1 1/8" Melamine.
- 168"W Boat-Shaped Top needs 3 bases; 72"W Middle Adder needs 1 base. All other tops need 2 bases.
- 120", 144", and 168"W Tops ship in 2 pieces to facilitate handling and installation; these top sizes will not have an exact grain alignment where the two halves meet, a reasonable match can be expected.
- ! Available in Harvest (C) and Mahogany (N) finishes only.
- ! Tops available in Boat Shape with G edge (2mm self edge) only; Middle Adder is rectangular with G edge.
- ! Edge finish always matches top finish.

HOW TO SPECIFY

<p>Select Model Number</p> <p>HTLB2048LP</p>	<p>Select Grommet Option</p> <p>N No grommet (only option)</p> <p>N</p>	<p>Select Laminate</p> <p>C Harvest N Mahogany</p> <p>C</p>	<p>Select Edge Color</p> <p>C Harvest N Mahogany</p> <p>C</p>
---	--	--	--

SCRAMBLE™ OCCASIONAL TABLES

Want to see more? Scan here
to check out hon.com.



Scramble™ Coffee Table shown with
West Hill™ Casual Lounge Seating.

SCRAMBLE™

For every tablet, coffee mug, or notepad there's a need for an occasional table. Don't scramble to find an open meeting room when you can move to where relaxed productivity happens whether it's a lounge, commons, or nook area. Designed to coordinate with any of HON's soft seating lines, Scramble occasional tables fit in any space you need to work comfortably.



FEATURES

- Select from Soft Rectangle, Soft Square, and Round top shapes.
- Multiple size ranges available from side to large coffee tables.
- Coordinate with any of HON's soft seating series to create a space that works.
- Angled hardwood legs with metal stretcher bars provide a mid-century feel.
- Assorted leg and stretcher bar finishes available to match any aesthetic.
- Match the style of any space, with laminate tops including both flat and knife edges, as well as premium back-painted glass tops.

SCRAMBLE™ Options

MODEL OPTIONS

HSCCSR2448LM
HSCCSR2448LMK
HSCCSR2448BPG



Coffee Table
Soft Rectangle

HSCCSS36LM, HSCCSS36LMK, HSCCSS36BPG
HSCCSS48LM, HSCCSS48LMK, HSCCSS48BPG



Coffee Table
Soft Square

HSCCR36LM, HSCCR36LMK, HSCCR36BPG
HSCCR48LM, HSCCSS48LMK, HSCCR48BPG



Coffee Table
Round

HSCSS24LM
HSCSS24LMK
HSCSS24BPG



End Table
Soft Square

HSCER24LM
HSCER24LMK
HSCER24BPG



End Table
Round

Available Laminates and Corresponding Edge:

Laminate	Edgeband	Laminate	Edgeband
Beigewood	LWBE	Beigewood	DE
Charcoal	S	Charcoal	S
Designer White	LDW1	Designer White	DW
Fawn Cypress	LFC1	Fawn Cypress	FC
Field Elm	LWFE	Field Elm	FE
Florence Walnut	LFW1	Florence Walnut	FW
Handspun Chestnut	LAHC	Loft	LOFT
Handspun Dove	LAHD	Fossil	EH
Handspun Pearl	LAHP	Fossil	EH
Handspun Slate	LAHS	Charcoal	S
Harvest	C	Harvest	C
Kingswood Walnut	LKI1	Kingswood Walnut	KI
Lowell Ash	LLA1	Lowell Ash	DL
Natural Maple	D	Natural Maple	D
Natural Recon	LNR1	Natural Recon	NR
Phantom Ecru	LPE1	Phantom Ecru	PE
Pinnacle	PINC	Pinnacle	PINC
Portico Teak	LPT1	Portico Teak	PT
Skyline Walnut	LSW1	Skyline Walnut	SW
Sterling Ash	LSA1	Sterling Ash	SA

EDGE & MATERIAL OPTIONS



Laminate
2mm Edge, 3/4" thick

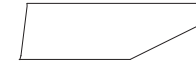

Laminate
Knife Edge, 1/8" thick

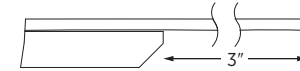

Back-Painted Glass

- 1/4" thick glass, painted on the bottom surface with frosted/etched top and sides.
- 3/4" MDF sub-top inset 3" from all sides, for attachment to base.

WOOD LEG OPTIONS

CODE	DESCRIPTION	PRICE
LFW1	Florence Walnut	+\$0
LKI1	Kingswood Walnut	+\$0
C	Harvest	+\$0
LLA1	Lowell Ash	+\$0
D	Natural Maple	+\$0
LNR1	Natural Recon	+\$0
LPE1	Phantom Ecru	+\$0
PINC	Pinnacle	+\$0
LPT1	Portico Teak	+\$0
LSW1	Skyline Walnut	+\$0
LSA1	Sterling Ash	+\$0
LE404	Warm White	+\$0
LE405	Mist	+\$0
LE408	Peppercorn	+\$0

NOTES: Wood Legs are stained solid maple. Stain finishes will be tonal matches to the respective laminate finishes. Some natural woodgrain may show through the stain; therefore, stained wood legs may have slight variation in appearance.

STRETCHER BAR PAINT OPTIONS

CODE	DESCRIPTION	PRICE
Grade P1		
P7A	Textured Charcoal	+\$0
P8V	Textured Titanium	+\$0
Grade P2		
PR5	Champagne Metallic	+\$23
P8X	Solar Black	+\$23

BACK-PAINTED GLASS OPTION



CODE	DESCRIPTION	PRICE
GWH1	Ice White, Glossy	+\$0



Icon Legend on page 19

SCRAMBLE™ Coffee Tables

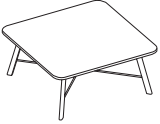
TABLES

	DESCRIPTION	MODEL	SHIP WEIGHT	CUBE	LIST PRICE BY LAMINATE GRADE		GLASS LIST PRICE
					L1	L2	
	Coffee Table, Soft Rectangle 24"D x 48"W x 16"H, Laminate Top, 2mm Edge	HSCCSR2448LM	46.5	9.7	\$1697	\$1720	
	24"D x 48"W x 16"H, Laminate Top, Knife Edge	HSCCSR2448LMK	94.0	6.4	\$1924	\$1947	
	24"D x 48"W x 16"H, Back-Painted Glass Top	HSCCSR2448BPG	61.5	5.9			\$3546
	Coffee Table, Soft Square 36"D x 36"W x 16"H, Laminate Top, 2mm Edge	HSCCSS36LM	48.5	9.0	\$1630	\$1653	
	48"D x 48"W x 16"H, Laminate Top, 2mm Edge	HSCCSS48LM	80.5	12.8	\$1763	\$1786	
	36"D x 36"W x 16"H, Laminate Top, Knife Edge	HSCCSS36LMK	63.0	6.7	\$1802	\$1825	
	48"D x 48"W x 16"H, Laminate Top, Knife Edge	HSCCSS48LMK	96.5	9.9	\$2046	\$2069	
	36"D x 36"W x 16"H, Back-Painted Glass Top	HSCCSS36BPG	66.0	6.2			\$3831
48"D x 48"W x 16"H, Back-Painted Glass Top	HSCCSS48BPG	110.5	9.1			\$4420	
	Coffee Table, Round 36"D x 16"H, Laminate Top, 2mm Edge	HSCCR36LM	41.0	8.8	\$1630	\$1653	
	48"D x 16"H, Laminate Top, 2mm Edge	HSCCR48LM	70.0	12.6	\$1763	\$1786	
	36"D x 16"H, Laminate Top, Knife Edge	HSCCR36LMK	49.0	6.7	\$1802	\$1825	
	48"D x 16"H, Laminate Top, Knife Edge	HSCCR48LMK	82.0	9.0	\$2046	\$2069	
	36"D x 16"H, Back-Painted Glass Top	HSCCR36BPG	49.0	6.2			\$3831
48"D x 16"H, Back-Painted Glass Top	HSCCR48BPG	90.0	8.2			\$4420	

HOW TO SPECIFY

Select Model Number H S C C S R 2 4 4 8 L M .	Select Laminate and Edge or Glass See page 112 L S A 1 S A .	Select Leg Finish See page 112 L S A 1 .	Select Stretcher Bar Paint Color See page 112 P 8 V
---	---	---	--

SCRAMBLE™ End Tables



Icon Legend on page 19



DESCRIPTION	MODEL	SHIP WEIGHT	CUBE	LIST PRICE BY LAMINATE GRADE		GLASS LIST PRICE
				L1	L2	
End Table, Soft Square 24"W x 24"D x 22"H, Laminate Top, 2mm Edge	HSCCESS24LM	34.5	19.0	\$1561	\$1584	
24"W x 24"D x 22"H, Laminate Top, Knife Edge	HSCCESS24LMK	42.0	3.9	\$1688	\$1711	
24"W x 24"D x 22"H, Back-Painted Glass Top	HSCCESS24BPG	38.0	3.7			\$3020



End Table, Round 24"D x 22"H, Laminate Top, 2mm Edge	HSCER24LM	32.0	19.0	\$1561	\$1584	
24"D x 22"H, Laminate Top, Knife Edge	HSCER24LMK	33.0	3.9	\$1688	\$1711	
24"D x 22"H, Back-Painted Glass Top	HSCER24BPG	33.0	3.7			\$3020

HOW TO SPECIFY

Select Model Number See page 112 H S C E S S 2 4 L M .	Select Laminate and Edge or Glass See page 112 L S A 1 S A .	Select Leg Finish See page 112 L S A 1 .	Select Stretcher Bar Paint Color See page 112 P 8 V
---	---	---	--



Sculpt™ Tables shown with Mav™ Chairs.

SCULPT™ TABLES

Sophisticated and subtle, HON's Sculpt™ collection is a breath of fresh air in any busy office space. Designed to be adaptable and customizable, these occasional and personal tables enhance the productivity of shared spaces while providing a multifunctional hub for a variety of needs, both individual and collaborative. And with a variety of elegant finishes, tops, and heights — plus layering and power capabilities — Sculpt™ is the ideal surface solution for lounges, touchdown spaces, private offices, and more. Make your space work with Sculpt™.



FEATURES

- Customize your office aesthetic with a variety of top shapes, heights, and elegant finishes.
- Find flexibility with both collaborative and single-use capabilities.
- Stay powered up with an integrated personal device holder.
- Enhance the beauty of your environment and offer a fresh perspective with Sculpt™ planters, designed to bring soothing nature into the workplace.

SCULPT™ ORDERING INFORMATION

LAMINATE

L1 LAMINATES CODES

Woodgrain

◆ Bourbon Cherry	H
◆ Cognac	COGN
◆ Field Elm	LWFE
◆ Florence Walnut	LFW1
◆ Harvest	C
◆ Kingswood Walnut	LK11
◆ Mahogany	N
◆ Mocha	MOCH
◆ Natural Maple	D
◆ Pinnacle	PINC
◆ Shaker Cherry	F
◆ Sterling Ash	LSA1

Solid

◆ Black	P
◆ Charcoal	S
◆ Designer White	LDW1
◆ Loft	LOFT

L2 LAMINATES CODES

Woodgrain

◆ Beigewood	LWBE
◆ Fawn Cypress	LFC1
◆ Lowell Ash	LLA1
◆ Natural Recon	LNR1
◆ Phantom Ecru	LPE1
◆ Portico Teak	LPT1
◆ Skyline Walnut	LSW1

WOOD

WOOD CODES

Beigewood	LE878
Bourbon Cherry	LE773
Cognac	LE702
Field Elm	LE599
Florence Walnut	LE579
Harvest	LE856
Kingswood Walnut	LE518
Lowell Ash	LE394
Mahogany	LE740
Mocha	LE121
Natural Maple	LE800
Natural Recon	LE896
Phantom Ecru	LE912
Pinnacle	LE679
Portico Teak	LE150
Shaker Cherry	LE774
Skyline Walnut	LE625
Sterling Ash	LE495

NOTES: Wood legs are stained solid maples. Stain finishes will be tonal matches to the respective laminate finishes. Some natural woodgrain may show through the stain; therefore, stained wood legs may have slight variation in appearance.

PAINT

PAINT CODES

P1

◆ Black	P71
◆ Brownstone	P7D
◆ Charcoal	P02
◆ Designer White	PJW
◆ Dune	P096
◆ Fossil	P28
◆ Harbor	P097
◆ Light Grey	Q
◆ Loft	LOFT
◆ Muslin	T3
◆ Putty	L
◆ Sage	P095
◆ Textured Brownstone	P7J
◆ Textured Charcoal	P7A
◆ Textured Designer White	PK7
◆ Textured Loft	P7L
◆ Textured Muslin	P7M
◆ Textured Titanium	P8T
◆ Titanium	P8T

P2

◆ Champagne Metallic	T4
◆ Gunmetal Metallic	PR3
◆ Platinum Metallic	T1
◆ Pyrite	PJE
◆ Silver	PR6
◆ Solar Black	P8X
◆ Textured Silver	PR8

P3

◆ Atom	P8S
◆ Blossom	P8K
◆ Bullseye	PJF
◆ Ember	P8P
◆ Ion	P8N
◆ Iris	P8J
◆ Krypton	P8F
◆ Ochre	P093
◆ Regatta	P8M
◆ Sienna	P092
◆ Succulent	P8A

SCULPT™ STATEMENT OF LINE

LAMINATE/WOOD TOP TABLES

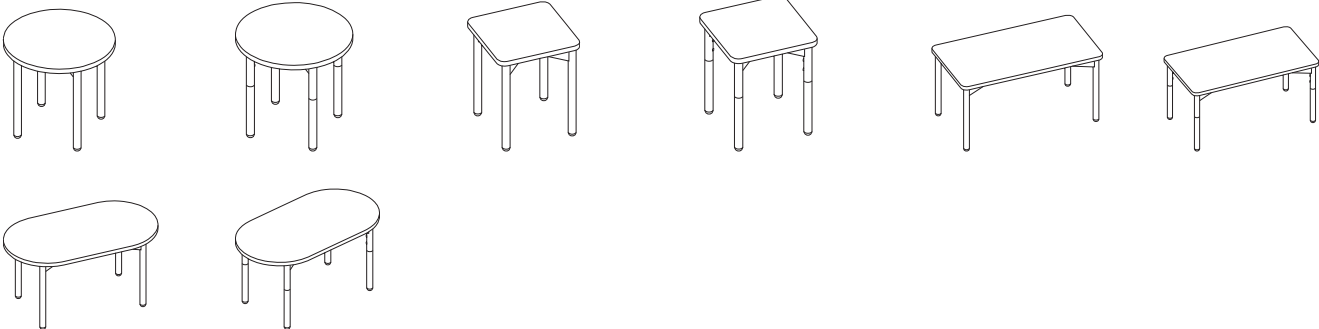

TRAY TOP TABLES

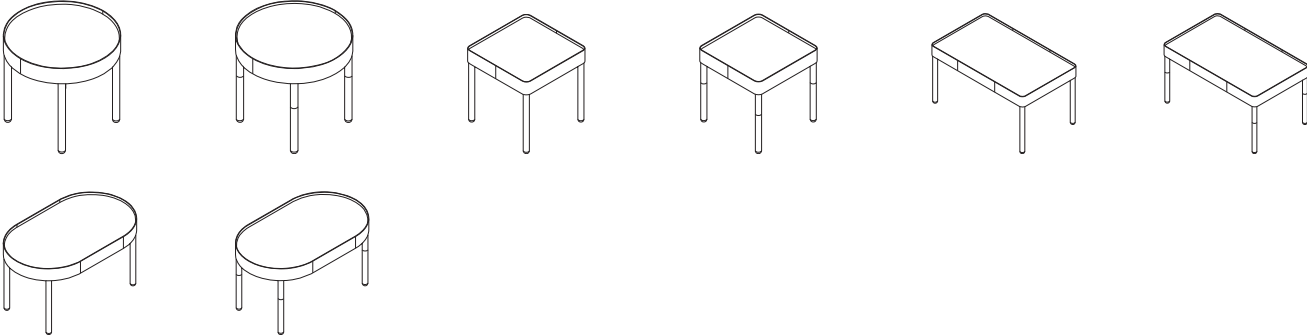

PERSONAL/CONSOLE TABLES

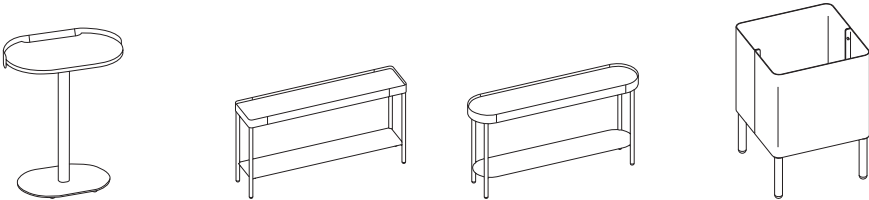

SCULPT™ Laminate Top Tables

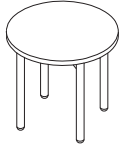

DESCRIPTION	MODEL	SHIP WEIGHT	CUBE	LIST PRICE	UPCHARGE BY LAMINATE/PAINT GRADE		
					L2	P2	P3
Round Laminate Top with Metal Legs							
16½"W x 15⅜"H, Low Metal Legs	HTLSCULRND16LML	19	3.0	\$785	\$12	\$59	\$88
16½"W x 18½"H, Medium Metal Legs	HTLSCULRND16MML	20	3.0	\$799	\$12	\$60	\$90
16½"W x 21⅝"H, High Metal Legs	HTLSCULRND16HML	20	3.0	\$805	\$12	\$61	\$91
30"W x 15⅜"H, Low Metal Legs	HTLSCULRND30LML	35	4.4	\$852	\$15	\$58	\$86



Square Laminate Top with Metal Legs							
12¾"W x 12¾"D x 15⅜"H, Low Metal Legs	HTLSCULSQR13LML	10	2.7	\$731	\$11	\$54	\$81
16½"W x 16½"D x 18½"H, Medium Metal Legs	HTLSCULSQR16MML	20	2.3	\$735	\$12	\$53	\$79
20¼"W x 20¼"D x 21⅝"H, High Metal Legs	HTLSCULSQR20HML	24	3.3	\$766	\$13	\$54	\$81
30"W x 30"D x 15⅜"H, Low Metal Legs	HTLSCULSQR30LML	35	2.5	\$838	\$16	\$55	\$82

! Cutout not available on 12¾" top.



Rectangle Laminate Top with Metal Legs							
60"W x 16½"D x 15⅜"H, Low Metal Legs	HTLSCULREC1660LML	42	4.1	\$985	\$16	\$68	\$102
30"W x 16½"D x 15⅜"H, Low Metal Legs	HTLSCULREC1630LML	24	5.7	\$842	\$14	\$59	\$88
30"W x 16½"D x 18½"H, Medium Metal Legs	HTLSCULREC1630MML	25	5.7	\$857	\$14	\$60	\$90





Pill Laminate Top with Metal Legs							
60"W x 16½"D x 15⅜"H, Low Metal Legs	HTLSCULPIL1660LML	41	6.7	\$985	\$17	\$68	\$101
30"W x 16½"D x 15⅜"H, Low Metal Legs	HTLSCULPIL1630LML	23	5.7	\$832	\$14	\$58	\$86
30"W x 16½"D x 18½"H, Medium Metal Legs	HTLSCULPIL1630MML	24	5.7	\$836	\$14	\$58	\$87

HOW TO SPECIFY

Select Model Number HTLSCULRND16LML	Select Cutout Option N No Cutout G Grommet Cutout (+ \$44)	Select Laminate See page 116	Select Leg Paint Color See page 116	Select Glide Option G Glide
HTLSCULRND16LML	G	H	P71	G

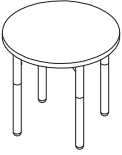
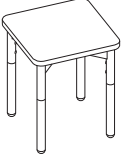
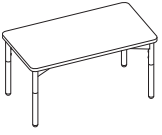
SCULPT™ Laminate Top Tables

	DESCRIPTION	MODEL	SHIP WEIGHT	CUBE	LIST PRICE	UPCHARGE BY		
						LAMINATE/PAIN	GRADE	
						L2	P2	P3
	Round Laminate Top with Wood Legs							
	16½"W x 15⅜"H, Low Wood Legs	HTLSCULRND16LWL	19	3.0	\$1070	\$12	\$57	\$86
	16½"W x 18½"H, Medium Wood Legs	HTLSCULRND16MWL	20	3.0	\$1098	\$12	\$57	\$86
	16½"W x 21⅝"H, High Wood Legs	HTLSCULRND16HWL	20	3.0	\$1135	\$12	\$58	\$86
	30"W x 15⅝"H, Low Wood Legs	HTLSCULRND30LWL	35	4.4	\$1294	\$15	\$73	\$107
	Square Laminate Top with Wood Legs							
	12¾"W x 12¾"D x 15⅜"H, Low Wood Legs	HTLSCULSQR13LWL	15	2.7	\$1109	\$11	\$61	\$153
	16½"W x 16½"D x 18½"H, Medium Wood Legs	HTLSCULSQR16MWL	20	2.3	\$1140	\$12	\$60	\$90
	20¼"W x 20¼"D x 21⅝"H, High Wood Legs	HTLSCULSQR20HWL	24	3.3	\$1203	\$13	\$61	\$153
	30"W x 30"D x 15⅝"H, Low Wood Legs	HTLSCULSQR30LWL	35	4.4	\$1230	\$16	\$64	\$95
	ⓘ Cutout not available on 12¾" top.							
	Rectangle Laminate Top with Wood Legs							
	60"W x 16½"D x 15⅝"H, Low Wood Legs	HTLSCULREC1660LWL	42	4.1	\$1248	\$16	\$64	\$97
	30"W x 16½"D x 15⅝"H, Low Wood Legs	HTLSCULREC1630LWL	24	5.7	\$1122	\$14	\$57	\$85
	30"W x 16½"D x 18½"H, Medium Wood Legs	HTLSCULREC1630MWL	25	5.7	\$1152	\$14	\$57	\$85
	Pill Laminate Top with Wood Legs							
	60"W x 16½"D x 15⅝"H, Low Wood Legs	HTLSCULPIL1660LWL	41	6.7	\$1260	\$17	\$65	\$98
	30"W x 16½"D x 15⅝"H, Low Wood Legs	HTLSCULPIL1630LWL	23	5.7	\$1106	\$14	\$55	\$83
	30"W x 16½"D x 18½"H, Medium Wood Legs	HTLSCULPIL1630MWL	24	5.7	\$1129	\$14	\$55	\$82

HOW TO SPECIFY

Select Model Number HTLSCULRND16LWL	Select Cutout Option N No Cutout G Grommet Cutout (+ \$44) G	Select Laminate See page 116 H	Select Wood Leg Finish See page 116 LE856	Select Leg Paint Color See page 116 P71
---	--	---	--	--

SCULPT™ Wood Top Tables

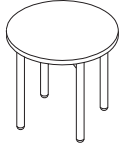

DESCRIPTION

Round Wood Top with Metal Legs
 16½"W x 15⅝"H, Low Metal Legs
 16½"W x 18½"H, Medium Metal Legs
 16½"W x 21⅝"H, High Metal Legs
 30"W x 15⅝"H, Low Metal Legs

MODEL

HTLSCUWRND16LML
HTLSCUWRND16MML
HTLSCUWRND16HML
HTLSCUWRND30LML

SHIP WEIGHT CUBE

19 3.0
 20 3.0
 20 3.0
 35 6.7

LIST PRICE BY PAINT GRADE

P1	P2	P3
\$1798	\$1857	\$1886
\$1812	\$1872	\$1902
\$1818	\$1879	\$1909
\$2090	\$2148	\$2176



Square Wood Top with Metal Legs

12¾"W x 12¾"D x 15⅝"H, Low Metal Legs
 16½"W x 16½"D x 18½"H, Medium Metal Legs
 20¼"W x 20¼"D x 21⅝"H, High Metal Legs
 30"W x 30"D x 15⅝"H, Low Metal Legs

HTLSCUWSQR13LML
HTLSCUWSQR16MML
HTLSCUWSQR20HML
HTLSCUWSQR30LML

15 2.7
 20 3.0
 24 3.3
 35 6.7

P1	P2	P3
\$1704	\$1758	\$1785
\$1704	\$1757	\$1783
\$1794	\$1848	\$1875
\$2060	\$2115	\$2142

! Cutout not available on 12¾" top.



Rectangle Wood Top with Metal Legs

60"W x 16½"D x 15⅝"H, Low Metal Legs
 30"W x 16½"D x 15⅝"H, Low Metal Legs
 30"W x 16½"D x 18½"H, Medium Metal Legs

HTLSCUWREC1660LML
HTLSCUWREC1630LML
HTLSCUWREC1630MML

42 6.6
 24 5.7
 25 5.7

P1	P2	P3
\$2389	\$2457	\$2491
\$1916	\$1975	\$2004
\$1931	\$1991	\$2021



Pill Wood Top with Metal Legs

60"W x 16½"D x 15⅝"H, Low Metal Legs
 30"W x 16½"D x 15⅝"H, Low Metal Legs
 30"W x 16½"D x 18½"H, Medium Metal Legs

HTLSCUWPIL1660LML
HTLSCUWPIL1630LML
HTLSCUWPIL1630MML



41 6.6
 23 5.7
 24 5.7

P1	P2	P3
\$2418	\$2486	\$2519
\$1900	\$1958	\$1986
\$1904	\$1962	\$1991

HOW TO SPECIFY

<p>Select Model Number</p> <p>HTLSCUWRND16LML .</p>	<p>Select Cutout Option</p> <p>N No Cutout G Grommet Cutout (+ \$44)</p> <p>G .</p>	<p>Select Wood Finish</p> <p>See page 116</p> <p>LE856 .</p>	<p>Select Leg Paint Color</p> <p>See page 116</p> <p>P71 .</p>	<p>Select Glide Option</p> <p>G Glide</p> <p>G</p>
--	---	---	---	--

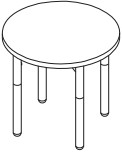
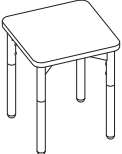

SCULPT™ Wood Top Tables

	DESCRIPTION	MODEL	SHIP WEIGHT	CUBE	LIST PRICE BY PAINT GRADE		
					P1	P2	P3
	Round Wood Top with Wood Legs 16½"W x 15⅜"H, Low Wood Legs	HTLSCUWRND16LWL	19	3.0	\$2083	\$2140	\$2169
	16½"W x 18½"H, Medium Wood Legs	HTLSCUWRND16MWL	20	3.0	\$2111	\$2168	\$2197
	16½"W x 21⅝"H, High Wood Legs	HTLSCUWRND16HWL	20	3.0	\$2148	\$2206	\$2234
	30"W x 15⅜"H, Low Wood Legs	HTLSCUWRND30LWL	35	6.7	\$2532	\$2605	\$2639
	Square Wood Top with Wood Legs 12¾"W x 12¾"D x 15⅜"H, Low Wood Legs	HTLSCUWSQR13LWL	15	2.7	\$2082	\$2143	\$2235
	16½"W x 16½"D x 18½"H, Medium Wood Legs	HTLSCUWSQR16MWL	20	3.0	\$2109	\$2169	\$2199
	20¼"W x 20¼"D x 21⅝"H, High Wood Legs	HTLSCUWSQR20HWL	24	3.3	\$2231	\$2292	\$2384
	30"W x 30"D x 15⅜"H, Low Wood Legs	HTLSCUWSQR30LWL	35	6.7	\$2452	\$2516	\$2547
	! Cutout not available on 12¾" top.						
	Rectangle Wood Top with Wood Legs 60"W x 16½"D x 15⅜"H, Low Wood Legs	HTLSCUWREC1660LWL	42	6.6	\$2652	\$2716	\$2749
	30"W x 16½"D x 15⅜"H, Low Wood Legs	HTLSCUWREC1630LWL	24	5.7	\$2196	\$2253	\$2281
	30"W x 16½"D x 18½"H, Medium Wood Legs	HTLSCUWREC1630MWL	25	5.7	\$2226	\$2283	\$2311
	Pill Wood Top with Wood Legs 60"W x 16½"D x 15⅜"H, Low Wood Legs	HTLSCUWPIL1660LWL	41	6.6	\$2693	\$2758	\$2791
	30"W x 16½"D x 15⅜"H, Low Wood Legs	HTLSCUWPIL1630LWL	23	5.7	\$2174	\$2229	\$2257
	30"W x 16½"D x 18½"H, Medium Wood Legs	HTLSCUWPIL1630MWL	24	5.7	\$2197	\$2252	\$2279

HOW TO SPECIFY

Select Model Number HTLSCUWRND16LWL	Select Cutout Option N No Cutout G Grommet Cutout (+ \$44) G	Select Wood Finish See page 116 LE856	Select Paint Color See page 116 P71
---	--	--	--

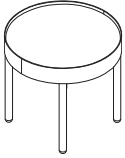
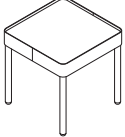
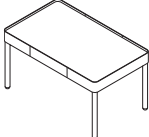

SCULPT™ Tray Top Tables

	DESCRIPTION	MODEL	SHIP WEIGHT	CUBE	LIST PRICE	UPCHARGE BY LAMINATE/PAINT GRADE		
						L2	P2	P3
	Round Tray Table Top with Metal Legs							
	18"W x 16 ³ / ₁₆ "H, Low Metal Legs	HTLSCURNDT18LML	37	3.1	\$1299	\$13	\$107	\$160
	18"W x 19 ³ / ₁₆ "H, Medium Metal Legs	HTLSCURNDT18MML	38	3.1	\$1487	\$13	\$126	\$189
	18"W x 22 ³ / ₁₆ "H, High Metal Legs	HTLSCURNDT18HML	39	3.1	\$1509	\$13	\$128	\$192
	30"W x 16 ³ / ₁₆ "H, Low Metal Legs	HTLSCURNDT30LML	53	6.7	\$1672	\$14	\$142	\$212
	Square Tray Table Top with Metal Legs							
	15 ³ / ₄ "W x 15 ³ / ₄ "D x 16 ³ / ₁₆ "H, Low Metal Legs	HTLSCUSQRT16LML	32	3.0	\$1199	\$12	\$99	\$150
	18"W x 18"D x 19 ³ / ₁₆ "H, Medium Metal Legs	HTLSCUSQRT18MML	42	3.1	\$1172	\$12	\$96	\$145
	20 ¹ / ₄ "W x 20 ¹ / ₄ "D x 22 ³ / ₁₆ "H, High Metal Legs	HTLSCUSQRT20HML	41	3.3	\$1452	\$13	\$124	\$185
	30"W x 30"D x 16 ³ / ₁₆ "H, Low Metal Legs	HTLSCUSQRT30LML	55	4.9	\$1546	\$15	\$128	\$193
	Rectangle Tray Table Top with Metal Legs							
	60"W x 18"D x 16 ³ / ₁₆ "H, Low Metal Legs	HTLSCURECT1860LML	64	6.9	\$1551	\$17	\$124	\$187
	30"W x 18"D x 16 ³ / ₁₆ "H, Low Metal Legs	HTLSCURECT1830LML	41	5.8	\$1766	\$20	\$139	\$208
	30"W x 18"D x 19 ³ / ₁₆ "H, Medium Metal Legs	HTLSCURECT1830MML	42	5.8	\$1776	\$20	\$140	\$209
	Pill Tray Table Top with Metal Legs							
	60"W x 18"D x 16 ³ / ₁₆ "H, Low Metal Legs	HTLSCUPILT1860LML	63	7.0	\$1826	\$17	\$153	\$228
	30"W x 18"D x 16 ³ / ₁₆ "H, Low Metal Legs	HTLSCUPILT1830LML	37	5.9	\$1437	\$14	\$118	\$177
	30"W x 18"D x 19 ³ / ₁₆ "H, Medium Metal Legs	HTLSCUPILT1830MML	38	5.9	\$1434	\$14	\$118	\$176

HOW TO SPECIFY

Select Model Number HTLSCURNDT18LML	Select Cutout Option N No Cutout G Grommet Cutout (+ \$44)	Select Laminate See page 116	Select Paint Color See page 116	Select Glide Option G Glide
---	---	--	---	---------------------------------------

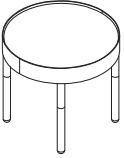
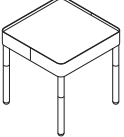
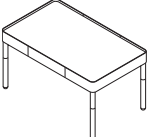
SCULPT™ Tray Top Tables

	DESCRIPTION	MODEL	SHIP WEIGHT	CUBE	LIST PRICE	UPCHARGE BY		
						LAMINATE/P2	PAINT/P2	GRADE/P3
	Round Tray Table Top with Wood Legs							
	18"W x 16 ³ / ₁₆ "H, Low Wood Legs	HTLSCURNDT18LWL	37	3.1	\$1688	\$13	\$117	\$174
	18"W x 19 ³ / ₁₆ "H, Medium Wood Legs	HTLSCURNDT18MWL	38	3.1	\$1688	\$13	\$114	\$169
	18"W x 22 ³ / ₁₆ "H, High Wood Legs	HTLSCURNDT18HWL	39	3.1	\$1718	\$13	\$114	\$169
	30"W x 16 ³ / ₁₆ "H, Low Wood Legs	HTLSCURNDT30LWL	53	6.7	\$2054	\$14	\$150	\$224
	Square Tray Table Top with Wood Legs							
	15 ³ / ₄ "W x 15 ³ / ₄ "D x 16 ³ / ₁₆ "H, Low Wood Legs	HTLSCUSQRT16LWL	32	3.0	\$1367	\$12	\$87	\$129
	18"W x 18"D x 19 ³ / ₁₆ "H, Medium Wood Legs	HTLSCUSQRT18MWL	42	3.1	\$1358	\$12	\$83	\$123
	20 ¹ / ₄ "W x 20 ¹ / ₄ "D x 22 ³ / ₁₆ "H, High Wood Legs	HTLSCUSQRT20HWL	41	3.3	\$1668	\$13	\$110	\$163
	30"W x 30"D x 16 ³ / ₁₆ "H, Low Wood Legs	HTLSCUSQRT30LWL	55	6.7	\$1958	\$15	\$140	\$210
	Rectangle Tray Table Top with Wood Legs							
	60"W x 18"D x 16 ³ / ₁₆ "H, Low Wood Legs	HTLSCURECT1860LWL	64	6.9	\$1726	\$17	\$113	\$167
	30"W x 18"D x 16 ³ / ₁₆ "H, Low Wood Legs	HTLSCURECT1830LWL	41	5.8	\$1933	\$20	\$125	\$188
	30"W x 18"D x 19 ³ / ₁₆ "H, Medium Wood Legs	HTLSCURECT1830MWL	42	5.8	\$1955	\$20	\$125	\$187
	Pill Tray Table Top with Wood Legs							
	60"W x 18"D x 16 ³ / ₁₆ "H, Low Wood Legs	HTLSCUPILT1860LWL	63	7.0	\$1996	\$17	\$140	\$209
	30"W x 18"D x 16 ³ / ₁₆ "H, Low Wood Legs	HTLSCUPILT1830LWL	37	5.9	\$1598	\$14	\$103	\$156
	30"W x 18"D x 19 ³ / ₁₆ "H, Medium Wood Legs	HTLSCUPILT1830MWL	38	5.9	\$1617	\$14	\$103	\$155

HOW TO SPECIFY

Select Model Number HTLSCURNDT18LWL	Select Cutout Option N No Cutout G Grommet Cutout (+ \$44) G	Select Laminate See page 116 H	Select Wood Leg Finish See page 116 P856	Select Paint Color See page 116 P71
---	--	---	---	--

SCULPT™ Personal & Console Tables

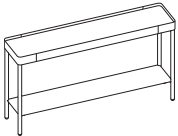
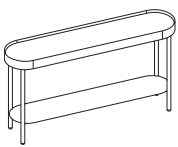
	DESCRIPTION	MODEL	SHIP WEIGHT	CUBE	LIST PRICE	UPCHARGE BY LAMINATE/PAINT GRADE		
						L2	P2	P3
	Personal Table with Metal Base 22"W x 13 ⁷ / ₈ "D x 29 ¹ / ₄ "H	HTLSCUPERTBL	39	8.0	\$946	\$10	\$79	\$117
	Rectangle Console Table with Metal Legs 53"W x 12"D x 28 ¹³ / ₁₆ "H	HTLSCURECCNSL1253	74	6.9	\$2311	\$16	\$202	\$304
	Pill Console Table with Metal Legs 53"W x 12"D x 28 ¹³ / ₁₆ "H	HTLSCUPILCNSL1253	81	6.9	\$2395	\$16	\$211	\$317

HOW TO SPECIFY

Select Model Number HTLSCUPERTBL	Select Laminate See page 116 H	Select Paint Color See page 116 P71
--	---	--

SCULPT™ Planters

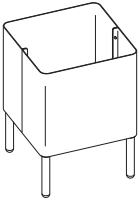

DESCRIPTION	MODEL	SHIP WEIGHT	CUBE	LIST PRICE BY PAINT GRADE		
				P1	P2	P3
Square Planters						
15"W x 15"D x 21 ⁵ / ₁₆ "H, Square Low Planter	HTLSCUSQRPLNT15L	40	4.5	\$1521	\$1674	\$1750
15"W x 15"D x 30 ⁵ / ₁₆ "H, Square High Planter	HTLSCUSQRPLNT15H	50	4.9	\$1888	\$2078	\$2173
30"W x 30"D x 15 ⁵ / ₁₆ "H, Square Low Planter	HTLSCUSQRPLNT30L	60	7.1	\$1809	\$1991	\$2081

NOTES:

- All planters come with a plastic tray insert.
- It is recommended to have all plants in pots for planters to avoid water damage to the product.
- For planning purposes, please see approximate internal dimensions for planters:
 - 15" Square = 11⁵/₁₆"W x 11⁵/₁₆"D x 13¹/₄"H
 - 30" Square = 26⁵/₁₆"W x 26⁵/₁₆"D x 7¹/₄"H

HOW TO SPECIFY

<p>Select Model Number</p> <p>HTLSCUSQRPLNT15L</p>	<p>Select Paint Color</p> <p>See page 116</p> <p>P71</p>	<p>Select Glide Option</p> <p>G Glide</p> <p>G</p>
--	--	--

SCULPT™ Accessories

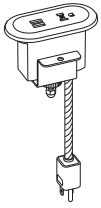

DESCRIPTION	MODEL	SHIP WEIGHT	CUBE	LIST PRICE
Power Grommet	HTGPWRKIA	3	0.2	\$271

HOW TO SPECIFY

Select
Model Number

H T G P W R K I A .

Select
Grommet Color

- P Black
- STRM Storm
- SNW Snow

S T R M .

Select
Cord Color

- STRM Storm

S T R M

CROSS REFERENCE BY APPLICATION

	Page
CLASSROOM	
Student Desks	
SmartLink® Student Desks	182-183
Teacher/Administration Desks	
SmartLink® Teacher Stations	188-189
Voi®	<i>See the Desks section in the 2025 Workspaces Pricer.</i>
10500 Series™ ...	<i>See the Desks section in the 2025 Workspaces Pricer.</i>
38000 Series™ ..	<i>See the Desks section in the 2025 Workspaces Pricer.</i>
Seating	
SmartLink® Seating	184-187
Perpetual® Nesting	453-455
Olson Stacker® - 4040 Series	
High-Density	448-449
Motivate® Seating	420-435
Volt® - 5700/5710/5720/5730 Series	499-506
Ignition®/Ignition® 2.0	377-406
Solve®	477-486
Convergence®	322-326
Storage & Files	
Brigade® 800 Series Lateral Files	<i>See the Storage section in the 2025 Workspaces Pricer.</i>
Brigade® 700 Series Lateral Files	<i>See the Storage section in the 2025 Workspaces Pricer.</i>
Brigade® 600 Series Lateral Files	<i>See the Storage section in the 2025 Workspaces Pricer.</i>
Lateral File Accessories	<i>See the Storage section in the 2025 Workspaces Pricer.</i>
310 Series Vertical Files - 26½"D	<i>See the Storage section in the 2025 Workspaces Pricer.</i>
510 Series Vertical Files - 25"D	<i>See the Storage section in the 2025 Workspaces Pricer.</i>
Flagship® Bookcases and Storage Cabinets	<i>See the Storage section in the 2025 Workspaces Pricer.</i>
Brigade® Storage Cabinets	<i>See the Storage section in the 2025 Workspaces Pricer.</i>
Brigade® Steel Bookcases	<i>See the Storage section in the 2025 Workspaces Pricer.</i>
1870 Series Bookcases	<i>See the Storage section in the 2025 Workspaces Pricer.</i>
Tables	
Huddle Multi-Purpose Tables	51-61
Motivate® Tables	65-72
Learning Applications	
SmartLink® Wall Rail System	190-191
Motivate® Mobile Markerboards	72
COMPUTER LAB	
Tables	
Huddle Multi-Purpose Tables	51-61
Motivate® Tables	65-72
Between™ Tables	33-38
Seating	
Motivate® Seating	420-435
Perpetual® Nesting	453-455

	Page
CAFETERIA	
Seating	
SmartLink® Seating	184-187
Motivate® Seating	420-435
Olson Stacker® - 4040 Series	
High-Density	448-449
Tables	
Huddle Multi-Purpose Tables	51-61
Motivate® Tables	65-72
Between™ Tables	33-38
COMMON AREAS	
Reception Seating	
Flock® Lounge	342-364
Grove®	365-376
Accommodate®	263-269
Cambia™ - 2160 Series	295-297
Tables	
Huddle Multi-Purpose Tables	51-61
Motivate® Tables	65-72
Laminate Occasional Tables	64
Flock®	44-50
Between™ Tables	33-38
LIBRARY / MEDIA CENTER	
Storage	
Flagship® Bookcases	<i>See the Storage section in the 2025 Workspaces Pricer.</i>
Brigade® Steel Bookcases	<i>See the Storage section in the 2025 Workspaces Pricer.</i>
Reception Seating	
Flock® Lounge	342-364
Grove®	365-376
Accommodate®	263-269
Cambia™ - 2160 Series	295-297
Student Seating	
SmartLink® Seating	184-187
Motivate® Seating	420-435
Accommodate®	263-269
Tables	
Huddle Multi-Purpose Tables	51-61
Motivate® Tables	65-72
Laminate Occasional Tables	64
Flock®	44-50
Between™ Tables	33-38

CROSS REFERENCE BY APPLICATION

	Page
ART ROOM	
Seating	
Motivate® Seating	420-435
Storage	
Flagship® Storage Cabinets	<i>See the Storage section in the 2025 Workspaces Pricer.</i>
Brigade® Storage Cabinets	<i>See the Storage section in the 2025 Workspaces Pricer.</i>
Flagship® Bookcases	<i>See the Storage section in the 2025 Workspaces Pricer.</i>
Brigade® Steel Bookcases	<i>See the Storage section in the 2025 Workspaces Pricer.</i>
1870 Series Bookcases	<i>See the Storage section in the 2025 Workspaces Pricer.</i>
Tables	
Huddle Multi-Purpose Tables	51-61
Motivate® Tables	65-72
TEACHER PLANNING	
Desks	
SmartLink® Teacher Stations	188-189
Voi®	<i>See the Desks section in the 2025 Workspaces Pricer.</i>
10500 Series™ ...	<i>See the Desks section in the 2025 Workspaces Pricer.</i>
38000 Series™ ..	<i>See the Desks section in the 2025 Workspaces Pricer.</i>
Seating	
Volt® - 5700/5710/5720/5730 Series	499-506
Ignition®/Ignition® 2.0	377-406
Solve®	477-486
Convergence®	322-326
Storage	
Brigade® 800 Series Lateral Files	<i>See the Storage section in the 2025 Workspaces Pricer.</i>
Brigade® 700 Series Lateral Files	<i>See the Storage section in the 2025 Workspaces Pricer.</i>
Brigade® 600 Series Lateral Files	<i>See the Storage section in the 2025 Workspaces Pricer.</i>
Flagship® Lateral Files	<i>See the Storage section in the 2025 Workspaces Pricer.</i>
400 Series Lateral Files	<i>See the Storage section in the 2025 Workspaces Pricer.</i>
Lateral File Accessories	<i>See the Storage section in the 2025 Workspaces Pricer.</i>
210 Series Vertical Files - 28½"D	<i>See the Storage section in the 2025 Workspaces Pricer.</i>
310 Series Vertical Files - 26½"D	<i>See the Storage section in the 2025 Workspaces Pricer.</i>
510 Series Vertical Files - 25"D	<i>See the Storage section in the 2025 Workspaces Pricer.</i>
Vertical File Accessories	<i>See the Storage section in the 2025 Workspaces Pricer.</i>
Flagship® Storage Cabinets	<i>See the Storage section in the 2025 Workspaces Pricer.</i>
Brigade® Storage Cabinets	<i>See the Storage section in the 2025 Workspaces Pricer.</i>
Flagship® Bookcases	<i>See the Storage section in the 2025 Workspaces Pricer.</i>
Brigade® Steel Bookcases	<i>See the Storage section in the 2025 Workspaces Pricer.</i>
1870 Series Bookcases	<i>See the Storage section in the 2025 Workspaces Pricer.</i>

	Page
TEACHER PLANNING (continued)	
Tables	
Huddle Multi-Purpose Tables	51-61
Motivate® Tables	65-72
Flock®	44-50
Between™ Tables	33-38
ADMINISTRATION	
Desks	
10500 Series™ ...	<i>See the Desks section in the 2025 Workspaces Pricer.</i>
38000 Series™ ..	<i>See the Desks section in the 2025 Workspaces Pricer.</i>
Reception Seating	
Cambia™ - 2160 Series	295-297
Task / Administrative Seating	
Ignition®/Ignition® 2.0	377-406
Motivate® Seating	420-435
Volt® - 5700/5710/5720/5730 Series	499-506
Solve®	477-486
Convergence®	322-326
Storage & Files	
Brigade® 800 Series Lateral Files	<i>See the Storage section in the 2025 Workspaces Pricer.</i>
Brigade® 700 Series Lateral Files	<i>See the Storage section in the 2025 Workspaces Pricer.</i>
Brigade® 600 Series Lateral Files	<i>See the Storage section in the 2025 Workspaces Pricer.</i>
Lateral File Accessories	<i>See the Storage section in the 2025 Workspaces Pricer.</i>
310 Series Vertical Files - 26½"D	<i>See the Storage section in the 2025 Workspaces Pricer.</i>
510 Series Vertical Files - 25"D	<i>See the Storage section in the 2025 Workspaces Pricer.</i>
Flagship® Bookcases and Storage Cabinets	<i>See the Storage section in the 2025 Workspaces Pricer.</i>
Brigade® Storage Cabinets	<i>See the Storage section in the 2025 Workspaces Pricer.</i>
Brigade® Steel Bookcases	<i>See the Storage section in the 2025 Workspaces Pricer.</i>
1870 Series Bookcases	<i>See the Storage section in the 2025 Workspaces Pricer.</i>
Tables	
Huddle Multi-Purpose Tables	51-61
Motivate® Tables	65-72
Flock®	44-50
Between™ Tables	33-38
Occasional Tables	
Laminate Occasional Tables	64
Flock®	44-50



Build™ Student Desks and Tables shown
with SmartLink® Seating and Storage.

BUILD™

Inspiring the next generation takes a higher degree of mobility and hands-on learning. The Build™ series, an educational product collection of tables, student desks, and seating, is lightweight, durable, reconfigurable, and customizable. Build encourages creativity and adaptability so students can support collaboration and social interaction or create personal space for focused study time. Build supports the movers and shakers, the hands-on doers, and the leaders who crave creativity. The future of education takes shape with Build.



FEATURES

- 15 table shapes and 6 student desk shapes make reconfiguration fun and easy.
- In addition to all standard HON laminates, Build tops are available in bright, bold laminates and a dry-erase markerboard finish to enhance any learning environment. Or try Butcher Block tops on Makerspace tables.
- Table legs are available in multiple height adjustable ranges and nesting bases to accommodate different user applications.
- Adjustable height student desk legs accommodate any students in K-12 grades and beyond.
- The durable Makerspace table features à la carte storage accessories and allows you to keep a creative space clean, organized, and customizable.

BUILD™ ORDERING INFORMATION

LAMINATE GROUP A (TOP LAMINATES)

L1 LAMINATES CODES

Woodgrain

- ◆ Bourbon Cherry H
- ◆ Cognac COGN
- ◆ Field Elm LWFE
- ◆ Florence Walnut LFW1
- ◆ Harvest C
- ◆ Kingswood Walnut LK11
- ◆ Mahogany N
- ◆ Mocha MOCH
- ◆ Natural Maple D
- ◆ Pinnacle PINC
- ◆ Shaker Cherry F
- ◆ Sterling Ash LSA1

Solid

- ◆ Black P
- ◆ Charcoal S
- ◆ Designer White LDW1
- ◆ Loft LOFT

Patterned

- ◆ Handspun Chestnut LAHC
- ◆ Handspun Dove LAHD
- ◆ Handspun Pearl LAHP
- ◆ Handspun Slate LAHS
- ◆ Magnolia LMG1
- ◆ Silver Mesh B9
- ◆ Steel Mesh A9
- ◆ Battleship LBT1
- ◆ Gray G2
- ◆ Mushroom LMH1
- ◆ White G1

L2 LAMINATES CODES

Woodgrain

- ◆ Beigewood LWBE
- ◆ Fawn Cypress LFC1
- ◆ Lowell Ash LLA1
- ◆ Natural Recon LNR1
- ◆ Phantom Ecru LPE1
- ◆ Portico Teak LPT1
- ◆ Skyline Walnut LSW1

L4 LAMINATES CODES

- ◆ White Markerboard FMQ1

LAMINATE GROUP B (SHELF LAMINATES)

L1 LAMINATES CODES

Woodgrain

- ◆ Bourbon Cherry H
- ◆ Cognac COGN
- ◆ Field Elm LWFE
- ◆ Florence Walnut LFW1
- ◆ Harvest C
- ◆ Kingswood Walnut LK11
- ◆ Mahogany N
- ◆ Natural Maple D
- ◆ Pinnacle PINC
- ◆ Shaker Cherry F
- ◆ Sterling Ash LSA1

Solid

- ◆ Black P
- ◆ Charcoal S
- ◆ Designer White LDW1
- ◆ Loft LOFT

L2 LAMINATES CODES

Woodgrain

- ◆ Beigewood LWBE
- ◆ Fawn Cypress LFC1
- ◆ Lowell Ash LLA1
- ◆ Natural Recon LNR1
- ◆ Phantom Ecru LPE1
- ◆ Portico Teak LPT1
- ◆ Skyline Walnut LSW1

PAINT GROUP A (TABLE AND STUDENT DESK LEG PAINT)

PAINT CODES

- P1**
- ◆ Black P
- P2**
- ◆ Platinum Metallic T1

PAINT GROUP B (MAKERSPACE TABLE BASE AND STOOL)

PAINT CODES

- P1**
- ◆ Black P
- ◆ Brownstone P7D
- ◆ Charcoal S
- ◆ Designer White PJW
- ◆ Fossil P28
- ◆ Loft LOFT
- ◆ Muslin T3
- ◆ Titanium P8T
- P2**
- ◆ Champagne Metallic T4
- ◆ Platinum Metallic T1
- ◆ Gunmetal Metallic PR3
- ◆ Silver PR6
- P3**
- ◆ Atom P8S
- ◆ Bullseye PJF
- ◆ Ember P8P
- ◆ Ion P8N
- ◆ Iris P8J
- ◆ Krypton P8F
- ◆ Regatta P8M

PAINT GROUP C (MAKERSPACE TABLE END PANEL)

PAINT CODES

- P1**
- ◆ Black P
- ◆ Brownstone P7D
- ◆ Charcoal S
- ◆ Designer White PJW
- ◆ Fossil P28
- ◆ Loft LOFT
- ◆ Muslin T3
- ◆ Titanium P8T
- P2**
- ◆ Champagne Metallic T4
- ◆ Platinum Metallic T1
- ◆ Silver PR6
- P3**
- ◆ Atom P8S
- ◆ Bullseye PJF
- ◆ Ember P8P
- ◆ Ion P8N
- ◆ Iris P8J
- ◆ Krypton P8F
- ◆ Regatta P8M
- P6**
- ◆ Markerboard MKB

MAKERSPACE BUTCHER BLOCK

- ◆ Butcher Block LH903

EDGE

EDGE CODES

Woodgrain

- ◆ Beigewood DE
- ◆ Cognac COGN
- ◆ Fawn Cypress FC
- ◆ Field Elm FE
- ◆ Florence Walnut FW
- ◆ Harvest C
- ◆ Kingswood Walnut KI
- ◆ Lowell Ash DL
- ◆ Mahogany N
- ◆ Mocha MOCH
- ◆ Natural Maple D
- ◆ Natural Recon NR
- ◆ Phantom Ecru PE
- ◆ Pinnacle PINC
- ◆ Portico Teak DP
- ◆ Shaker Cherry F
- ◆ Skyline Walnut SW
- ◆ Sterling Ash SA















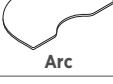

Solid

- ◆ Atom AT
- ◆ Black P
- ◆ Brownstone EY
- ◆ Bullseye BY
- ◆ Charcoal S
- ◆ Designer White DW
- ◆ Ember MR
- ◆ Fossil EH
- ◆ Greige R
- ◆ Ion IO
- ◆ Iris IR
- ◆ Krypton KT
- ◆ Loft LOFT
- ◆ Muslin T
- ◆ Platinum K
- ◆ Regatta RE

◆◆◆ For lead time information see page 21.

BUILD™ Shape Matrix

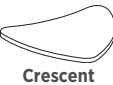
EDUCATION

Top Shape/Model	Tables				Student Desks
	Youth Height Leg Adjusts 13'-18"	Standard Height Leg Adjusts 22'-34"	Standing Height Leg Adjusts 30'-42"	Nesting Base	Seated Height Leg Adjusts 22'-34"
 Kite	X	X	X		
 Ribbon	X	X	X	X	X
 Wisp	X	X	X		
 Snap	X	X	X		
 Rectangle	X	X	X		X
 Half-Round	X	X	X		
 Arc	X	X	X		
 Round	X	X	X		
 Square	X	X	X		
 Trapezoid	X	X	X		X
 Horseshoe	X	X	X		
 Home Plate	X	X	X		
 Spooky	X	X	X	X	X
 Tide	X	X	X		
 Dart	X	X	X	X	
 Crescent					X
 Fin					X

Snap



3 PEOPLE/1 TABLE

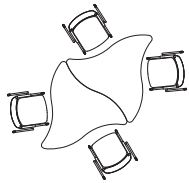

4 PEOPLE/2 TABLES

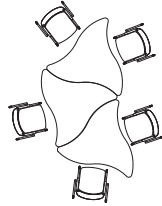

5 PEOPLE/3 TABLES

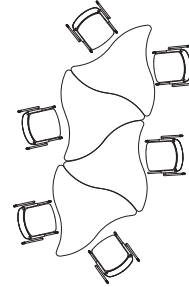

6 PEOPLE/4 TABLES

Tide

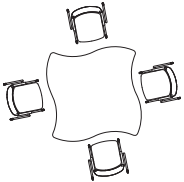

4 PEOPLE/1 TABLE

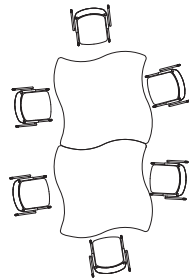

6 PEOPLE/2 TABLES

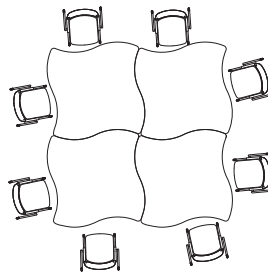

8 PEOPLE/4 TABLES

Kite



2 PEOPLE/1 TABLE

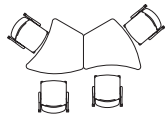

4 PEOPLE/2 TABLES

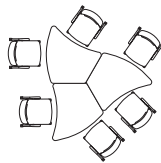

6 PEOPLE/3 TABLES

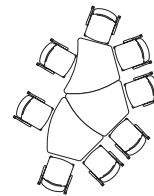

8 PEOPLE/3 TABLES

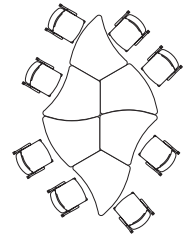

8 PEOPLE/6 TABLES

Dart

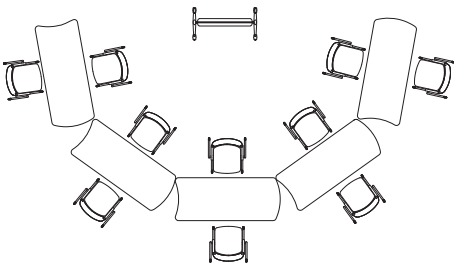

10 PEOPLE/5 TABLES

BUILD™ Table Configurations

Wisp



4 PEOPLE/1 TABLE

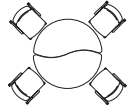

4 PEOPLE/2 TABLES



6 PEOPLE/3 TABLES

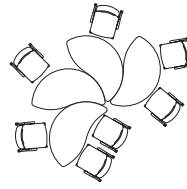

7 PEOPLE/4 TABLES

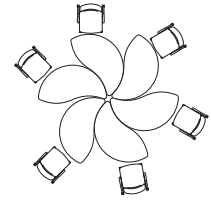

6 PEOPLE/6 TABLES

Ribbon

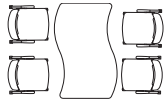

4 PEOPLE/1 TABLE

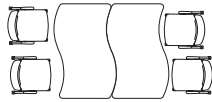

4 PEOPLE/2 TABLES

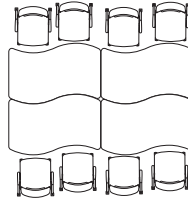

8 PEOPLE/4 TABLES

Home Plate

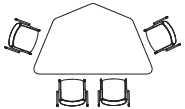

4 PEOPLE/1 TABLE

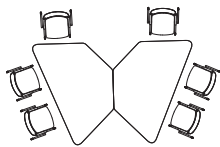

6 PEOPLE/2 TABLES

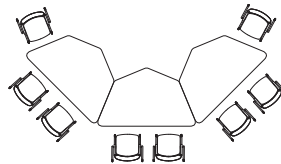

8 PEOPLE/3 TABLES

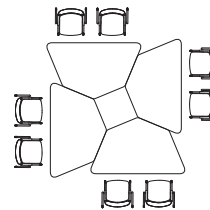

8 PEOPLE/4 TABLES

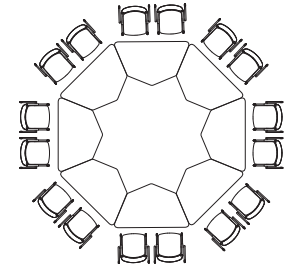

16 PEOPLE/8 TABLES

Horseshoe

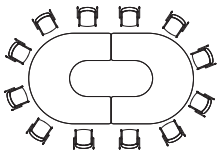

12 PEOPLE/2 TABLES

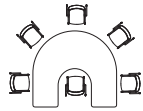

6 PEOPLE/1 TABLE

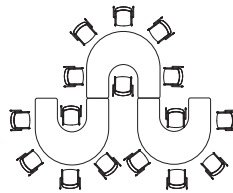

16 PEOPLE/3 TABLES

Spooky

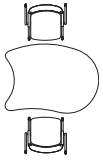

2 PEOPLE/1 TABLE

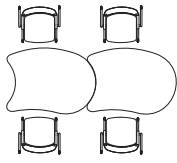

4 PEOPLE/2 TABLES

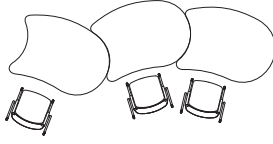

3 PEOPLE/3 TABLES

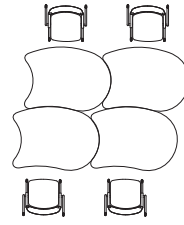

4 PEOPLE/4 TABLES

Combinations

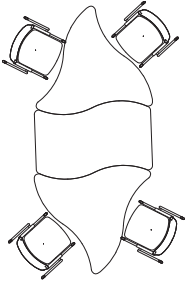

4 PEOPLE/3 TABLES
Ribbon and Snap

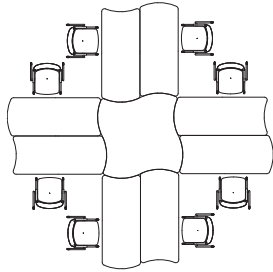

8 PEOPLE/9 TABLES
Tide and Dart

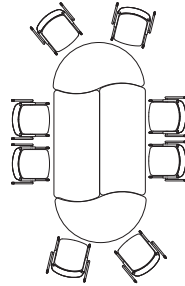





8 PEOPLE/4 TABLES
Dart and Wisp

BUILD™ Table Tops

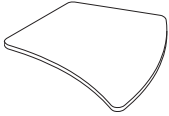

Icon Legend on page 19

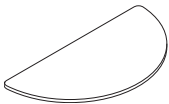
EDUCATION

	DESCRIPTION	MODEL	LEGS REQUIRED	SHIP WEIGHT	CUBE	LIST PRICE BY LAMINATE GRADE		
						L1	L2	L4
	Snap Table Top 54"W x 34"D	HESNP54E	3	46	2.8	\$625	\$652	\$702
	Kite Table Top 40"W x 24"D	HESA2440E	4	30	3.9	\$599	\$617	\$651
	50"W x 30"D	HESA3050E	4	50	5.8	\$625	\$648	\$692
	Wisp Table Top 54"W x 30"D	HESN3054E	4	63	4.6	\$605	\$628	\$672
	Half-Round Table Top 60"W x 30"D	HESH3060E	4	69	6.0	\$577	\$600	\$644
	Spooky Table Top 36"W x 54"D	HESY3654E	4	61	14.4	\$541	\$564	\$607
	Ribbon Table Top 54"W x 30"D	HESW3054E	4	65	5.4	\$539	\$562	\$606

NOTES:

- Quick set bracket factory installed for easy leg location and installation.
- ! Top and legs specified separately. Table tops compatible only with leg models on page 139.

HOW TO SPECIFY

<p>Select Model Number</p> <p>HESH3060E</p>	<p>Select Grommet</p> <p>N No Grommet</p> <p>N</p>	<p>Select Top Laminate</p> <p>See page 131, Group A</p> <p>LDW1</p>	<p>Select Edge Color</p> <p>See page 131</p> <p>DW</p>
--	---	--	---



Icon Legend on page 19

BUILD™ Table Tops

EDUCATION

	DESCRIPTION	MODEL	LEGS REQUIRED	SHIP WEIGHT	CUBE	LIST PRICE BY LAMINATE GRADE		
						L1	L2	L4
	Rectangle Table Top							
	48"W x 24"D	HETR2448E	4	71.0	3.6	\$458	\$476	\$510
	60"W x 24"D	HETR2460E	4	57.0	4.4	\$508	\$531	\$575
	72"W x 24"D	HETR2472E	4	68.0	4.9	\$561	\$584	\$628
	48"W x 30"D	HETR3048E	4	62.0	4.4	\$478	\$496	\$530
	60"W x 30"D	HETR3060E	4	71.0	5.4	\$523	\$546	\$590
	72"W x 30"D	HETR3072E	4	85.0	4.9	\$598	\$621	\$665
	Round Table Top							
	42" Diameter	HERD42E	4	51.0	4.7	\$409	\$427	\$459
	48" Diameter	HERD48E	4	66.0	6.1	\$462	\$482	\$519
	Square Table Top							
	36"W x 36"D	HESQ36E	4	46.0	3.7	\$349	\$365	\$393
	42"W x 42"D	HESQ42E	4	61.0	4.9	\$446	\$465	\$501
	48"W x 48"D	HESQ48E	4	76.0	6.2	\$488	\$509	\$548
	Tide Table Top							
	54"W x 54"D	HETD54E	4	106.0	9.2	\$766	\$798	\$858
	Trapezoid Table Top							
		HETZ3060E	4	58.1	4.8	\$433	\$452	\$487
	Home Plate Table Top							
	36"W x 60"D	HEHP3660E	4	64.0	15.9	\$523	\$546	\$590

NOTES:

- Quick set bracket factory installed for easy leg location and installation.
- ! Top and legs specified separately. Table tops compatible only with leg models on page 139.

HOW TO SPECIFY



Select Model Number H E T R 2 4 4 8 E	Select Grommet N No Grommet N	Select Top Laminate See page 131, Group A L D W 1	Select Edge Color See page 131 D W
---	--	--	---

BUILD™ Table Tops

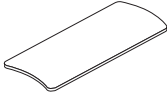

Icon Legend on page 19

EDUCATION

	DESCRIPTION	MODEL	LEGS REQUIRED	SHIP WEIGHT	CUBE	LIST PRICE BY LAMINATE GRADE		
						L1	L2	L4
	Dart Table Top 66"W x 27"D	HEDRT2766E	4	86	4.3	\$547	\$570	\$613
	Arc Table Top 72"W x 48"D	HESKD4872E	4	112	8.2	\$874	\$897	\$941
	Horseshoe Table Top 60"W x 66"D	HESH6066E	4	103	21.7	\$1038	\$1084	\$1172

NOTES:



- Quick set bracket factory installed for easy leg location and installation.
- ! Top and legs specified separately. Table tops compatible only with leg models on page 139.

HOW TO SPECIFY

<p>Select Model Number</p> <p>H E S H 6 0 6 6 E .</p>	<p>Select Grommet</p> <p>N No Grommet</p> <p>N .</p>	<p>Select Top Laminate</p> <p>See page 131, Group A</p> <p>L D W 1 .</p>	<p>Select Edge Color</p> <p>See page 131</p> <p>D W</p>
--	---	---	--

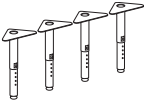
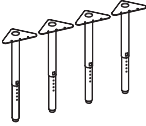

Icon Legend on page 19

	DESCRIPTION	MODEL	HEIGHT RANGE	SHIP WEIGHT	CUBE	LIST PRICE P1/P2
	Build™ Table Adjustable Height Leg Pack Youth Height Legs, Pack of 4	HEBY4LEG	13"-18"	19	0.9	\$197
	Build™ Table Adjustable Height Leg Pack Standard Table Height Legs, Pack of 4	HEB4LEG	22"-34"	19	1.2	\$260
	Build™ Table Adjustable Height Leg Pack Standing Height Legs, Pack of 4	HEBS4LEG	30"-42"	25	2.2	\$319

NOTES:

- Specify paint for upper portion of leg. Bottom is chrome.

❗ Compatible only with top models on pages 136-138.

	Yes	No
Standing		X
Youth	X	
Table	X	

❗ See pages 136-138 for number of legs required per top. Legs always ship 4 per carton. Use chart below for quantity of 4-leg packs required for shapes that utilize three legs.

DESKS	LEGS NEEDED	ADJUSTABLE POST LEGS 4-PACKS
1	3	1
2	6	2
3	9	3
4	12	3
5	15	4
6	18	5
7	21	6
8	24	6
9	27	7
10	30	8

HOW TO SPECIFY

Select Model Number H E B S 4 L E G .	Select Paint Color See page 131, Paint Group A T 1
---	---

BUILD™ Nesting Tables



EDUCATION



DESCRIPTION

Dart Table with Nesting Base
66"W x 27"D

MODEL

HEDRT-2766E-NS

SHIP WEIGHT

113

CUBE

8.7

LIST PRICE BY LAMINATE GRADE

L1

\$1485

L2

\$1508

L4

\$1551

NOTES: Ribbon, Wisp, Snap, Tide and Dart can all be used together.

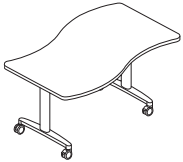

Ribbon Nesting Table
54"W x 30"D

HESW-3054E-NS

89

8.1

\$1473

\$1496

\$1540

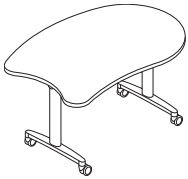

Spooky Nesting Table
54"W x 36"D

HESY-3654E-NS

85

17.1

\$1479

\$1502

\$1545

DESCRIPTION

Nesting Spacer Kit

MODEL

HESPCR

SHIP WEIGHT

2 Ⓞ

CUBE

0.1

LIST PRICE

\$70

NOTES: Use with Build™ standard height post legs and nesting bases to create even table heights. Specify 1 kit per nesting table.

ⓘ Available in P Black only. Specify: HESPCR.P.

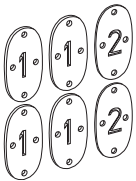





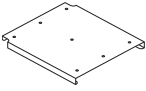
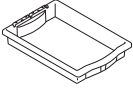

NOTES:

ⓘ Nesting bases are not intended to be used in combination with youth, standing, or desk post-legs.

ⓘ Nesting bases have a height difference of 1/2" when used with Build™ Standard Table Height Post Leg models. Use Nesting Spacer Kit HESPCR to create even table heights.

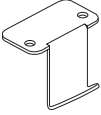
<p>Select Model Number</p> <p>HEDRT-2766E-NS</p>	<p>Select Grommet</p> <p>N No Grommet</p> <p>N</p>	<p>Select Laminate Color</p> <p>See page 131, Group A</p> <p>LBA1</p>	<p>Select Edge Color</p> <p>See page 131</p> <p>K</p>	<p>Select Caster</p> <p>C Caster ONLY</p> <p>C</p>	<p>Select Paint Color</p> <p>See page 131, Paint Group A</p> <p>T1</p>
---	---	--	--	---	---

	DESCRIPTION	MODEL	SHIP WEIGHT	CUBE	LIST PRICE
	<p>Book Box Bracket</p> <p>NOTES: Use with HFMBIN3 trays. Specify 1 bracket per tray. For full book box solution specify both HEBBXRL and HFMBIN3.</p> <ul style="list-style-type: none"> Available in P Black only. No specification needed. Minimum mounting clearance required: 13½"W x 15"D. Book Box Bracket rated up to 25 lbs. 	HEBBXRL	2.1	0.6	\$57
	<p>Accessories — Tray Kit</p> <p>3"H, 2 bins and 4 rails</p> <p>NOTES: For full book box solution specify both HEBBXRL and HFMBIN3. (1) HFMBIN3 needed for every (2) HEBBXRL as bins are ordered in a set of 2.</p> <ul style="list-style-type: none"> Semi-translucent white. No specification needed. Bins ship with rails intended for use in storage. When bins are used with Book Box Bracket, rails will not be used. 	HFMBIN3	7.0 	4.0	\$83
	<p>Locking Casters, 4-Pack</p> <ul style="list-style-type: none"> Black only 4 casters per pack Caster pack adds 1⅞" to the overall height. All casters lockable Threaded attachment bolts Can retrofit on Build™ units with glides. <p>For use on youth and standard table post legs only.</p> <p>* On 4-leg Build™ tables, can utilize 2 casters and 2 glides for easy repositioning of tables.</p>	HHABCASTER*	1.0	0.1	\$93
	<p>Ganging Hardware</p> <ul style="list-style-type: none"> Includes two ganging links and two screws No color designator when specifying. <i>Example: HMAGANG.</i> 	HMAGANG	1.0 	0.1	\$145
	<p>Back Pack Hook (10 per carton)</p> <p>2¼"W x 2⅜"D x 1¾"H</p> <p>NOTES: Attaches to bottom of surface with 2 screws, included.</p> <ul style="list-style-type: none"> Available in Platinum Metallic finish only, no specification needed. Back Pack Hook rated up to 25 lbs. 	HCLA65	10.0 	0.1	\$127

HOW TO SPECIFY

Select Model Number

H H A B C A S T E R

BUILD™ Student Desk Surface Dimensions

EDUCATION

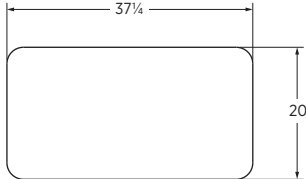
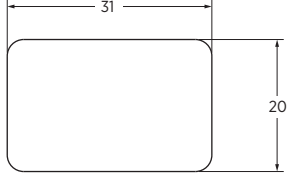
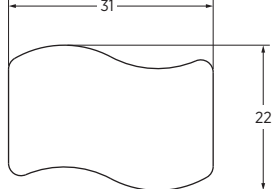
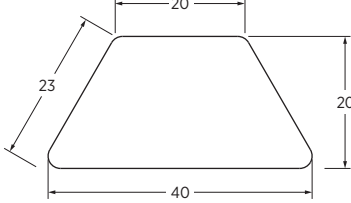
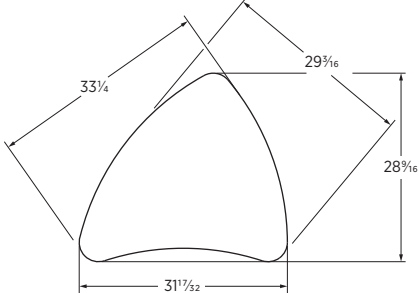
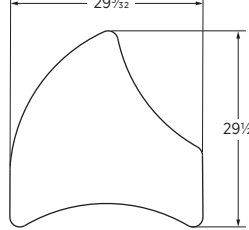
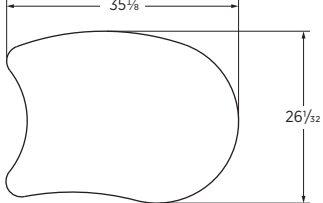
Name	Model	Dimensions
Rectangle	HBSDRECT2038	
Rectangle	HBSDRECT2031	
Ribbon	HBSDRBN2231	
Trapezoid	HBSDTRP2040	
Crescent	HBSDCSNT2832	
Fin	HBSDFN3030	
Spooky	HBSDSPY2636	

BUILD™ Student Desk Configurations

EDUCATION

Fin

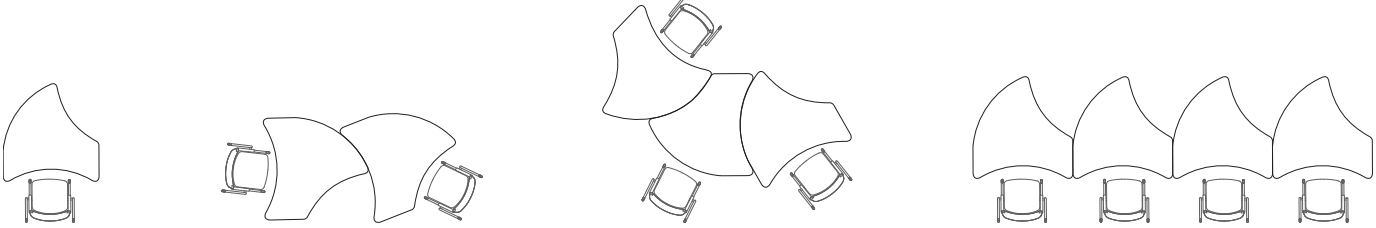

Crescent

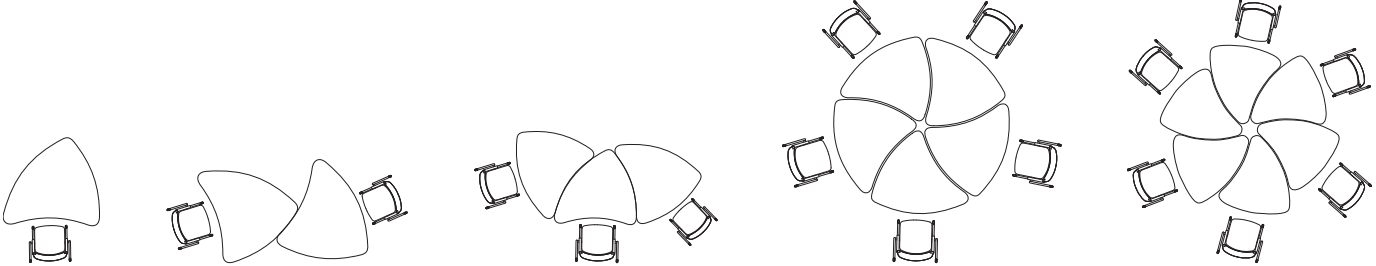

Trapezoid

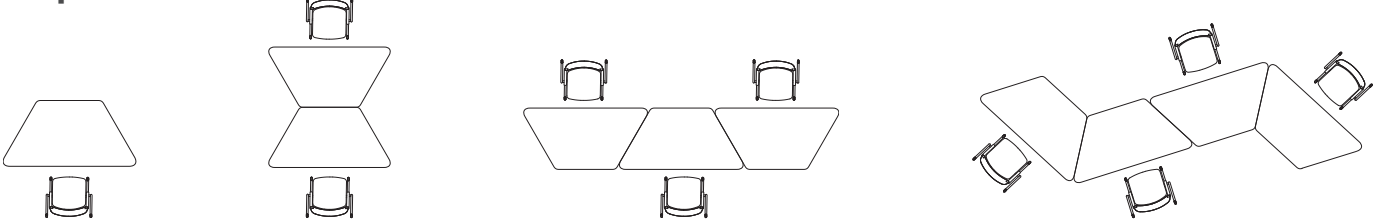

Spooky

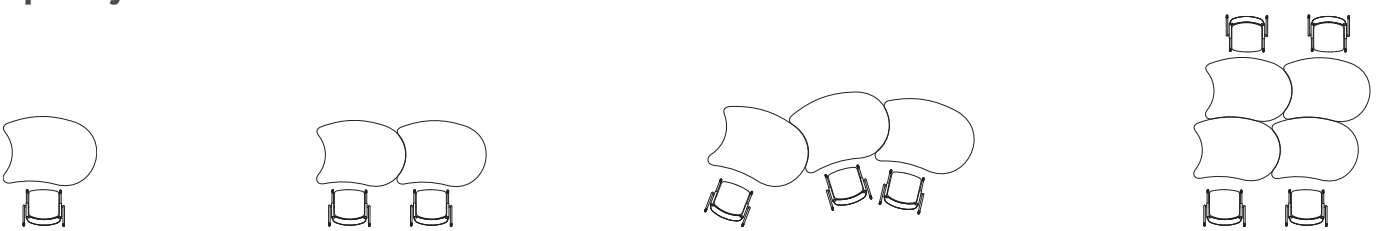

BUILD™ Student Desk Configurations

Rectangle

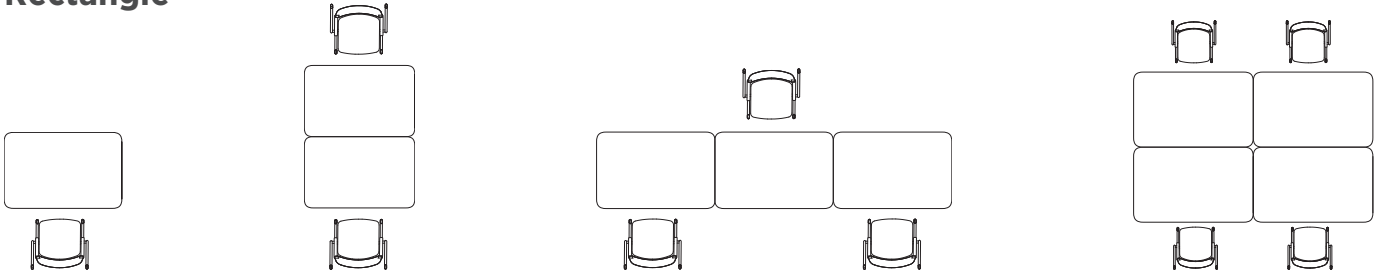

Ribbon

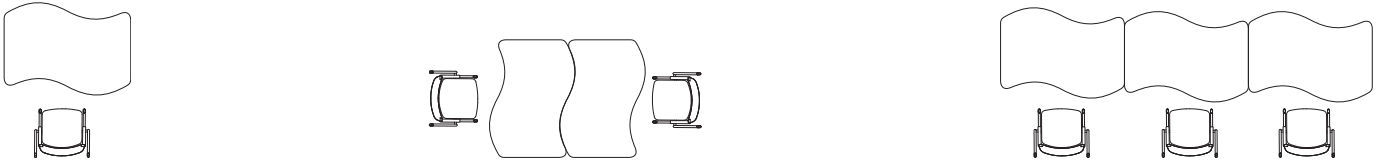





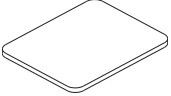

Icon Legend on page 19

BUILD™ Student Desks

EDUCATION

	DESCRIPTION	MODEL	LEGS REQUIRED	SHIP WEIGHT	CUBE	LIST PRICE BY LAMINATE GRADE		
						L1	L2	L4
 HBSDRECT2038	Rectangle Student Desk Top 31"W x 20"D	HBSDRECT2031 ⓘ	4	29	2.4	\$225	\$237	\$246
	38"W x 20"D	HBSDRECT2038*	4	33	2.0	\$229	\$241	\$250
	30"W x 24"D	HBSDRECT2430	4	27	2.2	\$227	\$239	\$248
* HBSDRECT2038 desk is wheelchair friendly. ⓘ HBSDRECT2430 can be used with casters to create a mobile student desk. Order student desk leg model number HEBSD4LEG and HHABCASTER. Casters are field installable. HBSDRECT2031 and HBSDRECT2038 are not compatible with casters as they do not pass BIFMA when used with casters.								
 HBSDRECT2430	Trapezoid Student Desk Top 40"W x 20"D	HBSDTRP2040	4	29	5.8	\$258	\$271	\$281
 HBSDRBN2231	Ribbon Student Desk Top 31"W x 22"D	HBSDRBN2231 ⓘ	4	27	2.2	\$229	\$241	\$250
 HBSDSPY2636	Spooky Student Desk Top 36"W x 26"D	HBSDSPY2636	4	32	6.5	\$258	\$271	\$281
 HBSDFN3030	Fin Student Desk Top 30"W x 30"D	HBSDFN3030	3	26	5.7	\$254	\$267	\$277
 HBSDCSNT2832	Crescent Student Desk Top 32"W x 28"D	HBSDCSNT2832	3	28	5.7	\$254	\$267	\$277

NOTES:

- Top and legs specified separately.
- ⓘ Desk tops compatible only with legs shown on page 146.

HOW TO SPECIFY

Select Model Number H B S D R B N 2 2 3 1 .	Select Grommet N No Grommet	Select Top Laminate See page 131, Group A L D W 1 .	Select Edge Color See page 131 D W
---	---------------------------------------	--	---

BUILD™ Student Desks



Icon Legend on page 19

DESCRIPTION	MODEL	HEIGHT RANGE	SHIP WEIGHT	CUBE	LIST PRICE P1/P2
Student Desk Leg, 4-Pack	HEBSD4LEG	22"-34"	15	1.1	\$229



NOTES:

• Specify paint for upper portion of leg. Bottom is chrome.

❗ Casters can only be used when specifying student desk worksurface model HBSDRECT2430. Specify HHABCASTER for caster pack. Casters are field installable. Other Build™ student desk sizes and shapes do not pass BIFMA when used with casters.

❗ See page 145 for number of legs required per top. Legs always ship 4 per carton. Use chart below for quantity of 4-leg packs required for shapes that utilize three legs.

❗ Student Desk Legs compatible only with Student Desk Tops shown on page 145.

DESKS	LEGS NEEDED	ADJUSTABLE POST LEGS 4-PACKS
1	3	1
2	6	2
3	9	3
4	12	3
5	15	4
6	18	5
7	21	6
8	24	6
9	27	7
10	30	8



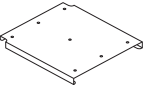
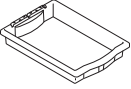

HOW TO SPECIFY

<p>Select Model Number</p> <p>HEBSD4LEG</p>	<p>Select Paint Color</p> <p>See page 131, Paint Group A</p> <p>T1</p>
---	--

	DESCRIPTION	MODEL	SHIP WEIGHT	CUBE	LIST PRICE
	<p>Book Box Bracket</p> <p>NOTES: Use with HFMBIN3 trays. Specify 1 bracket per tray. For full book box solution specify both HEBBXRL and HFMBIN3.</p> <ul style="list-style-type: none"> Available in P Black paint only. Minimum mounting clearance required: 13½"W x 15"D. Book Box Bracket rated up to 25 lbs. 	HEBBXRL	2.1	0.6	\$57
	<p>Accessories — Tray Kit</p> <p>3"H, 2 bins and 4 rails</p> <p>NOTES: For full book box solution specify both HEBBXRL and HFMBIN3. (1) HFMBIN3 needed for every (2) HEBBXRL as bins are ordered in a set of 2.</p> <ul style="list-style-type: none"> Semi-translucent white. No specification needed. Bins ship with rails intended for use in storage. When bins are used with Book Box Bracket, rails will not be used. 	HFMBIN3	7.0 Ⓢ	4.0	\$83

NOTES:

- Front and rear handles are integrated for easy handling/transport.

	DESCRIPTION	MODEL	SHIP WEIGHT	CUBE	LIST PRICE
    	<p>Back Pack Hook (10 per carton)</p> <p>2¼"W x 2¾"D x 1¾"H</p> <p>NOTES: Attaches to bottom of surface with 2 screws, included.</p> <ul style="list-style-type: none"> Available in Platinum Metallic finish only, no specification needed. Back Pack Hook rated up to 25 lbs. 	HCLA65	10 Ⓢ	0.1	\$127

HOW TO SPECIFY

<p>Select Model Number</p> <p>H E B B X R L .</p>	<p>Select Paint Color</p> <p>P</p>
---	------------------------------------

BUILD™ Makerspace Table



Icon Legend on page 19

EDUCATION



DESCRIPTION	MODEL	SHIP WEIGHT	CUBE	LIST PRICE	UPCHARGE BY LAMINATE/PAINT GRADE			
					L2	L4	P2	P3
Seated-Height Table with Laminate Top								
60"W x 42"D x 29"H	HEMKR426029L	153	9.4	\$2237	\$40	\$113	\$38	\$59
72"W x 42"D x 29"H	HEMKR427229L	169	9.7	\$2439	\$47	\$137	\$38	\$59
Seated-Height Table with Butcher Block Top								
60"W x 42"D x 29"H	HEMKR426029BB	179	9.9	\$3167	N/A	N/A	\$38	\$59
72"W x 42"D x 29"H	HEMKR427229BB	201	10.4	\$3524	N/A	N/A	\$38	\$59



Counter-Height Table with Laminate Top								
60"W x 42"D x 36"H	HEMKR426036L	158	10.4	\$2272	\$40	\$113	\$38	\$60
72"W x 42"D x 36"H	HEMKR427236L	174	10.8	\$2474	\$47	\$137	\$38	\$60
Counter-Height Table with Butcher Block Top								
60"W x 42"D x 36"H	HEMKR426036BB	184	11.0	\$3202	N/A	N/A	\$38	\$60
72"W x 42"D x 36"H	HEMKR427236BB	213	12.9	\$3559	N/A	N/A	\$38	\$60



Standing-Height Table with Laminate Top								
60"W x 42"D x 42"H	HEMKR426042L	173	11.4	\$2311	\$40	\$113	\$39	\$62
72"W x 42"D x 42"H	HEMKR427242L	189	11.7	\$2513	\$47	\$137	\$39	\$62
Standing-Height Table with Butcher Block Top								
60"W x 42"D x 42"H	HEMKR426042BB	199	11.9	\$3241	N/A	N/A	\$39	\$62
72"W x 42"D x 42"H	HEMKR427242BB	221	12.4	\$3597	N/A	N/A	\$39	\$62

NOTES:

- Laminate top is 1/8" thick and features 3" radius corners.
- Butcher Block top is 1 1/2" thick and features 1/2" radius corners with 1/8" radius around entire perimeter of top.
- Butcher Block tops will naturally feature variation between tops due to the nature of the real wood finish. Constructed of natural Birch wood, no two tops are exactly alike. Top is coated in a clear polyurethane finish for maximum durability.
- Both laminate and Butcher Block tops include threaded metal inserts for easy base connection. This also allows for easy base removal and reconnection if table needs to be moved through standard doorways.
- Up to 4 SmartLink® bins will fit between lower foot rails on standing-height table if desired. Applicable on counter height and standing height tables.
- HEBBXRL is not compatible with Makerspace tables.

HOW TO SPECIFY

Select Model Number H E M K R 4 2 7 2 2 9 L	Select Grommet N No Grommet	Select Laminate Color See page 131, Group A L S A 1	Select Edge Color See page 131 S A	Select Caster C Casters	Select Paint Color See page 131, Paint Group B P
---	---------------------------------------	--	---	-----------------------------------	---

Select Model Number H E M K R 4 2 7 2 2 9 B B	Select Grommet N No Grommet	Select Wood LH903 Butcher Block L H 9 0 3	Select Caster C Casters	Select Paint Color See page 131, Paint Group B P
---	---------------------------------------	--	-----------------------------------	---



Icon Legend on page 19

BUILD™ Makerspace Table

EDUCATION

	DESCRIPTION	MODEL	SHIP WEIGHT	CUBE	LIST PRICE BY PAINT GRADE			
					P1	P2	P3	P6
	Slotted/Pegboard End Panels For Seated-Height (2/pack)	HEMKREND29-SP	29	2.6	\$578	\$595	\$603	\$676
	For Counter-Height (2/pack)	HEMKREND36-SP	29	2.7	\$646	\$664	\$675	\$757
	For Standing-Height (2/pack)	HEMKREND42-SP	33	3.3	\$720	\$740	\$752	\$842
	Solid Full End Panels For Seated-Height (2/pack)	HEMKREND29-F	29	2.6	\$578	\$595	\$603	\$676
	For Counter-Height (2/pack)	HEMKREND36-F	29	2.7	\$646	\$664	\$675	\$757
	For Standing-Height (2/pack)	HEMKREND42-F	33	3.3	\$720	\$740	\$752	\$842

NOTES:

- Panels ship 2 per carton.
- Slotted/pegboard end panels accept Fuse™ hanging accessories or any standard ¼" pegboard accessory.
- End panels are magnetic.
- End panels feature welded vertical stiffener on inside of panel for maximum rigidity.
- End panels are installed after table is fully built allowing you to add on to table base at a later date if desired.
- End panels are non-handed.

STANDING-HEIGHT TABLES	
Top Slot	8¾"W
2nd Slot	10¼"W
3rd Slot	11¾"W
4th Slot	13¼"W

SEATED HEIGHT TABLES	
Top Slot	12¼"W
Bottom Slot	13¾"W

HOW TO SPECIFY

Select Model Number	Select Paint Color See page 131, Paint Group C
H E M K R E N D 2 9 - S P .	P

BUILD™ Makerspace Table



Icon Legend on page 19

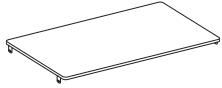

DESCRIPTION	MODEL	SHIP WEIGHT	CUBE	LIST PRICE	UPCHARGE BY LAMINATE/PAIN T GRADE		
					L2	P2	P3
Makerspace Table Shelf 50½"W x 31"D	HEMKRSHELF	39	1.1	\$835	\$24	\$10	\$14

! For use with standing-height tables only.

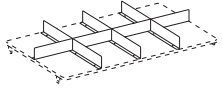

DESCRIPTION	MODEL	SHIP WEIGHT	CUBE	LIST PRICE BY PAINT GRADE		
				P1	P2	P3
Shelf Divider	HEMKRDIVIDER	10	0.6	\$209	\$217	\$220

! Shelf Divider (HEMKRDIVIDER) is only to be used when HEMKRSHELF is specified. HEMKRDIVIDER cannot be used as a stand-alone item. For use on standing-height tables only.

NOTES:

- Shelves are ¾" thick thermal-fused laminate with 1mm edgeband. Edge color is predetermined by and matches laminate selection.
- Shelf can be used with or without divider (specified separately).
- Shelf always contains small pilot through-holes for shelf divider installation.

EDUCATION

HOW TO SPECIFY

<p>Select Model Number</p> <p>HEMKRSHELF</p>	<p>Select Laminate Color</p> <p>See page 131, Laminate Group B</p> <p>LDW1</p>	<p>Select Paint Color</p> <p>See page 131, Paint Group B</p> <p>P</p>
--	--	---

<p>Select Model Number</p> <p>HEMKRDIVIDER</p>	<p>Select Paint Color</p> <p>See page 131, Paint Group B</p> <p>P</p>
--	---



Icon Legend on page 19



	DESCRIPTION	MODEL	SHIP WEIGHT	CUBE	LIST PRICE
	Side Saddle 12¼"W x 2½"D x 4"H	HAESS	0.6	0.1	\$56
	Hook 1⅝"W x 2¼"D x 3¼"H	HAECBH	0.1	0.1	\$39
	Hot File 12¼"W x 3⅞"D x 9½"H	HAEHF	0.7	1.5	\$82

NOTES:

- Hook weight limit 20 lbs.

	DESCRIPTION	MODEL	SHIP WEIGHT	CUBE	LIST PRICE
	Accessories — Tray Kit 3"H, 2 bins and 4 rails	HFMBIN3	7 	4.0	\$83
	6"H, 2 bins and 4 rails	HFMBIN6	10 	4.5	\$98
	12"H, 2 bins and 4 rails	HFMBIN12	12 	5.0	\$116

NOTES:

-  Semi-translucent white. No specification needed.
-  Bins ship with metal rails intended for use in SmartLink® Mobile Storage. When bins are used with shelf or foot rails on Makerspace table, rails will not be used.

HOW TO SPECIFY

Select Model Number	Select Color
HAESS	DW Designer White
	DW

BUILD™ Makerspace Stools



Icon Legend on page 19

EDUCATION



MODEL/DESCRIPTION	DEPTH	WIDTH	HEIGHT	SHIP		LIST PRICE BY PAINT GRADE		
				WEIGHT	CUBE	P1	P2	P3
HE4LSTL18 Seated-Height Stool				12	3.3	\$191	\$199	\$202
Maximum:	15½	15½	18					
Seat:	12	12	18					
Seat to Floor:			18					
Usable Seat Depth:	12							



HE4LSTL30 Café-Height Stool				17	7.6	\$258	\$267	\$271
Maximum:	16⅞	16⅞	30					
Seat:	12	12	30					
Seat to Floor:			30					
Usable Seat Depth:	12							

NOTES:

- Weight Rating: 300 lbs.
- Features non-leveling nylon glides.
- Stackable up to 4-high.

HOW TO SPECIFY

<p>Select Model Number</p> <p>HE4LSTL18 . T1</p>	<p>Select Paint Color</p> <p>See page 131, Paint Group B</p>
---	---

CLASS-IFI™

Want to see more? Scan here
to check out hon.com.



Class-ifi™ shown with Build™
Makerspace Tables and Stools.

EDUCATION

CLASS-IFI™

Every student and teacher deserves multifunctional, durable, and efficient organizational solutions that go the distance no matter what the subject. Class-ifi™ — a dynamic, effortlessly mobile education storage collection — is designed to maximize space, promote flexibility, and inspire creativity at any age or learning level. Today's education environments have discovered a more holistic approach to organization and kinesthetic learning, and that means more choices and smarter logistics. With its dynamic, multifunctional design, straightforward mobility, and exceptional organization capabilities, Class-ifi™ encourages healthy movement throughout the day and defines a variety of organizational and learning hubs for every student at every level. Make your space work with Class-ifi™.



FEATURES

- Choose from two panel options (Accessory End or Solid End), depending on your needs.
- Maximize your mobility with casters.
- Organize any size learning space with single- and double-sided bookcases and cubbies.
- Color your world with a variety of metal and laminate finish options.
- Reach for the stars or keep things at ground level with multiple height options.
- Open up your world with easy-access doors (also available without doors).
- Stash your stuff safely by adding a handy tote to any locker, tote storage, or Teacher Command Station (optional).
- Amp up your accessibility with Fuse™ accessories for all storage units, including hot file, side saddle, and bag hooks. (All work with slotted end planes.)
- Get a lift with a handy locker hook.
- Offer more options with a 1H bookcase or cubby that can be utilized as a seat.

CLASS-IFI™ ORDERING INFORMATION

LAMINATES

L1 LAMINATES	CODES
◆ Black	P
◆ Bourbon Cherry	H
◆ Charcoal	S
◆ Cognac	COGN
◆ Designer White	LDW1
◆ Field Elm	LWFE
◆ Florence Walnut	LFW1
◆ Harvest	C
◆ Kingswood Walnut	LK11
◆ Loft	LOFT
◆ Mahogany	N
◆ Mocha	MOCH
◆ Natural Maple	D
◆ Pinnacle	PINC
◆ Shaker Cherry	F
◆ Sterling Ash	LSA1
L2 LAMINATES	
◆ Beigewood	LWBE
◆ Fawn Cypress	LFC1
◆ Lowell Ash	LLA1
◆ Natural Recon	LNR1
◆ Phantom Ecru	LPE1
◆ Portico Teak	LPT1
◆ Skyline Walnut	LSW1

CASE AND FRAME PAINT

PAINT	CODES
P1	
◆ Black	P71
◆ Brownstone	P7D
◆ Charcoal	S
◆ Designer White	PJW
◆ Fossil	P28
◆ Loft	LOFT
◆ Muslin	T3
◆ Putty	L
◆ Titanium	P8T
P2	
◆ Champagne Metallic	PR5
◆ Gunmetal Metallic	PR3
◆ Platinum Metallic	T1

END PANEL PAINT

PAINT	CODES
P1	
◆ Black	P71
◆ Brownstone	P7D
◆ Charcoal	S
◆ Designer White	PJW
◆ Fossil	P28
◆ Light Grey	Q
◆ Loft	LOFT
◆ Muslin	T3
◆ Putty	L
◆ Titanium	P8T
P2	
◆ Champagne Metallic	PR5
◆ Gunmetal Metallic	PR3
◆ Platinum Metallic	T1
◆ Silver	PR6
◆ Solar Black	P8X
P3	
◆ Atom	P8S
◆ Blossom	P8K
◆ Bullseye	PJF
◆ Ember	P8P
◆ Ion	P8N
◆ Iris	P8J
◆ Krypton	P8F
◆ Ochre	P093
◆ Regatta	P8M
◆ Sienna	P092
◆ Succulent	P8A
P6	
◆ Markerboard	MKB

◆◆◆ For lead time information see page 21.

CLASS-IFI™ STATEMENT OF LINE

CUBBIES



18½"H, 3-Wide,
Single-Sided



18½"H, 3-Wide,
Double-Sided



31½"H, 3-Wide,
Single-Sided

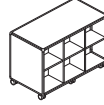

31½"H, 3-Wide,
Double-Sided

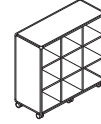

44½"H, 3-Wide,
Single-Sided

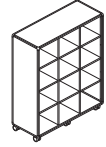

57½"H, 3-Wide,
Single-Sided

LOCKERS



31½"H, 2-Wide



31½"H, 3-Wide



44½"H, 2-Wide

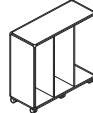

44½"H, 3-Wide

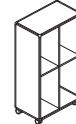

57½"H, 2-Wide

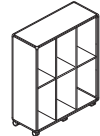

57½"H, 3-Wide

COMBOS



44½"H, 2-Wide



44½"H, 3-Wide

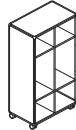

57½"H, 2-Wide

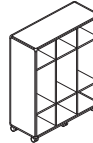

57½"H, 3-Wide

BOOKCASES



1-High, 3-Wide,
Single-Sided



1-High, 3-Wide,
Double-Sided



2-High, 3-Wide,
Single-Sided

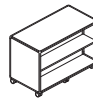

2-High, 3-Wide,
Double-Sided



3-High, 3-Wide,
Single-Sided



4-High, 3-Wide,
Single-Sided

CLASS-IFI™ STATEMENT OF LINE

TOTE STORAGE



31 1/4"H, 2-Wide



31 1/4"H, 3-Wide



44 1/4"H, 2-Wide

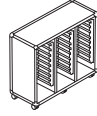

44 1/4"H, 3-Wide

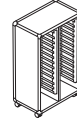

57 1/4"H, 2-Wide

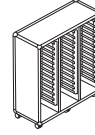

57 1/4"H, 3-Wide

COMMAND STATION

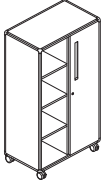

Right-Hand
Wardrobe

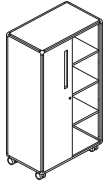

Left-Hand
Wardrobe

CLASS-IFI™ SPECIFYING INFORMATION

TOTE STORAGE CAPACITY PLANNING

Tote storage cases do not include bins; bins must be specified separately depending on available capacity and customer need. Utilize the diagram below to help in planning the number of bin kits needed based on cabinet size.

Hanging Slots	12" H Bin	6" H Bin	3" H Bin
1			
2			
3			
4			



HFMBIN12

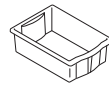

HFMBIN6

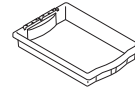

HFMBIN3

1	6
2	7
3	8
4	9
5	10
HEST2H2WS	

1	6	11
2	7	12
3	8	13
4	9	14
5	10	15
HEST2H3WS		

1	10
2	11
3	12
4	13
5	14
6	15
7	16
8	17
9	18
HEST3H2WS	

1	10	19
2	11	20
3	12	21
4	13	22
5	14	23
6	15	24
7	16	25
8	17	26
9	18	27
HEST3H3WS		

1	14
2	15
3	16
4	17
5	18
6	19
7	20
8	21
9	22
10	23
11	24
12	25
13	26
HEST4H2WS	

1	14	27
2	15	28
3	16	29
4	17	30
5	18	31
6	19	32
7	20	33
8	21	34
9	22	35
10	23	36
11	24	37
12	25	38
13	26	39
HEST4H3WS		

ACCESSORY END PANELS

Every cabinet type is available with either solid or accessory-compatible end panels. 1H cabinets feature two horizontal slots per side, while 2H, 3H, and 4H cabinets feature four.

Compatible accessories for these slots are specified separately, see page 165.

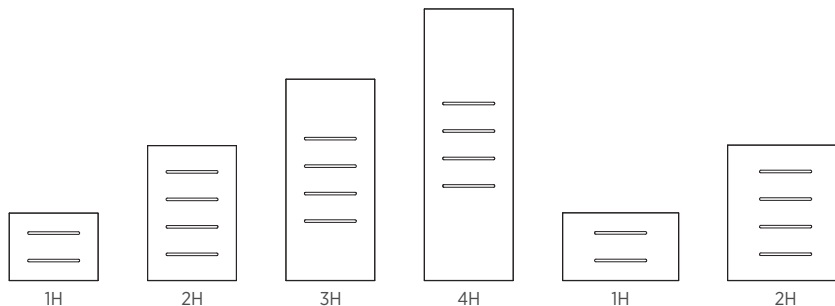

CLASS-IFI™ SPECIFYING INFORMATION

DOORS

Lockers, Combos, and Tote Storage available with or without doors. See below for door configuration based on storage type and size.

EDUCATION



2-High, 2-Wide

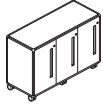

2-High, 3-Wide



3-High, 2-Wide



3-High, 3-Wide

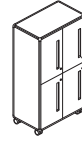

4-High, 2-Wide

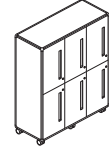

4-High, 3-Wide

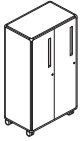

3-High, 2-Wide



3-High, 3-Wide

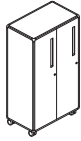

4-High, 2-Wide

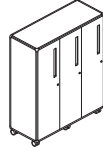

4-High, 3-Wide



2-High, 2-Wide

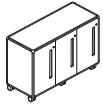

2-High, 3-Wide

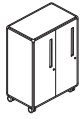

3-High, 2-Wide

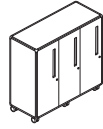

3-High, 3-Wide



4-High, 2-Wide

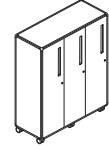

4-High, 3-Wide

FINISH SELECTION

Class-ifi™ allows for the specification of different finish options on a single model. Locations which allow for unique specification include:

- Laminate Interior
- Frame and Top/Back/Doors (if applicable)
- End Panels



Icon Legend on page 19

CLASS-IFI™ Lockers

EDUCATION

	DESCRIPTION	MODEL	SHIP WEIGHT	CUBE	LIST PRICE BY CASE PAINT GRADE			END PANEL UPCHARGE			L2 UPCHARGE
					P1	P2	P3	P2	P3	P6	
	31³/₈"H, 2-Wide 31 ⁵ / ₈ "W x 18 ³ / ₄ "D	HESL2H2WS	192	14.8	\$2046	\$2258	\$2574	\$18	\$23	\$57	\$212
NOTES: Upcharge with Door option (+ \$444). Select either Standard Lock, L , or Omit Lock, X (- \$42).											
	31³/₈"H, 3-Wide 46 ⁵ / ₈ "W x 18 ³ / ₄ "D	HESL2H3WS	181	21.1	\$2261	\$2495	\$2844	\$18	\$23	\$57	\$234
NOTES: Upcharge with Door option (+ \$501). Select either Standard Lock, L , or Omit Lock, X (- \$62).											
	44¹/₈"H, 2-Wide 31 ⁵ / ₈ "W x 18 ³ / ₄ "D	HESL3H2WS	212	21.0	\$2477	\$2734	\$3116	\$23	\$29	\$62	\$257
NOTES: Upcharge with Door option (+ \$501). Select either Standard Lock, L , or Omit Lock, X (- \$21).											
	44¹/₈"H, 3-Wide 46 ⁵ / ₈ "W x 18 ³ / ₄ "D	HESL3H3WS	232	29.9	\$2692	\$2971	\$3387	\$23	\$29	\$62	\$279
NOTES: Upcharge with Door option (+ \$528). Select either Standard Lock, L , or Omit Lock, X (- \$62).											
	57³/₈"H, 2-Wide 31 ⁵ / ₈ "W x 18 ³ / ₄ "D	HESL4H2WS	274	27.0	\$2584	\$2851	\$3250	\$29	\$34	\$67	\$267
NOTES: Upcharge with Door option (+ \$777). Select either Standard Lock, L , or Omit Lock, X (- \$83).											
	57³/₈"H, 3-Wide 46 ⁵ / ₈ "W x 18 ³ / ₄ "D	HESL4H3WS	334	38.4	\$2799	\$3089	\$3522	\$29	\$34	\$67	\$290
NOTES: Upcharge with Door option (+ \$1221). Select either Standard Lock, L , or Omit Lock, X (- \$124).											

NOTES:

- End panel specification selection applies to both end panels (either 2 solid end panels or 2 accessory end panels).
- Each locker compartment includes one double coat hook.
- When selected with doors, omit lock option is available. See page 157 for ordering instructions.
- Units ship assembled; casters are field installed.
- Casters are swivel, locking casters.

HOW TO SPECIFY

Select Model Number	Select Caster	Select Door and Pull	Select End Panel	Select Case Paint	Select Frame Paint	Select Panel Paint	Select Laminate
	C Caster	See product listing for upcharge D With Door N Integral Pull L Standard Lock X Omit Lock (- \$42, 2 Doors) (- \$62, 3 Doors) (- \$83, 4 Doors) (- \$124, 6 Doors) N Without Door	S Solid AB Accessory (+ \$167)	See page 154	NA Matches Case	See page 154	See page 154
HESL2H2WS	C	DNL	S	PR6	NA	PR6	LSA1

CLASS-IFI™ Cubbies



Icon Legend on page 19

EDUCATION

	DESCRIPTION	MODEL	SHIP WEIGHT	CUBE	LIST PRICE BY CASE PAINT GRADE			END PANEL UPCHARGE			L2 UPCHARGE
					P1	P2	P3	P2	P3	P6	
	18³/₈"H, 3-Wide Single-Sided	HESC1H3WS	124	12.4	\$2153	\$2376	\$2709	\$13	\$18	\$52	\$223
	46 ⁵ / ₈ "W x 18 ³ / ₄ "D x 18 ³ / ₈ "H										
	Double-Sided	HESC1H3WD	181	15.3	\$2477	\$2734	\$3116	\$18	\$23	\$57	\$257
	46 ⁵ / ₈ "W x 23 ⁷ / ₈ "D x 18 ³ / ₈ "H										
	31³/₈"H, 3-Wide Single-Sided	HESC2H3WS	192	25.9	\$2368	\$2613	\$2979	\$18	\$23	\$57	\$245
	46 ⁵ / ₈ "W x 18 ³ / ₄ "D x 31 ³ / ₈ "H										
	Double-Sided	HESC2H3WD	212	36.7	\$2584	\$2851	\$3250	\$23	\$29	\$62	\$267
	46 ⁵ / ₈ "W x 23 ⁷ / ₈ "D x 31 ³ / ₈ "H										
	44¹/₈"H, 3-Wide Single-Sided	HESC3H3WS	232	29.9	\$2692	\$2971	\$3387	\$23	\$29	\$62	\$279
	46 ⁵ / ₈ "W x 18 ³ / ₄ "D x 44 ¹ / ₈ "H										
	57³/₈"H, 3-Wide Single-Sided	HESC4H3WS	334	38.4	\$2799	\$3089	\$3522	\$29	\$34	\$67	\$290
	46 ⁵ / ₈ "W x 18 ³ / ₄ "D x 57 ³ / ₈ "H										

NOTES:

- End panel specification selection applies to both end panels (either 2 solid end panels or 2 accessory end panels).
- Units ship assembled; casters are field installed.
- Casters are swivel, locking casters.

HOW TO SPECIFY

Select Model Number	Select Caster	Select Door and Pull	Select End Panel	Select Case Paint	Select Frame Paint	Select Panel Paint	Select Laminate
	C Caster	N Without Door	S Solid AB Accessory (+ \$167)	See page 154	NA Matches Case	See page 154	See page 154
H E S C 1 H 3 W S .	C .	N .	S .	P R 6 .	N A .	P R 6 .	L S A 1



Icon Legend on page 19

CLASS-IFI™ Combos

EDUCATION

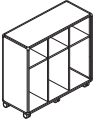
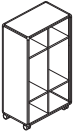
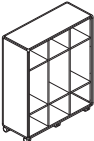
	DESCRIPTION	MODEL	SHIP WEIGHT	CUBE	LIST PRICE BY CASE PAINT GRADE			END PANEL UPCHARGE			L2 UPCHARGE
					P1	P2	P3	P2	P3	P6	
	44 1/8" H, 2-Wide 31 5/8" W x 18 3/4" D x 44 1/8" H	HESCO3H2WS	212	21.0	\$2477	\$2734	\$3116	\$23	\$29	\$62	\$257
	NOTES: Upcharge with Door option (+ \$501). Upcharge is applied per model. Select either Standard Lock, L , or Omit Lock, X (- \$21). Model comes with one (1) 12" H shelf.										
	44 1/8" H, 3-Wide 46 5/8" W x 18 3/4" D x 44 1/8" H	HESCO3H3WS	232	29.9	\$2692	\$2971	\$3387	\$23	\$29	\$62	\$279
	NOTES: Upcharge with Door option (+ \$528). Upcharge is applied per model. Select either Standard Lock, L , or Omit Lock, X (- \$62). Model comes with one (1) 12" H shelf.										
	57 3/8" H, 2-Wide 31 5/8" W x 18 3/4" D x 57 3/8" H	HESCO4H2WS	274	27.0	\$2584	\$2851	\$3250	\$29	\$34	\$67	\$267
	NOTES: Upcharge with Door option (+ \$528). Upcharge is applied per model. Select either Standard Lock, L , or Omit Lock, X (- \$42). Model comes with two (2) 12" H shelves.										
	57 3/8" H, 3-Wide 46 5/8" W x 18 3/4" D x 57 3/8" H	HESCO4H3WS	334	38.4	\$2799	\$3089	\$3522	\$29	\$34	\$67	\$290
	NOTES: Upcharge with Door option (+ \$556). Upcharge is applied per model. Select either Standard Lock, L , or Omit Lock, X (- \$62). Model comes with two (2) 12" H shelves.										

NOTES:

- End panel specification selection applies to both end panels (either 2 solid end panels or 2 accessory end panels).
- Each locker compartment includes one double coat hook.
- When selected with doors, omit lock option is available. See page 157 for ordering instructions.
- Units ship assembled; casters are field installed.
- Casters are swivel, locking casters.

HOW TO SPECIFY

Select Model Number	Select Caster	Select Door and Pull	Select End Panel	Select Case Paint	Select Frame Paint	Select Panel Paint	Select Laminate
	C Caster	See product listing for upcharge D With Door N Integral Pull L Standard Lock X Omit Lock (- \$21, 3H2W) (- \$62, 3H3W) (- \$42, 4H2W) (- \$62, 4H3W) N Without Door	S Solid AB Accessory (+ \$167)	See page 154	NA Matches Case	See page 154	See page 154
H E S C O 3 H 2 W S .	C .	D N L .	S .	P R 6 .	N A .	P R 6 .	L S A 1

CLASS-IFI™ Bookcases



Icon Legend on page 19

EDUCATION

	DESCRIPTION	MODEL	SHIP WEIGHT	CUBE	LIST PRICE BY CASE PAINT GRADE			END PANEL UPCHARGE			L2 UPCHARGE
					P1	P2	P3	P2	P3	P6	
	1-High Single-Sided 46 ⁵ / ₈ "W x 18 ³ / ₄ "D x 18 ³ / ₈ "H	HESB1H3WS	124	12.4	\$1831	\$2021	\$2304	\$13	\$18	\$52	\$190
	Double-Sided 46 ⁵ / ₈ "W x 23 ⁷ / ₈ "D x 18 ³ / ₈ "H	HESB1H3WD	181	15.3	\$2261	\$2495	\$2844	\$18	\$23	\$57	\$234
	2-High Single-Sided 46 ⁵ / ₈ "W x 18 ³ / ₄ "D x 31 ³ / ₈ "H	HESB2H3WS	192	21.1	\$2046	\$2258	\$2574	\$18	\$23	\$57	\$212
	Double-Sided 46 ⁵ / ₈ "W x 23 ⁷ / ₈ "D x 31 ³ / ₈ "H	HESB2H3WD	212	25.9	\$2368	\$2613	\$2979	\$23	\$29	\$62	\$245
	3-High Single-Sided 46 ⁵ / ₈ "W x 18 ³ / ₄ "D x 44 ¹ / ₈ "H	HESB3H3WS	232	29.9	\$2477	\$2734	\$3116	\$23	\$29	\$62	\$257
	4-High Single-Sided 46 ⁵ / ₈ "W x 18 ³ / ₄ "D x 57 ³ / ₈ "H	HESB4H3WS	334	38.4	\$2584	\$2851	\$3250	\$29	\$34	\$67	\$267

NOTES:

- End panel specification selection applies to both end panels (either 2 solid end panels or 2 accessory end panels).
- Units ship assembled; casters are field installed.
- Casters are swivel, locking casters.

HOW TO SPECIFY

Select Model Number	Select Caster	Select Door and Pull	Select End Panel	Select Case Paint	Select Frame Paint	Select Panel Paint	Select Laminate
	C Caster	N Without Door	S Solid AB Accessory (+ \$167)	See page 154	NA Matches Case	See page 154	See page 154
HESB1H3WS	C	N	S	PR6	NA	PR6	LSA1



Icon Legend on page 19

CLASS-IFI™ Tote Storage

	DESCRIPTION	MODEL	SHIP WEIGHT	CUBE	LIST PRICE BY CASE PAINT GRADE			END PANEL UPCHARGE			L2 UPCHARGE
					P1	P2	P3	P2	P3	P6	
	31 3/8" H, 2-Wide 31 5/8" W x 18 3/4" D x 31 3/8" H	HEST2H2WS	181	14.8	\$1616	\$1783	\$2033	\$18	\$23	\$57	\$167
NOTES: Upcharge with Door option (+ \$444). Upcharge is applied per model. Select either Standard Lock, L , or Omit Lock, X (- \$42).											
	31 3/8" H, 3-Wide 46 5/8" W x 18 3/4" D x 31 3/8" H	HEST2H3WS	192	21.1	\$1938	\$2139	\$2439	\$18	\$23	\$57	\$201
NOTES: Upcharge with Door option (+ \$501). Upcharge is applied per model. Select either Standard Lock, L , or Omit Lock, X (- \$62).											
	44 1/8" H, 2-Wide 31 5/8" W x 18 3/4" D x 44 1/8" H	HEST3H2WS	212	21.0	\$2046	\$2258	\$2574	\$23	\$29	\$62	\$212
NOTES: Upcharge with Door option (+ \$501). Upcharge is applied per model. Select either Standard Lock, L , or Omit Lock, X (- \$21).											
	44 1/8" H, 3-Wide 46 5/8" W x 18 3/4" D x 44 1/8" H	HEST3H3WS	232	29.9	\$2368	\$2613	\$2979	\$23	\$29	\$62	\$245
NOTES: Upcharge with Door option (+ \$528). Upcharge is applied per model. Select either Standard Lock, L , or Omit Lock, X (- \$62).											
	57 3/8" H, 2-Wide 31 5/8" W x 18 3/4" D x 57 3/8" H	HEST4H2WS	274	27.0	\$2584	\$2851	\$3250	\$29	\$34	\$67	\$267
NOTES: Upcharge with Door option (+ \$528). Upcharge is applied per model. Select either Standard Lock, L , or Omit Lock, X (- \$42).											
	57 3/8" H, 3-Wide 46 5/8" W x 18 3/4" D x 57 3/8" H	HEST4H3WS	334	38.4	\$2907	\$3208	\$3657	\$29	\$34	\$67	\$301
NOTES: Upcharge with Door option (+ \$556). Upcharge is applied per model. Select either Standard Lock, L , or Omit Lock, X (- \$62).											

NOTES:

- End panel specification selection applies to both end panels (either 2 solid end panels or 2 accessory end panels).
- When selected with doors, omit lock option is available. See page 157 for ordering instructions.
- Cases will accept a variety of tote configurations. Refer to page 157 for capacity planning guidelines.
- Units ship assembled; casters are field installed.
- Casters are swivel, locking casters.

! Specify totes separately, see page 157.

! Door upcharge is applied per model, not per door.

HOW TO SPECIFY

Select Model Number	Select Caster	Select Door and Pull	Select End Panel	Select Case Paint	Select Frame Paint	Select Panel Paint	Select Laminate
	C Caster	See product listing for upcharge D With Door N Integral Pull L Standard Lock X Omit Lock (- \$42, 2H2WS) (- \$62, 2H3WS) (- \$21, 3H2WS) (- \$62, 3H3WS) (- \$42, 4H2WS) (- \$62, 4H3WS) N Without Door	S Solid AB Accessory (+ \$167)	See page 154	NA Matches Case	See page 154	See page 154
H E S T 2 H 2 W S .	C .	D N L .	S .	P R 6 .	N A .	P R 6 .	L S A 1

EDUCATION

CLASS-IFI™ Command Station



EDUCATION

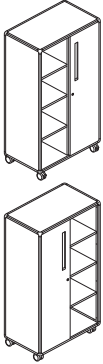









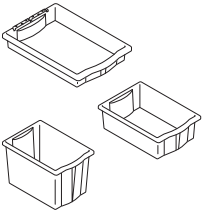

DESCRIPTION	MODEL	SHIP WEIGHT	CUBE	LIST PRICE BY CASE PAINT GRADE			END PANEL UPCHARGE			L2 UPCHARGE
				P1	P2	P3	P2	P3	P6	
Command Station RH Wardrobe 31 ⁵ / ₈ "W x 18 ³ / ₄ "D x 57 ³ / ₈ "H	HESCS4H2WSR	274	27.0	\$2799	\$3089	\$3522	\$29	\$34	\$67	\$290
LH Wardrobe 31 ⁵ / ₈ "W x 18 ³ / ₄ "D x 57 ³ / ₈ "H	HESCS4H2WSL	274	27.0	\$2799	\$3089	\$3522	\$29	\$34	\$67	\$290

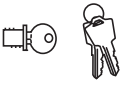
NOTES:

- End panel specification selection applies to both end panels (either 2 solid end panels or 2 accessory end panels).
- Wardrobe compartment includes one double coat hook.
- Omit lock option is available. See page 157 for ordering instructions.
- Units ship assembled; casters are field installed.
- Casters are swivel, locking casters.

HOW TO SPECIFY

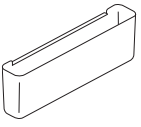
Select Model Number	Select Caster	Select Door, Pull, & Lock	Select End Panel	Select Case Paint	Select Frame Paint	Select Panel Paint	Select Laminate
	C Caster	D With Door N Integral Pull L Standard Lock X Omit Lock (- \$21)	S Solid AB Accessory (+ \$167)	See page 154	NA Matches Case	See page 154	See page 154
H E S C S 4 H 2 W S R .	C .	D N L .	S .	P R 6 .	N A .	P R 6 .	L S A 1

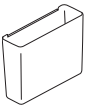
	DESCRIPTION	MODEL	SHIP WEIGHT	CUBE	LIST PRICE	
  	Accessories — Tote Tray Kits 3"H, 2 bins and 4 rails 6"H, 2 bins and 4 rails 12"H, 2 bins and 4 rails ⓘ Semi-translucent white.	HFMBIN3 HFMBIN6 HFMBIN12	7.0 ⓘ 10.0 ⓘ 12.0 ⓘ	4.0 4.5 5.0	\$83 \$98 \$116	
	  	Removable Lock Core Kit Satin Nickel • For stack-on and wall mounted storage laminate models (with locks) in 10500, Valido, Voi, and Concinity. • Specify quantity of each key number from 101E to 225E. • Includes: 1-core, 2-keys, 1-core removal tool, and instructions. NOTES: If key number isn't specified, number will be at random. When purchased separately without a configurable TAA compliant end product, not on GSA contract.	HF23S	0.2	0.02	\$65
	  	Master Key (one key) Will open all HON product with HON "One Key" interchangeable core removable locks. Available to authorized dealers only. Will open HF23B, HF23C, HF23S, HF24, HF27B, and HF27S locks numbered 101E-225E. Will open old HON style MB series locks.	HF22	0.1 ⓘ	0.1	\$43
		Side Saddle 12¼"W x 2½"D x 4"H	HAESS	0.6 ⓘ	0.1	\$56
	Hook 1½"W x 2¼"D x 3¼"H	HAECBH	0.1 ⓘ	0.1	\$39	
	Hot File 12¼"W x 3⅞"D x 9½"H	HAEHF	0.7 ⓘ	1.5	\$82	

HOW TO SPECIFY

Select Model Number H A E H F .	Select Paint Color DW Designer White
---	--



Confetti™ Floor Lounge.

CONFETTI™

Every educator wants their classroom to celebrate individuality, energize ideas, and inspire imaginations. Organic, fluid environments are essential to the physical and emotional comfort of every young learner — and Confetti™ Floor Cushions and Lounges pass every test with flying colors! These comfortable, portable seating solutions encourage young learners to sit where they please, gather with ease, and stay connected and creative in their own way — from the first day of school to the last. With soft foam support and integrated handles for easy portability, Confetti™ allows students to navigate the classroom in their own way to create a safe, stress-free learning environment. Make your space work with Confetti™.



FEATURES

- Maximize student mobility with integrated handles for easy portability.
- Create comfortable support with soft foam seating.
- Get a lot (or just one) — floor cushions are sold separately or in packs of 8.
- Keep things tidy with a floor cushion cart, designed to organize and store seating when not in use — plus, this handy solution fits under tables, so you'll save valuable floor space.
- Choose from an array of colorful fabric options.

CONFETTI™ ORDERING INFORMATION

HON BRANDED FABRICS

GRADE 1

Apex
Centurion
Compass
Contourett
Dapper
Emphasis
Ensemble
Hamilton
Noble Seating
Pebble
Vibe

GRADE 2

Appoint Seating
Blume
Clyde
Haute
Kai
Rush
Spin
Wavelength
Whisper Vinyl

GRADE 3

Bradbury
Cozy
Getaway
Moxie
Notion
Parker
Purl
Quill
Saxony

GRADE 4

Constance with Supreen™
Livi with Supreen™
Lucerne
Lugano with Supreen™
Oxford with Supreen™

PAINT

PAINT CODES

◆ Black P71

◆ Platinum Metallic T1

CONFETTI™

Statement of Line

FLOOR SEATING

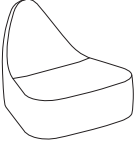

Floor Lounge



Floor Cushion

ACCESSORIES

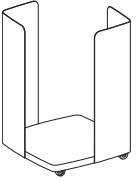

Floor Cushion Cart

EDUCATION



Icon Legend on page 19

CONFETTI™ Floor Seating

HEFL1

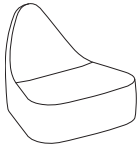

FLOOR LOUNGE

DIMENSIONS

Depth:	32½	Ship Weight:	20
Width:	30	Cube:	14.8
Seat Height:	12	COM:	2.4
Seat Depth:	17¼	Weight Rating:	300 lbs.

FABRIC PRICE CODES

1	\$1221	8	\$1556
2	\$1278	9	\$1600
3	\$1336	10	\$1648
4	\$1379	11	\$1698
5	\$1422	12	\$1749
6	\$1466	L	—
7	\$1510		

ⓘ Due to the natural properties and shape of the Floor Lounge, material gathers and visual variation can be expected from unit to unit as well as fabric to fabric.

HELP1



FLOOR CUSHION

DIMENSIONS

Depth:	16½	Ship Weight:	5
Width:	16½	Cube:	0.7
Seat Height:	3	COM:	0.65
		Weight Rating:	300 lbs.

FABRIC PRICE CODES

1	\$334	8	\$468
2	\$357	9	\$487
3	\$381	10	\$504
4	\$397	11	\$526
5	\$416	12	\$546
6	\$432	L	—
7	\$451		

EDUCATION

HOW TO SPECIFY

Select Model Number	Select Fabric
	See page 167
HEFL1	CU10

DESCRIPTION	MODEL	SHIP WEIGHT	CUBE	LIST PRICE BY PAINT GRADE		
				P1	P2	P3
Floor Cushion Cart	HECART	30	5.1	\$1110	\$1223	\$1389

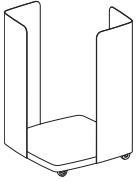

NOTES

- Cart holds quantity 8 of model HELP1.

HOW TO SPECIFY

<p>Select Model Number</p> <p>HECART</p>	<p>Select Paint Color</p> <p>See page 167</p> <p>P71</p>
---	---

REVEL™

Want to see more? Scan here
to check out hon.com.



Revel™ Fidget Stools shown with Build™ Student Desks and SmartLink® Seating.

EDUCATION

REVEL™

Revel in the movement and give classroom fidgeting a new meaning. Move side to side, back and forth, or spin in a full circle. Revel brings movement and mobility to active learners.



FEATURES

- Seat available in 3 colors, base available in 1.
- Adjust stool height with the push of a button. Stool ranges in height from 13¾”H-18½”H.
- With a slip resistant base and plastic body, you can feel comfortable using the stool in your most creative space with easy cleanup afterwards.
- Tested to hold up to 250 lbs.
- Backed by the HON Full Lifetime Warranty.

REVEL™ Stool



Icon Legend on page 19

HEFS01

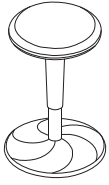

ADJUSTABLE HEIGHT FIDGET STOOL

DIMENSIONS

Depth:	15 ³ / ₈	Seat Height:	13 ³ / ₄ -18 ¹ / ₂
Width:	15 ³ / ₈	Ship Weight:	20.1
Height:	13 ³ / ₄ -18 ¹ / ₂	Cube:	1.4
Seat Depth:	15 ³ / ₈	Weight Rating:	250 lbs.
Seat Width:	15 ³ / ₈		

LIST PRICE

\$346

NOTES: Two buttons integrated in underside of seat for height adjustment control while maintaining a clean aesthetic. Stool seat and base are all plastic for easy cleanability. Anti-slip rubber attached to underside of base allows for comfortable movement of user while maintaining contact with floor. Base color is similar to HON Loft.

EDUCATION

HOW TO SPECIFY

Select
Model Number

Select
Seat Color

BZ Breeze
S Charcoal
BL Black

H E F S 0 1 .

B L

ROLL CALL™

Want to see more? Scan here
to check out hon.com.



Roll Call™ shown with SmartLink® Student Seating and Desks, and Class-ifi™ Storage.

EDUCATION

ROLL CALL™

Healthy, connected classrooms are never at a stand-still. To stay flexible and functional, today's learning spaces need solutions that can move anywhere, anytime. Roll Call™ — allows students and teachers alike to adjust, administer, and engage with ease. With ample height adjustability and smooth caster mobility, Roll Call™ encourages young minds and educators to create an imaginative environment that's all their own. Make your space work with Roll Call™.



FEATURES

- Open up your options with a pneumatic cylinder and hand lever that allows for easy height adjustment (between 28½"-43½").
- Maximize your mobility (or stay put!) with 4 casters that move with you or lock in place, depending on your needs.
- Spread out with a 20"D x 28"W worksurface, designed to hold everything from lesson books to laptops.
- Rely on the exceptional durability of an easy-to-clean laminate surface.
- Backed by The HON Company's Full Lifetime Warranty.

ROLL CALL™ ORDERING INFORMATION

WOODSURFACES

L1 LAMINATES CODES

Woodgrain

- ◆ Bourbon Cherry H
- ◆ Cognac COGN
- ◆ Field Elm LWFE
- ◆ Florence Walnut LFW1
- ◆ Harvest C
- ◆ Kingswood Walnut LK11
- ◆ Loft LOFT
- ◆ Mahogany N
- ◆ Mocha MOCH
- ◆ Natural Maple D
- ◆ Pinnacle PINC
- ◆ Shaker Cherry F
- ◆ Sterling Ash LSA1

Solid

- ◆ Black P
- ◆ Charcoal S
- ◆ Designer White LDW1
- ◆ Loft LOFT

Patterned

- ◆ Handspun Chestnut LAHC
- ◆ Handspun Dove LAHD
- ◆ Handspun Pearl LAHP
- ◆ Handspun Slate LAHS
- ◆ Silver Mesh B9
- ◆ Steel Mesh A9
- ◆ Battleship LBT1
- ◆ Gray G2
- ◆ Moroccan LMN1
- ◆ Mushroom LMH1
- ◆ Neon Carrot LNC1
- ◆ Tennis Ball LTB1
- ◆ White G1

L2 LAMINATES CODES

Woodgrain

- ◆ Beigewood LWBE
- ◆ Fawn Cypress LFC1
- ◆ Lowell Ash LLA1
- ◆ Natural Recon LNR1
- ◆ Phantom Ecru LPE1
- ◆ Portico Teak LPT1
- ◆ Skyline Walnut LSW1

L4 LAMINATES CODES

- ◆ White Markerboard FMQ1

EDGE

EDGE CODES

Woodgrain

- ◆ Beigewood DE
- ◆ Cognac COGN
- ◆ Fawn Cypress FC
- ◆ Field Elm FE
- ◆ Florence Walnut FW
- ◆ Kingswood Walnut KI
- ◆ Lowell Ash DL
- ◆ Mahogany N
- ◆ Mocha MOCH
- ◆ Natural Maple D
- ◆ Natural Recon NR
- ◆ Phantom Ecru PE
- ◆ Pinnacle PINC
- ◆ Portico Teak DP
- ◆ Shaker Cherry F
- ◆ Skyline Walnut SW
- ◆ Sterling Ash SA

Solid

- ◆ Atom AT
- ◆ Black P
- ◆ Brownstone EY
- ◆ Bullseye BY
- ◆ Charcoal S
- ◆ Designer White DW
- ◆ Ember MR
- ◆ Fossil EH
- ◆ Greige R
- ◆ Ion IO
- ◆ Iris IR
- ◆ Krypton KT
- ◆ Loft LOFT
- ◆ Muslin T
- ◆ Platinum K
- ◆ Regatta RE

CYLINDER PAINT

PAINT CODES

P1

- ◆ Black P71

P2

- ◆ Silver SVR

(No upcharge will be applied to cylinder color selection.)

BASE PAINT

PAINT CODES

P1

- ◆ Black P71
- ◆ Charblack CBK

P2

- ◆ Silver PR6
- ◆ Textured Silver PR8

◆◆◆ For lead time information see page 21.



Icon Legend on page 19

ROLL CALL™

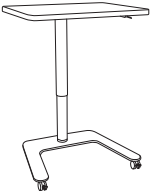
	DESCRIPTION	MODEL	SHIP WEIGHT	CUBE	LIST PRICE BY LAMINATE GRADE			P2 UPCHARGE
					L1	L2	L4	
	Pneumatic Laptop Table 28"W x 20"D, Rectangle Top	HETLEC-REC2028	74.1	5.7	\$950	\$961	\$981	\$40

NOTES:

- Adjusts from 28½"-43½".
- Pneumatic height adjustment. No electricity required.
- Ships knocked down and assembled on site.
- Features 4 locking casters.

EDUCATION

HOW TO SPECIFY

Select Model Number	Select Grommet Option	Select Laminate	Select Edge Color	Select Cylinder Color	Select Base Color
HETLEC-REC2028	N	LDW1	DW	P71	P71



SmartLink® Student Seating and Desks, Teacher Desk, and Storage.

SMARTLINK®

Show of hands — who loves long lectures? Today's classroom is more hands-on and collaborative, involving group interactions that better stimulate learning. That's why we've done our homework in the design of SmartLink. This collection of lightweight and mobile desks, chairs, storage, and presentation tools earns high marks by being easy to arrange and rearrange, keeping active minds and bodies fully engaged.



FEATURES

- Put teachers in control of their storage, technology and environment.
- Worksurface shape supports creative configurations.
- Designed to the unique ways students sit and move throughout the day.
- Organize lesson plans and make the most of unused wall space.
- Move educational tools wherever the activities demand.
- SmartLink chairs warranted for users up to 300 lbs.

SMARTLINK® ORDERING INFORMATION

TEACHER DESK & MODULAR STORAGE

LAMINATES CODES

L1	
◆ Harvest	CC
◆ Natural Maple	DD
◆ Silver Mesh	B9

PAINTS CODES

P1	
◆ Charcoal	S

P2

◆ Platinum Metallic	T1
---------------------	----

EDGE CODES

◆ Charcoal	S
◆ Platinum	K

STUDENT DESK

PLASTIC CODES

◆ Breeze	G9
◆ Harvest	CC
◆ Natural Maple	DD
◆ Sand	G8
◆ White	G1

PAINTS CODES

P1	
◆ Charcoal	S

P2

◆ Platinum Metallic	T1
---------------------	----

MOBILE STORAGE

PAINTS CODES

P1	
◆ Black	P
◆ Brownstone	P7D
◆ Charcoal	S
◆ Designer White	PJW
◆ Fossil	P28
◆ Loft	LOFT
◆ Muslin	T3
◆ Titanium	P8T

P2

◆ Champagne Metallic	T4
◆ Platinum Metallic	T1
◆ Silver	PR6

P3

◆ Atom	P8S
◆ Bullseye	PJF
◆ Ember	P8P
◆ Ion	P8N
◆ Iris	P8J
◆ Krypton	P8F
◆ Regatta	P8M

TEACHER DESK

LAMINATES CODES

L1

◆ Black	P
◆ Bourbon Cherry	H
◆ Charcoal	S
◆ Cognac	COGN
◆ Designer White	LDW1
◆ Florence Walnut	LFW1
◆ Handspun Chestnut	LAHC
◆ Handspun Dove	LAHD
◆ Handspun Pearl	LAHP
◆ Handspun Slate	LAHS
◆ Harvest	C
◆ Kingswood Walnut	LK11
◆ Loft	LOFT
◆ Mahogany	N
◆ Mocha	MOCH
◆ Natural Maple	D
◆ Pinnacle	PINC
◆ Shaker Cherry	F
◆ Silver Mesh	B9
◆ Steel Mesh	A9
◆ Sterling Ash	LSA1

L2

◆ Lowell Ash	LLA1
◆ Natural Recon	LNR1
◆ Phantom Ecru	LPE1
◆ Portico Teak	LPT1
◆ Skyline Walnut	LSW1

PAINTS CODES

P1	
◆ Charcoal	S
◆ Designer White	PJW
◆ Titanium	P8T

P2

◆ Platinum Metallic	T1
◆ Silver	PR6

P3

◆ Atom	P8S
◆ Bullseye	PJF
◆ Ember	P8P
◆ Ion	P8N
◆ Iris	P8J
◆ Krypton	P8F
◆ Regatta	P8M

EDGE CODES

◆ Atom	AT
◆ Bullseye	BY
◆ Charcoal	S
◆ Ember	MR
◆ Ion	IO
◆ Iris	IR
◆ Krypton	KT
◆ Platinum	K
◆ Regatta	RE

STUDENT DESK

PLASTIC CODES

◆ Breeze	G9
◆ Harvest	CC
◆ Natural Maple	DD
◆ Sand	G8
◆ White	G1

PAINTS CODES

P1

◆ Charcoal	S
◆ Designer White	PJW
◆ Titanium	P8T

P2

◆ Platinum Metallic	T1
◆ Silver	PR6

P3

◆ Atom	P8S
◆ Bullseye	PJF
◆ Ember	P8P
◆ Ion	P8N
◆ Iris	P8J
◆ Krypton	P8F
◆ Regatta	P8M

UNIVERSAL MODESTY PANEL

PAINTS CODES

P1

◆ Black	P
◆ Brownstone	P7D
◆ Charblack	CBK
◆ Charcoal	S
◆ Designer White	PJW
◆ Fossil	P28
◆ Light Gray	Q
◆ Loft	LOFT
◆ Muslin	T3
◆ Putty	L
◆ Textured Platinum	
Metallic	PLAT
◆ Titanium	P8T

P2

◆ Champagne Metallic	T4
◆ Platinum Metallic	T1
◆ Silver	PR6
◆ Solar Black	P8X
◆ Textured Silver	PR8

P3

◆ Atom	P8S
◆ Bullseye	PJF
◆ Ember	P8P
◆ Ion	P8N
◆ Iris	P8J
◆ Krypton	P8F
◆ Regatta	P8M

4-LEG, CANTILEVER CHAIR, TASK CHAIR, STOOL SHELLS

SHELL CODES

◆ Calypso	CP
◆ Cherry	CR
◆ Lava	LA
◆ Lime	LM
◆ Mulberry	MB
◆ Onyx	ON
◆ Platinum	PT
◆ Regatta	RE
◆ Shadow	SD
◆ Surf	BU
◆ Tangelo	RG

4-LEG AND CANTILEVER CHAIR AND STOOL FRAME

PAINTS CODES

P1

◆ Designer White Texture	PK7
◆ Textured Charcoal	P7A
◆ Textured Platinum	
Metallic	PLAT
◆ Textured Titanium	P8V

P2

◆ Silver Texture	PR8
------------------	-----

P3

◆ Atom	P8S
◆ Bullseye	PJF
◆ Ember	P8P
◆ Ion	P8N
◆ Iris	P8J
◆ Krypton	P8F
◆ Regatta	P8M

P4

◆ Polished Chrome*	Y
--------------------	---

* \$59 upcharge. Polished Chrome not available on models HSS4L-06A, HSS4L-24B, and HSS4L-30B.

◆◆◆ For lead time information see page 21.

SMARTLINK® SPECIFYING INFORMATION

EDUCATION

STEP 1

Choose a grade range to find the recommended SmartLink® desk and table height.

Recommended space from chair seat to underside of table is 8"-11"							
Seat Height	6"	12"	14"	16"	18"	24"	30"
Table Height	14"	22"	24"	27"	29"	36"	42"
Pre-K							
Kindergarten - Grade 1							
Grade 2 - 4							
Grade 5 - 12							

STEP 2

Pick the SmartLink® model that meets the student height needs.



Model: HLDV-M3A
Adjustable Height
23"-33" Height Range

Use the color-coated circles in the chart on the right to find a compatible chair.



Model: HLDV-M3F
Fixed Height
30" Fixed Height

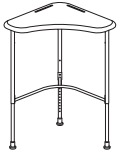

Model: HLDV-M3T
Sit-to-Stand
30"-43" Height Range

STEP 3

Determine the suggested chair height within your desk size range.

Desk Height		Chair Seat Height	Type of Chair
22"	●	12"	4-Leg, Cantilever or Task
23-24"	●		
25-27"	●		
28-29"	●	16-18"	
30"	●○●	18"	
31-33"	●○	22-24"	
34-41"	○	24-31"	
42-43"	○	30-32"	

SMARTLINK® SPECIFYING INFORMATION

Individual Layouts

- The non-handed top allows the desk to be positioned to better support right-handed or left-handed individuals or be used in a forward position.



LH Position



Forward Position



RH Position

Group/Collaborative Layouts

Below are examples of how the student desks can be configured to support multiple students or group activities.

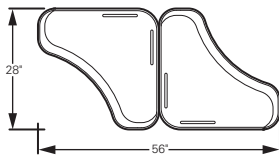

Student Desk
2-Desk Configuration

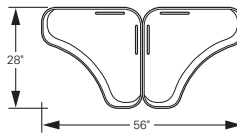

Opposing Student Desk
2-Desk Configuration

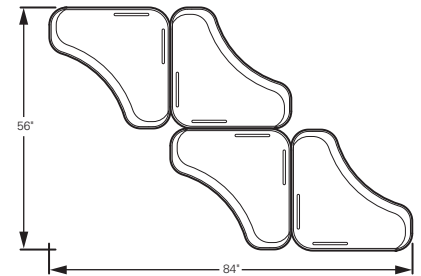

Student Desk
4-Desk Configuration

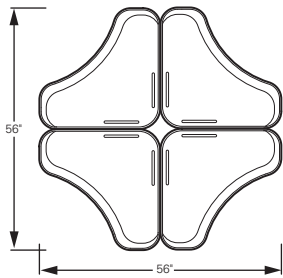

Student Desk
4-Desk Cluster Configuration

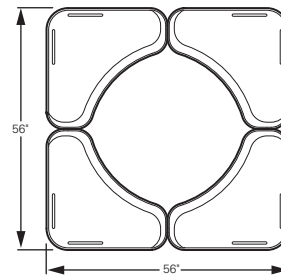

Student Desk
4-Desk Work Group Configuration
Can accommodate up to 8 students

Teacher Centered Layouts

- Reverse the layout and use the student desks to create layouts for teacher centers that can accommodate up to 6 students.
- 23 $\frac{5}{8}$ " distance between legs when used from either side.

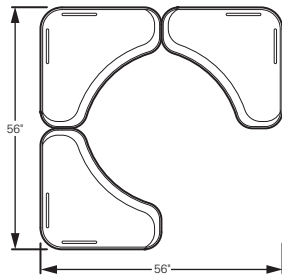

Teacher Centered Layout

Standard Row Layout

While a variety of classroom configurations are possible, a standard row layout shown below with 25 student desks utilizes a footprint of 199" deep by 284" wide. A 30 student desk row layout (5 rows deep by 6 rows wide) will require a footprint of 199" deep by 348" wide.

These dimensions are based upon 36"W aisles. Actual dimensions should be based upon local building codes.

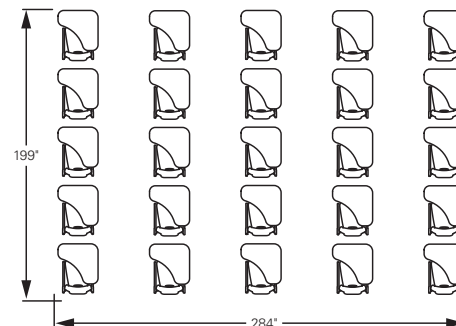

SMARTLINK® SPECIFYING INFORMATION

TEACHER STATION

SmartLink®

The following planning and specifying information is intended to help you imagine and create stimulating SmartLink classrooms that can integrate technology while helping rooms stay adaptable, organized and attractive. SmartLink offers you everything you need to create flexible, clutter-free learning environments for students of all ages.

Teacher Station – Double Pedestal with Modesty Panel

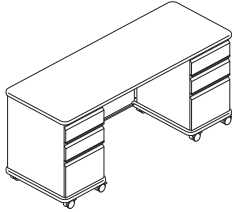

HLTV2466TMOD-33

Storage

- Box/box/file pedestal is always standard for both the left and right handed side of the desk. Pedestals are locking.
- Available kneespace is 33¼"W x 20"D for all models.
- Non-locking Center Drawer (HD8X) may be field installed in the kneespace. Tops are pre-drilled to accept the drawer.
- Center drawers and CPU holders cannot be installed together.

Teacher Station – Double Pedestal

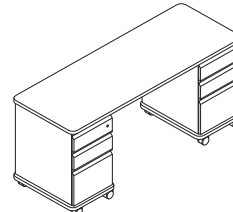

HLTV2466T-33

- Larger top size provides ample work/conference area or space for equipment.
- Standard with Heavy-duty 3", 360-degree swivel + locking casters.
- Storage options include: Locking box/box/file.
- Modesty specified separately.
- Power modules can be ordered separately and mounted to the desk. See Power & Cable Management page 248.

Teacher Station – Single Pedestal with Modesty Panel



HLTV2460TMOD-3

Storage

- Single pedestal desk available in Left-hand or Right-hand. Right or left handedness determined when installing in the field.
- Pedestal options include Box/Box/File locking.

Teacher Station – Single Pedestal

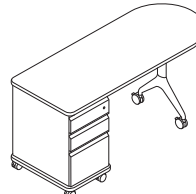

HLTV2460T-3

- Standard with Heavy-duty 3", 360-degree swivel + locking casters.
- Storage options include: Locking box/box/file.
- Right or left assembled in the field.
- D-shape top encourages conferencing and provides ample work and conference area.
- Modesty specified separately.
- Power modules can be ordered separately and mounted to the desk. See Power & Cable Management page 248.

SMARTLINK® SPECIFYING INFORMATION

WALL RAIL SYSTEM

The SmartLink® wall rail is a multi-layered, multi-functional system that can accommodate a variety of presentation boards and accessories. The multiple tracks allow boards to be easily positioned and changed to support today's interactive learning environments.

Planning Notes

- Installation of the wall rail system over existing white or chalkboards is not recommended.
- The rail and wall bracket provide three separate tracks for the Learning boards. The REAR or wall/bracket track is occupied by the fixed wall board. The MIDDLE and FRONT tracks are for sliding boards.
- To allow for greater utilization of the rear fixed board a maximum width of 96" of sliding boards on the middle or front track is recommended.

The illustration below shows the overall wall space requirements for the rail system and recommended mounting height for use in K-12 classroom applications.

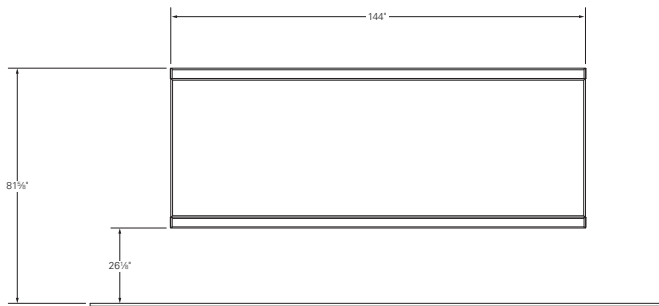

Sliding boards are removable and reversible so a wide variety of layouts are possible. The following illustrations highlight a couple of the more common applications. Layouts 2A and 2B provide the greatest amount of board space and overall flexibility. When used with rail mounted worksurfaces, use 24"W boards on the front rail as shown in 2C in front of each worksurface to provide information specific to that work area. Boards could then be added to the middle rail for information/work to be shared between the stations.

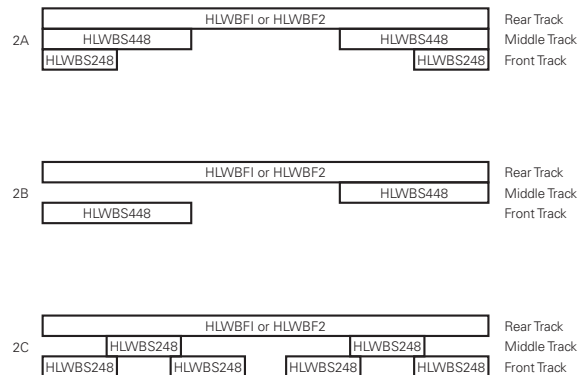





Specification Notes

- Boards are specified individually.
- Hardware to mount to the wall brackets is not provided by HON and MUST BE SOURCED LOCALLY.
- Learning board only applications require two (2) HLWR-12 rails to be specified.
- REFER TO PRODUCT INSTALLATION INSTRUCTIONS FOR DETAILED INSTALLATION INFORMATION.

SMARTLINK® Series Student Desks

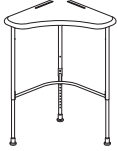

EDUCATION

	DESCRIPTION	MODEL	SHIP WEIGHT	CUBE	LIST PRICE BY PAINT GRADE		
					P1	P2	P3
	Student Desk, Fixed Height 28"W x 28"W, User side 36¼"W 30" Fixed Height Hard Plastic Top	HLDV-M3F	63	18.0	\$793	\$793	\$827
	NOTES: The cross-brace is installed to maximize kneespace but will not allow for book box (HLDA-15) installation. The cross-brace orientation can be switched in the field to allow for book basket install. ⓘ Student Desks are ordered and shipped two (2) desks per carton. Legs and cross-brace ship attached. Lower adjustable legs ship unattached for field installation. Pricing shown is <u>per carton</u> . Ordering two of model HLDV-M3F will result in 2 cartons being shipped, giving you 4 desks.						
	Student Desk, Adjustable Height 28"W x 28"W, User side 36¼"W Adjustable: 23"-33" height adjustment range. Hard Plastic Top	HLDV-M3A	59	12.5	\$793	\$793	\$827
	NOTES: Accepts book box (HLDA-15) installation without repositioning crossbar. ⓘ Student Desks are ordered and shipped two (2) desks per carton. Upper leg and cross-brace ship attached. Lower adjustable legs ship unattached for field installation. Pricing shown is <u>per carton</u> . Ordering two of model HLDV-M3A will result in 2 cartons being shipped, giving you 4 desks.						
	Student Desk, Sit-to-Stand 28"W x 28"W, User side 36¼"W Adjustable: 30"-43" height adjustment range. Leg height is set during field installation. Hard Plastic Top	HLDV-M3T	61	15.3	\$1127	\$1127	\$1150
	NOTES: Accepts book box (HLDA-15). ⓘ Student Desks are ordered and shipped two (2) desks per carton. Legs and cross-brace ship attached. Pricing shown is <u>per carton</u> . Ordering two of model HLDV-M3T will result in 2 cartons being shipped, giving you 4 desks.						
	Rectangle Student Desk, Adjustable Height 20"W x 26"D Adjustable: 23"-33" height adjustment range. Hard Plastic Top	HLDV-MRECT2026A	57	9.19	\$793	\$793	\$827
	NOTES: Accepts book box (HLDA-15) installation without repositioning crossbar. Lower adjustable legs ship unattached for field installation. ⓘ Student Desks are ordered and shipped two (2) desks per carton. Legs and cross-brace ship attached. Pricing shown is <u>per carton</u> . Ordering two of model HLDV-MRECT2026A will result in 2 cartons being shipped, giving you 4 desks.						

NOTES:

- Upper leg is painted, lower leg standard chrome finish on Adjustable Height models.
- Non-handed desk top constructed of ¾" hard plastic.
- Hard plastic tops include pencil grooves.
- Nylon swivel glides are standard on adjustable and fixed leg models.
- Fixed Height models ship fully assembled. Adjustable models have the upper leg and cross-brace installed. The lower leg ships unattached for field installation.
- 29.60" distance between legs on user side. Outside distance between legs is 23⅜".
- Accepts optional backpack hooks (HCLA65).
- Book boxes are only available as an accessory for field installation on Series desks.

SPECIFICATION TIP: Consider available kneespace when specifying under desk storage Metal Book Box. Available kneespace will vary significantly given set desk height. Use the following example to calculate the available and usable kneespace.

EXAMPLE: HLDV-M3A Student Desk, HLDA-15 Metal Book Box
 (user set desk height – top thickness – seat height = available kneespace)
 (29"H – 1" thickness – 18" seat height = 10" available kneespace)
 (available kneespace – book basket/box height = usable kneespace)
 (10" available kneespace – 5" basket height = 5" usable kneespace)

- ! Field installed felt glide caps (HGDK3-F) are recommended for use on VCT flooring.
- ! All Student Desks are ordered and shipped two (2) desks per carton. Ordering two of any model will result in 2 cartons being shipped, giving you 4 desks.





HOW TO SPECIFY

Select Model Number H L D V - M 3 F .	Select Glide Option E Hard-Surface (no upcharge)	Select Top Color See page 177 G 9 .	Select Upper Leg Color See page 177 S
---	--	--	--

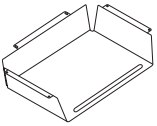

Icon Legend on page 19

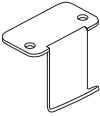
SMARTLINK® Student Accessories

	DESCRIPTION	MODEL	SHIP WEIGHT	CUBE	LIST PRICE
  	<p>Metal Book Box (4 per Carton) 19½"W x 13"D x 5"H</p> <p>NOTES: Attaches to bottom of desk with 6 screws, included. Screws included are for SmartLink® plastic tops only. Field installed. Features integrated, full-width pencil holder.</p> <ul style="list-style-type: none"> ⚠ Platinum finish only. ⚠ Book Box rated up to 25 lbs. 	HLDA-15	15	2.0	\$342
 	<p>Back Pack Hook (10 per carton)</p> <p>NOTES: Assembly: attaches to bottom of desk with (2) screws, included.</p> <ul style="list-style-type: none"> ⚠ Available in Platinum Metallic finish only, no specification needed. ⚠ Back Pack Hook rated up to 25 lbs. 	HCLA65	10	0.1	\$127
	<p>Glide Kit — Felt Glide Caps</p> <ul style="list-style-type: none"> • Recommended for use on VCT flooring. • Caps easily and securely snap over existing nylon swivel glide. • Kit includes 100 caps. • Field installed. <p>⚠ Not designed to be used with Sit-to-Stand Bell Glides (model HLDV-M3T).</p> <p>Must be ordered with a configurable end product. If ordered separately, not on GSA Contract.</p>	HGDK3-F	2	0.2	\$165

EDUCATION

HOW TO SPECIFY

Select
Model Number





HLDA-15

SMARTLINK® Chairs

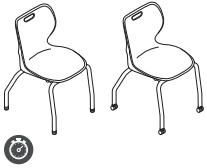
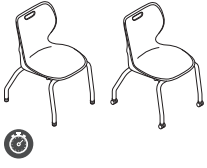

Icon Legend on page 19

EDUCATION

	MODEL/DESCRIPTION	DEPTH	WIDTH	HEIGHT	SHIP WEIGHT	CUBE	LIST PRICE PER CARTON			
							P1	P2	P3	
	HSS4L-18B 18"H 4-Leg Chair, Armless	Maximum: Seat: Back: Seat to Floor: Usable Seat Depth:	19 ⁵ / ₈ 16 ¹ / ₄	19 ¹ / ₂ 16 ¹ / ₂ 15 ³ / ₈	31 18 13 ³ / ₈ 18	58	15.6	\$760	\$760	\$793
	HSS4L-16B 16"H 4-Leg Chair, Armless	Maximum: Seat: Back: Seat to Floor: Usable Seat Depth:	19 ⁵ / ₈ 16 ¹ / ₄	19 ¹ / ₄ 16 ¹ / ₂ 15 ³ / ₈	29 16 13 ³ / ₈ 16	54	15.6	\$760	\$760	\$793
	HSS4L-14A 14"H 4-Leg Chair, Armless	Maximum: Seat: Back: Seat to Floor: Usable Seat Depth:	17 14 ¹ / ₄	17 14 ⁵ / ₈ 13 ³ / ₈	25 ¹ / ₂ 14 11 ⁵ / ₈ 14	49	11.9	\$725	\$725	\$757
	HSS4L-12A 12"H 4-Leg Chair, Armless	Maximum: Seat: Back: Seat to Floor: Usable Seat Depth:	17 14 ¹ / ₄	17 14 ⁵ / ₈ 13 ³ / ₈	23 ¹ / ₂ 12 11 ⁵ / ₈ 12	45	11.9	\$725	\$725	\$757
	HSS4L-06A 6"H 4-Leg Chair, Armless	Maximum: Seat: Back: Seat to Floor: Usable Seat Depth:	17 14 ¹ / ₄	17 14 ⁵ / ₈ 13 ³ / ₈	17 ¹ / ₂ 6 11 ⁵ / ₈ 6	37	8.6	\$706	\$706	\$737

NOTES:

- High strength tubular steel frame.
- Seat Shell is one-piece injection molded.
- 16"H and 18"H models accept Wire Storage Basket model HSSA-WB1618.
- Casters are available on 16"H and 18"H chairs only.
- 4-Leg models stack 5-high on floor.
- Nylon or steel glides accept felt glide caps (HGDK3-F) which are recommended for use on VCT flooring.
- Durable textured powder coated paint finish or chrome option finish.

 SmartLink® 4-Leg Chairs are ordered and shipped four (4) chairs per carton. Pricing shown is per carton. Each set of four chairs (one carton) must have the same shell/frame color combination. Ordering 2 of Model HSS4L-06A, HSS4L-12A, HSS4L-14A, HSS4L-16B or HSS4L-18B will result in 2 cartons being shipped, giving you 8 chairs.

HOW TO SPECIFY





<p>Select Model Number</p> <p>HSS4L-12A</p>	<p>Select Glide Option</p> <p>E Nylon Glide N Nickel Steel Glide C Caster (+ \$219)</p> <p>Caster option not available for models HSS4L-06A, HSS4L-12A or HSS4L-14A</p> <p>E</p>	<p>Select Shell Color</p> <p>See page 177</p> <p>RG</p>	<p>Select Frame Color</p> <p>See page 177</p> <p>P4 option Polished Chrome (Y) (+ \$59)</p> <p>PLAT</p>
--	---	--	--



Icon Legend on page 19

SMARTLINK® Chairs

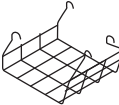
EDUCATION

	MODEL/DESCRIPTION	DEPTH	WIDTH	HEIGHT	SHIP WEIGHT	CUBE	LIST PRICE BY PAINT GRADE		
							P1	P2	P3
	HSS4L-24B 24" H 4-Leg Stool, Armless				30	16.8	\$370	\$370	\$388
	Maximum:	21½	22	38¼					
	Seat:	16¼	16½	24					
	Back:		15¾	13¾					
	Seat to Floor:			24					
	Usable Seat Depth:	30							
	HSS4L-30B 30" H 4-Leg Stool, Armless				31	19.1	\$391	\$391	\$409
	Maximum:	23½	22½	43¾					
	Seat:	16¼	16½	30					
	Back:		15¾	13¾					
	Seat to Floor:			30					
	Usable Seat Depth:	30							
	Wire Storage Basket (4 per carton) 15¾"W x 12¼"D x 9¾"H								
					HSSA-WB1618 ⓘ	14	1.6		\$186
	<ul style="list-style-type: none"> ⓘ For 16" and 18" 4-Leg Chairs only. Chrome finish only, no specification needed. ⓘ Chairs cannot be stacked when utilizing Wire Storage Basket. ⓘ Not compatible with 4-Leg Stools or Cantilever Chairs. ⓘ Storage Basket rated up to 25 lbs. 								
	Felt Cap Glide Kit for 4-Leg SmartLink®								
					HGDK3-F	2 ⓘ	0.2		\$165
	<ul style="list-style-type: none"> • Recommended for use on VCT flooring. • Caps easily and securely snap over the existing nylon swivel glide. • Kit includes 100 caps for 25 chairs or desks. • Field installed. 								
	ⓘ Must be ordered with a configurable end product. If ordered separately, not on GSA Contract.								

NOTES:

- 4-Leg Stools may stack up to 5-high on floor.
- Lead times may vary by shell color.
- ⓘ Polished Chrome (Y) not available on models HSS4L-24B and HSS4L-30B.

HOW TO SPECIFY



<p>Select Model Number</p> <p>H S S 4 L - 2 4 B</p>	<p>Select Glide Option</p> <p>E Nylon Glide N Nickel Steel Glide</p> <p>E</p>	<p>Select Shell Color</p> <p>See page 177</p> <p>R G</p>	<p>Select Frame Color</p> <p>See page 177</p> <p>P L A T</p>
--	--	---	---

SMARTLINK® Chairs



Icon Legend on page 19

EDUCATION

	MODEL/DESCRIPTION	DEPTH	WIDTH	HEIGHT	SHIP WEIGHT	CUBE	LIST PRICE PER CARTON			
							P1	P2	P3	
	HSSCL-18B 18"H Cantilever Base Chair, Armless	Maximum: Seat: Back: Seat to Floor: Usable Seat Depth:	21¾ 16⅞ 15⅜ 18¾ 16⅞	22¾ 16½ 15⅜ 13⅜ 18¾	31¼ 18 13⅜ 18¾	80	23.7	\$1118	\$1118	\$1166
	HSSCL-16B 16"H Cantilever Base Chair, Armless	Maximum: Seat: Back: Seat to Floor: Usable Seat Depth:	21¾ 16⅞ 15⅜ 16¼ 16⅞	22¾ 16½ 15⅜ 13⅜ 16¼	29¼ 16 13⅜ 16¼	55	16.8	\$1064	\$1064	\$1110
	HSSCL-14A 14"H Cantilever Base Chair, Armless	Maximum: Seat: Back: Seat to Floor: Usable Seat Depth:	21¾ 16⅞ 15⅜ 14¼ 16⅞	22¾ 16½ 15⅜ 13⅜ 14¼	27¼ 14 13⅜ 14¼	52	16.8	\$1044	\$1044	\$1089

NOTES:



- High strength tubular steel frame.
 - Glides available with nylon or felt inserts. See ordering information below.
 - Seat shell is one-piece injection molded.
 - Cantilever models stack 5-high on floor.
 - Durable textured powder coated paint or chrome option finish.
-  SmartLink® Cantilever Chairs are ordered and shipped four (4) chairs per carton. Pricing shown is per carton. Each set of four chairs (one carton) must have the same shell/frame color combination. Ordering 2 of Model HSSCL-18B will result in 2 cartons being shipped, giving you 8 chairs.

HOW TO SPECIFY

<p>Select Model Number</p> <p>H S S C L - 1 8 B .</p>	<p>Select Glide Option</p> <p>E All-purpose Glide Insert (no upcharge) F Felt Glide Insert (+ \$42; \$11 per single unit see page 183)</p> <p>E .</p>	<p>Select Shell Color</p> <p>See page 177</p> <p>R G .</p>	<p>Select Frame Color</p> <p>See page 177 <i>P4 option Polished Chrome (Y) (+ \$59)</i></p> <p>P L A T</p>
--	---	---	--



Icon Legend on page 19

	MODEL/DESCRIPTION	DEPTH	WIDTH	HEIGHT	SHIP WEIGHT	CUBE	PER CARTON LIST
	HSSTK-18B 18"H Task Swivel Chair, Pneumatic Seat Height Adjustment				23	5.2	\$416
	Maximum:	22 ⁵ / ₈	22 ¹ / ₂	34 ³ / ₄			
	Seat:	16 ¹ / ₄	16 ¹ / ₂	18			
	Back:		15 ³ / ₈	13 ³ / ₈			
	Seat to Floor: Usable Seat Depth:	16 ¹ / ₈		16-21			
	HSSST-18B 18"H Task Swivel Stool, Pneumatic Seat Height Adjustment, Footring Adjustment				28	12.8	\$510
	Maximum:	24 ¹ / ₄	25 ³ / ₄	45 ¹ / ₂			
	Seat:	16 ¹ / ₄	16 ¹ / ₂	18			
	Back:		15 ³ / ₈	13 ³ / ₈			
	Seat to Floor: Usable Seat Depth:	16 ³ / ₈		22-32			

NOTES:

- Seat Shell is one-piece injection molded.
 - Task Swivel Chair has a pneumatic seat height adjustment.
 - Choose between hard and soft casters (no upcharge) or bell glide (+ \$29) options.
 - Stool has an adjustable footring.
 - Swivel Task Chair and Stool ship one per carton.
- ! Swivel Task Chair and Stool are available with a black frame only.

HOW TO SPECIFY

<p>Select Model Number</p> <p>H S S T K - 1 8 B</p>	<p>Select Glide Option</p> <p>S Soft Caster (no upcharge) H Hard Caster (no upcharge) G Bell Glide (+ \$29)</p> <p>S</p>	<p>Select Shell Color</p> <p>See page 177</p> <p>R G</p>
--	---	---

SMARTLINK® Teacher Stations



Icon Legend on page 19

EDUCATION

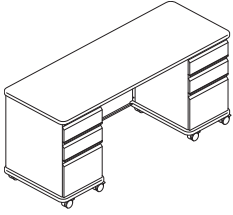

DESCRIPTION	MODEL	SHIP WEIGHT	CUBE	LIST PRICE BY PAINT GRADE			L2 UPCHARGE
				P1	P2	P3	
Teacher Station with Modesty Panel 66"W x 24"D x 30"H, Rectangle	HLTV2466TMOD-33	254	37.2	\$2653	\$2723	\$2781	\$67
66"W x 30"D x 30"H, Rectangle	HLTV3066TMOD-33	278	20.4	\$2734	\$2806	\$2863	\$72
Box/Box/File Pedestal, Left							
Box/Box/File Pedestal, Right							
NOTES: Ships standard with full height modesty panel for field installation.							

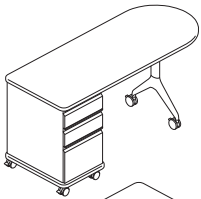

Teacher Station with Modesty Panel 60"W x 24"D x 30"H, Peninsula	HLTV2460TMOD-3	136	29.3	\$2040	\$2093	\$2133	\$46
60"W x 30"D x 30"H, Peninsula	HLTV3060TMOD-3	186	12.6	\$2103	\$2157	\$2198	\$47
Box/Box/File Storage							
NOTES: Ships standard with half height modesty panel for field installation.							

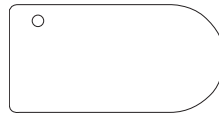
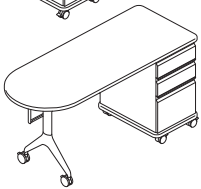

GL

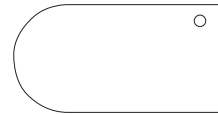

GR

NOTES

- Tops/Bases are Laminate with T-mold edge.
- Standard with Heavy-duty 3", 360-degree swivel casters.
- Storage options include: Locking box/box/file.
- Kneewell space accommodates separately specified and field installed non-locking center drawer and CPU holders (see page 231).
- Peninsula top encourages conferencing and provides ample work and conference area.
- Right or left assembled in the field.
- Modesty panel included in model.
- Power modules can be ordered separately and mounted to the desk.
- 30"D desks with have a 6 5/8" overhang on the approach side of desk.
- 30"D desks available with optional 3" round grommet, specified in the dot option.

HOW TO SPECIFY

Select Model Number <i>For 24"D Models Only</i> H L T V 2 4 6 6 T M O D - 3 3	Select Top and Base Color Laminate See page 177 B 9	Select T-Mold Color See page 177 K	Select Paint Color See page 177 T 1
--	---	---	--



Select Model Number <i>For 30"D Models Only</i> H L T V 3 0 6 6 T M O D - 3 3	Select Grommet Option 30"D Models Only N No Grommet GL Single Round Grommet, Left Hand Desk (+ \$16) <i>(Only available on 60"W desk)</i> GR Single Round Grommet, Right Hand Desk (+ \$16) <i>(Only available on 60"W desk)</i> G2 2 Round Grommets, (+ \$31) <i>(Only available on 66"W desk)</i> G 2	Select Top and Base Color Laminate See page 177 B 9	Select T-Mold Color See page 177 K	Select Paint Color See page 177 T 1
--	---	---	---	--



Icon Legend on page 19

SMARTLINK® Teacher Stations

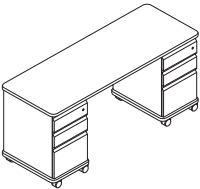
EDUCATION



	DESCRIPTION	MODEL	SHIP WEIGHT	CUBE	LIST PRICE BY PAINT GRADE		
					P1	P2	P3
	Teacher Station without Modesty 66"W x 24"D x 30"H Box/Box/File Pedestal, Left Box/Box/File Pedestal, Right NOTES: Accepts universal modesty panel (HMTUMOD32).	HLTV2466T-33	240	21.1	\$2374	\$2412	\$2435
 	Teacher Station without Modesty 60"W x 24"D x 30"H Box/Box/File Storage NOTES: Accepts universal modesty panel (HMTUMOD32).	HLTV2460T-3	158	14.18	\$1806	\$1836	\$1855

NOTES:

- Tops/Bases are Laminate with T-mold edge.
- Standard with Heavy-duty 3", 360-degree swivel casters.
- Storage options include: Locking box/box/file.
- Kneewell space accommodates separately specified and field installed non-locking center drawer and CPU holders (see page 231).
- D-shape top encourages conferencing and provides ample work and conference area.
- Right or left assembled in the field.
- Modesty specified separately.
- Power modules can be ordered separately and mounted to the desk.

HOW TO SPECIFY

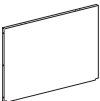
Select Model Number H L T V 2 4 6 6 T - 3 3 .	Select Top and Base Color Laminate See page 177 B 9 .	Select T-Mold Color See page 177 K .	Select Paint Color See page 177 T 1
---	---	---	--

	DESCRIPTION	MODEL	SHIP WEIGHT	CUBE	LIST PRICE BY PAINT GRADE		
					P1	P2	P3
 	Modesty Panel 34"W x 24½"H, for Rectangle Teacher Desk 35"W x 12"H, for Peninsula Teacher Desk NOTES: Modesty panels can be retrofitted to existing SmartLink® Teacher Stations.	HLTVMODFULL	17	2.3	\$279	\$313	\$346
		HLTVMODPART	10	1.3	\$234	\$257	\$280

HOW TO SPECIFY

Select Model Number H L T V M O D F U L L .	Select Paint Color See page 177 S
---	--

SMARTLINK® Wall Rail System



Icon Legend on page 19

EDUCATION

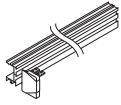

DESCRIPTION	MODEL	SHIP WEIGHT	CUBE	LIST PRICE
Wall Rail 144"	HLWR-12	22	1.4	\$1119

NOTES: Rail model includes: 1 – 144" rail, 9 – wall mounting brackets and 2 – rail end caps.

- ❗ Must be mounted in accordance with published installation instructions. Wall mounting hardware NOT INCLUDED. Must be sourced locally.
- ❗ Must order Quantity 2 rails when using with Whiteboards and Whiteboards/Tackboards.
- ❗ Platinum finish only.

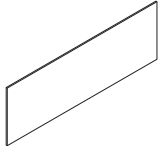

Learning Board, Fixed Whiteboard, 1-sided 144"W x 48"H, Quantity 1	HLWBF1-1248W	124	13.0	\$2671
--	---------------------	-----	------	---------------

SPECIFYING EXAMPLE: HLWBF-1248W.X

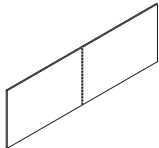

Learning Board, Fixed Whiteboards, 1-sided 72"W x 48"H, Quantity 2 with spacer (included)	HLWBF2-1248W	125	6.7	\$2671
---	---------------------	-----	-----	---------------

NOTES: Includes center cover/spacer.
SPECIFYING EXAMPLE: HLWBF2-1248W.X

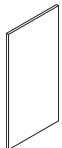

Learning Board, Sliding Whiteboard/Whiteboard 48"W x 48"H	HLWBS-448WW	47	4.6	\$1290
24"W x 48"H	HLWBS-248WW	26	2.5	\$826

SPECIFYING EXAMPLE: HLWBS-448WW.X

Model HLWBS-248WW shown

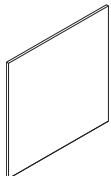

Learning Board, Sliding Whiteboard/Tackboard 48"W x 48"H	HLWBS-448WT	64	4.6	\$1342
24"W x 48"H	HLWBS-248WT	34	2.5	\$861

NOTES: Tackboard Side available in the following fabric: Lucy Neutra (LC24).
SPECIFYING EXAMPLE: HLWBS-448WT.X.LC24

Model HLWBS-448WT shown

NOTES:

- Multi-functional wall rails can accommodate whiteboards and organizational accessories. See above and page 191.
- Multi-track rail allows for up to three layers of whiteboards. Rear track supports a fixed board, middle and front tracks support sliding boards. Outer rail channel is for attachment of organizational accessories.
- Sliding learning boards are removable and reversible.
- All fixed and sliding boards:
 - Require two (upper and lower) rails for installation.
 - Feature a full aluminum frame.
 - Are high-quality porcelain over steel and non-shadowing.
 - Are low gloss for projection use and allows for use of magnets.

HOW TO SPECIFY

Select Model Number <div style="border: 1px solid #ccc; padding: 2px; display: flex; gap: 5px;"> HLWBS-448WT. </div>	Select Side A Color <div style="border: 1px solid #ccc; padding: 2px; display: flex; gap: 5px;"> X </div>	Select Tackboard Fabric <div style="border: 1px solid #ccc; padding: 2px; display: flex; gap: 5px;"> LC24 </div> <p>LC24 Lucy Neutra Specify for models HLWBS-448WT and HLWBS-248WT only</p>
--	--	--



Icon Legend on page 19

SMARTLINK® Wall Rail System Accessories

**DESCRIPTION**

Marker Tray (Single Pack)
7"W x 3½"D x 2"H

NOTES: Holds dry-erase markers, push pins and other small objects.

MODEL

HPPMMT

**SHIP
WEIGHT**

1

CUBE

0.2

LIST PRICE BY PAINT GRADE**P1**

\$132

P2

\$147

P3

\$159

NOTES:

- Use on the Wall Rail System — see page 190.
- Marker Tray mounts on the rail's outer channel and may be used with sliding boards.
- May be mounted and moved to any position along the width of the rail.
- May be easily removed from the rail.

EDUCATION

HOW TO SPECIFY

Select
Model Number

H P P M M T .

Select
Paint Color

See page 177

T 1

SMARTLINK® Mobile Storage



Icon Legend on page 19

EDUCATION

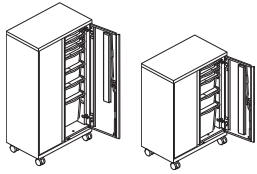

HLVMSC5630R HLVMSC4330R

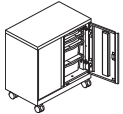

HLVMSC3330R

DESCRIPTION

Mobile Storage Cabinet with Bins

18"D x 30"W x 32¼"H
18"D x 30"W x 42¼"H
18"D x 30"W x 56"H

MODEL

HLVMSC3330R
HLVMSC4330R 
HLVMSC5630R

SHIP WEIGHT CUBE

152.6 13.4
171.6 18.0
209.6 23.5

LIST PRICE BY PAINT GRADE

P1	P2	P3
\$1891	\$1941	\$1974
\$2078	\$2133	\$2168
\$2392	\$2454	\$2495

NOTES:

- Full radius "R" handle on doors.
- Units include 2 locking and 2 non-locking casters.
- Equipped with HON "One Key" interchangeable core removable locks.

 Pre-configured trays and rails included in mobile storage cabinets with bins. See chart below for configurations and capacity. Additional bin and rail kits may be purchased separately.

DESCRIPTION

Accessories — Tray Kit

3"H, 2 bins and 4 rails
6"H, 2 bins and 4 rails
12"H, 2 bins and 4 rails

MODEL

HFMBIN3
HFMBIN6
HFMBIN12

SHIP WEIGHT

7 
10 
12 

CUBE

4.0
4.5
5.0

LIST PRICE

\$83
\$98
\$116

NOTES: Mobile storage cabinets ship with pre-determined rails and bins. Additional bins and rails may be ordered in sets of two utilizing the models shown. Availability and usage are outlined below. HFMBIN3/6/12 are compatible with SmartLink® and Class-ifi™ Storage.

 Semi-translucent white.

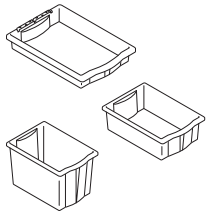

Pre-Configured Cabinets/Tray Kits

56"H Cabinet

1	2
3	4
5	6
1	2
3	4
5	6
1	2

42¼"H Cabinet

1	2
3	4
1	2
3	4
1	2

32¼"H Cabinet

1	2
3	4
1	2
3	4

56"H Cabinet

1	14
2	15
3	16
4	17
5	18
6	19
7	20
8	21
9	22
10	23
11	24
12	25
13	26

Hanging Slots 12"H Bin 6"H Bin 3"H Bin

1		
2		
3		
4		

42¼"H Cabinet

1	11
2	12
3	13
4	14
5	15
6	16
7	17
8	18
9	19
10	20

32¼"H Cabinet

1	7
2	8
3	9
4	10
5	11
6	12

26 - 12"W Openings

20 - 12"W Openings

12 - 12"W Openings

HOW TO SPECIFY

Select Model Number

H L V M S C 3 3 3 0 R .

Select Lock Option

- L Lock (no upcharge)
X Omit Lock (- \$21)

L .

Select Paint Color

See page 177

P J W



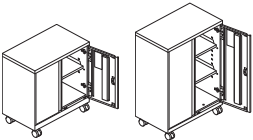
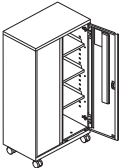

Icon Legend on page 19

SMARTLINK® Mobile Storage

	DESCRIPTION	MODEL	SHIP WEIGHT	CUBE	LIST PRICE BY PAINT GRADE		
					P1	P2	P3
 HLVSC3330R HLVSC4330R	Mobile Storage Cabinet without Bins						
	18"D x 30"W x 32¼"H	HLVSC3330R	152.6	13.4	\$1721	\$1767	\$1796
	18"D x 30"W x 42¼"H	HLVSC4330R	171.6	18.0	\$1891	\$1941	\$1974
 HLVSC5630R	18"D x 30"W x 56"H	HLVSC5630R	209.6	23.5	\$2268	\$2327	\$2365

NOTES:

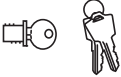
- Full radius "R" handle on doors.
- Units include 2 locking and 2 non-locking casters.
- Includes shelves which are adjustable in 2" increments.
- Equipped with HON "One Key" interchangeable core removable locks.
- Wire management grommet in back of unit.

	DESCRIPTION	MODEL	SHIP WEIGHT	CUBE	LIST PRICE
	Chrome Removable Lock Core Kit (for metal casegoods) • Use when specifying omit lock application. • Specify quantity of each key number from 101E-225E. • Includes: 1-core, 2-keys, 1-core removal tool and instructions. • Removable lock core kits with specific key number must be ordered to facilitate keying alike in the field. • For specific models, look for the Omit Lock Core icon throughout this publication.	HF23C	0.1 	0.1	\$67
	NOTES: If key number isn't specified, number will be at random. Core matches manufactured lock on metal casegoods product but can be used with Contain® and laminate product. When purchased separately without a configurable TAA compliant end product, not on GSA contract.				

HOW TO SPECIFY

Select Model Number <div style="border: 1px solid black; padding: 2px; display: flex; gap: 5px;"> HLVSC3330R </div>	Select Lock Option L Lock (no upcharge) X Omit Lock (- \$21) <div style="border: 1px solid black; padding: 2px; display: flex; gap: 5px;"> L </div>	Select Paint Color See page 177 <div style="border: 1px solid black; padding: 2px; display: flex; gap: 5px;"> PJW </div>
---	--	--

SMARTLINK® Mobile Storage



Icon Legend on page 19

EDUCATION

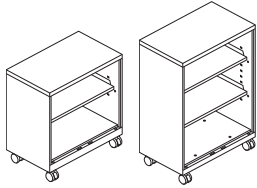

HLVBC3330

HLVBC4330

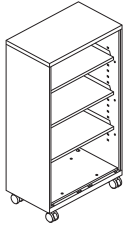

HLVBC5630

DESCRIPTION

Mobile Bookcases

18"D x 30"W x 31¼"H

18"D x 30"W x 42¼"H

18"D x 30"W x 56"H

MODEL	SHIP WEIGHT	CUBE	LIST PRICE BY PAINT GRADE		
			P1	P2	P3
HLVBC3330	118.6	13.4	\$1562	\$1604	\$1629
HLVBC4330	134.6	18.0	\$1721	\$1767	\$1796
HLVBC5630	157.6	23.5	\$2063	\$2118	\$2152

NOTES:

- Units include 2 locking and 2 non-locking casters.
- Shelves adjust in 2" increments.
- Wire management grommet in back of unit.

HOW TO SPECIFY

Select Model Number

Select Paint Color

See page 177

HLVBC3330

PJW

STORYLINE™

Want to see more? Scan here
to check out hon.com.



Storyline™ shown with SmartLink® Seating, Build™ Tables, & Confetti™.

EDUCATION

STORYLINE™

Libraries and media centers aren't just for study halls and research anymore — they're the heartbeat of the school. These once basic spaces have shifted to thoughtful, holistic community hubs designed to inspire not just students, but anyone who wants to connect and create. Storyline — a versatile bookcase collection that offers organic movement and customized learning zone options — is an open book when it comes to inspired synergy in shared spaces. Whether it's an early morning reading circle, a mid-afternoon small group project, or an evening town hall meeting, Storyline bridges the gap between people and places.



FEATURES

- Utilize 18"H bookcases as both storage and a seat.
- Single-sided bookcases and bistro tables utilize steel back to accept magnets.
- Case and shelf constructed using 1 $\frac{1}{8}$ " laminate for durability and longevity.
- Cases ship fully assembled. Casters and shelves installed on site.

STORYLINE™ ORDERING INFORMATION

LAMINATE

L1 LAMINATES CODES

Woodgrain

- ◆ Bourbon Cherry H
- ◆ Cognac COGN
- ◆ Field Elm LWFE
- ◆ Florence Walnut LFW1
- ◆ Harvest C
- ◆ Kingswood Walnut LK11
- ◆ Mahogany N
- ◆ Mocha MOCH
- ◆ Natural Maple D
- ◆ Pinnacle PINC
- ◆ Shaker Cherry F
- ◆ Sterling Ash LSA1

Solid

- ◆ Black P
- ◆ Charcoal S
- ◆ Designer White LDW1
- ◆ Loft LOFT

L2 LAMINATES CODES

Woodgrain

- ◆ Beigewood LWBE
- ◆ Fawn Cypress LFC1
- ◆ Lowell Ash LLA1
- ◆ Natural Recon LNR1
- ◆ Phantom Ecru LPE1
- ◆ Portico Teak LPT1
- ◆ Skyline Walnut LSW1

PAINT

P1 CODES

- ◆ Black P71
- ◆ Brownstone P7D
- ◆ Charcoal S
- Cove P096
- ◆ Designer White PJW
- Dune P094
- Fog FOG
- ◆ Fossil P28
- Harbor P097
- ◆ Light Grey Q
- ◆ Loft LOFT
- ◆ Muslin T3
- ◆ Putty L
- Sage P095
- ◆ Titanium P8T

P2 CODES

- ◆ Champagne Metallic PR5
- ◆ Gunmetal Metallic PR3
- ◆ Platinum Metallic T1
- ◆ Silver PR6
- ◆ Solar Black P8X

P3 CODES

- ◆ Atom P8S
- ◆ Blossom P8K
- ◆ Bullseye PJF
- ◆ Ember P8P
- ◆ Ion P8N
- ◆ Iris P8J
- ◆ Krypton P8F
- ◆ Ochre P093
- ◆ Regatta P8M
- ◆ Sienna P092
- ◆ Succulent P8A

P6 CODES

- ◆ Markerboard MKB

◆◆ For lead time information see page 21.

STORYLINE™ SPECIFYING INFORMATION

Statement of Line

SINGLE-SIDED BOOKCASES

Linear

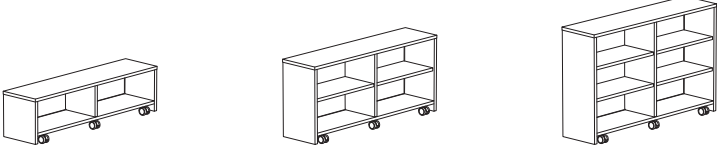

Curved In

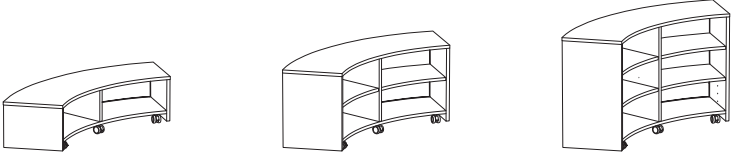

Curved Out



DOUBLE-SIDED BOOKCASES

Linear

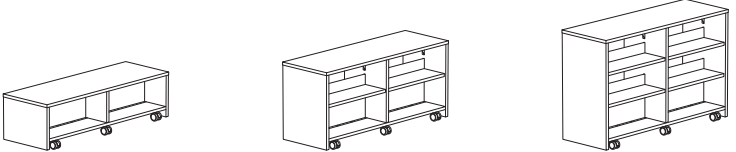

Curved

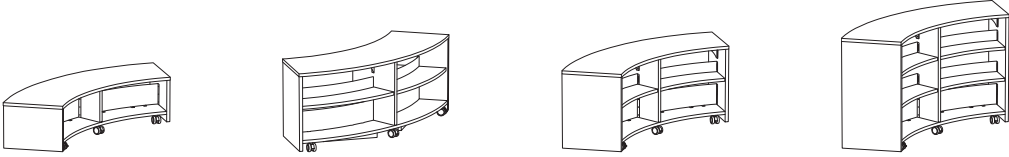

STORYLINE™ SPECIFYING INFORMATION

Statement of Line

BISTRO TABLES

Linear

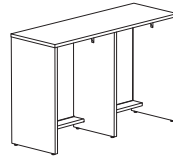
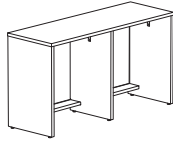
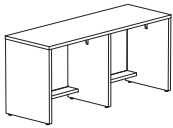

Curved

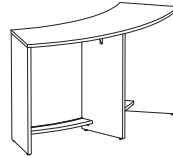
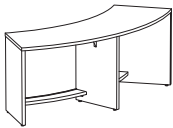

ACCESSORIES

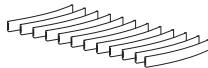

STORYLINE™ SPECIFYING INFORMATION

Dimensions

Linear Bookcases

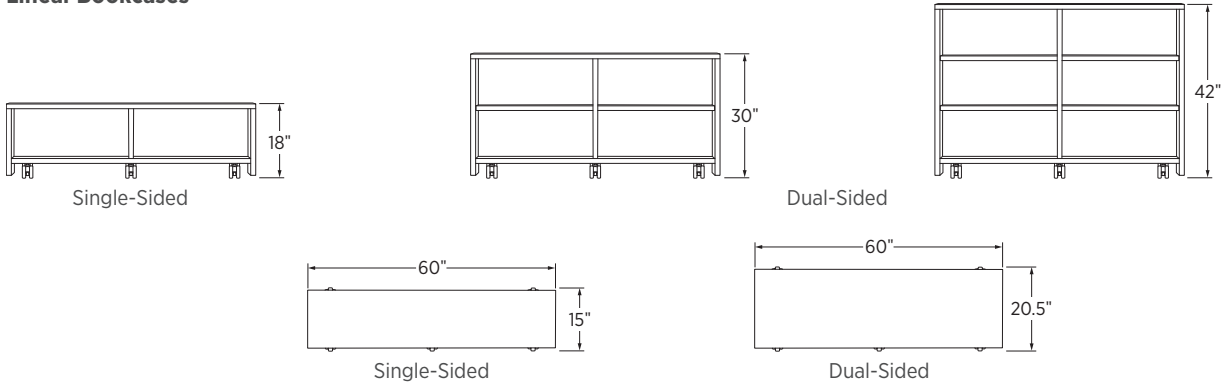

Curved Bookcases

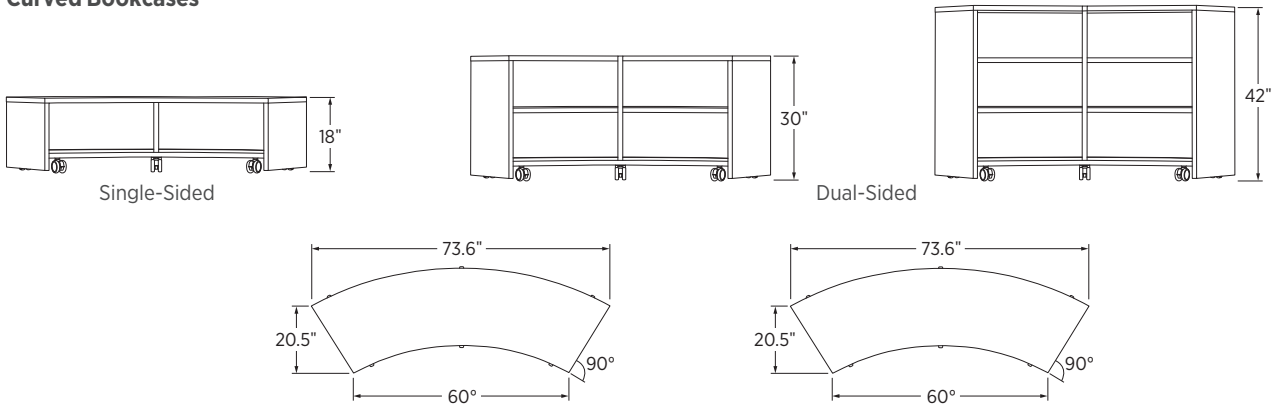

Space Planning

The chart below provides the amount of linear feet of storage per bookcase. The calculation does not include the top of the bookcases.

	Linear		Curved	
	Single	Dual	Single	Dual
18"H	4.7	9.4	4.4	9.6
30"H	9.4	18.7	8.7	19.2
42"H	14.1	28.1	13.1	28.8

Various Book Thickness by Grade	HESWLS18 HESWLS30 HESWLS42			HESWLD18 HESWLD30 HESWLD42			HESWCO18 HESWCO30 HESWCO42			HESWCD18 HESWCD30 HESWCD42		
	4.7 LFT	9.4 LFT	14.1 LFT	9.4 LFT	18.7 LFT	28.1 LFT	4.4 LFT	8.7 LFT	13.1 LFT	9.6 LFT	19.2 LFT	28.2 LFT
K-2 GRADE LEVEL												
Picture Book 1/8"	451	902	1,353	902	1,795	2,697	422	835	1,257	921	1,843	2,707
Picture Book 1/4"	225	451	676	451	897	1,348	211	417	628	460	921	1,353
3-5 GRADE LEVEL												
Adventure Book 1/4"	225	451	676	451	897	1,348	211	417	628	460	921	1,353
Mythology Book 1"	56	112	169	112	224	337	52	104	157	115	230	338
6-8 GRADE LEVEL												
Fiction Book 1/2"	112	225	338	225	448	674	105	208	314	230	460	676
Science Fiction Book 1"	56	112	169	112	224	337	52	104	157	115	230	338
9-12 GRADE LEVEL												
Adventure Book 3/4"	75	150	225	150	299	449	70	139	209	153	307	451
Novel 1/2"	112	225	338	225	448	674	105	208	314	230	460	676

STORYLINE™ Linear Bookcases

ABI

Icon Legend on page 19

EDUCATION

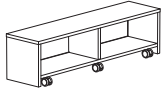

DESCRIPTION

Single-Sided

18”H
30”H
42”H

MODEL

HESWLS18
HESWLS30
HESWLS42

SHIP WEIGHT

91
139
187

CUBE

20.8
31.1
41.5

LIST PRICE

\$2143
\$2411
\$2678

UPCHARGE BY LAMINATE/PAINT GRADE

L2

\$108
\$121
\$134

P2

\$108
\$121
\$134

P3

\$215
\$242
\$268

P6

\$429
\$483
\$536

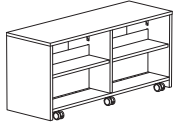

Dual-Sided

18”H
30”H
42”H

HESWLD18
HESWLD30
HESWLD42

125
190
251

28.0
42.0
56.0

\$2555
\$2720
\$2987

\$128
\$136
\$150

\$128
\$136
\$150

\$256
\$272
\$299

\$511
\$544
\$598

NOTES:

- 18”H units can be used as seat.
- Bookcases available in both glides or casters.
- Casters are locking casters that are recessed under the bookcase.
- Shelves ship disassembled and will be installed on site.
- Shelves are adjustable. Screwdriver required for adjustment.
- Shelves are adjustable in 1/4” increments.
- Double-sided units come with gussets for added rigidity. Gussets color will match paint selection.
- Double-sided units come with metal dividers.
- See page 199 for overall dimensions of bookcases.
- Units specified with glides will match height of units specified with casters.

HOW TO SPECIFY

Select Model Number

HESWLS18

Select Glide/Caster Option

- G Glide
- C Caster (+ \$52)

G

Select Laminate

See page 196

LSA1

Select Paint Color

See page 196

T1

STORYLINE™ Curved Bookcases

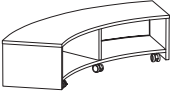
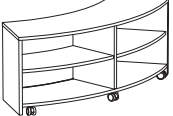
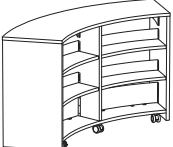
	DESCRIPTION	MODEL	SHIP WEIGHT	CUBE	LIST PRICE	UPCHARGE BY LAMINATE/PAINT GRADE			
						L2	P2	P3	P6
	Single-Sided Curved In								
	18”H	HESWCI18	131	39.6	\$2555	\$128	\$128	\$256	\$511
	30”H	HESWCI30	201	59.4	\$2874	\$145	\$145	\$288	\$575
	42”H	HESWCI42	271	79.1	\$3193	\$160	\$160	\$320	\$639
	Single-Sided Curved Out								
	18”H	HESWCO18	128	39.6	\$2555	\$128	\$128	\$256	\$511
	30”H	HESWCO30	197	59.4	\$2874	\$145	\$145	\$288	\$575
	42”H	HESWCO42	265	79.1	\$3193	\$160	\$160	\$320	\$639
	Dual-Sided								
	18”H	HESWCD18	134	39.6	\$2967	\$149	\$149	\$297	\$594
	30”H	HESWCD30	203	59.4	\$3183	\$160	\$160	\$319	\$637
	42”H	HESWCD42	268	79.1	\$3502	\$176	\$176	\$351	\$701

EDUCATION

NOTES:

- 18”H units can be used as seat.
- Bookcases available in both glides or casters.
- Casters are locking casters that are recessed under the bookcase.
- Shelves ship disassembled and will be installed on site.
- Shelves are adjustable. Screwdriver required for adjustment.
- Shelves are adjustable in 1/4” increments.
- Double-sided units come with gussets for added rigidity. Gussets color will match paint selection.
- Double-sided units come with metal septums.
- See page 199 for overall dimensions of bookcases.
- Units specified with glides will match height of units specified with casters.

HOW TO SPECIFY

<p>Select Model Number</p> <p>H E S W C I 1 8 .</p>	<p>Select Glide/Caster Option</p> <p>G Glide C Caster (+ \$52)</p> <p>G .</p>	<p>Select Laminate</p> <p>See page 196</p> <p>L S A 1 .</p>	<p>Select Paint Color</p> <p>See page 196</p> <p>T 1</p>
--	--	--	---

STORYLINE™ Bistro Tables

ABI

Icon Legend on page 19

EDUCATION

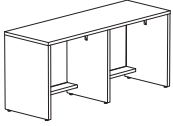
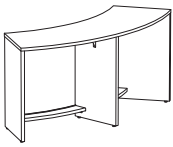
DESCRIPTION	MODEL	SHIP WEIGHT	CUBE	LIST PRICE	UPCHARGE BY LAMINATE/PAINT GRADE			
					L2	P2	P3	P6
 <p>Linear Bistro Tables 30"H 36"H 42"H</p>	HESWLB30	127	33.9	\$1929	\$97	\$97	\$193	\$386
	HESWLB36	141	45.1	\$2044	\$102	\$102	\$204	\$409
	HESWLB42	156	45.1	\$2143	\$108	\$108	\$215	\$429
 <p>Curved Bistro Tables 30"H 36"H 42"H</p>	HESWCB30	130	59.4	\$2299	\$116	\$116	\$230	\$460
	HESWCB36	145	69.2	\$2437	\$122	\$122	\$245	\$488
	HESWCB42	159	79.1	\$2555	\$128	\$128	\$256	\$511

NOTES:

- Bistro tables are only available with glides.
- Bistro tables include gussets for added rigidity.
- Paint color selection will determine back and gusset color.
- Linear bistro table worksurface dimensions are 60"W x 20½"D.
- Bistro tables specified with glides will match height of bookcases specified with glides or casters.
- Bistro tables have integrated footrest.
- See page 199 for overall dimensions of bookcases.



HOW TO SPECIFY

<p>Select Model Number</p> <p>H E S W C B 3 0 .</p>	<p>Select Glide</p> <p>G Glide</p> <p>G .</p>	<p>Select Laminate</p> <p>See page 196</p> <p>L S A 1 .</p>	<p>Select Paint Color</p> <p>See page 196</p> <p>P R 8</p>
--	--	--	---

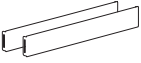
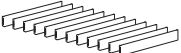

Icon Legend on page 19

STORYLINE™ Accessories

	DESCRIPTION	MODEL	SHIP WEIGHT	CUBE	LIST PRICE	UPCHARGE BY		
						LAMINATE/P2	PAINT/P3	GRADE/P6
	Linear Dividers							
	2-pack	HESWLD2	7.0	0.9	\$103	\$11	\$26	\$42
	12-pack	HESWLD12	17.0	5.9	\$618	\$62	\$155	\$248
								
	Curved Dividers							
	2-pack	HESWCD2	7.5	1.0	\$103	\$11	\$26	\$42
	12-pack	HESWCD12	19.0	6.7	\$618	\$62	\$155	\$248

EDUCATION

NOTES:

- Shelf dividers are optional on single-sided units. Used to prevent books from being pushed back on shelves.
- Dividers attach with hardware that is included when ordering.
- All dual-sided units come standard with dividers.

HOW TO SPECIFY

Select Model Number	Select Paint Color See page 196
H E S W L D 2 .	T 1



TANGRAM™

Tangram™ soft seating is the shape of things to come in education spaces. With 27 easily configurable shape and size options, high- and low-back models, and tiered seating, it offers the ability to create custom layouts that breathe new life into unconventional learning environments distinctive to each student. And with its single or multi-fabric options, rainbow of color choices, and playful aesthetic, this solution puts the “fun” in functional.

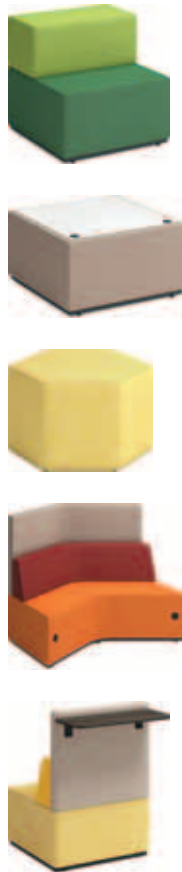

FEATURES

- Ottomans, In-Line Tables, Story Steps, and Modular units can be used together.
- Story Steps can be combined to create multiple-level learning layouts.
- Available in high- or low-back models.
- High-back models create a quiet space without losing sight lines for educators.
- In-Line Tables provide durable, easy to clean worksurfaces with optional integrated power.
- Flexible brackets allow units to be ganged together.
- Metal bases keep upholstered parts off the ground for easy cleaning.
- Stay connected with optional built-in power.
- Adjustable glides.
- Proportionately designed to fit K-12 students.
- Poufs and Ottomans offer additional seating.
- All models ship fully assembled in one carton.
- Available in a wide range of cleanable fabrics.
- Multi-fabric option — seat, back, and screen can be specified in different fabrics.
- Bistro-back models encourage additional ways to sit comfortably and offer an easily cleanable laminate surface for high-traffic daily use.

TANGRAM™ ORDERING INFORMATION

LAMINATE

L1 LAMINATES CODES

Woodgrain

- ◆ Bourbon Cherry H
- ◆ Cognac COGN
- ◆ Field Elm LWFE
- ◆ Florence Walnut LFW1
- ◆ Harvest C
- ◆ Kingswood Walnut LKI1
- ◆ Mahogany N
- ◆ Mocha MOCH
- ◆ Natural Maple D
- ◆ Pinnacle PINC
- ◆ Shaker Cherry F
- ◆ Sterling Ash LSA1

Solid

- ◇ Black P
- ◆ Charcoal S
- ◆ Designer White LDW1
- ◆ Loft LOFT

Patterned

- ◇ Battleship LBT1
- ◇ Gray G2
- ◆ Handspun Chestnut LAHC
- ◆ Handspun Dove LAHD
- ◆ Handspun Pearl LAHP
- ◆ Handspun Slate LAHS
- ◆ Moroccan LMN1
- ◆ Mushroom LMH1
- ◆ Neon Carrot LNC1
- ◆ Silver Mesh B9
- ◆ Steel Mesh A9
- ◆ Tennis Ball LTB1
- ◇ White G1

L2 LAMINATES CODES

Woodgrain

- ◇ Beigewood LWBE
- ◆ Fawn Cypress LFC1
- ◆ Lowell Ash LLA1
- ◆ Natural Recon LNR1
- ◆ Phantom Ecu LPE1
- ◆ Portico Teak LPT1
- ◆ Skyline Walnut LSW1

L4 LAMINATES CODES

- ◇ White Markerboard FMQ1

IN-LINE TABLE EDGE

EDGE CODES

Solid

- ◇ Black P

BISTRO EDGE

EDGE CODES

- ◇ Beigewood DE
- ◇ Black P
- ◆ Bourbon Cherry H
- ◆ Brownstone EY
- ◆ Charcoal S
- ◆ Cognac COGN
- ◆ Designer White DW
- ◆ Fawn Cypress FC
- ◆ Field Elm FE
- ◆ Florence Walnut FW
- ◇ Fossil EH
- ◇ Greige R
- ◆ Harvest C
- ◆ Kingswood Walnut KI
- ◇ Light Gray Q
- ◆ Loft LOFT
- ◆ Lowell Ash DL
- ◆ Mahogany N
- ◆ Mocha MOCH
- ◇ Muslin T
- ◆ Natural Maple D
- ◆ Natural Recon NR
- ◆ Phantom Ecu PE
- ◆ Pinnacle PINC
- ◇ Platinum K
- ◆ Portico Teak DP
- ◆ Shaker Cherry F
- ◆ Skyline Walnut SW
- ◆ Sterling Ash SA

◆◆◆ For lead time information see page 21.

TANGRAM™ ORDERING INFORMATION

HON BRANDED FABRICS

Seat, Ottoman, Pouf

GRADE 1	GRADE 2	GRADE 3	GRADE 4
Centurion	Appoint Seating	Bradbury	Constance with Supreen™
Compass	Blume	Cozy	Livi with Supreen™
Contourett	Clyde	Getaway	Lucerne
Dapper	Haute	Moxie	Lugano with Supreen™
Emphasis	Kai	Notion	Oxford with Supreen™
Ensemble	Rush	Parker	
Hamilton	Spin	Purl	
Noble Seating	Wavelength	Quill	
Pebble	Whisper Vinyl	Saxony	
Vibe			

Single Fabric Upholstery, Back, Screen

GRADE 1	GRADE 2	GRADE 3	GRADE 4
Centurion	Appoint Seating	Bradbury	Constance with Supreen™
Compass	Blume	Cozy	Livi with Supreen™
Contourett	Clyde	Getaway	Lucerne
Dapper	Haute	Moxie	Lugano with Supreen™
Emphasis	Kai	Notion	Oxford with Supreen™
Ensemble	Rush	Parker	
Hamilton	Wavelength	Purl	
Noble Seating	Whisper Vinyl	Quill	
Pebble		Saxony	
Vibe			

For a complete list of fabrics, including partnership fabrics, go to hon.com/fabricsandfinishes.

Reference Fabric Color Combinations on pages 20-25 for color codes and legend on page 21 for lead times.

COM YARDAGE

MODEL	COM		
	Seat	Back	Screen
HECSRSP	4.5	—	—
HECSRST	1.5	—	—
HECSRP	2.5	—	—
HECSRB	2	—	—
HECSRSPMF	3	2	—
HECSITT	2	—	—
HECSITD	2.5	—	—
HECSITS	2.5	—	—
HECSMSLB	4.5	—	—
HECSMAILB	6.5	—	—
HECSMAOLB	6.5	—	—
HECSMTLB	5.5	—	—
HECSMSHB	—	6	—
HECSMAIHB	—	8.5	—
HECSMAOHB	—	8.5	—
HECSMTHB	—	8	—

MODEL	COM		
	Seat	Back	Screen
HECSMSLBMF	3.5	2	—
HECSMAILBMF	4	2.5	—
HECSMAOLBMF	4.5	2.5	—
HECSMTLBMF	4	2.5	—
HECSMSHBMF	3	1.5	2.5
HECSMAIHBMF	4	2	3.5
HECSMAOHBMF	4.5	2	3.5
HECSMTHBMF	4	1.5	3
HECSOSQ	3	—	—
HECSOD	3	—	—
HECSOTR	2.5	—	—
HECSOTP	4	—	—
HECSOSE	2.5	—	—
HECSOEL	2.5	—	—
HECSOER	2.5	—	—
HECSOC	4	—	—
HECSVAP	2.5	—	—
HECSVHP	2	—	—
HECSJVAP	2	—	—
HECSJVHP	2	—	—

NOTES: Due to fabric pattern nesting and potential reduction of fabric yield, some multi-fabric models may require more total yardage than standard single fabric models.

STORY STEPS

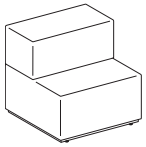

Stoop

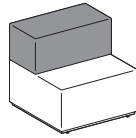

Stoop
Multi-Fabric

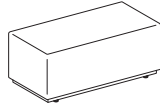

Step

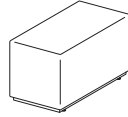

Bench

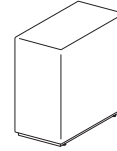

Perch

LOW-BACK SEATING

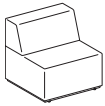

Low-Back Square

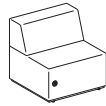

Low-Back Square
with Power

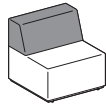

Low-Back Square
Multi-Fabric

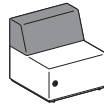

Low-Back Square
Multi-Fabric with Power

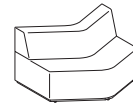

Low-Back Arrow Out

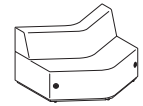

Low-Back Arrow Out
with Power

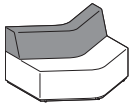

Low-Back Arrow Out
Multi-Fabric

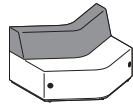

Low-Back Arrow Out
Multi-Fabric with Power



Low-Back Arrow In



Low-Back Arrow In
with Power

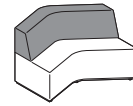

Low-Back Arrow In
Multi-Fabric

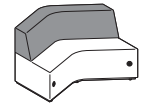

Low-Back Arrow In
Multi-Fabric with Power



Low-Back Trapezoid

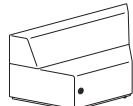

Low-Back Trapezoid
with Power

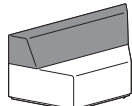

Low-Back Trapezoid
Multi-Fabric

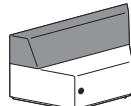

Low-Back Trapezoid
Multi-Fabric with Power

HIGH-BACK SEATING

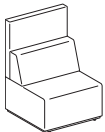

High-Back Square

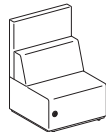

High-Back Square
with Power

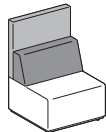

High-Back Square
Multi-Fabric

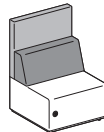

High-Back Square
Multi-Fabric with Power

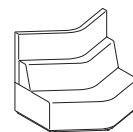

High-Back Arrow Out

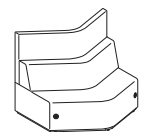

High-Back Arrow Out
with Power

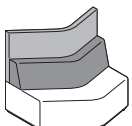

High-Back Arrow Out
Multi-Fabric

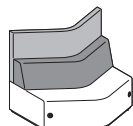

High-Back Arrow Out
Multi-Fabric with Power



High-Back Arrow In

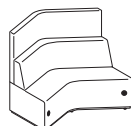

High-Back Arrow In
with Power

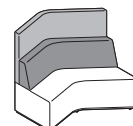

High-Back Arrow In
Multi-Fabric

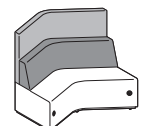

High-Back Arrow In
Multi-Fabric with Power

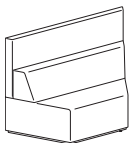

High-Back Trapezoid

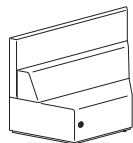

High-Back Trapezoid
with Power

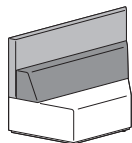

High-Back Trapezoid
Multi-Fabric

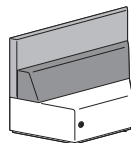

High-Back Trapezoid
Multi-Fabric with Power

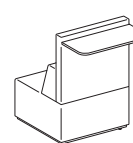

Bistro-Back Square

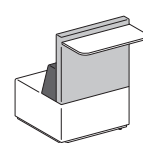

Bistro-Back Square
Multi-Fabric

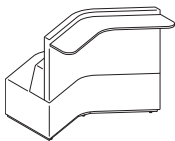

Bistro-Back Arrow Out

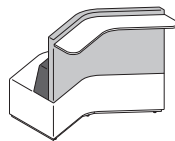

Bistro-Back Arrow Out
Multi-Fabric

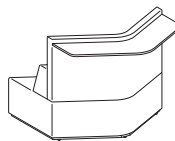

Bistro-Back Arrow In

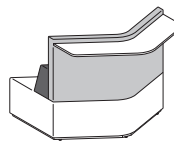

Bistro-Back Arrow In
Multi-Fabric



Bistro-Back Trapezoid

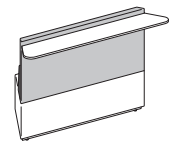

Bistro-Back Trapezoid
Multi-Fabric

TANGRAM™

Statement of Line

OTTOMANS

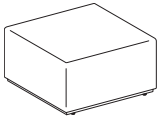

Square Ottoman

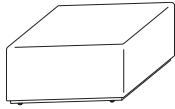

Diamond Ottoman

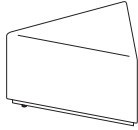

Triangle Ottoman

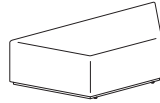

Trapezoid Ottoman



Left End Ottoman

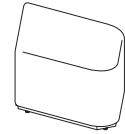

Right End Ottoman

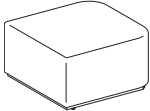

Straight End Ottoman



120° Ottoman

POUFS

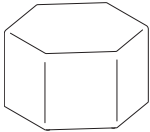

Varsity Hexagon Pouf

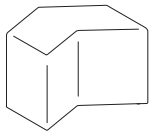

Varsity Arrow Pouf

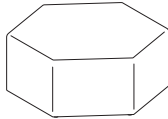

Junior Varsity Hexagon Pouf

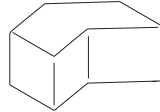

Junior Varsity Arrow Pouf

TABLES

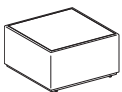

Square Table

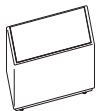

Diamond Table

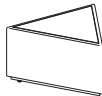

Triangle Table

TANGRAM™ Typicals

QTY	DESCRIPTION	MODEL	LIST PRICE	PRICE EXTENSION
2	High-Back Modular Seating Arrow In	HECSMAIHB	\$4,907	\$9,814
2	High-Back Modular Seating Arrow Out	HECSMAOHB	\$4,810	\$9,620
2	Ottoman Straight End	HECSESE	\$1,615	\$3,230
TOTAL:			\$22,664	

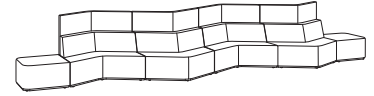

COMMONS

QTY	DESCRIPTION	MODEL	LIST PRICE	PRICE EXTENSION
2	Stoop 30"H x 30½"W	HECSRSP	\$2,265	\$4,530
4	Step 13"H x 30½"W	HECSRST	\$1,247	\$4,988
7	Perch 30"H x 30½"W	HECSRSP	\$1,698	\$11,886
1	In-Line Table 16¾"H x 30½"W	HECSITS	\$2,138	\$2,138
4	Bench 17"H x 30½"W	HECSRB	\$1,472	\$5,888
TOTAL:			\$29,430	

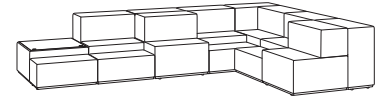

LIBRARY

QTY	DESCRIPTION	MODEL	LIST PRICE	PRICE EXTENSION
4	Low-Back Modular Seating Square	HECSMSLB	\$2,435	\$9,740
4	Perch 30"H x 30½"W	HECSRSP	\$1,698	\$6,792
TOTAL:			\$16,532	

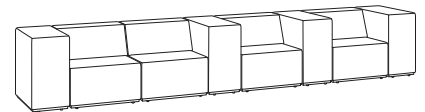

**NON-TRADITIONAL
LEARNING**

QTY	DESCRIPTION	MODEL	LIST PRICE	PRICE EXTENSION
3	Low-Back Modular Seating Arrow In	HECSMAILB	\$3,635	\$10,905
2	Low-Back Modular Seating Trapezoid	HECSMTLB	\$3,090	\$6,180
1	Ottoman Angled End, Left	HECSOAL	\$1,615	\$1,615
1	Ottoman Angled End, Right	HECSOAR	\$1,615	\$1,615
3	Ottoman Diamond	HECSOD	\$1,749	\$5,247
1	In-Line Table Diamond	HECSITD	\$2,275	\$2,275
1	Junior Varsity Pouf Hexagon	HECSJVHP	\$1,017	\$1,017
TOTAL:			\$28,854	

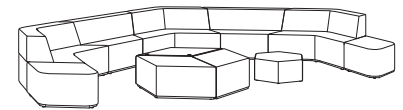

**NON-TRADITIONAL
LEARNING**

TANGRAM™ Typicals

EDUCATION

QTY	DESCRIPTION	MODEL	LIST PRICE	PRICE EXTENSION
2	High-Back Modular Seating Arrow In	HECSMAIHB	\$4,907	\$9,814
2	Ottoman Diamond	HECSOD	\$1,749	\$3,498
2	Junior Varsity Pouf Arrow	HECSJVAP	\$931	\$1,862
TOTAL:				\$15,174

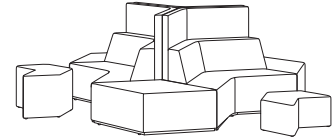

SCHOOL LOBBY

QTY	DESCRIPTION	MODEL	LIST PRICE	PRICE EXTENSION
4	High-Back Modular Seating Arrow In	HECSMAIHB	\$4,907	\$19,628
2	Ottoman Triangle	HECSOTR	\$1,445	\$2,890
2	Single Pedestal Base Lounge-Height	HCWTSBL27	\$1,089	\$2,178
2	Table Top with Flat Edge 42"W	HCWTRND42G	\$641	\$1,282
TOTAL:				\$25,978

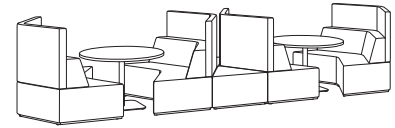

BREAKOUT SPACE

QTY	DESCRIPTION	MODEL	LIST PRICE	PRICE EXTENSION
2	Low-Back Modular Seating Arrow In	HECSMAILB	\$3,635	\$7,270
1	Ottoman Diamond	HECSOD	\$1,749	\$1,749
TOTAL:				\$9,019

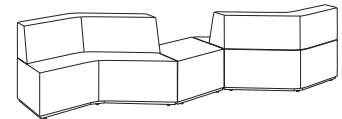

CAFETERIA



Icon Legend on page 19

TANGRAM™ Story Steps

EDUCATION

HECSRSP

STOOP

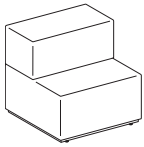

DIMENSIONS

Depth:	30½	Ship Weight:	79
Width:	30½	Cube:	17.5
Seat Height:	17	COM:	See page 206
Back Height:	30	Weight Rating:	300 lbs.

FABRIC PRICE CODES

1	\$2265	8	\$3033
2	\$2399	9	\$3133
3	\$2534	10	\$3240
4	\$2634	11	\$3356
5	\$2732	12	\$3475
6	\$2833	L	\$4294
7	\$2930		

HECSRST

STEP

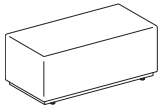

DIMENSIONS

Depth:	15¼	Ship Weight:	42
Height:	13	Cube:	4.4
Width:	30½	COM:	See page 206
		Weight Rating:	300 lbs.

FABRIC PRICE CODES

1	\$1247	8	\$1555
2	\$1302	9	\$1595
3	\$1357	10	\$1638
4	\$1396	11	\$1684
5	\$1435	12	\$1732
6	\$1475	L	\$2058
7	\$1513		

HECSRB

BENCH

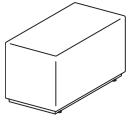

DIMENSIONS

Depth:	15¼	Ship Weight:	47
Height:	17	Cube:	5.3
Width:	30½	COM:	See page 206
		Weight Rating:	300 lbs.

FABRIC PRICE CODES

1	\$1472	8	\$1780
2	\$1527	9	\$1820
3	\$1582	10	\$1863
4	\$1621	11	\$1909
5	\$1660	12	\$1957
6	\$1700	L	\$2283
7	\$1738		

HECSR P

PERCH

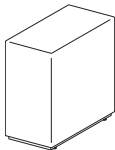

DIMENSIONS

Depth:	15¼	Ship Weight:	55
Height:	30	Cube:	9.2
Width:	30½	COM:	See page 206
		Weight Rating:	300 lbs.

FABRIC PRICE CODES

1	\$1698	8	\$2160
2	\$1780	9	\$2219
3	\$1860	10	\$2284
4	\$1920	11	\$2354
5	\$1979	12	\$2424
6	\$2039	L	\$2916
7	\$2098		

HOW TO SPECIFY

<p>Select Model Number</p> <p>H E C S R S P .</p>	<p>Select Power</p> <p>N None</p> <p>N .</p>	<p>Select Fabric</p> <p>See page 206</p> <p>H A M L 1 6 .</p>	<p>Select Base and Color</p> <p>P Plinth P71 Black</p> <p>P P 7 1</p>
--	--	--	--

TANGRAM™

Multi-Fabric Story Steps



Icon Legend on page 19

HECSRSPMF

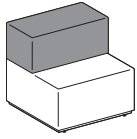

STOOP

Multi-Fabric

DIMENSIONS

Depth: 30½
 Width: 30½
 Seat Height: 17
 Back Height: 30

Ship Weight: 79
 Cube: 17.5
 COM: See page 206
 Weight Rating: 300 lbs.

FABRIC PRICE CODES

1 \$2332

Add to Base Price Above

	Seat	Back
2	\$82	\$55
3	\$162	\$110
4	\$222	\$149
5	\$281	\$188
6	\$341	\$228
7	\$400	\$266
8	\$462	\$308
9	\$521	\$348
10	\$586	\$391
11	\$656	\$437
12	\$726	\$485
L	\$1218	\$811

EDUCATION

HOW TO SPECIFY

<p>Select Model Number</p> <p>HECSRSPMF</p>	<p>Select Power</p> <p>N None</p> <p>N</p>	<p>Select Seat Fabric</p> <p>See page 206</p> <p>HAML16</p>	<p>Select Back Fabric</p> <p>See page 206</p> <p>HAML20</p>	<p>Select Base and Color</p> <p>P Plinth P71 Black</p> <p>PP71</p>
--	---	--	--	---



Icon Legend on page 19

TANGRAM™ In-Line Tables

EDUCATION

HECSITS

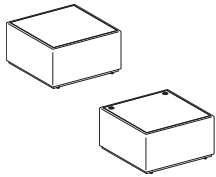

SQUARE

In-Line Table

DIMENSIONS

Depth: 30½ Ship Weight: 76
 Height: 16¾ Cube: 9.3
 Width: 30½ COM: See page 206

FABRIC PRICE CODES

1	\$2138	8	\$2600
2	\$2220	9	\$2659
3	\$2300	10	\$2724
4	\$2360	11	\$2794
5	\$2419	12	\$2864
6	\$2479	L	\$3356
7	\$2538		

UPCHARGE BY LAMINATE GRADE

L1	L2	L4
\$0	\$57	\$113

HECSITD

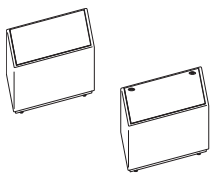

DIAMOND

In-Line Table

DIMENSIONS

Depth: 26½ Ship Weight: 70
 Height: 16¾ Cube: 13.7
 Width: 46 COM: See page 206

FABRIC PRICE CODES

1	\$2275	8	\$2737
2	\$2357	9	\$2796
3	\$2437	10	\$2861
4	\$2497	11	\$2931
5	\$2556	12	\$3001
6	\$2616	L	\$3493
7	\$2675		

UPCHARGE BY LAMINATE GRADE

L1	L2	L4
\$0	\$67	\$134

HECSITT

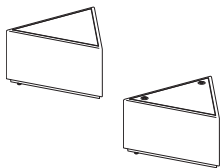

TRIANGLE

In-Line Table

DIMENSIONS

Depth: 27 Ship Weight: 48
 Height: 16¾ Cube: 9.3
 Width: 31 COM: See page 206

FABRIC PRICE CODES

1	\$2026	8	\$2334
2	\$2081	9	\$2374
3	\$2136	10	\$2417
4	\$2175	11	\$2463
5	\$2214	12	\$2511
6	\$2254	L	\$2837
7	\$2292		

UPCHARGE BY LAMINATE GRADE

L1	L2	L4
\$0	\$57	\$113

HOW TO SPECIFY

Select Model Number H E C S I T S	Select Power N None 2 Two Power (+ \$114)	Select Fabric See page 206	Select Base and Color P Plinth P71 Black	Select Laminate See page 205	Select Edge Color P Black
H E C S I T S .	2 .	H A M L 1 6 .	P P 7 1 .	H .	P .

TANGRAM™ Modular Seating



Icon Legend on page 19

EDUCATION

HECSMSLB

LOW-BACK

DIMENSIONS

FABRIC PRICE CODES

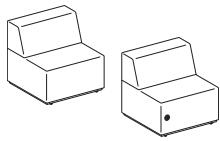

Square

Depth: 30½
Width: 30½
Seat Height: 17
Back Height: 30
Ship Weight: 70
Cube: 18.1
COM: See page 206
Weight Rating: 300 lbs.

1	\$2435	8	\$3203
2	\$2569	9	\$3303
3	\$2704	10	\$3410
4	\$2804	11	\$3526
5	\$2902	12	\$3645
6	\$3003	L	\$4464
7	\$3100		

HECSMTLB

LOW-BACK

DIMENSIONS

FABRIC PRICE CODES

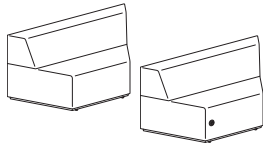

Trapezoid

Depth: 30½
Width: 60
Seat Height: 17
Back Height: 30
Ship Weight: 107
Cube: 29.9
COM: See page 206
Weight Rating: 300 lbs.

1	\$3090	8	\$4012
2	\$3251	9	\$4131
3	\$3415	10	\$4260
4	\$3533	11	\$4401
5	\$3650	12	\$4540
6	\$3771	L	\$5522
7	\$3888		

HECSMAILB

LOW-BACK

DIMENSIONS

FABRIC PRICE CODES

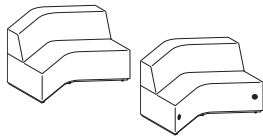

Arrow In

Depth: 43½
Width: 52½
Seat Height: 17
Back Height: 30
Ship Weight: 130
Cube: 43.4
COM: See page 206
Weight Rating: 300 lbs.

1	\$3635	8	\$4710
2	\$3823	9	\$4849
3	\$4012	10	\$4999
4	\$4152	11	\$5163
5	\$4289	12	\$5327
6	\$4431	L	\$6474
7	\$4566		

NOTES: Due to the inherent design of the Arrow In, material gathers will be present in the back.

HECSMAOLB

LOW-BACK

DIMENSIONS

FABRIC PRICE CODES

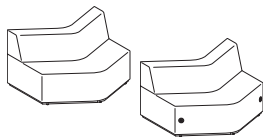

Arrow Out

Depth: 43½
Width: 52½
Seat Height: 17
Back Height: 30
Ship Weight: 130
Cube: 43.4
COM: See page 206
Weight Rating: 300 lbs.

1	\$3562	8	\$4637
2	\$3750	9	\$4776
3	\$3939	10	\$4926
4	\$4079	11	\$5090
5	\$4216	12	\$5254
6	\$4358	L	\$6401
7	\$4493		

HOW TO SPECIFY

<p>Select Model Number</p> <p>HECSMSLB.</p>	<p>Select Power</p> <p>N None 1R One Power, Right-Hand User Side (+ \$57) <i>Specify for Square and Trapezoid only</i> 2B Two Power, Both Sides (+ \$114) <i>Specify for Arrow In and Arrow Out only</i></p> <p>1R.</p>	<p>Select Fabric</p> <p>See page 206</p> <p>HAML16.</p>	<p>Select Base and Color</p> <p>P Plinth P71 Black</p> <p>PP71</p>
--	--	--	---



Icon Legend on page 19

TANGRAM™ Modular Seating — Multi-Fabric

HECSMSLBMF

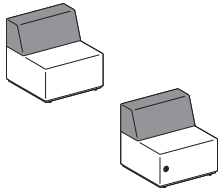

LOW-BACK

Square, Multi-Fabric

DIMENSIONS

Depth: 30½ Ship Weight: 70
 Width: 30½ Cube: 18.1
 Seat Height: 17 COM: See page 206
 Back Height: 30 Weight Rating: 300 lbs.

FABRIC PRICE CODES

1	\$2509	
<i>Add to Base Price Above</i>		
	Seat	Back
2	\$94	\$42
3	\$190	\$83
4	\$260	\$113
5	\$328	\$141
6	\$399	\$170
7	\$466	\$201
8	\$538	\$231
9	\$608	\$261
10	\$683	\$293
11	\$764	\$329
12	\$846	\$364
L	\$1421	\$609

HECSMTLBMF

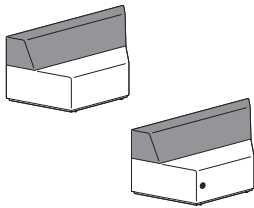

LOW-BACK

Trapezoid, Multi-Fabric

DIMENSIONS

Depth: 30½ Ship Weight: 107
 Width: 60 Cube: 29.9
 Seat Height: 17 COM: See page 206
 Back Height: 30 Weight Rating: 300 lbs.

FABRIC PRICE CODES

1	\$3183	
<i>Add to Base Price Above</i>		
	Seat	Back
2	\$109	\$67
3	\$217	\$135
4	\$296	\$186
5	\$374	\$234
6	\$455	\$286
7	\$533	\$333
8	\$614	\$385
9	\$695	\$434
10	\$780	\$488
11	\$874	\$547
12	\$968	\$605
L	\$1622	\$1015

EDUCATION

HOW TO SPECIFY

Select Model Number H E C S M S L B M F .	Select Power N None 1R One Power, Right-Hand User Side (+ \$57) <i>Specify for Square and Trapezoid only</i> 2B Two Power, Both Sides (+ \$114) <i>Specify for Arrow In and Arrow Out only</i> 1 R .	Select Seat Fabric See page 206 H A M L 1 6 .	Select Back Fabric See page 206 H A M L 2 0 .	Select Base and Color P Plinth P71 Black P P 7 1
---	---	--	--	--

TANGRAM™ Modular Seating — Multi-Fabric



Icon Legend on page 19

EDUCATION

HECSMAILBMF

LOW-BACK

Arrow In, Multi-Fabric

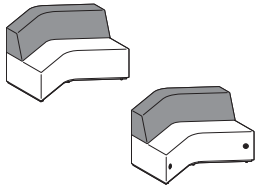

DIMENSIONS

Depth:	43½	Ship Weight:	130
Width:	52½	Cube:	43.4
Seat Height:	17	COM:	See page 206
Back Height:	30	Weight Rating:	300 lbs.

FABRIC PRICE CODES

1	\$3744
<i>Add to Base Price Above</i>	
	Seat Back
2	\$121 \$67
3	\$243 \$135
4	\$333 \$186
5	\$421 \$234
6	\$511 \$286
7	\$599 \$333
8	\$691 \$385
9	\$781 \$434
10	\$877 \$488
11	\$982 \$547
12	\$1088 \$605
L	\$1826 \$1015

NOTES: Due to the inherent design of the Arrow In, material gathers will be present in the back.

HECSMAOLBMF

LOW-BACK

Arrow Out, Multi-Fabric

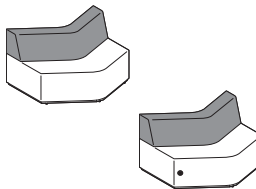

DIMENSIONS

Depth:	43½	Ship Weight:	130
Width:	52½	Cube:	43.4
Seat Height:	17	COM:	See page 206
Back Height:	30	Weight Rating:	300 lbs.

FABRIC PRICE CODES

1	\$3669
<i>Add to Base Price Above</i>	
	Seat Back
2	\$121 \$67
3	\$243 \$135
4	\$333 \$186
5	\$421 \$234
6	\$511 \$286
7	\$599 \$333
8	\$691 \$385
9	\$781 \$434
10	\$877 \$488
11	\$982 \$547
12	\$1088 \$605
L	\$1826 \$1015

HOW TO SPECIFY

Select Model Number H E C S M A I L B M F .	Select Power N None 1R One Power, Right-Hand User Side (+ \$57) <i>Specify for Square and Trapezoid only</i> 2B Two Power, Both Sides (+ \$114) <i>Specify for Arrow In and Arrow Out only</i> 2 B .	Select Seat Fabric See page 206 H A M L 1 6 .	Select Back Fabric See page 206 H A M L 2 0 .	Select Base and Color P Plinth P71 Black P P 7 1
---	---	--	--	--



Icon Legend on page 19

TANGRAM™ Modular Seating

EDUCATION

HECSMSHB

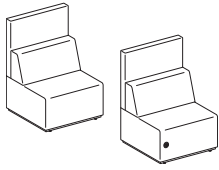

HIGH-BACK

Square

DIMENSIONS

Depth:	30½	Ship Weight:	82
Width:	30½	Cube:	29.7
Seat Height:	17	COM:	See page 206
Back Height:	30	Weight Rating:	300 lbs.
Screen Height:	44		

FABRIC PRICE CODES

1	\$3167	8	\$4089
2	\$3328	9	\$4208
3	\$3492	10	\$4337
4	\$3610	11	\$4478
5	\$3727	12	\$4617
6	\$3848	L	\$5599
7	\$3965		

HECSMTHB

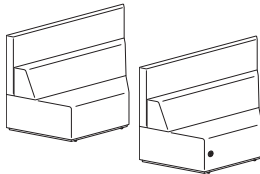

HIGH-BACK

Trapezoid

DIMENSIONS

Depth:	30½	Ship Weight:	121
Width:	60	Cube:	50.7
Seat Height:	17	COM:	See page 206
Back Height:	30	Weight Rating:	300 lbs.
Screen Height:	44		

FABRIC PRICE CODES

1	\$4171	8	\$5398
2	\$4386	9	\$5558
3	\$4603	10	\$5731
4	\$4762	11	\$5916
5	\$4918	12	\$6104
6	\$5079	L	\$7415
7	\$5235		

HECSMAIHB

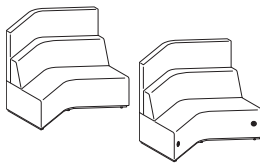

HIGH-BACK

Arrow In

DIMENSIONS

Depth:	43½	Ship Weight:	154
Width:	52½	Cube:	68.8
Seat Height:	17	COM:	See page 206
Back Height:	30	Weight Rating:	300 lbs.
Screen Height:	44		

FABRIC PRICE CODES

1	\$4907	8	\$6290
2	\$5146	9	\$6467
3	\$5392	10	\$6661
4	\$5571	11	\$6871
5	\$5747	12	\$7082
6	\$5928	L	\$8557
7	\$6102		

NOTES: Due to the inherent design of the Arrow In, material gathers will be present in the back.

HECSMAOHB

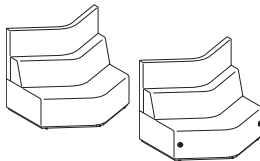

HIGH-BACK

Arrow Out

DIMENSIONS

Depth:	43½	Ship Weight:	154
Width:	52½	Cube:	68.8
Seat Height:	17	COM:	See page 206
Back Height:	30	Weight Rating:	300 lbs.
Screen Height:	44		

FABRIC PRICE CODES

1	\$4810	8	\$6193
2	\$5049	9	\$6370
3	\$5295	10	\$6564
4	\$5474	11	\$6774
5	\$5650	12	\$6985
6	\$5831	L	\$8460
7	\$6005		

HOW TO SPECIFY

<p>Select Model Number</p> <p>HECSMSHB</p>	<p>Select Power</p> <p>N None 1R One Power, Right-Hand User Side (+ \$57) <i>Specify for Square and Trapezoid only</i> 2B Two Power, Both Sides (+ \$114) <i>Specify for Arrow In and Arrow Out only</i></p> <p>1R</p>	<p>Select Fabric</p> <p>See page 206</p> <p>HAML16</p>	<p>Select Base and Color</p> <p>P Plinth P71 Black</p> <p>PP71</p>
---	---	---	---

TANGRAM™

Modular Seating — Multi-Fabric



Icon Legend on page 19

EDUCATION

HECSMSHBMF

HIGH-BACK

Square, Multi-Fabric

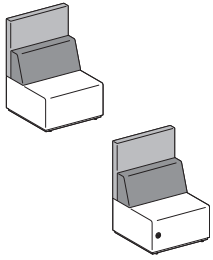

DIMENSIONS

Depth: 30½
 Width: 30½
 Seat Height: 17
 Back Height: 30
 Screen Height: 44

Ship Weight:
 Cube:
 COM:
 Weight Rating:

82
 29.7
 See page 206
 300 lbs.

FABRIC PRICE CODES

1 \$3263

Add to Base Price Above

	Seat	Back	Screen
2	\$82	\$42	\$55
3	\$162	\$83	\$110
4	\$222	\$113	\$149
5	\$281	\$141	\$188
6	\$341	\$170	\$228
7	\$400	\$201	\$266
8	\$462	\$231	\$308
9	\$521	\$261	\$348
10	\$586	\$293	\$391
11	\$656	\$329	\$437
12	\$726	\$364	\$485
L	\$1218	\$609	\$811

HECSMTHBMF

HIGH-BACK

Trapezoid, Multi-Fabric

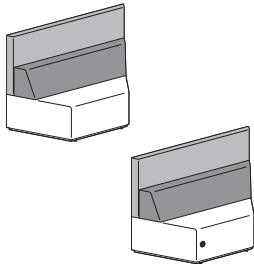

DIMENSIONS

Depth: 30½
 Width: 60
 Seat Height: 17
 Back Height: 30
 Screen Height: 44

Ship Weight:
 Cube:
 COM:
 Weight Rating:

121
 50.7
 See page 206
 300 lbs.

FABRIC PRICE CODES

1 \$4297

Add to Base Price Above

	Seat	Back	Screen
2	\$109	\$42	\$94
3	\$217	\$83	\$190
4	\$296	\$113	\$260
5	\$374	\$141	\$328
6	\$455	\$170	\$399
7	\$533	\$201	\$466
8	\$614	\$231	\$538
9	\$695	\$261	\$608
10	\$780	\$293	\$683
11	\$874	\$329	\$764
12	\$968	\$364	\$846
L	\$1622	\$609	\$1421

HOW TO SPECIFY

Select Model Number	Select Power	Select Seat Fabric	Select Back Fabric	Select Screen Fabric	Select Base and Color
HECSMSHBMF	<p>N None</p> <p>1R One Power, Right-Hand User Side (+ \$57) Specify for Square and Trapezoid only</p> <p>2B Two Power, Both Sides (+ \$114) Specify for Arrow In and Arrow Out only</p>	See page 206	See page 206	See page 206	<p>P Plinth</p> <p>P71 Black</p>
HECSMSHBMF	1R	HAML16	HAML20	HAML16	PP71



Icon Legend on page 19

TANGRAM™ Modular Seating — Multi-Fabric

HECSMAIHBMF

HIGH-BACK

Arrow In, Multi-Fabric

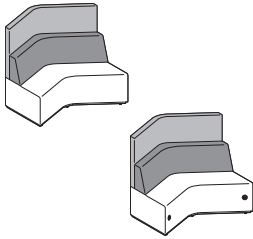

DIMENSIONS

Depth:	43½	Ship Weight:	154
Width:	52½	Cube:	68.8
Seat Height:	17	COM:	See page 206
Back Height:	30	Weight Rating:	300 lbs.
Screen Height:	44		

FABRIC PRICE CODES

1	\$5055		
	<i>Add to Base Price Above</i>		
	Seat	Back	Screen
2	\$121	\$55	\$94
3	\$243	\$110	\$190
4	\$333	\$149	\$260
5	\$421	\$188	\$328
6	\$511	\$228	\$399
7	\$599	\$266	\$466
8	\$691	\$308	\$538
9	\$781	\$348	\$608
10	\$877	\$391	\$683
11	\$982	\$437	\$764
12	\$1088	\$485	\$846
L	\$1826	\$811	\$1421

NOTES: Due to the inherent design of the Arrow In, material gathers will be present in the back.

HECSMAOHBMF

HIGH-BACK

Arrow Out, Multi-Fabric

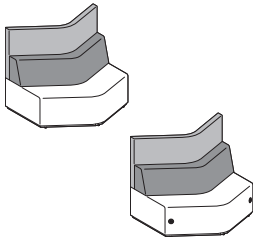

DIMENSIONS

Depth:	43½	Ship Weight:	154
Width:	52½	Cube:	68.8
Seat Height:	17	COM:	See page 206
Back Height:	30	Weight Rating:	300 lbs.
Screen Height:	44		

FABRIC PRICE CODES

1	\$4955		
	<i>Add to Base Price Above</i>		
	Seat	Back	Screen
2	\$121	\$55	\$67
3	\$243	\$110	\$135
4	\$333	\$149	\$186
5	\$421	\$188	\$234
6	\$511	\$228	\$286
7	\$599	\$266	\$333
8	\$691	\$308	\$385
9	\$781	\$348	\$434
10	\$877	\$391	\$488
11	\$982	\$437	\$547
12	\$1088	\$485	\$605
L	\$1826	\$811	\$1015

HOW TO SPECIFY

Select Model Number H E C S M A I H B M F .	Select Power N None 1R One Power, Right-Hand User Side (+ \$57) <i>Specify for Square and Trapezoid only</i> 2B Two Power, Both Sides (+ \$114) <i>Specify for Arrow In and Arrow Out only</i>	Select Seat Fabric See page 206 H A M L 1 6 .	Select Back Fabric See page 206 H A M L 2 0 .	Select Screen Fabric See page 206 H A M L 1 6 .	Select Base and Color P Plinth P71 Black P P 7 1
---	---	--	--	--	--

TANGRAM™ Modular Seating — Bistro-Back



Icon Legend on page 19

EDUCATION

HECSMSBB

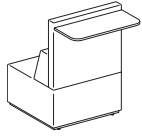

BISTRO-BACK

Square

DIMENSIONS

Depth:	30½	Ship Weight:	70
Width:	30½	Cube:	18.1
Seat Height:	17	COM:	See page 206
Back Height:	30	Seat Weight Rating:	300 lbs.
Width of Worksurface:	30½		
Depth of Worksurface:	12		
Worksurface Height:	42		

FABRIC PRICE CODES

1	\$3833	8	\$4755
2	\$3994	9	\$4874
3	\$4158	10	\$5003
4	\$4276	11	\$5144
5	\$4393	12	\$5283
6	\$4514	L	\$6265
7	\$4631		

UPCHARGE BY LAMINATE GRADE

L1	L2	L4
\$0	\$67	\$134

HECSMTBB

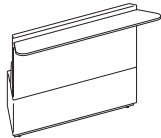

BISTRO-BACK

Trapezoid

DIMENSIONS

Depth:	30½	Ship Weight:	107
Width:	60	Cube:	29.9
Seat Height:	17	COM:	See page 206
Back Height:	30	Seat Weight Rating:	300 lbs.
Width of Worksurface:	69		
Depth of Worksurface:	12		
Worksurface Height:	42		

FABRIC PRICE CODES

1	\$5059	8	\$6286
2	\$5274	9	\$6446
3	\$5491	10	\$6619
4	\$5650	11	\$6804
5	\$5806	12	\$6992
6	\$5967	L	\$8303
7	\$6123		

UPCHARGE BY LAMINATE GRADE

L1	L2	L4
\$0	\$90	\$180

HECSMAIBB

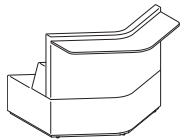

BISTRO-BACK

Arrow In

DIMENSIONS

Depth:	43½	Ship Weight:	130
Width:	52½	Cube:	43.4
Seat Height:	17	COM:	See page 206
Back Height:	30	Seat Weight Rating:	300 lbs.
Width of Worksurface:	52½		
Depth of Worksurface:	12		
Worksurface Height:	42		
Depth of Arrow:	25½		

FABRIC PRICE CODES

1	\$5795	8	\$7178
2	\$6034	9	\$7355
3	\$6280	10	\$7549
4	\$6459	11	\$7759
5	\$6635	12	\$7970
6	\$6816	L	\$9445
7	\$6990		

UPCHARGE BY LAMINATE GRADE

L1	L2	L4
\$0	\$90	\$180

NOTES: Due to the inherent design of the Arrow In, material gathers will be present in the back.

HECSMAOBB

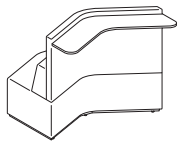

BISTRO-BACK

Arrow Out

DIMENSIONS

Depth:	43½	Ship Weight:	130
Width:	52½	Cube:	43.4
Seat Height:	17	COM:	See page 206
Back Height:	30	Seat Weight Rating:	300 lbs.
Width of Worksurface:	52½		
Depth of Worksurface:	12		
Worksurface Height:	42		
Depth of Arrow:	27½		

FABRIC PRICE CODES

1	\$5698	8	\$7081
2	\$5937	9	\$7258
3	\$6183	10	\$7452
4	\$6362	11	\$7662
5	\$6538	12	\$7873
6	\$6719	L	\$9348
7	\$6893		

UPCHARGE BY LAMINATE GRADE

L1	L2	L4
\$0	\$90	\$180

HOW TO SPECIFY

Select Model Number H E C S M S B B .	Select Power N None 1R One Power, Right-Hand User Side (+ \$57) <i>Specify for Square and Trapezoid only</i> 2B Two Power, Both Sides (+ \$114) <i>Specify for Arrow In and Arrow Out only</i>	Select Fabric See page 206 H A M L 1 6 .	Select Base P Plinth P71 Black P P 7 1 .	Select Laminate See page 205 L F W 1 .	Select Edge See page 205 F W
---	--	---	--	---	---



Icon Legend on page 19

HECSMSBBMF

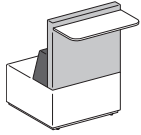

BISTRO-BACK

Square, Multi-Fabric

DIMENSIONS

Depth:	30½	Ship Weight:	70
Width:	30½	Cube:	18.1
Seat Height:	17	COM:	See page 206
Back Height:	30	Seat Weight Rating:	300 lbs.
Width of Worksurface:	30½		
Depth of Worksurface:	12		
Worksurface Height:	42		

FABRIC PRICE CODES

1	\$3929		
<i>Add to Base Price Above</i>			
	Seat	Back	Screen
2	\$82	\$42	\$55
3	\$162	\$83	\$110
4	\$222	\$113	\$149
5	\$281	\$141	\$188
6	\$341	\$170	\$228
7	\$400	\$201	\$266
8	\$462	\$231	\$308
9	\$521	\$261	\$348
10	\$586	\$293	\$391
11	\$656	\$329	\$437
12	\$726	\$364	\$485
L	\$1218	\$609	\$811

UPCHARGE BY LAMINATE GRADE

L1	L2	L4
\$0	\$67	\$134

HECSMTBBMF

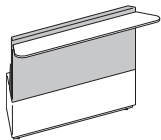

BISTRO-BACK

Trapezoid, Multi-Fabric

DIMENSIONS

Depth:	30½	Ship Weight:	107
Width:	60	Cube:	29.9
Seat Height:	17	COM:	See page 206
Back Height:	30	Seat Weight Rating:	300 lbs.
Width of Worksurface:	69		
Depth of Worksurface:	12		
Worksurface Height:	42		

FABRIC PRICE CODES

1	\$5185		
<i>Add to Base Price Above</i>			
	Seat	Back	Screen
2	\$109	\$42	\$94
3	\$217	\$83	\$190
4	\$296	\$113	\$260
5	\$374	\$141	\$328
6	\$455	\$170	\$399
7	\$533	\$201	\$466
8	\$614	\$231	\$538
9	\$695	\$261	\$608
10	\$780	\$293	\$683
11	\$874	\$329	\$764
12	\$968	\$364	\$846
L	\$1622	\$609	\$1421

UPCHARGE BY LAMINATE GRADE

L1	L2	L4
\$0	\$90	\$180

HOW TO SPECIFY

Select Model Number	Select Power	Select Seat Fabric	Select Back Fabric	Select Screen Fabric	Select Base	Select Laminate	Select Edge
	N None 1R One Power, Right-Hand User Side (+ \$57) <i>Specify for Square and Trapezoid only</i> 2B Two Power, Both Sides (+ \$114) <i>Specify for Arrow In and Arrow Out only</i>	See page 206	See page 206	See page 206	P Plinth P71 Black	See page 205	See page 205
HECSMSBBMF	1R	HAML16	HAML20	HAML16	PP71	LFW1	FW

TANGRAM™

Modular Seating — Bistro-Back, Multi-Fabric



Icon Legend on page 19

EDUCATION

HECSMAIBBMF

BISTRO-BACK

Arrow In, Multi-Fabric

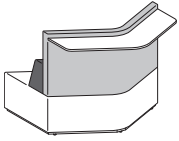

DIMENSIONS

Depth:	43½	Ship Weight:	130
Width:	52½	Cube:	43.4
Seat Height:	17	COM:	See page 206
Back Height:	30	Seat Weight Rating:	300 lbs.
Width of Worksurface:	52½		
Depth of Worksurface:	12		
Worksurface Height:	42		
Depth of Arrow:	25½		

FABRIC PRICE CODES

1 \$5943

Add to Base Price Above

	Seat	Back	Screen
2	\$121	\$55	\$94
3	\$243	\$110	\$190
4	\$333	\$149	\$260
5	\$421	\$188	\$328
6	\$511	\$228	\$399
7	\$599	\$266	\$466
8	\$691	\$308	\$538
9	\$781	\$348	\$608
10	\$877	\$391	\$683
11	\$982	\$437	\$764
12	\$1088	\$485	\$846
L	\$1826	\$811	\$1421

UPCHARGE BY LAMINATE GRADE

L1	L2	L4
\$0	\$90	\$180

NOTES: Due to the inherent design of the Arrow In, material gathers will be present in the back.

HECSMAOBBMF

BISTRO-BACK

Arrow Out, Multi-Fabric

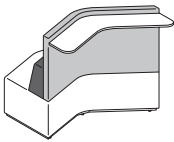

DIMENSIONS

Depth:	43½	Ship Weight:	130
Width:	52½	Cube:	43.4
Seat Height:	17	COM:	See page 206
Back Height:	30	Seat Weight Rating:	300 lbs.
Width of Worksurface:	52½		
Depth of Worksurface:	12		
Worksurface Height:	42		
Depth of Arrow:	27¾		

FABRIC PRICE CODES

1 \$5843

Add to Base Price Above

	Seat	Back	Screen
2	\$121	\$55	\$67
3	\$243	\$110	\$135
4	\$333	\$149	\$186
5	\$421	\$188	\$234
6	\$511	\$228	\$286
7	\$599	\$266	\$333
8	\$691	\$308	\$385
9	\$781	\$348	\$434
10	\$877	\$391	\$488
11	\$982	\$437	\$547
12	\$1088	\$485	\$605
L	\$1826	\$811	\$1015

UPCHARGE BY LAMINATE GRADE

L1	L2	L4
\$0	\$90	\$180

HOW TO SPECIFY

Select Model Number	Select Power	Select Seat Fabric	Select Back Fabric	Select Screen Fabric	Select Base	Select Laminate	Select Edge
HECSMAIBBMF	N None 1R One Power, Right-Hand User Side (+ \$57) <i>Specify for Square and Trapezoid only</i> 2B Two Power, Both Sides (+ \$114) <i>Specify for Arrow In and Arrow Out only</i>	See page 206	See page 206	See page 206	P Plinth P71 Black	See page 205	See page 205
HECSMAOBBMF	1R	HAML16	HAML20	HAML16	PP71	LFW1	FW



Icon Legend on page 19

TANGRAM™ Ottomans

EDUCATION

HECSOSQ

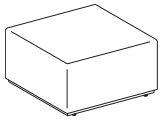

OTTOMAN

Square

DIMENSIONS

Depth: 30½ Ship Weight: 56
 Height: 17 Cube: 10.4
 Width: 30½ COM: See page 206
 Weight Rating: 300 lbs.

FABRIC PRICE CODES

1	\$1698	8	\$2160
2	\$1780	9	\$2219
3	\$1860	10	\$2284
4	\$1920	11	\$2354
5	\$1979	12	\$2424
6	\$2039	L	\$2916
7	\$2098		

HECSOD

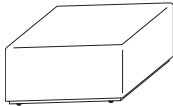

OTTOMAN

Diamond

DIMENSIONS

Depth: 26½ Ship Weight: 52
 Height: 17 Cube: 12.8
 Width: 46 COM: See page 206
 Weight Rating: 300 lbs.

FABRIC PRICE CODES

1	\$1749	8	\$2363
2	\$1858	9	\$2444
3	\$1966	10	\$2529
4	\$2045	11	\$2623
5	\$2123	12	\$2717
6	\$2204	L	\$3371
7	\$2282		

HECSOTR

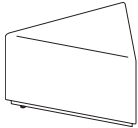

OTTOMAN

Triangle

DIMENSIONS

Depth: 27 Ship Weight: 36
 Height: 17 Cube: 8.5
 Width: 31 COM: See page 206
 Weight Rating: 300 lbs.

FABRIC PRICE CODES

1	\$1445	8	\$1907
2	\$1527	9	\$1966
3	\$1607	10	\$2031
4	\$1667	11	\$2101
5	\$1726	12	\$2171
6	\$1786	L	\$2663
7	\$1845		

HECSOTP

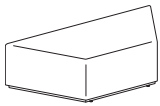

OTTOMAN

Trapezoid

DIMENSIONS

Depth: 26½ Ship Weight: 92
 Height: 17 Cube: 17.0
 Width: 60 COM: See page 206
 Weight Rating: 300 lbs.

FABRIC PRICE CODES

1	\$1869	8	\$2483
2	\$1978	9	\$2564
3	\$2086	10	\$2649
4	\$2165	11	\$2743
5	\$2243	12	\$2837
6	\$2324	L	\$3491
7	\$2402		

HOW TO SPECIFY

<p>Select Model Number</p> <p>HECSOSQ</p>	<p>Select Power</p> <p>N None</p> <p>N</p>	<p>Select Fabric</p> <p>See page 206</p> <p>HAML16</p>	<p>Select Base and Color</p> <p>P Plinth P71 Black</p> <p>P P71</p>
---	--	--	---

TANGRAM™ Ottomans



Icon Legend on page 19

EDUCATION

HECSEOSE

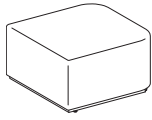

OTTOMAN

Straight End

DIMENSIONS

Depth: 30½ Ship Weight: 57
 Height: 17 Cube: 10.0
 Width: 30½ COM: See page 206
 Weight Rating: 300 lbs.

FABRIC PRICE CODES

1	\$1615	8	\$2077
2	\$1697	9	\$2136
3	\$1777	10	\$2201
4	\$1837	11	\$2271
5	\$1896	12	\$2341
6	\$1956	L	\$2833
7	\$2015		

HECSOAEI

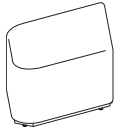

OTTOMAN

Angled End, Left

DIMENSIONS

Depth: 26½ Ship Weight: 52
 Height: 17 Cube: 12.0
 Width: 42 COM: See page 206
 Weight Rating: 300 lbs.

FABRIC PRICE CODES

1	\$1615	8	\$2077
2	\$1697	9	\$2136
3	\$1777	10	\$2201
4	\$1837	11	\$2271
5	\$1896	12	\$2341
6	\$1956	L	\$2833
7	\$2015		

HECSOAEI



OTTOMAN

Angled End, Right

DIMENSIONS

Depth: 26½ Ship Weight: 52
 Height: 17 Cube: 12.0
 Width: 42 COM: See page 206
 Weight Rating: 300 lbs.

FABRIC PRICE CODES

1	\$1615	8	\$2077
2	\$1697	9	\$2136
3	\$1777	10	\$2201
4	\$1837	11	\$2271
5	\$1896	12	\$2341
6	\$1956	L	\$2833
7	\$2015		

HECSOC

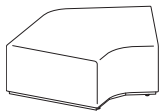

OTTOMAN

120 Degree

DIMENSIONS

Depth: 41 Ship Weight: 110
 Height: 17 Cube: 20.0
 Width: 53 COM: See page 206
 Weight Rating: 300 lbs.

FABRIC PRICE CODES

1	\$1615	8	\$2229
2	\$1724	9	\$2310
3	\$1832	10	\$2395
4	\$1911	11	\$2489
5	\$1989	12	\$2583
6	\$2070	L	\$3237
7	\$2148		

HOW TO SPECIFY

Select Model Number H E C S O S E .	Select Power N None	Select Fabric See page 206 H A M L 1 6 .	Select Base and Color P Plinth P71 Black
---	-------------------------------	---	---



Icon Legend on page 19

TANGRAM™ Poufs

EDUCATION

HECSVAP

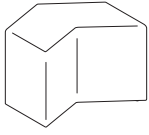

POUF

Varsity Arrow

DIMENSIONS

Depth: 23¼
 Height: 18¼
 Width: 26½
 Ship Weight: 37
 Cube: 7.3
 COM: See page 206
 Weight Rating: 300 lbs.

FABRIC PRICE CODES

1	\$1035	8	\$1497
2	\$1117	9	\$1556
3	\$1197	10	\$1621
4	\$1257	11	\$1691
5	\$1316	12	\$1761
6	\$1376	L	\$2253
7	\$1435		

HECSVHP

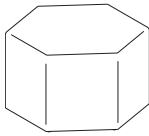

POUF

Varsity Hexagon

DIMENSIONS

Depth: 31
 Height: 18¼
 Width: 26½
 Ship Weight: 55
 Cube: 10.1
 COM: See page 206
 Weight Rating: 300 lbs.

FABRIC PRICE CODES

1	\$1129	8	\$1591
2	\$1211	9	\$1650
3	\$1291	10	\$1715
4	\$1351	11	\$1785
5	\$1410	12	\$1855
6	\$1470	L	\$2347
7	\$1529		

HECSJVAP

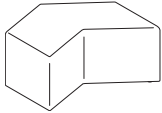

POUF

Junior Varsity Arrow

DIMENSIONS

Depth: 23¼
 Height: 12¼
 Width: 26½
 Ship Weight: 30
 Cube: 6.0
 COM: See page 206
 Weight Rating: 300 lbs.

FABRIC PRICE CODES

1	\$931	8	\$1239
2	\$986	9	\$1279
3	\$1041	10	\$1322
4	\$1080	11	\$1368
5	\$1119	12	\$1416
6	\$1159	L	\$1742
7	\$1197		

HECSJVHP

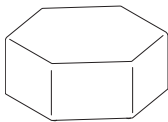

POUF

Junior Varsity Hexagon

DIMENSIONS

Depth: 31
 Height: 12¼
 Width: 26½
 Ship Weight: 44
 Cube: 8.3
 COM: See page 206
 Weight Rating: 300 lbs.

FABRIC PRICE CODES

1	\$1017	8	\$1325
2	\$1072	9	\$1365
3	\$1127	10	\$1408
4	\$1166	11	\$1454
5	\$1205	12	\$1502
6	\$1245	L	\$1828
7	\$1283		

HOW TO SPECIFY

Select Model Number H E C S V A P .	Select Fabric See page 206 H A M L 1 6 .	Select Base G Glide
---	---	-------------------------------

TANGRAM™ Accessories



Icon Legend on page 19

DESCRIPTION	MODEL	SHIP WEIGHT	CUBE	LIST PRICE
Ganging Bracket, 2/Pack	HECSG	5	0.5	\$109
Ganging Bracket Bulk Pack, 12/Pack	HECSBG	10	0.6	\$649

NOTES:

- Ganging brackets used to provide alignment between adjacent pieces but can be easily removed and repositioned for reconfiguration.
- Two ganging brackets used per side; for example, if ganging a Stoop + Perch, specify one HECSG.
- Ganging brackets are unpainted anodized aluminum.
- ! Perch units automatically ship with ganging brackets and L-brackets required for proper stability.

EDUCATION

HOW TO SPECIFY

Select Model Number

HECSG

WORKPLACE TOOLS



Flock® Modular Seating with Dean Power Module Under-Surface Mount.

WORKPLACE TOOLS

Workplace tools provide the finishing touch on any high-performance workspace. From storage options to technological tools and lighting solutions, HON's Workplace Tools deliver organization and efficiency to the office. Workplace Tools put everything you need to be productive within arm's reach, provide easy access to the connectivity you need to be successful and help you keep your workspace neat.



PRODUCT CATEGORIES

- Monitor Arms
- Keyboard Trays and Center Drawers
- Paper Management and Organizational Tools
- Task Lights
- Electrical and Power Management Accessories
- Ergonomic and Healthy Workplace Solutions

WORKPLACE TOOLS ORDERING INFORMATION

LAMINATE CENTER DRAWERS, LAMINATE PAPER MANAGEMENT MODELS HLVP1/HLDST1/ HLSL1472LS/HLSL1460LS

L1 LAMINATES CODES

Woodgrain

- ◆ Bourbon Cherry H
- ◆ Cognac COGN
- ◆ Florence Walnut LFW1
- ◆ Harvest C
- ◆ Kingswood Walnut LK11
- ◆ Mahogany N
- ◆ Mocha MOCH
- ◆ Natural Maple D
- ◆ Pinnacle PINC
- ◆ Shaker Cherry F
- ◆ Sterling Ash LSA1

Solid

- ◆ Black P
- ◆ Charcoal S
- ◆ Designer White LDW1
- ◆ Loft LOFT

L2 LAMINATES CODES

Woodgrain

- ◆ Lowell Ash LLA1
- ◆ Natural Recon LNR1
- ◆ Phantom Ecreu LPE1
- ◆ Portico Teak LPT1
- ◆ Skyline Walnut LSW1

LAMINATE KEYBOARD PLATFORM MODELS H4022/HE4022

L1 LAMINATES CODES

Woodgrain

- ◆ Bourbon Cherry H
- ◆ Cognac COGN
- ◆ Field Elm LWFE
- ◆ Florence Walnut LFW1
- ◆ Harvest C
- ◆ Kingswood Walnut LK11
- ◆ Mahogany N
- ◆ Mocha MOCH
- ◆ Natural Maple D
- ◆ Pinnacle PINC
- ◆ Shaker Cherry F
- ◆ Sterling Ash LSA1

Solid

- ◆ Black P
- ◆ Charcoal S
- ◆ Designer White LDW1

Patterned

- ◆ Handspun Chestnut LAHC
- ◆ Handspun Dove LAHD
- ◆ Handspun Pearl LAHP
- ◆ Handspun Slate LAHS
- ◆ Silver Mesh B9
- ◆ Steel Mesh A9
- ◆ Gray G2
- ◆ White G1

L2 LAMINATES CODES

Woodgrain

- ◆ Beigewood LWBE
- ◆ Fawn Cypress LFC1
- ◆ Lowell Ash LLA1
- ◆ Natural Recon LNR1
- ◆ Phantom Ecreu LPE1
- ◆ Portico Teak LPT1
- ◆ Skyline Walnut LSW1

METAL PAPER MANAGEMENT MODELS HHPS1 AND HDPS1

PAINT CODES

P1

- ◆ Black P
- ◆ Brownstone P7D
- ◆ Charcoal S
- ◆ Designer White PJW
- ◆ Fossil P28
- ◆ Light Gray Q
- ◆ Loft LOFT
- ◆ Muslin T3
- ◆ Putty L
- ◆ Titanium P8T

P2

- ◆ Champagne Metallic T4
- ◆ Gunmetal Metallic PR3
- ◆ Platinum Metallic T1
- ◆ Silver PR6

P3

- ◆ Atom P8S
- ◆ Blossom P8K
- ◆ Bullseye PJF
- ◆ Ember P8P
- ◆ Ion P8N
- ◆ Iris P8J
- ◆ Krypton P8F
- ◆ Ochre P093
- ◆ Regatta P8M
- ◆ Sienna P092
- ◆ Succulent P8A

METAL CENTER DRAWERS*, CORNER SLEEVES, METAL KEYBOARD PLATFORM, STORAGE CUBES, DRAWER ORGANIZER, HAND SANITIZER STATION

PAINT CODES

P1

- ◆ Black P
- ◆ Brownstone P7D
- ◆ Charcoal S
- ◆ Designer White PJW
- ◆ Fossil P28
- ◆ Light Gray Q
- ◆ Loft LOFT
- ◆ Muslin T3
- ◆ Putty L
- ◆ Titanium P8T

P2







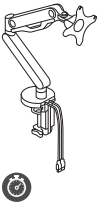
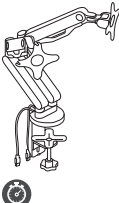
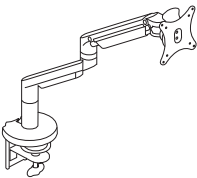

- ◆ Champagne Metallic T4
- ◆ Gunmetal Metallic PR3
- ◆ Platinum Metallic T1
- ◆ Silver PR6
- ◆ Solar Black P8X

P3

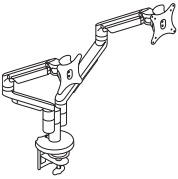
- ◆ Atom P8S
- ◆ Blossom P8K
- ◆ Bullseye PJF
- ◆ Ember P8P
- ◆ Ion P8N
- ◆ Iris P8J
- ◆ Krypton P8F
- ◆ Ochre P093
- ◆ Regatta P8M
- ◆ Sienna P092
- ◆ Succulent P8A

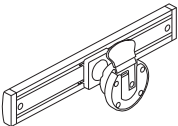
* Metal center drawer models HD2 and HD8 limited to P1 Paints, Champagne Metallic, and Platinum Metallic.

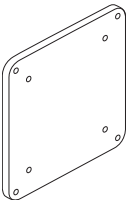
◆◆◆ For lead time information see page 21.

	DESCRIPTION	MODEL	SHIP WEIGHT	CUBE	LIST PRICE
	<p>Single Monitor Arm with 2 USB Ports</p> <p>NOTES: Easy adjustment. Height adjusts to 17" tall. Monitor tilt and swivel capability. Enclosed cable management. Grommet or desktop mounting. Clean appearance. HON 5-Year Limited Warranty.</p> <ul style="list-style-type: none"> Available in Silver only, no specification needed. Cannot be used in Empower® height adjustable applications. Arm holds monitors up to 19 lbs. 	HBSMAUSB	38.6	2.4	\$351
	<p>Dual Monitor Arm with 2 USB Ports</p> <p>NOTES: Easy adjustment. Height adjusts to 17" tall. Monitor tilt and swivel capability. Enclosed cable management. Grommet or desktop mounting. Clean appearance. In some applications the Monitor Arms may extend 12 or more inches into the worksurface. HON 5-Year Limited Warranty.</p> <ul style="list-style-type: none"> Available in Silver only, no specification needed. Cannot be used in Empower® height adjustable applications. Each arm holds monitors up to 19 lbs. 	HBDMAUSB	41.9	2.6	\$523
	<p>Single Dynamic Monitor Arm</p> <ul style="list-style-type: none"> 180° of rotation at base with optional 360° rotation. Arms extend 22" and retract up to 3". Monitor mount rotates 180° and tilts +/-30°. Monitor can be rotated from landscape to portrait position. <ul style="list-style-type: none"> Arms hold monitors from 6.2-18 lbs. Optional counterweight HPACW available to support monitors as low as 5 lbs. Back side of monitor arm base features opening for wire management through grommet when utilizing clamp mount. 	HMASTS	11.5 	0.8	\$637
	<p>Dual Dynamic Monitor Arm</p> <ul style="list-style-type: none"> Arms have 65° rotation at base with optional 130° and 360° rotations. Arms extend 22" and retract up to 3". Monitor mount rotates 180° and tilts +/-30°. Monitor can be rotated from landscape to portrait position. <ul style="list-style-type: none"> Arms hold monitors from 6.2-18 lbs. Optional counterweight HPACW available to support monitors as low as 5 lbs. Back side of monitor arm base features opening for wire management through grommet when utilizing clamp mount. 	HMASD 	17.0 	1.1	\$1223
	<p>Sliding Mount for Monitor Arm</p> <ul style="list-style-type: none"> Supports monitors up to 18 lbs. Compatible with VESA 75mm and 100mm mounts. Compatible with models HMASTS, HMASD, HPASD, HPADD, and HPATF. Available in two paint finishes, Silver (SVR) and Black (BLK). Plastic components ship in like color with specified paint finish. 	HPACSM	3.0 	0.3	\$264
	<p>Monitor Arm Counterweight</p> <ul style="list-style-type: none"> Optional counterweight for monitors as low as 5 lbs. Minimum weight for monitors without counterweight is 6.2 lbs. <ul style="list-style-type: none"> Available in Black only, no specification needed. Compatible with models HMASTS, HPASD, HMASD, HPADD, and HPATF. 	HPACW	3.0 	0.1	\$41

HOW TO SPECIFY

<p>Select Model Number</p> <p>H M A S T S .</p>	<p>Select Finish</p> <p>SVR Silver BLK Black</p> <p>S V R</p>
--	--

MONITOR ARMS



Icon Legend on page 19

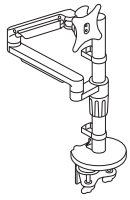

DESCRIPTION

Post Mount with Single Dynamic Arm

- Arm has 360° rotation at base.
- Monitor mount rotates 180° and tilts +/-30°.
- Monitor can be rotated from landscape to portrait position.
- Arm extends up to 20".
- Arm has 17¾" of vertical adjustment.

⚠ Available in Silver (SVR) finish only.

⚠ Arms hold monitors from 6.2-18 lbs. Optional counterweight HPACW available to support monitors as low as 5 lbs. (see page 229).

MODEL SHIP WEIGHT CUBE LIST PRICE

HPASD 15.5 1.3 \$891

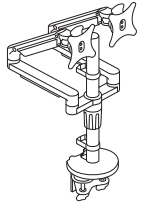

Post Mount with Dual Dynamic Arms

- Arms have 360° rotation at base.
- Monitor mount rotates 180° and tilts +/-30°.
- Monitor can be rotated from landscape to portrait position.
- Arms extend up to 20".
- Arms have 17¾" of vertical adjustment.

⚠ Available in Silver (SVR) finish only.

⚠ Arms hold monitors from 6.2-18 lbs. Optional counterweight HPACW available to support monitors as low as 5 lbs. (see page 229).

HPADD 19.5 1.3 \$1294

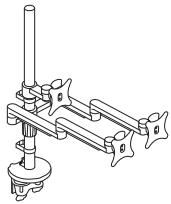

Post Mount with Triple Fixed Arms

- Features two fixed extended arms and one fixed center mount.
- Arms have 360° rotation at base.
- Monitor mount rotates 180° and tilts +/-30°.
- Monitor can be rotated from landscape to portrait position.
- Arms extend up to 20".
- Arms have 27½" of vertical adjustment.

⚠ Available in Silver (SVR) finish only.

⚠ Arms hold monitors from 6.2-18 lbs. Optional counterweight HPACW available to support monitors as low as 5 lbs. (see page 229).

HPATF 22.0 1.9 \$1481

WORKPLACE TOOLS

HOW TO SPECIFY

Select Model Number	Select Finish
HPASD.	SVR Silver
HPASD.	SVR



Icon Legend on page 19

CPU HOLDERS

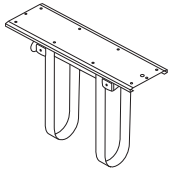

DESCRIPTION

360° Swivel CPU Holder with Adjustable Straps

- Supports CPUs 3¾" wide up to 64" perimeter and holds up to 75 lbs.
- 360° rotation.
- Ships complete and includes necessary mounting hardware and instruction sheet.

ⓘ Available in Black only, no specification needed.

MODEL	SHIP WEIGHT	CUBE	LIST PRICE
HCPU1	7	0.2	\$332

HOW TO SPECIFY



Select Model Number

H C P U 1

KEYBOARD TRAYS

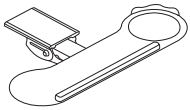

Icon Legend on page 19

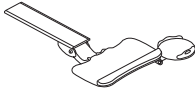
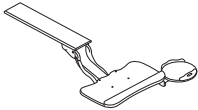
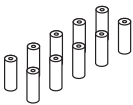
	DESCRIPTION	MODEL	SHIP WEIGHT	CUBE	LIST PRICE
	Short Track and Keyboard Platform <ul style="list-style-type: none"> Height adjustable total of 5$\frac{3}{4}$" (1$\frac{3}{4}$" above and 4" below). +10°, -20° of tilt adjustment. 360° rotation. 	HKTSHORT	10 	0.8	\$767
	Mid Track with Keyboard and Mouse Platform <ul style="list-style-type: none"> Height adjustable total of 8" (3" above and 5" below). +10°, -20° of tilt adjustment. 360° rotation. 	HKT MID	17	1.2	\$705
	Sit to Stand Long Track with Keyboard and Mouse <ul style="list-style-type: none"> Height adjustable total of 12$\frac{1}{2}$" (7$\frac{1}{2}$" above and 5" below). +10°, -20° of tilt adjustment. 360° rotation. 	HKTLONG	17	0.8	\$823
	Keyboard Spacer <ul style="list-style-type: none"> Used when attaching HKT MID or HKTLONG to Coordinate™ and Voi® or Systems Worksurface with an external channel. The kit includes ten cylinder spacers and ten screws. Spacers are $\frac{3}{4}$"W x 2$\frac{1}{8}$"H. Specify one kit per keyboard tray. 	HKBS	1	0.8	\$136

NOTES:

 Available in Black only, no specification needed.

WORKPLACE TOOLS

HOW TO SPECIFY

Select Model Number

H K T M I D



Icon Legend on page 19

KEYBOARD TRAYS

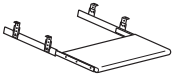
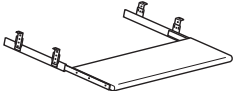
	DESCRIPTION	MODEL	SHIP WEIGHT	CUBE	LIST PRICE BY LAMINATE GRADE	
					L1	L2
	Laminate Keyboard Platform <ul style="list-style-type: none"> Laminate Tray dimensions: 21½"W x 10"D x 1⅛" Thick. Minimum clearance for mounting: 22⅞"W x 17"D. Surface can be positioned 2", 2½", 3" or 3½" below bottom of worksurface. Will not fit on a 37" x 24" Corner worksurface. 	H4022	10	0.6	\$292	\$310
	Laminate Keyboard Platform with Extended Tray <ul style="list-style-type: none"> Laminate Tray dimensions: 30"W x 10"D x 1⅛" Thick. Minimum clearance for mounting: 32½"W x 17"D. Surface can be positioned 2", 2½", 3" or 3½" below bottom of worksurface. Will not fit on a 37" x 24" Corner worksurface. Ball-bearing slide; slide and brackets are Black. 	HE4022	12	0.7	\$411	\$429

HOW TO SPECIFY

Select Model Number	Select Laminate
H 4 0 2 2 .	H
See page 228	

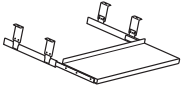
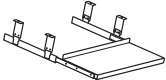
	DESCRIPTION	MODEL	SHIP WEIGHT	CUBE	LIST PRICE BY PAINT GRADE		
					P1	P2	P3
	30"W Metal Keyboard and Mouse Tray <ul style="list-style-type: none"> Designed to hold keyboards and allow room for mouse pads. Tray dimensions: 30"W x 10"D. Minimum clearance for mounting: 32½"W x 15"D. 	H4028	11	1.5	\$211	\$224	\$232
	24"W Metal Keyboard Tray <ul style="list-style-type: none"> Designed to hold ONLY keyboards. Tray dimensions: 24"W x 10"D. Minimum clearance for mounting: 26½"W x 15"D. 	H4029	11	1.5	\$191	\$204	\$212

NOTES:

- Surface is positioned 3" below bottom of worksurface.
- Non-articulating, only movement is front-to-back. Does not tilt or swivel.

HOW TO SPECIFY

Select Model Number	Select Paint Color
H 4 0 2 8 .	P
See page 228	

CORNER SLEEVES



Icon Legend on page 19

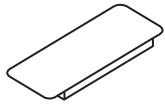

DESCRIPTION

Metal Corner Sleeves

22 1/2" W Leading Edge x 9" D

- Fits 1/8" thick square edge detail.

MODEL	SHIP WEIGHT	CUBE	LIST PRICE BY PAINT GRADE		
			P1	P2	P3
H51204	10	1.5	\$231	\$241	\$248
H51206	10	1.5	\$231	\$244	\$251

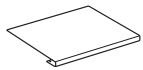

22 1/2" W Leading Edge x 18" D

- Fits 1/8" thick square edge detail.

NOTES:

- Corner sleeve connects intersecting worksurfaces to create "corner desk" work areas.

Edge Detail



HOW TO SPECIFY

<p>Select Model Number</p> <p>H 5 1 2 0 4 . P</p>	<p>Select Paint Color</p> <p>See page 228</p>
---	---



Icon Legend on page 19

CENTER DRAWERS



Angled front

DESCRIPTION

Laminate Center Drawer

22"W x 15⁵/₈"D x 2¹/₂"H

- Ball-bearing slide suspension.
- 12" drawer extension (3/4).
- Inside drawer dimension for H1522: 18⁷/₈"W x 15¹/₂"D x 1¹/₂"H.
- Minimum clearance for mounting H1522: 22³/₄"W x 18¹/₂"D compatible with 72"W x 36"D, 66"W x 30"D, 60"W x 30"D Double Pedestal Desks, 72"W x 36"D, 66"W x 30"D Single Pedestal Desks, Bullet and P-Shaped Peninsulas, 72"W x 24"D, 66"W x 24"D, 60"W x 24"D Credenza w/Kneespace, 72"W x 24"D, 66"W x 24"D Single Pedestal Credenzas, 48"W x 24"D, 42"W x 24"D Returns.
- Designed for use with Concinnity™, Voi®, Valido® and 10500 Series™.
- Includes pencil tray.

NOTES: For 60"W x 30"D Modular Desk Shells with two 15⁵/₈"W Storage Pedestals or 60"W x 24"D Modular Credenza Shells with two 15⁵/₈"W Storage Pedestals, use center drawer H1522.

MODEL	SHIP WEIGHT	CUBE	L1 LIST PRICE	L2 LIST PRICE
H1522	11	1.1	\$266	\$284

HOW TO SPECIFY

Select Model Number

H 1 5 2 2 .

Select Laminate

See page 228

H

CENTER DRAWERS



Icon Legend on page 19

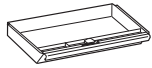

Angled front

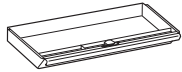

Angled front



DESCRIPTION

Metal Center Drawer w/Lock

19"W x 14³/₄"D x 3"H

- Ball-bearing slide suspension.
- 12" drawer extension (3/4).
- Inside drawer dimension: 19"W x 13"D x 2³/₈"H.
- Minimum clearance for mounting: 21³/₄"W x 19¹/₄"D.
- Core removable lock.

24³/₄"W x 14³/₄"D x 3"H

- Ball-bearing slide suspension.
- 12" drawer extension (3/4).
- Inside drawer dimension: 24¹/₂"W x 13"D x 2³/₈"H.
- Minimum clearance for mounting: 27³/₈"W x 19¹/₄"D.
- Core removable lock.

MODEL	SHIP WEIGHT	CUBE	LIST PRICE BY PAINT GRADE	
			P1	P2

HD2	9 Ⓔ	1.0	\$401	\$414
------------	------------	-----	--------------	--------------

HD8	12 Ⓔ	1.2	\$401	\$414
------------	-------------	-----	--------------	--------------

DESCRIPTION

Polymer Center Drawer

- Material: ABS.
- Minimum clearance for mounting: 23"W x 16¹/₄"D x 2"H.
- Retracts on 16" ball-bearing slides.
- Can be used on worksurfaces with Coordinate™ Height Adjustable Bases as long as it is attached with spacer model HKBS.
- Can store up to 25 lbs.

! Black finish only, no specification needed.

MODEL	SHIP WEIGHT	CUBE	LIST PRICE
-------	-------------	------	------------

HCD1	7	0.5	\$170
-------------	---	-----	--------------

NOTES:

- All metal center drawers feature pencil trays with three compartments for storage.
- All metal center drawers feature core removable locks for greater personal and departmental security.

WORKPLACE TOOLS

HOW TO SPECIFY

Select Model Number

Select Paint Color

See page 228

HD2.

P

CHAIR MATS

	DESCRIPTION	MODEL	SHIP WEIGHT	CUBE	LIST PRICE
	Lipped Chair Mat with Studs 48"W x 36"D	HCM3648LS ⓘ	8.8	0.6	\$127
	Lipped Chair Mat without Studs 60"W x 46"D 48"W x 36"D	HCM4660LN HCM3648LN ⓘ	13.2 8.3	0.5 0.3	\$212 \$127

NOTES:

- Available with studs for carpet and without studs for hard-surface floors.
 - Ships rolled.
 - **HON 5-Year Limited Warranty.**
- ⓘ Available in Clear finish only, no specification needed.

HOW TO SPECIFY

Select Model Number

H C M 3 6 4 8 L S

TASK LIGHTS



Icon Legend on page 19



DESCRIPTION

Articulating Desk Lamp

Articulating Desk Lamp w/ Occupancy Sensor

- Full-range dimming from 10% to 100%.
- Designed for 50,000 hours of life.
- Occupancy sensor is built into the head of the lamp and will automatically shut the lamp off after 6 minutes of undetected movement.
- Base swivel is 180 degrees.
- Uses only 5 watts of energy.
- Light comes with a silver 9' 4" power cord.
- Base diameter is 7.5".
- 3500K Color Temperature.
- 80 Color Rendering Index.
- TAA Compliant.

! Available in Matte Silver finish only, no specification needed.

MODEL SHIP WEIGHT CUBE LIST PRICE

MODEL	SHIP WEIGHT	CUBE	LIST PRICE
HLED1	1.2	6.5	\$548
HLED1OC	1.2	6.5	\$666



Task Desk Lamp

- Full-range dimming from 10% to 100%.
- Designed for 50,000 hours of life.
- Lamp is 15.83" tall.
- Desk lamp does not articulate at base. The pivoting head provides custom positioning, as it can be twisted 360 degrees.
- Uses only 5 watts of energy.
- Light comes with a silver 9' 4" power cord.
- Base diameter is 6.7".
- 3500K Color Temperature.
- 80 Color Rendering Index.
- TAA Compliant.

! Available in Brushed Nickel finish only, no specification needed.

MODEL	SHIP WEIGHT	CUBE	LIST PRICE
HLED2	0.7	3.0	\$476

WORKPLACE TOOLS

HOW TO SPECIFY

Select Model Number

HLED1



Icon Legend on page 19

TASK LIGHTS

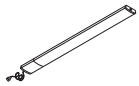

DESCRIPTION

LED Task Lights

17" LED Light with Power Supply (Single)
31" LED Light with Power Supply (Single)

17" LED Light with Power Supply for Daisy-chain (Starter)
31" LED Light with Power Supply for Daisy-chain (Starter)

17" LED Light with 8" Jumper Cord for Daisy-chain (Follower)
31" LED Light with 8" Jumper Cord for Daisy-chain (Follower)

Undercabinet Occupancy Sensor with 1" End to End Connector

NOTES: To use the daisy chain application, must start with model HLED17A or HLED31A. No finish specification required. Attaches magnetically to underside of overhead storage, or attaches with provided screws or double-sided tape. Occupancy sensor attaches to a single or starter LED light and will automatically turn the light off after no motion is detected for 30 minutes. Just like all the LED light models, the occupancy sensor features a soft-touch on/off switch. LED task lights have a lifetime of 50,000 hours and have a dimmer feature that allows the user to adjust the amount of light output.

MODEL

SHIP WEIGHT

CUBE

LIST PRICE

MODEL	SHIP WEIGHT	CUBE	LIST PRICE
HLED17AS	1.2	0.05	\$574
HLED31AS	1.5	0.09	\$768
HLED17A	1.0	0.05	\$628
HLED31A	1.4	0.09	\$842
HLED17AUO	1.0	0.03	\$514
HLED31AUO	1.0	0.05	\$686
HLEDOSA	0.2	0.01	\$126

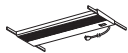

Recessed Task Lights

- Color: Black.
- Slim profile design.
- Mount to stack-on storage and wall mounted storage cabinets.
- 9-foot black cord and switch off right rear corner.
- Features LED strip.
- Lights ordered after October 4, 2021 will feature new LED light strip.

18 ³ / ₈ "W x 3 ¹ / ₁₆ "D x 1 ¹ / ₈ "H	HH870924	5.0	0.40	\$312
Chicago code version (with fused plug)	HH870924CH	5.0	0.40	\$394
22 ⁷ / ₈ "W x 3 ¹ / ₁₆ "D x 1 ¹ / ₈ "H	HH870930	7.0	0.60	\$316
Chicago code version (with fused plug)	HH870930CH	7.0	0.60	\$410
34 ⁵ / ₈ "W x 3 ¹ / ₁₆ "D x 1 ¹ / ₈ "H	HH870942	10.0	0.90	\$341
Chicago code version (with fused plug)	HH870942CH	10.0	0.90	\$433
46 ¹ / ₂ "W x 3 ¹ / ₁₆ "D x 1 ¹ / ₈ "H	HH870960	12.0	1.10	\$370
Chicago code version (with fused plug)	HH870960CH	12.0	1.10	\$460

WORKPLACE TOOLS

HOW TO SPECIFY

Select Model Number

HH870924

PAPER MANAGEMENT & ORGANIZATIONAL TOOLS



Icon Legend on page 19

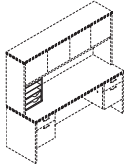

Not available in two-tone laminate

DESCRIPTION	MODEL	SHIP WEIGHT	CUBE	LIST PRICE BY LAMINATE GRADE	
				L1	L2
Vertical Paper Manager 14 $\frac{7}{8}$ "W x 10 $\frac{7}{8}$ "D x 19 $\frac{3}{8}$ "H NOTES: Keeps papers, files, and books neatly organized and within easy reach from a seated position. Designed for desk, credenza, and return tops. Fits under stack-on storage models. Two pullout drawers and three fixed shelves. Not available in pattern laminate colors. Ships fully assembled. ⓘ Requires 19 $\frac{3}{4}$ "H minimum of clear space between underside of overhead storage unit and worksurface. SPECIFYING EXAMPLE: HLVPM1.N	HLVPM1	27	2.8	\$468	\$481

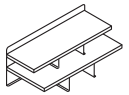

Not available in two-tone laminate



Desktop Storage Terrace 26 $\frac{1}{2}$ "W x 12 $\frac{1}{2}$ "D x 10 $\frac{1}{2}$ "H NOTES: For use on the tops of 29 $\frac{1}{2}$ "H desks, credenzas, and returns. Features six storage sections plus top display shelf. Keeps work-in-process, priority files, loose pages, and mail neatly organized and in view. Mixed material design comprised of sturdy laminate shelves with metal back and support panels. Not available in two-tone laminate combination or pattern laminate colors. Choose from Platinum Metallic (T1), Black (P), and Charcoal (S) for the metal components. Sized to fit in stack-on and wall mount storage cabinets in 10500, Valido, Concinnity, 94000, and 38000 Series. Fits in Concinnity and Voi sliding door models, except for 48"W or smaller models. Specify: Model.Laminate.Paint SPECIFYING EXAMPLE: HLDST1.N.T1	HLDST1	24	1.1	\$438	\$451
---	---------------	----	-----	--------------	--------------

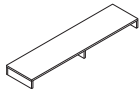

Layering Shelf 72"W x 14 $\frac{1}{2}$ "D x 5 $\frac{1}{2}$ "H 60"W x 14 $\frac{1}{2}$ "D x 5 $\frac{1}{2}$ "H NOTES: Layering shelf works with lower credenzas to provide additional storage areas. ⓘ Layering Shelves cannot be stacked. ⓘ Cannot add a hutch on top of a layering shelf.	HLSL1472LS HLSL1460LS	50 39	4.6 1.3	\$629 \$528	\$642 \$541
---	--	----------	------------	------------------------------	------------------------------

WORKPLACE TOOLS

HOW TO SPECIFY

Select Model Number H L V P M 1 . N	Select Laminate See page 228
---	--



Icon Legend on page 19

PAPER MANAGEMENT & ORGANIZATIONAL TOOLS

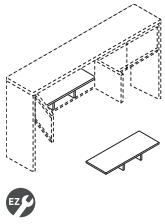

DESCRIPTION

Stacked Paper Management

32½"W x 12½"D x 4¼"H

MODEL SHIP WEIGHT CUBE LIST PRICE

HLVPM2 22 1.25 \$235

NOTES: Segments and organizes stack-on and wall mount storage compartments, as well as bookcase shelves. Unit can be used in Models H105327, H10534, H105322, H105321, H105382 and H105381.

- Available in Black finish only, no specification needed.
- In some cases, installation of Stacked Paper Management may require removing the stack-on or wall mount storage doors.

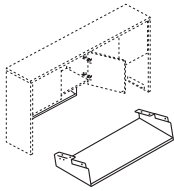

DESCRIPTION

Hanging Paper Shelf

28½"W x 11½"D x 4¾"H

MODEL SHIP WEIGHT CUBE LIST PRICE BY PAINT GRADE

HHPS1 7 2.9 \$287 \$298 \$310

NOTES: Attaches quickly and easily (screws included). Maximizes worksurface space; de-clutters desktop while placing priority communications and active project folders within easy reach. Angled design allows contents to be distinguished at a glance. Mixed material styling features strong painted metal frame with a frosted shelf.

Attaches quickly and easily to laminate stack-on and wall mount storage models (except the 36"W Voi® overhead hutch with O-legs or panel mount brackets). Not for use with 38000 Series™ and Systems.

Specify: Model.Paint

SPECIFYING EXAMPLE: HHPS1.T1

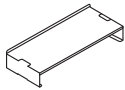

Desktop Paper Shelf

28½"W x 11½"D x 5"H

HDPS1 7 2.9 \$287 \$298 \$310

NOTES: Desktop Paper Shelf and Storage Terrace include protective, non-slip pads on the base. Paper Shelf can stack two-high. Organizer shelf provides a place and space for work-in-process and piling to keep worksurfaces neat and tidy. Convenient, scalable design with interlocking side supports allow two units to be stacked and integrated. Durable painted metal frame with a frosted shelf; mixed material styling matches hanging paper shelf.

Can also be used inside select overhead storage, including the following stack-on with clearance and hinged door models: 10500 and Valido 36", 42", 66", 72", 78"W.

Specify: Model.Paint

SPECIFYING EXAMPLE: HDPS1.T1

WORKPLACE TOOLS

HOW TO SPECIFY

Select Model Number	Select Paint Color							
	See page 228							
<table border="1"> <tr> <td>H</td> <td>H</td> <td>P</td> <td>S</td> <td>1</td> <td>.</td> </tr> </table>	H	H	P	S	1	.	<table border="1"> <tr> <td>P</td> </tr> </table>	P
H	H	P	S	1	.			
P								

PAPER MANAGEMENT & ORGANIZATIONAL TOOLS



Icon Legend on page 19



DESCRIPTION

Storage Cube
12"W x 12"D
SPECIFYING EXAMPLE: HLSL1212.P8S

MODEL

HLSL1212

SHIP WEIGHT

1

CUBE

0.3

LIST PRICE BY PAINT GRADE

P1

\$421

P2

\$421

P3

\$421

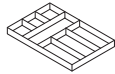

Drawer Organizer
12"W x 14½"D x 1½"H

SPECIFYING EXAMPLE: HSLDRWORG.P8F

HSLDRWORG

1

0.5

\$230

\$230

\$230

DESCRIPTION

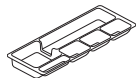
Optional Pencil Tray

 ⓘ For use with mobile and freestanding pedestal models.
 ⓘ No specification required.

MODEL

HV-UT1

SHIP WEIGHT

0.5

CUBE

0.1

LIST PRICE

\$100

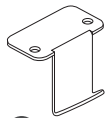

Back Pack Hook (10 per carton)
2¼"W x 2¾"D x 1¾"H

NOTES: Assembly: attaches to bottom of desk with (2) screws, included.

ⓘ Available in Platinum Metallic finish only, no specification needed.

HCLA65

10.0 ⓘ

0.1

\$127

WORKPLACE TOOLS

HOW TO SPECIFY

<p>Select Model Number</p> <p>H L S L 1 2 1 2 . P 8 S</p>	<p>Select Paint Color</p> <p>See page 228 Only specify for models HLSL1212 and HSLDRWORG</p>
---	--



Icon Legend on page 19

PAPER MANAGEMENT & ORGANIZATIONAL TOOLS

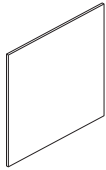

DESCRIPTION

Wall Mount Tackboard

36"W x 35¼"H
30"W x 35¼"H

36"W x 48⅝"H
30"W x 48⅝"H

NOTES: When positioned above 29½"H floor-standing storage, the sizes align with overhead storage height options. Can be positioned side-by-side with corresponding wall mount markerboard sizes. Easy to install; includes mounting hardware. Attaches to wall with horizontally mounted, interlocking Z-clip brackets. For the space directly below stack-on and wall mount storage cabinets, use the 18"H tackboard models listed in the Desks section in the 2025 Workspaces Pricer.

SPECIFYING EXAMPLE: HNL3636TB.APN15

MODEL

SHIP WEIGHT

CUBE

LIST PRICE

HNL3636TB

20

2.9

\$431

HNL3630TB

16

2.9

\$366

HNL4936TB

27

5.5

\$502

HNL4930TB

22

3.7

\$417

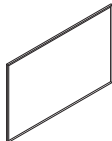

Markerboard

48"W x 31"H

NOTES: Wall mounted.

⚠ No specification required.

HLSL4831MB

44

3.4

\$948



HOW TO SPECIFY

Select Model Number

H N L 3 6 3 6 T B

Select Fabric Color

See pages 26-27

A P N 1 1

INTERLINK IQ ELECTRICAL

Specification guide for IQ Electrical on Training tables

Determine table width, the type of power access being used (3" grommet or 4x8 pop-up) and the desired number per table (Columns 1, 2 or 3). The table will then identify the type and quantity of components needed per table along with the maximum table run. Note that this is in addition to the Power base in-feed which is needed for each run. For example, a 48"W table with two 3" power grommets per table will require (1) HQH5-3 harness and (1) HQH1-3 harness per table with a maximum run of four tables.

Top Width	POWER ONE (1) PER TABLE 3" ROUND POWER GROMMET		POWER TWO (2) PER TABLE 3" ROUND POWER GROMMETS		POWER ONE (1) PER TABLE 4x8 POP-UP PORT	
36"	(1) HQH5-3	8 Table Run Maximum	N/A	N/A	(1) HQH5-P	8 Max Table Run
42"	(1) HQH5-3	8 Table Run Maximum	N/A	N/A	(1) HQH5-P	8 Max Table Run
48"	(1) HQH5-3	8 Table Run Maximum	(1) HQH5-3 (1) HQH1-3	4 Max Table Run	(1) HQH5-P	8 Max Table Run
54"	(1) HQH5-3	8 Table Run Maximum	(1) HQH5-3 (1) HQH1-3	4 Max Table Run	(1) HQH5-P	8 Max Table Run
60"	(1) HQH5-3	8 Table Run Maximum	(1) HQH5-3 (1) HQH1-3	4 Max Table Run	(1) HQH5-P	8 Max Table Run
66"	(1) HQH5-3 (1) HJQJ3	4 Table Run Maximum	(1) HQH5-3 (1) HQH1-3	4 Max Table Run	(1) HQH5-P (1) HJQJ3	4 Max Table Run
72"	(1) HQH5-3 (1) HJQJ3	4 Table Run Maximum	(1) HQH5-3 (1) HQH1-3	4 Max Table Run	(1) HQH5-P (1) HJQJ3	4 Max Table Run
84"	(1) HQH5-3 (1) HJQJ3	4 Table Run Maximum	(2) HQH5-3	4 Max Table Run	(1) HQH5-P (1) HJQJ3	4 Max Table Run
96"	(1) HQH5-3 (1) HJQJ3	4 Table Run Maximum	(2) HQH5-3	4 Max Table Run	(1) HQH5-P (1) HJQJ3	4 Max Table Run
Half-Round (all sizes)	(1) HQH1-3	2 Tables Maximum	N/A	N/A	(1) HQH5-P	2 Max Table Run
Trapezoid (all sizes)	(1) HQH5-3	8 Table Run Maximum	N/A	N/A	(1) HQH5-P	8 Max Table Run



NOTES:

- Interlink IQ Electrical is a pluggable, single circuit electrical system.
 - All electrical models include wire management clips and hardware.
 - Interlink IQ Electrical is non-sequential/non-directional.
 - Interlink IQ Electrical is UL Recognized as a Powered Table System and meets the requirements of UL 962 when paired with Motivate® or Huddle tables.
- ⓘ 40' maximum run, or no more than 8 units, whichever comes first. Interlink IQ system will automatically shut off if maximum requirements are exceeded. Maximum run is based upon electrical harness width, not table width.

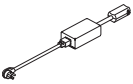
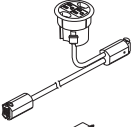
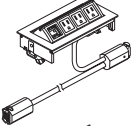
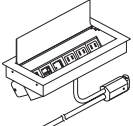
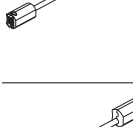
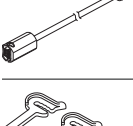
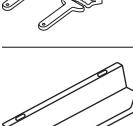
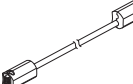

Icon Legend on page 19

INTERLINK IQ ELECTRICAL

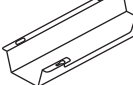
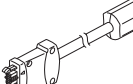
	DESCRIPTION	MODEL	SHIP WEIGHT	CUBE	LIST PRICE
	Power Base In-Feed <ul style="list-style-type: none"> 12 amp circuit breaker is built in to the Power Base In-Feed. Available in Black finish, no specification needed. 	HQB ☺	2.0	0.2	\$697
	Power Harness – 1' Power Hub, 3" Round Grommet Mount <ul style="list-style-type: none"> Available in Black finish, no specification needed. 	HQH1-3 ☺	2.0	0.2	\$230
	Power Harness – 5' Power Hub, 3" Round Grommet Mount <ul style="list-style-type: none"> Available in Black finish, no specification needed. 	HQH5-3 ☺	2.0	0.2	\$257
	Power Harness – 5' with 4" x 8" Pop-Up Port (3 Power, 1 Blank) <ul style="list-style-type: none"> For use with tables G1 grommet. Specify paint. 	HQH5-P-3P1B	3.0	0.3	\$502
	Power Harness – 5' with 5" x 11" Flip-Top Port (3 Power, 3 Blank) <ul style="list-style-type: none"> For use with Preside® G2 grommet. Specify paint. 	HQH5-E-3P3B	5.0	0.2	\$528
	Power Harness – 5' with 5" x 11" Flip-Top Port (3 Power, 1 Extron Double Space) <ul style="list-style-type: none"> For use with Preside® G2 grommet. Specify paint. 	HQH5-E-3P1E	5.0	0.2	\$557
	Power Harness – 5' with 5" x 11" Flip-Top Port (3 Power, 2 USB A+C, 2 Blank) <ul style="list-style-type: none"> For use with Preside® G2 grommet. Specify paint. 	HQH5-E-3P1U2B	5.0	0.2	\$581
	Power Jumper – 3' <ul style="list-style-type: none"> Available in Black finish, no specification needed. 	HQJ3 ☺	2.0	0.2	\$146
	Ganging Hardware <ul style="list-style-type: none"> Includes two ganging links and two screws. No color designator when specifying. <i>Example: HMAGANG.</i> 	HMAGANG ☺	1.0	0.1	\$145
	Cable Management Troughs 17"W – Single ! Graphite only, no specification needed. NOTES: For additional information see page 253.	HPWRTRGH17 ☺	2.7	0.5	\$96
	IQ 1.0 Backward Compatible Jumper 36" <ul style="list-style-type: none"> Available in Black finish, no specification needed. Use when connecting Interlink IQ 1.0 power harness (rectangle end) to Interlink IQ 2.0 (oval end) power harness. ! If using Interlink IQ 2.0 in-feed with Interlink IQ 1.0 power harness please contact Customer Support.	HQBCJ36	2.0	0.2	\$111

WORKPLACE TOOLS

NOTES:

- Use HQH5-P models with G1 table top cutouts and HQH5-E models with G2 table top cutouts.
- Interlink IQ Electrical is a pluggable, single circuit electrical system.
- All electrical models include wire management clips and hardware.
- Interlink IQ Electrical is non-sequential/non-directional.
- Interlink IQ Electrical is UL Recognized as a Powered Table System and meets the requirements of UL 962 when paired with Motivate® or Huddle tables.
- !** 40' maximum run, or no more than 8 units, whichever comes first. Interlink IQ system will automatically shut off if maximum requirements are exceeded. Maximum run is based upon electrical harness width, not table width.

HOW TO SPECIFY

Select Model Number HQH5-E-3P3B	Select Paint Color FOG Fog SVR Silver BLK Black SVR
---	--

4-TRAC HARDWIRE ELECTRICAL SYSTEM

4-Trac Electrical System

The 4-Trac Electrical System is a UL-recognized Manufactured Wiring System that seamlessly passes power from one worksurface to another. This low-profile non-sequential electrical system allows tables to be “daisy-chained” together in any desired order and allows users to reconfigure quickly due to simple connectable/disconnectable links.

- Meets requirements of UL 183 and National Electric Code Article 604
- 4-Wires, 2-circuits, 20 Amps each (Circuit 1 and Circuit 2 only)
- 13 Duplex Receptacles per circuit, 26, 15 Amp Duplex receptacle per power in-feed
- Electrical system attaches directly to underside of worksurface with included brackets
- Up to twelve tables can be linked together

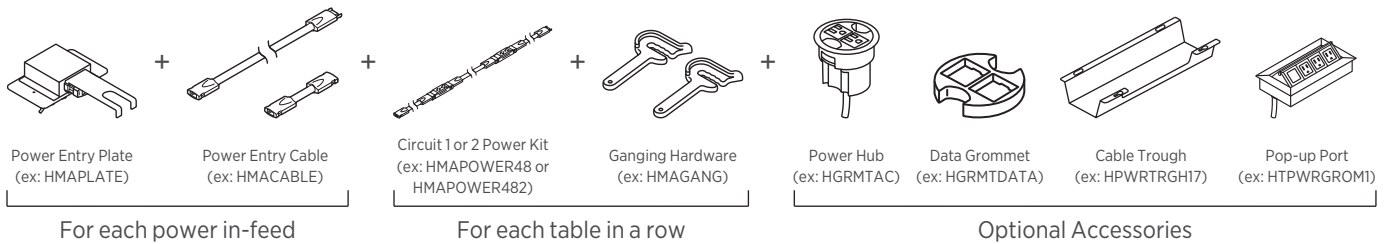

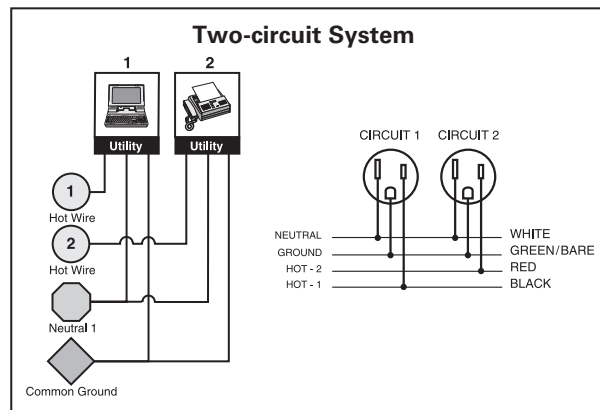
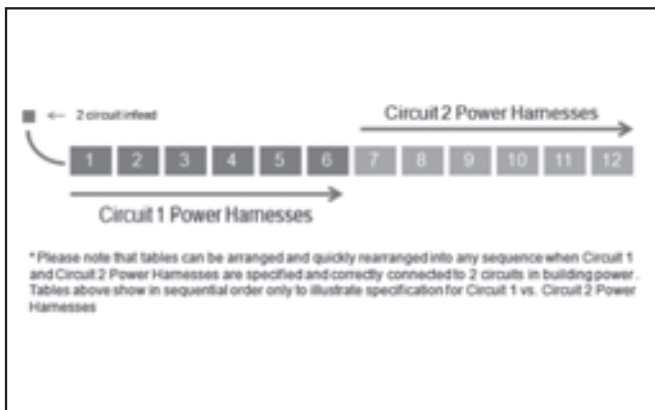

Steps for Electrical Specifications:

- Determine how many rows of tables are needed and order the following:
 - One HMAPLATE per row (or power in-feed)
 - One HMACABLE per row (or power in-feed)
- Order one power harness per table in each row
 - For 1-6 tables in a row (see illustration 1)
 - Order Circuit 1 Power Harnesses (ex. If powering six 24x60 tables order six sets of HMAPOWER60)
 - For 7-12 tables in a row (see illustration 1)
 - Order Circuit 1 Power Harness for first six tables and Circuit 2 Power Harness for remaining tables (ex. If powering eight 24x60 tables, order six sets of HMAPOWER60 and two sets of HMAPOWER602)
- Order one set of ganging hardware per table (ex. HMAGANG)
- Determine which accessories are needed:
 - Power Hub model HGRMTAC — to access power at worksurface.
 - Data Grommet model HGRMTDATA — to access data at worksurface.
 - Wire Management strips model HBTMS — for vertical and horizontal wire management.

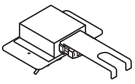
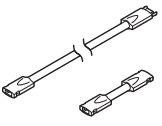
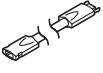

4-TRAC HARDWIRE ELECTRICAL SYSTEM

	DESCRIPTION	MODEL	SHIP WEIGHT	CUBE	LIST PRICE
	Power Entry Plate	HMAPLATE ⓘ	1.0	0.2	\$145
	Power Entry Cable • 6' power entry cable with male/female adapter. • Connects table to power entry plate.	HMACABLE ⓘ	1.8	0.2	\$224
	Power Jumper Cable To connect tables front to front	HMAJUMP ⓘ	0.5	0.3	\$78
	Circuit 1 Power Kit for 36" W Table	HMAPOWER36	1.5 ⓘ	0.3	\$404
	Circuit 1 Power Kit for 42" W Table	HMAPOWER42	1.8 ⓘ	0.3	\$410
	Circuit 1 Power Kit for 48" W Table	HMAPOWER48	1.8 ⓘ	0.3	\$412
	Circuit 1 Power Kit for 54" W Table	HMAPOWER54	2.0 ⓘ	0.3	\$419
	Circuit 1 Power Kit for 60" W Table	HMAPOWER60 ⓘ	2.0 ⓘ	0.3	\$422
	Circuit 1 Power Kit for 66" W Table	HMAPOWER66	2.2 ⓘ	0.3	\$430
	Circuit 1 Power Kit for 72" W Table	HMAPOWER72	2.2 ⓘ	0.3	\$433
	Circuit 1 Power Kit for 84" W Table	HMAPOWER84	2.4 ⓘ	0.3	\$449
	Circuit 1 Power Kit for 96" W Table	HMAPOWER96	2.6 ⓘ	0.3	\$464
	Circuit 2 Power Kit for 36" W Table	HMAPOWER362	1.5 ⓘ	0.3	\$404
	Circuit 2 Power Kit for 42" W Table	HMAPOWER422	1.8 ⓘ	0.3	\$410
	Circuit 2 Power Kit for 48" W Table	HMAPOWER482	1.8 ⓘ	0.3	\$412
	Circuit 2 Power Kit for 54" W Table	HMAPOWER542	2.0 ⓘ	0.3	\$419
	Circuit 2 Power Kit for 60" W Table	HMAPOWER602	2.0 ⓘ	0.3	\$422
Circuit 2 Power Kit for 66" W Table	HMAPOWER662	2.2 ⓘ	0.3	\$430	
Circuit 2 Power Kit for 72" W Table	HMAPOWER722	2.2 ⓘ	0.3	\$433	
Circuit 2 Power Kit for 84" W Table	HMAPOWER842	2.4 ⓘ	0.3	\$449	
Circuit 2 Power Kit for 96" W Table	HMAPOWER962	2.6 ⓘ	0.3	\$464	
	Electrical Connectors 4-Way Splitter ⓘ Available in Black (P) only. SPECIFYING EXAMPLE: HMASPLIT.P	HMASPLIT	0.9 ⓘ	0.1	\$73

NOTES:

- Each power kit includes two duplex receptacles and attaches to the underside of the worksurface with included brackets.
- Power Kits are compatible with various base types including nesting bases.
- Available in Black finish, no specification needed.

HOW TO SPECIFY







Select Model Number

H M A P L A T E

POWER & CABLE MANAGEMENT

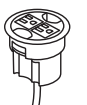

Icon Legend on page 19

	DESCRIPTION	MODEL	SHIP WEIGHT	CUBE	LIST PRICE
 <i>Black only</i>	Black Field Installable Grommet with One Access Hole <ul style="list-style-type: none"> Intended for use in tops and end panels to route/hide cords and facilitate reaching wall electrical outlets. Requires a 2½" diameter hole saw and drill for installation (not included). Grommet cap measures 3" diameter and includes a ¾" diameter cord access hole. Grommet sleeve measures 2½" O.D. x ¾" thick. Includes instructions to locate grommet position for desks, credenzas, returns and bridges. <p>⚠ The grommet is not designed to be used with the following HON Series: 94000, 38000, Metro Classic or 34000.</p>	HFLDGRMT	0.1	0.01	\$48
	Black Field Installable Grommet with Two Access Holes <ul style="list-style-type: none"> Requires a 3" diameter hole saw and drill for installation (not included). Grommet outside dimensions measures 3½" diameter. Grommet sleeve measures 3" O.D. x 1" thick. Includes instructions to locate grommet position for desks, credenzas, returns and bridges. 	HFLDGRMT3	0.1	0.3	\$48
	Platinum Field Installable Grommet with Two Access Holes <ul style="list-style-type: none"> Requires a 3" diameter hole saw and drill for installation (not included). Outside dimension measures 3½" diameter. Sleeve hole in worksurface measures 3" O.D. x 1" thick. Includes instructions to locate grommet position for desks, credenzas, returns, and bridges. 	HFLDGRMT4	0.1	0.01	\$48
	Power Hub, 3" Grommet Mount, 6' Cord <ul style="list-style-type: none"> Fits in 3" round grommet holes. Two grounded AC power outlets. Includes 6' cord with three-prong plug. Field installed with Plug-and-play ease. <p>⚠ Available in black only (no color designation so use .X - Specify: HGRMTAC.X).</p>	HGRMTAC	1.3	0.2	\$179
	3" Round Power Grommet - 2 Outlets, 10' Cord <ul style="list-style-type: none"> Includes 10' cord with three-prong plug. Fits in 3" round grommet holes. Two grounded AC power outlets. Field installed with Plug-and-play ease. <p>NOTES: Power Modules will also work with standing-height applications for 10500 Series™ and Voi® desks. Optional Memory Control allows preset worksurface heights for consistency. Ships separately. Dynamic load capacity when worksurface is moving is 300 lbs.</p> <p>⚠ Available in black finish only, no specification needed.</p>	HGRMTAC2	1.5	0.2	\$211
	Power/USB Hub, 3" Grommet Mount <ul style="list-style-type: none"> One grounded AC power outlet with 1 USB-A, 1 USB-C ports. UL Listed. <p>⚠ Available in black only (no color designation so use .X - Specify: HGRMTUSB2.X).</p> <p>⚠ Not compatible with Arrange® tables.</p>	HGRMTUSB2	1.3	0.2	\$319
	Data Grommet <p>Blank grommet kit that includes adapters for a variety of manufacturers jacks and couplers.</p> <ul style="list-style-type: none"> Fits in existing 3" round grommet housing. <p>⚠ Available in black only. Specify P when ordering. Example: HGRMTDATA.P.</p>	HGRMTDATA	0.2	0.2	\$34

WORKPLACE TOOLS

HOW TO SPECIFY

Select Model Number

H F L D G R M T

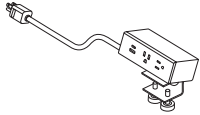

Model HPWRMOD.AC.S shown

DESCRIPTION

Dean Power Modules with Worksurface Clamp

- 2 receptacles, 1 USB-A, and 1 USB-C (AC) or 2 receptacles, 1 USB-A, and wireless charging (QA).
- 10' Straight cord only with standard three-prong plug (S). UL Listed.
- Available in Snow (SNW) and Storm (STRM).
- Worksurface clamp models work on any top with 4" overhang.

SPECIFYING EXAMPLE: HPWRMOD.AC.S.SNW

MODEL	SHIP WEIGHT	CUBE	LIST PRICE
HPWRMOD	2.75 Ⓞ	0.3	\$524

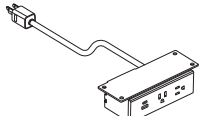

Model HUPWRMOD.AC.S shown

Dean Power Modules with Under-Worksurface Mounting Bracket

- 2 receptacles, 1 USB-A, and 1 USB-C (AC).
- Power cord choices include a 10' Straight (S), 5' Interlink (I), 10' Hardwire (H), and 10' Chevron Fog and Storm Braided (B) cord.
- Available in Snow (SNW), Storm (STRM), and Black (BLK).
- Under-worksurface mounting bracket models work with any top that has a 5" x 5" square clearance.
- UL Listed.

SPECIFYING EXAMPLE: HUPWRMOD.AC.S.BLK

MODEL	SHIP WEIGHT	CUBE	LIST PRICE
HUPWRMOD	4.5 Ⓞ	0.2	\$524

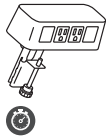

Power & Data Center

- 2 Receptacles 2 Data Accessory.
- Standard with two receptacles and openings for two data ports.
- 10' power cord with standard three-prong plug.
- Fits on any worksurface with a 4" overhang.
- UL Listed.

⚠ Color finish coordinates with HON's Loft. *Specify LOFT when ordering.*

SPECIFYING EXAMPLE: HCPWRMOD.LOFT.

MODEL	SHIP WEIGHT	CUBE	LIST PRICE
HCPWRMOD	2.5 Ⓞ	0.2	\$403

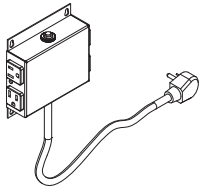

Under Worksurface Power Module — 4 Outlets, 10' Cord

- Includes 10' cord with three-prong plug.
- Fits in cable management troughs. See page 253.
- 4 outlets on side create easy access.

NOTES: Power Modules will also work with standing-height applications for 10500 Series™ and Voi® desks.

MODEL	SHIP WEIGHT	CUBE	LIST PRICE
HPWR4TAP	1.5 Ⓞ	0.1	\$550



Vesta Mobile Power Station

- Includes 10' retractable cord with three-prong plug.
- 3 AC, 1 Dual USB-A, 1 USB-C at top.
- 2 AC at base.
- Specify Paint and Plastic.

SPECIFYING EXAMPLE: HPWRMOB1.BLK.STRM

MODEL	SHIP WEIGHT	CUBE	LIST PRICE
HPWRMOB1	14.0 Ⓞ	3.3	\$1398

HOW TO SPECIFY

<p>Select Model Number</p> <p>HPWRMOD .</p>	<p>Select Ports</p> <p><i>Specify for Dean models</i></p> <p>AC USB A+C QA Wireless charging with USB-A port (+ \$129)</p> <p>AC .</p>	<p>Select Cord</p> <p><i>Specify for Dean models</i></p> <p>S Straight Cord B Braided Chevron Fog and Storm Cord (+ \$63) I Interlink Cord (+ \$38) H Hardwire Cord (+ \$73)</p> <p>S .</p>	<p>Select Paint Color</p> <p><i>Specify applicable paint color for Dean and Power/Data Center models</i></p> <p>SNW Snow STRM Storm BLK Black LOFT Loft</p> <p>STRM</p>
<p>Select Model Number</p> <p>HPWRMOB1 .</p>	<p>Select Exterior Paint Color</p> <p><i>Specify for model HPWRMOB1 only</i></p> <p>FOG Fog STRM Storm BLK Black SNW Snow</p> <p>BLK .</p>	<p>Select Paint Color</p> <p><i>Specify for model HPWRMOB1 only</i></p> <p>FOG Fog STRM Storm BLK Black SNW Snow</p> <p>STRM</p>	

POWER



Icon Legend on page 19

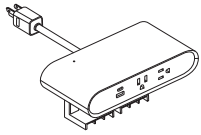

Model HRNDPWRMOD.AC.S shown

DESCRIPTION

Round Power Modules with Worksurface Clamp

- 2 receptacles, 1 USB-A, and 1 USB-C (AC) or 2 receptacles, 1 USB-A, 1 USB-C, and wireless charging (QA).
- 9' Straight cord only (S).
- Available in Snow (SNW) and Storm (STRM).
- Worksurface clamp can be used on any surface with a 2½" overhang.
- UL Listed.

SPECIFYING EXAMPLE: HRNDPWRMOD.AC.S.SNW

MODEL

HRNDPWRMOD

SHIP WEIGHT

2.25 Ⓞ

CUBE

0.3

LIST PRICE

\$511

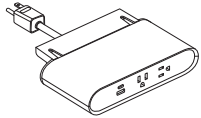

Model HURNDPWRMOD.AC.S shown

Round Power Modules with Under-Worksurface Mounting Bracket

- 2 receptacles, 1 USB-A, and 1 USB-C (AC).
- 9' Straight cord only (S).
- Available in Snow (SNW), Storm (STRM), and Black (BLK).
- Under surface mounting can be used on any surface with a 5" clearance.
- UL Listed.

SPECIFYING EXAMPLE: HURNDPWRMOD.AC.S.BLK

MODEL

HURNDPWRMOD

SHIP WEIGHT

2.25 Ⓞ

CUBE

0.3

LIST PRICE

\$511

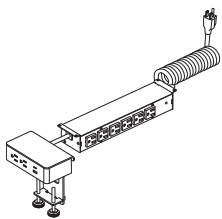

Model HABPWRMOD.AC.Q shown

Above/Below Worksurface Power Modules

- Desktop unit includes 2 receptacles, 1 USB-A, & 1 USB-C (AC).
- Under worksurface unit includes 6 receptacles and comes in Black only, no specification needed.
- Power cord choices include a 6' straight cord (S) or 6' coiled cord (Q).
- Desktop unit available in White (DWT) or Gray (DGY).

SPECIFYING EXAMPLE: HABPWRMOD.AC.S.DWT

MODEL

HABPWRMOD

SHIP WEIGHT

2.6 Ⓞ

CUBE

0.2

LIST PRICE

\$843

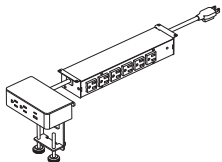

Model HABPWRMOD.AC.S shown

WORKPLACE TOOLS

HOW TO SPECIFY

<p>Select Model Number</p> <p>HRNDPWRMOD .</p>	<p>Select Ports</p> <p>Specify for Round Power Modules</p> <p>AC USB A+C QA Wireless charging with USB-A port (+ \$129)</p> <p>AC .</p>	<p>Select Cord</p> <p>Specify for Round Power Modules</p> <p>S Straight Cord</p> <p>S .</p>	<p>Select Paint Color</p> <p>Specify applicable paint color for Round Power modules</p> <p>SNW Snow STRM Storm BLK Black</p> <p>STRM</p>
---	--	---	--

<p>Select Model Number</p> <p>HABPWRMOD .</p>	<p>Select Ports</p> <p>Specify for Above/Below Power Modules</p> <p>AC USB A+C</p> <p>AC .</p>	<p>Select Cord</p> <p>Specify for Above/Below Power Modules</p> <p>S Straight Cord Q Coiled cord</p> <p>Q .</p>	<p>Select Paint Color</p> <p>Specify desktop unit paint color for Above/Below Power Modules</p> <p>DWT White DGY Gray</p> <p>DWT</p>
--	--	--	---



Icon Legend on page 19

POWER

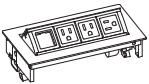
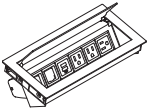
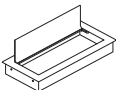
	DESCRIPTION	MODEL	SHIP WEIGHT	CUBE	LIST PRICE
	MhoB 4' x 8' Pop-up Port <ul style="list-style-type: none"> Specify G1 cutout in table top. Pop-up Port provides three power ports and one blank data receptacle. Sits flush with worksurface when closed. Includes 6' cord with three-prong plug. 	HTG1PWR-3P-1B	5	0.3	\$523
	ElloRB 5' x 11' Flip-top Port <ul style="list-style-type: none"> Specify G2 cutout in table top. Flip-top Port provides four power ports and two blank data receptacles. Conceals wires and allows power cords to be plugged in while in use. Includes 10' cord with three-prong circuit breaker plug. <p>NOTES: Two circuit breaker plugs do not fit into one duplex.</p>	HTG2PWR-4P-2B	5	0.3	\$770
	ElloRB 5' x 11' Flip-top Port <ul style="list-style-type: none"> Specify G2 cutout in table top. Flip-top Port provides one blank for Extron plate (HTPLATEVHAU) and three power ports. Extron AAP plates can be integrated into grommet to support changing technology. Conceals wires and allows power cords to be plugged in while in use. Includes 10' cord with three-prong plug. 	HTG2PWR-3P-1E	5	0.3	\$942
	ElloRB 5' x 11' Flip-top Port <ul style="list-style-type: none"> Specify G2 cutout in table top. Flip-top Port provides 3 Power, 1 USB-A, 1 USB-C, and 2 Blank Data Ports. Conceals wires and allows power cords to be plugged in while in use. Includes 10' cord with three-prong plug. 	HTG2PWR-3P-2B-2U	5	0.3	\$1117
	ElloRB 5' x 11' Flip-top Port <ul style="list-style-type: none"> Specify G2 cutout in table top. Flip-top Port provides 3 Power, 1 USB-A, 1 USB-C, and Qi wireless charging lid. Conceals wires and allows power cords to be plugged in while in use. Includes 10' cord with three-prong plug. 	HTG2PWR-3P-1U-W	5	0.3	\$1143
	Blank G1 Cutout Insert	HGROM1BLANK	2	0.2	\$201
	Blank G2 Cutout Insert	HGROM2BLANK	2	0.2	\$307
	! Grommets available in BLK, FOG, and SVR only.				

WORKPLACE TOOLS

HOW TO SPECIFY

Select Model Number HTG2PWR-4P-2B	Select Paint Color SVR Silver BLK Black FOG Fog
HTG2PWR-4P-2B.	BLK

POWER



Icon Legend on page 19

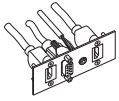

DESCRIPTION

Extron Plate (Double Space) — VGA, HDMI, HDMI, Audio

MODEL

HTPLATEVHAU

SHIP WEIGHT

1

CUBE

0.1

LIST PRICE

\$527

NOTES:

• 1 Double Space Plate can be used with HTG2PWR-3P-1E or HTPWRGROM4 Flip-top Port.

! Available in Black finish only, no specification needed.

WORKPLACE TOOLS

HOW TO SPECIFY

Select
Model Number

HTPLATEVHAU



Icon Legend on page 29

POWER & CABLE MANAGEMENT

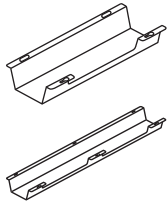

DESCRIPTION

Cable Management Troughs

17"W — Single
36"W — Single

MODEL

HPWRTRGH17
HPWRTRGH36

SHIP WEIGHT **CUBE**

2.7 0.5
4.9 0.9

LIST PRICE BY PAINT GRADE

P1	P2	P3
\$96	N/A	N/A
\$159	N/A	N/A

- Metal cable management troughs ship flat packed.
- The troughs attach to underneath the worksurface with screws.
- Cutouts in trough allow access to power without the need to detach from surface. 17"W = 1 cutout; 36"W = 2 cutouts.
- TAA Compliant.

Graphite only, no specification needed.

SPECIFYING EXAMPLE: HPWRTRGH17

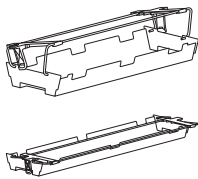

Flip-Down Wire Management Troughs

20"W
32"W

HFDTRGH20
HFDTRGH32

4.5 0.8
5.5 1.1

P1	P2	P3
\$261	N/A	N/A
\$300	N/A	N/A

NOTES: Mounts beneath a worksurface. Flips open towards user and shuts close. Used to conceal extra cord length and power strips. May be used in conjunction with quad tap unit HPWR4TAP to reduce the number of cords routed from a worksurface to a beam. For any worksurface less than 58"W, a 20"W Flip-Down Trough is recommended. For worksurfaces 58"W and wider, a 20"W or 32"W Flip-Down Trough may be used. Only HKTSHORT keyboard tray is recommended for use in conjunction with the Flip-Down Trough.

Available in Black only, specify "P" for finish option.

SPECIFYING EXAMPLE: HFDTRGH20.P

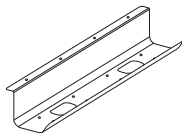

Cable Management Tray

24"
36"

HJTRGH24
HJTRGH36

2.0 0.5
3.0 1.3

P1	P2	P3
\$99	N/A	N/A
\$121	N/A	N/A

Available in Black only.

SPECIFYING EXAMPLE: HJTRGH24.P

Black only



Vertical Wire Management Vertebræ

HMPVWM28

3.0 0.3

P1	P2	P3
\$313	N/A	N/A

NOTES: 30"H x 3/16"W x 1 1/2"D. Ships unassembled.

Clear finish. Specify "X" for finish option.

SPECIFYING EXAMPLE: HMPVWM28.X

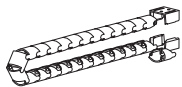

Cord Management Chain

Cord Management Chain is 36" long

HPWRSNK36

2.0 0.3

P1	P2	P3
\$306	N/A	N/A

NOTES: Conceals and routes cords on Height Adjustable Table. Pairs with Coordinate™. Includes two mounting brackets, mounting hardware and double-sided VHB tape. Top bracket connects under height adjustable worksurface, bottom bracket can connect underneath Gravitation™ power rail with double-sided VHB tape. Material is plastic.

Available in White (DW), Silver (TI), and Black (BL), specify desired plastic finish.

SPECIFYING EXAMPLE: HPWRSNK36.DW

HOW TO SPECIFY

Select Model Number H J T R G H 2 4 .	Select Paint Color (if applicable) P Black P
---	---

Select Model Number H M P V W M 2 8 .	Select Plastic Color (if applicable) X Clear DW White TI Silver BL Black X
---	--

WORKPLACE TOOLS

POWER & CABLE MANAGEMENT



Icon Legend on page 19

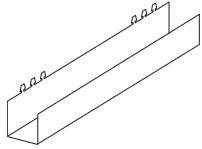

DESCRIPTION

Panel Mounted Wire Chase

- Panel Chase is 17"H.
- Available in standard metal paint finishes, specify desired finish.
- See page 228 for finish options.

NOTES: Provides additional cord management below the worksurface in a cubicle. Hooks between panels on Accelerate® and Abound® into slotted standards.

SPECIFYING EXAMPLE: HMPCHASE.PJW

MODEL	SHIP WEIGHT	CUBE	LIST PRICE BY PAINT GRADE		
			P1	P2	P3
HMPCHASE	1.0	0.1	\$99	\$110	\$115

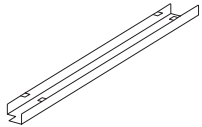

O-Leg Chase

- O-Leg Chase is 26"H.
- Available in standard metal paint finishes, specify desired finish.
- See the Desks section of the 2025 Workspaces Pricer for Voi® O-Leg finishes to match chase finish to O-Leg.

NOTES: Works with Voi® O-Legs, matches leg profile on models HLSL30280 and HLSL24280. Attaches to legs via magnets. Metal chase can fit qty. 12, 3/16" diameter cords.

SPECIFYING EXAMPLE: HLEGCHASE26.P7D

HLEGCHASE26	1.0	0.4	\$120	\$133	\$139
-------------	-----	-----	-------	-------	-------



Wire Cleat

- Available in standard metal paint finish, specify desired finish.
- See page 228 for finish options.

NOTES: Wraps up extra cord length. Comes with screws and VHB tape to attach to various surfaces. Do not screw Wire Cleat into the side of a Height Adjustable Table leg; attach with VHB tape instead.

SPECIFYING EXAMPLE: HWIRECLT.PJW

HWIRECLT	0.5	0.2	\$89	\$99	\$103
----------	-----	-----	------	------	-------

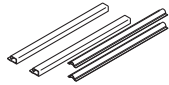

Wire Management Strips

NOTES: Four plastic wire management strips with two profiles. Self-adhesive backing. May be trimmed to desired size. Available in Black only, no specification needed.

HBTMS	3.0	0.25	\$170	N/A	N/A
-------	-----	------	-------	-----	-----

WORKPLACE TOOLS

HOW TO SPECIFY

<p>Select Model Number</p> <p>H M P C H A S E .</p>	<p>Select Paint Color</p> <p>See page 228</p> <p>P J W</p>
---	--

POWER & CABLE MANAGEMENT

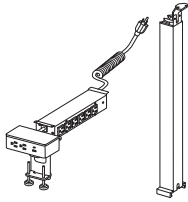

DESCRIPTION

2-Stage Metal HAT Telescoping Wire Chase
3-Stage Metal HAT Telescoping Wire Chase

MODEL

HHATPWROMD2S
HHATPWROMD3S

SHIP WEIGHT CUBE

5.6 Ⓞ 0.6
 5.6 Ⓞ 0.6

LIST PRICE BY PAINT GRADE

P1	P2	P3
\$1093	\$1121	\$1135
\$1118	\$1148	\$1164

• Metal Telescoping Chase available in the same paint finishes as Coordinate™ HAT bases, specify desired paint finish.

NOTES: 2 and 3-stage Metal HAT Telescoping chases include an Above/Below Power Module and a metal telescoping chase to conceal coiled cord on the Above/Below Power Module unit. Four feet of straight cord length extends from the base of Telescoping Chase. Telescoping Chase solution provides power access above and below the worksurface on Coordinate™ Height Adjustable Tables while concealing cord slack. Telescoping chase matches profile of Coordinate™ HAT leg and rises up and down with the unit. To match Metal Telescoping Chase to HAT base, specify matching paint color to HAT base.

SPECIFYING EXAMPLE: HHATPWROMD2S.AC.DWT.PJW

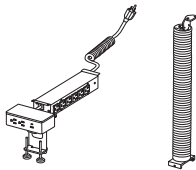

Fabric Elastic HAT Wire Chase

HHATPWROMDF

3.6 Ⓞ 0.3

\$1007 \$1026 \$1035

• Fabric Chase comes in Light (LGT), Medium (MDD), and Dark (DRK) fabrics, specify desired fabric.
 • Fabric HAT mounting brackets available in the same paint finishes as Coordinate™ HAT bases, specify desired paint finish.

NOTES: Fabric Elastic Chase includes an Above/Below Power Module and a fabric chase to conceal coiled cord on the Above/Below Power Module unit. Four feet of straight cord length extends from the base of Fabric Chase. Fabric Chase solution provides power access above and below the worksurface on Coordinate™ Height Adjustable Tables while concealing cord slack. Works on either 2-stage or 3-stage HAT bases. Fabric chase wraps around coiled cord and stretches up and down with a Coordinate™ HAT leg. To match Fabric Chase's metal mounting brackets to HAT base, specify matching paint color to HAT base.

SPECIFYING EXAMPLE: HHATPWROMDF.AC.DWT.LGT.PJW

NOTES:

- Desktop power module comes with 2 receptacles, 1 USB-A, and 1 USB-C port only, specify "AC."
- Desktop power module available in White (DWT) or Gray (DGY) finishes, specify desired finish.
- Under worksurface power strip comes with 6 receptacles and is available in Black only, no specification needed.

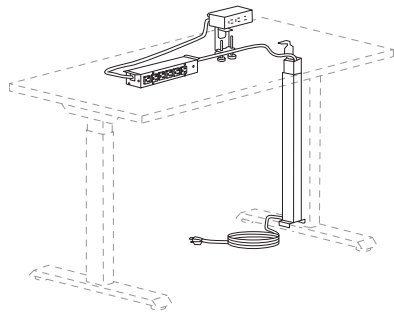

2-Stage Metal Telescoping HAT Wire Management

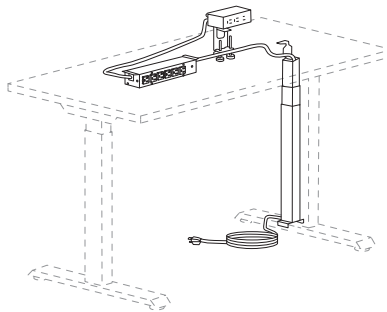

3-Stage Metal Telescoping HAT Wire Management

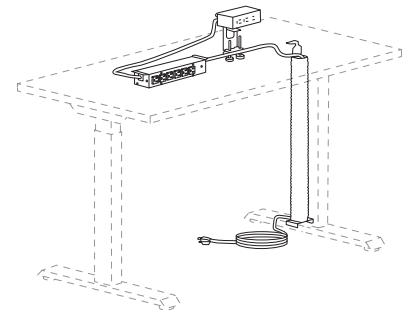

2 or 3-stage Fabric Elastic HAT Wire Management

HOW TO SPECIFY

Select Model Number	Select Ports	Select Power Module Paint	Select Fabric Chase Finish	Select Paint Color
Specify for Above/Below Power Modules	Specify for Above/Below Power Modules	Specify for Above/Below Power Modules	For Fabric Chase only	Specify paint for Telescoping Chase or Fabric Chase Mounting Brackets
AC USB A+C	DWT White DGY Gray	LGT Light MDD Medium DRK Dark	See page 116 for finishes	
HHATPWROMDF .	AC .	DWT .	LGT .	PJW

SEATING FUNCTIONS

Work/task chairs need to be adjusted to deliver optimum support. Cross-reference the letter key below to identify the chairs in this section that best meet your needs.

PROPORTIONAL ADJUSTMENTS

These controls adapt the dimensions of the chair to fit the user.



A. Pneumatic seat height adjustment — Regulates height of chair relative to floor.

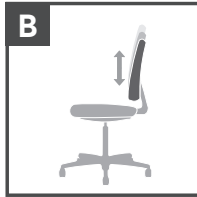

B. Back height adjustment — Positions lumbar support within a fixed range.

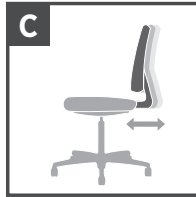

C. Seat depth adjustment — Positions chair back relative to seat.

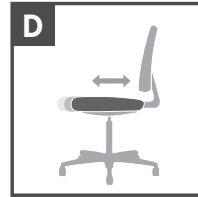

D. Seat slide mechanism — Seat cushion travels forward and back, then locks into position.

ARM OPTIONS

These adjustments accommodate different sized users and support keyboarding.



Q. Adjustable height arms — Provide improved upper-torso support. Can be adjusted periodically to relieve strain and provide variety.

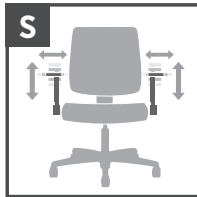

S. Height and width adjustable arms — Controls both height and width of arms for optimum comfort.



T. Loop arms — Largely specified for aesthetics. Frequently used in management settings.

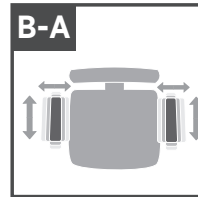

B-A. All-adjustable arms — Arms adjust in height, width, and depth.

POSTURE CONTROLS

The controls modify the position and angle of the seat and back to respond to changing tasks.



E. 360° Swivel

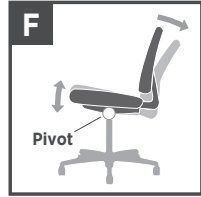

F. Tilt — Pivot point located directly above center of chair base.

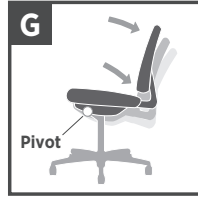

G. Mid-range knee tilt — Pivot point located slightly ahead of center of chair base. Allows user to recline at a slightly more relaxed angle than conventional tilt.

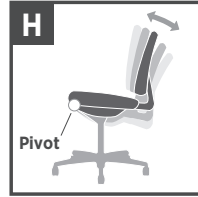

H. Knee tilt — Pivot point located near front edge of chair. Allows user to keep feet flat on floor while chair reclines.

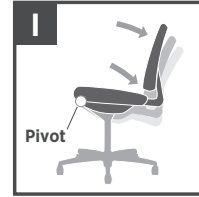

I. Synchronized knee tilt — Back reclines at a 2-to-1 ratio to seat angle. Pivot point located near front edge of chair.

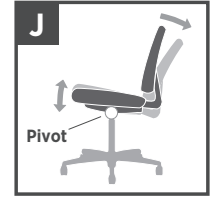

J. Synchro-tilt — Back reclines at a 2-to-1 ratio to seat angle. Allows user to recline while keeping seat cushion relatively level to floor.



K. Tilt tension — Controls rate and ease of recline.



L. Tilt lock — Locks out tilt function.



M. Posture mechanism/lock — Back angle adjusts independently of seat, and can be locked in an infinite number of positions within a fixed range.



N. Multi-task control — Adjusts seat and back angles independently with a single lever (infinite locking within a fixed range).



O. Asynchronous control — High performance system with three levers to modify: angle of back relative to seat, tilt (free float or infinite locking) and forward tilt.

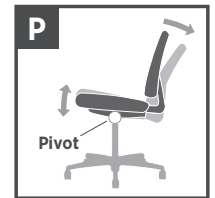

P. Weight-activated synchro-tilt — Back reclines at a 2 to 1 ratio to seat angle. Tilt tension automatically adjusts to user's body weight as user reclines.



W. Integral lumbar support — Easily adjusts to enhance comfort.



X. Dual-clutch posture control — Adjusts seat and back angles independently with two levers (infinite locking within a fixed range).

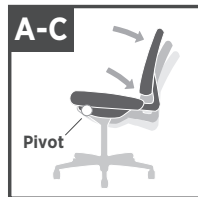

A-C. Synchronized tilt — Back reclines at a 2.5 to 1 ratio to seat angle. Variable lock.

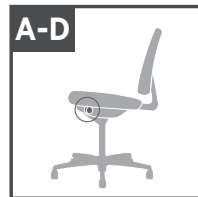

A-D. Side tilt tension — Controls rate and ease of recline. Conveniently located on the right side.



A-E. Back reclines at a 2 to 1 ratio to seat angle. Back angle adjusts independently of seat and can be locked in infinite number of positions within a fixed range.

SEATING CONTROLS

	Convergence®	Endorse®	Ignition®	Solve®	Current Nucleus®	Nucleus® Recharged	Cofi™	Cipher™	Flexion™	Cliq™
F										
F0									X	
S										
S0		X	X			X				
S1		X	X			X				
S2			X							
W										
W0							X			X
W2			X			X				
W5										
W6								X		
Y										
Y0			X	X			X			
Y1	X		X	X		X				
Y2		X	X	X	X	X	X			
Y3		X	X							
Y4		X	X							
Z										
Z1	X									

- F**
0 Flex Mechanism One lever controls seat height and tilt lock. Bumpers integrated into seat/control to enable flexing seat.
- S**
S0 Limited recline synchro-tilt Same as Y controls except do not recline as far. Used on stools.
S1 Limited recline synchro-tilt w/seat slider
S2 Limited recline advanced synchro-tilt S2 used on Ignition® Mesh Seat.
- W**
W0 Weight activated No tension knob — recline adjusts to user.
W2 Weight activated synchro-tilt w/seat slider
W6 Integrated weight activated synchro-tilt w/seat slider *Cipher™ only.
- Y**
Y0 Synchro-tilt Simple synchro-tilt (no seat slide).
Y1 Synchro-tilt w/seat slider Same as Y0 + seat slider.
Y2 Advanced synchro-tilt Synchro-tilt control with tilt tension (incl. seat slide).
Y3 Synchro-tilt w/independent back angle Same as Y2 and back also moves separate from seat.
Y4 Synchro-tilt B&T Same as Y2 for B&T — reduced recline than Y2.
- Z**
Z1 Swivel-tilt Simple swivel-tilt (no seat slide) — back attached to seat.

PERFORMANCE SEATING ARM MATRIX

	ARM & PAD MOVEMENT			FIXED ARMS		
	2-D or A		4-D or V	Armless	Fixed Polymer	Fixed Polished Aluminum
	Width Adjustment Bracket 1) Entire arm moves wider and narrower 2) Arm moves up and down	Pad Width Adjustment 1) Pad slides side-to-side 2) Arm moves up and down	1) Pad or entire arm slides side-to-side 2) Pad slides front-to-back 3) Pad pivots wider and narrower 4) Arm moves up and down			
Convergence*	X			X		
Cliq™				X	X	
Solve*		X	X	X	X	
Endorse* Standard	X		X	X	X	X
Endorse* B&T		X	X	X		
Ignition* Standard	X		X	X	X	X
Ignition* B&T		X	X	X		
Flexion™				X	X	
Nucleus*		X	X	X	X	X
Cipher™			X	X		
Cofi™				X	X	X

ORDERING INFORMATION

Seating	Standard Fabric Selections by Series with Price Code and Fabric Material																								
	1	1	1	1	1	1	1	1	1	1	1	1	1	2	2	2	2	2	2	3	3	3	3	L	L
Model/Series	APX	EB	VA	GA	MM	EA	CU	COMP	UR	DAPR	ENSB	HAML	PBLE	PNS	BLME	CLYD	RUSH	SPNN	WP	SX	PRKR	PURL	QUL	DAV	SS
	Apex	Black & Burgundy Vinyl	Black, Charcoal, & Navy Fabric	Black & Navy Fabric	Black Sandwich Mesh Fabric	Black Vinyl	Centurion	Compass	Contourett	Dapper	Ensemble	Hamilton	Pebble	Appoint Seating	Blume	Clyde	Rush	Spin Seating	Whisper Vinyl	Moxie	Parker	Purl	Quill	Davenport Leather	Denver Leather**
Accommodate®	•						•	•	•	•	•	•	•	•	•	•	•	•	•	•	•	•	•		•
Adjustable Task/Lab Stool						•																			
Astir™	•						•	•	•	•	•	•	•	•	•	•	•	•	•	•	•	•	•	•	
Cliq™	•						•	•	•	•	•	•	•	•	•	•	•	•	•	•	•	•	•	•	
Cofi™	•						•	•	•	•	•	•	•	•	•	•	•	•	•	•	•	•	•	•	
Convergence®	•						•	•	•	•	•	•	•	•	•	•	•	•	•	•	•	•	•	•	
Endorse® Task***	•						•	•	•	•	•	•	•	•	•	•	•	•	•	•	•	•	•	•	
Flock**	•						•	•	•	•	•	•	•	•	•	•	•	•	•	•	•	•	•	•	•
Flock® Round Lounge HFLRC1/DF	•						•	•	•	•	•	•	•	•	•	•	•	•	•	•	•	•	•	•	•
Grove®	•						•	•	•	•	•	•	•	•	•	•	•	•	•	•	•	•	•	•	•
Ignition® Series	•						•	•	•	•	•	•	•	•	•	•	•	•	•	•	•	•	•	•	•
Lota® H2285			•																						
Mav™	•						•	•	•	•	•	•	•	•	•	•	•	•	•	•	•	•	•	•	•
Motivate®	•						•	•	•	•	•	•	•	•	•	•	•	•	•	•	•	•	•	•	•
Nucleus® Series	•						•	•	•	•	•	•	•	•	•	•	•	•	•	•	•	•	•	•	•
Perpetual® Nesting	•						•	•	•	•	•	•	•	•	•	•	•	•	•	•	•	•	•	•	•
Pillow-Soft® 2090 Series	•	•					•	•	•	•	•	•	•	•	•	•	•	•	•	•	•	•	•	•	•
Solve®	•						•	•	•	•	•	•	•	•	•	•	•	•	•	•	•	•	•	•	• (Seat Only)
Soothe®	•						•	•	•	•	•	•	•	•	•	•	•	•	•	•	•	•	•	•	•
Volt® 5700/5710 Series				•																					
Volt® 5720/5730 Series	•						•	•	•	•	•	•	•	•	•	•	•	•	•	•	•	•	•	•	•
West Hill™	•						•	•	•	•	•	•	•	•	•	•	•	•	•	•	•	•	•	•	•
Credenza/Pedestal Cushions	•						•	•	•	•	•	•	•	•	•	•	•	•	•	•	•	•	•	•	•

*Flock® chair model HFLRC1 has fabric limitations, please see the Flock® seating pages 346-353 for details.

**Denver Leather (SS) may not be available on every model within a specific series, please refer to the model's page for details.

***Pebble available on Endorse® Task as seat option only.

ORDERING INFORMATION

- Seating pages are now arranged in alpha, then numeric, order.
- **All specifications in this publication are based on the latest product information available at the time of print.**
- COM Ordering Information and pricing on page 13.
- Remember to add an FC to the base model number when fire code fabric is selected. See page 262 for available models/fabrics.
- Wood components are well-seasoned select hardwoods, chosen for their strength, their ability to machine well and their superior uniformity of stain and finish.
- Chairs with leather feature matching vinyl backs and vinyl seat bottom when applicable (Non-contact areas are vinyl).

Wood Seating	Finish Codes								Standard Fabric Selections by Series with Price Code and Fabric Material											
									1	1	1	1	1	2	2	2	2	2	3	L
Model/Series	Bourbon Cherry	Cognac	Harvest	Mahogany	Mocha	Natural Maple	Pinnacle	Shaker Cherry	EB	CU	COMP	DAPR	HAML	PNS	CLYD	RUSH	SPNN	WP	PURL	SS
Cambia™ 2160 Series	H	COGN	C	N	MOCH	D	PINC	F		•	•	•	•	•	•	•	•	•	•	•
Park Avenue Collection® 5000 Series	H	COGN	C	N	MOCH	D	PINC	F		•	•	•	•	•	•	•	•	•	•	•
Pillow-Soft® 2190 Series	H	COGN	C	N	MOCH	D	PINC	F	•	•	•	•	•	•	•	•	•	•	•	•
Versant® Wood	H	COGN	C	N	MOCH	D	PINC	F		•	•	•	•	•	•	•	•	•	•	•

Note: Gathers and creases may be more visible with AI and OP fabrics due to the inherent design and construction of these fabrics. Harvest, Cognac, Natural Maple, and Pinnacle de-emphasized for Park Avenue® and Pillow-Soft® Seating.

FIRE CODE/COMPLIANT SEATING

FIRE SAFETY

Definitive Protection — CAL TB 117-2013

- TB 117-2013 — The State of California, Department of Consumer Affairs, Bureau of Electronic and Home Appliance Repair, Home Furnishings and Thermal Insulation (BEARHFTI) Technical Bulletin (TB) 117-2013 is the industry flammability standard for upholstered furniture, and provides methods for smolder resistance of cover fabrics, barrier materials, resilient filling materials, and decking materials for use in upholstered furniture.
- The fabrics and resilient filling materials used in upholstered seating manufactured by The HON Company meet or exceed the flame retardant requirements of State of California TB 117-2013. The label attached to the seat bottom indicates compliance with these requirements.

Elevate Fire Safety to a Higher Standard — CAL TB 133

- The State of California announced in January 2019 that Technical Bulletin (TB) 113, The Flammability Test Procedure for Seating Furniture for Use in Public Occupancies has been repealed effective January 22, 2019.
- While the CAL 133 standard has been repealed, a select subset of The HON Company's most popular chair models are still available in an array of fabrics that include an advanced barrier of fire protection to help comply with CAL 133 requirements.
- To ensure that the chairs you order comply with CAL 133, specify one of the fabrics listed below. Then simply add "FC" to the model number when ordering one of the select available models. A standard upcharge of \$90 will be applied per seat model for all single seat chairs.
- **SPECIFYING EXAMPLE: HIWMMFC.Y2.A.H.IM.CU10.NL.SB.T**

CAL 133 COMPLIANT MODELS

IGNITION® SEATING

HIEH1FC, HIEH2FC, HIEH3FC, HIWM1FC, HIWM2FC, HIWM3FC, HITL1FC, HITL2FC, HITL3FC, HIGCLFC, HIGS6FC, HISB6FC, HICS7FC, HIB50FC, HITLMFC, HIWMMFC, HITSMFC

NOTES:

- Creases and gathers may be visible with CAL 133 Fire Code seating due to the construction of the fire barrier material used.
- Please refer to each model's page for specific fabric availability.
- Contact HON Tailored Solutions Team for all other requests.

CAL 133 COMPLIANT FABRIC

GRADE 1

APX	Apex
COMP	Compass
CU	Centurion
DAPR	Dapper
ENSB	Ensemble
HAML	Hamilton

GRADE 2

BLME	Blume
CLYD	Clyde
KAI	Kai
PNS	Appoint Seating
RUSH	Rush
SPNN	Spin
WP	Whisper Vinyl
WVL	Wavelength

GRADE 3

GTWY	Getaway
PURL	Purl
QUL	Quill

GRADE 4

LIVI	Livi with Supreen™
OXFD	Oxford with Supreen™

GRADE L

SS	Leather
-----------	---------

ACCOMMODATE®

Want to see more? Scan here
to check out hon.com.



Accommodate® Café-Height Stools shown in Centurion Black.

ACCOMMODATE®

The key to designing a collaborative environment is to support productivity throughout the space. From waiting areas and cafés to meeting spaces and offices, Accommodate creates opportunities for people to get work done in a comfortable, casual setting. Cluster together. Form neat rows. Stack four high. With guest and bariatric chairs, as well as café and counter-height stools, Accommodate brings greater comfort, versatility and continuity throughout your space with a seating collection that adapts to your environment, people and budget.



FEATURES

- Thin profile seat cushion conforms to your body.
- Contoured back ergonomically supports the spine.
- Chairs can stack up to four high.
- Chairs can gang together to form neat rows.
- Waterfall seat edge enhances leg circulation.
- Lightweight frame is easy to move.
- Nylon glides slide effortlessly on hard surfaces.
- Tube rolled steel frame adds durability.
- Wall-saver design protects walls and cabinets.
- Warranted for users up to 300 lbs. (Models HSB50 and HSB50DF are warranted for users up to 500 lbs.)
- Available in Seated-, Counter-, and Café-heights.

SEATING

ACCOMMODATE® Options

MODEL OPTIONS

HSGS6
HSGS6DF - Multi-Fabric



Guest Chair

HSCS1
HSCS1DF - Multi-Fabric



Counter-Height Stool

HSCS2
HSCS2DF - Multi-Fabric



Café-Height Stool

HSB50
HSB50DF - Multi-Fabric

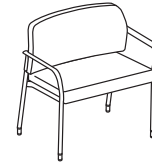

Bariatric Chair





ARM STYLE

	CODE	DESCRIPTION	PRICE
	N	Armless	+\$0
	F	Fixed Arms	+\$33

FRAME

	CODE	DESCRIPTION	PRICE
	CBK	Charblack	+\$0
	PK7	Textured Designer White	+\$0
	P7J	Textured Brownstone	+\$0
	P7A	Textured Charcoal	+\$0
	P7L	Textured Loft	+\$0
	P7M	Textured Muslin	+\$0
	PR8	Textured Silver	+\$0
	P8V	Textured Titanium	+\$0

CASTERS/ GLIDES

	CODE	DESCRIPTION	PRICE
	E	Standard Nylon Glide	+\$0
	H	Black Hard Caster	+\$0
	S	Black Soft Caster	+\$33
	B	Both Hard Casters and Standard Nylon Glides	+\$22

*Options H, S & B available for HSGS6 and HSGS6DF models only

ACCOMMODATE®

Fabric Options

HON BRANDED FABRICS

GRADE 1	GRADE 2	GRADE 3	GRADE 4
Apex*	Appoint Seating	Bradbury	Constance with Supreen™
Centurion	Blume	Cozy	Lucerne
Compass	Clyde	Getaway	Livi with Supreen™
Contourett*	Haute	Moxie	Lugano with Supreen™
Dapper	Kai	Notion	Oxford with Supreen™
Emphasis	Rush	Parker*	
Ensemble	Spin	Purl	
Hamilton	Wavelength	Quill	
Noble Seating	Whisper Vinyl	Saxony	
Pebble			
Vibe			

For a complete list of fabrics, including partnership fabrics, go to hon.com/fabricsandfinishes.

Reference Fabric Color Combinations on pages 20-25 for color codes and legend on page 21 for lead times.

*Only available as a seat fabric on Multi-Fabric models. Cannot be used with any Single-Fabric models.

HSGS6

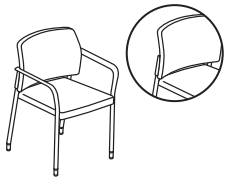

GUEST CHAIR

Set of Two Guest Chairs

DIMENSIONS

Depth:	22¼	Seat to Floor Height:	18¼
Height:	31½	Usable Seat Depth:	17
Seat Depth:	20¾	Ship Weight (with arms):	50
Seat Width:	17½	Ship Weight (armless):	48
Back Width:	19¾	Cube (with arms):	15.8
Back Height:	16¼	Cube (armless):	15.8
Width (with arms):	23½	COM (per 2 pack):	3.0
Width (armless):	19¾	Weight Rating:	300 lbs.
Arm Width:	20¼		

FABRIC PRICE CODES

1	\$1046	8	\$1492
2	\$1125	9	\$1551
3	\$1202	10	\$1609
4	\$1260	11	\$1667
5	\$1318	12	\$1725
6	\$1376	L	—
7	\$1435		

NOTES: For Ganging Brackets see page 269. Accommodate® Guest Chairs stack 4-high.

HSCS1

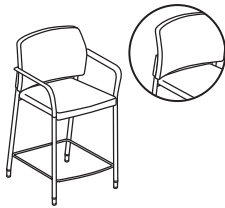

COUNTER-HEIGHT STOOL

DIMENSIONS

Depth:	23½	Seat to Floor Height:	25½
Height:	38¾	Usable Seat Depth:	17
Seat Depth:	20¾	Ship Weight (with arms):	36
Seat Width:	17½	Ship Weight (armless):	35
Back Width:	19¾	Cube (with arms):	15.8
Back Height:	16¼	Cube (armless):	15.8
Width (with arms):	23½	COM:	2.0
Width (armless):	19¾	Weight Rating:	300 lbs.
Arm Width:	20¼		

FABRIC PRICE CODES

1	\$634	8	\$858
2	\$674	9	\$887
3	\$713	10	\$916
4	\$742	11	\$945
5	\$770	12	\$974
6	\$799	L	—
7	\$829		

HSGANG

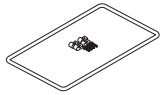

GANGING BRACKET

(hardware included)

DIMENSIONS

Ship Weight: **5** Ⓞ

LIST PRICE

\$51

NOTES: For use on models HSGS6 and HSGS6DF.

! No specification required for bracket. The ganging bracket is only available in black. The ganging bracket does not work on the bariatric unit.

HON Recommendation: HSGS6.N.E.CU__PR8 - List Price \$1046

HOW TO SPECIFY

<p>Select Model Number</p> <p>H S G S 6 .</p>	<p>Select Arm Type</p> <p>N Armless F Fixed Arms (+ \$33 per chair)</p> <p>N .</p>	<p>Select Caster/Glide</p> <p>E Standard Nylon Glide H Hard Caster S Soft Caster (+ \$33 per chair) B Both Hard Casters and Standard Nylon Glides (+ \$22 per chair) <i>Options H, S & B available for HSGS6 model only</i></p> <p>E .</p>	<p>Select Fabric</p> <p>See page 265</p> <p>C U 1 0 .</p>	<p>Select Frame</p> <p>See page 264</p> <p>P R 8</p>
--	---	---	--	---



Icon Legend on page 19

ACCOMMODATE®

HSCS2

CAFÉ-HEIGHT STOOL

DIMENSIONS

FABRIC PRICE CODES



Depth:	24½	Seat to Floor Height:	31½
Height:	44¾	Usable Seat Depth:	17
Seat Depth:	20¾	Ship Weight (with arms):	38
Seat Width:	17½	Ship Weight (armless):	37
Back Width:	19¾	Cube (with arms):	19.1
Back Height:	16¼	Cube (armless):	19.1
Width (with arms):	23½	COM:	2.0
Width (armless):	19¾	Weight Rating:	300 lbs.
Arm Width:	20¼		

1	\$696	8	\$920
2	\$736	9	\$949
3	\$775	10	\$978
4	\$804	11	\$1007
5	\$832	12	\$1036
6	\$861	L	—
7	\$891		

HSB50

BARIATRIC CHAIR

DIMENSIONS

FABRIC PRICE CODES

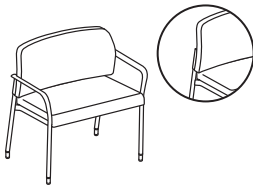

Depth:	21½	Seat to Floor Height:	19
Height:	32½	Usable Seat Depth:	16¾
Seat Depth:	20¼	Ship Weight (with arms):	50
Seat Width:	28	Ship Weight (armless):	49
Back Width:	29	Cube (with arms):	27.2
Back Height:	16½	Cube (armless):	27.2
Width (with arms):	33½	COM:	2.0
Width (armless):	30	Weight Rating:	500 lbs.
Arm Width:	30		

1	\$1121	8	\$1419
2	\$1174	9	\$1458
3	\$1226	10	\$1496
4	\$1264	11	\$1536
5	\$1303	12	\$1574
6	\$1342	L	—
7	\$1380		

HON Recommendation: HSCS2.N.E.CU__PR8 - List Price \$696

HOW TO SPECIFY

<p>Select Model Number</p> <p>H S C S 2 .</p>	<p>Select Arm Type</p> <p>N Armless F Fixed Arms (+ \$33 per chair)</p> <p>N .</p>	<p>Select Caster/Glide</p> <p>E Standard Nylon Glide</p> <p>E .</p>	<p>Select Fabric</p> <p>See page 265</p> <p>C U 1 0 .</p>	<p>Select Frame</p> <p>See page 264</p> <p>P R 8</p>
--	---	--	--	---

ACCOMMODATE®



Icon Legend on page 19

HSGS6DF

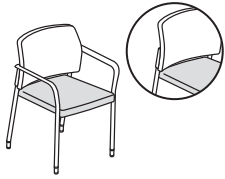

GUEST CHAIR

Multi-Fabric
Set of Two Guest Chairs

DIMENSIONS

Depth:	22¼	Seat to Floor Height:	18¼
Height:	31½	Usable Seat Depth:	17
Seat Depth:	20¾	Ship Weight (with arms):	50
Seat Width:	17½	Ship Weight (armless):	48
Back Width:	19¾	Cube (with arms):	15.8
Back Height:	16¼	Cube (armless):	15.8
Width (with arms):	23½	COM (Seat, per 2 pack):	1.5
Width (armless):	19¾	COM (Back, per 2 pack):	1.5
Arm Width:	20¼	Weight Rating:	300 lbs.

FABRIC PRICE CODES

1	\$1226	
<i>Add to Base Price Above</i>		
	Back	Seat
2	\$40	\$40
3	\$79	\$79
4	\$108	\$108
5	\$136	\$136
6	\$165	\$165
7	\$195	\$195
8	\$224	\$224
9	\$253	\$253
10	\$282	\$282
11	\$311	\$311
12	\$340	\$340

NOTES: For Ganging Brackets see page 269. Accommodate® Guest Chairs stack 4-high.

HSCS1DF

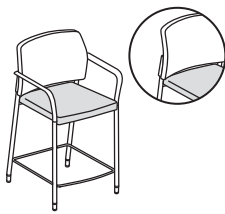

COUNTER-HEIGHT STOOL

Multi-Fabric

DIMENSIONS

Depth:	23½	Seat to Floor Height:	25½
Height:	38¾	Usable Seat Depth:	17
Seat Depth:	20¾	Ship Weight (with arms):	36
Seat Width:	17½	Ship Weight (armless):	35
Back Width:	19¾	Cube (with arms):	15.8
Back Height:	16¼	Cube (armless):	15.8
Width (with arms):	23½	COM (Seat):	1.0
Width (armless):	19¾	COM (Back):	1.0
Arm Width:	20¼	Weight Rating:	300 lbs.

FABRIC PRICE CODES

1	\$724	
<i>Add to Base Price Above</i>		
	Back	Seat
2	\$20	\$20
3	\$40	\$40
4	\$55	\$55
5	\$68	\$68
6	\$84	\$84
7	\$98	\$98
8	\$113	\$113
9	\$127	\$127
10	\$142	\$142
11	\$156	\$156
12	\$171	\$171

HON Recommendation: HSGS6DF.N.E.CU__CU__PR8 - List Price \$1226

HOW TO SPECIFY

Select Model Number H S G S 6 D F .	Select Arm Type N Armless F Fixed Arms (+ \$33 per chair)	Select Caster/Glide E Standard Nylon Glide H Hard Caster S Soft Caster (+ \$33 per chair) B Both Hard Casters and Standard Nylon Glides (+ \$22 per chair) <i>Options H, S & B available for HSGS6DF model only</i>	Select Back Fabric See page 265	Select Seat Fabric See page 265	Select Frame See page 264
	N .	E .	CU 2 2 .	CU 1 0 .	PR 8

HSCS2DF



CAFÉ-HEIGHT STOOL

Multi-Fabric

DIMENSIONS

Depth:	24½	Seat to Floor Height:	31½
Height:	44¾	Usable Seat Depth:	17
Seat Depth:	20¾	Ship Weight (with arms):	38
Seat Width:	17½	Ship Weight (armless):	37
Back Width:	19¾	Cube (with arms):	19.1
Back Height:	16¼	Cube (armless):	19.1
Width (with arms):	23½	COM (Seat):	1.0
Width (armless):	19¾	COM (Back):	1.0
Arm Width:	20¼	Weight Rating:	300 lbs.

FABRIC PRICE CODES

1	\$786	
<i>Add to Base Price Above</i>		
	Back	Seat
2	\$20	\$20
3	\$40	\$40
4	\$55	\$55
5	\$68	\$68
6	\$84	\$84
7	\$98	\$98
8	\$113	\$113
9	\$127	\$127
10	\$142	\$142
11	\$156	\$156
12	\$171	\$171

HSB50DF

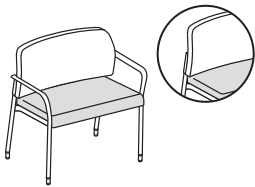

BARIATRIC CHAIR

Multi-Fabric

DIMENSIONS

Depth:	21½	Seat to Floor Height:	19
Height:	32½	Usable Seat Depth:	16¾
Seat Depth:	20¼	Ship Weight (with arms):	50
Seat Width:	28	Ship Weight (armless):	49
Back Width:	29	Cube (with arms):	27.2
Back Height:	16½	Cube (armless):	27.2
Width (with arms):	33½	COM (Seat):	1.0
Width (armless):	30	COM (Back):	1.0
Arm Width:	30	Weight Rating:	500 lbs.

FABRIC PRICE CODES

1	\$1211	
<i>Add to Base Price Above</i>		
	Back	Seat
2	\$27	\$27
3	\$53	\$53
4	\$72	\$72
5	\$91	\$91
6	\$111	\$111
7	\$130	\$130
8	\$150	\$150
9	\$169	\$169
10	\$188	\$188
11	\$208	\$208
12	\$227	\$227

HSGANG

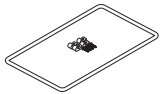

GANGING BRACKET

(hardware included)

DIMENSIONS

Ship Weight: 5 Ⓞ

LIST PRICE

\$51

NOTES: For use on models HSGS6 and HSGS6DF.

ⓘ No specification required for bracket. The ganging bracket is only available in black. The ganging bracket does not work on the bariatric unit.

HON Recommendation: HSCS2DF.N.E.CU__CU__PR8 - List Price \$786

HOW TO SPECIFY

<p>Select Model Number</p> <p>H S C S 2 D F .</p>	<p>Select Arm Type</p> <p>N Armless F Fixed Arms (+ \$33)</p> <p>N .</p>	<p>Select Caster/Glide</p> <p>E Standard Nylon Glide</p> <p>E .</p>	<p>Select Back Fabric</p> <p>See page 265</p> <p>C U 2 2 .</p>	<p>Select Seat Fabric</p> <p>See page 265</p> <p>C U 1 0 .</p>	<p>Select Frame</p> <p>See page 264</p> <p>P R 8</p>
--	---	--	---	---	---

ADJUSTABLE TASK/LAB Stools



Icon Legend on page 19

HMTS01



TASK/LAB STOOL

without Back

Pneumatic
Swivel

Functions: **A, E**

(Function Key on pages 256-257)

DIMENSIONS

Depth:	27¼	Seat to Floor Height:	17¾-22
Width:	24⅝	Usable Seat Depth:	16
Height:	17¾-22	Ship Weight:	22
Seat:	16" Dia.	Cube:	2.5
		Weight Rating:	250 lbs.

FABRIC PRICE CODE

1 \$525

NOTES: EA vinyl is a healthcare covering that meets AATCC Test Method 147-2004.

ⓘ Available in polished base ONLY. Available in Grade 1, Black, EA11 fabric ONLY.

HMTS11

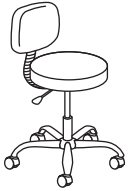

TASK/LAB STOOL

with Back

Pneumatic
Back Height
Seat Depth
Swivel

Functions: **A, B, C, E**

(Function Key on pages 256-257)

DIMENSIONS

Depth:	27¼	Seat to Floor Height:	17¾-22
Width:	24⅝	Usable Seat Depth:	14¾-16
Height:	31½-38	Ship Weight:	29
Seat:	16" Dia.	Cube:	2.7
Back Width:	15½	Weight Rating:	250 lbs.
Back Height:	8¾-16		

FABRIC PRICE CODE

1 \$703

NOTES: EA vinyl is a healthcare covering that meets AATCC Test Method 147-2004.

ⓘ Available in polished base ONLY. Available in Grade 1, Black, EA11 fabric ONLY.

HOW TO SPECIFY

Select
Model Number

Select
Vinyl

EA11 Black, Grade 1 (only)

H M T S 0 1 .

E A 1 1



Altern™ Seating shown with Mod Desking.

ALTERN™

A task chair that delivers all-day comfort and style without a hefty price tag should be within everyone's reach. Altern™ provides dependable support, thoughtful features, and a clean design that fits effortlessly into any office setting. Choose from the classic black frame and mesh, or a sophisticated grey mesh with a crisp white frame. So, go ahead — navigate your day, your way. Make your space work with Altern™.



FEATURES

- Optimize your daily ergonomic well-being with an adjustable lumbar (available on all mesh models) and an attachable headrest (available on mesh task chair models).
- Get comfortable with height-adjustable arms featuring a polished accent for an aesthetic upgrade.
- Recline with ease with Altern's™ limited recline synchro-tilt with seat slide control.
- Simplify your style with Altern™ Value models that offer a simple black fabric with a black mesh and black frame or a grey fabric with a grey mesh and white frame.
- Elevate your style with Altern™ Custom models that offer a wide selection of colorful fabrics.
- Give yourself a boost with Altern™ task stools featuring an adjustable footrest for additional lower body support.
- Enjoy a variety of back height and style options on Altern's™ mid-back mesh task chairs and stools or low-back upholstered task chairs and stools.
- Warranted for users up to 275 lbs.
- **HON Full Lifetime Warranty.**

ALTERN™ Options

MODEL OPTIONS

HPTCC1-TIUM



Mid-Back Task Chair

Mesh Back

HPTCC1-T1UU



Low-Back Task Chair

Upholstered Back

HPTCC2-TIUM



Mid-Back Task Chair

Mesh Back

HPTCC2-T1UU



Low-Back Task Chair

Upholstered Back

HPTCC2-T3UM



Mid-Back Task Stool

Mesh Back

HPTCC2-T3UU



Low-Back Task Stool

Upholstered Back

FRAME

CODE	DESCRIPTION	PRICE
BLK	Black	+\$0
WHT	White	+\$45

*White only available on HPTCC1-TIUM, HPTCC2-TIUM, and HPTCC2-T1UU

HON BRANDED FABRICS

GRADE 1

Apex
Centurion
Compass
Contourett
Dapper
Emphasis
Ensemble
Hamilton
Noble Seating
Pebble
Vibe

GRADE 2

Appoint Seating
Blume
Clyde
Haute
Kai
Rush
Spin Seating
Wavelength
Whisper Vinyl

GRADE 3

Bradbury
Cozy
Getaway
Moxie
Notion
Parker
Purl
Quill
Saxony

GRADE 4

Constance with Supreen™
Livi with Supreen™
Lucerne with Supreen™
Lugano with Supreen™
Oxford with Supreen™

For a complete list of fabrics, including partnership fabrics, go to hon.com/fabricsandfinishes.

Reference Fabric Color Combinations on pages 20-25 for color codes and legend on page 21 for lead times. For additional HON to Supply COM fabric grade pricing, go to hon.com and click on the HON to Supply COM link.

ALTERN™ Value Models



Icon Legend on page 19

HPTCC1-T1UM



MID-BACK TASK CHAIR

Mesh Back
Pneumatic
Swivel
Synchro-tilt
Tilt Tension
Tilt Lock
Adjustable Lumbar
Seat Slide
Height-Adjustable Arms
Fixed Headrest Included
Black Hard Casters

DIMENSIONS

Depth:	29 ³ / ₄	Seat to Floor Height:	18-21 ¹ / ₂
Width:	28 ³ / ₄	Usable Seat Depth:	18 ¹ / ₂ -19 ¹ / ₂
Height:	49 ⁴ / ₅	Ship Weight:	44
Seat Width:	19 ³ / ₄	Cube:	7.1
Back Width:	17 ⁵ / ₈	Weight Rating:	275 lbs.
Back Height:	24 ¹ / ₂		
Arm Width:	19 ¹ / ₂		

FABRIC PRICE CODES

1 \$500

NOTES: The Optional Fixed Headrest is not designed to be removed after installation. Product ships knocked down.

HPTCC1-T1UU



LOW-BACK TASK CHAIR

Upholstered Back
Pneumatic
Swivel
Synchro-tilt
Tilt Tension
Tilt Lock
Seat Slide
Height-Adjustable Arms
Black Hard Casters

DIMENSIONS

Depth:	28 ⁹ / ₁₀	Seat to Floor Height:	16 ¹ / ₂ -19 ³ / ₈
Width:	28 ³ / ₄	Usable Seat Depth:	18 ¹ / ₂ -19 ¹ / ₂
Height:	38 ⁹ / ₁₀	Ship Weight:	46
Seat Width:	19 ³ / ₄	Cube:	6.3
Back Width:	17 ⁷ / ₈	Weight Rating:	275 lbs.
Back Height:	23 ³ / ₁₀		
Arm Width:	19 ¹ / ₂		

FABRIC PRICE CODES

1 \$500

NOTES: Product ships knocked down.

HON Recommendation: HPTCC1-T1UM.BLK - List Price \$500

HOW TO SPECIFY

Select
Model Number

HPTCC1-T1UM

Select
Frame Color

BLK Black Frame
Comes with Black Mesh on HPTCC1-T1UM. Fabric is always Black.

WHT White Frame (+ \$45)
Only available on HPTCC1-T1UM. Mesh and Fabric is always Grey.

BLK



Icon Legend on page 19

ALTERN™ Custom Models

HPTCC2-T1UM



MID-BACK TASK CHAIR

Mesh Back
Pneumatic
Swivel
Synchro-tilt
Tilt Tension
Tilt Lock
Adjustable Lumbar
Seat Slide
Height-Adjustable Arms
Fixed Headrest Included
Black Hard Casters

DIMENSIONS

Depth: 29³/₄ Seat to Floor Height: 18-21¹/₁₀
Width: 28³/₄ Usable Seat Depth: 18¹/₂-19¹/₂
Height: 49⁴/₅ Ship Weight: 44
Seat Width: 19³/₄ Cube: 7.1
Back Width: 17⁵/₈ COM: 1.0
Back Height: 24¹/₁₀ Weight Rating: 275 lbs.
Arm Width: 19¹/₂

FABRIC PRICE CODES

1	\$575	8	\$651
2	\$589	9	\$660
3	\$602	10	\$669
4	\$612	11	\$680
5	\$621	12	\$689
6	\$631	L	—
7	\$640		

NOTES: The Optional Fixed Headrest is not designed to be removed after installation. Product ships knocked down.

HPTCC2-T1UU



LOW-BACK TASK CHAIR

Upholstered Back
Pneumatic
Swivel
Synchro-tilt
Tilt Tension
Tilt Lock
Seat Slide
Height-Adjustable Arms
Black Hard Casters

DIMENSIONS

Depth: 28⁹/₁₀ Seat to Floor Height: 16¹/₂-19³/₅
Width: 28³/₄ Usable Seat Depth: 18¹/₂-19¹/₂
Height: 38⁹/₁₀ Ship Weight: 46
Seat Width: 19³/₄ Cube: 6.3
Back Width: 17⁷/₈ COM: 1.5
Back Height: 23³/₁₀ Weight Rating: 275 lbs.
Arm Width: 19¹/₂

FABRIC PRICE CODES

1	\$575	8	\$725
2	\$602	9	\$744
3	\$628	10	\$763
4	\$647	11	\$783
5	\$666	12	\$802
6	\$686	L	—
7	\$705		

NOTES: Product ships knocked down.

HON Recommendation: HPTCC2-T1UM.BLK.CU10 - List Price \$575

HOW TO SPECIFY

Select
Model Number

HPTCC2-T1UM.

Select
Frame Color

BLK Black Frame
Comes with Black Mesh on HPTCC2-T1UM. Fabric selected through separate option.

WHT White Frame (+ \$45)
Comes with Grey Mesh on HPTCC2-T1UM. Fabric selected through separate option.

BLK.

Select
Fabric

See page 273

CU10

ALTERN™ Custom Models



Icon Legend on page 19

HPTCC2-T3UM



MID-BACK TASK STOOL

- Mesh Back
- Pneumatic
- Swivel
- Synchro-tilt
- Tilt Tension
- Tilt Lock
- Adjustable Lumbar
- Seat Slide
- Height-Adjustable Arms
- Black Hard Casters
- Adjustable Foot Ring

DIMENSIONS

Depth:	28 ⁹ / ₁₀	Seat to Floor Height:	24 ¹ / ₅ -32 ² / ₅
Width:	28 ³ / ₄	Usable Seat Depth:	18 ¹ / ₂ -19 ¹ / ₂
Height:	53 ¹ / ₄	Ship Weight:	49
Seat Width:	19 ³ / ₄	Cube:	7.6
Back Width:	17 ⁵ / ₈	COM	1.0
Back Height:	24 ¹ / ₁₀	Weight Rating:	275 lbs.
Arm Width:	19 ¹ / ₂		

FABRIC PRICE CODES

1	\$635	8	\$711
2	\$649	9	\$720
3	\$662	10	\$729
4	\$672	11	\$740
5	\$681	12	\$749
6	\$691	L	—
7	\$700		

NOTES: Product ships knocked down.

HPTCC2-T3UU



LOW-BACK TASK STOOL

- Upholstered Back
- Pneumatic
- Swivel
- Synchro-tilt
- Tilt Tension
- Tilt Lock
- Seat Slide
- Height-Adjustable Arms
- Black Hard Casters

DIMENSIONS

Depth:	28 ⁹ / ₁₀	Seat to Floor Height:	23 ³ / ₅ -32 ⁷ / ₈
Width:	28 ³ / ₄	Usable Seat Depth:	18 ¹ / ₂ -19 ¹ / ₂
Height:	50 ⁷ / ₁₀	Ship Weight:	51
Seat Width:	19 ³ / ₄	Cube:	7.3
Back Width:	17 ⁷ / ₈	COM	1.5
Back Height:	23 ³ / ₁₀	Weight Rating:	275 lbs.
Arm Width:	19 ¹ / ₂		

FABRIC PRICE CODES

1	\$635	8	\$785
2	\$662	9	\$804
3	\$688	10	\$823
4	\$707	11	\$843
5	\$726	12	\$862
6	\$746	L	—
7	\$765		

NOTES: Product ships knocked down.

HON Recommendation: HPTCC2-T3UM.BLK.CU10 - List Price \$635

HOW TO SPECIFY

Select Model Number

HPTCC2-T3UM

Select Frame Color

BLK Black Frame
Comes with Black Mesh on HPTCC2-T3UM. Fabric selected through separate option.

BLK

Select Fabric

See page 273

CU10



Icon Legend on page 19

ALTERN™ Accessories

HSCASTER

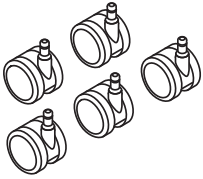

SET OF 5 ALL-SURFACE CASTERS

DIMENSIONS

Size: 60mm
Ship Weight: 2
Cube: 0.1

LIST PRICE

\$75

ⓘ Available in Black finish only, no specification needed.

SEATING

HOW TO SPECIFY

Select
Model Number

H S C A S T E R

ASTIR™

Want to see more?
Scan here to check
out hon.com.



Astir™ Seating shown with Birk™ Tables and Acoustic Solutions by Unika Vaev.

ASTIR™

Astir™ answers the call for soft seating solutions while providing separate work spaces and sturdy posture support for those looking to step away from their desks. The line provides a soft yet upright sit to keep employees engaged and working comfortably at a table setting. High-back and side options help keep private conversations private — so teams don't have to be confined in close quarters, such as a conference room. And a unique, single-seat style with high screens on three sides creates a quiet, secure, and comfortable space for individual focus.



FEATURES

- Seat height and back angle are scaled for more of an upright working posture.
- Choose from One+, Two-, or Three-Seat Lounges in low- or high-back options.
- High-back screens available in knit mesh or fabric options provide visual privacy on back and sides.
- Fabric high-back screen option available in cleanable fabrics (see HON's cleaning guide for instructions).
- Choose from three different leg styles to customize your look.
- Two- or Three-Seat Benches add extra seating for commons or reception areas.
- Pouf model functions as both impromptu seating and a place to kick up your feet.
- Replaceable seat cushion enhances comfort and cleanability, and allows for easy changing.
- With the multi-fabric options, seat cushion and frame can be specified in different fabrics for a modern aesthetic.
- Add an optional power module to route power directly underneath the seat.

MODEL OPTIONS

**HASLB1, HASLB1MF -
Multi-Fabric**

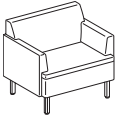

Lounge
One+ Seat, Low-Back

**HASLB2, HASLB2MF -
Multi-Fabric**

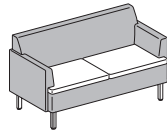

Lounge
Two-Seat, Low-Back

**HASLB3, HASLB3MF -
Multi-Fabric**

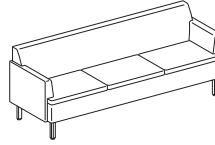

Lounge
Three-Seat, Low-Back

**HASLBTC, HASLBTCMF -
Multi-Fabric**

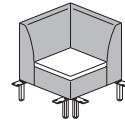

Lounge
True Corner, Low-Back

**HASHB1, HASHB1MF -
Multi-Fabric**

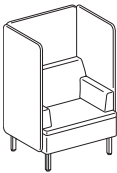

Lounge
One+ Seat, High-Back Screen

**HASHB2, HASHB2MF -
Multi-Fabric**

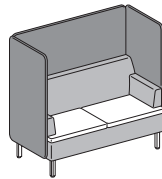

Lounge
Two-Seat, High-Back Screen

**HASHB3, HASHB3MF -
Multi-Fabric**

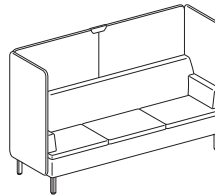

Lounge
Three-Seat, High-Back Screen

**HASHBTC, HASHBTCMF -
Multi-Fabric**

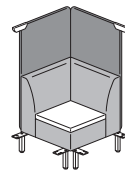

Lounge
True Corner, High-Back Screen

**HASB2, HASB2MF -
Multi-Fabric**

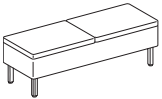

Bench
Two-Seat Bench

**HASB3, HASB3MF -
Multi-Fabric**

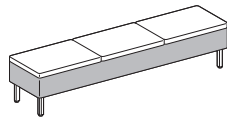

Bench
Three-Seat Bench

**HASPSS, HASPSSMF -
Multi-Fabric**



Pouf

Low-Back, Multi-Fabric



High-Back, Multi-Fabric



ASTIR™ Finish Options

HON BRANDED FABRICS

GRADE 1	GRADE 2	GRADE 3	GRADE 4	KNIT
Apex	Appoint Seating	Bradbury	Constance with Supreen™	Light
Centurion	Blume	Cozy	Livi with Supreen™	Medium
Contourett	Clyde	Getaway	Lucerne	Dark
Dapper	Haute	Moxie	Lugano with Supreen™	
Emphasis	Kai	Notion	Oxford with Supreen™	FABRICS
Ensemble	Rush	Purl		Apex
Hamilton	Wavelength	Quill		Blume
Noble Seating	Whisper Vinyl	Saxony		Contourett
Pebble				Moxie
Vibe				Pebble
				Whisper Vinyl

For a complete list of fabrics, including partnership fabrics, go to hon.com/fabricsandfinishes.

Reference Fabric Color Combinations on pages 20-25 for color codes and legend on page 21 for lead times.

For more details on Upholstery Pattern Match for this series, please see page 14.

SCREEN FABRIC OPTIONS

LEG STYLE

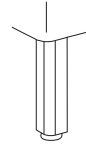

CODE	DESCRIPTION	PRICE
PM	Post Metal	+\$57
<i>Available in the following finishes:</i>		
P8V	Textured Titanium	
P7A	Textured Charcoal	+\$23
P8X	Solar Black	+\$23
PR5	Champagne Metallic	+\$23

LEG STYLE

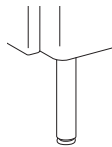

CODE	DESCRIPTION	PRICE
DW	Dowel Wood	+\$0
<i>Available in the following finishes:</i>		
LE878	Beigewood	
H	Bourbon Cherry	
COGN	Cognac	
LE599	Field Elm	
LFW1	Florence Walnut	
C	Harvest	
LKI1	Kingswood Walnut	
LLA1	Lowell Ash	
N	Mahogany	
MOCH	Mocha	
D	Natural Maple	
LNR1	Natural Recon	
LPE1	Phantom Ecru	
PINC	Pinnacle	
LPT1	Portico Teak	
F	Shaker Cherry	
LSW1	Skyline Walnut	
LSA1	Sterling Ash	

Due to wood being a natural material, color may differ between pieces. Stains will be tonal matches and will not replicate the grain contrast of the coordinating laminate.

LEG STYLE

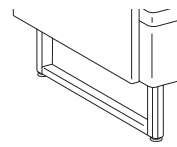

CODE	DESCRIPTION	PRICE
SW	Sled Wood	+\$113
<i>Available in the following finishes:</i>		
LE878	Beigewood	
H	Bourbon Cherry	
COGN	Cognac	
LE599	Field Elm	
LFW1	Florence Walnut	
C	Harvest	
LKI1	Kingswood Walnut	
LLA1	Lowell Ash	
N	Mahogany	
MOCH	Mocha	
D	Natural Maple	
LNR1	Natural Recon	
LPE1	Phantom Ecru	
PINC	Pinnacle	
LPT1	Portico Teak	
F	Shaker Cherry	
LSW1	Skyline Walnut	
LSA1	Sterling Ash	

Due to wood being a natural material, color may differ between pieces. Stains will be tonal matches and will not replicate the grain contrast of the coordinating laminate.

MULTI-FABRIC COM YARDAGE

Due to fabric pattern nesting and potential reduction of fabric yield, some multi-fabric models may require more total yardage than standard models.

MODEL	COM (ARMLESS)			COM (ONE ARM/SIDE)			COM (BOTH ARMS/SIDES)		
	Seat	Back/Frame	Screen	Seat	Back/Frame	Screen	Seat	Back/Frame	Screen
HASLB1	—	—	—	—	—	—	—	6.5	—
HASLB1MF	—	—	—	—	—	—	1.5	5.0	—
HASLBTC	—	5.0	—	—	—	—	—	—	—
HASLBTCMF	1.5	4.0	—	—	—	—	—	—	—
HASLB2	—	7.0	—	—	8.0	—	—	9.0	—
HASLB2MF	3.0	4.5	—	3.0	5.5	—	3.0	6.5	—
HASLB3	—	10.0	—	—	11.0	—	—	12.0	—
HASLB3MF	4.0	6.0	—	4.0	7.5	—	4.0	8.5	—
HASHB1	—	—	—	—	—	—	—	4.5	8.0
HASHB1MF	—	—	—	—	—	—	1.5	3.5	8.0
HASHBTC	—	5.0	5.5	—	—	—	—	—	—
HASHBTCMF	1.5	4.0	5.5	—	—	—	—	—	—
HASHB2	—	7.0	5.5	—	7.0	8.0	—	7.0	11.0
HASHB2MF	3.0	4.5	5.5	3.0	4.5	8.0	3.0	4.5	11.0
HASHB3	—	10.5	5.5	—	10.5	8.0	—	10.5	11.0
HASHB3MF	4.0	7.0	5.5	4.0	7.0	8.0	4.0	7.0	11.0
HAS PSS	—	2.0	—	—	—	—	—	—	—
HAS PSSMF	1.0	1.5	—	—	—	—	—	—	—
HASB2	—	4.5	—	—	—	—	—	—	—
HASB2MF	3.0	2.0	—	—	—	—	—	—	—
HASB3	—	6.5	—	—	—	—	—	—	—
HASB3MF	4.0	2.5	—	—	—	—	—	—	—

ASTIR™ Collaborative Work Seating



Icon Legend on page 19

HASLB1

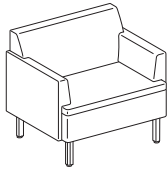

ONE+ SEAT — LOW-BACK DIMENSIONS

Depth:	29	Back Height:	16
Height:	32	Back Width:	33½
Width:	36½	Arm Height:	7½
Usable Seat Depth:	19¾	Ship Weight:	95
Seat to Floor Height:	18¾	Cube:	21.2
Seat Width:	27	COM:	See page 280
		Weight Rating:	300 lbs.

FABRIC PRICE CODES

1	\$2875	8	\$4183
2	\$3050	9	\$4214
3	\$3226	10	\$4391
4	\$3373	11	\$4567
5	\$3569	12	\$4744
6	\$3769	L	—
7	\$3973		

HASLB1MF

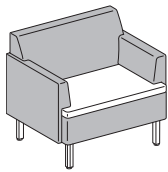

ONE+ SEAT — LOW-BACK, MULTI-FABRIC DIMENSIONS

Depth:	29	Back Height:	16
Height:	32	Back Width:	33½
Width:	36½	Arm Height:	7½
Usable Seat Depth:	19¾	Ship Weight:	95
Seat to Floor Height:	18¾	Cube:	21.2
Seat Width:	27	COM:	See page 280
		Weight Rating:	300 lbs.

FABRIC PRICE CODES

1	\$3094	
<i>Add to Base Price Above</i>		
	Seat	Frame/Back
2	\$42	\$134
3	\$83	\$269
4	\$116	\$383
5	\$161	\$534
6	\$208	\$688
7	\$255	\$845
8	\$303	\$1006
9	\$311	\$1032
10	\$351	\$1166
11	\$392	\$1301
12	\$433	\$1438

HON Recommendation: HASLB1.B.PURL__DW__ - List Price \$3226

HOW TO SPECIFY

<p>Select Model Number</p> <p>HASLB1MF.</p>	<p>Select Arm Type</p> <p>B Both Arms</p> <p>B.</p>	<p>Select Fabric</p> <p>See page 280 Specify for Single Fabric model only</p> <p>PBLE07.</p>	<p>Select Seat Cushion Fabric</p> <p>See page 280 Specify for MF model only</p> <p>PBLE09.</p>	<p>Select Back and Frame Fabric</p> <p>See page 280 Specify for MF model only</p> <p>PBLE06.</p>	<p>Select Leg and Color</p> <p>DW Dowel Wood PM Post Metal (+ \$57) SW Sled Wood (+ \$113)</p> <p>See page 280 for colors</p> <p>PMP8V</p>
--	--	---	---	---	---



Icon Legend on page 19

ASTIR™ Collaborative Work Seating

HASHB1

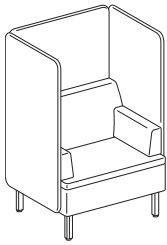

ONE+ SEAT — HIGH-BACK SCREEN

DIMENSIONS

Depth:	29¾	Back Height:	16
Height:	54	Back Width:	33½
Width:	35	Arm Height:	7½
Usable Seat Depth:	19¾	Ship Weight*:	124
Seat to Floor Height:	18¾	Cube:	24.1
Seat Width:	25½	COM:	See page 280
		Weight Rating:	300 lbs.

FABRIC PRICE CODES

1		\$3923	
<i>Add to Base Price Above</i>			
	Unit	Knit	Screen
1	—	1	\$167
2	\$134	2	\$381
3	\$269	3	\$598
4	\$383	4	\$777
5	\$534	5	\$1019
6	\$688	6	\$1265
7	\$845	7	\$1517
8	\$1006	8	\$1775
9	\$1032	9	\$1815
10	\$1166	10	\$2033
11	\$1301	11	\$2250
12	\$1438	12	\$2466

*Ships in two cartons.

HASHB1MF

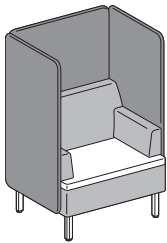

ONE+ SEAT — HIGH-BACK SCREEN, MULTI-FABRIC

DIMENSIONS

Depth:	29¾	Back Height:	16
Height:	54	Back Width:	33½
Width:	35	Arm Height:	7½
Usable Seat Depth:	19¾	Ship Weight*:	124
Seat to Floor Height:	18¾	Cube:	24.1
Seat Width:	25½	COM:	See page 280
		Weight Rating:	300 lbs.

FABRIC PRICE CODES

1		\$4140	
<i>Add to Base Price Above</i>			
	Seat	Back/ Frame	Knit Screen
1	—	—	1 \$167
2	\$42	\$109	2 \$381
3	\$83	\$217	3 \$598
4	\$116	\$306	4 \$777
5	\$161	\$428	5 \$1019
6	\$208	\$551	6 \$1265
7	\$255	\$677	7 \$1517
8	\$303	\$805	8 \$1775
9	\$311	\$826	9 \$1815
10	\$351	\$934	10 \$2033
11	\$392	\$1043	11 \$2250
12	\$433	\$1151	12 \$2466

*Ships in two cartons.

HON Recommendation: HASHB1.B.PURL__KMD.DW__ - List Price \$4192

HOW TO SPECIFY

Select Model Number H A S H B 1 M F .	Select Arm Type B Both Side Screens	Select Fabric See page 280 <i>Specify for Single Fabric model only</i>	Select Seat Cushion Fabric See page 280 <i>Specify for MF model only</i>	Select Back and Frame Fabric See page 280 <i>Specify for MF model only</i>	Select Screen Knit or Fabric Knit Options: KLT Light KMD Medium KDK Dark See page 280 for all options	Select Leg and Color DW Dowel Wood PM Post Metal (+ \$57) SW Sled Wood (+ \$113) See page 280 for colors
	B .	P B L E 0 7 .	P B L E 0 9 .	P B L E 0 6 .	K M D .	P M P 8 V

SEATING

ASTIR™ Collaborative Work Seating



Icon Legend on page 19

HASLB2

TWO-SEAT LOUNGE — LOW-BACK

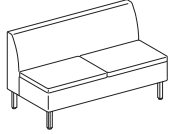

Armless

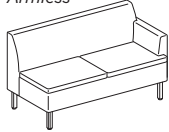

Left

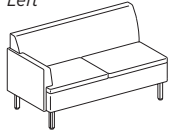

Right

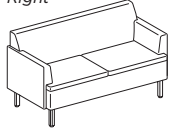

Both Arms

DIMENSIONS

Depth:	29	Back Height:	16
Height:	32	Back Width:	56½
Width (armless):	56½	Arm Height:	7½
Width (one arm):	58	Ship Weight (armless):	113
Width (both arms):	59½	Ship Weight (one arm):	122
Usable Seat Depth:	19¾	Ship Weight (both arms):	131
Seat to Floor Height:	18¾	Cube:	35.1
Seat Width (armless):	56½	COM:	See page 280
Seat Width (one arm):	53¼	Weight Rating:	300 lbs. (per seat)
Seat Width (both arms):	50		

FABRIC PRICE CODES

1	\$3210	8	\$5020
2	\$3449	9	\$5064
3	\$3695	10	\$5510
4	\$3898	11	\$5554
5	\$4169	12	\$5798
6	\$4446	L	—
7	\$4730		

HASLB2MF

TWO-SEAT LOUNGE — LOW-BACK, MULTI-FABRIC

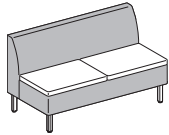

Armless

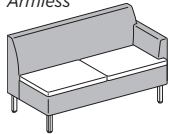

Left

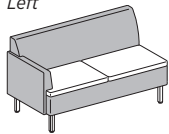

Right

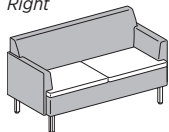

Both Arms

DIMENSIONS

Depth:	29	Back Height:	16
Height:	32	Back Width:	56½
Width (armless):	56½	Arm Height:	7½
Width (one arm):	58	Ship Weight (armless):	113
Width (both arms):	59½	Ship Weight (one arm):	122
Usable Seat Depth:	19¾	Ship Weight (both arms):	131
Seat to Floor Height:	18¾	Cube:	35.1
Seat Width (armless):	56½	COM:	See page 280
Seat Width (one arm):	53¼	Weight Rating:	300 lbs. (per seat)
Seat Width (both arms):	50		

FABRIC PRICE CODES

1	\$3428		
<i>Add to Base Price Above</i>			
		Seat	Frame/Back
2	\$82	\$175	
3	\$162	\$351	
4	\$230	\$498	
5	\$321	\$694	
6	\$412	\$894	
7	\$508	\$1098	
8	\$605	\$1308	
9	\$620	\$1339	
10	\$701	\$1516	
11	\$782	\$1692	
12	\$865	\$1869	

HON Recommendation: HASLB2.B.PURL__DW__ - List Price \$4198

HOW TO SPECIFY

Select Model Number HASLB2MF	Select Arm Type N Armless L Left Side (+ \$252) R Right Side (+ \$252) B Both Arms (+ \$503)	Select Fabric See page 280 Specify for Single Fabric model only	Select Seat Cushion Fabric See page 280 Specify for MF model only	Select Back and Frame Fabric See page 280 Specify for MF model only	Select Leg and Color DW Dowel Wood PM Post Metal (+ \$57) SW Sled Wood (+ \$113) See page 280 for colors
HASLB2MF	B	PBLE07	PBLE09	PBLE06	PMP8V



Icon Legend on page 19

ASTIR™ Collaborative Work Seating

HASHB2

TWO-SEAT LOUNGE — HIGH-BACK SCREEN

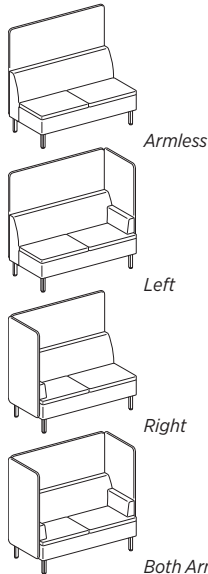

DIMENSIONS

Depth:	29¾	Back Height:	16
Height:	54	Back Width:	56½
Width (armless):	56½	Arm Height:	7½
Width (one arm):	57¼	Ship Weight* (armless):	136
Width (both arms):	58	Ship Weight* (one arm):	156
Usable Seat Depth:	19¾	Ship Weight* (both arms):	176
Seat to Floor Height:	18¾	Cube:	29.4
Seat Width (armless):	56½	COM:	See page 280
Seat Width (one arm):	52¼	Weight Rating:	300 lbs. (per seat)
Seat Width (both arms):	48¼		

FABRIC PRICE CODES

1	\$4519		
<i>Add to Base Price Above</i>			
	Unit	Knit	Screen
1	—	1	—
2	\$215	2	\$167
3	\$432	3	\$459
4	\$611	4	\$759
5	\$853	5	\$1006
6	\$1100	6	\$1338
7	\$1351	7	\$1676
8	\$1609	8	\$2024
9	\$1648	9	\$2378
10	\$1866	10	\$2432
11	\$2083	11	\$2731
12	\$2300	12	\$3030

*Ships in two cartons.

HASHB2MF

TWO-SEAT LOUNGE — HIGH-BACK SCREEN, MULTI-FABRIC

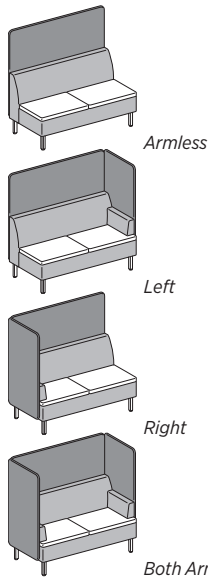

DIMENSIONS

Depth:	29¾	Back Height:	16
Height:	54	Back Width:	56½
Width (armless):	56½	Arm Height:	7½
Width (one arm):	57¼	Ship Weight* (armless):	136
Width (both arms):	58	Ship Weight* (one arm):	156
Usable Seat Depth:	19¾	Ship Weight* (both arms):	176
Seat to Floor Height:	18¾	Cube:	29.4
Seat Width (armless):	56½	COM:	See page 280
Seat Width (one arm):	52¼	Weight Rating:	300 lbs. (per seat)
Seat Width (both arms):	48¼		

FABRIC PRICE CODES

1	\$4737		
<i>Add to Base Price Above</i>			
	Seat	Back/Frame	Screen
		Knit	—
1	—	—	1
2	\$82	\$134	2
3	\$162	\$269	3
4	\$230	\$383	4
5	\$321	\$534	5
6	\$412	\$688	6
7	\$508	\$845	7
8	\$605	\$1006	8
9	\$620	\$1032	9
10	\$701	\$1166	10
11	\$782	\$1301	11
12	\$865	\$1438	12

*Ships in two cartons.

HON Recommendation: HASHB2.B.PURL__KMD.DW__ - List Price \$5953

HOW TO SPECIFY

Select Model Number	Select Arm Type	Select Fabric	Select Seat Cushion Fabric	Select Back and Frame Fabric	Select Screen Knit or Fabric	Select Leg and Color
	N Armless L Left Side (+ \$501) R Right Side (+ \$501) B Both Side Screens (+ \$1002)	See page 280 <i>Specify for Single Fabric model only</i>	See page 280 <i>Specify for MF model only</i>	See page 280 <i>Specify for MF model only</i>	Knit Options: KLT Light KMD Medium KDK Dark See page 280 for all options	DW Dowel Wood PM Post Metal (+ \$57) SW Sled Wood (+ \$113) See page 280 for colors
H A S H B 2 M F .	B .	P B L E 0 7 .	P B L E 0 9 .	P B L E 0 6 .	K M D .	P M P 8 V

SEATING

ASTIR™ Collaborative Work Seating



Icon Legend on page 19

HASLB3

THREE-SEAT LOUNGE — LOW-BACK

DIMENSIONS

Depth:	29	Back Height:	16
Height:	32	Back Width:	84½
Width (armless):	84½	Arm Height:	7½
Width (one arm):	86	Ship Weight (armless):	152
Width (both arms):	87½	Ship Weight (one arm):	161
Usable Seat Depth:	19¾	Ship Weight (both arms):	170
Seat to Floor Height:	18¾	Cube:	47.9
Seat Width (armless):	84½	COM:	See page 280
Seat Width (one arm):	81¼	Weight Rating:	300 lbs. (per seat)
Seat Width (both arms):	78		

FABRIC PRICE CODES

1	\$4242	8	\$6654
2	\$4561	9	\$6714
3	\$4889	10	\$7040
4	\$5158	11	\$7365
5	\$5521	12	\$7691
6	\$5889	L	—
7	\$6269		

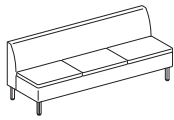

Armless

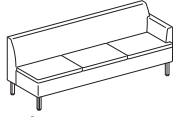

Left

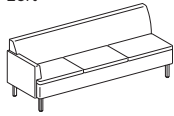

Right

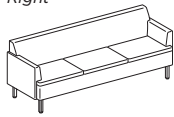

Both Arms

HASLB3MF

THREE-SEAT LOUNGE — LOW-BACK, MULTI-FABRIC

DIMENSIONS

Depth:	29	Back Height:	16
Height:	32	Back Width:	84½
Width (armless):	84½	Arm Height:	7½
Width (one arm):	86	Ship Weight (armless):	152
Width (both arms):	87½	Ship Weight (one arm):	161
Usable Seat Depth:	19¾	Ship Weight (both arms):	170
Seat to Floor Height:	18¾	Cube:	47.9
Seat Width (armless):	84½	COM:	See page 280
Seat Width (one arm):	81¼	Weight Rating:	300 lbs. (per seat)
Seat Width (both arms):	78		

FABRIC PRICE CODES

1	\$4459	
<i>Add to Base Price Above</i>		
	Seat	Frame/Back
2	\$109	\$227
3	\$217	\$458
4	\$306	\$649
5	\$428	\$906
6	\$551	\$1167
7	\$677	\$1435
8	\$805	\$1709
9	\$826	\$1753
10	\$934	\$1983
11	\$1043	\$2213
12	\$1151	\$2445

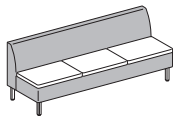

Armless

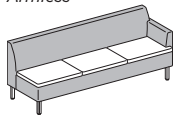

Left

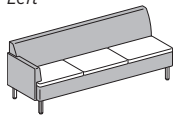

Right

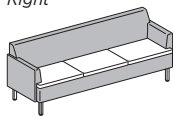

Both Arms

HON Recommendation: HASLB3.B.PURL__DW__ - List Price \$5392

HOW TO SPECIFY

Select Model Number HASLB3MF	Select Arm Type N Armless L Left Side (+ \$252) R Right Side (+ \$252) B Both Arms (+ \$503)	Select Fabric See page 280 <i>Specify for Single Fabric model only</i>	Select Seat Cushion Fabric See page 280 <i>Specify for MF model only</i>	Select Back and Frame Fabric See page 280 <i>Specify for MF model only</i>	Select Leg and Color DW Dowel Wood PM Post Metal (+ \$57) SW Sled Wood (+ \$113) See page 280 for colors
H A S L B 3 M F .	B .	P B L E 0 7 .	P B L E 0 9 .	P B L E 0 6 .	P M P 8 V



Icon Legend on page 19

ASTIR™ Collaborative Work Seating

HASHB3

THREE-SEAT LOUNGE — HIGH-BACK SCREEN

DIMENSIONS

Depth:	29¾	Back Height:	16
Height:	54	Back Width:	84½
Width (armless):	84½	Arm Height:	7½
Width (one arm):	85¼	Ship Weight* (armless):	185
Width (both arms):	86	Ship Weight* (one arm):	205
Usable Seat Depth:	19¾	Ship Weight* (both arms):	225
Seat to Floor Height:	18¾	Cube:	39
Seat Width (armless):	84½	COM:	See page 280
Seat Width (one arm):	80½	Weight Rating:	300 lbs. (per seat)
Seat Width (both arms):	76½		

FABRIC PRICE CODES

1	\$6172		
<i>Add to Base Price Above</i>			
	Unit	Knit	Screen
1	—	1	—
2	\$280	2	\$167
3	\$565	3	\$459
4	\$802	4	\$759
5	\$1119	5	\$1006
6	\$1442	6	\$1338
7	\$1773	7	\$1676
8	\$2111	8	\$2024
9	\$2163	9	\$2378
10	\$2449	10	\$2432
11	\$2733	11	\$2731
12	\$3018	12	\$3030

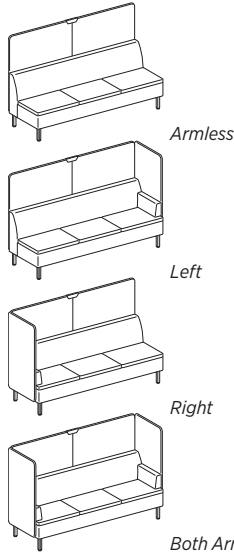

Both Arms *Ships in two cartons.

HASHB3MF

THREE-SEAT LOUNGE — HIGH-BACK SCREEN, MULTI-FABRIC

DIMENSIONS

Depth:	29¾	Back Height:	16
Height:	54	Back Width:	84½
Width (armless):	84½	Arm Height:	7½
Width (one arm):	85¼	Ship Weight* (armless):	185
Width (both arms):	86	Ship Weight* (one arm):	205
Usable Seat Depth:	19¾	Ship Weight* (both arms):	225
Seat to Floor Height:	18¾	Cube:	39
Seat Width (armless):	84½	COM:	See page 280
Seat Width (one arm):	80½	Weight Rating:	300 lbs. (per seat)
Seat Width (both arms):	76½		

FABRIC PRICE CODES

1	\$6390		
<i>Add to Base Price Above</i>			
	Seat	Back/Frame	Screen
1	—	1	—
2	\$109	2	\$167
3	\$217	3	\$459
4	\$306	4	\$759
5	\$428	5	\$1006
6	\$551	6	\$1338
7	\$677	7	\$1676
8	\$805	8	\$2024
9	\$826	9	\$2378
10	\$934	10	\$2432
11	\$1043	11	\$2731
12	\$1151	12	\$3030

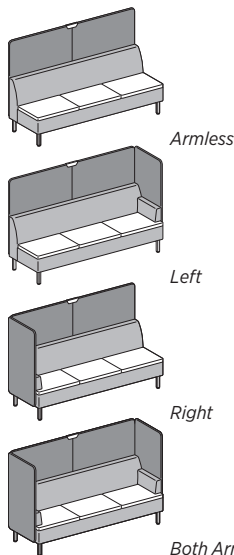

Both Arms *Ships in two cartons.

HON Recommendation: HASHB3.B.PURL__KMD.DW__ - List Price \$7739

HOW TO SPECIFY

Select Model Number HASHB3MF	Select Arm Type N Armless L Left Side (+ \$501) R Right Side (+ \$501) B Both Side Screens (+ \$1002)	Select Fabric See page 280 <i>Specify for Single Fabric model only</i>	Select Seat Cushion Fabric See page 280 <i>Specify for MF model only</i>	Select Back and Frame Fabric See page 280 <i>Specify for MF model only</i>	Select Screen Knit or Fabric Knit Options: KLT Light KMD Medium KDK Dark See page 280 for all options	Select Leg and Color DW Dowel Wood PM Post Metal (+ \$57) SW Sled Wood (+ \$113) See page 280 for colors
H A S H B 3 M F .	B .	P B L E 0 7 .	P B L E 0 9 .	P B L E 0 6 .	K M D .	P M P 8 V

ASTIR™ Collaborative Work Seating



Icon Legend on page 19

HASLBTC

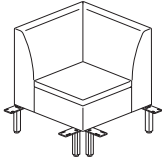

TRUE CORNER LOUNGE — LOW-BACK

DIMENSIONS

Depth:	29	Back Height:	16
Height:	32	Back Width:	29
Width:	29	Ship Weight:	90
Usable Seat Depth:	19¾	Cube:	21.2
Seat to Floor Height:	18¾	COM:	See page 280
Seat Width:	20¼	Weight Rating:	300 lbs.

FABRIC PRICE CODES

1	\$3008	8	\$4014
2	\$3142	9	\$4040
3	\$3277	10	\$4174
4	\$3391	11	\$4309
5	\$3542	12	\$4446
6	\$3696	L	—
7	\$3853		

NOTES: True Corner uses legs from adjacent units, and can work with all leg styles. For adjacent units with sled legs, pick a single leg option for the True Corner rear leg.

- ⚠ True Corner designed to act as a corner between two adjacent units, not as a stand-alone unit.
- ⚠ True Corner leg selection refers to back corner leg only, and ships with only that leg.

HASLBTCMF

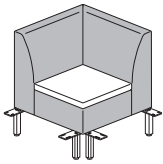

TRUE CORNER LOUNGE — LOW-BACK, MULTI-FABRIC

DIMENSIONS

Depth:	29	Back Height:	16
Height:	32	Back Width:	29
Width:	29	Ship Weight:	90
Usable Seat Depth:	19¾	Cube:	21.2
Seat to Floor Height:	18¾	COM:	See page 280
Seat Width:	20¼	Weight Rating:	300 lbs.

FABRIC PRICE CODES

1	\$3226	
<i>Add to Base Price Above</i>		
	Seat	Frame/Back
2	\$42	\$109
3	\$83	\$217
4	\$116	\$306
5	\$161	\$428
6	\$208	\$551
7	\$255	\$677
8	\$303	\$805
9	\$311	\$826
10	\$351	\$934
11	\$392	\$1043
12	\$433	\$1151

NOTES: True Corner uses legs from adjacent units, and can work with all leg styles. For adjacent units with sled legs, pick a single leg option for the True Corner rear leg.

- ⚠ True Corner designed to act as a corner between two adjacent units, not as a stand-alone unit.
- ⚠ True Corner leg selection refers to back corner leg only, and ships with only that leg.

HON Recommendation: HASLBTC.PURL__DW__ - List Price \$3277

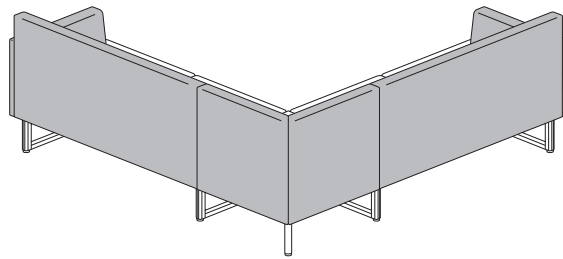
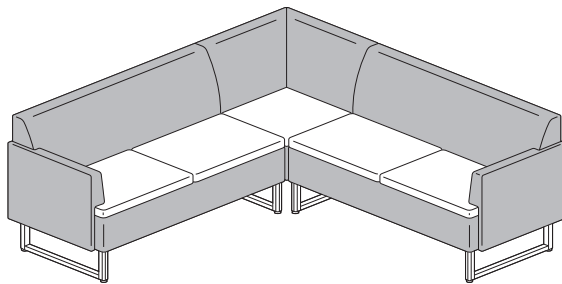

SEATING

HOW TO SPECIFY

<p>Select Model Number</p> <p>See page 280</p>	<p>Select Fabric</p> <p>See page 280</p> <p><i>Specify for Single Fabric model only</i></p>	<p>Select Seat Cushion Fabric</p> <p>See page 280</p> <p><i>Specify for MF model only</i></p>	<p>Select Back and Frame Fabric</p> <p>See page 280</p> <p><i>Specify for MF model only</i></p>	<p>Select Leg and Color</p> <p>DW Dowel Wood PM Post Metal (+ \$57)</p> <p>See page 280 for colors</p>
HASLBTCMF	PBLE07	PBLE09	PBLE06	PMP8V



Icon Legend on page 29

ASTIR™ Collaborative Work Seating

HASHBTC

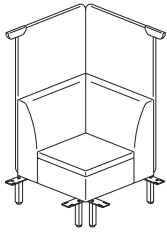

TRUE CORNER LOUNGE — HIGH-BACK SCREEN

DIMENSIONS

Depth:	29¾	Back Height:	16
Height:	54	Back Width:	29
Width:	29¾	Ship Weight:	119
Usable Seat Depth:	19¾	Cube:	28.1
Seat to Floor Height:	18¾	COM:	See page 280
Seat Width:	20¼	Weight Rating:	300 lbs.

FABRIC PRICE CODES

1		\$4139	
<i>Add to Base Price Above</i>			
	Unit	Knit	Screen
1	—	1	\$167
2	\$134	2	\$314
3	\$269	3	\$464
4	\$383	4	\$587
5	\$534	5	\$753
6	\$688	6	\$923
7	\$845	7	\$1095
8	\$1006	8	\$1273
9	\$1032	9	\$1299
10	\$1166	10	\$1449
11	\$1301	11	\$1599
12	\$1438	12	\$1747

NOTES: True Corner uses legs from adjacent units, and can work with all leg styles. For adjacent units with sled legs, pick a single leg option for the True Corner rear leg.

- ❗ True Corner designed to act as a corner between two adjacent units, not as a stand-alone unit.
- ❗ True Corner leg selection refers to back corner leg only, and ships with only that leg.

HASHBTCMF

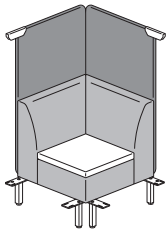

TRUE CORNER LOUNGE — HIGH-BACK SCREEN, MULTI-FABRIC

DIMENSIONS

Depth:	29¾	Back Height:	16
Height:	54	Back Width:	29
Width:	29¾	Ship Weight:	119
Usable Seat Depth:	19¾	Cube:	28.1
Seat to Floor Height:	18¾	COM:	See page 280
Seat Width:	20¼	Weight Rating:	300 lbs.

FABRIC PRICE CODES

1		\$4357	
<i>Add to Base Price Above</i>			
	Seat	Back/Frame	Knit Screen
1	—	1	\$167
2	\$42	\$109	\$314
3	\$83	\$217	\$464
4	\$116	\$306	\$587
5	\$161	\$428	\$753
6	\$208	\$551	\$923
7	\$255	\$677	\$1095
8	\$303	\$805	\$1273
9	\$311	\$826	\$1299
10	\$351	\$934	\$1449
11	\$392	\$1043	\$1599
12	\$433	\$1151	\$1747

NOTES: True Corner uses legs from adjacent units, and can work with all leg styles. For adjacent units with sled legs, pick a single leg option for the True Corner rear leg.

- ❗ True Corner designed to act as a corner between two adjacent units, not as a stand-alone unit.
- ❗ True Corner leg selection refers to back corner leg only, and ships with only that leg.

HON Recommendation: HASHBTC.PURL__KMD.DW__ - List Price \$4408

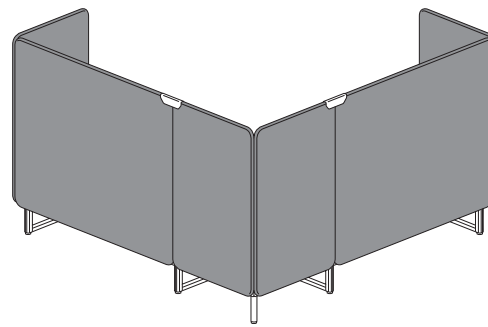
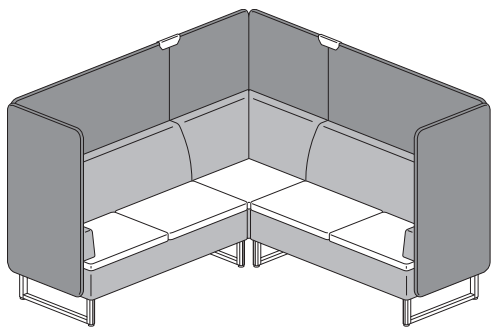

HOW TO SPECIFY

Select Model Number HASHBTCMF	Select Fabric See page 280 <i>Specify for Single Fabric model only</i> PBLE07	Select Seat Cushion Fabric See page 280 <i>Specify for MF model only</i> PBLE09	Select Back and Frame Fabric See page 280 <i>Specify for MF model only</i> PBLE06	Select Screen Knit or Fabric Knit Options: KLT Light KMD Medium KDK Dark See page 280 for all options KMD	Select Leg and Color DW Dowel Wood PM Post Metal (+ \$57) See page 280 for colors PMP8V
---	---	---	---	---	--

SEATING

ASTIR™ Collaborative Work Seating



Icon Legend on page 19

HASB2

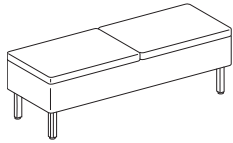

TWO-SEAT BENCH

DIMENSIONS

Depth:	20¼	Seat Width:	56¼
Height:	19	Ship Weight:	46
Width:	56½	Cube:	8.7
Usable Seat Depth:	20¼	COM:	See page 280
Seat to Floor Height:	18¾	Weight Rating:	300 lbs. (per seat)

FABRIC PRICE CODES

1	\$2905	8	\$3810
2	\$3026	9	\$3834
3	\$3148	10	\$3955
4	\$3248	11	\$4078
5	\$3385	12	\$4199
6	\$3525	L	—
7	\$3666		

HASB2MF

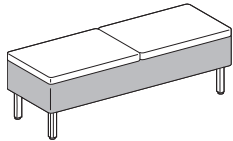

TWO-SEAT BENCH, MULTI-FABRIC

DIMENSIONS

Depth:	20¼	Seat Width:	56¼
Height:	19	Ship Weight:	46
Width:	56½	Cube:	8.7
Usable Seat Depth:	20¼	COM:	See page 280
Seat to Floor Height:	18¾	Weight Rating:	300 lbs. (per seat)

FABRIC PRICE CODES

1	\$3123	
<i>Add to Base Price Above</i>		
	Seat	Frame
2	\$82	\$55
3	\$162	\$110
4	\$230	\$154
5	\$321	\$215
6	\$412	\$277
7	\$508	\$338
8	\$605	\$403
9	\$620	\$412
10	\$701	\$467
11	\$782	\$522
12	\$865	\$576

HON Recommendation: HASB2.PURL__DW__ - List Price \$3148

HOW TO SPECIFY

<p>Select Model Number</p> <p>HASB2MF .</p>	<p>Select Fabric</p> <p>See page 280 <i>Specify for Single Fabric model only</i></p> <p>PBLE07 .</p>	<p>Select Seat Cushion Fabric</p> <p>See page 280 <i>Specify for MF model only</i></p> <p>PBLE09 .</p>	<p>Select Frame Fabric</p> <p>See page 280 <i>Specify for MF model only</i></p> <p>PBLE06 .</p>	<p>Select Leg and Color</p> <p>DW Dowel Wood PM Post Metal (+ \$57) SW Sled Wood (+ \$113) See page 280 for colors</p> <p>PMP8V</p>
--	---	---	--	--



Icon Legend on page 19

ASTIR™ Collaborative Work Seating

HASB3

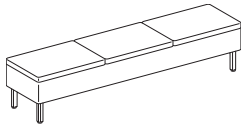

THREE-SEAT BENCH

DIMENSIONS

Depth:	20¼	Seat Width:	84½
Height:	19	Ship Weight:	61
Width:	84½	Cube:	12.2
Usable Seat Depth:	20¼	COM:	See page 280
Seat to Floor Height:	18¾	Weight Rating:	300 lbs. (per seat)

FABRIC PRICE CODES

1	\$3631	8	\$4939
2	\$3806	9	\$4970
3	\$3982	10	\$5147
4	\$4129	11	\$5323
5	\$4325	12	\$5500
6	\$4525	L	—
7	\$4729		

HASB3MF

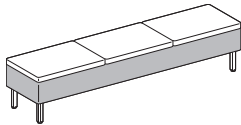

THREE-SEAT BENCH, MULTI-FABRIC

DIMENSIONS

Depth:	20¼	Seat Width:	84½
Height:	19	Ship Weight:	61
Width:	84½	Cube:	12.2
Usable Seat Depth:	20¼	COM:	See page 280
Seat to Floor Height:	18¾	Weight Rating:	300 lbs. (per seat)

FABRIC PRICE CODES

1	\$3849		
<i>Add to Base Price Above</i>			
	Seat	Frame	
2	\$109	\$67	
3	\$217	\$135	
4	\$306	\$192	
5	\$428	\$267	
6	\$551	\$343	
7	\$677	\$423	
8	\$805	\$504	
9	\$826	\$515	
10	\$934	\$583	
11	\$1043	\$652	
12	\$1151	\$720	

HON Recommendation: HASB3.PURL__DW__ - List Price \$3982

HOW TO SPECIFY

Select Model Number <div style="border: 1px solid black; padding: 2px; display: flex; justify-content: space-between;"> HASB3MF </div>	Select Fabric See page 280 <i>Specify for Single Fabric model only</i> <div style="border: 1px solid black; padding: 2px; display: flex; justify-content: space-between;"> PBLE07 </div>	Select Seat Cushion Fabric See page 280 <i>Specify for MF model only</i> <div style="border: 1px solid black; padding: 2px; display: flex; justify-content: space-between;"> PBLE09 </div>	Select Frame Fabric See page 280 <i>Specify for MF model only</i> <div style="border: 1px solid black; padding: 2px; display: flex; justify-content: space-between;"> PBLE06 </div>	Select Leg and Color DW Dowel Wood PM Post Metal (+ \$57) SW Sled Wood (+ \$113) See page 280 for colors <div style="border: 1px solid black; padding: 2px; display: flex; justify-content: space-between;"> PMP8V </div>
---	--	--	---	---

ASTIR™ Collaborative Work Seating



Icon Legend on page 19

HASPSS

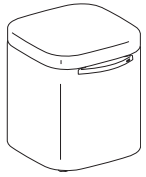

POUF

DIMENSIONS

Depth:	17¼	Seat Width:	16½
Height:	18¾	Ship Weight:	25
Width:	16½	Cube:	3.5
Usable Seat Depth:	16½	COM:	See page 280
Seat to Floor Height:	17½	Weight Rating:	300 lbs. (per seat)

FABRIC PRICE CODES

1	\$867	8	\$1270
2	\$922	9	\$1279
3	\$977	10	\$1334
4	\$1021	11	\$1389
5	\$1082	12	\$1443
6	\$1144	L	—
7	\$1205		

HASPSSMF

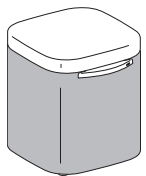

POUF, MULTI-FABRIC

DIMENSIONS

Depth:	17¼	Seat Width:	16½
Height:	18¾	Ship Weight:	25
Width:	16½	Cube:	3.5
Usable Seat Depth:	16½	COM:	See page 280
Seat to Floor Height:	17½	Weight Rating:	300 lbs. (per seat)

FABRIC PRICE CODES

1	\$1084	
<i>Add to Base Price Above</i>		
	Seat	Frame
2	\$28	\$42
3	\$55	\$83
4	\$79	\$116
5	\$109	\$161
6	\$139	\$208
7	\$169	\$255
8	\$202	\$303
9	\$208	\$311
10	\$234	\$351
11	\$262	\$392
12	\$289	\$433

HON Recommendation: HASPSS.PURL__H.BL - List Price \$977

SEATING

HOW TO SPECIFY

<p>Select Model Number</p> <p>H A S P S S .</p>	<p>Select Fabric</p> <p>See page 280</p> <p>P B L E 0 7 .</p>	<p>Select Leg and Color</p> <p>HG Hidden Glide H Caster</p> <p>H G .</p>	<p>Select Handle Color</p> <p>BL Black Handle</p> <p>B L</p>
--	--	---	---

HOW TO SPECIFY

<p>Select Model Number</p> <p>H A S P S S M F .</p>	<p>Select Seat Cushion Fabric</p> <p>See page 280</p> <p>P B L E 0 7 .</p>	<p>Select Frame Fabric</p> <p>See page 280</p> <p>P B L E 0 6 .</p>	<p>Select Leg and Color</p> <p>HG Hidden Glide H Caster</p> <p>H G .</p>	<p>Select Handle Color</p> <p>BL Black Handle</p> <p>B L</p>
--	---	--	---	---



Icon Legend on page 19

ASTIR™ Collaborative Work Seating

HASSP

HIGH-BACK SCREEN — SIDE PRIVACY

DIMENSIONS

Ship Weight: 3.2
Cube: 3.2
COM: 3.0

LIST PRICE

Knit \$2180

1	\$2237	7	\$2743
2	\$2316	8	\$2840
3	\$2398	9	\$2855
4	\$2466	10	\$2937
5	\$2556	11	\$3017
6	\$2648	12	\$3099

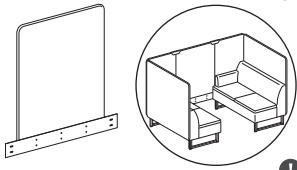

ⓘ Requires High-Back Screen units with arms on each unit.

HASGBSL

SHARED LEG GANGING BRACKET

DIMENSIONS

Ship Weight: 4
Cube: 0.1

LIST PRICE

\$293

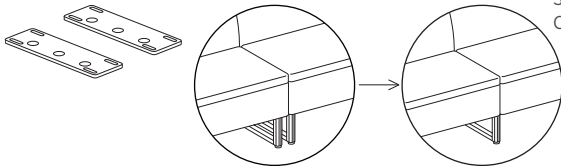

NOTES: Uses existing legs on units being ganged. No specification needed.
SPECIFYING EXAMPLE: HASGBSL

HASSGC

SCREEN GANGING CLIP

DIMENSIONS

Ship Weight: 1
Cube: 0.1

LIST PRICE

\$147

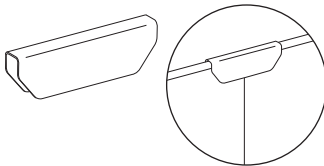

ⓘ Required when ganging multiple high-back units together.
ⓘ Already included on individual units where applicable.

HOW TO SPECIFY

<p>Select Model Number</p> <p>HASSP.</p>	<p>Select Screen Knit or Fabric</p> <p>Knit Options: KLT Light KMD Medium KDK Dark See page 280 for all options</p> <p>KMD</p>
--	--

HOW TO SPECIFY

<p>Select Model Number</p> <p>HASSGC.</p>	<p>Select Paint Color</p> <p>P7A Textured Charcoal</p> <p>P7A</p>
---	---

DESCRIPTION
Vesta Mobile Power Station

- Includes 10' retractable cord with three-prong plug.
- 3 AC, 1 Dual USB-A, 1 USB-C at top
- Specify Paint and Plastic.

SPECIFYING EXAMPLE: HPWRMOB1.BLK.STRM
MODEL
HPWRMOB1
SHIP WEIGHT

14

CUBE

3.3

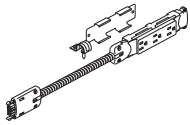
LIST PRICE
\$1398

Triplex Electrical Harness

 48"W, Circuit 1
 60"W, Circuit 1
 72"W, Circuit 1

HTPKIT48

5

0.3

\$276
HTPKIT60

5

0.3

\$281
HTPKIT72

5

0.3

\$289

 48"W, Circuit 2
 60"W, Circuit 2
 72"W, Circuit 2

HTPKIT482

5

0.3

\$276
HTPKIT602

5

0.3

\$281
HTPKIT722

5

0.3

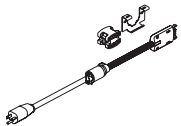
\$289

Triplex Corded In-Feed

 48"W Corded In-feed
 72"W Corded In-feed

HTPCIF48

5

0.3

\$357
HTPCIF72

5

0.3

\$377

NOTES: Corded in-feed ships with (1) 4-way splitter, (1) 4-way splitter mounting bracket, (1) conduit clip, and (1) in-feed. Utilizes standard 3-prong plug for easy setup and installation. Use with circuit 1 harnesses only. Corded in-feed not UL listed.

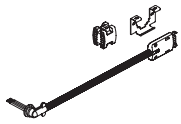
Triplex Hardwire In-Feed

48"W Hardwire In-feed

HTPHWIF72

5

0.3

\$307

NOTES: Hardwire in-feed ships with (1) 4-way splitter, (1) 4-way splitter mounting bracket, (1) conduit clip, and (1) in-feed. Hardwire in-feed must be installed by a licensed electrician.

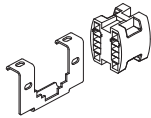
Triplex 4-Way Splitter

4-Way Splitter

HTPSPLIT

5

0.3

\$94

NOTES: 4-way splitter utilized in instances where one power harness feeds into 2-3 power harnesses.

NOTES:

- Triplex is a 4-trac system with 3 connected simplexes per harness.
- Choose either a corded or hardwire in-feed.
- UL listed as a manufactured wiring system (UL 183) when hardwire in-feed is used.
- cUL Certified for Canada with hardwire in-feed.
- Hardwire in-feed complies with municipal standards such as in New York, Los Angeles, and San Francisco. However, it is customer's responsibility to verify local code compliance.
- Plug in any standard 2- or 3-prong plug accessory to triplex simplexes to get power to where you need it most.

HOW TO SPECIFY
Select Model Number

HPWRMOB1

Select Exterior Paint Color
Specify for model HPWRMOB1 only
FOG Fog
STRM Storm
BLK Black
SNW Snow

BLK

Select Paint Color
Specify for model HPWRMOB1 only
FOG Fog
STRM Storm
BLK Black
SNW Snow

STRM

CAMBIA™ 2160 SERIES

Want to see more? Scan here
to check out hon.com.



Cambia Upholstered Back Guest
Chairs shown with Preside® table.

CAMBIA™ 2160 SERIES

Cambia's comfort and style is a warm invitation for any guest or coworker. With two back variations and arm options, this is a guest chair collection designed to adapt. Each back option offers a choice of a wood slat design or upholstered panel to suit any space or personal taste. Choose from eight rich hardwood finishes and hundreds of quality HON fabrics to express your style and reflect your brand.



FEATURES

- Wood slat back panel complements a variety of surroundings.
- Upholstered seat and back features cushioning for additional comfort and support.
- Personalize your space with a choice of back styles.
- Fixed arms provide support and take pressure off the upper body and shoulders.
- Solid hardwood in one of eight attractive finishes.
- Available in hundreds of quality HON fabrics.
- Warranted for users up to 250 lbs.

CAMBIA™ 2160 Series Options

MODEL OPTIONS

H2164



Guest Chair

Upholstered Back, Leg Base,
Arch Arms

H2165



Guest Chair

Wood Slat Back, Leg Base,
Arch Arms

AVAILABLE FINISHES

Cambia™ 2160 Series Seating is available in 8 wood finishes.

WOOD FINISHES

Bourbon Cherry (H)

Cognac (COGN)

Harvest (C)

Mahogany (N)

Mocha (MOCH)

Natural Maple (D)

Pinnacle (PINC)

Shaker Cherry (F)

Due to wood being a natural material, color may differ between pieces. Stains will be tonal matches and will not replicate the grain contrast of the coordinating laminate. Prolonged exposure to sunlight can affect the appearance of wood furniture, leading to variations in hue and tone.

HON BRANDED FABRICS

GRADE 1

Apex
Centurion
Compass
Contourett
Dapper
Emphasis
Ensemble
Hamilton
Noble Seating
Pebble
Vibe

GRADE 2

Appoint Seating
Blume
Clyde
Haute
Kai
Rush
Spin
Wavelength
Whisper Vinyl

GRADE 3

Bradbury
Cozy
Getaway
Moxie
Notion
Parker
Purl
Quill
Saxony

GRADE 4

Constance with Supreen™
Livi with Supreen™
Lucerne
Lugano with Supreen™
Oxford with Supreen™

GRADE L

Denver Leather

For a complete list of fabrics, including partnership fabrics, go to hon.com/fabricsandfinishes.

Reference Fabric Color Combinations on pages 20-25 for color codes and legend on page 21 for lead times. For additional HON to Supply COM fabric grade pricing, go to hon.com and click on the HON to Supply COM link.



Icon Legend on page 19

CAMBIA™ 2160 Series

H2164



GUEST CHAIR

Upholstered Back
Leg Base
Arch Arms

DIMENSIONS

Depth:	24¼	Arm Width:	19
Width:	21¾	Seat to Floor Height:	19
Height:	31¾	Usable Seat Depth:	21
Seat Depth:	21	Ship Weight:	30
Seat Width:	21¾	Cube:	22.6
Back Width:	21¾	COM:	1.5
Back Height:	13¾	Weight Rating:	250 lbs.

FABRIC PRICE CODES

1	\$975	8	\$1359
2	\$1042	9	\$1409
3	\$1109	10	\$1459
4	\$1160	11	\$1509
5	\$1209	12	\$1558
6	\$1260	L	\$1531
7	\$1309		

H2165



GUEST CHAIR

Wood Slat Back
Leg Base
Arch Arms

DIMENSIONS

Depth:	24¼	Arm Width:	19
Width:	21¾	Seat to Floor Height:	19
Height:	31¾	Usable Seat Depth:	21
Seat Depth:	21	Ship Weight:	30
Seat Width:	21¾	Cube:	22.6
Back Width:	21¾	COM:	1.3
Back Height:	13¾	Weight Rating:	250 lbs.

FABRIC PRICE CODES

1	\$1025	8	\$1256
2	\$1067	9	\$1286
3	\$1107	10	\$1316
4	\$1137	11	\$1346
5	\$1166	12	\$1376
6	\$1195	L	\$1359
7	\$1226		

HON Recommendation: H2164.MOCH.CU__ - List Price \$975

HOW TO SPECIFY

<p>Select Model Number</p> <p>H 2 1 6 4 .</p>	<p>Select Finish</p> <p>See page 296</p> <p>M O C H .</p>	<p>Select Fabric</p> <p>See page 296</p> <p>C U 1 0 .</p>
--	--	--

SEATING



Cipher™ Seating.

CIPHER™

From important client consultations to project planning to impending deadlines, busy professionals are required to meet more than a few expectations throughout the day. That's why easy support and intuitive performance should be status quo when it comes to your office chair — and Cipher™ seating goes above and beyond. With intuitive functionality and customizable controls, this smart, streamlined seating solution lets you focus on the task at hand instead of distracted by clumsy mechanisms and constant adjustments. A thoughtful natural leader, Cipher™ moves with you to meet the demands of the day so you can concentrate on what lies ahead.



FEATURES

- Crack the code to productivity with intuitive functionality and thoughtful design.
- Keep things simple with an integrated weight-activated control that automatically adjusts to you as you move.
- Personalize your sit with independently adjustable lumbar support, customizable for user height and pressure preferences.
- Add a pop of color with nine Colorway™ accent options.
- Get the look you want with nine contrast stitching color choices or a fabric-matched stitch.
- Elevate your aesthetic with a thin, modern profile and open back design.
- Find the right fit for your space with three different cylinder height options.
- Stay cool with 4-Way Stretch Mesh flexes in every direction to dynamically move with you — available in 7 colors.
- Choose from 3 frame options: Salt, Charcoal, and Black.

MODEL OPTIONS

HCFRT



Task Chair

HCFRG

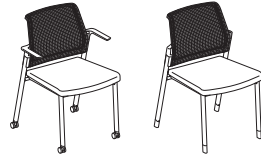

Guest Chair

HON BRANDED FABRICS

GRADE 1

Apex
Centurion
Compass
Contourett
Dapper
Emphasis
Ensemble
Hamilton
Noble Seating
Pebble
Vibe

GRADE 2

Appoint Seating
Blume
Clyde
Haute
Kai
Rush
Spin Seating
Wavelength
Whisper Vinyl

GRADE 3

Bradbury
Cozy
Getaway
Moxie
Notion
Parker
Purl
Quill
Saxony

GRADE 4

Constance with Supreen™
Livi with Supreen™
Lucerne
Lugano with Supreen™
Oxford with Supreen™

GRADE L1

Davenport Leather

For a complete list of fabrics, including partnership fabrics, go to hon.com/fabricsandfinishes.

Reference Fabric Color Combinations on pages 20-25 for color codes and legend on page 21 for lead times.

CIPHER™ Task Options

ARM STYLE



CODE	DESCRIPTION	PRICE
N	Armless	+\$0
H	Height-Adjustable	+\$92
V	All-Adjustable (Includes Pivot)	+\$141

ACCENT COLOR



CODE	DESCRIPTION	PRICE
BL	Black	+\$0
S	Charcoal	+\$0
ST	Salt	+\$0
BY	Bullseye	+\$0
KT	Krypton	+\$0
MR	Ember	+\$0
RE	Regatta	+\$0
IR	Iris	+\$0
AT	Atom	+\$0

CASTERS/ GLIDES



CODE	DESCRIPTION	PRICE
H	Black Hard Caster	+\$0
S	Black All-Surface Caster	+\$44
E9	Charcoal All-Surface Caster	+\$44
ST	Salt All-Surface Caster	+\$44
TS	Titanium All-Surface Caster	+\$44
R	Black Roll Control Caster	+\$55
G	Black Bell Glide	+\$28

MESH COLOR

CODE	DESCRIPTION	PRICE
IM	Black	+\$0
IB	Breeze	+\$0
IK	Brownstone	+\$0
IC	Charcoal	+\$0
IF	Fog	+\$0
IR	Regatta	+\$0
IT	Titanium	+\$0

STITCH COLOR

CODE	DESCRIPTION	PRICE
TC00	Fabric-Matched	+\$0
TC01	Yellow	+\$17
TC02	Tan	+\$17
TC03	Natural	+\$17
TC04	Black	+\$17
TC05	Light Red	+\$17
TC06	Orange	+\$17
TC07	Medium Green	+\$17
TC08	Blue	+\$17
TC09	Light Gray	+\$17

BASE

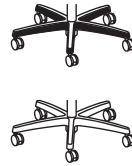

CODE	DESCRIPTION	PRICE
SB	Standard Base	+\$0
PA	Polished Aluminum	+\$119

CYLINDER

CODE	DESCRIPTION	PRICE
STC	Standard Cylinder	+\$0
SHC	Short Cylinder	+\$0
TLC	Tall Cylinder	+\$0

LUMBAR



CODE	DESCRIPTION	PRICE
NL	No Lumbar	+\$0
AL	Adjustable Lumbar	+\$55

FRAME COLOR

CODE	DESCRIPTION	PRICE
T	Black	+\$0
S	Charcoal	+\$39
STX	Salt	+\$39

CIPHER™

Guest Options

ARM STYLE

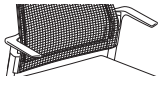

CODE	DESCRIPTION	PRICE
N	Armless	+\$0
F	Fixed Arms	+\$33

CASTERS/ GLIDE



CODE	DESCRIPTION	PRICE
H	Black Hard Caster	+\$0
S	Black All-Surface Caster	+\$33
E	Glide	+\$0

FRAME PAINT

CODE	DESCRIPTION	PRICE
P71	Black	+\$0
CBK	Charblack	+\$0
P7A	Textured Charcoal	+\$39
P8Z	Textured Salt	+\$39

MESH COLOR

CODE	DESCRIPTION	PRICE
IM	Black	+\$0
IB	Breeze	+\$0
IK	Brownstone	+\$0
IC	Charcoal	+\$0
IF	Fog	+\$0
IR	Regatta	+\$0
IT	Titanium	+\$0

FRAME COLOR

CODE	DESCRIPTION	PRICE
T	Black	+\$0
S	Charcoal	+\$39
STX	Salt	+\$39

CIPHER™ Task Dimensions

	Model	Task								
	Arms	Armless			1D			4D		
	Cylinder	Standard	Short	Tall	Standard	Short	Tall	Standard	Short	Tall
Max Width		27.5	27.5	27.5	27.5	27.5	27.5	29.5	29.5	29.5
Max Depth		26.75	26.75	26.75	26.75	26.75	26.75	26.75	26.75	26.75
Max Height		43.125	40.625	45.125	43.125	40.625	45.125	45.125	40.625	45.125
Chair Weight		30	30	30	35	35	35	35	35	35
Shipping Weight		38	38	38	43	43	43	43	43	43
Shipping Weight (KD)		NA	NA	NA	NA	NA	NA	NA	NA	NA
Cubes		10.73	10.73	10.73	10.73	10.73	10.73	10.73	10.73	10.73
Cubes (KD)		NA	NA	NA	NA	NA	NA	NA	NA	NA
Seat	Width	19.5	19.5	19.5	19.5	19.5	19.5	19.5	19.5	19.5
	Usable Depth	18.62 - 16.58	18.62 - 16.58	18.62 - 16.58	18.62 - 16.58	18.62 - 16.58	18.62 - 16.58	18.62 - 16.58	18.62 - 16.58	18.62 - 16.58
	Height from Floor	15.00 - 19.625	14.335 - 16.875	17.00 - 21.625	15.00 - 19.625	14.335 - 16.875	17.00 - 21.625	15.00 - 19.625	14.335 - 16.875	17.00 - 21.625
	Seat Depth	18	18	18	18	18	18	18	18	18
Back	Back Lumbar Height	5.9 - 11.0	5.9 - 11.0	5.9 - 11.0	5.9 - 11.0	5.9 - 11.0	5.9 - 11.0	5.9 - 11.0	5.9 - 11.0	5.9 - 11.0
	Lumbar Protrusion	.512 - .787	.512 - .787	.512 - .787	.512 - .787	.512 - .787	.512 - .787	.512 - .787	.512 - .787	.512 - .787
	Width	18.75	18.75	18.75	18.75	18.75	18.75	18.75	18.75	18.75
	Height	24.016	24.016	24.016	24.016	24.016	24.016	24.016	24.016	24.016
Angles	Seat Angle from Floor	-1.4	-1.4	-1.4	-1.4	-1.4	-1.4	-1.4	-1.4	-1.4
	Seat Angle Reclined	-6	-6	-6	-6	-6	-6	-6	-6	-6
	Back Angle from Seat	97	97	97	97	97	97	97	97	97
	Back Angle from Seat Reclined	117	117	117	117	117	117	117	117	117
Arms	Distance Between Arms	NA	NA	NA	18.813	18.813	18.813	12.625 - 19.750	12.625 - 19.750	12.625 - 19.750
	Height from Floor	NA	NA	NA	22.50 - 31.625	21.375 - 28.125	24.50 - 33.625	23.0 - 32.125	21.875 - 28.625	25.0 - 34.125
	Height from Seat	NA	NA	NA	4.938 - 8.625	4.938 - 8.625	4.938 - 8.625	4.938 - 8.625	5.438 - 9.125	5.438 - 9.125
	Width	NA	NA	NA	3.875	3.875	3.875	3.875	3.875	3.875
	Length	NA	NA	NA	9.3125	9.3125	9.3125	9.3125	9.3125	9.3125
	Arm Set-Back	NA	NA	NA	4.212 - 6.259	4.212 - 6.259	4.212 - 6.259	4.212 - 6.259	4.212 - 6.259	4.212 - 6.259



Icon Legend on page 19

CIPHER™

HCFRT



TASK CHAIR

- Mesh Back**
- Pneumatic
- Swivel
- Weight-activated
- Synchro-tilt
- Tilt Lock
- Seat Slide

Functions: **A, D, E, J, L, P**
 (Function Key on pages 256-257)

DIMENSIONS

Depth:	26¾	Seat to Floor Height:	15-19¾
Width:	27½	Usable Seat Depth:	16½-18½
Height:	43⅝	Ship Weight:	43
Seat Depth:	18	Cube:	10.7
Seat Width:	19½	COM:	1.0
Back Width:	18¾	Weight Rating:	300 lbs.
Back Height:	24		

FABRIC PRICE CODES

1	\$890	8	\$1040
2	\$917	9	\$1059
3	\$943	10	\$1078
4	\$962	11	\$1098
5	\$981	12	\$1117
6	\$1001	L	\$1300
7	\$1020		

NOTES: If armless and no lumbar are selected, choose the frame color in the Accent Color field and the Frame Color field. Features weight-activated control with easy access at seat height.

HON Recommendation: HCFRT.STC.H.H.IC.CU__TC09.AL.AT.SB.S - List Price \$1093

HOW TO SPECIFY

Select Model Number	Select Cylinder	Select Arm	Select Caster	Select Mesh Color	Select Fabric	Select Seat Stitch Color	Select Lumbar	Select Accent Color	Select Base	Select Frame
STC Standard SHC Short Cylinder TLC Tall Cylinder	N Armless H Height Adjustable (+ \$92) V All-Adjustable (+ \$141)	H Black Hard Caster S Black All-Surface Caster (+ \$44) E9 Charcoal All-Surface Caster (+ \$44) ST Salt All-Surface Caster (+ \$44) TS Titanium All-Surface Caster (+ \$44) R Black Roll Control Caster (+ \$55) G Black Bell Glide (+ \$28)	IM Black IF Fog IC Charcoal IT Titanium IK Brownstone IR Regatta IB Breeze	See page 299	See page 300 (+ \$17 for non-fabric matched options)	NL No Lumbar AL Adjustable Lumbar (+ \$55)	BL Black S Charcoal ST Salt BY Bullseye KT Krypton MR Ember RE Regatta IR Iris AT Atom	SB Standard PA Polished Aluminum (+ \$119)	T Black S Charcoal (+ \$39) STX Salt (+ \$39)	
HCFRT	STC	H	H	IM	APX13	TC00	AL	BL	SB	T

SEATING

HCFRG



GUEST CHAIR

Mesh Back

DIMENSIONS

Depth:	24 ¹ / ₈	Seat to Floor Height:	19 ³ / ₄
Width:	24 ¹ / ₄	Usable Seat Depth:	17 ¹ / ₄
Height:	33 ¹ / ₂	Ship Weight:	30
Seat Depth:	17 ³ / ₈	Cube:	15.8
Seat Width:	19	COM:	1.0
Back Width:	19	Weight Rating:	300 lbs.
Back Height:	18		

FABRIC PRICE CODES

1	\$648	8	\$798
2	\$675	9	\$817
3	\$701	10	\$836
4	\$720	11	\$856
5	\$739	12	\$875
6	\$759	L	\$1058
7	\$778		

HON Recommendation: HCFRG.F.S.APX__APX__.TC09.S.P7A - List Price \$809

HOW TO SPECIFY

Select Model Number	Select Arms	Select Caster	Select Back Material	Select Fabric	Select Seat Stitch Color	Select Frame	Select Paint Color
	N Armless F Fixed Arms (+ \$33)	H Black Hard Caster S Black All-Surface Caster (+ \$33) E Black Bell Glide	See page 299	See page 299	See page 300 (+ \$17 for non-fabric matched options)	T Black S Charcoal (+ \$39) STX Salt (+ \$39)	P71 Black CBK Charblack P7A Textured Charcoal (+ \$39) P8Z Textured Salt (+ \$39)
HCFRG	F	S	APX13	APX13	TC00	T	P71



ClIQ™ Seating shown with Empower® Benching.

CLIQ™

Some of the best work results from a collaborative effort. That's why Cliq brings people together. Designed with a weight-activated control that responds to your body and its movements, Cliq just gets you — providing instant comfort without a lot of adjustments. It's light-scaled for a modern look that's also easy to maneuver around wherever the group discussion takes you. Available as a task chair or stool, Cliq features a wide selection of fabric choices and frame and mesh colors. Intuitive, stylish, and supportive — it just clicks with any collaborative environment.



FEATURES

- Intuitive functionality and design provides comfort and support without the need for multiple adjustments.
- Weight-activated control automatically adjusts to you as you sit.
- Thin profile offers a modern aesthetic, while a wide range of fabric choices ensures the perfect look within any space.
- 4-Way Stretch Mesh flexes in every direction to dynamically move with you — available in 7 colors.
- Choose between fixed arms or armless to get exactly the look you want.
- Task Chairs are available with a conference cylinder or task cylinder so you can choose the chair that best fits your space.
- Task Stools feature an adjustable footring for additional lower body support.
- One-touch seat height adjustment easily moves the seat up and down.
- Choose from 3 frame options: Black, Titanium, and Designer White.

CLIQ™ Fabric Options

HON BRANDED FABRICS

GRADE 1

Apex
Centurion
Compass
Contourett
Dapper
Emphasis
Ensemble
Hamilton
Noble Seating
Pebble
Vibe

GRADE 2

Appoint Seating
Blume
Clyde
Haute
Kai
Rush
Spin Seating
Wavelength
Whisper Vinyl

GRADE 3

Bradbury
Cozy
Getaway
Moxie
Notion
Parker
Purl
Quill
Saxony

GRADE 4

Constance with Supreen™
Livi with Supreen™
Lucerne
Lugano with Supreen™
Oxford with Supreen™

For a complete list of fabrics, including partnership fabrics, go to hon.com/fabricsandfinishes.

Reference Fabric Color Combinations on pages 20-25 for color codes and legend on page 21 for lead times.



Icon Legend on page 19

CLIQ™

HCLQT



LIGHT TASK CHAIR

Mesh Back

- Pneumatic
- Swivel
- Weight-activated
- Synchro-tilt
- Tilt Lock

Functions: **A, E, J, L, P**
(Function Key on pages 256-257)

DIMENSIONS

Depth:	27	Seat to Floor Height	
Width:	27	(Task Cylinder):	17-22
Height:	41	Seat to Floor Height	
Seat Depth:	17	(Conference Cylinder):	15 ⁵ / ₈ -19 ³ / ₈
Seat Width:	19 ¹ / ₄	Usable Seat Depth:	17
Back Width:	19 ¹ / ₄	Ship Weight:	45
Back Height:	21	Cube:	10.7
		COM:	1.0
		Weight Rating:	300 lbs.

FABRIC PRICE CODES

1	\$771	8	\$921
2	\$798	9	\$940
3	\$824	10	\$959
4	\$843	11	\$979
5	\$862	12	\$998
6	\$882	L	—
7	\$901		

NOTES: When selecting the Conference Cylinder, the maximum arm height from floor is 28¹/₂".

HON Recommendation: HCLQT.W0.TC.F.S.IT.CU__NL.SB.TI - List Price \$843

HOW TO SPECIFY

Select Model Number	Select Control Type	Select Cylinder	Select Arm Type	Select Caster	Select Back Option	Select Fabric	Select Lumbar	Select Base	Select Frame
W0 Weight-Activated	TC2 Task Cylinder (standard height) CC1 Conference Cylinder (low height)	N Armless F Fixed (+ \$33)	S Black All-Surface Caster	IM Black IB Breeze IK Brownstone IC Charcoal IF Fog IR Regatta IT Titanium	See page 306	NL No Lumbar	SB Standard Base PA Polished Aluminum (+ \$119)	T Black TI Titanium (+ \$39) DW Designer White (+ \$39)	
HCLQT	W0	TC	F	S	IT	CU19	NL	SB	TI

SEATING

HCLQS

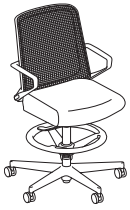

TASK STOOL

Mesh Back
 Pneumatic
 Swivel
 Weight-activated
 Synchro-tilt
 Tilt Lock
 Functions: **A, E, J, L, P**
 (Function Key on pages 256-257)

DIMENSIONS

Depth:	28¾	Seat to Floor Height:	23-33
Width:	28¾	Usable Seat Depth:	17
Height:	52	Ship Weight:	50
Seat Depth:	17	Cube:	10.7
Seat Width:	19¼	Weight Rating:	300 lbs.
Back Width:	19¼		
Back Height:	21		

FABRIC PRICE CODES

1	\$855	8	\$1005
2	\$882	9	\$1024
3	\$908	10	\$1043
4	\$927	11	\$1063
5	\$946	12	\$1082
6	\$966	L	—
7	\$985		

HON Recommendation: HCLQS.W0.SC2.F.S.IT.CU__NL.SB.TI - List Price \$948

HOW TO SPECIFY

Select Model Number	Select Control Type	Select Cylinder	Select Arm Type	Select Caster	Select Back Option	Select Fabric	Select Lumbar	Select Base	Select Frame
	W0 Weight-Activated	SC2 Stool Cylinder	N Armless F Fixed (+\$33)	S Black All-Surface Caster	IM Black IB Breeze IK Brownstone IC Charcoal IF Fog IR Regatta IT Titanium	See page 306	NL No Lumbar	SB Standard Base PA Polished Aluminum (+\$119)	T Black TI Titanium (+\$60) DW Designer White (+\$60)
HCLQS	W0	SC2	F	S	IT	CU19	NL	SB	TI



Best of
NeoCon
2022

Gold



Cofi™ Seating shown with Preside® and Acoustic Solutions by Unika Vaev.

COFI™

You never get a second chance to make a first impression — so why not make a memorable one with Cofi™? This eye-catching seating solution supports individual needs throughout the day with its upscale design and easy control mechanisms. Fine stitching, premium materials, and endless customization options make it easy to celebrate your unique style — and with its thoughtful detailing, and contemporary back, finish, and fabric choices, closing the deal has never been more stylish or sophisticated.



FEATURES

- Get your choice of an Executive or Managerial back.
- Amp up your aesthetic with three different back stitch details — Channel, Quilt, or Solid.
- Color your world with nine contrast stitching color choices.
- Elevate the look with polished aluminum arm and base options.
- Get comfortable with height and width adjustable arms or all-adjustable arms for additional pivot support.
- Make the most of your conference room meetings with simple functionality and comfort.
- Go contemporary with a thin, tapered profile.
- Achieve a signature look with premium detailing and elevated design.
- Find your ideal sit and fit with three handy control mechanisms.
- Clean things up with a fabric-matched thread option.
- Add a little luxury with multi-fabric and contrast stitching choices.

COFI™ Options

MODEL OPTIONS

HCFEU



Executive Chair

HCFEUMF



Executive Chair
Multi-Fabric

HCFMU



Managerial Chair

HCFMUMF



Managerial Chair
Multi-Fabric

HON BRANDED FABRICS

GRADE 1

Apex
Centurion
Compass
Contourett
Dapper
Emphasis
Ensemble
Hamilton
Noble Seating
Pebble
Vibe

GRADE 2

Appoint Seating
Blume
Clyde
Haute
Kai
Rush
Spin Seating
Wavelength
Whisper Vinyl

GRADE 3

Bradbury
Cozy
Getaway
Moxie
Notion
Parker*
Purl
Quill
Saxony

GRADE 4

Constance with Supreen™
Livi with Supreen™
Lucerne
Lugano with Supreen™
Oxford with Supreen™

GRADE L1

Davenport Leather

For a complete list of fabrics, including partnership fabrics, go to hon.com/fabricsandfinishes.

Reference Fabric Color Combinations on pages 20-25 for color codes and legend on page 21 for lead times. For additional HON to Supply COM fabric grade pricing, go to hon.com and click on the HON to Supply COM link.

*Only available as a seat fabric on Multi-Fabric models. Cannot be used with any Single-Fabric models.

Parker and Quill are not approved on the Cofi™ back.

ARM STYLE

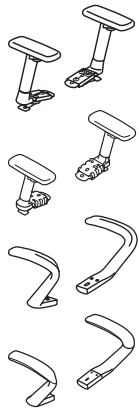

CODE	DESCRIPTION	PRICE
N	Armless	+\$0
A	Height and Width Adjustable Arms	+\$92
V	All-Adjustable Arms Arms (Includes Pivot)	+\$141
F	Fixed Arms	+\$71
P	Fixed Polished Aluminum Arms	+\$189

CASTERS/ GLIDE



CODE	DESCRIPTION	PRICE
H	Black Hard Caster	+\$0
S	Black All-Surface Caster	+\$44
R	Black Roll Control Caster	+\$55
G	Black Bell Glide	+\$28

STITCH COLOR

CODE	DESCRIPTION	PRICE
TC00	Fabric-Matched	+\$0
TC01	Yellow	+\$55
TC02	Tan	+\$55
TC03	Natural	+\$55
TC04	Black	+\$55
TC05	Light Red	+\$55
TC06	Orange	+\$55
TC07	Medium Green	+\$55
TC08	Blue	+\$55
TC09	Light Gray	+\$55

STITCH DETAIL

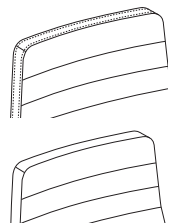

Contrast Stitch (TC01-09)

When chosen, the perimeter of the back, back panels, and seat will include a top stitch in contrasting color.

Fabric-Matched Stitch (TC00)

When chosen, top stitches listed above will not be added in those locations.

MECHANISM

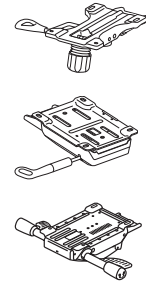

CODE	DESCRIPTION	PRICE
YO	Synchro-Tilt A, E, J, K, L	+\$0
WO	Weight-Activated A, E	+\$28
Y2	Advanced Synchro-Tilt w/ Seat Slider A, D, E, J, L, A-D	+\$71

BASE

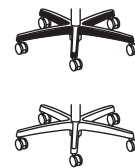

CODE	DESCRIPTION	PRICE
SB	Standard Base	+\$0
PA	Polished Aluminum	+\$119

CYLINDER

CODE	DESCRIPTION	PRICE
STC	Standard Cylinder	+\$0
SHC	Short Cylinder	+\$0
TLC	Tall Cylinder	+\$0

BACK STITCH

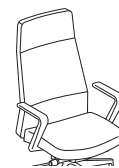

CODE	DESCRIPTION	PRICE
SLB	Solid Stitch	+\$0



CODE	DESCRIPTION	PRICE
CHS	Channel Stitch	+\$0

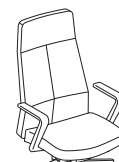

CODE	DESCRIPTION	PRICE
QLT	Quilt Stitch	+\$0

COFI™ Dimensions

MODEL		HCFEU	HCFMU
Overall Width	Armless	25¼	25¼
	Fixed Arms	26	26
Overall Depth	Y0	27½	26⅝
	Y2	26⅝	26
	W0	26⅝	26
Overall Height*	Y0	43¼ - 48¼	35½ - 40½
	Y2	44 - 49	36¼ - 41¼
	W0	43½ - 48½	35¾ - 40¾
Seat Width		20½	20½
Seat Depth		17¾	17¾
Usable Seat Depth	Y0	17¼	17¼
	Y2	16¾ - 19¾	16¾ - 19¾
	W0	16¾	16¾
Seat Height*	Y0	15¾ - 20¾	15¾ - 20¾
	Y2	16¾ - 21¾	16¾ - 21¾
	W0	15½ - 20½	15½ - 20½
Back Width		20	20
Back Height	Y0	27½	20
	Y2	27	19½
	W0	28	20½
Ship Weight Armless	Y0	40	39⅝
	Y2	45¼	45
	W0	41¼	41
Ship Weight F Arms	Y0	47¼	47
	Y2	52⅝	52¼
	W0	48⅝	48¼
Ship Weight P Arms	Y0	49⅝	49
	Y2	54¾	54⅜
	W0	50¾	50⅜
Width Between Arms	Fixed Arms	21	21
Cube		16½	10¾
COM		3	3
Weight Capacity		300 lbs	300 lbs

*Dimensions are based on Standard Cylinder.

Short Cylinder: Reduce lowered seat height by 2" and raised seat height by 4¼".

Tall Cylinder: Increase seat height by 1" for lowered and raised positions.



Icon Legend on page 19

COFI™

HCFEU

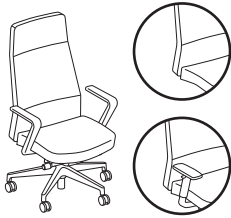

EXECUTIVE HIGH-BACK

- Pneumatic
- Swivel
- Synchro-tilt
- Tilt Tension
- Tilt Lock

DIMENSIONS

Depth:	26-27½	Width (with arms):	26
Height:	43¼-49	Width (armless):	25¼
Seat Depth:	17¾	Ship Weight:	63
Seat Width:	20½	Cube:	16.5
Back Width:	20	COM:	3.0
Back Height:	27½-28	Weight Rating:	300 lbs.

FABRIC PRICE CODES

1	\$1119	8	\$1491
2	\$1184	9	\$1540
3	\$1249	10	\$1588
4	\$1298	11	\$1637
5	\$1346	12	\$1685
6	\$1395	L	\$1959
7	\$1443		

HCFMU

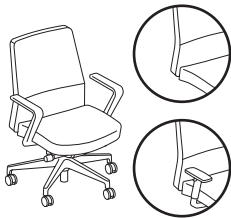

MANAGERIAL BACK

- Pneumatic
- Swivel
- Synchro-tilt
- Tilt Tension
- Tilt Lock

DIMENSIONS

Depth:	26	Width (with arms):	26
Height:	35¼-41¼	Width (armless):	25¼
Seat Depth:	17¾	Ship Weight:	55
Seat Width:	20½	Cube:	10.7
Back Width:	20	COM:	3.0
Back Height:	19½-20½	Weight Rating:	300 lbs.

FABRIC PRICE CODES

1	\$1026	8	\$1324
2	\$1079	9	\$1363
3	\$1131	10	\$1401
4	\$1169	11	\$1441
5	\$1208	12	\$1479
6	\$1247	L	\$1530
7	\$1285		

HON Recommendation: HCFEU.Y2.STC.P.H.DAV__CHSTC00.PA - List Price \$2338

HOW TO SPECIFY

Select Model Number	Select Control Type	Select Cylinder	Select Arm Type	Select Caster	Select Fabric	Select Back Detail and Stitch Color	Select Base
	Y0 Synchro-Tilt W0 Weight-Activated (+ \$28) Y2 Advanced Synchro-Tilt w/ Seat Slider (+ \$71)	STC Standard Cylinder SHC Short Cylinder TLC Tall Cylinder	N Armless A Height and Width Adjustable Arms (+ \$92) V All-Adjustable Arm (Includes Pivot) (+ \$141) F Fixed (+ \$71) P Fixed Polished Aluminum (+ \$189)	H Black Hard Caster S Black All-Surface Caster (+ \$44) R Black Roll Control Caster (+ \$55) G Black Bell Glide (+ \$28)	See page 310	SLB Solid Stitch CHS Channel Stitch QLT Quilt Stitch See page 311 for Stitch Colors and Pricing	SB Standard Base PA Polished Aluminum (+ \$119)
H C F E U	Y 2	S T C	F	H	A P X 1 3	S L B T C 0 0	S B

SEATING



HCFEUMF

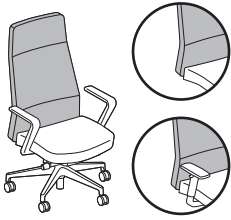

EXECUTIVE HIGH-BACK, MULTI-FABRIC

Pneumatic
Swivel
Synchro-tilt
Tilt Tension
Tilt Lock

DIMENSIONS

Depth: 26-27½ Width (with arms): 26
 Height: 43¼-49 Width (armless): 25¼
 Seat Depth: 17¾ Ship Weight: 63
 Seat Width: 20½ Cube: 16.5
 Back Width: 20 Back COM: 2.5
 Back Height: 27½-28 Seat COM: 1.0
 Weight Rating: 300 lbs.

FABRIC PRICE CODES

1	\$1163	
<i>Add to Base Price Above</i>		
	Back	Seat
2	\$40	\$27
3	\$79	\$53
4	\$108	\$72
5	\$136	\$91
6	\$165	\$111
7	\$195	\$130
8	\$224	\$150
9	\$253	\$169
10	\$282	\$188
11	\$311	\$208
12	\$340	\$227

HCFMUMF

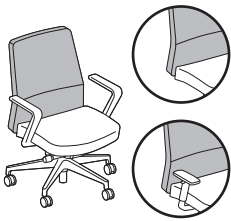

MANAGERIAL BACK, MULTI-FABRIC

Pneumatic
Swivel
Synchro-tilt
Tilt Tension
Tilt Lock

DIMENSIONS

Depth: 26 Width (with arms): 26
 Height: 35¼-41¼ Width (armless): 25¼
 Seat Depth: 17¾ Ship Weight: 55
 Seat Width: 20½ Cube: 10.7
 Back Width: 20 Back COM: 2.5
 Back Height: 19½-20½ Seat COM: 1.0
 Weight Rating: 300 lbs.

FABRIC PRICE CODES

1	\$1069	
<i>Add to Base Price Above</i>		
	Back	Seat
2	\$27	\$27
3	\$53	\$53
4	\$72	\$72
5	\$91	\$91
6	\$111	\$111
7	\$130	\$130
8	\$150	\$150
9	\$169	\$169
10	\$188	\$188
11	\$208	\$208
12	\$227	\$227

HON Recommendation: HCFEUMF.Y2.STC.P.H.WP__CHSTC04.WP__TC04.PA - List Price \$1664

HOW TO SPECIFY

Select Model Number	Select Control Type	Select Cylinder	Select Arm Type	Select Caster	Select Back Fabric	Select Back Detail and Stitch Color	Select Seat Fabric	Select Seat Stitch Color	Select Base
YO Synchro-Tilt WO Weight-Activated (+ \$28) Y2 Advanced Synchro-Tilt w/ Seat Slider (+ \$71)	STC Standard Cylinder SHC Short Cylinder TLC Tall Cylinder	N Armless A Height and Width Adjustable Arms (+ \$92) V All-Adjustable Arm (Includes Pivot) (+ \$141) F Fixed (+ \$71) P Fixed Polished Aluminum (+ \$189)	H Black Hard Caster S Black All-Surface Caster (+ \$44) R Black Roll Control Caster (+ \$55) G Black Bell Glide (+ \$28)	See page 310	SLB Solid Stitch CHS Channel Stitch QLT Quilt Stitch See page 311 for Stitch Colors and Pricing	See page 310 for Stitch Colors and Pricing	SB Standard Base PA Polished Aluminum (+ \$119)		
H C F E U M F	. Y 2 .	S T C .	F .	H .	A P X 2 5 .	S L B T C 0 0 .	A P X 1 3 .	T C 0 0 .	S B



Confer™ Seating shown with Preside®
Table and 10500 Series™ Desking.

CONFER™

Confer™ — HON's sculptured, mid-century modern approach to guest seating — has a persuasive offer on the table. Not only does this graceful chair pair beautifully with the HON casegoods portfolio, it lends a retro contemporary aesthetic and reliable durability to a variety of spaces.



FEATURES

- Designed to support user functionality, Confer's integrated back handle makes reconfiguration simple and straightforward.
- Angled back legs are thoughtfully crafted to protect your walls from damage.
- Sloped arm design offers a comfortable, supportive sit.
- Multiple back styles — upholstered back, wood back with pad, and wood back.
- Choose from arm or armless models.
- Multi-fabric option available in upholstered back and wood back with pad options.
- Constructed of hard maple wood.
- Available in 18 wood stains that tonally match existing laminates.
- Ships fully assembled.
- Full lifetime warranty.

CONFER™ Options

MODEL OPTIONS

HWCUSUBA



Upholstered Back
Arms

HWCUSUBAMF

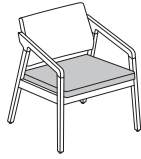

Upholstered Back
Arms, Multi-Fabric

HWCUSUBN



Upholstered Back
Armless

HWCUSUBNMF

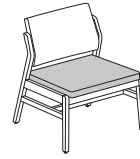

Upholstered Back
Armless, Multi-Fabric

HWCUSPBA



Wood Back with Pad
Arms

HWCUSPBAMF



Wood Back with Pad
Arms, Multi-Fabric

HWCUSPBN

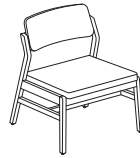

Wood Back with Pad
Armless

HWCUSPBNMF

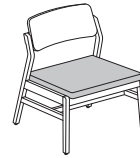

Wood Back with Pad
Armless, Multi-Fabric

HWCUSWBA



Wood Back
Arms

HWCUSWBN



Wood Back
Armless

HON BRANDED FABRICS

GRADE 1	GRADE 2	GRADE 3	GRADE 4
Apex	Appoint Seating	Bradbury	Constance with Supreen™
Centurion	Blume	Cozy	Livi with Supreen™
Compass	Clyde	Getaway	Lucerne
Contourett	Haute	Moxie	Lugano with Supreen™
Dapper	Kai	Notion	Oxford with Supreen™
Emphasis	Rush	Parker	
Ensemble	Spin	Purl	
Hamilton	Wavelength	Quill	
Noble Seating	Whisper Vinyl	Saxony	
Pebble			
Vibe			

For a complete list of fabrics, including partnership fabrics, go to hon.com/fabricsandfinishes.

Reference Fabric Color Combinations on pages 20-25 for color codes and legend on page 21 for lead times. For additional HON to Supply COM fabric grade pricing, go to hon.com and click on the HON to Supply COM link.

WOOD FINISHES

CODE	DESCRIPTION	PRICE
LE702	Cognac	+\$0
LE878	Beigewood	+\$0
LE773	Bourbon Cherry	+\$0
LE121	Mocha	+\$0
LE599	Field Elm	+\$0
LE579	Florence Walnut	+\$0
LE856	Harvest	+\$0
LE518	Kingswood Walnut	+\$0
LE394	Lowell Ash	+\$0
LE740	Mahogany	+\$0
LE800	Natural Maple	+\$0
LE896	Natural Recon	+\$0
LE912	Phantom Ecrú	+\$0
LE679	Pinnacle	+\$0
LE150	Portico Teak	+\$0
LE774	Shaker Cherry	+\$0
LE625	Skyline Walnut	+\$0
LE495	Sterling Ash	+\$0

Due to wood being a natural material, color may differ between pieces. Stains will be tonal matches and will not replicate the grain contrast of the coordinating laminate.

COM YARDAGE						
Model	Fabric/Vinyl (P)	Fabric/Vinyl Seat (P)	Fabric/Vinyl Back (P)	Fabric/Vinyl (RR)	Fabric/Vinyl Seat (RR)	Fabric/Vinyl Back (RR)
HWCUSUBA	1.1	—	—	1.2	—	—
HWCUSUBAMF	—	0.8	0.6	—	0.6	0.6
HWCUSUBN	1.1	—	—	1.2	—	—
HWCUSUBNMF	—	0.8	0.6	—	0.6	0.6
HWCUSPBA	1	—	—	0.9	—	—
HWCUSPBAMF	—	0.8	0.4	—	0.6	0.7
HWCUSPBN	1	—	—	0.9	—	—
HWCUSPBNMF	—	0.8	0.4	—	0.6	0.7
HWCUSWBA	—	0.8	—	—	0.6	—
HWCUSWBN	—	0.8	—	—	0.6	—

HWCUSUBA



GUEST CHAIR

Upholstered Back
Arms

DIMENSIONS

Depth:	24	Arm Width:	19
Width:	24¾	Seat to Floor Height:	18
Height:	31¾	Usable Seat Depth:	16
Seat Depth:	20¼	Ship Weight:	26
Seat Width:	19¼	Cube:	15.9
Back Width:	19	COM:	See page 317
Back Height:	14¾	Weight Rating:	275 lbs.

FABRIC PRICE CODES

1	\$1380	8	\$1626
2	\$1422	9	\$1659
3	\$1464	10	\$1694
4	\$1496	11	\$1731
5	\$1528	12	\$1769
6	\$1561	L	—
7	\$1593		

NOTES: Ships fully assembled.

HWCUSWBA



GUEST CHAIR

Wood Back
Arms

DIMENSIONS

Depth:	24	Arm Width:	19
Width:	24¾	Seat to Floor Height:	18
Height:	31	Usable Seat Depth:	17
Seat Depth:	20¼	Ship Weight:	27
Seat Width:	19¼	Cube:	15.9
Back Width:	19	COM:	See page 317
Back Height:	14¾	Weight Rating:	275 lbs.

FABRIC PRICE CODES

1	\$1440	8	\$1563
2	\$1461	9	\$1579
3	\$1482	10	\$1597
4	\$1498	11	\$1616
5	\$1514	12	\$1635
6	\$1531	L	—
7	\$1546		

NOTES: Ships fully assembled.

HWCUSPBA



GUEST CHAIR

Wood Back with Pad
Arms

DIMENSIONS

Depth:	24	Arm Width:	19
Width:	24¾	Seat to Floor Height:	18
Height:	31	Usable Seat Depth:	16¼
Seat Depth:	20¼	Ship Weight:	28
Seat Width:	19¼	Cube:	15.9
Back Width:	19	COM:	See page 317
Back Height:	15	Weight Rating:	275 lbs.

FABRIC PRICE CODES

1	\$1470	8	\$1716
2	\$1512	9	\$1749
3	\$1554	10	\$1784
4	\$1586	11	\$1821
5	\$1618	12	\$1859
6	\$1651	L	—
7	\$1683		

NOTES: Ships fully assembled.

HON Recommendation: HWCUSUBA.LE599.GTWY__ - List Price \$1464

HOW TO SPECIFY

Select
Model Number

HWCUSUBA .

Select
Finish

See page 317

LE599 .

Select
Fabric

See page 317

GTWY08



Icon Legend on page 19

HWCUSUBN



GUEST CHAIR

Upholstered Back
Armless

DIMENSIONS

Depth:	24	Seat to Floor Height:	18
Width:	24¾	Usable Seat Depth:	16
Height:	31¾	Ship Weight:	25
Seat Depth:	20¼	Cube:	15.9
Seat Width:	19¼	COM:	See page 317
Back Width:	19	Weight Rating:	275 lbs.
Back Height:	14¾		

FABRIC PRICE CODES

1	\$1340	8	\$1586
2	\$1382	9	\$1619
3	\$1424	10	\$1654
4	\$1456	11	\$1691
5	\$1488	12	\$1729
6	\$1521	L	—
7	\$1553		

NOTES: Ships fully assembled.

HWCUSWBN



GUEST CHAIR

Wood Back
Armless

DIMENSIONS

Depth:	24	Seat to Floor Height:	18
Width:	24¾	Usable Seat Depth:	17
Height:	31	Ship Weight:	26
Seat Depth:	20¼	Cube:	15.9
Seat Width:	19¼	COM:	See page 317
Back Width:	19	Weight Rating:	275 lbs.
Back Height:	14¾		

FABRIC PRICE CODES

1	\$1400	8	\$1523
2	\$1421	9	\$1539
3	\$1442	10	\$1557
4	\$1458	11	\$1576
5	\$1474	12	\$1595
6	\$1491	L	—
7	\$1506		

NOTES: Ships fully assembled.

HWCUSPBN



GUEST CHAIR

Wood Back with Pad
Armless

DIMENSIONS

Depth:	24	Seat to Floor Height:	18
Width:	24¾	Usable Seat Depth:	16¼
Height:	31	Ship Weight:	27
Seat Depth:	20¼	Cube:	15.9
Seat Width:	19¼	COM:	See page 317
Back Width:	19	Weight Rating:	275 lbs.
Back Height:	15		

FABRIC PRICE CODES

1	\$1430	8	\$1615
2	\$1461	9	\$1639
3	\$1493	10	\$1665
4	\$1517	11	\$1693
5	\$1541	12	\$1722
6	\$1566	L	—
7	\$1590		

NOTES: Ships fully assembled.

HON Recommendation: HWCUSWBN.LE518.HAML__ - List Price \$1400

HOW TO SPECIFY

<p>Select Model Number</p> <p style="text-align: center;">HWCUSWBN</p>	<p>Select Finish</p> <p style="text-align: center;">See page 317</p> <p style="text-align: center;">LE518</p>	<p>Select Fabric</p> <p style="text-align: center;">See page 317</p> <p style="text-align: center;">HAML11</p>
---	--	---

HWCUSUBAMF

GUEST CHAIR



Upholstered Back
Arms
Multi-Fabric

DIMENSIONS

Depth:	24	Arm Width	19
Width:	24¾	Seat to Floor Height:	18
Height:	31¾	Usable Seat Depth:	16
Seat Depth:	20¼	Ship Weight:	26
Seat Width:	19¼	Cube:	15.9
Back Width:	19	COM:	See page 317
Back Height:	14¾	Weight Rating:	275 lbs.

FABRIC PRICE CODES

1	\$1470	
<i>Add to Base Price Above</i>		
	Seat	Back
2	\$21	\$21
3	\$42	\$42
4	\$58	\$58
5	\$74	\$74
6	\$91	\$91
7	\$106	\$106
8	\$123	\$123
9	\$139	\$139
10	\$157	\$157
11	\$176	\$176
12	\$195	\$195
L	—	—

NOTES: Ships fully assembled.

HWCUSPBAMF

GUEST CHAIR



Wood Back with Pad
Arms
Multi-Fabric

DIMENSIONS

Depth:	24	Arm Width	19
Width:	24¾	Seat to Floor Height:	18
Height:	31	Usable Seat Depth:	16¼
Seat Depth:	20¼	Ship Weight:	28
Seat Width:	19¼	Cube:	15.9
Back Width:	19	COM:	See page 317
Back Height:	15	Weight Rating:	275 lbs.

FABRIC PRICE CODES

1	\$1560	
<i>Add to Base Price Above</i>		
	Seat	Back
2	\$21	\$21
3	\$42	\$42
4	\$58	\$58
5	\$74	\$74
6	\$91	\$91
7	\$106	\$106
8	\$123	\$123
9	\$139	\$139
10	\$157	\$157
11	\$176	\$176
12	\$195	\$195
L	—	—

NOTES: Ships fully assembled.

HON Recommendation: HWCUSUBAMF.LE679.CU__CU__ - List Price \$1470

HOW TO SPECIFY

<p>Select Model Number</p> <p>See page 317</p>	<p>Select Finish</p> <p>See page 317</p>	<p>Select Seat Fabric</p> <p>See page 317</p>	<p>Select Back Fabric</p> <p>See page 317</p>
HWCUSUBAMF	LE679	CU10	CU03



Icon Legend on page 19

HWCUSUBNMF

GUEST CHAIR



Upholstered Back
Armless
Multi-Fabric

DIMENSIONS

Depth:	24	Seat to Floor Height:	18
Width:	24¾	Usable Seat Depth:	16
Height:	31¾	Ship Weight:	25
Seat Depth:	20¼	Cube:	15.9
Seat Width:	19¼	COM:	See page 317
Back Width:	19	Weight Rating:	275 lbs.
Back Height:	14¾		

FABRIC PRICE CODES

1	\$1430	
<i>Add to Base Price Above</i>		
	Seat	Back
2	\$21	\$21
3	\$42	\$42
4	\$58	\$58
5	\$74	\$74
6	\$91	\$91
7	\$106	\$106
8	\$123	\$123
9	\$139	\$139
10	\$157	\$157
11	\$176	\$176
12	\$195	\$195
L	—	—

NOTES: Ships fully assembled.

HWCUSPBNMF

GUEST CHAIR



Wood Back with Pad
Armless
Multi-Fabric

DIMENSIONS

Depth:	24	Seat to Floor Height:	18
Width:	24¾	Usable Seat Depth:	16¼
Height:	31	Ship Weight:	27
Seat Depth:	20¼	Cube:	15.9
Seat Width:	19¼	COM:	See page 317
Back Width:	19	Weight Rating:	275 lbs.
Back Height:	15		

FABRIC PRICE CODES

1	\$1520	
<i>Add to Base Price Above</i>		
	Seat	Back
2	\$21	\$10
3	\$42	\$21
4	\$58	\$29
5	\$74	\$37
6	\$91	\$45
7	\$106	\$53
8	\$123	\$62
9	\$139	\$70
10	\$157	\$78
11	\$176	\$88
12	\$195	\$97
L	—	—

NOTES: Ships fully assembled.

HON Recommendation: HWCUSPBNMF.LE912.VIBE__VIBE__ - List Price \$1520

HOW TO SPECIFY

<p>Select Model Number</p> <p>HWCUSPBNMF</p>	<p>Select Finish</p> <p>See page 317</p> <p>LE912</p>	<p>Select Seat Fabric</p> <p>See page 317</p> <p>VIBE14</p>	<p>Select Back Fabric</p> <p>See page 317</p> <p>VIBE11</p>
---	--	--	--

CONVERGENCE®

Want to see more? Scan here
to check out hon.com.



Convergence® Task Seating shown with Preside® Table.

CONVERGENCE®

What happens when support and affordability come together? Convergence. This is the task chair that is as attainable as it is comfortable with customizable features. Lumbar support that adds a little extra lower back comfort. Thick seat cushions to take the stress off the lower body throughout the day. Arm choices that let you decide how much upper body support you want. A breathable mesh back that flexes and responds to your movements. Convergence puts all the features you're looking for into one low-priced task chair.



FEATURES

- Choice of swivel tilt or synchro-tilt control with seat slide.
- Black mesh back is breathable for all-day comfort and support.
- Comfort options include adjustable lumbar support, adjustable arms, seat glide and synchro-tilt.
- Three arm options.
- Two control options.
- Integrated handle on the back makes it easy to move and reposition the chair.
- Hard casters move effortlessly on any surface.
- Black frame sits atop a durable five-star base.
- Warranted for users up to 275 lbs.
- 3" thick seat cushion.

BACK OPTIONS

HCT1MM



Mid-back

Mesh Task Chair
with Adjustable
Lumbar Support

MECHANISM				BACK STYLE			
	CODE	FUNCTIONS	PRICE		CODE	DESCRIPTION	PRICE
	Z1	Swivel-Tilt Control A, E, F, K, L, W	+\$0		M	Mesh	+\$0
	Y1	Limited Synchro-Tilt A, D, E, J, K, L, W	+\$39				
(See pages 256-257 for Seating Functions.)				BASE			
ARM STYLE					CODE	DESCRIPTION	PRICE
	N	Armless	+\$0		SB	Standard Base	+\$0
	H	Height-Adjustable Arms	+\$60				
	A	Height and Width Adjustable Arms	+\$92	LUMBAR			
					AL	Adjustable Lumbar	+\$0
CASTERS				FRAME			
	H	Black Hard Caster	+\$0		T	Black	+\$0

CONVERGENCE®

Fabric Options

HON BRANDED FABRICS

GRADE 1

Apex
Centurion
Compass
Contourett
Dapper
Emphasis
Ensemble
Hamilton
Noble Seating
Pebble
Vibe

GRADE 2

Appoint Seating
Blume
Clyde
Haute
Kai
Rush
Spin
Wavelength
Whisper Vinyl

GRADE 3

Bradbury
Cozy
Getaway
Moxie
Notion
Parker
Purl
Quill
Saxony

GRADE 4

Constance with Supreen™
Livi with Supreen™
Lucerne
Lugano with Supreen™
Oxford with Supreen™

For a complete list of fabrics, including partnership fabrics, go to hon.com/fabricsandfinishes.

Reference Fabric Color Combinations on pages 20-25 for color codes and legend on page 21 for lead times. For additional HON to Supply COM fabric grade pricing, go to hon.com and click on the HON to Supply COM link.



Icon Legend on page 19

CONVERGENCE® Standard Task Chairs

HCT1MM



MID-BACK TASK

Mesh Back
Pneumatic
Swivel
Tilt Tension
Tilt Lock
Adjustable Lumbar Support

Functions: **A, E, K, L, W**
(Function Key on pages 256-257)

DIMENSIONS

Depth:	27½	Adjustable Arms Width:	20
Width:	27¾	Seat to Floor Height:	15¾-20
Height:	42	Usable Seat Depth:	17-19
Seat Depth:	19	Ship Weight:	44
Seat Width:	20	Cube:	5.8
Back Width:	18	COM:	1.0
Back Height:	22	Weight Rating:	275 lbs.

FABRIC PRICE CODES

1	\$456	7	\$521
2	\$470	8	\$532
3	\$483	9	\$541
4	\$493	10	\$550
5	\$502	11	\$561
6	\$512	12	\$570

NOTES: Arm width adjustment range is 3" (from 17"-20"). Lumbar adjustment is 3". Seat depth range is only for Y1 control. Seat depth on Z1 control is 19".

HSCASTER

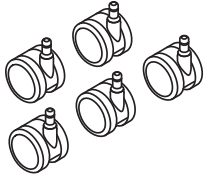

SET OF 5 ALL-SURFACE CASTERS

DIMENSIONS

Size:	60mm
Ship Weight:	2
Cube:	0.1

LIST PRICE

\$75

! Available in Black finish only, no specification needed.

HON Recommendation: HCT1MM.Y1.A.H.M.CU10.AL.SB.T - List Price \$587

HOW TO SPECIFY

Select Model Number	Select Control Type	Select Arm Type	Select Caster	Select Back Type	Select Upholstery	Select Lumbar	Select Base	Select Frame
HCT1MM	Z1 Swivel-Tilt Control Y1 Simple Synchro-Tilt w/ Seat Slide Control (+ \$39)	N Armless A Height & Width Adjustable Arms (+ \$92)	H Black Hard Casters	M Mesh	See page 324	AL Adjustable Lumbar	SB Standard Base	T Black

CONVERGENCE[®]

Value Task Chairs



Icon Legend on page 19

HSCASTER

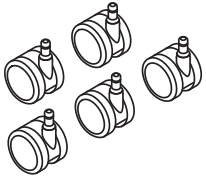

SET OF 5 ALL-SURFACE CASTERS

DIMENSIONS

Size: 60mm
Ship Weight: 2
Cube: 0.1

LIST PRICE

\$75

ⓘ Available in Black finish only, no specification needed.

SEATING

HOW TO SPECIFY

Select
Model Number

H S C A S T E R



Icon Legend on page 19

CRIO™ Mesh Chairs

HVL581



HIGH-BACK

Pneumatic
Swivel
Tilt
Tilt Tension
Tilt Lock
Height and Width Adjustable
Arms
Adjustable Lumbar

Functions: **A, E, F, K, L, S, W**
(Function Key on pages 256-257)

NOTES: Comfortable and breathable mesh back. Black fabric or Black Bonded Leather. Black frame. Height and width adjustable arms. Adjustable lumbar. **HON 5-Year Limited Warranty.**

HON Recommendation: HVL581.ES10.T - List Price \$544

DIMENSIONS

Depth:	25½	Arm Width:	19⅞
Width:	28¾	Seat to Floor Height:	16½-20¼
Height:	42⅞	Usable Seat Depth:	17¼
Seat Depth:	17¼	Ship Weight:	39.8
Seat Width:	20¼	Cube:	4.8
Back Width:	18½	Weight Rating:	250 lbs.

PRICE CODE

Fabric	\$544
Leather	\$572

HVL582



HIGH-BACK

Pneumatic
Swivel
Tilt
Tilt Tension
Tilt Lock
Asynchronous Control
Seat Glide Mechanism
Adjustable Lumbar
Height and Width Adjustable
Arms

Functions: **A, E, F, L, O, S, W**
(Function Key on pages 256-257)

NOTES: Comfortable and breathable mesh back. Black fabric or Black Bonded Leather. Black frame. Height and width adjustable arms. Seat glide mechanism. Asynchronous control with independent seat and back angle adjustment. Adjustable lumbar. **HON 5-Year Limited Warranty.**

HON Recommendation: HVL582.ES10.T - List Price \$671

DIMENSIONS

Depth:	27½	Arm Width:	19⅞
Width:	28¾	Seat to Floor Height:	20½-22¾
Height:	43¾	Usable Seat Depth:	17¼
Seat Depth:	17¼	Ship Weight:	50.4
Seat Width:	19⅞	Cube:	6.8
Back Width:	18½	Weight Rating:	250 lbs.

PRICE CODE

Fabric	\$671
Leather	\$699

HVL585



EXECUTIVE BIG AND TALL

Pneumatic
Swivel
Tilt
Tilt Tension
Tilt Lock
Height and Width Adjustable
Arms
Adjustable Lumbar

Functions: **A, E, F, K, L, S, W**
(Function Key on pages 256-257)

NOTES: Large scale model HVL585 will support 450 lbs with normal use. Black fabric. Black frame. Height and width adjustable arms. Adjustable lumbar. **HON 5-Year Limited Warranty.**

ⓘ Available in Black fabric only.

HON Recommendation: HVL585.ES10.T - List Price \$942

DIMENSIONS

Depth:	29⅞	Arm Width:	20½
Width:	28⅞	Seat to Floor Height:	17⅞-21¾
Height:	45⅞	Usable Seat Depth:	19⅞
Seat Depth:	19⅞	Ship Weight:	55.4
Seat Width:	22	Cube:	7.2
Back Width:	20⅞	Weight Rating:	450 lbs.

PRICE CODE

Fabric	\$942
---------------	--------------

HOW TO SPECIFY

Select
Model Number

H V L 5 8 1 .

Select
Fabric

ES10 Black
SB11 Black Bonded Leather
Available on HVL581 and HVL582 only

E S 1 0 .

Select
Frame

T Black

T

DEFINE™ Executive Chairs



Icon Legend on page 19

HVL108



HIGH-BACK

Pneumatic
Swivel
Synchro-tilt
Height-adjustable Arms
Functions: **A, E, J, K, Q**
(Function Key on pages 256-257)

DIMENSIONS

Depth:	29 ³ / ₄	Arm Width:	19 ¹ / ₂
Width:	29 ³ / ₄	Seat to Floor Height:	17 ¹ / ₈ -21 ³ / ₈
Height:	46 ⁷ / ₈	Usable Seat Depth:	17 ¹ / ₂
Seat Depth:	17 ¹ / ₂	Ship Weight:	47.3
Seat Width:	21	Cube:	7.2
Back Width:	20	Weight Rating:	250 lbs.
Back Height:	26 ¹ / ₂		

PRICE CODE

Leather **\$873**

NOTES: Available in Black Bonded Leather. Polished base. Polished arm accents. Height-adjustable arms. **HON 5-Year Limited Warranty.**

HON Recommendation: HVL108.SB11 - List Price \$873

SEATING

HOW TO SPECIFY

Select Model Number H V L 1 0 8 .	Select Fabric SB11 Black Bonded Leather S B 1 1
---	--

ENDORSE® COLLECTION

Want to see more? Scan here
to check out hon.com.



Endorse® Seating shown with Huddle Tables.

ENDORSE® COLLECTION

You need inviting, comfy seats up front, and task chairs that support productivity in workstations. Achieve harmony throughout your space with a multi-functional collection of Endorse task seating. Endorse supports the diversity of applications throughout your workplace with sophisticated design. Varied options. Diverse materials. Simply pick the model that suits your space and people. Add the options that fit your needs. Then get ready to Endorse a higher level of productivity.



TASK CHAIR FEATURES

- Available in mid- and low-back options.
- Available in mesh back.
- Comfort options include adjustable lumbar support, adjustable arms, seat glide, multi-position tilt and synchro-tilt.
- Optional seat slide adjustment adapts to users of various heights.
- Control options include limited synchro-tilt, advanced synchro-tilt, advanced synchro-tilt with independent back angle and weight-activated control.
- Arm options include fixed, armless, height- and width-adjustable and all-adjustable.
- Caster options include hard, All-Surface and roll control.
- Available in hundreds of quality HON fabrics.
- Warranted for users up to 300 lbs.
(450 lbs. for Big and Tall chairs)

ENDORSE® Options

BACK OPTIONS

HLWM
HLWMBT - Big & Tall



Mid-back

Mesh with Adjustable
Lumbar Support

HLTM
HLTSM - Stool



Low-back

Mesh with Adjustable
Lumbar Support

MESH BACK COLOR CODES (no upcharge): Black - **IM** Breeze - **IB** Brownstone - **IK** Charcoal - **IC** Fog - **IF** Regatta - **IR**
Titanium - **IT**

MECHANISM	CODE	FUNCTIONS	PRICE
	S0	Limited Recline Synchro-Tilt A, E, J, K, L	+\$0
	S1	Limited Recline Synchro-Tilt w/ Seat Slider (available on Stools only) A, D, E, J, K, L	+\$22
	Y2	Advanced Synchro-Tilt A, D, E, J, L, W, A-D	+\$71
	Y3	Advanced Synchro-Tilt with Independent Back Angle A, D, E, J, L, W, A-E	+\$114
	Y4	Synchro-Tilt A, D, E, J, L, W, A-D (Big and Tall models only)	+\$0

(See pages 256-257 for Seating Functions.)

BASE	CODE	DESCRIPTION	PRICE
	SB	Standard Base	+\$0
	PA	Polished Aluminum	+\$119

ARM STYLE	CODE	DESCRIPTION	PRICE
	N	Armless	+\$0
	F	Fixed - Black	+\$71
	A	Height and Width Adjustable Arms	+\$92
	V	All-Adjustable Arms - includes pivot	+\$141
	P	Fixed - Polished Alum.	+\$189

CASTERS	CODE	DESCRIPTION	PRICE
	A	Black All-Surface Caster (High-back and Big and Tall models only)	+\$0
	H	Black Hard Caster	+\$0
	S	Black All-Surface Caster	+\$44
	R	Black Roll Control Caster	+\$55

TASK DIMENSIONS

MODEL		HLWM	HLTM
Overall Width Armless		28½	28½
Overall Width with Arms	A/V	28½	28½
	F/P	28½	28½
Overall Depth		28½	28½
Overall Height	S0	45½	42
	Y2	46¼	42¾
	Y3	46	42½
	W5	48⅜	43
Seat Width		20	19
Seat Depth		18½	18⅜
Usable Seat Depth	S0	17¾	17⅝
	Y2	15½-18	15½-18
	Y3	15¼-18¼	15¼-18¼
	W5	15½-17¾	15½-17¾
Seat Height (mechanism)	S0	17-21½	17-21½
	Y2	17¾-22¼	17¾-22¼
	Y3	17½-22	17½-22
	W5	17¼-21¾	17¼-21¾
Back Width		19¼	18
Back Height		25	21¾
Ship Weight Armless	S0	40	41
	Y2	45 Ⓢ	46 Ⓢ
	Y3	48 Ⓢ	50 Ⓢ
	W5	44 Ⓢ	45 Ⓢ
Weight with Arms	S0	48	49
	Y2	53 Ⓢ	54 Ⓢ
	Y3	56 Ⓢ	58 Ⓢ
	W5	52 Ⓢ	53 Ⓢ
Between Arms	A/V	18-20 ^{17/20}	16¾-19
	F/P	20½	20½
COM		1.0	1.0
Weight Capacity		300 lbs	300 lbs

BIG & TALL & STOOL DIMENSIONS

MODEL		HLWMBT	HLTSM
Overall Width Armless		28½	28½
Overall Width with Arms	A/V	28½	28½
	F/P	28½	28½
Overall Depth		28½	28½
Overall Height	S0/S1	-	53
	Y4	49	-
Seat Width		23	19
Seat Depth	S0/S1	-	18⅜
	Y4	20¼	-
Usable Seat Depth	S0	-	17⅝
	S1	-	15¼-18¼
	Y4	17¼-18¾	-
Seat Height (mechanism)	S0/S1	-	22¾-32¾
	Y4	17½-22	-
Back Width		22½	19¾
Back Height		25¾	22¾
Ship Weight Armless	S0	-	42
	S1	-	44
	Y4	57	-
Weight with Arms	S0	-	50
	S1	-	52
	Y4	65	-
Between Arms	A/V	20½-23	16¾-19
	F/P	23½	20½
COM		1.5	2.0
Weight Capacity		450 lbs	300 lbs

ENDORSE® Fabric Options

HON BRANDED FABRICS *(For Seating)*

GRADE 1

Apex
Centurion
Compass
Contourett
Dapper
Emphasis
Ensemble
Hamilton
Noble Seating
Pebble
Vibe

GRADE 2

Appoint Seating
Blume
Clyde
Haute
Kai
Rush
Spin Seating
Wavelength
Whisper Vinyl

GRADE 3

Bradbury
Cozy
Getaway
Moxie
Notion
Parker
Purl
Quill
Saxony

GRADE 4

Constance with Supreen™
Livi with Supreen™
Lucerne
Lugano with Supreen™
Oxford with Supreen™

For a complete list of fabrics, including partnership fabrics, go to hon.com/fabricsandfinishes.

Reference Fabric Color Combinations on pages 20-25 for color codes and legend on page 21 for lead times. For additional HON to Supply COM fabric grade pricing, go to hon.com and click on the HON to Supply COM link.

HLWM



TASK MID-BACK

4-Way Stretch Back

- Pneumatic
- Swivel
- Synchro-tilt
- Tilt Tension
- Tilt Lock
- Integral Lumbar Support
- Optional Seat Glide

Functions: **A, E, J, K, L, W**
 (Function Key on pages 256-257)

NOTES: For Mesh Back models, specify the 4-Way Stretch back option below. Headrest available on Mid-back 4-Way Stretch models only - Black only.

! See page 331 for additional specifications and dimensions.

DIMENSIONS

Depth:	28½	Back Width:	19
Width:	28½	Back Height:	25
Height:	44½	Cube:	10.8
Seat Depth:	15¾	COM:	1.0
Seat Width:	19¾	Weight Rating:	300 lbs.

FABRIC PRICE CODES

1	\$1153	8	\$1303
2	\$1180	9	\$1322
3	\$1206	10	\$1341
4	\$1225	11	\$1361
5	\$1244	12	\$1380
6	\$1264	L	—
7	\$1283		

HON Recommendation: HLWM.Y2.A.H.IM.CU__SB.N - List Price \$1316

HOW TO SPECIFY

Select Model Number	Select Control Type	Select Arm Type	Select Caster/Glide	Select Mesh Back	Select Fabric	Select Base	Select Headrest
S0 Limited Recline Synchro-Tilt	Y2 Advanced Synchro-Tilt (+ \$71)	N Armless	H Black Hard Caster	4-Way Stretch options	See page 332	SB Standard Base	N No Headrest
Y2 Advanced Synchro-Tilt (+ \$71)	Y3 Synchro-Tilt with Independent Back Angle (+ \$114)	F Fixed Arms - Black (+ \$71)	S Black All- Surface Caster (+ \$44)	IM Black		PA Polished Aluminum (+ \$119)	HR Headrest (+ \$87)
Y3 Synchro-Tilt with Independent Back Angle (+ \$114)		A Height and Width Adjustable Arms (+ \$92)	R Black Roll Control Caster (+ \$55)	IB Breeze			<i>Black only. Specify for model HLWM only</i>
		V All-Adjustable Arms (includes pivot) (+ \$141)		IK Brownstone			
		P Fixed Arms - Polished (+ \$189)		IC Charcoal			
				IF Fog			
				IR Regatta			
				IT Titanium			
				<i>Specify the back for Mesh Back models only</i>			
HLWM	Y2	A	H	IM	CU10	SB	N

HLTM



TASK LOW-BACK

4-Way Stretch Back

- Pneumatic
- Swivel
- Synchro-tilt
- Tilt Tension
- Tilt Lock
- Integral Lumbar Support
- Optional Seat Glide

Functions: **A, E, J, K, L, W**

(Function Key on pages 256-257)

NOTES: For Mesh Back models, specify the 4-Way Stretch back option below.

❗ See page 331 for additional specifications and dimensions.

DIMENSIONS

Depth:	28½	Back Width:	17¾
Width:	28½	Back Height:	21¾
Height:	40¾	Cube:	10.8
Seat Depth:	15½	COM:	1.0
Seat Width:	18¾	Weight Rating:	300 lbs.

FABRIC PRICE CODES

1	\$1073	8	\$1223
2	\$1100	9	\$1242
3	\$1126	10	\$1261
4	\$1145	11	\$1281
5	\$1164	12	\$1300
6	\$1184	L	—
7	\$1203		

HON Recommendation: HLTM.Y2.A.H.IM.CU__SB - List Price \$1236

HOW TO SPECIFY

Select Model Number	Select Control Type	Select Arm Type	Select Caster/Glide	Select Mesh Back	Select Fabric	Select Base
HLTM	<ul style="list-style-type: none"> S0 Limited Recline Synchro-Tilt Y2 Advanced Synchro-Tilt (+ \$71) Y3 Synchro-Tilt with Independent Back Angle (+ \$114) 	<ul style="list-style-type: none"> N Armless F Fixed Arms - Black (+ \$71) A Height and Width Adjustable Arms (+ \$92) V All-Adjustable Arms (includes pivot) (+ \$141) P Fixed Arms - Polished (+ \$189) 	<ul style="list-style-type: none"> H Black Hard Caster S Black All-Surface Caster (+ \$44) R Black Roll Control Caster (+ \$55) 	<ul style="list-style-type: none"> 4-Way Stretch options IM Black IB Breeze IK Brownstone IC Charcoal IF Fog IR Regatta IT Titanium <p><i>Specify the back for Mesh Back models only</i></p>	See page 332	<ul style="list-style-type: none"> SB Standard Base PA Polished Aluminum (+ \$119)
	Y2	A	H	IM	CU10	SB



Icon Legend on page 19

ENDORSE®

HLWMBT

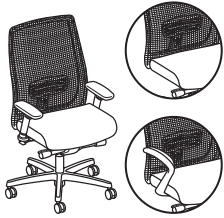

TASK MID-BACK

Big and Tall 4-Way Stretch Back

- Pneumatic
- Seat-glide
- Swivel
- Synchro-tilt
- Tilt Lock
- Side Tilt Tension
- Integral Lumbar Support

Functions: **A, D, E, A-D, J, L, W**
(Function Key on pages 256-257)

NOTES: For Mesh Back models, specify the 4-Way Stretch back option below. Headrest available on Mid-back 4-Way Stretch models only - Black only.

DIMENSIONS

Depth:	31½	Adjustable Arms Width:	21½-23¾
Width:	31½	Fixed Arms Width:	24
Height:	44½	Seat to Floor Height:	18-22
Seat Depth:	21	Usable Seat Depth:	17¼-18¾
Seat Width:	23	Ship Weight:	75
Back Width:	22½	Cube:	15.3
Back Height:	25¾	COM:	1.5
		Weight Rating:	450 lbs.

FABRIC PRICE CODES

1	\$1914	8	\$2138
2	\$1954	9	\$2167
3	\$1993	10	\$2196
4	\$2022	11	\$2225
5	\$2050	12	\$2254
6	\$2079	L	—
7	\$2109		

HON Recommendation: HLWMBT.Y4.A.A.IM.CU__SB.N - List Price \$2006

HOW TO SPECIFY

Select Model Number	Select Control Type	Select Arm Type	Select Caster/Glide	Select Mesh Back	Select Fabric	Select Base	Select Headrest
HLWMBT	Y4 Synchro-Tilt <i>Y4 is the only control option for the Big and Tall models</i>	N Armless A Height and Width Adjustable Arms (+ \$92) V All-Adjustable Arms (includes pivot) (+ \$141)	A Black All-Surface Caster	4-Way Stretch option <i>Black only</i> IM Black <i>Specify the back for Mesh Back models only</i>	See page 332	SB Standard Base	N No Headrest HR Headrest (+ \$87) <i>Black only. Specify for model HLWMBT only</i>
	Y4	A	A	IM	CU10	SB	N

SEATING

HLTSM

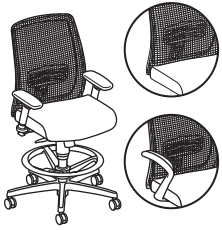

STOOL

4-Way Stretch Back

- Pneumatic
- Swivel
- Synchro-tilt
- Tilt Tension
- Tilt Lock
- Integral Lumbar Support

Functions: **A, E, J, K, L, W**
 (Function Key on pages 256-257)

DIMENSIONS

Depth:	28½	Back Width:	17¾
Width:	28½	Back Height:	21¾
Height:	52½	Cube:	10.8
Seat Depth:	15½	COM:	1.0
Seat Width:	18¾	Weight Rating:	300 lbs.

FABRIC PRICE CODES

1	\$1279	8	\$1429
2	\$1306	9	\$1448
3	\$1332	10	\$1467
4	\$1351	11	\$1487
5	\$1370	12	\$1506
6	\$1390	L	—
7	\$1409		

NOTES: For Mesh Back models, specify the 4-Way Stretch back option below. See page 331 for additional specifications and dimensions.

HON Recommendation: HLTSM.S1.A.H.IM.CU__SB - List Price \$1393

HOW TO SPECIFY

Select Model Number	Select Control Type	Select Arm Type	Select Caster/Glide	Select Mesh Back	Select Fabric	Select Base
<p>S0 Limited Recline Synchro-Tilt</p> <p>S1 Limited Recline Synchro-Tilt w/ Seat Slider (+ \$22)</p>	<p>N Armless</p> <p>F Fixed Arms - Black (+ \$71)</p> <p>A Height and Width Adjustable Arms (+ \$92)</p> <p>V All-Adjustable Arms (includes pivot) (+ \$141)</p> <p>P Fixed Arms - Polished (+ \$189)</p>	<p>H Black Hard Caster</p> <p>S Black All-Surface Caster (+ \$44)</p> <p>R Black Roll Control Caster (+ \$55)</p>	<p>4-Way Stretch options</p> <p>IM Black</p> <p>IB Breeze</p> <p>IK Brownstone</p> <p>IC Charcoal</p> <p>IF Fog</p> <p>IR Regatta</p> <p>IT Titanium</p> <p><i>Specify the back for Mesh Back models only</i></p>	See page 332	<p>SB Standard Base</p> <p>PA Polished Aluminum (+ \$119)</p>	
HLTSM	S1	A	H	IM	CU10	SB



Icon Legend on page 19

HL2DARM

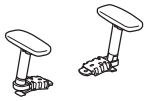

ADJUSTABLE T-ARMS

Height and Width

Functions: **S**
(Function Key on pages 256-257)

DIMENSIONS

Adjustable Arms Width: 16 3/4-19 (low-back and stool models)
Adjustable Arms Width: 18-20 7/20 (mid-back models)
Height from Seat: 7 1/4-11
Ship Weight: 8
Cube: 1.0

LIST PRICE

\$170

- Available in Black only. No need to specify.
- Can only be used with standard models. Contact Customer Support for Big & Tall arm packs.

HL4DARM



ALL-ADJUSTABLE ARMS

Height, Width, Depth and Pivot

DIMENSIONS

Adjustable Arms Width: 16 3/4-19 (low-back and stool models)
Adjustable Arms Width: 18-20 7/20 (mid-back models)
Height from Seat: 7 1/4-11
Ship Weight: 8
Cube: 1.0

LIST PRICE

\$229

- Available in Black only. No need to specify.
- Can only be used with standard models. Contact Customer Support for Big & Tall arm packs.

HI2FHA



FIXED HEIGHT ARMS

DIMENSIONS

Arm Width: 20
Height from Seat: 9 1/2
Ship Weight: 7
Cube: 1.0

LIST PRICE

\$151

- Can only be used with standard models. Contact Customer Support for Big & Tall arm packs.

HIPAA

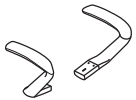

POLISHED ALUMINUM ARMS

Fixed Height

DIMENSIONS

Arm Width: 20
Height from Seat: 9 1/2
Ship Weight: 10
Cube: 1.0

LIST PRICE

\$249

- Can only be used with standard models. Contact Customer Support for Big & Tall arm packs.

HLMSHHR



MESH HEADREST

DIMENSIONS

Mesh Width: 12
Mesh Height: 6
Ship Weight: 3
Cube: 1.0

QA DIMENSIONS

(Attachment Mechanism)

Width: 12
Depth: 6
Height: 12

LIST PRICE

\$189

- Available in Black Mesh (IM) only. For use with Mesh Mid-back models only.

HSCASTER

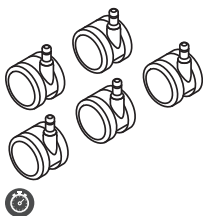

SET OF 5 ALL-SURFACE CASTERS

DIMENSIONS

Size: 60mm
Ship Weight: 2
Cube: 0.1

LIST PRICE

\$75

- Available in Black finish only, no specification needed.

FLEXION™

Want to see more? Scan here
to check out hon.com.



Flexion™ Seating shown with Empower®
Workstation and Contain® Mobile Pedestal.

FLEXION™

Multiple meetings and hands-on project planning requires hassle free seating — you need a chair that moves and adapts to your body and your day. Flexion™ features a versatile seat for versatile work. With a clean, nimble aesthetic and straightforward mechanisms, this flexible seating solution supports an on-the-go workstyle, with minimum adjustments and ample comfort.



FEATURES

- Get comfortable with weight-activated flex functionality that responds and adapts to you as you sit.
- Move around freely with 4-point seat suspension that allows for dynamic postures.
- Maximize your back and shoulder support with a back frame designed with torsion in mind to move and flex with you.
- Find the right fit with one-touch seat height adjustment.
- Take your pick of adjustable arms, fixed arms, or an armless aesthetic.
- Meet the needs of your space with 3 different cylinder height options.
- Stay cool with 4-Way Stretch Mesh — available in 7 colors.
- Choose from 3 frame options: Salt, Titanium, and Black.

MODEL OPTIONS

HFXT1



Task Chair

HON BRANDED FABRICS

GRADE 1

Apex
Centurion
Compass
Contourett
Dapper
Emphasis
Ensemble
Hamilton
Noble Seating
Pebble
Vibe

GRADE 2

Appoint Seating
Blume
Clyde
Haute
Kai
Rush
Spin Seating
Wavelength
Whisper Vinyl

GRADE 3

Bradbury
Cozy
Getaway
Moxie
Notion
Parker
Purl
Quill
Saxony

GRADE 4

Constance with Supreen™
Livi with Supreen™
Lucerne
Lugano with Supreen™
Oxford with Supreen™

GRADE L

Davenport Leather

For a complete list of fabrics, including partnership fabrics, go to hon.com/fabricsandfinishes.

Reference Fabric Color Combinations on pages 20-25 for color codes and legend on page 21 for lead times.

FLEXION™ Options

ARM STYLE



CODE	DESCRIPTION	PRICE
N	Armless	+\$0
A	Height-Adjustable	+\$82
F	Fixed Arms	+\$71

CASTERS/ GLIDES



CODE	DESCRIPTION	PRICE
H	Hard Caster	+\$0
S	Black All-Surface Caster	+\$33
TS	Titanium All-Surface Caster	+\$33
SS	Salt All-Surface Caster	+\$33
R	Roll Control Caster	+\$55

CYLINDER

CODE	DESCRIPTION	PRICE
STC	Standard Cylinder	+\$0
SHC	Short Cylinder	+\$0
TLC	Tall Cylinder	+\$0

BASE

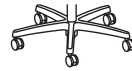

CODE	DESCRIPTION	PRICE
SB	Standard Base	+\$0
PA	Polished Aluminum	+\$119

FRAME COLOR

CODE	DESCRIPTION	PRICE
T	Black	+\$0
TI	Titanium	+\$39
ST	Salt	+\$39



Icon Legend on page 19

FLEXION™

HFXT1



TASK CHAIR

Mesh Back

DIMENSIONS

Depth:	25	Seat to Floor Height:	15-19 $\frac{3}{8}$
Width:	27 $\frac{1}{8}$	Usable Seat Depth:	16 $\frac{1}{2}$ -18 $\frac{5}{8}$
Height:	42 $\frac{1}{2}$	Ship Weight:	35
Seat Depth:	17 $\frac{3}{8}$	Cube:	10.7
Seat Width:	19 $\frac{1}{8}$	COM:	1.0
Back Width:	18 $\frac{3}{4}$	Weight Rating:	300 lbs.
Back Height:	24		

FABRIC PRICE CODES

1	\$804	8	\$954
2	\$831	9	\$973
3	\$857	10	\$992
4	\$876	11	\$1012
5	\$895	12	\$1031
6	\$915	L	\$1093
7	\$934		

HON Recommendation: HFXT1.F0.STC.A.H.IT.CU__.NL.SB.TI - List Price \$925

HOW TO SPECIFY

Select Model Number	Select Control Type	Select Cylinder	Select Arm Type	Select Caster	Select Mesh Color	Select Fabric	Select Lumbar	Select Base	Select Frame
FO Weight-Activated Flex	STC Standard SHC Short TLC Tall	N Armless A Height Adjustable Arms (+ \$82) F Fixed (+ \$71)	H Hard Caster S Black All-Surface Caster (+ \$33) TS Titanium All-Surface Caster (+ \$33) SS Salt All-Surface Caster (+ \$33) R Roll Control Caster (+ \$55)	IM Black IF Fog IC Charcoal IT Titanium IK Brownstone IR Regatta IB Breeze	See page 339	NL No Lumbar	SB Standard PA Polished Aluminum (+ \$119)	T Black (+ \$0) TI Titanium (+ \$39) ST Salt (+ \$39)	
H F X T 1 .	F 0 .	S T C .	A .	H .	I M .	A P X 2 5 .	N L .	S B .	T

SEATING



Flock® Seating shown with Scramble™ Tables.

FLOCK®

Break away. Come together. Wherever people migrate within a space, Flock is designed to support their needs. With a full collection of modular and comfortable seating elements and coordinating collaborative tables that work seamlessly together, you can make the most of every square inch of your space. Modular lounge chairs and ottomans stand alone or combine to create large arrangements. Multi-purpose stools and chairs add comfort to open spaces. Collaborative tables bring the whole group together. Flock helps people interact with each other, challenge one another, and receive the support they need.



CHAIR FEATURES

- Round and square lounge chairs are fully upholstered.
- The contemporary aesthetic easily matches a variety of surroundings.
- Support everything from one-on-one conversations to large meetings.
- Choose from four leg options — standard, tapered round, tapered square, hard casters, or a 4-star base.
- Swivel, X-, or 4-star base options include return-to-center feature.
- 4-Leg guest chairs and counter- and bar-height stools available with both metal and wood legs.
- Available in hundreds of quality HON fabrics.
- Warranted for users up to 300 lbs.

COLLABORATIVE TABLES

- Choose from round, square, rectangle, or racetrack shaped table tops.
- Optional grommets neatly route cords.
- Bases available in disc, T-leg, and X-leg styles.
- Choose bases with or without footings.

MODEL OPTIONS

HFLSC1
HFLSC1DF - Multi-Fabric

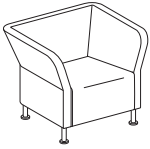

Lounge Chair
Square

HFLRC1
HFLRC1DF - Multi-Fabric



Lounge Chair
Round

HFLMC1
HFLMC1DF - Multi-Fabric



Modular Chair

HFLML1
HFLML1DF - Multi-Fabric

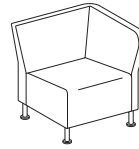

Modular
Left End

HFLMR1
HFLMR1DF - Multi-Fabric

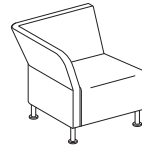

Modular
Right End

HFLCC1
HFLCC1DF - Multi-Fabric

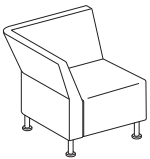

True Chair
Corner

HFLW145
HFLW145DF - Multi-Fabric

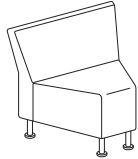

Wedge
Inside

HFLW045
HFLW045DF - Multi-Fabric



Wedge
Outside

HFL450

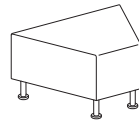

Wedge Ottoman

LEG STYLE



L Standard Leg **+\$0**



TS Tapered Square **+\$0**



TR Tapered Round **+\$0**



H Hard Casters **+\$0**

LEG COLOR

CODE DESCRIPTION PRICE

PR8 Textured Silver **+\$0**
P7A Textured Charcoal **+\$0**

**Specify PR8 & P7A for Standard Legs and Tapered Round & Tapered Square Legs only*

T Black Hard Caster **+\$0**

**Specify for Hard Caster option only*

FLOCK® Options

MODEL OPTIONS

HFLB2

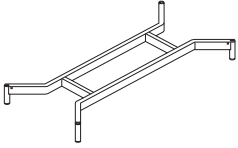

Two-Seat Base Frame

HFLB3

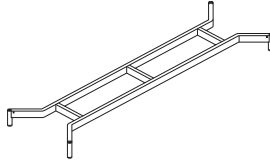

Three-Seat Base Frame

HTSSRD

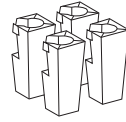

Tapered Square
Leg - Shroud Pack

COMPATIBLE MODELS

HFLMC1
HFLMC1DF - Multi-Fabric



Modular Chair

HFLML1
HFLML1DF - Multi-Fabric

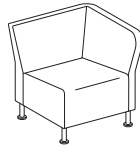

Modular
Left End

HFLMR1
HFLMR1DF - Multi-Fabric



Modular
Right End

HFLCC1
HFLCC1DF - Multi-Fabric

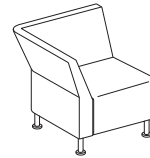

True Chair
Corner

HFLSO1

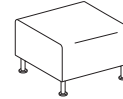

Square Ottoman

LEG STYLE



CODE	DESCRIPTION	PRICE
RS	Round Straight Leg	+\$0

Available in the following finishes:

PR8	Textured Silver
P7A	Textured Charcoal



TS	Tapered Square	+\$85
-----------	----------------	--------------

Available in the following finishes:

PR8	Textured Silver
P7A	Textured Charcoal

HON BRANDED FABRICS

GRADE 1	GRADE 2	GRADE 3	GRADE 4	GRADE L
Apex	Appoint Seating	Bradbury	Constance with Supreen™	Denver Leather*
Centurion	Blume	Cozy	Livi with Supreen™	
Compass	Clyde	Getaway	Lucerne	
Contourett	Haute	Moxie	Lugano with Supreen™	
Dapper	Kai	Notion	Oxford with Supreen™	
Emphasis	Rush	Parker		
Ensemble	Spin Seating	Purl		
Hamilton	Wavelength	Quill		
Noble Seating	Whisper Vinyl	Saxony		
Pebble				
Vibe				

For a complete list of fabrics, including partnership fabrics, go to hon.com/fabricsandfinishes.

Flock® chair model HFLRC1 has fabric limitations, please see the Flock® seating pages 346-353 for details.

Reference Fabric Color Combinations on pages 20-25 for color codes and legend on page 21 for lead times.

*Denver Leather (SS) may not be available on every model within a specific series, please refer to the model's page for details.

For more details on Upholstery Pattern Match for this series, please see page 14.

⚠ Due to the inherent characteristics of upholstery materials, the seat of Flock® may become more relaxed to show wrinkles over time.

FLOCK® ROUND LOUNGE HFLRC1/DF HON BRANDED FABRICS

GRADE 1	GRADE 2	GRADE 3	GRADE 4	GRADE L
Apex	Appoint Seating	Bradbury	Constance with Supreen™	Denver Leather**
Centurion	Blume	Cozy	Livi with Supreen™**	
Compass	Clyde	Getaway	Lucerne	
Contourett	Haute	Moxie	Lugano with Supreen™	
Dapper	Kai	Notion	Oxford with Supreen™**	
Emphasis	Rush	Parker		
Ensemble	Spin Seating*	Purl		
Hamilton	Wavelength	Quill		
Noble Seating	Whisper Vinyl	Saxony		
Pebble				
Vibe				

For a complete list of fabrics, including partnership fabrics, go to hon.com/fabricsandfinishes.

Reference Fabric Color Combinations on pages 20-25 for color codes and legend on page 21 for lead times.

*Available on seat only.

**Denver Leather (SS) may not be available on every model within a specific series, please refer to the model's page for details.

For more details on Upholstery Pattern Match for this series, please see page 14.

⚠ Due to the inherent characteristics of upholstery materials, the seat of Flock® may become more relaxed to show wrinkles over time.

HFLSC1

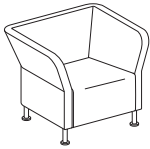

LOUNGE CHAIR

Square

DIMENSIONS

Depth:	28½	Arm Width:	27½
Width:	34¼	Seat to Floor Height:	17
Height:	28	Usable Seat Depth:	20½
Seat Depth:	20½	Ship Weight:	79
Seat Width:	21½	Cube:	21.9
Back Width:	21½	COM:	5.0
Back Height:	18½	Weight Rating:	300 lbs.

FABRIC PRICE CODES

1	\$2484	8	\$3174
2	\$2605	9	\$3264
3	\$2724	10	\$3354
4	\$2815	11	\$3443
5	\$2905	12	\$3533
6	\$2994	L	\$3484
7	\$3084		

! Leg options – Standard Leg (L), Tapered Square (TS) and Tapered Round (TR) are available in Textured Silver (PR8) and Textured Charcoal (P7A) only. Hard Casters (H) are available on Black (T) only.

HFLRC1



Due to the inherent design of the Round Lounge chair, material gathers will be present in the back.

LOUNGE CHAIR

Round

DIMENSIONS

Depth:	29	Arm Width:	27½
Width:	33½	Seat to Floor Height:	17
Height:	28	Usable Seat Depth:	20½
Seat Depth:	20½	Ship Weight:	57
Seat Width:	20½	Cube:	21.9
Back Width:	20½	Weight Rating:	300 lbs.
Back Height:	18½		

FABRIC PRICE CODES

1	\$2594	8	\$3207
2	\$2703	9	\$3288
3	\$2809	10	\$3367
4	\$2888	11	\$3447
5	\$2968	12	\$3527
6	\$3048	L	\$3482
7	\$3128		

! Round Lounge models HFLRC1 / HFLRC1DF are offered in select fabrics; for availability, please see the Fabric Matrix on page 345. Also approved in limited Partnership Fabrics. Leg options – Standard Leg (L), Tapered Square (TS) and Tapered Round (TR) are available in Textured Silver (PR8) and Textured Charcoal (P7A) only. Hard Casters (H) are available on Black (T) only.

! Customer's Own Material (COM) is not available on Flock® model HFLRC1.

HON Recommendation: HFLSC1.TS.PNS__PR8 - List Price \$2690

HOW TO SPECIFY

<p>Select Model Number</p> <p>HFLSC1</p>	<p>Select Leg Option</p> <p>L Standard Leg TS Tapered Square TR Tapered Round H Hard Casters</p> <p>TS</p>	<p>Select Fabric</p> <p>See page 345</p> <p>PNS007</p>	<p>Select Leg Color</p> <p>PR8 Textured Silver P7A Textured Charcoal</p> <p><i>Specify for Standard, Tapered Round and Tapered Square legs only</i></p> <p>T Black Hard Caster <i>Specify for Hard Caster option only</i></p> <p>PR8</p>
---	--	---	---



Icon Legend on page 19

HFLMC1

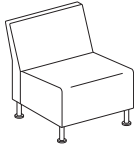

MODULAR CHAIR

DIMENSIONS

Depth:	28½	Seat to Floor Height:	17
Width:	25	Usable Seat Depth:	20½
Height:	28	Ship Weight:	54
Seat Depth:	20½	Cube:	21.9
Seat Width:	25	COM:	3.0
Back Width:	25	Weight Rating:	300 lbs.
Back Height:	18½		

FABRIC PRICE CODES

1	\$1821	8	\$2281
2	\$1903	9	\$2342
3	\$1982	10	\$2401
4	\$2042	11	\$2461
5	\$2102	12	\$2521
6	\$2161	L	\$2487
7	\$2222		

! Leg options – Standard Leg (L), Tapered Square (TS) and Tapered Round (TR) are available in Textured Silver (PR8) and Textured Charcoal (P7A) only. Hard Casters (H) are available on Black (T) only.

HFLML1

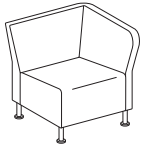

MODULAR

Left End

DIMENSIONS

Depth:	28½	Seat to Floor Height:	17
Width:	28½	Usable Seat Depth:	20½
Height:	28	Ship Weight:	72
Seat Depth:	20½	Cube:	21.9
Seat Width:	22¼	COM:	4.0
Back Width:	22¼	Weight Rating:	300 lbs.
Back Height:	18½		

FABRIC PRICE CODES

1	\$2147	8	\$2760
2	\$2256	9	\$2841
3	\$2362	10	\$2920
4	\$2441	11	\$3000
5	\$2521	12	\$3080
6	\$2601	L	\$3035
7	\$2681		

! Leg options – Standard Leg (L), Tapered Square (TS) and Tapered Round (TR) are available in Textured Silver (PR8) and Textured Charcoal (P7A) only. Hard Casters (H) are available on Black (T) only.

HFLMR1



MODULAR

Right End

DIMENSIONS

Depth:	28½	Seat to Floor Height:	17
Width:	28½	Usable Seat Depth:	20½
Height:	28	Ship Weight:	72
Seat Depth:	20½	Cube:	21.9
Seat Width:	22¼	COM:	4.0
Back Width:	22¼	Weight Rating:	300 lbs.
Back Height:	18½		

FABRIC PRICE CODES

1	\$2147	8	\$2760
2	\$2256	9	\$2841
3	\$2362	10	\$2920
4	\$2441	11	\$3000
5	\$2521	12	\$3080
6	\$2601	L	\$3035
7	\$2681		

! Leg options – Standard Leg (L), Tapered Square (TS) and Tapered Round (TR) are available in Textured Silver (PR8) and Textured Charcoal (P7A) only. Hard Casters (H) are available on Black (T) only.

HON Recommendation: HFLMC1.TS.PNS___.PR8 - List Price \$1988

HOW TO SPECIFY

<p>Select Model Number</p> <p>H F L M C 1 .</p>	<p>Select Leg Option</p> <p>L Standard Leg TS Tapered Square TR Tapered Round H Hard Casters</p> <p>T S .</p>	<p>Select Fabric</p> <p>See page 345</p> <p>P N S 0 0 7 .</p>	<p>Select Leg Color</p> <p>PR8 Textured Silver P7A Textured Charcoal</p> <p><i>Specify for Standard, Tapered Round and Tapered Square legs only</i></p> <p>T Black Hard Caster <i>Specify for Hard Caster option only</i></p> <p>P R 8</p>
--	---	--	---

HFLCC1

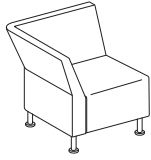

TRUE CORNER CHAIR

DIMENSIONS

Depth:	28½	Seat to Floor Height:	17
Width:	28½	Usable Seat Depth:	20½
Height:	28	Ship Weight:	60
Seat Depth:	20½	Cube:	21.9
Seat Width:	20½	COM:	4.0
Back Width:	22¼	Weight Rating:	300 lbs.
Back Height:	18½		

FABRIC PRICE CODES

1	\$2138	8	\$3009
2	\$2247	9	\$3146
3	\$2353	10	\$3284
4	\$2459	11	\$3422
5	\$2596	12	\$3559
6	\$2734	L	\$3026
7	\$2871		

! Leg options – Standard Leg (L), Tapered Square (TS) and Tapered Round (TR) are available in Textured Silver (PR8) and Textured Charcoal (P7A) only.

HFLWI45

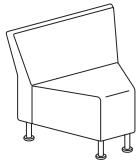

INSIDE WEDGE

DIMENSIONS

Depth:	26¼	Seat to Floor Height:	17
Width:	31½	Usable Seat Depth:	19
Height:	28	Ship Weight:	45
Seat Depth:	19½	Cube:	21.9
Seat Width:	25¾	COM:	3.0
Back Width:	31½	Weight Rating:	300 lbs.
Back Height:	18½		

FABRIC PRICE CODES

1	\$2136	8	\$3007
2	\$2245	9	\$3144
3	\$2351	10	\$3282
4	\$2457	11	\$3420
5	\$2594	12	\$3557
6	\$2732	L	\$3024
7	\$2869		

! Leg options – Standard Leg (L), Tapered Square (TS) and Tapered Round (TR) are available in Textured Silver (PR8) and Textured Charcoal (P7A) only.

HFLWO45



OUTSIDE WEDGE

DIMENSIONS

Depth:	26¼	Seat to Floor Height:	17
Width:	32	Usable Seat Depth:	19
Height:	28	Ship Weight:	35
Seat Depth:	19½	Cube:	21.9
Seat Width:	32	COM:	3.0
Back Width:	16¼	Weight Rating:	300 lbs.
Back Height:	18½		

FABRIC PRICE CODES

1	\$2136	8	\$3007
2	\$2245	9	\$3144
3	\$2351	10	\$3282
4	\$2457	11	\$3420
5	\$2594	12	\$3557
6	\$2732	L	\$3024
7	\$2869		

! Leg options – Standard Leg (L), Tapered Square (TS) and Tapered Round (TR) are available in Textured Silver (PR8) and Textured Charcoal (P7A) only.

HON Recommendation: HFLCC1.TS.PNS__PR8 - List Price \$2332

HOW TO SPECIFY

<p>Select Model Number</p> <p>HFLCC1</p>	<p>Select Leg Option</p> <p>L Standard Leg TS Tapered Square TR Tapered Round</p> <p>TS</p>	<p>Select Fabric</p> <p>See page 345</p> <p>PNS007</p>	<p>Select Leg Color</p> <p>PR8 Textured Silver P7A Textured Charcoal</p> <p><i>Specify for Standard, Tapered Round and Tapered Square legs only</i></p> <p>PR8</p>
---	--	---	---



Icon Legend on page 19

HFL450

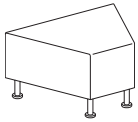

WEDGE OTTOMAN

DIMENSIONS

Depth:	23½	Usable Seat Depth:	23½
Width:	32	Ship Weight:	33
Height:	17	Cube:	12.6
Seat Depth:	23½	COM:	2.0
Seat Width:	32	Weight Rating:	300 lbs.
Seat to Floor Height:	17		

FABRIC PRICE CODES

1	\$1050	8	\$1486
2	\$1105	9	\$1555
3	\$1159	10	\$1624
4	\$1211	11	\$1693
5	\$1280	12	\$1761
6	\$1349	L	\$1494
7	\$1417		

! Leg options – Standard Leg (L), Tapered Square (TS) and Tapered Round (TR) are available in Textured Silver (PR8) and Textured Charcoal (P7A) only.

HFLS01

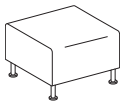

OTTOMAN

Square

DIMENSIONS

Depth:	25	Ship Weight:	30.0
Width:	25	Cube:	7.5
Height:	17	COM:	2.0
Seat Depth:	25	Weight Rating:	300 lbs.
Seat Width:	25		

FABRIC PRICE CODES

1	\$1066	8	\$1373
2	\$1121	9	\$1414
3	\$1175	10	\$1453
4	\$1214	11	\$1494
5	\$1254	12	\$1533
6	\$1294	L	\$1510
7	\$1333		

! Leg options – Standard Leg (L), Tapered Square (TS) and Tapered Round (TR) are available in Textured Silver (PR8) and Textured Charcoal (P7A) only. Hard Casters (H) are available on Black (T) only.

! While the top surface of the ottoman is flat, modular models (pages 347-348 and 351-353) have a slight angle to their seats. Therefore, there will not be alignment between these units when placed side-by-side.

HFLGANG



GANGING BRACKET

For Flock® Modular Seating Models

- Can be used for in-line ganging ONLY
- Use bracket set to connect two models. Do not connect more than four models.
- No specification required for bracket

DIMENSIONS

Ship Weight:	0.5
Cube:	0.1

LIST PRICE

\$51

HON Recommendation: HFLS01.TS.PNS__PR8 - List Price \$1206

HOW TO SPECIFY

<p>Select Model Number</p> <p>H F L S 0 1</p>	<p>Select Leg Option</p> <p>L Standard Leg TS Tapered Square TR Tapered Round H Hard Casters</p> <p>T S</p>	<p>Select Fabric</p> <p>See page 345</p> <p>P N S 0 0 7</p>	<p>Select Leg Color</p> <p>PR8 Textured Silver P7A Textured Charcoal</p> <p><i>Specify for Standard, Tapered Round and Tapered Square legs only</i></p> <p>T Black Hard Caster <i>Specify for Hard Caster option only</i></p> <p>P R 8</p>
--	---	--	---

FLOCK® Multi-Fabric Collaborative



Icon Legend on page 19

HFLSC1DF

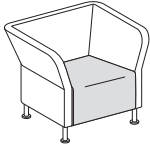

LOUNGE CHAIR

Multi-Fabric
Square

DIMENSIONS

Depth:	28½	Arm Width:	27½
Width:	34¼	Seat to Floor Height:	17
Height:	28	Usable Seat Depth:	20½
Seat Depth:	20½	Ship Weight:	48
Seat Width:	21½	Cube:	27.0
Back Width:	21½	COM:	See page 362
Back Height:	18½	Weight Rating:	300 lbs.

FABRIC PRICE CODES

1	\$2583	
	<i>Add to Base Price Above</i>	
	Back	Seat
2	\$90	\$32
3	\$180	\$63
4	\$245	\$87
5	\$312	\$111
6	\$379	\$133
7	\$444	\$157
8	\$511	\$181
9	\$577	\$204
10	\$644	\$228
11	\$710	\$252
12	\$776	\$274
L	\$739	\$261

For multi-fabric models, start with the base price, then add the additional amount for the back and seat from the corresponding matrix to determine the final list price. Choose any combination of fabric grades for the back and seat.

Example: HFLSC1DF base price (\$2583) + Grade 2 back fabric (add \$90) + Grade 4 seat fabric (add \$87) = Total \$2760 List
 HFLSC1DF base price (\$2583) + Grade 5 back fabric (add \$312) + Grade 3 seat fabric (add \$63) = Total \$2958 List

HFLRC1DF

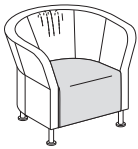

LOUNGE CHAIR

Multi-Fabric
Round

DIMENSIONS

Depth:	29	Arm Width:	27½
Width:	33½	Seat to Floor Height:	17
Height:	28	Usable Seat Depth:	20½
Seat Depth:	20½	Ship Weight:	39
Seat Width:	20½	Cube:	27.0
Back Width:	20½	Weight Rating:	300 lbs.
Back Height:	18½		

FABRIC PRICE CODES

1	\$2692	
	<i>Add to Base Price Above</i>	
	Back	Seat
2	\$81	\$29
3	\$159	\$57
4	\$218	\$79
5	\$278	\$97
6	\$336	\$119
7	\$395	\$140
8	\$454	\$161
9	\$513	\$182
10	\$573	\$202
11	\$631	\$223
12	\$691	\$243
L	\$658	\$232

NOTES: Due to the inherent design of the Round Lounge chair, material gathers will be present in the back.
 ⓘ Round Lounge models HFLRC1 / HFLRC1DF are offered in select fabrics; for availability, please see the Fabric Matrix on page 345. Also approved in limited Partnership Fabrics.

For multi-fabric models, start with the base price, then add the additional amount for the back and seat from the corresponding matrix to determine the final list price. Choose any combination of fabric grades for the back and seat.

Example: HFLRC1DF base price (\$2692) + Grade 2 back fabric (add \$81) + Grade 4 seat fabric (add \$79) = Total \$2852 List
 HFLRC1DF base price (\$2692) + Grade 5 back fabric (add \$278) + Grade 3 seat fabric (add \$57) = Total \$3027 List

HON Recommendation: HFLSC1DF.TS.PNS__PNS__PR8 - List Price \$2790

SEATING

HOW TO SPECIFY

<p>Select Model Number</p> <p>HFLSC1DF</p>	<p>Select Leg Option</p> <p>L Standard Leg TS Tapered Square TR Tapered Round H Hard Casters</p> <p>TS</p>	<p>Select Back Fabric</p> <p>See page 345</p> <p>PNS004</p>	<p>Select Seat Fabric</p> <p>See page 345</p> <p>PNS007</p>	<p>Select Leg Color</p> <p>PR8 Textured Silver P7A Textured Charcoal</p> <p><i>Specify for Standard, Tapered Round and Tapered Square legs only</i></p> <p>T Black Hard Caster</p> <p><i>Specify for Hard Caster option only</i></p> <p>PR8</p>
---	--	--	--	---



Icon Legend on page 19

FLOCK® Multi-Fabric Collaborative

HFLMC1DF

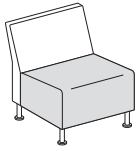

MODULAR CHAIR

Multi-Fabric

DIMENSIONS

Depth:	28½	Seat to Floor Height:	17
Width:	25	Usable Seat Depth:	20½
Height:	28	Ship Weight:	52
Seat Depth:	20½	Cube:	24.0
Seat Width:	25	COM:	See page 362
Back Width:	25	Weight Rating:	300 lbs.
Back Height:	18½		

FABRIC PRICE CODES

1	\$1920	
<i>Add to Base Price Above</i>		
	Back	Seat
2	\$42	\$42
3	\$82	\$82
4	\$112	\$112
5	\$141	\$141
6	\$170	\$170
7	\$201	\$201
8	\$231	\$231
9	\$261	\$261
10	\$291	\$291
11	\$321	\$321
12	\$351	\$351
L	\$334	\$334

HFLML1DF

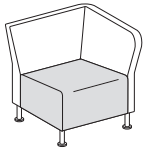

MODULAR LEFT END

Multi-Fabric

DIMENSIONS

Depth:	28½	Seat to Floor Height:	17
Width:	28½	Usable Seat Depth:	20½
Height:	28	Ship Weight:	72
Seat Depth:	20½	Cube:	24.0
Seat Width:	22¼	COM:	See page 362
Back Width:	22¼	Weight Rating:	300 lbs.
Back Height:	18½		

FABRIC PRICE CODES

1	\$2246	
<i>Add to Base Price Above</i>		
	Back	Seat
2	\$81	\$29
3	\$159	\$57
4	\$218	\$79
5	\$278	\$97
6	\$336	\$119
7	\$395	\$140
8	\$454	\$161
9	\$513	\$182
10	\$573	\$202
11	\$631	\$223
12	\$691	\$243
L	\$658	\$232

HON Recommendation: HFLMC1DF.TS.PNS__PNS__PR8 - List Price \$2089

HOW TO SPECIFY

<p>Select Model Number</p> <p>HFLMC1DF</p>	<p>Select Leg Option</p> <p>L Standard Leg TS Tapered Square TR Tapered Round H Hard Casters</p> <p>TS</p>	<p>Select Back Fabric</p> <p>See page 345</p> <p>PNS004</p>	<p>Select Seat Fabric</p> <p>See page 345</p> <p>PNS007</p>	<p>Select Leg Color</p> <p>PR8 Textured Silver P7A Textured Charcoal</p> <p><i>Specify for Standard, Tapered Round and Tapered Square legs only</i></p> <p>T Black Hard Caster</p> <p><i>Specify for Hard Caster option only</i></p> <p>PR8</p>
---	--	--	--	---

FLOCK® Multi-Fabric Collaborative



Icon Legend on page 19

HFLMR1DF

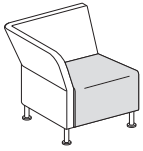

MODULAR RIGHT END

Multi-Fabric

DIMENSIONS

Depth:	28½	Seat to Floor Height:	17
Width:	28½	Usable Seat Depth:	20½
Height:	28	Ship Weight:	72.0
Seat Depth:	20½	Cube:	24.0
Seat Width:	22¼	COM:	See page 362
Back Width:	22¼	Weight Rating:	300 lbs.
Back Height:	18½		

FABRIC PRICE CODES

1	\$2246	
<i>Add to Base Price Above</i>		
	Back	Seat
2	\$81	\$29
3	\$159	\$57
4	\$218	\$79
5	\$278	\$97
6	\$336	\$119
7	\$395	\$140
8	\$454	\$161
9	\$513	\$182
10	\$573	\$202
11	\$631	\$223
12	\$691	\$243
L	\$658	\$232

HON Recommendation: HFLMR1DF.TS.PNS__PNS__.PR8 - List Price \$2441

SEATING

HOW TO SPECIFY

<p>Select Model Number</p>	<p>Select Leg Option</p> <p>L Standard Leg TS Tapered Square TR Tapered Round H Hard Casters</p>	<p>Select Back Fabric</p> <p>See page 345</p>	<p>Select Seat Fabric</p> <p>See page 345</p>	<p>Select Leg Color</p> <p>PR8 Textured Silver P7A Textured Charcoal</p> <p><i>Specify for Standard, Tapered Round and Tapered Square legs only</i></p> <p>T Black Hard Caster <i>Specify for Hard Caster option only</i></p>
H F L M R 1 D F .	T S .	P N S 0 0 4 .	P N S 0 0 7 .	P R 8



Icon Legend on page 19

HFLCC1DF

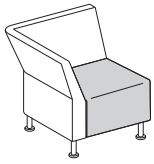

TRUE CORNER CHAIR

Multi-Fabric

DIMENSIONS

Depth:	28½	Seat to Floor Height:	17
Width:	28½	Usable Seat Depth:	21
Height:	28	Ship Weight:	60
Seat Depth:	20½	Cube:	21.9
Seat Width:	20½	COM:	See page 362
Back Width:	22¼	Weight Rating:	300 lbs.
Back Height:	18½		

FABRIC PRICE CODES

1	\$2237	
<i>Add to Base Price Above</i>		
	Back	Seat
2	\$55	\$55
3	\$109	\$109
4	\$161	\$161
5	\$230	\$230
6	\$299	\$299
7	\$367	\$367
8	\$436	\$436
9	\$505	\$505
10	\$574	\$574
11	\$643	\$643
12	\$711	\$711
L	\$444	\$444

! Leg options – Standard Leg (L), Tapered Square (TS) and Tapered Round (TR) are available in Textured Silver (PR8) and Textured Charcoal (P7A) only. Hard Casters (H) are available on Black (T) only.

HFLWI45DF

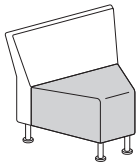

INSIDE WEDGE

Multi-Fabric

DIMENSIONS

Depth:	26¼	Seat to Floor Height:	17
Width:	31½	Usable Seat Depth:	19
Height:	28	Ship Weight:	45
Seat Depth:	19½	Cube:	21.9
Seat Width:	25¾	COM:	See page 362
Back Width:	31½	Weight Rating:	300 lbs.
Back Height:	18½		

FABRIC PRICE CODES

1	\$2235	
<i>Add to Base Price Above</i>		
	Back	Seat
2	\$55	\$55
3	\$109	\$109
4	\$161	\$161
5	\$230	\$230
6	\$299	\$299
7	\$367	\$367
8	\$436	\$436
9	\$505	\$505
10	\$574	\$574
11	\$643	\$643
12	\$711	\$711
L	\$444	\$444

! Leg options – Standard Leg (L), Tapered Square (TS) and Tapered Round (TR) are available in Textured Silver (PR8) and Textured Charcoal (P7A) only. Hard Casters (H) are available on Black (T) only.

HFLWO45DF

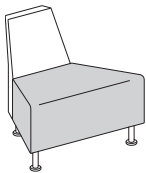

OUTSIDE WEDGE

Multi-Fabric

DIMENSIONS

Depth:	26½	Seat to Floor Height:	17
Width:	32	Usable Seat Depth:	19
Height:	28	Ship Weight:	35
Seat Depth:	19½	Cube:	21.9
Seat Width:	32	COM:	See page 362
Back Width:	16¼	Weight Rating:	300 lbs.
Back Height:	18½		

FABRIC PRICE CODES

1	\$2235	
<i>Add to Base Price Above</i>		
	Back	Seat
2	\$55	\$55
3	\$109	\$109
4	\$161	\$161
5	\$230	\$230
6	\$299	\$299
7	\$367	\$367
8	\$436	\$436
9	\$505	\$505
10	\$574	\$574
11	\$643	\$643
12	\$711	\$711
L	\$444	\$444

! Leg options – Standard Leg (L), Tapered Square (TS) and Tapered Round (TR) are available in Textured Silver (PR8) and Textured Charcoal (P7A) only. Hard Casters (H) are available on Black (T) only.

HOW TO SPECIFY

HON Recommendation: HFLCC1DF.TS.PNS___.PNS___.PR8 - List Price \$2432

<p>Select Model Number</p> <p>HFLCC1DF.</p>	<p>Select Leg Option</p> <p>L Standard Leg TS Tapered Square TR Tapered Round H Hard Casters</p> <p>TS.</p>	<p>Select Back Fabric</p> <p>See page 345</p> <p>PNS004.</p>	<p>Select Seat Fabric</p> <p>See page 345</p> <p>PNS007.</p>	<p>Select Leg Color</p> <p>PR8 Textured Silver P7A Textured Charcoal</p> <p><i>Specify for Standard, Tapered Round and Tapered Square legs only</i></p> <p>T Black Hard Caster <i>Specify for Hard Caster option only</i></p> <p>PR8</p>
--	---	---	---	---

FLOCK® Base Frames and Legs



Icon Legend on page 19

	DESCRIPTION	MODEL	SHIP WEIGHT	CUBE	LIST PRICE
	Two-Seat Base Frame	HFLB2	25	5.9	\$565
	Three-Seat Base Frame	HFLB3	33	7.8	\$704

HOW TO SPECIFY

<p>Select Model Number</p> <p>H F L B 2 .</p>	<p>Select Leg Option</p> <p>RS Round Straight Leg TS Tapered Square Leg (+ \$85)</p> <p>Select Leg Color</p> <p>PR8 Textured Silver P7A Textured Charcoal</p> <p>R S P R 8</p>
--	--

	DESCRIPTION	MODEL	SHIP WEIGHT	CUBE	LIST PRICE
	Tapered Square Leg — Shroud Pack	HTSSRD	2	1.0	\$111

HOW TO SPECIFY

<p>Select Model Number</p> <p>H T S S R D .</p>	<p>Select Leg Color</p> <p>PR8 Textured Silver P7A Textured Charcoal</p> <p>P R 8</p>
--	--

MODEL OPTIONS

HFCG6
HFCG6DF -
Multi-Fabric



Guest Chair
4-Leg

HFCS64L
HFCS64LDF -
Multi-Fabric



Counter-Height Stool
4-Leg

HFSS74L
HFSS74LDF -
Multi-Fabric



Bar/Café-Height Stool
4-Leg

4-LEG STOOL, METAL LEG COLOR

CODE	DESCRIPTION	PRICE
PR8	Textured Silver	+ \$0

HFCG6WD
HFCG6WDDF -
Multi-Fabric



Guest Chair
Wood Leg

HFCS64LWD
HFCS64LWDDF -
Multi-Fabric



Counter-Height Stool
Wood Leg

HFSS74LWD
HFSS74LWDDF -
Multi-Fabric



Bar/Café-Height Stool
Wood Leg

WOOD LEG COLOR

CODE	DESCRIPTION	PRICE
LE702	Cognac	+ \$0
LE878	Beigewood	+ \$0
LE773	Bourbon Cherry	+ \$0
LE121	Mocha	+ \$0
LE599	Field Elm	+ \$0
LE579	Florence Walnut	+ \$0
LE856	Harvest	+ \$0
LE518	Kingswood Walnut	+ \$0
LE394	Lowell Ash	+ \$0
LE740	Mahogany	+ \$0
LE800	Natural Maple	+ \$0
LE896	Natural Recon	+ \$0
LE912	Phantom Ecru	+ \$0
LE679	Pinnacle	+ \$0
LE150	Portico Teak	+ \$0
LE774	Shaker Cherry	+ \$0
LE625	Skyline Walnut	+ \$0
LE495	Sterling Ash	+ \$0

Due to wood being a natural material, color may differ between pieces. Stains will be tonal matches and will not replicate the grain contrast of the coordinating laminate. Prolonged exposure to sunlight can affect the appearance of wood furniture, leading to variations in hue and tone.

HFCL2
HFCL2DF - Multi-Fabric



Wide Lounge Chair
With 4-Star Return-to-Center

HFLSC2
HFLSC2DF - Multi-Fabric



Square Chair
With 4-Star Return-to-Center

BASE COLOR 4-LEG STOOL, FOOTRING COLOR

CODE	DESCRIPTION	PRICE
PR8	Silver Texture	\$0
P8X	Solar Black	\$0
P7A	Textured Charcoal	\$0

BASE COLOR	CODE	DESCRIPTION	PRICE
	4S	4-Star Return-to-Center	+ \$0

Available in the following finishes:

PR8	Textured Silver
P7A	Textured Charcoal

HFCG6



GUEST CHAIR

4-Leg

DIMENSIONS

Depth:	23 ⁵ / ₁₆	Seat to Floor Height:	18 ¹ / ₄
Width:	19	Usable Seat Depth:	16 ⁷ / ₈
Height:	32 ¹ / ₂	Ship Weight:	27
Seat Depth:	16 ⁷ / ₈	Cube:	12.5
Seat Width:	19	COM:	2.0
Back Width:	19	Weight Rating:	300 lbs.
Back Height:	14 ¹ / ₄		

FABRIC PRICE CODES

1	\$843	8	\$1150
2	\$898	9	\$1191
3	\$952	10	\$1230
4	\$991	11	\$1271
5	\$1031	12	\$1310
6	\$1071	L	\$1287
7	\$1110		

HFCS64L



COUNTER-HEIGHT STOOL

4-Leg

DIMENSIONS

Depth:	20 ⁵ / ₈	Seat to Floor Height:	23 ⁷ / ₈
Width:	17 ¹ / ₂	Usable Seat Depth:	15 ⁷ / ₈
Height:	34 ¹ / ₄	Ship Weight:	35
Seat Depth:	15 ⁵ / ₈	Cube:	12.6
Seat Width:	18	COM:	1.5
Back Width:	18	Weight Rating:	300 lbs.
Back Height:	10 ⁷ / ₈		

FABRIC PRICE CODES

1	\$1018	8	\$1326
2	\$1073	9	\$1366
3	\$1128	10	\$1409
4	\$1167	11	\$1455
5	\$1206	12	\$1503
6	\$1246	L	\$1625
7	\$1284		

HFSS74L



BAR/CAFÉ-HEIGHT STOOL

4-Leg

DIMENSIONS

Depth:	21 ¹ / ₈	Seat to Floor Height:	30
Width:	18	Usable Seat Depth:	15 ⁷ / ₈
Height:	40 ⁷ / ₈	Ship Weight:	37
Seat Depth:	15 ⁷ / ₈	Cube:	12.6
Seat Width:	18	COM:	1.5
Back Width:	18	Weight Rating:	300 lbs.
Back Height:	10 ⁷ / ₈		

FABRIC PRICE CODES

1	\$1059	8	\$1366
2	\$1114	9	\$1407
3	\$1168	10	\$1446
4	\$1207	11	\$1487
5	\$1247	12	\$1526
6	\$1287	L	\$1503
7	\$1326		

HON Recommendation: HFCG6.PURL__PR8 - List Price \$952

HOW TO SPECIFY

<p>Select Model Number</p> <p>HFSS74L</p>	<p>Select Fabric</p> <p>See page 345</p> <p>PURL12</p>	<p>Select Leg Color</p> <p>See page 355</p> <p>PR8</p>
--	---	---



Icon Legend on page 19

HF CG6WD



GUEST CHAIR

Wood Leg

DIMENSIONS

Depth:	23 ³ / ₄	Seat to Floor Height:	18
Width:	22 ² / ₈	Usable Seat Depth:	16 ⁷ / ₈
Height:	32	Ship Weight:	27
Seat Depth:	16 ⁷ / ₈	Cube:	12.5
Seat Width:	19	COM:	2.0
Back Width:	19	Weight Rating:	300 lbs.
Back Height:	14 ¹ / ₄		

FABRIC PRICE CODES

1	\$1196	8	\$1504
2	\$1251	9	\$1544
3	\$1306	10	\$1587
4	\$1345	11	\$1633
5	\$1384	12	\$1681
6	\$1424	L	\$1803
7	\$1462		

HF CS64LWD



COUNTER-HEIGHT STOOL

Wood Leg

DIMENSIONS

Depth:	19 ¹ / ₂	Seat to Floor Height:	23 ⁵ / ₈
Width:	19 ³ / ₈	Usable Seat Depth:	15 ¹ / ₈
Height:	34 ¹ / ₂	Ship Weight:	30
Seat Depth:	15 ⁵ / ₈	Cube:	12.6
Seat Width:	18	COM:	1.5
Back Width:	18	Weight Rating:	300 lbs.
Back Height:	10 ⁷ / ₈		

FABRIC PRICE CODES

1	\$1372	8	\$1680
2	\$1427	9	\$1720
3	\$1482	10	\$1763
4	\$1521	11	\$1809
5	\$1560	12	\$1857
6	\$1600	L	\$1979
7	\$1638		

HF SS74LWD



BAR/CAFÉ-HEIGHT STOOL

Wood Leg

DIMENSIONS

Depth:	20 ¹ / ₂	Seat to Floor Height:	29 ¹ / ₂
Width:	20 ³ / ₄	Usable Seat Depth:	15 ⁷ / ₈
Height:	40 ¹ / ₂	Ship Weight:	31
Seat Depth:	15 ⁷ / ₈	Cube:	12.6
Seat Width:	18	COM:	1.5
Back Width:	18	Weight Rating:	300 lbs.
Back Height:	10 ⁷ / ₈		

FABRIC PRICE CODES

1	\$1414	8	\$1722
2	\$1469	9	\$1762
3	\$1524	10	\$1805
4	\$1563	11	\$1851
5	\$1602	12	\$1899
6	\$1642	L	\$2021
7	\$1680		

HON Recommendation: HF CG6WD.PURL__D - List Price \$1306

HOW TO SPECIFY

<p>Select Model Number</p> <p>HF CG6WD</p>	<p>Select Fabric</p> <p>See page 345</p> <p>PURL12</p>	<p>Select Wood Leg Color</p> <p>See page 355</p> <p>D</p>	<p>Select Footring Color</p> <p><i>Specify for Stools only</i></p> <p>See page 355</p> <p>P7A</p>
---	---	--	--

HFCL2



WIDE LOUNGE CHAIR

with 4-Star Return-to-Center

DIMENSIONS

Depth:	27½	Seat to Floor Height:	17
Width:	26¾	Usable Seat Depth:	19
Height:	32¼	Ship Weight:	53
Seat Width:	26	Cube:	25.1
Back Width:	25½	COM:	2.5
Back Height:	19½	Weight Rating:	300 lbs.

FABRIC PRICE CODES

1	\$1433	8	\$1893
2	\$1515	9	\$1954
3	\$1594	10	\$2013
4	\$1654	11	\$2073
5	\$1714	12	\$2133
6	\$1773	L	\$2099
7	\$1834		

HFLSC2



SQUARE CHAIR

with 4-Star Return-to-Center

DIMENSIONS

Depth:	26½	Seat to Floor Height:	18
Width:	27½	Usable Seat Depth:	18¾
Height:	32¼	Ship Weight:	46
Seat Width:	17½	Cube:	25.1
Back Width:	16	COM:	See note
Back Height:	17¾	Weight Rating:	300 lbs.

FABRIC PRICE CODES

1	\$2065	8	\$2525
2	\$2147	9	\$2586
3	\$2226	10	\$2645
4	\$2286	11	\$2705
5	\$2346	12	\$2765
6	\$2405	L	\$2731
7	\$2466		

NOTES: Due to fabric limitations, COM is unavailable for back upholstery. See HFLSC2DF for COM available on the seat only.

HON Recommendation: HFLSC2.PURL__4SPR8 - List Price \$2226

HOW TO SPECIFY

<p>Select Model Number</p> <p>H F L S C 2</p>	<p>Select Fabric</p> <p>See page 345</p> <p>P U R L 1 2</p>	<p>Select Base Option</p> <p>See page 355</p> <p>4 S P R 8</p>
--	--	---



Icon Legend on page 19

HFCG6DF



GUEST CHAIR

4-Leg, Multi-Fabric

DIMENSIONS

Depth:	23 ⁵ / ₁₆	Seat to Floor Height:	18 ¹ / ₄
Width:	19	Usable Seat Depth:	16 ⁷ / ₈
Height:	32 ¹ / ₂	Ship Weight:	27
Seat Depth:	16 ⁷ / ₈	Cube:	12.5
Seat Width:	19	COM:	See page 362
Back Width:	19	Weight Rating:	300 lbs.
Back Height:	14 ¹ / ₄		

FABRIC PRICE CODES

1	\$942	
<i>Add to Base Price Above</i>		
	Back	Seat
2	\$28	\$28
3	\$55	\$55
4	\$75	\$75
5	\$94	\$94
6	\$115	\$115
7	\$134	\$134
8	\$155	\$155
9	\$175	\$175
10	\$194	\$194
11	\$215	\$215
12	\$234	\$234
L	\$223	\$223

HFCS64LDF



COUNTER-HEIGHT STOOL

4-Leg, Multi-Fabric

DIMENSIONS

Depth:	20 ³ / ₈	Seat to Floor Height:	23 ⁷ / ₈
Width:	17 ¹ / ₂	Usable Seat Depth:	15 ⁷ / ₈
Height:	34 ¹ / ₄	Ship Weight:	35
Seat Depth:	15 ⁵ / ₈	Cube:	12.6
Seat Width:	18	COM:	See page 362
Back Width:	18	Weight Rating:	300 lbs.
Back Height:	10 ⁷ / ₈		

FABRIC PRICE CODES

1	\$1117	
<i>Add to Base Price Above</i>		
	Back	Seat
2	\$28	\$28
3	\$55	\$55
4	\$75	\$75
5	\$94	\$94
6	\$115	\$115
7	\$134	\$134
8	\$155	\$155
9	\$175	\$175
10	\$196	\$196
11	\$220	\$220
12	\$243	\$243
L	\$304	\$304

HFSS74LDF



BAR/CAFÉ-HEIGHT STOOL

4-Leg, Multi-Fabric

DIMENSIONS

Depth:	21 ⁷ / ₈	Seat to Floor Height:	30
Width:	18	Usable Seat Depth:	15 ⁷ / ₈
Height:	40 ⁷ / ₈	Ship Weight:	37
Seat Depth:	15 ⁵ / ₈	Cube:	12.6
Seat Width:	18	COM:	See page 362
Back Width:	18	Weight Rating:	300 lbs.
Back Height:	10 ⁷ / ₈		

FABRIC PRICE CODES

1	\$1158	
<i>Add to Base Price Above</i>		
	Back	Seat
2	\$28	\$28
3	\$55	\$55
4	\$75	\$75
5	\$94	\$94
6	\$115	\$115
7	\$134	\$134
8	\$155	\$155
9	\$175	\$175
10	\$194	\$194
11	\$215	\$215
12	\$234	\$234
L	\$223	\$223

HON Recommendation: HFCG6DF.PURL__PURL__.PR8 - List Price \$1052

HOW TO SPECIFY

Select Model Number HFSS74LDF	Select Back Fabric See page 345 PURL12	Select Seat Fabric See page 345 PURL12	Select Leg Color See page 355 PR8
---	---	---	--

HF CG6WDDF



GUEST CHAIR

Wood Leg, Multi-Fabric

DIMENSIONS

Depth:	23 ³ / ₄	Seat to Floor Height:	18
Width:	22 ³ / ₈	Usable Seat Depth:	16 ⁷ / ₈
Height:	32	Ship Weight:	27
Seat Depth:	16 ⁷ / ₈	Cube:	12.5
Seat Width:	19	COM:	See page 362
Back Width:	19	Weight Rating:	300 lbs.
Back Height:	14 ¹ / ₄		

FABRIC PRICE CODES

1	\$1295	
	<i>Add to Base Price Above</i>	
	Back	Seat
2	\$28	\$28
3	\$55	\$55
4	\$75	\$75
5	\$94	\$94
6	\$115	\$115
7	\$134	\$134
8	\$155	\$155
9	\$175	\$175
10	\$196	\$196
11	\$220	\$220
12	\$243	\$243
L	\$304	\$304

HF CS64LWDDF



COUNTER-HEIGHT STOOL

Wood Leg, Multi-Fabric

DIMENSIONS

Depth:	19 ¹ / ₂	Seat to Floor Height:	23 ⁵ / ₈
Width:	19 ³ / ₈	Usable Seat Depth:	15 ⁷ / ₈
Height:	34 ¹ / ₂	Ship Weight:	30
Seat Depth:	15 ⁷ / ₈	Cube:	12.6
Seat Width:	18	COM:	See page 362
Back Width:	18	Weight Rating:	300 lbs.
Back Height:	10 ⁷ / ₈		

FABRIC PRICE CODES

1	\$1471	
	<i>Add to Base Price Above</i>	
	Back	Seat
2	\$28	\$28
3	\$55	\$55
4	\$75	\$75
5	\$94	\$94
6	\$115	\$115
7	\$134	\$134
8	\$155	\$155
9	\$175	\$175
10	\$196	\$196
11	\$220	\$220
12	\$243	\$243
L	\$304	\$304

HF SS74LWDDF



BAR/CAFÉ-HEIGHT STOOL

Wood Leg, Multi-Fabric

DIMENSIONS

Depth:	20 ¹ / ₂	Seat to Floor Height:	29 ¹ / ₂
Width:	20 ³ / ₄	Usable Seat Depth:	15 ⁷ / ₈
Height:	40 ¹ / ₂	Ship Weight:	31
Seat Depth:	15 ⁷ / ₈	Cube:	12.6
Seat Width:	18	COM:	See page 362
Back Width:	18	Weight Rating:	300 lbs.
Back Height:	10 ⁷ / ₈		

FABRIC PRICE CODES

1	\$1513	
	<i>Add to Base Price Above</i>	
	Back	Seat
2	\$28	\$28
3	\$55	\$55
4	\$75	\$75
5	\$94	\$94
6	\$115	\$115
7	\$134	\$134
8	\$155	\$155
9	\$175	\$175
10	\$196	\$196
11	\$220	\$220
12	\$243	\$243
L	\$304	\$304

HON Recommendation: HF CG6WDDF.PURL__PURL__D - List Price \$1405

HOW TO SPECIFY

Select Model Number HFSS74LWDDF	Select Back Fabric See page 345 PURL12	Select Seat Fabric See page 345 PURL12	Select Wood Leg Color See page 355 D	Select Footring Color Specify for Stools only See page 355 P7A
---	---	---	---	--



Icon Legend on page 19

FLOCK[®] Multi-Fabric Collaborative

HFCL2DF



WIDE LOUNGE CHAIR

with 4-Star Return-to-Center

DIMENSIONS

Depth:	27½	Seat to Floor Height:	17
Width:	26¾	Usable Seat Depth:	19
Height:	32¼	Ship Weight:	53
Seat Width:	26	Cube:	25.1
Back Width:	25½	COM:	See page 362
Back Height:	19½	Weight Rating:	300 lbs.

FABRIC PRICE CODES

1	\$1532	
<i>Add to Base Price Above</i>		
	Back	Seat
2	\$42	\$42
3	\$121	\$121
4	\$182	\$182
5	\$240	\$240
6	\$301	\$301
7	\$361	\$361
8	\$421	\$421
9	\$480	\$480
10	\$540	\$540
11	\$600	\$600
12	\$660	\$660
L	\$334	\$334

HFLSC2DF



SQUARE CHAIR

with 4-Star Return-to-Center

DIMENSIONS

Depth:	26½	Seat to Floor Height:	18
Width:	27½	Usable Seat Depth:	18¾
Height:	32¼	Ship Weight:	46
Seat Width:	17½	Cube:	25.1
Back Width:	16	COM:	See note
Back Height:	17¾	Weight Rating:	300 lbs.

FABRIC PRICE CODES

1	\$2164	
<i>Add to Base Price Above</i>		
	Back	Seat
2	\$55	\$28
3	\$134	\$109
4	\$194	\$167
5	\$255	\$228
6	\$314	\$288
7	\$374	\$348
8	\$434	\$407
9	\$493	\$467
10	\$554	\$527
11	\$613	\$587
12	\$674	\$647
L	\$444	\$223

NOTES: Due to fabric limitations, COM is unavailable for back upholstery. See HFLSC2DF for COM available on the seat only.

HON Recommendation: HFLSC2DF.PURL___.PURL___.4SPR8 - List Price \$2407

HOW TO SPECIFY

Select Model Number <div style="border: 1px solid black; padding: 2px;">H F L S C 2 D F</div>	Select Back Fabric See page 345 <div style="border: 1px solid black; padding: 2px;">P U R L 1 2</div>	Select Seat Fabric See page 345 <div style="border: 1px solid black; padding: 2px;">P U R L 1 2</div>	Select Base Option See page 355 <div style="border: 1px solid black; padding: 2px;">4 S P R 8</div>
---	--	--	--

FLOCK® Options

MODEL OPTIONS

HFLCO1
HFLCO1DF - Multi-Fabric

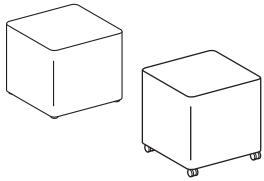

Mini Cube

HFLYO1
HFLYO1DF - Multi-Fabric

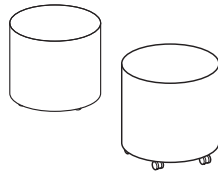

Mini Cylinder

CASTER/ GLIDES

CODE	DESCRIPTION	PRICE
A	Active Base*	+\$85
<i>*Available on models HFLYO1 and HFLYO1DF only</i>		
H	Hard Caster	+\$0
HG	Hidden Glide	+\$0
LPR8	Textured Silver Disc Glide	+\$52
LP7A	Textured Charcoal Disc Glide	+\$52

MULTI-FABRIC COM YARDAGE

Due to fabric pattern nesting and potential reduction of fabric yield, some multi-fabric models may require more total yardage than standard models.

MODEL	BACK COM	SEAT COM
HFLMC1DF	1.6	1.5
HFLML1DF	2.9	1.4
HFLMR1DF	2.9	1.4
HFCS64LDF/HFCGCWDDF	1.0	1.5
HFCS64LDF/HFCS64LWDDF	1.0	1.0
HFSS74LDF/HFSS74LDF	1.0	1.0
HFLWI45DF	2.3	1.4
HFLWO45DF	1.0	1.4
HFLCC1DF	3.6	1.4
HFCL2DF	N/A	2.0
HFLSC2DF	N/A	3.0
	TOP	SIDE
HFLCO1DF	0.7	1.2
HFLYO1DF	0.7	1.2

HON BRANDED FABRICS

GRADE 1

Apex
Centurion
Compass
Contourett
Dapper
Emphasis
Ensemble
Hamilton
Noble Seating
Pebble
Vibe

GRADE 2

Appoint Seating
Blume
Clyde
Haute
Kai
Rush
Spin Seating
Wavelength
Whisper Vinyl

GRADE 3

Bradbury
Cozy
Getaway
Moxie
Notion
Parker
Purl
Quill
Saxony

GRADE 4

Constance with Supreen™
Livi with Supreen™
Lucerne
Lugano with Supreen™
Oxford with Supreen™

GRADE L

Denver Leather

For a complete list of fabrics, including partnership fabrics, go to hon.com/fabricsandfinishes.

Reference Fabric Color Combinations on pages 20-25 for color codes and legend on page 21 for lead times.

HFLCO1

MINI CUBE

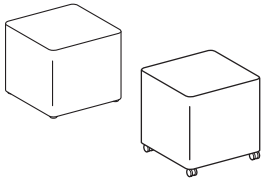

DIMENSIONS

Depth:	18½	Seat to Floor Height:	17
Width:	18½	Usable Seat Depth:	18½
Height:	17	Ship Weight:	15
Seat Depth:	18½	Cube:	5.0
Seat Width:	18½	COM:	2.0
		Weight Rating:	300 lbs.

FABRIC PRICE CODES

1	\$639	8	\$870
2	\$681	9	\$900
3	\$721	10	\$930
4	\$751	11	\$960
5	\$780	12	\$990
6	\$809	L	\$973
7	\$840		

HFLYO1

MINI CYLINDER

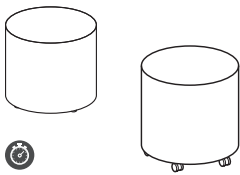

DIMENSIONS

Depth:	18½	Seat to Floor Height:	17
Width:	18½	Usable Seat Depth:	18½
Height:	17	Ship Weight:	13
Seat Depth:	18½	Cube:	5.0
Seat Width:	18½	COM:	2.0
		Weight Rating:	300 lbs.

FABRIC PRICE CODES

1	\$637	8	\$868
2	\$679	9	\$898
3	\$719	10	\$928
4	\$749	11	\$958
5	\$778	12	\$988
6	\$807	L	\$971
7	\$838		

HON Recommendation: HFLYO1.LPR8.PNS__ - List Price \$731

HOW TO SPECIFY

<p>Select Model Number</p> <p>H F L Y O 1 .</p>	<p>Select Base</p> <p>A Active Base* (+ \$85) *Available on model HFLYO1 only</p> <p>H Caster</p> <p>HG Hidden Glide</p> <p>LPR8 Textured Silver Disc Glide (+ \$52)</p> <p>LP7A Textured Charcoal Disc Glide (+ \$52)</p> <p>L P R 8 .</p>	<p>Select Fabric</p> <p>See page 362</p> <p>P N S 0 0 7 .</p>
---	--	---

FLOCK® Multi-Fabric Mini Cube and Cylinder



HFLCO1DF

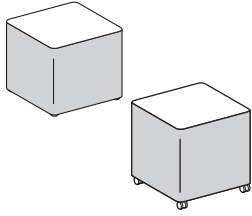

MINI CUBE
Multi-Fabric

DIMENSIONS

Depth:	18½	Seat to Floor Height:	17
Width:	18½	Usable Seat Depth:	18½
Height:	17	Ship Weight:	15
Seat Depth:	18½	Cube:	5.0
Seat Width:	18½	COM:	See page 362
		Weight Rating:	300 lbs.

FABRIC PRICE CODES

1	\$737	
<i>Add to Base Price Above</i>		
	Top	Sides
2	\$14	\$29
3	\$25	\$57
4	\$34	\$79
5	\$44	\$98
6	\$53	\$120
7	\$61	\$141
8	\$70	\$162
9	\$80	\$184
10	\$88	\$204
11	\$96	\$226
12	\$107	\$246
L	\$101	\$234

HFLYO1DF

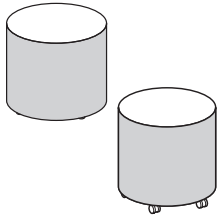

MINI CYLINDER
Multi-Fabric

DIMENSIONS

Depth:	18½	Seat to Floor Height:	17
Width:	18½	Usable Seat Depth:	18½
Height:	17	Ship Weight:	13
Seat Depth:	18½	Cube:	5.0
Seat Width:	18½	COM:	See page 362
		Weight Rating:	300 lbs.

FABRIC PRICE CODES

1	\$736	
<i>Add to Base Price Above</i>		
	Top	Sides
2	\$14	\$29
3	\$25	\$57
4	\$34	\$79
5	\$44	\$98
6	\$53	\$120
7	\$61	\$141
8	\$70	\$162
9	\$80	\$184
10	\$88	\$204
11	\$96	\$226
12	\$107	\$246
L	\$101	\$234

HON Recommendation: HFLCO1DF.HG.PNS___.PNS__ - List Price \$780

HOW TO SPECIFY

<p>Select Model Number</p>	<p>Select Base</p> <p>A Active Base* (+ \$85) <i>*Available on model HFLYO1DF only</i></p> <p>H Caster HG Hidden Glide LPR8 Textured Silver Disc Glide (+ \$52) LP7A Textured Charcoal Disc Glide (+ \$52)</p>	<p>Select Top Fabric</p> <p>See page 362</p>	<p>Select Side Fabric</p> <p>See page 362</p>
H F L C O 1 D F .	H G .	P N S 0 0 7 .	P N S 0 0 4



Grove® Seating shown with Flock® Table.

GROVE®

Find a comfy place to put your feet up, huddle up, and power up. Grove is versatile lounge seating designed to help you greet, meet, focus, relax, and accomplish more. This change-of-pace collection delivers the comfort people crave, while encouraging focus and interaction throughout the workplace. Grove's attractive design is rivaled only by its flexibility. Models include a single seat, two-seat, three-seat, and two-seat with table — all with three arm style and two leg style options, as well as accessories that support connectivity and collaboration. Grove has the look you're going for, and the comfort and versatility people have been waiting for.



FEATURES

- Each model can be combined to create arrangements suitable for any space.
- Optional integrated worksurfaces create more personal space and provide a convenient work surface.
- Design complements Flock ottomans and tables.
- Integrated power grommets keep laptops and phones powered up anywhere.
- The multi-fabric option coordinates two high-quality HON fabrics for a contemporary look.
- Choose from Single Seat, Two-Seat, Three-Seat Lounge, or Two-Seat with Table options.
- Choose from 3 arm options — Armless (N), Straight Arms (A), or Tapered Arms (B).
- Table available with two grommets and an accessory port option.
- Offers a table between the seats that provides separation and a usable work surface.
- Warranted for users up to 300 lbs.

MODEL OPTIONS

HML1S
HML1SDF - Multi-Fabric

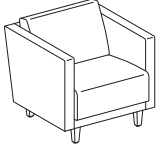

Lounge
Single Seat

HML2S
HML2SDF - Multi-Fabric

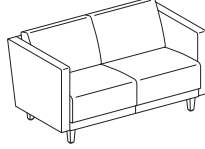

Lounge
Two-Seat

HML3S
HML3SDF - Multi-Fabric

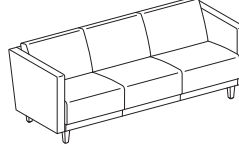

Lounge
Three-Seat

HML2ST
HML2STDF - Multi-Fabric

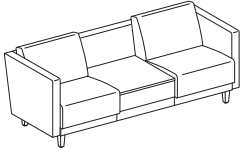

Lounge
Two-Seat with Table

ARM STYLE

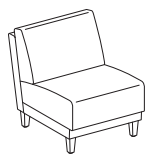

CODE	DESCRIPTION	PRICE
N	Armless	+\$0

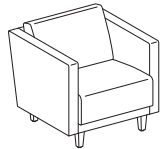

A	Straight Arms	+\$334
----------	---------------	---------------

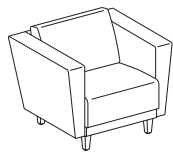

B	Tapered Arms	+\$389
----------	--------------	---------------

L1 LAMINATE

COLOR CODE

Black	P
Bourbon Cherry	H
Designer White	LDW1
Charcoal	S
Cognac	COGN
Field Elm	LWFE
Florence Walnut	LFW1
Harvest	C
Kingswood Walnut	LK11
Loft	LOFT
Mahogany	N
Mocha	MOCH
Natural Maple	D
Pinnacle	PINC
Shaker Cherry	F
Sterling Ash	LSA1

L2 LAMINATE

COLOR CODE

Beigewood	LWBE
Fawn Cypress	LFC1
Lowell Ash	LLA1
Natural Recon	LNRI
Phantom Ecu	LPE1
Portico Teak	LPT1
Skyline Walnut	LSW1

*Specify for models HML2ST and HML2STDF only

LEG STYLE



CODE	DESCRIPTION	PRICE
TS	Tapered Square	+\$0



TR	Tapered Round	+\$0
-----------	---------------	-------------

LEG COLOR

CODE	DESCRIPTION	PRICE
PR8	Textured Silver	+\$0
P7A	Textured Charcoal	+\$0
H	Bourbon Cherry	+\$113
F	Shaker Cherry	+\$113
N	Mahogany	+\$113
C	Harvest	+\$113
D	Natural Maple	+\$113
LFW1	Florence Walnut	+\$113
LK11	Kingswood Walnut	+\$113
LSW1	Skyline Walnut	+\$113
LLA1	Lowell Ash	+\$113
LSA1	Sterling Ash	+\$113
COGN	Cognac	+\$113
MOCH	Mocha	+\$113
PINC	Pinnacle	+\$113
LNRI	Natural Recon	+\$113
LPE1	Phantom Ecu	+\$113
LPT1	Portico Teak	+\$113

Due to wood being a natural material, color may differ between pieces. Stains will be tonal matches and will not replicate the grain contrast of the coordinating laminate.

CUT OUT

CODE	DESCRIPTION	PRICE
N	No Cutout	+\$0
G	Round Grommet Cutout	+\$34
G1	Pop-Up Port Cutout	+\$46

*Specify for models HML2ST and HML2STDF only

ACCESSORY PORT LOCATION

CODE	DESCRIPTION	PRICE
0	No Port	+\$0
2	Two Tablet Ports Opposite	+\$23

*Specify for models HML2ST and HML2STDF only

GROVE® Fabric Options

HON BRANDED FABRICS

GRADE 1	GRADE 2	GRADE 3	GRADE 4	GRADE L
Apex	Appoint Seating	Bradbury	Constance with Supreen™	Denver Leather
Centurion	Blume	Cozy	Livi with Supreen™	
Compass	Clyde	Getaway	Lucerne	
Contourett	Haute	Moxie	Lugano with Supreen™	
Dapper	Kai	Notion	Oxford with Supreen™	
Emphasis	Rush	Parker		
Ensemble	Spin Seating	Purl		
Hamilton	Wavelength	Quill		
Noble Seating	Whisper Vinyl	Saxony		
Pebble				
Vibe				

For a complete list of fabrics, including partnership fabrics, go to hon.com/fabricsandfinishes.

Reference Fabric Color Combinations on pages 20-25 for color codes and legend on page 21 for lead times. For additional HON to Supply COM fabric grade pricing, go to hon.com and click on the HON to Supply COM link.

For more details on Upholstery Pattern Match for this series, please see page 14.

⚠ Due to the inherent characteristics of upholstery materials, the seat of Grove® may become more relaxed to show wrinkles over time.

MULTI-FABRIC COM YARDAGE

Due to fabric pattern nesting and potential reduction of fabric yield, some multi-fabric models may require more total yardage than standard models.

MODEL	COM (ARMLESS)		COM (w/ STRAIGHT ARMS)		COM (w/ TAPERED ARMS)	
	Back	Seat	Back	Seat	Back	Seat
HML1S	3		5		5	
HML1SDF	1.5	2	4	2	4	2
HML2S	5		7.5		7.5	
HML2SDF	2	3.5	4	3.5	4	3.5
HML2ST	6		8		8	
HML2STDF	3	3.5	5.5	3.5	5.5	3.5
HML3	7.5		9		9.5	
HML3DF	3	5	5.5	5	5.5	5

HML1S

LOUNGE

Single Seat

DIMENSIONS

Depth:	31½	Ship Weight (armless):	61
Height:	29¼	Ship Weight (with straight arms):	77
Seat Width:	23½	Ship Weight (with tapered arms):	85
Back Width:	23½	Cube (armless):	19.8
Back Height:	19	Cube (with straight arms):	19.8
Width (armless):	23½	Cube (with tapered arms):	19.8
Width (with straight arms):	29¾	COM:	See
Width (with tapered arms):	35		page
Arm Width:	23½		368
Seat to Floor Height:	16	Weight Rating:	300 lbs.
Usable Seat Depth:	18¾		(per seat)

FABRIC PRICE CODES

1	\$1945	8	\$2405
2	\$2027	9	\$2466
3	\$2106	10	\$2525
4	\$2166	11	\$2585
5	\$2226	12	\$2645
6	\$2285	L	\$2611
7	\$2346		

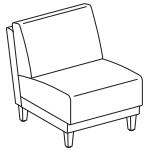

Armless

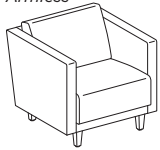

Straight Arms

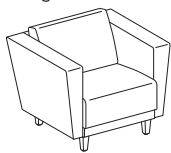

Tapered Arms

HML2S

LOUNGE

Two-Seat

DIMENSIONS

Depth:	31½	Ship Weight (armless):	100
Height:	29¼	Ship Weight (with straight arms):	116
Seat Width:	48	Ship Weight (with tapered arms):	124
Back Width:	48	Cube (armless):	35.6
Back Height:	19	Cube (with straight arms):	35.6
Width (armless):	48	Cube (with tapered arms):	35.6
Width (with straight arms):	54¼	COM:	See
Width (with tapered arms):	59½		page
Arm Width:	48		368
Seat to Floor Height:	16	Weight Rating:	300 lbs.
Usable Seat Depth:	18¾		(per seat)

FABRIC PRICE CODES

1	\$3072	8	\$3839
2	\$3206	9	\$3939
3	\$3339	10	\$4039
4	\$3439	11	\$4139
5	\$3539	12	\$4237
6	\$3638	L	\$4182
7	\$3738		

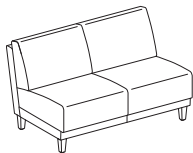

Armless

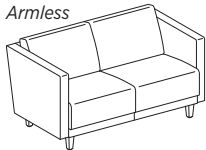

Straight Arms

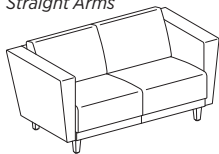

Tapered Arms

HON Recommendation: HML1S.A.PNS__TS.P7A - List Price \$2361

HOW TO SPECIFY

Select Model Number	Select Arm Type	Select Fabric	Select Leg Type	Select Leg Color
HML1S	<p>N Armless</p> <p>A Straight Arms (+ \$334)</p> <p>B Tapered Arms (+ \$389)</p>	See page 368	<p>TS Tapered Square</p> <p>TR Tapered Round</p>	<p>PR8 Textured Silver</p> <p>P7A Textured Charcoal</p> <p>H Bourbon Cherry (+ \$113)</p> <p>F Shaker Cherry (+ \$113)</p> <p>N Mahogany (+ \$113)</p> <p>C Harvest (+ \$113)</p> <p>D Natural Maple (+ \$113)</p> <p>LFW1 Florence Walnut (+ \$113)</p> <p>LK11 Kingswood Walnut (+ \$113)</p> <p>LSW1 Skyline Walnut (+ \$113)</p> <p>LLA1 Lowell Ash (+ \$113)</p> <p>LSA1 Sterling Ash (+ \$113)</p> <p>COGN Cognac (+ \$113)</p> <p>MOCH Mocha (+ \$113)</p> <p>PINC Pinnacle (+ \$113)</p> <p>LNRI Natural Recon (+ \$113)</p> <p>LPE1 Phantom Ecru (+ \$113)</p> <p>LPT1 Portico Teak (+ \$113)</p>
HML1S	A	PNS007	TS	P7A

! Leg options - Tapered Square (TS) and Tapered Round (TR) are available in 2 poly and 13 woodgrain options.

HML3S

LOUNGE

Three-Seat

DIMENSIONS

Depth:	31½	Ship Weight (armless):	141
Height:	29¼	Ship Weight (with straight arms):	157
Seat Width:	71½	Ship Weight (with tapered arms):	165
Back Width:	71½	Cube (armless):	48.9
Back Height:	19	Cube (with straight arms):	48.9
Width (armless):	71½	Cube (with tapered arms):	48.9
Width (with straight arms):	77½	COM:	See
Width (with tapered arms):	82½		page
Arm Width:	71½		368
Seat to Floor Height:	16	Weight Rating:	300 lbs.
Usable Seat Depth:	18¾		(per seat)

FABRIC PRICE CODES

1	\$4119	8	\$5268
2	\$4320	9	\$5417
3	\$4520	10	\$5567
4	\$4670	11	\$5717
5	\$4819	12	\$5866
6	\$4968	L	\$5784
7	\$5119		

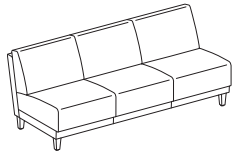

Armless

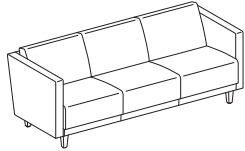

Straight Arms

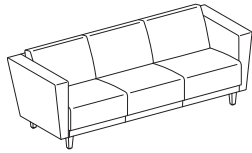

Tapered Arms

HON Recommendation: HML3S.A.PNS__TS.P7A - List Price \$4654

HOW TO SPECIFY

SEATING

Select Model Number

Select Arm Type

- N Armless
- A Straight Arms (+ \$334)
- B Tapered Arms (+ \$389)

Select Fabric

See page 368

Select Leg Type

- TS Tapered Square
- TR Tapered Round

Select Leg Color

- PR8 Textured Silver
- P7A Textured Charcoal
- H Bourbon Cherry (+ \$113)
- F Shaker Cherry (+ \$113)
- N Mahogany (+ \$113)
- C Harvest (+ \$113)
- D Natural Maple (+ \$113)
- LFW1 Florence Walnut (+ \$113)
- LK11 Kingswood Walnut (+ \$113)
- LSW1 Skyline Walnut (+ \$113)
- LLA1 Lowell Ash (+ \$113)
- LSA1 Sterling Ash (+ \$113)
- COGN Cognac (+ \$113)
- MOCH Mocha (+ \$113)
- PINC Pinnacle (+ \$113)
- LNRI Natural Recon (+ \$113)
- LPE1 Phantom Ecru (+ \$113)
- LPT1 Portico Teak (+ \$113)

HML3S -

A -

PNS007 -

TS -

P7A

! Leg options - Tapered Square (TS) and Tapered Round (TR) are available in 2 poly and 13 woodgrain options.

HML2ST

LOUNGE

Two-Seat with Table

DIMENSIONS

Depth:	31½	Ship Weight (armless):	146
Height:	29¼	Ship Weight (with straight arms):	162
Seat Width:	71½	Ship Weight (with tapered arms):	170
Back Width:	71½	Cube (armless):	48.9
Back Height:	19	Cube (with straight arms):	48.9
Width (armless):	71½	Cube (with tapered arms):	48.9
Width (with straight arms):	77½	COM:	See
Width (with tapered arms):	82½		page
Arm Width:	71½		368
Seat to Floor Height:	16	Weight Rating:	300 lbs.
Usable Seat Depth:	18¾		(per seat)

FABRIC PRICE CODES

1	\$4439	8	\$5358
2	\$4600	9	\$5479
3	\$4760	10	\$5597
4	\$4879	11	\$5718
5	\$4999	12	\$5837
6	\$5119	L	\$5770
7	\$5239		

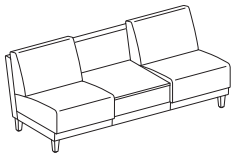

Armless

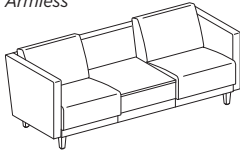

Straight Arms

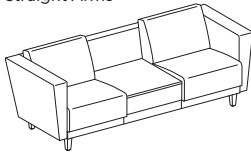

Tapered Arms

NOTES: Offers a table between the seats that provides separation and a usable workspace. Table available with two grommet and an accessory port option.

HON Recommendation: HML2ST.A.PNS__TS.P7A.N.G1.0 - List Price \$4980

HOW TO SPECIFY

Select Model Number	Select Arm Type	Select Fabric	Select Leg Type	Select Leg Color	Select Laminate	Select Cut Out	Accessory Port Location
HML2ST	<ul style="list-style-type: none"> N Armless A Straight Arms (+ \$334) B Tapered Arms (+ \$389) 	See page 368	<ul style="list-style-type: none"> TS Tapered Square TR Tapered Round 	<ul style="list-style-type: none"> PR8 Textured Silver P7A Textured Charcoal H Bourbon Cherry (+ \$113) F Shaker Cherry (+ \$113) N Mahogany (+ \$113) C Harvest (+ \$113) D Natural Maple (+ \$113) LFW1 Florence Walnut (+ \$113) LK11 Kingswood Walnut (+ \$113) LSW1 Skyline Walnut (+ \$113) LLA1 Lowell Ash (+ \$113) LSA1 Sterling Ash (+ \$113) COGN Cognac (+ \$113) MOCH Mocha (+ \$113) PINC Pinnacle (+ \$113) LLA1 Lowell Ash (+ \$113) LNRI Natural Recon (+ \$113) LPE1 Phantom Ecru (+ \$113) LPT1 Portico Teak (+ \$113) 	<p>See Chart on page 367</p> <p>L2 (+ \$140)</p>	<ul style="list-style-type: none"> N No Cutout G Round Grommet Cutout (+ \$34) G1 Pop-Up Port Cutout (+ \$46) 	<ul style="list-style-type: none"> 0 No Port 2 Two Tablet Ports Opposite (+ \$23)
HML2ST	A	PNS007	TS	P7A	N	G1	0

! Leg options - Tapered Square (TS) and Tapered Round (TR) are available in 2 poly and 8 woodgrain options.

GROVE® Multi-Fabric



Icon Legend on page 19

HML1SDF

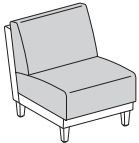

Armless

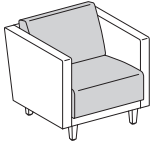

Straight Arms

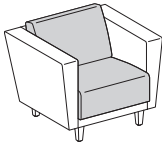

Tapered Arms

SINGLE SEAT LOUNGE

Multi-Fabric

DIMENSIONS

Depth:	31½	Ship Weight (armless):	61
Height:	29¾	Ship Weight (with straight arms):	77
Seat Width:	23½	Ship Weight (with tapered arms):	85
Back Width:	23½	Cube (armless):	19.8
Back Height:	19	Cube (with straight arms):	19.8
Width (armless):	23½	Cube (with tapered arms):	19.8
Width (with straight arms):	29¾	COM:	See
Width (with tapered arms):	35		page
Arm Width:	23½		368
Seat to Floor Height:	16	Weight Rating:	300 lbs.
Usable Seat Depth:	18¾		(per seat)

FABRIC PRICE CODES

1 \$2041

Add to Base Price Above

	Frame/ Arms	Back/Seat Cushions
2	\$42	\$55
3	\$82	\$109
4	\$112	\$148
5	\$141	\$188
6	\$170	\$228
7	\$201	\$267
8	\$231	\$307
9	\$261	\$348
10	\$291	\$387
11	\$321	\$428
12	\$351	\$467
L	\$334	\$444

For multi-fabric models, start with the base price, then add the additional amount for the back and seat from the corresponding matrix to determine the final list price. Choose any combination of fabric grades for the back and seat.

Example: HML1SDF base price (\$2041) + Grade 2 frame/arms fabric (add \$42) + Grade 4 back/seat fabric (add \$148) = Total \$2231 List
 HML1SDF base price (\$2041) + Grade 5 frame/arms fabric (add \$141) + Grade 3 back/seat fabric (add \$109) = Total \$2291 List

HON Recommendation: HML1SDF.A.PNS___.PNS___.TS.P7A - List Price \$2472

HOW TO SPECIFY

Select Model Number	Select Arm Type	Select Frame/Arms Fabric	Select Back/Seat Cushions Fabric	Select Leg Type	Select Leg Color
HML1SDF	N Armless A Straight Arms (+ \$334) B Tapered Arms (+ \$389)	See page 368	See page 368	TS Tapered Square TR Tapered Round	PR8 Textured Silver P7A Textured Charcoal H Bourbon Cherry (+ \$113) F Shaker Cherry (+ \$113) N Mahogany (+ \$113) C Harvest (+ \$113) D Natural Maple (+ \$113) LFW1 Florence Walnut (+ \$113) LK11 Kingswood Walnut (+ \$113) LSW1 Skyline Walnut (+ \$113) LLA1 Lowell Ash (+ \$113) LSA1 Sterling Ash (+ \$113) COGN Cognac (+ \$113) MOCH Mocha (+ \$113) PINC Pinnacle (+ \$113) LNR1 Natural Recon (+ \$113) LPE1 Phantom Ecru (+ \$113) LPT1 Portico Teak (+ \$113)
HML1SDF	A	PNS004	PNS007	TS	P7A

! Leg options - Tapered Square (TS) and Tapered Round (TR) are available in 2 poly and 8 woodgrain options.



Icon Legend on page 19

GROVE® Multi-Fabric

HML2SDF

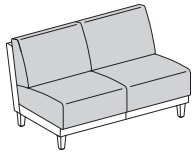

Armless

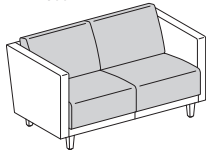

Straight Arms

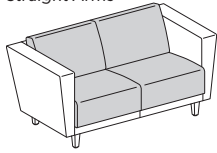

Tapered Arms

TWO-SEAT LOUNGE

Multi-Fabric

DIMENSIONS

Depth:	31½	Ship Weight (armless):	100
Height:	29¾	Ship Weight (with straight arms):	116
Seat Width:	48	Ship Weight (with tapered arms):	124
Back Width:	48	Cube (armless):	35.6
Back Height:	19	Cube (with straight arms):	35.6
Width (armless):	48	Cube (with tapered arms):	35.6
Width (with straight arms):	54¼	COM:	See
Width (with tapered arms):	59½		page
Arm Width:	48		368
Seat to Floor Height:	16	Weight Rating:	300 lbs.
Usable Seat Depth:	18¾		(per seat)

FABRIC PRICE CODES

1	\$3168	
<i>Add to Base Price Above</i>		
	Frame/ Arms	Back/Seat Cushions
2	\$67	\$94
3	\$134	\$188
4	\$185	\$258
5	\$234	\$328
6	\$285	\$398
7	\$334	\$467
8	\$384	\$537
9	\$434	\$607
10	\$484	\$677
11	\$534	\$747
12	\$583	\$817
L	\$556	\$777

For multi-fabric models, start with the base price, then add the additional amount for the back and seat from the corresponding matrix to determine the final list price. Choose any combination of fabric grades for the back and seat.

Example: HML2SDF base price (\$3168) + Grade 2 frame/arms fabric (add \$67) + Grade 4 back/seat fabric (add \$258) = Total \$3493 List
 HML2SDF base price (\$3168) + Grade 5 frame/arms fabric (add \$234) + Grade 3 back/seat fabric (add \$188) = Total \$3590 List

HON Recommendation: HML2SDF.A.PNS__PNS__TS.P7A - List Price \$3663

HOW TO SPECIFY

Select Model Number	Select Arm Type	Select Frame/Arms Fabric	Select Back/Seat Cushions Fabric	Select Leg Type	Select Leg Color
HML2SDF	N Armless A Straight Arms (+ \$334) B Tapered Arms (+ \$389)	See page 368	See page 368	TS Tapered Square TR Tapered Round	PR8 Textured Silver P7A Textured Charcoal H Bourbon Cherry (+ \$113) F Shaker Cherry (+ \$113) N Mahogany (+ \$113) C Harvest (+ \$113) D Natural Maple (+ \$113) LFW1 Florence Walnut (+ \$113) LK11 Kingswood Walnut (+ \$113) LSW1 Skyline Walnut (+ \$113) LLA1 Lowell Ash (+ \$113) LSA1 Sterling Ash (+ \$113) COGN Cognac (+ \$113) MOCH Mocha (+ \$113) PINC Pinnacle (+ \$113) LNR1 Natural Recon (+ \$113) LPE1 Phantom Ecran (+ \$113) LPT1 Portico Teak (+ \$113)
HML2SDF	A	PNS004	PNS007	TS	P7A

! Leg options - Tapered Square (TS) and Tapered Round (TR) are available in 2 poly and 8 woodgrain options.

SEATING

GROVE® Multi-Fabric



Icon Legend on page 19

HML3SDF

THREE-SEAT LOUNGE

DIMENSIONS

FABRIC PRICE CODES

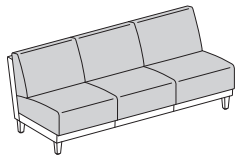

Armless

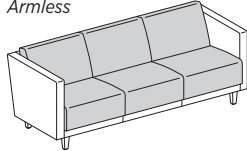

Straight Arms

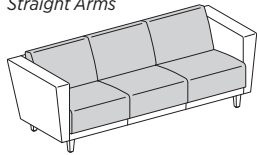

Tapered Arms

Multi-Fabric

Depth:	31½	Ship Weight (armless):	141
Height:	29¼	Ship Weight (with straight arms):	157
Seat Width:	71½	Ship Weight (with tapered arms):	165
Back Width:	71½	Cube (armless):	48.9
Back Height:	19	Cube (with straight arms):	48.9
Width (armless):	71½	Cube (with tapered arms):	48.9
Width (with straight arms):	77½	COM:	See
Width (with tapered arms):	82½		page
Arm Width:	71½		368
Seat to Floor Height:	16	Weight Rating:	300 lbs.
Usable Seat Depth:	18¾		(per seat)

Add to Base Price Above

	Frame/ Arms	Back/Seat Cushions
1	\$4215	
2	\$82	\$148
3	\$161	\$294
4	\$221	\$404
5	\$281	\$513
6	\$340	\$624
7	\$401	\$733
8	\$460	\$843
9	\$521	\$952
10	\$580	\$1063
11	\$640	\$1173
12	\$700	\$1282
L	\$666	\$1221

For multi-fabric models, start with the base price, then add the additional amount for the back and seat from the corresponding matrix to determine the final list price. Choose any combination of fabric grades for the back and seat.

Example: HML3SDF base price (\$4215) + Grade 2 frame/arms fabric (add \$82) + Grade 4 back/seat fabric (add \$404) = Total \$4701 List
 HML3SDF base price (\$4215) + Grade 5 frame/arms fabric (add \$281) + Grade 3 back/seat fabric (add \$294) = Total \$4790 List

HON Recommendation: HML3SDF.A.PNS__PNS__.TS.P7A - List Price \$4779

HOW TO SPECIFY

SEATING

Select Model Number	Select Arm Type	Select Frame/Arms Fabric	Select Back/Seat Cushions Fabric	Select Leg Type	Select Leg Color
HML3SDF	N Armless A Straight Arms (+ \$334) B Tapered Arms (+ \$389)	See page 368	See page 368	TS Tapered Square TR Tapered Round	PR8 Textured Silver P7A Textured Charcoal H Bourbon Cherry (+ \$113) F Shaker Cherry (+ \$113) N Mahogany (+ \$113) C Harvest (+ \$113) D Natural Maple (+ \$113) LFW1 Florence Walnut (+ \$113) LK11 Kingswood Walnut (+ \$113) LSW1 Skyline Walnut (+ \$113) LLA1 Lowell Ash (+ \$113) LSA1 Sterling Ash (+ \$113) COGN Cognac (+ \$113) MOCH Mocha (+ \$113) PINC Pinnacle (+ \$113) LNR1 Natural Recon (+ \$113) LPE1 Phantom Ecru (+ \$113) LPT1 Portico Teak (+ \$113)
HML3SDF	A	PNS004	PNS007	TS	P7A

! Leg options - Tapered Square (TS) and Tapered Round (TR) are available in 2 poly and 8 woodgrain options.



Icon Legend on page 19

GROVE® Multi-Fabric

HML2STDF

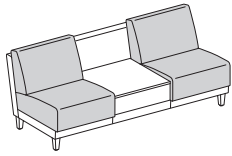

Armless

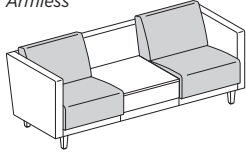

Straight Arms

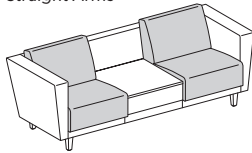

Tapered Arms

TWO-SEAT WITH TABLE

Multi-Fabric

DIMENSIONS

Depth:	31½	Ship Weight (armless):	146
Height:	29¼	Ship Weight (with straight arms):	162
Seat Width:	71½	Ship Weight (with tapered arms):	170
Back Width:	71½	Cube (armless):	48.9
Back Height:	19	Cube (with straight arms):	48.9
Width (armless):	71½	Cube (with tapered arms):	48.9
Width (with straight arms):	77½	COM:	See
Width (with tapered arms):	82½		page
Arm Width:	71½		368
Seat to Floor Height:	16	Weight Rating:	300 lbs.
Usable Seat Depth:	18¾		(per seat)

FABRIC PRICE CODES

1	\$4535		
<i>Add to Base Price Above</i>			
	Frame/Arms	Back/Seat Cushions	
2	\$82	\$94	
3	\$161	\$188	
4	\$221	\$258	
5	\$281	\$328	
6	\$340	\$398	
7	\$401	\$467	
8	\$460	\$537	
9	\$521	\$607	
10	\$580	\$677	
11	\$640	\$747	
12	\$700	\$817	
L	\$666	\$777	

NOTES: Offers a table between the seats that provides separation and a usable worksurface. Table available with two grommet and an accessory port option.

HON Recommendation: HML2STDF.A.PNS___.PNS___.TS.P7A.N.G1.0 - List Price \$5091

HOW TO SPECIFY

Select Model Number	Select Arm Type	Select Frame/Arms Fabric	Select Back/Seat Cushions Fabric	Select Leg Type	Select Leg Color	Select Laminate	Select Cut Out	Accessory Port Location
	N Armless A Straight Arms (+ \$334) B Tapered Arms (+ \$389)	See page 368	See page 368	TS Tapered Square TR Tapered Round	PR8 Textured Silver P7A Textured Charcoal H Bourbon Cherry (+ \$113) F Shaker Cherry (+ \$113) N Mahogany (+ \$113) C Harvest (+ \$113) D Natural Maple (+ \$113) LFW1 Florence Walnut (+ \$113) LK11 Kingswood Walnut (+ \$113) LSW1 Skyline Walnut (+ \$113) LLA1 Lowell Ash (+ \$113) LSA1 Sterling Ash (+ \$113) COGN Cognac (+ \$113) MOCH Mocha (+ \$113) PINC Pinnacle (+ \$113) LNRI Natural Recon (+ \$113) LPE1 Phantom Ecu (+ \$113) LPT1 Portico Teak (+ \$113)	<i>See Chart on page 367</i> L2 (+ \$140)	N No Cutout G Round Grommet Cutout (+ \$34) G1 Pop-Up Port Cutout (+ \$46)	0 No Port 2 Two Tablet Ports Opposite (+ \$23)
HML2STDF	A	PNS004	PNS007	TS	P7A	N	G1	0

! Leg options - Tapered Square (TS) and Tapered Round (TR) are available in 2 poly and 8 woodgrain options.

SEATING

HGRMTAC

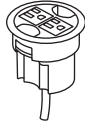

POWER HUB

3" Grommet Mount, 6' Cord

DIMENSIONS

Ship Weight: 1.3
Cube: 0.2

LIST PRICE

\$179

NOTES: Fits in 3" round grommet holes. Field installed with Plug-and-play ease. Two grounded AC power outlets. Includes 6' cord with three-prong plug.

Available in black only (no color designation so use .X)

HGRMTAC2

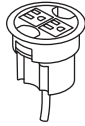

3" ROUND POWER GROMMET

2 Outlets, 10' Cord

DIMENSIONS

Ship Weight: 1.5
Cube: 0.2

LIST PRICE

\$211

NOTES: Power Modules will also work with standing-height applications for 10500 Series™ and Voi® desks. Optional Memory Control allows preset worksurface heights for consistency. Ships separately. Dynamic load capacity when worksurface is moving is 300 lbs. Includes 10' cord with three-prong plug. Fits in 3" round grommet holes on the following product lines: Coordinate™, Huddle, Motivate®, all laminate and veneer caseload series, and Systems Worksurfaces. Two grounded AC power outlets. Field installed with Plug-and-play ease.

Available in black finish only, no specification needed.

HGRMTUSB2



POWER/USB HUB

3" Grommet Mount

DIMENSIONS

Ship Weight: 1.3
Cube: 0.2

LIST PRICE

\$319

NOTES: One grounded AC power outlet with 1 USB-A, 1 USB-C ports. UL Listed.

Available in black only (no color designation so use .X)

HFTTAL14



TABLET ACCESSORY

Laminate

DIMENSIONS

Diameter: 14 Ship Weight: 6.0
Height from Table Top: 10 Cube: 2.5

LIST PRICE

\$556

NOTES: Use with Collaborative Cube and Cylinder tables for additional workspace. Attaches to tables through ports. Multiple port location options are available. Tablet pivots/swivels toward the user.

HTG1PWR-3P-1B

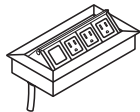

POP-UP PORT

DIMENSIONS

Ship Weight: 5.0
Cube: 0.3

LIST PRICE

\$523

NOTES: Fits into 4" x 8" cutout. Specify G1 cutout in table top. Pop-up Port provides three power ports and one blank data receptacle. Sits flush with worksurface when closed. Finish is anodized aluminum. Includes 6' cord with three-prong plug.

HOW TO SPECIFY

Select
Model Number

H G R M T A C



Ignition® Seating.

IGNITION®

People come in all shapes and sizes, which is why Ignition does as well. From guest and lounge chairs to executive seating, Ignition allows you to mix and match adjustment features, back height, lumbar, and other options to fit your chair to your needs. It's the easy, affordable way to furnish an entire workplace in style and comfort. Ignition fits who you are, where you work and how you work.



FEATURES

IGNITION® 2.0

- Choice of upholstered, 4-Way Stretch, Spectrum Mesh, or ReActiv® back options.
- ReActiv® back features zonal comfort that delivers optimal support and flexibility.
- The unique hammock-like inner support allows the upholstered back version to feature a slim profile and provide built-in comfort.
- Optional adjustable lumbar allows users to tailor their support.
- 8 different adjustable lumbar colors available on 4-Way Stretch mesh and ReActiv® task chair models.
- Passive movement back adjusts with you.
- Multiple arm options to accommodate user requirements.
- Available in 7 colors of 4-Way Stretch mesh, 22 colors of Spectrum Mesh, and 3 Reactiv® colors.
- Molded foam seat for better support and added comfort.
- Black, Titanium, and Designer White frame.
- Mesh seat option with waterfall seat available to reduce pressure points and provide breathability.
- Warranted for users up to 300 lbs., 450 lbs. for Big & Tall.











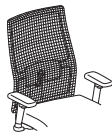

IGNITION®

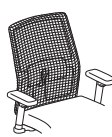
- Ignition Series seating addresses the needs of the total office with Executive, Task, Stool, Guest and Lounge Seating Solutions.
- Three different back sizes, three different controls and multiple arm options to fit you and how you work.
- Back height adjustment moves the back up or down to fit various body sizes.
- Contoured back on multi-purpose seating offers greater comfort than typical stack chairs or stools.
- Warranted for users up to 300 lbs., 450 lbs. for Big & Tall.
- Multi-purpose chair stacks four high.

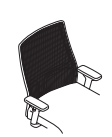
IGNITION® Options

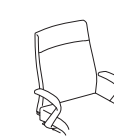
MODEL OPTIONS

<p>HITLM</p>  <p>Task Low-Back 4-Way Stretch or Spectrum Mesh Back, Pneumatic, Swivel, Synchro-tilt, Tilt Tension, Tilt Lock, Optional Lumbar Support</p>	<p>HITSM</p>  <p>Task Low-Back Stool 4-Way Stretch or Spectrum Mesh Back, Pneumatic, Swivel, Synchro-tilt, Tilt Tension, Tilt Lock, Optional Lumbar Support</p>	<p>HITLRA</p>  <p>Task Low-Back ReActiv® ReActiv® Back, Pneumatic, Swivel, Synchro-tilt, Tilt Tension, Tilt Lock, Optional Lumbar Support</p>	<p>HITSRA</p>  <p>Task Low-Back Stool ReActiv® ReActiv® Back, Pneumatic, Swivel, Synchro-tilt, Tilt Tension, Tilt Lock, Optional Lumbar Support</p>
<p>HIWMM</p>  <p>Task Mid-Back 4-Way Stretch or Spectrum Mesh Back, Pneumatic, Swivel, Synchro-tilt, Tilt Tension, Tilt Lock, Optional Lumbar Support</p>	<p>HIWMMHR</p>  <p>Task Mid-Back w/Headrest 4-Way Stretch or Spectrum Mesh Back, Pneumatic, Swivel, Synchro-tilt, Tilt Tension, Tilt Lock, Optional Lumbar Support, Headrest</p>	<p>HIWMS</p>  <p>Task Mid-Back w/Mesh Seat 4-Way Stretch Mesh Back, Pneumatic, Swivel, Synchro-tilt, Tilt Tension, Tilt Lock, Optional Lumbar Support, Mesh Seat</p>	<p>HIWMBT</p>  <p>Task Mid-Back Big & Tall 4-Way Stretch or Spectrum Mesh Back, Pneumatic, Swivel, Synchro-tilt, Tilt Tension, Tilt Lock, Optional Lumbar Support</p>
<p>HIWMRA</p>  <p>Task Mid-Back ReActiv® ReActiv® Back, Pneumatic, Swivel, Synchro-tilt, Tilt Tension, Tilt Lock, Optional Lumbar Support</p>	<p>HIWMU</p>  <p>Upholstered Mid-Back Upholstered Back, Pneumatic, Swivel, Synchro-tilt, Tilt Tension, Tilt Lock</p>	<p>HIWMUL</p>  <p>Upholstered Mid-Back with Lumbar Support Upholstered Back, Pneumatic, Swivel, Synchro-tilt, Tilt Tension, Tilt Lock, Adjustable Lumbar</p>	

SEATING

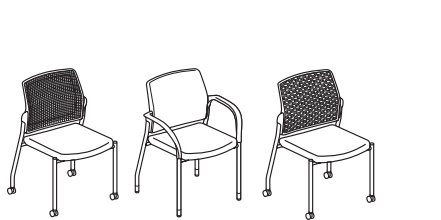
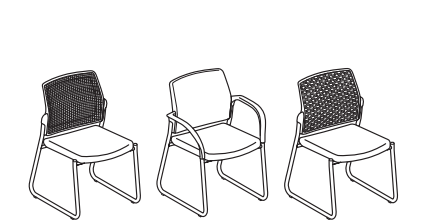
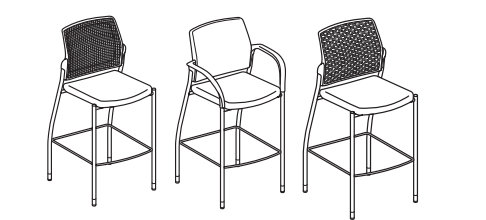
<p>HIGS6</p>  <p>Multi-Purpose Four Legs</p>	<p>HISB6</p>  <p>Multi-Purpose Sled Base</p>	<p>HICS7</p>  <p>Café-Height Stool Four Legs</p>
--	---	--

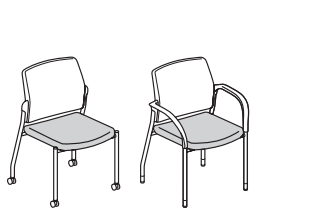
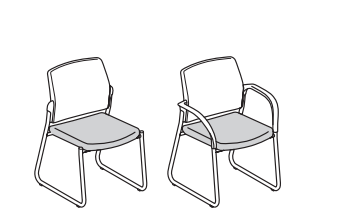
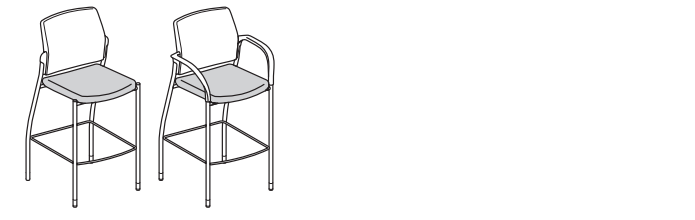
<p>HIGS6DF - Multi-Fabric</p>  <p>Multi-Purpose Four Legs</p>	<p>HISB6DF - Multi-Fabric</p>  <p>Multi-Purpose Sled Base</p>	<p>HICS7DF - Multi-Fabric</p>  <p>Café-Height Stool Four Legs</p>
---	--	---

MODEL OPTIONS

HIGCL



Guest Chair

Fixed Arms, Glides

HIB50

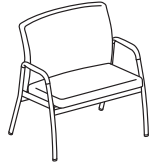

Bariatric Lounge

Fixed Arms, Glides

HITL1



Task Low-Back

Pneumatic, Back Height Adjustment, Swivel, Tilt, Tilt Tension, Tilt Lock

HITL2



Task Low-Back

Pneumatic, Back Height Adjustment, Synchro-tilt, Tilt Tension, Tilt Lock, Seat Glide

HITL3



Task Low-Back

Pneumatic, Back Height Adjustment, Synchro-tilt, Back Angle Adjustment, Tilt Tension, Tilt Lock, Seat Glide

HITS5



Task Stool

Pneumatic, Swivel Back Height Adjustment, Adjustable Footrest

HIWM1



Mid-Back

Pneumatic, Back Height Adjustment, Swivel, Tilt, Tilt Tension, Tilt Lock

HIWM2



Mid-Back

Pneumatic, Back Height Adjustment, Synchro-tilt, Tilt Tension, Tilt Lock, Seat Glide

HIWM3



Mid-Back

Pneumatic, Back Height Adjustment, Synchro-tilt, Back Angle Adjustment, Tilt Tension, Tilt Lock, Seat Glide

HIEH1



Executive High-Back

Pneumatic, Back Height Adjustment, Swivel, Tilt, Tilt Tension, Tilt Lock

HIEH2



Executive High-Back

Pneumatic, Back Height Adjustment, Synchro-tilt, Tilt Tension, Seat Glide

HIEH3



Executive High-Back

Pneumatic, Back Height Adjustment, Synchro-tilt, Back Angle Adjustment, Tilt Tension, Seat Glide

HIWM8*

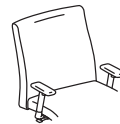



Task Mid-Back





Big and Tall, Pneumatic, Swivel-tilt, Tilt Tension







* De-emphasized

IGNITION® 2.0

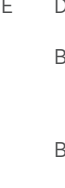
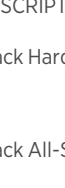
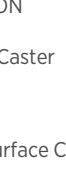
Options

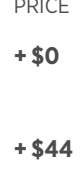
ARM STYLE	CODE	DESCRIPTION	PRICE
	N	Armless	+\$0
	F	Fixed Arms	+\$71
	A	Height and Width Adjustable Arms	+\$92
	V	All-Adjustable Arms (includes Pivot)	+\$141
	P	Fixed Polished Aluminum Arms	+\$189

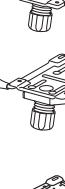
CASTERS	CODE	DESCRIPTION	PRICE
	H	Black Hard Caster	+\$0
	S	Black All-Surface Caster	+\$44
	R	Black Roll Control Caster	+\$55
	TS	Titanium All-Surface Caster	+\$44
	A	Black All-Surface Caster (Big & Tall models only)	+\$0

MECHANISM	CODE	DESCRIPTION	PRICE
	Y0	Synchro-Tilt A, E, J, K, L	+\$0
	Y1	Synchro-Tilt w/ Seat Slider A, D, E, J, K, L	+\$22
	Y2	Advanced Synchro-Tilt A, D, E, J, L, A-D	+\$71
	Y3	Synchro-Tilt with Independent Back Angle A, D, E, J, L, A-E	+\$114
	Y4	Synchro-Tilt (Big & Tall models only) A, D, E, J, L, A-D	+\$0
	W2	Weight-Activated Synchro-Tilt w/ Seat Slider A, D, E, L, P	+\$71
	S0	Limited Recline Synchro-Tilt A, E, J, K, L	+\$0
	S1	Limited Recline Synchro-Tilt w/ Seat Slider A, D, E, J, K, L	+\$22
<i>*Only available on HITSM</i>			
	S2	Limited Recline Advanced Synchro-Tilt A, D, E, J, L, A-D	+\$71
<i>*Only available on HIWMMS, HIWMMSKD</i>			

LUMBAR	CODE	DESCRIPTION	PRICE
	NL	No Lumbar	+\$0
	BL	Black Adjustable Lumbar	+\$33
	BY	Bullseye Adjustable Lumbar	+\$33
	DW	Designer White Adjustable Lumbar	+\$33
	MR	Ember Adjustable Lumbar	+\$33
	IR	Iris Adjustable Lumbar	+\$33
	KT	Krypton Adjustable Lumbar	+\$33
	RE	Regatta Adjustable Lumbar	+\$33
	TL	Titanium Adjustable Lumbar	+\$33
<i>*Adjustable Lumbar not available on CAL 133 (FC) models</i>			

IGNITION® 2.0 Options

BASE

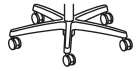

CODE	DESCRIPTION	PRICE
SB	Standard Base	+\$0
PA	Polished Aluminum	+\$119

FRAME

CODE	DESCRIPTION	PRICE
T	Black Frame	+\$0
DWX	Designer White	+\$39
TI	Titanium Frame	+\$39

BACK STYLE

CODE	DESCRIPTION	PRICE
<i>4-Way Stretch mesh back options:</i>		
IM	Black	+\$0
IB	Breeze	+\$0
IK	Brownstone	+\$0
IC	Charcoal	+\$0
IF	Fog	+\$0
IR	Regatta	+\$0
IT	Titanium	+\$0

Spectrum mesh back options:

RM27	Beacon	+\$25
RM20	Blueberry	+\$25
RM16	Brick	+\$25
RM17	Bullseye	+\$25
RM10	Carbon	+\$25
RM28	Chalk	+\$25
RM14	Cobalt	+\$25
RM15	Espresso	+\$25
RM31	Gold Dust	+\$25
RM23	Kermit	+\$25
RM32	Key Lime	+\$25
RM21	Leaf	+\$25
RM30	Linen	+\$25
RM12	Loft	+\$25
RM24	Midnight	+\$25
RM13	Onyx	+\$25
RM29	Pear	+\$25
RM33	Quicksand	+\$25
RM25	Salamander	+\$25
RM19	Sky	+\$25
RM26	Steel	+\$25
RM11	Titanium	+\$25

ReActiv® back options:

OS	Charcoal	+\$0
DWR	Designer White	+\$0
TI	Titanium	+\$0

IGNITION® 2.0

Dimensions

TASK DIMENSIONS

MODEL		HIWMM, HIWMRA, HIWMU, & HIWMUL	HIWMMHR	HIWMS	HITLM & HITLRA	HITSM & HITSRA
Overall Width Armless		21	21	21	20	20
Overall Width with Arms	A	27	27	27	26	26
Overall Depth		24	24	24	22	22
Overall Height	S0/S1	-	-	-	-	52½
	Y0/Y1	43¾	54	43¾	40½	-
	S2	-	-	44½	-	-
	Y2	44½	55	-	41¼	-
	Y3	44½	55	-	41¼	-
	Y4	-	-	-	-	-
	W2	44½	55	44½	41¼	-
Seat Width		20	20	20	18½	18½
Seat Depth		18⅝	18⅝	18⅝	17⅝	17⅝
Usable Seat Depth	S0	-	-	-	-	16¾
	S1	-	-	-	-	15½ - 16⅝
	S2	-	-	16½ - 18¼	-	-
	Y0	17¾	17¾	17½	16¾	-
	Y1	17½ - 19½	17½ - 19½	16¾ - 18¼	15½ - 17½	-
	Y2	16¼ - 19¼	16¼ - 19¼	-	15¾ - 18½	-
	Y3	16½ - 19½	16½ - 19½	-	16¼ - 18¾	-
	Y4	-	-	-	-	-
	W2	16¼ - 18½	16¼ - 18½	16¾ - 18¼	15¾ - 17¾	-
Seat Height	S0/S1	-	-	-	-	22⅞ - 31¾
	S2	-	-	17½ - 22¼	-	-
	Y0/Y1	16⅝ - 21¼	16⅝ - 21¼	16¾ - 21½	16¾ - 21¼	-
	Y2	17⅞ - 21½	17⅞ - 21½	-	17⅞ - 21½	-
	Y3	17½ - 21½	17½ - 21½	-	17¾ - 21¾	-
	Y4	-	-	-	-	-
	W2	17⅞ - 21½	17⅞ - 21½	17 - 21½	17⅞ - 21½	-
Back Width		19	19	19	19	17½
Back Height		23	23	23	19	19
Ship Weight Armless	S0	-	-	-	-	44 Ⓢ
	S1	-	-	-	-	46 Ⓢ
	S2	-	-	42 Ⓢ	-	-
	Y0	38 Ⓢ	38 Ⓢ	38 Ⓢ	38 Ⓢ	-
	Y1	38 Ⓢ	38 Ⓢ	38 Ⓢ	38 Ⓢ	-
	Y2	42 Ⓢ	42 Ⓢ	-	42 Ⓢ	-
	Y3	46 Ⓢ	46 Ⓢ	-	45 Ⓢ	-
	Y4	-	-	-	-	-
	W2	42 Ⓢ	42 Ⓢ	42 Ⓢ	42 Ⓢ	-
Ship Weight with Arms	S0	-	-	-	-	51 Ⓢ
	S1	-	-	-	-	53 Ⓢ
	S2	-	-	49 Ⓢ	-	-
	Y0	45 Ⓢ	45 Ⓢ	45 Ⓢ	45 Ⓢ	-
	Y1	45 Ⓢ	45 Ⓢ	45 Ⓢ	45 Ⓢ	-
	Y2	49 Ⓢ	49 Ⓢ	-	49 Ⓢ	-
	Y3	53 Ⓢ	53 Ⓢ	-	52 Ⓢ	-
	Y4	-	-	-	-	-
	W2	49 Ⓢ	49 Ⓢ	49 Ⓢ	49 Ⓢ	-
Width Between Arms	F	20¼	20¼	20¾	19	19
	P	20¼	20¼	20¾	19	19
	A	18 - 20 ¹⁷ / ₂₀	18 - 20 ¹⁷ / ₂₀	18 - 20 ¹⁷ / ₂₀	16¾ - 19	16¾ - 19
	V	18 - 20 ¹⁷ / ₂₀	18 - 20 ¹⁷ / ₂₀	18 - 20 ¹⁷ / ₂₀	16¾ - 19	16¾ - 19
	Cube	10.8	10.8	10.8	10.8	10.8
Cube with Y3 Control		12	12	-	12	-
COM		1.0	1.0	-	1.0	1.0
Weight Capacity		300 lbs	300 lbs	300 lbs	300 lbs	300 lbs

IGNITION® 2.0

Dimensions

TASK DIMENSIONS

MODEL		HITLMKD & HITLRAKD	HIWMMKD, HIWMRAKD, HIWUMKD, & HIWMULKD	HIWMMSKD	HIWMBT
Overall Width Armless		20	21	21	31½
Overall Width with Arms	A	26	27	27	31½
Overall Depth		22	24	24	31½
Overall Height	S0/S1	-	-	-	-
	Y0/Y1	40½	43¾	43¾	-
	S2	-	-	44½	-
	Y2	-	-	-	-
	Y3	-	-	-	-
	Y4	-	-	-	45½ (+10½ for HR)
	W2	41¼	44½	44½	-
Seat Width		18½	20	20	23½
Seat Depth		17⅝	18⅝	18⅝	20¼
Usable Seat Depth	S0	-	-	-	-
	S1	-	-	-	-
	S2	-	-	16½ - 18¼	-
	Y0	16¾	17¾	-	-
	Y1	15½ - 17½	17½ - 19½	16¾ - 18¼	-
	Y2	-	-	-	-
	Y3	-	-	-	-
	Y4	-	-	-	17¾ - 19½
	W2	15¾ - 17¾	16¼ - 18½	16¾ - 18¼	-
Seat Height	S0/S1	-	-	-	-
	S2	-	-	17½ - 22¼	-
	Y0/Y1	16¾ - 21¼	16⅝ - 21¼	16¾ - 21½	-
	Y2	-	-	-	-
	Y3	-	-	-	-
	Y4	-	-	-	18 - 22¼
	W2	17⅝ - 21½	17⅝ - 21½	17 - 21½	-
Back Width		17½	19	19	22¾
Back Height		19	23	23	24¾
Ship Weight Armless	S0	-	-	-	-
	S1	-	-	-	-
	S2	-	-	42 Ⓢ	-
	Y0	38 Ⓢ	38 Ⓢ	-	-
	Y1	38 Ⓢ	38 Ⓢ	38 Ⓢ	-
	Y2	-	-	-	-
	Y3	-	-	-	-
	Y4	-	-	-	68
	W2	42 Ⓢ	42 Ⓢ	42 Ⓢ	-
Ship Weight with Arms	S0	-	-	-	-
	S1	-	-	-	-
	S2	-	-	49 Ⓢ	-
	Y0	45 Ⓢ	45 Ⓢ	-	-
	Y1	45 Ⓢ	45 Ⓢ	45 Ⓢ	-
	Y2	-	-	-	-
	Y3	-	-	-	-
	Y4	-	-	-	75
	W2	49 Ⓢ	49 Ⓢ	49 Ⓢ	-
Width Between Arms	F	19	20¼	20¼	-
	P	19	20¼	20¼	-
	A	17 - 19½	18 - 20½	18 - 20½	-
	V	11½ - 26½	12½ - 27½	12½ - 27½	14 - 29
Cube		5.6	6.3	10.8	15.3
Cube with Y3 Control		-	-	-	-
COM		-	-	-	1.5
Weight Capacity		300 lbs	300 lbs	300 lbs	450 lbs

IGNITION® 2.0



Icon Legend on page 19

HITLM

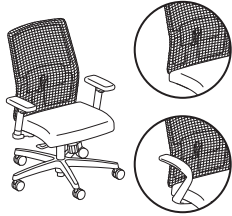

TASK LOW-BACK

4-Way Stretch or Spectrum Mesh Back

- Pneumatic
- Swivel
- Synchro-tilt
- Tilt Tension
- Tilt Lock
- Optional Lumbar Support

See page 382 for additional specifications and dimensions.

DIMENSIONS

Depth:	22	Width (with arms):	26
Height:	40½	Width (armless):	20
Seat Depth:	16	Cube:	10.8
Seat Width:	18½	COM:	1.0
Back Width:	17½	Weight Rating:	300 lbs.
Back Height:	19		

FABRIC PRICE CODES

1	\$661	8	\$811
2	\$688	9	\$830
3	\$714	10	\$849
4	\$733	11	\$869
5	\$752	12	\$888
6	\$772	L	\$877
7	\$791		

HIWMM

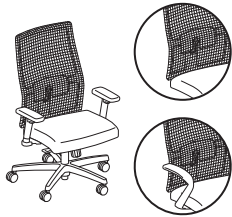

TASK MID-BACK

4-Way Stretch or Spectrum Mesh Back

- Pneumatic
- Swivel
- Synchro-tilt
- Tilt Tension
- Tilt Lock
- Optional Lumbar Support

See page 382 for additional specifications and dimensions.

DIMENSIONS

Depth:	24	Width (with arms):	27
Height:	43¾	Width (armless):	21
Seat Depth:	17¾	Cube:	10.8
Seat Width:	20	COM:	1.0
Back Width:	19	Weight Rating:	300 lbs.
Back Height:	23		

FABRIC PRICE CODES

1	\$724	8	\$874
2	\$751	9	\$893
3	\$777	10	\$912
4	\$796	11	\$932
5	\$815	12	\$951
6	\$835	L	\$940
7	\$854		

HITSM

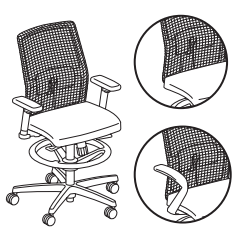

TASK LOW-BACK STOOL

4-Way Stretch or Spectrum Mesh Back

- Pneumatic
- Swivel
- Synchro-tilt
- Tilt Tension
- Tilt Lock
- Optional Lumbar Support

See page 382 for additional specifications and dimensions.

Not available in Polished Aluminum Base.

DIMENSIONS

Depth:	22	Width (with arms):	26
Height:	52½	Width (armless):	20
Seat Depth:	16	Cube:	10.8
Seat Width:	18½	COM:	1.0
Back Width:	17½	Weight Rating:	300 lbs.
Back Height:	19		

FABRIC PRICE CODES

1	\$792	8	\$942
2	\$819	9	\$961
3	\$845	10	\$980
4	\$864	11	\$1000
5	\$883	12	\$1019
6	\$903	L	\$1008
7	\$922		

HON Recommendation: HIWMM.Y2.A.H.IM.CU__BL.SB.T - List Price \$920

HOW TO SPECIFY

Select Model Number	Select Control Type	Select Arm Type	Select Caster	Select Mesh	Select Fabric	Select Lumbar	Select Base	Select Frame
Y0 Synchro-Tilt Y1 Synchro-Tilt w/ Seat Slider (+ \$22) Y2 Advanced Synchro-Tilt (+ \$71) Y3 Synchro-Tilt with Independent Back Angle (+ \$114) S0 Limited Recline Synchro-Tilt (for HITSM only) S1 Limited Recline Synchro-Tilt w/ Seat Slider (+ \$22 for HITSM only) W2 Weight-Activated Synchro-Tilt w/ Seat Slider (+ \$71)	N Armless A Height and Width Adjustable Arms (+ \$92) V All-Adjustable Arms (includes pivot) (+ \$141) F Fixed Arms (+ \$71) P Fixed Arms - Polished (+ \$189)	H Black Hard Caster S Black All-Surface Caster (+ \$44) TS Titanium All-Surface Caster (+ \$44) R Black Roll Control Caster (+ \$55)	IM Black IB Breeze IK Brownstone IC Charcoal IF Fog IR Regatta IT Titanium See page 381 for Spectrum Mesh colors, codes, and upcharges.	See page 401	NL No Lumbar BL Black Adjustable Lumbar (+ \$33) BY Bullseye Adjustable Lumbar (+ \$33) DW Designer White Adjustable Lumbar (+ \$33) MR Ember Adjustable Lumbar (+ \$33) IR Iris Adjustable Lumbar (+ \$33) KT Krypton Adjustable Lumbar (+ \$33) RE Regatta Adjustable Lumbar (+ \$33) TL Titanium Adjustable Lumbar (+ \$33)	SB Standard Base PA Polished Aluminum (+ \$119)	T Black DWX Designer White (+ \$39 for HITLM and HIWMM; + \$60 for HITSM) TI Titanium (+ \$39 for HITLM and HIWMM; + \$60 for HITSM)	
HITLM	Y2	A	H	IM	CU10	BL	SB	T



Icon Legend on page 19

IGNITION® 2.0

HIWMMHR



TASK MID-BACK

4-Way Stretch or Spectrum Mesh Back w/ Headrest

- Pneumatic
- Swivel
- Synchro-tilt
- Tilt Tension
- Tilt Lock
- Optional Lumbar Support
- Headrest

DIMENSIONS

Depth:	24	Width (with arms):	27
Height:	54	Width (armless):	21
Seat Depth:	17¾	Cube:	10.8
Seat Width:	20	COM:	1.0
Back Width:	19	Weight Rating:	300 lbs.
Back Height:	23		

FABRIC PRICE CODES

1	\$724	8	\$874
2	\$751	9	\$893
3	\$777	10	\$912
4	\$796	11	\$932
5	\$815	12	\$951
6	\$835	L	\$940
7	\$854		

! See page 382 for additional specifications and dimensions.

HON Recommendation: HIWMMHR.Y2.A.TS.IF.CU__DW.SB.DWX.HR - List Price \$1090

HOW TO SPECIFY

Select Model Number	Select Control Type	Select Arm Type	Select Caster	Select Mesh	Select Fabric	Select Lumbar	Select Base	Select Frame	Select Headrest																											
YO Synchro-Tilt w/ Seat Slider (+ \$22)	Y1 Synchro-Tilt w/ Seat Slider (+ \$22)	Y2 Advanced Synchro-Tilt (+ \$71)	Y3 Synchro-Tilt with Independent Back Angle (+ \$114)	W2 Weight-Activated Synchro-Tilt w/ Seat Slider (+ \$71)	N Armless	A Height and Width Adjustable Arms (+ \$92)	V All-Adjustable Arms (includes pivot) (+ \$141)	F Fixed Arms (+ \$71)	P Fixed Arms - Polished (+ \$189)	H Black Hard Caster	S Black All-Surface Caster (+ \$44)	TS Titanium All-Surface Caster (+ \$44)	R Black Roll Control Caster (+ \$55)	IM Black	IB Breeze	IK Brownstone	IC Charcoal	IF Fog	IR Regatta	IT Titanium	See page 401	NL No Lumbar	BL Black Adjustable Lumbar (+ \$33)	BY Bullseye Adjustable Lumbar (+ \$33)	DW Designer White Adjustable Lumbar (+ \$33)	MR Ember Adjustable Lumbar (+ \$33)	IR Iris Adjustable Lumbar (+ \$33)	KT Krypton Adjustable Lumbar (+ \$33)	RE Regatta Adjustable Lumbar (+ \$33)	TL Titanium Adjustable Lumbar (+ \$33)	SB Standard Base	PA Polished Aluminum (+ \$119)	T Black	DWX Designer White (+ \$39)	TI Titanium (+ \$39)	HR Headrest (+ \$87) <i>Headrest color will match chair frame selection. Headrest mesh color will match mesh back color selection.</i>
HIWMMHR	Y2	A	H	IM	CU10	BL	SB	T	HR																											

SEATING

IGNITION® 2.0



Icon Legend on page 19

HITLMKD



TASK LOW-BACK

4-Way Stretch or Spectrum Mesh Back

- Pneumatic
- Swivel
- Synchro-tilt
- Tilt Tension
- Tilt Lock
- Optional Lumbar Support

DIMENSIONS

Depth:	22	Back Height:	19
Height:	40½	Width (with arms):	26
Seat Depth:	16	Width (armless):	20
Seat Width:	18½	Cube:	5.6
Back Width:	17½	Weight Rating:	300 lbs.

FABRIC PRICE CODES

1	\$621	8	\$771
2	\$648	9	\$790
3	\$674	10	\$809
4	\$693	11	\$829
5	\$712	12	\$848
6	\$732	L	\$837
7	\$751		

See page 383 for additional specifications and dimensions.

HIWMMKD



TASK MID-BACK

4-Way Stretch or Spectrum Mesh Back

- Pneumatic
- Swivel
- Synchro-tilt
- Tilt Tension
- Tilt Lock
- Optional Lumbar Support

DIMENSIONS

Depth:	24	Back Height:	23
Height:	43¾	Width (with arms):	27
Seat Depth:	17¾	Width (armless):	21
Seat Width:	20	Cube:	6.3
Back Width:	19	Weight Rating:	300 lbs.

FABRIC PRICE CODES

1	\$684	8	\$834
2	\$711	9	\$853
3	\$737	10	\$872
4	\$756	11	\$892
5	\$775	12	\$911
6	\$795	L	\$900
7	\$814		

See page 383 for additional specifications and dimensions.

HON Recommendation: HIWMMKD.Y2.A.H.IM.CU__BL.SB.T - List Price \$880

HOW TO SPECIFY

SEATING

Select Model Number	Select Control Type	Select Arm Type	Select Caster	Select Mesh	Select Fabric	Select Lumbar	Select Base	Select Frame
Y1 Synchro-Tilt w/ Seat Slider (+ \$22)	A Height and Width Adjustable Arms (+ \$92)	H Black Hard Caster	IM Black IB Breeze IK Brownstone IC Charcoal IF Fog IR Regatta IT Titanium See page 381 for Spectrum Mesh colors, codes, and upcharges.	See page 401	NL No Lumbar BL Black Adjustable Lumbar (+ \$33) BY Bullseye Adjustable Lumbar (+ \$33) DW Designer White Adjustable Lumbar (+ \$33) MR Ember Adjustable Lumbar (+ \$33) IR Iris Adjustable Lumbar (+ \$33) KT Krypton Adjustable Lumbar (+ \$33) RE Regatta Adjustable Lumbar (+ \$33) TL Titanium Adjustable Lumbar (+ \$33)	SB Standard Base	T Black DWX Designer White (+ \$39) TI Titanium (+ \$39)	
Y2 Advanced Synchro-Tilt (+ \$71)								
W2 Weight-Activated Synchro-Tilt w/ Seat Slider (+ \$71)								

HIWMMKD . Y2 . A . H . IM . CU10 . BL . SB . T



Icon Legend on page 19

IGNITION® 2.0

HIWMBT



TASK MID-BACK BIG & TALL

4-Way Stretch or Spectrum Mesh Back

- Pneumatic
- Swivel
- Synchro-tilt
- Tilt Tension
- Tilt Lock
- Optional Lumbar Support

! See page 383 for additional specifications and dimensions.

DIMENSIONS

Depth:	31½	Width (with arms):	31½
Height:	45½	Width (armless):	31½
Seat Depth:	20¼	Cube:	15.3
Seat Width:	23½	COM:	1.5
Seat Height:	18"-22¼"	Weight Rating:	450 lbs.
Back Width:	22¾		
Back Height:	24¾		

FABRIC PRICE CODES

1	\$1217	8	\$1367
2	\$1244	9	\$1386
3	\$1270	10	\$1405
4	\$1289	11	\$1425
5	\$1308	12	\$1444
6	\$1328	L	\$1433
7	\$1347		

HON Recommendation: HIWMBT.Y4.V.A.IC.CU__TL.SB.TI.N - List Price \$1430

HOW TO SPECIFY

Select Model Number	Select Control Type	Select Arm Type	Select Caster	Select Mesh	Select Fabric	Select Lumbar	Select Base	Select Frame	Select Headrest
	Y4 Synchro-Tilt	V All-Adjustable Arms (includes pivot) (+ \$141) N Armless	A All-Surface Caster	IM Black IF Fog IC Charcoal See page 381 for Spectrum Mesh colors, codes, and upcharges.	See page 401	NL No Lumbar BL Black Adjustable Lumbar (+ \$33) BY Bullseye Adjustable Lumbar (+ \$33) DW Designer White Adjustable Lumbar (+ \$33) MR Ember Adjustable Lumbar (+ \$33) IR Iris Adjustable Lumbar (+ \$33) KT Krypton Adjustable Lumbar (+ \$33) RE Regatta Adjustable Lumbar (+ \$33) TL Titanium Adjustable Lumbar (+ \$33)	SB Standard Base	T Black DWX Designer White (+ \$39) TI Titanium (+ \$39)	N No Headrest HR Headrest (+ \$87) Big & Tall headrest frame is black. Mesh color matches mesh back selection.
HIWMBT	Y4	V	A	IM	CU10	BL	SB	T	HR

SEATING

IGNITION® 2.0



Icon Legend on page 19

HIWMMS



TASK MID-BACK

4-Way Stretch Mesh Back and Seat
 Pneumatic
 Swivel
 Synchro-tilt
 Tilt Tension
 Tilt Lock
 Optional Lumbar Support
 Optional Headrest

DIMENSIONS

Depth: 24
 Height: 43¾
 Seat Depth: 17¾
 Seat Width: 20
 Back Width: 19
 Back Height: 23
 Width (with arms): 27
 Width (armless): 21
 Cube: 10.8
 Weight Rating: 300 lbs.

LIST PRICE

\$846

! See page 382 for additional specifications and dimensions.

HIWMMSKD



TASK MID-BACK

4-Way Stretch Mesh Back and Seat
 Pneumatic
 Swivel
 Synchro-tilt
 Tilt Tension
 Tilt Lock
 Optional Lumbar Support
 Optional Headrest

DIMENSIONS

Depth: 24
 Height: 43¾
 Seat Depth: 17¾
 Seat Width: 20
 Back Width: 19
 Back Height: 23
 Width (with arms): 27
 Width (armless): 21
 Cube: 7.9
 Weight Rating: 300 lbs.

LIST PRICE

\$806

! See page 383 for all other control specifications.

HON Recommendation: HIWMMS.S2.A.H.IM.IMS.BL.SB.T.N - List Price \$1042

HOW TO SPECIFY

Select Model Number	Select Control Type	Select Arm Type	Select Caster	Select Back Mesh	Select Seat Mesh	Select Lumbar	Select Base	Select Frame	Select Headrest
	Y0 Synchro-Tilt <i>Available on model HIWMMS only</i> Y1 Synchro-Tilt w/ Seat Slider (+ \$22) S2 Limited Recline Advanced Synchro-Tilt (+ \$71) W2 Weight-Activated Synchro-Tilt w/ Seat Slider (+ \$71)	N Armless A Height and Width Adjustable Arms (+ \$92) F Fixed Arms (+ \$71) V All-Adjustable Arms (+ \$141) P Fixed Polished Arms (+ \$189) <i>F, V, and P available on model HIWMMS only</i>	H Black Hard Caster S Black All-Surface Caster (+ \$44) <i>Available on model HIWMMS only</i>	IM Black	IMS Black Mesh	NL No Lumbar BL Black Adjustable Lumbar (+ \$33) BY Bullseye Adjustable Lumbar (+ \$33) DW Designer White Adjustable Lumbar (+ \$33) MR Ember Adjustable Lumbar (+ \$33) IR Iris Adjustable Lumbar (+ \$33) KT Krypton Adjustable Lumbar (+ \$33) RE Regatta Adjustable Lumbar (+ \$33) TL Titanium Adjustable Lumbar (+ \$33)	SB Standard Base PA Polished Aluminum (+ \$119) <i>Available on model HIWMMS only</i>	T Black	N No Headrest HR Headrest (+ \$87) <i>Headrest frame color will match chair frame selection. Headrest mesh color will match mesh back selection.</i>
HIWMMS	Y1	A	H	IM	IMS	BL	SB	T	N

SEATING



Icon Legend on page 19

IGNITION® 2.0 ReActiv®

HITLRA

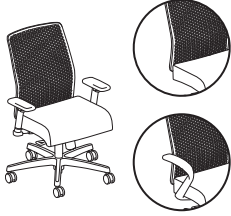

TASK LOW-BACK

ReActiv® Back
Pneumatic
Swivel
Synchro-tilt
Tilt Tension
Tilt Lock
Optional Lumbar Support

DIMENSIONS

Depth: 22
Height: 40½
Seat Depth: 16
Seat Width: 18½
Back Width: 17½
Back Height: 19
Width (with arms): 26
Width (armless): 20
Cube: 10.8
COM: 1.0
Weight Rating: 300 lbs.

FABRIC PRICE CODES

1	\$696	8	\$846
2	\$723	9	\$865
3	\$749	10	\$884
4	\$768	11	\$904
5	\$787	12	\$923
6	\$807	L	\$912
7	\$826		

! See page 382 for all other control specifications.

HIWMRA

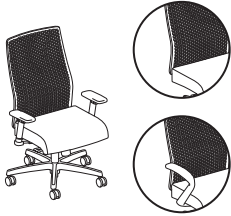

TASK MID-BACK

ReActiv® Back
Pneumatic
Swivel
Synchro-tilt
Tilt Tension
Tilt Lock
Optional Lumbar Support

DIMENSIONS

Depth: 24
Height: 43¾
Seat Depth: 17¾
Seat Width: 20
Back Width: 19
Back Height: 23
Width (with arms): 27
Width (armless): 21
Cube: 10.8
COM: 1.0
Weight Rating: 300 lbs.

FABRIC PRICE CODES

1	\$759	8	\$909
2	\$786	9	\$928
3	\$812	10	\$947
4	\$831	11	\$967
5	\$850	12	\$986
6	\$870	L	\$975
7	\$889		

! See page 382 for all other control specifications.

HITSRA

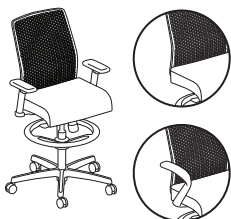

TASK LOW-BACK STOOL

ReActiv® Back
Pneumatic
Swivel
Synchro-tilt
Tilt Tension
Tilt Lock
Optional Lumbar Support

DIMENSIONS

Depth: 22
Height: 52½
Seat Depth: 16
Seat Width: 18½
Back Width: 17½
Back Height: 19
Width (with arms): 26
Width (armless): 20
Cube: 10.8
COM: 1.0
Weight Rating: 300 lbs.

FABRIC PRICE CODES

1	\$827	8	\$977
2	\$854	9	\$996
3	\$880	10	\$1015
4	\$899	11	\$1035
5	\$918	12	\$1054
6	\$938	L	\$1043
7	\$957		

! See page 382 for all other control specifications.
! Not available in Polished Aluminum Base.

HON Recommendation: HIWMRA.Y2.A.H.___CU___BL.SB.T - List Price \$955

HOW TO SPECIFY

Select Model Number	Select Control Type	Select Arm Type	Select Caster	Select Back Color	Select Fabric	Select Lumbar	Select Base	Select Frame
Y0 Synchro-Tilt Y1 Synchro-Tilt w/ Seat Slider (+ \$22) Y2 Advanced Synchro-Tilt (+ \$71) Y3 Synchro-Tilt with Independent Back Angle (+ \$114) S0 Limited Synchro-Tilt (for HITSRA only) S1 Limited Synchro-Tilt w/ Seat Slider (+ \$22 for HITSRA only) W2 Weight-Activated Synchro-Tilt w/ Seat Slider (+ \$71) <i>Specify S0 or S1 for HITSRA model ONLY</i>	N Armless A Height and Width Adjustable Arms (+ \$92) V All-Adjustable Arms (includes pivot) (+ \$141) F Fixed Arms (+ \$71) P Fixed Arms - Polished (+ \$189)	H Black Hard Caster S Black All-Surface Caster (+ \$44) TS Titanium All-Surface Caster (+ \$44) R Black Roll Control Caster (+ \$55)	OS Charcoal ReActiv® DWR Designer White ReActiv® TI Titanium ReActiv®	See page 401	NL No Lumbar BL Black Adjustable Lumbar (+ \$33) BY Bullseye Adjustable Lumbar (+ \$33) DW Designer White Adjustable Lumbar (+ \$33) MR Ember Adjustable Lumbar (+ \$33) IR Iris Adjustable Lumbar (+ \$33) KT Krypton Adjustable Lumbar (+ \$33) RE Regatta Adjustable Lumbar (+ \$33) TL Titanium Adjustable Lumbar (+ \$33)	SB Standard Base PA Polished Aluminum (+ \$119)	T Black DWXX Designer White (+ \$39 for HITLRA and HIWMRA; + \$60 for HITSRA) TI Titanium (+ \$39 for HITLRA and HIWMRA; + \$60 for HITSRA)	

HITLRA . Y2 . A . H . OS . CU10 . BL . SB . T

SEATING

IGNITION® 2.0 ReActiv®



Icon Legend on page 19

HITLRAKD

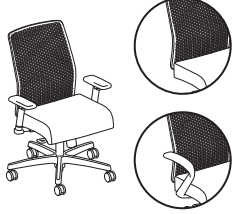

TASK LOW-BACK

ReActiv® Back
Pneumatic
Swivel
Synchro-tilt
Tilt Tension
Tilt Lock
Optional Lumbar Support

DIMENSIONS

Depth: 22
Height: 40½
Seat Depth: 16
Seat Width: 18½
Back Width: 17½
Back Height: 25½
Width (with arms): 26
Width (armless): 20
Cube: 5.6
Weight Rating: 300 lbs.

FABRIC PRICE CODES

1	\$656	8	\$806
2	\$683	9	\$825
3	\$709	10	\$844
4	\$728	11	\$864
5	\$747	12	\$883
6	\$767	L	\$872
7	\$786		

! See page 383 for all other control specifications.

HIWMRAKD

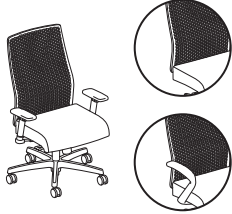

TASK MID-BACK

ReActiv® Back
Pneumatic
Swivel
Synchro-tilt
Tilt Tension
Tilt Lock
Optional Lumbar Support

DIMENSIONS

Depth: 24
Height: 43¾
Seat Depth: 17¾
Seat Width: 20
Back Width: 19
Back Height: 29
Width (with arms): 27
Width (armless): 21
Cube: 6.3
Weight Rating: 300 lbs.

FABRIC PRICE CODES

1	\$719	8	\$869
2	\$746	9	\$888
3	\$772	10	\$907
4	\$791	11	\$927
5	\$810	12	\$946
6	\$830	L	\$935
7	\$849		

! See page 383 for all other control specifications.

HON Recommendation: HIWMRAKD.Y2.A.H.___CU___.BL.SB.T - List Price \$915

HOW TO SPECIFY

Select Model Number	Select Control Type	Select Arm Type	Select Caster	Select Back Color	Select Fabric	Select Lumbar	Select Base	Select Frame
	Y1 Synchro-Tilt w/ Seat Slider (+ \$22) Y2 Advanced Synchro-Tilt (+ \$71) W2 Weight-Activated Synchro-Tilt w/ Seat Slider (+ \$71)	N Armless A Height and Width Adjustable Arms (+ \$92)	H Black Hard Caster	OS Charcoal ReActiv® DWR Designer White ReActiv® TI Titanium ReActiv®	See page 401	NL No Lumbar BL Black Adjustable Lumbar (+ \$33) BY Bullseye Adjustable Lumbar (+ \$33) DW Designer White Adjustable Lumbar (+ \$33) MR Ember Adjustable Lumbar (+ \$33) IR Iris Adjustable Lumbar (+ \$33) KT Krypton Adjustable Lumbar (+ \$33) RE Regatta Adjustable Lumbar (+ \$33) TL Titanium Adjustable Lumbar (+ \$33)	SB Standard Base	T Black DWX Designer White (+ \$39) TI Titanium (+ \$39)
H I W M R A K D .	Y 2 .	A .	H .	O S .	C U 1 0 .	B L .	S B .	T



Icon Legend on page 19

IGNITION® 2.0 Upholstered

HIWMU



TASK MID-BACK

- Upholstered Back**
- Pneumatic
- Swivel
- Synchro-tilt
- Tilt Tension
- Tilt Lock

DIMENSIONS

Depth:	24	Width (with arms):	27
Height:	43¾	Width (armless):	21
Seat Depth:	17¾	Cube:	10.8
Seat Width:	20	COM:	3.0
Back Width:	19	Weight Rating:	300 lbs.
Back Height:	23		

FABRIC PRICE CODES

1	\$724	7	\$1048
2	\$789	8	\$1096
3	\$854	9	\$1145
4	\$903	10	\$1193
5	\$951	11	\$1242
6	\$1000	12	\$1290

! See page 382 for additional specifications and dimensions.

HIWMUL



TASK MID-BACK WITH ADJUSTABLE LUMBAR

- Upholstered Back**
- Pneumatic
- Swivel
- Synchro-tilt
- Tilt Tension
- Tilt Lock
- Adjustable Lumbar

DIMENSIONS

Depth:	24½	Width (with arms):	27
Height:	43¾	Width (armless):	21
Seat Depth:	17¾	Cube:	10.8
Seat Width:	20	COM:	3.0
Back Width:	19	Weight Rating:	300 lbs.
Back Height:	23		

FABRIC PRICE CODES

1	\$765	7	\$1089
2	\$830	8	\$1137
3	\$895	9	\$1186
4	\$944	10	\$1234
5	\$992	11	\$1283
6	\$1041	12	\$1331

! See page 382 for additional specifications and dimensions.

HON Recommendation: HIWMU.Y2.A.H.CU__NL.SB.T - List Price \$887

HOW TO SPECIFY

Select Model Number	Select Control Type	Select Arm Type	Select Caster	Select Fabric	Select Lumbar	Select Base	Select Frame
<p>Y0 Synchro-Tilt</p> <p>Y1 Synchro-Tilt w/ Seat Slider (+ \$22)</p> <p>Y2 Advanced Synchro-Tilt (+ \$71)</p> <p>Y3 Synchro-Tilt with Independent Back Angle (+ \$114)</p> <p>W2 Weight-Activated Synchro-Tilt w/ Seat Slider (+ \$71)</p>	<p>N Armless</p> <p>A Height and Width Adjustable Arms (+ \$92)</p> <p>V All-Adjustable Arms (+ \$141)</p> <p>F Fixed Arms (+ \$71)</p> <p>P Fixed Arms - Polished (+ \$189)</p>	<p>H Black Hard Caster</p> <p>S Black All-Surface Caster (+ \$44)</p> <p>TS Titanium All-Surface Caster (+ \$44)</p> <p>R Black Roll Control Caster (+ \$55)</p>	<p>See page 401</p>	<p>NL No Lumbar</p> <p><i>Specify for model HIWMU only</i></p> <p>AL Adjustable Lumbar</p> <p><i>Specify for model HIWMUL only</i></p>	<p>SB Standard Base</p> <p>PA Polished Aluminum (+ \$119)</p>	<p>T Black</p> <p>DWX Designer White (+ \$39)</p> <p>TI Titanium (+ \$39)</p>	
HIWMU	Y2	A	H	CU10	NL	SB	T

IGNITION® 2.0 Upholstered



Icon Legend on page 19

HIWMUKD



TASK MID-BACK

Upholstered Back
Pneumatic
Swivel
Synchro-tilt
Tilt Tension
Tilt Lock

DIMENSIONS

Depth:	24	Back Height:	23
Height:	43¾	Width (with arms):	27
Seat Depth:	17¾	Width (armless):	21
Seat Width:	20	Cube:	6.3
Back Width:	19	Weight Rating:	300 lbs.

FABRIC PRICE CODES

1	\$684	8	\$1056
2	\$749	9	\$1105
3	\$814	10	\$1153
4	\$863	11	\$1202
5	\$911	12	\$1250
6	\$960	L	\$1223
7	\$1008		

! See page 383 for additional specifications and dimensions.

HIWMULKD

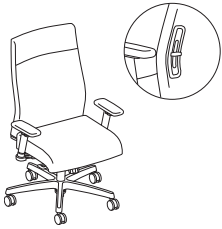

TASK MID-BACK WITH ADJUSTABLE LUMBAR

Upholstered Back
Pneumatic
Swivel
Synchro-tilt
Tilt Tension
Tilt Lock
Adjustable Lumbar

DIMENSIONS

Depth:	24½	Back Height:	23
Height:	43¾	Width (with arms):	27
Seat Depth:	17¾	Width (armless):	21
Seat Width:	20	Cube:	6.3
Back Width:	19	Weight Rating:	300 lbs.

FABRIC PRICE CODES

1	\$725	8	\$1097
2	\$790	9	\$1146
3	\$855	10	\$1194
4	\$904	11	\$1243
5	\$952	12	\$1291
6	\$1001	L	\$1264
7	\$1049		

! See page 383 for additional specifications and dimensions.

HON Recommendation: HIWMUKD.Y2.A.H.CU__NL.SB.T - List Price \$847

HOW TO SPECIFY

Select Model Number	Select Control Type	Select Arm Type	Select Caster	Select Fabric	Select Lumbar	Select Base	Select Frame
HIWMUKD	<p>Y1 Synchro-Tilt w/ Seat Slider (+ \$22)</p> <p>Y2 Advanced Synchro-Tilt (+ \$71)</p> <p>W2 Weight-Activated Synchro-Tilt w/ Seat Slider (+ \$71)</p>	<p>N Armless</p> <p>A Height and Width Adjustable Arms (+ \$92)</p>	H Black Hard Caster	See page 401	<p>NL No Lumbar <i>Specify for model HIWMUKD only</i></p> <p>AL Adjustable Lumbar <i>Specify for model HIWMULKD only</i></p>	SB Standard Base	<p>T Black</p> <p>DW Designer White (+ \$39)</p> <p>TI Titanium (+ \$39)</p>
HIWMUKD	Y2	A	H	CU10	NL	SB	T



Icon Legend on page 19

IGNITION® 2.0 Accessories

HI2ATA

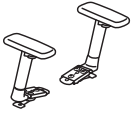

ADJUSTABLE ARMS

Height and Width
Functions: **S**
(Function Key on pages 256-257)

DIMENSIONS

Adjustable Arms Width: 16¾-19 (low-back and stool models)
Adjustable Arms Width: 18-20^{17/20} (mid-back models)
Height from Seat: 8-11
Ship Weight: 8
Cube: 1.0

LIST PRICE

\$163

ⓘ Can only be used with standard models. Contact Customer Support for Big & Tall arm packs.

HI2AAA

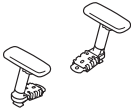

ALL-ADJUSTABLE ARMS

Height, Width, Depth and Pivot

DIMENSIONS

Adjustable Arms Width: 16¾-19 (low-back and stool models)
Adjustable Arms Width: 18-20^{17/20} (mid-back models)
Height from Seat: 7-11
Ship Weight: 8
Cube: 1.0

LIST PRICE

\$219

ⓘ Can only be used with standard models. Contact Customer Support for Big & Tall arm packs.

HI2FHA

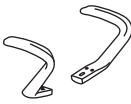

FIXED HEIGHT ARMS

DIMENSIONS

Arm Width: 20
Height from Seat: 9½
Ship Weight: 7
Cube: 1.0

LIST PRICE

\$151

ⓘ Can only be used with standard models. Contact Customer Support for Big & Tall arm packs.

HIPAA

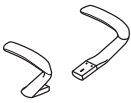

POLISHED ALUMINUM ARMS

Fixed Height

DIMENSIONS

Arm Width: 20
Height from Seat: 9½
Ship Weight: 10
Cube: 1.0

LIST PRICE

\$249

ⓘ Can only be used with standard models. Contact Customer Support for Big & Tall arm packs.

HILMBR

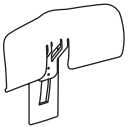

LUMBAR SUPPORT

DIMENSIONS

Ship Weight: 8
Cube: 1.0

LIST PRICE

\$45

HSCASTER

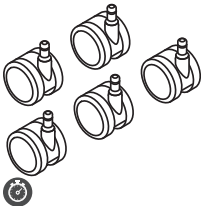

SET OF 5 ALL-SURFACE CASTERS

DIMENSIONS

Size: 60mm
Ship Weight: 2
Cube: 0.1

LIST PRICE

\$75

ⓘ Available in Black finish only, no specification needed.

HOW TO SPECIFY

Select Model Number	Select Frame
	T Black DWX Designer White TI Titanium <i>Not specified for model HIPAA</i>
HI2ATA	T

HOW TO SPECIFY

Select Model Number	Select Lumbar Color
	BL Black MR Ember RE Regatta BY Bullseye IR Iris TL Titanium DW Designer White KT Krypton
HILMBR	BL

IGNITION® 2.0 Accessories



Icon Legend on page 19

HI2HR

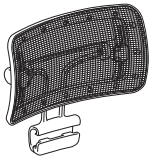

MESH HEADREST

DIMENSIONS

Mesh Width:	12
Mesh Height:	6
Ship Weight:	3
Cube:	1.0

LIST PRICE

\$180

NOTES: Headrest is compatible with Ignition® mid-back mesh back models HIWMM, HIWMMKD, HIWMMMS, and HIWMMSKD purchased after July 2021.

HI2BTHR

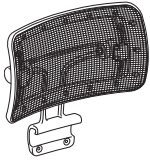

BIG & TALL MESH HEADREST

DIMENSIONS

Mesh Width:	12
Mesh Height:	6
Ship Weight:	3
Cube:	1.0

LIST PRICE

\$189

NOTES: Headrest is compatible with Ignition® mid-back mesh back Big & Tall model HIWMBT.

HOW TO SPECIFY

Select Model Number

Select Mesh

- IM** Black
- IB** Breeze
- IK** Brownstone
- IC** Charcoal
- IF** Fog
- IR** Regatta See page 381 for Spectrum Mesh colors, codes, and upcharges.
- IT** Titanium

Select Frame

- T** Black
- DWX** Designer White (+ \$39)
- TI** Titanium (+ \$39)

HI2HR.

IM.

T

HOW TO SPECIFY

Select Model Number

Select Mesh

- IM** Black
- IC** Charcoal See page 381 for Spectrum Mesh colors, codes, and upcharges.
- IF** Fog

Select Frame

- T** Black

HI2BTHR.

IM.

T

IGNITION® Multi-Purpose Chair Options

ARM STYLE	CODE	DESCRIPTION	PRICE
	N	Armless	+\$0
	F	Fixed Arms	+\$33



CASTERS/ GLIDE	CODE	DESCRIPTION	PRICE
	H	Black Hard Caster	+\$0
	S	Black All-Surface Caster	+\$33
	E	Glide	+\$0



Casters only available on HIGS6

BACK STYLE	CODE	DESCRIPTION	PRICE
<i>4-Way Stretch mesh back options:</i>			
	IM	Black	+\$0
	IB	Breeze	+\$0
	IK	Brownstone	+\$0
	IC	Charcoal	+\$0
	IF	Fog	+\$0
	IR	Regatta	+\$0
	IT	Titanium	+\$0

Spectrum mesh back options:

RM27	Beacon	+\$25
RM20	Blueberry	+\$25
RM16	Brick	+\$25
RM17	Bullseye	+\$25
RM10	Carbon	+\$25
RM28	Chalk	+\$25
RM14	Cobalt	+\$25
RM15	Espresso	+\$25
RM31	Gold Dust	+\$25
RM23	Kermit	+\$25
RM32	Key Lime	+\$25
RM21	Leaf	+\$25
RM30	Linen	+\$25
RM12	Loft	+\$25
RM24	Midnight	+\$25
RM13	Onyx	+\$25
RM29	Pear	+\$25
RM33	Quicksand	+\$25
RM25	Salamander	+\$25
RM19	Sky	+\$25
RM26	Steel	+\$25
RM11	Titanium	+\$25

ReActiv® back options:

OS	Charcoal	+\$33
DWR	Designer White	+\$33
TI	Titanium	+\$33

Upholstered back option:

U	Upholstered	+\$0
----------	-------------	-------------

FRAME	CODE	DESCRIPTION	PRICE
	T	Black	+\$0
	CBK	Charblack	+\$0
	PK7	Textured Designer White	+\$39
	PLAT	Textured Platinum Metallic	+\$0
	PR8T	Textured Silver	+\$39

By selecting PR8T, unit will be produced with titanium colored arm caps, back frame, & glides

By selecting PK7, unit will be produced with Designer White colored arm caps, back frame, & glides

By selecting PLAT, unit will be produced with black arm caps, black back frame, black glides, and platinum colored legs

Refer to Configurator on HON.com for visualization

IGNITION® Multi-Purpose



Icon Legend on page 19

HIGS6

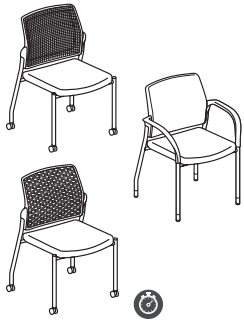

MULTI-PURPOSE

Four Legs

DIMENSIONS

Depth:	21¾	Seat to Floor Height:	18¾
Width:	25	Usable Seat Depth:	17¾
Height:	33½	Ship Weight:	28
Seat Depth:	17¾	Cube:	15.1
Seat Width:	18¾	COM (upholstered back):	1.5
Back Width:	18¼	COM (mesh/ReActiv® back):	1.0
Back Height:	18½	Weight Rating:	300 lbs.
Arm Width:	21½		

FABRIC PRICE CODES

1	\$576	8	\$800
2	\$616	9	\$829
3	\$655	10	\$858
4	\$684	11	\$887
5	\$712	12	\$916
6	\$741	L	\$900
7	\$771		

NOTES: Stacks 4-high.

! ReActiv® back option not available on FC models.

HISB6



MULTI-PURPOSE

Sled Base

DIMENSIONS

Depth:	23¾	Seat to Floor Height:	18¾
Width:	25	Usable Seat Depth:	17¾
Height:	33½	Ship Weight:	30
Seat Depth:	17¾	Cube:	15.1
Seat Width:	18¾	COM (upholstered back):	1.5
Back Width:	18¼	COM (mesh/ReActiv® back):	1.0
Back Height:	18½	Weight Rating:	300 lbs.
Arm Width:	21½		

FABRIC PRICE CODES

1	\$576	8	\$800
2	\$616	9	\$829
3	\$655	10	\$858
4	\$684	11	\$887
5	\$712	12	\$916
6	\$741	L	\$900
7	\$771		

! ReActiv® back option not available on FC models.

HICS7



CAFÉ-HEIGHT STOOL

Four Legs

DIMENSIONS

Depth:	23	Seat to Floor Height:	31
Width:	25	Usable Seat Depth:	17¾
Height:	46½	Ship Weight:	37
Seat Depth:	17¾	Cube:	21.8
Seat Width:	18¾	COM (upholstered back):	1.5
Back Width:	18¼	COM (mesh/ReActiv® back):	1.0
Back Height:	18½	Weight Rating:	300 lbs.
Arm Width:	21½		

FABRIC PRICE CODES

1	\$727	8	\$951
2	\$767	9	\$980
3	\$806	10	\$1009
4	\$835	11	\$1038
5	\$863	12	\$1067
6	\$892	L	\$1051
7	\$922		

! ReActiv® back option not available on FC models.

HON Recommendation: HIGS6.F.H.IM.CU__T - List Price \$609

HOW TO SPECIFY

Select Model Number	Select Arm Type	Select Glide	Select Back Type	Select Fabric	Select Frame
F Fixed Arms (+ \$33) N Armless	E Glide H Black Hard Caster S Black All-Surface Caster (+ \$33) <i>Casters available on HIGS6 only</i>	IM Black IB Breeze IK Brownstone IC Charcoal OS Charcoal ReActiv® (+ \$33) DWR Designer White ReActiv® (+ \$33)	IF Fog IR Regatta IT Titanium TI Titanium ReActiv® (+ \$33) U Upholstered See page 395 for Spectrum Mesh colors, codes, and upcharges.	See page 401	T Black CBK Charblack PK7 Textured Designer White (+ \$39) PLAT Textured Platinum Metallic PR8T Textured Silver (+ \$39)
HIGS6	F	H	IM	CU10	T



Icon Legend on page 19

IGNITION® Multi-Fabric Multi-Purpose

HIGS6DF

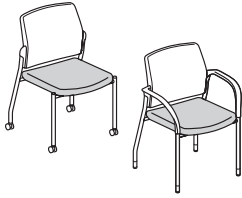

MULTI-PURPOSE

Multi-Fabric
Four Legs

DIMENSIONS

Depth:	21 ³ / ₄	Arm Width:	21 ¹ / ₂
Width:	25	Seat to Floor Height:	18 ³ / ₈
Height:	33 ¹ / ₂	Usable Seat Depth:	17 ³ / ₈
Seat Depth:	17 ³ / ₈	Ship Weight (upholstered back):	28
Seat Width:	18 ³ / ₄	Cube (upholstered back):	15.1
Back Width:	18 ¹ / ₄	COM (back):	0.75
Back Height:	18 ¹ / ₈	COM (seat):	0.75
		Weight Rating:	300 lbs.

FABRIC PRICE CODES

1	\$654	
<i>Add to Base Price Above</i>		
	Back	Seat
2	\$20	\$20
3	\$40	\$40
4	\$55	\$55
5	\$68	\$68
6	\$84	\$84
7	\$98	\$98
8	\$113	\$113
9	\$127	\$127
10	\$142	\$142
11	\$156	\$156
12	\$171	\$171
L	\$162	\$162

NOTES: Stacks 4-high.

HISB6DF

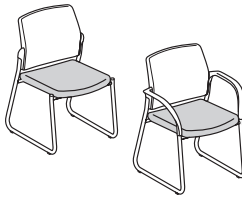

MULTI-PURPOSE

Multi-Fabric
Sled Base

DIMENSIONS

Depth:	23 ³ / ₄	Arm Width:	21 ¹ / ₂
Width:	25	Seat to Floor Height:	18 ³ / ₈
Height:	33 ¹ / ₂	Usable Seat Depth:	17 ³ / ₈
Seat Depth:	17 ³ / ₈	Ship Weight (upholstered back):	30
Seat Width:	18 ³ / ₄	Cube (upholstered back):	15.1
Back Width:	18 ¹ / ₄	COM (back):	0.75
Back Height:	18 ¹ / ₈	COM (seat):	0.75
		Weight Rating:	300 lbs.

FABRIC PRICE CODES

1	\$651	
<i>Add to Base Price Above</i>		
	Back	Seat
2	\$20	\$20
3	\$40	\$40
4	\$55	\$55
5	\$68	\$68
6	\$84	\$84
7	\$98	\$98
8	\$113	\$113
9	\$127	\$127
10	\$142	\$142
11	\$156	\$156
12	\$171	\$171
L	\$162	\$162

HON Recommendation: HIGS6DF.F.S.U.CU__UR__T - List Price \$720

HOW TO SPECIFY

Select Model Number	Select Arm Type	Select Glide	Select Back Type	Select Back Fabric	Select Seat Fabric	Select Frame
	F Fixed Arms (+ \$33) N Armless	E Glide H Black Hard Caster S Black All-Surface Caster (+ \$33) <i>Casters available on HIGS6DF only</i>	U Upholstered	See page 401	See page 401	T Black CBK Charblack PK7 Textured Designer White (+ \$39) PLAT Textured Platinum Metallic PR8T Textured Silver (+ \$39)
HIGS6DF	F	H	U	CU10	UR10	T

IGNITION® Multi-Fabric Stools



Icon Legend on page 19

HICS7DF



CAFÉ-HEIGHT STOOL

Multi-Fabric
Four Legs

DIMENSIONS

Depth:	23	Arm Width:	21½
Width:	25	Seat to Floor Height:	31
Height:	46½	Usable Seat Depth:	17¾
Seat Depth:	17¾	Ship Weight (upholstered back):	37
Seat Width:	18¾	Cube (upholstered back):	21.8
Back Width:	18¼	COM (back):	0.75
Back Height:	18½	COM (seat):	0.75
		Weight Rating:	300 lbs.

FABRIC PRICE CODES

1 \$802

Add to Base Price Above

	Back	Seat
2	\$20	\$20
3	\$40	\$40
4	\$55	\$55
5	\$68	\$68
6	\$84	\$84
7	\$98	\$98
8	\$113	\$113
9	\$127	\$127
10	\$142	\$142
11	\$156	\$156
12	\$171	\$171
L	\$162	\$162

HON Recommendation: HICS7DF.F.E.U.CU__UR__T - List Price \$835

HOW TO SPECIFY

Select Model Number	Select Arm Type	Select Glide	Select Back Type	Select Back Fabric	Select Seat Fabric	Select Frame
F Fixed Arms (+ \$33) N Armless	E Glide	U Upholstered	See page 401	See page 401	See page 401	T Black CBK Charblack PK7 Textured Designer White (+ \$39) PLAT Textured Platinum Metallic PR8T Textured Silver (+ \$39)
HICS7DF	F	E	U	CU10	UR10	T



Icon Legend on page 19

HIGCL



GUEST CHAIR

Fixed Arms
Glides

DIMENSIONS

Depth:	24	Arm Width:	19¼
Width:	23	Seat to Floor Height:	18½
Height:	35½	Usable Seat Depth:	16¾
Seat Depth:	18	Ship Weight:	42
Seat Width:	19½	Cube:	15.2
Back Width:	19½	COM:	2.0
Back Height:	20	Weight Rating:	300 lbs.

FABRIC PRICE CODES

1	\$633	8	\$931
2	\$686	9	\$970
3	\$738	10	\$1008
4	\$776	11	\$1048
5	\$815	12	\$1086
6	\$854	L	—
7	\$892		

HON Recommendation: HIGCL.E.U.CU__T - List Price \$633

HOW TO SPECIFY

Select Model Number HIGCL	Select Glide E Glide	Select Back Type U Upholstered	Select Fabric See page 401 CU10	Select Frame T Black CBK Charblack PLAT Textured Platinum Metallic
--	---------------------------------------	---	---	--

HIB50

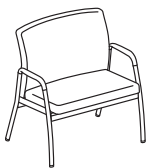

BARIATRIC LOUNGE

Fixed Arms
Glides

DIMENSIONS

Depth:	25½	Arm Width:	30
Width:	33¾	Seat to Floor Height:	20
Height:	35¾	Usable Seat Depth:	18¾
Seat Depth:	18¾	Ship Weight:	70
Seat Width:	29¾	Cube:	27.5
Back Width:	29	COM:	2.5
Back Height:	19¼	Weight Rating:	500 lbs.



FABRIC PRICE CODES



1	\$1837	8	\$2209
2	\$1902	9	\$2258
3	\$1967	10	\$2306
4	\$2016	11	\$2355
5	\$2064	12	\$2403
6	\$2113	L	—
7	\$2161		



HOW TO SPECIFY

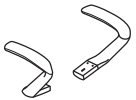

Select Model Number HIB50	Select Arm Type F Fixed Arms	Select Glide E Glide	Select Back Type U Upholstered	Select Fabric See page 401 CU10	Select Frame T Black CBK Charblack PLAT Textured Platinum Metallic
--	---	---------------------------------------	---	---	--

IGNITION[®] Task Chair Options

ARM STYLE	CODE	DESCRIPTION	PRICE
	N	Armless	+\$0
	F	Fixed Arms	+\$71
	A	Height and Width Adjustable Arms	+\$92
	V	All-Adjustable Arms (includes Pivot)	+\$141
	P	Fixed Polished Aluminum Arms	+\$189

CASTERS	CODE	DESCRIPTION	PRICE
	H	Black Hard Caster	+\$0
	S	Black All-Surface Caster	+\$44

BACK STYLE	CODE	DESCRIPTION	PRICE
	U	Upholstered	+\$0
	M	Mesh	+\$0

BASE	CODE	DESCRIPTION	PRICE
	SB	Standard Base	+\$0
	PA	Polished Aluminum	+\$119

HON BRANDED FABRICS

GRADE 1	GRADE 2	GRADE 3	GRADE 4	GRADE L
Apex	Appoint Seating	Bradbury	Constance with Supreen™	Denver Leather*
Centurion	Blume	Cozy	Livi with Supreen™	
Compass**	Clyde	Getaway	Lucerne	
Contourett	Haute	Moxie	Lugano with Supreen™	
Dapper	Kai	Notion	Oxford with Supreen™	
Emphasis	Rush	Parker**		
Ensemble	Spectrum Mesh***	Purl		
Hamilton	Spin Seating	Quill		
Noble Seating	Wavelength	Saxony		
Pebble	Whisper Vinyl			
Vibe				

For a complete list of fabrics, including partnership fabrics, go to hon.com/fabricsandfinishes.

Reference Fabric Color Combinations on pages 20-25 for color codes and legend on page 21 for lead times. For additional HON to Supply COM fabric grade pricing, go to hon.com and click on the HON to Supply COM link.

*Denver Leather (SS) may not be available on every model within a specific series, please refer to the model's page for details.

**Not available as a back upholstery on Ignition[®] 2.0.

***Only available on the seats of certain Ignition[®] 2.0 models. Please refer to the Product Configurator for exact availability.

 For Fire Code model, availability, and ordering method, refer to page 262. Available on select models, contact HON Customer Support for availability.

HITL1



TASK LOW-BACK

Pneumatic
Back Height Adjustment
Swivel
Tilt
Tilt Tension
Tilt Lock
Functions: **A, B, E, J, K, L**
(Function Key on pages 256-257)

DIMENSIONS

Upholstered Back
Width: 17½
Upholstered Back
Height: 18¾-21¾
Mesh Back Width: 17½
Mesh Back Height: 20¾-23¼
Depth: 36
Width: 27½
Height: 41
Seat Depth: 17
Seat Width: 19

Adjustable Arms Width: 17-19½
Fixed Arms Width: 20
Seat to Floor Height: 17-21½
Usable Seat Depth: 15¾
Ship Weight (upholstered back): 50
Ship Weight (mesh back): 45
Cube (upholstered back): 10.8
Cube (mesh back): 10.8
COM (upholstered back): 2.0
COM (mesh back): 1.0
Weight Rating: 300 lbs.

FABRIC PRICE CODES

1	\$833	8	\$1131
2	\$886	9	\$1170
3	\$938	10	\$1208
4	\$976	11	\$1248
5	\$1015	12	\$1286
6	\$1054	L	—
7	\$1092		

NOTES: See page 406 for arm packs.

HITL2



TASK LOW-BACK

Pneumatic
Back Height Adjustment
Synchro-tilt
Tilt Tension
Tilt Lock
Seat Glide
Functions: **A, B, D, E, J, A-D, L**
(Function Key on pages 256-257)

DIMENSIONS

Upholstered Back
Width: 17½
Upholstered Back
Height: 19½-22½
Mesh Back Width: 17½
Mesh Back Height: 20¾-23¼
Depth: 38½
Width: 27½
Height: 43
Seat Depth: 16-18
Seat Width: 19

Adjustable Arms Width: 17-19½
Fixed Arms Width: 20
Seat to Floor Height: 17-21½
Usable Seat Depth: 15½-17½
Ship Weight (upholstered back): 54
Ship Weight (mesh back): 49
Cube (upholstered back): 10.8
Cube (mesh back): 10.8
COM (upholstered back): 2.0
COM (mesh back): 1.0
Weight Rating: 300 lbs.

FABRIC PRICE CODES

1	\$939	8	\$1237
2	\$992	9	\$1276
3	\$1044	10	\$1314
4	\$1082	11	\$1354
5	\$1121	12	\$1392
6	\$1160	L	—
7	\$1198		

NOTES: See page 406 for arm packs.

HITL3



TASK LOW-BACK

Pneumatic
Back Height Adjustment
Synchro-tilt
Back Angle Adjustment
Tilt Lock
Seat Glide
Functions: **A, B, D, E, A-D, A-E, L**
(Function Key on pages 256-257)

DIMENSIONS

Upholstered Back
Width: 17½
Upholstered Back
Height: 20¾-23¾
Mesh Back Width: 17½
Mesh Back Height: 20¾-23¼
Depth: 39
Width: 27
Height: 44
Seat Depth: 16-18
Seat Width: 19

Adjustable Arms Width: 17-19½
Fixed Arms Width: 20
Seat to Floor Height: 17-21½
Usable Seat Depth: 14½-16½
Ship Weight (upholstered back): 58
Ship Weight (mesh back): 53
Cube (upholstered back): 10.8
Cube (mesh back): 10.8
COM (upholstered back): 2.0
COM (mesh back): 1.0
Weight Rating: 300 lbs.

FABRIC PRICE CODES

1	\$1001	8	\$1299
2	\$1054	9	\$1338
3	\$1106	10	\$1376
4	\$1144	11	\$1416
5	\$1183	12	\$1454
6	\$1222	L	—
7	\$1260		

NOTES: See page 406 for arm packs.

HON Recommendation: HITL1.A.H.M.CU__T.SB - List Price \$925

HOW TO SPECIFY

Select Model Number HITL1	Select Arm Type N Armless F Fixed Arms - Black (+ \$71) A Height and Width Adjustable Arms (+ \$92) V All-Adjustable Arms (includes Pivot) (+ \$141) P Fixed Arms - Polished (+ \$189)	Select Caster/Glide H Black Hard Caster S Black All-Surface Caster (+ \$44)	Select Back Type U Upholstered M Mesh	Select Fabric See page 401	Select Frame T Black	Select Base SB Standard Base PA Polished Aluminum (+ \$119)
HITL1	A	H	M	CU10	T	SB



Icon Legend on page 19

HIWM1



MID-BACK

Pneumatic
Back Height Adjustment
Swivel
Tilt
Tilt Tension
Tilt Lock
Functions: **A, B, E, J, K, L**
(Function Key on pages 256-257)

DIMENSIONS

Upholstered Back Width:	18½	Seat to Floor Height:	17-21½
Upholstered Back Height:	21-24	Usable Seat Depth:	17½
Mesh Back Width:	19	Ship Weight (upholstered back):	54
Mesh Back Height:	21½-24	Ship Weight (mesh back):	48
Depth:	35½	Cube (upholstered back):	10.8
Width:	27	Cube (mesh back):	10.8
Height:	44	COM (upholstered back):	2.0
Seat Depth:	18	COM (mesh back):	1.0
Seat Width:	20	Weight Rating:	300 lbs.
Adjustable Arms Width:	18-20½		
Fixed Arms Width:	20		

FABRIC PRICE CODES

1	\$914	8	\$1212
2	\$967	9	\$1251
3	\$1019	10	\$1289
4	\$1057	11	\$1329
5	\$1096	12	\$1367
6	\$1135	L	\$1238
7	\$1173		

NOTES: See page 406 for arm packs.

HIWM2



MID-BACK

Pneumatic
Back Height Adjustment
Synchro-tilt
Tilt Tension
Tilt Lock
Seat Glide
Functions:
A, B, D, E, J, A-D, L
(Function Key on pages 256-257)

DIMENSIONS

Upholstered Back Width:	18½	Seat to Floor Height:	17¼-21¾
Upholstered Back Height:	21-24	Usable Seat Depth:	16¼-18¼
Mesh Back Width:	19	Ship Weight (upholstered back):	58
Mesh Back Height:	21½-24	Ship Weight (mesh back):	52
Depth:	38	Cube (upholstered back):	10.8
Width:	27	Cube (mesh back):	10.8
Height:	46½	COM (upholstered back):	2.0
Seat Depth:	17-19	COM (mesh back):	1.0
Seat Width:	20	Weight Rating:	300 lbs.
Adjustable Arms Width:	18-20½		
Fixed Arms Width:	20		

FABRIC PRICE CODES

1	\$1012	8	\$1310
2	\$1065	9	\$1349
3	\$1117	10	\$1387
4	\$1155	11	\$1427
5	\$1194	12	\$1465
6	\$1233	L	\$1336
7	\$1271		

NOTES: See page 406 for arm packs.

HIWM3



MID-BACK

Pneumatic
Back Height Adjustment
Synchro-tilt
Back Angle Adjustment
Tilt Tension
Tilt Lock
Seat Glide
Functions:
A, B, D, E, A-D, A-E, L
(Function Key on pages 256-257)

DIMENSIONS

Upholstered Back Width:	18½	Seat to Floor Height:	17¼-21¾
Upholstered Back Height:	21-24	Usable Seat Depth:	15¼-17¼
Mesh Back Width:	19	Ship Weight (upholstered back):	63
Mesh Back Height:	21½-24	Ship Weight (mesh back):	58
Depth:	39	Cube (upholstered back):	10.8
Width:	27	Cube (mesh back):	10.8
Height:	44	COM (upholstered back):	2.0
Seat Depth:	17-19	COM (mesh back):	1.0
Seat Width:	20	Weight Rating:	300 lbs.
Adjustable Arms Width:	18-20½		
Fixed Arms Width:	20		

FABRIC PRICE CODES

1	\$1079	8	\$1377
2	\$1132	9	\$1416
3	\$1184	10	\$1454
4	\$1222	11	\$1494
5	\$1261	12	\$1532
6	\$1300	L	\$1403
7	\$1338		

NOTES: See page 406 for arm packs.

HON Recommendation: HIWM2.A.H.M.CU__T.SB - List Price \$1104

HOW TO SPECIFY

Select Model Number	Select Arm Type	Select Caster/Glide	Select Back Type	Select Fabric	Select Frame	Select Base
N Armless F Fixed Arms - Black (+ \$71) A Height and Width Adjustable Arms (+ \$92) V All-Adjustable Arms (includes Pivot) (+ \$141) P Fixed Arms - Polished (+ \$189)	H Black Hard Caster S Black All-Surface Caster (+ \$44)	U Upholstered M Mesh	See page 401	T Black	SB Standard Base PA Polished Aluminum (+ \$119)	
HIWM1	A	H	M	CU10	T	SB

HIEH1



EXECUTIVE HIGH-BACK

Pneumatic
Back Height Adjustment
Swivel
Tilt
Tilt Tension
Tilt Lock
Functions: **A, B, E, F, K, L**
(Function Key on pages 256-257)

DIMENSIONS

Depth: 38½
Width: 27
Height: 47½
Seat Depth: 18
Seat Width: 20
Back Width: 20
Back Height: 24¾-27¾
Arm Width: 20
Seat to Floor Height: 16¾-21¼
Usable Seat Depth: 17⅞
Ship Weight: 56
Cube: 16.0
COM: 2.5
Weight Rating: 300 lbs.

FABRIC PRICE CODES

1	\$946	8	\$1244
2	\$999	9	\$1283
3	\$1051	10	\$1321
4	\$1089	11	\$1361
5	\$1128	12	\$1399
6	\$1167	L	\$1270
7	\$1205		

NOTES: See page 406 for arm packs.

HIEH2



EXECUTIVE HIGH-BACK

Pneumatic
Back Height Adjustment
Synchro-tilt
Tilt Tension
Seat Glide
Functions: **A, B, D, E, J, A-D, L**
(Function Key on pages 256-257)

DIMENSIONS

Depth: 41
Width: 27
Height: 49
Seat Depth: 17-19
Seat Width: 20
Back Width: 19½
Back Height: 24¾-27¾
Arm Width: 20
Seat to Floor Height: 17-21½
Usable Seat Depth: 16½-18
Ship Weight: 61
Cube: 16.0
COM: 2.5
Weight Rating: 300 lbs.

FABRIC PRICE CODES

1	\$1052	8	\$1350
2	\$1105	9	\$1389
3	\$1157	10	\$1427
4	\$1195	11	\$1467
5	\$1234	12	\$1505
6	\$1273	L	\$1376
7	\$1311		

NOTES: See page 406 for arm packs.

HIEH3



EXECUTIVE HIGH-BACK

Pneumatic
Back Height Adjustment
Synchro-tilt
Back Angle Adjustment
Tilt Tension
Seat Glide
Functions: **A, B, D, E, A-D, A-E, L**
(Function Key on pages 256-257)

DIMENSIONS

Depth: 45½
Width: 27
Height: 49
Seat Depth: 17-19
Seat Width: 20
Back Width: 19½
Back Height: 24¾-27¾
Arm Width: 20
Seat to Floor Height: 17-21½
Usable Seat Depth: 15¼-17¼
Ship Weight: 65
Cube: 16.0
COM: 2.5
Weight Rating: 300 lbs.

FABRIC PRICE CODES

1	\$1113	8	\$1411
2	\$1166	9	\$1450
3	\$1218	10	\$1488
4	\$1256	11	\$1528
5	\$1295	12	\$1566
6	\$1334	L	\$1437
7	\$1372		

NOTES: See page 406 for arm packs.

HON Recommendation: HIEH1.A.H.U.CU___.T.SB - List Price \$1038

HOW TO SPECIFY

Select Model Number	Select Arm Type	Select Caster/Glide	Select Back Type	Select Fabric	Select Frame	Select Base
N Armless F Fixed Arms - Black (+ \$71) A Height and Width Adjustable Arms (+ \$92) V All-Adjustable Arms (includes Pivot) (+ \$141) P Fixed Arms - Polished (+ \$189)	H Black Hard Caster S Black All-Surface Caster (+ \$44)	U Upholstered	See page 401	T Black	SB Standard Base PA Polished Aluminum (+ \$119)	
H I E H 1 .	F .	H .	U .	C U 1 0 .	T .	S B

HITS5



TASK STOOL

Pneumatic
Swivel Back Height
Adjustment
Adjustable Footrest
Functions: **A, B, E**
(Function Key on pages
256-257)

DIMENSIONS

Upholstered Back
Width: 17½
Upholstered Back
Height: 18¾-21¾
Mesh Back Width: 17½
Mesh Back Height: 20¾-23¾
Depth: 27½
Width: 27
Height: 44
Seat Depth: 17
Seat Width: 19

Adjustable Arms Width: 17-19½
Fixed Arms Width: 20
Seat to Floor Height: 23⅝-33⅝
Usable Seat Depth: 15¾
Ship Weight (upholstered back): 56 Ⓢ
Ship Weight (mesh back): 51 Ⓢ
Cube (upholstered back): 10.8
Cube (mesh back): 10.8
COM (upholstered back): 2.0
COM (mesh back): 1.0
Weight Rating: 300 lbs.

FABRIC PRICE CODES

1	\$983	8	\$1281
2	\$1036	9	\$1320
3	\$1088	10	\$1358
4	\$1126	11	\$1398
5	\$1165	12	\$1436
6	\$1204	L	—
7	\$1242		

NOTES: See page 406 for arm packs.

HIWM8*



TASK MID-BACK

Big and Tall
Pneumatic
Swivel-tilt
Tilt Tension
Functions: **A, E, F, K, L**
(Function Key on pages
256-257)

DIMENSIONS

Depth: 28
Width: 32¼
Height: 43⅝
Seat Depth: 19½
Seat Width: 23½
Back Width: 23½
Back Height: 23

Arm Width: 23-25½
Seat to Floor Height: 16⅝-20⅝
Usable Seat Depth: 19½
Ship Weight: 60
Cube: 16.0
COM: 3.0
Weight Rating: 450 lbs.

FABRIC PRICE CODES

1	\$1753	8	\$2186
2	\$1829	9	\$2243
3	\$1904	10	\$2299
4	\$1960	11	\$2355
5	\$2017	12	\$2412
6	\$2073	L	—
7	\$2130		

NOTES: See page 406 for arm packs.

HON Recommendation: HITS5.A.H.M.CU__T.SB - List Price \$1075

* De-emphasized

HOW TO SPECIFY

Select Model Number	Select Arm Type	Select Caster/Glide	Select Back Type	Select Fabric	Select Frame	Select Base
N Armless (+ \$0) F Fixed Arms - Black (+ \$71) A Height and Width Adjustable Arms (+ \$92) V All-Adjustable Arms (includes Pivot) (+ \$141) P Fixed Arms - Polished (+ \$189)	H Black Hard Caster (+ \$0) S Black All-Surface Caster (+ \$44) A Black All-Surface Caster (available on model HIWM8 only) + \$44	U Upholstered M Mesh	See page 401	T Black	SB Standard Base	
HITS5	A	H	M	CU10	T	SB

HI2ATA



ADJUSTABLE ARMS

Height and Width
Functions: **S**
(Function Key on pages 256-257)

DIMENSIONS

Adjustable Arms Width: 16³/₄-19 (low-back and stool models)
Adjustable Arms Width: 18-20⁷/₂₀ (mid-back models)
Height from Seat: 8-11
Ship Weight: 8
Cube: 1.0

LIST PRICE

\$163

HI2AAA

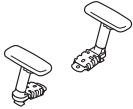

ALL-ADJUSTABLE ARMS

Height, Width, Depth and Pivot

DIMENSIONS

Adjustable Arms Width: 16³/₄-19 (low-back and stool models)
Adjustable Arms Width: 18-20⁷/₂₀ (mid-back models)
Height from Seat: 7-11
Ship Weight: 8
Cube: 1.0

LIST PRICE

\$219

HI2FHA



FIXED HEIGHT ARMS

DIMENSIONS

Arm Width: 20
Height from Seat: 9¹/₂
Ship Weight: 7
Cube: 1.0

LIST PRICE

\$151

HIPAA

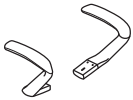

POLISHED ALUMINUM ARMS

Fixed Height

DIMENSIONS

Arm Width: 20
Height from Seat: 9¹/₂
Ship Weight: 10
Cube: 1.0

LIST PRICE

\$249

HSCASTER

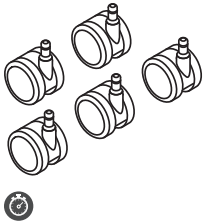

SET OF 5 ALL-SURFACE CASTERS

DIMENSIONS

Size: 60mm
Ship Weight: 2
Cube: 0.1

LIST PRICE

\$75

! Available in Black finish only, no specification needed.

HOW TO SPECIFY

Select Model Number

Select Frame

Specify for models HI2ATA, HI2AAA, and HI2FHA

T Black
DWX Designer White
TI Titanium

HI2ATA.

T



Lota® Multi-Purpose Seating
shown with HON Utility Tables.

LOTA®

If you're looking for all-day comfort without breaking the bank, look no further than Lota. This mesh back guest chair offers advanced features for customizable comfort that make it an upscale choice at an affordable price. If you sit for hours on end, put yourself in more control over your comfort.



FEATURES

- Multi-purpose chairs feature black arms and base.
- H2285 available in black fabric only.
- Multi-purpose chairs stack four high on the floor.
- Warranted for users up to 275 lbs.

LOTA[®] Options

MODEL OPTION

H2285



Multi-Purpose (Mesh Back)

4-Leg Stacking Frame, Fixed Arms

FRAME	CODE	DESCRIPTION	PRICE
	T	Black	+\$0



Icon Legend on page 19

H2285



MULTI-PURPOSE CHAIR

Mesh Back
4-Leg Stacking Frame
Fixed Arms

DIMENSIONS

Depth:	24 ³ / ₄	Arm Width:	19 ¹ / ₈
Width:	23	Seat to Floor Height:	19 ¹ / ₈
Height:	34 ¹ / ₂	Usable Seat Depth:	17 ³ / ₄
Seat Depth:	17 ³ / ₄	Ship Weight:	20
Seat Width:	18 ⁷ / ₈	Cube:	2.8
Back Width:	17 ¹ / ₈	Weight Rating:	275 lbs.
Back Height:	17 ³ / ₄		

LIST PRICE

\$556

NOTES: Casters and glides ship packaged together for customer's assembly choice. Stacks 4-high on floor.
ⓘ Available in VA10 Black fabric seat and Black frame only. Black Mesh back only.

HOW TO SPECIFY

<p>Select Model Number</p> <p>H 2 2 8 5 .</p>	<p>Select Fabric</p> <p>VA10 Black Fabric</p> <p>V A 1 0 .</p>	<p>Select Frame</p> <p>T Black</p> <p>T</p>
---	--	---



Matter™ Upholstered Chair with
5-Star Base with Preside® Table.

MATTER™

This modern take on the traditional task chair combines the comfort of a lounge chair and posture of a task chair. The swivel-tilt control allows you to find that reclining position that's just right for you, and the five-star base lets you move around effortlessly. This cool twist on the traditional guest chair puts the comfort of a lounge chair right on top of a traditional four-leg base.



FEATURES

- Brings a modern design aesthetic into any reception or guest area.
- Available in a 5-star base and 4-leg natural wood base. Hardwood legs in Harvest.
- Swivel-tilt mechanism offers a full range of reclining positions.
- Chrome base provides a contemporary accent.
- 360-degree swivel.
- Easily assembled in minutes.
- Backed by **HON 5-Year Limited Warranty.**



Icon Legend on page 19

MATTER™ Multi-Purpose Chairs

HVL232



GRAY UPHOLSTERED CHAIR

with 5-Star Base
Swivel
Tilt

DIMENSIONS

Depth:	24 ⁴ / ₈	Arm Width:	3
Width:	23	Seat to Floor Height:	19-22 ¹ / ₂
Height:	31-34 ¹ / ₂	Usable Seat Depth:	18
Seat Depth:	18 ³ / ₁₀	Ship Weight:	21
Seat Width:	16 ¹ / ₂	Cube:	5.6
Back Width:	23	Weight Rating:	250 lbs.
Back Height:	12 ² / ₈		

LIST PRICE

\$691

NOTES: HON 5-Year Limited Warranty.

HVL238



GRAY UPHOLSTERED CHAIR

Wood Leg Base
Harvest Wood Legs
4-Leg Wood Base

DIMENSIONS

Depth:	24 ⁴ / ₈	Arm Width:	3
Width:	23	Seat to Floor Height:	19 ¹ / ₄
Height:	31 ¹ / ₂	Usable Seat Depth:	18
Seat Depth:	18 ³ / ₁₀	Ship Weight:	21
Seat Width:	16 ¹ / ₂	Cube:	5.6
Back Width:	23	Weight Rating:	250 lbs.
Back Height:	12 ² / ₈		

LIST PRICE

\$637

NOTES: HON 5-Year Limited Warranty.

HOW TO SPECIFY

Select Model Number	Select Fabric
	GRY01 Light Gray
H V L 2 3 8 .	G R Y 0 1

SEATING



Mav™ Single Lounge shown with West Hill™ Seating and Scramble™ Coffee Table.

MAV™

With plenty of base, back, and seat options offset with mid-century flair and richly colored fabrics, the Mav Single Lounge Series is designed to function well in virtually any space. Whether it's configured for a multi-use zone, in a private office, or to stand alone as a statement piece, Mav is an ideal place for impromptu or collaborative gatherings, a quick break, or focused, heads-down work.



FEATURES

- Subtle seat and back contours and refined details create an inviting, contemporary aesthetic.
- Choose from a mid-back or high-back option.
- Contoured arms provide support and create a striking look.
- Armless models offer a range of seated postures.
- High-back models available with a 4-star metal base with return-to-center, 4-leg wood base, or 5-star base with swivel knee tilt.
- Mid-back models offered in 4-star metal base with return-to-center, 4-leg wood base, wire sled base, or 5-star base with swivel knee tilt.
- Multi-Fabric option — seat cushion and frame can be specified in different fabrics for a modern aesthetic.
- Ottoman lets you kick up your feet or use as impromptu seating.
- Seat cushion attaches with Velcro for easy cleaning or replacement.
- Available in a wide range of cleanable fabrics to achieve the perfect look (see HON's Cleaning Guide).
- Choose from 18 wood base or 4 metal base finish options.

HON BRANDED FABRICS

GRADE 1	GRADE 2	GRADE 3	GRADE 4
Apex	Appoint Seating	Bradbury	Constance with Supreen™
Centurion	Blume	Cozy	Lucerne
Compass	Clyde	Getaway	Livi with Supreen™
Contourett**	Haute	Moxie**	Lugano with Supreen™
Dapper	Kai	Notion	Oxford with Supreen™
Emphasis	Rush	Parker**	
Ensemble	Spin Seating	Purl	
Hamilton	Wavelength	Quill	
Noble Seating	Whisper Vinyl**	Saxony	
Pebble			
Vibe			

For a complete list of fabrics, including partnership fabrics, go to hon.com/fabricsandfinishes.

Reference Fabric Color Combinations on pages 20-25 for color codes and legend on page 21 for lead times.

*Not available on Single Fabric models or as multi-fabric frame option.

**Due to the inherent design of Mav™ high-back chairs, coated fabrics may show material gathers, particularly around the headrest.

For more details on Upholstery Pattern Match for this series, please see page 14.

LEG STYLE



CODE	DESCRIPTION	PRICE
4S	4-Star Return-to-Center	+ \$0
<i>Available in the following finishes:</i>		
P8V	Textured Titanium	
P7A	Textured Charcoal	
P8X	Solar Black	+ \$23
Y	Polished	+ \$57

LEG STYLE

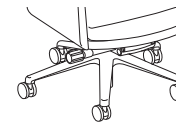

CODE	DESCRIPTION	PRICE
5S	5-Star w/Swivel Knee Tilt, Hard Caster	+ \$29
5SS	5-Star w/Swivel Knee Tilt, All-Surface Caster	+ \$62
<i>Available in the following finishes:</i>		
P8V	Textured Titanium	
P7A	Textured Charcoal	
P8X	Solar Black	+ \$23
Y	Polished	+ \$57

LEG STYLE

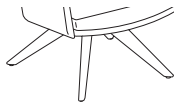

CODE	DESCRIPTION	PRICE
WD	Wood	+ \$279

Available in the following finishes:

LE878	Beigewood
H	Bourbon Cherry
COGN	Cognac
LE599	Field Elm
LFW1	Florence Walnut
C	Harvest
LK11	Kingswood Walnut
LLA1	Lowell Ash
N	Mahogany
MOCH	Mocha
D	Natural Maple
LNRI	Natural Recon
LPE1	Phantom Ecru
PINC	Pinnacle
LPT1	Portico Teak
F	Shaker Cherry
LSW1	Skyline Walnut
LSA1	Sterling Ash

Due to wood being a natural material, color may differ between pieces. Stains will be tonal matches and will not replicate the grain contrast of the coordinating laminate. Prolonged exposure to sunlight can affect the appearance of wood furniture, leading to variations in hue and tone.

LEG STYLE



CODE	DESCRIPTION	PRICE
SD	Sled*	+ \$0
<i>Available in the following finishes:</i>		
P8V	Textured Titanium	
P7A	Textured Charcoal	
P8X	Solar Black	+ \$23
Y	Polished	+ \$57

**Available on Mid-Back models only*

MAV™ Finish Options

Low-Back, Multi-Fabric



High-Back, Multi-Fabric



HMAVMN



MID-BACK SINGLE LOUNGE, ARMLESS

DIMENSIONS

Depth (4-Star, 5-Star, & Wood):	28¾	Back Height:	18¾
Depth (Sled):	27½	Back Width:	20
Height (4-Star):	29½	Ship Weight:	45
Height (5-Star):	33½-37¼	Ship Weight (5-Star):	55
Height (Wood):	30	Cube:	20.1
Height (Sled):	30¾	COM:	3.5
Width:	24	Weight Rating:	300 lbs.
Usable Seat Depth:	19		
Seat to Floor Height:	17		
Seat to Floor Height (5-Star):	17¼-21		
Seat Width:	21		

FABRIC PRICE CODES

1	\$1892	8	\$2596
2	\$1986	9	\$2615
3	\$2082	10	\$2710
4	\$2160	11	\$2803
5	\$2266	12	\$2899
6	\$2374	L	—
7	\$2484		

HMAVMNMF



MID-BACK SINGLE LOUNGE, ARMLESS, MULTI-FABRIC

DIMENSIONS

Depth (4-Star, 5-Star, & Wood):	28¾	Back Height:	18¾
Depth (Sled):	27½	Back Width:	20
Height (4-Star):	29½	Ship Weight:	45
Height (5-Star):	33½-37¼	Ship Weight (5-Star):	55
Height (Wood):	30	Cube:	20.1
Height (Sled):	30¾	COM (Seat Cushion):	1.5
Width:	24	COM (Back/Frame):	2.5
Usable Seat Depth:	19	Weight Rating:	300 lbs.
Seat to Floor Height:	17		
Seat to Floor Height (5-Star):	17¼-21		
Seat Width:	21		

FABRIC PRICE CODES

1	\$2099	
	<i>Add to Base Price Above</i>	
	Seat	Frame
2	\$28	\$67
3	\$55	\$135
4	\$79	\$192
5	\$109	\$267
6	\$139	\$343
7	\$169	\$423
8	\$202	\$504
9	\$208	\$515
10	\$234	\$583
11	\$262	\$652
12	\$289	\$720

HON Recommendation: HMAVMNMF.PURL__PURL__4S__ - List Price \$2289

HOW TO SPECIFY

<p>Select Model Number</p>	<p>Select Fabric</p> <p>See page 413 Specify for single fabric model only</p>	<p>Select Seat Fabric</p> <p>See page 413 Specify for multi-fabric model only</p>	<p>Select Frame Fabric</p> <p>See page 413 Specify for multi-fabric model only</p>	<p>Select Base and Base Color</p> <p>See page 413</p> <p>4S 4-Star Return-to-Center 5S 5-Star, Hard Caster (+ \$29) 5SS 5-Star, All-Surface Caster (+ \$62) WD Wood (+ \$279) SD Sled</p>
HMAVMNMF	PURL05	PURL05	PURL03	4SP7A

HMAVMA



MID-BACK SINGLE LOUNGE, ARMS

DIMENSIONS

Depth (4-Star, 5-Star, & Wood):	28¾	Back Height:	18¾
Depth (Sled):	27½	Back Width:	20
Height (4-Star):	29½	Arm Height:	8½
Height (5-Star):	33½-37¼	Ship Weight:	53
Height (Wood):	30	Ship Weight (5-Star):	63
Height (Sled):	30¾	Cube:	20.1
Width:	25	COM:	4.0
Usable Seat Depth:	19	Weight Rating:	300 lbs.
Seat to Floor Height:	17		
Seat to Floor Height (5-Star):	17¼-21		
Seat Width:	21		

FABRIC PRICE CODES

1	\$2374	8	\$3179
2	\$2483	9	\$3200
3	\$2591	10	\$3308
4	\$2680	11	\$3417
5	\$2802	12	\$3525
6	\$2925	L	—
7	\$3051		

HMAVMAMF



MID-BACK SINGLE LOUNGE, ARMS, MULTI-FABRIC

DIMENSIONS

Depth (4-Star, 5-Star, & Wood):	28¾	Back Height:	18¾
Depth (Sled):	27½	Back Width:	20
Height (4-Star):	29½	Arm Height:	8½
Height (5-Star):	33½-37¼	Ship Weight:	53
Height (Wood):	30	Ship Weight (5-Star):	63
Height (Sled):	30¾	Cube:	20.1
Width:	25	COM (Seat Cushion):	1.5
Usable Seat Depth:	19	COM (Back/Frame):	4.0
Seat to Floor Height:	17	Weight Rating:	300 lbs.
Seat to Floor Height (5-Star):	17¼-21		
Seat Width:	21		

FABRIC PRICE CODES

1	\$2579		
		<i>Add to Base Price Above</i>	
		Seat	Back
2	\$28	\$28	\$82
3	\$55	\$55	\$162
4	\$79	\$79	\$230
5	\$109	\$109	\$321
6	\$139	\$139	\$412
7	\$169	\$169	\$508
8	\$202	\$202	\$605
9	\$208	\$208	\$620
10	\$234	\$234	\$701
11	\$262	\$262	\$782
12	\$289	\$289	\$865

HON Recommendation: HMAVMAMF.PURL__PURL__4S__ - List Price \$2796

HOW TO SPECIFY

<p>Select Model Number</p>	<p>Select Fabric</p> <p>See page 413</p> <p><i>Specify for single fabric model only</i></p>	<p>Select Seat Fabric</p> <p>See page 413</p> <p><i>Specify for multi-fabric model only</i></p>	<p>Select Frame Fabric</p> <p>See page 413</p> <p><i>Specify for multi-fabric model only</i></p>	<p>Select Base and Base Color</p> <p>See page 413</p> <p>4S 4-Star Return-to-Center</p> <p>5S 5-Star w/Swivel Knee Tilt, Hard Caster (+ \$29)</p> <p>5SS 5-Star w/Swivel Knee Tilt, All-Surface Caster (+ \$62)</p> <p>WD Wood (+ \$279)</p> <p>SD Sled</p>
HMAVMAMF	PURL05	PURL05	PURL03	4SP7A

HMAVHN



HIGH-BACK SINGLE LOUNGE, ARMLESS

DIMENSIONS

Depth:	30¼	Back Height:	32½
Height (4-Star):	43½	Back Width:	20
Height (5-Star):	47-50¾	Ship Weight:	50
Height (Wood):	44	Ship Weight (5-Star):	59
Width:	24	Cube:	29
Usable Seat Depth:	19	COM:	4.0
Seat to Floor Height:	17	Weight Rating:	300 lbs.
Seat to Floor Height (5-Star):	17¼-21		
Seat Width:	21		

FABRIC PRICE CODES

1	\$2133	8	\$2837
2	\$2227	9	\$2856
3	\$2323	10	\$2951
4	\$2401	11	\$3044
5	\$2507	12	\$3140
6	\$2615	L	—
7	\$2725		

HMAVHNMF

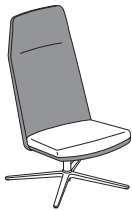

HIGH-BACK SINGLE LOUNGE, ARMLESS, MULTI-FABRIC

DIMENSIONS

Depth:	30¼	Back Height:	32½
Height (4-Star):	43½	Back Width:	20
Height (5-Star):	47-50¾	Ship Weight:	50
Height (Wood):	44	Ship Weight (5-Star):	59
Width:	24	Cube:	29
Usable Seat Depth:	19	COM (Seat Cushion):	1.5
Seat to Floor Height:	17	COM (Back/Frame):	3.5
Seat to Floor Height (5-Star):	17¼-21	Weight Rating:	300 lbs.
Seat Width:	21		

FABRIC PRICE CODES

1	\$2339	
	<i>Add to Base Price Above</i>	
	Seat	Frame
2	\$28	\$67
3	\$55	\$135
4	\$79	\$192
5	\$109	\$267
6	\$139	\$343
7	\$169	\$423
8	\$202	\$504
9	\$208	\$515
10	\$234	\$583
11	\$262	\$652
12	\$289	\$720

HON Recommendation: HMAVHNMF.PURL__PURL__4S__ - List Price \$2529

HOW TO SPECIFY

<p>Select Model Number</p> <p>See page 413</p>	<p>Select Fabric</p> <p>See page 413</p> <p><i>Specify for single fabric model only</i></p>	<p>Select Seat Fabric</p> <p>See page 413</p> <p><i>Specify for multi-fabric model only</i></p>	<p>Select Frame Fabric</p> <p>See page 413</p> <p><i>Specify for multi-fabric model only</i></p>	<p>Select Base and Base Color</p> <p>See page 413</p> <p>4S 4-Star Return-to-Center 5S 5-Star w/Swivel Knee Tilt, Hard Caster (+ \$29) 5SS 5-Star w/Swivel Knee Tilt, All-Surface Caster (+ \$62) WD Wood (+ \$279)</p>
HMAVHNMF	PURL05	PURL05	PURL03	4SP7A

HMAVHA



HIGH-BACK SINGLE LOUNGE, ARMS

DIMENSIONS

Depth:	30¼	Back Height:	32½
Height (4-Star):	43½	Back Width:	20
Height (5-Star):	47-50¾	Arm Height:	8½
Height (Wood):	44	Ship Weight:	59
Width:	25	Ship Weight (5-Star):	67
Usable Seat Depth:	19	Cube:	29
Seat to Floor Height:	17	COM:	5.0
Seat to Floor Height (5-Star):	17¼-21	Weight Rating:	300 lbs.
Seat Width:	21		

FABRIC PRICE CODES

1	\$2614	8	\$3419
2	\$2723	9	\$3440
3	\$2831	10	\$3548
4	\$2920	11	\$3657
5	\$3042	12	\$3765
6	\$3165	L	—
7	\$3291		

HMAVHAMF



HIGH-BACK SINGLE LOUNGE, ARMS, MULTI-FABRIC

DIMENSIONS

Depth:	30¼	Back Height:	32½
Height (4-Star):	43½	Back Width:	20
Height (5-Star):	47-50¾	Arm Height:	8½
Height (Wood):	44	Ship Weight:	59
Width:	25	Ship Weight (5-Star):	67
Usable Seat Depth:	19	Cube:	29
Seat to Floor Height:	17	COM (Seat Cushion):	1.5
Seat to Floor Height (5-Star):	17¼-21	COM (Back/Frame):	4.0
Seat Width:	21	Weight Rating:	300 lbs.

FABRIC PRICE CODES

1	\$2820		
		<i>Add to Base Price Above</i>	
		Seat	Frame
2	\$28	\$82	
3	\$55	\$162	
4	\$79	\$230	
5	\$109	\$321	
6	\$139	\$412	
7	\$169	\$508	
8	\$202	\$605	
9	\$208	\$620	
10	\$234	\$701	
11	\$262	\$782	
12	\$289	\$865	

HON Recommendation: HMAVHAMF.PURL__PURL__4S__ - List Price \$3037

HOW TO SPECIFY

<p>Select Model Number</p> <p>See page 413</p> <p><i>Specify for single fabric model only</i></p>	<p>Select Fabric</p> <p>See page 413</p> <p><i>Specify for multi-fabric model only</i></p>	<p>Select Seat Fabric</p> <p>See page 413</p> <p><i>Specify for multi-fabric model only</i></p>	<p>Select Frame Fabric</p> <p>See page 413</p> <p><i>Specify for multi-fabric model only</i></p>	<p>Select Base and Base Color</p> <p>See page 413</p> <p>4S 4-Star Return-to-Center 5S 5-Star w/Swivel Knee Tilt, Hard Caster (+ \$29) 5SS 5-Star w/Swivel Knee Tilt, All-Surface Caster (+ \$62) WD Wood (+ \$279)</p>
<p>HMAVHAMF .</p>	<p>PURL05 .</p>	<p>PURL05 .</p>	<p>PURL03 .</p>	<p>4SP7A</p>



Icon Legend on page 19

MAV™

HMAVO



SINGLE LOUNGE OTTOMAN

DIMENSIONS

Depth:	22	Ship Weight:	33
Height:	15	Cube:	9.5
Width:	24	COM:	3.5
Usable Seat Depth:	24	Weight Rating:	300 lbs.
Seat to Floor Height:	15		
Seat Width:	22		

FABRIC PRICE CODES

1	\$1171	8	\$1976
2	\$1280	9	\$1997
3	\$1388	10	\$2105
4	\$1477	11	\$2214
5	\$1599	12	\$2322
6	\$1722	L	—
7	\$1848		

HMAVOMF



SINGLE LOUNGE OTTOMAN, MULTI-FABRIC

DIMENSIONS

Depth:	22	Ship Weight:	33
Height:	15	Cube:	9.5
Width:	24	COM (Seat Cushion):	1.5
Usable Seat Depth:	24	COM (Frame):	2.5
Seat to Floor Height:	15	Weight Rating:	300 lbs.
Seat Width:	22		

FABRIC PRICE CODES

1	\$1275		
<i>Add to Base Price Above</i>			
	Seat	Frame	
2	\$28	\$82	
3	\$55	\$162	
4	\$79	\$230	
5	\$109	\$321	
6	\$139	\$412	
7	\$169	\$508	
8	\$202	\$605	
9	\$208	\$620	
10	\$234	\$701	
11	\$262	\$782	
12	\$289	\$865	

HON Recommendation: HMAVOMF.PURL___.PURL___.4S__ - List Price \$1492

HOW TO SPECIFY

<p>Select Model Number</p> <p>HMAVOMF .</p>	<p>Select Fabric</p> <p>See page 413 Specify for single fabric model only</p> <p>PURL05 .</p>	<p>Select Seat Fabric</p> <p>See page 413 Specify for multi-fabric model only</p> <p>PURL05 .</p>	<p>Select Frame Fabric</p> <p>See page 413 Specify for multi-fabric model only</p> <p>PURL03 .</p>	<p>Select Base and Base Color</p> <p>See page 413 4S 4-Star</p> <p>4SP7A</p>
--	--	--	---	---

SEATING

MOTIVATE® CHAIRS

Want to see more? Scan here
to check out hon.com.



Motivate® 4-Leg Stacking Chairs and Between™ Table.

MOTIVATE® CHAIRS

A presentation in the morning. A training session in the afternoon. Today's multi-purpose spaces are in constant flux, and need an adaptable seating solution that delivers instant comfort for all, while easily moving around to support various activities. Motivate task chairs, stacking/nesting chairs and guest chairs create a streamlined collection of seating that intuitively responds to your body's natural movements and curves. Whether sitting for five minutes or five hours, when you Motivate your team you put everyone at ease.



FEATURES

- Choose plastic, upholstered or 4-Way Stretch mesh back.
- Easily move chairs around the space for quick rearrangement.
- HMN1 nesting/stacking chairs stack four high on the floor.
- HMS1 sled base chairs stack 12 high on the floor or 40 high on a cart.
- HMS2 sled base chairs stack six high on the floor.
- Dynamic flex-zone motion in seat and back provides balance and lumbar support.
- Model HMT5 task stool features an adjustable footring.
- Plastic shell is available in 13 colors.
- Available in hundreds of quality HON fabrics.
- Warranted for users up to 300 lbs.

TASK CHAIR FEATURES

- One-touch seat height adjustment easily moves the seat up and down.
- 360-degree swivel provides freedom of movement in any direction.
- Warranted for users up to 300 lbs.

MOTIVATE® Task Chair Options

MODEL OPTIONS

HMT1



Flex-back

Upholstered Seat,
Pneumatic, Swivel

HMT5



Flex-back

Upholstered Seat,
Pneumatic, Swivel
Adjustable Footring

ARM STYLE

CODE	DESCRIPTION	PRICE
N	Armless	+\$0
A	Adjustable Arms	+\$77



CASTERS

CODE	DESCRIPTION	PRICE
H	Hard Caster	+\$0
S	All-Surface Caster	+\$44



BACK STYLE

CODE	DESCRIPTION	PRICE
------	-------------	-------

Plastic/Upholstered Options:

PS	Plastic Shell	+\$0
-----------	---------------	-------------



PB	Upholstered	+\$77
-----------	-------------	--------------



4-Way Stretch Options:

IM	Black	+\$87
IB	Breeze	+\$87
IK	Brownstone	+\$87
IC	Charcoal	+\$87
IF	Fog	+\$87
IR	Regatta	+\$87
IT	Titanium	+\$87



PLASTIC SHELL COLOR CODES (no upcharge):	Tangelo - RG	Cherry - CR	Lime - LM	Calypso - CP	Surf - BU
	Regatta - RE	Mulberry - MB	Loft - LO	Platinum - PT	Shadow - SD
	Lava - LA	Onyx - ON	White - WT		

BASE

CODE	DESCRIPTION	PRICE
SB	Standard Base	+\$0



FRAME COLOR

CODE	DESCRIPTION	PRICE
T	Black	+\$0

SEATING

MOTIVATE[®]

Task Chair Fabric Options

HON BRANDED FABRICS

GRADE 1

Apex
Centurion
Compass
Contourett
Dapper
Emphasis
Ensemble
Hamilton
Noble Seating
Pebble
Vibe

GRADE 2

Appoint Seating
Blume
Clyde
Haute
Kai
Rush
Spin Seating
Wavelength
Whisper Vinyl

GRADE 3

Bradbury
Cozy
Getaway
Moxie
Notion
Parker
Purl
Quill
Saxony

GRADE 4

Constance with Supreen™
Livi with Supreen™
Lucerne
Lugano with Supreen™
Oxford with Supreen™

GRADE L

Denver Leather

For a complete list of fabrics, including partnership fabrics, go to hon.com/fabricsandfinishes.

Reference Fabric Color Combinations on pages 20-25 for color codes and legend on page 21 for lead times.



Icon Legend on page 19

MOTIVATE® Task Chairs

HMT1

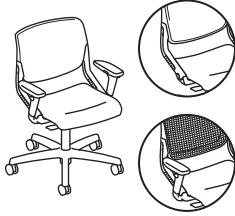

TASK CHAIR

Flex-back
Upholstered Seat
Pneumatic
Swivel

DIMENSIONS

Depth:	27½	Seat to Floor Height:	17-22½
Width:	27½	Usable Seat Depth:	18
Height:	37½	Ship Weight (upholstered back):	39
Seat Depth:	18	Ship Weight (plastic/mesh back):	38
Seat Width:	17½	Cube (upholstered back):	10.0
Back Width:	19½	Cube (plastic/mesh back):	10.0
Back Height:	17¾	COM (upholstered back):	1.5
Arm Width:	18½-20	COM (plastic/mesh back):	1.0
		Weight Rating:	300 lbs.

FABRIC PRICE CODES

1	\$601	8	\$825
2	\$641	9	\$854
3	\$680	10	\$883
4	\$709	11	\$912
5	\$737	12	\$941
6	\$766	L	—
7	\$796		

❗ When a Plastic Shell (PS) or Upholstered Back (PB) option is chosen, you must select a shell color. If the mesh back option is chosen, the shell color is not specified.

HMT5

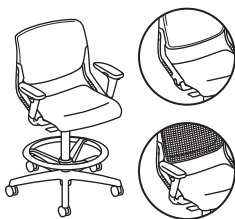

TASK STOOL

Flex-back
Upholstered Seat
Pneumatic
Swivel Adjustable Footring

DIMENSIONS

Depth:	28¼	Seat to Floor Height:	22½-32½
Width:	28¼	Usable Seat Depth:	18
Height:	50½	Ship Weight (upholstered back):	44
Seat Depth:	18	Ship Weight (plastic/mesh back):	43
Seat Width:	17½	Cube (upholstered back):	10.0
Back Width:	19½	Cube (plastic/mesh back):	10.0
Back Height:	17¾	COM (upholstered back):	1.5
Arm Width:	18½-20	COM (plastic/mesh back):	1.0
		Weight Rating:	300 lbs.

FABRIC PRICE CODES

1	\$682	8	\$906
2	\$722	9	\$935
3	\$761	10	\$964
4	\$790	11	\$993
5	\$818	12	\$1022
6	\$847	L	—
7	\$877		

NOTES: Stool model has adjustable footring.

❗ When a Plastic Shell (PS) or Upholstered Back (PB) option is chosen, you must select a shell color. If the mesh back option is chosen, the shell color is not specified.

HON Recommendation: HMT1.A.H.IM.CU__SB.T - List Price \$765

HOW TO SPECIFY

Select Model Number	Select Arm Type	Select Caster	Select Back Type/Color	Select Fabric	Select Base	Select Frame
	A Adjustable Arms (+ \$77) N Armless	H Hard Caster S All-Surface Caster (+ \$44)	PS Plastic Shell PB Upholstered (+ \$77) If PS or PB options are chosen, select shell color. Plastic Shell Colors RG Tangelo LO Loft CR Cherry PT Platinum LM Lime SD Shadow CP Calypso LA Lava BU Surf ON Onyx RE Regatta WT White MB Mulberry 4-Way Stretch options (+ \$87) IM Black IF Fog IB Breeze IR Regatta IK Brownstone IT Titanium IC Charcoal	See page 422	SB Standard Base	T Black
HMT1	A	H	IM	CU10	SB	T
HMT1	A	H	PSLA	CU10	SB	T

SEATING

MOTIVATE® High-Density Sled Base Chair Options

MODEL OPTIONS

HMS1



High-Density Stacker

Sled Leg Base, Set of 4

HMS2



High-Density Stacker

Upholstered Seat, Sled Leg Base, Set of 4

ARM STYLE

CODE	DESCRIPTION	PRICE
F	Fixed Arms	+\$33



N	Armless	+\$0
----------	---------	-------------



FRAME

CODE	DESCRIPTION	PRICE
Y	Chrome	+\$0

P1 PAINT: **+\$0**

CBK	Charblack
P7J	Textured Brownstone
P7A	Textured Charcoal
PK7	Textured Designer White
P7L	Textured Loft
P7M	Textured Muslin
PLAT	Textured Platinum Metallic
P8V	Textured Titanium

P2 PAINT: **+\$0**

PR8	Textured Silver
------------	-----------------

P3 PAINT: **+\$33**

P8S	Atom
PJF	Bullseye
P8P	Ember
P8N	Ion
P8J	Iris
P8F	Krypton
P8M	Regatta

PLASTIC SHELL COLOR CODES (no upcharge):

Tangelo - **RG**
Regatta - **RE**
Lava - **LA**

Cherry - **CR**
Mulberry - **MB**
Onyx - **ON**

Lime - **LM**
Loft - **LO**
White - **WT**

Calypso - **CP**
Platinum - **PT**

Surf - **BU**
Shadow - **SD**

HON BRANDED FABRICS

GRADE 1

Apex
Centurion
Compass
Contourett
Dapper
Emphasis
Ensemble
Hamilton
Noble Seating
Pebble
Vibe

GRADE 2

Appoint Seating
Blume
Clyde
Haute
Kai
Rush
Spin Seating
Wavelength
Whisper Vinyl

GRADE 3

Bradbury
Cozy
Getaway
Moxie
Notion
Parker
Purl
Quill
Saxony

GRADE 4

Constance with Supreen™
Livi with Supreen™
Lucerne
Lugano with Supreen™
Oxford with Supreen™

For a complete list of fabrics, including partnership fabrics, go to hon.com/fabricsandfinishes.

Reference Fabric Color Combinations on pages 20-25 for color codes and legend on page 21 for lead times.

NOTES: Upcharges shown on this page are per chair.



Icon Legend on page 29

MOTIVATE® High-Density Sled Base Chairs

HMS1

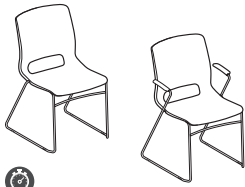

HIGH-DENSITY STACKER

Sled Leg Base
Set of 4

DIMENSIONS

Depth:	23	Arm Width:	18 $\frac{1}{8}$
Width:	21	Seat to Floor Height:	17 $\frac{3}{4}$
Height:	32 $\frac{1}{4}$	Usable Seat Depth:	18 $\frac{1}{4}$
Seat Depth:	18 $\frac{1}{4}$	Ship Weight:	72
Seat Width:	17 $\frac{3}{4}$	Cube:	15.2
Back Width:	17 $\frac{1}{4}$	Weight Rating:	300 lbs.
Back Height:	18		

LIST PRICE PER CARTON

\$1146
(reference single unit @ \$286.50)

NOTES: HMS1 Sled Base chairs stack 12-high on the floor, or 40-high on the chair cart model HMSCART. Field installed glides must be ordered separately and snap-on using existing locations on the sled base frames.

! Ganging Chair Glides must be ordered separately and are designed for use on armless models of the Motivate® High-Density Sled Base Chairs only.

HMS2

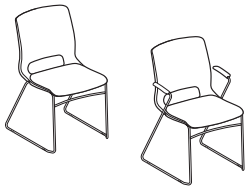

HIGH-DENSITY STACKER

Upholstered Seat
Sled Leg Base
Set of 4

DIMENSIONS

Depth:	23	Arm Width:	18 $\frac{1}{8}$
Width:	21	Seat to Floor Height:	18 $\frac{1}{4}$
Height:	32 $\frac{1}{4}$	Usable Seat Depth:	18 $\frac{1}{4}$
Seat Depth:	18 $\frac{1}{4}$	Ship Weight:	80
Seat Width:	17 $\frac{3}{4}$	Cube:	15.2
Back Width:	17 $\frac{1}{4}$	COM (per 4 pack):	1.6
Back Height:	17 $\frac{1}{2}$	Weight Rating:	300 lbs.

FABRIC PRICE CODES

1	\$1467	8	\$1617
2	\$1494	9	\$1636
3	\$1520	10	\$1655
4	\$1539	11	\$1675
5	\$1558	12	\$1694
6	\$1578	L	—
7	\$1597		

NOTES: HMS2 Sled Base chairs stack 6-high on the floor. Field installed glides must be ordered separately and snap-on using existing locations on the sled base frames.

! Ganging Chair Glides must be ordered separately and are designed for use on armless models of the Motivate® High-Density Sled Base Chairs only.

HMSCART

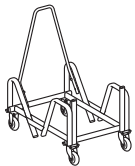

CART FOR HMS1 STACKING CHAIRS

DIMENSIONS

Depth:	34 $\frac{1}{4}$	Ship Weight:	40
Width:	21 $\frac{1}{8}$	Cube:	7.8
Height:	36 $\frac{1}{8}$		

LIST PRICE

\$659

Holds up to 40 Stacking Chairs.

! Motivate® Sled Base Chairs are ordered and shipped four (4) chairs per carton. Pricing shown is per carton. Each set of four chairs (one carton), must have the same shell/frame color combination. Ordering 2 of Model HMS1, HMS2 will result in 2 cartons being shipped, giving you 8 chairs.

HON Recommendation: HMS1.N.ON.Y - List Price \$1146

HOW TO SPECIFY

Select Model Number	Select Arm Type	Select Shell Color	Select Fabric	Select Frame
	F Fixed Arms (+ \$33 per chair) N Armless	RG Tangelo CR Cherry LM Lime CP Calypso BU Surf RE Regatta MB Mulberry	LO Loft PT Platinum SD Shadow LA Lava ON Onyx WT White	See page 424 <i>For HMS2 model only</i>
HMS1	N	ON	CU10	BLCK
HMS2	N	ON		BLCK

MOTIVATE® High-Density Sled Base Chairs



HMSGLD

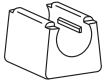

GLIDES FOR MOTIVATE® HIGH-DENSITY STACKER

- Kit includes 48 glides for 12 chairs
- Field installed
- Snap-on using existing locations on frames

DIMENSIONS

Ship Weight: 1
Cube: 0.2

LIST PRICE

\$90

HMSFLTGLD



FELT GLIDES FOR MOTIVATE® HIGH-DENSITY STACKER

- Kit includes 48 glides for 12 chairs
- Field installed
- Snap-on using existing locations on frames

DIMENSIONS

Ship Weight: 1
Cube: 0.2

LIST PRICE

\$226

HMSSTLGLD



STEEL GLIDES FOR MOTIVATE® HIGH-DENSITY STACKER

- Kit includes 48 glides for 12 chairs
- Field installed
- Snap-on using existing locations on frames

DIMENSIONS

Ship Weight: 1
Cube: 0.2

LIST PRICE

\$226

HMSGANG

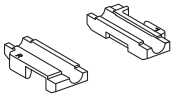

GANGING CONNECTORS FOR MOTIVATE® HIGH- DENSITY STACKER

- 48 ganging connectors
- Requires 4 connectors per ganging connection
- For use on HMS1.N and HMS2.N only (armless models)
- Field installed
- Snap-on using existing locations on frames

DIMENSIONS

Ship Weight: 1
Cube: 0.2

LIST PRICE

\$164

Floor Covering	TYPE OF GLIDE		
	Polycarbonate/Nylon	Felt	Steel
Carpet	Best	Not Recommended	Good
Polished concrete	Best	Good	Not Recommended
Hard wood	Not Recommended	Best	Not Recommended
Vinyl (includes LVT)	Best	Better	Good
VCT	Best	Good	Not Recommended
Tile (Porcelain/Ceramic)	Best	Good	Not Recommended

HOW TO SPECIFY

Select
Model Number

H M S G L D

MOTIVATE® 4-Leg Chair Options

MODEL OPTIONS

HMG1



Stack Chair

Four Legs, Set of 2

HMG2



Stack Chair

Four Legs, Upholstered Seat, Set of 2

HMG3

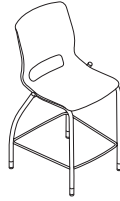

Counter-Height Stool

Four Legs

HMG4



Counter-Height Stool

Four Legs, Upholstered Seat

HMG5



Café-Height Stool

Four Legs

HMG7



Café-Height Stool

Four Legs, Upholstered Seat

ARM STYLE



CODE	DESCRIPTION	PRICE
F	Fixed Arms	+\$33



N	Armless	+\$0
----------	---------	-------------

CASTERS/ GLIDES



CODE	DESCRIPTION	PRICE
H	Hard Caster	+\$0



S	All-Surface Caster	+\$33
----------	--------------------	--------------

**Casters only available on HMG1 and HMG2*



E	Standard Nylon Glide	+\$0
----------	----------------------	-------------

F	Felt Glide	+\$33
----------	------------	--------------

R	Rubber Glide	+\$33
----------	--------------	--------------

T	Steel Glide	+\$33
----------	-------------	--------------

FRAME

CODE	DESCRIPTION	PRICE
P1 PAINT:		+\$0
CBK	Charblack	
P7J	Textured Brownstone	
P7A	Textured Charcoal	
PK7	Textured Designer White	
P7L	Textured Loft	
P7M	Textured Muslin	
PLAT	Textured Platinum Metallic	
P8V	Textured Titanium	
P2 PAINT:		+\$0
PR8	Textured Silver	
P3 PAINT:		+\$33
P8S	Atom	
PJF	Bullseye	
P8P	Ember	
P8N	Ion	
P8J	Iris	
P8F	Krypton	
P8M	Regatta	

PLASTIC SHELL COLOR CODES (no upcharge):				
Tangelo - RG	Cherry - CR	Lime - LM	Calypso - CP	Surf - BU
Regatta - RE	Mulberry - MB	Loft - LO	Platinum - PT	Shadow - SD
Lava - LA	Onyx - ON	White - WT		

NOTES: Upcharges shown on this page are per chair.

SEATING

MOTIVATE® 4-Leg Chairs



Icon Legend on page 19

HMG1

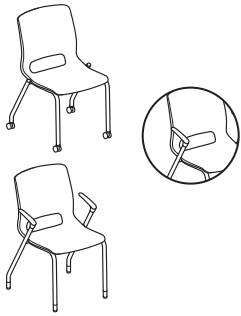

STACK CHAIR

Four Legs
Set of 2

DIMENSIONS

Depth:	23	Arm Width:	18
Width:	21	Seat to Floor Height:	17¾
Height:	32¼	Usable Seat Depth:	18¼
Seat Depth:	18¼	Ship Weight:	38
Seat Width:	17¾	Cube:	13.0
Back Width:	17¼	Weight Rating:	300 lbs.
Back Height:	18		

LIST PRICE PER CARTON

\$745

(reference single unit @ \$372.50)

NOTES: 4-Leg chairs stack 6-high on the floor.

📦 Ships two (2) chairs per carton.

HMG2

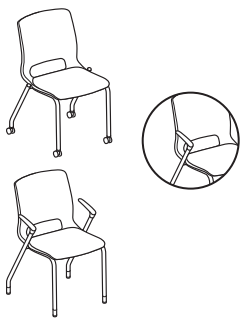

STACK CHAIR

Four Legs
Upholstered Seat
Set of 2

DIMENSIONS

Depth:	23	Arm Width:	18
Width:	21	Seat to Floor Height:	18¼
Height:	32¼	Usable Seat Depth:	18¼
Seat Depth:	18¼	Ship Weight:	44
Seat Width:	17¾	Cube:	13.0
Back Width:	17¼	COM (per 2 pack):	1.0
Back Height:	17½	Weight Rating:	300 lbs.

FABRIC PRICE CODES

1	\$917	8	\$1067
2	\$944	9	\$1086
3	\$970	10	\$1105
4	\$989	11	\$1125
5	\$1008	12	\$1144
6	\$1028	L	—
7	\$1047		

NOTES: 4-Leg chairs stack 6-high on the floor.

📦 Motivate® 4-leg Chairs are ordered and shipped two (2) chairs per carton. Pricing shown is per carton. Each set of two chairs (one carton), must have the same shell/frame color combination. Ordering 2 of Model HMG1, HMG2 will result in 2 cartons being shipped, giving you 4 chairs. 4-Leg chairs stack 6-high on the floor.

HON Recommendation: HMG1.N.H.ON.PLAT - List Price \$745

HOW TO SPECIFY

Select Model Number	Select Arm Type	Select Caster/Glide	Select Shell Color	Select Fabric	Select Frame
F Fixed Arms (+ \$33 per chair) N Armless	H Hard Caster S All-Surface Caster (+ \$33 per chair) <i>Casters only available on HMG1 and HMG2</i> E Standard Nylon Glide F Felt Glide (+ \$33 per chair) R Rubber Glide (+ \$33 per chair) T Steel Glide (+ \$33 per chair)	RG Tangelo CR Cherry LM Lime CP Calypso BU Surf RE Regatta MB Mulberry	LO Loft PT Platinum SD Shadow LA Lava ON Onyx WT White	See page 424 <i>For HMG2 and HMG4 models only</i>	See page 427
HMG1 .	N .	H .	ON .		PLAT
HMG2 .	N .	H .	ON .	CU10 .	PLAT



Icon Legend on page 19

MOTIVATE® 4-Leg Chairs

HMG3

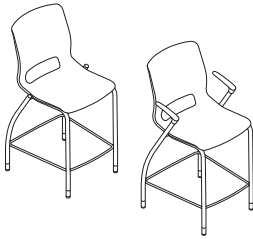

COUNTER-HEIGHT STOOL

Four Legs

DIMENSIONS

Depth:	23	Arm Width:	18
Width:	21	Seat to Floor Height:	24½
Height:	40½	Usable Seat Depth:	18½
Seat Depth:	18½	Ship Weight:	26
Seat Width:	17¾	Cube:	13.8
Back Width:	17¼	Weight Rating:	300 lbs.
Back Height:	18		

LIST PRICE

\$524

HMG4

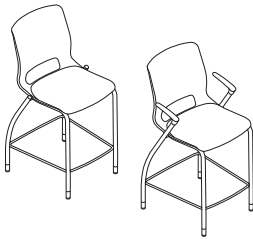

COUNTER-HEIGHT STOOL

Four Legs
Upholstered Seat

DIMENSIONS

Depth:	23	Arm Width:	18
Width:	21	Seat to Floor Height:	25
Height:	40½	Usable Seat Depth:	18¼
Seat Depth:	18½	Ship Weight:	26
Seat Width:	17¾	Cube:	13.8
Back Width:	17¼	COM:	1.0
Back Height:	17½	Weight Rating:	300 lbs.

FABRIC PRICE CODES

1	\$622	8	\$772
2	\$649	9	\$791
3	\$675	10	\$810
4	\$694	11	\$830
5	\$713	12	\$849
6	\$733	L	—
7	\$752		

HMG5

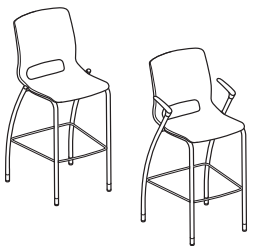

CAFÉ-HEIGHT STOOL

Four Legs

DIMENSIONS

Depth:	23	Arm Width:	18
Width:	21	Seat to Floor Height:	30
Height:	44½	Usable Seat Depth:	18½
Seat Depth:	18½	Ship Weight:	30
Seat Width:	17¾	Cube:	19.3
Back Width:	17¼	Weight Rating:	300 lbs.
Back Height:	18		

LIST PRICE

\$551

HMG7

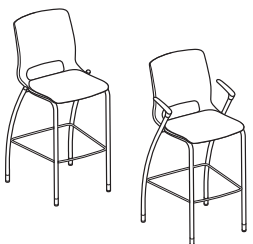

CAFÉ-HEIGHT STOOL

Four Legs
Upholstered Seat

DIMENSIONS

Depth:	23	Arm Width:	18
Width:	21	Seat to Floor Height:	30½
Height:	44½	Usable Seat Depth:	18¼
Seat Depth:	18½	Ship Weight:	34
Seat Width:	17¾	Cube:	19.3
Back Width:	17¼	COM:	1.0
Back Height:	17½	Weight Rating:	300 lbs.

FABRIC PRICE CODES

1	\$651	8	\$801
2	\$678	9	\$820
3	\$704	10	\$839
4	\$723	11	\$859
5	\$742	12	\$878
6	\$762	L	—
7	\$781		

HON Recommendation: HMG5.N.E.ON.PLAT - List Price \$551

HOW TO SPECIFY

Select Model Number	Select Arm Type	Select Glide	Select Shell Color	Select Fabric	Select Frame
F Fixed Arms (+ \$33 per chair) N Armless	E Standard Nylon Glide F Felt Glide (+ \$33 per chair) R Rubber Glide (+ \$33 per chair) T Steel Glide (+ \$33 per chair)	RG Tangelo CR Cherry LM Lime CP Calypso BU Surf RE Regatta MB Mulberry	LO Loft PT Platinum SD Shadow LA Lava ON Onyx WT White	See page 424 For HMG2 and HMG4 models only	See page 427
HMG5	N	E	ON		PLAT
HMG7	N	E	ON	CUT0	PLAT

SEATING

MOTIVATE® Nesting/Stacking Flex-Back Chair Options

MODEL OPTIONS

HMN1



Flex-back

Nesting/Stacking,
Four Legs

HMN2



Flex-back

Nesting/Stacking, Four
Legs, Upholstered Seat

ARM STYLE

CODE DESCRIPTION PRICE



F Fixed Arms **+\$55**



N Armless **+\$0**

CASTERS/ GLIDE

CODE DESCRIPTION PRICE



H Hard Caster **+\$0**



S All-Surface Caster **+\$33**



E Standard Nylon Glide **+\$0**

BACK STYLE

CODE DESCRIPTION PRICE

Plastic/Upholstered Options:



PS Plastic Shell **+\$0**



PB Upholstered **+\$77**

**PB only available on HMN2*

4-Way Stretch Options:



IM Black **+\$87**

IF Fog **+\$87**

IC Charcoal **+\$87**

FRAME

CODE DESCRIPTION PRICE

P1 PAINT: **+\$0**

CBK Charblack

P7J Textured Brownstone

P7A Textured Charcoal

PK7 Textured Designer White

P7L Textured Loft

P7M Textured Muslin

PLAT Textured Platinum

Metallic

P8V Textured Titanium

P2 PAINT: **+\$0**

PR8 Textured Silver

P3 PAINT: **+\$33**

P8S Atom

PJF Bullseye

P8P Ember

P8N Ion

P8J Iris

P8F Krypton

P8M Regatta

PLASTIC SHELL COLOR CODES (no upcharge):

Tangelo - **RG**

Regatta - **RE**

Lava - **LA**

Cherry - **CR**

Mulberry - **MB**

Onyx - **ON**

Lime - **LM**

Loft - **LO**

White - **WT**

Calypso - **CP**

Platinum - **PT**

Surf - **BU**

Shadow - **SD**

MOTIVATE® Nesting/Stacking Flex-Back Chairs

HMN1

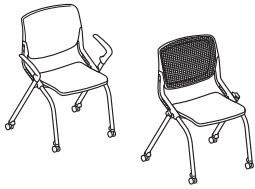

CHAIR

Flex-back
Nesting/Stacking
Four Legs

DIMENSIONS

Depth:	23 ³ / ₈	Arm Width:	24
Width:	26 ³ / ₄	Seat to Floor Height:	18 ¹ / ₄
Height:	34	Usable Seat Depth:	16 ³ / ₄
Seat Depth:	16 ³ / ₄	Ship Weight:	27
Seat Width:	17	Cube:	15.1
Back Width:	19 ¹ / ₂	Weight Rating:	300 lbs.
Back Height:	19		

LIST PRICE

\$625

NOTES: Stack 4-high on floor.

! When selecting the mesh back option, seat shell will be in the specified shell color chosen but the frame around the mesh will always be black.

HMN2



CHAIR

Flex-back
Nesting/Stacking
Four Legs
Upholstered Seat

DIMENSIONS

Depth:	23 ³ / ₈	Seat to Floor Height:	19 ¹ / ₄
Width:	26 ³ / ₄	Usable Seat Depth:	17
Height:	34	Ship Weight (upholstered back):	29
Seat Depth:	17	Ship Weight (plastic/mesh back):	28
Seat Width:	17 ³ / ₈	Cube (upholstered back):	15.1
Back Width:	19 ¹ / ₂	Cube (plastic/mesh back):	15.1
Back Height:	18 ³ / ₈	COM (upholstered back):	1.0
Arm Width:	24	COM (plastic/mesh back):	1.0
		Weight Rating:	300 lbs.

FABRIC PRICE CODES

1	\$709	8	\$859
2	\$736	9	\$878
3	\$762	10	\$897
4	\$781	11	\$917
5	\$800	12	\$936
6	\$820	L	—
7	\$839		

NOTES: Stack 4-high on floor.

! When selecting the mesh back option, seat shell will be in the specified shell color chosen but the frame around the mesh will always be black.

HON Recommendation: HMN2.F.H.IM.ON.CU__PLAT - List Price \$851

HOW TO SPECIFY

Select Model Number	Select Arm Type	Select Caster/Glide	Select Back Type	Select Shell Color	Select Fabric	Select Frame
<p>F Fixed Arms (+ \$55)</p> <p>N Armless</p>	<p>E Standard Nylon Glide</p> <p>H Hard Caster</p> <p>S All-Surface Caster (+ \$33)</p>	<p>PS Plastic Shell</p> <p>PB Upholstered (+ \$77)</p> <p><i>PB option available on HMN2 only</i></p> <p>4-Way Stretch options (+ \$87)</p> <p>IM Black</p> <p>IF Fog</p> <p>IC Charcoal</p>	<p>RG Tangelo</p> <p>CR Cherry</p> <p>LM Lime</p> <p>CP Calypso</p> <p>BU Surf</p> <p>RE Regatta</p> <p>MB Mulberry</p>	<p>LO Loft</p> <p>PT Platinum</p> <p>SD Shadow</p> <p>LA Lava</p> <p>ON Onyx</p> <p>WT White</p>	<p>See page 424</p> <p><i>Specify for model HMN2 only</i></p>	<p>See page 430</p>
<p>HMN1</p> <p>HMN2</p>	<p>N</p> <p>N</p>	<p>H</p> <p>H</p>	<p>IM</p> <p>PB</p>	<p>ON</p> <p>ON</p>	<p>CU10</p>	<p>PLAT</p> <p>PLAT</p>

MOTIVATE[®]

Chair with Tablet Arm Options

MODEL OPTIONS

HMG1



with Tablet Arm

Four Legs

HMG2



with Tablet Arm

Four Legs, Upholstered Seat

CASTERS/ GLIDES



CODE	DESCRIPTION	PRICE
H	Hard Caster	+\$0



S	All-Surface Caster	+\$33
----------	--------------------	--------------



E	Standard Nylon Glide	+\$0
F	Felt Glide	+\$33
R	Rubber Glide	+\$33
T	Steel Glide	+\$33

TABLET SIDE



CODE	DESCRIPTION	PRICE
RT	Right Side	+\$0
LT	Left Side	+\$0



TABLET COLOR

CODE	DESCRIPTION	PRICE
T	Black	+\$0
D	Natural Maple	+\$0

FRAME

CODE	DESCRIPTION	PRICE
P1 PAINT:		+\$0
CBK	Charblack	
P7J	Textured Brownstone	
P7A	Textured Charcoal	
PK7	Textured Designer White	
P7L	Textured Loft	
P7M	Textured Muslin	
PLAT	Textured Platinum Metallic	
P8V	Textured Titanium	
P2 PAINT:		+\$0
PR8	Textured Silver	
P3 PAINT:		+\$33
P8S	Atom	
PJF	Bullseye	
P8P	Ember	
P8N	Ion	
P8J	Iris	
P8F	Krypton	
P8M	Regatta	

PLASTIC SHELL COLOR CODES (no upcharge):

Tangelo - **RG**
Regatta - **RE**
Lava - **LA**

Cherry - **CR**
Mulberry - **MB**
Onyx - **ON**

Lime - **LM**
Loft - **LO**
White - **WT**

Calypso - **CP**
Platinum - **PT**

Surf - **BU**
Shadow - **SD**



Icon Legend on page 19

MOTIVATE[®] Chair with Tablet Arm

HMGT1

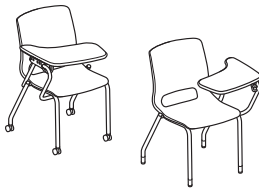

CHAIR

with Tablet Arm
Four Legs

DIMENSIONS

Depth:	30	Back Width:	17¼
Width:	21	Back Height:	18
Height:	32¼	Seat to Floor Height:	17¾
Seat Depth:	18¼	Tablet Height from Floor:	28¾
Seat Width:	17¾	Ship Weight:	41
		Cube:	18.4
		Weight Rating:	300 lbs.

LIST PRICE

\$781

NOTES: Tablet can be specified on right or left side.

❗ Cannot be stacked.

HMGT2

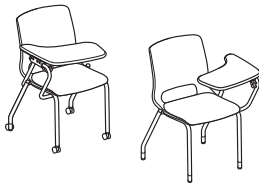

CHAIR

with Tablet Arm
Four Legs
Upholstered Seat

DIMENSIONS

Depth:	30	Back Width:	17¼
Width:	21	Back Height:	17½
Height:	32¼	Seat to Floor Height:	18¼
Seat Depth:	18¼	Tablet Height from Floor:	28¾
Seat Width:	17¾	Ship Weight:	43
		Cube:	18.4
		Weight Rating:	300 lbs.

FABRIC PRICE CODES

1	\$890	8	\$1040
2	\$917	9	\$1059
3	\$943	10	\$1078
4	\$962	11	\$1098
5	\$981	12	\$1117
6	\$1001	L	—
7	\$1020		

NOTES: Tablet can be specified on right or left side.

❗ Cannot be stacked.

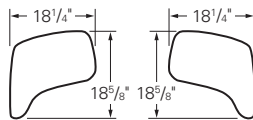

HON Recommendation: HMGT1.E.ON.RT.D.PLAT - List Price \$781

HOW TO SPECIFY

Select Model Number	Select Caster/Glide	Select Shell Color	Select Fabric	Select Tablet Side	Select Tablet Color	Select Frame
H Hard Caster S All-Surface Caster (+ \$33 per chair) E Standard Nylon Glide F Felt Glide (+ \$33 per chair) R Rubber Glide (+ \$33 per chair) T Steel Glide (+ \$33 per chair)	RG Tangelo CR Cherry LM Lime CP Calypso BU Surf RE Regatta MB Mulberry	LO Loft PT Platinum SD Shadow LA Lava ON Onyx WT White	See page 424 <i>Not specified for HMGT1 models</i>	RT Right Side LT Left Side	T Black D Natural Maple	See page 432
HMGT1 .	E .	ON .		RT .	D .	PLAT
HMGT2 .	E .	ON .	CU10 .	RT .	D .	PLAT

MOTIVATE® Flex-Back Chair with Tablet Arm Options

MODEL OPTIONS

HMNT1



Flex-back with Tablet Arm

HMNT2



Flex-back with Tablet Arm

Upholstered Seat

CASTERS/ GLIDE



CODE	DESCRIPTION	PRICE
H	Hard Caster	+\$0



S	All-Surface Caster	+\$33
----------	--------------------	--------------



E	Standard Nylon Glide	+\$0
----------	----------------------	-------------

TABLET SIDE



CODE	DESCRIPTION	PRICE
RT	Right Side	+\$0
LT	Left Side	+\$0



BACK STYLE



CODE	DESCRIPTION	PRICE
<i>Plastic/Upholstered Options:</i>		
PS	Plastic Shell	+\$0



PB	Upholstered	+\$77
-----------	-------------	--------------

TABLET COLOR

CODE	DESCRIPTION	PRICE
T	Black	+\$0
D	Natural Maple	+\$0

FRAME

CODE	DESCRIPTION	PRICE
P1 PAINT:		+\$0
CBK	Charblack	
P7J	Textured Brownstone	
P7A	Textured Charcoal	
PK7	Textured Designer White	
P7L	Textured Loft	
P7M	Textured Muslin	
PLAT	Textured Platinum Metallic	
P8V	Textured Titanium	
P2 PAINT:		+\$0
PR8	Textured Silver	
P3 PAINT:		+\$33
P8S	Atom	
PJF	Bullseye	
P8P	Ember	
P8N	Ion	
P8J	Iris	
P8F	Krypton	
P8M	Regatta	

4-Way Stretch Options:

IM	Black	+\$87
IF	Fog	+\$87
IC	Charcoal	+\$87



SEATING

PLASTIC SHELL COLOR CODES (no upcharge):

Tangelo - **RG**
Regatta - **RE**
Lava - **LA**

Cherry - **CR**
Mulberry - **MB**
Onyx - **ON**

Lime - **LM**
Loft - **LO**
White - **WT**

Calypso - **CP**
Platinum - **PT**

Surf - **BU**
Shadow - **SD**

MOTIVATE® Flex-Back Chair with Tablet Arm

HMNT1

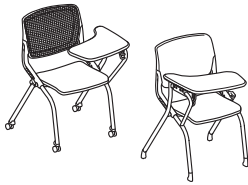

CHAIR

Flex-back with Tablet Arm

DIMENSIONS

Depth:	30 ³ / ₈	Seat to Floor Height:	18 ¹ / ₄
Width:	23 ¹ / ₂	Tablet Height from Floor:	29 ¹ / ₂
Height:	34	Ship Weight:	41
Seat Depth:	17 ¹ / ₄	Cube:	18.4
Seat Width:	17	Weight Rating:	300 lbs.
Back Width:	19 ¹ / ₂		
Back Height:	19		

LIST PRICE

\$1071

NOTES: Tablet can be specified on right or left side.

❗ Model HMNT1 is not available with an upholstered back.

❗ When selecting the mesh back option, seat shell will be in the specified shell color chosen but the frame around the mesh will always be black.

❗ Cannot be nested or stacked.

HMNT2

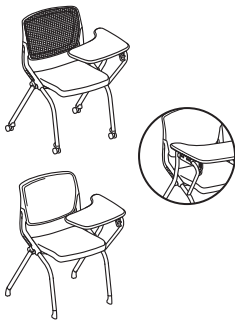

CHAIR

Flex-back with Tablet Arm
Upholstered Seat

DIMENSIONS

Depth:	30 ³ / ₈	Seat to Floor Height:	19 ¹ / ₄
Width:	23 ¹ / ₂	Tablet Height from Floor:	29 ¹ / ₂
Height:	34	Ship Weight:	42
Seat Depth:	17 ⁵ / ₈	Cube:	18.4
Seat Width:	17 ⁵ / ₈	Weight Rating:	300 lbs.
Back Width:	19 ¹ / ₂		
Back Height:	18 ³ / ₈		

FABRIC PRICE CODES

1	\$1180	8	\$1330
2	\$1207	9	\$1349
3	\$1233	10	\$1368
4	\$1252	11	\$1388
5	\$1271	12	\$1407
6	\$1291	L	—
7	\$1310		

NOTES: Tablet can be specified on right or left side.

❗ When selecting the mesh back option, seat shell will be in the specified shell color chosen but the frame around the mesh will always be black.

❗ Cannot be nested or stacked.

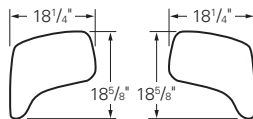

HON Recommendation: HMNT1.E.IM.ON.RT.D.PLAT - List Price \$1158

HOW TO SPECIFY

Select Model Number	Select Caster/Glide	Select Back Type	Select Shell Color	Select Fabric	Select Tablet Side	Select Tablet Color	Select Frame
HMNT1	E Standard Nylon Guide H Hard Caster S All-Surface Caster (+ \$33)	PS Plastic Shell PB Upholstered (+ \$77) <i>PB option not available on HMNT1</i> 4-Way Stretch options (+ \$87) IM Black IF Fog IC Charcoal	RG Tangelo CR Cherry LM Lime CP Calypso BU Surf RE Regatta MB Mulberry	LO Loft PT Platinum SD Shadow LA Lava ON Onyx WT White	See page 424 <i>Specify for model HMNT2 only</i>	RT Right Side LT Left Side	T Black D Natural Maple
HMNT2	E	IM	ON	CU10	RT	D	PLAT

NOTES



Nucleus® seating shown with Empower®.

NUCLEUS®

Experience comfort from the inside out. Nucleus® puts the science into seating, combining a sophisticated, high-tech aesthetic with meticulously researched ergonomic support. **The mesh back flexes with the spine while the seat cradles you like a hammock, creating your very own custom fit with targeted support.** The modern style features an organic, rounded look, making Nucleus® the family of seating that brings cool and comfortable together.



FEATURES

- Advanced suspension material in the seat combines with molded foam to create unparalleled support.
- Available in 7 colors of 4-Way-Stretch Mesh and 22 colors of Spectrum Mesh.
- Choose between armless, fixed arms, height and width adjustable, or all-adjustable arms.
- Task chairs are available in three different cylinder height options so you can find your perfect fit.
- Optional adjustable lumbar allows users to tailor their support — available in 8 colors.
- Choose from 3 frame options: Black, Titanium, and Designer White.
- Task Stools feature an adjustable footring for additional lower body support.
- Stacking chairs stack up to four high on the floor.
- Guest chairs are available with glides, hard, or all-surface casters.
- Warranted for users up to 300 lbs.
- Guest back pivots for added comfort.

NUCLEUS[®] Task Chair Options

MODEL OPTIONS

HNRI,
HNRIKD





Task Chair

HNRS



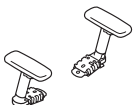
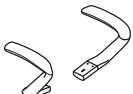

Task Stool

ARM STYLE	CODE	DESCRIPTION	PRICE
	N	Armless	+\$0
	F	Fixed Arms	+\$71
	A	Height and Width Adjustable Arms	+\$92
	V	All-Adjustable Arms (includes Pivot)	+\$141
	P	Fixed Polished Aluminum Arms	+\$189

CYLINDER	CODE	DESCRIPTION	PRICE
	STC	Standard Cylinder	+\$0
	SHC	Short Cylinder	+\$0
	TLC	Tall Cylinder	+\$0
	SC2	Stool Cylinder	+\$0

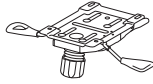
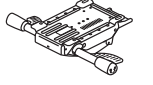
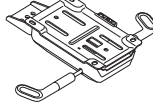
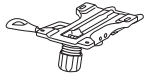
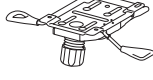
*SC2 only available on model HNRS

MECHANISM	CODE	DESCRIPTION	PRICE
	Y1	Synchro-Tilt w/ Seat Slider A, D, E, J, K, L	+\$22
	Y2	Advanced Synchro-Tilt A, D, E, J, L, A-D	+\$71
	W2	Weight-Activated with Seat Slider A, D, E, L, P	+\$71
	S0	Limited Recline Synchro-Tilt A, E, J, K, L	+\$0
	S1	Limited Recline Synchro-Tilt w/ Seat Slider A, D, E, J, K, L	+\$22

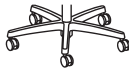
BASE	CODE	DESCRIPTION	PRICE
	SB	Standard Base	+\$0
	PA	Polished Aluminum	+\$119

NOTES: Limited finish, control, and arm options depending on base model. See product pages for details.

NUCLEUS® Task Chair Options

CASTERS



CODE	DESCRIPTION	PRICE
H	Black Hard Caster	+\$0



S	Black All-Surface Caster	+\$44
----------	--------------------------	--------------



TS	Titanium All-Surface Caster	+\$44
-----------	-----------------------------	--------------



R	Roll Control Caster	+\$55
----------	---------------------	--------------



G	Bell Glide	+\$28
----------	------------	--------------

BACK STYLE

CODE	DESCRIPTION	PRICE
------	-------------	-------

4-Way Stretch mesh back options:

IM	Black	+\$0
IB	Breeze	+\$0
IK	Brownstone	+\$0
IC	Charcoal	+\$0
IF	Fog	+\$0
IR	Regatta	+\$0
IT	Titanium	+\$0

Spectrum mesh back options:

RM27	Beacon	+\$25
RM20	Blueberry	+\$25
RM16	Brick	+\$25
RM17	Bullseye	+\$25
RM10	Carbon	+\$25
RM28	Chalk	+\$25
RM14	Cobalt	+\$25
RM15	Espresso	+\$25
RM31	Gold Dust	+\$25
RM23	Kermit	+\$25
RM32	Key Lime	+\$25
RM21	Leaf	+\$25
RM30	Linen	+\$25
RM12	Loft	+\$25
RM24	Midnight	+\$25
RM13	Onyx	+\$25
RM29	Pear	+\$25
RM33	Quicksand	+\$25
RM25	Salamander	+\$25
RM19	Sky	+\$25
RM26	Steel	+\$25
RM11	Titanium	+\$25

FRAME

CODE	DESCRIPTION	PRICE
T	Black	+\$0

Model HNR1 and HNRS available with above Frame option along with those below:

		Task	Stool
TI	Titanium	+\$39	+\$60
DWX	Designer White	+\$39	+\$60

LUMBAR

CODE	DESCRIPTION	PRICE
NL	No Lumbar	+\$0
BL	Black	+\$33
TL	Titanium	+\$33
DW	Designer White	+\$33
BY	Bullseye	+\$33
KT	Krypton	+\$33
MR	Ember	+\$33
RE	Regatta	+\$33
IR	Iris	+\$33

NUCLEUS® Guest and Multi-Purpose Options

MODEL OPTION

HNR6



Guest Chair

Four Legs

ARM STYLE

CODE	DESCRIPTION	PRICE
N	Armless	+\$0
F	Fixed Arms	+\$33



HNR6 Fixed Arms

CASTERS/ GLIDE

CODE	DESCRIPTION	PRICE
H	Black Hard Caster	+\$0
S	Black All-Surface Caster	+\$33
E	Glide	+\$0



BACK STYLE

CODE	DESCRIPTION	PRICE
------	-------------	-------

Spectrum mesh back options:

RM27	Beacon	+\$25
RM20	Blueberry	+\$25
RM16	Brick	+\$25
RM17	Bullseye	+\$25
RM10	Carbon	+\$25
RM28	Chalk	+\$25
RM14	Cobalt	+\$25
RM15	Espresso	+\$25
RM31	Gold Dust	+\$25
RM23	Kermit	+\$25
RM32	Key Lime	+\$25
RM21	Leaf	+\$25
RM30	Linen	+\$25
RM12	Loft	+\$25
RM24	Midnight	+\$25
RM13	Onyx	+\$25
RM29	Pear	+\$25
RM33	Quicksand	+\$25
RM25	Salamander	+\$25
RM19	Sky	+\$25
RM26	Steel	+\$25
RM11	Titanium	+\$25

BACK STYLE

CODE	DESCRIPTION	PRICE
------	-------------	-------

4-Way Stretch mesh back options:

IM	Black	+\$0
IB	Breeze	+\$0
IK	Brownstone	+\$0
IC	Charcoal	+\$0
IF	Fog	+\$0
IR	Regatta	+\$0
IT	Titanium	+\$0

*HNR6 back pivots to flex to the desired position.
Available on HNR6 only.*



FRAME COLOR

CODE	DESCRIPTION	PRICE
T	Black	+\$0
DWX	Designer White	+\$39
TI	Titanium	+\$39

BASE PAINT COLOR

CODE	DESCRIPTION	PRICE
------	-------------	-------

Model HNR6 available in the following Frame options:

P71	Black	+\$0
CBK	Charblack	+\$0
P8V	Textured Titanium	+\$39
PK7	Textured Designer White	+\$39

HON BRANDED FABRICS

GRADE 1

Apex
Centurion
Compass
Contourett
Dapper
Emphasis
Ensemble
Hamilton
Noble Seating
Pebble
Vibe

GRADE 2

Appoint Seating
Blume
Clyde
Haute
Kai
Rush
Spectrum Mesh
Spin Seating
Wavelength
Whisper Vinyl

GRADE 3

Bradbury
Cozy
Getaway
Moxie
Notion
Parker
Purl
Quill
Saxony

GRADE 4

Constance with Supreen™
Livi with Supreen™
Lucerne
Lugano with Supreen™
Oxford with Supreen™

GRADE L

Davenport Leather*

For a complete list of fabrics, including partnership fabrics, go to hon.com/fabricsandfinishes.

Reference Fabric Color Combinations on pages 20-25 for color codes and legend on page 21 for lead times. For additional HON to Supply COM fabric grade pricing, go to hon.com and click on the HON to Supply COM link.

*Davenport Leather available on Nucleus[®] Recharged models only. Leather not available on Nucleus[®] Guest.

NUCLEUS[®] Dimensions

NUCLEUS[®] RECHARGED TASK

Control	Y1												
	Armless			Fixed*			2D			4D			
	Standard	Short	Tall	Standard	Short	Tall	Standard	Short	Tall	Standard	Short	Tall	
Max Width	29.00	29.00	29.00	29.00	29.00	29.00	29.00	29.00	29.00	29.00	29.00	29.00	29.00
Max Depth	29.00	29.00	29.00	29.00	29.00	29.00	29.00	29.00	29.00	29.00	29.00	29.00	29.00
Max Height	42.75	40.82	46.25	42.75	40.82	46.25	42.75	40.82	46.25	42.75	40.82	46.25	
Chair Weight**	29.20	28.80	29.60	35.50	35.10	35.90	32.90	32.50	33.30	33.10	32.70	33.50	
Shipping Weight**	38.10	37.70	38.50	44.40	44.00	44.80	41.80	41.40	42.20	44.00	41.60	42.40	
Shipping Weight (KD)**	NA	NA	NA	NA	NA	NA	40.80	NA	NA	NA	NA	NA	
Cubes	10.73	10.73	10.73	10.73	10.73	10.73	10.73	10.73	10.73	10.73	10.73	10.73	
Cubes (KD)	NA	NA	NA	NA	NA	NA	7.92	NA	NA	NA	NA	NA	
Seat Width	18.70	18.70	18.70	18.70	18.70	18.70	18.70	18.70	18.70	18.70	18.70	18.70	
Seat Usable Depth	17.91 - 19.76	17.91 - 19.76	17.91 - 19.76	17.91 - 19.76	17.91 - 19.76	17.91 - 19.76	17.91 - 19.76	17.91 - 19.76	17.91 - 19.76	17.91 - 19.76	17.91 - 19.76	17.91 - 19.76	
Seat Height from Floor	16.25 - 20.125	15.68 - 18.20	18.46 - 23.63	16.25 - 20.125	15.68 - 18.20	18.46 - 23.63	16.25 - 20.125	15.68 - 18.20	18.46 - 23.63	16.25 - 20.125	15.68 - 18.20	18.46 - 23.63	
Seat Depth	18	18	18	18	18	18	18	18	18	18	18	18	
Back Lumbar Height	5.9 - 9.4	5.9 - 9.4	5.9 - 9.4	5.9 - 9.4	5.9 - 9.4	5.9 - 9.4	5.9 - 9.4	5.9 - 9.4	5.9 - 9.4	5.9 - 9.4	5.9 - 9.4	5.9 - 9.4	
Back Width	18.63	18.63	18.63	18.63	18.63	18.63	18.63	18.63	18.63	18.63	18.63	18.63	
Back Height	23.94	23.94	23.94	23.94	23.94	23.94	23.94	23.94	23.94	23.94	23.94	23.94	
Seat Angle from Floor	-1.60	-1.60	-1.60	-1.60	-1.60	-1.60	-1.60	-1.60	-1.60	-1.60	-1.60	-1.60	
Seat Angle Reclined	-10.60	-10.60	-10.60	-10.60	-10.60	-10.60	-10.60	-10.60	-10.60	-10.60	-10.60	-10.60	
Back Angle from Seat	94.00	94.00	94.00	94.00	94.00	94.00	94.00	94.00	94.00	94.00	94.00	94.00	
Back Angle Reclined	112.00	112.00	112.00	112.00	112.00	112.00	112.00	112.00	112.00	112.00	112.00	112.00	
Distance Between Arms	NA	NA	NA	30.38	30.38	30.38	16.50 - 19.63	16.50 - 19.63	16.50 - 19.63	16.50 - 19.63	16.50 - 19.63	16.50 - 19.63	
Arm Height from Floor	NA	NA	NA	25 - 28.88	24.43 - 26.95	27.21 - 32.38	24 - 31.88	23.43 - 29.95	26.21 - 35.38	24 - 31.88	23.43 - 22.07	26.21 - 35.38	
Arm Height from Seat	NA	NA	NA	6.63	6.63	6.63	5.69 - 9.5	5.69 - 9.5	5.69 - 9.5	5.69 - 9.5	5.69 - 9.5	5.69 - 9.5	
Arm Width	NA	NA	NA	2.25	2.25	2.25	3.19	3.19	3.19	3.19	3.19	3.19	
Arm Length	NA	NA	NA	9.84	9.84	9.84	10.16	10.16	10.16	10.16	10.16	10.16	
Arm Set-Back	NA	NA	NA	2.99 - 4.94	2.99 - 4.95	2.99 - 4.96	3.93 - 5.78	3.93 - 5.78	3.93 - 5.78	3.93 - 5.78	3.93 - 5.78	3.93 - 5.78	

Control	Y2											
	Armless			Fixed*			2D			4D		
	Standard	Short	Tall	Standard	Short	Tall	Standard	Short	Tall	Standard	Short	Tall
Max Width	29.00	29.00	29.00	29.00	29.00	29.00	29.00	29.00	29.00	29.00	29.00	29.00
Max Depth	29.00	29.00	29.00	29.00	29.00	29.00	29.00	29.00	29.00	29.00	29.00	29.00
Max Height	43.38	41.45	46.88	43.38	41.45	46.88	43.38	41.45	46.88	43.38	41.45	46.88
Chair Weight**	31.20	30.80	31.60	37.50	37.10	37.90	34.90	34.50	35.30	35.10	34.70	35.50
Shipping Weight**	40.10	39.70	40.50	46.40	46.00	46.80	43.80	43.40	44.20	44.00	43.60	44.40
Shipping Weight (KD)**	NA	NA	NA	NA	NA	NA	40.80	NA	NA	NA	NA	NA
Cubes	10.73	10.73	10.73	10.73	10.73	10.73	10.73	10.73	10.73	10.73	10.73	10.73
Cubes (KD)	NA	NA	NA	NA	NA	NA	7.92	NA	NA	NA	NA	NA
Seat Width	18.70	18.70	18.70	18.70	18.70	18.70	18.70	18.70	18.70	18.70	18.70	18.70
Seat Usable Depth	18.27 - 21.06	18.27 - 21.06	18.27 - 21.06	18.27 - 21.06	18.27 - 21.06	18.27 - 21.06	18.27 - 21.06	18.27 - 21.06	18.27 - 21.06	18.27 - 21.06	18.27 - 21.06	18.27 - 21.06
Seat Height from Floor	16.63 - 21.13	16.06 - 19.20	18.84 - 24.63	16.63 - 21.13	16.06 - 19.20	18.84 - 24.63	16.63 - 21.13	16.06 - 19.20	18.84 - 24.63	16.63 - 21.13	16.06 - 19.20	18.84 - 24.63
Seat Depth	18	18	18	18	18	18	18	18	18	18	18	18
Back Lumbar Height	5.9 - 9.4	5.9 - 9.4	5.9 - 9.4	5.9 - 9.4	5.9 - 9.4	5.9 - 9.4	5.9 - 9.4	5.9 - 9.4	5.9 - 9.4	5.9 - 9.4	5.9 - 9.4	5.9 - 9.4
Back Width	18.63	18.63	18.63	18.63	18.63	18.63	18.63	18.63	18.63	18.63	18.63	18.63
Back Height	23.75	23.75	23.75	23.75	23.75	23.75	23.75	23.75	23.75	23.75	23.75	23.75
Seat Angle from Floor	-2.70	-2.70	-2.70	-2.70	-2.70	-2.70	-2.70	-2.70	-2.70	-2.70	-2.70	-2.70
Seat Angle Reclined	-10.60	-10.60	-10.60	-10.60	-10.60	-10.60	-10.60	-10.60	-10.60	-10.60	-10.60	-10.60
Back Angle from Seat	94.00	94.00	94.00	94.00	94.00	94.00	94.00	94.00	94.00	94.00	94.00	94.00
Back Angle Reclined*	111.00	111.00	111.00	111.00	111.00	111.00	111.00	111.00	111.00	111.00	111.00	111.00
Distance Between Arms	NA	NA	NA	30.38	30.38	30.38	16.50 - 19.63	16.50 - 19.63	16.50 - 19.63	16.50 - 19.63	16.50 - 19.63	16.50 - 19.63
Arm Height from Floor	NA	NA	NA	25.5 - 29.38	24.93 - 27.45	27.71 - 32.88	24.5 - 32.25	23.93 - 30.32	26.71 - 35.75	24.5 - 32.25	23.93 - 30.32	26.71 - 35.75
Arm Height from Seat	NA	NA	NA	6.63	6.63	6.63	5.69 - 9.31	5.69 - 9.31	5.69 - 9.31	5.69 - 9.31	5.69 - 9.31	5.69 - 9.31
Arm Width	NA	NA	NA	2.25	2.25	2.25	3.19	3.19	3.19	3.19	3.19	3.19
Arm Length	NA	NA	NA	9.84	9.84	9.84	10.16	10.16	10.16	10.16	10.16	10.16
Arm Set-Back	NA	NA	NA	2.66 - 4.16	2.66 - 4.16	2.66 - 4.16	3.97 - 6.76	3.97 - 6.76	3.97 - 6.76	3.97 - 6.76	3.97 - 6.76	3.97 - 6.76

Weight
Adds

**Base Polished Aluminum = 1.40 lbs.
*Fixed Arm Polished Aluminum = 1.50 lbs.

NUCLEUS® RECHARGED TASK

Control	W2											
	Armless			Fixed*			2D			4D		
Arms												
Cylinder	Standard	Short	Tall	Standard	Short	Tall	Standard	Short	Tall	Standard	Short	Tall
Max Width	29.00	29.00	29.00	29.00	29.00	29.00	29.00	29.00	29.00	29.00	29.00	29.00
Max Depth	29.00	29.00	29.00	29.00	29.00	29.00	29.00	29.00	29.00	29.00	29.00	29.00
Max Height	43.00	41.07	46.50	42.75	43.00	41.07	46.50	42.75	43.00	41.07	46.50	42.75
Chair Weight**	29.20	28.80	29.60	35.50	35.10	35.90	32.90	32.50	33.30	33.10	32.70	33.50
Shipping Weight**	38.10	37.70	38.50	44.40	44.00	44.80	41.80	41.40	42.20	44.00	41.60	42.40
Shipping Weight (KD)**	NA	NA	NA	NA	NA	NA	40.80	NA	NA	NA	NA	NA
Cubes	10.73	10.73	10.73	10.73	10.73	10.73	10.73	10.73	10.73	10.73	10.73	10.73
Cubes (KD)	NA	NA	NA	NA	NA	NA	7.92	NA	NA	NA	NA	NA
Seat Width	18.70	18.70	18.70	18.70	18.70	18.70	18.70	18.70	18.70	18.70	18.70	18.70
Seat Usable Depth	17.88 - 19.80	17.88 - 19.80	17.88 - 19.80	17.88 - 19.80	17.88 - 19.80	17.88 - 19.80	17.88 - 19.80	17.88 - 19.80	17.88 - 19.80	17.88 - 19.80	17.88 - 19.80	17.88 - 19.80
Seat Height from Floor	15.88 - 20	15.30 - 18.07	18.09 - 23.5	15.88 - 20	15.30 - 18.07	18.09 - 23.5	15.88 - 20	15.30 - 18.07	18.09 - 23.5	15.88 - 20	15.30 - 18.07	18.09 - 23.5
Seat Depth	18	18	18	18	18	18	18	18	18	18	18	18
Back Lumbar Height	5.9 - 9.4	5.9 - 9.4	5.9 - 9.4	5.9 - 9.4	5.9 - 9.4	5.9 - 9.4	5.9 - 9.4	5.9 - 9.4	5.9 - 9.4	5.9 - 9.4	5.9 - 9.4	5.9 - 9.4
Back Width	18.63	18.63	18.63	18.63	18.63	18.63	18.63	18.63	18.63	18.63	18.63	18.63
Back Height	23.68	23.68	23.68	23.68	23.68	23.68	23.68	23.68	23.68	23.68	23.68	23.68
Seat Angle from Floor	-0.40	-0.40	-0.40	-0.40	-0.40	-0.40	-0.40	-0.40	-0.40	-0.40	-0.40	-0.40
Seat Angle Reclined	-5.10	-5.10	-5.10	-5.10	-5.10	-5.10	-5.10	-5.10	-5.10	-5.10	-5.10	-5.10
Back Angle from Seat	96.00	96.00	96.00	96.00	96.00	96.00	96.00	96.00	96.00	96.00	96.00	96.00
Back Angle Reclined	115.00	115.00	115.00	115.00	115.00	115.00	115.00	115.00	115.00	115.00	115.00	115.00
Distance Between Arms	NA	NA	NA	30.38	30.38	30.38	16.50 - 19.63	16.50 - 19.63	16.50 - 19.63	16.50 - 19.63	16.50 - 19.63	16.50 - 19.63
Arm Height from Floor	NA	NA	NA	25 - 28.88	24.43 - 26.95	27.21 - 32.38	24.06 - 31.88	23.5 - 29.95	26.27 - 35.38	24.06 - 31.88	23.5 - 29.95	26.27 - 35.38
Arm Height from Seat	NA	NA	NA	6.63	6.63	6.63	5.69 - 9.38	5.69 - 9.38	5.69 - 9.38	5.69 - 9.38	5.69 - 9.38	5.69 - 9.38
Arm Width	NA	NA	NA	2.25	2.25	2.25	3.19	3.19	3.19	3.19	3.19	3.19
Arm Length	NA	NA	NA	9.84	9.84	9.84	10.16	10.16	10.16	10.16	10.16	10.16
Arm Set-Back	NA	NA	NA	2.83 - 4.75	2.83 - 4.75	2.83 - 4.75	3.95 - 5.88	3.95 - 5.88	3.95 - 5.88	3.95 - 5.88	3.95 - 5.88	3.95 - 5.88

Control	S0				S1			
	Armless	Fixed*	2D	4D	Armless	Fixed*	2D	4D
Arms								
Cylinder	Stool	Stool	Stool	Stool	Stool	Stool	Stool	Stool
Max Width	29.00	29.00	29.00	29.00	29.00	29.00	29.00	29.00
Max Depth	29.00	29.00	29.00	29.00	29.00	29.00	29.00	29.00
Max Height	56.50	56.50	56.50	56.50	56.50	56.50	56.50	56.50
Chair Weight**	34.35	40.65	38.05	36.75	35.20	41.50	38.90	37.60
Shipping Weight**	45.35	51.65	49.05	47.75	46.20	52.50	49.90	48.60
Cubes	12.11	12.11	12.11	12.11	12.11	12.11	12.11	12.11
Seat Width	18.70	18.70	18.70	18.70	18.70	18.70	18.70	18.70
Seat Usable Depth	18.50	18.50	18.50	18.50	17.83 - 19.33	17.83 - 19.33	17.83 - 19.33	17.83 - 19.33
Seat Height from Floor	23.44 - 33	23.44 - 33	23.44 - 33	23.44 - 33	23.44 - 33	23.44 - 33	23.44 - 33	23.44 - 33
Seat Depth	18	18	18	18	18	18	18	18
Back Lumbar Height	5.9 - 9.4	5.9 - 9.4	5.9 - 9.4	5.9 - 9.4	5.9 - 9.4	5.9 - 9.4	5.9 - 9.4	5.9 - 9.4
Back Width	18.63	18.63	18.63	18.63	18.63	18.63	18.63	18.63
Back Height	23.94	23.94	23.94	23.94	23.94	23.94	23.94	23.94
Seat Angle from Floor	-1.50	-1.50	-1.50	-1.50	-1.50	-1.50	-1.50	-1.50
Seat Angle Reclined	-7.00	-7.00	-7.00	-7.00	-7.00	-7.00	-7.00	-7.00
Back Angle from Seat	96.00	96.00	96.00	96.00	96.00	96.00	96.00	96.00
Back Angle Reclined*	105.00	105.00	105.00	105.00	105.00	105.00	105.00	105.00
Distance Between Arms	NA	30.38	16.5 - 19.63	16.5 - 19.63	NA	30.38	16.5 - 19.63	16.5 - 19.63
Arm Height from Floor	NA	32.25 - 42.5	31.25 - 45.38	31.25 - 45.38	NA	32.25 - 42.5	31.25 - 45.38	31.25 - 45.38
Arm Height from Seat	NA	6.63	5.63 - 9.5	5.63 - 9.5	NA	6.63	5.63 - 9.5	5.63 - 9.5
Arm Width	NA	2.25	3.19	3.19	NA	2.25	3.19	3.19
Arm Length	NA	9.84	10.16	10.16	NA	9.84	10.16	10.16
Arm Set-Back	NA	2.66 - 4.16	3.66 - 5.16	3.66 - 5.16	NA	2.66 - 4.16	3.66 - 5.16	3.66 - 5.16

Weight
Adders

**Base Polished Aluminum = 1.40 lbs.
*Fixed Arm Polished Aluminum = 1.50 lbs.

HNRI

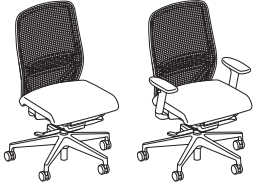

TASK CHAIR

4-Way Stretch or Spectrum Mesh Back

- Pneumatic
- Swivel
- Seat Glide
- Synchro-tilt
- Tilt Tension
- Tilt Lock

DIMENSIONS

Depth:	29	Arm Width:	16½-19¾
Width:	29	Seat to Floor Height:	16¼-20⅞
Height:	42¾	Usable Seat Depth:	18-19¾
Seat Depth:	18	Ship Weight:	41.8
Seat Width:	18¾	Cube:	10.7
Back Width:	18⅞	COM:	1.0
Back Height:	24	Weight Rating:	300 lbs.

FABRIC PRICE CODES

1	\$843	8	\$993
2	\$870	9	\$1012
3	\$896	10	\$1031
4	\$915	11	\$1051
5	\$934	12	\$1070
6	\$954	L	\$1142
7	\$973		

HON Recommendation: HNRI.Y2.STC.A.H.IM.CU__BL.SB.T - List Price \$1039

HOW TO SPECIFY

Select Model Number	Select Control Type	Select Cylinder	Select Arm Type	Select Caster	Select Back Type	Select Fabric	Select Lumbar	Select Base	Select Frame
Y1 Synchro-Tilt w/ Seat Slider (+ \$22)	STC Standard Cylinder	N Armless	H Hard Caster	See page 439	See page 441	See page 439	SB Standard Base	T Black (+ \$0)	
Y2 Advanced Synchro-Tilt (+ \$71)	SHC Short Cylinder	A Height and Width Adjustable Arms (+ \$92)	S Black All-Surface Caster (+ \$44)			<i>Adding lumbar (+ \$33)</i>	PA Polished Aluminum (+ \$119)	DWX Designer White (+ \$39)	
W2 Weight-Activated w/ Seat Slider (+ \$71)	TLC Tall Cylinder	V All-Adjustable Arms (+ \$141)	TS Titanium All-Surface Caster (+ \$44)					TI Titanium (+ \$39)	
		F Fixed Arms (+ \$71)	R Roll Control Caster (+ \$55)						
		P Fixed Polished (+ \$189)	G Bell Glide (+ \$28)						
HNRI	Y1	STC	A	S	IM	CU10	DW	SB	DWX



Icon Legend on page 19

NUCLEUS®

HNR1KD



TASK CHAIR KD

4-Way Stretch or Spectrum Mesh Back

- Pneumatic
- Swivel
- Seat Glide
- Synchro-tilt
- Tilt Tension
- Tilt Lock

i KD (Knock Down) requires arm, back, and cylinder assembly on site.

DIMENSIONS

Depth:	29	Arm Width:	16½-19¾
Width:	29	Seat to Floor Height:	16¼-20⅞
Height:	42¾	Usable Seat Depth:	18-19¾
Seat Depth:	18	Ship Weight:	40.8
Seat Width:	18¾	Cube:	10.7
Back Width:	18⅞	COM:	1.0
Back Height:	24	Weight Rating:	300 lbs.

FABRIC PRICE CODES

1	\$803	8	\$953
2	\$830	9	\$972
3	\$856	10	\$991
4	\$875	11	\$1011
5	\$894	12	\$1030
6	\$914	L	\$1102
7	\$933		

HON Recommendation: HNR1KD.Y2.STC.A.H.IM.CU__BL.SB.T - List Price \$999

HOW TO SPECIFY

Select Model Number	Select Control Type	Select Cylinder	Select Arm Type	Select Caster	Select Back Type	Select Fabric	Select Lumbar	Select Base	Select Frame
Y1 Synchro-Tilt w/ Seat Slider (+ \$22) Y2 Advanced Synchro-Tilt (+ \$71) W2 Weight-Activated w/ Seat Slider (+ \$71)	STC Standard	N Armless A Height and Width Adjustable Arms (+ \$92)	H Hard Caster	See page 439	See page 441	See page 439 <i>Adding lumbar (+ \$33)</i>	SB Standard Base PA Polished Aluminum (+ \$119)	T Black (+ \$0) DWX Designer White (+ \$39) TI Titanium (+ \$39)	
HNR1KD	Y1	STC	A	H	IM	CU10	DW	SB	DWX

HNRS



TASK STOOL

4-Way Stretch or Spectrum Mesh Back

- Pneumatic
- Swivel
- Seat Glide
- Synchro-tilt
- Tilt Tension
- Tilt Lock

DIMENSIONS

Depth:	29	Arm Width:	16½-19¾
Width:	29	Seat to Floor Height:	23¾-33
Height:	56½	Usable Seat Depth:	17⅞-19¾
Seat Depth:	18	Ship Weight:	49.9
Seat Width:	18¾	Cube:	12.11
Back Width:	18⅞	COM:	1.0
Back Height:	24	Weight Rating:	300 lbs.

FABRIC PRICE CODES

1	\$970	8	\$1120
2	\$997	9	\$1139
3	\$1023	10	\$1158
4	\$1042	11	\$1178
5	\$1061	12	\$1197
6	\$1081	L	\$1269
7	\$1100		

HON Recommendation: HNRS.S1.SC2.A.H.IM.CU__BL.SB.T - List Price \$1117

HOW TO SPECIFY

Select Model Number	Select Control Type	Select Cylinder	Select Arm Type	Select Caster	Select Back Type	Select Fabric	Select Lumbar	Select Base	Select Frame
S0 Limited Recline Synchro-Tilt S1 Limited Recline Synchro-Tilt w/ Seat Slider (+ \$22)	SC2 Stool Cylinder	N Armless A Height and Width Adjustable Arms (+ \$92) V All-Adjustable Arms (+ \$141) F Fixed Arms (+ \$71) P Fixed Polished (+ \$189)	H Black Hard Caster S Black All-Surface Caster (+ \$44) TS Titanium All-Surface Caster (+ \$44) R Roll Control Caster (+ \$55) G Bell Glide (+ \$28)	See page 439	See page 441	See page 439	SB Standard Base PA Polished Aluminum (+ \$119)	T Black (+ \$0) DWX Designer White (+ \$60) TI Titanium (+ \$60)	
H N R S	S 1	S C 2	A	S	I M	C U 1 0	D W	S B	D W X



Icon Legend on page 19

NUCLEUS®

HNR6

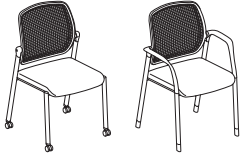

GUEST CHAIR

4-Way Stretch or Spectrum Mesh Back
Four Legs

DIMENSIONS

Depth:	23½	Arm Width:	21-24 ¹⁵ / ₁₆
Width:	20 ⁹ / ₁₆	Seat to Floor Height:	17 ⁵ / ₈
Height:	36 ³ / ₈	Usable Seat Depth:	17 ¹¹ / ₁₆
Seat Depth:	19½	Ship Weight:	20
Seat Width:	19	Cube:	15.8
Back Width:	17	COM:	1.0
Back Height:	19 ⁹ / ₁₆	Weight Rating:	300 lbs.

FABRIC PRICE CODES

1	\$623	8	\$773
2	\$650	9	\$792
3	\$676	10	\$811
4	\$695	11	\$831
5	\$714	12	\$850
6	\$734	L	\$922
7	\$753		

NOTES: Back includes pivot for added comfort.

HON Recommendation: HNR6.F.E.IM.CU__T.P71 - List Price \$656

HOW TO SPECIFY

Select Model Number	Select Arm Type	Select Caster/Glide	Select Back Type	Select Fabric	Select Frame Color	Select Base Paint Color
	F Fixed Arms (+ \$33) N Armless	E Glide H Black Hard Caster S Black All-Surface Caster (+ \$33)	See page 440	See page 441	T Black DWX Designer White (+ \$39) TI Titanium (+ \$39)	P71 Black CBK Charblack P8V Textured Titanium (+ \$39) PK7 Textured Designer White (+ \$39)
HNR6	F	H	IM	CU10	DWX	P71

HIGH-DENSITY OLSON STACKER® 4040 SERIES

Want to see more?
Scan here to check
out hon.com.



Olson Stacker.

HIGH-DENSITY OLSON STACKER® 4040 SERIES

Adaptable spaces such as multi-purpose and training areas demand a chair equally flexible. Olson stacking chairs fit that bill with a lightweight frame that is easy to move throughout a space. Chairs stack up to 12 high on the floor or up to 40 high on their specially designed cart to maximize floor space when not in use. A convenient cutout in the back makes it easy to pick up and move, while the molded seat shells deliver surprising comfort. Olson stacking chairs ship in sets of four to accommodate large groups. With Olson, the benefits really stack up.



FEATURES

- Chairs ship four per carton.
- Contoured seat and back shell provide targeted support.
- Integrated lumbar support delivers long-lasting comfort.
- Integrated handle makes chair easy to carry.
- Optional ganging brackets connect chairs to form neat rows.
- Stacks up to 12 high on floor.
- Stacks up to 40 high on cart.
- Shell colors are CA Technical Bulletin 133 compliant.
- Warranted for users up to 300 lbs.



Icon Legend on page 19

HIGH-DENSITY OLSON STACKER® 4040 Series

H4041



POLYMER SEAT AND BACK DIMENSIONS

7/16" Steel Rod Frame
Chrome Legs

Depth:	21 5/8	Seat to Floor Height:	17 3/4
Width:	19 5/8	Usable Seat Depth:	17
Height:	30 5/8	Ship Weight:	57
Seat Depth:	18 3/4	Cube:	10.6
Seat Width:	17 3/4	Weight Rating:	300 lbs.
Back Width:	17 1/2		
Back Height:	16 1/4		

LIST PRICE PER CARTON

\$1017
(reference single unit @ \$254.25)

⊕ 4040 Series is ordered and shipped four (4) chairs per carton. Pricing shown is per carton. Each set of four (one carton), must have the same shell color. Ordering 2 of Model H4041 will result in 2 cartons being shipped, giving you 8 chairs.

⚠ Shipped fully assembled — 4 chairs per carton. All High-Density Olson Stacker® shell colors are CA Technical Bulletin 133 compliant (no upcharge).

H4043

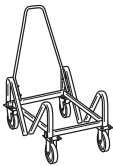

CART FOR STACKING CHAIRS

DIMENSIONS

Depth:	35 1/2	Ship Weight:	34
Width:	21 3/8	Cube:	7.8
Height:	37		

LIST PRICE

\$709

NOTES: Holds 40 stack chairs (6'-8"), some assembly required. (Chairs stack 12 high without cart.)

⚠ Specify Black paint (T) ONLY.

H4048

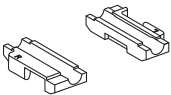

GANGING CHAIR GLIDES

DIMENSIONS

Box of 48	Ship Weight:	1
For use on models H4041, HG51 and HG52	Cube:	0.04

LIST PRICE

\$160

H4049

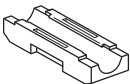

NON-GANGING CHAIR GLIDES

DIMENSIONS

Box of 48	Ship Weight:	1
For use on models H4041, HFLEX01, HG51 and HG52	Cube:	0.04

LIST PRICE

\$126

HOW TO SPECIFY

<p>Select Model Number</p> <p>H 4 0 4 1 .</p>	<p>Select Shell Color</p> <table border="0"> <tr> <td>RG Tangelo</td> <td>LO Loft</td> </tr> <tr> <td>CR Cherry</td> <td>PT Platinum</td> </tr> <tr> <td>LM Lime</td> <td>SD Shadow</td> </tr> <tr> <td>CP Calypso</td> <td>LA Lava</td> </tr> <tr> <td>BU Surf</td> <td>ON Onyx</td> </tr> <tr> <td>RE Regatta</td> <td>WT White</td> </tr> <tr> <td>MB Mulberry</td> <td></td> </tr> </table> <p>ON .</p>	RG Tangelo	LO Loft	CR Cherry	PT Platinum	LM Lime	SD Shadow	CP Calypso	LA Lava	BU Surf	ON Onyx	RE Regatta	WT White	MB Mulberry		<p>Select Frame</p> <p>Y Chrome</p> <p>Y</p>
RG Tangelo	LO Loft															
CR Cherry	PT Platinum															
LM Lime	SD Shadow															
CP Calypso	LA Lava															
BU Surf	ON Onyx															
RE Regatta	WT White															
MB Mulberry																

SEATING



Parkwyn™ Lounge Seating
shown with Occasional Tables.

PARKWYN™

The Parkwyn™ series offers soft, comfort, ample support, and clean lines in a cozy reception area to welcome guests or in a shared space for collaboration. With a choice of a club chair, loveseat, sofa, and coordinating ottoman, this soft seating collection provides smart sophistication with a budget-friendly bottom line.



FEATURES

- Parkwyn's soft, contoured profile allows it to work in many settings including reception lobbies, collaboration areas, and private offices.
- Models include single-seat club chair, two-seat loveseat, three-seat sofa, and coordinating ottoman.
- Choice of black polyurethane with black metal legs or gray fabric with medium oak wood legs.
- Back cushions attach with integrated Velcro to maintain user support and comfort and retain long-term structure.
- Back cushions are removable for easy cleaning.
- Tall legs offer a contemporary look while making it easy to clean underneath.
- Simple, toolless assembly with the legs screwed in by hand, and easy movement with lightweight construction.
- Club chair and ottoman are small-package shippable.

MODEL OPTIONS

HVLVL1

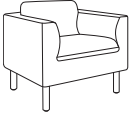

Lounge

Single-Seat Club Chair

HVLVL2



Lounge

Loveseat

HVLVL3

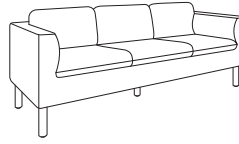

Lounge

Sofa

HVLVLOT



Lounge

Ottoman

NOTES: Black polyurethane models are available with black metal legs and gray fabric models are available with medium oak wood legs.

PARKWYN™ Club/Lounge



Icon Legend on page 19

HVLVL1

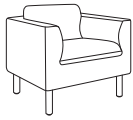

CLUB CHAIR

DIMENSIONS

Depth:	26¾	Arm Width:	5½
Width:	33	Seat to Floor Height:	18¾
Height:	30	Usable Seat Depth:	18
Seat Depth:	18	Ship Weight:	45
Seat Width:	21½	Cube:	10.2
Back Width:	21½	Weight Rating:	300 lbs.
Back Height:	25¾		

LIST PRICE

\$1506

NOTES: HON 5-Year Limited Warranty.

HVLVL2

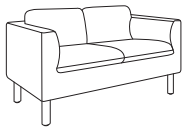

LOVESEAT

DIMENSIONS

Depth:	26¾	Arm Width:	5½
Width:	53½	Seat to Floor Height:	18¾
Height:	30	Usable Seat Depth:	18
Seat Depth:	18	Ship Weight:	65
Seat Width:	42½	Cube:	17.2
Back Width:	42½	Weight Rating:	300 lbs. (per seat)
Back Height:	25¾		

LIST PRICE

\$2055

NOTES: HON 5-Year Limited Warranty.

HVLVL3

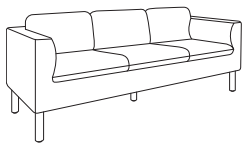

SOFA

DIMENSIONS

Depth:	26¾	Arm Width:	5½
Width:	77	Seat to Floor Height:	18¾
Height:	30	Usable Seat Depth:	19¾
Seat Depth:	19¾	Ship Weight:	85
Seat Width:	65¾	Cube:	24.7
Back Width:	65¾	Weight Rating:	300 lbs. (per seat)
Back Height:	25¾		

LIST PRICE

\$2575

NOTES: HON 5-Year Limited Warranty.

HVLVLOT



OTTOMAN

DIMENSIONS

Depth:	23¼
Width:	23¼
Height:	18¼
Ship Weight:	22
Cube:	3.6
Weight Rating:	300 lbs.

LIST PRICE

\$1047

NOTES: HON 5-Year Limited Warranty.

SEATING

HOW TO SPECIFY

Select
Model Number

Select
Fabric

BLK01 Black Polyurethane
GRY02 Gray Fabric

H V L V L 1 .

B L K 0 1

PERPETUAL[®] NESTING CHAIRS

Want to see more? Scan here
to check out [hon.com](https://www.hon.com).



Perpetual Nesting Chairs and Huddle[®] Tables.

PERPETUAL[®] NESTING CHAIRS

Provide full-time comfort to even part-time workers with the Perpetual line of multi-purpose seating. The flip-up seat design maximizes space by allowing Perpetual to be easily nested. The passive back design moves with the user to deliver added comfort for all day meetings. Save space without sacrificing comfort with Perpetual.



FEATURES

- Flip-up seat allows chairs to nest and save floor space.
- Backrest reclines for added comfort.
- Tube rolled steel frame adds durability.
- Underside of seat is fully-upholstered for a clean appearance when nested.
- All-surface casters roll effortlessly and silently.
- Available in hundreds of quality HON fabrics.
- Warranted for users up to 300 lbs.

PERPETUAL[®] Nesting Chairs Options

MODEL OPTIONS

HPN1



Nesting Chair (Flex-back)

Armless, Four Legs

HPN2



Nesting Chair (Flex-back)

Fixed Arms, Four Legs

CASTER/ GLIDE



CODE	DESCRIPTION	PRICE
A	All-Surface	+\$0
G	Bell Glide	+\$28

FRAME

CODE	DESCRIPTION	PRICE
T	Black	+\$0
T1	Platinum Metallic	+\$0

BACK STYLE



CODE	DESCRIPTION	PRICE
UU	Upholstered Back	+\$0

HON BRANDED FABRICS

GRADE 1

Apex
Centurion
Compass
Contourett
Dapper
Emphasis
Ensemble
Hamilton
Noble Seating
Pebble
Vibe

GRADE 2

Appoint Seating
Blume
Clyde
Haute
Kai
Rush
Spin Seating
Wavelength
Whisper Vinyl

GRADE 3

Bradbury
Cozy
Getaway
Moxie
Notion
Parker
Purl
Quill
Saxony

GRADE 4

Constance with Supreen™
Livi with Supreen™
Lucerne
Lugano with Supreen™
Oxford with Supreen™

For a complete list of fabrics, including partnership fabrics, go to hcn.com/fabricsandfinishes.

Reference Fabric Color Combinations on pages 20-25 for color codes and legend on page 21 for lead times. For additional HON to Supply COM fabric grade pricing, go to hcn.com and click on the HON to Supply COM link.



Icon Legend on page 19

PERPETUAL[®] Nesting Chairs

HPN1



Model HPN1AUU shown

NESTING CHAIR

Flex-back
Armless
Four Legs

DIMENSIONS

Depth:	26	Seat to Floor Height:	19 $\frac{1}{8}$
Width:	26	Usable Seat Depth:	16 $\frac{1}{2}$
Height:	36	Ship Weight:	38
Seat Depth:	17 $\frac{3}{4}$	Cube:	15.2
Seat Width:	17	COM:	1.5
Back Width:	17 $\frac{1}{2}$	Weight Rating:	300 lbs.
Back Height:	15 $\frac{3}{4}$		

FABRIC PRICE CODES

1	\$1022	8	\$1246
2	\$1062	9	\$1275
3	\$1101	10	\$1304
4	\$1130	11	\$1333
5	\$1158	12	\$1362
6	\$1187	L	—
7	\$1217		

HPN2



Model HPN2AUU shown

NESTING CHAIR

Flex-back
Fixed Arms
Four Legs

DIMENSIONS

Depth:	26	Arm Width:	20 $\frac{3}{4}$
Width:	26	Seat to Floor Height:	19 $\frac{1}{8}$
Height:	36	Usable Seat Depth:	16 $\frac{1}{2}$
Seat Depth:	17 $\frac{3}{4}$	Ship Weight:	41
Seat Width:	17	Cube:	15.2
Back Width:	17 $\frac{1}{2}$	COM:	1.5
Back Height:	15 $\frac{3}{4}$	Weight Rating:	300 lbs.

FABRIC PRICE CODES

1	\$1130	8	\$1354
2	\$1170	9	\$1383
3	\$1209	10	\$1412
4	\$1238	11	\$1441
5	\$1266	12	\$1470
6	\$1295	L	—
7	\$1325		

HOW TO SPECIFY

<p>Select Model Number</p> <p>HPN1</p>	<p>Select Caster/Glide</p> <p>A All-Surface G Glide (+ \$28)</p> <p>A</p>	<p>Select Back Type</p> <p>UU Upholstered Back</p> <p>UU</p>	<p>Select Fabric</p> <p>Note: For models with upholstered back, seat and back are always matching fabric See page 454</p> <p>CU10</p>	<p>Select Frame</p> <p>T Black T1 Platinum Metallic</p> <p>T</p>
---	--	---	--	---

PILLOW-SOFT® 2090 SERIES

Want to see more? Scan here
to check out hon.com.



Pillow-Soft® Seating shown
with 10500 Series™ desk.

PILLOW-SOFT® 2090 SERIES

Pillow-Soft chairs combine comfort, style and selection to deliver the ultimate seating experience. Each executive chair in the collection combines thick memory foam cushioning with built-in lumbar support to reduce fatigue and increase comfort. Besides the full body support, it adds an authoritative presence to the office. The plush tufted leather or fabric will add a touch of sophistication to your office.



FEATURES

- Responsive memory foam eliminates pressure points and provides lasting comfort.
- Loop arms relieve stress on the shoulder and neck.
- Fully-upholstered outer back.
- Memory foam seat cushion reduces pressure points and responds to contours of the body for lasting comfort.
- Task chairs come standard with pneumatic seat height adjustment, tilt, tilt tension and tilt lock.
- Dual-wheel casters roll effortlessly and silently.
- Warranted for users up to 300 lbs.
- H2095 model warranted for users up to 275 lbs.

PILLOW-SOFT® 2090 Series Options

MODEL OPTIONS

H2091



Executive High-Back

Pneumatic, Swivel, Tilt, Tilt Tension, Tilt Lock, Arms

H2095



Executive High-Back

Pneumatic, Swivel, Tilt, Tilt Tension, Tilt Lock, Arms

H2092



Managerial Mid-Back

Pneumatic, Swivel, Tilt, Tilt Tension, Tilt Lock, Arms

H2093



Guest Chair

Sled Base, Arms

CASTERS



CODE	DESCRIPTION	PRICE
H	Black Hard Caster	+ \$0



S	Black All-Surface Caster	+ \$44
----------	--------------------------	---------------

HON BRANDED FABRICS

GRADE 1

Apex
Black Vinyl
Burgundy Vinyl
Centurion
Compass
Contourett
Dapper
Emphasis
Ensemble
Hamilton
Noble Seating
Pebble
Vibe

GRADE 2

Appoint Seating
Blume
Clyde
Haute
Kai
Rush
Spin Seating
Wavelength
Whisper Vinyl

GRADE 3

Bradbury
Cozy
Getaway
Moxie
Notion
Parker
Purl
Quill
Saxony

GRADE 4

Constance with Supreen™
Livi with Supreen™
Lucerne
Lugano with Supreen™
Oxford with Supreen™

For a complete list of fabrics, including partnership fabrics, go to hon.com/fabricsandfinishes.

Reference Fabric Color Combinations on pages 20-25 for color codes and legend on page 21 for lead times. For additional HON to Supply COM fabric grade pricing, go to hon.com and click on the HON to Supply COM link.

PILLOW-SOFT® 2090 Series



Icon Legend on page 19

H2091



EXECUTIVE HIGH-BACK

Pneumatic
Swivel
Tilt
Tilt Tension
Tilt Lock
Arms
Functions: **A, E, F, K, L**
(Function Key on pages 256-257)

DIMENSIONS

Depth: 29¾
Width: 26¼
Height: 46½
Seat Depth: 21
Seat Width: 22
Back Width: 22
Back Height: 25
Arm Width: 20¼
Seat to Floor Height: 16¾-21¼
Usable Seat Depth: 18½
Ship Weight: 57
16.0
COM: 3.0
Weight Rating: 300 lbs.

FABRIC PRICE CODES

1	\$1011	8	\$1457
2	\$1090	9	\$1516
3	\$1167	10	\$1574
4	\$1225	11	\$1632
5	\$1283	12	\$1690
6	\$1341	L	\$1173
7	\$1400		

NOTES: When selecting leather, the 2090 Series uses SR Leather only. All models are also available in Grade 1 EB vinyl (which matches SR Leather).

H2095



EXECUTIVE HIGH-BACK

Pneumatic
Swivel
Tilt
Tilt Tension
Tilt Lock
Padded Loop Arms
Functions: **A, E, F, K, L**
(Function Key on pages 256-257)

DIMENSIONS

Depth: 29½
Width: 26¾
Height: 47½
Seat Depth: 17½
Seat Width: 21
Back Width: 21
Back Height: 29½
Arm Width: 21
Seat to Floor Height: 16-21
Usable Seat Depth: 17½
Ship Weight: 57
7.1
COM: N/A
Weight Rating: 275 lbs.

FABRIC PRICE CODES

Fabric
PWST10 \$801 (Black)
Black Bonded Leather
PWST11 \$823 (Black)

NOTES: When selecting upholstery, the H2095 is only available in PWST10 (Black fabric) and PWST11 (Black Bonded Leather).

H2092



MANAGERIAL MID-BACK

Pneumatic
Swivel
Tilt
Tilt Tension
Tilt Lock
Arms
Functions: **A, E, F, K, L**
(Function Key on pages 256-257)

DIMENSIONS

Depth: 28¾
Width: 26¼
Height: 41¾
Seat Depth: 21
Seat Width: 22
Back Width: 22
Back Height: 19⅝
Arm Width: 20¼
Seat to Floor Height: 16¾-21¼
Usable Seat Depth: 18½
Ship Weight: 54
Cube: 16.0
COM: 3.0
Weight Rating: 300 lbs.

FABRIC PRICE CODES

1	\$965	8	\$1411
2	\$1044	9	\$1470
3	\$1121	10	\$1528
4	\$1179	11	\$1586
5	\$1237	12	\$1644
6	\$1295	L	\$1127
7	\$1354		

NOTES: When selecting leather, the 2090 Series uses SR Leather only. All models are also available in Grade 1 EB vinyl (which matches SR Leather).

H2093



GUEST CHAIR

Sled Base
Arms
Depth: 27¾
Width: 23¼
Height: 36
Seat Depth: 21½
Seat Width: 20¾
Back Width: 21½
Back Height: 19¼

DIMENSIONS

Arm Width: 19¾
Seat to Floor Height: 19½
Usable Seat Depth: 19
Ship Weight: 38
Cube: 16.1
COM: 2.5
Weight Rating: 300 lbs.

FABRIC PRICE CODES

1	\$771	8	\$1143
2	\$836	9	\$1192
3	\$901	10	\$1240
4	\$950	11	\$1289
5	\$998	12	\$1337
6	\$1047	L	\$933
7	\$1095		

NOTES: When selecting leather, the 2090 Series uses SR Leather only. All models are also available in Grade 1 EB vinyl (which matches SR Leather).

HON Recommendation: H2091.H.SR11.T - List Price \$1173

HOW TO SPECIFY

<p>Select Model Number</p> <p>H 2 0 9 1 .</p>	<p>Select Caster</p> <p>H Black Hard Caster S Black All-Surface Caster (+ \$44) <i>Does not apply to models H2093 or H2095</i></p> <p>H .</p>	<p>Select Fabric</p> <p>See page 457 <i>H2095 only available in 2 fabric options. See above for pricing and selection.</i></p> <p>S R 1 1 .</p>	<p>Select Frame</p> <p>T Black</p> <p>T</p>
--	--	--	---



Icon Legend on page 19

PROMINENT™ Mesh Chairs

HVL531



HIGH-BACK

Pneumatic
Swivel
Tilt
Tilt Tension
Tilt Lock
Height-adjustable Arms

Functions: **A, E, F, K, L, Q**
(Function Key on pages 256-257)

DIMENSIONS

Depth:	27	Arm Width:	20¼
Width:	27	Seat to Floor Height:	18-22
Height:	42½	Usable Seat Depth:	18
Seat Depth:	18	Ship Weight:	36
Seat Width:	21½	Cube:	5.1
Back Width:	18¾	Weight Rating:	250 lbs.
Back Height:	23		

PRICE CODE

Sandwich Mesh	\$600
Leather	\$628

NOTES: Comfortable and breathable mesh back. Black Sandwich Mesh or Black Bonded Leather seat. Black frame. Height-adjustable arms. **HON 5-Year Limited Warranty.**

HON Recommendation: HVL531.MM10 - List Price \$600

HVL532



HIGH-BACK

Mesh Back
Pneumatic
Swivel
Asynchronous Control
Tilt
Tilt Tension
Tilt Lock
Seat Glide Mechanism
Back Height Adjustment
Height and Width Adjustable Arms

Functions: **A, B, D, E, F, L, O, S**
(Function Key on pages 256-257)

DIMENSIONS

Depth:	26	Back Height:	23¼-24½
Width:	30¾	Arm Width:	18-22½
Height:	44½	Seat to Floor Height:	17-20½
Seat Depth:	17⅞-20⅞	Ship Weight:	50
Seat Width:	20½	Cube:	6.5
Back Width:	19⅞	Weight Rating:	250 lbs.

PRICE CODE

Sandwich Mesh	\$714
Leather	\$742

NOTES: Comfortable and breathable mesh back. Black Sandwich Mesh or Black Bonded Leather seat. Black frame. Height and width adjustable arms. Seat glide mechanism. Asynchronous control with independent seat and back angle adjustment. **HON 5-Year Limited Warranty.**

HON Recommendation: HVL532.MM10 - List Price \$714

HVL539



TASK STOOL

Mesh Back
Pneumatic
Swivel
Height and Width Adjustable Arms
Adjustable Footring

Functions: **A, E, S**
(Function Key on pages 256-257)

DIMENSIONS

Depth:	27⅞	Arm Width:	18⅞
Width:	28⅞	Seat to Floor Height:	21⅞-28⅞
Height:	50	Usable Seat Depth:	17⅞
Seat Depth:	17⅞	Ship Weight:	44.0
Seat Width:	20⅞	Cube:	5.7
Back Width:	17⅞	Weight Rating:	250 lbs.
Back Height:	22⅞		

PRICE CODE

Sandwich Mesh	\$656
----------------------	--------------

NOTES: Prominent™ HVL539. Black upholstered seat. Height and width adjustable arms. **HON 5-Year Limited Warranty.**

HON Recommendation: HVL539.MM10 - List Price \$656

HOW TO SPECIFY

Select Model Number	Select Fabric
	MM10 Black Sandwich Mesh Fabric
H V L 5 3 9 .	M M 1 0

SEATING



Ruck™ Seating shown with West Hill™ Casual Lounge, Scramble™ Occasional Tables, and Unika Vaev Screens.

RUCK™

Easy on the eyes and even easier to move and stack, Ruck™ seating brings effortless style to working alone or together.

Available in a variety of finishes in both seated and stool heights, Ruck clicks with its surroundings — whether that’s in a collaborative area, café setting, or as a side chair in a private office. Crafted with gentle, molded contours, Ruck makes being on the edge of your seat a more comfortable place to be.



FEATURES

- Available in both a seated and stool-height option.
- Lightweight frame can be easily moved to rearrange seating configurations.
- Waterfall seat edge promotes better leg circulation.
- Glides move effortlessly on hard surfaces.
- Both the chair and stool stack six high on the floor to maximize space.
- Single-piece shell can be quickly wiped down for easy maintenance.
- Choose from 6 laminate and 4 veneer shell colors.
- Legs are available in a variety of finish options to match or complement other HON product lines.
- Backed by HON’s industry-leading Lifetime Warranty.

MODEL OPTIONS

HRUCK1L



Chair

Laminate Shell

HRUCK5L



Stool

Laminate Shell

HRUCK1W



Chair

Wood Shell

HRUCK5W



Stool

Wood Shell

AVAILABLE FINISHES

Ruck Seating is available in 7 laminate finishes and 4 wood finishes.

LAMINATE FINISHES

Charcoal (S)

Designer White (LDW1)

Field Elm (LWFE)

Florence Walnut (LFW1)

Kingswood Walnut (LK11)

Natural Maple (D)

Pinnacle (PINC)

WOOD FINISHES

Black Wash (QA997)

Natural (QA447)

Pinnacle Walnut (QA679)

White Wash (QA921)

FRAME

CODE	DESCRIPTION	PRICE
CBK	Charblack	+\$0
P7J	Textured Brownstone	+\$0
P7A	Textured Charcoal	+\$0
PK7	Textured Designer White	+\$0
P7L	Textured Loft	+\$0
P7M	Textured Muslin	+\$0
PR8	Textured Silver	+\$0
P8V	Textured Titanium	+\$0

RUCK™ Laminate Seating



Icon Legend on page 19

HRUCK1L



CHAIR, LAMINATE SHELL

DIMENSIONS

Depth:	22 ⁵ / ₈	Seat to Floor Height:	17 ³ / ₄
Width:	21 ⁵ / ₈	Usable Seat Depth:	18 ¹ / ₄
Height:	32 ⁵ / ₁₆	Ship Weight:	24
Seat Depth:	18 ¹ / ₄	Cube:	15.8
Seat Width:	17 ¹ / ₂	Weight Rating:	300 lbs.
Back Width:	17		
Back Height:	15 ⁵ / ₈		

LIST PRICE

\$679

HRUCK5L



STOOL, LAMINATE SHELL

DIMENSIONS

Depth:	22 ⁵ / ₈	Seat to Floor Height:	30
Width:	21 ⁵ / ₈	Usable Seat Depth:	18 ¹ / ₄
Height:	44 ¹ / ₂	Ship Weight:	32
Seat Depth:	18 ¹ / ₄	Cube:	22.2
Seat Width:	17 ¹ / ₂	Weight Rating:	300 lbs.
Back Width:	17		
Back Height:	15 ⁵ / ₈		

LIST PRICE

\$814

HON Recommendation: HRUCK1L.PINC.P8V - List Price \$679

HOW TO SPECIFY

Select
Model Number

HRUCK1L .

Select
Laminate

See page 461

PINC .

Select
Frame

See page 461

P8V



Icon Legend on page 19

RUCK™ Wood Seating

HRUCK1W

CHAIR, WOOD SHELL

DIMENSIONS

Depth:	22 ⁵ / ₈	Seat to Floor Height:	17 ³ / ₄
Width:	21 ⁵ / ₈	Usable Seat Depth:	18 ¹ / ₄
Height:	32 ⁵ / ₁₆	Ship Weight:	24
Seat Depth:	18 ¹ / ₄	Cube:	15.8
Seat Width:	17 ¹ / ₂	Weight Rating:	300 lbs.
Back Width:	17		
Back Height:	15 ⁵ / ₈		

LIST PRICE

\$713



HRUCK5W

STOOL, WOOD SHELL

DIMENSIONS

Depth:	22 ⁵ / ₈	Seat to Floor Height:	30
Width:	21 ⁵ / ₈	Usable Seat Depth:	18 ¹ / ₄
Height:	44 ¹ / ₂	Ship Weight:	32
Seat Depth:	18 ¹ / ₄	Cube:	22.2
Seat Width:	17 ¹ / ₂	Weight Rating:	300 lbs.
Back Width:	17		
Back Height:	15 ⁵ / ₈		

LIST PRICE

\$849



HON Recommendation: HRUCK1W.QA997.P8V - List Price \$713

HOW TO SPECIFY

Select
Model Number

HRUCK1W

Select
Finish

See page 461

QA997

Select
Frame

See page 461

P8V

SCATTER™ Guest Chairs



Icon Legend on page 19

HVL606



GUEST CHAIR

Leg Base
Armless
Stacks up to Four High

DIMENSIONS

Depth:	21	Seat to Floor Height:	19
Width:	21¼	Usable Seat Depth:	17½
Height:	32¾	Ship Weight:	16
Seat Depth:	17½	Cube:	1.7
Seat Width:	19	Weight Rating:	250 lbs.
Back Width:	18½		
Back Height:	16		

PRICE CODE

Fabric	\$227
Leather	\$260

NOTES: Fabric or Black Bonded Leather. Stackable up to four high. Round tube construction. Frame available in Black. Casters and glides ship packaged together for customer's assembly choice. **HON 5-Year Limited Warranty.**

HON Recommendation: HVL606.VA10 - List Price \$227

HVL616



GUEST CHAIR

Leg Base
Arms
Stacks up to Four High

DIMENSIONS

Depth:	21	Arm Width:	20⅝
Width:	23¾	Seat to Floor Height:	19
Height:	32¾	Usable Seat Depth:	17½
Seat Depth:	17½	Ship Weight:	18
Seat Width:	19	Cube:	2.1
Back Width:	18½	Weight Rating:	250 lbs.
Back Height:	16		

PRICE CODE

Fabric	\$257
Leather	\$290

NOTES: Fabric or Black Bonded Leather. Stackable up to four high. Round tube construction. Frame available in Black. Casters and glides ship packaged together for customer's assembly choice. **HON 5-Year Limited Warranty.**

HON Recommendation: HVL616.VA10 - List Price \$257

HOW TO SPECIFY

Select
Model Number

Select
Fabric

- SB11** Black Bonded Leather
- VA10** Black Fabric
- VA19** Charcoal Fabric
- VA90** Navy Fabric

H V L 6 0 6 .

V A 1 0

SKIP

Want to see more? Scan here
to check out hon.com.



Skip shown with Flock® Cylinder Table.

SKIP

It's hard to get creative when you're feeling all buttoned up. That's why workplaces are adding less formal, more dynamic spaces to foster greater creativity and connection between workers. Designed to put the fun back in functional, Skip seating offers an engaging, active sit that lets you rock a meeting — literally. When it comes to casual and collaborative seating that's as lively as it is practical, this chair doesn't Skip a beat.



FEATURES

- Built-in handle makes it easy to move around.
- Textured finish is durable, easy to clean, UV resistant, and suitable for outdoor sitting.
- Optional cushion stays in place but is not permanently affixed.
- Cushion fabric is easy to wipe clean.
- Hard plastic frame is multicolored.

SKIP Collaborative Chair



Icon Legend on page 19

HQQ1



COLLABORATIVE CHAIR

DIMENSIONS

Depth:	35½	Seat to Floor Height:	17
Width:	28	Usable Seat Depth:	17
Height:	31	Ship Weight:	35
Seat Depth:	18	Cube:	20.0
Seat Width:	28	Weight Rating:	275 lbs.
Back Width:	28		
Back Height:	21		

LIST PRICE

\$1197

NOTES: Hard plastic frame is multicolored. **HON 5-Year Limited Warranty.**

HQQ1CUSH



CUSHION

DIMENSIONS

Depth:	17½	Ship Weight:	5 Ⓞ
Width:	25¾	Cube:	2.0
Height:	1½		

LIST PRICE

\$234

NOTES: **HON 5-Year Limited Warranty.**

SEATING

HOW TO SPECIFY

Select Model Number

HQQ1

HOW TO SPECIFY

Select Model Number

HQQ1CUSH.

Select Fabric

SLT Slate
NVY Navy

SLT



SoCo™ shown with Sculpt™ Tables.

SoCo™

Today's busy professionals are taking meetings and project planning in a variety of different ways and places. SoCo™ is an intuitive modular lounge series designed to encourage the ease of both collaborative and individual work while supporting how people like to sit and get comfortable. Multiple shapes come together to create a wide range of configuration possibilities, from understated and sophisticated to fun and playful. Power is cleanly integrated within the design and is located where multiple users can access and utilize its functionality to stay connected. SoCo™ offers soft, comfortable support and a tailored aesthetic in spaces that allow you to get away from the workstation throughout the day.

FEATURES

- SoCo™ supports dynamic collaboration and casual focused work with a soft, organic, tailored aesthetic that delivers comfort for a variety of sitting postures.
- Seven modular shapes work together to create unlimited linear and curvilinear configurations.
- A fully upholstered design with a multi-fabric seat/back option softens the corporate aesthetic.
- Optional plug-in or hardwire electrical is available on select shapes and supports both USB-A and USB-C compatibility.
- Dual-purpose glides allow two functions: without glide caps furniture stays in place; with glide caps furniture easily moves for reconfiguration.

SoCo™ Statement of Line

SQUARE SEATING



Single Seat



Single Seat w/ Back



Single Seat w/ Back
w/ Power



Single Seat w/ Back
Multi-Fabric



Single Seat w/ Back
Multi-Fabric w/ Power



Square Corner Seat
w/ Back



Square Corner Seat
w/ Back Multi-Fabric

CURVE SEATING

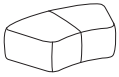

Curve Seat

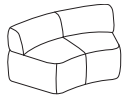

Inside Curve Seat
w/ Back



Inside Curve Seat
w/ Back w/ Power

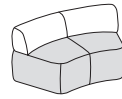

Inside Curve Seat
w/ Back Multi-Fabric

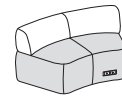

Inside Curve Seat w/ Back
Multi-Fabric w/ Power

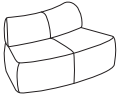

Outside Curve Seat
w/ Back



Outside Curve Seat
w/ Back w/ Power

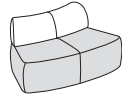

Outside Curve Seat
w/ Back Multi-Fabric

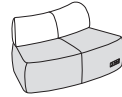

Outside Curve Seat
w/ Back Multi-Fabric w/ Power



Quarter Circle Seat

HON BRANDED FABRICS

GRADE 1

Apex
Centurion
Compass
Contourett*
Dapper
Emphasis
Ensemble
Hamilton
Noble Seating
Vibe

GRADE 2

Appoint Seating
Blume
Clyde
Kai
Rush
Spin Seating
Taylor
Whisper Vinyl*

GRADE 3

Bradbury
Cozy
Moxie*
Notion
Parker*
Purl
Saxony

GRADE 4

Constance with Supreen™**
Livi with Supreen™**
Lucerne
Lugano with Supreen™**
Oxford with Supreen™**

For a complete list of fabrics, including partnership fabrics, go to hon.com/fabricsandfinishes.

Reference Fabric Color Combinations on pages 20-25 for color codes and legend on page 21 for lead times.

Upholstery Expectations

❗ Solid, non-patterned fabrics are recommended due to SoCo's curvilinear profile. HON does not pattern match fabrics that have a distinct linear or repeating pattern. It is recommended to choose from one of HON's many standard non-patterned fabrics. For more details on Upholstery Pattern Match for this series, please see page 14.

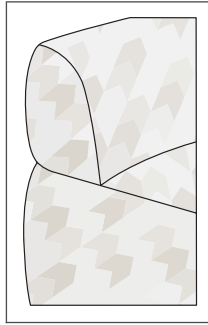

*Due to the inherent characteristics of upholstery materials, such as coated textiles and stiffer fabrics, and the curved nature of SoCo™, fabric may show some wrinkles along seams and may become more relaxed to show additional wrinkles over time.

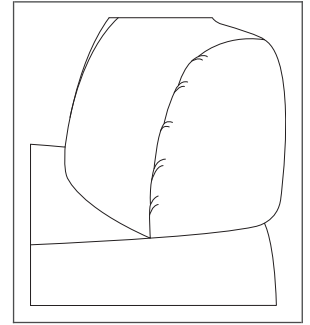

COM YARDAGE

MODEL	COM											
	Fabric (P)	Vinyl (P)	Fabric Seat (P)	Vinyl Seat (P)	Fabric Back (P)	Vinyl Back (P)	Fabric (R)	Vinyl (R)	Fabric Seat (R)	Vinyl Seat (R)	Fabric Back (R)	Vinyl Back (R)
EXISTING SINGLE FAB UNITS												
HSLMSS	3	3	—	—	—	—	2.75	2.75	—	—	—	—
HSLMSB1	4	4	—	—	—	—	3.5	3.5	—	—	—	—
HSLMSB2	—	—	3	3	1.5	1.5	—	—	2.75	2.75	1.5	1.5
HSLMTCB1	5	5	—	—	—	—	3.75	3.75	—	—	—	—
HSLMTCB2	—	—	3	3	2	2	—	—	2.75	2.75	1.75	1.75
HSLMCS	3.75	3.75	—	—	—	—	3.5	3.5	—	—	—	—
HSLMICB1	5.5	5.5	—	—	—	—	5.25	5.25	—	—	—	—
HSLMICB2	—	—	3.75	3.75	2	2	—	—	3.5	3.5	1.75	1.75
HSLMOCB1	5	5	—	—	—	—	5	5	—	—	—	—
HSLMOCB2	—	—	3.75	3.75	1.5	1.5	—	—	3.5	3.5	1.5	1.5
HSLMQCS	2.5	2.5	—	—	—	—	2.5	2.5	—	—	—	—

SoCo™ Typicals

QTY	DESCRIPTION	MODEL	LIST PRICE	PRICE EXTENSION
2	Curve Seat	HSLMCS	\$2,070	\$4,140
2	Inside Curve Seat w/ Back	HSLMICB1	\$3,470	\$6,940
2	Outside Curve Seat w/ Back	HSLMOCB1	\$3,470	\$6,940
TOTAL:				\$18,020

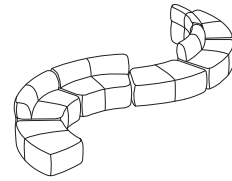

SERPENTINE

QTY	DESCRIPTION	MODEL	LIST PRICE	PRICE EXTENSION
2	Single Seat	HSLMSS	\$1,440	\$2,880
2	Single Seat w/ Back	HSLMSB1	\$2,340	\$4,680
2	Square Corner Seat w/ Back	HSLMTCB1	\$2,440	\$4,880
2	Quarter Circle Seat	HSLMQCS	\$1,240	\$2,480
TOTAL:				\$14,920

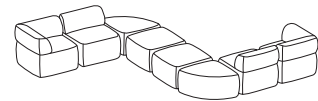

ZIGZAG

QTY	DESCRIPTION	MODEL	LIST PRICE	PRICE EXTENSION
2	Curve Seat	HSLMCS	\$2,070	\$4,140
2	Inside Curve Seat w/ Back	HSLMICB1	\$3,470	\$6,940
TOTAL:				\$11,080

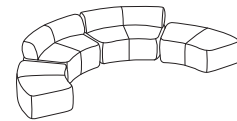

HALF-CIRCLE

QTY	DESCRIPTION	MODEL	LIST PRICE	PRICE EXTENSION
4	Single Seat w/ Back	HSLMSB1	\$2,340	\$9,360
4	Quarter Circle Seat	HSLMQCS	\$1,240	\$4,960
TOTAL:				\$14,320



ISLAND

HSLMSS

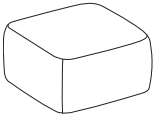

LOUNGE

Single Seat

DIMENSIONS

Depth: 30 Ship Weight: 44.0
 Width: 30 Cube: 11.3
 Height: 18½ COM: See page 469
 Weight Rating: 300 lbs.

FABRIC PRICE CODES

1	\$1440	8	\$1883
2	\$1516	9	\$1942
3	\$1592	10	\$2005
4	\$1650	11	\$2073
5	\$1707	12	\$2141
6	\$1766	L	—
7	\$1824		

! No Power Cutout Option

HSLMSB1

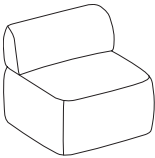

LOUNGE

Single Seat w/ Back

DIMENSIONS

Depth: 30 Ship Weight: 57.4
 Width: 30 Cube: 18.3
 Height: 30 COM: See page 469
 Usable Seat Depth 20½ Weight Rating: 300 lbs.
 Seat to Floor Height 18½

FABRIC PRICE CODES

1	\$2340	8	\$2910
2	\$2437	9	\$2985
3	\$2535	10	\$3066
4	\$2609	11	\$3153
5	\$2682	12	\$3241
6	\$2760	L	—
7	\$2833		

NOTES: Power models specified separately. Power models found on page 476.

! Optional Power Cutout

HSLMSB2

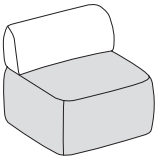

LOUNGE

Single Seat w/ Back —
 Multi-Fabric

DIMENSIONS

Depth: 30 Ship Weight: 57.4
 Width: 30 Cube: 18.3
 Height: 30 COM: See page 469
 Usable Seat Depth 20½ Weight Rating: 300 lbs.
 Seat to Floor Height 18½

FABRIC PRICE CODES

1 \$2440
Add to Base Price Above

	Seat	Back
2	\$76	\$32
3	\$152	\$65
4	\$210	\$90
5	\$267	\$115
6	\$326	\$141
7	\$384	\$164
8	\$443	\$190
9	\$502	\$216
10	\$565	\$243
11	\$633	\$271
12	\$701	\$300
L	—	—

NOTES: Power models specified separately. Power models found on page 476.

! Optional Power Cutout

HOW TO SPECIFY

<p>Select Model Number</p> <p>H S L M S S .</p>	<p>Select FSC Wood</p> <p>F S C .</p>	<p>Select Power</p> <p>Y Power Cutout (+ \$42) N No Power Cutout</p>	<p>Select Seat Fabric</p> <p>See page 469</p>	<p>Select Back Fabric (if applicable)</p> <p>See page 469</p>
--	--	--	--	--

HSLMTCB1

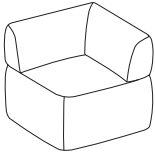

LOUNGE

Square Corner Seat w/ Back

DIMENSIONS

Depth: 30 Ship Weight: 67.8
 Width: 30 Cube: 18.5
 Height: 30 COM: See page 469
 Usable Seat Depth: 20½ Weight Rating: 300 lbs.
 Seat to Floor Height: 18½

FABRIC PRICE CODES

1	\$2440	8	\$3137
2	\$2558	9	\$3228
3	\$2678	10	\$3327
4	\$2769	11	\$3433
5	\$2859	12	\$3541
6	\$2952	L	—
7	\$3042		

! No Power Cutout Option

HSLMTCB2

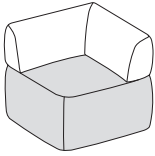

LOUNGE

Square Corner Seat w/ Back — Multi-Fabric

DIMENSIONS

Depth: 30 Ship Weight: 67.8
 Width: 30 Cube: 18.5
 Height: 30 COM: See page 469
 Usable Seat Depth: 20½ Weight Rating: 300 lbs.
 Seat to Floor Height: 18½

FABRIC PRICE CODES

1 \$2540

Add to Base Price Above

	Seat	Back
2	\$76	\$54
3	\$152	\$109
4	\$210	\$150
5	\$267	\$191
6	\$326	\$233
7	\$384	\$273
8	\$443	\$317
9	\$502	\$359
10	\$565	\$403
11	\$633	\$452
12	\$701	\$500
L	—	—

! No Power Cutout Option

HOW TO SPECIFY

<p>Select Model Number</p> <p>H S L M T C B 1 .</p>	<p>Select FSC Wood</p> <p>F S C .</p>	<p>Select Seat Fabric</p> <p>See page 469</p>	<p>Select Back Fabric (if applicable)</p> <p>See page 469</p>
---	---------------------------------------	---	---

HSLMCS

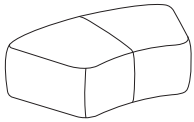

LOUNGE

Curve Seat

DIMENSIONS

Depth: 30 Ship Weight: 54.9
 Width: 55 Cube: 20.7
 Height: 18½ COM: See page 469
 Weight Rating: 300 lbs.

FABRIC PRICE CODES

1	\$2070	8	\$2577
2	\$2156	9	\$2643
3	\$2244	10	\$2715
4	\$2309	11	\$2793
5	\$2374	12	\$2871
6	\$2442	L	—
7	\$2508		

❗ No Power Cutout Option

HSLMICB1

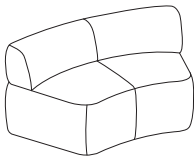

LOUNGE

Inside Curve Seat w/ Back

DIMENSIONS

Depth: 30 Ship Weight: 72.9
 Width: 55 Cube: 33.9
 Height: 30 COM: See page 469
 Usable Seat Depth 20½ Weight Rating: 300 lbs.
 Seat to Floor Height 18½

FABRIC PRICE CODES

1	\$3470	8	\$4231
2	\$3599	9	\$4330
3	\$3730	10	\$4438
4	\$3829	11	\$4554
5	\$3927	12	\$4670
6	\$4029	L	—
7	\$4127		

NOTES: Power models specified separately. Power models found on page 476.

❗ Optional Power Cutout

HSLMICB2

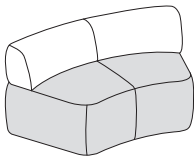

LOUNGE

Inside Curve Seat w/ Back —
Multi-Fabric

DIMENSIONS

Depth: 30 Ship Weight: 72.9
 Width: 55 Cube: 33.9
 Height: 30 COM: See page 469
 Usable Seat Depth 20½ Weight Rating: 300 lbs.
 Seat to Floor Height 18½

FABRIC PRICE CODES

1 \$3570
 Add to Base Price Above

	Seat	Back
2	\$86	\$54
3	\$174	\$109
4	\$239	\$150
5	\$304	\$191
6	\$372	\$233
7	\$438	\$273
8	\$507	\$317
9	\$573	\$359
10	\$645	\$403
11	\$723	\$452
12	\$801	\$500
L	—	—

NOTES: Power models specified separately. Power models found on page 476.

❗ Optional Power Cutout

HOW TO SPECIFY

<p>Select Model Number</p> <p>H S L M C S .</p>	<p>Select FSC Wood</p> <p>F S C .</p>	<p>Select Power</p> <p>Y Power Cutout (+ \$42) N No Power Cutout</p>	<p>Select Seat Fabric</p> <p>See page 469</p>	<p>Select Back Fabric (if applicable)</p> <p>See page 469</p>
--	--	--	--	--

HSLMOCB1

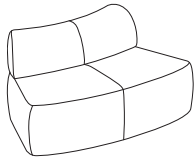

LOUNGE

Outside Curve Seat w/ Back

DIMENSIONS

Depth:	30	Ship Weight:	67.2
Width:	55	Cube:	33.9
Height:	30	COM:	See page 469
Usable Seat Depth	20½	Weight Rating:	300 lbs.
Seat to Floor Height	18½		

FABRIC PRICE CODES

1	\$3470	8	\$4231
2	\$3599	9	\$4330
3	\$3730	10	\$4438
4	\$3829	11	\$4554
5	\$3927	12	\$4670
6	\$4029	L	—
7	\$4127		

NOTES: Power models specified separately. Power models found on page 476.
 ⓘ Optional Power Cutout

HSLMOCB2

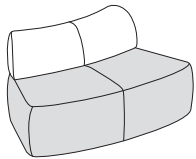

LOUNGE

Outside Curve Seat w/ Back — Multi-Fabric

DIMENSIONS

Depth:	30	Ship Weight:	67.2
Width:	55	Cube:	33.9
Height:	30	COM:	See page 469
Usable Seat Depth	20½	Weight Rating:	300 lbs.
Seat to Floor Height	18½		

FABRIC PRICE CODES

1	\$3570	
	<i>Add to Base Price Above</i>	
	Seat	Back
2	\$86	\$54
3	\$174	\$109
4	\$239	\$150
5	\$304	\$191
6	\$372	\$233
7	\$438	\$273
8	\$507	\$317
9	\$573	\$359
10	\$645	\$403
11	\$723	\$452
12	\$801	\$500
L	—	—

NOTES: Power models specified separately. Power models found on page 476.
 ⓘ Optional Power Cutout

HSLMQCS

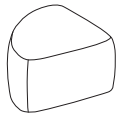

LOUNGE

Quarter Circle Seat

DIMENSIONS

Depth:	30	Ship Weight:	32.4
Width:	30	Cube:	11.3
Height:	18½	COM:	See page 469
		Weight Rating:	300 lbs.

FABRIC PRICE CODES

1	\$1240	8	\$1621
2	\$1304	9	\$1670
3	\$1370	10	\$1724
4	\$1420	11	\$1782
5	\$1469	12	\$1840
6	\$1520	L	—
7	\$1569		

ⓘ No Power Cutout Option.

HOW TO SPECIFY

<p>Select Model Number</p> <p>H S L M O C B 1</p>	<p>Select FSC Wood</p> <p>F S C</p>	<p>Select Power</p> <p>Y Power Cutout (+ \$42) N No Power Cutout</p>	<p>Select Seat Fabric</p> <p>See page 469</p>	<p>Select Back Fabric (if applicable)</p> <p>See page 469</p>
--	--	---	--	--



Icon Legend on page 19

SoCo™

HSLMGK

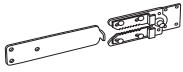

LOUNGE

Ganging Kit (2-Pack)

DIMENSIONS

Ship Weight: 6.3
Cube: 0.1

LIST PRICE

\$65

NOTES: Ganging brackets used to provide alignment between adjacent pieces but can be easily disengaged allowing pieces to be reconfigured.

SEATING

HOW TO SPECIFY

Select
Model Number

H S L M Q C S

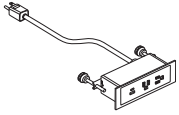

DESCRIPTION

Dean Power Module
 In-Surface Bezel Mount
 2 Receptacles
 1 USB-A
 1 USB-C

- Straight (10'), Braided (10'), Hardwire (10'), and cord options available.
- In-Surface Bezel Mount model applicable in SoCo power module cutout.
- UL Listed.

MODEL	SHIP WEIGHT	CUBE	LIST PRICE
HBPWRMOD	4.5 Ⓞ	0.2	\$524

HOW TO SPECIFY

Select Model Number

H B P W R M O D .

Select Last Port Option

AC USB-A/C

A C .

Select Cord Type

- S Straight
- B Braided (+ \$65)
- H Hardwire (+ \$76)

S .

Select Color/Finish

- SNW Snow
- STRM Storm
- BLK Black

S N W



Solve® Seating with Mod Desking.

SOLVE®

If you want to make a powerful statement, simply have a seat. With three back materials and an optional adjustable lumbar support, Solve answers the need for a higher level of personalization. Solve task chairs feature a geometric ReActiv® back to create a contemporary look, while the 4-Way Stretch mesh back offers a softer, more relaxed feel. The synchronized seat and back move in harmony with the user to provide continuous comfort that can be customized. Helping anyone achieve optimal balance, proper alignment and lumbar support, Solve is an ideal solution for everywhere and everybody.



FEATURES

- Synchronized seat and back create continuous comfort.
- Waterfall seat edge encourages leg circulation.
- Optional seat depth adjustment adapts to users of various heights.
- ReActiv® back design moves with your body to provide continuous support and airflow for lasting comfort.
- Available with three control types — synchro-tilt, synchro-tilt with seat slider and advanced synchro-tilt.
- Choose from four different arm options — armless, fixed, height- and width-adjustable or all-adjustable arms.
- Optional lumbar support delivers long-lasting comfort.
- Available with bell glides, hard casters or all-surface casters.
- Choose from 3 frame options: Black, Titanium and White.
- Available in seven mesh back and seven lumbar colors and thousands of fabrics.
- Warranted for users up to 300 lbs.

SOLVE[®] Options

MODEL OPTIONS

HSLVTMM



Mid-Back Task (4-Way Stretch Back)

Pneumatic, Swivel, Synchro-tilt, Tilt Tension, Tilt Lock

HSLVSMM



Stool (4-Way Stretch Back)

Pneumatic, Swivel, Synchro-tilt, Tilt Tension, Tilt Lock

HSLVTMMS



Mid-Back Task (4-Way Stretch Back) with Designer White frame

Pneumatic, Swivel, Synchro-tilt, Tilt Tension, Tilt Lock

HSLVSMMS



Stool (4-Way Stretch Back) with Designer White frame

Pneumatic, Swivel, Synchro-tilt, Tilt Tension, Tilt Lock

HSLVTMR



Mid-Back Task (ReActiv[®] Back)

Pneumatic, Swivel, Synchro-tilt, Tilt Tension, Tilt Lock

HSLVSMR



Stool (ReActiv[®] Back)

Pneumatic, Swivel, Synchro-tilt, Tilt Tension, Tilt Lock

HSLVTMRS



Mid-Back Task (ReActiv[®] Back) with Designer White frame

Pneumatic, Swivel, Synchro-tilt, Tilt Tension, Tilt Lock

HSLVSMRS







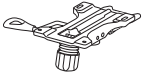
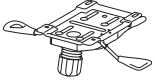
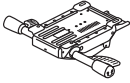

Stool (ReActiv[®] Back) with Designer White frame

Pneumatic, Swivel, Synchro-tilt, Tilt Tension, Tilt Lock

MECHANISM	CODE	DESCRIPTION	PRICE
	Y0	Synchro-Tilt A, E, J, K, L	+\$0
	Y1	Synchro-Tilt w/Seat Slider A, D, E, J, K, L	+\$22
	Y2	Advanced Synchro-Tilt A, D, E, J, L, A-D	+\$71

**Y2 control not available on stool models*

ARM STYLE	CODE	DESCRIPTION	PRICE
	N	Armless	+\$0
	F	Fixed Arms	+\$71
		<i>*Not available on Designer White models</i>	
	A	Height and Width Adjustable Arms	+\$92
	V	All-Adjustable Arms (includes Pivot)	+\$141
		<i>*Not available on Designer White models</i>	
	ADW	Height and Width Adjustable Arms	+\$92

CASTERS/ GLIDE	CODE	DESCRIPTION	PRICE
	H	Black Hard Caster	+\$0
	S	Black All-Surface Caster	+\$44
	R	Roll Control Caster	+\$55
	G	Bell Glide	+\$28

BACK STYLE	CODE	DESCRIPTION	PRICE
		<i>4-Way Stretch mesh back options:</i>	
	IM	Black	+\$0
	IB	Breeze	+\$0
	IK	Brownstone	+\$0
	IC	Charcoal	+\$0
	IF	Fog	+\$0
	IR	Regatta	+\$0
	IT	Titanium	+\$0
		<i>ReActiv® back options:</i>	
	OS	Charcoal	+\$0
	DW	Designer White	+\$0
	TI	Titanium	+\$0

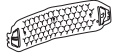
LUMBAR	CODE	DESCRIPTION	PRICE
	NL	No Lumbar	+\$0
	BL	Black Adjustable Lumbar	+\$33
	BY	Bullseye Adjustable Lumbar	+\$33
	DW	Designer White Adjustable Lumbar	+\$33
	KT	Krypton Adjustable Lumbar	+\$33
	MR	Ember Adjustable Lumbar	+\$33
	RE	Regatta Adjustable Lumbar	+\$33
	TL	Titanium Adjustable Lumbar	+\$33

BASE	CODE	DESCRIPTION	PRICE
	SB	Standard Base	+\$0

FRAME	CODE	DESCRIPTION	PRICE
	T	Black	+\$0
	TI	Titanium	+\$39
	DW	Designer White	+\$39

HON BRANDED FABRICS

GRADE 1	GRADE 2	GRADE 3	GRADE 4	GRADE L
Apex	Appoint Seating	Bradbury	Constance with Supreen™	Denver Leather (Seat Only)
Centurion	Blume	Cozy	Livi with Supreen™	
Compass	Clyde	Getaway	Lucerne	
Contourett	Haute	Moxie	Lugano with Supreen™	
Dapper	Kai	Notion	Oxford with Supreen™	
Emphasis	Rush	Parker		
Ensemble	Spin Seating	Purl		
Hamilton	Wavelength	Quill*		
Noble Seating	Whisper Vinyl	Saxony		
Pebble				
Vibe				

For a complete list of fabrics, including partnership fabrics, go to hon.com/fabricsandfinishes.

Reference Fabric Color Combinations on pages 20-25 for color codes and legend on page 21 for lead times.

*Quill available on Seat only.

DIMENSIONS

NOTE: When selecting the .TI Titanium or .DW Designer White frame option, the chair's back frame, arms, and base will match. 4-Way Stretch, ReActiv[®], and/or lumbar color must be selected separately.

MODEL		HSLVTMM /HSLVTMMS	HSLVSM /HSLVSMMS	HSLVTMR /HSLVTMRS	HSLVSMR /HSLVSMRS
Overall Width Armless		29½"	29½"	29½"	29½"
Overall Width with Arms	(A)	29½"	29½"	29½"	29½"
Overall Depth		29½"	29½"	29½"	29½"
Overall Height - Max	(Y0/Y1)	41¾"	52¾"	41¾"	52¾"
	(Y2)	42½"	—	42½"	—
Seat Width		19"	19"	19"	19"
Seat Depth (Cushion)		19¼"	19¼"	19¼"	19¼"
Usable Seat Depth	(Y0)	17⅝"	17⅝"	17⅝"	17⅝"
	(Y1)	16¼"-18½"	16¼"-18½"	16¼"-18½"	16¼"-18½"
	(Y2)	16¼"-19¼"	—	16¼"-19¼"	—
Seat Height	(Y0/Y1)	16¾"-21¾"	22¾"-32¾"	16¾"-21¾"	22¾"-32¾"
	(Y2)	17½"-22½"	—	17½"-22½"	—
Back Width		18¼"	18¼"	18¼"	18¼"
Back Height		21½"	21½"	21½"	21½"
Ship Weight Armless	(Y0)	40 Ⓢ	45 Ⓢ	41 Ⓢ	46 Ⓢ
	(Y1)	42 Ⓢ	47 Ⓢ	43 Ⓢ	48 Ⓢ
	(Y2)	45 Ⓢ	—	46 Ⓢ	—
Ship Weight with Arms	(Y0)	44 Ⓢ	49 Ⓢ	45 Ⓢ	50 Ⓢ
	(Y1)	46 Ⓢ	51 Ⓢ	47 Ⓢ	52 Ⓢ
	(Y2)	49 Ⓢ	—	50 Ⓢ	—
Width Between Arms		17½"-20"	17½"-20"	17½"-20"	17½"-20"
COM		1.0	1.0	1.0	1.0
Weight Capacity		300 lbs	300 lbs	300 lbs	300 lbs



Icon Legend on page 19

SOLVE[®]

HSLVTMM

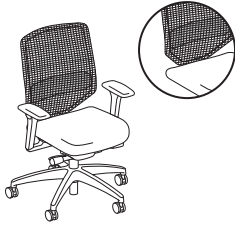

MID-BACK TASK

- 4-Way Stretch Back**
- Pneumatic
- Swivel
- Synchro-tilt
- Tilt Tension
- Tilt Lock

DIMENSIONS

Seat Depth:	19¼	Arm Width:	17½-20
Seat Width:	19	Cube:	10.8
Back Width:	18¼	Weight Rating:	300 lbs.
Back Height:	21½		

FABRIC PRICE CODES

1	\$647	8	\$723
2	\$661	9	\$732
3	\$674	10	\$741
4	\$684	11	\$752
5	\$693	12	\$761
6	\$703	L	\$756
7	\$712		

NOTES: Please reference pages 478-480 for additional specifications and mechanism information.

HSLVTMMS

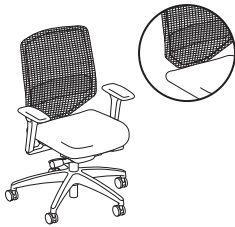

MID-BACK TASK IN DESIGNER WHITE

- 4-Way Stretch Back**
- Pneumatic
- Swivel
- Synchro-tilt
- Tilt Tension
- Tilt Lock

DIMENSIONS

Seat Depth:	19¼	Arm Width:	17½-20
Seat Width:	19	Cube:	10.8
Back Width:	18¼	Weight Rating:	300 lbs.
Back Height:	21½		

FABRIC PRICE CODES

1	\$647	8	\$723
2	\$661	9	\$732
3	\$674	10	\$741
4	\$684	11	\$752
5	\$693	12	\$761
6	\$703	L	\$756
7	\$712		

NOTES: Please reference pages 478-480 for additional specifications and mechanism information.

HON Recommendation: HSLVTMM.Y1.A.H.IM.CU__BL.SB.T - List Price \$794

HOW TO SPECIFY

Select Model Number	Select Control Type	Select Arm Type	Select Caster/Glide	Select Mesh Back	Select Fabric	Select Lumbar	Select Base	Select Frame
	Y0 Synchro-Tilt Y1 Synchro-Tilt w/ Seat Slider (+ \$22) Y2 Advanced Synchro-Tilt (+ \$71)	HSLVTMM Options N Armless F Fixed Arms (+ \$71) A Height and Width Adjustable Arms (+ \$92) V All-Adjustable Arms (includes pivot) (+ \$141)	H Black Hard Caster S Black All-Surface Caster (+ \$44) G Bell Glide (+ \$28) R Black Roll Control Caster (+ \$55)	4-Way Stretch options IM Black IB Breeze IK Brownstone IC Charcoal IF Fog IR Regatta IT Titanium	See page 480	NL No Lumbar BL Black Adjustable Lumbar (+ \$33) BY Bullseye Adjustable Lumbar (+ \$33) DW Designer White Adjustable Lumbar (+ \$33) KT Krypton Adjustable Lumbar (+ \$33) MR Ember Adjustable Lumbar (+ \$33) RE Regatta Adjustable Lumbar (+ \$33) TL Titanium Adjustable Lumbar (+ \$33)	SB Standard Base	HSLVTMM Options T Black TI Titanium (+ \$39)
H S L V T M M	Y 1	A	S	I M	C U 1 0	B L	S B	T

SEATING

HSLVSMM



STOOL

- 4-Way Stretch Back**
- Pneumatic
- Swivel
- Synchro-tilt
- Tilt Tension
- Tilt Lock

DIMENSIONS

Seat Depth:	19¼	Arm Width:	17½-20
Seat Width:	19	Cube:	10.8
Back Width:	18¼	Weight Rating:	300 lbs.
Back Height:	21½		

FABRIC PRICE CODES

1	\$726	8	\$802
2	\$740	9	\$811
3	\$753	10	\$820
4	\$763	11	\$831
5	\$772	12	\$840
6	\$782	L	\$835
7	\$791		

NOTES: Please reference pages 478-480 for additional specifications and mechanism information.

HSLVSMMS



STOOL IN DESIGNER WHITE

- 4-Way Stretch Back**
- Pneumatic
- Swivel
- Synchro-tilt
- Tilt Tension
- Tilt Lock

DIMENSIONS

Seat Depth:	19¼	Arm Width:	17½-20
Seat Width:	19	Cube:	10.8
Back Width:	18¼	Weight Rating:	300 lbs.
Back Height:	21½		

FABRIC PRICE CODES

1	\$726	8	\$802
2	\$740	9	\$811
3	\$753	10	\$820
4	\$763	11	\$831
5	\$772	12	\$840
6	\$782	L	\$835
7	\$791		

NOTES: Please reference pages 478-480 for additional specifications and mechanism information.

HON Recommendation: HSLVSMM.Y1.A.H.IM.CU__BL.SB.T - List Price \$873

HOW TO SPECIFY

Select Model Number	Select Control Type	Select Arm Type	Select Caster/Glide	Select Mesh Back	Select Fabric	Select Lumbar	Select Base	Select Frame
<p>YO Synchro-Tilt</p> <p>Y1 Synchro-Tilt w/ Seat Slider (+ \$22)</p>	<p>HSLVSMM Options</p> <p>N Armless</p> <p>F Fixed Arms (+ \$71)</p> <p>A Height and Width Adjustable Arms (+ \$92)</p> <p>V All-Adjustable Arms (includes pivot) (+ \$141)</p> <p>HSLVSMMS Options</p> <p>ADW Height and Width Adjustable Arms (+ \$92) <i>Available for model HSLVSMMS only</i></p>	<p>H Black Hard Caster</p> <p>S Black All-Surface Caster (+ \$44)</p> <p>G Bell Glide (+ \$28)</p> <p>R Black Roll Control Caster (+ \$55)</p>	<p>4-Way Stretch options</p> <p>IM Black</p> <p>IB Breeze</p> <p>IK Brownstone</p> <p>IC Charcoal</p> <p>IF Fog</p> <p>IR Regatta</p> <p>IT Titanium</p>	See page 480	<p>NL No Lumbar</p> <p>BL Black Adjustable Lumbar (+ \$33)</p> <p>BY Bullseye Adjustable Lumbar (+ \$33)</p> <p>DW Designer White Adjustable Lumbar (+ \$33)</p> <p>KT Krypton Adjustable Lumbar (+ \$33)</p> <p>MR Ember Adjustable Lumbar (+ \$33)</p> <p>RE Regatta Adjustable Lumbar (+ \$33)</p> <p>TL Titanium Adjustable Lumbar (+ \$33)</p>	<p>SB Standard Base</p>	<p>T Black</p> <p>TI Titanium (+ \$60 for HSLVSMM)</p> <p>DW Designer White (+ \$60; available on HSLVSMMS only)</p>	
H S L V S M M .	Y 1 .	A .	S .	I M .	C U I O .	B L .	S B .	T

HSLVTMR

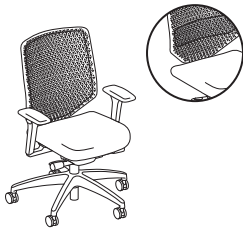

MID-BACK TASK

- ReActiv® Back**
- Pneumatic
- Swivel
- Synchro-tilt
- Tilt Tension
- Tilt Lock

DIMENSIONS

- Seat Depth: 19¼
- Seat Width: 19
- Back Width: 18¾
- Back Height: 21½
- Arm Width: 17½-20
- Cube: 10.8
- Weight Rating: 300 lbs.

FABRIC PRICE CODES

- | | | | |
|---|-------|----|-------|
| 1 | \$682 | 8 | \$758 |
| 2 | \$696 | 9 | \$767 |
| 3 | \$709 | 10 | \$776 |
| 4 | \$719 | 11 | \$787 |
| 5 | \$728 | 12 | \$796 |
| 6 | \$738 | L | \$791 |
| 7 | \$747 | | |

NOTES: Please reference pages 478-480 for additional specifications and mechanism information.

HSLVTMRS

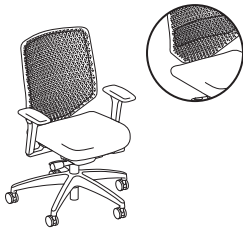

MID-BACK TASK IN DESIGNER WHITE

- ReActiv® Back**
- Pneumatic
- Swivel
- Synchro-tilt
- Tilt Tension
- Tilt Lock

DIMENSIONS

- Seat Depth: 19¼
- Seat Width: 19
- Back Width: 18¾
- Back Height: 21½
- Arm Width: 17½-20
- Cube: 10.8
- Weight Rating: 300 lbs.

FABRIC PRICE CODES

- | | | | |
|---|-------|----|-------|
| 1 | \$682 | 8 | \$758 |
| 2 | \$696 | 9 | \$767 |
| 3 | \$709 | 10 | \$776 |
| 4 | \$719 | 11 | \$787 |
| 5 | \$728 | 12 | \$796 |
| 6 | \$738 | L | \$791 |
| 7 | \$747 | | |

NOTES: Please reference pages 478-480 for additional specifications and mechanism information.

HON Recommendation: HSLVTMR.Y1.A.H.OS.CU__NL.SB.T - List Price \$796

HOW TO SPECIFY

Select Model Number	Select Control Type	Select Arm Type	Select Caster/Glide	Select Back Color	Select Fabric	Select Lumbar	Select Base	Select Frame
	Y0 Synchro-Tilt Y1 Synchro-Tilt w/ Seat Slider (+ \$22) Y2 Advanced Synchro-Tilt (+ \$71)	HSLVTMR Options N Armless F Fixed Arms (+ \$71) A Height and Width Adjustable Arms (+ \$92) V All-Adjustable Arms (includes pivot) (+ \$141)	H Black Hard Caster S Black All-Surface Caster (+ \$44) G Bell Glide (+ \$28) R Black Roll Control Caster (+ \$55)	OS Charcoal TI Titanium DW Designer White	See page 480	NL No Lumbar BL Black Adjustable Lumbar (+ \$33) BY Bullseye Adjustable Lumbar (+ \$33) DW Designer White Adjustable Lumbar (+ \$33) KT Krypton Adjustable Lumbar (+ \$33) MR Ember Adjustable Lumbar (+ \$33) RE Regatta Adjustable Lumbar (+ \$33) TL Titanium Adjustable Lumbar (+ \$33)	SB Standard Base	HSLVTMR Options T Black TI Titanium (+ \$39)
		HSLVTMRS Options ADW Height and Width Adjustable Arms (+ \$92) Available for model HSLVTMRS only						HSLVTMRS Options DW Designer White (+ \$39) Available for model HSLVTMRS only
H S L V T M R .	Y 1 .	A .	H .	O S .	C U 1 0 .	N L .	S B .	T

SEATING

HSLVSMR



STOOL

ReActiv® Back
Pneumatic
Swivel
Synchro-tilt
Tilt Tension
Tilt Lock

DIMENSIONS

Seat Depth: 19¼ Arm Width: 17½-20
Seat Width: 19 Cube: 10.8
Back Width: 18¼ Weight Rating: 300 lbs.
Back Height: 21½

FABRIC PRICE CODES

1	\$761	8	\$837
2	\$775	9	\$846
3	\$788	10	\$855
4	\$798	11	\$866
5	\$807	12	\$875
6	\$817	L	\$870
7	\$826		

NOTES: Please reference pages 478-480 for additional specifications and mechanism information.

HSLVSMRS



STOOL IN DESIGNER WHITE

ReActiv® Back
Pneumatic
Swivel
Synchro-tilt
Tilt Tension
Tilt Lock

DIMENSIONS

Seat Depth: 19¼ Arm Width: 17½-20
Seat Width: 19 Cube: 10.8
Back Width: 18¼ Weight Rating: 300 lbs.
Back Height: 21½

FABRIC PRICE CODES

1	\$761	8	\$837
2	\$775	9	\$846
3	\$788	10	\$855
4	\$798	11	\$866
5	\$807	12	\$875
6	\$817	L	\$870
7	\$826		

NOTES: Please reference pages 478-480 for additional specifications and mechanism information.

HON Recommendation: HSLVSMR.Y1.A.H.OS.CU__NL.SB.T - List Price \$875

HOW TO SPECIFY

Select Model Number	Select Control Type	Select Arm Type	Select Caster/Glide	Select Back Color	Select Fabric	Select Lumbar	Select Base	Select Frame
Y1 Synchro-Tilt w/ Seat Slider (+ \$22)	YO Synchro-Tilt Y1 Synchro-Tilt w/ Seat Slider (+ \$22)	HSLVSMR Options N Armless F Fixed Arms (+ \$71) A Height and Width Adjustable Arms (+ \$92) V All-Adjustable Arms (includes pivot) (+ \$141) HSLVSMRS Options ADW Height and Width Adjustable Arms (+ \$92) <i>Available for model HSLVSMRS only</i>	H Black Hard Caster S Black All-Surface Caster (+ \$44) G Bell Glide (+ \$28) R Black Roll Control Caster (+ \$55)	OS Charcoal TI Titanium DW Designer White	See page 480	NL No Lumbar BL Black Adjustable Lumbar (+ \$33) BY Bullseye Adjustable Lumbar (+ \$33) DW Designer White Adjustable Lumbar (+ \$33) KT Krypton Adjustable Lumbar (+ \$33) MR Ember Adjustable Lumbar (+ \$33) RE Regatta Adjustable Lumbar (+ \$33) TL Titanium Adjustable Lumbar (+ \$33)	SB Standard Base	T Black TI Titanium (+ \$60 for HSLVSMR) DW Designer White (+ \$60; available on HSLVSMRS only)
H S L V S M R .	Y 1 .	A .	H .	O S .	C U I O .	N L .	S B .	T

SEATING



Icon Legend on page 19

SOLVE[®]

HSLVTMMKD

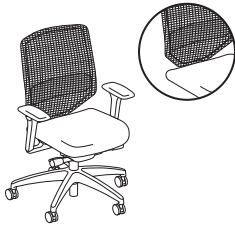

MID-BACK TASK

4-Way Stretch Back
Pneumatic
Swivel
Synchro-tilt
Tilt Tension
Tilt Lock

DIMENSIONS

Seat Depth: 19¼ Arm Width: 17½-20
Seat Width: 19 Cube: 5.6
Back Width: 18¼ Weight Rating: 300 lbs.
Back Height: 21½

FABRIC PRICE CODES

1	\$607	8	\$683
2	\$621	9	\$692
3	\$634	10	\$701
4	\$644	11	\$712
5	\$653	12	\$721
6	\$663	L	\$716
7	\$672		

NOTES: Please reference pages 478-480 for additional specifications and mechanism information.

HSLVTMRKD

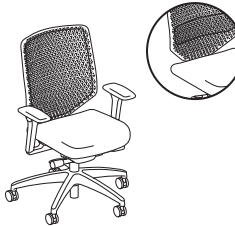

MID-BACK TASK

ReActiv[®] Back
Pneumatic
Swivel
Synchro-tilt
Tilt Tension
Tilt Lock

DIMENSIONS

Seat Depth: 19¼ Arm Width: 17½-20
Seat Width: 19 Cube: 5.6
Back Width: 18¼ Weight Rating: 300 lbs.
Back Height: 21½

FABRIC PRICE CODES

1	\$642	8	\$718
2	\$656	9	\$727
3	\$669	10	\$736
4	\$679	11	\$747
5	\$688	12	\$756
6	\$698	L	\$751
7	\$707		

NOTES: Please reference pages 478-480 for additional specifications and mechanism information.

HON Recommendation: HSLVTMMKD.Y1.A.H.IM.CU__BL.SB.T - List Price \$754

HOW TO SPECIFY

Select Model Number	Select Control Type	Select Arm Type	Select Caster	Select Mesh Back	Select Back Color	Select Back Fabric	Select Seat Fabric	Select Lumbar	Select Base	Select Frame
	Y1 Synchro-Tilt w/ Seat Slider (+ \$22)	A Height and Width Adjustable Arms (+ \$92)	H Black Hard Caster	4-Way Stretch options IM Black Specify for model HSLVTMMKD only	OS Charcoal TI Titanium Specify for model HSLVTMRKD only	COMF46 Bittersweet COMF10 Ink COMF82 Meadow COMF90 Midnight COMF22 Putty COMF19 Sterling	See page 480	NL No Lumbar BL Black Adjustable Lumbar (+ \$33)	SB Standard Base	T Black
HSLVTMMKD	Y1	A	H	IM			CU10	BL	SB	T
HSLVTMRKD	Y1	A	H		OS		CU10	BL	SB	T
HSLVTMUKD	Y1	A	H		OS	COMF46	CU10	BL	SB	T

SEATING

SOLVE[®] Accessories



Icon Legend on page 19

HSLVLMBR

LUMBAR PACK

DIMENSIONS

LIST PRICE

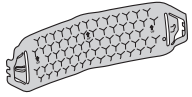

Ship Weight: 1
Cube: 0.2

\$48

HOW TO SPECIFY

Select
Model Number

Select
Color

BY Bullseye Adjustable Lumbar
DW Designer White Adjustable Lumbar
KT Krypton Adjustable Lumbar
MR Ember Adjustable Lumbar
RE Regatta Adjustable Lumbar
T Black
TI Titanium

H S L V L M B R .

T

HSLVFAP

FIXED ARM PACK

DIMENSIONS

LIST PRICE



Ship Weight: 6
Cube: 1.0

\$153

HSLV2DAP

ADJUSTABLE ARM PACK

DIMENSIONS

LIST PRICE



Height and Width

Adjustable Arms Width: 17½-20
Height from Seat: 7¼-11¼
Ship Weight: 6
Cube: 1.0

\$166

HSLV4DAP

ALL-ADJUSTABLE ARM PACK

DIMENSIONS

LIST PRICE



Including Pivot

Ship Weight: 6
Cube: 1.0

\$224

HSCASTER

SET OF 5 ALL-SURFACE CASTERS

DIMENSIONS

LIST PRICE

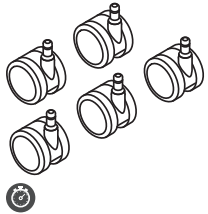

Size: 60mm
Ship Weight: 2
Cube: 0.1

\$75

ⓘ Available in Black finish only, no specification needed.

HOW TO SPECIFY

Select
Model Number

Select
Color

T Black
TI Titanium
DW Designer White (available on HSLV2DAP only)

H S L V 2 D A P .

T



Soothe Guest
Chairs and Tables.

SOOTHE®

Soothe offers the comfort and versatility to support a variety of healthcare and waiting environments. This family of patient and guest seats is constructed from durable materials and thoughtfully designed to be easily cleaned. The entire collection maximizes comfort along the patient's journey to recovery, enhances functionality for the caregiver, and creates the versatility required to deliver a higher level of care.



FEATURES

- Available in Charcoal Urethane arm caps.
- Wipeout space at the back of the seat allows for easy maintenance.
- Bench seating is available in two-seat or three-seat options.
- Choose one of eight frame finishes.
- Multi-fabric option offers endless color combinations.
- Chairs can be ganged together to create straight rows.
- Warranted for users up to 350 lbs. (Model HHCG50 bariatric chair warranted for 750 lbs.)
- Wall-saver design protects walls and cabinets.

SOOTHE[®] Options

MODEL OPTIONS

HHCG11
HHCG11DF - Multi-Fabric



Guest Chair

HHCG21
HHCG21DF - Multi-Fabric

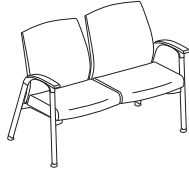

Two-Seat Chair

HHCG50
HHCG50DF - Multi-Fabric

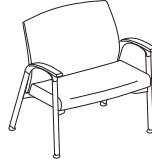

Bariatric Chair

HHCGB21

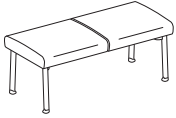

Two-Seat Bench

HHCGB31

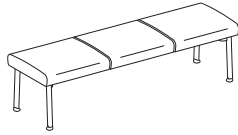

Three-Seat Bench

ARM CAP FINISH

CODE	DESCRIPTION	PRICE
S	Charcoal Urethane	+\$0

FRAME

CODE	DESCRIPTION	PRICE
GRADE P1		
CBK	Charblack	+\$0
PK7	Textured Designer White	+\$0
P7A	Textured Charcoal	+\$0
P7J	Textured Brownstone	+\$0
P7L	Textured Loft	+\$0
P7M	Textured Muslin	+\$0
P8V	Textured Titanium	+\$0
GRADE P2		
PR8	Textured Silver	+\$0

HON BRANDED FABRICS

GRADE 1

Apex
Centurion
Compass
Contourett
Dapper
Emphasis
Ensemble
Hamilton
Noble Seating
Pebble
Vibe

GRADE 2

Appoint Seating
Blume
Clyde
Haute
Kai
Rush
Spin Seating
Wavelength
Whisper Vinyl

GRADE 3

Bradbury
Cozy
Getaway
Moxie*
Notion
Parker
Purl
Quill
Saxony

GRADE 4

Constance with Supreen™
Livi with Supreen™
Lucerne
Lugano with Supreen™
Oxford with Supreen™

For a complete list of fabrics, including partnership fabrics, go to hon.com/fabricsandfinishes.

Reference Fabric Color Combinations on pages 20-25 for color codes and legend on page 21 for lead times. For Fire Code and Moisture Barrier model availability and ordering method, refer to pages 262. For additional HON to Supply COM fabric grade pricing, go to hon.com and click on the HON to Supply COM link.

*High Back models approved in Moxie only.

MULTI-FABRIC COM YARDAGE

Due to fabric pattern nesting and potential reduction of fabric yield, some multi-fabric models may require more total yardage than standard models.

	SEAT	BACK
HHCG11DF	1.4 yd	1.5 yd
HHCG21DF	1.7 yd	2.3 yd
HHCG50DF	1.4 yd	2.3 yd

HHCG11

GUEST CHAIR



DIMENSIONS

Depth:	27	Arm Width:	20½
Width:	25½	Seat to Floor Height:	18⅝
Height:	35	Usable Seat Depth:	18
Seat Depth:	18	Ship Weight:	55
Seat Width:	21½	Cube:	14.9
Back Width:	21	COM:	2.0
Back Height:	20½	Weight Rating:	350 lbs.

FABRIC PRICE CODES

1	\$1579	8	\$1877
2	\$1632	9	\$1916
3	\$1684	10	\$1954
4	\$1722	11	\$1994
5	\$1761	12	\$2032
6	\$1800	L	—
7	\$1838		

HHCG21

TWO-SEAT CHAIR

Outside Arms

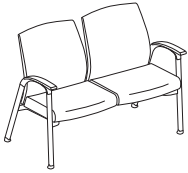

DIMENSIONS

Depth:	27	Arm Width:	42¾
Width:	48	Seat to Floor Height:	18⅝
Height:	35	Usable Seat Depth:	18
Each Seat Depth:	18	Ship Weight:	109
Each Seat Width:	21½	Cube:	33.8
Each Back Width:	21	COM:	3.4
Each Back Height:	20¼	Weight Rating:	350 lbs.

FABRIC PRICE CODES

1	\$2607	8	\$3128
2	\$2698	9	\$3196
3	\$2789	10	\$3264
4	\$2857	11	\$3332
5	\$2925	12	\$3400
6	\$2993	L	—
7	\$3060		

HHCG50

BARIATRIC CHAIR



DIMENSIONS

Depth:	26	Arm Width:	29½
Width:	34½	Seat to Floor Height:	18⅝
Height:	35	Usable Seat Depth:	18
Seat Depth:	18	Ship Weight:	80
Seat Width:	30½	Cube:	25.1
Back Width:	30	COM:	3.0
Back Height:	20½	Weight Rating:	750 lbs.

FABRIC PRICE CODES

1	\$1980	8	\$2501
2	\$2071	9	\$2569
3	\$2162	10	\$2637
4	\$2230	11	\$2705
5	\$2298	12	\$2773
6	\$2366	L	—
7	\$2433		

! HHCG50 is a Single Seat Bariatric chair warranted to 750 lbs.

HOW TO SPECIFY

Select Model Number HHCG11	Select Arm Cap Finish S Charcoal Urethane	Select Fabric AI90 See page 489	Select Frame PR8 See page 489
--------------------------------------	---	---	---



Icon Legend on page 19

SOOTHE[®] Multi-Fabric

HHCG11DF



GUEST CHAIR

Multi-Fabric

DIMENSIONS

Depth:	27	Arm Width:	20½
Width:	25½	Seat to Floor Height:	18⅞
Height:	35	Usable Seat Depth:	18
Seat Depth:	18	Ship Weight:	55
Seat Width:	21½	Cube:	14.9
Back Width:	21	COM:	See page 489
Back Height:	20½	Weight Rating:	350 lbs.

FABRIC PRICE CODES

1	\$1672	
<i>Add to Base Price Above</i>		
	Back	Seat
2	\$27	\$27
3	\$53	\$53
4	\$72	\$72
5	\$91	\$91
6	\$111	\$111
7	\$130	\$130
8	\$150	\$150
9	\$169	\$169
10	\$188	\$188
11	\$208	\$208
12	\$227	\$227

NOTES: For multi-fabric models, start with the base price, then add the additional amount for the back and seat from the corresponding matrix to determine final price. Choose any combination of fabric grades for back and seat. See examples below:
HHCG11DF base price (\$1672)

HHCG21DF

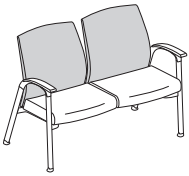

TWO-SEAT CHAIR

Multi-Fabric
Outside Arms

DIMENSIONS

Depth:	27	Arm Width:	42¾
Width:	48	Seat to Floor Height:	18⅞
Height:	35	Usable Seat Depth:	18
Each Seat Depth:	18	Ship Weight:	109
Each Seat Width:	21½	Cube:	33.8
Each Back Width:	21	COM:	See page 489
Each Back Height:	20¼	Weight Rating:	350 lbs.

FABRIC PRICE CODES

1	\$2699	
<i>Add to Base Price Above</i>		
	Back	Seat
2	\$53	\$40
3	\$105	\$79
4	\$143	\$108
5	\$182	\$136
6	\$220	\$166
7	\$258	\$196
8	\$297	\$225
9	\$335	\$254
10	\$374	\$283
11	\$414	\$313
12	\$452	\$341

NOTES: For multi-fabric models, start with the base price, then add the additional amount for the back and seat from the corresponding matrix to determine final price. Choose any combination of fabric grades for back and seat. See examples below:
HHCG21DF base price (\$2699)

HOW TO SPECIFY

Select Model Number H H C G 1 1 D F	Select Arm Cap Finish S Charcoal Urethane	Select Back Fabric See page 489	Select Seat Fabric See page 489	Select Frame See page 489
H H C G 1 1 D F	S	A 1 9 0	R S 1 4	P R 8

SOOTHE[®] Multi-Fabric



Icon Legend on page 19

HHCG50DF

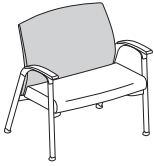

BARIATRIC CHAIR

Multi-Fabric

DIMENSIONS

Depth:	26	Arm Width:	29½
Width:	34½	Seat to Floor Height:	18⅝
Height:	35	Usable Seat Depth:	18
Seat Depth:	18	Ship Weight:	80
Seat Width:	30½	Cube:	25.1
Back Width:	30	COM:	See page 489
Back Height:	20½	Weight Rating:	750 lbs.

FABRIC PRICE CODES

1	\$2073	
<i>Add to Base Price Above</i>		
	Back	Seat
2	\$53	\$40
3	\$105	\$79
4	\$143	\$108
5	\$182	\$136
6	\$220	\$166
7	\$258	\$196
8	\$297	\$225
9	\$335	\$254
10	\$374	\$283
11	\$414	\$313
12	\$452	\$341

NOTES: For multi-fabric models, start with the base price, then add the additional amount for the back and seat from the corresponding matrix to determine final price. Choose any combination of fabric grades for back and seat. See examples below:
HHCG50DF base price (\$2073)

HHGGBRCH

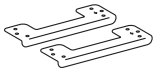

GANGING BRACKET

DIMENSIONS

Ship Weight:	2
Cube:	0.2

LIST PRICE

\$123

NOTES: For chair to chair connection. Does not connect a bench to other type of seating. Ganging brackets can be used with the seating models on pages 490-492. Bench models do not gang. Brackets are Charcoal only.

HOW TO SPECIFY

Select Model Number	Select Arm Cap Finish S Charcoal Urethane	Select Back Fabric See page 489	Select Seat Fabric See page 489	Select Frame See page 489
HHCG50DF	S	A190	RS14	PR8



Icon Legend on page 19

SOOTHE[®] Benches

HHCGB21

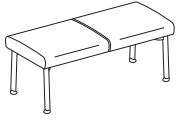

TWO-SEAT BENCH

DIMENSIONS

Depth:	20½	Seat to Floor Height:	17¾
Width:	44	Usable Seat Depth:	17¼
Height:	18¾	Ship Weight:	55
Seat Width:	22	Cube:	18.4
		COM:	1.9
		Weight Rating:	350 lbs.

FABRIC PRICE CODES

1	\$1890	8	\$2114
2	\$1930	9	\$2143
3	\$1969	10	\$2172
4	\$1998	11	\$2201
5	\$2026	12	\$2230
6	\$2055	L	—
7	\$2085		

ⓘ Benches cannot be ganged.

HHCGB31

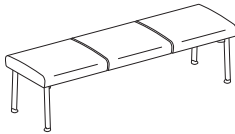

THREE-SEAT BENCH

DIMENSIONS

Depth:	20½	Seat to Floor Height:	17¾
Width:	66	Usable Seat Depth:	17¼
Height:	18¾	Ship Weight:	69
Seat Width:	22	Cube:	25.7
		COM:	2.6
		Weight Rating:	350 lbs.

FABRIC PRICE CODES

1	\$2433	8	\$2657
2	\$2473	9	\$2686
3	\$2512	10	\$2715
4	\$2541	11	\$2744
5	\$2569	12	\$2773
6	\$2598	L	—
7	\$2628		

ⓘ Benches cannot be ganged.

HOW TO SPECIFY

<p>Select Model Number</p> <p style="font-family: monospace; font-size: 1.2em; letter-spacing: 0.5em;">H H C G B 2 1</p>	<p>Select Fabric</p> <p>See page 489</p> <p style="font-family: monospace; font-size: 1.2em; letter-spacing: 0.5em;">R S 1 4</p>	<p>Select Frame</p> <p>See page 489</p> <p style="font-family: monospace; font-size: 1.2em; letter-spacing: 0.5em;">P R 8</p>
---	---	--

TORCH™ Mesh Chairs



Icon Legend on page 19

HVL511



MID-BACK

Pneumatic
Swivel
Tilt
Tilt Tension
Tilt Lock
Fixed Arms

Functions: **A, E, F, K, L**

(Function Key on pages 256-257)

DIMENSIONS

Depth:	26	Arm Width:	18¾
Width:	26	Seat to Floor Height:	16⅞-20⅝
Height:	40½	Usable Seat Depth:	18¾
Seat Depth:	18¼	Ship Weight:	30
Seat Width:	19½	Cube:	3.8
Back Width:	17¾	Weight Rating:	250 lbs.
Back Height:	21¾		

PRICE CODE

Fabric **\$425**

NOTES: Mid-back Mesh chair. Comfortable and breathable mesh back. Black fabric seat. Black frame. Fixed arms. **HON 5-Year Limited Warranty.**

HON Recommendation: HVL511.LH10 - List Price \$425

HVL515

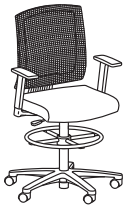

TASK STOOL

Pneumatic
Swivel
Fixed Arms

Functions: **A, E**

(Function Key on pages 256-257)

DIMENSIONS

Depth:	26	Arm Width:	18¾
Width:	26	Seat to Floor Height:	23⅞-33
Height:	52	Usable Seat Depth:	18¾
Seat Depth:	18¼	Ship Weight:	38
Seat Width:	19½	Cube:	4.6
Back Width:	17¾	Weight Rating:	250 lbs.
Back Height:	21¾		

PRICE CODE

Fabric **\$592**

NOTES: Comfortable and breathable mesh back. Black fabric seat. Fixed arms. **HON 5-Year Limited Warranty.**

HON Recommendation: HVL515.LH10 - List Price \$592

HOW TO SPECIFY

Select
Model Number

Select
Fabric

LH10 Black Fabric

H V L 5 1 1 .

L H 1 0



Versant® Seating shown
with Laminate Occasional Tables.

VERSANT®

Everyone deserves a break from time to time, and a comfy seat in which to enjoy one. Bring stylish support to your welcome areas, public spaces, and breakrooms with Versant. With a combination of chairs and benches, it's ideal for both healthcare environments and offices. Arched arms support the upper body and padded seats put people at ease for longer periods of time. Versant brings versatility to every corner of your space.



FEATURES

- Stylish arched arm offers greater upper body support.
- Seats are removable for easy cleaning.
- Contrasting fabric options are available as special order (please contact customer service).
- Solid hardwood in one of eight attractive finishes.
- Available in hundreds of quality HON fabrics.
- Warranted for users up to 350 lbs. (Model HHCB50 is warranted for users up to 500 lbs.)

VERSANT® Options

MODEL OPTIONS

HHB02



Two-Seat Bench

HHB03

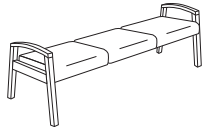

Three-Seat Bench

HHCT01

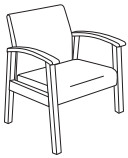

Single Seat

Leg Base, Arms

HHCB50

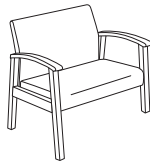

Bariatric Chair

Leg Base, Arms

AVAILABLE FINISHES

Versant® Seating is available in 8 wood finishes.

WOOD FINISHES

Bourbon Cherry (H)

Cognac (COGN)

Harvest (C)

Mahogany (N)

Mocha (MOCH)

Natural Maple (D)

Pinnacle (PINC)

Shaker Cherry (F)

Due to wood being a natural material, color may differ between pieces. Stains will be tonal matches and will not replicate the grain contrast of the coordinating laminate. Prolonged exposure to sunlight can affect the appearance of wood furniture, leading to variations in hue and tone.

HON BRANDED FABRICS

GRADE 1

Apex
Centurion
Contourett
Dapper
Emphasis
Ensemble
Hamilton
Noble Seating
Pebble
Vibe

GRADE 2

Appoint Seating
Blume
Clyde
Haute
Kai
Rush
Spin Seating
Wavelength
Whisper Vinyl

GRADE 3

Bradbury
Cozy
Getaway
Moxie
Notion
Parker
Purl
Quill
Saxony

GRADE 4

Constance with Supreen™
Livi with Supreen™
Lucerne
Lugano with Supreen™
Oxford with Supreen™

For a complete list of fabrics, including partnership fabrics, go to hon.com/fabricsandfinishes.

Reference Fabric Color Combinations on pages 20-25 for color codes and legend on page 21 for lead times. Contrasting fabric options on seat and back are available as special order. Please contact Customer Service. For additional HON to Supply COM fabric grade pricing, go to hon.com and click on the HON to Supply COM link.



Icon Legend on page 19

VERSANT®

HHB02

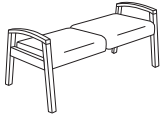

TWO-SEAT BENCH

DIMENSIONS

Depth:	20 ³ / ₈	Seat to Floor Height:	19 ¹ / ₂
Width:	45 ¹ / ₂	Usable Seat Depth:	19 ³ / ₄
Height:	23	Ship Weight:	62
Each Seat Depth:	20 ³ / ₈	Cube:	16.2
Each Seat Width:	21 ¹ / ₂	COM:	2.0
Arm Width:	42 ¹ / ₂	Weight Rating:	350 lbs. (per seat)

FABRIC PRICE CODES

1	\$2470	8	\$2777
2	\$2525	9	\$2818
3	\$2579	10	\$2857
4	\$2618	11	\$2898
5	\$2658	12	\$2937
6	\$2698	L	\$2914
7	\$2737		

HHB03

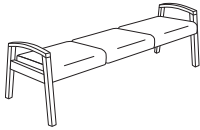

THREE-SEAT BENCH

DIMENSIONS

Depth:	20 ³ / ₈	Seat to Floor Height:	19 ¹ / ₂
Width:	66 ¹ / ₂	Usable Seat Depth:	19 ³ / ₄
Height:	23	Ship Weight:	80
Each Seat Depth:	20 ³ / ₈	Cube:	24.5
Each Seat Width:	21 ¹ / ₂	COM:	2.5
Arm Width:	63 ¹ / ₂	Weight Rating:	350 lbs. (per seat)

FABRIC PRICE CODES

1	\$3175	8	\$3559
2	\$3242	9	\$3609
3	\$3309	10	\$3659
4	\$3360	11	\$3709
5	\$3409	12	\$3758
6	\$3460	L	\$3731
7	\$3509		

HON Recommendation: HHB02.MOCH.SX__ - List Price \$2579

HOW TO SPECIFY

<p>Select Model Number</p> <p>HHB02</p>	<p>Select Finish</p> <p>See page 496</p> <p>MOCH</p>	<p>Select Seat Fabric</p> <p>See page 496</p> <p>SX05</p>
---	--	---

HHCT01



SINGLE SEAT

Leg Base
Arms

DIMENSIONS

Depth:	27	Arm Width:	20½
Width:	25	Seat to Floor Height:	18
Height:	34	Usable Seat Depth:	19¼
Seat Depth:	20¼	Ship Weight:	57
Seat Width:	21	Cube:	20.1
Back Width:	21	COM:	2.0
Back Height:	17	Weight Rating:	350 lbs.

FABRIC PRICE CODES

1	\$1886	8	\$2193
2	\$1941	9	\$2234
3	\$1995	10	\$2273
4	\$2034	11	\$2314
5	\$2074	12	\$2353
6	\$2114	L	\$2330
7	\$2153		

HHCB50

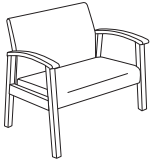

BARIATRIC SINGLE SEAT

Leg Base
Arms

DIMENSIONS

Depth:	27	Arm Width:	29
Width:	33½	Seat to Floor Height:	18
Height:	34	Usable Seat Depth:	19¼
Each Seat Depth:	20¼	Ship Weight:	80
Each Seat Width:	30	Cube:	29.0
Each Back Width:	30	COM:	3.0
Each Back Height:	17	Weight Rating:	500 lbs.

FABRIC PRICE CODES

1	\$2820	8	\$3280
2	\$2902	9	\$3341
3	\$2981	10	\$3400
4	\$3041	11	\$3460
5	\$3101	12	\$3520
6	\$3160	L	\$3486
7	\$3221		

HON Recommendation: HHCT01.MOCH.SX__ - List Price \$1995

HOW TO SPECIFY

Select
Model Number

HHCT01

Select
Finish

See page 496

MOCH

Select
Seat Fabric

See page 496

SX05



Volt® Task Chairs and Stools
shown with Voi® Desks.

VOLT®

Customizable comfort, distinctive styling and an affordable price point make Volt the family of task seating that supports your body and your budget. The stylish V-shaped back design can be specified in fabric, leather or breathable mesh, giving you more control over your look and feel. The personalized controls and generously proportioned seat and back deliver greater comfort, and are designed support to a wider variety of users. Volt delivers the look you desire, the comfort you demand, and the quality you expect. That's the power of practicality.



FEATURES

- Optional synchro-tilt control provides a smooth, natural recline.
- Optional height-adjustable arms provide a custom fit.
- Optional mesh back offers breathable support.
- Task stools feature an adjustable footring for additional lower body support.
- One-touch seat height adjustment easily moves the seat up and down.
- Tilt tension controls the rate and ease of recline.
- Tilt lock allows the user to lock out the tilt function.
- 360-degree swivel provides freedom of movement in any direction.
- Select models available in hundreds of quality HON fabrics.
- Warranted for users up to 275 lbs.

VOLT® 5700/5710 Series Options

MODEL OPTIONS

H5701



Task Chair

Pneumatic, Swivel, Tilt, Tilt Tension, Tilt Lock

H5703



Task Chair

Pneumatic, Swivel, Synchro-tilt, Tilt Tension, Tilt Lock

H5705



Task Stool

Pneumatic, Swivel, Adjustable Footring

H5711



Task Chair (Mesh Back)

Pneumatic, Swivel, Tilt, Tilt Tension, Tilt Lock

H5713



Task Chair (Mesh Back)

Pneumatic, Swivel, Synchro-tilt, Tilt Tension, Tilt Lock

H5715



Task Stool (Mesh Back)

Pneumatic, Swivel, Adjustable Footring

HON BRANDED FABRICS

GRADE 1

Black Fabric
Navy Fabric

For a complete list of fabrics, including partnership fabrics, go to [hon.com/fabricsandfinishes](https://www.hon.com/fabricsandfinishes).

Navy only available on select models.

Reference Fabric Color Combinations on pages 20-25 for color codes and legend on page 21 for lead times.



Icon Legend on page 19

VOLT® 5700 Series

H5701



TASK CHAIR

Pneumatic
Swivel
Tilt
Tilt Tension
Tilt Lock

Functions: **A, E, F, K, L**
(Function Key on pages 256-257)

DIMENSIONS

Depth:	25 ³ / ₄	Seat to Floor Height:	18-22 ¹ / ₄
Width:	26	Usable Seat Depth:	18 ³ / ₄
Height:	40	Ship Weight:	29
Seat Depth:	18 ³ / ₄	Cube:	5.1
Seat Width:	18 ¹ / ₂	Weight Rating:	275 lbs.
Back Width:	17 ¹ / ₄		
Back Height:	18 ³ / ₄		

FABRIC PRICE CODES

1 \$385 L \$418

H5703



TASK CHAIR

Pneumatic
Swivel
Synchro-tilt
Tilt Tension
Tilt Lock

Functions: **A, E, J, K, L**
(Function Key on pages 256-257)

DIMENSIONS

Depth:	25 ³ / ₄	Seat to Floor Height:	18-22 ¹ / ₄
Width:	26	Usable Seat Depth:	18 ³ / ₄
Height:	40	Ship Weight:	29
Seat Depth:	18 ³ / ₄	Cube:	5.1
Seat Width:	18 ¹ / ₂	Weight Rating:	275 lbs.
Back Width:	17 ¹ / ₄		
Back Height:	18 ³ / ₄		

FABRIC PRICE CODES

1 \$445 L \$478

H5705



TASK STOOL

Pneumatic
Swivel
Adjustable Footring

Functions: **A, E**
(Function Key on pages 256-257)

DIMENSIONS

Depth:	29 ¹ / ₂	Seat to Floor Height:	22 ⁷ / ₈ -32 ³ / ₈
Width:	27	Usable Seat Depth:	18
Height:	49 ⁷ / ₈	Ship Weight:	36
Seat Depth:	20	Cube:	6.0
Seat Width:	19	Weight Rating:	275 lbs.
Back Width:	16 ¹ / ₂		
Back Height:	20		

FABRIC PRICE CODES

1 \$628 L \$661

H5795

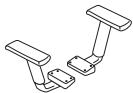

HEIGHT-ADJUSTABLE ARMS

Non-upholstered

Functions: **Q**
(Function Key on pages 256-257)

DIMENSIONS

Adjustable Arms Width:	17 ³ / ₈
Height from Seat:	7 ⁵ / ₈ -10 ⁵ / ₈
Ship Weight:	5
Cube:	0.6

LIST PRICE

\$122

HON Recommendation: H5703.GA10.T with H5795 Arm Pack - List Price \$567

HOW TO SPECIFY

Select
Model Number

H 5 7 0 3

Select
Fabric

SB11 Black Bonded Leather
GA10 Black
GA90 Navy (only available on H5701)

G A 1 0

Select
Frame

T Black

T

VOLT® 5710 Series



Icon Legend on page 19

H5711



TASK CHAIR

Mesh Back
Pneumatic
Swivel
Tilt
Tilt Tension
Tilt Lock
Functions: **A, E, F, K, L**
(Function Key on pages 256-257)

DIMENSIONS

Depth: 25³/₄ Seat to Floor Height: 18³/₄-22³/₈
Width: 26 Usable Seat Depth: 18
Height: 38³/₄ Ship Weight: 29
Seat Depth: 18³/₄ Cube: 5.1
Seat Width: 19¹/₄ Weight Rating: 275 lbs.
Back Width: 18
Back Height: 18³/₄

FABRIC PRICE CODES

1 \$531 L \$564

H5713



TASK CHAIR

Mesh Back
Pneumatic
Swivel
Synchro-tilt
Tilt Tension
Tilt Lock
Functions: **A, E, J, K, L**
(Function Key on pages 256-257)

DIMENSIONS

Depth: 25³/₄ Seat to Floor Height: 17³/₄-21⁵/₈
Width: 26 Usable Seat Depth: 17⁷/₈
Height: 38¹/₂ Ship Weight: 32
Seat Depth: 18³/₄ Cube: 5.1
Seat Width: 19¹/₄ Weight Rating: 275 lbs.
Back Width: 18
Back Height: 18³/₄

FABRIC PRICE CODES

1 \$596 L \$629

H5715



TASK STOOL

Mesh Back
Pneumatic
Swivel
Adjustable Footring
Functions: **A, E**
(Function Key on pages 256-257)

DIMENSIONS

Depth: 28 Seat to Floor Height: 22⁷/₈-32³/₈
Width: 26 Usable Seat Depth: 18
Height: 49⁷/₈ Ship Weight: 36
Seat Depth: 20 Cube: 6.0
Seat Width: 19 Weight Rating: 275 lbs.
Back Width: 18
Back Height: 18¹/₂

FABRIC PRICE CODES

1 \$781 L \$814

H5795

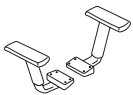

HEIGHT-ADJUSTABLE ARMS

Non-upholstered
Functions: **Q**
(Function Key on pages 256-257)

DIMENSIONS

Adjustable Arms Width: 17³/₈
Height from Seat: 7³/₈-10³/₈
Ship Weight: 5
Cube: 0.6

LIST PRICE

\$122

HON Recommendation: H5713.GA10.T with H5795 Arm Pack - List Price \$718

SEATING

HOW TO SPECIFY

<p>Select Model Number</p> <p>H 5 7 1 3 .</p>	<p>Select Fabric</p> <p>SB11 Black Bonded Leather GA10 Black</p> <p>G A 1 0 .</p>	<p>Select Frame</p> <p>T Black</p> <p>T</p>
---	---	---

VOLT® 5720/5730 Series Options

MODEL OPTIONS

H5721



Task Chair

Pneumatic, Swivel, Tilt, Tilt Tension, Tilt Lock

H5723



Task Chair

Pneumatic, Swivel, Synchro-tilt, Tilt Tension, Tilt Lock

H5725



Task Stool

Pneumatic, Swivel, Adjustable Footring

H5731



Task Chair (Mesh Back)

Pneumatic, Swivel, Tilt, Tilt Tension, Tilt Lock

H5733



Task Chair (Mesh Back)

Pneumatic, Swivel, Synchro-tilt, Tilt Tension, Tilt Lock

H5735



Task Stool (Mesh Back)

Pneumatic, Swivel, Adjustable Footring

CASTERS



CODE	DESCRIPTION	PRICE
H	Black Hard Caster	+\$0



S	Black All-Surface Caster	+\$44
----------	--------------------------	--------------

FRAME

CODE	DESCRIPTION	PRICE
T	Black	+\$0

VOLT®

5720/5730 Series Fabric Options

HON BRANDED FABRICS

GRADE 1

Apex
Centurion
Contourett
Dapper
Ensemble
Hamilton
Pebble

GRADE 2

Appoint Seating
Blume
Clyde
Haute
Kai
Rush
Spin Seating
Wavelength
Whisper Vinyl

GRADE 3

Cozy
Getaway
Moxie
Parker
Purl
Quill

GRADE 4

Livi with Supreen™
Lucerne
Oxford with Supreen™

For a complete list of fabrics, including partnership fabrics, go to hon.com/fabricsandfinishes.

Reference Fabric Color Combinations on pages 20-25 for color codes and legend on page 21 for lead times. For additional HON to Supply COM fabric grade pricing, go to hon.com and click on the HON to Supply COM link.



Icon Legend on page 19

VOLT® 5720 Series

H5721



TASK CHAIR

Pneumatic
Swivel
Tilt
Tilt Tension
Tilt Lock

Functions: **A, E, F, K, L**
(Function Key on pages 256-257)

DIMENSIONS

Depth:	25 ³ / ₄	Seat to Floor Height:	17 ¹ / ₄ -22 ¹ / ₄
Width:	25 ³ / ₄	Usable Seat Depth:	18 ³ / ₄
Height:	40	Ship Weight:	36
Seat Depth:	18 ³ / ₄	Cube:	5.1
Seat Width:	18 ¹ / ₂	COM:	1.5
Back Width:	17 ¹ / ₄	Weight Rating:	275 lbs.
Back Height:	18 ³ / ₄		

FABRIC PRICE CODES

1	\$503	8	\$653
2	\$530	9	\$672
3	\$556	10	\$691
4	\$575	11	\$711
5	\$594	12	\$730
6	\$614	L	—
7	\$633		

H5723



TASK CHAIR

Pneumatic
Swivel
Synchro-tilt
Tilt Tension
Tilt Lock

Functions: **A, E, J, K, L**
(Function Key on pages 256-257)

DIMENSIONS

Depth:	25 ³ / ₄	Seat to Floor Height:	17 ¹ / ₄ -22 ¹ / ₄
Width:	25 ³ / ₄	Usable Seat Depth:	18 ³ / ₄
Height:	40	Ship Weight:	38
Seat Depth:	18 ³ / ₄	Cube:	5.1
Seat Width:	18 ¹ / ₂	COM:	1.5
Back Width:	17 ¹ / ₄	Weight Rating:	275 lbs.
Back Height:	18 ³ / ₄		

FABRIC PRICE CODES

1	\$560	8	\$710
2	\$587	9	\$729
3	\$613	10	\$748
4	\$632	11	\$768
5	\$651	12	\$787
6	\$671	L	—
7	\$690		

H5725

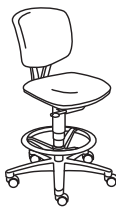

TASK STOOL

Pneumatic
Swivel
Adjustable Footring

Functions: **A, E**
(Function Key on pages 256-257)

DIMENSIONS

Depth:	29 ¹ / ₂	Seat to Floor Height:	22 ⁷ / ₈ -32 ³ / ₈
Width:	27	Usable Seat Depth:	18 ³ / ₄
Height:	49 ⁷ / ₈	Ship Weight:	39
Seat Depth:	20	Cube:	6.0
Seat Width:	19	COM:	1.5
Back Width:	17 ¹ / ₄	Weight Rating:	275 lbs.
Back Height:	18 ³ / ₄		

FABRIC PRICE CODES

1	\$730	8	\$880
2	\$757	9	\$899
3	\$783	10	\$918
4	\$802	11	\$938
5	\$821	12	\$957
6	\$841	L	—
7	\$860		

H5795

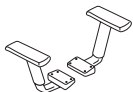

HEIGHT-ADJUSTABLE ARMS

Non-upholstered

Functions: **Q**
(Function Key on pages 256-257)

DIMENSIONS

Adjustable Arms Width:	17 ³ / ₈
Height from Seat:	7 ⁷ / ₈ -10 ⁵ / ₈
Ship Weight:	5
Cube:	0.6

LIST PRICE

\$122

HSCASTER

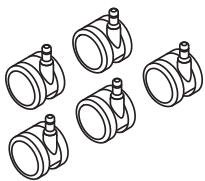

SET OF 5 ALL-SURFACE CASTERS

DIMENSIONS

Size:	60mm
Ship Weight:	2
Cube:	0.1

LIST PRICE

\$75

Available in Black finish only, no specification needed.

HON Recommendation: H5723.H.CU__T with H5795 Arm Pack - List Price \$682

HOW TO SPECIFY

Select Model Number H 5 7 2 3	Select Caster H Black Hard Caster S Black All-Surface Caster (+ \$44)	Select Fabric See page 504	Select Frame T Black
---	--	--------------------------------------	--------------------------------

VOLT® 5730 Series



Icon Legend on page 19

H5731



TASK CHAIR

Mesh Back
Pneumatic
Swivel
Tilt
Tilt Tension
Tilt Lock
Functions: **A, E, F, K, L**
(Function Key on pages 256-257)

DIMENSIONS

Depth: 25³/₄ Seat to Floor Height: 18³/₄-22³/₈
Width: 26 Usable Seat Depth: 18
Height: 38³/₄ Ship Weight: 29
Seat Depth: 18³/₄ Cube: 5.1
Seat Width: 19¹/₄ COM: 1.5
Back Width: 18 Weight Rating: 275 lbs.
Back Height: 18³/₄

FABRIC PRICE CODES

1	\$652	8	\$728
2	\$666	9	\$737
3	\$679	10	\$746
4	\$689	11	\$757
5	\$698	12	\$766
6	\$708	L	—
7	\$717		

H5733



TASK CHAIR

Mesh Back
Pneumatic
Swivel
Synchro-tilt
Tilt Tension
Tilt Lock
Functions: **A, E, J, K, L**
(Function Key on pages 256-257)

DIMENSIONS

Depth: 25³/₄ Seat to Floor Height: 17³/₄-21¹/₈
Width: 26 Usable Seat Depth: 17⁷/₈
Height: 38¹/₂ Ship Weight: 32
Seat Depth: 18³/₄ Cube: 5.1
Seat Width: 19¹/₄ COM: 1.5
Back Width: 18 Weight Rating: 275 lbs.
Back Height: 18³/₄

FABRIC PRICE CODES

1	\$714	8	\$790
2	\$728	9	\$799
3	\$741	10	\$808
4	\$751	11	\$819
5	\$760	12	\$828
6	\$770	L	—
7	\$779		

H5735



TASK STOOL

Mesh Back
Pneumatic
Swivel
Adjustable Footring
Functions: **A, E**
(Function Key on pages 256-257)

DIMENSIONS

Depth: 28 Seat to Floor Height: 22⁷/₈-32³/₈
Width: 26 Usable Seat Depth: 18
Height: 49⁷/₈ Ship Weight: 36
Seat Depth: 20 Cube: 6.0
Seat Width: 19 COM: 1.5
Back Width: 18 Weight Rating: 275 lbs.
Back Height: 18¹/₂

FABRIC PRICE CODES

1	\$886	8	\$962
2	\$900	9	\$971
3	\$913	10	\$980
4	\$923	11	\$991
5	\$932	12	\$1000
6	\$942	L	—
7	\$951		

H5795

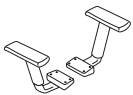

HEIGHT-ADJUSTABLE ARMS

Non-upholstered
Functions: **Q**
(Function Key on pages 256-257)

DIMENSIONS

Adjustable Arms Width: 17³/₈
Height from Seat: 7³/₈-10³/₈
Ship Weight: 5
Cube: 0.6

LIST PRICE

\$122

HSCASTER

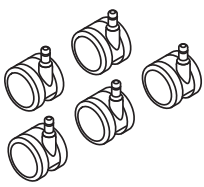

SET OF 5 ALL-SURFACE CASTERS

ⓘ Available in Black finish only, no specification needed.

DIMENSIONS

Size: 60mm
Ship Weight: 2
Cube: 0.1

LIST PRICE

\$75

HON Recommendation: H5733.H.CU__T with H5795 Arm Pack - List Price \$836

HOW TO SPECIFY

Select Model Number H 5 7 3 3	Select Caster H Black Hard Caster S Black All-Surface Caster (+ \$44)	Select Fabric See page 504 CU 1 0	Select Frame T Black
---	--	--	--------------------------------



Icon Legend on page 19

WAVE™ Mesh Chairs

HVL701



HIGH-BACK

Pneumatic
Swivel
Knee Tilt
Tilt Tension
Infinite Tilt Lock
Adjustable Lumbar
Height-adjustable Arms

DIMENSIONS

Depth:	28	Arm Width:	19½
Width:	27½	Seat to Floor Height:	18½-21¼
Height:	44⅝	Usable Seat Depth:	19¼
Seat Depth:	20¾	Ship Weight:	53
Seat Width:	22	Cube:	5.8
Back Width:	23	Weight Rating:	250 lbs.
Back Height:	23¾		

PRICE CODE

Leather **\$1006**

Functions: **A, E, H, K, L, Q, W**
(Function Key on pages 256-257)

NOTES: Comfortable and breathable mesh back. Sturdy textured black frame. HVL701 has a Black Bonded Leather upholstered seat with side mesh panels. Adjustable lumbar support. **HON 5-Year Limited Warranty.**

HON Recommendation: HVL701.SB11 - List Price \$1006

HVL702



HIGH-BACK

Pneumatic
Swivel
Synchro-tilt
Tilt Tension
Tilt Lock
Height-adjustable Arms

DIMENSIONS

Depth:	26½	Arm Width:	19½
Width:	26½	Seat to Floor Height:	18½-23½
Height:	40½	Usable Seat Depth:	19¾
Seat Depth:	19¾	Ship Weight:	40
Seat Width:	21	Cube:	5.0
Back Width:	19½	Weight Rating:	250 lbs.
Back Height:	24		

PRICE CODE

Sandwich Mesh **\$816**

Functions: **A, E, J, K, L, Q**
(Function Key on pages 256-257)

NOTES: Black Sandwich Mesh seat and mesh back. **HON 5-Year Limited Warranty.**

HON Recommendation: HVL702.MM10 - List Price \$816

HVL705



EXECUTIVE BIG AND TALL

Pneumatic
Knee Tilt
Tilt Tension
Tilt Lock
Height and Width Adjustable Arms
Integrated Lumbar Support

DIMENSIONS

Depth:	25⅝	Back Height:	28
Width:	30¼	Seat to Floor Height:	18¾-23¾
Height:	43⅝	Usable Seat Depth:	18¾
Seat Depth:	18¾	Ship Weight:	59
Seat Width:	21⅝	Cube:	6.1
Back Width:	22¾	Weight Rating:	450 lbs.

PRICE CODE

Mesh **\$1197**

Functions: **A, E, H, K, L, S**
(Function Key on pages 256-257)

NOTES: Large scale model HVL705 will support up to 450 lbs with normal use. Available in Black Mesh fabric VM10. **HON 5-Year Limited Warranty.**

HON Recommendation: HVL705.VM10 - List Price \$1197

HVL712



MID-BACK

Pneumatic
Swivel
Synchro-tilt
Tilt Tension
Tilt Lock
Height-adjustable Arms

DIMENSIONS

Depth:	28½	Arm Width:	18⅝
Width:	29½	Seat to Floor Height:	18-22¼
Height:	41¾	Usable Seat Depth:	18
Seat Depth:	18½	Ship Weight:	39
Seat Width:	19¾	Cube:	5.4
Back Width:	20½	Weight Rating:	250 lbs.
Back Height:	20¾		

PRICE CODE

Sandwich Mesh **\$689**

Functions: **A, E, J, K, L, Q**
(Function Key on pages 256-257)

NOTES: Black Sandwich Mesh seat and mesh back. **HON 5-Year Limited Warranty.**

HON Recommendation: HVL712.MM10 - List Price \$689

HOW TO SPECIFY

Select Model Number

Select Fabric

- SB11** Black Bonded Leather
Specify for model HVL701 only
- MM10** Black Sandwich Mesh Fabric
Specify for models HVL702 and HVL712 only
- VM10** Black Mesh Fabric
Specify for model HVL705 only

HVL701

SB11

SEATING

WEST HILL™ CASUAL LOUNGE SEATING

Want to see more? Scan here
to check out hon.com.



West Hill™ Casual Lounge Seating
shown with Scramble™ Coffee Table.

WEST HILL™

Whether you're a thought leader, innovator, or highly motivated team player, West Hill casual lounge creates an inviting space that inspires relaxed productivity, sustains concentration, and sparks creativity.

With solid construction, a multitude of back cushion styling, seating options from a single seat to three or more, and choices in leg styles, fabrics, and configurations, West Hill makes it easier to make your space exceptional.



FEATURES

- Contoured seat cushion design brings living room comfort to the work space.
- Choose between a Square Back or sink into a comfy Pillow Back cushion.
- Semi-attached back and seat cushions make replacement easy.
- Square, welted back cushion creates a modern look while providing casual comfort.
- The multi-fabric option allows you to specify up to three fabrics on one model.
- Select one of two square metal leg options or hardwood cone feet in one of 18 finishes.
- Order an optional Throw Pillow to add a little extra comfort or a splash of color.
- Cushion packs available in both Standard and Pillow Back, apply to both side and back applications.
- Each seat is warranted for users up to 300 pounds.
- Pair with Scramble™ Occasional Tables to complete the modern aesthetic.

MODEL OPTIONS

HWH1SS, HWH1SP
HWH1SSCF, HWH1SPCF -
Multi-Fabric



Lounge
Single Seat

HWH2SS, HWH2SP
HWH2SSCF, HWH2SPCF -
Multi-Fabric

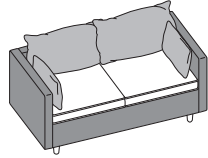

Lounge
Two-Seat

HWH3SS, HWH3SP
HWH3SSCF, HWH3SPCF -
Multi-Fabric

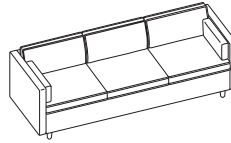

Lounge
Three-Seat

HWHITCS, HWHITCP
HWHITCSCF, HWHITPCPF -
Multi-Fabric

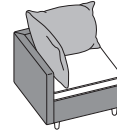

Lounge
True Corner

HWH1C
HWH1CCF - Multi-Fabric



Ottoman

HWHACPS, HWHACPP

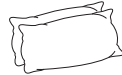

Arm Cushion Pack

HWHBCPS, HWHBCPP

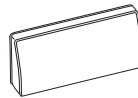

Back Cushion Pack

HWHLP, HWHSP18



**Lumbar and 18" Square
Throw Pillow**

Pillow Back Option, Multi-Fabric



Standard Back Option, Multi-Fabric

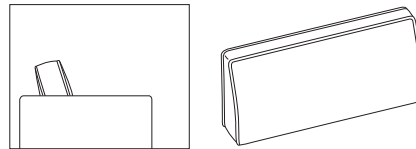
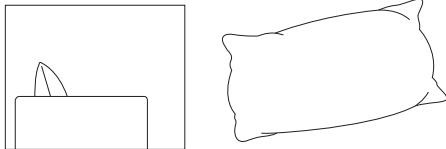

Choose from standard Single Fabric or Multi-Fabric options.
Specify up to three fabrics with the Multi-Fabric option.

WEST HILL™ Finish Options

HON BRANDED FABRICS

GRADE 1	GRADE 2	GRADE 3	GRADE 4
Apex	Apport Seating	Bradbury	Constance with Supreen™
Centurion	Blume	Cozy	Livi with Supreen™
Contourett	Clyde	Getaway	Lucerne
Dapper	Haute	Moxie*	Lugano with Supreen™
Emphasis	Kai	Notion	Oxford with Supreen™
Ensemble	Rush	Parker	
Hamilton	Spin Seating	Purl	
Noble Seating	Wavelength	Quill	
Pebble	Whisper Vinyl*	Saxony	
Vibe			

For a complete list of fabrics, including partnership fabrics, go to hon.com/fabricsandfinishes.

Reference Fabric Color Combinations on pages 20-25 for color codes and legend on page 21 for lead times.

*Because of the differing upholstery process for the standard back and pillow back options, these fabrics are not available as an option for the pillow back. Contact your HON representative for questions.

For more details on Upholstery Pattern Match for this series, please see page 14.

⚠ Due to the inherent characteristics of upholstery materials and the casual nature of West Hill™, fabric may relax to show wrinkles over time especially on the pillow back options.

LEG STYLE	CODE	DESCRIPTION	PRICE
	CW	Cone Wood	+ \$0
		<i>Available in the following finishes:</i>	
	LE878	Beigewood	
	H	Bourbon Cherry	
	COGN	Cognac	
	LE599	Field Elm	
	LFW1	Florence Walnut	
	C	Harvest	
	LK11	Kingswood Walnut	
	LLA1	Lowell Ash	
	N	Mahogany	
	MOCH	Mocha	
	D	Natural Maple	
	LNRI	Natural Recon	
	LPE1	Phantom Ecru	
	PINC	Pinnacle	
	LPT1	Portico Teak	
	F	Shaker Cherry	
	LSW1	Skyline Walnut	
	LSA1	Sterling Ash	

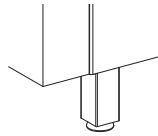
LEG STYLE	CODE	DESCRIPTION	PRICE
	SM	Square Metal	+ \$57
		<i>Available in the following finishes:</i>	
	P7A	Textured Charcoal	
	P8V	Textured Titanium	

Due to wood being a natural material, color may differ between pieces. Stains will be tonal matches and will not replicate the grain contrast of the coordinating laminate. Prolonged exposure to sunlight can affect the appearance of wood furniture, leading to variations in hue and tone.

MULTI-FABRIC COM YARDAGE

Due to fabric pattern nesting and potential reduction of fabric yield, some multi-fabric models may require more total yardage than standard models.

MODEL	COM (ARMLESS)			COM (ONE ARM)			COM (BOTH ARMS)		
	Seat	Frame	Back	Seat	Frame	Back	Seat	Frame	Back
HWH1SS		—			—			7.0	
HWH1SSCF	—	—	—	—	—	—	1.5	5.0	2.5
HWH1SP		—			—			7.0	
HWH1SPCF	—	—	—	—	—	—	1.5	5.0	1.5
HWH2SS		8.5			9.5			10.5	
HWH2SSCF	3.0	4.0	2.5	3.0	5.0	3.0	3.0	6.0	3.0
HWH2SP		8.5			9.5			11.0	
HWH2SPCF	3.0	4.0	2.0	3.0	5.0	2.5	3.0	6.0	3.0
HWH3SS		12.0			13.0			14.0	
HWH3SSCF	4.0	5.5	3.0	4.0	6.5	3.5	4.0	7.5	3.5
HWH3SP		12.5			13.5			14.5	
HWH3SPCF	4.0	5.5	3.0	4.0	6.5	3.5	4.0	7.5	4.0
HWHIC		3.0			—			—	
HWHICCF	1.5	2.0	—	—	—	—	—	—	—
HWHITCS		6.0			—			—	
HWHITCSCF	1.5	3.5	2.5	—	—	—	—	—	—
HWHITCP		7.0			—			—	
HWHITPCF	1.5	3.5	2.0	—	—	—	—	—	—

WEST HILL™ Casual Lounge Seating



Icon Legend on page 19

HWH1SS

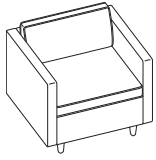

SINGLE SEAT LOUNGE — STANDARD CUSHION

DIMENSIONS

Depth:	30½	Back Height:	12
Height:	29¾	Back Width:	26¾
Width:	33¾	Arm Height:	8
Usable Seat Depth:	19	Ship Weight:	81
Seat to Floor Height:	17¾	Cube:	18.4
Seat Width:	26¾	COM:	See page 510
		Weight Rating:	300 lbs.

FABRIC PRICE CODES

1	\$2706	8	\$4113
2	\$2894	9	\$4148
3	\$3083	10	\$4339
4	\$3241	11	\$4529
5	\$3453	12	\$4718
6	\$3667	L	—
7	\$3888		

HWH1SP

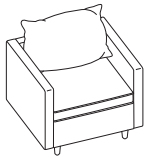

SINGLE SEAT LOUNGE — PILLOW CUSHION

DIMENSIONS

Depth:	30½	Back Height:	13¾
Height:	31½	Back Width:	26¾
Width:	33¾	Arm Height:	8
Usable Seat Depth:	16½	Ship Weight:	81
Seat to Floor Height:	17¾	Cube:	18.4
Seat Width:	26¾	COM:	See page 510
		Weight Rating:	300 lbs.

FABRIC PRICE CODES

1	\$2706	8	\$4113
2	\$2894	9	\$4148
3	\$3083	10	\$4339
4	\$3241	11	\$4529
5	\$3453	12	\$4718
6	\$3667	L	—
7	\$3888		

HON Recommendation: HWH1SP.B.PURL__CW__ - List Price \$3083

HOW TO SPECIFY

Select
Model Number

HWH1SP

Select
Arm Type

B Both Arms

B

Select
Fabric

See page 510

PBLE03

Select
Foot and Foot Color

SM Square Metal (+ \$57)

CW Cone Wood

See page 510 for colors

SMP8V



Icon Legend on page 19

WEST HILL™ Casual Lounge Seating

HWH1SSCF

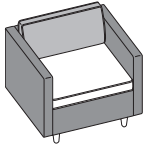

**SINGLE SEAT LOUNGE —
STANDARD CUSHION,
MULTI-FABRIC**

DIMENSIONS

Depth:	30½	Back Height:	12
Height:	29¾	Back Width:	26¾
Width:	33¼	Arm Height:	8
Usable Seat Depth:	19	Ship Weight:	81
Seat to Floor Height:	17¾	Cube:	18.4
Seat Width:	26¾	COM:	See page 510
		Weight Rating:	300 lbs.

FABRIC PRICE CODES

1	\$2915		
<i>Add to Base Price Above</i>			
	Seat	Frame	Back
2	\$42	\$134	\$42
3	\$83	\$269	\$83
4	\$116	\$383	\$116
5	\$161	\$534	\$161
6	\$208	\$688	\$208
7	\$255	\$845	\$255
8	\$303	\$1006	\$303
9	\$311	\$1032	\$311
10	\$351	\$1166	\$351
11	\$392	\$1301	\$392
12	\$433	\$1438	\$433

HWH1SPCF

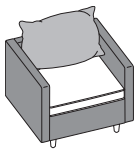

**SINGLE SEAT LOUNGE —
PILLOW CUSHION,
MULTI-FABRIC**

DIMENSIONS

Depth:	30½	Back Height:	13¾
Height:	31½	Back Width:	26¾
Width:	33¼	Arm Height:	8
Usable Seat Depth:	16½	Ship Weight:	81
Seat to Floor Height:	17¾	Cube:	18.4
Seat Width:	26¾	COM:	See page 510
		Weight Rating:	300 lbs.

FABRIC PRICE CODES

1	\$2915		
<i>Add to Base Price Above</i>			
	Seat	Frame	Back
2	\$42	\$134	\$42
3	\$83	\$269	\$83
4	\$116	\$383	\$116
5	\$161	\$534	\$161
6	\$208	\$688	\$208
7	\$255	\$845	\$255
8	\$303	\$1006	\$303
9	\$311	\$1032	\$311
10	\$351	\$1166	\$351
11	\$392	\$1301	\$392
12	\$433	\$1438	\$433

HON Recommendation: HWH1SPCF.B.PURL__PURL__PURL__CW__ - List Price \$3350

SEATING

HOW TO SPECIFY

Select Model Number HWH1SPCF	Select Arm Type B Both Arms B	Select Seat Fabric See page 510 PBLE07	Select Frame Fabric See page 510 PBLE03	Select Back Fabric See page 510 PBLE01	Select Foot and Foot Color SM Square Metal (+ \$57) CW Cone Wood See page 510 for colors SMP8V
--	--	---	--	---	---

WEST HILL™ Casual Lounge Seating



Icon Legend on page 19

HWH2SS

TWO SEAT LOUNGE — STANDARD CUSHION

DIMENSIONS

FABRIC PRICE CODES



Armless

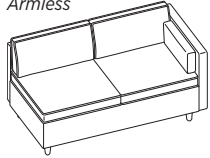

Left

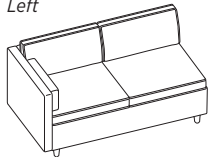

Right

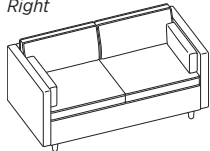

Both Arms

Depth:	30½	Back Height:	12
Height:	29¾	Back Width:	53¾
Width (armless):	53¾	Arm Height:	8
Width (one arm):	57	Ship Weight (armless):	107
Width (both arms):	60¼	Ship Weight (one arm):	121
Usable Seat Depth:	19	Ship Weight (both arms):	135
Seat to Floor Height:	17¾	Cube:	34.0
Seat Width (armless):	53¾	COM:	See page 510
Seat Width (one arm):	49½	Weight Rating:	300 lbs. (per seat)
Seat Width (both arms):	45¼		

1	\$3680	8	\$5791
2	\$3960	9	\$5843
3	\$4245	10	\$6129
4	\$4482	11	\$6413
5	\$4799	12	\$6698
6	\$5122	L	—
7	\$5453		

NOTES: Includes semi-attached arm cushions as shown.

HWH2SP

TWO SEAT LOUNGE — PILLOW CUSHION

DIMENSIONS

FABRIC PRICE CODES



Armless



Left

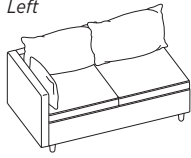

Right

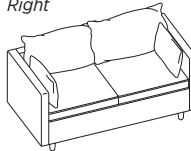

Both Arms

Depth:	30½	Back Height:	13¾
Height:	29¾	Back Width:	53¾
Width (armless):	53¾	Arm Height:	8
Width (one arm):	57	Ship Weight (armless):	107
Width (both arms):	60¼	Ship Weight (one arm):	121
Usable Seat Depth:	16½	Ship Weight (both arms):	135
Seat to Floor Height:	17¾	Cube:	34.0
Seat Width (armless):	53¾	COM:	See page 510
Seat Width (one arm):	48½	Weight Rating:	300 lbs. (per seat)
Seat Width (both arms):	43¾		

1	\$3680	8	\$5891
2	\$3973	9	\$5946
3	\$4272	10	\$6245
4	\$4520	11	\$6544
5	\$4853	12	\$6843
6	\$5190	L	—
7	\$5538		

NOTES: Includes semi-attached arm cushions as shown.

HON Recommendation: HWH2SP.B.PURL__CW__ - List Price \$4662

HOW TO SPECIFY

<p>Select Model Number</p> <p>HWH2SP</p>	<p>Select Arm Type</p> <p>N No Arms L Left Arm Only (+ \$195) R Right Arm Only (+ \$195) B Both Arms (+ \$390)</p> <p>B</p>	<p>Select Fabric</p> <p>See page 510</p> <p>PBLE03</p>	<p>Select Foot and Foot Color</p> <p>SM Square Metal (+ \$57) CW Cone Wood See page 510 for colors</p> <p>SMP8V</p>
---	--	---	--



Icon Legend on page 19

WEST HILL™ Casual Lounge Seating

HWH2SSCF

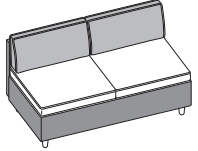

Armless

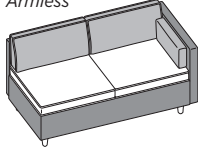

Left

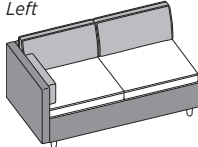

Right

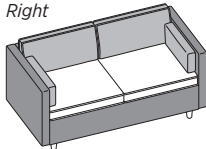

Both Arms

TWO SEAT LOUNGE — STANDARD CUSHION, MULTI-FABRIC

DIMENSIONS

Depth:	30½	Back Height:	12
Height:	29¾	Back Width:	53¾
Width (armless):	53¾	Arm Height:	8
Width (one arm):	57	Ship Weight (armless):	107
Width (both arms):	60¼	Ship Weight (one arm):	121
Usable Seat Depth:	19	Ship Weight (both arms):	135
Seat to Floor Height:	17¾	Cube:	34.0
Seat Width (armless):	53¾	COM:	See page 510
Seat Width (one arm):	49½	Weight Rating:	300 lbs. (per seat)
Seat Width (both arms):	45¼		

FABRIC PRICE CODES

1	\$3886		
<i>Add to Base Price Above</i>			
	Seat	Frame	Back
2	\$82	\$161	\$82
3	\$162	\$325	\$162
4	\$230	\$458	\$230
5	\$321	\$640	\$321
6	\$412	\$826	\$412
7	\$508	\$1014	\$508
8	\$605	\$1207	\$605
9	\$620	\$1236	\$620
10	\$701	\$1399	\$701
11	\$782	\$1563	\$782
12	\$865	\$1725	\$865

NOTES: Includes semi-attached arm cushions as shown.

HWH2SPCF

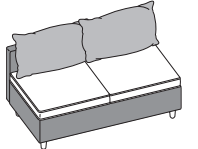

Armless

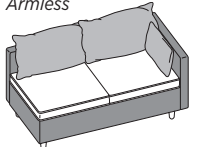

Left

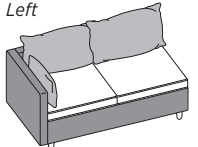

Right

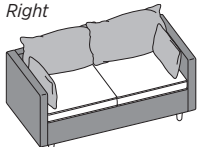

Both Arms

TWO SEAT LOUNGE — PILLOW CUSHION, MULTI-FABRIC

DIMENSIONS

Depth:	30½	Back Height:	13¾
Height:	29¾	Back Width:	53¾
Width (armless):	53¾	Arm Height:	8
Width (one arm):	57	Ship Weight (armless):	107
Width (both arms):	60¼	Ship Weight (one arm):	121
Usable Seat Depth:	16½	Ship Weight (both arms):	135
Seat to Floor Height:	17¾	Cube:	34.0
Seat Width (armless):	53¾	COM:	See page 510
Seat Width (one arm):	48½	Weight Rating:	300 lbs. (per seat)
Seat Width (both arms):	43¼		

FABRIC PRICE CODES

1	\$3886		
<i>Add to Base Price Above</i>			
	Seat	Frame	Back
2	\$82	\$161	\$82
3	\$162	\$325	\$162
4	\$230	\$458	\$230
5	\$321	\$640	\$321
6	\$412	\$826	\$412
7	\$508	\$1014	\$508
8	\$605	\$1207	\$605
9	\$620	\$1236	\$620
10	\$701	\$1399	\$701
11	\$782	\$1563	\$782
12	\$865	\$1725	\$865

NOTES: Includes semi-attached arm cushions as shown.

HON Recommendation: HWH2SPCF.B.PURL__PURL__PURL__CW__ - List Price \$4925

HOW TO SPECIFY

Select Model Number HWH2SPCF	Select Arm Type N No Arms L Left Arm Only (+ \$195) R Right Arm Only (+ \$195) B Both Arms (+ \$390)	Select Seat Fabric See page 510	Select Frame Fabric See page 510	Select Back Fabric See page 510	Select Foot and Foot Color SM Square Metal (+ \$57) CW Cone Wood See page 510 for colors
HWH2SPCF	B	PBLE07	PBLE03	PBLE01	SMP8V

SEATING

WEST HILL™ Casual Lounge Seating



Icon Legend on page 19

HWH3SS

THREE SEAT LOUNGE — STANDARD CUSHION

DIMENSIONS

Depth:	30½	Back Height:	12
Height:	29¾	Back Width:	80¾
Width (armless):	80¾	Arm Height:	8
Width (one arm):	84	Ship Weight (armless):	146
Width (both arms):	87¼	Ship Weight (one arm):	160
Usable Seat Depth:	19	Ship Weight (both arms):	174
Seat to Floor Height:	17¾	Cube:	46.5
Seat Width (armless):	80¾	COM:	See page
Seat Width (one arm):	76½		510
Seat Width (both arms):	72¼	Weight Rating:	300 lbs. (per seat)

FABRIC PRICE CODES

1	\$4996	8	\$7810
2	\$5369	9	\$7879
3	\$5750	10	\$8261
4	\$6065	11	\$8641
5	\$6487	12	\$9020
6	\$6918	L	—
7	\$7358		

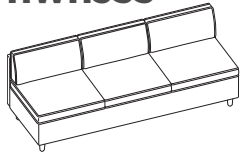

Armless

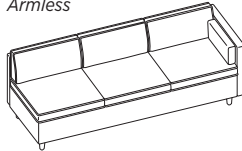

Left

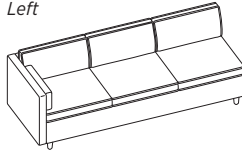

Right

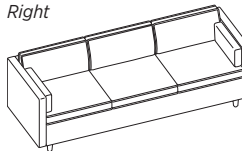

Both Arms

NOTES: Includes semi-attached arm cushions as shown.

HWH3SP

THREE SEAT LOUNGE — PILLOW CUSHION

DIMENSIONS

Depth:	30½	Back Height:	13¾
Height:	31½	Back Width:	80¾
Width (armless):	80¾	Arm Height:	8
Width (one arm):	84	Ship Weight (armless):	146
Width (both arms):	87¼	Ship Weight (one arm):	160
Usable Seat Depth:	16½	Ship Weight (both arms):	174
Seat to Floor Height:	17¾	Cube:	46.5
Seat Width (armless):	80¾	COM:	See page
Seat Width (one arm):	75½		510
Seat Width (both arms):	70¼	Weight Rating:	300 lbs. (per seat)

FABRIC PRICE CODES

1	\$4996	8	\$7910
2	\$5382	9	\$7983
3	\$5777	10	\$8377
4	\$6103	11	\$8770
5	\$6539	12	\$9164
6	\$6987	L	—
7	\$7444		

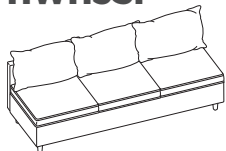

Armless

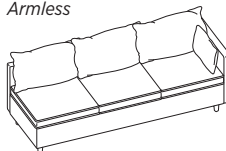

Left

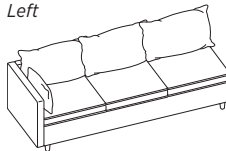

Right

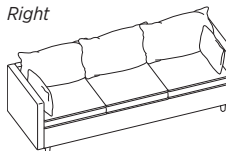

Both Arms

NOTES: Includes semi-attached arm cushions as shown.

HON Recommendation: HWH3SP.B.PURL__CW__ - List Price \$6167

HOW TO SPECIFY

Select Model Number H W H 3 S P .	Select Arm Type N No Arms L Left Arm Only (+ \$195) R Right Arm Only (+ \$195) B Both Arms (+ \$390)	Select Fabric See page 510 P B L E O 3 .	Select Foot and Foot Color SM Square Metal (+ \$57) CW Cone Wood See page 510 for colors S M P 8 V
---	---	---	---



Icon Legend on page 19

WEST HILL™ Casual Lounge Seating

HWH3SSCF

THREE SEAT LOUNGE — STANDARD CUSHION, MULTI-FABRIC

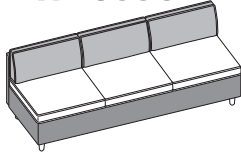

Armless

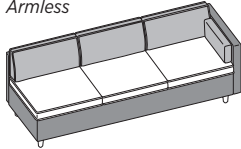

Left

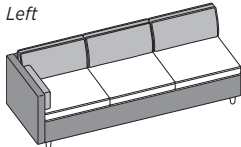

Right

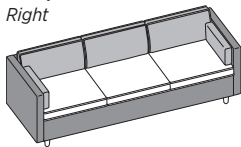

Both Arms

DIMENSIONS

Depth:	30½	Back Height:	12
Height:	29¾	Back Width:	80¾
Width (armless):	80¾	Arm Height:	8
Width (one arm):	84	Ship Weight (armless):	146
Width (both arms):	87¼	Ship Weight (one arm):	160
Usable Seat Depth:	19	Ship Weight (both arms):	174
Seat to Floor Height:	17¾	Cube:	46.5
Seat Width (armless):	80¾	COM:	See page 510
Seat Width (one arm):	76½	Weight Rating:	300 lbs. (per seat)
Seat Width (both arms):	72¼		

FABRIC PRICE CODES

1	\$5205		
<i>Add to Base Price Above</i>			
	Seat	Frame	Back
2	\$109	\$201	\$94
3	\$217	\$405	\$190
4	\$306	\$574	\$268
5	\$428	\$800	\$374
6	\$551	\$1030	\$482
7	\$677	\$1266	\$592
8	\$805	\$1508	\$704
9	\$826	\$1545	\$723
10	\$934	\$1748	\$818
11	\$1043	\$1953	\$911
12	\$1151	\$2156	\$1007

NOTES: Includes semi-attached arm cushions as shown.

HWH3SPCF

THREE SEAT LOUNGE — PILLOW CUSHION, MULTI-FABRIC

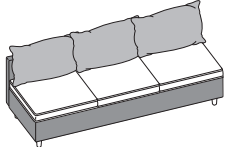

Armless

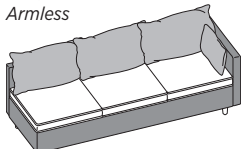

Left

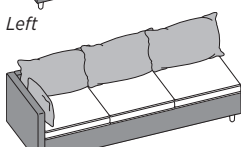

Right

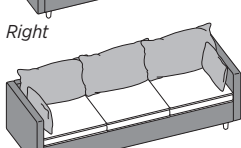

Both Arms

DIMENSIONS

Depth:	30½	Back Height:	13¾
Height:	31½	Back Width:	80¾
Width (armless):	80¾	Arm Height:	8
Width (one arm):	84	Ship Weight (armless):	146
Width (both arms):	87¼	Ship Weight (one arm):	160
Usable Seat Depth:	16½	Ship Weight (both arms):	174
Seat to Floor Height:	17¾	Cube:	46.5
Seat Width (armless):	80¾	COM:	See page 510
Seat Width (one arm):	75½	Weight Rating:	300 lbs. (per seat)
Seat Width (both arms):	70¼		

FABRIC PRICE CODES

1	\$5205		
<i>Add to Base Price Above</i>			
	Seat	Frame	Back
2	\$109	\$201	\$109
3	\$217	\$405	\$217
4	\$306	\$574	\$306
5	\$428	\$800	\$428
6	\$551	\$1030	\$551
7	\$677	\$1266	\$677
8	\$805	\$1508	\$805
9	\$826	\$1545	\$826
10	\$934	\$1748	\$934
11	\$1043	\$1953	\$1043
12	\$1151	\$2156	\$1151

NOTES: Includes semi-attached arm cushions as shown.

HON Recommendation: HWH3SPCF.B.PURL__PURL__PURL__CW__ - List Price \$6434

HOW TO SPECIFY

Select Model Number HWH3SPCF	Select Arm Type N No Arms L Left Arm Only (+ \$195) R Right Arm Only (+ \$195) B Both Arms (+ \$390)	Select Seat Fabric See page 510	Select Frame Fabric See page 510	Select Back Fabric See page 510	Select Foot and Foot Color SM Square Metal (+ \$57) CW Cone Wood See page 510 for colors
HWH3SPCF	B	PBLE07	PBLE03	PBLE01	SMP8V

WEST HILL™ Ottomans



Icon Legend on page 19

HWH1C

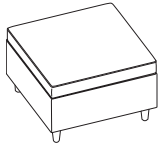

OTTOMAN

DIMENSIONS

Depth:	27¼	Ship Weight:	47
Height:	17¾	Cube:	18.4
Width:	27¼	COM:	See page 510
Usable Seat Depth:	27¼	Weight Rating:	300 lbs.
Seat to Floor Height:	17¾		
Seat Width:	27¼		

FABRIC PRICE CODES

1	\$1598	8	\$2203
2	\$1680	9	\$2218
3	\$1760	10	\$2299
4	\$1828	11	\$2380
5	\$1919	12	\$2463
6	\$2010	L	—
7	\$2106		

HWH1CCF

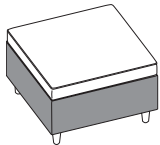

OTTOMAN, MULTI-FABRIC

DIMENSIONS

Depth:	27¼	Ship Weight:	47
Height:	17¾	Cube:	18.4
Width:	27¼	COM:	See page 510
Usable Seat Depth:	27¼	Weight Rating:	300 lbs.
Seat to Floor Height:	17¾		
Seat Width:	27¼		

FABRIC PRICE CODES

1	\$1807	
<i>Add to Base Price Above</i>		
	Seat	Frame
2	\$42	\$42
3	\$83	\$83
4	\$116	\$116
5	\$161	\$161
6	\$208	\$208
7	\$255	\$255
8	\$303	\$303
9	\$311	\$311
10	\$351	\$351
11	\$392	\$392
12	\$433	\$433

HON Recommendation: HWH1C.PURL___.CW__ - List Price \$1760

HOW TO SPECIFY

<p>Select Model Number</p> <p>See page 510</p> <p>HWH1CCF .</p>	<p>Select Fabric</p> <p>See page 510</p> <p>PBLE03 .</p>	<p>Select Seat Fabric</p> <p><i>Specify for model HWH1CCF only</i></p> <p>PBLE03 .</p>	<p>Select Frame Fabric</p> <p><i>Specify for model HWH1CCF only</i></p> <p>PBLE07 .</p>	<p>Select Foot and Foot Color</p> <p>SM Square Metal (+ \$57) CW Cone Wood</p> <p>See page 510 for colors</p> <p>SMP8V</p>
--	---	---	--	---



Icon Legend on page 19

WEST HILL™ Casual Lounge Seating

HWH1TCS

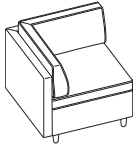

TRUE CORNER — STANDARD CUSHION

DIMENSIONS

Depth:	30½	Ship Weight:	73
Height:	29¾	Cube:	18.4
Width:	30½	COM:	See page 510
Usable Seat Depth:	19	Weight Rating:	300 lbs.
Seat to Floor Height:	17¾		
Back Height:	12		

FABRIC PRICE CODES

1	\$2706	8	\$3913
2	\$2867	9	\$3942
3	\$3031	10	\$4105
4	\$3164	11	\$4269
5	\$3346	12	\$4431
6	\$3532	L	—
7	\$3720		

HWH1TCP



TRUE CORNER — PILLOW CUSHION

DIMENSIONS

Depth:	30½	Ship Weight:	73
Height:	31½	Cube:	18.4
Width:	30½	COM:	See page 510
Usable Seat Depth:	16½	Weight Rating:	300 lbs.
Seat to Floor Height:	17¾		
Back Height:	13¾		

FABRIC PRICE CODES

1	\$2706	8	\$4113
2	\$2894	9	\$4148
3	\$3083	10	\$4339
4	\$3241	11	\$4529
5	\$3453	12	\$4718
6	\$3667	L	—
7	\$3888		

HON Recommendation: HWH1TCP.PURL__CW__ - List Price \$3083

HOW TO SPECIFY

Select
Model Number

HWH1TCP

Select
Fabric

See page 510

PBLE03

Select
Foot and Foot Color

SM Square Metal (+ \$57)

CW Cone Wood

See page 510 for colors

SMP8V

WEST HILL™ Casual Lounge Seating



Icon Legend on page 19

HWH1TCSCF

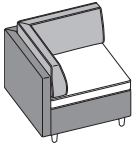

**TRUE CORNER —
STANDARD CUSHION,
MULTI-FABRIC**

DIMENSIONS

Depth:	30½	Ship Weight:	73
Height:	29¾	Cube:	18.4
Width:	30½	COM:	See page 510
Usable Seat Depth:	19	Weight Rating:	300 lbs.
Seat to Floor Height:	17¾		
Back Height:	12		

FABRIC PRICE CODES

1 \$2915

Add to Base Price Above

	Seat	Frame	Back
2	\$42	\$94	\$67
3	\$83	\$190	\$135
4	\$116	\$268	\$192
5	\$161	\$374	\$267
6	\$208	\$482	\$343
7	\$255	\$592	\$423
8	\$303	\$704	\$504
9	\$311	\$723	\$515
10	\$351	\$818	\$583
11	\$392	\$911	\$652
12	\$433	\$1007	\$720

HWH1TCPCF



**TRUE CORNER —
PILLOW CUSHION,
MULTI-FABRIC**

DIMENSIONS

Depth:	30½	Ship Weight:	73
Height:	31½	Cube:	18.4
Width:	30½	COM:	See page 510
Usable Seat Depth:	16½	Weight Rating:	300 lbs.
Seat to Floor Height:	17¾		
Back Height:	13¾		

FABRIC PRICE CODES

1 \$2915

Add to Base Price Above

	Seat	Frame	Back
2	\$42	\$94	\$55
3	\$83	\$190	\$110
4	\$116	\$268	\$154
5	\$161	\$374	\$215
6	\$208	\$482	\$277
7	\$255	\$592	\$338
8	\$303	\$704	\$403
9	\$311	\$723	\$412
10	\$351	\$818	\$467
11	\$392	\$911	\$522
12	\$433	\$1007	\$576

HON Recommendation: HWH1TCPCF.PURL__PURL__PURL__CW__ - List Price \$3298

HOW TO SPECIFY

Select Model Number

HWH1TCPCF .

Select Seat Fabric

See page 510

PBLE07 .

Select Frame Fabric

See page 510

PBLE03 .

Select Back Fabric

See page 510

PBLE01 .

Select Foot and Foot Color

SM Square Metal (+ \$57)
CW Cone Wood
See page 510 for colors

SMP8V



Icon Legend on page 19

THROW PILLOWS

HWHLP



LUMBAR THROW PILLOW

DIMENSIONS

Height: 10
 Width: 18
 COM: 1.0
 Ship Weight: 2.5
 Cube: 2.3

FABRIC PRICE CODES

1	\$190	8	\$392
2	\$218	9	\$398
3	\$245	10	\$424
4	\$269	11	\$452
5	\$299	12	\$479
6	\$329	L	—
7	\$359		

HWHSP18



18" SQUARE THROW PILLOW

DIMENSIONS

Height: 18
 Width: 18
 COM: 1.0
 Ship Weight: 3.0
 Cube: 2.3

FABRIC PRICE CODES

1	\$233	8	\$435
2	\$261	9	\$441
3	\$288	10	\$467
4	\$312	11	\$495
5	\$342	12	\$522
6	\$372	L	—
7	\$402		

HOW TO SPECIFY

<p>Select Model Number</p> <p>H W H S P 1 8</p>	<p>Select Fabric</p> <p>See page 510</p> <p>P B L E 0 3</p>
--	--

HWHACPS

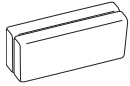

ARM CUSHION PACK — STANDARD

DIMENSIONS

COM: 1.0
Ship Weight: 4.1
Cube: 3.9

FABRIC PRICE CODES

1	\$281	8	\$483
2	\$309	9	\$489
3	\$336	10	\$515
4	\$360	11	\$543
5	\$390	12	\$570
6	\$420	L	—
7	\$450		

NOTES: Includes both L and R Arm Cushions.

ⓘ Cushion arm cushions can be replaced or switched out with these cushion packs.

HWHACPP



ARM CUSHION PACK — PILLOW

DIMENSIONS

COM: 1.0
Ship Weight: 5.7
Cube: 3.9

FABRIC PRICE CODES

1	\$281	8	\$483
2	\$309	9	\$489
3	\$336	10	\$515
4	\$360	11	\$543
5	\$390	12	\$570
6	\$420	L	—
7	\$450		

NOTES: Includes both L and R Arm Cushions.

ⓘ Cushion arm cushions can be replaced or switched out with these cushion packs.

HWHBCPS

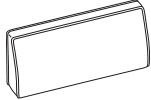

BACK CUSHION PACK — STANDARD

DIMENSIONS

COM: 2.5
Ship Weight: 8.1
Cube: 3.9

FABRIC PRICE CODES

1	\$281	8	\$785
2	\$348	9	\$796
3	\$416	10	\$864
4	\$473	11	\$933
5	\$548	12	\$1001
6	\$624	L	—
7	\$704		

NOTES: Includes a single Standard Back Cushion.

ⓘ Cushion backs can be replaced or switched out with these cushion packs.

HWHBCPP

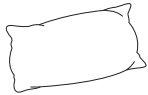

BACK CUSHION PACK — PILLOW

DIMENSIONS

COM: 1.5
Ship Weight: 8.1
Cube: 3.9

FABRIC PRICE CODES

1	\$281	8	\$584
2	\$323	9	\$592
3	\$364	10	\$632
4	\$397	11	\$673
5	\$442	12	\$714
6	\$489	L	—
7	\$536		

NOTES: Includes a single Pillow Back Cushion.

ⓘ Cushion backs can be replaced or switched out with these cushion packs.

HWHGB

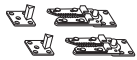

GANGING BRACKET

DIMENSIONS

Ship Weight: 1.0
Cube: 0.1

LIST PRICE

\$73

SPECIFYING EXAMPLE: HWHGB

HOW TO SPECIFY

Select Model Number	Select Fabric
	See page 510
H W H B C P P .	P B L E 0 3



Icon Legend on page 19

EXECUTIVE CHAIRS

HVL151



HIGH-BACK

Pneumatic
Swivel
Tilt
Tilt Tension
Tilt Lock
Fixed Padded Loop Arms

Functions: **A, E, F, K, L, T**
(Function Key on pages 256-257)

DIMENSIONS

Depth:	37½	Arm Width:	20½
Width:	27	Seat to Floor Height:	17¾-21½
Height:	45½	Usable Seat Depth:	18⅝
Seat Depth:	18⅝	Ship Weight:	38
Seat Width:	20½	Cube:	5.1
Back Width:	20½	Weight Rating:	250 lbs.
Back Height:	27¼		

PRICE CODE

Leather **\$574**

NOTES: Black Bonded Leather. Black frame. Padded loop arms. **HON 5-Year Limited Warranty.**

HON Recommendation: HVL151.SB11 - List Price \$574

HOW TO SPECIFY

Select Model Number

Select Fabric

SB11 Black Bonded Leather

H V L 1 5 1 .

S B 1 1

EXECUTIVE CHAIRS



Icon Legend on page 19

HVL402



HIGH-BACK

Pneumatic
Swivel
Tilt
Tilt Tension
Tilt Lock
Fixed Padded Loop Arms

Functions: **A, E, F, K, L, T**
(Function Key on pages 256-257)

DIMENSIONS

Depth:	28	Arm Width:	19½
Width:	26	Seat to Floor Height:	16½-20½
Height:	45½	Usable Seat Depth:	17½
Seat Depth:	17½	Ship Weight:	44
Seat Width:	19½	Cube:	6.1
Back Width:	19	Weight Rating:	250 lbs.
Back Height:	24½		

PRICE CODE

Vinyl **\$639**

NOTES: Available in Black and Brown vinyl with contrasting top stitch. EN11 features silver frame. EN45 features black frame. Padded loop arms. **HON 5-Year Limited Warranty.**

HON Recommendation: HVL402.EN11 - List Price \$639

HVL601



HIGH-BACK

Pneumatic
Swivel
Tilt
Tilt Tension
Tilt Lock
Loop Arms

Functions: **A, E, F, K, L, T**
(Function Key on pages 256-257)

DIMENSIONS

Depth:	27	Arm Width:	20½
Width:	26½	Seat to Floor Height:	16¾-20½
Height:	44	Usable Seat Depth:	17
Seat Depth:	17	Ship Weight:	38
Seat Width:	20½	Cube:	4.1
Back Width:	20½	Weight Rating:	250 lbs.
Back Height:	26½		

PRICE CODE

Fabric **\$424**
Leather **\$457**

NOTES: Tailored stitching detail in Black Bonded Leather or Black fabric. Fixed loop arms. Black frame. **HON 5-Year Limited Warranty.**

HON Recommendation: HVL601.SB11 - List Price \$457

HOW TO SPECIFY

Select Model Number	Select Fabric
	SB11 Black Bonded Leather <i>Specify for model HVL601 only</i>
	EN11 Black Vinyl <i>Specify for model HVL402 only</i>
	EN45 Brown Vinyl <i>Specify for model HVL402 only</i>
	VA10 Black Fabric <i>Specify for model HVL601 only</i>

H	V	L	6	0	1	S	B	1	1
---	---	---	---	---	---	---	---	---	---



Icon Legend on page 19

WORKPLACE TOOLS

Ergonomic Solutions

HSCASTER

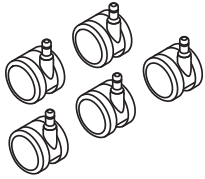

SET OF 5 SOFT CASTERS

DIMENSIONS

Size: 60mm
Ship Weight: 2 **9**
Cube: 0.1

LIST PRICE

\$75

i Available in Black finish only, no specification needed.

SEATING





HOW TO SPECIFY

Select
Model Number

H S C A S T E R

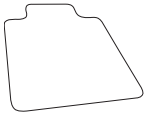
WORKPLACE TOOLS

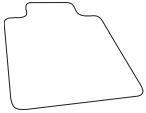
Chair Mats

	DESCRIPTION	MODEL	SHIP WEIGHT	CUBE	LIST PRICE
	Lipped Chair Mat with Studs 48"W x 36"D	HCM3648LS 	8.8	0.6	\$127
	Lipped Chair Mat without Studs 60"W x 46"D 48"W x 36"D	HCM4660LN HCM3648LN 	13.2 8.3	0.5 0.3	\$212 \$127

NOTES:

- Available with studs for carpet and without studs for hard-surface floors.
- Ships rolled.
- **HON 5-Year Limited Warranty.**

 Available in Clear finish only, no specification needed.

HOW TO SPECIFY

Select Model Number

H C M 3 6 4 8 L S

CROSS REFERENCE INDEX

MODEL	PAGE	MODEL	PAGE	MODEL	PAGE	MODEL	PAGE
H1522	235	HBPWARMOD	476	HCTRECT3072	30	HEBY4LEG	139
H2091	458	HBSDCSNT2832	145	HCTRND24	30	HECART	170
H2092	458	HBSDFN3030	145	HCTRND30	30	HECSBG	226
H2093	458	HBSDRBN2231	145	HCTRND36	30	HECSG	226
H2095	458	HBSDRECT2031	145	HCTRND42	30	HECSITD	213
H2164	297	HBSDRECT2038	145	HCTSDS	32	HECSITS	213
H2165	297	HBSDRECT2430	145	HCTSFT24	30	HECSITT	213
H2285	409	HBSDSPY2636	145	HCTSFT30	30	HECSJVAP	225
H4022	233	HBSDTRP2040	145	HCTSFT36	30	HECSJVHP	225
H4028	233	HBSMAUSB	229	HCTSFT42	30	HECSMAIBB	220
H4029	233	HBTMS	61, 254	HCTSQR24	30	HECSMAIBBMF	222
H4041	449	HBTTCW	36	HCTSQR30	30	HECSMAIHB	217
H4043	449	HBTTD30	36	HCTSQR36	30	HECSMAIHBMF	219
H4048	449	HBTTD42	36	HCTSQR42	30	HECSMAILB	214
H4049	449	HBTTTRND30	35	HCWPT	43	HECSMAILBMF	216
H51204	234	HBTTTRND36	35	HCWTB3656G	41	HECSMAOBB	220
H51206	234	HBTTTRND42	35	HCWTB3656J	41	HECSMAOBBMF	222
H5701	501	HBTTSTFT30	35	HCWTB3684G	41	HECSMAOHB	217
H5703	501	HBTTSTFT36	35	HCWTB3684J	41	HECSMAOHBMF	219
H5705	501	HBTTSTFT42	35	HCWTDSDM27	42	HECSMAOLB	214
H5711	502	HBTTSTQR30	35	HCWTDSDM29	42	HECSMAOLBMF	216
H5713	502	HBTTSTQR36	35	HCWTDSDM36	42	HECSMSBB	220
H5715	502	HBTTSTQR42	35	HCWTDSDM42	42	HECSMSBBMF	221
H5721	505	HBTTX30L	36	HCWTRND30G	41	HECSMSHB	217
H5723	505	HBTTX30S	36	HCWTRND30J	41	HECSMSHBMF	218
H5725	505	HBTTX42L	36	HCWTRND36G	41	HECSMSLB	214
H5731	506	HBTTX42S	36	HCWTRND36J	41	HECSMSLBMF	215
H5733	506	HCD1	236	HCWTRND42G	41	HECSMTBB	220
H5735	506	HCFEU	313	HCWTRND42J	41	HECSMTBBMF	221
H5795	501, 502, 505, 506	HCFEUMF	314	HCWTSBL18	42	HECSMTHB	217
H80170	64	HCFMU	313	HCWTSBL27	42	HECSMTHBMF	218
H80180	64	HCFMUMF	314	HCWTSBL29	42	HECSMTLB	214
H80191	64	HCFRG	304	HCWTSBL36	42	HECSMTLBMF	215
H80192	64	HCFRT	303	HCWTSBL42	42	HECSOAL	224
H80193	64	HCLA65	141, 147, 183, 242	HCWTSBM18	42	HECSOAL	224
HABPWARMOD	250	HCLQS	308	HCWTSBM27	42	HECSOC	224
HAECBH	151, 165	HCLQT	307	HCWTSBM29	42	HECSOD	223
HAEHF	151, 165	HCM3648LN	237, 526	HCWTSBM36	42	HECSOSE	224
HAESS	151, 165	HCM3648LS	237, 526	HCWTSBM42	42	HECSOSQ	223
HASB2	290	HCM4660LN	237, 526	HCWTSFTS30G	41	HECSOTP	223
HASB2MF	290	HCPUI	231	HCWTSFTS30J	41	HECSOTR	223
HASB3	291	HCPWARMOD	249	HCWTSFTS36G	41	HECSR	211
HASB3MF	291	HCTIMM	325	HCWTSFTS36J	41	HECSR	211
HASGBSL	293	HCT29LX	31	HCWTSFTS42G	41	HECSRSP	211
HASHB1	283	HCT29MT	31	HCWTSFTS42J	41	HECSRSPMF	212
HASHB1MF	283	HCT29MX	31	HCWTSQR30G	41	HECSRST	211
HASHB2	285	HCT29ST	31	HCWTSQR30J	41	HECSVAP	225
HASHB2MF	285	HCT29SX	31	HCWTSQR36G	41	HECSVHP	225
HASHB3	287	HCT36LX	31	HCWTSQR36J	41	HEDRT-2766E-NS	140
HASHB3MF	287	HCT36MT	31	HCWTSQR42G	41	HEDRT2766E	138
HASHBTC	289	HCT36MX	31	HCWTSQR42J	41	HEFL1	169
HASHBTCMF	289	HCT36ST	31	HCWTSR3656G	41	HEFSO1	172
HASLB1	282	HCT36SX	31	HCWTSR3656J	41	HEHP3660E	137
HASLB1MF	282	HCT42LX	31	HCWTSR3684G	41	HELPI	169
HASLB2	284	HCT42MT	31	HCWTSR3684J	41	HEMKR426029BB	148
HASLB2MF	284	HCT42MX	31	HD2	236	HEMKR426029L	148
HASLB3	286	HCT42ST	31	HD8	236	HEMKR426036BB	148
HASLB3MF	286	HCT42SX	31	HDPS1	241	HEMKR426036L	148
HASLBTC	288	HCTLDS	32	HE4022	233	HEMKR426042BB	148
HASLBTCMF	288	HCTMDS	32	HE4LSTL18	152	HEMKR426042L	148
HASPSS	292	HCTRECT2448	30	HE4LSTL30	152	HEMKR427229BB	148
HASPSSMF	292	HCTRECT2460	30	HEB4LEG	139	HEMKR427229L	148
HASSGC	293	HCTRECT2472	30	HEBBXRL	141, 147	HEMKR427236BB	148
HASSP	293	HCTRECT3048	30	HEBS4LEG	139	HEMKR427236L	148
HBDMAUSB	229	HCTRECT3060	30	HEBSD4LEG	146	HEMKR427242BB	148

CROSS REFERENCE INDEX

MODEL	PAGE	MODEL	PAGE	MODEL	PAGE	MODEL	PAGE
HEMKR427242L	148	HESWCO18	201	HFLML1DF	351	HHABCASTER	141
HEMKRDIVIDER	150	HESWCO30	201	HFLMR1	347	HHATPWRRMOD2S	255
HEMKREND29-F	149	HESWCO42	201	HFLMR1DF	352	HHATPWRRMOD3S	255
HEMKREND29-SP	149	HESWLB30	202	HFLRC1	346	HHATPWRRMODF	255
HEMKREND36-F	149	HESWLB36	202	HFLRC1DF	350	HHB02	497
HEMKREND36-SP	149	HESWLB42	202	HFLSC1	346	HHB03	497
HEMKREND42-F	149	HESWLD12	203	HFLSC1DF	350	HHCB50	498
HEMKREND42-SP	149	HESWLD18	200	HFLSC2	358	HHCG11	490
HEMKRSHELF	150	HESWLD2	203	HFLSC2DF	361	HHCG11DF	491
HERD42E	137	HESWLD30	200	HFLSO1	349	HHCG21	490
HERD48E	137	HESWLD42	200	HFLWI45	348	HHCG21DF	491
HESA2440E	136	HESWLS18	200	HFLWI45DF	353	HHCG50	490
HESA3050E	136	HESWLS30	200	HFLWO45	348	HHCG50DF	492
HESB1H3WD	162	HESWLS42	200	HFLWO45DF	353	HHCGB21	493
HESB1H3WS	162	HESY-3654E-NS	140	HFLYO1	363	HHCGB31	493
HESB2H3WD	162	HESY3654E	136	HFLYO1DF	364	HHCGBRCH	492
HESB2H3WS	162	HETD54E	137	HFMBIN12	151, 165, 192	HHCTO1	498
HESB3H3WS	162	HETLEC-REC2028	175	HFMBIN3	141, 147, 151, 165, 192	HHPS1	241
HESB4H3WS	162	HETR2448E	137	HFMBIN6	151, 165, 192	HI2AAA	393, 406
HESCIH3WD	160	HETR2460E	137	HFSS74L	356	HI2ATA	393, 406
HESCIH3WS	160	HETR2472E	137	HFSS74LDF	359	HI2BTHR	394
HESC2H3WD	160	HETR3048E	137	HFSS74LWD	357	HI2FHA	337, 393, 406
HESC2H3WS	160	HETR3060E	137	HFSS74LWDDF	360	HI2HR	394
HESC3H3WS	160	HETR3072E	137	HFTB17N	48	HIB50	399
HESC4H3WS	160	HETZ3060E	137	HFTLA2460	47	HICS7	396
HESCO3H2WS	161	HF22	165	HFTLA3372	47	HICS7DF	398
HESCO3H3WS	161	HF23C	193	HFTLA3384	47	HIEH1	404
HESCO4H2WS	161	HF23S	165	HFTLA3396	47	HIEH2	404
HESCO4H3WS	161	HFCG6	356	HFTLC2460	47	HIEH3	404
HESCS4H2WSL	164	HFCG6DF	359	HFTLC3372	47	HIGCL	399
HESCS4H2WSR	164	HFCG6WD	357	HFTLC3384	47	HIGS6	396
HESH3060E	136	HFCG6WDDF	360	HFTLC3396	47	HIGS6DF	397
HESH6066E	138	HFCL2	358	HFTLD26	49	HIIMBR	393
HESKD4872E	138	HFCL2DF	361	HFTLD30	47	HIPAA	337, 393, 406
HESL2H2WS	159	HFCS64L	356	HFTLD36	47	HISB6	396
HESL2H3WS	159	HFCS64LDF	359	HFTLR12	50	HISB6DF	397
HESL3H2WS	159	HFCS64LWD	357	HFTLS24	49	HITL1	402
HESL3H3WS	159	HFCS64LWDDF	360	HFTLS30	47	HITL2	402
HESL4H2WS	159	HFDB17B	48	HFTLS36	47	HITL3	402
HESL4H3WS	159	HFDB17N	48	HFTLW45	50	HITLM	384
HESN3054E	136	HFDB29A	48	HFTPTL18	49	HITLMKD	386
HESNP54E	136	HFDB29AN	48	HFTTAL14	50, 376	HITLRA	389
HESPCR	140	HFDB29B	48	HFXB17B	48	HITLRAKD	390
HESQ36E	137	HFDB42A	48	HFXB29A	48	HITS5	405
HESQ42E	137	HFDB42AF	48	HFXB29AN	48	HITSM	384
HESQ48E	137	HFDB42AFN	48	HFXB29B	48	HITSRA	389
HEST2H2WS	163	HFDB42AN	48	HFXB42A	48	HIWM1	403
HEST2H3WS	163	HFDB42B	48	HFXB42AN	48	HIWM2	403
HEST3H2WS	163	HFDB42BF	48	HFXB42B	48	HIWM3	403
HEST3H3WS	163	HFDRGRH20	253	HFXT1	341	HIWM8	405
HEST4H2WS	163	HFDRGRH32	253	HGDK3-F	183, 185	HIWMBT	387
HEST4H3WS	163	HFL45O	349	HGRMTAC	32, 248, 376	HIWMM	384
HESW-3054E-NS	140	HFLB2	354	HGRMTAC2	32, 248, 376	HIWMMHR	385
HESW3054E	136	HFLB3	354	HGRMTDATA	248	HIWMMKD	386
HESWCB30	202	HFLCC1	348	HGRMTUSB2	248, 376	HIWMMS	388
HESWCB36	202	HFLCC1DF	353	HGROM1BLANK	251	HIWMMSKD	388
HESWCB42	202	HFLCO1	363	HGROM2BLANK	251	HIWMRA	389
HESWCD12	203	HFLCO1DF	364	HH870924	239	HIWMRAKD	390
HESWCD18	201	HFLDGRMT	248	HH870924CH	239	HIWMU	391
HESWCD2	203	HFLDGRMT3	248	HH870930	239	HIWMUKD	392
HESWCD30	201	HFLDGRMT4	248	HH870930CH	239	HIWMUL	391
HESWCD42	201	HFLGANG	349	HH870942	239	HIWMULKD	392
HESWCI18	201	HFLMC1	347	HH870942CH	239	HJTRGH24	253
HESWCI30	201	HFLMC1DF	351	HH870960	239	HJTRGH36	253
HESWCI42	201	HFLML1	347	HH870960CH	239	HKBS	232

CROSS REFERENCE INDEX

MODEL	PAGE	MODEL	PAGE	MODEL	PAGE	MODEL	PAGE
HKTLONG	232	HMAPOWER422	247	HMPTBNTL	37	HMVPCSS-4C9C	72
HKT MID	232	HMAPOWER48	247	HMPTBNTS	37	HMVPCSS-40	72
HKTSHORT	232	HMAPOWER482	247	HMPTT2448	37	HMVPCSS-404C	72
HL2DARM	337	HMAPOWER54	247	HMPTT2460	37	HMVPCSS-409C	72
HL4DARM	337	HMAPOWER542	247	HMPTT2472	37	HMVR-1848(?)-AH	70
HLDA-15	183	HMAPOWER60	247	HMPPT3048	37	HMVR-1848(?)-FX	68
HL DST1	240	HMAPOWER602	247	HMPPT3060	37	HMVR-1848(?)-NS	69
HL DV-M3A	182	HMAPOWER66	247	HMPPT3072	37	HMVR-1860(?)-AH	70
HL DV-M3F	182	HMAPOWER662	247	HMPVWM28	253	HMVR-1860(?)-FX	68
HL DV-M3T	182	HMAPOWER72	247	HMS1	425	HMVR-1860(?)-NS	69
HL DV-MRECT2026A	182	HMAPOWER722	247	HMS2	425	HMVR-1872(?)-AH	70
HLED1	238	HMAPOWER84	247	HMSCART	425	HMVR-1872(?)-FX	68
HLED17A	239	HMAPOWER842	247	HMSFLTGLD	426	HMVR-1872(?)-NS	69
HLED17AS	239	HMAPOWER96	247	HMSGANG	426	HMVR-2436(?)-AH	70
HLED17AUO	239	HMAPOWER962	247	HMSGLD	426	HMVR-2436(?)-FX	68
HLED1IOC	238	HMASD	229	HMSSTLGLD	426	HMVR-2436(?)-NS	69
HLED2	238	HMASPLIT	247	HMT1	423	HMVR-2442(?)-AH	70
HLED31A	239	HMASTS	229	HMT1848E	58	HMVR-2442(?)-FX	68
HLED31AS	239	HMAVHA	418	HMT1848G	58	HMVR-2442(?)-NS	69
HLED31AUO	239	HMAVHAMF	418	HMT1860E	58	HMVR-2448(?)-AH	70
HLEDOSA	239	HMAVHN	417	HMT1860G	58	HMVR-2448(?)-FX	68
HLEGCHASE26	254	HMAVHNMF	417	HMT1872E	58	HMVR-2448(?)-NS	69
HLMSHHR	337	HMAVMA	416	HMT1872G	58	HMVR-2454(?)-AH	70
HL SL1212	242	HMAVMAMF	416	HMT2448E	58	HMVR-2454(?)-FX	68
HL SL1460LS	240	HMAVMN	415	HMT2448G	58	HMVR-2454(?)-NS	69
HL SL1472LS	240	HMAVMNMF	415	HMT2460E	58	HMVR-2460(?)-AH	70
HL SL4831MB	108, 243	HMAVO	419	HMT2460G	58	HMVR-2460(?)-FX	68
HL SLDRWORG	242	HMAVOMF	419	HMT2472E	58	HMVR-2460(?)-NS	69
HL TM	334	HMBFLIP18L	59	HMT2472G	58	HMVR-2466(?)-AH	70
HL TSM	336	HMBFLIP18S	59	HMT3048E	58	HMVR-2466(?)-FX	68
HL TV2460T-3	189	HMBFLIP24L	59	HMT3048G	58	HMVR-2466(?)-NS	69
HL TV2460TMOD-3	188	HMBFLIP24S	59	HMT3060E	58	HMVR-2472(?)-AH	70
HL TV2466T-33	189	HMBFLIP30L	59	HMT3060G	58	HMVR-2472(?)-FX	68
HL TV2466TMOD-33	188	HMBFLIP30S	59	HMT3072E	58	HMVR-2472(?)-NS	69
HL TV3060TMOD-3	188	HMBPOST	59	HMT3072G	58	HMVR-2484(?)-FX	68
HL TV3066TMOD-33	188	HMBTLEG18	59	HMT5	423	HMVR-2484(?)-NS	69
HL TVMODFULL	189	HMBTLEG24	59	HMTS01	270	HMVR-2496(?)-FX	68
HL TVMODPART	189	HMG1	428	HMTS11	270	HMVR-2496(?)-NS	69
HL VBC3330	194	HMG2	428	HMTUMOD26	71	HMVR-3036(?)-AH	70
HL VBC4330	194	HMG3	429	HMTUMOD32	61, 71	HMVR-3036(?)-FX	68
HL VBC5630	194	HMG4	429	HMTUMOD38	38, 71	HMVR-3036(?)-NS	69
HL VMSC3330R	192	HMG5	429	HMTUMOD44	61, 71	HMVR-3042(?)-AH	70
HL VMSC4330R	192	HMG7	429	HMTUMOD50	38, 71	HMVR-3042(?)-FX	68
HL VMSC5630R	192	HMG1	433	HMTUMOD56	71	HMVR-3042(?)-NS	69
HL VPM1	240	HMG2	433	HMTUMOD62	71	HMVR-3048(?)-AH	70
HL VPM2	241	HML1S	369	HMTUMOD74	71	HMVR-3048(?)-FX	68
HL VSC3330R	193	HML1SDF	372	HMTUMOD86	71	HMVR-3048(?)-NS	69
HL VSC4330R	193	HML2S	369	HMVH-2448(?)-FX	68	HMVR-3054(?)-AH	70
HL VSC5630R	193	HML2SDF	373	HMVH-2448(?)-NS	69	HMVR-3054(?)-FX	68
HL WBF1-1248W	190	HML2ST	371	HMVH-3060(?)-FX	68	HMVR-3054(?)-NS	69
HL WBF2-1248W	190	HML2STDF	375	HMVH-3060(?)-NS	69	HMVR-3060(?)-AH	70
HL WBS-248WT	190	HML3S	370	HMVH-3672(?)-FX	68	HMVR-3060(?)-FX	68
HL WBS-248WW	190	HML3SDF	374	HMVH-3672(?)-NS	69	HMVR-3060(?)-NS	69
HL WBS-448WT	190	HMN1	431	HMVMB-3072WW	72	HMVR-3066(?)-AH	70
HL WBS-448WW	190	HMN2	431	HMVMB-3672WW	72	HMVR-3066(?)-FX	68
HL WM	333	HMNT1	435	HMVPC-DTLG	72	HMVR-3066(?)-NS	69
HL WMBT	335	HMNT2	435	HMVPC-MP	72	HMVR-3072(?)-AH	70
HL WR-12	190	HMPCHASE	254	HMVPCA1-1830G	72	HMVR-3072(?)-FX	68
HMACABLE	247	HMPT2448NS	38	HMVPCA1-1830R	72	HMVR-3072(?)-NS	69
HMAGANG	61, 141, 245	HMPT2460NS	38	HMVPCA2-1830G	72	HMVR-3084(?)-FX	68
HMAJUMP	247	HMPT2472NS	38	HMVPCA2-1830R	72	HMVR-3084(?)-NS	69
HMAPLATE	247	HMPT3048NS	38	HMVPCF-1830G	72	HMVR-3096(?)-FX	68
HMAPOWER36	247	HMPT3060NS	38	HMVPCF-1830R	72	HMVR-3096(?)-NS	69
HMAPOWER362	247	HMPT3072NS	38	HMVPCSS-4C	72	HMVR-3648(?)-AH	70
HMAPOWER42	247	HMPTBFI	37	HMVPCSS-4C4C	72	HMVR-3648(?)-FX	68

CROSS REFERENCE INDEX

MODEL	PAGE	MODEL	PAGE	MODEL	PAGE	MODEL	PAGE
HMVR-3648(?)-NS	69	HPTCC2-T1UU	275	HSLMSB2	471	HT29FB48120	92
HMVR-3660(?)-AH	70	HPTCC2-T3UM	276	HSLMSS	471	HT29FB48144	92
HMVR-3660(?)-FX	68	HPTCC2-T3UU	276	HSLMTCB1	472	HT29FB48168	91
HMVR-3660(?)-NS	69	HPWR4TAP	249	HSLMTCB2	472	HT29FB48180	91
HMVR-3672(?)-AH	70	HPWRMOB1	249, 294	HSLV2DAP	486	HT29FB48192	91
HMVR-3672(?)-FX	68	HPWRMOD	249	HSLV4DAP	486	HT29FB48216	91
HMVR-3672(?)-NS	69	HPWRSNK36	253	HSLVFAP	486	HT29FB48240	91
HNL1530FD	107	HPWRTRGH17	245, 253	HSLVLMBR	486	HT29FB4896	92
HNL1530LD	106	HPWRTRGH36	253	HSLVSMM	482	HT29FBM	92
HNL1530LL	106	HQB	245	HSLVSMMS	482	HT36FB3060	92
HNL1536FD	107	HQBCJ36	245	HSLVSMR	484	HT36FB3660	92
HNL1536LD	106	HQH1-3	245	HSLVSMRS	484	HT36FB3672	92
HNL1536LL	106	HQH5-3	245	HSLVTMM	481	HT36FB4284	92
HNL1542FD	107	HQH5-E-3PIE	245	HSLVTMMKD	485	HT36FB48108	92
HNL1542LD	106	HQH5-E-3PIU2B	245	HSLVTMMS	481	HT36FB48120	92
HNL1542LL	106	HQH5-E-3P3B	245	HSLVTMR	483	HT36FB48144	92
HNL1548FD	107	HQH5-P-3P1B	245	HSLVTMRKD	485	HT36FB48168	91
HNL1548LD	106	HQJ3	245	HSLVTMRS	483	HT36FB48180	91
HNL1548LL	106	HQQ1	466	HSS4L-06A	184	HT36FB48192	91
HNL1548SD	107	HQQICUSH	466	HSS4L-12A	184	HT36FB48216	91
HNL1560FD	107	HRNDPWRMOD	250	HSS4L-14A	184	HT36FB48240	91
HNL1560LD	106	HRUCK1L	462	HSS4L-16B	184	HT36FB4896	92
HNL1560LL	106	HRUCK1W	463	HSS4L-18B	184	HT36FBM	92
HNL1560SD	107	HRUCK5L	462	HSS4L-24B	185	HT42AL2PK	93
HNL1566FD	107	HRUCK5W	463	HSS4L-30B	185	HT42AL60	93
HNL1566LD	106	HSB50	267	HSSA-WB1618	185	HT42AL72	93
HNL1566LL	106	HSB50DF	269	HSSCL-14A	186	HT42AL84	93
HNL1566SD	107	HSCASTER	277, 325, 326, 337, 393,	HSSCL-16B	186	HT42AL96	93
HNL1572FD	107		406, 486, 505, 506, 525	HSSCL-18B	186	HT42ALEG	93
HNL1572LD	106	HSCCR36BPG	113	HSSST-18B	187	HT42FB3060	92
HNL1572LL	106	HSCCR36LM	113	HSSTK-18B	187	HT42FB3660	92
HNL1572SD	107	HSCCR36LMK	113	HT27FB3060	92	HT42FB3672	92
HNL1578FD	107	HSCCR48BPG	113	HT27FB3660	92	HT42FB4284	92
HNL1578LD	106	HSCCR48LM	113	HT27FB3672	92	HT42FB48108	92
HNL1578LL	106	HSCCR48LMK	113	HT27FB4284	92	HT42FB48120	92
HNL1578SD	107	HSCCSR2448BPG	113	HT27FB48108	92	HT42FB48144	92
HNL3630TB	243	HSCCSR2448LM	113	HT27FB48120	92	HT42FB48168	91
HNL3636TB	243	HSCCSR2448LMK	113	HT27FB48144	92	HT42FB48180	91
HNL4930TB	243	HSCCSS36BPG	113	HT27FB48168	91	HT42FB48192	91
HNL4936TB	243	HSCCSS36LM	113	HT27FB48180	91	HT42FB48216	91
HNLMP3628	105	HSCCSS36LMK	113	HT27FB48192	91	HT42FB48240	91
HNLMP5428	105	HSCCSS48BPG	113	HT27FB48216	91	HT42FB4896	92
HNLMP7228	105	HSCCSS48LM	113	HT27FB48240	91	HT42FBM	92
HNLMP9028	105	HSCCSS48LMK	113	HT27FB4896	92	HTALWMGR29	93
HNLRC2436	105	HSCER24BPG	114	HT27FBM	92	HTALWMGR42	93
HNLRC2454	105	HSCER24LM	114	HT29AL108	93	HTBINSLIDE	103
HNLRC2472	105	HSCER24LMK	114	HT29AL120	93	HTFWMGR27	92
HNLRC2490	105	HSCER24BPG	114	HT29AL144	93	HTFWMGR29	92
HNR1	444	HSCER24LM	114	HT29AL168	93	HTFWMGR36	92
HNR1KD	445	HSCER24LMK	114	HT29AL180	93	HTFWMGR42	92
HNR6	447	HSCS1	266	HT29AL192	93	HTFXL27	95
HNRS	446	HSCS1DF	268	HT29AL216	93	HTFXL27C	95
HPACSM	229	HSCS2	267	HT29AL240	93	HTFXL27P	95
HPACW	229	HSCS2DF	269	HT29AL2PK	93	HTFXL29	95
HPADD	230	HSGANG	266, 269	HT29AL60	93	HTFXL29C	95
HPASD	230	HSGS6	266	HT29AL72	93	HTFXL29P	95
HPATF	230	HSGS6DF	268	HT29AL84	93	HTFXL36	95
HPHAP2028E	60	HSLMCS	473	HT29AL96	93	HTFXL36C	95
HPHAP2028G	60	HSLMGK	475	HT29ALEG	93	HTFXL36P	95
HPN1	455	HSLMICB1	473	HT29ALM	93	HTFXL42	95
HPN2	455	HSLMICB2	473	HT29FB3060	92	HTFXL42C	95
HPPMT	191	HSLMOCB1	474	HT29FB3660	92	HTFXL42P	95
HPTCC1-TIUM	274	HSLMOCB2	474	HT29FB3672	92	HTFXM27	95
HPTCC1-TIUU	274	HSLMQCS	474	HT29FB4284	92	HTFXM27C	95
HPTCC2-TIUM	275	HSLMSB1	471	HT29FB48108	92	HTFXM27P	95

CROSS REFERENCE INDEX

MODEL	PAGE	MODEL	PAGE	MODEL	PAGE	MODEL	PAGE
HTFXM29	95	HTLB1448LP	110	HTLC4272HCTPL	97	HTLHPM	89
HTFXM29C	95	HTLB1648LP	110	HTLC4272HCTPR	97	HTLLECTA	102
HTFXM29P	95	HTLB16848P	109	HTLC4272LCTFP	96	HTLM4272	86
HTFXM36	95	HTLB1848LP	110	HTLC4272LCTFPL	97	HTLM4872	86
HTFXM36C	95	HTLB2048LP	110	HTLC4272LCTFPR	97	HTLM5472	86
HTFXM36P	95	HTLBENCH30	102	HTLC4272LCTP	96	HTLM7248P	109
HTFXM42	95	HTLBENCH48	102	HTLC4272LCTPL	97	HTLMC1828DL	104
HTFXM42C	95	HTLBENCH60	102	HTLC4272LCTPR	97	HTLMC1828DR	104
HTFXM42P	95	HTLBENCHCUSH30	102	HTLC4296HCTFP	96	HTLMC1828L	104
HTFXS27	95	HTLBENCHCUSH48	102	HTLC4296HCTFPL	97	HTLMC1828O	104
HTFXS27P	95	HTLBENCHCUSH60	102	HTLC4296HCTFPR	97	HTLMC1828R	104
HTFXS29	95	HTLBMR60144	87	HTLC4296HCTP	96	HTLMED4860	87
HTFXS29P	95	HTLBMR60168	87	HTLC4296HCTPL	97	HTLMT4260H	101
HTFXS36	95	HTLC3060HCTFP	98	HTLC4296HCTPR	97	HTLMT4260HFR	101
HTFXS36P	95	HTLC3060HCTFPL	99	HTLC4296LCTFP	96	HTLMT4260L	101
HTFXS42	95	HTLC3060HCTFPR	99	HTLC4296LCTFPL	97	HTLMT4272H	101
HTFXS42P	95	HTLC3060HCTP	98	HTLC4296LCTFPR	97	HTLMT4272HFR	101
HTFXT27	95	HTLC3060HCTPL	99	HTLC4296LCTP	96	HTLMT4272L	101
HTFXT27P	95	HTLC3060HCTPR	99	HTLC4296LCTPL	97	HTLMTHBACK	101
HTFXT29	95	HTLC3060LCTFP	98	HTLC4296LCTPR	97	HTLMTLBACK	101
HTFXT29P	95	HTLC3060LCTFPL	99	HTLCRED42	103	HTLMTTV	101
HTG1PWR-3P-1B	251, 376	HTLC3060LCTFPR	99	HTLCRED42S	103	HTLP108	89
HTG2PWR-3P-1E	251	HTLC3060LCTP	98	HTLCRED57	103	HTLP120	89
HTG2PWR-3P-1U-W	251	HTLC3060LCTPL	99	HTLCRED57S	103	HTLP144	89
HTG2PWR-3P-2B-2U	251	HTLC3060LCTPR	99	HTLCRED72	103	HTLP168	89
HTG2PWR-4P-2B	251	HTLC3072HCTFP	98	HTLCRED72S	103	HTLP180	89
HTGPWRKIA	126	HTLC3072HCTFPL	99	HTLCUBE108	90	HTLP192	89
HTL(?)24	88	HTLC3072HCTFPR	99	HTLCUBE120	90	HTLP216	89
HTL(?)30	88	HTLC3072HCTP	98	HTLCUBE144	90	HTLP240	89
HTL(?)3060	86	HTLC3072HCTPL	99	HTLCUBE168	90	HTLP60	89
HTL(?)36	88	HTLC3072HCTPR	99	HTLCUBE180	90	HTLP72	89
HTL(?)3672	86	HTLC3072LCTFP	98	HTLCUBE192	90	HTLP84	89
HTL(?)42	88	HTLC3072LCTFPL	99	HTLCUBE216	90	HTLP96	89
HTL(?)42108	86	HTLC3072LCTFPR	99	HTLCUBE240	90	HTLPB	109
HTL(?)42120	86	HTLC3072LCTP	98	HTLCUBE48	94	HTLPBS	109
HTL(?)42144	86	HTLC3072LCTPL	99	HTLCUBE84	90	HTLPM	89
HTL(?)42168	86	HTLC3072LCTPR	99	HTLCUBE96	90	HTLPRES	108
HTL(?)42180	86	HTLC3096HCTFP	98	HTLCUBEM	90	HTLR108	90
HTL(?)42192	86	HTLC3096HCTFPL	99	HTLCUBES108	90	HTLR120	90
HTL(?)42216	86	HTLC3096HCTFPR	99	HTLCUBES120	90	HTLR144	90
HTL(?)42240	86	HTLC3096HCTP	98	HTLCUBES144	90	HTLR168	90
HTL(?)4284	86	HTLC3096HCTPL	99	HTLCUBES168	90	HTLR180	90
HTL(?)4296	86	HTLC3096HCTPR	99	HTLCUBES180	90	HTLR192	90
HTL(?)48	88	HTLC3096LCTFP	98	HTLCUBES192	90	HTLR216	90
HTL(?)48108	86	HTLC3096LCTFPL	99	HTLCUBES216	90	HTLR240	90
HTL(?)48120	86	HTLC3096LCTFPR	99	HTLCUBES240	90	HTLR36	94
HTL(?)48144	86	HTLC3096LCTP	98	HTLCUBES48	94	HTLR42	94
HTL(?)48168	86	HTLC3096LCTPL	99	HTLCUBES96	90	HTLR48	94
HTL(?)48180	86	HTLC3096LCTPR	99	HTLCUBESM	90	HTLR84	90
HTL(?)48192	86	HTLC4260HCTFP	96	HTLCVN3060	87	HTLR96	90
HTL(?)48216	86	HTLC4260HCTFPL	97	HTLCVN3072	87	HTLRC108	90
HTL(?)48240	86	HTLC4260HCTFPR	97	HTLCVN3660	87	HTLRC120	90
HTL(?)4896	86	HTLC4260HCTP	96	HTLCVN3672	87	HTLRC144	90
HTL(?)54108	86	HTLC4260HCTPL	97	HTLD60	88	HTLRC168	90
HTL(?)54120	86	HTLC4260HCTPR	97	HTLHP108	89	HTLRC180	90
HTL(?)54144	86	HTLC4260LCTFP	96	HTLHP120	89	HTLRC192	90
HTL(?)54168	86	HTLC4260LCTFPL	97	HTLHP144	89	HTLRC216	90
HTL(?)54180	86	HTLC4260LCTFPR	97	HTLHP168	89	HTLRC240	90
HTL(?)54192	86	HTLC4260LCTP	96	HTLHP180	89	HTLRC48	94
HTL(?)54216	86	HTLC4260LCTPL	97	HTLHP192	89	HTLRC84	90
HTL(?)54240	86	HTLC4260LCTPR	97	HTLHP216	89	HTLRC96	90
HTLB1048LP	110	HTLC4272HCTFP	96	HTLHP240	89	HTLRM	90
HTLB12048P	109	HTLC4272HCTFPL	97	HTLHP84	89	HTLRM	90
HTLB1248LP	110	HTLC4272HCTFPR	97	HTLHP96	89	HTLSULPIL1630LML	118
HTLB14448P	109	HTLC4272HCTP	96	HTLHPB	89	HTLSULPIL1630LWL	119

CROSS REFERENCE INDEX

MODEL	PAGE	MODEL	PAGE	MODEL	PAGE	MODEL	PAGE
HTLSCULPIL1630MML	118	HTLSCUSQRPLNT15L	125	HTMC424260	100	HVL585	327
HTLSCULPIL1630MWL	119	HTLSCUSQRPLNT30L	125	HTMC424260BB	100	HVL601	524
HTLSCULPIL1660LML	118	HTLSCUSQRT16LML	122	HTMC424272	100	HVL606	464
HTLSCULPIL1660LWL	119	HTLSCUSQRT16LWL	123	HTMC424272BB	100	HVL616	464
HTLSCULREC1630LML	118	HTLSCUSQRT18MML	122	HTMC424296	100	HVL701	507
HTLSCULREC1630LWL	119	HTLSCUSQRT18MWL	123	HTMC424296BB	100	HVL702	507
HTLSCULREC1630MML	118	HTLSCUSQRT20HML	122	HTPCIF48	294	HVL705	507
HTLSCULREC1630MWL	119	HTLSCUSQRT20HWL	123	HTPCIF72	294	HVL712	507
HTLSCULREC1660LML	118	HTLSCUSQRT30LML	122	HTPHWIF72	294	HVLVL1	452
HTLSCULREC1660LWL	119	HTLSCUSQRT30LWL	123	HTPKIT48	294	HVLVL2	452
HTLSCULRND16HML	118	HTLSCUWPIL1630LML	120	HTPKIT482	294	HVLVL3	452
HTLSCULRND16HWL	119	HTLSCUWPIL1630LWL	121	HTPKIT60	294	HVLVLOT	452
HTLSCULRND16LML	118	HTLSCUWPIL1630MML	120	HTPKIT602	294	HVPWLKB48	87
HTLSCULRND16LWL	119	HTLSCUWPIL1630MWL	121	HTPKIT72	294	HWCUSPBA	318
HTLSCULRND16MML	118	HTLSCUWPIL1660LML	120	HTPKIT722	294	HWCUSPBAMF	320
HTLSCULRND16MWL	119	HTLSCUWPIL1660LWL	121	HTPLATEVHAU	252	HWCUSPBN	319
HTLSCULRND30LML	118	HTLSCUWREC1630LML	120	HTPSPLIT	294	HWCUSPBNMF	321
HTLSCULRND30LWL	119	HTLSCUWREC1630LWL	121	HTRACK	103	HWCUSUBA	318
HTLSCULSQR13LML	118	HTLSCUWREC1630MML	120	HTSSRD	354	HWCUSUBAMF	320
HTLSCULSQR13LWL	119	HTLSCUWREC1630MWL	121	HTTLEG108	93	HWCUSUBN	319
HTLSCULSQR16MML	118	HTLSCUWREC1660LML	120	HTTLEG120	93	HWCUSUBNMF	321
HTLSCULSQR16MWL	119	HTLSCUWREC1660LWL	121	HTTLEG144	93	HWCUSWBA	318
HTLSCULSQR20HML	118	HTLSCUWRND16HML	120	HTTLEG168	93	HWCUSWBN	319
HTLSCULSQR20HWL	119	HTLSCUWRND16HWL	121	HTTLEG180	93	HWHIC	518
HTLSCULSQR30LML	118	HTLSCUWRND16LML	120	HTTLEG192	93	HWHICCF	518
HTLSCULSQR30LWL	119	HTLSCUWRND16LWL	121	HTTLEG216	93	HWHISP	512
HTLSCUPERTBL	124	HTLSCUWRND16MML	120	HTTLEG240	93	HWHISPCF	513
HTLSCUPILCNSL1253	124	HTLSCUWRND16MWL	121	HTTLEG60	93	HWHISS	512
HTLSCUPILT1830LML	122	HTLSCUWRND30LML	120	HTTLEG72	93	HWHISSCF	513
HTLSCUPILT1830LWL	123	HTLSCUWRND30LWL	121	HTTLEG84	93	HWHITCP	519
HTLSCUPILT1830MML	122	HTLSCUWSQR13LML	120	HTTLEG96	93	HWHITCPCF	520
HTLSCUPILT1830MWL	123	HTLSCUWSQR13LWL	121	HTTLEGM	93	HWHITCS	519
HTLSCUPILT1860LML	122	HTLSCUWSQR16MML	120	HTXLEG	95	HWHITCSCF	520
HTLSCUPILT1860LWL	123	HTLSCUWSQR16MWL	121	HTXLEGSH	95	HWH2SP	514
HTLSCURECCNSL1253	124	HTLSCUWSQR20HML	120	HUPWRMOD	249	HWH2SPCF	515
HTLSCURECT1830LML	122	HTLSCUWSQR20HWL	121	HURNDPWRMOD	250	HWH2SS	514
HTLSCURECT1830LWL	123	HTLSCUWSQR30LML	120	HV-UT1	242	HWH2SSCF	515
HTLSCURECT1830MML	122	HTLSCUWSQR30LWL	121	HVL108	328	HWH3SP	516
HTLSCURECT1830MWL	123	HTLSHELF	103	HVL151	523	HWH3SPCF	517
HTLSCURECT1860LML	122	HTLTPR4896	87	HVL232	411	HWH3SS	516
HTLSCURECT1860LWL	123	HTLTPR60120	87	HVL238	411	HWH3SSCF	517
HTLSCURNDT18HML	122	HTLXP36	94	HVL402	524	HWHACPP	522
HTLSCURNDT18HWL	123	HTLXP42	94	HVL511	494	HWHACPS	522
HTLSCURNDT18LML	122	HTLXP48	94	HVL515	494	HWHBCPP	522
HTLSCURNDT18LWL	123	HTMC304260	100	HVL531	459	HWHBCPS	522
HTLSCURNDT18MML	122	HTMC304260BB	100	HVL532	459	HWHGB	522
HTLSCURNDT18MWL	123	HTMC304272	100	HVL539	459	HWHLP	521
HTLSCURNDT30LML	122	HTMC304272BB	100	HVL581	327	HWHSP18	521
HTLSCURNDT30LWL	123	HTMC304296	100	HVL582	327	HWIRECLT	254
HTLSCUSQRPLNT15H	125	HTMC304296BB	100				

NOTES

NOTES

NOTES

NOTES

NOTES

INFORMATION ON ORDERING PARTS

When parts are needed to repair HON products, the following guidelines should be followed to expedite the process.

1. Warranty orders are submitted on the Website at hon.com via the Quick Claim tool.
2. There are no discounts applied to parts. Pricing quoted is the net value. Parts pricing is subject to change without notice.
3. For a part not covered by warranty applicable shipping charges will apply.
4. All keys are \$6.00 each plus a shipping and handling fee of \$3.00 per shipping location.
5. Parts may be paid for with an approved credit card. Approved Cards: MasterCard, VISA and American Express.
6. Payment terms for invoiced parts are Net 30 days.
7. Due to short leadtimes on parts, no changes will be accepted after the order has been placed.
8. When placing a **warranty** parts order:

If the product is under warranty, the product serial number must be provided. Most finished goods products have a serial number placed on them at the factory. The label containing the serial number is located:

Vertical Files — right side of the uppermost drawer

Lateral Files — left side of the uppermost drawer or shelf

Desk Towers — outside of top drawer

Desks, Credenzas, & Returns — on the outside, kneespace side of the top drawer. Fully extend the drawer to find it.

Desks, Credenzas, Corner Units, Bridges, Peninsulas & Returns without drawers — underside of top

Tables and Stands — underside of the top

Table Trucks — underside of side rail

Cabinets & Bookcases — left inner side of the case

Modular Component Top and Backs — underside of top

Modular End Panels — top inside surface

Reception Stations — top inside surface of back panel

Organizers — top inside surface of left end panel near back panel

Vertical Paper Manager — back panel inside surface near top

Pedestals — bottom drawer right side exterior

Seating — underside of the seat

Panels — underside of the top cap

Hutches, Storage Units, Overhead Storage — underside of the shelf

Hanging Bookshelves — underside of shelf

NOTE: Removal of the serial number tag from the product voids the warranty.

An important note regarding Product Serial Numbers:

HON desks, tables, chairs, files and systems components are tagged with a serial number. This number helps us identify *when and where your product was made*, and to identify and correct the root causes for the problem. **NEITHER THE DEALER NOR THE CONSUMER SHOULD REMOVE THIS TAG UNDER ANY CIRCUMSTANCES.** To do so immediately voids your Warranty coverage for that particular item *and prevents us from further identifying it*. Instead, please transcribe the number and call your Dealer.



The HON Company
Muscatine, IA 52761
800.833.3964
hon.com

©2025 The HON Company. Form No. H6080 (1/25). HON is a registered trademark of HNI Technologies, under license to The HON Company.

Supersedes HON List Pricer

Dated February 2025



Front Cover: Mod Desk shown with Altern™ Seating

Back Cover: Preside® Table shown with Ignition® 2.0 Seating