

LINEA CONFERENCE TABLES  
LIST PRICES EFFECTIVE  
FEBRUARY 1, 2024

LINEA  
CONFERENCE  
TABLES



STATE OF SOUTH CAROLINA

2 0 2 4



**Mailing Address:**

**HBF**  
PO Box 8  
Hickory NC 28603-0008

**Shipping Address:**

**HBF**  
900 - 12th Street Drive NW  
Hickory NC 28601-4763

**Contact:**

Phone: 1.855.HBF.2020  
828.328.2064  
Fax: 828.485.2690  
Info: hbfservice@hbf.com  
www.hbf.com

**Order Processing:**

Phone: 1.855.HBF.2020  
828.328.2064  
Fax: 828.485.2690  
hbforders@hbf.com

**PAGE**

REFERENCE \_\_\_\_\_ 2-27

Overview \_\_\_\_\_ 2

Scope of Line \_\_\_\_\_ 3

Materials & Finishes \_\_\_\_\_ 5

Edge Details \_\_\_\_\_ 2, 13

Locks and Keying \_\_\_\_\_ 7, 11

Technical Specifications \_\_\_\_\_ 8

How to Specify + GSA Information \_\_\_\_\_ 13-14

Breadth of Line \_\_\_\_\_ 16-18

Height Reference \_\_\_\_\_ 15

Grain Direction \_\_\_\_\_ 17-18

Product Reference \_\_\_\_\_ 19-21

Floor Monument Locations \_\_\_\_\_ 22

TABLE TOPS \_\_\_\_\_ 24-28

Round \_\_\_\_\_ 24

Rectangular \_\_\_\_\_ 25

TECHNOLOGY \_\_\_\_\_ 29-40

Powered Grommets & MediaConnect Tech Unit \_\_\_\_\_ 30-31

MediaConnect Wiring Schematics \_\_\_\_\_ 32-33

Data Path Tech Units - Wiring Schematic \_\_\_\_\_ 34

DataPath Unit \_\_\_\_\_ 35

Single Space AAP \_\_\_\_\_ 36-38

Double Space AAP \_\_\_\_\_ 39

Miscellaneous Accessories \_\_\_\_\_ 40

TABLE BASES \_\_\_\_\_ 42-44

Drum Base \_\_\_\_\_ 42

Open 6" Rectangular Base \_\_\_\_\_ 43

Solid 6" Rectangular Base \_\_\_\_\_ 44

CREDENZAS AND ANCILLARY \_\_\_\_\_ 45-55

Overview \_\_\_\_\_ 46

Conference Cabinets \_\_\_\_\_ 47-50

Projection and TV Lift Cabinets \_\_\_\_\_ 51

Carts \_\_\_\_\_ 52

Lecterns \_\_\_\_\_ 55

Cutlery Tray \_\_\_\_\_ 56

WEIGHTS AND CUBES \_\_\_\_\_ 57



PLEASE SPECIFY THE FOLLOWING TO ORDER:

MODEL NUMBER

TECHNOLOGY CUTOUT

(Insert option from shaded area on next page)

--	--

OPTION OVERVIEW

**WOOD TOPS**

Linea Conference tops come standard with a solid wood edgeband on the perimeter of the table. When specifying any of the 4 top materials, a wood finish still needs to be specified for the edgeband.

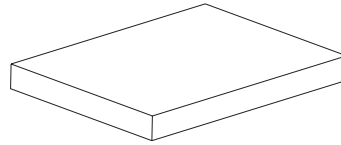

Flat Edge  
Available on  
Table Tops

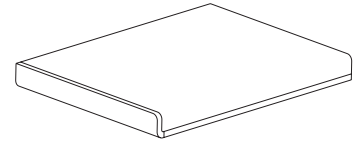

Waterfall Edge  
Available on  
Conference Cabinets,  
Carts and Lecterns.

**TECHNOLOGY CUTOUT**

There are a variety of cutout option sets for the different size tops in the Linea Conference Series. Please see the corresponding cut out matrices for each size top and if cut outs are desired, order the technology separately on the specified page.

TABLE TOPS

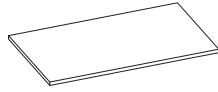

Rectangular

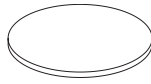

Round

BASES FOR RECTANGULAR TOPS

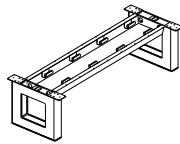

Open Rectangular Base

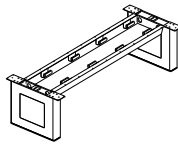

Solid Rectangular Base

BASES FOR ROUND TOPS

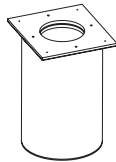

Drum Base

CREDENZAS & ANCILLARY

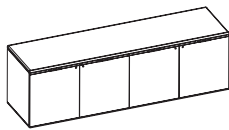

Conference Cabinets

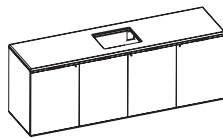

Projection Cabinets

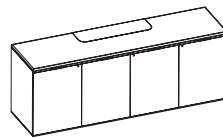

TV Lift Cabinet

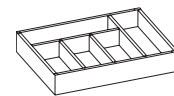

Cutlery Tray



Mobile Media Cart

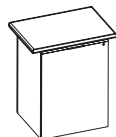

Mobile Buffet Cart

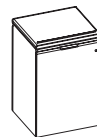

Lectern

TECHNOLOGY

MediaConnect Tech Unit – Closed

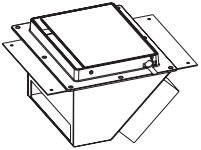

MediaConnect Tech Unit – Open

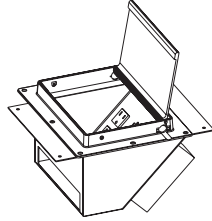

MediaConnect Tech Unit – Front View

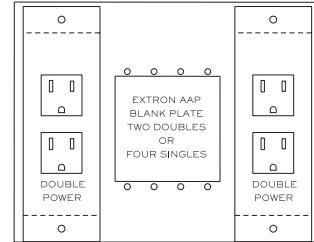

Power Grommet – Closed

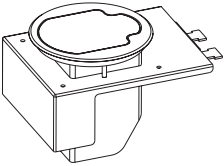

Power Grommet – Open

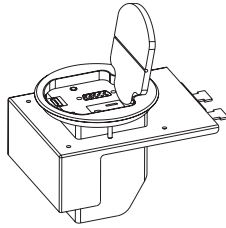

Power Grommet – Front View

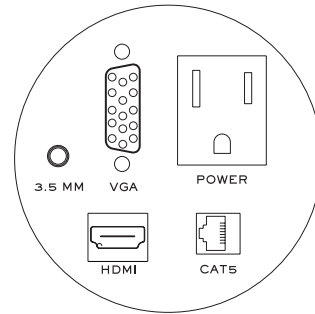

60" DataPath Tech Unit – Closed

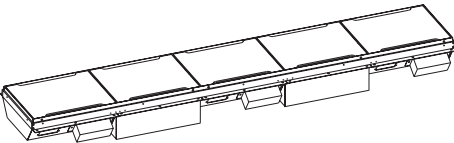

60" DataPath Tech Unit – Open

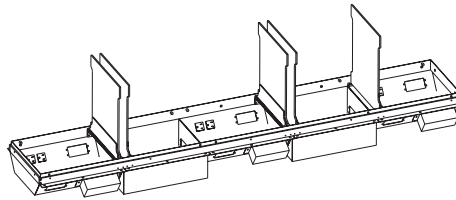

60" DataPath Tech Unit – Front View

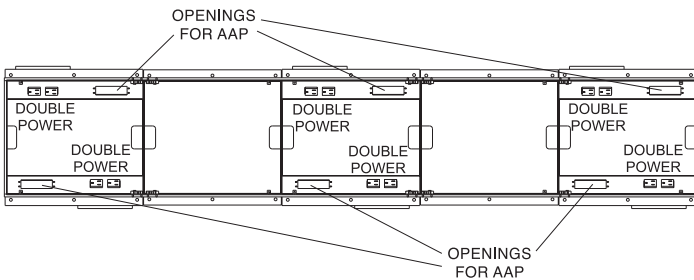



---

VENEER 1	PLAIN SLICED MAPLE	
	Natural Maple	NE800
	Honey Maple	NE873
	PLAIN SLICED CHERRY	
	Wheat Cherry	NC706
	Light Cherry	NC701
	Canyon Cherry	NC744
	Burnished Cherry	NC777
	Medium Brown Cherry	NC215
	Chestnut Cherry	NC293
	Dark Red Cherry	NC511
	Chicory Cherry	NC284
	PLAIN SLICED WALNUT	
	Light Roast Walnut	NT601
	Coffee Walnut	NT615
	Sumatra Walnut	NT693
	Charcoal Grey Walnut	NT637
	Dark Roast Walnut	NT684
	Nutmeg Walnut	NT629
	Ebony Walnut	**NT509

---

VENEER 2	QUARTER SLICED MAPLE	
	Natural Maple	QE800
	Honey Maple	QE873
	QUARTER SLICED CHERRY	
	Wheat Cherry	QC706
	Light Cherry	QC701
	Canyon Cherry	QC744
	Burnished Cherry	QC777
	Medium Brown Cherry	QC215
	Chestnut Cherry	QC293
	Dark Red Cherry	QC511
	Chicory Cherry	QC284
	QUARTER SLICED WALNUT	
	Light Roast Walnut	QT601
	Coffee Walnut	QT615
	Sumatra Walnut	QT693
	Charcoal Grey Walnut	QT637
	Dark Roast Walnut	QT684
	Nutmeg Walnut	QT629
	Ebony Walnut	**QT509
	RIFT CUT OAK	
	Light Rift Oak	RF301
	Dark Rift Oak	RF331

\*\* Ebony Walnut Veneer only available on wood bases

---

PAINT	Soft White - Designer White	WPSW
	Loft - Grey Cloud	WPLF

Note: Painted wood finishes are not available for conference tops

---

FSC PRODUCT

HBF holds Forest Stewardship Council® (FSC) Chain-of-Custody Certification® (SCS-COC-002143). This certification agreement allows HBF to offer FSC® certified veneer or core on a project specific basis.

An upcharge of 5% list per unit for conference products, will apply to all FSC® specified units.

For FSC® Certified Product add "FSC" to beginning of finish option code. (Example: FSCNC701)

---

CUSTOM FINISHES

An upcharge of 10% Net per unit for conference products, with a minimum upcharge of \$500 Net per order, will apply for any custom wood veneer finish.



MAPLE



NE800 Natural Maple  
NE873 Honey Maple

OAK



RF301 Light Rift Oak  
RF331 Dark Rift Oak

METALS

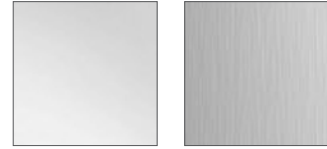

PA Polished Aluminum  
BA Brushed Aluminum

CHERRY



NC701 Light Cherry  
NC744 Canyon Cherry  
NC215 Med. Brown Cherry  
NC511 Dark Red Cherry  
NC706 Wheat Cherry  
NC777 Burnished Cherry  
NC293 Chestnut Cherry  
NC284 Chicory Cherry

WALNUT



NT629 Nutmeg Walnut  
NT615 Coffee Walnut  
NT637 Charcoal Grey Walnut  
NT684 Dark Roast Walnut  
NT601 Light Roast Walnut  
NT693 Sumatra Walnut

***HBF Legacy finishes are considered match panel finishes. They will include a 5% net up-charge for seating/occasional tables and a 10% net up-charge for conference OR a minimum up-charge of \$500 per order.***

Screen images are intended as a guide only and should not be regarded as absolutely correct. For exact color/texture, please contact the HBF Surface Materials at [HBFSurfaceMaterials@hbf.com](mailto:HBFSurfaceMaterials@hbf.com) for an actual sample.

Wood owes its inherent beauty to variations in color, grain, and texture; therefore, these variations are not considered defects. Due to the natural color and grain variances of wood substance, the final finish color, texture and grain may vary from one furniture piece to another, even though they are finished at the same time. Exposure to light and the aging process will cause changes in surface color of natural wood products. Light finishes on wood products do not mask the natural characteristics of wood. HBF does not guarantee the exact matching of grain, pattern and color.

All HBF products are standard in a 30° sheen.



**FACTORY INSTALLED  
LOCKS**

Two lock options are available. When the factory installed lock option is selected lock cores are installed at the factory. Note: when the random option is selected some units may be shipped with the same key number. When the field installed lock option is selected each unit is shipped with an empty lock cylinder. Locks are Silver or Black.

OPTION 1	option code
SILVER RANDOM KEYS	<b>RMS</b>
BLACK RANDOM KEYS	<b>RMB</b>
OPTION 2	specify a number between
SILVER DESIGNATED KEYS	<b>FT100TAS - FT150TAS</b>
BLACK DESIGNATED KEYS	<b>FT100TA - FT150TA</b>

**FIELD INSTALLED  
LOCKS**

Field installed locks are also available. When field installed locks are specified each unit is shipped with an empty lock cylinder. A separate line item must be ordered to receive the numbered lock cores for field installation. Field installed locks are available at an additional charge of \$5 list per lock core.

	model number	option code
SILVER DESIGNATED KEYS	HK1LCKFLD	<b>100TAS-150TAS</b>
BLACK DESIGNATED KEYS	HK1LCKFLD	<b>100TA-150TA</b>



---

## WOOD TABLE TOPS

Wood veneer tops feature a balanced 3-ply construction and are 1 1/2" thick, comprised of a particleboard substrate. Wood veneer tops are faced with premium veneer and backed with a polymer resin impregnated moisture resistant backer material. Linea wood tops are available with a flat edge detail. Multi-piece tops are connected with 1/8" thick plastic splines for vertical alignment and steel mechanical fasteners for horizontal alignment to firmly connect the tops end to end.

- Flat edge – banded with 1mm ebgebands

---

## OPEN & SOLID 6" WOOD TABLE BASES

Linea wood base external panels are constructed of balanced 3 ply, 3/4" particleboard or MDF panels. Panels are faced with premium veneer and backed with a polymer resin impregnated moisture resistant backer material. Panels are securely fastened together with solid hardwood cleats, fluted glued dowels and pocket bore screws. Bottom panel is balanced 3 ply 1/2" MDF, includes threaded glide inserts and glides with 1 1/8" of vertical adjustment. A steel top plate is connected to the internal solid hardwood cleats with screws. The steel top plate is used to connect the base to the table top. The internal side of the base includes pre-bored connection points for the beam attachment and two 2 7/8" diameter holes for routing wires down the base.

Open bases include an 18"w x 15 3/4"h opening in the center of the base to provide a lighter aesthetic. This internal area is framed with removable panels on the sides and bottom. These panels are held into place with magnetic catches and can be removed for wire management from the floor through the base.

The solid base external panel includes a reveal that mirrors the shape of the internal removable cover. The solid base internal panel includes a removable wire management panel. This panel is held into place on the bottom with steel brackets and the top of the panel held into place with a magnetic catch. Door includes a pull for access.

---

## BEAM SUPPORT UNDERSTRUCTURE

Linea panel base assemblies include a dual beam construction. A powder coated extruded aluminum beam assembly (5 3/4"h x 1 7/8"w at top) spans between the bases to provide support to the table top over long spans. The extruded aluminum beam is connected to the bases with steel screws and tapped bosses located in the frame. The extruded aluminum beam profile includes a notch for the connection of plastic wire management clips. Wire management clips are included with the beam assembly. The bottom of the beam is covered with a 1/2" thick MDF balanced 3 ply panel, faced and backed with a polymer resin impregnated moisture resistant material. Cover attaches to the bottom of the beam with nylon thumb screws. The beam, wire management clips and cover provide an area to neatly house all the electrical and data wires under the table top.

See base ordering pages for number of frame sections. Longer frames ship in multiple sections. Be sure to note the length of frames and sections to accommodate any building logistical issues. Multiple section frames are field assembled.

---

**WOOD DRUM BASES**

Inner material consists of a wood composite tube. Top and bottom panels are 3/4" particleboard glued and pinned to the composite tube. Top and bottom panels include appropriate cutouts for routing wires from the top to the floor for wire management models. The cylinder core is faced with a 2-ply material utilizing an outer veneer on a 1/28" poplar cross band. This 2-ply face material is attached to the cylinder core with permanent bond PVA glue. A 3/4" sub-top is attached to the base with screws and provides an attachment method to connect the base to the top. The sub-top is pre-bored for screws for easy attachment to top. Glides with 1 1/8" of vertical adjustment are included for leveling.

---

**CONFERENCE CABINETS**

Linea conference cabinet tops are standard 1 1/2" thickness available in wood and include a standard waterfall edge profile. All credenza tops are 1 piece. See table top section for additional technical specifications.

All chassis are constructed of balanced 3-ply, 3/4" particleboard panels. Panels are securely fastened together with fluted glued dowels and pocket bore screws. All fronts feature horizontal grain veneer and the top of the drawer fronts include a profiled integrated hardwood band to complement the waterfall edge. End panels feature vertical veneer. Bottom rail is solid hardwood, 1 piece to span the pedestals. Internal pedestals are held together with steel mechanical fasteners. Standard Linea 6" edge pull centered on the top of each door. The bottom of the cabinet includes threaded steel corner brackets and glides that provide 1 1/8" of vertical adjustment for leveling cabinet. Hinged door cabinets include fully adjustable, 100° swing, self closing hinges. All credenza backs are unfinished.

- Shelf Storage pedestal – 1 adjustable shelf. Hinged door front can be left or right handed depending on specified location. Internal dimensions – 23 5/8" d x 22 1/2" w x 23 3/16" h.
- Drawer Storage pedestal – 4 extendable drawers behind a hinged door. Hinged door front can be left or right handed depending on specified location. Drawer internal dimensions are 14 5/8" d x 19 1/2" w x 3 3/8" h. Drawers are mounted on progressive steel ball bearing slides.
- Trash receptacle – 1 adjustable shelf. Shelf cut to accept depth of trash receptacle. Hinged door front can be left or right handed depending on specified location. Includes 3.5 gallon, black rubber trash can. Unit connects to back side of credenza door with steel sheet metal mounting bracket.
- Recycling center – Door extends with four-unit pull out recycling center. Recycling unit contained in black melamine panels. Units are mounted on progressive steel ball bearing slides. Removable recycling bins are polymer white, 25 quart capacity, dimensions: 9" d x 18 3/4" w x 19" h.
- Refrigeration pedestal – Hinged door front can be left or right handed depending on specified location. Unit includes a large cutout in back panel and circular holes in bottom panel for proper ventilation. Internal dimensions – 23 5/8" d x 22 1/2" w x 23 3/16" h. Refrigeration unit NOT included.
- AV rack pedestal – Hinged door front can be left or right handed depending on specified location. Unit includes a large cutout in back panel for proper ventilation. Internal dimensions – 23 5/8" d x 22 1/2" w x 23 3/16" h. AV rack supplied. Rack is Middle Atlantic; model SRS2-12, used for 19" wide rack mounted A/V equipment. Black finish, weight capacity 100 lbs, 12 useable rack spaces or 21" of useable height, extends 19" for equipment servicing. For complete AV rack technical specifications please refer to the Middle Atlantic website at <http://www.middleatlantic.com/>
- Projection Cabinet – Includes two hinged doors, only available on a 96" wide, 35" high buffet cabinet. Projection section of the cabinet is 48" wide. The upper portion of the cabinet is designed to hold a short throw projector. The back panel in the projection area includes two active ventilation fans. Interior dimensions are 23 5/8" d x 46 1/2" w x 8 3/4" h. Short throw projector NOT included. The lower section of the cabinet includes a vertical divider and two adjustable shelves. Worksurface includes a cutout 14 1/4" d x 18" w with clear tempered glass for the projection beam.
- TV Lift Cabinet – Includes four hinged doors, only available on a 96" wide, 35" high buffet cabinet. The center of the cabinet is divided into two sections. The front half of the cabinet includes a vertical divider and two adjustable shelves. The rear section of the cabinet includes a false back panel and opening to house the included TV lift mechanism. The storage pedestals on the ends are full depth. The top of the cabinet includes a cutout 35 1/2" w x 10 1/2" d to allow the TV to pass through the opening. The TV lift cabinet includes a Nexus 21 model L-27 full width TV lift system. TV lift will accommodate screen sizes up to 33 3/4" wide and 24" tall, and 4" deep, with a lift capacity of 110 lbs. For complete TV lift specifications please refer to the Nexus website at <http://www.tvlift.com/compact-tv-lift.html>

---

**CUTLERY TRAY**

This is an accessory drop in tray with 5 compartments. Drawer constructed of ½" thick beech plywood, dowel construction. This tray will fit in the optional 4 drawer conference credenza storage pedestal.

---

**MOBILE BUFFET CART**

Buffet carts are constructed of balanced 3 ply, ¾" thick particleboard panels. Tops are standard with 1 ½" thickness wood waterfall edge profile and a 3" overhang on sides. Cart panels are held together with glued fluted dowels and mechanical fasteners. The mobile cabinet is supported by (4) 2 ½" dual wheel locking casters. Hinged door includes fully adjustable, 100° swing, self closing hinges. Unit includes (1) adjustable shelf and extendable cutlery tray mounted on progressive steel ball bearing slides. Optional locks are available.

---

**MOBILE MEDIA CART**

Media carts are constructed of balanced 3 ply, ¾" thick particleboard panels. Tops are standard with 1 ½" thickness wood waterfall edge profile. Cart panels are held together with glued fluted dowels and mechanical fasteners. The mobile cabinet is supported by (4) 2 ½" dual wheel locking casters. The media cart is available with or without a door. Hinged door version includes fully adjustable, 100° swing, self closing hinges. Unit includes (1) adjustable shelf and (1) fixed shelf. Optional locks are available.

---

**LECTERN**

Lecterns are constructed of balanced 3 ply, ¾" thick particleboard panels. Top are standard with 1 ½" thickness wood waterfall edge profile. Lectern panels held together with glued fluted dowels and mechanical fasteners. The mobile cabinet is supported by (4) 2 ½" dual-wheel locking casters. Hinged door includes fully adjustable, 100° swing, self closing hinges. Unit includes (1) adjustable shelf, (1) fixed shelf and an angle adjustable lectern top. Lectern top also includes a powder coated steel pencil lip. Lecterns include optional locks and a technology package (microphone, gooseneck light, power/data unit).

Microphone manufacturer is audio-technica. The 18.94" version of the U857Q, the U857QL cardioid condenser quick-mount gooseneck microphone is designed to plug directly into a panel or desk-mounted XLR-type connector. The microphone offers unsurpassed immunity from radio frequency. It features an ultra-flexible small-diameter gooseneck and accepts interchangeable elements, available in cardioid, hypercardioid, omnidirectional and UniLine® line cardioid polar patterns. Equipped with self-contained electronics, the phantom-powered microphone also offers an 80 Hz low-cut UniSteep® filter that reduces pickup of low-frequency ambient noise. For complete specifications on the microphone reference, [http://www.audio-technica.com/cms/wired\\_mics/a4b81557c190ae16/index.html](http://www.audio-technica.com/cms/wired_mics/a4b81557c190ae16/index.html)

Gooseneck light is a Littlite (IS #2-LED) L-18-LED with bottom mount cord for a clean, cord free installation. Littlite LED lampset includes three-way rotary switch which enables the user to toggle between white light and red light output. Littlite lampsets have a twelve-inch cord set terminating in a 2.1mm socket. GXF-10 power supply (included) has a six-foot cable terminating in a 2.1mm plug. For complete specifications on the gooseneck light reference, <http://www.littlite.com/products/product/164>

Power/data unit is 4 7/16"D x 8 5/16"W, silver clear anodized aluminum finish. Unit includes a 6'-ft, 15 amp standard plug-in power cord, (2) electrical outlets and (2) voice/data openings. Voice/data communication adapter kit included. Cover is touch latch and remains open during use. Unit is field installed. UL Listed. Note: voice/data jacks NOT included.

---

**MEDIACONNECT**

Recessed in table top, unit is 6 1/2"d x 8 ½"w, silver finish. Cover flips up to access power and data ports. Veneer table tops are available with a satin pewter powdercoat door.

Each powder coated sheet metal enclosure is rated for 15 amp, 125 volt with circuit breaker. Units can be specified with 10' grounded standard plug or 6' hardwire conduit option. Units include (4) electrical outlets and (2) double space Extron AAP plates or (4) single space Extron AAP plates. Numerous jack options available, see ordering page for available options. Unit is field installed. UL Listed. For complete specifications on the Extron AAP plates reference the Extron website, Architectural Connectivity – <http://www.extron.com/product/index.aspx>



---

**ROUND POWER DATA**

Recessed in table top, unit is 3.88" diameter with a brushed aluminum finish. Each machined aluminum enclosure contains a simplex power receptacle, HDMI connector, VGA connector, 3.5mm audio connector and an RJ45 cat 5E connector. Unit only available with a 10' grounded standard plug. Unit is field installed. UL Listed – 12 amp, 125 VAC and 60Hz. Units can be specified for veneer, laminate, solid surface or glass table tops.

---

**DATAPATH TROUGH**

DataPath port units can only be specified in veneer tops. Recessed in table top, unit is available in 10"d x 60"w (5) door unit, standard silver anodized finish. The (5) door, 60" unit includes (3) power data modules and (2) storage modules. Doors are hinged and pivot across the width of the table. Interior dimensions of storage module – 10"d x 12"w x 4"h. Storage module includes a cutout for (1) double space Extron AAP plates or (2) single space Extron AAP plates.

Each power module enclosure contains (4) electrical outlets and (2) double space Extron AAP plates or (4) single space Extron AAP plates. Each power module is rated for 15 amp, 125 volt with circuit breaker. Units can be specified with 10' grounded standard plug or 6' hardwire conduit option. Numerous jack options available, see ordering page for available options. Cover flips up to access power and data ports. Unit is field installed. UL Listed.

Module doors are constructed of 3/16" brown acrylic, available with an applied brushed aluminum sheet metal or veneer covering.

---

**POWER CABLE KIT**

Convenient way to connect all power cords to a single power source. Unit includes 10' power in feed conduit. The power cable kit is rated for 20 amps per circuit allowing the use of 2 circuits with 2 line conductors, 1 neutral and 1 ground. The line conductors, neutral and ground are all 12 AWG. The kit can be wired in both single and 3-phase configurations, 240/ 120V, 208/ 120V, respectively. UL Listed, to be installed by certified electrician.

---

**DRAWERS**

All drawers are constructed of four sides and a bottom, which are attached to a drawer front with screws for easy removal. Drawer fronts feature vertically matched veneer within each pedestal set. The drawer side material is 9-ply construction, finished with a roll-coated 7-level UV cured polyester/acrylic finish that provides a high level of chemical and scratch resistance. The drawers are fastened together at each corner with dowel joinery for maximum drawer strength. The bottom material is a 3-ply substrate consisting of high density fiberboard core with a melamine face and backer.

---

**SUSPENSIONS**

All HBF conference products utilize silver steel roll formed zinc plated high-grade drawer suspensions. All suspensions are warranted for the lifetime of the product. Suspensions feature positive dampened start/stop fully progressive actions. Box drawers are full extension, featuring precision steel ball bearings for a smoother quieter range of motion and are load rated for 100 lbs.

---

**LOCKS**

Silver or black face locks are optional on most units. Lock plugs are either factory or field installed.

---

**KEYING**

Keying is available either factory or field installed. Factory installed keying offers two options: random or designated. When the random keying option is selected an arbitrary key number will be assigned to the unit. Note: some furniture units may have like key numbers when random keying is selected. When the designated keying option is selected a key number must be specified between 100TAS-150TAS for silver lock core and 100TA-150TA for black lock cores. All keys are solid brass. When the field installed keying option is selected, a lock cylinder will not be included in the furniture unit. A lock master key and lock cylinder package must be specified separately to install the lock cylinders in the field. The master key provides the ability for lock cylinders to be easily installed and removed in the field.



#### TRASH CAN ACCESSORY

Includes a 3.5 gallon, black rubber trash can. Unit connects to back side of credenza door with sheet metal mounting bracket.

---

#### WOOD FINISH

All HBF tops feature a 20 sheen, open pore, water based, UV cured low-emitting finish. The open pore finish accentuates the natural texture of the wood. All non-writing surfaces (wood chassis) receive an application of 30 sheen, low-emitting, conversion varnish finish. Both processes enhance the beauty of the natural wood and ensure the depth, clarity, color consistency and durability throughout the life of the product.

---

#### CLEANING WOOD

Dust with damp cloth. Remove fingerprints or soiling with mild solution; 3 parts water with small amount of mild dish detergent. Apply solution with spray bottle, wipe clean and dry with soft cloth. Note: Do not use furniture polishes containing oil, wax or silicone, which can produce an oily film or haze.



HOW TO ORDER  
LINEA TABLES

HBF's Linea Conference tables are available in two shapes and several sizes designed to fulfill a multitude of conferencing requirements from informal meeting areas to the executive boardroom.

STEP 1  
SELECT SHAPE

Select the table shape that meets your requirements.

Round

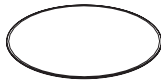

Rectangle

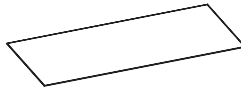

STEP 2  
SELECT SIZE

Select the table size that fits the footprint of the conference area.

Round	Rectangular			
36	42x72	48x72	54x120	60x120
42	42x84	48x84	54x144	60x144
48	42x96	48x96		
54	42x108	48x108		
60	42x120	48x120		
66		48x144		
72				

STEP 3  
SELECT  
TOP MATERIAL  
AND EDGE DETAIL

Wood  
W

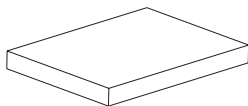

Flat Edge (FE)  
Available on: Tables

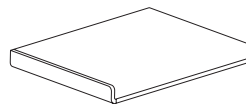

Waterfall Edge (WF)  
Available on: Conference  
Cabinets, Carts and Lecterns.

STEP 4  
SELECT TOP FINISH

Linea Conference tables are available in a variety of finishes. Please see page 5 for specific option codes for tops.



---

**STEP 5****SELECT TECHNOLOGY****CUTOUTS**

HBF's Linea Conference tables offer a choice in technology integration. When specifying a table top, use the top's corresponding cut-out matrix to see the available cut-outs for that size. Linea tables are available with some or all of the options below depending on the top size:

GN – No Grommet on the table

GCR – 1 Centered Round Grommet (for Round Table Tops only)

ICM – 1 Centered MediaConnect Unit in the center of the table

2EM – 2 Equally Spaced MediaConnect Units on the table

3EM – 3 Equally Spaced MediaConnect Units on the table

DP – DataPath Tech Units on the table

---

**STEP 6****SELECT TECHNOLOGY****INTEGRATION**

After choosing the cut-outs desired for the table top, use the matrix to determine how many technology units need to be ordered to be integrated into the table. MediaConnect Tech Units are available with a satin pewter powdercoat door.

Use the diagrams on the corresponding MediaConnect Tech Unit pages to determine what Extron plates can be fit into the unit. Extron plates are available in single or double space AAP models.

For more information on the Extron plates, please use the given Extron part number to locate the plate on Extron's website at: [www.extron.com](http://www.extron.com)

---

**STEP 7****SELECT BASE**

HBF's Linea round tables are available with a drum base. Drum bases are available in wood. Base models are made for use with specific top sizes, so please be aware of those sizes noted on the pages.

Conference table bases are available in paint or wood. As with the round table tops, these bases are to be used with certain size tops, and should be ordered based on the "For use w/ top size" column noted on each page.

For example: HD1BSRA2472-SW is a solid 6" rectangular wood base for use with rectangular table tops. This is noted as "For use w/ top size 42/48 x 72." This means that this base model can be specified with either a 42 x 72 table top or a 48 x 72 table top.

Additionally, the number of bases are called out on the panel base pages. When ordering, please refer to page 22 if you need floor monument dimensions based on top sizes. Panel bases come standard with a thin profile base cover. Refer to Linea product reference pages for dimensions and more information.

---

**GSA | FEDERAL CONTRACT INFORMATION****GSA CONTRACT NUMBER 47Q5MA22D08P9**

Model numbers identified with the following verbiage "When purchased separately without a configurable TAA compliant end product, not on GSA contract" is to mean that these configurable parts or components:

- Have no functionality or capability without being integrated into an end product; and
- Are considered **Open Market** if purchased without a configurable TAA compliant end product.

HEIGHT REFERENCE

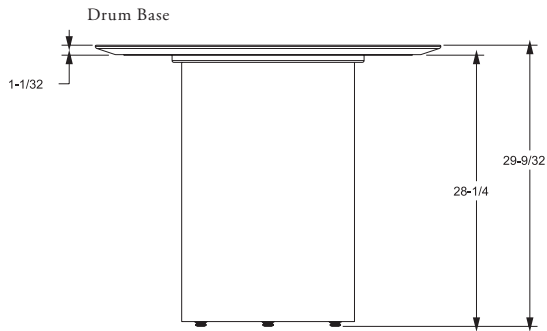
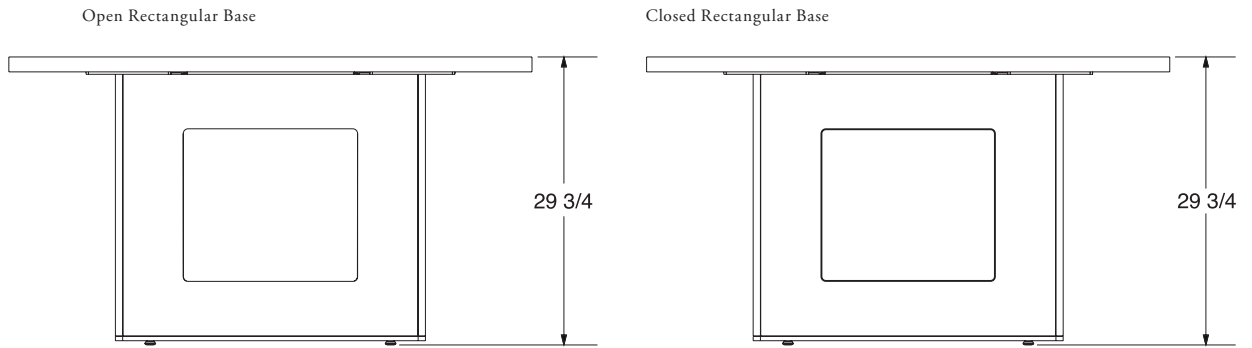

Conference Cabinet – Standard Height

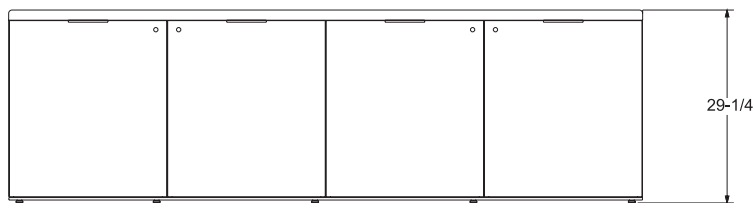

Conference Cabinet – Buffet Height

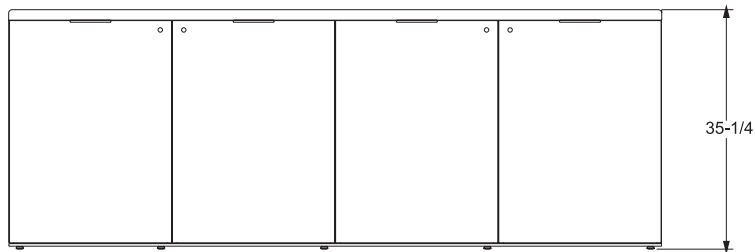





BREADTH OF LINE

144" W				
120" W				
108" W				
96" W				
84" W				
72" W				
	42" D	48" D	54" D	60" D

Note: Lines above represent number of sections per table top.

BREADTH OF LINE

**Primary Use:**

Conference room table tops for board rooms, staff conference rooms, and meeting rooms.

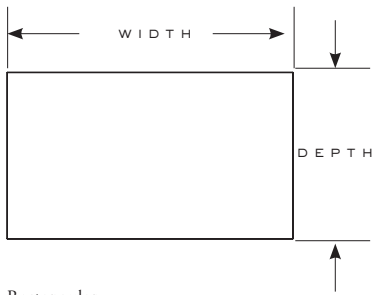

Rectangular

**Grain Direction:**

All Linea tops run short grain.

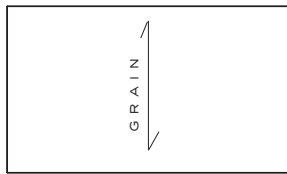

**Example:**

Grain Running Depth of Top

d x w	seating capacity	# of top sections
42 x 72	4-6	1
42 x 84	6-8	1
42 x 96	6-8	1
42 x 108	6-8	1
42 x 120	8-10	1
48 x 72	4-6	1
48 x 84	6-8	1
48 x 96	6-8	1
48 x 108	8-10	1
48 x 120	8-10	1
48 x 144	10-12	2
54 x 120	8-10	3
54 x 144	10-12	3
60 x 120	8-10	3
60 x 144	10-12	3

BREADTH OF LINE



36

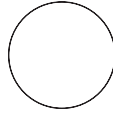

42

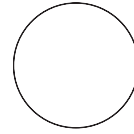

48

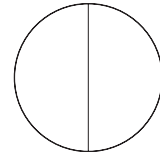

54

ROUND

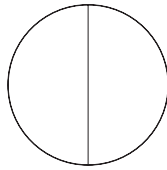

60

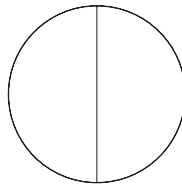

68

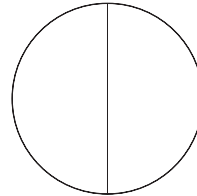

72

Note: Lines above represent number of sections per table top.

**Primary Use:**

Conference room table tops for video conference, meeting rooms, and small staff conference rooms.

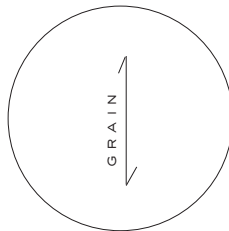

ROUND	diameter	seating capacity	# of top sections
	36	3-4	1
	42	3-5	1
	48	3-5	1
	54	5-6	2
	60	5-7	2
	66	5-7	2
	72	6-8	2

OPEN 6" RECTANGULAR BASE

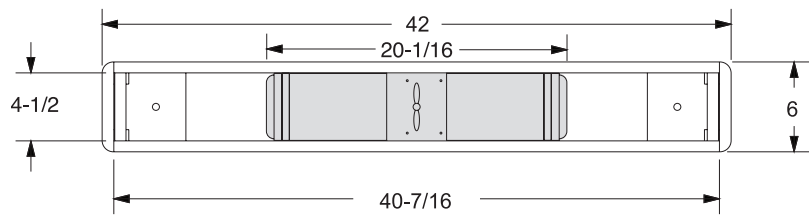
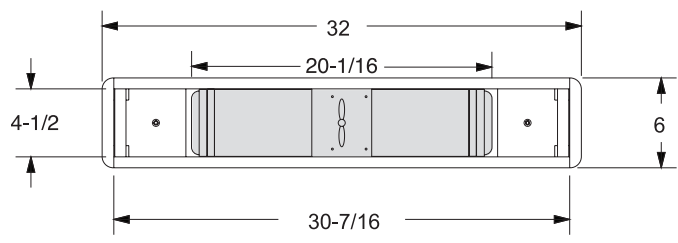
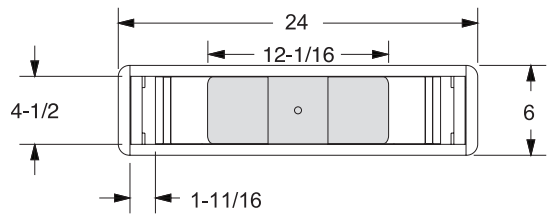
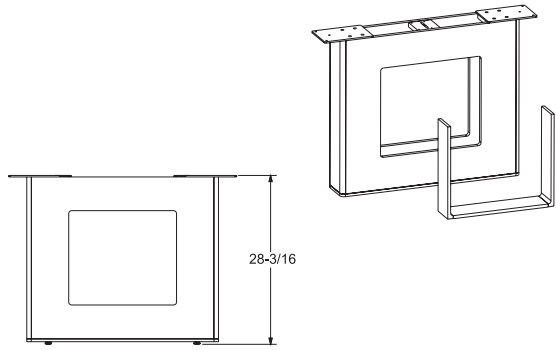
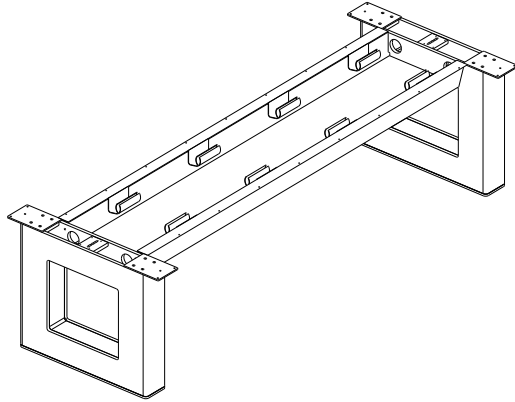

■ = Wire Management Opening

SOLID 6" RECTANGULAR BASE

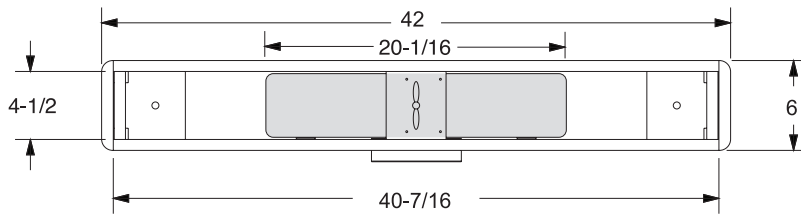
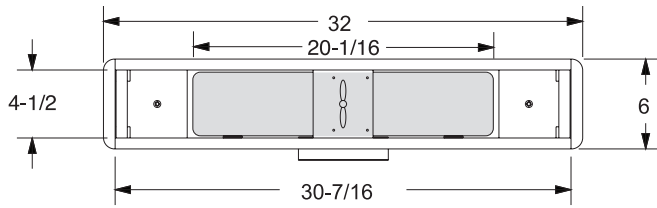
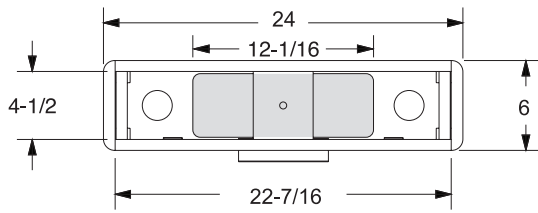
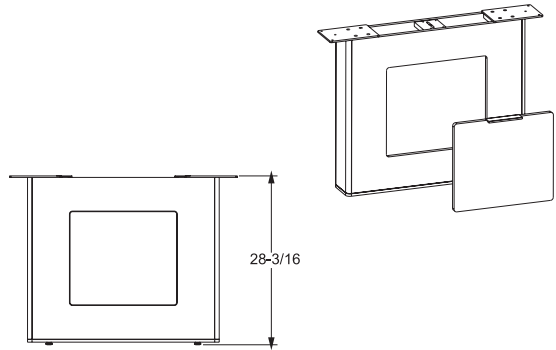
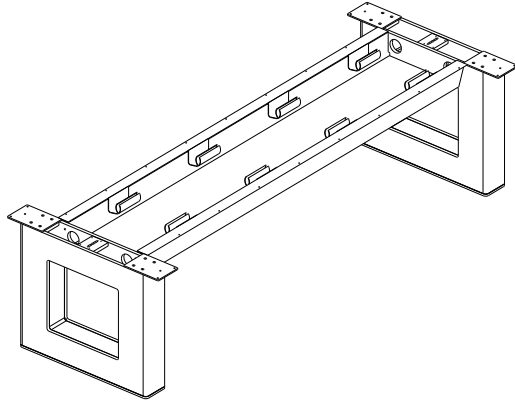

■ = Wire Management Opening

DRUM BASE DIMENSIONS FOR USE WITH ROUND TABLE TOPS

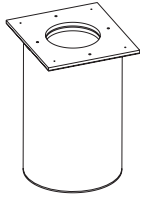

Standard

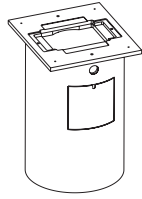

Wire Access Door

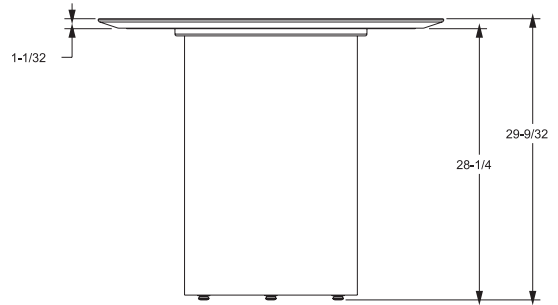

36/42/48" Base

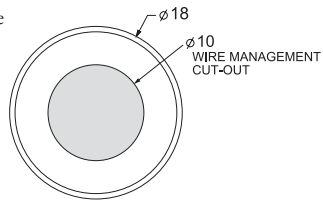

54/60" Base

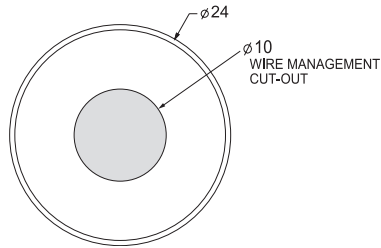

66/72" Base

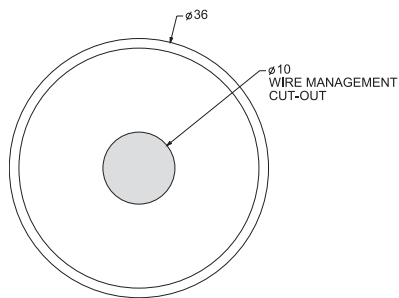

■ = Wire Management Opening

RECTANGULAR BASES

**Primary Use:**

Conference room table tops for video conference, meeting rooms, and small staff conference rooms.

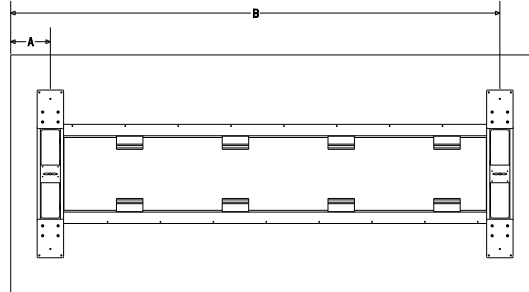

	d x w	center of base A	center of base B
RECTANGULAR TOPS	42 x 72	21	51
	42 x 84	21	63
	42 x 96	21	75
	42 x 108	21	87
	42 x 120	21	99
	48 x 72	21	51
	48 x 84	21	63
	48 x 96	21	75
	48 x 108	21	87
	48 x 120	21	99
48 x 144	21	123	
54 x 120	21	99	
54 x 144	21	123	
60 x 120	21	99	
60 x 144	21	123	

**Note:**

Base location dimensions for all special tables can be found on customer approval drawings. Please contact your Client Experience Representative for further information.



	<b>PAGE</b>
TABLE TOPS.....	24-28
Round.....	24
Rectangular.....	25





FLAT EDGE

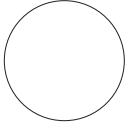

WOOD TOP

Model	Dimensions DIA	List Price Veneer 1	Veneer 2
HD1TRD36-FEW	36	2,170	2,335
HD1TRD42-FEW	42	2,400	2,580
HD1TRD48-FEW	48	2,985	3,210
HD1TRD54-FEW	54	3,490	3,750
HD1TRD60-FEW	60	4,000	4,300
HD1TRD66-FEW	66	5,075	5,455
HD1TRD72-FEW	72	6,575	7,070

ROUND TABLE TOPS

technology cut-out option	cut-out option code	description	36 DIAMETER	42 DIAMETER	48 DIAMETER	54 DIAMETER	60 DIAMETER	66 DIAMETER	72 DIAMETER	technology model # required	quantity
	GN	No Grommet	•	•	•	•	•	•	•	N/A	N/A
	GCR	Round Grommet	•	•	•	•	•	•	•	HK1PG-___	1
	1CM	1 Centered MediaConnect unit	•	•	•	•	•	•	•	HK1MC-___	1

NOTE: Above options are for cut-out only, technology ports ordered separately on pages 30-31.

PLEASE SPECIFY THE FOLLOWING TO ORDER: \_\_\_\_\_

MODEL NUMBER

WOOD FINISH

TECHNOLOGY CUTOUT

See page 5

(Insert option from shaded area on next page)



Example Order String: HD1TRD36-FEW.NC215.GN

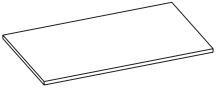

FLAT EDGE



WOOD TOP

Model	Dimensions		List Price	Veneer 1	Veneer 2
	OD	OW			
HD1TRT4272-FEW	42	72	3,740	4,020	
HD1TRT4284-FEW	42	84	4,185	4,500	
HD1TRT4296-FEW	42	96	4,690	5,040	
HD1TRT42108-FEW	42	108	5,080	5,460	
HD1TRT42120-FEW	42	120	5,625	6,045	

42" DEPTH TOPS

technology cut-out option	cut-out option code	description	42" DEPTH TOPS					technology model # required	quantity
			42 x 72	42 x 84	42 x 96	42 x 108	42 x 120		
	GN	No Grommet	•	•	•	•	•	N/A	N/A
	1CM	1 Centered MediaConnect Unit	•	•	•	•	•	HK1MC-___	1
	2EM	2 Equally Spaced MediaConnect Units			•	•	•	HK1MC-___	2
	3EM	3 Equally Spaced MediaConnect Units					•	HK1MC-___	3
	DP*	1 Centered 60" DataPath Unit*					•	HD1DP60-___	1

NOTE: Above options are for cut-out only, technology ports ordered separately on pages 31-35.

PLEASE SPECIFY THE FOLLOWING TO ORDER: \_\_\_\_\_

MODEL NUMBER

WOOD FINISH

TECHNOLOGY CUTOUT

See page 5

(Insert option from shaded area on next page)



Example Order String: HD1TRT4272-FEW.NC215.GN

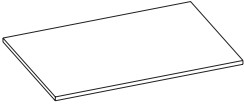

FLAT EDGE



WOOD TOP

Model	Dimensions		List Price	Veneer 1	Veneer 2
	OD	OW			
HD1TRT4872-FEW	48	72	4,405	4,735	
HD1TRT4884-FEW	48	84	4,925	5,295	
HD1TRT4896-FEW	48	96	5,515	5,930	
HD1TRT48108-FEW	48	108	6,175	6,640	
HD1TRT48120-FEW	48	120	6,590	7,085	
HD1TRT48144-FEW	48	144	8,490	9,125	

48" DEPTH TOPS

technology cut-out option	cut-out option code	description	48" DEPTH TOPS						technology model # required	quantity
			48 x 72	48 x 84	48 x 96	48 x 108	48 x 120	48 x 144		
	GN	No Grommet	•	•	•	•	•	•	N/A	N/A
	1CM	1 Centered MediaConnect Unit	•	•	•	•	•	•	HK1MC-___	1
	2EM	2 Equally Spaced MediaConnect Units			•	•	•	•	HK1MC-___	2
	3EM	3 Equally Spaced MediaConnect Units					•	•	HK1MC-___	3
	DP*	1 Centered 60" DataPath Unit*					•	•	HK1DP60-___	1

NOTE: Above options are for cut-out only, technology ports ordered separately on pages 31-35.

PLEASE SPECIFY THE FOLLOWING TO ORDER: \_\_\_\_\_

MODEL NUMBER

WOOD FINISH

TECHNOLOGY CUTOOUT

See page 5

(Insert option from shaded area on next page)



Example Order String: HD1TRT4872-FEW.NC215.GN

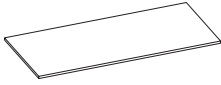

FLAT EDGE

Model	Dimensions		List Price	Veneer 1	Veneer 2
	OD	OW			
HD1TRT54120-FEW	54	120	<b>6,630</b>	<b>7,125</b>	
HD1TRT54144-FEW	54	144	<b>8,770</b>	<b>9,430</b>	



WOOD TOP

54" DEPTH TOPS

technology cut-out option	cut-out option code	description	Dimensions		technology model # required	quantity
			54 x 120	54 x 144		
	GN	No Grommet	•	•	N/A	N/A
	1CM	1 Centered MediaConnect Unit	•	•	HK1MC-___	1
	2EM	2 Equally Spaced MediaConnect Units	•	•	HK1MC-___	2
	3EM	3 Equally Spaced MediaConnect Units	•	•	HK1MC-___	3
	DP*	1 Centered 60" DataPath Unit*	•	•	HK1DP60-___	1

**NOTE:** Above options are for cut-out only, technology ports ordered separately on pages 31-35.

PLEASE SPECIFY THE FOLLOWING TO ORDER: \_\_\_\_\_

MODEL NUMBER

WOOD FINISH

TECHNOLOGY CUTOUT

See page 5

(Insert option from shaded area on next page)

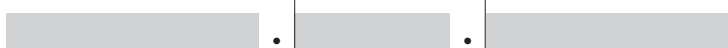

Example Order String: HD1TRT54120-FEW.NC215.GN

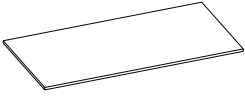

FLAT EDGE

Model	Dimensions		List Price	Veneer 1	Veneer 2
	OD	OW			
HD1TRT60120-FEW	60	120	8,375		9,005
HD1TRT60144-FEW	60	144	9,975		10,725



WOOD TOP

60" DEPTH TOPS

technology cut-out option	cut-out option code	description	Dimensions		technology model # required	quantity
			60 x 120	60 x 144		
	GN	No Grommet	•	•	N/A	N/A
	1CM	1 Centered MediaConnect Unit	•	•	HK1MC-___	1
	2EM	2 Equally Spaced MediaConnect Units	•	•	HK1MC-___	2
	3EM	3 Equally Spaced MediaConnect Units	•	•	HK1MC-___	3
	DP*	1 Centered 60" DataPath Unit*	•	•	HK1DP60-___	1
	DP*	2 Equally Spaced 60" DataPath Units*			HK1DP60-___	2

NOTE: Above options are for cut-out only, technology ports ordered separately on pages 31-35.

PLEASE SPECIFY THE FOLLOWING TO ORDER: \_\_\_\_\_

MODEL NUMBER

WOOD FINISH

TECHNOLOGY CUTOUT

See page 5

(Insert option from shaded area on next page)



Example Order String: HD1TRT60120-FEW.NC215.GN



	<b>PAGE</b>
TECHNOLOGY_____	29-40
Powered Grommets & MediaConnect Tech Unit_____	30-31
MediaConnect Wiring Schematics_____	32-33
Data Path Tech Wiring Schematics_____	34
Data Path Unit_____	35
Single Space AAP_____	36-38
Double Space AAP_____	39
Miscellaneous Accessories_____	40



	Model	Description	Dimensions		List Price
			OD	OW	
SOFTWARE	HK1PG-SP	Brushed Aluminum	4 1/4	6 1/4	<b>1,745</b>

- For use on wood, round tops

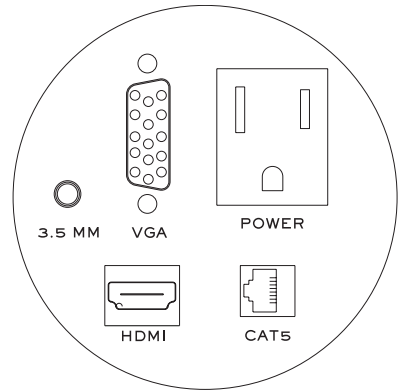
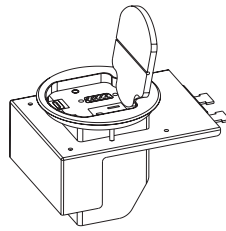
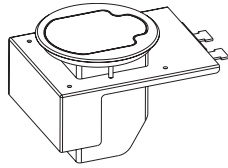

PLEASE SPECIFY THE FOLLOWING TO ORDER: \_\_\_\_\_

MODEL NUMBER



Example Order String: HK1PG-SP



	Model	Description	Dimensions OD	OW	List Price Metal
HARDWIRE	HK1MC-GHW	Satin Pewter Powder Coat Door	11 1/4	10 1/4	<b>1,665</b>
SOFTWARE	HK1MC-GSP	Satin Pewter Powder Coat Door	11 1/4	10 1/4	<b>1,665</b>

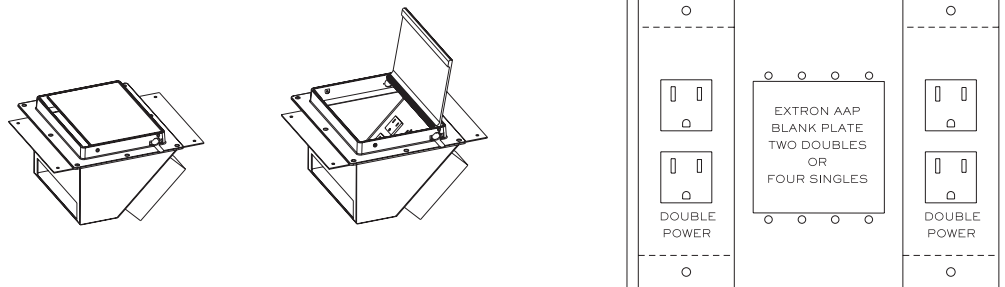

PLEASE SPECIFY THE FOLLOWING TO ORDER: \_\_\_\_\_

MODEL NUMBER



Example Order String: HK1MC-GHW



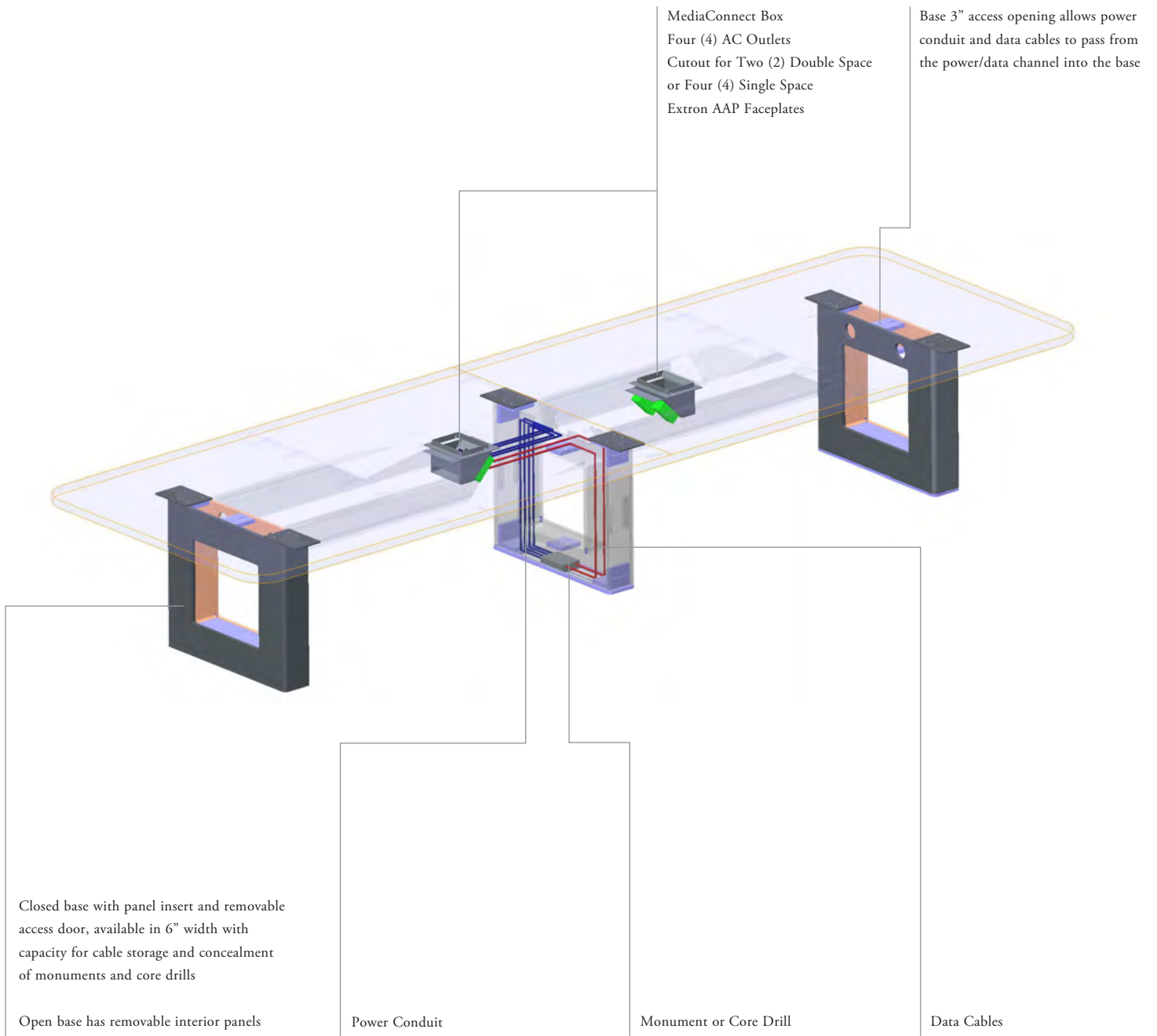

**Note:**

Image above for reference only, showing one possible wire routing application. It is recommended to coordinate & route the wiring based on the customers' electrical needs.

Cutouts for Two (2) Double Space  
or Four (4) Single Space Extron  
AAP Faceplates

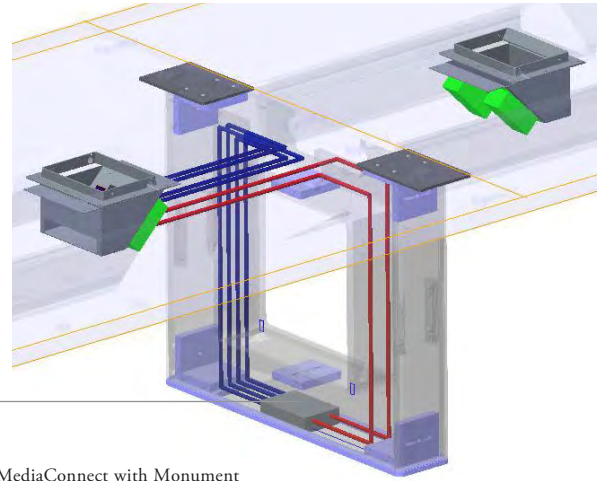

MediaConnect Box  
Four (4) 110 Volt Power Outlets  
Cutouts for Two (2) Double Space  
or Four (4) Single Space  
Extron AAP Faceplates

MediaConnect with Monument  
Located Outside the Base

Media Connect Box

Wire Management Clip

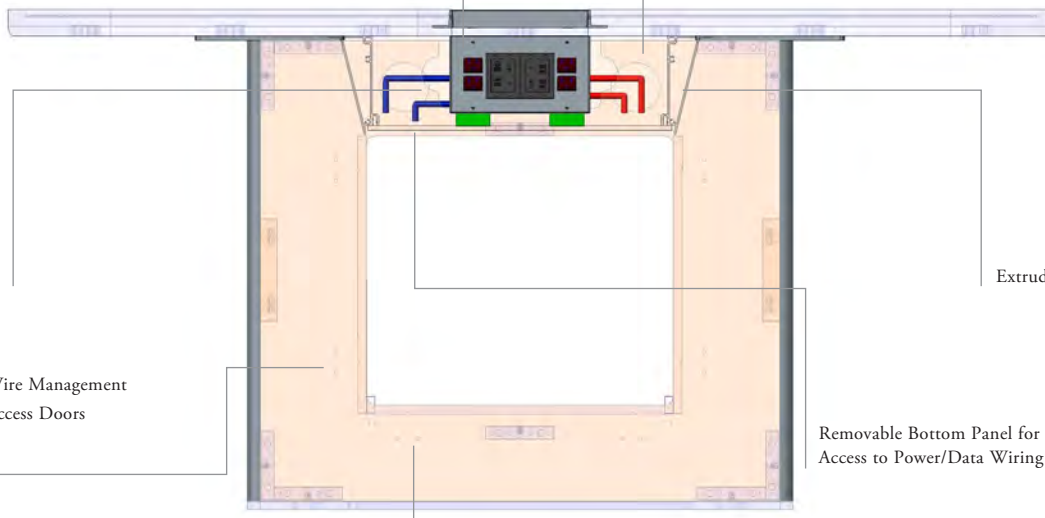

Flexible Conduit  
and Data Cables

Extruded Aluminum Support

Wire Management  
Access Doors

Removable Bottom Panel for  
Access to Power/Data Wiring

Shown with 36" 3-Door Data Path  
(Power-Storage-Power)  
Eight (8) AC Outlets  
Cutouts for Four (4) Double Space or  
Eight (8) Single Space Extron AAP Faceplates

Option for 60" 5-Door DataPath  
(Power-Storage-Power-Storage-Power)  
Twelve (12) AC Outlets  
Cutouts for Six (6) Double Space or  
Twelve (12) Single Space Extron AAP Faceplates

Base 3" access opening allows power conduit and data cables to pass from the power/data channel into the base

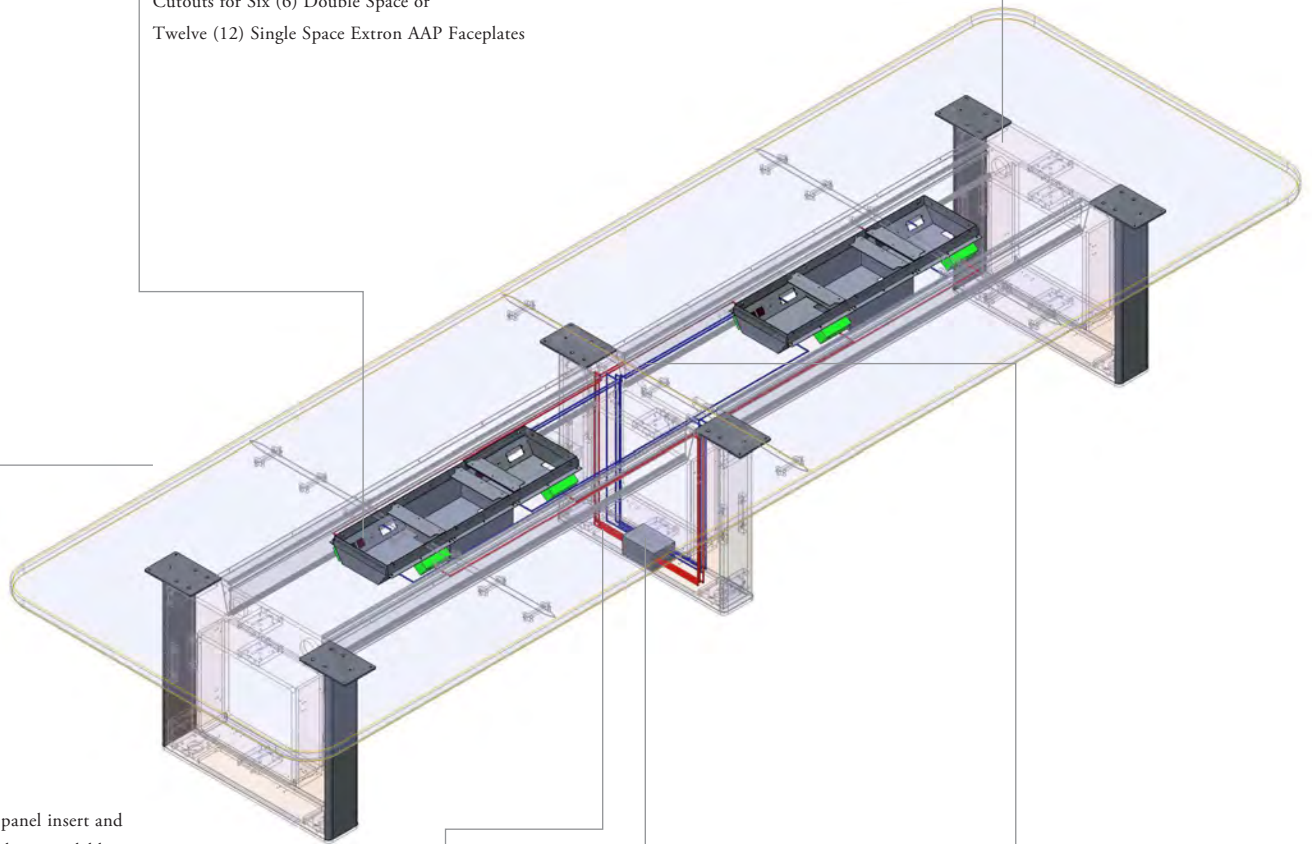

Closed base with panel insert and removable access door, available in 6" width with capacity for cable storage and concealment of monuments and core drills

Open base has removable interior panels

Power Conduit

Monument or Core Drill

Data Cables

**Note:**

Image above for reference only, showing one possible wire routing application. It is recommended to coordinate & route the wiring based on the customers' electrical needs.



	Model	Description	Dimensions		List Price
			OD	OW	Metal
HARDWARE	HK1DP60-AHW	60" - 5 Aluminum Doors	15 2/5	63 3/8	<b>6,020</b>
SOFTWARE	HK1DP60-ASP	60" - 5 Aluminum Doors	15 2/5	63 3/8	<b>6,020</b>

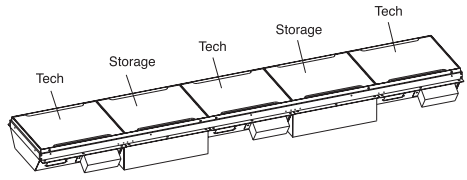

60" DataPath – 5 Doors

NOTE:

- Interior dimensions of storage area: 11 29/32" D x 9 3/4" W x 3 31/32" H
- Storage areas fit (2) single space AAPs or (1) Double Space AAP
- See page 4 for DataPath layouts and page 12 for technical specifications



PLEASE SPECIFY THE FOLLOWING TO ORDER: \_\_\_\_\_

MODEL NUMBER	FINISH
	See page 5

NOTES:  
Finish option only required when choosing wood door models.

Example Order String: HK1DP60-AHW



	Model	List Price
	HK17009011	55
<ul style="list-style-type: none"> <li>• Blank</li> <li>• Extron Part Number: 70-090-11</li> </ul>		
	HK17010173	235
<ul style="list-style-type: none"> <li>• Labeled (1) Audio</li> <li>• (1) VGA F-F</li> <li>• Extron Part Number: 70-101-73</li> </ul>		
	HK17041111	130
<ul style="list-style-type: none"> <li>• (1) RJ11 Phone F-F</li> <li>• Extron Part Number: 70-411-11</li> </ul>		



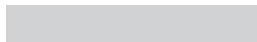

PLEASE SPECIFY THE FOLLOWING TO ORDER: \_\_\_\_\_

MODEL NUMBER



Example Order String: HK17009011



	Model	List Price
	HK17049111	<b>200</b>
<ul style="list-style-type: none"> <li>• (2) RJ45 Data F-F</li> <li>• Extron Part Number: 70-491-11</li> </ul>		HK17049112
<ul style="list-style-type: none"> <li>• (2) RJ45 Data F-Punchdown for CAT6 AMP</li> <li>• Extron Part Number: 70-491-12</li> </ul>	<b>270</b>	
	HK17049114	<b>270</b>
<ul style="list-style-type: none"> <li>• (2) RJ45 Data F-Punchdown for CAT6 Otronics</li> <li>• Extron Part Number: 70-491-14</li> </ul>		HK17049115
<ul style="list-style-type: none"> <li>• (2) RJ45 Data F-Punchdown for CAT6 Leviton</li> <li>• Extron Part Number: 70-491-15</li> </ul>	<b>270</b>	



PLEASE SPECIFY THE FOLLOWING TO ORDER: \_\_\_\_\_

MODEL NUMBER



Example Order String: HK17049111



	Model	List Price
	HK17049116	270
	HK17061602	205
	HK17045412	205

- (2) RJ45 Data F-Punchdown for CAT6 Panduit
- Extron Part Number: 70-491-16

- HDMI Plate F/F
- Extron Part Number: 70-616-02

- Two USB A Female to Two USB A Female on 10' Pigtails
- Extron Part Number: 70-454-12





PLEASE SPECIFY THE FOLLOWING TO ORDER: \_\_\_\_\_

MODEL NUMBER



Example Order String: HK17049116

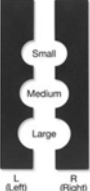

	Model	List Price
	<p>HK170107602</p> <ul style="list-style-type: none"> <li>• (1) HDMI, (1) VGA, (1) Audio, (1) USB</li> <li>• Female to Female on 10" Pigtails</li> <li>• Extron Part Number: 70-1076-02</li> </ul>	<p>525</p>
	<p>HK17009012</p> <ul style="list-style-type: none"> <li>• Blank</li> <li>• Extron Part Number: 70-090-12</li> </ul>	<p>75</p>
	<p>HK17010011</p> <ul style="list-style-type: none"> <li>• (2) RJ45 Data F-F</li> <li>• Extron Part Number: 70-100-11</li> </ul>	<p>180</p>
	<p>HK17014712</p> <ul style="list-style-type: none"> <li>• Extender AAP (1) Audio</li> <li>• (1) VGA</li> <li>• Extron Part Number: 70-147-12</li> </ul>	<p>1,405</p>
	<p>HK17026701</p> <ul style="list-style-type: none"> <li>• Cable Pass Through Set</li> <li>• This is a set of Extron Part Numbers: Left Black: 70-270-01 Right Black: 70-267-01</li> </ul>	<p>325</p>

PLEASE SPECIFY THE FOLLOWING TO ORDER: \_\_\_\_\_

MODEL NUMBER

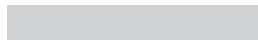

Example Order String: HK17017602





	Model	Dimensions		List Price
		OD	OW	
POWER CABLE KIT	HK1PWRKT12		244	975



- Power Cable Kit with 12 outlets

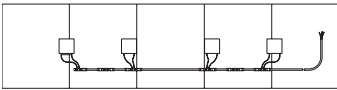

TRASH CAN	HK1TRASH	8 1/2	11 1/2	200
-----------	----------	-------	--------	-----



- Credenza Trash Can Accessory

PLEASE SPECIFY THE FOLLOWING TO ORDER: \_\_\_\_\_

MODEL NUMBER



Example Order String: HK1PWRKT12



	<b>PAGE</b>
TABLE BASES _____	42-44
Drum Base _____	42
Open 6" Rectangular Base _____	43
Solid 6" Rectangular Base _____	44



	Model	For use w/ top size	Dimensions OD	OW	List Price Veneer 1	Veneer 2
STANDARD	HK1BSD18-W	36, 42, 48	18	20	<b>1,855</b>	<b>1,995</b>
	HK1BSD24-W	54, 60	24	26	<b>2,455</b>	<b>2,640</b>
	HK1BSD36-W	66, 72	36	38	<b>3,195</b>	<b>3,435</b>

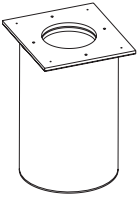

WIRE ACCESS DOOR	HK1BSDA18-W	36, 42, 48	18	20	<b>3,275</b>	<b>3,520</b>
	HK1BSDA24-W	54, 60	24	28	<b>4,015</b>	<b>4,315</b>
	HK1BSDA36-W	66, 72	36	38	<b>4,755</b>	<b>5,110</b>

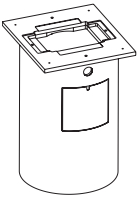

PLEASE SPECIFY THE FOLLOWING TO ORDER: \_\_\_\_\_

MODEL NUMBER

WOOD FINISH

See page 5



Example Order String: HK1BSD18-W.NC215

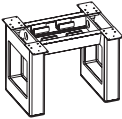

	Model	For use w/ top size	Dimensions		List Price	Veneer 1	Veneer 2
			OD	OW			
<p>FOR 42" AND 48" TOPS</p> 	HD1BSRA2472-XW	42/48 X 72	30 1/16	36	<b>3,010</b>	<b>3,235</b>	
	HD1BSRA2484-XW	42/48 X 84	30 1/16	48	<b>3,385</b>	<b>3,640</b>	
	HD1BSRA2496-XW	42/48 X 96	30 1/16	60	<b>3,785</b>	<b>4,070</b>	
	HD1BSRA24108-XW	42/48 X 108	30 1/16	72	<b>4,245</b>	<b>4,565</b>	
	HD1BSRA24120-XW	42/48 X 120	30 1/16	84	<b>4,515</b>	<b>4,855</b>	
	HD1BSRA24144-XW	42/48 X 144	30 1/16	108	<b>5,825</b>	<b>6,260</b>	

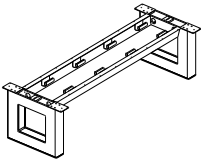
<p>FOR 54" AND 60" TOPS</p> 	HD1BSRA32120-XW	54/60 X 120	38 1/16	84	<b>5,740</b>	<b>6,170</b>
	HD1BSRA32144-XW	54/60 X 144	38 1/16	108	<b>6,845</b>	<b>7,360</b>

PLEASE SPECIFY THE FOLLOWING TO ORDER: \_\_\_\_\_

MODEL NUMBER

WOOD FINISH

See page 5

Example Order String: HD1BSRA2472-XW.NC215

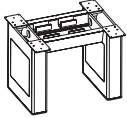

	Model	For use w/ top size	Dimensions		List Price	Veneer 1	Veneer 2
			OD	OW			
<p>FOR 42" AND 48" TOPS</p> 	HD1BSRA2472-SW	42/48 X 72	30 1/16	36	<b>2,865</b>	<b>3,080</b>	
	HD1BSRA2484-SW	42/48 X 84	30 1/16	48	<b>3,205</b>	<b>3,445</b>	
	HD1BSRA2496-SW	42/48 X 96	30 1/16	60	<b>3,585</b>	<b>3,855</b>	
	HD1BSRA24108-SW	42/48 X 108	30 1/16	72	<b>4,015</b>	<b>4,315</b>	
	HD1BSRA24120-SW	42/48 X 120	30 1/16	84	<b>4,280</b>	<b>4,600</b>	
	HD1BSRA24144-SW	42/48 X 144	30 1/16	108	<b>5,510</b>	<b>5,925</b>	

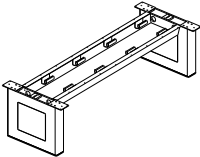
<p>FOR 54" AND 60" TOPS</p> 	HD1BSRA32120-SW	54/60 X 120	38 1/16	84	<b>5,450</b>	<b>5,860</b>
	HD1BSRA32144-SW	54/60 X 144	38 1/16	108	<b>6,470</b>	<b>6,955</b>

PLEASE SPECIFY THE FOLLOWING TO ORDER: \_\_\_\_\_

MODEL NUMBER

WOOD FINISH

See page 5



Example Order String: HD1BSRA2472-SW.NC215



	<b>PAGE</b>
CREDENZAS AND ANCILLARY _____	
Conference Cabinets _____	47-50
Projection Cabinet _____	51
TV Lift Cabinet _____	51
Carts _____	52
Lectern _____	55



---

CREDENZAS	Linea credenzas are available in multiple sizes and pedestal configurations by using the HBF “build a credenza” specifications. Credenzas are based on 24” modules and the available pedestals and components may be placed in multiple configurations in order to maximize the functionality of each conference area. Credenza heights include the standard 29” height and a buffet height of 35”. HBF’s standard five-year warranty applies only to the credenza components that we manufacture.
-----------	--

---

STORAGE PEDESTAL	Linea storage pedestals are available in two options: as a shelf only unit with one adjustable shelf (option SP1) or as a storage pedestal with 4 drawers (option SP4). Any of the drawers may be supplemented with a natural finished beech cutlery tray. Both storage pedestals are available in 29” and 35” high credenzas and must be specified as left or right hinge.
------------------	---

---

TRASH RECEPTACLE PEDESTAL	The trash receptacle pedestal (option TRS) includes a standard black Rubbermaid® 13 quart trash receptacle mounted on the inside of the door. The pedestal contains an adjustable shelf that is notched to accommodate the trash receptacle when the door is closed.
---------------------------	--

---

RECYCLING CENTER PEDESTAL	The recycling center pedestal (option RCY) includes a pull out unit containing four removable receptacles enabling the user to presort disposables to containers for paper, plastic, glass, and aluminum.
---------------------------	---

---

REFRIGERATION PEDESTAL	The refrigeration pedestal (option RFG) <b>does not include a refrigerator</b> . The RFG image shows what it will look like with a refrigerator inside of the vented back pedestal. The interior dimensions for the pedestal are: 23 5/8”D x 22 1/2”W x 23 1/4”H. A recommended refrigerator is the Danby Energy Star compliant compact refrigerator with automatic defrost system and mechanical thermostat. Interior of the refrigeration unit contains wire shelves, tall bottle storage, and the Danby second-generation Canstor® beverage dispenser for maximum storage versatility. The Danby DAR195BL provides 1.8 cu. ft. of refrigeration.
------------------------	---

---

AV PEDESTAL	The A/V pedestal (option AVR) includes a Middle Atlantic Products EIA compliant SRSR Series Rotating Sliding Rail System. The ball-bearing slides allow the unit to be pulled out and rotated 90° in either direction for easy access to wiring and components. A front mounted tab will rotate the rack and locks in place at 0°, 60°, and 90° positions. A front mounted lever locks the rack in the extended position. The black, brushed and anodized finished rack includes an integral cable management system.
-------------	---

---



	Model	Dimensions			List Price	Veneer 1	Veneer 2
		OD	OW	OH			
STANDARD 29" HEIGHT	HD1CCS2648-WFW	26	48	29	5,025	5,400	

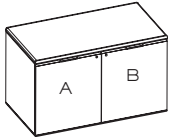

BUFFET 35" HEIGHT	HD1CCB2648-WFW	26	48	35	5,775	6,210
-------------------	----------------	----	----	----	-------	-------

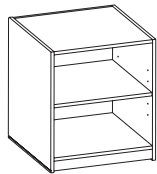
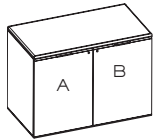

**SP1**  
Storage Pedestal -  
1 Adjustable Shelf  
(no upcharge)  
Shown without door



**SP4**  
Storage Pedestal -  
4 Drawers  
(\$500 upcharge)  
Shown without door

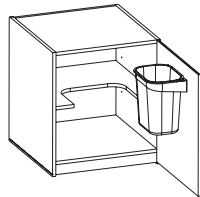

**TRS**  
Trash Receptacle  
with Shelf  
(\$185 upcharge)

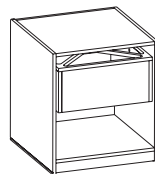

**RCY**  
Recycling with  
4 Receptacles  
(\$370 upcharge)  
Shown without door

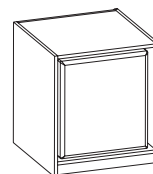

**RFG**  
Refrigeration Pedestal  
with Vented Back  
(no upcharge)  
**Refrigerator not  
included;** shown  
without door

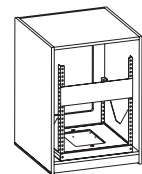

**AVR**  
AV Rack -  
Swivel & Pull Out  
(\$745 upcharge)  
Shown without door

PLEASE SPECIFY THE FOLLOWING TO ORDER: \_\_\_\_\_

MODEL NUMBER

PEDESTAL  
LOCATION A

PEDESTAL  
LOCATION B

VENEER &  
FINISH

LOCKS

KEYING

See page 5

See page 7

See page 11

Example Order String: HD1CCS2648-WFW.SP1.SP4.NC215.LY.RMS





	Model	Dimensions			List Price	
		OD	OW	OH	Veneer 1	Veneer 2
STANDARD 29" HEIGHT	HD1CCS2672-WFW	26	72	29	7,625	8,195

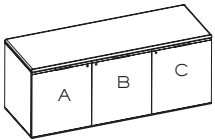

BUFFET 35" HEIGHT	HD1CCB2672-WFW	26	72	35	8,765	9,420
-------------------	----------------	----	----	----	-------	-------

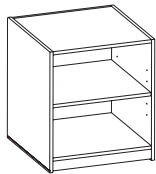
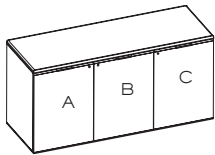

**SP1**  
Storage Pedestal -  
1 Adjustable Shelf  
(no upcharge)  
Shown without door

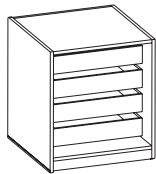

**SP4**  
Storage Pedestal -  
4 Drawers  
(\$500 upcharge)  
Shown without door

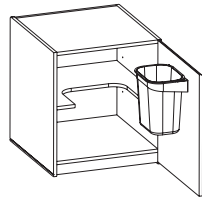

**TRS**  
Trash Receptacle  
with Shelf  
(\$185 upcharge)

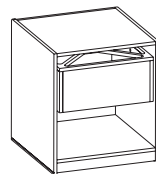

**RCY**  
Recycling with  
4 Receptacles  
(\$370 upcharge)  
Shown without door

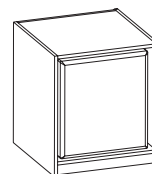

**RFG**  
Refrigeration Pedestal  
with Vented Back  
(no upcharge)  
**Refrigerator not  
included;** shown  
without door

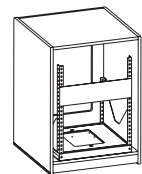

**AVR**  
AV Rack -  
Swivel & Pull Out  
(\$745 upcharge)  
Shown without door

PLEASE SPECIFY THE FOLLOWING TO ORDER: \_\_\_\_\_

MODEL NUMBER	PEDESTAL LOCATION A	PEDESTAL LOCATION B	PEDESTAL LOCATION C	VENEER & FINISH See page 5	LOCKS See page 7	KEYING See page 11

Example Order String: HD1CCS2672-WFW.SP1.SP4.TRS.NC215.LY.RMS



	Model	Dimensions			List Price	Veneer 1	Veneer 2
		OD	OW	OH			
STANDARD 29" HEIGHT	HD1CCS2696-WFW	26	96	29	<b>9,780</b>	<b>10,515</b>	

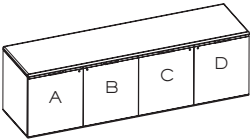

BUFFET 35" HEIGHT	HD1CCB2696-WFW	26	96	35	<b>11,230</b>	<b>12,070</b>
-------------------	----------------	----	----	----	---------------	---------------

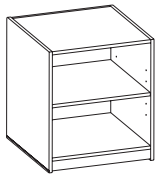
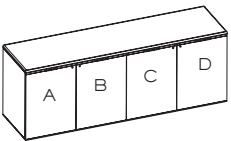

**SP1**  
Storage Pedestal -  
1 Adjustable Shelf  
**(no upcharge)**  
Shown without door



**SP4**  
Storage Pedestal -  
4 Drawers  
**(\$500 upcharge)**  
Shown without door

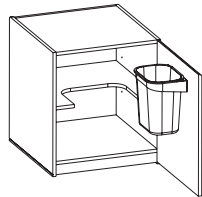

**TRS**  
Trash Receptacle  
with Shelf  
**(\$185 upcharge)**

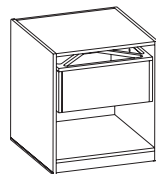

**RCY**  
Recycling with  
4 Receptacles  
**(\$370 upcharge)**  
Shown without door

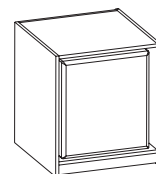

**RFG**  
Refrigeration Pedestal  
with Vented Back  
**(no upcharge)**  
**Refrigerator not included;** shown  
without door

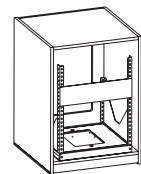

**AVR**  
AV Rack -  
Swivel & Pull Out  
**(\$745 upcharge)**  
Shown without door

PLEASE SPECIFY THE FOLLOWING TO ORDER:

MODEL NUMBER	PEDESTAL LOCATION A	PEDESTAL LOCATION B	PEDESTAL LOCATION C	PEDESTAL LOCATION D	VENEER & FINISH	LOCKS	KEYING
					See page 5	See page 7	See page 11

Example Order String: HD1CCS2696-WFW.SP1.SP4.TRS.RCY.NC215.LY.RMS



	Model	Dimensions			List Price	Veneer 1	Veneer 2
		OD	OW	OH			
STANDARD 29" HEIGHT	HD1CCS26120-WFW	26	120	29	11,250	12,095	

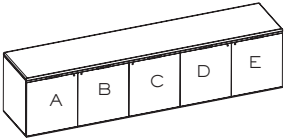

BUFFET 35" HEIGHT	HD1CCB26120-WFW	26	120	35	12,935	13,905
-------------------	-----------------	----	-----	----	--------	--------

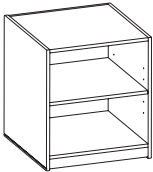
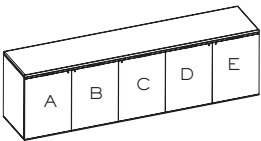

**SP1**  
Storage Pedestal -  
1 Adjustable Shelf  
**(no upcharge)**  
Shown without door



**SP4**  
Storage Pedestal -  
4 Drawers  
**(\$500 upcharge)**  
Shown without door

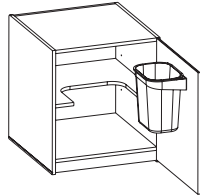

**TRS**  
Trash Receptacle  
with Shelf  
**(\$185 upcharge)**

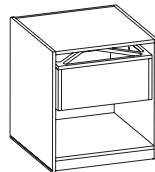

**RCY**  
Recycling with  
4 Receptacles  
**(\$370 upcharge)**  
Shown without door

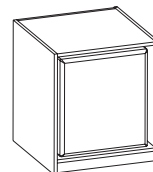

**RFG**  
Refrigeration Pedestal  
with Vented Back  
**(no upcharge)**  
**Refrigerator not**  
**included;** shown  
without door

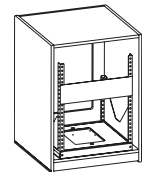

**AVR**  
AV Rack -  
Swivel & Pull Out  
**(\$745 upcharge)**  
Shown without door

PLEASE SPECIFY THE FOLLOWING TO ORDER:

MODEL NUMBER	PEDESTAL LOCATION A	PEDESTAL LOCATION B	PEDESTAL LOCATION C	PEDESTAL LOCATION D	PEDESTAL LOCATION E	VENEER & FINISH	LOCKS	KEYING
						See page 5	See page 7	See page 11

Example Order String: HD1CCS26120-WFW.SP1.SP4.TRS.RCY.RFG.NC215.LY.RMS



	Model	Dimensions			List Price	Veneer 1	Veneer 2
		OD	OW	OH			
PROJECTION CABINET	HD1CCBP2696-WFW	26	96	35	<b>12,810</b>		<b>13,770</b>

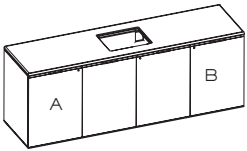

- Buffet Height 35"
- Waterfall Edges
- When specifying pedestals in order string, pedestal location A is the far left pedestal and pedestal location B is the far right pedestal.
- The inner 2 pedestals are used for the placement of the projector.
- **Projector NOT included with Projection Cabinet.**
- Interior Dimensions for projector are: 23 5/8" D x 46 9/16" W x 8 3/4" H

TV LIFT CABINET	HD1CCBV2696-WFW	26	96	35	<b>19,725</b>		<b>21,205</b>
-----------------	-----------------	----	----	----	---------------	--	---------------

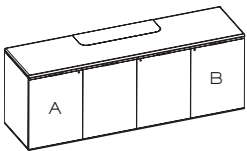

- Buffet Height 35"
- Waterfall Edges
- When specifying pedestals in order string, pedestal location A is the far left pedestal and pedestal location B is the far right pedestal.
- The inner 2 pedestals are used for the placement of the TV lift.
- **TV NOT included with TV Lift Cabinet**
- Interior Dimensions for TV are: 9" D x 46 9/16" W x 19 1/4" H



**SP1**  
Storage Pedestal -  
1 Adjustable Shelf  
**(no upcharge)**  
Shown without door



**SP4**  
Storage Pedestal -  
4 Drawers  
**(\$500 upcharge)**  
Shown without door

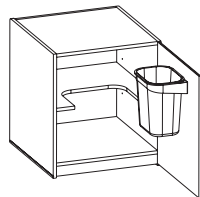

**TRS**  
Trash Receptacle  
with Shelf  
**(\$185 upcharge)**

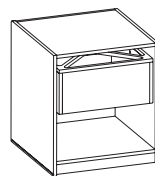

**RCY**  
Recycling with  
4 Receptacles  
**(\$370 upcharge)**  
Shown without door

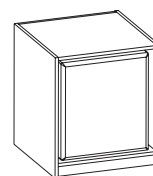

**RFG**  
Refrigeration Pedestal  
with Vented Back  
**(no upcharge)**  
**Refrigerator not included;** shown  
without door

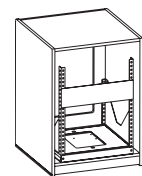

**AVR**  
AV Rack -  
Swivel & Pull Out  
**(\$745 upcharge)**  
Shown without door

PLEASE SPECIFY THE FOLLOWING TO ORDER:

MODEL NUMBER	PEDESTAL LOCATION A	PEDESTAL LOCATION B	veneer & FINISH	LOCKS	KEYING
			See page 5	See page 7	See page 11

Example Order String: HD1CCBP2696-WFW.SP1.SP4.NC215.LY.RMS



	Model	Dimensions OD	OW	OH	List Price Veneer 1	Veneer 2
WOOD TOP	HD1CMB-WFW	21	23	35 1/4	<b>4,140</b>	<b>4,450</b>



- Waterfall Edges

PLEASE SPECIFY THE FOLLOWING TO ORDER: \_\_\_\_\_

MODEL NUMBER

WOOD FINISH

AV RACK

See page 5

AVY AV Rack Yes  
 (+\$255)  
 AVN AV Rack No



Example Order String: HD1CMB-WFW.NC215



	Model	Dimensions OD	OW	OH	List Price Veneer 1	Veneer 2
WOOD TOP	HD1CMCD-WFW	21	23	35 1/4	<b>5,005</b>	<b>5,380</b>

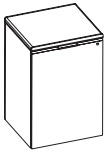

- Waterfall Edges

PLEASE SPECIFY THE FOLLOWING TO ORDER:

MODEL NUMBER	FINISH	LOCKS	KEYING	AV RACK
	See page 5	See page 7	See page 11	AVY AV Rack Yes (+\$255) AVN AV Rack No
_____	_____	_____	_____	_____

Example Order String: HD1CMCD-WFW.NC215.LY.RMS.AVY



	Model	Dimensions OD	OW	OH	List Price	Veneer 1	Veneer 2
WOOD TOP	HD1CBC-WFW	21	30	34 5/6	<b>5,505</b>		<b>5,920</b>

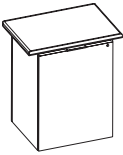

- Waterfall Edges

PLEASE SPECIFY THE FOLLOWING TO ORDER:

MODEL NUMBER

FINISH

LOCKS

KEYING

See page 5

See page 7

See page 11



Example Order String: HD1CBC-WFW.NC215.LY.RMS



	Model	Dimensions OD	OW	OH	List Price	Veneer 1	Veneer 2
WOOD TOP	HD1LCT-WFW	21	23	35 1/4	<b>6,550</b>		<b>7,040</b>

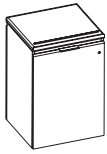

- Waterfall Edges

PLEASE SPECIFY THE FOLLOWING TO ORDER:

MODEL NUMBER	FINISH	LOCKS	KEYING	AV RACK	TECHNOLOGY OPTION
	See page 5	See page 7	See page 11	AVY AV Rack Yes (+\$255) AVN AV Rack No	LTY Technology Yes – Microphone, Gooseneck Light, Power/Data Unit (+\$1,655) LTN Technology No
_____	• _____	• _____	• _____	• _____	• _____

Example Order String: HD1LCT-WFW.NC215.LY.RMS.AVY.LTY





	Model	Dimensions			List Price
		OD	OW	OH	
CUTLERY TRAY	HDITRAY	14 1/2	19 11/32	3 1/4	<b>230</b>

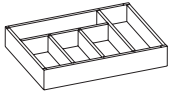

- No options required when ordering cutlery tray
- Cutlery tray can be used in conjunction with Storage Pedestal – 1 adjustable shelf (SP1) and Storage Pedestal – 4 drawers (SP4)

PLEASE SPECIFY THE FOLLOWING TO ORDER: \_\_\_\_\_

MODEL NUMBER



Example Order String: HDITRAY



MODEL NUMBER	WEIGHT	CUBES	PAGE
HD1BSRA24108-SW	131 LBS.	13.7	44
HD1BSRA24108-XW	112 LBS.	13.7	43
HD1BSRA24120-SW	136 LBS.	14.4	44
HD1BSRA24120-XW	118 LBS.	14.4	43
HD1BSRA24144-SW	147 LBS.	15.8	44
HD1BSRA24144-XW	128 LBS.	15.8	43
HD1BSRA2472-SW	114 LBS.	11.6	44
HD1BSRA2472-XW	95 LBS.	11.6	43
HD1BSRA2484-SW	119 LBS.	12.3	44
HD1BSRA2484-XW	101 LBS.	12.3	43
HD1BSRA2496-SW	125 LBS.	13.0	44
HD1BSRA2496-XW	107 LBS.	13.0	43
HD1BSRA32120-SW	161 LBS.	21.8	44
HD1BSRA32120-XW	142 LBS.	21.8	43
HD1BSRA32144-SW	172 LBS.	24.2	44
HD1BSRA32144-XW	154 LBS.	24.2	43
HD1CBC-WFW	155 LBS.	17.3	54
HD1CCB26120-WFW	723 LBS.	78.3	50
HD1CCB2648-WFW	296 LBS.	32.5	47
HD1CCB2672-WFW	428 LBS.	47.7	48
HD1CCB2696-WFW	581 LBS.	63.0	49
HD1CCBP2696-WFW	530 LBS.	63.0	51
HD1CCBV2696-WFW	582 LBS.	63.0	51
HD1CCS26120-WFW	656 LBS.	66.1	50
HD1CCS2648-WFW	269 LBS.	27.3	47
HD1CCS2672-WFW	398 LBS.	40.3	48
HD1CCS2696-WFW	527 LBS.	53.2	49
HD1CMCB-WFW	122 LBS.	13.8	52
HD1CMCD-WFW	139 LBS.	13.8	53
HD1LCT-WFW	136 LBS.	13.8	55
HD1TRAY	17 LBS.	1.4	56
HD1TRD36-FEW	50 LBS.	4.0	24
HD1TRD42-FEW	65 LBS.	5.3	24
HD1TRD48-FEW	81 LBS.	6.8	24
HD1TRD54-FEW	100 LBS.	8.5	24
HD1TRD60-FEW	121 LBS.	10.3	24
HD1TRD66-FEW	145 LBS.	12.4	24
HD1TRD72-FEW	171 LBS.	14.6	24
HD1TRT42108-FEW	194 LBS.	13.0	25
HD1TRT42120-FEW	214 LBS.	14.4	25
HD1TRT4272-FEW	132 LBS.	8.8	25
HD1TRT4284-FEW	153 LBS.	10.2	25
HD1TRT4296-FEW	173 LBS.	11.6	25
HD1TRT48108-FEW	220 LBS.	14.7	26
HD1TRT48120-FEW	243 LBS.	16.3	26
HD1TRT48144-FEW	290 LBS.	19.5	26
HD1TRT4872-FEW	150 LBS.	10.0	26
HD1TRT4884-FEW	173 LBS.	11.6	26
HD1TRT4896-FEW	197 LBS.	13.1	26
HD1TRT4896-WFW	197 LBS.	13.1	26
HD1TRT54120-FEW	272 LBS.	18.3	27
HD1TRT54144-FEW	325 LBS.	21.8	27

MODEL NUMBER	WEIGHT	CUBES	PAGE
HD1TRT60120-FEW	302 LBS.	20.2	28
HD1TRT60144-FEW	360 LBS.	24.1	28
HK17009011	1 LBS.	0.1	36
HK17009012	1 LBS.	0.1	39
HK17010011	1 LBS.	0.1	39
HK17010173	1 LBS.	0.1	36
HK170107602	1 LBS.	0.1	39
HK17014712	1 LBS.	0.1	39
HK17026701	1 LBS.	0.1	39
HK17041111	1 LBS.	0.1	36
HK17045412	1 LBS.	0.1	38
HK17049111	1 LBS.	0.1	37
HK17049112	1 LBS.	0.1	37
HK17049114	1 LBS.	0.1	37
HK17049115	1 LBS.	0.1	37
HK17049116	1 LBS.	0.1	38
HK17061602	1 LBS.	0.1	38
HK1BSD18-W	220 LBS.	8.7	42
HK1BSD24-W	230 LBS.	14.2	42
HK1BSD36-W	265 LBS.	28.9	42
HK1BSDA18-W	220 LBS.	8.7	42
HK1BSDA24-W	230 LBS.	14.2	42
HK1BSDA36-W	265 LBS.	28.9	42
HK1DP60-AHW	49 LBS.	4.8	35
HK1DP60-ASP	49 LBS.	4.8	35
HK1MC-GHW	12 LBS.	1.1	31
HK1MC-GSP	12 LBS.	1.1	31
HK1PG-SP	7 LBS.	0.3	30
HK1PWRKT12	8 LBS.	5.0	40
HK1TRASH	5 LBS.	1.4	40