

zilenzio + Allsteel

PRICE LIST

2023

USD



TABLE OF CONTENTS

ZILENZIO PRO

Zilenzio Pro is part of our THE GREEN TAG manifesto, a symbol of our commitment to create high quality products with a long life cycle. All products in the series are made with stone wool for superior sound absorption, a recyclable and durable material that is both non-flammable and water-resistant. Many of the products are supplied with replaceable fabric to further extend life and provide a truly sustainable option. Zilenzio Pro adheres to the market's certification and reporting requirements, both on the Swedish and international markets. The three foundations of this standard are quality (technical requirements), environment and sustainable supply chains where social, work environment and ethical responsibility are considered.

DECIBEL FAMILY

With a simple and timeless design and the best functionality on the market, the Decibel family covers every office need. All products are made with stone wool, which is recyclable and has the highest possible fire classification. Many of the products are supplied with replaceable fabric, which makes the new Dezibel a very durable alternative.

Dezibel Duo	35
Dezibel Flexible	14
Dezibel Table	6
Dezibel Floor	80
Dezibel Print	134
Dezibel Wall	126
Dezibel Ceiling	164
Dezibel Suspended ceiling	157
Dezibel Divider	150

DELTA FAMILY

Designed by Constance Guisset for Zilenzio. Delta is a series of wall and ceiling sound absorbers. The panels can be combined in many different ways and provide unlimited possibilities to create a personally adapted quiet environment for work or rest.

Delta Leaves (NEW)	207
Delta Ceiling	209
Delta Wall	211

TUNE FAMILY

Tune is a sound absorbing sofa series designed by Norm Architects for Zilenzio. Tune is part of the Zilenzio Pro family and uses stone wool for the best sound absorption. Tune sofas and armchairs have upholstered sound-absorbing backs and comfortable cushions.

Tune Pouf	191
Tune Chair	193
Tune Sofa	195
Tune Coffee Table	197
Tune Laptop Table	197

OTHER

Zermatt	36
Arc	50
Classic	56
Dotz	125
Kyoto	62
Mezzo	70
Offizz	102
Skog	74
Zorla	42
Fazett	138
Timber	144
Cloudz	158
Tone	182

TABLE OF CONTENTS

ZILENZIO STUDIO

Zilenzio Studio is designed to suit projects with somewhat lower sound absorption requirements. The screen is available with removable fabric, several of feet and coupling options. Zilenzio Studio adheres to the market's certification and reporting requirements, both on the Swedish and international markets. The three foundations of this standard are quality (technical requirements), environment and sustainable supply chains where social, work environment and ethical responsibility are considered.

FOCUS FAMILY

For a growing group of digital nomads and those who still operate in more traditional workspaces, it is important to find a personal place in an otherwise public space – whether an open office landscape, café, hotel lobby or school. Welcome to the Focus family: Privacy, simplicity and endless flexibility.

Focus® Desk Divider	175
Focus® Floor Divider	179
Focus® Pod	181
Focus® Table	177

OPTIMA FAMILY

Optima family: Integrity, simplicity and infinity

Optima Floor	101
Optima Table	22

Fabric covers	212
General terms and conditions	223



Tips - Find what you're looking for quickly!

All products are divided by function under the bookmarks.

Open the bookmarks by clicking on the bookmark icon in your PDF viewer.



FUNCTION

Phones ringing, people conversing, a printer going at full speed and the constant pings of colleagues' incoming emails on their computers. Does this sound familiar?

For many, this is a fairly accurate description of their standard work day. Many are unaware that the noise level at their workplace is too high. A high noise level affects not only our ability to do our work efficiently, but also our health and quality of life, both during and after working hours.

Unwanted and unnecessary sounds, what we refer to as noise, can lead to loss of hearing, fatigue and trouble concentrating. Noise also triggers our stress hormones and increases the risk of high blood pressure. For employers, poor acoustics in the workplace often translates to long-term sick leave or dismissals.

Open office landscapes are becoming increasingly common. Open office landscapes are both practical and social because they make it easier to communicate with your employees, but there are many risks.

People conversing is one of the biggest sources of sound at the workplace. Unfortunately our ears are unable to filter out this kind of noise. When we are exposed to a conversation between two people in our vicinity, we risk becoming as much as 66% less productive than if the noise level was lower. This makes it more difficult to focus on the task, which leads to poorer results.



At Zilenzio, we create silence for both ears and eyes. We combine relevant data and in-depth knowledge of sound and design, with a responsive and sustainable process, to deliver well-thought-out quality products. We deliver products and services that help our customers reduce aural and visual noise to comfortable and productive levels.

Dezibel Table

The Dezibel table screen is designed to reduce the noise level between work surfaces with optimal dimensions and the best possible design. The desk screen creates an efficient and creative work environment by lowering the level of both acoustic and visual noise, thus improving the workplace experience. The screen has a solid wood (FSC) frame, filled with stone wool, a recyclable and plastic-free material, and covered with fabric.

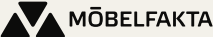

This product is part of the Zilenzio Pro family.
Zilenzio Pro combines the ultimate in function, design and durability.
All products in the series use stone wool for optimal sound absorption. Stone wool is recyclable, free of plastics and has the highest possible fire classification.

FABRICS

Our selected fabrics are divided into four price groups, with prices ascending from group one to four.

PRICE GROUP 1

Sawana	Davis								
Cara 170	Camira								
Carlow 170	Camira								
Event Screen+ 170	Gabriel								
Mica 170	Gabriel								
Tonal 170	Gabriel								

PRICE GROUP 2

Focus M Screen 170	Gabriel								
Event	Gabriel								
Hush 170	Gabriel								
Soul Melange 170	Gabriel								
Twist 170	Gabriel								
Twist Melange 170	Gabriel								
Floyd Screen 170	Kvadrat								
Slope 170	Nevotex								
Blazer Lite 170	Camira								
Era 170	Camira								

PRICE GROUP 3

Blazer	Camira								
Era	Camira								
Main Line Flax	Camira								
Rivet	Camira								
Synergy	Camira								
Focus	Gabriel								
Focus Melange	Gabriel								
Step	Gabriel								
Step Melange	Gabriel								
Field	Kvadrat								
Floyd	Kvadrat								
Remix	Kvadrat								
Remix Screen	Kvadrat								
Revive	Kvadrat								
Broken Twill Weave	Kvadrat								
Hint 170	Kvadrat								
Reflect	Kvadrat								
Wooly	Nevotex								
Wooly wide 170	Nevotex								
Lido	Nevotex								

PRICE GROUP 4

Yoredale	Camira								
Crisp	Gabriel								
Canvas	Kvadrat								
Divina	Kvadrat								
Fiord	Kvadrat								
Hallingdal	Kvadrat								
Hero	Kvadrat								
Melange Nap	Kvadrat								
Re-wool	Kvadrat								
Steelcut	Kvadrat								
Steelcut Trio	Kvadrat								
Lani	Vescom								
Gamut	Vescom								
Barnum	Nevotex								

CERTIFICATIONS

-  Recycled contents
-  OEKO Tex Standard 100
-  EN1021-1&2
-  OEKO Tex Standard 100
-  EU Ecolabel
-  Crib 5
-  Greenguard Certificate
-  CA TB 117

DESIGN

Solid wood frame construction (FSC).
Filling 1.6" comprised of stone wool with fire classification A1 (Non-combustible) free from plastics and polyethers.

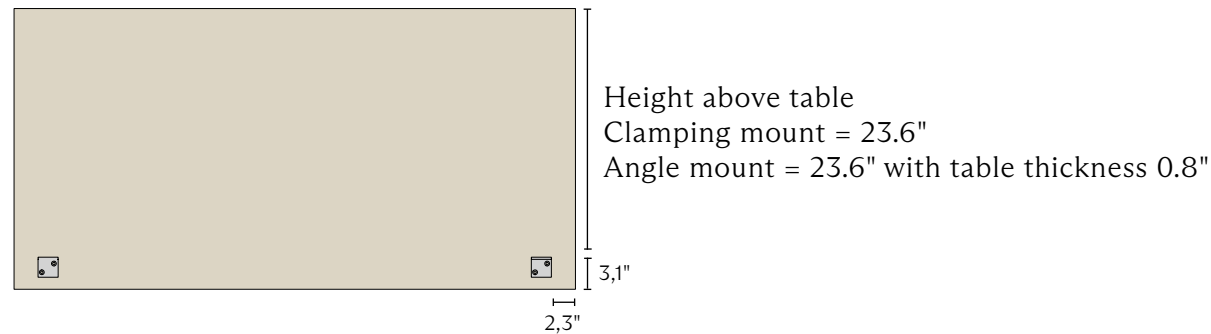

MEASUREMENTS

Length:	24", 30", 42", 48", 54", 60", 66", 72", 78", 84"
Height:	27.6"
Height above table:	Clamping mount 23.6" Angle bracket 23.6" at table thickness 0.8"
Thickness:	1.6"
Corners:	Straight or rounded R 1.2"

OPTIONS & CUSTOMIZATIONS

For other customizations, contact support@zilenzio.com for a quote.

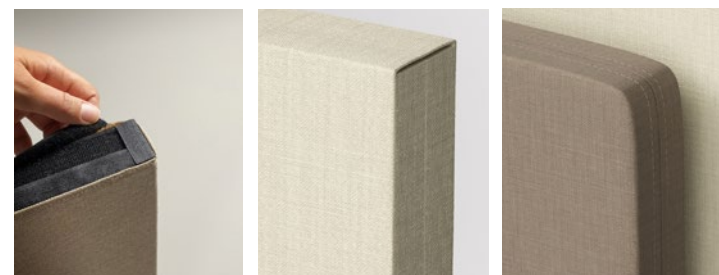

Removable fabric Straight corners Rounded corners

Customizations	Item no	Price/customization
Customization measurements	MOD-001	Offer
Options		Price/screen
Magnetic coupling	30-ADD-01	50

SOUND

SS-EN ISO 354, ISO 11654 Class A
SS-EN ISO 354:2003 evaluated SS 25269
Noise Reduction Coefficient (NRC): 0.55

ENVIRONMENT & SAFETY

Möbelfakta Certified Reg. No.: 0120170605
EN 1023-1:1996
EN 1023-2:78.7"
EN 1023-3:78.7"
EN 14073-2

BRACKETS

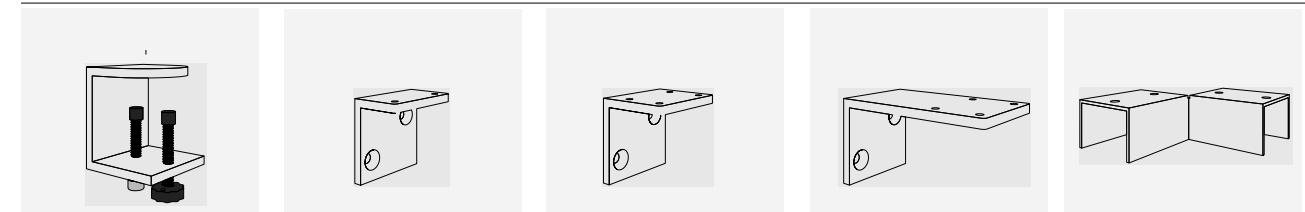

Clamp mount
Gap 1.9"

Angle mount
Length 1.1"

Angle mount
Length 1.8"

Angle mount
Length 3.7"

Corner fitting 90°
Depth 1.6"

Standard color on Brackets

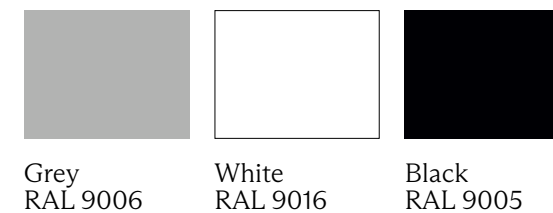

Grey
RAL 9006

White
RAL 9016

Black
RAL 9005

Brackets	Color item no			Price/pc
	Grey	White	Black	
Clamp mount	91-006	91-007	91-008	57
Angle mount 1.3"	91-014	91-015	91-016	43
Angle mount 1.8"	91-001	91-002	91-003	43
Angle mount 3.7"	91-010	91-011	91-012	43
Corner fitting 90°	91-105	91-106	91-107	45

Dezibel Table

with removable fabric



Art.no.	Size	Corner	Price gr.1	Price gr.2	Price gr.3	Price gr.4	Weight	Brackets
	WxHxD						Pounds	pcs/screen
30-2427-R	24" x 27.6" x 1.6"	Straight	426	497	596	702	11	2
30-3027-R	30" x 27.6" x 1.6"	Straight	469	560	682	817	15,4	2
30-4227-R	42" x 27.6" x 1.6"	Straight	686	812	990	1 180	17,6	2
30-4827-R	48" x 27.6" x 1.6"	Straight	686	812	990	1 180	22	2
30-5427-R	54" x 27.6" x 1.6"	Straight	744	885	1 089	1 310	24,2	2
30-6027-R	60" x 27.6" x 1.6"	Straight	795	956	1 187	1 434	28,6	2
30-6627-R	66" x 27.6" x 1.6"	Straight	840	1 023	1 279	1 552	33	2
30-7227-R	72" x 27.6" x 1.6"	Straight	894	1 094	1 376	1 678	37,5	2
30-7827-R	78" x 27.6" x 1.6"	Straight	894	1 094	1 376	1 678	41,9	2
30-8427-R	84" x 27.6" x 1.6"	Straight	953	1 169	1 480	1 808	46,3	2

31-2427-R	24" x 27.6" x 1.6"	Rounded	497	567	666	772	11	2
31-3027-R	30" x 27.6" x 1.6"	Rounded	541	629	753	887	15,4	2
31-4227-R	42" x 27.6" x 1.6"	Rounded	755	882	1 061	1 251	17,6	2
31-4827-R	48" x 27.6" x 1.6"	Rounded	755	882	1 061	1 251	22	2
31-5427-R	54" x 27.6" x 1.6"	Rounded	813	956	1 164	1 379	24,2	2
31-6027-R	60" x 27.6" x 1.6"	Rounded	862	1 026	1 257	1 506	28,6	2
31-6627-R	66" x 27.6" x 1.6"	Rounded	911	1 089	1 349	1 624	33	2
31-7227-R	72" x 27.6" x 1.6"	Rounded	964	1 164	1 447	1 747	37,5	2
31-7827-R	78" x 27.6" x 1.6"	Rounded	964	1 164	1 447	1 747	41,9	2
31-8427-R	84" x 27.6" x 1.6"	Rounded	1 023	1 238	1 549	1 882	46,3	2

Brackets	Color item no			Price/pc
	Grey	White	Black	
Clamp mount	91-006	91-007	91-008	57
Angle mount 1.3"	91-014	91-015	91-016	43
Angle mount 1.8"	91-001	91-002	91-003	43
Angle mount 3.7"	91-010	91-011	91-012	43
Corner fitting 90°	91-105	91-106	91-107	45

This product is part of the Zilenzio Pro family.
Zilenzio Pro combines the ultimate in function, design and durability.
All products in the series use stone wool for optimal sound absorption. Stone wool is recyclable, free of plastics and has the highest possible fire classification.



Dezibel Table



Art.no.	Size WxHxD	Corner	Price gr.1	Price gr.2	Price gr.3	Price gr.4	Weight	Brackets
							Pounds	pcs/screen
30-2427	24" x 27.6" x 1.6"	Straight	426	497	596	702	11	2
30-3027	30" x 27.6" x 1.6"	Straight	469	560	682	817	15,4	2
30-4227	42" x 27.6" x 1.6"	Straight	686	812	990	1 180	17,6	2
30-4827	48" x 27.6" x 1.6"	Straight	686	812	990	1 180	22	2
30-5427	54" x 27.6" x 1.6"	Straight	744	885	1 089	1 310	24,2	2
30-6027	60" x 27.6" x 1.6"	Straight	795	956	1 187	1 434	28,6	2
30-6627	66" x 27.6" x 1.6"	Straight	840	1 023	1 279	1 552	33	2
30-7227	72" x 27.6" x 1.6"	Straight	894	1 094	1 376	1 678	37,5	2
30-7827	78" x 27.6" x 1.6"	Straight	894	1 094	1 376	1 678	41,9	2
30-8427	84" x 27.6" x 1.6"	Straight	953	1 169	1 480	1 808	46,3	2

31-2427	24" x 27.6" x 1.6"	Rounded	497	567	666	772	11	2
31-3027	30" x 27.6" x 1.6"	Rounded	541	629	753	887	15,4	2
31-4227	42" x 27.6" x 1.6"	Rounded	755	882	1 061	1 251	17,6	2
31-4827	48" x 27.6" x 1.6"	Rounded	755	882	1 061	1 251	22	2
31-5427	54" x 27.6" x 1.6"	Rounded	813	956	1 164	1 379	24,2	2
31-6027	60" x 27.6" x 1.6"	Rounded	862	1 026	1 257	1 506	28,6	2
31-6627	66" x 27.6" x 1.6"	Rounded	911	1 089	1 349	1 624	33	2
31-7227	72" x 27.6" x 1.6"	Rounded	964	1 164	1 447	1 747	37,5	2
31-7827	78" x 27.6" x 1.6"	Rounded	964	1 164	1 447	1 747	41,9	2
31-8427	84" x 27.6" x 1.6"	Rounded	1 023	1 238	1 549	1 882	46,3	2

Brackets	Color item no			Price/pc
	Grey	White	Black	
Clamp mount	91-006	91-007	91-008	57
Angle mount 1.3"	91-014	91-015	91-016	43
Angle mount 1.8"	91-001	91-002	91-003	43
Angle mount 3.7"	91-010	91-011	91-012	43
Corner fitting 90°	91-105	91-106	91-107	45

This product is part of the Zilenzio Pro family.
Zilenzio Pro combines the ultimate in function, design and durability.
All products in the series use stone wool for optimal sound absorption. Stone wool is recyclable, free of plastics and has the highest possible fire classification.

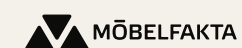

Dezibel Flexible

Dezibel Flexible is developed with a focus on sound absorption, flexibility and the ability to make large tables more versatile. It mainly functions as a barrier to be placed strategically to divide and block sound.



DESIGNER

Note Design Studio

This product is part of the Zilenzio Pro family.
Zilenzio Pro combines the ultimate in function, design and durability.
All products in the series use stone wool for optimal sound absorption. Stone wool is recyclable, free of plastics and has the highest possible fire classification.



FABRICS

Our selected fabrics are divided into four price groups, with prices ascending from group one to four.

PRICE GROUP 1

Sawana	Davis						
Cara 170	Camira						
Carlow 170	Camira						
Event Screen+ 170	Gabriel						
Mica 170	Gabriel						
Tonal 170	Gabriel						

PRICE GROUP 2

Focus M Screen 170	Gabriel						
Event	Gabriel						
Hush 170	Gabriel						
Soul Melange 170	Gabriel						
Twist 170	Gabriel						
Twist Melange 170	Gabriel						
Floyd Screen 170	Kvadrat						
Slope 170	Nevotex						
Blazer Lite 170	Camira						
Era 170	Camira						

PRICE GROUP 3

Blazer	Camira						
Era	Camira						
Main Line Flax	Camira						
Rivet	Camira						
Synergy	Camira						
Focus	Gabriel						
Focus Melange	Gabriel						
Step	Gabriel						
Step Melange	Gabriel						
Field	Kvadrat						
Floyd	Kvadrat						
Remix	Kvadrat						
Remix Screen	Kvadrat						
Revive	Kvadrat						
Broken Twill Weave	Kvadrat						
Hint 170	Kvadrat						
Reflect	Kvadrat						
Wooly	Nevotex						
Wooly wide 170	Nevotex						
Lido	Nevotex						

PRICE GROUP 4

Yoredale	Camira						
Crisp	Gabriel						
Canvas	Kvadrat						
Divina	Kvadrat						
Fiord	Kvadrat						
Hallingdal	Kvadrat						
Hero	Kvadrat						
Melange Nap	Kvadrat						
Re-wool	Kvadrat						
Steelcut	Kvadrat						
Steelcut Trio	Kvadrat						
Lani	Vescom						
Gamut	Vescom						
Barnum	Nevotex						

CERTIFICATIONS

- Recycled contents
- OEKO Tex Standard 100

- OEKO Tex Standard 100
- EU Ecolabel
- Greenguard Certificate

- EN1021-1&2
- Crib 5
- CA TB 117

DESIGN

Solid wood frame construction (FSC).
 Filling 1.6" comprised of stone wool with fire classification A1 (Non-combustible)
 free from plastics and polyethers.
 Solid ash feet.

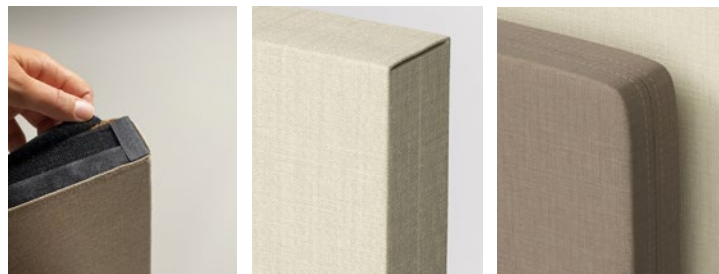

Removable fabric Straight corners Rounded corners

MEASUREMENTS

Length: 23.6", 31.5", 39.4", 47.2"
 Height: 13.8", 17.7"
 Thickness: 1.6"
 Corners: Straight or rounded R 1,2"

SOUND

SS-EN ISO 354, ISO 11654 Class A
 SS-EN ISO 354:2003 evaluated SS 25269

N10
 Dezibel 47.2" x 17.7" - 14

ENVIRONMENT & SAFETY

Möbelfakta Certified
 EN 1023-1:1996
 EN 1023-2:78.7"
 EN 1023-3:78.7"
 EN 14073-2

FEET

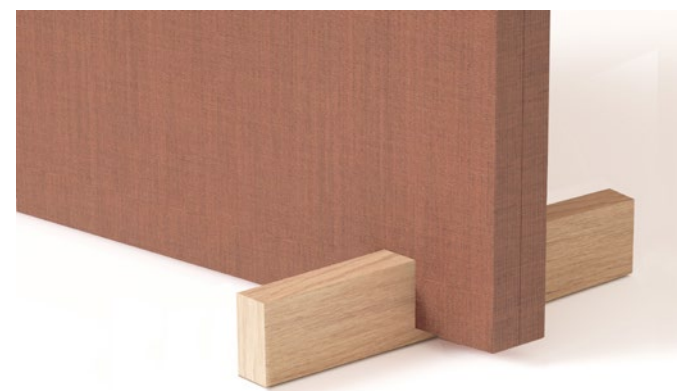

Flexible foot

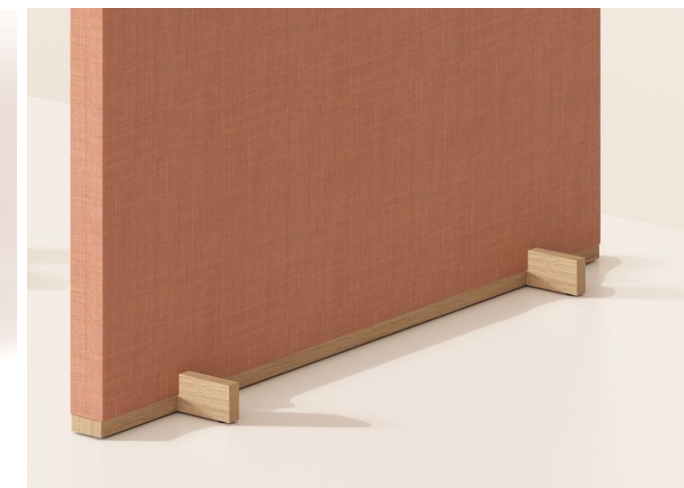

Flexible foot + Base



Ash

Feet	Item no.	Price/screen
Flexible foot, Ash	91-500-1	79
Flexible foot + Base 23.6"	91-501-01-1	159
Flexible foot + Base 31.5"	91-501-02-1	171
Flexible foot + Base 39.4"	91-501-03-1	177
Flexible foot + Base 47.2"	91-501-04-1	184

Dezibel Flexible

with removable fabric



Item no.	Measurements WxHxD	Corners	Price gr. 1	Price gr. 2	Price gr. 3	Price gr. 4	Weight Pounds
33-0603-R	23.6" x 13.8" x 1.6"	Straight	406	425	488	536	1
33-0803-R	31.5" x 13.8" x 1.6"	Straight	440	465	544	600	1
33-1003-R	39.4" x 13.8" x 1.6"	Straight	597	629	713	781	2
33-1203-R	47.2" x 13.8" x 1.6"	Straight	631	670	767	848	2
33-0604-R	23.6" x 17.7" x 1.6"	Straight	406	425	488	536	1
33-0804-R	31.5" x 17.7" x 1.6"	Straight	440	465	544	600	1
33-1004-R	39.4" x 17.7" x 1.6"	Straight	597	629	713	781	2
33-1204-R	47.2" x 17.7" x 1.6"	Straight	631	670	767	848	2
34-0603-R	23.6" x 13.8" x 1.6"	Rounded	449	468	532	577	1
34-0803-R	31.5" x 13.8" x 1.6"	Rounded	482	510	583	640	1
34-1003-R	39.4" x 13.8" x 1.6"	Rounded	644	673	757	825	2
34-1203-R	47.2" x 13.8" x 1.6"	Rounded	677	715	810	891	2
34-0604-R	23.6" x 17.7" x 1.6"	Rounded	470	492	554	599	1
34-0804-R	31.5" x 17.7" x 1.6"	Rounded	509	537	612	669	1
34-1004-R	39.4" x 17.7" x 1.6"	Rounded	680	709	794	862	2
34-1204-R	47.2" x 17.7" x 1.6"	Rounded	714	756	850	930	2

Feet	Item no.	Price/screen
Flexible foot, Ash	91-500-1	79
Flexible foot + Base 23.6"	91-501-01-1	159
Flexible foot + Base 31.5"	91-501-02-1	171
Flexible foot + Base 39.4"	91-501-03-1	177
Flexible foot + Base 47.2"	91-501-04-1	184

NOTE! Foot chosen separately

This product is part of the Zilenzio Pro family.
Zilenzio Pro combines the ultimate in function, design and durability.
 All products in the series use stone wool for optimal sound absorption. Stone wool is recyclable, free of plastics and has the highest possible fire classification.

Dezibel Flexible

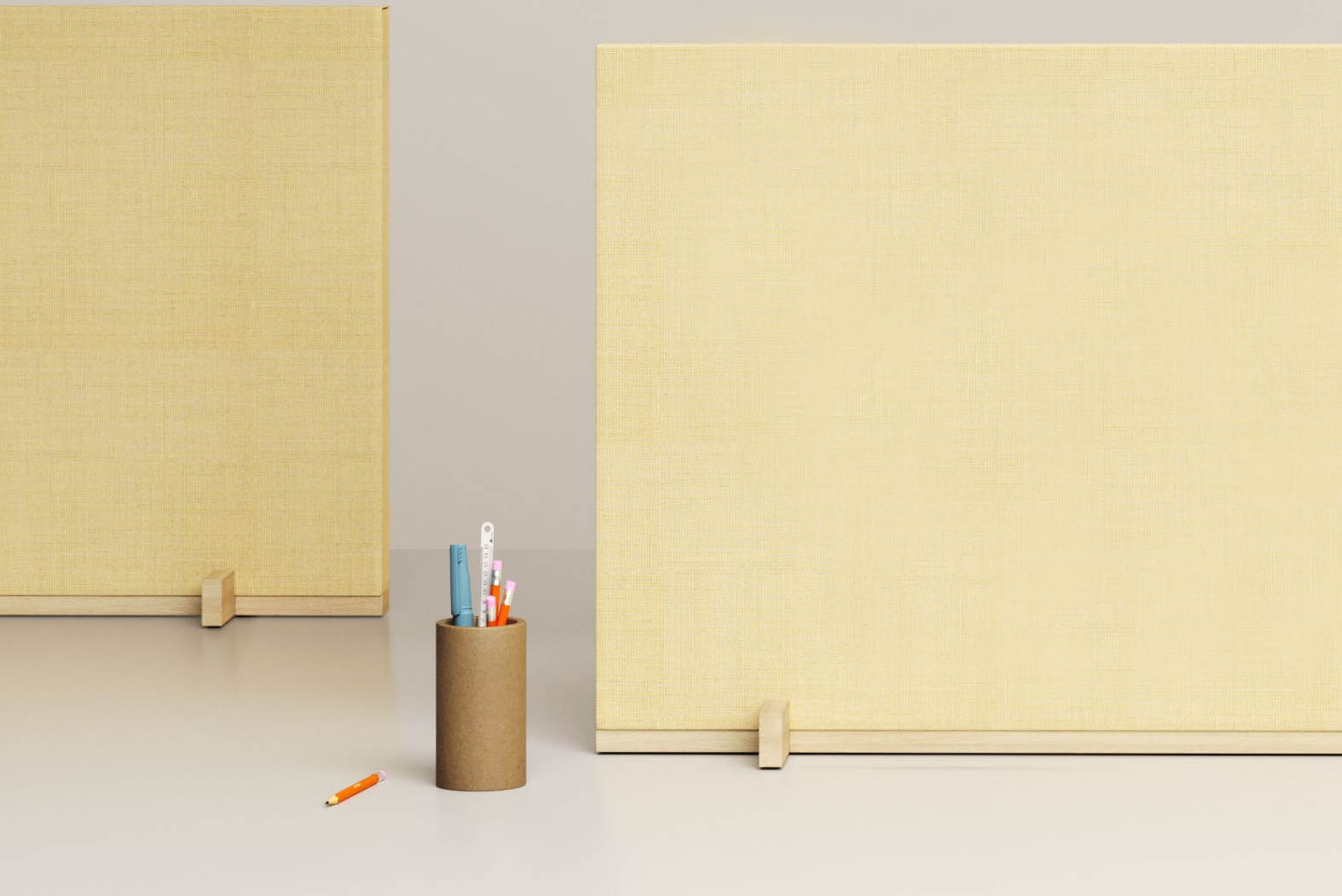

Item no.	Measurements WxHxD	Corners	Price gr. 1	Price gr. 2	Price gr. 3	Price gr. 4	Weight Pounds
33-0603	23.6" x 13.8" x 1.6"	Straight	406	425	488	536	1
33-0803	31.5" x 13.8" x 1.6"	Straight	440	465	544	600	1
33-1003	39.4" x 13.8" x 1.6"	Straight	597	629	713	781	2
33-1203	47.2" x 13.8" x 1.6"	Straight	631	670	767	848	2
33-0604	23.6" x 17.7" x 1.6"	Straight	428	447	510	557	1
33-0804	31.5" x 17.7" x 1.6"	Straight	467	492	571	628	1
33-1004	39.4" x 17.7" x 1.6"	Straight	633	665	751	818	2
33-1204	47.2" x 17.7" x 1.6"	Straight	672	711	804	888	2
34-0603	23.6" x 13.8" x 1.6"	Rounded	449	468	532	577	1
34-0803	31.5" x 13.8" x 1.6"	Rounded	482	510	583	640	1
34-1003	39.4" x 13.8" x 1.6"	Rounded	644	673	757	825	2
34-1203	47.2" x 13.8" x 1.6"	Rounded	677	715	810	891	2
34-0604	23.6" x 17.7" x 1.6"	Rounded	470	492	554	599	1
34-0804	31.5" x 17.7" x 1.6"	Rounded	509	537	612	669	1
34-1004	39.4" x 17.7" x 1.6"	Rounded	680	709	794	862	2
34-1204	47.2" x 17.7" x 1.6"	Rounded	714	756	850	930	2

Flexible foot, Ash	Item no.	Price/screen
Flexible foot + Base 23.6"	91-500-1	79
Flexible foot + Base 31.5"	91-501-01-1	159
Flexible foot + Base 39.4"	91-501-02-1	171
Flexible foot + Base 47.2"	91-501-03-1	177
Flexible foot + Base 47.2"	91-501-04-1	184

NOTE! Foot chosen separately

This product is part of the Zilenzio Pro family.
*Zilenzio Pro combines the ultimate in function, design and durability.
 All products in the series use stone wool for optimal sound absorption. Stone wool is
 recyclable, free of plastics and has the highest possible fire classification.*

Optima Table

Optima is environmentally friendly in a number of ways. It is made up of recycled PET and has sound absorption class A. The screen can easily be covered with a fabric that can be changed to another fabric or color after any number of years.

The screens are light and can therefore be ergonomically mounted.



FABRICS

Our selected fabrics are divided into four price groups, with prices ascending from group one to four.

PRICE GROUP 1

Sawana	Davis						
Cara 170	Camira						
Carlow 170	Camira						
Event Screen+ 170	Gabriel						
Mica 170	Gabriel						
Tonal 170	Gabriel						

PRICE GROUP 2

Focus M Screen 170	Gabriel						
Event	Gabriel						
Hush 170	Gabriel						
Soul Melange 170	Gabriel						
Twist 170	Gabriel						
Twist Melange 170	Gabriel						
Floyd Screen 170	Kvadrat						
Slope 170	Nevotex						
Blazer Lite 170	Camira						
Era 170	Camira						

PRICE GROUP 3

Blazer	Camira						
Era	Camira						
Main Line Flax	Camira						
Rivet	Camira						
Synergy	Camira						
Focus	Gabriel						
Focus Melange	Gabriel						
Step	Gabriel						
Step Melange	Gabriel						
Field	Kvadrat						
Floyd	Kvadrat						
Remix	Kvadrat						
Remix Screen	Kvadrat						
Revive	Kvadrat						
Broken Twill Weave	Kvadrat						
Hint 170	Kvadrat						
Reflect	Kvadrat						
Wooly	Nevotex						
Wooly wide 170	Nevotex						
Lido	Nevotex						

PRICE GROUP 4

Yoredale	Camira						
Crisp	Gabriel						
Canvas	Kvadrat						
Divina	Kvadrat						
Fiord	Kvadrat						
Hallingdal	Kvadrat						
Hero	Kvadrat						
Melange Nap	Kvadrat						
Re-wool	Kvadrat						
Steelcut	Kvadrat						
Steelcut Trio	Kvadrat						
Lani	Vescom						
Gamut	Vescom						
Barnum	Nevotex						

CERTIFICATIONS

- Recycled contents
- OEKO Tex Standard 100

- OEKO Tex Standard 100
- EU Ecolabel
- Greenguard Certificate

- EN1021-1&2
- Crib 5
- CA TB 117

DESIGN

Solid wood frame construction.
Filling consisting of A class recycled PET fiber with good sound absorbing properties.
Attaches to table using 2 table brackets.

MEASUREMENTS

Length screen 24", 30", 42", 48", 54", 60", 66", 72", 78",
Height: 25.2"

Height above table: Clamping mount 20.6"
Angle mount 20.6" with table thickness 0.8"

Thickness: 1.2", 1.6"
Corners: Straight or rounded R 1,2"

OPTIONS & CUSTOMIZATIONS

These are our standard screen options & customizations.
For other customizations, contact support@zilenzio.com for a quote.

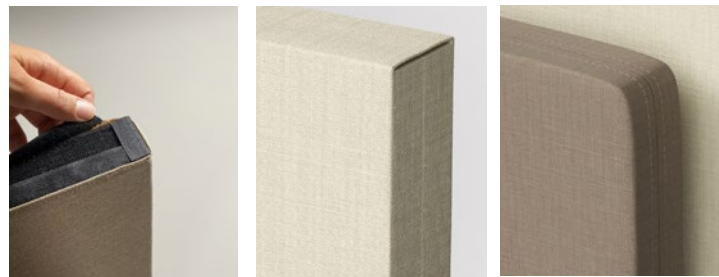

Removable fabric Straight corners Rounded corners

Customizations	Item no	Price/customization
Options		Price/screen
Magnetic coupling	20-ADD-01	50

BRACKETS

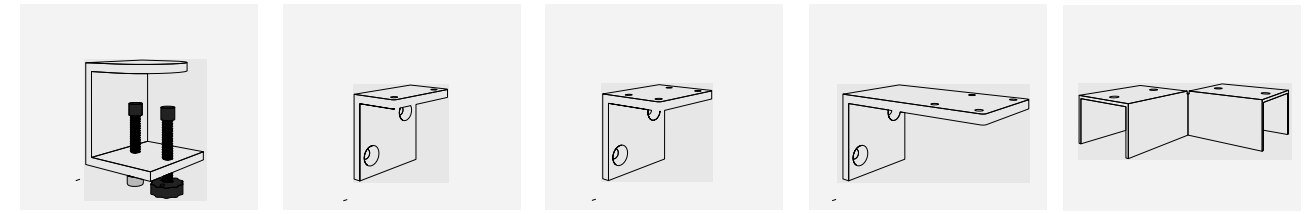

Clamp mount
Gap 50

Angle mount
Length 1.1"

Angle mount
Length 1.8"

Angle mount
Length 3.7"

Corner fitting 90°
Depth 1.6"

Standard color on brackets



Grey
RAL 9006

White
RAL 9016

Black
RAL 9005

Brackets	Color item no			Price/pc
	Grey	White	Black	
Clamp mount	91-006	91-007	91-008	57
Angle mount 1.3"	91-014	91-015	91-016	43
Angle mount 1.8"	91-001	91-002	91-003	43
Angle mount 3.7"	91-010	91-011	91-012	43
Corner fitting 90°	91-105	91-106	91-107	45

Optima Table 30



Art.no.	Size	Corner	Price gr.1	Price gr.2	Price gr.3	Price gr.4	Weight	Fixtures
	WxHxD						Pounds	pcs/screen
20-2425	24" x 25.2" x 1.2"	Straight	335	360	440	479	8,8	2
20-3025	30" x 25.2" x 1.2"	Straight	351	383	472	526	13,2	2
20-4825	48" x 25.2" x 1.2"	Straight	368	405	498	558	15,4	2
20-5425	54" x 25.2" x 1.2"	Straight	451	499	608	679	19,8	2
20-6025	60" x 25.2" x 1.2"	Straight	467	517	638	721	22	2
20-6625	66" x 25.2" x 1.2"	Straight	479	543	671	770	24,2	2
20-7225	72" x 25.2" x 1.2"	Straight	516	583	724	832	28,6	2
20-7825	78" x 25.2" x 1.2"	Straight	540	617	771	888	30,8	2
21-2425	24" x 25.2" x 1.2"	Rounded	374	395	475	515	8,8	2
21-3025	30" x 25.2" x 1.2"	Rounded	390	419	510	562	13,2	2
21-4825	48" x 25.2" x 1.2"	Rounded	407	440	539	591	15,4	2
21-5425	54" x 25.2" x 1.2"	Rounded	493	536	646	718	19,8	2
21-6025	60" x 25.2" x 1.2"	Rounded	505	558	677	761	22	2
21-6625	66" x 25.2" x 1.2"	Rounded	521	583	711	808	24,2	2
21-7225	72" x 25.2" x 1.2"	Rounded	552	620	761	871	28,6	2
21-7825	78" x 25.2" x 1.2"	Rounded	579	656	807	929	30,8	2

Brackets	Color item no			Price/pc
	Grey	White	Black	
Clamp mount	91-006	91-007	91-008	57
Angle mount 1.3"	91-014	91-015	91-016	43
Angle mount 1.8"	91-001	91-002	91-003	43
Angle mount 3.7"	91-010	91-011	91-012	43
Corner fitting 90°	91-105	91-106	91-107	45

Optima Table 30

with removable fabric



Art.no.	Size WxHxD	Corner	Price gr.1	Price gr.2	Price gr.3	Price gr.4	Weight	Fixtures
							Pounds	pcs/screen
20-2425-R	24" x 25.2" x 1.2"	Straight	367	388	469	506	8,8	2
20-3025-R	30" x 25.2" x 1.2"	Straight	383	416	504	553	13,2	2
20-4825-R	48" x 25.2" x 1.2"	Straight	398	430	529	583	15,4	2
20-5425-R	54" x 25.2" x 1.2"	Straight	488	531	640	716	19,8	2
20-6025-R	60" x 25.2" x 1.2"	Straight	499	553	673	758	22	2
20-6625-R	66" x 25.2" x 1.2"	Straight	517	575	708	803	24,2	2
20-7225-R	72" x 25.2" x 1.2"	Straight	549	618	759	868	28,6	2
20-7825-R	78" x 25.2" x 1.2"	Straight	577	653	806	926	30,8	2

21-2425-R	24" x 25.2" x 1.2"	Rounded	404	426	510	545	8,8	2
21-3025-R	30" x 25.2" x 1.2"	Rounded	422	455	545	592	13,2	2
21-4825-R	48" x 25.2" x 1.2"	Rounded	438	471	567	625	15,4	2
21-5425-R	54" x 25.2" x 1.2"	Rounded	531	573	683	754	19,8	2
21-6025-R	60" x 25.2" x 1.2"	Rounded	543	596	715	801	22	2
21-6625-R	66" x 25.2" x 1.2"	Rounded	560	617	748	845	24,2	2
21-7225-R	72" x 25.2" x 1.2"	Rounded	595	662	802	911	28,6	2
21-7825-R	78" x 25.2" x 1.2"	Rounded	621	697	849	968	30,8	2

Brackets	Color item no			Price/pc
	Grey	White	Black	
Clamp mount	91-006	91-007	91-008	57
Angle mount 1.3"	91-014	91-015	91-016	43
Angle mount 1.8"	91-001	91-002	91-003	43
Angle mount 3.7"	91-010	91-011	91-012	43
Corner fitting 90°	91-105	91-106	91-107	45

Optima Table 40



Art.no.	Size	Corner	Price gr.1	Price gr.2	Price gr.3	Price gr.4	Weight	Fixtures
	WxHxD						Pounds	pcs/screen
22-2425	24" x 25.2" x 1.6"	Straight	353	379	461	500	8,8	2
22-3025	30" x 25.2" x 1.6"	Straight	376	408	498	549	13,2	2
22-4825	48" x 25.2" x 1.6"	Straight	397	429	526	588	15,4	2
22-5425	54" x 25.2" x 1.6"	Straight	486	532	641	716	19,8	2
22-6025	60" x 25.2" x 1.6"	Straight	501	554	676	761	22	2
22-6625	66" x 25.2" x 1.6"	Straight	518	575	712	806	24,2	2
22-7225	72" x 25.2" x 1.6"	Straight	553	622	768	877	28,6	2
22-7825	78" x 25.2" x 1.6"	Straight	585	659	814	935	30,8	2
23-2425	24" x 25.2" x 1.6"	Rounded	392	417	499	537	8,8	2
23-3025	30" x 25.2" x 1.6"	Rounded	412	444	536	587	13,2	2
23-4825	48" x 25.2" x 1.6"	Rounded	437	471	567	625	15,4	2
23-5425	54" x 25.2" x 1.6"	Rounded	528	573	683	754	19,8	2
23-6025	60" x 25.2" x 1.6"	Rounded	542	593	714	801	22	2
23-6625	66" x 25.2" x 1.6"	Rounded	558	619	750	847	24,2	2
23-7225	72" x 25.2" x 1.6"	Rounded	594	664	807	915	28,6	2
23-7825	78" x 25.2" x 1.6"	Rounded	624	702	855	974	30,8	2

Brackets	Color item no			Price/pc
	Grey	White	Black	
Clamp mount	91-006	91-007	91-008	57
Angle mount 1.3"	91-014	91-015	91-016	43
Angle mount 1.8"	91-001	91-002	91-003	43
Angle mount 3.7"	91-010	91-011	91-012	43
Corner fitting 90°	91-105	91-106	91-107	45

Optima Table 40

with removable fabric



Art.no.	Size WxHxD	Corner	Price gr.1	Price gr.2	Price gr.3	Price gr.4	Weight	Fixtures
							Pounds	pcs/screen
22-2425-R	24" x 25.2" x 1.6"	Straight	386	407	489	528	8,8	2
22-3025-R	30" x 25.2" x 1.6"	Straight	404	438	526	579	13,2	2
22-4825-R	48" x 25.2" x 1.6"	Straight	429	464	560	616	15,4	2
22-5425-R	54" x 25.2" x 1.6"	Straight	524	566	678	750	19,8	2
22-6025-R	60" x 25.2" x 1.6"	Straight	537	592	707	795	22	2
22-6625-R	66" x 25.2" x 1.6"	Straight	551	615	743	844	24,2	2
22-7225-R	72" x 25.2" x 1.6"	Straight	593	663	804	910	28,6	2
22-7825-R	78" x 25.2" x 1.6"	Straight	623	698	852	972	30,8	2
23-2425-R	24" x 25.2" x 1.6"	Rounded	425	448	526	565	8,8	2
23-3025-R	30" x 25.2" x 1.6"	Rounded	446	476	566	616	13,2	2
23-4825-R	48" x 25.2" x 1.6"	Rounded	469	500	599	652	15,4	2
23-5425-R	54" x 25.2" x 1.6"	Rounded	564	609	717	785	19,8	2
23-6025-R	60" x 25.2" x 1.6"	Rounded	578	630	749	830	22	2
23-6625-R	66" x 25.2" x 1.6"	Rounded	596	655	784	879	24,2	2
23-7225-R	72" x 25.2" x 1.6"	Rounded	639	705	843	951	28,6	2
23-7825-R	78" x 25.2" x 1.6"	Rounded	669	743	890	1 013	30,8	2

Brackets	Color item no			Price/pc
	Grey	White	Black	
Clamp mount	91-006	91-007	91-008	57
Angle mount 1.3"	91-014	91-015	91-016	43
Angle mount 1.8"	91-001	91-002	91-003	43
Angle mount 3.7"	91-010	91-011	91-012	43
Corner fitting 90°	91-105	91-106	91-107	45

Dezibel Duo

add-on for double desk

DEZIBEL DUO is an add-on that converts the Dezibel Table for double desks. The add-on enables customer customization for the attachment.

We adapt the attachment in the screen to the desktop.

NOTE! Always send with plan on the table
Contact support@zilenzio.com for a quote or for more information



Add-on	Item no.	Price/pcs
Dezibel Duo	30-MOD-03	154

Zermatt

Zermatt – a desktop screen that divides without feeling static. The screen's welcoming design creates a special sense of space simultaneously with a better focus. When several desktop screens are placed against each other, a dynamic and undulating landscape results. Zermatt is available as a front and side screen in one piece, or a front screen only, and can be adapted to desks sizes from 47.2" to 131.5"



DESIGNER

Studio Stockholm Arkitektur

This product is part of the Zilenzio Pro family.
Zilenzio Pro combines the ultimate in function, design and durability.
All products in the series use stone wool for optimal sound absorption. Stone wool is recyclable, free of plastics and has the highest possible fire classification.



FABRICS

Our selected fabrics are divided into price groups, with prices ascending from group two to four.

PRICE GROUP 2

Focus M Screen 170	Gabriel						
Hush 170	Gabriel						
Blazer Lite 170	Camira						

PRICE GROUP 3

Blazer	Camira						
Synergy	Camira						
Focus	Gabriel						
Focus Melange	Gabriel						

PRICE GROUP 4

Divina	Kvadrat						
Barnum	Nevotex						

CERTIFICATIONS

- Recycled contents
- OEKO Tex Standard 100

- OEKO Tex Standard 100
- EU Ecolabel
- Greenguard Certificate

- EN1021-1&2
- Crib 5
- CA TB 117

DESIGN

Solid wood frame construction (FSC).

Filling 1.6" comprised of stone wool with fire classification A1 (Non-combustible)

MEASUREMENTS

Length:	48", 54", 60", 66", 72"
Height:	21,6" - 31,5"
Height above table:	15"-19.6" (for table thickness 0.8")
Thickness:	1.6"
Corners:	R 3"
Space between screen and table:	1"
Mount under table:	1.9"

SOUND

SS-EN ISO 354, ISO 11654 Class A
SS-EN ISO 354:2003 evaluated SS 25269

N10
63" 5.6

Measurements examples:
Zermatt Long 60"

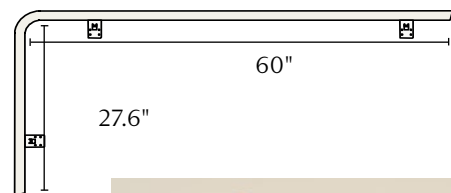

ENVIRONMENT & SAFETY

Möbelfakta Certified
EN 1023-1:1996
EN 1023-2:78.7"
EN 1023-3:78.7"
EN 14073-2

Measurements examples:
Zermatt Short 60"

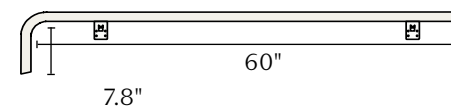

BRACKETS

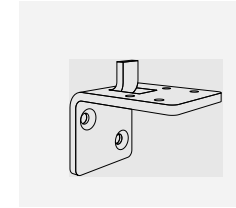

Angle mount
Zermatt
Length 2.9" of
which 1.9"
under table

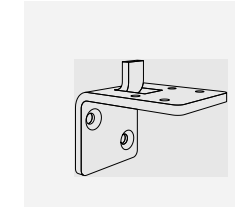

Angle mount
Zermatt
Length 4.5" of
which 3.5"
under table

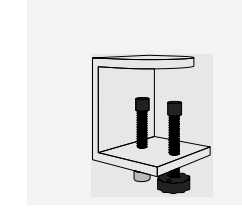

Bracket Clamp
Zermatt
With spacers and 1.4"
bolt

Standard color on brackets



White
RAL 9016



Black
RAL 9005

Brackets	Color item no			Price/pc
	Grey	White	Black	
Zermatt Angle Mount 2.9"	-	91-027-2	91-027-3	57
Zermatt Angle Mount 4.5"*	-	91-028-2	91-028-3	57
Zermatt Bracket Clamp with spacers		91-007-S	91-008-S	60

*Works with beveled edges.



Item no.	Size	Side screen		Price gr. 1	Price gr. 2	Price gr. 3	Price gr. 4	Weight	Mounts
	WxHxD	Form	Width						
32-4832-LL	48"x21,6"-32,3"x1,6"	Long left	27.5"	-	1 307	1 576	-	40.7	3
32-5432-LL	54"x21,6"-32,3"x1,6"	Long left	27.5"	-	1 375	1 668	-	40.7	3
32-6032-LL	60"x21,6"-32,3"x1,6"	Long left	27.5"	-	1 440	1 757	-	40.7	3
32-6632-LL	66"x21,6"-32,3"x1,6"	Long left	27.5"	-	1 501	1 841	-	40.7	3
32-7232-LL	72"x21,6"-32,3"x1,6"	Long left	27.5"	-	1 538	1 894	-		
32-4832-LR	48"x21,6"-32,3"x1,6"	Long right	27.5"	-	1 307	1 576	-	40.7	3
32-5432-LR	54"x21,6"-32,3"x1,6"	Long right	27.5"	-	1 375	1 668	-	40.7	3
32-6032-LR	60"x21,6"-32,3"x1,6"	Long right	27.5"	-	1 440	1 757	-	40.7	3
32-6632-LR	66"x21,6"-32,3"x1,6"	Long right	27.5"	-	1 501	1 841	-	40.7	3
32-7232-LR	72"x21,6"-32,3"x1,6"	Long right	27.5"	-	1 538	1 894	-		
32-4832-SL	48"x21,6"-32,3"x1,6"	Short left	7.9"	-	1 020	1 221	-	33.7	2
32-5432-SL	54"x21,6"-32,3"x1,6"	Short left	7.9"	-	1 102	1 333	-	33.7	2
32-6032-SL	60"x21,6"-32,3"x1,6"	Short left	7.9"	-	1 185	1 446	-	33.7	2
32-6632-SL	66"x21,6"-32,3"x1,6"	Short left	7.9"	-	1 261	1 551	-	33.7	2
32-7232-SL	72"x21,6"-32,3"x1,6"	Short left	7.9"	-	1 301	1 591	-		
32-4832-SR	48"x21,6"-32,3"x1,6"	Short right	7.9"	-	1 020	1 221	-	33.7	2
32-5432-SR	54"x21,6"-32,3"x1,6"	Short right	7.9"	-	1 102	1 333	-	33.7	2
32-6032-SR	60"x21,6"-32,3"x1,6"	Short right	7.9"	-	1 185	1 446	-	33.7	2
32-6632-SR	66"x21,6"-32,3"x1,6"	Short right	7.9"	-	1 261	1 551	-	33.7	2
32-7232-SR	72"x21,6"-32,3"x1,6"	Short right	7.9"	-	1 301	1 591	-	33.7	

Brackets	Color item no			Price/pc
	Grey	White	Black	
Zermatt Angle Mount 2.9"	-	91-027-2	91-027-3	57
Zermatt Angle Mount 4.5"	-	91-028-2	91-028-3	57

This product is part of the Zilenzio Pro family.
Zilenzio Pro combines the ultimate in function, design and durability.
All products in the series use stone wool for optimal sound absorption. Stone wool is recyclable, free of plastics and has the highest possible fire classification.

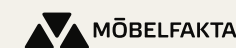

Zorla

The Zorla capitalize shelf is a mobile floor-standing room divider with sound-absorbing effect that also provides open storage. The Zorla Shelf is a valued piece of furniture for office environments! When the wooden top box is filled with our artificial plants or pot for living plants, it easily becomes a decorative element. It also fulfills an extremely important function in open room solutions through its effective sound dampening.



DESIGNER

Anca Inredningsarkitekter AB

This product is part of the Zilenzio Pro family.
Zilenzio Pro combines the ultimate in function, design and durability.
All products in the series use stone wool for optimal sound absorption. Stone wool is recyclable, free of plastics and has the highest possible fire classification.



FABRICS

Our selected fabrics are divided into four price groups, with prices ascending from group one to four.

PRICE GROUP 1

Sawana	Davis								
Cara 170	Camira								
Carlow 170	Camira								
Event Screen+ 170	Gabriel								
Mica 170	Gabriel								
Tonal 170	Gabriel								

PRICE GROUP 2

Focus M Screen 170	Gabriel								
Event	Gabriel								
Hush 170	Gabriel								
Soul Melange 170	Gabriel								
Twist 170	Gabriel								
Twist Melange 170	Gabriel								
Floyd Screen 170	Kvadrat								
Slope 170	Nevotex								
Blazer Lite 170	Camira								
Era 170	Camira								

PRICE GROUP 3

Blazer	Camira								
Era	Camira								
Main Line Flax	Camira								
Rivet	Camira								
Synergy	Camira								
Focus	Gabriel								
Focus Melange	Gabriel								
Step	Gabriel								
Step Melange	Gabriel								
Field	Kvadrat								
Floyd	Kvadrat								
Remix	Kvadrat								
Remix Screen	Kvadrat								
Revive	Kvadrat								
Broken Twill Weave	Kvadrat								
Hint 170	Kvadrat								
Reflect	Kvadrat								
Wooly	Nevotex								
Wooly wide 170	Nevotex								
Lido	Nevotex								

PRICE GROUP 4

Yoredale	Camira								
Crisp	Gabriel								
Canvas	Kvadrat								
Divina	Kvadrat								
Fiord	Kvadrat								
Hallingdal	Kvadrat								
Hero	Kvadrat								
Melange Nap	Kvadrat								
Re-wool	Kvadrat								
Steelcut	Kvadrat								
Steelcut Trio	Kvadrat								
Lani	Vescom								
Gamut	Vescom								
Barnum	Nevotex								

CERTIFICATIONS

- Recycled contents
- OEKO Tex Standard 100

- OEKO Tex Standard 100
- EU Ecolabel
- Greenguard Certificate

- EN1021-1&2
- Crib 5
- CA TB 117

DESIGN

ZORLA

Wooden frame, stone wool filled sides.
Outside covered with fabric all around.
Foot with lockable wheels

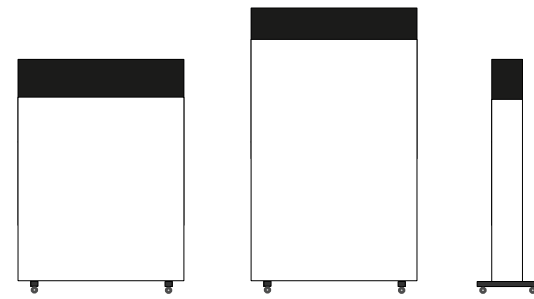

W: 47.2"
H: 47.2" incl. wheel

W: 47.2"
H: 63" incl. wheel

Frame depth: 8.8"
Foot: 21.6"x2.1"x1.8"
H: 4.1" incl. wheel

ZORLA WITH SHELF

Wooden frame, one side filled with stone wool,
fabric covered. Opposite side with shelves.
Foot with lockable wheels

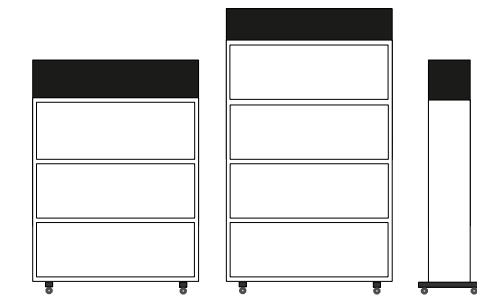

W: 47.2"
H: 54" with shelf
incl. wheel

W: 47.2"
H: 67.7" with
shelf incl. wheel

Frame depth: 31.8"
Foot: 21.6"x2.1"x1.8"
H: 4.1" incl. wheel

STANDARD COLORS



Ash veneer
natural



Ash veneer
white stained

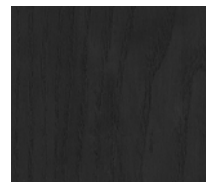

Ash veneer
black stained



Wheels Black and
Grey

MEASUREMENTS

Length: 47.2", 63", 70.8"
Height: 47.2", 63"
Metal base option reduces height to: 43.3", 59"
Depth: 8.8"

Length with shelf: 47.2"
Height with shelf: 53.9", 170.8"
Depth with shelf: 31.8"

Wooden foot: 21.6"x2.1"x1.8"
Metal foot (Plate): 9.4" x 15.7" x 0.2"

ARTIFICIAL PLANTS

Zorla 47.2"

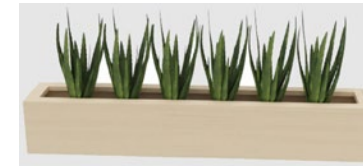

Art. no. 97-AP-120-1
(6 pcs Aloe)



Art. no. 97-AP-120-2
(3 pcs Cissus + 2 pcs Alocasia)

Zorla 63"



Art. no. 97-AP-160-1
(8 pcs Aloe)



Art. no. 97-AP-160-2
(3 pcs Cissus + 3 pcs Alocasia)

Zorla 70.9"



Art. no. 97-AP-180-1
(9 pcs Aloe)



Art. no. 97-AP-180-2
(4 pcs Cissus + 3 pcs Alocasia)

	Zorla width	Item no.	Price
Plant package - 6 pcs Aloe	47.2"	97-AP-120-1	1 596
Plant package - 3 pcs Cissus + 2 pcs Alocasia	47.2"	97-AP-120-2	900
Plant package - 8 pcs Aloe	63"	97-AP-160-1	2 129
Plant package - 3 pcs Cissus + 3 pcs Alocasia	63"	97-AP-160-2	1 123
Plant package - 9 pcs Aloe	70.9"	97-AP-180-1	2 395
Plant package - 4 pcs Cissus + 3 pcs Alocasia	70.9"	97-AP-180-2	1 274

WATERING BOX

Watering box for plants Use only for real plants.

	Box dimensions	Item no.	Price
Watering box up to width 47.2"	2 × 21.6"x7"x6.7"	97-050	148
Watering box up to width 62.9"	2 × 29.5"x7"x6.7"	97-050-1	183
Watering box up to width 70.9"	3 × 21.6"x7"x6.7"	97-050-2	221



Self-watering, spacious and practical box. For long lasting watering with a large water and soil reservoir. Made from recycled plastic

METAL FOOT

Optional metal foot*	Color			Price
	Grey	White	Black	
Zorla metal foot plate	-	97-060-1	97-060-2	318

* 2 metal feet measuring 9.4" x 15.7" x 0.2" are included
Metal base option reduces height to: 43.3", 59"
replaces the wooden base with wheels.





Item no.	Measurements WxHxD	Price gr. 1	Price gr. 2	Price gr. 3	Price gr. 4	Weight Pounds
15-1212	47.2" x 47.2" x 8.9"	4 214	4 315	4 437	4 596	99
15-1612	63.0" x 47.2" x 8.9"	4 112	4 254	4 578	4 787	121
15-1812	70.8" x 47.2" x 8.9"	4 748	4 899	5 262	5 486	143
15-1216	47.2" x 63.0" x 8.9"	4 365	4 467	4 590	4 749	121
15-1616	63.0" x 63.0" x 8.9"	4 675	4 941	5 241	5 633	153
15-1816	70.8" x 63.0" x 8.9"	5 105	5 370	5 670	6 063	167

This product is part of the Zilenzio Pro family.
Zilenzio Pro combines the ultimate in function, design and durability.
All products in the series use stone wool for optimal sound absorption. Stone wool is recyclable, free of plastics and has the highest possible fire classification.



Zorla

with shelf



Item no.	Measurements WxHxD	Price gr. 1	Price gr. 2	Price gr. 3	Price gr. 4	Weight Pounds
15-1213-H	47.2" x 53.9" x 13.6"	5 908	5 952	6 002	6 063	75
15-1613-H	63.0" x 53.9" x 13.6"	9 277	9 427	9 597	9 819	107
15-1813-H	70.8" x 53.9" x 13.6"	9 926	10 094	10 284	10 532	122
15-1217-H	47.2" x 67.7" x 13.6"	6 318	6 371	6 435	6 514	90
15-1617-H	63.0" x 67.7" x 13.6"	10 488	10 638	10 808	11 030	134
15-1817-H	70.8" x 67.7" x 13.6"	11 374	11 542	11 732	11 980	155

This product is part of the Zilenzio Pro family.
Zilenzio Pro combines the ultimate in function, design and durability.
All products in the series use stone wool for optimal sound absorption. Stone wool is recyclable, free of plastics and has the highest possible fire classification.



Arc

Arc is a sound absorbing ceiling that is used in combination with floor screen. The ceiling and floor screens together create a secluded area with a sense of space. Can be placed on its own in the room or leaning against a wall, to easily create a sense of calm.



FABRICS

Our selected fabrics are divided into price groups, with prices ascending from group two to four.

PRICE GROUP 2

Focus M Screen 170	Gabriel						
Hush 170	Gabriel						
Blazer Lite 170	Camira						

PRICE GROUP 3

Blazer	Camira						
Synergy	Camira						
Focus	Gabriel						
Focus Melange	Gabriel						

PRICE GROUP 4

Divina	Kvadrat						
Barnum	Nevotex						

CERTIFICATIONS

- Recycled contents
- OEKO Tex Standard 100

- OEKO Tex Standard 100
- EU Ecolabel
- Greenguard Certificate

- EN1021-1&2
- Crib 5
- CA TB 117

This product is part of the Zilenzio Pro family.
 Zilenzio Pro combines the ultimate in function, design and durability.
 All products in the series use stone wool for optimal sound absorption. Stone wool is recyclable, free of plastics and has the highest possible fire classification.



DESIGN

Plywood frame, externally covered with textile.
Filling comprised of stone wool with fire classification A1 (Non-combustible)

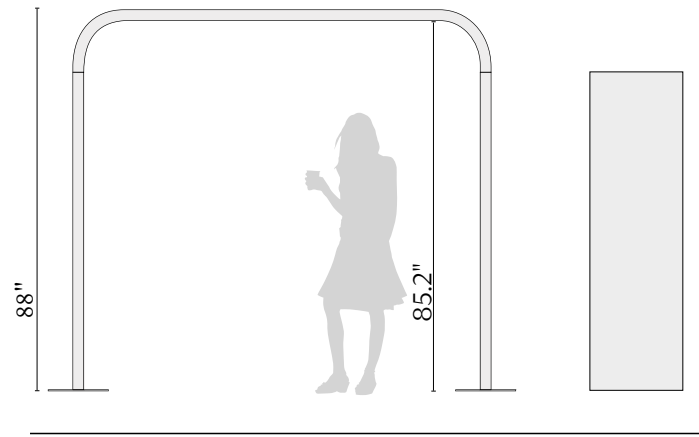

Arc lengths 59", 78.7", 98.4" is the inside dimension between the floor screens

MEASUREMENTS

Widths:	23.6", 31.5, 39.4"
Lengths:	59", 78.7, 98.4"
"The measurement is calculated as the inner dimension between the floor screens"	
Height:	87.8" incl. floor screen 74.8"
Thickness:	2.6"
Radius:	Inside 8.8" , outside 11.2"
Length of foot:	31.9"

SOUND

SS-EN ISO 354, SS-EN ISO 11654 Class A
SS-EN ISO 354:2003 evaluated ISO 20189:2018

N10
W39.4" x L59.1" 1.6

ENVIRONMENT & SAFETY

Möbelfakta Certified

BRACKETS

Standard color

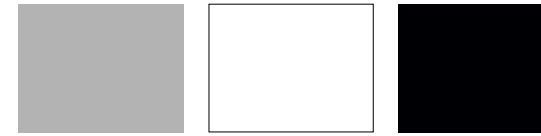

Grey RAL 9006 White RAL 9016 Black RAL 9005

Foot	Color item no			Price
	Grey	White	Black	
Arc foot pack	91-398-1	91-398-2	91-398-3	881

Arc foot pack with 8 feet and 4 couplings



Arc



Item no.	Size WxLxD	Price gr. 1	Price gr. 2	Price gr. 3	Price gr. 4	Weight Pounds
13-0615	23.6" x 59.1" x 70	-	4 979	5 729	-	176
13-0815	31.5" x 59.1" x 70	-	5 217	6 002	-	198
13-1015	39.4" x 59.1" x 70	-	5 561	6 426	-	220
13-0620	23.6" x 78.7" x 70	-	5 050	5 821	-	198
13-0820	31.5" x 78.7" x 70	-	5 299	6 132	-	220
13-1020	39.4" x 78.7" x 70	-	5 672	6 577	-	242
13-0625	23.6" x 98.4" x 70	-	5 118	5 898	-	220
13-0825	31.5" x 98.4" x 70	-	5 438	6 308	-	242
13-1025	39.4" x 98.4" x 70	-	5 797	6 945	-	265

Foot	Color item no			Price
	Grey	White	Black	
Arc foot pack	91-398-1	91-398-2	91-398-3	881

Arc foot pack with 8 feet and 4 couplings

Classic

The Classic floor screen has a stylish design with maximum sound dampening. Classic can be used alone or connected to screen different types of environments.



This product is part of the Zilenzio Pro family.
Zilenzio Pro combines the ultimate in function, design and durability.
All products in the series use stone wool for optimal sound absorption. Stone wool is recyclable, free of plastics and has the highest possible fire classification.



FABRICS

Our selected fabrics are divided into four price groups, with prices ascending from group one to four.

PRICE GROUP 1

Sawana	Davis								
Cara 170	Camira								
Carlow 170	Camira								
Event Screen+ 170	Gabriel								
Mica 170	Gabriel								
Tonal 170	Gabriel								

PRICE GROUP 2

Focus M Screen 170	Gabriel								
Event	Gabriel								
Hush 170	Gabriel								
Soul Melange 170	Gabriel								
Twist 170	Gabriel								
Twist Melange 170	Gabriel								
Floyd Screen 170	Kvadrat								
Slope 170	Nevotex								
Blazer Lite 170	Camira								
Era 170	Camira								

PRICE GROUP 3

Blazer	Camira								
Era	Camira								
Main Line Flax	Camira								
Rivet	Camira								
Synergy	Camira								
Focus	Gabriel								
Focus Melange	Gabriel								
Step	Gabriel								
Step Melange	Gabriel								
Field	Kvadrat								
Floyd	Kvadrat								
Remix	Kvadrat								
Remix Screen	Kvadrat								
Revive	Kvadrat								
Broken Twill Weave	Kvadrat								
Hint 170	Kvadrat								
Reflect	Kvadrat								
Wooly	Nevotex								
Wooly wide 170	Nevotex								
Lido	Nevotex								

PRICE GROUP 4

Yoredale	Camira								
Crisp	Gabriel								
Canvas	Kvadrat								
Divina	Kvadrat								
Fiord	Kvadrat								
Hallingdal	Kvadrat								
Hero	Kvadrat								
Melange Nap	Kvadrat								
Re-wool	Kvadrat								
Steelcut	Kvadrat								
Steelcut Trio	Kvadrat								
Lani	Vescom								
Gamut	Vescom								
Barnum	Nevotex								

CERTIFICATIONS

- Recycled contents
- OEKO Tex Standard 100

- OEKO Tex Standard 100
- EU Ecolabel
- Greenguard Certificate

- EN1021-1&2
- Crib 5
- CA TB 117

DESIGN

MDF frame, externally covered with textile.
 Filling comprised of stone wool with fire classification A1 (Non-combustible)
 Hidden magnets are included for direct connection

MEASUREMENTS

Width: 23.6", 31.5" 39,4", 47.2", 55.1", 63", 131.5"
 Height: 47.2", 59", 65", 74.8"
 Thickness: 70

SOUND

SS-EN ISO 354, ISO 11654 Class A
 SS-EN ISO 354:2003 evaluated SS 25269

N10	
31.5" x 59"	5
31.5" x 74.8"	4
47.2" x 70.9"	3

OPTIONS & CUSTOMIZATIONS

These are our standard screen options & customizations.
 For other customizations, contact support@zilenzio.com for a quote.

Customizations	Item no	Price/customization
Customization measurements	MOD-001	Offer

BRACKETS

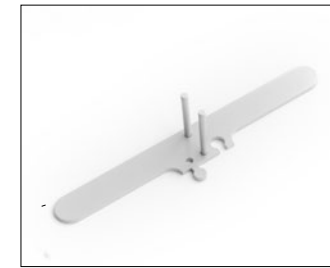

Standard color



Grey
RAL 9006



White
RAL 9016



Black
RAL 9005

Brackets	Color item no.			Price
	Grey	White	Black	
Foot	91-201	91-202	91-203	104
Top fitting straight	91-135	91-137	91-138	111
Coupling 90°	91-274	91-273	91-219	165
3-way coupling	91-275	91-390	91-220	165
4-way coupling	91-276	91-391	91-221	167

Classic



This product is part of the Zilenzio Pro family.
 Zilenzio Pro combines the ultimate in function, design and durability.
 All products in the series use stone wool for optimal sound absorption. Stone wool is recyclable, free of plastics and has the highest possible fire classification.



Art.no.	Size WxHxD	Price gr.1	Price gr.2	Price gr.3	Price gr.4	Weight Pounds	Feet pcs/screen
2-0612	23.6" x 47.2" x 70	1 004	1 152	1 372	1 618	30,8	2
2-0812	31.5" x 47.2" x 70	1 040	1 188	1 412	1 653	35,3	2
2-1012	39.4" x 47.2" x 70	1 099	1 258	1 492	1 749	44,1	2
2-1212	47.2" x 47.2" x 70	1 142	1 316	1 568	1 837	52,9	2
2-1412	55.1" x 47.2" x 70	1 247	1 426	-	-	57,3	3
2-1612	63" x 47.2" x 70	1 687	1 858	-	-	66,1	3
2-1812	70.9" x 47.2" x 70	1 737	1 917	-	-	70,6	3
2-0615	23.6" x 59.1" x 70	1 064	1 243	1 508	1 795	39,7	2
2-0815	31.5" x 59.1" x 70	1 107	1 290	1 554	1 840	44,1	2
2-1015	39.4" x 59.1" x 70	1 175	1 365	1 641	1 945	55,1	2
2-1215	47.2" x 59.1" x 70	1 232	1 429	1 724	2 040	66,1	2
2-1415	55.1" x 59.1" x 70	1 341	1 548	-	-	75	3
2-1615	63" x 59.1" x 70	1 787	1 985	-	-	86	3
2-1815	70.9" x 59.1" x 70	1 842	2 051	-	-	94,8	3
2-0616	23.6" x 65" x 70	1 111	1 310	1 605	1 922	41,9	2
2-0816	31.5" x 65" x 70	1 158	1 357	1 649	1 971	46,3	2
2-1016	39.4" x 65" x 70	1 228	1 438	1 746	2 080	57,3	2
2-1216	47.2" x 65" x 70	1 338	1 557	1 877	2 226	68,4	2
2-1416	55.1" x 65" x 70	1 399	1 620	-	-	77,2	3
2-1616	63" x 65" x 70	1 845	2 060	-	-	88,2	3
2-1816	70.9" x 65" x 70	1 907	2 130	-	-	97	3
2-0619	23.6" x 74.8" x 70	1 139	1 353	1 659	1 995	48,5	2
2-0819	31.5" x 74.8" x 70	1 210	1 418	1 728	2 060	52,9	2
2-0919	35.4" x 74.8" x 70	1 275	1 502	1 832	2 190	57,3	2
2-1019	39.4" x 74.8" x 70	1 325	1 541	1 863	2 213	66,1	2
2-1219	47.2" x 74.8" x 70	1 393	1 620	1 953	2 318	79,4	2

Brackets	Color			Price
	Grey	White	Black	
Foot	91-201	91-202	91-203	104
Top fitting straight	91-135	91-137	91-138	111
Coupling 90°	91-274	91-273	91-219	165
3-way coupling	91-275	91-390	91-220	165
4-way coupling	91-276	91-391	91-221	167

Kyoto

Kyoto is an adaptable modular system where you can build a quiet room in the open indoor landscape that is easily adapted to different room constellations. The design was inspired by the Japanese teahouses, characterized by a clear, simple and incredibly beautiful presentation.



DESIGNER

Note Design Studio

This product is part of the Zilenzio Pro family.
Zilenzio Pro combines the ultimate in function, design and durability.
All products in the series use stone wool for optimal sound absorption. Stone wool is recyclable, free of plastics and has the highest possible fire classification.



FABRICS

Our selected fabrics are divided into four price groups, with prices ascending from group one to four.

PRICE GROUP 1

Sawana	Davis								
Cara 170	Camira								
Carlow 170	Camira								
Event Screen+ 170	Gabriel								
Mica 170	Gabriel								
Tonal 170	Gabriel								

PRICE GROUP 2

Focus M Screen 170	Gabriel								
Event	Gabriel								
Hush 170	Gabriel								
Soul Melange 170	Gabriel								
Twist 170	Gabriel								
Twist Melange 170	Gabriel								
Floyd Screen 170	Kvadrat								
Slope 170	Nevotex								
Blazer Lite 170	Camira								
Era 170	Camira								

PRICE GROUP 3

Blazer	Camira								
Era	Camira								
Main Line Flax	Camira								
Rivet	Camira								
Synergy	Camira								
Focus	Gabriel								
Focus Melange	Gabriel								
Step	Gabriel								
Step Melange	Gabriel								
Field	Kvadrat								
Floyd	Kvadrat								
Remix	Kvadrat								
Remix Screen	Kvadrat								
Revive	Kvadrat								
Broken Twill Weave	Kvadrat								
Hint 170	Kvadrat								
Reflect	Kvadrat								
Wooly	Nevotex								
Wooly wide 170	Nevotex								
Lido	Nevotex								

PRICE GROUP 4

Yoredale	Camira								
Crisp	Gabriel								
Canvas	Kvadrat								
Divina	Kvadrat								
Fiord	Kvadrat								
Hallingdal	Kvadrat								
Hero	Kvadrat								
Melange Nap	Kvadrat								
Re-wool	Kvadrat								
Steelcut	Kvadrat								
Steelcut Trio	Kvadrat								
Lani	Vescom								
Gamut	Vescom								
Barnum	Nevotex								

CERTIFICATIONS

- Recycled contents
- OEKO Tex Standard 100
- EN1021-1&2
- OEKO Tex Standard 100
- EU Ecolabel
- Crib 5
- Greenguard Certificate
- CA TB 117

DESIGN

Solid wood frame construction.
 Filling comprised of stone wool with fire classification A1 (Non-combustible)
 The system consists of 3 different heights on bolts in ash, white or black, and you can choose screens with two different floor clearances, 3.9" and 11.8".

MEASUREMENTS

Length: 26.6", 31.5", 39.4", 48", 55.9", 63.8"
 Height: 51.1", 64.9", 74.8"
 Thickness, acoustic panel: 1.9"
 Thickness, post: 3.1"

Whiteboard
 Length: 21.6", 37.4"
 Height: 51.1"

Hanger: 16.9"x2.8"x3.8"

SOUND

SS-EN ISO 354, ISO 11654 Class A
 SS-EN ISO 354:2003 evaluated SS 25269
 Noise Reduction Coefficient (NRC): 0.75

N10
 W23.6"xH47.2" 9.1

ACCESSORIES & CUSTOMIZATIONS

These are our standard screen options & customizations.
 For other customizations, contact support@zilenzio.com for a quote.

Customizations	Item no	Price/customization
Customization measurements	MOD-001	Offer

Accessories	Wood			Price/pc
	Natural ash	White stained	Black stained	
Clothes hanger W16.9"	11-H430-1	11-H430-2	11-H430-3	557
*Whiteboard W21.6"	11-W550-1	11-W550-2	11-W550-3	1 385
*Whiteboard W37.4"	11-W950-1	11-W950-2	11-W950-3	1 565

*Only used with Kyoto in heights 64.9" or 74.8"

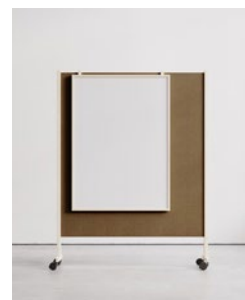

STANDARD COLORS



Natural ash White stained Black stained

POSTS

POSTS	Height	Wood			Price/pc
		Natural ash	White stained	Black stained	
Post end	51.1"	11-13-11	11-13-12	11-13-13	334
Post straight	51.1"	11-13-21	11-13-22	11-13-23	373
Post 3-way	51.1"	11-13-31	11-13-32	11-13-33	604
Post 4-way	51.1"	11-13-41	11-13-42	11-13-43	716
Post 90°	51.1"	11-13-51	11-13-52	11-13-53	502
Post straight with foot	51.1"	11-13-2F1	11-13-2F2	11-13-2F3	442
Pole end with wheels	51.1"	11-13-1FW1	11-13-1FW2	11-13-1FW3	471
Post end with foot	51.1"	11-13-1F1	11-13-1F2	11-13-1F3	402
Post end	64.9"	11-16-11	11-16-12	11-16-13	368
Post straight	64.9"	11-16-21	11-16-22	11-16-23	416
Post 3-way	64.9"	11-16-31	11-16-32	11-16-33	701
Post 4-way	64.9"	11-16-41	11-16-42	11-16-43	850
Post 90°	64.9"	11-16-51	11-16-52	11-16-53	573
Post straight with foot	64.9"	11-16-2F1	11-16-2F2	11-16-2F3	486
Pole end with wheels	64.9"	11-16-1FW1	11-16-1FW2	11-16-1FW3	506
Post end with foot	64.9"	11-16-1F1	11-16-1F2	11-16-1F3	437
Post end	74.8"	11-19-11	11-19-12	11-19-13	391
Post straight	74.8"	11-19-21	11-19-22	11-19-23	432
Post 3-way	74.8"	11-19-31	11-19-32	11-19-33	756
Post 4-way	74.8"	11-19-41	11-19-42	11-19-43	918
Post 90°	74.8"	11-19-51	11-19-52	11-19-53	610
Post straight with foot	74.8"	11-19-2F1	11-19-2F2	11-19-2F3	502
Pole end with wheels	74.8"	11-19-1FW1	11-19-1FW2	11-19-1FW3	525
Post end with foot	74.8"	11-19-1F1	11-19-1F2	11-19-1F3	459



Post end



Post straight

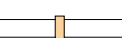

Post 90°



Post 3-way



Post 4-way



Tips!

If using more than 3 in a row, use a pole with a foot.
 For a standalone screen, a pole with a foot is always used, 2 pcs/screen.

Kyoto

3.9" from the floor



Item no.	Size		Acoustic panel Drop	Price gr. 1	Price gr. 2	Price gr. 3	Price gr. 4	Weight Pounds
	Width	Height						
11-0613-1	23.6"	51.1"	3.9"	923	1 046	1 208	1 385	13
11-0813-1	31.5"	51.1"	3.9"	1 075	1 309	1 621	1 966	17
11-1013-1	39.4"	51.1"	3.9"	1 153	1 386	1 697	2 043	24
11-1213-1	48"	51.1"	3.9"	1 232	1 466	1 778	2 122	28
11-1413-1	55.9"	* 51.1"	3.9"	1 309	1 541	-	-	33
11-1613-1	63.7"	* 51.1"	3.9"	1 384	1 619	-	-	37
11-0616-1	23.6"	64.9"	3.9"	1 072	1 226	1 431	1 655	17
11-0816-1	31.5"	64.9"	3.9"	1 256	1 554	1 948	2 387	27
11-1016-1	39.4"	64.9"	3.9"	1 346	1 642	2 038	2 476	28
11-1216-1	48"	64.9"	3.9"	1 433	1 729	2 126	2 562	35
11-1416-1	55.9"	* 64.9"	3.9"	1 522	1 818	-	-	42
11-1616-1	63.7"	* 64.9"	3.9"	1 609	1 904	-	-	48
11-0619-1	23.6"	74.8"	3.9"	1 145	1 320	1 554	1 814	22
11-0819-1	31.5"	74.8"	3.9"	1 340	1 680	2 136	2 640	29
11-1019-1	39.4"	74.8"	3.9"	1 438	1 779	2 236	2 739	35
11-1219-1	48"	74.8"	3.9"	1 530	1 872	2 326	2 831	42
11-1419-1	55.9"	* 74.8"	3.9"	1 601	1 945	-	-	49

* Width 55.9", 63.7" not possible with Sawana, price group 3, price group 4

This product is part of the Zilenzio Pro family.
*Zilenzio Pro combines the ultimate in function, design and durability.
 All products in the series use stone wool for optimal sound absorption. Stone wool is recyclable, free of plastics and has the highest possible fire classification.*



Kyoto

11.8" from the floor

Item no.	Size		Acoustic panel Drop	Price gr. 1	Price gr. 2	Price gr. 3	Price gr. 4	Weight Pounds
	Width	Height						
11-0613-3	23.6"	51.1"	11.8"	885	988	1 279	1 279	13
11-0813-3	31.5"	51.1"	11.8"	1 022	1 218	1 481	1 774	17
11-1013-3	39.4"	51.1"	11.8"	1 103	1 302	1 565	1 855	24
11-1213-3	48"	51.1"	11.8"	1 176	1 373	1 639	1 928	28
11-1413-3	55.9"	* 51.1"	11.8"	1 255	1 451	-	-	33
11-1613-3	63.7"	* 51.1"	11.8"	1 332	1 528	-	-	37
11-0616-3	23.6"	64.9"	11.8"	979	1 114	1 293	1 492	17
11-0816-3	31.5"	64.9"	11.8"	1 151	1 412	1 758	2 143	27
11-1016-3	39.4"	64.9"	11.8"	1 228	1 490	1 838	2 222	28
11-1216-3	48"	64.9"	11.8"	1 316	1 576	1 924	2 307	35
11-1416-3	55.9"	* 64.9"	11.8"	1 394	1 653	-	-	42
11-1616-3	63.7"	* 64.9"	11.8"	1 482	1 742	-	-	48
11-0619-3	23.6"	74.8"	11.8"	1 086	1 223	1 403	1 602	22
11-0819-3	31.5"	74.8"	11.8"	1 282	1 589	1 997	2 447	29
11-1019-3	39.4"	74.8"	11.8"	1 367	1 673	2 080	2 532	35
11-1219-3	48"	74.8"	11.8"	1 455	1 760	2 168	2 617	42
11-1419-3	55.9"	* 74.8"	11.8"	1 530	1 836	-	-	49

* Width 55.9", 63.7" not possible with Sawana, price group 3, price group 4

This product is part of the Zilenzio Pro family.
Zilenzio Pro combines the ultimate in function, design and durability.
All products in the series use stone wool for optimal sound absorption. Stone wool is recyclable, free of plastics and has the highest possible fire classification.



Mezzo

Mezzo is a two-in-one versatile mobile project screen and bulletin board; sound absorbing with a white glass whiteboard and a notice board on the fabric-covered part – all combined into one product.



DESIGNER

Note Design Studio

This product is part of the Zilenzio Pro family.
Zilenzio Pro combines the ultimate in function, design and durability.
All products in the series use stone wool for optimal sound absorption. Stone wool is recyclable, free of plastics and has the highest possible fire classification.



FABRICS

Our selected fabrics are divided into four price groups, with prices ascending from group one to four.

PRICE GROUP 1

Sawana	Davis								
Cara 170	Camira								
Carlow 170	Camira								
Event Screen+ 170	Gabriel								
Mica 170	Gabriel								
Tonal 170	Gabriel								

PRICE GROUP 2

Focus M Screen 170	Gabriel								
Event	Gabriel								
Hush 170	Gabriel								
Soul Melange 170	Gabriel								
Twist 170	Gabriel								
Twist Melange 170	Gabriel								
Floyd Screen 170	Kvadrat								
Slope 170	Nevotex								
Blazer Lite 170	Camira								
Era 170	Camira								

PRICE GROUP 3

Blazer	Camira								
Era	Camira								
Main Line Flax	Camira								
Rivet	Camira								
Synergy	Camira								
Focus	Gabriel								
Focus Melange	Gabriel								
Step	Gabriel								
Step Melange	Gabriel								
Field	Kvadrat								
Floyd	Kvadrat								
Remix	Kvadrat								
Remix Screen	Kvadrat								
Revive	Kvadrat								
Broken Twill Weave	Kvadrat								
Hint 170	Kvadrat								
Reflect	Kvadrat								
Wooly	Nevotex								
Wooly wide 170	Nevotex								
Lido	Nevotex								

PRICE GROUP 4

Yoredale	Camira								
Crisp	Gabriel								
Canvas	Kvadrat								
Divina	Kvadrat								
Fiord	Kvadrat								
Hallingdal	Kvadrat								
Hero	Kvadrat								
Melange Nap	Kvadrat								
Re-wool	Kvadrat								
Steelcut	Kvadrat								
Steelcut Trio	Kvadrat								
Lani	Vescom								
Gamut	Vescom								
Barnum	Nevotex								

CERTIFICATIONS

- Recycled contents
- OEKO Tex Standard 100

- OEKO Tex Standard 100
- EU Ecolabel
- Greenguard Certificate

- EN1021-1&2
- Crib 5
- CA TB 117

Mezzo



Item no.	Form	Color	Measurements	Price gr. 1	Price gr. 2	Price gr. 3	Price gr. 4	Weight
		Stand & wheels	WxHxD					Pounds
57-0819-s	Tall	Black	31.5" x 74.8" x 1.8"	3 212	3 297	3 434	3 558	55
57-0819-v	Tall	White	31.5" x 74.8" x 1.8"	3 212	3 297	3 434	3 558	55
57-1619-s	Wide	Black	63" x 74.8" x 1.8"	3 894	4 054	4 299	4 541	207
57-1619-v	Wide	White	63" x 74.8" x 1.8"	3 894	4 054	4 299	4 541	207

Item no.	Options	Price
57-MOD-01	Initial cost of custom paint RAL	10000

DESIGN

Chipboard frame, stone wool filling, fabric covered.
 One side features a white glass whiteboard.
 Legs and handles are made of steel painted black or white.
 The frame has a shelf for pens.
 The wheels are lockable.

STANDARD LACQUER STAND

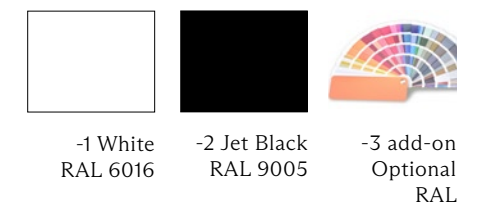

One side of the screen has a white glass whiteboard

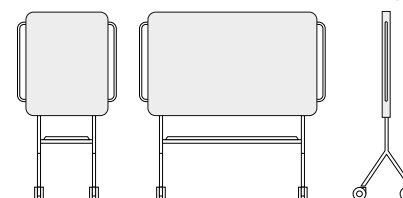

Mezzo Tall
800x1900

Mezzo Wide
1600x1900

Skog

The Skog floor screen has high quality design and sound attenuation and can be used both in the interior design of public spaces and as screening in office environments.



DESIGNER

Note Design Studio

This product is part of the Zilenzio Pro family.
Zilenzio Pro combines the ultimate in function, design and durability.
All products in the series use stone wool for optimal sound absorption. Stone wool is recyclable, free of plastics and has the highest possible fire classification.



FABRICS

Our selected fabrics are divided into four price groups, with prices ascending from group one to four.

PRICE GROUP 1

Sawana	Davis								
Cara 170	Camira								
Carlow 170	Camira								
Event Screen+ 170	Gabriel								
Mica 170	Gabriel								
Tonal 170	Gabriel								

PRICE GROUP 2

Focus M Screen 170	Gabriel								
Event	Gabriel								
Hush 170	Gabriel								
Soul Melange 170	Gabriel								
Twist 170	Gabriel								
Twist Melange 170	Gabriel								
Floyd Screen 170	Kvadrat								
Slope 170	Nevotex								
Blazer Lite 170	Camira								
Era 170	Camira								

PRICE GROUP 3

Blazer	Camira								
Era	Camira								
Main Line Flax	Camira								
Rivet	Camira								
Synergy	Camira								
Focus	Gabriel								
Focus Melange	Gabriel								
Step	Gabriel								
Step Melange	Gabriel								
Field	Kvadrat								
Floyd	Kvadrat								
Remix	Kvadrat								
Remix Screen	Kvadrat								
Revive	Kvadrat								
Broken Twill Weave	Kvadrat								
Hint 170	Kvadrat								
Reflect	Kvadrat								
Wooly	Nevotex								
Wooly wide 170	Nevotex								
Lido	Nevotex								

PRICE GROUP 4

Yoredale	Camira								
Crisp	Gabriel								
Canvas	Kvadrat								
Divina	Kvadrat								
Fiord	Kvadrat								
Hallingdal	Kvadrat								
Hero	Kvadrat								
Melange Nap	Kvadrat								
Re-wool	Kvadrat								
Steelcut	Kvadrat								
Steelcut Trio	Kvadrat								
Lani	Vescom								
Gamut	Vescom								
Barnum	Nevotex								

CERTIFICATIONS

- Recycled contents
- OEKO Tex Standard 100
- EU Ecolabel
- Greenguard Certificate
- EN1021-1&2
- Crib 5
- CA TB 117

DESIGN

Wooden frame, filling comprised of stone wool with fire classification A1 (Non-combustible)
Foot on base plate in lacquered steel RAL 7032. Post in white-stained solid ash.

STANDARD COLOR



White stained ash Silicon Grey
RAL 7032

MEASUREMENTS

Round:	Ø 100.8", H: 130.8"
Square:	W: 47.2", H: 59"
Wide:	W: 63"/70"/78.7", H: 59"
Tall:	W: 23.6", H: 181.9"
Thickness:	1.9"
Height at foot:	11.8"
Foot plate Round:	Ø 19.2"
Foot plate other models:	19.2"×19.2"

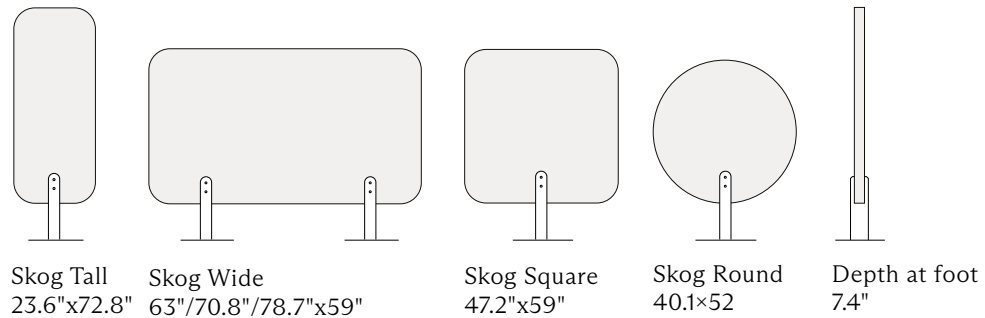

SOUND

SS-EN ISO 354, ISO 11654 Class A
SS-EN ISO 354:2003 evaluated SS 25269

ENVIRONMENT & SAFETY

Möbelfakta Certified
EN 1023-1:1996
EN 1023-2:78.7"
EN 1023-3:78.7"
EN 14073-2





Item no.	Form	Measurements WxHxD	Price gr. 1	Price gr. 2	Price gr. 3	Price gr. 4	Weight Pounds
7-1013	Round	40.2" x 52" x 1.9"	2 310	2 452	2 641	2 850	59,5
7-1215	Square	47.2" x 59.1" x 1.9"	2 223	2 442	2 761	3 087	70,6
7-0618	Tall	23.6" x 72.8" x 1.9"	2 099	2 323	2 655	2 992	83,8
7-1615	Wide	63" x 59.1" x 1.9"	3 427	3 700	4 104	4 511	114,7
7-1815	Wide	70.9" x 59.1" x 1.9"	3 518	3 821	4 268	4 719	123,5
7-2015	Wide	78.7" x 59.1" x 1.9"	3 607	3 942	4 432	4 926	130,1

Item no.	Options	Price
7-MOD-02	Initial cost of custom lacquer foot RAL	1 361
7-MOD-01	Initial cost custom varnish post NCS	227

This product is part of the Zilenzio Pro family.
Zilenzio Pro combines the ultimate in function, design and durability.
All products in the series use stone wool for optimal sound absorption. Stone wool is recyclable, free of plastics and has the highest possible fire classification.



Dezibel Floor

Dezibel Floor has a minimalistic design combined with maximum noise reduction. It is design to create a good acoustic environment between workspaces. It contains stone wool that provides a comfortable sound environment. The floor screen is available in a wide range of fabrics, allowing you to customize texture and color.

Dezibel Floor has removable fabric as an option at no extra cost.



This product is part of the Zilenzio Pro family.
Zilenzio Pro combines the ultimate in function, design and durability.
All products in the series use stone wool for optimal sound absorption. Stone wool is recyclable, free of plastics and has the highest possible fire classification.



FABRICS

Our selected fabrics are divided into four price groups, with prices ascending from group one to four.

PRICE GROUP 1

Sawana	Davis								
Cara 170	Camira								
Carlow 170	Camira								
Event Screen+ 170	Gabriel								
Mica 170	Gabriel								
Tonal 170	Gabriel								

PRICE GROUP 2

Focus M Screen 170	Gabriel								
Event	Gabriel								
Hush 170	Gabriel								
Soul Melange 170	Gabriel								
Twist 170	Gabriel								
Twist Melange 170	Gabriel								
Floyd Screen 170	Kvadrat								
Slope 170	Nevotex								
Blazer Lite 170	Camira								
Era 170	Camira								

PRICE GROUP 3

Blazer	Camira								
Era	Camira								
Main Line Flax	Camira								
Rivet	Camira								
Synergy	Camira								
Focus	Gabriel								
Focus Melange	Gabriel								
Step	Gabriel								
Step Melange	Gabriel								
Field	Kvadrat								
Floyd	Kvadrat								
Remix	Kvadrat								
Remix Screen	Kvadrat								
Revive	Kvadrat								
Broken Twill Weave	Kvadrat								
Hint 170	Kvadrat								
Reflect	Kvadrat								
Wooly	Nevotex								
Wooly wide 170	Nevotex								
Lido	Nevotex								

PRICE GROUP 4

Yoredale	Camira								
Crisp	Gabriel								
Canvas	Kvadrat								
Divina	Kvadrat								
Fiord	Kvadrat								
Hallingdal	Kvadrat								
Hero	Kvadrat								
Melange Nap	Kvadrat								
Re-wool	Kvadrat								
Steelcut	Kvadrat								
Steelcut Trio	Kvadrat								
Lani	Vescom								
Gamut	Vescom								
Barnum	Nevotex								

CERTIFICATIONS

- Recycled contents
- OEKO Tex Standard 100
- EN1021-1&2
- OEKO Tex Standard 100
- EU Ecolabel
- Crib 5
- Greenguard Certificate
- CA TB 117

DESIGN

Solid wood frame construction (FSC).
Filling 1.6" comprised of stone wool with fire classification A1 (Non-combustible)
free from plastics and polyethers.
Feet in natural or black-stained oak.

MEASUREMENTS

Length:	31.5", 33", 37", 39.4", 47.2", 48.8", 56.6", 56.7", 64.5", 181.6" (64.5" and 181.6" have a maximum height of 63")
Height:	51.1", 63", 74.8"
Thickness:	1.6"
Beam foot:	14.1" x 1.6" x 1.6"
Metal foot:	14.1" x 1.6" x 0.2"

SOUND

SS-EN ISO 354, ISO 11654 Class A
SS-EN ISO 354:2003 evaluated SS 25269
Noise Reduction Coefficient (NRC): 0.55

N10	
1840x63"	2.7
840x51.1"	7.1

OPTIONS & CUSTOMIZATIONS

These are our standard screen options & customizations.
For other customizations, contact support@zilenzio.com for a quote.

Customizations	Item no	Price/customization
Customization measurements	MOD-001	Offer
Beam base		Offer

ENVIRONMENT & SAFETY

Möbelfakta Certified Reg. No.: 0120170605
EN 1023-1:1996
EN 1023-2:78.7"
EN 1023-3:78.7"
EN 14073-2

BRACKETS

Brackets - Wood	Color item no.		Price
	Oak	Black	
Beam foot	91-506-1	91-506-2	74
Cube foot	91-505-1	91-505-2	52
Connection pack Beam 2-screen	91-521-1	91-521-2	156
Connection pack 2-screen	91-517-1	91-517-2	96
Connection pack 3-screen	91-518-1	91-518-2	122
Connection pack 4-screen	91-519-1	91-519-2	194
Connection pack T-screen	91-520-1	91-520-2	169



Add-on for Beam Foot	Price	
KIT Wheels (2 pcs)*	97-041	82

* NOTE! Wheels only
For each Beam foot add 1 KIT wheel

Brackets - Metal	White	Black	Price
	RAL 9016	RAL 9005	
Metal Beam foot	91-504-3	91-504-2	74
Metal Cube foot	91-540-3	91-540-1	52
Metal Connection pack 2-screen	91-552-3	91-552-1	93
Metal Connection pack 3-screen	91-553-3	91-553-1	119
Metal Connection pack 4-screen	91-554-3	91-554-1	183
Metal Connection pack T-screen	91-555-3	91-555-1	156
Metal Connection pack Beam 2-screen	91-556-3	91-556-1	156
Top Fittings high+low incl. feet	-	91-522-1	61

Color

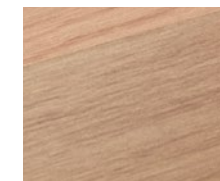

Oak

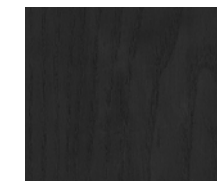

Black stained oak



Metal White
RAL 9016



Metal Black
RAL 9005



BEAM & CUBE FOOT

Beam foot oak (item no. 91-506-1)
Beam foot black (item no. 91-506-2)



Cube foot oak (item no. 91-505-1)
Cube foot black (item 91-505-2)



Beam foot metal (item no. 91-504-2)



Cube foot metal (item no. 91-540-1)

COUPLING BEAM 2 SCREENS



Connection pack Beam 2-screen oak
Connection pack Beam 2-screen black

(item no. 91-521-1)
(item no. 91-521-2)

Top view

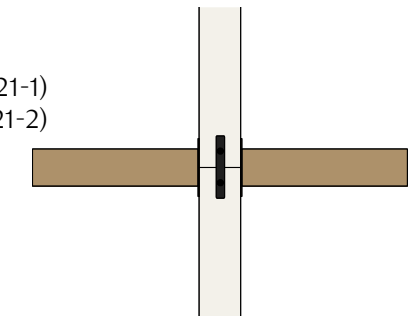

Connection pack Beam 2-screen metal

(item no. 91-556-1)

COUPLING 2 SCREENS



Connection pack 2-screen oak (item no. 91-517-1)
 Connection pack 2-screen black (item no. 91-517-2)



Connection pack 2-screen metal (item no. 91-552-1)

Top view

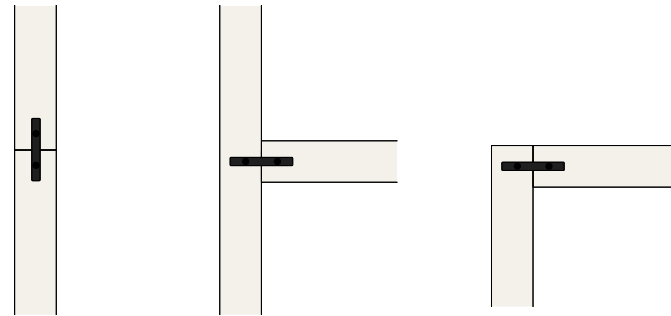

COUPLING 4 SCREENS



Connection pack 4-screen oak (item no. 91-519-1)
 Connection pack 4-screen black (item no. 91-519-2)



Connection pack 4-screen metal (item no. 91-554-1)

Top view

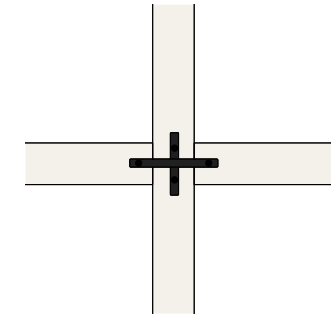

COUPLING 3 SCREENS



Connection pack 3-screen oak (item no. 91-518-1)
 Connection pack 3-screen black (item no. 91-518-2)



Connection pack 3-screen metal (item no. 91-553-1)

Top view

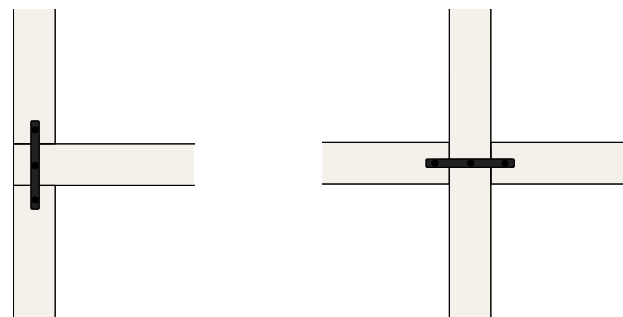

COUPLING (T) 3 SCREENS



Connection pack T-screen oak (item no. 91-520-1)
 Connection pack T-screen black (item no. 91-520-2)



Connection pack T-screen-screen metal (item no. 91-555-1)

Top view

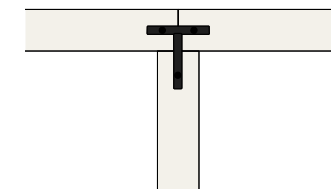

EXAMPLE (STRAIGHT)

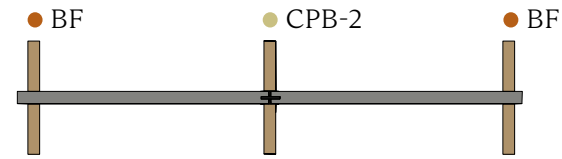

EXAMPLE (L-BOOTH)

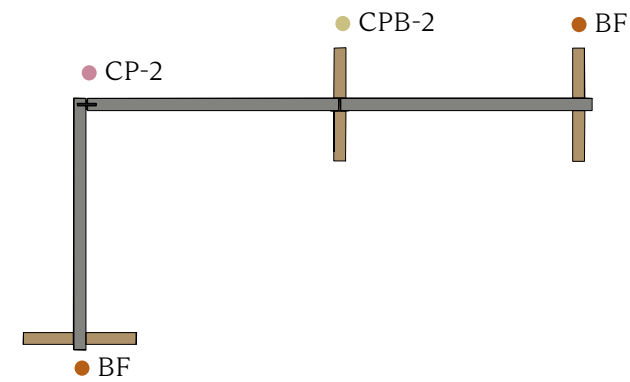

EXAMPLE (CP-3)

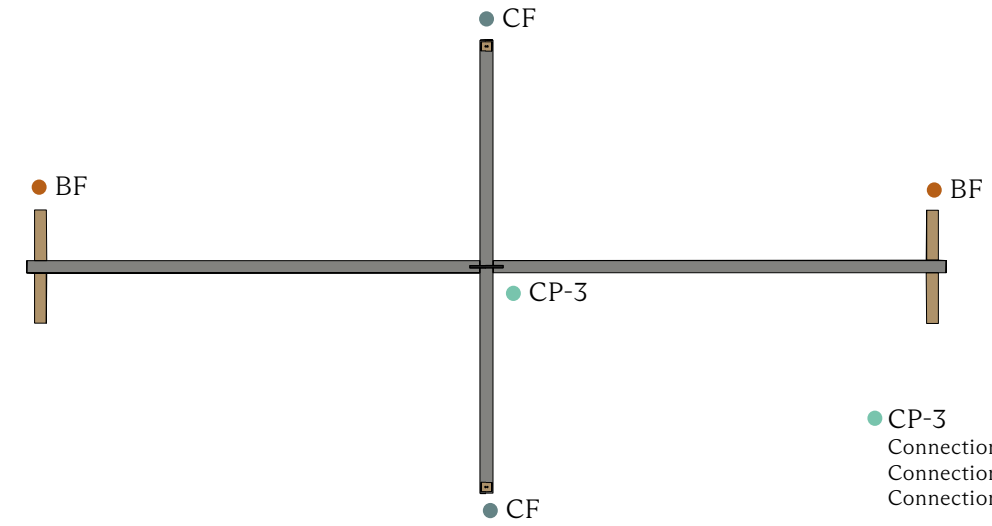

- CP-3
Connection pack 3-screen oak (item no. 91-518-1)
Connection pack 3-screen black (item no. 91-518-2)
Connection pack 3-screen metal (item no. 91-553-1)

EXAMPLE (2-BOOTH)

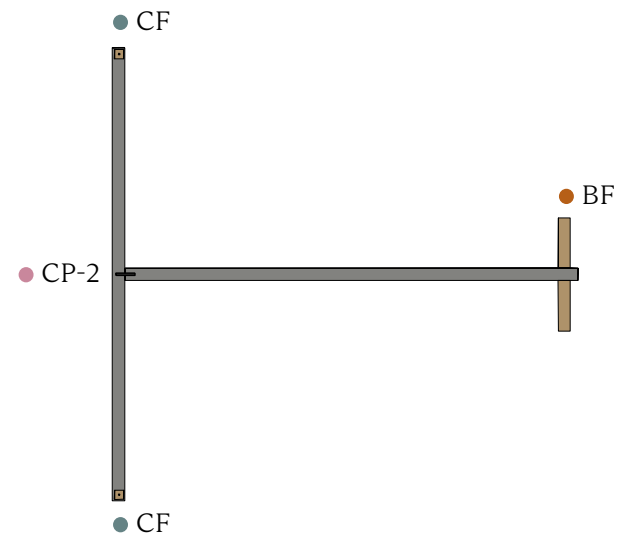

EXAMPLE (H-BOOTH)

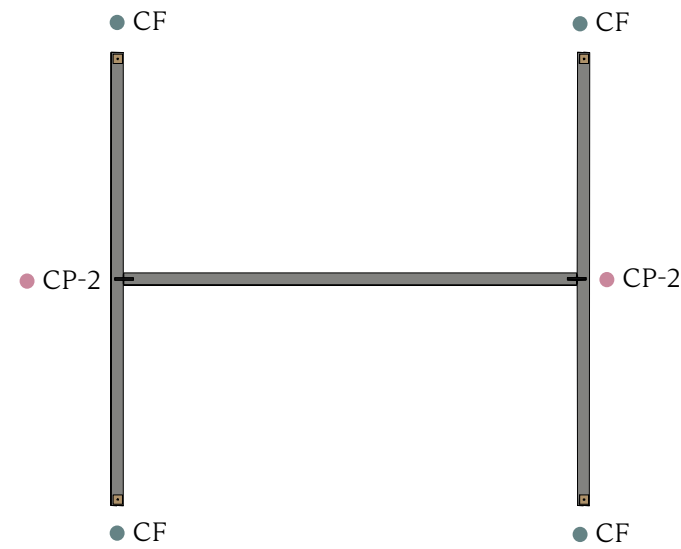

EXAMPLE (CP-T)

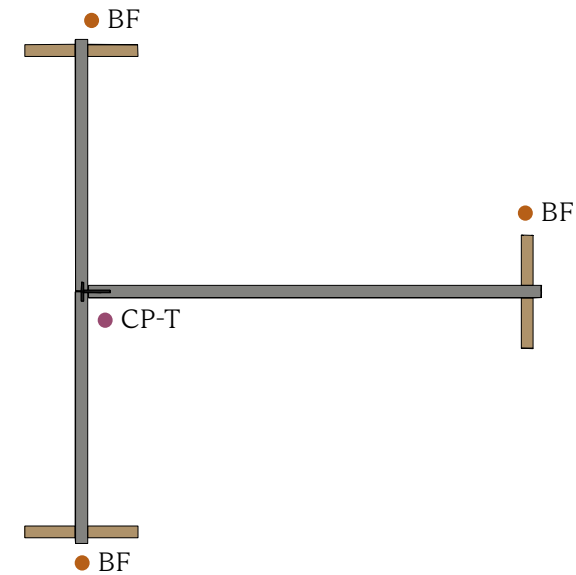

- CP-T
Connection pack T-screen oak (item no. 91-520-1)
Connection pack T-screen black (item no. 91-520-2)
Connection pack T-screen metal (item no. 91-555-1)

- BF
Beam foot oak (item no. 91-506-1)
Beam foot black (item no. 91-506-2)
Beam foot metal (item no. 91-504-2)

- CF
Cube foot oak (item no. 91-505-1)
Cube foot black (item no. 91-505-2)
Cube foot metal (item no. 91-540-1)

- CPB-2
Connection pack Beam 2-screen oak (item no. 91-521-1)
Connection pack Beam 2-screen black (item no. 91-521-2)
Connection pack Beam 2-screen metal (item no. 91-556-1)

- CP-2
Connection pack 2-screen oak (item no. 91-517-1)
Connection pack 2-screen black (item no. 91-517-2)
Connection pack 2-screen black (item no. 91-517-2)
Connection pack 2-screen metal (item no. 91-552-1)

EXAMPLE (CP-4)

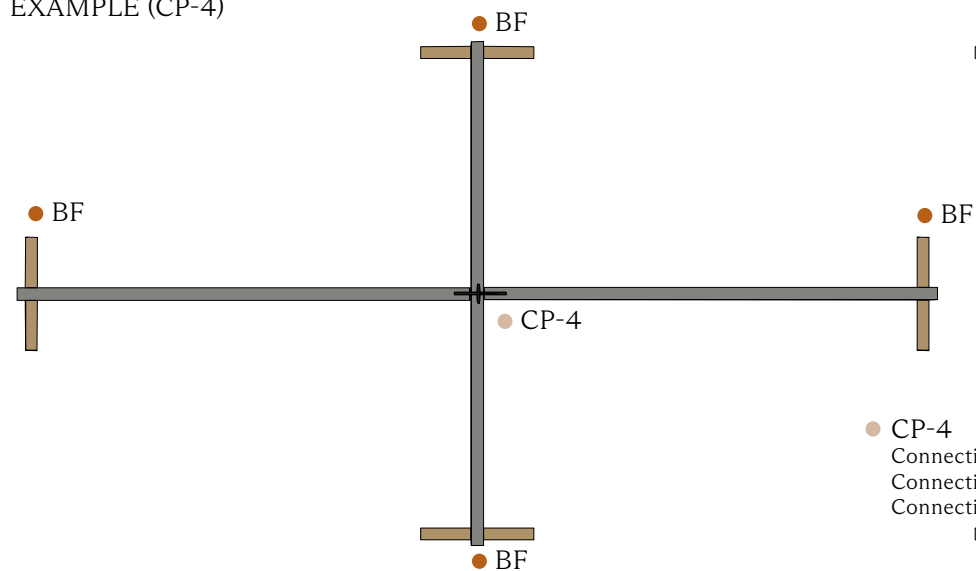

- CP-4
Connection pack 4-screen oak (item no. 91-519-1)
Connection pack 4-screen black (item no. 91-519-2)
Connection pack 4-screen metal (item no. 91-554-1)

Dezibel Floor

with removable fabric



Item no.	Size WxHxD	Price gr. 1	Price gr. 2	Price gr. 3	Price gr. 4	Weight Pounds
37-0813-R	31.5" x 51.2" x 1.6"	922	1 003	1 156	1 293	8.2
37-08413-R	33.1" x 51.2" x 1.6"	933	1 023	1 180	1 322	8.6
37-09413-R	37" x 51.2" x 1.6"	953	1 050	1 220	1 383	9.6
37-1013-R	39.4" x 51.2" x 1.6"	974	1 076	1 257	1 430	10.2
37-1213-R	47.2" x 51.2" x 1.6"	1 034	1 159	1 368	1 575	12.2
37-12413-R	48.8" x 51.2" x 1.6"	1 046	1 175	1 392	1 604	12.7
37-14413-R	56.7" x 51.2" x 1.6"	1 087	1 244	1 489	1 736	15.4
37-16413-R	64.6" x 51.2" x 1.6"	1 432	1 595	1 894	2 163	16.2
37-18413-R	72.4" x 51.2" x 1.6"	1 526	1 707	2 036	2 341	17.3
37-0816-R	31.5" x 63" x 1.6"	968	1 052	1 457	1 727	10.1
37-08416-R	33.1" x 63" x 1.6"	974	1 062	1 460	1 731	10.1
37-09416-R	37" x 63" x 1.6"	1 015	1 111	1 494	1 767	11.9
37-1016-R	39.4" x 63" x 1.6"	1 034	1 138	1 509	1 778	12.6
37-1216-R	47.2" x 63" x 1.6"	1 103	1 233	1 570	1 840	15.1
37-12416-R	48.8" x 63" x 1.6"	1 106	1 241	1 575	1 845	15.6
37-14416-R	56.7" x 63" x 1.6"	1 167*	1 323	2 248*	2 910*	16.6
37-16416-R	64.6" x 63" x 1.6"	1 513*	1 679	2 861*	3 708*	19.0
37-18416-R	72.4" x 63" x 1.6"	1 641*	1 826	3 168*	4 126*	21.3
37-0819-R	31.5" x 74.8" x 1.6"	1 114	1 316	1 630	1 953	12.0
37-08419-R	33.1" x 74.8" x 1.6"	1 124	1 327	1 640	1 962	12.6
37-09419-R	37" x 74.8" x 1.6"	1 157	1 357	1 673	1 994	14.0
37-1019-R	39.4" x 74.8" x 1.6"	1 181	1 385	1 698	2 020	15.0
37-1219-R	47.2" x 74.8" x 1.6"	1 236	1 439	1 754	2 077	18.0
37-12419-R	48.8" x 74.8" x 1.6"	1 241	1 447	1 764	2 084	18.6
37-14419-R	56.7" x 74.8" x 1.6"	1 322*	1 527	2 711*	3 552*	19.8

* Fabrics with a fabric width other than 66.9" will be sewn with a joint if the screen dimensions are 56.7"x63" or larger.

This product is part of the Zilenzio Pro family.
*Zilenzio Pro combines the ultimate in function, design and durability.
 All products in the series use stone wool for optimal sound absorption. Stone wool is recyclable, free of plastics and has the highest possible fire classification.*



Dezibel Floor



Item no.	Size WxHxD	Price gr. 1	Price gr. 2	Price gr. 3	Price gr. 4	Weight Pounds
37-0813	31.5" x 51.2" x 1.6"	922	1 003	1 156	1 293	8.2
37-08413	33.1" x 51.2" x 1.6"	933	1 023	1 180	1 322	8.6
37-09413	37" x 51.2" x 1.6"	953	1 050	1 220	1 383	9.6
37-1013	39.4" x 51.2" x 1.6"	974	1 076	1 257	1 430	10.2
37-1213	47.2" x 51.2" x 1.6"	1 034	1 159	1 368	1 575	12.2
37-12413	48.8" x 51.2" x 1.6"	1 046	1 175	1 392	1 604	12.7
37-14413	56.7" x 51.2" x 1.6"	1 087	1 244	1 489	1 736	15.4
37-16413	64.6" x 51.2" x 1.6"	1 432	1 595	1 894	2 163	16.2
37-18413	72.4" x 51.2" x 1.6"	1 526	1 707	2 036	2 341	17.3
37-0816	31.5" x 63" x 1.6"	968	1 052	1 457	1 727	10.1
37-08416	33.1" x 63" x 1.6"	974	1 062	1 460	1 731	10.1
37-09416	37" x 63" x 1.6"	1 015	1 111	1 494	1 767	11.9
37-1016	39.4" x 63" x 1.6"	1 034	1 138	1 509	1 778	12.6
37-1216	47.2" x 63" x 1.6"	1 103	1 233	1 570	1 840	15.1
37-12416	48.8" x 63" x 1.6"	1 106	1 241	1 575	1 845	15.6
37-14416	56.7" x 63" x 1.6"	* 1 167*	1 323	2 268*	2 945*	16.6
37-16416	64.6" x 63" x 1.6"	* 1 513*	1 679	2 909*	3 788*	19.0
37-18416	72.4" x 63" x 1.6"	* 1 641*	1 826	3 218*	4 210*	21.3
37-0819	31.5" x 74.8" x 1.6"	1 114	1 316	1 630	1 953	12.0
37-08419	33.1" x 74.8" x 1.6"	1 124	1 327	1 640	1 962	12.6
37-09419	37" x 74.8" x 1.6"	1 157	1 357	1 673	1 994	14.0
37-1019	39.4" x 74.8" x 1.6"	1 181	1 385	1 698	2 020	15.0
37-1219	47.2" x 74.8" x 1.6"	1 236	1 439	1 754	2 077	18.0
37-12419	48.8" x 74.8" x 1.6"	1 241	1 447	1 764	2 084	18.6
37-14419	56.7" x 74.8" x 1.6"	1 322	1 527	2 740*	3 601*	19.8

* Fabrics with a fabric width other than 66.9" will be sewn with a joint if the screen dimensions are 56.7"x63" or larger.

This product is part of the Zilenzio Pro family.
Zilenzio Pro combines the ultimate in function, design and durability.
All products in the series use stone wool for optimal sound absorption. Stone wool is recyclable, free of plastics and has the highest possible fire classification.



Optima Floor

Optima is environmentally friendly in a number of ways. It is made up of recycled PET and has sound absorption class A. The screen can easily be covered with a fabric that can be changed to another fabric or color after any number of years. The screens are light and can therefore be ergonomically mounted. Meets all the Möbelfakta requirements for the environment, quality and social responsibility.



FABRICS

Our selected fabrics are divided into four price groups, with prices ascending from group one to four.

PRICE GROUP 1

Sawana	Davis						
Cara 170	Camira						
Carlow 170	Camira						
Event Screen+ 170	Gabriel						
Mica 170	Gabriel						
Tonal 170	Gabriel						

PRICE GROUP 2

Focus M Screen 170	Gabriel						
Event	Gabriel						
Hush 170	Gabriel						
Soul Melange 170	Gabriel						
Twist 170	Gabriel						
Twist Melange 170	Gabriel						
Floyd Screen 170	Kvadrat						
Slope 170	Nevotex						
Blazer Lite 170	Camira						
Era 170	Camira						

PRICE GROUP 3

Blazer	Camira						
Era	Camira						
Main Line Flax	Camira						
Rivet	Camira						
Synergy	Camira						
Focus	Gabriel						
Focus Melange	Gabriel						
Step	Gabriel						
Step Melange	Gabriel						
Field	Kvadrat						
Floyd	Kvadrat						
Remix	Kvadrat						
Remix Screen	Kvadrat						
Revive	Kvadrat						
Broken Twill Weave	Kvadrat						
Hint 170	Kvadrat						
Reflect	Kvadrat						
Wooly	Nevotex						
Wooly wide 170	Nevotex						
Lido	Nevotex						

PRICE GROUP 4

Yoredale	Camira						
Crisp	Gabriel						
Canvas	Kvadrat						
Divina	Kvadrat						
Fiord	Kvadrat						
Hallingdal	Kvadrat						
Hero	Kvadrat						
Melange Nap	Kvadrat						
Re-wool	Kvadrat						
Steelcut	Kvadrat						
Steelcut Trio	Kvadrat						
Lani	Vescom						
Gamut	Vescom						
Barnum	Nevotex						

CERTIFICATIONS

- Recycled contents
- OEKO Tex Standard 100

- OEKO Tex Standard 100
- EU Ecolabel
- Greenguard Certificate

- EN1021-1&2
- Crib 5
- CA TB 117

DESIGN

Solid wood frame construction. Filling consists of A-class recycled PET fiber, with good sound-absorbing properties.

MEASUREMENTS

Length:	31.5", 33", 37", 39.4", 47.2", 48.8", 56.6", 56.7", 64.5", 181.6" (64.5" and 181.6" have a maximum height of 63")
Height:	51.1", 63", 74.8"
Thickness:	1.6"
Beam foot:	14.1" x 1.6" x 1.6"
Metal foot:	14.1" x 1.6" x 0.2"

SOUND

SS-EN ISO 354, ISO 11654 Class A
SS-EN ISO 354:2003 evaluated SS 25269

ENVIRONMENT & SAFETY

Möbelfakta Certified Reg. No.: 0120170605
EN 1023-1:1996
EN 1023-2:78.7"
EN 1023-3:78.7"
EN 14073-2

OPTIONS & CUSTOMIZATIONS

These are our standard screen options & customizations.
For other customizations, contact support@zilenzio.com for a quote.

Customizations	Item no	Price/customization
Customization measurements	MOD-001	Offer
Beam base		Offer

BRACKETS

Brackets - Wood	Color item no.		Price
	Oak	Black	
Beam foot	91-506-1	91-506-2	74
Cube foot	91-505-1	91-505-2	52
Connection pack Beam 2-screen	91-521-1	91-521-2	156
Connection pack 2-screen	91-517-1	91-517-2	96
Connection pack 3-screen	91-518-1	91-518-2	122
Connection pack 4-screen	91-519-1	91-519-2	194
Connection pack T-screen	91-520-1	91-520-2	169



Add-on for Beam Foot	Price	
KIT Wheels (2 pcs)*	97-041	82

* NOTE! Wheels only
For each Beam foot add 1 KIT wheel

Brackets - Metal	White	Black	Price
	RAL 9016	RAL 9005	
Metal Beam foot	91-504-3	91-504-2	74
Metal Cube foot	91-540-3	91-540-1	52
Metal Connection pack 2-screen	91-552-3	91-552-1	93
Metal Connection pack 3-screen	91-553-3	91-553-1	119
Metal Connection pack 4-screen	91-554-3	91-554-1	183
Metal Connection pack T-screen	91-555-3	91-555-1	156
Metal Connection pack Beam 2-screen	91-556-3	91-556-1	156
Top Fittings high+low incl. feet	-	91-522-1	61

COLOR

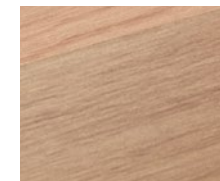

Oak



Black stained oak



Metal White
RAL 9016



Metal Black
RAL 9005

Optima Floor



Item no.	Size WxHxD	Price gr. 1	Price gr. 2	Price gr. 3	Price gr. 4
27-0813	31.5" x 51.2" x 1.6"	719	785	903	1 012
27-08413	33.1" x 51.2" x 1.6"	729	797	921	1 033
27-09413	37" x 51.2" x 1.6"	742	817	953	1 080
27-1013	39.4" x 51.2" x 1.6"	755	838	979	1 116
27-1213	47.2" x 51.2" x 1.6"	802	901	1 067	1 228
27-12413	48.8" x 51.2" x 1.6"	808	913	1 085	1 251
27-14413	56.7" x 51.2" x 1.6"	845	962	1 160	1 353
27-16413	64.6" x 51.2" x 1.6"	1 103	1 236	1 469	1 687
27-18413	72.4" x 51.2" x 1.6"	1 177	1 322	1 585	1 823
27-0816	31.5" x 63" x 1.6"	750	817	1 137	1 355
27-08416	33.1" x 63" x 1.6"	757	826	1 142	1 359
27-09416	37" x 63" x 1.6"	785	863	1 166	1 383
27-1016	39.4" x 63" x 1.6"	801	885	1 179	1 393
27-1216	47.2" x 63" x 1.6"	852	954	1 224	1 440
27-12416	48.8" x 63" x 1.6"	855	962	1 226	1 442
27-14416	56.7" x 63" x 1.6"	*	900	1 023	-
27-16416	64.6" x 63" x 1.6"	*	1 165	1 292	-
27-18416	72.4" x 63" x 1.6"	*	1 267	1 415	-
27-0819	31.5" x 74.8" x 1.6"	866	1 028	1 275	1 530
27-08419	33.1" x 74.8" x 1.6"	875	1 040	1 285	1 540
27-09419	37" x 74.8" x 1.6"	895	1 059	1 308	1 564
27-1019	39.4" x 74.8" x 1.6"	915	1 078	1 326	1 579
27-1219	47.2" x 74.8" x 1.6"	956	1 120	1 370	1 624
27-12419	48.8" x 74.8" x 1.6"	961	1 124	1 373	1 629
27-14419	56.7" x 74.8" x 1.6"	*	1 018	1 180	-

* Fabrics with a fabric width other than 66.9" will be sewn with a joint if the screen dimensions are 56.7"x63" or larger.

Optima Floor

with removable fabric



Item no.	Size WxHxD	Price gr. 1	Price gr. 2	Price gr. 3	Price gr. 4
27-0813-R	31.5" x 51.2" x 1.6"	763	825	942	1 052
27-08413-R	33.1" x 51.2" x 1.6"	768	839	962	1 074
27-09413-R	37" x 51.2" x 1.6"	783	861	998	1 122
27-1013-R	39.4" x 51.2" x 1.6"	801	881	1 019	1 156
27-1213-R	47.2" x 51.2" x 1.6"	844	944	1 106	1 269
27-12413-R	48.8" x 51.2" x 1.6"	853	952	1 125	1 291
27-14413-R	56.7" x 51.2" x 1.6"	885	1 004	1 199	1 390
27-16413-R	64.6" x 51.2" x 1.6"	1 146	1 276	1 512	1 727
27-18413-R	72.4" x 51.2" x 1.6"	1 218	1 364	1 624	1 864

27-0816-R	31.5" x 63" x 1.6"	794	857	1 178	1 393
27-08416-R	33.1" x 63" x 1.6"	797	866	1 183	1 396
27-09416-R	37" x 63" x 1.6"	829	908	1 207	1 422
27-1016-R	39.4" x 63" x 1.6"	840	922	1 216	1 434
27-1216-R	47.2" x 63" x 1.6"	896	995	1 266	1 479
27-12416-R	48.8" x 63" x 1.6"	900	1 003	1 268	1 481
27-14416-R	56.7" x 63" x 1.6"	*	944	1 062	-
27-16416-R	64.6" x 63" x 1.6"	*	1 206	1 340	-
27-18416-R	72.4" x 63" x 1.6"	*	1 307	1 458	-

27-0819-R	31.5" x 74.8" x 1.6"	909	1 071	1 315	1 571
27-08419-R	33.1" x 74.8" x 1.6"	917	1 077	1 324	1 578
27-09419-R	37" x 74.8" x 1.6"	936	1 098	1 344	1 598
27-1019-R	39.4" x 74.8" x 1.6"	958	1 119	1 366	1 621
27-1219-R	47.2" x 74.8" x 1.6"	996	1 160	1 407	1 664
27-12419-R	48.8" x 74.8" x 1.6"	1 000	1 165	1 411	1 668
27-14419-R	56.7" x 74.8" x 1.6"	*	1 060	1 221	-

* Fabrics with a fabric width other than 66.9" will be sewn with a joint if the screen dimensions are 56.7"x63" or larger.

Offizz

The Offizz floor screen is designed to dampen the general noise level and provide screening in office environments. Offizz is available in several standard versions with different formats and surface layers to suit many types of environments.



This product is part of the Zilenzio Pro family.
Zilenzio Pro combines the ultimate in function, design and durability.
All products in the series use stone wool for optimal sound absorption. Stone wool is recyclable, free of plastics and has the highest possible fire classification.



FABRICS

Our selected fabrics are divided into four price groups, with prices ascending from group one to four.

PRICE GROUP 1

Sawana	Davis								
Cara 170	Camira								
Carlow 170	Camira								
Event Screen+ 170	Gabriel								
Mica 170	Gabriel								
Tonal 170	Gabriel								

PRICE GROUP 2

Focus M Screen 170	Gabriel								
Event	Gabriel								
Hush 170	Gabriel								
Soul Melange 170	Gabriel								
Twist 170	Gabriel								
Twist Melange 170	Gabriel								
Floyd Screen 170	Kvadrat								
Slope 170	Nevotex								
Blazer Lite 170	Camira								
Era 170	Camira								

PRICE GROUP 3

Blazer	Camira								
Era	Camira								
Main Line Flax	Camira								
Rivet	Camira								
Synergy	Camira								
Focus	Gabriel								
Focus Melange	Gabriel								
Step	Gabriel								
Step Melange	Gabriel								
Field	Kvadrat								
Floyd	Kvadrat								
Remix	Kvadrat								
Remix Screen	Kvadrat								
Revive	Kvadrat								
Broken Twill Weave	Kvadrat								
Hint 170	Kvadrat								
Reflect	Kvadrat								
Wooly	Nevotex								
Wooly wide 170	Nevotex								
Lido	Nevotex								

PRICE GROUP 4

Yoredale	Camira								
Crisp	Gabriel								
Canvas	Kvadrat								
Divina	Kvadrat								
Fiord	Kvadrat								
Hallingdal	Kvadrat								
Hero	Kvadrat								
Melange Nap	Kvadrat								
Re-wool	Kvadrat								
Steelcut	Kvadrat								
Steelcut Trio	Kvadrat								
Lani	Vescom								
Gamut	Vescom								
Barnum	Nevotex								

CERTIFICATIONS

- Recycled contents
- OEKO Tex Standard 100

- OEKO Tex Standard 100
- EU Ecolabel
- Greenguard Certificate

- EN1021-1&2
- Crib 5
- CA TB 117

DESIGN

Stone wool filling, external textile cover, alternatively laminate.
MDF dividing strip is always at a height of 70 from the floor.
You choose the filling at the bottom and top.
Available with tempered glass (H15.7") at the top, with or without frame

MEASUREMENTS

Length: 23.6", 31.5", 39.4", 47.2"
Height: 43", 59", 74.8"
Thickness: 2,7"

SOUND

SS-EN ISO 354, ISO 11654 Class A
SS-EN ISO 354:2003 evaluated SS 25269
Noise Reduction Coefficient (NRC): 0.75

N10
47.2"x 74.8" 2.8
39.4"x 59" 4.5
31.5"x 47.2" 5.8

ENVIRONMENT & SAFETY

Möbelfakta Certified
EN 1023-1:1996
EN 1023-2:78.7"
EN 1023-3:78.7"
EN 14073-2

OPTIONS & CUSTOMIZATIONS

These are our standard screen options & customizations.
For other customizations, contact support@zilenzio.com for a quote.

Customizations	Item no	Price	Optional frameless glass	Item no	Price
		customization	WxH		
Customization measurements	MOD-001	Offer	23.6"x15.7"	90-049	212
Perforated at the bottom	1-MOD-06	33	31.5"x15.7"	90-050	233
Whiteboard one side at the top	1-MOD-08	743	39.4"x15.7"	90-051	259
Cable hole	1-MOD-03	122	47.2"x15.7"	90-052	286
Frosted glass	1-MOD-05	104			
Lacquered in any NSC	1-MOD-01	Offer	Aluminum strip*	91-278	47
* For frameless glass, used with straight coupling					



STANDARD COLORS

Standard colors on wood (Frames/filling)

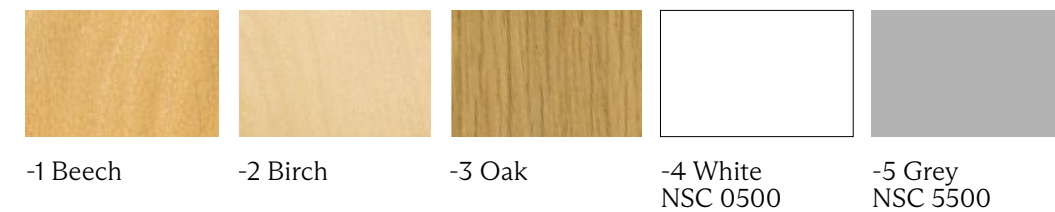

Standard color on brackets

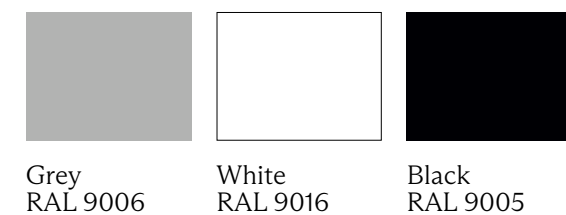

BRACKETS

Brackets	Color item no.			Price
	Grey	White	Black	
Foot	91-201	91-202	91-203	104
Foot reinforced*	91-206	91-207	91-208	138
Top fitting straight	91-247	91-131	91-134	20
3-way coupling (incl. foot, top fitting, cover strip)	91-251	91-380	91-384	314
4-Way coupling (incl. foot, top fitting)	91-254	91-381	91-385	320
Coupling 90° angle (incl. foot, top fitting, cover strip)	91-256	91-382	91-386	254
Coupling 45° angle (incl. foot, top fitting, cover strip)	91-255	-	-	206
Coupling Y-120° (incl. foot, top fitting)	91-253	-	-	318
Top fitting straight high+low	91-222	-	-	51
Coupling 90° high+low (Left)	91-283	-	-	91-283
Coupling 90° high+low (Right)	91-282	-	-	91-282
Wall bracket incl. stand foot	91-222	-	-	51
Clothes hook	91-248	-	-	49
Stand foot	91-245	-	-	17
Name plate	91-249	91-250	-	62

* Reinforced foot is used at a height of 74.8" or screens with glass

Brackets for add-on module	Color item no.	Price/pc
	Grey	
Add-on straight	91-277	40
Add-on 3-way	91-262	297
Add-on 90° angle	91-284	91-284
Add-on 45° angle	91-285	91-285



Foot
Grey 91-201
White 91-202
Black 91-203

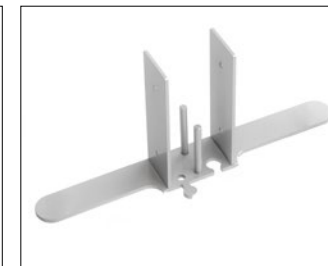

Foot reinforced
Grey 91-206
White 91-207
Black 91-205



Top fitting straight
Grey 91-247
White 91-131
Black 91-134



Coupling Y-120°
Grey 91-223



Coupling 45°
Grey 91-255

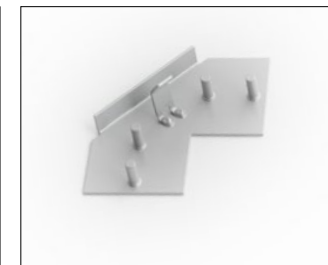

Coupling 90°
Grey 91-256
White 91-382
Black 91-386

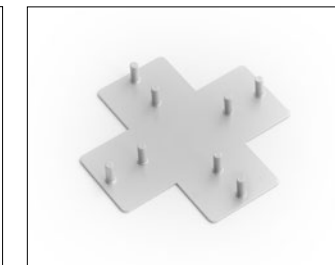

4-way coupling
Grey 91-254
White 91-381
Black 91-385

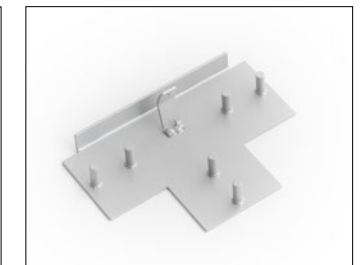

3-way coupling
Grey 91-251
White 91-380
Black 91-384

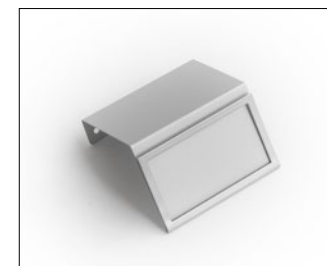

Name plate
Grey 91-249



Top fitting straight high+low
Grey 91-222



Clothes hook
Grey 91-248

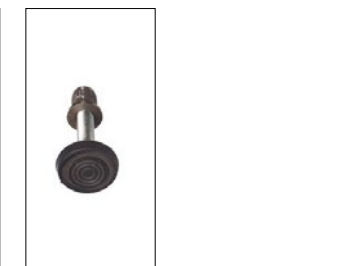

Stand foot
Grey 91-245

White 91-250

EXAMPLE (Straight)

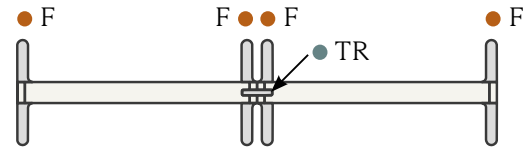

EXAMPLE (Standalone)



EXAMPLE (3-way coupling)

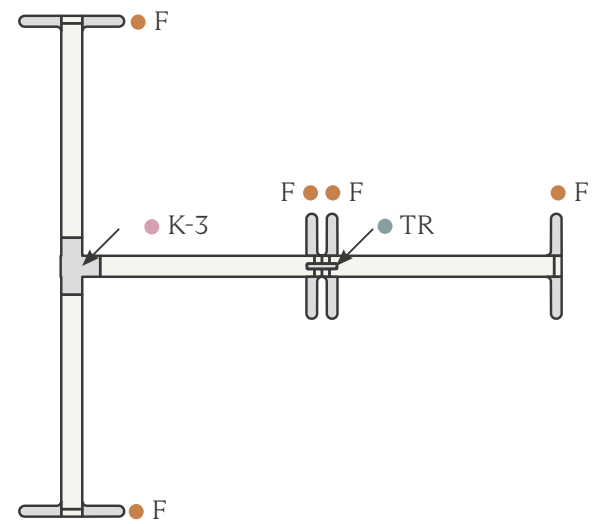

EXAMPLE (Coupling 90°)

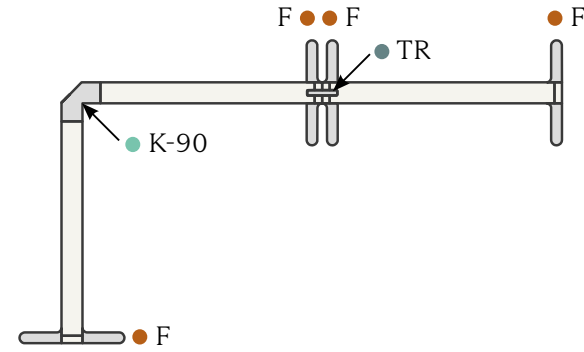

EXAMPLE (4-way coupling)

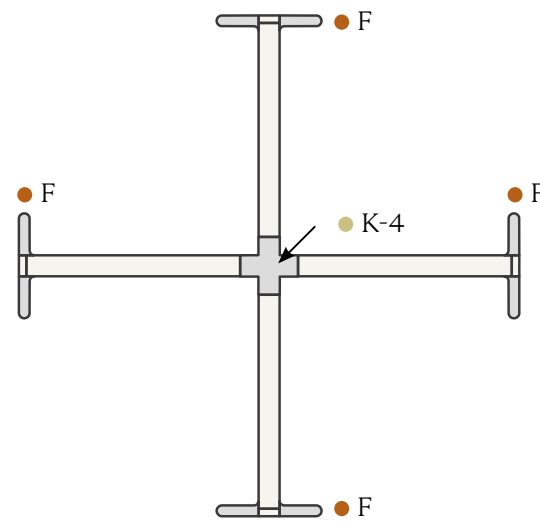

EXAMPLE (Coupling 45°)

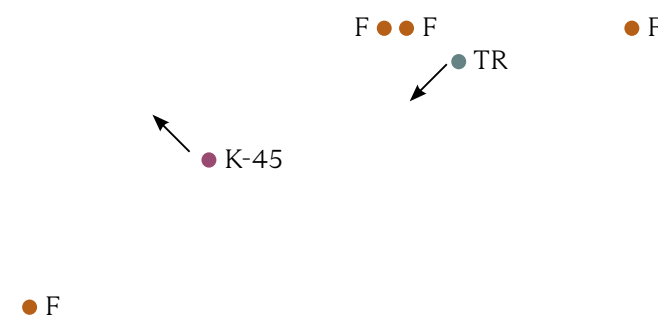

EXAMPLE (Coupling Y-120°)

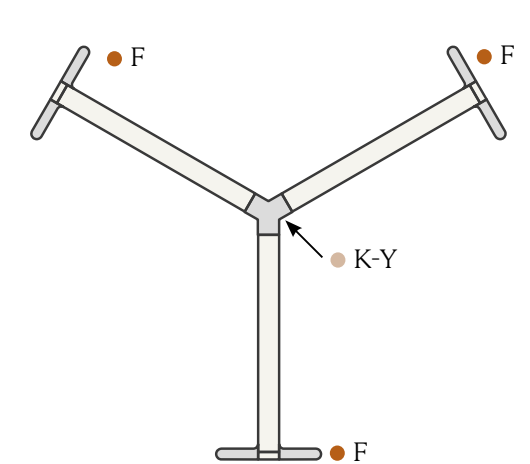

EXAMPLE (High + low couplings)

Coupling high+low
Item no. 91-222

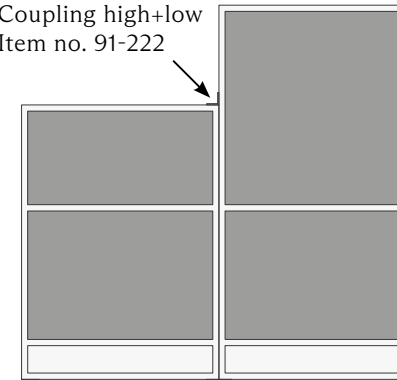

Coupling 90° high + low (Left)
Item no. 91-283 (Grey)

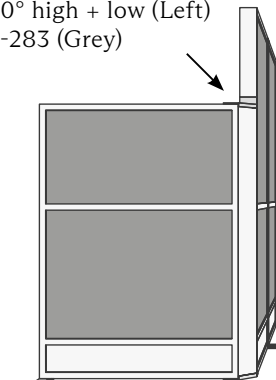

Coupling 90° high + low (Right)
Item no. 91-282 (Grey)

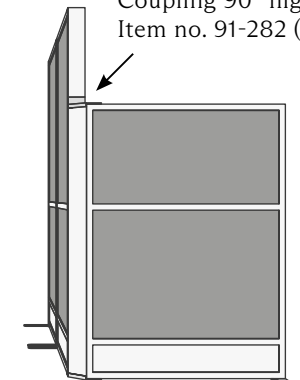

- F (Foot)
Foot, Grey (item no. 91-201)
Foot, white (item no. 91-202)
Foot, black (item no. 91-203)

- TR (Top fitting straight)
Top fitting straight, Grey (item no. 91-247)
Top fitting straight, white (item no. 91-131)
Top fitting straight, black (item no. 91-134)

- K-4 (Coupling 4-way)
Coupling 4-way, Grey (item no. 91-254)
Coupling 4-way, white (item no. 91-381)
Coupling 4-way, black (item no. 91-385)

- K-3 (3-way coupling)
3-way coupling, Grey (item no. 91-251)
Coupling 3-way, white (item no. 91-380)
Coupling 3-way (item no. 91-384)

- K-90 (Coupling 90°)
Coupling 90°, Grey (item no. 91-256)
Coupling 90°, white (item no. 91-382)
Coupling 90°, black (item no. 91-386)

- K-45 (Coupling 45°)
Coupling 45°, Grey (item no. 91-255)

- KY (Coupling Y-120°)
Coupling Y-120°, Grey (item no. 91-253)

EXAMPLE (Add-on module)

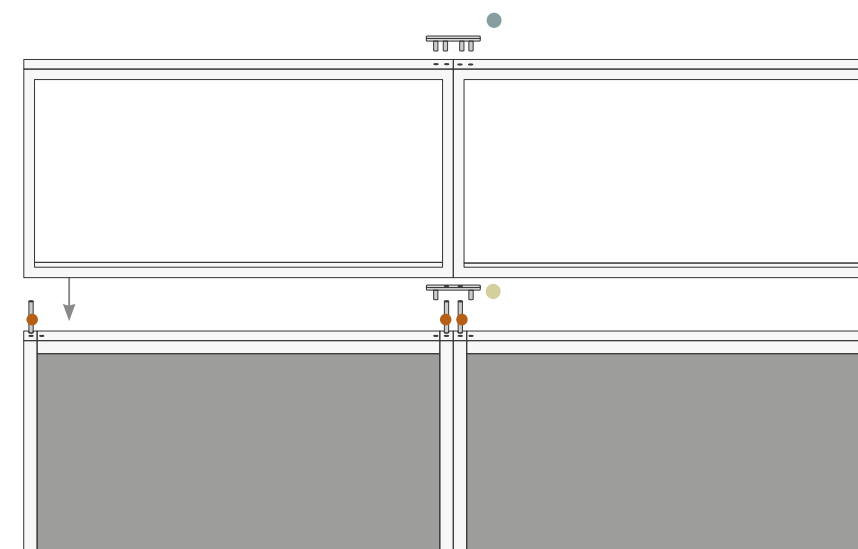

- Top fitting straight (item no. 91-247)
- Add-on coupling straight (item no. 91-277)



Item no.	Size WxHxD	Price gr. 1	Price gr. 2	Price gr. 3	Price gr. 4	Weight Pounds
1-0611-3	23.6" x 43" x 2,7"	964	1 083	1 231	1 406	28,6
1-0811-3	31.5" x 43" x 2,7"	1 102	1 221	1 370	1 545	39,7
1-1011-3	39.4" x 43" x 2,7"	1 185	1 331	1 514	1 730	55,1
1-1211-3	47.2" x 43" x 2,7"	1 258	1 439	1 667	1 934	63,9
1-0615-3	23.6" x 59" x 2,7"	1 074	1 193	1 341	1 516	39,7
1-0815-3	31.5" x 59" x 2,7"	1 197	1 315	1 464	1 640	50,7
1-1015-3	39.4" x 59" x 2,7"	1 274	1 420	1 604	1 821	27,6
1-1215-3	47.2" x 59" x 2,7"	1 341	1 522	1 915	2 017	79,4
1-0619-3	23.6" x 74.8" x 2,7"	1 132	1 314	1 541	1 810	55,1
1-0819-3	31.5" x 74.8" x 2,7"	1 272	1 453	1 681	1 948	66,1
1-1019-3	39.4" x 74.8" x 2,7"	1 390	1 613	1 894	2 223	72,8
1-1219-3	47.2" x 74.8" x 2,7"	1 471	1 743	2 085	2 487	83,8

Brackets	Color item no.			Price
	Grey	White	Black	
Foot	91-201	91-202	91-203	104
Foot reinforced*	91-206	91-207	91-208	138
Top fitting straight	91-247	91-131	91-134	20
3-way coupling (incl. foot, top fitting, cover strip)	91-251	91-380	91-384	314
4-Way coupling (incl. foot, top fitting)	91-254	91-381	91-385	320
Coupling 90° angle (incl. foot, top fitting, cover strip)	91-256	91-382	91-386	254

This product is part of the Zilenzio Pro family.
*Zilenzio Pro combines the ultimate in function, design and durability.
 All products in the series use stone wool for optimal sound absorption. Stone wool is recyclable, free of plastics and has the highest possible fire classification.*

Fully covered incl. 400 glass on top



Item no.	Size WxHxD	Price gr. 1	Price gr. 2	Price gr. 3	Price gr. 4	Weight Pounds
1-0615-5	23.6" x 59" x 2,7"	1 075	1 193	1 342	1 517	39,7
1-0815-5	31.5" x 59" x 2,7"	1 255	1 374	1 522	1 698	50,7
1-1015-5	39.4" x 59" x 2,7"	1 396	1 543	1 726	1 942	2,7",6
1-1215-5	47.2" x 59" x 2,7"	1 482	1 665	1 891	2 161	79,4
1-0619-5	23.6" x 74.8" x 2,7"	1 234	1 415	1 643	1 911	55,1
1-0819-5	31.5" x 74.8" x 2,7"	1 394	1 575	1 803	2 070	66,1
1-1019-5	39.4" x 74.8" x 2,7"	1 519	1 741	2 022	2 351	72,8
1-1219-5	47.2" x 74.8" x 2,7"	1 618	1 890	2 231	2 633	83,8

Brackets	Color item no.			Price
	Grey	White	Black	
Foot	91-201	91-202	91-203	104
Foot reinforced*	91-206	91-207	91-208	138
Top fitting straight	91-247	91-131	91-134	20
3-way coupling (incl. foot, top fitting, cover strip)	91-251	91-380	91-384	314
4-Way coupling (incl. foot, top fitting)	91-254	91-381	91-385	320
Coupling 90° angle (incl. foot, top fitting, cover strip)	91-256	91-382	91-386	254

This product is part of the Zilenzio Pro family.
Zilenzio Pro combines the ultimate in function, design and durability.
All products in the series use stone wool for optimal sound absorption. Stone wool is recyclable, free of plastics and has the highest possible fire classification.



Item no.	Size WxHxD	Price gr. 1	Price gr. 2	Price gr. 3	Price gr. 4	Weight Pounds
1-0611-2	23.6" x 43" x 2,7"	926	985	1 234	1 409	28,6
1-0811-2	31.5" x 43" x 2,7"	1 004	1 063	1 313	1 487	39,7
1-1011-2	39.4" x 43" x 2,7"	1 089	1 162	1 470	1 687	55,1
1-1211-2	47.2" x 43" x 2,7"	1 137	1 228	1 608	1 876	63,9
1-0615-2	23.6" x 59" x 2,7"	968	1 027	1 276	1 451	39,7
1-0815-2	31.5" x 59" x 2,7"	1 133	1 192	1 441	1 616	50,7
1-1015-2	39.4" x 59" x 2,7"	1 169	1 242	1 550	1 766	27,6
1-1215-2	47.2" x 59" x 2,7"	1 200	1 291	1 672	1 940	79,4
1-0619-2	23.6" x 74.8" x 2,7"	1 031	1 149	1 298	1 474	55,1
1-0819-2	31.5" x 74.8" x 2,7"	1 141	1 260	1 408	1 584	66,1
1-1019-2	39.4" x 74.8" x 2,7"	1 307	1 453	1 637	1 853	72,8
1-1219-2	47.2" x 74.8" x 2,7"	1 356	1 538	1 765	2 032	83,8

Brackets	Color item no.			Price
	Grey	White	Black	
Foot	91-201	91-202	91-203	104
Foot reinforced*	91-206	91-207	91-208	138
Top fitting straight	91-247	91-131	91-134	20
3-way coupling (incl. foot, top fitting, cover strip)	91-251	91-380	91-384	314
4-Way coupling (incl. foot, top fitting)	91-254	91-381	91-385	320
Coupling 90° angle (incl. foot, top fitting, cover strip)	91-256	91-382	91-386	254

This product is part of the Zilenzio Pro family.
*Zilenzio Pro combines the ultimate in function, design and durability.
 All products in the series use stone wool for optimal sound absorption. Stone wool is recyclable, free of plastics and has the highest possible fire classification.*

Half covered incl. 400 glass on top



Item no.	Size WxHxD	Price gr. 1	Price gr. 2	Price gr. 3	Price gr. 4	Weight Pounds
1-0615-4	23.6" x 59" x 2,7"	1 033	1 093	1 342	1 517	39,7
1-0815-4	31.5" x 59" x 2,7"	1 145	1 205	1 454	1 630	50,7
1-1015-4	39.4" x 59" x 2,7"	1 275	1 348	1 656	1 871	27,6
1-1215-4	47.2" x 59" x 2,7"	1 381	1 471	1 852	2 120	79,4
1-0619-4	23.6" x 74.8" x 2,7"	1 122	1 240	1 389	1 564	55,1
1-0819-4	31.5" x 74.8" x 2,7"	1 230	1 348	1 497	1 672	66,1
1-1019-4	39.4" x 74.8" x 2,7"	1 402	1 548	1 731	1 949	72,8
1-1219-4	47.2" x 74.8" x 2,7"	1 491	1 672	1 900	2 168	83,8

Brackets	Color item no.			Price
	Grey	White	Black	
Foot	91-201	91-202	91-203	104
Foot reinforced*	91-206	91-207	91-208	138
Top fitting straight	91-247	91-131	91-134	20
3-way coupling (incl. foot, top fitting, cover strip)	91-251	91-380	91-384	314
4-Way coupling (incl. foot, top fitting)	91-254	91-381	91-385	320
Coupling 90° angle (incl. foot, top fitting, cover strip)	91-256	91-382	91-386	254

This product is part of the Zilenzio Pro family.
Zilenzio Pro combines the ultimate in function, design and durability.
All products in the series use stone wool for optimal sound absorption. Stone wool is recyclable, free of plastics and has the highest possible fire classification.





Item no.	Size	Price	Weight
	WxHxD		
1-0611-1	23.6" x 43" x 2,7"	849	28,6
1-0811-1	31.5" x 43" x 2,7"	968	39,7
1-1011-1	39.4" x 43" x 2,7"	1 082	55,1
1-1211-1	47.2" x 43" x 2,7"	1 128	63,9
1-0615-1	23.6" x 59" x 2,7"	969	39,7
1-0815-1	31.5" x 59" x 2,7"	1 165	50,7
1-1015-1	39.4" x 59" x 2,7"	1 267	2,7",6
1-1215-1	47.2" x 59" x 2,7"	1 348	79,4
1-0619-1	23.6" x 74.8" x 2,7"	1 017	55,1
1-0819-1	31.5" x 74.8" x 2,7"	1 227	66,1
1-1019-1	39.4" x 74.8" x 2,7"	1 375	72,8
1-1219-1	47.2" x 74.8" x 2,7"	1 463	83,8

Brackets	Color item no.			Price
	Grey	White	Black	
Foot	91-201	91-202	91-203	104
Foot reinforced*	91-206	91-207	91-208	138
Top fitting straight	91-247	91-131	91-134	20
3-way coupling (incl. foot, top fitting, cover strip)	91-251	91-380	91-384	314
4-Way coupling (incl. foot, top fitting)	91-254	91-381	91-385	320
Coupling 90° angle (incl. foot, top fitting, cover strip)	91-256	91-382	91-386	254

This product is part of the Zilenzio Pro family.
Zilenzio Pro combines the ultimate in function, design and durability.
All products in the series use stone wool for optimal sound absorption. Stone wool is recyclable, free of plastics and has the highest possible fire classification.



Offizz

Full wooden panel incl. 400 on top



Item no.	Size	Price	Weight
	WxHxD		Pounds
1-0615-61	23.6" x 59" x 2,7"	932	39,7
1-0815-61	31.5" x 59" x 2,7"	1 074	50,7
1-1015-61	39.4" x 59" x 2,7"	1 207	2,7",6
1-1215-61	47.2" x 59" x 2,7"	1 287	79,4
1-0619-61	23.6" x 74.8" x 2,7"	1 238	55,1
1-0819-61	31.5" x 74.8" x 2,7"	1 252	66,1
1-1019-61	39.4" x 74.8" x 2,7"	1 173	72,8
1-1219-61	47.2" x 74.8" x 2,7"	1 495	83,8

Brackets	Color item no.			Price
	Grey	White	Black	
Foot	91-201	91-202	91-203	104
Foot reinforced*	91-206	91-207	91-208	138
Top fitting straight	91-247	91-131	91-134	20
3-way coupling (incl. foot, top fitting, cover strip)	91-251	91-380	91-384	314
4-Way coupling (incl. foot, top fitting)	91-254	91-381	91-385	320
Coupling 90° angle (incl. foot, top fitting, cover strip)	91-256	91-382	91-386	254

This product is part of the Zilenzio Pro family.
*Zilenzio Pro combines the ultimate in function, design and durability.
 All products in the series use stone wool for optimal sound absorption. Stone wool is recyclable, free of plastics and has the highest possible fire classification.*



Add-on module fabric covered on both sides

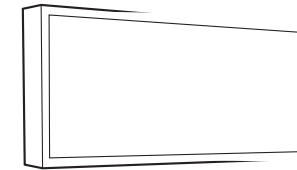

Item no.	Size	Price gr. 1	Price gr. 2	Price gr. 3	Price gr. 4	Weight
	WxHxD					Pounds
12-642	23.6" x 15.7" x 2,7"	609	646	-	-	5
12-842	31.5" x 15.7" x 2,7"	667	725	-	-	7
12-142	39.4" x 15.7" x 2,7"	706	779	-	-	9
12-242	47.2" x 15.7" x 2,7"	734	856	-	-	11
12-652	23.6" x 19.6" x 2,7"	714	774	-	-	6
12-852	31.5" x 19.6" x 2,7"	714	774	-	-	8
12-152	39.4" x 19.6" x 2,7"	725	800	-	-	10
12-252	47.2" x 19.6" x 2,7"	781	866	-	-	12
12-662	23.6" x 23.6" x 2,7"	703	753	-	-	7
12-862	31.5" x 23.6" x 2,7"	732	796	-	-	9
12-162	39.4" x 23.6" x 2,7"	744	819	-	-	11
12-262	47.2" x 23.6" x 2,7"	801	887	-	-	13

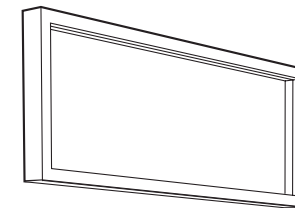

Add-on module with glass

Item no.	Size	Glass	Weight
	WxHxD	with frame	Pounds
12-649	23.6" x 15.7" x 70	649	5
12-849	31.5" x 15.7" x 70	703	7
12-149	39.4" x 15.7" x 70	744	9
12-249	47.2" x 15.7" x 70	774	11
12-659	23.6" x 19.6" x 70	703	6
12-859	31.5" x 19.6" x 70	732	8
12-159	39.4" x 19.6" x 70	744	10
12-259	47.2" x 19.6" x 70	801	12
12-669	23.6" x 23.6" x 70	719	7
12-869	31.5" x 23.6" x 70	744	9
12-169	39.4" x 23.6" x 70	761	11
12-269	47.2" x 23.6" x 70	814	13





Dotz

Dotz is an add-on for the Offizz screen. The simple circle pattern is lively, playful and dynamic. You can create a beautiful pattern image by choosing different fabrics in the perforation. Dotz is available in several standard designs, formats and materials.

Add-on	Item no.	Price
Dotz	1-ADD-01	103

This product is part of the Zilenzio Pro family.
Zilenzio Pro combines the ultimate in function, design and durability.
All products in the series use stone wool for optimal sound absorption. Stone wool is recyclable, free of plastics and has the highest possible fire classification.

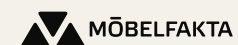

Dezibel Wall

Dezibel is available in various shapes and sizes. Design the wall absorbents freely from different fabrics and motif prints. Also works well as bulletin boards.



This product is part of the Zilenzio Pro family.
Zilenzio Pro combines the ultimate in function, design and durability.
All products in the series use stone wool for optimal sound absorption. Stone wool is recyclable, free of plastics and has the highest possible fire classification.



FABRICS

Our selected fabrics are divided into four price groups, with prices ascending from group one to four.

PRICE GROUP 1

Sawana	Davis								
Cara 170	Camira								
Carlow 170	Camira								
Event Screen+ 170	Gabriel								
Mica 170	Gabriel								
Tonal 170	Gabriel								

PRICE GROUP 2

Focus M Screen 170	Gabriel								
Event	Gabriel								
Hush 170	Gabriel								
Soul Melange 170	Gabriel								
Twist 170	Gabriel								
Twist Melange 170	Gabriel								
Floyd Screen 170	Kvadrat								
Slope 170	Nevotex								
Blazer Lite 170	Camira								
Era 170	Camira								

PRICE GROUP 3

Blazer	Camira								
Era	Camira								
Main Line Flax	Camira								
Rivet	Camira								
Synergy	Camira								
Focus	Gabriel								
Focus Melange	Gabriel								
Step	Gabriel								
Step Melange	Gabriel								
Field	Kvadrat								
Floyd	Kvadrat								
Remix	Kvadrat								
Remix Screen	Kvadrat								
Revive	Kvadrat								
Broken Twill Weave	Kvadrat								
Hint 170	Kvadrat								
Reflect	Kvadrat								
Wooly	Nevotex								
Wooly wide 170	Nevotex								
Lido	Nevotex								

PRICE GROUP 4

Yoredale	Camira								
Crisp	Gabriel								
Canvas	Kvadrat								
Divina	Kvadrat								
Fiord	Kvadrat								
Hallingdal	Kvadrat								
Hero	Kvadrat								
Melange Nap	Kvadrat								
Re-wool	Kvadrat								
Steelcut	Kvadrat								
Steelcut Trio	Kvadrat								
Lani	Vescom								
Gamut	Vescom								
Barnum	Nevotex								

CERTIFICATIONS

- Recycled contents
- OEKO Tex Standard 100
- EN1021-1&2
- OEKO Tex Standard 100
- EU Ecolabel
- Crib 5
- Greenguard Certificate
- CA TB 117

*Fabric Remix cannot be used on circles

DESIGN

Back side in perforated MDF. Stone wool filling, externally covered with textile. Easily mounted with MDF suspension strip with a depth of 0.7" from the wall.

MEASUREMENTS

Rectangle: 35.4"x23.6", 47.2"x450, 47.2"x23.6", 47.2"x31.5", 63"x31.5", 70.8"x23.6", 70.8"x31.5"
Square: 23.6"x23.6", 700x700, 31.5"x31.5", 39.4"x39.4", 47.2"x47.2"
Circle: Ø23.6", Ø31.5", Ø39.4", Ø47.2"
Thickness: Absorbent 2", including distance from wall 2.8"

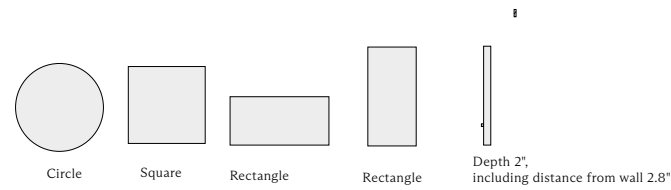

SOUND

SS-EN ISO 354, ISO 11654 Class A
SS-EN ISO 354:2003 evaluated SS 25269
Noise Reduction Coefficient (NRC): 1.05

N10	
23.6"x23.6"	17
700x700	14
39.4"x39.4"	7
47.2"x47.2"	5
47.2"x23.6"	10
47.2"x31.5"	8
63"x31.5"	6
70.8"x23.6"	7

ENVIRONMENT & SAFETY

Möbelfakta Certified
EN 1023-1:1996
EN 1023-2:78.7"
EN 1023-3:78.7"
EN 14073-2



Dezibel Wall 2"

Item no.	Form	Size	Price gr. 1	Price gr. 2	Price gr. 3	Price gr. 4	Weight
		WxHxD					Pounds
6-023.6"	Circle	Ø23.6" x 2"	605	647	685	758	4
6-031.5"	Circle	Ø31.5" x 2"	749	798	845	932	7
6-39.4"	Circle	Ø39.4" x 2"	918	973	1 033	1 131	9
6-47.2"	Circle	Ø47.2" x 2"	1 039	1 110	1 182	1 298	13
6-0505	Square	19.7" x 19.7" x 2"	501	543	578	630	4
6-0606	Square	23.6" x 23.6" x 2"	512	554	597	666	5
6-0707	Square	700 x 700 x 2"	603	653	697	773	6
6-0808	Square	31.5" x 31.5" x 2"	669	714	769	857	8
6-1010	Square	39.4" x 39.4" x 2"	833	896	958	1 058	13
6-1212	Square	47.2" x 47.2" x 2"	957	1 030	1 100	1 219	18
6-0906	Horizontal	35.4" x 23.6" x 2"	624	666	710	776	7
6-1204	Horizontal	47.2" x 450 x 2"	597	632	667	724	7
6-1206	Horizontal	47.2" x 23.6" x 2"	610	654	700	770	9
6-1208	Horizontal	47.2" x 31.5" x 2"	758	814	867	952	12
6-1210	Horizontal	47.2" x 39.4" x 2"	924	935	1 018	1 149	14
6-1608	Horizontal	63" x 31.5" x 2"	1 084	1 172	1 262	1 409	16
6-1612	Horizontal	63" x 47.2" x 2"	1 295	1 391	1 491	1 656	18
6-1806	Horizontal	70.8" x 23.6" x 2"	1 154	1 246	1 343	1 507	14
6-1808	Horizontal	70.8" x 31.5" x 2"	1 233	1 328	1 424	1 589	18
6-1812	Horizontal	70.8" x 47.2" x 2"	1 349	1 441	1 543	1 704	20
6-0609	Vertical	23.6" x 35.4" x 2"	624	666	710	776	7
6-0412	Vertical	450 x 47.2" x 2"	597	632	667	724	7
6-0612	Vertical	23.6" x 47.2" x 2"	610	654	700	770	9
6-0812	Vertical	31.5" x 47.2" x 2"	758	814	867	952	12
6-1012	Vertical	39.4" x 47.2" x 2"	924	935	1 018	1 149	14
6-0816	Vertical	31.5" x 63" x 2"	1 084	1 172	1 262	1 409	16
6-1216	Vertical	47.2" x 63" x 2"	1 295	1 391	1 491	1 656	18
6-0618	Vertical	23.6" x 70.8" x 2"	1 154	1 246	1 343	1 507	14
6-0818	Vertical	31.5" x 70.8" x 2"	1 233	1 328	1 424	1 589	18
6-1218	Vertical	47.2" x 70.8" x 2"	1 349	1 441	1 543	1 704	20

*Fabric Remix cannot be used on circles

Item no.	Options	Price/pc
6-MOD-01	Velcro mounting 10	82
6-MOD-04	Double mounting strips	82
6-MOD-05	Keyhole suspension (dikt an)	81



This product is part of the Zilenzio Pro family.
Zilenzio Pro combines the ultimate in function, design and durability.
All products in the series use stone wool for optimal sound absorption. Stone wool is recyclable, free of plastics and has the highest possible fire classification.



THE GREEN TAG

Dezibel Wall 30

Item no.	Form	Size	Price gr. 1	Price gr. 2	Price gr. 3	Price gr. 4	Weight
		WxHxD					Pounds
63-023.6"	Circle	Ø23.6" x 1.2"	547	584	629	700	4
63-031.5"	Circle	Ø31.5" x 1.2"	686	735	786	869	7
63-39.4"	Circle	Ø39.4" x 1.2"	852	911	971	1 071	9
63-47.2"	Circle	Ø47.2" x 1.2"	977	1 049	1 117	1 233	13
63-0505	Square	19.7" x 19.7" x 1.2"	446	489	524	578	4
63-0606	Square	23.6" x 23.6" x 1.2"	452	494	537	608	5
63-0707	Square	700 × 700 × 1.2"	545	593	638	715	6
63-0808	Square	31.5" x 31.5" x 1.2"	605	659	712	798	8
63-1010	Square	39.4" x 39.4" x 1.2"	771	832	891	995	13
63-1212	Square	47.2" x 47.2" x 1.2"	891	964	1 037	1 158	18
63-0906	Horizontal	35.4" x 23.6" x 1.2"	562	606	650	718	7
63-1204	Horizontal	47.2" x 450 × 1.2"	534	570	605	661	7
63-1206	Horizontal	47.2" x 23.6" x 1.2"	549	593	639	710	9
63-1208	Horizontal	47.2" x 31.5" x 1.2"	698	754	803	890	12
63-1210	Horizontal	47.2" x 39.4" x 1.2"	865	879	960	1 091	14
63-1608	Horizontal	63" x 31.5" x 1.2"	1 021	1 109	1 195	1 344	16
63-1612	Horizontal	63" x 47.2" x 1.2"	1 234	1 328	1 429	1 646	18
63-1806	Horizontal	70.8" x 23.6" x 1.2"	1 091	1 184	1 279	1 445	14
63-1808	Horizontal	70.8" x 31.5" x 1.2"	1 168	1 265	1 360	1 526	18
63-1812	Horizontal	70.8" x 47.2" x 1.2"	1 290	1 381	1 481	1 642	20
63-0609	Vertical	23.6" x 35.4" x 1.2"	562	606	650	718	7
63-0412	Vertical	450 × 47.2" x 1.2"	534	570	605	661	7
63-0612	Vertical	23.6" x 47.2" x 1.2"	549	593	639	710	9
63-0812	Vertical	31.5" x 47.2" x 1.2"	698	754	803	890	12
63-1012	Vertical	39.4" x 47.2" x 1.2"	865	879	960	1 091	14
63-0816	Vertical	31.5" x 63" x 1.2"	1 021	1 109	1 195	1 344	16
63-1216	Vertical	47.2" x 63" x 1.2"	1 234	1 328	1 429	1 646	18
63-0618	Vertical	23.6" x 70.8" x 1.2"	1 091	1 184	1 279	1 445	14
63-0818	Vertical	31.5" x 70.8" x 1.2"	1 168	1 265	1 360	1 526	18
63-1218	Vertical	47.2" x 70.8" x 1.2"	1 290	1 381	1 481	1 642	20

*Fabric Remix cannot be used on circles

Item no.	Options	Price/pc
6-MOD-01	Velcro mounting 10	82
6-MOD-04	Double mounting strips	82
6-MOD-05	Keyhole suspension (dikt an)	81

This product is part of the Zilenzio Pro family.
*Zilenzio Pro combines the ultimate in function, design and durability.
 All products in the series use stone wool for optimal sound absorption. Stone wool is recyclable, free of plastics and has the highest possible fire classification.*



Dezibel Print

An easy way to give your absorber a unique character is to make a print directly on the fabric. Perhaps your company logo or pattern?
It's your canvas, and the possibilities are endless.



This product is part of the Zilenzio Pro family.
Zilenzio Pro combines the ultimate in function, design and durability.
All products in the series use stone wool for optimal sound absorption. Stone wool is recyclable, free of plastics and has the highest possible fire classification.





Print

See all designs at zilenzio.com or submit your own design.

Item no.	Add-on own submitted image/logo	Price/pc
64-ADD-01	Submitted image	63

Submit your own design via the link or scan the QR code.

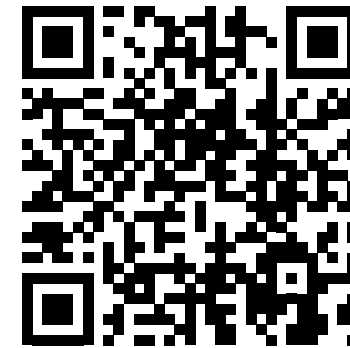

[Upload your own design](#)

Mark with your order number and e-mail address for approval of corrections.
File format: JPG, TIF, EPS, AI, PDF

For questions send to support@zilenzio.com



Dezibel Print

An easy way to give your absorbent a unique character is to make a print directly on the fabric. Perhaps your company logo or pattern? It's your canvas, and the possibilities are endless. If creativity fails, our website has several ready-made designs to choose from.

Item no.	Form	Size	Price	Weight
		WxHxD	Incl. WP design	Pounds
64-0505	Square	500 × 500 × 2"	985	4
64-0606	Square	23.6" x 23.6" x 2"	1 017	5
64-0707	Square	700 × 700 × 2"	1 181	6
64-0808	Square	31.5" x 31.5" x 2"	1 202	8
64-1010	Square	39.4" x 39.4" x 2"	1 251	13
64-1212	Square	47.2" x 47.2" x 2"	1 407	18
64-0906	Horizontal	35.4" x 23.6" x 2"	1 105	7
64-1204	Horizontal	47.2" x 450 × 2"	1 047	7
64-1206	Horizontal	47.2" x 23.6" x 2"	1 113	9
64-1208	Horizontal	47.2" x 31.5" x 2"	1 205	12
64-1210	Horizontal	47.2" x 39.4" x 2"	1 368	14
64-1608	Horizontal	63" x 31.5" x 2"	1 578	16
64-1612	Horizontal	63" x 47.2" x 2"	1 740	18
64-1806	Horizontal	70.8" x 23.6" x 2"	1 621	14
64-1808	Horizontal	70.8" x 31.5" x 2"	1 788	18
64-1812	Horizontal	70.8" x 47.2" x 2"	1 887	20
64-0609	Vertical	23.6" x 35.4" x 2"	1 105	7
64-0412	Vertical	450 × 47.2" x 2"	1 047	7
64-0612	Vertical	23.6" x 47.2" x 2"	1 113	9
64-0812	Vertical	31.5" x 47.2" x 2"	1 205	12
64-1012	Vertical	39.4" x 47.2" x 2"	1 368	14
64-0816	Vertical	31.5" x 63" x 2"	1 578	16
64-1216	Vertical	47.2" x 63" x 2"	1 740	18
64-0618	Vertical	23.6" x 70.8" x 2"	1 621	14
64-0818	Vertical	31.5" x 70.8" x 2"	1 788	18
64-1218	Vertical	47.2" x 70.8" x 2"	1 887	20

Item no.	Add-on own submitted image/logo	Price/pc
64-ADD-01	Submitted image	63

This product is part of the Zilenzio Pro family.
Zilenzio Pro combines the ultimate in function, design and durability.
All products in the series use stone wool for optimal sound absorption. Stone wool is recyclable, free of plastics and has the highest possible fire classification.



Fazett

The Fazett wall system actually consists of a single building block, a rhombus that can be combined in many ways. By covering them in different colored fabrics, you can create patterns that can cover both small and large surfaces. They create a decorative pattern and at the same time act as effective sound absorbers.



DESIGNER

Note Design Studio

This product is part of the Zilenzio Pro family.
 Zilenzio Pro combines the ultimate in function, design and durability.
 All products in the series use stone wool for optimal sound absorption. Stone wool is recyclable, free of plastics and has the highest possible fire classification.



FABRICS

Our selected fabrics are divided into four price groups, with prices ascending from group one to four.

PRICE GROUP 1

Sawana	Davis						
Cara 170	Camira						
Carlow 170	Camira						
Event Screen+ 170	Gabriel						
Mica 170	Gabriel						
Tonal 170	Gabriel						

PRICE GROUP 2

Focus M Screen 170	Gabriel						
Event	Gabriel						
Hush 170	Gabriel						
Soul Melange 170	Gabriel						
Twist 170	Gabriel						
Twist Melange 170	Gabriel						
Floyd Screen 170	Kvadrat						
Slope 170	Nevotex						
Blazer Lite 170	Camira						
Era 170	Camira						

PRICE GROUP 3

Blazer	Camira						
Era	Camira						
Main Line Flax	Camira						
Rivet	Camira						
Synergy	Camira						
Focus	Gabriel						
Focus Melange	Gabriel						
Step	Gabriel						
Step Melange	Gabriel						
Field	Kvadrat						
Floyd	Kvadrat						
Remix	Kvadrat						
Remix Screen	Kvadrat						
Revive	Kvadrat						
Broken Twill Weave	Kvadrat						
Hint 170	Kvadrat						
Reflect	Kvadrat						
Wooly	Nevotex						
Wooly wide 170	Nevotex						
Lido	Nevotex						

PRICE GROUP 4

Yoredale	Camira						
Crisp	Gabriel						
Canvas	Kvadrat						
Divina	Kvadrat						
Fiord	Kvadrat						
Hallingdal	Kvadrat						
Hero	Kvadrat						
Melange Nap	Kvadrat						
Re-wool	Kvadrat						
Steelcut	Kvadrat						
Steelcut Trio	Kvadrat						
Lani	Vescom						
Gamut	Vescom						
Barnum	Nevotex						

CERTIFICATIONS

- Recycled contents
- OEKO Tex Standard 100
- EN1021-1&2
- OEKO Tex Standard 100
- EU Ecolabel
- Crib 5
- Greenguard Certificate
- CA TB 117

DESIGN

Back side in perforated MDF. Stone wool filling, externally covered with textile.
Easily mounted with a Velcro-covered MDF spacer.
The spacer builds 0.7" deep from the wall.

MEASUREMENTS

Fazett	(61-0704)	27.5"x15.7"
Fazett half	(61-0304)	13.8"x15.7"
Fazett half	(61-0702)	27.5"x7.9"

Thickness: 2"

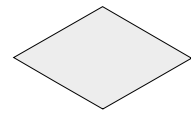

Fazett
27.5"x15.7"

item no. 61-0704

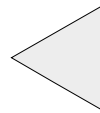

Fazett half
13.8"x15.7"

item no. 61-0304



Fazett half
27.5"x7.9"

item no. 61-0702

SAMPLE PATTERN

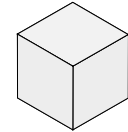

27"x31.5"

3 pcs 27.5"x15.8"

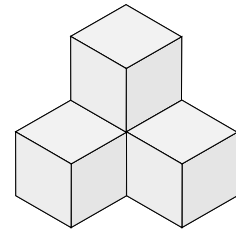

55.1"x55.1"

9 pcs 27.5"x15.8"

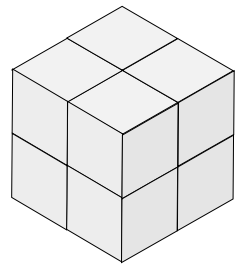

55.1"x63"

12 pcs 27.5"x15.8"

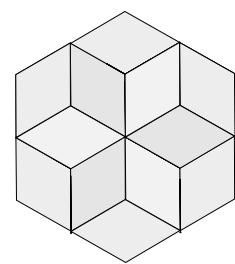

55.1"x63"

12 pcs 27.5"x15.8"

SOUND

SS-EN ISO 354, ISO 11654 Class A
SS-EN ISO 354:2003 evaluated SS 25269

N10

3 pcs	Fazett 27.5"x15.8"	14
12 pcs	Fazett 27.5"x15.8"	5

ENVIRONMENT & SAFETY

Möbelfakta Certified



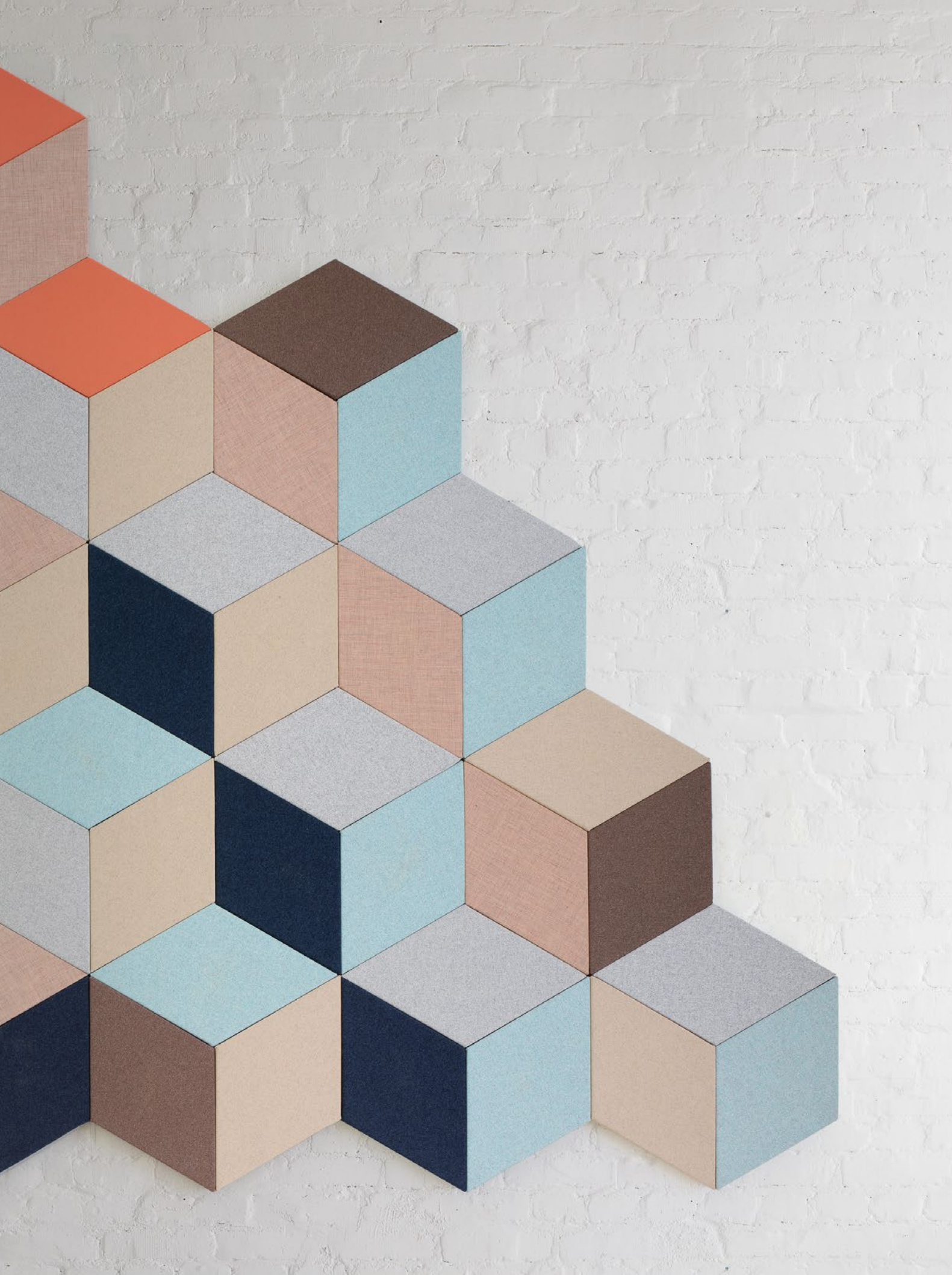

Fazett

Item no.	Size WxHxD	Form	Price gr. 1	Price gr. 2	Price gr. 3	Price gr. 4	Weight Pounds
61-0704	27.5" x 15.8" x 2"	Whole	266	279	291	308	6,6
61-0304	13.8" x 15.7" x 2"	Half	260	269	281	296	4,4
61-0702	27.5" x 7.9" x 2"	Half	266	276	291	308	4,4

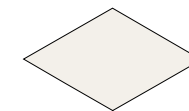

Fazett
27.5"x15.8"

item no. 61-0704

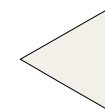

Fazett half
13.8"x15.7"

item no. 61-0304



Fazett half
27.5"x7.9"

item no. 61-0702

This product is part of the Zilenzio Pro family.
Zilenzio Pro combines the ultimate in function, design and durability.
 All products in the series use stone wool for optimal sound absorption. Stone wool is recyclable, free of plastics and has the highest possible fire classification.



Timber

Timber can be used ex. classic wall panels, imitate wood panels or used to create various elegant patterns; eg herringbone pattern.
Designed for Zilenzio.



DESIGNER

Norm Architects

This product is part of the Zilenzio Pro family.
Zilenzio Pro combines the ultimate in function, design and durability.
All products in the series use stone wool for optimal sound absorption. Stone wool is recyclable, free of plastics and has the highest possible fire classification.



FABRICS

Our selected fabrics are divided into four price groups, with prices ascending from group one to four.

PRICE GROUP 1

Sawana	Davis								
Cara 170	Camira								
Carlow 170	Camira								
Event Screen+ 170	Gabriel								
Mica 170	Gabriel								
Tonal 170	Gabriel								

PRICE GROUP 2

Focus M Screen 170	Gabriel								
Event	Gabriel								
Hush 170	Gabriel								
Soul Melange 170	Gabriel								
Twist 170	Gabriel								
Twist Melange 170	Gabriel								
Floyd Screen 170	Kvadrat								
Slope 170	Nevotex								
Blazer Lite 170	Camira								
Era 170	Camira								

PRICE GROUP 3

Blazer	Camira								
Era	Camira								
Main Line Flax	Camira								
Rivet	Camira								
Synergy	Camira								
Focus	Gabriel								
Focus Melange	Gabriel								
Step	Gabriel								
Step Melange	Gabriel								
Field	Kvadrat								
Floyd	Kvadrat								
Remix	Kvadrat								
Remix Screen	Kvadrat								
Revive	Kvadrat								
Broken Twill Weave	Kvadrat								
Hint 170	Kvadrat								
Reflect	Kvadrat								
Wooly	Nevotex								
Wooly wide 170	Nevotex								
Lido	Nevotex								

PRICE GROUP 4

Yoredale	Camira								
Crisp	Gabriel								
Canvas	Kvadrat								
Divina	Kvadrat								
Fiord	Kvadrat								
Hallingdal	Kvadrat								
Hero	Kvadrat								
Melange Nap	Kvadrat								
Re-wool	Kvadrat								
Steelcut	Kvadrat								
Steelcut Trio	Kvadrat								
Lani	Vescom								
Gamut	Vescom								
Barnum	Nevotex								

CERTIFICATIONS

- Recycled contents
- OEKO Tex Standard 100

- OEKO Tex Standard 100
- EU Ecolabel
- Greenguard Certificate

- EN1021-1&2
- Crib 5
- CA TB 117

DESIGN

Absorber 2", distance from the wall 0.4".
 Design: MDF back. Stone wool filling externally covered with fabric.
 Mounts easily with the included Velcro covered spacer.

MEASUREMENTS

Timber	68-0106	5.9"×23.6"
Timber	68-0108	5.9"×31.5"
Timber	68-0110	5.9"×39.4"
Timber	68-0112	5.9"×47.2"
Timber	68-0114	5.9"×55.1"
Timber	68-P001	23.6"×78.7"
Timber	68-P002	23.6"×118.1"

Thickness 2" absorbent
 distance from the wall 0.4"

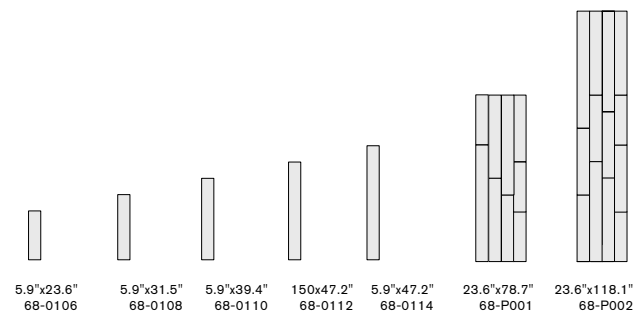

Larger installations can easily be constructed from our two ready-defined units, 23.6" wide, 78.7" and 118." high respectively. These are then repeated to the desired width with every other unit rotated to provide variety.

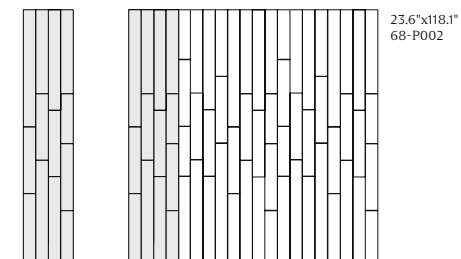
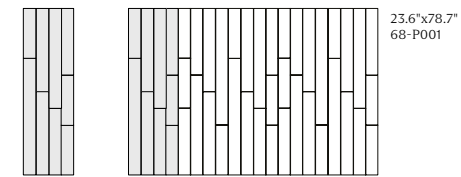

SAMPLE PATTERN



SOUND

SS-EN ISO 354, ISO 11654 Class A
 SS-EN ISO 354:2003 evaluated SS 25269

N10		
3 pcs	Fazett 27.5"×15.8"	14
12 pcs	Fazett 27.5"×15.8"	5

ENVIRONMENT & SAFETY

Möbelfakta Certified



Timber



Item no.	Size WxHxD	Price gr. 1	Price gr. 2	Price gr. 3	Price gr. 4	Weight Pounds
68-0106	5.9" x 23.6" x 2"	181	191	212	228	1,8
68-0108	5.9" x 31.5" x 2"	200	214	228	248	2,2
68-0110	5.9" x 39.4" x 2"	210	222	239	260	2,7
68-0112	5.9" x 47.2" x 2"	246	261	274	295	3,1
68-0114	5.9" x 55.1" x 2"	296	364	458	562	3,5
68-P001	23.6" x 78.7" x 2"	1 903	2 071	2 303	2 556	21,2
68-P002	23.6" x 118.1" x 2"	2 785	2 999	3 297	3 625	31,7

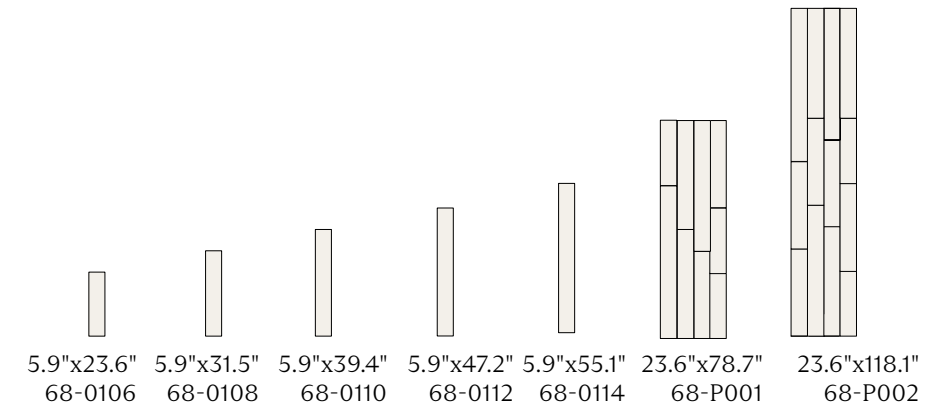

This product is part of the Zilenzio Pro family.
*Zilenzio Pro combines the ultimate in function, design and durability.
 All products in the series use stone wool for optimal sound absorption. Stone wool is recyclable, free of plastics and has the highest possible fire classification.*



Dezibel Divider

Dezibel Divider is a sound-absorbing module that can be combined in many different ways. The absorbents hang at 50 or 3.9" intervals. Hang it from the ceiling to create spatial boundaries and effective sound barriers.



This product is part of the Zilenzio Pro family.
Zilenzio Pro combines the ultimate in function, design and durability.
All products in the series use stone wool for optimal sound absorption. Stone wool is recyclable, free of plastics and has the highest possible fire classification.



FABRICS

Our selected fabrics are divided into four price groups, with prices ascending from group one to four.

PRICE GROUP 1

Sawana	Davis								
Cara 170	Camira								
Carlow 170	Camira								
Event Screen+ 170	Gabriel								
Mica 170	Gabriel								
Tonal 170	Gabriel								

PRICE GROUP 2

Focus M Screen 170	Gabriel								
Event	Gabriel								
Hush 170	Gabriel								
Soul Melange 170	Gabriel								
Twist 170	Gabriel								
Twist Melange 170	Gabriel								
Floyd Screen 170	Kvadrat								
Slope 170	Nevotex								
Blazer Lite 170	Camira								
Era 170	Camira								

PRICE GROUP 3

Blazer	Camira								
Era	Camira								
Main Line Flax	Camira								
Rivet	Camira								
Synergy	Camira								
Focus	Gabriel								
Focus Melange	Gabriel								
Step	Gabriel								
Step Melange	Gabriel								
Field	Kvadrat								
Floyd	Kvadrat								
Remix	Kvadrat								
Remix Screen	Kvadrat								
Revive	Kvadrat								
Broken Twill Weave	Kvadrat								
Hint 170	Kvadrat								
Reflect	Kvadrat								
Wooly	Nevotex								
Wooly wide 170	Nevotex								
Lido	Nevotex								

PRICE GROUP 4

Yoredale	Camira								
Crisp	Gabriel								
Canvas	Kvadrat								
Divina	Kvadrat								
Fiord	Kvadrat								
Hallingdal	Kvadrat								
Hero	Kvadrat								
Melange Nap	Kvadrat								
Re-wool	Kvadrat								
Steelcut	Kvadrat								
Steelcut Trio	Kvadrat								
Lani	Vescom								
Gamut	Vescom								
Barnum	Nevotex								

CERTIFICATIONS

- Recycled contents
- OEKO Tex Standard 100
- EN1021-1&2
- OEKO Tex Standard 100
- EU Ecolabel
- Crib 5
- Greenguard Certificate
- CA TB 117

DESIGN

Solid wood frame construction.
The filling consists of Stone wool, covered with textile.
Mounted with wire and wire lock. Standard wire length 59".
Hook for ceiling attachment not included.

MEASUREMENTS

WxH	WxH (Contains several modules)
14.7" x 22.6"	375 x 47.2"
22.6" x 22.6"	22.6" x 47.2"
31.5" x 22.6"	31.5" x 47.2"
47.2" x 22.6"	47.2" x 47.2"
22.6" x 47.2"	375 x 71.8"
	22.6" x 71.8"
	31.5" x 71.8"
	47.2" x 71.8"
	22.6" x 71.8"
	47.2" x 71.8"
	47.2" x 71.8"

Thickness: 1.6"

SOUND

SS-EN ISO 354, ISO 11654 Class A
SS-EN ISO 354:2003 evaluated SS 25269

N10	
22.6" x 22.6"	15
47.2" x 22.6"	9
47.2" x 71.8"	2

ENVIRONMENT & SAFETY

Möbelfakta Certified





Dezibel Divider

Item no.	Modules Pcs./set	Size WxHxD	Price gr. 1	Price gr. 2	Price gr. 3	Price gr. 4	Weight Pounds
35-0305	1	14.8" x 22.6" x 1.6"	590	618	664	708	8,8
35-0505	1	22.6" x 22.6" x 1.6"	595	623	667	710	11
35-0805	1	31.5" x 22.6" x 1.6"	903	941	1 002	1 062	13,2
35-1205	1	47.2" x 22.6" x 1.6"	935	991	1 074	1 161	19,8
35-0512	1	22.6" x 47.2" x 1.6"	928	979	1 058	1 144	19,8
35-P001	2	14.8" x 47.2" x 1.6"	1 178	1 236	1 327	1 417	17,6
35-P002	2	22.6" x 47.2" x 1.6"	1 190	1 247	1 336	1 418	22
35-P003	2	31.5" x 47.2" x 1.6"	1 811	1 884	2 006	2 125	26,4
35-P004	2	47.2" x 47.2" x 1.6"	1 876	1 982	2 150	2 326	39,7
35-P005	3	14.8" x 71.9" x 1.6"	1 767	1 857	1 989	2 124	39,7
35-P006	3	22.6" x 71.9" x 1.6"	1 784	1 870	2 003	2 132	19,8
35-P007	3	31.5" x 71.9" x 1.6"	2 713	2 824	3 007	3 188	26,4
35-P008	3	47.2" x 71.9" x 1.6"	2 812	2 973	3 225	3 483	33
35-P009	2	22.6" x 71.9" x 1.6"	1 524	1 600	1 724	1 852	39,7
35-P010	4	47.2" x 71.9" x 1.6"	3 061	3 226	3 483	3 742	66,1
35-P011	5	47.2" x 71.9" x 1.6"	3 313	3 481	3 741	4 000	66,1

Item no.	Options	Price/pc
91-292	Suspended ceiling bracket 1 pc/wire	9
90-059	Extra long wire L118.1"	25
90-060	Extra long wire L196,8"	25

2 wire L59" included

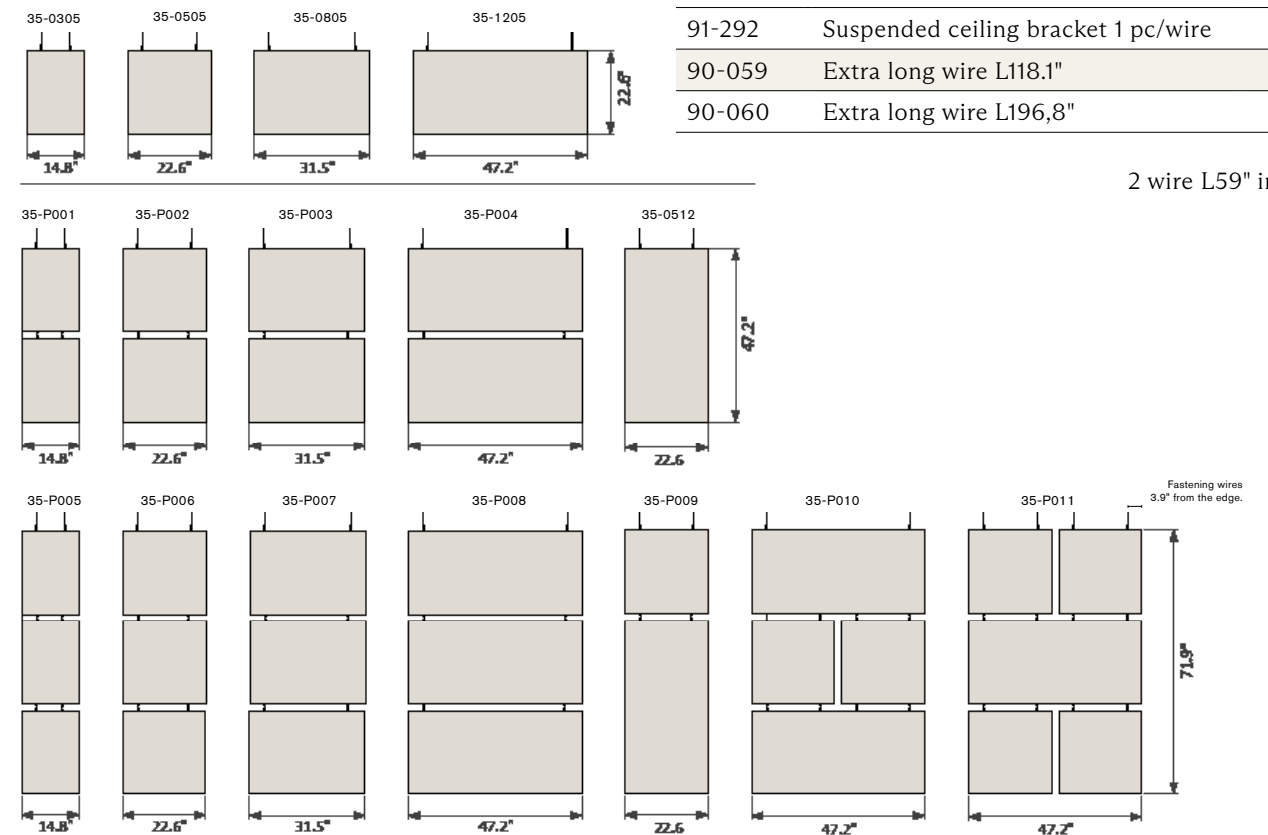



Dezibel Suspended ceiling

Many suspended ceilings are too thin. With Zilenzio ceiling tiles you can easily improve your suspended ceiling to create a better sound environment.

Item no.	Size	Price gr. 1	Price gr. 2	Price gr. 3	Price gr. 4
	WxLxD				
18-0606	W 23.2"x L23.2"x D1.9"	143	-	-	-

FABRICS

PRICE GROUP 1

Sawana	Davis						
Cara 170	Camira						
Carlow 170	Camira						
Event Screen+ 170	Gabriel						
Mica 170	Gabriel						
Tonal 170	Gabriel						

CERTIFICATIONS

- Recycled contents
- OEKO Tex Standard 100

- OEKO Tex Standard 100
- EU Ecolabel
- Greenguard Certificate

- EN1021-1&2
- Crib 5
- CA TB 117



590 x 590
18-0606

Cloudz

Cloudz are ceiling absorbents designed to hang in layers above each other and therefore have holes where a wire can be pulled through to attach to the underlying absorbent. They are available in five different types to create a varied and playful impression. A ceiling absorber is often a great complement to other types of absorption measures.



DESIGNER

Lisa Notman

This product is part of the Zilenzio Pro family.
Zilenzio Pro combines the ultimate in function, design and durability.
All products in the series use stone wool for optimal sound absorption. Stone wool is recyclable, free of plastics and has the highest possible fire classification.



FABRICS

Our selected fabrics are divided into four price groups, with prices ascending from group one to four.

PRICE GROUP 1

Sawana	Davis								
Cara 170	Camira								
Carlow 170	Camira								
Event Screen+ 170	Gabriel								
Mica 170	Gabriel								
Tonal 170	Gabriel								

PRICE GROUP 2

Focus M Screen 170	Gabriel								
Event	Gabriel								
Hush 170	Gabriel								
Soul Melange 170	Gabriel								
Twist 170	Gabriel								
Twist Melange 170	Gabriel								
Floyd Screen 170	Kvadrat								
Slope 170	Nevotex								
Blazer Lite 170	Camira								
Era 170	Camira								

PRICE GROUP 3

Blazer	Camira								
Era	Camira								
Main Line Flax	Camira								
Rivet	Camira								
Synergy	Camira								
Focus	Gabriel								
Focus Melange	Gabriel								
Step	Gabriel								
Step Melange	Gabriel								
Field	Kvadrat								
Floyd	Kvadrat								
Remix	Kvadrat								
Remix Screen	Kvadrat								
Revive	Kvadrat								
Broken Twill Weave	Kvadrat								
Hint 170	Kvadrat								
Reflect	Kvadrat								
Wooly	Nevotex								
Wooly wide 170	Nevotex								
Lido	Nevotex								

PRICE GROUP 4

Yoredale	Camira								
Crisp	Gabriel								
Canvas	Kvadrat								
Divina	Kvadrat								
Fiord	Kvadrat								
Hallingdal	Kvadrat								
Hero	Kvadrat								
Melange Nap	Kvadrat								
Re-wool	Kvadrat								
Steelcut	Kvadrat								
Steelcut Trio	Kvadrat								
Lani	Vescom								
Gamut	Vescom								
Barnum	Nevotex								

CERTIFICATIONS

- Recycled contents
- OEKO Tex Standard 100

- OEKO Tex Standard 100
- EU Ecolabel
- Greenguard Certificate

- EN1021-1&2
- Crib 5
- CA TB 117

DESIGN

MDF back. Stone wool filling, externally covered with textile. Mounted with wire and wire lock.
4 pcs. wire 59" included. Hook for ceiling attachment not included.

MEASUREMENTS

Cloud One	37" x 37"
Cloud Two	35" x 46.1"
Cloud Three	44.1" x 46.1"
Cloud Four	61" x 47.2"
Cloud Five	67.7" x 44.5"

Thickness: 2"



SOUND

SS-EN ISO 354, ISO 11654 Class A
SS-EN ISO 354:2003 evaluated SS 25269

N10	
Cloudz One	20
Cloudz Three	9
Cloudz Five	6

ENVIRONMENT & SAFETY

Möbelfakta Certified



Cloudz



Item no.	Form	Size	Price gr. 1	Price gr. 2	Price gr. 3	Price gr. 4	Weight
		Horizontal mounting WxLxD					Pounds
66-0909	Cloudz One	37" x 37" x 2.1"	1 534	1 578	1 652	1 722	24,2
66-0811	Cloudz Two	35" x 46.1" x 2.1"	1 525	1 566	1 639	1 707	24,2
66-1111	Cloudz Three	44.1" x 46.1" x 2.1"	1 551	1 599	1 692	1 775	28,6
66-1512	Cloudz Four	61" x 47.2" x 2.1"	1 688	1 757	1 872	1 983	37,5
66-1711	Cloudz Five	67.7" x 44.5" x 2.1"	1 666	1 739	1 867	1 987	44,1

This product is part of the Zilenzio Pro family.
Zilenzio Pro combines the ultimate in function, design and durability.
All products in the series use stone wool for optimal sound absorption. Stone wool is recyclable, free of plastics and has the highest possible fire classification.



Dezibel Ceiling

Dezibel Ceiling is available as circles, rectangles and squares lying against the ceiling.



This product is part of the Zilenzio Pro family.
Zilenzio Pro combines the ultimate in function, design and durability.
All products in the series use stone wool for optimal sound absorption. Stone wool is recyclable, free of plastics and has the highest possible fire classification.



FABRICS

Our selected fabrics are divided into four price groups, with prices ascending from group one to four.

PRICE GROUP 1

Sawana	Davis								
Cara 170	Camira								
Carlow 170	Camira								
Event Screen+ 170	Gabriel								
Mica 170	Gabriel								
Tonal 170	Gabriel								

PRICE GROUP 2

Focus M Screen 170	Gabriel								
Event	Gabriel								
Hush 170	Gabriel								
Soul Melange 170	Gabriel								
Twist 170	Gabriel								
Twist Melange 170	Gabriel								
Floyd Screen 170	Kvadrat								
Slope 170	Nevotex								
Blazer Lite 170	Camira								
Era 170	Camira								

PRICE GROUP 3

Blazer	Camira								
Era	Camira								
Main Line Flax	Camira								
Rivet	Camira								
Synergy	Camira								
Focus	Gabriel								
Focus Melange	Gabriel								
Step	Gabriel								
Step Melange	Gabriel								
Field	Kvadrat								
Floyd	Kvadrat								
Remix	Kvadrat								
Remix Screen	Kvadrat								
Revive	Kvadrat								
Broken Twill Weave	Kvadrat								
Hint 170	Kvadrat								
Reflect	Kvadrat								
Wooly	Nevotex								
Wooly wide 170	Nevotex								
Lido	Nevotex								

PRICE GROUP 4

Yoredale	Camira								
Crisp	Gabriel								
Canvas	Kvadrat								
Divina	Kvadrat								
Fiord	Kvadrat								
Hallingdal	Kvadrat								
Hero	Kvadrat								
Melange Nap	Kvadrat								
Re-wool	Kvadrat								
Steelcut	Kvadrat								
Steelcut Trio	Kvadrat								
Lani	Vescom								
Gamut	Vescom								
Barnum	Nevotex								

CERTIFICATIONS

- Recycled contents
- OEKO Tex Standard 100
- EN1021-1&2
- OEKO Tex Standard 100
- EU Ecolabel
- Crib 5
- Greenguard Certificate
- CA TB 117

*Remix cannot be used on circles



Dezibel Ceiling

Item no.	Form	Size	Price gr. 1	Price gr. 2	Price gr. 3	Price gr. 4	Wire	Weight
		Horizontal mounting WxLxD					Amount	Pounds
65-1206	Rectangle	47.2" x 23.6" x 2"	656	687	746	796	4	13,2
65-0812	Rectangle	47.2" x 31.5" x 2"	691	728	802	862	4	17,6
65-1212	Kvadrat	47.2" x 47.2" x 2"	1 090	1 142	1 237	1 321	4	26,4
65-023.6"	Circle*	Ø 23.6" x 2"	765	795	851	903	4	11
65-031.5"	Circle*	Ø 31.5" x 2"	806	842	913	971	4	17,6
65-39.4"	Circle*	Ø 39.4" x 2"	1 065	1 108	1 192	1 264	4	22
65-47.2"	Circle*	Ø 47.2" x 2"	1 120	1 170	1 266	1 352	4	30,8

*Fabric Remix cannot be used on circles

Item no.	Options	Price/pc
91-292	Suspended ceiling bracket 1 pc/wire	9
90-059	Extra long wire L118.1"*	25
90-060	Extra long wire L196.8"*	25

4 wire included

Suspended ceiling bracket 91-292



This product is part of the Zilenzio Pro family.
Zilenzio Pro combines the ultimate in function, design and durability.
 All products in the series use stone wool for optimal sound absorption. Stone wool is recyclable, free of plastics and has the highest possible fire classification.

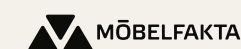

The Focus® family



For the growing county of digital nomads and those who still operate in more traditional workspaces, it is important to find a personal place in an otherwise public space – whether an open office landscape, café, hotel lobby or school. Welcome to the Focus family: Privacy, simplicity and endless flexibility.



DESIGN

The outside of the screen is made entirely of fabric, which on the inside is held up by wooden strips. Focus is sewn with a characteristic seam that makes it foldable.

DESIGNER

Note Design Studio

FOCUS® FLOOR

Focus Floor is a textile screen. The featherweight construction makes it easy to move the Focus Floor around when you need to create new room solutions for a flexible office.



FOCUS® TABLE

We have noticed that something is missing from public spaces when it comes to creating your own personal space. The Focus Table is a textile screen with a flexible construction that gives the screen the ability to take on the required shape. It can be easily folded and stored.



Focus® Pod

The Focus Pod is an easy-to-place and functional screen that also includes a seating area with a table. A designed and comfortable seat that gives a calm and cozy feeling.



DESIGN

Frame and table in white stained ash. Back and seat cushion in textile, held up on the inside by 2.5 wooden strips. The table can be used on both the left and right side Ø 250



Frame & table
White stained ash



Stand
Jet Black RAL 35.4"5

OPTIONS

Pillow	Item no.	Price gr. 1	Price gr. 2	Price gr. 3	Price gr. 4
Focus Pillow	75-1015-P	1 076	1 127	1 225	1 318
Power	Item no			Pris/pc	
Powerdot MIDI EL/USB (SE)	97-022			239	
Powerdot MIDI EL/USB (UK)	97-023			239	

FOCUS® DESK DIVIDER (PREVIEW - LAUNCH LATE 2023)

The Focus Desk Divider creates a calming cocoon that blocks distracting impressions and promotes concentration. A new addition to the Focus® family whose design, created by Note Design Studio, is both efficient and inviting.



The screen can be used to create an individual workplace at home or a personal space in an open office landscape or public place. Choose between rounded and straight corners.

FABRICS FOCUS® FLOOR, FOCUS® TABLE, FOCUS® DESK DIVIDER

Our selected fabrics are divided into four price groups, with prices ascending from group one to four.

PRICE GROUP 1

Cara 170	Camira			🌱				
Carlow 170	Camira			🌱				
Event Screen+ 170	Gabriel	♻️	⚙️	🌱				
Mica 170	Gabriel	♻️	⚙️	🌱				
Tonal 170	Gabriel	♻️	⚙️	🌱	🔥	🔥		

PRICE GROUP 2

Focus M Screen 170	Gabriel	♻️	⚙️	🌱	🔥	🔥		
Event	Gabriel	♻️	⚙️	🌱	🔥	🔥		
Hush 170	Gabriel		⚙️					
Soul Melange 170	Gabriel		⚙️		🔥			
Twist 170	Gabriel		⚙️	🌱				
Twist Melange 170	Gabriel		⚙️	🌱				
Floyd Screen 170	Kvadrat			🌍				
Slope 170	Nevotex		⚙️					
Blazer Lite 170	Camira							
Era 170	Camira		⚙️		🔥			

PRICE GROUP 3

Blazer	Camira				🔥			
Era	Camira		⚙️		🔥			
Main Line Flax	Camira			🌱	🔥	🔥		
Rivet	Camira			🌱	🔥			
Synergy	Camira			🌱	🔥			
Focus	Gabriel		⚙️	🌱	🔥	🔥		
Focus Melange	Gabriel		⚙️	🌱	🔥	🔥		
Step	Gabriel		⚙️	🌱	🔥	🔥	🔥	
Step Melange	Gabriel		⚙️		🔥	🔥	🔥	
Field	Kvadrat			🌱	🌍	🔥	🔥	🔥
Floyd	Kvadrat			🌍	🔥		🔥	
Remix	Kvadrat			🌱	🌍	🔥		🔥
Remix Screen	Kvadrat			🌱	🌍			🔥
Revive	Kvadrat	♻️		🌍	🔥		🔥	
Broken Twill Weave	Kvadrat	♻️		🌍	🔥		🔥	
Hint 170	Kvadrat			🌍				
Wooly	Nevotex	♻️		🌍	🔥		🔥	
Wooly wide 170	Nevotex							
Lido	Nevotex		⚙️					

PRICE GROUP 4

Yoredale	Camira					🔥		
Crisp	Gabriel	♻️	⚙️					
Canvas	Kvadrat			🌱	🌍	🔥		🔥
Divina	Kvadrat			🌱	🌍	🔥		🔥
Fiord	Kvadrat			🌱	🌍	🔥		🔥
Hallingdal	Kvadrat			🌱	🌍	🔥	🔥	🔥
Hero	Kvadrat			🌍	🔥		🔥	
Melange Nap	Kvadrat			🌱	🌍	🔥		🔥
Re-wool	Kvadrat	♻️		🌱	🌍	🔥		🔥
Steelcut	Kvadrat			🌱	🌍	🔥		🔥
Steelcut Trio	Kvadrat			🌱	🌍	🔥		🔥
Lani	Vescom			⚙️	🌍	🔥		🔥
Gamut	Vescom	♻️						🔥
Barnum	Nevotex		⚙️					🔥

CERTIFICATIONS

- ♻️ Recycled contents
- ⚙️ OEKO Tex Standard 100
- 🌱 EU Ecolabel
- 🌍 Greenguard Certificate
- 🔥 EN1021-1&2
- 🔥 Crib 5
- 🔥 CA TB 117

FABRICS FOCUS® POD

Our selected fabrics are divided into four price groups, with prices ascending from group one to four.

PRICE GROUP 1

Lido	Nevotex		⚙️					

PRICE GROUP 2

Main line flax	Camira			🌱	🔥	🔥		
Main line twist	Camira			🌱	🔥	🔥		
Sumi	Camira			🌱	🔥			

PRICE GROUP 3

Blazer	Camira				🔥			
Era	Camira		⚙️		🔥			
Rivet	Camira			🌱	🔥			
Synergy	Camira			🌱	🔥			
Focus	Gabriel		⚙️	🌱	🔥	🔥		🔥
Focus Melange	Gabriel		⚙️	🌱	🔥	🔥		🔥
Step	Gabriel		⚙️	🌱	🔥	🔥	🔥	🔥
Step Melange	Gabriel				🔥	🔥	🔥	🔥
Field	Kvadrat			🌱	🌍	🔥	🔥	🔥
Floyd	Kvadrat			🌍	🔥		🔥	
Remix	Kvadrat			🌱	🌍			🔥
Revive	Kvadrat	♻️		🌍	🔥		🔥	
Wooly	Nevotex	♻️			🔥		🔥	

PRICE GROUP 4

Yoredale	Camira					🔥		
Crisp	Gabriel	♻️	⚙️					
Canvas	Kvadrat			🌱	🌍	🔥		🔥
Clara	Kvadrat			🌱	🌍	🔥		🔥
Divina	Kvadrat			🌱	🌍	🔥		🔥
Fiord	Kvadrat			🌱	🌍	🔥		🔥
Hallingdal	Kvadrat			🌱	🌍	🔥	🔥	🔥
Hero	Kvadrat			🌍	🔥		🔥	
Melange Nap	Kvadrat			🌱	🌍	🔥		🔥
Re-wool	Kvadrat	♻️		🌱	🌍	🔥		🔥
Steelcut	Kvadrat			🌱	🌍	🔥		🔥
Steelcut Trio	Kvadrat			🌱	🌍	🔥		🔥
Gamut	Vescom	♻️						🔥
Barnum	Nevotex		⚙️					🔥

CERTIFICATIONS

- ♻️ Recycled contents
- ⚙️ OEKO Tex Standard 100
- 🌱 EU Ecolabel
- 🌍 Greenguard Certificate
- 🔥 EN1021-1&2
- 🔥 Crib 5
- 🔥 CA TB 117



Focus® Desk Divider

The Focus® Desk Divider creates a calming cocoon that screens out disturbing impressions and promotes concentration.

PREVIEW – LAUNCH LATE 2023

For more information, please contact Support@zilenzio.com

This product is part of the Focus® family.
For the growing county of digital nomads and those who still operate in more traditional workspaces, it is important to find a personal place in an otherwise public space – whether an open office landscape, café, hotel lobby or school.



Focus® Table



Item no.	Size WxHxD	Price gr. 1	Price gr. 2	Price gr. 3	Price gr. 4	Weight Pounds
70-1103	46.7" x 12.6" x 0.4"	564	628	723	817	2,2
70-1903	78" x 12.6" x 0.4"	734	835	980	1 136	4,4
70-2903	116.9" x 12.6" x 0.4"	1 016	1 168	1 379	1 598	6,6
70-1104	46.7" x 17.7" x 0.4"	570	634	728	824	4,4
70-1904	78" x 17.7" x 0.4"	738	842	985	1 136	6,6
70-2904	116.9" x 17.7" x 0.4"	1 043	1 191	1 403	1 626	8,8



2970 x 450
70-2904

1980 x 450
70-1904

1185 x 450
70-1104

1185 x 320
70-1103

1980 x 320
70-1903

2970 x 320
70-2903

Focus® Floor Divider



Item no.	Size WxHxD	Price gr. 1	Price gr. 2	Price gr. 3	Price gr. 4	Weight Pounds
71-2112	82.7" x 47.2" x 0.4"	1 873	2 127	2 491	2 872	9
71-2412	94.5" x 47.2" x 0.4"	2 031	2 302	2 690	3 093	10
71-2712	106.3" x 47.2" x 0.4"	2 178	2 559	3 097	3 665	12
71-2115	82.7" x 59.1" x 0.4"	2 037	2 350	2 799	3 269	11
71-2415	94.5" x 59.1" x 0.4"	2 138	2 455	2 904	3 376	13
71-2715	106.3" x 59.1" x 0.4"	2 454	2 925	3 589	4 296	15

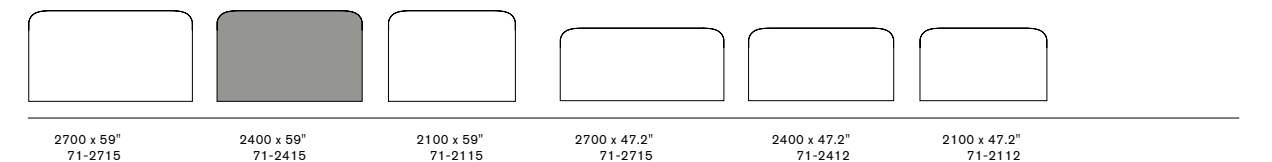

Focus® Pod



Item no.	Size	Furniture pg.1	Furniture pg.2	Furniture pg.3	Furniture pg.4	Weight
	WxHxD					Pounds
75-1015	39.4" x 59" x 20.5"	4 980	5 369	5 812	6 392	52.9

ADD-ONS

Pillow	Item no.	Furniture pg.1	Furniture pg.2	Furniture pg.3	Furniture pg.4
Focus Pillow	75-1015-P	1 076	1 127	1 225	1 318

Power	Item no	Pris/pc
Powerdot MIDI EL/USB (SE)	97-022	239
Powerdot MIDI EL/USB (UK)	97-023	239

Customer customization	Item no	Price
Optional RAL lacquer foot	7-MOD-02	1 361
Optional NCS lacquer frame & table	7-MOD-01	227

* Starting cost per new color

Tone

Tone is a collection of sound-absorbing acoustic furniture, designed to be placed discreetly where it is most needed, to create focus and concentration in the workplace or at home and contribute to a more balanced sound environment.



DESIGNER





Norm Architects

This product is part of the Zilenzio Pro family.
Zilenzio Pro combines the ultimate in function, design and durability.
 All products in the series use stone wool for optimal sound absorption. Stone wool is recyclable, free of plastics and has the highest possible fire classification.









FABRICS

PRICE GROUP 3

Remix Kvadrat      

CERTIFICATIONS

-  Recycled contents
-  OEKO Tex Standard 100
-  EU Ecolabel
-  Greenguard Certificate
-  EN1021-1&2
-  Crib 5
-  CA TB 117

DESIGN

Solid wood storage, filled with stone wool. Fully fabric covered exterior. The stand and accessories are made of metal.

Standard lacquer stand



Dusty grey
RAL 7037

Jet Black
RAL 9005

MEASUREMENTS

Width: 21.6", 43", 161.9"
 Height: 17.3", 83.1"
 Height of stand: 10.2", 27.6"
 Depth: 40.8"

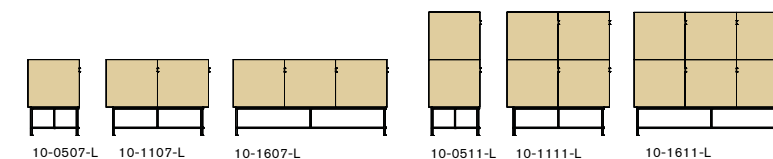

INNER MEASUREMENT

Width: 19.1"
 Height: 15.1"
 Depth: 32.2"

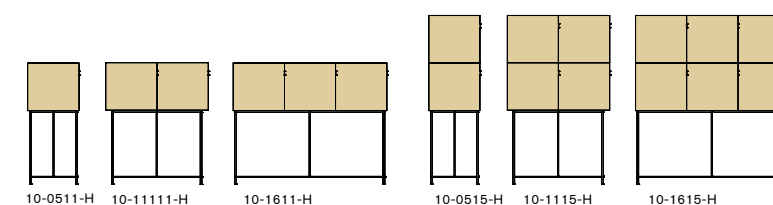

OPTIONS

Options	Item no.	Price/pc
Cable hole	10-MOD-01	235
Starting cost any RAL	10-MOD-02	2 221
Shelving	10-MOD-03	237
Hatch in a different fabric color	10-MOD-04	218
User card FlexLOCK Mifare	90-089	60
User card FlexLOCK EM	90-085	60



Tone



Item no.	Shutters	Stand	Size WxHxD	Price		FlexLock		Weight Pounds
				Remix	Mifare	EC	Price	
10-0507-L	Tone One	Low stand	21.7" x 27.6" x 16.5"	4 036	97-031	97-025	905	19,8
10-1107-L	Tone Two	Low stand	43.3" x 27.6" x 16.5"	6 454	97-032	97-026	1 468	77,2
10-1607-L	Tone Three	Low stand	65" x 27.6" x 16.5"	8 084	97-033	97-027	2 130	112,5
10-0511-L	Tone Two	Low stand	21.7" x 44.9" x 16.5"	6 455	97-032	97-026	1 468	72,8
10-1111-L	Tone Four	Low stand	43.3" x 44.9" x 16.5"	9 434	97-034	97-028	2 786	139,9
10-1611-L	Tone Six	Low stand	65" x 44.9" x 16.5"	13 225	97-036	97-030	3 444	205,1
<hr/>								
10-0511-H	Tone One	High stand	21.7" x 44.9" x 16.5"	4 197	97-031	97-025	905	48,5
10-1111-H	Tone Two	High stand	43.3" x 44.9" x 16.5"	6 618	97-032	97-026	1 468	81,6
10-1611-H	Tone Three	High stand	65" x 44.9" x 16.5"	8 244	97-033	97-027	2 130	116,7
10-0515-H	Tone Two	High stand	21.7" x 62.2" x 16.5"	6 619	97-032	97-026	1 468	79,4
10-1115-H	Tone Four	High stand	43.3" x 62.2" x 16.5"	9 596	97-034	97-028	2 786	143,3
10-1615-H	Tone Six	High stand	65" x 62.2" x 16.5"	13 386	97-036	97-030	3 444	209,5

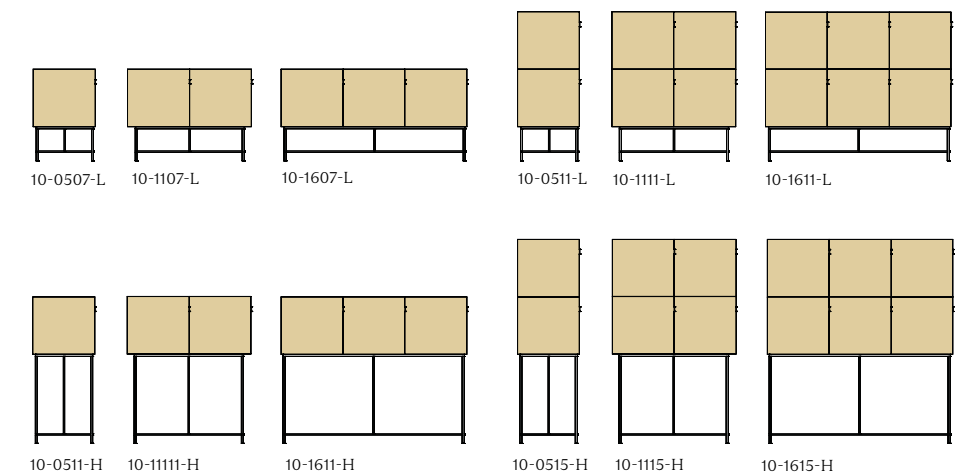

This product is part of the Zilenzio Pro family.
*Zilenzio Pro combines the ultimate in function, design and durability.
 All products in the series use stone wool for optimal sound absorption. Stone wool is recyclable, free of plastics and has the highest possible fire classification.*



The Tune family

The Tune family: Tune is a sound absorbing sofa series designed by Norm Architects for Zilenzio. Tune is part of the Zilenzio Pro family and uses stone wool for the best sound absorption. Tune sofas and armchairs have upholstered sound-absorbing backs and comfortable cushions.



DESIGNER

Norm Architects

This product is part of the Zilenzio Pro family.
Zilenzio Pro combines the ultimate in function, design and durability.
All products in the series use stone wool for optimal sound absorption. Stone wool is recyclable, free of plastics and has the highest possible fire classification.



FABRICS

Our selected fabrics are divided into four price groups, with prices ascending from group one to four.

PRICE GROUP 1

Lido	Nevotex						

PRICE GROUP 2

Main line flax	Camira						
Main line twist	Camira						
Sumi	Camira						

PRICE GROUP 3

Blazer	Camira						
Era	Camira						
Rivet	Camira						
Synergy	Camira						
Focus	Gabriel						
Focus Melange	Gabriel						
Step	Gabriel						
Step Melange	Gabriel						
Field	Kvadrat						
Floyd	Kvadrat						
Remix	Kvadrat						
Revive	Kvadrat						
Wooly	Nevotex						

PRICE GROUP 4

Yoredale	Camira						
Crisp	Gabriel						
Canvas	Kvadrat						
Clara	Kvadrat						
Divina	Kvadrat						
Fiord	Kvadrat						
Hallingdal	Kvadrat						
Hero	Kvadrat						
Melange Nap	Kvadrat						
Re-wool	Kvadrat						
Steelcut	Kvadrat						
Steelcut Trio	Kvadrat						
Gamut	Vescom						
Barnum	Nevotex						

CERTIFICATIONS

- Recycled contents
- OEKO Tex Standard 100
- EN1021-1&2
- EU Ecolabel
- Greenguard Certificate
- Crib 5
- CA TB 117

TUNE SOFA

Tune is a sound absorbing series designed by Norm Architects for Zilenzio. Tune consists of sofa, armchair and pouf, all products are filled with sound absorbing stone wool. Both the sofa and the armchair can be had with a high or low back and the sofa can be open right or left. Feel free to complement your sofa with a Tune coffee table or a laptop table.



MEASUREMENT

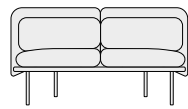

59" x 26.3" x 26.3"
item no. 9-1508

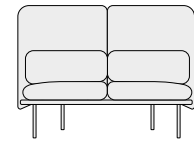

59" x 47.2" x 26.3"
item no. 9-1512

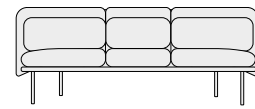

81.1" x 26.3" x 26.3"
item no. 9-2008

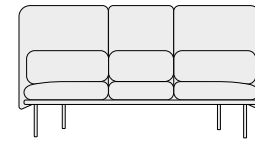

81.1" x 47.2" x 26.3"
item no. 9-2012

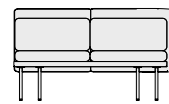

59" x 26.3" x 26.3"
item no. 9-1508-V
Open left

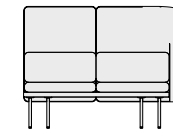

59" x 47.2" x 26.3"
item no. 9-1512-V
Open left

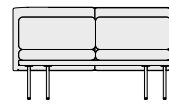

59" x 26.3" x 26.3"
item no. 9-1508-H
Open right

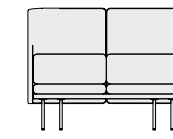

59" x 47.2" x 26.3"
item no. 9-1512-H
Open right

VARNISH



Jet Black
RAL 9005

TUNE CHAIR



MEASUREMENTS

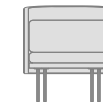

33.1" x 31.5" x 26.3"
item no. 9-0808

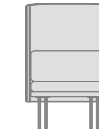

33.1" x 47.2" x 26.3"
item no. 9-0812

COLOR



Jet Black
RAL 9005

TUNE POUF



MEASUREMENTS



27.9" x 19.7" x 24"
item no. 9-0705

COLOR



Jet Black
RAL 9005

TUNE COFFEE & LAPTOP TABLE

A flexible table for the modern workplace. The Tune laptop appears to float effortlessly over the floor thanks to the asymmetrically positioned post, which makes it easy to get the table over a sofa edge, for example, to create an ergonomic and comfortable workplace.



Tune Pouf



Item no.	Size WxHxD	Form	Furniture pg.1	Furniture pg.2	Furniture pg.3	Furniture pg.4	Weight Pounds
9-0705	27.9" x 19.7 x 24"	Pouf	2 290	2 394	2 579	2 827	99

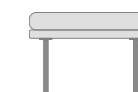

27.9" x 19.7 x 24"
item no. 9-0705

This product is part of the Zilenzio Pro family.
Zilenzio Pro combines the ultimate in function, design and durability.
All products in the series use stone wool for optimal sound absorption. Stone wool is recyclable, free of plastics and has the highest possible fire classification.



Tune Chair



Item no.	Size WxHxD	Form	Back	Furniture pg.1	Furniture pg.2	Furniture pg.3	Furniture pg.4	Weight Pounds
9-0808	33" x 31.5" x 26.3"	1-seater	Low	4 861	5 153	5 669	6 366	99
9-0812	33" x 47.2" x 26.3"	1-seater	High	5 314	5 649	6 238	7 034	107

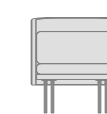

33" x 31.5" x 26.3"
item no. 9-0808



33" x 47.2" x 26.3"
item no. 9-0812

This product is part of the Zilenzio Pro family.
Zilenzio Pro combines the ultimate in function, design and durability.
All products in the series use stone wool for optimal sound absorption. Stone wool is recyclable, free of plastics and has the highest possible fire classification.



Tune Sofa



TUNE SOFA HIGH BACK

Item no.	Size WxHxD	Form	Back	Furniture pg.1	Furniture pg.2	Furniture pg.3	Furniture pg.4	Weight Pounds
9-1512	59.1" x 47.2" x 26.4"	2-seater	High	8 404	9 682	10 562	12 422	121
9-2012	81.1" x 47.2" x 26.4"	3-seater	High	9 354	10 581	12 111	14 225	154

TUNE SOFA LOW BACK

Item no.	Size WxHxD	Form	Back	Furniture pg.1	Furniture pg.2	Furniture pg.3	Furniture pg.4	Weight Pounds
9-1508	59.1" x 34.1" x 26.4"	2-seater	Low	7 548	8 420	9 545	11 079	99
9-2008	81.1" x 34.1" x 26.4"	3-seater	Low	8 571	9 593	10 904	12 692	132

TUNE SOFA HIGH BACK OPEN ONE SIDE

Item no.	Size WxHxD	Form	Back	Open	Furniture pg.1	Furniture pg.2	Furniture pg.3	Furniture pg.4	Weight Pounds
9-1512-H	59.1" x 47.2" x 26.4"	2-seater	High	Right	8 149	9 254	10 562	12 422	121
9-1512-V	59.1" x 47.2" x 26.4"	2-seater	High	Left	8 149	9 254	10 562	12 422	121

TUNE SOFA LOW BACK OPEN ON ONE SIDE

Item no.	Size WxHxD	Form	Back	Open	Furniture pg.1	Furniture pg.2	Furniture pg.3	Furniture pg.4	Weight Pounds
9-1508-H	59.1" x 34.1" x 26.4"	2-seater	Low	Right	7 548	8 420	9 545	11 079	99
9-1508-V	59.1" x 34.1" x 26.4"	2-seater	Low	Left	7 548	8 420	9 545	11 079	99



Tune Coffee Table

Item no.	Size	Form	Coffee table
	WxD		
16-0505	19.7" x 19.7"	Small	2 432
16-1005	39.4" x 19.7"	Large	3 261



Tune Laptop Table

Item no.	Size	Laptop Table
	WxHxD	
17-0503	19.3" x 13.8"	689

The Delta family

The Delta family: Delta is a series of wall and ceiling sound absorbers. The panels can be combined in many different ways and provide unlimited possibilities to create a personally adapted quiet environment for work or rest.



DESIGNER

Constance Guisset

This product is part of the Zilenzio Pro family.
Zilenzio Pro combines the ultimate in function, design and durability.
All products in the series use stone wool for optimal sound absorption. Stone wool is recyclable, free of plastics and has the highest possible fire classification.



FABRICS

Our selected fabrics are divided into four price groups, with prices ascending from group one to four.

PRICE GROUP 1

Sawana	Davis								
Cara 170	Camira								
Carlow 170	Camira								
Event Screen+ 170	Gabriel								
Mica 170	Gabriel								
Tonal 170	Gabriel								

PRICE GROUP 2

Focus M Screen 170	Gabriel								
Event	Gabriel								
Hush 170	Gabriel								
Soul Melange 170	Gabriel								
Twist 170	Gabriel								
Twist Melange 170	Gabriel								
Floyd Screen 170	Kvadrat								
Slope 170	Nevotex								
Blazer Lite 170	Camira								
Era 170	Camira								

PRICE GROUP 3

Blazer	Camira								
Era	Camira								
Main Line Flax	Camira								
Rivet	Camira								
Synergy	Camira								
Focus	Gabriel								
Focus Melange	Gabriel								
Step	Gabriel								
Step Melange	Gabriel								
Field	Kvadrat								
Floyd	Kvadrat								
Remix	Kvadrat								
Remix Screen	Kvadrat								
Revive	Kvadrat								
Broken Twill Weave	Kvadrat								
Hint 170	Kvadrat								
Reflect	Kvadrat								
Wooly	Nevotex								
Wooly wide 170	Nevotex								
Lido	Nevotex								

PRICE GROUP 4

Yoredale	Camira								
Crisp	Gabriel								
Canvas	Kvadrat								
Divina	Kvadrat								
Fiord	Kvadrat								
Hallingdal	Kvadrat								
Hero	Kvadrat								
Melange Nap	Kvadrat								
Re-wool	Kvadrat								
Steelcut	Kvadrat								
Steelcut Trio	Kvadrat								
Lani	Vescom								
Gamut	Vescom								
Barnum	Nevotex								

CERTIFICATIONS

- Recycled contents
- OEKO Tex Standard 100

- OEKO Tex Standard 100
- EU Ecolabel
- Greenguard Certificate

- EN1021-1&2
- Crib 5
- CA TB 117



DELTA LEAVES

Delta Leaves is a series of sound absorbing panels that can be combined in many different ways and provide unlimited possibilities to create a personally adapted quiet environment for work or rest. The panels are available in three sizes and are designed to fit any environment – from the smallest meeting room to the large office landscape. They can be used individually or together, horizontally or vertically, and combined in an infinite number of compositions.

With their soft geometric shapes, the panels can be discreetly incorporated into a sophisticated environment – or be used to create more playful installations. The collection also invites you to experiment with colors and textures.

This product is part of the Zilenzio Pro family.
Zilenzio Pro combines the ultimate in function, design and durability.
All products in the series use stone wool for optimal sound absorption. Stone wool is recyclable, free of plastics and has the highest possible fire classification.



DESIGN

MDF core, stone wool filling, polyether edges and external textile cover.
 Easily mounted using a suspension strip.

MEASUREMENT

DELTA LEAVES

Leaves One:	21.3" x 131.6"
Leaves Two:	35.4" x 35.4"
Leaves Three:	21.3 x 51.6"
Thickness:	2,3"

SHELF

Shelf 500:	7.9" x 19.7"
Shelf 700:	7.9" x 27.6"
Thickness:	1"

SOUND

SS-EN ISO 354, ISO 11654 Class A
 SS-EN ISO 354:2003 evaluated ISO 20189:2018

N10

Delta Leaves One	11
Delta Leaves Two	10
Delta Leaves Three	26
Delta Leaves One-Two-Three Combination	4.8

ADD-ON

Two optional shelves make the series complete. They are designed specifically for the panels and add another layer of functionality to maximize the use of the wall surface.





DELTA CEILING

Delta Ceiling is a sound absorber that is suspended from the ceiling. The discreet suspension makes them appear to float freely in the room. It can also be angled to effectively absorb sounds from different directions and create an aesthetic playfulness.

This product is part of the Zilenzio Pro family.
Zilenzio Pro combines the ultimate in function, design and durability.
All products in the series use stone wool for optimal sound absorption. Stone wool is recyclable, free of plastics and has the highest possible fire classification.



MEASUREMENT

Delta One	21.3"×131,2"
Delta Two	28.7"×39"
Delta Three	20.5"×81,2"

Thickness: 2,3"

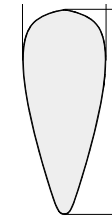

Delta One
62-0513

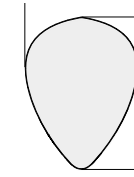

Delta Two
62-0709

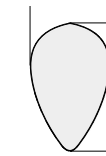

Delta Three
62-0508

ADD-ON

Optional Delta Ceiling	Item no	Price/st
Suspended ceiling bracket 1 pc/wire	91-292	9
Extra cable wire L196.8"	90-060	25

2 pieces of wire L118.1" included/absorbent



Suspended ceiling bracket 91-292

DESIGN

MDF core, stone wool filling, polyether edges and external textile cover.
 Mounted with 2 pieces of wire L118.1".

SOUND

SS-EN ISO 354, ISO 11654 Class A
 SS-EN ISO 354:2003 evaluated SS 25269

ENVIRONMENT & SAFETY

Möbelfakta Certified



DELTA WALL

The Delta Wall is part of our Delta series with its characteristic soft design. Available in three different sizes that create decorative patterns on the wall.

This product is part of the Zilenzio Pro family.
Zilenzio Pro combines the ultimate in function, design and durability.
All products in the series use stone wool for optimal sound absorption. Stone wool is recyclable, free of plastics and has the highest possible fire classification.



MEASUREMENT

Delta One	21.3"×131,2"
Delta Two	28.7"×39"
Delta Three	20.5"×81,2"
Thickness:	2,3"

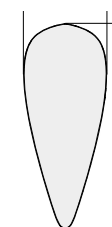

Delta One
69-0513

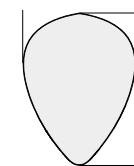

Delta Two
69-0709

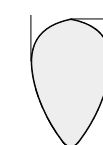

Delta Three
69-0508

DESIGN

MDF core, stone wool filling, polyether edges and external textile cover.
 Easily mounted with a Velcro-covered MDF spacer.
 The spacer builds 0.4" deep from the wall.

SOUND

SS-EN ISO 354, ISO 11654 Class A
 SS-EN ISO 354:2003 evaluated SS 25269

ENVIRONMENT & SAFETY

Möbelfakta Certified

Delta Leaves



Item no.	Form	Size WxHxD	Price gr. 1	Price gr. 2	Price gr. 3	Price gr. 4	Weight Pounds
691-1305	Leaves One	52.8" x 21.3" x 2.7"	1 026	1 195	1 422	1 672	22
691-0909	Leaves Two	35.4" x 35.4" x 2.7"	1 031	1 153	1 650	1 994	27
691-0505	Leaves Three	21.3" x 21.3" x 2.7"	736	821	934	1 059	20

Item no.	Ash shelf	Size WxHxD	Price
691-05-1	Shelf 500	19.7" x 7.9" x 1"	534
691-07-1	Shelf 700	27.6" x 7.9" x 1"	644

This product is part of the Zilenzio Pro family.
*Zilenzio Pro combines the ultimate in function, design and durability.
 All products in the series use stone wool for optimal sound absorption. Stone wool is recyclable, free of plastics and has the highest possible fire classification.*



Delta Ceiling



Item no.	Form	Size WxHxD	Price gr. 1	Price gr. 2	Price gr. 3	Price gr. 4	Weight Pounds
62-0513	Delta One	21.3" x 52.4" x 2.4"	1 009	1 168	1 246	1 357	13,2
62-0709	Delta Two	28.7" x 39" x 2.4"	1 010	1 175	1 238	1 345	15,4
62-0508	Delta Three	20.5" x 32.7" x 2.4"	926	1 017	1 065	1 165	11

Accessories	Item no	Price/st
Suspended ceiling bracket 1 pc/wire	91-292	9
Extra cable wire L196.8"	90-060	25

2 pieces of wire L118.1" included/absorbent

This product is part of the Zilenzio Pro family.
Zilenzio Pro combines the ultimate in function, design and durability.
All products in the series use stone wool for optimal sound absorption. Stone wool is recyclable, free of plastics and has the highest possible fire classification.



Delta Wall



Item no.	Form	Size	Price gr. 1	Price gr. 2	Price gr. 3	Price gr. 4	Weight
		WxHxD					Pounds
69-0513	Delta One	21.3" x 52.4" x 2.4"	934	1 085	1 164	1 272	13,2
69-0709	Delta Two	28.7" x 39" x 2.4"	938	1 091	1 173	1 282	15,4
69-0508	Delta Three	20.5" x 32.7" x 2.4"	845	932	978	1 075	11

This product is part of the Zilenzio Pro family.
Zilenzio Pro combines the ultimate in function, design and durability.
All products in the series use stone wool for optimal sound absorption. Stone wool is recyclable, free of plastics and has the highest possible fire classification.





Fabric covers

Renew the product by changing the fabric cover.
Works on any screen equipped with removable fabric.

OPTIMA FLOOR COVER

Item no.	Size WxHxD	Price gr. 1	Price gr. 2	Price gr. 3	Price gr. 4
27-0813-C	31.5" x 51.2" x 1.6"	275	349	449	568
27-08413-C	33.1" x 51.2" x 1.6"	283	358	464	584
27-09413-C	37" x 51.2" x 1.6"	288	376	491	627
27-1013-C	39.4" x 51.2" x 1.6"	295	389	509	656
27-1213-C	47.2" x 51.2" x 1.6"	316	428	572	744
27-12413-C	48.8" x 51.2" x 1.6"	320	435	583	761
27-14413-C	56.7" x 51.2" x 1.6"	337	473	642	848
27-16413-C	64.6" x 51.2" x 1.6"	362	514	705	936
27-18413-C	72.4" x 51.2" x 1.6"	385	557	769	1 032
27-0816-C	31.5" x 63" x 1.6"	284	358	668	900
27-08416-C	33.1" x 63" x 1.6"	287	364	670	900
27-09416-C	37" x 63" x 1.6"	302	387	677	906
27-1016-C	39.4" x 63" x 1.6"	307	398	677	907
27-1216-C	47.2" x 63" x 1.6"	326	438	690	916
27-12416-C	48.8" x 63" x 1.6"	331	444	690	916
27-14416-C	56.7" x 63" x 1.6"	352	484	-	-
27-16416-C	64.6" x 63" x 1.6"	371	522	-	-
27-18416-C	72.4" x 63" x 1.6"	407	571	-	-
27-0819-C	31.5" x 74.8" x 1.6"	365	542	765	1 034
27-08419-C	33.1" x 74.8" x 1.6"	367	542	766	1 035
27-09419-C	37" x 74.8" x 1.6"	371	548	771	1 041
27-1019-C	39.4" x 74.8" x 1.6"	376	555	777	1 046
27-1219-C	47.2" x 74.8" x 1.6"	386	562	787	1 054
27-12419-C	48.8" x 74.8" x 1.6"	380	559	781	1 050
27-14419-C	56.7" x 74.8" x 1.6"	399	575	-	-

DEZIBEL FLEXIBLE COVER

Item no.	Size WxHxD	Corners	Price gr. 1	Price gr. 2	Price gr. 3	Price gr. 4
33-0603-C	23.6" x 13.8" x 1.6"	Straight	249	274	312	359
33-0803-C	31.5" x 13.8" x 1.6"	Straight	257	293	346	405
33-1003-C	39.4" x 13.8" x 1.6"	Straight	272	314	377	452
33-1203-C	47.2" x 13.8" x 1.6"	Straight	281	333	406	497
33-0604-C	23.6" x 17.7" x 1.6"	Straight	250	277	316	362
33-0804-C	31.5" x 17.7" x 1.6"	Straight	273	299	348	407
33-1004-C	39.4" x 17.7" x 1.6"	Straight	271	317	379	454
33-1204-C	47.2" x 17.7" x 1.6"	Straight	281	336	409	498
34-0603-C	23.6" x 13.8" x 1.6"	Rounded	290	316	352	397
34-0803-C	31.5" x 13.8" x 1.6"	Rounded	299	333	384	440
34-1003-C	39.4" x 13.8" x 1.6"	Rounded	308	352	414	485
34-1203-C	47.2" x 13.8" x 1.6"	Rounded	320	372	447	529
34-0604-C	23.6" x 17.7" x 1.6"	Rounded	291	316	354	397
34-0804-C	31.5" x 17.7" x 1.6"	Rounded	314	336	387	445
34-1004-C	39.4" x 17.7" x 1.6"	Rounded	314	354	415	487
34-1204-C	47.2" x 17.7" x 1.6"	Rounded	323	375	449	531



Fabric covers

Renew the product by changing the fabric cover.
Works on any screen equipped with removable fabric.

DEZIBEL FLOOR COVER

Item no.	Size WxHxD	Price gr. 1	Price gr. 2	Price gr. 3	Price gr. 4
37-0813-C	31.5" x 51.2" x 1.6"	340	430	558	705
37-08413-C	33.1" x 51.2" x 1.6"	346	441	574	725
37-09413-C	37" x 51.2" x 1.6"	353	463	610	779
37-1013-C	39.4" x 51.2" x 1.6"	363	480	635	814
37-1213-C	47.2" x 51.2" x 1.6"	386	526	712	922
37-12413-C	48.8" x 51.2" x 1.6"	394	537	725	944
37-14413-C	56.7" x 51.2" x 1.6"	417	580	798	1 054
37-16413-C	64.6" x 51.2" x 1.6"	441	629	878	1 165
37-18413-C	72.4" x 51.2" x 1.6"	473	683	959	1 280
37-0816-C	31.5" x 63" x 1.6"	350	442	833	1 116
37-08416-C	33.1" x 63" x 1.6"	354	450	833	1 116
37-09416-C	37" x 63" x 1.6"	368	475	843	1 125
37-1016-C	39.4" x 63" x 1.6"	376	490	845	1 126
37-1216-C	47.2" x 63" x 1.6"	400	540	856	1 140
37-12416-C	48.8" x 63" x 1.6"	404	547	856	1 140
37-14416-C	56.7" x 63" x 1.6"	431	595	-	-
37-16416-C	64.6" x 63" x 1.6"	453	642	-	-
37-18416-C	72.4" x 63" x 1.6"	494	706	-	-
37-0819-C	31.5" x 74.8" x 1.6"	447	666	952	1 284
37-08419-C	33.1" x 74.8" x 1.6"	448	668	955	1 285
37-09419-C	37" x 74.8" x 1.6"	456	673	958	1 293
37-1019-C	39.4" x 74.8" x 1.6"	464	680	965	1 299
37-1219-C	47.2" x 74.8" x 1.6"	476	692	977	1 312
37-12419-C	48.8" x 74.8" x 1.6"	474	694	978	1 308
37-14419-C	56.7" x 74.8" x 1.6"	489	707	-	-

Fabric covers



Renew the product by changing the fabric cover.
Works on any screen with straight corners.
Choose the desired color from the Moss collection

FABRIC COVER MOSS PRICE EXAMPLE

Size	Price
WxHxD	Fabric Moss
63" x 57.6" x 1.6"	3525

REUPHOLSTERING EXISTING SCREENS

For price send quotation request with measurements of existing screens to support@zilenzio.com



SUSTAINABILITY

Zilenzio thinks sustainably in all parts of its business

We constantly strive to create ambitious design solutions and smart processes with an aim to offer the best products, bold and innovative, without leaving a heavy footprint on our planet. As part of our efforts to create sustainable solutions, we have launched THE GREEN TAG, our latest initiative to review and transform our own sustainability work across our entire product range.

THE GREEN TAG MANIFESTO

At Zilenzio we strive to:

- Use our innovative approach to develop more sustainable products and ensure a positive environmental impact for our business model.
 - Follow the Möbelfakta guidelines to ensure that we deliver first-class quality combined with a strong focus on environmental awareness and social responsibility.
 - Only use FSC certified wood, sourced from responsibly managed forests.
- Offer removable fabric that is easy to clean or replace when necessary.
- Promote the use of stone wool, a unique material made from natural stone. Stone wool is free from plastic and other dangerous substances, is fireproof, and absorbs sound brilliantly.
 - Partner liability. We build long-term relationships with our partners who are serious about sustainability and promote transparency in every part of the production chain.
 - Start our program with a new collaboration with Ragn-Sells and STONE WOOL in the Nordic countries. Our goal is to lead the shift towards products that are reliable yet leave a smaller footprint.

We challenge the integrity and long-term sustainability of our brand from the inside out, And we invite our customers and partners to join us on this exciting and important journey.

We are currently exploring the possibility of using a labeling system that identifies products that meet specific green criteria, such as products made from recycled stone wool and removable upholstery.

Designing and manufacturing beautiful products of the highest quality and with the longest possible lifespan is our calling. We make sure that every step is carefully thought out – from the way we manufacture and choose materials to packaging and recommended maintenance. With replaceable parts and the ability to recycle products, an intelligent approach to repairs and reuse is a natural part of our brand.

THE GREEN TAG
zilenzio

Head Office
Boställsvägen 6
702 27 Örebro
Sweden

Tel +46 19-672 17 00

support@zilenzio.com

www.zilenzio.com
#selling silence

©2023 Zilenzio

TERMS AND CONDITIONS

PRODUCTION AND DELIVERY

The Goods shall be produced upon purchase order. Production time is approx. five (5) business weeks after confirmed purchase order.

The production time for the models Tone, Tune or Kyoto shall be approx. eight (8) business weeks. Production or delivery time are not of the essence and all lead times are reserved for delays caused by external factors such as delayed fabric.

Any delivery time confirmed by Zilenzio refers to dispatch from factory.

All Goods shall be delivered DAP shipping to a Harbor the USA to the Delivery Location. Standard Freight & Distribution costs will be charged by Zilenzio.

Delivery shall be made during the Customer's normal business hours or as otherwise instructed by the customer and agreed by Zilenzio.

Title passes to Customer upon delivery. Title and Risk of loss follows Incoterms DAP Delivery Location.

The Customer shall inspect Goods delivered hereunder within ten calendar days from the date of arrival at the

Delivery Location and within such ten (10) day period shall notify Zilenzio in writing of particulars of all alleged defects in the Goods.

Such written notification is a condition

precedent to any claims by Customer in relation to defects reasonably detectable upon a visual inspection of the Goods.

WARRANTY

Zilenzio provides a warranty that all Goods for a period of twenty (20) years will:

- a) be free from any defects in workmanship, material and design;
- b) conform to applicable specifications and other requirements specified by Zilenzio within 5 millimeters deviation depending on fabric thickness;
- c) be fit for the Goods intended purpose and operate as intended;
- d) be merchantable, and;
- e) be free and clear of all liens, security interests or other encumbrances.

Normal wear and tear damage to the Goods are not covered by the warranty.

If Goods delivered under this Agreement at Delivery are damaged, defective or otherwise do not conform to the SKU listed in the applicable purchase order or were delivered to the Customer as a result of Zilenzio's error Zilenzio may at his sole discretion choose to:

- a) refund payment for the Goods plus any shipping, handling and transportation charges paid by the Customer, or;
- b) prompt correct or replace such Goods.

Zilenzio disclaims all warranties, express or implied, including without limitation warranties of merchantability and fitness, other than the express warranties stated or referred to in this Agreement.

Zilenzio disclaims all responsibility for any incorrect installation of the Zilenzio products as Zilenzio never carries out the installation.

Installation should be done by the dealer's own or by an approved installer.

PRICES

All prices are quoted in USD exclusive of VAT.

All previous price lists are canceled by this price list.

We reserve the right to adjust prices according to changes of material, exchange rate, commodity prices, tax changes or any other reason

RESERVATION

Texts and images may contain mistakes, we reserve the right to make changes as necessary.

The price list only contains standard modules.

For other finishes please request more information.

Zilenzio

#selling silence

Head office
Boställsvägen 6
702 27 Örebro
Sweden

Phone +46 19-672 17 00
Mail support@zilenzio.com

Furniture
Fogia, Mass Production, Fritz,
Allsteel, Hansen, Swedese

© 2013 - 2023 Zilenzio
Photos: Mathias Nero
Art Direction: Note Design Studio

www.zilenzio.com
Facebook: [zilenzio](https://www.facebook.com/zilenzio)
Instagram: [@zilenzio](https://www.instagram.com/zilenzio)