

Make your space work.

**HON.**

2024 List Pricer

# SHARED SPACES

Tables | Education | Seating



Effective Date | February 2024 | Updated April 2024

# LIST PRICER

## Effective Date: February 2024

- All illustrations and specifications in this publication are based on the latest product information available at the time of print. For the most recent version, please go to [www.hon.com](http://www.hon.com).
- Software support packages furnished to the customer, either by The HON Company or by another source, which support the sale of HON products are superseded by printed price lists.
- All dimensions shown in this publication are nominal.
- Pricing is subject to change without notice.
- All orders are subject to prices in effect at the time of order.
- Ordering information appears at the beginning of a section complete with examples on how to specify. These specifying information pages are referenced at the bottom center of product pages.
- HON Full Lifetime Warranty applies unless otherwise noted.
- HON nationwide customer service:  
Phone: (800) 833-3964

# HON LIST PRICER

## Table of Contents

### INTRODUCTION

Table of Contents.....	1-3
Additions.....	4-5
Discontinuations.....	6
HON Full Lifetime Warranty Information.....	7
HON Limited 5-Year Warranty Information.....	8
Ordering Information.....	9
HON Design Services.....	10
Tailored Solutions Ordering Information.....	11
Customer's Own Material Ordering Information.....	12-13
Partnership Textile Information.....	14
Paint Program.....	15
HON Open Line Laminate Program.....	16
Environmental Statement.....	17
Important Information.....	18
Legend.....	19
Fabric Patterns & Codes.....	20
Lead Times.....	21
Seating Fabric Patterns & Codes.....	22-25
Panel Fabric Patterns & Codes.....	26-27

### TABLES

<b>Arrange™</b> .....	28
<b>Arrange™ Café Tables Ordering Information</b> .....	29
Arrange™ Café Table Tops.....	30
Arrange™ Café Table Bases.....	31
Arrange™ Café Accessories.....	32
<b>Between™ Tables</b> .....	33
<b>Between™ Ordering Information</b> .....	34
Between™ Table Tops.....	35
Between™ Table Bases.....	36
Between™ Rectangular Table Tops.....	37
Between™ Table Bases for Rectangular Tops.....	37
Between™ Nesting Tables.....	38
Between™ Shared Components.....	38
<b>Birk™ Tables</b> .....	39
<b>Birk™ Ordering Information</b> .....	40
Birk™ Table Tops.....	41
Birk™ Bases.....	42
Birk™ Personal Table.....	43
<b>Flock™</b> .....	44
<b>Flock™ Collaborative Tables Ordering Information</b> .....	45
<b>Flock™ Collaborative Solutions Table Specifying Information</b> .....	46
Flock™ Collaborative Laminate Table Tops.....	47
Flock™ Collaborative Table Bases.....	48
Flock™ Collaborative Tables.....	49-50
<b>Huddle</b> .....	51
<b>Huddle Ordering Information</b> .....	52
<b>Huddle Multi-Purpose Tables</b> .....	53
Interlink IQ Electrical.....	54
4-Trac Hardwire Electrical System.....	55
Huddle Typical.....	56-57
Huddle Multi-Purpose Table Tops.....	58
Huddle Multi-Purpose Table Bases.....	59
Huddle Mobile Laptop Table.....	60
Huddle Table Accessories.....	61

<b>Occasional Tables</b> .....	62
<b>Laminate Occasional Tables Options</b> .....	63
Laminate Occasional Tables.....	64
<b>Motivate™</b> .....	65
<b>Motivate™ Tables Specifying Information</b> .....	66
4-Trac Hardwire Electrical System.....	67
Motivate™ Fixed Height Tables.....	68
Motivate™ Nesting Tables.....	69
Motivate™ Adjustable Height Tables.....	70
Motivate™ Shared Components.....	71-72
<b>Preside™</b> .....	73
<b>Preside™ Ordering Information</b> .....	74
<b>Preside™ Specifying Information</b> .....	75-84
Preside™ Grommet Cutout Placement.....	85
Preside™ Laminate Table Tops.....	86-87
Preside™ Laminate Bases.....	88-89
Preside™ Metal Bases.....	90-92
Preside™ Laminate Bases.....	93
Preside™ Metal Bases.....	94
Preside™ Collaborative Tables.....	95
Preside™ Ganging Tables.....	96
Preside™ Collaborative Tables.....	97
Preside™ Ganging Tables.....	98
Preside™ Mobile Collaborative Tables.....	99
Preside™ Team Touchdown Tables.....	100
Preside™ Ancillary.....	101
Preside™ Laminate Storage.....	102-103
Modular Components.....	104
Modular Components Back Panels.....	104
Wall Mount Storage.....	105-106
Preside™ Laminate Shared Components.....	107
Preside™ Laminate Tables.....	108
Preside™ Laminate Tables — Pre-defined Typical.....	109
<b>Scramble™ Occasional Tables</b> .....	110
<b>Scramble™ Options</b> .....	111
Scramble™ Coffee Tables.....	112
Scramble™ End Tables.....	113
<b>Sculpt™</b> .....	114
<b>Sculpt™ Ordering Information</b> .....	115
<b>Sculpt™ Statement of Line</b> .....	116
Sculpt™ Laminate Top Tables.....	117-118
Sculpt™ Wood Top Tables.....	119-120
Sculpt™ Tray Top Tables.....	121-122
Sculpt™ Personal & Console Tables.....	123
Sculpt™ Planters.....	124
Sculpt™ Accessories.....	125

### EDUCATION

<b>Cross Reference by Application</b> .....	126-127
<b>Build™</b> .....	128
<b>Build™ Ordering Information</b> .....	129
Build™ Shape Matrix.....	130
Build™ Table Configurations.....	131-133
Build™ Table Tops.....	134-136
Build™ Tables.....	137
Build™ Nesting Tables.....	138
Build™ Accessories.....	139
Build™ Student Desk Surface Dimensions.....	140

Build™ Student Desk Configurations.....	141-142
Build™ Student Desks.....	143-144
Build™ Student Desk Accessories.....	145
Build™ Makerspace Table.....	146-148
Build™ Makerspace Table Accessories.....	149
Build™ Makerspace Stools.....	150
<b>Class-ifi™</b> .....	151
<b>Class-ifi™ Ordering Information</b> .....	152
<b>Class-ifi™ Statement of Line</b> .....	153-154
<b>Class-ifi™ Specifying Information</b> .....	155-156
Class-ifi™ Lockers.....	157
Class-ifi™ Cubbies.....	158
Class-ifi™ Combos.....	159
Class-ifi™ Bookcases.....	160
Class-ifi™ Tote Storage.....	161
Class-ifi™ Command Station.....	162
Class-ifi™ Accessories.....	163
<b>Confetti™</b> .....	164
<b>Confetti™ Ordering Information</b> .....	165
<b>Confetti™ Statement of Line</b> .....	166
Confetti™ Floor Seating.....	167
Confetti™ Accessories.....	168
<b>Revel™</b> .....	169
Revel™ Stool.....	170
<b>Roll Call™</b> .....	171
<b>Roll Call™ Ordering Information</b> .....	172
Roll Call™.....	173
<b>SmartLink™</b> .....	174
<b>SmartLink™ Ordering Information</b> .....	175
<b>SmartLink™ Specifying Information</b> .....	176-179
SmartLink™ Series Student Desks.....	180
SmartLink™ Wall Rail System Accessories.....	181
SmartLink™ Chairs.....	182-185
SmartLink™ Teacher Stations.....	186-187
SmartLink™ Wall Rail System.....	188
SmartLink™ Wall Rail System Accessories.....	189
SmartLink™ Mobile Storage.....	190-192
<b>Storyline™</b> .....	193
<b>Storyline™ Ordering Information</b> .....	194
<b>Storyline™ Specifying Information</b> .....	195-197
Storyline™ Linear Bookcases.....	198
Storyline™ Curved Bookcases.....	199
Storyline™ Bistro Tables.....	200
Storyline™ Accessories.....	201
<b>Tangram™</b> .....	202
<b>Tangram™ Ordering Information</b> .....	203-204
<b>Tangram™ Statement of Line</b> .....	205-206
Tangram™ Typical.....	207-208
Tangram™ Story Steps.....	209
Tangram™ Multi-Fabric Story Steps.....	210
Tangram™ In-Line Tables.....	211
Tangram™ Modular Seating.....	212
Tangram™ Modular Seating — Multi-Fabric.....	213-214
Tangram™ Modular Seating.....	215
Tangram™ Modular Seating — Multi-Fabric.....	216-217
Tangram™ Modular Seating — Bistro-Back.....	218
Tangram™ Modular Seating — Bistro-Back, Multi-Fabric.....	219-220

For information regarding HON registered and unregistered trademarks, please go to [hon.com/protected-marks](http://hon.com/protected-marks). Haworth®, Herman Miller®, Knoll®, and Steelcase® are registered trademarks of their respective owners and use of the marks do not imply affiliation or endorsement of The HON Company or its products.

# LIST PRICER

Effective Date: February 2024

- All illustrations and specifications in this publication are based on the latest product information available at the time of print. For the most recent version, please go to [www.hon.com](http://www.hon.com).
- Software support packages furnished to the customer, either by The HON Company or by another source, which support the sale of HON products are superseded by printed price lists.
- All dimensions shown in this publication are nominal.
- Pricing is subject to change without notice.

- All orders are subject to prices in effect at the time of order.
- Ordering information appears at the beginning of a section complete with examples on how to specify. These specifying information pages are referenced at the bottom center of product pages.
- HON Full Lifetime Warranty applies unless otherwise noted.
- HON nationwide customer service:  
Phone: (800) 833-3964

## HON LIST PRICER Table of Contents

Tangram™ Ottomans .....	221-222	<b>Crio™</b> Mesh Chairs.....	308	<b>Motivate®</b> Chairs.....	405
Tangram™ Poufs .....	223	<b>Define™</b> Executive Chairs .....	309	<b>Motivate®</b> Task Chair Options .....	406
Tangram™ Accessories .....	224	<b>Endorse®</b> Collection.....	310	<b>Motivate®</b> Task Chair Fabric Options .....	407
<b>WORKPLACE TOOLS</b>		<b>Endorse®</b> Options .....	311	Motivate® Task Chairs .....	408
<b>Workplace Tools</b> .....	225	<b>Endorse®</b> Dimensions .....	312	<b>Motivate®</b> High-Density Sled Base Chair Options.....	409
<b>Workplace Tools Ordering Information</b> .....	226	<b>Endorse®</b> Fabric Options .....	313	Motivate® High-Density Sled Base Chairs .....	410-411
Monitor Arms .....	227-228	Endorse® .....	314-317	<b>Motivate®</b> 4-Leg Chair Options .....	412
CPU Holders .....	229	Endorse® Accessories.....	318	Motivate® 4-Leg Chairs.....	413-414
Keyboard Trays.....	230-231	<b>Flexion™</b> .....	319	<b>Motivate®</b> Nesting/Stacking Flex-Back Chair	
Corner Sleeves .....	232	<b>Flexion™</b> Options.....	320-321	Options.....	415
Center Drawers .....	233-234	Flexion™ .....	322	Motivate® Nesting/Stacking Flex-Back Chairs.....	416
Desktop Riser .....	235	<b>Flock®</b> .....	323	<b>Motivate®</b> Chair with Tablet Arm Options.....	417
Chair Mats .....	236	<b>Flock®</b> Options .....	324-325	Motivate® Chair with Tablet Arm.....	418
Task Lights.....	237-238	<b>Flock®</b> Fabric Options.....	326	<b>Motivate®</b> Flex-Back Chair with Tablet Arm	
Paper Management & Organizational Tools.....	239-242	Flock® Collaborative .....	327-330	Options.....	419
Interlink IQ Electrical .....	243-244	Flock® Multi-Fabric Collaborative .....	331-334	Motivate® Flex-Back Chair with Tablet Arm .....	420
4-Trac Hardwire Electrical System.....	245-246	Flock® Base Frames and Legs .....	335	<b>Nucleus®</b> .....	421
Power & Cable Management .....	247	<b>Flock®</b> Options .....	336	<b>Nucleus®</b> Task Chair Options.....	422-423
Power .....	248-250	Flock® Collaborative .....	337-341	<b>Nucleus®</b> Guest and Multi-Purpose Options .....	424
Power & Cable Management .....	251	Flock® Multi-Fabric Collaborative .....	342	<b>Nucleus®</b> Fabric Options.....	425
		<b>Flock®</b> Options .....	343	<b>Nucleus®</b> Dimensions.....	426-427
		Flock® Mini Cube and Cylinders .....	344	Nucleus® .....	428-431
		Flock® Multi-Fabric Mini Cube and Cylinder .....	345	<b>High-Density Olson Stacker® 4040 Series</b> .....	432
		<b>Gateway™</b> .....	346	High-Density Olson Stacker® 4040 Series.....	433
		<b>Gateway™</b> Fabric Options.....	347	<b>Parkwyn™</b> .....	434
		Gateway™ Standard Task Chair.....	348	<b>Parkwyn™</b> Options .....	435
		Gateway™ Value Task Chair .....	349	Parkwyn™ Club/Lounge .....	436
		<b>Grove®</b> .....	350	<b>Perpetual®</b> Nesting Chairs .....	437
		<b>Grove®</b> Options .....	351-352	<b>Perpetual®</b> Nesting Chairs Options.....	438
		<b>Grove®</b> Fabric Options.....	353	Perpetual® Nesting Chairs .....	439
		Grove® .....	354-356	<b>Pillow-Soft® 2090 Series</b> .....	440
		Grove® Multi-Fabric .....	357-360	<b>Pillow-Soft® 2090 Series Options</b> .....	441
		Grove® Accessories.....	361	Pillow-Soft® 2090 Series.....	442
		<b>Ignition®</b> .....	363	<b>Prominent™</b> Mesh Chairs .....	443
		<b>Ignition®</b> Options .....	364-365	<b>Ruck™</b> .....	444
		<b>Ignition® 2.0 Options</b> .....	366-367	<b>Ruck™</b> Options .....	445
		<b>Ignition® 2.0 Dimensions</b> .....	368-369	Ruck™ Laminate Seating.....	446
		Ignition® 2.0 .....	370-374	Ruck™ Wood Seating.....	447
		Ignition® 2.0 ReActiv® .....	375-376	<b>Scatter™</b> Guest Chairs .....	448
		Ignition® 2.0 Upholstered.....	377-378	<b>Skip</b> .....	449
		Ignition® 2.0 Accessories.....	379-380	Skip Collaborative Chair.....	450
		<b>Ignition®</b> Multi-Purpose Chair Options .....	381	<b>SoCo™</b> .....	451
		Ignition® Multi-Purpose.....	382	<b>SoCo™</b> Statement of Line .....	452
		Ignition® Multi-Fabric Multi-Purpose.....	383	<b>SoCo™</b> Fabric Options.....	453
		Ignition® Multi-Fabric Stools .....	384	SoCo™ Typicals .....	454
		Ignition® Guest .....	385	SoCo™ .....	455-459
		<b>Ignition®</b> Task Chair Options .....	386	SoCo™ Power .....	460
		<b>Ignition®</b> Fabric Options .....	387	<b>Solve®</b> .....	461
		Ignition® .....	388-391	<b>Solve®</b> Options .....	462-464
		Ignition® Accessories.....	392	Solve® .....	465-471
		<b>Lota®</b> .....	393	Solve® Accessories.....	472
		<b>Lota®</b> Options.....	394	<b>Soothe®</b> .....	473
		Lota® .....	395	<b>Soothe®</b> Options .....	474-475
		<b>Matter™</b> .....	396	Soothe® .....	476
		Matter™ Multi-Purpose Chairs .....	397	Soothe® Multi-Fabric .....	477-478
		<b>Mav™</b> .....	398	Soothe® Bracket.....	478
		<b>Mav™</b> Finish Options.....	399	Soothe® Benches.....	479
		Mav™ .....	400-404	<b>Torch™</b> Mesh Chairs .....	480

For information regarding HON registered and unregistered trademarks, please go to [hon.com/protected-marks](http://hon.com/protected-marks). Haworth®, Herman Miller®, Knoll®, and Steelcase® are registered trademarks of their respective owners and use of the marks do not imply affiliation or endorsement of The HON Company or its products.

# LIST PRICER

## Effective Date: February 2024

- All illustrations and specifications in this publication are based on the latest product information available at the time of print. For the most recent version, please go to [www.hon.com](http://www.hon.com).
- Software support packages furnished to the customer, either by The HON Company or by another source, which support the sale of HON products are superseded by printed price lists.
- All dimensions shown in this publication are nominal.
- Pricing is subject to change without notice.
- All orders are subject to prices in effect at the time of order.
- Ordering information appears at the beginning of a section complete with examples on how to specify. These specifying information pages are referenced at the bottom center of product pages.
- HON Full Lifetime Warranty applies unless otherwise noted.
- HON nationwide customer service:  
Phone: (800) 833-3964

# HON LIST PRICER

## Table of Contents

<b>Versant®</b> .....	481	<b>Volt® 5720 Series</b> .....	491	<b>Throw Pillows</b> .....	506
<b>Versant® Options</b> .....	482	<b>Volt® 5730 Series</b> .....	492	<b>West Hill™ Accessories</b> .....	507
<b>Versant®</b> .....	483-484	<b>Wave™ Mesh Chairs</b> .....	493	<b>Executive Chairs</b> .....	508-509
<b>Volt®</b> .....	485	<b>West Hill™ Casual Lounge Seating</b> .....	494	<b>Workplace Tools Ergonomic Solutions</b> .....	510
<b>Volt® 5700/5710 Series Options</b> .....	486	<b>West Hill™ Options</b> .....	495	<b>Workplace Tools Chair Mats</b> .....	511
<b>Volt® 5700 Series</b> .....	487	<b>West Hill™ Finish Options</b> .....	496		
<b>Volt® 5710 Series</b> .....	488	<b>West Hill™ Casual Lounge Seating</b> .....	497-502	<b>INDEX</b>	
<b>Volt® 5720/5730 Series Options</b> .....	489	<b>West Hill™ Ottomans</b> .....	503	<b>Cross Reference Index</b> .....	512-517
<b>Volt® 5720/5730 Series Fabric Options</b> .....	490	<b>West Hill™ Casual Lounge Seating</b> .....	504-505	<b>Information on Ordering Parts</b> .....	528

For information regarding HON registered and unregistered trademarks, please go to [hon.com/protected-marks](http://hon.com/protected-marks). Haworth®, Herman Miller®, Knoll®, and Steelcase® are registered trademarks of their respective owners and use of the marks do not imply affiliation or endorsement of The HON Company or its products.



# ADDITIONS

## NEW ADDITIONS: PRODUCTS

Tables	Effective Date
<b>Scramble™</b> Models: HSCCSR2448LMK, HSCCSR2448BPG, HSCCSS36LMK, HSCCSS48LMK, HSCCSS36BPG, HSCCSS48BPG, HSCCR36LMK, HSCCR48LMK, HSCCR36BPG, HSCCR48BPG, HSCCSS24LMK, HSCCSS24BPG, HSCER24LMK, HSCER24BPG	January 5, 2022
<b>Sculpt™</b> Models: HTGPWRKIA, HTLSCULPIL1630LML, HTLSCULPIL1630LWL, HTLSCULPIL1630MML, HTLSCULPIL1630MWL, HTLSCULPIL1660LML, HTLSCULPIL1660LWL, HTLSCULREC1630LML, HTLSCULREC1630LWL, HTLSCULREC1630MML, HTLSCULREC1630MWL, HTLSCULREC1660LML, HTLSCULREC1660LWL, HTLSCULRND16HML, HTLSCULRND16HWL, HTLSCULRND16LML, HTLSCULRND16LWL, HTLSCULRND16MML, HTLSCULRND16MWL, HTLSCULRND30LML, HTLSCULRND30LWL, HTLSCULSQR13LML, HTLSCULSQR13LWL, HTLSCULSQR16MML, HTLSCULSQR16MWL, HTLSCULSQR20HML, HTLSCULSQR20HWL, HTLSCULSQR30LML, HTLSCULSQR30LWL, HTLSCUPERTBL, HTLSCUPIL1830LWL, HTLSCUPIL1830MWL, HTLSCUPIL1860LWL, HTLSCUPILCNSL1253, HTLSCUPIL1830LML, HTLSCUPIL1830MML, HTLSCUPIL1860LML, HTLSCUREC1830LWL, HTLSCUREC1830MWL, HTLSCUREC1860LWL, HTLSCURECCNSL1253, HTLSCURECT1830LML, HTLSCURECT1830MML, HTLSCURECT1860LML, HTLSCURND18HWL, HTLSCURND18LWL, HTLSCURND18MWL, HTLSCURND30LWL, HTLSCURNDT18HML, HTLSCURNDT18LML, HTLSCURNDT18MML, HTLSCURNDT30LML, HTLSCUSQR15PLNTH, HTLSCUSQR15PLNTH, HTLSCUSQR16LWL, HTLSCUSQR18MWL, HTLSCUSQR20HWL, HTLSCUSQR30LWL, HTLSCUSQR30PLNTH, HTLSCUSQRT16LML, HTLSCUSQRT18MML, HTLSCUSQRT20HML, HTLSCUSQRT30LML, HTLSCUWPIL1630LML, HTLSCUWPIL1630LWL, HTLSCUWPIL1630MML, HTLSCUWPIL1630MWL, HTLSCUWPIL1660LML, HTLSCUWPIL1660LWL, HTLSCUWREC1630LML, HTLSCUWREC1630LWL, HTLSCUWREC1630MML, HTLSCUWREC1630MWL, HTLSCUWREC1660LML, HTLSCUWREC1660LWL, HTLSCUWRND16HML, HTLSCUWRND16HWL, HTLSCUWRND16LML, HTLSCUWRND16LWL, HTLSCUWRND16MML, HTLSCUWRND16MWL, HTLSCUWRND30LML, HTLSCUWRND30LWL, HTLSCUWSQR13LML, HTLSCUWSQR13LWL, HTLSCUWSQR16MML, HTLSCUWSQR16MWL, HTLSCUWSQR20HML, HTLSCUWSQR20HWL, HTLSCUWSQR30LML, HTLSCUWSQR30LWL	April 1, 2023

Education	Effective Date
<b>Roll Call™</b> Model: HETLEC-REC2430	April 1, 2023
<b>Tangram™</b> Models: HECSRSP, HECSRST, HECSRB, HECSRSP, HECSRSPMF, HECSITS, HECSITD, HECSITT, HECSMSLB, HECSMTLB, HECSMAILB, HECSMAOLB, HECSMSLBMF, HECSMTLBMF, HECSMAILBMF, HECSMAOLBMF, HECSMSHB, HECSMTHB, HECSMAIHB, HECSMAOHB, HECSMSHBMF, HECSMTHBMF, HECSMAIHBMF, HECSMAOHBMF, HECSOSQ, HECSOD, HECSOTR, HECSOTP, HECSOSE, HECSOAE, HECSOAE, HECSOAE, HECSOC, HECSVAP, HECSVHP, HECSJVAP, HECSJVHP, HECSG, HECSBG	January 5, 2022

Workplace Tools	Effective Date
<b>Accessories</b> Models: HJTRGH24, HJTRGH36	January 5, 2024

Seating	Effective Date
<b>SoCo™</b> Models: HBPWRMOD, HSLMCS, HSLMGK, HSLMICB1, HSLMICB2, HSLMOCB1, HSLMOCB2, HSLMQCS, HSLMSB1, HSLMSB2, HSLMSS, HSLMTCB1, HSLMTCB2	January 5, 2024

Fabrics and Finishes	Effective Date
<b>Edge</b> Beigewood (DE) Fawn Cypress (FC) Field Elm (FE)	October 1, 2022 October 1, 2022 October 1, 2022
<b>Fabrics</b> Davenport Leather Atlantis (DAV02) Bittersweet (DAV03) Black (DAV01) Brown (DAV14) Camel (DAV13) Cream (DAV11) Fog (DAV05) Olive (DAV09) Porcellana (DAV12) Rosewood (DAV10) Saddle (DAV07) Smoke (DAV06) Storm (DAV08) Wet Sand (DAV15)	January 5, 2022
<b>Getaway</b> Brig (GTWY15) Canoe (GTWY03) Catamaran (GTWY08) Cruise Ship (GTWY10) Cuddy (GTWY01) Ferry (GTWY11) Gondola (GTWY02) Jet Ski (GTWY09) Kayak (GTWY05) Pontoon (GTWY13) Runabout (GTWY14) Sailboat (GTWY07) Speedboat (GTWY12) Wakeboard (GTWY06) Yacht (GTWY04)	January 1, 2023
<b>Kai</b> Algae (KAI07) Barnacle (KAI19) Clownfish (KAI04) Coastal (KAI13) Conch (KAI02) Coral Reef (KAI16) Crab (KAI01) Ebb (KAI12) Flow (KAI11) Inlet (KAI03) Jellyfish (KAI18) Kelp (KAI08) Orca (KAI26) Otter (KAI22) Puffer (KAI06) Salty (KAI23) Seahorse (KAI05) Seashell (KAI20) Seaweed (KAI09) Shark (KAI24) Shoreline (KAI21) Stingray (KAI25) Tide (KAI14) Turtle (KAI10) Urchin (KAI17) Wave (KAI15)	January 1, 2023

# ADDITIONS

## NEW ADDITIONS: PRODUCTS

Fabrics and Finishes	Effective Date	Fabrics and Finishes	Effective Date
<i>Fabrics continued</i>		<i>Fabrics continued</i>	
Livi with Supreen™	January 1, 2023	Oxford with Supreen™	January 1, 2023
Asphalt (LIVI01)		Armor (OXFD01)	
Atlantis (LIVI02)		Azurite (OXFD02)	
Bouquet (LIVI03)		Cadet (OXFD03)	
Branch (LIVI04)		Cider (OXFD04)	
Coastal (LIVI05)		Clover (OXFD05)	
Cowboy (LIVI06)		Coal (OXFD16)	
Dawn (LIVI07)		Coin (OXFD06)	
Earth (LIVI09)		Crema (OXFD07)	
Evergreen (LIVI10)		Currant (OXFD08)	
Fennel (LIVI11)		Deluge (OXFD09)	
Fog (LIVI12)		Dewberry (OXFD10)	
Honeycomb (LIVI13)		Falcon (OXFD11)	
Jade (LIVI14)		Gingerbread (OXFD12)	
Limestone (LIVI15)		Laurel (OXFD13)	
Monochrome (LIVI16)		Odyssey (OXFD14)	
Night (LIVI17)		Pavement (OXFD15)	
Overcast (LIVI18)		Redvine (OXFD17)	
Pebble (LIVI19)		Seadrift (OXFD18)	
Pillow (LIVI08)		Shoji (OXFD19)	
Plum (LIVI20)		Tourmaline (OXFD20)	
Pumpkin (LIVI21)		Vignette (OXFD21)	
Rhubarb (LIVI22)		Vast	January 1, 2023
Saxon (LIVI23)		Atmosphere (VST06)	
Seaside (LIVI24)		Bay (VST04)	
Twine (LIVI25)		Beach (VST11)	
Noble	January 1, 2023	Country Side (VST13)	
Aegean (NBLE18)		Desert (VST12)	
Amethyst (NBLE19)		Garden (VST02)	
Aspen (NBLE14)		Grasslands (VST03)	
Aster (NBLE20)		Highway (VST09)	
Blossom (NBLE21)		Mountain Range (VST08)	
Bluebell (NBLE22)		Ocean (VST07)	
Bordeaux (NBLE01)		Open Air (VST05)	
Brick (NBLE02)		Tundra (VST10)	
Chambray (NBLE10)		Vineyard (VST01)	
Chamomile (NBLE23)		Wavelength	January 1, 2023
Clementine (NBLE04)		Base (WVL21)	
Conifer (NBLE24)		Crest (WVL14)	
Cottage (NBLE25)		Cycle (WVL20)	
Darkness (NBLE26)		Energy (WVL03)	
Dawn (NBLE13)		Frequency (WVL04)	
Denim (NBLE09)		Infrared (WVL01)	
Desert Sand (NBLE27)		Motion (WVL13)	
Dewfall (NBLE28)		Movement (WVL05)	
Dusted Sage (NBLE29)		Peak (WVL11)	
Flax (NBLE30)		Pressure (WVL06)	
Grass (NBLE07)		Shallow (WVL02)	
Gunmetal (NBLE15)		Still (WVL07)	
Harmony (NBLE31)		Surface (WVL18)	
Harvest (NBLE12)		Surge (WVL10)	
Ice Caves (NBLE32)		Swell (WVL08)	
Icicle (NBLE33)		Tide (WVL16)	
Inky (NBLE34)		Transition (WVL15)	
Iris (NBLE35)		Trough (WVL19)	
Jade (NBLE06)		Tsunami (WVL09)	
Knight (NBLE17)		Ultraviolet (WVL12)	
Mesa (NBLE03)		White Caps (WVL17)	
Monarch (NBLE36)		Laminates	
Pacific (NBLE08)		Beigewood (LWBE)	October 1, 2022
Pitch (NBLE37)		Fawn Cypress (LFC1)	October 1, 2022
Queen Bee (NBLE38)		Field Elm (LWFE)	October 1, 2022
Rainforest (NBLE05)			
Regal (NBLE11)			
Sandcastle (NBLE39)			
Sedona (NBLE40)			
Stormy (NBLE16)			
Sunbeam (NBLE41)			
Voyager (NBLE42)			
Windy Day (NBLE43)			

# DISCONTINUATIONS

Education	Effective Date
Smartlink® Models: HLD-M3F, HLD-M3FA, HLD-M3FB, HLD-M3A, HLD-M3AA, HLD-M3AB, HLD-M3T, HLT2672T-23, HLT2460T-R3, HLT2460T-L3, HLTA-TR24, HLSC36T-1N, HLSC36T-2N, HLSC52T-21N, HLSC52T-3N, HLSF52T-21N, HLSF52T-3N, HLSC36T-ID, HLSC36T-2D, HLSC52T-21D, HLSC52T-3D, HLSF52T-21D, HLSF52T-3D, HLSA-SK1220T, HLSA-SK3020T, HLSA-CR12, HLSA-WBK52, HLSA-HRK, HLSA-TK3, HLSA-TK6, HLSA-TK12	November 30, 2023

Seating	Effective Date
Assemble™ Model: HVL314	December 31, 2023
Ceres® Models: HCG6, HCG6DF	December 31, 2023
Circulate™ Model: HVL872	February 13, 2023
Circulate™ Models: HVL871, HVL873	June 30, 2023
Client™ Model: HVL693	December 31, 2023
Comfortask® Models: H5905, H5901, H5902, H5995, H5991	December 31, 2023
Convergence® Model: HCAT1MM	June 30, 2024
Coordinate™ Model: HVL991	June 30, 2023
Entire™ Model: HVL541	November 17, 2023
Executive Chairs Model: HVL131	June 30, 2023
Exposure™ Model: HVL721	June 30, 2023
Gateway™ Model: HGV1MM	June 30, 2024
GuestStacker® Models: H4031, H4033, H4039	June 30, 2023
HVL Seating Models: HVL171, HVL521	December 31, 2023
Ignition® Models: HIWM8, HIWM8FC Model: HFIREKD	June 30, 2023 December 31, 2023
Invitation® 2110 Series Models: H2111, H2112, H2111FC, H2112FC	December 31, 2023
Nesting Chairs Model: HVL303	June 30, 2023
Network™ Models: HVL282, HVL283	June 30, 2023
Neutralize™ Model: HVL791	June 30, 2023
Nucleus® Model: HNIU	June 30, 2023
Performance Seating Models: HVL653, HVL685	June 30, 2024
Prominent™ Model: HVL534	January 30, 2023
Sadie™ Models: HVST401, HVST402	June 30, 2023
Sadie™ Model: HVST341	November 8, 2023
Sadie™ Models: HVST315, HVST911, HVST121	June 30, 2024
Sadie™ Models: HVST331, HVST101, HVST102	While Supplies Last
Solutions Seating® 4000 Series Models: H4008, H4003	December 31, 2023
Solve® Models: HSLVTMU, HSLVSMU, HSLVTMUS, HSLVSMUS	June 30, 2024
Soothe® Models: HHCPI, HHCPIDF, HHC11MB, HHC21MB, HHCGB21MB, HHCGB31MB, HHCPI1MB, HHC50MB, HHC11DFMB, HHC21DFMB, HHCPIDFMB, HHC50DFMB, HHC1C, HHC1TRT, HHC1S, HHC1L4, HHCGBR, .F, .C, .D, .N, .MOCH, .PINC, .LKI1	December 31, 2023
Traction™ Model: HVL102, HVL103	June 30, 2023
ValuTask® Models: HVL205, HVL210	June 30, 2023

Tables	Effective Date
Motivate® Models: HMVTTNS3672G, HMVTT3672G	January 27, 2023

Fabrics and Finishes	Effective Date
Fabrics	
Analog Album (ANLG06), Cartridge (ANLG04), Cassette (ANLG09), Dial (ANLG02), Media (ANLG08), Reel (ANLG07), Signal (ANLG03), Stereo (ANLG01), Track (ANLG05)	December 31, 2023
Compass Foam Bittersweet (COMF46), Ink (COMF10), Meadow (COMF82), Midnight (COMF90), Putty (COMF22), Sterling (COMF19)	
Dotty Candy (DOT63), Gelato (DOT34), Indigo (DOT31), Onyx (DOT35), Park (DOT83), Peat (DOT24), Peony (DOT32), Suit (DOT20), Sunflower (DOT33), Tailor (DOT21), Tide (DOT90), Velum (DOT29), Violet (DOT30)	December 31, 2024
Factor Bark (FACT20), Barley (FACT15), Cascade (FACT25), Feather (FACT30),	December 31, 2023
Inertia Amethyst (NR61), Calypso (NR98), Cherry (NR66), Cobalt (NR91), Coffee (NR49), Fog (NR19), Fuchsia (NR63), Gecko (NR76), Glow (NR27), Leaf (NR75), Lime (NR82), Loft (NR22), Mandarin (NR47), Meteor (NR30), Mustard (NR26), Nickel (NR23), Onyx (NR10), Regatta (NR90), Shadow (NR20), Surf (NR96), Tangelo (NR46)	December 31, 2024
Mica (Panel) Anthracite (MCA11), Breeze (MCA18), Bronze (MCA13), Buff (MCA14), Cremini (MCA17), Crystal (MCAWIT), Dew (MCA20), Dove (MCA12), Fresh (MCA16), Mineral (MCA15), Nectar (MCA19), Shale (MCA10)	December 31, 2024
Optic Aurora (OP72), Bark (OP24), Canopy (OP84), Char (OP49), Ruby (OP42), Sand (OP17), Sky (OP83), Slate (OP19), Sprout (OP74), Starry Night (OP11), Storm (OP56), Wildfire (OP66)	June 30, 2024
Whisper Vinyl Brick Red (WP99), Carotene (WP97), Cucumber (WP88), Forest (WP82), Gravel (WP19), Merlot (WP27), Ochre (WP96), Putty (WP84), Sangre (WP28), Zest (WP87)	December 31, 2023
Paint Amethyst (P091) Cobalt Mica (P090)	December 31, 2023

# HON FULL LIFETIME WARRANTY INFORMATION



## FULL LIFETIME WARRANTY

### YOUR HON FULL LIFETIME WARRANTY

Every time you purchase a HON product, you're making an investment in your future. We're proud to play a part in that future, and you can trust us to do our best for as long as you need us.

The HON Full Lifetime Warranty is our assurance to you that the HON desks, workstations, seating, tables, or storage you purchase will be free from defective material or workmanship for the life of the product.

In the unlikely event that any HON product or component covered by the HON Full Lifetime Warranty should fail under normal workplace use as a result of defective material or workmanship, HON shall repair or replace with comparable product (at HON's discretion), free of charge.

### WHAT'S COVERED BY THE HON FULL LIFETIME WARRANTY?

Your HON Full Lifetime Warranty applies to product manufactured after January 1, 2011. All HON product lines, materials, and components are covered by the HON Full Lifetime Warranty except for the items described below.

The specific product lines, materials, and components listed below are covered under HON's Full 12-Year, Full 10-Year, and Full 5-Year Warranties (from date of purchase).

#### HON'S FULL 12-YEAR WARRANTY

- Electrical components (lamps and ballasts are not covered)
- 4-Way Stretch Mesh
- Seating controls
- Pneumatic Cylinders
- Wood Seating
- Accessories
- Laminate Surfaces

#### HON'S FULL 10-YEAR WARRANTY

- Coordinate™ Height Adjustable Bases (HHATB)

#### HON'S FULL 7-YEAR WARRANTY

- Coordinate™ Legacy Bases (HHAB and HREC)
- Workwall Markerboard Glass Tiles

#### HON'S FULL 5-YEAR WARRANTY

- All LED task lights
- Panel and seating textiles
- Mesh not branded/marketed as '4-Way Stretch Mesh'
- Coze™
- Between™ Multi-Purpose Table
- Acoustic Solutions by Unika Vaev
- Mod

#### HON'S FULL 1-YEAR WARRANTY

- Acrylic Screens

These warranties apply to HON products sold within the United States of America, U.S. Territories, and Canada, as well as U.S. Military and Federal Agency purchases (regardless of location).

### IS ANYTHING NOT COVERED?

There are a few exclusions to the HON Full Lifetime Warranty and to the 12-, 10-, and 5-year warranties. These exclusions are:

- All HON products that are covered under a separate 5-year warranty.
- Color-fastness or matching of colors, woodgrains, or textures occurring in wood, leather, or other materials that naturally exhibit inherent color variations.
- Customer's own materials (COM) selected by and used at the request of the user.
- Modifications or attachments to the product that are not approved by The HON Company and product failures resulting from such modifications or attachments.
- Product normal wear and tear, which are to be expected over the course of ownership.
- Products that were not installed, used, or maintained in accordance with product instructions and warnings.
- Products used for rental purposes.
- Damage caused by cleaning chemicals.
- Dye transfer caused by external contaminants (including clothing and accessory dyes such as those used on denim jeans) may migrate to lighter colors. This phenomenon is increased by humidity and temperature and is irreversible.
- Fabric pattern match seat to back or chair to chair. If pattern match is needed, please submit a Tailored Solutions request or contact HON Customer Support/Tailored Solutions with questions.
- Storage Digilocks come with a 2-year warranty.

### WARRANTY REQUESTS OR QUESTIONS?

Your HON Dealer is our mutual partner in supporting your warranty requests. To obtain service under this warranty, please contact your HON dealer. If you are not sure who your dealer is, please call HON Customer Support at 800.833.3964.

**THAT'S YOUR HON FULL LIFETIME WARRANTY AS AN OWNER OF HON PRODUCT, THE WARRANTY EXPLAINED HERE IS YOUR SOLE AND EXCLUSIVE REMEDY. THERE ARE SOME EXCEPTIONS IF YOU PURCHASED THE PRODUCT FOR HOME OR PERSONAL USE WHICH ARE EXPLAINED BELOW. TO THE EXTENT ALLOWED BY LAW, THE HON COMPANY MAKES NO OTHER WARRANTY, EITHER EXPRESS OR IMPLIED, INCLUDING ANY WARRANTY OF MERCHANTABILITY OR FITNESS FOR A PARTICULAR PURPOSE. THE HON COMPANY WILL NOT BE LIABLE FOR ANY CONSEQUENTIAL OR INCIDENTAL DAMAGES.**

### A WORD ABOUT PURCHASES FOR HOME OR PERSONAL USE

Please note, this section only applies if you purchased your HON product for your home or for your own personal or family use. HON's warranties give you specific legal rights and you may have other rights, which vary from state to state. As a consumer purchaser, the complete exclusion of implied warranties noted in the above paragraph does not apply to you, however, to the extent allowed by applicable state law, the implied warranties are limited to the applicable term of the warranty. Some states do not allow the exclusion or limitation of incidental or consequential damages, so the above exclusion or limitation may not apply to you.



# HON LIMITED 5-YEAR WARRANTY INFORMATION



## LIMITED 5-YEAR WARRANTY

The HON Company promises to repair or replace HON products or components covered under this warranty that are found to be defective in material or workmanship within five (5) years from the date of original purchase so long as you, the original purchaser, still owns it. This is your sole and exclusive remedy. This warranty is subject to the provisions below. It applies to the products listed here manufactured after January 1, 2018.

### LIMITATIONS:

- Upholstery on chairs is warranted for two years from date of purchase.
- Damage caused by the carrier in-transit is handled under separate terms.

### EXCLUSIONS:

This warranty does not apply and no other warranty applies to:

- Normal wear and tear, which are to be expected over the course of ownership.
- Modifications or attachments to the product that are not approved by The HON Company.
- Products that were not installed, used or maintained in accordance with product instructions and warnings.
- Products used for rental purposes.

### SEATING USAGE

Normal commercial use for seating is identified as the equivalent of a single shift, forty-(40) hour workweek. To the extent that a seating product is used in a manner exceeding this, the applicable warranty period will be reduced in a pro-rata manner.

### A WORD ABOUT COLOR VARIATIONS, FABRICS AND FINISHES:

The HON Company does not warrant the color-fastness or matching of colors, grains or textures of covering materials.

### CUSTOMER'S OWN MATERIAL (COM)

Not available on HON products covered under the HON 5-year warranty.

**TO THE EXTENT ALLOWED BY LAW, THE HON COMPANY MAKES NO OTHER WARRANTY, EITHER EXPRESS OR IMPLIED, INCLUDING ANY WARRANTY OF MERCHANTABILITY OR FITNESS FOR A PARTICULAR PURPOSE. THE HON COMPANY WILL NOT BE LIABLE FOR ANY CONSEQUENTIAL OR INCIDENTAL DAMAGES.**

### NOTICE TO PURCHASERS FOR HOME OR PERSONAL USE:

Federal law does not permit the exclusion of certain implied warranties for consumer products. Therefore, if you are purchasing this product for home or personal use, the exclusion of implied warranties noted in the above paragraph does not apply to you. Some states do not allow the exclusion or limitation of incidental or consequential damages, so the above limitation or exclusion may not apply to you. This warranty gives you specific legal rights, and you may also have other rights which vary from state to state.

This warranty applies only to products sold within the United States of America and the Commonwealth of Canada.

### TO OBTAIN SERVICE UNDER THIS WARRANTY:

Your HON® Dealer is our mutual partner in supporting your warranty requests. By following the procedures outlined below, you can be assured of the best level of service. Please note: Consent of The HON Company must be obtained before any warranty work is performed. To obtain consent, please take the following steps:

1. Contact the Dealer from whom the product was purchased within 30 days of discovery of the defect. Be prepared to affirm that you are the original purchaser of the product and to provide the serial number(s) from the product in question.
2. Your Dealer will gather all pertinent information regarding the claim, inspect the product and contact a HON Company customer service representative. (Please allow a reasonable amount of time for inspection and review.)
3. If The HON Company affirms that the product in question is eligible under the conditions of the warranty as stated above, the customer service representative or another representative of the Company will determine whether to provide replacement parts, authorize repairs or replace the product.

## ORDERING

Electronic ordering is the standard order process for HON. HON supports the following primary methods for the electronic transmission of orders and order related documents:

### Electronic Ordering

Available in the HONReady portal at [honready.hon.com](https://honready.hon.com). There are multiple options available for processing orders electronically.

Integration with the standard Office Furniture business systems or other pre-approved proprietary software packages.

SIF file upload using fully optioned SIF files into the electronic ordering applications.

Manual entry of line items into the electronic ordering application.

### EDI-System to System Integration

With standard Office Product systems or other pre-approved proprietary software systems.

Training, technical set-up and support is available through our Dealer Operations Team at [honready@honcompany.com](mailto:honready@honcompany.com).

## ORDER REQUIREMENTS

- Customer must provide complete and correct information, including complete model number, finishes, colors, options, and quantity.
- If a bid quotation or other special pricing applies, such information must be clearly stated on the order with applicable bid number or contract number.
- Order Management contact name and phone number.
- Delivery Appointment contact name and phone number at the dealership or installation company. HON does not accept orders with end user appointment contacts.
- Dealer Sales Representative, primary or multiple DSRs.
- “Best Date Available” for the entire order is standard service for HON. If eligible, other Date Requests may be requested and must be submitted with the order. Other Date Requests are subject to review by HON prior to acceptance:
  - “Ship After” requests are eligible on all order sizes
  - “Deliver On” requests are eligible for full truckload orders
- Additional services outside of HON’s standard services may be available through HON’s ‘Enhanced Services’ for a corresponding fee. Requested services from ‘Enhanced Services’ must be provided at time of order placement.
- Failure to provide complete and accurate information results in delayed order entry and acknowledgment. Incomplete orders will not be produced and will be returned to Dealer for correction.

## ACKNOWLEDGMENT SERVICE

- E-mailed acknowledgments are available by customer request.
- An acknowledgment will be emailed the morning of the next business day, unless order is placed on credit or other order hold.
- The order will not receive an acknowledged shipment date until all order holds are released.

## ORDER CHANGES OR CANCELLATIONS

For Order Changes or Cancellations, please contact Customer Support at 800-833-3964.

## TERMS AND CONDITIONS

See **HON NOW** on [honready.hon.com](https://honready.hon.com) for more information about HON NOW delivery, services and ordering information.

# HON DESIGN SERVICES

## HON DESIGN STUDIO

Need design assistance? We can help! Our expert design staff will create a professional design package that is sure to put you one step ahead of the competition. And the best part is – it's free!

### AUDIT

We will check your drawing and parts list for accuracy. We verify quantity, specification accuracy, product compatibility and structural support.

### DESIGN

We will provide a professional design package including a 2D furniture plan, renderings, and complete parts list based on the rough sketch and project information you supply.

### CONSULTATION

A 1:1 meeting will be scheduled where we will provide guidance on product positioning, answer specification questions, and recommend value engineering opportunities.

## CONTACT HON DESIGN SERVICES

Questions? Please reach out to your region's dedicated designer. Not sure how to reach your designer? Send us a note at the email below.

E-Mail: [integrateddesign@honcompany.com](mailto:integrateddesign@honcompany.com)



**Solve® Chair shown with Coordinate™ Height Adjustable Table.**

## Project Space

### A place for all HON Project Services

Project Space provides one platform to access the full portfolio of HON services including:

- Design
- Audit
- Product Modification
- Special Laminates
- Consultation
- Customer's Own Material
- Dual Fabric Applications
- Special Paints
- Project Bid Pricing

**Submit your request on the Community powered by HNI, Projects.**

Project lead time expectation is 3-5 business days, depending on scope of work.

# TAILORED SOLUTIONS ORDERING INFORMATION

## PRODUCT MODIFICATIONS

Modifications include structural and dimensional modifications to existing product and Dual Fabric Applications, when standard model is not available.

The HON Company, at its own discretion, may modify standard products to meet specific needs. Product specials can be requested on HON brand product only.

List prices contained in published list pricers are for standard catalog items only. Changes or alterations to catalog items other than those listed as catalog options are subject to additional charges. Pricing will only be furnished upon approval of the special request.

Requests to have the product produced in more than one fabric (e.g., fabric on the seat is different than the fabric on the back), are considered a Dual Fabric Applications request and follow the Product Modification request process within the Community.

## SPECIAL LAMINATES

Special laminates include requests for laminates not available as part of The HON Company's standard offering. Requests for special laminates are subject to manufacturing approval and minimum order quantities. The HON Company approved special laminates will be subject to a designated upcharge per unit.

Requests for special laminates should be submitted through the Community. Pricing will only be furnished upon approval of the special request.

## SPECIAL PAINTS

- The HON Company's paint matching equipment can match almost any color, excluding some metallic and whites.
- Special paint requests must be submitted on the Community.
- In order to request a paint sample, the customer must have a minimum order of 10 like product units. Any requests with less than that amount will not be processed.
  - For each new paint request, there will be a \$250 net charge. A sample of the exact color desired is required for matching and approval. The HON Company will match the color and provide a production sample for the customer to review and approve.

- Once written approval is received by The HON Company, the request will be approved.
- Each unique color or finish combination incurs a designated upcharge per color per order (all standard discounts/competitive project pricing applies).

**Special note:** Some special colors could fall outside of this program due to production costs or not meeting The HON Company's quality standards. The HON Company may apply additional charges to some colors which are costly to apply, and refuse some orders on colors that cannot meet The HON Company's high-quality standards. The HON Company will notify the customer upon completion of The HON Company's evaluation if a change in price is required or rejection of the order.

## DISCONTINUED PRODUCT

Requests for discontinued product require engineering evaluation, safety review, and testing to current standards prior to approval. Many discontinued products are not available for order. Requests for discontinued products should be submitted through the Community.

## LEAD TIMES FOR SPECIALS PRODUCT

Lead times on orders containing specials are subject to production capacity and material availability. When possible, the customer should order special products separately to avoid extended lead times for standard products. Extended lead times will be noted on Compass.

## CHANGES TO SPECIALS PRODUCT

A special model will be provided for each approved special item to process orders. Once an order is placed, no changes or cancellations can be made to the order without approval from Tailored Solutions.

## CONTACT TAILORED SOLUTIONS

Phone: 800.833.3964 and listen for Tailored Solutions offering on the menu.

Email: HONSpecials@honcompany.com



# CUSTOMER'S OWN MATERIAL ORDERING INFORMATION

## CUSTOMER'S OWN MATERIAL (COM) PROGRAM

Customer's Own Material (COM) is a request to use fabrics not available as part of HON's standard fabric offering. Manufacture to Supply (MTS) and Dealer to Supply (DTS) are the two ordering methods. The HON Company has partnered with fabric manufacturers to provide competitive pricing and selection through the MTS program. MTS will be the standard offering unless The HON Company is unable to procure the fabric. If there is a DTS request submitted, The HON Company will advise at the time of the request if DTS is available.

## CUSTOMER WARRANTY EXCLUSION

The HON Company shall have no responsibility for the condition, quality, value, performance, physical properties, or any other aspects of the COM.

The HON Company shall have no liability for any damages, injuries, or losses to the customer or to any third party that shall be caused by any COM or product modification, and the customer shall hold The HON Company harmless for all liability.

The HON Company assumes no responsibility for the overall appearance, flammability, normal durability, colorfastness, or any other quality of the COM or product modification after its application on a HON product beyond normal quality standards. The HON Company reserves the right to reject a COM fabric if the quality of the COM is not satisfactory for the product. Should this occur, the customer will be notified with an explanation of the issue.

The HON Company is not responsible for fabric that has become obsolete at the COM supplier, that is of poor quality, or that is delivered late to The HON Company from the COM supplier. The HON Company is not responsible for excess yardage created by DTS orders or yardage not attached to an order and reserves the right to dispose of the excess fabric.

As a standard HON does not pattern match any standard, partnership or COM fabric, therefore pattern match is not applicable under warranty. If pattern match is needed please submit a Tailored Solutions request or contact HON Customer Support/Tailored Solutions once your COM has been approved.

## COM TESTING

As a result of recent legal requirements, The HON Company will need to obtain specific information from the fabric supplier about treatments and chemicals used in the fabric. To the extent the supplier is unwilling or unable to provide the necessary information, which could extend the testing lead time of the request.

To check if a COM has been tested previously, utilize the COM Search Tool on the HON Ready Portal > Design Resources > Textiles & Finishes section using the following information:

- COM Supplier's Name
- Fabric Pattern Name
- Color Name
- If the COM fabric has been tested and previously approved, the COM will not need to be re-tested unless testing standards have changed, fabric is to be used on a different series, or direction of the fabric has changed from what was previously approved. Please note that Panel product must be approved for each model and color.
- If the pattern has previously been tested and approved, but not in the specific requested color, the customer will need to request an order code for that color only. No further testing will be necessary since the pattern has already been approved.

If the fabric has not previously been tested, the customer must enter the COM request on the HON Ready Portal > Textiles & Finishes > COM Search Tool.

Complete the Supplier Name, Pattern, and Color drop-down fields. For quicker results in these fields, type the first letter of the (supplier, pattern, color) name and, when done, click Add and then Submit. (Multiple series can be added to the same request if they are the same supplier, pattern, and color.)

An email will be sent to the requestor stating the COM Request was successfully submitted. Up to four emails could be received: submitted, in testing, testing materials requested, and final approval/denial with price grade and fabric code. The testing process takes approximately 48 hours.

COM yardage in the pricer is shown as pattern cut only.

## COM TESTING — FLAMMABILITY TESTING INFORMATION

The customer is responsible for ensuring that the COM fabric is certified to meet all flame-retardant requirements. All COM seating fabric must, at minimum, meet CAL 117 requirements. If the customer requires the chair be tested to meet the fire safety standards of CAL 133, additional testing and information is required.

## MTS COM

As previously mentioned, MTS is the primary COM method.

If the COM fabric has not been tested, a COM request must be submitted on the HON Ready Portal.

For MTS orders, The HON Company will procure fabric needed for production. Should The HON Company not be able to obtain fabric yardage, the customer will be contacted.

# CUSTOMER'S OWN MATERIAL ORDERING INFORMATION

When testing has been completed, the customer will be notified by the COM team of the test results. If the COM is approved, The HON Company will provide a COM tracking order code for MTS. That tracking code is required on the order in place of the standard fabric code.

If approved, MTS product will be assigned an appropriate fabric grade for pricing. The pricing can be found on the HON Ready Portal > Design Resources > Textiles & Finishes. (All standard discounts/competitive project pricing applies).

Written COM price quotes are valid for 90 days after the issue date.

## DTS COM

DTS COM is only available if the COM fabric cannot be procured by The HON Company. If the fabric can be procured by The HON Company, the customer will be contacted to switch to MTS or cancel the request.

If your fabric is not listed as approved, and it is not a Partnership fabric you may request a "Dealer to Supply" code. Select the "Request COM Test" link on the COM Search website. Complete the Supplier Name, Pattern, and Color drop-down fields. For quicker results in these fields, type the first letter of the (supplier, pattern, color) name and, when done, click Add and then Submit. (Multiple series can be added to the same request if they are the same supplier, pattern, and color.)

An email will be sent to the requestor stating the COM Request was successfully submitted. Up to four emails could be received: submitted, in testing, testing materials requested, and final approval/denial with price grade and fabric code. It's rare actual test yardage is required. Testing is mainly done by reviewing the attributes of the fabric. The testing process takes approximately 48 hours.

If the COM has not been tested, a COM request must be submitted on the HON Ready Portal > Design Resources > Textiles & Finishes.

When testing has been completed, the customer will be notified by the COM team of the test results. If the COM is approved, The HON Company will provide a COM tracking order code. That tracking code is required on the order in the place of the standard fabric code.

DTS product is priced at the following grades (all standard discounts/competitive project pricing applies):

- Chairs are a Grade 4
- Panel product is a Grade D

Written COM price quotes are valid for 90 days after the issue date.

## COM LEAD TIME

Ship dates will be based on fabric receipt and The HON Company's standard lead time. All fabric must be properly tagged and shipped to the appropriate producing location (provided in the approval email).

- Specific to DTS orders, COM orders will not receive a ship (acknowledged) date until The HON Company has the fabric in its possession for production.
- Specific to DTS orders, the customer may send the required yardage for the order to the address listed on the approval email to arrive no sooner than 4 weeks in advance of the acknowledgment date.

HON will make every effort to locate mis-directed COM shipments on behalf of the customer. However, The HON Company will not be responsible for any COM received without a tracking number or incorrectly shipped by the fabric vendor to an incorrect producing facility.

## COM ORDERING INFORMATION

The following information must appear on or accompany the product purchase order:

- Approval tracking number and the customer's purchase order number
- COM supplier, pattern, and color name/number

The packing list for the COM must include the following information when The HON Company receives the shipment for production:

- Dealer or Wholesaler Name
- Purchase order number submitted to The HON Company
- Fabric name
- Yardage shipped
- Approval ordering code

Specific to DTS orders; the customer should send only the amount needed for the order. Excess yardage or yardage not tied to an order will be disposed of at The HON Company.

## CHANGES TO COM PRODUCT

Once a COM product is ordered, no changes or cancellations can be made to the COM product without approval from the HON COM team.

## CONTACT COM TEAM

Phone: 800.833.3964 and listen for COM TEAM offering on the menu.

COM Email: HONCOMTeam@honcompany.com

# PARTNERSHIP TEXTILE INFORMATION

Partnership Textiles is the result of The HON Company's partnership with textile industry leaders Camira, HBF Textiles, Maharam, Momentum, Stinson, and Ultrafabrics, LLC. The extensive collection of design-driven textiles create a superior offering at a great value. Partnership Textiles significantly updates HON's offering, expanding it with fresh and exciting options.

- Fabric Warranty: Partnership Textiles are covered by HON's Full Lifetime Warranty.
- Lead Times: Orders specified with Partnership Textiles will be acknowledged based on the supplier's availability and delivery schedule.
- Availability: The HON Company will regularly introduce new Partnership Textiles and reserves the right to change the offering at any time.
- Fabric Cards: A curated set of Partnership Textiles are carded jointly by HON and the supplier.

## Camira

- Blazer

## HBF Textiles\*

- Cloverleaf
- Denim Wash
- Everyday Textiles II
- Everyday Textures

\*HBF Textiles patterns are graded in to HON's offering.

## Maharam

- Apt
- Bluff
- Collection 1
- Lariat
- Meld
- 6M

## Momentum

- Chroma
- **Jumpstart**
- Nexus
- Smart Fusion

## Stinson

- Elevate II

## Ultrafabrics, LLC

- Brisa

Fabric Memo Samples: Please contact the supplier directly:

Camira: [memos@camirafabrics.com](mailto:memos@camirafabrics.com)

HBF Textiles: Phone: +1 (877) 494-5727, [orders@hbftextiles.com](mailto:orders@hbftextiles.com)

Maharam: (800) 645-3943

Momentum: [customerservice@momtex.com](mailto:customerservice@momtex.com) (800) 366-6839

Stinson: (800) 841-6279

Ultrafabrics: (877) 309-6648

## HON BRANDED, PARTNERSHIP AND COM PATTERN MATCH

- Pattern matching provides alignment of patterns or stripes across individual chair surfaces. Additional yardage may be required depending on pattern repeat. If Pattern Match is needed, please contact HON Customer Support/Tailored Solutions.
- Chair to Chair Pattern Match provides identical pattern alignment from unit to unit and is available with an upcharge. Chair to Chair Pattern Match is reviewed on a case by case basis as several factors are reviewed to determine additional yardage required, including repeat and pattern direction. If Chair to Chair Pattern Match is needed, please contact HON Customer Support/Tailored Solutions.



The HON Company has established paint grades to allow customers flexibility and ease in doing business with HON. HON has three paint grades P1, P2, and P3.

## P1 PAINT COLORS

HON has established P1 paints which are available on a majority of core products.

## P2 PAINT COLORS

Please see individual pricer pages for eligible series and upcharges for P2 paints. P2 paints are listed in the pricer pages under the column P2. Upcharges vary by product (all standard discounts/competitive project pricing applies). No minimum quantity required.

## P3 PAINT COLORS

Please see individual pricer pages for eligible series and upcharges for P3 paints. P3 paints are listed in the pricer pages under the column P3. Upcharges vary by product (all standard discounts/competitive project pricing applies). No minimum quantity required.

## SPECIAL PAINT COLORS (P4-P6)

With The HON Company's state of the art color matching equipment just about any color can be matched, excluding some metallic and whites. A sample of the exact color desired is required for matching and approval.

- For each newly requested paint, a net fee of \$250 will be charged to cover costs associated with the matching process.
- For existing, previously matched paints, there is no matching fee, however there is a \$100 net fee for sample panels required for the approval process. Refer to MyProjects on the HON Portal for a list of approved special paints.

For all special paint requests, HON will send a production sample for the customer to review and approve. Once the signed paint sample is received at HON the order can be entered. Upcharges vary by product (all standard discounts/competitive project pricing applies). A quantity of 10 like-model minimum order is required for special paints. For complete program details, access Tailored Solutions on the HON Ready Portal at [honready.hon.com](http://honready.hon.com).

Some special colors could fall outside of this program due to production costs or not meeting HON quality standards. The HON Company may apply additional charges to some colors which are costly to apply, and deny some orders on colors that cannot meet our high-quality standards. We will notify the customer upon completion of our evaluation if a change in price is required or if the request is denied.



# HON OPEN LINE LAMINATE PROGRAM

The Open Line Laminate (OLL) program makes it even easier for a customer to tailor their HON product for a custom look. Select HON furniture products accommodate hundreds of graded-in high-pressure laminates (HPL) from the leading laminate manufacturers' open lines.

Laminates that are currently available in the program can be viewed in specification tools.

Requests to add laminates to the standard specials program can be submitted through the CET Specials Integration tool as well as Community.

Matching edge options are not available offered for laminates in the OLL program. When selecting a laminate please select an edge option from the HON standard offering. If a matching edge is required a modification request can be submitted through the CET Specials Integration tool as well as Community.

The OLL program is available with the following HON products and series:

- Abound® Hard-Surface Tiles
- Birk™ Tables
- Build™ Tables
- Coordinate™ Worksurfaces
- Gallery Panels
- Huddle Tables
- Preside® Tops
- Sculpt™/Occasional Tables
- SmartLink® Value Teacher Desk
- Systems Worksurfaces
- Tangram™
- Universal Screens

Due to manufacturing techniques, materials, quality issues of varying laminates, and minimum order quantities, some product exclusions will apply and some requests may be declined.

Extended lead times may apply on orders containing special laminates.

Contact the Tailored Products Group for questions or additional information regarding pre-approved laminates and pricing.

## HON

Phone: 888-255-7833, Option 4.5

Email: [HONSpecials@honcompany.com](mailto:HONSpecials@honcompany.com)

For edgeband recommendations from the HON standard offering, please email the HNI Workplace Colors, Materials, and Finishes team at [honfinishes@honcompany.com](mailto:honfinishes@honcompany.com).

For laminate samples, please contact the manufacturer directly:

### Wilsonart

<https://www.wilsonart.com/>  
1-800-433-3222

### Formica

<https://www.formica.com/en-us/>  
1-800-FORMICA (367-6422)

### Nevamar and Pionite

<https://www.panolam.com>  
877-726-6526

# ENVIRONMENTAL STATEMENT

We continually reevaluate our purpose and processes, from fostering transparency and circularity in our supply chain to empowering our members to do and be better. We do it so the environments you create will be safer, more socially responsible, and more sustainable.

We've pursued product certifications to help communicate our commitment to developing sustainable products.

## Clearing the air.

In 2006, The HON Company became one of the first office furniture manufacturer to have products certified under the Indoor Advantage™ program. Virtually all manufactured products emit chemical compounds into the air. Indoor Advantage™ certification helps assure customers that certified products will help improve the air quality within their offices and workspaces.

Developed by SCS Global Services, Indoor Advantage™ evaluates products against indoor air quality standards, like ANSI/BIFMA Furniture Emissions Standard, M7.1/X7.1 and CDPH Standard Method v1.1. The ANSI/BIFMA X7.1 standard allows manufacturers to test individual components, as well as complete products for emissions from volatile organic compounds (VOCs). This allows us to identify problematic materials and phase them out of our products.

Indoor Advantage™ certified products meet the LEED and WELL criteria for low-emitting materials.

Indoor Advantage™ offers two levels of certification, including Indoor Advantage™ and Indoor Advantage™ Gold.



## On the LEVEL®.

LEVEL®, the certification program for the BIFMA e3 Sustainability Standard, was developed in response to increasing demand for proof that manufacturers were living up to their environmental claims. LEVEL® is a multi-attribute sustainability certification label for products that have met criteria in four categories of impact: Materials, Energy and Atmosphere, Human and Ecosystem Health, and Social Responsibility.

HON's products are certified to LEVEL 2 and LEVEL 3, the highest achievement. BIFMA LEVEL 2 and LEVEL 3 certified products can contribute to LEED and WELL projects.



## Evaluating Our Impacts.

HON has begun studying the impacts our products have on the environment through lifecycle assessments and creating Environmental Product Declarations (EPDs). EPDs provide an understandable report of a product's environmental impact throughout its life cycle; including raw material extraction and processing, product assembly, distribution and use, and end-of-life.

Products that meet these specifications are identified throughout this publication with the following icons:

Certified SCS Indoor Advantage™

LEVEL® certified to the BIFMA e3 Sustainability Standard

Environmental Product Declarations

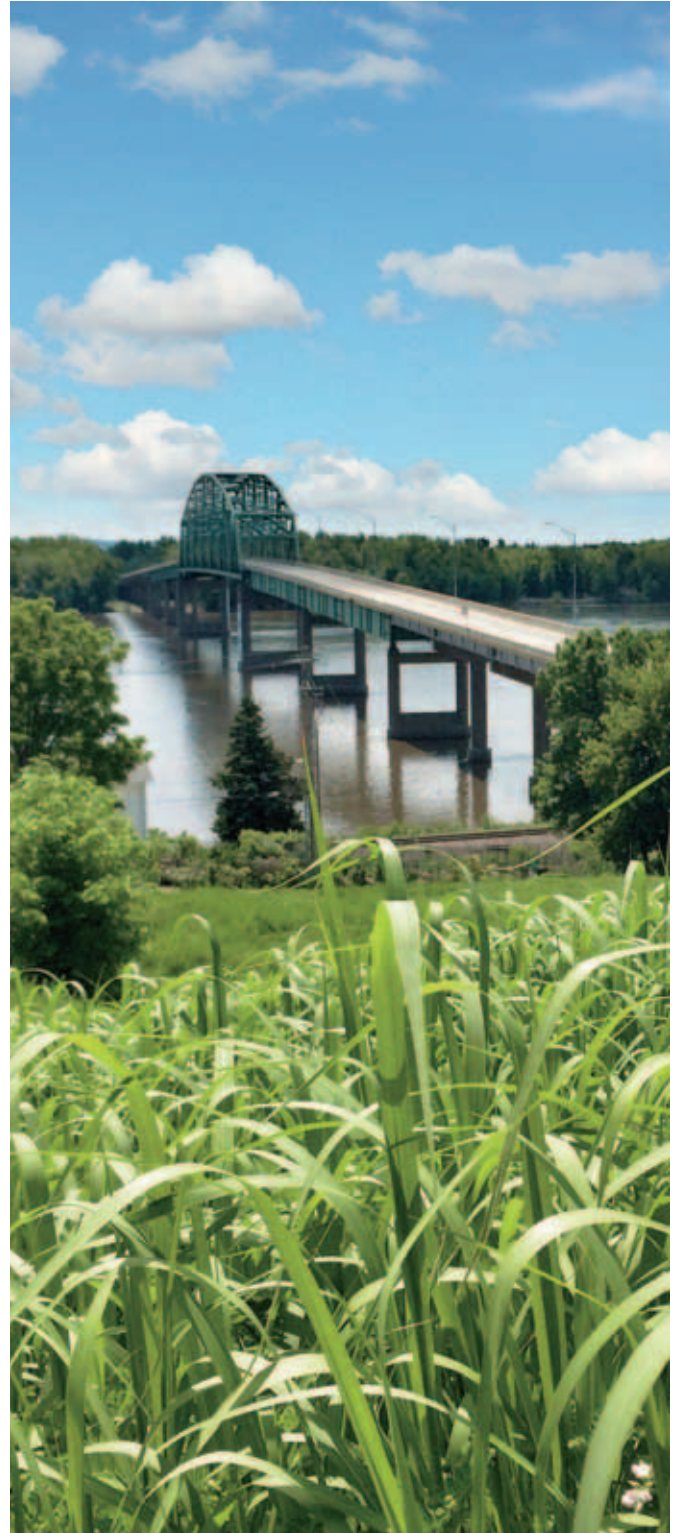

# IMPORTANT INFORMATION

## HON NOW™

### SUPERIOR OFFICE SOLUTIONS AT THE SPEED YOU NEED

To keep your business at peak productivity, waiting is not always an option. The HON NOW™ Quickship program was designed for movers and shakers like you who want exceptional quality, durability, and versatility without compromising valuable time. Whether you're outfitting a brand new workspace or simply expanding the one you already have, we've got a variety of dependable and supportive office furniture solutions designed to fit your needs and your schedule — in a hurry, without the hassle.

To learn more, visit [hon.com/hon-now](https://hon.com/hon-now).

### GSA CONTRACT INFORMATION

Model numbers identified with the verbiage “**Open Market**” are not offered on HON's GSA contract GS-27F-0015S. Model numbers identified with the following verbiage “Must be purchased with a configurable end product. If ordered separately, not on GSA contract” is to mean that these configurable components or options:

- Have no functionality or capability without being integrated into an end product, and
- Are not separately orderable; an eligible Schedule ordering activity may only purchase them with a configured system that is on contract.

### GSA/FEDERAL CONTRACT INFORMATION

Model numbers identified with the following verbiage “When purchased separately without a configurable TAA compliant end product, not on GSA contract” is to mean that these configurable parts or components:

- Have no functionality or capability without being integrated into an end product; and
- Are considered Open Market if purchased without a configurable TAA compliant end product.

### HON CUSTOMER SUPPORT CONTACT INFORMATION

**Nationwide CS Phone** – (800) 833-3964

**Nationwide Order Entry** – [HONOE@honcompany.com](mailto:HONOE@honcompany.com)

**GSA Order Entry:** [HONGSAOE@honcompany.com](mailto:HONGSAOE@honcompany.com)

**Integrated Design Solutions** – [integrateddesign@honcompany.com](mailto:integrateddesign@honcompany.com)

**Online Order and Tool Support** – [HONReady@honcompany.com](mailto:HONReady@honcompany.com)

**DASH (transportation and delivery assistance)** – (800) 334-8057

**HON Literature Fulfillment Phone** – (800) 466-4808

**Government Support:**

[GovernmentSupport@hniworkplacefurnishings.com](mailto:GovernmentSupport@hniworkplacefurnishings.com)

**Product, Parts, Non-Warranty Parts Orders:**

[ProductSupport@hniworkplacefurnishings.com](mailto:ProductSupport@hniworkplacefurnishings.com)

**Quick Ship Orders:** [QuickShip@hniworkplacefurnishings.com](mailto:QuickShip@hniworkplacefurnishings.com)

**Order Status:** [OrderStatus@hniworkplacefurnishings.com](mailto:OrderStatus@hniworkplacefurnishings.com)

**General Inquiries:** [GeneralSupport@hniworkplacefurnishings.com](mailto:GeneralSupport@hniworkplacefurnishings.com)



**Nationwide CS Phone**

**800-833-3964**

## THE FOLLOWING ICONS MAY BE USED THROUGHOUT THIS PUBLICATION

	Meets or exceeds ANSI/BIFMA and ISTA performance standards		Readily Available. For additional lead time information see page 21.
	Certified SCS Indoor Advantage™ See page 17 for more details.		Available within a “standard” or “extended” lead time. For additional lead time information see page 21.
	Complies to the BIFMA e3 Sustainability Standard. See page 17 for more details.		May have extended lead times. For additional lead time information see page 21.
	Caution		Product shipped two to a carton
	Easy to assemble		Product shipped four to a carton
	Shippable by small-package carrier		Fire Code
	Wheel-chair compatible		Core Product Line
	Soft-tread caster option available		ColorCorrect® Eligible Product
	HON “One Key” Interchangeable core removable locks (see the Accessories section in the 2024 Workspaces Pricer).		Product scheduled for discontinuation. See page 6 for details.
	Omit core removable lock option available. Allows keyed alike workstations (see the Accessories section in the 2024 Workspaces Pricer).		<b>DE-EMPHASIZED:</b> Product or fabric/surface material is de-emphasized. Not carded.
	Base models available on the HON NOW Quickship Program with select options and finishes. View the entire NOW collection at <a href="http://honready.hon.com">honready.hon.com</a> .		Warranted for multiple shift use, 24 hours a day 7 days a week



# FABRIC PATTERNS & CODES



## FABRIC PATTERNS & CODES

- For additional HON to Supply COM fabric grade pricing, go to [honready.hon.com](https://honready.hon.com) and search on the HON to Supply COM link.
- All specifications in this publication are based on the latest product information available at the time of print.
- Certain dyes (including clothing and accessory dyes such as those used on denim jeans) may migrate to lighter colors. This phenomenon is increased by humidity and temperature and is irreversible. The HON Company LLC does not assume responsibility for dye transfer caused by external contaminants.
- COM Ordering Information and pricing on page 13.
- See page 14 for Partnership Textile program information.
- All standard fabrics are carded. Cards are available through HON Literature Fulfillment.
- Fabrics and foam meet requirements for CAL-TB 117-2013.
- ! Different fabrics and finishes have different recommended cleaning and maintenance methods. For the correct product care for all finishes view the HON Product Care guide at [hon.com/customer-support/product-care](https://hon.com/customer-support/product-care).

# LEAD TIMES

## THE FOLLOWING ICONS ARE USED TO DENOTE FABRIC OPTION LEAD TIMES

### FABRIC/FINISH LEAD TIME INDICATOR



Fabric is readily available. Products using these fabrics will receive the best available product lead time and are a good option for standards programs as they will be in the HON portfolio for several years. Go to [honready.hon.com](https://honready.hon.com) and use **Compass** for product lead times by series.



Fabric is available within standard lead times. Products using these fabrics will receive a “standard” or “extended” lead time. The lead time will be determined by the combination of product and fabric. Go to [honready.hon.com](https://honready.hon.com) and use **Compass** for product lead times by series.



Fabric may have extended lead times. Products using these fabrics will typically have a 4+ week lead time. Go to [honready.hon.com](https://honready.hon.com) and use the **Compass** tool for product lead times by series.

### HON EXPRESS QUICK SHIP PROGRAM

For the full list of products delivered in 5 business days or less, visit [honready.hon.com](https://honready.hon.com).

### PRODUCT LEAD TIMES

Standard lead times for products are between 2-4 weeks. For current exceptions to our standard lead time, go to [honready.hon.com](https://honready.hon.com) and use the **Compass** tool.

In order to establish accurate expectations for your project, please review this listing prior to submitting your purchase order.

Lead time calculation begins when order is free from any holds (i.e., bad lines, material, credit, etc.).

Please note, these production lead time estimates do NOT include delivery time. All published lead times are estimates, not guarantees of delivery.

For further information concerning lead times, please contact HON Customer Support via email [HONTeamBox@honcompany](mailto:HONTeamBox@honcompany) or by phone at **800-833-3964**.

# SEATING FABRIC PATTERNS & CODES

Scan here to check out our full Chair Fabrics solutions



## GRADE 1

APEX	APX
◆ Basalt	APX25
◆ Beet	APX12
◆ Blackberry	APX20
◆ Chive	APX05
◆ Iris	APX03
◆ Kiwi	APX06
◆ Lemonade	APX08
◆ Navy	APX13
◆ Papaya	APX09
◆ Pumice	APX23
◆ Rain	APX19
◆ Resort	APX15
◆ Royal	APX14
◆ Tiki	APX29
◆ Tomato	APX11

BLACK FABRIC	ACCF
◆ Black	ACCF10

BLACK MESH	ACCM
◆ Black	ACCM10

CENTURION	CU
◆ Apricot	CU47
◆ Bark	CU25
◆ Black	CU10
◆ Espresso	CU49
◆ Fog	CU03
◆ Frost	CU22
◆ Goldenrod	CU27
◆ Indigo	CU06
◆ Iris	CU50
◆ Iron Ore	CU19
◆ Jade	CU83
◆ Marsala	CU63
◆ Morel	CU24
◆ Navy	CU98
◆ Peacock	CU97
◆ Pear	CU84
◆ Ruby	CU67
◆ Sapphire	CU09

COMPASS	COMP
◆ Beach	COMP16
◆ Bittersweet	COMP46
◆ Chocolate	COMP49
◆ Ink	COMP10
◆ Meadow	COMP82
◆ Midnight	COMP90
◆ Putty	COMP22
◆ Ruby	COMP62
◆ Sterling	COMP19
◆ Taupe	COMP26
◆ Tide	COMP96

## GRADE 1 *continued*

COMPASS FOAM* ◆	COMF
◆ Bittersweet	COMF46
◆ Ink	COMF10
◆ Meadow	COMF82
◆ Midnight	COMF90
◆ Putty	COMF22
◆ Sterling	COMF19

*\*This fabric available for Solve\* Upholstered Back models only.*

CONTOURETT	UR
◆ Baltic	UR94
◆ Beach	UR23
◆ Black	UR10
◆ Bordeaux	UR63
◆ Buff	UR22
◆ Cloud	UR18
◆ Coffee Bean	UR49
◆ Crater	UR51
◆ Flame	UR62
◆ Graphite	UR19
◆ Iron	UR20
◆ Luggage	UR26
◆ Marine	UR92
◆ Navy	UR95
◆ Nimbus	UR93
◆ Ocean	UR96
◆ Pumpkin	UR42
◆ Quarry	UR24
◆ Red	UR64
◆ Safari	UR27
◆ Sage	UR82
◆ Steel	UR21
◆ Storm	UR17
◆ Taupe	UR28
◆ Trunk	UR50

DAPPER	DAPR
◆ Ash	DAPR20
◆ Breeze	DAPR06
◆ Canvas	DAPR25
◆ Charcoal	DAPR01
◆ Clover	DAPR22
◆ Currant	DAPR00
◆ Fawn	DAPR35
◆ Fern	DAPR85
◆ Gerbera	DAPR16
◆ Grape	DAPR33
◆ Jewel	DAPR08
◆ Marigold	DAPR65
◆ Onyx	DAPR10
◆ Orchid	DAPR90
◆ Parrot	DAPR59
◆ Poppy	DAPR19
◆ Sapphire	DAPR07
◆ Scarlet	DAPR45

## GRADE 1 *continued*

DAPPER <i>continued</i>	DAPR
◆ Sepia	DAPR30
◆ Sky	DAPR44
◆ Slate	DAPR15
◆ Sorbet	DAPR55
◆ Spring	DAPR80
◆ Terracotta	DAPR13
◆ Titanium	DAPR17
◆ Varsity	DAPR09
◆ Zest	DAPR70

ENSEMBLE	ENSB
◆ Aquamarine	ENSB30
◆ Ash	ENSB39
◆ Greige	ENSB36
◆ Harbor	ENSB34
◆ Navy	ENSB35
◆ Oat	ENSB37
◆ Pear	ENSB33
◆ Sand	ENSB38
◆ Scarlet	ENSB32
◆ Slate	ENSB31
◆ Stone	ENSB40

HAMILTON	HAML
◆ Agave	HAML28
◆ Azure	HAML10
◆ Biscotti	HAML11
◆ Cabernet	HAML08
◆ Caribbean	HAML29
◆ Carolina	HAML21
◆ Charcoal	HAML17
◆ Chocolate	HAML13
◆ Cloud	HAML18
◆ Dane	HAML16
◆ Deep	HAML27
◆ Dove Grey	HAML33
◆ Dusty Rose	HAML07
◆ Esmeralda	HAML06
◆ Fern	HAML04
◆ Fresh	HAML03
◆ Garnet	HAML22
◆ Granola	HAML19
◆ Hearth	HAML34
◆ Lilac	HAML14
◆ Lime	HAML05
◆ Lipstick	HAML09
◆ Mellow	HAML25
◆ Mossy Green	HAML26
◆ Oxford	HAML20
◆ Passion Fruit	HAML02
◆ Pepper	HAML15
◆ Powder	HAML12
◆ Royalty	HAML31
◆ Serene	HAML30
◆ Sunny Day	HAML24
◆ Sunrise	HAML01
◆ Terracotta	HAML23
◆ Winter Sky	HAML32

## GRADE 1 *continued*

INERTIA ◆	NR
◆ Amethyst	NR61
◆ Calypso	NR98
◆ Cherry	NR66
◆ Cobalt	NR91
◆ Coffee	NR49
◆ Fog	NR19
◆ Fuchsia	NR63
◆ Gecko	NR76
◆ Glow	NR27
◆ Leaf	NR75
◆ Lime	NR82
◆ Loft	NR22
◆ Mandarin	NR47
◆ Meteor	NR30
◆ Mustard	NR26
◆ Nickel	NR23
◆ Onyx	NR10
◆ Regatta	NR90
◆ Shadow	NR20
◆ Surf	NR96
◆ Tangelo	NR46

NOBLE SEATING	SNBLE
◆ Aegean	SNBLE18
◆ Amethyst	SNBLE19
◆ Aspen	SNBLE14
◆ Aster	SNBLE20
◆ Blossom	SNBLE21
◆ Bluebell	SNBLE22
◆ Bordeaux	SNBLE01
◆ Brick	SNBLE02
◆ Chambray	SNBLE10
◆ Chamomile	SNBLE23
◆ Clementine	SNBLE04
◆ Conifer	SNBLE24
◆ Cottage	SNBLE25
◆ Darkness	SNBLE26
◆ Dawn	SNBLE13
◆ Denim	SNBLE09
◆ Desert Sand	SNBLE27
◆ Dewfall	SNBLE28
◆ Dusted Sage	SNBLE29
◆ Flax	SNBLE30
◆ Grass	SNBLE07
◆ Gunmetal	SNBLE15
◆ Harmony	SNBLE31
◆ Harvest	SNBLE12
◆ Ice Caves	SNBLE32
◆ Icicle	SNBLE33
◆ Inky	SNBLE34
◆ Iris	SNBLE35
◆ Jade	SNBLE06
◆ Knight	SNBLE17
◆ Mesa	SNBLE03
◆ Monarch	SNBLE36
◆ Pacific	SNBLE08
◆ Pitch	SNBLE37
◆ Queen Bee	SNBLE38

\* Fabric is de-emphasized.



Scan here to check out  
our full Chair Fabrics  
solutions

# SEATING FABRIC PATTERNS & CODES

## GRADE 1 *continued*

NOBLE SEATING <i>continued</i>	SNBLE
◆ Rainforest	SNBLE05
◆ Regal	SNBLE11
◆ Sandcastle	SNBLE39
◆ Sedona	SNBLE40
◆ Stormy	SNBLE16
◆ Sunbeam	SNBLE41
◆ Voyager	SNBLE42
◆ Windy Day	SNBLE43

OPTIC *	OP
◆ Aurora	OP72
◆ Bark	OP24
◆ Canopy	OP84
◆ Char	OP49
◆ Ruby	OP42
◆ Sand	OP17
◆ Sky	OP83
◆ Slate	OP19
◆ Sprout	OP74
◆ Starry Night	OP11
◆ Storm	OP56
◆ Wildfire	OP66

PEBBLE	PBLE
◆ Amber	PBLE01
◆ Chalk	PBLE02
◆ Coal	PBLE03
◆ Gravel	PBLE04
◆ Magma	PBLE06
◆ Moss	PBLE05
◆ Sandstone	PBLE07
◆ Talc	PBLE08
◆ Topaz	PBLE09
◆ Zircon	PBLE10

VIBE	VIBE
◆ Bliss	VIBE03
◆ Calm	VIBE06
◆ Carefree	VIBE08
◆ Cheerful	VIBE17
◆ Compassion	VIBE01
◆ Connected	VIBE13
◆ Content	VIBE19
◆ Courage	VIBE12
◆ Dazed	VIBE21
◆ Delight	VIBE18
◆ Euphoria	VIBE15
◆ Gleeful	VIBE04
◆ Gloomy	VIBE22
◆ Hope	VIBE07
◆ Moody	VIBE05
◆ Nostalgia	VIBE09
◆ Perplexed	VIBE10
◆ Pride	VIBE02
◆ Relaxed	VIBE20
◆ Secure	VIBE16
◆ Serenity	VIBE11
◆ Trust	VIBE14

## GRADE 2

APPOINT SEATING	PNS
◆ Artichoke	PNS014
◆ Blackberry	PNS012
◆ Bronze	PNS002
◆ Carbon	PNS008
◆ Chai	PNS013
◆ Cherry	PNS010
◆ Dark Pewter	PNS017
◆ Dune	PNS015
◆ Espresso	PNS003
◆ Framboise	PNS011
◆ Frost	PNS034
◆ Jet	PNS007
◆ Lawn	PNS005
◆ Mandarin	PNS009
◆ Morel	PNS001
◆ Nimbus	PNS016
◆ Platinum	PNS004
◆ Turquoise	PNS006

BLUME	BLME
◆ Chalk	BLME03
◆ Char	BLME00
◆ Coin	BLME02
◆ Driftwood	BLME05
◆ Emerald City	BLME07
◆ Fir	BLME09
◆ Harvest	BLME04
◆ Haze	BLME08
◆ Hyacinth	BLME14
◆ Jasper	BLME13
◆ Merlot	BLME10
◆ Moonstone	BLME01
◆ Opal	BLME06
◆ Scarlet	BLME11
◆ Slate	BLME12

CLYDE	CLYD
◆ Antique	CLYD04
◆ Artifact	CLYD01
◆ Blacksmith	CLYD10
◆ Claret	CLYD13
◆ Craftsman	CLYD08
◆ Crate	CLYD12
◆ Fossil	CLYD02
◆ Heirloom	CLYD05
◆ Iron	CLYD11
◆ Keepsake	CLYD15
◆ Linen	CLYD14
◆ Relic	CLYD06
◆ Seasoned	CLYD03
◆ Trestle	CLYD07

## GRADE 2 *continued*

DOTTY *	DOT
◆ Candy	DOT63
◆ Gelato	DOT34
◆ Indigo	DOT31
◆ Onyx	DOT35
◆ Park	DOT83
◆ Peat	DOT24
◆ Peony	DOT32
◆ Suit	DOT20
◆ Sunflower	DOT33
◆ Tailor	DOT21
◆ Tide	DOT90
◆ Velum	DOT29
◆ Violet	DOT30

KAI	KAI
◆ Algae	KAI07
◆ Barnacle	KAI19
◆ Clownfish	KAI04
◆ Coastal	KAI13
◆ Conch	KAI02
◆ Coral Reef	KAI16
◆ Crab	KAI01
◆ Ebb	KAI12
◆ Flow	KAI11
◆ Inlet	KAI03
◆ Jellyfish	KAI18
◆ Kelp	KAI08
◆ Orca	KAI26
◆ Otter	KAI22
◆ Puffer	KAI06
◆ Salty	KAI23
◆ Seahorse	KAI05
◆ Seashell	KAI20
◆ Seaweed	KAI09
◆ Shark	KAI24
◆ Shoreline	KAI21
◆ Stingray	KAI25
◆ Tide	KAI14
◆ Turtle	KAI10
◆ Urchin	KAI17
◆ Wave	KAI15

## GRADE 2 *continued*

RUSH	RUSH
◆ Anchor	RUSH07
◆ Basil	RUSH16
◆ Blueberry	RUSH10
◆ Blue Sky	RUSH57
◆ Browned Butter	RUSH25
◆ Cherry Pie	RUSH40
◆ Cinnamon Sugar	RUSH35
◆ Dried Herb	RUSH62
◆ Flamingo	RUSH21
◆ Forest Green	RUSH67
◆ Greenery	RUSH15
◆ Greyhound	RUSH06
◆ Marina	RUSH13
◆ Merlot	RUSH19
◆ Midnight	RUSH11
◆ Mint	RUSH09
◆ Mulberry	RUSH18
◆ Obsidian	RUSH90
◆ Petals	RUSH77
◆ Pumice	RUSH01
◆ Punch	RUSH20
◆ Rain Drop	RUSH54
◆ Rush Smoke	RUSH84
◆ Sage	RUSH14
◆ Salsa	RUSH24
◆ Sand	RUSH05
◆ Seal	RUSH08
◆ Slate	RUSH89
◆ Soot	RUSH02
◆ Stout	RUSH03
◆ Sunshine	RUSH23
◆ Tapestry	RUSH04
◆ Tiger	RUSH22
◆ Vintage	RUSH17
◆ Wave	RUSH12

SPIN SEATING	SPNN
◆ Alabaster	SPNN02
◆ Cavern	SPNN03
◆ Cobblestone	SPNN04
◆ Ember	SPNN06
◆ Flame	SPNN07
◆ Heron	SPNN13
◆ Oat	SPNN01
◆ Ocean	SPNN12
◆ Plum	SPNN15
◆ Pool	SPNN11
◆ Raven	SPNN10
◆ Rhubarb	SPNN14
◆ Tropic	SPNN08
◆ Willow	SPNN05

\* Fabric is de-emphasized.

# SEATING FABRIC PATTERNS & CODES

Scan here to check out our full Chair Fabrics solutions



## GRADE 2 *continued*

WAVELENGTH	WVL
◆ Base	WVL21
◆ Crest	WVL14
◆ Cycle	WVL20
◆ Energy	WVL03
◆ Frequency	WVL04
◆ Infrared	WVL01
◆ Motion	WVL13
◆ Movement	WVL05
◆ Peak	WVL11
◆ Pressure	WVL06
◆ Shallow	WVL02
◆ Still	WVL07
◆ Surface	WVL18
◆ Surge	WVL10
◆ Swell	WVL08
◆ Tide	WVL16
◆ Transition	WVL15
◆ Trough	WVL19
◆ Tsunami	WVL09
◆ Ultraviolet	WVL12
◆ White Caps	WVL17

WHISPER VINYL	WP
◆ Antelope	WP20
◆ Auburn	WP02
◆ Black	WP40
◆ Bone	WP17
◆ Bordeaux	WP26
◆ Breeze	WP76
◆ Camel	WP18
◆ Cappuccino	WP21
◆ Cashew	WP29
◆ Cerulean	WP36
◆ Charcoal	WP39
◆ Cinnamon	WP25
◆ Coastal	WP81
◆ Cognac	WP62
◆ Elephant	WP38
◆ Emerald	WP80
◆ Espresso	WP49
◆ Farro	WP73
◆ Fawn	WP91
◆ Fog	WP100
◆ Fossil	WP01

## GRADE 2 *continued*

WHISPER VINYL <i>continued</i>	WP
◆ Herbal	WP79
◆ Indigo	WP86
◆ Islet	WP77
◆ Luggage	WP23
◆ Mahogany	WP93
◆ Mallard	WP90
◆ Molten	WP98
◆ Navy	WP37
◆ Paradise	WP85
◆ Patina	WP34
◆ Pavestone	WP74
◆ Pearl	WP71
◆ Pewter	WP83
◆ Powder	WP70
◆ Saddle	WP03
◆ Salsa	WP42
◆ Sand	WP72
◆ Sassafras	WP89
◆ Silver Leaf	WP78
◆ Slate	WP04
◆ Storm	WP92
◆ Terracotta	WP75
◆ Truffle	WP95
◆ Wolf Grey	WP55

## GRADE 3

BRADBURY	BDY
◆ Acorn	BDY01
◆ Alabaster	BDY02
◆ Aspire	BDY03
◆ Blueberry	BDY04
◆ Carbon	BDY05
◆ Concord	BDY06
◆ Cozumel	BDY07
◆ Dolphin	BDY08
◆ Gala	BDY09
◆ Honey	BDY10
◆ Mushroom	BDY11
◆ Mystic	BDY12
◆ Oat	BDY13
◆ Rhino	BDY14
◆ Scallion	BDY15
◆ Sidewalk	BDY16
◆ Terrazzo	BDY17
◆ Vellum	BDY18
◆ Walnut	BDY19

## GRADE 3 *continued*

GETAWAY	GTWY
◆ Brig	GTWY15
◆ Canoe	GTWY03
◆ Catamaran	GTWY08
◆ Cruise Ship	GTWY10
◆ Cuddy	GTWY01
◆ Ferry	GTWY11
◆ Gondola	GTWY02
◆ Jet Ski	GTWY09
◆ Kayak	GTWY05
◆ Pontoon	GTWY13
◆ Runabout	GTWY14
◆ Sailboat	GTW07
◆ Speedboat	GTWY12
◆ Wakeboard	GTWY06
◆ Yacht	GTWY04

MOXIE	SX
◆ Barnwood	SX09
◆ Basalt	SX23
◆ Bayou	SX02
◆ Bermuda	SX52
◆ Biscotti	SX08
◆ Blackberry	SX48
◆ Blarney	SX49
◆ Blueberry	SX05
◆ Bonsai	SX20
◆ Brigade	SX53
◆ Butterscotch	SX54
◆ Carob	SX24
◆ Chalk	SX50
◆ Chartreuse	SX34
◆ Cherry	SX38
◆ Cinnamon	SX13
◆ Cobalt	SX01
◆ Coconut	SX06
◆ Concrete	SX43
◆ Cozumel	SX55
◆ Cumin	SX32
◆ Dover	SX56
◆ Dragonfly	SX44
◆ Earl Grey	SX40
◆ Elysian	SX04
◆ Evergreen	SX21
◆ Fatigue	SX18
◆ Fawn	SX30
◆ Flint	SX39
◆ Forsythia	SX57
◆ Grenache	SX58
◆ Hazel	SX31
◆ Hemp	SX45
◆ Hickory	SX25
◆ Holly	SX51
◆ Jam	SX16
◆ Kelly	SX33
◆ Lemongrass	SX19

## GRADE 3 *continued*

MOXIE <i>continued</i>	SX
◆ Lime	SX41
◆ Macintosh	SX12
◆ Midnight	SX59
◆ Mulberry	SX15
◆ Muslin	SX60
◆ Pacifica	SX61
◆ Parchment	SX07
◆ Peacock	SX03
◆ Phantom	SX62
◆ Pineapple	SX42
◆ Plum	SX17
◆ Punch	SX46
◆ Riverstone	SX47
◆ Russet	SX14
◆ Smokestack	SX22
◆ Tangerine	SX37
◆ Terracotta	SX11
◆ Thicket	SX35
◆ Walnut	SX10
◆ Whirlwind	SX63

NOTION	NTN
◆ Agave	NTN01
◆ Bark	NTN02
◆ Beeswax	NTN03
◆ Carbon	NTN04
◆ Cassis	NTN05
◆ Cement	NTN06
◆ Char	NTN07
◆ Chroma	NTN08
◆ Dockside	NTN09
◆ Drifter	NTN10
◆ Fog	NTN11
◆ Fountain	NTN12
◆ Fox	NTN13
◆ Grassland	NTN14
◆ Henna	NTN15
◆ Horizon	NTN16
◆ Ivy	NTN17
◆ Linen	NTN18
◆ Mykonos	NTN19
◆ Peat	NTN20
◆ Poppy	NTN21
◆ Rockfall	NTN22
◆ Sandwash	NTN23
◆ Stoneware	NTN24
◆ Sumac	NTN25
◆ Twilight	NTN26

For a complete list of fabrics, including partnership fabrics, go to [hon.com/fabricsandfinishes](http://hon.com/fabricsandfinishes).





Scan here to check out  
our full Chair Fabrics  
solutions

# SEATING FABRIC PATTERNS & CODES

## GRADE 3 *continued*

PARKER	PRKR
◆ Aloe	PRKR01
◆ Cumulus	PRKR05
◆ Cyan	PRKR06
◆ Domino	PRKR07
◆ Fossil	PRKR10
◆ Graphite	PRKR11
◆ Grass	PRKR12
◆ Grenadine	PRKR13
◆ Griffin	PRKR14
◆ Kiln	PRKR16
◆ Magnesium	PRKR18
◆ Magnet	PRKR19
◆ Mica	PRKR20
◆ Mink	PRKR21
◆ Nightfall	PRKR22
◆ Paprika	PRKR24
◆ Pine	PRKR25
◆ Rapids	PRKR28
◆ Rioja	PRKR30

PURL	PURL
◆ Alpaca	PURL08
◆ Braid	PURL10
◆ Deep	PURL12
◆ Graze	PURL05
◆ Loom	PURL06
◆ Needle	PURL07
◆ Pasture	PURL02
◆ Ranch	PURL04
◆ Shuttle	PURL09
◆ Skein	PURL01
◆ Thistle	PURL11
◆ Yearling	PURL03

QUILL	QUL
◆ Aviary	QUL03
◆ Feather	QUL02
◆ Fountain	QUL06
◆ Ink	QUL05
◆ Metal	QUL04
◆ Reed	QUL08
◆ Scroll	QUL01
◆ Well	QUL07

## GRADE 3 *continued*

SAXONY	SXNY
◆ Arctic	SXNY14
◆ Azure	SXNY11
◆ Black	SXNY21
◆ Clover	SXNY06
◆ Cobalt	SXNY12
◆ Emerald	SXNY08
◆ Flare	SXNY02
◆ Fog	SXNY18
◆ Grass	SXNY05
◆ Iron	SXNY20
◆ Lagoon	SXNY07
◆ Lipstick	SXNY01
◆ Mandarin	SXNY03
◆ Navy	SXNY13
◆ Sand	SXNY16
◆ Sea	SXNY10
◆ Shell	SXNY15
◆ Sky	SXNY09
◆ Storm Cloud	SXNY19
◆ Taupe	SXNY17
◆ Zest	SXNY04

## GRADE 4

CONSTANCE WITH SUPREEN™	CNST
◆ Airy	CNST01
◆ Aztec	CNST02
◆ Cassis	CNST03
◆ Copperplate	CNST04
◆ Cornerstone	CNST05
◆ Envy	CNST06
◆ Flagstone	CNST07
◆ Flax	CNST08
◆ Frost	CNST09
◆ Gateway	CNST10
◆ Grounds	CNST11
◆ Hayfield	CNST12
◆ Inkpad	CNST13
◆ Pewter	CNST14
◆ Pistachio	CNST15
◆ Pompeii	CNST16
◆ Poseidon	CNST17
◆ Reflection	CNST18
◆ Scuba	CNST19
◆ Stoic	CNST20
◆ Stonnington	CNST21
◆ Thunder	CNST22
◆ Waterfall	CNST23

## GRADE 4 *continued*

LIVI WITH SUPREEN™	LIVI
◆ Asphalt	LIVI01
◆ Atlantis	LIVI02
◆ Bouquet	LIVI03
◆ Branch	LIVI04
◆ Coastal	LIVI05
◆ Cowboy	LIVI06
◆ Dawn	LIVI07
◆ Earth	LIVI09
◆ Evergreen	LIVI10
◆ Fennel	LIVI11
◆ Fog	LIVI12
◆ Honeycomb	LIVI13
◆ Jade	LIVI14
◆ Limestone	LIVI15
◆ Monochrome	LIVI16
◆ Night	LIVI17
◆ Overcast	LIVI18
◆ Pebble	LIVI19
◆ Pillow	LIVI08
◆ Plum	LIVI20
◆ Pumpkin	LIVI21
◆ Rhubarb	LIVI22
◆ Saxon	LIVI23
◆ Seaside	LIVI24
◆ Twine	LIVI25

LUGANO WITH SUPREEN™	LUG
◆ Andromeda	LUG01
◆ Aquarelle	LUG02
◆ Bayou	LUG03
◆ Caviar	LUG04
◆ Cloud	LUG05
◆ Cobblestone	LUG06
◆ Dutch	LUG07
◆ Flirt	LUG08
◆ Florence	LUG09
◆ Frost	LUG10
◆ Ganache	LUG11
◆ Gravel	LUG12
◆ Juniper	LUG13
◆ Lapis	LUG14
◆ Moonstone	LUG15
◆ Mustard Seed	LUG16
◆ Sandstone	LUG17
◆ Sconce	LUG18
◆ Semolina	LUG19
◆ Spice Market	LUG20
◆ Sterling	LUG21

## GRADE 4 *continued*

OXFORD WITH SUPREEN™	OXFD
◆ Armor	OXFD01
◆ Azurite	OXFD02
◆ Cadet	OXFD03
◆ Cider	OXFD04
◆ Clover	OXFD05
◆ Coal	OXFD16
◆ Coin	OXFD06
◆ Crema	OXFD07
◆ Currant	OXFD08
◆ Deluge	OXFD09
◆ Dewberry	OXFD10
◆ Falcon	OXFD11
◆ Gingerbread	OXFD12
◆ Laurel	OXFD13
◆ Odyssey	OXFD14
◆ Pavement	OXFD15
◆ Redvine	OXFD17
◆ Seadrift	OXFD18
◆ Shoji	OXFD19
◆ Tourmaline	OXFD20
◆ Vignette	OXFD21

## GRADE L1

DENVER LEATHER	SS
◆ Black	SS11

# PANEL FABRIC PATTERNS & CODES

Scan here to check out our full Panel Fabric solutions



PRICE CODE A		PRICE CODE A <i>continued</i>		PRICE CODE A <i>continued</i>		PRICE CODE A <i>continued</i>	
APPOINT	APN	ETCH*	ECH	NOBLE	NBLE	REFLECTIONS*	REF
◆ Artichoke	APN11	◆ Axis	ECH13	◆ Aegean	NBLE18	◆ Galvanized	REF29
◆ Blackberry	APN32	◆ Blend	ECH14	◆ Amethyst	NBLE19	◆ Ice	REF20
◆ Bronze	APN22	◆ Cast	ECH12	◆ Aspen	NBLE14	◆ Loggia	REF21
◆ Carbon	APN28	◆ Highlight	ECH10	◆ Aster	NBLE20	◆ Mistral	REF28
◆ Chai	APN12	◆ Midtone	ECH11	◆ Blossom	NBLE21	◆ Moonstone	REF23
◆ Cherry	APN30	◆ Outline	ECH08	◆ Bluebell	NBLE22	◆ Pewter	REF22
◆ Dark Pewter	APN17	◆ Shade	ECH09	◆ Bordeaux	NBLE01	◆ Stainless	REF24
◆ Dune	APN15	◆ Tonal	ECH16	◆ Brick	NBLE02	◆ Vanilla	REF25
◆ Espresso	APN23	◆ Vanish	ECH15	◆ Chambray	NBLE10	◆ Winter	REF27
◆ Framboise	APN31			◆ Chamomile	NBLE23		
◆ Frost	APN34	LANDSCAPE*	LN	◆ Clementine	NBLE04	REFUGE*	RFG
◆ Jet	APN27	◆ Azure	LN55	◆ Conifer	NBLE24	◆ Artesian	RFG96
◆ Lawn	APN25	◆ Cornsilk	LN15	◆ Cottage	NBLE25	◆ Dune	RFG92
◆ Mandarin	APN29	◆ Drift	LN05	◆ Darkness	NBLE26	◆ Eclipse	RFG90
◆ Morel	APN09	◆ Khaki	LN20	◆ Dawn	NBLE13	◆ Frost	RFG93
◆ Nimbus	APN16	◆ Sheen	LN10	◆ Denim	NBLE09	◆ Glacier	RFG91
◆ Platinum	APN24	◆ Slate	LN35	◆ Desert Sand	NBLE27	◆ Mineral	RFG98
◆ Turquoise	APN26	◆ Umber	LN25	◆ Dewfall	NBLE28	◆ Tidal	RFG94
		◆ Urban	LN30	◆ Dusted Sage	NBLE29		
CENTURION	CU	LUCY*	LC	◆ Flax	NBLE30	TEMPEST*	TP
◆ Apricot	CU47	◆ Aspen	LC32	◆ Grass	NBLE07	◆ Dragonfly	TP30
◆ Bark	CU25	◆ Cornsilk	LC30	◆ Gunmetal	NBLE15	◆ Frost	TP15
◆ Black	CU10	◆ Dusk	LC22	◆ Harmony	NBLE31	◆ Full Stream	TP80
◆ Espresso	CU49	◆ Fawn	LC33	◆ Harvest	NBLE12	◆ Gold Rush	TP10
◆ Fog	CU03	◆ Fawn	LC33	◆ Ice Caves	NBLE32	◆ Slate	TP45
◆ Frost	CU22	◆ Graphite	LC34	◆ Icicle	NBLE33	◆ Tumbleweed	TP70
◆ Goldenrod	CU27	◆ Mist	LC20	◆ Inky	NBLE34	◆ Wind Chill	TP40
◆ Indigo	CU06	◆ Neutra	LC24	◆ Iris	NBLE35	◆ Zebra	TP35
◆ Iris	CU50	◆ Pewter	LC35	◆ Jade	NBLE06		
◆ Iron Ore	CU19	◆ Snowdrop	LC28	◆ Knight	NBLE17	VAST	VST
◆ Jade	CU83			◆ Mesa	NBLE03	◆ Atmosphere	VST06
◆ Marsala	CU63			◆ Monarch	NBLE36	◆ Bay	VST04
◆ Morel	CU24			◆ Pacific	NBLE08	◆ Beach	VST11
◆ Navy	CU98			◆ Pitch	NBLE37	◆ Country Side	VST13
◆ Peacock	CU97			◆ Queen Bee	NBLE38	◆ Desert	VST12
◆ Pear	CU84			◆ Rainforest	NBLE05	◆ Garden	VST02
◆ Ruby	CU67			◆ Regal	NBLE11	◆ Grasslands	VST03
◆ Sapphire	CU09			◆ Sandcastle	NBLE39	◆ Highway	VST09
				◆ Sedona	NBLE40	◆ Mountain Range	VST08
				◆ Stormy	NBLE16	◆ Ocean	VST07
				◆ Sunbeam	NBLE41	◆ Open Air	VST05
				◆ Voyager	NBLE42	◆ Tundra	VST10
				◆ Windy Day	NBLE43	◆ Vineyard	VST01

NOTES: Centurion fabrics not available on panels that exceed a width and height of 54"H.

Disperse is applied pattern cut and is not available on 72"W Accelerate® panels and not available on 66"W tackboards, Voi® screens, and Empower®.

◆◆◆ For lead time information see page 21.

\* Directional fabrics



Scan here to check out  
our full Panel Fabric  
solutions

# PANEL FABRIC PATTERNS & CODES

## PRICE CODE B

COAST*	COA
<i>Not available on Accelerate®</i>	
◆ Channel	COA14
◆ Dune	COA03
◆ Headlands	COA10
◆ Marsh	COA02
◆ Pebble	COA12
◆ Pier	COA13
◆ Shoal	COA01
◆ Silt	COA06
◆ Tide	COA08

DISPERSE*	DISP
◆ Autumn	DISP03
◆ Branch	DISP10
◆ Coffee Bean	DISP13
◆ Dusk	DISP09
◆ Emerald City	DISP08
◆ Gold Rush	DISP02
◆ Igloo	DISP11
◆ Ink	DISP06
◆ Mist	DISP12
◆ Oatmeal	DISP15
◆ Prince	DISP07
◆ Reservoir	DISP01
◆ Rose	DISP04
◆ Spring	DISP05
◆ Steel	DISP16
◆ Taupe	DISP14

## PRICE CODE B *continued*

MICA* *	MCA
◆ Anthracite	MCA11
◆ Breeze	MCA18
◆ Bronze	MCA13
◆ Buff	MCA14
◆ Cremini	MCA17
◆ Crystal	MCAWIT
◆ Dew	MCA20
◆ Dove	MCA12
◆ Fresh	MCA16
◆ Mineral	MCA15
◆ Nectar	MCA19
◆ Shale	MCA10

SPIN*	SPIN
◆ Alabaster	SPIN02
◆ Cavern	SPIN03
◆ Cobblestone	SPIN04
◆ Ember	SPIN06
◆ Flame	SPIN07
◆ Heron	SPIN13
◆ Oat	SPIN01
◆ Ocean	SPIN12
◆ Plum	SPIN15
◆ Pool	SPIN11
◆ Raven	SPIN10
◆ Rhubarb	SPIN14
◆ Tropic	SPIN08
◆ Willow	SPIN05

## PRICE CODE B *continued*

TERRAIN*	TRRN
◆ Bay	TRRN05
◆ Bayou	TRRN35
◆ Canyon	TRRN30
◆ Cliff	TRRN45
◆ Crest	TRRN25
◆ Delta	TRRN10
◆ Plateau	TRRN15
◆ Ridge	TRRN20
◆ Valley	TRRN40

NOTES: Disperse is applied pattern cut and is not available on 72"W Accelerate® panels and not available on 66"W tackboards, Voi® screens, and Empower®.

◆◆◆ For lead time information see page 21.

\* Directional fabrics

\* Fabric is de-emphasized.

# ARRANGE®

Want to see more? Scan here  
to check out hon.com.



Arrange® Tables shown with Ignition® Multi-Purpose Seating.

## ARRANGE®

Non-traditional workspace? Transform it with Arrange tables. Ideal for cafés and other collaborative spaces, Arrange tables are available in seated, counter and standing-heights, and can accommodate anywhere from two to eight people. With four tabletop shapes and more than 40 different finish options, you can create a unique and usable space that brings people together.



## FEATURES

- Simple, clean design coordinates nicely with other HON furniture.
- The traditional x-base can be updated with a disc shroud.
- Tables come with optional cord grommets and outlets to accommodate a wide range of technical needs — or none at all.
- Aluminum bases are durable, long-lasting and lightweight, making it easy to move and rearrange floor plans.
- Laminate surfaces are durable and resist scratches, spills and stains.

# ARRANGE® CAFÉ TABLES ORDERING INFORMATION

## LAMINATE

### TOPS/L1 LAMINATES ..... CODES

#### Woodgrain

- ◆ Bourbon Cherry ..... H
- ◆ Cognac ..... COGN
- ◆ Field Elm ..... LWFE
- ◆ Florence Walnut ..... LFW1
- ◆ Harvest ..... C
- ◆ Kingswood Walnut ..... LK11
- ◆ Mahogany ..... N
- ◆ Mocha ..... MOCH
- ◆ Natural Maple ..... D
- ◆ Pinnacle ..... PINC
- ◆ Shaker Cherry ..... F
- ◆ Sterling Ash ..... LSA1

#### Solid

- ◆ Black ..... P
- ◆ Charcoal ..... S
- ◆ Designer White ..... LDW1
- ◆ Loft ..... LOFT

#### Patterned

- ◆ Handspun Chestnut ..... LAHC
- ◆ Handspun Dove ..... LAHD
- ◆ Handspun Pearl ..... LAHP
- ◆ Handspun Slate ..... LAHS
- ◆ Silver Mesh ..... B9
- ◆ Gray ..... G2
- ◆ White ..... G1

### TOPS/L2 LAMINATES ..... CODES

#### Woodgrain

- ◆ Beigewood ..... LWBE
- ◆ Fawn Cypress ..... LFC1
- ◆ Lowell Ash ..... LLA1
- ◆ Natural Recon ..... LNRI
- ◆ Phantom Ecru ..... LPE1
- ◆ Portico Teak ..... LPT1
- ◆ Skyline Walnut ..... LSW1

## PAINT

### PAINT ..... CODES

#### P1

- ◆ Charblack ..... CBK
- ◆ Textured Brownstone ..... P7J
- ◆ Textured Charcoal ..... P7A
- ◆ Textured Designer White ... PK7
- ◆ Textured Loft ..... P7L
- ◆ Textured Muslin ..... P7M
- ◆ Textured Platinum  
Metallic ..... PLAT
- ◆ Textured Titanium ..... P8V

#### P2

- ◆ Solar Black ..... P8X
- ◆ Textured Silver ..... PR8

## EDGE BAND

### EDGE BAND ..... CODES

- ◆ Beigewood ..... DE
- ◆ Black ..... P
- ◆ Bourbon Cherry ..... H
- ◆ Brownstone ..... EY
- ◆ Charcoal ..... S
- ◆ Cognac ..... COGN
- ◆ Designer White ..... DW
- ◆ Fawn Cypress ..... FC
- ◆ Field Elm ..... FE
- ◆ Florence Walnut ..... FW
- ◆ Fossil ..... EH
- ◆ Greige ..... R
- ◆ Harvest ..... C
- ◆ Kingswood Walnut ..... KI
- ◆ Loft ..... LOFT
- ◆ Lowell Ash ..... DL
- ◆ Mahogany ..... N
- ◆ Mocha ..... MOCH
- ◆ Muslin ..... T
- ◆ Natural Maple ..... D
- ◆ Natural Recon ..... NR
- ◆ Phantom Ecru ..... PE
- ◆ Pinnacle ..... PINC
- ◆ Platinum ..... K
- ◆ Portico Teak ..... DP
- ◆ Shaker Cherry ..... F
- ◆ Skyline Walnut ..... SW
- ◆ Sterling Ash ..... SA

### Recommended Edgeband Color Selection:

Laminate		Edgeband	
Bourbon Cherry	H	Bourbon Cherry	H
Cognac	COGN	Cognac	COGN
Florence Walnut	LFW1	Florence Walnut	FW
Harvest	C	Harvest	C
Kingswood Walnut	LK11	Kingswood Walnut	KI
Mahogany	N	Mahogany	N
Mocha	MOCH	Mocha	MOCH
Natural Maple	D	Natural Maple	D
Pinnacle	PINC	Pinnacle	PINC
Shaker Cherry	F	Shaker Cherry	F
Sterling Ash	LSA1	Sterling Ash	SA
Black	P	Black	P
Charcoal	S	Charcoal	S
Designer White	LDW1	Designer White	DW
Handspun Chestnut	LAHC	Brownstone	EY
Handspun Dove	LAHD	Fossil	EH
Handspun Pearl	LAHP	Fossil	EH
Handspun Slate	LAHS	Charcoal	S
Silver Mesh	B9	Loft	LOFT
Steel Mesh	A9	Charcoal	S
Lowell Ash	LLA1	Lowell Ash	DL
Natural Recon	LNRI	Natural Recon	NR
Phantom Ecru	LPE1	Phantom Ecru	PE
Portico Teak	LPT1	Portico Teak	DP
Skyline Walnut	LSW1	Skyline Walnut	SW
Loft	LOFT	Loft	LOFT

◆◆◆ For lead time information see page 21.



# ARRANGE<sup>®</sup> Café Table Tops

GSA SIN 33721



Icon Legend on page 19

	DESCRIPTION	MODEL	SHIP WEIGHT	CUBE	LIST PRICE BY LAMINATE GRADE	
					L1	L2
	<b>Café Round Table Tops</b>					
	24"W Round Top	<b>HCTRND24</b>	19	1.9	<b>\$439</b>	<b>\$456</b>
	30"W Round Top	<b>HCTRND30</b>	31	2.9	<b>\$472</b>	<b>\$489</b>
	36"W Round Top	<b>HCTRND36</b>	44	4.0	<b>\$514</b>	<b>\$531</b>
	42"W Round Top	<b>HCTRND42</b>	57	5.4	<b>\$609</b>	<b>\$631</b>
	<b>Square Table Tops</b>					
	24"W Square Top	<b>HCTSQR24</b>	19	2.2	<b>\$417</b>	<b>\$434</b>
	30"W Square Top	<b>HCTSQR30</b>	31	2.9	<b>\$449</b>	<b>\$466</b>
	36"W Square Top	<b>HCTSQR36</b>	44	4.1	<b>\$490</b>	<b>\$507</b>
	42"W Square Top	<b>HCTSQR42</b>	57	5.6	<b>\$583</b>	<b>\$605</b>
	<b>Soft Square Table Tops</b>					
	24"W Soft Square Top	<b>HCTSFT24</b>	19	1.9	<b>\$439</b>	<b>\$456</b>
	30"W Soft Square Top	<b>HCTSFT30</b>	31	2.9	<b>\$472</b>	<b>\$489</b>
	36"W Soft Square Top	<b>HCTSFT36</b>	44	4.0	<b>\$514</b>	<b>\$531</b>
	42"W Soft Square Top	<b>HCTSFT42</b>	57	5.4	<b>\$609</b>	<b>\$631</b>
	<b>Rectangle Table Tops</b>					
	48"W x 24"D Rectangle Top	<b>HCTRECT2448</b>	36	3.6	<b>\$495</b>	<b>\$512</b>
	60"W x 24"D Rectangle Top	<b>HCTRECT2460</b>	44	4.4	<b>\$542</b>	<b>\$559</b>
	72"W x 24"D Rectangle Top	<b>HCTRECT2472</b>	56	4.9	<b>\$574</b>	<b>\$596</b>
	48"W x 30"D Rectangle Top	<b>HCTRECT3048</b>	51	4.4	<b>\$514</b>	<b>\$531</b>
	60"W x 30"D Rectangle Top	<b>HCTRECT3060</b>	63	5.4	<b>\$574</b>	<b>\$591</b>
	72"W x 30"D Rectangle Top	<b>HCTRECT3072</b>	75	6.0	<b>\$637</b>	<b>\$659</b>

**NOTES:**

- 2 grommet cutouts on Rectangles which will be positioned over the installed bases.
- For compatible round grommet options, see page 247.
- ! HGRMTUSB2 is not compatible with Arrange<sup>®</sup> bases.

## HOW TO SPECIFY

<p><b>Select Model Number</b></p> <p>H C T R N D 2 4 .</p>	<p><b>Select Grommet Option</b></p> <p><b>G</b> Round Grommet (\$17 upcharge) <b>N</b> No Grommet</p> <p>Upcharge doubles for HCTRECT models</p> <p>G .</p>	<p><b>Select Laminate</b></p> <p>See page 29</p> <p>C .</p>	<p><b>Select Edge Color</b></p> <p>See page 29</p> <p>C</p>
--	---	---	---



Icon Legend on page 19

# ARRANGE® Café Table Bases

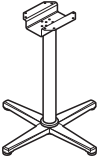
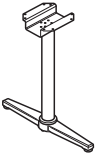
	DESCRIPTION	MODEL	SHIP WEIGHT	CUBE	LIST PRICE	P2 UPCHARGE
	<b>Café Table Bases — X-Base</b>					
	Seated-Height X-base for 24"-30"D Surfaces	<b>HCT29SX</b>	22	3.3	<b>\$663</b>	<b>\$22</b>
	Seated-Height X-base for 36"D Surfaces	<b>HCT29MX</b>	23	3.3	<b>\$737</b>	<b>\$22</b>
	Seated-Height X-base for 42"D Surfaces	<b>HCT29LX</b>	25	3.3	<b>\$809</b>	<b>\$22</b>
	Counter-Height X-base for 24"-30"D Surfaces	<b>HCT36SX</b>	24	4.6	<b>\$737</b>	<b>\$22</b>
	Counter-Height X-base for 36"D Surfaces	<b>HCT36MX</b>	25	4.6	<b>\$809</b>	<b>\$22</b>
	Counter-Height X-base for 42"D Surfaces	<b>HCT36LX</b>	27	4.6	<b>\$883</b>	<b>\$22</b>
	Bar-Height X-base for 24"-30"D Surfaces	<b>HCT42SX</b>	25	4.6	<b>\$809</b>	<b>\$22</b>
	Bar-Height X-base for 36"D Surfaces	<b>HCT42MX</b>	26	4.6	<b>\$883</b>	<b>\$22</b>
Bar-Height X-base for 42"D Surfaces	<b>HCT42LX</b>	27	4.6	<b>\$955</b>	<b>\$22</b>	
	<b>Café Table Bases — T-Leg Base</b>					
	Seated-Height T-legs for 24"D Surfaces (2 bases incl.)	<b>HCT29ST</b>	33	3.3	<b>\$897</b>	<b>\$22</b>
	Seated-Height T-legs for 30"D Surfaces (2 bases incl.)	<b>HCT29MT</b>	34	3.3	<b>\$998</b>	<b>\$22</b>
	Counter-Height T-legs for 24"D Surfaces (2 bases incl.)	<b>HCT36ST</b>	36	4.6	<b>\$965</b>	<b>\$22</b>
	Counter-Height T-legs for 30"D Surfaces (2 bases incl.)	<b>HCT36MT</b>	37	4.6	<b>\$1040</b>	<b>\$22</b>
	Bar-Height T-legs for 24"D Surfaces (2 bases incl.)	<b>HCT42ST</b>	37	4.6	<b>\$1035</b>	<b>\$22</b>
Bar-Height T-legs for 30"D Surfaces (2 bases incl.)	<b>HCT42MT</b>	38	4.6	<b>\$1110</b>	<b>\$22</b>	

**NOTES:**

- Wire management is standard through table column.
- Adjustable glides available on all feet.

## HOW TO SPECIFY

<b>Select Model Number</b>	<b>Select Paint Color</b>
	See page 29
HCT29SX	BLCK

# ARRANGE<sup>®</sup> Café Accessories

GSA SIN 3372IT EXCEPT AS NOTED



Icon Legend on page 19

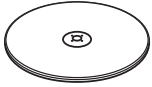

SIN 33721



**DESCRIPTION**

**Café Table Bases — Disc Shroud**

Small Disc Shroud for bases that support 24"-30" Surfaces  
 Medium Disc Shroud for bases that support 36" Surfaces  
 Large Disc Shroud for bases that support 42" Surfaces

**MODEL**

**HCTS DS**  
**HCTM DS**  
**HCTL DS**

**SHIP WEIGHT**

9.0  
 12.0  
 17.0

**CUBE**

2.0  
 2.4  
 3.4

**LIST PRICE**

**\$134**  
**\$156**  
**\$180**

NOTES: Shroud is used as an optional accessory to provide the aesthetic of a disc base. Shroud can be added to existing X-base configurations to provide a new and updated aesthetic. Shroud is made of 18 gauge steel.

- ! Shroud to be used in conjunction with X-bases only and cannot be used with a T-leg configuration.
- ! Shroud cannot be used as a support piece by itself.

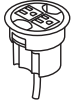

**Power Hub, 3" Grommet Mount, 6' Cord**

**HGRMTAC**

1.3

0.2

**\$173**

- Fits in 3" round grommet cutouts.
- Two grounded AC power outlets.
- Includes 6' cord with three-prong plug.
- Field installed with Plug-and-play ease.

NOTES: For additional information see page 247.

- ! Available in black only (no color designation so use .X - Specify: HGRMTAC.X).

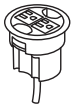

**Power Hub, 3" Grommet Mount, 10' Cord**

**HGRMTAC2**

1.5

0.2

**\$204**

- Includes 10' cord with three-prong plug.
- Fits in 3" round grommet holes.
- Two grounded AC power outlets.
- Field installed with Plug-and-play ease.

- ! Available in black finish only, no specification needed.

**NOTES:**

- ! HGRMTUSB2 is not compatible with Arrange<sup>®</sup> bases.

## HOW TO SPECIFY

Select Model Number

Select Paint Color

For HCTS DS, HCTM DS and HCTL DS models only  
 See page 29

H C T S D S .

B L C K

# BETWEEN™ TABLES

Want to see more? Scan here  
to check out hon.com.



Between™ Tables shown  
with Ruck™ Seating.

## BETWEEN™ TABLES

That moment when everything you want meets everything you need. Choose Between table options that offer up a variety of sizes and top shapes, seated or café heights, training tables with fixed or nesting bases, and a wide range of laminates to fit in with any environment. With so many different uses, it will be easy to pick Between. Whether you're working here, there, or anywhere Between, this table collection's got you covered.



## FEATURES

- Allows you to get the most out of every inch of space by creating hubs for people to engage, socialize, and be productive.
- This versatile, lightweight table line is simple to specify and easy to reconfigure, all at a competitive price point.
- Round, square, soft square, or rectangle tops and fixed, nesting, disc, or X-bases, allow versatility in design and function.
- With both standing- and seated-height options, Between tables can be used in multiple areas throughout your office, such as breakrooms, cafés, or breakaway spaces that support today's agile workforce.
- Choose from multiple, durable, high-quality laminate, edge, and finish options.

# BETWEEN™ ORDERING INFORMATION

## LAMINATE

### TOPS/L1 LAMINATES ..... CODES

#### Woodgrain

- ◆ Bourbon Cherry ..... **H**
- ◆ Cognac ..... **COGN**
- ◆ Field Elm ..... **LWFE**
- ◆ Florence Walnut ..... **LFW1**
- ◆ Harvest ..... **C**
- ◆ Kingswood Walnut ..... **LKI1**
- ◆ Mahogany ..... **N**
- ◆ Mocha ..... **MOCH**
- ◆ Natural Maple ..... **D**
- ◆ Pinnacle ..... **PINC**
- ◆ Shaker Cherry ..... **F**
- ◆ Sterling Ash ..... **LSA1**

#### Solid

- ◆ Black ..... **P**
- ◆ Charcoal ..... **S**
- ◆ Designer White ..... **LDW1**
- ◆ Loft ..... **LOFT**

#### Patterned

- ◆ Handspun Chestnut ..... **LAHC**
- ◆ Handspun Dove ..... **LAHD**
- ◆ Handspun Pearl ..... **LAHP**
- ◆ Handspun Slate ..... **LAHS**
- ◆ Silver Mesh ..... **B9**
- ◆ Steel Mesh ..... **A9**

### TOPS/L2 LAMINATES ..... CODES

#### Woodgrain

- ◆ Beigewood ..... **LWBE**
- ◆ Fawn Cypress ..... **LFC1**
- ◆ Lowell Ash ..... **LLA1**
- ◆ Natural Recon ..... **LNRI**
- ◆ Phantom Ecru ..... **LPE1**
- ◆ Portico Teak ..... **LPT1**
- ◆ Skyline Walnut ..... **LSW1**

## SEATED-, STANDING-, AND X-BASES

### PAINT ..... CODES

- P1**
- ◆ Charblack ..... **CBK**
  - ◆ Textured Brownstone ..... **P7J**
  - ◆ Textured Charcoal ..... **P7A**
  - ◆ Textured Designer White ... **PK7**
  - ◆ Textured Loft ..... **P7L**
  - ◆ Textured Muslin ..... **P7M**
  - ◆ Textured Titanium ..... **P8V**
- P2**
- ◆ Textured Silver ..... **PR8**

### FIXED AND NESTING BASES

### PAINT ..... CODES

- P1**
- ◆ Black ..... **P71**
  - ◆ Brownstone ..... **P7D**
  - ◆ Charcoal ..... **P02**
  - ◆ Designer White ..... **PJW**
  - ◆ Fossil ..... **P28**
  - ◆ Greige ..... **T5**
  - ◆ Loft ..... **LOFT**
  - ◆ Muslin ..... **T3**
  - ◆ Titanium ..... **P8T**
- P2**
- ◆ Silver ..... **PR6**

## EDGE BAND

### EDGE BAND ..... CODES

- ◆ Beigewood ..... **DE**
- ◆ Black ..... **P**
- ◆ Bourbon Cherry ..... **H**
- ◆ Brownstone ..... **EY**
- ◆ Charcoal ..... **S**
- ◆ Cognac ..... **COGN**
- ◆ Designer White ..... **DW**
- ◆ Fawn Cypress ..... **FC**
- ◆ Field Elm ..... **FE**
- ◆ Florence Walnut ..... **FW**
- ◆ Fossil ..... **EH**
- ◆ Greige ..... **R**
- ◆ Harvest ..... **C**
- ◆ Kingswood Walnut ..... **KI**
- ◆ Loft ..... **LOFT**
- ◆ Lowell Ash ..... **DL**
- ◆ Mahogany ..... **N**
- ◆ Mocha ..... **MOCH**
- ◆ Muslin ..... **T**
- ◆ Natural Maple ..... **D**
- ◆ Natural Recon ..... **NR**
- ◆ Phantom Ecru ..... **PE**
- ◆ Pinnacle ..... **PINC**
- ◆ Platinum ..... **K**
- ◆ Portico Teak ..... **DP**
- ◆ Shaker Cherry ..... **F**
- ◆ Skyline Walnut ..... **SW**
- ◆ Sterling Ash ..... **SA**

### Recommended Edgeband Color Selection:

Laminate		Edgeband	
Bourbon Cherry	<b>H</b>	Bourbon Cherry	<b>H</b>
Cognac	<b>COGN</b>	Cognac	<b>COGN</b>
Florence Walnut	<b>LFW1</b>	Florence Walnut	<b>FW</b>
Harvest	<b>C</b>	Harvest	<b>C</b>
Kingswood Walnut	<b>LKI1</b>	Kingswood Walnut	<b>KI</b>
Mahogany	<b>N</b>	Mahogany	<b>N</b>
Mocha	<b>MOCH</b>	Mocha	<b>MOCH</b>
Natural Maple	<b>D</b>	Natural Maple	<b>D</b>
Pinnacle	<b>PINC</b>	Pinnacle	<b>PINC</b>
Shaker Cherry	<b>F</b>	Shaker Cherry	<b>F</b>
Sterling Ash	<b>LSA1</b>	Sterling Ash	<b>SA</b>
Black	<b>P</b>	Black	<b>P</b>
Charcoal	<b>S</b>	Charcoal	<b>S</b>
Designer White	<b>LDW1</b>	Designer White	<b>DW</b>
Handspun Chestnut	<b>LAHC</b>	Brownstone	<b>EY</b>
Handspun Dove	<b>LAHD</b>	Fossil	<b>EH</b>
Handspun Pearl	<b>LAHP</b>	Fossil	<b>EH</b>
Handspun Slate	<b>LAHS</b>	Charcoal	<b>S</b>
Silver Mesh	<b>B9</b>	Loft	<b>LOFT</b>
Steel Mesh	<b>A9</b>	Charcoal	<b>S</b>
Lowell Ash	<b>LLA1</b>	Lowell Ash	<b>DL</b>
Natural Recon	<b>LNRI</b>	Natural Recon	<b>NR</b>
Phantom Ecru	<b>LPE1</b>	Phantom Ecru	<b>PE</b>
Portico Teak	<b>LPT1</b>	Portico Teak	<b>DP</b>
Skyline Walnut	<b>LSW1</b>	Skyline Walnut	<b>SW</b>
Loft	<b>LOFT</b>	Loft	<b>LOFT</b>



◆◆◆ For lead time information see page 21.



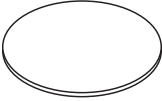

Icon Legend on page 19

# BETWEEN™ Table Tops

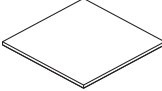
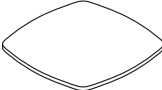
	DESCRIPTION	MODEL	SHIP WEIGHT	CUBE	LIST PRICE BY LAMINATE GRADE	
					L1	L2
	<b>Round Table Tops</b>					
	30"W Round Top	<b>HBTRND30</b>	31	2.9	<b>\$415</b>	<b>\$432</b>
	36"W Round Top	<b>HBTRND36</b> 	44	4.0	<b>\$454</b>	<b>\$472</b>
	42"W Round Top	<b>HBTRND42</b>	57	5.4	<b>\$535</b>	<b>\$557</b>
	<b>Square Table Tops</b>					
	30"W Square Top	<b>HBTSQR30</b>	31	2.9	<b>\$395</b>	<b>\$411</b>
	36"W Square Top	<b>HBTSQR36</b>	44	4.1	<b>\$431</b>	<b>\$449</b>
	42"W Square Top	<b>HBTSQR42</b>	57	5.6	<b>\$513</b>	<b>\$534</b>
	<b>Soft Square Table Tops</b>					
	30"W Soft Square Top	<b>HBTSFT30</b>	31	2.9	<b>\$415</b>	<b>\$432</b>
	36"W Soft Square Top	<b>HBTSFT36</b>	44	4.0	<b>\$454</b>	<b>\$472</b>
	42"W Soft Square Top	<b>HBTSFT42</b>	57	5.4	<b>\$535</b>	<b>\$557</b>

## HOW TO SPECIFY

<p><b>Select Model Number</b></p> <p>H B T T R N D 3 0</p>	<p><b>Select Grommet Option</b></p> <p>N No Grommet</p> <p>N</p>	<p><b>Select Laminate</b></p> <p>See page 34</p> <p>C</p>	<p><b>Select Edge Color</b></p> <p>See page 34</p> <p>C</p>
--	--	---	---

# BETWEEN™ Table Bases

OPEN MARKET EXCEPT AS NOTED



Icon Legend on page 19

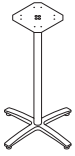

SIN 33721

DESCRIPTION	MODEL	SHIP WEIGHT	CUBE	LIST PRICE
<b>X-Base</b>				
Seated-Height X-base for Support of 30", 36" Tops	<b>HBTTX30S</b>	27	5.2	<b>\$399</b>
Seated-Height X-base for Support of 42" Tops	<b>HBTTX30L</b>	29	5.2	<b>\$582</b>
Bar-Height X-base for Support of 30", 36" Tops	<b>HBTTX42S</b> ⓘ	30	5.2	<b>\$479</b>
Bar-Height X-base for 42" Tops	<b>HBTTX42L</b> ⓘ	34	5.2	<b>\$669</b>

**NOTES:**

- Seated-Height (30¾" to top of surface).
- Bar-Height (42¼" to top of surface).
- Adjustable glides with ¾" adjustment available on all feet.



<b>Seated-Height Disc Base</b>	<b>HBTTD30</b>	24	3.3	<b>\$480</b>
ⓘ Disc Base not for use with 42" square top.				

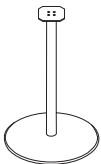

<b>Standing-Height Disc Base</b>	<b>HBTTD42</b>	27	3.3	<b>\$568</b>
ⓘ Disc Base not for use with 42" square top.				



<b>Counterweight Kit for Disc Base</b>	<b>HBTTCW</b>	16	0.2	<b>\$193</b>
ⓘ Required when using disc base with 42" round and soft square tops. Optional for smaller top sizes.				

**NOTES:**

- Seated-Height (29" to top of surface).
- Bar-Height (42" to top of surface).
- Counterweight Kit required when using disc base with 42" round or soft square tops. Kit can be used for added stability on 30" or 36" round, square, and soft square tops if desired.

## HOW TO SPECIFY

<p><b>Select Model Number</b></p> <p>HBTTX30S .</p>	<p><b>Select Paint Color</b></p> <p>See page 34</p> <p>PR8</p>
---	--

OPEN MARKET



Icon Legend on page 19

# BETWEEN™ Rectangular Table Tops

TABLES

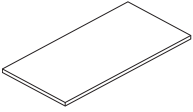
	DESCRIPTION	MODEL	SHIP WEIGHT	CUBE	LIST PRICE BY LAMINATE GRADE	
					L1	L2
	<b>Rectangular Table Tops</b>					
	48"W x 24"D	<b>HMPTT2448</b>	45	3.7	<b>\$464</b>	<b>\$483</b>
	60"W x 24"D	<b>HMPTT2460</b>	57	4.5	<b>\$513</b>	<b>\$534</b>
	72"W x 24"D	<b>HMPTT2472</b>	68	5.0	<b>\$568</b>	<b>\$591</b>
	48"W x 30"D	<b>HMPTT3048</b>	57	4.4	<b>\$483</b>	<b>\$503</b>
	60"W x 30"D	<b>HMPTT3060</b>	71	5.4	<b>\$529</b>	<b>\$551</b>
	72"W x 30"D	<b>HMPTT3072</b>	85	6.0	<b>\$602</b>	<b>\$626</b>

**NOTES:**

- HON 5-Year Limited Warranty.

### HOW TO SPECIFY

<p><b>Select Model Number</b></p> <p>HMPTT2448</p>	<p><b>Select Grommet Option</b></p> <p>N No Grommet</p> <p>N</p>	<p><b>Select Laminate</b></p> <p>See page 34</p> <p>C</p>	<p><b>Select Edge Color</b></p> <p>See page 34</p> <p>C</p>
--	--	---	---

OPEN MARKET



Icon Legend on page 19

# BETWEEN™ Table Bases for Rectangular Tops

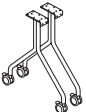
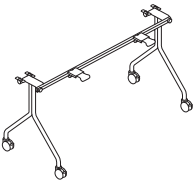
	DESCRIPTION	MODEL	SHIP WEIGHT	CUBE	LIST PRICE
	<b>Fixed Leg</b>	<b>HMPTBFX</b>	27	6.3	<b>\$352</b>
	<b>Nesting Base</b>				
	For use with 48"W Rectangular Tops	<b>HMPTBNSS</b>	18	6.3	<b>\$405</b>
	For use with 60"W and 72"W Rectangular Tops	<b>HMPTBNSL</b>	19	6.3	<b>\$432</b>

**NOTES:**

- Tops and bases ship in separate cartons.
- Recommend ordering HMAGANG when intending to gang multiple tables together. See page 61.
- HON 5-Year Limited Warranty.

### HOW TO SPECIFY

<p><b>Select Model Number</b></p> <p>HMPTBFX</p>	<p><b>Select Paint Color</b></p> <p>See page 34</p> <p>P71</p>
--	--

# BETWEEN™ Nesting Tables

OPEN MARKET



Icon Legend on page 19

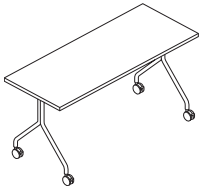

**DESCRIPTION**

**Nesting Table**  
 48"W x 24"D  
 60"W x 24"D  
 72"W x 24"D  
  
 48"W x 30"D  
 60"W x 30"D  
 72"W x 30"D

**MODEL**

**SHIP WEIGHT**

**CUBE**

**LIST PRICE**

<b>HMPT2448NS</b>	69	8.9	<b>\$781</b>
<b>HMPT2460NS</b>	81	10.7	<b>\$849</b>
<b>HMPT2472NS</b>	92	12.4	<b>\$898</b>
<b>HMPT3048NS</b>	81	10.9	<b>\$798</b>
<b>HMPT3060NS</b>	95	13.1	<b>\$863</b>
<b>HMPT3072NS</b>	109	15.0	<b>\$929</b>

**NOTES:**

- Top and base ship in one carton.
- Limited finishes available on single-carton tables.
- Recommend ordering HMAGANG when intending to gang multiple tables together. See page 61.
- **HON 5-Year Limited Warranty.**

## HOW TO SPECIFY

<p><b>Select Model Number</b></p> <p>HMPT2448NS</p>	<p><b>Select Grommet Option</b></p> <p>N No Grommet</p> <p>N</p>	<p><b>Select Laminate/Edge</b></p> <p><b>B9LOFT</b> Silver Mesh/Loft Edge  <b>FF</b> Shaker Cherry/Shaker Cherry Edge  <b>PINCPINC</b> Pinnacle/Pinnacle Edge</p> <p>B9LOFT</p>	<p><b>Select Base Paint</b></p> <p><b>P71</b> Black</p> <p>P71</p>
---	--	---	--

# BETWEEN™ Shared Components

GSA SIN 33721



Icon Legend on page 19

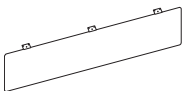

**DESCRIPTION**

**Universal Modesty Panel**  
 For 48"W Between™ Tables  
 For 60"/72"W Between™ Tables

**MODEL**

**SHIP WEIGHT**

**CUBE**

**LIST PRICE BY PAINT GRADE**

**P1**

**P2**

<b>HMTUMOD38</b>	11	2.2	<b>\$291</b>	<b>\$313</b>
<b>HMTUMOD50</b>	14	3.1	<b>\$318</b>	<b>\$340</b>

**NOTES:**

- Table Modesty Panels are hinged for use with Nesting Table models.

## HOW TO SPECIFY

<p><b>Select Model Number</b></p> <p>HMTUMOD38</p>	<p><b>Select Paint Color</b></p> <p>See page 34</p> <p>T1</p>
--	---

# BIRK™ TABLES

Want to see more? Scan here  
to check out hon.com.



Birk™ Tables shown with Flock® Seating.

## BIRK™ TABLES

Why complicate matters when you can keep it simple? Offering a modern, minimalist design, Birk tables have a look that's as streamlined as its specification process. Whether you're looking for something well-rounded or think it's hip to be square, Birk is there for you with a variety of top shapes, sizes, and table heights. It's the support system you need to help people come together, collaborate, and socialize — anywhere.



## FEATURES

- Ideal for informal meeting spaces and hospitality areas.
- Modern, minimalist design makes it easy to match a variety of styles.
- Designed for use with HON chairs, stools, and soft seating.
- Five different base heights outfit a variety of spaces.
- Five unique top shapes and sizes coordinate seamlessly with any surrounding aesthetic.
- The personal table is light in scale and gives people the ability to take notes and work in a lounge setting.



# BIRK™ ORDERING INFORMATION

## LAMINATE

### L1 LAMINATES ..... CODES

- Woodgrain**
- ◆ Bourbon Cherry ..... **H**
  - ◆ Cognac ..... **COGN**
  - ◆ Field Elm ..... **LWFE**
  - ◆ Florence Walnut ..... **LFW1**
  - ◆ Harvest ..... **C**
  - ◆ Kingswood Walnut ..... **LKI1**
  - ◆ Mahogany ..... **N**
  - ◆ Mocha ..... **MOCH**
  - ◆ Natural Maple ..... **D**
  - ◆ Pinnacle ..... **PINC**
  - ◆ Shaker Cherry ..... **F**
  - ◆ Sterling Ash ..... **LSA1**

- Solid**
- ◆ Black ..... **P**
  - ◆ Charcoal ..... **S**
  - ◆ Designer White ..... **LDW1**
  - ◆ Loft ..... **LOFT**

- Patterned**
- ◆ Handspun Chestnut ..... **LAHC**
  - ◆ Handspun Dove ..... **LAHD**
  - ◆ Handspun Pearl ..... **LAHP**
  - ◆ Handspun Slate ..... **LAHS**
  - ◆ Silver Mesh ..... **B9**
  - ◆ Steel Mesh ..... **A9**

### L2 LAMINATES ..... CODES

- Woodgrain**
- ◆ Beigewood ..... **LWBE**
  - ◆ Fawn Cypress ..... **LFC1**
  - ◆ Lowell Ash ..... **LLA1**
  - ◆ Natural Recon ..... **LNRI**
  - ◆ Phantom Ecru ..... **LPE1**
  - ◆ Portico Teak ..... **LPT1**
  - ◆ Skyline Walnut ..... **LSW1**

## EDGE BAND

### EDGE BAND ..... CODES

- ◆ Beigewood ..... **DE**
- ◆ Black ..... **P**
- ◆ Bourbon Cherry ..... **H**
- ◆ Brownstone ..... **EY**
- ◆ Charcoal ..... **S**
- ◆ Cognac ..... **COGN**
- ◆ Designer White ..... **DW**
- ◆ Fawn Cypress ..... **FC**
- ◆ Field Elm ..... **FE**
- ◆ Florence Walnut ..... **FW**
- ◆ Fossil ..... **EH**
- ◆ Greige ..... **R**
- ◆ Harvest ..... **C**
- ◆ Kingswood Walnut ..... **KI**
- ◆ Loft ..... **LOFT**
- ◆ Lowell Ash ..... **DL**
- ◆ Mahogany ..... **N**
- ◆ Mocha ..... **MOCH**
- ◆ Muslin ..... **T**
- ◆ Natural Maple ..... **D**
- ◆ Natural Recon ..... **NR**
- ◆ Phantom Ecru ..... **PE**
- ◆ Pinnacle ..... **PINC**
- ◆ Platinum ..... **K**
- ◆ Portico Teak ..... **DP**
- ◆ Shaker Cherry ..... **F**
- ◆ Skyline Walnut ..... **SW**
- ◆ Sterling Ash ..... **SA**

## PAINT

### PAINT ..... CODES

- P1**
- ◆ Charblack ..... **CBK**
  - ◆ Textured Brownstone ..... **P7J**
  - ◆ Textured Charcoal ..... **P7A**
  - ◆ Textured Designer White ... **PK7**
  - ◆ Textured Loft ..... **P7L**
  - ◆ Textured Muslin ..... **P7M**
  - ◆ Textured Titanium ..... **P8V**
- P2**
- ◆ Solar Black ..... **P8X**
  - ◆ Textured Silver ..... **PR8**

### Recommended Edgeband Color Selection:

Laminate		Edgeband	
Beigewood	<b>LWBE</b>	Beigewood	<b>DE</b>
Bourbon Cherry	<b>H</b>	Bourbon Cherry	<b>H</b>
Cognac	<b>COGN</b>	Cognac	<b>COGN</b>
Fawn Cypress	<b>LFC1</b>	Fawn Cypress	<b>FC</b>
Field Elm	<b>LWFE</b>	Field Elm	<b>FE</b>
Florence Walnut	<b>LFW1</b>	Florence Walnut	<b>FW</b>
Harvest	<b>C</b>	Harvest	<b>C</b>
Kingswood Walnut	<b>LKI1</b>	Kingswood Walnut	<b>KI</b>
Mahogany	<b>N</b>	Mahogany	<b>N</b>
Mocha	<b>MOCH</b>	Mocha	<b>MOCH</b>
Natural Maple	<b>D</b>	Natural Maple	<b>D</b>
Pinnacle	<b>PINC</b>	Pinnacle	<b>PINC</b>
Shaker Cherry	<b>F</b>	Shaker Cherry	<b>F</b>
Sterling Ash	<b>LSA1</b>	Sterling Ash	<b>SA</b>
Black	<b>P</b>	Black	<b>P</b>
Charcoal	<b>S</b>	Charcoal	<b>S</b>
Designer White	<b>LDW1</b>	Designer White	<b>DW</b>
Handspun Chestnut	<b>LAHC</b>	Brownstone	<b>EY</b>
Handspun Dove	<b>LAHD</b>	Fossil	<b>EH</b>
Handspun Pearl	<b>LAHP</b>	Fossil	<b>EH</b>
Handspun Slate	<b>LAHS</b>	Charcoal	<b>S</b>
Silver Mesh	<b>B9</b>	Loft	<b>LOFT</b>
Steel Mesh	<b>A9</b>	Charcoal	<b>S</b>
Lowell Ash	<b>LLA1</b>	Lowell Ash	<b>DL</b>
Natural Recon	<b>LNRI</b>	Natural Recon	<b>NR</b>
Phantom Ecru	<b>LPE1</b>	Phantom Ecru	<b>PE</b>
Portico Teak	<b>LPT1</b>	Portico Teak	<b>DP</b>
Skyline Walnut	<b>LSW1</b>	Skyline Walnut	<b>SW</b>
Loft	<b>LOFT</b>	Loft	<b>LOFT</b>



Icon Legend on page 19

# BIRK™ Table Tops

	DESCRIPTION	MODEL	SHIP WEIGHT	CUBE	LIST PRICE BY LAMINATE GRADE	
					L1	L2
	<b>Round Tops with Knife Edge</b>					
	30"W Round Top	HCWTRND30J	28	2.8	\$621	\$647
	36"W Round Top	HCWTRND36J	38	3.8	\$678	\$706
	42"W Round Top	HCWTRND42J	50	5.1	\$799	\$831
	<b>Round Tops with Flat Edge</b>					
	30"W Round Top	HCWTRND30G	28	2.8	\$482	\$501
	36"W Round Top	HCWTRND36G	38	3.8	\$521	\$542
	42"W Round Top	HCWTRND42G	50	5.1	\$616	\$640
	<b>Square Tops with Knife Edge</b>					
	30"W Square Top	HCWTSQR30J	34	2.6	\$549	\$571
	36"W Square Top	HCWTSQR36J	47	3.8	\$644	\$670
	42"W Square Top	HCWTSQR42J	62	5.0	\$763	\$794
	<b>Square Tops with Flat Edge</b>					
	30"W Square Top	HCWTSQR30G	34	2.6	\$425	\$443
	36"W Square Top	HCWTSQR36G	47	3.8	\$497	\$517
	42"W Square Top	HCWTSQR42G	62	5.0	\$590	\$613
	<b>Soft Square Tops with Knife Edge</b>					
	30"W Soft Square Top	HCWTSFTS30J	34	2.6	\$621	\$647
	36"W Soft Square Top	HCWTSFTS36J	47	3.8	\$678	\$706
	42"W Soft Square Top	HCWTSFTS42J	62	5.0	\$799	\$831
	<b>Soft Square Tops with Flat Edge</b>					
	30"W Soft Square Top	HCWTSFTS30G	34	2.6	\$482	\$501
	36"W Soft Square Top	HCWTSFTS36G	47	3.8	\$521	\$542
	42"W Soft Square Top	HCWTSFTS42G	62	5.0	\$616	\$640
	<b>Booth Tops with Knife Edge</b>					
	56"W x 36"D Booth Top	HCWTB3656J	90	5.6	\$861	\$895
	84"W x 36"D Booth Top	HCWTB3684J	150	8.2	\$1297	\$1349
	<b>Booth Tops with Flat Edge</b>					
	56"W x 36"D Booth Top	HCWTB3656G	90	5.6	\$662	\$689
	84"W x 36"D Booth Top	HCWTB3684G	150	8.2	\$998	\$1038
	<b>Soft Rectangle Tops with Knife Edge</b>					
	56"W x 36"D Soft Rectangle Top	HCWTSR3656J	90	5.6	\$896	\$932
	84"W x 36"D Soft Rectangle Top	HCWTSR3684J	150	8.2	\$1333	\$1386
	<b>Soft Rectangle Tops with Flat Edge</b>					
	56"W x 36"D Soft Rectangle Top	HCWTSR3656G	90	5.6	\$689	\$717
	84"W x 36"D Soft Rectangle Top	HCWTSR3684G	150	8.2	\$1027	\$1068

**NOTES:**

- Tops configured with pilot holes for easy installation of base.

## HOW TO SPECIFY

<p>Select Model Number</p> <p>H C W T S Q R 3 6 J .</p>	<p>Select Grommet Option</p> <p>N No Grommet</p> <p>N .</p>	<p>Select Laminate</p> <p>See page 40</p> <p>L S A 1 .</p>	<p>Select Edge Color</p> <p>See page 40</p> <p>S A</p>
---	---	--	--



	DESCRIPTION	MODEL	SHIP WEIGHT	CUBE	LIST PRICE BY PAINT GRADE	
					P1	P2
	<b>Single Pedestal, Medium</b>					
	Occasional-Height Single Pedestal Base	<b>HCWTSBM18</b>	60	3.3	<b>\$774</b>	<b>\$834</b>
	Working Lounge-Height Single Pedestal Base	<b>HCWTSBM27</b>	60	3.3	<b>\$778</b>	<b>\$839</b>
	Seated-Height Single Pedestal Base	<b>HCWTSBM29</b>	60	3.3	<b>\$785</b>	<b>\$846</b>
	Counter-Height Single Pedestal Base	<b>HCWTSBM36</b>	62	3.3	<b>\$793</b>	<b>\$855</b>
	Bar-Height Single Pedestal Base	<b>HCWTSBM42</b>	66	3.6	<b>\$803</b>	<b>\$866</b>
	<b>Single Pedestal, Large</b>					
	Occasional-Height Single Pedestal Base	<b>HCWTSBL18</b>	95	3.8	<b>\$1010</b>	<b>\$1089</b>
	Working Lounge-Height Single Pedestal Base	<b>HCWTSBL27</b>	95	3.8	<b>\$1046</b>	<b>\$1128</b>
	Seated-Height Single Pedestal Base	<b>HCWTSBL29</b>	95	3.8	<b>\$1093</b>	<b>\$1178</b>
	Counter-Height Single Pedestal Base	<b>HCWTSBL36</b>	98	3.8	<b>\$1108</b>	<b>\$1194</b>
	Bar-Height Single Pedestal Base	<b>HCWTSBL42</b>	101	4.2	<b>\$1129</b>	<b>\$1217</b>
	<b>Double Pedestal, Medium</b>					
	Working Lounge-Height Double Pedestal Base	<b>HCWTDSBM27</b>	120	6.5	<b>\$1556</b>	<b>\$1678</b>
	Seated-Height Double Pedestal Base	<b>HCWTDSBM29</b>	120	6.5	<b>\$1570</b>	<b>\$1692</b>
	Counter-Height Double Pedestal Base	<b>HCWTDSBM36</b>	124	6.5	<b>\$1586</b>	<b>\$1710</b>
	Bar-Height Double Pedestal Base	<b>HCWTDSBM42</b>	132	7.2	<b>\$1606</b>	<b>\$1732</b>

**NOTES:**

- See application matrix for top and base compatibility.
- Bases feature 1/4"H non-leveling slide glides.
- Some assembly required.

Top & Base Compatibility Matrix						
		Top				
		Round, Square, Soft Square			Booth, Soft Rectangle	
		30"W	36"W	42"W	56"W	84"W
Base	Single Pedestal, Medium	•	•			
	Single Pedestal, Large			•		
	Double Pedestal, Medium				•	•

## HOW TO SPECIFY

<p><b>Select Model Number</b></p> <p>HCWTSBL36</p>	<p><b>Select Paint Color</b></p> <p>See page 40</p> <p>PR8</p>
--	--



Icon Legend on page 19

# BIRK™ Personal Table



**DESCRIPTION**

**Personal Table**  
17"W x 15"D x 28"H

MODEL	SHIP WEIGHT	CUBE	LIST PRICE BY LAMINATE GRADE	
			L1	L2
HCWPT	18	2.7	\$447	\$459

**NOTES:**

- Top features flat edge on all sides.
- Top configured with pilot holes for easy installation of base.
- Some assembly required.

## HOW TO SPECIFY

<p><b>Select Model Number</b></p> <p>HCWPT</p>	<p><b>Select Laminate</b></p> <p>See page 40</p> <p>LSA1</p>	<p><b>Select Edge Color</b></p> <p>See page 40</p> <p>SA</p>	<p><b>Select Paint Color</b></p> <p>See page 40</p> <p>P2 upcharge + \$14</p> <p>PR8</p>
--	--	--	--

**FLOCK®**

Want to see more? Scan here  
to check out [hon.com](https://www.hon.com).



Flock® Tables and Seating.

## FLOCK®

Great things happen when people come together, and Flock Collaborative Tables create the places that help make that possible. Quiet corners. Vibrant communal areas. Beautiful, comfortable spaces where clean lines and distinctive geometric design improve productivity and inspire big ideas. Choose from a variety of mix-and-match shapes and sizes to design spaces where your Flock will flourish.



## FEATURES

- Flock Tables coordinate seamlessly with Flock Seating to support collaborative areas in any workplace.
- Choose from Square, Round, Rectangle, or Racetrack shaped table tops.
- Table bases available in multiple heights and styles.
- Add convenient options like integrated power, cord grommets, and tablet pedestals, and Flock is ready to work.
- Configurable and scalable, Flock Tables offer smaller footprints to better fit compact spaces.

# COLLABORATIVE TABLES ORDERING INFORMATION

**LAMINATE**

**TOPS/L1 LAMINATES ..... CODES**

**Woodgrain**

- ◆ Bourbon Cherry ..... **H**
- ◆ Cognac ..... **COGN**
- ◆ Field Elm ..... **LWFE**
- ◆ Florence Walnut ..... **LFW1**
- ◆ Harvest ..... **C**
- ◆ Kingswood Walnut ..... **LKI1**
- ◆ Mahogany ..... **N**
- ◆ Mocha ..... **MOCH**
- ◆ Natural Maple ..... **D**
- ◆ Pinnacle ..... **PINC**
- ◆ Shaker Cherry ..... **F**
- ◆ Sterling Ash ..... **LSA1**

**Solid**

- ◆ Black ..... **P**
- ◆ Charcoal ..... **S**
- ◆ Designer White ..... **LDW1**
- ◆ Loft ..... **LOFT**

**Patterned**

- ◆ Handspun Chestnut ..... **LAHC**
- ◆ Handspun Dove ..... **LAHD**
- ◆ Handspun Pearl ..... **LAHP**
- ◆ Handspun Slate ..... **LAHS**
- ◆ Silver Mesh ..... **B9**
- ◆ Steel Mesh ..... **A9**

**TOPS/L2 LAMINATES ..... CODES**

**Woodgrain**

- ◆ Beigewood ..... **LWBE**
- ◆ Fawn Cypress ..... **LFC1**
- ◆ Lowell Ash ..... **LLA1**
- ◆ Natural Recon ..... **LNRI**
- ◆ Phantom Ecru ..... **LPE1**
- ◆ Portico Teak ..... **LPT1**
- ◆ Skyline Walnut ..... **LSW1**

**PAINT**

**PAINT ..... CODES**

- P1**
- ◆ Textured Charcoal ..... **P7A**
- P2**
- ◆ Textured Silver ..... **PR8**

**EDGE BAND**

**EDGE BAND ..... CODES**

- ◆ Beigewood ..... **DE**
- ◆ Black ..... **P**
- ◆ Bourbon Cherry ..... **H**
- ◆ Brownstone ..... **EY**
- ◆ Charcoal ..... **S**
- ◆ Cognac ..... **COGN**
- ◆ Designer White ..... **DW**
- ◆ Fawn Cypress ..... **FC**
- ◆ Field Elm ..... **FE**
- ◆ Florence Walnut ..... **FW**
- ◆ Fossil ..... **EH**
- ◆ Greige ..... **R**
- ◆ Harvest ..... **C**
- ◆ Kingswood Walnut ..... **KI**
- ◆ Loft ..... **LOFT**
- ◆ Lowell Ash ..... **DL**
- ◆ Mahogany ..... **N**
- ◆ Mocha ..... **MOCH**
- ◆ Muslin ..... **T**
- ◆ Natural Maple ..... **D**
- ◆ Natural Recon ..... **NR**
- ◆ Phantom Ecru ..... **PE**
- ◆ Pinnacle ..... **PINC**
- ◆ Platinum ..... **K**
- ◆ Portico Teak ..... **DP**
- ◆ Shaker Cherry ..... **F**
- ◆ Skyline Walnut ..... **SW**
- ◆ Sterling Ash ..... **SA**

**Recommended Edgeband Color Selection:**

Laminate		Edgeband	
Bourbon Cherry	<b>H</b>	Bourbon Cherry	<b>H</b>
Cognac	<b>COGN</b>	Cognac	<b>COGN</b>
Florence Walnut	<b>LFW1</b>	Florence Walnut	<b>FW</b>
Harvest	<b>C</b>	Harvest	<b>C</b>
Kingswood Walnut	<b>LKI1</b>	Kingswood Walnut	<b>KI</b>
Mahogany	<b>N</b>	Mahogany	<b>N</b>
Mocha	<b>MOCH</b>	Mocha	<b>MOCH</b>
Natural Maple	<b>D</b>	Natural Maple	<b>D</b>
Pinnacle	<b>PINC</b>	Pinnacle	<b>PINC</b>
Shaker Cherry	<b>F</b>	Shaker Cherry	<b>F</b>
Sterling Ash	<b>LSA1</b>	Sterling Ash	<b>SA</b>
Black	<b>P</b>	Black	<b>P</b>
Charcoal	<b>S</b>	Charcoal	<b>S</b>
Designer White	<b>LDW1</b>	Designer White	<b>DW</b>
Handspun Chestnut	<b>LAHC</b>	Brownstone	<b>EY</b>
Handspun Dove	<b>LAHD</b>	Fossil	<b>EH</b>
Handspun Pearl	<b>LAHP</b>	Fossil	<b>EH</b>
Handspun Slate	<b>LAHS</b>	Charcoal	<b>S</b>
Silver Mesh	<b>B9</b>	Loft	<b>LOFT</b>
Steel Mesh	<b>A9</b>	Charcoal	<b>S</b>
Lowell Ash	<b>LLA1</b>	Lowell Ash	<b>DL</b>
Natural Recon	<b>LNRI</b>	Natural Recon	<b>NR</b>
Phantom Ecru	<b>LPE1</b>	Phantom Ecru	<b>PE</b>
Portico Teak	<b>LPT1</b>	Portico Teak	<b>DP</b>
Skyline Walnut	<b>LSW1</b>	Skyline Walnut	<b>SW</b>
Loft	<b>LOFT</b>	Loft	<b>LOFT</b>

◆◆◆ For lead time information see page 21.



# FLOCK®

## COLLABORATIVE SOLUTIONS TABLE SPECIFYING INFORMATION

### TOP SHAPES

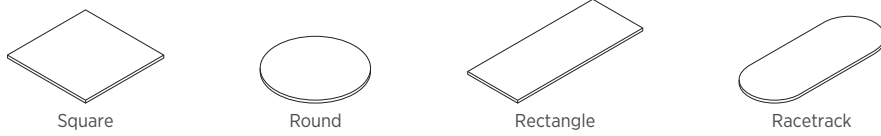

### TABLE BASES

#### For Occasional-Height Tables

#### For Seated-Height Tables

#### For 41”H Bar-Height Tables

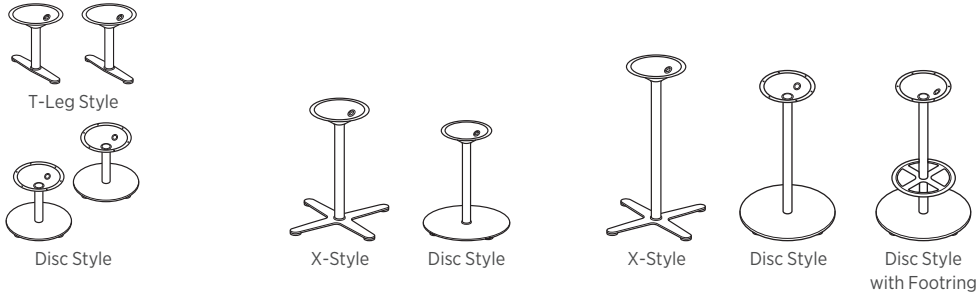

### OCCASIONAL TABLES

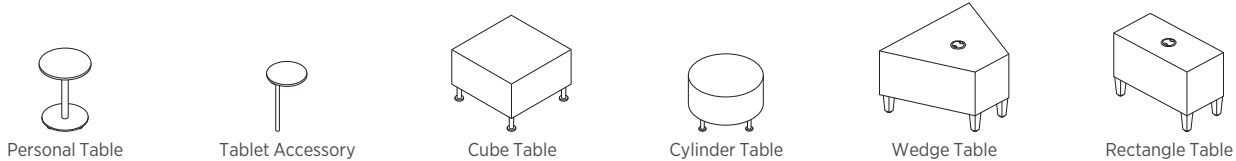

### GROMMET MATRIX — ALL TABLES/TOPS

TOP WIDTH	NO GROMMET	1-3” ROUND GROMMET CENTERED	2-3” ROUND GROMMET LEFT & RIGHT
SIF OPTION CODE	N	G	G
24” Cube	YES	YES	N/A
26” Cylinder	YES	YES	N/A
18” Personal	N/A	N/A	N/A
30” Square/Round	YES	YES	N/A
36” Square/Round	YES	YES	N/A
60” Rectangle/Racetrack	YES	N/A	YES
72” Rectangle/Racetrack	YES	N/A	YES
84” Rectangle/Racetrack	YES	N/A	YES
96” Rectangle/Racetrack	YES	N/A	YES

NOTES: 3” round grommet color will need to be specified for tops. Grommet will coordinate with paint color specified for cube/cylinder tables. Charcoal grommets will be used with Textured Charcoal paint and Platinum Metallic grommets will be used with Textured Silver paint.

Grommet options can be used in conjunction with accessory ports on cube/cylinder tables. Grommet models HGRMTAC and HGRMTDATA on page 247 can also be used with Flock® tables.

#### 3” ROUND GROMMET LOCATIONS

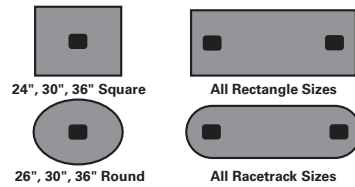

#### ACCESSORY PORT LOCATIONS

Only applies to models HFTLS24 and HFTLD26.

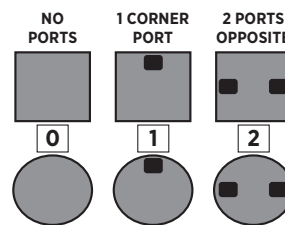

NOTES:  
 Port location 1 allows for one tablet accessory — see model on pages 49-50.  
 Port location 2 allows for two tablet accessories — see model on pages 49-50.



# Collaborative Laminate Table Tops

	DESCRIPTION	MODEL	SHIP WEIGHT	CUBE	LIST PRICE BY LAMINATE GRADE	
					L1	L2
	<b>Laminate Table Tops</b>					
	36" Square Top	<b>HFTLS36</b>	45	1.2	<b>\$622</b>	<b>\$644</b>
	30" Square Top	<b>HFTLS30</b>	32	1.0	<b>\$552</b>	<b>\$574</b>
	36" Round Top	<b>HFTLD36</b>	35	1.2	<b>\$622</b>	<b>\$644</b>
	30" Round Top	<b>HFTLD30</b>	25	1.0	<b>\$552</b>	<b>\$574</b>
	96"W x 33"D Rectangle Top	<b>HFTLC3396</b>	105	2.9	<b>\$1095</b>	<b>\$1134</b>
	84"W x 33"D Rectangle Top	<b>HFTLC3384</b>	90	2.5	<b>\$937</b>	<b>\$970</b>
	72"W x 33"D Rectangle Top	<b>HFTLC3372</b>	78	2.2	<b>\$784</b>	<b>\$812</b>
	60"W x 24"D Rectangle Top	<b>HFTLC2460</b>	47	1.3	<b>\$573</b>	<b>\$590</b>
	96"W x 33"D Racetrack Top	<b>HFTLA3396</b>	101	2.9	<b>\$1095</b>	<b>\$1134</b>
84"W x 33"D Racetrack Top	<b>HFTLA3384</b>	83	2.5	<b>\$937</b>	<b>\$970</b>	
72"W x 33"D Racetrack Top	<b>HFTLA3372</b>	70	2.2	<b>\$784</b>	<b>\$812</b>	
60"W x 24"D Racetrack Top	<b>HFTLA2460</b>	43	1.3	<b>\$573</b>	<b>\$590</b>	

**NOTES:**

- Grommet models HGRMTAC and HGRMTDATA on page 247 can also be used with Flock® tables.
- Rectangle and Racetrack tops come with 2 grommet cutouts if specified with Round grommet.
- For a complete line of compatible Flock® collaborative seating solutions, please see pages 323-345.
- For compatible round grommet options, see page 247.

## HOW TO SPECIFY







<p><b>Select Model Number</b></p> <p>HFTLS36</p>	<p><b>Select Edge Detail</b></p> <p>G 2mm Edge</p> <p><b>Select Edge Color</b></p> <p>See page 45</p> <p>GK</p>	<p><b>Select Grommet Option</b></p> <p>N No Grommet G Round Grommet (\$17 upcharge per grommet cutout) See page 46 for Grommet placement</p> <p><b>Select Grommet Color</b></p> <p>S Charcoal T1 Platinum Metallic</p> <p>GT1</p>	<p><b>Select Laminate Color</b></p> <p>See page 45</p> <p>K7</p>
--	---	---	--

# FLOCK® Collaborative Table Bases

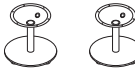
GSA SIN 33721

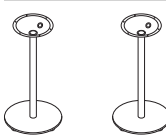

Icon Legend on page 19

	DESCRIPTION	MODEL	SHIP WEIGHT	CUBE	LIST PRICE BY PAINT GRADE	
					P1	P2
	<b>Base   T-Leg Style — For 17”H Tables</b> For 60”W x 24”D Rectangle or Racetrack Table Tops • Two bases shipped in separate cartons.	<b>HFTB17N</b>	40	6.0	<b>\$1384</b>	<b>\$1406</b>
	<b>Base   Disc Style — For 17”H Tables</b> • Use with 60”W x 24”D Racetrack or Rectangle table tops only. • Two bases shipped in separate cartons.	<b>HFDB17N</b>	74	6.0	<b>\$1516</b>	<b>\$1538</b>
	<b>Base   Disc Style — For 17”H Tables</b> For 30” and 36” Round or Square Table Tops	<b>HFDB17B</b>	37	3.0	<b>\$744</b>	<b>\$766</b>
	<b>Base   X-Style — For 29½”H Tables</b> For 30” Round or Square Table Tops For 36” Round or Square Table Tops Use with 33”D x 72”W x 84”W and 96”W Rectangle or Racetrack Table Tops • Two bases shipped in separate cartons	<b>HFXB29A</b> <b>HFXB29B</b> <b>HFXB29AN</b>	40 53 80	16.1 16.1 32.2	<b>\$863</b> <b>\$911</b> <b>\$1726</b>	<b>\$885</b> <b>\$933</b> <b>\$1770</b>
	<b>Base   X-Style — For 18”H Tables</b> For 30” and 36” Round or Square Table Tops	<b>HFXB17B</b>	37	3.0	<b>\$744</b>	<b>\$766</b>
	<b>Base   Disc Style — For 29½”H Tables</b> For 30” Round or Square Table Tops For 36” Round or Square Table Tops Use with 33”D x 72”W x 84”W and 96”W Rectangle or Racetrack Table Tops • Two bases shipped in separate cartons	<b>HFDB29A</b> <b>HFDB29B</b> <b>HFDB29AN</b>	40 56 80	16.1 16.1 32.2	<b>\$863</b> <b>\$911</b> <b>\$1726</b>	<b>\$875</b> <b>\$933</b> <b>\$1748</b>
	<b>Base   X-Style — For 41”H Standing-Height Tables</b> • Use with 33”D x 72”W, 84”W and 96”W Rectangle or Racetrack Table Tops • Two bases shipped in separate cartons	<b>HFXB42AN</b>	84	36.4	<b>\$1810</b>	<b>\$1854</b>
	<b>Base   X-Style — For 41”H Standing-Height Tables</b> For 30” Round or Square Table Tops For 36” Round or Square Table Tops	<b>HFXB42A</b> <b>HFXB42B</b>	42 55	18.2 16.1	<b>\$905</b> <b>\$955</b>	<b>\$927</b> <b>\$977</b>
	<b>Base   Disc Style — For 41”H Standing-Height Tables</b> • Use with 33”D x 72”W, 84”W and 96”W Rectangle or Racetrack table tops, when a Footring is not desired • Two bases shipped in separate cartons	<b>HFDB42AN</b>	92	19.0	<b>\$1754</b>	<b>\$1798</b>
	<b>Base   Disc Style — For 41”H Standing-Height Tables</b> For 30” Round or Square Table Tops For 36” Round or Square Table Tops	<b>HFDB42A</b> <b>HFDB42B</b>	46 62	9.5 13.5	<b>\$877</b> <b>\$932</b>	<b>\$899</b> <b>\$954</b>
	<b>Base   Disc Style with Footring — For 41”H Standing-Height Tables</b> For 30” Round or Square Table Tops For 36” Round or Square Table Tops Use with 33”D x 72”W x 84”W and 96”W Rectangle or Racetrack Table Tops • Two bases shipped in separate cartons	<b>HFDB42AF</b> <b>HFDB42BF</b> <b>HFDB42AFN</b>	56 68 112	9.5 13.5 32.2	<b>\$1137</b> <b>\$1191</b> <b>\$2274</b>	<b>\$1159</b> <b>\$1213</b> <b>\$2318</b>

**NOTES:**  
 • Each base includes adjustable leveling glides.

## HOW TO SPECIFY

<b>Select Model Number</b> HFTB17N	<b>Select Paint Color</b> PR8 Textured Silver P7A Textured Charcoal
---------------------------------------	---





# FLOCK® Collaborative Tables

	DESCRIPTION	MODEL	SHIP WEIGHT	CUBE	L1 LIST PRICE	L2 UPCHARGE
	<b>Laminate Personal Table</b> 18" Dia. x 25"H	<b>HFTPTL18</b>	36	4.5	<b>\$897</b>	<b>\$14</b>

## HOW TO SPECIFY

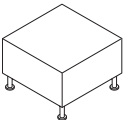
<b>Select Model Number</b>  H F T P T L 1 8 .	<b>Select Edge Detail</b> G 2mm Edge  <b>Select Edge Color</b> See page 45 G K .	<b>Select Laminate Top Color</b> See page 45 H .	<b>Select Base Paint Color</b> PR8 Textured Silver P7A Textured Charcoal \$22 upcharge per model, for P2 paint P R 8
---	---	--	--

	DESCRIPTION	MODEL	SHIP WEIGHT	CUBE	L1 LIST PRICE	L2 UPCHARGE
	<b>Laminate Collaborative Cube and Cylinder Tables</b> 24" Laminate Cube Table — 24"W x 24"D x 17½"H	<b>HFTLS24</b>	44	5.0	<b>\$1076</b>	<b>\$33</b>
	26" Laminate Cylinder Table — 26" Dia. x 17½"H	<b>HFTLD26</b>	39	5.0	<b>\$987</b>	<b>\$33</b>
	NOTES: Accessory port quantity and configuration on tables should correspond to the accessories planned for the table. For grommet and port information, see page 46.					

**NOTES:**

- Accessory port options on the collaborative cube and cylinder tables allow for tablet accessory to be added.
- For grommet and port information, see page 46.
- HGRMTAC and HGRMTDATA on page 247 can also be used with Flock® tables.
- Standard Leg (L) can be adjusted for leveling.
- For a complete line of compatible Flock® collaborative seating solutions, please see pages 323-345.
- For compatible round grommet options, see page 247.

## HOW TO SPECIFY

<b>Select Model Number</b>  H F T L S 2 4 .	<b>Select Grommet Option</b> See page 46 for Grommet placement N No Grommet G Round Grommet — centered (\$17 upcharge) N .	<b>Select Accessory Port Option</b> See page 46 for Port placement 0 No Port 1 One Corner Port 2 Two Ports — Opposite (\$12 for one corner port, \$22 for two ports, \$33 for three ports) 2 D .	<b>Select Laminate</b> See page 45 H .	<b>Select Leg Option</b> L Standard Leg <b>Leg Options</b> TR Tapered Round Leg TS Tapered Square Leg T R .	<b>Select Paint Color</b> PR8 Textured Silver P7A Textured Charcoal \$22 upcharge per model, for P2 paint P R 8
---	--	--	--	--	---

# FLOCK® Collaborative Tables

GSA SIN AS NOTED



Icon Legend on page 19

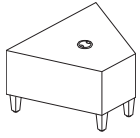

Shown with Round Grommet

OPEN MARKET

**DESCRIPTION**

**Laminate Wedge Table**  
22.17"W x 29.43"D x 17"H

**MODEL**

**HFTLW45**

**SHIP WEIGHT**

34

**CUBE**

7.7

**L1 LIST PRICE**

**\$1026**

**L2 UPCHARGE**

**\$33**

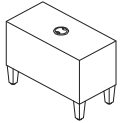

Shown with Round Grommet

OPEN MARKET

**Laminate Rectangle Table**  
24"W x 12"D x 17"H

**HFTLR12**

29

3.9

**\$717**

**\$22**



SIN 33721

**Laminate Tablet Accessory**  
14" Dia. x 10"H from table top

**HFTTAL14**

6

2.5

**\$534**

**\$17**

NOTES: Use with Collaborative Cube and Cylinder tables for additional workspace. Attaches to tables through ports. Multiple port location options are available. Tablet pivots/swivels toward the user.

**NOTES:**

- Accessory Port options on the Collaborative Cube and Cylinder Tables allow for Tablet Accessory to be added.
- For grommet and port information, see page 46.
- HGRMTAC and HGRMTDATA on page 247 can also be used with Flock® tables.
- Standard Leg (L) can be adjusted for leveling.
- For a complete line of compatible Flock® collaborative seating solutions, please see pages 323-345.
- For compatible round grommet options, see page 247.

## HOW TO SPECIFY

<p><b>Select Model Number</b></p> <p>HFTLW45</p>	<p><b>Select Grommet Option</b></p> <p>See page 46 for Grommet placement</p> <p><b>N</b> No Grommet <b>G</b> Round Grommet — centered (\$17 upcharge)</p> <p>N</p>	<p><b>Select Accessory Port Option</b></p> <p>See page 46 for Port placement</p> <p><b>O</b> No Port</p> <p>O</p>	<p><b>Select Laminate Top Color</b></p> <p>See page 45</p> <p>N</p>	<p><b>Select Leg Option</b></p> <p><b>L</b> Standard Leg <b>Leg Options</b> <b>TR</b> Tapered Round Leg <b>TS</b> Tapered Square Leg</p> <p>TS</p>	<p><b>Select Paint Color</b></p> <p><b>PR8</b> Textured Silver <b>P7A</b> Textured Charcoal \$22 upcharge per model, for P2 paint</p> <p>P7A</p>
--	--	---	---	--	--

<p><b>Select Model Number</b></p> <p>HFTTAL14</p>	<p><b>Select Edge Detail</b></p> <p><b>G</b> 2mm Edge</p> <p><b>Select Edge Color</b></p> <p>See page 45</p> <p>GK</p>	<p><b>Select Laminate Top Color</b></p> <p>See page 45</p> <p>H</p>	<p><b>Select Paint Color</b></p> <p><b>PR8</b> Textured Silver <b>P7A</b> Textured Charcoal \$22 upcharge per model, for P2 paint</p> <p>PR8</p>
---	--	---	--

# HUDDLE

Want to see more? Scan here  
to check out hon.com.



Huddle Tables shown with Motivate® Seating.

## HUDDLE

These sturdy, versatile tables link and unlink to quickly transform a space. Temporary workstation? Done. Impromptu conference table? Easy! Training session? No problem. Huddle helps you maximize time and square footage — not costs. And for today's businesses, that's a nice change of pace.



## FEATURES

- 1½" thick solid core top is made from durable high-performance particleboard.
- Heavy-grade, warp-resistant particleboard tops and bases withstand heavy activity.
- Mobile nesting base option lets tables fold up and roll away until you need them.
- Choose wiring and power options so Huddle tables are ready to work when you are.
- Modesty panels offer the added level of privacy your employees want.
- Two edge profiles in over 20 colors and patterns to accommodate differing tastes.
- Height adjustable laptop table offers a mobile, personal table for working anywhere.



# HUDDLE ORDERING INFORMATION

## LAMINATE

### TOPS/L1 LAMINATES ..... CODES

- Woodgrain**
- ◆ Bourbon Cherry ..... **H**
  - ◆ Cognac ..... **COGN**
  - ◆ Field Elm ..... **LWFE**
  - ◆ Florence Walnut ..... **LFW1**
  - ◆ Harvest ..... **C**
  - ◆ Kingswood Walnut ..... **LKI1**
  - ◆ Mahogany ..... **N**
  - ◆ Mocha ..... **MOCH**
  - ◆ Natural Maple ..... **D**
  - ◆ Pinnacle ..... **PINC**
  - ◆ Shaker Cherry ..... **F**
  - ◆ Sterling Ash ..... **LSA1**
- Solid**
- ◆ Black ..... **P**
  - ◆ Charcoal ..... **S**
  - ◆ Designer White ..... **LDW1**
  - ◆ Loft ..... **LOFT**
- Patterned**
- ◆ Handspun Chestnut ..... **LAHC**
  - ◆ Handspun Dove ..... **LAHD**
  - ◆ Handspun Pearl ..... **LAHP**
  - ◆ Handspun Slate ..... **LAHS**
  - ◆ Silver Mesh ..... **B9**
  - ◆ Steel Mesh ..... **A9**
  - ◆ Battleship ..... **LBT1\***
  - ◆ Gray ..... **G2**
  - ◆ Moroccan ..... **LMN1\***
  - ◆ Mushroom ..... **LMH1\***
  - ◆ Neon Carrot ..... **LN1\***
  - ◆ Tennis Ball ..... **LTB1\***
  - ◆ White ..... **G1**

### TOPS/L2 LAMINATES ..... CODES

- Woodgrain**
- ◆ Beigewood ..... **LWBE**
  - ◆ Fawn Cypress ..... **LFC1**
  - ◆ Lowell Ash ..... **LLA1**
  - ◆ Natural Recon ..... **LN1\***
  - ◆ Phantom Ecreu ..... **LPE1**
  - ◆ Portico Teak ..... **LPT1**
  - ◆ Skyline Walnut ..... **LSW1**

## EDGE BAND

### EDGES/ EDGE BAND (2MM) ..... CODES

- ◆ Beigewood ..... **DE**
- ◆ Black ..... **P**
- ◆ Bourbon Cherry ..... **H**
- ◆ Brownstone ..... **EY**
- ◆ Charcoal ..... **S**
- ◆ Cognac ..... **COGN**
- ◆ Designer White ..... **DW**
- ◆ Fawn Cypress ..... **FC**
- ◆ Field Elm ..... **FE**
- ◆ Florence Walnut ..... **FW**
- ◆ Fossil ..... **EH**
- ◆ Greige ..... **R**
- ◆ Harvest ..... **C**
- ◆ Kingswood Walnut ..... **KI**
- ◆ Loft ..... **LOFT**
- ◆ Lowell Ash ..... **DL**
- ◆ Mahogany ..... **N**
- ◆ Mocha ..... **MOCH**
- ◆ Muslin ..... **T**
- ◆ Natural Maple ..... **D**
- ◆ Natural Recon ..... **NR**
- ◆ Phantom Ecreu ..... **PE**
- ◆ Pinnacle ..... **PINC**
- ◆ Platinum ..... **K**
- ◆ Portico Teak ..... **DP**
- ◆ Shaker Cherry ..... **F**
- ◆ Skyline Walnut ..... **SW**
- ◆ Sterling Ash ..... **SA**

## T-MOLD

### T-MOLD ..... CODES

- ◆ Atom ..... **AT\***
- ◆ Beigewood ..... **DE**
- ◆ Black ..... **P**
- ◆ Brownstone ..... **EY**
- ◆ Bullseye ..... **BY\***
- ◆ Charcoal ..... **S\***
- ◆ Designer White ..... **DW**
- ◆ Ember ..... **MR\***
- ◆ Fawn Cypress ..... **FC**
- ◆ Field Elm ..... **FE**
- ◆ Fossil ..... **EH**
- ◆ Greige ..... **R**
- ◆ Ion ..... **IO\***
- ◆ Iris ..... **IR\***
- ◆ Krypton ..... **KT\***
- ◆ Loft ..... **LOFT**
- ◆ Lowell Ash ..... **DL**
- ◆ Muslin ..... **T**
- ◆ Natural Recon ..... **NR**
- ◆ Phantom Ecreu ..... **PE**
- ◆ Platinum ..... **K**
- ◆ Portico Teak ..... **DP**
- ◆ Regatta ..... **RE\***
- ◆ Skyline Walnut ..... **SW**

## PAINT

### BASE PAINT ..... CODES

- P1**
- ◆ Black ..... **P**
  - ◆ Brownstone ..... **P7D**
  - ◆ Charcoal ..... **S**
  - ◆ Designer White ..... **PJW**
  - ◆ Fossil ..... **P28**
  - ◆ Greige ..... **T5**
  - ◆ Light Gray ..... **Q**
  - ◆ Loft ..... **LOFT**
  - ◆ Muslin ..... **T3**
  - ◆ Putty ..... **L**
  - ◆ Titanium ..... **P8T**
- P2**
- ◆ Champagne Metallic ..... **T4**
  - ◆ Platinum Metallic ..... **T1**
  - ◆ Silver ..... **PR6**
- P3**
- ◆ Atom ..... **P8S**
  - ◆ Bullseye ..... **PJF**
  - ◆ Ember ..... **P8P**
  - ◆ Ion ..... **P8N**
  - ◆ Iris ..... **P8J**
  - ◆ Krypton ..... **P8F**
  - ◆ Regatta ..... **P8M**

### Recommended Edgeband Color Selection:

Laminate		Edge	
Bourbon Cherry	<b>H</b>	Bourbon Cherry	<b>H</b>
Cognac	<b>COGN</b>	Cognac	<b>COGN</b>
Florence Walnut	<b>LFW1</b>	Florence Walnut	<b>FW</b>
Harvest	<b>C</b>	Harvest	<b>C</b>
Kingswood Walnut	<b>LKI1</b>	Kingswood Walnut	<b>KI</b>
Mahogany	<b>N</b>	Mahogany	<b>N</b>
Mocha	<b>MOCH</b>	Mocha	<b>MOCH</b>
Natural Maple	<b>D</b>	Natural Maple	<b>D</b>
Pinnacle	<b>PINC</b>	Pinnacle	<b>PINC</b>
Shaker Cherry	<b>F</b>	Shaker Cherry	<b>F</b>
Sterling Ash	<b>LSA1</b>	Sterling Ash	<b>SA</b>
Black	<b>P</b>	Black	<b>P</b>
Charcoal	<b>S</b>	Charcoal	<b>S</b>
Designer White	<b>LDW1</b>	Designer White	<b>DW</b>
Handspun Chestnut	<b>LAHC</b>	Brownstone	<b>EY</b>
Handspun Dove	<b>LAHD</b>	Fossil	<b>EH</b>
Handspun Pearl	<b>LAHP</b>	Fossil	<b>EH</b>
Handspun Slate	<b>LAHS</b>	Charcoal	<b>S</b>
Loft	<b>LOFT</b>	Loft	<b>LOFT</b>
Silver Mesh	<b>B9</b>	Loft	<b>LOFT</b>
Steel Mesh	<b>A9</b>	Charcoal	<b>S</b>
Gray	<b>G2</b>	Charcoal	<b>S</b>
White	<b>G1</b>	Charcoal	<b>S</b>
Lowell Ash	<b>LLA1</b>	Lowell Ash	<b>DL</b>
Natural Recon	<b>LN1*</b>	Natural Recon	<b>NR</b>
Phantom Ecreu	<b>LPE1</b>	Phantom Ecreu	<b>PE</b>
Portico Teak	<b>LPT1</b>	Portico Teak	<b>DP</b>
Skyline Walnut	<b>LSW1</b>	Skyline Walnut	<b>SW</b>

\* Available on Laptop Table only.

◆◆◆ For lead time information see page 21.

# HUDDLE Multi-Purpose Tables

Huddle Multi-Purpose Tables are ready to jump into action for training, meetings, collaboration and more. Thoughtful design, flexibility and plenty of base, edge and finish options, make Huddle tables capable of meeting the needs of smart, agile businesses.

### Tops - Rectangle

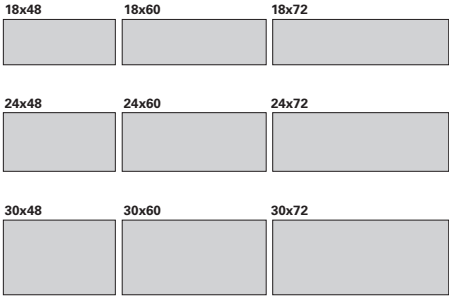

### Edge Options

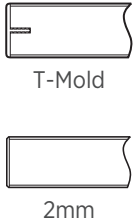

### Bases

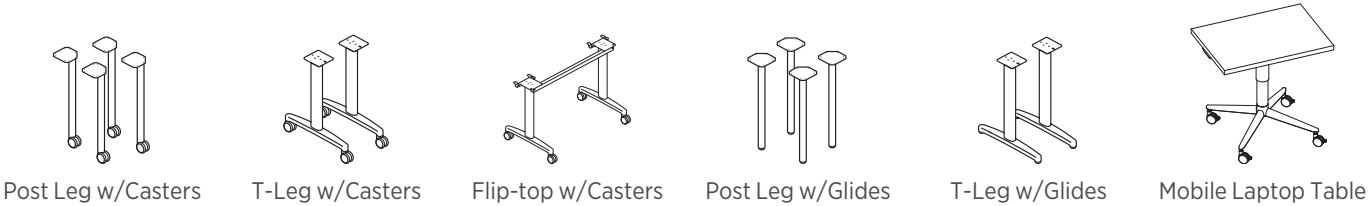

### Accessories

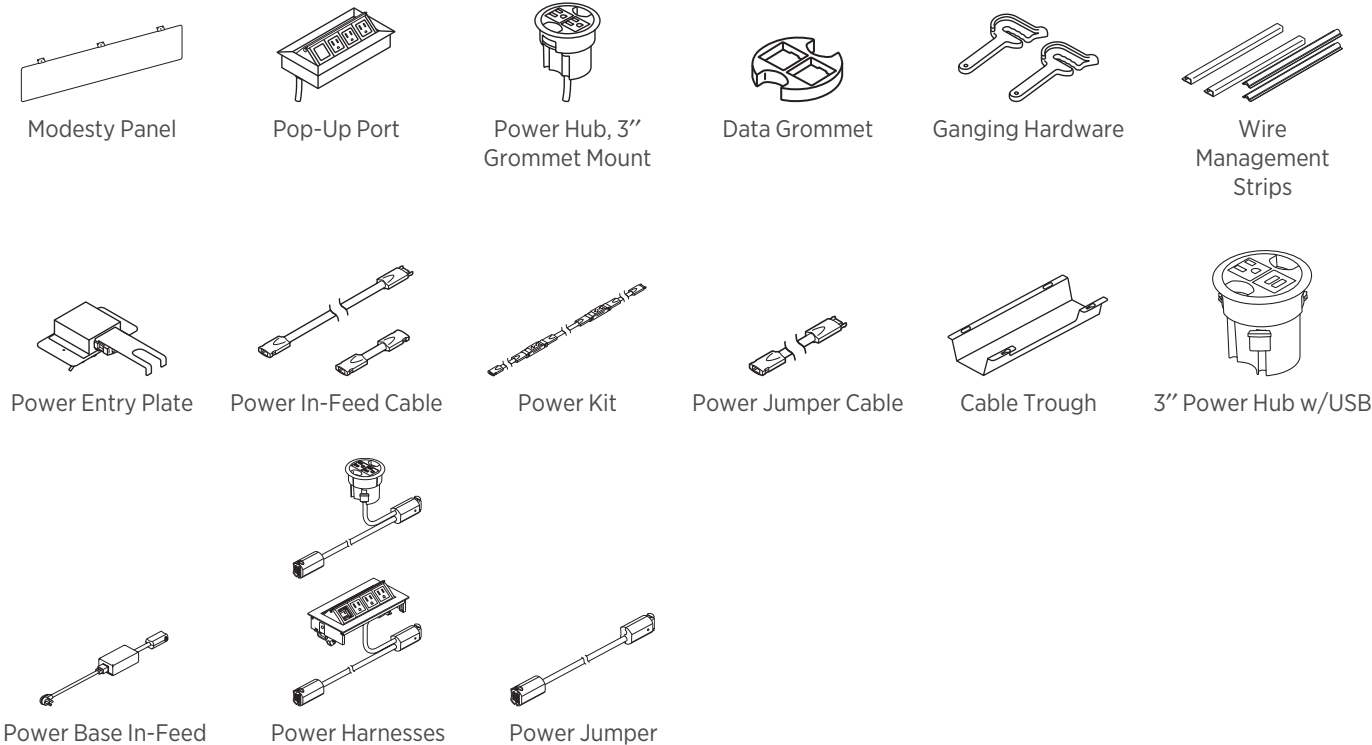

# INTERLINK IQ ELECTRICAL

## Specification guide for IQ Electrical on Huddle tables

Determine table width, the type of power access being used (3" grommet or 4x8 pop-up) and the desired number per table (Columns 1, 2 or 3). The table will then identify the type and quantity of components needed per table along with the maximum table run. Note that this is in addition to the Power base in-feed which is needed for each run. For example, a 48"W table with two 3" power grommets per table will require (1) HQH5-3 harness and (1) HQH1-3 harness per table with a maximum run of four tables.

Top Width	POWER ONE (1) PER TABLE 3" ROUND POWER GROMMET		POWER TWO (2) PER TABLE 3" ROUND POWER GROMMETS		POWER ONE (1) PER TABLE 4x8 POP-UP PORT	
	Component	Quantity	Component	Quantity	Component	Quantity
36"	(1) HQH5-3	8 Table Run Maximum	N/A	N/A	(1) HQH5-P	8 Max Table Run
42"	(1) HQH5-3	8 Table Run Maximum	N/A	N/A	(1) HQH5-P	8 Max Table Run
48"	(1) HQH5-3	8 Table Run Maximum	(1) HQH5-3 (1) HQH1-3	4 Max Table Run	(1) HQH5-P	8 Max Table Run
54"	(1) HQH5-3	8 Table Run Maximum	(1) HQH5-3 (1) HQH1-3	4 Max Table Run	(1) HQH5-P	8 Max Table Run
60"	(1) HQH5-3	8 Table Run Maximum	(1) HQH5-3 (1) HQH1-3	4 Max Table Run	(1) HQH5-P	8 Max Table Run
66"	(1) HQH5-3 (1) HQJ3	4 Table Run Maximum	(1) HQH5-3 (1) HQH1-3	4 Max Table Run	(1) HQH5-P (1) HQJ3	4 Max Table Run
72"	(1) HQH5-3 (1) HQJ3	4 Table Run Maximum	(1) HQH5-3 (1) HQH1-3	4 Max Table Run	(1) HQH5-P (1) HQJ3	4 Max Table Run
84"	(1) HQH5-3 (1) HQJ3	4 Table Run Maximum	(2) HQH5-3	4 Max Table Run	(1) HQH5-P (1) HQJ3	4 Max Table Run
96"	(1) HQH5-3 (1) HQJ3	4 Table Run Maximum	(2) HQH5-3	4 Max Table Run	(1) HQH5-P (1) HQJ3	4 Max Table Run
Half-Round (all sizes)	(1) HQH1-3	2 Tables Maximum	N/A	N/A	(1) HQH5-P	2 Max Table Run
Trapezoid (all sizes)	(1) HQH5-3	8 Table Run Maximum	N/A	N/A	(1) HQH5-P	8 Max Table Run

### NOTES:

- Interlink IQ Electrical is a pluggable, single circuit electrical system.
- All electrical models include wire management clips and hardware.
- Interlink IQ Electrical is non-sequential/non-directional. It can be installed in any direction.
- Interlink IQ Electrical is UL Recognized as a Powered Table System and meets the requirements of UL 962.
- For compatible Interlink IQ Electrical solutions, see page 244.

⚠ 40' maximum run, or no more than 8 units, whichever comes first. Interlink IQ system will automatically shut off if maximum requirements are exceeded. Maximum run is based upon electrical harness width, not table width.

# 4-TRAC HARDWIRE ELECTRICAL SYSTEM

## 4-Trac Electrical System

The 4-Trac Electrical System is a UL-recognized Manufactured Wiring System that seamlessly passes power from one worksurface to another. This low-profile non-sequential electrical system allows tables to be “daisy-chained” together in any desired order and allows users to reconfigure quickly due to simple connectable/disconnectable links.

- Meets requirements of UL 183 and National Electric Code Article 604
- 4-Wires, 2-circuits, 20 Amps each (Circuit 1 and Circuit 2 only)
- 13 Duplex Receptacles per circuit, 26, 15 Amp Duplex receptacle per power in-feed
- Electrical system attaches directly to underside of worksurface with included brackets
- Up to twelve tables can be linked together
- For compatible 4-Trac Electrical solutions, see page 246.

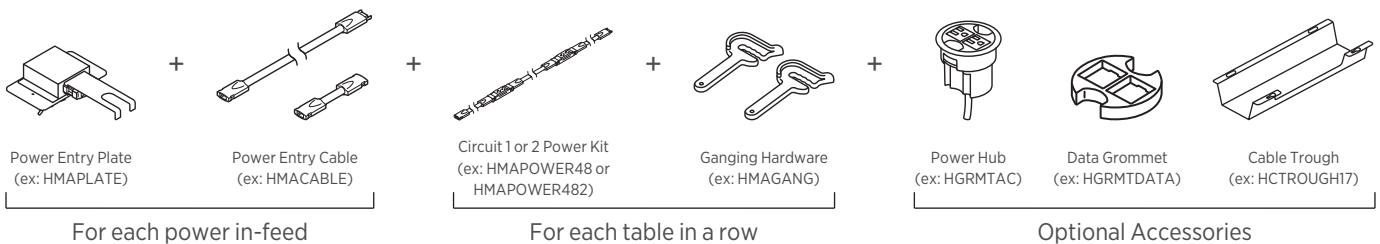

## Steps for Electrical Specifications:

- Determine how many rows of tables are needed and order the following:
  - One HMAPLATE per row (or power in-feed)
  - One HMACABLE per row (or power in-feed)
- Order one power harness per table in each row
  - For 1-6 tables in a row (see illustration 1)
    - Order Circuit 1 Power Harnesses (ex. If powering six 24x60 tables order six sets of HMAPOWER60)
  - For 7-12 tables in a row (see illustration 1)
    - Order Circuit 1 Power Harness for first six tables and Circuit 2 Power Harness for remaining tables (ex. If powering eight 24x60 tables, order six sets of HMAPOWER60 and two sets of HMAPOWER602)
- Order one set of ganging hardware per table (ex. HMAGANG)
- Determine which accessories are needed:
  - Power Hub model HGRMTAC — to access power at worksurface.
  - Data Grommet model HGRMTDATA — to access data at worksurface.
  - Wire Management strips model HBTMS — for vertical and horizontal wire management.

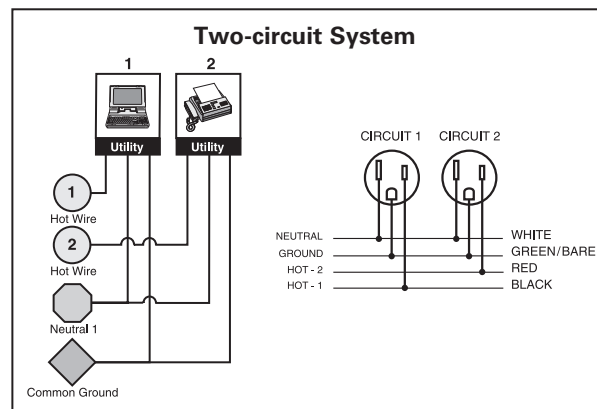
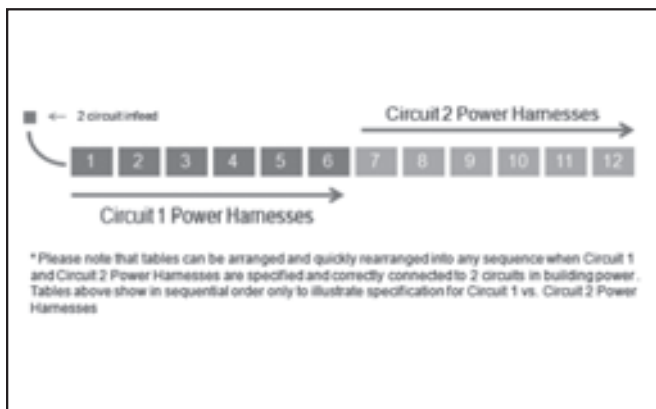

# HUDDLE Typicals



Icon Legend on page 19

QTY	DESCRIPTION	MODEL	LIST PRICE	PRICE EXTENSION
12	Rectangular Table Top 60"W x 24"D	HMT2460G	\$566	\$6,792
12	Flip-top Base	HMBFLIP24L.C	\$910	\$10,920
21	Perpetual® Nesting Chair	HPN1	\$1,022	\$21,462
<b>TOTAL:</b>				<b>\$39,174</b>

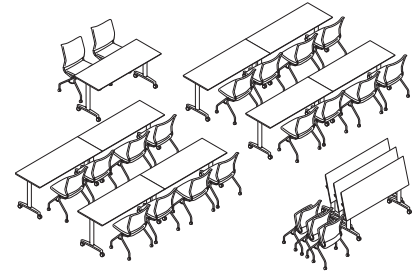

**TRAINING**

QTY	DESCRIPTION	MODEL	LIST PRICE	PRICE EXTENSION
4	Rectangular Table Top 72"W x 30"D	HMT3072G	\$667	\$2,668
4	Post Leg Base	HMBPOST	\$526	\$2,104
8	Perpetual® Nesting Chair	HPN1	\$1,022	\$8,176
<b>TOTAL:</b>				<b>\$12,948</b>

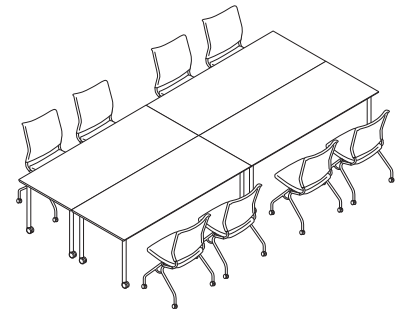

**MEETING/CONFERENCE**



Icon Legend on page 19

# HUDDLE Typicals

QTY	DESCRIPTION	MODEL	LIST PRICE	PRICE EXTENSION
8	Rectangular Table Top 60"W x 30"D	HMT3060G	\$586	\$4,688
8	Fixed Height T-Leg Base with Casters	HMBTLEG24.C	\$621	\$4,968
8	Perpetual® Nesting Chair	HPN1	\$1,022	\$8,176
<b>TOTAL:</b>				<b>\$17,832</b>

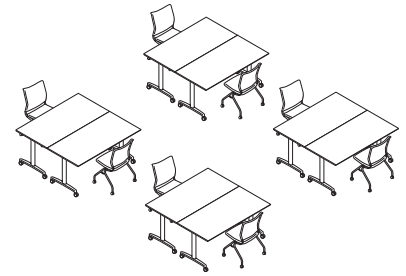

**GROUP BREAKOUT**

QTY	DESCRIPTION	MODEL	LIST PRICE	PRICE EXTENSION
6	Rectangular Table Top 72"W x 24"D	HMT2472G	\$627	\$3,762
6	Fixed Height T-Leg Base with Casters	HMBTLEG24.C	\$621	\$3,726
12	Perpetual® Nesting Chair	HPN1	\$1,022	\$12,264
<b>TOTAL:</b>				<b>\$19,752</b>

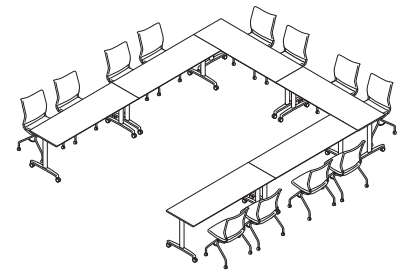

**PRESENTATION**



# HUDDLE

## Multi-Purpose Table Tops

GSA SIN 33721



Icon Legend on page 19

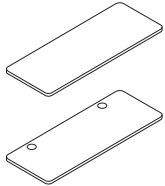

HMT1848E

**DESCRIPTION**

**Rectangular T-Mold Table Tops**

48"W x 18"D  
60"W x 18"D  
72"W x 18"D

48"W x 24"D  
60"W x 24"D  
72"W x 24"D

48"W x 30"D  
60"W x 30"D  
72"W x 30"D

**MODEL**

**HMT1848E**  
**HMT1860E**  
**HMT1872E**

**HMT2448E**  
**HMT2460E**  
**HMT2472E**

**HMT3048E**  
**HMT3060E**  
**HMT3072E**

**SHIP WEIGHT**

**CUBE**

**LIST PRICE BY LAMINATE GRADE**

**L1**

**L2**

34 2.9  
42 3.5  
51 3.9

45 3.7  
57 4.5  
68 5.0

57 4.4  
71 5.4  
85 6.0

**\$456** **\$468**  
**\$484** **\$501**  
**\$595** **\$612**

**\$512** **\$529**  
**\$566** **\$588**  
**\$627** **\$649**

**\$534** **\$551**  
**\$586** **\$608**  
**\$667** **\$689**

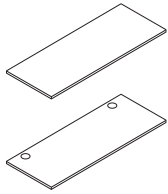

HMT1848G

**Rectangular Edgeband Table Tops**

48"W x 18"D  
60"W x 18"D  
72"W x 18"D

48"W x 24"D  
60"W x 24"D  
72"W x 24"D

48"W x 30"D  
60"W x 30"D  
72"W x 30"D

**HMT1848G**  
**HMT1860G**  
**HMT1872G**

**HMT2448G**  
**HMT2460G** ⓘ  
**HMT2472G**

**HMT3048G**  
**HMT3060G**  
**HMT3072G**

34 2.9  
42 3.5  
51 3.9

45 3.7  
57 4.5  
68 5.0

57 4.4  
71 5.4  
85 6.0

**\$456** **\$468**  
**\$484** **\$501**  
**\$595** **\$612**

**\$512** **\$529**  
**\$566** **\$588**  
**\$627** **\$649**

**\$534** **\$551**  
**\$586** **\$608**  
**\$667** **\$689**

**NOTES:**

- Table tops are 1/8" thick.
- When post legs are used with 18"D tops, post leg to be specified with glides only.
- For compatible 4-Trac Electrical solutions, see page 246.
- For compatible Interlink IQ Electrical solutions, see page 244.
- 60"W and 72"W rectangular tops ship with external stiffener for stability.



- ⓘ Round grommets available in Black only.
- ⓘ Pop-up Port option (G1) is unfinished. Insert accessory must be ordered separately.

**HOW TO SPECIFY**

<p><b>Select Model Number</b></p> <p>HMT1848G</p>	<p><b>Select Grommet Option</b></p> <p><b>N</b> No Grommet <b>G</b> 2 Grommets (Black only) (\$33 upcharge) <b>G1</b> Cutout for Pop-up Port (\$44 upcharge). Order port separately.</p> <p>N</p>	<p><b>Select Laminate</b></p> <p>See page 52</p> <p>D</p>	<p><b>Select Edge Color</b></p> <p>See page 52</p> <p>D</p>
---	---	---	---

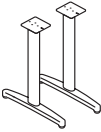

# HUDDLE Multi-Purpose Table Bases

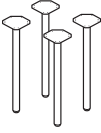
	DESCRIPTION	MODEL	SHIP WEIGHT	CUBE	LIST PRICE BY PAINT GRADE		
					P1	P2	P3
	<b>Fixed Height T-Leg Base (Includes 2 T-legs)</b>						
	For 18"D Table Tops For 24"D and 30"D Table Tops	<b>HMBTLEG18</b> <b>HMBTLEG24</b> ☉	12 14	3.6 3.6	<b>\$621</b> <b>\$621</b>	<b>\$643</b> <b>\$643</b>	<b>\$654</b> <b>\$654</b>
	<b>Flip-top Base (Includes 1 Complete Base)</b>						
	For 18"D x 48"W Rectangular Table Tops	<b>HMBFLIP18S</b>	23	4.1	<b>\$910</b>	<b>\$932</b>	<b>\$943</b>
	For 18"D x 60"W, 72"W Rectangular Table Tops	<b>HMBFLIP18L</b>	26	4.1	<b>\$910</b>	<b>\$932</b>	<b>\$943</b>
	For 24"D x 48"W and 32"D x 48"W Rectangular Tops and 30"D x 60"W Half-Round Table Tops	<b>HMBFLIP24S</b>	24	4.1	<b>\$910</b>	<b>\$932</b>	<b>\$943</b>
	For 24"D x 60"W, 72"W Rectangular Table Tops	<b>HMBFLIP24L</b> ☉	27	4.1	<b>\$910</b>	<b>\$932</b>	<b>\$943</b>
	For 30"D x 48"W Rectangular Table Tops For 30"D x 60"W, 72"W Rectangular Table Tops	<b>HMBFLIP30S</b> <b>HMBFLIP30L</b>	24 27	4.1 4.1	<b>\$910</b> <b>\$910</b>	<b>\$932</b> <b>\$932</b>	<b>\$943</b> <b>\$943</b>
	<b>Post Leg Base (Includes 4 Post Legs)</b>						
For all Tops	<b>HMBPOST</b>	18	2.3	<b>\$526</b>	<b>\$548</b>	<b>\$559</b>	

**Table Top to Base Compatibility Chart:**

	Flip-Top	T-Leg	Post Leg
18"D x 48"W	HMBFLIP18S	HMBTLEG18	HMBPOST*
18"D x 60"W	HMBFLIP18L	HMBTLEG18	HMBPOST*
18"D x 72"W	HMBFLIP18L	HMBTLEG18	HMBPOST*
24"D x 48"W	HMBFLIP24S	HMBTLEG24	HMBPOST
32"D x 48"W HR	HMBFLIP24S	HMBTLEG24	N/A
30"D x 60"W HR	HMBFLIP24S	HMBTLEG24	HMBPOST
24"D x 60"W	HMBFLIP24L	HMBTLEG24	HMBPOST
24"D x 72"W	HMBFLIP24L	HMBTLEG24	HMBPOST
30"D x 48"W	HMBFLIP30S	HMBTLEG24	HMBPOST
30"D x 60"W	HMBFLIP30L	HMBTLEG24	HMBPOST
30"D x 72"W	HMBFLIP30L	HMBTLEG24	HMBPOST

\*Post legs should be specified with glides for use on 18"D worksurfaces.  
NOTE: Glides/casters are NOT interchangeable on Post Leg and T-base.

**NOTES:**

- When glides are specified, adjustable range is 1".
- Flip-top base is standard with casters.
- When post legs are used with 18"D tops, post leg to be specified with glides only.

**HOW TO SPECIFY**

<p><b>Select Model Number</b></p> <p>H M B T L E G 1 8</p>	<p><b>Select Glide/Caster Option</b></p> <p><b>G</b> Glide <b>C</b> Caster</p> <p>Flip-top base is available with casters only</p> <p>When post legs are used with 18"D tops, specify with glides only</p> <p>G</p>	<p><b>Select Paint Color</b></p> <p>See page 52</p> <p>\$22 upcharge per model, for P2 paint</p> <p>\$33 upcharge per model, for P3 paint</p> <p>T 1</p>
--	---	--

# HUDDLE

## Mobile Laptop Table

GSA SIN 33721



Icon Legend on page 19



DESCRIPTION	MODEL	SHIP WEIGHT	CUBE	LIST PRICE	UPCHARGE BY LAMINATE/PAINT GRADE			
					L2	L5	P2	P3
<b>T-Mold</b> 28"W x 20"D	<b>HPHAP2028E</b>	59	8.7	\$1181	\$22	\$87	\$22	\$33



<b>Edgeband</b> 28"W x 20"D	<b>HPHAP2028G</b>	59	8.7	\$1181	\$22	\$87	\$22	\$33
--------------------------------	-------------------	----	-----	--------	------	------	------	------

**NOTES:**



- Tables adjust from 26"-33"H.
- Pneumatic height adjustment so no electricity is required to adjust height of table.

### HOW TO SPECIFY

<p><b>Select Model Number</b></p> <p>See page 52</p> <p>HPHAP2028E</p>	<p><b>Select Laminate</b></p> <p>See page 52</p> <p>LFW1</p>	<p><b>Select Edge Color</b></p> <p>See page 52</p> <p>FW</p>	<p><b>Select Paint Color</b></p> <p>See page 52</p> <p>P8T</p>
--	--	--	--

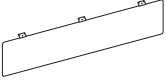

# HUDDLE Table Accessories

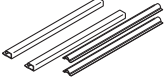
	DESCRIPTION	MODEL	SHIP WEIGHT	CUBE	LIST PRICE BY PAINT GRADE		
					P1	P2	P3
	<b>Universal Modesty Panel</b>						
	For 48"W Huddle Tables	<b>HMTUMOD32</b>	9	1.9	<b>\$281</b>	<b>\$303</b>	<b>\$314</b>
	For 60"W & 72"W Huddle Tables	<b>HMTUMOD44</b>	12	2.5	<b>\$305</b>	<b>\$327</b>	<b>\$338</b>
	NOTES: Universal Modesty Panels nest between the table legs.						
	<b>Ganging Hardware</b>	<b>HMAGANG</b>	1 	0.1	<b>\$140</b>		
	<ul style="list-style-type: none"> <li>Includes two ganging links and two screws</li> <li>No color designator when specifying. <i>Example: HMAGANG.</i></li> </ul>						
	<b>DESCRIPTION</b>	<b>MODEL</b>	<b>SHIP WEIGHT</b>	<b>CUBE</b>	<b>LIST PRICE</b>		
	<b>Wire Management Strips</b>	<b>HBTMS</b>		3	0.25	<b>\$165</b>	
	NOTES: Only available in black.						

**NOTES:**

- Ganging Hardware must be ordered and installed on tables when using 4-trac electrical systems.
- Ganging hardware attaches to underside of table in pre-drilled pilot holes.
- Vertical Wire Management Strips must be trimmed when applied to legs of T-Leg and Flip-Top Bases with casters.

## HOW TO SPECIFY

<p><b>Select Model Number</b></p> <p>H M T U M O D 3 2</p>	<p><b>Select Paint Color</b></p> <p>See page 52</p> <p>S</p>
--	--

# OCCASIONAL TABLES

Want to see more? Scan here  
to check out hon.com.



Occasional Tables shown with Ceres® Seating.

## OCCASIONAL TABLES

Durable materials and construction make HON Occasional Tables ideal for high-traffic areas such as lobbies, reception areas and lounges. The versatile design also dresses up any corner of the executive office where casual, but important, conversations are held. Use them to hold lamps, magazines and more. They're available in 14 woodgrain, patterned or solid color laminates to coordinate with any decor.



## FEATURES

- A high-quality solution for any organization wanting to make a great impression on clients and visitors.
- Scratch-, spill- and stain-resistant laminate stands up to heavy use.
- Heavy-grade, warp-resistant particleboard features high recycled content.
- Complement many interiors and furniture designs.
- Brings people together comfortably in reception areas, lounges and offices.

# LAMINATE OCCASIONAL TABLES OPTIONS

## H80191, H80192, H80193

### L1 LAMINATES ..... CODES

#### Woodgrain

- ◆ Bourbon Cherry ..... H
- ◆ Cognac ..... COGN
- ◆ Field Elm ..... LWFE
- ◆ Florence Walnut ..... LFW1
- ◆ Harvest ..... C
- ◆ Kingswood Walnut ..... LKI1
- ◆ Mahogany ..... N
- ◆ Mocha ..... MOCH
- ◆ Natural Maple ..... D
- ◆ Pinnacle ..... PINC
- ◆ Shaker Cherry ..... F
- ◆ Sterling Ash ..... LSA1

#### Solid

- ◆ Black ..... P
- ◆ Charcoal ..... S
- ◆ Designer White ..... LDW1
- ◆ Loft ..... LOFT

#### Patterned Top\*

- ◆ Handspun Chestnut ..... LAHC
- ◆ Handspun Dove ..... LAHD
- ◆ Handspun Pearl ..... LAHP
- ◆ Handspun Slate ..... LAHS
- ◆ Silver Mesh ..... A9

## H80170, H80180

### L1 LAMINATES ..... CODES

#### Woodgrain

- ◆ Bourbon Cherry ..... H
- ◆ Cognac ..... COGN
- ◆ Florence Walnut ..... LFW1
- ◆ Harvest ..... C
- ◆ Kingswood Walnut ..... LKI1
- ◆ Mahogany ..... N
- ◆ Mocha ..... MOCH
- ◆ Natural Maple ..... D
- ◆ Pinnacle ..... PINC
- ◆ Shaker Cherry ..... F
- ◆ Sterling Ash ..... LSA1

#### Solid

- ◆ Black ..... P
- ◆ Charcoal ..... S
- ◆ Designer White ..... LDW1
- ◆ Loft ..... LOFT

## Two-Tone Recommended Options for Laminate Occasional Tables (H80191, H80192 and H80193)

Beigewood/Black (LWBEP)	Handspun Dove/Designer White (LAHDLDW1)
Beigewood/Charcoal (LWBES)	Handspun Pearl/Black (LAHPP)
Beigewood/Designer White (LWBELDW1)	Handspun Pearl/Charcoal (LAHPS)
Black/Charcoal (PS)	Handspun Pearl/Designer White (LAHPLDW1)
Black/Designer White (PLDW1)	Handspun Slate/Black (LAHSP)
Bourbon Cherry/Black (HP)	Handspun Slate/Charcoal (LAHSS)
Bourbon Cherry/Charcoal (HS)	Handspun Slate/Designer White (LAHSLDW1)
Bourbon Cherry/Designer White (HLDW1)	Harvest/Black (CP)
Charcoal/Black (SP)	Harvest/Charcoal (CS)
Charcoal/Designer White (SLDW1)	Harvest/Designer White (CLDW1)
Cognac/Black (COGNP)	Kingswood Walnut/Black (LKI1P)
Cognac/Charcoal (COGNS)	Kingswood Walnut/Charcoal (LKI1S)
Cognac/Designer White (COGNLDW1)	Kingswood Walnut/Designer White (LKI1LDW1)
Designer White/Black (LDW1P)	Loft/Black (LOFTP)
Designer White/Bourbon Cherry (LDW1H)	Loft/Charcoal (LOFTS)
Designer White/Charcoal (LDW1S)	Loft/Designer White (LOFTLDW1)
Designer White/Cognac (LDW1COGN)	Mahogany/Black (NP)
Designer White/Harvest (LDW1C)	Mahogany/Charcoal (NS)
Designer White/Mahogany (LDW1N)	Mahogany/Designer White (NLDW1)
Designer White/Mocha (LDW1MOCH)	Mocha/Black (MOCHP)
Designer White/Natural Maple (LDW1D)	Mocha/Charcoal (MOCHS)
Designer White/Pinnacle (LDW1PINC)	Mocha/Designer White (MOCHLDW1)
Designer White/Shaker Cherry (LDW1F)	Natural Maple/Black (DP)
Fawn Cypress/Black (LFC1P)	Natural Maple/Charcoal (DS)
Fawn Cypress/Charcoal (LFC1S)	Natural Maple/Designer White (DLDW1)
Fawn Cypress/Designer White (LFC1LDW1)	Pinnacle/Black (PINCP)
Field Elm/Black (LWFEP)	Pinnacle/Charcoal (PINCS)
Field Elm/Charcoal (LWFES)	Pinnacle/Designer White (PINCLDW1)
Field Elm/Designer White (LWFELDW1)	Shaker Cherry/Black (FP)
Florence Walnut/Black (LFW1P)	Shaker Cherry/Charcoal (FS)
Florence Walnut/Charcoal (LFW1S)	Shaker Cherry/Designer White (FLDW1)
Florence Walnut/Designer White (LFW1LDW1)	Silver Mesh/Black (B9P)
Handspun Chestnut/Black (LAHCP)	Silver Mesh/Charcoal (B9S)
Handspun Chestnut/Charcoal (LAHCS)	Silver Mesh/Designer White (B9LDW1)
Handspun Chestnut/Designer White (LAHCLDW1)	Sterling Ash/Black (LSA1P)
Handspun Dove/Black (LAHDP)	Sterling Ash/Charcoal (LSA1S)
Handspun Dove/Charcoal (LAHDS)	Sterling Ash/Designer White (LSA1LDW1)

\* NOTE: For patterned top laminates, select one of the following for the edgeband around the top, apron, and legs — Black (P), Bourbon Cherry (H), Charcoal (S), Cognac (COGN), Designer White (LDW1), Florence Walnut (LFW1), Harvest (C), Kingswood Walnut (LKI1), Mahogany (N), Mocha (MOCH), Natural Maple (D), Pinnacle (PINC), Shaker Cherry (F), Sterling Ash (LSA1).

◆◆◆ For lead time information see page 21.









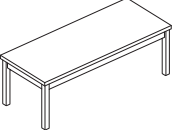

# LAMINATE Occasional Tables

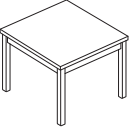
GSA SIN 33721

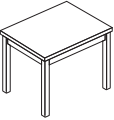

Icon Legend on page 19

	DESCRIPTION	MODEL	SHIP WEIGHT	CUBE	LIST PRICE
 	<b>Coffee Table</b> 48"W x 20"D x 16"H	<b>H80191</b>	48 	3.4	<b>\$705</b>
 	<b>Corner Table</b> 24"W x 24"D x 20"H	<b>H80192</b>	35 	2.1	<b>\$608</b>
 	<b>End Table</b> 24"W x 20"D x 20"H	<b>H80193</b>	29 	1.8	<b>\$580</b>
	<b>Cylinder Table</b> 20" Diameter x 20"H	<b>H80170</b>	40	6.2	<b>\$947</b>
	<b>Cube Table</b> 24"W x 24"D x 20"H	<b>H80180</b>	55	8.6	<b>\$1025</b>

**NOTES:**

- Durable material and construction make laminate occasional tables ideal for high traffic areas such as lobbies, reception rooms and lounges. Versatile design is also well suited to private offices.
- Coffee, Corner and End Tables feature top-over-apron styling with square corner detail, which complements many interiors and furniture designs, including the 10500 Series.
- Tables accommodate lamps, magazines, plants, laptops and more.
- Tops are abrasion- and stain-resistant laminate over 1/8" thick solid core high-performance particleboard.
- Cylinder and cube tables have recessed black plinth base with tack glides. Tops and sides are covered with high-pressure laminate.



H80191, H80192, H80193  
Edge Detail

## HOW TO SPECIFY

<p><b>Select Model Number</b></p> <p>H 8 0 1 9 1 .</p>	<p><b>Select Laminate</b></p> <p>See page 63 for Select Laminate noted with each model</p> <p>N N</p>
--	---

# MOTIVATE®

Want to see more? Scan here  
to check out hon.com.



Motivate® Tables, Chairs, and Markerboard.

## MOTIVATE®

Motivate tables were designed with flexible spaces in mind. Work patterns can change throughout the day. Task areas become collaborative areas. Learning areas become conference areas. Created for HON by designer Wolfgang Deisig, Motivate tables are mobile, lightweight and ready to support the many ways you work — adapting and reacting to your needs with ease. Because flexible spaces make for dynamic workplaces.



## FEATURES

- 1½” thick solid core top is made from durable high-performance particleboard.
- Motivate Tables are available in three base options — fixed, nesting and height adjustable.
- Optional modular power can be ganged together without any tools.
- Motivate Tables coordinate perfectly with Motivate chairs — an ideal fit for flexible spaces.
- Add a mobile presentation cart or markerboard for increased function and productivity in your workspace.
- Available in multiple top shapes, edge types, and bases with a variety of laminate and paint finish options.

# MOTIVATE® TABLES SPECIFYING INFORMATION

## LAMINATE

### L1 LAMINATES ..... CODES

- Woodgrain**
- ◆ Bourbon Cherry ..... H
  - ◆ Cognac ..... **COGN**
  - ◆ Field Elm ..... **LWFE**
  - ◆ Florence Walnut ..... **LFW1**
  - ◆ Harvest ..... C
  - ◆ Kingswood Walnut ..... **LKI1**
  - ◆ Mahogany ..... N
  - ◆ Mocha ..... **MOCH**
  - ◆ Natural Maple ..... D
  - ◆ Pinnacle ..... **PINC**
  - ◆ Shaker Cherry ..... F
  - ◆ Sterling Ash ..... **LSA1**

- Solid**
- ◆ Black ..... P
  - ◆ Charcoal ..... S
  - ◆ Designer White ..... **LDW1**
  - ◆ Loft ..... **LOFT**

- Patterned**
- ◆ Handspun Chestnut ..... **LAHC**
  - ◆ Handspun Dove ..... **LAHD**
  - ◆ Handspun Pearl ..... **LAHP**
  - ◆ Handspun Slate ..... **LAHS**
  - ◆ Silver Mesh ..... **B9**
  - ◆ Steel Mesh ..... **A9**
  - ◆ Gray ..... **G2**
  - ◆ White ..... **G1**

### L2 LAMINATES ..... CODES

- Woodgrain**
- ◆ Beigewood ..... **LWBE**
  - ◆ Fawn Cypress ..... **LFC1**
  - ◆ Lowell Ash ..... **LLA1**
  - ◆ Natural Recon ..... **LNRI**
  - ◆ Phantom Ecrú ..... **LPE1**
  - ◆ Portico Teak ..... **LPT1**
  - ◆ Skyline Walnut ..... **LSW1**

## EDGE BAND

### EDGE BAND 2mm ..... CODES

- ◆ Beigewood ..... DE
- ◆ Black ..... P
- ◆ Bourbon Cherry ..... H
- ◆ Brownstone ..... EY
- ◆ Charcoal ..... S
- ◆ Cognac ..... **COGN**
- ◆ Designer White ..... DW
- ◆ Fawn Cypress ..... FC
- ◆ Field Elm ..... FE
- ◆ Florence Walnut ..... FW
- ◆ Fossil ..... EH
- ◆ Greige ..... R
- ◆ Harvest ..... C
- ◆ Kingswood Walnut ..... KI
- ◆ Loft ..... **LOFT**
- ◆ Lowell Ash ..... DL
- ◆ Mahogany ..... N
- ◆ Mocha ..... **MOCH**
- ◆ Muslin ..... T
- ◆ Natural Maple ..... D
- ◆ Natural Recon ..... NR
- ◆ Phantom Ecrú ..... PE
- ◆ Pinnacle ..... **PINC**
- ◆ Platinum ..... K
- ◆ Portico Teak ..... DP
- ◆ Shaker Cherry ..... F
- ◆ Skyline Walnut ..... SW
- ◆ Sterling Ash ..... SA

## ERGO

### ERGO-EDGE ..... CODES

- ◆ Black ..... P
- ◆ Platinum ..... K

## PAINT

### PAINT ..... CODES

- P1**
- ◆ Black ..... P
  - ◆ Brownstone ..... **P7D**
  - ◆ Charcoal ..... S
  - ◆ Charblack ..... **CBK**
  - ◆ Designer White ..... **PJW**
  - ◆ Fossil ..... **P28**
  - ◆ Greige ..... T5
  - ◆ Loft ..... **LOFT**
  - ◆ Muslin ..... **T3**
  - ◆ Putty ..... L
  - ◆ Textured Platinum  
Metallic ..... **PLAT**
  - ◆ Titanium ..... **P8T**
- P2**
- ◆ Champagne Metallic ..... T4
  - ◆ Platinum Metallic ..... T1
  - ◆ Silver ..... **PR6**
  - ◆ Solar Black ..... **P8X**
  - ◆ Textured Silver ..... **PR8**
- P3**
- ◆ Atom ..... **P8S**
  - ◆ Bullseye ..... **PJF**
  - ◆ Ember ..... **P8P**
  - ◆ Ion ..... **P8N**
  - ◆ Iris ..... **P8J**
  - ◆ Krypton ..... **P8F**
  - ◆ Regatta ..... **P8M**

### Recommended Edgeband Color Selection:

Laminate		Edgeband	
Bourbon Cherry	H	Bourbon Cherry	H
Cognac	COGN	Cognac	COGN
Florence Walnut	LFW1	Florence Walnut	FW
Harvest	C	Harvest	C
Kingswood Walnut	LKI1	Kingswood Walnut	KI
Mahogany	N	Mahogany	N
Mocha	MOCH	Mocha	MOCH
Natural Maple	D	Natural Maple	D
Pinnacle	PINC	Pinnacle	PINC
Shaker Cherry	F	Shaker Cherry	F
Sterling Ash	LSA1	Sterling Ash	SA
Black	P	Black	P
Charcoal	S	Charcoal	S
Designer White	LDW1	Designer White	DW
Handspun Chestnut	LAHC	Brownstone	EY
Handspun Dove	LAHD	Fossil	EH
Handspun Pearl	LAHP	Fossil	EH
Handspun Slate	LAHS	Charcoal	S
Silver Mesh	B9	Loft	LOFT
Steel Mesh	A9	Charcoal	S
Gray	G2	Charcoal	S
White	G1	Charcoal	S
Lowell Ash	LLA1	Lowell Ash	DL
Natural Recon	LNRI	Natural Recon	NR
Phantom Ecrú	LPE1	Phantom Ecrú	PE
Portico Teak	LPT1	Portico Teak	DP
Skyline Walnut	LSW1	Skyline Walnut	SW
Loft	LOFT	Loft	LOFT

- Edge Treatments** • HOW TO ORDER
- 1) Select desired model numbers.
  - 2) Select desired top edge treatment.
  - 3) Replace the (?) after each model number with the suffix representing the chosen top edge treatment.



"G" 2mm Edge



"R" Ergo Edge

◆◆◆ For lead time information see page 21.

# 4-TRAC HARDWIRE ELECTRICAL SYSTEM

## 4-Trac Electrical System

The 4-Trac Electrical System is a UL-recognized Manufactured Wiring System that seamlessly passes power from one worksurface to another. This low-profile non-sequential electrical system allows tables to be “daisy-chained” together in any desired order and allows users to reconfigure quickly due to simple connectable/disconnectable links.

- Meets requirements of UL 183 and National Electric Code Article 604
- 4-Wires, 2-circuits, 20 Amps each (Circuit 1 and Circuit 2 only)
- 13 Duplex Receptacles per circuit, 26, 15 Amp Duplex receptacle per power in-feed
- Electrical system attaches directly to underside of worksurface with included brackets
- Up to twelve tables can be linked together
- For compatible 4-Trac Electrical solutions, see page 246.

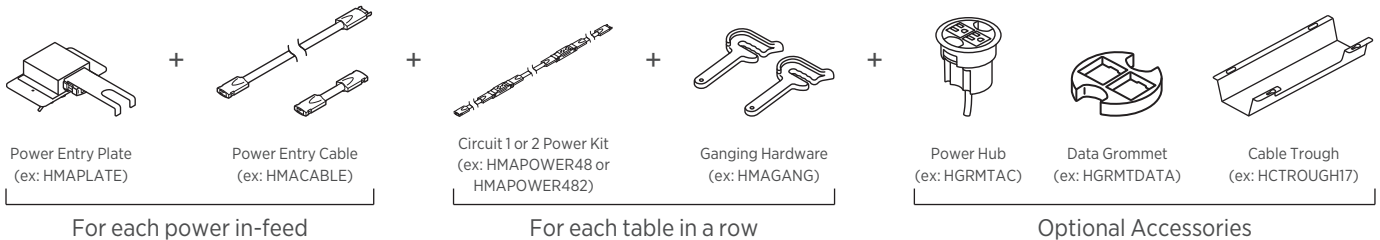

## Steps for Electrical Specifications:

- Determine how many rows of tables are needed and order the following:
  - One HMAPLATE per row (or power in-feed)
  - One HMAPOWER482 per row (or power in-feed)
- Order one power harness per table in each row
  - For 1-6 tables in a row (see illustration 1)
    - Order Circuit 1 Power Harnesses (ex. If powering six 24x60 tables order six sets of HMAPOWER60)
  - For 7-12 tables in a row (see illustration 1)
    - Order Circuit 1 Power Harness for first six tables and Circuit 2 Power Harness for remaining tables (ex. If powering eight 24x60 tables, order six sets of HMAPOWER60 and two sets of HMAPOWER602)
- Order one set of ganging hardware per table (ex. HMAGANG)
- Determine which accessories are needed:
  - Power Hub model HGRMTAC — to access power at worksurface.
  - Data Grommet model HGRMTDATA — to access data at worksurface.
  - Wire Management strips model HBTMS — for vertical and horizontal wire management.

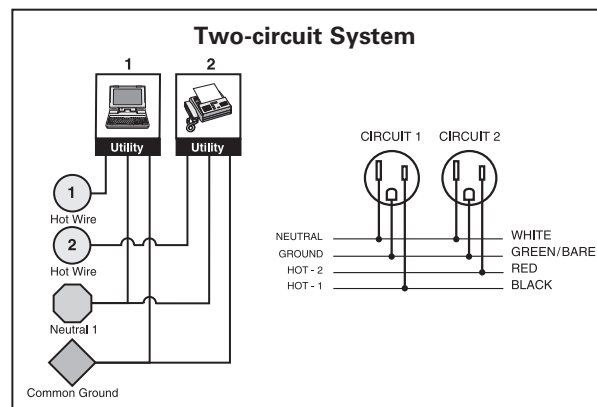
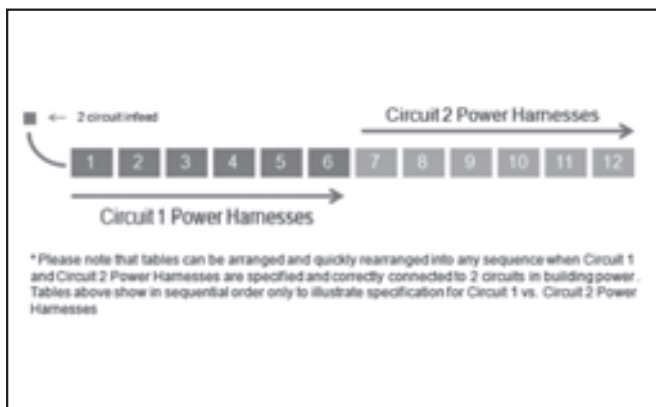

# MOTIVATE® Fixed Height Tables

GSA SIN 33721



Icon Legend on page 19



DESCRIPTION	MODEL	SHIP WEIGHT	CUBE	LIST PRICE BY LAMINATE GRADE			
				"G" 2MM EDGE		"R" ERGO EDGE	
				L1	L2	L1	L2
<b>Rectangular Tables, Fixed Base</b>							
72"W x 18"D	HMVR-1872(?) -FX	80	6.6	\$1238	\$1255	\$1637	\$1654
60"W x 18"D	HMVR-1860(?) -FX	70	6.0	\$1139	\$1156	\$1486	\$1503
48"W x 18"D	HMVR-1848(?) -FX	54	5.3	\$1129	\$1141	\$1441	\$1453
96"W x 24"D	HMVR-2496(?) -FX	118	8.8	\$1584	\$1612	N/A	N/A
84"W x 24"D	HMVR-2484(?) -FX	109	8.1	\$1520	\$1548	N/A	N/A
72"W x 24"D	HMVR-2472(?) -FX	96	7.3	\$1263	\$1285	\$1684	\$1706
66"W x 24"D	HMVR-2466(?) -FX	90	7.3	\$1239	\$1261	N/A	N/A
60"W x 24"D	HMVR-2460(?) -FX	83	6.6	\$1211	\$1233	\$1591	\$1613
54"W x 24"D	HMVR-2454(?) -FX	71	6.6	\$1188	\$1210	N/A	N/A
48"W x 24"D	HMVR-2448(?) -FX	65	5.8	\$1162	\$1179	\$1503	\$1520
42"W x 24"D	HMVR-2442(?) -FX	60	5.4	\$1137	\$1154	N/A	N/A
36"W x 24"D	HMVR-2436(?) -FX	54	5.1	\$1117	\$1134	N/A	N/A
96"W x 30"D	HMVR-3096(?) -FX	145	10.7	\$1715	\$1743	N/A	N/A
84"W x 30"D	HMVR-3084(?) -FX	131	10.7	\$1700	\$1728	N/A	N/A
72"W x 30"D	HMVR-3072(?) -FX	115	9.8	\$1378	\$1400	\$1824	\$1846
66"W x 30"D	HMVR-3066(?) -FX	108	9.8	\$1340	\$1362	N/A	N/A
60"W x 30"D	HMVR-3060(?) -FX	100	8.9	\$1307	\$1329	\$1716	\$1738
54"W x 30"D	HMVR-3054(?) -FX	87	8.9	\$1283	\$1305	N/A	N/A
48"W x 30"D	HMVR-3048(?) -FX	80	7.9	\$1265	\$1282	\$1624	\$1641
42"W x 30"D	HMVR-3042(?) -FX	73	7.4	\$1234	\$1251	N/A	N/A
36"W x 30"D	HMVR-3036(?) -FX	65	6.9	\$1210	\$1227	N/A	N/A
72"W x 36"D	HMVR-3672(?) -FX	131	10.8	\$1577	\$1605	N/A	N/A
60"W x 36"D	HMVR-3660(?) -FX	114	9.7	\$1463	\$1491	N/A	N/A
48"W x 36"D	HMVR-3648(?) -FX	91	9.7	\$1366	\$1388	N/A	N/A
<b>Half-Round Tables, Fixed Base</b>							
72"W x 36"D	HMVH-3672(?) -FX	103	10.8	\$1642	\$1670	N/A	N/A
60"W x 30"D	HMVH-3060(?) -FX	75	7.6	\$1280	\$1308	\$1716	\$1744
48"W x 24"D	HMVH-2448(?) -FX	56	5.8	\$1195	\$1217	\$1563	\$1585

**NOTES:**

- Specification includes top and base, however, top and base are boxed separately.
- Ergo edge is a bullnose on user side and 3mm on all other sides.
- Tops are 1 1/8" thick.
- Fixed Height base is standard 29 1/2" seated-height.
- See grommet matrix on page 243 for grommet location/placement.
- 36"-42" tops and all half-round and trapezoid tops standard with one 3" round grommet, 48"-96" tops standard with two 3" round grommets. When G1 grommet is selected, all tops standard with one cutout.
- For compatible 4-Trac Electrical solutions, see page 246.
- For compatible Interlink IQ Electrical solutions, see page 244.



**HOW TO SPECIFY**

<p><b>Select Model Number</b></p> <p>HMVR-1872G-FX</p>	<p><b>Select Grommet Option</b></p> <p>N No Grommet G Grommet (\$17 upcharge PER grommet) G1 Electrical Port (\$44 upcharge)</p> <p>N</p>	<p><b>Select Laminate</b></p> <p>See page 66</p> <p>C</p>	<p><b>Select Edge Color</b></p> <p>See page 66</p> <p>C</p>	<p><b>Select Caster/Glide Option</b></p> <p>C Multi-Surface Caster G Glide</p> <p>T</p>	<p><b>Select Base Paint Color</b></p> <p>See page 66 \$22 upcharge per model, for P2 paint</p> <p>C</p>
--	---	---	---	---	---



Icon Legend on page 19

# MOTIVATE® Nesting Tables

DESCRIPTION	MODEL	SHIP WEIGHT	CUBE	LIST PRICE BY LAMINATE GRADE			
				"G" 2MM EDGE		"R" ERGO EDGE	
				L1	L2	L1	L2
<b>Rectangular Nesting Tables</b>							
 72"W x 18"D	<b>HMVR-1872(?) -NS</b>	90	8.5	\$1630	\$1647	\$2029	\$2046
60"W x 18"D	<b>HMVR-1860(?) -NS</b>	79	7.6	\$1526	\$1543	\$1853	\$1870
48"W x 18"D	<b>HMVR-1848(?) -NS</b>	60	6.5	\$1520	\$1532	\$1825	\$1837
96"W x 24"D	<b>HMVR-2496(?) -NS</b>	134	11.4	\$1950	\$1978	N/A	N/A
84"W x 24"D	<b>HMVR-2484(?) -NS</b>	122	10.4	\$1912	\$1940	N/A	N/A
72"W x 24"D	<b>HMVR-2472(?) -NS</b>	106	9.2	\$1655	\$1677	\$2076	\$2098
66"W x 24"D	<b>HMVR-2466(?) -NS</b>	100	9.1	\$1626	\$1648	N/A	N/A
60"W x 24"D	<b>HMVR-2460(?) -NS</b>	92	8.2	\$1598	\$1620	\$1978	\$2000
54"W x 24"D	<b>HMVR-2454(?) -NS</b>	80	8.2	\$1580	\$1602	N/A	N/A
48"W x 24"D	<b>HMVR-2448(?) -NS</b>	73	7.2	\$1546	\$1563	\$1887	\$1904
42"W x 24"D	<b>HMVR-2442(?) -NS</b>	67	6.6	\$1524	\$1541	N/A	N/A
36"W x 24"D	<b>HMVR-2436(?) -NS</b>	60	6.3	\$1501	\$1518	N/A	N/A
96"W x 30"D	<b>HMVR-3096(?) -NS</b>	161	13.3	\$2132	\$2160	N/A	N/A
84"W x 30"D	<b>HMVR-3084(?) -NS</b>	144	13.0	\$2117	\$2145	N/A	N/A
72"W x 30"D	<b>HMVR-3072(?) -NS</b>	125	11.7	\$1795	\$1817	\$2241	\$2263
66"W x 30"D	<b>HMVR-3066(?) -NS</b>	118	11.6	\$1752	\$1774	N/A	N/A
60"W x 30"D	<b>HMVR-3060(?) -NS</b>	109	10.5	\$1719	\$1741	\$2111	\$2133
54"W x 30"D	<b>HMVR-3054(?) -NS</b>	96	10.5	\$1700	\$1722	N/A	N/A
48"W x 30"D	<b>HMVR-3048(?) -NS</b>	88	9.3	\$1674	\$1691	\$2033	\$2050
42"W x 30"D	<b>HMVR-3042(?) -NS</b>	80	8.1	\$1646	\$1663	N/A	N/A
36"W x 30"D	<b>HMVR-3036(?) -NS</b>	71	8.1	\$1619	\$1636	N/A	N/A
72"W x 36"D	<b>HMVR-3672(?) -NS</b>	141	12.7	\$1994	\$2022	N/A	N/A
60"W x 36"D	<b>HMVR-3660(?) -NS</b>	123	11.3	\$1875	\$1903	N/A	N/A
48"W x 36"D	<b>HMVR-3648(?) -NS</b>	99	11.1	\$1775	\$1797	N/A	N/A
<b>Half-Round Nesting Tables</b>							
 72"W x 36"D	<b>HMVH-3672(?) -NS</b>	111	12.2	\$2051	\$2079	N/A	N/A
60"W x 30"D	<b>HMVH-3060(?) -NS</b>	82	8.8	\$1771	\$1799	\$2207	\$2235
48"W x 24"D	<b>HMVH-2448(?) -NS</b>	62	7.0	\$1579	\$1601	\$1947	\$1969

**NOTES:**

- Ergo edge is a bullnose on user side and 3mm on all other sides.
- Tops are 1 1/8" thick.
- Specification includes top and base, however, top and base are boxed separately.
- See grommet matrix on page 243 for grommet location/placement.
- 36"-42" tops and all half-round and trapezoid tops standard with one 3" round grommet, 48"-96" tops standard with two 3" round grommets. When G1 grommet is selected, all tops standard with one cutout.
- For compatible 4-Trac Electrical solutions, see page 246.
- For compatible Interlink IQ Electrical solutions, see page 244.

**HOW TO SPECIFY**

<p><b>Select Model Number</b></p> <p>HMVR-1872G-NS</p>	<p><b>Select Grommet Option</b></p> <p>N No Grommet G Grommet (\$17 upcharge PER grommet) G1 Electrical Port (\$44 upcharge)</p> <p>N</p>	<p><b>Select Laminate</b></p> <p>See page 66</p> <p>C</p>	<p><b>Select Edge Color</b></p> <p>See page 66</p> <p>C</p>	<p><b>Select Caster/Glide Option</b></p> <p>C Multi-Surface Caster G Glide</p> <p>C</p>	<p><b>Select Base Paint Color</b></p> <p>See page 66 \$22 upcharge per model, for P2 paint</p> <p>T1</p>
--	---	---	---	---	--

# MOTIVATE® Adjustable Height Tables

GSA SIN 33721



Icon Legend on page 19

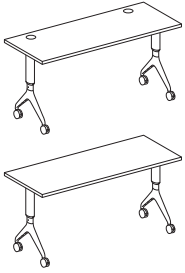

DESCRIPTION	MODEL	SHIP WEIGHT	CUBE	LIST PRICE BY LAMINATE GRADE				
				"G" 2MM EDGE		"R" ERGO EDGE		
				L1	L2	L1	L2	
<b>Rectangular Tables, Adjustable Height Base</b>								
72"W x 18"D	HMVR-1872(?) -AH	83	6.6	\$1611	\$1628	\$2010	\$2027	
60"W x 18"D	HMVR-1860(?) -AH	73	6.0	\$1512	\$1529	\$1859	\$1876	
48"W x 18"D	HMVR-1848(?) -AH	57	5.3	\$1502	\$1514	\$1814	\$1826	
72"W x 24"D	HMVR-2472(?) -AH	99	7.3	\$1636	\$1658	\$2057	\$2079	
66"W x 24"D	HMVR-2466(?) -AH	93	7.3	\$1612	\$1634	N/A	N/A	
60"W x 24"D	HMVR-2460(?) -AH	86	6.6	\$1584	\$1606	\$1964	\$1986	
54"W x 24"D	HMVR-2454(?) -AH	74	6.6	\$1561	\$1583	N/A	N/A	
48"W x 24"D	HMVR-2448(?) -AH	68	5.8	\$1535	\$1552	\$1876	\$1893	
42"W x 24"D	HMVR-2442(?) -AH	63	5.4	\$1510	\$1527	N/A	N/A	
36"W x 24"D	HMVR-2436(?) -AH	57	5.1	\$1490	\$1507	N/A	N/A	
72"W x 30"D	HMVR-3072(?) -AH	118	9.8	\$1775	\$1797	\$2221	\$2243	
66"W x 30"D	HMVR-3066(?) -AH	111	9.8	\$1737	\$1759	N/A	N/A	
60"W x 30"D	HMVR-3060(?) -AH	103	8.9	\$1704	\$1726	\$2113	\$2135	
54"W x 30"D	HMVR-3054(?) -AH	90	8.9	\$1680	\$1702	N/A	N/A	
48"W x 30"D	HMVR-3048(?) -AH	83	7.9	\$1662	\$1679	\$2021	\$2038	
42"W x 30"D	HMVR-3042(?) -AH	76	7.4	\$1631	\$1648	N/A	N/A	
36"W x 30"D	HMVR-3036(?) -AH	68	6.9	\$1607	\$1624	N/A	N/A	
72"W x 36"D	HMVR-3672(?) -AH	134	10.8	\$1974	\$2002	N/A	N/A	
60"W x 36"D	HMVR-3660(?) -AH	117	9.7	\$1860	\$1888	N/A	N/A	
48"W x 36"D	HMVR-3648(?) -AH	94	9.7	\$1763	\$1785	N/A	N/A	

**NOTES:**

- Ergo edge is a bullnose on user side and 3mm on all other sides.
  - Tops are 1 1/8" thick.
  - Specification includes top and base, however, top and base are boxed separately.
  - Seated height adjustment from 27 1/2" - 32 1/2" in 1" increments.
  - See grommet matrix on page 243 for grommet location/placement.
  - 36"-42" tops and all half-round and trapezoid tops standard with one 3" round grommet, 48"-96" tops standard with two 3" round grommets. When G1 grommet is selected, all tops standard with one cutout.
  - For compatible 4-Trac Electrical solutions, see page 246.
  - For compatible Interlink IQ Electrical solutions, see page 244.
- ! No tool required, adjustable bases have ratchet style adjustment mechanism.

**HOW TO SPECIFY**

<p><b>Select Model Number</b></p> <p>HMVR-1872G-AH</p>	<p><b>Select Grommet Option</b></p> <p>N No Grommet G Grommet (\$17 upcharge PER grommet) G1 Electrical Port (\$44 upcharge)</p> <p>N</p>	<p><b>Select Laminate</b></p> <p>See page 66</p> <p>C</p>	<p><b>Select Edge Color</b></p> <p>See page 66</p> <p>C</p>	<p><b>Select Caster/Glide Option</b></p> <p>C Multi-Surface Caster G Glide</p> <p>C</p>	<p><b>Select Base Paint Color</b></p> <p>See page 66 \$22 upcharge per model, for P2 paint</p> <p>P</p>
--	---	---	---	---	---



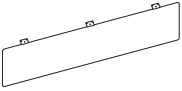

# MOTIVATE® Shared Components

DESCRIPTION	MODEL	SHIP WEIGHT	CUBE	LIST PRICE BY PAINT GRADE	
				P1	P2
 <p><b>Universal Modesty Panel</b>                      For 96"W Motivate® Tables                      For 84"W Motivate® Tables                      For 72"W Motivate® Tables                      For 66"W Motivate® Tables                      For 60"W Motivate® Tables                      For 54"W Motivate® Tables                      For 48"W Motivate® Tables                      For 42"W Motivate® Tables                      For 36"W Motivate® Tables</p>	<b>HMTUMOD86</b>	21	4.8	<b>\$367</b>	<b>\$389</b>
	<b>HMTUMOD74</b>	20	4.4	<b>\$356</b>	<b>\$378</b>
	<b>HMTUMOD62</b>	17	3.6	<b>\$342</b>	<b>\$364</b>
	<b>HMTUMOD56</b>	16	3.4	<b>\$330</b>	<b>\$352</b>
	<b>HMTUMOD50</b>	14	3.1	<b>\$318</b>	<b>\$340</b>
	<b>HMTUMOD44</b>	12	2.5	<b>\$305</b>	<b>\$327</b>
	<b>HMTUMOD38</b>	11	2.2	<b>\$291</b>	<b>\$313</b>
	<b>HMTUMOD32</b>	9	1.9	<b>\$281</b>	<b>\$303</b>
	<b>HMTUMOD26</b>	8	1.7	<b>\$267</b>	<b>\$289</b>

**NOTES:**

- Modesty Panels are hinged to nest along with Nesting Tables. Modesty Panels can be used with all base types.
- ! Use field installed Table Modesty Panels with all table widths 36"-96". Cannot be used with Half-Round or Trapezoid tables.

## HOW TO SPECIFY

<p><b>Select Model Number</b></p> <p>HMTUMOD86</p>	<p><b>Select Paint Color</b></p> <p>See page 66                      \$22 upcharge per model, for P2 paint</p> <p>T1</p>
--	--

# MOTIVATE® Shared Components

GSA SIN 33721 EXCEPT AS NOTED



Icon Legend on page 19

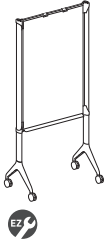

DESCRIPTION	MODEL	SHIP WEIGHT	CUBE	LIST PRICE
<b>Mobile Markerboard</b> 36"W x 72"H 30"W x 72"H  Actual Markerboard size: HMVMB-3672WW – 36¼"W x 42"H HMVMB-3072WW – 30¼"W x 42"H  NOTES: 2-Sided Mobile Markerboard is porcelain over steel with four locking casters. Mobile Markerboard includes marker tray and flip-chart paper clips.  Porcelain Markerboard cleaning instructions: For everyday cleaning, use Clorox wipes. Use a citrus cleaner if a permanent marker is used by accident.  ⚠ A citrus cleaner is not recommended for everyday use as it leaves residue. ⚠ \$22 list upcharge for P2 paint. <b>Specify Model.Base.Casters.Paint SPECIFYING EXAMPLE: HMVMB-3072WW.C.P</b>	<b>HMVMB-3672WW</b>	59	7.9	<b>\$1920</b>
	<b>HMVMB-3072WW</b>	53	7.1	<b>\$1884</b>

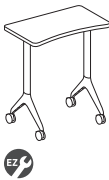

<b>Presentation Cart, Concave Front, Fixed Leg</b> 18"D x 30"W x 35"H, 2mm Edge 18"D x 30"W x 35"H, Ergo Edge  NOTES: Presentation Cart tops are 1⅝" thick with a concave user side. Choose from a 2mm or Ergo edge.  ⚠ \$12 list upcharge for L2 laminates. ⚠ \$22 list upcharge for P2 paint. <b>Specify Model.Caster.TopLaminate.EdgeColor.Paint SPECIFYING EXAMPLE: HMVPCF-1830G.C.D.D.T1</b>	<b>HMVPCF-1830G</b>	38	3.9	<b>\$1178</b>
	<b>HMVPCF-1830R</b>	38	3.9	<b>\$1593</b>



<b>Presentation Cart, Concave Front, Seated Height Adjustable-Leg</b> 18"D x 30"W x 27½"-34½"H, 2mm Edge 18"D x 30"W x 27½"-34½"H, Ergo Edge  NOTES: Presentation Cart tops are 1⅝" thick with a concave user side. Choose from a 2mm or Ergo edge.  ⚠ \$12 list upcharge for L2 laminates. ⚠ \$22 list upcharge for P2 paint. <b>Specify Model.Caster.TopLaminate.EdgeColor.Paint SPECIFYING EXAMPLE: HMVPCA1-1830G.C.D.D.T1</b>	<b>HMVPCA1-1830G</b> Ⓢ	40	3.9	<b>\$1553</b>
	<b>HMVPCA1-1830R</b>	40	3.9	<b>\$1985</b>

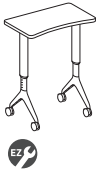

<b>Presentation Cart, Concave Front, Standing-Height Adjustable-Leg</b> 18"D x 30"W x 31½"-38½"H, 2mm Edge 18"D x 30"W x 31½"-38½"H, Ergo Edge  NOTES: Presentation Cart tops are 1⅝" thick with a concave user side. Choose from a 2mm or Ergo edge.  ⚠ \$12 list upcharge for L2 laminates. ⚠ \$22 list upcharge for P2 paint. <b>Specify Model.Caster.TopLaminate.EdgeColor.Paint SPECIFYING EXAMPLE: HMVPCA1-1830G.C.D.D.T1</b>	<b>HMVPCA2-1830G</b>	42	3.9	<b>\$1553</b>
	<b>HMVPCA2-1830R</b>	42	3.9	<b>\$1985</b>



<b>Presentation Cart, Modesty Panel</b> <b>Specify Model.Paint SPECIFYING EXAMPLE: HMVPC-MP.P</b>	<b>HMVPC-MP</b>	6	1.4	<b>\$242</b>
--	-----------------	---	-----	--------------

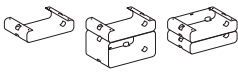

<b>Presentation Cart, Storage Shelves</b> Single, 4" Open Back Double, 4" Open Back / 4" Closed Back Double, 4" Open Back / 9" Closed Back Single, 4" Closed Back Double, 4" Closed Back / 4" Closed Back Double, 4" Closed Back / 9" Closed Back  NOTES: Storage Shelves for Presentation Carts are available in three preconfigured sizes and may be used on fixed or adjustable height models. <b>Specify Model.Paint SPECIFYING EXAMPLE: HMVPCSS-40.T1</b>	<b>HMVPCSS-40</b>	8	1.4	<b>\$124</b>
	<b>HMVPCSS-404C</b>	17	2.6	<b>\$251</b>
	<b>HMVPCSS-409C</b>	20	3.6	<b>\$392</b>
	<b>HMVPCSS-4C</b>	9	1.4	<b>\$135</b>
	<b>HMVPCSS-4C4C</b> Ⓢ	18	2.6	<b>\$263</b>
	<b>HMVPCSS-4C9C</b>	21	3.6	<b>\$403</b>

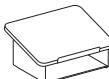

OPEN MARKET

<b>Presentation Cart Desk Top Lectern, 2mm Edge</b> NOTES: Desk Top Lectern may be used on the Presentation Cart or is removable for use on table tops.  ⚠ \$17 list upcharge for L2 laminates. ⚠ Desktop Lectern only available with 2mm edge. <b>Specify Model.LaminateTop.EdgeColor.Paint SPECIFYING EXAMPLE: HMVPC-DTLG.D.D.T1</b>	<b>HMVPC-DTLG</b>	16	2.4	<b>\$450</b>
---	-------------------	----	-----	--------------

## HOW TO SPECIFY

Select Model Number

H M V M B - 3 6 7 2 W W



Preside® tables and bench shown  
with Flock® guest seating.

## PRESIDE®

Whether you're craving social interaction or breaking away for some "me time", Preside tables support the work activities you need to get it done. Versatile enough for touchdown spaces, meeting rooms, and even cafés, Preside offers everything from a contemporary light-scale vibe to a more classic aesthetic. Add in optional power for a dynamic table collection that lets you work your way.



## FEATURES

- Preside offers a complete line of conference accessories, including presentation cabinets, hospitality and more.
- Optional flip-top and pop-up ports provide options today and for future data and power needs.
- Scratch-, spill- and stain-resistant laminate will look great for years to come.
- Add a splash of color to Preside using Colorwav™ paints to brighten any space.
- Enhanced aesthetics with power management options to keep the workspace tidy and looking its best.

# PRESIDE® ORDERING INFORMATION

## LAMINATE GROUP A

### L1 LAMINATES ..... CODES

- Woodgrain**
- ◆ Bourbon Cherry ..... H
  - ◆ Cognac ..... COGN
  - ◆ Field Elm ..... LWFE
  - ◆ Florence Walnut ..... LFW1
  - ◆ Harvest ..... C
  - ◆ Kingswood Walnut ..... LK11
  - ◆ Mahogany ..... N
  - ◆ Mocha ..... MOCH
  - ◆ Natural Maple ..... D
  - ◆ Pinnacle ..... PINC
  - ◆ Shaker Cherry ..... F
  - ◆ Sterling Ash ..... LSA1

- Solid**
- ◆ Black ..... P
  - ◆ Charcoal ..... S
  - ◆ Designer White ..... LDW1
  - ◆ Loft ..... LOFT

- Patterned**
- ◆ Handspun Chestnut ..... LAHC
  - ◆ Handspun Dove ..... LAHD
  - ◆ Handspun Pearl ..... LAHP
  - ◆ Handspun Slate ..... LAHS
  - ◆ Silver Mesh ..... B9
  - ◆ Steel Mesh ..... A9
  - ◆ Gray ..... G2
  - ◆ White ..... G1

### L2 LAMINATES ..... CODES

- Woodgrain**
- ◆ Beigewood ..... LWBE
  - ◆ Fawn Cypress ..... LFC1
  - ◆ Lowell Ash ..... LLA1
  - ◆ Natural Recon ..... LNRI
  - ◆ Phantom Ecru ..... LPE1
  - ◆ Portico Teak ..... LPT1
  - ◆ Skyline Walnut ..... LSW1

## LAMINATE GROUP B

### L1 LAMINATES ..... CODES

- Woodgrain**
- ◆ Bourbon Cherry ..... H
  - ◆ Cognac ..... COGN
  - ◆ Field Elm ..... LWFE
  - ◆ Florence Walnut ..... LFW1
  - ◆ Harvest ..... C
  - ◆ Kingswood Walnut ..... LK11
  - ◆ Mahogany ..... N
  - ◆ Mocha ..... MOCH
  - ◆ Natural Maple ..... D
  - ◆ Pinnacle ..... PINC
  - ◆ Shaker Cherry ..... F
  - ◆ Sterling Ash ..... LSA1

- Solid**
- ◆ Black ..... P
  - ◆ Charcoal ..... S
  - ◆ Designer White ..... LDW1
  - ◆ Loft ..... LOFT

### L2 LAMINATES ..... CODES

- Woodgrain**
- ◆ Beigewood ..... LWBE
  - ◆ Fawn Cypress ..... LFC1
  - ◆ Lowell Ash ..... LLA1
  - ◆ Natural Recon ..... LNRI
  - ◆ Phantom Ecru ..... LPE1
  - ◆ Portico Teak ..... LPT1
  - ◆ Skyline Walnut ..... LSW1

## LAMINATE GROUP C

### L1 LAMINATES ..... CODES

- Woodgrain**
- ◆ Bourbon Cherry ..... H
  - ◆ Cognac ..... COGN
  - ◆ Field Elm ..... LWFE
  - ◆ Florence Walnut ..... LFW1
  - ◆ Harvest ..... C
  - ◆ Kingswood Walnut ..... LK11
  - ◆ Mahogany ..... N
  - ◆ Mocha ..... MOCH
  - ◆ Natural Maple ..... D
  - ◆ Pinnacle ..... PINC
  - ◆ Shaker Cherry ..... F
  - ◆ Sterling Ash ..... LSA1

- Solid**
- ◆ Black ..... P
  - ◆ Charcoal ..... S
  - ◆ Designer White ..... LDW1
  - ◆ Loft ..... LOFT

### L2 LAMINATES ..... CODES

- Woodgrain**
- ◆ Beigewood ..... LWBE
  - ◆ Fawn Cypress ..... LFC1
  - ◆ Lowell Ash ..... LLA1
  - ◆ Natural Recon ..... LNRI
  - ◆ Phantom Ecru ..... LPE1
  - ◆ Portico Teak ..... LPT1
  - ◆ Skyline Walnut ..... LSW1

## LAMINATE GROUP D

### L1 LAMINATES ..... CODES

- Woodgrain**
- ◆ Mahogany ..... N

## PAINT GROUP A

### P1 ..... CODES

- ◆ Black ..... P
- ◆ Brownstone ..... P7D
- ◆ Charcoal ..... S
- ◆ Designer White ..... PJW
- ◆ Fossil ..... P28
- ◆ Greige ..... T5
- ◆ Loft ..... LOFT
- ◆ Muslin ..... T3
- ◆ Titanium ..... P8T

### P2 ..... CODES

- ◆ Champagne Metallic ..... T4
- ◆ Platinum Metallic ..... T1
- ◆ Silver ..... PR6
- ◆ Solar Black ..... P8X

### P3 ..... CODES

- ◆ Atom ..... P8S
- ◆ Bullseye ..... PJF
- ◆ Ember ..... P8P
- ◆ Ion ..... P8N
- ◆ Iris ..... P8J
- ◆ Krypton ..... P8F
- ◆ Regatta ..... P8M

## HON BRANDED FABRICS

### GRADE 1

- Apex
- Centurion
- Compass
- Contourett
- Dapper
- Ensemble
- Hamilton
- Inertia
- Noble Seating
- Optic
- Pebble
- Vibe

### GRADE 2

- Appoint Seating
- Blume
- Clyde
- Dotty
- Kai
- Rush
- Spin
- Wavelength
- Whisper Vinyl

### GRADE 3

- Bradbury
- Getaway
- Moxie
- Notion
- Parker
- Saxony

### GRADE 4

- Constance with Supreen™
- Livi with Supreen™
- Lugano with Supreen™
- Oxford with Supreen™

NOTES: Fabrics on Preside® bench cushion are upholstered in the railroad direction.

◆◆◆ For lead time information see page 21.

# PRESIDE® SPECIFYING INFORMATION

EDGE BAND OPTIONS	CODES	2mm (G)	Knife (J)	T-Mold (E)
Beigewood	DE	•	•	•
Bourbon Cherry	H	•	•	
Cognac	COGN	•	•	•
Fawn Cypress	FC	•	•	•
Field Elm	FE	•	•	•
Florence Walnut	FW	•	•	•
Harvest	C	•	•	
Kingswood Walnut	KI	•	•	•
Light Gray	Q	•	•	•
Mahogany	N	•	•	•
Mocha	MOCH	•	•	•
Natural Maple	D	•	•	
Shaker Cherry	F	•	•	
Sterling Ash	SA	•	•	•
Black	P	•	•	•
Brownstone	EY	•	•	•
Charcoal	S	•	•	•
Designer White	DW	•	•	•
Fossil	EH	•	•	•
Greige	R	•	•	•
Loft	LOFT	•	•	•
Muslin	T	•	•	•
Pinnacle	PINC	•	•	•
Platinum	K	•	•	•
Lowell Ash	DL	•	•	
Natural Recon	NR	•	•	
Phantom Ecu	PE	•	•	
Portico Teak	DP	•	•	•
Skyline Walnut	SW	•	•	•

**Recommended Edgeband Color Selection:**

Laminate		Edge	
Beigewood	LWBE	Beigewood	DE
Bourbon Cherry	H	Bourbon Cherry	H
Cognac	COGN	Cognac	COGN
Fawn Cypress	LFC1	Fawn Cypress	FC
Field Elm	LWFE	Field Elm	FE
Florence Walnut	LFW1	Florence Walnut	FW
Harvest	C	Harvest	C
Kingswood Walnut	LKI1	Kingswood Walnut	KI
Mahogany	N	Mahogany	N
Mocha	MOCH	Mocha	MOCH
Natural Maple	D	Natural Maple	D
Pinnacle	PINC	Pinnacle	PINC
Shaker Cherry	F	Shaker Cherry	F
Sterling Ash	LSA1	Sterling Ash	SA
Black	P	Black	P
Charcoal	S	Charcoal	S
Designer White	LDW1	Designer White	DW
Handspun Chestnut	LAHC	Brownstone	EY
Handspun Dove	LAHD	Fossil	EH
Handspun Pearl	LAHP	Fossil	EH
Handspun Slate	LAHS	Charcoal	S
Loft	LOFT	Loft	LOFT
Silver Mesh	B9	Loft	LOFT
Steel Mesh	A9	Charcoal	S
Gray	G2	Charcoal	S
White	G1	Charcoal	S
Lowell Ash	LLA1	Lowell Ash	DL
Natural Recon	LNRI	Natural Recon	NR
Phantom Ecu	LPE1	Phantom Ecu	PE
Portico Teak	LPTI	Portico Teak	DP
Skyline Walnut	LSW1	Skyline Walnut	SW

# PRESIDE® SPECIFYING INFORMATION

## Statement of Line

### TOP SHAPES



Square



Round



Soft Square



Rectangle

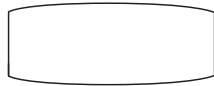

Boat



Racetrack



Arc End

### TOP EDGE PROFILES

For Laminate Tops

Square/2mm Edgeband (1/8")



Knife Edge (1/8")



T-Mold Edge (1/8")



### BASES

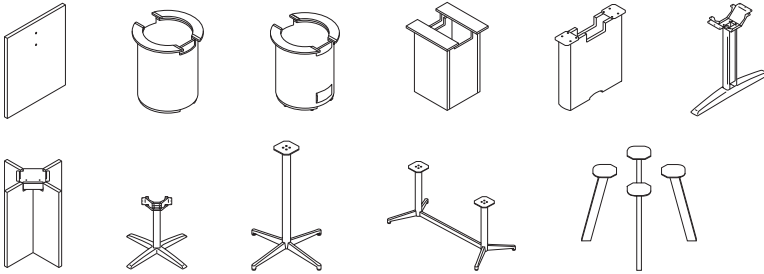

### ANCILLARY COMPONENTS

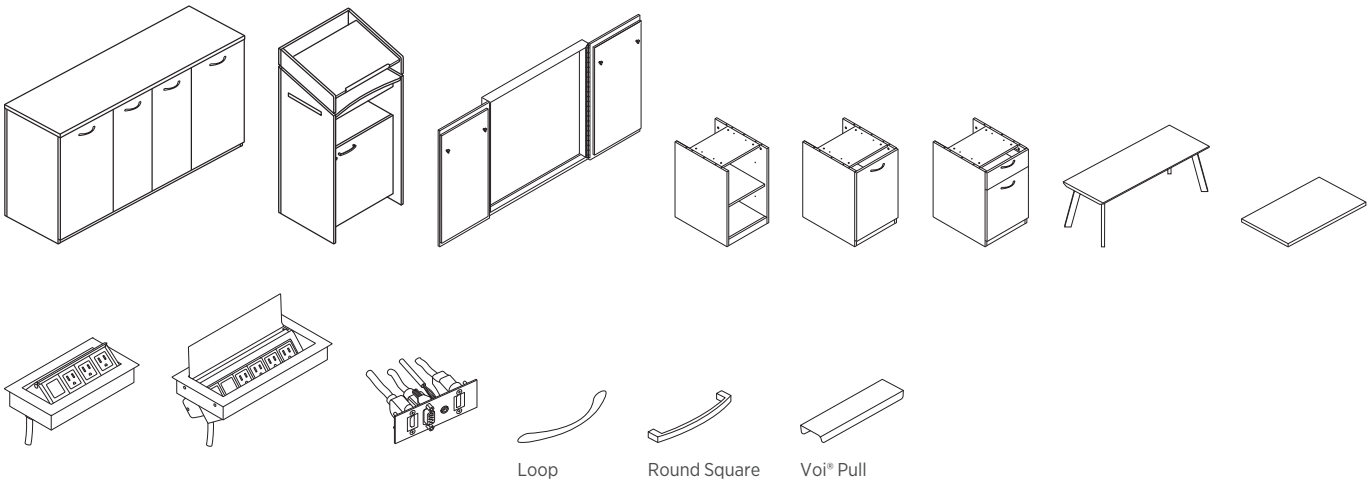

Loop

Round Square

Voi® Pull







# PRESIDE® SPECIFYING INFORMATION

Preside conference tops come in single piece or multi-piece sections depending on specified size. See below for top sizes, sections, and suggested seating capacity.





## Product Reference: Sizes, Sections, Seating Capacity

**Multi-piece tops: Rectangle, Racetrack, Boat, and Arc End Tops.**



**Notes:** Single- and two-piece tops ship in one carton, three-piece tops ship in two cartons.  
Three-piece tops and larger will not contain grain match for all pieces.

	Feet	Inches	42"D	48"D	54"D	Suggested Capacity
	30	360"	6   6   6   6   6	6   6   6   6   6	6   6   6   6   6	28-30
	28	336"	5   6   6   6   5	5   6   6   6   5	5   6   6   6   5	26-28
	26	312"	7   6   6   7	7   6   6   7	7   6   6   7	24-26
	24	288"	6   6   6   6	6   6   6   6	6   6   6   6	22-24
	22	264"	5   6   6   5	5   6   6   5	5   6   6   5	20-22
	20	240"	7   6   7	7   6   7	7   6   7	18-20
	18	216"	6   6   6	6   6   6	6   6   6	16-18
	16	192"	5   6   5	5   6   5	5   6   5	14-16
	15	180"	4½   6   4½	4½   6   4½	4½   6   4½	14-16
	14	168"	7   7	7   7	7   7	12-14
	12	144"	6   6	6   6	6   6	10-12
	10	120"	5   5	5   5	5   5	8-10
	9	108"	4½   4½	4½   4½	4½   4½	8-10

### Single-piece tops: Rectangle, Racetrack, Boat, and Arc End Tops

	Feet	Inches	30"D	36"D	42"D	48"D	Suggested Capacity
	8	96"			8	8	6-8
	7	84"			7		4-6
	6	72"		6			4-6
	5	60"	5				4-6

### Single-piece tops: Round, Square, and Soft Square

		24"	30"	36"	42"	48"	60"*	Suggested Capacity
	Round	○	○	○	○	○	○	2-4 (*2-5)
	Square	□	□	□	□	□		2-4
	Soft Square	○	○	○	○	○		2-4





# PRESIDE® SPECIFYING INFORMATION

Material	Type	Shape	Size					
			24"	30"	36"	42"	48"	60"
Laminate	Cylinder	Round	N/A	N/A	● ○ ○ ○ ○ ● ○ ○ ○ ○	○ ○ ○ ○ ○ ● ○ ○ ○ ○	○ ○ ○ ○ ○ ● ○ ○ ○ ○	N/A
		Square	N/A	N/A	○ ○ ○ ○ ○ ● ○ ○ ○ ○	○ ○ ○ ○ ○ ● ○ ○ ○ ○	○ ○ ○ ○ ○ ● ○ ○ ○ ○	
		Soft Square	N/A	N/A	○ ○ ○ ○ ○ ● ○ ○ ○ ○	○ ○ ○ ○ ○ ● ○ ○ ○ ○	○ ○ ○ ○ ○ ● ○ ○ ○ ○	
	Cube	Round	N/A	N/A	N/A	N/A	○ ○ ○ ○ ○ ● ○ ○ ○ ○	○ ○ ○ ○ ○ ● ○ ○ ○ ○
		Square	N/A	N/A	N/A	N/A	○ ○ ○ ○ ○ ● ○ ○ ○ ○	
		Soft Square	N/A	N/A	N/A	N/A	○ ○ ○ ○ ○ ● ○ ○ ○ ○	
	X-Base	Round	N/A	N/A	○ ○ ○ ○ ○ ● ○ ○ ○ ○	○ ○ ○ ○ ○ ● ○ ○ ○ ○	○ ○ ○ ○ ○ ● ○ ○ ○ ○	N/A
		Square	N/A	N/A	○ ○ ○ ○ ○ ● ○ ○ ○ ○	○ ○ ○ ○ ○ ● ○ ○ ○ ○	○ ○ ○ ○ ○ ● ○ ○ ○ ○	
		Soft Square	N/A	N/A	○ ○ ○ ○ ○ ● ○ ○ ○ ○	○ ○ ○ ○ ○ ● ○ ○ ○ ○	○ ○ ○ ○ ○ ● ○ ○ ○ ○	
	Traditional X-Base	Round	N/A	N/A	○ ○ ○ ○ ○ ● ○ ○ ○ ○	○ ○ ○ ○ ○ ● ○ ○ ○ ○	○ ○ ○ ○ ○ ● ○ ○ ○ ○	N/A
		Square	N/A	N/A	○ ○ ○ ○ ○ ● ○ ○ ○ ○	○ ○ ○ ○ ○ ● ○ ○ ○ ○	N/A	
		Soft Square	N/A	N/A	○ ○ ○ ○ ○ ● ○ ○ ○ ○	○ ○ ○ ○ ○ ● ○ ○ ○ ○	N/A	

●	●	●	●
○	○	○	○
Working Lounge	Seated	Counter	Standing
27H	29H	36H	42H
● Available			
○ Unavailable or Not Compatible			

# PRESIDE® SPECIFYING INFORMATION

		Rectangle - Boat - Racetrack - Arc End													
Material	Type	Width	60"	72"	84"	96"	108"	120"	144"	168"	180"	192"	216"	240"	72" Adder
		Depth													
Painted	Footed Y-Base	30"	●●●●●												
		36"		●●●●●											
		42"			●●●●●	●●●●●	●●●●●	●●●●●	●●●●●	●●●●●	●●●●●	●●●●●	●●●●●	●●●●●	●●●●●
		48"				●●●●●	●●●●●	●●●●●	●●●●●	●●●●●	●●●●●	●●●●●	●●●●●	●●●●●	●●●●●
		54"					N/A	N/A	N/A	N/A	N/A	N/A	N/A	N/A	N/A
	Angled Leg	30"	○●●●●												
		36"		○●●●●											
		42"			○●●●●	○●●●●	○●●●●	○●●●●	○●●●●	○●●●●	○●●●●	○●●●●	○●●●●	○●●●●	○●●●●
		48"				○●●●●	○●●●●	○●●●●	○●●●●	○●●●●	○●●●●	○●●●●	○●●●●	○●●●●	○●●●●
		54"					○●●●●	○●●●●	○●●●●	○●●●●	○●●●●	○●●●●	○●●●●	○●●●●	○●●●●
	T-Leg	30"	○●●●●												
		36"		○●●●●											
		42"			○●●●●	○●●●●	○●●●●	○●●●●	○●●●●	○●●●●	○●●●●	○●●●●	○●●●●	○●●●●	○●●●●
		48"				○●●●●	○●●●●	○●●●●	○●●●●	○●●●●	○●●●●	○●●●●	○●●●●	○●●●●	○●●●●
		54"					○●●●●	○●●●●	○●●●●	○●●●●	○●●●●	○●●●●	○●●●●	○●●●●	○●●●●

	<ul style="list-style-type: none"> <li>● Available</li> <li>○ Unavailable or Not Compatible</li> </ul>
--	--

# PRESIDE® SPECIFYING INFORMATION

		Rectangle - Boat - Racetrack - Arc End														
Material	Type	Width	60"	72"	84"	96"	108"	120"	144"	168"	180"	192"	216"	240"	72" Adder	
		Depth														
Laminate	Panel	30"	○ ○ ○ ○ ○ ○ ● ○ ○ ○ ○ ○													
		36"		○ ○ ○ ○ ○ ○ ● ○ ○ ○ ○ ○												
		42"			○ ○ ○ ○ ○ ○ ● ○ ○ ○ ○ ○	○ ○ ○ ○ ○ ○ ● ○ ○ ○ ○ ○	○ ○ ○ ○ ○ ○ ● ○ ○ ○ ○ ○	○ ○ ○ ○ ○ ○ ● ○ ○ ○ ○ ○	○ ○ ○ ○ ○ ○ ● ○ ○ ○ ○ ○	○ ○ ○ ○ ○ ○ ● ○ ○ ○ ○ ○	○ ○ ○ ○ ○ ○ ● ○ ○ ○ ○ ○	○ ○ ○ ○ ○ ○ ● ○ ○ ○ ○ ○	○ ○ ○ ○ ○ ○ ● ○ ○ ○ ○ ○	○ ○ ○ ○ ○ ○ ● ○ ○ ○ ○ ○	○ ○ ○ ○ ○ ○ ● ○ ○ ○ ○ ○	
		48"				○ ○ ○ ○ ○ ○ ● ○ ○ ○ ○ ○	○ ○ ○ ○ ○ ○ ● ○ ○ ○ ○ ○	○ ○ ○ ○ ○ ○ ● ○ ○ ○ ○ ○	○ ○ ○ ○ ○ ○ ● ○ ○ ○ ○ ○	○ ○ ○ ○ ○ ○ ● ○ ○ ○ ○ ○	○ ○ ○ ○ ○ ○ ● ○ ○ ○ ○ ○	○ ○ ○ ○ ○ ○ ● ○ ○ ○ ○ ○	○ ○ ○ ○ ○ ○ ● ○ ○ ○ ○ ○	○ ○ ○ ○ ○ ○ ● ○ ○ ○ ○ ○	○ ○ ○ ○ ○ ○ ● ○ ○ ○ ○ ○	○ ○ ○ ○ ○ ○ ● ○ ○ ○ ○ ○
		54"					○ ○ ○ ○ ○ ○ ● ○ ○ ○ ○ ○	○ ○ ○ ○ ○ ○ ● ○ ○ ○ ○ ○	○ ○ ○ ○ ○ ○ ● ○ ○ ○ ○ ○	○ ○ ○ ○ ○ ○ ● ○ ○ ○ ○ ○	○ ○ ○ ○ ○ ○ ● ○ ○ ○ ○ ○	○ ○ ○ ○ ○ ○ ● ○ ○ ○ ○ ○	○ ○ ○ ○ ○ ○ ● ○ ○ ○ ○ ○	○ ○ ○ ○ ○ ○ ● ○ ○ ○ ○ ○	○ ○ ○ ○ ○ ○ ● ○ ○ ○ ○ ○	○ ○ ○ ○ ○ ○ ● ○ ○ ○ ○ ○
	Hollow Panel	30"	N/A													
		36"		N/A												
		42"*			○ ○ ○ ○ ○ ○ ● ○ ○ ○ ○ ○	○ ○ ○ ○ ○ ○ ● ○ ○ ○ ○ ○	○ ○ ○ ○ ○ ○ ● ○ ○ ○ ○ ○	○ ○ ○ ○ ○ ○ ● ○ ○ ○ ○ ○	○ ○ ○ ○ ○ ○ ● ○ ○ ○ ○ ○	○ ○ ○ ○ ○ ○ ● ○ ○ ○ ○ ○	○ ○ ○ ○ ○ ○ ● ○ ○ ○ ○ ○	○ ○ ○ ○ ○ ○ ● ○ ○ ○ ○ ○	○ ○ ○ ○ ○ ○ ● ○ ○ ○ ○ ○	○ ○ ○ ○ ○ ○ ● ○ ○ ○ ○ ○	○ ○ ○ ○ ○ ○ ● ○ ○ ○ ○ ○	○ ○ ○ ○ ○ ○ ● ○ ○ ○ ○ ○
		48"				○ ○ ○ ○ ○ ○ ● ○ ○ ○ ○ ○	○ ○ ○ ○ ○ ○ ● ○ ○ ○ ○ ○	○ ○ ○ ○ ○ ○ ● ○ ○ ○ ○ ○	○ ○ ○ ○ ○ ○ ● ○ ○ ○ ○ ○	○ ○ ○ ○ ○ ○ ● ○ ○ ○ ○ ○	○ ○ ○ ○ ○ ○ ● ○ ○ ○ ○ ○	○ ○ ○ ○ ○ ○ ● ○ ○ ○ ○ ○	○ ○ ○ ○ ○ ○ ● ○ ○ ○ ○ ○	○ ○ ○ ○ ○ ○ ● ○ ○ ○ ○ ○	○ ○ ○ ○ ○ ○ ● ○ ○ ○ ○ ○	○ ○ ○ ○ ○ ○ ● ○ ○ ○ ○ ○
		54"					○ ○ ○ ○ ○ ○ ● ○ ○ ○ ○ ○	○ ○ ○ ○ ○ ○ ● ○ ○ ○ ○ ○	○ ○ ○ ○ ○ ○ ● ○ ○ ○ ○ ○	○ ○ ○ ○ ○ ○ ● ○ ○ ○ ○ ○	○ ○ ○ ○ ○ ○ ● ○ ○ ○ ○ ○	○ ○ ○ ○ ○ ○ ● ○ ○ ○ ○ ○	○ ○ ○ ○ ○ ○ ● ○ ○ ○ ○ ○	○ ○ ○ ○ ○ ○ ● ○ ○ ○ ○ ○	○ ○ ○ ○ ○ ○ ● ○ ○ ○ ○ ○	○ ○ ○ ○ ○ ○ ● ○ ○ ○ ○ ○

\*NOTE: With 42" deep Hollow Base will result in decreased leg room at base location.

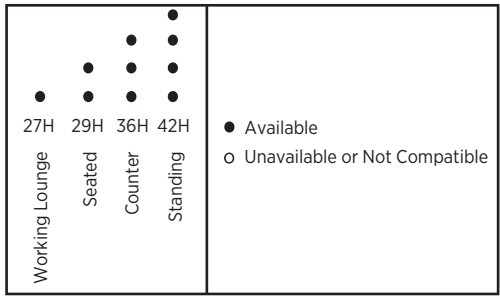



# PRESIDE® SPECIFYING INFORMATION

## Specify Preside tables with two steps—select a top and select a base.

### 1. Select desired top size, shape, and edge profile.

#### Multi-piece Tops:

Multi-piece tops are made of 108", 120", 144" and 168" two-piece "starter-sections" in rectangle, boat, arc end, or racetrack shapes in 42", 48", or 54" depths. For tables up to 20', models are preconfigured for you. If you need a table top longer than 20', add as many 72" adder sections as you need. The examples below illustrate preconfigured sizes as well as how starter section and adder section tops can be used to create tables in virtually any length. **Please note that 2-piece tops, in woodgrain colors, will not have exact grain alignment in the center where the two halves meet, a reasonable match can be expected. For tops utilizing an adder section, there will not be a grain match for those pieces.**

#### Preconfigured and Modular Size Examples

	Feet	Inches	Ex. Top Starter Section	Quantity	Adder Section	Quantity	Total Number of Top Sections
Preconfigured Sizes	9'	108"	HTLC48108	1	n/a	n/a	2
	10'	120"	HTLC48120	1	n/a	n/a	2
	12'	144"	HTLC48144	1	n/a	n/a	2
	14'	168"	HTLC48168	1	n/a	n/a	2
	15'	180"	HTLC48180	1	n/a	n/a	3
	16'	192"	HTLC48192	1	n/a	n/a	3
	18'	216"	HTLC48216	1	n/a	n/a	3
	20'	240"	HTLC48240	1	n/a	n/a	3
Modular Sizes	22'	264"	HTLC48120	1	HTLM4872	2	4
	24'	288"	HTLC48144	1	HTLM4872	2	4
	26'	312"	HTLC48168	1	HTLM4872	2	4
	28'	336"	HTLC48120	1	HTLM4872	3	5
	30'	360"	HTLC48144	1	HTLM4872	3	5

Note: Beyond 30', tables can be configured in 6' increments to any length.

#### Illustrations of Preconfigured Tops

48" x 108" Table Top (9')

54"	54"
-----	-----

Ex: HTLC48108

48" x 120" Table Top (10')

60"	60"
-----	-----

Ex: HTLC48120

48" x 144" Table Top (12')

72"	72"
-----	-----

Ex: HTLC48144

48" x 168" Table Top (14')

84"	84"
-----	-----

Ex: HTLC48168

48" x 180" Table Top (15')

54"	72"	54"
-----	-----	-----

Ex: HTLC48180

48" x 192" Table Top (16')

60"	72"	60"
-----	-----	-----

Ex: HTLC48192

48" x 216" Table Top (18')

72"	72"	72"
-----	-----	-----

Ex: HTLC48216

48" x 240" Table Top (20')

84"	72"	84"
-----	-----	-----

Ex: HTLC48240

#### Illustrations of User Configured Modular Tops

48" x 72" Adder Section

72"
-----

Ex: HTLM4872

48"D x 360"W Table Top (30')

72"	72"	72"	72"	72"
-----	-----	-----	-----	-----

Ex: HTLC48144 + HTLM4872 + HTLM4872 + HTLM4872

# PRESIDE® SPECIFYING INFORMATION

## 2. Select desired base style and identify model that coincides with top length.

### Bases for Tops in Preconfigured Sizes

Bases include the appropriate number of supports for tables up to 20'. Simply identify the length of the table top in inches and specify the base with the same length in the model number. The example below illustrates how to select a base for a preconfigured size top.

#### Examples of Base for Preconfigured Top Size

Example top: HTLC48240 Top Description: 240" Rectangle Top  
 Example base: HTLHP240 Base Description: Hollow Panel Base for 240" Top

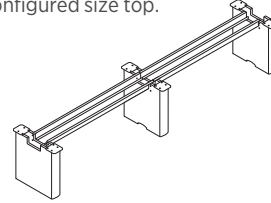

Example: HTLHP240

### Bases for Tops in User Configured Modular Sizes

If you need a table top longer than 20', add as many 72" adder section bases as needed. The examples below illustrate preconfigured sizes as well as how starter section and adder section bases can be used to create tables in any desired length.

#### Examples of Tops and Bases for User Configured Modular Top

	Feet	Inches	Ex. Top Starter Section	Quantity	Ex. Top Adder Section	Quantity	Ex. Base Starter Section	Quantity	Ex. Base Adder Section	Quantity	Total # of Top Sections
Preconfigured Sizes	9'	108"	HTLC48108	1	n/a	n/a	HTLHP108	1	n/a	n/a	2
	10'	120"	HTLC48120	1	n/a	n/a	HTLHP120	1	n/a	n/a	2
	12'	144"	HTLC48144	1	n/a	n/a	HTLHP144	1	n/a	n/a	2
	14'	168"	HTLC48168	1	n/a	n/a	HTLHP168	1	n/a	n/a	2
	15'	180"	HTLC48180	1	n/a	n/a	HTLHP180	1	n/a	n/a	3
	16'	192"	HTLC48192	1	n/a	n/a	HTLHP192	1	n/a	n/a	3
	18'	216"	HTLC48216	1	n/a	n/a	HTLHP216	1	n/a	n/a	3
	20'	240"	HTLC48240	1	n/a	n/a	HTLHP240	1	n/a	n/a	3
Modular Sizes	22'	264"	HTLC48120	1	HTLM4872	2	HTLHP120	1	HTLHPM	2	4
	24'	288"	HTLC48144	1	HTLM4872	2	HTLHP144	1	HTLHPM	2	4
	26'	312"	HTLC48168	1	HTLM4872	2	HTLHP168	1	HTLHPM	2	4
	28'	336"	HTLC48120	1	HTLM4872	3	HTLHP120	1	HTLHPM	3	5
	30'	360"	HTLC48144	1	HTLM4872	3	HTLHP144	1	HTLHPM	3	5

Note: Tables can be configured to any desired length beyond 30' in 6' increments.

**Note:** Preconfigured bases include the appropriate number of supports for tables up to 20'. Depending on base type, number of required supports varies. For information regarding total number of supports please refer to chart below.

Feet	Inches	HTLP	HTTLEG	HTLHP	HTLCUBE/S	HTLR/C	HTYLEG	HTALEG
9'	108"	2	2	2	2	2	3	6
10'	120"	2	2	2	2	2	3	6
12'	144"	2	2	2	2	2	3	6
14'	168"	3	3	3	2	2	3	6
15'	180"	3	3	3	3	3	4	8
16'	192"	3	3	3	3	3	4	8
18'	216"	3	3	3	3	3	4	8
20'	240"	4	4	3	3	3	4	8

#### Base Model Descriptions

HTLP = Panel Base  
 HTTLEG = Aluminum T-Leg  
 HTLHP = Hollow Panel Base  
 HTLCUBE = Cube Base  
 HTLCUBES = Standing-Height Cube Base

HTLR = Cylinder Base  
 HTLRC = Wire Management Cylinder Base  
 HTYLEG = Footed Y-Leg Base  
 HTALEG = Angled Leg

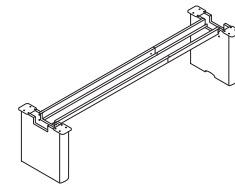

Example: HTLHP168

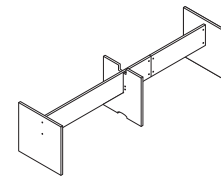

Example: HTLHP168



# PRESIDE® Grommet Cutout Placement

Tops specified with a grommet cutout get one cutout per section of top, centered in both directions. Cutouts do not include blank or powered inserts. Inserts must be specified separately.

- For compatible 4-Trac Electrical solutions, see page 246.
- For compatible grommet solutions, see page 249.

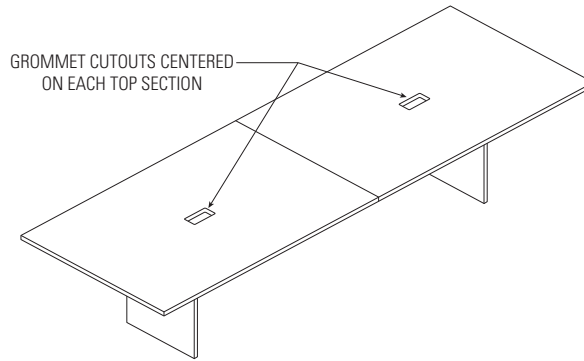

Upcharges for grommet cutouts (\$17 per G cutout, \$44 per G1 cutout, \$55 per G2 cutout)

Top Width	# Cutouts	G	G1	G2
24"	1	\$17	N/A	N/A
30"	1	\$17	N/A	N/A
36"	1	N/A	\$44	\$55
42"	1	N/A	\$44	\$55
48"	1	N/A	\$44	\$55
60"	1	N/A	\$44	\$55
72"	1	N/A	\$44	\$55
84"	1	N/A	\$44	\$55
96"	1	N/A	\$44	\$55
108"	2	N/A	\$87	\$109
120"	2	N/A	\$87	\$109
144"	2	N/A	\$87	\$109
168"	2	N/A	\$87	\$109
180"	3	N/A	\$130	\$162
192"	3	N/A	\$130	\$162
216"	3	N/A	\$130	\$162
240"	3	N/A	\$130	\$162

# PRESIDE® Laminate Table Tops

GSA SIN 33721



Icon Legend on page 19

	DESCRIPTION	MODEL	SHIP WEIGHT	CUBE	LIST PRICE BY EDGE TREATMENT			L2 UPCHARGE	
					"E"	"G"	"J"		
<b>Laminate Boat, Racetrack, Rectangle and Arc End Shaped Tops</b>									
 A = Racetrack	240"W x 54"D	HTL(?)54240	425	25.1	N/A	\$3549	\$5492	\$135	
	216"W x 54"D	HTL(?)54216	384	23.3	N/A	\$3105	\$4691	\$114	
	192"W x 54"D	HTL(?)54192	345	21.4	N/A	\$2894	\$4445	\$109	
	180"W x 54"D	HTL(?)54180	442	21.4	N/A	\$2894	\$4445	\$109	
	168"W x 54"D	HTL(?)54168	300	13.5	\$2222	\$2382	\$3587	\$92	
	144"W x 54"D	HTL(?)54144	259	11.6	\$1815	\$1938	\$2786	\$71	
	120"W x 54"D	HTL(?)54120	220	9.8	\$1613	\$1727	\$2539	\$65	
	108"W x 54"D	HTL(?)54108	324	9.8	\$1613	\$1727	\$2539	\$65	
	 B = Boat	240"W x 48"D	HTL(?)48240	392	21.9	N/A	\$2885	\$4463	\$114
		216"W x 48"D	HTL(?)48216	351	19.7	N/A	\$2529	\$3827	\$98
192"W x 48"D		HTL(?)48192	312	18.1	N/A	\$2361	\$3628	\$92	
180"W x 48"D		HTL(?)48180	300	18.6	N/A	\$2361	\$3628	\$92	
168"W x 48"D		HTL(?)48168	281	12.1	\$1778	\$1908	\$2869	\$77	
144"W x 48"D		HTL(?)48144	240	9.8	\$1454	\$1552	\$2233	\$60	
120"W x 48"D		HTL(?)48120	201	8.2	\$1292	\$1384	\$2035	\$55	
108"W x 48"D		HTL(?)48108	203	9.8	\$1292	\$1384	\$2035	\$55	
96"W x 48"D		HTL(?)4896	153	13.2	\$1096	\$1130	\$1635	\$55	
 C = Rectangle		240"W x 42"D	HTL(?)42240	382	27.1	\$2538	\$2652	\$3995	\$108
	216"W x 42"D	HTL(?)42216	350	25.8	\$2267	\$2362	\$3568	\$95	
	192"W x 42"D	HTL(?)42192	317	22.2	\$2131	\$2218	\$3355	\$90	
	180"W x 42"D	HTL(?)42180	302	22.2	\$2131	\$2218	\$3355	\$90	
	168"W x 42"D	HTL(?)42168	255	18.7	\$1695	\$1809	\$2669	\$72	
	144"W x 42"D	HTL(?)42144	223	17.4	\$1424	\$1519	\$2242	\$60	
	120"W x 42"D	HTL(?)42120	190	13.8	\$1288	\$1375	\$2028	\$55	
	108"W x 42"D	HTL(?)42108	175	13.8	\$1288	\$1375	\$2028	\$55	
	96"W x 42"D	HTL(?)4296	159	22.8	N/A	\$1142	\$1647	\$44	
	84"W x 42"D	HTL(?)4284	157	12.1	\$1096	\$1130	\$1635	\$44	
 E = Arc End	72"W x 36"D	HTL(?)3672	90	7.9	\$732	\$791	\$1229	\$33	
	60"W x 30"D	HTL(?)3060	63	5.6	\$580	\$627	\$989	\$22	
	<b>Laminate Adder Section for Boat, Racetrack, Rectangle and Arc Shaped Tops</b>								
 M = Mid-section Adder	72"W x 54"D	HTLM5472	125	11.6	N/A	\$1167	\$1906	\$44	
	72"W x 48"D	HTLM4872	111	9.8	N/A	\$977	\$1594	\$39	
	72"W x 42"D	HTLM4272	127	8.4	N/A	\$900	\$1328	\$37	

! Adder section cannot be used as stand-alone table. Only long edges are finished.

**NOTES:**

- Tops with E and G edge details feature durable laminate tops over solid core high-performance particleboard. Tops with J edge feature an MDF core.
- Tops with E edge detail have 3" radius corners. All other edge details have 90 degree corners.
- See page 85 for number of cutouts for each table top size.
- See page 246 for compatible 4-Trac Electrical solutions and 249 for compatible grommet solutions.

! See pages 77-82 for top and base compatibility.

**HOW TO SPECIFY**

<p><b>Select Model Number</b></p> <p>HTLC4296</p>	<p><b>Select Edge Detail and Edge Color</b></p> <p>See page 75</p> <p>J C</p>	<p><b>Select Cutout Option</b></p> <p>N No Cutout  G1 Cutout for Pop-up Port (\$44 upcharge per cutout)  G2 Cutout for Flip-top Port (\$55 upcharge per cutout)  Flip-top Port cannot be specified for Round or Square tops</p> <p>G 2</p>	<p><b>Select Laminate</b></p> <p>See page 74, Laminate Group A</p> <p>D</p>
---	---	--	---



# PRESIDE® Laminate Table Tops

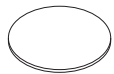

D = Round

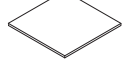

S = Square



SFT = Soft Square

DESCRIPTION	MODEL	SHIP WEIGHT				LIST PRICE BY EDGE TREATMENT			L2 UPCHARGE
		ROUND	SQUARE	SOFT SQUARE	CUBE	"E"	"G"	"J"	
<b>Laminate Round, Square, and Soft Square Tops</b>									
60" Round Top	<b>HTLD60</b>	95	N/A	N/A	10.1	<b>\$786</b>	<b>\$840</b>	<b>\$1237</b>	<b>\$34</b>
48" Top	<b>HTL(?)48</b>	66	76	80	6.3	<b>\$629</b>	<b>\$673</b>	<b>\$1045</b>	<b>\$28</b>
42" Top	<b>HTL(?)42</b>	51	61	61	4.9	<b>\$561</b>	<b>\$608</b>	<b>\$970</b>	<b>\$22</b>
36" Top	<b>HTL(?)36</b>	36	46	46	3.7	<b>\$491</b>	<b>\$555</b>	<b>\$831</b>	<b>\$22</b>
30" Top	<b>HTL(?)30</b>	28	33	33	3.0	<b>\$443</b>	<b>\$474</b>	<b>\$697</b>	<b>\$19</b>
24" Top	<b>HTL(?)24</b>	19	23	23	2.1	<b>\$411</b>	<b>\$440</b>	<b>\$646</b>	<b>\$18</b>

NOTES: Tops are available in three shapes: Round (D), Square (S), and Soft Square (SFT). Replace the (?) shown in each model with D, S, or SFT to specify shape.

ⓘ 60" top only available in Round (D) shape.

**NOTES:**

- Tops with E and G edge details feature durable laminate tops over solid core high-performance particleboard. Tops with J edge feature an MDF core.
- Tops with E edge detail have 3" radius corners. All other edge details have 90 degree corners.
- See page 85 for number of cutouts for each table top size.
- For compatible grommet solutions, see pages 247 and 249.

ⓘ See pages 77-82 for top and base compatibility.

## HOW TO SPECIFY

<p><b>Select Model Number</b></p> <p>HTLD48</p>	<p><b>Select Edge Detail and Edge Color</b></p> <p>See page 75</p> <p>JC</p>	<p><b>Select Cutout Option</b></p> <p><b>N</b> No Cutout  <b>G</b> Cutout for 24" and 30" tops (+ \$17 upcharge)  <b>G1</b> Cutout for Pop-up Port (+ \$44 upcharge per cutout)  <b>G2</b> Cutout for Flip-top Port (+ \$55 upcharge per cutout)</p> <p>G1</p>	<p><b>Select Laminate</b></p> <p>See page 74, Laminate Group A</p> <p>D</p>
---	--	--	---

# PRESIDE® Laminate Bases

GSA SIN 33721



Icon Legend on page 19

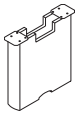
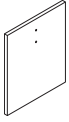

DESCRIPTION	PANELS INCLUDED PER KIT	MODEL	SHIP WEIGHT	CUBE	LIST PRICE BY LAMINATE GRADE	
					L1	L2
<b>Laminate Seated-Height Panel Base for Tops 60" or Wider</b>						
For 240"W Table Tops	4	<b>HTLP240</b>	197	16.4	<b>\$1803</b>	<b>\$1890</b>
For 216"W Table Tops	3	<b>HTLP216</b>	158	12.4	<b>\$1378</b>	<b>\$1440</b>
For 192"W Table Tops	3	<b>HTLP192</b>	147	11.6	<b>\$1378</b>	<b>\$1440</b>
For 180"W Table Tops	3	<b>HTLP180</b>	147	11.6	<b>\$1378</b>	<b>\$1440</b>
For 168"W Table Tops	3	<b>HTLP168</b>	136	10.6	<b>\$1203</b>	<b>\$1263</b>
For 144"W Table Tops	2	<b>HTLP144</b>	97	6.6	<b>\$778</b>	<b>\$814</b>
For 120"W Table Tops	2	<b>HTLP120</b>	86	5.8	<b>\$778</b>	<b>\$814</b>
For 108"W Table Tops	2	<b>HTLP108</b>	86	5.8	<b>\$778</b>	<b>\$814</b>
For 96"W Table Tops	2	<b>HTLP96</b>	75	4.9	<b>\$778</b>	<b>\$814</b>
For 84"W Table Tops	2	<b>HTLP84</b>	75	5.0	<b>\$778</b>	<b>\$814</b>
For 72"W Table Tops	2	<b>HTLP72</b>	25	2.9	<b>\$731</b>	<b>\$767</b>
For 60"W Table Tops	2	<b>HTLP60</b>	25	2.9	<b>\$731</b>	<b>\$767</b>
For 72" Adder Section	1	<b>HTLPM</b>	61	5.8	<b>\$600</b>	<b>\$628</b>
<b>Laminate Seated-Height Hollow Panel Base for Tops 84" or Wider</b>						
For 240"W Table Tops	3	<b>HTLHP240</b>	206	17.5	<b>\$3912</b>	<b>\$4042</b>
For 216"W Table Tops	3	<b>HTLHP216</b>	204	17.3	<b>\$3810</b>	<b>\$3940</b>
For 192"W Table Tops	3	<b>HTLHP192</b>	202	17.1	<b>\$3723</b>	<b>\$3853</b>
For 180"W Table Tops	3	<b>HTLHP180</b>	202	17.1	<b>\$3723</b>	<b>\$3853</b>
For 168"W Table Tops	3	<b>HTLHP168</b>	193	16.9	<b>\$3601</b>	<b>\$3731</b>
For 144"W Table Tops	2	<b>HTLHP144</b>	133	11.4	<b>\$2472</b>	<b>\$2559</b>
For 120"W Table Tops	2	<b>HTLHP120</b>	131	11.2	<b>\$2385</b>	<b>\$2472</b>
For 108"W Table Tops	2	<b>HTLHP108</b>	131	11.2	<b>\$2385</b>	<b>\$2472</b>
For 96"W Table Tops	2	<b>HTLHP96</b>	125	11.0	<b>\$2300</b>	<b>\$2387</b>
For 84"W Table Tops	2	<b>HTLHP84</b>	125	11.0	<b>\$2300</b>	<b>\$2387</b>
For 72" Adder Section	1	<b>HTLHPM</b>	71	5.9	<b>\$1338</b>	<b>\$1382</b>

**NOTES:**

- Tops and bases are sold and shipped separately.
- End caps for Hollow Panel bases can be matched to woodgrain finishes or specified in select solid colors.
- Bases ship with appropriate number of supports for table width. See page 84 for details.
- Laminate panel bases feature sturdy 1½" thick x 12"H particleboard support beam in matching finish.
- ! For Base and Top compatibility, see base information on pages 77-84.
- ! Laminate hollow panel bases feature dual aluminum support beams with integrated wire management.

**HOW TO SPECIFY**

<p><b>Select Model Number</b></p> <p>HTLHP240</p>	<p><b>Select Laminate</b></p> <p>See page 74, Laminate Group B</p> <p>D</p>	<p><b>Select Endcap/Inlay Option</b></p> <p>See page 74, Laminate Group C (Specify for Hollow Panel Bases only)</p> <p>LFW1</p>
---	---	---



Icon Legend on page 19

# PRESIDE® Laminate Bases

DESCRIPTION	PANELS INCLUDED		SHIP WEIGHT	CUBE	LIST PRICE BY LAMINATE GRADE	
	PER KIT	MODEL			L1	L2
<b>Laminate Seated-Height Cube Base for Tops 84" or Wider</b>						
For 240"W Table Tops	3	<b>HTLCUBE240</b>	278	29.2	<b>\$4683</b>	<b>\$4830</b>
For 216"W Table Tops	3	<b>HTLCUBE216</b>	276	29.0	<b>\$4581</b>	<b>\$4728</b>
For 192"W Table Tops	3	<b>HTLCUBE192</b>	274	28.8	<b>\$4494</b>	<b>\$4641</b>
For 180"W Table Tops	3	<b>HTLCUBE180</b>	274	28.8	<b>\$4494</b>	<b>\$4641</b>
For 168"W Table Tops	2	<b>HTLCUBE168</b>	183	19.4	<b>\$3088</b>	<b>\$3186</b>
For 144"W Table Tops	2	<b>HTLCUBE144</b>	181	19.2	<b>\$2986</b>	<b>\$3084</b>
For 120"W Table Tops	2	<b>HTLCUBE120</b>	179	19.0	<b>\$2899</b>	<b>\$2997</b>
For 108"W Table Tops	2	<b>HTLCUBE108</b>	179	19.0	<b>\$2899</b>	<b>\$2997</b>
For 96"W Table Tops	2	<b>HTLCUBE96</b>	164	18.2	<b>\$2568</b>	<b>\$2666</b>
For 84"W Table Tops	2	<b>HTLCUBE84</b>	164	18.2	<b>\$2568</b>	<b>\$2666</b>
For 72" Adder Section	1	<b>HTLCUBEM</b>	95	9.8	<b>\$1595</b>	<b>\$1645</b>
<b>Laminate Standing-Height Cube Base for Tops 48" or Wider</b>						
For 240"W Table Tops	3	<b>HTLCUBES240</b>	302	45.7	<b>\$5661</b>	<b>\$5840</b>
For 216"W Table Tops	3	<b>HTLCUBES216</b>	300	45.5	<b>\$5559</b>	<b>\$5738</b>
For 192"W Table Tops	3	<b>HTLCUBES192</b>	298	45.3	<b>\$5472</b>	<b>\$5651</b>
For 180"W Table Tops	3	<b>HTLCUBES180</b>	298	45.3	<b>\$5472</b>	<b>\$5651</b>
For 168"W Table Tops	2	<b>HTLCUBES168</b>	199	30.4	<b>\$3740</b>	<b>\$3859</b>
For 144"W Table Tops	2	<b>HTLCUBES144</b>	197	30.2	<b>\$3638</b>	<b>\$3757</b>
For 120"W Table Tops	2	<b>HTLCUBES120</b>	195	30.0	<b>\$3551</b>	<b>\$3670</b>
For 108"W Table Tops	2	<b>HTLCUBES108</b>	195	30.0	<b>\$3551</b>	<b>\$3670</b>
For 96"W Table Tops	2	<b>HTLCUBES96</b>	180	29.2	<b>\$3220</b>	<b>\$3339</b>
For 72" Adder	1	<b>HTLCUBESM</b>	103	15.3	<b>\$1921</b>	<b>\$1981</b>
<b>Laminate Seated-Height Cylinder Base for Tops 84" or Wider</b>						
For 240"W Table Tops	3	<b>HTLR240</b>	191	51.9	<b>\$3795</b>	<b>\$3909</b>
For 216"W Table Tops	3	<b>HTLR216</b>	189	51.7	<b>\$3693</b>	<b>\$3807</b>
For 192"W Table Tops	3	<b>HTLR192</b>	187	51.5	<b>\$3606</b>	<b>\$3720</b>
For 180"W Table Tops	3	<b>HTLR180</b>	187	51.5	<b>\$3606</b>	<b>\$3720</b>
For 168"W Table Tops	2	<b>HTLR168</b>	125	34.5	<b>\$2496</b>	<b>\$2573</b>
For 144"W Table Tops	2	<b>HTLR144</b>	123	34.3	<b>\$2394</b>	<b>\$2471</b>
For 120"W Table Tops	2	<b>HTLR120</b>	121	34.1	<b>\$2307</b>	<b>\$2384</b>
For 108"W Table Tops	2	<b>HTLR108</b>	121	34.1	<b>\$2307</b>	<b>\$2384</b>
For 96"W Table Tops	2	<b>HTLR96</b>	106	33.3	<b>\$1976</b>	<b>\$2053</b>
For 84"W Table Tops	2	<b>HTLR84</b>	106	33.3	<b>\$1976</b>	<b>\$2053</b>
For 72" Adder Section	1	<b>HTLRM</b>	66	17.4	<b>\$1299</b>	<b>\$1338</b>
<b>Laminate Seated-Height Cylinder Base with Wire Management for Tops 84" or Wider</b>						
For 240"W Table Tops	3	<b>HTLRC240</b>	191	51.9	<b>\$4932</b>	<b>\$5079</b>
For 216"W Table Tops	3	<b>HTLRC216</b>	189	51.7	<b>\$4830</b>	<b>\$4977</b>
For 192"W Table Tops	3	<b>HTLRC192</b>	187	51.4	<b>\$4743</b>	<b>\$4890</b>
For 180"W Table Tops	3	<b>HTLRC180</b>	187	51.4	<b>\$4743</b>	<b>\$4890</b>
For 168"W Table Tops	2	<b>HTLRC168</b>	125	34.5	<b>\$3254</b>	<b>\$3352</b>
For 144"W Table Tops	2	<b>HTLRC144</b>	123	34.3	<b>\$3152</b>	<b>\$3250</b>
For 120"W Table Tops	2	<b>HTLRC120</b>	121	34.1	<b>\$3065</b>	<b>\$3163</b>
For 108"W Table Tops	2	<b>HTLRC108</b>	121	34.1	<b>\$3065</b>	<b>\$3163</b>
For 96"W Table Tops	2	<b>HTLRC96</b>	106	33.3	<b>\$2734</b>	<b>\$2832</b>
For 84"W Table Tops	2	<b>HTLRC84</b>	106	33.3	<b>\$2734</b>	<b>\$2832</b>
For 72" Adder	1	<b>HTLRM</b>	66	17.4	<b>\$1678</b>	<b>\$1728</b>

**NOTES:**

- Tops and bases are sold and shipped separately.
- Bases ship with appropriate number of supports for table width. See page 84 for details.
- Standing-Height Cube Bases are 39"H.
- Laminate cube and cylinder bases for tops 108"W and greater feature dual aluminum support beams with integrated wire management.
- Cube bases feature removable door to allow access to cables and enable wire routing.
- Standing-Height Bases feature a hinged door for easy access and for cable routing through the base.

ⓘ Seated Cube Base and Cylinder Base require 150 lbs. of sand or other ballast in each base for stability (not supplied). Standing-Height Cube Base does not require additional ballast.

ⓘ For Base and Top compatibility, see base information on pages 77-84.

**HOW TO SPECIFY**

<b>Select Model Number</b>	<b>Select Laminate</b>	See page 74, Laminate Group B
HTLCUBE180.	LFW1	

# PRESIDE® Metal Bases

GSA SIN 33721



Icon Legend on page 19



DESCRIPTION	MODEL	SHIP WEIGHT	CUBE	LIST PRICE BY PAINT GRADE		
				P1	P2	P3
<b>Footed Y-Base for Tops 60" or Wider</b>						
42½"H Standing Height Base for 42" and 48" x 240" Tops	HT42FB48240	88	10.8	\$3248	\$3518	\$3653
42½"H Standing Height Base for 42" and 48" x 216" Tops	HT42FB48216	85	10.4	\$3104	\$3363	\$3493
42½"H Standing Height Base for 42" and 48" x 192" Tops	HT42FB48192	82	10.1	\$2993	\$3243	\$3366
42½"H Standing Height Base for 42" and 48" x 180" Tops	HT42FB48180	82	10.1	\$2993	\$3243	\$3366
42½"H Standing Height Base for 42" and 48" x 168" Tops	HT42FB48168	67	9.3	\$2296	\$2487	\$2583
<b>Counter Height Bases</b>						
36½"H Counter Height Base for 42" and 48" x 240" Tops	HT36FB48240	86	10.8	\$3168	\$3434	\$3565
36½"H Counter Height Base for 42" and 48" x 216" Tops	HT36FB48216	83	10.4	\$3024	\$3279	\$3404
36½"H Counter Height Base for 42" and 48" x 192" Tops	HT36FB48192	80	10.1	\$2913	\$3159	\$3278
36½"H Counter Height Base for 42" and 48" x 180" Tops	HT36FB48180	80	10.1	\$2913	\$3159	\$3278
36½"H Counter Height Base for 42" and 48" x 168" Tops	HT36FB48168	65	9.3	\$2236	\$2424	\$2517
<b>Seated Height Bases</b>						
29½"H Seated Height Base for 42" and 48" x 240" Tops	HT29FB48240	84	10.8	\$3100	\$3357	\$3489
29½"H Seated Height Base for 42" and 48" x 216" Tops	HT29FB48216	81	10.4	\$2956	\$3203	\$3327
29½"H Seated Height Base for 42" and 48" x 192" Tops	HT29FB48192	78	10.1	\$2845	\$3081	\$3201
29½"H Seated Height Base for 42" and 48" x 180" Tops	HT29FB48180	78	10.1	\$2845	\$3081	\$3201
29½"H Seated Height Base for 42" and 48" x 168" Tops	HT29FB48168	63	9.3	\$2185	\$2367	\$2459
<b>Working Lounge Bases</b>						
27¼"H Working Lounge Base for 42" and 48" x 240" Tops	HT27FB48240	82	10.8	\$3044	\$3297	\$3424
27¼"H Working Lounge Base for 42" and 48" x 216" Tops	HT27FB48216	79	10.4	\$2900	\$3143	\$3263
27¼"H Working Lounge Base for 42" and 48" x 192" Tops	HT27FB48192	76	10.1	\$2789	\$3021	\$3137
27¼"H Working Lounge Base for 42" and 48" x 180" Tops	HT27FB48180	76	10.1	\$2789	\$3021	\$3137
27¼"H Working Lounge Base for 42" and 48" x 168" Tops	HT27FB48168	61	9.3	\$2143	\$2322	\$2411

**NOTES:**

- Tops and bases are sold and shipped separately.
- Bases ship with appropriate number of supports for table width.
- ⚠ Footed base not to be used on 54"D conference tables.
- ⚠ See pages 77-82 for top and base compatibility.
- ⚠ Footed Y-base for tops 84"W or greater feature dual aluminum support beams with integrated wire management. Footed Y-base for 60"W and 72"W tops do not include aluminum beams.

**HOW TO SPECIFY**

<p>Select Model Number</p> <p>HT27FB48168</p>	<p>Select Paint Color</p> <p>See page 74, Paint Group A</p> <p>T1</p>
---	---



# PRESIDE® Metal Bases

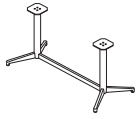

DESCRIPTION	MODEL	SHIP WEIGHT	CUBE	LIST PRICE BY PAINT GRADE		
				P1	P2	P3
<b>Footed Y-Base for Tops 60" or Wider</b>						
42½"H Standing Height Base for 42" and 48" x 144" Tops	HT42FB48144	64	8.9	\$2152	\$2333	\$2422
42½"H Standing Height Base for 42" and 48" x 120" Tops	HT42FB48120	61	8.7	\$2041	\$2212	\$2296
42½"H Standing Height Base for 42" and 48" x 108" Tops	HT42FB48108	61	8.7	\$2041	\$2212	\$2296
42½"H Standing Height Base for 42" and 48" x 96" Tops	HT42FB4896	37	4.9	\$1381	\$1496	\$1555
42½"H Standing Height Base for 42" x 84" Tops	HT42FB4284	36	4.8	\$1360	\$1474	\$1531
42½"H Standing Height Base for 36" x 72" Tops	HT42FB3672	27	4.2	\$1228	\$1321	\$1368
42½"H Standing Height Base for 30" x 60" Tops	HT42FB3060	25	4.2	\$1078	\$1168	\$1213
<b>36½"H Counter Height Base for 42" and 48" x 144" Tops</b>						
36½"H Counter Height Base for 42" and 48" x 120" Tops	HT36FB48120	59	8.7	\$1981	\$2148	\$2230
36½"H Counter Height Base for 42" and 48" x 108" Tops	HT36FB48108	59	8.7	\$1981	\$2148	\$2230
36½"H Counter Height Base for 42" and 48" x 96" Tops	HT36FB4896	36	4.9	\$1341	\$1454	\$1510
36½"H Counter Height Base for 42" x 84" Tops	HT36FB4284	35	4.8	\$1320	\$1432	\$1486
36½"H Counter Height Base for 36" x 72" Tops	HT36FB3672	26	4.2	\$1188	\$1279	\$1323
36½"H Counter Height Base for 30" x 60" Tops	HT36FB3060	24	4.2	\$1042	\$1130	\$1173
<b>29½"H Seated Height Base for 42" and 48" x 144" Tops</b>						
29½"H Seated Height Base for 42" and 48" x 120" Tops	HT29FB48120	57	8.7	\$1930	\$2091	\$2173
29½"H Seated Height Base for 42" and 48" x 108" Tops	HT29FB48108	57	8.7	\$1930	\$2091	\$2173
29½"H Seated Height Base for 42" and 48" x 96" Tops	HT29FB4896	35	4.9	\$1307	\$1416	\$1471
29½"H Seated Height Base for 42" x 84" Tops	HT29FB4284	34	4.8	\$1286	\$1394	\$1448
29½"H Seated Height Base for 36" x 72" Tops	HT29FB3672	25	4.2	\$1154	\$1241	\$1285
29½"H Seated Height Base for 30" x 60" Tops	HT29FB3060	23	4.2	\$1000	\$1084	\$1125
<b>27¼"H Working Lounge Base for 42" and 48" x 144" Tops</b>						
27¼"H Working Lounge Base for 42" and 48" x 120" Tops	HT27FB48120	55	8.7	\$1888	\$2046	\$2123
27¼"H Working Lounge Base for 42" and 48" x 108" Tops	HT27FB48108	55	8.7	\$1888	\$2046	\$2123
27¼"H Working Lounge Base for 42" and 48" x 96" Tops	HT27FB4896	34	4.9	\$1279	\$1386	\$1439
27¼"H Working Lounge Base for 42" x 84" Tops	HT27FB4284	33	4.8	\$1258	\$1364	\$1416
27¼"H Working Lounge Base for 36" x 72" Tops	HT27FB3672	24	4.2	\$1126	\$1211	\$1253
27¼"H Working Lounge Base for 30" x 60" Tops	HT27FB3060	22	4.2	\$976	\$1058	\$1099

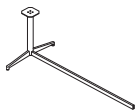

<b>Footed Base Adder for 72"W or Wider Tops</b>						
42"H	HT42FBM	40	4.9	\$2192	\$2322	\$2387
36"H	HT36FBM	39	4.9	\$2132	\$2260	\$2322
29"H	HT29FBM	38	4.9	\$2081	\$2205	\$2267
27"H	HT27FBM	37	4.9	\$2039	\$2161	\$2221



<b>Wire Manager</b>						
Manager for 42"H Footed Base — 1-Pack	HTFWMGR42	2	0.3	\$190	\$207	\$214
Manager for 36"H Footed Base — 1-Pack	HTFWMGR36	1	0.3	\$180	\$196	\$203
Manager for 29"H Footed Base — 1-Pack	HTFWMGR29	1	0.4	\$170	\$185	\$192
Manager for 27"H Footed Base — 1-Pack	HTFWMGR27	1	0.4	\$159	\$173	\$179

**NOTES:**

- Tops and bases are sold and shipped separately.
- Bases ship with appropriate number of supports for table width.
- To conceal any power cords from table top to floor, specify wire manager based on table height. Wire manager adheres to the vertical column of the base.
- ❗ Footed base not to be used on 54"D conference tables.
- ❗ See pages 77-82 for top and base compatibility.
- ❗ Footed Y-base for tops 84"W or greater feature dual aluminum support beams with integrated wire management. Footed Y-base for 60"W and 72"W tops do not include aluminum beams.

## HOW TO SPECIFY

<p>Select Model Number</p> <p>HT29FB48144</p>	<p>Select Paint Color</p> <p>See page 74, Paint Group A</p> <p>T1</p>
---	---



# PRESIDE® Metal Bases

GSA SIN 33721



Icon Legend on page 19

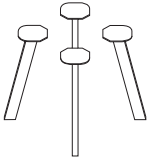

DESCRIPTION	MODEL	SHIP		LIST PRICE BY PAINT GRADE		
		WEIGHT	CUBE	P1	P2	P3
<b>Angled Leg</b>						
42½" Standing Height Base for Round, Square, and Soft Square Tops	<b>HT42ALEG</b>	32	2.6	\$2074	\$2248	\$2333
29½" Seated Height Base for Round, Square, and Soft Square Tops	<b>HT29ALEG</b>	25	2.6	\$1686	\$1827	\$1898
42½" Standing Height Base for 96"W Tops	<b>HT42AL96</b>	32	2.6	\$3111	\$3370	\$3500
42½" Standing Height Base for 84"W Tops	<b>HT42AL84</b>	41	3.1	\$2320	\$2514	\$2611
42½" Standing Height Base for 72"W Tops	<b>HT42AL72</b>	32	2.6	\$2074	\$2248	\$2333
42½" Standing Height Base for 60"W Tops	<b>HT42AL60</b>	32	2.6	\$2074	\$2248	\$2333
29½" Seated Height Base for 240"W Tops	<b>HT29AL240</b>	57	4.5	\$4203	\$4554	\$4731
29½" Seated Height Base for 216"W Tops	<b>HT29AL216</b>	55	4.2	\$4101	\$4443	\$4615
29½" Seated Height Base for 192"W Tops	<b>HT29AL192</b>	53	4.0	\$4014	\$4348	\$4518
29½" Seated Height Base for 180"W Tops	<b>HT29AL180</b>	53	4.0	\$4014	\$4348	\$4518
29½" Seated Height Base for 168"W Tops	<b>HT29AL168</b>	44	3.8	\$3049	\$3304	\$3432
29½" Seated Height Base for 144"W Tops	<b>HT29AL144</b>	42	3.5	\$2947	\$3194	\$3317
29½" Seated Height Base for 120"W Tops	<b>HT29AL120</b>	40	3.3	\$2860	\$3098	\$3219
29½" Seated Height Base for 108"W Tops	<b>HT29AL108</b>	40	3.3	\$2860	\$3098	\$3219
29½" Seated Height Base for 96"W Tops	<b>HT29AL96</b>	37	3.3	\$1934	\$2093	\$2173
29½" Seated Height Base for 84"W Tops	<b>HT29AL84</b>	34	3.1	\$1932	\$2093	\$2176
29½" Seated Height Base for 72"W Tops	<b>HT29AL72</b>	25	2.6	\$1686	\$1827	\$1898
29½" Seated Height Base for 60"W Tops	<b>HT29AL60</b>	25	2.6	\$1686	\$1827	\$1898
29½" Seated Height Base for 72"W Adder	<b>HT29ALM</b>	38	3.3	\$1154	\$1251	\$1300



DESCRIPTION	MODEL	SHIP WEIGHT	SHIP CUBE	P1	P2	P3
<b>Wire Manager</b>						
Angled Leg Wire Manager for 42½"H Leg	<b>HTALWMGR42</b>	3	4.0	\$126	\$138	\$143
Angled Leg Wire Manager for 29½"H Leg	<b>HTALWMGR29</b>	2	4.0	\$100	\$110	\$114

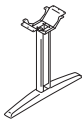

DESCRIPTION	LEGS INCLUDED PER KIT	MODEL	SHIP		LIST PRICE BY PAINT GRADE		
			WEIGHT	CUBE	P1	P2	P3
<b>Aluminum T-Leg for Tops 60" or Wider</b>							
For 240"W Table Tops	4	<b>HTTLEG240</b>	76	8.9	\$2453	\$2497	\$2518
For 216"W Table Tops	3	<b>HTTLEG216</b>	65	8.6	\$1962	\$2006	\$2027
For 192"W Table Tops	3	<b>HTTLEG192</b>	63	8.4	\$1875	\$1919	\$1940
For 180"W Table Tops	3	<b>HTTLEG180</b>	63	8.4	\$1875	\$1919	\$1940
For 168"W Table Tops	3	<b>HTTLEG168</b>	54	8.2	\$1753	\$1797	\$1818
For 144"W Table Tops	2	<b>HTTLEG144</b>	39	4.5	\$1229	\$1251	\$1262
For 120"W Table Tops	2	<b>HTTLEG120</b>	37	4.3	\$1142	\$1164	\$1175
For 108"W Table Tops	2	<b>HTTLEG108</b>	37	4.2	\$1142	\$1164	\$1175
For 96"W Table Tops	2	<b>HTTLEG96</b>	31	4.0	\$1057	\$1079	\$1090
For 84"W Table Tops	2	<b>HTTLEG84</b>	31	4.0	\$1057	\$1079	\$1090
For 72"W Table Tops	2	<b>HTTLEG72</b>	26	3.5	\$811	\$833	\$844
For 60"W Table Tops	2	<b>HTTLEG60</b>	22	3.5	\$811	\$833	\$844
For 72" Adder Section	1	<b>HTTLEGM</b>	26	4.2	\$733	N/A	N/A

**NOTES:**

- Tops and bases are sold and shipped separately.
- Bases ship with appropriate number of supports for table width.
- To conceal any power cords from table top to floor, specify wire manager based on table height. Angled leg wire manager is friction fit with magnets to hold in place.
- ❗ Aluminum T-legs for tops 84" and greater feature dual aluminum support beams with integrated wire management. Aluminum T-legs for 60" and 72" tops do not include aluminum beams.
- ❗ Footed base not to be used on 54"D conference tables.
- ❗ See pages 77-82 for top and base compatibility.

**HOW TO SPECIFY**

<p>Select Model Number</p>	<p>Select Paint Color</p> <p>See page 74, Paint Group A</p>
<p>HT42ALEG</p>	<p>PR6</p>



# PRESIDE® Laminate Bases

	DESCRIPTION	BASES INCLUDED		SHIP WEIGHT	CUBE	LIST PRICE BY LAMINATE GRADE		
		PER KIT	MODEL			L1	L2	
	<b>Laminate Cube Base for Round, Square, and Soft Square Tops</b>							
	For 60" Round and all 48" Tops, Seated-Height	1	<b>HTLCUBE48</b>	82	9.1	<b>\$1284</b>	<b>\$1334</b>	
	For 60" Round and all 48" Tops, Standing-Height	1	<b>HTLCUBES48</b>	90	14.6	<b>\$1610</b>	<b>\$1670</b>	
<hr/>								
	<b>Laminate Cylinder Base for Round, Square, and Soft Square Tops</b>							
	For 48" Tops	1	<b>HTLR48</b>	53	16.7	<b>\$988</b>	<b>\$1027</b>	
	For 42" Tops	1	<b>HTLR42</b>	42	11.6	<b>\$892</b>	<b>\$931</b>	
	For 36" Tops	1	<b>HTLR36</b>	42	11.6	<b>\$892</b>	<b>\$931</b>	
<i>Used with 36" and 42" table tops</i>	<i>Used with 48" table tops</i>	For 48" Tops, with Wire Management	1	<b>HTLRC48</b>	53	16.7	<b>\$1367</b>	<b>\$1417</b>
<hr/>								
	<b>Laminate Panel X-Base</b>	1	<b>HTLXP48</b>	54	5.2	<b>\$574</b>	<b>\$596</b>	
		1	<b>HTLXP42</b>	54	5.2	<b>\$574</b>	<b>\$596</b>	
		1	<b>HTLXP36</b>	47	4.7	<b>\$535</b>	<b>\$557</b>	
NOTES: Can be used with 36", 42" and 48" Round and Soft Square Tops, and 36" and 42" Square Tops.								
Not compatible with cutouts or power ports.								

**NOTES:**

- Tops and bases are sold and shipped separately.
- Cube Base features removable door for wire management.
- Cube and Cylinder Bases require 150 lbs. of sand or other ballast in each base for stability (not supplied).
- See pages 77-82 for top and base compatibility.

## HOW TO SPECIFY

<b>Select Model Number</b>	<b>Select Laminate</b>
HTLCUBE48	See page 74, Laminate Group B
D	

# PRESIDE® Metal Bases

GSA SIN 33721



Icon Legend on page 19



DESCRIPTION	MODEL	SHIP WEIGHT	CUBE	LIST PRICE	P2 LIST PRICE
Aluminum X-Leg Base for 36", 42", and 48" Round, Square, and Soft Square Tops	HTXLEG	16	3.5	\$643	\$665

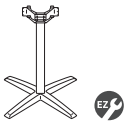

Standing-Height Aluminum X-Leg Base for 36" and 42" Round, Square, and Soft Square Tops	HTXLEGSH	17	3.5	\$804	\$826
---	----------	----	-----	-------	-------



DESCRIPTION	MODEL	SHIP WEIGHT	CUBE	LIST PRICE BY PAINT GRADE		
				P1	P2	P3
<b>Footed Café X-Base</b>						
42½"H Standing Height X-Base for 48" Tops	HTFXL42	32	3.7	\$889	\$965	\$1001
42½"H Standing Height X-Base for 36" and 42" Tops	HTFXM42	31	3.7	\$811	\$879	\$913
42½"H Standing Height X-Base for 30" Tops	HTFXS42	30	3.7	\$696	\$755	\$784
36½"H Counter Height X-Base for 48" Tops	HTFXL36	31	3.7	\$831	\$901	\$936
36½"H Counter Height X-Base for 36" and 42" Tops	HTFXM36	30	3.7	\$750	\$813	\$844
36½"H Counter Height X-Base for 30" Tops	HTFXS36	29	3.7	\$650	\$705	\$732
29½"H Seated Height X-Base for 48" and 60" Tops	HTFXL29	30	3.7	\$740	\$802	\$833
29½"H Seated Height X-Base for 36" and 42" Tops	HTFXM29	29	3.7	\$682	\$740	\$768
29½"H Seated Height X-Base for 30" Tops	HTFXS29	28	3.7	\$605	\$657	\$682
29½"H Seated Height X-Base for 24" Tops	HTFXT29	27	3.7	\$554	\$601	\$624
27¼"H Working Lounge X-Base for 48" and 60" Tops	HTFXL27	29	3.7	\$676	\$733	\$761
27¼"H Working Lounge X-Base for 36" and 42" Tops	HTFXM27	28	3.7	\$616	\$669	\$695
27¼"H Working Lounge X-Base for 30" Tops	HTFXS27	27	3.7	\$546	\$592	\$614
27¼"H Working Lounge X-Base for 24" Tops	HTFXT27	26	3.7	\$520	\$564	\$585

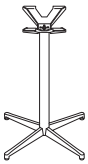

<b>Footed Café X-Base w/Power</b>						
42½"H Standing Height X-Base for 48" Tops	HTFXL42P	32	3.7	\$889	\$965	\$1001
42½"H Standing Height X-Base for 36" and 42" Tops	HTFXM42P	31	3.7	\$811	\$879	\$913
42½"H Standing Height X-Base for 30" Tops	HTFXS42P	30	3.7	\$696	\$755	\$784
36½"H Counter Height X-Base for 48" Tops	HTFXL36P	31	3.7	\$831	\$901	\$936
36½"H Counter Height X-Base for 36" and 42" Tops	HTFXM36P	31	3.7	\$750	\$813	\$844
36½"H Counter Height X-Base for 30" Tops	HTFXS36P	29	3.7	\$650	\$705	\$732
29½"H Seated Height X-Base for 48" and 60" Tops	HTFXL29P	30	3.7	\$740	\$802	\$833
29½"H Seated Height X-Base for 36" and 42" Tops	HTFXM29P	29	3.7	\$682	\$740	\$768
29½"H Seated Height X-Base for 30" Tops	HTFXS29P	28	3.7	\$605	\$657	\$682
29½"H Seated Height X-Base for 24" Tops	HTFXT29P	27	3.7	\$554	\$601	\$624
27¼"H Working Lounge X-Base for 48" and 60" Tops	HTFXL27P	29	3.7	\$676	\$733	\$761
27¼"H Working Lounge X-Base for 36" and 42" Tops	HTFXM27P	28	3.7	\$616	\$669	\$695
27¼"H Working Lounge X-Base for 30" Tops	HTFXS27P	27	3.7	\$546	\$592	\$614
27¼"H Working Lounge X-Base for 24" Tops	HTFXT27P	26	3.7	\$520	\$564	\$585



<b>Footed Café X-Base w/Casters</b>						
42½"H Standing Height X-Base for 48" Tops	HTFXL42C	32	3.7	\$920	\$998	\$1036
42½"H Standing Height X-Base for 36" and 42" Tops	HTFXM42C	31	3.7	\$843	\$914	\$950
36½"H Counter Height X-Base for 48" Tops	HTFXL36C	31	3.7	\$864	\$938	\$973
36½"H Counter Height X-Base for 36" and 42" Tops	HTFXM36C	30	3.7	\$783	\$849	\$882
29½"H Seated Height X-Base for 48" Tops	HTFXL29C	30	3.7	\$772	\$837	\$870
29½"H Seated Height X-Base for 36" and 42" Tops	HTFXM29C	29	3.7	\$713	\$773	\$803
27¼"H Working Lounge X-Base for 48" Tops	HTFXL27C	29	3.7	\$708	\$768	\$797
27¼"H Working Lounge X-Base for 36" and 42" Tops	HTFXM27C	28	3.7	\$650	\$705	\$732

**NOTES:**

- Tops and bases are sold and shipped separately.
- HTXLEG and HTXLEGSH allow wires to pass through the center of the leg.
- Grommet cutouts not compatible with Footed Café X-Base and Footed Café X-Base with Casters.
- ❗ Footed Café X-Base with Power allows wires to pass through the center of the leg except when using power compatible with a G2 cutout.
- ❗ Cannot specify grommet cutouts in top when using footed X-base and footed X-base with casters. Utilize footed X-base with power for situations where power/grommet cutouts are needed.
- ❗ See pages 77-82 for top and base compatibility.

**HOW TO SPECIFY**

<p>Select Model Number</p> <p>HTFXL42 .</p>	<p>Select Paint Color</p> <p>See page 74, Paint Group A</p> <p>P J W</p>
---	--



Icon Legend on page 19

# PRESIDE® Collaborative Tables

	DESCRIPTION	MODEL	SHIP WEIGHT	CUBE	LIST PRICE BY LAMINATE GRADE	
					L1	L2
	<b>Seated-Height, Collaborative Table with Partial Modesty Panel</b>					
	60"W x 42"D	<b>HTLC4260LCTP</b>	152	2.8	<b>\$1498</b>	<b>\$1522</b>
	72"W x 42"D	<b>HTLC4272LCTP</b>	167	14.5	<b>\$1782</b>	<b>\$1815</b>
	96"W x 42"D	<b>HTLC4296LCTP</b>	122	18.3	<b>\$2195</b>	<b>\$2228</b>
	<b>Standing-Height, Collaborative Table with Partial Modesty Panel</b>					
	60"W x 42"D	<b>HTLC4260HCTP</b>	187	3.7	<b>\$1710</b>	<b>\$1734</b>
	72"W x 42"D	<b>HTLC4272HCTP</b>	187	15.7	<b>\$1994</b>	<b>\$2027</b>
	96"W x 42"D	<b>HTLC4296HCTP</b>	242	19.4	<b>\$2407</b>	<b>\$2440</b>
	<b>Seated-Height, Collaborative Table with Full Modesty Panel</b>					
	60"W x 42"D	<b>HTLC4260LCTFP</b>	167	13.4	<b>\$1498</b>	<b>\$1522</b>
	72"W x 42"D	<b>HTLC4272LCTFP</b>	175	14.9	<b>\$1782</b>	<b>\$1815</b>
	96"W x 42"D	<b>HTLC4296LCTFP</b>	233	18.8	<b>\$2195</b>	<b>\$2228</b>
	<b>Standing-Height, Collaborative Table with Full Modesty Panel</b>					
	60"W x 42"D	<b>HTLC4260HCTFP</b>	202	17.0	<b>\$1710</b>	<b>\$1734</b>
	72"W x 42"D	<b>HTLC4272HCTFP</b>	211	17.9	<b>\$1994</b>	<b>\$2027</b>
	96"W x 42"D	<b>HTLC4296HCTFP</b>	275	22.4	<b>\$2407</b>	<b>\$2440</b>

**NOTES:**

- Tops feature 2mm flat edge.
- Partial modesty models will feature different modesty heights than units produced on or before March 16, 2020.
- Tables with partial and full modesty panels always feature cutout in modesty panel to accommodate grommet inserts in the top. However, top cutout is optional. Wire management is not included in legs.

## HOW TO SPECIFY

<p><b>Select Model Number</b></p> <p>HTLC4272LCTP</p>	<p><b>Select Cutout Option</b></p> <p><b>N</b> No Cutout  <b>G1</b> Cutout for Pop-up Port (\$44 upcharge)  <b>G2</b> Cutout for Flip-top Port (\$55 upcharge)</p> <p>N</p>	<p><b>Select Top Laminate Color</b></p> <p>See page 74, Laminate Group A</p> <p>H</p>	<p><b>Select Base Laminate Color</b></p> <p>See page 74, Laminate Group B</p> <p>H</p>	<p><b>Select Modesty Laminate Color</b></p> <p>See page 74, Laminate Group B  <i>Do not specify for Power Management models</i></p> <p>LDW1</p>	<p><b>Select 2mm Edge Color</b></p> <p>See page 75</p> <p>H</p>
---	---	---	--	---	---

# PRESIDE® Ganging Tables

GSA SIN 33721



Icon Legend on page 19

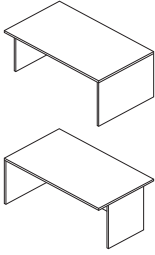

DESCRIPTION	MODEL	SHIP WEIGHT	CUBE	LIST PRICE BY LAMINATE GRADE	
				L1	L2
<b>Seated-Height, Partial Modesty — Full Right Leg</b>					
60"W x 42"D	HTLC4260LCTPR	165	13.8	\$1506	\$1530
72"W x 42"D	HTLC4272LCTPR	170	14.2	\$1790	\$1823
96"W x 42"D	HTLC4296LCTPR	223	38.9	\$2203	\$2250
<b>Seated-Height, Partial Modesty — Full Left Leg</b>					
60"W x 42"D	HTLC4260LCTPL	165	13.8	\$1506	\$1530
72"W x 42"D	HTLC4272LCTPL	170	14.2	\$1790	\$1823
96"W x 42"D	HTLC4296LCTPL	223	38.9	\$2203	\$2250
<b>Standing-Height, Partial Modesty — Full Right Leg</b>					
60"W x 42"D	HTLC4260HCTPR	207	16.2	\$1721	\$1745
72"W x 42"D	HTLC4272HCTPR	216	16.9	\$2005	\$2038
96"W x 42"D	HTLC4296HCTPR	274	41.6	\$2418	\$2465
<b>Standing-Height, Partial Modesty — Full Left Leg</b>					
60"W x 42"D	HTLC4260HCTPL	207	16.2	\$1721	\$1745
72"W x 42"D	HTLC4272HCTPL	216	16.9	\$2005	\$2038
96"W x 42"D	HTLC4296HCTPL	274	41.6	\$2418	\$2465

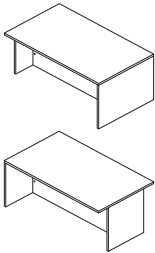

<b>Seated-Height, Full Modesty — Full Right Leg</b>					
60"W x 42"D	HTLC4260LCTFPR	180	14.2	\$1506	\$1530
72"W x 42"D	HTLC4272LCTFPR	188	14.2	\$1790	\$1823
96"W x 42"D	HTLC4296LCTFPR	247	39.3	\$2203	\$2250
<b>Seated-Height, Full Modesty — Full Left Leg</b>					
60"W x 42"D	HTLC4260LCTFPL	180	14.2	\$1506	\$1530
72"W x 42"D	HTLC4272LCTFPL	188	14.2	\$1790	\$1823
96"W x 42"D	HTLC4296LCTFPL	247	39.3	\$2203	\$2250
<b>Standing-Height, Full Modesty — Full Right Leg</b>					
60"W x 42"D	HTLC4260HCTFPR	223	18.0	\$1721	\$1745
72"W x 42"D	HTLC4272HCTFPR	234	18.9	\$2005	\$2038
96"W x 42"D	HTLC4296HCTFPR	299	44.7	\$2418	\$2465
<b>Standing-Height, Full Modesty — Full Left Leg</b>					
60"W x 42"D	HTLC4260HCTFPL	223	18.0	\$1721	\$1745
72"W x 42"D	HTLC4272HCTFPL	234	18.9	\$2005	\$2038
96"W x 42"D	HTLC4296HCTFPL	299	44.7	\$2418	\$2465

**NOTES:**

- Maximum of 2 ganging tables can be used together. However, different widths may be combined to optimize your space (i.e., 60"W left-hand and 96"W right-hand can be combined).
- Ganging tables ship with all required hardware and light gap filler strip for use between the two partial legs.
- Tops feature 2mm flat edge.

ⓘ Tables with partial and full modesty panels always feature cutout in modesty panel to accommodate grommet inserts in the top. However, top cutout is optional. Wire management is not included in legs.

## HOW TO SPECIFY

<p><b>Select Model Number</b></p>	<p><b>Select Grommet Cutout</b></p> <p><b>N</b> No Grommet  <b>G1</b> G1 Grommet (centered, + \$44 upcharge)  <b>G2</b> G2 Grommet (centered, + \$55 upcharge)</p>	<p><b>Select Top Laminate Color</b></p> <p>See page 74, Laminate Group A</p>	<p><b>Select Base Laminate Color</b></p> <p>See page 74, Laminate Group B</p>	<p><b>Select Modesty Laminate Color</b></p> <p>See page 74, Laminate Group B  <i>Do not specify for Power Management models</i></p>	<p><b>Select 2mm Edge Color</b></p> <p>See page 75</p>
<p>H T L C 4 2 6 0 L C T P R .</p>	<p>G 1 .</p>	<p>L S A 1 .</p>	<p>H .</p>	<p>L S A 1 .</p>	<p>H</p>



Icon Legend on page 19

# PRESIDE® Collaborative Tables

	DESCRIPTION	MODEL	SHIP WEIGHT	CUBE	LIST PRICE BY LAMINATE GRADE	
					L1	L2
	<b>Seated-Height, Collaborative Table with Partial Modesty Panel</b>					
	60"W x 30"D	<b>HTLC3060LCTP</b>	136	11.1	<b>\$1269</b>	<b>\$1290</b>
	72"W x 30"D	<b>HTLC3072LCTP</b>	150	12.6	<b>\$1531</b>	<b>\$1560</b>
	96"W x 30"D	<b>HTLC3096LCTP</b>	184	15.7	<b>\$1902</b>	<b>\$1943</b>
	<b>Standing-Height, Collaborative Table with Partial Modesty Panel</b>					
	60"W x 30"D	<b>HTLC3060HCTP</b>	174	13.1	<b>\$1451</b>	<b>\$1472</b>
	72"W x 30"D	<b>HTLC3072HCTP</b>	192	14.8	<b>\$1713</b>	<b>\$1742</b>
	96"W x 30"D	<b>HTLC3096HCTP</b>	232	18.0	<b>\$2084</b>	<b>\$2125</b>
	<b>Seated-Height, Collaborative Table with Full Modesty Panel</b>					
	60"W x 30"D	<b>HTLC3060LCTFP</b>	151	11.5	<b>\$1269</b>	<b>\$1290</b>
	72"W x 30"D	<b>HTLC3072LCTFP</b>	168	13.1	<b>\$1531</b>	<b>\$1560</b>
	96"W x 30"D	<b>HTLC3096LCTFP</b>	208	16.1	<b>\$1902</b>	<b>\$1943</b>
	<b>Standing-Height, Collaborative Table with Full Modesty Panel</b>					
	60"W x 30"D	<b>HTLC3060HCTFP</b>	190	14.8	<b>\$1451</b>	<b>\$1472</b>
	72"W x 30"D	<b>HTLC3072HCTFP</b>	210	16.9	<b>\$1713</b>	<b>\$1742</b>
	96"W x 30"D	<b>HTLC3096HCTFP</b>	256	21.1	<b>\$2084</b>	<b>\$2125</b>

**NOTES:**

• Tops feature 2mm flat edge.

! Tables with partial and full modesty panels always feature cutout in modesty panel to accommodate grommet inserts in the top. However, top cutout is optional. Wire management is not included in legs.

! 30"D Preside Collaborative tables grommet is offset. Please see reference diagram below for exact location.

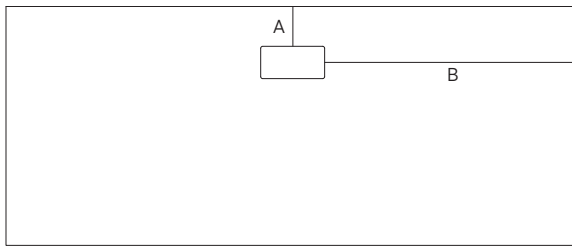

G1 CUTOUT		
WORKSURFACE WIDTH	"A" DIMENSION	"B" DIMENSION
60"	5.0"	25.96"
72"	5.0"	31.96"
96"	5.0"	43.96"

G2 CUTOUT		
WORKSURFACE WIDTH	"A" DIMENSION	"B" DIMENSION
60"	4.02"	24.45"
72"	4.02"	30.45"
96"	4.02"	42.45"

**HOW TO SPECIFY**

<p><b>Select Model Number</b></p> <p>HTLC3060LCTP .</p>	<p><b>Select Cutout Option</b></p> <p><b>N</b> No Cutout  <b>G1</b> Cutout for Pop-up Port (\$44 upcharge)  <b>G2</b> Cutout for Flip-top Port (\$55 upcharge)</p> <p>N .</p>	<p><b>Select Top Laminate Color</b></p> <p>See page 74, Laminate Group A</p> <p>H .</p>	<p><b>Select Base Laminate Color</b></p> <p>See page 74, Laminate Group B</p> <p>H .</p>	<p><b>Select Modesty Laminate Color</b></p> <p>See page 74, Laminate Group B  <i>Do not specify for Power Management models</i></p> <p>LDW1 .</p>	<p><b>Select 2mm Edge Color</b></p> <p>See page 75</p> <p>H</p>
---	---	---	--	---	---

# PRESIDE® Ganging Tables

GSA SIN 33721



Icon Legend on page 19

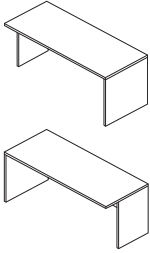

DESCRIPTION	MODEL	SHIP WEIGHT	CUBE	LIST PRICE BY LAMINATE GRADE	
				L1	L2
<b>Seated-Height, Partial Modesty — Full Right Leg</b>					
60"W x 30"D	HTLC3060LCTPR	128	11.1	\$1269	\$1290
72"W x 30"D	HTLC3072LCTPR	175	12.6	\$1531	\$1560
96"W x 30"D	HTLC3096LCTPR	286	15.7	\$1902	\$1943
<b>Seated-Height, Partial Modesty — Full Left Leg</b>					
60"W x 30"D	HTLC3060LCTPL	128	11.1	\$1269	\$1290
72"W x 30"D	HTLC3072LCTPL	175	12.6	\$1531	\$1560
96"W x 30"D	HTLC3096LCTPL	286	15.7	\$1902	\$1943
<b>Standing-Height, Partial Modesty — Full Right Leg</b>					
60"W x 30"D	HTLC3060HCTPR	163	13.1	\$1451	\$1472
72"W x 30"D	HTLC3072HCTPR	180	14.8	\$1713	\$1742
96"W x 30"D	HTLC3096HCTPR	220	18.0	\$2084	\$2125
<b>Standing-Height, Partial Modesty — Full Left Leg</b>					
60"W x 30"D	HTLC3060HCTPL	163	13.1	\$1451	\$1472
72"W x 30"D	HTLC3072HCTPL	180	14.8	\$1713	\$1742
96"W x 30"D	HTLC3096HCTPL	220	18.0	\$2084	\$2125

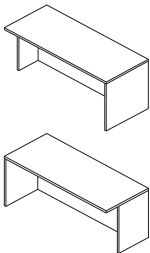

<b>Seated-Height, Full Modesty — Full Right Leg</b>					
60"W x 30"D	HTLC3060LCTFPR	143	11.5	\$1269	\$1290
72"W x 30"D	HTLC3072LCTFPR	160	13.1	\$1531	\$1560
96"W x 30"D	HTLC3096LCTFPR	200	16.1	\$1902	\$1943
<b>Seated-Height, Full Modesty — Full Left Leg</b>					
60"W x 30"D	HTLC3060LCTFPL	143	11.5	\$1269	\$1290
72"W x 30"D	HTLC3072LCTFPL	160	13.1	\$1531	\$1560
96"W x 30"D	HTLC3096LCTFPL	200	16.1	\$1902	\$1943
<b>Standing-Height, Full Modesty — Full Right Leg</b>					
60"W x 30"D	HTLC3060HCTFPR	178	14.8	\$1451	\$1472
72"W x 30"D	HTLC3072HCTFPR	199	16.9	\$1713	\$1742
96"W x 30"D	HTLC3096HCTFPR	245	21.1	\$2084	\$2125
<b>Standing-Height, Full Modesty — Full Left Leg</b>					
60"W x 30"D	HTLC3060HCTFPL	178	14.8	\$1451	\$1472
72"W x 30"D	HTLC3072HCTFPL	199	16.9	\$1713	\$1742
96"W x 30"D	HTLC3096HCTFPL	245	21.1	\$2084	\$2125

**NOTES:**

- Maximum of 2 ganging tables can be used together. However, different widths may be combined to optimize your space (i.e., 60"W left-hand and 96"W right-hand can be combined).
- Ganging tables ship with all required hardware and light gap filler strip for use between the two partial legs.
- Tops feature 2mm flat edge.
- ⚠ Tables with partial and full modesty panels always feature cutout in modesty panel to accommodate grommet inserts in the top. However, top cutout is optional. Wire management is not included in legs.
- ⚠ Collaborative Tables with power management will not have modesty panels.
- ⚠ 30"D Collaborative Table Modesty Panel will be offset to allow more leg room on one side of the table.

**HOW TO SPECIFY**

Select Model Number	Select Grommet Cutout	Select Top Laminate Color	Select Base Laminate Color	Select Modesty Laminate Color	Select 2mm Edge Color
N G1 G2	No Grommet G1 G1 Grommet (centered, + \$44 upcharge) G2 G2 Grommet (centered, + \$55 upcharge)	See page 74, Laminate Group A	See page 74, Laminate Group B	See page 74, Laminate Group B	See page 75
HTLC3060LCTPR	G1	LSA1	H	LSA1	H





# PRESIDE® Mobile Collaborative Tables

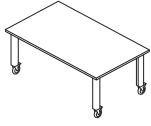

DESCRIPTION	MODEL	SHIP WEIGHT	CUBE	LIST PRICE BY LAMINATE GRADE	
				L1	L2
<b>Mobile Collaborative Tables</b>					
42" x 96" Seated	HTMC304296	205	16.5	\$2809	\$2856
42" x 72" Seated	HTMC304272	167	13.4	\$2463	\$2504
42" x 60" Seated	HTMC304260	147	12.1	\$2141	\$2172
<b>Mobile Collaborative Tables with Butcher Block Top</b>					
42" x 96" Standing	HTMC424296	219	17.8	\$2903	\$2950
42" x 72" Standing	HTMC424272	181	14.6	\$2557	\$2598
42" x 60" Standing	HTMC424260	161	13.3	\$2235	\$2266

DESCRIPTION	MODEL	SHIP WEIGHT	CUBE	BUTCHER BLOCK
42" x 96" Seated	HTMC304296BB	206	9.6	\$4192
42" x 72" Seated	HTMC304272BB	191	7.6	\$3595
42" x 60" Seated	HTMC304260BB	167	7.1	\$3154
42" x 96" Standing	HTMC424296BB	220	10.9	\$4286
42" x 72" Standing	HTMC424272BB	205	8.9	\$3689
42" x 60" Standing	HTMC424260BB	181	8.5	\$3248

**NOTES:**

- Mobile collaborative tables standard with 4 locking 5" casters.
- Laminate tops feature 2mm flat edge.
- Butcher block top is 1½" thick and features 1½" radius corners.
- Butcher block tops will naturally feature variation between tops due to the nature of the real wood finish. Constructed of natural Birch wood, no two tops are exactly alike. Top is coated in a clear polyurethane finish for maximum durability.

## HOW TO SPECIFY

<b>Select Model Number</b>	<b>Select Grommet Cutout</b> N No Grommet	<b>Select Top Laminate Color</b> See page 74, Laminate Group A	<b>Select Edge Color</b> See page 75	<b>Select Caster</b> C With Caster	<b>Select Paint Color</b> See page 74
HTMC304296	N	LSA1	LSA1	C	T1

<b>Select Model Number</b>	<b>Select Grommet Cutout</b> N No Grommet	<b>Select Wood</b> LH903 Butcher Block	<b>Select Caster</b> C With Caster	<b>Select Paint Color</b> See page 74
HTMC304296BB	N	LH903	C	T1

# PRESIDE® Team Touchdown Tables

GSA SIN 33721



Icon Legend on page 19

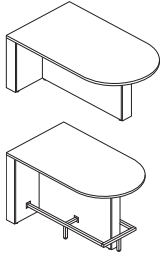

DESCRIPTION	MODEL	SHIP WEIGHT	CUBE	LIST PRICE BY LAMINATE GRADE	
				L1	L2
<b>Team Touchdown Tables</b>					
42" x 72" Seated Table	<b>HTLMT4272L</b>	202	12.5	<b>\$1701</b>	<b>\$1740</b>
42" x 60" Seated Table	<b>HTLMT4260L</b>	170	10.0	<b>\$1402</b>	<b>\$1433</b>
42" x 72" Standing Table	<b>HTLMT4272H</b>	246	14.2	<b>\$2089</b>	<b>\$2128</b>
42" x 60" Standing Table	<b>HTLMT4260H</b>	208	11.4	<b>\$1731</b>	<b>\$1762</b>
42" x 72" Standing Table w/ Footring	<b>HTLMT4272HFR</b>	272	24.5	<b>\$3421</b>	<b>\$3460</b>
42" x 60" Standing Table w/ Footring	<b>HTLMT4260HFR</b>	231	19.6	<b>\$2846</b>	<b>\$2877</b>

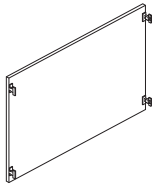

Back Panel for Seated Team Touchdown Table	<b>HTLMTLBACK</b>	23	3.2	<b>\$387</b>	<b>\$404</b>
Back Panel for Standing Team Touchdown Table	<b>HTLMTLHBACK</b>	33	4.5	<b>\$437</b>	<b>\$456</b>

NOTES: Specify Laminate, see page 74, Laminate Group B.  
**SPECIFYING EXAMPLE: HTLMTLBACK.LSA1**

**NOTES:**

- Team Touchdown Tables feature open back standard. If closed back is desired, back panels must be specified separately.
- Back panel provides clearance for TV mount.
- Tops feature 2mm flat edge.

**HOW TO SPECIFY**

<p><b>Select Model Number</b></p> <p>HTLMT4272L</p>	<p><b>Select Grommet Cutout</b></p> <p><b>N</b> No Grommet  <b>G1</b> G1 Grommet (centered, + \$44 upcharge)  <b>G2</b> G2 Grommet (centered, + \$55 upcharge)</p> <p>G1</p>	<p><b>Select Top Laminate Color</b></p> <p>See page 74, Laminate Group A</p> <p>LSA1</p>	<p><b>Select Edge Color</b></p> <p>See page 75</p> <p>LSA1</p>	<p><b>Select Chassis Laminate</b></p> <p>See page 74, Laminate Group B</p> <p>LSA1</p>	<p><b>Select Paint Color</b></p> <p><i>Footring only available on FR models in CBK only</i></p> <p>CBK</p>
---	--	--	--	--	--

DESCRIPTION	MODEL	SHIP WEIGHT	CUBE	LIST PRICE BY PAINT GRADE	
				P1	P2
<b>TV Mount</b>	<b>HTLMTTV</b>	4	1.0	<b>\$391</b>	<b>\$424</b>

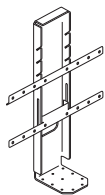

**NOTES:**

- TV mount is used to mount a television to the flat end of a Team Touchdown Table.
- Mounting hardware provided for television sizes 32" to 50" with VESA mounts of 100x100 to 200x200; for some televisions, additional hardware will be required (not provided).

**HOW TO SPECIFY**

<p><b>Select Model Number</b></p> <p>HTLMTTV</p>	<p><b>Select Paint Color</b></p> <p><b>P</b> Black</p> <p>P</p>
--	---

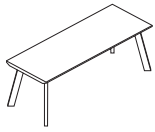

DESCRIPTION	MODEL	SHIP WEIGHT	CUBE	LIST PRICE BY PAINT GRADE		L2 UPCHARGE
				P1	P2	
<b>Benches</b>						
18"D x 60"W	<b>HTLBENCH60</b>	23	2.3	\$1912	\$2021	\$27
18"D x 48"W	<b>HTLBENCH48</b>	21	1.8	\$1557	\$1644	\$22
18"D x 30"W	<b>HTLBENCH30</b>	18	1.8	\$1137	\$1200	\$17

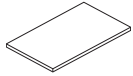

DESCRIPTION	MODEL	SHIP WEIGHT	CUBE	LIST PRICE BY FABRIC GRADE					
				1	2	3	4	5	6
<b>Bench Cushion</b>									
18"D x 60"W	<b>HTLBENCHCUSH60</b>	16	3.6	\$436	\$484	\$563	\$585	\$646	\$710
18"D x 48"W	<b>HTLBENCHCUSH48</b>	12	2.9	\$388	\$431	\$502	\$521	\$575	\$634
18"D x 30"W	<b>HTLBENCHCUSH30</b>	8	1.9	\$330	\$367	\$427	\$443	\$489	\$538

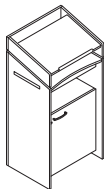

DESCRIPTION	MODEL	SHIP WEIGHT	CUBE	LIST PRICE BY LAMINATE GRADE	
				L1	L2
<b>Laminate Lectern</b>	<b>HTLLECTA</b>	132	15.6	\$1946	\$2017
<ul style="list-style-type: none"> <li>• Overall cabinet dimensions 24"W x 18"D x 50"H.</li> <li>• Adjustable top worksurface features 3 tilt positions.</li> <li>• Top of lectern can be removed and used on table top.</li> <li>• Laptop shelf slides left or right.</li> <li>• Includes 2 locking and 2 non-locking casters.</li> <li>• Includes adjustable shelf in storage compartment.</li> <li>• Features scallops in rear of lectern to route and conceal cables and wires.</li> <li>• Metal components standard in black finish.</li> </ul>					

**NOTES:**

- Bench features knife edge along two long sides of seat; depth edges of top features flat edge allowing benches to be placed side by side without gaps.
- Bench cushions attach to bench seat with hook and loop.
- Fabric for bench cushions is upholstered in the railroad direction.

## HOW TO SPECIFY

<p>Select Model Number</p> <p>HTLBENCH48</p>	<p>Select Top Laminate Color</p> <p>See page 74, Laminate Group A</p> <p>LSA1</p>	<p>Select Edge Color</p> <p>See page 75</p> <p>SA</p>	<p>Select Paint Color</p> <p>See page 74, Paint Group A</p> <p>T1</p>
<p>Select Model Number</p> <p>HTLBENCHCUSH48</p>	<p>Select Fabric</p> <p>See page 74</p> <p>PBLE09</p>		
<p>Select Model Number</p> <p>HTLLECTA</p>	<p>Select Laminate</p> <p>See page 74, Laminate Group B</p> <p>H</p>	<p>Select Pull</p> <p>J Loop Satin Nickel G Loop Black</p> <p>G</p>	

# PRESIDE® Laminate Storage

GSA SIN AS NOTED



Icon Legend on page 19

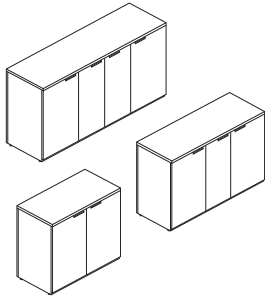

**DESCRIPTION**

**Hospitality Credenza**  
 21<sup>1</sup>/<sub>16</sub>"D x 72"W x 36"H  
 21<sup>1</sup>/<sub>16</sub>"D x 57"W x 36"H  
 21<sup>1</sup>/<sub>16</sub>"D x 42"W x 36"H

MODEL	SHIP WEIGHT	CUBE	L1 LIST PRICE
<b>HTLCRED72</b>	301	40.0	<b>\$3623</b>
<b>HTLCRED57</b>	250	31.8	<b>\$3143</b>
<b>HTLCRED42</b>	200	23.7	<b>\$2502</b>

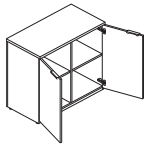

**Hospitality Credenza with Shelves**

21<sup>1</sup>/<sub>16</sub>"D x 72"W x 36"H  
 21<sup>1</sup>/<sub>16</sub>"D x 57"W x 36"H  
 21<sup>1</sup>/<sub>16</sub>"D x 42"W x 36"H

<b>HTLCRED72S</b>	311	41.5	<b>\$3807</b>
<b>HTLCRED57S</b>	260	33.3	<b>\$3327</b>
<b>HTLCRED42S</b>	210	25.2	<b>\$2686</b>

NOTES: Hospitality credenzas with shelves ship with 2 shelves in separate cartons. Additional shelves can be ordered separately if desired.

## HOW TO SPECIFY

Select Model Number	Select Top Laminate Color	Select 2mm Edge Color	Select Chassis Laminate	Select Pull	Select Back Cutout	Select Shelf Laminate
See page 74, Laminate Group A L2 (+ \$55)	See page 74, Laminate Group B L2 (+ \$82)	See page 75	See page 74, Laminate Group B L2 (+ \$82)	See page 76 for line art visual <b>J</b> Loop Satin Nickel <b>G</b> Loop Black <b>3</b> Rounded Square Matte Chrome <b>4</b> Rounded Square Black <b>VP</b> HLSL Voi® Pull Black <b>VPJW</b> HLSL Voi® Pull Designer White <b>VT4</b> HLSL Voi® Pull Champagne Metallic <b>VT1</b> HLSL Voi® Pull Platinum Metallic <b>VPR6</b> HLSL Voi® Pull Silver <b>VP8X</b> HLSL Voi® Pull Solar Black	<b>C</b> Vent Cutout (+ \$55) <b>N</b> No Cutout	See page 74, Laminate Group B L2 (+ \$22) <i>Specify for shelf models only</i>
<b>H T L C R E D 5 7 S .</b>	<b>L S A 1 .</b>	<b>S A .</b>	<b>L S A 1 .</b>	<b>J .</b>	<b>C .</b>	<b>T 1</b>

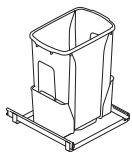

OPEN MARKET

**DESCRIPTION**

**Trash Bin Slide**  
 • Holds a 35 quart bin.  
 • Trash bin is included with model.  
 • Can be used in outer compartments of credenza models above.

MODEL	SHIP WEIGHT	CUBE	L1 LIST PRICE	L2 UPCHARGE
<b>HTBINSLIDE</b>	15	3.5	<b>\$272</b>	<b>N/A</b>

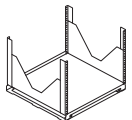

SIN 33721

**Mounted AV Rack**

• Can be used in outer compartments of credenza models above.

<b>HTRACK</b>	15	4.8	<b>\$2457</b>	<b>N/A</b>
---------------	----	-----	---------------	------------



SIN 33721

**Laminate Credenza Shelf**

• Shelf can be utilized in the outer compartments of the credenza.  
 • 3 mounting locations within outer compartment on the credenza.  
 • Mounting locations are 6" apart.

<b>HTLSHELF</b>	10	1.5	<b>\$92</b>	<b>\$12</b>
-----------------	----	-----	-------------	-------------

## HOW TO SPECIFY

Select Model Number	Select Laminate
See page 74, Laminate Group B	See page 74, Laminate Group B
<b>H T L S H E L F .</b>	<b>H</b>



Icon Legend on page 19

# PRESIDE® Laminate Storage

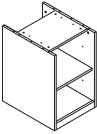
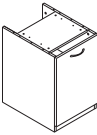
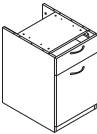
	DESCRIPTION	MODEL	SHIP WEIGHT	CUBE	LIST PRICE BY LAMINATE GRADE	
					L1	L2
 <i>Model HTLMC1828O shown</i>	Modular Pedestal, Bookshelf, No Door	HTLMC1828O	70	9.8	\$711	\$739
 <i>Model HTLMC1828L shown</i>	Modular Pedestal, Bookshelf, with Door (left)	HTLMC1828L	70	9.8	\$868	\$901
	Modular Pedestal, Bookshelf, with Door (right)	HTLMC1828R	70	9.8	\$868	\$901
 <i>Model HTLMC1828DR shown</i>	Modular Pedestal, Box Drawer, Cabinet Door (left)	HTLMC1828DL	70	9.8	\$922	\$955
	Modular Pedestal, Box Drawer, Cabinet Door (right)	HTLMC1828DR	70	9.8	\$922	\$955

**NOTES:**

- Use Concinnity™ laminate tops and backs with Preside® modular storage for a finished look. See page 104.

## HOW TO SPECIFY

<p><b>Select Model Number</b></p> <p>HTLMC1828L</p>	<p><b>Select Pull Option</b></p> <p>J Loop Satin Handle                  G Loop Black                  3 Rounded Square Matte Chrome                  4 Rounded Square Black                  X No Pull (for model HTLMC1828O only)</p> <p>J</p>	<p><b>Select Laminate</b></p> <p>See page 74, Laminate Group B</p> <p>N</p>
---	--	---

# MODULAR COMPONENTS

GSA SIN 33721



Icon Legend on page 19

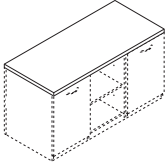

DESCRIPTION	MODEL	SHIP WEIGHT	CUBE	LIST PRICE BY LAMINATE GRADE	
				L1	L2
<b>Concinnity™ Rectangle Worksurface with Horizontal Grain</b>					
90"W x 24"D	<b>HNLRC2490</b>	75	5.5	<b>\$714</b>	<b>\$747</b>
72"W x 24"D	<b>HNLRC2472</b>	60	4.6	<b>\$502</b>	<b>\$524</b>
54"W x 24"D	<b>HNLRC2454</b>	45	3.5	<b>\$410</b>	<b>\$432</b>
36"W x 24"D Rectangle Worksurface/Pedestal Top	<b>HNLRC2436</b>	30	2.4	<b>\$318</b>	<b>\$335</b>

NOTES: Use Concinnity™ laminate tops and backs with Preside® modular storage for a finished look.

- ! Grain direction on all rectangle worksurfaces runs horizontal (side-to-side) except as follows: 30"W - 36"W - 42"W - 48"W - 54"W - 60"W x 24"D tops can be specified with horizontal (side-to-side) or vertical (front-to-back) grain.
- ! 42"W and 48"W x 20"D tops are available with vertical (front-to-back) grain only.

## HOW TO SPECIFY

**Select Model Number**

H N L R C 2 4 9 0 .

**Select Edge Profile and Edge Color**

See page 31 in the 2024 Workspaces Pricer

B H .

**Select Worksurface Grommet Finish**

P Black  
T1 Platinum  
X No Grommet

P .

**Select Worksurface Color**

See page 31 in the 2024 Workspaces Pricer

H

# MODULAR COMPONENTS

## Back Panels

GSA SIN 33721



Icon Legend on page 19

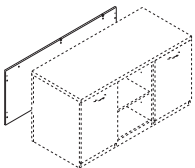

DESCRIPTION	MODEL	SHIP WEIGHT	CUBE	LIST PRICE BY LAMINATE GRADE	
				L1	L2
<b>Concinnity™ Modesty/Back Panels — Full-Length</b>					
90"W x 27 <sup>7</sup> / <sub>8</sub> "H	<b>HNLMP9028</b>	58	6.7	<b>\$572</b>	<b>\$600</b>
72"W x 27 <sup>7</sup> / <sub>8</sub> "H	<b>HNLMP7228</b>	46	5.3	<b>\$393</b>	<b>\$415</b>
54"W x 27 <sup>7</sup> / <sub>8</sub> "H	<b>HNLMP5428</b>	34	4.0	<b>\$323</b>	<b>\$345</b>
36"W x 27 <sup>7</sup> / <sub>8</sub> "H Modesty/Pedestal Back Panel	<b>HNLMP3628</b>	22	2.8	<b>\$260</b>	<b>\$274</b>

NOTES: Component is 3/4" thick. Provide approach-side kneespace privacy for user seated at desks, credenzas, returns, and bridges.

## HOW TO SPECIFY

**Select Model Number**

H N L M P 7 2 2 8 .

**Select Grommet**

P Black  
X No Grommet

X .

**Select Laminate Color**

See page 31 in the 2024 Workspaces Pricer

H



# WALL MOUNT STORAGE

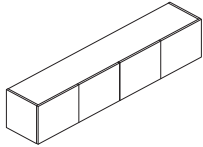

**DESCRIPTION**

**Concinnity™ Wall Mount Storage, Laminate Doors**

- 78"W x 15"D x 15"H — 4 doors, 2 compartments
- 72"W x 15"D x 15"H — 4 doors, 2 compartments
- 66"W x 15"D x 15"H — 4 doors, 2 compartments
- 60"W x 15"D x 15"H — 4 doors, 2 compartments
- 48"W x 15"D x 15"H — 3 doors, 2 compartments
- 42"W x 15"D x 15"H — 2 doors, 1 compartment
- 36"W x 15"D x 15"H — 2 doors, 1 compartment
- 30"W x 15"D x 15"H — 2 doors, 1 compartment

MODEL	SHIP WEIGHT	CUBE	L1 LIST	L2 UPCHARGES	
				CHASSIS	FRONTS
<b>HNL1578LD</b>	126	17.1	<b>\$1697</b>	<b>\$39</b>	<b>\$22</b>
<b>HNL1572LD</b>	118	15.9	<b>\$1576</b>	<b>\$28</b>	<b>\$22</b>
<b>HNL1566LD</b>	109	14.6	<b>\$1502</b>	<b>\$28</b>	<b>\$22</b>
<b>HNL1560LD</b>	100	13.3	<b>\$1348</b>	<b>\$28</b>	<b>\$22</b>
<b>HNL1548LD</b>	83	10.9	<b>\$1217</b>	<b>\$22</b>	<b>\$22</b>
<b>HNL1542LD</b>	68	9.7	<b>\$1150</b>	<b>\$22</b>	<b>\$12</b>
<b>HNL1536LD</b>	60	8.4	<b>\$1049</b>	<b>\$22</b>	<b>\$12</b>
<b>HNL1530LD</b>	51	7.2	<b>\$969</b>	<b>\$22</b>	<b>\$12</b>

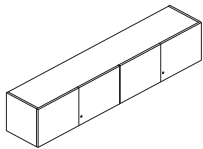

**Concinnity™ Wall Mount Storage, Laminate Locking Doors**

- 78"W x 15"D x 15"H — 4 doors, 2 compartments
- 72"W x 15"D x 15"H — 4 doors, 2 compartments
- 66"W x 15"D x 15"H — 4 doors, 2 compartments
- 60"W x 15"D x 15"H — 4 doors, 2 compartments
- 48"W x 15"D x 15"H — 3 doors, 2 compartments
- 42"W x 15"D x 15"H — 2 doors, 1 compartment
- 36"W x 15"D x 15"H — 2 doors, 1 compartment
- 30"W x 15"D x 15"H — 2 doors, 1 compartment

<b>HNL1578LL</b>	126	17.1	<b>\$1806</b>	<b>\$39</b>	<b>\$22</b>
<b>HNL1572LL</b>	118	15.9	<b>\$1685</b>	<b>\$28</b>	<b>\$22</b>
<b>HNL1566LL</b>	109	14.6	<b>\$1612</b>	<b>\$28</b>	<b>\$22</b>
<b>HNL1560LL</b>	100	13.3	<b>\$1460</b>	<b>\$28</b>	<b>\$22</b>
<b>HNL1548LL</b>	83	10.9	<b>\$1300</b>	<b>\$22</b>	<b>\$22</b>
<b>HNL1542LL</b>	68	9.7	<b>\$1204</b>	<b>\$22</b>	<b>\$12</b>
<b>HNL1536LL</b>	60	8.4	<b>\$1105</b>	<b>\$22</b>	<b>\$12</b>
<b>HNL1530LL</b>	51	7.2	<b>\$1025</b>	<b>\$22</b>	<b>\$12</b>

**!** Lock available in Black (P) or Satin (SA) finish. Lock is core removable. Keyed alike cores must be ordered separately. For stack-on and wall mount storage with locking hinged doors, specify model HF27B (Black) or HF27S (Satin) and the key number, see the Desks section in the 2024 Workspaces Pricer. Model HNL1548LL has one lock, which secures two of the three doors.

**NOTES:**

- Preside® tables pair well with Concinnity™ Wall Mounted Storage to create a complete conference or collaborative layout.
- Convenient off-the-worksurface storage requires no additional floor space.
- Available with laminate doors, frosted/silver doors, or sliding door.
- Doors are sized to overlap the top, end panels and light valance, to provide a clean design.
- Laminate and frosted/silver door units are equipped with self-closing, adjustable hinges.
- Laminate hinged door units are available with or without a lock.
- For tackboards, see the Desks section in the 2024 Workspaces Pricer.
- For task lights, see the Desks section in the 2024 Workspaces Pricer.
- For paper organizers, see the Desks section in the 2024 Workspaces Pricer.
- **IMPORTANT: See installation guidelines in the Desks section in the 2024 Workspaces Pricer.**

## HOW TO SPECIFY

<p><b>Select Model Number</b></p> <p>H N L 1 5 7 8 L D</p>	<p><b>Select Chassis Color</b></p> <p>See page 31 in the 2024 Workspaces Pricer</p> <p>H</p>	<p><b>Select Door Front Color</b></p> <p>See page 31 in the 2024 Workspaces Pricer</p> <p>H</p>	
<p><b>Select Model Number</b></p> <p>H N L 1 5 7 8 L L</p>	<p><b>Select Lock Finish</b></p> <p>See page 31 in the 2024 Workspaces Pricer</p> <p>P</p>	<p><b>Select Chassis Color</b></p> <p>See page 31 in the 2024 Workspaces Pricer</p> <p>H</p>	<p><b>Select Door Front Color</b></p> <p>See page 31 in the 2024 Workspaces Pricer</p> <p>H</p>



# WALL MOUNT STORAGE

GSA SIN 33721



Icon Legend on page 19

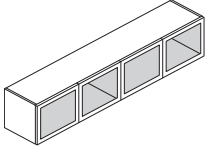

DESCRIPTION	MODEL	SHIP WEIGHT	CUBE	L1 LIST	L2 UPCHARGES	
					CHASSIS	FRONTS
<b>Concinnity™ Wall Mount Storage, Frosted Doors with Silver Frame</b>						
78"W x 15"D x 15"H — 4 doors, 2 compartments	<b>HNL1578FD</b>	106	17.1	<b>\$2564</b>	<b>\$39</b>	<b>N/A</b>
72"W x 15"D x 15"H — 4 doors, 2 compartments	<b>HNL1572FD</b>	99	15.9	<b>\$2441</b>	<b>\$28</b>	<b>N/A</b>
66"W x 15"D x 15"H — 4 doors, 2 compartments	<b>HNL1566FD</b>	92	14.6	<b>\$2365</b>	<b>\$28</b>	<b>N/A</b>
60"W x 15"D x 15"H — 4 doors, 2 compartments	<b>HNL1560FD</b>	85	13.3	<b>\$2212</b>	<b>\$28</b>	<b>N/A</b>
48"W x 15"D x 15"H — 3 doors, 2 compartments	<b>HNL1548FD</b>	71	10.9	<b>\$1865</b>	<b>\$22</b>	<b>N/A</b>
42"W x 15"D x 15"H — 2 doors, 1 compartment	<b>HNL1542FD</b>	57	9.7	<b>\$1586</b>	<b>\$22</b>	<b>N/A</b>
36"W x 15"D x 15"H — 2 doors, 1 compartment	<b>HNL1536FD</b>	50	8.4	<b>\$1486</b>	<b>\$22</b>	<b>N/A</b>
30"W x 15"D x 15"H — 2 doors, 1 compartment	<b>HNL1530FD</b>	43	7.2	<b>\$1404</b>	<b>\$22</b>	<b>N/A</b>

❗ Frosted door models do not have a lock option.

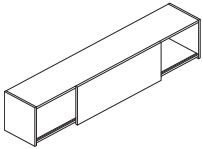

<b>Concinnity™ Wall Mount Storage, Sliding Door</b>						
78"W x 15"D x 15"H	<b>HNL1578SD</b>	114	17.1	<b>\$1650</b>	<b>\$39</b>	<b>\$22</b>
72"W x 15"D x 15"H	<b>HNL1572SD</b>	107	15.9	<b>\$1515</b>	<b>\$28</b>	<b>\$22</b>
66"W x 15"D x 15"H	<b>HNL1566SD</b>	99	14.6	<b>\$1413</b>	<b>\$28</b>	<b>\$22</b>
60"W x 15"D x 15"H	<b>HNL1560SD</b>	91	13.3	<b>\$1284</b>	<b>\$28</b>	<b>\$22</b>
48"W x 15"D x 15"H	<b>HNL1548SD</b>	76	10.9	<b>\$1202</b>	<b>\$22</b>	<b>\$22</b>

NOTES: One door per unit. Standard with black lock, which is located on the inside vertical support panel.

**NOTES:**

- Preside® tables pair well with Concinnity™ Wall Mounted Storage to create a complete conference or collaborative layout.
- Convenient off-the-worksurface storage requires no additional floor space.
- Available with laminate doors, frosted/silver doors, or sliding door.
- Doors are sized to overlap the top, end panels and light valance, to provide a clean design.
- Laminate and frosted/silver door units are equipped with self-closing, adjustable hinges.
- Laminate hinged door units are available with or without a lock.
- For tackboards, see the Desks section in the 2024 Workspaces Pricer.
- For task lights, see the Desks section in the 2024 Workspaces Pricer.
- For paper organizers, see the Desks section in the 2024 Workspaces Pricer.
- **IMPORTANT: See installation guidelines in the Desks section in the 2024 Workspaces Pricer.**

## HOW TO SPECIFY

<p>Select Model Number</p> <p><b>H N L 1 5 7 8 F D</b></p>	<p>Select Chassis Color</p> <p>See page 31 in the 2024 Workspaces Pricer</p> <p><b>H</b></p>	
<p>Select Model Number</p> <p><b>H N L 1 5 7 8 S D</b></p>	<p>Select Chassis Color</p> <p>See page 31 in the 2024 Workspaces Pricer</p> <p><b>H</b></p>	<p>Select Door Front Color</p> <p>See page 31 in the 2024 Workspaces Pricer</p> <p><b>H</b></p>



Icon Legend on page 19

# Laminate Shared Components

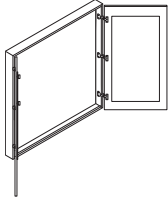

**DESCRIPTION**

**Laminate Presentation Cabinet**

- Overall cabinet dimensions 48<sup>7</sup>/<sub>8</sub>"W x 5"D x 49<sup>1</sup>/<sub>2</sub>"H.
- Mounts to wall.
- Presentation cabinet features one magnetic white board, one tackboard and one paper pad.
- Self-adjusting hinges ensure doors are in alignment.

MODEL	SHIP WEIGHT	CUBE	LIST PRICE BY LAMINATE GRADE	
			L1	L2
HTLPRES	169	10.9	\$2132	\$2219

## HOW TO SPECIFY

Select Model Number

H T L P R E S .

Select Laminate

See page 74, Laminate Group B

D

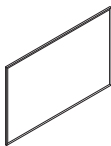

OPEN MARKET

**DESCRIPTION**

**Markerboard**

- Overall markerboard dimensions 48"W x 31"H.
- Mounts on wall. Can be mounted horizontally or vertically.
- Markerboard is magnetic.
- No specification required.

MODEL	SHIP WEIGHT	CUBE	LIST PRICE
HLSL4831MB	44.0	3.4	\$920

## HOW TO SPECIFY

Select Model Number

H L S L 4 8 3 1 M B

# PRESIDE® Laminate Tables

GSA SIN 33721

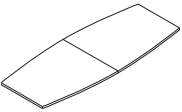
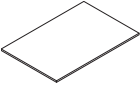
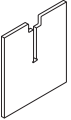

Icon Legend on page 19

	DESCRIPTION	MODEL	SHIP WEIGHT	CUBE	LIST PRICE
	<b>Laminate Boat Shaped Table Tops with Stretcher</b>				
	168"W x 48"D	<b>HTLB16848P</b>	319	11.9	<b>\$1875</b>
	144"W x 48"D	<b>HTLB14448P</b>	266	9.8	<b>\$1490</b>
	120"W x 48"D	<b>HTLB12048P</b>	217	8.2	<b>\$1351</b>
	<b>Laminate Adder Section with Stretcher</b> 72"W x 48"D	<b>HTLM7248P</b>	144	9.8	<b>\$991</b>
	<b>Laminate Bases</b>				
	<b>Laminate Panel Bases, Double Pack</b>	<b>HTLPB</b>	53	3.1	<b>\$539</b>
	<b>Laminate Panel Bases, Single Pack</b>	<b>HTLPBS</b>	28	3.1	<b>\$327</b>

	With Panel Base
HTLB12048P HTLB14448P	1 x HTLPB (Laminate Panel Base)
HTLB16848P	1 x HTLPB (Laminate Panel Base) 1 x HTLPBS (Laminate Panel Mid-Base)
HTLM7248P	1 x HTLPBS (Laminate Panel Mid-Base)

**NOTES:**

- Tops and Modesty Panels are 1 1/8" Melamine.
- 168"W Boat-Shaped Top needs 3 bases; 72"W Middle Adder needs 1 base. All other tops need 2 bases.
- 120", 144", and 168"W Tops ship in 2 pieces to facilitate handling and installation; these top sizes will not have an exact grain alignment where the two halves meet, a reasonable match can be expected.
- ! Tops with Stretcher and Adder Section with Stretcher available in Harvest (C) and Mahogany (N) finishes only.
- ! Tops available in Boat Shape with G edge (2mm self edge) only; Middle Adder is rectangular with G edge.
- ! Edge finish always matches top finish.

**HOW TO SPECIFY**

<p><b>Select Model Number</b></p> <p>HTLB16848P .</p>	<p><b>Select Grommet Option</b></p> <p>N No grommet (only option)</p> <p>N .</p>	<p><b>Select Laminate</b></p> <p>C Harvest N Mahogany</p> <p>C</p>
---	--	--

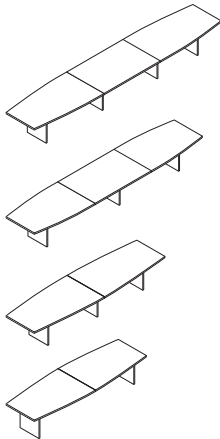

**DESCRIPTION**

**Boat Shape Laminate Tables with Panel Base**

240"W x 48"D  
 216"W x 48"D  
 192"W x 48"D  
 168"W x 48"D  
 144"W x 48"D  
 120"W x 48"D

**MODEL**

**HTLB2048LP**  
**HTLB1848LP**  
**HTLB1648LP**  
**HTLB1448LP**  
**HTLB1248LP**  
**HTLB1048LP**

**SHIP WEIGHT**

572  
 491  
 442  
 400  
 319  
 270

**CUBE**

31.0  
 25.9  
 24.3  
 18.1  
 12.9  
 11.3

**LIST PRICE**

**\$4059**  
**\$3347**  
**\$3208**  
**\$2741**  
**\$2029**  
**\$1890**

NOTES: Order entire typical with one model number to get desired table size. Table top and bases are included.

**NOTES:**

- Tops and Modesty Panels are 1/4" Melamine.
- 168"W Boat-Shaped Top needs 3 bases; 72"W Middle Adder needs 1 base. All other tops need 2 bases.
- 120", 144", and 168"W Tops ship in 2 pieces to facilitate handling and installation; these top sizes will not have an exact grain alignment where the two halves meet, a reasonable match can be expected.
- ! Available in Harvest (C) and Mahogany (N) finishes only.
- ! Tops available in Boat Shape with G edge (2mm self edge) only; Middle Adder is rectangular with G edge.
- ! Edge finish always matches top finish.

**HOW TO SPECIFY**

<p><b>Select Model Number</b></p> <p>HTLB2048LP.</p>	<p><b>Select Grommet Option</b></p> <p>N No grommet (only option)</p> <p>N.</p>	<p><b>Select Laminate</b></p> <p>C Harvest                  N Mahogany</p> <p>C.</p>	<p><b>Select Edge Color</b></p> <p>C Harvest                  N Mahogany</p> <p>C.</p>
--	---	--	--

# SCRAMBLE™ OCCASIONAL TABLES

Want to see more? Scan here  
to check out hon.com.



Scramble™ Coffee Table shown with  
West Hill™ Casual Lounge Seating.

## SCRAMBLE™

For every tablet, coffee mug, or notepad there's a need for an occasional table. Don't scramble to find an open meeting room when you can move to where relaxed productivity happens whether it's a lounge, commons, or nook area. Designed to coordinate with any of HON's soft seating lines, Scramble occasional tables fit in any space you need to work comfortably.



## FEATURES

- Select from Soft Rectangle, Soft Square, and Round top shapes.
- Multiple size ranges available from side to large coffee tables.
- Coordinate with any of HON's soft seating series to create a space that works.
- Angled hardwood legs with metal stretcher bars provide a mid-century feel.
- Assorted leg and stretcher bar finishes available to match any aesthetic.
- Match the style of any space, with laminate tops including both flat and knife edges, as well as premium back-painted glass tops.

# SCRAMBLE™ Options

## MODEL OPTIONS

HSCCSR2448LM  
HSCCSR2448LMK  
HSCCSR2448BPG

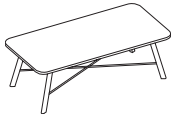

**Coffee Table**  
Soft Rectangle

HSCCSS36LM, HSCCSS36LMK, HSCCSS36BPG  
HSCCSS48LM, HSCCSS48LMK, HSCCSS48BPG



**Coffee Table**  
Soft Square

HSCCR36LM, HSCCR36LMK, HSCCR36BPG  
HSCCR48LM, HSCCSS48LMK, HSCCR48BPG



**Coffee Table**  
Round

HSCCESS24LM  
HSCCESS24LMK  
HSCCESS24BPG



**End Table**  
Soft Square

HSCER24LM  
HSCER24LMK  
HSCER24BPG



**End Table**  
Round

### Available Laminates and Corresponding Edge:

Laminate		Edgeband	
Beigewood	LWBE	Beigewood	DE
Charcoal	S	Charcoal	S
Designer White	LDW1	Designer White	DW
Fawn Cypress	LFC1	Fawn Cypress	FC
Field Elm	LWFE	Field Elm	FE
Florence Walnut	LFW1	Florence Walnut	FW
Handspun Chestnut	LAHC	Loft	LOFT
Handspun Dove	LAHD	Fossil	EH
Handspun Pearl	LAHP	Fossil	EH
Handspun Slate	LAHS	Charcoal	S
Kingswood Walnut	LK1I	Kingswood Walnut	KI
Lowell Ash	LLA1	Lowell Ash	DL
Natural Maple	D	Natural Maple	D
Natural Recon	LNRI	Natural Recon	NR
Phantom Ecru	LPE1	Phantom Ecru	PE
Pinnacle	PINC	Pinnacle	PINC
Portico Teak	LPT1	Portico Teak	PT
Skyline Walnut	LSW1	Skyline Walnut	SW
Sterling Ash	LSA1	Sterling Ash	SA

## WOOD LEG OPTIONS

CODE	DESCRIPTION	PRICE
LFW1	Florence Walnut	+\$0
LK1I	Kingswood Walnut	+\$0
LLA1	Lowell Ash	+\$0
D	Natural Maple	+\$0
LNRI	Natural Recon	+\$0
LPE1	Phantom Ecru	+\$0
PINC	Pinnacle	+\$0
LPT1	Portico Teak	+\$0
LSW1	Skyline Walnut	+\$0
LSA1	Sterling Ash	+\$0
LE404	Warm White	+\$0
LE405	Mist	+\$0
LE408	Peppercorn	+\$0

NOTES: Wood Legs are stained solid maple. Stain finishes will be tonal matches to the respective laminate finishes. Some natural woodgrain may show through the stain; therefore, stained wood legs may have slight variation in appearance.

## EDGE & MATERIAL OPTIONS

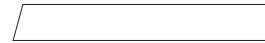

**Laminate**  
2mm Edge, 3/4" thick



**Laminate**  
Knife Edge, 1/8" thick

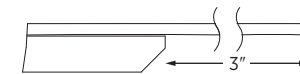

**Back-Painted Glass**

- 1/4" thick glass, painted on the bottom surface with frosted/etched top and sides.
- 3/4" MDF sub-top inset 3" from all sides, for attachment to base.

## STRETCHER BAR PAINT OPTIONS

CODE	DESCRIPTION	PRICE
<b>Grade P1</b>		
P7A	Textured Charcoal	+\$0
P8V	Textured Titanium	+\$0
<b>Grade P2</b>		
PR5	Champagne Metallic	+\$22
P8X	Solar Black	+\$22

## BACK-PAINTED GLASS OPTION



CODE	DESCRIPTION	PRICE
GWH1	Ice White, Etched	+\$0

# SCRAMBLE™ Coffee Tables

OPEN MARKET EXCEPT AS NOTED



Icon Legend on page 19

	DESCRIPTION	MODEL	SHIP WEIGHT	CUBE	LIST PRICE BY LAMINATE GRADE		GLASS LIST PRICE
					L1	L2	
	<b>Coffee Table, Soft Rectangle</b> 24"D x 48"W x 16"H, Laminate Top, 2mm Edge	<b>HSCCSR2448LM*</b>	46.5	9.7	<b>\$1647</b>	<b>\$1669</b>	
	24"D x 48"W x 16"H, Laminate Top, Knife Edge	<b>HSCCSR2448LMK</b>	94.0	6.4	<b>\$1867</b>	<b>\$1889</b>	
	24"D x 48"W x 16"H, Back-Painted Glass Top	<b>HSCCSR2448BPG</b>	61.5	5.9			<b>\$3442</b>
	<b>Coffee Table, Soft Square</b> 36"D x 36"W x 16"H, Laminate Top, 2mm Edge	<b>HSCCSS36LM*</b>	48.5	9.0	<b>\$1582</b>	<b>\$1604</b>	
	48"D x 48"W x 16"H, Laminate Top, 2mm Edge	<b>HSCCSS48LM*</b>	80.5	12.8	<b>\$1711</b>	<b>\$1733</b>	
	36"D x 36"W x 16"H, Laminate Top, Knife Edge	<b>HSCCSS36LMK</b>	63.0	6.7	<b>\$1749</b>	<b>\$1771</b>	
	48"D x 48"W x 16"H, Laminate Top, Knife Edge	<b>HSCCSS48LMK</b>	96.5	9.9	<b>\$1985</b>	<b>\$2007</b>	
	36"D x 36"W x 16"H, Back-Painted Glass Top	<b>HSCCSS36BPG</b>	66.0	6.2			<b>\$3718</b>
	48"D x 48"W x 16"H, Back-Painted Glass Top	<b>HSCCSS48BPG</b>	110.5	9.1			<b>\$4290</b>
	<b>Coffee Table, Round</b> 36"D x 16"H, Laminate Top, 2mm Edge	<b>HSCCR36LM*</b>	41.0	8.8	<b>\$1582</b>	<b>\$1604</b>	
	48"D x 16"H, Laminate Top, 2mm Edge	<b>HSCCR48LM*</b>	70.0	12.6	<b>\$1711</b>	<b>\$1733</b>	
	36"D x 16"H, Laminate Top, Knife Edge	<b>HSCCR36LMK</b>	49.0	6.7	<b>\$1749</b>	<b>\$1771</b>	
	48"D x 16"H, Laminate Top, Knife Edge	<b>HSCCR48LMK</b>	82.0	9.0	<b>\$1985</b>	<b>\$2007</b>	
	36"D x 16"H, Back-Painted Glass Top	<b>HSCCR36BPG</b>	49.0	6.2			<b>\$3718</b>
	48"D x 16"H, Back-Painted Glass Top	<b>HSCCR48BPG</b>	90.0	8.2			<b>\$4290</b>

\* GSA SIN 33721

## HOW TO SPECIFY

<p>Select Model Number</p> <p>H S C C S R 2 4 4 8 L M .</p>	<p>Select Laminate and Edge or Glass</p> <p>See page 111</p> <p>L S A 1 S A .</p>	<p>Select Leg Finish</p> <p>See page 111</p> <p>L S A 1 .</p>	<p>Select Stretcher Bar Paint Color</p> <p>See page 111</p> <p>P 8 V</p>
---	---	---	--





OPEN MARKET EXCEPT AS NOTED



Icon Legend on page 19

# SCRAMBLE™ End Tables

TABLES

	DESCRIPTION	MODEL	SHIP WEIGHT	CUBE	LIST PRICE BY LAMINATE GRADE		GLASS LIST PRICE
					L1	L2	
	<b>End Table, Soft Square</b>						
	24"W x 24"D x 22"H, Laminate Top, 2mm Edge	<b>HSCCESS24LM*</b>	34.5	19.0	\$1515	\$1537	
	24"W x 24"D x 22"H, Laminate Top, Knife Edge	<b>HSCCESS24LMK</b>	42.0	3.9	\$1638	\$1660	
	24"W x 24"D x 22"H, Back-Painted Glass Top	<b>HSCCESS24BPG</b>	38.0	3.7			\$2931
	<b>End Table, Round</b>						
	24"D x 22"H, Laminate Top, 2mm Edge	<b>HSCER24LM*</b>	32.0	19.0	\$1515	\$1537	
	24"D x 22"H, Laminate Top, Knife Edge	<b>HSCER24LMK</b>	33.0	3.9	\$1638	\$1660	
	24"D x 22"H, Back-Painted Glass Top	<b>HSCER24BPG</b>	33.0	3.7			\$2931

\* GSA SIN 33721

## HOW TO SPECIFY

<p><b>Select Model Number</b></p> <p>H S C E S S 2 4 L M .</p>	<p><b>Select Laminate and Edge or Glass</b></p> <p>See page 111</p> <p>L S A 1 S A .</p>	<p><b>Select Leg Finish</b></p> <p>See page 111</p> <p>L S A 1 .</p>	<p><b>Select Stretcher Bar Paint Color</b></p> <p>See page 111</p> <p>P 8 V</p>
--	--	--	---

# SCULPT™

Want to see more? Scan here  
to check out hon.com.



Sculpt™ Tables shown with Mav™ Chairs.

## SCULPT™ TABLES

Sophisticated and subtle, HON's Sculpt™ collection is a breath of fresh air in any busy office space. Designed to be adaptable and customizable, these occasional and personal tables enhance the productivity of shared spaces while providing a multifunctional hub for a variety of needs, both individual and collaborative. And with a variety of elegant finishes, tops, and heights — plus layering and power capabilities — Sculpt™ is the ideal surface solution for lounges, touchdown spaces, private offices, and more. Make your space work with Sculpt™.



## FEATURES

- Customize your office aesthetic with a variety of top shapes, heights, and elegant finishes.
- Find flexibility with both collaborative and single-use capabilities.
- Stay powered up with an integrated personal device holder.
- Enhance the beauty of your environment and offer a fresh perspective with Sculpt™ planters, designed to bring soothing nature into the workplace.

# SCULPT™ ORDERING INFORMATION

## LAMINATE

### L1 LAMINATES ..... CODES

#### Woodgrain

◆ Bourbon Cherry .....	H
◆ Cognac .....	COGN
◆ Field Elm .....	LWFE
◆ Florence Walnut .....	LFW1
◆ Harvest .....	C
◆ Kingswood Walnut .....	LK11
◆ Mahogany .....	N
◆ Mocha .....	MOCH
◆ Natural Maple .....	D
◆ Pinnacle .....	PINC
◆ Shaker Cherry .....	F
◆ Sterling Ash .....	LSA1

#### Solid

◆ Black .....	P
◆ Charcoal .....	S
◆ Designer White .....	LDW1
◆ Loft .....	LOFT

### L2 LAMINATES ..... CODES

#### Woodgrain

◆ Beigewood .....	LWBE
◆ Fawn Cypress .....	LFC1
◆ Lowell Ash .....	LLA1
◆ Natural Recon .....	LNR1
◆ Phantom Ecru .....	LPE1
◆ Portico Teak .....	LPT1
◆ Skyline Walnut .....	LSW1

## WOOD

### WOOD ..... CODES

Beigewood .....	LE878
Bourbon Cherry .....	LE773
Cognac .....	LE702
Field Elm .....	LE599
Florence Walnut .....	LE579
Harvest .....	LE856
Kingswood Walnut .....	LE518
Lowell Ash .....	LE394
Mahogany .....	LE740
Mocha .....	LE121
Natural Maple .....	LE800
Natural Recon .....	LE896
Phantom Ecru .....	LE912
Pinnacle .....	LE679
Portico Teak .....	LE150
Shaker Cherry .....	LE774
Skyline Walnut .....	LE625
Sterling Ash .....	LE495

NOTES: Wood legs are stained solid maples. Stain finishes will be tonal matches to the respective laminate finishes. Some natural woodgrain may show through the stain; therefore, stained wood legs may have slight variation in appearance.

## PAINT

### PAINT ..... CODES

#### P1

◆ Black .....	P71
◆ Brownstone .....	P7D
◆ Charcoal .....	P02
◆ Designer White .....	PJW
◆ Fossil .....	P28
◆ Greige .....	T5
◆ Light Grey .....	Q
◆ Loft .....	LOFT
◆ Muslin .....	T3
◆ Putty .....	L
◆ Textured Brownstone .....	P7J
◆ Textured Charcoal .....	P7A
◆ Textured Designer White .....	PK7
◆ Textured Loft .....	P7L
◆ Textured Muslin .....	P7M
◆ Textured Titanium .....	P8T
◆ Titanium .....	P8T

#### P2

◆ Champagne Metallic .....	T4
◆ Gunmetal Metallic .....	PR3
◆ Platinum Metallic .....	T1
◆ Pyrite .....	PJE
◆ Silver .....	PR6
◆ Solar Black .....	P8X
◆ Textured Silver .....	PR8

#### P3

◆ Atom .....	P8S
◆ Blossom .....	P8K
◆ Bullseye .....	PJF
◆ Ember .....	P8P
◆ Ion .....	P8N
◆ Iris .....	P8J
◆ Krypton .....	P8F
◆ Ochre .....	P093
◆ Regatta .....	P8M
◆ Sienna .....	P092
◆ Succulent .....	P8A

# SCULPT™ STATEMENT OF LINE

## LAMINATE/WOOD TOP TABLES

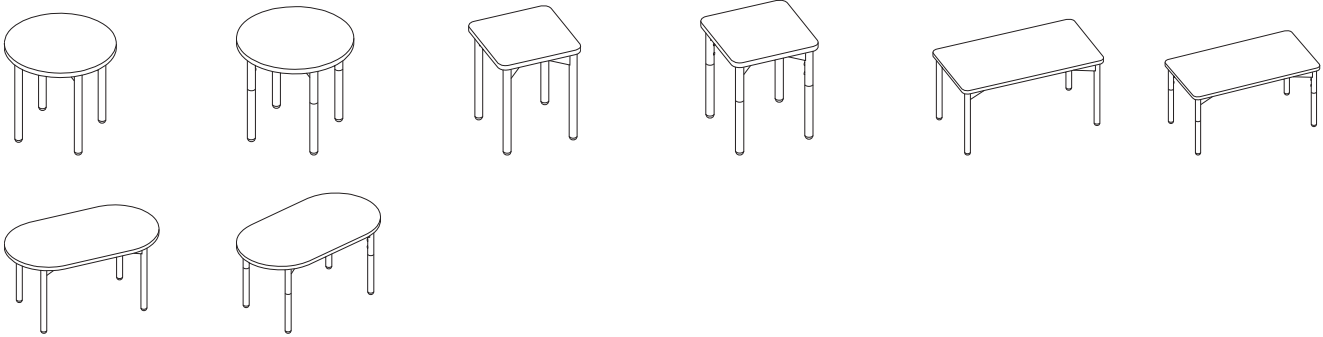

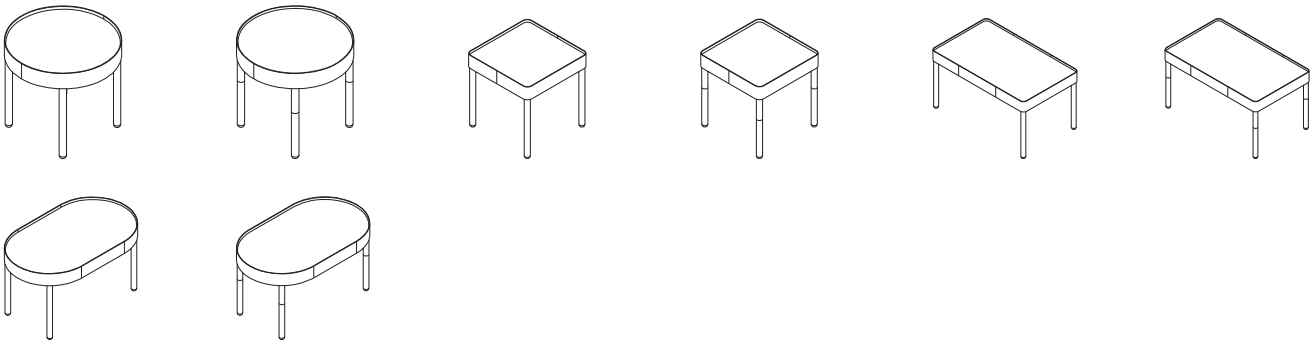

## TRAY TOP TABLES

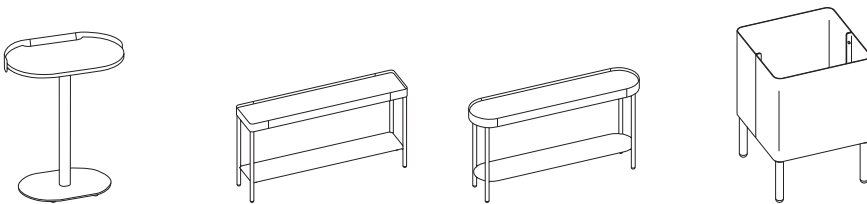

## PERSONAL/CONSOLE TABLES

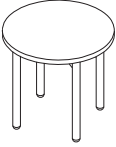
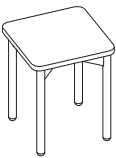

# SCULPT™ Laminate Top Tables

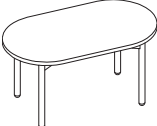
	DESCRIPTION	MODEL	SHIP WEIGHT	CUBE	LIST PRICE	UPCHARGE BY		
						LAMINATE/PAIN	GRADE	
						L2	P2	P3
	<b>Round Laminate Top with Metal Legs</b>							
	16½"W x 15⅜"H, Low Metal Legs	HTLSCULRND16LML	19	3.0	\$762	\$11	\$57	\$85
	16½"W x 18½"H, Medium Metal Legs	HTLSCULRND16MML	20	3.0	\$775	\$11	\$58	\$87
	16½"W x 21⅝"H, High Metal Legs	HTLSCULRND16HML	20	3.0	\$781	\$11	\$59	\$88
	30"W x 15⅜"H, Low Metal Legs	HTLSCULRND30LML	35	4.4	\$826	\$14	\$56	\$83
	<b>Square Laminate Top with Metal Legs</b>							
	12¾"W x 12¾"D x 15⅜"H, Low Metal Legs	HTLSCULSQR13LML	10	2.7	\$709	\$10	\$52	\$78
	16½"W x 16½"D x 18½"H, Medium Metal Legs	HTLSCULSQR16MML	20	2.3	\$712	\$11	\$51	\$76
	20¼"W x 20¼"D x 21⅝"H, High Metal Legs	HTLSCULSQR20HML	24	3.3	\$743	\$12	\$52	\$78
	30"W x 30"D x 15⅜"H, Low Metal Legs	HTLSCULSQR30LML	35	2.5	\$813	\$15	\$53	\$79
	! Cutout not available on 12¾" top.							
	<b>Rectangle Laminate Top with Metal Legs</b>							
	60"W x 16½"D x 15⅜"H, Low Metal Legs	HTLSCULREC1660LML	42	4.1	\$956	\$15	\$66	\$99
	30"W x 16½"D x 15⅜"H, Low Metal Legs	HTLSCULREC1630LML	24	5.7	\$817	\$13	\$57	\$85
	30"W x 16½"D x 18½"H, Medium Metal Legs	HTLSCULREC1630MML	25	5.7	\$831	\$13	\$58	\$87
	<b>Pill Laminate Top with Metal Legs</b>							
	60"W x 16½"D x 15⅜"H, Low Metal Legs	HTLSCULPIL1660LML	41	6.7	\$956	\$16	\$66	\$98
	30"W x 16½"D x 15⅜"H, Low Metal Legs	HTLSCULPIL1630LML	23	5.7	\$807	\$13	\$56	\$83
	30"W x 16½"D x 18½"H, Medium Metal Legs	HTLSCULPIL1630MML	24	5.7	\$811	\$13	\$56	\$84

## HOW TO SPECIFY

<b>Select Model Number</b> HTLSCULRND16LML	<b>Select Cutout Option</b> N No Cutout G Grommet Cutout (+ \$42) G	<b>Select Laminate</b> See page 115 H	<b>Select Leg Paint Color</b> See page 115 P71	<b>Select Glide Option</b> G Glide G
---	--	---	--	--

# SCULPT™ Laminate Top Tables

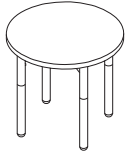

DESCRIPTION	MODEL	SHIP WEIGHT	CUBE	LIST PRICE	UPCHARGE BY LAMINATE/PAINT GRADE		
					L2	P2	P3
<b>Round Laminate Top with Wood Legs</b>							
16½"W x 15¾"H, Low Wood Legs	HTLSCULRND16LWL	19	3.0	\$1038	\$11	\$55	\$83
16½"W x 18½"H, Medium Wood Legs	HTLSCULRND16MWL	20	3.0	\$1065	\$11	\$55	\$83
16½"W x 21¾"H, High Wood Legs	HTLSCULRND16HWL	20	3.0	\$1101	\$11	\$56	\$83
30"W x 15¾"H, Low Wood Legs	HTLSCULRND30LWL	35	4.4	\$1255	\$14	\$70	\$103



<b>Square Laminate Top with Wood Legs</b>							
12¾"W x 12¾"D x 15¾"H, Low Wood Legs	HTLSCULSQR13LWL	15	2.7	\$1076	\$10	\$59	\$148
16½"W x 16½"D x 18½"H, Medium Wood Legs	HTLSCULSQR16MWL	20	2.3	\$1105	\$11	\$58	\$87
20¼"W x 20¼"D x 21¾"H, High Wood Legs	HTLSCULSQR20HWL	24	3.3	\$1167	\$12	\$59	\$148
30"W x 30"D x 15¾"H, Low Wood Legs	HTLSCULSQR30LWL	35	4.4	\$1193	\$15	\$62	\$92

ⓘ Cutout not available on 12¾" top.

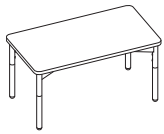

<b>Rectangle Laminate Top with Wood Legs</b>							
60"W x 16½"D x 15¾"H, Low Wood Legs	HTLSCULREC1660LWL	42	4.1	\$1211	\$15	\$62	\$94
30"W x 16½"D x 15¾"H, Low Wood Legs	HTLSCULREC1630LWL	24	5.7	\$1088	\$13	\$55	\$82
30"W x 16½"D x 18½"H, Medium Wood Legs	HTLSCULREC1630MWL	25	5.7	\$1117	\$13	\$55	\$82







<b>Pill Laminate Top with Wood Legs</b>							
60"W x 16½"D x 15¾"H, Low Wood Legs	HTLSCULPIL1660LWL	41	6.7	\$1223	\$16	\$63	\$95
30"W x 16½"D x 15¾"H, Low Wood Legs	HTLSCULPIL1630LWL	23	5.7	\$1073	\$13	\$53	\$80
30"W x 16½"D x 18½"H, Medium Wood Legs	HTLSCULPIL1630MWL	24	5.7	\$1095	\$13	\$53	\$79

## HOW TO SPECIFY

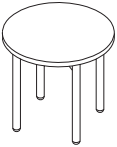
<b>Select Model Number</b> HTLSCULRND16LWL	<b>Select Cutout Option</b> N No Cutout G Grommet Cutout (+ \$42)	<b>Select Laminate</b> See page 115	<b>Select Wood Leg Finish</b> See page 115	<b>Select Leg Paint Color</b> See page 115
HTLSCULRND16LWL	G	H	LE856	P71

# SCULPT™ Wood Top Tables

	DESCRIPTION	MODEL	SHIP WEIGHT	CUBE	LIST PRICE BY PAINT GRADE		
					P1	P2	P3
	<b>Round Wood Top with Metal Legs</b> 16½"W x 15⅜"H, Low Metal Legs	<b>HTLSCUWRND16LML</b>	19	3.0	\$1745	\$1802	\$1830
	16½"W x 18½"H, Medium Metal Legs	<b>HTLSCUWRND16MML</b>	20	3.0	\$1758	\$1816	\$1845
	16½"W x 21⅝"H, High Metal Legs	<b>HTLSCUWRND16HML</b>	20	3.0	\$1764	\$1823	\$1852
	30"W x 15⅜"H, Low Metal Legs	<b>HTLSCUWRND30LML</b>	35	6.7	\$2028	\$2084	\$2111
	<b>Square Wood Top with Metal Legs</b> 12¾"W x 12¾"D x 15⅜"H, Low Metal Legs	<b>HTLSCUWSQR13LML</b>	15	2.7	\$1653	\$1705	\$1731
	16½"W x 16½"D x 18½"H, Medium Metal Legs	<b>HTLSCUWSQR16MML</b>	20	3.0	\$1653	\$1704	\$1729
	20¼"W x 20¼"D x 21⅝"H, High Metal Legs	<b>HTLSCUWSQR20HML</b>	24	3.3	\$1741	\$1793	\$1819
	30"W x 30"D x 15⅜"H, Low Metal Legs	<b>HTLSCUWSQR30LML</b>	35	6.7	\$1999	\$2052	\$2078
	<b>!</b> Cutout not available on 12¾" top.						
	<b>Rectangle Wood Top with Metal Legs</b> 60"W x 16½"D x 15⅜"H, Low Metal Legs	<b>HTLSCUWREC1660LML</b>	42	6.6	\$2319	\$2385	\$2418
	30"W x 16½"D x 15⅜"H, Low Metal Legs	<b>HTLSCUWREC1630LML</b>	24	5.7	\$1860	\$1917	\$1945
	30"W x 16½"D x 18½"H, Medium Metal Legs	<b>HTLSCUWREC1630MML</b>	25	5.7	\$1874	\$1932	\$1961
	<b>Pill Wood Top with Metal Legs</b> 60"W x 16½"D x 15⅜"H, Low Metal Legs	<b>HTLSCUWPIL1660LML</b>	41	6.6	\$2347	\$2413	\$2445
	30"W x 16½"D x 15⅜"H, Low Metal Legs	<b>HTLSCUWPIL1630LML</b>	23	5.7	\$1844	\$1900	\$1927
	30"W x 16½"D x 18½"H, Medium Metal Legs	<b>HTLSCUWPIL1630MML</b>	24	5.7	\$1848	\$1904	\$1932

## HOW TO SPECIFY

<b>Select Model Number</b> HTLSCUWRND16LML	<b>Select Cutout Option</b> N No Cutout G Grommet Cutout (+ \$42)	<b>Select Wood Finish</b> See page 115	<b>Select Leg Paint Color</b> See page 115	<b>Select Glide Option</b> G Glide
HTLSCUWRND16LML	G	LE856	P71	G



# SCULPT™ Wood Top Tables

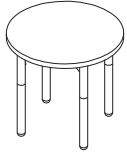

**DESCRIPTION**

**Round Wood Top with Wood Legs**  
 16½"W x 15⅜"H, Low Wood Legs  
 16½"W x 18½"H, Medium Wood Legs  
 16½"W x 21⅝"H, High Wood Legs  
 30"W x 15⅜"H, Low Wood Legs

**MODEL**

**HTLSCUWRND16LWL**  
**HTLSCUWRND16MWL**  
**HTLSCUWRND16HWL**  
**HTLSCUWRND30LWL**

**SHIP WEIGHT CUBE**

19 3.0  
 20 3.0  
 20 3.0  
 35 6.7

**LIST PRICE BY PAINT GRADE**

P1	P2	P3
\$2021	\$2076	\$2104
\$2048	\$2103	\$2131
\$2084	\$2140	\$2167
\$2457	\$2527	\$2560



**Square Wood Top with Wood Legs**

12¾"W x 12¾"D x 15⅜"H, Low Wood Legs  
 16½"W x 16½"D x 18½"H, Medium Wood Legs  
 20¼"W x 20¼"D x 21⅝"H, High Wood Legs  
 30"W x 30"D x 15⅜"H, Low Wood Legs

**HTLSCUWSQR13LWL**  
**HTLSCUWSQR16MWL**  
**HTLSCUWSQR20HWL**  
**HTLSCUWSQR30LWL**

15 2.7  
 20 3.0  
 24 3.3  
 35 6.7

P1	P2	P3
\$2020	\$2079	\$2168
\$2046	\$2104	\$2133
\$2165	\$2224	\$2313
\$2379	\$2441	\$2471

ⓘ Cutout not available on 12¾" top.

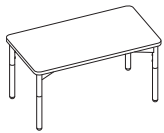

**Rectangle Wood Top with Wood Legs**

60"W x 16½"D x 15⅜"H, Low Wood Legs  
 30"W x 16½"D x 15⅜"H, Low Wood Legs  
 30"W x 16½"D x 18½"H, Medium Wood Legs

**HTLSCUWREC1660LWL**  
**HTLSCUWREC1630LWL**  
**HTLSCUWREC1630MWL**

42 6.6  
 24 5.7  
 25 5.7

P1	P2	P3
\$2574	\$2636	\$2668
\$2131	\$2186	\$2213
\$2160	\$2215	\$2242



**Pill Wood Top with Wood Legs**

60"W x 16½"D x 15⅜"H, Low Wood Legs  
 30"W x 16½"D x 15⅜"H, Low Wood Legs  
 30"W x 16½"D x 18½"H, Medium Wood Legs

**HTLSCUWPIL1660LWL**  
**HTLSCUWPIL1630LWL**  
**HTLSCUWPIL1630MWL**

41 6.6  
 23 5.7  
 24 5.7

P1	P2	P3
\$2614	\$2677	\$2709
\$2110	\$2163	\$2190
\$2132	\$2185	\$2211

## HOW TO SPECIFY

Select Model Number

H T L S C U W R N D 1 6 L W L .

Select Cutout Option

**N** No Cutout  
**G** Grommet Cutout (+ \$42)

G .

Select Wood Finish

See page 115



L E 8 5 6 .

Select Paint Color

See page 115

P 7 1

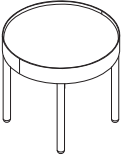
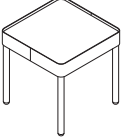
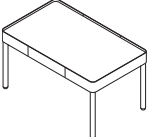

# SCULPT™ Tray Top Tables

	DESCRIPTION	MODEL	SHIP WEIGHT	CUBE	LIST PRICE	UPCHARGE BY		
						LAMINATE/P2	PAINT/P2	GRADE/P3
	<b>Round Tray Table Top with Metal Legs</b>							
	18"W x 16 <sup>3</sup> / <sub>16</sub> "H, Low Metal Legs	<b>HTLSCURNDT18LML</b>	37	3.1	<b>\$1260</b>	<b>\$12</b>	<b>\$103</b>	<b>\$155</b>
	18"W x 19 <sup>3</sup> / <sub>16</sub> "H, Medium Metal Legs	<b>HTLSCURNDT18MML</b>	38	3.1	<b>\$1443</b>	<b>\$12</b>	<b>\$122</b>	<b>\$183</b>
	18"W x 22 <sup>3</sup> / <sub>16</sub> "H, High Metal Legs	<b>HTLSCURNDT18HML</b>	39	3.1	<b>\$1464</b>	<b>\$12</b>	<b>\$124</b>	<b>\$186</b>
	30"W x 16 <sup>3</sup> / <sub>16</sub> "H, Low Metal Legs	<b>HTLSCURNDT30LML</b>	53	6.7	<b>\$1623</b>	<b>\$13</b>	<b>\$137</b>	<b>\$205</b>
	<b>Square Tray Table Top with Metal Legs</b>							
	15 <sup>3</sup> / <sub>4</sub> "W x 15 <sup>3</sup> / <sub>4</sub> "D x 16 <sup>3</sup> / <sub>16</sub> "H, Low Metal Legs	<b>HTLSCUSQRT16LML</b>	32	3.0	<b>\$1163</b>	<b>\$11</b>	<b>\$96</b>	<b>\$145</b>
	18"W x 18"D x 19 <sup>3</sup> / <sub>16</sub> "H, Medium Metal Legs	<b>HTLSCUSQRT18MML</b>	42	3.1	<b>\$1137</b>	<b>\$11</b>	<b>\$93</b>	<b>\$140</b>
	20 <sup>1</sup> / <sub>4</sub> "W x 20 <sup>1</sup> / <sub>4</sub> "D x 22 <sup>3</sup> / <sub>16</sub> "H, High Metal Legs	<b>HTLSCUSQRT20HML</b>	41	3.3	<b>\$1409</b>	<b>\$12</b>	<b>\$120</b>	<b>\$179</b>
	30"W x 30"D x 16 <sup>3</sup> / <sub>16</sub> "H, Low Metal Legs	<b>HTLSCUSQRT30LML</b>	55	4.9	<b>\$1500</b>	<b>\$14</b>	<b>\$124</b>	<b>\$187</b>
	<b>Rectangle Tray Table Top with Metal Legs</b>							
	60"W x 18"D x 16 <sup>3</sup> / <sub>16</sub> "H, Low Metal Legs	<b>HTLSCURECT1860LML</b>	64	6.9	<b>\$1505</b>	<b>\$16</b>	<b>\$120</b>	<b>\$181</b>
	30"W x 18"D x 16 <sup>3</sup> / <sub>16</sub> "H, Low Metal Legs	<b>HTLSCURECT1830LML</b>	41	5.8	<b>\$1713</b>	<b>\$19</b>	<b>\$134</b>	<b>\$201</b>
	30"W x 18"D x 19 <sup>3</sup> / <sub>16</sub> "H, Medium Metal Legs	<b>HTLSCURECT1830MML</b>	42	5.8	<b>\$1723</b>	<b>\$19</b>	<b>\$135</b>	<b>\$202</b>
	<b>Pill Tray Table Top with Metal Legs</b>							
	60"W x 18"D x 16 <sup>3</sup> / <sub>16</sub> "H, Low Metal Legs	<b>HTLSCUPILT1860LML</b>	63	7.0	<b>\$1772</b>	<b>\$16</b>	<b>\$148</b>	<b>\$221</b>
	30"W x 18"D x 16 <sup>3</sup> / <sub>16</sub> "H, Low Metal Legs	<b>HTLSCUPILT1830LML</b>	37	5.9	<b>\$1394</b>	<b>\$13</b>	<b>\$114</b>	<b>\$171</b>
	30"W x 18"D x 19 <sup>3</sup> / <sub>16</sub> "H, Medium Metal Legs	<b>HTLSCUPILT1830MML</b>	38	5.9	<b>\$1391</b>	<b>\$13</b>	<b>\$114</b>	<b>\$170</b>

## HOW TO SPECIFY

<b>Select Model Number</b> HTLSCURNDT18LML	<b>Select Cutout Option</b> N No Cutout G Grommet Cutout (+ \$42) G	<b>Select Laminate</b> See page 115 H	<b>Select Paint Color</b> See page 115 P71	<b>Select Glide Option</b> G Glide G
---	--	---	--	--

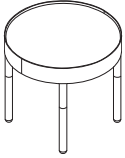
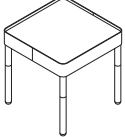
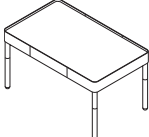
# SCULPT™ Tray Top Tables

	DESCRIPTION	MODEL	SHIP WEIGHT	CUBE	LIST PRICE	UPCHARGE BY LAMINATE/PAINT GRADE		
						L2	P2	P3
	<b>Round Tray Table Top with Wood Legs</b>							
	18"W x 16 <sup>3</sup> / <sub>16</sub> "H, Low Wood Legs	HTLSCURNDT18LWL	37	3.1	\$1638	\$12	\$113	\$168
	18"W x 19 <sup>3</sup> / <sub>16</sub> "H, Medium Wood Legs	HTLSCURNDT18MWL	38	3.1	\$1638	\$12	\$110	\$164
	18"W x 22 <sup>3</sup> / <sub>16</sub> "H, High Wood Legs	HTLSCURNDT18HWL	39	3.1	\$1667	\$12	\$110	\$164
	30"W x 16 <sup>3</sup> / <sub>16</sub> "H, Low Wood Legs	HTLSCURNDT30LWL	53	6.7	\$1993	\$13	\$145	\$217
	<b>Square Tray Table Top with Wood Legs</b>							
	15 <sup>3</sup> / <sub>4</sub> "W x 15 <sup>3</sup> / <sub>4</sub> "D x 16 <sup>3</sup> / <sub>16</sub> "H, Low Wood Legs	HTLSCUSQRT16LWL	32	3.0	\$1326	\$11	\$84	\$125
	18"W x 18"D x 19 <sup>3</sup> / <sub>16</sub> "H, Medium Wood Legs	HTLSCUSQRT18MWL	42	3.1	\$1317	\$11	\$80	\$119
	20 <sup>1</sup> / <sub>4</sub> "W x 20 <sup>1</sup> / <sub>4</sub> "D x 22 <sup>3</sup> / <sub>16</sub> "H, High Wood Legs	HTLSCUSQRT20HWL	41	3.3	\$1618	\$12	\$106	\$158
	30"W x 30"D x 16 <sup>3</sup> / <sub>16</sub> "H, Low Wood Legs	HTLSCUSQRT30LWL	55	6.7	\$1900	\$14	\$135	\$203
	<b>Rectangle Tray Table Top with Wood Legs</b>							
	60"W x 18"D x 16 <sup>3</sup> / <sub>16</sub> "H, Low Wood Legs	HTLSCURECT1860LWL	64	6.9	\$1674	\$16	\$109	\$162
	30"W x 18"D x 16 <sup>3</sup> / <sub>16</sub> "H, Low Wood Legs	HTLSCURECT1830LWL	41	5.8	\$1875	\$19	\$121	\$182
	30"W x 18"D x 19 <sup>3</sup> / <sub>16</sub> "H, Medium Wood Legs	HTLSCURECT1830MWL	42	5.8	\$1896	\$19	\$121	\$181
	<b>Pill Tray Table Top with Wood Legs</b>							
	60"W x 18"D x 16 <sup>3</sup> / <sub>16</sub> "H, Low Wood Legs	HTLSCUPILT1860LWL	63	7.0	\$1937	\$16	\$135	\$202
	30"W x 18"D x 16 <sup>3</sup> / <sub>16</sub> "H, Low Wood Legs	HTLSCUPILT1830LWL	37	5.9	\$1550	\$13	\$100	\$151
	30"W x 18"D x 19 <sup>3</sup> / <sub>16</sub> "H, Medium Wood Legs	HTLSCUPILT1830MWL	38	5.9	\$1569	\$13	\$100	\$150

## HOW TO SPECIFY

<b>Select Model Number</b> HTLSCURNDT18LWL	<b>Select Cutout Option</b> N No Cutout G Grommet Cutout (+ \$42)	<b>Select Laminate</b> See page 115	<b>Select Wood Leg Finish</b> See page 115	<b>Select Paint Color</b> See page 115
HTLSCURNDT18LWL	G	H	P856	P71

# SCULPT™ Personal & Console Tables

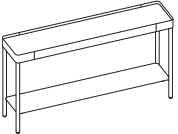
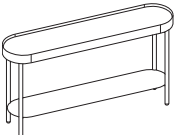
	DESCRIPTION	MODEL	SHIP WEIGHT	CUBE	LIST PRICE	UPCHARGE BY		
						LAMINATE/P3	PAINT/P2	GRADE/L2
	<b>Personal Table with Metal Base</b> 22"W x 13 <sup>7</sup> / <sub>8</sub> "D x 29 <sup>1</sup> / <sub>4</sub> "H	HTLSCUPERTBL	39	8.0	\$917	\$9	\$76	\$113
	<b>Rectangle Console Table with Metal Legs</b> 53"W x 12"D x 28 <sup>13</sup> / <sub>16</sub> "H	HTLSCURECCNSL1253	74	6.9	\$2242	\$15	\$196	\$295
	<b>Pill Console Table with Metal Legs</b> 53"W x 12"D x 28 <sup>13</sup> / <sub>16</sub> "H	HTLSCUPILCNSL1253	81	6.9	\$2324	\$15	\$204	\$306

## HOW TO SPECIFY

<b>Select Model Number</b> HTLSCUPERTBL	<b>Select Laminate</b> See page 115 H	<b>Select Paint Color</b> See page 115 P71
--	---	--

# SCULPT™ Planters

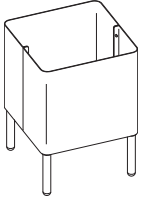

DESCRIPTION	MODEL	SHIP WEIGHT	CUBE	LIST PRICE BY PAINT GRADE		
				P1	P2	P3
<b>Square Planters</b>						
15"W x 15"D x 21 <sup>5</sup> / <sub>16</sub> "H, Square Low Planter	<b>HTLSCUSQRPLNT15L</b>	40	4.5	<b>\$1476</b>	<b>\$1624</b>	<b>\$1698</b>
15"W x 15"D x 30 <sup>5</sup> / <sub>16</sub> "H, Square High Planter	<b>HTLSCUSQRPLNT15H</b>	50	4.9	<b>\$1833</b>	<b>\$2017</b>	<b>\$2109</b>
30"W x 30"D x 15 <sup>5</sup> / <sub>16</sub> "H, Square Low Planter	<b>HTLSCUSQRPLNT30L</b>	60	7.1	<b>\$1756</b>	<b>\$1932</b>	<b>\$2020</b>

**NOTES:**

- All planters come with a plastic tray insert.
- It is recommended to have all plants in pots for planters to avoid water damage to the product.
- For planning purposes, please see approximate internal dimensions for planters:
  - 15" Square = 11<sup>5</sup>/<sub>16</sub>"W x 11<sup>5</sup>/<sub>16</sub>"D x 13<sup>1</sup>/<sub>4</sub>"H
  - 30" Square = 26<sup>5</sup>/<sub>16</sub>"W x 26<sup>5</sup>/<sub>16</sub>"D x 7<sup>1</sup>/<sub>4</sub>"H

**HOW TO SPECIFY**

<p>Select Model Number</p> <p>HTLSCUSQRPLNT15L .</p>	<p>Select Paint Color</p> <p>See page 115</p> <p>P71 .</p>	<p>Select Glide Option</p> <p>G Glide</p> <p>G</p>
--	--	--

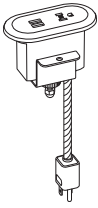

**DESCRIPTION**

Power Grommet

**MODEL**

HTGPWRKIA

**SHIP WEIGHT**

3

**CUBE**

0.2

**LIST PRICE**

\$263

## HOW TO SPECIFY

Select  
Model Number

HTGPWRKIA

Select  
Grommet Color

- P Black
- STRM Storm
- SNW Snow

STRM

Select  
Cord Color

- STRM Storm

STRM

# CROSS REFERENCE BY APPLICATION

	Page
<b>CLASSROOM</b>	
<b>Student Desks</b>	
SmartLink® Student Desks .....	180-181
<b>Teacher/Administration Desks</b>	
SmartLink® Teacher Stations .....	186-187
Voi® .....	<i>See the Desks section in the 2024 Workspaces Pricer.</i>
10500 Series™ ...	<i>See the Desks section in the 2024 Workspaces Pricer.</i>
38000 Series™ ..	<i>See the Desks section in the 2024 Workspaces Pricer.</i>
<b>Seating</b>	
SmartLink® Seating .....	182-185
Perpetual® Nesting .....	437-439
Olson Stacker® - 4040 Series	
High-Density .....	432-433
Motivate® Seating .....	405-420
Volt® - 5700/5710/5720/5730 Series .....	485-492
Ignition®/Ignition® 2.0 .....	363-392
Solve® .....	461-472
Convergence® .....	303-307
<b>Storage &amp; Files</b>	
Brigade® 800 Series Lateral Files .....	<i>See the Storage section in the 2024 Workspaces Pricer.</i>
Brigade® 700 Series Lateral Files .....	<i>See the Storage section in the 2024 Workspaces Pricer.</i>
Brigade® 600 Series Lateral Files .....	<i>See the Storage section in the 2024 Workspaces Pricer.</i>
Lateral File Accessories .....	<i>See the Storage section in the 2024 Workspaces Pricer.</i>
310 Series Vertical Files - 26½"D .....	<i>See the Storage section in the 2024 Workspaces Pricer.</i>
510 Series Vertical Files - 25"D .....	<i>See the Storage section in the 2024 Workspaces Pricer.</i>
Flagship® Bookcases and Storage Cabinets ....	<i>See the Storage section in the 2024 Workspaces Pricer.</i>
Brigade® Storage Cabinets .....	<i>See the Storage section in the 2024 Workspaces Pricer.</i>
Brigade® Steel Bookcases .....	<i>See the Storage section in the 2024 Workspaces Pricer.</i>
1870 Series Bookcases .....	<i>See the Storage section in the 2024 Workspaces Pricer.</i>
<b>Tables</b>	
Huddle Multi-Purpose Tables .....	51-61
Motivate® Tables .....	65-72
<b>Learning Applications</b>	
SmartLink® Wall Rail System .....	188-189
Motivate® Mobile Markerboards .....	72
<b>COMPUTER LAB</b>	
<b>Tables</b>	
Huddle Multi-Purpose Tables .....	51-61
Motivate® Tables .....	65-72
Between™ Tables .....	33-38
<b>Seating</b>	
Motivate® Seating .....	405-420
Perpetual® Nesting .....	437-439

	Page
<b>CAFETERIA</b>	
<b>Seating</b>	
SmartLink® Seating .....	182-185
Motivate® Seating .....	405-420
Olson Stacker® - 4040 Series	
High-Density .....	432-433
<b>Tables</b>	
Huddle Multi-Purpose Tables .....	51-61
Motivate® Tables .....	65-72
Between™ Tables .....	33-38
<b>COMMON AREAS</b>	
<b>Reception Seating</b>	
Flock® Lounge .....	323-345
Grove® .....	350-361
Accommodate® .....	259-265
Cambia™ - 2160 Series .....	283-285
<b>Tables</b>	
Huddle Multi-Purpose Tables .....	51-61
Motivate® Tables .....	65-72
Laminate Occasional Tables .....	64
Flock® .....	44-50
Between™ Tables .....	33-38
<b>LIBRARY / MEDIA CENTER</b>	
<b>Storage</b>	
Flagship® Bookcases .....	<i>See the Storage section in the 2024 Workspaces Pricer.</i>
Brigade® Steel Bookcases .....	<i>See the Storage section in the 2024 Workspaces Pricer.</i>
<b>Reception Seating</b>	
Flock® Lounge .....	323-345
Grove® .....	350-361
Accommodate® .....	259-265
Cambia™ - 2160 Series .....	283-285
<b>Student Seating</b>	
SmartLink® Seating .....	182-185
Motivate® Seating .....	405-420
Accommodate® .....	259-265
<b>Tables</b>	
Huddle Multi-Purpose Tables .....	51-61
Motivate® Tables .....	65-72
Laminate Occasional Tables .....	64
Flock® .....	44-50
Between™ Tables .....	33-38

# CROSS REFERENCE BY APPLICATION

	Page
<b>ART ROOM</b>	
<b>Seating</b>	
Motivate® Seating .....	405-420
<b>Storage</b>	
Flagship® Storage Cabinets .....	<i>See the Storage section in the 2024 Workspaces Pricer.</i>
Brigade® Storage Cabinets .....	<i>See the Storage section in the 2024 Workspaces Pricer.</i>
Flagship® Bookcases .....	<i>See the Storage section in the 2024 Workspaces Pricer.</i>
Brigade® Steel Bookcases .....	<i>See the Storage section in the 2024 Workspaces Pricer.</i>
1870 Series Bookcases .....	<i>See the Storage section in the 2024 Workspaces Pricer.</i>
<b>Tables</b>	
Huddle Multi-Purpose Tables .....	51-61
Motivate® Tables .....	65-72
<b>TEACHER PLANNING</b>	
<b>Desks</b>	
SmartLink® Teacher Stations .....	186-187
Voi® .....	<i>See the Desks section in the 2024 Workspaces Pricer.</i>
10500 Series™ ...	<i>See the Desks section in the 2024 Workspaces Pricer.</i>
38000 Series™ ..	<i>See the Desks section in the 2024 Workspaces Pricer.</i>
<b>Seating</b>	
Volt® - 5700/5710/5720/5730 Series .....	485-492
Ignition®/Ignition® 2.0 .....	363-392
Solve® .....	461-472
Convergence® .....	303-307
<b>Storage</b>	
Brigade® 800 Series Lateral Files .....	<i>See the Storage section in the 2024 Workspaces Pricer.</i>
Brigade® 700 Series Lateral Files .....	<i>See the Storage section in the 2024 Workspaces Pricer.</i>
Brigade® 600 Series Lateral Files .....	<i>See the Storage section in the 2024 Workspaces Pricer.</i>
Flagship® Lateral Files .....	<i>See the Storage section in the 2024 Workspaces Pricer.</i>
400 Series Lateral Files .....	<i>See the Storage section in the 2024 Workspaces Pricer.</i>
Lateral File Accessories .....	<i>See the Storage section in the 2024 Workspaces Pricer.</i>
210 Series Vertical Files - 28½"D .....	<i>See the Storage section in the 2024 Workspaces Pricer.</i>
310 Series Vertical Files - 26½"D .....	<i>See the Storage section in the 2024 Workspaces Pricer.</i>
510 Series Vertical Files - 25"D .....	<i>See the Storage section in the 2024 Workspaces Pricer.</i>
Vertical File Accessories .....	<i>See the Storage section in the 2024 Workspaces Pricer.</i>
Flagship® Storage Cabinets .....	<i>See the Storage section in the 2024 Workspaces Pricer.</i>
Brigade® Storage Cabinets .....	<i>See the Storage section in the 2024 Workspaces Pricer.</i>
Flagship® Bookcases .....	<i>See the Storage section in the 2024 Workspaces Pricer.</i>
Brigade® Steel Bookcases .....	<i>See the Storage section in the 2024 Workspaces Pricer.</i>
1870 Series Bookcases .....	<i>See the Storage section in the 2024 Workspaces Pricer.</i>

	Page
<b>TEACHER PLANNING (continued)</b>	
<b>Tables</b>	
Huddle Multi-Purpose Tables .....	51-61
Motivate® Tables .....	65-72
Flock® .....	44-50
Between™ Tables .....	33-38
<b>ADMINISTRATION</b>	
<b>Desks</b>	
10500 Series™ ...	<i>See the Desks section in the 2024 Workspaces Pricer.</i>
38000 Series™ ..	<i>See the Desks section in the 2024 Workspaces Pricer.</i>
<b>Reception Seating</b>	
Cambia™ - 2160 Series .....	283-285
<b>Task / Administrative Seating</b>	
Ignition®/Ignition® 2.0 .....	363-392
Motivate® Seating .....	405-420
Volt® - 5700/5710/5720/5730 Series .....	485-492
Solve® .....	461-472
Convergence® .....	303-307
<b>Storage &amp; Files</b>	
Brigade® 800 Series Lateral Files .....	<i>See the Storage section in the 2024 Workspaces Pricer.</i>
Brigade® 700 Series Lateral Files .....	<i>See the Storage section in the 2024 Workspaces Pricer.</i>
Brigade® 600 Series Lateral Files .....	<i>See the Storage section in the 2024 Workspaces Pricer.</i>
Lateral File Accessories .....	<i>See the Storage section in the 2024 Workspaces Pricer.</i>
310 Series Vertical Files - 26½"D .....	<i>See the Storage section in the 2024 Workspaces Pricer.</i>
510 Series Vertical Files - 25"D .....	<i>See the Storage section in the 2024 Workspaces Pricer.</i>
Flagship® Bookcases and Storage Cabinets ...	<i>See the Storage section in the 2024 Workspaces Pricer.</i>
Brigade® Storage Cabinets .....	<i>See the Storage section in the 2024 Workspaces Pricer.</i>
Brigade® Steel Bookcases .....	<i>See the Storage section in the 2024 Workspaces Pricer.</i>
1870 Series Bookcases .....	<i>See the Storage section in the 2024 Workspaces Pricer.</i>
<b>Tables</b>	
Huddle Multi-Purpose Tables .....	51-61
Motivate® Tables .....	65-72
Flock® .....	44-50
Between™ Tables .....	33-38
<b>Occasional Tables</b>	
Laminate Occasional Tables .....	64
Flock® .....	44-50





Build™ Student Desks and Tables shown  
with SmartLink® Seating and Storage.

## BUILD™

Inspiring the next generation takes a higher degree of mobility and hands-on learning. The Build™ series, an educational product collection of tables, student desks, and seating, is lightweight, durable, reconfigurable, and customizable. Build encourages creativity and adaptability so students can support collaboration and social interaction or create personal space for focused study time. Build supports the movers and shakers, the hands-on doers, and the leaders who crave creativity. The future of education takes shape with Build.



## FEATURES

- 15 table shapes and 6 student desk shapes make reconfiguration fun and easy.
- In addition to all standard HON laminates, Build tops are available in bright, bold laminates and a dry-erase markerboard finish to enhance any learning environment. Or try Butcher Block tops on Makerspace tables.
- Table legs are available in multiple height adjustable ranges and nesting bases to accommodate different user applications.
- Adjustable height student desk legs accommodate any students in K-12 grades and beyond.
- The durable Makerspace table features à la carte storage accessories and allows you to keep a creative space clean, organized, and customizable.

# BUILD™ ORDERING INFORMATION

## LAMINATE GROUP A (TOP LAMINATES)

### L1 LAMINATES ..... CODES

#### Woodgrain

- ◆ Bourbon Cherry ..... H
- ◆ Cognac ..... COGN
- ◆ Field Elm ..... LWFE
- ◆ Florence Walnut ..... LFW1
- ◆ Harvest ..... C
- ◆ Kingswood Walnut ..... LK11
- ◆ Loft ..... LOFT
- ◆ Mahogany ..... N
- ◆ Mocha ..... MOCH
- ◆ Natural Maple ..... D
- ◆ Pinnacle ..... PINC
- ◆ Shaker Cherry ..... F
- ◆ Sterling Ash ..... LSA1

#### Solid

- ◆ Black ..... P
- ◆ Charcoal ..... S
- ◆ Designer White ..... LDW1
- ◆ Loft ..... LOFT

#### Patterned

- ◆ Handspun Chestnut ..... LAHC
- ◆ Handspun Dove ..... LAHD
- ◆ Handspun Pearl ..... LAHP
- ◆ Handspun Slate ..... LAHS
- ◆ Silver Mesh ..... B9
- ◆ Steel Mesh ..... A9
- ◆ Battleship ..... LBT1
- ◆ Gray ..... G2
- ◆ Mushroom ..... LMH1
- ◆ Neon Carrot ..... LNC1
- ◆ Tennis Ball ..... LTB1
- ◆ White ..... G1

### L2 LAMINATES ..... CODES

#### Woodgrain

- ◆ Beigewood ..... LWBE
- ◆ Fawn Cypress ..... LFC1
- ◆ Lowell Ash ..... LLA1
- ◆ Natural Recon ..... LNR1
- ◆ Phantom Ecru ..... LPE1
- ◆ Portico Teak ..... LPT1
- ◆ Skyline Walnut ..... LSW1

### L4 LAMINATES ..... CODES

- ◆ White Markerboard ..... FMQ1

## LAMINATE GROUP B (SHELF LAMINATES)

### L1 LAMINATES ..... CODES

#### Woodgrain

- ◆ Bourbon Cherry ..... H
- ◆ Cognac ..... COGN
- ◆ Field Elm ..... LWFE
- ◆ Florence Walnut ..... LFW1
- ◆ Harvest ..... C
- ◆ Kingswood Walnut ..... LK11
- ◆ Mahogany ..... N
- ◆ Natural Maple ..... D
- ◆ Pinnacle ..... PINC
- ◆ Shaker Cherry ..... F
- ◆ Sterling Ash ..... LSA1

#### Solid

- ◆ Black ..... P
- ◆ Charcoal ..... S
- ◆ Designer White ..... LDW1
- ◆ Loft ..... LOFT

### L2 LAMINATES ..... CODES

#### Woodgrain

- ◆ Beigewood ..... LWBE
- ◆ Fawn Cypress ..... LFC1
- ◆ Lowell Ash ..... LLA1
- ◆ Natural Recon ..... LNR1
- ◆ Phantom Ecru ..... LPE1
- ◆ Portico Teak ..... LPT1
- ◆ Skyline Walnut ..... LSW1

## PAINT GROUP A (TABLE AND STUDENT DESK LEG PAINT)

### PAINT ..... CODES

- P1**
- ◆ Black ..... P
- P2**
- ◆ Platinum Metallic ..... T1

## PAINT GROUP B (MAKERSPACE TABLE BASE AND STOOL)

### PAINT ..... CODES

#### P1

- ◆ Black ..... P
- ◆ Brownstone ..... P7D
- ◆ Charcoal ..... S
- ◆ Designer White ..... PJW
- ◆ Fossil ..... P28
- ◆ Greige ..... T5
- ◆ Loft ..... LOFT
- ◆ Muslin ..... T3
- ◆ Titanium ..... P8T

#### P2

- ◆ Champagne Metallic ..... T4
- ◆ Platinum Metallic ..... T1
- ◆ Gunmetal Metallic ..... PR3
- ◆ Silver ..... PR6

#### P3

- ◆ Atom ..... P8S
- ◆ Bullseye ..... PJF
- ◆ Ember ..... P8P
- ◆ Ion ..... P8N
- ◆ Iris ..... P8J
- ◆ Krypton ..... P8F
- ◆ Regatta ..... P8M

## PAINT GROUP C (MAKERSPACE TABLE END PANEL)

### PAINT ..... CODES

#### P1

- ◆ Black ..... P
- ◆ Brownstone ..... P7D
- ◆ Charcoal ..... S
- ◆ Designer White ..... PJW
- ◆ Fossil ..... P28
- ◆ Greige ..... T5
- ◆ Loft ..... LOFT
- ◆ Muslin ..... T3
- ◆ Titanium ..... P8T

#### P2

- ◆ Champagne Metallic ..... T4
- ◆ Platinum Metallic ..... T1
- ◆ Silver ..... PR6

#### P3

- ◆ Atom ..... P8S
- ◆ Bullseye ..... PJF
- ◆ Ember ..... P8P
- ◆ Ion ..... P8N
- ◆ Iris ..... P8J
- ◆ Krypton ..... P8F
- ◆ Regatta ..... P8M

#### P6

- ◆ Markerboard ..... MKB

## MAKERSPACE BUTCHER BLOCK

- ◆ Butcher Block ..... LH903

## EDGE

### EDGE ..... CODES

#### Woodgrain

- ◆ Beigewood ..... DE
- ◆ Cognac ..... COGN
- ◆ Fawn Cypress ..... FC
- ◆ Field Elm ..... FE
- ◆ Florence Walnut ..... FW
- ◆ Kingswood Walnut ..... KI
- ◆ Lowell Ash ..... DL
- ◆ Mahogany ..... N
- ◆ Mocha ..... MOCH
- ◆ Natural Maple ..... D
- ◆ Natural Recon ..... NR
- ◆ Phantom Ecru ..... PE
- ◆ Pinnacle ..... PINC
- ◆ Portico Teak ..... DP
- ◆ Shaker Cherry ..... F
- ◆ Skyline Walnut ..... SW
- ◆ Sterling Ash ..... SA















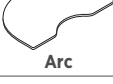

#### Solid

- ◆ Atom ..... AT
- ◆ Black ..... P
- ◆ Brownstone ..... EY
- ◆ Bullseye ..... BY
- ◆ Charcoal ..... S
- ◆ Designer White ..... DW
- ◆ Ember ..... MR
- ◆ Fossil ..... EH
- ◆ Greige ..... R
- ◆ Ion ..... IO
- ◆ Iris ..... IR
- ◆ Krypton ..... KT
- ◆ Loft ..... LOFT
- ◆ Muslin ..... T
- ◆ Platinum ..... K
- ◆ Regatta ..... RE

◆◆◆ For lead time information see page 21.

# BUILD™ Shape Matrix

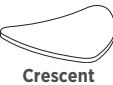
EDUCATION

Top Shape/Model	Tables			Student Desks	
	Youth Height Leg Adjusts 13"-18"	Standard Height Leg Adjusts 22"-34"	Standing Height Leg Adjusts 30"-42"	Nesting Base	Seated Height Leg Adjusts 22"-34"
 Kite	X	X	X		
 Ribbon	X	X	X	X	X
 Wisp	X	X	X		
 Snap	X	X	X		
 Rectangle	X	X	X		X
 Half-Round	X	X	X		
 Arc	X	X	X		
 Round	X	X	X		
 Square	X	X	X		
 Trapezoid	X	X	X		X
 Horseshoe	X	X	X		
 Home Plate	X	X	X		
 Spooky	X	X	X	X	X
 Tide	X	X	X		
 Dart	X	X	X	X	
 Crescent					X
 Fin					X

## Snap



3 PEOPLE/1 TABLE

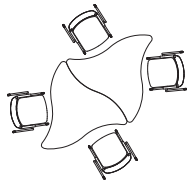

4 PEOPLE/2 TABLES

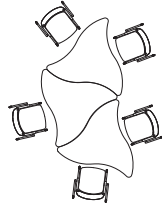

5 PEOPLE/3 TABLES

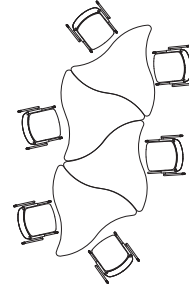

6 PEOPLE/4 TABLES

## Tide

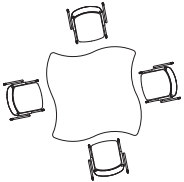

4 PEOPLE/1 TABLE

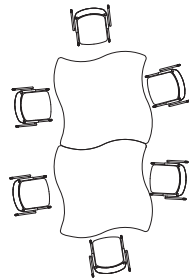

6 PEOPLE/2 TABLES

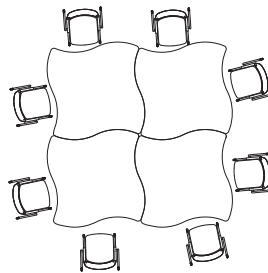

8 PEOPLE/4 TABLES

## Kite



2 PEOPLE/1 TABLE



4 PEOPLE/2 TABLES

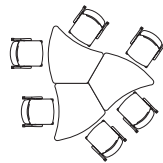

6 PEOPLE/3 TABLES

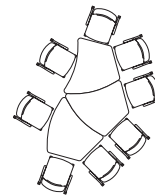

8 PEOPLE/3 TABLES

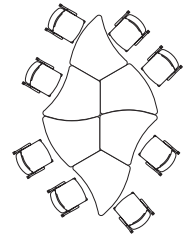

8 PEOPLE/6 TABLES

## Dart

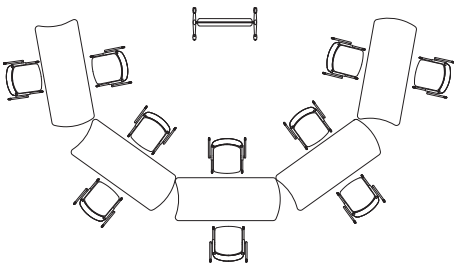

10 PEOPLE/5 TABLES

# BUILD™ Table Configurations

EDUCATION

## Wisp



4 PEOPLE/1 TABLE

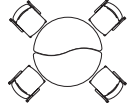

4 PEOPLE/2 TABLES



6 PEOPLE/3 TABLES

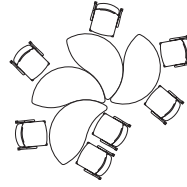

7 PEOPLE/4 TABLES

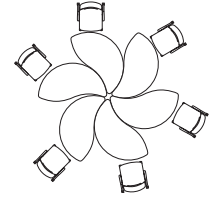

6 PEOPLE/6 TABLES

## Ribbon

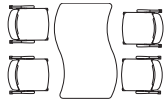

4 PEOPLE/1 TABLE

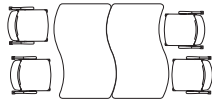

4 PEOPLE/2 TABLES

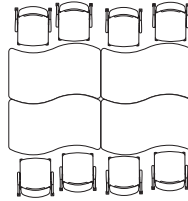

8 PEOPLE/4 TABLES

## Home Plate

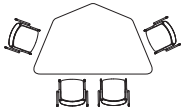

4 PEOPLE/1 TABLE

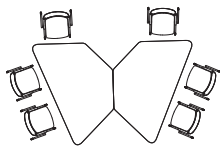

6 PEOPLE/2 TABLES

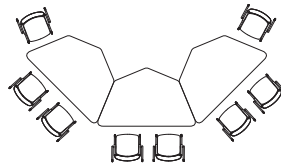

8 PEOPLE/3 TABLES

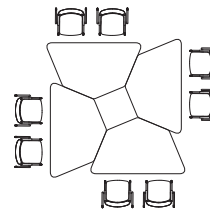

8 PEOPLE/4 TABLES

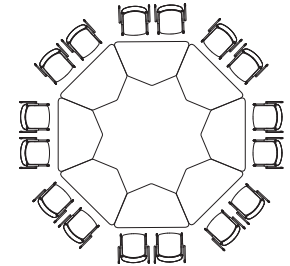

16 PEOPLE/8 TABLES

## Horseshoe

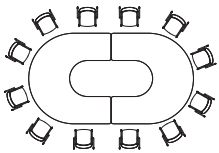

12 PEOPLE/2 TABLES

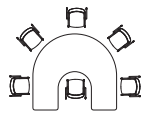

6 PEOPLE/1 TABLE

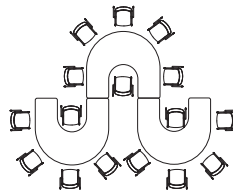

16 PEOPLE/3 TABLES

# BUILD™ Table Configurations

## Spooky



2 PEOPLE/1 TABLE

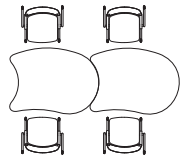

4 PEOPLE/2 TABLES

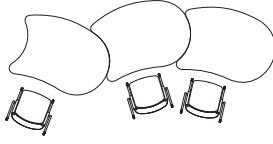

3 PEOPLE/3 TABLES

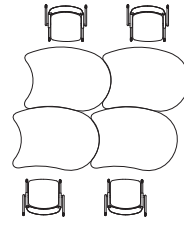

4 PEOPLE/4 TABLES

## Combinations

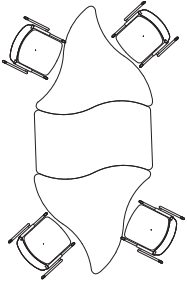

4 PEOPLE/3 TABLES  
*Ribbon and Snap*

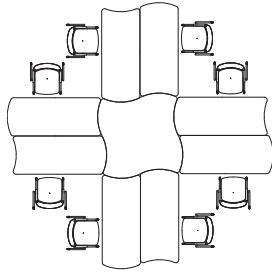

8 PEOPLE/9 TABLES  
*Tide and Dart*

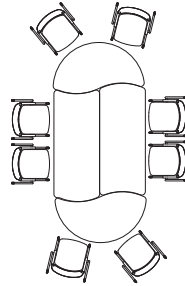

8 PEOPLE/4 TABLES  
*Dart and Wisp*





# BUILD™ Table Tops

GSA SIN 33721 EXCEPT AS NOTED

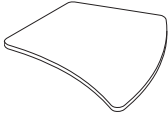

Icon Legend on page 19

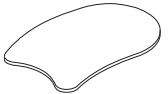
EDUCATION

	DESCRIPTION	MODEL	LEGS REQUIRED	SHIP WEIGHT	CUBE	LIST PRICE BY LAMINATE GRADE		
						L1	L2	L4
	<b>Snap Table Top</b> 54"W x 34"D	<b>HESNP54E</b>	3	46	2.8	<b>\$606</b>	<b>\$632</b>	<b>\$680</b>
<b>OPEN MARKET</b>								
	<b>Kite Table Top</b> 40"W x 24"D	<b>HESA2440E*</b>	4	30	3.9	<b>\$581</b>	<b>\$598</b>	<b>\$631</b>
	50"W x 30"D	<b>HESA3050E</b>	4	50	5.8	<b>\$606</b>	<b>\$628</b>	<b>\$671</b>
	<b>Wisp Table Top</b> 54"W x 30"D	<b>HESN3054E</b>	4	63	4.6	<b>\$587</b>	<b>\$609</b>	<b>\$652</b>
	<b>Half-Round Table Top</b> 60"W x 30"D	<b>HESH3060E</b>	4	69	6.0	<b>\$560</b>	<b>\$582</b>	<b>\$625</b>
	<b>Spooky Table Top</b> 36"W x 54"D	<b>HESY3654E</b>	4	61	14.4	<b>\$525</b>	<b>\$547</b>	<b>\$589</b>
<b>OPEN MARKET</b>								
	<b>Ribbon Table Top</b> 54"W x 30"D	<b>HESW3054E</b>	4	65	5.4	<b>\$523</b>	<b>\$545</b>	<b>\$588</b>

**NOTES:**

- Quick set bracket factory installed for easy leg location and installation.
- ! Top and legs specified separately. Table tops compatible only with leg models on page 137.

\* OPEN MARKET

## HOW TO SPECIFY

<b>Select Model Number</b> H E S H 3 0 6 0 E .	<b>Select Grommet</b> N No Grommet	<b>Select Top Laminate</b> See page 129, Group A L D W 1 .	<b>Select Edge Color</b> See page 129 D W
---	---------------------------------------	--	---



# BUILD™ Table Tops

EDUCATION

	DESCRIPTION	MODEL	LEGS REQUIRED	SHIP WEIGHT	CUBE	LIST PRICE BY LAMINATE GRADE		
						L1	L2	L4
	<b>Rectangle Table Top</b>							
	48"W x 24"D	<b>HETR2448E</b>	4	71.0	3.6	<b>\$444</b>	<b>\$461</b>	<b>\$494</b>
	60"W x 24"D	<b>HETR2460E</b>	4	57.0	4.4	<b>\$493</b>	<b>\$515</b>	<b>\$558</b>
	72"W x 24"D	<b>HETR2472E</b>	4	68.0	4.9	<b>\$544</b>	<b>\$566</b>	<b>\$609</b>
	48"W x 30"D	<b>HETR3048E</b>	4	62.0	4.4	<b>\$464</b>	<b>\$481</b>	<b>\$514</b>
	60"W x 30"D	<b>HETR3060E</b>	4	71.0	5.4	<b>\$507</b>	<b>\$529</b>	<b>\$572</b>
	72"W x 30"D	<b>HETR3072E</b>	4	85.0	4.9	<b>\$580</b>	<b>\$602</b>	<b>\$645</b>
	<b>Round Table Top</b>							
	42" Diameter	<b>HERD42E</b>	4	51.0	4.7	<b>\$397</b>	<b>\$414</b>	<b>\$445</b>
	48" Diameter	<b>HERD48E</b>	4	66.0	6.1	<b>\$448</b>	<b>\$467</b>	<b>\$503</b>
	<b>Square Table Top</b>							
	36"W x 36"D	<b>HESQ36E</b>	4	46.0	3.7	<b>\$338</b>	<b>\$353</b>	<b>\$380</b>
	42"W x 42"D	<b>HESQ42E</b>	4	61.0	4.9	<b>\$433</b>	<b>\$451</b>	<b>\$486</b>
	48"W x 48"D	<b>HESQ48E</b>	4	76.0	6.2	<b>\$473</b>	<b>\$493</b>	<b>\$531</b>
	<b>Tide Table Top</b>							
	54"W x 54"D	<b>HETD54E</b>	4	106.0	9.2	<b>\$743</b>	<b>\$774</b>	<b>\$832</b>
	<b>Trapezoid Table Top</b>							
		<b>HETZ3060E</b>	4	58.1	4.8	<b>\$420</b>	<b>\$438</b>	<b>\$472</b>
	<b>Home Plate Table Top</b>							
	36"W x 60"D	<b>HEHP3660E</b>	4	64.0	15.9	<b>\$507</b>	<b>\$529</b>	<b>\$572</b>

**NOTES:**

- Quick set bracket factory installed for easy leg location and installation.
- ! Top and legs specified separately. Table tops compatible only with leg models on page 137.

## HOW TO SPECIFY

<p>Select Model Number</p> <p>H E T R 2 4 4 8 E .</p>	<p>Select Grommet</p> <p>N No Grommet</p> <p>N .</p>	<p>Select Top Laminate</p> <p>See page 129, Group A</p> <p>L D W 1 .</p>	<p>Select Edge Color</p> <p>See page 129</p> <p>D W</p>
---	--	--	---





# BUILD™ Table Tops

OPEN MARKET

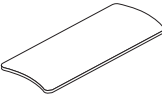

Icon Legend on page 19

EDUCATION

	DESCRIPTION	MODEL	LEGS REQUIRED	SHIP WEIGHT	CUBE	LIST PRICE BY LAMINATE GRADE		
						L1	L2	L4
	<b>Dart Table Top</b> 66"W x 27"D	<b>HEDRT2766E</b>	4	86	4.3	<b>\$531</b>	<b>\$553</b>	<b>\$595</b>
	<b>Arc Table Top</b> 72"W x 48"D	<b>HESKD4872E</b>	4	112	8.2	<b>\$848</b>	<b>\$870</b>	<b>\$913</b>
	<b>Horseshoe Table Top</b> 60"W x 66"D	<b>HESH6066E</b>	4	103	21.7	<b>\$1007</b>	<b>\$1051</b>	<b>\$1137</b>

**NOTES:**

- Quick set bracket factory installed for easy leg location and installation.
- ! Top and legs specified separately. Table tops compatible only with leg models on page 137.

## HOW TO SPECIFY

<p><b>Select Model Number</b></p> <p>H E S H 6 0 6 6 E .</p>	<p><b>Select Grommet</b></p> <p>N No Grommet</p> <p>N .</p>	<p><b>Select Top Laminate</b></p> <p>See page 129, Group A</p> <p>L D W 1 .</p>	<p><b>Select Edge Color</b></p> <p>See page 129</p> <p>D W</p>
--	---	---	--



	DESCRIPTION	MODEL	HEIGHT RANGE	SHIP WEIGHT	CUBE	LIST PRICE P1/P2
	<b>Build™ Table Adjustable Height Leg Pack</b> Youth Height Legs, Pack of 4	HEBY4LEG	13"-18"	19	0.9	\$191
	<b>Build™ Table Adjustable Height Leg Pack</b> Standard Table Height Legs, Pack of 4	HEB4LEG	22"-34"	19	1.2	\$252
	<b>Build™ Table Adjustable Height Leg Pack</b> Standing Height Legs, Pack of 4	HEBS4LEG	30"-42"	25	2.2	\$309

**NOTES:**

- Specify paint for upper portion of leg. Bottom is chrome.

**!** Compatible only with top models on pages 134-136.

CASTER COMPATIBILITY CHART		
	Yes	No
Standing		X
Youth	X	
Table	X	

**!** See pages 134-136 for number of legs required per top. Legs always ship 4 per carton. Use chart below for quantity of 4-leg packs required for shapes that utilize three legs.

DESKS	LEGS NEEDED	ADJUSTABLE POST LEGS 4-PACKS
1	3	1
2	6	2
3	9	3
4	12	3
5	15	4
6	18	5
7	21	6
8	24	6
9	27	7
10	30	8

## HOW TO SPECIFY

<b>Select Model Number</b>	<b>Select Paint Color</b>
HEBS4LEG.	See page 129, Paint Group A
T1	

# BUILD™ Nesting Tables

GSA SIN 33721 EXCEPT AS NOTED



Icon Legend on page 19

EDUCATION



**DESCRIPTION**

**Dart Table with Nesting Base**  
66"W x 27"D

**MODEL**

**HEDRT-2766E-NS**

**SHIP WEIGHT**

113

**CUBE**

8.7

**LIST PRICE BY LAMINATE GRADE**

**L1**

**\$1441**

**L2**

**\$1463**

**L4**

**\$1505**

NOTES: Ribbon, Wisp, Snap, Tide and Dart can all be used together.

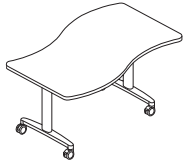

**Ribbon Nesting Table**  
54"W x 30"D

**HESW-3054E-NS**

89

8.1

**\$1429**

**\$1451**

**\$1494**

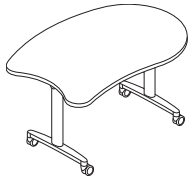

**Spooky Nesting Table**  
54"W x 36"D

**HESY-3654E-NS**

85

17.1

**\$1435**

**\$1457**

**\$1499**

**DESCRIPTION**

**Nesting Spacer Kit**

**MODEL**

**HESPCR**

**SHIP WEIGHT**

2 Ⓞ

**CUBE**

0.1

**LIST PRICE**

**\$67**

NOTES: Use with Build™ standard height post legs and nesting bases to create even table heights. Specify 1 kit per nesting table.

ⓘ Available in P Black only. Specify: HESPCR.P.

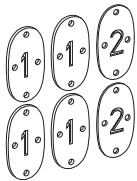

OPEN MARKET







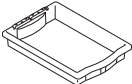

**NOTES:**

ⓘ Nesting bases are not intended to be used in combination with youth, standing, or desk post-legs.

ⓘ Nesting bases have a height difference of 1/2" when used with Build™ Standard Table Height Post Leg models. Use Nesting Spacer Kit HESPCR to create even table heights.

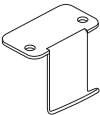
<p><b>Select Model Number</b></p> <p>HEDRT-2766E-NS</p>	<p><b>Select Grommet</b></p> <p>N No Grommet</p> <p>N</p>	<p><b>Select Laminate Color</b></p> <p>See page 129, Group A</p> <p>LBA1</p>	<p><b>Select Edge Color</b></p> <p>See page 129</p> <p>K</p>	<p><b>Select Caster</b></p> <p>C Caster ONLY</p> <p>C</p>	<p><b>Select Paint Color</b></p> <p>See page 129, Paint Group A</p> <p>T1</p>
---	---	--	--	---	---



	DESCRIPTION	MODEL	SHIP WEIGHT	CUBE	LIST PRICE
 <b>OPEN MARKET</b>	<b>Book Box Bracket</b> NOTES: Use with HFMBIN3 trays. Specify 1 bracket per tray. For full book box solution specify both HEBBXRL and HFMBIN3. ⓘ Available in P Black only. No specification needed. ⓘ Minimum mounting clearance required: 13½"W x 15"D. ⓘ Book Box Bracket rated up to 25 lbs.	<b>HEBBXRL</b>	2.1	0.6	<b>\$55</b>
 <b>SIN 33721</b>	<b>Accessories — Tray Kit</b> 3"H, 2 bins and 4 rails NOTES: For full book box solution specify both HEBBXRL and HFMBIN3. (1) HFMBIN3 needed for every (2) HEBBXRL as bins are ordered in a set of 2. ⓘ Semi-translucent white. No specification needed. ⓘ Bins ship with rails intended for use in storage. When bins are used with Book Box Bracket, rails will not be used.	<b>HFMBIN3</b>	7.0 ⓘ	4.0	<b>\$80</b>
 <b>SIN 33721</b> 	<b>Locking Casters, 4-Pack</b> <ul style="list-style-type: none"> <li>• Black only</li> <li>• 4 casters per pack</li> <li>• Caster pack adds 1⅞" to the overall height.</li> <li>• All casters lockable</li> <li>• Threaded attachment bolts</li> <li>• Can retrofit on Build™ units with glides.</li> </ul> ⓘ For use on youth and standard table post legs only. * On 4-leg Build™ tables, can utilize 2 casters and 2 glides for easy repositioning of tables.	<b>HHABCASTER*</b>	1.0	0.1	<b>\$93</b>
 <b>SIN 33721</b>	<b>Ganging Hardware</b> <ul style="list-style-type: none"> <li>• Includes two ganging links and two screws</li> <li>• No color designator when specifying. <i>Example: HMAGANG.</i></li> </ul>	<b>HMAGANG</b>	1.0 ⓘ	0.1	<b>\$140</b>
 <b>OPEN MARKET</b>    	<b>Back Pack Hook (10 per carton)</b> 2¼"W x 2⅜"D x 1¾"H NOTES: Attaches to bottom of surface with 2 screws, included. ⓘ Available in Platinum Metallic finish only, no specification needed. ⓘ Back Pack Hook rated up to 25 lbs.	<b>HCLA65</b>	10.0 ⓘ	0.1	<b>\$123</b>

## HOW TO SPECIFY

Select Model Number

H H A B C A S T E R

# BUILD™ Student Desk Surface Dimensions

EDUCATION

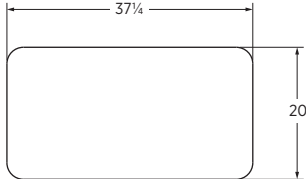
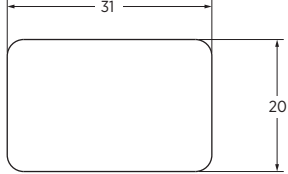
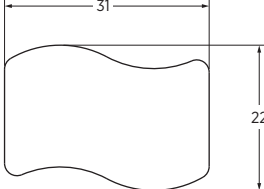
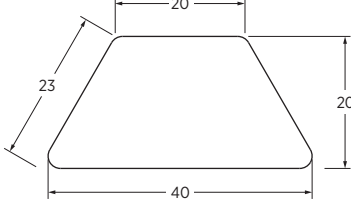
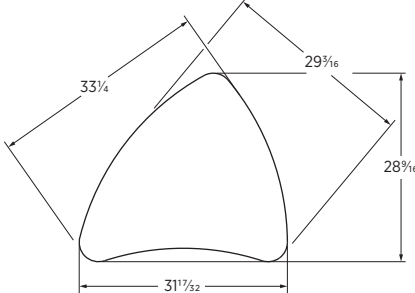
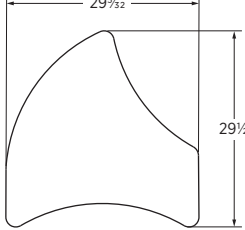
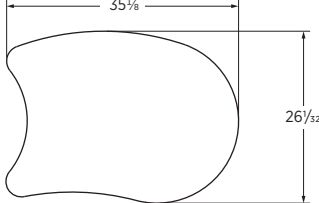
Name	Model	Dimensions
Rectangle	HBSDRECT2038	
Rectangle	HBSDRECT2031	
Ribbon	HBSDRBN2231	
Trapezoid	HBSDTRP2040	
Crescent	HBSDCSNT2832	
Fin	HBSDFN3030	
Spooky	HBSDSPY2636	

# BUILD™ Student Desk Configurations

EDUCATION

## Fin

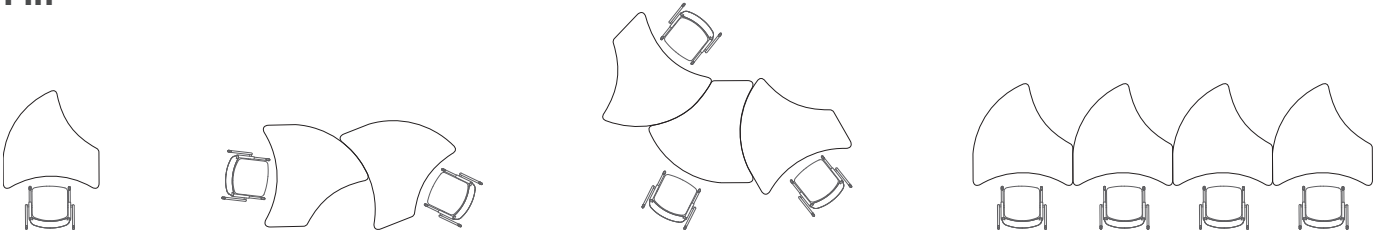

## Crescent

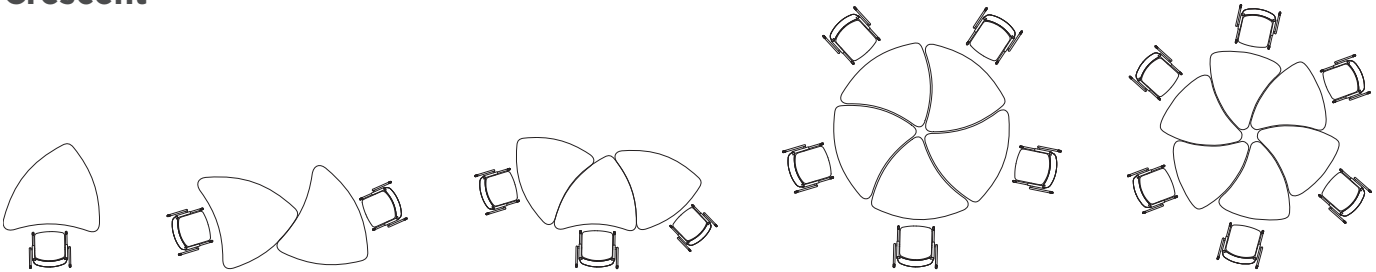

## Trapezoid

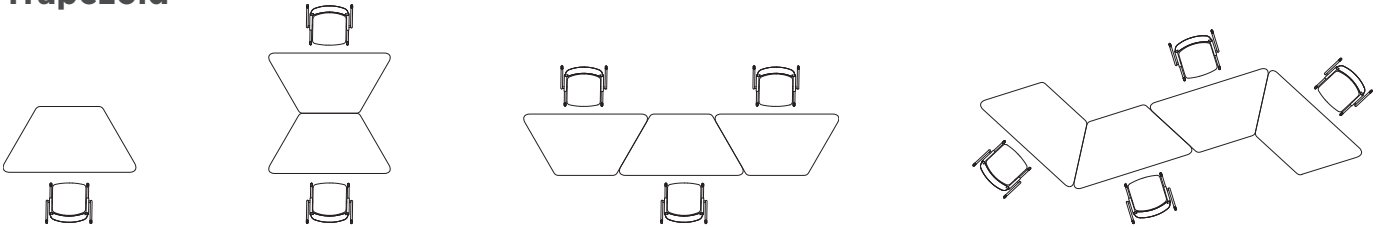

## Spooky

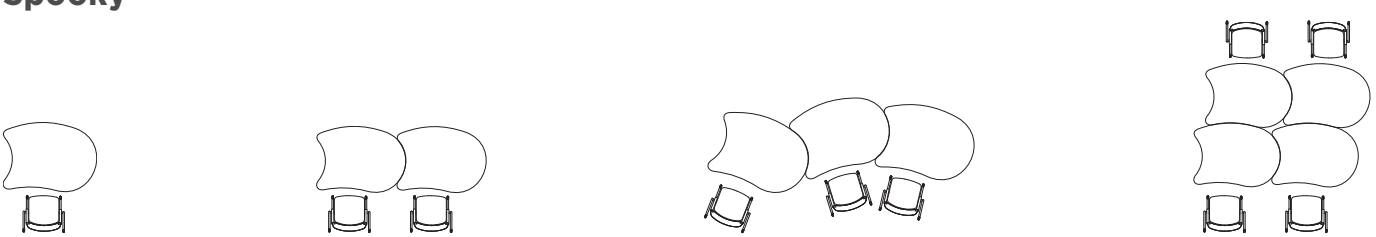

# BUILD™ Student Desk Configurations

## Rectangle

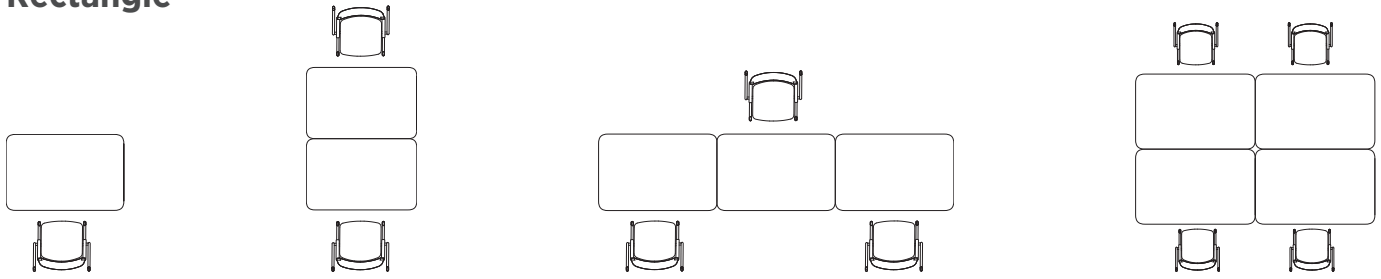



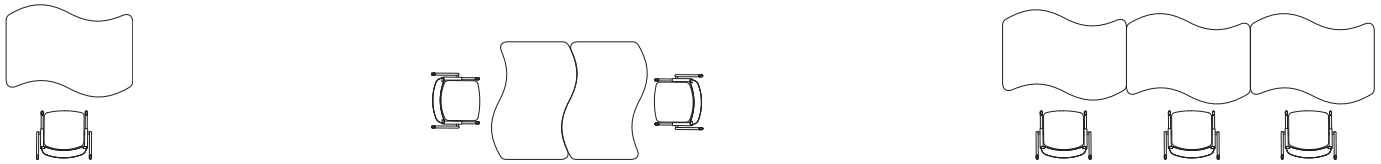

## Ribbon



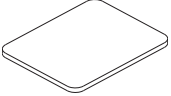

# BUILD™ Student Desks

	DESCRIPTION	MODEL	LEGS REQUIRED	SHIP WEIGHT	CUBE	LIST PRICE BY LAMINATE GRADE		
						L1	L2	L4
 HBSDRECT2038	<b>Rectangle Student Desk Top</b> 31"W x 20"D	<b>HBSDRECT2031</b>	4	29	2.4	\$225	\$236	\$264
	38"W x 20"D	<b>HBSDRECT2038*</b>	4	33	2.0	\$229	\$240	\$259
	30"W x 24"D	<b>HBSDRECT2430</b>	4	27	2.2	\$227	\$238	\$257
* HBSDRECT2038 desk is wheelchair friendly. ! HBSDRECT2430 can be used with casters to create a mobile student desk. Order student desk leg model number HEBSD4LEG and HHABCASTER. Casters are field installable. HBSDRECT2031 and HBSDRECT2038 are not compatible with casters as they do not pass BIFMA when used with casters.								
 HBSDRECT2430	<b>Trapezoid Student Desk Top</b> 40"W x 20"D	<b>HBSDTRP2040</b>	4	29	5.8	\$258	\$270	\$291
	<b>Ribbon Student Desk Top</b> 31"W x 22"D	<b>HBSDRBN2231</b>	4	27	2.2	\$229	\$240	\$259
	<b>Spooky Student Desk Top</b> 36"W x 26"D	<b>HBSDSPY2636</b>	4	32	6.5	\$258	\$270	\$291
	<b>Fin Student Desk Top</b> 30"W x 30"D	<b>HBSDFN3030</b>	3	26	5.7	\$254	\$266	\$287
	<b>Crescent Student Desk Top</b> 32"W x 28"D	<b>HBSDCSNT2832</b>	3	28	5.7	\$254	\$266	\$287

**NOTES:**

- Top and legs specified separately.
- ! Desk tops compatible only with legs shown on page 144.

## HOW TO SPECIFY

<b>Select Model Number</b> H B S D R B N 2 2 3 1 .	<b>Select Grommet</b> N No Grommet	<b>Select Top Laminate</b> See page 129, Group A L D W 1 .	<b>Select Edge Color</b> See page 129 D W
---	---------------------------------------	--	---



# BUILD™ Student Desks

OPEN MARKET



Icon Legend on page 19

## DESCRIPTION

Student Desk Leg, 4-Pack

## MODEL

HEBSD4LEG

## HEIGHT RANGE

22"-34"

## SHIP WEIGHT

15

## CUBE

1.1

## LIST PRICE P1/P2

\$229



### NOTES:

• Specify paint for upper portion of leg. Bottom is chrome.

❗ Casters can only be used when specifying student desk worksurface model HBSDRECT2430. Specify HHABCASTER for caster pack. Casters are field installable. Other Build™ student desk sizes and shapes do not pass BIFMA when used with casters.

❗ See page 143 for number of legs required per top. Legs always ship 4 per carton. Use chart below for quantity of 4-leg packs required for shapes that utilize three legs.

❗ Student Desk Legs compatible only with Student Desk Tops shown on page 143.

DESKS	LEGS NEEDED	ADJUSTABLE POST LEGS 4-PACKS
1	3	1
2	6	2
3	9	3
4	12	3
5	15	4
6	18	5
7	21	6
8	24	6
9	27	7
10	30	8



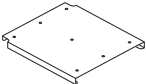

## HOW TO SPECIFY

<p>Select Model Number</p> <p>HEBSD4LEG</p>	<p>Select Paint Color</p> <p>See page 129, Paint Group A</p> <p>T1</p>
---	--

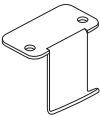

	DESCRIPTION	MODEL	SHIP WEIGHT	CUBE	LIST PRICE
 <b>OPEN MARKET</b>	<b>Book Box Bracket</b> NOTES: Use with HFMBIN3 trays. Specify 1 bracket per tray. For full book box solution specify both HEBBXRL and HFMBIN3. ⓘ Available in P Black paint only. ⓘ Minimum mounting clearance required: 13½"W x 15"D. ⓘ Book Box Bracket rated up to 25 lbs.	<b>HEBBXRL</b>	2.1	0.6	<b>\$55</b>
	<b>Accessories — Tray Kit</b> 3"H, 2 bins and 4 rails NOTES: For full book box solution specify both HEBBXRL and HFMBIN3. (1) HFMBIN3 needed for every (2) HEBBXRL as bins are ordered in a set of 2. ⓘ Semi-translucent white. No specification needed. ⓘ Bins ship with rails intended for use in storage. When bins are used with Book Box Bracket, rails will not be used.	<b>HFMBIN3</b>	7.0 ⓘ	4.0	<b>\$80</b>

**NOTES:**  
 • Front and rear handles are integrated for easy handling/transport.

	DESCRIPTION	MODEL	SHIP WEIGHT	CUBE	LIST PRICE
 <b>OPEN MARKET</b>    	<b>Back Pack Hook (10 per carton)</b> 2¼"W x 2¾"D x 1¾"H NOTES: Attaches to bottom of surface with 2 screws, included. ⓘ Available in Platinum Metallic finish only, no specification needed. ⓘ Back Pack Hook rated up to 25 lbs.	<b>HCLA65</b>	10 ⓘ	0.1	<b>\$123</b>

**HOW TO SPECIFY**

Select Model Number H E B B X R L .	Select Paint Color P
--	-------------------------

# BUILD™ Makerspace Table

GSA SIN 33721



Icon Legend on page 19

EDUCATION



DESCRIPTION	MODEL	SHIP WEIGHT	CUBE	LIST PRICE	UPCHARGE BY LAMINATE/PAINT GRADE				
					L2	L4	P2	P3	
<b>Seated-Height Table with Laminate Top</b>									
60"W x 42"D x 29"H	<b>HEMKR426029L</b>	153	9.4	<b>\$2151</b>	<b>\$38</b>	<b>\$109</b>	<b>\$36</b>	<b>\$57</b>	
72"W x 42"D x 29"H	<b>HEMKR427229L</b>	169	9.7	<b>\$2345</b>	<b>\$45</b>	<b>\$133</b>	<b>\$36</b>	<b>\$57</b>	
<b>Seated-Height Table with Butcher Block Top</b>									
60"W x 42"D x 29"H	<b>HEMKR426029BB</b>	179	9.9	<b>\$3045</b>	<b>N/A</b>	<b>N/A</b>	<b>\$36</b>	<b>\$57</b>	
72"W x 42"D x 29"H	<b>HEMKR427229BB</b>	201	10.4	<b>\$3388</b>	<b>N/A</b>	<b>N/A</b>	<b>\$36</b>	<b>\$57</b>	



<b>Counter-Height Table with Laminate Top</b>									
60"W x 42"D x 36"H	<b>HEMKR426036L</b>	158	10.4	<b>\$2185</b>	<b>\$38</b>	<b>\$109</b>	<b>\$36</b>	<b>\$58</b>	
72"W x 42"D x 36"H	<b>HEMKR427236L</b>	174	10.8	<b>\$2379</b>	<b>\$45</b>	<b>\$133</b>	<b>\$36</b>	<b>\$58</b>	
<b>Counter-Height Table with Butcher Block Top</b>									
60"W x 42"D x 36"H	<b>HEMKR426036BB</b>	184	11.0	<b>\$3079</b>	<b>N/A</b>	<b>N/A</b>	<b>\$36</b>	<b>\$58</b>	
72"W x 42"D x 36"H	<b>HEMKR427236BB</b>	213	12.9	<b>\$3422</b>	<b>N/A</b>	<b>N/A</b>	<b>\$36</b>	<b>\$58</b>	



<b>Standing-Height Table with Laminate Top</b>									
60"W x 42"D x 42"H	<b>HEMKR426042L</b>	173	11.4	<b>\$2222</b>	<b>\$38</b>	<b>\$109</b>	<b>\$37</b>	<b>\$60</b>	
72"W x 42"D x 42"H	<b>HEMKR427242L</b>	189	11.7	<b>\$2416</b>	<b>\$45</b>	<b>\$133</b>	<b>\$37</b>	<b>\$60</b>	
<b>Standing-Height Table with Butcher Block Top</b>									
60"W x 42"D x 42"H	<b>HEMKR426042BB</b>	199	11.9	<b>\$3116</b>	<b>N/A</b>	<b>N/A</b>	<b>\$37</b>	<b>\$60</b>	
72"W x 42"D x 42"H	<b>HEMKR427242BB</b>	221	12.4	<b>\$3459</b>	<b>N/A</b>	<b>N/A</b>	<b>\$37</b>	<b>\$60</b>	

**NOTES:**

- Laminate top is 1/8" thick and features 3" radius corners.
- Butcher Block top is 1 1/2" thick and features 1/2" radius corners with 1/8" radius around entire perimeter of top.
- Butcher Block tops will naturally feature variation between tops due to the nature of the real wood finish. Constructed of natural Birch wood, no two tops are exactly alike. Top is coated in a clear polyurethane finish for maximum durability.
- Both laminate and Butcher Block tops include threaded metal inserts for easy base connection. This also allows for easy base removal and reconnection if table needs to be moved through standard doorways.
- Up to 4 SmartLink® bins will fit between lower foot rails on standing-height table if desired. Applicable on counter height and standing height tables.
- HEBBXRL is not compatible with Makerspace tables.

**HOW TO SPECIFY**

<b>Select Model Number</b> H E M K R 4 2 7 2 2 9 L	<b>Select Grommet</b> N No Grommet	<b>Select Laminate Color</b> See page 129, Group A L S A 1	<b>Select Edge Color</b> See page 129 S A	<b>Select Caster</b> C Casters	<b>Select Paint Color</b> See page 129, Paint Group B P
---	---------------------------------------	--	---	-----------------------------------	---

<b>Select Model Number</b> H E M K R 4 2 7 2 2 9 B B	<b>Select Grommet</b> N No Grommet	<b>Select Wood</b> LH903 Butcher Block L H 9 0 3	<b>Select Caster</b> C Casters	<b>Select Paint Color</b> See page 129, Paint Group B P
---	---------------------------------------	--	-----------------------------------	---



# BUILD™ Makerspace Table

	DESCRIPTION	MODEL	SHIP WEIGHT	CUBE	LIST PRICE BY PAINT GRADE			
					P1	P2	P3	P6
	<b>Slotted/Pegboard End Panels</b> For Seated-Height (2/pack)	<b>HEMKREND29-SP</b>	29	2.6	\$556	\$572	\$580	\$651
	For Counter-Height (2/pack)	<b>HEMKREND36-SP</b>	29	2.7	\$621	\$638	\$649	\$728
	For Standing-Height (2/pack)	<b>HEMKREND42-SP</b>	33	3.3	\$692	\$711	\$723	\$810
	<b>Solid Full End Panels</b> For Seated-Height (2/pack)	<b>HEMKREND29-F</b>	29	2.6	\$556	\$572	\$580	\$651
	For Counter-Height (2/pack)	<b>HEMKREND36-F</b>	29	2.7	\$621	\$638	\$649	\$728
	For Standing-Height (2/pack)	<b>HEMKREND42-F</b>	33	3.3	\$692	\$711	\$723	\$810

**NOTES:**

- Panels ship 2 per carton.
- Slotted/pegboard end panels accept Fuse™ hanging accessories or any standard ¼" pegboard accessory.
- End panels are magnetic.
- End panels feature welded vertical stiffener on inside of panel for maximum rigidity.
- End panels are installed after table is fully built allowing you to add on to table base at a later date if desired.
- End panels are non-handed.

STANDING-HEIGHT TABLES	
Top Slot	8¾"W
2nd Slot	10¼"W
3rd Slot	11¾"W
4th Slot	13¼"W

SEATED HEIGHT TABLES	
Top Slot	12¼"W
Bottom Slot	13¾"W

## HOW TO SPECIFY

<p><b>Select Model Number</b></p> <p>HEMKREND29-SP . P</p>	<p><b>Select Paint Color</b></p> <p>See page 129, Paint Group C</p>
--	---

# BUILD™ Makerspace Table

GSA SIN 33721



Icon Legend on page 19

EDUCATION

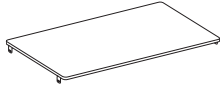

DESCRIPTION	MODEL	SHIP WEIGHT	CUBE	LIST PRICE	UPCHARGE BY LAMINATE/PAINT GRADE		
					L2	P2	P3
<b>Makerspace Table Shelf</b> 50½"W x 31"D	<b>HEMKRSHELF</b>	39	1.1	<b>\$803</b>	<b>\$23</b>	<b>\$9</b>	<b>\$13</b>

! For use with standing-height tables only.

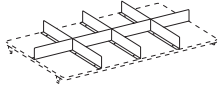

DESCRIPTION	MODEL	SHIP WEIGHT	CUBE	LIST PRICE BY PAINT GRADE		
				P1	P2	P3
<b>Shelf Divider</b>	<b>HEMKRDIVIDER</b>	10	0.6	<b>\$201</b>	<b>\$208</b>	<b>\$211</b>

! Shelf Divider (HEMKRDIVIDER) is only to be used when HEMKRSHELF is specified. HEMKRDIVIDER cannot be used as a stand-alone item. For use on standing-height tables only.

**NOTES:**

- Shelves are ¾" thick thermal-fused laminate with 1mm edgeband. Edge color is predetermined by and matches laminate selection.
- Shelf can be used with or without divider (specified separately).
- Shelf always contains small pilot through-holes for shelf divider installation.

## HOW TO SPECIFY

<p>Select Model Number</p> <p>HEMKRSHELF</p>	<p>Select Laminate Color</p> <p>See page 129, Laminate Group B</p> <p>LDW1</p>	<p>Select Paint Color</p> <p>See page 129, Paint Group B</p> <p>P</p>
--	--	---

<p>Select Model Number</p> <p>HEMKRDIVIDER</p>	<p>Select Paint Color</p> <p>See page 129, Paint Group B</p> <p>P</p>
--	---



Icon Legend on page 19

# Makerspace Table Accessories

EDUCATION

	DESCRIPTION	MODEL	SHIP WEIGHT	CUBE	LIST PRICE
	<b>Side Saddle</b> 12¼"W x 2½"D x 4"H	HAESS	0.6	0.1	\$54
	<b>Hook</b> 1⅝"W x 2¼"D x 3¼"H	HAECBH	0.1	0.1	\$37
	<b>Hot File</b> 12¼"W x 3⅞"D x 9½"H	HAEHF	0.7	1.5	\$79

**NOTES:**

- Hook weight limit 20 lbs.

	DESCRIPTION	MODEL	SHIP WEIGHT	CUBE	LIST PRICE
	<b>Accessories — Tray Kit</b>				
	3"H, 2 bins and 4 rails	HFMBIN3	7 Ⓞ	4.0	\$80
	6"H, 2 bins and 4 rails	HFMBIN6	10 Ⓞ	4.5	\$95
	12"H, 2 bins and 4 rails	HFMBIN12	12 Ⓞ	5.0	\$112

SIN 33721

**NOTES:**

- ! Semi-translucent white. No specification needed.
- ! Bins ship with metal rails intended for use in SmartLink® Mobile Storage. When bins are used with shelf or foot rails on Makerspace table, rails will not be used.

## HOW TO SPECIFY

<b>Select Model Number</b>	<b>Select Color</b>
HAESS	DW Designer White
HAESS	DW

# BUILD™ Makerspace Stools

OPEN MARKET



Icon Legend on page 19

EDUCATION



MODEL/DESCRIPTION	DEPTH	WIDTH	HEIGHT	SHIP		LIST PRICE BY PAINT GRADE		
				WEIGHT	CUBE	P1	P2	P3
<b>HE4LSTL18</b> <b>Seated-Height Stool</b>				12	3.3	\$185	\$192	\$195
Maximum:	15½	15½	18					
Seat:	12	12	18					
Seat to Floor:			18					
Usable Seat Depth:	12							



<b>HE4LSTL30</b> <b>Café-Height Stool</b>				17	7.6	\$250	\$258	\$262
Maximum:	16⅞	16⅞	30					
Seat:	12	12	30					
Seat to Floor:			30					
Usable Seat Depth:	12							

**NOTES:**

- Weight Rating: 300 lbs.
- Features non-leveling nylon glides.
- Stackable up to 4-high.

## HOW TO SPECIFY

Select Model Number

Select Paint Color

See page 129, Paint Group B

HE4LSTL18

T1

# CLASS-IFI™

Want to see more? Scan here  
to check out hon.com.



Class-ifi™ shown with Build™  
Makerspace Tables and Stools.

EDUCATION

## CLASS-IFI™

Every student and teacher deserves multifunctional, durable, and efficient organizational solutions that go the distance no matter what the subject. Class-ifi™ — a dynamic, effortlessly mobile education storage collection — is designed to maximize space, promote flexibility, and inspire creativity at any age or learning level. Today's education environments have discovered a more holistic approach to organization and kinesthetic learning, and that means more choices and smarter logistics. With its dynamic, multifunctional design, straightforward mobility, and exceptional organization capabilities, Class-ifi™ encourages healthy movement throughout the day and defines a variety of organizational and learning hubs for every student at every level. Make your space work with Class-ifi™.



## FEATURES

- Choose from two panel options (Accessory End or Solid End), depending on your needs.
- Maximize your mobility with casters.
- Organize any size learning space with single- and double-sided bookcases and cubbies.
- Color your world with a variety of metal and laminate finish options.
- Reach for the stars or keep things at ground level with multiple height options.
- Open up your world with easy-access doors (also available without doors).
- Stash your stuff safely by adding a handy tote to any locker, tote storage, or Teacher Command Station (optional).
- Amp up your accessibility with Fuse™ accessories for all storage units, including hot file, side saddle, and bag hooks. (All work with slotted end planes.)
- Get a lift with a handy locker hook.
- Offer more options with a 1H bookcase or cubby that can be utilized as a seat.



# CLASS-IFI™ ORDERING INFORMATION

## LAMINATES

L1 LAMINATES	CODES
◆ Black	P
◆ Bourbon Cherry	H
◆ Charcoal	S
◆ Cognac	COGN
◆ Designer White	LDW1
◆ Field Elm	LWFE
◆ Florence Walnut	LFW1
◆ Harvest	C
◆ Kingswood Walnut	LK11
◆ Loft	LOFT
◆ Mahogany	N
◆ Mocha	MOCH
◆ Natural Maple	D
◆ Pinnacle	PINC
◆ Shaker Cherry	F
◆ Sterling Ash	LSA1
L2 LAMINATES	CODES
◆ Beigewood	LWBE
◆ Fawn Cypress	LFC1
◆ Lowell Ash	LLA1
◆ Natural Recon	LNR1
◆ Phantom Ecru	LPE1
◆ Portico Teak	LPT1
◆ Skyline Walnut	LSW1

## CASE AND FRAME PAINT

PAINT	CODES
<b>P1</b>	
◆ Black	P71
◆ Brownstone	P7D
◆ Charcoal	S
◆ Designer White	PJW
◆ Fossil	P28
◆ Greige	T5
◆ Loft	LOFT
◆ Muslin	T3
◆ Putty	L
◆ Titanium	P8T
<b>P2</b>	
◆ Champagne Metallic	PR5
◆ Gunmetal Metallic	PR3
◆ Platinum Metallic	T1

## END PANEL PAINT

PAINT	CODES
<b>P1</b>	
◆ Black	P71
◆ Brownstone	P7D
◆ Charcoal	S
◆ Designer White	PJW
◆ Fossil	P28
◆ Greige	T5
◆ Light Grey	Q
◆ Loft	LOFT
◆ Muslin	T3
◆ Putty	L
◆ Titanium	P8T
<b>P2</b>	
◆ Champagne Metallic	PR5
◆ Gunmetal Metallic	PR3
◆ Platinum Metallic	T1
◆ Silver	PR6
◆ Solar Black	P8X
<b>P3</b>	
◆ Atom	P8S
◆ Blossom	P8K
◆ Bullseye	PJF
◆ Ember	P8P
◆ Ion	P8N
◆ Iris	P8J
◆ Krypton	P8F
◆ Ochre	P093
◆ Regatta	P8M
◆ Sienna	P092
◆ Succulent	P8A
<b>P6</b>	
◆ Markerboard	MKB

◆◆◆ For lead time information see page 21.

# CLASS-IFI™ STATEMENT OF LINE

### CUBBIES



18 1/2"H, 3-Wide,  
Single-Sided



18 1/2"H, 3-Wide,  
Double-Sided



31 1/2"H, 3-Wide,  
Single-Sided



31 1/2"H, 3-Wide,  
Double-Sided



44 1/2"H, 3-Wide,  
Single-Sided

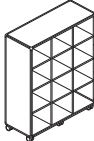

57 1/2"H, 3-Wide,  
Single-Sided

### LOCKERS



31 1/2"H, 2-Wide



31 1/2"H, 3-Wide



44 1/2"H, 2-Wide

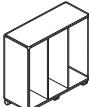

44 1/2"H, 3-Wide

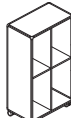

57 1/2"H, 2-Wide



57 1/2"H, 3-Wide

### COMBOS



44 1/2"H, 2-Wide

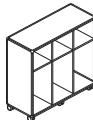

44 1/2"H, 3-Wide

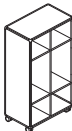

57 1/2"H, 2-Wide

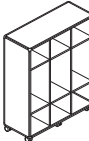

57 1/2"H, 3-Wide

### BOOKCASES



1-High, 3-Wide,  
Single-Sided



1-High, 3-Wide,  
Double-Sided



2-High, 3-Wide,  
Single-Sided



2-High, 3-Wide,  
Double-Sided

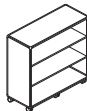

3-High, 3-Wide,  
Single-Sided



4-High, 3-Wide,  
Single-Sided

# CLASS-IFI™ STATEMENT OF LINE

## TOTE STORAGE



31 1/4"H, 2-Wide



31 1/4"H, 3-Wide



44 1/4"H, 2-Wide

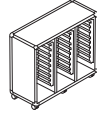

44 1/4"H, 3-Wide

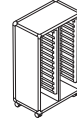

57 1/4"H, 2-Wide

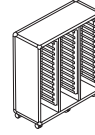

57 1/4"H, 3-Wide

## COMMAND STATION

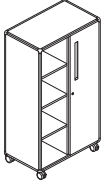

Right-Hand  
Wardrobe

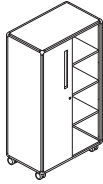

Left-Hand  
Wardrobe

# CLASS-IFI™ SPECIFYING INFORMATION

## TOTE STORAGE CAPACITY PLANNING

Tote storage cases do not include bins; bins must be specified separately depending on available capacity and customer need. Utilize the diagram below to help in planning the number of bin kits needed based on cabinet size.

Hanging Slots	12" H Bin	6" H Bin	3" H Bin
1			
2			
3			
4			



HFMBIN12

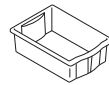

HFMBIN6

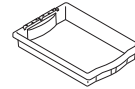

HFMBIN3

1	6
2	7
3	8
4	9
5	10
HEST2H2WS	

1	6	11
2	7	12
3	8	13
4	9	14
5	10	15
HEST2H3WS		

1	10
2	11
3	12
4	13
5	14
6	15
7	16
8	17
9	18
HEST3H2WS	

1	10	19
2	11	20
3	12	21
4	13	22
5	14	23
6	15	24
7	16	25
8	17	26
9	18	27
HEST3H3WS		

1	14
2	15
3	16
4	17
5	18
6	19
7	20
8	21
9	22
10	23
11	24
12	25
13	26
HEST4H2WS	

1	14	27
2	15	28
3	16	29
4	17	30
5	18	31
6	19	32
7	20	33
8	21	34
9	22	35
10	23	36
11	24	37
12	25	38
13	26	39
HEST4H3WS		

## ACCESSORY END PANELS

Every cabinet type is available with either solid or accessory-compatible end panels. 1H cabinets feature two horizontal slots per side, while 2H, 3H, and 4H cabinets feature four.

Compatible accessories for these slots are specified separately, see page 163.

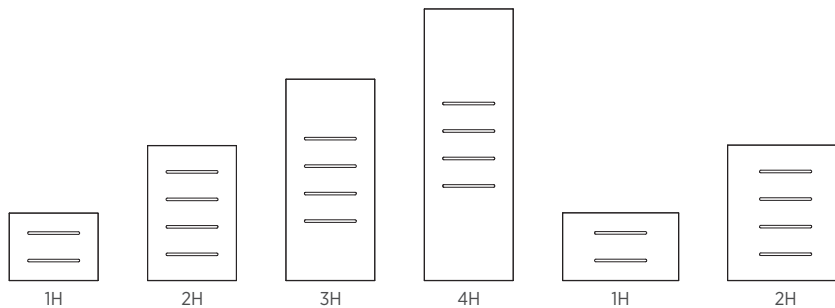

# CLASS-IFI™ SPECIFYING INFORMATION

## DOORS

Lockers, Combos, and Tote Storage available with or without doors. See below for door configuration based on storage type and size.

EDUCATION

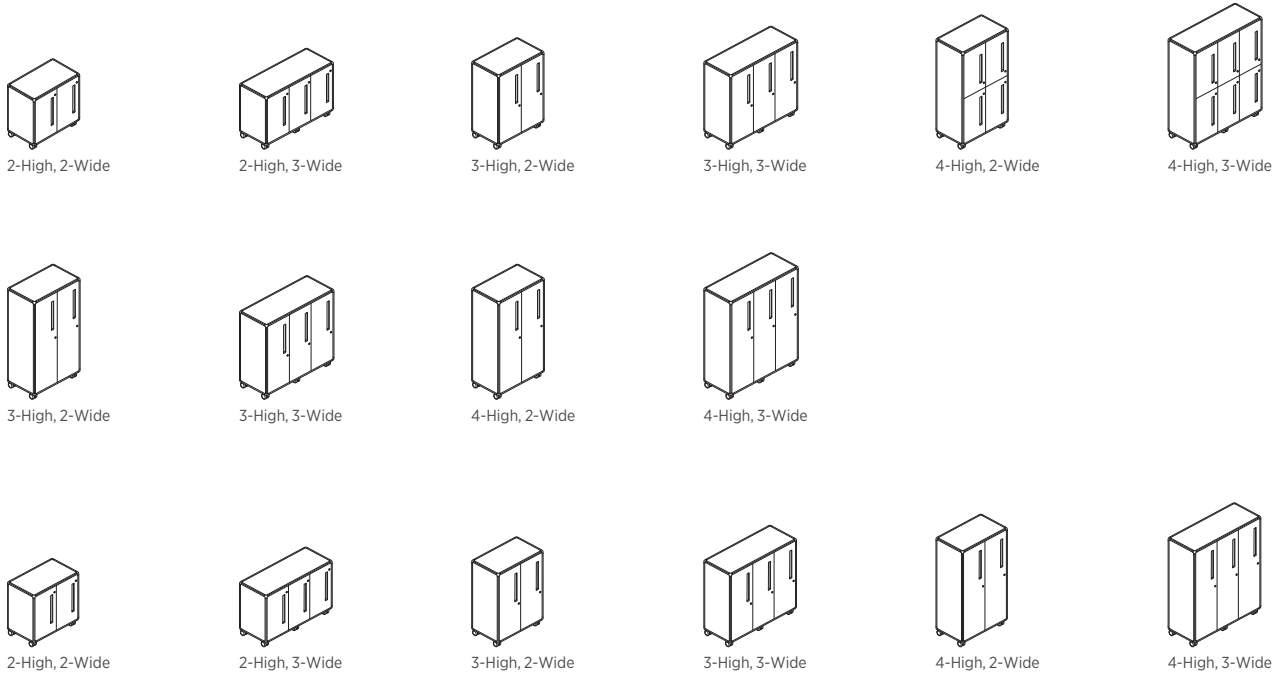

## FINISH SELECTION

Class-ifi™ allows for the specification of different finish options on a single model. Locations which allow for unique specification include:

- Laminate Interior
- Frame and Top/Back/Doors (if applicable)
- End Panels



Icon Legend on page 19

	DESCRIPTION	MODEL	SHIP WEIGHT	CUBE	LIST PRICE BY CASE PAINT GRADE			END PANEL UPCHARGE			L2 UPCHARGE
					P1	P2	P3	P2	P3	P6	
	<b>31<sup>3</sup>/<sub>8</sub>"H, 2-Wide</b> 31 <sup>5</sup> / <sub>8</sub> "W x 18 <sup>3</sup> / <sub>4</sub> "D	<b>HESL2H2WS</b>	192	14.8	\$2046	\$2251	\$2558	\$17	\$22	\$55	\$205
	NOTES: Upcharge with Door option (+ \$431). Select either Standard Lock, <b>L</b> , or Omit Lock, <b>X</b> (- \$40).										
	<b>31<sup>3</sup>/<sub>8</sub>"H, 3-Wide</b> 46 <sup>5</sup> / <sub>8</sub> "W x 18 <sup>3</sup> / <sub>4</sub> "D	<b>HESL2H3WS</b>	181	21.1	\$2261	\$2488	\$2827	\$17	\$22	\$55	\$227
	NOTES: Upcharge with Door option (+ \$486). Select either Standard Lock, <b>L</b> , or Omit Lock, <b>X</b> (- \$60).										
	<b>44<sup>1</sup>/<sub>8</sub>"H, 2-Wide</b> 31 <sup>5</sup> / <sub>8</sub> "W x 18 <sup>3</sup> / <sub>4</sub> "D	<b>HESL3H2WS</b>	212	21.0	\$2477	\$2726	\$3097	\$22	\$28	\$60	\$249
	NOTES: Upcharge with Door option (+ \$486). Select either Standard Lock, <b>L</b> , or Omit Lock, <b>X</b> (- \$20).										
	<b>44<sup>1</sup>/<sub>8</sub>"H, 3-Wide</b> 46 <sup>5</sup> / <sub>8</sub> "W x 18 <sup>3</sup> / <sub>4</sub> "D	<b>HESL3H3WS</b>	232	29.9	\$2692	\$2962	\$3366	\$22	\$28	\$60	\$270
	NOTES: Upcharge with Door option (+ \$512). Select either Standard Lock, <b>L</b> , or Omit Lock, <b>X</b> (- \$60).										
	<b>57<sup>3</sup>/<sub>8</sub>"H, 2-Wide</b> 31 <sup>5</sup> / <sub>8</sub> "W x 18 <sup>3</sup> / <sub>4</sub> "D	<b>HESL4H2WS</b>	274	27.0	\$2584	\$2843	\$3230	\$28	\$33	\$65	\$259
	NOTES: Upcharge with Door option (+ \$754). Select either Standard Lock, <b>L</b> , or Omit Lock, <b>X</b> (- \$80).										
	<b>57<sup>3</sup>/<sub>8</sub>"H, 3-Wide</b> 46 <sup>5</sup> / <sub>8</sub> "W x 18 <sup>3</sup> / <sub>4</sub> "D	<b>HESL4H3WS</b>	334	38.4	\$2799	\$3080	\$3500	\$28	\$33	\$65	\$281
	NOTES: Upcharge with Door option (+ \$1185). Select either Standard Lock, <b>L</b> , or Omit Lock, <b>X</b> (- \$120).										

**NOTES:**

- End panel specification selection applies to both end panels (either 2 solid end panels or 2 accessory end panels).
- Each locker compartment includes one double coat hook.
- When selected with doors, omit lock option is available. See page 155 for ordering instructions.
- Units ship assembled; casters are field installed.
- Casters are swivel, locking casters.

## HOW TO SPECIFY

Select Model Number	Select Caster	Select Door and Pull	Select End Panel	Select Case Paint	Select Frame Paint	Select Panel Paint	Select Laminate
	<b>C</b> Caster	See product listing for upcharge <b>D</b> With Door <b>N</b> Without Door <b>N</b> Integral Pull <b>L</b> Standard Lock <b>X</b> Omit Lock - \$40 (2 Doors) - \$60 (3 Doors) - \$80 (4 Doors) - \$120 (6 Doors)	<b>S</b> Solid <b>AB</b> Accessory (+ \$162)	See page 152	<b>NA</b> Matches Case	See page 152	See page 152
<b>HESL2H2WS</b>	<b>C</b>	<b>DNL</b>	<b>S</b>	<b>PR6</b>	<b>NA</b>	<b>PR6</b>	<b>LSA1</b>





# CLASS-IFI™ Cubbies

GSA SIN 33721T

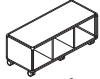

Icon Legend on page 19

EDUCATION

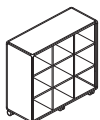
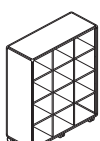
	DESCRIPTION	MODEL	SHIP WEIGHT	CUBE	LIST PRICE BY CASE PAINT GRADE			END PANEL UPCHARGE			L2 UPCHARGE
					P1	P2	P3	P2	P3	P6	
	<b>18<sup>3</sup>/<sub>8</sub>"H, 3-Wide</b> Single-Sided 46 <sup>5</sup> / <sub>8</sub> "W x 18 <sup>3</sup> / <sub>4</sub> "D x 18 <sup>3</sup> / <sub>8</sub> "H	<b>HESC1H3WS</b>	124	12.4	\$2153	\$2369	\$2692	\$12	\$17	\$50	\$216
	Double-Sided 46 <sup>5</sup> / <sub>8</sub> "W x 23 <sup>7</sup> / <sub>8</sub> "D x 18 <sup>3</sup> / <sub>8</sub> "H	<b>HESC1H3WD</b>	181	15.3	\$2477	\$2726	\$3097	\$17	\$22	\$55	\$249
	<b>31<sup>3</sup>/<sub>8</sub>"H, 3-Wide</b> Single-Sided 46 <sup>5</sup> / <sub>8</sub> "W x 18 <sup>3</sup> / <sub>4</sub> "D x 31 <sup>3</sup> / <sub>8</sub> "H	<b>HESC2H3WS</b>	192	25.9	\$2368	\$2605	\$2961	\$17	\$22	\$55	\$237
	Double-Sided 46 <sup>5</sup> / <sub>8</sub> "W x 23 <sup>7</sup> / <sub>8</sub> "D x 31 <sup>3</sup> / <sub>8</sub> "H	<b>HESC2H3WD</b>	212	36.7	\$2584	\$2843	\$3230	\$22	\$28	\$60	\$259
	<b>44<sup>1</sup>/<sub>8</sub>"H, 3-Wide</b> Single-Sided 46 <sup>5</sup> / <sub>8</sub> "W x 18 <sup>3</sup> / <sub>4</sub> "D x 44 <sup>1</sup> / <sub>8</sub> "H	<b>HESC3H3WS</b>	232	29.9	\$2692	\$2962	\$3366	\$22	\$28	\$60	\$270
	<b>57<sup>3</sup>/<sub>8</sub>"H, 3-Wide</b> Single-Sided 46 <sup>5</sup> / <sub>8</sub> "W x 18 <sup>3</sup> / <sub>4</sub> "D x 57 <sup>3</sup> / <sub>8</sub> "H	<b>HESC4H3WS</b>	334	38.4	\$2799	\$3080	\$3500	\$28	\$33	\$65	\$281



**NOTES:**

- End panel specification selection applies to both end panels (either 2 solid end panels or 2 accessory end panels).
- Units ship assembled; casters are field installed.
- Casters are swivel, locking casters.

## HOW TO SPECIFY

<b>Select Model Number</b>	<b>Select Caster</b>	<b>Select Door and Pull</b>	<b>Select End Panel</b>	<b>Select Case Paint</b>	<b>Select Frame Paint</b>	<b>Select Panel Paint</b>	<b>Select Laminate</b>
	C Caster	N Without Door	S Solid AB Accessory (+ \$162)	See page 152	NA Matches Case	See page 152	See page 152
H E S C 1 H 3 W S .	C .	N .	S .	P R 6 .	N A .	P R 6 .	L S A 1

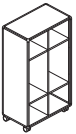
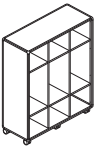

	DESCRIPTION	MODEL	SHIP WEIGHT	CUBE	LIST PRICE BY CASE PAINT GRADE			END PANEL UPCHARGE			L2 UPCHARGE
					P1	P2	P3	P2	P3	P6	
	<b>44 1/8" H, 2-Wide</b> 31 5/8" W x 18 3/4" D x 44 1/8" H	<b>HESCO3H2WS</b>	212	21.0	\$2477	\$2726	\$3097	\$22	\$28	\$60	\$249
	NOTES: Upcharge with Door option (+ \$486). <b>Upcharge is applied per model.</b> Select either Standard Lock, <b>L</b> , or Omit Lock, <b>X</b> (- \$20). Model comes with one (1) 12" H shelf.										
	<b>44 1/8" H, 3-Wide</b> 46 5/8" W x 18 3/4" D x 44 1/8" H	<b>HESCO3H3WS</b>	232	29.9	\$2692	\$2962	\$3366	\$22	\$28	\$60	\$270
	NOTES: Upcharge with Door option (+ \$512). <b>Upcharge is applied per model.</b> Select either Standard Lock, <b>L</b> , or Omit Lock, <b>X</b> (- \$60). Model comes with one (1) 12" H shelf.										
	<b>57 3/8" H, 2-Wide</b> 31 5/8" W x 18 3/4" D x 57 3/8" H	<b>HESCO4H2WS</b>	274	27.0	\$2584	\$2843	\$3230	\$28	\$33	\$65	\$259
	NOTES: Upcharge with Door option (+ \$512). <b>Upcharge is applied per model.</b> Select either Standard Lock, <b>L</b> , or Omit Lock, <b>X</b> (- \$40). Model comes with two (2) 12" H shelves.										
	<b>57 3/8" H, 3-Wide</b> 46 5/8" W x 18 3/4" D x 57 3/8" H	<b>HESCO4H3WS</b>	334	38.4	\$2799	\$3080	\$3500	\$28	\$33	\$65	\$281
	NOTES: Upcharge with Door option (+ \$539). <b>Upcharge is applied per model.</b> Select either Standard Lock, <b>L</b> , or Omit Lock, <b>X</b> (- \$60). Model comes with two (2) 12" H shelves.										

EDUCATION

**NOTES:**

- End panel specification selection applies to both end panels (either 2 solid end panels or 2 accessory end panels).
- Each locker compartment includes one double coat hook.
- When selected with doors, omit lock option is available. See page 155 for ordering instructions.
- Units ship assembled; casters are field installed.
- Casters are swivel, locking casters.

## HOW TO SPECIFY

Select Model Number	Select Caster	Select Door and Pull	Select End Panel	Select Case Paint	Select Frame Paint	Select Panel Paint	Select Laminate
	C Caster	See product listing for upcharge D With Door N Integral Pull L Standard Lock X Omit Lock - \$20 (3H2W) - \$60 (3H3W) - \$40 (4H2W) - \$60 (4H3W) N Without Door	S Solid AB Accessory (+ \$162)	See page 152	NA Matches Case	See page 152	See page 152
H E S C O 3 H 2 W S .	C .	D N L .	S .	P R 6 .	N A .	P R 6 .	L S A 1



# CLASS-IFI™ Bookcases

GSA SIN 33721T



Icon Legend on page 19

EDUCATION

	DESCRIPTION	MODEL	SHIP WEIGHT	CUBE	LIST PRICE BY CASE PAINT GRADE			END PANEL UPCHARGE			L2 UPCHARGE
					P1	P2	P3	P2	P3	P6	
	<b>1-High</b> Single-Sided 46 <sup>5</sup> / <sub>8</sub> "W x 18 <sup>3</sup> / <sub>4</sub> "D x 18 <sup>3</sup> / <sub>8</sub> "H	<b>HESB1H3WS</b>	124	12.4	\$1831	\$2015	\$2290	\$12	\$17	\$50	\$184
	Double-Sided 46 <sup>5</sup> / <sub>8</sub> "W x 23 <sup>7</sup> / <sub>8</sub> "D x 18 <sup>3</sup> / <sub>8</sub> "H	<b>HESB1H3WD</b>	181	15.3	\$2261	\$2488	\$2827	\$17	\$22	\$55	\$227
	<b>2-High</b> Single-Sided 46 <sup>5</sup> / <sub>8</sub> "W x 18 <sup>3</sup> / <sub>4</sub> "D x 31 <sup>3</sup> / <sub>8</sub> "H	<b>HESB2H3WS</b>	192	21.1	\$2046	\$2251	\$2558	\$17	\$22	\$55	\$205
	Double-Sided 46 <sup>5</sup> / <sub>8</sub> "W x 23 <sup>7</sup> / <sub>8</sub> "D x 31 <sup>3</sup> / <sub>8</sub> "H	<b>HESB2H3WD</b>	212	25.9	\$2368	\$2605	\$2961	\$22	\$28	\$60	\$237
	<b>3-High</b> Single-Sided 46 <sup>5</sup> / <sub>8</sub> "W x 18 <sup>3</sup> / <sub>4</sub> "D x 44 <sup>1</sup> / <sub>8</sub> "H	<b>HESB3H3WS</b>	232	29.9	\$2477	\$2726	\$3097	\$22	\$28	\$60	\$249
	<b>4-High</b> Single-Sided 46 <sup>5</sup> / <sub>8</sub> "W x 18 <sup>3</sup> / <sub>4</sub> "D x 57 <sup>3</sup> / <sub>8</sub> "H	<b>HESB4H3WS</b>	334	38.4	\$2584	\$2843	\$3230	\$28	\$33	\$65	\$259

**NOTES:**

- End panel specification selection applies to both end panels (either 2 solid end panels or 2 accessory end panels).
- Units ship assembled; casters are field installed.
- Casters are swivel, locking casters.

## HOW TO SPECIFY

<b>Select Model Number</b>	<b>Select Caster</b>	<b>Select Door and Pull</b>	<b>Select End Panel</b>	<b>Select Case Paint</b>	<b>Select Frame Paint</b>	<b>Select Panel Paint</b>	<b>Select Laminate</b>
	C Caster	N Without Door	S Solid AB Accessory (+ \$162)	See page 152	NA Matches Case	See page 152	See page 152
HESB1H3WS	C	N	S	PR6	NA	PR6	LSA1



# CLASS-IFI™ Tote Storage

	DESCRIPTION	MODEL	SHIP WEIGHT	CUBE	LIST PRICE BY CASE PAINT GRADE			END PANEL UPCHARGE			L2 UPCHARGE
					P1	P2	P3	P2	P3	P6	
	<b>31 3/8" H, 2-Wide</b> 31 5/8" W x 18 3/4" D x 31 3/8" H	<b>HEST2H2WS</b>	181	14.8	\$1616	\$1778	\$2020	\$17	\$22	\$55	\$162
NOTES: Upcharge with Door option (+ \$431). <b>Upcharge is applied per model.</b> Select either Standard Lock, <b>L</b> , or Omit Lock, <b>X</b> (- \$40).											
	<b>31 3/8" H, 3-Wide</b> 46 5/8" W x 18 3/4" D x 31 3/8" H	<b>HEST2H3WS</b>	192	21.1	\$1938	\$2133	\$2424	\$17	\$22	\$55	\$195
NOTES: Upcharge with Door option (+ \$486). <b>Upcharge is applied per model.</b> Select either Standard Lock, <b>L</b> , or Omit Lock, <b>X</b> (- \$60).											
	<b>44 1/8" H, 2-Wide</b> 31 5/8" W x 18 3/4" D x 44 1/8" H	<b>HEST3H2WS</b>	212	21.0	\$2046	\$2251	\$2558	\$22	\$28	\$60	\$205
NOTES: Upcharge with Door option (+ \$486). <b>Upcharge is applied per model.</b> Select either Standard Lock, <b>L</b> , or Omit Lock, <b>X</b> (- \$20).											
	<b>44 1/8" H, 3-Wide</b> 46 5/8" W x 18 3/4" D x 44 1/8" H	<b>HEST3H3WS</b>	232	29.9	\$2368	\$2605	\$2961	\$22	\$28	\$60	\$237
NOTES: Upcharge with Door option (+ \$512). <b>Upcharge is applied per model.</b> Select either Standard Lock, <b>L</b> , or Omit Lock, <b>X</b> (- \$60).											
	<b>57 3/8" H, 2-Wide</b> 31 5/8" W x 18 3/4" D x 57 3/8" H	<b>HEST4H2WS</b>	274	27.0	\$2584	\$2843	\$3230	\$28	\$33	\$65	\$259
NOTES: Upcharge with Door option (+ \$512). <b>Upcharge is applied per model.</b> Select either Standard Lock, <b>L</b> , or Omit Lock, <b>X</b> (- \$40).											
	<b>57 3/8" H, 3-Wide</b> 46 5/8" W x 18 3/4" D x 57 3/8" H	<b>HEST4H3WS</b>	334	38.4	\$2907	\$3199	\$3635	\$28	\$33	\$65	\$292
NOTES: Upcharge with Door option (+ \$539). <b>Upcharge is applied per model.</b> Select either Standard Lock, <b>L</b> , or Omit Lock, <b>X</b> (- \$60).											

**NOTES:**

- End panel specification selection applies to both end panels (either 2 solid end panels or 2 accessory end panels).
- When selected with doors, omit lock option is available. See page 155 for ordering instructions.
- Cases will accept a variety of tote configurations. Refer to page 155 for capacity planning guidelines.
- Units ship assembled; casters are field installed.
- Casters are swivel, locking casters.

**Specify totes separately, see page 155.**

**Door upcharge is applied per model, not per door.**

## HOW TO SPECIFY

Select Model Number	Select Caster	Select Door and Pull	Select End Panel	Select Case Paint	Select Frame Paint	Select Panel Paint	Select Laminate
	<b>C</b> Caster	See product listing for upcharge <b>D</b> With Door <b>N</b> Integral Pull <b>L</b> Standard Lock <b>X</b> Omit Lock - \$40 (2H2WS) - \$60 (2H3WS) - \$20 (3H2WS) - \$60 (3H3WS) - \$40 (4H2WS) - \$60 (4H3WS) <b>N</b> Without Door	<b>S</b> Solid <b>AB</b> Accessory (+ \$162)	See page 152	<b>NA</b> Matches Case	See page 152	See page 152
<b>H E S T 2 H 2 W S</b>	<b>C</b>	<b>D N L</b>	<b>S</b>	<b>P R 6</b>	<b>N A</b>	<b>P R 6</b>	<b>L S A 1</b>

# CLASS-IFI™ Command Station

GSA SIN 33721T



Icon Legend on page 19

EDUCATION

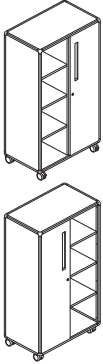

DESCRIPTION	MODEL	SHIP WEIGHT	CUBE	LIST PRICE BY CASE PAINT GRADE			END PANEL UPCHARGE			L2 UPCHARGE
				P1	P2	P3	P2	P3	P6	
<b>Command Station</b> RH Wardrobe 31 <sup>5</sup> / <sub>8</sub> "W x 18 <sup>3</sup> / <sub>4</sub> "D x 57 <sup>3</sup> / <sub>8</sub> "H	<b>HESCS4H2WSR</b>	274	27.0	\$2799	\$3080	\$3500	\$28	\$33	\$65	\$281
LH Wardrobe 31 <sup>5</sup> / <sub>8</sub> "W x 18 <sup>3</sup> / <sub>4</sub> "D x 57 <sup>3</sup> / <sub>8</sub> "H	<b>HESCS4H2WSL</b>	274	27.0	\$2799	\$3080	\$3500	\$28	\$33	\$65	\$281







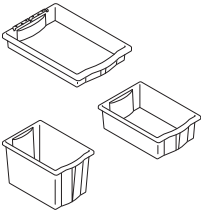

**NOTES:**

- End panel specification selection applies to both end panels (either 2 solid end panels or 2 accessory end panels).
- Wardrobe compartment includes one double coat hook.
- Omit lock option is available. See page 155 for ordering instructions.
- Units ship assembled; casters are field installed.
- Casters are swivel, locking casters.

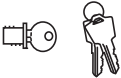
**HOW TO SPECIFY**

Select Model Number	Select Caster	Select Door, Pull, & Lock	Select End Panel	Select Case Paint	Select Frame Paint	Select Panel Paint	Select Laminate
	C Caster	D With Door N Integral Pull L Standard Lock X Omit Lock (-\$20)	S Solid AB Accessory (+\$162)	See page 152	NA Matches Case	See page 152	See page 152
H E S C S 4 H 2 W S R .	C .	D N L .	S .	P R 6 .	N A .	P R 6 .	L S A 1

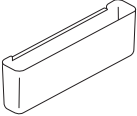
Icon Legend on page 19

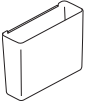
	DESCRIPTION	MODEL	SHIP WEIGHT	CUBE	LIST PRICE	
 	<b>Accessories — Tote Tray Kits</b> 3”H, 2 bins and 4 rails 6”H, 2 bins and 4 rails 12”H, 2 bins and 4 rails ⓘ Semi-translucent white.	<b>HFMBIN3</b> <b>HFMBIN6</b> <b>HFMBIN12</b>	7.0 ⓘ 10.0 ⓘ 12.0 ⓘ	4.0 4.5 5.0	<b>\$80</b> <b>\$95</b> <b>\$112</b>	
	 	<b>Removable Lock Core Kit</b> Satin Nickel • For stack-on and wall mounted storage laminate models (with locks) in 10500, Valido, Voi, and Concinity. • Specify quantity of each key number from 101E to 225E. • Includes: 1-core, 2-keys, 1-core removal tool, and instructions. NOTES: If key number isn’t specified, number will be at random. When purchased separately without a configurable TAA compliant end product, not on GSA contract.	<b>HF23S</b>	0.2	0.02	<b>\$63</b>
	 <b>OPEN MARKET</b> 	<b>Master Key (one key)</b> Will open all HON product with HON “One Key” interchangeable core removable locks. Available to authorized dealers only. Will open HF23B, HF23C, HF23S, HF24, HF27B, and HF27S locks numbered 101E-225E. Will open old HON style MB series locks.	<b>HF22</b>	0.1 ⓘ	0.1	<b>\$41</b>
		<b>Side Saddle</b> 12¼”W x 2½”D x 4”H	<b>HAESS</b>	0.6 ⓘ	0.1	<b>\$54</b>
	<b>Hook</b> 1½”W x 2¼”D x 3¼”H	<b>HAECBH</b>	0.1 ⓘ	0.1	<b>\$37</b>	
	<b>Hot File</b> 12¼”W x 3⅞”D x 9½”H	<b>HAEHF</b>	0.7 ⓘ	1.5	<b>\$79</b>	

## HOW TO SPECIFY

<b>Select Model Number</b> H A E H F .	<b>Select Paint Color</b> DW Designer White
H A E H F .	DW



Confetti™ Floor Lounge.

## CONFETTI™

Every educator wants their classroom to celebrate individuality, energize ideas, and inspire imaginations. Organic, fluid environments are essential to the physical and emotional comfort of every young learner — and Confetti™ Floor Cushions and Lounges pass every test with flying colors! These comfortable, portable seating solutions encourage young learners to sit where they please, gather with ease, and stay connected and creative in their own way — from the first day of school to the last. With soft foam support and integrated handles for easy portability, Confetti™ allows students to navigate the classroom in their own way to create a safe, stress-free learning environment. Make your space work with Confetti™.

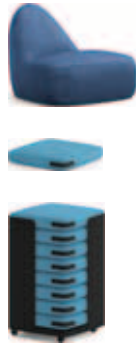

## FEATURES

- Maximize student mobility with integrated handles for easy portability.
- Create comfortable support with soft foam seating.
- Get a lot (or just one) — floor cushions are sold separately or in packs of 8.
- Keep things tidy with a floor cushion cart, designed to organize and store seating when not in use — plus, this handy solution fits under tables, so you'll save valuable floor space.
- Choose from an array of colorful fabric options.

# CONFETTI™ ORDERING INFORMATION

## HON BRANDED FABRICS

### GRADE 1

Apex  
Centurion  
Compass  
Contourett  
Dapper  
Ensemble  
Hamilton  
Inertia  
Noble Seating  
Optic  
Pebble  
Vibe

### GRADE 2

Appoint Seating  
Blume  
Clyde  
Dotty  
Kai  
Rush  
Spin  
Wavelength  
Whisper Vinyl

### GRADE 3

Bradbury  
Getaway  
Moxie  
Notion  
Parker  
Purl  
Quill  
Saxony

### GRADE 4

Constance with Supreen™  
Livi with Supreen™  
Lugano with Supreen™  
Oxford with Supreen™

# CONFETTI™

## Statement of Line

### FLOOR SEATING

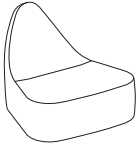

Floor Lounge



Floor Cushion

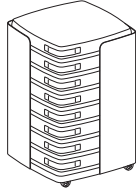

Eight Cushions and Cart

### ACCESSORIES

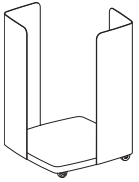

Floor Cushion Cart

EDUCATION



# CONFETTI™ Floor Seating

## HEFL1

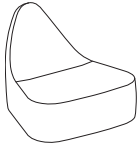

### FLOOR LOUNGE

### DIMENSIONS

Depth:	32½	Ship Weight:	20
Width:	30	Cube:	14.8
Seat Height:	12	Weight Rating:	300 lbs.
Seat Depth:	17¼		

### FABRIC PRICE CODES

1	\$1185	8	\$1510
2	\$1240	9	\$1552
3	\$1296	10	\$1599
4	\$1338	11	\$1648
5	\$1380	12	\$1697
6	\$1422	L	—
7	\$1465		

ⓘ Due to the natural properties and shape of the Floor Lounge, material gathers and visual variation can be expected from unit to unit as well as fabric to fabric.

## HELP1



### FLOOR CUSHION

### DIMENSIONS

Depth:	16½	Ship Weight:	5
Width:	16½	Cube:	0.7
Seat Height:	3	Weight Rating:	300 lbs.

### FABRIC PRICE CODES

1	\$324	8	\$454
2	\$346	9	\$472
3	\$369	10	\$489
4	\$385	11	\$510
5	\$403	12	\$529
6	\$419	L	—
7	\$437		

## HECLP8

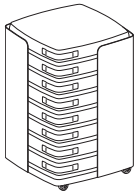

### EIGHT CUSHIONS WITH CART

### DIMENSIONS

Ship Weight:	70
Cube:	5.1
Weight Rating:	300 lbs.

### FABRIC PRICE CODES

1	\$3669	8	\$4709
2	\$3845	9	\$4853
3	\$4029	10	\$4989
4	\$4157	11	\$5157
5	\$4301	12	\$5309
6	\$4429	L	—
7	\$4573		

### NOTES:

- Only one fabric can be specified on model HECLP8. If multiple fabrics are requested on the floor cushion, order the cushion and cart separately.

## HOW TO SPECIFY

<p><b>Select Model Number</b></p> <p>HECLP8</p>	<p><b>Select Fabric</b></p> <p>See page 165</p> <p>CU10</p>	<p><b>Select Paint Color</b></p> <p>See page 165</p> <p>Specify for HECLP8 only</p> <p>P71</p>
---	---	--





**DESCRIPTION**

Floor Cushion Cart

**MODEL**

HECART

**SHIP WEIGHT**

30

**CUBE**

5.1

**LIST PRICE BY PAINT GRADE**

**P1**

\$1077

**P2**

\$1186

**P3**

\$1347

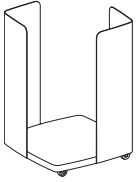

**NOTES**

- Cart holds quantity 8 of model HELP1.

EDUCATION

## HOW TO SPECIFY

Select Model Number

HECART

Select Paint Color

See page 165

P71

# REVEL™

Want to see more? Scan here  
to check out hon.com.



Revel™ Fidget Stools shown with Build™ Student Desks and SmartLink® Seating.

EDUCATION

## REVEL™

Revel in the movement and give classroom fidgeting a new meaning. Move side to side, back and forth, or spin in a full circle. Revel brings movement and mobility to active learners.



## FEATURES

- Seat available in 3 colors, base available in 1.
- Adjust stool height with the push of a button. Stool ranges in height from 13¾”H-18½”H.
- With a slip resistant base and plastic body, you can feel comfortable using the stool in your most creative space with easy cleanup afterwards.
- Tested to hold up to 250 lbs.
- Backed by the HON Full Lifetime Warranty.

# REVEL™ Stool

OPEN MARKET



Icon Legend on page 19

## HEFS01

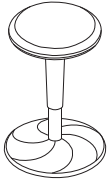

### ADJUSTABLE HEIGHT FIDGET STOOL

### DIMENSIONS

Depth:	15 <sup>3</sup> / <sub>8</sub>	Seat Height:	13 <sup>3</sup> / <sub>4</sub> -18 <sup>1</sup> / <sub>2</sub>
Width:	15 <sup>3</sup> / <sub>8</sub>	Ship Weight:	20.1
Height:	13 <sup>3</sup> / <sub>4</sub> -18 <sup>1</sup> / <sub>2</sub>	Cube:	1.4
Seat Depth:	15 <sup>3</sup> / <sub>8</sub>	Weight Rating:	250 lbs.
Seat Width:	15 <sup>3</sup> / <sub>8</sub>		

### LIST PRICE

**\$335**

NOTES: Two buttons integrated in underside of seat for height adjustment control while maintaining a clean aesthetic. Stool seat and base are all plastic for easy cleanability. Anti-slip rubber attached to underside of base allows for comfortable movement of user while maintaining contact with floor. Base color is similar to HON Loft.

EDUCATION

## HOW TO SPECIFY

Select  
Model Number

Select  
Seat Color

- BZ** Breeze
- S** Charcoal
- BL** Black

H E F S 0 1 .

B L

# ROLL CALL™

Want to see more? Scan here  
to check out hon.com.



Roll Call™ shown with SmartLink® Student Seating and Desks, and Class-ifi™ Storage.

EDUCATION

## ROLL CALL™

Healthy, connected classrooms are never at a stand-still. To stay flexible and functional, today's learning spaces need solutions that can move anywhere, anytime. Roll Call™ — HON's light scale, easy-to-use lectern — allows students and teachers alike to adjust, administer, and engage with ease. With ample height adjustability and smooth caster mobility, Roll Call™ encourages young minds and educators to create an imaginative environment that's all their own. Make your space work with Roll Call™.



## FEATURES

- Open up your options with a pneumatic cylinder and hand lever that allows for easy height adjustment (between 28½"-43½").
- Maximize your mobility (or stay put!) with 4 casters that move with you or lock in place, depending on your needs.
- Spread out with a 24"D x 30"W worksurface, designed to hold everything from lesson books to laptops.
- Rely on the exceptional durability of an easy-to-clean laminate surface.
- Backed by The HON Company's Full Lifetime Warranty.

# ROLL CALL™ ORDERING INFORMATION

## WOODSURFACES

### L1 LAMINATES ..... CODES

#### Woodgrain

- ◆ Bourbon Cherry ..... H
- ◆ Cognac ..... COGN
- ◆ Field Elm ..... LWFE
- ◆ Florence Walnut ..... LFW1
- ◆ Harvest ..... C
- ◆ Kingswood Walnut ..... LK11
- ◆ Loft ..... LOFT
- ◆ Mahogany ..... N
- ◆ Mocha ..... MOCH
- ◆ Natural Maple ..... D
- ◆ Pinnacle ..... PINC
- ◆ Shaker Cherry ..... F
- ◆ Sterling Ash ..... LSA1

#### Solid

- ◆ Black ..... P
- ◆ Charcoal ..... S
- ◆ Designer White ..... LDW1
- ◆ Loft ..... LOFT

#### Patterned

- ◆ Handspun Chestnut ..... LAHC
- ◆ Handspun Dove ..... LAHD
- ◆ Handspun Pearl ..... LAHP
- ◆ Handspun Slate ..... LAHS
- ◆ Silver Mesh ..... B9
- ◆ Steel Mesh ..... A9
- ◆ Battleship ..... LBT1
- ◆ Gray ..... G2
- ◆ Moroccan ..... LMN1
- ◆ Mushroom ..... LMH1
- ◆ Neon Carrot ..... LNC1
- ◆ Tennis Ball ..... LTB1
- ◆ White ..... G1

### L2 LAMINATES ..... CODES

#### Woodgrain

- ◆ Beigewood ..... LWBE
- ◆ Fawn Cypress ..... LFC1
- ◆ Lowell Ash ..... LLA1
- ◆ Natural Recon ..... LNR1
- ◆ Phantom Ecru ..... LPE1
- ◆ Portico Teak ..... LPT1
- ◆ Skyline Walnut ..... LSW1

### L4 LAMINATES ..... CODES

- ◆ White Markerboard ..... FMQ1

## EDGE

### EDGE ..... CODES

#### Woodgrain

- ◆ Beigewood ..... DE
- ◆ Cognac ..... COGN
- ◆ Fawn Cypress ..... FC
- ◆ Field Elm ..... FE
- ◆ Florence Walnut ..... FW
- ◆ Kingswood Walnut ..... KI
- ◆ Lowell Ash ..... DL
- ◆ Mahogany ..... N
- ◆ Mocha ..... MOCH
- ◆ Natural Maple ..... D
- ◆ Natural Recon ..... NR
- ◆ Phantom Ecru ..... PE
- ◆ Pinnacle ..... PINC
- ◆ Portico Teak ..... DP
- ◆ Shaker Cherry ..... F
- ◆ Skyline Walnut ..... SW
- ◆ Sterling Ash ..... SA

#### Solid

- ◆ Atom ..... AT
- ◆ Black ..... P
- ◆ Brownstone ..... EY
- ◆ Bullseye ..... BY
- ◆ Charcoal ..... S
- ◆ Designer White ..... DW
- ◆ Ember ..... MR
- ◆ Fossil ..... EH
- ◆ Greige ..... R
- ◆ Ion ..... IO
- ◆ Iris ..... IR
- ◆ Krypton ..... KT
- ◆ Loft ..... LOFT
- ◆ Muslin ..... T
- ◆ Platinum ..... K
- ◆ Regatta ..... RE

## CYLINDER PAINT

### PAINT ..... CODES

#### P1

- ◆ Black ..... P71

#### P2

- ◆ Silver ..... SVR

(No upcharge will be applied to cylinder color selection.)

## BASE PAINT

### PAINT ..... CODES

#### P1

- ◆ Black ..... P71
- ◆ Charblack ..... CBK

#### P2

- ◆ Silver ..... PR6
- ◆ Textured Silver ..... PR8

◆◆◆ For lead time information see page 21.

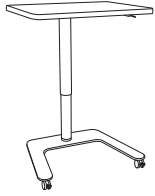

DESCRIPTION	MODEL	SHIP WEIGHT	CUBE	LIST PRICE BY LAMINATE GRADE		
				L1	L2	L4
<b>Pneumatic Lectern</b> 30"W x 24"D, Rectangle Top	<b>HETLEC-REC2430</b>	74.1	5.7	\$1155	\$1165	\$1184

**NOTES:**

- Lectern adjusts from 28½"-43½".
  - Pneumatic height adjustment. No electricity required.
  - Ships knocked down and assembled on site.
  - Features 4 locking casters.
- ! SmartLink® Book Box, HLDA-15, is compatible with Roll Call™. Book box hardware pack does not include wood screws which are needed to install book box to a laminate worksurface. Installer to provide wood screws. Each book box requires 6, #12 phillips panhead, ¾" long screws for installation.

## HOW TO SPECIFY

<p><b>Select Model Number</b></p> <p>HETLEC-REC2430</p>	<p><b>Select Grommet Option</b></p> <p>N No Grommet</p> <p>N</p>	<p><b>Select Laminate</b></p> <p>See page 172</p> <p>LDW1</p>	<p><b>Select Edge Color</b></p> <p>See page 172</p> <p>DW</p>	<p><b>Select Cylinder Color</b></p> <p>See page 172</p> <p>P71</p>	<p><b>Select Base Color</b></p> <p>See page 172</p> <p>P2 Upcharge \$70</p> <p>P71</p>
---	--	---	---	--	--



**SmartLink® Student Seating and Desks, Teacher Desk, and Storage.**

## SMARTLINK®

Show of hands — who loves long lectures? Today's classroom is more hands-on and collaborative, involving group interactions that better stimulate learning. That's why we've done our homework in the design of SmartLink. This collection of lightweight and mobile desks, chairs, storage, and presentation tools earns high marks by being easy to arrange and rearrange, keeping active minds and bodies fully engaged.



## FEATURES

- Put teachers in control of their storage, technology and environment.
- Worksurface shape supports creative configurations.
- Designed to the unique ways students sit and move throughout the day.
- Organize lesson plans and make the most of unused wall space.
- Move educational tools wherever the activities demand.
- SmartLink chairs warranted for users up to 300 lbs.



# SMARTLINK® ORDERING INFORMATION

## TEACHER DESK & MODULAR STORAGE

### LAMINATES ..... CODES

- L1**  
 ◆ Harvest ..... CC  
 ◆ Natural Maple ..... DD  
 ◆ Silver Mesh ..... B9

### PAINTS ..... CODES

- P1**  
 ◆ Charcoal ..... S

### P2

- ◆ Platinum Metallic ..... T1

### EDGE ..... CODES

- ◆ Charcoal ..... S  
 ◆ Platinum ..... K

## STUDENT DESK

### PLASTIC ..... CODES

- ◆ Breeze ..... G9  
 ◆ Harvest ..... CC  
 ◆ Natural Maple ..... DD  
 ◆ Sand ..... G8  
 ◆ White ..... G1

### PAINTS ..... CODES

- P1**  
 ◆ Charcoal ..... S

### P2

- ◆ Platinum Metallic ..... T1

## MOBILE STORAGE

### PAINTS ..... CODES

- P1**  
 ◆ Black ..... P  
 ◆ Brownstone ..... P7D  
 ◆ Charcoal ..... S  
 ◆ Designer White ..... PJW  
 ◆ Fossil ..... P28  
 ◆ Greige ..... T5  
 ◆ Loft ..... LOFT  
 ◆ Muslin ..... T3  
 ◆ Titanium ..... P8T

### P2

- ◆ Champagne Metallic ..... T4  
 ◆ Platinum Metallic ..... T1  
 ◆ Silver ..... PR6

### P3

- ◆ Atom ..... P8S  
 ◆ Bullseye ..... PJF  
 ◆ Ember ..... P8P  
 ◆ Ion ..... P8N  
 ◆ Iris ..... P8J  
 ◆ Krypton ..... P8F  
 ◆ Regatta ..... P8M

## TEACHER DESK

### LAMINATES ..... CODES

#### L1

- ◆ Black ..... P  
 ◆ Bourbon Cherry ..... H  
 ◆ Charcoal ..... S  
 ◆ Cognac ..... COGN  
 ◆ Designer White ..... LDW1  
 ◆ Florence Walnut ..... LFW1  
 ◆ Handspun Chestnut ..... LAHC  
 ◆ Handspun Dove ..... LAHD  
 ◆ Handspun Pearl ..... LAHP  
 ◆ Handspun Slate ..... LAHS  
 ◆ Harvest ..... C  
 ◆ Kingswood Walnut ..... LK11  
 ◆ Loft ..... LOFT  
 ◆ Mahogany ..... N  
 ◆ Mocha ..... MOCH  
 ◆ Natural Maple ..... D  
 ◆ Pinnacle ..... PINC  
 ◆ Shaker Cherry ..... F  
 ◆ Silver Mesh ..... B9  
 ◆ Steel Mesh ..... A9  
 ◆ Sterling Ash ..... LSA1

#### L2

- ◆ Lowell Ash ..... LLA1  
 ◆ Natural Recon ..... LNR1  
 ◆ Phantom Ecru ..... LPE1  
 ◆ Portico Teak ..... LPT1  
 ◆ Skyline Walnut ..... LSW1

### PAINTS ..... CODES

- P1**  
 ◆ Charcoal ..... S  
 ◆ Designer White ..... PJW  
 ◆ Titanium ..... P8T

### P2

- ◆ Platinum Metallic ..... T1  
 ◆ Silver ..... PR6

### P3

- ◆ Atom ..... P8S  
 ◆ Bullseye ..... PJF  
 ◆ Ember ..... P8P  
 ◆ Ion ..... P8N  
 ◆ Iris ..... P8J  
 ◆ Krypton ..... P8F  
 ◆ Regatta ..... P8M

### EDGE ..... CODES

- ◆ Atom ..... AT  
 ◆ Bullseye ..... BY  
 ◆ Charcoal ..... S  
 ◆ Ember ..... MR  
 ◆ Ion ..... IO  
 ◆ Iris ..... IR  
 ◆ Krypton ..... KT  
 ◆ Platinum ..... K  
 ◆ Regatta ..... RE

## STUDENT DESK

### PLASTIC ..... CODES

- ◆ Breeze ..... G9  
 ◆ Harvest ..... CC  
 ◆ Natural Maple ..... DD  
 ◆ Sand ..... G8  
 ◆ White ..... G1

### PAINTS ..... CODES

#### P1

- ◆ Charcoal ..... S  
 ◆ Designer White ..... PJW  
 ◆ Titanium ..... P8T

#### P2

- ◆ Platinum Metallic ..... T1  
 ◆ Silver ..... PR6

#### P3

- ◆ Atom ..... P8S  
 ◆ Bullseye ..... PJF  
 ◆ Ember ..... P8P  
 ◆ Ion ..... P8N  
 ◆ Iris ..... P8J  
 ◆ Krypton ..... P8F  
 ◆ Regatta ..... P8M

## UNIVERSAL MODESTY PANEL

### PAINTS ..... CODES

#### P1

- ◆ Black ..... P  
 ◆ Brownstone ..... P7D  
 ◆ Charblack ..... CBK  
 ◆ Charcoal ..... S  
 ◆ Designer White ..... PJW  
 ◆ Fossil ..... P28  
 ◆ Greige ..... T5  
 ◆ Light Gray ..... Q  
 ◆ Loft ..... LOFT  
 ◆ Muslin ..... T3  
 ◆ Putty ..... L  
 ◆ Textured Platinum  
 Metallic ..... PLAT  
 ◆ Titanium ..... P8T

#### P2

- ◆ Champagne Metallic ..... T4  
 ◆ Platinum Metallic ..... T1  
 ◆ Silver ..... PR6  
 ◆ Solar Black ..... P8X  
 ◆ Textured Silver ..... PR8

#### P3

- ◆ Atom ..... P8S  
 ◆ Bullseye ..... PJF  
 ◆ Ember ..... P8P  
 ◆ Ion ..... P8N  
 ◆ Iris ..... P8J  
 ◆ Krypton ..... P8F  
 ◆ Regatta ..... P8M

## 4-LEG, CANTILEVER CHAIR, TASK CHAIR, STOOL SHELLS

### SHELL ..... CODES

- ◆ Calypso ..... CP  
 ◆ Cherry ..... CR  
 ◆ Lava ..... LA  
 ◆ Lime ..... LM  
 ◆ Mulberry ..... MB  
 ◆ Onyx ..... ON  
 ◆ Platinum ..... PT  
 ◆ Regatta ..... RE  
 ◆ Shadow ..... SD  
 ◆ Surf ..... BU  
 ◆ Tangelo ..... RG

## 4-LEG AND CANTILEVER CHAIR AND STOOL FRAME

### PAINTS ..... CODES

#### P1

- ◆ Designer White Texture ..... PK7  
 ◆ Textured Charcoal ..... P7A  
 ◆ Textured Platinum  
 Metallic ..... PLAT  
 ◆ Textured Titanium ..... P8V

#### P2

- ◆ Silver Texture ..... PR8

#### P3

- ◆ Atom ..... P8S  
 ◆ Bullseye ..... PJF  
 ◆ Ember ..... P8P  
 ◆ Ion ..... P8N  
 ◆ Iris ..... P8J  
 ◆ Krypton ..... P8F  
 ◆ Regatta ..... P8M

#### P4

- ◆ Polished Chrome\* ..... Y

\* \$57 upcharge. Polished Chrome not available on models HSS4L-06A, HSS4L-24B, and HSS4L-30B.

◆◆◆ For lead time information see page 21.



# SMARTLINK® SPECIFYING INFORMATION

## STEP 1

Choose a grade range to find the recommended SmartLink® desk and table height.

Recommended space from chair seat to underside of table is 8"-11"							
Seat Height	6"	12"	14"	16"	18"	24"	30"
Table Height	14"	22"	24"	27"	29"	36"	42"
Pre-K							
Kindergarten - Grade 1							
Grade 2 - 4							
Grade 5 - 12							

## STEP 2

Pick the SmartLink® model that meets the student height needs.



Model: HLDV-M3A  
Adjustable Height  
23"-33" Height Range

**Use the color-coated circles in the chart on the right to find a compatible chair.**



Model: HLDV-M3F  
Fixed Height  
30" Fixed Height



Model: HLDV-M3T  
Sit-to-Stand  
30"-43" Height Range

## STEP 3

Determine the suggested chair height within your desk size range.

Desk Height	Chair Seat Height	Type of Chair
22"	12"	4-Leg, Cantilever or Task
23-24"		
25-27"		
28-29"	16-18"	
30"		
31-33"	22-24"	
34-41"		
42-43"	30-32"	

# SMARTLINK® SPECIFYING INFORMATION

## Individual Layouts

- The non-handed top allows the desk to be positioned to better support right-handed or left-handed individuals or be used in a forward position.



LH Position



Forward Position



RH Position

## Group/Collaborative Layouts

Below are examples of how the student desks can be configured to support multiple students or group activities.

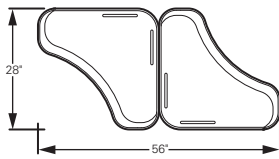

Student Desk  
2-Desk Configuration

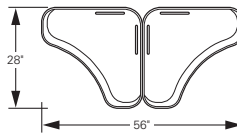

Opposing Student Desk  
2-Desk Configuration

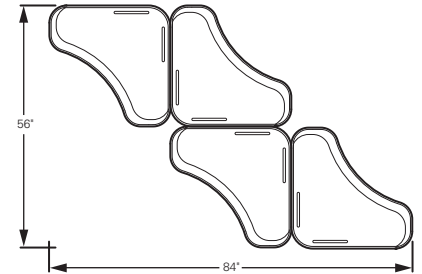

Student Desk  
4-Desk Configuration

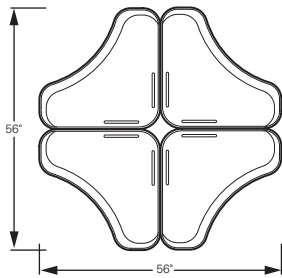

Student Desk  
4-Desk Cluster Configuration

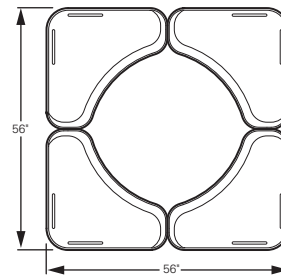

Student Desk  
4-Desk Work Group Configuration  
*Can accommodate up to 8 students*

## Teacher Centered Layouts

- Reverse the layout and use the student desks to create layouts for teacher centers that can accommodate up to 6 students.
- 23 $\frac{5}{8}$ " distance between legs when used from either side.

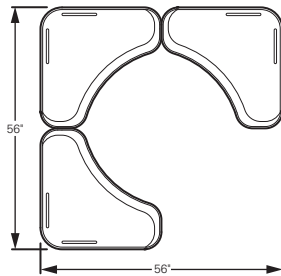

Teacher Centered Layout

## Standard Row Layout

While a variety of classroom configurations are possible, a standard row layout shown below with 25 student desks utilizes a footprint of 199" deep by 284" wide. A 30 student desk row layout (5 rows deep by 6 rows wide) will require a footprint of 199" deep by 348" wide.

These dimensions are based upon 36"W aisles. Actual dimensions should be based upon local building codes.

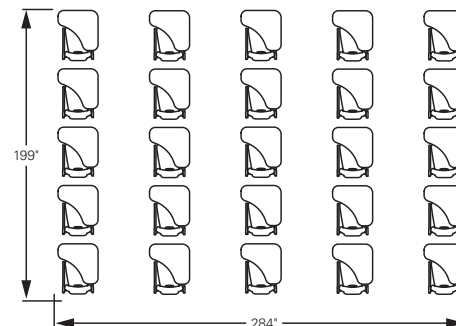

# SMARTLINK® SPECIFYING INFORMATION

## TEACHER STATION

### SmartLink®

The following planning and specifying information is intended to help you imagine and create stimulating SmartLink classrooms that can integrate technology while helping rooms stay adaptable, organized and attractive. SmartLink offers you everything you need to create flexible, clutter-free learning environments for students of all ages.

#### Teacher Station – Double Pedestal with Modesty Panel

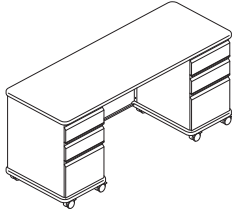

HLTV2466TMOD-33

#### Storage

- Box/box/file pedestal is always standard for both the left and right handed side of the desk. Pedestals are locking.
- Available kneespace is 33¼"W x 20"D for all models.
- Non-locking Center Drawer (HD8X) may be field installed in the kneespace. Tops are pre-drilled to accept the drawer.
- Center drawers and CPU holders cannot be installed together.

#### Teacher Station – Double Pedestal

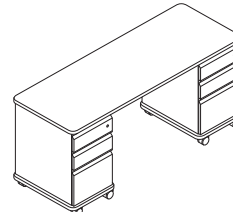

HLTV2466T-33

- Larger top size provides ample work/conference area or space for equipment.
- Standard with Heavy-duty 3", 360-degree swivel + locking casters.
- Storage options include: Locking box/box/file.
- Modesty specified separately.
- Power modules can be ordered separately and mounted to the desk. See Power & Cable Management page 247.

#### Teacher Station – Single Pedestal with Modesty Panel



HLTV2466TMOD-3

#### Storage

- Single pedestal desk available in Left-hand or Right-hand. Right or left handedness determined when installing in the field.
- Pedestal options include Box/Box/File locking.

#### Teacher Station – Single Pedestal

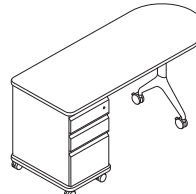

HLTV2460T-3

- Standard with Heavy-duty 3", 360-degree swivel + locking casters.
- Storage options include: Locking box/box/file.
- Right or left assembled in the field.
- D-shape top encourages conferencing and provides ample work and conference area.
- Modesty specified separately.
- Power modules can be ordered separately and mounted to the desk. See Power & Cable Management page 247.

# SMARTLINK® SPECIFYING INFORMATION

## WALL RAIL SYSTEM

The SmartLink® wall rail is a multi-layered, multi-functional system that can accommodate a variety of presentation boards and accessories. The multiple tracks allow boards to be easily positioned and changed to support today's interactive learning environments.

### Planning Notes

- Installation of the wall rail system over existing white or chalkboards is not recommended.
- The rail and wall bracket provide three separate tracks for the Learning boards. The REAR or wall/bracket track is occupied by the fixed wall board. The MIDDLE and FRONT tracks are for sliding boards.
- To allow for greater utilization of the rear fixed board a maximum width of 96" of sliding boards on the middle or front track is recommended.

The illustration below shows the overall wall space requirements for the rail system and recommended mounting height for use in K-12 classroom applications.

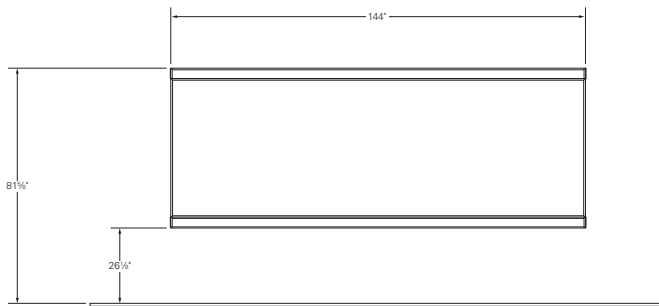

Sliding boards are removable and reversible so a wide variety of layouts are possible. The following illustrations highlight a couple of the more common applications. Layouts 2A and 2B provide the greatest amount of board space and overall flexibility. When used with rail mounted worksurfaces, use 24"W boards on the front rail as shown in 2C in front of each worksurface to provide information specific to that work area. Boards could then be added to the middle rail for information/work to be shared between the stations.

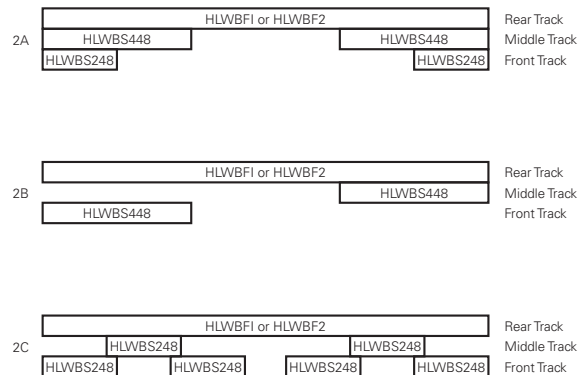

### Specification Notes

- Boards are specified individually.
- Hardware to mount to the wall brackets is not provided by HON and MUST BE SOURCED LOCALLY.
- Learning board only applications require two (2) HLWR-12 rails to be specified.
- REFER TO PRODUCT INSTALLATION INSTRUCTIONS FOR DETAILED INSTALLATION INFORMATION.

# SMARTLINK® Series Student Desks

GSA SIN 33721T



Icon Legend on page 19

EDUCATION



**DESCRIPTION**

**Student Desk, Fixed Height**

28"W x 28"W, User side 36¼"W  
30" Fixed Height

**Hard Plastic Top**

**MODEL**

**HLDV-M3F**

**SHIP WEIGHT**

63

**CUBE**

18.0

**LIST PRICE BY PAINT GRADE**

**P1**

**\$769**

**P2**

**\$769**

**P3**

**\$802**

NOTES: The cross-brace is installed to maximize kneespace but will not allow for book box (HLDA-15) installation. The cross-brace orientation can be switched in the field to allow for book basket install.

ⓘ Student Desks are ordered and shipped two (2) desks per carton. Legs and cross-brace ship attached. Lower adjustable legs ship unattached for field installation. Pricing shown is per carton. Ordering two of model HLDV-M3F will result in 2 cartons being shipped, giving you 4 desks.



**Student Desk, Adjustable Height**

28"W x 28"W, User side 36¼"W  
Adjustable: 23"-33" height adjustment range.

**Hard Plastic Top**

**HLDV-M3A**

59

12.5

**\$769**

**\$769**

**\$802**

NOTES: Accepts book box (HLDA-15) installation without repositioning crossbar.

ⓘ Student Desks are ordered and shipped two (2) desks per carton. Upper leg and cross-brace ship attached. Lower adjustable legs ship unattached for field installation. Pricing shown is per carton. Ordering two of model HLDV-M3A will result in 2 cartons being shipped, giving you 4 desks.

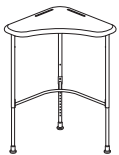

**Student Desk, Sit-to-Stand**

28"W x 28"W, User side 36¼"W  
Adjustable: 30"-43" height adjustment range.  
Leg height is set during field installation.

**Hard Plastic Top**

**HLDV-M3T**

61

15.3

**\$1094**

**\$1094**

**\$1116**

NOTES: Accepts book box (HLDA-15).

ⓘ Student Desks are ordered and shipped two (2) desks per carton. Legs and cross-brace ship attached. Pricing shown is per carton. Ordering two of model HLDV-M3T will result in 2 cartons being shipped, giving you 4 desks.

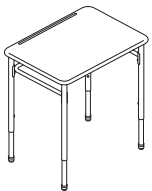

**Rectangle Student Desk, Adjustable Height**

20"W x 26"D  
Adjustable: 23"-33" height adjustment range.

**HLDV-MRECT2026A**

57

9.19

**\$769**

**\$769**

**\$802**

NOTES: Accepts book box (HLDA-15) installation without repositioning crossbar. Lower adjustable legs ship unattached for field installation.

ⓘ Student Desks are ordered and shipped two (2) desks per carton. Legs and cross-brace ship attached. Pricing shown is per carton. Ordering two of model HLDV-MRECT2026A will result in 2 cartons being shipped, giving you 4 desks.

**NOTES:**

- Upper leg is painted, lower leg standard chrome finish on Adjustable Height models.
- Non-handed desk top constructed of ¾" hard plastic.
- Hard plastic tops include pencil grooves.
- Nylon swivel glides are standard on adjustable and fixed leg models.
- Fixed Height models ship fully assembled. Adjustable models have the upper leg and cross-brace installed. The lower leg ships unattached for field installation.
- 29.60" distance between legs on user side. Outside distance between legs is 23⅝".
- Accepts optional backpack hooks (HCLA65).
- Book boxes are only available as an accessory for field installation on Series desks.

SPECIFICATION TIP: Consider available kneespace when specifying under desk storage Metal Book Box. Available kneespace will vary significantly given set desk height. Use the following example to calculate the available and usable kneespace.

EXAMPLE: HLDV-M3A Student Desk, HLDA-15 Metal Book Box

(user set desk height – top thickness – seat height = available kneespace)

(29"H – 1" thickness – 18" seat height = 10" available kneespace)

(available kneespace – book basket/box height = usable kneespace)

(10" available kneespace – 5" basket height = 5" usable kneespace)

ⓘ Field installed felt glide caps (HGDK3-F) are recommended for use on VCT flooring.







ⓘ All Student Desks are ordered and shipped two (2) desks per carton. Ordering two of any model will result in 2 cartons being shipped, giving you 4 desks.

**HOW TO SPECIFY**

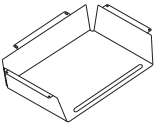
<p><b>Select Model Number</b></p> <p>H L D V - M 3 F .</p>	<p><b>Select Glide Option</b></p> <p>E Hard-Surface (no upcharge)</p> <p>E .</p>	<p><b>Select Top Color</b></p> <p>See page 175</p> <p>G 9 .</p>	<p><b>Select Upper Leg Color</b></p> <p>See page 175</p> <p>S</p>
--	--	---	---

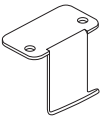

# SMARTLINK® Student Accessories

	DESCRIPTION	MODEL	SHIP WEIGHT	CUBE	LIST PRICE
 <b>SIN 33721T</b>  	<b>Metal Book Box (4 per Carton)</b> 19½"W x 13"D x 5"H NOTES: Attaches to bottom of desk with 6 screws, included. Screws included are for SmartLink® plastic tops only. Field installed. Features integrated, full-width pencil holder. ⓘ Platinum finish only. ⓘ Book Box rated up to 25 lbs. ⓘ SmartLink® Book Box, HLDA-15, is compatible with Roll Call™. Book box hardware pack does not include wood screws which are needed to install book box to a laminate worksurface. Installer to provide wood screws. Each book box requires 6, #12 phillips panhead, ¾" long screws for installation.	<b>HLDA-15</b>	15	2.0	<b>\$332</b>
 <b>OPEN MARKET</b>  	<b>Back Pack Hook (10 per carton)</b> NOTES: Assembly: attaches to bottom of desk with (2) screws, included. ⓘ Available in Platinum Metallic finish only, no specification needed. ⓘ Back Pack Hook rated up to 25 lbs.	<b>HCLA65</b>	10	0.1	<b>\$123</b>
 <b>OPEN MARKET</b>	<b>Glide Kit — Felt Glide Caps</b> <ul style="list-style-type: none"> <li>• Recommended for use on VCT flooring.</li> <li>• Caps easily and securely snap over existing nylon swivel glide.</li> <li>• Kit includes 100 caps.</li> <li>• Field installed.</li> </ul> ⓘ Not designed to be used with Sit-to-Stand Bell Glides (model HLDV-M3T). <b>Must be ordered with a configurable end product. If ordered separately, not on GSA Contract.</b>	<b>HGDK3-F</b>	2	0.2	<b>\$160</b>

## HOW TO SPECIFY

Select Model Number

HLDA-15

	MODEL/DESCRIPTION	DEPTH	WIDTH	HEIGHT	SHIP WEIGHT	CUBE	LIST PRICE PER CARTON		
							P1	P2	P3
	<b>HSS4L-18B</b> 18"H 4-Leg Chair, Armless				58	15.6	\$737	\$737	\$769
	Maximum:	19 <sup>5</sup> / <sub>8</sub>	19 <sup>1</sup> / <sub>2</sub>	31					
	Seat:	16 <sup>1</sup> / <sub>4</sub>	16 <sup>1</sup> / <sub>2</sub>	18					
	Back:		15 <sup>3</sup> / <sub>8</sub>	13 <sup>3</sup> / <sub>8</sub>					
	Seat to Floor:			18					
	Usable Seat Depth:	16 <sup>1</sup> / <sub>8</sub>							
	<b>HSS4L-16B</b> 16"H 4-Leg Chair, Armless				54	15.6	\$737	\$737	\$769
	Maximum:	19 <sup>5</sup> / <sub>8</sub>	19 <sup>1</sup> / <sub>4</sub>	29					
	Seat:	16 <sup>1</sup> / <sub>4</sub>	16 <sup>1</sup> / <sub>2</sub>	16					
	Back:		15 <sup>3</sup> / <sub>8</sub>	13 <sup>3</sup> / <sub>8</sub>					
	Seat to Floor:			16					
	Usable Seat Depth:	16 <sup>1</sup> / <sub>8</sub>							
	<b>HSS4L-14A</b> 14"H 4-Leg Chair, Armless				49	11.9	\$703	\$703	\$734
	Maximum:	17	17	25 <sup>1</sup> / <sub>2</sub>					
	Seat:	14 <sup>1</sup> / <sub>4</sub>	14 <sup>5</sup> / <sub>8</sub>	14					
	Back:		13 <sup>3</sup> / <sub>8</sub>	11 <sup>5</sup> / <sub>8</sub>					
	Seat to Floor:			14					
	Usable Seat Depth:	14							
	<b>HSS4L-12A</b> 12"H 4-Leg Chair, Armless				45	11.9	\$703	\$703	\$734
	Maximum:	17	17	23 <sup>1</sup> / <sub>2</sub>					
	Seat:	14 <sup>1</sup> / <sub>4</sub>	14 <sup>5</sup> / <sub>8</sub>	12					
	Back:		13 <sup>3</sup> / <sub>8</sub>	11 <sup>5</sup> / <sub>8</sub>					
	Seat to Floor:			12					
	Usable Seat Depth:	14							
	<b>HSS4L-06A</b> 6"H 4-Leg Chair, Armless				37	8.6	\$685	\$685	\$715
	Maximum:	17	17	17 <sup>1</sup> / <sub>2</sub>					
	Seat:	14 <sup>1</sup> / <sub>4</sub>	14 <sup>5</sup> / <sub>8</sub>	6					
	Back:		13 <sup>3</sup> / <sub>8</sub>	11 <sup>5</sup> / <sub>8</sub>					
	Seat to Floor:			6					
	Usable Seat Depth:	14							

**NOTES:**





- High strength tubular steel frame.
- Seat Shell is one-piece injection molded.
- 16"H and 18"H models accept Wire Storage Basket model HSSA-WB1618.
- Casters are available on 16"H and 18"H chairs only.
- 4-Leg models stack 5-high on floor.
- Nylon or steel glides accept felt glide caps (HGDK3-F) which are recommended for use on VCT flooring.
- Durable textured powder coated paint finish or chrome option finish.

⊕ SmartLink® 4-Leg Chairs are ordered and shipped four (4) chairs per carton. Pricing shown is per carton. Each set of four chairs (one carton) must have the same shell/frame color combination. Ordering 2 of Model HSS4L-06A, HSS4L-12A, HSS4L-14A, HSS4L-16B or HSS4L-18B will result in 2 cartons being shipped, giving you 8 chairs.

**HOW TO SPECIFY**

<p><b>Select Model Number</b></p> <p>HSS4L-12A</p>	<p><b>Select Glide Option</b></p> <p>E Nylon Glide N Nickel Steel Glide C Caster (\$212 upcharge)</p> <p>Caster option not available for models HSS4L-06A, HSS4L-12A or HSS4L-14A</p> <p>E</p>	<p><b>Select Shell Color</b></p> <p>See page 175</p> <p>RG</p>	<p><b>Select Frame Color</b></p> <p>See page 175</p> <p>P4 option Polished Chrome (Y) \$57 upcharge</p> <p>PLAT</p>
--	--	--	---

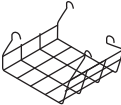

	MODEL/DESCRIPTION	DEPTH	WIDTH	HEIGHT	SHIP		LIST PRICE BY PAINT GRADE		
					WEIGHT	CUBE	P1	P2	P3
	<b>HSS4L-24B</b> 24" H 4-Leg Stool, Armless  Maximum: Seat: Back: Seat to Floor: Usable Seat Depth:	21½	22	38¼	30	16.8	\$359	\$359	\$376
	<b>HSS4L-30B</b> 30" H 4-Leg Stool, Armless  Maximum: Seat: Back: Seat to Floor: Usable Seat Depth:	23½	22½	43¾	31	19.1	\$379	\$379	\$396
	<b>Wire Storage Basket (4 per carton)</b> 15¾"W x 12¼"D x 9¾"H  ❗ For 16" and 18" 4-Leg Chairs only. Chrome finish only, no specification needed. ❗ Chairs cannot be stacked when utilizing Wire Storage Basket. ❗ Not compatible with 4-Leg Stools or Cantilever Chairs. ❗ Storage Basket rated up to 25 lbs.								
	<b>Felt Cap Glide Kit for 4-Leg SmartLink®</b> • Recommended for use on VCT flooring. • Caps easily and securely snap over the existing nylon swivel glide. • Kit includes 100 caps for 25 chairs or desks. • Field installed.  ❗ Must be ordered with a configurable end product. If ordered separately, not on GSA Contract.								

**NOTES:**

- 4-Leg Stools may stack up to 5-high on floor.
- Lead times may vary by shell color.
- ❗ Polished Chrome (Y) not available on models HSS4L-24B and HSS4L-30B.

## HOW TO SPECIFY

<p><b>Select Model Number</b></p> <p>H S S 4 L - 2 4 B</p>	<p><b>Select Glide Option</b></p> <p>E Nylon Glide N Nickel Steel Glide</p> <p>E</p>	<p><b>Select Shell Color</b></p> <p>See page 175</p> <p>R G</p>	<p><b>Select Frame Color</b></p> <p>See page 175</p> <p>P L A T</p>
--	--	---	---



	MODEL/DESCRIPTION	DEPTH	WIDTH	HEIGHT	SHIP WEIGHT	CUBE	LIST PRICE PER CARTON			
							P1	P2	P3	
	<b>HSSCL-18B</b> 18"H Cantilever Base Chair, Armless	Maximum: Seat: Back: Seat to Floor: Usable Seat Depth:	21¾ 16⅞ 15⅜ 18¾ 16⅞	22¾ 16½ 15⅜ 13⅜ 18¾	31¼ 18 13⅜ 18¾	80	23.7	\$1085	\$1085	\$1131
	<b>HSSCL-16B</b> 16"H Cantilever Base Chair, Armless	Maximum: Seat: Back: Seat to Floor: Usable Seat Depth:	21¾ 16⅞ 15⅜ 16¼ 16⅞	22¾ 16½ 15⅜ 13⅜ 16¼	29¼ 16 13⅜ 16¼	55	16.8	\$1033	\$1033	\$1077
	<b>HSSCL-14A</b> 14"H Cantilever Base Chair, Armless	Maximum: Seat: Back: Seat to Floor: Usable Seat Depth:	21¾ 16⅞ 15⅜ 14¼ 16⅞	22¾ 16½ 15⅜ 13⅜ 14¼	27¼ 14 13⅜ 14¼	52	16.8	\$1013	\$1013	\$1056

**NOTES:**

- High strength tubular steel frame.
- Glides available with nylon or felt inserts. See ordering information below.
- Seat shell is one-piece injection molded.
- Cantilever models stack 5-high on floor.
- Durable textured powder coated paint or chrome option finish.

SmartLink® Cantilever Chairs are ordered and shipped four (4) chairs per carton. Pricing shown is per carton. Each set of four chairs (one carton) must have the same shell/frame color combination. Ordering 2 of Model HSSCL-18B will result in 2 cartons being shipped, giving you 8 chairs.

**HOW TO SPECIFY**

<p><b>Select Model Number</b></p> <p>H S S C L - 1 8 B .</p>	<p><b>Select Glide Option</b></p> <p><b>E</b> All-purpose Glide Insert (no upcharge)  <b>F</b> Felt Glide Insert (\$40 list upcharge; \$10 per single unit see page 181)</p> <p>E .</p>	<p><b>Select Shell Color</b></p> <p>See page 175</p> <p>R G .</p>	<p><b>Select Frame Color</b></p> <p>See page 175  <i>P4 option Polished Chrome (Y) \$57 upcharge</i></p> <p>P L A T</p>
--	---	---	---

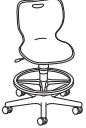

	MODEL/DESCRIPTION	DEPTH	WIDTH	HEIGHT	SHIP WEIGHT	CUBE	PER CARTON LIST
	<b>HSSTK-18B</b> <b>18"H Task Swivel Chair,</b> <b>Pneumatic Seat Height</b> <b>Adjustment</b>				23	5.2	<b>\$403</b>
	Maximum:	22 <sup>5</sup> / <sub>8</sub>	22 <sup>1</sup> / <sub>2</sub>	34 <sup>3</sup> / <sub>4</sub>			
	Seat:	16 <sup>1</sup> / <sub>4</sub>	16 <sup>1</sup> / <sub>2</sub>	18			
	Back:		15 <sup>3</sup> / <sub>8</sub>	13 <sup>3</sup> / <sub>8</sub>			
	Seat to Floor:			16-21			
	<b>HSSST-18B</b> <b>18"H Task Swivel Stool,</b> <b>Pneumatic Seat Height</b> <b>Adjustment, Footring</b> <b>Adjustment</b>				28	12.8	<b>\$495</b>
Maximum:	24 <sup>1</sup> / <sub>4</sub>	25 <sup>3</sup> / <sub>4</sub>	45 <sup>1</sup> / <sub>2</sub>				
Seat:	16 <sup>1</sup> / <sub>4</sub>	16 <sup>1</sup> / <sub>2</sub>	18				
Back:		15 <sup>3</sup> / <sub>8</sub>	13 <sup>3</sup> / <sub>8</sub>				
Seat to Floor:			22-32				
Usable Seat Depth:	16 <sup>3</sup> / <sub>8</sub>						

**NOTES:**

- Seat Shell is one-piece injection molded.
- Task Swivel Chair has a pneumatic seat height adjustment.
- Choose between hard and soft casters (no upcharge) or bell glide (\$28 upcharge) options.
- Stool has an adjustable footring.
- Swivel Task Chair and Stool ship one per carton.
- ! Swivel Task Chair and Stool are available with a black frame only.

**HOW TO SPECIFY**

<p><b>Select Model Number</b></p> <p>H S S T K - 1 8 B</p>	<p><b>Select Glide Option</b></p> <p>S Soft Caster (no upcharge) H Hard Caster (no upcharge) G Bell Glide (\$28 upcharge)</p> <p>S</p>	<p><b>Select Shell Color</b></p> <p>See page 175</p> <p>R G</p>
--	--	---

# SMARTLINK® Teacher Stations

GSA SIN 33721T



Icon Legend on page 19

EDUCATION

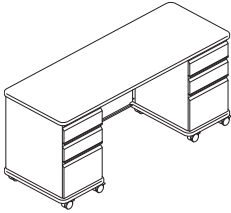

DESCRIPTION	MODEL	SHIP WEIGHT	CUBE	LIST PRICE BY PAINT GRADE			L2 UPCHARGE
				P1	P2	P3	
<b>Teacher Station with Modesty Panel</b> 66"W x 24"D x 30"H, Rectangle Box/Box/File Pedestal, Left Box/Box/File Pedestal, Right NOTES: Ships standard with full height modesty panel for field installation.	<b>HLTV2466TMOD-33</b>	254	37.2	\$2573	\$2640	\$2697	\$65

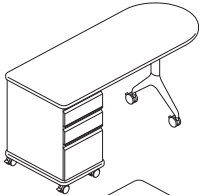

<b>Teacher Station with Modesty Panel</b> 60"W x 24"D x 30"H, Peninsula Box/Box/File Storage NOTES: Ships standard with half height modesty panel for field installation.	<b>HLTV2460TMOD-3</b>	136	29.3	\$1979	\$2030	\$2069	\$44
--	-----------------------	-----	------	--------	--------	--------	------

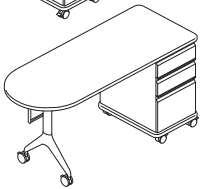

**NOTES**

- Tops/Bases are Laminate with T-mold edge.
- Standard with Heavy-duty 3", 360-degree swivel casters.
- Storage options include: Locking box/box/file.
- Kneewell space accommodates separately specified and field installed non-locking center drawer and CPU holders (see page 229).
- Peninsula top encourages conferencing and provides ample work and conference area.
- Right or left assembled in the field.
- Modesty panel included in model.
- Power modules can be ordered separately and mounted to the desk.

**HOW TO SPECIFY**

<b>Select Model Number</b> H L T V 2 4 6 6 T M O D - 3 3 .	<b>Select Top and Base Color</b> Laminate See page 175 B 9 .	<b>Select T-Mold Color</b> See page 175 K .	<b>Select Paint Color</b> See page 175 T 1
---	---	---	--

DESCRIPTION	MODEL	SHIP WEIGHT	CUBE	LIST PRICE BY PAINT GRADE		
				P1	P2	P3
<b>Modesty Panel</b> 34"W x 24½"H, for Rectangle Teacher Desk 35"W x 12"H, for Peninsula Teacher Desk NOTES: Modesty panels can be retrofitted to existing SmartLink® Teacher Stations.	<b>HLTVMODFULL</b>	17	2.3	\$270	\$303	\$335
	<b>HLTVMODPART</b>	10	1.3	\$227	\$249	\$271

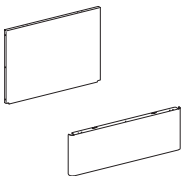

**HOW TO SPECIFY**



<b>Select Model Number</b> H L T V M O D F U L L .	<b>Select Paint Color</b> See page 175 S
---	--



Icon Legend on page 19

# SMARTLINK® Teacher Stations

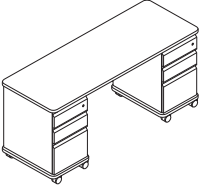
EDUCATION

	DESCRIPTION	MODEL	SHIP WEIGHT	CUBE	LIST PRICE BY PAINT GRADE		
					P1	P2	P3
	<b>Teacher Station</b> 66"W x 24"D x 30"H Box/Box/File Pedestal, Left Box/Box/File Pedestal, Right NOTES: Accepts universal modesty panel (HMTUMOD32).	<b>HLTV2466T-33</b>	240	21.1	<b>\$2303</b>	<b>\$2339</b>	<b>\$2362</b>
  	<b>Teacher Station</b> 60"W x 24"D x 30"H Box/Box/File Storage NOTES: Accepts universal modesty panel (HMTUMOD32).	<b>HLTV2460T-3</b>	158	14.18	<b>\$1752</b>	<b>\$1781</b>	<b>\$1799</b>

**NOTES:**

- Tops/Bases are Laminate with T-mold edge.
- Standard with Heavy-duty 3", 360-degree swivel casters.
- Storage options include: Locking box/box/file.
- Kneewell space accommodates separately specified and field installed non-locking center drawer and CPU holders (see page 229).
- D-shape top encourages conferencing and provides ample work and conference area.
- Right or left assembled in the field.
- Modesty specified separately.
- Power modules can be ordered separately and mounted to the desk.

## HOW TO SPECIFY

<b>Select Model Number</b>  H L T V 2 4 6 6 T - 3 3	<b>Select Top and Base Color</b> <b>Laminate</b> See page 175  B 9	<b>Select T-Mold Color</b> See page 175  K	<b>Select Paint Color</b> See page 175  T 1
---	--	---	--

# SMARTLINK® Wall Rail System

GSA SIN 33721T



Icon Legend on page 19

EDUCATION

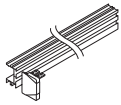

DESCRIPTION	MODEL	SHIP WEIGHT	CUBE	LIST PRICE
<b>Wall Rail</b> 144"	<b>HLWR-12</b>	22	1.4	<b>\$1086</b>

NOTES: Rail model includes: 1 – 144" rail, 9 – wall mounting brackets and 2 – rail end caps.

- ❗ Must be mounted in accordance with published installation instructions. Wall mounting hardware NOT INCLUDED. Must be sourced locally.
- ❗ Must order Quantity 2 rails when using with Whiteboards and Whiteboards/Tackboards.
- ❗ Platinum finish only.

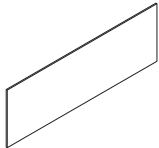

<b>Learning Board, Fixed Whiteboard, 1-sided</b> 144"W x 48"H, Quantity 1	<b>HLWBF1-1248W</b>	124	13.0	<b>\$2593</b>
--	---------------------	-----	------	---------------

**SPECIFYING EXAMPLE: HLWBF-1248W.X**

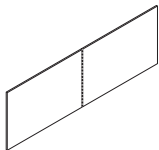

<b>Learning Board, Fixed Whiteboards, 1-sided</b> 72"W x 48"H, Quantity 2 with spacer (included)	<b>HLWBF2-1248W</b>	125	6.7	<b>\$2593</b>
---	---------------------	-----	-----	---------------

NOTES: Includes center cover/spacer.  
**SPECIFYING EXAMPLE: HLWBF2-1248W.X**

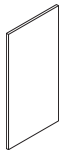

<b>Learning Board, Sliding Whiteboard/Whiteboard</b> 48"W x 48"H	<b>HLWBS-448WW</b>	47	4.6	<b>\$1252</b>
24"W x 48"H	<b>HLWBS-248WW</b>	26	2.5	<b>\$801</b>

**SPECIFYING EXAMPLE: HLWBS-448WW.X**

Model HLWBS-248WW shown

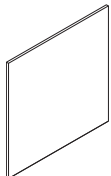

<b>Learning Board, Sliding Whiteboard/Tackboard</b> 48"W x 48"H	<b>HLWBS-448WT</b>	64	4.6	<b>\$1302</b>
24"W x 48"H	<b>HLWBS-248WT</b>	34	2.5	<b>\$835</b>

NOTES: Tackboard Side available in the following fabric: Lucy Neutra (LC24).  
**SPECIFYING EXAMPLE: HLWBS-448WT.X.LC24**

Model HLWBS-448WT shown

## NOTES:

- Multi-functional wall rails can accommodate whiteboards and organizational accessories. See above and page 189.
- Multi-track rail allows for up to three layers of whiteboards. Rear track supports a fixed board, middle and front tracks support sliding boards. Outer rail channel is for attachment of organizational accessories.
- Sliding learning boards are removable and reversible.
- All fixed and sliding boards:
  - Require two (upper and lower) rails for installation.
  - Feature a full aluminum frame.
  - Are high-quality porcelain over steel and non-shadowing.
  - Are low gloss for projection use and allows for use of magnets.

## HOW TO SPECIFY

<b>Select Model Number</b>  <div style="border: 1px solid #ccc; padding: 2px; display: flex; gap: 5px;"> <span>H</span><span>L</span><span>W</span><span>B</span><span>S</span><span>-</span><span>4</span><span>4</span><span>8</span><span>W</span><span>T</span><span>.</span> </div>	<b>Select Side A Color</b>  <div style="border: 1px solid #ccc; padding: 2px; display: flex; gap: 5px;"> <span>X</span> </div>	<b>Select Tackboard Fabric</b>  <div style="border: 1px solid #ccc; padding: 2px; display: flex; gap: 5px;"> <span>L</span><span>C</span><span>2</span><span>4</span> </div>
--	--	--



**DESCRIPTION**

**Marker Tray (Single Pack)**  
7"W x 3½"D x 2"H

NOTES: Holds dry-erase markers, push pins and other small objects.

MODEL	SHIP WEIGHT	CUBE	LIST PRICE BY PAINT GRADE		
			P1	P2	P3
HPPMMT	1	0.2	\$128	\$142	\$154

**NOTES:**

- Use on the Wall Rail System — see page 188.
- Marker Tray mounts on the rail's outer channel and may be used with sliding boards.
- May be mounted and moved to any position along the width of the rail.
- May be easily removed from the rail.

**HOW TO SPECIFY**

<p><b>Select Model Number</b></p> <p>H P P M M T .</p>	<p><b>Select Paint Color</b></p> <p>See page 175</p> <p>T 1</p>
--	---

# SMARTLINK® Mobile Storage

GSA SIN AS NOTED



Icon Legend on page 19

EDUCATION

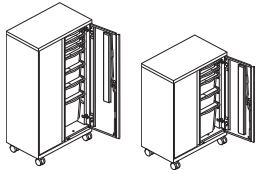

HLVMSC5630R HLVMSC4330R

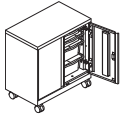

HLVMSC3330R

## DESCRIPTION

### Mobile Storage Cabinet with Bins

18"D x 30"W x 32¼"H  
18"D x 30"W x 42¼"H  
18"D x 30"W x 56"H

## MODEL

HLVMSC3330R  
HLVMSC4330R   
HLVMSC5630R

## SHIP WEIGHT

152.6  
171.6  
209.6

## CUBE

13.4  
18.0  
23.5

## LIST PRICE BY PAINT GRADE

P1 P2 P3

\$1835 \$1883 \$1915  
\$2017 \$2070 \$2104  
\$2322 \$2382 \$2422

SIN 33721T

## NOTES:

- Full radius "R" handle on doors.
- Units include 2 locking and 2 non-locking casters.
- Equipped with HON "One Key" interchangeable core removable locks.

 Pre-configured trays and rails included in mobile storage cabinets with bins. See chart below for configurations and capacity. Additional bin and rail kits may be purchased separately.

## DESCRIPTION

### Accessories — Tray Kit

3"H, 2 bins and 4 rails  
6"H, 2 bins and 4 rails  
12"H, 2 bins and 4 rails

## MODEL

HFMBIN3  
HFMBIN6  
HFMBIN12

## SHIP WEIGHT

7   
10   
12 

## CUBE

4.0  
4.5  
5.0

## LIST PRICE

\$80  
\$95  
\$112

NOTES: Mobile storage cabinets ship with pre-determined rails and bins. Additional bins and rails may be ordered in sets of two utilizing the models shown. Availability and usage are outlined below. HFMBIN3/6/12 are compatible with SmartLink® and Class-ifi™ Storage.

 Semi-translucent white.

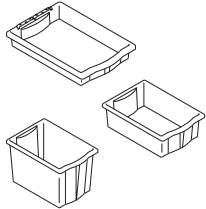

SIN 33721

## Pre-Configured Cabinets/Tray Kits

### 56"H Cabinet

1	2
3	4
5	6
1	2
3	4
5	6
1	2

### 42¼"H Cabinet

1	2
3	4
1	2
3	4
1	2

### 32¼"H Cabinet

1	2
3	4
1	2
3	4

### 56"H Cabinet

1	14
2	15
3	16
4	17
5	18
6	19
7	20
8	21
9	22
10	23
11	24
12	25
13	26

Hanging Slots 12"H Bin 6"H Bin 3"H Bin

1		
2		
3		
4		

### 42¼"H Cabinet

1	11
2	12
3	13
4	14
5	15
6	16
7	17
8	18
9	19
10	20

### 32¼"H Cabinet

1	7
2	8
3	9
4	10
5	11
6	12

26 - 12"W Openings

20 - 12"W Openings

12 - 12"W Openings

## HOW TO SPECIFY

Select Model Number

H L V M S C 3 3 3 0 R .

Select Lock Option

- L Lock (no upcharge)
- X Omit Lock (deduct \$20)

L .

Select Paint Color

See page 175

P J W



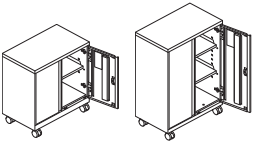
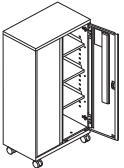

# SMARTLINK® Mobile Storage

	DESCRIPTION	MODEL	SHIP WEIGHT	CUBE	LIST PRICE BY PAINT GRADE		
					P1	P2	P3
 HLVSC3330R    HLVSC4330R	<b>Mobile Storage Cabinet without Bins</b>						
	18"D x 30"W x 32¼"H	<b>HLVSC3330R</b>	152.6	13.4	<b>\$1670</b>	<b>\$1714</b>	<b>\$1742</b>
	18"D x 30"W x 42¼"H	<b>HLVSC4330R</b>	171.6	18.0	<b>\$1835</b>	<b>\$1883</b>	<b>\$1915</b>
	18"D x 30"W x 56"H	<b>HLVSC5630R</b>	209.6	23.5	<b>\$2201</b>	<b>\$2258</b>	<b>\$2295</b>
 HLVSC5630R <b>SIN 33721T</b>							

**NOTES:**

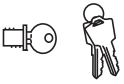
- Full radius "R" handle on doors.
- Units include 2 locking and 2 non-locking casters.
- Includes shelves which are adjustable in 2" increments.
- Equipped with HON "One Key" interchangeable core removable locks.
- Wire management grommet in back of unit.

	DESCRIPTION	MODEL	SHIP WEIGHT	CUBE	LIST PRICE
 <b>SIN 33721</b>	<b>Chrome Removable Lock Core Kit (for metal casegoods)</b> <ul style="list-style-type: none"> <li>• Use when specifying omit lock application.</li> <li>• Specify quantity of each key number from 101E-225E.</li> <li>• Includes: 1-core, 2-keys, 1-core removal tool and instructions.</li> <li>• Removable lock core kits with specific key number must be ordered to facilitate keying alike in the field.</li> <li>• For specific models, look for the Omit Lock Core icon throughout this publication.</li> </ul> NOTES: If key number isn't specified, number will be at random. Core matches manufactured lock on metal casegoods product but can be used with Contain® and laminate product. When purchased separately without a configurable TAA compliant end product, not on GSA contract.	<b>HF23C</b>	0.1 	0.1	<b>\$65</b>

## HOW TO SPECIFY

<b>Select Model Number</b> H L V S C 3 3 3 0 R .	<b>Select Lock Option</b> L Lock (no upcharge) X Omit Lock (deduct \$20)	<b>Select Paint Color</b> See page 175 P J W
---	--	--



# SMARTLINK® Mobile Storage

GSA SIN 33721T



Icon Legend on page 19

EDUCATION

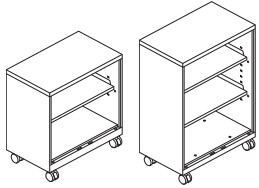

HLVBC3330

HLVBC4330

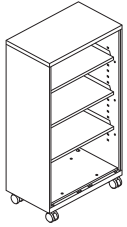

HLVBC5630

## DESCRIPTION

### Mobile Bookcases

18"D x 30"W x 31¼"H

18"D x 30"W x 42¼"H

18"D x 30"W x 56"H

MODEL	SHIP WEIGHT	CUBE	LIST PRICE BY PAINT GRADE		
			P1	P2	P3
HLVBC3330	118.6	13.4	\$1516	\$1556	\$1581
HLVBC4330	134.6	18.0	\$1670	\$1714	\$1742
HLVBC5630	157.6	23.5	\$2002	\$2055	\$2088

## NOTES:

- Units include 2 locking and 2 non-locking casters.
- Shelves adjust in 2" increments.
- Wire management grommet in back of unit.

## HOW TO SPECIFY

Select Model Number

Select Paint Color

See page 175

HLVBC3330

PJW

# STORYLINE™

Want to see more? Scan here to check out hon.com.



Storyline™ shown with SmartLink® Seating, Build™ Tables, & Confetti™.

EDUCATION

## STORYLINE™

Libraries and media centers aren't just for study halls and research anymore — they're the heartbeat of the school. These once basic spaces have shifted to thoughtful, holistic community hubs designed to inspire not just students, but anyone who wants to connect and create. Storyline — a versatile bookcase collection that offers organic movement and customized learning zone options — is an open book when it comes to inspired synergy in shared spaces. Whether it's an early morning reading circle, a mid-afternoon small group project, or an evening town hall meeting, Storyline bridges the gap between people and places.



## FEATURES

- Utilize 18"H bookcases as both storage and a seat.
- Single-sided bookcases and bistro tables utilize steel back to accept magnets.
- Case and shelf constructed using 1 1/8" laminate for durability and longevity.
- Cases ship fully assembled. Casters and shelves installed on site.

# STORYLINE™ ORDERING INFORMATION

## LAMINATE

### L1 LAMINATES ..... CODES

#### Woodgrain

- ◆ Bourbon Cherry ..... H
- ◆ Cognac ..... COGN
- ◆ Field Elm ..... LWFE
- ◆ Florence Walnut ..... LFW1
- ◆ Harvest ..... C
- ◆ Kingswood Walnut ..... LK11
- ◆ Mahogany ..... N
- ◆ Mocha ..... MOCH
- ◆ Natural Maple ..... D
- ◆ Pinnacle ..... PINC
- ◆ Shaker Cherry ..... F
- ◆ Sterling Ash ..... LSA1

#### Solid

- ◆ Black ..... P
- ◆ Charcoal ..... S
- ◆ Designer White ..... LDW1
- ◆ Loft ..... LOFT

### L2 LAMINATES ..... CODES

#### Woodgrain

- ◆ Beigewood ..... LWBE
- ◆ Fawn Cypress ..... LFC1
- ◆ Lowell Ash ..... LLA1
- ◆ Natural Recon ..... LNR1
- ◆ Phantom Ecru ..... LPE1
- ◆ Portico Teak ..... LPT1
- ◆ Skyline Walnut ..... LSW1

## PAINT

### P1 ..... CODES

- ◆ Black ..... P71
- ◆ Brownstone ..... P7D
- ◆ Charcoal ..... S
- Cove ..... P096
- ◆ Designer White ..... PJW
- Dune ..... P094
- Fog ..... FOG
- ◆ Fossil ..... P28
- ◆ Greige ..... T5
- Harbor ..... P097
- ◆ Light Grey ..... Q
- ◆ Loft ..... LOFT
- ◆ Muslin ..... T3
- ◆ Putty ..... L
- Sage ..... P095
- ◆ Titanium ..... P8T

### P2 ..... CODES

- ◆ Champagne Metallic ..... PR5
- ◆ Gunmetal Metallic ..... PR3
- ◆ Platinum Metallic ..... T1
- ◆ Silver ..... PR6
- ◆ Solar Black ..... P8X

### P3 ..... CODES

- ◆ Atom ..... P8S
- ◆ Blossom ..... P8K
- ◆ Bullseye ..... PJF
- ◆ Ember ..... P8P
- ◆ Ion ..... P8N
- ◆ Iris ..... P8J
- ◆ Krypton ..... P8F
- ◆ Ochre ..... P093
- ◆ Regatta ..... P8M
- ◆ Sienna ..... P092
- ◆ Succulent ..... P8A

### P6 ..... CODES

- ◆ Markerboard ..... MKB

◆◆ For lead time information see page 21.

# STORYLINE™ SPECIFYING INFORMATION

## Statement of Line

### SINGLE-SIDED BOOKCASES

#### Linear

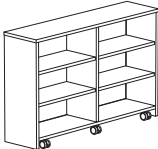
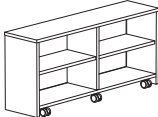
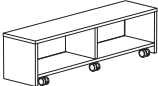

#### Curved In

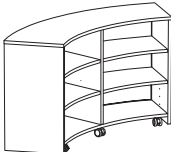
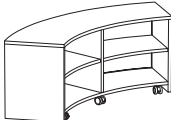
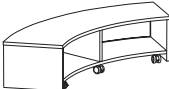

#### Curved Out

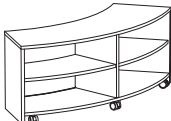

### DOUBLE-SIDED BOOKCASES

#### Linear

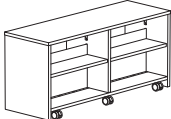
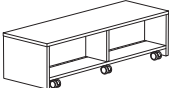

#### Curved

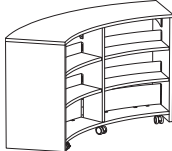
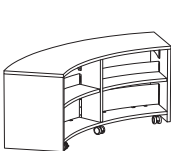
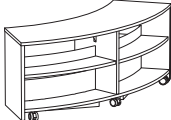
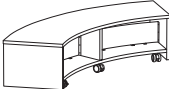

# STORYLINE™ SPECIFYING INFORMATION

## Statement of Line

### BISTRO TABLES

#### Linear

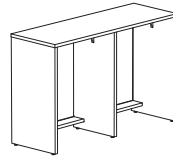
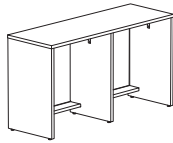
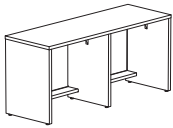

#### Curved

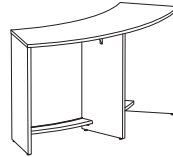
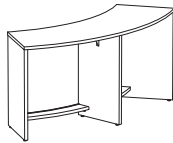
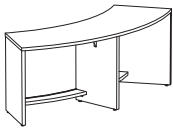

### ACCESSORIES

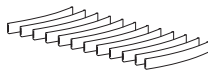
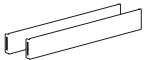

# STORYLINE™ SPECIFYING INFORMATION

## Dimensions

### Linear Bookcases

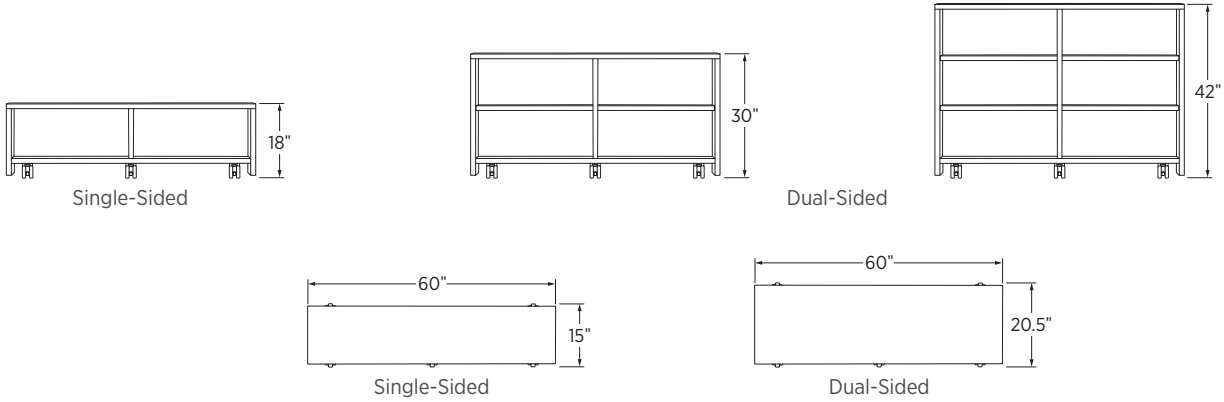

### Curved Bookcases

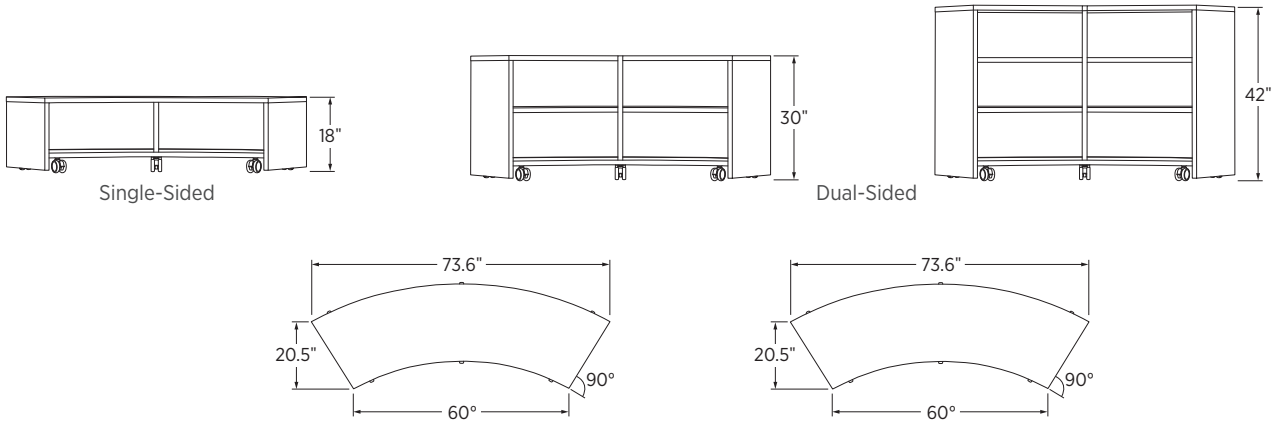

### Space Planning

- The chart below provides the amount of linear feet of storage per bookcase. The calculation does not include the top of the bookcases.

	Linear		Curved	
	Single	Dual	Single	Dual
18"H	4.7	9.4	4.4	9.6
30"H	9.4	18.7	8.7	19.2
42"H	14.1	28.1	13.1	28.8

# STORYLINE™ Linear Bookcases

GSA SIN 33721



Icon Legend on page 19

EDUCATION

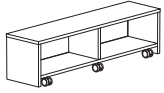

**DESCRIPTION**

**Single-Sided**

18”H  
30”H  
42”H

**MODEL**

**HESWLS18**  
**HESWLS30**  
**HESWLS42**

**SHIP WEIGHT**

91  
139  
187

**CUBE**

20.8  
31.1  
41.5

**LIST PRICE**

**\$2080**  
**\$2340**  
**\$2600**

**UPCHARGE BY LAMINATE/PAINT GRADE**

**L2**

**\$104**  
**\$117**  
**\$130**

**P2**

**\$104**  
**\$117**  
**\$130**

**P3**

**\$208**  
**\$234**  
**\$260**

**P6**

**\$416**  
**\$468**  
**\$520**



**Dual-Sided**

18”H  
30”H  
42”H

**HESWLD18**  
**HESWLD30**  
**HESWLD42**

125  
190  
251

28.0  
42.0  
56.0

**\$2480**  
**\$2640**  
**\$2900**

**\$124**  
**\$132**  
**\$145**

**\$124**  
**\$132**  
**\$145**

**\$248**  
**\$264**  
**\$290**

**\$496**  
**\$528**  
**\$580**

**NOTES:**

- 18”H units can be used as seat.
- Bookcases available in both glides or casters.
- Casters are locking casters that are recessed under the bookcase.
- Shelves ship disassembled and will be installed on site.
- Shelves are adjustable. Screwdriver required for adjustment.
- Shelves are adjustable in 1/4” increments.
- Double-sided units come with gussets for added rigidity. Gussets color will match paint selection.
- Double-sided units come with metal dividers.
- See page 197 for overall dimensions of bookcases.
- Units specified with glides will match height of units specified with casters.

**HOW TO SPECIFY**

Select Model Number

HESWLS18

Select Glide/Caster Option

- G Glide
- C Caster (+ \$50)

G

Select Laminate

See page 194

LSA1

Select Paint Color

See page 194

T1

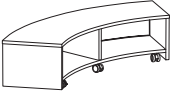
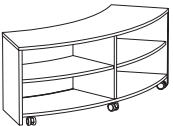
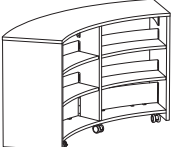

# STORYLINE™ Curved Bookcases

	DESCRIPTION	MODEL	SHIP WEIGHT	CUBE	LIST PRICE	UPCHARGE BY LAMINATE/PAINT GRADE			
						L2	P2	P3	P6
	<b>Single-Sided Curved In</b>								
	18”H	<b>HESWCI18</b>	131	39.6	<b>\$2480</b>	<b>\$124</b>	<b>\$124</b>	<b>\$248</b>	<b>\$496</b>
	30”H	<b>HESWCI30</b>	201	59.4	<b>\$2790</b>	<b>\$140</b>	<b>\$140</b>	<b>\$279</b>	<b>\$558</b>
	42”H	<b>HESWCI42</b>	271	79.1	<b>\$3100</b>	<b>\$155</b>	<b>\$155</b>	<b>\$310</b>	<b>\$620</b>
	<b>Single-Sided Curved Out</b>								
	18”H	<b>HESWCO18</b>	128	39.6	<b>\$2480</b>	<b>\$124</b>	<b>\$124</b>	<b>\$248</b>	<b>\$496</b>
	30”H	<b>HESWCO30</b>	197	59.4	<b>\$2790</b>	<b>\$140</b>	<b>\$140</b>	<b>\$279</b>	<b>\$558</b>
	42”H	<b>HESWCO42</b>	265	79.1	<b>\$3100</b>	<b>\$155</b>	<b>\$155</b>	<b>\$310</b>	<b>\$620</b>
	<b>Dual-Sided</b>								
	18”H	<b>HESWCD18</b>	134	39.6	<b>\$2880</b>	<b>\$144</b>	<b>\$144</b>	<b>\$288</b>	<b>\$576</b>
	30”H	<b>HESWCD30</b>	203	59.4	<b>\$3090</b>	<b>\$155</b>	<b>\$155</b>	<b>\$309</b>	<b>\$618</b>
	42”H	<b>HESWCD42</b>	268	79.1	<b>\$3400</b>	<b>\$170</b>	<b>\$170</b>	<b>\$340</b>	<b>\$680</b>

EDUCATION

**NOTES:**

- 18”H units can be used as seat.
- Bookcases available in both glides or casters.
- Casters are locking casters that are recessed under the bookcase.
- Shelves ship disassembled and will be installed on site.
- Shelves are adjustable. Screwdriver required for adjustment.
- Shelves are adjustable in 1/4” increments.
- Double-sided units come with gussets for added rigidity. Gussets color will match paint selection.
- Double-sided units come with metal septums.
- See page 197 for overall dimensions of bookcases.
- Units specified with glides will match height of units specified with casters.

**HOW TO SPECIFY**

<p><b>Select Model Number</b></p> <p>H E S W C I 1 8 .</p>	<p><b>Select Glide/Caster Option</b></p> <p>G Glide C Caster (+ \$50)</p> <p>G .</p>	<p><b>Select Laminate</b></p> <p>See page 194</p> <p>L S A 1 .</p>	<p><b>Select Paint Color</b></p> <p>See page 194</p> <p>T 1</p>
--	--	--	---



# STORYLINE™ Bistro Tables

GSA SIN 33721



Icon Legend on page 19

EDUCATION

DESCRIPTION	MODEL	SHIP WEIGHT	CUBE	LIST PRICE	UPCHARGE BY LAMINATE/PAINT GRADE				
					L2	P2	P3	P6	
<b>Linear Bistro Tables</b>									
30"H	HESWLB30	127	33.9	\$1872	\$94	\$94	\$187	\$374	
36"H	HESWLB36	141	45.1	\$1984	\$99	\$99	\$198	\$397	
42"H	HESWLB42	156	45.1	\$2080	\$104	\$104	\$208	\$416	
<b>Curved Bistro Tables</b>									
30"H	HESWCB30	130	59.4	\$2232	\$112	\$112	\$223	\$446	
36"H	HESWCB36	145	69.2	\$2366	\$118	\$118	\$237	\$473	
42"H	HESWCB42	159	79.1	\$2480	\$124	\$124	\$248	\$496	

**NOTES:**

- Bistro tables are only available with glides.
- Bistro tables include gussets for added rigidity.
- Paint color selection will determine back and gusset color.
- Linear bistro table worksurface dimensions are 60"W x 20½"D.
- Bistro tables specified with glides will match height of bookcases specified with glides or casters.
- Bistro tables have integrated footrest.
- See page 197 for overall dimensions of bookcases.

**HOW TO SPECIFY**

<p><b>Select Model Number</b></p> <p>H E S W C B 3 0 .</p>	<p><b>Select Glide</b></p> <p>G Glide</p> <p>G .</p>	<p><b>Select Laminate</b></p> <p>See page 194</p> <p>L S A 1 .</p>	<p><b>Select Paint Color</b></p> <p>See page 194</p> <p>P R 8</p>
--	--	--	---



	DESCRIPTION	MODEL	SHIP WEIGHT	CUBE	LIST PRICE	UPCHARGE BY		
						LAMINATE/P2	PAINT/P3	GRADE/P6
	<b>Linear Dividers</b>							
	2-pack	<b>HESWLD2</b>	7.0	0.9	<b>\$100</b>	<b>\$10</b>	<b>\$25</b>	<b>\$40</b>
	12-pack	<b>HESWLD12</b>	17.0	5.9	<b>\$600</b>	<b>\$60</b>	<b>\$150</b>	<b>\$240</b>
	<b>Curved Dividers</b>							
	2-pack	<b>HESWCD2</b>	7.5	1.0	<b>\$100</b>	<b>\$10</b>	<b>\$25</b>	<b>\$40</b>
	12-pack	<b>HESWCD12</b>	19.0	6.7	<b>\$600</b>	<b>\$60</b>	<b>\$150</b>	<b>\$240</b>

EDUCATION

**NOTES:**

- Shelf dividers are optional on single-sided units. Used to prevent books from being pushed back on shelves.
- Dividers attach with hardware that is included when ordering.
- All dual-sided units come standard with dividers.

## HOW TO SPECIFY

<p>Select Model Number</p> <p>H E S W L D 2 .</p>	<p>Select Paint Color</p> <p>See page 194</p> <p>T 1</p>
---	--



Tangram™ Seating.

## TANGRAM™

Tangram™ soft seating is the shape of things to come in education spaces. With 27 easily configurable shape and size options, high- and low-back models, and tiered seating, it offers the ability to create custom layouts that breathe new life into unconventional learning environments distinctive to each student. And with its single or multi-fabric options, rainbow of color choices, and playful aesthetic, this solution puts the “fun” in functional.

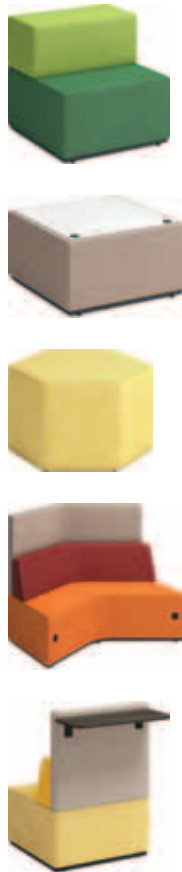

## FEATURES

- Ottomans, In-Line Tables, Story Steps, and Modular units can be used together.
- Story Steps can be combined to create multiple-level learning layouts.
- Available in high- or low-back models.
- High-back models create a quiet space without losing sight lines for educators.
- In-Line Tables provide durable, easy to clean worksurfaces with optional integrated power.
- Flexible brackets allow units to be ganged together.
- Metal bases keep upholstered parts off the ground for easy cleaning.
- Stay connected with optional built-in power.
- Adjustable glides.
- Proportionately designed to fit K-12 students.
- Poufs and Ottomans offer additional seating.
- All models ship fully assembled in one carton.
- Available in a wide range of cleanable fabrics.
- Multi-fabric option — seat, back, and screen can be specified in different fabrics.
- Bistro-back models encourage additional ways to sit comfortably and offer an easily cleanable laminate surface for high-traffic daily use.

# TANGRAM™ ORDERING INFORMATION

## LAMINATE

### L1 LAMINATES ..... CODES

#### Woodgrain

◆ Bourbon Cherry .....	H
◆ Cognac .....	COGN
◆ Field Elm .....	LWFE
◆ Florence Walnut .....	LFW1
◆ Harvest .....	C
◆ Kingswood Walnut .....	LKI1
◆ Mahogany .....	N
◆ Mocha .....	MOCH
◆ Natural Maple .....	D
◆ Pinnacle .....	PINC
◆ Shaker Cherry .....	F
◆ Sterling Ash .....	LSA1

#### Solid

◆ Black .....	P
◆ Charcoal .....	S
◆ Designer White .....	LDW1
◆ Loft .....	LOFT

#### Patterned

◆ Battleship .....	LBT1
◆ Gray .....	G2
◆ Handspun Chestnut .....	LAHC
◆ Handspun Dove .....	LAHD
◆ Handspun Pearl .....	LAHP
◆ Handspun Slate .....	LAHS
◆ Moroccan .....	LMN1
◆ Mushroom .....	LMH1
◆ Neon Carrot .....	LNC1
◆ Silver Mesh .....	B9
◆ Steel Mesh .....	A9
◆ Tennis Ball .....	LTB1
◆ White .....	G1

### L2 LAMINATES ..... CODES

#### Woodgrain

◆ Beigewood .....	LWBE
◆ Fawn Cypress .....	LFC1
◆ Lowell Ash .....	LLA1
◆ Natural Recon .....	LNR1
◆ Phantom Ecu .....	LPE1
◆ Portico Teak .....	LPT1
◆ Skyline Walnut .....	LSW1

### L4 LAMINATES ..... CODES

◆ White Markerboard .....	FMQ1
---------------------------	------

## IN-LINE TABLE EDGE

### EDGE ..... CODES

#### Solid

◆ Black .....	P
---------------	---

## BISTRO EDGE

### EDGE ..... CODES

◆ Beigewood .....	DE
◆ Black .....	P
◆ Bourbon Cherry .....	H
◆ Brownstone .....	EY
◆ Charcoal .....	S
◆ Cognac .....	COGN
◆ Designer White .....	DW
◆ Fawn Cypress .....	FC
◆ Field Elm .....	FE
◆ Florence Walnut .....	FW
◆ Fossil .....	EH
◆ Greige .....	R
◆ Harvest .....	C
◆ Kingswood Walnut .....	KI
◆ Light Gray .....	Q
◆ Loft .....	LOFT
◆ Lowell Ash .....	DL
◆ Mahogany .....	N
◆ Mocha .....	MOCH
◆ Muslin .....	T
◆ Natural Maple .....	D
◆ Natural Recon .....	NR
◆ Phantom Ecu .....	PE
◆ Pinnacle .....	PINC
◆ Platinum .....	K
◆ Portico Teak .....	DP
◆ Shaker Cherry .....	F
◆ Skyline Walnut .....	SW
◆ Sterling Ash .....	SA

◆◆◆ For lead time information see page 21.

# TANGRAM™ ORDERING INFORMATION

## HON BRANDED FABRICS

### Seat, Ottoman, Pouf

GRADE 1	GRADE 2	GRADE 3	GRADE 4
Centurion	Appoint Seating	Bradbury	Constance with Supreen™
Compass	Blume	Getaway	Livi with Supreen™
Contourett	Clyde	Moxie	Lugano with Supreen™
Dapper	Dotty	Notion	Oxford with Supreen™
Ensemble	Kai	Parker	
Hamilton	Rush	Purl	
Inertia	Spin	Quill	
Noble Seating	Wavelength	Saxony	
Optic	Whisper Vinyl		
Pebble			
Vibe			

### Single Fabric Upholstery, Back, Screen

GRADE 1	GRADE 2	GRADE 3	GRADE 4
Centurion	Appoint Seating	Bradbury	Constance with Supreen™
Compass	Blume	Getaway	Livi with Supreen™
Contourett	Clyde	Moxie	Lugano with Supreen™
Dapper	Dotty	Notion	Oxford with Supreen™
Ensemble	Kai	Parker	
Hamilton	Rush	Purl	
Noble Seating	Wavelength	Quill	
Optic	Whisper Vinyl	Saxony	
Pebble			
Vibe			

EDUCATION

For a complete list of fabrics, including partnership fabrics, go to [hon.com/fabricsandfinishes](https://hon.com/fabricsandfinishes).

Reference Fabric Color Combinations on pages 20-25 for color codes and legend on page 21 for lead times.

## COM YARDAGE

MODEL	COM		
	Seat	Back	Screen
HECSRSP	4.5	—	—
HECSRST	1.5	—	—
HECSRP	2.5		—
HECSRB	2	—	—
HECSRSPMF	3	2	—
HECSITT	2	—	—
HECSITD	2.5	—	—
HECSITS	2.5	—	—
HECSMSLB	4.5		—
HECSMAILB	6.5		—
HECSMAOLB	6.5		—
HECSMTLB	5.5		—
HECSMSHB	6		
HECSMAIHB	8.5		
HECSMAOHB	8.5		
HECSMTHB	8		

MODEL	COM		
	Seat	Back	Screen
HECSMSLBMF	3.5	2	—
HECSMAILBMF	4	2.5	—
HECSMAOLBMF	4.5	2.5	—
HECSMTLBMF	4	2.5	—
HECSMSHBMF	3	1.5	2.5
HECSMAIHBMF	4	2	3.5
HECSMAOHBMF	4.5	2	3.5
HECSMTHBMF	4	1.5	3
HECSOSQ	3	—	—
HECSOD	3	—	—
HECSOTR	2.5	—	—
HECSOTP	4	—	—
HECSOSE	2.5	—	—
HECSOAEL	2.5	—	—
HECSOAER	2.5	—	—
HECSOC	4	—	—
HECSVAP	2.5	—	—
HECSVHP	2	—	—
HECSJVAP	2	—	—
HECSJVHP	2	—	—

NOTES: Due to fabric pattern nesting and potential reduction of fabric yield, some multi-fabric models may require more total yardage than standard single fabric models.

### STORY STEPS

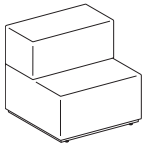

Stoop

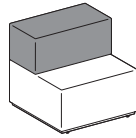

Stoop  
Multi-Fabric

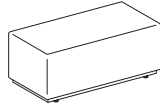

Step

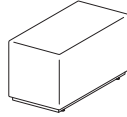

Bench

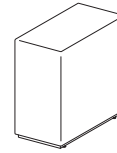

Perch

### LOW-BACK SEATING

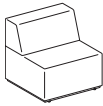

Low-Back Square

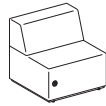

Low-Back Square  
with Power

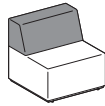

Low-Back Square  
Multi-Fabric

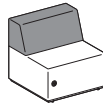

Low-Back Square  
Multi-Fabric with Power



Low-Back Arrow Out

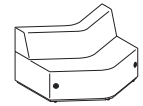

Low-Back Arrow Out  
with Power

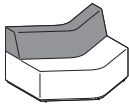

Low-Back Arrow Out  
Multi-Fabric

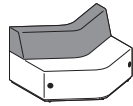

Low-Back Arrow Out  
Multi-Fabric with Power



Low-Back Arrow In

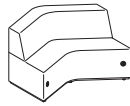

Low-Back Arrow In  
with Power

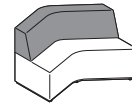

Low-Back Arrow In  
Multi-Fabric

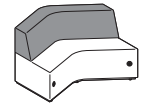

Low-Back Arrow In  
Multi-Fabric with Power



Low-Back Trapezoid



Low-Back Trapezoid  
with Power

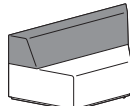

Low-Back Trapezoid  
Multi-Fabric

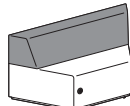

Low-Back Trapezoid  
Multi-Fabric with Power

### HIGH-BACK SEATING

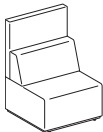

High-Back Square

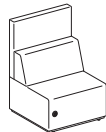

High-Back Square  
with Power

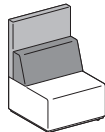

High-Back Square  
Multi-Fabric

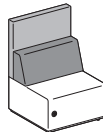

High-Back Square  
Multi-Fabric with Power

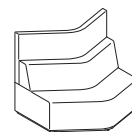

High-Back Arrow Out

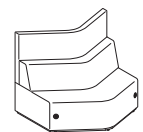

High-Back Arrow Out  
with Power

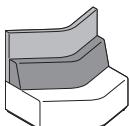

High-Back Arrow Out  
Multi-Fabric

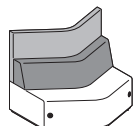

High-Back Arrow Out  
Multi-Fabric with Power



High-Back Arrow In

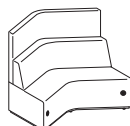

High-Back Arrow In  
with Power

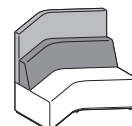

High-Back Arrow In  
Multi-Fabric

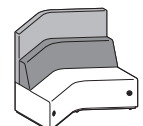

High-Back Arrow In  
Multi-Fabric with Power

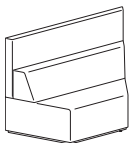

High-Back Trapezoid

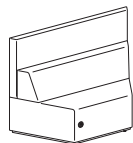

High-Back Trapezoid  
with Power

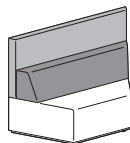

High-Back Trapezoid  
Multi-Fabric

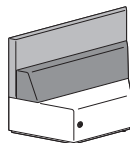

High-Back Trapezoid  
Multi-Fabric with Power

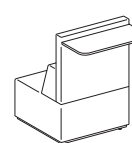

Bistro-Back Square

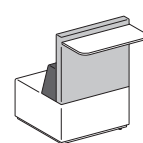

Bistro-Back Square  
Multi-Fabric

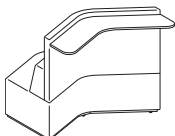

Bistro-Back Arrow Out

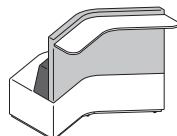

Bistro-Back Arrow Out  
Multi-Fabric

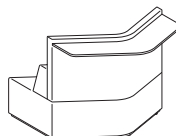

Bistro-Back Arrow In

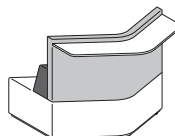

Bistro-Back Arrow In  
Multi-Fabric



Bistro-Back Trapezoid

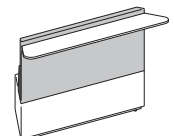

Bistro-Back Trapezoid  
Multi-Fabric

# TANGRAM™

## Statement of Line

### OTTOMANS

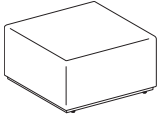

Square Ottoman

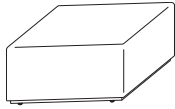

Diamond Ottoman

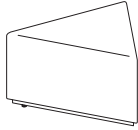

Triangle Ottoman

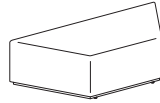

Trapezoid Ottoman



Left End Ottoman



Right End Ottoman

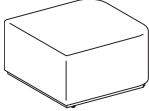

Straight End Ottoman



120° Ottoman

### POUFS

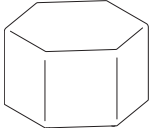

Varsity Hexagon Pouf

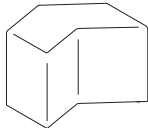

Varsity Arrow Pouf

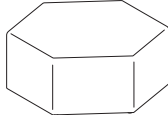

Junior Varsity Hexagon Pouf

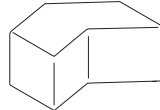

Junior Varsity Arrow Pouf

### TABLES

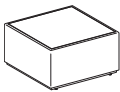

Square Table

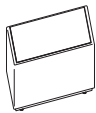

Diamond Table

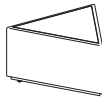

Triangle Table

# TANGRAM™ Typicals

QTY	DESCRIPTION	MODEL	LIST PRICE	PRICE EXTENSION
2	<b>High-Back Modular Seating</b> Arrow In	HECSMAIHB	\$4,764	\$9,528
2	<b>High-Back Modular Seating</b> Arrow Out	HECSMAOHB	\$4,669	\$9,338
2	<b>Ottoman</b> Straight End	HECSESE	\$1,567	\$3,134
<b>TOTAL:</b>			<b>\$22,000</b>	

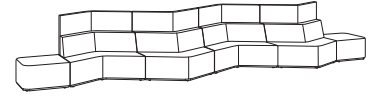

**COMMONS**

QTY	DESCRIPTION	MODEL	LIST PRICE	PRICE EXTENSION
2	<b>Stoop</b> 30"H x 30½"W	HECSRSP	\$2,199	\$4,398
4	<b>Step</b> 13"H x 30½"W	HECSRST	\$1,210	\$4,840
7	<b>Perch</b> 30"H x 30½"W	HECSRSP	\$1,648	\$11,536
1	<b>In-Line Table</b> 16¾"H x 30½"W	HECSITS	\$2,074	\$2,074
4	<b>Bench</b> 17"H x 30½"W	HECSRBB	\$1,429	\$5,716
<b>TOTAL:</b>			<b>\$28,564</b>	

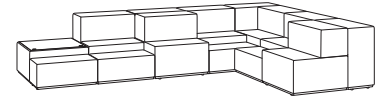

**LIBRARY**

QTY	DESCRIPTION	MODEL	LIST PRICE	PRICE EXTENSION
4	<b>Low-Back Modular Seating</b> Square	HECSMSLB	\$2,364	\$9,456
4	<b>Perch</b> 30"H x 30½"W	HECSRSP	\$1,648	\$6,592
<b>TOTAL:</b>			<b>\$16,048</b>	

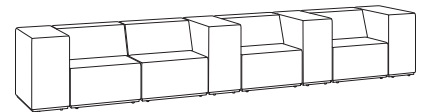

**NON-TRADITIONAL  
LEARNING**

QTY	DESCRIPTION	MODEL	LIST PRICE	PRICE EXTENSION
3	<b>Low-Back Modular Seating</b> Arrow In	HECSMAILB	\$3,529	\$10,587
2	<b>Low-Back Modular Seating</b> Trapezoid	HECSMTLB	\$3,000	\$6,000
1	<b>Ottoman</b> Angled End, Left	HECSOAL	\$1,567	\$1,567
1	<b>Ottoman</b> Angled End, Right	HECSOAR	\$1,567	\$1,567
3	<b>Ottoman</b> Diamond	HECSOD	\$1,698	\$5,094
1	<b>In-Line Table</b> Diamond	HECSITD	\$2,208	\$2,208
1	<b>Junior Varsity Pouf</b> Hexagon	HECSJVHP	\$987	\$987
<b>TOTAL:</b>			<b>\$28,010</b>	

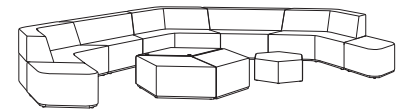

**NON-TRADITIONAL  
LEARNING**



# TANGRAM™ Typicals

EDUCATION

QTY	DESCRIPTION	MODEL	LIST PRICE	PRICE EXTENSION
2	<b>High-Back Modular Seating</b> Arrow In	HECSMAIHB	\$4,764	\$9,528
2	<b>Ottoman</b> Diamond	HECSOD	\$1,698	\$3,396
2	<b>Junior Varsity Pouf</b> Arrow	HECSJVAP	\$903	\$1,806
<b>TOTAL:</b>				<b>\$14,730</b>

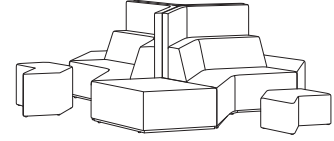

**SCHOOL LOBBY**

QTY	DESCRIPTION	MODEL	LIST PRICE	PRICE EXTENSION
4	<b>High-Back Modular Seating</b> Arrow In	HECSMAIHB	\$4,764	<b>\$19,056</b>
2	<b>Ottoman</b> Triangle	HECSOTR	\$1,402	\$2,804
2	<b>Single Pedestal Base</b> Lounge-Height	HCWTSBL27	\$1,046	\$2,092
2	<b>Table Top with Flat Edge</b> 42"W	HCWTRND42G	\$616	\$1,232
<b>TOTAL:</b>				<b>\$25,184</b>

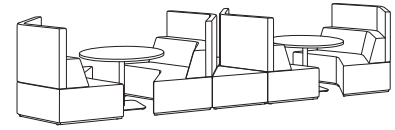

**BREAKOUT SPACE**

QTY	DESCRIPTION	MODEL	LIST PRICE	PRICE EXTENSION
2	<b>Low-Back Modular Seating</b> Arrow In	HECSMAILB	\$3,529	\$7,058
1	<b>Ottoman</b> Diamond	HECSOD	\$1,698	\$1,698
<b>TOTAL:</b>				<b>\$8,756</b>

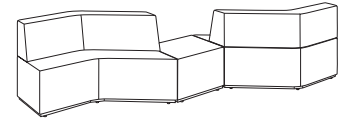

**CAFETERIA**



### HECSRSP

#### STOOP

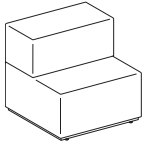

#### DIMENSIONS

Depth:	30½	Ship Weight:	79
Width:	30½	Cube:	17.5
Seat Height:	17	COM:	See page 204
Back Height:	30	Weight Rating:	300 lbs.

#### FABRIC PRICE CODES

1	\$2199	8	\$2944
2	\$2329	9	\$3041
3	\$2460	10	\$3145
4	\$2557	11	\$3258
5	\$2652	12	\$3373
6	\$2750	L	\$4168
7	\$2844		

### HECSRST

#### STEP

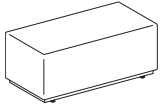

#### DIMENSIONS

Depth:	15¼	Ship Weight:	42
Height:	13	Cube:	4.4
Width:	30½	COM:	See page 204
		Weight Rating:	300 lbs.

#### FABRIC PRICE CODES

1	\$1210	8	\$1509
2	\$1263	9	\$1547
3	\$1316	10	\$1589
4	\$1354	11	\$1634
5	\$1392	12	\$1680
6	\$1431	L	\$1997
7	\$1468		

### HECSRB

#### BENCH

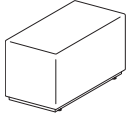

#### DIMENSIONS

Depth:	15¼	Ship Weight:	47
Height:	17	Cube:	5.3
Width:	30½	COM:	See page 204
		Weight Rating:	300 lbs.

#### FABRIC PRICE CODES

1	\$1429	8	\$1728
2	\$1482	9	\$1766
3	\$1535	10	\$1808
4	\$1573	11	\$1853
5	\$1611	12	\$1899
6	\$1650	L	\$2216
7	\$1687		

### HECSRP

#### PERCH

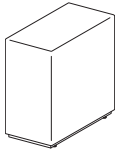

#### DIMENSIONS

Depth:	15¼	Ship Weight:	55
Height:	30	Cube:	9.2
Width:	30½	COM:	See page 204
		Weight Rating:	300 lbs.

#### FABRIC PRICE CODES

1	\$1648	8	\$2096
2	\$1727	9	\$2153
3	\$1805	10	\$2216
4	\$1863	11	\$2284
5	\$1920	12	\$2352
6	\$1979	L	\$2830
7	\$2036		

## HOW TO SPECIFY

<p><b>Select Model Number</b></p> <p>HECSRSP</p>	<p><b>Select Power</b></p> <p>N None</p> <p>N</p>	<p><b>Select Fabric</b></p> <p>See page 204</p> <p>H A M L 1 6</p>	<p><b>Select Base and Color</b></p> <p>P Plinth P71 Black</p> <p>P P 7 1</p>
--	---	--	--

# TANGRAM™

## Multi-Fabric Story Steps

GSA SIN 33721T



Icon Legend on page 19

### HECSRSPMF

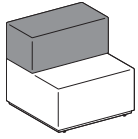

#### STOOP

Multi-Fabric

#### DIMENSIONS

Depth:	30½	Ship Weight:	79
Width:	30½	Cube:	17.5
Seat Height:	17	COM:	See page 204
Back Height:	30	Weight Rating:	300 lbs.

#### FABRIC PRICE CODES

<b>1</b>	<b>\$2264</b>	
<i>Add to Base Price Above</i>		
	<b>Seat</b>	<b>Back</b>
<b>2</b>	<b>\$79</b>	<b>\$53</b>
<b>3</b>	<b>\$157</b>	<b>\$106</b>
<b>4</b>	<b>\$215</b>	<b>\$144</b>
<b>5</b>	<b>\$272</b>	<b>\$182</b>
<b>6</b>	<b>\$331</b>	<b>\$221</b>
<b>7</b>	<b>\$388</b>	<b>\$258</b>
<b>8</b>	<b>\$448</b>	<b>\$299</b>
<b>9</b>	<b>\$505</b>	<b>\$337</b>
<b>10</b>	<b>\$568</b>	<b>\$379</b>
<b>11</b>	<b>\$636</b>	<b>\$424</b>
<b>12</b>	<b>\$704</b>	<b>\$470</b>
<b>L</b>	<b>\$1182</b>	<b>\$787</b>

EDUCATION

### HOW TO SPECIFY

<p><b>Select Model Number</b></p>	<p><b>Select Power</b></p> <p>N None</p>	<p><b>Select Seat Fabric</b></p> <p>See page 204</p>	<p><b>Select Back Fabric</b></p> <p>See page 204</p>	<p><b>Select Base and Color</b></p> <p>P Plinth P71 Black</p>
<p>HECSRSPMF .</p>	<p>N .</p>	<p>HAML16 .</p>	<p>HAML20 .</p>	<p>PP71</p>



# TANGRAM™ In-Line Tables

## HECSITS

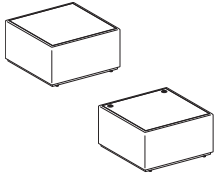

### SQUARE

In-Line Table

### DIMENSIONS

Depth: 30½      Ship Weight: 76  
 Height: 16¾      Cube: 9.3  
 Width: 30½      COM: See page 204

### FABRIC PRICE CODES

1	\$2074	8	\$2522
2	\$2153	9	\$2579
3	\$2231	10	\$2642
4	\$2289	11	\$2710
5	\$2346	12	\$2778
6	\$2405	L	\$3256
7	\$2462		

### UPCHARGE BY LAMINATE GRADE

L1	L2	L4
\$0	\$55	\$109

## HECSITD

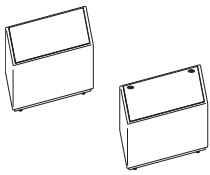

### DIAMOND

In-Line Table

### DIMENSIONS

Depth: 26½      Ship Weight: 70  
 Height: 16¾      Cube: 13.7  
 Width: 46      COM: See page 204

### FABRIC PRICE CODES

1	\$2208	8	\$2656
2	\$2287	9	\$2713
3	\$2365	10	\$2776
4	\$2423	11	\$2844
5	\$2480	12	\$2912
6	\$2539	L	\$3390
7	\$2596		

### UPCHARGE BY LAMINATE GRADE

L1	L2	L4
\$0	\$65	\$130

## HECSITT

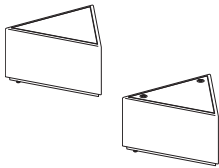

### TRIANGLE

In-Line Table

### DIMENSIONS

Depth: 27      Ship Weight: 48  
 Height: 16¾      Cube: 9.3  
 Width: 31      COM: See page 204

### FABRIC PRICE CODES

1	\$1966	8	\$2265
2	\$2019	9	\$2303
3	\$2072	10	\$2345
4	\$2110	11	\$2390
5	\$2148	12	\$2436
6	\$2187	L	\$2753
7	\$2224		

### UPCHARGE BY LAMINATE GRADE

L1	L2	L4
\$0	\$55	\$109

## HOW TO SPECIFY

<b>Select Model Number</b> HECSITS	<b>Select Power</b> N None 2 Two Power (+ \$110)	<b>Select Fabric</b> See page 204 H A M L 1 6	<b>Select Base and Color</b> P Plinth P71 Black	<b>Select Laminate</b> See page 203 H	<b>Select Edge Color</b> P Black
---------------------------------------	--	---	---	---	-------------------------------------

# TANGRAM™ Modular Seating

GSA SIN 33721T



Icon Legend on page 19

EDUCATION

## HECSMSLB

### LOW-BACK

Square

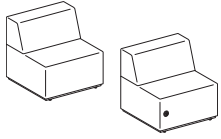

### DIMENSIONS

Depth:	30½	Ship Weight:	70
Width:	30½	Cube:	18.1
Seat Height:	17	COM:	See page 204
Back Height:	30	Weight Rating:	300 lbs.

### FABRIC PRICE CODES

1	\$2364	8	\$3109
2	\$2494	9	\$3206
3	\$2625	10	\$3310
4	\$2722	11	\$3423
5	\$2817	12	\$3538
6	\$2915	L	\$4333
7	\$3009		

## HECSMTLB

### LOW-BACK

Trapezoid

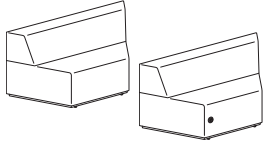

### DIMENSIONS

Depth:	30½	Ship Weight:	107
Width:	60	Cube:	29.9
Seat Height:	17	COM:	See page 204
Back Height:	30	Weight Rating:	300 lbs.

### FABRIC PRICE CODES

1	\$3000	8	\$3895
2	\$3156	9	\$4010
3	\$3315	10	\$4135
4	\$3430	11	\$4272
5	\$3543	12	\$4407
6	\$3661	L	\$5361
7	\$3774		

## HECSMAILB

### LOW-BACK

Arrow In

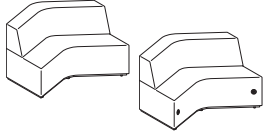

### DIMENSIONS

Depth:	43½	Ship Weight:	130
Width:	52½	Cube:	43.4
Seat Height:	17	COM:	See page 204
Back Height:	30	Weight Rating:	300 lbs.

### FABRIC PRICE CODES

1	\$3529	8	\$4572
2	\$3711	9	\$4707
3	\$3895	10	\$4853
4	\$4030	11	\$5012
5	\$4163	12	\$5171
6	\$4301	L	\$6285
7	\$4432		

NOTES: Due to the inherent design of the Arrow In, material gathers will be present in the back.

## HECSMAOLB

### LOW-BACK

Arrow Out

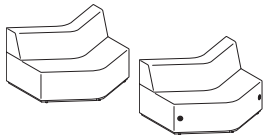

### DIMENSIONS

Depth:	43½	Ship Weight:	130
Width:	52½	Cube:	43.4
Seat Height:	17	COM:	See page 204
Back Height:	30	Weight Rating:	300 lbs.

### FABRIC PRICE CODES

1	\$3458	8	\$4501
2	\$3640	9	\$4636
3	\$3824	10	\$4782
4	\$3959	11	\$4941
5	\$4092	12	\$5100
6	\$4230	L	\$6214
7	\$4361		

## HOW TO SPECIFY

<p><b>Select Model Number</b></p> <p>HECSMSLB</p>	<p><b>Select Power</b></p> <p><b>N</b> None  <b>1R</b> One Power, Right-Hand User Side (+ \$55)  <i>Specify for Square and Trapezoid only</i>  <b>2B</b> Two Power, Both Sides (+ \$110)  <i>Specify for Arrow In and Arrow Out only</i></p> <p>1R</p>	<p><b>Select Fabric</b></p> <p>See page 204</p> <p>HAML16</p>	<p><b>Select Base and Color</b></p> <p><b>P</b> Plinth  <b>P71</b> Black</p> <p>PP71</p>
---	--	---	--



# TANGRAM™ Modular Seating — Multi-Fabric

## HECSMSLBMF

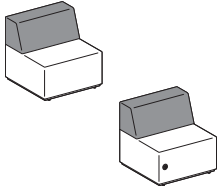

### LOW-BACK

Square, Multi-Fabric

### DIMENSIONS

Depth:	30½	Ship Weight:	70
Width:	30½	Cube:	18.1
Seat Height:	17	COM:	See page 204
Back Height:	30	Weight Rating:	300 lbs.

### FABRIC PRICE CODES

<b>1</b>	<b>\$2435</b>	
<i>Add to Base Price Above</i>		
	<b>Seat</b>	<b>Back</b>
<b>2</b>	<b>\$91</b>	<b>\$40</b>
<b>3</b>	<b>\$184</b>	<b>\$80</b>
<b>4</b>	<b>\$252</b>	<b>\$109</b>
<b>5</b>	<b>\$318</b>	<b>\$136</b>
<b>6</b>	<b>\$387</b>	<b>\$165</b>
<b>7</b>	<b>\$452</b>	<b>\$195</b>
<b>8</b>	<b>\$522</b>	<b>\$224</b>
<b>9</b>	<b>\$590</b>	<b>\$253</b>
<b>10</b>	<b>\$663</b>	<b>\$284</b>
<b>11</b>	<b>\$741</b>	<b>\$319</b>
<b>12</b>	<b>\$821</b>	<b>\$353</b>
<b>L</b>	<b>\$1379</b>	<b>\$591</b>

## HECSMTLBMF

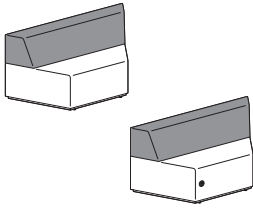

### LOW-BACK

Trapezoid, Multi-Fabric

### DIMENSIONS

Depth:	30½	Ship Weight:	107
Width:	60	Cube:	29.9
Seat Height:	17	COM:	See page 204
Back Height:	30	Weight Rating:	300 lbs.

### FABRIC PRICE CODES

<b>1</b>	<b>\$3090</b>	
<i>Add to Base Price Above</i>		
	<b>Seat</b>	<b>Back</b>
<b>2</b>	<b>\$105</b>	<b>\$65</b>
<b>3</b>	<b>\$210</b>	<b>\$131</b>
<b>4</b>	<b>\$287</b>	<b>\$180</b>
<b>5</b>	<b>\$363</b>	<b>\$227</b>
<b>6</b>	<b>\$441</b>	<b>\$277</b>
<b>7</b>	<b>\$517</b>	<b>\$323</b>
<b>8</b>	<b>\$596</b>	<b>\$373</b>
<b>9</b>	<b>\$674</b>	<b>\$421</b>
<b>10</b>	<b>\$757</b>	<b>\$473</b>
<b>11</b>	<b>\$848</b>	<b>\$531</b>
<b>12</b>	<b>\$939</b>	<b>\$587</b>
<b>L</b>	<b>\$1574</b>	<b>\$985</b>

EDUCATION

## HOW TO SPECIFY

<p><b>Select Model Number</b></p> <p>HECSMSLBMF</p>	<p><b>Select Power</b></p> <p><b>N</b> None  <b>1R</b> One Power, Right-Hand User Side (+ \$55)  <i>Specify for Square and Trapezoid only</i>  <b>2B</b> Two Power, Both Sides (+ \$110)  <i>Specify for Arrow In and Arrow Out only</i></p> <p>1R</p>	<p><b>Select Seat Fabric</b></p> <p>See page 204</p> <p>HAML16</p>	<p><b>Select Back Fabric</b></p> <p>See page 204</p> <p>HAML20</p>	<p><b>Select Base and Color</b></p> <p><b>P</b> Plinth  <b>P71</b> Black</p> <p>PP71</p>
---	--	--	--	--

# TANGRAM™

## Modular Seating — Multi-Fabric

GSA SIN 33721T



Icon Legend on page 19

EDUCATION

### HECSMAILBMF

LOW-BACK

Arrow In, Multi-Fabric

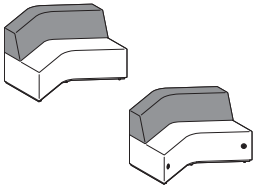

#### DIMENSIONS

Depth:	43½	Ship Weight:	130
Width:	52½	Cube:	43.4
Seat Height:	17	COM:	See page 204
Back Height:	30	Weight Rating:	300 lbs.

#### FABRIC PRICE CODES

<b>1</b>	<b>\$3634</b>	
<i>Add to Base Price Above</i>		
	<b>Seat</b>	<b>Back</b>
<b>2</b>	<b>\$117</b>	<b>\$65</b>
<b>3</b>	<b>\$235</b>	<b>\$131</b>
<b>4</b>	<b>\$323</b>	<b>\$180</b>
<b>5</b>	<b>\$408</b>	<b>\$227</b>
<b>6</b>	<b>\$496</b>	<b>\$277</b>
<b>7</b>	<b>\$581</b>	<b>\$323</b>
<b>8</b>	<b>\$670</b>	<b>\$373</b>
<b>9</b>	<b>\$758</b>	<b>\$421</b>
<b>10</b>	<b>\$851</b>	<b>\$473</b>
<b>11</b>	<b>\$953</b>	<b>\$531</b>
<b>12</b>	<b>\$1056</b>	<b>\$587</b>
<b>L</b>	<b>\$1772</b>	<b>\$985</b>

NOTES: Due to the inherent design of the Arrow In, material gathers will be present in the back.

### HECSMAOLBMF

LOW-BACK

Arrow Out, Multi-Fabric

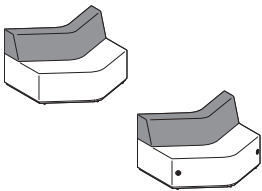

#### DIMENSIONS

Depth:	43½	Ship Weight:	130
Width:	52½	Cube:	43.4
Seat Height:	17	COM:	See page 204
Back Height:	30	Weight Rating:	300 lbs.

#### FABRIC PRICE CODES

<b>1</b>	<b>\$3562</b>	
<i>Add to Base Price Above</i>		
	<b>Seat</b>	<b>Back</b>
<b>2</b>	<b>\$117</b>	<b>\$65</b>
<b>3</b>	<b>\$235</b>	<b>\$131</b>
<b>4</b>	<b>\$323</b>	<b>\$180</b>
<b>5</b>	<b>\$408</b>	<b>\$227</b>
<b>6</b>	<b>\$496</b>	<b>\$277</b>
<b>7</b>	<b>\$581</b>	<b>\$323</b>
<b>8</b>	<b>\$670</b>	<b>\$373</b>
<b>9</b>	<b>\$758</b>	<b>\$421</b>
<b>10</b>	<b>\$851</b>	<b>\$473</b>
<b>11</b>	<b>\$953</b>	<b>\$531</b>
<b>12</b>	<b>\$1056</b>	<b>\$587</b>
<b>L</b>	<b>\$1772</b>	<b>\$985</b>

## HOW TO SPECIFY

<p><b>Select Model Number</b></p> <p>HECSMAILBMF</p>	<p><b>Select Power</b></p> <p><b>N</b> None  <b>1R</b> One Power, Right-Hand User Side (+ \$55)  <i>Specify for Square and Trapezoid only</i>  <b>2B</b> Two Power, Both Sides (+ \$110)  <i>Specify for Arrow In and Arrow Out only</i></p> <p>2B</p>	<p><b>Select Seat Fabric</b></p> <p>See page 204</p> <p>HAML16</p>	<p><b>Select Back Fabric</b></p> <p>See page 204</p> <p>HAML20</p>	<p><b>Select Base and Color</b></p> <p><b>P</b> Plinth  <b>P71</b> Black</p> <p>PP71</p>
--	--	--	--	--



# TANGRAM™ Modular Seating

## HECSMSHB

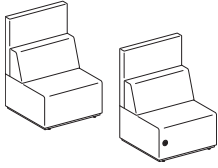

### HIGH-BACK

Square

### DIMENSIONS

Depth:	30½	Ship Weight:	82
Width:	30½	Cube:	29.7
Seat Height:	17	COM:	See page 204
Back Height:	30	Weight Rating:	300 lbs.
Screen Height:	44		

### FABRIC PRICE CODES

1	\$3074	8	\$3969
2	\$3230	9	\$4084
3	\$3389	10	\$4209
4	\$3504	11	\$4346
5	\$3617	12	\$4481
6	\$3735	L	\$5435
7	\$3848		

## HECSMTHB

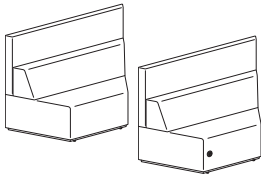

### HIGH-BACK

Trapezoid

### DIMENSIONS

Depth:	30½	Ship Weight:	121
Width:	60	Cube:	50.7
Seat Height:	17	COM:	See page 204
Back Height:	30	Weight Rating:	300 lbs.
Screen Height:	44		

### FABRIC PRICE CODES

1	\$4049	8	\$5240
2	\$4257	9	\$5395
3	\$4468	10	\$5563
4	\$4622	11	\$5743
5	\$4774	12	\$5925
6	\$4930	L	\$7198
7	\$5082		

## HECSMAIHB

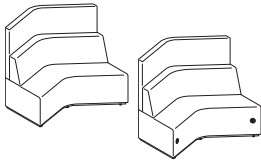

### HIGH-BACK

Arrow In

### DIMENSIONS

Depth:	43½	Ship Weight:	154
Width:	52½	Cube:	68.8
Seat Height:	17	COM:	See page 204
Back Height:	30	Weight Rating:	300 lbs.
Screen Height:	44		

### FABRIC PRICE CODES

1	\$4764	8	\$6106
2	\$4996	9	\$6278
3	\$5234	10	\$6466
4	\$5408	11	\$6670
5	\$5579	12	\$6875
6	\$5755	L	\$8307
7	\$5924		

NOTES: Due to the inherent design of the Arrow In, material gathers will be present in the back.

## HECSMAOHB

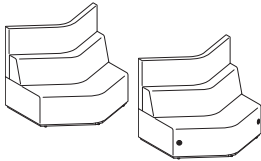

### HIGH-BACK

Arrow Out

### DIMENSIONS

Depth:	43½	Ship Weight:	154
Width:	52½	Cube:	68.8
Seat Height:	17	COM:	See page 204
Back Height:	30	Weight Rating:	300 lbs.
Screen Height:	44		

### FABRIC PRICE CODES

1	\$4669	8	\$6011
2	\$4901	9	\$6183
3	\$5139	10	\$6371
4	\$5313	11	\$6575
5	\$5484	12	\$6780
6	\$5660	L	\$8212
7	\$5829		

## HOW TO SPECIFY

<p><b>Select Model Number</b></p> <p>HECSMSHB</p>	<p><b>Select Power</b></p> <p>N None  <b>1R</b> One Power, Right-Hand User Side (+ \$55)  <i>Specify for Square and Trapezoid only</i>  <b>2B</b> Two Power, Both Sides (+ \$110)  <i>Specify for Arrow In and Arrow Out only</i></p> <p>1R</p>	<p><b>Select Fabric</b></p> <p>See page 204</p> <p>HAML16</p>	<p><b>Select Base and Color</b></p> <p>P Plinth  <b>P71</b> Black</p> <p>PP71</p>
---	---	---	---



# TANGRAM™

## Modular Seating — Multi-Fabric

GSA SIN 33721T



Icon Legend on page 19

EDUCATION

### HECSMSHBMF

#### HIGH-BACK

Square, Multi-Fabric

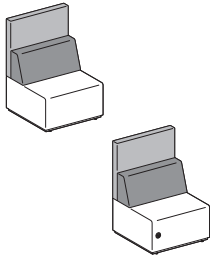

#### DIMENSIONS

Depth: 30½  
Width: 30½  
Seat Height: 17  
Back Height: 30  
Screen Height: 44

Ship Weight:  
Cube:  
COM:  
Weight Rating:

82  
29.7  
See page 204  
300 lbs.

#### FABRIC PRICE CODES

1 \$3167

Add to Base Price Above

	Seat	Back	Screen
2	\$79	\$40	\$53
3	\$157	\$80	\$106
4	\$215	\$109	\$144
5	\$272	\$136	\$182
6	\$331	\$165	\$221
7	\$388	\$195	\$258
8	\$448	\$224	\$299
9	\$505	\$253	\$337
10	\$568	\$284	\$379
11	\$636	\$319	\$424
12	\$704	\$353	\$470
L	\$1182	\$591	\$787

### HECSMTHBMF

#### HIGH-BACK

Trapezoid, Multi-Fabric

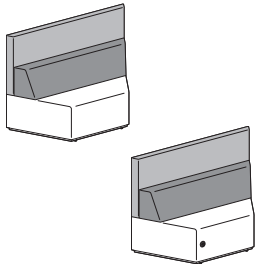

#### DIMENSIONS

Depth: 30½  
Width: 60  
Seat Height: 17  
Back Height: 30  
Screen Height: 44

Ship Weight:  
Cube:  
COM:  
Weight Rating:

121  
50.7  
See page 204  
300 lbs.

#### FABRIC PRICE CODES

1 \$4171

Add to Base Price Above

	Seat	Back	Screen
2	\$105	\$40	\$91
3	\$210	\$80	\$184
4	\$287	\$109	\$252
5	\$363	\$136	\$318
6	\$441	\$165	\$387
7	\$517	\$195	\$452
8	\$596	\$224	\$522
9	\$674	\$253	\$590
10	\$757	\$284	\$663
11	\$848	\$319	\$741
12	\$939	\$353	\$821
L	\$1574	\$591	\$1379

## HOW TO SPECIFY

Select Model Number	Select Power	Select Seat Fabric	Select Back Fabric	Select Screen Fabric	Select Base and Color
HECSMSHBMF	<p><b>N</b> None</p> <p><b>1R</b> One Power, Right-Hand User Side (+ \$55) <i>Specify for Square and Trapezoid only</i></p> <p><b>2B</b> Two Power, Both Sides (+ \$110) <i>Specify for Arrow In and Arrow Out only</i></p>	See page 204	See page 204	See page 204	<p><b>P</b> Plinth</p> <p><b>P71</b> Black</p>
HECSMSHBMF	1R	HAML16	HAML20	HAML16	PP71



# TANGRAM™ Modular Seating — Multi-Fabric

## HECSMAIHBMF

### HIGH-BACK

Arrow In, Multi-Fabric

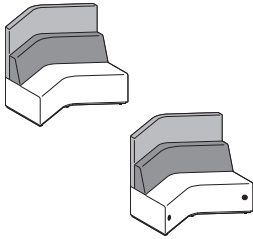

### DIMENSIONS

Depth:	43½	Ship Weight:	154
Width:	52½	Cube:	68.8
Seat Height:	17	COM:	See page 204
Back Height:	30	Weight Rating:	300 lbs.
Screen Height:	44		

### FABRIC PRICE CODES

<b>1</b>	<b>\$4907</b>		
<i>Add to Base Price Above</i>			
	<b>Seat</b>	<b>Back</b>	<b>Screen</b>
<b>2</b>	\$117	\$53	\$91
<b>3</b>	\$235	\$106	\$184
<b>4</b>	\$323	\$144	\$252
<b>5</b>	\$408	\$182	\$318
<b>6</b>	\$496	\$221	\$387
<b>7</b>	\$581	\$258	\$452
<b>8</b>	\$670	\$299	\$522
<b>9</b>	\$758	\$337	\$590
<b>10</b>	\$851	\$379	\$663
<b>11</b>	\$953	\$424	\$741
<b>12</b>	\$1056	\$470	\$821
<b>L</b>	\$1772	\$787	\$1379

NOTES: Due to the inherent design of the Arrow In, material gathers will be present in the back.

## HECSMAOHBMF

### HIGH-BACK

Arrow Out, Multi-Fabric

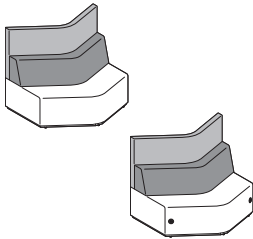

### DIMENSIONS

Depth:	43½	Ship Weight:	154
Width:	52½	Cube:	68.8
Seat Height:	17	COM:	See page 204
Back Height:	30	Weight Rating:	300 lbs.
Screen Height:	44		

### FABRIC PRICE CODES

<b>1</b>	<b>\$4810</b>		
<i>Add to Base Price Above</i>			
	<b>Seat</b>	<b>Back</b>	<b>Screen</b>
<b>2</b>	\$117	\$53	\$65
<b>3</b>	\$235	\$106	\$131
<b>4</b>	\$323	\$144	\$180
<b>5</b>	\$408	\$182	\$227
<b>6</b>	\$496	\$221	\$277
<b>7</b>	\$581	\$258	\$323
<b>8</b>	\$670	\$299	\$373
<b>9</b>	\$758	\$337	\$421
<b>10</b>	\$851	\$379	\$473
<b>11</b>	\$953	\$424	\$531
<b>12</b>	\$1056	\$470	\$587
<b>L</b>	\$1772	\$787	\$985

## HOW TO SPECIFY

Select Model Number	Select Power	Select Seat Fabric	Select Back Fabric	Select Screen Fabric	Select Base and Color
	<b>N</b> None <b>1R</b> One Power, Right-Hand User Side (+ \$55) <i>Specify for Square and Trapezoid only</i> <b>2B</b> Two Power, Both Sides (+ \$110) <i>Specify for Arrow In and Arrow Out only</i>	See page 204	See page 204	See page 204	<b>P</b> Plinth <b>P71</b> Black
HECSMAIHBMF	2B	HAML16	HAML20	HAML16	PP71

# TANGRAM™ Modular Seating — Bistro-Back

GSA SIN 33721T



Icon Legend on page 19

EDUCATION

## HECSMSBB

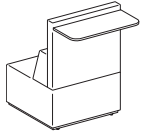

### BISTRO-BACK

Square

### DIMENSIONS

Depth:	30½	Ship Weight:	70
Width:	30½	Cube:	18.1
Seat Height:	17	COM:	See page 204
Back Height:	30	Seat Weight Rating:	300 lbs.
Width of Worksurface:	30½		
Depth of Worksurface:	12		
Worksurface Height:	42		

### FABRIC PRICE CODES

1	\$3720	8	\$4615
2	\$3876	9	\$4730
3	\$4035	10	\$4855
4	\$4150	11	\$4992
5	\$4263	12	\$5127
6	\$4381	L	\$6081
7	\$4494		

### UPCHARGE BY LAMINATE GRADE

L1	L2	L4
\$0	\$65	\$130

## HECSMTBB

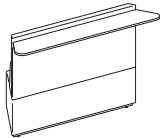

### BISTRO-BACK

Trapezoid

### DIMENSIONS

Depth:	30½	Ship Weight:	107
Width:	60	Cube:	29.9
Seat Height:	17	COM:	See page 204
Back Height:	30	Seat Weight Rating:	300 lbs.
Width of Worksurface:	69		
Depth of Worksurface:	12		
Worksurface Height:	42		

### FABRIC PRICE CODES

1	\$4911	8	\$6102
2	\$5119	9	\$6257
3	\$5330	10	\$6425
4	\$5484	11	\$6605
5	\$5636	12	\$6787
6	\$5792	L	\$8060
7	\$5944		

### UPCHARGE BY LAMINATE GRADE

L1	L2	L4
\$0	\$87	\$174

## HECSMAIBB

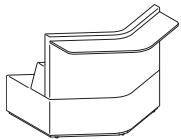

### BISTRO-BACK

Arrow In

### DIMENSIONS

Depth:	43½	Ship Weight:	130
Width:	52½	Cube:	43.4
Seat Height:	17	COM:	See page 204
Back Height:	30	Seat Weight Rating:	300 lbs.
Width of Worksurface:	52½		
Depth of Worksurface:	12		
Worksurface Height:	42		
Depth of Arrow:	25½		

### FABRIC PRICE CODES

1	\$5626	8	\$6968
2	\$5858	9	\$7140
3	\$6096	10	\$7328
4	\$6270	11	\$7532
5	\$6441	12	\$7737
6	\$6617	L	\$9169
7	\$6786		

### UPCHARGE BY LAMINATE GRADE

L1	L2	L4
\$0	\$87	\$174

NOTES: Due to the inherent design of the Arrow In, material gathers will be present in the back.

## HECSMAOBB

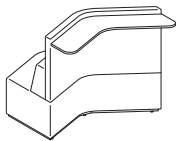

### BISTRO-BACK

Arrow Out

### DIMENSIONS

Depth:	43½	Ship Weight:	130
Width:	52½	Cube:	43.4
Seat Height:	17	COM:	See page 204
Back Height:	30	Seat Weight Rating:	300 lbs.
Width of Worksurface:	52½		
Depth of Worksurface:	12		
Worksurface Height:	42		
Depth of Arrow:	27½		

### FABRIC PRICE CODES

1	\$5531	8	\$6873
2	\$5763	9	\$7045
3	\$6001	10	\$7233
4	\$6175	11	\$7437
5	\$6346	12	\$7642
6	\$6522	L	\$9074
7	\$6691		

### UPCHARGE BY LAMINATE GRADE

L1	L2	L4
\$0	\$87	\$174

## HOW TO SPECIFY

<b>Select Model Number</b>  H E C S M S B B .	<b>Select Power</b>  N None 1R One Power, Right-Hand User Side (+ \$55) <i>Specify for Square and Trapezoid only</i> 2B Two Power, Both Sides (+ \$110) <i>Specify for Arrow In and Arrow Out only</i>	<b>Select Fabric</b>  See page 204  H A M L 1 6 .	<b>Select Base</b>  P Plinth P71 Black  P P 7 1 .	<b>Select Laminate</b>  See page 203  L F W 1 .	<b>Select Edge</b>  See page 203  F W
---	--	---	--	---	---



## Modular Seating — Bistro-Back, Multi-Fabric

### HECSMSBBMF

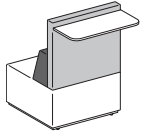

#### BISTRO-BACK

Square, Multi-Fabric

#### DIMENSIONS

Depth:	30½	Ship Weight:	70
Width:	30½	Cube:	18.1
Seat Height:	17	COM:	See page 204
Back Height:	30	Seat Weight Rating:	300 lbs.
Width of Worksurface:	30½		
Depth of Worksurface:	12		
Worksurface Height:	42		

#### FABRIC PRICE CODES

<b>1</b>	<b>\$3813</b>		
<i>Add to Base Price Above</i>			
	<b>Seat</b>	<b>Back</b>	<b>Screen</b>
<b>2</b>	<b>\$79</b>	<b>\$40</b>	<b>\$53</b>
<b>3</b>	<b>\$157</b>	<b>\$80</b>	<b>\$106</b>
<b>4</b>	<b>\$215</b>	<b>\$109</b>	<b>\$144</b>
<b>5</b>	<b>\$272</b>	<b>\$136</b>	<b>\$182</b>
<b>6</b>	<b>\$331</b>	<b>\$165</b>	<b>\$221</b>
<b>7</b>	<b>\$388</b>	<b>\$195</b>	<b>\$258</b>
<b>8</b>	<b>\$448</b>	<b>\$224</b>	<b>\$299</b>
<b>9</b>	<b>\$505</b>	<b>\$253</b>	<b>\$337</b>
<b>10</b>	<b>\$568</b>	<b>\$284</b>	<b>\$379</b>
<b>11</b>	<b>\$636</b>	<b>\$319</b>	<b>\$424</b>
<b>12</b>	<b>\$704</b>	<b>\$353</b>	<b>\$470</b>
<b>L</b>	<b>\$1182</b>	<b>\$591</b>	<b>\$787</b>

#### UPCHARGE BY LAMINATE GRADE

<b>L1</b>	<b>L2</b>	<b>L4</b>
<b>\$0</b>	<b>\$65</b>	<b>\$130</b>

EDUCATION

### HECSMTBBMF

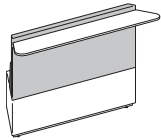

#### BISTRO-BACK

Trapezoid, Multi-Fabric

#### DIMENSIONS

Depth:	30½	Ship Weight:	107
Width:	60	Cube:	29.9
Seat Height:	17	COM:	See page 204
Back Height:	30	Seat Weight Rating:	300 lbs.
Width of Worksurface:	69		
Depth of Worksurface:	12		
Worksurface Height:	42		

#### FABRIC PRICE CODES

<b>1</b>	<b>\$5033</b>		
<i>Add to Base Price Above</i>			
	<b>Seat</b>	<b>Back</b>	<b>Screen</b>
<b>2</b>	<b>\$105</b>	<b>\$40</b>	<b>\$91</b>
<b>3</b>	<b>\$210</b>	<b>\$80</b>	<b>\$184</b>
<b>4</b>	<b>\$287</b>	<b>\$109</b>	<b>\$252</b>
<b>5</b>	<b>\$363</b>	<b>\$136</b>	<b>\$318</b>
<b>6</b>	<b>\$441</b>	<b>\$165</b>	<b>\$387</b>
<b>7</b>	<b>\$517</b>	<b>\$195</b>	<b>\$452</b>
<b>8</b>	<b>\$596</b>	<b>\$224</b>	<b>\$522</b>
<b>9</b>	<b>\$674</b>	<b>\$253</b>	<b>\$590</b>
<b>10</b>	<b>\$757</b>	<b>\$284</b>	<b>\$663</b>
<b>11</b>	<b>\$848</b>	<b>\$319</b>	<b>\$741</b>
<b>12</b>	<b>\$939</b>	<b>\$353</b>	<b>\$821</b>
<b>L</b>	<b>\$1574</b>	<b>\$591</b>	<b>\$1379</b>

#### UPCHARGE BY LAMINATE GRADE

<b>L1</b>	<b>L2</b>	<b>L4</b>
<b>\$0</b>	<b>\$87</b>	<b>\$174</b>

### HOW TO SPECIFY

Select Model Number	Select Power	Select Seat Fabric	Select Back Fabric	Select Screen Fabric	Select Base	Select Laminate	Select Edge
	<b>N</b> None <b>1R</b> One Power, Right-Hand User Side (+ \$55) <i>Specify for Square and Trapezoid only</i> <b>2B</b> Two Power, Both Sides (+ \$110) <i>Specify for Arrow In and Arrow Out only</i>	See page 204	See page 204	See page 204	<b>P</b> Plinth <b>P71</b> Black	See page 203	See page 203
HECSMSBBMF	1R	HAML16	HAML20	HAML16	PP71	LFW1	FW

# TANGRAM™

## Modular Seating — Bistro-Back, Multi-Fabric

GSA SIN 33721T



Icon Legend on page 19

EDUCATION

### HECSMAIBBMF

#### BISTRO-BACK

Arrow In, Multi-Fabric

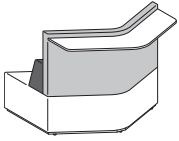

#### DIMENSIONS

Depth:	43½	Ship Weight:	130
Width:	52½	Cube:	43.4
Seat Height:	17	COM:	See page 204
Back Height:	30	Seat Weight Rating:	300 lbs.
Width of Worksurface:	52½		
Depth of Worksurface:	12		
Worksurface Height:	42		
Depth of Arrow:	25½		

#### FABRIC PRICE CODES

<b>1</b>	<b>\$5769</b>		
<i>Add to Base Price Above</i>			
	<b>Seat</b>	<b>Back</b>	<b>Screen</b>
<b>2</b>	<b>\$117</b>	<b>\$53</b>	<b>\$91</b>
<b>3</b>	<b>\$235</b>	<b>\$106</b>	<b>\$184</b>
<b>4</b>	<b>\$323</b>	<b>\$144</b>	<b>\$252</b>
<b>5</b>	<b>\$408</b>	<b>\$182</b>	<b>\$318</b>
<b>6</b>	<b>\$496</b>	<b>\$221</b>	<b>\$387</b>
<b>7</b>	<b>\$581</b>	<b>\$258</b>	<b>\$452</b>
<b>8</b>	<b>\$670</b>	<b>\$299</b>	<b>\$522</b>
<b>9</b>	<b>\$758</b>	<b>\$337</b>	<b>\$590</b>
<b>10</b>	<b>\$851</b>	<b>\$379</b>	<b>\$663</b>
<b>11</b>	<b>\$953</b>	<b>\$424</b>	<b>\$741</b>
<b>12</b>	<b>\$1056</b>	<b>\$470</b>	<b>\$821</b>
<b>L</b>	<b>\$1772</b>	<b>\$787</b>	<b>\$1379</b>

#### UPCHARGE BY LAMINATE GRADE

<b>L1</b>	<b>L2</b>	<b>L4</b>
<b>\$0</b>	<b>\$87</b>	<b>\$174</b>

NOTES: Due to the inherent design of the Arrow In, material gathers will be present in the back.

### HECSMAOBBMF

#### BISTRO-BACK

Arrow Out, Multi-Fabric

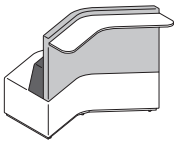

#### DIMENSIONS

Depth:	43½	Ship Weight:	130
Width:	52½	Cube:	43.4
Seat Height:	17	COM:	See page 204
Back Height:	30	Seat Weight Rating:	300 lbs.
Width of Worksurface:	52½		
Depth of Worksurface:	12		
Worksurface Height:	42		
Depth of Arrow:	27½		

#### FABRIC PRICE CODES

<b>1</b>	<b>\$5672</b>		
<i>Add to Base Price Above</i>			
	<b>Seat</b>	<b>Back</b>	<b>Screen</b>
<b>2</b>	<b>\$117</b>	<b>\$53</b>	<b>\$65</b>
<b>3</b>	<b>\$235</b>	<b>\$106</b>	<b>\$131</b>
<b>4</b>	<b>\$323</b>	<b>\$144</b>	<b>\$180</b>
<b>5</b>	<b>\$408</b>	<b>\$182</b>	<b>\$227</b>
<b>6</b>	<b>\$496</b>	<b>\$221</b>	<b>\$277</b>
<b>7</b>	<b>\$581</b>	<b>\$258</b>	<b>\$323</b>
<b>8</b>	<b>\$670</b>	<b>\$299</b>	<b>\$373</b>
<b>9</b>	<b>\$758</b>	<b>\$337</b>	<b>\$421</b>
<b>10</b>	<b>\$851</b>	<b>\$379</b>	<b>\$473</b>
<b>11</b>	<b>\$953</b>	<b>\$424</b>	<b>\$531</b>
<b>12</b>	<b>\$1056</b>	<b>\$470</b>	<b>\$587</b>
<b>L</b>	<b>\$1772</b>	<b>\$787</b>	<b>\$985</b>

#### UPCHARGE BY LAMINATE GRADE

<b>L1</b>	<b>L2</b>	<b>L4</b>
<b>\$0</b>	<b>\$87</b>	<b>\$174</b>

### HOW TO SPECIFY

Select Model Number	Select Power	Select Seat Fabric	Select Back Fabric	Select Screen Fabric	Select Base	Select Laminate	Select Edge
	<b>N</b> None <b>1R</b> One Power, Right-Hand User Side (+ \$55) <i>Specify for Square and Trapezoid only</i> <b>2B</b> Two Power, Both Sides (+ \$110) <i>Specify for Arrow In and Arrow Out only</i>	See page 204	See page 204	See page 204	<b>P</b> Plinth <b>P71</b> Black	See page 203	See page 203
HECSMAIBBMF	1R	HAML16	HAML20	HAML16	PP71	LFW1	FW



## HECSOSQ

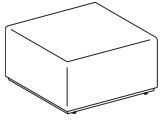

### OTTOMAN

Square

### DIMENSIONS

Depth: 30½      Ship Weight: 56  
 Height: 17      Cube: 10.4  
 Width: 30½      COM: See page 204  
 Weight Rating: 300 lbs.

### FABRIC PRICE CODES

1	\$1648	8	\$2096
2	\$1727	9	\$2153
3	\$1805	10	\$2216
4	\$1863	11	\$2284
5	\$1920	12	\$2352
6	\$1979	L	\$2830
7	\$2036		

## HECSOD

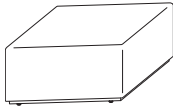

### OTTOMAN

Diamond

### DIMENSIONS

Depth: 26½      Ship Weight: 52  
 Height: 17      Cube: 12.8  
 Width: 46      COM: See page 204  
 Weight Rating: 300 lbs.

### FABRIC PRICE CODES

1	\$1698	8	\$2294
2	\$1803	9	\$2372
3	\$1908	10	\$2455
4	\$1985	11	\$2546
5	\$2061	12	\$2637
6	\$2139	L	\$3272
7	\$2215		

## HECSOTR

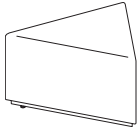

### OTTOMAN

Triangle

### DIMENSIONS

Depth: 27      Ship Weight: 36  
 Height: 17      Cube: 8.5  
 Width: 31      COM: See page 204  
 Weight Rating: 300 lbs.

### FABRIC PRICE CODES

1	\$1402	8	\$1850
2	\$1481	9	\$1907
3	\$1559	10	\$1970
4	\$1617	11	\$2038
5	\$1674	12	\$2106
6	\$1733	L	\$2584
7	\$1790		

## HECSOTP

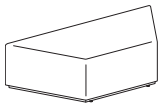

### OTTOMAN

Trapezoid

### DIMENSIONS

Depth: 26½      Ship Weight: 92  
 Height: 17      Cube: 17.0  
 Width: 60      COM: See page 204  
 Weight Rating: 300 lbs.

### FABRIC PRICE CODES

1	\$1814	8	\$2410
2	\$1919	9	\$2488
3	\$2024	10	\$2571
4	\$2101	11	\$2662
5	\$2177	12	\$2753
6	\$2255	L	\$3388
7	\$2331		

## HOW TO SPECIFY

<p><b>Select Model Number</b></p> <p>HECSOSQ</p>	<p><b>Select Power</b></p> <p>N None</p> <p>N</p>	<p><b>Select Fabric</b></p> <p>See page 204</p> <p>HAML16</p>	<p><b>Select Base and Color</b></p> <p>P Plinth P71 Black</p> <p>PP71</p>
--	---	---	---

# TANGRAM™ Ottomans

GSA SIN 33721T



Icon Legend on page 19

EDUCATION

## HECSEOSE

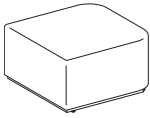

### OTTOMAN

Straight End

### DIMENSIONS

Depth: 30½      Ship Weight: 57  
 Height: 17      Cube: 10.0  
 Width: 30½      COM: See page 204  
 Weight Rating: 300 lbs.

### FABRIC PRICE CODES

1	\$1567	8	\$2015
2	\$1646	9	\$2072
3	\$1724	10	\$2135
4	\$1782	11	\$2203
5	\$1839	12	\$2271
6	\$1898	L	\$2749
7	\$1955		

## HECSOAEEL

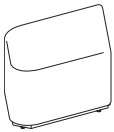

### OTTOMAN

Angled End, Left

### DIMENSIONS

Depth: 26½      Ship Weight: 52  
 Height: 17      Cube: 12.0  
 Width: 42      COM: See page 204  
 Weight Rating: 300 lbs.

### FABRIC PRICE CODES

1	\$1567	8	\$2015
2	\$1646	9	\$2072
3	\$1724	10	\$2135
4	\$1782	11	\$2203
5	\$1839	12	\$2271
6	\$1898	L	\$2749
7	\$1955		

## HECSOAER



### OTTOMAN

Angled End, Right

### DIMENSIONS

Depth: 26½      Ship Weight: 52  
 Height: 17      Cube: 12.0  
 Width: 42      COM: See page 204  
 Weight Rating: 300 lbs.

### FABRIC PRICE CODES

1	\$1567	8	\$2015
2	\$1646	9	\$2072
3	\$1724	10	\$2135
4	\$1782	11	\$2203
5	\$1839	12	\$2271
6	\$1898	L	\$2749
7	\$1955		

## HECSOC



### OTTOMAN

120 Degree

### DIMENSIONS

Depth: 41      Ship Weight: 110  
 Height: 17      Cube: 20.0  
 Width: 53      COM: See page 204  
 Weight Rating: 300 lbs.

### FABRIC PRICE CODES

1	\$1567	8	\$2163
2	\$1672	9	\$2241
3	\$1777	10	\$2324
4	\$1854	11	\$2415
5	\$1930	12	\$2506
6	\$2008	L	\$3141
7	\$2084		

## HOW TO SPECIFY

<p>Select Model Number</p> <p>HECSEOSE</p>	<p>Select Power</p> <p>N None</p> <p>N</p>	<p>Select Fabric</p> <p>See page 204</p> <p>HAML16</p>	<p>Select Base and Color</p> <p>P Plinth P71 Black</p> <p>PP71</p>
--	--	--	--



## HECSVAP

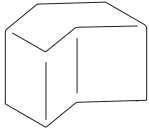

### POUF

Varsity Arrow

### DIMENSIONS

Depth:	23¼	Ship Weight:	37
Height:	18¼	Cube:	7.3
Width:	26½	COM:	See page 204
		Weight Rating:	300 lbs.

### FABRIC PRICE CODES

1	\$1004	8	\$1452
2	\$1083	9	\$1509
3	\$1161	10	\$1572
4	\$1219	11	\$1640
5	\$1276	12	\$1708
6	\$1335	L	\$2186
7	\$1392		

## HECSVHP

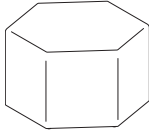

### POUF

Varsity Hexagon

### DIMENSIONS

Depth:	31	Ship Weight:	55
Height:	18¼	Cube:	10.1
Width:	26½	COM:	See page 204
		Weight Rating:	300 lbs.

### FABRIC PRICE CODES

1	\$1096	8	\$1544
2	\$1175	9	\$1601
3	\$1253	10	\$1664
4	\$1311	11	\$1732
5	\$1368	12	\$1800
6	\$1427	L	\$2278
7	\$1484		

## HECSJVAP

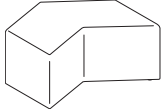

### POUF

Junior Varsity Arrow

### DIMENSIONS

Depth:	23¼	Ship Weight:	30
Height:	12¼	Cube:	6.0
Width:	26½	COM:	See page 204
		Weight Rating:	300 lbs.

### FABRIC PRICE CODES

1	\$903	8	\$1202
2	\$956	9	\$1240
3	\$1009	10	\$1282
4	\$1047	11	\$1327
5	\$1085	12	\$1373
6	\$1124	L	\$1690
7	\$1161		

## HECSJVHP

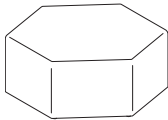

### POUF

Junior Varsity Hexagon

### DIMENSIONS

Depth:	31	Ship Weight:	44
Height:	12¼	Cube:	8.3
Width:	26½	COM:	See page 204
		Weight Rating:	300 lbs.

### FABRIC PRICE CODES

1	\$987	8	\$1286
2	\$1040	9	\$1324
3	\$1093	10	\$1366
4	\$1131	11	\$1411
5	\$1169	12	\$1457
6	\$1208	L	\$1774
7	\$1245		

## HOW TO SPECIFY

<p>Select Model Number</p> <p>HECSVAP</p>	<p>Select Fabric</p> <p>See page 204</p> <p>HAML16</p>	<p>Select Base</p> <p>G Glide</p> <p>G</p>
---	--	--





DESCRIPTION	MODEL	SHIP WEIGHT	CUBE	LIST PRICE
Gangng Bracket, 2/Pack	HECSG	5	0.5	\$105
Gangng Bracket Bulk Pack, 12/Pack	HECSBG	10	0.6	\$630

**NOTES:**

- Gangng brackets used to provide alignment between adjacent pieces but can be easily removed and repositioned for reconfiguration.
- Two gangng brackets used per side; for example, if gangng a Stoop + Perch, specify one HECSG.
- Gangng brackets are unpainted anodized aluminum.
- ! Perch units automatically ship with gangng brackets and L-brackets required for proper stability.

## HOW TO SPECIFY

Select  
Model Number

HECSG

# WORKPLACE TOOLS



Flock® Modular Seating with Dean Power Module Under-Surface Mount.

## WORKPLACE TOOLS

Workplace tools provide the finishing touch on any high-performance workspace. From storage options to technological tools and lighting solutions, HON's Workplace Tools deliver organization and efficiency to the office. Workplace Tools put everything you need to be productive within arm's reach, provide easy access to the connectivity you need to be successful and help you keep your workspace neat.



## PRODUCT CATEGORIES

- Monitor Arms
- Keyboard Trays and Center Drawers
- Paper Management and Organizational Tools
- Task Lights
- Electrical and Power Management Accessories
- Ergonomic and Healthy Workplace Solutions

# WORKPLACE TOOLS ORDERING INFORMATION

## LAMINATE CENTER DRAWERS, LAMINATE PAPER MANAGEMENT MODELS HLVP1/HLDST1/ HLSL1472LS/HLSL1460LS

### L1 LAMINATES ..... CODES

#### Woodgrain

- ◆ Bourbon Cherry ..... H
- ◆ Cognac ..... COGN
- ◆ Florence Walnut ..... LFW1
- ◆ Harvest ..... C
- ◆ Kingswood Walnut ..... LK11
- ◆ Mahogany ..... N
- ◆ Mocha ..... MOCH
- ◆ Natural Maple ..... D
- ◆ Pinnacle ..... PINC
- ◆ Shaker Cherry ..... F
- ◆ Sterling Ash ..... LSA1

#### Solid

- ◆ Black ..... P
- ◆ Charcoal ..... S
- ◆ Designer White ..... LDW1
- ◆ Loft ..... LOFT

### L2 LAMINATES ..... CODES

#### Woodgrain

- ◆ Lowell Ash ..... LLA1
- ◆ Natural Recon ..... LNR1
- ◆ Phantom Ecreu ..... LPE1
- ◆ Portico Teak ..... LPT1
- ◆ Skyline Walnut ..... LSW1

## LAMINATE KEYBOARD PLATFORM MODELS H4022/HE4022

### L1 LAMINATES ..... CODES

#### Woodgrain

- ◆ Bourbon Cherry ..... H
- ◆ Cognac ..... COGN
- ◆ Field Elm ..... LWFE
- ◆ Florence Walnut ..... LFW1
- ◆ Harvest ..... C
- ◆ Kingswood Walnut ..... LK11
- ◆ Mahogany ..... N
- ◆ Mocha ..... MOCH
- ◆ Natural Maple ..... D
- ◆ Pinnacle ..... PINC
- ◆ Shaker Cherry ..... F
- ◆ Sterling Ash ..... LSA1

#### Solid

- ◆ Black ..... P
- ◆ Charcoal ..... S
- ◆ Designer White ..... LDW1

#### Patterned

- ◆ Handspun Chestnut ..... LAHC
- ◆ Handspun Dove ..... LAHD
- ◆ Handspun Pearl ..... LAHP
- ◆ Handspun Slate ..... LAHS
- ◆ Silver Mesh ..... B9
- ◆ Steel Mesh ..... A9
- ◆ Gray ..... G2
- ◆ White ..... G1

### L2 LAMINATES ..... CODES

#### Woodgrain

- ◆ Beigewood ..... LWBE
- ◆ Fawn Cypress ..... LFC1
- ◆ Lowell Ash ..... LLA1
- ◆ Natural Recon ..... LNR1
- ◆ Phantom Ecreu ..... LPE1
- ◆ Portico Teak ..... LPT1
- ◆ Skyline Walnut ..... LSW1

## METAL PAPER MANAGEMENT MODELS HHPS1 AND HDPS1

### PAINT ..... CODES

#### P1

- ◆ Black ..... P
- ◆ Brownstone ..... P7D
- ◆ Charcoal ..... S
- ◆ Designer White ..... PJW
- ◆ Fossil ..... P28
- ◆ Greige ..... T5
- ◆ Light Gray ..... Q
- ◆ Loft ..... LOFT
- ◆ Muslin ..... T3
- ◆ Putty ..... L
- ◆ Titanium ..... P8T

#### P2

- ◆ Champagne Metallic ..... T4
- ◆ Gunmetal Metallic ..... PR3
- ◆ Platinum Metallic ..... T1
- ◆ Silver ..... PR6

#### P3

- ◆ Atom ..... P8S
- ◆ Blossom ..... P8K
- ◆ Bullseye ..... PJF
- ◆ Ember ..... P8P
- ◆ Ion ..... P8N
- ◆ Iris ..... P8J
- ◆ Krypton ..... P8F
- ◆ Ochre ..... P093
- ◆ Regatta ..... P8M
- ◆ Sienna ..... P092
- ◆ Succulent ..... P8A

## METAL CENTER DRAWERS\*, CORNER SLEEVES, METAL KEYBOARD PLATFORM, STORAGE CUBES, DRAWER ORGANIZER, HAND SANITIZER STATION

### PAINT ..... CODES

#### P1

- ◆ Black ..... P
- ◆ Brownstone ..... P7D
- ◆ Charcoal ..... S
- ◆ Designer White ..... PJW
- ◆ Fossil ..... P28
- ◆ Greige ..... T5
- ◆ Light Gray ..... Q
- ◆ Loft ..... LOFT
- ◆ Muslin ..... T3
- ◆ Putty ..... L
- ◆ Titanium ..... P8T

#### P2

- ◆ Champagne Metallic ..... T4
- ◆ Gunmetal Metallic ..... PR3
- ◆ Platinum Metallic ..... T1
- ◆ Silver ..... PR6
- ◆ Solar Black ..... P8X

#### P3

- ◆ Atom ..... P8S
- ◆ Blossom ..... P8K
- ◆ Bullseye ..... PJF
- ◆ Ember ..... P8P
- ◆ Ion ..... P8N
- ◆ Iris ..... P8J
- ◆ Krypton ..... P8F
- ◆ Ochre ..... P093
- ◆ Regatta ..... P8M
- ◆ Sienna ..... P092
- ◆ Succulent ..... P8A







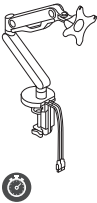
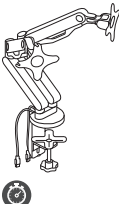
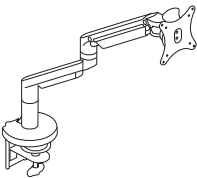

\* Metal center drawer models HD2 and HD8 limited to P1 Paints, Champagne Metallic, and Platinum Metallic.

◆◆◆ For lead time information see page 21.

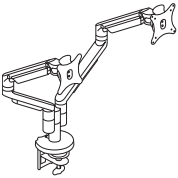

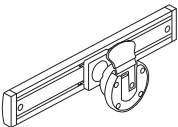
Icon Legend on page 19

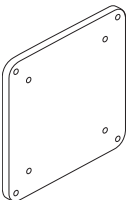
# MONITOR ARMS

	DESCRIPTION	MODEL	SHIP WEIGHT	CUBE	LIST PRICE
	<p><b>Single Monitor Arm with 2 USB Ports</b></p> <p>NOTES: Easy adjustment. Height adjusts to 17" tall. Monitor tilt and swivel capability. Enclosed cable management. Grommet or desktop mounting. Clean appearance. <b>HON 5-Year Limited Warranty.</b></p> <ul style="list-style-type: none"> <li>Available in Silver only, no specification needed.</li> <li>Cannot be used in Empower® height adjustable applications.</li> <li>Arm holds monitors up to 19 lbs.</li> </ul>	<b>HBSMAUSB</b>	38.6	2.4	<b>\$340</b>
	<p><b>Dual Monitor Arm with 2 USB Ports</b></p> <p>NOTES: Easy adjustment. Height adjusts to 17" tall. Monitor tilt and swivel capability. Enclosed cable management. Grommet or desktop mounting. Clean appearance. In some applications the Monitor Arms may extend 12 or more inches into the worksurface. <b>HON 5-Year Limited Warranty.</b></p> <ul style="list-style-type: none"> <li>Available in Silver only, no specification needed.</li> <li>Cannot be used in Empower® height adjustable applications.</li> <li>Each arm holds monitors up to 19 lbs.</li> </ul>	<b>HBDMAUSB</b>	41.9	2.6	<b>\$507</b>
	<p><b>Single Dynamic Monitor Arm</b></p> <ul style="list-style-type: none"> <li>180° of rotation at base with optional 360° rotation.</li> <li>Arms extend 22" and retract up to 3".</li> <li>Monitor mount rotates 180° and tilts +/-30°.</li> <li>Monitor can be rotated from landscape to portrait position.</li> </ul> <ul style="list-style-type: none"> <li>Arms hold monitors from 6.2-18 lbs. Optional counterweight HPACW available to support monitors as low as 5 lbs.</li> <li>Back side of monitor arm base features opening for wire management through grommet when utilizing clamp mount.</li> </ul>	<b>HMASTS</b>	11.5 	0.8	<b>\$618</b>
	<p><b>Dual Dynamic Monitor Arm</b></p> <ul style="list-style-type: none"> <li>Arms have 65° rotation at base with optional 130° and 360° rotations.</li> <li>Arms extend 22" and retract up to 3".</li> <li>Monitor mount rotates 180° and tilts +/-30°.</li> <li>Monitor can be rotated from landscape to portrait position.</li> </ul> <ul style="list-style-type: none"> <li>Arms hold monitors from 6.2-18 lbs. Optional counterweight HPACW available to support monitors as low as 5 lbs.</li> <li>Back side of monitor arm base features opening for wire management through grommet when utilizing clamp mount.</li> </ul>	<b>HMASD</b>	17.0 	1.1	<b>\$1187</b>
	<p><b>Sliding Mount for Monitor Arm</b></p> <ul style="list-style-type: none"> <li>Supports monitors up to 18 lbs.</li> <li>Compatible with VESA 75mm and 100mm mounts.</li> <li>Compatible with models HMASTS, HMASD, HPASD, HPADD, and HPATF.</li> <li>Available in two paint finishes, Silver (SVR) and Black (BLK). Plastic components ship in like color with specified paint finish.</li> </ul>	<b>HPACSM</b>	3.0 	0.3	<b>\$256</b>
	<p><b>Monitor Arm Counterweight</b></p> <ul style="list-style-type: none"> <li>Optional counterweight for monitors as low as 5 lbs.</li> <li>Minimum weight for monitors without counterweight is 6.2 lbs.</li> </ul> <ul style="list-style-type: none"> <li>Available in Black only, no specification needed.</li> <li>Compatible with models HMASTS, HPASD, HMASD, HPADD, and HPATF.</li> </ul>	<b>HPACW</b>	3.0 	0.1	<b>\$39</b>

SIN 33721

WORKPLACE TOOLS

## HOW TO SPECIFY

<p>Select Model Number</p> <p>H M A S T S .</p>	<p>Select Finish</p> <p>SVR Silver BLK Black</p> <p>S V R</p>
---	---



# MONITOR ARMS

### DESCRIPTION

**MODEL    SHIP WEIGHT    CUBE    LIST PRICE**

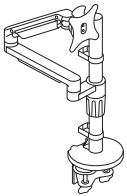

**Post Mount with Single Dynamic Arm**

- Arm has 360° rotation at base.
- Monitor mount rotates 180° and tilts +/-30°.
- Monitor can be rotated from landscape to portrait position.
- Arm extends up to 20".
- Arm has 17¾" of vertical adjustment.

⚠ Available in Silver (SVR) finish only.

⚠ Arms hold monitors from 6.2-18 lbs. Optional counterweight HPACW available to support monitors as low as 5 lbs. (see page 227).

**HPASD                    15.5                    1.3                    \$865**

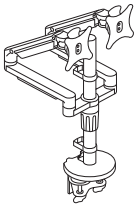

**Post Mount with Dual Dynamic Arms**

- Arms have 360° rotation at base.
- Monitor mount rotates 180° and tilts +/-30°.
- Monitor can be rotated from landscape to portrait position.
- Arms extend up to 20".
- Arms have 17¾" of vertical adjustment.

⚠ Available in Silver (SVR) finish only.

⚠ Arms hold monitors from 6.2-18 lbs. Optional counterweight HPACW available to support monitors as low as 5 lbs. (see page 227).

**HPADD                    19.5                    1.3                    \$1256**

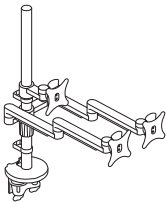

**Post Mount with Triple Fixed Arms**

- Features two fixed extended arms and one fixed center mount.
- Arms have 360° rotation at base.
- Monitor mount rotates 180° and tilts +/-30°.
- Monitor can be rotated from landscape to portrait position.
- Arms extend up to 20".
- Arms have 27½" of vertical adjustment.

⚠ Available in Silver (SVR) finish only.

⚠ Arms hold monitors from 6.2-18 lbs. Optional counterweight HPACW available to support monitors as low as 5 lbs. (see page 227).

**HPATF                    22.0                    1.9                    \$1437**

WORKPLACE TOOLS

### HOW TO SPECIFY

<b>Select Model Number</b>	<b>Select Finish</b>
HPASD.	SVR Silver
<input type="checkbox"/> H <input type="checkbox"/> P <input type="checkbox"/> A <input type="checkbox"/> S <input type="checkbox"/> D .	<input type="checkbox"/> S <input type="checkbox"/> V <input type="checkbox"/> R



# CPU HOLDERS

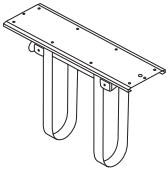

**DESCRIPTION**

**360° Swivel CPU Holder with Adjustable Straps**

- Supports CPUs 3¾" wide up to 64" perimeter and holds up to 75 lbs.
- 360° rotation.
- Ships complete and includes necessary mounting hardware and instruction sheet.

ⓘ Available in Black only, no specification needed.

MODEL	SHIP WEIGHT	CUBE	LIST PRICE
HCPU1	7	0.2	\$322

## HOW TO SPECIFY



Select Model Number

H C P U 1

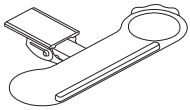

Icon Legend on page 19

# KEYBOARD TRAYS

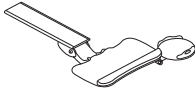
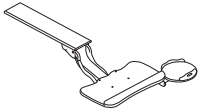
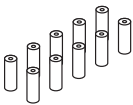
	DESCRIPTION	MODEL	SHIP WEIGHT	CUBE	LIST PRICE
	<b>Short Track and Keyboard Platform</b> <ul style="list-style-type: none"> <li>Height adjustable total of 5 3/4" (1 3/4" above and 4" below).</li> <li>+10°, -20° of tilt adjustment.</li> <li>360° rotation.</li> </ul>	<b>HKTSHORT</b>	10 	0.8	<b>\$744</b>
	<b>Mid Track with Keyboard and Mouse Platform</b> <ul style="list-style-type: none"> <li>Height adjustable total of 8" (3" above and 5" below).</li> <li>+10°, -20° of tilt adjustment.</li> <li>360° rotation.</li> </ul>	<b>HKT MID</b>	17	1.2	<b>\$684</b>
	<b>Sit to Stand Long Track with Keyboard and Mouse</b> <ul style="list-style-type: none"> <li>Height adjustable total of 12 1/2" (7 1/2" above and 5" below).</li> <li>+10°, -20° of tilt adjustment.</li> <li>360° rotation.</li> </ul>	<b>HKT LONG</b>	17	0.8	<b>\$799</b>
	<b>Keyboard Spacer</b> <ul style="list-style-type: none"> <li>Used when attaching HKT MID or HKT LONG to Coordinate™ and Voi® or Systems Worksurface with an external channel.</li> <li>The kit includes ten cylinder spacers and ten screws.</li> <li>Spacers are 3/4"W x 2 1/8"H.</li> <li>Specify one kit per keyboard tray.</li> </ul>	<b>HKBS</b>	1	0.8	<b>\$132</b>

SIN 33721

**NOTES:**

-  Available in Black only, no specification needed.

WORKPLACE TOOLS

## HOW TO SPECIFY

Select Model Number

H K T M I D



Icon Legend on page 19

# KEYBOARD TRAYS

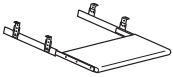
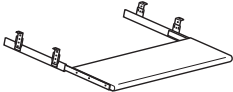
	DESCRIPTION	MODEL	SHIP WEIGHT	CUBE	LIST PRICE BY LAMINATE GRADE	
					L1	L2
	<b>Laminated Keyboard Platform</b> <ul style="list-style-type: none"> <li>Laminated Tray dimensions: 21½"W x 10"D x 1⅞" Thick.</li> <li>Minimum clearance for mounting: 22⅞"W x 17"D.</li> <li>Surface can be positioned 2", 2½", 3" or 3½" below bottom of worksurface.</li> <li>Will not fit on a 37" x 24" Corner worksurface.</li> </ul>	<b>H4022</b>	10	0.6	<b>\$283</b>	<b>\$300</b>
	<b>Laminated Keyboard Platform with Extended Tray</b> <ul style="list-style-type: none"> <li>Laminated Tray dimensions: 30"W x 10"D x 1⅞" Thick.</li> <li>Minimum clearance for mounting: 32½"W x 17"D.</li> <li>Surface can be positioned 2", 2½", 3" or 3½" below bottom of worksurface.</li> <li>Will not fit on a 37" x 24" Corner worksurface.</li> <li>Ball-bearing slide; slide and brackets are Black.</li> </ul>	<b>HE4022</b>	12	0.7	<b>\$399</b>	<b>\$416</b>

## HOW TO SPECIFY

<b>Select Model Number</b> <input type="text" value="H"/> <input type="text" value="4"/> <input type="text" value="0"/> <input type="text" value="2"/> <input type="text" value="2"/> .	<b>Select Laminate</b> See page 226 <input type="text" value="H"/>
--	--

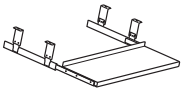
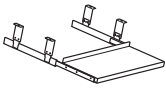
	DESCRIPTION	MODEL	SHIP WEIGHT	CUBE	LIST PRICE BY PAINT GRADE		
					P1	P2	P3
	<b>Metal Keyboard Platforms</b> <b>30"W Metal Keyboard and Mouse Tray</b> <ul style="list-style-type: none"> <li>Designed to hold keyboards and allow room for mouse pads.</li> <li>Tray dimensions: 30"W x 10"D.</li> <li>Minimum clearance for mounting: 32½"W x 15"D.</li> </ul>	<b>H4028</b>	11	1.5	<b>\$204</b>	<b>\$216</b>	<b>\$224</b>
<b>OPEN MARKET</b>							
	<b>24"W Metal Keyboard Tray</b> <ul style="list-style-type: none"> <li>Designed to hold ONLY keyboards.</li> <li>Tray dimensions: 24"W x 10"D.</li> <li>Minimum clearance for mounting: 26½"W x 15"D.</li> </ul>	<b>H4029</b>	11	1.5	<b>\$185</b>	<b>\$197</b>	<b>\$205</b>
<b>OPEN MARKET</b>							

**NOTES:**

- Surface is positioned 3" below bottom of worksurface.
- Non-articulating, only movement is front-to-back. Does not tilt or swivel.

## HOW TO SPECIFY

<b>Select Model Number</b> <input type="text" value="H"/> <input type="text" value="4"/> <input type="text" value="0"/> <input type="text" value="2"/> <input type="text" value="8"/> .	<b>Select Paint Color</b> See page 226 <input type="text" value="P"/>
--	---

WORKPLACE TOOLS





Icon Legend on page 19

# CORNER SLEEVES

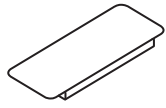

## DESCRIPTION

### Metal Corner Sleeves

#### 22½"W Leading Edge x 9"D

- Fits 1/8" thick square edge detail.

MODEL	SHIP WEIGHT	CUBE	LIST PRICE BY PAINT GRADE		
			P1	P2	P3
H51204	10	1.5	\$224	\$233	\$240
H51206	10	1.5	\$224	\$236	\$243

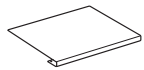

#### 22½"W Leading Edge x 18"D

- Fits 1/8" thick square edge detail.

## NOTES:

- Corner sleeve connects intersecting worksurfaces to create "corner desk" work areas.

### Edge Detail



## HOW TO SPECIFY

Select  
Model Number

H 5 1 2 0 4 .

Select  
Paint Color

See page 226

P



# CENTER DRAWERS



Angled front

**DESCRIPTION**

**Laminate Center Drawer**

22"W x 15<sup>3</sup>/<sub>8</sub>"D x 2<sup>1</sup>/<sub>2</sub>"H

- Ball-bearing slide suspension.
- 12" drawer extension (3/4).
- Inside drawer dimension for H1522: 18<sup>7</sup>/<sub>8</sub>"W x 15<sup>1</sup>/<sub>2</sub>"D x 1<sup>1</sup>/<sub>2</sub>"H.
- Minimum clearance for mounting H1522: 22<sup>3</sup>/<sub>4</sub>"W x 18<sup>1</sup>/<sub>2</sub>"D compatible with 72"W x 36"D, 66"W x 30"D, 60"W x 30"D Double Pedestal Desks, 72"W x 36"D, 66"W x 30"D Single Pedestal Desks, Bullet and P-Shaped Peninsulas, 72"W x 24"D, 66"W x 24"D, 60"W x 24"D Credenza w/Kneespace, 72"W x 24"D, 66"W x 24"D Single Pedestal Credenzas, 48"W x 24"D, 42"W x 24"D Returns.
- Designed for use with Concinnity™, Voi®, Valido® and 10500 Series™.
- Includes pencil tray.

NOTES: For 60"W x 30"D Modular Desk Shells with two 15<sup>5</sup>/<sub>8</sub>"W Storage Pedestals or 60"W x 24"D Modular Credenza Shells with two 15<sup>5</sup>/<sub>8</sub>"W Storage Pedestals, use center drawer H1522.

MODEL	SHIP WEIGHT	CUBE	L1 LIST PRICE	L2 LIST PRICE
H1522	11	1.1	\$258	\$275

## HOW TO SPECIFY

<b>Select Model Number</b>	<b>Select Laminate</b>
H 1 5 2 2 .	See page 226
	H



Icon Legend on page 19

# CENTER DRAWERS

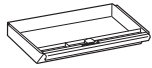

Angled front

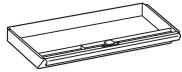

Angled front



**DESCRIPTION**

**Metal Center Drawer w/Lock**

- 19"W x 14<sup>3</sup>/<sub>4</sub>"D x 3"H
- Ball-bearing slide suspension.
- 12" drawer extension (3/4).
- Inside drawer dimension: 19"W x 13"D x 2<sup>3</sup>/<sub>8</sub>"H.
- Minimum clearance for mounting: 21<sup>3</sup>/<sub>4</sub>"W x 19<sup>1</sup>/<sub>4</sub>"D.
- Core removable lock.

**24<sup>3</sup>/<sub>4</sub>"W x 14<sup>3</sup>/<sub>4</sub>"D x 3"H**

- Ball-bearing slide suspension.
- 12" drawer extension (3/4).
- Inside drawer dimension: 24<sup>1</sup>/<sub>2</sub>"W x 13"D x 2<sup>3</sup>/<sub>8</sub>"H.
- Minimum clearance for mounting: 27<sup>3</sup>/<sub>8</sub>"W x 19<sup>1</sup>/<sub>4</sub>"D.
- Core removable lock.

MODEL	SHIP WEIGHT	CUBE	LIST PRICE BY PAINT GRADE	
			P1	P2

<b>HD2</b>	9	1.0	<b>\$389</b>	<b>\$401</b>
------------	---	-----	--------------	--------------

<b>HD8</b>	12	1.2	<b>\$389</b>	<b>\$401</b>
------------	----	-----	--------------	--------------

**DESCRIPTION**

**Polymer Center Drawer**

- Material: ABS.
- Minimum clearance for mounting: 23"W x 16<sup>1</sup>/<sub>4</sub>"D x 2"H.
- Retracts on 16" ball-bearing slides.
- Can be used on worksurfaces with Coordinate™ Height Adjustable Bases as long as it is attached with spacer model HKBS.
- Can store up to 25 lbs.

Black finish only, no specification needed.

MODEL	SHIP WEIGHT	CUBE	LIST PRICE
-------	-------------	------	------------

<b>HCD1</b>	7	0.5	<b>\$165</b>
-------------	---	-----	--------------

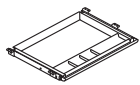

OPEN MARKET

**NOTES:**

- All metal center drawers feature pencil trays with three compartments for storage.
- All metal center drawers feature core removable locks for greater personal and departmental security.

WORKPLACE TOOLS

## HOW TO SPECIFY

<p><b>Select Model Number</b></p> <p>HD2 .</p>	<p><b>Select Paint Color</b></p> <p>See page 226</p> <p>P</p>
--	---



Icon Legend on page 19

# DESKTOP RISER



**DESCRIPTION**

**Portable Desktop Riser**  
31"D x 5"-16½"H x 35"W

NOTES: Available in White (WHT) finish. Desktop riser dimensions (without keyboard tray): 22"D x 5"-16½"H x 35"W. Keyboard tray dimensions: 9"D x 30"W. Max loading capacity is 33 lbs for the desktop riser surface and 4 lbs for the keyboard tray. Easily transition from seated to standing positions throughout the workday. Sits atop an existing desk to create sit-to-stand functionality by raising the computer. Includes keyboard tray and surface for computer monitors. **HON 5-Year Limited Warranty.**

**!** Not intended for use on mobile workstations.

**MODEL      SHIP WEIGHT      CUBE      LIST PRICE**

**HBXRISER      54      4.1      \$855**

**HOW TO SPECIFY**

Select Model Number

HBXRISER.

Select Finish

WHT White

WHT

# CHAIR MATS

	DESCRIPTION	MODEL	SHIP WEIGHT	CUBE	LIST PRICE
	<b>Lipped Chair Mat with Studs</b> 48"W x 36"D	<b>HCM3648LS</b> ⓘ	8.8	0.6	<b>\$127</b>
	<b>Lipped Chair Mat without Studs</b> 60"W x 46"D 48"W x 36"D	<b>HCM4660LN</b> <b>HCM3648LN</b> ⓘ	13.2 8.3	0.5 0.3	<b>\$212</b> <b>\$127</b>

- NOTES:**
- Available with studs for carpet and without studs for hard-surface floors.
  - Ships rolled.
  - **HON 5-Year Limited Warranty.**
- ⓘ Available in Clear finish only, no specification needed.

WORKPLACE TOOLS



## HOW TO SPECIFY

Select Model Number

H C M 3 6 4 8 L S



# TASK LIGHTS

	DESCRIPTION	MODEL	SHIP WEIGHT	CUBE	LIST PRICE
	<b>Articulating Desk Lamp</b> <b>Articulating Desk Lamp w/ Occupancy Sensor</b> <ul style="list-style-type: none"> <li>• Full-range dimming from 10% to 100%.</li> <li>• Designed for 50,000 hours of life.</li> <li>• Occupancy sensor is built into the head of the lamp and will automatically shut the lamp off after 6 minutes of undetected movement.</li> <li>• Base swivel is 180 degrees.</li> <li>• Uses only 5 watts of energy.</li> <li>• Light comes with a silver 9' 4" power cord.</li> <li>• Base diameter is 7.5".</li> <li>• 3500K Color Temperature.</li> <li>• 80 Color Rendering Index.</li> <li>• TAA Compliant.</li> </ul>	<b>HLED1</b> <b>HLED10C</b>	1.2 1.2	6.5 6.5	<b>\$532</b> <b>\$646</b>
	<p>! Available in Matte Silver finish only, no specification needed.</p>				
	<b>Task Desk Lamp</b> <ul style="list-style-type: none"> <li>• Full-range dimming from 10% to 100%.</li> <li>• Designed for 50,000 hours of life.</li> <li>• Lamp is 15.83" tall.</li> <li>• Desk lamp does not articulate at base. The pivoting head provides custom positioning, as it can be twisted 360 degrees.</li> <li>• Uses only 5 watts of energy.</li> <li>• Light comes with a silver 9' 4" power cord.</li> <li>• Base diameter is 6.7".</li> <li>• 3500K Color Temperature.</li> <li>• 80 Color Rendering Index.</li> <li>• TAA Compliant.</li> </ul>	<b>HLED2</b>	0.7	3.0	<b>\$462</b>
	<p>! Available in Brushed Nickel finish only, no specification needed.</p>				

## HOW TO SPECIFY

 Select  
 Model Number

H L E D 1



# TASK LIGHTS



DESCRIPTION	MODEL	SHIP WEIGHT	CUBE	LIST PRICE
<b>LED Task Lights</b>				
17" LED Light with Power Supply (Single)	<b>HLED17AS</b>	1.2	0.05	<b>\$557</b>
31" LED Light with Power Supply (Single)	<b>HLED31AS</b>	1.5	0.09	<b>\$745</b>
17" LED Light with Power Supply for Daisy-chain (Starter)	<b>HLED17A</b>	1.0	0.05	<b>\$609</b>
31" LED Light with Power Supply for Daisy-chain (Starter)	<b>HLED31A</b>	1.4	0.09	<b>\$817</b>
17" LED Light with 8" Jumper Cord for Daisy-chain (Follower)	<b>HLED17AUO</b>	1.0	0.03	<b>\$499</b>
31" LED Light with 8" Jumper Cord for Daisy-chain (Follower)	<b>HLED31AUO</b>	1.0	0.05	<b>\$666</b>
<b>Undercabinet Occupancy Sensor with 1" End to End Connector</b>	<b>HLEDOSA</b>	0.2	0.01	<b>\$122</b>

NOTES: To use the daisy chain application, must start with model HLED17A or HLED31A. No finish specification required. Attaches magnetically to underside of overhead storage, or attaches with provided screws or double-sided tape. Occupancy sensor attaches to a single or starter LED light and will automatically turn the light off after no motion is detected for 30 minutes. Just like all the LED light models, the occupancy sensor features a soft-touch on/off switch. LED task lights have a lifetime of 50,000 hours and have a dimmer feature that allows the user to adjust the amount of light output.



DESCRIPTION	MODEL	SHIP WEIGHT	CUBE	LIST PRICE
<b>Recessed Task Lights</b>				
<ul style="list-style-type: none"> <li>• Color: Black.</li> <li>• Slim profile design.</li> <li>• Mount to stack-on storage and wall mounted storage cabinets.</li> <li>• 9-foot black cord and switch off right rear corner.</li> <li>• Features LED strip.</li> <li>• Lights ordered after October 4, 2021 will feature new LED light strip.</li> </ul>				
18 <sup>3</sup> / <sub>8</sub> "W x 3 <sup>1</sup> / <sub>16</sub> "D x 1 <sup>1</sup> / <sub>8</sub> "H	<b>HH870924</b>	5.0	0.40	<b>\$302</b>
Chicago code version (with fused plug)	<b>HH870924CH</b>	5.0	0.40	<b>\$382</b>
22 <sup>7</sup> / <sub>8</sub> "W x 3 <sup>1</sup> / <sub>16</sub> "D x 1 <sup>1</sup> / <sub>8</sub> "H	<b>HH870930</b>	7.0	0.60	<b>\$306</b>
Chicago code version (with fused plug)	<b>HH870930CH</b>	7.0	0.60	<b>\$398</b>
34 <sup>5</sup> / <sub>8</sub> "W x 3 <sup>1</sup> / <sub>16</sub> "D x 1 <sup>1</sup> / <sub>8</sub> "H	<b>HH870942</b>	10.0	0.90	<b>\$331</b>
Chicago code version (with fused plug)	<b>HH870942CH</b>	10.0	0.90	<b>\$420</b>
46 <sup>1</sup> / <sub>2</sub> "W x 3 <sup>1</sup> / <sub>16</sub> "D x 1 <sup>1</sup> / <sub>8</sub> "H	<b>HH870960</b>	12.0	1.10	<b>\$359</b>
Chicago code version (with fused plug)	<b>HH870960CH</b>	12.0	1.10	<b>\$446</b>

## HOW TO SPECIFY

Select  
Model Number

H H 8 7 0 9 2 4



# PAPER MANAGEMENT & ORGANIZATIONAL TOOLS

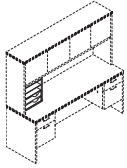

Not available in two-tone laminate

DESCRIPTION	MODEL	SHIP WEIGHT	CUBE	LIST PRICE BY LAMINATE GRADE	
				L1	L2

**Vertical Paper Manager**  
 14<sup>7</sup>/<sub>8</sub>"W x 10<sup>7</sup>/<sub>8</sub>"D x 19<sup>3</sup>/<sub>16</sub>"H  
**HLVPM1**      27      2.8      **\$454**      **\$466**

NOTES: Keeps papers, files, and books neatly organized and within easy reach from a seated position. Designed for desk, credenza, and return tops. Fits under stack-on storage models. Two pullout drawers and three fixed shelves. Not available in pattern laminate colors. Ships fully assembled.

⚠ Requires 19<sup>3</sup>/<sub>4</sub>"H minimum of clear space between underside of overhead storage unit and worksurface.  
**SPECIFYING EXAMPLE: HLVPM1.N**

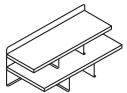

Not available in two-tone laminate



**Desktop Storage Terrace**  
 26<sup>1</sup>/<sub>2</sub>"W x 12<sup>1</sup>/<sub>2</sub>"D x 10<sup>1</sup>/<sub>2</sub>"H  
**HLDST1**      24      1.1      **\$425**      **\$437**

NOTES: For use on the tops of 29<sup>1</sup>/<sub>2</sub>"H desks, credenzas, and returns. Features six storage sections plus top display shelf. Keeps work-in-process, priority files, loose pages, and mail neatly organized and in view. Mixed material design comprised of sturdy laminate shelves with metal back and support panels. Not available in two-tone laminate combination or pattern laminate colors. Choose from Platinum Metallic (T1), Black (P), and Charcoal (S) for the metal components. Sized to fit in stack-on and wall mount storage cabinets in 10500, Valido, Concinnity, 94000, and 38000 Series. Fits in Concinnity and Voi sliding door models, except for 48"W or smaller models. Specify: Model.Laminate.Paint

**SPECIFYING EXAMPLE: HLDST1.N.T1**

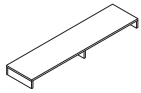

**Layering Shelf**  
 72"W x 14<sup>1</sup>/<sub>2</sub>"D x 5<sup>1</sup>/<sub>2</sub>"H      **HLSL1472LS**      50      4.6      **\$610**      **\$622**  
 60"W x 14<sup>1</sup>/<sub>2</sub>"D x 5<sup>1</sup>/<sub>2</sub>"H      **HLSL1460LS**      39      1.3      **\$512**      **\$524**

NOTES: Layering shelf works with lower credenzas to provide additional storage areas.

⚠ Layering Shelves cannot be stacked.  
 ⚠ Cannot add a hutch on top of a layering shelf.

## HOW TO SPECIFY

<b>Select Model Number</b> HLVP M1 . N	<b>Select Laminate</b> See page 226
---	--



# PAPER MANAGEMENT & ORGANIZATIONAL TOOLS

GSA SIN 33721



Icon Legend on page 19

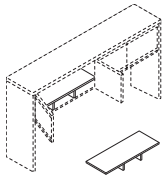

## DESCRIPTION

**Stacked Paper Management**  
32½"W x 12½"D x 4¼"H

**MODEL SHIP WEIGHT CUBE LIST PRICE**

**HLVPM2 22 1.25 \$228**

NOTES: Segments and organizes stack-on and wall mount storage compartments, as well as bookcase shelves. Unit can be used in Models H105327, H10534, H105322, H105321, H105382 and H105381.

- Available in Black finish only, no specification needed.
- In some cases, installation of Stacked Paper Management may require removing the stack-on or wall mount storage doors.

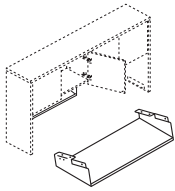

## DESCRIPTION

**Hanging Paper Shelf**  
28½"W x 11¼"D x 4¾"H

**MODEL SHIP WEIGHT CUBE LIST PRICE BY PAINT GRADE**

**HHPS1 7 2.9 \$278 \$288 \$300**

NOTES: Attaches quickly and easily (screws included). Maximizes worksurface space; de-clutters desktop while placing priority communications and active project folders within easy reach. Angled design allows contents to be distinguished at a glance. Mixed material styling features strong painted metal frame with a frosted shelf.

Attaches quickly and easily to laminate stack-on and wall mount storage models (except the 36"W Voi® overhead hutch with O-legs or panel mount brackets). Not for use with 38000 Series™ and Systems.

Specify: Model.Paint

**SPECIFYING EXAMPLE: HHPS1.T1**

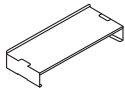

**Desktop Paper Shelf**  
28½"W x 11½"D x 5"H

**HDPS1 7 2.9 \$278 \$288 \$300**

NOTES: Desktop Paper Shelf and Storage Terrace include protective, non-slip pads on the base. Paper Shelf can stack two-high. Organizer shelf provides a place and space for work-in-process and piling to keep worksurfaces neat and tidy. Convenient, scalable design with interlocking side supports allow two units to be stacked and integrated. Durable painted metal frame with a frosted shelf; mixed material styling matches hanging paper shelf.

Can also be used inside select overhead storage, including the following stack-on with clearance and hinged door models: 10500 and Valido 36", 42", 66", 72", 78"W.

Specify: Model.Paint

**SPECIFYING EXAMPLE: HDPS1.T1**

WORKPLACE TOOLS

## HOW TO SPECIFY

Select Model Number

Select Paint Color

See page 226





HHPS1.

P

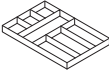
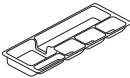
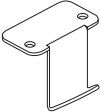

Icon Legend on page 19

# PAPER MANAGEMENT & ORGANIZATIONAL TOOLS

	DESCRIPTION	MODEL	SHIP WEIGHT	CUBE	LIST PRICE BY PAINT GRADE		
					P1	P2	P3
	<b>Storage Cube</b> 12"W x 12"D SPECIFYING EXAMPLE: HLSL1212.P8S	HLSL1212	1	0.3	\$408	\$408	\$408
							
	<b>Drawer Organizer</b> 12"W x 14½"D x 1½"H SPECIFYING EXAMPLE: HSLDRWORG.P8F	HSLDRWORG	1	0.5	\$223	\$223	\$223
	<b>DESCRIPTION</b>	<b>MODEL</b>	<b>SHIP WEIGHT</b>	<b>CUBE</b>	<b>LIST PRICE</b>		
	<b>Optional Pencil Tray</b> ⚠ For use with mobile and freestanding pedestal models. ⚠ No specification required.	HV-UT1	0.5	0.1	\$97		
	<b>Back Pack Hook (10 per carton)</b> 2¼"W x 2¾"D x 1¾"H NOTES: Assembly: attaches to bottom of desk with (2) screws, included. ⚠ Available in Platinum Metallic finish only, no specification needed.	HCLA65	10.0	0.1	\$123		
<b>OPEN MARKET</b>							
							

WORKPLACE TOOLS

## HOW TO SPECIFY

<p>Select Model Number</p> <p>H L S L 1 2 1 2 .</p>	<p>Select Paint Color</p> <p>See page 226 Only specify for models HLSL1212 and HSLDRWORG</p> <p>P 8 S</p>
---	---

# PAPER MANAGEMENT & ORGANIZATIONAL TOOLS

GSA SIN 33721 EXCEPT AS NOTED



Icon Legend on page 19

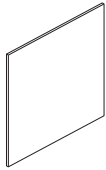

## DESCRIPTION

### Wall Mount Tackboard

36"W x 35¼"H  
30"W x 35¼"H

36"W x 48⅝"H  
30"W x 48⅝"H

## MODEL

**HNL3636TB**  
**HNL3630TB**

**HNL4936TB**  
**HNL4930TB**

## SHIP WEIGHT

20  
16

27  
22

## CUBE

2.9  
2.9

5.5  
3.7

## LIST PRICE

**\$418**  
**\$355**

**\$464**  
**\$404**

NOTES: When positioned above 29½"H floor-standing storage, the sizes align with overhead storage height options. Can be positioned side-by-side with corresponding wall mount markerboard sizes. Easy to install; includes mounting hardware. Attaches to wall with horizontally mounted, interlocking Z-clip brackets. For the space directly below stack-on and wall mount storage cabinets, use the 18"H tackboard models listed in the Desks section in the 2024 Workspaces Pricer.

**SPECIFYING EXAMPLE: HNL3636TB.APN15**

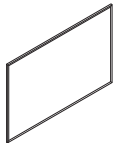

### Markerboard

48"W x 31"H

NOTES: Wall mounted.

! No specification required.

**HL4831MB**

44

3.4

**\$920**

## OPEN MARKET



WORKPLACE TOOLS

## HOW TO SPECIFY

Select Model Number

Select Fabric Color

See pages 26-27

H N L 3 6 3 6 T B .

A P N 1 1

# INTERLINK IQ ELECTRICAL

## Specification guide for IQ Electrical on Training tables

Determine table width, the type of power access being used (3" grommet or 4x8 pop-up) and the desired number per table (Columns 1, 2 or 3). The table will then identify the type and quantity of components needed per table along with the maximum table run. Note that this is in addition to the Power base in-feed which is needed for each run. For example, a 48"W table with two 3" power grommets per table will require (1) HQH5-3 harness and (1) HQH1-3 harness per table with a maximum run of four tables.

Top Width	POWER ONE (1) PER TABLE 3" ROUND POWER GROMMET		POWER TWO (2) PER TABLE 3" ROUND POWER GROMMETS		POWER ONE (1) PER TABLE 4x8 POP-UP PORT	
	Quantity	Table Run Maximum	Quantity	Table Run Maximum	Quantity	Table Run Maximum
36"	(1) HQH5-3	8	N/A	N/A	(1) HQH5-P	8
42"	(1) HQH5-3	8	N/A	N/A	(1) HQH5-P	8
48"	(1) HQH5-3	8	(1) HQH5-3 (1) HQH1-3	4 Max Table Run	(1) HQH5-P	8 Max Table Run
54"	(1) HQH5-3	8	(1) HQH5-3 (1) HQH1-3	4 Max Table Run	(1) HQH5-P	8 Max Table Run
60"	(1) HQH5-3	8	(1) HQH5-3 (1) HQH1-3	4 Max Table Run	(1) HQH5-P	8 Max Table Run
66"	(1) HQH5-3 (1) HQTJ3	4	(1) HQH5-3 (1) HQH1-3	4 Max Table Run	(1) HQH5-P (1) HQTJ3	4 Max Table Run
72"	(1) HQH5-3 (1) HQTJ3	4	(1) HQH5-3 (1) HQH1-3	4 Max Table Run	(1) HQH5-P (1) HQTJ3	4 Max Table Run
84"	(1) HQH5-3 (1) HQTJ3	4	(2) HQH5-3	4 Max Table Run	(1) HQH5-P (1) HQTJ3	4 Max Table Run
96"	(1) HQH5-3 (1) HQTJ3	4	(2) HQH5-3	4 Max Table Run	(1) HQH5-P (1) HQTJ3	4 Max Table Run
Half-Round (all sizes)	(1) HQTJ3	2	N/A	N/A	(1) HQH5-P	2
Trapezoid (all sizes)	(1) HQH5-3	8	N/A	N/A	(1) HQH5-P	8

### NOTES:

- Interlink IQ Electrical is a pluggable, single circuit electrical system.
  - All electrical models include wire management clips and hardware.
  - Interlink IQ Electrical is non-sequential/non-directional.
  - Interlink IQ Electrical is UL Recognized as a Powered Table System and meets the requirements of UL 962 when paired with Motivate® or Huddle tables.
- ⓘ 40' maximum run, or no more than 8 units, whichever comes first. Interlink IQ system will automatically shut off if maximum requirements are exceeded. Maximum run is based upon electrical harness width, not table width.

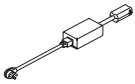
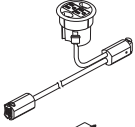
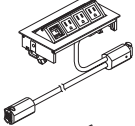
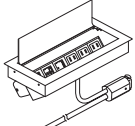
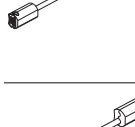
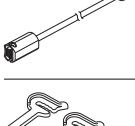
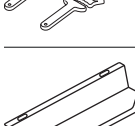
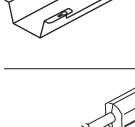
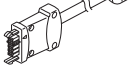
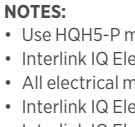
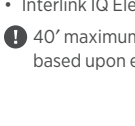

# INTERLINK IQ ELECTRICAL

	DESCRIPTION	MODEL	SHIP WEIGHT	CUBE	LIST PRICE
	<b>Power Base In-Feed</b> <ul style="list-style-type: none"> <li>12 amp circuit breaker is built in to the Power Base In-Feed.</li> <li>Available in Black finish, no specification needed.</li> </ul>	<b>HQB</b>	2.0	0.2	<b>\$697</b>
	<b>Power Harness – 1' Power Hub, 3'' Round Grommet Mount</b> <ul style="list-style-type: none"> <li>Available in Black finish, no specification needed.</li> </ul>	<b>HQH1-3</b>	2.0	0.2	<b>\$230</b>
	<b>Power Harness – 5' Power Hub, 3'' Round Grommet Mount</b> <ul style="list-style-type: none"> <li>Available in Black finish, no specification needed.</li> </ul>	<b>HQH5-3</b>	2.0	0.2	<b>\$257</b>
	<b>Power Harness – 5' with 4'' x 8'' Pop-Up Port (3 Power, 1 Blank)</b> <ul style="list-style-type: none"> <li>For use with tables G1 grommet. Specify paint.</li> </ul>	<b>HQH5-P-3P1B</b>	3.0	0.3	<b>\$502</b>
	<b>Power Harness – 5' with 5'' x 11'' Flip-Top Port (3 Power, 3 Blank)</b> <ul style="list-style-type: none"> <li>For use with Preside® G2 grommet. Specify paint.</li> </ul>	<b>HQH5-E-3P3B</b>	5.0	0.2	<b>\$528</b>
	<b>Power Harness – 5' with 5'' x 11'' Flip-Top Port (3 Power, 1 Extron Double Space)</b> <ul style="list-style-type: none"> <li>For use with Preside® G2 grommet. Specify paint.</li> </ul>	<b>HQH5-E-3P1E</b>	5.0	0.2	<b>\$557</b>
	<b>Power Harness – 5' with 5'' x 11'' Flip-Top Port (3 Power, 2 USB A+C, 2 Blank)</b> <ul style="list-style-type: none"> <li>For use with Preside® G2 grommet. Specify paint.</li> </ul>	<b>HQH5-E-3P1U2B</b>	5.0	0.2	<b>\$581</b>
	<b>Power Jumper – 3'</b> <ul style="list-style-type: none"> <li>Available in Black finish, no specification needed.</li> </ul>	<b>HQJ3</b>	2.0	0.2	<b>\$146</b>
	<b>Ganging Hardware</b> <ul style="list-style-type: none"> <li>Includes two ganging links and two screws.</li> <li>No color designator when specifying. <i>Example: HMAGANG.</i></li> </ul>	<b>HMAGANG</b>	1.0	0.1	<b>\$140</b>
	<b>Cable Management Troughs</b> 17''W – Single 17''W – 10-Pack <ul style="list-style-type: none"> <li>Available in Graphite finish, no specification needed.</li> </ul> NOTES: For additional information see page 251.	<b>HCTROUGH17</b> <b>HCTROUGH1710</b>	2.7 14.0	0.5 0.5	<b>\$96</b> <b>\$858</b>
	<b>IQ 1.0 Backward Compatible Jumper</b> 36'' <ul style="list-style-type: none"> <li>Available in Black finish, no specification needed.</li> <li>Use when connecting Interlink IQ 1.0 power harness (rectangle end) to Interlink IQ 2.0 (oval end) power harness.</li> </ul> <b>! If using Interlink IQ 2.0 in-feed with Interlink IQ 1.0 power harness please contact Customer Support.</b>	<b>HQBCJ36</b>	2.0	0.2	<b>\$111</b>

## NOTES:

- Use HQH5-P models with G1 table top cutouts and HQH5-E models with G2 table top cutouts.
- Interlink IQ Electrical is a pluggable, single circuit electrical system.
- All electrical models include wire management clips and hardware.
- Interlink IQ Electrical is non-sequential/non-directional.
- Interlink IQ Electrical is UL Recognized as a Powered Table System and meets the requirements of UL 962 when paired with Motivate® or Huddle tables.
- !** 40' maximum run, or no more than 8 units, whichever comes first. Interlink IQ system will automatically shut off if maximum requirements are exceeded. Maximum run is based upon electrical harness width, not table width.

## HOW TO SPECIFY

<b>Select Model Number</b> HQH5-E-3P3B	<b>Select Paint Color</b> FOG Fog SVR Silver BLK Black SVR
---	--

# 4-TRAC HARDWIRE ELECTRICAL SYSTEM

## 4-Trac Electrical System

The 4-Trac Electrical System is a UL-recognized Manufactured Wiring System that seamlessly passes power from one worksurface to another. This low-profile non-sequential electrical system allows tables to be “daisy-chained” together in any desired order and allows users to reconfigure quickly due to simple connectable/disconnectable links.

- Meets requirements of UL 183 and National Electric Code Article 604
- 4-Wires, 2-circuits, 20 Amps each (Circuit 1 and Circuit 2 only)
- 13 Duplex Receptacles per circuit, 26, 15 Amp Duplex receptacle per power in-feed
- Electrical system attaches directly to underside of worksurface with included brackets
- Up to twelve tables can be linked together

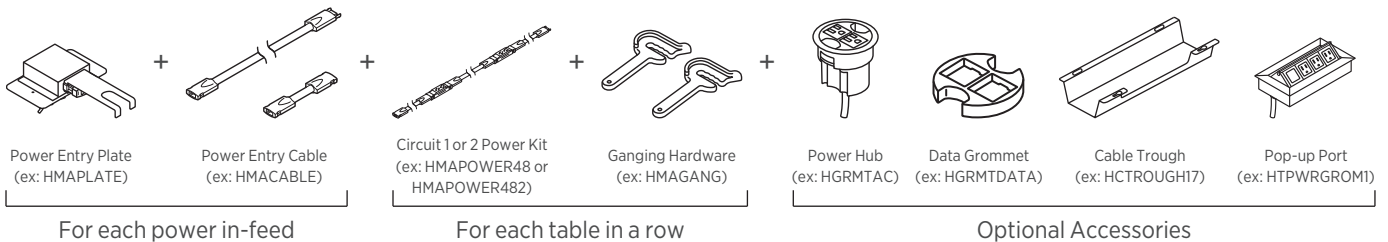



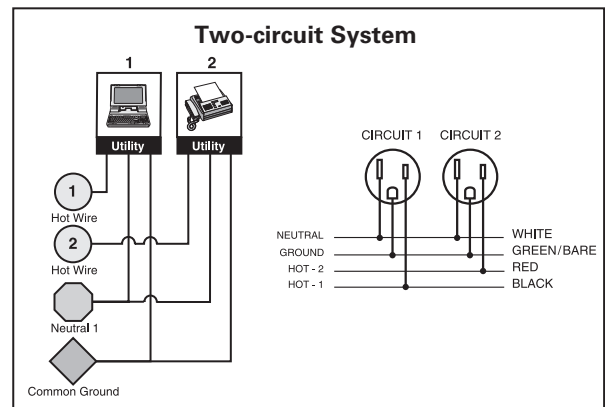
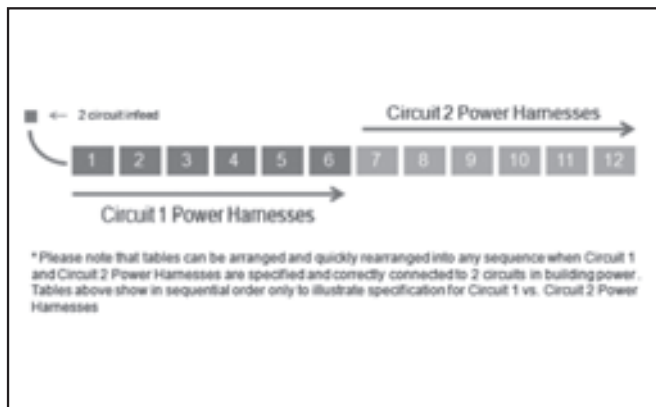

## Steps for Electrical Specifications:

- Determine how many rows of tables are needed and order the following:
  - One HMAPLATE per row (or power in-feed)
  - One HMAPOWER48 per row (or power in-feed)
- Order one power harness per table in each row
  - For 1-6 tables in a row (see illustration 1)
    - Order Circuit 1 Power Harnesses (ex. If powering six 24x60 tables order six sets of HMAPOWER60)
  - For 7-12 tables in a row (see illustration 1)
    - Order Circuit 1 Power Harness for first six tables and Circuit 2 Power Harness for remaining tables (ex. If powering eight 24x60 tables, order six sets of HMAPOWER60 and two sets of HMAPOWER602)
- Order one set of ganging hardware per table (ex. HMAGANG)
- Determine which accessories are needed:
  - Power Hub model HGRMTAC — to access power at worksurface.
  - Data Grommet model HGRMTDATA — to access data at worksurface.
  - Wire Management strips model HBTMS — for vertical and horizontal wire management.

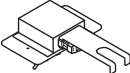
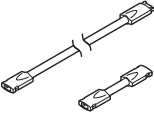

# 4-TRAC HARDWIRE ELECTRICAL SYSTEM

Icon Legend on page 19

	DESCRIPTION	MODEL	SHIP WEIGHT	CUBE	LIST PRICE
	<b>Power Entry Plate</b>	<b>HMAPLATE</b>	1.0	0.2	<b>\$140</b>
	<b>Power Entry Cable</b> • 6' power entry cable with male/female adapter. • Connects table to power entry plate.	<b>HMACABLE</b>	1.8	0.2	<b>\$217</b>
	<b>Power Jumper Cable</b> To connect tables front to front	<b>HMAJUMP</b>	0.5	0.3	<b>\$75</b>
	<b>Circuit 1 Power Kit for 36" W Table</b>	<b>HMAPOWER36</b>	1.5	0.3	<b>\$392</b>
	<b>Circuit 1 Power Kit for 42" W Table</b>	<b>HMAPOWER42</b>	1.8	0.3	<b>\$398</b>
	<b>Circuit 1 Power Kit for 48" W Table</b>	<b>HMAPOWER48</b>	1.8	0.3	<b>\$400</b>
	<b>Circuit 1 Power Kit for 54" W Table</b>	<b>HMAPOWER54</b>	2.0	0.3	<b>\$406</b>
	<b>Circuit 1 Power Kit for 60" W Table</b>	<b>HMAPOWER60</b>	2.0	0.3	<b>\$409</b>
	<b>Circuit 1 Power Kit for 66" W Table</b>	<b>HMAPOWER66</b>	2.2	0.3	<b>\$417</b>
	<b>Circuit 1 Power Kit for 72" W Table</b>	<b>HMAPOWER72</b>	2.2	0.3	<b>\$420</b>
	<b>Circuit 1 Power Kit for 84" W Table</b>	<b>HMAPOWER84</b>	2.4	0.3	<b>\$435</b>
	<b>Circuit 1 Power Kit for 96" W Table</b>	<b>HMAPOWER96</b>	2.6	0.3	<b>\$450</b>
	<b>Circuit 2 Power Kit for 36" W Table</b>	<b>HMAPOWER362</b>	1.5	0.3	<b>\$392</b>
	<b>Circuit 2 Power Kit for 42" W Table</b>	<b>HMAPOWER422</b>	1.8	0.3	<b>\$398</b>
	<b>Circuit 2 Power Kit for 48" W Table</b>	<b>HMAPOWER482</b>	1.8	0.3	<b>\$400</b>
	<b>Circuit 2 Power Kit for 54" W Table</b>	<b>HMAPOWER542</b>	2.0	0.3	<b>\$406</b>
	<b>Circuit 2 Power Kit for 60" W Table</b>	<b>HMAPOWER602</b>	2.0	0.3	<b>\$409</b>
<b>Circuit 2 Power Kit for 66" W Table</b>	<b>HMAPOWER662</b>	2.2	0.3	<b>\$417</b>	
<b>Circuit 2 Power Kit for 72" W Table</b>	<b>HMAPOWER722</b>	2.2	0.3	<b>\$420</b>	
<b>Circuit 2 Power Kit for 84" W Table</b>	<b>HMAPOWER842</b>	2.4	0.3	<b>\$435</b>	
<b>Circuit 2 Power Kit for 96" W Table</b>	<b>HMAPOWER962</b>	2.6	0.3	<b>\$450</b>	
	<b>Electrical Connectors</b> 4-Way Splitter  Available in Black (P) only. <b>SPECIFYING EXAMPLE: HMASPLIT.P</b>	<b>HMASPLIT</b>	0.9	0.1	<b>\$70</b>

**NOTES:**







- Each power kit includes two duplex receptacles and attaches to the underside of the worksurface with included brackets.
- Power Kits are compatible with various base types including nesting bases.
- Available in Black finish, no specification needed.

**HOW TO SPECIFY**

Select  
Model Number

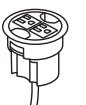
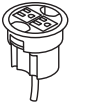
H M A P L A T E

## POWER &amp; CABLE MANAGEMENT

	DESCRIPTION	MODEL	SHIP WEIGHT	CUBE	LIST PRICE
 <p>Black only SIN 33721</p>	<p><b>Black Field Installable Grommet with One Access Hole</b></p> <ul style="list-style-type: none"> <li>Intended for use in tops and end panels to route/hide cords and facilitate reaching wall electrical outlets.</li> <li>Requires a 2½" diameter hole saw and drill for installation (not included).</li> <li>Grommet cap measures 3" diameter and includes a ¾" diameter cord access hole.</li> <li>Grommet sleeve measures 2½" O.D. x ¾" thick.</li> <li>Includes instructions to locate grommet position for desks, credenzas, returns and bridges.</li> </ul> <p>⚠ The grommet is not designed to be used with the following HON Series: 94000, 38000, Metro Classic or 34000.</p>	HFLDGRMT	0.1 Ⓢ	0.01	\$46
 <p>SIN 33721</p>	<p><b>Black Field Installable Grommet with Two Access Holes</b></p> <ul style="list-style-type: none"> <li>Requires a 3" diameter hole saw and drill for installation (not included).</li> <li>Grommet outside dimensions measures 3½" diameter.</li> <li>Grommet sleeve measures 3" O.D. x 1" thick.</li> <li>Includes instructions to locate grommet position for desks, credenzas, returns and bridges.</li> </ul>	HFLDGRMT3	0.1 Ⓢ	0.3	\$46
 <p>OPEN MARKET</p>	<p><b>Platinum Field Installable Grommet with Two Access Holes</b></p> <ul style="list-style-type: none"> <li>Requires a 3" diameter hole saw and drill for installation (not included).</li> <li>Outside dimension measures 3½" diameter.</li> <li>Sleeve hole in worksurface measures 3" O.D. x 1" thick.</li> <li>Includes instructions to locate grommet position for desks, credenzas, returns, and bridges.</li> </ul>	HFLDGRMT4	0.1	0.01	\$46
 <p>SIN 33721T</p>	<p><b>Power Hub, 3" Grommet Mount, 6' Cord</b></p> <ul style="list-style-type: none"> <li>Fits in 3" round grommet holes.</li> <li>Two grounded AC power outlets.</li> <li>Includes 6' cord with three-prong plug.</li> <li>Field installed with Plug-and-play ease.</li> </ul> <p>⚠ Available in black only (no color designation so use .X - Specify: HGRMTAC.X).</p>	HGRMTAC	1.3	0.2	\$173
 <p>SIN 33721T</p> <p></p>	<p><b>3" Round Power Grommet - 2 Outlets, 10' Cord</b></p> <ul style="list-style-type: none"> <li>Includes 10' cord with three-prong plug.</li> <li>Fits in 3" round grommet holes.</li> <li>Two grounded AC power outlets.</li> <li>Field installed with Plug-and-play ease.</li> </ul> <p>NOTES: Power Modules will also work with standing-height applications for 10500 Series™ and Voi® desks. Optional Memory Control allows preset worksurface heights for consistency. Ships separately. Dynamic load capacity when worksurface is moving is 300 lbs.</p> <p>⚠ Available in black finish only, no specification needed.</p>	HGRMTAC2	1.5	0.2	\$204
 <p>SIN 33721T</p>	<p><b>Power/USB Hub, 3" Grommet Mount</b></p> <ul style="list-style-type: none"> <li>One grounded AC power outlet with 1 USB-A, 1 USB-C ports.</li> <li>UL Listed.</li> </ul> <p>⚠ Available in black only (no color designation so use .X - Specify: HGRMTUSB2.X).</p> <p>⚠ Not compatible with Arrange® tables.</p>	HGRMTUSB2	1.3 Ⓢ	0.2	\$309
 <p>SIN 33721</p>	<p><b>Data Grommet</b></p> <p>Blank grommet kit that includes adapters for a variety of manufacturers jacks and couplers.</p> <ul style="list-style-type: none"> <li>Fits in existing 3" round grommet housing.</li> </ul> <p>⚠ Available in black only. Specify P when ordering. Example: HGRMTDATA.P.</p>	HGRMTDATA	0.2	0.2	\$33

## HOW TO SPECIFY

Select Model Number

H F L D G R M T





Icon Legend on page 19

# POWER

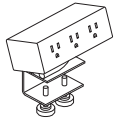

Model HPWRMOD3WC shown

### DESCRIPTION

#### Dean Power Modules with Worksurface Clamp

- 3 Receptacles
- 2 Receptacles, 1 USB-A, 1 USB-C
- 2 Receptacles, 1 USB with Qi Wireless Charging Top
- 6' power cord with standard three-prong plug.
- Worksurface clamp models work on any top with a 4" overhang.
- UL Listed.

### MODEL

- HPWRMOD3WC
- HPWRMOD2WC
- HPWRMOD4WC

### SHIP WEIGHT

- 2.3
- 2.3
- 2.3

### CUBE

- 0.2
- 0.2
- 0.2

### LIST PRICE

- \$422
- \$672
- \$912

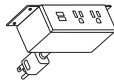

Model HPWRMOD2UWM shown

#### Dean Power Modules with Under-Worksurface Mounting Bracket

- 3 Receptacles
- 2 Receptacles, 1 USB-A, 1 USB-C
- 6' power cord with standard three-prong plug.
- Under-worksurface mounting bracket models work with any top that has a 5" x 5" square clearance.
- UL Listed.

- HPWRMOD3UWM
- HPWRMOD2UWM

- 2.3
- 2.3

- 0.2
- 0.2

- \$422
- \$672



#### Power & Data Center

- 2 Receptacles 2 Data Accessory
- Standard with two receptacles and openings for two data ports.
- 6' power cord with standard three-prong plug.
- Fits on any worksurface with a 4" overhang.
- UL Listed.

#### HCOMDOME2

2.5

0.2

\$403

Color finish coordinates with HON's Loft. Specify LOFT when ordering. Example: HCOMDOME2.LOFT.

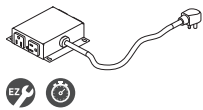

#### Under Worksurface Power Module -- 4 Outlets, 10' Cord

- Includes 10' cord with three-prong plug.
- Fits in cable management troughs. See page 251.
- 4 outlets on side create easy access.

#### HPWRMOD2

1.5

0.2

\$550

NOTES: Power Modules will also work with standing-height applications for 10500 Series™ and Voi® desks.

Available in black finish only, no specification needed.

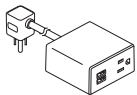

OPEN MARKET

#### Miki Surface Sit Power Module

- Includes 6' cord with three-prong plug.
- 1 Receptacle, 2 USB
- Unit features non-slip grip on underside.

#### HSMPWR-1P-2U

2.0

0.6

\$206

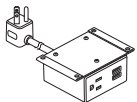

OPEN MARKET

#### Miki Under-Worksurface Power Module

- Includes 6' cord with three-prong plug.
- 1 Receptacle, 2 USB

#### HUMPWR-1P-2U

2.0

0.6

\$237

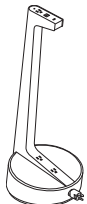

OPEN MARKET

#### Vesta Mobile Power Station

- Includes 10' retractable cord with three-prong plug.
- 3 AC, 1 Dual USB-A, 1 USB-C at top
- 2 AC at base
- Specify Paint and Plastic.

#### HPWRMOB1

14.0

3.3

\$1357

SPECIFYING EXAMPLE: HPWRMOB1.BLK.STRM

## HOW TO SPECIFY

Select Model Number

HSMPWR-1P-2U

Select Plastic

Specify for Dean and Miki models

- STRM Storm
- SNW Snow

SNW

Select Model Number

HPWRMOB1

Select Exterior Paint Color

Specify for model HPWRMOB1 only

- FOG Fog
- STRM Storm
- BLK Black
- SNW Snow

BLK

Select Paint Color

Specify for model HPWRMOB1 only

- FOG Fog
- STRM Storm
- BLK Black
- SNW Snow

STRM

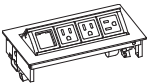
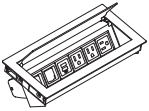
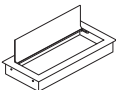

	DESCRIPTION	MODEL	SHIP WEIGHT	CUBE	LIST PRICE
	<p><b>MhoB 4" x 8" Pop-up Port</b></p> <ul style="list-style-type: none"> <li>Specify G1 cutout in table top.</li> <li>Pop-up Port provides three power ports and one blank data receptacle.</li> <li>Sits flush with worksurface when closed.</li> <li>Includes 6' cord with three-prong plug.</li> </ul>	<b>HTG1PWR-3P-1B</b>	5	0.3	<b>\$523</b>
	<p><b>ElloaB 5" x 11" Flip-top Port</b></p> <ul style="list-style-type: none"> <li>Specify G2 cutout in table top.</li> <li>Flip-top Port provides four power ports and two blank data receptacles.</li> <li>Conceals wires and allows power cords to be plugged in while in use.</li> <li>Includes 10' cord with three-prong circuit breaker plug.</li> </ul> <p>NOTES: Two circuit breaker plugs do not fit into one duplex.</p>	<b>HTG2PWR-4P-2B</b>	5	0.3	<b>\$770</b>
	<p><b>ElloaB 5" x 11" Flip-top Port</b></p> <ul style="list-style-type: none"> <li>Specify G2 cutout in table top.</li> <li>Flip-top Port provides one blank for Extron plate (HTPLATEVHAU) and three power ports.</li> <li>Extron AAP plates can be integrated into grommet to support changing technology.</li> <li>Conceals wires and allows power cords to be plugged in while in use.</li> <li>Includes 10' cord with three-prong plug.</li> </ul>	<b>HTG2PWR-3P-1E</b>	5	0.3	<b>\$942</b>
	<p><b>ElloaB 5" x 11" Flip-top Port</b></p> <ul style="list-style-type: none"> <li>Specify G2 cutout in table top.</li> <li>Flip-top Port provides 3 Power, 1 USB-A, 1 USB-C, and 2 Blank Data Ports.</li> <li>Conceals wires and allows power cords to be plugged in while in use.</li> <li>Includes 10' cord with three-prong plug.</li> </ul>	<b>HTG2PWR-3P-2B-2U</b>	5	0.3	<b>\$1117</b>
	<p><b>ElloaB 5" x 11" Flip-top Port</b></p> <ul style="list-style-type: none"> <li>Specify G2 cutout in table top.</li> <li>Flip-top Port provides 3 Power, 1 USB-A, 1 USB-C, and Qi wireless charging lid.</li> <li>Conceals wires and allows power cords to be plugged in while in use.</li> <li>Includes 10' cord with three-prong plug.</li> </ul>	<b>HTG2PWR-3P-1U-W</b>	5	0.3	<b>\$1143</b>
	Blank G1 Cutout Insert	<b>HGROM1BLANK</b>	2	0.2	<b>\$201</b>
	Blank G2 Cutout Insert	<b>HGROM2BLANK</b>	2	0.2	<b>\$307</b>
	! Grommets available in BLK, FOG, and SVR only.				

## HOW TO SPECIFY

<p>Select Model Number</p>	<p>Select Paint Color</p> <p><b>SVR</b> Silver  <b>BLK</b> Black  <b>FOG</b> Fog</p>
<p>H T G 2 P W R - 4 P - 2 B .</p>	<p>B L K</p>

# POWER

OPEN MARKET



Icon Legend on page 19

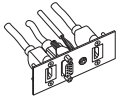

DESCRIPTION	MODEL	SHIP WEIGHT	CUBE	LIST PRICE
Extron Plate (Double Space) — VGA, HDMI, HDMI, Audio	HTPLATEVHAU	1	0.1	\$527

#### NOTES:

• 1 Double Space Plate can be used with HTG2PWR-3P-1E or HTPWRGROM4 Flip-top Port.

! Available in Black finish only, no specification needed.

WORKPLACE TOOLS

## HOW TO SPECIFY

Select  
Model Number

HTPLATEVHAU



Icon Legend on page 19

# POWER & CABLE MANAGEMENT

	DESCRIPTION	MODEL	SHIP WEIGHT	CUBE	LIST PRICE
	<b>Cable Management Troughs</b>				
	17"W — Single	<b>HCTROUGH17</b>	2.7 <b>Ⓔ</b>	0.5	<b>\$96</b>
	17"W — 10-Pack	<b>HCTROUGH1710</b>	14.0 <b>Ⓔ</b>	0.5	<b>\$858</b>
	36"W — Single	<b>HCTROUGH36</b>	4.9 <b>Ⓔ</b>	0.9	<b>\$159</b>
	36"W — 10-Pack	<b>HCTROUGH3610</b>	30.0 <b>Ⓔ</b>	0.9	<b>\$1444</b>
	<ul style="list-style-type: none"> <li>• Cable management troughs ship flat packed.</li> <li>• The troughs attach to underneath the worksurface with screws.</li> <li>• Cutouts in trough allow access to power without the need to detach from surface. 17"W = 1 cutout; 36"W = 2 cutouts.</li> <li>• Color: Graphite.</li> <li>• Material: Metal.</li> <li>• TAA Compliant.</li> </ul>				
 <p><b>OPEN MARKET</b></p>	<b>O-Leg Cord Clips</b>				
	Clips for 28½" Worksurface O-Legs — 8-Pack	<b>HWMCLIPLG</b>	0.8 <b>Ⓔ</b>	0.1	<b>\$139</b>
	Clips for Stack-on Storage, Hutch and Layering O-Legs — 4-Pack	<b>HWMCLIPSM</b>	0.5 <b>Ⓔ</b>	0.1	<b>\$92</b>
	<p>NOTES: Wire clips work with 7" Low Credenza O-leg and 29"H Support O-leg. Wire clips also work with the 50" and 65" Overhead O-leg supports.</p> <p>⚠ Available in frosted plastic material only.</p>				
 <p><i>Black only</i></p>	<b>Cable Management Tray</b>				
	24"	<b>HJTRGH24</b>	2.0 <b>Ⓔ</b>	0.3	<b>\$99</b>
	36"	<b>HJTRGH36</b>	3.0 <b>Ⓔ</b>	0.4	<b>\$121</b>
	⚠ Available in Black only.				
	<b>Vertical Wire Management Vertebrae</b>	<b>HMPVWM28</b>	3.0	0.3	<b>\$303</b>
	<p>NOTES: 30"H x 3¼"W x 1½"D. Ships unassembled.</p> <p>⚠ Clear finish. Specify "X" for finish option.</p> <p><b>SPECIFYING EXAMPLE: HMPVWM28.X</b></p>				

WORKPLACE TOOLS

## HOW TO SPECIFY

<p>Select Model Number</p> <p>H J T R G H 2 4 .</p>	<p>Select Paint Color</p> <p>P Black</p> <p>P</p>
---	---

# SEATING FUNCTIONS

Work/task chairs need to be adjusted to deliver optimum support. Cross-reference the letter key below to identify the chairs in this section that best meet your needs.

## PROPORTIONAL ADJUSTMENTS

These controls adapt the dimensions of the chair to fit the user.



**A. Pneumatic seat height adjustment** — Regulates height of chair relative to floor.

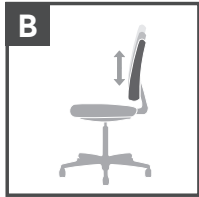

**B. Back height adjustment** — Positions lumbar support within a fixed range.



**C. Seat depth adjustment** — Positions chair back relative to seat.



**D. Seat slide mechanism** — Seat cushion travels forward and back, then locks into position.

## ARM OPTIONS

These adjustments accommodate different sized users and support keyboarding.



**Q. Adjustable height arms** — Provide improved upper-torso support. Can be adjusted periodically to relieve strain and provide variety.

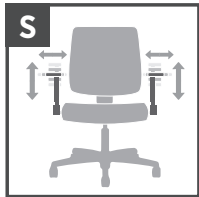

**S. Height and width adjustable arms** — Controls both height and width of arms for optimum comfort.



**T. Loop arms** — Largely specified for aesthetics. Frequently used in management settings.

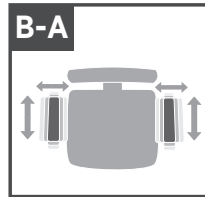

**B-A. All-adjustable arms** — Arms adjust in height, width, and depth.

## POSTURE CONTROLS

The controls modify the position and angle of the seat and back to respond to changing tasks.



**E. 360° Swivel**

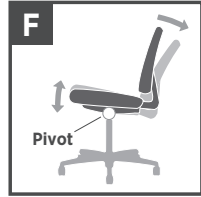

**F. Tilt** — Pivot point located directly above center of chair base.

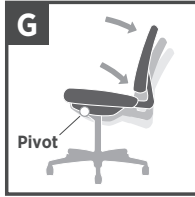

**G. Mid-range knee tilt** — Pivot point located slightly ahead of center of chair base. Allows user to recline at a slightly more relaxed angle than conventional tilt.

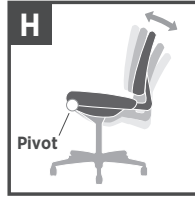

**H. Knee tilt** — Pivot point located near front edge of chair. Allows user to keep feet flat on floor while chair reclines.

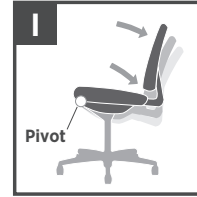

**I. Synchronized knee tilt** — Back reclines at a 2-to-1 ratio to seat angle. Pivot point located near front edge of chair.

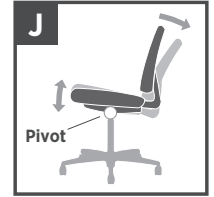

**J. Synchro-tilt** — Back reclines at a 2-to-1 ratio to seat angle. Allows user to recline while keeping seat cushion relatively level to floor.



**K. Tilt tension** — Controls rate and ease of recline.



**L. Tilt lock** — Locks out tilt function.



**M. Posture mechanism/lock** — Back angle adjusts independently of seat, and can be locked in an infinite number of positions within a fixed range.



**N. Multi-task control** — Adjusts seat and back angles independently with a single lever (infinite locking within a fixed range).



**O. Asynchronous control** — High performance system with three levers to modify: angle of back relative to seat, tilt (free float or infinite locking) and forward tilt.

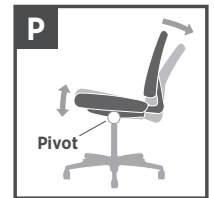

**P. Weight-activated synchro-tilt** — Back reclines at a 2 to 1 ratio to seat angle. Tilt tension automatically adjusts to user's body weight as user reclines.



**W. Integral lumbar support** — Easily adjusts to enhance comfort.



**X. Dual-clutch posture control** — Adjusts seat and back angles independently with two levers (infinite locking within a fixed range).

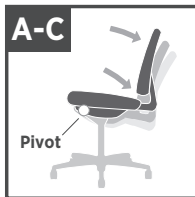

**A-C. Synchronized tilt** — Back reclines at a 2.5 to 1 ratio to seat angle. Variable lock.

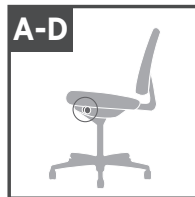

**A-D. Side tilt tension** — Controls rate and ease of recline. Conveniently located on the right side.

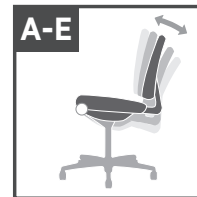

**A-E. Back reclines at a 2 to 1 ratio to seat angle.** Back angle adjusts independently of seat and can be locked in infinite number of positions within a fixed range.

# SEATING CONTROLS

	Gateway™	Convergence®	Endorse®	Ignition®	Solve®	Current Nucleus®	Nucleus® Recharged	Cofi™	Cipher™	Flexion™	Cliq™
<b>F</b>											
F0										X	
<b>S</b>											
S0			X	X			X				
S1			X	X			X				
S2				X							
<b>W</b>											
W0								X			X
W2				X			X				
W5											
W6									X		
<b>Y</b>											
Y0				X	X			X			
Y1		X		X	X		X				
Y2			X	X	X	X	X	X			
Y3			X	X							
Y4			X	X							
<b>Z</b>											
Z1	X	X									

- F**  
 0 Flex Mechanism One lever controls seat height and tilt lock. Bumpers integrated into seat/control to enable flexing seat.
- S**  
 S0 Limited recline synchro-tilt Same as Y controls except do not recline as far. Used on stools.  
 S1 Limited recline synchro-tilt w/seat slider  
 S2 Limited recline advanced synchro-tilt S2 used on Ignition® Mesh Seat.
- W**  
 W0 Weight activated No tension knob — recline adjusts to user.  
 W2 Weight activated synchro-tilt w/seat slider  
 W6 Integrated weight activated synchro-tilt w/seat slider \*Cipher™ only.
- Y**  
 Y0 Synchro-tilt Simple synchro-tilt (no seat slide).  
 Y1 Synchro-tilt w/seat slider Same as Y0 + seat slider.  
 Y2 Advanced synchro-tilt Synchro-tilt control with tilt tension (incl. seat slide).  
 Y3 Synchro-tilt w/independent back angle Same as Y2 and back also moves separate from seat.  
 Y4 Synchro-tilt B&T Same as Y2 for B&T — reduced recline than Y2.
- Z**  
 Z1 Swivel-tilt Simple swivel-tilt (no seat slide) — back attached to seat.

# PERFORMANCE SEATING ARM MATRIX

	ARM & PAD MOVEMENT			FIXED ARMS		
	2-D or A		4-D or V	Armless	Fixed Polymer	Fixed Polished Aluminum
	<b>Width Adjustment Bracket</b> 1) Entire arm moves wider and narrower 2) Arm moves up and down	<b>Pad Width Adjustment</b> 1) Pad slides side-to-side 2) Arm moves up and down	1) Pad slides side-to-side 2) Pad slides front-to-back 3) Pad pivots wider and narrower 4) Arm moves up and down			
<b>Gateway™</b>				X	X	
<b>Convergence*</b>	X			X		
<b>Cliq™</b>				X	X	
<b>Solve*</b>		X	X	X	X	
<b>Endorse* Standard</b>	X	X	X	X	X	X
<b>Endorse* B&amp;T</b>		X	X	X		
<b>Ignition* Standard</b>	X	X	X	X	X	X
<b>Ignition* B&amp;T</b>		X	X	X		
<b>Flexion™</b>				X	X	
<b>Nucleus*</b>		X	X	X	X	X
<b>Cipher™</b>			X	X		
<b>Cofi™</b>				X	X	X



# ORDERING INFORMATION

Seating	Standard Fabric Selections by Series with Price Code and Fabric Material																														
Model/Series	1	1	1	1	1	1	1	1	1	1	1	1	1	1	1	1	1	2	2	2	2	2	2	2	2	3	3	3	3	L	L
	APX	EB	VA	GA	MM	EA	CU	COMP	COMF	UR	DAPR	ENSB	HAML	NR	OP	PBLE	PNS	BLME	CLYD	DOT	RUSH	SPNN	WP	SX	PRKR	PURL	GUL	DAV	SS		
	Apex	Black & Burgundy Vinyl	Black, Charcoal, & Navy Fabric	Black & Navy Fabric	Black Sandwich Mesh Fabric	Black Vinyl	Centurion	Compass	Compass Foam	Contourett	Dapper	Ensemble	Hamilton	Inertia	Optic	Pebble	Appoint Seating	Blume	Clyde	Doty	Rush	Spin Seating	Whisper Vinyl	Moxie	Parker	Purl	Guill	Davenport Leather	Denver Leather**		
Accommodate®	•						•	•		•	•	•	•	•	•	•	•	•	•	•	•	•	•	•	•	•	•		•		
Adjustable Task/Lab Stool						•																									
Astir™	•						•	•		•	•	•	•	•	•	•	•	•	•	•	•	•	•	•	•	•	•	•			
Cliq™	•						•	•		•	•	•	•	•	•	•	•	•	•	•	•	•	•	•	•	•	•	•			
Cofi™	•						•	•		•	•	•	•	•	•	•	•	•	•	•	•	•	•	•	•	•	•	•	•		
Convergence®	•						•	•		•	•	•	•	•	•	•	•	•	•	•	•	•	•	•	•	•	•	•			
Endorse® Task***	•						•	•		•	•	•	•	•	•	•	•	•	•	•	•	•	•	•	•	•	•	•			
Flock**	•						•	•		•	•	•	•	•	•	•	•	•	•	•	•	•	•	•	•	•	•	•	•	•	
Flock® Round Lounge HFLRC1/DF	•						•	•		•	•	•	•	•	•	•	•	•	•	•	•	•	•	•	•	•	•	•	•	•	
Grove®	•						•	•		•	•	•	•	•	•	•	•	•	•	•	•	•	•	•	•	•	•	•	•	•	
Ignition® Series	•						•	•		•	•	•	•	•	•	•	•	•	•	•	•	•	•	•	•	•	•	•	•	•	
Lota® H2285			•																												
Mav™	•						•	•		•	•	•	•	•	•	•	•	•	•	•	•	•	•	•	•	•	•	•	•	•	
Motivate®	•						•	•		•	•	•	•	•	•	•	•	•	•	•	•	•	•	•	•	•	•	•	•	•	
Nucleus® Series	•						•	•		•	•	•	•	•	•	•	•	•	•	•	•	•	•	•	•	•	•	•	•	•	
Perpetual® Nesting	•						•	•		•	•	•	•	•	•	•	•	•	•	•	•	•	•	•	•	•	•	•	•	•	
Pillow-Soft® 2090 Series	•	•					•	•		•	•	•	•	•	•	•	•	•	•	•	•	•	•	•	•	•	•	•	•	•	
Solve®	•						•	•	•	•	•	•	•	•	•	•	•	•	•	•	•	•	•	•	•	•	•	•	•	•	•
Soothe®	•						•	•		•	•	•	•	•	•	•	•	•	•	•	•	•	•	•	•	•	•	•	•	•	•
Volt® 5700/5710 Series				•																											
Volt® 5720/5730 Series	•						•	•		•	•	•	•	•	•	•	•	•	•	•	•	•	•	•	•	•	•	•	•	•	
West Hill™	•						•	•		•	•	•	•	•	•	•	•	•	•	•	•	•	•	•	•	•	•	•	•	•	
Credenza/Pedestal Cushions	•						•	•		•	•	•	•	•	•	•	•	•	•	•	•	•	•	•	•	•	•	•	•	•	

\*Flock® chair model HFLRC1 has fabric limitations, please see the Flock® seating pages 327-334 for details.

\*\*Denver Leather (SS) may not be available on every model within a specific series, please refer to the model's page for details.

\*\*\*Pebble available on Endorse® Task as seat option only.

# ORDERING INFORMATION

- Seating pages are now arranged in alpha, then numeric, order.
- **All specifications in this publication are based on the latest product information available at the time of print.**
- COM Ordering Information and pricing on page 13.
- Remember to add an FC to the base model number when fire code fabric is selected. See page 258 for available models/fabrics.
- Wood components are well-seasoned select hardwoods, chosen for their strength, their ability to machine well and their superior uniformity of stain and finish.
- Chairs with leather feature matching vinyl backs and vinyl seat bottom when applicable (Non-contact areas are vinyl).

Wood Seating	Finish Codes								Standard Fabric Selections by Series with Price Code and Fabric Material														
									1	1	1	1	1	1	1	2	2	2	2	2	2	3	L
Model/Series	Bourbon Cherry	Cognac	Harvest	Mahogany	Mocha	Natural Maple	Pinnacle	Shaker Cherry	EB	CU	COMP	DAPR	HAML	NR	OP	PNS	CLYD	DOT	RUSH	SPNN	WP	PURL	SS
Cambia™ 2160 Series	H	COGN	C	N	MOCH	D	PINC	F		•	•	•	•	•	•	•	•	•	•	•	•	•	•
Park Avenue Collection® 5000 Series	H	COGN	C	N	MOCH	D	PINC	F		•	•	•	•	•	•	•	•	•	•	•	•	•	•
Pillow-Soft® 2190 Series	H	COGN	C	N	MOCH	D	PINC	F	•	•	•	•	•	•	•	•	•	•	•	•	•	•	•
Versant® Wood	H	COGN	C	N	MOCH	D	PINC	F		•	•	•	•	•	•	•	•	•	•	•	•	•	•

Note: Gathers and creases may be more visible with AI and OP fabrics due to the inherent design and construction of these fabrics. Harvest, Cognac, Natural Maple, and Pinnacle de-emphasized for Park Avenue® and Pillow-Soft® Seating.

# FIRE CODE/COMPLIANT SEATING

## FIRE SAFETY

### Definitive Protection — CAL TB 117-2013

- TB 117-2013 — The State of California, Department of Consumer Affairs, Bureau of Electronic and Home Appliance Repair, Home Furnishings and Thermal Insulation (BEARHFTI) Technical Bulletin (TB) 117-2013 is the industry flammability standard for upholstered furniture, and provides methods for smolder resistance of cover fabrics, barrier materials, resilient filling materials, and decking materials for use in upholstered furniture.
- The fabrics and resilient filling materials used in upholstered seating manufactured by The HON Company meet or exceed the flame retardant requirements of State of California TB 117-2013. The label attached to the seat bottom indicates compliance with these requirements.

### Elevate Fire Safety to a Higher Standard — CAL TB 133

- The State of California announced in January 2019 that Technical Bulletin (TB) 113, The Flammability Test Procedure for Seating Furniture for Use in Public Occupancies has been repealed effective January 22, 2019.
- While the CAL 133 standard has been repealed, a select subset of The HON Company's most popular chair models are still available in an array of fabrics that include an advanced barrier of fire protection to help comply with CAL 133 requirements.
- To ensure that the chairs you order comply with CAL 133, specify one of the fabrics listed below. Then simply add "FC" to the model number when ordering one of the select available models. A standard upcharge of \$90 will be applied per seat model for all single seat chairs.
- **SPECIFYING EXAMPLE: HIWMMFC.Y2.A.H.IM.CU10.NL.SB.T**

## CAL 133 COMPLIANT MODELS

### IGNITION® SEATING

HIEH1FC, HIEH2FC, HIEH3FC, HIWM1FC, HIWM2FC, HIWM3FC, HITL1FC, HITL2FC, HITL3FC, HIGCLFC, HIGS6FC, HISB6FC, HICS7FC, HIB50FC, HITLMFC, HIWMMFC, HITSMFC

### MOTIVATE® SEATING

HMN2FC — Available in Onyx (ON) shell only.

#### NOTES:

- Creases and gathers may be visible with CAL 133 Fire Code seating due to the construction of the fire barrier material used.
- Please refer to each model's page for specific fabric availability.
- Contact HON Tailored Solutions Team for all other requests.

## CAL 133 COMPLIANT FABRIC

### GRADE 1

<b>APX</b>	Apex
<b>COMP</b>	Compass
<b>CU</b>	Centurion
<b>DAPR</b>	Dapper
<b>ENSB</b>	Ensemble
<b>HAML</b>	Hamilton
<b>NR</b>	Inertia
<b>OP</b>	Optic

### GRADE 2

<b>BLME</b>	Blume
<b>CLYD</b>	Clyde
<b>DOT</b>	Dotty
<b>KAI</b>	Kai
<b>PNS</b>	Appoint Seating
<b>RUSH</b>	Rush
<b>SPNN</b>	Spin
<b>WP</b>	Whisper Vinyl
<b>WVL</b>	Wavelength

### GRADE 3

<b>GTWY</b>	Getaway
<b>PURL</b>	Purl
<b>QUL</b>	Quill

### GRADE 4

<b>LIVI</b>	Livi with Supreen™
<b>OXFD</b>	Oxford with Supreen™

### GRADE L

<b>SS</b>	Leather
-----------	---------

# ACCOMMODATE®

Want to see more? Scan here  
to check out hon.com.



Accommodate® Café-Height Stools shown in  
Centurion Black.

## ACCOMMODATE®

The key to designing a collaborative environment is to support productivity throughout the space. From waiting areas and cafés to meeting spaces and offices, Accommodate creates opportunities for people to get work done in a comfortable, casual setting. Cluster together. Form neat rows. Stack four high. With guest and bariatric chairs, as well as café and counter-height stools, Accommodate brings greater comfort, versatility and continuity throughout your space with a seating collection that adapts to your environment, people and budget.



## FEATURES

- Thin profile seat cushion conforms to your body.
- Contoured back ergonomically supports the spine.
- Chairs can stack up to four high.
- Chairs can gang together to form neat rows.
- Waterfall seat edge enhances leg circulation.
- Lightweight frame is easy to move.
- Nylon glides slide effortlessly on hard surfaces.
- Tube rolled steel frame adds durability.
- Wall-saver design protects walls and cabinets.
- Warranted for users up to 300 lbs. (Models HSB50 and HSB50DF are warranted for users up to 500 lbs.)
- Available in Seated-, Counter-, and Café-heights.

SEATING

# ACCOMMODATE® Options

## MODEL OPTIONS

HSGS6  
HSGS6DF - Multi-Fabric



Guest Chair

HSCS1  
HSCS1DF - Multi-Fabric



Counter-Height Stool

HSCS2  
HSCS2DF - Multi-Fabric



Café-Height Stool

HSB50  
HSB50DF - Multi-Fabric

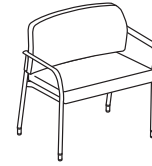

Bariatric Chair





### ARM STYLE

	CODE	DESCRIPTION	PRICE
	<b>N</b>	Armless	<b>+\$0</b>
	<b>F</b>	Fixed Arms	<b>+\$33</b>

### FRAME

	CODE	DESCRIPTION	PRICE
	<b>CBK</b>	Charblack	<b>+\$0</b>
	<b>PK7</b>	Textured Designer White	<b>+\$0</b>
	<b>P7J</b>	Textured Brownstone	<b>+\$0</b>
	<b>P7A</b>	Textured Charcoal	<b>+\$0</b>
	<b>P7L</b>	Textured Loft	<b>+\$0</b>
	<b>P7M</b>	Textured Muslin	<b>+\$0</b>
	<b>PR8</b>	Textured Silver	<b>+\$0</b>
	<b>P8V</b>	Textured Titanium	<b>+\$0</b>

### CASTERS/ GLIDES

	CODE	DESCRIPTION	PRICE
	<b>E</b>	Standard Nylon Glide	<b>+\$0</b>
	<b>H</b>	Black Hard Caster	<b>+\$0</b>
	<b>S</b>	Black Soft Caster	<b>+\$33</b>
	<b>B</b>	Both Hard Casters and Standard Nylon Glides	<b>+\$22</b>

\*Options H, S & B available for HSGS6 and HSGS6DF models only

# ACCOMMODATE® Fabric Options

## HON BRANDED FABRICS

### GRADE 1

Apex\*  
Centurion  
Compass  
Contourett\*  
Dapper  
Ensemble  
Hamilton  
Inertia  
Noble Seating  
Optic  
Pebble  
Vibe

### GRADE 2

Appoint Seating  
Blume  
Clyde  
Dotty  
Kai  
Rush  
Spin  
Wavelength  
Whisper Vinyl

### GRADE 3

Bradbury  
Getaway  
Moxie  
Notion  
Parker\*  
Purl  
Quill  
Saxony

### GRADE 4

Constance with Supreen™  
Livi with Supreen™  
Lugano with Supreen™  
Oxford with Supreen™

**For a complete list of fabrics, including partnership fabrics, go to [hon.com/fabricsandfinishes](https://hon.com/fabricsandfinishes).**

Reference Fabric Color Combinations on pages 20-25 for color codes and legend on page 21 for lead times.

\*Only available as a seat fabric on Multi-Fabric models. Cannot be used with any Single-Fabric models.

# ACCOMMODATE®

GSA SIN 33721



Icon Legend on page 19

## HSGS6

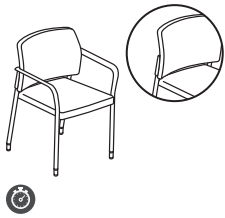

### GUEST CHAIR

Set of Two Guest Chairs

### DIMENSIONS

Depth:	22¼	Seat to Floor Height:	18¼
Height:	31½	Usable Seat Depth:	17
Seat Depth:	20¾	Ship Weight (with arms):	50
Seat Width:	17½	Ship Weight (armless):	48
Back Width:	19¾	Cube (with arms):	15.8
Back Height:	16¼	Cube (armless):	15.8
Width (with arms):	23½	COM (per 2 pack):	3.0
Width (armless):	19¾	Weight Rating:	300 lbs.
Arm Width:	20¼		

### FABRIC PRICE CODES

<b>1</b>	<b>\$1046</b>	<b>8</b>	<b>\$1492</b>
<b>2</b>	<b>\$1125</b>	<b>9</b>	<b>\$1551</b>
<b>3</b>	<b>\$1202</b>	<b>10</b>	<b>\$1609</b>
<b>4</b>	<b>\$1260</b>	<b>11</b>	<b>\$1667</b>
<b>5</b>	<b>\$1318</b>	<b>12</b>	<b>\$1725</b>
<b>6</b>	<b>\$1376</b>	<b>L</b>	<b>—</b>
<b>7</b>	<b>\$1435</b>		

NOTES: For Ganging Brackets see page 265. Accommodate® Guest Chairs stack 4-high.

## HSCS1

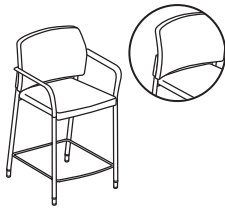

### COUNTER-HEIGHT STOOL

### DIMENSIONS

Depth:	23½	Seat to Floor Height:	25½
Height:	38¾	Usable Seat Depth:	17
Seat Depth:	20¾	Ship Weight (with arms):	36
Seat Width:	17½	Ship Weight (armless):	35
Back Width:	19¾	Cube (with arms):	15.8
Back Height:	16¼	Cube (armless):	15.8
Width (with arms):	23½	COM:	2.0
Width (armless):	19¾	Weight Rating:	300 lbs.
Arm Width:	20¼		

### FABRIC PRICE CODES

<b>1</b>	<b>\$634</b>	<b>8</b>	<b>\$858</b>
<b>2</b>	<b>\$674</b>	<b>9</b>	<b>\$887</b>
<b>3</b>	<b>\$713</b>	<b>10</b>	<b>\$916</b>
<b>4</b>	<b>\$742</b>	<b>11</b>	<b>\$945</b>
<b>5</b>	<b>\$770</b>	<b>12</b>	<b>\$974</b>
<b>6</b>	<b>\$799</b>	<b>L</b>	<b>—</b>
<b>7</b>	<b>\$829</b>		

## HSGANG

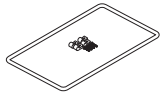

### GANGING BRACKET

(hardware included)

### DIMENSIONS

Ship Weight: **5** Ⓢ

### LIST PRICE

**\$51**

NOTES: For use on models HSGS6 and HSGS6DF.

! No specification required for bracket. The ganging bracket is only available in black. The ganging bracket does not work on the bariatric unit.

**HON Recommendation: HSGS6.N.E.CU\_\_PR8 - List Price \$1046**

SEATING

## HOW TO SPECIFY

<p><b>Select Model Number</b></p> <p>H S G S 6 .</p>	<p><b>Select Arm Type</b></p> <p><b>N</b> Armless <b>F</b> Fixed Arms (+ \$33 per chair)</p> <p>N .</p>	<p><b>Select Caster/Glide</b></p> <p><b>E</b> Standard Nylon Glide <b>H</b> Hard Caster <b>S</b> Soft Caster (+ \$33 per chair) <b>B</b> Both Hard Casters and Standard Nylon Glides (+ \$22 per chair) <i>Options H, S &amp; B available for HSGS6 model only</i></p> <p>E .</p>	<p><b>Select Fabric</b></p> <p>See page 261</p> <p>C U 1 0 .</p>	<p><b>Select Frame</b></p> <p>See page 260</p> <p>P R 8</p>
--	---	---	--	---



# ACCOMMODATE®

## HSCS2

### CAFÉ-HEIGHT STOOL



### DIMENSIONS

Depth:	24½	Seat to Floor Height:	31½
Height:	44¾	Usable Seat Depth:	17
Seat Depth:	20¾	Ship Weight (with arms):	38
Seat Width:	17½	Ship Weight (armless):	37
Back Width:	19¾	Cube (with arms):	19.1
Back Height:	16¼	Cube (armless):	19.1
Width (with arms):	23½	COM:	2.0
Width (armless):	19¾	Weight Rating:	300 lbs.
Arm Width:	20¼		

### FABRIC PRICE CODES

1	\$696	8	\$920
2	\$736	9	\$949
3	\$775	10	\$978
4	\$804	11	\$1007
5	\$832	12	\$1036
6	\$861	L	—
7	\$891		

## HSB50

### BARIATRIC CHAIR

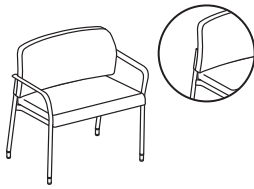

### DIMENSIONS

Depth:	21½	Seat to Floor Height:	19
Height:	32½	Usable Seat Depth:	16¾
Seat Depth:	20¼	Ship Weight (with arms):	50
Seat Width:	28	Ship Weight (armless):	49
Back Width:	29	Cube (with arms):	27.2
Back Height:	16½	Cube (armless):	27.2
Width (with arms):	33½	COM:	2.0
Width (armless):	30	Weight Rating:	500 lbs.
Arm Width:	30		

### FABRIC PRICE CODES

1	\$1121	8	\$1419
2	\$1174	9	\$1458
3	\$1226	10	\$1496
4	\$1264	11	\$1536
5	\$1303	12	\$1574
6	\$1342	L	—
7	\$1380		

**HON Recommendation: HSCS2.N.E.CU\_\_PR8 - List Price \$696**

## HOW TO SPECIFY

<p><b>Select Model Number</b></p> <p>H S C S 2 .</p>	<p><b>Select Arm Type</b></p> <p>N Armless F Fixed Arms (+ \$33 per chair)</p> <p>N .</p>	<p><b>Select Caster/Glide</b></p> <p>E Standard Nylon Glide</p> <p>E .</p>	<p><b>Select Fabric</b></p> <p>See page 261</p> <p>C U 1 0 .</p>	<p><b>Select Frame</b></p> <p>See page 260</p> <p>P R 8</p>
--	---	--	--	---



# ACCOMMODATE®



Icon Legend on page 19

## HSGS6DF

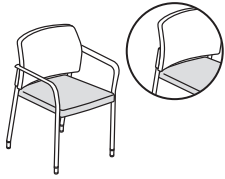

### GUEST CHAIR

**Multi-Fabric**  
Set of Two Guest Chairs

### DIMENSIONS

Depth:	22¼	Seat to Floor Height:	18¼
Height:	31½	Usable Seat Depth:	17
Seat Depth:	20¾	Ship Weight (with arms):	50
Seat Width:	17½	Ship Weight (armless):	48
Back Width:	19¾	Cube (with arms):	15.8
Back Height:	16¼	Cube (armless):	15.8
Width (with arms):	23½	COM (Seat, per 2 pack):	1.5
Width (armless):	19¾	COM (Back, per 2 pack):	1.5
Arm Width:	20¼	Weight Rating:	300 lbs.

### FABRIC PRICE CODES

<b>1</b>	<b>\$1226</b>	
<i>Add to Base Price Above</i>		
	<b>Back</b>	<b>Seat</b>
<b>2</b>	<b>\$40</b>	<b>\$40</b>
<b>3</b>	<b>\$79</b>	<b>\$79</b>
<b>4</b>	<b>\$108</b>	<b>\$108</b>
<b>5</b>	<b>\$136</b>	<b>\$136</b>
<b>6</b>	<b>\$165</b>	<b>\$165</b>
<b>7</b>	<b>\$195</b>	<b>\$195</b>
<b>8</b>	<b>\$224</b>	<b>\$224</b>
<b>9</b>	<b>\$253</b>	<b>\$253</b>
<b>10</b>	<b>\$282</b>	<b>\$282</b>
<b>11</b>	<b>\$311</b>	<b>\$311</b>
<b>12</b>	<b>\$340</b>	<b>\$340</b>

NOTES: For Ganging Brackets see page 265. Accommodate® Guest Chairs stack 4-high.

## HSCS1DF

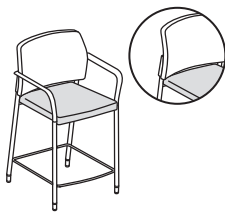

### COUNTER-HEIGHT STOOL

**Multi-Fabric**

### DIMENSIONS

Depth:	23½	Seat to Floor Height:	25½
Height:	38¾	Usable Seat Depth:	17
Seat Depth:	20¾	Ship Weight (with arms):	36
Seat Width:	17½	Ship Weight (armless):	35
Back Width:	19¾	Cube (with arms):	15.8
Back Height:	16¼	Cube (armless):	15.8
Width (with arms):	23½	COM (Seat):	1.0
Width (armless):	19¾	COM (Back):	1.0
Arm Width:	20¼	Weight Rating:	300 lbs.

### FABRIC PRICE CODES

<b>1</b>	<b>\$724</b>	
<i>Add to Base Price Above</i>		
	<b>Back</b>	<b>Seat</b>
<b>2</b>	<b>\$20</b>	<b>\$20</b>
<b>3</b>	<b>\$40</b>	<b>\$40</b>
<b>4</b>	<b>\$55</b>	<b>\$55</b>
<b>5</b>	<b>\$68</b>	<b>\$68</b>
<b>6</b>	<b>\$84</b>	<b>\$84</b>
<b>7</b>	<b>\$98</b>	<b>\$98</b>
<b>8</b>	<b>\$113</b>	<b>\$113</b>
<b>9</b>	<b>\$127</b>	<b>\$127</b>
<b>10</b>	<b>\$142</b>	<b>\$142</b>
<b>11</b>	<b>\$156</b>	<b>\$156</b>
<b>12</b>	<b>\$171</b>	<b>\$171</b>

**HON Recommendation: HSGS6DF.N.E.CU\_\_CU\_\_PR8 - List Price \$1226**

## HOW TO SPECIFY

<p><b>Select Model Number</b></p> <p>H S G S 6 D F .</p>	<p><b>Select Arm Type</b></p> <p><b>N</b> Armless <b>F</b> Fixed Arms (+ \$33 per chair)</p> <p>N .</p>	<p><b>Select Caster/Glide</b></p> <p><b>E</b> Standard Nylon Glide <b>H</b> Hard Caster <b>S</b> Soft Caster (+ \$33 per chair) <b>B</b> Both Hard Casters and Standard Nylon Glides (+ \$22 per chair)</p> <p><i>Options H, S &amp; B available for HSGS6DF model only</i></p> <p>E .</p>	<p><b>Select Back Fabric</b></p> <p>See page 261</p> <p>C U 2 2 .</p>	<p><b>Select Seat Fabric</b></p> <p>See page 261</p> <p>C U 1 0 .</p>	<p><b>Select Frame</b></p> <p>See page 260</p> <p>P R 8</p>
--	---	--	---	---	---



## HSCS2DF



### CAFÉ-HEIGHT STOOL

Multi-Fabric

### DIMENSIONS

Depth:	24½	Seat to Floor Height:	31½
Height:	44¾	Usable Seat Depth:	17
Seat Depth:	20¾	Ship Weight (with arms):	38
Seat Width:	17½	Ship Weight (armless):	37
Back Width:	19¾	Cube (with arms):	19.1
Back Height:	16¼	Cube (armless):	19.1
Width (with arms):	23½	COM (Seat):	1.0
Width (armless):	19¾	COM (Back):	1.0
Arm Width:	20¼	Weight Rating:	300 lbs.

### FABRIC PRICE CODES

<b>1</b>	<b>\$786</b>	
<i>Add to Base Price Above</i>		
	<b>Back</b>	<b>Seat</b>
<b>2</b>	<b>\$20</b>	<b>\$20</b>
<b>3</b>	<b>\$40</b>	<b>\$40</b>
<b>4</b>	<b>\$55</b>	<b>\$55</b>
<b>5</b>	<b>\$68</b>	<b>\$68</b>
<b>6</b>	<b>\$84</b>	<b>\$84</b>
<b>7</b>	<b>\$98</b>	<b>\$98</b>
<b>8</b>	<b>\$113</b>	<b>\$113</b>
<b>9</b>	<b>\$127</b>	<b>\$127</b>
<b>10</b>	<b>\$142</b>	<b>\$142</b>
<b>11</b>	<b>\$156</b>	<b>\$156</b>
<b>12</b>	<b>\$171</b>	<b>\$171</b>

## HSB50DF

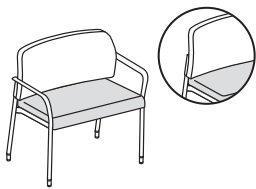

### BARIATRIC CHAIR

Multi-Fabric

### DIMENSIONS

Depth:	21½	Seat to Floor Height:	19
Height:	32½	Usable Seat Depth:	16¾
Seat Depth:	20¼	Ship Weight (with arms):	50
Seat Width:	28	Ship Weight (armless):	49
Back Width:	29	Cube (with arms):	27.2
Back Height:	16½	Cube (armless):	27.2
Width (with arms):	33½	COM (Seat):	1.0
Width (armless):	30	COM (Back):	1.0
Arm Width:	30	Weight Rating:	500 lbs.

### FABRIC PRICE CODES

<b>1</b>	<b>\$1211</b>	
<i>Add to Base Price Above</i>		
	<b>Back</b>	<b>Seat</b>
<b>2</b>	<b>\$27</b>	<b>\$27</b>
<b>3</b>	<b>\$53</b>	<b>\$53</b>
<b>4</b>	<b>\$72</b>	<b>\$72</b>
<b>5</b>	<b>\$91</b>	<b>\$91</b>
<b>6</b>	<b>\$111</b>	<b>\$111</b>
<b>7</b>	<b>\$130</b>	<b>\$130</b>
<b>8</b>	<b>\$150</b>	<b>\$150</b>
<b>9</b>	<b>\$169</b>	<b>\$169</b>
<b>10</b>	<b>\$188</b>	<b>\$188</b>
<b>11</b>	<b>\$208</b>	<b>\$208</b>
<b>12</b>	<b>\$227</b>	<b>\$227</b>

## HSGANG

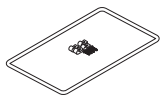

### GANGING BRACKET

(hardware included)

### DIMENSIONS

Ship Weight: 5 Ⓞ

### LIST PRICE

\$51

NOTES: For use on models HSGS6 and HSGS6DF.

ⓘ No specification required for bracket. The ganging bracket is only available in black. The ganging bracket does not work on the bariatric unit.

**HON Recommendation: HSCS2DF.N.E.CU\_\_CU\_\_PR8 - List Price \$786**

## HOW TO SPECIFY

<p><b>Select Model Number</b></p> <p>H S C S 2 D F .</p>	<p><b>Select Arm Type</b></p> <p>N Armless F Fixed Arms (+ \$33)</p> <p>N .</p>	<p><b>Select Caster/Glide</b></p> <p>E Standard Nylon Glide</p> <p>E .</p>	<p><b>Select Back Fabric</b></p> <p>See page 261</p> <p>C U 2 2 .</p>	<p><b>Select Seat Fabric</b></p> <p>See page 261</p> <p>C U 1 0 .</p>	<p><b>Select Frame</b></p> <p>See page 260</p> <p>P R 8</p>
--	---	--	---	---	---

# ADJUSTABLE TASK/LAB Stools

OPEN MARKET



Icon Legend on page 19

## HMTS01

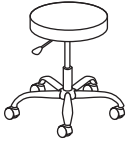

### TASK/LAB STOOL

#### without Back

Pneumatic  
Swivel

Functions: **A, E**

(Function Key on pages 252-253)

### DIMENSIONS

Depth:	27¼	Seat to Floor Height:	17¾-22
Width:	24⅝	Usable Seat Depth:	16
Height:	17¾-22	Ship Weight:	22
Seat:	16" Dia.	Cube:	2.5
		Weight Rating:	250 lbs.

### FABRIC PRICE CODE

**1 \$525**

NOTES: EA vinyl is a healthcare covering that meets AATCC Test Method 147-2004.

ⓘ Available in polished base ONLY. Available in Grade 1, Black, EA11 fabric ONLY.

## HMTS11

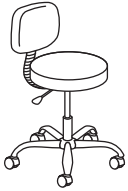

### TASK/LAB STOOL

#### with Back

Pneumatic  
Back Height  
Seat Depth  
Swivel

Functions: **A, B, C, E**

(Function Key on pages 252-253)

### DIMENSIONS

Depth:	27¼	Seat to Floor Height:	17¾-22
Width:	24⅝	Usable Seat Depth:	14¾-16
Height:	31½-38	Ship Weight:	29
Seat:	16" Dia.	Cube:	2.7
Back Width:	15½	Weight Rating:	250 lbs.
Back Height:	8¾-16		

### FABRIC PRICE CODE

**1 \$703**

NOTES: EA vinyl is a healthcare covering that meets AATCC Test Method 147-2004.

ⓘ Available in polished base ONLY. Available in Grade 1, Black, EA11 fabric ONLY.

## HOW TO SPECIFY

Select  
Model Number

H M T S 0 1 .

Select  
Vinyl

EA11 Black, Grade 1 (only)

E A 1 1

# ASTIR™ COLLABORATIVE WORK SEATING

Want to see more?  
Scan here to check  
out hon.com.



Astir™ Collaborative Work Seating shown with Birk™ Tables and Acoustic Solutions by Unika Vaev.

## ASTIR™

Astir™ Collaborative Work answers the call for soft seating solutions while providing separate work spaces and sturdy posture support for those looking to step away from their desks. The line provides a soft yet upright sit to keep employees engaged and working comfortably at a table setting. High-back and side options help keep private conversations private — so teams don't have to be confined in close quarters, such as a conference room. And a unique, single-seat style with high screens on three sides creates a quiet, secure, and comfortable space for individual focus.



## FEATURES

- Seat height and back angle are scaled for more of an upright working posture.
- Choose from One+, Two-, or Three-Seat Lounges in low- or high-back options.
- High-back screens available in knit mesh or fabric options provide visual privacy on back and sides.
- Fabric high-back screen option available in cleanable fabrics (see HON's cleaning guide for instructions).
- Choose from three different leg styles to customize your look.
- Two- or Three-Seat Benches add extra seating for commons or reception areas.
- Pouf model functions as both impromptu seating and a place to kick up your feet.
- Replaceable seat cushion enhances comfort and cleanability, and allows for easy changing.
- With the multi-fabric options, seat cushion and frame can be specified in different fabrics for a modern aesthetic.
- Add an optional power module to route power directly underneath the seat.

# ASTIR™ Options

## MODEL OPTIONS

**HASLB1, HASLB1MF -  
Multi-Fabric**



**Lounge**  
One+ Seat, Low-Back

**HASLB2, HASLB2MF -  
Multi-Fabric**

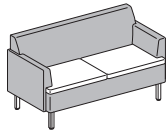

**Lounge**  
Two-Seat, Low-Back

**HASLB3, HASLB3MF -  
Multi-Fabric**

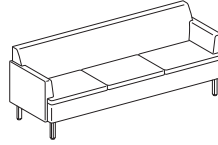

**Lounge**  
Three-Seat, Low-Back

**HASLBTC, HASLBTCMF -  
Multi-Fabric**

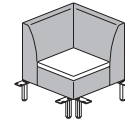

**Lounge**  
True Corner, Low-Back

**HASHB1, HASHB1MF -  
Multi-Fabric**

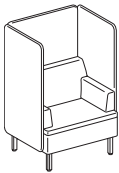

**Lounge**  
One+ Seat, High-Back Screen

**HASHB2, HASHB2MF -  
Multi-Fabric**

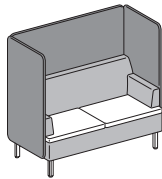

**Lounge**  
Two-Seat, High-Back Screen

**HASHB3, HASHB3MF -  
Multi-Fabric**

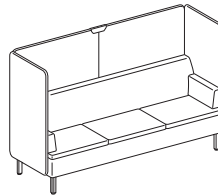

**Lounge**  
Three-Seat, High-Back Screen

**HASHBTC, HASHBTCMF -  
Multi-Fabric**

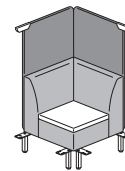

**Lounge**  
True Corner, High-Back Screen

**HASB2, HASB2MF -  
Multi-Fabric**

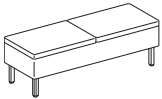

**Bench**  
Two-Seat Bench

**HASB3, HASB3MF -  
Multi-Fabric**

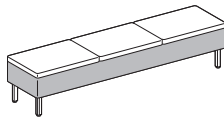

**Bench**  
Three-Seat Bench

**HASPSS, HASPSSMF -  
Multi-Fabric**



**Pouf**

### Low-Back, Multi-Fabric



### High-Back, Multi-Fabric



## SCREEN FABRIC OPTIONS

### HON BRANDED FABRICS

GRADE 1	GRADE 2	GRADE 3	GRADE 4	KNIT
Apex	Apport Seating	Bradbury	Constance with Supreen™	Light
Centurion	Blume	Getaway	Livi with Supreen™	Medium
Contourett	Clyde	Moxie	Lugano with Supreen™	Dark
Dapper	Kai	Notion	Oxford with Supreen™	
Ensemble	Rush	Purl		<b>FABRICS</b>
Hamilton	Wavelength	Quill		Apex
Inertia	Whisper Vinyl	Saxony		Blume
Noble Seating				Contourett
Pebble				Moxie
Vibe				Pebble
				Whisper Vinyl

### LEG STYLE

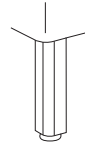

CODE	DESCRIPTION	PRICE
<b>PM</b>	Post Metal	<b>+ \$55</b>
<i>Available in the following finishes:</i>		
<b>P8V</b>	Textured Titanium	
<b>P7A</b>	Textured Charcoal	
<b>P8X</b>	Solar Black	<b>+ \$22</b>
<b>PR5</b>	Champagne Metallic	<b>+ \$22</b>

For a complete list of fabrics, including partnership fabrics, go to [hon.com/fabricsandfinishes](http://hon.com/fabricsandfinishes).

Reference Fabric Color Combinations on pages 20-25 for color codes and legend on page 21 for lead times.

For more details on Upholstery Pattern Match for this series, please see page 14.

### LEG STYLE

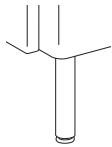

CODE	DESCRIPTION	PRICE
<b>DW</b>	Dowel Wood	<b>+ \$0</b>
<i>Available in the following finishes:</i>		
<b>LFW1</b>	Florence Walnut	
<b>LKI1</b>	Kingswood Walnut	
<b>LLA1</b>	Lowell Ash	
<b>D</b>	Natural Maple	
<b>LNRI</b>	Natural Recon	
<b>LPE1</b>	Phantom Ecru	
<b>PINC</b>	Pinnacle	
<b>LPT1</b>	Portico Teak	
<b>LSW1</b>	Skyline Walnut	
<b>LSA1</b>	Sterling Ash	

### LEG STYLE

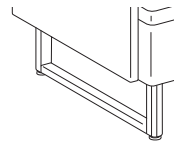

CODE	DESCRIPTION	PRICE
<b>SW</b>	Sled Wood	<b>+ \$109</b>
<i>Available in the following finishes:</i>		
<b>LFW1</b>	Florence Walnut	
<b>LKI1</b>	Kingswood Walnut	
<b>LLA1</b>	Lowell Ash	
<b>D</b>	Natural Maple	
<b>LNRI</b>	Natural Recon	
<b>LPE1</b>	Phantom Ecru	
<b>PINC</b>	Pinnacle	
<b>LPT1</b>	Portico Teak	
<b>LSW1</b>	Skyline Walnut	
<b>LSA1</b>	Sterling Ash	

## MULTI-FABRIC COM YARDAGE

Due to fabric pattern nesting and potential reduction of fabric yield, some multi-fabric models may require more total yardage than standard models.

MODEL	COM (ARMLESS)			COM (ONE ARM/SIDE)			COM (BOTH ARMS/SIDES)		
	Seat	Back/Frame	Screen	Seat	Back/Frame	Screen	Seat	Back/Frame	Screen
HASLB1	—	—	—	—	—	—	6.5		
HASLB1MF	—	—	—	—	—	—	1.5	5.0	—
HASLBTC	—	5.0	—	—	—	—	—	—	—
HASLBTCMF	1.5	4.0	—	—	—	—	—	—	—
HASLB2	—	7.0	—	—	8.0	—	9.0		
HASLB2MF	3.0	4.5	—	3.0	5.5	—	3.0	6.5	—
HASLB3	—	10.0	—	—	11.0	—	12.0		
HASLB3MF	4.0	6.0	—	4.0	7.5	—	4.0	8.5	—
HASHB1	—	—	—	—	—	—	4.5		8.0
HASHB1MF	—	—	—	—	—	—	1.5	3.5	8.0
HASHBTC	—	5.0	—	—	—	—	—	—	—
HASHBTCMF	1.5	4.0	5.5	—	—	—	—	—	—
HASHB2	—	7.0	5.5	—	7.0	8.0	7.0		
HASHB2MF	3.0	4.5	5.5	3.0	4.5	8.0	3.0	4.5	11.0
HASHB3	—	10.5	5.5	—	10.5	8.0	10.5		
HASHB3MF	4.0	7.0	5.5	4.0	7.0	8.0	4.0	7.0	11.0
HASPS5	—	2.0	—	—	—	—	—	—	—
HASPS5MF	1.0	1.5	—	—	—	—	—	—	—
HASB2	—	4.5	—	—	—	—	—	—	—
HASB2MF	3.0	2.0	—	—	—	—	—	—	—
HASB3	—	6.5	—	—	—	—	—	—	—
HASB3MF	4.0	2.5	—	—	—	—	—	—	—

# ASTIR™ Collaborative Work Seating

GSA SIN 33721



Icon Legend on page 19

## HASLB1

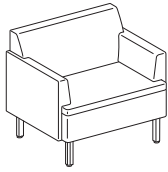

### ONE+ SEAT — LOW-BACK DIMENSIONS

Depth:	29	Back Height:	16
Height:	32	Back Width:	33½
Width:	36½	Arm Height:	7½
Usable Seat Depth:	19¾	Ship Weight:	95
Seat to Floor Height:	18¾	Cube:	21.2
Seat Width:	27	COM:	See page 269
		Weight Rating:	300 lbs.

### FABRIC PRICE CODES

1	\$2738	8	\$4007
2	\$2907	9	\$4038
3	\$3078	10	\$4209
4	\$3221	11	\$4380
5	\$3411	12	\$4552
6	\$3605	L	—
7	\$3804		

## HASLB1MF

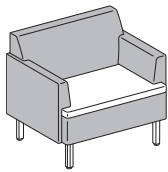

### ONE+ SEAT — LOW-BACK, MULTI-FABRIC DIMENSIONS

Depth:	29	Back Height:	16
Height:	32	Back Width:	33½
Width:	36½	Arm Height:	7½
Usable Seat Depth:	19¾	Ship Weight:	95
Seat to Floor Height:	18¾	Cube:	21.2
Seat Width:	27	COM:	See page 269
		Weight Rating:	300 lbs.

### FABRIC PRICE CODES

1	\$2946	
<i>Add to Base Price Above</i>		
	<b>Seat</b>	<b>Frame/Back</b>
2	\$40	\$130
3	\$80	\$261
4	\$112	\$371
5	\$156	\$518
6	\$201	\$667
7	\$247	\$820
8	\$294	\$976
9	\$301	\$1001
10	\$340	\$1132
11	\$380	\$1263
12	\$420	\$1396

**HON Recommendation: HASLB1.B.PURL\_\_DW\_\_ - List Price \$3078**

## HOW TO SPECIFY

<p><b>Select Model Number</b></p> <p>HASLB1MF.</p>	<p><b>Select Arm Type</b></p> <p>B Both Arms</p> <p>B.</p>	<p><b>Select Fabric</b></p> <p>See page 269 <i>Specify for Single Fabric model only</i></p> <p>PBLE07.</p>	<p><b>Select Seat Cushion Fabric</b></p> <p>See page 269 <i>Specify for MF model only</i></p> <p>PBLE09.</p>	<p><b>Select Back and Frame Fabric</b></p> <p>See page 269 <i>Specify for MF model only</i></p> <p>PBLE06.</p>	<p><b>Select Leg and Color</b></p> <p>DW Dowel Wood PM Post Metal (+ \$55) SW Sled Wood (+ \$109)</p> <p>See page 269 for colors</p> <p>PMP8V</p>
--	--	--	--	--	---



# ASTIR™ Collaborative Work Seating

## HASHB1

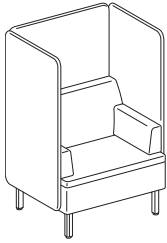

### ONE+ SEAT — HIGH-BACK SCREEN

#### DIMENSIONS

Depth:	29¾	Back Height:	16
Height:	54	Back Width:	33½
Width:	35	Arm Height:	7½
Usable Seat Depth:	19¾	Ship Weight*:	124
Seat to Floor Height:	18¾	Cube:	24.1
Seat Width:	25½	COM:	See page 269
		Weight Rating:	300 lbs.

#### FABRIC PRICE CODES

1 \$3736

Add to Base Price Above

	Unit	Knit	Screen
1	—	1	—
2	\$130	2	\$162
3	\$261	3	\$369
4	\$371	4	\$580
5	\$518	5	\$754
6	\$667	6	\$989
7	\$820	7	\$1228
8	\$976	8	\$1472
9	\$1001	9	\$1723
10	\$1132	10	\$1973
11	\$1263	11	\$2184
12	\$1396	12	\$2394

\*Ships in two cartons.

## HASHB1MF

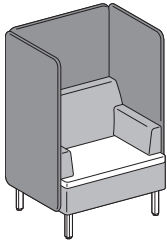

### ONE+ SEAT — HIGH-BACK SCREEN, MULTI-FABRIC

#### DIMENSIONS

Depth:	29¾	Back Height:	16
Height:	54	Back Width:	33½
Width:	35	Arm Height:	7½
Usable Seat Depth:	19¾	Ship Weight*:	124
Seat to Floor Height:	18¾	Cube:	24.1
Seat Width:	25½	COM:	See page 269
		Weight Rating:	300 lbs.

#### FABRIC PRICE CODES

1 \$3942

Add to Base Price Above

	Seat	Back/ Frame	Knit	Screen
1	—	—	1	—
2	\$40	\$105	2	\$162
3	\$80	\$210	3	\$369
4	\$112	\$297	4	\$580
5	\$156	\$415	5	\$754
6	\$201	\$534	6	\$989
7	\$247	\$657	7	\$1228
8	\$294	\$781	8	\$1472
9	\$301	\$801	9	\$1723
10	\$340	\$906	10	\$1973
11	\$380	\$1012	11	\$2184
12	\$420	\$1117	12	\$2394

\*Ships in two cartons.

HON Recommendation: HASHB1.B.PURL\_\_KMD.DW\_\_ - List Price \$3997

## HOW TO SPECIFY

Select Model Number	Select Arm Type	Select Fabric	Select Seat Cushion Fabric	Select Back and Frame Fabric	Select Screen Knit or Fabric	Select Leg and Color
	<b>B</b> Both Side Screens	See page 269 Specify for Single Fabric model only	See page 269 Specify for MF model only	See page 269 Specify for MF model only	Knit Options: <b>KLT</b> Light <b>KMD</b> Medium <b>KDK</b> Dark See page 269 for all options	<b>DW</b> Dowel Wood <b>PM</b> Post Metal (+ \$55) <b>SW</b> Sled Wood (+ \$109) See page 269 for colors
H A S H B 1 M F .	B .	P B L E 0 7 .	P B L E 0 9 .	P B L E 0 6 .	K M D .	P M P 8 V



# ASTIR™ Collaborative Work Seating

GSA SIN 33721



Icon Legend on page 19

## HASLB2

### TWO-SEAT LOUNGE — LOW-BACK

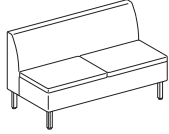

Armless

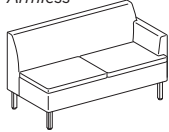

Left

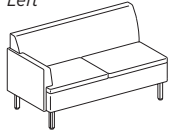

Right

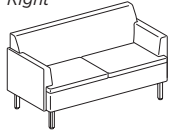

Both Arms

### DIMENSIONS

Depth:	29	Back Height:	16
Height:	32	Back Width:	56½
Width (armless):	56½	Arm Height:	7½
Width (one arm):	58	Ship Weight (armless):	113
Width (both arms):	59½	Ship Weight (one arm):	122
Usable Seat Depth:	19¾	Ship Weight (both arms):	131
Seat to Floor Height:	18¾	Cube:	35.1
Seat Width (armless):	56½	COM:	See page 269
Seat Width (one arm):	53¼		269
Seat Width (both arms):	50	Weight Rating:	300 lbs. (per seat)

### FABRIC PRICE CODES

1	\$3057	8	\$4814
2	\$3289	9	\$4857
3	\$3527	10	\$5095
4	\$3724	11	\$5332
5	\$3988	12	\$5569
6	\$4257	L	—
7	\$4532		

## HASLB2MF

### TWO-SEAT LOUNGE — LOW-BACK, MULTI-FABRIC

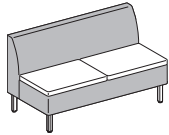

Armless

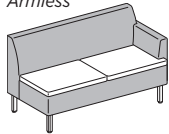

Left

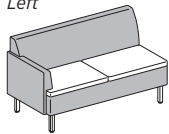

Right

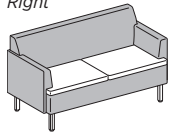

Both Arms

### DIMENSIONS

Depth:	29	Back Height:	16
Height:	32	Back Width:	56½
Width (armless):	56½	Arm Height:	7½
Width (one arm):	58	Ship Weight (armless):	113
Width (both arms):	59½	Ship Weight (one arm):	122
Usable Seat Depth:	19¾	Ship Weight (both arms):	131
Seat to Floor Height:	18¾	Cube:	35.1
Seat Width (armless):	56½	COM:	See page 269
Seat Width (one arm):	53¼		269
Seat Width (both arms):	50	Weight Rating:	300 lbs. (per seat)

### FABRIC PRICE CODES

1	\$3264		
<i>Add to Base Price Above</i>			
		<b>Seat</b>	<b>Frame/Back</b>
2	\$79	\$169	\$169
3	\$157	\$340	\$340
4	\$223	\$483	\$483
5	\$311	\$673	\$673
6	\$400	\$867	\$867
7	\$493	\$1066	\$1066
8	\$587	\$1269	\$1269
9	\$601	\$1300	\$1300
10	\$680	\$1471	\$1471
11	\$759	\$1642	\$1642
12	\$839	\$1814	\$1814

HON Recommendation: HASLB2.B.PURL\_\_DW\_\_ - List Price \$4015

## HOW TO SPECIFY

<b>Select Model Number</b>  HASLB2MF	<b>Select Arm Type</b> N Armless L Left Side (+ \$244) R Right Side (+ \$244) B Both Arms (+ \$488)	<b>Select Fabric</b> See page 269 Specify for Single Fabric model only	<b>Select Seat Cushion Fabric</b> See page 269 Specify for MF model only	<b>Select Back and Frame Fabric</b> See page 269 Specify for MF model only	<b>Select Leg and Color</b> DW Dowel Wood PM Post Metal (+ \$55) SW Sled Wood (+ \$109) See page 269 for colors
HASLB2MF	B	PBLE07	PBLE09	PBLE06	PMP8V



# ASTIR™ Collaborative Work Seating

## HASHB2

### TWO-SEAT LOUNGE — HIGH-BACK SCREEN

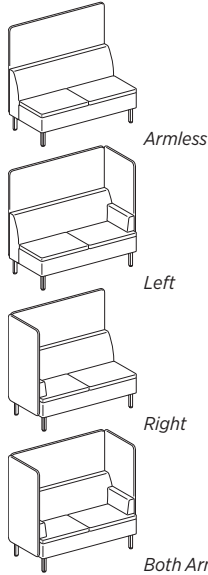

#### DIMENSIONS

Depth:	29¾	Back Height:	16
Height:	54	Back Width:	56½
Width (armless):	56½	Arm Height:	7½
Width (one arm):	57¼	Ship Weight* (armless):	136
Width (both arms):	58	Ship Weight* (one arm):	156
Usable Seat Depth:	19¾	Ship Weight* (both arms):	176
Seat to Floor Height:	18¾	Cube:	29.4
Seat Width (armless):	56½	COM:	See page 269
Seat Width (one arm):	52¼		
Seat Width (both arms):	48¼	Weight Rating:	300 lbs. (per seat)

#### FABRIC PRICE CODES

<b>1</b>	<b>\$4303</b>		
<i>Add to Base Price Above</i>			
	<b>Unit</b>	<b>Knit</b>	<b>Screen</b>
<b>1</b>	—	<b>1</b>	—
<b>2</b>	<b>\$208</b>	<b>2</b>	<b>\$162</b>
<b>3</b>	<b>\$419</b>	<b>3</b>	<b>\$445</b>
<b>4</b>	<b>\$593</b>	<b>4</b>	<b>\$736</b>
<b>5</b>	<b>\$828</b>	<b>5</b>	<b>\$976</b>
<b>6</b>	<b>\$1067</b>	<b>6</b>	<b>\$1299</b>
<b>7</b>	<b>\$1311</b>	<b>7</b>	<b>\$1965</b>
<b>8</b>	<b>\$1562</b>	<b>8</b>	<b>\$2308</b>
<b>9</b>	<b>\$1600</b>	<b>9</b>	<b>\$2361</b>
<b>10</b>	<b>\$1811</b>	<b>10</b>	<b>\$2651</b>
<b>11</b>	<b>\$2022</b>	<b>11</b>	<b>\$2941</b>
<b>12</b>	<b>\$2233</b>	<b>12</b>	<b>\$3232</b>

\*Ships in two cartons.

## HASHB2MF

### TWO-SEAT LOUNGE — HIGH-BACK SCREEN, MULTI-FABRIC

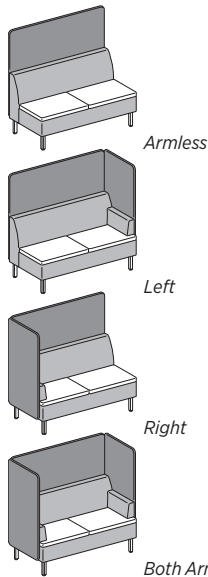

#### DIMENSIONS

Depth:	29¾	Back Height:	16
Height:	54	Back Width:	56½
Width (armless):	56½	Arm Height:	7½
Width (one arm):	57¼	Ship Weight* (armless):	136
Width (both arms):	58	Ship Weight* (one arm):	156
Usable Seat Depth:	19¾	Ship Weight* (both arms):	176
Seat to Floor Height:	18¾	Cube:	29.4
Seat Width (armless):	56½	COM:	See page 269
Seat Width (one arm):	52¼		
Seat Width (both arms):	48¼	Weight Rating:	300 lbs. (per seat)

#### FABRIC PRICE CODES

<b>1</b>	<b>\$4511</b>		
<i>Add to Base Price Above</i>			
	<b>Seat</b>	<b>Back/Frame</b>	<b>Knit Screen</b>
<b>1</b>	—	—	<b>1</b> —
<b>2</b>	<b>\$79</b>	<b>\$130</b>	<b>2</b> <b>\$445</b>
<b>3</b>	<b>\$157</b>	<b>\$261</b>	<b>3</b> <b>\$736</b>
<b>4</b>	<b>\$223</b>	<b>\$371</b>	<b>4</b> <b>\$976</b>
<b>5</b>	<b>\$311</b>	<b>\$518</b>	<b>5</b> <b>\$1299</b>
<b>6</b>	<b>\$400</b>	<b>\$667</b>	<b>6</b> <b>\$1627</b>
<b>7</b>	<b>\$493</b>	<b>\$820</b>	<b>7</b> <b>\$1965</b>
<b>8</b>	<b>\$587</b>	<b>\$976</b>	<b>8</b> <b>\$2308</b>
<b>9</b>	<b>\$601</b>	<b>\$1001</b>	<b>9</b> <b>\$2361</b>
<b>10</b>	<b>\$680</b>	<b>\$1132</b>	<b>10</b> <b>\$2651</b>
<b>11</b>	<b>\$759</b>	<b>\$1263</b>	<b>11</b> <b>\$2941</b>
<b>12</b>	<b>\$839</b>	<b>\$1396</b>	<b>12</b> <b>\$3232</b>

\*Ships in two cartons.

**HON Recommendation: HASHB2.B.PURL\_\_KMD.DW\_\_ - List Price \$5694**

## HOW TO SPECIFY

Select Model Number	Select Arm Type	Select Fabric	Select Seat Cushion Fabric	Select Back and Frame Fabric	Select Screen Knit or Fabric	Select Leg and Color
	<b>N</b> Armless <b>L</b> Left Side (+ \$486) <b>R</b> Right Side (+ \$486) <b>B</b> Both Side Screens (+ \$972)	See page 269 <i>Specify for Single Fabric model only</i>	See page 269 <i>Specify for MF model only</i>	See page 269 <i>Specify for MF model only</i>	Knit Options: <b>KLT</b> Light <b>KMD</b> Medium <b>KDK</b> Dark See page 269 for all options	<b>DW</b> Dowel Wood <b>PM</b> Post Metal (+ \$55) <b>SW</b> Sled Wood (+ \$109) See page 269 for colors
H A S H B 2 M F .	B .	P B L E 0 7 .	P B L E 0 9 .	P B L E 0 6 .	K M D .	P M P 8 V

# ASTIR™ Collaborative Work Seating

GSA SIN 33721



Icon Legend on page 19

## HASLB3

### THREE-SEAT LOUNGE — LOW-BACK

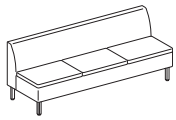

Armless

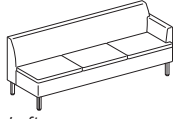

Left

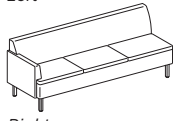

Right

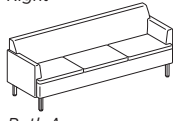

Both Arms

### DIMENSIONS

Depth:	29	Back Height:	16
Height:	32	Back Width:	84½
Width (armless):	84½	Arm Height:	7½
Width (one arm):	86	Ship Weight (armless):	152
Width (both arms):	87½	Ship Weight (one arm):	161
Usable Seat Depth:	19¾	Ship Weight (both arms):	170
Seat to Floor Height:	18¾	Cube:	47.9
Seat Width (armless):	84½	COM:	See page 269
Seat Width (one arm):	81¼	Weight Rating:	300 lbs. (per seat)
Seat Width (both arms):	78		

### FABRIC PRICE CODES

1	\$4040	8	\$6381
2	\$4349	9	\$6440
3	\$4668	10	\$6756
4	\$4929	11	\$7072
5	\$5281	12	\$7388
6	\$5639	L	—
7	\$6007		

## HASLB3MF

### THREE-SEAT LOUNGE — LOW-BACK, MULTI-FABRIC

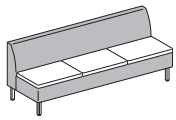

Armless

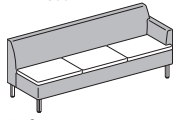

Left

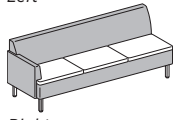

Right

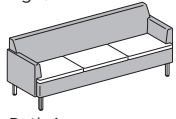

Both Arms

### DIMENSIONS

Depth:	29	Back Height:	16
Height:	32	Back Width:	84½
Width (armless):	84½	Arm Height:	7½
Width (one arm):	86	Ship Weight (armless):	152
Width (both arms):	87½	Ship Weight (one arm):	161
Usable Seat Depth:	19¾	Ship Weight (both arms):	170
Seat to Floor Height:	18¾	Cube:	47.9
Seat Width (armless):	84½	COM:	See page 269
Seat Width (one arm):	81¼	Weight Rating:	300 lbs. (per seat)
Seat Width (both arms):	78		

### FABRIC PRICE CODES

1	\$4246		
<i>Add to Base Price Above</i>			
	<b>Seat</b>	<b>Frame/Back</b>	
2	\$105	\$220	
3	\$210	\$444	
4	\$297	\$630	
5	\$415	\$879	
6	\$534	\$1133	
7	\$657	\$1393	
8	\$781	\$1659	
9	\$801	\$1701	
10	\$906	\$1925	
11	\$1012	\$2148	
12	\$1117	\$2373	

HON Recommendation: HASLB3.B.PURL\_\_DW\_\_ - List Price \$5156

## HOW TO SPECIFY

<b>Select Model Number</b> HASLB3MF	<b>Select Arm Type</b> N Armless L Left Side (+ \$244) R Right Side (+ \$244) B Both Arms (+ \$488)	<b>Select Fabric</b> See page 269 Specify for Single Fabric model only	<b>Select Seat Cushion Fabric</b> See page 269 Specify for MF model only	<b>Select Back and Frame Fabric</b> See page 269 Specify for MF model only	<b>Select Leg and Color</b> DW Dowel Wood PM Post Metal (+ \$55) SW Sled Wood (+ \$109) See page 269 for colors
HASLB3MF	B	PBLE07	PBLE09	PBLE06	PMP8V



# ASTIR™ Collaborative Work Seating

## HASHB3

### THREE-SEAT LOUNGE — HIGH-BACK SCREEN

#### DIMENSIONS

Depth:	29¾	Back Height:	16
Height:	54	Back Width:	84½
Width (armless):	84½	Arm Height:	7½
Width (one arm):	85¼	Ship Weight* (armless):	185
Width (both arms):	86	Ship Weight* (one arm):	205
Usable Seat Depth:	19¾	Ship Weight* (both arms):	225
Seat to Floor Height:	18¾	Cube:	39
Seat Width (armless):	84½	COM:	See page 269
Seat Width (one arm):	80½	Weight Rating:	300 lbs. (per seat)
Seat Width (both arms):	76½		

#### FABRIC PRICE CODES

1 **\$5878**

*Add to Base Price Above*

	Unit	Knit	Screen
1	—	1	—
2	\$271	2	\$162
3	\$548	3	\$445
4	\$778	4	\$736
5	\$1086	5	\$976
6	\$1400	6	\$1299
7	\$1721	7	\$1627
8	\$2049	8	\$1965
9	\$2100	9	\$2308
10	\$2377	10	\$2651
11	\$2653	11	\$2941
12	\$2930	12	\$3232

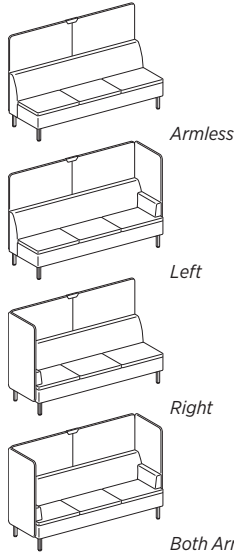

Both Arms \*Ships in two cartons.

## HASHB3MF

### THREE-SEAT LOUNGE — HIGH-BACK SCREEN, MULTI-FABRIC

#### DIMENSIONS

Depth:	29¾	Back Height:	16
Height:	54	Back Width:	84½
Width (armless):	84½	Arm Height:	7½
Width (one arm):	85¼	Ship Weight* (armless):	185
Width (both arms):	86	Ship Weight* (one arm):	205
Usable Seat Depth:	19¾	Ship Weight* (both arms):	225
Seat to Floor Height:	18¾	Cube:	39
Seat Width (armless):	84½	COM:	See page 269
Seat Width (one arm):	80½	Weight Rating:	300 lbs. (per seat)
Seat Width (both arms):	76½		

#### FABRIC PRICE CODES

1 **\$6085**

*Add to Base Price Above*

	Seat	Back/Frame	Knit	Screen
1	—	—	1	—
2	\$105	\$182	2	\$162
3	\$210	\$366	3	\$445
4	\$297	\$519	4	\$736
5	\$415	\$725	5	\$976
6	\$534	\$933	6	\$1299
7	\$657	\$1147	7	\$1627
8	\$781	\$1366	8	\$1965
9	\$801	\$1400	9	\$2308
10	\$906	\$1585	10	\$2651
11	\$1012	\$1769	11	\$2941
12	\$1117	\$1953	12	\$3232

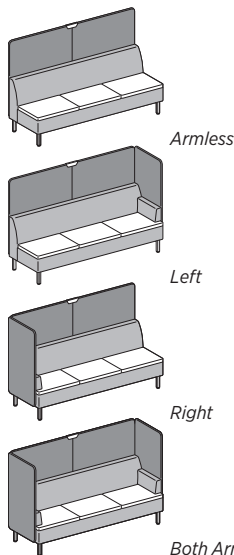

Both Arms \*Ships in two cartons.

**HON Recommendation: HASHB3.B.PURL\_\_KMD.DW\_\_ - List Price \$7398**

## HOW TO SPECIFY

Select Model Number	Select Arm Type	Select Fabric	Select Seat Cushion Fabric	Select Back and Frame Fabric	Select Screen Knit or Fabric	Select Leg and Color
N Armless L Left Side (+ \$486) R Right Side (+ \$486) B Both Side Screens (+ \$972)	See page 269 <i>Specify for Single Fabric model only</i>	See page 269 <i>Specify for MF model only</i>	See page 269 <i>Specify for MF model only</i>	See page 269 <i>Specify for MF model only</i>	Knit Options: KLT Light (+ \$55) KMD Medium (+ \$109) KDK Dark See page 269 for all options	DW Dowel Wood PM Post Metal (+ \$55) SW Sled Wood (+ \$109) See page 269 for colors
H A S H B 3 M F .	B .	P B L E 0 7 .	P B L E 0 9 .	P B L E 0 6 .	K M D .	P M P 8 V

# ASTIR™ Collaborative Work Seating

GSA SIN 33721



Icon Legend on page 19

## HASLBTC

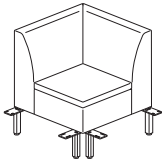

### TRUE CORNER LOUNGE — LOW-BACK

#### DIMENSIONS

Depth:	29	Back Height:	16
Height:	32	Back Width:	29
Width:	29	Ship Weight:	90
Usable Seat Depth:	19¾	Cube:	21.2
Seat to Floor Height:	18¾	COM:	See page 269
Seat Width:	20¼	Weight Rating:	300 lbs.

#### FABRIC PRICE CODES

1	\$2864	8	\$3840
2	\$2994	9	\$3865
3	\$3125	10	\$3996
4	\$3235	11	\$4127
5	\$3382	12	\$4260
6	\$3531	L	—
7	\$3684		

NOTES: True Corner uses legs from adjacent units, and can work with all leg styles. For adjacent units with sled legs, pick a single leg option for the True Corner rear leg.

- ⚠ True Corner designed to act as a corner between two adjacent units, not as a stand-alone unit.
- ⚠ True Corner leg selection refers to back corner leg only, and ships with only that leg.

## HASLBTCMF

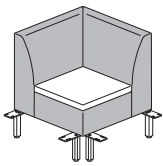

### TRUE CORNER LOUNGE — LOW-BACK, MULTI-FABRIC

#### DIMENSIONS

Depth:	29	Back Height:	16
Height:	32	Back Width:	29
Width:	29	Ship Weight:	90
Usable Seat Depth:	19¾	Cube:	21.2
Seat to Floor Height:	18¾	COM:	See page 269
Seat Width:	20¼	Weight Rating:	300 lbs.

#### FABRIC PRICE CODES

1	\$3072	
<i>Add to Base Price Above</i>		
	Seat	Frame/Back
2	\$40	\$105
3	\$80	\$210
4	\$112	\$297
5	\$156	\$415
6	\$201	\$534
7	\$247	\$657
8	\$294	\$781
9	\$301	\$801
10	\$340	\$906
11	\$380	\$1012
12	\$420	\$1117

NOTES: True Corner uses legs from adjacent units, and can work with all leg styles. For adjacent units with sled legs, pick a single leg option for the True Corner rear leg.

- ⚠ True Corner designed to act as a corner between two adjacent units, not as a stand-alone unit.
- ⚠ True Corner leg selection refers to back corner leg only, and ships with only that leg.

**HON Recommendation: HASLBTC.PURL\_\_DW\_\_ - List Price \$3125**

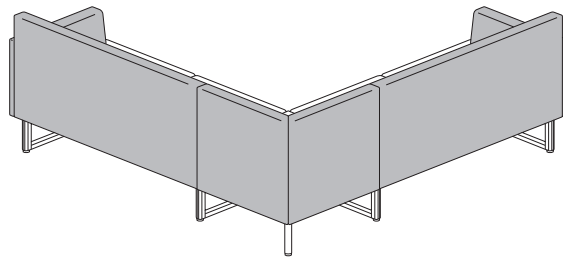
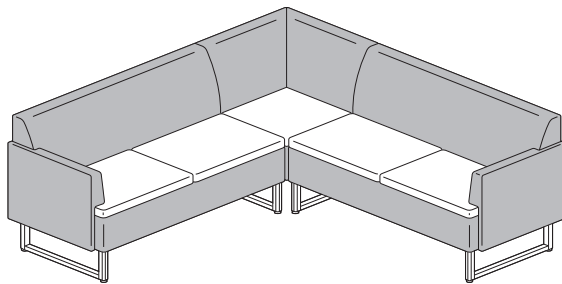

SEATING

## HOW TO SPECIFY

<p><b>Select Model Number</b></p>	<p><b>Select Fabric</b></p> <p>See page 269 Specify for Single Fabric model only</p>	<p><b>Select Seat Cushion Fabric</b></p> <p>See page 269 Specify for MF model only</p>	<p><b>Select Back and Frame Fabric</b></p> <p>See page 269 Specify for MF model only</p>	<p><b>Select Leg and Color</b></p> <p><b>DW</b> Dowel Wood <b>PM</b> Post Metal (+ \$55) See page 269 for colors</p>
HASLBTCMF	PBLE07	PBLE09	PBLE06	PMP8V



# ASTIR™ Collaborative Work Seating

## HASHBTC

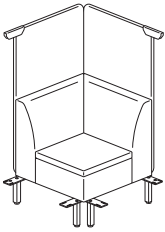

### TRUE CORNER LOUNGE — HIGH-BACK SCREEN

#### DIMENSIONS

Depth:	29¾	Back Height:	16
Height:	54	Back Width:	29
Width:	29¾	Ship Weight:	119
Usable Seat Depth:	19¾	Cube:	28.1
Seat to Floor Height:	18¾	COM:	See page 269
Seat Width:	20¼	Weight Rating:	300 lbs.

#### FABRIC PRICE CODES

1 \$3941			
<i>Add to Base Price Above</i>			
	<b>Unit</b>	<b>Knit</b>	<b>Screen</b>
1	—	1	\$162
2	\$130	2	\$304
3	\$261	3	\$450
4	\$371	4	\$569
5	\$518	5	\$731
6	\$667	6	\$896
7	\$820	7	\$1063
8	\$976	8	\$1235
9	\$1001	9	\$1261
10	\$1132	10	\$1406
11	\$1263	11	\$1552
12	\$1396	12	\$1696

NOTES: True Corner uses legs from adjacent units, and can work with all leg styles. For adjacent units with sled legs, pick a single leg option for the True Corner rear leg.

- ❗ True Corner designed to act as a corner between two adjacent units, not as a stand-alone unit.
- ❗ True Corner leg selection refers to back corner leg only, and ships with only that leg.

## HASHBTCMF

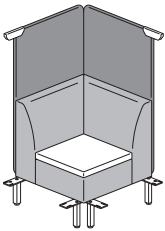

### TRUE CORNER LOUNGE — HIGH-BACK SCREEN, MULTI-FABRIC

#### DIMENSIONS

Depth:	29¾	Back Height:	16
Height:	54	Back Width:	29
Width:	29¾	Ship Weight:	119
Usable Seat Depth:	19¾	Cube:	28.1
Seat to Floor Height:	18¾	COM:	See page 269
Seat Width:	20¼	Weight Rating:	300 lbs.

#### FABRIC PRICE CODES

1 \$4149			
<i>Add to Base Price Above</i>			
	<b>Seat</b>	<b>Back/Frame</b>	<b>Knit Screen</b>
1	—	1	\$162
2	\$40	\$105	2 \$304
3	\$80	\$210	3 \$450
4	\$112	\$297	4 \$569
5	\$156	\$415	5 \$731
6	\$201	\$534	6 \$896
7	\$247	\$657	7 \$1063
8	\$294	\$781	8 \$1235
9	\$301	\$801	9 \$1261
10	\$340	\$906	10 \$1406
11	\$380	\$1012	11 \$1552
12	\$420	\$1117	12 \$1696

NOTES: True Corner uses legs from adjacent units, and can work with all leg styles. For adjacent units with sled legs, pick a single leg option for the True Corner rear leg.

- ❗ True Corner designed to act as a corner between two adjacent units, not as a stand-alone unit.
- ❗ True Corner leg selection refers to back corner leg only, and ships with only that leg.

**HON Recommendation: HASHBTC.PURL\_\_KMD.DW\_\_ - List Price \$4202**

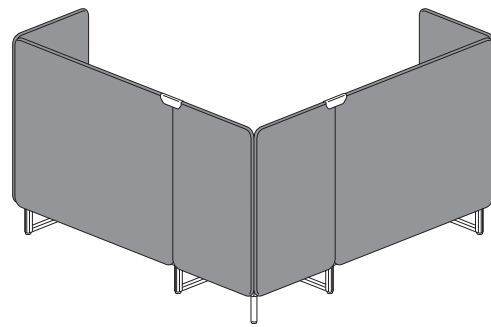
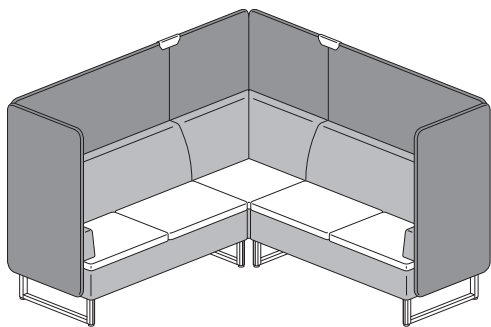

## HOW TO SPECIFY

<p><b>Select Model Number</b></p> <p>H A S H B T C M F .</p>	<p><b>Select Fabric</b></p> <p>See page 269 <i>Specify for Single Fabric model only</i></p> <p>P B L E 0 7 .</p>	<p><b>Select Seat Cushion Fabric</b></p> <p>See page 269 <i>Specify for MF model only</i></p> <p>P B L E 0 9 .</p>	<p><b>Select Back and Frame Fabric</b></p> <p>See page 269 <i>Specify for MF model only</i></p> <p>P B L E 0 6 .</p>	<p><b>Select Screen Knit or Fabric</b></p> <p>Knit Options:  <b>KLT</b> Light  <b>KMD</b> Medium  <b>KDK</b> Dark                  See page 269 for all options</p> <p>K M D .</p>	<p><b>Select Leg and Color</b></p> <p><b>DW</b> Dowel Wood  <b>PM</b> Post Metal (+ \$55)                  See page 269 for colors</p> <p>P M P 8 V</p>
--	--	--	--	--	---

SEATING

# ASTIR™ Collaborative Work Seating

GSA SIN 33721



Icon Legend on page 19

## HASB2

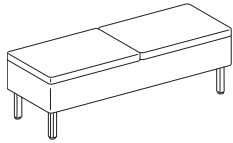

### TWO-SEAT BENCH

### DIMENSIONS

Depth:	20¼	Seat Width:	56¼
Height:	19	Ship Weight:	46
Width:	56½	Cube:	8.7
Usable Seat Depth:	20¼	COM:	See page 269
Seat to Floor Height:	18¾	Weight Rating:	300 lbs. (per seat)

### FABRIC PRICE CODES

1	\$2766	8	\$3644
2	\$2883	9	\$3667
3	\$3001	10	\$3785
4	\$3099	11	\$3904
5	\$3232	12	\$4022
6	\$3367	L	—
7	\$3504		

## HASB2MF

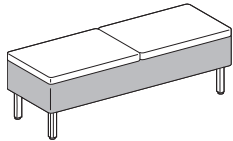

### TWO-SEAT BENCH, MULTI-FABRIC

### DIMENSIONS

Depth:	20¼	Seat Width:	56¼
Height:	19	Ship Weight:	46
Width:	56½	Cube:	8.7
Usable Seat Depth:	20¼	COM:	See page 269
Seat to Floor Height:	18¾	Weight Rating:	300 lbs. (per seat)

### FABRIC PRICE CODES

1	\$2974	
<i>Add to Base Price Above</i>		
	<b>Seat</b>	<b>Frame</b>
2	\$79	\$53
3	\$157	\$106
4	\$223	\$149
5	\$311	\$208
6	\$400	\$268
7	\$493	\$328
8	\$587	\$391
9	\$601	\$400
10	\$680	\$453
11	\$759	\$506
12	\$839	\$559

**HON Recommendation: HASB2.PURL\_\_DW\_\_ - List Price \$3001**

SEATING

## HOW TO SPECIFY

<p><b>Select Model Number</b></p> <p>HASB2MF .</p>	<p><b>Select Fabric</b></p> <p>See page 269 Specify for Single Fabric model only</p> <p>PBLE07 .</p>	<p><b>Select Seat Cushion Fabric</b></p> <p>See page 269 Specify for MF model only</p> <p>PBLE09 .</p>	<p><b>Select Frame Fabric</b></p> <p>See page 269 Specify for MF model only</p> <p>PBLE06 .</p>	<p><b>Select Leg and Color</b></p> <p>DW Dowel Wood PM Post Metal (+ \$55) SW Sled Wood (+ \$109) See page 269 for colors</p> <p>PMP8V</p>
--	--	--	---	--



## HASB3

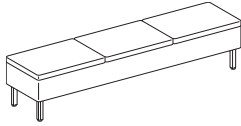

### THREE-SEAT BENCH

### DIMENSIONS

Depth:	20¼	Seat Width:	84½
Height:	19	Ship Weight:	61
Width:	84½	Cube:	12.2
Usable Seat Depth:	20¼	COM:	See page 269
Seat to Floor Height:	18¾	Weight Rating:	300 lbs. (per seat)

### FABRIC PRICE CODES

1	\$3458	8	\$4727
2	\$3627	9	\$4758
3	\$3798	10	\$4929
4	\$3941	11	\$5100
5	\$4131	12	\$5272
6	\$4325	L	—
7	\$4524		

## HASB3MF

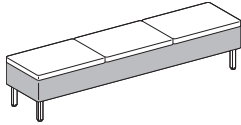

### THREE-SEAT BENCH, MULTI-FABRIC

### DIMENSIONS

Depth:	20¼	Seat Width:	84½
Height:	19	Ship Weight:	61
Width:	84½	Cube:	12.2
Usable Seat Depth:	20¼	COM:	See page 269
Seat to Floor Height:	18¾	Weight Rating:	300 lbs. (per seat)

### FABRIC PRICE CODES

1	\$3665		
<i>Add to Base Price Above</i>			
	<b>Seat</b>	<b>Frame</b>	
2	\$105	\$65	
3	\$210	\$131	
4	\$297	\$186	
5	\$415	\$259	
6	\$534	\$333	
7	\$657	\$410	
8	\$781	\$489	
9	\$801	\$500	
10	\$906	\$566	
11	\$1012	\$633	
12	\$1117	\$699	

**HON Recommendation: HASB3.PURL\_\_\_.DW\_\_ - List Price \$3798**

## HOW TO SPECIFY

<p><b>Select Model Number</b></p>	<p><b>Select Fabric</b></p> <p>See page 269 Specify for Single Fabric model only</p>	<p><b>Select Seat Cushion Fabric</b></p> <p>See page 269 Specify for MF model only</p>	<p><b>Select Frame Fabric</b></p> <p>See page 269 Specify for MF model only</p>	<p><b>Select Leg and Color</b></p> <p><b>DW</b> Dowel Wood <b>PM</b> Post Metal (+ \$55) <b>SW</b> Sled Wood (+ \$109) See page 269 for colors</p>
HASB3MF	PBLE07	PBLE09	PBLE06	PMP8V



# ASTIR™ Collaborative Work Seating

GSA SIN 33721



Icon Legend on page 19

## HASPSS

POUF

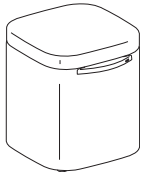

### DIMENSIONS

Depth:	17¼	Seat Width:	16½
Height:	18¾	Ship Weight:	25
Width:	16½	Cube:	3.5
Usable Seat Depth:	16½	COM:	See page 269
Seat to Floor Height:	17½	Weight Rating:	300 lbs. (per seat)

### FABRIC PRICE CODES

1	\$825	8	\$1216
2	\$878	9	\$1225
3	\$931	10	\$1278
4	\$974	11	\$1331
5	\$1033	12	\$1384
6	\$1093	L	—
7	\$1153		

## HASPSSMF

POUF, MULTI-FABRIC

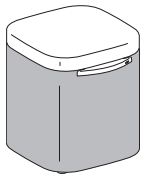

### DIMENSIONS

Depth:	17¼	Seat Width:	16½
Height:	18¾	Ship Weight:	25
Width:	16½	Cube:	3.5
Usable Seat Depth:	16½	COM:	See page 269
Seat to Floor Height:	17½	Weight Rating:	300 lbs. (per seat)

### FABRIC PRICE CODES

1	\$1032	
<i>Add to Base Price Above</i>		
	Seat	Frame
2	\$27	\$40
3	\$53	\$80
4	\$76	\$112
5	\$105	\$156
6	\$134	\$201
7	\$164	\$247
8	\$196	\$294
9	\$201	\$301
10	\$227	\$340
11	\$254	\$380
12	\$280	\$420

**HON Recommendation: HASPSS.PURL\_\_H.BL - List Price \$931**

SEATING

## HOW TO SPECIFY

<p>Select Model Number</p> <p>H A S P S S .</p>	<p>Select Fabric</p> <p>See page 269</p> <p>P B L E 0 7 .</p>	<p>Select Leg and Color</p> <p>HG Hidden Glide H Caster</p> <p>H G .</p>	<p>Select Handle Color</p> <p>BL Black Handle</p> <p>B L</p>
---	---	--	--

## HOW TO SPECIFY

<p>Select Model Number</p> <p>H A S P S S M F .</p>	<p>Select Seat Cushion Fabric</p> <p>See page 269</p> <p>P B L E 0 7 .</p>	<p>Select Frame Fabric</p> <p>See page 269</p> <p>P B L E 0 6 .</p>	<p>Select Leg and Color</p> <p>HG Hidden Glide H Caster</p> <p>H G .</p>	<p>Select Handle Color</p> <p>BL Black Handle</p> <p>B L</p>
---	--	---	--	--



# ASTIR™ Collaborative Work Seating

## HASSP

### HIGH-BACK SCREEN — SIDE PRIVACY

#### DIMENSIONS

Ship Weight: 3.2  
 Cube: 3.2  
 COM: 3.0

#### LIST PRICE

Knit \$2076

1	\$2131	7	\$2622
2	\$2208	8	\$2716
3	\$2287	9	\$2731
4	\$2353	10	\$2810
5	\$2441	11	\$2888
6	\$2530	12	\$2968

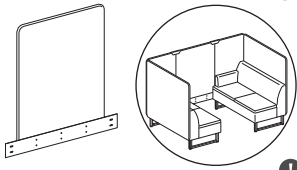

ⓘ Requires High-Back Screen units with arms on each unit.

## HASGBSL

### SHARED LEG GANGING BRACKET

#### DIMENSIONS

Ship Weight: 4  
 Cube: 0.1

#### LIST PRICE

\$279

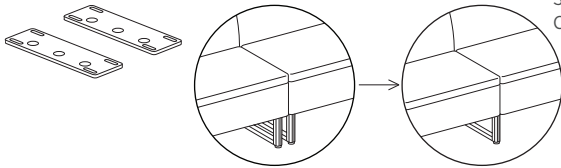

NOTES: Uses existing legs on units being ganged. No specification needed.

**SPECIFYING EXAMPLE: HASGBSL**

## HASSGC

### SCREEN GANGING CLIP

#### DIMENSIONS

Ship Weight: 1  
 Cube: 0.1

#### LIST PRICE

\$140

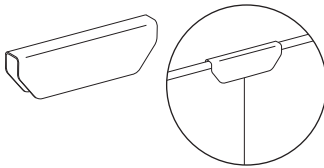

ⓘ Required when ganging multiple high-back units together.  
 ⓘ Already included on individual units where applicable.

## HOW TO SPECIFY

<p><b>Select Model Number</b></p> <p>HASSP.</p>	<p><b>Select Screen Knit or Fabric</b></p> <p>Knit Options:  <b>KLT</b> Light  <b>KMD</b> Medium  <b>KDK</b> Dark                  See page 269 for all options</p> <p>KMD</p>
---	--

## HOW TO SPECIFY

<p><b>Select Model Number</b></p> <p>HASSGC.</p>	<p><b>Select Paint Color</b></p> <p><b>P7A</b> Textured Charcoal</p> <p>P7A</p>
--	---

SEATING

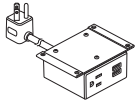

SIN 33721

**DESCRIPTION**

**Miki Under-Mount Power Module**  
 • Includes 6' cord with three-prong plug.  
 • 1 Receptacle, 2 USB  
 • Available in **STRM** Storm and **SNW** Snow.  
**SPECIFYING EXAMPLE: HUMPWR-1P-2U.STRM**

MODEL	SHIP WEIGHT	CUBE	LIST PRICE
<b>HUMPWR-1P-2U</b>	2	0.6	<b>\$237</b>



SIN 33721

**Vesta Mobile Power Station**  
 • Includes 10' retractable cord with three-prong plug.  
 • 3 AC, 1 Dual USB-A, 1 USB-C at top  
 • Specify Paint and Plastic.  
**SPECIFYING EXAMPLE: HPWRMOB1.BLK.STRM**

<b>HPWRMOB1</b>	14	3.3	<b>\$1357</b>
-----------------	----	-----	---------------

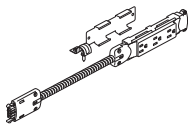

**Triplex Electrical Harness**  
 48"W, Circuit 1  
 60"W, Circuit 1  
 72"W, Circuit 1

<b>HTPKIT48</b>	5	0.3	<b>\$267</b>
<b>HTPKIT60</b>	5	0.3	<b>\$272</b>
<b>HTPKIT72</b>	5	0.3	<b>\$280</b>

48"W, Circuit 2  
 60"W, Circuit 2  
 72"W, Circuit 2

<b>HTPKIT482</b>	5	0.3	<b>\$267</b>
<b>HTPKIT602</b>	5	0.3	<b>\$272</b>
<b>HTPKIT722</b>	5	0.3	<b>\$280</b>

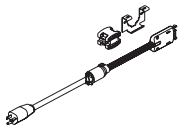

**Triplex Corded In-Feed**  
 48"W Corded In-feed  
 72"W Corded In-feed

<b>HTPCIF48</b>	5	0.3	<b>\$346</b>
<b>HTPCIF72</b>	5	0.3	<b>\$366</b>

NOTES: Corded in-feed ships with (1) 4-way splitter, (1) 4-way splitter mounting bracket, (1) conduit clip, and (1) in-feed. Utilizes standard 3-prong plug for easy setup and installation. Use with circuit 1 harnesses only. Corded in-feed not UL listed.

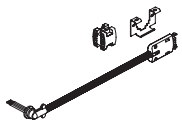

**Triplex Hardwire In-Feed**  
 48"W Hardwire In-feed

<b>HTPHWIF72</b>	5	0.3	<b>\$298</b>
------------------	---	-----	--------------

NOTES: Hardwire in-feed ships with (1) 4-way splitter, (1) 4-way splitter mounting bracket, (1) conduit clip, and (1) in-feed. Hardwire in-feed must be installed by a licensed electrician.

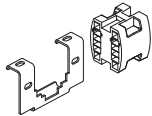

**Triplex 4-Way Splitter**  
 4-Way Splitter

<b>HTPSPLIT</b>	5	0.3	<b>\$91</b>
-----------------	---	-----	-------------

NOTES: 4-way splitter utilized in instances where one power harness feeds into 2-3 power harnesses.

**NOTES:**

- Triplex is a 4-trac system with 3 connected simplexes per harness.
- Choose either a corded or hardwire in-feed.
- UL listed as a manufactured wiring system (UL 183) when hardwire in-feed is used.
- cUL Certified for Canada with hardwire in-feed.
- Hardwire in-feed complies with municipal standards such as in New York, Los Angeles, and San Francisco. However, it is customer's responsibility to verify local code compliance.
- Plug in any standard 2- or 3-prong plug accessory to triplex simplexes to get power to where you need it most.

**HOW TO SPECIFY**

Select Model Number

Select Exterior Paint Color

Select Paint Color

*Specify for model HPWRMOB1 only*

*Specify for model HPWRMOB1 only*

- FOG** Fog
- STRM** Storm
- BLK** Black
- SNW** Snow

- FOG** Fog
- STRM** Storm
- BLK** Black
- SNW** Snow

**H P W R M O B 1** .

**B L K** .

**S T R M**

# CAMBIA™ 2160 SERIES

Want to see more? Scan here  
to check out hon.com.



Cambia Upholstered Back Guest  
Chairs shown with Preside® table.

## CAMBIA™ 2160 SERIES

Cambia's comfort and style is a warm invitation for any guest or coworker. With two back variations and arm options, this is a guest chair collection designed to adapt. Each back option offers a choice of a wood slat design or upholstered panel to suit any space or personal taste. Choose from eight rich hardwood finishes and hundreds of quality HON fabrics to express your style and reflect your brand.



### FEATURES

- Wood slat back panel complements a variety of surroundings.
- Upholstered seat and back features cushioning for additional comfort and support.
- Personalize your space with a choice of back styles.
- Fixed arms provide support and take pressure off the upper body and shoulders.
- Solid hardwood in one of eight attractive finishes.
- Available in hundreds of quality HON fabrics.
- Warranted for users up to 250 lbs.

# CAMBIA™ 2160 Series Options

## MODEL OPTIONS

H2164



**Guest Chair**

Upholstered Back, Leg Base,  
Arch Arms

H2165



**Guest Chair**

Wood Slat Back, Leg Base,  
Arch Arms

## AVAILABLE FINISHES

Cambia™ 2160 Series Seating is available in 8 wood finishes.

### WOOD FINISHES

Bourbon Cherry (H)

Cognac (COGN)

Harvest (C)

Mahogany (N)

Mocha (MOCH)

Natural Maple (D)

Pinnacle (PINC)

Shaker Cherry (F)

## HON BRANDED FABRICS

### GRADE 1

Apex  
Centurion  
Compass  
Contourett  
Dapper  
Ensemble  
Hamilton  
Inertia  
Noble Seating  
Optic  
Pebble  
Vibe

### GRADE 2

Appoint Seating  
Blume  
Clyde  
Dotty  
Kai  
Rush  
Spin  
Wavelength  
Whisper Vinyl

### GRADE 3

Bradbury  
Getaway  
Moxie  
Notion  
Parker  
Purl  
Quill  
Saxony

### GRADE 4

Constance with Supreen™  
Livi with Supreen™  
Lugano with Supreen™  
Oxford with Supreen™

### GRADE L

Denver Leather

**For a complete list of fabrics, including partnership fabrics, go to [hon.com/fabricsandfinishes](https://hon.com/fabricsandfinishes).**

Reference Fabric Color Combinations on pages 20-25 for color codes and legend on page 21 for lead times. For additional HON to Supply COM fabric grade pricing, go to [honready.hon.com](https://honready.hon.com) and click on the HON to Supply COM link.



# CAMBIA™ 2160 Series

## H2164



### GUEST CHAIR

**Upholstered Back**  
Leg Base  
Arch Arms

### DIMENSIONS

Depth:	24¼	Arm Width:	19
Width:	21¾	Seat to Floor Height:	19
Height:	31¾	Usable Seat Depth:	21
Seat Depth:	21	Ship Weight:	30
Seat Width:	21¾	Cube:	22.6
Back Width:	21¾	COM:	1.5
Back Height:	13¾	Weight Rating:	250 lbs.

### FABRIC PRICE CODES

1	\$946	8	\$1318
2	\$1011	9	\$1367
3	\$1076	10	\$1415
4	\$1125	11	\$1464
5	\$1173	12	\$1512
6	\$1222	L	\$1485
7	\$1270		

## H2165



### GUEST CHAIR

**Wood Slat Back**  
Leg Base  
Arch Arms

### DIMENSIONS

Depth:	24¼	Arm Width:	19
Width:	21¾	Seat to Floor Height:	19
Height:	31¾	Usable Seat Depth:	21
Seat Depth:	21	Ship Weight:	30
Seat Width:	21¾	Cube:	22.6
Back Width:	21¾	COM:	1.3
Back Height:	13¾	Weight Rating:	250 lbs.

### FABRIC PRICE CODES

1	\$995	8	\$1219
2	\$1035	9	\$1248
3	\$1074	10	\$1277
4	\$1103	11	\$1306
5	\$1131	12	\$1335
6	\$1160	L	\$1319
7	\$1190		

**HON Recommendation: H2164.MOCH.CU\_\_ - List Price \$946**

## HOW TO SPECIFY

<p><b>Select Model Number</b></p> <p>H 2 1 6 4</p>	<p><b>Select Finish</b></p> <p>See page 284</p> <p>MOCH</p>	<p><b>Select Fabric</b></p> <p>See page 284</p> <p>CU10</p>
--	---	---



Cipher™ Seating.

## CIPHER™

From important client consultations to project planning to impending deadlines, busy professionals are required to meet more than a few expectations throughout the day. That's why easy support and intuitive performance should be status quo when it comes to your office chair — and Cipher™ seating goes above and beyond. With intuitive functionality and customizable controls, this smart, streamlined seating solution lets you focus on the task at hand instead of distracted by clumsy mechanisms and constant adjustments. A thoughtful natural leader, Cipher™ moves with you to meet the demands of the day so you can concentrate on what lies ahead.



## FEATURES

- Crack the code to productivity with intuitive functionality and thoughtful design.
- Keep things simple with an integrated weight-activated control that automatically adjusts to you as you move.
- Personalize your sit with independently adjustable lumbar support, customizable for user height and pressure preferences.
- Add a pop of color with nine Colorway™ accent options.
- Get the look you want with nine contrast stitching color choices or a fabric-matched stitch.
- Elevate your aesthetic with a thin, modern profile and open back design.
- Find the right fit for your space with three different cylinder height options.
- Stay cool with 4-Way Stretch Mesh flexes in every direction to dynamically move with you — available in 7 colors.
- Choose from 3 frame options: Salt, Charcoal, and Black.

## MODEL OPTIONS

### HCFRT



Task Chair

### HCFRG

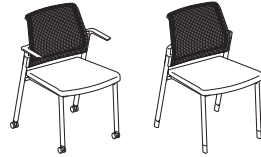

Guest Chair

## HON BRANDED FABRICS

### GRADE 1

Apex  
Centurion  
Compass  
Contourett  
Dapper  
Ensemble  
Hamilton  
Inertia  
Noble Seating  
Optic  
Pebble  
Vibe

### GRADE 2

Appoint Seating  
Blume  
Clyde  
Dotty  
Kai  
Rush  
Spin Seating  
Wavelength  
Whisper Vinyl

### GRADE 3

Bradbury  
Getaway  
Moxie  
Notion  
Parker  
Purl  
Quill  
Saxony

### GRADE 4

Constance with Supreen™  
Livi with Supreen™  
Lugano with Supreen™  
Oxford with Supreen™

### GRADE L1

Davenport Leather

**For a complete list of fabrics, including partnership fabrics, go to [hon.com/fabricsandfinishes](https://hon.com/fabricsandfinishes).**

Reference Fabric Color Combinations on pages 20-25 for color codes and legend on page 21 for lead times.



# CIPHER™ Task Options

## ARM STYLE



CODE	DESCRIPTION	PRICE
<b>N</b>	Armless	<b>+\$0</b>
<b>H</b>	Height-Adjustable	<b>+\$92</b>
<b>V</b>	All-Adjustable (Includes Pivot)	<b>+\$141</b>

## ACCENT COLOR



CODE	DESCRIPTION	PRICE
<b>BL</b>	Black	<b>+\$0</b>
<b>S</b>	Charcoal	<b>+\$0</b>
<b>ST</b>	Salt	<b>+\$0</b>
<b>BY</b>	Bullseye	<b>+\$0</b>
<b>KT</b>	Krypton	<b>+\$0</b>
<b>MR</b>	Ember	<b>+\$0</b>
<b>RE</b>	Regatta	<b>+\$0</b>
<b>IR</b>	Iris	<b>+\$0</b>
<b>AT</b>	Atom	<b>+\$0</b>

## CASTERS/ GLIDES



CODE	DESCRIPTION	PRICE
<b>H</b>	Black Hard Caster	<b>+\$0</b>
<b>S</b>	Black All-Surface Caster	<b>+\$44</b>
<b>E9</b>	Charcoal All-Surface Caster	<b>+\$44</b>
<b>ST</b>	Salt All-Surface Caster	<b>+\$44</b>
<b>TS</b>	Titanium All-Surface Caster	<b>+\$44</b>
<b>R</b>	Black Roll Control Caster	<b>+\$55</b>
<b>G</b>	Black Bell Glide	<b>+\$28</b>

## MESH COLOR

CODE	DESCRIPTION	PRICE
<b>IM</b>	Black	<b>+\$0</b>
<b>IB</b>	Breeze	<b>+\$0</b>
<b>IK</b>	Brownstone	<b>+\$0</b>
<b>IC</b>	Charcoal	<b>+\$0</b>
<b>IF</b>	Fog	<b>+\$0</b>
<b>IR</b>	Regatta	<b>+\$0</b>
<b>IT</b>	Titanium	<b>+\$0</b>

## STITCH COLOR

CODE	DESCRIPTION	PRICE
<b>TC00</b>	Fabric-Matched	<b>+\$0</b>
<b>TC01</b>	Yellow	<b>+\$17</b>
<b>TC02</b>	Tan	<b>+\$17</b>
<b>TC03</b>	Natural	<b>+\$17</b>
<b>TC04</b>	Black	<b>+\$17</b>
<b>TC05</b>	Light Red	<b>+\$17</b>
<b>TC06</b>	Orange	<b>+\$17</b>
<b>TC07</b>	Medium Green	<b>+\$17</b>
<b>TC08</b>	Blue	<b>+\$17</b>
<b>TC09</b>	Light Gray	<b>+\$17</b>

## BASE

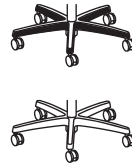

CODE	DESCRIPTION	PRICE
<b>SB</b>	Standard Base	<b>+\$0</b>
<b>PA</b>	Polished Aluminum	<b>+\$119</b>

## CYLINDER

CODE	DESCRIPTION	PRICE
<b>STC</b>	Standard Cylinder	<b>+\$0</b>
<b>SHC</b>	Short Cylinder	<b>+\$0</b>
<b>TLC</b>	Tall Cylinder	<b>+\$0</b>

## LUMBAR



CODE	DESCRIPTION	PRICE
<b>NL</b>	No Lumbar	<b>+\$0</b>
<b>AL</b>	Adjustable Lumbar	<b>+\$55</b>

## FRAME COLOR

CODE	DESCRIPTION	PRICE
<b>T</b>	Black	<b>+\$0</b>
<b>S</b>	Charcoal	<b>+\$39</b>
<b>STX</b>	Salt	<b>+\$39</b>

# CIPHER™

## Guest Options

### ARM STYLE

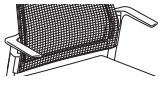

CODE	DESCRIPTION	PRICE
<b>N</b>	Armless	<b>+\$0</b>
<b>F</b>	Fixed Arms	<b>+\$33</b>

### CASTERS/ GLIDE



CODE	DESCRIPTION	PRICE
<b>H</b>	Black Hard Caster	<b>+\$0</b>
<b>S</b>	Black All-Surface Caster	<b>+\$33</b>
<b>E</b>	Glide	<b>+\$0</b>

### FRAME PAINT

CODE	DESCRIPTION	PRICE
<b>P71</b>	Black	<b>+\$0</b>
<b>CBK</b>	Charblack	<b>+\$0</b>
<b>P7A</b>	Textured Charcoal	<b>+\$39</b>
<b>P8Z</b>	Textured Salt	<b>+\$39</b>

### MESH COLOR

CODE	DESCRIPTION	PRICE
<b>IM</b>	Black	<b>+\$0</b>
<b>IB</b>	Breeze	<b>+\$0</b>
<b>IK</b>	Brownstone	<b>+\$0</b>
<b>IC</b>	Charcoal	<b>+\$0</b>
<b>IF</b>	Fog	<b>+\$0</b>
<b>IR</b>	Regatta	<b>+\$0</b>
<b>IT</b>	Titanium	<b>+\$0</b>

### FRAME COLOR

CODE	DESCRIPTION	PRICE
<b>T</b>	Black	<b>+\$0</b>
<b>S</b>	Charcoal	<b>+\$39</b>
<b>STX</b>	Salt	<b>+\$39</b>

# CIPHER™ Task Dimensions

	Model	Task								
	Arms	Armless			1D			4D		
	Cylinder	Standard	Short	Tall	Standard	Short	Tall	Standard	Short	Tall
<b>Max Width</b>		27.5	27.5	27.5	27.5	27.5	27.5	29.5	29.5	29.5
<b>Max Depth</b>		26.75	26.75	26.75	26.75	26.75	26.75	26.75	26.75	26.75
<b>Max Height</b>		43.125	40.625	45.125	43.125	40.625	45.125	45.125	40.625	45.125
<b>Chair Weight</b>		30	30	30	35	35	35	35	35	35
<b>Shipping Weight</b>		38	38	38	43	43	43	43	43	43
<b>Shipping Weight (KD)</b>		NA	NA	NA	NA	NA	NA	NA	NA	NA
<b>Cubes</b>		10.73	10.73	10.73	10.73	10.73	10.73	10.73	10.73	10.73
<b>Cubes (KD)</b>		NA	NA	NA	NA	NA	NA	NA	NA	NA
<b>Seat</b>	<b>Width</b>	19.5	19.5	19.5	19.5	19.5	19.5	19.5	19.5	19.5
	<b>Usable Depth</b>	18.62 - 16.58	18.62 - 16.58	18.62 - 16.58	18.62 - 16.58	18.62 - 16.58	18.62 - 16.58	18.62 - 16.58	18.62 - 16.58	18.62 - 16.58
	<b>Height from Floor</b>	15.00 - 19.625	14.335 - 16.875	17.00 - 21.625	15.00 - 19.625	14.335 - 16.875	17.00 - 21.625	15.00 - 19.625	14.335 - 16.875	17.00 - 21.625
	<b>Seat Depth</b>	18	18	18	18	18	18	18	18	18
<b>Back</b>	<b>Back Lumbar Height</b>	5.9 - 11.0	5.9 - 11.0	5.9 - 11.0	5.9 - 11.0	5.9 - 11.0	5.9 - 11.0	5.9 - 11.0	5.9 - 11.0	5.9 - 11.0
	<b>Lumbar Protrusion</b>	.512 - .787	.512 - .787	.512 - .787	.512 - .787	.512 - .787	.512 - .787	.512 - .787	.512 - .787	.512 - .787
	<b>Width</b>	18.75	18.75	18.75	18.75	18.75	18.75	18.75	18.75	18.75
	<b>Height</b>	24.016	24.016	24.016	24.016	24.016	24.016	24.016	24.016	24.016
<b>Angles</b>	<b>Seat Angle from Floor</b>	-1.4	-1.4	-1.4	-1.4	-1.4	-1.4	-1.4	-1.4	-1.4
	<b>Seat Angle Reclined</b>	-6	-6	-6	-6	-6	-6	-6	-6	-6
	<b>Back Angle from Seat</b>	97	97	97	97	97	97	97	97	97
	<b>Back Angle from Seat Reclined</b>	117	117	117	117	117	117	117	117	117
<b>Arms</b>	<b>Distance Between Arms</b>	NA	NA	NA	18.813	18.813	18.813	12.625 - 19.750	12.625 - 19.750	12.625 - 19.750
	<b>Height from Floor</b>	NA	NA	NA	22.50 - 31.625	21.375 - 28.125	24.50 - 33.625	23.0 - 32.125	21.875 - 28.625	25.0 - 34.125
	<b>Height from Seat</b>	NA	NA	NA	4.938 - 8.625	4.938 - 8.625	4.938 - 8.625	4.938 - 8.625	5.438 - 9.125	5.438 - 9.125
	<b>Width</b>	NA	NA	NA	3.875	3.875	3.875	3.875	3.875	3.875
	<b>Length</b>	NA	NA	NA	9.3125	9.3125	9.3125	9.3125	9.3125	9.3125
	<b>Arm Set-Back</b>	NA	NA	NA	4.212 - 6.259	4.212 - 6.259	4.212 - 6.259	4.212 - 6.259	4.212 - 6.259	4.212 - 6.259



**HCFRT**



**TASK CHAIR**

- Mesh Back**
- Pneumatic
- Swivel
- Weight-activated
- Synchro-tilt
- Tilt Lock
- Seat Slide

Functions: **A, D, E, J, L, P**  
 (Function Key on pages 252-253)

**DIMENSIONS**

Depth:	26¾	Seat to Floor Height:	15-19¾
Width:	27½	Usable Seat Depth:	16½-18½
Height:	43⅝	Ship Weight:	43
Seat Depth:	18	Cube:	10.7
Seat Width:	19½	COM:	1.0
Back Width:	18¾	Weight Rating:	300 lbs.
Back Height:	24		

**FABRIC PRICE CODES**

<b>1</b>	<b>\$864</b>	<b>8</b>	<b>\$1014</b>
<b>2</b>	<b>\$891</b>	<b>9</b>	<b>\$1033</b>
<b>3</b>	<b>\$917</b>	<b>10</b>	<b>\$1052</b>
<b>4</b>	<b>\$936</b>	<b>11</b>	<b>\$1072</b>
<b>5</b>	<b>\$955</b>	<b>12</b>	<b>\$1091</b>
<b>6</b>	<b>\$975</b>	<b>L</b>	<b>\$1274</b>
<b>7</b>	<b>\$994</b>		

NOTES: If armless and no lumbar are selected, choose the frame color in the Accent Color field and the Frame Color field. Features weight-activated control with easy access at seat height.

**HON Recommendation: HCFRT.STC.H.H.IC.CU\_\_TC09.AL.AT.SB.S - List Price \$1067**

**HOW TO SPECIFY**

Select Model Number	Select Cylinder	Select Arm	Select Caster	Select Mesh Color	Select Fabric	Select Seat Stitch Color	Select Lumbar	Select Accent Color	Select Base	Select Frame
<b>STC</b> Standard <b>SHC</b> Short Cylinder <b>TLC</b> Tall Cylinder	<b>N</b> Armless <b>H</b> Height Adjustable (+ \$92) <b>V</b> All-Adjustable (+ \$141)	<b>H</b> Black Hard Caster <b>S</b> Black All-Surface Caster (+ \$44) <b>E9</b> Charcoal All-Surface Caster (+ \$44) <b>ST</b> Salt All-Surface Caster (+ \$44) <b>TS</b> Titanium All-Surface Caster (+ \$44) <b>R</b> Black Roll Control Caster (+ \$55) <b>G</b> Black Bell Glide (+ \$28)	<b>IM</b> Black <b>IF</b> Fog <b>IC</b> Charcoal <b>IT</b> Titanium <b>IK</b> Brownstone <b>IR</b> Regatta <b>IB</b> Breeze	See page 287	See page 288 (+ \$17 for non-fabric matched options)	<b>NL</b> No Lumbar <b>AL</b> Adjustable Lumbar (+ \$55)	<b>BL</b> Black <b>S</b> Charcoal <b>ST</b> Salt <b>BY</b> Bullseye <b>KT</b> Krypton <b>MR</b> Ember <b>RE</b> Regatta <b>IR</b> Iris <b>AT</b> Atom	<b>SB</b> Standard <b>PA</b> Polished Aluminum (+ \$119)	<b>T</b> Black <b>S</b> Charcoal (+ \$39) <b>STX</b> Salt (+ \$39)	
<b>HCFRT</b>	<b>STC</b>	<b>H</b>	<b>H</b>	<b>IM</b>	<b>APX13</b>	<b>TC00</b>	<b>AL</b>	<b>BL</b>	<b>SB</b>	<b>T</b>

**SEATING**



Icon Legend on page 19

## HCFRG



### GUEST CHAIR

Mesh Back

### DIMENSIONS

Depth:	24 <sup>1</sup> / <sub>8</sub>	Seat to Floor Height:	19 <sup>3</sup> / <sub>4</sub>
Width:	24 <sup>1</sup> / <sub>4</sub>	Usable Seat Depth:	17 <sup>1</sup> / <sub>4</sub>
Height:	33 <sup>1</sup> / <sub>2</sub>	Ship Weight:	30
Seat Depth:	17 <sup>3</sup> / <sub>8</sub>	Cube:	15.8
Seat Width:	19	COM:	1.0
Back Width:	19	Weight Rating:	300 lbs.
Back Height:	18		

### FABRIC PRICE CODES

1	\$629	8	\$779
2	\$656	9	\$798
3	\$682	10	\$817
4	\$701	11	\$837
5	\$720	12	\$856
6	\$740	L	\$1039
7	\$759		

HON Recommendation: HCFRG.F.S.APX\_\_APX\_\_.TC09.S.P7A - List Price \$790

## HOW TO SPECIFY

Select Model Number	Select Arms	Select Caster	Select Back Material	Select Fabric	Select Seat Stitch Color	Select Frame	Select Paint Color
N F	H S E	See page 287	See page 287	See page 288 (+ \$17 for non-fabric matched options)	T S STX	P71 CBK P7A P8Z	
HCFRG	F	S	APX13	APX13	TC00	T	P71



Cliq™ Seating shown with Preside® Table and Credenza.

## CLIQ™

Some of the best work results from a collaborative effort. That's why Cliq brings people together. Designed with a weight-activated control that responds to your body and its movements, Cliq just gets you — providing instant comfort without a lot of adjustments. It's light-scaled for a modern look that's also easy to maneuver around wherever the group discussion takes you. Available as a task chair or stool, Cliq features a wide selection of fabric choices and frame and mesh colors. Intuitive, stylish, and supportive — it just clicks with any collaborative environment.



## FEATURES

- Intuitive functionality and design provides comfort and support without the need for multiple adjustments.
- Weight-activated control automatically adjusts to you as you sit.
- Thin profile offers a modern aesthetic, while a wide range of fabric choices ensures the perfect look within any space.
- 4-Way Stretch Mesh flexes in every direction to dynamically move with you — available in 7 colors.
- Choose between fixed arms or armless to get exactly the look you want.
- Task Chairs are available with a conference cylinder or task cylinder so you can choose the chair that best fits your space.
- Task Stools feature an adjustable footring for additional lower body support.
- One-touch seat height adjustment easily moves the seat up and down.
- Choose from 3 frame options: Black, Titanium, and Designer White.

# CLIQ™ Fabric Options

## HON BRANDED FABRICS

### GRADE 1

Apex  
Centurion  
Compass  
Contourett  
Dapper  
Ensemble  
Hamilton  
Inertia  
Noble Seating  
Optic  
Pebble  
Vibe

### GRADE 2

Appoint Seating  
Blume  
Clyde  
Dotty  
Kai  
Rush  
Spin Seating  
Wavelength  
Whisper Vinyl

### GRADE 3

Bradbury  
Getaway  
Moxie  
Notion  
Parker  
Purl  
Quill  
Saxony

### GRADE 4

Constance with Supreen™  
Livi with Supreen™  
Lugano with Supreen™  
Oxford with Supreen™

**For a complete list of fabrics, including partnership fabrics, go to [hon.com/fabricsandfinishes](https://hon.com/fabricsandfinishes).**

Reference Fabric Color Combinations on pages 20-25 for color codes and legend on page 21 for lead times.



**HCLQT**



**LIGHT TASK CHAIR**

**Mesh Back**

- Pneumatic
- Swivel
- Weight-activated
- Synchro-tilt
- Tilt Lock

Functions: **A, E, J, L, P**  
 (Function Key on pages 252-253)

**DIMENSIONS**

Depth:	27	Seat to Floor Height	
Width:	27	(Task Cylinder):	17-22
Height:	41	Seat to Floor Height	
Seat Depth:	17	(Conference Cylinder):	15 <sup>5</sup> / <sub>8</sub> -19 <sup>3</sup> / <sub>8</sub>
Seat Width:	19 <sup>1</sup> / <sub>4</sub>	Usable Seat Depth:	17
Back Width:	19 <sup>1</sup> / <sub>4</sub>	Ship Weight:	45
Back Height:	21	Cube:	10.7
		COM:	1.0
		Weight Rating:	300 lbs.

**FABRIC PRICE CODES**

<b>1</b>	<b>\$771</b>	<b>8</b>	<b>\$921</b>
<b>2</b>	<b>\$798</b>	<b>9</b>	<b>\$940</b>
<b>3</b>	<b>\$824</b>	<b>10</b>	<b>\$959</b>
<b>4</b>	<b>\$843</b>	<b>11</b>	<b>\$979</b>
<b>5</b>	<b>\$862</b>	<b>12</b>	<b>\$998</b>
<b>6</b>	<b>\$882</b>	<b>L</b>	<b>—</b>
<b>7</b>	<b>\$901</b>		

NOTES: When selecting the Conference Cylinder, the maximum arm height from floor is 28<sup>1</sup>/<sub>2</sub>".

**HON Recommendation: HCLQT.W0.TC.F.S.IT.CU\_\_NL.SB.TI - List Price \$843**

**HOW TO SPECIFY**

Select Model Number	Select Control Type	Select Cylinder	Select Arm Type	Select Caster	Select Back Option	Select Fabric	Select Lumbar	Select Base	Select Frame
<b>W0</b> Weight-Activated	<b>TC2</b> Task Cylinder (standard height) <b>CC1</b> Conference Cylinder (low height)	<b>N</b> Armless <b>F</b> Fixed (+ \$33)	<b>S</b> Black All-Surface Caster	<b>IM</b> Black <b>IB</b> Breeze <b>IK</b> Brownstone <b>IC</b> Charcoal <b>IF</b> Fog <b>IR</b> Regatta <b>IT</b> Titanium	See page 294	<b>NL</b> No Lumbar	<b>SB</b> Standard Base <b>PA</b> Polished Aluminum (+ \$119)	<b>T</b> Black <b>TI</b> Titanium (+ \$39) <b>DW</b> Designer White (+ \$39)	
HCLQT	W0	TC	F	S	IT	CU19	NL	SB	TI





## HCLQS

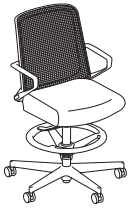

### TASK STOOL

**Mesh Back**  
 Pneumatic  
 Swivel  
 Weight-activated  
 Synchro-tilt  
 Tilt Lock  
 Functions: **A, E, J, L, P**  
 (Function Key on pages 252-253)

### DIMENSIONS

Depth:	28¾	Seat to Floor Height:	23-33
Width:	28¾	Usable Seat Depth:	17
Height:	52	Ship Weight:	50
Seat Depth:	17	Cube:	10.7
Seat Width:	19¼	Weight Rating:	300 lbs.
Back Width:	19¼		
Back Height:	21		

### FABRIC PRICE CODES

<b>1</b>	<b>\$855</b>	<b>8</b>	<b>\$1005</b>
<b>2</b>	<b>\$882</b>	<b>9</b>	<b>\$1024</b>
<b>3</b>	<b>\$908</b>	<b>10</b>	<b>\$1043</b>
<b>4</b>	<b>\$927</b>	<b>11</b>	<b>\$1063</b>
<b>5</b>	<b>\$946</b>	<b>12</b>	<b>\$1082</b>
<b>6</b>	<b>\$966</b>	<b>L</b>	<b>—</b>
<b>7</b>	<b>\$985</b>		

**HON Recommendation: HCLQS.W0.SC2.F.S.IT.CU\_\_NL.SB.TI - List Price \$948**

## HOW TO SPECIFY

Select Model Number	Select Control Type	Select Cylinder	Select Arm Type	Select Caster	Select Back Option	Select Fabric	Select Lumbar	Select Base	Select Frame
	<b>W0</b> Weight-Activated	<b>SC2</b> Stool Cylinder	<b>N</b> Armless <b>F</b> Fixed (+ \$33)	<b>S</b> Black All-Surface Caster	<b>IM</b> Black <b>IB</b> Breeze <b>IK</b> Brownstone <b>IC</b> Charcoal <b>IF</b> Fog <b>IR</b> Regatta <b>IT</b> Titanium	See page 294	<b>NL</b> No Lumbar	<b>SB</b> Standard Base <b>PA</b> Polished Aluminum (+ \$119)	<b>T</b> Black <b>TI</b> Titanium (+ \$60) <b>DW</b> Designer White (+ \$60)
<b>HCLQS</b>	<b>W0</b>	<b>SC2</b>	<b>F</b>	<b>S</b>	<b>IT</b>	<b>CU19</b>	<b>NL</b>	<b>SB</b>	<b>TI</b>



Best of  
NeoCon  
2022

Gold



Cofi™ Seating shown with Preside® and Acoustic Solutions by Unika Vaev.

## COFI™

You never get a second chance to make a first impression — so why not make a memorable one with Cofi™? This eye-catching seating solution supports individual needs throughout the day with its upscale design and easy control mechanisms. Fine stitching, premium materials, and endless customization options make it easy to celebrate your unique style — and with its thoughtful detailing, and contemporary back, finish, and fabric choices, closing the deal has never been more stylish or sophisticated.



## FEATURES

- Get your choice of an Executive or Managerial back.
- Amp up your aesthetic with three different back stitch details — Channel, Quilt, or Solid.
- Color your world with nine contrast stitching color choices.
- Elevate the look with polished aluminum arm and base options.
- Get comfortable with height and width adjustable arms or all-adjustable arms for additional pivot support.
- Make the most of your conference room meetings with simple functionality and comfort.
- Go contemporary with a thin, tapered profile.
- Achieve a signature look with premium detailing and elevated design.
- Find your ideal sit and fit with three handy control mechanisms.
- Clean things up with a fabric-matched thread option.
- Add a little luxury with multi-fabric and contrast stitching choices.

## MODEL OPTIONS

HCFEU



Executive Chair

HCFEUMF



Executive Chair  
Multi-Fabric

HCFMU



Managerial Chair

HCFMUMF



Managerial Chair  
Multi-Fabric

## HON BRANDED FABRICS

### GRADE 1

Apex  
Centurion  
Compass  
Contourett  
Dapper  
Ensemble  
Hamilton  
Inertia  
Noble Seating  
Optic  
Pebble  
Vibe

### GRADE 2

Appoint Seating  
Blume  
Clyde  
Dotty  
Kai  
Rush  
Spin Seating  
Wavelength  
Whisper Vinyl

### GRADE 3

Bradbury  
Getaway  
Moxie  
Notion  
Parker\*  
Purl  
Quill  
Saxony

### GRADE 4

Constance with Supreen™  
Livi with Supreen™  
Lugano with Supreen™  
Oxford with Supreen™

### GRADE L1

Davenport Leather

**For a complete list of fabrics, including partnership fabrics, go to [honesty.hon.com/fabricsandfinishes](https://honesty.hon.com/fabricsandfinishes).**

Reference Fabric Color Combinations on pages 20-25 for color codes and legend on page 21 for lead times. For additional HON to Supply COM fabric grade pricing, go to [honesty.hon.com](https://honesty.hon.com) and click on the HON to Supply COM link.

\*Only available as a seat fabric on Multi-Fabric models. Cannot be used with any Single-Fabric models.

Dotty, Parker, and Quill are not approved on the Cofi™ back.

## ARM STYLE

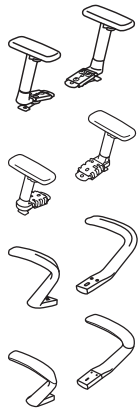

CODE	DESCRIPTION	PRICE
<b>N</b>	Armless	<b>+\$0</b>
<b>A</b>	Height and Width Adjustable Arms	<b>+\$92</b>
<b>V</b>	All-Adjustable Arms Arms (Includes Pivot)	<b>+\$141</b>
<b>F</b>	Fixed Arms	<b>+\$71</b>
<b>P</b>	Fixed Polished Aluminum Arms	<b>+\$189</b>

## CASTERS/ GLIDE



CODE	DESCRIPTION	PRICE
<b>H</b>	Black Hard Caster	<b>+\$0</b>
<b>S</b>	Black All-Surface Caster	<b>+\$44</b>
<b>R</b>	Black Roll Control Caster	<b>+\$55</b>
<b>G</b>	Black Bell Glide	<b>+\$28</b>

## STITCH COLOR

CODE	DESCRIPTION	PRICE
<b>TC00</b>	Fabric-Matched	<b>+\$0</b>
<b>TC01</b>	Yellow	<b>+\$55</b>
<b>TC02</b>	Tan	<b>+\$55</b>
<b>TC03</b>	Natural	<b>+\$55</b>
<b>TC04</b>	Black	<b>+\$55</b>
<b>TC05</b>	Light Red	<b>+\$55</b>
<b>TC06</b>	Orange	<b>+\$55</b>
<b>TC07</b>	Medium Green	<b>+\$55</b>
<b>TC08</b>	Blue	<b>+\$55</b>
<b>TC09</b>	Light Gray	<b>+\$55</b>

## STITCH DETAIL

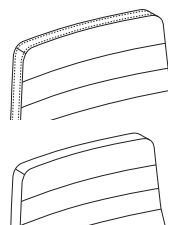

### Contrast Stitch (TC01-09)

When chosen, the perimeter of the back, back panels, and seat will include a top stitch in contrasting color.

### Fabric-Matched Stitch (TC00)

When chosen, top stitches listed above will not be added in those locations.

## MECHANISM

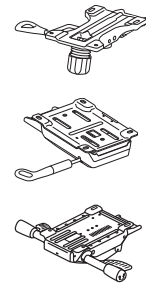

CODE	DESCRIPTION	PRICE
<b>YO</b>	Synchro-Tilt A, E, J, K, L	<b>+\$0</b>
<b>WO</b>	Weight-Activated A, E	<b>+\$28</b>
<b>Y2</b>	Advanced Synchro-Tilt w/ Seat Slider A, D, E, J, L, A-D	<b>+\$71</b>

## BASE

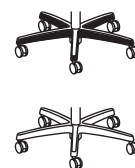

CODE	DESCRIPTION	PRICE
<b>SB</b>	Standard Base	<b>+\$0</b>
<b>PA</b>	Polished Aluminum	<b>+\$119</b>

## CYLINDER

CODE	DESCRIPTION	PRICE
<b>STC</b>	Standard Cylinder	<b>+\$0</b>
<b>SHC</b>	Short Cylinder	<b>+\$0</b>
<b>TLC</b>	Tall Cylinder	<b>+\$0</b>

## BACK STITCH

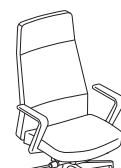

CODE	DESCRIPTION	PRICE
<b>SLB</b>	Solid Stitch	<b>+\$0</b>



CODE	DESCRIPTION	PRICE
<b>CHS</b>	Channel Stitch	<b>+\$0</b>

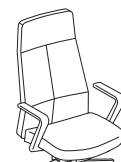

CODE	DESCRIPTION	PRICE
<b>QLT</b>	Quilt Stitch	<b>+\$0</b>

# COFI™ Dimensions

MODEL		HCFEU	HCFMU
Overall Width	Armless	25¼	25¼
	Fixed Arms	26	26
Overall Depth	Y0	27½	26⅝
	Y2	26⅝	26
	W0	26⅝	26
Overall Height*	Y0	43¼ - 48¼	35½ - 40½
	Y2	44 - 49	36¼ - 41¼
	W0	43½ - 48½	35¾ - 40¾
Seat Width		20½	20½
Seat Depth		17¾	17¾
Usable Seat Depth	Y0	17¼	17¼
	Y2	16¾ - 19¾	16¾ - 19¾
	W0	16¾	16¾
Seat Height*	Y0	15¾ - 20¾	15¾ - 20¾
	Y2	16¾ - 21¾	16¾ - 21¾
	W0	15½ - 20½	15½ - 20½
Back Width		20	20
Back Height	Y0	27½	20
	Y2	27	19½
	W0	28	20½
Ship Weight Armless	Y0	40	39⅝
	Y2	45¼	45
	W0	41¼	41
Ship Weight F Arms	Y0	47¼	47
	Y2	52⅝	52¼
	W0	48⅝	48¼
Ship Weight P Arms	Y0	49⅝	49
	Y2	54¾	54⅜
	W0	50¾	50⅜
Width Between Arms	Fixed Arms	21	21
Cube		16½	10¾
COM		3	3
Weight Capacity		300 lbs	300 lbs

\*Dimensions are based on Standard Cylinder.

Short Cylinder: Reduce lowered seat height by 2" and raised seat height by 4¼".

Tall Cylinder: Increase seat height by 1" for lowered and raised positions.

**HCFEU**

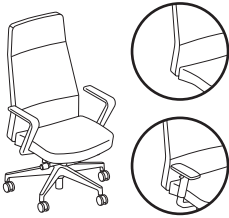

**EXECUTIVE HIGH-BACK**

- Pneumatic
- Swivel
- Synchro-tilt
- Tilt Tension
- Tilt Lock

**DIMENSIONS**

Depth:	26-27½	Width (with arms):	26
Height:	43¼-49	Width (armless):	25¼
Seat Depth:	17¾	Ship Weight:	63
Seat Width:	20½	Cube:	16.5
Back Width:	20	COM:	3.0
Back Height:	27½-28	Weight Rating:	300 lbs.

**FABRIC PRICE CODES**

<b>1</b>	<b>\$1065</b>	<b>8</b>	<b>\$1437</b>
<b>2</b>	<b>\$1130</b>	<b>9</b>	<b>\$1486</b>
<b>3</b>	<b>\$1195</b>	<b>10</b>	<b>\$1534</b>
<b>4</b>	<b>\$1244</b>	<b>11</b>	<b>\$1583</b>
<b>5</b>	<b>\$1292</b>	<b>12</b>	<b>\$1631</b>
<b>6</b>	<b>\$1341</b>	<b>L</b>	<b>\$1905</b>
<b>7</b>	<b>\$1389</b>		

**HCFMU**

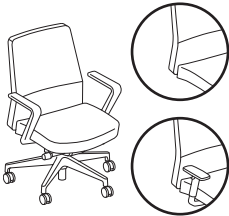

**MANAGERIAL BACK**

- Pneumatic
- Swivel
- Synchro-tilt
- Tilt Tension
- Tilt Lock

**DIMENSIONS**

Depth:	26	Width (with arms):	26
Height:	35¼-41¼	Width (armless):	25¼
Seat Depth:	17¾	Ship Weight:	55
Seat Width:	20½	Cube:	10.7
Back Width:	20	COM:	3.0
Back Height:	19½-20½	Weight Rating:	300 lbs.

**FABRIC PRICE CODES**

<b>1</b>	<b>\$977</b>	<b>8</b>	<b>\$1275</b>
<b>2</b>	<b>\$1030</b>	<b>9</b>	<b>\$1314</b>
<b>3</b>	<b>\$1082</b>	<b>10</b>	<b>\$1352</b>
<b>4</b>	<b>\$1120</b>	<b>11</b>	<b>\$1392</b>
<b>5</b>	<b>\$1159</b>	<b>12</b>	<b>\$1430</b>
<b>6</b>	<b>\$1198</b>	<b>L</b>	<b>\$1481</b>
<b>7</b>	<b>\$1236</b>		

**HON Recommendation: HCFEU.Y2.STC.P.H.DAV\_\_CHSTC00.PA - List Price \$2284**

**HOW TO SPECIFY**

Select Model Number	Select Control Type	Select Cylinder	Select Arm Type	Select Caster	Select Fabric	Select Back Detail and Stitch Color	Select Base
	<b>Y0</b> Synchro-Tilt <b>W0</b> Weight-Activated (+ \$28) <b>Y2</b> Advanced Synchro-Tilt w/ Seat Slider (+ \$71)	<b>STC</b> Standard Cylinder <b>SHC</b> Short Cylinder <b>TLC</b> Tall Cylinder	<b>N</b> Armless <b>A</b> Height and Width Adjustable Arms (+ \$92) <b>V</b> All-Adjustable Arm (Includes Pivot) (+ \$141) <b>F</b> Fixed (+ \$71) <b>P</b> Fixed Polished Aluminum (+ \$189)	<b>H</b> Black Hard Caster <b>S</b> Black All-Surface Caster (+ \$44) <b>R</b> Black Roll Control Caster (+ \$55) <b>G</b> Black Bell Glide (+ \$28)	See page 298	<b>SLB</b> Solid Stitch <b>CHS</b> Channel Stitch <b>QLT</b> Quilt Stitch See page 299 for Stitch Colors and Pricing	<b>SB</b> Standard Base <b>PA</b> Polished Aluminum (+ \$119)
<b>H C F E U</b>	<b>Y 2</b>	<b>S T C</b>	<b>F</b>	<b>H</b>	<b>A P X 1 3</b>	<b>S L B T C 0 0</b>	<b>S B</b>

# COFI™

## HCFEUMF

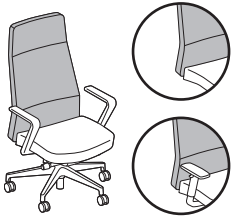

### EXECUTIVE HIGH-BACK, MULTI-FABRIC

- Pneumatic Swivel
- Synchro-tilt
- Tilt Tension
- Tilt Lock

### DIMENSIONS

Depth:	26-27½	Width (with arms):	26
Height:	43¼-49	Width (armless):	25¼
Seat Depth:	17¾	Ship Weight:	63
Seat Width:	20½	Cube:	16.5
Back Width:	20	Back COM:	2.5
Back Height:	27½-28	Seat COM:	1.0
		Weight Rating:	300 lbs.

### FABRIC PRICE CODES

<b>1</b>	<b>\$1107</b>	
<i>Add to Base Price Above</i>		
	<b>Back</b>	<b>Seat</b>
<b>2</b>	<b>\$40</b>	<b>\$27</b>
<b>3</b>	<b>\$79</b>	<b>\$53</b>
<b>4</b>	<b>\$108</b>	<b>\$72</b>
<b>5</b>	<b>\$136</b>	<b>\$91</b>
<b>6</b>	<b>\$165</b>	<b>\$111</b>
<b>7</b>	<b>\$195</b>	<b>\$130</b>
<b>8</b>	<b>\$224</b>	<b>\$150</b>
<b>9</b>	<b>\$253</b>	<b>\$169</b>
<b>10</b>	<b>\$282</b>	<b>\$188</b>
<b>11</b>	<b>\$311</b>	<b>\$208</b>
<b>12</b>	<b>\$340</b>	<b>\$227</b>

## HCFMUMF

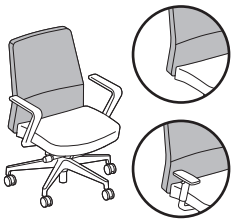

### MANAGERIAL BACK, MULTI-FABRIC

- Pneumatic Swivel
- Synchro-tilt
- Tilt Tension
- Tilt Lock

### DIMENSIONS

Depth:	26	Width (with arms):	26
Height:	35¼-41¼	Width (armless):	25¼
Seat Depth:	17¾	Ship Weight:	55
Seat Width:	20½	Cube:	10.7
Back Width:	20	Back COM:	2.5
Back Height:	19½-20½	Seat COM:	1.0
		Weight Rating:	300 lbs.

### FABRIC PRICE CODES

<b>1</b>	<b>\$1018</b>	
<i>Add to Base Price Above</i>		
	<b>Back</b>	<b>Seat</b>
<b>2</b>	<b>\$27</b>	<b>\$27</b>
<b>3</b>	<b>\$53</b>	<b>\$53</b>
<b>4</b>	<b>\$72</b>	<b>\$72</b>
<b>5</b>	<b>\$91</b>	<b>\$91</b>
<b>6</b>	<b>\$111</b>	<b>\$111</b>
<b>7</b>	<b>\$130</b>	<b>\$130</b>
<b>8</b>	<b>\$150</b>	<b>\$150</b>
<b>9</b>	<b>\$169</b>	<b>\$169</b>
<b>10</b>	<b>\$188</b>	<b>\$188</b>
<b>11</b>	<b>\$208</b>	<b>\$208</b>
<b>12</b>	<b>\$227</b>	<b>\$227</b>

**HON Recommendation: HCFEUMF.Y2.STC.P.H.WP\_\_CHSTC04.WP\_\_TC04.PA - List Price \$1608**

## HOW TO SPECIFY

Select Model Number	Select Control Type	Select Cylinder	Select Arm Type	Select Caster	Select Back Fabric	Select Back Detail and Stitch Color	Select Seat Fabric	Select Seat Stitch Color	Select Base
<b>YO</b> Synchro-Tilt <b>WO</b> Weight-Activated (+ \$28) <b>Y2</b> Advanced Synchro-Tilt w/ Seat Slider (+ \$71)	<b>STC</b> Standard Cylinder <b>SHC</b> Short Cylinder <b>TLC</b> Tall Cylinder	<b>N</b> Armless <b>A</b> Height and Width Adjustable Arms (+ \$92) <b>V</b> All-Adjustable Arm (Includes Pivot) (+ \$141) <b>F</b> Fixed (+ \$71) <b>P</b> Fixed Polished Aluminum (+ \$189)	<b>H</b> Black Hard Caster <b>S</b> Black All-Surface Caster (+ \$44) <b>R</b> Black Roll Control Caster (+ \$55) <b>G</b> Black Bell Glide (+ \$28)	See page 298	<b>SLB</b> Solid Stitch <b>CHS</b> Channel Stitch <b>QLT</b> Quilt Stitch See page 299 for Stitch Colors and Pricing	See page 298	See page 299 for Stitch Colors and Pricing	<b>SB</b> Standard Base <b>PA</b> Polished Aluminum (+ \$119)	
H C F E U M F	. Y 2 .	S T C .	F .	H .	A P X 2 5 .	S L B T C 0 0 .	A P X 1 3 .	T C 0 0 .	S B



# CONVERGENCE®

Want to see more? Scan here  
to check out hon.com.



Convergence® Task Chairs shown with  
Empower® Height-Adjustable Workstations.

## CONVERGENCE®

What happens when support and affordability come together? Convergence. This is the task chair that is as attainable as is it comfortable with customizable features. Lumbar support that adds a little extra lower back comfort. Thick seat cushions to take the stress off the lower body throughout the day. Arm choices that let you decide how much upper body support you want. A breathable mesh back that flexes and responds to your movements. Convergence puts all the features you're looking for into one low-priced task chair.



## FEATURES

- Choice of swivel tilt or synchro-tilt control with seat slide.
- Black mesh back is breathable for all-day comfort and support.
- Comfort options include adjustable lumbar support, adjustable arms, seat glide and synchro-tilt.
- Three arm options.
- Two control options.
- Integrated handle on the back makes it easy to move and reposition the chair.
- Hard casters move effortlessly on any surface.
- Black frame sits atop a durable five-star base.
- Warranted for users up to 275 lbs.
- 3" thick seat cushion.

SEATING



# CONVERGENCE®

## Options



### BACK OPTIONS

HCT1MM

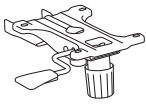

#### Mid-back

Mesh Task Chair  
with Adjustable  
Lumbar Support

MECHANISM	CODE	FUNCTIONS	PRICE
	<b>ZI</b>	Swivel-Tilt Control A, E, F, K, L, W	<b>+\$0</b>
	<b>YI</b>	Limited Synchro-Tilt A, D, E, J, K, L, W	<b>+\$39</b>

(See pages 252-253 for Seating Functions.)

ARM STYLE	CODE	DESCRIPTION	PRICE
	<b>N</b>	Armless	<b>+\$0</b>
	<b>H</b>	Height-Adjustable Arms	<b>+\$60</b>
	<b>A</b>	Height and Width Adjustable Arms	<b>+\$92</b>

CASTERS	CODE	DESCRIPTION	PRICE
	<b>H</b>	Black Hard Caster	<b>+\$0</b>

BACK STYLE	CODE	DESCRIPTION	PRICE
	<b>M</b>	Mesh	<b>+\$0</b>

BASE	CODE	DESCRIPTION	PRICE
	<b>SB</b>	Standard Base	<b>+\$0</b>

LUMBAR	CODE	DESCRIPTION	PRICE
	<b>AL</b>	Adjustable Lumbar	<b>+\$0</b>

FRAME	CODE	DESCRIPTION	PRICE
	<b>T</b>	Black	<b>+\$0</b>

### HON BRANDED FABRICS

GRADE 1	GRADE 2	GRADE 3	GRADE 4
Apex	Appoint Seating	Bradbury	Constance with Supreen™
Centurion	Blume	Getaway	Livi with Supreen™
Compass	Clyde	Moxie	Lugano with Supreen™
Contourett	Dotty	Notion	Oxford with Supreen™
Dapper	Kai	Parker	
Ensemble	Rush	Purl	
Hamilton	Spin	Quill	
Inertia	Wavelength	Saxony	
Noble Seating	Whisper Vinyl		
Optic			
Pebble			
Vibe			

**For a complete list of fabrics, including partnership fabrics, go to [hon.com/fabricsandfinishes](https://hon.com/fabricsandfinishes).**

Reference Fabric Color Combinations on pages 20-25 for color codes and legend on page 21 for lead times. For additional HON to Supply COM fabric grade pricing, go to [honready.hon.com](https://honready.hon.com) and click on the HON to Supply COM link.

# CONVERGENCE®

## Standard Task Chairs

GSA SIN 33721 EXCEPT AS NOTED



Icon Legend on page 19

### HCT1MM



#### MID-BACK TASK

**Mesh Back**  
Pneumatic  
Swivel  
Tilt Tension  
Tilt Lock  
Adjustable Lumbar Support

Functions: **A, E, K, L, W**  
(Function Key on pages 252-253)

#### DIMENSIONS

Depth:	27½	Adjustable Arms Width:	20
Width:	27¾	Seat to Floor Height:	15¾-20
Height:	42	Usable Seat Depth:	17-19
Seat Depth:	19	Ship Weight:	44
Seat Width:	20	Cube:	5.8
Back Width:	18	COM:	1.0
Back Height:	22	Weight Rating:	275 lbs.

#### FABRIC PRICE CODES

<b>1</b>	<b>\$456</b>	<b>7</b>	<b>\$521</b>
<b>2</b>	<b>\$470</b>	<b>8</b>	<b>\$532</b>
<b>3</b>	<b>\$483</b>	<b>9</b>	<b>\$541</b>
<b>4</b>	<b>\$493</b>	<b>10</b>	<b>\$550</b>
<b>5</b>	<b>\$502</b>	<b>11</b>	<b>\$561</b>
<b>6</b>	<b>\$512</b>	<b>12</b>	<b>\$570</b>

NOTES: Arm width adjustment range is 3" (from 17"-20"). Lumbar adjustment is 3". Seat depth range is only for Y1 control. Seat depth on Z1 control is 19".

### HSCASTER

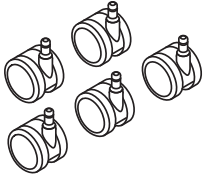

OPEN MARKET

#### SET OF 5 ALL-SURFACE CASTERS

#### DIMENSIONS

Size:	60mm
Ship Weight:	2
Cube:	0.1

#### LIST PRICE

\$75

! Available in Black finish only, no specification needed.

**HON Recommendation: HCT1MM.Y1.A.H.M.CU10.AL.SB.T - List Price \$587**

SEATING

### HOW TO SPECIFY

Select Model Number	Select Control Type	Select Arm Type	Select Caster	Select Back Type	Select Upholstery	Select Lumbar	Select Base	Select Frame
HCT1MM	Z1 Swivel-Tilt Control Y1 Simple Synchro-Tilt w/ Seat Slide Control (+ \$39)	N Armless A Height & Width Adjustable Arms (+ \$92)	H Black Hard Casters	M Mesh	See page 305	AL Adjustable Lumbar	SB Standard Base	T Black



Icon Legend on page 19

# CONVERGENCE® Value Task Chairs

## HCAT1MM\*



### MID-BACK TASK VALUE MODEL

#### Mesh Back

- Pneumatic
- Swivel
- Tilt Tension
- Tilt Lock
- Adjustable Lumbar Support

Functions: **A, E, K, L, W**  
(Function Key on pages 252-253)

NOTES: Lumbar adjustment is 3". Seat depth range is only for Y1 control. Seat depth on Z1 control is 19".

### DIMENSIONS

Depth:	27½	Adjustable Arms Width:	17-20
Width:	27¾	Seat to Floor Height:	15¾-20
Height:	42	Usable Seat Depth:	17-19
Seat Depth:	19	Ship Weight:	44
Seat Width:	20	Cube:	5.8
Back Width:	18	Weight Rating:	275 lbs.
Back Height:	22		

### LIST PRICE

**\$527**

## HSCASTER

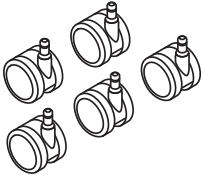

### SET OF 5 ALL-SURFACE CASTERS

### DIMENSIONS

Size:	60mm
Ship Weight:	2
Cube:	0.1

### LIST PRICE

**\$75**

ⓘ Available in Black finish only, no specification needed.

**HON Recommendation: HCAT1MM.Z1.A.H.M.ACCF10.AL.SB.T - List Price \$527**

\* De-emphasized

## HOW TO SPECIFY

Select Model Number	Select Control Type	Select Arm Type	Select Caster	Select Back Type	Select Upholstery	Select Lumbar	Select Base	Select Frame
Z1 Swivel-Tilt Control Y1 Simple Synchro-Tilt w/ Seat Slide Control (+ \$39)	A Height & Width Adjustable Arms	H Black Hard Casters	M Mesh	ACCF10 Black	AL Adjustable Lumbar	SB Standard Base	T Black	
H C A T 1 M M .	Y 1 .	A .	H .	M .	A C C F 1 0 .	A L .	S B .	T .

# CRIO™ Mesh Chairs

OPEN MARKET



Icon Legend on page 19

## HVL581



### HIGH-BACK

Pneumatic  
Swivel  
Tilt  
Tilt Tension  
Tilt Lock  
Height and Width Adjustable  
Arms  
Adjustable Lumbar

Functions: **A, E, F, K, L, S, W**  
(Function Key on pages 252-253)

NOTES: Comfortable and breathable mesh back. Black fabric or Black Bonded Leather. Black frame. Height and width adjustable arms. Adjustable lumbar. **HON 5-Year Limited Warranty.**

**HON Recommendation: HVL581.ES10.T - List Price \$544**

### DIMENSIONS

Depth:	25½	Arm Width:	19⅞
Width:	28¾	Seat to Floor Height:	16½-20¼
Height:	42⅞	Usable Seat Depth:	17¼
Seat Depth:	17¼	Ship Weight:	39.8
Seat Width:	20¼	Cube:	4.8
Back Width:	18½	Weight Rating:	250 lbs.

### PRICE CODE

<b>Fabric</b>	<b>\$544</b>
<b>Leather</b>	<b>\$572</b>

## HVL582



### HIGH-BACK

Pneumatic  
Swivel  
Tilt  
Tilt Tension  
Tilt Lock  
Asynchronous Control  
Seat Glide Mechanism  
Adjustable Lumbar  
Height and Width Adjustable  
Arms

Functions: **A, E, F, L, O, S, W**  
(Function Key on pages 252-253)

NOTES: Comfortable and breathable mesh back. Black fabric or Black Bonded Leather. Black frame. Height and width adjustable arms. Seat glide mechanism. Asynchronous control with independent seat and back angle adjustment. Adjustable lumbar. **HON 5-Year Limited Warranty.**

**HON Recommendation: HVL582.ES10.T - List Price \$671**

### DIMENSIONS

Depth:	27½	Arm Width:	19⅞
Width:	28¾	Seat to Floor Height:	20½-22⅞
Height:	43¾	Usable Seat Depth:	17¼
Seat Depth:	17¼	Ship Weight:	50.4
Seat Width:	19⅞	Cube:	6.8
Back Width:	18½	Weight Rating:	250 lbs.

### PRICE CODE

<b>Fabric</b>	<b>\$671</b>
<b>Leather</b>	<b>\$699</b>

## HVL585



### EXECUTIVE BIG AND TALL

Pneumatic  
Swivel  
Tilt  
Tilt Tension  
Tilt Lock  
Height and Width Adjustable  
Arms  
Adjustable Lumbar

Functions: **A, E, F, K, L, S, W**  
(Function Key on pages 252-253)

NOTES: Large scale model HVL585 will support 450 lbs with normal use. Black fabric. Black frame. Height and width adjustable arms. Adjustable lumbar. **HON 5-Year Limited Warranty.**

ⓘ Available in Black fabric only.

**HON Recommendation: HVL585.ES10.T - List Price \$942**

### DIMENSIONS

Depth:	29⅞	Arm Width:	20½
Width:	28⅞	Seat to Floor Height:	17⅞-21¾
Height:	45⅞	Usable Seat Depth:	19⅞
Seat Depth:	19⅞	Ship Weight:	55.4
Seat Width:	22	Cube:	7.2
Back Width:	20⅞	Weight Rating:	450 lbs.

### PRICE CODE

<b>Fabric</b>	<b>\$942</b>
---------------	--------------

SEATING

## HOW TO SPECIFY

Select  
Model Number

H V L 5 8 1 .

Select  
Fabric

**ES10** Black  
**SB11** Black Bonded Leather  
*Available on HVL581 and HVL582 only*

E S 1 0 .

Select  
Frame

**T** Black

T



# DEFINE™ Executive Chairs

## HVL108



### HIGH-BACK

Pneumatic  
Swivel  
Synchro-tilt  
Height-adjustable Arms  
Functions: **A, E, J, K, Q**  
(Function Key on pages 252-253)

### DIMENSIONS

Depth:	29¾	Arm Width:	19½
Width:	29¾	Seat to Floor Height:	17⅞-21⅜
Height:	46⅞	Usable Seat Depth:	17½
Seat Depth:	17½	Ship Weight:	47.3
Seat Width:	21	Cube:	7.2
Back Width:	20	Weight Rating:	250 lbs.
Back Height:	26½		

### PRICE CODE

**Leather**      **\$873**

NOTES: Available in Black Bonded Leather. Polished base. Polished arm accents. Height-adjustable arms. **HON 5-Year Limited Warranty.**

**HON Recommendation: HVL108.SB11 - List Price \$873**

SEATING

## HOW TO SPECIFY

<b>Select Model Number</b>	<b>Select Fabric</b>
	<b>SB11</b> Black Bonded Leather
H V L 1 0 8 .	S B 1 1

# ENDORSE® COLLECTION

Want to see more? Scan here  
to check out hon.com.



Endorse® Seating shown with Huddle Tables.

## ENDORSE® COLLECTION

You need inviting, comfy seats up front, and task chairs that support productivity in workstations. Achieve harmony throughout your space with a multi-functional collection of Endorse task seating. Endorse supports the diversity of applications throughout your workplace with sophisticated design. Varied options. Diverse materials. Simply pick the model that suits your space and people. Add the options that fit your needs. Then get ready to Endorse a higher level of productivity.



## TASK CHAIR FEATURES

- Available in high-, mid- and low-back options.
- Available in three different back materials — upholstered, mesh and plastic outer back.
- Comfort options include adjustable lumbar support, adjustable arms, seat glide, multi-position tilt and synchro-tilt.
- Optional seat slide adjustment adapts to users of various heights.
- Control options include limited synchro-tilt, advanced synchro-tilt, advanced synchro-tilt with independent back angle and weight-activated control.
- Arm options include fixed, armless, height- and width-adjustable and all-adjustable.
- Caster options include hard, All-Surface and roll control.
- Available in hundreds of quality HON fabrics.
- Warranted for users up to 300 lbs.  
*(450 lbs. for Big and Tall chairs)*

## BACK OPTIONS

**HLWM**  
HLWMBT - Big & Tall

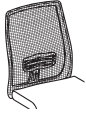

**Mid-back**

Mesh with Adjustable  
Lumbar Support



**HLTM**  
HLTSM - Stool





**Low-back**

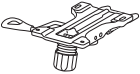
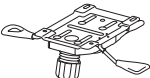
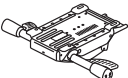

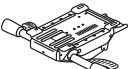
Mesh with Adjustable  
Lumbar Support





**MESH BACK COLOR CODES** (no upcharge): Black - **IM** Breeze - **IB** Brownstone - **IK** Charcoal - **IC** Fog - **IF** Regatta - **IR**  
Titanium - **IT**

MECHANISM	CODE	FUNCTIONS	PRICE
	<b>S0</b>	Limited Recline Synchro-Tilt A, E, J, K, L	<b>+\$0</b>
	<b>S1</b>	Limited Recline Synchro-Tilt w/ Seat Slider (available on Stools only) A, D, E, J, K, L	<b>+\$22</b>
	<b>Y2</b>	Advanced Synchro-Tilt A, D, E, J, L, W, A-D	<b>+\$71</b>
	<b>Y3</b>	Advanced Synchro-Tilt with Independent Back Angle A, D, E, J, L, W, A-E	<b>+\$114</b>
	<b>Y4</b>	Synchro-Tilt A, D, E, J, L, W, A-D (Big and Tall models only)	<b>+\$0</b>

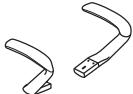
(See pages 252-253 for Seating Functions.)

BASE	CODE	DESCRIPTION	PRICE
	<b>SB</b>	Standard Base	<b>+\$0</b>
	<b>PA</b>	Polished Aluminum	<b>+\$119</b>

ARM STYLE	CODE	DESCRIPTION	PRICE
	<b>N</b>	Armless	<b>+\$0</b>
	<b>F</b>	Fixed - Black	<b>+\$71</b>
	<b>A</b>	Height and Width Adjustable Arms	<b>+\$92</b>
	<b>V</b>	All-Adjustable Arms - includes pivot	<b>+\$141</b>
	<b>P</b>	Fixed - Polished Alum.	<b>+\$189</b>

CASTERS	CODE	DESCRIPTION	PRICE
	<b>A</b>	Black All-Surface Caster (High-back and Big and Tall models only)	<b>+\$0</b>
	<b>H</b>	Black Hard Caster	<b>+\$0</b>
	<b>S</b>	Black All-Surface Caster	<b>+\$44</b>
	<b>R</b>	Black Roll Control Caster	<b>+\$55</b>



# ENDORSE® Dimensions

## TASK DIMENSIONS

MODEL		HLWM	HLTM
Overall Width Armless		28½	28½
Overall Width with Arms	A/V	28½	28½
	F/P	28½	28½
Overall Depth		28½	28½
Overall Height	S0	45½	42
	Y2	46¼	42¾
	Y3	46	42½
	W5	48⅜	43
Seat Width		20	19
Seat Depth		18½	18⅜
Usable Seat Depth	S0	17¾	17⅝
	Y2	15½-18	15½-18
	Y3	15¼-18¼	15¼-18¼
	W5	15½-17¾	15½-17¾
Seat Height (mechanism)	S0	17-21½	17-21½
	Y2	17¾-22¼	17¾-22¼
	Y3	17½-22	17½-22
	W5	17¼-21¾	17¼-21¾
Back Width		19¼	18
Back Height		25	21¾
Ship Weight Armless	S0	40	41
	Y2	45 Ⓢ	46 Ⓢ
	Y3	48 Ⓢ	50 Ⓢ
	W5	44 Ⓢ	45 Ⓢ
Weight with Arms	S0	48	49
	Y2	53 Ⓢ	54 Ⓢ
	Y3	56 Ⓢ	58 Ⓢ
	W5	52 Ⓢ	53 Ⓢ
Between Arms	A/V	17½-20	16¾-19¼
	F/P	20½	20½
COM		1.0	1.0
Weight Capacity		300 lbs	300 lbs

## BIG & TALL & STOOL DIMENSIONS

MODEL		HLWMBT	HLTSM
Overall Width Armless		28½	28½
Overall Width with Arms	A/V	28½	28½
	F/P	28½	28½
Overall Depth		28½	28½
Overall Height	S0/S1	-	53
	Y4	49	-
Seat Width		23	19
Seat Depth	S0/S1	-	18⅜
	Y4	20¼	-
Usable Seat Depth	S0	-	17⅝
	S1	-	15¼-18¼
	Y4	17¼-18¾	-
Seat Height (mechanism)	S0/S1	-	22¾-32¾
	Y4	17½-22	-
Back Width		22½	19¾
Back Height		25¾	22¾
Ship Weight Armless	S0	-	42
	S1	-	44
	Y4	57	-
Weight with Arms	S0	-	50
	S1	-	52
	Y4	65	-
Between Arms	A/V	20½-23	16¾-19¼
	F/P	23½	20½
COM		1.5	2.0
Weight Capacity		450 lbs	300 lbs

## HON BRANDED FABRICS *(For Seating)*

GRADE 1	GRADE 2	GRADE 3	GRADE 4
Apex	Appoint Seating	Bradbury	Constance with Supreen™
Centurion	Blume	Getaway	Livi with Supreen™
Compass	Clyde	Moxie	Lugano with Supreen™
Contourett	Dotty	Notion	Oxford with Supreen™
Dapper	Kai	Parker	
Ensemble	Rush	Purl	
Hamilton	Spin Seating	Quill	
Inertia	Wavelength	Saxony	
Noble Seating	Whisper Vinyl		
Optic			
Pebble			
Vibe			

**For a complete list of fabrics, including partnership fabrics, go to [hon.com/fabricsandfinishes](https://hon.com/fabricsandfinishes).**

Reference Fabric Color Combinations on pages 20-25 for color codes and legend on page 21 for lead times. For additional HON to Supply COM fabric grade pricing, go to [honready.hon.com](https://honready.hon.com) and click on the HON to Supply COM link.



## HLWM

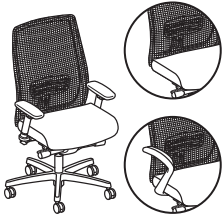

### TASK MID-BACK

#### 4-Way Stretch Back

- Pneumatic
- Swivel
- Synchro-tilt
- Tilt Tension
- Tilt Lock
- Integral Lumbar Support
- Optional Seat Glide

Functions: **A, E, J, K, L, W**

(Function Key on pages 252-253)

NOTES: For Mesh Back models, specify the 4-Way Stretch back option below. Headrest available on Mid-back 4-Way Stretch models only - Black only.

! See page 312 for additional specifications and dimensions.

### DIMENSIONS

Depth:	28½	Back Width:	19
Width:	28½	Back Height:	25
Height:	44½	Cube:	10.8
Seat Depth:	15¾	COM:	1.0
Seat Width:	19¾	Weight Rating:	300 lbs.

### FABRIC PRICE CODES

<b>1</b>	<b>\$1153</b>	<b>8</b>	<b>\$1303</b>
<b>2</b>	<b>\$1180</b>	<b>9</b>	<b>\$1322</b>
<b>3</b>	<b>\$1206</b>	<b>10</b>	<b>\$1341</b>
<b>4</b>	<b>\$1225</b>	<b>11</b>	<b>\$1361</b>
<b>5</b>	<b>\$1244</b>	<b>12</b>	<b>\$1380</b>
<b>6</b>	<b>\$1264</b>	<b>L</b>	<b>—</b>
<b>7</b>	<b>\$1283</b>		

**HON Recommendation: HLWM.Y2.A.H.IM.CU\_\_SB.N - List Price \$1316**

## HOW TO SPECIFY

Select Model Number	Select Control Type	Select Arm Type	Select Caster/Glide	Select Mesh Back	Select Fabric	Select Base	Select Headrest
HLWM	<ul style="list-style-type: none"> <li><b>S0</b> Limited Recline Synchro-Tilt</li> <li><b>Y2</b> Advanced Synchro-Tilt (+ \$71)</li> <li><b>Y3</b> Synchro-Tilt with Independent Back Angle (+ \$114)</li> </ul>	<ul style="list-style-type: none"> <li><b>N</b> Armless</li> <li><b>F</b> Fixed Arms - Black (+ \$71)</li> <li><b>A</b> Height and Width Adjustable Arms (+ \$92)</li> <li><b>V</b> All-Adjustable Arms (includes pivot) (+ \$141)</li> <li><b>P</b> Fixed Arms - Polished (+ \$189)</li> </ul>	<ul style="list-style-type: none"> <li><b>H</b> Black Hard Caster</li> <li><b>S</b> Black All-Surface Caster (+ \$44)</li> <li><b>R</b> Black Roll Control Caster (+ \$55)</li> </ul>	<p>4-Way Stretch options</p> <ul style="list-style-type: none"> <li><b>IM</b> Black</li> <li><b>IB</b> Breeze</li> <li><b>IK</b> Brownstone</li> <li><b>IC</b> Charcoal</li> <li><b>IF</b> Fog</li> <li><b>IR</b> Regatta</li> <li><b>IT</b> Titanium</li> </ul> <p><i>Specify the back for Mesh Back models only</i></p>	See page 313	<ul style="list-style-type: none"> <li><b>SB</b> Standard Base</li> <li><b>PA</b> Polished Aluminum (+ \$119)</li> </ul>	<ul style="list-style-type: none"> <li><b>N</b> No Headrest</li> <li><b>HR</b> Headrest (+ \$87)</li> </ul> <p><i>Black only. Specify for model HLWM only</i></p>
HLWM	Y2	A	H	IM	CU10	SB	N



Icon Legend on page 19

**HLTM**



**TASK LOW-BACK**

**4-Way Stretch Back**

- Pneumatic
- Swivel
- Synchro-tilt
- Tilt Tension
- Tilt Lock
- Integral Lumbar Support
- Optional Seat Glide

Functions: **A, E, J, K, L, W**  
 (Function Key on pages 252-253)

NOTES: For Mesh Back models, specify the 4-Way Stretch back option below.  
 ⓘ See page 312 for additional specifications and dimensions.

**DIMENSIONS**

Depth:	28½	Back Width:	17¾
Width:	28½	Back Height:	21¾
Height:	40¾	Cube:	10.8
Seat Depth:	15⅝	COM:	1.0
Seat Width:	18⅝	Weight Rating:	300 lbs.

**FABRIC PRICE CODES**

<b>1</b>	<b>\$1073</b>	<b>8</b>	<b>\$1223</b>
<b>2</b>	<b>\$1100</b>	<b>9</b>	<b>\$1242</b>
<b>3</b>	<b>\$1126</b>	<b>10</b>	<b>\$1261</b>
<b>4</b>	<b>\$1145</b>	<b>11</b>	<b>\$1281</b>
<b>5</b>	<b>\$1164</b>	<b>12</b>	<b>\$1300</b>
<b>6</b>	<b>\$1184</b>	<b>L</b>	<b>—</b>
<b>7</b>	<b>\$1203</b>		

**HON Recommendation: HLTM.Y2.A.H.IM.CU\_\_\_.SB - List Price \$1236**

**HOW TO SPECIFY**

Select Model Number	Select Control Type	Select Arm Type	Select Caster/Glide	Select Mesh Back	Select Fabric	Select Base
<b>S0</b> Limited Recline Synchro-Tilt <b>Y2</b> Advanced Synchro-Tilt (+ \$71) <b>Y3</b> Synchro-Tilt with Independent Back Angle (+ \$114)	<b>N</b> Armless <b>F</b> Fixed Arms - Black (+ \$71) <b>A</b> Height and Width Adjustable Arms (+ \$92) <b>V</b> All-Adjustable Arms (includes pivot) (+ \$141) <b>P</b> Fixed Arms - Polished (+ \$189)	<b>H</b> Black Hard Caster <b>S</b> Black All-Surface Caster (+ \$44) <b>R</b> Black Roll Control Caster (+ \$55)	<b>IM</b> Black <b>IB</b> Breeze <b>IK</b> Brownstone <b>IC</b> Charcoal <b>IF</b> Fog <b>IR</b> Regatta <b>IT</b> Titanium  <i>Specify the back for Mesh Back models only</i>	See page 313	<b>SB</b> Standard Base <b>PA</b> Polished Aluminum (+ \$119)	
<b>HLTM</b> .	<b>Y2</b> .	<b>A</b> .	<b>H</b> .	<b>IM</b> .	<b>CU10</b> .	<b>SB</b>



## HLWMBT

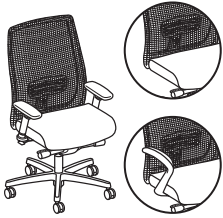

### TASK MID-BACK

#### Big and Tall 4-Way Stretch Back

- Pneumatic
- Seat-glide
- Swivel
- Synchro-tilt
- Tilt Lock
- Side Tilt Tension
- Integral Lumbar Support

Functions: **A, D, E, A-D, J, L, W**  
(Function Key on pages 252-253)

NOTES: For Mesh Back models, specify the 4-Way Stretch back option below. Headrest available on Mid-back 4-Way Stretch models only - Black only.

### DIMENSIONS

Depth:	31½	Adjustable Arms Width:	21½-23¾
Width:	31½	Fixed Arms Width:	24
Height:	44⅝	Seat to Floor Height:	18-22
Seat Depth:	21	Usable Seat Depth:	17¼-18¾
Seat Width:	23	Ship Weight:	75
Back Width:	22½	Cube:	15.3
Back Height:	25¾	COM:	1.5
		Weight Rating:	450 lbs.

### FABRIC PRICE CODES

<b>1</b>	<b>\$1914</b>	<b>8</b>	<b>\$2138</b>
<b>2</b>	<b>\$1954</b>	<b>9</b>	<b>\$2167</b>
<b>3</b>	<b>\$1993</b>	<b>10</b>	<b>\$2196</b>
<b>4</b>	<b>\$2022</b>	<b>11</b>	<b>\$2225</b>
<b>5</b>	<b>\$2050</b>	<b>12</b>	<b>\$2254</b>
<b>6</b>	<b>\$2079</b>	<b>L</b>	<b>—</b>
<b>7</b>	<b>\$2109</b>		

**HON Recommendation: HLWMBT.Y4.A.A.IM.CU\_\_SB.N - List Price \$2006**

## HOW TO SPECIFY

<b>Select Model Number</b>  HLWMBT	<b>Select Control Type</b>  <b>Y4</b> Synchro-Tilt <i>Y4 is the only control option for the Big and Tall models</i>	<b>Select Arm Type</b>  <b>A</b> Armless <b>A</b> Height and Width Adjustable Arms (+ \$92) <b>V</b> All-Adjustable Arms (includes pivot) (+ \$141)	<b>Select Caster/Glide</b>  <b>A</b> Black All-Surface Caster	<b>Select Mesh Back</b>  4-Way Stretch option <i>Black only</i> <b>IM</b> Black <i>Specify the back for Mesh Back models only</i>	<b>Select Fabric</b>  See page 313	<b>Select Base</b>  <b>SB</b> Standard Base	<b>Select Headrest</b>  <b>N</b> No Headrest <b>HR</b> Headrest (+ \$87)  <i>Black only. Specify for model HLWMBT only</i>
--	--	---	---	--	--	---	---



Icon Legend on page 19

## HLTSM

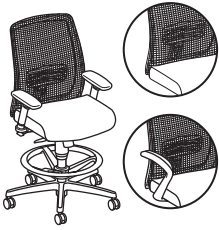

### STOOL

#### 4-Way Stretch Back

- Pneumatic
- Swivel
- Synchro-tilt
- Tilt Tension
- Tilt Lock
- Integral Lumbar Support

Functions: **A, E, J, K, L, W**  
 (Function Key on pages 252-253)

NOTES: For Mesh Back models, specify the 4-Way Stretch back option below. See page 312 for additional specifications and dimensions.

### DIMENSIONS

Depth:	28½	Back Width:	17¾
Width:	28½	Back Height:	21¾
Height:	52½	Cube:	10.8
Seat Depth:	15⅝	COM:	1.0
Seat Width:	18⅝	Weight Rating:	300 lbs.

### FABRIC PRICE CODES

1	\$1279	8	\$1429
2	\$1306	9	\$1448
3	\$1332	10	\$1467
4	\$1351	11	\$1487
5	\$1370	12	\$1506
6	\$1390	L	—
7	\$1409		

**HON Recommendation: HLTSM.S1.A.H.IM.CU\_\_SB - List Price \$1393**

## HOW TO SPECIFY

Select Model Number	Select Control Type	Select Arm Type	Select Caster/Glide	Select Mesh Back	Select Fabric	Select Base
	<b>S0</b> Limited Recline Synchro-Tilt <b>S1</b> Limited Recline Synchro-Tilt w/ Seat Slider (+ \$22)	<b>N</b> Armless <b>F</b> Fixed Arms - Black (+ \$71) <b>A</b> Height and Width Adjustable Arms (+ \$92) <b>V</b> All-Adjustable Arms (includes pivot) (+ \$141) <b>P</b> Fixed Arms - Polished (+ \$189)	<b>H</b> Black Hard Caster <b>S</b> Black All-Surface Caster (+ \$44) <b>R</b> Black Roll Control Caster (+ \$55)	4-Way Stretch options <b>IM</b> Black <b>IB</b> Breeze <b>IK</b> Brownstone <b>IC</b> Charcoal <b>IF</b> Fog <b>IR</b> Regatta <b>IT</b> Titanium Specify the back for Mesh Back models only	See page 313	<b>SB</b> Standard Base <b>PA</b> Polished Aluminum (+ \$119)
HLTSM	S1	A	H	IM	CU10	SB



## HL2DARM



### ADJUSTABLE T-ARMS

Height and Width  
Functions: **S**  
(Function Key on pages 252-253)

### DIMENSIONS

Adjustable Arms Width: 16¾-19¼  
Height from Seat: 7¼-11  
Ship Weight: 8  
Cube: 1.0

### LIST PRICE

**\$170**

- Available in Black only. No need to specify.
- Can only be used with standard models. Contact Customer Support for Big & Tall arm packs.

## HL4DARM



### ALL-ADJUSTABLE ARMS

Height, Width, Depth and Pivot

### DIMENSIONS

Adjustable Arms Width: 16¾-19¼  
Height from Seat: 7¼-11  
Ship Weight: 8  
Cube: 1.0

### LIST PRICE

**\$229**

- Available in Black only. No need to specify.
- Can only be used with standard models. Contact Customer Support for Big & Tall arm packs.

## HI2FHA



### FIXED HEIGHT ARMS

### DIMENSIONS

Arm Width: 20  
Height from Seat: 9½  
Ship Weight: 7  
Cube: 1.0

### LIST PRICE

**\$151**

- Can only be used with standard models. Contact Customer Support for Big & Tall arm packs.

## HIPAA

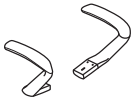

### POLISHED ALUMINUM ARMS

Fixed Height

### DIMENSIONS

Arm Width: 20  
Height from Seat: 9½  
Ship Weight: 10  
Cube: 1.0

### LIST PRICE

**\$249**

- Can only be used with standard models. Contact Customer Support for Big & Tall arm packs.

## HLMSHHR



### MESH HEADREST

### DIMENSIONS

Mesh Width: 12  
Mesh Height: 6  
Ship Weight: 3  
Cube: 1.0

### QA DIMENSIONS

(Attachment Mechanism)

Width: 12  
Depth: 6  
Height: 12

### LIST PRICE

**\$189**

- Available in Black Mesh (IM) only. For use with Mesh Mid-back models only.

## HSCASTER

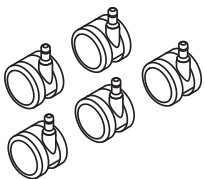

### SET OF 5 ALL-SURFACE CASTERS

### DIMENSIONS

Size: 60mm  
Ship Weight: 2  
Cube: 0.1

### LIST PRICE

**\$75**

- Available in Black finish only, no specification needed.

OPEN MARKET

# FLEXION™

Want to see more? Scan here  
to check out hon.com.



Flexion™ Seating shown with Empower® Workstation and Contain® Mobile Pedestal.

## FLEXION™

Multiple meetings and hands-on project planning requires hassle free seating — you need a chair that moves and adapts to your body and your day. Flexion™ features a versatile seat for versatile work. With a clean, nimble aesthetic and straightforward mechanisms, this flexible seating solution supports an on-the-go workstyle, with minimum adjustments and ample comfort.



## FEATURES

- Get comfortable with weight-activated flex functionality that responds and adapts to you as you sit.
- Move around freely with 4-point seat suspension that allows for dynamic postures.
- Maximize your back and shoulder support with a back frame designed with torsion in mind to move and flex with you.
- Find the right fit with one-touch seat height adjustment.
- Take your pick of adjustable arms, fixed arms, or an armless aesthetic.
- Meet the needs of your space with 3 different cylinder height options.
- Stay cool with 4-Way Stretch Mesh — available in 7 colors.
- Choose from 3 frame options: Salt, Titanium, and Black.

SEATING



# FLEXION™ Options

## MODEL OPTIONS

HFXT1



Task Chair

## HON BRANDED FABRICS

### GRADE 1

Apex  
Centurion  
Compass  
Contourett  
Dapper  
Ensemble  
Hamilton  
Inertia  
Noble Seating  
Optic  
Pebble  
Vibe

### GRADE 2

Appoint Seating  
Blume  
Clyde  
Dotty  
Kai  
Rush  
Spin Seating  
Wavelength  
Whisper Vinyl

### GRADE 3

Bradbury  
Getaway  
Moxie  
Notion  
Parker  
Purl  
Quill  
Saxony

### GRADE 4

Constance with Supreen™  
Livi with Supreen™  
Lugano with Supreen™  
Oxford with Supreen™

### GRADE L

Davenport Leather

**For a complete list of fabrics, including partnership fabrics, go to [hon.com/fabricsandfinishes](https://www.hon.com/fabricsandfinishes).**

Reference Fabric Color Combinations on pages 20-25 for color codes and legend on page 21 for lead times.

# FLEXION™ Options

## ARM STYLE



CODE	DESCRIPTION	PRICE
<b>N</b>	Armless	<b>+\$0</b>
<b>A</b>	Height-Adjustable	<b>+\$82</b>
<b>F</b>	Fixed Arms	<b>+\$71</b>

## CASTERS/ GLIDES



CODE	DESCRIPTION	PRICE
<b>H</b>	Hard Caster	<b>+\$0</b>
<b>S</b>	Black All-Surface Caster	<b>+\$33</b>
<b>TS</b>	Titanium All-Surface Caster	<b>+\$33</b>
<b>SS</b>	Salt All-Surface Caster	<b>+\$33</b>
<b>R</b>	Roll Control Caster	<b>+\$55</b>

## CYLINDER

CODE	DESCRIPTION	PRICE
<b>STC</b>	Standard Cylinder	<b>+\$0</b>
<b>SHC</b>	Short Cylinder	<b>+\$0</b>
<b>TLC</b>	Tall Cylinder	<b>+\$0</b>

## BASE

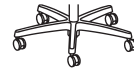

CODE	DESCRIPTION	PRICE
<b>SB</b>	Standard Base	<b>+\$0</b>
<b>PA</b>	Polished Aluminum	<b>+\$119</b>

## FRAME COLOR

CODE	DESCRIPTION	PRICE
<b>T</b>	Black	<b>+\$0</b>
<b>TI</b>	Titanium	<b>+\$39</b>
<b>ST</b>	Salt	<b>+\$39</b>

# FLEXION™

Icon Legend on page 19

## HFX T1



### TASK CHAIR

Mesh Back

### DIMENSIONS

Depth:	25	Seat to Floor Height:	15-19 <sup>3</sup> / <sub>8</sub>
Width:	27 <sup>1</sup> / <sub>8</sub>	Usable Seat Depth:	16 <sup>1</sup> / <sub>2</sub> -18 <sup>5</sup> / <sub>8</sub>
Height:	42 <sup>1</sup> / <sub>2</sub>	Ship Weight:	35
Seat Depth:	17 <sup>3</sup> / <sub>8</sub>	Cube:	10.7
Seat Width:	19 <sup>1</sup> / <sub>8</sub>	COM:	1.0
Back Width:	18 <sup>3</sup> / <sub>4</sub>	Weight Rating:	300 lbs.
Back Height:	24		

### FABRIC PRICE CODES

<b>1</b>	<b>\$804</b>	<b>8</b>	<b>\$954</b>
<b>2</b>	<b>\$831</b>	<b>9</b>	<b>\$973</b>
<b>3</b>	<b>\$857</b>	<b>10</b>	<b>\$992</b>
<b>4</b>	<b>\$876</b>	<b>11</b>	<b>\$1012</b>
<b>5</b>	<b>\$895</b>	<b>12</b>	<b>\$1031</b>
<b>6</b>	<b>\$915</b>	<b>L</b>	<b>\$1093</b>
<b>7</b>	<b>\$934</b>		

HON Recommendation: HFX T1.F0.STC.A.H.IT.CU\_\_.NL.SB.TI - List Price \$925

## HOW TO SPECIFY

Select Model Number	Select Control Type	Select Cylinder	Select Arm Type	Select Caster	Select Mesh Color	Select Fabric	Select Lumbar	Select Base	Select Frame
<b>FO</b> Weight-Activated Flex	<b>STC</b> Standard <b>SHC</b> Short <b>TLC</b> Tall	<b>N</b> Armless <b>A</b> Height Adjustable Arms (+ \$82) <b>F</b> Fixed (\$71)	<b>H</b> Hard Caster <b>S</b> Black All-Surface Caster (+ \$33) <b>TS</b> Titanium All-Surface Caster (+ \$33) <b>SS</b> Salt All-Surface Caster (+ \$33) <b>R</b> Roll Control Caster (+ \$55)	<b>IM</b> Black <b>IF</b> Fog <b>IC</b> Charcoal <b>IT</b> Titanium <b>IK</b> Brownstone <b>IR</b> Regatta <b>IB</b> Breeze	See page 320	<b>NL</b> No Lumbar	<b>SB</b> Standard <b>PA</b> Polished Aluminum (+ \$119)	<b>T</b> Black (+ \$0) <b>TI</b> Titanium (+ \$39) <b>ST</b> Salt (+ \$39)	
HFX T1 .	F0 .	STC .	A .	H .	IM .	APX25 .	NL .	SB .	T



Flock® Seating and Tables.

## FLOCK®

Break away. Come together. Wherever people migrate within a space, Flock is designed to support their needs. With a full collection of modular and comfortable seating elements and coordinating collaborative tables that work seamlessly together, you can make the most of every square inch of your space. Modular lounge chairs and ottomans stand alone or combine to create large arrangements. Multi-purpose stools and chairs add comfort to open spaces. Collaborative tables bring the whole group together. Flock helps people interact with each other, challenge one another, and receive the support they need.



### CHAIR FEATURES

- Round and square lounge chairs are fully upholstered.
- The contemporary aesthetic easily matches a variety of surroundings.
- Support everything from one-on-one conversations to large meetings.
- Choose from four leg options — standard, tapered round, tapered square, hard casters, or a 4-star base.
- Swivel, X-, or 4-star base options include return-to-center feature.
- 4-Leg guest chairs and counter- and bar-height stools available with both metal and wood legs.
- Available in hundreds of quality HON fabrics.
- Warranted for users up to 300 lbs.

### COLLABORATIVE TABLES

- Choose from round, square, rectangle, or racetrack shaped table tops.
- Optional grommets neatly route cords.
- Bases available in disc, T-leg, and X-leg styles.
- Choose bases with or without footings.

# FLOCK® Options

## MODEL OPTIONS

**HFLSC1**  
HFLSC1DF - Multi-Fabric

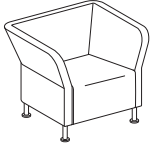

**Lounge Chair**  
Square

**HFLRC1**  
HFLRC1DF - Multi-Fabric

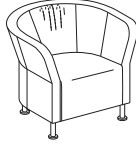

**Lounge Chair**  
Round

**HFLMC1**  
HFLMC1DF - Multi-Fabric



**Modular Chair**

**HFLML1**  
HFLML1DF - Multi-Fabric

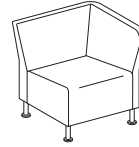

**Modular**  
Left End

**HFLMR1**  
HFLMR1DF - Multi-Fabric

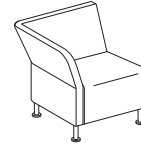

**Modular**  
Right End

**HFLCC1**  
HFLCC1DF - Multi-Fabric

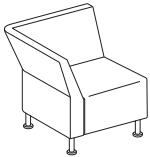

**True Chair**  
Corner

**HFLWI45**  
HFLWI45DF - Multi-Fabric

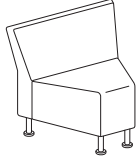

**Wedge**  
Inside

**HFLWO45**  
HFLWO45DF - Multi-Fabric



**Wedge**  
Outside

**HFL450**

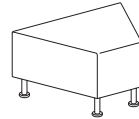

**Wedge Ottoman**

### LEG STYLE



CODE	DESCRIPTION	PRICE
<b>L</b>	Standard Leg	<b>+\$0</b>



<b>TS</b>	Tapered Square	<b>+\$0</b>
-----------	----------------	-------------



<b>TR</b>	Tapered Round	<b>+\$0</b>
-----------	---------------	-------------



<b>H</b>	Hard Casters	<b>+\$0</b>
----------	--------------	-------------

### LEG COLOR

CODE	DESCRIPTION	PRICE
<b>PR8</b>	Textured Silver	<b>+\$0</b>
<b>P7A</b>	Textured Charcoal	<b>+\$0</b>

*\*Specify PR8 & P7A for Standard Legs and Tapered Round & Tapered Square Legs only*

<b>T</b>	Black Hard Caster	<b>+\$0</b>
----------	-------------------	-------------

*\*Specify for Hard Caster option only*

## MODEL OPTIONS

HFLB2

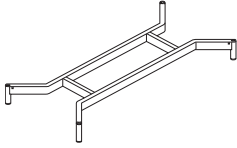

Two-Seat Base Frame

HFLB3

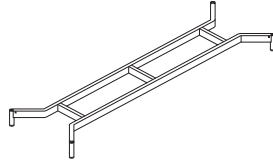

Three-Seat Base Frame

HTSSRD



Tapered Square  
Leg - Shroud Pack

## COMPATIBLE MODELS

HFLMC1  
HFLMC1DF - Multi-Fabric

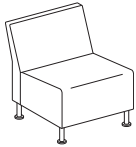

Modular Chair

HFLML1  
HFLML1DF - Multi-Fabric

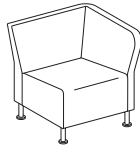

Modular  
Left End

HFLMR1  
HFLMR1DF - Multi-Fabric



Modular  
Right End

HFLCC1  
HFLCC1DF - Multi-Fabric

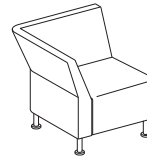

True Chair  
Corner

HFLSO1

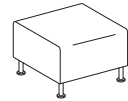

Square Ottoman

## LEG STYLE



CODE	DESCRIPTION	PRICE
<b>RS</b>	Round Straight Leg	<b>+\$0</b>

*Available in the following finishes:*

<b>PR8</b>	Textured Silver
<b>P7A</b>	Textured Charcoal



<b>TS</b>	Tapered Square	<b>+\$82</b>
-----------	----------------	--------------

*Available in the following finishes:*

<b>PR8</b>	Textured Silver
<b>P7A</b>	Textured Charcoal

# FLOCK® Fabric Options

## HON BRANDED FABRICS

GRADE 1	GRADE 2	GRADE 3	GRADE 4	GRADE L
Apex	Appoint Seating	Bradbury	Constance with Supreen™	Denver Leather*
Centurion	Blume	Getaway	Livi with Supreen™	
Compass	Clyde	Moxie	Lugano with Supreen™	
Contourett	Dotty	Notion	Oxford with Supreen™	
Dapper	Kai	Parker		
Ensemble	Rush	Purl		
Hamilton	Spin Seating	Quill		
Inertia	Wavelength	Saxony		
Noble Seating	Whisper Vinyl			
Optic				
Pebble				
Vibe				

**For a complete list of fabrics, including partnership fabrics, go to [hon.com/fabricsandfinishes](https://hon.com/fabricsandfinishes).**

Flock® chair model HFLRC1 has fabric limitations, please see the Flock® seating pages 327-334 for details.

Reference Fabric Color Combinations on pages 20-25 for color codes and legend on page 21 for lead times.

\*Denver Leather (SS) may not be available on every model within a specific series, please refer to the model's page for details.

For more details on Upholstery Pattern Match for this series, please see page 14.

⚠ Due to the inherent characteristics of upholstery materials, the seat of Flock® may become more relaxed to show wrinkles over time.

## FLOCK® ROUND LOUNGE HFLRC1/DF HON BRANDED FABRICS

GRADE 1	GRADE 2	GRADE 3	GRADE 4	GRADE L
Apex	Appoint Seating	Bradbury	Constance with Supreen™	Denver Leather**
Centurion	Blume	Getaway	Livi with Supreen™**	
Compass	Clyde	Moxie	Lugano with Supreen™	
Contourett	Dotty*	Notion	Oxford with Supreen™**	
Dapper	Kai	Parker		
Ensemble	Rush	Purl		
Hamilton	Spin Seating*	Quill		
Inertia	Wavelength	Saxony		
Noble Seating	Whisper Vinyl			
Optic				
Pebble				
Vibe				

**For a complete list of fabrics, including partnership fabrics, go to [hon.com/fabricsandfinishes](https://hon.com/fabricsandfinishes).**

Reference Fabric Color Combinations on pages 20-25 for color codes and legend on page 21 for lead times.

\*Available on seat only.

\*\*Denver Leather (SS) may not be available on every model within a specific series, please refer to the model's page for details.

For more details on Upholstery Pattern Match for this series, please see page 14.

⚠ Due to the inherent characteristics of upholstery materials, the seat of Flock® may become more relaxed to show wrinkles over time.



## HFLSC1

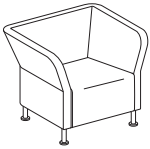

### LOUNGE CHAIR

Square

### DIMENSIONS

Depth:	28½	Arm Width:	27½
Width:	34¼	Seat to Floor Height:	17
Height:	28	Usable Seat Depth:	20½
Seat Depth:	20½	Ship Weight:	79
Seat Width:	21½	Cube:	21.9
Back Width:	21½	COM:	5.0
Back Height:	18½	Weight Rating:	300 lbs.

### FABRIC PRICE CODES

1	\$2411	8	\$3080
2	\$2528	9	\$3168
3	\$2644	10	\$3255
4	\$2732	11	\$3342
5	\$2819	12	\$3429
6	\$2906	L	\$3381
7	\$2993		

ⓘ Leg options – Standard Leg (L), Tapered Square (TS) and Tapered Round (TR) are available in Textured Silver (PR8) and Textured Charcoal (P7A) only. Hard Casters (H) are available on Black (T) only.

## HFLRC1

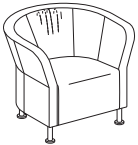

Due to the inherent design of the Round Lounge chair, material gathers will be present in the back.

### LOUNGE CHAIR

Round

### DIMENSIONS

Depth:	29	Arm Width:	27½
Width:	33½	Seat to Floor Height:	17
Height:	28	Usable Seat Depth:	20½
Seat Depth:	20½	Ship Weight:	57
Seat Width:	20½	Cube:	21.9
Back Width:	20½	Weight Rating:	300 lbs.
Back Height:	18½		

### FABRIC PRICE CODES

1	\$2518	8	\$3113
2	\$2623	9	\$3191
3	\$2726	10	\$3268
4	\$2803	11	\$3346
5	\$2881	12	\$3423
6	\$2958	L	\$3380
7	\$3036		

ⓘ Round Lounge models HFLRC1 / HFLRCIDF are offered in select fabrics; for availability, please see the Fabric Matrix on page 326. Also approved in limited Partnership Fabrics. Leg options – Standard Leg (L), Tapered Square (TS) and Tapered Round (TR) are available in Textured Silver (PR8) and Textured Charcoal (P7A) only. Hard Casters (H) are available on Black (T) only.  
 ⓘ Customer's Own Material (COM) is not available on Flock® model HFLRC1.

**HON Recommendation: HFLSC1.TS.PNS\_\_PR8 - List Price \$2610**

## HOW TO SPECIFY

<p><b>Select Model Number</b></p> <p>H F L S C 1</p>	<p><b>Select Leg Option</b></p> <p>L Standard Leg                  TS Tapered Square                  TR Tapered Round                  H Hard Casters</p> <p>T S</p>	<p><b>Select Fabric</b></p> <p>See page 326</p> <p>P N S 0 0 7</p>	<p><b>Select Leg Color</b></p> <p>PR8 Textured Silver                  P7A Textured Charcoal</p> <p><i>Specify for Standard, Tapered Round and Tapered Square legs only</i></p> <p>T Black Hard Caster  <i>Specify for Hard Caster option only</i></p> <p>P R 8</p>
--	---	--	---





## HFLMC1



### MODULAR CHAIR

### DIMENSIONS

Depth:	28½	Seat to Floor Height:	17
Width:	25	Usable Seat Depth:	20½
Height:	28	Ship Weight:	54
Seat Depth:	20½	Cube:	21.9
Seat Width:	25	COM:	3.0
Back Width:	25	Weight Rating:	300 lbs.
Back Height:	18½		

### FABRIC PRICE CODES

<b>1</b>	<b>\$1767</b>	<b>8</b>	<b>\$2213</b>
<b>2</b>	<b>\$1846</b>	<b>9</b>	<b>\$2272</b>
<b>3</b>	<b>\$1923</b>	<b>10</b>	<b>\$2330</b>
<b>4</b>	<b>\$1981</b>	<b>11</b>	<b>\$2388</b>
<b>5</b>	<b>\$2039</b>	<b>12</b>	<b>\$2446</b>
<b>6</b>	<b>\$2097</b>	<b>L</b>	<b>\$2413</b>
<b>7</b>	<b>\$2156</b>		

! Leg options – Standard Leg (L), Tapered Square (TS) and Tapered Round (TR) are available in Textured Silver (PR8) and Textured Charcoal (P7A) only. Hard Casters (H) are available on Black (T) only.

## HFLML1

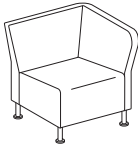

### MODULAR

Left End

### DIMENSIONS

Depth:	28½	Seat to Floor Height:	17
Width:	28½	Usable Seat Depth:	20½
Height:	28	Ship Weight:	72
Seat Depth:	20½	Cube:	21.9
Seat Width:	22¼	COM:	4.0
Back Width:	22¼	Weight Rating:	300 lbs.
Back Height:	18½		

### FABRIC PRICE CODES

<b>1</b>	<b>\$2084</b>	<b>8</b>	<b>\$2679</b>
<b>2</b>	<b>\$2189</b>	<b>9</b>	<b>\$2757</b>
<b>3</b>	<b>\$2292</b>	<b>10</b>	<b>\$2834</b>
<b>4</b>	<b>\$2369</b>	<b>11</b>	<b>\$2912</b>
<b>5</b>	<b>\$2447</b>	<b>12</b>	<b>\$2989</b>
<b>6</b>	<b>\$2524</b>	<b>L</b>	<b>\$2946</b>
<b>7</b>	<b>\$2602</b>		

! Leg options – Standard Leg (L), Tapered Square (TS) and Tapered Round (TR) are available in Textured Silver (PR8) and Textured Charcoal (P7A) only. Hard Casters (H) are available on Black (T) only.

## HFLMR1

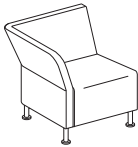

### MODULAR

Right End

### DIMENSIONS

Depth:	28½	Seat to Floor Height:	17
Width:	28½	Usable Seat Depth:	20½
Height:	28	Ship Weight:	72
Seat Depth:	20½	Cube:	21.9
Seat Width:	22¼	COM:	4.0
Back Width:	22¼	Weight Rating:	300 lbs.
Back Height:	18½		

### FABRIC PRICE CODES

<b>1</b>	<b>\$2084</b>	<b>8</b>	<b>\$2679</b>
<b>2</b>	<b>\$2189</b>	<b>9</b>	<b>\$2757</b>
<b>3</b>	<b>\$2292</b>	<b>10</b>	<b>\$2834</b>
<b>4</b>	<b>\$2369</b>	<b>11</b>	<b>\$2912</b>
<b>5</b>	<b>\$2447</b>	<b>12</b>	<b>\$2989</b>
<b>6</b>	<b>\$2524</b>	<b>L</b>	<b>\$2946</b>
<b>7</b>	<b>\$2602</b>		

! Leg options – Standard Leg (L), Tapered Square (TS) and Tapered Round (TR) are available in Textured Silver (PR8) and Textured Charcoal (P7A) only. Hard Casters (H) are available on Black (T) only.

**HON Recommendation: HFLMC1.TS.PNS\_\_\_.PR8 - List Price \$1928**

## HOW TO SPECIFY

Select Model Number

HFLMC1 .

Select Leg Option

- L Standard Leg
- TS Tapered Square
- TR Tapered Round
- H Hard Casters

TS .

Select Fabric

See page 326

PNS007 .

Select Leg Color

- PR8 Textured Silver
- P7A Textured Charcoal

*Specify for Standard, Tapered Round and Tapered Square legs only*

- T Black Hard Caster

*Specify for Hard Caster option only*

PR8



## HFLCC1

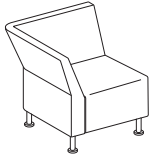

### TRUE CORNER CHAIR

### DIMENSIONS

Depth:	28½	Seat to Floor Height:	17
Width:	28½	Usable Seat Depth:	20½
Height:	28	Ship Weight:	60
Seat Depth:	20½	Cube:	21.9
Seat Width:	20½	COM:	4.0
Back Width:	22¼	Weight Rating:	300 lbs.
Back Height:	18½		

### FABRIC PRICE CODES

1	\$2075	8	\$2920
2	\$2180	9	\$3053
3	\$2283	10	\$3187
4	\$2386	11	\$3321
5	\$2519	12	\$3454
6	\$2653	L	\$2937
7	\$2786		

ⓘ Leg options – Standard Leg (L), Tapered Square (TS) and Tapered Round (TR) are available in Textured Silver (PR8) and Textured Charcoal (P7A) only.

## HFLWI45

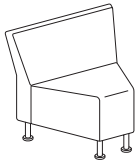

### INSIDE WEDGE

### DIMENSIONS

Depth:	26¼	Seat to Floor Height:	17
Width:	31½	Usable Seat Depth:	19
Height:	28	Ship Weight:	45
Seat Depth:	19½	Cube:	21.9
Seat Width:	25¾	COM:	3.0
Back Width:	31½	Weight Rating:	300 lbs.
Back Height:	18½		

### FABRIC PRICE CODES

1	\$2073	8	\$2918
2	\$2178	9	\$3051
3	\$2281	10	\$3185
4	\$2384	11	\$3319
5	\$2517	12	\$3452
6	\$2651	L	\$2935
7	\$2784		

ⓘ Leg options – Standard Leg (L), Tapered Square (TS) and Tapered Round (TR) are available in Textured Silver (PR8) and Textured Charcoal (P7A) only.

## HFLWO45



### OUTSIDE WEDGE

### DIMENSIONS

Depth:	26¼	Seat to Floor Height:	17
Width:	32	Usable Seat Depth:	19
Height:	28	Ship Weight:	35
Seat Depth:	19½	Cube:	21.9
Seat Width:	32	COM:	3.0
Back Width:	16¼	Weight Rating:	300 lbs.
Back Height:	18½		

### FABRIC PRICE CODES

1	\$2073	8	\$2918
2	\$2178	9	\$3051
3	\$2281	10	\$3185
4	\$2384	11	\$3319
5	\$2517	12	\$3452
6	\$2651	L	\$2935
7	\$2784		

ⓘ Leg options – Standard Leg (L), Tapered Square (TS) and Tapered Round (TR) are available in Textured Silver (PR8) and Textured Charcoal (P7A) only.

**HON Recommendation: HFLCC1.TS.PNS\_\_\_.PR8 - List Price \$2262**

## HOW TO SPECIFY

<p><b>Select Model Number</b></p> <p>HFLCC1</p>	<p><b>Select Leg Option</b></p> <p>L Standard Leg TS Tapered Square TR Tapered Round</p> <p>TS</p>	<p><b>Select Fabric</b></p> <p>See page 326</p> <p>PNS007</p>	<p><b>Select Leg Color</b></p> <p>PR8 Textured Silver P7A Textured Charcoal</p> <p><i>Specify for Standard, Tapered Round and Tapered Square legs only</i></p> <p>PR8</p>
---	--	---	---



## HFL450

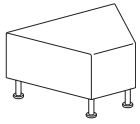

### WEDGE OTTOMAN

### DIMENSIONS

Depth:	23 3/8	Usable Seat Depth:	23 3/8
Width:	32	Ship Weight:	33
Height:	17	Cube:	12.6
Seat Depth:	23 3/8	COM:	2.0
Seat Width:	32	Weight Rating:	300 lbs.
Seat to Floor Height:	17		

### FABRIC PRICE CODES

<b>1</b>	<b>\$1019</b>	<b>8</b>	<b>\$1442</b>
<b>2</b>	<b>\$1072</b>	<b>9</b>	<b>\$1509</b>
<b>3</b>	<b>\$1124</b>	<b>10</b>	<b>\$1576</b>
<b>4</b>	<b>\$1175</b>	<b>11</b>	<b>\$1643</b>
<b>5</b>	<b>\$1242</b>	<b>12</b>	<b>\$1709</b>
<b>6</b>	<b>\$1309</b>	<b>L</b>	<b>\$1450</b>
<b>7</b>	<b>\$1375</b>		

! Leg options – Standard Leg (L), Tapered Square (TS) and Tapered Round (TR) are available in Textured Silver (PR8) and Textured Charcoal (P7A) only.

## HFLS01

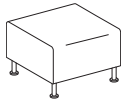

### OTTOMAN

Square

### DIMENSIONS

Depth:	25	Ship Weight:	30.0
Width:	25	Cube:	7.5
Height:	17	COM:	2.0
Seat Depth:	25	Weight Rating:	300 lbs.
Seat Width:	25		

### FABRIC PRICE CODES

<b>1</b>	<b>\$1034</b>	<b>8</b>	<b>\$1332</b>
<b>2</b>	<b>\$1087</b>	<b>9</b>	<b>\$1371</b>
<b>3</b>	<b>\$1139</b>	<b>10</b>	<b>\$1409</b>
<b>4</b>	<b>\$1177</b>	<b>11</b>	<b>\$1449</b>
<b>5</b>	<b>\$1216</b>	<b>12</b>	<b>\$1487</b>
<b>6</b>	<b>\$1255</b>	<b>L</b>	<b>\$1465</b>
<b>7</b>	<b>\$1293</b>		

! Leg options – Standard Leg (L), Tapered Square (TS) and Tapered Round (TR) are available in Textured Silver (PR8) and Textured Charcoal (P7A) only. Hard Casters (H) are available on Black (T) only.

! While the top surface of the ottoman is flat, modular models (pages 328-329 and 332-334) have a slight angle to their seats. Therefore, there will not be alignment between these units when placed side-by-side.

## HFLGANG



### GANGING BRACKET

For Flock® Modular Seating Models

- Can be used for in-line ganging ONLY
- Use bracket set to connect two models. Do not connect more than four models.
- No specification required for bracket

### DIMENSIONS

Ship Weight:	0.5
Cube:	0.1

### LIST PRICE

\$51

**HON Recommendation: HFLS01.TS.PNS\_\_PR8 - List Price \$1169**

## HOW TO SPECIFY

<p><b>Select Model Number</b></p> <p>H F L S 0 1</p>	<p><b>Select Leg Option</b></p> <p>L Standard Leg              TS Tapered Square              TR Tapered Round              H Hard Casters</p> <p>T S</p>	<p><b>Select Fabric</b></p> <p>See page 326</p> <p>P N S 0 0 7</p>	<p><b>Select Leg Color</b></p> <p>PR8 Textured Silver              P7A Textured Charcoal</p> <p><i>Specify for Standard, Tapered Round and Tapered Square legs only</i></p> <p>T Black Hard Caster  <i>Specify for Hard Caster option only</i></p> <p>P R 8</p>
--	---	--	---



**HFLSC1DF**

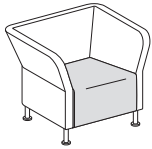

**LOUNGE CHAIR**

**Multi-Fabric**  
Square

**DIMENSIONS**

Depth:	28½	Arm Width:	27½
Width:	34¼	Seat to Floor Height:	17
Height:	28	Usable Seat Depth:	20½
Seat Depth:	20½	Ship Weight:	48
Seat Width:	21½	Cube:	27.0
Back Width:	21½	COM:	See page 343
Back Height:	18½	Weight Rating:	300 lbs.

**FABRIC PRICE CODES**

<b>1</b>	<b>\$2510</b>	
<i>Add to Base Price Above</i>		
	<b>Back</b>	<b>Seat</b>
<b>2</b>	<b>\$87</b>	<b>\$31</b>
<b>3</b>	<b>\$174</b>	<b>\$61</b>
<b>4</b>	<b>\$237</b>	<b>\$84</b>
<b>5</b>	<b>\$302</b>	<b>\$107</b>
<b>6</b>	<b>\$367</b>	<b>\$129</b>
<b>7</b>	<b>\$431</b>	<b>\$152</b>
<b>8</b>	<b>\$496</b>	<b>\$175</b>
<b>9</b>	<b>\$560</b>	<b>\$198</b>
<b>10</b>	<b>\$625</b>	<b>\$221</b>
<b>11</b>	<b>\$689</b>	<b>\$244</b>
<b>12</b>	<b>\$753</b>	<b>\$266</b>
<b>L</b>	<b>\$717</b>	<b>\$253</b>

For multi-fabric models, start with the base price, then add the additional amount for the back and seat from the corresponding matrix to determine the final list price. Choose any combination of fabric grades for the back and seat.

Example: HFLSC1DF base price (\$2510) + Grade 2 back fabric (add \$87) + Grade 4 seat fabric (add \$84) = Total \$2681 List  
 HFLSC1DF base price (\$2510) + Grade 5 back fabric (add \$302) + Grade 3 seat fabric (add \$61) = Total \$2873 List

**HFLRC1DF**

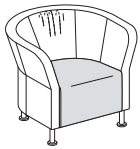

**LOUNGE CHAIR**

**Multi-Fabric**  
Round

**DIMENSIONS**

Depth:	29	Arm Width:	27½
Width:	33½	Seat to Floor Height:	17
Height:	28	Usable Seat Depth:	20½
Seat Depth:	20½	Ship Weight:	39
Seat Width:	20½	Cube:	27.0
Back Width:	20½	Weight Rating:	300 lbs.
Back Height:	18½		

**FABRIC PRICE CODES**

<b>1</b>	<b>\$2616</b>	
<i>Add to Base Price Above</i>		
	<b>Back</b>	<b>Seat</b>
<b>2</b>	<b>\$78</b>	<b>\$28</b>
<b>3</b>	<b>\$154</b>	<b>\$55</b>
<b>4</b>	<b>\$211</b>	<b>\$76</b>
<b>5</b>	<b>\$269</b>	<b>\$94</b>
<b>6</b>	<b>\$326</b>	<b>\$115</b>
<b>7</b>	<b>\$383</b>	<b>\$135</b>
<b>8</b>	<b>\$440</b>	<b>\$156</b>
<b>9</b>	<b>\$498</b>	<b>\$176</b>
<b>10</b>	<b>\$556</b>	<b>\$196</b>
<b>11</b>	<b>\$612</b>	<b>\$216</b>
<b>12</b>	<b>\$670</b>	<b>\$235</b>
<b>L</b>	<b>\$638</b>	<b>\$225</b>

NOTES: Due to the inherent design of the Round Lounge chair, material gathers will be present in the back.  
 ⓘ Round Lounge models HFLRC1 / HFLRC1DF are offered in select fabrics; for availability, please see the Fabric Matrix on page 326. Also approved in limited Partnership Fabrics.

For multi-fabric models, start with the base price, then add the additional amount for the back and seat from the corresponding matrix to determine the final list price. Choose any combination of fabric grades for the back and seat.

Example: HFLRC1DF base price (\$2616) + Grade 2 back fabric (add \$78) + Grade 4 seat fabric (add \$76) = Total \$2770 List  
 HFLRC1DF base price (\$2616) + Grade 5 back fabric (add \$269) + Grade 3 seat fabric (add \$55) = Total \$2940 List

**HON Recommendation: HFLSC1DF.TS.PNS\_\_PNS\_\_PR8 - List Price \$2710**

**HOW TO SPECIFY**

<p><b>Select Model Number</b></p> <p>HFLSC1DF</p>	<p><b>Select Leg Option</b></p> <p>L Standard Leg                  TS Tapered Square                  TR Tapered Round                  H Hard Casters</p> <p>TS</p>	<p><b>Select Back Fabric</b></p> <p>See page 326</p> <p>PNS004</p>	<p><b>Select Seat Fabric</b></p> <p>See page 326</p> <p>PNS007</p>	<p><b>Select Leg Color</b></p> <p>PR8 Textured Silver                  P7A Textured Charcoal</p> <p><i>Specify for Standard, Tapered Round and Tapered Square legs only</i></p> <p>T Black Hard Caster  <i>Specify for Hard Caster option only</i></p> <p>PR8</p>
---	--	--	--	---

# FLOCK® Multi-Fabric Collaborative

GSA SIN 33721



Icon Legend on page 19

## HFLMC1DF

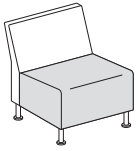

### MODULAR CHAIR

Multi-Fabric

### DIMENSIONS

Depth:	28½	Seat to Floor Height:	17
Width:	25	Usable Seat Depth:	20½
Height:	28	Ship Weight:	52
Seat Depth:	20½	Cube:	24.0
Seat Width:	25	COM:	See page 343
Back Width:	25	Weight Rating:	300 lbs.
Back Height:	18½		

### FABRIC PRICE CODES

<b>1</b>	<b>\$1866</b>	
	<i>Add to Base Price Above</i>	
	<b>Back</b>	<b>Seat</b>
<b>2</b>	<b>\$40</b>	<b>\$40</b>
<b>3</b>	<b>\$79</b>	<b>\$79</b>
<b>4</b>	<b>\$108</b>	<b>\$108</b>
<b>5</b>	<b>\$136</b>	<b>\$136</b>
<b>6</b>	<b>\$165</b>	<b>\$165</b>
<b>7</b>	<b>\$195</b>	<b>\$195</b>
<b>8</b>	<b>\$224</b>	<b>\$224</b>
<b>9</b>	<b>\$253</b>	<b>\$253</b>
<b>10</b>	<b>\$282</b>	<b>\$282</b>
<b>11</b>	<b>\$311</b>	<b>\$311</b>
<b>12</b>	<b>\$340</b>	<b>\$340</b>
<b>L</b>	<b>\$324</b>	<b>\$324</b>

## HFLML1DF

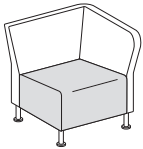

### MODULAR LEFT END

Multi-Fabric

### DIMENSIONS

Depth:	28½	Seat to Floor Height:	17
Width:	28½	Usable Seat Depth:	20½
Height:	28	Ship Weight:	72
Seat Depth:	20½	Cube:	24.0
Seat Width:	22¼	COM:	See page 343
Back Width:	22¼	Weight Rating:	300 lbs.
Back Height:	18½		

### FABRIC PRICE CODES

<b>1</b>	<b>\$2183</b>	
	<i>Add to Base Price Above</i>	
	<b>Back</b>	<b>Seat</b>
<b>2</b>	<b>\$78</b>	<b>\$28</b>
<b>3</b>	<b>\$154</b>	<b>\$55</b>
<b>4</b>	<b>\$211</b>	<b>\$76</b>
<b>5</b>	<b>\$269</b>	<b>\$94</b>
<b>6</b>	<b>\$326</b>	<b>\$115</b>
<b>7</b>	<b>\$383</b>	<b>\$135</b>
<b>8</b>	<b>\$440</b>	<b>\$156</b>
<b>9</b>	<b>\$498</b>	<b>\$176</b>
<b>10</b>	<b>\$556</b>	<b>\$196</b>
<b>11</b>	<b>\$612</b>	<b>\$216</b>
<b>12</b>	<b>\$670</b>	<b>\$235</b>
<b>L</b>	<b>\$638</b>	<b>\$225</b>

HON Recommendation: HFLMC1DF.TS.PNS\_\_PNS\_\_PR8 - List Price \$2028

SEATING

## HOW TO SPECIFY

<p><b>Select Model Number</b></p>	<p><b>Select Leg Option</b></p> <p>L Standard Leg              TS Tapered Square              TR Tapered Round              H Hard Casters</p>	<p><b>Select Back Fabric</b></p> <p>See page 326</p>	<p><b>Select Seat Fabric</b></p> <p>See page 326</p>	<p><b>Select Leg Color</b></p> <p>PR8 Textured Silver              P7A Textured Charcoal</p> <p><i>Specify for Standard, Tapered Round and Tapered Square legs only</i></p> <p>T Black Hard Caster</p> <p><i>Specify for Hard Caster option only</i></p>
HFLMC1DF	TS	PNS004	PNS007	PR8



**HFLMR1DF**

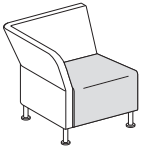

**MODULAR RIGHT END**

Multi-Fabric

**DIMENSIONS**

Depth:	28½	Seat to Floor Height:	17
Width:	28½	Usable Seat Depth:	20½
Height:	28	Ship Weight:	72.0
Seat Depth:	20½	Cube:	24.0
Seat Width:	22¼	COM:	See page 343
Back Width:	22¼	Weight Rating:	300 lbs.
Back Height:	18½		

**FABRIC PRICE CODES**

<b>1</b>	<b>\$2183</b>	
<i>Add to Base Price Above</i>		
	<b>Back</b>	<b>Seat</b>
<b>2</b>	<b>\$78</b>	<b>\$28</b>
<b>3</b>	<b>\$154</b>	<b>\$55</b>
<b>4</b>	<b>\$211</b>	<b>\$76</b>
<b>5</b>	<b>\$269</b>	<b>\$94</b>
<b>6</b>	<b>\$326</b>	<b>\$115</b>
<b>7</b>	<b>\$383</b>	<b>\$135</b>
<b>8</b>	<b>\$440</b>	<b>\$156</b>
<b>9</b>	<b>\$498</b>	<b>\$176</b>
<b>10</b>	<b>\$556</b>	<b>\$196</b>
<b>11</b>	<b>\$612</b>	<b>\$216</b>
<b>12</b>	<b>\$670</b>	<b>\$235</b>
<b>L</b>	<b>\$638</b>	<b>\$225</b>

**HON Recommendation: HFLMR1DF.TS.PNS\_\_PNS\_\_PR8 - List Price \$2371**

**HOW TO SPECIFY**

<p><b>Select Model Number</b></p> <p>H F L M R 1 D F .</p>	<p><b>Select Leg Option</b></p> <p>L Standard Leg                  TS Tapered Square                  TR Tapered Round                  H Hard Casters</p> <p>T S .</p>	<p><b>Select Back Fabric</b></p> <p>See page 326</p> <p>P N S 0 0 4 .</p>	<p><b>Select Seat Fabric</b></p> <p>See page 326</p> <p>P N S 0 0 7 .</p>	<p><b>Select Leg Color</b></p> <p>PR8 Textured Silver                  P7A Textured Charcoal</p> <p><i>Specify for Standard, Tapered Round and Tapered Square legs only</i></p> <p>T Black Hard Caster</p> <p><i>Specify for Hard Caster option only</i></p> <p>P R 8</p>
--	---	---	---	---

SEATING

# FLOCK® Multi-Fabric Collaborative

GSA SIN 33721



Icon Legend on page 19

## HFLCC1DF

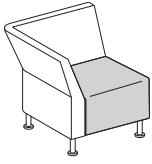

### TRUE CORNER CHAIR

Multi-Fabric

### DIMENSIONS

Depth:	28½	Seat to Floor Height:	17
Width:	28½	Usable Seat Depth:	21
Height:	28	Ship Weight:	60
Seat Depth:	20½	Cube:	21.9
Seat Width:	20½	COM:	See page 343
Back Width:	22¼	Weight Rating:	300 lbs.
Back Height:	18½		

### FABRIC PRICE CODES

<b>1</b>	<b>\$2174</b>	
	<i>Add to Base Price Above</i>	
	<b>Back</b>	<b>Seat</b>
<b>2</b>	<b>\$53</b>	<b>\$53</b>
<b>3</b>	<b>\$105</b>	<b>\$105</b>
<b>4</b>	<b>\$156</b>	<b>\$156</b>
<b>5</b>	<b>\$223</b>	<b>\$223</b>
<b>6</b>	<b>\$290</b>	<b>\$290</b>
<b>7</b>	<b>\$356</b>	<b>\$356</b>
<b>8</b>	<b>\$423</b>	<b>\$423</b>
<b>9</b>	<b>\$490</b>	<b>\$490</b>
<b>10</b>	<b>\$557</b>	<b>\$557</b>
<b>11</b>	<b>\$624</b>	<b>\$624</b>
<b>12</b>	<b>\$690</b>	<b>\$690</b>
<b>L</b>	<b>\$431</b>	<b>\$431</b>

! Leg options – Standard Leg (L), Tapered Square (TS) and Tapered Round (TR) are available in Textured Silver (PR8) and Textured Charcoal (P7A) only. Hard Casters (H) are available on Black (T) only.

## HFLWI45DF

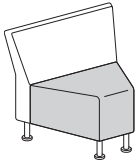

### INSIDE WEDGE

Multi-Fabric

### DIMENSIONS

Depth:	26¼	Seat to Floor Height:	17
Width:	31½	Usable Seat Depth:	19
Height:	28	Ship Weight:	45
Seat Depth:	19½	Cube:	21.9
Seat Width:	25¾	COM:	See page 343
Back Width:	31½	Weight Rating:	300 lbs.
Back Height:	18½		

### FABRIC PRICE CODES

<b>1</b>	<b>\$2172</b>	
	<i>Add to Base Price Above</i>	
	<b>Back</b>	<b>Seat</b>
<b>2</b>	<b>\$53</b>	<b>\$53</b>
<b>3</b>	<b>\$105</b>	<b>\$105</b>
<b>4</b>	<b>\$156</b>	<b>\$156</b>
<b>5</b>	<b>\$223</b>	<b>\$223</b>
<b>6</b>	<b>\$290</b>	<b>\$290</b>
<b>7</b>	<b>\$356</b>	<b>\$356</b>
<b>8</b>	<b>\$423</b>	<b>\$423</b>
<b>9</b>	<b>\$490</b>	<b>\$490</b>
<b>10</b>	<b>\$557</b>	<b>\$557</b>
<b>11</b>	<b>\$624</b>	<b>\$624</b>
<b>12</b>	<b>\$690</b>	<b>\$690</b>
<b>L</b>	<b>\$431</b>	<b>\$431</b>

! Leg options – Standard Leg (L), Tapered Square (TS) and Tapered Round (TR) are available in Textured Silver (PR8) and Textured Charcoal (P7A) only. Hard Casters (H) are available on Black (T) only.

## HFLWO45DF

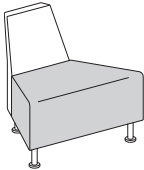

### OUTSIDE WEDGE

Multi-Fabric

### DIMENSIONS

Depth:	26½	Seat to Floor Height:	17
Width:	32	Usable Seat Depth:	19
Height:	28	Ship Weight:	35
Seat Depth:	19½	Cube:	21.9
Seat Width:	32	COM:	See page 343
Back Width:	16¼	Weight Rating:	300 lbs.
Back Height:	18½		

### FABRIC PRICE CODES

<b>1</b>	<b>\$2172</b>	
	<i>Add to Base Price Above</i>	
	<b>Back</b>	<b>Seat</b>
<b>2</b>	<b>\$53</b>	<b>\$53</b>
<b>3</b>	<b>\$105</b>	<b>\$105</b>
<b>4</b>	<b>\$156</b>	<b>\$156</b>
<b>5</b>	<b>\$223</b>	<b>\$223</b>
<b>6</b>	<b>\$290</b>	<b>\$290</b>
<b>7</b>	<b>\$356</b>	<b>\$356</b>
<b>8</b>	<b>\$423</b>	<b>\$423</b>
<b>9</b>	<b>\$490</b>	<b>\$490</b>
<b>10</b>	<b>\$557</b>	<b>\$557</b>
<b>11</b>	<b>\$624</b>	<b>\$624</b>
<b>12</b>	<b>\$690</b>	<b>\$690</b>
<b>L</b>	<b>\$431</b>	<b>\$431</b>

! Leg options – Standard Leg (L), Tapered Square (TS) and Tapered Round (TR) are available in Textured Silver (PR8) and Textured Charcoal (P7A) only. Hard Casters (H) are available on Black (T) only.

## HOW TO SPECIFY **HON Recommendation: HFLCC1DF.TS.PNS\_\_PNS\_\_PR8 - List Price \$2362**

<b>Select Model Number</b>  HFLCC1DF	<b>Select Leg Option</b>  L Standard Leg TS Tapered Square TR Tapered Round H Hard Casters	<b>Select Back Fabric</b>  See page 326	<b>Select Seat Fabric</b>  See page 326	<b>Select Leg Color</b>  PR8 Textured Silver P7A Textured Charcoal <i>Specify for Standard, Tapered Round and Tapered Square legs only</i>  T Black Hard Caster <i>Specify for Hard Caster option only</i>
HFLCC1DF	TS	PNS004	PNS007	PR8



	DESCRIPTION	MODEL	SHIP WEIGHT	CUBE	LIST PRICE
	Two-Seat Base Frame	HFLB2	25	5.9	\$548
	Three-Seat Base Frame	HFLB3	33	7.8	\$683

**HOW TO SPECIFY**

<p><b>Select Model Number</b></p> <p>H F L B 2 .</p>	<p><b>Select Leg Option</b></p> <p>RS Round Straight Leg TS Tapered Square Leg (+ \$82)</p> <p><b>Select Leg Color</b></p> <p>PR8 Textured Silver P7A Textured Charcoal</p> <p>R S P R 8</p>
--	--

	DESCRIPTION	MODEL	SHIP WEIGHT	CUBE	LIST PRICE
	Tapered Square Leg — Shroud Pack	HTSSRD	2	1.0	\$107

**HOW TO SPECIFY**

<p><b>Select Model Number</b></p> <p>H T S S R D .</p>	<p><b>Select Leg Color</b></p> <p>PR8 Textured Silver P7A Textured Charcoal</p> <p>P R 8</p>
--	--

SEATING



# FLOCK® Options

## MODEL OPTIONS

**HFCG6**  
**HFCG6DF -**  
Multi-Fabric



**Guest Chair**  
4-Leg

**HFCS64L**  
**HFCS64LDF -**  
Multi-Fabric



**Counter-Height Stool**  
4-Leg

**HFSS74L**  
**HFSS74LDF -**  
Multi-Fabric



**Bar/Café-Height Stool**  
4-Leg

**HFCG6WD**  
**HFCG6WDDF -**  
Multi-Fabric



**Guest Chair**  
Wood Leg

**HFCS64LWD**  
**HFCS64LWDDF -**  
Multi-Fabric



**Counter-Height Stool**  
Wood Leg

**HFSS74LWD**  
**HFSS74LWDDF -**  
Multi-Fabric



**Bar/Café-Height Stool**  
Wood Leg

## 4-LEG STOOL, METAL LEG COLOR

CODE	DESCRIPTION	PRICE
<b>PR8</b>	Textured Silver	<b>+\$0</b>

## WOOD LEG COLOR

CODE	DESCRIPTION	PRICE
<b>LE702</b>	Cognac	<b>+\$0</b>
<b>LE878</b>	Beigewood	<b>+\$0</b>
<b>LE773</b>	Bourbon Cherry	<b>+\$0</b>
<b>LE121</b>	Mocha	<b>+\$0</b>
<b>LE599</b>	Field Elm	<b>+\$0</b>
<b>LE579</b>	Florence Walnut	<b>+\$0</b>
<b>LE856</b>	Harvest	<b>+\$0</b>
<b>LE518</b>	Kingswood Walnut	<b>+\$0</b>
<b>LE394</b>	Lowell Ash	<b>+\$0</b>
<b>LE740</b>	Mahogany	<b>+\$0</b>
<b>LE800</b>	Natural Maple	<b>+\$0</b>
<b>LE896</b>	Natural Recon	<b>+\$0</b>
<b>LE912</b>	Phantom Ecru	<b>+\$0</b>
<b>LE679</b>	Pinnacle	<b>+\$0</b>
<b>LE150</b>	Portico Teak	<b>+\$0</b>
<b>LE774</b>	Shaker Cherry	<b>+\$0</b>
<b>LE625</b>	Skyline Walnut	<b>+\$0</b>
<b>LE495</b>	Sterling Ash	<b>+\$0</b>

Due to wood being a natural material, color may differ between pieces. Stains will be tonal matches and will not replicate the grain contrast of the coordinating laminate.

SEATING

**HFCL2**  
**HFCL2DF - Multi-Fabric**



**Wide Lounge Chair**  
With 4-Star Return-to-Center

**HFLSC2**  
**HFLSC2DF - Multi-Fabric**



**Square Chair**  
With 4-Star Return-to-Center

## BASE COLOR 4-LEG STOOL, FOOTRING COLOR

CODE	DESCRIPTION	PRICE
<b>PR8</b>	Silver Texture	<b>\$0</b>
<b>P8X</b>	Solar Black	<b>\$0</b>
<b>P7A</b>	Textured Charcoal	<b>\$0</b>

## BASE COLOR

CODE	DESCRIPTION	PRICE
<b>4S</b>	4-Star Return-to-Center	<b>+\$0</b>

Available in the following finishes:

<b>PR8</b>	Textured Silver
<b>P7A</b>	Textured Charcoal



## HFCG6



### GUEST CHAIR

4-Leg

### DIMENSIONS

Depth:	23 <sup>5</sup> / <sub>16</sub>	Seat to Floor Height:	18 <sup>1</sup> / <sub>4</sub>
Width:	19	Usable Seat Depth:	16 <sup>7</sup> / <sub>8</sub>
Height:	32 <sup>1</sup> / <sub>2</sub>	Ship Weight:	27
Seat Depth:	16 <sup>5</sup> / <sub>8</sub>	Cube:	12.5
Seat Width:	19	COM:	2.0
Back Width:	19	Weight Rating:	300 lbs.
Back Height:	14 <sup>1</sup> / <sub>4</sub>		

### FABRIC PRICE CODES

1	\$818	8	\$1116
2	\$871	9	\$1155
3	\$923	10	\$1193
4	\$961	11	\$1233
5	\$1000	12	\$1271
6	\$1039	L	\$1249
7	\$1077		

## HFCS64L



### COUNTER-HEIGHT STOOL

4-Leg

### DIMENSIONS

Depth:	20 <sup>5</sup> / <sub>8</sub>	Seat to Floor Height:	23 <sup>7</sup> / <sub>8</sub>
Width:	17 <sup>1</sup> / <sub>2</sub>	Usable Seat Depth:	15 <sup>1</sup> / <sub>8</sub>
Height:	34 <sup>1</sup> / <sub>4</sub>	Ship Weight:	35
Seat Depth:	15 <sup>5</sup> / <sub>8</sub>	Cube:	12.6
Seat Width:	18	COM:	1.5
Back Width:	18	Weight Rating:	300 lbs.
Back Height:	10 <sup>7</sup> / <sub>8</sub>		

### FABRIC PRICE CODES

1	\$988	8	\$1287
2	\$1041	9	\$1325
3	\$1094	10	\$1367
4	\$1132	11	\$1412
5	\$1170	12	\$1458
6	\$1209	L	\$1577
7	\$1246		

## HFSS74L



### BAR/CAFÉ-HEIGHT STOOL

4-Leg

### DIMENSIONS

Depth:	21 <sup>5</sup> / <sub>8</sub>	Seat to Floor Height:	30
Width:	18	Usable Seat Depth:	15 <sup>7</sup> / <sub>8</sub>
Height:	40 <sup>7</sup> / <sub>8</sub>	Ship Weight:	37
Seat Depth:	15 <sup>7</sup> / <sub>8</sub>	Cube:	12.6
Seat Width:	18	COM:	1.5
Back Width:	18	Weight Rating:	300 lbs.
Back Height:	10 <sup>7</sup> / <sub>8</sub>		

### FABRIC PRICE CODES

1	\$1028	8	\$1326
2	\$1081	9	\$1365
3	\$1133	10	\$1403
4	\$1171	11	\$1443
5	\$1210	12	\$1481
6	\$1249	L	\$1459
7	\$1287		

**HON Recommendation: HFCG6.PURL\_\_\_.PR8 - List Price \$923**

## HOW TO SPECIFY

<p><b>Select Model Number</b></p> <div style="border: 1px solid black; padding: 5px; display: flex; gap: 5px;"> <span>H</span><span>F</span><span>S</span><span>S</span><span>7</span><span>4</span><span>L</span> </div>	<p><b>Select Fabric</b></p> <p>See page 326</p> <div style="border: 1px solid black; padding: 5px; display: flex; gap: 5px;"> <span>P</span><span>U</span><span>R</span><span>L</span><span>1</span><span>2</span> </div>	<p><b>Select Leg Color</b></p> <p>See page 336</p> <div style="border: 1px solid black; padding: 5px; display: flex; gap: 5px;"> <span>P</span><span>R</span><span>8</span> </div>
---	---	--



## HF CG6WD



### GUEST CHAIR

Wood Leg

### DIMENSIONS

Depth:	23 <sup>3</sup> / <sub>4</sub>	Seat to Floor Height:	18
Width:	22 <sup>5</sup> / <sub>8</sub>	Usable Seat Depth:	16 <sup>7</sup> / <sub>8</sub>
Height:	32	Ship Weight:	27
Seat Depth:	16 <sup>7</sup> / <sub>8</sub>	Cube:	12.5
Seat Width:	19	COM:	2.0
Back Width:	19	Weight Rating:	300 lbs.
Back Height:	14 <sup>1</sup> / <sub>4</sub>		

### FABRIC PRICE CODES

1	\$1161	8	\$1460
2	\$1214	9	\$1498
3	\$1267	10	\$1540
4	\$1305	11	\$1585
5	\$1343	12	\$1631
6	\$1382	L	\$1750
7	\$1419		

## HF CS64LWD



### COUNTER-HEIGHT STOOL

Wood Leg

### DIMENSIONS

Depth:	19 <sup>1</sup> / <sub>2</sub>	Seat to Floor Height:	23 <sup>5</sup> / <sub>8</sub>
Width:	19 <sup>5</sup> / <sub>8</sub>	Usable Seat Depth:	15 <sup>7</sup> / <sub>8</sub>
Height:	34 <sup>1</sup> / <sub>2</sub>	Ship Weight:	30
Seat Depth:	15 <sup>5</sup> / <sub>8</sub>	Cube:	12.6
Seat Width:	18	COM:	1.5
Back Width:	18	Weight Rating:	300 lbs.
Back Height:	10 <sup>7</sup> / <sub>8</sub>		

### FABRIC PRICE CODES

1	\$1332	8	\$1631
2	\$1385	9	\$1669
3	\$1438	10	\$1711
4	\$1476	11	\$1756
5	\$1514	12	\$1802
6	\$1553	L	\$1921
7	\$1590		

## HF SS74LWD



### BAR/CAFÉ-HEIGHT STOOL

Wood Leg

### DIMENSIONS

Depth:	20 <sup>1</sup> / <sub>2</sub>	Seat to Floor Height:	29 <sup>1</sup> / <sub>2</sub>
Width:	20 <sup>3</sup> / <sub>4</sub>	Usable Seat Depth:	15 <sup>7</sup> / <sub>8</sub>
Height:	40 <sup>1</sup> / <sub>2</sub>	Ship Weight:	31
Seat Depth:	15 <sup>7</sup> / <sub>8</sub>	Cube:	12.6
Seat Width:	18	COM:	1.5
Back Width:	18	Weight Rating:	300 lbs.
Back Height:	10 <sup>7</sup> / <sub>8</sub>		

### FABRIC PRICE CODES

1	\$1372	8	\$1671
2	\$1425	9	\$1709
3	\$1478	10	\$1751
4	\$1516	11	\$1796
5	\$1554	12	\$1842
6	\$1593	L	\$1961
7	\$1630		

HON Recommendation: HF CG6WD.PURL\_\_D - List Price \$1267

## HOW TO SPECIFY

<p><b>Select Model Number</b></p> <p>HF CG6WD</p>	<p><b>Select Fabric</b></p> <p>See page 326</p> <p>PURL12</p>	<p><b>Select Wood Leg Color</b></p> <p>See page 336</p> <p>D</p>	<p><b>Select Footring Color</b></p> <p>Specify for Stools only</p> <p>See page 336</p> <p>P7A</p>
---	---	--	---



## HFCL2



### WIDE LOUNGE CHAIR

with 4-Star Return-to-Center

### DIMENSIONS

Depth:	27½	Seat to Floor Height:	17
Width:	26¾	Usable Seat Depth:	19
Height:	32¼	Ship Weight:	53
Seat Width:	26	Cube:	25.1
Back Width:	25½	COM:	2.5
Back Height:	19½	Weight Rating:	300 lbs.

### FABRIC PRICE CODES

1	\$1391	8	\$1837
2	\$1470	9	\$1896
3	\$1547	10	\$1954
4	\$1605	11	\$2012
5	\$1663	12	\$2070
6	\$1721	L	\$2037
7	\$1780		

## HFLSC2



### SQUARE CHAIR

with 4-Star Return-to-Center

### DIMENSIONS

Depth:	26½	Seat to Floor Height:	18
Width:	27½	Usable Seat Depth:	18¾
Height:	32¼	Ship Weight:	46
Seat Width:	17½	Cube:	25.1
Back Width:	16	COM:	See note
Back Height:	17¾	Weight Rating:	300 lbs.

### FABRIC PRICE CODES

1	\$2004	8	\$2450
2	\$2083	9	\$2509
3	\$2160	10	\$2567
4	\$2218	11	\$2625
5	\$2276	12	\$2683
6	\$2334	L	\$2650
7	\$2393		

NOTES: Due to fabric limitations, COM is unavailable for back upholstery. See HFLSC2DF for COM available on the seat only.

**HON Recommendation: HFLSC2.PURL\_\_4SPR8 - List Price \$2160**

## HOW TO SPECIFY

<p>Select Model Number</p> <p>H F L S C 2</p>	<p>Select Fabric</p> <p>See page 326</p> <p>P U R L 1 2</p>	<p>Select Base Option</p> <p>See page 336</p> <p>4 S P R 8</p>
---	---	--



## HF CG6DF



### GUEST CHAIR

4-Leg, Multi-Fabric

### DIMENSIONS

Depth:	23 <sup>5</sup> / <sub>16</sub>	Seat to Floor Height:	18 <sup>1</sup> / <sub>4</sub>
Width:	19	Usable Seat Depth:	16 <sup>7</sup> / <sub>8</sub>
Height:	32 <sup>1</sup> / <sub>2</sub>	Ship Weight:	27
Seat Depth:	16 <sup>7</sup> / <sub>8</sub>	Cube:	12.5
Seat Width:	19	COM:	See page 343
Back Width:	19	Weight Rating:	300 lbs.
Back Height:	14 <sup>1</sup> / <sub>4</sub>		

### FABRIC PRICE CODES

<b>1</b>	<b>\$917</b>	
	<i>Add to Base Price Above</i>	
	<b>Back</b>	<b>Seat</b>
<b>2</b>	<b>\$27</b>	<b>\$27</b>
<b>3</b>	<b>\$53</b>	<b>\$53</b>
<b>4</b>	<b>\$72</b>	<b>\$72</b>
<b>5</b>	<b>\$91</b>	<b>\$91</b>
<b>6</b>	<b>\$111</b>	<b>\$111</b>
<b>7</b>	<b>\$130</b>	<b>\$130</b>
<b>8</b>	<b>\$150</b>	<b>\$150</b>
<b>9</b>	<b>\$169</b>	<b>\$169</b>
<b>10</b>	<b>\$188</b>	<b>\$188</b>
<b>11</b>	<b>\$208</b>	<b>\$208</b>
<b>12</b>	<b>\$227</b>	<b>\$227</b>
<b>L</b>	<b>\$216</b>	<b>\$216</b>

## HF CS64LDF



### COUNTER-HEIGHT STOOL

4-Leg, Multi-Fabric

### DIMENSIONS

Depth:	20 <sup>3</sup> / <sub>8</sub>	Seat to Floor Height:	23 <sup>7</sup> / <sub>8</sub>
Width:	17 <sup>1</sup> / <sub>2</sub>	Usable Seat Depth:	15 <sup>1</sup> / <sub>2</sub>
Height:	34 <sup>1</sup> / <sub>4</sub>	Ship Weight:	35
Seat Depth:	15 <sup>5</sup> / <sub>8</sub>	Cube:	12.6
Seat Width:	18	COM:	See page 343
Back Width:	18	Weight Rating:	300 lbs.
Back Height:	10 <sup>7</sup> / <sub>8</sub>		

### FABRIC PRICE CODES

<b>1</b>	<b>\$1087</b>	
	<i>Add to Base Price Above</i>	
	<b>Back</b>	<b>Seat</b>
<b>2</b>	<b>\$27</b>	<b>\$27</b>
<b>3</b>	<b>\$53</b>	<b>\$53</b>
<b>4</b>	<b>\$72</b>	<b>\$72</b>
<b>5</b>	<b>\$91</b>	<b>\$91</b>
<b>6</b>	<b>\$111</b>	<b>\$111</b>
<b>7</b>	<b>\$130</b>	<b>\$130</b>
<b>8</b>	<b>\$150</b>	<b>\$150</b>
<b>9</b>	<b>\$169</b>	<b>\$169</b>
<b>10</b>	<b>\$190</b>	<b>\$190</b>
<b>11</b>	<b>\$213</b>	<b>\$213</b>
<b>12</b>	<b>\$235</b>	<b>\$235</b>
<b>L</b>	<b>\$295</b>	<b>\$295</b>

## HF SS74LDF



### BAR/CAFÉ-HEIGHT STOOL

4-Leg, Multi-Fabric

### DIMENSIONS

Depth:	21 <sup>7</sup> / <sub>8</sub>	Seat to Floor Height:	30
Width:	18	Usable Seat Depth:	15 <sup>1</sup> / <sub>2</sub>
Height:	40 <sup>7</sup> / <sub>8</sub>	Ship Weight:	37
Seat Depth:	15 <sup>5</sup> / <sub>8</sub>	Cube:	12.6
Seat Width:	18	COM:	See page 343
Back Width:	18	Weight Rating:	300 lbs.
Back Height:	10 <sup>7</sup> / <sub>8</sub>		

### FABRIC PRICE CODES

<b>1</b>	<b>\$1127</b>	
	<i>Add to Base Price Above</i>	
	<b>Back</b>	<b>Seat</b>
<b>2</b>	<b>\$27</b>	<b>\$27</b>
<b>3</b>	<b>\$53</b>	<b>\$53</b>
<b>4</b>	<b>\$72</b>	<b>\$72</b>
<b>5</b>	<b>\$91</b>	<b>\$91</b>
<b>6</b>	<b>\$111</b>	<b>\$111</b>
<b>7</b>	<b>\$130</b>	<b>\$130</b>
<b>8</b>	<b>\$150</b>	<b>\$150</b>
<b>9</b>	<b>\$169</b>	<b>\$169</b>
<b>10</b>	<b>\$188</b>	<b>\$188</b>
<b>11</b>	<b>\$208</b>	<b>\$208</b>
<b>12</b>	<b>\$227</b>	<b>\$227</b>
<b>L</b>	<b>\$216</b>	<b>\$216</b>

HON Recommendation: HF CG6DF.PURL\_\_PURL\_\_PR8 - List Price \$1023

## HOW TO SPECIFY

<b>Select Model Number</b> See page 326	<b>Select Back Fabric</b> See page 326	<b>Select Seat Fabric</b> See page 326	<b>Select Leg Color</b> See page 336
HFSS74LDF	PURL12	PURL12	PR8



## HFCG6WDDF



### GUEST CHAIR

Wood Leg, Multi-Fabric

### DIMENSIONS

Depth:	23 <sup>3</sup> / <sub>4</sub>	Seat to Floor Height:	18
Width:	22 <sup>5</sup> / <sub>8</sub>	Usable Seat Depth:	16 <sup>7</sup> / <sub>8</sub>
Height:	32	Ship Weight:	27
Seat Depth:	16 <sup>5</sup> / <sub>8</sub>	Cube:	12.5
Seat Width:	19	COM:	See page 343
Back Width:	19	Weight Rating:	300 lbs.
Back Height:	14 <sup>1</sup> / <sub>4</sub>		

### FABRIC PRICE CODES

<b>1</b>	<b>\$1260</b>	
<i>Add to Base Price Above</i>		
	<b>Back</b>	<b>Seat</b>
<b>2</b>	<b>\$27</b>	<b>\$27</b>
<b>3</b>	<b>\$53</b>	<b>\$53</b>
<b>4</b>	<b>\$72</b>	<b>\$72</b>
<b>5</b>	<b>\$91</b>	<b>\$91</b>
<b>6</b>	<b>\$111</b>	<b>\$111</b>
<b>7</b>	<b>\$130</b>	<b>\$130</b>
<b>8</b>	<b>\$150</b>	<b>\$150</b>
<b>9</b>	<b>\$169</b>	<b>\$169</b>
<b>10</b>	<b>\$190</b>	<b>\$190</b>
<b>11</b>	<b>\$213</b>	<b>\$213</b>
<b>12</b>	<b>\$235</b>	<b>\$235</b>
<b>L</b>	<b>\$295</b>	<b>\$295</b>

## HFCS64LWDDF



### COUNTER-HEIGHT STOOL

Wood Leg, Multi-Fabric

### DIMENSIONS

Depth:	19 <sup>1</sup> / <sub>2</sub>	Seat to Floor Height:	23 <sup>5</sup> / <sub>8</sub>
Width:	19 <sup>3</sup> / <sub>8</sub>	Usable Seat Depth:	15 <sup>5</sup> / <sub>8</sub>
Height:	34 <sup>1</sup> / <sub>2</sub>	Ship Weight:	30
Seat Depth:	15 <sup>5</sup> / <sub>8</sub>	Cube:	12.6
Seat Width:	18	COM:	See page 343
Back Width:	18	Weight Rating:	300 lbs.
Back Height:	10 <sup>5</sup> / <sub>8</sub>		

### FABRIC PRICE CODES

<b>1</b>	<b>\$1431</b>	
<i>Add to Base Price Above</i>		
	<b>Back</b>	<b>Seat</b>
<b>2</b>	<b>\$27</b>	<b>\$27</b>
<b>3</b>	<b>\$53</b>	<b>\$53</b>
<b>4</b>	<b>\$72</b>	<b>\$72</b>
<b>5</b>	<b>\$91</b>	<b>\$91</b>
<b>6</b>	<b>\$111</b>	<b>\$111</b>
<b>7</b>	<b>\$130</b>	<b>\$130</b>
<b>8</b>	<b>\$150</b>	<b>\$150</b>
<b>9</b>	<b>\$169</b>	<b>\$169</b>
<b>10</b>	<b>\$190</b>	<b>\$190</b>
<b>11</b>	<b>\$213</b>	<b>\$213</b>
<b>12</b>	<b>\$235</b>	<b>\$235</b>
<b>L</b>	<b>\$295</b>	<b>\$295</b>

## HFSS74LWDDF



### BAR/CAFÉ-HEIGHT STOOL

Wood Leg, Multi-Fabric

### DIMENSIONS

Depth:	20 <sup>1</sup> / <sub>2</sub>	Seat to Floor Height:	29 <sup>1</sup> / <sub>2</sub>
Width:	20 <sup>3</sup> / <sub>4</sub>	Usable Seat Depth:	15 <sup>5</sup> / <sub>8</sub>
Height:	40 <sup>1</sup> / <sub>2</sub>	Ship Weight:	31
Seat Depth:	15 <sup>5</sup> / <sub>8</sub>	Cube:	12.6
Seat Width:	18	COM:	See page 343
Back Width:	18	Weight Rating:	300 lbs.
Back Height:	10 <sup>5</sup> / <sub>8</sub>		

### FABRIC PRICE CODES

<b>1</b>	<b>\$1471</b>	
<i>Add to Base Price Above</i>		
	<b>Back</b>	<b>Seat</b>
<b>2</b>	<b>\$27</b>	<b>\$27</b>
<b>3</b>	<b>\$53</b>	<b>\$53</b>
<b>4</b>	<b>\$72</b>	<b>\$72</b>
<b>5</b>	<b>\$91</b>	<b>\$91</b>
<b>6</b>	<b>\$111</b>	<b>\$111</b>
<b>7</b>	<b>\$130</b>	<b>\$130</b>
<b>8</b>	<b>\$150</b>	<b>\$150</b>
<b>9</b>	<b>\$169</b>	<b>\$169</b>
<b>10</b>	<b>\$190</b>	<b>\$190</b>
<b>11</b>	<b>\$213</b>	<b>\$213</b>
<b>12</b>	<b>\$235</b>	<b>\$235</b>
<b>L</b>	<b>\$295</b>	<b>\$295</b>

HON Recommendation: HFCG6WDDF.PURL\_\_\_.PURL\_\_\_.D - List Price \$1366

## HOW TO SPECIFY

<p><b>Select Model Number</b></p> <p>HFSS74LWDDF .</p>	<p><b>Select Back Fabric</b></p> <p>See page 326</p> <p>PURL12 .</p>	<p><b>Select Seat Fabric</b></p> <p>See page 326</p> <p>PURL12 .</p>	<p><b>Select Wood Leg Color</b></p> <p>See page 336</p> <p>D .</p>	<p><b>Select Footring Color</b></p> <p><i>Specify for Stools only</i></p> <p>See page 336</p> <p>P7A</p>
--	--	--	--	--

# FLOCK® Multi-Fabric Collaborative

OPEN MARKET



Icon Legend on page 19

## HFCL2DF



### WIDE LOUNGE CHAIR

with 4-Star Return-to-Center

### DIMENSIONS

Depth:	27½	Seat to Floor Height:	17
Width:	26¾	Usable Seat Depth:	19
Height:	32¼	Ship Weight:	53
Seat Width:	26	Cube:	25.1
Back Width:	25½	COM:	See page 343
Back Height:	19½	Weight Rating:	300 lbs.

### FABRIC PRICE CODES

<b>1</b>	<b>\$1490</b>	
<i>Add to Base Price Above</i>		
	<b>Back</b>	<b>Seat</b>
<b>2</b>	<b>\$40</b>	<b>\$40</b>
<b>3</b>	<b>\$117</b>	<b>\$117</b>
<b>4</b>	<b>\$176</b>	<b>\$176</b>
<b>5</b>	<b>\$233</b>	<b>\$233</b>
<b>6</b>	<b>\$292</b>	<b>\$292</b>
<b>7</b>	<b>\$350</b>	<b>\$350</b>
<b>8</b>	<b>\$408</b>	<b>\$408</b>
<b>9</b>	<b>\$466</b>	<b>\$466</b>
<b>10</b>	<b>\$524</b>	<b>\$524</b>
<b>11</b>	<b>\$582</b>	<b>\$582</b>
<b>12</b>	<b>\$640</b>	<b>\$640</b>
<b>L</b>	<b>\$324</b>	<b>\$324</b>

## HFLSC2DF



### SQUARE CHAIR

with 4-Star Return-to-Center

### DIMENSIONS

Depth:	26½	Seat to Floor Height:	18
Width:	27½	Usable Seat Depth:	18¾
Height:	32¼	Ship Weight:	46
Seat Width:	17½	Cube:	25.1
Back Width:	16	COM:	See note
Back Height:	17¾	Weight Rating:	300 lbs.

### FABRIC PRICE CODES

<b>1</b>	<b>\$2103</b>	
<i>Add to Base Price Above</i>		
	<b>Back</b>	<b>Seat</b>
<b>2</b>	<b>\$53</b>	<b>\$27</b>
<b>3</b>	<b>\$130</b>	<b>\$105</b>
<b>4</b>	<b>\$188</b>	<b>\$162</b>
<b>5</b>	<b>\$247</b>	<b>\$221</b>
<b>6</b>	<b>\$304</b>	<b>\$279</b>
<b>7</b>	<b>\$363</b>	<b>\$337</b>
<b>8</b>	<b>\$421</b>	<b>\$395</b>
<b>9</b>	<b>\$478</b>	<b>\$453</b>
<b>10</b>	<b>\$537</b>	<b>\$511</b>
<b>11</b>	<b>\$595</b>	<b>\$569</b>
<b>12</b>	<b>\$654</b>	<b>\$628</b>
<b>L</b>	<b>\$431</b>	<b>\$216</b>

NOTES: Due to fabric limitations, COM is unavailable for back upholstery. See HFLSC2DF for COM available on the seat only.

**HON Recommendation: HFLSC2DF.PURL\_\_PURL\_\_4SPR8 - List Price \$2338**

SEATING

## HOW TO SPECIFY

<b>Select Model Number</b> H F L S C 2 D F .	<b>Select Back Fabric</b> See page 326 P U R L 1 2 .	<b>Select Seat Fabric</b> See page 326 P U R L 1 2 .	<b>Select Base Option</b> See page 336 4 S P R 8
---	--	--	--

## MODEL OPTIONS

**HFLCO1**  
HFLCO1DF - Multi-Fabric

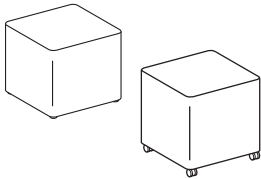

Mini Cube

**HFLYO1**  
HFLYO1DF - Multi-Fabric

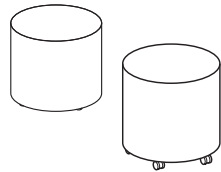

Mini Cylinder

### CASTER/ GLIDES

CODE	DESCRIPTION	PRICE
<b>A</b>	Active Base*	<b>+\$82</b>
<i>*Available on models HFLYO1 and HFLYO1DF only</i>		
<b>H</b>	Hard Caster	<b>+\$0</b>
<b>HG</b>	Hidden Glide	<b>+\$0</b>
<b>LPR8</b>	Textured Silver Disc Glide	<b>+\$50</b>
<b>LP7A</b>	Textured Charcoal Disc Glide	<b>+\$50</b>

### MULTI-FABRIC COM YARDAGE

Due to fabric pattern nesting and potential reduction of fabric yield, some multi-fabric models may require more total yardage than standard models.

MODEL	BACK COM	SEAT COM
HFLMC1DF	1.6	1.5
HFLML1DF	2.9	1.4
HFLMR1DF	2.9	1.4
HFCG6DF/HFCGCWDDF	1.0	1.5
HFCS64LDF/HFCS64LWDDF	1.0	1.0
HFSS74LDF/HFSS74LDF	1.0	1.0
HFLW145DF	2.3	1.4
HFLW045DF	1.0	1.4
HFLCC1DF	3.6	1.4
HFCL2DF	N/A	2.0
HFLSC2DF	N/A	3.0
TOP		SIDE
HFLCO1DF	0.7	1.2
HFLYO1DF	0.7	1.2

## HON BRANDED FABRICS

### GRADE 1

Apex  
Centurion  
Compass  
Contourett  
Dapper  
Ensemble  
Hamilton  
Inertia  
Noble Seating  
Optic  
Pebble  
Vibe

### GRADE 2

Appoint Seating  
Blume  
Clyde  
Dotty  
Kai  
Rush  
Spin Seating  
Wavelength  
Whisper Vinyl

### GRADE 3

Bradbury  
Getaway  
Moxie  
Notion  
Parker  
Purl  
Quill  
Saxony

### GRADE 4

Constance with Supreen™  
Livi with Supreen™  
Lugano with Supreen™  
Oxford with Supreen™

### GRADE L

Denver Leather

For a complete list of fabrics, including partnership fabrics, go to [hon.com/fabricsandfinishes](https://hon.com/fabricsandfinishes).

Reference Fabric Color Combinations on pages 20-25 for color codes and legend on page 21 for lead times.



# FLOCK® Mini Cube and Cylinders

GSA SIN 33721



Icon Legend on page 19

## HFLCO1

### MINI CUBE

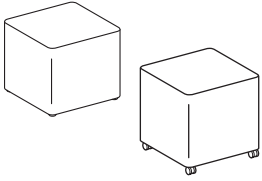

### DIMENSIONS

Depth:	18½	Seat to Floor Height:	17
Width:	18½	Usable Seat Depth:	18½
Height:	17	Ship Weight:	15
Seat Depth:	18½	Cube:	5.0
Seat Width:	18½	COM:	2.0
		Weight Rating:	300 lbs.

### FABRIC PRICE CODES

1	\$620	8	\$844
2	\$660	9	\$873
3	\$699	10	\$902
4	\$728	11	\$931
5	\$756	12	\$960
6	\$785	L	\$944
7	\$815		

## HFLY01

### MINI CYLINDER

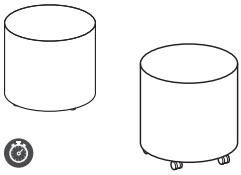

### DIMENSIONS

Depth:	18½	Seat to Floor Height:	17
Width:	18½	Usable Seat Depth:	18½
Height:	17	Ship Weight:	13
Seat Depth:	18½	Cube:	5.0
Seat Width:	18½	COM:	2.0
		Weight Rating:	300 lbs.

### FABRIC PRICE CODES

1	\$618	8	\$842
2	\$658	9	\$871
3	\$697	10	\$900
4	\$726	11	\$929
5	\$754	12	\$958
6	\$783	L	\$942
7	\$813		

**HON Recommendation: HFLY01.LPR8.PNS\_\_ - List Price \$708**

SEATING

## HOW TO SPECIFY

### Select Model Number

HFLY01

### Select Base

- A** Active Base\* (+ \$82)
- \*Available on model HFLY01 only*
- H** Caster
- HG** Hidden Glide
- LPR8** Textured Silver Disc Glide (+ \$50)
- LP7A** Textured Charcoal Disc Glide (+ \$50)

LPR8

### Select Fabric

See page 343

PNS007



# Multi-Fabric Mini Cube and Cylinder

## HFLCO1DF

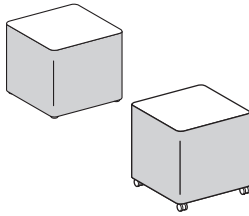

### MINI CUBE

Multi-Fabric

### DIMENSIONS

Depth:	18½	Seat to Floor Height:	17
Width:	18½	Usable Seat Depth:	18½
Height:	17	Ship Weight:	15
Seat Depth:	18½	Cube:	5.0
Seat Width:	18½	COM:	See page 343
		Weight Rating:	300 lbs.

### FABRIC PRICE CODES

<b>1</b>	<b>\$718</b>	
<i>Add to Base Price Above</i>		
	<b>Top</b>	<b>Sides</b>
<b>2</b>	<b>\$13</b>	<b>\$28</b>
<b>3</b>	<b>\$24</b>	<b>\$55</b>
<b>4</b>	<b>\$33</b>	<b>\$76</b>
<b>5</b>	<b>\$42</b>	<b>\$95</b>
<b>6</b>	<b>\$51</b>	<b>\$116</b>
<b>7</b>	<b>\$59</b>	<b>\$136</b>
<b>8</b>	<b>\$67</b>	<b>\$157</b>
<b>9</b>	<b>\$77</b>	<b>\$178</b>
<b>10</b>	<b>\$85</b>	<b>\$198</b>
<b>11</b>	<b>\$93</b>	<b>\$219</b>
<b>12</b>	<b>\$103</b>	<b>\$238</b>
<b>L</b>	<b>\$98</b>	<b>\$227</b>

## HFLYO1DF

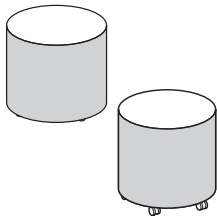

### MINI CYLINDER

Multi-Fabric

### DIMENSIONS

Depth:	18½	Seat to Floor Height:	17
Width:	18½	Usable Seat Depth:	18½
Height:	17	Ship Weight:	13
Seat Depth:	18½	Cube:	5.0
Seat Width:	18½	COM:	See page 343
		Weight Rating:	300 lbs.

### FABRIC PRICE CODES

<b>1</b>	<b>\$717</b>	
<i>Add to Base Price Above</i>		
	<b>Top</b>	<b>Sides</b>
<b>2</b>	<b>\$13</b>	<b>\$28</b>
<b>3</b>	<b>\$24</b>	<b>\$55</b>
<b>4</b>	<b>\$33</b>	<b>\$76</b>
<b>5</b>	<b>\$42</b>	<b>\$95</b>
<b>6</b>	<b>\$51</b>	<b>\$116</b>
<b>7</b>	<b>\$59</b>	<b>\$136</b>
<b>8</b>	<b>\$67</b>	<b>\$157</b>
<b>9</b>	<b>\$77</b>	<b>\$178</b>
<b>10</b>	<b>\$85</b>	<b>\$198</b>
<b>11</b>	<b>\$93</b>	<b>\$219</b>
<b>12</b>	<b>\$103</b>	<b>\$238</b>
<b>L</b>	<b>\$98</b>	<b>\$227</b>

**HON Recommendation: HFLCO1DF.HG.PNS\_\_\_.PNS\_\_ - List Price \$759**

## HOW TO SPECIFY

<p><b>Select Model Number</b></p> <p>H F L C O 1 D F .</p>	<p><b>Select Base</b></p> <p><b>A</b> Active Base* (+ \$82) *Available on model HFLYO1DF only</p> <p><b>H</b> Caster <b>HG</b> Hidden Glide <b>LPR8</b> Textured Silver Disc Glide (+ \$50) <b>LP7A</b> Textured Charcoal Disc Glide (+ \$50)</p> <p>H G .</p>	<p><b>Select Top Fabric</b></p> <p>See page 343</p> <p>P N S 0 0 7 .</p>	<p><b>Select Side Fabric</b></p> <p>See page 343</p> <p>P N S 0 0 4 .</p>
--	--	--	---

# GATEWAY™

Want to see more? Scan here  
to check out hon.com.



Gateway™ Chairs shown  
with Huddle Tables.

## GATEWAY™

So you need a new chair, but it has to look as cool as it is comfortable. We've got you covered. Gateway takes the complexity out of finding the perfect chair by focusing on exactly what you're looking for. Cool, breathable mesh. Personalized seat fabrics. Targeted back support. Just what you need. Nothing you don't. All at a price you'll have to look at twice to make sure it's not a typo.



### FEATURES

- Seat has comfortable, waterfall edge.
- Mesh back material flexes for a relaxed fit.
- Adjustable lumbar.
- Adjustable tilt to recline based on body type.
- Three arm options.
- Carton is 2 cubic feet smaller than the industry average.

## HON BRANDED FABRICS

### GRADE 1

Centurion  
Contourett

### GRADE 2

Dotty

**For a complete list of fabrics, including partnership fabrics, go to [hon.com/fabricsandfinishes](https://hon.com/fabricsandfinishes).**

Reference Fabric Color Combinations on pages 20-25 for color codes and legend on page 21 for lead times.

# GATEWAY™ Standard Task Chair

OPEN MARKET



Icon Legend on page 19

## HGTMM

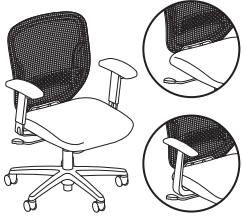

### TASK CHAIR

- Mesh Back
- Pneumatic
- Swivel
- Tilt Tension
- Tilt Lock
- Adjustable Lumbar Support

Functions: **A, E, F, K, L, W**  
(Function Key on pages 252-253)

NOTES: **HON 5-Year Limited Warranty.**

### DIMENSIONS

Depth:	25¼	Seat to Floor Height:	17-22
Width:	27	Usable Seat Depth:	19
Height:	38	Ship Weight:	35
Seat Depth:	19	Cube:	3.4
Seat Width:	18½	Weight Rating:	250 lbs.
Back Width:	18		
Back Height:	18½		

### FABRIC PRICE CODES

<b>1</b>	<b>\$401</b>
<b>2</b>	<b>\$415</b>

**HON Recommendation: HGTMM.Z1.H.H.M.CU\_\_AL.SB.T - List Price \$461**

SEATING

## HOW TO SPECIFY

Select Model Number	Select Control Type	Select Arm Type	Select Caster	Select Back Type	Select Fabric	Select Lumbar	Select Base	Select Frame
Z1	Swivel-Tilt Control	N Armless F Fixed Arms (+ \$39) H Height-Adjustable Arms (+ \$60)	H Black Hard Caster	M Mesh	See page 347	AL Adjustable Lumbar	SB Standard Base	T Black
HGTMM	Z1	H	H	M	CU10	AL	SB	T



# GATEWAY™ Value Task Chair

## HGV1MM \*



### TASK CHAIR VALUE MODEL

#### Mesh Back

- Pneumatic
- Swivel
- Tilt Tension
- Tilt Lock
- Adjustable Lumbar Support

Functions: **A, E, F, K, L, W**  
(Function Key on pages 252-253)

NOTES: **HON 5-Year Limited Warranty.**

### DIMENSIONS

Depth:	25¼	Seat to Floor Height:	17-22
Width:	27	Usable Seat Depth:	19
Height:	38	Ship Weight:	35
Seat Depth:	19	Cube:	3.4
Seat Width:	18½	Weight Rating:	250 lbs.
Back Width:	18		
Back Height:	18½		

### LIST PRICE

**\$357**

**HON Recommendation: HGV1MM.Z1.H.H.M.ACCF10.AL.SB.T - List Price \$417**

\* De-emphasized

## HOW TO SPECIFY

Select Model Number	Select Control Type	Select Arm Type	Select Caster	Select Back Type	Select Fabric	Select Lumbar	Select Base	Select Frame
	<b>Z1</b> Swivel-Tilt Control	<b>N</b> Armless <b>F</b> Fixed Arms (+ \$39) <b>H</b> Height-Adjustable Arms (+ \$60)	<b>H</b> Black Hard Caster	<b>M</b> Mesh	<b>ACCF10</b> Black	<b>AL</b> Adjustable Lumbar	<b>SB</b> Standard Base	<b>T</b> Black
HGV1MM	Z1	H	H	M	ACCF10	AL	SB	T



Grove® Lounge shown with Flock® Table.

## GROVE®

Find a comfy place to put your feet up, huddle up, and power up. Grove is versatile lounge seating designed to help you greet, meet, focus, relax, and accomplish more. This change-of-pace collection delivers the comfort people crave, while encouraging focus and interaction throughout the workplace. Grove's attractive design is rivaled only by its flexibility. Models include a single seat, two-seat, three-seat, and two-seat with table — all with three arm style and two leg style options, as well as accessories that support connectivity and collaboration. Grove has the look you're going for, and the comfort and versatility people have been waiting for.



## FEATURES

- Each model can be combined to create arrangements suitable for any space.
- Optional integrated worksurfaces create more personal space and provide a convenient worksurface.
- Design complements Flock ottomans and tables.
- Integrated power grommets keep laptops and phones powered up anywhere.
- The multi-fabric option coordinates two high-quality HON fabrics for a contemporary look.
- Choose from Single Seat, Two-Seat, Three-Seat Lounge, or Two-Seat with Table options.
- Choose from 3 arm options — Armless (N), Straight Arms (A), or Tapered Arms (B).
- Table available with two grommets and an accessory port option.
- Offers a table between the seats that provides separation and a usable worksurface.
- Warranted for users up to 300 lbs.

**MODEL OPTIONS**

**HML1S**  
HML1SDF - Multi-Fabric

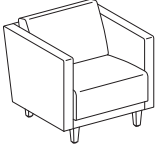

**Lounge**  
Single Seat

**HML2S**  
HML2SDF - Multi-Fabric

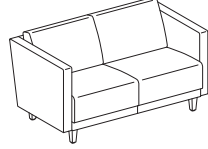

**Lounge**  
Two-Seat

**HML3S**  
HML3SDF - Multi-Fabric

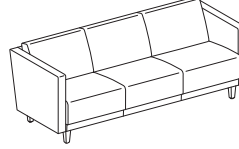

**Lounge**  
Three-Seat

**HML2ST**  
HML2STDF - Multi-Fabric

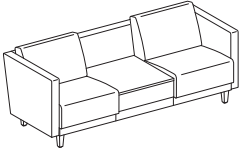

**Lounge**  
Two-Seat with Table



# GROVE® Options

## ARM STYLE

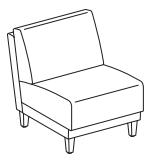

CODE	DESCRIPTION	PRICE
<b>N</b>	Armless	<b>+\$0</b>

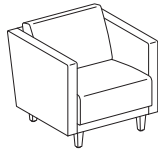

<b>A</b>	Straight Arms	<b>+\$324</b>
----------	---------------	---------------

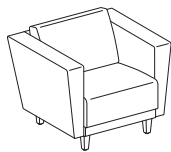

<b>B</b>	Tapered Arms	<b>+\$377</b>
----------	--------------	---------------

## LEG STYLE



CODE	DESCRIPTION	PRICE
<b>TS</b>	Tapered Square	<b>+\$0</b>



<b>TR</b>	Tapered Round	<b>+\$0</b>
-----------	---------------	-------------

## LEG COLOR

CODE	DESCRIPTION	PRICE
<b>PR8</b>	Textured Silver	<b>+\$0</b>
<b>P7A</b>	Textured Charcoal	<b>+\$0</b>
<b>H</b>	Bourbon Cherry	<b>+\$109</b>
<b>F</b>	Shaker Cherry	<b>+\$109</b>
<b>N</b>	Mahogany	<b>+\$109</b>
<b>C</b>	Harvest	<b>+\$109</b>
<b>D</b>	Natural Maple	<b>+\$109</b>
<b>LK11</b>	Kingswood Walnut	<b>+\$109</b>
<b>LSW1</b>	Skyline Walnut	<b>+\$109</b>
<b>LLA1</b>	Lowell Ash	<b>+\$109</b>
<b>LSA1</b>	Sterling Ash	<b>+\$109</b>
<b>COGN</b>	Cognac	<b>+\$109</b>
<b>MOCH</b>	Mocha	<b>+\$109</b>
<b>PINC</b>	Pinnacle	<b>+\$109</b>
<b>LNR1</b>	Natural Recon	<b>+\$109</b>
<b>LPE1</b>	Phantom Ecrú	<b>+\$109</b>
<b>LPT1</b>	Portico Teak	<b>+\$109</b>

### L1 LAMINATE COLOR CODE

Black	<b>P</b>
Bourbon Cherry	<b>H</b>
Designer White	<b>LDW1</b>
Charcoal	<b>S</b>
Cognac	<b>COGN</b>
Field Elm	<b>LWFE</b>
Florence Walnut	<b>LFW1</b>
Harvest	<b>C</b>
Kingswood Walnut	<b>LK11</b>
Loft	<b>LOFT</b>
Mahogany	<b>N</b>
Mocha	<b>MOCH</b>
Natural Maple	<b>D</b>
Pinnacle	<b>PINC</b>
Shaker Cherry	<b>F</b>
Sterling Ash	<b>LSA1</b>

### L2 LAMINATE COLOR CODE

Beigewood	<b>LWBE</b>
Fawn Cypress	<b>LFC1</b>
Lowell Ash	<b>LLA1</b>
Natural Recon	<b>LNR1</b>
Phantom Ecrú	<b>LPE1</b>
Portico Teak	<b>LPT1</b>
Skyline Walnut	<b>LSW1</b>

\*Specify for models HML2ST and HML2STDF only

## CUT OUT

CODE	DESCRIPTION	PRICE
<b>N</b>	No Cutout	<b>+\$0</b>
<b>G</b>	Round Grommet Cutout	<b>+\$33</b>
<b>G1</b>	Pop-Up Port Cutout	<b>+\$44</b>

\*Specify for models HML2ST and HML2STDF only

## ACCESSORY PORT LOCATION

CODE	DESCRIPTION	PRICE
<b>0</b>	No Port	<b>+\$0</b>
<b>2</b>	Two Tablet Ports Opposite	<b>+\$22</b>

\*Specify for models HML2ST and HML2STDF only

## HON BRANDED FABRICS

GRADE 1	GRADE 2	GRADE 3	GRADE 4	GRADE L
Apex	Appoint Seating	Bradbury	Constance with Supreen™	Denver Leather
Centurion	Blume	Getaway	Livi with Supreen™	
Compass	Clyde	Moxie	Lugano with Supreen™	
Contourett	Dotty	Notion	Oxford with Supreen™	
Dapper	Kai	Parker		
Ensemble	Rush	Purl		
Hamilton	Spin Seating	Quill		
Inertia	Wavelength	Saxony		
Noble Seating	Whisper Vinyl			
Optic				
Pebble				
Vibe				

**For a complete list of fabrics, including partnership fabrics, go to [hon.com/fabricsandfinishes](https://hon.com/fabricsandfinishes).**

Reference Fabric Color Combinations on pages 20-25 for color codes and legend on page 21 for lead times. For additional HON to Supply COM fabric grade pricing, go to [honready.hon.com](https://honready.hon.com) and click on the HON to Supply COM link.

For more details on Upholstery Pattern Match for this series, please see page 14.

**!** Due to the inherent characteristics of upholstery materials, the seat of Grove® may become more relaxed to show wrinkles over time.

## MULTI-FABRIC COM YARDAGE

Due to fabric pattern nesting and potential reduction of fabric yield, some multi-fabric models may require more total yardage than standard models.

MODEL	COM (ARMLESS)		COM (w/ STRAIGHT ARMS)		COM (w/ TAPERED ARMS)	
	Back	Seat	Back	Seat	Back	Seat
HML1S	3		5		5	
HML1SDF	1.5	2	4	2	4	2
HML2S	5		7.5		7.5	
HML2SDF	2	3.5	4	3.5	4	3.5
HML2ST	6		8		8	
HML2STDF	3	3.5	5.5	3.5	5.5	3.5
HML3	7.5		9		9.5	
HML3DF	3	5	5.5	5	5.5	5

## HML1S

### LOUNGE

Single Seat

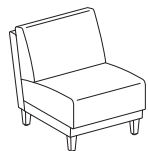

Armless

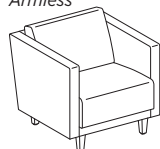

Straight Arms

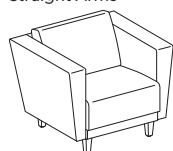

Tapered Arms

### DIMENSIONS

Depth:	31½	Ship Weight (armless):	61
Height:	29¾	Ship Weight (with straight arms):	77
Seat Width:	23½	Ship Weight (with tapered arms):	85
Back Width:	23½	Cube (armless):	19.8
Back Height:	19	Cube (with straight arms):	19.8
Width (armless):	23½	Cube (with tapered arms):	19.8
Width (with straight arms):	29¾	COM:	See
Width (with tapered arms):	35		page
Arm Width:	23½		353
Seat to Floor Height:	16	Weight Rating:	300 lbs.
Usable Seat Depth:	18¾		(per seat)

### FABRIC PRICE CODES

<b>1</b>	<b>\$1888</b>	<b>8</b>	<b>\$2334</b>
<b>2</b>	<b>\$1967</b>	<b>9</b>	<b>\$2393</b>
<b>3</b>	<b>\$2044</b>	<b>10</b>	<b>\$2451</b>
<b>4</b>	<b>\$2102</b>	<b>11</b>	<b>\$2509</b>
<b>5</b>	<b>\$2160</b>	<b>12</b>	<b>\$2567</b>
<b>6</b>	<b>\$2218</b>	<b>L</b>	<b>\$2534</b>
<b>7</b>	<b>\$2277</b>		

## HML2S

### LOUNGE

Two-Seat

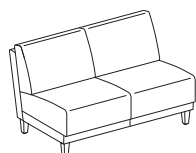

Armless

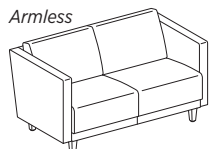

Straight Arms

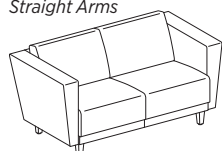

Tapered Arms

### DIMENSIONS

Depth:	31½	Ship Weight (armless):	100
Height:	29¾	Ship Weight (with straight arms):	116
Seat Width:	48	Ship Weight (with tapered arms):	124
Back Width:	48	Cube (armless):	35.6
Back Height:	19	Cube (with straight arms):	35.6
Width (armless):	48	Cube (with tapered arms):	35.6
Width (with straight arms):	54¾	COM:	See
Width (with tapered arms):	59½		page
Arm Width:	48		353
Seat to Floor Height:	16	Weight Rating:	300 lbs.
Usable Seat Depth:	18¾		(per seat)

### FABRIC PRICE CODES

<b>1</b>	<b>\$2982</b>	<b>8</b>	<b>\$3726</b>
<b>2</b>	<b>\$3112</b>	<b>9</b>	<b>\$3823</b>
<b>3</b>	<b>\$3241</b>	<b>10</b>	<b>\$3920</b>
<b>4</b>	<b>\$3338</b>	<b>11</b>	<b>\$4017</b>
<b>5</b>	<b>\$3435</b>	<b>12</b>	<b>\$4113</b>
<b>6</b>	<b>\$3531</b>	<b>L</b>	<b>\$4059</b>
<b>7</b>	<b>\$3628</b>		

HON Recommendation: HML1S.A.PNS\_\_TS.P7A - List Price \$2291

## HOW TO SPECIFY

Select Model Number	Select Arm Type	Select Fabric	Select Leg Type	Select Leg Color
HML1S	<ul style="list-style-type: none"> <li><b>N</b> Armless</li> <li><b>A</b> Straight Arms (+ \$324)</li> <li><b>B</b> Tapered Arms (+ \$377)</li> </ul>	See page 353	<ul style="list-style-type: none"> <li><b>TS</b> Tapered Square</li> <li><b>TR</b> Tapered Round</li> </ul>	<ul style="list-style-type: none"> <li><b>PR8</b> Textured Silver</li> <li><b>P7A</b> Textured Charcoal</li> <li><b>H</b> Bourbon Cherry (+ \$109)</li> <li><b>F</b> Shaker Cherry (+ \$109)</li> <li><b>N</b> Mahogany (+ \$109)</li> <li><b>C</b> Harvest (+ \$109)</li> <li><b>D</b> Natural Maple (+ \$109)</li> <li><b>LK11</b> Kingswood Walnut (+ \$109)</li> <li><b>LSW1</b> Skyline Walnut (+ \$109)</li> <li><b>LLA1</b> Lowell Ash (+ \$109)</li> <li><b>LSA1</b> Sterling Ash (+ \$109)</li> <li><b>COGN</b> Cognac (+ \$109)</li> <li><b>MOCH</b> Mocha (+ \$109)</li> <li><b>PINC</b> Pinnacle (+ \$109)</li> <li><b>LNRI</b> Natural Recon (+ \$109)</li> <li><b>LPE1</b> Phantom Ecru (+ \$109)</li> <li><b>LPT1</b> Portico Teak (+ \$109)</li> </ul>
HML1S	A	PNS007	TS	P7A

! Leg options - Tapered Square (TS) and Tapered Round (TR) are available in 2 poly and 13 woodgrain options.



### HML3S

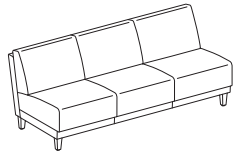

Armless

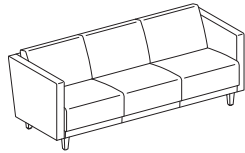

Straight Arms

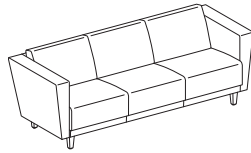

Tapered Arms

#### LOUNGE

Three-Seat

#### DIMENSIONS

Depth:	31½	Ship Weight (armless):	141
Height:	29¼	Ship Weight (with straight arms):	157
Seat Width:	71⅓	Ship Weight (with tapered arms):	165
Back Width:	71⅓	Cube (armless):	48.9
Back Height:	19	Cube (with straight arms):	48.9
Width (armless):	71⅓	Cube (with tapered arms):	48.9
Width (with straight arms):	77⅝	COM:	See
Width (with tapered arms):	82⅝		page
Arm Width:	71⅓		353
Seat to Floor Height:	16	Weight Rating:	300 lbs.
Usable Seat Depth:	18¾		(per seat)

#### FABRIC PRICE CODES

<b>1</b>	<b>\$3999</b>	<b>8</b>	<b>\$5114</b>
<b>2</b>	<b>\$4194</b>	<b>9</b>	<b>\$5259</b>
<b>3</b>	<b>\$4388</b>	<b>10</b>	<b>\$5404</b>
<b>4</b>	<b>\$4533</b>	<b>11</b>	<b>\$5550</b>
<b>5</b>	<b>\$4678</b>	<b>12</b>	<b>\$5695</b>
<b>6</b>	<b>\$4823</b>	<b>L</b>	<b>\$5615</b>
<b>7</b>	<b>\$4969</b>		

**HON Recommendation: HML3S.A.PNS\_\_TS.P7A - List Price \$4518**

### HOW TO SPECIFY

<p><b>Select Model Number</b></p> <p>HML3S .</p>	<p><b>Select Arm Type</b></p> <p>N Armless A Straight Arms (+ \$324) B Tapered Arms (+ \$377)</p> <p>A .</p>	<p><b>Select Fabric</b></p> <p>See page 353</p> <p>PNS007 .</p>	<p><b>Select Leg Type</b></p> <p>TS Tapered Square TR Tapered Round</p> <p>TS .</p>	<p><b>Select Leg Color</b></p> <p>PR8 Textured Silver P7A Textured Charcoal H Bourbon Cherry (+ \$109) F Shaker Cherry (+ \$109) N Mahogany (+ \$109) C Harvest (+ \$109) D Natural Maple (+ \$109) LK11 Kingswood Walnut (+ \$109) LSW1 Skyline Walnut (+ \$109) LLA1 Lowell Ash (+ \$109) LSA1 Sterling Ash (+ \$109) COGN Cognac (+ \$109) MOCH Mocha (+ \$109) PINC Pinnacle (+ \$109) LNRI Natural Recon (+ \$109) LPE1 Phantom Ecru (+ \$109) LP11 Portico Teak (+ \$109)</p> <p>P7A</p>
--	--	---	---	--

ⓘ Leg options – Tapered Square (TS) and Tapered Round (TR) are available in 2 poly and 13 woodgrain options.

## HML2ST

### LOUNGE

Two-Seat with Table

### DIMENSIONS

Depth:	31½	Ship Weight (armless):	146
Height:	29¼	Ship Weight (with straight arms):	162
Seat Width:	71½	Ship Weight (with tapered arms):	170
Back Width:	71½	Cube (armless):	48.9
Back Height:	19	Cube (with straight arms):	48.9
Width (armless):	71½	Cube (with tapered arms):	48.9
Width (with straight arms):	77½	COM:	See
Width (with tapered arms):	82½		page
Arm Width:	71½		353
Seat to Floor Height:	16	Weight Rating:	300 lbs.
Usable Seat Depth:	18¾		(per seat)

### FABRIC PRICE CODES

<b>1</b>	<b>\$4309</b>	<b>8</b>	<b>\$5201</b>
<b>2</b>	<b>\$4465</b>	<b>9</b>	<b>\$5318</b>
<b>3</b>	<b>\$4620</b>	<b>10</b>	<b>\$5433</b>
<b>4</b>	<b>\$4736</b>	<b>11</b>	<b>\$5550</b>
<b>5</b>	<b>\$4852</b>	<b>12</b>	<b>\$5666</b>
<b>6</b>	<b>\$4969</b>	<b>L</b>	<b>\$5601</b>
<b>7</b>	<b>\$5085</b>		

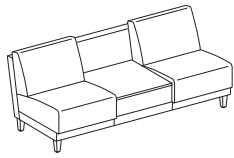

Armless

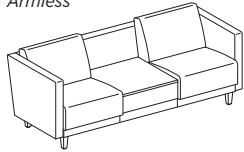

Straight Arms

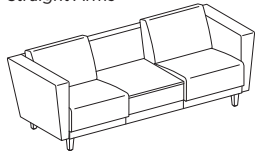

Tapered Arms

NOTES: Offers a table between the seats that provides separation and a usable worksurface. Table available with two grommet and an accessory port option.

**HON Recommendation: HML2ST.A.PNS\_\_TS.P7A.N.G1.0 - List Price \$4833**

## HOW TO SPECIFY

SEATING

Select Model Number	Select Arm Type	Select Fabric	Select Leg Type	Select Leg Color	Select Laminate	Select Cut Out	Accessory Port Location
HML2ST	<ul style="list-style-type: none"> <li><b>N</b> Armless</li> <li><b>A</b> Straight Arms (+ \$324)</li> <li><b>B</b> Tapered Arms (+ \$377)</li> </ul>	See page 353	<ul style="list-style-type: none"> <li><b>TS</b> Tapered Square</li> <li><b>TR</b> Tapered Round</li> </ul>	<ul style="list-style-type: none"> <li><b>PR8</b> Textured Silver</li> <li><b>P7A</b> Textured Charcoal</li> <li><b>H</b> Bourbon Cherry (+ \$109)</li> <li><b>F</b> Shaker Cherry (+ \$109)</li> <li><b>N</b> Mahogany (+ \$109)</li> <li><b>C</b> Harvest (+ \$109)</li> <li><b>D</b> Natural Maple (+ \$109)</li> <li><b>LK11</b> Kingswood Walnut (+ \$109)</li> <li><b>LSW1</b> Skyline Walnut (+ \$109)</li> <li><b>LLA1</b> Lowell Ash (+ \$109)</li> <li><b>LSA1</b> Sterling Ash (+ \$109)</li> <li><b>COGN</b> Cognac (+ \$109)</li> <li><b>MOCH</b> Mocha (+ \$109)</li> <li><b>PINC</b> Pinnacle (+ \$109)</li> <li><b>LLA1</b> Lowell Ash (+ \$109)</li> <li><b>LNR1</b> Natural Recon (+ \$109)</li> <li><b>LPE1</b> Phantom Ecru (+ \$109)</li> <li><b>LPT1</b> Portico Teak (+ \$109)</li> </ul>	<p>See Chart on page 352</p> <ul style="list-style-type: none"> <li><b>L2</b> (+ \$135)</li> </ul>	<ul style="list-style-type: none"> <li><b>N</b> No Cutout</li> <li><b>G</b> Round Grommet Cutout (+ \$33)</li> <li><b>G1</b> Pop-Up Port Cutout (+ \$44)</li> </ul>	<ul style="list-style-type: none"> <li><b>0</b> No Port</li> <li><b>2</b> Two Tablet Ports Opposite (+ \$22)</li> </ul>
HML2ST	A	PNS007	TS	P7A	N	G1	0

! Leg options - Tapered Square (TS) and Tapered Round (TR) are available in 2 poly and 8 woodgrain options.



## HML1SDF

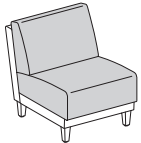

Armless

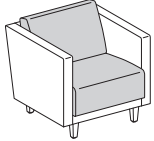

Straight Arms

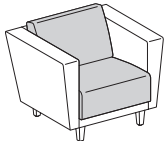

Tapered Arms

### SINGLE SEAT LOUNGE

Multi-Fabric

### DIMENSIONS

Depth:	31½	Ship Weight (armless):	61
Height:	29¾	Ship Weight (with straight arms):	77
Seat Width:	23½	Ship Weight (with tapered arms):	85
Back Width:	23½	Cube (armless):	19.8
Back Height:	19	Cube (with straight arms):	19.8
Width (armless):	23½	Cube (with tapered arms):	19.8
Width (with straight arms):	29¾	COM:	See
Width (with tapered arms):	35		page
Arm Width:	23½		353
Seat to Floor Height:	16	Weight Rating:	300 lbs.
Usable Seat Depth:	18¾		(per seat)

### FABRIC PRICE CODES

<b>1</b>	<b>\$1984</b>		
<i>Add to Base Price Above</i>			
		<b>Frame/ Arms</b>	<b>Back/Seat Cushions</b>
<b>2</b>	<b>\$40</b>		<b>\$53</b>
<b>3</b>	<b>\$79</b>		<b>\$105</b>
<b>4</b>	<b>\$108</b>		<b>\$143</b>
<b>5</b>	<b>\$136</b>		<b>\$182</b>
<b>6</b>	<b>\$165</b>		<b>\$221</b>
<b>7</b>	<b>\$195</b>		<b>\$259</b>
<b>8</b>	<b>\$224</b>		<b>\$298</b>
<b>9</b>	<b>\$253</b>		<b>\$337</b>
<b>10</b>	<b>\$282</b>		<b>\$375</b>
<b>11</b>	<b>\$311</b>		<b>\$415</b>
<b>12</b>	<b>\$340</b>		<b>\$453</b>
<b>L</b>	<b>\$324</b>		<b>\$431</b>

For multi-fabric models, start with the base price, then add the additional amount for the back and seat from the corresponding matrix to determine the final list price. Choose any combination of fabric grades for the back and seat.

Example: HML1SDF base price (\$1984) + Grade 2 frame/arms fabric (add \$40) + Grade 4 back/seat fabric (add \$143) = Total \$2167 List  
 HML1SDF base price (\$1984) + Grade 5 frame/arms fabric (add \$136) + Grade 3 back/seat fabric (add \$105) = Total \$2225 List

**HON Recommendation: HML1SDF.A.PNS\_\_\_.PNS\_\_\_.TS.P7A - List Price \$2401**

## HOW TO SPECIFY

Select Model Number	Select Arm Type	Select Frame/Arms Fabric	Select Back/Seat Cushions Fabric	Select Leg Type	Select Leg Color
	<b>N</b> Armless <b>A</b> Straight Arms (+ \$324) <b>B</b> Tapered Arms (+ \$377)	See page 353	See page 353	<b>TS</b> Tapered Square <b>TR</b> Tapered Round	<b>PR8</b> Textured Silver <b>P7A</b> Textured Charcoal <b>H</b> Bourbon Cherry (+ \$109) <b>F</b> Shaker Cherry (+ \$109) <b>N</b> Mahogany (+ \$109) <b>C</b> Harvest (+ \$109) <b>D</b> Natural Maple (+ \$109) <b>LK11</b> Kingswood Walnut (+ \$109) <b>LSW1</b> Skyline Walnut (+ \$109) <b>LLA1</b> Lowell Ash (+ \$109) <b>LSA1</b> Sterling Ash (+ \$109) <b>COGN</b> Cognac (+ \$109) <b>MOCH</b> Mocha (+ \$109) <b>PINC</b> Pinnacle (+ \$109) <b>LNR1</b> Natural Recon (+ \$109) <b>LPE1</b> Phantom Ecrú (+ \$109) <b>LPT1</b> Portico Teak (+ \$109)
HML1SDF	A	PNS004	PNS007	TS	P7A

! Leg options - Tapered Square (TS) and Tapered Round (TR) are available in 2 poly and 8 woodgrain options.



## HML2SDF

### TWO-SEAT LOUNGE

### DIMENSIONS

### FABRIC PRICE CODES

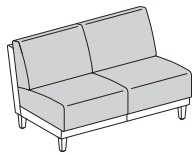

Armless

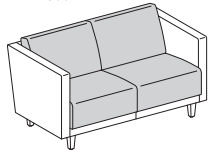

Straight Arms

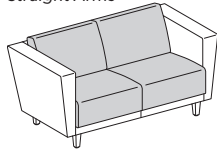

Tapered Arms

Multi-Fabric

Depth:	31½	Ship Weight (armless):	100
Height:	29¾	Ship Weight (with straight arms):	116
Seat Width:	48	Ship Weight (with tapered arms):	124
Back Width:	48	Cube (armless):	35.6
Back Height:	19	Cube (with straight arms):	35.6
Width (armless):	48	Cube (with tapered arms):	35.6
Width (with straight arms):	54¼	COM:	See
Width (with tapered arms):	59½		page
Arm Width:	48		353
Seat to Floor Height:	16	Weight Rating:	300 lbs.
Usable Seat Depth:	18¾		(per seat)

**1 \$3078**

*Add to Base Price Above*

	Frame/ Arms	Back/Seat Cushions
<b>2</b>	<b>\$65</b>	<b>\$91</b>
<b>3</b>	<b>\$130</b>	<b>\$182</b>
<b>4</b>	<b>\$179</b>	<b>\$250</b>
<b>5</b>	<b>\$227</b>	<b>\$318</b>
<b>6</b>	<b>\$276</b>	<b>\$386</b>
<b>7</b>	<b>\$324</b>	<b>\$453</b>
<b>8</b>	<b>\$372</b>	<b>\$521</b>
<b>9</b>	<b>\$421</b>	<b>\$589</b>
<b>10</b>	<b>\$469</b>	<b>\$657</b>
<b>11</b>	<b>\$518</b>	<b>\$725</b>
<b>12</b>	<b>\$566</b>	<b>\$793</b>
<b>L</b>	<b>\$539</b>	<b>\$754</b>

For multi-fabric models, start with the base price, then add the additional amount for the back and seat from the corresponding matrix to determine the final list price. Choose any combination of fabric grades for the back and seat.

Example: HML2SDF base price (\$3078) + Grade 2 frame/arms fabric (add \$65) + Grade 4 back/seat fabric (add \$250) = Total \$3393 List  
 HML2SDF base price (\$3078) + Grade 5 frame/arms fabric (add \$227) + Grade 3 back/seat fabric (add \$182) = Total \$3487 List

**HON Recommendation: HML2SDF.A.PNS\_\_PNS\_\_TS.P7A - List Price \$3558**

## HOW TO SPECIFY

SEATING

Select Model Number	Select Arm Type	Select Frame/Arms Fabric	Select Back/Seat Cushions Fabric	Select Leg Type	Select Leg Color
HML2SDF	N Armless A Straight Arms (+ \$324) B Tapered Arms (+ \$377)	See page 353	See page 353	TS Tapered Square TR Tapered Round	PR8 Textured Silver P7A Textured Charcoal H Bourbon Cherry (+ \$109) F Shaker Cherry (+ \$109) N Mahogany (+ \$109) C Harvest (+ \$109) D Natural Maple (+ \$109) LK11 Kingswood Walnut (+ \$109) LSW1 Skyline Walnut (+ \$109) LLA1 Lowell Ash (+ \$109) LSA1 Sterling Ash (+ \$109) COGN Cognac (+ \$109) MOCH Mocha (+ \$109) PINC Pinnacle (+ \$109) LNR1 Natural Recon (+ \$109) LPE1 Phantom Ecru (+ \$109) LPT1 Portico Teak (+ \$109)
HML2SDF	A	PNS004	PNS007	TS	P7A

! Leg options - Tapered Square (TS) and Tapered Round (TR) are available in 2 poly and 8 woodgrain options.



## HML3SDF

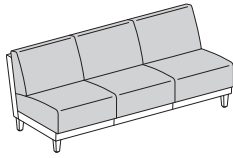

Armless

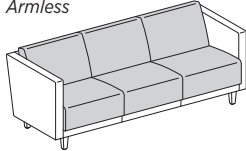

Straight Arms

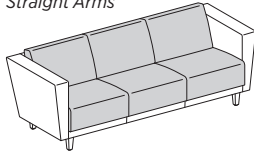

Tapered Arms

### THREE-SEAT LOUNGE

Multi-Fabric

### DIMENSIONS

Depth:	31½	Ship Weight (armless):	141
Height:	29¼	Ship Weight (with straight arms):	157
Seat Width:	71½	Ship Weight (with tapered arms):	165
Back Width:	71½	Cube (armless):	48.9
Back Height:	19	Cube (with straight arms):	48.9
Width (armless):	71½	Cube (with tapered arms):	48.9
Width (with straight arms):	77½	COM:	See
Width (with tapered arms):	82½		page 353
Arm Width:	71½	Weight Rating:	300 lbs.
Seat to Floor Height:	16	(per seat)	
Usable Seat Depth:	18¾		

### FABRIC PRICE CODES

<b>1</b>	<b>\$4095</b>		
<i>Add to Base Price Above</i>			
		<b>Frame/ Arms</b>	<b>Back/Seat Cushions</b>
<b>2</b>	<b>\$79</b>		<b>\$143</b>
<b>3</b>	<b>\$156</b>		<b>\$285</b>
<b>4</b>	<b>\$214</b>		<b>\$392</b>
<b>5</b>	<b>\$272</b>		<b>\$498</b>
<b>6</b>	<b>\$330</b>		<b>\$605</b>
<b>7</b>	<b>\$389</b>		<b>\$711</b>
<b>8</b>	<b>\$446</b>		<b>\$818</b>
<b>9</b>	<b>\$505</b>		<b>\$924</b>
<b>10</b>	<b>\$563</b>		<b>\$1032</b>
<b>11</b>	<b>\$621</b>		<b>\$1138</b>
<b>12</b>	<b>\$679</b>		<b>\$1244</b>
<b>L</b>	<b>\$646</b>		<b>\$1185</b>

For multi-fabric models, start with the base price, then add the additional amount for the back and seat from the corresponding matrix to determine the final list price. Choose any combination of fabric grades for the back and seat.

Example: HML3SDF base price (\$4095) + Grade 2 frame/arms fabric (add \$79) + Grade 4 back/seat fabric (add \$392) = Total \$4566 List  
 HML3SDF base price (\$4095) + Grade 5 frame/arms fabric (add \$272) + Grade 3 back/seat fabric (add \$285) = Total \$4652 List

**HON Recommendation: HML3SDF.A.PNS\_\_.PNS\_\_.TS.P7A - List Price \$4641**

## HOW TO SPECIFY

Select Model Number	Select Arm Type	Select Frame/Arms Fabric	Select Back/Seat Cushions Fabric	Select Leg Type	Select Leg Color
	<b>N</b> Armless <b>A</b> Straight Arms (+ \$324) <b>B</b> Tapered Arms (+ \$377)	See page 353	See page 353	<b>TS</b> Tapered Square <b>TR</b> Tapered Round	<b>PR8</b> Textured Silver <b>P7A</b> Textured Charcoal <b>H</b> Bourbon Cherry (+ \$109) <b>F</b> Shaker Cherry (+ \$109) <b>N</b> Mahogany (+ \$109) <b>C</b> Harvest (+ \$109) <b>D</b> Natural Maple (+ \$109) <b>LKI1</b> Kingswood Walnut (+ \$109) <b>LSW1</b> Skyline Walnut (+ \$109) <b>LLA1</b> Lowell Ash (+ \$109) <b>LSA1</b> Sterling Ash (+ \$109) <b>COGN</b> Cognac (+ \$109) <b>MOCH</b> Mocha (+ \$109) <b>PINC</b> Pinnacle (+ \$109) <b>LNR1</b> Natural Recon (+ \$109) <b>LPE1</b> Phantom Ecrú (+ \$109) <b>LPT1</b> Portico Teak (+ \$109)
HML3SDF	A	PNS004	PNS007	TS	P7A

! Leg options - Tapered Square (TS) and Tapered Round (TR) are available in 2 poly and 8 woodgrain options.



# GROVE® Multi-Fabric

GSA SIN 33721



Icon Legend on page 19

## HML2STDF

### TWO-SEAT WITH TABLE

Multi-Fabric

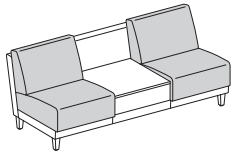

Armless

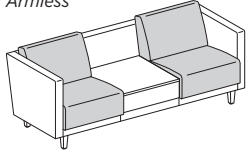

Straight Arms

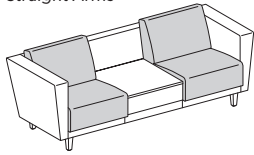

Tapered Arms

### DIMENSIONS

Depth:	31½	Ship Weight (armless):	146
Height:	29¼	Ship Weight (with straight arms):	162
Seat Width:	71½	Ship Weight (with tapered arms):	170
Back Width:	71½	Cube (armless):	48.9
Back Height:	19	Cube (with straight arms):	48.9
Width (armless):	71½	Cube (with tapered arms):	48.9
Width (with straight arms):	77½	COM:	See page 353
Width (with tapered arms):	82½	Weight Rating:	300 lbs. (per seat)
Arm Width:	71½		
Seat to Floor Height:	16		
Usable Seat Depth:	18¾		

### FABRIC PRICE CODES

<b>1</b>	<b>\$4405</b>		
<i>Add to Base Price Above</i>			
	<b>Frame/Arms</b>	<b>Back/Seat Cushions</b>	
<b>2</b>	<b>\$79</b>	<b>\$91</b>	
<b>3</b>	<b>\$156</b>	<b>\$182</b>	
<b>4</b>	<b>\$214</b>	<b>\$250</b>	
<b>5</b>	<b>\$272</b>	<b>\$318</b>	
<b>6</b>	<b>\$330</b>	<b>\$386</b>	
<b>7</b>	<b>\$389</b>	<b>\$453</b>	
<b>8</b>	<b>\$446</b>	<b>\$521</b>	
<b>9</b>	<b>\$505</b>	<b>\$589</b>	
<b>10</b>	<b>\$563</b>	<b>\$657</b>	
<b>11</b>	<b>\$621</b>	<b>\$725</b>	
<b>12</b>	<b>\$679</b>	<b>\$793</b>	
<b>L</b>	<b>\$646</b>	<b>\$754</b>	

NOTES: Offers a table between the seats that provides separation and a usable worksurface. Table available with two grommet and an accessory port option.

**HON Recommendation: HML2STDF.A.PNS\_\_PNS\_\_TS.P7A.N.G1.0 - List Price \$4943**

## HOW TO SPECIFY

Select Model Number	Select Arm Type	Select Frame/Arms Fabric	Select Back/Seat Cushions Fabric	Select Leg Type	Select Leg Color	Select Laminate	Select Cut Out	Accessory Port Location
	<b>N</b> Armless <b>A</b> Straight Arms (+ \$324) <b>B</b> Tapered Arms (+ \$377)	See page 353	See page 353	<b>TS</b> Tapered Square <b>TR</b> Tapered Round	<b>PR8</b> Textured Silver <b>P7A</b> Textured Charcoal <b>H</b> Bourbon Cherry (+ \$109) <b>F</b> Shaker Cherry (+ \$109) <b>N</b> Mahogany (+ \$109) <b>C</b> Harvest (+ \$109) <b>D</b> Natural Maple (+ \$109) <b>LK11</b> Kingswood Walnut (+ \$109) <b>LSW1</b> Skyline Walnut (+ \$109) <b>LLA1</b> Lowell Ash (+ \$109) <b>LSA1</b> Sterling Ash (+ \$109) <b>COGN</b> Cognac (+ \$109) <b>MOCH</b> Mocha (+ \$109) <b>PINC</b> Pinnacle (+ \$109) <b>LNRI</b> Natural Recon (+ \$109) <b>LPE1</b> Phantom Ecu (+ \$109) <b>LPT1</b> Portico Teak (+ \$109)	See <i>Chart on page 352</i> <b>L2</b> (+ \$135)	<b>N</b> No Cutout <b>G</b> Round Grommet Cutout (+ \$33) <b>G1</b> Pop-Up Port Cutout (+ \$44)	<b>0</b> No Port <b>2</b> Two Tablet Ports Opposite (+ \$22)
HML2STDF	A	PNS004	PNS007	TS	P7A	N	G1	0

! Leg options - Tapered Square (TS) and Tapered Round (TR) are available in 2 poly and 8 woodgrain options.

SEATING



## HGRMTAC

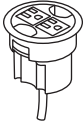

SIN 33721T

### POWER HUB

3" Grommet Mount, 6' Cord

### DIMENSIONS

Ship Weight: 1.3  
Cube: 0.2

### LIST PRICE

\$173

NOTES: Fits in 3" round grommet holes. Field installed with Plug-and-play ease. Two grounded AC power outlets. Includes 6' cord with three-prong plug.

ⓘ Available in black only (no color designation so use .X)

## HGRMTAC2

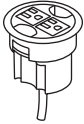

SIN 33721T

### 3" ROUND POWER GROMMET

2 Outlets, 10' Cord

### DIMENSIONS

Ship Weight: 1.5  
Cube: 0.2

### LIST PRICE

\$204

NOTES: Power Modules will also work with standing-height applications for 10500 Series™ and Voi® desks. Optional Memory Control allows preset worksurface heights for consistency. Ships separately. Dynamic load capacity when worksurface is moving is 300 lbs. Includes 10' cord with three-prong plug. Fits in 3" round grommet holes on the following product lines: Coordinate™, Huddle, Motivate®, all laminate and veneer casegoods series, and Systems Worksurfaces. Two grounded AC power outlets. Field installed with Plug-and-play ease.

ⓘ Available in black finish only, no specification needed.

## HGRMTUSB2

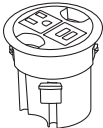

SIN 33721T

### POWER/USB HUB

3" Grommet Mount

### DIMENSIONS

Ship Weight: 1.3 ⓘ  
Cube: 0.2

### LIST PRICE

\$309

NOTES: One grounded AC power outlet with 1 USB-A, 1 USB-C ports. UL Listed.

ⓘ Available in black only (no color designation so use .X)

## HFTTAL14



SIN 33721

### TABLET ACCESSORY

Laminate

### DIMENSIONS

Diameter: 14      Ship Weight: 6.0  
Height from Table Top: 10      Cube: 2.5

### LIST PRICE

\$534

NOTES: Use with Collaborative Cube and Cylinder tables for additional workspace. Attaches to tables through ports. Multiple port location options are available. Tablet pivots/swivels toward the user.

## HTG1PWR-3P-1B

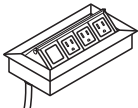

SIN 33721

### POP-UP PORT

### DIMENSIONS

Ship Weight: 5.0  
Cube: 0.3

### LIST PRICE

\$523

NOTES: Fits into 4" x 8" cutout. Specify G1 cutout in table top. Pop-up Port provides three power ports and one blank data receptacle. Sits flush with worksurface when closed. Finish is anodized aluminum. Includes 6' cord with three-prong plug.

## HOW TO SPECIFY

Select Model Number

H G R M T A C

# NOTES



Ignition® Seating.

## IGNITION®

People come in all shapes and sizes, which is why Ignition does as well. From guest and lounge chairs to executive seating, Ignition allows you to mix and match adjustment features, back height, lumbar, and other options to fit your chair to your needs. It's the easy, affordable way to furnish an entire workplace in style and comfort. Ignition fits who you are, where you work and how you work.



## FEATURES

### IGNITION® 2.0

- Choice of upholstered, 4-Way Stretch mesh or ReActiv® back options.
- ReActiv® back features zonal comfort that delivers optimal support and flexibility.
- The unique hammock-like inner support allows the upholstered back version to feature a slim profile and provide built-in comfort.
- Optional adjustable lumbar allows users to tailor their support.
- 8 different adjustable lumbar colors available on 4-Way Stretch mesh and ReActiv® task chair models.
- Passive movement back adjusts with you.
- Multiple arm options to accommodate user requirements.
- Available in 7 colors of 4-Way Stretch mesh and 3 ReActiv® colors.
- Molded foam seat for better support and added comfort.
- Black, Titanium, and Designer White frame.
- Mesh seat option with waterfall seat available to reduce pressure points and provide breathability.
- Warranted for users up to 300 lbs., 450 lbs. for Big & Tall.











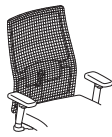

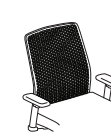
## IGNITION®

- Ignition Series seating addresses the needs of the total office with Executive, Task, Stool, Guest and Lounge Seating Solutions.
- Three different back sizes, three different controls and multiple arm options to fit you and how you work.
- Back height adjustment moves the back up or down to fit various body sizes.
- Contoured back on multi-purpose seating offers greater comfort than typical stack chairs or stools.
- Warranted for users up to 300 lbs., 450 lbs. for Big & Tall.
- Multi-purpose chair stacks four high.

# IGNITION® Options

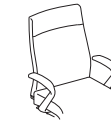
## MODEL OPTIONS

<p><b>HITLM</b></p>  <p><b>Task Low-Back</b> 4-Way Stretch Mesh Back, Pneumatic, Swivel, Synchro-tilt, Tilt Tension, Tilt Lock, Optional Lumbar Support</p>	<p><b>HITSM</b></p>  <p><b>Task Low-Back Stool</b> 4-Way Stretch Mesh Back, Pneumatic, Swivel, Synchro-tilt, Tilt Tension, Tilt Lock, Optional Lumbar Support</p>	<p><b>HITLRA</b></p>  <p><b>Task Low-Back ReActiv®</b> ReActiv® Back, Pneumatic, Swivel, Synchro-tilt, Tilt Tension, Tilt Lock, Optional Lumbar Support</p>	<p><b>HITSRA</b></p>  <p><b>Task Low-Back Stool ReActiv®</b> ReActiv® Back, Pneumatic, Swivel, Synchro-tilt, Tilt Tension, Tilt Lock, Optional Lumbar Support</p>
<p><b>HIWMM</b></p>  <p><b>Task Mid-Back</b> 4-Way Stretch Mesh Back, Pneumatic, Swivel, Synchro-tilt, Tilt Tension, Tilt Lock, Optional Lumbar Support</p>	<p><b>HIWMMHR</b></p>  <p><b>Task Mid-Back w/Headrest</b> 4-Way Stretch Mesh Back, Pneumatic, Swivel, Synchro-tilt, Tilt Tension, Tilt Lock, Optional Lumbar Support, Headrest</p>	<p><b>HIWMS</b></p>  <p><b>Task Mid-Back w/Mesh Seat</b> 4-Way Stretch Mesh Back, Pneumatic, Swivel, Synchro-tilt, Tilt Tension, Tilt Lock, Optional Lumbar Support, Mesh Seat</p>	<p><b>HIWMBT</b></p>  <p><b>Task Mid-Back Big &amp; Tall</b> 4-Way Stretch Mesh Back, Pneumatic, Swivel, Synchro-tilt, Tilt Tension, Tilt Lock, Optional Lumbar Support</p>
<p><b>HIWMRA</b></p>  <p><b>Task Mid-Back ReActiv®</b> ReActiv® Back, Pneumatic, Swivel, Synchro-tilt, Tilt Tension, Tilt Lock, Optional Lumbar Support</p>	<p><b>HIWMMU</b></p>  <p><b>Upholstered Mid-Back</b> Upholstered Back, Pneumatic, Swivel, Synchro-tilt, Tilt Tension, Tilt Lock</p>	<p><b>HIWMUL</b></p>  <p><b>Upholstered Mid-Back with Lumbar Support</b> Upholstered Back, Pneumatic, Swivel, Synchro-tilt, Tilt Tension, Tilt Lock, Adjustable Lumbar</p>	

SEATING

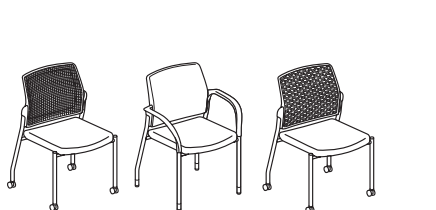
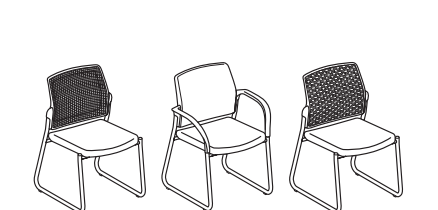
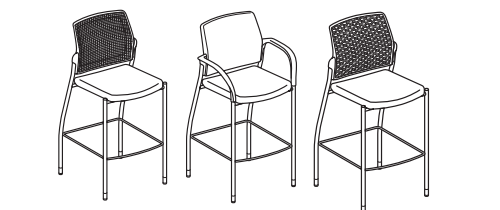
<p><b>HIGS6</b></p>  <p><b>Multi-Purpose</b> Four Legs</p>	<p><b>HISB6</b></p>  <p><b>Multi-Purpose</b> Sled Base</p>	<p><b>HICS7</b></p>  <p><b>Café-Height Stool</b> Four Legs</p>
--	---	--

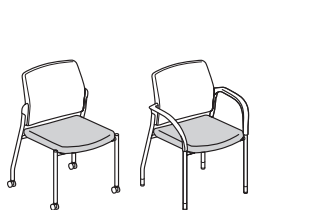
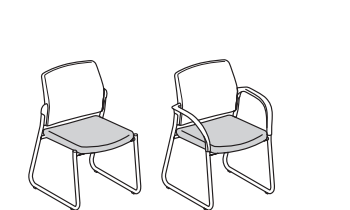
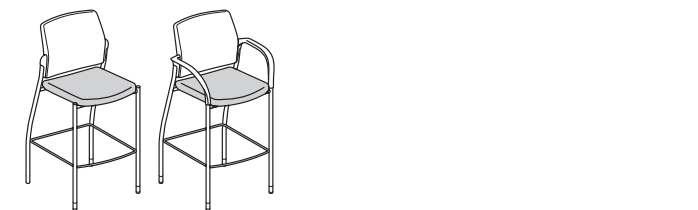
<p><b>HIGS6DF - Multi-Fabric</b></p>  <p><b>Multi-Purpose</b> Four Legs</p>	<p><b>HISB6DF - Multi-Fabric</b></p>  <p><b>Multi-Purpose</b> Sled Base</p>	<p><b>HICS7DF - Multi-Fabric</b></p>  <p><b>Café-Height Stool</b> Four Legs</p>
---	--	---

## MODEL OPTIONS

**HIGCL**



**Guest Chair**

Fixed Arms, Glides

**HIB50**

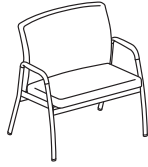

**Bariatric Lounge**

Fixed Arms, Glides

**HITL1**



**Task Low-Back**

Pneumatic, Back Height Adjustment, Swivel, Tilt, Tilt Tension, Tilt Lock

**HITL2**



**Task Low-Back**

Pneumatic, Back Height Adjustment, Synchro-tilt, Tilt Tension, Tilt Lock, Seat Glide

**HITL3**



**Task Low-Back**

Pneumatic, Back Height Adjustment, Synchro-tilt, Back Angle Adjustment, Tilt Tension, Tilt Lock, Seat Glide

**HITS5**



**Task Stool**

Pneumatic, Swivel Back Height Adjustment, Adjustable Footrest

**HIWM1**



**Mid-Back**

Pneumatic, Back Height Adjustment, Swivel, Tilt, Tilt Tension, Tilt Lock

**HIWM2**



**Mid-Back**

Pneumatic, Back Height Adjustment, Synchro-tilt, Tilt Tension, Tilt Lock, Seat Glide

**HIWM3**



**Mid-Back**

Pneumatic, Back Height Adjustment, Synchro-tilt, Back Angle Adjustment, Tilt Tension, Tilt Lock, Seat Glide

**HIEH1**



**Executive High-Back**

Pneumatic, Back Height Adjustment, Swivel, Tilt, Tilt Tension, Tilt Lock

**HIEH2**



**Executive High-Back**

Pneumatic, Back Height Adjustment, Synchro-tilt, Tilt Tension, Seat Glide

**HIEH3**













**Executive High-Back**







Pneumatic, Back Height Adjustment, Synchro-tilt, Back Angle Adjustment, Tilt Tension, Seat Glide

# IGNITION® 2.0

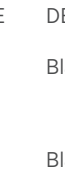
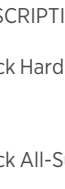
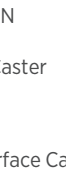
## Options

ARM STYLE	CODE	DESCRIPTION	PRICE
	<b>N</b>	Armless	<b>+\$0</b>
	<b>F</b>	Fixed Arms	<b>+\$71</b>
	<b>A</b>	Height and Width Adjustable Arms	<b>+\$92</b>
	<b>V</b>	All-Adjustable Arms (includes Pivot)	<b>+\$141</b>
	<b>P</b>	Fixed Polished Aluminum Arms	<b>+\$189</b>

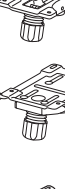
CASTERS	CODE	DESCRIPTION	PRICE
	<b>H</b>	Black Hard Caster	<b>+\$0</b>
	<b>S</b>	Black All-Surface Caster	<b>+\$44</b>
	<b>R</b>	Black Roll Control Caster	<b>+\$55</b>
	<b>TS</b>	Titanium All-Surface Caster	<b>+\$44</b>
	<b>A</b>	Black All-Surface Caster (Big & Tall models only)	<b>+\$0</b>

MECHANISM	CODE	DESCRIPTION	PRICE
	<b>Y0</b>	Synchro-Tilt A, E, J, K, L	<b>+\$0</b>
	<b>Y1</b>	Synchro-Tilt w/ Seat Slider A, D, E, J, K, L	<b>+\$22</b>
	<b>Y2</b>	Advanced Synchro-Tilt A, D, E, J, L, A-D	<b>+\$71</b>
	<b>Y3</b>	Synchro-Tilt with Independent Back Angle A, D, E, J, L, A-E	<b>+\$114</b>
	<b>Y4</b>	Synchro-Tilt (Big & Tall models only) A, D, E, J, L, A-D	<b>+\$0</b>
	<b>W2</b>	Weight-Activated Synchro-Tilt w/ Seat Slider A, D, E, L, P	<b>+\$71</b>
	<b>S0</b>	Limited Recline Synchro-Tilt A, E, J, K, L	<b>+\$0</b>
	<b>S1</b>	Limited Recline Synchro-Tilt w/ Seat Slider A, D, E, J, K, L	<b>+\$22</b>
		<i>*Only available on HITSM</i>	
	<b>S2</b>	Limited Recline Advanced Synchro-Tilt A, D, E, J, L, A-D	<b>+\$71</b>
		<i>*Only available on HIWMMS, HIWMMSKD</i>	

LUMBAR	CODE	DESCRIPTION	PRICE
	<b>NL</b>	No Lumbar	<b>+\$0</b>
	<b>BL</b>	Black Adjustable Lumbar	<b>+\$33</b>
	<b>BY</b>	Bullseye Adjustable Lumbar	<b>+\$33</b>
	<b>DW</b>	Designer White Adjustable Lumbar	<b>+\$33</b>
	<b>MR</b>	Ember Adjustable Lumbar	<b>+\$33</b>
	<b>IR</b>	Iris Adjustable Lumbar	<b>+\$33</b>
	<b>KT</b>	Krypton Adjustable Lumbar	<b>+\$33</b>
	<b>RE</b>	Regatta Adjustable Lumbar	<b>+\$33</b>
	<b>TL</b>	Titanium Adjustable Lumbar	<b>+\$33</b>
		<i>*Adjustable Lumbar not available on CAL 133 (FC) models</i>	

# IGNITION® 2.0 Options

## BASE



CODE	DESCRIPTION	PRICE
<b>SB</b>	Standard Base	<b>+\$0</b>

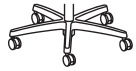

<b>PA</b>	Polished Aluminum	<b>+\$119</b>
-----------	-------------------	---------------

## FRAME

CODE	DESCRIPTION	PRICE
<b>T</b>	Black Frame	<b>+\$0</b>
<b>DWX</b>	Designer White	<b>+\$39</b>
<b>TI</b>	Titanium Frame	<b>+\$39</b>

## BACK STYLE

CODE	DESCRIPTION	PRICE
------	-------------	-------

*4-Way Stretch mesh back options:*

<b>IM</b>	Black	<b>+\$0</b>
<b>IB</b>	Breeze	<b>+\$0</b>
<b>IK</b>	Brownstone	<b>+\$0</b>
<b>IC</b>	Charcoal	<b>+\$0</b>
<b>IF</b>	Fog	<b>+\$0</b>
<b>IR</b>	Regatta	<b>+\$0</b>
<b>IT</b>	Titanium	<b>+\$0</b>

*ReActiv® back options:*

<b>OS</b>	Charcoal	<b>+\$0</b>
<b>DWR</b>	Designer White	<b>+\$0</b>
<b>TI</b>	Titanium	<b>+\$0</b>



# IGNITION® 2.0

## Dimensions

### TASK DIMENSIONS

MODEL		HIWMM, HIWMRA, HIWMU, & HIWMUL	HIWMMHR	HIWMMS	HITLM & HITLRA	HITSM & HITSRA
Overall Width Armless		21	21	21	20	20
Overall Width with Arms	A	27	27	27	26	26
Overall Depth		24	24	24	22	22
Overall Height	S0/S1	-	-	-	-	52½
	Y0/Y1	43¾	54	43¾	40½	-
	S2	-	-	44½	-	-
	Y2	44½	55	-	41¼	-
	Y3	44½	55	-	41¼	-
	Y4	-	-	-	-	-
	W2	44½	55	44½	41¼	-
Seat Width		20	20	20	18½	18½
Seat Depth		18⅝	18⅝	18⅝	17⅝	17⅝
Usable Seat Depth	S0	-	-	-	-	16¾
	S1	-	-	-	-	15½ - 16⅝
	S2	-	-	16½ - 18¼	-	-
	Y0	17¾	17¾	17½	16¾	-
	Y1	17½ - 19½	17½ - 19½	16¾ - 18¼	15½ - 17½	-
	Y2	16¼ - 19¼	16¼ - 19¼	-	15¾ - 18½	-
	Y3	16½ - 19½	16½ - 19½	-	16¼ - 18¾	-
	Y4	-	-	-	-	-
	W2	16¼ - 18½	16¼ - 18½	16¾ - 18¼	15¾ - 17¾	-
Seat Height	S0/S1	-	-	-	-	22⅞ - 31¾
	S2	-	-	17½ - 22¼	-	-
	Y0/Y1	16⅝ - 21¼	16⅝ - 21¼	16¾ - 21½	16¾ - 21¼	-
	Y2	17⅞ - 21½	17⅞ - 21½	-	17⅞ - 21½	-
	Y3	17½ - 21½	17½ - 21½	-	17¾ - 21¾	-
	Y4	-	-	-	-	-
	W2	17⅞ - 21½	17⅞ - 21½	17 - 21½	17⅞ - 21½	-
Back Width		19	19	19	19	17½
Back Height		23	23	23	19	19
Ship Weight Armless	S0	-	-	-	-	44 Ⓢ
	S1	-	-	-	-	46 Ⓢ
	S2	-	-	42 Ⓢ	-	-
	Y0	38 Ⓢ	38 Ⓢ	38 Ⓢ	38 Ⓢ	-
	Y1	38 Ⓢ	38 Ⓢ	38 Ⓢ	38 Ⓢ	-
	Y2	42 Ⓢ	42 Ⓢ	-	42 Ⓢ	-
	Y3	46 Ⓢ	46 Ⓢ	-	45 Ⓢ	-
	Y4	-	-	-	-	-
	W2	42 Ⓢ	42 Ⓢ	42 Ⓢ	42 Ⓢ	-
Ship Weight with Arms	S0	-	-	-	-	51 Ⓢ
	S1	-	-	-	-	53 Ⓢ
	S2	-	-	49 Ⓢ	-	-
	Y0	45 Ⓢ	45 Ⓢ	45 Ⓢ	45 Ⓢ	-
	Y1	45 Ⓢ	45 Ⓢ	45 Ⓢ	45 Ⓢ	-
	Y2	49 Ⓢ	49 Ⓢ	-	49 Ⓢ	-
	Y3	53 Ⓢ	53 Ⓢ	-	52 Ⓢ	-
	Y4	-	-	-	-	-
	W2	49 Ⓢ	49 Ⓢ	49 Ⓢ	49 Ⓢ	-
Width Between Arms	F	20¼	20¼	20¾	19	19
	P	20¼	20¼	20¾	19	19
	A	18 - 20½	18 - 20½	17½ - 21	17 - 19½	17 - 19½
	V	12½ - 27½	12½ - 27½	12 - 27	11½ - 26½	11½ - 26⅝
Cube		10.8	10.8	10.8	10.8	10.8
Cube with Y3 Control		12	12	-	12	-
COM		1.0	1.0	-	1.0	1.0
Weight Capacity		300 lbs	300 lbs	300 lbs	300 lbs	300 lbs

# IGNITION® 2.0

## Dimensions

### TASK DIMENSIONS

MODEL		HITLMKD & HITLRAKD	HIWMMKD, HIWMRAKD, HIWUMKD, & HIWMULKD	HIWMMSKD	HIWMBT
Overall Width Armless		20	21	21	30
Overall Width with Arms	A	26	27	27	30
Overall Depth		22	24	24	30
Overall Height	S0/S1	-	-	-	-
	Y0/Y1	40½	43¾	43¾	-
	S2	-	-	44½	-
	Y2	-	-	-	-
	Y3	-	-	-	-
	Y4	-	-	-	46 (+10½ for HR)
	W2	41¼	44½	44½	-
Seat Width		18½	20	20	23½
Seat Depth		17⅝	18⅝	18⅝	20¼
Usable Seat Depth	S0	-	-	-	-
	S1	-	-	-	-
	S2	-	-	16½ - 18¼	-
	Y0	16¾	17¾	-	-
	Y1	15½ - 17½	17½ - 19½	16¾ - 18¼	-
	Y2	-	-	-	-
	Y3	-	-	-	-
	Y4	-	-	-	17¾ - 19½
	W2	15¾ - 17¾	16¼ - 18½	16¾ - 18¼	-
Seat Height	S0/S1	-	-	-	-
	S2	-	-	17½ - 22¼	-
	Y0/Y1	16¾ - 21¼	16⅝ - 21¼	16¾ - 21½	-
	Y2	-	-	-	-
	Y3	-	-	-	-
	Y4	-	-	-	18 - 22¼
	W2	17⅝ - 21½	17⅝ - 21½	17 - 21½	-
Back Width		17½	19	19	22¾
Back Height		19	23	23	24¾
Ship Weight Armless	S0	-	-	-	-
	S1	-	-	-	-
	S2	-	-	42 Ⓢ	-
	Y0	38 Ⓢ	38 Ⓢ	-	-
	Y1	38 Ⓢ	38 Ⓢ	38 Ⓢ	-
	Y2	-	-	-	-
	Y3	-	-	-	-
	Y4	-	-	-	68
	W2	42 Ⓢ	42 Ⓢ	42 Ⓢ	-
Ship Weight with Arms	S0	-	-	-	-
	S1	-	-	-	-
	S2	-	-	49 Ⓢ	-
	Y0	45 Ⓢ	45 Ⓢ	-	-
	Y1	45 Ⓢ	45 Ⓢ	45 Ⓢ	-
	Y2	-	-	-	-
	Y3	-	-	-	-
	Y4	-	-	-	75
	W2	49 Ⓢ	49 Ⓢ	49 Ⓢ	-
Width Between Arms	F	19	20¼	20¼	-
	P	19	20¼	20¼	-
	A	17 - 19½	18 - 20½	18 - 20½	-
	V	11½ - 26½	12½ - 27½	12½ - 27½	14 - 29
Cube		5.6	6.3	10.8	15.3
Cube with Y3 Control		-	-	-	-
COM		-	-	-	1.5
Weight Capacity		300 lbs	300 lbs	300 lbs	450 lbs

# IGNITION® 2.0



Icon Legend on page 19

## HITLM

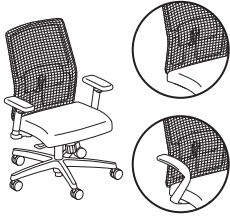

### TASK LOW-BACK

- 4-Way Stretch Mesh Back**
- Pneumatic
- Swivel
- Synchro-tilt
- Tilt Tension
- Tilt Lock
- Optional Lumbar Support

### DIMENSIONS

Depth:	22	Width (with arms):	26
Height:	40½	Width (armless):	20
Seat Depth:	16	Cube:	10.8
Seat Width:	18½	COM:	1.0
Back Width:	17½	Weight Rating:	300 lbs.
Back Height:	19		

### FABRIC PRICE CODES

<b>1</b>	<b>\$661</b>	<b>8</b>	<b>\$811</b>
<b>2</b>	<b>\$688</b>	<b>9</b>	<b>\$830</b>
<b>3</b>	<b>\$714</b>	<b>10</b>	<b>\$849</b>
<b>4</b>	<b>\$733</b>	<b>11</b>	<b>\$869</b>
<b>5</b>	<b>\$752</b>	<b>12</b>	<b>\$888</b>
<b>6</b>	<b>\$772</b>	<b>L</b>	<b>\$877</b>
<b>7</b>	<b>\$791</b>		

! See page 368 for additional specifications and dimensions.

## HIWMM

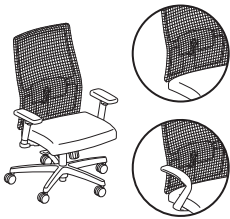

### TASK MID-BACK

- 4-Way Stretch Mesh Back**
- Pneumatic
- Swivel
- Synchro-tilt
- Tilt Tension
- Tilt Lock
- Optional Lumbar Support

### DIMENSIONS

Depth:	24	Width (with arms):	27
Height:	43¾	Width (armless):	21
Seat Depth:	17¾	Cube:	10.8
Seat Width:	20	COM:	1.0
Back Width:	19	Weight Rating:	300 lbs.
Back Height:	23		

### FABRIC PRICE CODES

<b>1</b>	<b>\$724</b>	<b>8</b>	<b>\$874</b>
<b>2</b>	<b>\$751</b>	<b>9</b>	<b>\$893</b>
<b>3</b>	<b>\$777</b>	<b>10</b>	<b>\$912</b>
<b>4</b>	<b>\$796</b>	<b>11</b>	<b>\$932</b>
<b>5</b>	<b>\$815</b>	<b>12</b>	<b>\$951</b>
<b>6</b>	<b>\$835</b>	<b>L</b>	<b>\$940</b>
<b>7</b>	<b>\$854</b>		

! See page 368 for additional specifications and dimensions.

## HITSM



### TASK LOW-BACK STOOL

- 4-Way Stretch Mesh Back**
- Pneumatic
- Swivel
- Synchro-tilt
- Tilt Tension
- Tilt Lock
- Optional Lumbar Support

### DIMENSIONS

Depth:	22	Width (with arms):	26
Height:	52½	Width (armless):	20
Seat Depth:	16	Cube:	10.8
Seat Width:	18½	COM:	1.0
Back Width:	17½	Weight Rating:	300 lbs.
Back Height:	19		

### FABRIC PRICE CODES

<b>1</b>	<b>\$792</b>	<b>8</b>	<b>\$942</b>
<b>2</b>	<b>\$819</b>	<b>9</b>	<b>\$961</b>
<b>3</b>	<b>\$845</b>	<b>10</b>	<b>\$980</b>
<b>4</b>	<b>\$864</b>	<b>11</b>	<b>\$1000</b>
<b>5</b>	<b>\$883</b>	<b>12</b>	<b>\$1019</b>
<b>6</b>	<b>\$903</b>	<b>L</b>	<b>\$1008</b>
<b>7</b>	<b>\$922</b>		

! See page 368 for additional specifications and dimensions.

! Not available in Polished Aluminum Base.

**HON Recommendation: HIWMM.Y2.A.H.IM.CU\_\_BL.SB.T - List Price \$920**

## HOW TO SPECIFY

Select Model Number	Select Control Type	Select Arm Type	Select Caster	Select Mesh	Select Fabric	Select Lumbar	Select Base	Select Frame
<b>Y0</b> Synchro-Tilt	<b>N</b> Armless	<b>H</b> Black Hard Caster	<b>IM</b> Black	See page 387	<b>NL</b> No Lumbar	<b>SB</b> Standard Base	<b>T</b> Black	
<b>Y1</b> Synchro-Tilt w/ Seat Slider (+ \$22)	<b>A</b> Height and Width Adjustable Arms (+ \$92)	<b>S</b> Black All-Surface Caster (+ \$44)	<b>IB</b> Breeze		<b>BL</b> Black Adjustable Lumbar (+ \$33)	<b>PA</b> Polished Aluminum (+ \$119)	<b>DWX</b> Designer White (+ \$39 for HITLM and HIWMM; + \$60 for HITSM)	
<b>Y2</b> Advanced Synchro-Tilt (+ \$71)	<b>V</b> All-Adjustable Arms (includes pivot) (+ \$141)	<b>TS</b> Titanium All-Surface Caster (+ \$44)	<b>IK</b> Brownstone		<b>BY</b> Bullseye Adjustable Lumbar (+ \$33)		<b>TI</b> Titanium (+ \$39 for HITLM and HIWMM; + \$60 for HITSM)	
<b>Y3</b> Synchro-Tilt with Independent Back Angle (+ \$114)	<b>F</b> Fixed Arms (+ \$71)	<b>R</b> Black Roll Control Caster (+ \$55)	<b>IC</b> Charcoal		<b>DW</b> Designer White Adjustable Lumbar (+ \$33)			
<b>S0</b> Limited Recline Synchro-Tilt (for HITSM only)	<b>P</b> Fixed Arms - Polished (+ \$189)		<b>IF</b> Fog		<b>MR</b> Ember Adjustable Lumbar (+ \$33)			
<b>S1</b> Limited Recline Synchro-Tilt w/ Seat Slider (+ \$22 for HITSM only)			<b>IR</b> Regatta		<b>IR</b> Iris Adjustable Lumbar (+ \$33)			
<b>W2</b> Weight-Activated Synchro-Tilt w/ Seat Slider (+ \$71)			<b>IT</b> Titanium		<b>KT</b> Krypton Adjustable Lumbar (+ \$33)			
					<b>RE</b> Regatta Adjustable Lumbar (+ \$33)			
					<b>TL</b> Titanium Adjustable Lumbar (+ \$33)			

HITLM . Y2 . A . H . IM . CU10 . BL . SB . T



Icon Legend on page 19

# IGNITION® 2.0

## HIWMMHR



### TASK MID-BACK

- 4-Way Stretch Mesh Back w/ Headrest**
- Pneumatic
- Swivel
- Synchro-tilt
- Tilt Tension
- Tilt Lock
- Optional Lumbar Support
- Headrest

### DIMENSIONS

Depth:	24	Width (with arms):	27
Height:	54	Width (armless):	21
Seat Depth:	17¾	Cube:	10.8
Seat Width:	20	COM:	1.0
Back Width:	19	Weight Rating:	300 lbs.
Back Height:	23		

### FABRIC PRICE CODES

<b>1</b>	<b>\$724</b>	<b>8</b>	<b>\$874</b>
<b>2</b>	<b>\$751</b>	<b>9</b>	<b>\$893</b>
<b>3</b>	<b>\$777</b>	<b>10</b>	<b>\$912</b>
<b>4</b>	<b>\$796</b>	<b>11</b>	<b>\$932</b>
<b>5</b>	<b>\$815</b>	<b>12</b>	<b>\$951</b>
<b>6</b>	<b>\$835</b>	<b>L</b>	<b>\$940</b>
<b>7</b>	<b>\$854</b>		

❗ See page 368 for additional specifications and dimensions.

**HON Recommendation: HIWMMHR.Y2.A.TS.IF.CU\_\_DW.SB.DWX.HR - List Price \$1090**

## HOW TO SPECIFY

Select Model Number	Select Control Type	Select Arm Type	Select Caster	Select Mesh	Select Fabric	Select Lumbar	Select Base	Select Frame	Select Headrest
<b>YO</b> Synchro-Tilt	<b>N</b> Armless	<b>H</b> Black Hard Caster	<b>IM</b> Black	See page 387	<b>NL</b> No Lumbar	<b>SB</b> Standard Base	<b>T</b> Black	<b>HR</b> Headrest (+ \$87)	
<b>Y1</b> Synchro-Tilt w/ Seat Slider (+ \$22)	<b>A</b> Height and Width Adjustable Arms (+ \$92)	<b>S</b> Black All-Surface Caster (+ \$44)	<b>IB</b> Breeze		<b>BL</b> Black Adjustable Lumbar (+ \$33)	<b>PA</b> Polished Aluminum (+ \$119)	<b>DWX</b> Designer White (+ \$39)		
<b>Y2</b> Advanced Synchro-Tilt (+ \$71)	<b>V</b> All-Adjustable Arms (includes pivot) (+ \$141)	<b>TS</b> Titanium All-Surface Caster (+ \$44)	<b>IK</b> Brownstone		<b>BY</b> Bullseye Adjustable Lumbar (+ \$33)		<b>TI</b> Titanium (+ \$39)	<i>Headrest color will match chair frame selection. Headrest mesh color will match mesh back color selection.</i>	
<b>Y3</b> Synchro-Tilt with Independent Back Angle (+ \$114)	<b>F</b> Fixed Arms (+ \$71)	<b>R</b> Black Roll Control Caster (+ \$55)	<b>IC</b> Charcoal		<b>DW</b> Designer White Adjustable Lumbar (+ \$33)				
<b>W2</b> Weight-Activated Synchro-Tilt w/ Seat Slider (+ \$71)	<b>P</b> Fixed Arms - Polished (+ \$189)		<b>IF</b> Fog		<b>MR</b> Ember Adjustable Lumbar (+ \$33)				
			<b>IR</b> Regatta		<b>IR</b> Iris Adjustable Lumbar (+ \$33)				
			<b>IT</b> Titanium		<b>KT</b> Krypton Adjustable Lumbar (+ \$33)				
					<b>RE</b> Regatta Adjustable Lumbar (+ \$33)				
					<b>TL</b> Titanium Adjustable Lumbar (+ \$33)				

SEATING

# IGNITION® 2.0



Icon Legend on page 19

## HITLMKD



### TASK LOW-BACK

- 4-Way Stretch Mesh Back
- Pneumatic
- Swivel
- Synchro-tilt
- Tilt Tension
- Tilt Lock
- Optional Lumbar Support

### DIMENSIONS

Depth:	22	Back Height:	19
Height:	40½	Width (with arms):	26
Seat Depth:	16	Width (armless):	20
Seat Width:	18½	Cube:	5.6
Back Width:	17½	Weight Rating:	300 lbs.

### FABRIC PRICE CODES

1	\$621	8	\$771
2	\$648	9	\$790
3	\$674	10	\$809
4	\$693	11	\$829
5	\$712	12	\$848
6	\$732	L	\$837
7	\$751		

! See page 369 for additional specifications and dimensions.

## HIWMMKD



### TASK MID-BACK

- 4-Way Stretch Mesh Back
- Pneumatic
- Swivel
- Synchro-tilt
- Tilt Tension
- Tilt Lock
- Optional Lumbar Support

### DIMENSIONS

Depth:	24	Back Height:	23
Height:	43¾	Width (with arms):	27
Seat Depth:	17¾	Width (armless):	21
Seat Width:	20	Cube:	6.3
Back Width:	19	Weight Rating:	300 lbs.

### FABRIC PRICE CODES

1	\$684	8	\$834
2	\$711	9	\$853
3	\$737	10	\$872
4	\$756	11	\$892
5	\$775	12	\$911
6	\$795	L	\$900
7	\$814		

! See page 369 for additional specifications and dimensions.

**HON Recommendation: HIWMMKD.Y2.A.H.IM.CU\_\_BL.SB.T - List Price \$880**

## HOW TO SPECIFY

Select Model Number	Select Control Type	Select Arm Type	Select Caster	Select Mesh	Select Fabric	Select Lumbar	Select Base	Select Frame
	<b>Y1</b> Synchro-Tilt w/ Seat Slider (+ \$22) <b>Y2</b> Advanced Synchro-Tilt (+ \$71) <b>W2</b> Weight-Activated Synchro-Tilt w/ Seat Slider (+ \$71)	<b>A</b> Height and Width Adjustable Arms (+ \$92)	<b>H</b> Black Hard Caster	<b>IM</b> Black <b>IF</b> Fog <b>IC</b> Charcoal	See page 387	<b>NL</b> No Lumbar <b>BL</b> Black Adjustable Lumbar (+ \$33) <b>BY</b> Bullseye Adjustable Lumbar (+ \$33) <b>DW</b> Designer White Adjustable Lumbar (+ \$33) <b>MR</b> Ember Adjustable Lumbar (+ \$33) <b>IR</b> Iris Adjustable Lumbar (+ \$33) <b>KT</b> Krypton Adjustable Lumbar (+ \$33) <b>RE</b> Regatta Adjustable Lumbar (+ \$33) <b>TL</b> Titanium Adjustable Lumbar (+ \$33)	<b>SB</b> Standard Base	<b>T</b> Black <b>DWX</b> Designer White (+ \$39) <b>TI</b> Titanium (+ \$39)
H I W M M K D .	Y 2 .	A .	H .	I M .	C U 1 0 .	B L .	S B .	T



Icon Legend on page 19

# IGNITION® 2.0

## HIWMBT



### TASK MID-BACK BIG & TALL

#### 4-Way Stretch Mesh Back

- Pneumatic
- Swivel
- Synchro-tilt
- Tilt Tension
- Tilt Lock
- Optional Lumbar Support

### DIMENSIONS

Depth:	30	Width (with arms):	30
Height:	47	Width (armless):	30
Seat Depth:	20¼	Cube:	15.3
Seat Width:	23½	COM:	1.5
Seat Height:	18"-22¼"	Weight Rating:	450 lbs.
Back Width:	22¾		
Back Height:	24¾		

### FABRIC PRICE CODES

1	\$1217	8	\$1367
2	\$1244	9	\$1386
3	\$1270	10	\$1405
4	\$1289	11	\$1425
5	\$1308	12	\$1444
6	\$1328	L	\$1433
7	\$1347		

❗ See page 369 for additional specifications and dimensions.

**HON Recommendation: HIWMBT.Y4.V.A.IC.CU\_\_TL.SB.TI.N - List Price \$1430**

## HOW TO SPECIFY

Select Model Number	Select Control Type	Select Arm Type	Select Caster	Select Mesh	Select Fabric	Select Lumbar	Select Base	Select Frame	Select Headrest
	Y4 Synchro-Tilt	V All-Adjustable Arms (includes pivot) (+ \$141) N Armless	A All-Surface Caster	IM Black IF Fog IC Charcoal	See page 387	NL No Lumbar BL Black Adjustable Lumbar (+ \$33) BY Bullseye Adjustable Lumbar (+ \$33) DW Designer White Adjustable Lumbar (+ \$33) MR Ember Adjustable Lumbar (+ \$33) IR Iris Adjustable Lumbar (+ \$33) KT Krypton Adjustable Lumbar (+ \$33) RE Regatta Adjustable Lumbar (+ \$33) TL Titanium Adjustable Lumbar (+ \$33)	SB Standard Base	T Black DWX Designer White (+ \$39) TI Titanium (+ \$39)	N No Headrest HR Headrest (+ \$87) <i>Big &amp; Tall headrest frame is black. Mesh color matches mesh back selection.</i>
HIWMBT	Y4	V	A	IM	CU10	BL	SB	T	HR

SEATING

# IGNITION® 2.0



Icon Legend on page 19

## HIWMMS



### TASK MID-BACK

- 4-Way Stretch Mesh Back and Seat**
- Pneumatic
- Swivel
- Synchro-tilt
- Tilt Tension
- Tilt Lock
- Optional Lumbar Support
- Optional Headrest

### DIMENSIONS

Depth:	24	Width (with arms):	27
Height:	43¾	Width (armless):	21
Seat Depth:	17¾	Cube:	10.8
Seat Width:	20	Weight Rating:	300 lbs.
Back Width:	19		
Back Height:	23		

### LIST PRICE

**\$846**

! See page 368 for additional specifications and dimensions.

## HIWMMSKD



### TASK MID-BACK

- 4-Way Stretch Mesh Back and Seat**
- Pneumatic
- Swivel
- Synchro-tilt
- Tilt Tension
- Tilt Lock
- Optional Lumbar Support
- Optional Headrest

### DIMENSIONS

Depth:	24	Width (with arms):	27
Height:	43¾	Width (armless):	21
Seat Depth:	17¾	Cube:	7.9
Seat Width:	20	Weight Rating:	300 lbs.
Back Width:	19		
Back Height:	23		

### LIST PRICE

**\$806**

! See page 369 for all other control specifications.

**HON Recommendation: HIWMMS.S2.A.H.IM.IMS.BL.SB.T.N - List Price \$1042**

## HOW TO SPECIFY

Select Model Number	Select Control Type	Select Arm Type	Select Caster	Select Back Mesh	Select Seat Mesh	Select Lumbar	Select Base	Select Frame	Select Headrest
	<b>Y0</b> Synchro-Tilt <i>Available on model HIWMMS only</i> <b>Y1</b> Synchro-Tilt w/ Seat Slider (+ \$22) <b>S2</b> Limited Recline Advanced Synchro-Tilt (+ \$71) <b>W2</b> Weight-Activated Synchro-Tilt w/ Seat Slider (+ \$71)	<b>N</b> Armless <b>A</b> Height and Width Adjustable Arms (+ \$92) <b>F</b> Fixed Arms (+ \$71) <b>V</b> All-Adjustable Arms (+ \$141) <b>P</b> Fixed Polished Arms (+ \$189) <i>F, V, and P available on model HIWMMS only</i>	<b>H</b> Black Hard Caster <b>S</b> Black All-Surface Caster (+ \$44) <i>Available on model HIWMMS only</i>	<b>IM</b> Black	<b>IMS</b> Black Mesh	<b>NL</b> No Lumbar <b>BL</b> Black Adjustable Lumbar (+ \$33) <b>BY</b> Bullseye Adjustable Lumbar (+ \$33) <b>DW</b> Designer White Adjustable Lumbar (+ \$33) <b>MR</b> Ember Adjustable Lumbar (+ \$33) <b>IR</b> Iris Adjustable Lumbar (+ \$33) <b>KT</b> Krypton Adjustable Lumbar (+ \$33) <b>RE</b> Regatta Adjustable Lumbar (+ \$33) <b>TL</b> Titanium Adjustable Lumbar (+ \$33)	<b>SB</b> Standard Base <b>PA</b> Polished Aluminum (+ \$119) <i>Available on model HIWMMS only</i>	<b>T</b> Black	<b>N</b> No Headrest <b>HR</b> Headrest (+ \$87) <i>Headrest frame color will match chair frame selection. Headrest mesh color will match mesh back selection.</i>
HIWMMS	Y1	A	H	IM	IMS	BL	SB	T	N

SEATING



Icon Legend on page 19

# IGNITION® 2.0 ReActiv®

## HITLRA

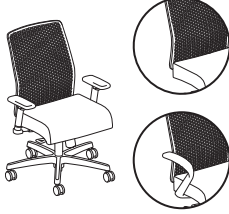

### TASK LOW-BACK

- ReActiv® Back**
- Pneumatic
- Swivel
- Synchro-tilt
- Tilt Tension
- Tilt Lock
- Optional Lumbar Support

### DIMENSIONS

Depth:	22	Width (with arms):	26
Height:	40½	Width (armless):	20
Seat Depth:	16	Cube:	10.8
Seat Width:	18½	COM:	1.0
Back Width:	17½	Weight Rating:	300 lbs.
Back Height:	19		

### FABRIC PRICE CODES

<b>1</b>	<b>\$696</b>	<b>8</b>	<b>\$846</b>
<b>2</b>	<b>\$723</b>	<b>9</b>	<b>\$865</b>
<b>3</b>	<b>\$749</b>	<b>10</b>	<b>\$884</b>
<b>4</b>	<b>\$768</b>	<b>11</b>	<b>\$904</b>
<b>5</b>	<b>\$787</b>	<b>12</b>	<b>\$923</b>
<b>6</b>	<b>\$807</b>	<b>L</b>	<b>\$912</b>
<b>7</b>	<b>\$826</b>		

❗ See page 368 for all other control specifications.

## HIWMRA

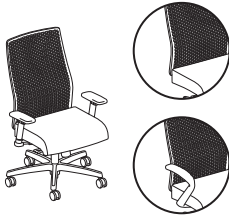

### TASK MID-BACK

- ReActiv® Back**
- Pneumatic
- Swivel
- Synchro-tilt
- Tilt Tension
- Tilt Lock
- Optional Lumbar Support

### DIMENSIONS

Depth:	24	Width (with arms):	27
Height:	43¾	Width (armless):	21
Seat Depth:	17¾	Cube:	10.8
Seat Width:	20	COM:	1.0
Back Width:	19	Weight Rating:	300 lbs.
Back Height:	23		

### FABRIC PRICE CODES

<b>1</b>	<b>\$759</b>	<b>8</b>	<b>\$909</b>
<b>2</b>	<b>\$786</b>	<b>9</b>	<b>\$928</b>
<b>3</b>	<b>\$812</b>	<b>10</b>	<b>\$947</b>
<b>4</b>	<b>\$831</b>	<b>11</b>	<b>\$967</b>
<b>5</b>	<b>\$850</b>	<b>12</b>	<b>\$986</b>
<b>6</b>	<b>\$870</b>	<b>L</b>	<b>\$975</b>
<b>7</b>	<b>\$889</b>		

❗ See page 368 for all other control specifications.

## HITSRA

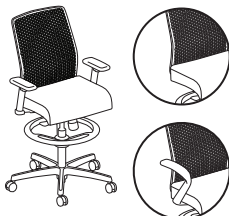

### TASK LOW-BACK STOOL

- ReActiv® Back**
- Pneumatic
- Swivel
- Synchro-tilt
- Tilt Tension
- Tilt Lock
- Optional Lumbar Support

### DIMENSIONS

Depth:	22	Width (with arms):	26
Height:	52½	Width (armless):	20
Seat Depth:	16	Cube:	10.8
Seat Width:	18½	COM:	1.0
Back Width:	17½	Weight Rating:	300 lbs.
Back Height:	19		

### FABRIC PRICE CODES

<b>1</b>	<b>\$827</b>	<b>8</b>	<b>\$977</b>
<b>2</b>	<b>\$854</b>	<b>9</b>	<b>\$996</b>
<b>3</b>	<b>\$880</b>	<b>10</b>	<b>\$1015</b>
<b>4</b>	<b>\$899</b>	<b>11</b>	<b>\$1035</b>
<b>5</b>	<b>\$918</b>	<b>12</b>	<b>\$1054</b>
<b>6</b>	<b>\$938</b>	<b>L</b>	<b>\$1043</b>
<b>7</b>	<b>\$957</b>		

❗ See page 368 for all other control specifications.

❗ Not available in Polished Aluminum Base.

**HON Recommendation: HIWMRA.Y2.A.H.\_\_\_CU\_\_BL.SB.T - List Price \$955**

## HOW TO SPECIFY

Select Model Number	Select Control Type	Select Arm Type	Select Caster	Select Back Color	Select Fabric	Select Lumbar	Select Base	Select Frame
<b>Y0</b> Synchro-Tilt	<b>N</b> Armless	<b>H</b> Black Hard Caster	<b>OS</b> Charcoal ReActiv®	See page 387	<b>NL</b> No Lumbar	<b>SB</b> Standard Base	<b>T</b> Black	
<b>Y1</b> Synchro-Tilt w/ Seat Slider (+ \$22)	<b>A</b> Height and Width Adjustable Arms (+ \$92)	<b>S</b> Black All-Surface Caster (+ \$44)	<b>DWR</b> Designer White ReActiv®		<b>BL</b> Black Adjustable Lumbar (+ \$33)	<b>PA</b> Polished Aluminum (+ \$119)	<b>DWX</b> Designer White (+ \$39 for HITLRA and HIWMRA; + \$60 for HITSRA)	
<b>Y2</b> Advanced Synchro-Tilt (+ \$71)	<b>V</b> All-Adjustable Arms (includes pivot) (+ \$141)	<b>TS</b> Titanium All-Surface Caster (+ \$44)	<b>TI</b> Titanium ReActiv®		<b>BY</b> Bullseye Adjustable Lumbar (+ \$33)		<b>TI</b> Titanium (+ \$39 for HITLRA and HIWMRA; + \$60 for HITSRA)	
<b>Y3</b> Synchro-Tilt with Independent Back Angle (+ \$114)	<b>F</b> Fixed Arms (+ \$71)	<b>R</b> Black Roll Control Caster (+ \$55)			<b>DW</b> Designer White Adjustable Lumbar (+ \$33)			
<b>S0</b> Limited Synchro-Tilt (for HITSRA only)	<b>P</b> Fixed Arms - Polished (+ \$189)				<b>MR</b> Ember Adjustable Lumbar (+ \$33)			
<b>S1</b> Limited Synchro-Tilt w/ Seat Slider (+ \$22 for HITSRA only)					<b>IR</b> Iris Adjustable Lumbar (+ \$33)			
<b>W2</b> Weight-Activated Synchro-Tilt w/ Seat Slider (+ \$71)					<b>KT</b> Krypton Adjustable Lumbar (+ \$33)			
					<b>RE</b> Regatta Adjustable Lumbar (+ \$33)			
					<b>TL</b> Titanium Adjustable Lumbar (+ \$33)			

*Specify S0 or S1 for HITSRA model ONLY*

**H I T L R A . Y 2 . A . H . O S . C U 1 0 . B L . S B . T**



# IGNITION® 2.0 ReActiv®

GSA SIN 33721



Icon Legend on page 19

## HITLRAKD

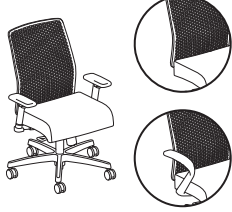

### TASK LOW-BACK

**ReActiv® Back**  
Pneumatic  
Swivel  
Synchro-tilt  
Tilt Tension  
Tilt Lock  
Optional Lumbar Support

### DIMENSIONS

Depth: 22  
Height: 40½  
Seat Depth: 16  
Seat Width: 18½  
Back Width: 17½  
Back Height: 25½  
Width (with arms): 26  
Width (armless): 20  
Cube: 5.6  
Weight Rating: 300 lbs.

### FABRIC PRICE CODES

1	\$656	8	\$806
2	\$683	9	\$825
3	\$709	10	\$844
4	\$728	11	\$864
5	\$747	12	\$883
6	\$767	L	\$872
7	\$786		

! See page 369 for all other control specifications.

## HIWMRAKD

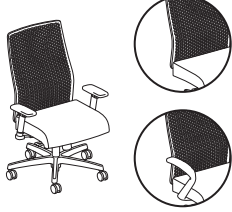

### TASK MID-BACK

**ReActiv® Back**  
Pneumatic  
Swivel  
Synchro-tilt  
Tilt Tension  
Tilt Lock  
Optional Lumbar Support

### DIMENSIONS

Depth: 24  
Height: 43¾  
Seat Depth: 17¾  
Seat Width: 20  
Back Width: 19  
Back Height: 29  
Width (with arms): 27  
Width (armless): 21  
Cube: 6.3  
Weight Rating: 300 lbs.

### FABRIC PRICE CODES

1	\$719	8	\$869
2	\$746	9	\$888
3	\$772	10	\$907
4	\$791	11	\$927
5	\$810	12	\$946
6	\$830	L	\$935
7	\$849		

! See page 369 for all other control specifications.

**HON Recommendation: HIWMRAKD.Y2.A.H.\_\_\_CU\_\_BL.SB.T - List Price \$915**

SEATING

## HOW TO SPECIFY

Select Model Number	Select Control Type	Select Arm Type	Select Caster	Select Back Color	Select Fabric	Select Lumbar	Select Base	Select Frame
	<b>Y1</b> Synchro-Tilt w/ Seat Slider (+ \$22) <b>Y2</b> Advanced Synchro-Tilt (+ \$71) <b>W2</b> Weight-Activated Synchro-Tilt w/ Seat Slider (+ \$71)	<b>N</b> Armless <b>A</b> Height and Width Adjustable Arms (+ \$92)	<b>H</b> Black Hard Caster	<b>OS</b> Charcoal ReActiv® <b>DWR</b> Designer White ReActiv® <b>TI</b> Titanium ReActiv®	See page 387	<b>NL</b> No Lumbar <b>BL</b> Black Adjustable Lumbar (+ \$33) <b>BY</b> Bullseye Adjustable Lumbar (+ \$33) <b>DW</b> Designer White Adjustable Lumbar (+ \$33) <b>MR</b> Ember Adjustable Lumbar (+ \$33) <b>IR</b> Iris Adjustable Lumbar (+ \$33) <b>KT</b> Krypton Adjustable Lumbar (+ \$33) <b>RE</b> Regatta Adjustable Lumbar (+ \$33) <b>TL</b> Titanium Adjustable Lumbar (+ \$33)	<b>SB</b> Standard Base	<b>T</b> Black <b>DWX</b> Designer White (+ \$39) <b>TI</b> Titanium (+ \$39)
H I W M R A K D .	Y 2 .	A .	H .	O S .	C U 1 0 .	B L .	S B .	T



Icon Legend on page 19

# IGNITION® 2.0 Upholstered

## HIWMU



### TASK MID-BACK

- Upholstered Back**
- Pneumatic
- Swivel
- Synchro-tilt
- Tilt Tension
- Tilt Lock

### DIMENSIONS

Depth:	24	Width (with arms):	27
Height:	43¾	Width (armless):	21
Seat Depth:	17¾	Cube:	10.8
Seat Width:	20	COM:	3.0
Back Width:	19	Weight Rating:	300 lbs.
Back Height:	23		

### FABRIC PRICE CODES

<b>1</b>	<b>\$724</b>	<b>7</b>	<b>\$1048</b>
<b>2</b>	<b>\$789</b>	<b>8</b>	<b>\$1096</b>
<b>3</b>	<b>\$854</b>	<b>9</b>	<b>\$1145</b>
<b>4</b>	<b>\$903</b>	<b>10</b>	<b>\$1193</b>
<b>5</b>	<b>\$951</b>	<b>11</b>	<b>\$1242</b>
<b>6</b>	<b>\$1000</b>	<b>12</b>	<b>\$1290</b>

! See page 368 for additional specifications and dimensions.

## HIWMUL

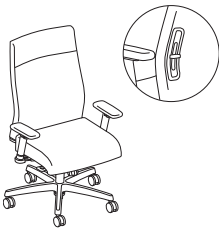

### TASK MID-BACK WITH ADJUSTABLE LUMBAR

- Upholstered Back**
- Pneumatic
- Swivel
- Synchro-tilt
- Tilt Tension
- Tilt Lock
- Adjustable Lumbar

### DIMENSIONS

Depth:	24½	Width (with arms):	27
Height:	43¾	Width (armless):	21
Seat Depth:	17¾	Cube:	10.8
Seat Width:	20	COM:	3.0
Back Width:	19	Weight Rating:	300 lbs.
Back Height:	23		

### FABRIC PRICE CODES

<b>1</b>	<b>\$765</b>	<b>7</b>	<b>\$1089</b>
<b>2</b>	<b>\$830</b>	<b>8</b>	<b>\$1137</b>
<b>3</b>	<b>\$895</b>	<b>9</b>	<b>\$1186</b>
<b>4</b>	<b>\$944</b>	<b>10</b>	<b>\$1234</b>
<b>5</b>	<b>\$992</b>	<b>11</b>	<b>\$1283</b>
<b>6</b>	<b>\$1041</b>	<b>12</b>	<b>\$1331</b>

! See page 368 for additional specifications and dimensions.

**HON Recommendation: HIWMU.Y2.A.H.CU\_\_NL.SB.T - List Price \$887**

## HOW TO SPECIFY

Select Model Number	Select Control Type	Select Arm Type	Select Caster	Select Fabric	Select Lumbar	Select Base	Select Frame
<p><b>Y0</b> Synchro-Tilt</p> <p><b>Y1</b> Synchro-Tilt w/ Seat Slider (+ \$22)</p> <p><b>Y2</b> Advanced Synchro-Tilt (+ \$71)</p> <p><b>Y3</b> Synchro-Tilt with Independent Back Angle (+ \$114)</p> <p><b>W2</b> Weight-Activated Synchro-Tilt w/ Seat Slider (+ \$71)</p>	<p><b>N</b> Armless</p> <p><b>A</b> Height and Width Adjustable Arms (+ \$92)</p> <p><b>V</b> All-Adjustable Arms (+ \$141)</p> <p><b>F</b> Fixed Arms (+ \$71)</p> <p><b>P</b> Fixed Arms - Polished (+ \$189)</p>	<p><b>H</b> Black Hard Caster</p> <p><b>S</b> Black All-Surface Caster (+ \$44)</p> <p><b>TS</b> Titanium All-Surface Caster (+ \$44)</p> <p><b>R</b> Black Roll Control Caster (+ \$55)</p>	<p>See page 387</p>	<p><b>NL</b> No Lumbar</p> <p><i>Specify for model HIWMU only</i></p> <p><b>AL</b> Adjustable Lumbar</p> <p><i>Specify for model HIWMUL only</i></p>	<p><b>SB</b> Standard Base</p> <p><b>PA</b> Polished Aluminum (+ \$119)</p>	<p><b>T</b> Black</p> <p><b>DWX</b> Designer White (+ \$39)</p> <p><b>TI</b> Titanium (+ \$39)</p>	
HIWMU	Y2	A	H	CU10	NL	SB	T

# IGNITION® 2.0 Upholstered

GSA SIN 33721



Icon Legend on page 19

## HIWMUKD



### TASK MID-BACK

**Upholstered Back**  
Pneumatic  
Swivel  
Synchro-tilt  
Tilt Tension  
Tilt Lock

### DIMENSIONS

Depth:	24	Back Height:	23
Height:	43¾	Width (with arms):	27
Seat Depth:	17¾	Width (armless):	21
Seat Width:	20	Cube:	6.3
Back Width:	19	Weight Rating:	300 lbs.

### FABRIC PRICE CODES

1	\$684	8	\$1056
2	\$749	9	\$1105
3	\$814	10	\$1153
4	\$863	11	\$1202
5	\$911	12	\$1250
6	\$960	L	\$1223
7	\$1008		

! See page 369 for additional specifications and dimensions.

## HIWMULKD

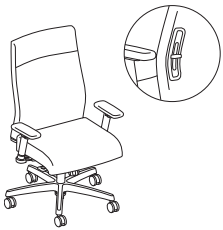

### TASK MID-BACK WITH ADJUSTABLE LUMBAR

**Upholstered Back**  
Pneumatic  
Swivel  
Synchro-tilt  
Tilt Tension  
Tilt Lock  
Adjustable Lumbar

### DIMENSIONS

Depth:	24½	Back Height:	23
Height:	43¾	Width (with arms):	27
Seat Depth:	17¾	Width (armless):	21
Seat Width:	20	Cube:	6.3
Back Width:	19	Weight Rating:	300 lbs.

### FABRIC PRICE CODES

1	\$725	8	\$1097
2	\$790	9	\$1146
3	\$855	10	\$1194
4	\$904	11	\$1243
5	\$952	12	\$1291
6	\$1001	L	\$1264
7	\$1049		

! See page 369 for additional specifications and dimensions.

**HON Recommendation: HIWMUKD.Y2.A.H.CU\_\_NL.SB.T - List Price \$847**

## HOW TO SPECIFY

Select Model Number	Select Control Type	Select Arm Type	Select Caster	Select Fabric	Select Lumbar	Select Base	Select Frame
Y1 Synchro-Tilt w/ Seat Slider (+ \$22) Y2 Advanced Synchro-Tilt (+ \$71) W2 Weight-Activated Synchro-Tilt w/ Seat Slider (+ \$71)	N Armless A Height and Width Adjustable Arms (+ \$92)	H Black Hard Caster	See page 387	NL No Lumbar <i>Specify for model HIWMUKD only</i> AL Adjustable Lumbar <i>Specify for model HIWMULKD only</i>	SB Standard Base	T Black DWX Designer White (+ \$39) TI Titanium (+ \$39)	
HIWMUKD	Y2	A	H	CU10	NL	SB	T



Icon Legend on page 19

# IGNITION® 2.0 Accessories

## HI2ATA

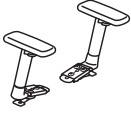

### ADJUSTABLE ARMS

Height and Width  
Functions: **S**  
(Function Key on pages 252-253)

### DIMENSIONS

Adjustable Arms Width: 17-19½  
Height from Seat: 8-11  
Ship Weight: 8  
Cube: 1.0

### LIST PRICE

\$163

! Can only be used with standard models. Contact Customer Support for Big & Tall arm packs.

## HI2AAA

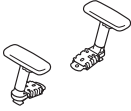

### ALL-ADJUSTABLE ARMS

Height, Width, Depth and Pivot

### DIMENSIONS

Adjustable Arms Width: 17-20  
Height from Seat: 7-11  
Ship Weight: 8  
Cube: 1.0

### LIST PRICE

\$219

! Can only be used with standard models. Contact Customer Support for Big & Tall arm packs.

## HI2FHA



### FIXED HEIGHT ARMS

### DIMENSIONS

Arm Width: 20  
Height from Seat: 9½  
Ship Weight: 7  
Cube: 1.0

### LIST PRICE

\$151

! Can only be used with standard models. Contact Customer Support for Big & Tall arm packs.

## HIPAA

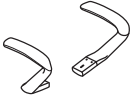

### POLISHED ALUMINUM ARMS

Fixed Height

### DIMENSIONS

Arm Width: 20  
Height from Seat: 9½  
Ship Weight: 10  
Cube: 1.0

### LIST PRICE

\$249

! Can only be used with standard models. Contact Customer Support for Big & Tall arm packs.

## HILMBR

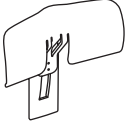

### LUMBAR SUPPORT

### DIMENSIONS

Ship Weight: 8  
Cube: 1.0

### LIST PRICE

\$45

## HSCASTER

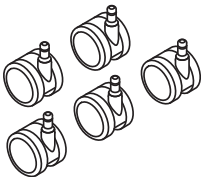

### SET OF 5 ALL-SURFACE CASTERS

### DIMENSIONS

Size: 60mm  
Ship Weight: 2  
Cube: 0.1

### LIST PRICE

\$75

! Available in Black finish only, no specification needed.

OPEN MARKET

## HOW TO SPECIFY

<b>Select Model Number</b>	<b>Select Frame</b>
	<b>T</b> Black <b>DWX</b> Designer White <b>TI</b> Titanium Not specified for model HIPAA
HI2ATA.	T

## HOW TO SPECIFY

<b>Select Model Number</b>	<b>Select Lumbar Color</b>
	<b>BL</b> Black <b>MR</b> Ember <b>RE</b> Regatta <b>BY</b> Bullseye <b>IR</b> Iris <b>TL</b> Titanium <b>DW</b> Designer White <b>KT</b> Krypton
HILMBR.	BL

SEATING

# IGNITION® 2.0 Accessories

GSA SIN 33721



Icon Legend on page 19

## HI2HR

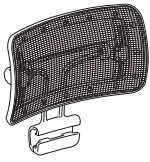

### MESH HEADREST

### DIMENSIONS

Mesh Width:	12
Mesh Height:	6
Ship Weight:	3
Cube:	1.0

### LIST PRICE

**\$180**

NOTES: Headrest is compatible with Ignition® mid-back mesh back models HIWMM, HIWMMKD, HIWMMS, and HIWMMSKD purchased after July 2021.

## HI2BTHR

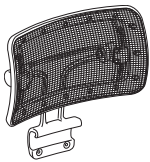

### BIG & TALL MESH HEADREST

### DIMENSIONS

Mesh Width:	12
Mesh Height:	6
Ship Weight:	3
Cube:	1.0

### LIST PRICE

**\$189**

NOTES: Headrest is compatible with Ignition® mid-back mesh back Big & Tall model HIWMBT.

## HOW TO SPECIFY

<b>Select Model Number</b>  HI2HR.	<b>Select Mesh</b> IM Black IB Breeze IK Brownstone IC Charcoal IF Fog IR Regatta IT Titanium	<b>Select Frame</b> T Black DWX Designer White (+ \$39) TI Titanium (+ \$39)
--	--	---

## HOW TO SPECIFY

<b>Select Model Number</b>  HI2BTHR.	<b>Select Mesh</b> IM Black IC Charcoal IF Fog	<b>Select Frame</b> T Black
--	---	--------------------------------

SEATING

# IGNITION<sup>®</sup>

## Multi-Purpose Chair Options

ARM STYLE	CODE	DESCRIPTION	PRICE
	<b>N</b>	Armless	<b>+\$0</b>
	<b>F</b>	Fixed Arms	<b>+\$33</b>



CASTERS/ GLIDE	CODE	DESCRIPTION	PRICE
	<b>H</b>	Black Hard Caster	<b>+\$0</b>
	<b>S</b>	Black All-Surface Caster	<b>+\$33</b>
	<b>E</b>	Glide	<b>+\$0</b>

*Castors only available on HIGS6*



MESH STYLE	CODE	DESCRIPTION	PRICE
	<b>IM</b>	Black	<b>+\$0</b>
	<b>IB</b>	Breeze	<b>+\$0</b>
	<b>IK</b>	Brownstone	<b>+\$0</b>
	<b>IC</b>	Charcoal	<b>+\$0</b>
	<b>IF</b>	Fog	<b>+\$0</b>
	<b>IR</b>	Regatta	<b>+\$0</b>
	<b>IT</b>	Titanium	<b>+\$0</b>
	<b>U</b>	Upholstered	<b>+\$0</b>

FRAME	CODE	DESCRIPTION	PRICE
	<b>T</b>	Black	<b>+\$0</b>
	<b>CBK</b>	Charblack	<b>+\$0</b>
	<b>PK7</b>	Textured Designer White	<b>+\$39</b>
	<b>PLAT</b>	Textured Platinum Metallic	<b>+\$0</b>
	<b>PR8T</b>	Textured Silver	<b>+\$39</b>

*By selecting PR8T, unit will be produced with titanium colored arm caps, back frame, & glides*

*By selecting PK7, unit will be produced with Designer White colored arm caps, back frame, & glides*

*By selecting PLAT, unit will be produced with black arm caps, black back frame, black glides, and platinum colored legs*

*Refer to Configurator on HON.com for visualization*

# IGNITION® Multi-Purpose

GSA SIN 33721



Icon Legend on page 19

## HIGS6

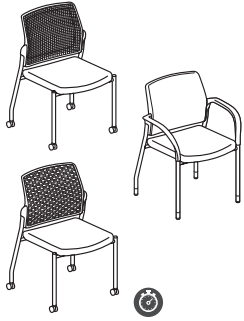

### MULTI-PURPOSE

Four Legs

### DIMENSIONS

Depth:	21 <sup>3</sup> / <sub>4</sub>	Seat to Floor Height:	18 <sup>3</sup> / <sub>8</sub>
Width:	25	Usable Seat Depth:	17 <sup>3</sup> / <sub>8</sub>
Height:	33 <sup>1</sup> / <sub>2</sub>	Ship Weight:	28
Seat Depth:	17 <sup>3</sup> / <sub>8</sub>	Cube:	15.1
Seat Width:	18 <sup>3</sup> / <sub>4</sub>	COM (upholstered back):	1.5
Back Width:	18 <sup>1</sup> / <sub>4</sub>	COM (mesh/ReActiv® back):	1.0
Back Height:	18 <sup>1</sup> / <sub>8</sub>	Weight Rating:	300 lbs.
Arm Width:	21 <sup>1</sup> / <sub>2</sub>		

### FABRIC PRICE CODES

<b>1</b>	<b>\$576</b>	<b>8</b>	<b>\$800</b>
<b>2</b>	<b>\$616</b>	<b>9</b>	<b>\$829</b>
<b>3</b>	<b>\$655</b>	<b>10</b>	<b>\$858</b>
<b>4</b>	<b>\$684</b>	<b>11</b>	<b>\$887</b>
<b>5</b>	<b>\$712</b>	<b>12</b>	<b>\$916</b>
<b>6</b>	<b>\$741</b>	<b>L</b>	<b>\$900</b>
<b>7</b>	<b>\$771</b>		

NOTES: Stacks 4-high.

! ReActiv® back option not available on FC models.

## HISB6

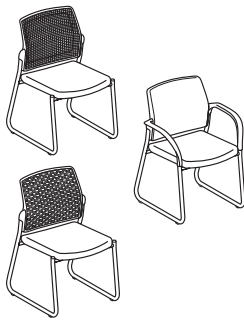

### MULTI-PURPOSE

Sled Base

### DIMENSIONS

Depth:	23 <sup>3</sup> / <sub>4</sub>	Seat to Floor Height:	18 <sup>3</sup> / <sub>8</sub>
Width:	25	Usable Seat Depth:	17 <sup>3</sup> / <sub>8</sub>
Height:	33 <sup>1</sup> / <sub>2</sub>	Ship Weight:	30
Seat Depth:	17 <sup>3</sup> / <sub>8</sub>	Cube:	15.1
Seat Width:	18 <sup>3</sup> / <sub>4</sub>	COM (upholstered back):	1.5
Back Width:	18 <sup>1</sup> / <sub>4</sub>	COM (mesh/ReActiv® back):	1.0
Back Height:	18 <sup>1</sup> / <sub>8</sub>	Weight Rating:	300 lbs.
Arm Width:	21 <sup>1</sup> / <sub>2</sub>		

### FABRIC PRICE CODES

<b>1</b>	<b>\$576</b>	<b>8</b>	<b>\$800</b>
<b>2</b>	<b>\$616</b>	<b>9</b>	<b>\$829</b>
<b>3</b>	<b>\$655</b>	<b>10</b>	<b>\$858</b>
<b>4</b>	<b>\$684</b>	<b>11</b>	<b>\$887</b>
<b>5</b>	<b>\$712</b>	<b>12</b>	<b>\$916</b>
<b>6</b>	<b>\$741</b>	<b>L</b>	<b>\$900</b>
<b>7</b>	<b>\$771</b>		

! ReActiv® back option not available on FC models.

## HICS7



### CAFÉ-HEIGHT STOOL

Four Legs

### DIMENSIONS

Depth:	23	Seat to Floor Height:	31
Width:	25	Usable Seat Depth:	17 <sup>3</sup> / <sub>8</sub>
Height:	46 <sup>1</sup> / <sub>2</sub>	Ship Weight:	37
Seat Depth:	17 <sup>3</sup> / <sub>8</sub>	Cube:	21.8
Seat Width:	18 <sup>3</sup> / <sub>4</sub>	COM (upholstered back):	1.5
Back Width:	18 <sup>1</sup> / <sub>4</sub>	COM (mesh/ReActiv® back):	1.0
Back Height:	18 <sup>1</sup> / <sub>8</sub>	Weight Rating:	300 lbs.
Arm Width:	21 <sup>1</sup> / <sub>2</sub>		

### FABRIC PRICE CODES

<b>1</b>	<b>\$727</b>	<b>8</b>	<b>\$951</b>
<b>2</b>	<b>\$767</b>	<b>9</b>	<b>\$980</b>
<b>3</b>	<b>\$806</b>	<b>10</b>	<b>\$1009</b>
<b>4</b>	<b>\$835</b>	<b>11</b>	<b>\$1038</b>
<b>5</b>	<b>\$863</b>	<b>12</b>	<b>\$1067</b>
<b>6</b>	<b>\$892</b>	<b>L</b>	<b>\$1051</b>
<b>7</b>	<b>\$922</b>		

! ReActiv® back option not available on FC models.

HON Recommendation: HIGS6.F.H.IM.CU\_\_T - List Price \$609

## HOW TO SPECIFY

Select Model Number	Select Arm Type	Select Glide	Select Back Type	Select Fabric	Select Frame
F Fixed Arms (+ \$33) N Armless	E Glide H Black Hard Caster S Black All-Surface Caster (+ \$33) <i>Casters available on HIGS6 only</i>	IM Black IB Breeze IK Brownstone IC Charcoal OS Charcoal ReActiv® (+ \$33) DWR Designer White ReActiv® (+ \$33)	IF Fog IR Regatta IT Titanium TI Titanium ReActiv® (+ \$33) U Upholstered	See page 387	T Black CBK Charblack PK7 Textured Designer White (+ \$39) PLAT Textured Platinum Metallic PR8T Textured Silver (+ \$39)
HIGS6	F	H	IM	CU10	T



Icon Legend on page 19

# Multi-Fabric Multi-Purpose

## HIGS6DF

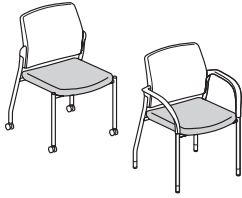

### MULTI-PURPOSE

**Multi-Fabric**  
Four Legs

### DIMENSIONS

Depth:	21 <sup>3</sup> / <sub>4</sub>	Arm Width:	21 <sup>1</sup> / <sub>2</sub>
Width:	25	Seat to Floor Height:	18 <sup>3</sup> / <sub>8</sub>
Height:	33 <sup>1</sup> / <sub>2</sub>	Usable Seat Depth:	17 <sup>3</sup> / <sub>8</sub>
Seat Depth:	17 <sup>3</sup> / <sub>8</sub>	Ship Weight (upholstered back):	28
Seat Width:	18 <sup>3</sup> / <sub>4</sub>	Cube (upholstered back):	15.1
Back Width:	18 <sup>1</sup> / <sub>4</sub>	COM (back):	0.75
Back Height:	18 <sup>1</sup> / <sub>8</sub>	COM (seat):	0.75
		Weight Rating:	300 lbs.

### FABRIC PRICE CODES

<b>1</b>	<b>\$654</b>	
<i>Add to Base Price Above</i>		
	<b>Back</b>	<b>Seat</b>
<b>2</b>	<b>\$20</b>	<b>\$20</b>
<b>3</b>	<b>\$40</b>	<b>\$40</b>
<b>4</b>	<b>\$55</b>	<b>\$55</b>
<b>5</b>	<b>\$68</b>	<b>\$68</b>
<b>6</b>	<b>\$84</b>	<b>\$84</b>
<b>7</b>	<b>\$98</b>	<b>\$98</b>
<b>8</b>	<b>\$113</b>	<b>\$113</b>
<b>9</b>	<b>\$127</b>	<b>\$127</b>
<b>10</b>	<b>\$142</b>	<b>\$142</b>
<b>11</b>	<b>\$156</b>	<b>\$156</b>
<b>12</b>	<b>\$171</b>	<b>\$171</b>
<b>L</b>	<b>\$162</b>	<b>\$162</b>

NOTES: Stacks 4-high.

## HISB6DF

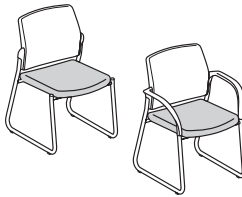

### MULTI-PURPOSE

**Multi-Fabric**  
Sled Base

### DIMENSIONS

Depth:	23 <sup>3</sup> / <sub>4</sub>	Arm Width:	21 <sup>1</sup> / <sub>2</sub>
Width:	25	Seat to Floor Height:	18 <sup>3</sup> / <sub>8</sub>
Height:	33 <sup>1</sup> / <sub>2</sub>	Usable Seat Depth:	17 <sup>3</sup> / <sub>8</sub>
Seat Depth:	17 <sup>3</sup> / <sub>8</sub>	Ship Weight (upholstered back):	30
Seat Width:	18 <sup>3</sup> / <sub>4</sub>	Cube (upholstered back):	15.1
Back Width:	18 <sup>1</sup> / <sub>4</sub>	COM (back):	0.75
Back Height:	18 <sup>1</sup> / <sub>8</sub>	COM (seat):	0.75
		Weight Rating:	300 lbs.

### FABRIC PRICE CODES

<b>1</b>	<b>\$651</b>	
<i>Add to Base Price Above</i>		
	<b>Back</b>	<b>Seat</b>
<b>2</b>	<b>\$20</b>	<b>\$20</b>
<b>3</b>	<b>\$40</b>	<b>\$40</b>
<b>4</b>	<b>\$55</b>	<b>\$55</b>
<b>5</b>	<b>\$68</b>	<b>\$68</b>
<b>6</b>	<b>\$84</b>	<b>\$84</b>
<b>7</b>	<b>\$98</b>	<b>\$98</b>
<b>8</b>	<b>\$113</b>	<b>\$113</b>
<b>9</b>	<b>\$127</b>	<b>\$127</b>
<b>10</b>	<b>\$142</b>	<b>\$142</b>
<b>11</b>	<b>\$156</b>	<b>\$156</b>
<b>12</b>	<b>\$171</b>	<b>\$171</b>
<b>L</b>	<b>\$162</b>	<b>\$162</b>

**HON Recommendation: HIGS6DF.F.S.U.CU\_\_UR\_\_T - List Price \$720**

## HOW TO SPECIFY

Select Model Number	Select Arm Type	Select Glide	Select Back Type	Select Back Fabric	Select Seat Fabric	Select Frame
	<b>F</b> Fixed Arms (+ \$33) <b>N</b> Armless	<b>E</b> Glide <b>H</b> Black Hard Caster <b>S</b> Black All-Surface Caster (+ \$33) <i>Casters available on HIGS6DF only</i>	<b>U</b> Upholstered	See page 387	See page 387	<b>T</b> Black <b>CBK</b> Charblack <b>PK7</b> Textured Designer White (+ \$39) <b>PLAT</b> Textured Platinum Metallic <b>PR8T</b> Textured Silver (+ \$39)
HIGS6DF	F	H	U	CU10	UR10	T



# IGNITION® Multi-Fabric Stools

GSA SIN 33721



Icon Legend on page 19

## HICS7DF

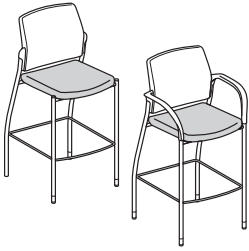

### CAFÉ-HEIGHT STOOL

**Multi-Fabric**  
Four Legs

### DIMENSIONS

Depth:	23	Arm Width:	21½
Width:	25	Seat to Floor Height:	31
Height:	46½	Usable Seat Depth:	17¾
Seat Depth:	17¾	Ship Weight (upholstered back):	37
Seat Width:	18¾	Cube (upholstered back):	21.8
Back Width:	18¼	COM (back):	0.75
Back Height:	18½	COM (seat):	0.75
		Weight Rating:	300 lbs.

### FABRIC PRICE CODES

**1 \$802**

*Add to Base Price Above*

	Back	Seat
<b>2</b>	<b>\$20</b>	<b>\$20</b>
<b>3</b>	<b>\$40</b>	<b>\$40</b>
<b>4</b>	<b>\$55</b>	<b>\$55</b>
<b>5</b>	<b>\$68</b>	<b>\$68</b>
<b>6</b>	<b>\$84</b>	<b>\$84</b>
<b>7</b>	<b>\$98</b>	<b>\$98</b>
<b>8</b>	<b>\$113</b>	<b>\$113</b>
<b>9</b>	<b>\$127</b>	<b>\$127</b>
<b>10</b>	<b>\$142</b>	<b>\$142</b>
<b>11</b>	<b>\$156</b>	<b>\$156</b>
<b>12</b>	<b>\$171</b>	<b>\$171</b>
<b>L</b>	<b>\$162</b>	<b>\$162</b>

**HON Recommendation: HICS7DF.F.E.U.CU\_\_UR\_\_T - List Price \$835**

SEATING

## HOW TO SPECIFY

Select Model Number	Select Arm Type	Select Glide	Select Back Type	Select Back Fabric	Select Seat Fabric	Select Frame
<b>F</b> Fixed Arms (+ \$33) <b>N</b> Armless	<b>E</b> Glide	<b>U</b> Upholstered	See page 387	See page 387	See page 387	<b>T</b> Black <b>CBK</b> Charblack <b>PK7</b> Textured Designer White (+ \$39) <b>PLAT</b> Textured Platinum Metallic <b>PR8T</b> Textured Silver (+ \$39)
HICS7DF	F	E	U	CU10	UR10	T



## HIGCL



### GUEST CHAIR

Fixed Arms  
Glides

### DIMENSIONS

Depth:	24	Arm Width:	19¼
Width:	23	Seat to Floor Height:	18½
Height:	35½	Usable Seat Depth:	16¾
Seat Depth:	18	Ship Weight:	42
Seat Width:	19½	Cube:	15.2
Back Width:	19½	COM:	2.0
Back Height:	20	Weight Rating:	300 lbs.

### FABRIC PRICE CODES

<b>1</b>	<b>\$633</b>	<b>8</b>	<b>\$931</b>
<b>2</b>	<b>\$686</b>	<b>9</b>	<b>\$970</b>
<b>3</b>	<b>\$738</b>	<b>10</b>	<b>\$1008</b>
<b>4</b>	<b>\$776</b>	<b>11</b>	<b>\$1048</b>
<b>5</b>	<b>\$815</b>	<b>12</b>	<b>\$1086</b>
<b>6</b>	<b>\$854</b>	<b>L</b>	<b>—</b>
<b>7</b>	<b>\$892</b>		

HON Recommendation: HIGCL.E.U.CU\_\_T - List Price \$633

## HOW TO SPECIFY

<b>Select Model Number</b>  HIGCL	<b>Select Glide</b> E Glide E	<b>Select Back Type</b> U Upholstered U	<b>Select Fabric</b> See page 387 CU10	<b>Select Frame</b> T Black CBK Charblack PLAT Textured Platinum Metallic T
---	-------------------------------------	---	--	---

## HIB50

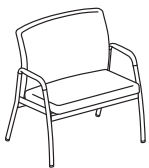

### BARIATRIC LOUNGE

Fixed Arms  
Glides

### DIMENSIONS

Depth:	25½	Arm Width:	30
Width:	33¾	Seat to Floor Height:	20
Height:	35¾	Usable Seat Depth:	18¾
Seat Depth:	18¾	Ship Weight:	70
Seat Width:	29¾	Cube:	27.5
Back Width:	29	COM:	2.5
Back Height:	19¼	Weight Rating:	500 lbs.



### FABRIC PRICE CODES



<b>1</b>	<b>\$1837</b>	<b>8</b>	<b>\$2209</b>
<b>2</b>	<b>\$1902</b>	<b>9</b>	<b>\$2258</b>
<b>3</b>	<b>\$1967</b>	<b>10</b>	<b>\$2306</b>
<b>4</b>	<b>\$2016</b>	<b>11</b>	<b>\$2355</b>
<b>5</b>	<b>\$2064</b>	<b>12</b>	<b>\$2403</b>
<b>6</b>	<b>\$2113</b>	<b>L</b>	<b>—</b>
<b>7</b>	<b>\$2161</b>		



## HOW TO SPECIFY

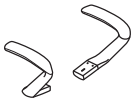

<b>Select Model Number</b>  HIB50	<b>Select Arm Type</b> F Fixed Arms F	<b>Select Glide</b> E Glide E	<b>Select Back Type</b> U Upholstered U	<b>Select Fabric</b> See page 387 CU10	<b>Select Frame</b> T Black CBK Charblack PLAT Textured Platinum Metallic T
---	---	-------------------------------------	---	--	---

# IGNITION<sup>®</sup> Task Chair Options

ARM STYLE	CODE	DESCRIPTION	PRICE
	<b>N</b>	Armless	<b>+\$0</b>
	<b>F</b>	Fixed Arms	<b>+\$71</b>
	<b>A</b>	Height and Width Adjustable Arms	<b>+\$92</b>
	<b>V</b>	All-Adjustable Arms (includes Pivot)	<b>+\$141</b>
	<b>P</b>	Fixed Polished Aluminum Arms	<b>+\$189</b>

CASTERS	CODE	DESCRIPTION	PRICE
	<b>H</b>	Black Hard Caster	<b>+\$0</b>
	<b>S</b>	Black All-Surface Caster	<b>+\$44</b>

BACK STYLE	CODE	DESCRIPTION	PRICE
	<b>U</b>	Upholstered	<b>+\$0</b>
	<b>M</b>	Mesh	<b>+\$0</b>

BASE	CODE	DESCRIPTION	PRICE
	<b>SB</b>	Standard Base	<b>+\$0</b>
	<b>PA</b>	Polished Aluminum	<b>+\$119</b>

## HON BRANDED FABRICS

GRADE 1	GRADE 2	GRADE 3	GRADE 4	GRADE L
Apex	Appoint Seating	Bradbury	Constance with Supreen™	Denver Leather*
Centurion	Blume	Getaway	Livi with Supreen™	
Compass**	Clyde	Moxie	Lugano with Supreen™	
Contourett	Dotty	Notion	Oxford with Supreen™	
Dapper	Kai	Parker**		
Ensemble	Rush	Purl		
Hamilton	Spin Seating	Quill		
Inertia	Wavelength	Saxony		
Noble Seating	Whisper Vinyl			
Optic**				
Pebble				
Vibe				

**For a complete list of fabrics, including partnership fabrics, go to [hon.com/fabricsandfinishes](https://hon.com/fabricsandfinishes).**

Reference Fabric Color Combinations on pages 20-25 for color codes and legend on page 21 for lead times. For additional HON to Supply COM fabric grade pricing, go to [honready.hon.com](https://honready.hon.com) and click on the HON to Supply COM link.

\*Denver Leather (SS) may not be available on every model within a specific series, please refer to the model's page for details.

\*\*Not available as a back upholstery on Ignition<sup>®</sup> 2.0.

 For Fire Code model, availability, and ordering method, refer to page 258. Available on select models, contact HON Customer Support for availability.

# IGNITION®



Icon Legend on page 19

## HITL1



### TASK LOW-BACK

Pneumatic  
Back Height Adjustment  
Swivel  
Tilt  
Tilt Tension  
Tilt Lock  
Functions: **A, B, E, J, K, L**  
(Function Key on pages 252-253)

### DIMENSIONS

Upholstered Back  
Width: 17½  
Upholstered Back  
Height: 18¾-21¾  
Mesh Back Width: 17½  
Mesh Back Height: 20¾-23¼  
Depth: 36  
Width: 27½  
Height: 41  
Seat Depth: 17  
Seat Width: 19

Adjustable Arms Width: 17-19½  
Fixed Arms Width: 20  
Seat to Floor Height: 17-21½  
Usable Seat Depth: 15¾  
Ship Weight (upholstered back): 50  
Ship Weight (mesh back): 45  
Cube (upholstered back): 10.8  
Cube (mesh back): 10.8  
COM (upholstered back): 2.0  
COM (mesh back): 1.0  
Weight Rating: 300 lbs.

### FABRIC PRICE CODES

1	\$833	8	\$1131
2	\$886	9	\$1170
3	\$938	10	\$1208
4	\$976	11	\$1248
5	\$1015	12	\$1286
6	\$1054	L	—
7	\$1092		

NOTES: See page 392 for arm packs.

## HITL2



### TASK LOW-BACK

Pneumatic  
Back Height Adjustment  
Synchro-tilt  
Tilt Tension  
Tilt Lock  
Seat Glide  
Functions: **A, B, D, E, J, A-D, L**  
(Function Key on pages 252-253)

### DIMENSIONS

Upholstered Back  
Width: 17½  
Upholstered Back  
Height: 19½-22½  
Mesh Back Width: 17½  
Mesh Back Height: 20¾-23¼  
Depth: 38½  
Width: 27½  
Height: 43  
Seat Depth: 16-18  
Seat Width: 19

Adjustable Arms Width: 17-19½  
Fixed Arms Width: 20  
Seat to Floor Height: 17-21½  
Usable Seat Depth: 15½-17½  
Ship Weight (upholstered back): 54  
Ship Weight (mesh back): 49  
Cube (upholstered back): 10.8  
Cube (mesh back): 10.8  
COM (upholstered back): 2.0  
COM (mesh back): 1.0  
Weight Rating: 300 lbs.

### FABRIC PRICE CODES

1	\$939	8	\$1237
2	\$992	9	\$1276
3	\$1044	10	\$1314
4	\$1082	11	\$1354
5	\$1121	12	\$1392
6	\$1160	L	—
7	\$1198		

NOTES: See page 392 for arm packs.

## HITL3



### TASK LOW-BACK

Pneumatic  
Back Height Adjustment  
Synchro-tilt  
Back Angle Adjustment  
Tilt Lock  
Seat Glide  
Functions: **A, B, D, E, A-D, A-E, L**  
(Function Key on pages 252-253)

### DIMENSIONS

Upholstered Back  
Width: 17½  
Upholstered Back  
Height: 20¾-23¾  
Mesh Back Width: 17½  
Mesh Back Height: 20¾-23¼  
Depth: 39  
Width: 27  
Height: 44  
Seat Depth: 16-18  
Seat Width: 19

Adjustable Arms Width: 17-19½  
Fixed Arms Width: 20  
Seat to Floor Height: 17-21½  
Usable Seat Depth: 14½-16½  
Ship Weight (upholstered back): 58  
Ship Weight (mesh back): 53  
Cube (upholstered back): 10.8  
Cube (mesh back): 10.8  
COM (upholstered back): 2.0  
COM (mesh back): 1.0  
Weight Rating: 300 lbs.

### FABRIC PRICE CODES

1	\$1001	8	\$1299
2	\$1054	9	\$1338
3	\$1106	10	\$1376
4	\$1144	11	\$1416
5	\$1183	12	\$1454
6	\$1222	L	—
7	\$1260		

NOTES: See page 392 for arm packs.

**HON Recommendation: HITL1.A.H.M.CU\_\_T.SB - List Price \$925**

SEATING

## HOW TO SPECIFY

<b>Select Model Number</b> HITL1	<b>Select Arm Type</b> N Armless F Fixed Arms - Black (+ \$71) A Height and Width Adjustable Arms (+ \$92) V All-Adjustable Arms (includes Pivot) (+ \$141) P Fixed Arms - Polished (+ \$189)	<b>Select Caster/Glide</b> H Black Hard Caster S Black All-Surface Caster (+ \$44)	<b>Select Back Type</b> U Upholstered M Mesh	<b>Select Fabric</b> See page 387	<b>Select Frame</b> T Black	<b>Select Base</b> SB Standard Base PA Polished Aluminum (+ \$119)
HITL1	A	H	M	CU10	T	SB



**HIWM1**



**MID-BACK**

Pneumatic  
Back Height Adjustment  
Swivel  
Tilt  
Tilt Tension  
Tilt Lock  
Functions: **A, B, E, J, K, L**  
(Function Key on pages 252-253)

**DIMENSIONS**

Upholstered Back Width:	18½	Seat to Floor Height:	17-21½
Upholstered Back Height:	21-24	Usable Seat Depth:	17½
Mesh Back Width:	19	Ship Weight (upholstered back):	54
Mesh Back Height:	21½-24	Ship Weight (mesh back):	48
Depth:	35½	Cube (upholstered back):	10.8
Width:	27	Cube (mesh back):	10.8
Height:	44	COM (upholstered back):	2.0
Seat Depth:	18	COM (mesh back):	1.0
Seat Width:	20	Weight Rating:	300 lbs.
Adjustable Arms Width:	18-20½		
Fixed Arms Width:	20		

**FABRIC PRICE CODES**

<b>1</b>	<b>\$914</b>	<b>8</b>	<b>\$1212</b>
<b>2</b>	<b>\$967</b>	<b>9</b>	<b>\$1251</b>
<b>3</b>	<b>\$1019</b>	<b>10</b>	<b>\$1289</b>
<b>4</b>	<b>\$1057</b>	<b>11</b>	<b>\$1329</b>
<b>5</b>	<b>\$1096</b>	<b>12</b>	<b>\$1367</b>
<b>6</b>	<b>\$1135</b>	<b>L</b>	<b>\$1238</b>
<b>7</b>	<b>\$1173</b>		

NOTES: See page 392 for arm packs.

**HIWM2**



**MID-BACK**

Pneumatic  
Back Height Adjustment  
Synchro-tilt  
Tilt Tension  
Tilt Lock  
Seat Glide  
Functions:  
**A, B, D, E, J, A-D, L**  
(Function Key on pages 252-253)

**DIMENSIONS**

Upholstered Back Width:	18½	Seat to Floor Height:	17¼-21¾
Upholstered Back Height:	21-24	Usable Seat Depth:	16¼-18¼
Mesh Back Width:	19	Ship Weight (upholstered back):	58
Mesh Back Height:	21½-24	Ship Weight (mesh back):	52
Depth:	38	Cube (upholstered back):	10.8
Width:	27	Cube (mesh back):	10.8
Height:	46½	COM (upholstered back):	2.0
Seat Depth:	17-19	COM (mesh back):	1.0
Seat Width:	20	Weight Rating:	300 lbs.
Adjustable Arms Width:	18-20½		
Fixed Arms Width:	20		

**FABRIC PRICE CODES**

<b>1</b>	<b>\$1012</b>	<b>8</b>	<b>\$1310</b>
<b>2</b>	<b>\$1065</b>	<b>9</b>	<b>\$1349</b>
<b>3</b>	<b>\$1117</b>	<b>10</b>	<b>\$1387</b>
<b>4</b>	<b>\$1155</b>	<b>11</b>	<b>\$1427</b>
<b>5</b>	<b>\$1194</b>	<b>12</b>	<b>\$1465</b>
<b>6</b>	<b>\$1233</b>	<b>L</b>	<b>\$1336</b>
<b>7</b>	<b>\$1271</b>		

NOTES: See page 392 for arm packs.

**HIWM3**



**MID-BACK**

Pneumatic  
Back Height Adjustment  
Synchro-tilt  
Back Angle Adjustment  
Tilt Tension  
Tilt Lock  
Seat Glide  
Functions:  
**A, B, D, E, A-D, A-E, L**  
(Function Key on pages 252-253)

**DIMENSIONS**

Upholstered Back Width:	18½	Seat to Floor Height:	17¼-21¾
Upholstered Back Height:	21-24	Usable Seat Depth:	15¼-17¼
Mesh Back Width:	19	Ship Weight (upholstered back):	63
Mesh Back Height:	21½-24	Ship Weight (mesh back):	58
Depth:	39	Cube (upholstered back):	10.8
Width:	27	Cube (mesh back):	10.8
Height:	44	COM (upholstered back):	2.0
Seat Depth:	17-19	COM (mesh back):	1.0
Seat Width:	20	Weight Rating:	300 lbs.
Adjustable Arms Width:	18-20½		
Fixed Arms Width:	20		

**FABRIC PRICE CODES**

<b>1</b>	<b>\$1079</b>	<b>8</b>	<b>\$1377</b>
<b>2</b>	<b>\$1132</b>	<b>9</b>	<b>\$1416</b>
<b>3</b>	<b>\$1184</b>	<b>10</b>	<b>\$1454</b>
<b>4</b>	<b>\$1222</b>	<b>11</b>	<b>\$1494</b>
<b>5</b>	<b>\$1261</b>	<b>12</b>	<b>\$1532</b>
<b>6</b>	<b>\$1300</b>	<b>L</b>	<b>\$1403</b>
<b>7</b>	<b>\$1338</b>		

NOTES: See page 392 for arm packs.

**HON Recommendation: HIWM2.A.H.M.CU\_\_T.SB - List Price \$1104**

**HOW TO SPECIFY**

Select Model Number	Select Arm Type	Select Caster/Glide	Select Back Type	Select Fabric	Select Frame	Select Base
<b>N</b> Armless <b>F</b> Fixed Arms - Black (+ \$71) <b>A</b> Height and Width Adjustable Arms (+ \$92) <b>V</b> All-Adjustable Arms (includes Pivot) (+ \$141) <b>P</b> Fixed Arms - Polished (+ \$189)	<b>H</b> Black Hard Caster <b>S</b> Black All-Surface Caster (+ \$44)	<b>U</b> Upholstered <b>M</b> Mesh	See page 387	<b>T</b> Black	<b>SB</b> Standard Base <b>PA</b> Polished Aluminum (+ \$119)	
HIWM1	A	H	M	CU10	T	SB

# IGNITION®



Icon Legend on page 19

## HIEH1



### EXECUTIVE HIGH-BACK

Pneumatic  
Back Height Adjustment  
Swivel  
Tilt  
Tilt Tension  
Tilt Lock  
Functions: **A, B, E, F, K, L**  
(Function Key on pages 252-253)

### DIMENSIONS

Depth: 38½  
Width: 27  
Height: 47½  
Seat Depth: 18  
Seat Width: 20  
Back Width: 20  
Back Height: 24¾-27¾  
Arm Width: 20  
Seat to Floor Height: 16¾-21¼  
Usable Seat Depth: 17⅞  
Ship Weight: 56  
Cube: 16.0  
COM: 2.5  
Weight Rating: 300 lbs.

### FABRIC PRICE CODES

1	\$946	8	\$1244
2	\$999	9	\$1283
3	\$1051	10	\$1321
4	\$1089	11	\$1361
5	\$1128	12	\$1399
6	\$1167	L	\$1270
7	\$1205		

NOTES: See page 392 for arm packs.

## HIEH2



### EXECUTIVE HIGH-BACK

Pneumatic  
Back Height Adjustment  
Synchro-tilt  
Tilt Tension  
Seat Glide  
Functions: **A, B, D, E, J, A-D, L**  
(Function Key on pages 252-253)

### DIMENSIONS

Depth: 41  
Width: 27  
Height: 49  
Seat Depth: 17-19  
Seat Width: 20  
Back Width: 19½  
Back Height: 24¾-27¾  
Arm Width: 20  
Seat to Floor Height: 17-21½  
Usable Seat Depth: 16½-18  
Ship Weight: 61  
Cube: 16.0  
COM: 2.5  
Weight Rating: 300 lbs.

### FABRIC PRICE CODES

1	\$1052	8	\$1350
2	\$1105	9	\$1389
3	\$1157	10	\$1427
4	\$1195	11	\$1467
5	\$1234	12	\$1505
6	\$1273	L	\$1376
7	\$1311		

NOTES: See page 392 for arm packs.

## HIEH3

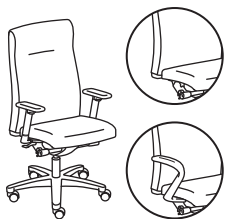

### EXECUTIVE HIGH-BACK

Pneumatic  
Back Height Adjustment  
Synchro-tilt  
Back Angle Adjustment  
Tilt Tension  
Seat Glide  
Functions: **A, B, D, E, A-D, A-E, L**  
(Function Key on pages 252-253)

### DIMENSIONS

Depth: 45½  
Width: 27  
Height: 49  
Seat Depth: 17-19  
Seat Width: 20  
Back Width: 19½  
Back Height: 24¾-27¾  
Arm Width: 20  
Seat to Floor Height: 17-21½  
Usable Seat Depth: 15¼-17¼  
Ship Weight: 65  
Cube: 16.0  
COM: 2.5  
Weight Rating: 300 lbs.

### FABRIC PRICE CODES

1	\$1113	8	\$1411
2	\$1166	9	\$1450
3	\$1218	10	\$1488
4	\$1256	11	\$1528
5	\$1295	12	\$1566
6	\$1334	L	\$1437
7	\$1372		

NOTES: See page 392 for arm packs.

**HON Recommendation: HIEH1.A.H.U.CU\_\_T.SB - List Price \$1038**

SEATING

## HOW TO SPECIFY

Select Model Number	Select Arm Type	Select Caster/Glide	Select Back Type	Select Fabric	Select Frame	Select Base
<b>N</b> Armless <b>F</b> Fixed Arms - Black (+ \$71) <b>A</b> Height and Width Adjustable Arms (+ \$92) <b>V</b> All-Adjustable Arms (includes Pivot) (+ \$141) <b>P</b> Fixed Arms - Polished (+ \$189)	<b>H</b> Black Hard Caster <b>S</b> Black All-Surface Caster (+ \$44)	<b>U</b> Upholstered	See page 387	<b>T</b> Black	<b>SB</b> Standard Base <b>PA</b> Polished Aluminum (+ \$119)	
<b>H I E H 1</b>	<b>F</b>	<b>H</b>	<b>U</b>	<b>C U 1 0</b>	<b>T</b>	<b>S B</b>



Icon Legend on page 19

## HITS5



### TASK STOOL

Pneumatic  
Swivel Back Height  
Adjustment  
Adjustable Footrest  
Functions: **A, B, E**  
(Function Key on pages  
252-253)

### DIMENSIONS

Upholstered Back Width:	17½	Adjustable Arms Width:	17-19½
Upholstered Back Height:	18¾-21¾	Fixed Arms Width:	20
Mesh Back Width:	17½	Seat to Floor Height:	23⅝-33⅝
Mesh Back Height:	20¾-23¾	Usable Seat Depth:	15¾
Depth:	27½	Ship Weight (upholstered back):	56 Ⓢ
Width:	27	Ship Weight (mesh back):	51 Ⓢ
Height:	44	Cube (upholstered back):	10.8
Seat Depth:	17	Cube (mesh back):	10.8
Seat Width:	19	COM (upholstered back):	2.0
		COM (mesh back):	1.0
		Weight Rating:	300 lbs.

### FABRIC PRICE CODES

<b>1</b>	<b>\$983</b>	<b>8</b>	<b>\$1281</b>
<b>2</b>	<b>\$1036</b>	<b>9</b>	<b>\$1320</b>
<b>3</b>	<b>\$1088</b>	<b>10</b>	<b>\$1358</b>
<b>4</b>	<b>\$1126</b>	<b>11</b>	<b>\$1398</b>
<b>5</b>	<b>\$1165</b>	<b>12</b>	<b>\$1436</b>
<b>6</b>	<b>\$1204</b>	<b>L</b>	<b>—</b>
<b>7</b>	<b>\$1242</b>		

NOTES: See page 392 for arm packs.

**HON Recommendation: HITS5.A.H.M.CU\_\_T.SB - List Price \$1075**

## HOW TO SPECIFY

Select Model Number	Select Arm Type	Select Caster/Glide	Select Back Type	Select Fabric	Select Frame	Select Base
	<b>N</b> Armless <b>F</b> Fixed Arms - Black (+ \$71) <b>A</b> Height and Width Adjustable Arms (+ \$92) <b>V</b> All-Adjustable Arms (includes Pivot) (+ \$141) <b>P</b> Fixed Arms - Polished (+ \$189)	<b>H</b> Black Hard Caster <b>S</b> Black All-Surface Caster (+ \$44)	<b>U</b> Upholstered <b>M</b> Mesh	See page 387	<b>T</b> Black	<b>SB</b> Standard Base
HITS5	A	H	M	CU10	T	SB



## HI2ATA

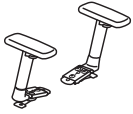

### ADJUSTABLE ARMS

Height and Width  
Functions: **S**  
(Function Key on pages 252-253)

### DIMENSIONS

Adjustable Arms Width: 17-19½  
Height from Seat: 8-11  
Ship Weight: 8  
Cube: 1.0

### LIST PRICE

**\$163**

## HI2AAA

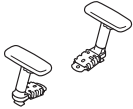

### ALL-ADJUSTABLE ARMS

Height, Width, Depth and Pivot

### DIMENSIONS

Adjustable Arms Width: 17-20  
Height from Seat: 7-11  
Ship Weight: 8  
Cube: 1.0

### LIST PRICE

**\$219**

## HI2FHA



### FIXED HEIGHT ARMS

### DIMENSIONS

Arm Width: 20  
Height from Seat: 9½  
Ship Weight: 7  
Cube: 1.0

### LIST PRICE

**\$151**

## HIPAA

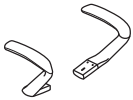

### POLISHED ALUMINUM ARMS

Fixed Height

### DIMENSIONS

Arm Width: 20  
Height from Seat: 9½  
Ship Weight: 10  
Cube: 1.0

### LIST PRICE

**\$249**

## HSCASTER

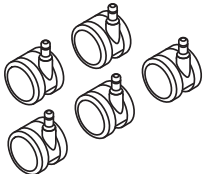

### SET OF 5 ALL-SURFACE CASTERS

### DIMENSIONS

Size: 60mm  
Ship Weight: 2  
Cube: 0.1

### LIST PRICE

**\$75**

! Available in Black finish only, no specification needed.

OPEN MARKET

## HOW TO SPECIFY

Select Model Number

Select Frame

Specify for models HI2ATA, HI2AAA, and HI2FHA

- T** Black
- DWX** Designer White
- TI** Titanium

HI2ATA.

T



Lota® Multi-Purpose Seating  
shown with HON Utility Tables.

## LOTA®

If you're looking for all-day comfort without breaking the bank, look no further than Lota. This mesh back guest chair offers advanced features for customizable comfort that make it an upscale choice at an affordable price. If you sit for hours on end, put yourself in more control over your comfort.



## FEATURES

- Multi-purpose chairs feature black arms and base.
- H2285 available in black fabric only.
- Multi-purpose chairs stack four high on the floor.
- Warranted for users up to 275 lbs.

# LOTA<sup>®</sup> Options

## MODEL OPTION

H2285



### Multi-Purpose (Mesh Back)

4-Leg Stacking Frame, Fixed Arms

FRAME	CODE	DESCRIPTION	PRICE
	T	Black	+ \$0

SEATING



## H2285



### MULTI-PURPOSE CHAIR

**Mesh Back**  
4-Leg Stacking Frame  
Fixed Arms

### DIMENSIONS

Depth:	24 <sup>3</sup> / <sub>4</sub>	Arm Width:	19 <sup>1</sup> / <sub>8</sub>
Width:	23	Seat to Floor Height:	19 <sup>1</sup> / <sub>8</sub>
Height:	34 <sup>1</sup> / <sub>2</sub>	Usable Seat Depth:	17 <sup>3</sup> / <sub>4</sub>
Seat Depth:	17 <sup>3</sup> / <sub>4</sub>	Ship Weight:	20
Seat Width:	18 <sup>7</sup> / <sub>8</sub>	Cube:	2.8
Back Width:	17 <sup>1</sup> / <sub>8</sub>	Weight Rating:	275 lbs.
Back Height:	17 <sup>3</sup> / <sub>4</sub>		

### LIST PRICE

**\$556**

NOTES: Casters and glides ship packaged together for customer's assembly choice. Stacks 4-high on floor.  
 ⓘ Available in VA10 Black fabric seat and Black frame only. Black Mesh back only.

## HOW TO SPECIFY

<p><b>Select Model Number</b></p> <p>H 2 2 8 5 .</p>	<p><b>Select Fabric</b></p> <p>VA10 Black Fabric</p> <p>V A 1 0 .</p>	<p><b>Select Frame</b></p> <p>T Black</p> <p>T</p>
--	---	--



Matter™ Upholstered Chair with  
5-Star Base with Preside® Table.

## MATTER™

This modern take on the traditional task chair combines the comfort of a lounge chair and posture of a task chair. The swivel-tilt control allows you to find that reclining position that's just right for you, and the five-star base lets you move around effortlessly. This cool twist on the traditional guest chair puts the comfort of a lounge chair right on top of a traditional four-leg base.



## FEATURES

- Brings a modern design aesthetic into any reception or guest area.
- Available in a 5-star base and 4-leg natural wood base. Hardwood legs in Harvest.
- Swivel-tilt mechanism offers a full range of reclining positions.
- Chrome base provides a contemporary accent.
- 360-degree swivel.
- Easily assembled in minutes.
- Backed by **HON 5-Year Limited Warranty.**



# MATTER™ Multi-Purpose Chairs

## HVL232



### GRAY UPHOLSTERED CHAIR

with 5-Star Base  
Swivel  
Tilt

### DIMENSIONS

Depth:	24 <sup>4</sup> / <sub>5</sub>	Arm Width:	3
Width:	23	Seat to Floor Height:	19-22 <sup>1</sup> / <sub>2</sub>
Height:	31-34 <sup>1</sup> / <sub>2</sub>	Usable Seat Depth:	18
Seat Depth:	18 <sup>3</sup> / <sub>10</sub>	Ship Weight:	21
Seat Width:	16 <sup>1</sup> / <sub>2</sub>	Cube:	5.6
Back Width:	23	Weight Rating:	250 lbs.
Back Height:	12 <sup>2</sup> / <sub>5</sub>		

### LIST PRICE

**\$670**

NOTES: **HON 5-Year Limited Warranty.**

## HVL238



### GRAY UPHOLSTERED CHAIR

Wood Leg Base  
Harvest Wood Legs  
4-Leg Wood Base

### DIMENSIONS

Depth:	24 <sup>4</sup> / <sub>5</sub>	Arm Width:	3
Width:	23	Seat to Floor Height:	19 <sup>1</sup> / <sub>4</sub>
Height:	31 <sup>1</sup> / <sub>2</sub>	Usable Seat Depth:	18
Seat Depth:	18 <sup>3</sup> / <sub>10</sub>	Ship Weight:	21
Seat Width:	16 <sup>1</sup> / <sub>2</sub>	Cube:	5.6
Back Width:	23	Weight Rating:	250 lbs.
Back Height:	12 <sup>2</sup> / <sub>5</sub>		

### LIST PRICE

**\$618**

NOTES: **HON 5-Year Limited Warranty.**

## HOW TO SPECIFY

<b>Select Model Number</b>	<b>Select Fabric</b>
	GRY01 Light Gray
H V L 2 3 8 .	G R Y 0 1





Mav™ Single Lounge shown with West Hill™ Seating and Scramble™ Coffee Table.

MAV™

With plenty of base, back, and seat options offset with mid-century flair and richly colored fabrics, the Mav Single Lounge Series is designed to function well in virtually any space. Whether it's configured for a multi-use zone, in a private office, or to stand alone as a statement piece, Mav is an ideal place for impromptu or collaborative gatherings, a quick break, or focused, heads-down work.

SEATING



FEATURES

- Subtle seat and back contours and refined details create an inviting, contemporary aesthetic.
- Choose from a mid-back or high-back option.
- Contoured arms provide support and create a striking look.
- Armless models offer a range of seated postures.
- High-back models available with a 4-star metal base with return-to-center, 4-leg wood base, or 5-star base with swivel knee tilt.
- Mid-back models offered in 4-star metal base with return-to-center, 4-leg wood base, wire sled base, or 5-star base with swivel knee tilt.
- Multi-Fabric option — seat cushion and frame can be specified in different fabrics for a modern aesthetic.
- Ottoman lets you kick up your feet or use as impromptu seating.
- Seat cushion attaches with Velcro for easy cleaning or replacement.
- Available in a wide range of cleanable fabrics to achieve the perfect look (see HON's Cleaning Guide).
- Choose from 10 wood base or 4 metal base finish options.

## HON BRANDED FABRICS

GRADE 1	GRADE 2	GRADE 3	GRADE 4
Apex	Appoint Seating	Bradbury	Constance with Supreen™
Centurion	Blume	Getaway	Livi with Supreen™
Compass	Clyde	Moxie**	Lugano with Supreen™
Contourett**	Dotty	Notion	Oxford with Supreen™
Dapper	Kai	Parker**	
Ensemble	Rush	Purl	
Hamilton	Spin Seating	Quill	
Inertia	Wavelength	Saxony	
Noble Seating	Whisper Vinyl**		
Optic*			
Pebble			
Vibe			

For a complete list of fabrics, including partnership fabrics, go to [hon.com/fabricsandfinishes](https://hon.com/fabricsandfinishes).

Reference Fabric Color Combinations on pages 20-25 for color codes and legend on page 21 for lead times.

\*Not available on Single Fabric models or as multi-fabric frame option.

\*\*Due to the inherent design of Mav™ high-back chairs, coated fabrics may show material gathers, particularly around the headrest.

For more details on Upholstery Pattern Match for this series, please see page 14.

### LEG STYLE



CODE	DESCRIPTION	PRICE
<b>4S</b>	4-Star Return-to-Center	<b>+ \$0</b>
<i>Available in the following finishes:</i>		
<b>P8V</b>	Textured Titanium	
<b>P7A</b>	Textured Charcoal	
<b>P8X</b>	Solar Black	<b>+ \$22</b>
<b>Y</b>	Polished	<b>+ \$55</b>

### LEG STYLE

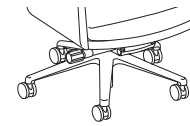

CODE	DESCRIPTION	PRICE
<b>5S</b>	5-Star w/Swivel Knee Tilt, Hard Caster	<b>+ \$28</b>
<b>5SS</b>	5-Star w/Swivel Knee Tilt, All-Surface Caster	<b>+ \$60</b>
<i>Available in the following finishes:</i>		
<b>P8V</b>	Textured Titanium	
<b>P7A</b>	Textured Charcoal	
<b>P8X</b>	Solar Black	<b>+ \$22</b>
<b>Y</b>	Polished	<b>+ \$55</b>

### LEG STYLE



CODE	DESCRIPTION	PRICE
<b>WD</b>	Wood	<b>+ \$270</b>
<i>Available in the following finishes:</i>		
<b>LFW1</b>	Florence Walnut	
<b>LKI1</b>	Kingswood Walnut	
<b>LLA1</b>	Lowell Ash	
<b>D</b>	Natural Maple	
<b>LNRI</b>	Natural Recon	
<b>LPE1</b>	Phantom Ecru	
<b>PINC</b>	Pinnacle	
<b>LPT1</b>	Portico Teak	
<b>LSW1</b>	Skyline Walnut	
<b>LSA1</b>	Sterling Ash	

### LEG STYLE



CODE	DESCRIPTION	PRICE
<b>SD</b>	Sled*	<b>+ \$0</b>
<i>Available in the following finishes:</i>		
<b>P8V</b>	Textured Titanium	
<b>P7A</b>	Textured Charcoal	
<b>P8X</b>	Solar Black	<b>+ \$22</b>
<b>Y</b>	Polished	<b>+ \$55</b>

\*Available on Mid-Back models only

Low-Back, Multi-Fabric



High-Back, Multi-Fabric





**HMAVMN**



**MID-BACK SINGLE LOUNGE, ARMLESS**

**DIMENSIONS**

Depth (4-Star, 5-Star, & Wood):	28¾	Back Height:	18¾
Depth (Sled):	27½	Back Width:	20
Height (4-Star):	29½	Ship Weight:	45
Height (5-Star):	33½-37¼	Ship Weight (5-Star):	55
Height (Wood):	30	Cube:	20.1
Height (Sled):	30¾	COM:	3.5
Width:	24	Weight Rating:	300 lbs.
Usable Seat Depth:	19		
Seat to Floor Height:	17		
Seat to Floor Height (5-Star):	17¼-21		
Seat Width:	21		

**FABRIC PRICE CODES**

<b>1</b>	<b>\$1836</b>	<b>8</b>	<b>\$2519</b>
<b>2</b>	<b>\$1927</b>	<b>9</b>	<b>\$2537</b>
<b>3</b>	<b>\$2020</b>	<b>10</b>	<b>\$2630</b>
<b>4</b>	<b>\$2096</b>	<b>11</b>	<b>\$2720</b>
<b>5</b>	<b>\$2199</b>	<b>12</b>	<b>\$2813</b>
<b>6</b>	<b>\$2303</b>	<b>L</b>	<b>\$3459</b>
<b>7</b>	<b>\$2410</b>		

**HMAVMNMF**



**MID-BACK SINGLE LOUNGE, ARMLESS, MULTI-FABRIC**

**DIMENSIONS**

Depth (4-Star, 5-Star, & Wood):	28¾	Back Height:	18¾
Depth (Sled):	27½	Back Width:	20
Height (4-Star):	29½	Ship Weight:	45
Height (5-Star):	33½-37¼	Ship Weight (5-Star):	55
Height (Wood):	30	Cube:	20.1
Height (Sled):	30¾	COM (Seat Cushion):	1.5
Width:	24	COM (Back/Frame):	2.5
Usable Seat Depth:	19	Weight Rating:	300 lbs.
Seat to Floor Height:	17		
Seat to Floor Height (5-Star):	17¼-21		
Seat Width:	21		

**FABRIC PRICE CODES**

<b>1</b>	<b>\$2037</b>	
	<i>Add to Base Price Above</i>	
	<b>Seat</b>	<b>Frame</b>
<b>2</b>	<b>\$27</b>	<b>\$65</b>
<b>3</b>	<b>\$53</b>	<b>\$131</b>
<b>4</b>	<b>\$76</b>	<b>\$186</b>
<b>5</b>	<b>\$105</b>	<b>\$259</b>
<b>6</b>	<b>\$134</b>	<b>\$333</b>
<b>7</b>	<b>\$164</b>	<b>\$410</b>
<b>8</b>	<b>\$196</b>	<b>\$489</b>
<b>9</b>	<b>\$201</b>	<b>\$500</b>
<b>10</b>	<b>\$227</b>	<b>\$566</b>
<b>11</b>	<b>\$254</b>	<b>\$633</b>
<b>12</b>	<b>\$280</b>	<b>\$699</b>

**HON Recommendation: HMAVMNMF.PURL\_\_PURL\_\_4S\_\_ - List Price \$2221**

**HOW TO SPECIFY**

<p><b>Select Model Number</b></p> <p>See page 399</p> <p><i>Specify for single fabric model only</i></p>	<p><b>Select Fabric</b></p> <p>See page 399</p> <p><i>Specify for single fabric model only</i></p>	<p><b>Select Seat Fabric</b></p> <p>See page 399</p> <p><i>Specify for multi-fabric model only</i></p>	<p><b>Select Frame Fabric</b></p> <p>See page 399</p> <p><i>Specify for multi-fabric model only</i></p>	<p><b>Select Base and Base Color</b></p> <p>See page 399</p> <p><b>4S</b> 4-Star Return-to-Center  <b>5S</b> 5-Star, Hard Caster (+ \$28)  <b>5SS</b> 5-Star, All-Surface Caster (+ \$60)  <b>WD</b> Wood (+ \$270)  <b>SD</b> Sled</p>
HMAVMNMF	PURL05	PURL05	PURL03	4SP7A



**HMAVMA**



**MID-BACK SINGLE LOUNGE, ARMS**

**DIMENSIONS**

Depth (4-Star, 5-Star, & Wood):	28¾	Back Height:	18¾
Depth (Sled):	27½	Back Width:	20
Height (4-Star):	29½	Arm Height:	8½
Height (5-Star):	33½-37¼	Ship Weight:	53
Height (Wood):	30	Ship Weight (5-Star):	63
Height (Sled):	30¾	Cube:	20.1
Width:	25	COM:	4.0
Usable Seat Depth:	19	Weight Rating:	300 lbs.
Seat to Floor Height:	17		
Seat to Floor Height (5-Star):	17¼-21		
Seat Width:	21		

**FABRIC PRICE CODES**

<b>1</b>	<b>\$2304</b>	<b>8</b>	<b>\$3085</b>
<b>2</b>	<b>\$2409</b>	<b>9</b>	<b>\$3105</b>
<b>3</b>	<b>\$2514</b>	<b>10</b>	<b>\$3210</b>
<b>4</b>	<b>\$2601</b>	<b>11</b>	<b>\$3316</b>
<b>5</b>	<b>\$2719</b>	<b>12</b>	<b>\$3421</b>
<b>6</b>	<b>\$2838</b>	<b>L</b>	<b>\$4158</b>
<b>7</b>	<b>\$2961</b>		

**HMAVMAMF**



**MID-BACK SINGLE LOUNGE, ARMS, MULTI-FABRIC**

**DIMENSIONS**

Depth (4-Star, 5-Star, & Wood):	28¾	Back Height:	18¾
Depth (Sled):	27½	Back Width:	20
Height (4-Star):	29½	Arm Height:	8½
Height (5-Star):	33½-37¼	Ship Weight:	53
Height (Wood):	30	Ship Weight (5-Star):	63
Height (Sled):	30¾	Cube:	20.1
Width:	25	COM (Seat Cushion):	1.5
Usable Seat Depth:	19	COM (Back/Frame):	4.0
Seat to Floor Height:	17	Weight Rating:	300 lbs.
Seat to Floor Height (5-Star):	17¼-21		
Seat Width:	21		

**FABRIC PRICE CODES**

<b>1</b>	<b>\$2503</b>	
	<i>Add to Base Price Above</i>	
	<b>Seat</b>	<b>Back</b>
<b>2</b>	<b>\$27</b>	<b>\$79</b>
<b>3</b>	<b>\$53</b>	<b>\$157</b>
<b>4</b>	<b>\$76</b>	<b>\$223</b>
<b>5</b>	<b>\$105</b>	<b>\$311</b>
<b>6</b>	<b>\$134</b>	<b>\$400</b>
<b>7</b>	<b>\$164</b>	<b>\$493</b>
<b>8</b>	<b>\$196</b>	<b>\$587</b>
<b>9</b>	<b>\$201</b>	<b>\$601</b>
<b>10</b>	<b>\$227</b>	<b>\$680</b>
<b>11</b>	<b>\$254</b>	<b>\$759</b>
<b>12</b>	<b>\$280</b>	<b>\$839</b>

**HON Recommendation: HMAVMAMF.PURL\_\_PURL\_\_4S\_\_ - List Price \$2713**

**HOW TO SPECIFY**

<p><b>Select Model Number</b></p>	<p><b>Select Fabric</b></p> <p>See page 399</p> <p><i>Specify for single fabric model only</i></p>	<p><b>Select Seat Fabric</b></p> <p>See page 399</p> <p><i>Specify for multi-fabric model only</i></p>	<p><b>Select Frame Fabric</b></p> <p>See page 399</p> <p><i>Specify for multi-fabric model only</i></p>	<p><b>Select Base and Base Color</b></p> <p>See page 399</p> <p><b>4S</b> 4-Star Return-to-Center</p> <p><b>5S</b> 5-Star w/Swivel Knee Tilt, Hard Caster (+ \$28)</p> <p><b>5SS</b> 5-Star w/Swivel Knee Tilt, All-Surface Caster (+ \$60)</p> <p><b>WD</b> Wood (+ \$270)</p> <p><b>SD</b> Sled</p>
HMAVMAMF	PURL05	PURL05	PURL03	4SP7A

**HMAVHN**



**HIGH-BACK SINGLE LOUNGE, ARMLESS**

**DIMENSIONS**

Depth:	30¼	Back Height:	32½
Height (4-Star):	43½	Back Width:	20
Height (5-Star):	47-50¾	Ship Weight:	50
Height (Wood):	44	Ship Weight (5-Star):	59
Width:	24	Cube:	29
Usable Seat Depth:	19	COM:	4.0
Seat to Floor Height:	17	Weight Rating:	300 lbs.
Seat to Floor Height (5-Star):	17¼-21		
Seat Width:	21		

**FABRIC PRICE CODES**

<b>1</b>	<b>\$2070</b>	<b>8</b>	<b>\$2753</b>
<b>2</b>	<b>\$2161</b>	<b>9</b>	<b>\$2771</b>
<b>3</b>	<b>\$2254</b>	<b>10</b>	<b>\$2864</b>
<b>4</b>	<b>\$2330</b>	<b>11</b>	<b>\$2954</b>
<b>5</b>	<b>\$2433</b>	<b>12</b>	<b>\$3047</b>
<b>6</b>	<b>\$2537</b>	<b>L</b>	<b>\$3693</b>
<b>7</b>	<b>\$2644</b>		

**HMAVHNMF**

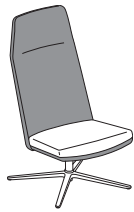

**HIGH-BACK SINGLE LOUNGE, ARMLESS, MULTI-FABRIC**

**DIMENSIONS**

Depth:	30¼	Back Height:	32½
Height (4-Star):	43½	Back Width:	20
Height (5-Star):	47-50¾	Ship Weight:	50
Height (Wood):	44	Ship Weight (5-Star):	59
Width:	24	Cube:	29
Usable Seat Depth:	19	COM (Seat Cushion):	1.5
Seat to Floor Height:	17	COM (Back/Frame):	3.5
Seat to Floor Height (5-Star):	17¼-21	Weight Rating:	300 lbs.
Seat Width:	21		

**FABRIC PRICE CODES**

<b>1</b>	<b>\$2270</b>		
		<i>Add to Base Price Above</i>	
		<b>Seat</b>	<b>Frame</b>
<b>2</b>	<b>\$27</b>	<b>\$65</b>	
<b>3</b>	<b>\$53</b>	<b>\$131</b>	
<b>4</b>	<b>\$76</b>	<b>\$186</b>	
<b>5</b>	<b>\$105</b>	<b>\$259</b>	
<b>6</b>	<b>\$134</b>	<b>\$333</b>	
<b>7</b>	<b>\$164</b>	<b>\$410</b>	
<b>8</b>	<b>\$196</b>	<b>\$489</b>	
<b>9</b>	<b>\$201</b>	<b>\$500</b>	
<b>10</b>	<b>\$227</b>	<b>\$566</b>	
<b>11</b>	<b>\$254</b>	<b>\$633</b>	
<b>12</b>	<b>\$280</b>	<b>\$699</b>	

HON Recommendation: HMAVHNMF.PURL\_\_PURL\_\_4S\_\_ - List Price \$2454

**HOW TO SPECIFY**

<p><b>Select Model Number</b></p> <p>See page 399</p> <p><i>Specify for single fabric model only</i></p>	<p><b>Select Fabric</b></p> <p>See page 399</p> <p><i>Specify for single fabric model only</i></p>	<p><b>Select Seat Fabric</b></p> <p>See page 399</p> <p><i>Specify for multi-fabric model only</i></p>	<p><b>Select Frame Fabric</b></p> <p>See page 399</p> <p><i>Specify for multi-fabric model only</i></p>	<p><b>Select Base and Base Color</b></p> <p>See page 399</p> <p><b>4S</b> 4-Star Return-to-Center  <b>5S</b> 5-Star w/Swivel Knee Tilt, Hard Caster (+ \$28)  <b>5SS</b> 5-Star w/Swivel Knee Tilt, All-Surface Caster (+ \$60)  <b>WD</b> Wood (+ \$270)</p>
<p>HMAVHNMF .</p>	<p>PURL05 .</p>	<p>PURL05 .</p>	<p>PURL03 .</p>	<p>4SP7A</p>



**HMAVHA**



**HIGH-BACK SINGLE LOUNGE, ARMS**

**DIMENSIONS**

Depth:	30¼	Back Height:	32½
Height (4-Star):	43½	Back Width:	20
Height (5-Star):	47-50¾	Arm Height:	8½
Height (Wood):	44	Ship Weight:	59
Width:	25	Ship Weight (5-Star):	67
Usable Seat Depth:	19	Cube:	29
Seat to Floor Height:	17	COM:	5.0
Seat to Floor Height (5-Star):	17¼-21	Weight Rating:	300 lbs.
Seat Width:	21		

**FABRIC PRICE CODES**

<b>1</b>	<b>\$2537</b>	<b>8</b>	<b>\$3318</b>
<b>2</b>	<b>\$2642</b>	<b>9</b>	<b>\$3338</b>
<b>3</b>	<b>\$2747</b>	<b>10</b>	<b>\$3443</b>
<b>4</b>	<b>\$2834</b>	<b>11</b>	<b>\$3549</b>
<b>5</b>	<b>\$2952</b>	<b>12</b>	<b>\$3654</b>
<b>6</b>	<b>\$3071</b>	<b>L</b>	<b>\$4391</b>
<b>7</b>	<b>\$3194</b>		

**HMAVHAMF**



**HIGH-BACK SINGLE LOUNGE, ARMS, MULTI-FABRIC**

**DIMENSIONS**

Depth:	30¼	Back Height:	32½
Height (4-Star):	43½	Back Width:	20
Height (5-Star):	47-50¾	Arm Height:	8½
Height (Wood):	44	Ship Weight:	59
Width:	25	Ship Weight (5-Star):	67
Usable Seat Depth:	19	Cube:	29
Seat to Floor Height:	17	COM (Seat Cushion):	1.5
Seat to Floor Height (5-Star):	17¼-21	COM (Back/Frame):	4.0
Seat Width:	21	Weight Rating:	300 lbs.

**FABRIC PRICE CODES**

<b>1</b>	<b>\$2737</b>		
		<i>Add to Base Price Above</i>	
		<b>Seat</b>	<b>Frame</b>
<b>2</b>	<b>\$27</b>	<b>\$79</b>	
<b>3</b>	<b>\$53</b>	<b>\$157</b>	
<b>4</b>	<b>\$76</b>	<b>\$223</b>	
<b>5</b>	<b>\$105</b>	<b>\$311</b>	
<b>6</b>	<b>\$134</b>	<b>\$400</b>	
<b>7</b>	<b>\$164</b>	<b>\$493</b>	
<b>8</b>	<b>\$196</b>	<b>\$587</b>	
<b>9</b>	<b>\$201</b>	<b>\$601</b>	
<b>10</b>	<b>\$227</b>	<b>\$680</b>	
<b>11</b>	<b>\$254</b>	<b>\$759</b>	
<b>12</b>	<b>\$280</b>	<b>\$839</b>	

**HON Recommendation: HMAVHAMF.PURL\_\_PURL\_\_4S\_\_ - List Price \$2947**

**HOW TO SPECIFY**

<p><b>Select Model Number</b></p> <p>See page 399</p>	<p><b>Select Fabric</b></p> <p>See page 399</p> <p><i>Specify for single fabric model only</i></p>	<p><b>Select Seat Fabric</b></p> <p>See page 399</p> <p><i>Specify for multi-fabric model only</i></p>	<p><b>Select Frame Fabric</b></p> <p>See page 399</p> <p><i>Specify for multi-fabric model only</i></p>	<p><b>Select Base and Base Color</b></p> <p>See page 399</p> <p><b>4S</b> 4-Star Return-to-Center  <b>5S</b> 5-Star w/Swivel Knee Tilt, Hard Caster (+ \$28)  <b>5SS</b> 5-Star w/Swivel Knee Tilt, All-Surface Caster (+ \$60)  <b>WD</b> Wood (+ \$270)</p>
HMAVHAMF	PURL05	PURL05	PURL03	4SP7A

## HMAVO



### SINGLE LOUNGE OTTOMAN

#### DIMENSIONS

Depth:	22	Ship Weight:	33
Height:	15	Cube:	9.5
Width:	24	COM:	3.5
Usable Seat Depth:	24	Weight Rating:	300 lbs.
Seat to Floor Height:	15		
Seat Width:	22		

#### FABRIC PRICE CODES

1	\$1136	8	\$1917
2	\$1241	9	\$1937
3	\$1346	10	\$2042
4	\$1433	11	\$2148
5	\$1551	12	\$2253
6	\$1670	L	\$2990
7	\$1793		

## HMAVOMF



### SINGLE LOUNGE OTTOMAN, MULTI-FABRIC

#### DIMENSIONS

Depth:	22	Ship Weight:	33
Height:	15	Cube:	9.5
Width:	24	COM (Seat Cushion):	1.5
Usable Seat Depth:	24	COM (Frame):	2.5
Seat to Floor Height:	15	Weight Rating:	300 lbs.
Seat Width:	22		

#### FABRIC PRICE CODES

1	\$1237		
<i>Add to Base Price Above</i>			
	<b>Seat</b>	<b>Frame</b>	
2	\$27	\$79	
3	\$53	\$157	
4	\$76	\$223	
5	\$105	\$311	
6	\$134	\$400	
7	\$164	\$493	
8	\$196	\$587	
9	\$201	\$601	
10	\$227	\$680	
11	\$254	\$759	
12	\$280	\$839	

**HON Recommendation: HMAVOMF.PURL\_\_PURL\_\_4S\_\_ - List Price \$1447**

## HOW TO SPECIFY

<p><b>Select Model Number</b></p> <p>HMAVOMF .</p>	<p><b>Select Fabric</b></p> <p>See page 399 Specify for single fabric model only</p> <p>PURL05 .</p>	<p><b>Select Seat Fabric</b></p> <p>See page 399 Specify for multi-fabric model only</p> <p>PURL05 .</p>	<p><b>Select Frame Fabric</b></p> <p>See page 399 Specify for multi-fabric model only</p> <p>PURL03 .</p>	<p><b>Select Base and Base Color</b></p> <p>See page 399 4S 4-Star</p> <p>4SP7A</p>
--	--	--	---	---

# MOTIVATE® CHAIRS

Want to see more? Scan here  
to check out hon.com.



Motivate® 4-Leg Stacking Chairs and Between™ Table.

## MOTIVATE® CHAIRS

A presentation in the morning. A training session in the afternoon. Today's multi-purpose spaces are in constant flux, and need an adaptable seating solution that delivers instant comfort for all, while easily moving around to support various activities. Motivate task chairs, stacking/nesting chairs and guest chairs create a streamlined collection of seating that intuitively responds to your body's natural movements and curves. Whether sitting for five minutes or five hours, when you Motivate your team you put everyone at ease.



## FEATURES

- Choose plastic, upholstered or 4-Way Stretch mesh back.
- Easily move chairs around the space for quick rearrangement.
- HMN1 nesting/stacking chairs stack four high on the floor.
- HMS1 sled base chairs stack 12 high on the floor or 40 high on a cart.
- HMS2 sled base chairs stack six high on the floor.
- Dynamic flex-zone motion in seat and back provides balance and lumbar support.
- Model HMT5 task stool features an adjustable footring.
- Plastic shell is available in 13 colors.
- Available in hundreds of quality HON fabrics.
- Warranted for users up to 300 lbs.

## TASK CHAIR FEATURES

- One-touch seat height adjustment easily moves the seat up and down.
- 360-degree swivel provides freedom of movement in any direction.
- Warranted for users up to 300 lbs.

# MOTIVATE® Task Chair Options

## MODEL OPTIONS

HMT1



### Flex-back

Upholstered Seat,  
Pneumatic, Swivel

HMT5



### Flex-back

Upholstered Seat,  
Pneumatic, Swivel  
Adjustable Footring

## ARM STYLE

CODE	DESCRIPTION	PRICE
<b>N</b>	Armless	<b>+\$0</b>
<b>A</b>	Adjustable Arms	<b>+\$77</b>

## CASTERS

CODE	DESCRIPTION	PRICE
<b>H</b>	Hard Caster	<b>+\$0</b>
<b>S</b>	All-Surface Caster	<b>+\$44</b>

## BACK STYLE

CODE	DESCRIPTION	PRICE
<i>Plastic/Upholstered Options:</i>		
<b>PS</b>	Plastic Shell	<b>+\$0</b>
<b>PB</b>	Upholstered	<b>+\$77</b>

### 4-Way Stretch Options:

<b>IM</b>	Black	<b>+\$87</b>
<b>IB</b>	Breeze	<b>+\$87</b>
<b>IK</b>	Brownstone	<b>+\$87</b>
<b>IC</b>	Charcoal	<b>+\$87</b>
<b>IF</b>	Fog	<b>+\$87</b>
<b>IR</b>	Regatta	<b>+\$87</b>
<b>IT</b>	Titanium	<b>+\$87</b>

### PLASTIC SHELL COLOR CODES (no upcharge):

Tangelo - **RG**  
Regatta - **RE**  
Lava - **LA**

Cherry - **CR**  
Mulberry - **MB**  
Onyx - **ON**

Lime - **LM**  
Loft - **LO**  
White - **WT**

Calypso - **CP**  
Platinum - **PT**

Surf - **BU**  
Shadow - **SD**

## BASE

CODE	DESCRIPTION	PRICE
<b>SB</b>	Standard Base	<b>+\$0</b>

## FRAME COLOR

CODE	DESCRIPTION	PRICE
<b>T</b>	Black	<b>+\$0</b>

# MOTIVATE<sup>®</sup>

## Task Chair Fabric Options

### HON BRANDED FABRICS

#### GRADE 1

Apex  
Centurion  
Compass  
Contourett  
Dapper  
Ensemble  
Hamilton  
Inertia  
Noble Seating  
Optic  
Pebble  
Vibe

#### GRADE 2

Appoint Seating  
Blume  
Clyde  
Dotty  
Kai  
Rush  
Spin Seating  
Wavelength  
Whisper Vinyl

#### GRADE 3

Bradbury  
Getaway  
Moxie  
Notion  
Parker  
Purl  
Quill  
Saxony

#### GRADE 4

Constance with Supreen™  
Livi with Supreen™  
Lugano with Supreen™  
Oxford with Supreen™

#### GRADE L

Denver Leather

**For a complete list of fabrics, including partnership fabrics, go to [hon.com/fabricsandfinishes](https://hon.com/fabricsandfinishes).**

Reference Fabric Color Combinations on pages 20-25 for color codes and legend on page 21 for lead times.



# MOTIVATE® Task Chairs

GSA SIN 33721



Icon Legend on page 19

## HMT1

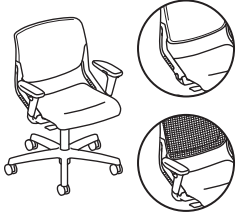

### TASK CHAIR

**Flex-back**  
Upholstered Seat  
Pneumatic  
Swivel

### DIMENSIONS

Depth:	27½	Seat to Floor Height:	17-22½
Width:	27½	Usable Seat Depth:	18
Height:	37½	Ship Weight (upholstered back):	39
Seat Depth:	18	Ship Weight (plastic/mesh back):	38
Seat Width:	17½	Cube (upholstered back):	10.0
Back Width:	19½	Cube (plastic/mesh back):	10.0
Back Height:	17¾	COM (upholstered back):	1.5
Arm Width:	18½-20	COM (plastic/mesh back):	1.0
		Weight Rating:	300 lbs.

### FABRIC PRICE CODES

<b>1</b>	<b>\$601</b>	<b>8</b>	<b>\$825</b>
<b>2</b>	<b>\$641</b>	<b>9</b>	<b>\$854</b>
<b>3</b>	<b>\$680</b>	<b>10</b>	<b>\$883</b>
<b>4</b>	<b>\$709</b>	<b>11</b>	<b>\$912</b>
<b>5</b>	<b>\$737</b>	<b>12</b>	<b>\$941</b>
<b>6</b>	<b>\$766</b>	<b>L</b>	<b>—</b>
<b>7</b>	<b>\$796</b>		

❗ When a Plastic Shell (PS) or Upholstered Back (PB) option is chosen, you must select a shell color. If the mesh back option is chosen, the shell color is not specified.

## HMT5

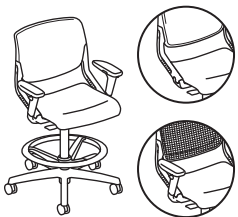

### TASK STOOL

**Flex-back**  
Upholstered Seat  
Pneumatic  
Swivel Adjustable Footring

### DIMENSIONS

Depth:	28¼	Seat to Floor Height:	22½-32½
Width:	28¼	Usable Seat Depth:	18
Height:	50½	Ship Weight (upholstered back):	44
Seat Depth:	18	Ship Weight (plastic/mesh back):	43
Seat Width:	17½	Cube (upholstered back):	10.0
Back Width:	19½	Cube (plastic/mesh back):	10.0
Back Height:	17¾	COM (upholstered back):	1.5
Arm Width:	18½-20	COM (plastic/mesh back):	1.0
		Weight Rating:	300 lbs.

### FABRIC PRICE CODES

<b>1</b>	<b>\$682</b>	<b>8</b>	<b>\$906</b>
<b>2</b>	<b>\$722</b>	<b>9</b>	<b>\$935</b>
<b>3</b>	<b>\$761</b>	<b>10</b>	<b>\$964</b>
<b>4</b>	<b>\$790</b>	<b>11</b>	<b>\$993</b>
<b>5</b>	<b>\$818</b>	<b>12</b>	<b>\$1022</b>
<b>6</b>	<b>\$847</b>	<b>L</b>	<b>—</b>
<b>7</b>	<b>\$877</b>		

NOTES: Stool model has adjustable footring.

❗ When a Plastic Shell (PS) or Upholstered Back (PB) option is chosen, you must select a shell color. If the mesh back option is chosen, the shell color is not specified.

**HON Recommendation: HMT1.A.H.IM.CU\_\_SB.T - List Price \$765**

## HOW TO SPECIFY

Select Model Number	Select Arm Type	Select Caster	Select Back Type/Color	Select Fabric	Select Base	Select Frame
A Adjustable Arms (+ \$77) N Armless	H Hard Caster S All-Surface Caster (+ \$44)	PS Plastic Shell PB Upholstered (+ \$77)  If PS or PB options are chosen, select shell color.  Plastic Shell Colors RG Tangelo      LO Loft CR Cherry        PT Platinum LM Lime          SD Shadow CP Calypso      LA Lava BU Surf          ON Onyx RE Regatta      WT White MB Mulberry  4-Way Stretch options (+ \$87) IM Black        IF Fog IB Breeze      IR Regatta IK Brownstone IT Titanium IC Charcoal	See page 407	SB Standard Base	T Black	
HMT1	A	H	IM	CU10	SB	T
HMT1	A	H	PSLA	CU10	SB	T

SEATING

# MOTIVATE® High-Density Sled Base Chair Options

## MODEL OPTIONS

HMS1



**High-Density Stacker**  
Sled Leg Base, Set of 4

HMS2



**High-Density Stacker**  
Upholstered Seat, Sled Leg  
Base, Set of 4

### ARM STYLE

CODE	DESCRIPTION	PRICE
<b>F</b>	Fixed Arms	<b>+\$33</b>
<b>N</b>	Armless	<b>+\$0</b>



### FRAME

CODE	DESCRIPTION	PRICE
<b>Y</b>	Chrome	<b>+\$0</b>
<b>P1 PAINT:</b>		<b>+\$0</b>
<b>CBK</b>	Charblack	
<b>P7J</b>	Textured Brownstone	
<b>P7A</b>	Textured Charcoal	
<b>PK7</b>	Textured Designer White	
<b>P7L</b>	Textured Loft	
<b>P7M</b>	Textured Muslin	
<b>PLAT</b>	Textured Platinum Metallic	
<b>P8V</b>	Textured Titanium	
<b>P2 PAINT:</b>		<b>+\$0</b>
<b>PR8</b>	Textured Silver	
<b>P3 PAINT:</b>		<b>+\$33</b>
<b>P8S</b>	Atom	
<b>PJF</b>	Bullseye	
<b>P8P</b>	Ember	
<b>P8N</b>	Ion	
<b>P8J</b>	Iris	
<b>P8F</b>	Krypton	
<b>P8M</b>	Regatta	

PLASTIC SHELL COLOR CODES (no upcharge):				
Tangelo - <b>RG</b>	Cherry - <b>CR</b>	Lime - <b>LM</b>	Calypso - <b>CP</b>	Surf - <b>BU</b>
Regatta - <b>RE</b>	Mulberry - <b>MB</b>	Loft - <b>LO</b>	Platinum - <b>PT</b>	Shadow - <b>SD</b>
Lava - <b>LA</b>	Onyx - <b>ON</b>	White - <b>WT</b>		

## HON BRANDED FABRICS

GRADE 1	GRADE 2	GRADE 3	GRADE 4
Apex	Appoint Seating	Bradbury	Constance with Supreen™
Centurion	Blume	Getaway	Livi with Supreen™
Compass	Clyde	Moxie	Lugano with Supreen™
Contourett	Dotty	Notion	Oxford with Supreen™
Dapper	Kai	Parker	
Ensemble	Rush	Purl	
Hamilton	Spin Seating	Quill	
Inertia	Wavelength	Saxony	
Noble Seating	Whisper Vinyl		
Optic			
Pebble			
Vibe			

For a complete list of fabrics, including partnership fabrics, go to [hon.com/fabricsandfinishes](https://hon.com/fabricsandfinishes).

Reference Fabric Color Combinations on pages 20-25 for color codes and legend on page 21 for lead times.

NOTES: Upcharges shown on this page are per chair.

# MOTIVATE® High-Density Sled Base Chairs

GSA SIN 33721



Icon Legend on page 19

## HMS1

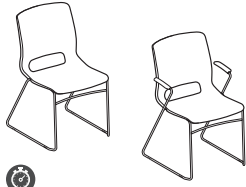

### HIGH-DENSITY STACKER

Sled Leg Base  
Set of 4

### DIMENSIONS

Depth:	23	Arm Width:	18 $\frac{1}{8}$
Width:	21	Seat to Floor Height:	17 $\frac{3}{4}$
Height:	32 $\frac{1}{4}$	Usable Seat Depth:	18 $\frac{1}{4}$
Seat Depth:	18 $\frac{1}{4}$	Ship Weight:	72
Seat Width:	17 $\frac{3}{4}$	Cube:	15.2
Back Width:	17 $\frac{1}{4}$	Weight Rating:	300 lbs.
Back Height:	18		

### LIST PRICE PER CARTON

**\$1146**

(reference single unit @ \$286.50)

NOTES: HMS1 Sled Base chairs stack 12-high on the floor, or 40-high on the chair cart model HMSCART. Field installed glides must be ordered separately and snap-on using existing locations on the sled base frames.

! Ganging Chair Glides must be ordered separately and are designed for use on armless models of the Motivate® High-Density Sled Base Chairs only.

## HMS2

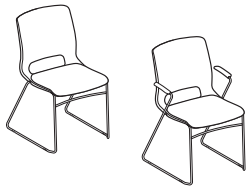

### HIGH-DENSITY STACKER

Upholstered Seat  
Sled Leg Base  
Set of 4

### DIMENSIONS

Depth:	23	Arm Width:	18 $\frac{1}{8}$
Width:	21	Seat to Floor Height:	18 $\frac{1}{4}$
Height:	32 $\frac{1}{4}$	Usable Seat Depth:	18 $\frac{1}{4}$
Seat Depth:	18 $\frac{1}{4}$	Ship Weight:	80
Seat Width:	17 $\frac{3}{4}$	Cube:	15.2
Back Width:	17 $\frac{1}{4}$	COM (per 4 pack):	1.6
Back Height:	17 $\frac{1}{2}$	Weight Rating:	300 lbs.

### FABRIC PRICE CODES

<b>1</b>	<b>\$1467</b>	<b>8</b>	<b>\$1617</b>
<b>2</b>	<b>\$1494</b>	<b>9</b>	<b>\$1636</b>
<b>3</b>	<b>\$1520</b>	<b>10</b>	<b>\$1655</b>
<b>4</b>	<b>\$1539</b>	<b>11</b>	<b>\$1675</b>
<b>5</b>	<b>\$1558</b>	<b>12</b>	<b>\$1694</b>
<b>6</b>	<b>\$1578</b>	<b>L</b>	<b>—</b>
<b>7</b>	<b>\$1597</b>		

NOTES: HMS2 Sled Base chairs stack 6-high on the floor. Field installed glides must be ordered separately and snap-on using existing locations on the sled base frames.

! Ganging Chair Glides must be ordered separately and are designed for use on armless models of the Motivate® High-Density Sled Base Chairs only.

## HMSCART



### CART FOR HMS1 STACKING CHAIRS

### DIMENSIONS

Depth:	34 $\frac{1}{4}$	Ship Weight:	40
Width:	21 $\frac{1}{8}$	Cube:	7.8
Height:	36 $\frac{1}{8}$		

### LIST PRICE

**\$659**

Holds up to 40 Stacking Chairs.

! Motivate® Sled Base Chairs are ordered and shipped four (4) chairs per carton. Pricing shown is per carton. Each set of four chairs (one carton), must have the same shell/frame color combination. Ordering 2 of Model HMS1, HMS2 will result in 2 cartons being shipped, giving you 8 chairs.

**HON Recommendation: HMS1.N.ON.Y - List Price \$1146**

SEATING

## HOW TO SPECIFY

<p><b>Select Model Number</b></p> <p>HMS1 .</p> <p>HMS2 .</p>	<p><b>Select Arm Type</b></p> <p>F Fixed Arms (+ \$33 per chair)</p> <p>N Armless</p> <p>N .</p> <p>N .</p>	<p><b>Select Shell Color</b></p> <p>RG Tangelo    LO Loft</p> <p>CR Cherry    PT Platinum</p> <p>LM Lime       SD Shadow</p> <p>CP Calypso   LA Lava</p> <p>BU Surf       ON Onyx</p> <p>RE Regatta   WT White</p> <p>MB Mulberry</p> <p>ON .</p> <p>ON .</p>	<p><b>Select Fabric</b></p> <p>See page 409</p> <p><i>For HMS2 model only</i></p> <p>CU10 .</p>	<p><b>Select Frame</b></p> <p>See page 409</p> <p>BLCK</p> <p>BLCK</p>
---	---	---	---	--



# MOTIVATE® High-Density Sled Base Chairs

## HMSGLD



### GLIDES FOR MOTIVATE® HIGH-DENSITY STACKER

- Kit includes 48 glides for 12 chairs
- Field installed
- Snap-on using existing locations on frames

### DIMENSIONS

Ship Weight: 1  
Cube: 0.2

### LIST PRICE

\$90

## HMSFLTGLD



### FELT GLIDES FOR MOTIVATE® HIGH-DENSITY STACKER

- Kit includes 48 glides for 12 chairs
- Field installed
- Snap-on using existing locations on frames

### DIMENSIONS

Ship Weight: 1  
Cube: 0.2

### LIST PRICE

\$226

## HMSSTLGLD



### STEEL GLIDES FOR MOTIVATE® HIGH-DENSITY STACKER

- Kit includes 48 glides for 12 chairs
- Field installed
- Snap-on using existing locations on frames

### DIMENSIONS

Ship Weight: 1  
Cube: 0.2

### LIST PRICE

\$226

## HMSGANG

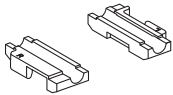

### GANGING CONNECTORS FOR MOTIVATE® HIGH-DENSITY STACKER

- 48 ganging connectors
- Requires 4 connectors per ganging connection
- For use on HMS1.N and HMS2.N only (armless models)
- Field installed
- Snap-on using existing locations on frames

### DIMENSIONS

Ship Weight: 1  
Cube: 0.2

### LIST PRICE

\$164

Floor Covering	TYPE OF GLIDE		
	Polycarbonate/Nylon	Felt	Steel
Carpet	Best	Not Recommended	Good
Polished concrete	Best	Good	Not Recommended
Hard wood	Not Recommended	Best	Not Recommended
Vinyl (includes LVT)	Best	Better	Good
VCT	Best	Good	Not Recommended
Tile (Porcelain/Ceramic)	Best	Good	Not Recommended





## HOW TO SPECIFY

Select Model Number

H M S G L D

# MOTIVATE® 4-Leg Chair Options

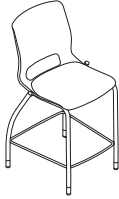
## MODEL OPTIONS

HMG1	HMG2	HMG3	HMG4	HMG5	HMG7
					
<b>Stack Chair</b> Four Legs, Set of 2	<b>Stack Chair</b> Four Legs, Upholstered Seat, Set of 2	<b>Counter-Height Stool</b> Four Legs	<b>Counter-Height Stool</b> Four Legs, Upholstered Seat	<b>Café-Height Stool</b> Four Legs	<b>Café-Height Stool</b> Four Legs, Upholstered Seat

ARM STYLE	CODE	DESCRIPTION	PRICE
	<b>F</b>	Fixed Arms	<b>+\$33</b>
	<b>N</b>	Armless	<b>+\$0</b>

CASTERS/ GLIDES	CODE	DESCRIPTION	PRICE
	<b>H</b>	Hard Caster	<b>+\$0</b>
	<b>S</b>	All-Surface Caster	<b>+\$33</b>

*\*Casters only available on HMG1 and HMG2*

FRAME	CODE	DESCRIPTION	PRICE
	<b>P1 PAINT:</b>		<b>+\$0</b>
	<b>CBK</b>	Charblack	
	<b>P7J</b>	Textured Brownstone	
	<b>P7A</b>	Textured Charcoal	
	<b>PK7</b>	Textured Designer White	
	<b>P7L</b>	Textured Loft	
	<b>P7M</b>	Textured Muslin	
	<b>PLAT</b>	Textured Platinum Metallic	
	<b>P8V</b>	Textured Titanium	
	<b>P2 PAINT:</b>		<b>+\$0</b>
	<b>PR8</b>	Textured Silver	
	<b>P3 PAINT:</b>		<b>+\$33</b>
	<b>P8S</b>	Atom	
	<b>PJF</b>	Bullseye	
	<b>P8P</b>	Ember	
	<b>P8N</b>	Ion	
	<b>P8J</b>	Iris	
	<b>P8F</b>	Krypton	
	<b>P8M</b>	Regatta	

	<b>E</b>	Standard Nylon Glide	<b>+\$0</b>
	<b>F</b>	Felt Glide	<b>+\$33</b>
	<b>R</b>	Rubber Glide	<b>+\$33</b>
	<b>T</b>	Steel Glide	<b>+\$33</b>

PLASTIC SHELL COLOR CODES (no upcharge):	Tangelo - <b>RG</b>	Cherry - <b>CR</b>	Lime - <b>LM</b>	Calypso - <b>CP</b>	Surf - <b>BU</b>
	Regatta - <b>RE</b>	Mulberry - <b>MB</b>	Loft - <b>LO</b>	Platinum - <b>PT</b>	Shadow - <b>SD</b>
	Lava - <b>LA</b>	Onyx - <b>ON</b>	White - <b>WT</b>		

NOTES: Upcharges shown on this page are per chair.



# MOTIVATE® 4-Leg Chairs

## HMG1

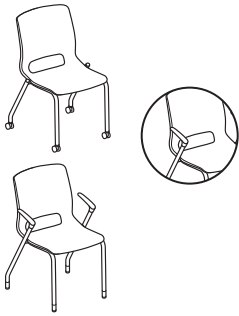

### STACK CHAIR

Four Legs  
Set of 2

### DIMENSIONS

Depth:	23	Arm Width:	18
Width:	21	Seat to Floor Height:	17¾
Height:	32¼	Usable Seat Depth:	18¼
Seat Depth:	18¼	Ship Weight:	38
Seat Width:	17¾	Cube:	13.0
Back Width:	17¼	Weight Rating:	300 lbs.
Back Height:	18		

### LIST PRICE PER CARTON

**\$745**  
**(reference single unit @ \$372.50)**

NOTES: 4-Leg chairs stack 6-high on the floor.

Ships two (2) chairs per carton.

## HMG2

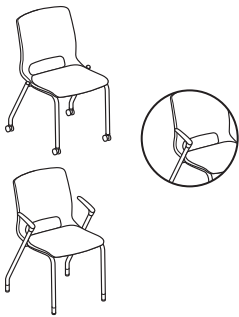

### STACK CHAIR

Four Legs  
Upholstered Seat  
Set of 2

### DIMENSIONS

Depth:	23	Arm Width:	18
Width:	21	Seat to Floor Height:	18¼
Height:	32¼	Usable Seat Depth:	18¼
Seat Depth:	18¼	Ship Weight:	44
Seat Width:	17¾	Cube:	13.0
Back Width:	17¼	COM (per 2 pack):	1.0
Back Height:	17½	Weight Rating:	300 lbs.

### FABRIC PRICE CODES

<b>1</b>	<b>\$917</b>	<b>8</b>	<b>\$1067</b>
<b>2</b>	<b>\$944</b>	<b>9</b>	<b>\$1086</b>
<b>3</b>	<b>\$970</b>	<b>10</b>	<b>\$1105</b>
<b>4</b>	<b>\$989</b>	<b>11</b>	<b>\$1125</b>
<b>5</b>	<b>\$1008</b>	<b>12</b>	<b>\$1144</b>
<b>6</b>	<b>\$1028</b>	<b>L</b>	<b>—</b>
<b>7</b>	<b>\$1047</b>		

NOTES: 4-Leg chairs stack 6-high on the floor.

Motivate® 4-leg Chairs are ordered and shipped two (2) chairs per carton. Pricing shown is per carton. Each set of two chairs (one carton), must have the same shell/frame color combination. Ordering 2 of Model HMG1, HMG2 will result in 2 cartons being shipped, giving you 4 chairs. 4-Leg chairs stack 6-high on the floor.

**HON Recommendation: HMG1.N.H.ON.PLAT - List Price \$745**

## HOW TO SPECIFY

Select Model Number	Select Arm Type	Select Caster/Glide	Select Shell Color	Select Fabric	Select Frame
F Fixed Arms (+ \$33 per chair) N Armless	H Hard Caster S All-Surface Caster (+ \$33 per chair) <i>Casters only available on HMG1 and HMG2</i> E Standard Nylon Glide F Felt Glide (+ \$33 per chair) R Rubber Glide (+ \$33 per chair) T Steel Glide (+ \$33 per chair)	RG Tangelo CR Cherry LM Lime CP Calypto BU Surf RE Regatta MB Mulberry	LO Loft PT Platinum SD Shadow LA Lava ON Onyx WT White	See page 409 <i>For HMG2 and HMG4 models only</i>	See page 412
HMG1	N	H	ON		PLAT
HMG2	N	H	ON	CUT0	PLAT

# MOTIVATE® 4-Leg Chairs

GSA SIN 33721



Icon Legend on page 19

## HMG3

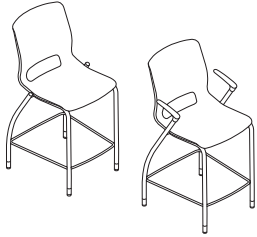

### COUNTER-HEIGHT STOOL

Four Legs

### DIMENSIONS

Depth:	23	Arm Width:	18
Width:	21	Seat to Floor Height:	24½
Height:	40½	Usable Seat Depth:	18½
Seat Depth:	18½	Ship Weight:	26
Seat Width:	17¾	Cube:	13.8
Back Width:	17¼	Weight Rating:	300 lbs.
Back Height:	18		

### LIST PRICE

\$524

## HMG4



### COUNTER-HEIGHT STOOL

Four Legs  
Upholstered Seat

### DIMENSIONS

Depth:	23	Arm Width:	18
Width:	21	Seat to Floor Height:	25
Height:	40½	Usable Seat Depth:	18¼
Seat Depth:	18½	Ship Weight:	26
Seat Width:	17¾	Cube:	13.8
Back Width:	17¼	COM:	1.0
Back Height:	17½	Weight Rating:	300 lbs.

### FABRIC PRICE CODES

<b>1</b>	<b>\$622</b>	<b>8</b>	<b>\$772</b>
<b>2</b>	<b>\$649</b>	<b>9</b>	<b>\$791</b>
<b>3</b>	<b>\$675</b>	<b>10</b>	<b>\$810</b>
<b>4</b>	<b>\$694</b>	<b>11</b>	<b>\$830</b>
<b>5</b>	<b>\$713</b>	<b>12</b>	<b>\$849</b>
<b>6</b>	<b>\$733</b>	<b>L</b>	<b>—</b>
<b>7</b>	<b>\$752</b>		

## HMG5

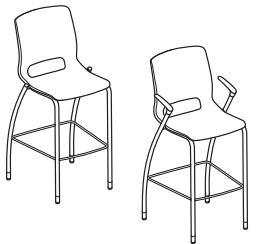

### CAFÉ-HEIGHT STOOL

Four Legs

### DIMENSIONS

Depth:	23	Arm Width:	18
Width:	21	Seat to Floor Height:	30
Height:	44½	Usable Seat Depth:	18½
Seat Depth:	18½	Ship Weight:	30
Seat Width:	17¾	Cube:	19.3
Back Width:	17¼	Weight Rating:	300 lbs.
Back Height:	18		

### LIST PRICE

\$551

## HMG7

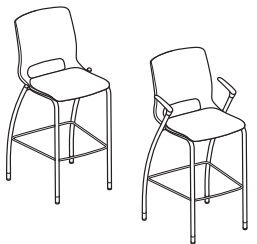

### CAFÉ-HEIGHT STOOL

Four Legs  
Upholstered Seat

### DIMENSIONS

Depth:	23	Arm Width:	18
Width:	21	Seat to Floor Height:	30½
Height:	44½	Usable Seat Depth:	18¼
Seat Depth:	18½	Ship Weight:	34
Seat Width:	17¾	Cube:	19.3
Back Width:	17¼	COM:	1.0
Back Height:	17½	Weight Rating:	300 lbs.

### FABRIC PRICE CODES

<b>1</b>	<b>\$651</b>	<b>8</b>	<b>\$801</b>
<b>2</b>	<b>\$678</b>	<b>9</b>	<b>\$820</b>
<b>3</b>	<b>\$704</b>	<b>10</b>	<b>\$839</b>
<b>4</b>	<b>\$723</b>	<b>11</b>	<b>\$859</b>
<b>5</b>	<b>\$742</b>	<b>12</b>	<b>\$878</b>
<b>6</b>	<b>\$762</b>	<b>L</b>	<b>—</b>
<b>7</b>	<b>\$781</b>		

**HON Recommendation: HMG5.N.E.ON.PLAT - List Price \$551**

## HOW TO SPECIFY

Select Model Number	Select Arm Type	Select Glide	Select Shell Color	Select Fabric	Select Frame
F Fixed Arms (+ \$33 per chair) N Armless	E Standard Nylon Glide F Felt Glide (+ \$33 per chair) R Rubber Glide (+ \$33 per chair) T Steel Glide (+ \$33 per chair)	RG Tangelo CR Cherry LM Lime CP Calypso BU Surf RE Regatta MB Mulberry	LO Loft PT Platinum SD Shadow LA Lava ON Onyx WT White	See page 409 <i>For HMG2 and HMG4 models only</i>	See page 412
HMG5	N	E	ON		PLAT
HMG7	N	E	ON	CUT0	PLAT

# MOTIVATE® Nesting/Stacking Flex-Back Chair Options

## MODEL OPTIONS

HMN1



**Flex-back**

Nesting/Stacking,  
Four Legs

HMN2



**Flex-back**

Nesting/Stacking, Four  
Legs, Upholstered Seat

### ARM STYLE

CODE	DESCRIPTION	PRICE
<b>F</b>	Fixed Arms	<b>+\$55</b>
<b>N</b>	Armless	<b>+\$0</b>



### CASTERS/ GLIDE



CODE	DESCRIPTION	PRICE
<b>H</b>	Hard Caster	<b>+\$0</b>
<b>S</b>	All-Surface Caster	<b>+\$33</b>
<b>E</b>	Standard Nylon Glide	<b>+\$0</b>

### BACK STYLE

CODE	DESCRIPTION	PRICE
<i>Plastic/Upholstered Options:</i>		
<b>PS</b>	Plastic Shell	<b>+\$0</b>
<b>PB</b>	Upholstered	<b>+\$77</b>
<i>*PB only available on HMN2</i>		
<i>4-Way Stretch Options:</i>		
<b>IM</b>	Black	<b>+\$87</b>
<b>IF</b>	Fog	<b>+\$87</b>
<b>IC</b>	Charcoal	<b>+\$87</b>



### FRAME

CODE	DESCRIPTION	PRICE
<b>P1 PAINT:</b>		<b>+\$0</b>
<b>CBK</b>	Charblack	
<b>P7J</b>	Textured Brownstone	
<b>P7A</b>	Textured Charcoal	
<b>PK7</b>	Textured Designer White	
<b>P7L</b>	Textured Loft	
<b>P7M</b>	Textured Muslin	
<b>PLAT</b>	Textured Platinum Metallic	
<b>P8V</b>	Textured Titanium	
<b>P2 PAINT:</b>		<b>+\$0</b>
<b>PR8</b>	Textured Silver	
<b>P3 PAINT:</b>		<b>+\$33</b>
<b>P8S</b>	Atom	
<b>PJF</b>	Bullseye	
<b>P8P</b>	Ember	
<b>P8N</b>	Ion	
<b>P8J</b>	Iris	
<b>P8F</b>	Krypton	
<b>P8M</b>	Regatta	

SEATING

PLASTIC SHELL COLOR CODES (no upcharge):				
Tangelo - <b>RG</b>	Cherry - <b>CR</b>	Lime - <b>LM</b>	Calypso - <b>CP</b>	Surf - <b>BU</b>
Regatta - <b>RE</b>	Mulberry - <b>MB</b>	Loft - <b>LO</b>	Platinum - <b>PT</b>	Shadow - <b>SD</b>
Lava - <b>LA</b>	Onyx - <b>ON</b>	White - <b>WT</b>		



# MOTIVATE® Nesting/Stacking Flex-Back Chairs

GSA SIN 33721



Icon Legend on page 19

## HMN1

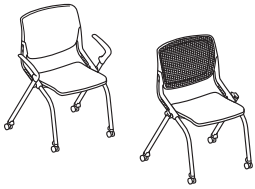

### CHAIR

**Flex-back**  
Nesting/Stacking  
Four Legs

### DIMENSIONS

Depth:	23 <sup>3</sup> / <sub>8</sub>	Arm Width:	24
Width:	26 <sup>3</sup> / <sub>4</sub>	Seat to Floor Height:	18 <sup>1</sup> / <sub>4</sub>
Height:	34	Usable Seat Depth:	16 <sup>3</sup> / <sub>4</sub>
Seat Depth:	16 <sup>3</sup> / <sub>4</sub>	Ship Weight:	27
Seat Width:	17	Cube:	15.1
Back Width:	19 <sup>1</sup> / <sub>2</sub>	Weight Rating:	300 lbs.
Back Height:	19		

### LIST PRICE

**\$625**

NOTES: Stack 4-high on floor.

⚠ When selecting the mesh back option, seat shell will be in the specified shell color chosen but the frame around the mesh will always be black.

## HMN2



### CHAIR

**Flex-back**  
Nesting/Stacking  
Four Legs  
Upholstered Seat

### DIMENSIONS

Depth:	23 <sup>3</sup> / <sub>8</sub>	Seat to Floor Height:	19 <sup>1</sup> / <sub>4</sub>
Width:	26 <sup>3</sup> / <sub>4</sub>	Usable Seat Depth:	17
Height:	34	Ship Weight (upholstered back):	29
Seat Depth:	17	Ship Weight (plastic/mesh back):	28
Seat Width:	17 <sup>3</sup> / <sub>8</sub>	Cube (upholstered back):	15.1
Back Width:	19 <sup>1</sup> / <sub>2</sub>	Cube (plastic/mesh back):	15.1
Back Height:	18 <sup>3</sup> / <sub>8</sub>	COM (upholstered back):	1.0
Arm Width:	24	COM (plastic/mesh back):	1.0
		Weight Rating:	300 lbs.

### FABRIC PRICE CODES

<b>1</b>	<b>\$709</b>	<b>8</b>	<b>\$859</b>
<b>2</b>	<b>\$736</b>	<b>9</b>	<b>\$878</b>
<b>3</b>	<b>\$762</b>	<b>10</b>	<b>\$897</b>
<b>4</b>	<b>\$781</b>	<b>11</b>	<b>\$917</b>
<b>5</b>	<b>\$800</b>	<b>12</b>	<b>\$936</b>
<b>6</b>	<b>\$820</b>	<b>L</b>	<b>—</b>
<b>7</b>	<b>\$839</b>		

NOTES: Stack 4-high on floor.

⚠ When selecting the mesh back option, seat shell will be in the specified shell color chosen but the frame around the mesh will always be black.

**HON Recommendation: HMN2.F.H.IM.ON.CU\_\_PLAT - List Price \$1,851**

SEATING

## HOW TO SPECIFY

Select Model Number	Select Arm Type	Select Caster/Glide	Select Back Type	Select Shell Color	Select Fabric	Select Frame
<p><b>F</b> Fixed Arms (+ \$55)</p> <p><b>N</b> Armless</p>	<p><b>E</b> Standard Nylon Glide</p> <p><b>H</b> Hard Caster</p> <p><b>S</b> All-Surface Caster (+ \$33)</p>	<p><b>PS</b> Plastic Shell</p> <p><b>PB</b> Upholstered (+ \$77)</p> <p><i>PB option available on HMN2 only</i></p> <p>4-Way Stretch options (+ \$87)</p> <p><b>IM</b> Black</p> <p><b>IF</b> Fog</p> <p><b>IC</b> Charcoal</p>	<p><b>RG</b> Tangelo</p> <p><b>CR</b> Cherry</p> <p><b>LM</b> Lime</p> <p><b>CP</b> Calypso</p> <p><b>BU</b> Surf</p> <p><b>RE</b> Regatta</p> <p><b>MB</b> Mulberry</p> <p><b>LO</b> Loft</p> <p><b>PT</b> Platinum</p> <p><b>SD</b> Shadow</p> <p><b>LA</b> Lava</p> <p><b>ON</b> Onyx</p> <p><b>WT</b> White</p>	<p>See page 409</p> <p><i>Specify for model HMN2 only</i></p>	<p>See page 415</p>	
<p>HMN1</p> <p>HMN2</p>	<p>N</p> <p>N</p>	<p>H</p> <p>H</p>	<p>IM</p> <p>PB</p>	<p>ON</p> <p>ON</p>	<p>CU10</p>	<p>PLAT</p> <p>PLAT</p>

# MOTIVATE® Chair with Tablet Arm Options

## MODEL OPTIONS

HMG1



with Tablet Arm

Four Legs

HMG2



with Tablet Arm

Four Legs, Upholstered Seat

### CASTERS/ GLIDES



CODE	DESCRIPTION	PRICE
<b>H</b>	Hard Caster	<b>+\$0</b>



<b>S</b>	All-Surface Caster	<b>+\$33</b>
----------	--------------------	--------------



<b>E</b>	Standard Nylon Glide	<b>+\$0</b>
<b>F</b>	Felt Glide	<b>+\$33</b>
<b>R</b>	Rubber Glide	<b>+\$33</b>
<b>T</b>	Steel Glide	<b>+\$33</b>

### TABLET SIDE



CODE	DESCRIPTION	PRICE
<b>RT</b>	Right Side	<b>+\$0</b>
<b>LT</b>	Left Side	<b>+\$0</b>



### TABLET COLOR

CODE	DESCRIPTION	PRICE
<b>T</b>	Black	<b>+\$0</b>
<b>D</b>	Natural Maple	<b>+\$0</b>

### FRAME

CODE	DESCRIPTION	PRICE
<b>P1 PAINT:</b>		<b>+\$0</b>
<b>CBK</b>	Charblack	
<b>P7J</b>	Textured Brownstone	
<b>P7A</b>	Textured Charcoal	
<b>PK7</b>	Textured Designer White	
<b>P7L</b>	Textured Loft	
<b>P7M</b>	Textured Muslin	
<b>PLAT</b>	Textured Platinum Metallic	
<b>P8V</b>	Textured Titanium	
<b>P2 PAINT:</b>		<b>+\$0</b>
<b>PR8</b>	Textured Silver	
<b>P3 PAINT:</b>		<b>+\$33</b>
<b>P8S</b>	Atom	
<b>PJF</b>	Bullseye	
<b>P8P</b>	Ember	
<b>P8N</b>	Ion	
<b>P8J</b>	Iris	
<b>P8F</b>	Krypton	
<b>P8M</b>	Regatta	

PLASTIC SHELL COLOR CODES (no upcharge):	Tangelo - <b>RG</b>	Cherry - <b>CR</b>	Lime - <b>LM</b>	Calypso - <b>CP</b>	Surf - <b>BU</b>
	Regatta - <b>RE</b>	Mulberry - <b>MB</b>	Loft - <b>LO</b>	Platinum - <b>PT</b>	Shadow - <b>SD</b>
	Lava - <b>LA</b>	Onyx - <b>ON</b>	White - <b>WT</b>		

SEATING

# MOTIVATE<sup>®</sup> Chair with Tablet Arm

GSA SIN 33721



Icon Legend on page 19

## HMGT1

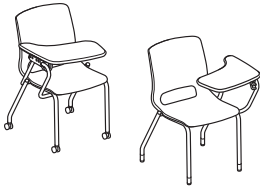

### CHAIR

with Tablet Arm  
Four Legs

### DIMENSIONS

Depth:	30	Back Width:	17¼
Width:	21	Back Height:	18
Height:	32¼	Seat to Floor Height:	17¾
Seat Depth:	18¼	Tablet Height from Floor:	28¾
Seat Width:	17¾	Ship Weight:	41
		Cube:	18.4
		Weight Rating:	300 lbs.

### LIST PRICE

**\$781**

NOTES: Tablet can be specified on right or left side.

❗ Cannot be stacked.

## HMGT2

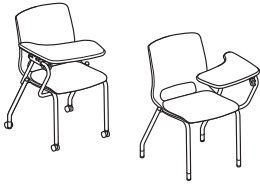

### CHAIR

with Tablet Arm  
Four Legs  
Upholstered Seat

### DIMENSIONS

Depth:	30	Back Width:	17¼
Width:	21	Back Height:	17½
Height:	32¼	Seat to Floor Height:	18¼
Seat Depth:	18¼	Tablet Height from Floor:	28¾
Seat Width:	17¾	Ship Weight:	43
		Cube:	18.4
		Weight Rating:	300 lbs.

### FABRIC PRICE CODES

<b>1</b>	<b>\$890</b>	<b>8</b>	<b>\$1040</b>
<b>2</b>	<b>\$917</b>	<b>9</b>	<b>\$1059</b>
<b>3</b>	<b>\$943</b>	<b>10</b>	<b>\$1078</b>
<b>4</b>	<b>\$962</b>	<b>11</b>	<b>\$1098</b>
<b>5</b>	<b>\$981</b>	<b>12</b>	<b>\$1117</b>
<b>6</b>	<b>\$1001</b>	<b>L</b>	<b>—</b>
<b>7</b>	<b>\$1020</b>		

NOTES: Tablet can be specified on right or left side.

❗ Cannot be stacked.

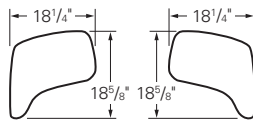

**HON Recommendation: HMGT1.E.ON.RT.D.PLAT - List Price \$781**

SEATING

## HOW TO SPECIFY

Select Model Number	Select Caster/Glide	Select Shell Color	Select Fabric	Select Tablet Side	Select Tablet Color	Select Frame
<p><b>H</b> Hard Caster</p> <p><b>S</b> All-Surface Caster (+ \$33 per chair)</p> <p><b>E</b> Standard Nylon Glide</p> <p><b>F</b> Felt Glide (+ \$33 per chair)</p> <p><b>R</b> Rubber Glide (+ \$33 per chair)</p> <p><b>T</b> Steel Glide (+ \$33 per chair)</p>	<p><b>RG</b> Tangelo</p> <p><b>CR</b> Cherry</p> <p><b>LM</b> Lime</p> <p><b>CP</b> Calypso</p> <p><b>BU</b> Surf</p> <p><b>RE</b> Regatta</p> <p><b>MB</b> Mulberry</p>	<p><b>LO</b> Loft</p> <p><b>PT</b> Platinum</p> <p><b>SD</b> Shadow</p> <p><b>LA</b> Lava</p> <p><b>ON</b> Onyx</p> <p><b>WT</b> White</p>	<p>See page 409</p> <p><i>Not specified for HMGT1 models</i></p>	<p><b>RT</b> Right Side</p> <p><b>LT</b> Left Side</p>	<p><b>T</b> Black</p> <p><b>D</b> Natural</p> <p>Maple</p>	<p>See page 417</p>
<p>HMGT1 .</p> <p>HMGT2 .</p>	<p>E .</p> <p>E .</p>	<p>ON .</p> <p>ON .</p>	<p>CU10 .</p>	<p>RT .</p> <p>RT .</p>	<p>D .</p> <p>D .</p>	<p>PLAT</p> <p>PLAT</p>

# MOTIVATE® Flex-Back Chair with Tablet Arm Options

## MODEL OPTIONS

HMNT1



Flex-back with Tablet Arm

HMNT2



Flex-back with Tablet Arm  
Upholstered Seat

### CASTERS/ GLIDE



CODE	DESCRIPTION	PRICE
<b>H</b>	Hard Caster	<b>+\$0</b>



<b>S</b>	All-Surface Caster	<b>+\$33</b>
----------	--------------------	--------------



<b>E</b>	Standard Nylon Glide	<b>+\$0</b>
----------	----------------------	-------------

### BACK STYLE



CODE	DESCRIPTION	PRICE
<i>Plastic/Upholstered Options:</i>		
<b>PS</b>	Plastic Shell	<b>+\$0</b>



<b>PB</b>	Upholstered	<b>+\$77</b>
-----------	-------------	--------------



*4-Way Stretch Options:*

<b>IM</b>	Black	<b>+\$87</b>
<b>IF</b>	Fog	<b>+\$87</b>
<b>IC</b>	Charcoal	<b>+\$87</b>

### TABLET SIDE



CODE	DESCRIPTION	PRICE
<b>RT</b>	Right Side	<b>+\$0</b>
<b>LT</b>	Left Side	<b>+\$0</b>



### TABLET COLOR

CODE	DESCRIPTION	PRICE
<b>T</b>	Black	<b>+\$0</b>
<b>D</b>	Natural Maple	<b>+\$0</b>

### FRAME

CODE	DESCRIPTION	PRICE
<b>P1 PAINT:</b>		<b>+\$0</b>
<b>CBK</b>	Charblack	
<b>P7J</b>	Textured Brownstone	
<b>P7A</b>	Textured Charcoal	
<b>PK7</b>	Textured Designer White	
<b>P7L</b>	Textured Loft	
<b>P7M</b>	Textured Muslin	
<b>PLAT</b>	Textured Platinum Metallic	
<b>P8V</b>	Textured Titanium	
<b>P2 PAINT:</b>		<b>+\$0</b>
<b>PR8</b>	Textured Silver	
<b>P3 PAINT:</b>		<b>+\$33</b>
<b>P8S</b>	Atom	
<b>PJF</b>	Bullseye	
<b>P8P</b>	Ember	
<b>P8N</b>	Ion	
<b>P8J</b>	Iris	
<b>P8F</b>	Krypton	
<b>P8M</b>	Regatta	

PLASTIC SHELL COLOR CODES (no upcharge):		Tangelo - <b>RG</b>	Cherry - <b>CR</b>	Lime - <b>LM</b>	Calypso - <b>CP</b>	Surf - <b>BU</b>
		Regatta - <b>RE</b>	Mulberry - <b>MB</b>	Loft - <b>LO</b>	Platinum - <b>PT</b>	Shadow - <b>SD</b>
		Lava - <b>LA</b>	Onyx - <b>ON</b>	White - <b>WT</b>		

SEATING

# MOTIVATE® Flex-Back Chair with Tablet Arm

GSA SIN 33721



Icon Legend on page 19

## HMNT1

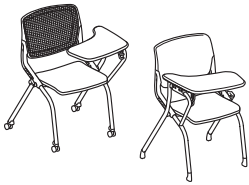

### CHAIR

**Flex-back with Tablet Arm**

### DIMENSIONS

Depth:	30 <sup>3</sup> / <sub>8</sub>	Seat to Floor Height:	18 <sup>1</sup> / <sub>4</sub>
Width:	23 <sup>1</sup> / <sub>2</sub>	Tablet Height from Floor:	29 <sup>1</sup> / <sub>2</sub>
Height:	34	Ship Weight:	41
Seat Depth:	17 <sup>1</sup> / <sub>4</sub>	Cube:	18.4
Seat Width:	17	Weight Rating:	300 lbs.
Back Width:	19 <sup>1</sup> / <sub>2</sub>		
Back Height:	19		

### LIST PRICE

**\$1071**

NOTES: Tablet can be specified on right or left side.

- ❗ Model HMNT1 is not available with an upholstered back.
- ❗ When selecting the mesh back option, seat shell will be in the specified shell color chosen but the frame around the mesh will always be black.
- ❗ Cannot be nested or stacked.

## HMNT2

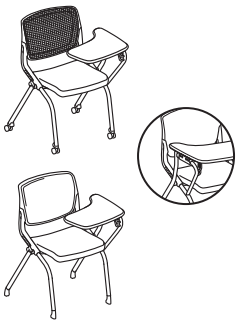

### CHAIR

**Flex-back with Tablet Arm**  
Upholstered Seat

### DIMENSIONS

Depth:	30 <sup>3</sup> / <sub>8</sub>	Seat to Floor Height:	19 <sup>1</sup> / <sub>4</sub>
Width:	23 <sup>1</sup> / <sub>2</sub>	Tablet Height from Floor:	29 <sup>1</sup> / <sub>2</sub>
Height:	34	Ship Weight:	42
Seat Depth:	17 <sup>5</sup> / <sub>8</sub>	Cube:	18.4
Seat Width:	17 <sup>3</sup> / <sub>8</sub>	Weight Rating:	300 lbs.
Back Width:	19 <sup>1</sup> / <sub>2</sub>		
Back Height:	18 <sup>3</sup> / <sub>8</sub>		

### FABRIC PRICE CODES

<b>1</b>	<b>\$1180</b>	<b>8</b>	<b>\$1330</b>
<b>2</b>	<b>\$1207</b>	<b>9</b>	<b>\$1349</b>
<b>3</b>	<b>\$1233</b>	<b>10</b>	<b>\$1368</b>
<b>4</b>	<b>\$1252</b>	<b>11</b>	<b>\$1388</b>
<b>5</b>	<b>\$1271</b>	<b>12</b>	<b>\$1407</b>
<b>6</b>	<b>\$1291</b>	<b>L</b>	<b>—</b>
<b>7</b>	<b>\$1310</b>		

NOTES: Tablet can be specified on right or left side.

- ❗ When selecting the mesh back option, seat shell will be in the specified shell color chosen but the frame around the mesh will always be black.
- ❗ Cannot be nested or stacked.

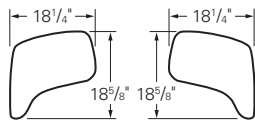

**HON Recommendation: HMNT1.E.IM.ON.RT.D.PLAT - List Price \$1158**

## HOW TO SPECIFY

SEATING

Select Model Number	Select Caster/Glide	Select Back Type	Select Shell Color	Select Fabric	Select Tablet Side	Select Tablet Color	Select Frame
<p><b>E</b> Standard Nylon Guide</p> <p><b>H</b> Hard Caster</p> <p><b>S</b> All-Surface Caster (+ \$33)</p>	<p><b>PS</b> Plastic Shell</p> <p><b>PB</b> Upholstered (+ \$77)</p> <p><i>PB option not available on HMNT1</i></p> <p>4-Way Stretch options (+ \$87)</p> <p><b>IM</b> Black</p> <p><b>IF</b> Fog</p> <p><b>IC</b> Charcoal</p>	<p><b>RG</b> Tangelo</p> <p><b>CR</b> Cherry</p> <p><b>LM</b> Lime</p> <p><b>CP</b> Calypso</p> <p><b>BU</b> Surf</p> <p><b>RE</b> Regatta</p> <p><b>MB</b> Mulberry</p> <p><b>LO</b> Loft</p> <p><b>PT</b> Platinum</p> <p><b>SD</b> Shadow</p> <p><b>LA</b> Lava</p> <p><b>ON</b> Onyx</p> <p><b>WT</b> White</p>	<p>See page 409</p> <p><i>Specify for model HMNT2 only</i></p>	<p><b>RT</b> Right Side</p> <p><b>LT</b> Left Side</p>	<p><b>T</b> Black</p> <p><b>D</b> Natural Maple</p>	<p>See page 419</p>	
<p>HMNT1</p>	<p>E</p>	<p>IM</p>	<p>ON</p>	<p>CU10</p>	<p>RT</p>	<p>D</p>	<p>PLAT</p>
<p>HMNT2</p>	<p>E</p>	<p>PB</p>	<p>ON</p>	<p>CU10</p>	<p>RT</p>	<p>D</p>	<p>PLAT</p>



Nucleus® Task Seating shown  
with Voi® Desk and Storage.

## NUCLEUS®

Experience comfort from the inside out. Nucleus® puts the science into seating, combining a sophisticated, high-tech aesthetic with meticulously researched ergonomic support. The 4-Way Stretch Mesh back flexes with the spine while the seat cradles you like a hammock, creating your very own custom fit with targeted support. The modern style features an organic, rounded look, making Nucleus® the family of seating that brings cool and comfortable together.



## FEATURES

- Advanced suspension material in the seat combines with molded foam to create unparalleled support.
- 4-Way Stretch Mesh flexes in every direction to dynamically move with you — available in 7 colors.
- Choose between armless, fixed arms, height and width adjustable, or all-adjustable arms.
- Task chairs are available in three different cylinder height options so you can find your perfect fit.
- Optional adjustable lumbar allows users to tailor their support — available in 8 colors.
- Choose from 3 frame options: Black, Titanium, and Designer White.
- Task Stools feature an adjustable footring for additional lower body support.
- Stacking chairs stack up to four high on the floor.
- Guest chairs are available with glides, hard, or all-surface casters.
- Warranted for users up to 300 lbs.
- Guest back pivots for added comfort.

# NUCLEUS<sup>®</sup> Task Chair Options

## MODEL OPTIONS

HNRI,  
HNRIKD





Task Chair

HNRS



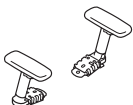
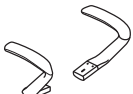

Task Stool

ARM STYLE	CODE	DESCRIPTION	PRICE
	<b>N</b>	Armless	<b>+\$0</b>
	<b>F</b>	Fixed Arms	<b>+\$71</b>
	<b>A</b>	Height and Width Adjustable Arms	<b>+\$92</b>
	<b>V</b>	All-Adjustable Arms (includes Pivot)	<b>+\$141</b>
	<b>P</b>	Fixed Polished Aluminum Arms	<b>+\$189</b>

CYLINDER	CODE	DESCRIPTION	PRICE
	<b>STC</b>	Standard Cylinder	<b>+\$0</b>
	<b>SHC</b>	Short Cylinder	<b>+\$0</b>
	<b>TLC</b>	Tall Cylinder	<b>+\$0</b>
	<b>SC2</b>	Stool Cylinder	<b>+\$0</b>

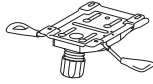
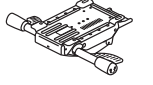
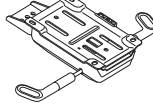
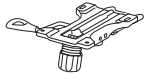
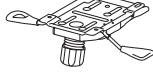
\*SC2 only available on model HNRS

MECHANISM	CODE	DESCRIPTION	PRICE
	<b>Y1</b>	Synchro-Tilt w/ Seat Slider A, D, E, J, K, L	<b>+\$22</b>
	<b>Y2</b>	Advanced Synchro-Tilt A, D, E, J, L, A-D	<b>+\$71</b>
	<b>W2</b>	Weight-Activated with Seat Slider A, D, E, L, P	<b>+\$71</b>
	<b>S0</b>	Limited Recline Synchro-Tilt A, E, J, K, L	<b>+\$0</b>
	<b>S1</b>	Limited Recline Synchro-Tilt w/ Seat Slider A, D, E, J, K, L	<b>+\$22</b>

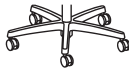
BASE	CODE	DESCRIPTION	PRICE
	<b>SB</b>	Standard Base	<b>+\$0</b>
	<b>PA</b>	Polished Aluminum	<b>+\$119</b>

NOTES: Limited finish, control, and arm options depending on base model. See product pages for details.

# NUCLEUS<sup>®</sup> Task Chair Options

## CASTERS



CODE	DESCRIPTION	PRICE
<b>H</b>	Black Hard Caster	<b>+\$0</b>



<b>S</b>	Black All-Surface Caster	<b>+\$44</b>
----------	--------------------------	--------------



<b>TS</b>	Titanium All-Surface Caster	<b>+\$44</b>
-----------	-----------------------------	--------------



<b>R</b>	Roll Control Caster	<b>+\$55</b>
----------	---------------------	--------------



<b>G</b>	Bell Glide	<b>+\$28</b>
----------	------------	--------------

## BACK STYLE

CODE	DESCRIPTION	PRICE
------	-------------	-------

*4-Way Stretch mesh back options:*

<b>IM</b>	Black	<b>+\$0</b>
<b>IB</b>	Breeze	<b>+\$0</b>
<b>IK</b>	Brownstone	<b>+\$0</b>
<b>IC</b>	Charcoal	<b>+\$0</b>
<b>IF</b>	Fog	<b>+\$0</b>
<b>IR</b>	Regatta	<b>+\$0</b>
<b>IT</b>	Titanium	<b>+\$0</b>

## FRAME

CODE	DESCRIPTION	PRICE
<b>T</b>	Black	<b>+\$0</b>

*Model HNR1 and HNRS available with above Frame option along with those below:*

		<u>Task</u>	<u>Stool</u>
<b>TI</b>	Titanium	<b>+\$39</b>	<b>+\$60</b>
<b>DWX</b>	Designer White	<b>+\$39</b>	<b>+\$60</b>

## LUMBAR

CODE	DESCRIPTION	PRICE
<b>NL</b>	No Lumbar	<b>+\$0</b>
<b>BL</b>	Black	<b>+\$33</b>
<b>TL</b>	Titanium	<b>+\$33</b>
<b>DW</b>	Designer White	<b>+\$33</b>
<b>BY</b>	Bullseye	<b>+\$33</b>
<b>KT</b>	Krypton	<b>+\$33</b>
<b>MR</b>	Ember	<b>+\$33</b>
<b>RE</b>	Regatta	<b>+\$33</b>
<b>IR</b>	Iris	<b>+\$33</b>



# NUCLEUS®

## Guest and Multi-Purpose Options

### MODEL OPTION

HNR6



Guest Chair

Four Legs

#### ARM STYLE



HNR6 Fixed Arms

CODE	DESCRIPTION	PRICE
<b>N</b>	Armless	<b>+\$0</b>
<b>F</b>	Fixed Arms	<b>+\$33</b>

#### CASTERS/ GLIDE



CODE	DESCRIPTION	PRICE
<b>H</b>	Black Hard Caster	<b>+\$0</b>
<b>S</b>	Black All-Surface Caster	<b>+\$33</b>
<b>E</b>	Glide	<b>+\$0</b>

#### BACK STYLE

4-Way Stretch mesh back options:

<b>IM</b>	Black	<b>+\$0</b>
<b>IB</b>	Breeze	<b>+\$0</b>
<b>IK</b>	Brownstone	<b>+\$0</b>
<b>IC</b>	Charcoal	<b>+\$0</b>
<b>IF</b>	Fog	<b>+\$0</b>
<b>IR</b>	Regatta	<b>+\$0</b>
<b>IT</b>	Titanium	<b>+\$0</b>



HNR6 back pivots to flex to the desired position.  
Available on HNR6 only.

#### FRAME COLOR

CODE	DESCRIPTION	PRICE
<b>T</b>	Black	<b>+\$0</b>
<b>DWX</b>	Designer White	<b>+\$39</b>
<b>TI</b>	Titanium	<b>+\$39</b>

#### BASE PAINT COLOR

CODE	DESCRIPTION	PRICE
<i>Model HNR6 available in the following Frame options:</i>		
<b>P71</b>	Black	<b>+\$0</b>
<b>CBK</b>	Charblack	<b>+\$0</b>
<b>P8V</b>	Textured Titanium	<b>+\$39</b>
<b>PK7</b>	Textured Designer White	<b>+\$39</b>

### HON BRANDED FABRICS

#### GRADE 1

Apex  
Centurion  
Compass  
Contourett  
Dapper  
Ensemble  
Hamilton  
Inertia  
Noble Seating  
Optic  
Pebble  
Vibe

#### GRADE 2

Appoint Seating  
Blume  
Clyde  
Dotty  
Kai  
Rush  
Spin Seating  
Wavelength  
Whisper Vinyl

#### GRADE 3

Bradbury  
Getaway  
Moxie  
Notion  
Parker  
Purl  
Quill  
Saxony

#### GRADE 4

Constance with Supreen™  
Livi with Supreen™  
Lugano with Supreen™  
Oxford with Supreen™

#### GRADE L

Davenport Leather\*

**For a complete list of fabrics, including partnership fabrics, go to [hon.com/fabricsandfinishes](https://hon.com/fabricsandfinishes).**

Reference Fabric Color Combinations on pages 20-25 for color codes and legend on page 21 for lead times. For additional HON to Supply COM fabric grade pricing, go to [honready.hon.com](https://honready.hon.com) and click on the HON to Supply COM link.

\*Davenport Leather available on Nucleus<sup>®</sup> Recharged models only. Leather not available on Nucleus<sup>®</sup> Guest.

# NUCLEUS® Dimensions

## NUCLEUS® RECHARGED TASK

Control	Y1												
	Arms			Fixed*			2D			4D			
	Cylinder	Standard	Short	Tall	Standard	Short	Tall	Standard	Short	Tall	Standard	Short	Tall
Max Width	29.00	29.00	29.00	29.00	29.00	29.00	29.00	29.00	29.00	29.00	29.00	29.00	29.00
Max Depth	29.00	29.00	29.00	29.00	29.00	29.00	29.00	29.00	29.00	29.00	29.00	29.00	29.00
Max Height	42.75	40.82	46.25	42.75	40.82	46.25	42.75	40.82	46.25	42.75	40.82	46.25	
Chair Weight**	29.20	28.80	29.60	35.50	35.10	35.90	32.90	32.50	33.30	33.10	32.70	33.50	
Shipping Weight**	38.10	37.70	38.50	44.40	44.00	44.80	41.80	41.40	42.20	44.00	41.60	42.40	
Shipping Weight (KD)**	NA	NA	NA	NA	NA	NA	40.80	NA	NA	NA	NA	NA	
Cubes	10.73	10.73	10.73	10.73	10.73	10.73	10.73	10.73	10.73	10.73	10.73	10.73	
Cubes (KD)	NA	NA	NA	NA	NA	NA	7.92	NA	NA	NA	NA	NA	
Seat Width	18.70	18.70	18.70	18.70	18.70	18.70	18.70	18.70	18.70	18.70	18.70	18.70	
Seat Usable Depth	17.91 - 19.76	17.91 - 19.76	17.91 - 19.76	17.91 - 19.76	17.91 - 19.76	17.91 - 19.76	17.91 - 19.76	17.91 - 19.76	17.91 - 19.76	17.91 - 19.76	17.91 - 19.76	17.91 - 19.76	
Seat Height from Floor	16.25 - 20.125	15.68 - 18.20	18.46 - 23.63	16.25 - 20.125	15.68 - 18.20	18.46 - 23.63	16.25 - 20.125	15.68 - 18.20	18.46 - 23.63	16.25 - 20.125	15.68 - 18.20	18.46 - 23.63	
Seat Depth	18	18	18	18	18	18	18	18	18	18	18	18	
Back Lumbar Height	5.9 - 9.4	5.9 - 9.4	5.9 - 9.4	5.9 - 9.4	5.9 - 9.4	5.9 - 9.4	5.9 - 9.4	5.9 - 9.4	5.9 - 9.4	5.9 - 9.4	5.9 - 9.4	5.9 - 9.4	
Back Width	18.63	18.63	18.63	18.63	18.63	18.63	18.63	18.63	18.63	18.63	18.63	18.63	
Back Height	23.94	23.94	23.94	23.94	23.94	23.94	23.94	23.94	23.94	23.94	23.94	23.94	
Seat Angle from Floor	-1.60	-1.60	-1.60	-1.60	-1.60	-1.60	-1.60	-1.60	-1.60	-1.60	-1.60	-1.60	
Seat Angle Reclined	-10.60	-10.60	-10.60	-10.60	-10.60	-10.60	-10.60	-10.60	-10.60	-10.60	-10.60	-10.60	
Back Angle from Seat	94.00	94.00	94.00	94.00	94.00	94.00	94.00	94.00	94.00	94.00	94.00	94.00	
Back Angle Reclined	112.00	112.00	112.00	112.00	112.00	112.00	112.00	112.00	112.00	112.00	112.00	112.00	
Distance Between Arms	NA	NA	NA	30.38	30.38	30.38	16.50 - 19.63	16.50 - 19.63	16.50 - 19.63	16.50 - 19.63	16.50 - 19.63	16.50 - 19.63	
Arm Height from Floor	NA	NA	NA	25 - 28.88	24.43 - 26.95	27.21 - 32.38	24 - 31.88	23.43 - 29.95	26.21 - 35.38	24 - 31.88	23.43 - 22.07	26.21 - 35.38	
Arm Height from Seat	NA	NA	NA	6.63	6.63	6.63	5.69 - 9.5	5.69 - 9.5	5.69 - 9.5	5.69 - 9.5	5.69 - 9.5	5.69 - 9.5	
Arm Width	NA	NA	NA	2.25	2.25	2.25	3.19	3.19	3.19	3.19	3.19	3.19	
Arm Length	NA	NA	NA	9.84	9.84	9.84	10.16	10.16	10.16	10.16	10.16	10.16	
Arm Set-Back	NA	NA	NA	2.99 - 4.94	2.99 - 4.95	2.99 - 4.96	3.93 - 5.78	3.93 - 5.78	3.93 - 5.78	3.93 - 5.78	3.93 - 5.78	3.93 - 5.78	

Control	Y2												
	Arms			Fixed*			2D			4D			
	Cylinder	Standard	Short	Tall	Standard	Short	Tall	Standard	Short	Tall	Standard	Short	Tall
Max Width	29.00	29.00	29.00	29.00	29.00	29.00	29.00	29.00	29.00	29.00	29.00	29.00	29.00
Max Depth	29.00	29.00	29.00	29.00	29.00	29.00	29.00	29.00	29.00	29.00	29.00	29.00	29.00
Max Height	43.38	41.45	46.88	43.38	41.45	46.88	43.38	41.45	46.88	43.38	41.45	46.88	
Chair Weight**	31.20	30.80	31.60	37.50	37.10	37.90	34.90	34.50	35.30	35.10	34.70	35.50	
Shipping Weight**	40.10	39.70	40.50	46.40	46.00	46.80	43.80	43.40	44.20	44.00	43.60	44.40	
Shipping Weight (KD)**	NA	NA	NA	NA	NA	NA	40.80	NA	NA	NA	NA	NA	
Cubes	10.73	10.73	10.73	10.73	10.73	10.73	10.73	10.73	10.73	10.73	10.73	10.73	
Cubes (KD)	NA	NA	NA	NA	NA	NA	7.92	NA	NA	NA	NA	NA	
Seat Width	18.70	18.70	18.70	18.70	18.70	18.70	18.70	18.70	18.70	18.70	18.70	18.70	
Seat Usable Depth	18.27 - 21.06	18.27 - 21.06	18.27 - 21.06	18.27 - 21.06	18.27 - 21.06	18.27 - 21.06	18.27 - 21.06	18.27 - 21.06	18.27 - 21.06	18.27 - 21.06	18.27 - 21.06	18.27 - 21.06	
Seat Height from Floor	16.63 - 21.13	16.06 - 19.20	18.84 - 24.63	16.63 - 21.13	16.06 - 19.20	18.84 - 24.63	16.63 - 21.13	16.06 - 19.20	18.84 - 24.63	16.63 - 21.13	16.06 - 19.20	18.84 - 24.63	
Seat Depth	18	18	18	18	18	18	18	18	18	18	18	18	
Back Lumbar Height	5.9 - 9.4	5.9 - 9.4	5.9 - 9.4	5.9 - 9.4	5.9 - 9.4	5.9 - 9.4	5.9 - 9.4	5.9 - 9.4	5.9 - 9.4	5.9 - 9.4	5.9 - 9.4	5.9 - 9.4	
Back Width	18.63	18.63	18.63	18.63	18.63	18.63	18.63	18.63	18.63	18.63	18.63	18.63	
Back Height	23.75	23.75	23.75	23.75	23.75	23.75	23.75	23.75	23.75	23.75	23.75	23.75	
Seat Angle from Floor	-2.70	-2.70	-2.70	-2.70	-2.70	-2.70	-2.70	-2.70	-2.70	-2.70	-2.70	-2.70	
Seat Angle Reclined	-10.60	-10.60	-10.60	-10.60	-10.60	-10.60	-10.60	-10.60	-10.60	-10.60	-10.60	-10.60	
Back Angle from Seat	94.00	94.00	94.00	94.00	94.00	94.00	94.00	94.00	94.00	94.00	94.00	94.00	
Back Angle Reclined*	111.00	111.00	111.00	111.00	111.00	111.00	111.00	111.00	111.00	111.00	111.00	111.00	
Distance Between Arms	NA	NA	NA	30.38	30.38	30.38	16.50 - 19.63	16.50 - 19.63	16.50 - 19.63	16.50 - 19.63	16.50 - 19.63	16.50 - 19.63	
Arm Height from Floor	NA	NA	NA	25.5 - 29.38	24.93 - 27.45	27.71 - 32.88	24.5 - 32.25	23.93 - 30.32	26.71 - 35.75	24.5 - 32.25	23.93 - 30.32	26.71 - 35.75	
Arm Height from Seat	NA	NA	NA	6.63	6.63	6.63	5.69 - 9.31	5.69 - 9.31	5.69 - 9.31	5.69 - 9.31	5.69 - 9.31	5.69 - 9.31	
Arm Width	NA	NA	NA	2.25	2.25	2.25	3.19	3.19	3.19	3.19	3.19	3.19	
Arm Length	NA	NA	NA	9.84	9.84	9.84	10.16	10.16	10.16	10.16	10.16	10.16	
Arm Set-Back	NA	NA	NA	2.66 - 4.16	2.66 - 4.16	2.66 - 4.16	3.97 - 6.76	3.97 - 6.76	3.97 - 6.76	3.97 - 6.76	3.97 - 6.76	3.97 - 6.76	

Weight  
Adds

\*\*Base Polished Aluminum = 1.40 lbs.  
\*Fixed Arm Polished Aluminum = 1.50 lbs.

## NUCLEUS® RECHARGED TASK

Control	W2											
	Armless			Fixed*			2D			4D		
Arms												
Cylinder	Standard	Short	Tall	Standard	Short	Tall	Standard	Short	Tall	Standard	Short	Tall
Max Width	29.00	29.00	29.00	29.00	29.00	29.00	29.00	29.00	29.00	29.00	29.00	29.00
Max Depth	29.00	29.00	29.00	29.00	29.00	29.00	29.00	29.00	29.00	29.00	29.00	29.00
Max Height	43.00	41.07	46.50	42.75	43.00	41.07	46.50	42.75	43.00	41.07	46.50	42.75
Chair Weight**	29.20	28.80	29.60	35.50	35.10	35.90	32.90	32.50	33.30	33.10	32.70	33.50
Shipping Weight**	38.10	37.70	38.50	44.40	44.00	44.80	41.80	41.40	42.20	44.00	41.60	42.40
Shipping Weight (KD)**	NA	NA	NA	NA	NA	NA	40.80	NA	NA	NA	NA	NA
Cubes	10.73	10.73	10.73	10.73	10.73	10.73	10.73	10.73	10.73	10.73	10.73	10.73
Cubes (KD)	NA	NA	NA	NA	NA	NA	7.92	NA	NA	NA	NA	NA
Seat Width	18.70	18.70	18.70	18.70	18.70	18.70	18.70	18.70	18.70	18.70	18.70	18.70
Seat Usable Depth	17.88 - 19.80	17.88 - 19.80	17.88 - 19.80	17.88 - 19.80	17.88 - 19.80	17.88 - 19.80	17.88 - 19.80	17.88 - 19.80	17.88 - 19.80	17.88 - 19.80	17.88 - 19.80	17.88 - 19.80
Seat Height from Floor	15.88 - 20	15.30 - 18.07	18.09 - 23.5	15.88 - 20	15.30 - 18.07	18.09 - 23.5	15.88 - 20	15.30 - 18.07	18.09 - 23.5	15.88 - 20	15.30 - 18.07	18.09 - 23.5
Seat Depth	18	18	18	18	18	18	18	18	18	18	18	18
Back Lumbar Height	5.9 - 9.4	5.9 - 9.4	5.9 - 9.4	5.9 - 9.4	5.9 - 9.4	5.9 - 9.4	5.9 - 9.4	5.9 - 9.4	5.9 - 9.4	5.9 - 9.4	5.9 - 9.4	5.9 - 9.4
Back Width	18.63	18.63	18.63	18.63	18.63	18.63	18.63	18.63	18.63	18.63	18.63	18.63
Back Height	23.68	23.68	23.68	23.68	23.68	23.68	23.68	23.68	23.68	23.68	23.68	23.68
Seat Angle from Floor	-0.40	-0.40	-0.40	-0.40	-0.40	-0.40	-0.40	-0.40	-0.40	-0.40	-0.40	-0.40
Seat Angle Reclined	-5.10	-5.10	-5.10	-5.10	-5.10	-5.10	-5.10	-5.10	-5.10	-5.10	-5.10	-5.10
Back Angle from Seat	96.00	96.00	96.00	96.00	96.00	96.00	96.00	96.00	96.00	96.00	96.00	96.00
Back Angle Reclined	115.00	115.00	115.00	115.00	115.00	115.00	115.00	115.00	115.00	115.00	115.00	115.00
Distance Between Arms	NA	NA	NA	30.38	30.38	30.38	16.50 - 19.63	16.50 - 19.63	16.50 - 19.63	16.50 - 19.63	16.50 - 19.63	16.50 - 19.63
Arm Height from Floor	NA	NA	NA	25 - 28.88	24.43 - 26.95	27.21 - 32.38	24.06 - 31.88	23.5 - 29.95	26.27 - 35.38	24.06 - 31.88	23.5 - 29.95	26.27 - 35.38
Arm Height from Seat	NA	NA	NA	6.63	6.63	6.63	5.69 - 9.38	5.69 - 9.38	5.69 - 9.38	5.69 - 9.38	5.69 - 9.38	5.69 - 9.38
Arm Width	NA	NA	NA	2.25	2.25	2.25	3.19	3.19	3.19	3.19	3.19	3.19
Arm Length	NA	NA	NA	9.84	9.84	9.84	10.16	10.16	10.16	10.16	10.16	10.16
Arm Set-Back	NA	NA	NA	2.83 - 4.75	2.83 - 4.75	2.83 - 4.75	3.95 - 5.88	3.95 - 5.88	3.95 - 5.88	3.95 - 5.88	3.95 - 5.88	3.95 - 5.88

Control	S0				S1			
	Armless	Fixed*	2D	4D	Armless	Fixed*	2D	4D
Arms								
Cylinder	Stool	Stool	Stool	Stool	Stool	Stool	Stool	Stool
Max Width	29.00	29.00	29.00	29.00	29.00	29.00	29.00	29.00
Max Depth	29.00	29.00	29.00	29.00	29.00	29.00	29.00	29.00
Max Height	56.50	56.50	56.50	56.50	56.50	56.50	56.50	56.50
Chair Weight**	34.35	40.65	38.05	36.75	35.20	41.50	38.90	37.60
Shipping Weight**	45.35	51.65	49.05	47.75	46.20	52.50	49.90	48.60
Cubes	12.11	12.11	12.11	12.11	12.11	12.11	12.11	12.11
Seat Width	18.70	18.70	18.70	18.70	18.70	18.70	18.70	18.70
Seat Usable Depth	18.50	18.50	18.50	18.50	17.83 - 19.33	17.83 - 19.33	17.83 - 19.33	17.83 - 19.33
Seat Height from Floor	23.44 - 33	23.44 - 33	23.44 - 33	23.44 - 33	23.44 - 33	23.44 - 33	23.44 - 33	23.44 - 33
Seat Depth	18	18	18	18	18	18	18	18
Back Lumbar Height	5.9 - 9.4	5.9 - 9.4	5.9 - 9.4	5.9 - 9.4	5.9 - 9.4	5.9 - 9.4	5.9 - 9.4	5.9 - 9.4
Back Width	18.63	18.63	18.63	18.63	18.63	18.63	18.63	18.63
Back Height	23.94	23.94	23.94	23.94	23.94	23.94	23.94	23.94
Seat Angle from Floor	-1.50	-1.50	-1.50	-1.50	-1.50	-1.50	-1.50	-1.50
Seat Angle Reclined	-7.00	-7.00	-7.00	-7.00	-7.00	-7.00	-7.00	-7.00
Back Angle from Seat	96.00	96.00	96.00	96.00	96.00	96.00	96.00	96.00
Back Angle Reclined*	105.00	105.00	105.00	105.00	105.00	105.00	105.00	105.00
Distance Between Arms	NA	30.38	16.5 - 19.63	16.5 - 19.63	NA	30.38	16.5 - 19.63	16.5 - 19.63
Arm Height from Floor	NA	32.25 - 42.5	31.25 - 45.38	31.25 - 45.38	NA	32.25 - 42.5	31.25 - 45.38	31.25 - 45.38
Arm Height from Seat	NA	6.63	5.63 - 9.5	5.63 - 9.5	NA	6.63	5.63 - 9.5	5.63 - 9.5
Arm Width	NA	2.25	3.19	3.19	NA	2.25	3.19	3.19
Arm Length	NA	9.84	10.16	10.16	NA	9.84	10.16	10.16
Arm Set-Back	NA	2.66 - 4.16	3.66 - 5.16	3.66 - 5.16	NA	2.66 - 4.16	3.66 - 5.16	3.66 - 5.16

Weight  
Adders

\*\*Base Polished Aluminum = 1.40 lbs.  
\*Fixed Arm Polished Aluminum = 1.50 lbs.



## HNRI



### TASK CHAIR

- 4-Way Stretch Back**
- Pneumatic
- Swivel
- Seat Glide
- Synchro-tilt
- Tilt Tension
- Tilt Lock

### DIMENSIONS

Depth:	29	Arm Width:	16½-19¾
Width:	29	Seat to Floor Height:	16¼-20⅞
Height:	42¾	Usable Seat Depth:	18-19¾
Seat Depth:	18	Ship Weight:	41.8
Seat Width:	18¾	Cube:	10.7
Back Width:	18⅞	COM:	1.0
Back Height:	24	Weight Rating:	300 lbs.

### FABRIC PRICE CODES

<b>1</b>	<b>\$843</b>	<b>8</b>	<b>\$993</b>
<b>2</b>	<b>\$870</b>	<b>9</b>	<b>\$1012</b>
<b>3</b>	<b>\$896</b>	<b>10</b>	<b>\$1031</b>
<b>4</b>	<b>\$915</b>	<b>11</b>	<b>\$1051</b>
<b>5</b>	<b>\$934</b>	<b>12</b>	<b>\$1070</b>
<b>6</b>	<b>\$954</b>	<b>L</b>	<b>\$1142</b>
<b>7</b>	<b>\$973</b>		

**HON Recommendation: HNRI.Y2.STC.A.H.IM.CU\_\_BL.SB.T - List Price \$1039**

## HOW TO SPECIFY

Select Model Number	Select Control Type	Select Cylinder	Select Arm Type	Select Caster	Select Back Type	Select Fabric	Select Lumbar	Select Base	Select Frame
<p><b>Y1</b> Synchro-Tilt w/ Seat Slider (+ \$22)</p> <p><b>Y2</b> Advanced Synchro-Tilt (+ \$71)</p> <p><b>W2</b> Weight-Activated w/ Seat Slider (+ \$71)</p>	<p><b>STC</b> Standard</p> <p><b>SHC</b> Short Cylinder</p> <p><b>TLC</b> Tall Cylinder</p>	<p><b>N</b> Armless</p> <p><b>A</b> Height and Width Adjustable Arms (+ \$92)</p> <p><b>V</b> All-Adjustable Arms (+ \$141)</p> <p><b>F</b> Fixed Arms (+ \$71)</p> <p><b>P</b> Fixed Polished (+ \$189)</p>	<p><b>H</b> Hard Caster</p> <p><b>S</b> Black All-Surface Caster (+ \$44)</p> <p><b>TS</b> Titanium All-Surface Caster (+ \$44)</p> <p><b>R</b> Roll Control Caster (+ \$55)</p> <p><b>G</b> Bell Glide (+ \$28)</p>	<p>See page 423</p> <p>See page 425</p>	<p>See page 423</p> <p><i>Adding lumbar adds + \$33 upcharge</i></p>	<p><b>SB</b> Standard Base</p> <p><b>PA</b> Polished Aluminum (+ \$119)</p>	<p><b>DWX</b> Designer White (+ \$39)</p>		
HNRI	Y1	STC	A	S	IM	CU10	DW	SB	DWX



Icon Legend on page 19

# NUCLEUS®

## HNR1KD



### TASK CHAIR KD

#### 4-Way Stretch Back

- Pneumatic
- Swivel
- Seat Glide
- Synchro-tilt
- Tilt Tension
- Tilt Lock

### DIMENSIONS

Depth:	29	Arm Width:	16½-19¾
Width:	29	Seat to Floor Height:	16¼-20½
Height:	42¾	Usable Seat Depth:	18-19¾
Seat Depth:	18	Ship Weight:	40.8
Seat Width:	18¾	Cube:	10.7
Back Width:	18⅝	COM:	1.0
Back Height:	24	Weight Rating:	300 lbs.

### FABRIC PRICE CODES

<b>1</b>	<b>\$803</b>	<b>8</b>	<b>\$953</b>
<b>2</b>	<b>\$830</b>	<b>9</b>	<b>\$972</b>
<b>3</b>	<b>\$856</b>	<b>10</b>	<b>\$991</b>
<b>4</b>	<b>\$875</b>	<b>11</b>	<b>\$1011</b>
<b>5</b>	<b>\$894</b>	<b>12</b>	<b>\$1030</b>
<b>6</b>	<b>\$914</b>	<b>L</b>	<b>\$1102</b>
<b>7</b>	<b>\$933</b>		

ⓘ KD (Knock Down) requires arm, back, and cylinder assembly on site.

**HON Recommendation: HNR1KD.Y2.STC.A.H.IM.CU\_\_BL.SB.T - List Price \$999**

## HOW TO SPECIFY

Select Model Number	Select Control Type	Select Cylinder	Select Arm Type	Select Caster	Select Back Type	Select Fabric	Select Lumbar	Select Base	Select Frame
<b>Y1</b> Synchro-Tilt w/ Seat Slider (+ \$22) <b>Y2</b> Advanced Synchro-Tilt (+ \$71) <b>W2</b> Weight-Activated w/ Seat Slider (+ \$71)	<b>STC</b> Standard	<b>N</b> Armless <b>A</b> Height and Width Adjustable Arms (+ \$92)	<b>H</b> Hard Caster	See page 423	See page 425	See page 423 <i>Adding lumbar adds + \$33 upcharge</i>	<b>SB</b> Standard Base <b>PA</b> Polished Aluminum (+ \$119)	<b>DWX</b> Designer White (+ \$39)	
<b>HNR1KD</b>	<b>Y1</b>	<b>STC</b>	<b>A</b>	<b>H</b>	<b>IM</b>	<b>CU10</b>	<b>DW</b>	<b>SB</b>	<b>DWX</b>



## HNRS



### TASK STOOL

- 4-Way Stretch Back**
- Pneumatic
- Swivel
- Seat Glide
- Synchro-tilt
- Tilt Tension
- Tilt Lock

### DIMENSIONS

Depth:	29	Arm Width:	16½-19¾
Width:	29	Seat to Floor Height:	23¾-33
Height:	56½	Usable Seat Depth:	17⅞-19¾
Seat Depth:	18	Ship Weight:	49.9
Seat Width:	18¾	Cube:	12.11
Back Width:	18⅞	COM:	1.0
Back Height:	24	Weight Rating:	300 lbs.

### FABRIC PRICE CODES

<b>1</b>	<b>\$970</b>	<b>8</b>	<b>\$1120</b>
<b>2</b>	<b>\$997</b>	<b>9</b>	<b>\$1139</b>
<b>3</b>	<b>\$1023</b>	<b>10</b>	<b>\$1158</b>
<b>4</b>	<b>\$1042</b>	<b>11</b>	<b>\$1178</b>
<b>5</b>	<b>\$1061</b>	<b>12</b>	<b>\$1197</b>
<b>6</b>	<b>\$1081</b>	<b>L</b>	<b>\$1269</b>
<b>7</b>	<b>\$1100</b>		

**HON Recommendation: HNRS.S1.SC2.A.H.IM.CU\_\_BL.SB.T - List Price \$1117**

## HOW TO SPECIFY

Select Model Number	Select Control Type	Select Cylinder	Select Arm Type	Select Caster	Select Back Type	Select Fabric	Select Lumbar	Select Base	Select Frame
HNRS	<ul style="list-style-type: none"> <li><b>SO</b> Limited Recline Synchro-Tilt</li> <li><b>S1</b> Limited Recline Synchro-Tilt w/ Seat Slider (+ \$22)</li> </ul>	<ul style="list-style-type: none"> <li><b>SC2</b> Stool Cylinder</li> </ul>	<ul style="list-style-type: none"> <li><b>N</b> Armless</li> <li><b>A</b> Height and Width Adjustable Arms (+ \$92)</li> <li><b>V</b> All-Adjustable Arms (+ \$141)</li> <li><b>F</b> Fixed Arms (+ \$71)</li> <li><b>P</b> Fixed Polished (+ \$189)</li> </ul>	<ul style="list-style-type: none"> <li><b>H</b> Black Hard Caster</li> <li><b>S</b> Black All-Surface Caster (+ \$44)</li> <li><b>TS</b> Titanium All-Surface Caster (+ \$44)</li> <li><b>R</b> Roll Control Caster (+ \$55)</li> <li><b>G</b> Bell Glide (+ \$28)</li> </ul>	See page 423	See page 425	See page 423	<ul style="list-style-type: none"> <li><b>SB</b> Standard Base</li> <li><b>PA</b> Polished Aluminum (+ \$119)</li> </ul>	<ul style="list-style-type: none"> <li><b>DWX</b> Designer White (+ \$60)</li> </ul>
HNRS	S1	SC2	A	S	IM	CU10	DW	SB	DWX



## HNR6

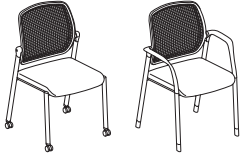

### GUEST CHAIR

**4-Way Stretch Back**  
Four Legs

### DIMENSIONS

Depth:	23½	Arm Width:	21-24 <sup>15</sup> / <sub>16</sub>
Width:	20 <sup>5</sup> / <sub>16</sub>	Seat to Floor Height:	17 <sup>5</sup> / <sub>8</sub>
Height:	36 <sup>3</sup> / <sub>8</sub>	Usable Seat Depth:	17 <sup>11</sup> / <sub>16</sub>
Seat Depth:	19½	Ship Weight:	20
Seat Width:	19	Cube:	15.8
Back Width:	17	COM:	1.0
Back Height:	19 <sup>9</sup> / <sub>16</sub>	Weight Rating:	300 lbs.

### FABRIC PRICE CODES

<b>1</b>	<b>\$623</b>	<b>8</b>	<b>\$773</b>
<b>2</b>	<b>\$650</b>	<b>9</b>	<b>\$792</b>
<b>3</b>	<b>\$676</b>	<b>10</b>	<b>\$811</b>
<b>4</b>	<b>\$695</b>	<b>11</b>	<b>\$831</b>
<b>5</b>	<b>\$714</b>	<b>12</b>	<b>\$850</b>
<b>6</b>	<b>\$734</b>	<b>L</b>	<b>\$922</b>
<b>7</b>	<b>\$753</b>		

NOTES: Back includes pivot for added comfort.

**HON Recommendation: HNR6.F.E.IM.CU\_\_T.P71 - List Price \$656**

## HOW TO SPECIFY

Select Model Number	Select Arm Type	Select Caster/Glide	Select Back Type	Select Fabric	Select Frame Color	Select Base Paint Color
	<b>F</b> Fixed Arms (+ \$33) <b>N</b> Armless	<b>E</b> Glide <b>H</b> Black Hard Caster <b>S</b> Black All-Surface Caster (+ \$39)	See page 424	See page 425	<b>T</b> Black <b>DWX</b> Designer White (+ \$39) <b>TI</b> Titanium (+ \$39)	<b>P71</b> Black <b>CBK</b> Charblack <b>P8V</b> Textured Titanium (+ \$39) <b>PK7</b> Textured Designer White (+ \$39)
<b>HNR6</b>	<b>F</b>	<b>H</b>	<b>IM</b>	<b>CU10</b>	<b>DWX</b>	<b>P71</b>



# HIGH-DENSITY OLSON STACKER® 4040 SERIES

Want to see more?  
Scan here to check  
out hon.com.



Olson Stacker.

## HIGH-DENSITY OLSON STACKER® 4040 SERIES

Adaptable spaces such as multi-purpose and training areas demand a chair equally flexible. Olson stacking chairs fit that bill with a lightweight frame that is easy to move throughout a space. Chairs stack up to 12 high on the floor or up to 40 high on their specially designed cart to maximize floor space when not in use. A convenient cutout in the back makes it easy to pick up and move, while the molded seat shells deliver surprising comfort. Olson stacking chairs ship in sets of four to accommodate large groups. With Olson, the benefits really stack up.



### FEATURES

- Chairs ship four per carton.
- Contoured seat and back shell provide targeted support.
- Integrated lumbar support delivers long-lasting comfort.
- Integrated handle makes chair easy to carry.
- Optional ganging brackets connect chairs to form neat rows.
- Stacks up to 12 high on floor.
- Stacks up to 40 high on cart.
- Shell colors are CA Technical Bulletin 133 compliant.
- Warranted for users up to 300 lbs.



# HIGH-DENSITY OLSON STACKER® 4040 Series

## H4041



### POLYMER SEAT AND BACK DIMENSIONS

7/16" Steel Rod Frame  
Chrome Legs

Depth:	21 5/8	Seat to Floor Height:	17 3/4
Width:	19 5/8	Usable Seat Depth:	17
Height:	30 5/8	Ship Weight:	57
Seat Depth:	18 3/4	Cube:	10.6
Seat Width:	17 3/4	Weight Rating:	300 lbs.
Back Width:	17 1/2		
Back Height:	16 1/4		

### LIST PRICE PER CARTON

**\$1017**  
**(reference single unit @ \$254.25)**

⊕ 4040 Series is ordered and shipped four (4) chairs per carton. Pricing shown is per carton. Each set of four (one carton), must have the same shell color. Ordering 2 of Model H4041 will result in 2 cartons being shipped, giving you 8 chairs.

⚠ Shipped fully assembled — 4 chairs per carton. All High-Density Olson Stacker® shell colors are CA Technical Bulletin 133 compliant (no upcharge).

## H4043

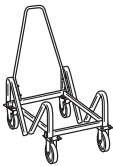

### CART FOR STACKING CHAIRS

### DIMENSIONS

Depth:	35 1/2	Ship Weight:	34
Width:	21 5/8	Cube:	7.8
Height:	37		

### LIST PRICE

**\$709**

NOTES: Holds 40 stack chairs (6'-8"), some assembly required. (Chairs stack 12 high without cart.)

⚠ Specify Black paint (T) ONLY.

## H4048

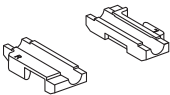

### GANGING CHAIR GLIDES

### DIMENSIONS

Box of 48	Ship Weight:	1
For use on models H4041, HG51 and HG52	Cube:	0.04

### LIST PRICE

**\$160**

## H4049

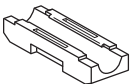

### NON-GANGING CHAIR GLIDES

### DIMENSIONS

Box of 48	Ship Weight:	1
For use on models H4041, HFLEX01, HG51 and HG52	Cube:	0.04

### LIST PRICE

**\$126**

## HOW TO SPECIFY

<p>Select Model Number</p> <div style="border: 1px solid black; padding: 5px; display: flex; gap: 5px;"> <span>H</span><span>4</span><span>0</span><span>4</span><span>1</span> </div>	<p>Select Shell Color</p> <table border="0"> <tr> <td><b>RG</b> Tangelo</td> <td><b>LO</b> Loft</td> </tr> <tr> <td><b>CR</b> Cherry</td> <td><b>PT</b> Platinum</td> </tr> <tr> <td><b>LM</b> Lime</td> <td><b>SD</b> Shadow</td> </tr> <tr> <td><b>CP</b> Calypso</td> <td><b>LA</b> Lava</td> </tr> <tr> <td><b>BU</b> Surf</td> <td><b>ON</b> Onyx</td> </tr> <tr> <td><b>RE</b> Regatta</td> <td><b>WT</b> White</td> </tr> <tr> <td><b>MB</b> Mulberry</td> <td></td> </tr> </table> <div style="border: 1px solid black; padding: 5px; display: flex; gap: 5px;"> <span>O</span><span>N</span> </div>	<b>RG</b> Tangelo	<b>LO</b> Loft	<b>CR</b> Cherry	<b>PT</b> Platinum	<b>LM</b> Lime	<b>SD</b> Shadow	<b>CP</b> Calypso	<b>LA</b> Lava	<b>BU</b> Surf	<b>ON</b> Onyx	<b>RE</b> Regatta	<b>WT</b> White	<b>MB</b> Mulberry		<p>Select Frame</p> <p>Y Chrome</p> <div style="border: 1px solid black; padding: 5px; display: flex; gap: 5px;"> <span>Y</span> </div>
<b>RG</b> Tangelo	<b>LO</b> Loft															
<b>CR</b> Cherry	<b>PT</b> Platinum															
<b>LM</b> Lime	<b>SD</b> Shadow															
<b>CP</b> Calypso	<b>LA</b> Lava															
<b>BU</b> Surf	<b>ON</b> Onyx															
<b>RE</b> Regatta	<b>WT</b> White															
<b>MB</b> Mulberry																



Parkwyn™ Lounge Seating  
shown with Occasional Tables.

## PARKWYN™

The Parkwyn™ series offers soft, comfort, ample support, and clean lines in a cozy reception area to welcome guests or in a shared space for collaboration. With a choice of a club chair, loveseat, sofa, and coordinating ottoman, this soft seating collection provides smart sophistication with a budget-friendly bottom line.



## FEATURES

- Parkwyn's soft, contoured profile allows it to work in many settings including reception lobbies, collaboration areas, and private offices.
- Models include single-seat club chair, two-seat loveseat, three-seat sofa, and coordinating ottoman.
- Choice of black polyurethane with black metal legs or gray fabric with medium oak wood legs.
- Back cushions attach with integrated Velcro to maintain user support and comfort and retain long-term structure.
- Back cushions are removable for easy cleaning.
- Tall legs offer a contemporary look while making it easy to clean underneath.
- Simple, toolless assembly with the legs screwed in by hand, and easy movement with lightweight construction.
- Club chair and ottoman are small-package shippable.

## MODEL OPTIONS

HVLVL1

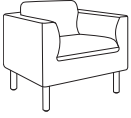

**Lounge**

Single-Seat Club Chair

HVLVL2



**Lounge**

Loveseat

HVLVL3

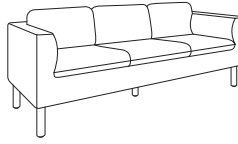

**Lounge**

Sofa

HVLVLOT



**Lounge**

Ottoman

NOTES: Black polyurethane models are available with black metal legs and gray fabric models are available with medium oak wood legs.

## HVLVL1

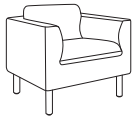

### CLUB CHAIR

### DIMENSIONS

Depth:	26¾	Arm Width:	5½
Width:	33	Seat to Floor Height:	18¾
Height:	30	Usable Seat Depth:	18
Seat Depth:	18	Ship Weight:	45
Seat Width:	21½	Cube:	10.2
Back Width:	21½	Weight Rating:	300 lbs.
Back Height:	25¾		

### LIST PRICE

**\$1434**

NOTES: HON 5-Year Limited Warranty.

## HVLVL2

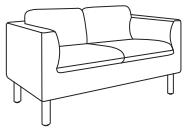

### LOVESEAT

### DIMENSIONS

Depth:	26¾	Arm Width:	5½
Width:	53½	Seat to Floor Height:	18¾
Height:	30	Usable Seat Depth:	18
Seat Depth:	18	Ship Weight:	65
Seat Width:	42½	Cube:	17.2
Back Width:	42½	Weight Rating:	300 lbs. (per seat)
Back Height:	25¾		

### LIST PRICE

**\$1957**

NOTES: HON 5-Year Limited Warranty.

## HVLVL3

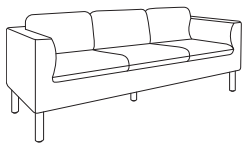

### SOFA

### DIMENSIONS

Depth:	26¾	Arm Width:	5½
Width:	77	Seat to Floor Height:	18¾
Height:	30	Usable Seat Depth:	19¾
Seat Depth:	19¾	Ship Weight:	85
Seat Width:	65¾	Cube:	24.7
Back Width:	65¾	Weight Rating:	300 lbs. (per seat)
Back Height:	25¾		

### LIST PRICE

**\$2452**

NOTES: HON 5-Year Limited Warranty.

## HVLVLOT



### OTTOMAN

### DIMENSIONS

Depth:	23¼
Width:	23¼
Height:	18¼
Ship Weight:	22
Cube:	3.6
Weight Rating:	300 lbs.

### LIST PRICE

**\$997**

NOTES: HON 5-Year Limited Warranty.

## HOW TO SPECIFY

<b>Select Model Number</b>  <div style="border: 1px solid #ccc; display: flex; gap: 5px; padding: 2px;"> <span>H</span><span>V</span><span>L</span><span>V</span><span>L</span><span>1</span> </div>	<b>Select Fabric</b>  <b>BLK01</b> Black Polyurethane <b>GRY02</b> Gray Fabric  <div style="border: 1px solid #ccc; display: flex; gap: 5px; padding: 2px;"> <span>B</span><span>L</span><span>K</span><span>0</span><span>1</span> </div>
--	---

# PERPETUAL<sup>®</sup> NESTING CHAIRS

Want to see more? Scan here  
to check out [hon.com](https://hon.com).



Perpetual Nesting Chairs and Huddle<sup>®</sup> Tables.

## PERPETUAL<sup>®</sup> NESTING CHAIRS

Provide full-time comfort to even part-time workers with the Perpetual line of multi-purpose seating. The flip-up seat design maximizes space by allowing Perpetual to be easily nested. The passive back design moves with the user to deliver added comfort for all day meetings. Save space without sacrificing comfort with Perpetual.



## FEATURES

- Flip-up seat allows chairs to nest and save floor space.
- Backrest reclines for added comfort.
- Tube rolled steel frame adds durability.
- Underside of seat is fully-upholstered for a clean appearance when nested.
- All-surface casters roll effortlessly and silently.
- Available in hundreds of quality HON fabrics.
- Warranted for users up to 300 lbs.

# PERPETUAL<sup>®</sup> Nesting Chairs Options

## MODEL OPTIONS

HPN1



**Nesting Chair (Flex-back)**

Armless, Four Legs

HPN2



**Nesting Chair (Flex-back)**

Fixed Arms, Four Legs

### CASTER/ GLIDE



CODE	DESCRIPTION	PRICE
<b>A</b>	All-Surface	<b>+\$0</b>
<b>G</b>	Bell Glide	<b>+\$28</b>

### FRAME

CODE	DESCRIPTION	PRICE
<b>T</b>	Black	<b>+\$0</b>
<b>T1</b>	Platinum Metallic	<b>+\$0</b>

### BACK STYLE



CODE	DESCRIPTION	PRICE
<b>UU</b>	Upholstered Back	<b>+\$0</b>

## HON BRANDED FABRICS

### GRADE 1

Apex  
Centurion  
Compass  
Contourett  
Dapper  
Ensemble  
Hamilton  
Inertia  
Noble Seating  
Optic  
Pebble  
Vibe

### GRADE 2

Appoint Seating  
Blume  
Clyde  
Doty  
Kai  
Rush  
Spin Seating  
Wavelength  
Whisper Vinyl

### GRADE 3

Bradbury  
Getaway  
Moxie  
Notion  
Parker  
Purl  
Quill  
Saxony

### GRADE 4

Constance with Supreen™  
Livi with Supreen™  
Lugano with Supreen™  
Oxford with Supreen™

**For a complete list of fabrics, including partnership fabrics, go to [hon.com/fabricsandfinishes](https://hon.com/fabricsandfinishes).**

Reference Fabric Color Combinations on pages 20-25 for color codes and legend on page 21 for lead times. For additional HON to Supply COM fabric grade pricing, go to [honready.hon.com](https://honready.hon.com) and click on the HON to Supply COM link.



# PERPETUAL<sup>®</sup> Nesting Chairs

## HPN1



Model HPN1AUU shown

### NESTING CHAIR

**Flex-back**  
Armless  
Four Legs

### DIMENSIONS

Depth:	26	Seat to Floor Height:	19 $\frac{1}{8}$
Width:	26	Usable Seat Depth:	16 $\frac{1}{2}$
Height:	36	Ship Weight:	38
Seat Depth:	17 $\frac{3}{4}$	Cube:	15.2
Seat Width:	17	COM:	1.5
Back Width:	17 $\frac{1}{2}$	Weight Rating:	300 lbs.
Back Height:	15 $\frac{3}{4}$		

### FABRIC PRICE CODES

1	\$1022	8	\$1246
2	\$1062	9	\$1275
3	\$1101	10	\$1304
4	\$1130	11	\$1333
5	\$1158	12	\$1362
6	\$1187	L	—
7	\$1217		

## HPN2



Model HPN2AUU shown

### NESTING CHAIR

**Flex-back**  
Fixed Arms  
Four Legs

### DIMENSIONS

Depth:	26	Arm Width:	20 $\frac{3}{4}$
Width:	26	Seat to Floor Height:	19 $\frac{1}{8}$
Height:	36	Usable Seat Depth:	16 $\frac{1}{2}$
Seat Depth:	17 $\frac{3}{4}$	Ship Weight:	41
Seat Width:	17	Cube:	15.2
Back Width:	17 $\frac{1}{2}$	COM:	1.5
Back Height:	15 $\frac{3}{4}$	Weight Rating:	300 lbs.

### FABRIC PRICE CODES

1	\$1130	8	\$1354
2	\$1170	9	\$1383
3	\$1209	10	\$1412
4	\$1238	11	\$1441
5	\$1266	12	\$1470
6	\$1295	L	—
7	\$1325		

## HOW TO SPECIFY

<p><b>Select Model Number</b></p> <p>HPN1</p>	<p><b>Select Caster/Glide</b></p> <p>A All-Surface G Glide (+ \$28)</p> <p>A</p>	<p><b>Select Back Type</b></p> <p>UU Upholstered Back</p> <p>UU</p>	<p><b>Select Fabric</b></p> <p>Note: For models with upholstered back, seat and back are always matching fabric See page 438</p> <p>CU10</p>	<p><b>Select Frame</b></p> <p>T Black T1 Platinum Metallic</p> <p>T</p>
---	--	---	--	---



# PILLOW-SOFT® 2090 SERIES

Want to see more? Scan here  
to check out hon.com.



Pillow-Soft® Seating shown  
with 10500 Series™ desk.

## PILLOW-SOFT® 2090 SERIES

Pillow-Soft chairs combine comfort, style and selection to deliver the ultimate seating experience. Each executive chair in the collection combines thick memory foam cushioning with built-in lumbar support to reduce fatigue and increase comfort. Besides the full body support, it adds an authoritative presence to the office. The plush tufted leather or fabric will add a touch of sophistication to your office.



## FEATURES

- Responsive memory foam eliminates pressure points and provides lasting comfort.
- Loop arms relieve stress on the shoulder and neck.
- Fully-upholstered outer back.
- Memory foam seat cushion reduces pressure points and responds to contours of the body for lasting comfort.
- Task chairs come standard with pneumatic seat height adjustment, tilt, tilt tension and tilt lock.
- Dual-wheel casters roll effortlessly and silently.
- Warranted for users up to 300 lbs.
- H2095 model warranted for users up to 275 lbs.

# PILLOW-SOFT® 2090 Series Options

## MODEL OPTIONS

H2091



### Executive High-Back

Pneumatic, Swivel, Tilt, Tilt Tension, Tilt Lock, Arms

H2095



### Executive High-Back

Pneumatic, Swivel, Tilt, Tilt Tension, Tilt Lock, Arms

H2092



### Managerial Mid-Back

Pneumatic, Swivel, Tilt, Tilt Tension, Tilt Lock, Arms

H2093



### Guest Chair

Sled Base, Arms

## CASTERS



CODE	DESCRIPTION	PRICE
<b>H</b>	Black Hard Caster	<b>+ \$0</b>



<b>S</b>	Black All-Surface Caster	<b>+ \$44</b>
----------	--------------------------	---------------

## HON BRANDED FABRICS

### GRADE 1

Apex  
Black Vinyl  
Burgundy Vinyl  
Centurion  
Compass  
Contourett  
Dapper  
Ensemble  
Hamilton  
Inertia  
Noble Seating  
Optic  
Pebble  
Vibe

### GRADE 2

Appoint Seating  
Blume  
Clyde  
Dotty  
Kai  
Rush  
Spin Seating  
Wavelength  
Whisper Vinyl

### GRADE 3

Bradbury  
Getaway  
Moxie  
Notion  
Parker  
Purl  
Quill  
Saxony

### GRADE 4

Constance with Supreen™  
Livi with Supreen™  
Lugano with Supreen™  
Oxford with Supreen™

**For a complete list of fabrics, including partnership fabrics, go to [hon.com/fabricsandfinishes](https://hon.com/fabricsandfinishes).**

Reference Fabric Color Combinations on pages 20-25 for color codes and legend on page 21 for lead times. For additional HON to Supply COM fabric grade pricing, go to [honready.hon.com](https://honready.hon.com) and click on the HON to Supply COM link.

# PILLOW-SOFT® 2090 Series

GSA SIN 33721 EXCEPT AS NOTED



Icon Legend on page 19

## H2091



### EXECUTIVE HIGH-BACK

Pneumatic  
Swivel  
Tilt  
Tilt Tension  
Tilt Lock  
Arms  
Functions: **A, E, F, K, L**   
(Function Key on pages 252-253)

### DIMENSIONS

Depth: 29¾  
Width: 26¼  
Height: 46½  
Seat Depth: 21  
Seat Width: 22  
Back Width: 22  
Back Height: 25  
Arm Width: 20¼  
Seat to Floor Height: 16¾-21¼  
Usable Seat Depth: 18½  
Ship Weight: 57   
Cube: 16.0  
COM: 3.0  
Weight Rating: 300 lbs.

### FABRIC PRICE CODES

1	\$1011	8	\$1457
2	\$1090	9	\$1516
3	\$1167	10	\$1574
4	\$1225	11	\$1632
5	\$1283	12	\$1690
6	\$1341	L	\$1173
7	\$1400		

NOTES: When selecting leather, the 2090 Series uses SR Leather only. All models are also available in Grade 1 EB vinyl (which matches SR Leather).

## H2095



OPEN MARKET

### EXECUTIVE HIGH-BACK

Pneumatic  
Swivel  
Tilt  
Tilt Tension  
Tilt Lock  
Padded Loop Arms  
Functions: **A, E, F, K, L**  
(Function Key on pages 252-253)

### DIMENSIONS

Depth: 29½  
Width: 26¾  
Height: 47½  
Seat Depth: 17½  
Seat Width: 21  
Back Width: 21  
Back Height: 29½  
Arm Width: 21  
Seat to Floor Height: 16-21  
Usable Seat Depth: 17½  
Ship Weight: 57   
Cube: 7.1  
COM: N/A  
Weight Rating: 275 lbs.

### FABRIC PRICE CODES

**Fabric**  
PWST10 \$801 (Black)  
**Black Bonded Leather**  
PWST11 \$823 (Black)

NOTES: When selecting upholstery, the H2095 is only available in PWST10 (Black fabric) and PWST11 (Black Bonded Leather).

## H2092



### MANAGERIAL MID-BACK

Pneumatic  
Swivel  
Tilt  
Tilt Tension  
Tilt Lock  
Arms  
Functions: **A, E, F, K, L**   
(Function Key on pages 252-253)

### DIMENSIONS

Depth: 28¾  
Width: 26¼  
Height: 41¾  
Seat Depth: 21  
Seat Width: 22  
Back Width: 22  
Back Height: 19⅝  
Arm Width: 20¼  
Seat to Floor Height: 16¾-21¼  
Usable Seat Depth: 18½  
Ship Weight: 54  
Cube: 16.0  
COM: 3.0  
Weight Rating: 300 lbs.

### FABRIC PRICE CODES

1	\$965	8	\$1411
2	\$1044	9	\$1470
3	\$1121	10	\$1528
4	\$1179	11	\$1586
5	\$1237	12	\$1644
6	\$1295	L	\$1127
7	\$1354		

NOTES: When selecting leather, the 2090 Series uses SR Leather only. All models are also available in Grade 1 EB vinyl (which matches SR Leather).

## H2093



### GUEST CHAIR

Sled Base  
Arms

### DIMENSIONS

Depth: 27¾  
Width: 23¼  
Height: 36  
Seat Depth: 21½  
Seat Width: 20¾  
Back Width: 21½  
Back Height: 19¼  
Arm Width: 19¾  
Seat to Floor Height: 19½  
Usable Seat Depth: 19  
Ship Weight: 38  
Cube: 16.1  
COM: 2.5  
Weight Rating: 300 lbs.

### FABRIC PRICE CODES

1	\$771	8	\$1143
2	\$836	9	\$1192
3	\$901	10	\$1240
4	\$950	11	\$1289
5	\$998	12	\$1337
6	\$1047	L	\$933
7	\$1095		

NOTES: When selecting leather, the 2090 Series uses SR Leather only. All models are also available in Grade 1 EB vinyl (which matches SR Leather).

## HOW TO SPECIFY

**HON Recommendation: H2091.H.SR11.T - List Price \$1173**

<p><b>Select Model Number</b></p> <p>H 2 0 9 1 .</p>	<p><b>Select Caster</b></p> <p>H Black Hard Caster S Black All-Surface Caster (+ \$44) Does not apply to models H2093 or H2095</p> <p>H .</p>	<p><b>Select Fabric</b></p> <p>See page 441 H2095 only available in 2 fabric options. See above for pricing and selection.</p> <p>S R 1 1 .</p>	<p><b>Select Frame</b></p> <p>T Black</p> <p>T</p>
--	---	---	--



# PROMINENT™ Mesh Chairs

## HVL531



### HIGH-BACK

Pneumatic  
Swivel  
Tilt  
Tilt Tension  
Tilt Lock  
Height-adjustable Arms

Functions: **A, E, F, K, L, Q**  
(Function Key on pages 252-253)

### DIMENSIONS

Depth:	27	Arm Width:	20¼
Width:	27	Seat to Floor Height:	18-22
Height:	42½	Usable Seat Depth:	18
Seat Depth:	18	Ship Weight:	36
Seat Width:	21½	Cube:	5.1
Back Width:	18¾	Weight Rating:	250 lbs.
Back Height:	23		

### PRICE CODE

<b>Sandwich Mesh</b>	<b>\$600</b>
<b>Leather</b>	<b>\$628</b>

NOTES: Comfortable and breathable mesh back. Black Sandwich Mesh or Black Bonded Leather seat. Black frame. Height-adjustable arms. **HON 5-Year Limited Warranty.**

**HON Recommendation: HVL531.MM10 - List Price \$600**

## HVL532



### HIGH-BACK

**Mesh Back**  
Pneumatic  
Swivel  
Asynchronous Control  
Tilt  
Tilt Tension  
Tilt Lock  
Seat Glide Mechanism  
Back Height Adjustment  
Height and Width Adjustable Arms

Functions: **A, B, D, E, F, L, O, S**  
(Function Key on pages 252-253)

### DIMENSIONS

Depth:	26	Back Height:	23¼-24½
Width:	30¾	Arm Width:	18-22½
Height:	44½	Seat to Floor Height:	17-20½
Seat Depth:	17⅞-20⅞	Ship Weight:	50
Seat Width:	20½	Cube:	6.5
Back Width:	19⅞	Weight Rating:	250 lbs.

### PRICE CODE

<b>Sandwich Mesh</b>	<b>\$714</b>
<b>Leather</b>	<b>\$742</b>

NOTES: Comfortable and breathable mesh back. Black Sandwich Mesh or Black Bonded Leather seat. Black frame. Height and width adjustable arms. Seat glide mechanism. Asynchronous control with independent seat and back angle adjustment. **HON 5-Year Limited Warranty.**

**HON Recommendation: HVL532.MM10 - List Price \$714**

## HVL539



### TASK STOOL

**Mesh Back**  
Pneumatic  
Swivel  
Height and Width Adjustable Arms  
Adjustable Footring

Functions: **A, E, S**  
(Function Key on pages 252-253)

### DIMENSIONS

Depth:	27⅞	Arm Width:	18⅞
Width:	28⅞	Seat to Floor Height:	21⅞-28⅞
Height:	50	Usable Seat Depth:	17⅞
Seat Depth:	17⅞	Ship Weight:	44.0
Seat Width:	20⅞	Cube:	5.7
Back Width:	17⅞	Weight Rating:	250 lbs.
Back Height:	22⅞		

### PRICE CODE

<b>Sandwich Mesh</b>	<b>\$656</b>
----------------------	--------------

NOTES: Prominent™ HVL539. Black upholstered seat. Height and width adjustable arms. **HON 5-Year Limited Warranty.**

**HON Recommendation: HVL539.MM10 - List Price \$656**

SEATING

## HOW TO SPECIFY

<b>Select Model Number</b>	<b>Select Fabric</b>
	<b>MM10</b> Black Sandwich Mesh Fabric
H V L 5 3 9 .	M M 1 0



Ruck™ Seating shown with West Hill™ Casual Lounge, Scramble™ Occasional Tables, and Unika Vaev Screens.

## RUCK™

Easy on the eyes and even easier to move and stack, Ruck™ seating brings effortless style to working alone or together.

Available in a variety of finishes in both seated and stool heights, Ruck clicks with its surroundings — whether that's in a collaborative area, café setting, or as a side chair in a private office. Crafted with gentle, molded contours, Ruck makes being on the edge of your seat a more comfortable place to be.



## FEATURES

- Available in both a seated and stool-height option.
- Lightweight frame can be easily moved to rearrange seating configurations.
- Waterfall seat edge promotes better leg circulation.
- Glides move effortlessly on hard surfaces.
- Both the chair and stool stack six high on the floor to maximize space.
- Single-piece shell can be quickly wiped down for easy maintenance.
- Choose from 6 laminate and 4 veneer shell colors.
- Legs are available in a variety of finish options to match or complement other HON product lines.
- Backed by HON's industry-leading Lifetime Warranty.

## MODEL OPTIONS

HRUCK1L



**Chair**

Laminate Shell

HRUCK5L



**Stool**

Laminate Shell

HRUCK1W



**Chair**

Wood Shell

HRUCK5W



**Stool**

Wood Shell

## AVAILABLE FINISHES

Ruck Seating is available in 7 laminate finishes and 4 wood finishes.

### LAMINATE FINISHES

Charcoal (S)

Designer White (LDW1)

Field Elm (LWFE)

Florence Walnut (LFW1)

Kingswood Walnut (LK11)

Natural Maple (D)

Pinnacle (PINC)

### WOOD FINISHES

Black Wash (QA997)

Natural (QA447)

Pinnacle Walnut (QA679)

White Wash (QA921)

## FRAME

CODE	DESCRIPTION	PRICE
<b>CBK</b>	Charblack	<b>+\$0</b>
<b>P7J</b>	Textured Brownstone	<b>+\$0</b>
<b>P7A</b>	Textured Charcoal	<b>+\$0</b>
<b>PK7</b>	Textured Designer White	<b>+\$0</b>
<b>P7L</b>	Textured Loft	<b>+\$0</b>
<b>P7M</b>	Textured Muslin	<b>+\$0</b>
<b>PR8</b>	Textured Silver	<b>+\$0</b>
<b>P8V</b>	Textured Titanium	<b>+\$0</b>

# RUCK™ Laminate Seating

GSA SIN 33721



Icon Legend on page 19

## HRUCK1L



### CHAIR, LAMINATE SHELL

### DIMENSIONS

Depth:	22 <sup>5</sup> / <sub>8</sub>	Seat to Floor Height:	17 <sup>3</sup> / <sub>4</sub>
Width:	21 <sup>5</sup> / <sub>8</sub>	Usable Seat Depth:	18 <sup>1</sup> / <sub>4</sub>
Height:	32 <sup>5</sup> / <sub>16</sub>	Ship Weight:	24
Seat Depth:	18 <sup>1</sup> / <sub>4</sub>	Cube:	15.8
Seat Width:	17 <sup>1</sup> / <sub>2</sub>	Weight Rating:	300 lbs.
Back Width:	17		
Back Height:	15 <sup>5</sup> / <sub>8</sub>		

### LIST PRICE

**\$646**

## HRUCK5L



### STOOL, LAMINATE SHELL

### DIMENSIONS

Depth:	22 <sup>5</sup> / <sub>8</sub>	Seat to Floor Height:	30
Width:	21 <sup>5</sup> / <sub>8</sub>	Usable Seat Depth:	18 <sup>1</sup> / <sub>4</sub>
Height:	44 <sup>1</sup> / <sub>2</sub>	Ship Weight:	32
Seat Depth:	18 <sup>1</sup> / <sub>4</sub>	Cube:	22.2
Seat Width:	17 <sup>1</sup> / <sub>2</sub>	Weight Rating:	300 lbs.
Back Width:	17		
Back Height:	15 <sup>5</sup> / <sub>8</sub>		

### LIST PRICE

**\$775**

**HON Recommendation: HRUCK1L.PINC.P8V - List Price \$646**

SEATING

## HOW TO SPECIFY

Select  
Model Number

HRUCK1L .

Select  
Laminate

See page 445

PINC .

Select  
Frame

See page 445

P8V



## HRUCK1W



### CHAIR, WOOD SHELL

### DIMENSIONS

Depth:	22 <sup>5</sup> / <sub>8</sub>	Seat to Floor Height:	17 <sup>3</sup> / <sub>4</sub>
Width:	21 <sup>5</sup> / <sub>8</sub>	Usable Seat Depth:	18 <sup>1</sup> / <sub>4</sub>
Height:	32 <sup>5</sup> / <sub>16</sub>	Ship Weight:	24
Seat Depth:	18 <sup>1</sup> / <sub>4</sub>	Cube:	15.8
Seat Width:	17 <sup>1</sup> / <sub>2</sub>	Weight Rating:	300 lbs.
Back Width:	17		
Back Height:	15 <sup>5</sup> / <sub>8</sub>		

### LIST PRICE

**\$679**

## HRUCK5W



### STOOL, WOOD SHELL

### DIMENSIONS

Depth:	22 <sup>5</sup> / <sub>8</sub>	Seat to Floor Height:	30
Width:	21 <sup>5</sup> / <sub>8</sub>	Usable Seat Depth:	18 <sup>1</sup> / <sub>4</sub>
Height:	44 <sup>1</sup> / <sub>2</sub>	Ship Weight:	32
Seat Depth:	18 <sup>1</sup> / <sub>4</sub>	Cube:	22.2
Seat Width:	17 <sup>1</sup> / <sub>2</sub>	Weight Rating:	300 lbs.
Back Width:	17		
Back Height:	15 <sup>5</sup> / <sub>8</sub>		

### LIST PRICE

**\$808**

**HON Recommendation: HRUCK1W.QA997.P8V - List Price \$679**

## HOW TO SPECIFY

<p><b>Select Model Number</b></p> <p>HRUCK1W</p>	<p><b>Select Finish</b></p> <p>See page 445</p> <p>QA997</p>	<p><b>Select Frame</b></p> <p>See page 445</p> <p>P8V</p>
--	--	---



# SCATTER™ Guest Chairs

OPEN MARKET



Icon Legend on page 19

## HVL606



### GUEST CHAIR

Leg Base  
Armless  
Stacks up to Four High

### DIMENSIONS

Depth:	21	Seat to Floor Height:	19
Width:	21¼	Usable Seat Depth:	17½
Height:	32¾	Ship Weight:	16
Seat Depth:	17½	Cube:	1.7
Seat Width:	19	Weight Rating:	250 lbs.
Back Width:	18½		
Back Height:	16		

### PRICE CODE

<b>Fabric</b>	<b>\$227</b>
<b>Leather</b>	<b>\$260</b>

NOTES: Fabric or Black Bonded Leather. Stackable up to four high. Round tube construction. Frame available in Black. Casters and glides ship packaged together for customer's assembly choice. **HON 5-Year Limited Warranty.**

**HON Recommendation: HVL606.VA10 - List Price \$227**

## HVL616



### GUEST CHAIR

Leg Base  
Arms  
Stacks up to Four High

### DIMENSIONS

Depth:	21	Arm Width:	20⅝
Width:	23¾	Seat to Floor Height:	19
Height:	32¾	Usable Seat Depth:	17½
Seat Depth:	17½	Ship Weight:	18
Seat Width:	19	Cube:	2.1
Back Width:	18½	Weight Rating:	250 lbs.
Back Height:	16		

### PRICE CODE

<b>Fabric</b>	<b>\$257</b>
<b>Leather</b>	<b>\$290</b>

NOTES: Fabric or Black Bonded Leather. Stackable up to four high. Round tube construction. Frame available in Black. Casters and glides ship packaged together for customer's assembly choice. **HON 5-Year Limited Warranty.**

**HON Recommendation: HVL616.VA10 - List Price \$257**

SEATING

## HOW TO SPECIFY

Select  
Model Number

Select  
Fabric

**SB11** Black Bonded Leather  
**VA10** Black Fabric  
**VA19** Charcoal Fabric  
**VA90** Navy Fabric

H V L 6 0 6 .

V A 1 0

# SKIP

Want to see more? Scan here  
to check out [hon.com](https://hon.com).



Skip shown with Flock® Cylinder Table.

## SKIP

It's hard to get creative when you're feeling all buttoned up. That's why workplaces are adding less formal, more dynamic spaces to foster greater creativity and connection between workers. Designed to put the fun back in functional, Skip seating offers an engaging, active sit that lets you rock a meeting — literally. When it comes to casual and collaborative seating that's as lively as it is practical, this chair doesn't Skip a beat.



## FEATURES

- Built-in handle makes it easy to move around.
- Textured finish is durable, easy to clean, UV resistant, and suitable for outdoor sitting.
- Optional cushion stays in place but is not permanently affixed.
- Cushion fabric is easy to wipe clean.
- Hard plastic frame is multicolored.

# SKIP Collaborative Chair

OPEN MARKET



Icon Legend on page 19

## HQQ1



### COLLABORATIVE CHAIR

### DIMENSIONS

Depth:	35½	Seat to Floor Height:	17
Width:	28	Usable Seat Depth:	17
Height:	31	Ship Weight:	35
Seat Depth:	18	Cube:	20.0
Seat Width:	28	Weight Rating:	275 lbs.
Back Width:	28		
Back Height:	21		

### LIST PRICE

**\$1140**

NOTES: Hard plastic frame is multicolored. **HON 5-Year Limited Warranty.**

## HQQ1CUSH



### CUSHION

### DIMENSIONS

Depth:	17½	Ship Weight:	5
Width:	25¾	Cube:	2.0
Height:	1½		

### LIST PRICE

**\$222**

NOTES: **HON 5-Year Limited Warranty.**

SEATING

## HOW TO SPECIFY

Select Model Number

HQQ1

## HOW TO SPECIFY

Select Model Number

Select Fabric

SLT Slate  
NVY Navy

HQQ1CUSH.

SLT



SoCo™ shown with Sculpt™ Tables.

## SoCo™

Today's busy professionals are taking meetings and project planning in a variety of different ways and places. SoCo™ is an intuitive modular lounge series designed to encourage the ease of both collaborative and individual work while supporting how people like to sit and get comfortable. Multiple shapes come together to create a wide range of configuration possibilities, from understated and sophisticated to fun and playful. Power is cleanly integrated within the design and is located where multiple users can access and utilize its functionality to stay connected. SoCo™ offers soft, comfortable support and a tailored aesthetic in spaces that allow you to get away from the workstation throughout the day.

## FEATURES

- SoCo™ supports dynamic collaboration and casual focused work with a soft, organic, tailored aesthetic that delivers comfort for a variety of sitting postures.
- Seven modular shapes work together to create unlimited linear and curvilinear configurations.
- A fully upholstered design with a multi-fabric seat/back option softens the corporate aesthetic.
- Optional plug-in or hardwire electrical is available on select shapes and supports both USB-A and USB-C compatibility.
- Dual-purpose glides allow two functions: without glide caps furniture stays in place; with glide caps furniture easily moves for reconfiguration.

# SoCo™ Statement of Line

## SQUARE SEATING



Single Seat



Single Seat w/ Back



Single Seat w/ Back  
w/ Power



Single Seat w/ Back  
Multi-Fabric



Single Seat w/ Back  
Multi-Fabric w/ Power



Square Corner Seat  
w/ Back



Square Corner Seat  
w/ Back Multi-Fabric

## CURVE SEATING

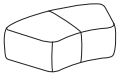

Curve Seat

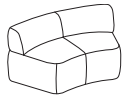

Inside Curve Seat  
w/ Back

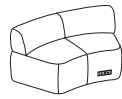

Inside Curve Seat  
w/ Back w/ Power

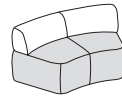

Inside Curve Seat  
w/ Back Multi-Fabric

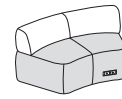

Inside Curve Seat w/ Back  
Multi-Fabric w/ Power

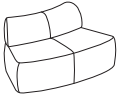

Outside Curve Seat  
w/ Back



Outside Curve Seat  
w/ Back w/ Power

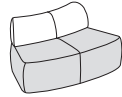

Outside Curve Seat  
w/ Back Multi-Fabric

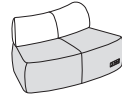

Outside Curve Seat  
w/ Back Multi-Fabric w/ Power



Quarter Circle Seat

## HON BRANDED FABRICS

### GRADE 1

Apex  
Centurion  
Compass  
Contourett\*  
Dapper  
Ensemble  
Hamilton  
Inertia  
Noble Seating  
Optic  
Vibe

### GRADE 2

Appoint Seating  
Blume  
Clyde  
Kai  
Rush  
Spin Seating  
Taylor  
Whisper Vinyl\*

### GRADE 3

Bradbury  
Moxie\*  
Notion  
Parker\*  
Purl  
Saxony

### GRADE 4

Constance with Supreen™\*  
Livi with Supreen™\*  
Lugano with Supreen™\*  
Oxford with Supreen™\*

For a complete list of fabrics, including partnership fabrics, go to [hon.com/fabricsandfinishes](https://hon.com/fabricsandfinishes).

Reference Fabric Color Combinations on pages 20-25 for color codes and legend on page 21 for lead times.

## Upholstery Expectations

! Solid, non-patterned fabrics are recommended due to SoCo's curvilinear profile. HON does not pattern match fabrics that have a distinct linear or repeating pattern. It is recommended to choose from one of HON's many standard non-patterned fabrics. For more details on Upholstery Pattern Match for this series, please see page 14.

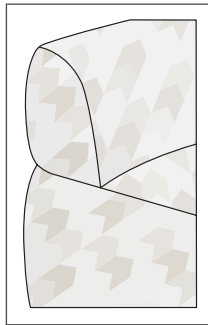

\*Due to the inherent characteristics of upholstery materials, such as coated textiles and stiffer fabrics, and the curved nature of SoCo™, fabric may show some wrinkles along seams and may become more relaxed to show additional wrinkles over time.

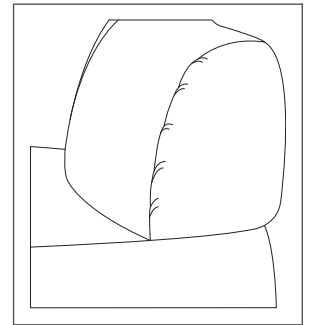

## COM YARDAGE

MODEL	COM											
	Fabric (P)	Vinyl (P)	Fabric Seat (P)	Vinyl Seat (P)	Fabric Back (P)	Vinyl Back (P)	Fabric (R)	Vinyl (R)	Fabric Seat (R)	Vinyl Seat (R)	Fabric Back (R)	Vinyl Back (R)
<b>EXISTING SINGLE FAB UNITS</b>												
HSLMSS	3	3	—	—	—	—	2.75	2.75	—	—	—	—
HSLMSB1	4	4	—	—	—	—	3.5	3.5	—	—	—	—
HSLMSB2	—	—	3	3	1.5	1.5	—	—	2.75	2.75	1.5	1.5
HSLMTCB1	5	5	—	—	—	—	3.75	3.75	—	—	—	—
HSLMTCB2	—	—	3	3	2	2	—	—	2.75	2.75	1.75	1.75
HSLMCS	3.75	3.75	—	—	—	—	3.5	3.5	—	—	—	—
HSLMICB1	5.5	5.5	—	—	—	—	5.25	5.25	—	—	—	—
HSLMICB2	—	—	3.75	3.75	2	2	—	—	3.5	3.5	1.75	1.75
HSLMOCB1	5	5	—	—	—	—	5	5	—	—	—	—
HSLMOCB2	—	—	3.75	3.75	1.5	1.5	—	—	3.5	3.5	1.5	1.5
HSLMQCS	2.5	2.5	—	—	—	—	2.5	2.5	—	—	—	—

# SoCo™ Typicals

QTY	DESCRIPTION	MODEL	LIST PRICE	PRICE EXTENSION
2	Curve Seat	HSLMCS	\$2,070	\$4,140
2	Inside Curve Seat w/ Back	HSLMICB1	\$3,470	\$6,940
2	Outside Curve Seat w/ Back	HSLMOCB1	\$3,470	\$6,940
<b>TOTAL:</b>			<b>\$18,020</b>	

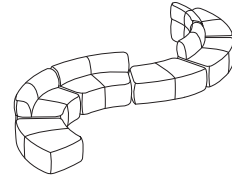

**SERPENTINE**

QTY	DESCRIPTION	MODEL	LIST PRICE	PRICE EXTENSION
2	Single Seat	HSLMSS	\$1,440	\$2,880
2	Single Seat w/ Back	HSLMSB1	\$2,340	\$4,680
2	Square Corner Seat w/ Back	HSLMTCB1	\$2,440	\$4,880
2	Quarter Circle Seat	HSLMQCS	\$1,240	\$2,480
<b>TOTAL:</b>			<b>\$14,920</b>	

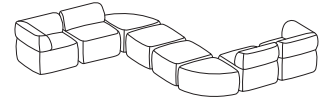

**ZIGZAG**

QTY	DESCRIPTION	MODEL	LIST PRICE	PRICE EXTENSION
2	Curve Seat	HSLMCS	\$2,070	\$4,140
2	Inside Curve Seat w/ Back	HSLMICB1	\$3,470	\$6,940
<b>TOTAL:</b>			<b>\$11,080</b>	

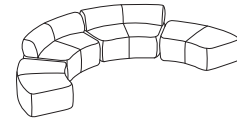

**HALF-CIRCLE**

QTY	DESCRIPTION	MODEL	LIST PRICE	PRICE EXTENSION
4	Single Seat w/ Back	HSLMSB1	\$2,340	\$9,360
4	Quarter Circle Seat	HSLMQCS	\$1,240	\$4,960
<b>TOTAL:</b>			<b>\$14,320</b>	

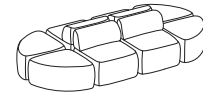

**ISLAND**

**HSLMSS**

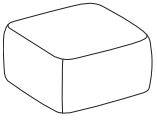

**LOUNGE**

Single Seat

**DIMENSIONS**

Depth: 30      Ship Weight: 44.0  
 Width: 30      Cube: 11.3  
 Height: 18½      COM: See page 453  
 Weight Rating: 300 lbs.

**FABRIC PRICE CODES**

1	\$1440	8	\$1870
2	\$1513	9	\$1927
3	\$1587	10	\$1988
4	\$1643	11	\$2054
5	\$1699	12	\$2120
6	\$1756	L	—
7	\$1812		

❗ No Power Cutout Option

**HSLMSB1**

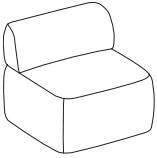

**LOUNGE**

Single Seat w/ Back

**DIMENSIONS**

Depth: 30      Ship Weight: 57.4  
 Width: 30      Cube: 18.3  
 Height: 30      COM: See page 453  
 Usable Seat Depth 20½      Weight Rating: 300 lbs.  
 Seat to Floor Height 18½

**FABRIC PRICE CODES**

1	\$2340	8	\$2893
2	\$2434	9	\$2966
3	\$2529	10	\$3044
4	\$2601	11	\$3129
5	\$2672	12	\$3214
6	\$2747	L	—
7	\$2818		

NOTES: Power models specified separately. Power models found on page 460.

❗ Optional Power Cutout

**HSLMSB2**

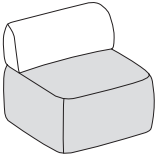

**LOUNGE**

Single Seat w/ Back —  
Multi-Fabric

**DIMENSIONS**

Depth: 30      Ship Weight: 57.4  
 Width: 30      Cube: 18.3  
 Height: 30      COM: See page 453  
 Usable Seat Depth 20½      Weight Rating: 300 lbs.  
 Seat to Floor Height 18½

**FABRIC PRICE CODES**

1    \$2440  
*Add to Base Price Above*

	Seat	Back
2	\$73	\$31
3	\$147	\$63
4	\$203	\$87
5	\$259	\$111
6	\$316	\$136
7	\$372	\$159
8	\$430	\$184
9	\$487	\$209
10	\$548	\$235
11	\$614	\$263
12	\$680	\$291
L	—	—

NOTES: Power models specified separately. Power models found on page 460.

❗ Optional Power Cutout

**HOW TO SPECIFY**

<p><b>Select Model Number</b></p> <p>H S L M S S .</p>	<p><b>Select FSC Wood</b></p> <p>F S C .</p>	<p><b>Select Power</b></p> <p>Y Power Cutout (+ \$40) N No Power Cutout</p>	<p><b>Select Seat Fabric</b></p> <p>See page 453</p>	<p><b>Select Back Fabric (if applicable)</b></p> <p>See page 453</p>
--	--	---	--	--



HSLMTCB1

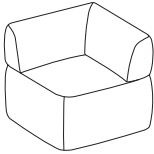

LOUNGE

Square Corner Seat w/ Back

DIMENSIONS

Depth: 30      Ship Weight: 67.8  
 Width: 30      Cube: 18.5  
 Height: 30      COM: See page 453  
 Usable Seat Depth: 20½      Weight Rating: 300 lbs.  
 Seat to Floor Height: 18½

FABRIC PRICE CODES

1	\$2440	8	\$3116
2	\$2554	9	\$3205
3	\$2671	10	\$3301
4	\$2759	11	\$3404
5	\$2846	12	\$3508
6	\$2937	L	—
7	\$3024		

! No Power Cutout Option

HSLMTCB2

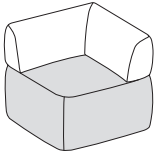

LOUNGE

Square Corner Seat w/ Back — Multi-Fabric

DIMENSIONS

Depth: 30      Ship Weight: 67.8  
 Width: 30      Cube: 18.5  
 Height: 30      COM: See page 453  
 Usable Seat Depth: 20½      Weight Rating: 300 lbs.  
 Seat to Floor Height: 18½

FABRIC PRICE CODES

1	\$2540	
<i>Add to Base Price Above</i>		
	Seat	Back
2	\$73	\$52
3	\$147	\$105
4	\$203	\$145
5	\$259	\$185
6	\$316	\$226
7	\$372	\$265
8	\$430	\$307
9	\$487	\$348
10	\$548	\$391
11	\$614	\$438
12	\$680	\$485
L	—	—

! No Power Cutout Option

HOW TO SPECIFY

<p>Select Model Number</p> <p>H S L M T C B 1 .</p>	<p>Select FSC Wood</p> <p>F S C .</p>	<p>Select Seat Fabric</p> <p>See page 453</p>	<p>Select Back Fabric (if applicable)</p> <p>See page 453</p>
---	---------------------------------------	---	---

### HSLMCS

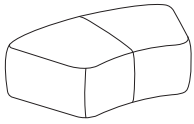

**LOUNGE**

Curve Seat

**DIMENSIONS**

Depth: 30      Ship Weight: 54.9  
 Width: 55      Cube: 20.7  
 Height: 18½      COM: See page 453  
 Weight Rating: 300 lbs.

**FABRIC PRICE CODES**

1	\$2070	8	\$2562
2	\$2153	9	\$2626
3	\$2238	10	\$2696
4	\$2302	11	\$2771
5	\$2365	12	\$2847
6	\$2431	L	—
7	\$2495		

❗ No Power Cutout Option

### HSLMICB1

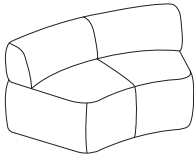

**LOUNGE**

Inside Curve Seat w/ Back

**DIMENSIONS**

Depth: 30      Ship Weight: 72.9  
 Width: 55      Cube: 33.9  
 Height: 30      COM: See page 453  
 Usable Seat Depth 20½      Weight Rating: 300 lbs.  
 Seat to Floor Height 18½

**FABRIC PRICE CODES**

1	\$3470	8	\$4208
2	\$3595	9	\$4304
3	\$3722	10	\$4409
4	\$3818	11	\$4522
5	\$3913	12	\$4635
6	\$4012	L	—
7	\$4107		

NOTES: Power models specified separately. Power models found on page 460.

❗ Optional Power Cutout

### HSLMICB2

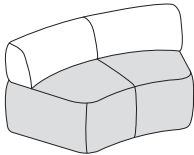

**LOUNGE**

Inside Curve Seat w/ Back —  
Multi-Fabric

**DIMENSIONS**

Depth: 30      Ship Weight: 72.9  
 Width: 55      Cube: 33.9  
 Height: 30      COM: See page 453  
 Usable Seat Depth 20½      Weight Rating: 300 lbs.  
 Seat to Floor Height 18½

**FABRIC PRICE CODES**

1    \$3570  
*Add to Base Price Above*

	Seat	Back
2	\$83	\$52
3	\$168	\$105
4	\$232	\$145
5	\$295	\$185
6	\$361	\$226
7	\$425	\$265
8	\$492	\$307
9	\$556	\$348
10	\$626	\$391
11	\$701	\$438
12	\$777	\$485
L	—	—

NOTES: Power models specified separately. Power models found on page 460.

❗ Optional Power Cutout

## HOW TO SPECIFY

<p><b>Select Model Number</b></p> <p>H S L M C S .</p>	<p><b>Select FSC Wood</b></p> <p>F S C .</p>	<p><b>Select Power</b></p> <p>Y Power Cutout (+ \$40) N No Power Cutout</p>	<p><b>Select Seat Fabric</b></p> <p>See page 453</p>	<p><b>Select Back Fabric (if applicable)</b></p> <p>See page 453</p>
--	--	---	--	--

**HSLMOCB1**

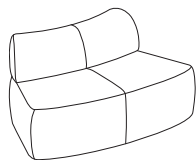

**LOUNGE**

Outside Curve Seat w/ Back

**DIMENSIONS**

Depth:	30	Ship Weight:	67.2
Width:	55	Cube:	33.9
Height:	30	COM:	See page 453
Usable Seat Depth	20½	Weight Rating:	300 lbs.
Seat to Floor Height	18½		

**FABRIC PRICE CODES**

1	\$3470	8	\$4208
2	\$3595	9	\$4304
3	\$3722	10	\$4409
4	\$3818	11	\$4522
5	\$3913	12	\$4635
6	\$4012	L	—
7	\$4107		

NOTES: Power models specified separately. Power models found on page 460.

! Optional Power Cutout

**HSLMOCB2**

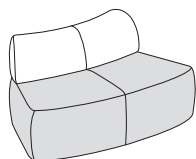

**LOUNGE**

Outside Curve Seat w/ Back — Multi-Fabric

**DIMENSIONS**

Depth:	30	Ship Weight:	67.2
Width:	55	Cube:	33.9
Height:	30	COM:	See page 453
Usable Seat Depth	20½	Weight Rating:	300 lbs.
Seat to Floor Height	18½		

**FABRIC PRICE CODES**

1 \$3570

Add to Base Price Above

	Seat	Back
2	\$83	\$52
3	\$168	\$105
4	\$232	\$145
5	\$295	\$185
6	\$361	\$226
7	\$425	\$265
8	\$492	\$307
9	\$556	\$348
10	\$626	\$391
11	\$701	\$438
12	\$777	\$485
L	—	—

NOTES: Power models specified separately. Power models found on page 460.

! Optional Power Cutout

**HSLMQCS**

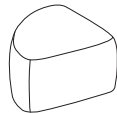

**LOUNGE**

Quarter Circle Seat

**DIMENSIONS**

Depth:	30	Ship Weight:	32.4
Width:	30	Cube:	11.3
Height:	18½	COM:	See page 453
		Weight Rating:	300 lbs.

**FABRIC PRICE CODES**

1	\$1240	8	\$1609
2	\$1302	9	\$1657
3	\$1366	10	\$1709
4	\$1414	11	\$1766
5	\$1462	12	\$1822
6	\$1511	L	—
7	\$1559		

! No Power Cutout Option.

**HOW TO SPECIFY**

<p>Select Model Number</p> <p>H S L M O C B 1 .</p>	<p>Select FSC Wood</p> <p>FSC FSC Wood</p> <p>F S C .</p>	<p>Select Power</p> <p>Y Power Cutout (+ \$40) N No Power Cutout</p>	<p>Select Seat Fabric</p> <p>See page 453</p>	<p>Select Back Fabric (if applicable)</p> <p>See page 453</p>
---	---	--	---	---

**HSLMGK**

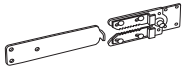

**LOUNGE**

Ganging Kit (2-Pack)

**DIMENSIONS**

Ship Weight: 6.3  
Cube: 0.1

**LIST PRICE**

**\$65**

NOTES: Ganging brackets used to provide alignment between adjacent pieces but can be easily disengaged allowing pieces to be reconfigured.

**HOW TO SPECIFY**

Select  
Model Number

H S L M Q C S

# SoCo™ Power

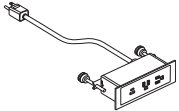

**DESCRIPTION**

**Dean Power Module**  
In-Surface Bezel Mount  
2 Receptacles  
1 USB-A  
1 USB-C

- Straight (10'), Braided (10'), Hardwire (10'), and cord options available.
- In-Surface Bezel Mount model applicable in SoCo power module cutout.
- UL Listed.

MODEL	SHIP WEIGHT	CUBE	LIST PRICE
HBPWRMOD	4.5 Ⓞ	0.2	\$524

SEATING

## HOW TO SPECIFY

Select Model Number

H B P W R M O D .

Select Last Port Option

AC USB-A/C

A C .

Select Cord Type

- S Straight
- B Braided (+ \$63)
- H Hardwire (+ \$73)

S .

Select Color/Finish

- SNW Snow
- STRM Storm
- BLK Black

S N W



Solve Task Chairs and Stools.

## SOLVE®

If you want to make a powerful statement, simply have a seat. With three back materials and an optional adjustable lumbar support, Solve answers the need for a higher level of personalization. Solve task chairs feature a geometric ReActiv® back to create a contemporary look, while the 4-Way Stretch mesh back offers a softer, more relaxed feel. The synchronized seat and back move in harmony with the user to provide continuous comfort that can be customized. Helping anyone achieve optimal balance, proper alignment and lumbar support, Solve is an ideal solution for everywhere and everybody.



## FEATURES

- Synchronized seat and back create continuous comfort.
- Waterfall seat edge encourages leg circulation.
- Optional seat depth adjustment adapts to users of various heights.
- ReActiv® back design moves with your body to provide continuous support and airflow for lasting comfort.
- Available with three control types — synchro-tilt, synchro-tilt with seat slider and advanced synchro-tilt.
- Choose from four different arm options — armless, fixed, height- and width-adjustable or all-adjustable arms.
- Optional lumbar support delivers long-lasting comfort.
- Available with bell glides, hard casters or all-surface casters.
- Upholstered ReActiv® back offers all the benefits of the ReActiv® back with a fabric cover for additional comfort.
- Back upholstery available in one of six attractive fabrics.
- Choose from 3 frame options: Black, Titanium and White.
- Available in seven mesh back and seven lumbar colors and thousands of fabrics.
- Warranted for users up to 300 lbs.

# SOLVE<sup>®</sup> Options

## MODEL OPTIONS

HSLVTMM



**Mid-Back Task (4-Way Stretch Back)**

Pneumatic, Swivel, Synchro-tilt, Tilt Tension, Tilt Lock

HSLVSMM



**Stool (4-Way Stretch Back)**

Pneumatic, Swivel, Synchro-tilt, Tilt Tension, Tilt Lock

HSLVTMMS



**Mid-Back Task (4-Way Stretch Back) with Designer White frame**

Pneumatic, Swivel, Synchro-tilt, Tilt Tension, Tilt Lock

HSLVSMMS



**Stool (4-Way Stretch Back) with Designer White frame**

Pneumatic, Swivel, Synchro-tilt, Tilt Tension, Tilt Lock

HSLVTMR



**Mid-Back Task (ReActiv<sup>®</sup> Back)**

Pneumatic, Swivel, Synchro-tilt, Tilt Tension, Tilt Lock

HSLVSMR



**Stool (ReActiv<sup>®</sup> Back)**

Pneumatic, Swivel, Synchro-tilt, Tilt Tension, Tilt Lock

HSLVTMRS



**Mid-Back Task (ReActiv<sup>®</sup> Back) with Designer White frame**

Pneumatic, Swivel, Synchro-tilt, Tilt Tension, Tilt Lock

HSLVSMRS



**Stool (ReActiv<sup>®</sup> Back) with Designer White frame**

Pneumatic, Swivel, Synchro-tilt, Tilt Tension, Tilt Lock

HSLVTMU \*



**Mid-Back Task (Upholstered Back)**

Pneumatic, Swivel, Synchro-tilt, Tilt Tension, Tilt Lock

HSLVSMU \*



**Stool (Upholstered Back)**

Pneumatic, Swivel, Synchro-tilt, Tilt Tension, Tilt Lock

HSLVTMUS \*



**Mid-Back Task (Upholstered Back) with Designer White frame**

Pneumatic, Swivel, Synchro-tilt, Tilt Tension, Tilt Lock

HSLVSMUS \*







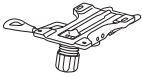
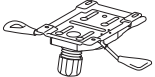
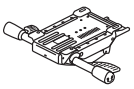

**Stool (Upholstered Back) with Designer White frame**

Pneumatic, Swivel, Synchro-tilt, Tilt Tension, Tilt Lock

MECHANISM	CODE	DESCRIPTION	PRICE
	<b>Y0</b>	Synchro-Tilt A, E, J, K, L	<b>+\$0</b>
	<b>Y1</b>	Synchro-Tilt w/Seat Slider A, D, E, J, K, L	<b>+\$22</b>
	<b>Y2</b>	Advanced Synchro-Tilt A, D, E, J, L, A-D	<b>+\$71</b>

*\*Y2 control not available on stool models*

ARM STYLE	CODE	DESCRIPTION	PRICE
	<b>N</b>	Armless	<b>+\$0</b>
	<b>F</b>	Fixed Arms	<b>+\$71</b>
		<i>*Not available on Designer White models</i>	
	<b>A</b>	Height and Width Adjustable Arms	<b>+\$92</b>
	<b>V</b>	All-Adjustable Arms (includes Pivot)	<b>+\$141</b>
		<i>*Not available on Designer White models</i>	
	<b>ADW</b>	Height and Width Adjustable Arms	<b>+\$92</b>

CASTERS/ GLIDE	CODE	DESCRIPTION	PRICE
	<b>H</b>	Black Hard Caster	<b>+\$0</b>
	<b>S</b>	Black All-Surface Caster	<b>+\$44</b>
	<b>R</b>	Roll Control Caster	<b>+\$55</b>
	<b>G</b>	Bell Glide	<b>+\$28</b>

BACK STYLE	CODE	DESCRIPTION	PRICE
		<i>4-Way Stretch mesh back options:</i>	
	<b>IM</b>	Black	<b>+\$0</b>
	<b>IB</b>	Breeze	<b>+\$0</b>
	<b>IK</b>	Brownstone	<b>+\$0</b>
	<b>IC</b>	Charcoal	<b>+\$0</b>
	<b>IF</b>	Fog	<b>+\$0</b>
	<b>IR</b>	Regatta	<b>+\$0</b>
	<b>IT</b>	Titanium	<b>+\$0</b>
		<i>ReActiv® back options:</i>	
	<b>OS</b>	Charcoal	<b>+\$0</b>
	<b>DW</b>	Designer White	<b>+\$0</b>
	<b>TI</b>	Titanium	<b>+\$0</b>

<i>Fabric options:</i>			
	<b>COMF46</b> *	Bittersweet	<b>+\$0</b>
	<b>COMF10</b> *	Ink	<b>+\$0</b>
	<b>COMF82</b> *	Meadow	<b>+\$0</b>
	<b>COMF90</b> *	Midnight	<b>+\$0</b>
	<b>COMF22</b> *	Putty	<b>+\$0</b>
	<b>COMF19</b> *	Sterling	<b>+\$0</b>

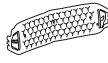
LUMBAR	CODE	DESCRIPTION	PRICE
	<b>NL</b>	No Lumbar	<b>+\$0</b>
	<b>BL</b>	Black Adjustable Lumbar	<b>+\$33</b>
	<b>BY</b>	Bullseye Adjustable Lumbar	<b>+\$33</b>
	<b>DW</b>	Designer White Adjustable Lumbar	<b>+\$33</b>
	<b>KT</b>	Krypton Adjustable Lumbar	<b>+\$33</b>
	<b>MR</b>	Ember Adjustable Lumbar	<b>+\$33</b>
	<b>RE</b>	Regatta Adjustable Lumbar	<b>+\$33</b>
	<b>TL</b>	Titanium Adjustable Lumbar	<b>+\$33</b>

BASE	CODE	DESCRIPTION	PRICE
	<b>SB</b>	Standard Base	<b>+\$0</b>

FRAME	CODE	DESCRIPTION	PRICE
	<b>T</b>	Black	<b>+\$0</b>
	<b>TI</b>	Titanium	<b>+\$39</b>
	<b>DW</b>	Designer White	<b>+\$39</b>

\* De-emphasized



# SOLVE® Options

## HON BRANDED FABRICS

GRADE 1	GRADE 2	GRADE 3	GRADE 4	GRADE L
Apex	ApPOINT Seating	Bradbury	Constance with Supreen™	Denver Leather (Seat Only)
Centurion	Blume	Getaway	Livi with Supreen™	
Compass	Clyde	Moxie	Lugano with Supreen™	
Compass Foam	Dotty	Notion	Oxford with Supreen™	
Contourett	Kai	Parker		
Dapper	Rush	Purl		
Ensemble	Spin Seating	Quill*		
Hamilton	Wavelength	Saxony		
Inertia	Whisper Vinyl			
Noble Seating				
Optic				
Pebble				
Vibe				

For a complete list of fabrics, including partnership fabrics, go to [hon.com/fabricsandfinishes](https://hon.com/fabricsandfinishes).

Reference Fabric Color Combinations on pages 20-25 for color codes and legend on page 21 for lead times.

\*Quill available on Seat only.

## DIMENSIONS

NOTE: When selecting the .TI Titanium or .DW Designer White frame option, the chair's back frame, arms, and base will match. 4-Way Stretch, ReActiv®, and/or lumbar color must be selected separately.

MODEL		HSLVTMM /HSLVTMMS	HSLVSMM /HSLVSMMS	HSLVTMR /HSLVTMRS	HSLVSMR /HSLVSMRS	HSLVTMU /HSLVTMUS	HSLVSMU /HSLVSMUS
Overall Width Armless		29½"	29½"	29½"	29½"	29½"	29½"
Overall Width with Arms	(A)	29½"	29½"	29½"	29½"	29½"	29½"
Overall Depth		29½"	29½"	29½"	29½"	29½"	29½"
Overall Height – Max	(Y0/Y1)	41¾"	52¾"	41¾"	52¾"	41¾"	52¾"
	(Y2)	42½"	—	42½"	—	42½"	—
Seat Width		19"	19"	19"	19"	19"	19"
Seat Depth (Cushion)		19¼"	19¼"	19¼"	19¼"	19¼"	19¼"
Usable Seat Depth	(Y0)	17⅝"	17⅝"	17⅝"	17⅝"	17⅝"	17⅝"
	(Y1)	16¼"-18½"	16¼"-18½"	16¼"-18½"	16¼"-18½"	16¼"-18½"	16¼"-18½"
	(Y2)	16¼"-19¼"	—	16¼"-19¼"	—	16¼"-19¼"	—
Seat Height	(Y0/Y1)	16¾"-21¾"	22¾"-32¾"	16¾"-21¾"	22¾"-32¾"	16¾"-21¾"	22¾"-32¾"
	(Y2)	17½"-22½"	—	17½"-22½"	—	17½"-22½"	—
Back Width		18¼"	18¼"	18¼"	18¼"	18¼"	18¼"
Back Height		21½"	21½"	21½"	21½"	21½"	21½"
Ship Weight Armless	(Y0)	40 <b>Ⓞ</b>	45 <b>Ⓞ</b>	41 <b>Ⓞ</b>	46 <b>Ⓞ</b>	41 <b>Ⓞ</b>	46 <b>Ⓞ</b>
	(Y1)	42 <b>Ⓞ</b>	47 <b>Ⓞ</b>	43 <b>Ⓞ</b>	48 <b>Ⓞ</b>	43 <b>Ⓞ</b>	48 <b>Ⓞ</b>
	(Y2)	45 <b>Ⓞ</b>	—	46 <b>Ⓞ</b>	—	46 <b>Ⓞ</b>	—
Ship Weight with Arms	(Y0)	44 <b>Ⓞ</b>	49 <b>Ⓞ</b>	45 <b>Ⓞ</b>	50 <b>Ⓞ</b>	45 <b>Ⓞ</b>	50 <b>Ⓞ</b>
	(Y1)	46 <b>Ⓞ</b>	51 <b>Ⓞ</b>	47 <b>Ⓞ</b>	52 <b>Ⓞ</b>	47 <b>Ⓞ</b>	52 <b>Ⓞ</b>
	(Y2)	49 <b>Ⓞ</b>	—	50 <b>Ⓞ</b>	—	50 <b>Ⓞ</b>	—
Width Between Arms		17½"-20"	17½"-20"	17½"-20"	17½"-20"	17½"-20"	17½"-20"
COM		1.0	1.0	1.0	1.0	1.0	1.0
Weight Capacity		300 lbs	300 lbs	300 lbs	300 lbs	300 lbs	300 lbs

SEATING



Icon Legend on page 19

**HSLVTMM**

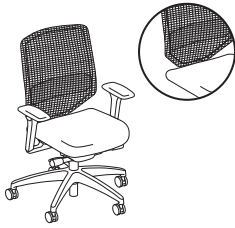

**MID-BACK TASK**

- 4-Way Stretch Back**
- Pneumatic
- Swivel
- Synchro-tilt
- Tilt Tension
- Tilt Lock

**DIMENSIONS**

Seat Depth:	19¼	Arm Width:	17½-20
Seat Width:	19	Cube:	10.8
Back Width:	18¼	Weight Rating:	300 lbs.
Back Height:	21½		

**FABRIC PRICE CODES**

<b>1</b>	<b>\$647</b>	<b>8</b>	<b>\$723</b>
<b>2</b>	<b>\$661</b>	<b>9</b>	<b>\$732</b>
<b>3</b>	<b>\$674</b>	<b>10</b>	<b>\$741</b>
<b>4</b>	<b>\$684</b>	<b>11</b>	<b>\$752</b>
<b>5</b>	<b>\$693</b>	<b>12</b>	<b>\$761</b>
<b>6</b>	<b>\$703</b>	<b>L</b>	<b>\$756</b>
<b>7</b>	<b>\$712</b>		

NOTES: Please reference pages 463-464 for additional specifications and mechanism information.

**HSLVTMMS**

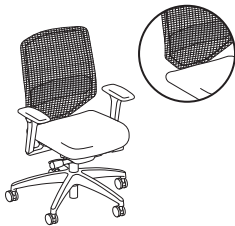

**MID-BACK TASK IN DESIGNER WHITE**

- 4-Way Stretch Back**
- Pneumatic
- Swivel
- Synchro-tilt
- Tilt Tension
- Tilt Lock

**DIMENSIONS**

Seat Depth:	19¼	Arm Width:	17½-20
Seat Width:	19	Cube:	10.8
Back Width:	18¼	Weight Rating:	300 lbs.
Back Height:	21½		

**FABRIC PRICE CODES**

<b>1</b>	<b>\$647</b>	<b>8</b>	<b>\$723</b>
<b>2</b>	<b>\$661</b>	<b>9</b>	<b>\$732</b>
<b>3</b>	<b>\$674</b>	<b>10</b>	<b>\$741</b>
<b>4</b>	<b>\$684</b>	<b>11</b>	<b>\$752</b>
<b>5</b>	<b>\$693</b>	<b>12</b>	<b>\$761</b>
<b>6</b>	<b>\$703</b>	<b>L</b>	<b>\$756</b>
<b>7</b>	<b>\$712</b>		

**OPEN MARKET**

NOTES: Please reference pages 463-464 for additional specifications and mechanism information.

**HON Recommendation: HSLVTMM.Y1.A.H.IM.CU\_\_BL.SB.T - List Price \$794**

**HOW TO SPECIFY**

Select Model Number	Select Control Type	Select Arm Type	Select Caster/Glide	Select Mesh Back	Select Fabric	Select Lumbar	Select Base	Select Frame
	<b>Y0</b> Synchro-Tilt <b>Y1</b> Synchro-Tilt w/ Seat Slider (+ \$22) <b>Y2</b> Advanced Synchro-Tilt (+ \$71)	<b>HSLVTMM Options</b> <b>N</b> Armless <b>F</b> Fixed Arms (+ \$71) <b>A</b> Height and Width Adjustable Arms (+ \$92) <b>V</b> All-Adjustable Arms (includes pivot) (+ \$141)	<b>H</b> Black Hard Caster <b>S</b> Black All-Surface Caster (+ \$44) <b>G</b> Bell Glide (+ \$28) <b>R</b> Black Roll Control Caster (+ \$55)	4-Way Stretch options <b>IM</b> Black <b>IB</b> Breeze <b>IK</b> Brownstone <b>IC</b> Charcoal <b>IF</b> Fog <b>IR</b> Regatta <b>IT</b> Titanium	See page 464	<b>NL</b> No Lumbar <b>BL</b> Black Adjustable Lumbar (+ \$33) <b>BY</b> Bullseye Adjustable Lumbar (+ \$33) <b>DW</b> Designer White Adjustable Lumbar (+ \$33) <b>KT</b> Krypton Adjustable Lumbar (+ \$33) <b>MR</b> Ember Adjustable Lumbar (+ \$33) <b>RE</b> Regatta Adjustable Lumbar (+ \$33) <b>TL</b> Titanium Adjustable Lumbar (+ \$33)	<b>SB</b> Standard Base	<b>HSLVTMM Options</b> <b>T</b> Black <b>TI</b> Titanium (+ \$39)
<b>H S L V T M M</b>	<b>Y 1</b>	<b>A</b>	<b>S</b>	<b>I M</b>	<b>C U 1 0</b>	<b>B L</b>	<b>S B</b>	<b>T</b>

**SEATING**



## HSLVSMM

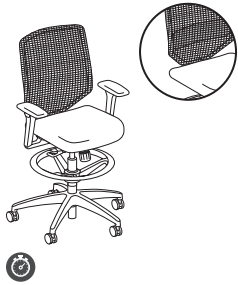

### STOOL

- 4-Way Stretch Back
- Pneumatic
- Swivel
- Synchro-tilt
- Tilt Tension
- Tilt Lock

### DIMENSIONS

Seat Depth:	19¼	Arm Width:	17½-20
Seat Width:	19	Cube:	10.8
Back Width:	18¼	Weight Rating:	300 lbs.
Back Height:	21½		

### FABRIC PRICE CODES

1	\$726	8	\$802
2	\$740	9	\$811
3	\$753	10	\$820
4	\$763	11	\$831
5	\$772	12	\$840
6	\$782	L	\$835
7	\$791		

NOTES: Please reference pages 463-464 for additional specifications and mechanism information.

## HSLVSMMS



### STOOL IN DESIGNER WHITE

- 4-Way Stretch Back
- Pneumatic
- Swivel
- Synchro-tilt
- Tilt Tension
- Tilt Lock

### DIMENSIONS

Seat Depth:	19¼	Arm Width:	17½-20
Seat Width:	19	Cube:	10.8
Back Width:	18¼	Weight Rating:	300 lbs.
Back Height:	21½		

### FABRIC PRICE CODES

1	\$726	8	\$802
2	\$740	9	\$811
3	\$753	10	\$820
4	\$763	11	\$831
5	\$772	12	\$840
6	\$782	L	\$835
7	\$791		

NOTES: Please reference pages 463-464 for additional specifications and mechanism information.

**HON Recommendation: HSLVSMM.Y1.A.H.IM.CU\_\_BL.SB.T - List Price \$873**

## HOW TO SPECIFY

Select Model Number	Select Control Type	Select Arm Type	Select Caster/Glide	Select Mesh Back	Select Fabric	Select Lumbar	Select Base	Select Frame
Y1	YO Synchro-Tilt Y1 Synchro-Tilt w/ Seat Slider (+ \$22)	<b>HSLVSMM Options</b> N Armless F Fixed Arms (+ \$71) A Height and Width Adjustable Arms (+ \$92) V All-Adjustable Arms (includes pivot) (+ \$141)  <b>HSLVSMMS Options</b> ADW Height and Width Adjustable Arms (+ \$92) <i>Available for model HSLVSMMS only</i>	H Black Hard Caster S Black All-Surface Caster (+ \$44) G Bell Glide (+ \$28) R Black Roll Control Caster (+ \$55)	4-Way Stretch options IM Black IB Breeze IK Brownstone IC Charcoal IF Fog IR Regatta IT Titanium	See page 464	NL No Lumbar BL Black Adjustable Lumbar (+ \$33) BY Bullseye Adjustable Lumbar (+ \$33) DW Designer White Adjustable Lumbar (+ \$33) KT Krypton Adjustable Lumbar (+ \$33) MR Ember Adjustable Lumbar (+ \$33) RE Regatta Adjustable Lumbar (+ \$33) TL Titanium Adjustable Lumbar (+ \$33)	SB Standard Base	T Black TI Titanium (+ \$60 for HSLVSMM) DW Designer White (+ \$60; available on HSLVSMMS only)
H S L V S M M .	Y 1 .	A .	S .	I M .	C U I O .	B L .	S B .	T

SEATING



Icon Legend on page 19

**HSLVTMR**



**MID-BACK TASK**

- ReActiv® Back**
- Pneumatic
- Swivel
- Synchro-tilt
- Tilt Tension
- Tilt Lock

**DIMENSIONS**

- Seat Depth: 19¼
- Seat Width: 19
- Back Width: 18¼
- Back Height: 21½
- Arm Width: 17½-20
- Cube: 10.8
- Weight Rating: 300 lbs.

**FABRIC PRICE CODES**

1	\$682	8	\$758
2	\$696	9	\$767
3	\$709	10	\$776
4	\$719	11	\$787
5	\$728	12	\$796
6	\$738	L	\$791
7	\$747		

NOTES: Please reference pages 463-464 for additional specifications and mechanism information.

**HSLVTMRS**

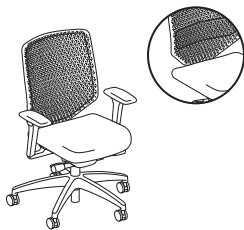

**MID-BACK TASK IN DESIGNER WHITE**

- ReActiv® Back**
- Pneumatic
- Swivel
- Synchro-tilt
- Tilt Tension
- Tilt Lock

**DIMENSIONS**

- Seat Depth: 19¼
- Seat Width: 19
- Back Width: 18¼
- Back Height: 21½
- Arm Width: 17½-20
- Cube: 10.8
- Weight Rating: 300 lbs.

**FABRIC PRICE CODES**

1	\$682	8	\$758
2	\$696	9	\$767
3	\$709	10	\$776
4	\$719	11	\$787
5	\$728	12	\$796
6	\$738	L	\$791
7	\$747		

**OPEN MARKET**

NOTES: Please reference pages 463-464 for additional specifications and mechanism information.

**HON Recommendation: HSLVTMR.Y1.A.H.OS.CU\_\_NL.SB.T - List Price \$796**

**HOW TO SPECIFY**

Select Model Number	Select Control Type	Select Arm Type	Select Caster/Glide	Select Back Color	Select Fabric	Select Lumbar	Select Base	Select Frame
<p><b>Y0</b> Synchro-Tilt</p> <p><b>Y1</b> Synchro-Tilt w/ Seat Slider (+ \$22)</p> <p><b>Y2</b> Advanced Synchro-Tilt (+ \$71)</p>	<p><b>HSLVTMR Options</b></p> <p><b>N</b> Armless</p> <p><b>F</b> Fixed Arms (+ \$71)</p> <p><b>A</b> Height and Width Adjustable Arms (+ \$92)</p> <p><b>V</b> All-Adjustable Arms (includes pivot) (+ \$141)</p> <p><b>HSLVTMRS Options</b></p> <p><b>ADW</b> Height and Width Adjustable Arms (+ \$0) Available for model HSLVTMRS only</p>	<p><b>H</b> Black Hard Caster</p> <p><b>S</b> Black All-Surface Caster (+ \$44)</p> <p><b>G</b> Bell Glide (+ \$28)</p> <p><b>R</b> Black Roll Control Caster (+ \$55)</p>	<p><b>OS</b> Charcoal</p> <p><b>TI</b> Titanium</p> <p><b>DW</b> Designer White</p>	See page 464	<p><b>NL</b> No Lumbar</p> <p><b>BL</b> Black Adjustable Lumbar (+ \$33)</p> <p><b>BY</b> Bullseye Adjustable Lumbar (+ \$33)</p> <p><b>DW</b> Designer White Adjustable Lumbar (+ \$33)</p> <p><b>KT</b> Krypton Adjustable Lumbar (+ \$33)</p> <p><b>MR</b> Ember Adjustable Lumbar (+ \$33)</p> <p><b>RE</b> Regatta Adjustable Lumbar (+ \$33)</p> <p><b>TL</b> Titanium Adjustable Lumbar (+ \$33)</p>	<p><b>SB</b> Standard Base</p>	<p><b>HSLVTMR Options</b></p> <p><b>T</b> Black</p> <p><b>TI</b> Titanium (+ \$39)</p> <p><b>HSLVTMRS Options</b></p> <p><b>DW</b> Designer White (+ \$39) Available for model HSLVTMRS only</p>	
H S L V T M R .	Y 1 .	A .	H .	O S .	C U 1 0 .	N L .	S B .	T

**SEATING**



## HSLVSMR



### STOOL

**ReActiv® Back**  
Pneumatic  
Swivel  
Synchro-tilt  
Tilt Tension  
Tilt Lock

### DIMENSIONS

Seat Depth: 19¼      Arm Width: 17½-20  
Seat Width: 19      Cube: 10.8  
Back Width: 18¼      Weight Rating: 300 lbs.  
Back Height: 21½

### FABRIC PRICE CODES

1	\$761	8	\$837
2	\$775	9	\$846
3	\$788	10	\$855
4	\$798	11	\$866
5	\$807	12	\$875
6	\$817	L	\$870
7	\$826		

NOTES: Please reference pages 463-464 for additional specifications and mechanism information.

## HSLVSMRS



### STOOL IN DESIGNER WHITE

**ReActiv® Back**  
Pneumatic  
Swivel  
Synchro-tilt  
Tilt Tension  
Tilt Lock

### DIMENSIONS

Seat Depth: 19¼      Arm Width: 17½-20  
Seat Width: 19      Cube: 10.8  
Back Width: 18¼      Weight Rating: 300 lbs.  
Back Height: 21½

### FABRIC PRICE CODES

1	\$761	8	\$837
2	\$775	9	\$846
3	\$788	10	\$855
4	\$798	11	\$866
5	\$807	12	\$875
6	\$817	L	\$870
7	\$826		

OPEN MARKET

NOTES: Please reference pages 463-464 for additional specifications and mechanism information.

**HON Recommendation: HSLVSMR.Y1.A.H.OS.CU\_\_NL.SB.T - List Price \$875**

## HOW TO SPECIFY

Select Model Number	Select Control Type	Select Arm Type	Select Caster/Glide	Select Back Color	Select Fabric	Select Lumbar	Select Base	Select Frame
<b>YO</b> Synchro-Tilt <b>Y1</b> Synchro-Tilt w/ Seat Slider (+ \$22)	<b>N</b> Armless <b>F</b> Fixed Arms (+ \$71) <b>A</b> Height and Width Adjustable Arms (+ \$92) <b>V</b> All-Adjustable Arms (includes pivot) (+ \$141)	<b>H</b> Black Hard Caster <b>S</b> Black All-Surface Caster (+ \$44) <b>G</b> Bell Glide (+ \$28) <b>R</b> Black Roll Control Caster (+ \$55)	<b>OS</b> Charcoal <b>TI</b> Titanium <b>DW</b> Designer White	See page 464	<b>NL</b> No Lumbar <b>BL</b> Black Adjustable Lumbar (+ \$33) <b>BY</b> Bullseye Adjustable Lumbar (+ \$33) <b>DW</b> Designer White Adjustable Lumbar (+ \$33) <b>KT</b> Krypton Adjustable Lumbar (+ \$33) <b>MR</b> Ember Adjustable Lumbar (+ \$33) <b>RE</b> Regatta Adjustable Lumbar (+ \$33) <b>TL</b> Titanium Adjustable Lumbar (+ \$33)	<b>SB</b> Standard Base	<b>T</b> Black <b>TI</b> Titanium (+ \$60 for HSLVSMR) <b>DW</b> Designer White (+ \$60; available on HSLVSMRS only)	
<b>H S L V S M R</b>	<b>Y 1</b>	<b>A</b>	<b>H</b>	<b>O S</b>	<b>C U 1 0</b>	<b>N L</b>	<b>S B</b>	<b>T</b>

SEATING



Icon Legend on page 19

**HSLVTMU** \*

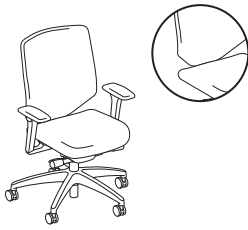

**MID-BACK TASK**

- Upholstered Back**
- Pneumatic
- Swivel
- Synchro-tilt
- Tilt Tension
- Tilt Lock

**DIMENSIONS**

- Seat Depth: 19¼
- Seat Width: 19
- Back Width: 18¼
- Back Height: 21½
- Arm Width: 17½-20
- Cube: 10.8
- Weight Rating: 300 lbs.

**FABRIC PRICE CODES**

- |   |       |    |       |
|---|-------|----|-------|
| 1 | \$712 | 8  | \$788 |
| 2 | \$726 | 9  | \$797 |
| 3 | \$739 | 10 | \$806 |
| 4 | \$749 | 11 | \$817 |
| 5 | \$758 | 12 | \$826 |
| 6 | \$768 | L  | \$821 |
| 7 | \$777 |    |       |

NOTES: Please reference pages 463-464 for additional specifications and mechanism information.

**HSLVTMUS** \*

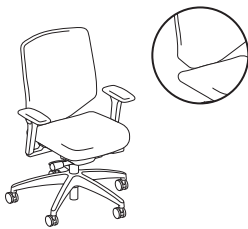

**MID-BACK TASK IN DESIGNER WHITE**

- Upholstered Back**
- Pneumatic
- Swivel
- Synchro-tilt
- Tilt Tension
- Tilt Lock

**DIMENSIONS**

- Seat Depth: 19¼
- Seat Width: 19
- Back Width: 18¼
- Back Height: 21½
- Arm Width: 17½-20
- Cube: 10.8
- Weight Rating: 300 lbs.

**FABRIC PRICE CODES**

- |   |       |    |       |
|---|-------|----|-------|
| 1 | \$712 | 8  | \$788 |
| 2 | \$726 | 9  | \$797 |
| 3 | \$739 | 10 | \$806 |
| 4 | \$749 | 11 | \$817 |
| 5 | \$758 | 12 | \$826 |
| 6 | \$768 | L  | \$821 |
| 7 | \$777 |    |       |

**OPEN MARKET**

NOTES: Please reference pages 463-464 for additional specifications and mechanism information.

**HON Recommendation: HSLVTMU.Y1.A.H.OS.COMF10.COMP10.NL.SB.T - List Price \$826**

\* De-emphasized

**HOW TO SPECIFY**

Select Model Number	Select Control Type	Select Arm Type	Select Caster/Glide	Select Back Color	Select Back Fabric	Select Seat Fabric	Select Lumbar	Select Base	Select Frame
	<b>Y0</b> Synchro-Tilt <b>Y1</b> Synchro-Tilt w/ Seat Slider (+ \$22) <b>Y2</b> Advanced Synchro-Tilt (+ \$71)	<b>HSLVTMU Options</b> <b>N</b> Armless <b>F</b> Fixed Arms (+ \$71) <b>A</b> Height and Width Adjustable Arms (+ \$92) <b>V</b> All-Adjustable Arms (includes pivot) (+ \$141)	<b>H</b> Black Hard Caster <b>S</b> Black All-Surface Caster (+ \$44) <b>G</b> Bell Glide (+ \$28) <b>R</b> Black Roll Control Caster (+ \$55)	<b>OS</b> Charcoal <b>TI</b> Titanium <b>DW</b> Designer White	<b>COMF46</b> Bittersweet <b>COMF10</b> Ink <b>COMF82</b> Meadow <b>COMF90</b> Midnight <b>COMF22</b> Putty <b>COMF19</b> Sterling	See page 464	<b>NL</b> No Lumbar <b>BL</b> Black Adjustable Lumbar (+ \$33) <b>BY</b> Bullseye Adjustable Lumbar (+ \$33) <b>DW</b> Designer White Adjustable Lumbar (+ \$33) <b>KT</b> Krypton Adjustable Lumbar (+ \$33) <b>MR</b> Ember Adjustable Lumbar (+ \$33) <b>RE</b> Regatta Adjustable Lumbar (+ \$33) <b>TL</b> Titanium Adjustable Lumbar (+ \$33)	<b>SB</b> Standard Base	<b>HSLVTMU Options</b> <b>T</b> Black <b>TI</b> Titanium (+ \$39)
		<b>HSLVTMUS Options</b> <b>ADW</b> Height and Width Adjustable Arms (+ \$92) Available for model HSLVTMUS only							<b>HSLVTMUS Options</b> <b>DW</b> Designer White (+ \$39) Available for model HSLVTMUS only
H S L V T M U	Y 1	A	H	O S	C O M F 1 0	C O M P 1 0	N L	S B	T

**SEATING**



## HSLVSMU \*

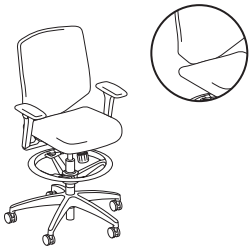

### STOOL

**Upholstered Back**  
Pneumatic  
Swivel  
Synchro-tilt  
Tilt Tension  
Tilt Lock

### DIMENSIONS

Seat Depth: 19¼      Arm Width: 17½-20  
Seat Width: 19      Cube: 10.8  
Back Width: 18¼      Weight Rating: 300 lbs.  
Back Height: 21½

### FABRIC PRICE CODES

1	\$791	8	\$867
2	\$805	9	\$876
3	\$818	10	\$885
4	\$828	11	\$896
5	\$837	12	\$905
6	\$847	L	\$900
7	\$856		

NOTES: Please reference pages 463-464 for additional specifications and mechanism information.

## HSLVSMUS \*

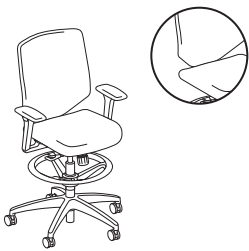

### STOOL IN DESIGNER WHITE

**Upholstered Back**  
Pneumatic  
Swivel  
Synchro-tilt  
Tilt Tension  
Tilt Lock

### DIMENSIONS

Seat Depth: 19¼      Arm Width: 17½-20  
Seat Width: 19      Cube: 10.8  
Back Width: 18¼      Weight Rating: 300 lbs.  
Back Height: 21½

### FABRIC PRICE CODES

1	\$791	8	\$867
2	\$805	9	\$876
3	\$818	10	\$885
4	\$828	11	\$896
5	\$837	12	\$905
6	\$847	L	\$900
7	\$856		

OPEN MARKET

NOTES: Please reference pages 463-464 for additional specifications and mechanism information.

**HON Recommendation: HSLVSMU.Y1.A.H.OS.COMF10.COMP10.NL.SB.T - List Price \$905**

\* De-emphasized

## HOW TO SPECIFY

Select Model Number	Select Control Type	Select Arm Type	Select Caster/Glide	Select Back Color	Select Back Fabric	Select Seat Fabric	Select Lumbar	Select Base	Select Frame
Y0 Synchro-Tilt Y1 Synchro-Tilt w/ Seat Slider (+ \$22)	<b>HSLVSMU Options</b> <b>N</b> Armless <b>F</b> Fixed Arms (+ \$71) <b>A</b> Height and Width Adjustable Arms (+ \$92) <b>V</b> All-Adjustable Arms (includes pivot) (+ \$141) <b>HSLVSMUS Options</b> <b>ADW</b> Height and Width Adjustable Arms (+ \$92) <i>Available for model HSLVSMUS only</i>	<b>H</b> Black Hard Caster <b>S</b> Black All-Surface Caster (+ \$44) <b>G</b> Bell Glide (+ \$28) <b>R</b> Black Roll Control Caster (+ \$55)	<b>OS</b> Charcoal <b>TI</b> Titanium <b>DW</b> Designer White	<b>COMF46</b> Bittersweet <b>COMF10</b> Ink <b>COMF82</b> Meadow <b>COMF90</b> Midnight <b>COMF22</b> Putty <b>COMF19</b> Sterling	See page 464	<b>NL</b> No Lumbar <b>BL</b> Black Adjustable Lumbar (+ \$33) <b>BY</b> Bullseye Adjustable Lumbar (+ \$33) <b>DW</b> Designer White Adjustable Lumbar (+ \$33) <b>KT</b> Krypton Adjustable Lumbar (+ \$33) <b>MR</b> Ember Adjustable Lumbar (+ \$33) <b>RE</b> Regatta Adjustable Lumbar (+ \$33) <b>TL</b> Titanium Adjustable Lumbar (+ \$33)	<b>SB</b> Standard Base	<b>T</b> Black <b>TI</b> Titanium (+ \$60 for HSLVSMU) <b>DW</b> Designer White (+ \$60; available on HSLVSMUS only)	
H S L V S M U	. Y 1 .	. A .	. H .	. O S .	. C O M F 1 0 .	. C O M P 1 0 .	. N L .	. S B .	. T

SEATING



Icon Legend on page 19

**HSLVTMMKD**



**MID-BACK TASK**

- 4-Way Stretch Back**
- Pneumatic
- Swivel
- Synchro-tilt
- Tilt Tension
- Tilt Lock

**DIMENSIONS**

- Seat Depth: 19¼
- Seat Width: 19
- Back Width: 18¼
- Back Height: 21½
- Arm Width: 17½-20
- Cube: 5.6
- Weight Rating: 300 lbs.

**FABRIC PRICE CODES**

1	\$607	8	\$683
2	\$621	9	\$692
3	\$634	10	\$701
4	\$644	11	\$712
5	\$653	12	\$721
6	\$663	L	\$716
7	\$672		

NOTES: Please reference pages 463-464 for additional specifications and mechanism information.

**HSLVTMRKD**

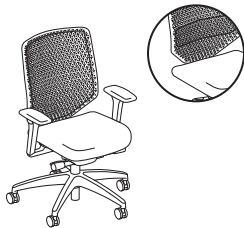

**MID-BACK TASK**

- ReActiv® Back**
- Pneumatic
- Swivel
- Synchro-tilt
- Tilt Tension
- Tilt Lock

**DIMENSIONS**

- Seat Depth: 19¼
- Seat Width: 19
- Back Width: 18¼
- Back Height: 21½
- Arm Width: 17½-20
- Cube: 5.6
- Weight Rating: 300 lbs.

**FABRIC PRICE CODES**

1	\$642	8	\$718
2	\$656	9	\$727
3	\$669	10	\$736
4	\$679	11	\$747
5	\$688	12	\$756
6	\$698	L	\$751
7	\$707		

NOTES: Please reference pages 463-464 for additional specifications and mechanism information.

**HSLVTMUKD** \*

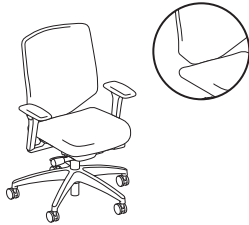

**MID-BACK TASK**

- Upholstered Back**
- Pneumatic
- Swivel
- Synchro-tilt
- Tilt Tension
- Tilt Lock

**DIMENSIONS**

- Seat Depth: 19¼
- Seat Width: 19
- Back Width: 18¼
- Back Height: 21½
- Arm Width: 17½-20
- Cube: 5.6
- Weight Rating: 300 lbs.

**FABRIC PRICE CODES**

1	\$672	8	\$748
2	\$686	9	\$757
3	\$699	10	\$766
4	\$709	11	\$777
5	\$718	12	\$786
6	\$728	L	\$781
7	\$737		

NOTES: Please reference pages 463-464 for additional specifications and mechanism information.

**HON Recommendation: HSLVTMMKD.Y1.A.H.IM.CU\_\_BL.SB.T - List Price \$754**

\* De-emphasized

**HOW TO SPECIFY**

Select Model Number	Select Control Type	Select Arm Type	Select Caster	Select Mesh Back	Select Back Color	Select Back Fabric	Select Seat Fabric	Select Lumbar	Select Base	Select Frame
HSLVTMMKD	Y1 Synchro-Tilt w/ Seat Slider (+ \$22)	A Height and Width Adjustable Arms (+ \$92)	H Black Hard Caster	4-Way Stretch options IM Black Specify for model HSLVTMMKD only	OS Charcoal TI Titanium Specify for models HSLVTMRKD and HSLVTMUKD only	COMF46 Bittersweet COMF10 Ink COMF82 Meadow COMF90 Midnight COMF22 Putty COMF19 Sterling Specify for model HSLVTMUKD only	See page 464	NL No Lumbar BL Black Adjustable Lumbar (+ \$33)	SB Standard Base	T Black
HSLVTMMKD	Y1	A	H	IM			CU10	BL	SB	T
HSLVTMRKD	Y1	A	H		OS		CU10	BL	SB	T
HSLVTMUKD	Y1	A	H		OS	COMF46	CU10	BL	SB	T





## HSLVLMBR

### LUMBAR PACK

### DIMENSIONS

### LIST PRICE

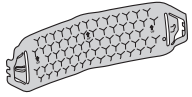

Ship Weight: 1  
Cube: 0.2

\$48

## HOW TO SPECIFY

Select Model Number

Select Color

- BY** Bullseye Adjustable Lumbar
- DW** Designer White Adjustable Lumbar
- KT** Krypton Adjustable Lumbar
- MR** Ember Adjustable Lumbar
- RE** Regatta Adjustable Lumbar
- T** Black
- TI** Titanium

H S L V L M B R . T

## HSLVFAP

### FIXED ARM PACK

### DIMENSIONS

### LIST PRICE



Ship Weight: 6  
Cube: 1.0

\$153

## HSLV2DAP

### ADJUSTABLE ARM PACK

### DIMENSIONS

### LIST PRICE



Height and Width

Adjustable Arms Width: 17½-20  
Height from Seat: 7¼-11¼  
Ship Weight: 6  
Cube: 1.0

\$166

## HSLV4DAP

### ALL-ADJUSTABLE ARM PACK

### DIMENSIONS

### LIST PRICE



Including Pivot

Ship Weight: 6  
Cube: 1.0

\$224

## HSCASTER

### SET OF 5 ALL-SURFACE CASTERS

### DIMENSIONS

### LIST PRICE

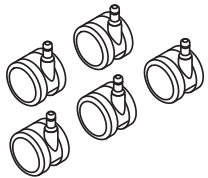

Size: 60mm  
Ship Weight: 2  
Cube: 0.1

\$75

ⓘ Available in Black finish only, no specification needed.

## HOW TO SPECIFY

Select Model Number

Select Color

- T** Black
- TI** Titanium
- DW** Designer White (available on HSLV2DAP only)

H S L V 2 D A P . T



Soothe Guest  
Chairs and Tables.

## SOOTHE®

Soothe offers the comfort and versatility to support a variety of healthcare and waiting environments. This family of patient and guest seats is constructed from durable materials and thoughtfully designed to be easily cleaned. The entire collection maximizes comfort along the patient's journey to recovery, enhances functionality for the caregiver, and creates the versatility required to deliver a higher level of care.



## FEATURES

- Available in Charcoal Urethane arm caps.
- Wipeout space at the back of the seat allows for easy maintenance.
- Bench seating is available in two-seat or three-seat options.
- Choose one of eight frame finishes.
- Multi-fabric option offers endless color combinations.
- Chairs can be ganged together to create straight rows.
- Warranted for users up to 350 lbs. (Model HHCG50 bariatric chair warranted for 750 lbs.)
- Wall-saver design protects walls and cabinets.

# SOOTHE<sup>®</sup>

## Options

### MODEL OPTIONS

HHCG11  
HHCG11DF - Multi-Fabric



Guest Chair

HHCG21  
HHCG21DF - Multi-Fabric

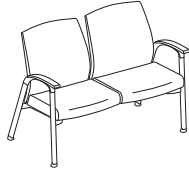

Two-Seat Chair

HHCG50  
HHCG50DF - Multi-Fabric

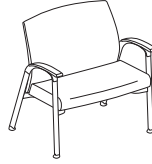

Bariatric Chair

HHCGB21

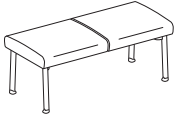

Two-Seat Bench

HHCGB31

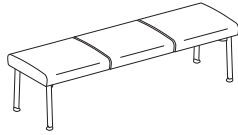

Three-Seat Bench

## ARM CAP FINISH

CODE	DESCRIPTION	PRICE
S	Charcoal Urethane	+\$0

## FRAME

CODE	DESCRIPTION	PRICE
<b>GRADE P1</b>		
CBK	Charblack	+\$0
PK7	Textured Designer White	+\$0
P7A	Textured Charcoal	+\$0
P7J	Textured Brownstone	+\$0
P7L	Textured Loft	+\$0
P7M	Textured Muslin	+\$0
P8V	Textured Titanium	+\$0
<b>GRADE P2</b>		
PR8	Textured Silver	+\$0

## HON BRANDED FABRICS

### GRADE 1

Apex  
Centurion  
Compass  
Contourett  
Dapper  
Ensemble  
Hamilton  
Inertia  
Noble Seating  
Pebble  
Vibe

### GRADE 2

Appoint Seating  
Blume  
Clyde  
Dotty  
Kai  
Rush  
Spin Seating  
Wavelength  
Whisper Vinyl

### GRADE 3

Bradbury  
Getaway  
Moxie\*  
Notion  
Parker  
Purl  
Quill  
Saxony

### GRADE 4

Constance with Supreen™  
Livi with Supreen™  
Lugano with Supreen™  
Oxford with Supreen™

For a complete list of fabrics, including partnership fabrics, go to [hon.com/fabricsandfinishes](https://hon.com/fabricsandfinishes).

Reference Fabric Color Combinations on pages 20-25 for color codes and legend on page 21 for lead times. For Fire Code and Moisture Barrier model availability and ordering method, refer to pages 258. For additional HON to Supply COM fabric grade pricing, go to [honready.hon.com](https://honready.hon.com) and click on the HON to Supply COM link.

\*High Back models approved in Moxie only.

## MULTI-FABRIC COM YARDAGE

Due to fabric pattern nesting and potential reduction of fabric yield, some multi-fabric models may require more total yardage than standard models.

	SEAT	BACK
HHCG11DF	1.4 yd	1.5 yd
HHCG21DF	1.7 yd	2.3 yd
HHCG50DF	1.4 yd	2.3 yd



Icon Legend on page 19

## HHCG11

### GUEST CHAIR



### DIMENSIONS

Depth:	27	Arm Width:	20½
Width:	25½	Seat to Floor Height:	18⅝
Height:	35	Usable Seat Depth:	18
Seat Depth:	18	Ship Weight:	55
Seat Width:	21½	Cube:	14.9
Back Width:	21	COM:	2.0
Back Height:	20½	Weight Rating:	350 lbs.

### FABRIC PRICE CODES

1	\$1503	8	\$1801
2	\$1556	9	\$1840
3	\$1608	10	\$1878
4	\$1646	11	\$1918
5	\$1685	12	\$1956
6	\$1724	L	—
7	\$1762		

## HHCG21

### TWO-SEAT CHAIR

Outside Arms

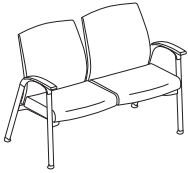

### DIMENSIONS

Depth:	27	Arm Width:	42¾
Width:	48	Seat to Floor Height:	18⅝
Height:	35	Usable Seat Depth:	18
Each Seat Depth:	18	Ship Weight:	109
Each Seat Width:	21½	Cube:	33.8
Each Back Width:	21	COM:	3.4
Each Back Height:	20¼	Weight Rating:	350 lbs.

### FABRIC PRICE CODES

1	\$2482	8	\$3003
2	\$2573	9	\$3071
3	\$2664	10	\$3139
4	\$2732	11	\$3207
5	\$2800	12	\$3275
6	\$2868	L	—
7	\$2935		

## HHCG50

### BARIATRIC CHAIR



### DIMENSIONS

Depth:	26	Arm Width:	29½
Width:	34½	Seat to Floor Height:	18⅝
Height:	35	Usable Seat Depth:	18
Seat Depth:	18	Ship Weight:	80
Seat Width:	30½	Cube:	25.1
Back Width:	30	COM:	3.0
Back Height:	20½	Weight Rating:	750 lbs.

### FABRIC PRICE CODES

1	\$1885	8	\$2406
2	\$1976	9	\$2474
3	\$2067	10	\$2542
4	\$2135	11	\$2610
5	\$2203	12	\$2678
6	\$2271	L	—
7	\$2338		

! HHCG50 is a Single Seat Bariatric chair warranted to 750 lbs.

## HOW TO SPECIFY

<p>Select Model Number</p> <p>HHCG11</p>	<p>Select Arm Cap Finish</p> <p>S Charcoal Urethane</p>	<p>Select Fabric</p> <p>See page 475</p>	<p>Select Frame</p> <p>See page 475</p>
--	---	--	---



# SOOTHE® Multi-Fabric

## HHCG11DF



### GUEST CHAIR

Multi-Fabric

### DIMENSIONS

Depth:	27	Arm Width:	20½
Width:	25½	Seat to Floor Height:	18⅞
Height:	35	Usable Seat Depth:	18
Seat Depth:	18	Ship Weight:	55
Seat Width:	21½	Cube:	14.9
Back Width:	21	COM:	See page 475
Back Height:	20½	Weight Rating:	350 lbs.

### FABRIC PRICE CODES

<b>1</b>	<b>\$1596</b>	
<i>Add to Base Price Above</i>		
	<b>Back</b>	<b>Seat</b>
<b>2</b>	<b>\$27</b>	<b>\$27</b>
<b>3</b>	<b>\$53</b>	<b>\$53</b>
<b>4</b>	<b>\$72</b>	<b>\$72</b>
<b>5</b>	<b>\$91</b>	<b>\$91</b>
<b>6</b>	<b>\$111</b>	<b>\$111</b>
<b>7</b>	<b>\$130</b>	<b>\$130</b>
<b>8</b>	<b>\$150</b>	<b>\$150</b>
<b>9</b>	<b>\$169</b>	<b>\$169</b>
<b>10</b>	<b>\$188</b>	<b>\$188</b>
<b>11</b>	<b>\$208</b>	<b>\$208</b>
<b>12</b>	<b>\$227</b>	<b>\$227</b>

NOTES: For multi-fabric models, start with the base price, then add the additional amount for the back and seat from the corresponding matrix to determine final price. Choose any combination of fabric grades for back and seat. See examples below:  
HHCG11DF base price (\$1596)

## HHCG21DF

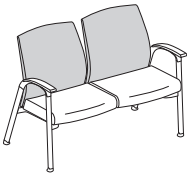

### TWO-SEAT CHAIR

Multi-Fabric  
Outside Arms

### DIMENSIONS

Depth:	27	Arm Width:	42¾
Width:	48	Seat to Floor Height:	18⅞
Height:	35	Usable Seat Depth:	18
Each Seat Depth:	18	Ship Weight:	109
Each Seat Width:	21½	Cube:	33.8
Each Back Width:	21	COM:	See page 475
Each Back Height:	20¼	Weight Rating:	350 lbs.

### FABRIC PRICE CODES

<b>1</b>	<b>\$2574</b>	
<i>Add to Base Price Above</i>		
	<b>Back</b>	<b>Seat</b>
<b>2</b>	<b>\$53</b>	<b>\$40</b>
<b>3</b>	<b>\$105</b>	<b>\$79</b>
<b>4</b>	<b>\$143</b>	<b>\$108</b>
<b>5</b>	<b>\$182</b>	<b>\$136</b>
<b>6</b>	<b>\$220</b>	<b>\$166</b>
<b>7</b>	<b>\$258</b>	<b>\$196</b>
<b>8</b>	<b>\$297</b>	<b>\$225</b>
<b>9</b>	<b>\$335</b>	<b>\$254</b>
<b>10</b>	<b>\$374</b>	<b>\$283</b>
<b>11</b>	<b>\$414</b>	<b>\$313</b>
<b>12</b>	<b>\$452</b>	<b>\$341</b>

NOTES: For multi-fabric models, start with the base price, then add the additional amount for the back and seat from the corresponding matrix to determine final price. Choose any combination of fabric grades for back and seat. See examples below:  
HHCG21DF base price (\$2574)

## HOW TO SPECIFY

<p><b>Select Model Number</b></p> <p>HHCG11DF</p>	<p><b>Select Arm Cap Finish</b></p> <p>S Charcoal Urethane</p> <p>S</p>	<p><b>Select Back Fabric</b></p> <p>See page 475</p> <p>A190</p>	<p><b>Select Seat Fabric</b></p> <p>See page 475</p> <p>RS14</p>	<p><b>Select Frame</b></p> <p>See page 475</p> <p>PR8</p>
---	---	--	--	---

# SOOTHE<sup>®</sup> Multi-Fabric

GSA SIN 33721



Icon Legend on page 19

## HHCG50DF

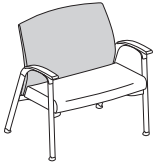

### BARIATRIC CHAIR

Multi-Fabric

### DIMENSIONS

Depth:	26	Arm Width:	29½
Width:	34½	Seat to Floor Height:	18⅝
Height:	35	Usable Seat Depth:	18
Seat Depth:	18	Ship Weight:	80
Seat Width:	30½	Cube:	25.1
Back Width:	30	COM:	See page 475
Back Height:	20½	Weight Rating:	750 lbs.

### FABRIC PRICE CODES

<b>1</b>	<b>\$1978</b>	
<i>Add to Base Price Above</i>		
	<b>Back</b>	<b>Seat</b>
<b>2</b>	<b>\$53</b>	<b>\$40</b>
<b>3</b>	<b>\$105</b>	<b>\$79</b>
<b>4</b>	<b>\$143</b>	<b>\$108</b>
<b>5</b>	<b>\$182</b>	<b>\$136</b>
<b>6</b>	<b>\$220</b>	<b>\$166</b>
<b>7</b>	<b>\$258</b>	<b>\$196</b>
<b>8</b>	<b>\$297</b>	<b>\$225</b>
<b>9</b>	<b>\$335</b>	<b>\$254</b>
<b>10</b>	<b>\$374</b>	<b>\$283</b>
<b>11</b>	<b>\$414</b>	<b>\$313</b>
<b>12</b>	<b>\$452</b>	<b>\$341</b>

NOTES: For multi-fabric models, start with the base price, then add the additional amount for the back and seat from the corresponding matrix to determine final price. Choose any combination of fabric grades for back and seat. See examples below:  
HHCG50DF base price (\$1978)

## HHGGBRCH

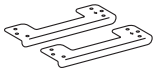

### GANGING BRACKET

### DIMENSIONS

Ship Weight:	2
Cube:	0.2

### LIST PRICE

**\$117**

NOTES: For chair to chair connection. Does not connect a bench to other type of seating. Ganging brackets can be used with the seating models on pages 476-478. Bench models do not gang. Brackets are Charcoal only.

SEATING

## HOW TO SPECIFY

<b>Select Model Number</b>	<b>Select Arm Cap Finish</b> S Charcoal Urethane	<b>Select Back Fabric</b> See page 475	<b>Select Seat Fabric</b> See page 475	<b>Select Frame</b> See page 475
HHCG50DF	S	A190	RS14	PR8



## HHCGB21

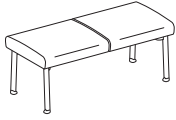

### TWO-SEAT BENCH

### DIMENSIONS

Depth:	20½	Seat to Floor Height:	17¾
Width:	44	Usable Seat Depth:	17¼
Height:	18¾	Ship Weight:	55
Seat Width:	22	Cube:	18.4
		COM:	1.9
		Weight Rating:	350 lbs.

### FABRIC PRICE CODES

1	\$1800	8	\$2024
2	\$1840	9	\$2053
3	\$1879	10	\$2082
4	\$1908	11	\$2111
5	\$1936	12	\$2140
6	\$1965	L	—
7	\$1995		

ⓘ Benches cannot be ganged.

## HHCGB31

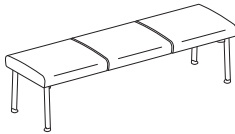

### THREE-SEAT BENCH

### DIMENSIONS

Depth:	20½	Seat to Floor Height:	17¾
Width:	66	Usable Seat Depth:	17¼
Height:	18¾	Ship Weight:	69
Seat Width:	22	Cube:	25.7
		COM:	2.6
		Weight Rating:	350 lbs.

### FABRIC PRICE CODES

1	\$2317	8	\$2541
2	\$2357	9	\$2570
3	\$2396	10	\$2599
4	\$2425	11	\$2628
5	\$2453	12	\$2657
6	\$2482	L	—
7	\$2512		

ⓘ Benches cannot be ganged.

## HOW TO SPECIFY

<p><b>Select Model Number</b></p> <p style="font-family: monospace; font-size: 1.2em; letter-spacing: 0.5em;">H H C G B 2 1</p>	<p><b>Select Fabric</b></p> <p>See page 475</p> <p style="font-family: monospace; font-size: 1.2em; letter-spacing: 0.5em;">R S 1 4</p>	<p><b>Select Frame</b></p> <p>See page 475</p> <p style="font-family: monospace; font-size: 1.2em; letter-spacing: 0.5em;">P R 8</p>
---	---	--



# TORCH™ Mesh Chairs

OPEN MARKET



Icon Legend on page 19

## HVL511



### MID-BACK

Pneumatic  
Swivel  
Tilt  
Tilt Tension  
Tilt Lock  
Fixed Arms

Functions: **A, E, F, K, L**  
(Function Key on pages 252-253)

### DIMENSIONS

Depth:	26	Arm Width:	18¾
Width:	26	Seat to Floor Height:	16⅞-20⅝
Height:	40½	Usable Seat Depth:	18¾
Seat Depth:	18¼	Ship Weight:	30
Seat Width:	19½	Cube:	3.8
Back Width:	17¾	Weight Rating:	250 lbs.
Back Height:	21¾		

### PRICE CODE

**Fabric**                      **\$425**

NOTES: Mid-back Mesh chair. Comfortable and breathable mesh back. Black fabric seat. Black frame. Fixed arms. **HON 5-Year Limited Warranty.**

**HON Recommendation: HVL511.LH10 - List Price \$425**

## HVL515

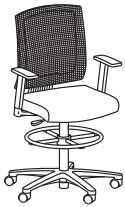

### TASK STOOL

Pneumatic  
Swivel  
Fixed Arms

Functions: **A, E**  
(Function Key on pages 252-253)

### DIMENSIONS

Depth:	26	Arm Width:	18¾
Width:	26	Seat to Floor Height:	23⅞-33
Height:	52	Usable Seat Depth:	18¾
Seat Depth:	18¼	Ship Weight:	38
Seat Width:	19½	Cube:	4.6
Back Width:	17¾	Weight Rating:	250 lbs.
Back Height:	21¾		

### PRICE CODE

**Fabric**                      **\$592**

NOTES: Comfortable and breathable mesh back. Black fabric seat. Fixed arms. **HON 5-Year Limited Warranty.**

**HON Recommendation: HVL515.LH10 - List Price \$592**

SEATING

## HOW TO SPECIFY

Select  
Model Number

Select  
Fabric

**LH10** Black Fabric

H V L 5 1 1 .

L H 1 0



**Versant® Seating and Laminate Occasional Tables.**

## VERSANT®

Everyone deserves a break from time to time, and a comfy seat in which to enjoy one. Bring stylish support to your welcome areas, public spaces, and breakrooms with Versant. With a combination of chairs and benches, it's ideal for both healthcare environments and offices. Arched arms support the upper body and padded seats put people at ease for longer periods of time. Versant brings versatility to every corner of your space.



## FEATURES

- Stylish arched arm offers greater upper body support.
- Seats are removable for easy cleaning and replacement.
- Contrasting covers are available as special order (please contact customer service).
- Solid hardwood in one of eight attractive finishes.
- Available in hundreds of quality HON fabrics.
- Warranted for users up to 350 lbs. (Model HHCB50 is warranted for users up to 500 lbs.)

# VERSANT® Options

## MODEL OPTIONS

HHB02

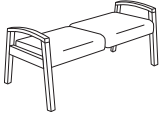

Two-Seat Bench

HHB03

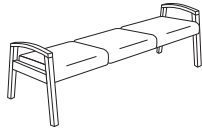

Three-Seat Bench

HHCT01

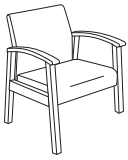

Single Seat

Leg Base, Arms

HHCB50

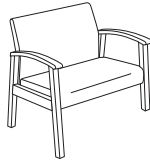

Bariatric Chair

Leg Base, Arms

## AVAILABLE FINISHES

Versant® Seating is available in 8 wood finishes.

### WOOD FINISHES

Bourbon Cherry (H)  
Cognac (COGN)  
Harvest (C)  
Mahogany (N)  
Mocha (MOCH)  
Natural Maple (D)  
Pinnacle (PINC)  
Shaker Cherry (F)

## AVAILABLE LAMINATES

Versant® Laminate Occasional Tables are available in 8 laminates.

### LAMINATES

Bourbon Cherry (H)  
Cognac (COGN)  
Harvest (C)  
Mahogany (N)  
Mocha (MOCH)  
Natural Maple (D)  
Pinnacle (PINC)  
Shaker Cherry (F)

## HON BRANDED FABRICS

### GRADE 1

Apex  
Centurion  
Contourett  
Dapper  
Ensemble  
Hamilton  
Inertia  
Noble Seating  
Optic  
Pebble  
Vibe

### GRADE 2

Appoint Seating  
Blume  
Clyde  
Doty  
Kai  
Rush  
Spin Seating  
Wavelength  
Whisper Vinyl

### GRADE 3

Bradbury  
Getaway  
Moxie  
Notion  
Parker  
Purl  
Quill  
Saxony

### GRADE 4

Constance with Supreen™  
Livi with Supreen™  
Lugano with Supreen™  
Oxford with Supreen™

For a complete list of fabrics, including partnership fabrics, go to [hon.com/fabricsandfinishes](https://hon.com/fabricsandfinishes).

Reference Fabric Color Combinations on pages 20-25 for color codes and legend on page 21 for lead times. Contrasting covers on seat and back are available as special order. Please contact Customer Service. For additional HON to Supply COM fabric grade pricing, go to [honready.hon.com](https://honready.hon.com) and click on the HON to Supply COM link.



## HHB02

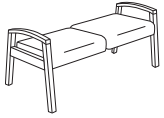

### TWO-SEAT BENCH

### DIMENSIONS

Depth:	20 <sup>3</sup> / <sub>8</sub>	Seat to Floor Height:	19 <sup>1</sup> / <sub>2</sub>
Width:	45 <sup>1</sup> / <sub>2</sub>	Usable Seat Depth:	19 <sup>3</sup> / <sub>4</sub>
Height:	23	Ship Weight:	62
Each Seat Depth:	20 <sup>3</sup> / <sub>8</sub>	Cube:	16.2
Each Seat Width:	21 <sup>1</sup> / <sub>2</sub>	COM:	2.0
Arm Width:	42 <sup>1</sup> / <sub>2</sub>	Weight Rating:	350 lbs. (per seat)

### FABRIC PRICE CODES

1	\$2398	8	\$2696
2	\$2451	9	\$2735
3	\$2503	10	\$2773
4	\$2541	11	\$2813
5	\$2580	12	\$2851
6	\$2619	L	\$2829
7	\$2657		

## HHB03

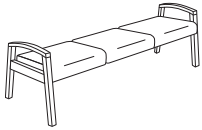

### THREE-SEAT BENCH

### DIMENSIONS

Depth:	20 <sup>3</sup> / <sub>8</sub>	Seat to Floor Height:	19 <sup>1</sup> / <sub>2</sub>
Width:	66 <sup>1</sup> / <sub>2</sub>	Usable Seat Depth:	19 <sup>3</sup> / <sub>4</sub>
Height:	23	Ship Weight:	80
Each Seat Depth:	20 <sup>3</sup> / <sub>8</sub>	Cube:	24.5
Each Seat Width:	21 <sup>1</sup> / <sub>2</sub>	COM:	2.5
Arm Width:	63 <sup>1</sup> / <sub>2</sub>	Weight Rating:	350 lbs. (per seat)

### FABRIC PRICE CODES

1	\$3082	8	\$3454
2	\$3147	9	\$3503
3	\$3212	10	\$3551
4	\$3261	11	\$3600
5	\$3309	12	\$3648
6	\$3358	L	\$3621
7	\$3406		

**HON Recommendation: HHB02.MOCH.SX\_\_ - List Price \$2503**

## HOW TO SPECIFY

<p><b>Select Model Number</b></p> <p style="text-align: center; border: 1px solid black; margin-top: 20px;">H H B 0 2</p>	<p><b>Select Finish</b></p> <p style="text-align: center; font-size: small;">See page 482</p> <p style="text-align: center; border: 1px solid black; margin-top: 20px;">M O C H</p>	<p><b>Select Seat Fabric</b></p> <p style="text-align: center; font-size: small;">See page 482</p> <p style="text-align: center; border: 1px solid black; margin-top: 20px;">S X 0 5</p>
---	---	--



## HHCT01

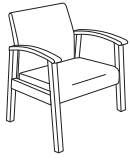

### SINGLE SEAT

Leg Base  
Arms

### DIMENSIONS

Depth:	27	Arm Width:	20½
Width:	25	Seat to Floor Height:	18
Height:	34	Usable Seat Depth:	19¼
Seat Depth:	20¼	Ship Weight:	57
Seat Width:	21	Cube:	20.1
Back Width:	21	COM:	2.0
Back Height:	17	Weight Rating:	350 lbs.

### FABRIC PRICE CODES

1	\$1831	8	\$2129
2	\$1884	9	\$2168
3	\$1936	10	\$2206
4	\$1974	11	\$2246
5	\$2013	12	\$2284
6	\$2052	L	\$2262
7	\$2090		

## HHCB50

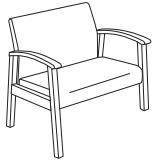

### BARIATRIC SINGLE SEAT

Leg Base  
Arms

### DIMENSIONS

Depth:	27	Arm Width:	29
Width:	33½	Seat to Floor Height:	18
Height:	34	Usable Seat Depth:	19¼
Each Seat Depth:	20¼	Ship Weight:	80
Each Seat Width:	30	Cube:	29.0
Each Back Width:	30	COM:	3.0
Each Back Height:	17	Weight Rating:	500 lbs.

### FABRIC PRICE CODES

1	\$2737	8	\$3183
2	\$2816	9	\$3242
3	\$2893	10	\$3300
4	\$2951	11	\$3358
5	\$3009	12	\$3416
6	\$3067	L	\$3383
7	\$3126		

**HON Recommendation: HHCT01.MOCH.SX\_\_ - List Price \$1936**

## HOW TO SPECIFY

Select  
Model Number

HHCT01

Select  
Finish

See page 482

MOCH

Select  
Seat Fabric

See page 482

SX05



Volt® Task Chairs and Stools  
shown with Voi® Desks.

## VOLT®

Customizable comfort, distinctive styling and an affordable price point make Volt the family of task seating that supports your body and your budget. The stylish V-shaped back design can be specified in fabric, leather or breathable mesh, giving you more control over your look and feel. The personalized controls and generously proportioned seat and back deliver greater comfort, and are designed support to a wider variety of users. Volt delivers the look you desire, the comfort you demand, and the quality you expect. That's the power of practicality.



## FEATURES

- Optional synchro-tilt control provides a smooth, natural recline.
- Optional height-adjustable arms provide a custom fit.
- Optional mesh back offers breathable support.
- Task stools feature an adjustable footring for additional lower body support.
- One-touch seat height adjustment easily moves the seat up and down.
- Tilt tension controls the rate and ease of recline.
- Tilt lock allows the user to lock out the tilt function.
- 360-degree swivel provides freedom of movement in any direction.
- Select models available in hundreds of quality HON fabrics.
- Warranted for users up to 275 lbs.

# VOLT® 5700/5710 Series Options

## MODEL OPTIONS

H5701



**Task Chair**

Pneumatic, Swivel, Tilt, Tilt Tension, Tilt Lock

H5703



**Task Chair**

Pneumatic, Swivel, Synchro-tilt, Tilt Tension, Tilt Lock

H5705



**Task Stool**

Pneumatic, Swivel, Adjustable Footring

H5711



**Task Chair (Mesh Back)**

Pneumatic, Swivel, Tilt, Tilt Tension, Tilt Lock

H5713



**Task Chair (Mesh Back)**

Pneumatic, Swivel, Synchro-tilt, Tilt Tension, Tilt Lock

H5715



**Task Stool (Mesh Back)**

Pneumatic, Swivel, Adjustable Footring

## HON BRANDED FABRICS

**GRADE 1**

Black Fabric  
Navy Fabric

**GRADE 2**

**GRADE 3**

**For a complete list of fabrics, including partnership fabrics, go to [hon.com/fabricsandfinishes](https://www.hon.com/fabricsandfinishes).**

Navy only available on select models.

Reference Fabric Color Combinations on pages 20-25 for color codes and legend on page 21 for lead times.



# VOLT® 5700 Series

## H5701



### TASK CHAIR

Pneumatic  
Swivel  
Tilt  
Tilt Tension  
Tilt Lock  
Functions: **A, E, F, K, L**  
(Function Key on pages 252-253)

### DIMENSIONS

Depth:	25 <sup>3</sup> / <sub>4</sub>	Seat to Floor Height:	18-22 <sup>1</sup> / <sub>4</sub>
Width:	26	Usable Seat Depth:	18 <sup>3</sup> / <sub>4</sub>
Height:	40	Ship Weight:	29
Seat Depth:	18 <sup>3</sup> / <sub>4</sub>	Cube:	5.1
Seat Width:	18 <sup>1</sup> / <sub>2</sub>	Weight Rating:	275 lbs.
Back Width:	17 <sup>1</sup> / <sub>4</sub>		
Back Height:	18 <sup>3</sup> / <sub>4</sub>		

### FABRIC PRICE CODES

**1 \$385 L \$418**

## H5703



### TASK CHAIR

Pneumatic  
Swivel  
Synchro-tilt  
Tilt Tension  
Tilt Lock  
Functions: **A, E, J, K, L**  
(Function Key on pages 252-253)

### DIMENSIONS

Depth:	25 <sup>3</sup> / <sub>4</sub>	Seat to Floor Height:	18-22 <sup>1</sup> / <sub>4</sub>
Width:	26	Usable Seat Depth:	18 <sup>3</sup> / <sub>4</sub>
Height:	40	Ship Weight:	29
Seat Depth:	18 <sup>3</sup> / <sub>4</sub>	Cube:	5.1
Seat Width:	18 <sup>1</sup> / <sub>2</sub>	Weight Rating:	275 lbs.
Back Width:	17 <sup>1</sup> / <sub>4</sub>		
Back Height:	18 <sup>3</sup> / <sub>4</sub>		

### FABRIC PRICE CODES

**1 \$445 L \$478**

## H5705



### TASK STOOL

Pneumatic  
Swivel  
Adjustable Footring  
Functions: **A, E**  
(Function Key on pages 252-253)

### DIMENSIONS

Depth:	29 <sup>1</sup> / <sub>2</sub>	Seat to Floor Height:	22 <sup>7</sup> / <sub>8</sub> -32 <sup>3</sup> / <sub>8</sub>
Width:	27	Usable Seat Depth:	18
Height:	49 <sup>7</sup> / <sub>8</sub>	Ship Weight:	36
Seat Depth:	20	Cube:	6.0
Seat Width:	19	Weight Rating:	275 lbs.
Back Width:	16 <sup>1</sup> / <sub>2</sub>		
Back Height:	20		

### FABRIC PRICE CODES

**1 \$628 L \$661**

## H5795

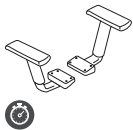

### HEIGHT-ADJUSTABLE ARMS

Non-upholstered  
Functions: **Q**  
(Function Key on pages 252-253)

### DIMENSIONS

Adjustable Arms Width:	17 <sup>3</sup> / <sub>8</sub>
Height from Seat:	7 <sup>5</sup> / <sub>8</sub> -10 <sup>5</sup> / <sub>8</sub>
Ship Weight:	5
Cube:	0.6

### LIST PRICE

**\$122**

**HON Recommendation: H5703.GA10.T with H5795 Arm Pack - List Price \$567**

## HOW TO SPECIFY

Select Model Number

**H 5 7 0 3**

Select Fabric

**SB11** Black Bonded Leather  
**GA10** Black  
**GA90** Navy (only available on H5701)

**G A 1 0**

Select Frame

**T** Black

**T**



# VOLT® 5710 Series

OPEN MARKET



Icon Legend on page 19

## H5711



### TASK CHAIR

**Mesh Back**  
Pneumatic  
Swivel  
Tilt  
Tilt Tension  
Tilt Lock  
Functions: **A, E, F, K, L**  
(Function Key on pages 252-253)

### DIMENSIONS

Depth: 25<sup>3</sup>/<sub>4</sub>      Seat to Floor Height: 18<sup>3</sup>/<sub>4</sub>-22<sup>3</sup>/<sub>8</sub>  
Width: 26      Usable Seat Depth: 18  
Height: 38<sup>3</sup>/<sub>4</sub>      Ship Weight: 29  
Seat Depth: 18<sup>3</sup>/<sub>4</sub>      Cube: 5.1  
Seat Width: 19<sup>1</sup>/<sub>4</sub>      Weight Rating: 275 lbs.  
Back Width: 18  
Back Height: 18<sup>3</sup>/<sub>4</sub>

### FABRIC PRICE CODES

**1 \$531      L \$564**

## H5713



### TASK CHAIR

**Mesh Back**  
Pneumatic  
Swivel  
Synchro-tilt  
Tilt Tension  
Tilt Lock  
Functions: **A, E, J, K, L**  
(Function Key on pages 252-253)

### DIMENSIONS

Depth: 25<sup>3</sup>/<sub>4</sub>      Seat to Floor Height: 17<sup>3</sup>/<sub>8</sub>-21<sup>3</sup>/<sub>8</sub>  
Width: 26      Usable Seat Depth: 17<sup>7</sup>/<sub>8</sub>  
Height: 38<sup>1</sup>/<sub>2</sub>      Ship Weight: 32  
Seat Depth: 18<sup>3</sup>/<sub>4</sub>      Cube: 5.1  
Seat Width: 19<sup>1</sup>/<sub>4</sub>      Weight Rating: 275 lbs.  
Back Width: 18  
Back Height: 18<sup>3</sup>/<sub>4</sub>

### FABRIC PRICE CODES

**1 \$596      L \$629**

## H5715



### TASK STOOL

**Mesh Back**  
Pneumatic  
Swivel  
Adjustable Footring  
Functions: **A, E**  
(Function Key on pages 252-253)

### DIMENSIONS

Depth: 28      Seat to Floor Height: 22<sup>7</sup>/<sub>8</sub>-32<sup>3</sup>/<sub>8</sub>  
Width: 26      Usable Seat Depth: 18  
Height: 49<sup>7</sup>/<sub>8</sub>      Ship Weight: 36  
Seat Depth: 20      Cube: 6.0  
Seat Width: 19      Weight Rating: 275 lbs.  
Back Width: 18  
Back Height: 18<sup>1</sup>/<sub>2</sub>

### FABRIC PRICE CODES

**1 \$781      L \$814**

## H5795

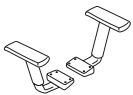

### HEIGHT-ADJUSTABLE ARMS

Non-upholstered  
Functions: **Q**  
(Function Key on pages 252-253)

### DIMENSIONS

Adjustable Arms Width: 17<sup>3</sup>/<sub>8</sub>  
Height from Seat: 7<sup>3</sup>/<sub>8</sub>-10<sup>3</sup>/<sub>8</sub>  
Ship Weight: 5  
Cube: 0.6

### LIST PRICE

**\$122**

**HON Recommendation: H5713.GA10.T with H5795 Arm Pack - List Price \$718**

SEATING

## HOW TO SPECIFY

<p>Select Model Number</p> <p>H 5 7 1 3 .</p>	<p>Select Fabric</p> <p>SB11 Black Bonded Leather GA10 Black</p> <p>G A 1 0 .</p>	<p>Select Frame</p> <p>T Black</p> <p>T</p>
---	---	---

# VOLT® 5720/5730 Series Options

## MODEL OPTIONS

H5721



**Task Chair**

Pneumatic, Swivel, Tilt, Tilt Tension, Tilt Lock

H5723



**Task Chair**

Pneumatic, Swivel, Synchro-tilt, Tilt Tension, Tilt Lock

H5725



**Task Stool**

Pneumatic, Swivel, Adjustable Footring

H5731



**Task Chair (Mesh Back)**

Pneumatic, Swivel, Tilt, Tilt Tension, Tilt Lock

H5733



**Task Chair (Mesh Back)**

Pneumatic, Swivel, Synchro-tilt, Tilt Tension, Tilt Lock

H5735



**Task Stool (Mesh Back)**

Pneumatic, Swivel, Adjustable Footring

### CASTERS



CODE	DESCRIPTION	PRICE
H	Black Hard Caster	+ \$0



S	Black All-Surface Caster	+ \$44
---	--------------------------	--------

### FRAME

CODE	DESCRIPTION	PRICE
T	Black	+ \$0

# VOLT®

## 5720/5730 Series Fabric Options

### HON BRANDED FABRICS

GRADE 1	GRADE 2	GRADE 3	GRADE 4
Apex	Appoint Seating	Getaway	Livi with Supreen™
Centurion	Blume	Moxie	Oxford with Supreen™
Contourett	Clyde	Parker	
Dapper	Dotty	Purl	
Ensemble	Kai	Quill	
Hamilton	Rush		
Inertia	Spin Seating		
Optic	Wavelength		
Pebble	Whisper Vinyl		

**For a complete list of fabrics, including partnership fabrics, go to [hon.com/fabricsandfinishes](https://hon.com/fabricsandfinishes).**

Reference Fabric Color Combinations on pages 20-25 for color codes and legend on page 21 for lead times. For additional HON to Supply COM fabric grade pricing, go to [honready.hon.com](https://honready.hon.com) and click on the HON to Supply COM link.



Icon Legend on page 19

# VOLT® 5720 Series

## H5721



### TASK CHAIR

Pneumatic  
Swivel  
Tilt  
Tilt Tension  
Tilt Lock

Functions: **A, E, F, K, L**   
(Function Key on pages 252-253)

### DIMENSIONS

Depth:	25 <sup>3</sup> / <sub>4</sub>	Seat to Floor Height:	17 <sup>1</sup> / <sub>4</sub> -22 <sup>1</sup> / <sub>4</sub>
Width:	25 <sup>3</sup> / <sub>4</sub>	Usable Seat Depth:	18 <sup>3</sup> / <sub>4</sub>
Height:	40	Ship Weight:	36
Seat Depth:	18 <sup>3</sup> / <sub>4</sub>	Cube:	5.1
Seat Width:	18 <sup>1</sup> / <sub>2</sub>	COM:	1.5
Back Width:	17 <sup>1</sup> / <sub>4</sub>	Weight Rating:	275 lbs.
Back Height:	18 <sup>3</sup> / <sub>4</sub>		

### FABRIC PRICE CODES

1	\$503	8	\$653
2	\$530	9	\$672
3	\$556	10	\$691
4	\$575	11	\$711
5	\$594	12	\$730
6	\$614	L	—
7	\$633		

## H5723



### TASK CHAIR

Pneumatic  
Swivel  
Synchro-tilt  
Tilt Tension  
Tilt Lock

Functions: **A, E, J, K, L**   
(Function Key on pages 252-253)

### DIMENSIONS

Depth:	25 <sup>3</sup> / <sub>4</sub>	Seat to Floor Height:	17 <sup>1</sup> / <sub>4</sub> -22 <sup>3</sup> / <sub>4</sub>
Width:	25 <sup>3</sup> / <sub>4</sub>	Usable Seat Depth:	18 <sup>3</sup> / <sub>4</sub>
Height:	40	Ship Weight:	38
Seat Depth:	18 <sup>3</sup> / <sub>4</sub>	Cube:	5.1
Seat Width:	18 <sup>1</sup> / <sub>2</sub>	COM:	1.5
Back Width:	17 <sup>1</sup> / <sub>4</sub>	Weight Rating:	275 lbs.
Back Height:	18 <sup>3</sup> / <sub>4</sub>		

### FABRIC PRICE CODES

1	\$560	8	\$710
2	\$587	9	\$729
3	\$613	10	\$748
4	\$632	11	\$768
5	\$651	12	\$787
6	\$671	L	—
7	\$690		

## H5725

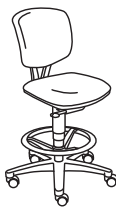

### TASK STOOL

Pneumatic  
Swivel  
Adjustable Footring

Functions: **A, E**   
(Function Key on pages 252-253)

### DIMENSIONS

Depth:	29 <sup>1</sup> / <sub>2</sub>	Seat to Floor Height:	22 <sup>7</sup> / <sub>8</sub> -32 <sup>3</sup> / <sub>8</sub>
Width:	27	Usable Seat Depth:	18 <sup>3</sup> / <sub>4</sub>
Height:	49 <sup>7</sup> / <sub>8</sub>	Ship Weight:	39
Seat Depth:	20	Cube:	6.0
Seat Width:	19	COM:	1.5
Back Width:	17 <sup>1</sup> / <sub>4</sub>	Weight Rating:	275 lbs.
Back Height:	18 <sup>3</sup> / <sub>4</sub>		

### FABRIC PRICE CODES

1	\$730	8	\$880
2	\$757	9	\$899
3	\$783	10	\$918
4	\$802	11	\$938
5	\$821	12	\$957
6	\$841	L	—
7	\$860		

## H5795

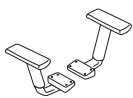

OPEN MARKET

### HEIGHT-ADJUSTABLE ARMS

Non-upholstered  
Functions: **Q**

(Function Key on pages 252-253)

### DIMENSIONS

Adjustable Arms Width:	17 <sup>3</sup> / <sub>8</sub>
Height from Seat:	7 <sup>5</sup> / <sub>8</sub> -10 <sup>5</sup> / <sub>8</sub>
Ship Weight:	5
Cube:	0.6

### LIST PRICE

\$122

## HSCASTER

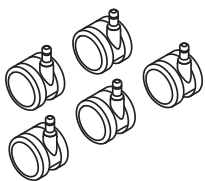

OPEN MARKET

### SET OF 5 ALL-SURFACE CASTERS

### DIMENSIONS

Size:	60mm
Ship Weight:	2
Cube:	0.1

### LIST PRICE

\$75

Available in Black finish only, no specification needed.

**HON Recommendation: H5723.H.CU\_\_T with H5795 Arm Pack - List Price \$682**

## HOW TO SPECIFY

<b>Select Model Number</b>  H 5 7 2 3 -	<b>Select Caster</b>  H Black Hard Caster S Black All-Surface Caster (+ \$44)  H -	<b>Select Fabric</b>  See page 490  CU10 -	<b>Select Frame</b>  T Black  T
---	---	--	---

# VOLT® 5730 Series

OPEN MARKET



Icon Legend on page 19

## H5731



### TASK CHAIR

**Mesh Back**  
Pneumatic  
Swivel  
Tilt  
Tilt Tension  
Tilt Lock  
Functions: **A, E, F, K, L**  
(Function Key on pages 252-253)

### DIMENSIONS

Depth: 25<sup>3</sup>/<sub>4</sub>      Seat to Floor Height: 18<sup>3</sup>/<sub>4</sub>-22<sup>3</sup>/<sub>8</sub>  
Width: 26      Usable Seat Depth: 18  
Height: 38<sup>3</sup>/<sub>4</sub>      Ship Weight: 29  
Seat Depth: 18<sup>3</sup>/<sub>4</sub>      Cube: 5.1  
Seat Width: 19<sup>1</sup>/<sub>4</sub>      COM: 1.5  
Back Width: 18      Weight Rating: 275 lbs.  
Back Height: 18<sup>3</sup>/<sub>4</sub>

### FABRIC PRICE CODES

1	\$652	8	\$728
2	\$666	9	\$737
3	\$679	10	\$746
4	\$689	11	\$757
5	\$698	12	\$766
6	\$708	L	—
7	\$717		

## H5733



### TASK CHAIR

**Mesh Back**  
Pneumatic  
Swivel  
Synchro-tilt  
Tilt Tension  
Tilt Lock  
Functions: **A, E, J, K, L**  
(Function Key on pages 252-253)

### DIMENSIONS

Depth: 25<sup>3</sup>/<sub>4</sub>      Seat to Floor Height: 17<sup>3</sup>/<sub>8</sub>-21<sup>7</sup>/<sub>8</sub>  
Width: 26      Usable Seat Depth: 17<sup>7</sup>/<sub>8</sub>  
Height: 38<sup>1</sup>/<sub>2</sub>      Ship Weight: 32  
Seat Depth: 18<sup>3</sup>/<sub>4</sub>      Cube: 5.1  
Seat Width: 19<sup>1</sup>/<sub>4</sub>      COM: 1.5  
Back Width: 18      Weight Rating: 275 lbs.  
Back Height: 18<sup>3</sup>/<sub>4</sub>

### FABRIC PRICE CODES

1	\$714	8	\$790
2	\$728	9	\$799
3	\$741	10	\$808
4	\$751	11	\$819
5	\$760	12	\$828
6	\$770	L	—
7	\$779		

## H5735



### TASK STOOL

**Mesh Back**  
Pneumatic  
Swivel  
Adjustable Footring  
Functions: **A, E**  
(Function Key on pages 252-253)

### DIMENSIONS

Depth: 28      Seat to Floor Height: 22<sup>7</sup>/<sub>8</sub>-32<sup>3</sup>/<sub>8</sub>  
Width: 26      Usable Seat Depth: 18  
Height: 49<sup>7</sup>/<sub>8</sub>      Ship Weight: 36  
Seat Depth: 20      Cube: 6.0  
Seat Width: 19      COM: 1.5  
Back Width: 18      Weight Rating: 275 lbs.  
Back Height: 18<sup>1</sup>/<sub>2</sub>

### FABRIC PRICE CODES

1	\$886	8	\$962
2	\$900	9	\$971
3	\$913	10	\$980
4	\$923	11	\$991
5	\$932	12	\$1000
6	\$942	L	—
7	\$951		

## H5795

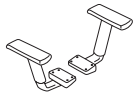

### HEIGHT-ADJUSTABLE ARMS

Non-upholstered  
Functions: **Q**  
(Function Key on pages 252-253)

### DIMENSIONS

Adjustable Arms Width: 17<sup>3</sup>/<sub>8</sub>  
Height from Seat: 7<sup>3</sup>/<sub>8</sub>-10<sup>3</sup>/<sub>8</sub>  
Ship Weight: 5  
Cube: 0.6

### LIST PRICE

\$122

## HSCASTER

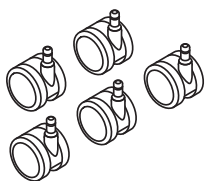

### SET OF 5 ALL-SURFACE CASTERS

Functions: **Q**  
(Function Key on pages 252-253)

### DIMENSIONS

Size: 60mm  
Ship Weight: 2  
Cube: 0.1

### LIST PRICE

\$75

ⓘ Available in Black finish only, no specification needed.

**HON Recommendation: H5733.H.CU\_\_T with H5795 Arm Pack - List Price \$836**

## HOW TO SPECIFY

<b>Select Model Number</b> H 5 7 3 3	<b>Select Caster</b> H Black Hard Caster S Black All-Surface Caster (+ \$44)	<b>Select Fabric</b> See page 490 CU 1 0	<b>Select Frame</b> T Black
---	--	--	--------------------------------



# WAVE™ Mesh Chairs

## HVL701



SIN 33721

### HIGH-BACK

Pneumatic  
Swivel  
Knee Tilt  
Tilt Tension  
Infinite Tilt Lock  
Adjustable Lumbar  
Height-adjustable Arms

Functions: **A, E, H, K, L, Q, W**  
(Function Key on pages 252-253)

### DIMENSIONS

Depth:	28	Arm Width:	19½
Width:	27½	Seat to Floor Height:	18½-21¼
Height:	44⅝	Usable Seat Depth:	19¼
Seat Depth:	20¾	Ship Weight:	53
Seat Width:	22	Cube:	5.8
Back Width:	23	Weight Rating:	250 lbs.
Back Height:	23¾		

### PRICE CODE

**Leather**      **\$1006**

NOTES: Comfortable and breathable mesh back. Sturdy textured black frame. HVL701 has a Black Bonded Leather upholstered seat with side mesh panels. Adjustable lumbar support. **HON 5-Year Limited Warranty.**

**HON Recommendation: HVL701.SB11 - List Price \$1006**

## HVL702



OPEN MARKET

### HIGH-BACK

Pneumatic  
Swivel  
Synchro-tilt  
Tilt Tension  
Tilt Lock  
Height-adjustable Arms

Functions: **A, E, J, K, L, Q**  
(Function Key on pages 252-253)

### DIMENSIONS

Depth:	26½	Arm Width:	19½
Width:	26½	Seat to Floor Height:	18½-23½
Height:	40½	Usable Seat Depth:	19¾
Seat Depth:	19¾	Ship Weight:	40
Seat Width:	21	Cube:	5.0
Back Width:	19½	Weight Rating:	250 lbs.
Back Height:	24		

### PRICE CODE

**Sandwich Mesh**      **\$816**

NOTES: Black Sandwich Mesh seat and mesh back. **HON 5-Year Limited Warranty.**

**HON Recommendation: HVL702.MM10 - List Price \$816**

## HVL705



OPEN MARKET

### EXECUTIVE BIG AND TALL

Pneumatic  
Knee Tilt  
Tilt Tension  
Tilt Lock  
Height and Width Adjustable Arms  
Integrated Lumbar Support

Functions: **A, E, H, K, L, S**  
(Function Key on pages 252-253)

### DIMENSIONS

Depth:	25⅝	Back Height:	28
Width:	30¼	Seat to Floor Height:	18¾-23¾
Height:	43⅝	Usable Seat Depth:	18¾
Seat Depth:	18¾	Ship Weight:	59
Seat Width:	21⅝	Cube:	6.1
Back Width:	22¾	Weight Rating:	450 lbs.

### PRICE CODE

**Mesh**      **\$1197**

NOTES: Large scale model HVL705 will support up to 450 lbs with normal use. Available in Black Mesh fabric VM10. **HON 5-Year Limited Warranty.**

**HON Recommendation: HVL705.VM10 - List Price \$1197**

## HVL712



SIN 33721

### MID-BACK

Pneumatic  
Swivel  
Synchro-tilt  
Tilt Tension  
Tilt Lock  
Height-adjustable Arms

Functions: **A, E, J, K, L, Q**  
(Function Key on pages 252-253)

### DIMENSIONS

Depth:	28½	Arm Width:	18⅝
Width:	29½	Seat to Floor Height:	18-22¼
Height:	41¾	Usable Seat Depth:	18
Seat Depth:	18½	Ship Weight:	39
Seat Width:	19¾	Cube:	5.4
Back Width:	20½	Weight Rating:	250 lbs.
Back Height:	20¾		

### PRICE CODE

**Sandwich Mesh**      **\$689**

NOTES: Black Sandwich Mesh seat and mesh back. **HON 5-Year Limited Warranty.**

**HON Recommendation: HVL712.MM10 - List Price \$689**

## HOW TO SPECIFY

### Select Model Number

### Select Fabric

- SB11** Black Bonded Leather  
*Specify for model HVL701 only*
- MM10** Black Sandwich Mesh Fabric  
*Specify for models HVL702 and HVL712 only*
- VM10** Black Mesh Fabric  
*Specify for model HVL705 only*

H V L 7 0 1 .

S B 1 1

# WEST HILL™ CASUAL LOUNGE SEATING

Want to see more? Scan here  
to check out hon.com.



West Hill™ Casual Lounge Seating  
shown with Scramble™ Coffee Table.

## WEST HILL™

Whether you're a thought leader, innovator, or highly motivated team player, West Hill casual lounge creates an inviting space that inspires relaxed productivity, sustains concentration, and sparks creativity.

With solid construction, a multitude of back cushion styling, seating options from a single seat to three or more, and choices in leg styles, fabrics, and configurations, West Hill makes it easier to make your space exceptional.



## FEATURES

- Contoured seat cushion design brings living room comfort to the work space.
- Choose between a Square Back or sink into a comfy Pillow Back cushion.
- Semi-attached back and seat cushions make replacement easy.
- Square, welted back cushion creates a modern look while providing casual comfort.
- The multi-fabric option allows you to specify up to three fabrics on one model.
- Select one of two square metal leg options or hardwood cone feet in one of 10 finishes.
- Order an optional Throw Pillow to add a little extra comfort or a splash of color.
- Cushion packs available in both Standard and Pillow Back, apply to both side and back applications.
- Each seat is warranted for users up to 300 pounds.
- Pair with Scramble™ Occasional Tables to complete the modern aesthetic.



## MODEL OPTIONS

HWH1SS, HWH1SP  
HWH1SSCF, HWH1SPCF -  
Multi-Fabric



**Lounge**  
Single Seat

HWH2SS, HWH2SP  
HWH2SSCF, HWH2SPCF -  
Multi-Fabric

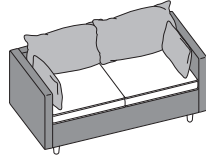

**Lounge**  
Two-Seat

HWH3SS, HWH3SP  
HWH3SSCF, HWH3SPCF -  
Multi-Fabric

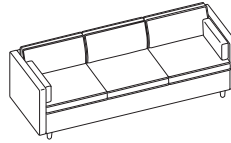

**Lounge**  
Three-Seat

HWHITCS, HWHITCP  
HWHITCSCF, HWHITPCPF -  
Multi-Fabric



**Lounge**  
True Corner

HWH1C  
HWH1CCF - Multi-Fabric



**Ottoman**

HWHACPS, HWHACPP

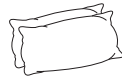

**Arm Cushion Pack**

HWHBCPS, HWHBCPP

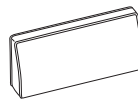

**Back Cushion Pack**

HWHLP, HWHSP18



**Lumbar and 18" Square  
Throw Pillow**

**Pillow Back Option, Multi-Fabric**



**Standard Back Option, Multi-Fabric**

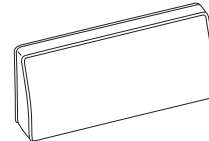
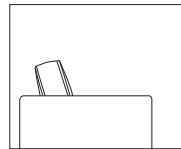
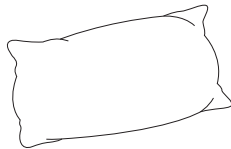
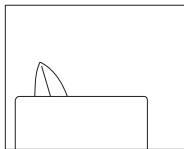

Choose from standard Single Fabric or Multi-Fabric options.  
Specify up to three fabrics with the Multi-Fabric option.



# WEST HILL™ Finish Options

## HON BRANDED FABRICS

GRADE 1	GRADE 2	GRADE 3	GRADE 4
Apex	Apport Seating	Bradbury	Constance with Supreen™
Centurion	Blume	Getaway	Livi with Supreen™
Contourett	Clyde	Moxie*	Lugano with Supreen™
Dapper	Dotty	Notion	Oxford with Supreen™
Ensemble	Kai	Parker	
Hamilton	Rush	Purl	
Inertia*	Spin Seating	Quill	
Noble Seating	Wavelength	Saxony	
Pebble	Whisper Vinyl*		
Vibe			

For a complete list of fabrics, including partnership fabrics, go to [hon.com/fabricsandfinishes](https://hon.com/fabricsandfinishes).

Reference Fabric Color Combinations on pages 20-25 for color codes and legend on page 21 for lead times.

\*Because of the differing upholstery process for the standard back and pillow back options, these fabrics are not available as an option for the pillow back. Contact your HON representative for questions.

For more details on Upholstery Pattern Match for this series, please see page 14.

⚠ Due to the inherent characteristics of upholstery materials and the casual nature of West Hill™, fabric may relax to show wrinkles over time especially on the pillow back options.

### LEG STYLE

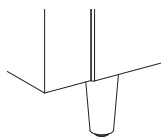

CODE	DESCRIPTION	PRICE
<b>CW</b>	Cone Wood	<b>+ \$0</b>
<i>Available in the following finishes:</i>		
<b>LFW1</b>	Florence Walnut	
<b>LK11</b>	Kingswood Walnut	
<b>LLA1</b>	Lowell Ash	
<b>D</b>	Natural Maple	
<b>LNRI</b>	Natural Recon	
<b>LPE1</b>	Phantom Ecru	
<b>PINC</b>	Pinnacle	
<b>LPT1</b>	Portico Teak	
<b>LSW1</b>	Skyline Walnut	
<b>LSA1</b>	Sterling Ash	

### LEG STYLE

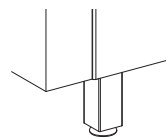

CODE	DESCRIPTION	PRICE
<b>SM</b>	Square Metal	<b>+ \$55</b>
<i>Available in the following finishes:</i>		
<b>P7A</b>	Textured Charcoal	
<b>P8V</b>	Textured Titanium	

## MULTI-FABRIC COM YARDAGE

Due to fabric pattern nesting and potential reduction of fabric yield, some multi-fabric models may require more total yardage than standard models.

MODEL	COM (ARMLESS)			COM (ONE ARM)			COM (BOTH ARMS)		
	Seat	Frame	Back	Seat	Frame	Back	Seat	Frame	Back
HWHISS		—			—			7.0	
HWHISSCF	—	—	—	—	—	—	1.5	5.0	2.5
HWHISP		—			—			7.0	
HWHISPCF	—	—	—	—	—	—	1.5	5.0	1.5
HWH2SS		8.5			9.5			10.5	
HWH2SSCF	3.0	4.0	2.5	3.0	5.0	3.0	3.0	6.0	3.0
HWH2SP		8.5			9.5			11.0	
HWH2SPCF	3.0	4.0	2.0	3.0	5.0	2.5	3.0	6.0	3.0
HWH3SS		12.0			13.0			14.0	
HWH3SSCF	4.0	5.5	3.0	4.0	6.5	3.5	4.0	7.5	3.5
HWH3SP		12.5			13.5			14.5	
HWH3SPCF	4.0	5.5	3.0	4.0	6.5	3.5	4.0	7.5	4.0
HWHIC		3.0			—			—	
HWHICCF	1.5	2.0	—	—	—	—	—	—	—
HWHITCS		6.0			—			—	
HWHITCSCF	1.5	3.5	2.5	—	—	—	—	—	—
HWHITCP		7.0			—			—	
HWHITPCF	1.5	3.5	2.0	—	—	—	—	—	—



# WEST HILL™ Casual Lounge Seating

## HWH1SS

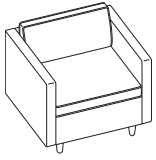

### SINGLE SEAT LOUNGE — STANDARD CUSHION

#### DIMENSIONS

Depth:	30½	Back Height:	12
Height:	29¾	Back Width:	26¾
Width:	33¾	Arm Height:	8
Usable Seat Depth:	19	Ship Weight:	81
Seat to Floor Height:	17¾	Cube:	18.4
Seat Width:	26¾	COM:	See page 496
		Weight Rating:	300 lbs.

#### FABRIC PRICE CODES

1	\$2627	8	\$3993
2	\$2809	9	\$4027
3	\$2993	10	\$4212
4	\$3146	11	\$4396
5	\$3352	12	\$4580
6	\$3560	L	—
7	\$3774		

## HWH1SP



### SINGLE SEAT LOUNGE — PILLOW CUSHION

#### DIMENSIONS

Depth:	30½	Back Height:	13¾
Height:	31½	Back Width:	26¾
Width:	33¾	Arm Height:	8
Usable Seat Depth:	16½	Ship Weight:	81
Seat to Floor Height:	17¾	Cube:	18.4
Seat Width:	26¾	COM:	See page 496
		Weight Rating:	300 lbs.

#### FABRIC PRICE CODES

1	\$2627	8	\$3993
2	\$2809	9	\$4027
3	\$2993	10	\$4212
4	\$3146	11	\$4396
5	\$3352	12	\$4580
6	\$3560	L	—
7	\$3774		

HON Recommendation: HWH1SP.B.PURL\_\_CW\_\_ - List Price \$2993

## HOW TO SPECIFY

<p><b>Select Model Number</b></p> <p>HWH1SP.</p>	<p><b>Select Arm Type</b></p> <p>B Both Arms</p> <p>B.</p>	<p><b>Select Fabric</b></p> <p>See page 496</p> <p>PBLE03.</p>	<p><b>Select Foot and Foot Color</b></p> <p>SM Square Metal (+ \$55) CW Cone Wood</p> <p>See page 496 for colors</p> <p>SMP8V</p>
--	--	--	---

# WEST HILL™ Casual Lounge Seating

GSA SIN 33721



Icon Legend on page 19

## HWH1SSCF

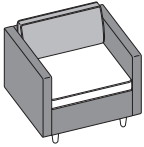

**SINGLE SEAT LOUNGE —  
STANDARD CUSHION,  
MULTI-FABRIC**

### DIMENSIONS

Depth:	30½	Back Height:	12
Height:	29¾	Back Width:	26¾
Width:	33¼	Arm Height:	8
Usable Seat Depth:	19	Ship Weight:	81
Seat to Floor Height:	17¾	Cube:	18.4
Seat Width:	26¾	COM:	See page 496
		Weight Rating:	300 lbs.

### FABRIC PRICE CODES

1 \$2830

Add to Base Price Above

	Seat	Frame	Back
2	\$40	\$130	\$40
3	\$80	\$261	\$80
4	\$112	\$371	\$112
5	\$156	\$518	\$156
6	\$201	\$667	\$201
7	\$247	\$820	\$247
8	\$294	\$976	\$294
9	\$301	\$1001	\$301
10	\$340	\$1132	\$340
11	\$380	\$1263	\$380
12	\$420	\$1396	\$420

## HWH1SPCF

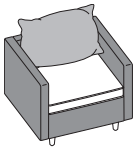

**SINGLE SEAT LOUNGE —  
PILLOW CUSHION,  
MULTI-FABRIC**

### DIMENSIONS

Depth:	30½	Back Height:	13¾
Height:	31½	Back Width:	26¾
Width:	33¼	Arm Height:	8
Usable Seat Depth:	16½	Ship Weight:	81
Seat to Floor Height:	17¾	Cube:	18.4
Seat Width:	26¾	COM:	See page 496
		Weight Rating:	300 lbs.

### FABRIC PRICE CODES

1 \$2830

Add to Base Price Above

	Seat	Frame	Back
2	\$40	\$130	\$40
3	\$80	\$261	\$80
4	\$112	\$371	\$112
5	\$156	\$518	\$156
6	\$201	\$667	\$201
7	\$247	\$820	\$247
8	\$294	\$976	\$294
9	\$301	\$1001	\$301
10	\$340	\$1132	\$340
11	\$380	\$1263	\$380
12	\$420	\$1396	\$420

HON Recommendation: HWH1SPCF.B.PURL\_\_PURL\_\_PURL\_\_CW\_\_ - List Price \$3251

## HOW TO SPECIFY

<p>Select Model Number</p> <p>HWH1SPCF .</p>	<p>Select Arm Type</p> <p>B Both Arms</p> <p>B .</p>	<p>Select Seat Fabric</p> <p>See page 496</p> <p>PBLE07 .</p>	<p>Select Frame Fabric</p> <p>See page 496</p> <p>PBLE03 .</p>	<p>Select Back Fabric</p> <p>See page 496</p> <p>PBLE01 .</p>	<p>Select Foot and Foot Color</p> <p>SM Square Metal (+ \$55) CW Cone Wood</p> <p>See page 496 for colors</p> <p>SMP8V</p>
--	--	---	--	---	--



# WEST HILL™ Casual Lounge Seating

## HWH2SS

### TWO SEAT LOUNGE — STANDARD CUSHION



Armless

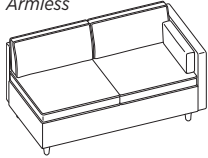

Left

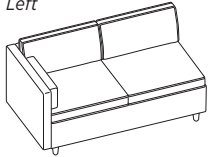

Right

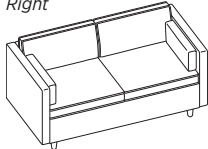

Both Arms

### DIMENSIONS

Depth:	30½	Back Height:	12
Height:	29¾	Back Width:	53¾
Width (armless):	53¾	Arm Height:	8
Width (one arm):	57	Ship Weight (armless):	107
Width (both arms):	60¼	Ship Weight (one arm):	121
Usable Seat Depth:	19	Ship Weight (both arms):	135
Seat to Floor Height:	17¾	Cube:	34.0
Seat Width (armless):	53¾	COM:	See page 496
Seat Width (one arm):	49½	Weight Rating:	300 lbs. (per seat)
Seat Width (both arms):	45¼		

### FABRIC PRICE CODES

1	\$3572	8	\$5621
2	\$3843	9	\$5672
3	\$4120	10	\$5949
4	\$4350	11	\$6225
5	\$4658	12	\$6502
6	\$4972	L	—
7	\$5293		

NOTES: Includes semi-attached arm cushions as shown.

## HWH2SP

### TWO SEAT LOUNGE — PILLOW CUSHION



Armless



Left

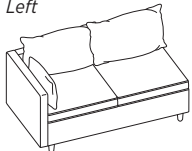

Right

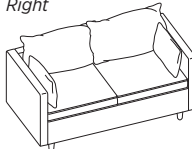

Both Arms

### DIMENSIONS

Depth:	30½	Back Height:	13¾
Height:	29¾	Back Width:	53¾
Width (armless):	53¾	Arm Height:	8
Width (one arm):	57	Ship Weight (armless):	107
Width (both arms):	60¼	Ship Weight (one arm):	121
Usable Seat Depth:	16½	Ship Weight (both arms):	135
Seat to Floor Height:	17¾	Cube:	34.0
Seat Width (armless):	53¾	COM:	See page 496
Seat Width (one arm):	48½	Weight Rating:	300 lbs. (per seat)
Seat Width (both arms):	43¼		

### FABRIC PRICE CODES

1	\$3572	8	\$5718
2	\$3856	9	\$5772
3	\$4146	10	\$6062
4	\$4387	11	\$6352
5	\$4710	12	\$6642
6	\$5038	L	—
7	\$5375		

NOTES: Includes semi-attached arm cushions as shown.

## HOW TO SPECIFY

**HON Recommendation: HWH2SP.B.PURL\_\_CW\_\_ - List Price \$4524**

<p><b>Select Model Number</b></p> <p>HWH2SP.</p>	<p><b>Select Arm Type</b></p> <p>N No Arms L Left Arm Only (+ \$189) R Right Arm Only (+ \$189) B Both Arms (+ \$378)</p> <p>B.</p>	<p><b>Select Fabric</b></p> <p>See page 496</p> <p>PBLE03.</p>	<p><b>Select Foot and Foot Color</b></p> <p>SM Square Metal (+ \$55) CW Cone Wood</p> <p>See page 496 for colors</p> <p>SMP8V</p>
--	---	--	---

SEATING

# WEST HILL™ Casual Lounge Seating

GSA SIN 33721



Icon Legend on page 19

## HWH2SSCF

**TWO SEAT LOUNGE —  
STANDARD CUSHION,  
MULTI-FABRIC**

### DIMENSIONS

Depth:	30½	Back Height:	12
Height:	29¾	Back Width:	53¾
Width (armless):	53¾	Arm Height:	8
Width (one arm):	57	Ship Weight (armless):	107
Width (both arms):	60¼	Ship Weight (one arm):	121
Usable Seat Depth:	19	Ship Weight (both arms):	135
Seat to Floor Height:	17¾	Cube:	34.0
Seat Width (armless):	53¾	COM:	See page 496
Seat Width (one arm):	49½	Weight Rating:	300 lbs. (per seat)
Seat Width (both arms):	45¼		

### FABRIC PRICE CODES

<b>1</b>	<b>\$3772</b>		
<i>Add to Base Price Above</i>			
	<b>Seat</b>	<b>Frame</b>	<b>Back</b>
<b>2</b>	<b>\$79</b>	<b>\$156</b>	<b>\$79</b>
<b>3</b>	<b>\$157</b>	<b>\$315</b>	<b>\$157</b>
<b>4</b>	<b>\$223</b>	<b>\$444</b>	<b>\$223</b>
<b>5</b>	<b>\$311</b>	<b>\$621</b>	<b>\$311</b>
<b>6</b>	<b>\$400</b>	<b>\$801</b>	<b>\$400</b>
<b>7</b>	<b>\$493</b>	<b>\$984</b>	<b>\$493</b>
<b>8</b>	<b>\$587</b>	<b>\$1171</b>	<b>\$587</b>
<b>9</b>	<b>\$601</b>	<b>\$1200</b>	<b>\$601</b>
<b>10</b>	<b>\$680</b>	<b>\$1358</b>	<b>\$680</b>
<b>11</b>	<b>\$759</b>	<b>\$1517</b>	<b>\$759</b>
<b>12</b>	<b>\$839</b>	<b>\$1674</b>	<b>\$839</b>

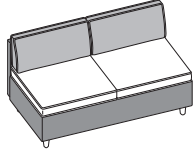

Armless

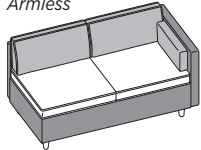

Left

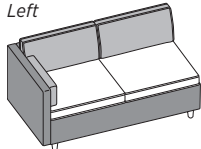

Right

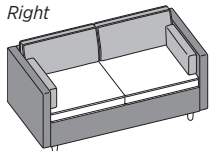

Both Arms

NOTES: Includes semi-attached arm cushions as shown.

## HWH2SPCF

**TWO SEAT LOUNGE —  
PILLOW CUSHION,  
MULTI-FABRIC**

### DIMENSIONS

Depth:	30½	Back Height:	13¾
Height:	29¾	Back Width:	53¾
Width (armless):	53¾	Arm Height:	8
Width (one arm):	57	Ship Weight (armless):	107
Width (both arms):	60¼	Ship Weight (one arm):	121
Usable Seat Depth:	16½	Ship Weight (both arms):	135
Seat to Floor Height:	17¾	Cube:	34.0
Seat Width (armless):	53¾	COM:	See page 496
Seat Width (one arm):	48½	Weight Rating:	300 lbs. (per seat)
Seat Width (both arms):	43¼		

### FABRIC PRICE CODES

<b>1</b>	<b>\$3772</b>		
<i>Add to Base Price Above</i>			
	<b>Seat</b>	<b>Frame</b>	<b>Back</b>
<b>2</b>	<b>\$79</b>	<b>\$156</b>	<b>\$79</b>
<b>3</b>	<b>\$157</b>	<b>\$315</b>	<b>\$157</b>
<b>4</b>	<b>\$223</b>	<b>\$444</b>	<b>\$223</b>
<b>5</b>	<b>\$311</b>	<b>\$621</b>	<b>\$311</b>
<b>6</b>	<b>\$400</b>	<b>\$801</b>	<b>\$400</b>
<b>7</b>	<b>\$493</b>	<b>\$984</b>	<b>\$493</b>
<b>8</b>	<b>\$587</b>	<b>\$1171</b>	<b>\$587</b>
<b>9</b>	<b>\$601</b>	<b>\$1200</b>	<b>\$601</b>
<b>10</b>	<b>\$680</b>	<b>\$1358</b>	<b>\$680</b>
<b>11</b>	<b>\$759</b>	<b>\$1517</b>	<b>\$759</b>
<b>12</b>	<b>\$839</b>	<b>\$1674</b>	<b>\$839</b>

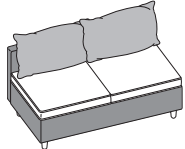

Armless



Left

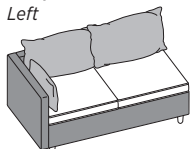

Right

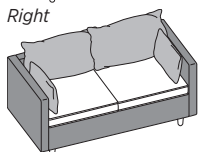

Both Arms

NOTES: Includes semi-attached arm cushions as shown.

**HON Recommendation: HWH2SPCF.B.PURL\_\_PURL\_\_PURL\_\_.CW\_\_ - List Price \$4779**

## HOW TO SPECIFY

<b>Select Model Number</b> HWH2SPCF	<b>Select Arm Type</b> N No Arms L Left Arm Only (+ \$189) R Right Arm Only (+ \$189) B Both Arms (+ \$378)	<b>Select Seat Fabric</b> See page 496	<b>Select Frame Fabric</b> See page 496	<b>Select Back Fabric</b> See page 496	<b>Select Foot and Foot Color</b> SM Square Metal (+ \$55) CW Cone Wood See page 496 for colors
HWH2SPCF	B	PBLE07	PBLE03	PBLE01	SMP8V



# WEST HILL™ Casual Lounge Seating

## HWH3SS

### THREE SEAT LOUNGE — STANDARD CUSHION

#### DIMENSIONS

#### FABRIC PRICE CODES

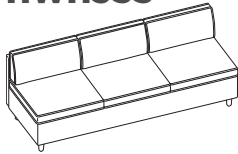

Armless

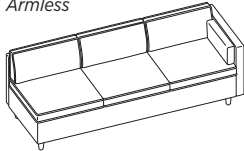

Left

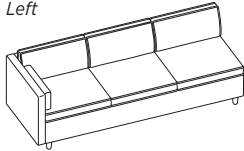

Right

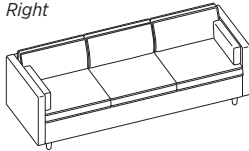

Both Arms

Depth:	30½	Back Height:	12
Height:	29¾	Back Width:	80¾
Width (armless):	80¾	Arm Height:	8
Width (one arm):	84	Ship Weight (armless):	146
Width (both arms):	87¼	Ship Weight (one arm):	160
Usable Seat Depth:	19	Ship Weight (both arms):	174
Seat to Floor Height:	17¾	Cube:	46.5
Seat Width (armless):	80¾	COM:	See page
Seat Width (one arm):	76½		496
Seat Width (both arms):	72¼	Weight Rating:	300 lbs. (per seat)

1	\$4850	8	\$7582
2	\$5212	9	\$7649
3	\$5582	10	\$8019
4	\$5887	11	\$8388
5	\$6297	12	\$8756
6	\$6716	L	—
7	\$7143		

NOTES: Includes semi-attached arm cushions as shown.

## HWH3SP

### THREE SEAT LOUNGE — PILLOW CUSHION

#### DIMENSIONS

#### FABRIC PRICE CODES

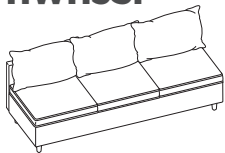

Armless

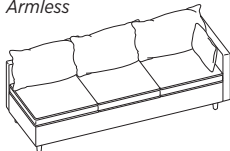

Left

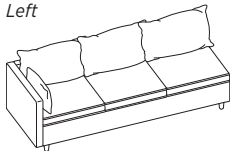

Right

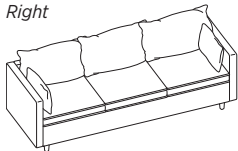

Both Arms

Depth:	30½	Back Height:	13¾
Height:	31½	Back Width:	80¾
Width (armless):	80¾	Arm Height:	8
Width (one arm):	84	Ship Weight (armless):	146
Width (both arms):	87¼	Ship Weight (one arm):	160
Usable Seat Depth:	16½	Ship Weight (both arms):	174
Seat to Floor Height:	17¾	Cube:	46.5
Seat Width (armless):	80¾	COM:	See page
Seat Width (one arm):	75½		496
Seat Width (both arms):	70¼	Weight Rating:	300 lbs. (per seat)

1	\$4850	8	\$7679
2	\$5224	9	\$7750
3	\$5608	10	\$8132
4	\$5924	11	\$8514
5	\$6348	12	\$8896
6	\$6783	L	—
7	\$7226		

NOTES: Includes semi-attached arm cushions as shown.

**HON Recommendation: HWH3SP.B.PURL\_\_CW\_\_ - List Price \$5986**

## HOW TO SPECIFY

<p><b>Select Model Number</b></p> <p>HWH3SP.</p>	<p><b>Select Arm Type</b></p> <p>N No Arms L Left Arm Only (+ \$189) R Right Arm Only (+ \$189) B Both Arms (+ \$378)</p> <p>B.</p>	<p><b>Select Fabric</b></p> <p>See page 496</p> <p>PBLE03.</p>	<p><b>Select Foot and Foot Color</b></p> <p>SM Square Metal (+ \$55) CW Cone Wood</p> <p>See page 496 for colors</p> <p>SMP8V</p>
--	---	--	---

SEATING

# WEST HILL™ Casual Lounge Seating

GSA SIN 33721



Icon Legend on page 19

## HWH3SSCF

### THREE SEAT LOUNGE — STANDARD CUSHION, MULTI-FABRIC

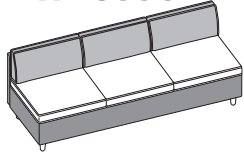

Armless

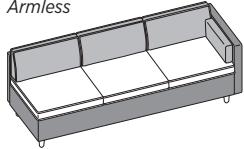

Left

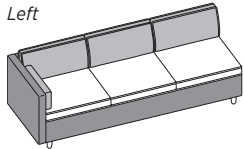

Right

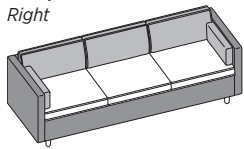

Both Arms

### DIMENSIONS

Depth:	30½	Back Height:	12
Height:	29¾	Back Width:	80¾
Width (armless):	80¾	Arm Height:	8
Width (one arm):	84	Ship Weight (armless):	146
Width (both arms):	87¼	Ship Weight (one arm):	160
Usable Seat Depth:	19	Ship Weight (both arms):	174
Seat to Floor Height:	17¾	Cube:	46.5
Seat Width (armless):	80¾	COM:	See page 496
Seat Width (one arm):	76½	Weight Rating:	300 lbs. (per seat)
Seat Width (both arms):	72¼		

### FABRIC PRICE CODES

<b>1</b>	<b>\$5053</b>		
<i>Add to Base Price Above</i>			
	<b>Seat</b>	<b>Frame</b>	<b>Back</b>
<b>2</b>	<b>\$105</b>	<b>\$195</b>	<b>\$91</b>
<b>3</b>	<b>\$210</b>	<b>\$393</b>	<b>\$184</b>
<b>4</b>	<b>\$297</b>	<b>\$557</b>	<b>\$260</b>
<b>5</b>	<b>\$415</b>	<b>\$776</b>	<b>\$363</b>
<b>6</b>	<b>\$534</b>	<b>\$1000</b>	<b>\$467</b>
<b>7</b>	<b>\$657</b>	<b>\$1229</b>	<b>\$574</b>
<b>8</b>	<b>\$781</b>	<b>\$1464</b>	<b>\$683</b>
<b>9</b>	<b>\$801</b>	<b>\$1500</b>	<b>\$701</b>
<b>10</b>	<b>\$906</b>	<b>\$1697</b>	<b>\$794</b>
<b>11</b>	<b>\$1012</b>	<b>\$1896</b>	<b>\$884</b>
<b>12</b>	<b>\$1117</b>	<b>\$2093</b>	<b>\$977</b>

NOTES: Includes semi-attached arm cushions as shown.

## HWH3SPCF

### THREE SEAT LOUNGE — PILLOW CUSHION, MULTI-FABRIC

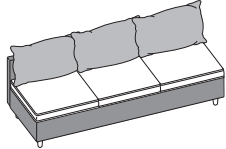

Armless

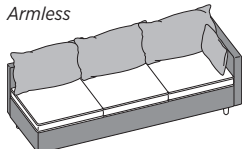

Left

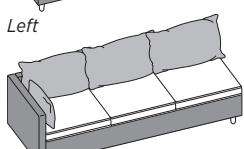

Right

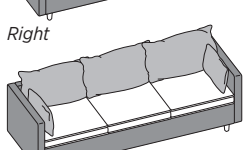

Both Arms

### DIMENSIONS

Depth:	30½	Back Height:	13¾
Height:	31½	Back Width:	80¾
Width (armless):	80¾	Arm Height:	8
Width (one arm):	84	Ship Weight (armless):	146
Width (both arms):	87¼	Ship Weight (one arm):	160
Usable Seat Depth:	16½	Ship Weight (both arms):	174
Seat to Floor Height:	17¾	Cube:	46.5
Seat Width (armless):	80¾	COM:	See page 496
Seat Width (one arm):	75½	Weight Rating:	300 lbs. (per seat)
Seat Width (both arms):	70¼		

### FABRIC PRICE CODES

<b>1</b>	<b>\$5053</b>		
<i>Add to Base Price Above</i>			
	<b>Seat</b>	<b>Frame</b>	<b>Back</b>
<b>2</b>	<b>\$105</b>	<b>\$195</b>	<b>\$105</b>
<b>3</b>	<b>\$210</b>	<b>\$393</b>	<b>\$210</b>
<b>4</b>	<b>\$297</b>	<b>\$557</b>	<b>\$297</b>
<b>5</b>	<b>\$415</b>	<b>\$776</b>	<b>\$415</b>
<b>6</b>	<b>\$534</b>	<b>\$1000</b>	<b>\$534</b>
<b>7</b>	<b>\$657</b>	<b>\$1229</b>	<b>\$657</b>
<b>8</b>	<b>\$781</b>	<b>\$1464</b>	<b>\$781</b>
<b>9</b>	<b>\$801</b>	<b>\$1500</b>	<b>\$801</b>
<b>10</b>	<b>\$906</b>	<b>\$1697</b>	<b>\$906</b>
<b>11</b>	<b>\$1012</b>	<b>\$1896</b>	<b>\$1012</b>
<b>12</b>	<b>\$1117</b>	<b>\$2093</b>	<b>\$1117</b>

NOTES: Includes semi-attached arm cushions as shown.

HON Recommendation: HWH3SPCF.B.PURL\_\_PURL\_\_PURL\_\_CW\_\_ - List Price \$6244

## HOW TO SPECIFY

<b>Select Model Number</b> HWH3SPCF	<b>Select Arm Type</b> N No Arms L Left Arm Only (+ \$189) R Right Arm Only (+ \$189) B Both Arms (+ \$378)	<b>Select Seat Fabric</b> See page 496	<b>Select Frame Fabric</b> See page 496	<b>Select Back Fabric</b> See page 496	<b>Select Foot and Foot Color</b> SM Square Metal (+ \$55) CW Cone Wood See page 496 for colors
HWH3SPCF	B	PBLE07	PBLE03	PBLE01	SMP8V



# WEST HILL™ Ottomans

## HWH1C

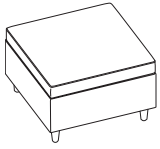

### OTTOMAN

### DIMENSIONS

Depth:	27¼	Ship Weight:	47
Height:	17¾	Cube:	18.4
Width:	27¼	COM:	See page 496
Usable Seat Depth:	27¼	Weight Rating:	300 lbs.
Seat to Floor Height:	17¾		
Seat Width:	27¼		

### FABRIC PRICE CODES

1	\$1551	8	\$2138
2	\$1630	9	\$2152
3	\$1708	10	\$2231
4	\$1774	11	\$2310
5	\$1862	12	\$2390
6	\$1951	L	—
7	\$2044		

## HWH1CCF

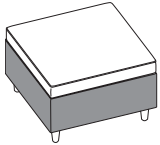

### OTTOMAN, MULTI-FABRIC

### DIMENSIONS

Depth:	27¼	Ship Weight:	47
Height:	17¾	Cube:	18.4
Width:	27¼	COM:	See page 496
Usable Seat Depth:	27¼	Weight Rating:	300 lbs.
Seat to Floor Height:	17¾		
Seat Width:	27¼		

### FABRIC PRICE CODES

1	\$1754	
<i>Add to Base Price Above</i>		
	Seat	Frame
2	\$40	\$40
3	\$80	\$80
4	\$112	\$112
5	\$156	\$156
6	\$201	\$201
7	\$247	\$247
8	\$294	\$294
9	\$301	\$301
10	\$340	\$340
11	\$380	\$380
12	\$420	\$420

HON Recommendation: HWH1C.PURL\_\_\_.CW\_\_ - List Price \$1708

## HOW TO SPECIFY

<p><b>Select Model Number</b></p> <p>HWH1CCF .</p>	<p><b>Select Fabric</b></p> <p>See page 496</p> <p>PBLE03 .</p>	<p><b>Select Seat Fabric</b></p> <p><i>Specify for model HWH1CCF only</i></p> <p>PBLE03 .</p>	<p><b>Select Frame Fabric</b></p> <p><i>Specify for model HWH1CCF only</i></p> <p>PBLE07 .</p>	<p><b>Select Foot and Foot Color</b></p> <p>SM Square Metal (+ \$55) CW Cone Wood</p> <p>See page 496 for colors</p> <p>SMP8V</p>
--	---	---	--	---



# WEST HILL™ Casual Lounge Seating

GSA SIN 33721



Icon Legend on page 19

## HWH1TCS

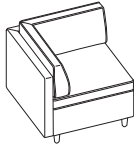

### TRUE CORNER — STANDARD CUSHION

#### DIMENSIONS

Depth:	30½	Ship Weight:	73
Height:	29¾	Cube:	18.4
Width:	30½	COM:	See page 496
Usable Seat Depth:	19	Weight Rating:	300 lbs.
Seat to Floor Height:	17¾		
Back Height:	12		

#### FABRIC PRICE CODES

1	\$2627	8	\$3798
2	\$2783	9	\$3827
3	\$2942	10	\$3985
4	\$3071	11	\$4144
5	\$3248	12	\$4301
6	\$3428	L	—
7	\$3611		

## HWH1TCP

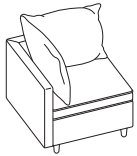

### TRUE CORNER — PILLOW CUSHION

#### DIMENSIONS

Depth:	30½	Ship Weight:	73
Height:	31½	Cube:	18.4
Width:	30½	COM:	See page 496
Usable Seat Depth:	16½	Weight Rating:	300 lbs.
Seat to Floor Height:	17¾		
Back Height:	13¾		

#### FABRIC PRICE CODES

1	\$2627	8	\$3993
2	\$2809	9	\$4027
3	\$2993	10	\$4212
4	\$3146	11	\$4396
5	\$3352	12	\$4580
6	\$3560	L	—
7	\$3774		

HON Recommendation: HWH1TCP.PURL\_\_CW\_\_ - List Price \$2993

SEATING

## HOW TO SPECIFY

Select  
Model Number

HWH1TCP.

Select  
Fabric

See page 496

PBLE03.

Select  
Foot and Foot Color

SM Square Metal (+ \$55)

CW Cone Wood

See page 496 for colors

SMP8V



# WEST HILL™ Casual Lounge Seating

## HWH1TCSCF

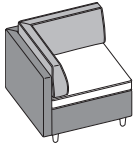

**TRUE CORNER —  
STANDARD CUSHION,  
MULTI-FABRIC**

### DIMENSIONS

Depth:	30½	Ship Weight:	73
Height:	29¾	Cube:	18.4
Width:	30½	COM:	See page 496
Usable Seat Depth:	19	Weight Rating:	300 lbs.
Seat to Floor Height:	17¾		
Back Height:	12		

### FABRIC PRICE CODES

1 \$2830

*Add to Base Price Above*

	Seat	Frame	Back
2	\$40	\$91	\$65
3	\$80	\$184	\$131
4	\$112	\$260	\$186
5	\$156	\$363	\$259
6	\$201	\$467	\$333
7	\$247	\$574	\$410
8	\$294	\$683	\$489
9	\$301	\$701	\$500
10	\$340	\$794	\$566
11	\$380	\$884	\$633
12	\$420	\$977	\$699

## HWH1TCPFCF



**TRUE CORNER —  
PILLOW CUSHION,  
MULTI-FABRIC**

### DIMENSIONS

Depth:	30½	Ship Weight:	73
Height:	31½	Cube:	18.4
Width:	30½	COM:	See page 496
Usable Seat Depth:	16½	Weight Rating:	300 lbs.
Seat to Floor Height:	17¾		
Back Height:	13¾		

### FABRIC PRICE CODES

1 \$2830

*Add to Base Price Above*

	Seat	Frame	Back
2	\$40	\$91	\$53
3	\$80	\$184	\$106
4	\$112	\$260	\$149
5	\$156	\$363	\$208
6	\$201	\$467	\$268
7	\$247	\$574	\$328
8	\$294	\$683	\$391
9	\$301	\$701	\$400
10	\$340	\$794	\$453
11	\$380	\$884	\$506
12	\$420	\$977	\$559

**HON Recommendation: HWH1TCPFCF.PURL\_\_PURL\_\_PURL\_\_CW\_\_ - List Price \$3200**

## HOW TO SPECIFY

<p><b>Select Model Number</b></p> <p>HWH1TCPFCF</p>	<p><b>Select Seat Fabric</b></p> <p>See page 496</p> <p>PBLE07</p>	<p><b>Select Frame Fabric</b></p> <p>See page 496</p> <p>PBLE03</p>	<p><b>Select Back Fabric</b></p> <p>See page 496</p> <p>PBLE01</p>	<p><b>Select Foot and Foot Color</b></p> <p>SM Square Metal (+ \$55) CW Cone Wood</p> <p>See page 496 for colors</p> <p>SMP8V</p>
---	--	---	--	---

SEATING



Icon Legend on page 19

# THROW PILLOWS

## HWHL P



### LUMBAR THROW PILLOW

#### DIMENSIONS

Height: 10  
 Width: 18  
 COM: 1.0  
 Ship Weight: 2.5  
 Cube: 2.3

#### FABRIC PRICE CODES

1	\$184	8	\$380
2	\$211	9	\$385
3	\$237	10	\$411
4	\$260	11	\$438
5	\$289	12	\$464
6	\$318	L	—
7	\$348		

## HWHSP18



### 18" SQUARE THROW PILLOW

#### DIMENSIONS

Height: 18  
 Width: 18  
 COM: 1.0  
 Ship Weight: 3.0  
 Cube: 2.3

#### FABRIC PRICE CODES

1	\$226	8	\$422
2	\$253	9	\$427
3	\$279	10	\$453
4	\$302	11	\$480
5	\$331	12	\$506
6	\$360	L	—
7	\$390		

SEATING

## HOW TO SPECIFY

Select Model Number

HWHSP18

Select Fabric

See page 496

PBLE03



Icon Legend on page 19

## HWHACPS

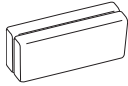

### ARM CUSHION PACK — STANDARD

#### DIMENSIONS

COM: 1.0  
Ship Weight: 4.1  
Cube: 3.9

#### FABRIC PRICE CODES

1	\$272	8	\$468
2	\$299	9	\$473
3	\$325	10	\$499
4	\$348	11	\$526
5	\$377	12	\$552
6	\$406	L	—
7	\$436		

NOTES: Includes both L and R Arm Cushions.

ⓘ Cushion arm cushions can be replaced or switched out with these cushion packs.

## HWHACPP



### ARM CUSHION PACK — PILLOW

#### DIMENSIONS

COM: 1.0  
Ship Weight: 5.7  
Cube: 3.9

#### FABRIC PRICE CODES

1	\$272	8	\$468
2	\$299	9	\$473
3	\$325	10	\$499
4	\$348	11	\$526
5	\$377	12	\$552
6	\$406	L	—
7	\$436		

NOTES: Includes both L and R Arm Cushions.

ⓘ Cushion arm cushions can be replaced or switched out with these cushion packs.

## HWHBCPS



### BACK CUSHION PACK — STANDARD

#### DIMENSIONS

COM: 2.5  
Ship Weight: 8.1  
Cube: 3.9

#### FABRIC PRICE CODES

1	\$272	8	\$761
2	\$337	9	\$772
3	\$403	10	\$838
4	\$458	11	\$905
5	\$531	12	\$971
6	\$605	L	—
7	\$682		

NOTES: Includes a single Standard Back Cushion.

ⓘ Cushion backs can be replaced or switched out with these cushion packs.

## HWHBCPP



### BACK CUSHION PACK — PILLOW

#### DIMENSIONS

COM: 1.5  
Ship Weight: 8.1  
Cube: 3.9

#### FABRIC PRICE CODES

1	\$272	8	\$566
2	\$312	9	\$573
3	\$352	10	\$612
4	\$384	11	\$652
5	\$428	12	\$692
6	\$473	L	—
7	\$519		

NOTES: Includes a single Pillow Back Cushion.

ⓘ Cushion backs can be replaced or switched out with these cushion packs.

## HWHGB

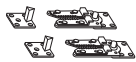

OPEN MARKET

### GANGING BRACKET

#### DIMENSIONS

Ship Weight: 1.0  
Cube: 0.1

#### LIST PRICE

\$70

SPECIFYING EXAMPLE: HWHGB

## HOW TO SPECIFY

<p>Select Model Number</p> <p>HWHBCPP</p>	<p>Select Fabric</p> <p>See page 496</p> <p>PBLE03</p>
---	--

# EXECUTIVE CHAIRS

OPEN MARKET



Icon Legend on page 19

## HVL151



### HIGH-BACK

Pneumatic  
Swivel  
Tilt  
Tilt Tension  
Tilt Lock  
Fixed Padded Loop Arms

Functions: **A, E, F, K, L, T**  
(Function Key on pages 252-253)

### DIMENSIONS

Depth:	37½	Arm Width:	20½
Width:	27	Seat to Floor Height:	17¾-21½
Height:	45½	Usable Seat Depth:	18⅝
Seat Depth:	18⅝	Ship Weight:	38
Seat Width:	20½	Cube:	5.1
Back Width:	20½	Weight Rating:	250 lbs.
Back Height:	27¼		

### PRICE CODE

**Leather**      **\$574**

NOTES: Black Bonded Leather. Black frame. Padded loop arms. **HON 5-Year Limited Warranty.**

**HON Recommendation: HVL151.SB11 - List Price \$574**

SEATING

## HOW TO SPECIFY

Select  
Model Number

H V L 1 5 1 .

Select  
Fabric

**SB11** Black Bonded Leather

S B 1 1



# EXECUTIVE CHAIRS

## HVL402



### HIGH-BACK

Pneumatic  
Swivel  
Tilt  
Tilt Tension  
Tilt Lock  
Fixed Padded Loop Arms

Functions: **A, E, F, K, L, T**  
(Function Key on pages 252-253)

### DIMENSIONS

Depth:	28	Arm Width:	19½
Width:	26	Seat to Floor Height:	16½-20½
Height:	45½	Usable Seat Depth:	17½
Seat Depth:	17½	Ship Weight:	44
Seat Width:	19½	Cube:	6.1
Back Width:	19	Weight Rating:	250 lbs.
Back Height:	24½		

### PRICE CODE

**Vinyl** **\$639**

NOTES: Available in Black and Brown Vinyl with contrasting top stitch. EN11 features silver frame. EN45 features black frame. Padded loop arms. **HON 5-Year Limited Warranty.**

**HON Recommendation: HVL402.EN11 - List Price \$639**

## HVL601



### HIGH-BACK

Pneumatic  
Swivel  
Tilt  
Tilt Tension  
Tilt Lock  
Loop Arms

Functions: **A, E, F, K, L, T**  
(Function Key on pages 252-253)

### DIMENSIONS

Depth:	27	Arm Width:	20½
Width:	26½	Seat to Floor Height:	16¾-20½
Height:	44	Usable Seat Depth:	17
Seat Depth:	17	Ship Weight:	38
Seat Width:	20½	Cube:	4.1
Back Width:	20½	Weight Rating:	250 lbs.
Back Height:	26½		

### PRICE CODE

**Fabric** **\$424**  
**Leather** **\$457**

NOTES: Tailored stitching detail in Black Bonded Leather or Black fabric. Fixed loop arms. Black frame. **HON 5-Year Limited Warranty.**

**HON Recommendation: HVL601.SB11 - List Price \$457**

## HOW TO SPECIFY

<p><b>Select Model Number</b></p>	<p><b>Select Fabric</b></p> <p><b>SB11</b> Black Bonded Leather <i>Specify for model HVL601 only</i></p> <p><b>EN11</b> Black Vinyl <i>Specify for model HVL402 only</i></p> <p><b>EN45</b> Brown Vinyl <i>Specify for model HVL402 only</i></p> <p><b>VA10</b> Black Fabric <i>Specify for model HVL601 only</i></p>
<p>H V L 6 0 1</p>	<p>S B 1 1</p>

# WORKPLACE TOOLS

## Ergonomic Solutions

OPEN MARKET



Icon Legend on page 19

### HSCASTER

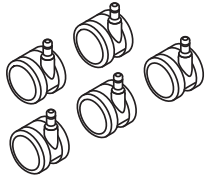

#### SET OF 5 SOFT CASTERS

#### DIMENSIONS

Size: 60mm  
Ship Weight: 2 **5**  
Cube: 0.1

#### LIST PRICE

**\$75**

**!** Available in Black finish only, no specification needed.

SEATING





### HOW TO SPECIFY

Select  
Model Number

H S C A S T E R

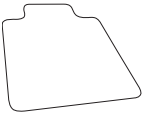
# WORKPLACE TOOLS

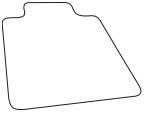
## Chair Mats

	DESCRIPTION	MODEL	SHIP WEIGHT	CUBE	LIST PRICE
	Lipped Chair Mat with Studs 48"W x 36"D	HCM3648LS 	8.8	0.6	\$127
	<b>Lipped Chair Mat without Studs</b> 60"W x 46"D 48"W x 36"D	HCM4660LN HCM3648LN 	13.2 8.3	0.5 0.3	\$212 \$127

**NOTES:**

- Available with studs for carpet and without studs for hard-surface floors.
  - Ships rolled.
  - **HON 5-Year Limited Warranty.**
-  Available in Clear finish only, no specification needed.

### HOW TO SPECIFY

Select Model Number

H	C	M	3	6	4	8	L	S
---	---	---	---	---	---	---	---	---



# CROSS REFERENCE INDEX

MODEL	PAGE	MODEL	PAGE	MODEL	PAGE	MODEL	PAGE
H1522	233	HBSDCSNT2832	143	HCTRECT3060	30	HE4LSTL30	150
H2091	442	HBSDFN3030	143	HCTRECT3072	30	HEB4LEG	137
H2092	442	HBSDRBN2231	143	HCTRND24	30	HEBBXRL	139, 145
H2093	442	HBSDRECT2031	143	HCTRND30	30	HEBS4LEG	137
H2095	442	HBSDRECT2038	143	HCTRND36	30	HEBSD4LEG	144
H2164	285	HBSDRECT2430	143	HCTRND42	30	HEBY4LEG	137
H2165	285	HBSDSPY2636	143	HCTROUGH17	244, 251	HECART	168
H2285	395	HBSDTRP2040	143	HCTROUGH1710	244, 251	HECLP8	167
H4022	231	HB SMAUSB	227	HCTROUGH36	251	HECSBG	224
H4028	231	HB TMS	61	HCTROUGH3610	251	HECSG	224
H4029	231	HB T TCW	36	HCTS DS	32	HECSITD	211
H4041	433	HB TTD30	36	HCTSFT24	30	HECSITS	211
H4043	433	HB TTD42	36	HCTSFT30	30	HECSITT	211
H4048	433	HB TTRND30	35	HCTSFT36	30	HECSJVAP	223
H4049	433	HB TTRND36	35	HCTSFT42	30	HECSJVHP	223
H51204	232	HB TTRND42	35	HCTSQR24	30	HECSMAIBB	218
H51206	232	HB TTSFT30	35	HCTSQR30	30	HECSMAIBBMF	220
H5701	487	HB TTSFT36	35	HCTSQR36	30	HECSMAIHB	215
H5703	487	HB TTSFT42	35	HCTSQR42	30	HECSMAIHBMF	217
H5705	487	HB TTSQR30	35	HCWPT	43	HECSMAILB	212
H5711	488	HB TTSQR36	35	HCWTB3656G	41	HECSMAILBMF	214
H5713	488	HB TTSQR42	35	HCWTB3656J	41	HECSMAOBB	218
H5715	488	HB TTX30L	36	HCWTB3684G	41	HECSMAOBBMF	220
H5721	491	HB TTX30S	36	HCWTB3684J	41	HECSMAOHB	215
H5723	491	HB TTX42L	36	HCWTD SBM27	42	HECSMAOHBMF	217
H5725	491	HB TTX42S	36	HCWTD SBM29	42	HECSMAOLB	212
H5731	492	HB X RISER	235	HCWTD SBM36	42	HECSMAOLBMF	214
H5733	492	HC AT IMM	307	HCWTD SBM42	42	HECSMSBB	218
H5735	492	HCD1	234	HCWTRND30G	41	HECSMSBBMF	219
H5795	487, 488, 491, 492	HC FEU	301	HCWTRND30J	41	HECSMSHB	215
H80170	64	HC FEUMF	302	HCWTRND36G	41	HECSMSHBMF	216
H80180	64	HC FMU	301	HCWTRND36J	41	HECSMSLB	212
H80191	64	HC FMUMF	302	HCWTRND42G	41	HECSMSLBMF	213
H80192	64	HC FRG	292	HCWTRND42J	41	HECSMTBB	218
H80193	64	HC FRT	291	HCWTSBL18	42	HECSMTBBMF	219
HA ECBH	149, 163	HCLA65	139, 145, 181, 241	HCWTSBL27	42	HECSMTHB	215
HA EHF	149, 163	HCLQS	296	HCWTSBL29	42	HECSMTHBMF	216
HA ESS	149, 163	HCLQT	295	HCWTSBL36	42	HECSMTLB	212
HASB2	278	HCM3648LN	236, 511	HCWTSBL42	42	HECSMTLBMF	213
HASB2MF	278	HCM3648LS	236, 511	HCWTSBM18	42	HECSO AEL	222
HASB3	279	HCM4660LN	236, 511	HCWTSBM27	42	HECSO AER	222
HASB3MF	279	HCOMDOME2	248	HCWTSBM29	42	HECSOC	222
HASGBSL	281	HCPUI	229	HCWTSBM36	42	HECSOD	221
HASHB1	271	HCT IMM	306	HCWTSBM42	42	HECSOSE	222
HASHB1MF	271	HCT29LX	31	HCWTSF TS30G	41	HECSOSQ	221
HASHB2	273	HCT29MT	31	HCWTSF TS30J	41	HECSOTP	221
HASHB2MF	273	HCT29MX	31	HCWTSF TS36G	41	HECSOTR	221
HASHB3	275	HCT29ST	31	HCWTSF TS36J	41	HECSR B	209
HASHB3MF	275	HCT29SX	31	HCWTSF TS42G	41	HECSR P	209
HASHBTC	277	HCT36LX	31	HCWTSF TS42J	41	HECSRSP	209
HASHBTCMF	277	HCT36MT	31	HCWTSQR30G	41	HECSRSPMF	210
HASLB1	270	HCT36MX	31	HCWTSQR30J	41	HECSRST	209
HASLB1MF	270	HCT36ST	31	HCWTSQR36G	41	HECSVAP	223
HASLB2	272	HCT36SX	31	HCWTSQR36J	41	HECSVHP	223
HASLB2MF	272	HCT42LX	31	HCWTSQR42G	41	HEDRT-2766E-NS	138
HASLB3	274	HCT42MT	31	HCWTSQR42J	41	HEDRT2766E	136
HASLB3MF	274	HCT42MX	31	HCWTSR3656G	41	HEFL1	167
HASLBTC	276	HCT42ST	31	HCWTSR3656J	41	HEFSO1	170
HASLBTCMF	276	HCT42SX	31	HCWTSR3684G	41	HEHP3660E	135
HAS PSS	280	HCTLDS	32	HCWTSR3684J	41	HELPI	167
HAS PSSMF	280	HCTMDS	32	HD2	234	HEMKR426029BB	146
HAS SGC	281	HCTRECT2448	30	HD8	234	HEMKR426029L	146
HAS SP	281	HCTRECT2460	30	HDPS1	240	HEMKR426036BB	146
HBDMAUSB	227	HCTRECT2472	30	HE4022	231	HEMKR426036L	146
HBPWRMOD	460	HCTRECT3048	30	HE4LSTL18	150	HEMKR426042BB	146

# CROSS REFERENCE INDEX

MODEL	PAGE	MODEL	PAGE	MODEL	PAGE	MODEL	PAGE
HEMKR426042L	146	HESWCD2	201	HFLGANG	330	HH870930	238
HEMKR427229BB	146	HESWCD30	199	HFLMCI	328	HH870930CH	238
HEMKR427229L	146	HESWCD42	199	HFLMCIDF	332	HH870942	238
HEMKR427236BB	146	HESWCI18	199	HFLML1	328	HH870942CH	238
HEMKR427236L	146	HESWCI30	199	HFLMLIDF	332	HH870960	238
HEMKR427242BB	146	HESWCI42	199	HFLMR1	328	HH870960CH	238
HEMKR427242L	146	HESWCO18	199	HFLMRIDF	333	HHABCASTER	139
HEMKRDIVIDER	148	HESWCO30	199	HFLRC1	327	HHB02	483
HEMKREND29-F	147	HESWCO42	199	HFLRCIDF	331	HHB03	483
HEMKREND29-SP	147	HESWLB30	200	HFLSCI	327	HHCB50	484
HEMKREND36-F	147	HESWLB36	200	HFLSCIDF	331	HHCG11	476
HEMKREND36-SP	147	HESWLB42	200	HFLSC2	339	HHCG1IDF	477
HEMKREND42-F	147	HESWLD12	201	HFLSC2DF	342	HHCG21	476
HEMKREND42-SP	147	HESWLD18	198	HFLSO1	330	HHCG2IDF	477
HEMKRSHELF	148	HESWLD2	201	HFLWI45	329	HHCG50	476
HERD42E	135	HESWLD30	198	HFLWI45DF	334	HHCG50DF	478
HERD48E	135	HESWLD42	198	HFLWO45	329	HHCGB21	479
HESA2440E	134	HESWLS18	198	HFLWO45DF	334	HHCGB31	479
HESA3050E	134	HESWLS30	198	HFLYO1	344	HHCGBRCH	478
HESBIH3WD	160	HESWLS42	198	HFLYOIDF	345	HHCTO1	484
HESBIH3WS	160	HESY-3654E-NS	138	HFMBIN12	149, 163, 190	HHPS1	240
HESB2H3WD	160	HESY3654E	134	HFMBIN3	139, 145, 149, 163, 190	HI2AAA	379, 392
HESB2H3WS	160	HETD54E	135	HFMBIN6	149, 163, 190	HI2ATA	379, 392
HESB3H3WS	160	HETLEC-REC2430	173	HFSS74L	337	HI2BTHR	380
HESB4H3WS	160	HETR2448E	135	HFSS74LDF	340	HI2FHA	318, 379, 392
HESCIH3WD	158	HETR2460E	135	HFSS74LWD	338	HI2HR	380
HESCIH3WS	158	HETR2472E	135	HFSS74LWDDF	341	HIB50	385
HESC2H3WD	158	HETR3048E	135	HFTB17N	48	HICS7	382
HESC2H3WS	158	HETR3060E	135	HFTLA2460	47	HICS7DF	384
HESC3H3WS	158	HETR3072E	135	HFTLA3372	47	HIEH1	390
HESC4H3WS	158	HETZ3060E	135	HFTLA3384	47	HIEH2	390
HESCO3H2WS	159	HF22	163	HFTLA3396	47	HIEH3	390
HESCO3H3WS	159	HF23C	191	HFTLC2460	47	HIGCL	385
HESCO4H2WS	159	HF23S	163	HFTLC3372	47	HIGS6	382
HESCO4H3WS	159	HFCG6	337	HFTLC3384	47	HIGS6DF	383
HESCS4H2WSL	162	HFCG6DF	340	HFTLC3396	47	HILMBR	379
HESCS4H2WSR	162	HFCG6WD	338	HFTLD26	49	HIPAA	318, 379, 392
HESH3060E	134	HFCG6WDDF	341	HFTLD30	47	HISB6	382
HESH6066E	136	HFCL2	339	HFTLD36	47	HISB6DF	383
HESKD4872E	136	HFCL2DF	342	HFTLR12	50	HITL1	388
HESL2H2WS	157	HFCS64L	337	HFTLS24	49	HITL2	388
HESL2H3WS	157	HFCS64LDF	340	HFTLS30	47	HITL3	388
HESL3H2WS	157	HFCS64LWD	338	HFTLS36	47	HITLM	370
HESL3H3WS	157	HFCS64LWDDF	341	HFTLW45	50	HITLMKD	372
HESL4H2WS	157	HFDB17B	48	HFTPTL18	49	HITLRA	375
HESL4H3WS	157	HFDB17N	48	HFTTAL14	50, 361	HITLRAKD	376
HESN3054E	134	HFDB29A	48	HFXB17B	48	HITS5	391
HESNP54E	134	HFDB29AN	48	HFXB29A	48	HITSM	370
HESPCR	138	HFDB29B	48	HFXB29AN	48	HITSRA	375
HESQ36E	135	HFDB42A	48	HFXB29B	48	HIWM1	389
HESQ42E	135	HFDB42AF	48	HFXB42A	48	HIWM2	389
HESQ48E	135	HFDB42AFN	48	HFXB42AN	48	HIWM3	389
HEST2H2WS	161	HFDB42AN	48	HFXB42B	48	HIWMBT	373
HEST2H3WS	161	HFDB42B	48	HFXT1	322	HIWMM	370
HEST3H2WS	161	HFDB42BF	48	HGDK3-F	181, 183	HIWMMHR	371
HEST3H3WS	161	HFL450	330	HGRMTAC	32, 247, 361	HIWMMKD	372
HEST4H2WS	161	HFLB2	335	HGRMTAC2	32, 247, 361	HIWMMS	374
HEST4H3WS	161	HFLB3	335	HGRMTDATA	247	HIWMMSKD	374
HESW-3054E-NS	138	HFLCC1	329	HGRMTUSB2	247, 361	HIWMRA	375
HESW3054E	134	HFLCCIDF	334	HGROM1BLANK	249	HIWMRAKD	376
HESWCB30	200	HFLCO1	344	HGROM2BLANK	249	HIWMMU	377
HESWCB36	200	HFLCO1DF	345	HGTMM	348	HIWMMUKD	378
HESWCB42	200	HFLDGRMT	247	HGVIMM	349	HIWMMUL	377
HESWCD12	201	HFLDGRMT3	247	HH870924	238	HIWMMULKD	378
HESWCD18	199	HFLDGRMT4	247	HH870924CH	238	HJTRGH24	251

# CROSS REFERENCE INDEX

MODEL	PAGE	MODEL	PAGE	MODEL	PAGE	MODEL	PAGE
HJTRGH36	251	HMAPOWER48	246	HMPTT2448	37	HMVPCSS-404C	72
HKBS	230	HMAPOWER482	246	HMPTT2460	37	HMVPCSS-409C	72
HKTLONG	230	HMAPOWER54	246	HMPTT2472	37	HMVR-1848(?)-AH	70
HKT MID	230	HMAPOWER542	246	HMPTT3048	37	HMVR-1848(?)-FX	68
HKTSHORT	230	HMAPOWER60	246	HMPTT3060	37	HMVR-1848(?)-NS	69
HL2DARM	318	HMAPOWER602	246	HMPTT3072	37	HMVR-1860(?)-AH	70
HL4DARM	318	HMAPOWER66	246	HMPVWM28	251	HMVR-1860(?)-FX	68
HLDA-15	181	HMAPOWER662	246	HMS1	410	HMVR-1860(?)-NS	69
HL DST1	239	HMAPOWER72	246	HMS2	410	HMVR-1872(?)-AH	70
HL DV-M3A	180	HMAPOWER722	246	HM SCART	410	HMVR-1872(?)-FX	68
HL DV-M3F	180	HMAPOWER84	246	HMSFLTGLD	411	HMVR-1872(?)-NS	69
HL DV-M3T	180	HMAPOWER842	246	HMSGANG	411	HMVR-2436(?)-AH	70
HL DV-MRECT2026A	180	HMAPOWER96	246	HMSGLD	411	HMVR-2436(?)-FX	68
HLED1	237	HMAPOWER962	246	HMSSTLGLD	411	HMVR-2436(?)-NS	69
HLED17A	238	HMASD	227	HMT1	408	HMVR-2442(?)-AH	70
HLED17AS	238	HMASPLIT	246	HMT1848E	58	HMVR-2442(?)-FX	68
HLED17AUO	238	HMASTS	227	HMT1848G	58	HMVR-2442(?)-NS	69
HLED1OC	237	HMAVHA	403	HMT1860E	58	HMVR-2448(?)-AH	70
HLED2	237	HMAVHAMF	403	HMT1860G	58	HMVR-2448(?)-FX	68
HLED31A	238	HMAVHN	402	HMT1872E	58	HMVR-2448(?)-NS	69
HLED31AS	238	HMAVHNMF	402	HMT1872G	58	HMVR-2454(?)-AH	70
HLED31AUO	238	HMAVMA	401	HMT2448E	58	HMVR-2454(?)-FX	68
HLEDOSA	238	HMAVMAMF	401	HMT2448G	58	HMVR-2454(?)-NS	69
HLSM SHHR	318	HMAVMN	400	HMT2460E	58	HMVR-2460(?)-AH	70
HLSL1212	241	HMAVMNMF	400	HMT2460G	58	HMVR-2460(?)-FX	68
HLSL1460LS	239	HMAVO	404	HMT2472E	58	HMVR-2460(?)-NS	69
HLSL1472LS	239	HMAVOMF	404	HMT2472G	58	HMVR-2466(?)-AH	70
HLSL4831MB	107, 242	HMBFLIP18L	59	HMT3048E	58	HMVR-2466(?)-FX	68
HLSLDRWORG	241	HMBFLIP18S	59	HMT3048G	58	HMVR-2466(?)-NS	69
HLTM	315	HMBFLIP24L	59	HMT3060E	58	HMVR-2472(?)-AH	70
HLTSM	317	HMBFLIP24S	59	HMT3060G	58	HMVR-2472(?)-FX	68
HLTV2460T-3	187	HMBFLIP30L	59	HMT3072E	58	HMVR-2472(?)-NS	69
HLTV2460T MOD-3	186	HMBFLIP30S	59	HMT3072G	58	HMVR-2484(?)-FX	68
HLTV2466T-33	187	HMBPOST	59	HMT5	408	HMVR-2484(?)-NS	69
HLTV2466T MOD-33	186	HMBTLEG18	59	HMTS01	266	HMVR-2496(?)-FX	68
HLTVMODFULL	186	HMBTLEG24	59	HMTS11	266	HMVR-2496(?)-NS	69
HLTVMODPART	186	HMG1	413	HMTUMOD26	71	HMVR-3036(?)-AH	70
HLVBC3330	192	HMG2	413	HMTUMOD32	61, 71	HMVR-3036(?)-FX	68
HLVBC4330	192	HMG3	414	HMTUMOD38	38, 71	HMVR-3036(?)-NS	69
HLVBC5630	192	HMG4	414	HMTUMOD44	61, 71	HMVR-3042(?)-AH	70
HLVMSC3330R	190	HMG5	414	HMTUMOD50	38, 71	HMVR-3042(?)-FX	68
HLVMSC4330R	190	HMG7	414	HMTUMOD56	71	HMVR-3042(?)-NS	69
HLVMSC5630R	190	HMG T1	418	HMTUMOD62	71	HMVR-3048(?)-AH	70
HLVPM1	239	HMG T2	418	HMTUMOD74	71	HMVR-3048(?)-FX	68
HLVPM2	240	HML1S	354	HMTUMOD86	71	HMVR-3048(?)-NS	69
HLVSC3330R	191	HML1SDF	357	HMVH-2448(?)-FX	68	HMVR-3054(?)-AH	70
HLVSC4330R	191	HML2S	354	HMVH-2448(?)-NS	69	HMVR-3054(?)-FX	68
HLVSC5630R	191	HML2SDF	358	HMVH-3060(?)-FX	68	HMVR-3054(?)-NS	69
HLWBF1-1248W	188	HML2ST	356	HMVH-3060(?)-NS	69	HMVR-3060(?)-AH	70
HLWBF2-1248W	188	HML2STDF	360	HMVH-3672(?)-FX	68	HMVR-3060(?)-FX	68
HLWBS-248WT	188	HML3S	355	HMVH-3672(?)-NS	69	HMVR-3060(?)-NS	69
HLWBS-248WW	188	HML3SDF	359	HMVMB-3072WWW	72	HMVR-3066(?)-AH	70
HLWBS-448WT	188	HMN1	416	HMVMB-3672WWW	72	HMVR-3066(?)-FX	68
HLWBS-448WW	188	HMN2	416	HMVPC-DTLG	72	HMVR-3066(?)-NS	69
HLWM	314	HMNT1	420	HMVPC-MP	72	HMVR-3072(?)-AH	70
HLWMBT	316	HMNT2	420	HMVPCA1-1830G	72	HMVR-3072(?)-FX	68
HLWR-12	188	HMPT2448NS	38	HMVPCA1-1830R	72	HMVR-3072(?)-NS	69
HMACABLE	246	HMPT2460NS	38	HMVPCA2-1830G	72	HMVR-3084(?)-FX	68
HMAGANG	61, 139, 244	HMPT2472NS	38	HMVPCA2-1830R	72	HMVR-3084(?)-NS	69
HMAJUMP	246	HMPT3048NS	38	HMVPCF-1830G	72	HMVR-3096(?)-FX	68
HMAPLATE	246	HMPT3060NS	38	HMVPCF-1830R	72	HMVR-3096(?)-NS	69
HMAPOWER36	246	HMPT3072NS	38	HMVPCSS-4C	72	HMVR-3648(?)-AH	70
HMAPOWER362	246	HMPTBFX	37	HMVPCSS-4C4C	72	HMVR-3648(?)-FX	68
HMAPOWER42	246	HMPTBNSL	37	HMVPCSS-4C9C	72	HMVR-3648(?)-NS	69
HMAPOWER422	246	HMPTBNSS	37	HMVPCSS-4O	72	HMVR-3660(?)-AH	70

# CROSS REFERENCE INDEX

MODEL	PAGE	MODEL	PAGE	MODEL	PAGE	MODEL	PAGE
HMVR-3660(?)-FX	68	HPWRMOD3WC	248	HSLVSMM	466	HT29FB48216	90
HMVR-3660(?)-NS	69	HPWRMOD4WC	248	HSLVSMMS	466	HT29FB48240	90
HMVR-3672(?)-AH	70	HQB	244	HSLVSMR	468	HT29FB4896	91
HMVR-3672(?)-FX	68	HQBCJ36	244	HSLVSMRS	468	HT29FBM	91
HMVR-3672(?)-NS	69	HQHI-3	244	HSLVSMU	470	HT36FB3060	91
HNL1530FD	106	HQH5-3	244	HSLVSMUS	470	HT36FB3672	91
HNL1530LD	105	HQH5-E-3PIE	244	HSLVTMM	465	HT36FB4284	91
HNL1530LL	105	HQH5-E-3PIU2B	244	HSLVTMMKD	471	HT36FB48108	91
HNL1536FD	106	HQH5-E-3P3B	244	HSLVTMMS	465	HT36FB48120	91
HNL1536LD	105	HQH5-P-3P1B	244	HSLVTMR	467	HT36FB48144	91
HNL1536LL	105	HQJ3	244	HSLVTMRKD	471	HT36FB48168	90
HNL1542FD	106	HQQ1	450	HSLVTMRS	467	HT36FB48180	90
HNL1542LD	105	HQQICUSH	450	HSLVTMU	469	HT36FB48192	90
HNL1542LL	105	HRUCKIL	446	HSLVTMUKD	471	HT36FB48216	90
HNL1548FD	106	HRUCK1W	447	HSLVTMUS	469	HT36FB48240	90
HNL1548LD	105	HRUCK5L	446	HSMPPWR-1P-2U	248	HT36FB4896	91
HNL1548LL	105	HRUCK5W	447	HSS4L-06A	182	HT36FBM	91
HNL1548SD	106	HSB50	263	HSS4L-12A	182	HT42AL60	92
HNL1560FD	106	HSB50DF	265	HSS4L-14A	182	HT42AL72	92
HNL1560LD	105	HSCASTER	306, 307, 318, 379, 392, 472, 491, 492, 510	HSS4L-16B	182	HT42AL84	92
HNL1560LL	105			HSS4L-18B	182	HT42AL96	92
HNL1560SD	106	HSCCR36BPG	112	HSS4L-24B	183	HT42ALEG	92
HNL1566FD	106	HSCCR36LM	112	HSS4L-30B	183	HT42FB3060	91
HNL1566LD	105	HSCCR36LMK	112	HSSA-WB1618	183	HT42FB3672	91
HNL1566LL	105	HSCCR48BPG	112	HSSCL-14A	184	HT42FB4284	91
HNL1566SD	106	HSCCR48LM	112	HSSCL-16B	184	HT42FB48108	91
HNL1572FD	106	HSCCR48LMK	112	HSSCL-18B	184	HT42FB48120	91
HNL1572LD	105	HSCCSR2448BPG	112	HSSST-18B	185	HT42FB48144	91
HNL1572LL	105	HSCCSR2448LM	112	HSSTK-18B	185	HT42FB48168	90
HNL1572SD	106	HSCCSR2448LMK	112	HT27FB3060	91	HT42FB48180	90
HNL1578FD	106	HSCCSS36BPG	112	HT27FB3672	91	HT42FB48192	90
HNL1578LD	105	HSCCSS36LM	112	HT27FB4284	91	HT42FB48216	90
HNL1578LL	105	HSCCSS36LMK	112	HT27FB48108	91	HT42FB48240	90
HNL1578SD	106	HSCCSS48BPG	112	HT27FB48120	91	HT42FB4896	91
HNL3630TB	242	HSCCSS48LM	112	HT27FB48144	91	HT42FBM	91
HNL3636TB	242	HSCCSS48LMK	112	HT27FB48168	90	HTALWMGR29	92
HNL4930TB	242	HSCER24BPG	113	HT27FB48180	90	HTALWMGR42	92
HNL4936TB	242	HSCER24LM	113	HT27FB48192	90	HTBINSIDE	102
HNLMP3628	104	HSCER24LMK	113	HT27FB48216	90	HTFWMGR27	91
HNLMP5428	104	HSCCESS24BPG	113	HT27FB48240	90	HTFWMGR29	91
HNLMP7228	104	HSCCESS24LM	113	HT27FB4896	91	HTFWMGR36	91
HNLMP9028	104	HSCCESS24LMK	113	HT27FBM	91	HTFWMGR42	91
HNLRC2436	104	HSCS1	262	HT29AL108	92	HTFXL27	94
HNLRC2454	104	HSCS1DF	264	HT29AL120	92	HTFXL27C	94
HNLRC2472	104	HSCS2	263	HT29AL144	92	HTFXL27P	94
HNLRC2490	104	HSCS2DF	265	HT29AL168	92	HTFXL29	94
HNR1	428	HSGANG	262, 265	HT29AL180	92	HTFXL29C	94
HNR1KD	429	HSGS6	262	HT29AL192	92	HTFXL29P	94
HNR6	431	HSGS6DF	264	HT29AL216	92	HTFXL36	94
HNRS	430	HSLMCS	457	HT29AL240	92	HTFXL36C	94
HPACSM	227	HSLMGK	459	HT29AL60	92	HTFXL36P	94
HPACW	227	HSLMICB1	457	HT29AL72	92	HTFXL42	94
HPADD	228	HSLMICB2	457	HT29AL84	92	HTFXL42C	94
HPASD	228	HSLMOCB1	458	HT29AL96	92	HTFXL42P	94
HPATF	228	HSLMOCB2	458	HT29ALEG	92	HTFXM27	94
HPHAP2028E	60	HSLMQCS	458	HT29ALM	92	HTFXM27C	94
HPHAP2028G	60	HSLMSB1	455	HT29FB3060	91	HTFXM27P	94
HPN1	439	HSLMSB2	455	HT29FB3672	91	HTFXM29	94
HPN2	439	HSLMSS	455	HT29FB4284	91	HTFXM29C	94
HPPMMT	189	HSLMTCB1	456	HT29FB48108	91	HTFXM29P	94
HPWRMOB1	248, 282	HSLMTCB2	456	HT29FB48120	91	HTFXM36	94
HPWRMOD2	248	HSLV2DAP	472	HT29FB48144	91	HTFXM36C	94
HPWRMOD2UWM	248	HSLV4DAP	472	HT29FB48168	90	HTFXM36P	94
HPWRMOD2WC	248	HSLVFAP	472	HT29FB48180	90	HTFXM42	94
HPWRMOD3UWM	248	HSLVLMBR	472	HT29FB48192	90	HTFXM42C	94

# CROSS REFERENCE INDEX

MODEL	PAGE	MODEL	PAGE	MODEL	PAGE	MODEL	PAGE
HTFXM42P	94	HTLBENCHCUSH30	101	HTLC4296HCTFPR	96	HTLMT4272HFR	100
HTFXS27	94	HTLBENCHCUSH48	101	HTLC4296HCTP	95	HTLMT4272L	100
HTFXS27P	94	HTLBENCHCUSH60	101	HTLC4296HCTPL	96	HTLMTBACK	100
HTFXS29	94	HTLC3060HCTFP	97	HTLC4296HCTPR	96	HTLMTLBACK	100
HTFXS29P	94	HTLC3060HCTFPL	98	HTLC4296LCTFP	95	HTLMTTV	100
HTFXS36	94	HTLC3060HCTFPR	98	HTLC4296LCTFPL	96	HTLP108	88
HTFXS36P	94	HTLC3060HCTP	97	HTLC4296LCTFPR	96	HTLP120	88
HTFXS42	94	HTLC3060HCTPL	98	HTLC4296LCTP	95	HTLP144	88
HTFXS42P	94	HTLC3060HCTPR	98	HTLC4296LCTPL	96	HTLP168	88
HTFXT27	94	HTLC3060LCTFP	97	HTLC4296LCTPR	96	HTLP180	88
HTFXT27P	94	HTLC3060LCTFPL	98	HTLCRED42	102	HTLP192	88
HTFXT29	94	HTLC3060LCTFPR	98	HTLCRED42S	102	HTLP216	88
HTFXT29P	94	HTLC3060LCTP	97	HTLCRED57	102	HTLP240	88
HTG1PWR-3P-1B	249, 361	HTLC3060LCTPL	98	HTLCRED57S	102	HTLP60	88
HTG2PWR-3P-1E	249	HTLC3060LCTPR	98	HTLCRED72	102	HTLP72	88
HTG2PWR-3P-1U-W	249	HTLC3072HCTFP	97	HTLCRED72S	102	HTLP84	88
HTG2PWR-3P-2B-2U	249	HTLC3072HCTFPL	98	HTLCUBE108	89	HTLP96	88
HTG2PWR-4P-2B	249	HTLC3072HCTFPR	98	HTLCUBE120	89	HTLPB	108
HTGPWRKIA	125	HTLC3072HCTP	97	HTLCUBE144	89	HTLPBS	108
HTL(?)24	87	HTLC3072HCTPL	98	HTLCUBE168	89	HTLPM	88
HTL(?)30	87	HTLC3072HCTPR	98	HTLCUBE180	89	HTLPRES	107
HTL(?)3060	86	HTLC3072LCTFP	97	HTLCUBE192	89	HTLR108	89
HTL(?)36	87	HTLC3072LCTFPL	98	HTLCUBE216	89	HTLR120	89
HTL(?)3672	86	HTLC3072LCTFPR	98	HTLCUBE240	89	HTLR144	89
HTL(?)42	87	HTLC3072LCTP	97	HTLCUBE48	93	HTLR168	89
HTL(?)42108	86	HTLC3072LCTPL	98	HTLCUBE84	89	HTLR180	89
HTL(?)42120	86	HTLC3072LCTPR	98	HTLCUBE96	89	HTLR192	89
HTL(?)42144	86	HTLC3096HCTFP	97	HTLCUBEM	89	HTLR216	89
HTL(?)42168	86	HTLC3096HCTFPL	98	HTLCUBES108	89	HTLR240	89
HTL(?)42180	86	HTLC3096HCTFPR	98	HTLCUBES120	89	HTLR36	93
HTL(?)42192	86	HTLC3096HCTP	97	HTLCUBES144	89	HTLR42	93
HTL(?)42216	86	HTLC3096HCTPL	98	HTLCUBES168	89	HTLR48	93
HTL(?)42240	86	HTLC3096HCTPR	98	HTLCUBES180	89	HTLR84	89
HTL(?)4284	86	HTLC3096LCTFP	97	HTLCUBES192	89	HTLR96	89
HTL(?)4296	86	HTLC3096LCTFPL	98	HTLCUBES216	89	HTLRC108	89
HTL(?)48	87	HTLC3096LCTFPR	98	HTLCUBES240	89	HTLRC120	89
HTL(?)48108	86	HTLC3096LCTP	97	HTLCUBES48	93	HTLRC144	89
HTL(?)48120	86	HTLC3096LCTPL	98	HTLCUBES96	89	HTLRC168	89
HTL(?)48144	86	HTLC3096LCTPR	98	HTLCUBESM	89	HTLRC180	89
HTL(?)48168	86	HTLC4260HCTFP	95	HTLD60	87	HTLRC192	89
HTL(?)48180	86	HTLC4260HCTFPL	96	HTLHP108	88	HTLRC216	89
HTL(?)48192	86	HTLC4260HCTFPR	96	HTLHP120	88	HTLRC240	89
HTL(?)48216	86	HTLC4260HCTP	95	HTLHP144	88	HTLRC48	93
HTL(?)48240	86	HTLC4260HCTPL	96	HTLHP168	88	HTLRC84	89
HTL(?)4896	86	HTLC4260HCTPR	96	HTLHP180	88	HTLRC96	89
HTL(?)54108	86	HTLC4260LCTFP	95	HTLHP192	88	HTLRCM	89
HTL(?)54120	86	HTLC4260LCTFPL	96	HTLHP216	88	HTLRM	89
HTL(?)54144	86	HTLC4260LCTFPR	96	HTLHP240	88	HTLSCULPIL1630LML	117
HTL(?)54168	86	HTLC4260LCTP	95	HTLHP84	88	HTLSCULPIL1630LWL	118
HTL(?)54180	86	HTLC4260LCTPL	96	HTLHP96	88	HTLSCULPIL1630MML	117
HTL(?)54192	86	HTLC4260LCTPR	96	HTLHPM	88	HTLSCULPIL1630MWL	118
HTL(?)54216	86	HTLC4272HCTFP	95	HTLLECTA	101	HTLSCULPIL1660LML	117
HTL(?)54240	86	HTLC4272HCTFPL	96	HTLM4272	86	HTLSCULPIL1660LWL	118
HTLB1048LP	109	HTLC4272HCTFPR	96	HTLM4872	86	HTLSCULREC1630LML	117
HTLB12048P	108	HTLC4272HCTP	95	HTLM5472	86	HTLSCULREC1630LWL	118
HTLB1248LP	109	HTLC4272HCTPL	96	HTLM7248P	108	HTLSCULREC1630MML	117
HTLB14448P	108	HTLC4272HCTPR	96	HTLMC1828DL	103	HTLSCULREC1630MWL	118
HTLB1448LP	109	HTLC4272LCTFP	95	HTLMC1828DR	103	HTLSCULREC1660LML	117
HTLB1648LP	109	HTLC4272LCTFPL	96	HTLMC1828L	103	HTLSCULREC1660LWL	118
HTLB16848P	108	HTLC4272LCTFPR	96	HTLMC1828O	103	HTLSCULRND16HML	117
HTLB1848LP	109	HTLC4272LCTP	95	HTLMC1828R	103	HTLSCULRND16HWL	118
HTLB2048LP	109	HTLC4272LCTPL	96	HTLMT4260H	100	HTLSCULRND16LML	117
HTLBENCH30	101	HTLC4272LCTPR	96	HTLMT4260HFR	100	HTLSCULRND16LWL	118
HTLBENCH48	101	HTLC4296HCTFP	95	HTLMT4260L	100	HTLSCULRND16MML	117
HTLBENCH60	101	HTLC4296HCTFPL	96	HTLMT4272H	100	HTLSCULRND16MWL	118

# CROSS REFERENCE INDEX

MODEL	PAGE	MODEL	PAGE	MODEL	PAGE	MODEL	PAGE
HTLSCULRND30LML	117	HTLSCUSQRT30LWL	122	HTMC424272BB	99	HVL539	443
HTLSCULRND30LWL	118	HTLSCUWPIL1630LML	119	HTMC424296	99	HVL581	308
HTLSCULSQR13LML	117	HTLSCUWPIL1630LWL	120	HTMC424296BB	99	HVL582	308
HTLSCULSQR13LWL	118	HTLSCUWPIL1630MML	119	HTPCIF48	282	HVL585	308
HTLSCULSQR16MML	117	HTLSCUWPIL1630MWL	120	HTPCIF72	282	HVL601	509
HTLSCULSQR16MWL	118	HTLSCUWPIL1660LML	119	HTPHWIF72	282	HVL606	448
HTLSCULSQR20HML	117	HTLSCUWPIL1660LWL	120	HTPKIT48	282	HVL616	448
HTLSCULSQR20HWL	118	HTLSCUWREC1630LML	119	HTPKIT482	282	HVL701	493
HTLSCULSQR30LML	117	HTLSCUWREC1630LWL	120	HTPKIT60	282	HVL702	493
HTLSCULSQR30LWL	118	HTLSCUWREC1630MML	119	HTPKIT602	282	HVL705	493
HTLSCUPERTBL	123	HTLSCUWREC1630MWL	120	HTPKIT72	282	HVL712	493
HTLSCUPILCNLS1253	123	HTLSCUWREC1660LML	119	HTPKIT722	282	HVLVL1	436
HTLSCUPILT1830LML	121	HTLSCUWREC1660LWL	120	HTPLATEVHAU	250	HVLVL2	436
HTLSCUPILT1830LWL	122	HTLSCUWRND16HML	119	HTPSPLIT	282	HVLVL3	436
HTLSCUPILT1830MML	121	HTLSCUWRND16HWL	120	HTRACK	102	HVLVLOT	436
HTLSCUPILT1830MWL	122	HTLSCUWRND16LML	119	HTSSRD	335	HWHIC	503
HTLSCUPILT1860LML	121	HTLSCUWRND16LWL	120	HTTLEGI08	92	HWHICCF	503
HTLSCUPILT1860LWL	122	HTLSCUWRND16MML	119	HTTLEGI20	92	HWHISP	497
HTLSCURECCNSL1253	123	HTLSCUWRND16MWL	120	HTTLEGI44	92	HWHISPCF	498
HTLSCURECT1830LML	121	HTLSCUWRND30LML	119	HTTLEGI68	92	HWHISS	497
HTLSCURECT1830LWL	122	HTLSCUWRND30LWL	120	HTTLEGI80	92	HWHISSCF	498
HTLSCURECT1830MML	121	HTLSCUWSQR13LML	119	HTTLEGI92	92	HWHITCP	504
HTLSCURECT1830MWL	122	HTLSCUWSQR13LWL	120	HTTLEGI216	92	HWHITCPCF	505
HTLSCURECT1860LML	121	HTLSCUWSQR16MML	119	HTTLEGI240	92	HWHITCS	504
HTLSCURECT1860LWL	122	HTLSCUWSQR16MWL	120	HTTLEGI60	92	HWHITCSCF	505
HTLSCURNDT18HML	121	HTLSCUWSQR20HML	119	HTTLEGI72	92	HWH2SP	499
HTLSCURNDT18HWL	122	HTLSCUWSQR20HWL	120	HTTLEGI84	92	HWH2SPCF	500
HTLSCURNDT18LML	121	HTLSCUWSQR30LML	119	HTTLEGI96	92	HWH2SS	499
HTLSCURNDT18LWL	122	HTLSCUWSQR30LWL	120	HTTLEGM	92	HWH2SSCF	500
HTLSCURNDT18MML	121	HTLSHELF	102	HTXLEG	94	HWH3SP	501
HTLSCURNDT18MWL	122	HTLXP36	93	HTXLEGSH	94	HWH3SPCF	502
HTLSCURNDT30LML	121	HTLXP42	93	HUMPWR-1P-2U	248, 282	HWH3SS	501
HTLSCURNDT30LWL	122	HTLXP48	93	HV-UT1	241	HWH3SSCF	502
HTLSCUSQRPLNT15H	124	HTMC304260	99	HVL108	309	HWHACPP	507
HTLSCUSQRPLNT15L	124	HTMC304260BB	99	HVL151	508	HWHACPS	507
HTLSCUSQRPLNT30L	124	HTMC304272	99	HVL232	397	HWHBCPP	507
HTLSCUSQRT16LML	121	HTMC304272BB	99	HVL238	397	HWHBCPS	507
HTLSCUSQRT16LWL	122	HTMC304296	99	HVL402	509	HWHGB	507
HTLSCUSQRT18MML	121	HTMC304296BB	99	HVL511	480	HWHLP	506
HTLSCUSQRT18MWL	122	HTMC424260	99	HVL515	480	HWHSP18	506
HTLSCUSQRT20HML	121	HTMC424260BB	99	HVL531	443	HWMCLIPLG	251
HTLSCUSQRT20HWL	122	HTMC424272	99	HVL532	443	HWMCLIPSM	251
HTLSCUSQRT30LML	121						

# NOTES





# NOTES



# NOTES



# NOTES



# NOTES





# INFORMATION ON ORDERING PARTS

When parts are needed to repair HON products, the following guidelines should be followed to expedite the process.

1. Warranty orders are submitted on HON Ready via the Quick Claim tool.
2. There are no discounts applied to parts. Pricing quoted is the net value. Parts pricing is subject to change without notice.
3. For a part not covered by warranty applicable shipping charges will apply.
4. All keys are \$6.00 each plus a shipping and handling fee of \$3.00 per shipping location.
5. Parts may be paid for with an approved credit card. Approved Cards: MasterCard, VISA and American Express.
6. Payment terms for invoiced parts are Net 30 days.
7. Due to short leadtimes on parts, no changes will be accepted after the order has been placed.
8. When placing a **warranty** parts order:

**If the product is under warranty, the product serial number must be provided.** Most finished goods products have a serial number placed on them at the factory. The label containing the serial number is located:

**Vertical Files** — right side of the uppermost drawer

**Lateral Files** — left side of the uppermost drawer or shelf

**Desk Towers** — outside of top drawer

**Desks, Credenzas, & Returns** — on the outside, kneespace side of the top drawer. Fully extend the drawer to find it.

**Desks, Credenzas, Corner Units, Bridges, Peninsulas & Returns without drawers** — underside of top

**Tables and Stands** — underside of the top

**Table Trucks** — underside of side rail

**Cabinets & Bookcases** — left inner side of the case

**Modular Component Top and Backs** — underside of top

**Modular End Panels** — top inside surface

**Reception Stations** — top inside surface of back panel

**Organizers** — top inside surface of left end panel near back panel

**Vertical Paper Manager** — back panel inside surface near top

**Pedestals** — bottom drawer right side exterior

**Seating** — underside of the seat

**Panels** — underside of the top cap

**Hutches, Storage Units, Overhead Storage** — underside of the shelf

**Hanging Bookshelves** — underside of shelf

NOTE: Removal of the serial number tag from the product voids the warranty.

## An important note regarding Product Serial Numbers:

HON desks, tables, chairs, files and systems components are tagged with a serial number. This number helps us identify *when and where your product was made*, and to identify and correct the root causes for the problem. NEITHER THE DEALER NOR THE CONSUMER SHOULD REMOVE THIS TAG UNDER ANY CIRCUMSTANCES. To do so immediately voids your Warranty coverage for that particular item *and prevents us from further identifying it*. Instead, please transcribe the number and call your Dealer.



The HON Company  
Muscatine, IA 52761  
800.833.3964  
hon.com

©2024 The HON Company. Form No. H6056 (1/24). HON is a registered trademark of HNI Technologies, under license to The HON Company.

**Supersedes HON List Pricer**

Dated January 2024



*Flock and Tangram™ seating shown with Storyline™*